

BUILD A UNIQUE CARD READER FOR YOUR PC

August 1995

Electronics

NOW

Combined with
Radio
Electronics

Has **DSS** Been Hacked?

Hacker sources say that the new small-dish satellite system has fallen to signal pirates

Remote Control Adapter

Control almost anything with any infrared remote control!

Wind Monitoring System

Monitor wind speed, direction maximum gusts, and more

Circuit Cookbook

AC and DC power control

Analyze Remote Control Signals

Use your PC to understand infrared output signals



\$3.50 U.S.
\$3.95 CAN.



Before you get turned on
by the front of a meter, make sure there's
something behind it.

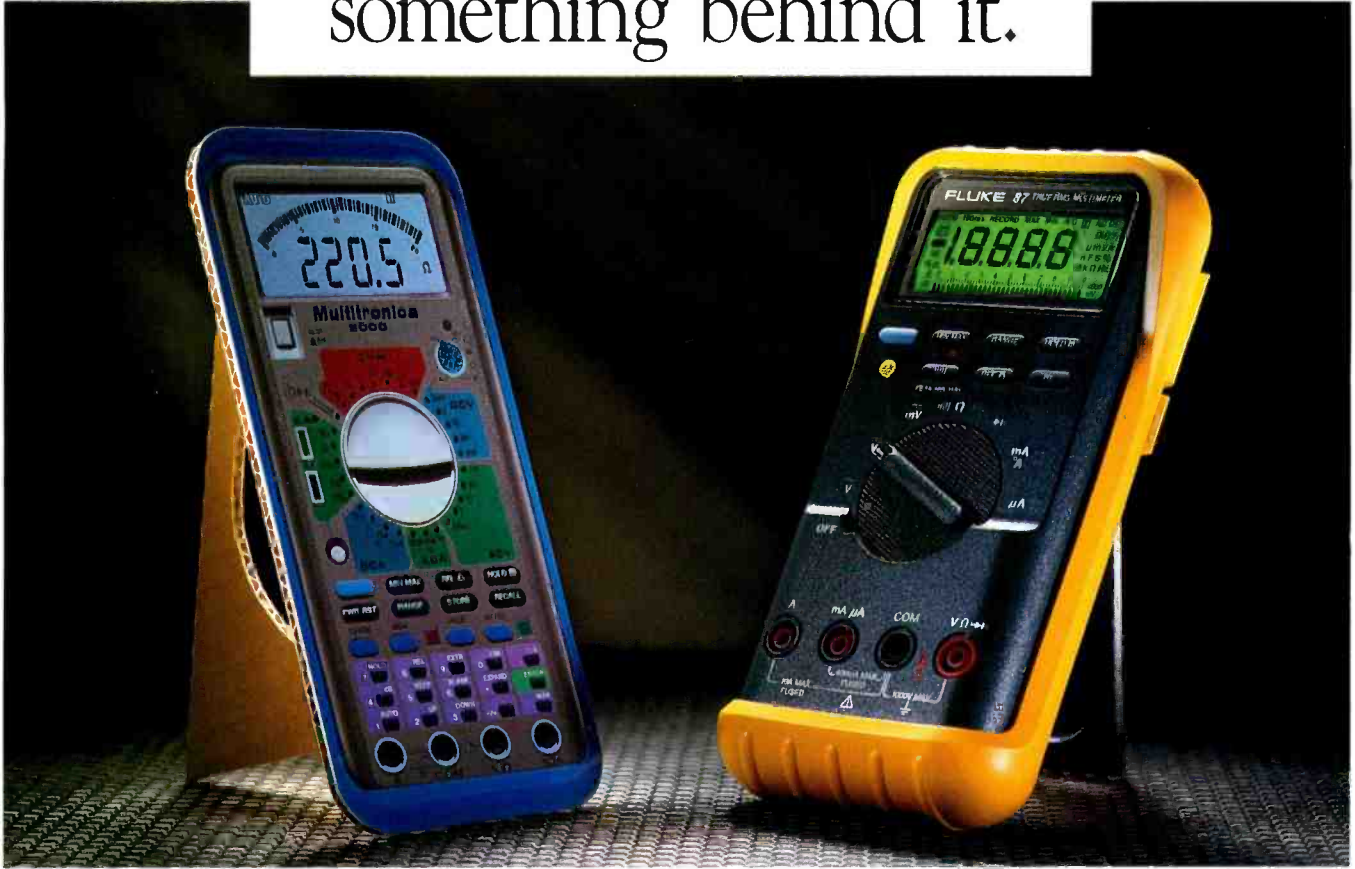

Fluke meters are designed for professionals who value function over frills.

There's nothing superficial about the Fluke family of versatile digital multimeters. Pick one up and you feel that it's a substantial tool. Designed to fit the application and the way you work. With features like our patented Touch Hold® function that freezes a reading on the display, and intelligently updates with each new reading. Automatically. Without requiring a third hand to push a button. Fluke meters attain stable, accurate readings in half the time of most imitations, making you more productive on the job.



Other meters are merely "designed to meet" certain guidelines; Fluke designs and builds a full line of meters that actually achieve UL, VDE and TÜV safety certification. Fluke's guarantee goes beyond manufacturing defects to include meter specifications for an entire year, so you can trust the readings.

And Fluke backs you with toll-free customer assistance numbers, and a world-wide service organization. Discover why more professionals around the world say, "Hand me the Fluke." See your local distributor, or call **1-800-87-FLUKE** for a catalog and the name of the distributor nearest you.

Serious Tools for Serious Work

FLUKE®

© 1994 Fluke Corporation. P.O. Box 9090, M/S 250E, Everett, WA,
USA 98206-9090. U.S. (206) 356-5400. Canada (905) 890-7600.
Europe (31 40) 644200. Other Countries (206) 356-5500.
All rights reserved. Ad No. 00567

CIRCLE 121 ON FREE INFORMATION CARD

www.americanradiohistory.com

MIXED-MODE SIMULATION

Design & Verify Faster with Electronics Workbench®

**New
Version 4**

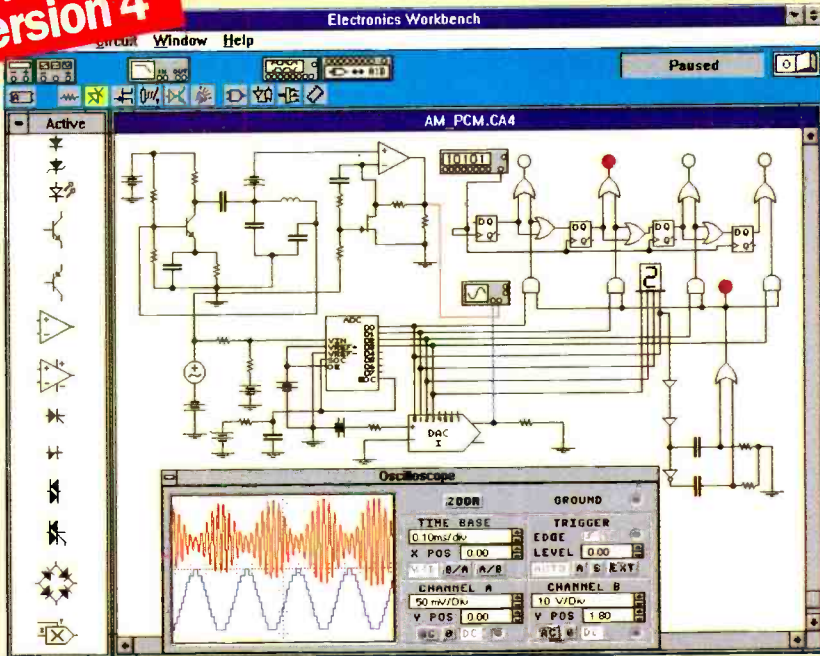

True mixed-mode simulation: Simultaneous AM transmission, digitization and pulse-code modulation of a signal.

Analog, Digital & Mixed Circuits

Electronics Workbench® Version 4 is a fully integrated schematic capture, simulator and graphical waveform generator. It is simple to mix analog and digital parts in any combination.

Design and Verify Circuits... Fast!

Electronics Workbench's simple, direct interface helps you build circuits in a fraction of the time. Try 'what if' scenarios and fine tune your designs painlessly.

Electronics Workbench delivers the power you need to design and verify analog, digital and true mixed mode circuits. Over 20,000 customers have already put Electronics Workbench to the test. The result: Better designs... Faster. And over 90% would recommend it to their colleagues.

Electronics Workbench will save you time and money. We guarantee it.*

Call Now: 800-263-5552

*30 day money-back guarantee
Free unlimited technical support

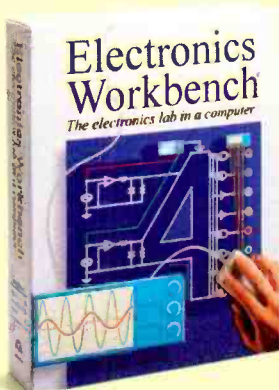

Electronics Workbench \$299

- Includes:
- Schematic capture
 - Simulator
 - Graphical waveform generator
 - 350 models
- + 15 S/H

Engineer's Pack \$599

- Includes:
- Electronics Workbench
 - 2,000 Extra Models
 - Export/Import to/from SPICE
 - Export to PCB packages
- + 15 S/H

Yes, I'm interested in
Electronics Workbench.

Name: _____

Title: _____

Organization: _____

Address: _____

Phone: _____

I prefer to be contacted by e-mail/fax at: _____

9EA1FP5

INTERACTIVE IMAGE TECHNOLOGIES LTD.
908 Niagara Falls Blvd. #068,
North Tonawanda, NY 14120-2060
Telephone: 416-977-5550
FAX: 416-977-1818
E-mail: ewb@interactiv.com
CompuServe: 71333,3435
BBS: 416-977-3540



Trademarks are property of their respective holders. Offer is in U.S. dollars and valid only in the United States and Canada.

Australia: 25193933 • Brazil: 11-4535588 • Cyprus: 2621068 • Czech Republic: 19224308 • Denmark: 33250109 • Finland: 02875033 • France: 140089000 • Germany: 711627740 • Greece: 15249981 • Hungary: 12150082
India: 115441343 • Indonesia: 21-4721730 • Israel: 36475613 • Italy: 11-4375549 • Japan: 333823136 • Malaysia: 37742189 • Mexico: 59935260 • Netherlands: 180317666 • New Zealand: 92671756 • Norway: 22-1670-45
Portugal: 181-46609 • Singapore: 777-2312 • Slovenia: 01-317890 • South Africa: 33166809 • South Korea: 222223431 • Spain: 1-5533234 • Sri Lanka: 1865970 • Sweden: 287405900 • Thailand: 662-3986952 • UAE: 4459075 • UK: 21323216

CIRCLE 126 ON FREE INFORMATION CARD

www.americanradiohistory.com

CONTENTS

AUGUST 1995

ON THE COVER

33 HAS DSS BEEN HACKED?

The RCA digital satellite system (DSS), introduced to the U.S. in mid-1994, is an all-digital, direct satellite broadcast system that delivers high-quality TV signals to satellite dishes only 18 inches in diameter. The system was designed to be un-

hackable. However, a little-known series of unbelievable events took place in Europe, when hackers there were able to stay one step ahead of the European VideoCrypt programmers and distribute up to half a million pirate "smart cards" that allowed viewers to

get the goods for free. (The European experience is detailed in an article that starts on page 37.) The DSS system's encryption technology is based on a modified version of the VideoCrypt system, and supposedly the DSS system is on the verge of being hacked. Pirate smart cards could be available by the time you read this. Will the pirates be able to get the better of DSS, or is the system secure? Turn to page 33 to find out.

— *John McCormac*

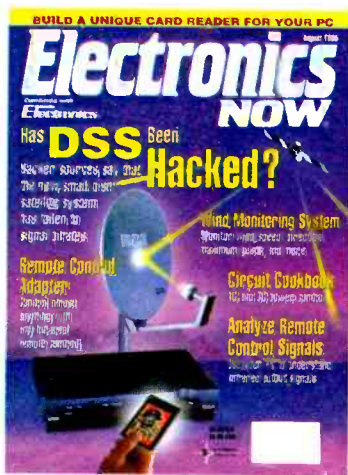

BUILD THIS

41 REMOTE CONTROL ADAPTER

This circuit lets you control virtually anything with any infrared remote control.

— *Terry J. Weeder*



50 50 ANALYZE REMOTE-CONTROL OUTPUT

Learn what kinds of signals are output from a remote control.

— *Barry Hamilton*



57 WIND MONITOR

Keep tabs on the weather with a microprocessor-based system.

— *Tom Leonik*

63 INFRARED CARD READER

Your PC can read information stored on a PcSwipe card.

— *James J. Barbarello*

As a service to readers, ELECTRONICS NOW publishes available plans or information relating to newsworthy products, techniques and scientific and technological developments. Because of possible variances in the quality and condition of materials and workmanship used by readers, ELECTRONICS NOW disclaims any responsibility for the safe and proper functioning of reader-built projects based upon or from plans or information published in this magazine.

Since some of the equipment and circuitry in ELECTRONICS NOW may relate to or be covered by U.S. patents, ELECTRONICS NOW disclaims any liability for the infringement of such patents by the making, using, or selling of any such equipment or circuitry, and suggests that anyone interested in such projects consult a patent attorney.

ELECTRONICS NOW, (ISSN 1067-9294) August 1995. Published monthly by Gernsback Publications, Inc., 500-B Bi-County Boulevard, Farmingdale, NY 11735. Second-Class Postage paid at Farmingdale, NY and additional mailing offices. Canada Post IPM Agreement No. 334103, authorized at Mississauga, Canada. One-year subscription rate U.S.A. and possessions \$19.97, Canada \$27.79 (includes G.S.T. Canadian Goods and Services Tax, Registration No. R125166280), all other countries \$28.97. All subscription orders payable in U.S.A. funds only, via international postal money order or check drawn on a U.S.A. bank. Single copies \$3.50. © 1995 by Gernsback Publications, Inc. All rights reserved. Printed in U.S.A.

POSTMASTER: Please send address changes to ELECTRONICS NOW, Subscription Dept., Box 55115, Boulder, CO 80321-5115.

A stamped self-address envelope must accompany all submitted manuscripts and/or artwork or photographs if their return is desired should they be rejected. We disclaim any responsibility for the loss or damage of manuscripts and/or artwork or photographs while in our possession or otherwise.

TECHNOLOGY

- 37 THE EUROPEAN EXPERIENCE**
How hackers in Europe made a mockery of the VideoCrypt system.
— *John McCormac*
- 69 AC & DC CONTROL CIRCUITS**
These circuits can control lights, motors, and appliances.
— *Ray Marston*



DEPARTMENTS

- 6 VIDEO NEWS**
What's new in this fast-changing field. — *David Lachenbruch*
- 16 EQUIPMENT REPORTS**
Chip Quik SMD Removal Kit.
- 26 COMPUTER CONNECTIONS**
Windows 95 will not satisfy everyone.
— *Jeff Holtzman*
- 77 HARDWARE HACKER**
Fourier series analysis, and more. — *Don Lancaster*
- 84 AUDIO UPDATE**
Sex and the experienced listener.
— *Larry Klein*
- 86 DRAWING BOARD**
A PC board for the audio router.
— *Robert Grossblatt*

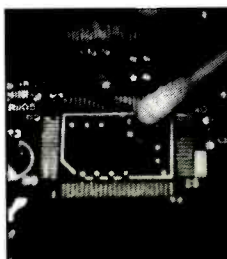

— AND MORE —

- | | |
|------------------------|-------------------------------------|
| 4 WHAT'S NEWS | 22 NEW LITERATURE |
| 8 Q&A | 89 BUYER'S MART |
| 12 LETTERS | 94 ADVERTISING SALES OFFICES |
| 18 NEW PRODUCTS | 94 ADVERTISING INDEX |

Electronics NOW®

Hugo Gernsback (1884-1967) founder

LARRY STECKLER, EHF, CET,
Editor-in-chief and publisher

EDITORIAL DEPARTMENT

BRIAN C. FENTON, editor
MARC SPIWAK, associate editor
NEIL SCLATER, associate editor
TERI SCADUTO, assistant editor
JEFFREY K. HOLTZMAN
 computer editor
ROBERT GROSSBLATT, circuits editor
LARRY KLEIN, audio editor
DAVID LACHENBRUCH
 contributing editor
DON LANCASTER
 contributing editor
EVELYN ROSE, editorial assistant
MICHAEL A. COVINGTON, N4TMI,
 contributing editor

ART DEPARTMENT

ANDRE DUZANT, art director
RUSSELL C. TRUELSON, illustrator

PRODUCTION DEPARTMENT

RUBY M. YEE, production director
KAREN S. BROWN
 advertising production
KATHRYN R. CAMPBELL
 production assistant
KEN COREN
 desktop production

CIRCULATION DEPARTMENT

JACQUELINE P. CHEESEBORO
 circulation director
THERESA LOMBARDO
 circulation assistant

REPRINT DEPARTMENT

MICHELE TORRILLO
 reprint bookstore

Typography by Mates Graphics
 Cover design by David Loewy

Electronics Now is indexed in *Applied Science & Technology Index*, and *Readers Guide to Periodical Literature*, *Academic Abstracts*, and *Magazine Article Summaries*.
 Microfilm & Microfiche editions are available. Contact circulation department for details.

Advertising Sales Offices listed on page 94.
 Electronics Now Executive and Administrative Offices
1-516-293-3000.
 Subscriber Customer Service:
1-800-288-0652.
 Order Entry for New Subscribers:
1-800-999-7139.



Audit Bureau
 of Circulations
 Member



WHAT'S NEWS

A REVIEW OF THE LATEST HAPPENINGS IN ELECTRONIC

GPS motorist-aid system

A REMOTE EMERGENCY SAT-ellite Cellular Unit, or RESCU, based on global positioning satellite (GPS) system and the cellular telephones will be an option in Lincoln Continental cars in 1996. The system will track the car's location and put a driver in direct voice contact with emergency services.

According to a spokesman for Ford Motor Co., the manufacturer of Lincoln Continental cars, drivers and passengers in any region of the country where cellular telephones work will be able to contact emergency repair or towing services as well as emergency medical, police, or fire services.

Keith Magee, a Ford vice president, said that emergency services say that even with cellular phones in their cars, many callers are unable to give their correct locations during emergencies. With the GPS system tie-in, determining location will no longer be a problem.

When the car is in a cellular phone area, pressing one button on the car's console marked with a tow-truck logo will call for roadside assistance while pressing the button with an ambulance logo will call for emergency medical, police or fire help. (Approximately 90% of the United States population lives and works in an area covered by the cellular network.) Automated dialing will respond to dial the emergency services for help.

The car's location, identification number, and its latitude and longitude (provided by the GPS system) will be transmitted. Also sent with that information will be the car's

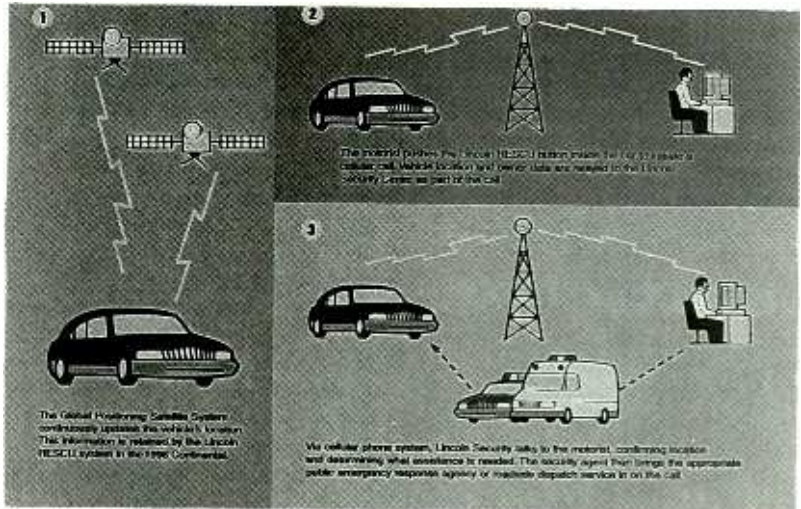

LINCOLN'S RESCU SYSTEM combines the cellular telephone and the GPS system to assist motorists in distress.

last recorded speed and direction, the time when the last position was noted, and the call-back phone number. This data will be sent to the Westinghouse Emergency Response Center in Irving, Texas.

That information will be relayed to the local 911 system or to the Ford's own roadside assistance system, where an operator will verify the nature of the request and the vehicle location.

A password is needed to verify the authenticity of the request if a button were pushed accidentally. If no password is given or the one given is incorrect, local police will be asked to go to the scene.

In addition to the data transmission, the system also maintains direct voice contact with the motorist until emergency help arrives. It will also notify a pre-designated family member or friend in the event of an emergency, will offer an estimated time of arrival of assistance, and will call back to confirm that the problem was resolved.

The Lincoln RESCU satellite

receiver and antenna will be located in the car's trunk. The trunk lid will be made from a carbon-fiber reinforced plastic that will allow the satellite signals to reach the antenna unimpeded. Based on the time it takes for GPS signals to reach the vehicle's receiver, an on-board computer will determine the vehicle's location, typically within an accuracy of +/-100 feet.

System for making denser, faster integrated circuits

EFFORTS TO CRAM EVEN more components on a silicon substrate to increase component density and increase speed of ICs have paid off. A new photolithographic system that can imprint integrated circuit features one-thousandth the width of a human hair (0.1 micron)—this is

Continued on page 92

Get a sample of reality.

Looking for analog confidence in a digital oscilloscope? Tektronix' TDS 350 sets the standard with Digital Real Time. ■ Its

incredible *one gigasample / second* sampling delivers real-life capture like never before —

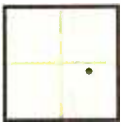

ONE POINT CAPTURED. SINGLE EVENT CAPTURE USING EQUIVALENT TIME SAMPLING. 20 MS/s 100 MHz DSO.

both for single shot or repetitive events.

Select peak detect for slow events, or push the scope to



REAL LIFE CAPTURE. SINGLE EVENT CAPTURE USING DIGITAL REAL TIME. 500 MS/s 100 MHz DSO.

its full 200 MHz bandwidth — while

minimizing aliasing. ■ And, like the entire TDS 300 family,

the TDS 350 sets a new standard in price/performance.

Analog look and feel.

The TDS 300 family is simple and intuitive; just like your trusty analog scope. Even the digital interface is simplified with on-screen

icons. You may never have to crack open the instruction manual!

High-end digital features. Each model features over 20 automatic measurements.

Continuous update for hands-free oper-

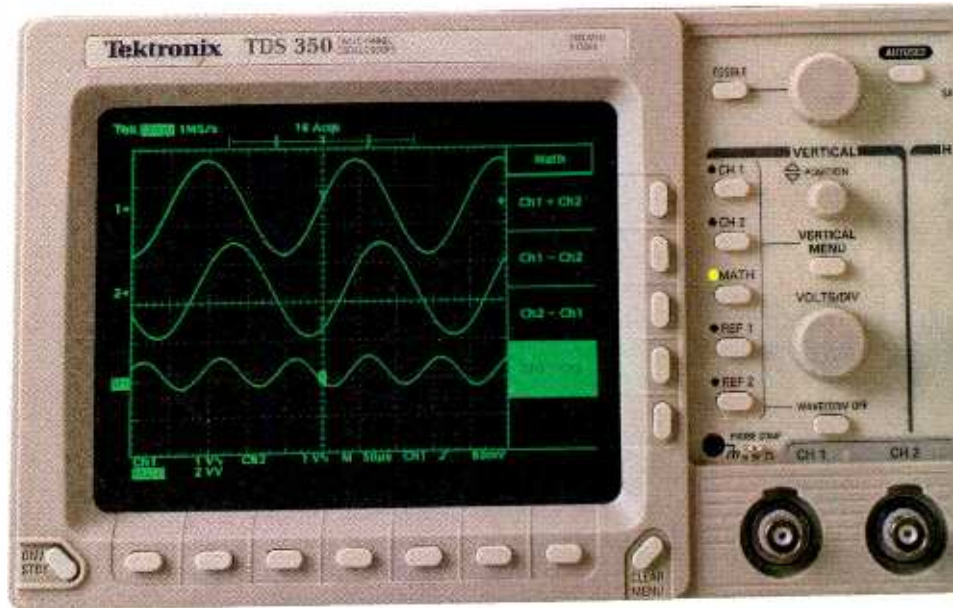

ation. Four acquisition modes and video trigger — perfect for tailoring the display.

And a communication option for hardcopy

to most printers, or to send/ receive waveforms and setups.

Get real. For more real-time benefits of the TDS 300 family, call your authorized Tektronix distributor

There's a TDS 300 Series scope for every application. And every budget.

FEATURES	TDS 310	TDS 320	TDS 350
Bandwidth	50 MHz	100 MHz	200 MHz
Max Sample Rate	200 MS/s/chan	500 MS/s/chan	1 GS/s/chan
Sweep Speeds	10 ns/div - 5 s/div	5 ns/div - 5 s/div	2.5 ns/div - 5 s/div
Channels	2	2	2
Vertical Sensitivity	2 mV - 10 V	2 mV - 10 V	2 mV - 10 V
Vertical Resolution	8 bits	8 bits	8 bits
Record Length	1K/channel	1K/channel	1K/channel
Standard Advanced Features	TV Line & Field Trigger, Roll Mode, Autoset, 21 Automatic Measurements, Peak Detect		
Comm. I/O (Option 1A)	GPIB, RS-232, Centronics and VGA video output		

today. Or call Tektronix at (800) 479-4490, action code 301.

Tektronix



VIDEO NEWS

WHAT'S NEW IN THE FAST-CHANGING VIDEO INDUSTRY

BY DAVID LACHENBRUCH

Plasma TV in '97.

Future big-screen direct-view TVs will use thin plasma displays instead of traditional cathode ray tubes, Mitsubishi says, and to back its convictions it already has announced that it will have a 40-inch plasma TV in its line in January 1997—at a rather pricey \$7000-\$10,000. The company says that the final design hasn't been completed, but the display will be only two to three inches thick and may hang on the wall. The tuner, power supply, and other components will be packaged in a separate console. Mitsubishi showed its dealers a 20-inch plasma display at a recent sales meeting, and says that it will also have a 27-inch version. Mitsubishi, the only company currently offering a 40-inch direct-view TV, feels that plasma is the solution to the growing bulk of big-screen direct-view sets because it can display a bright, detailed CRT-like picture without the CRT's size.

DVD battle lines shift.

The war of the digital video disc (DVD) systems has shifted from the TV to the computer arena. Toshiba and Time Warner have gained Hollywood and manufacturer adherents for their two-sided DVD system, while Philips and Sony are backing a competing system that can record two layers of information on a single side (*Electronics Now*, May 1995). Both camps are promoting their discs as all-purpose super-high density media to replace CD-ROMs in the future, and both made major pitches for computer industry support at a recent meeting of computer-

industry CD licensees.

Because computer manufacturers are opposed to two-sided discs requiring either manual or automatic turnover to play both sides, the Toshiba-Time Warner group came up with a new twist, courtesy of Matsushita Electric (Panasonic), a member of the group. This is a disc that is laminated from two separate thin discs (like the two-sided disc) but it uses the dual-layer system so that the entire disc can be read from a single side (like the Sony-Philips disc).

Although it appeared that Sony-Philips had the advantage for computer use, the major computer manufacturers declined to pick a single system, but instead urged the warring parties to get together on a single system. A statement signed by computer giants Apple, Compaq, Hewlett-Packard, IBM, and Microsoft, among others, said flatly that they wouldn't choose between two formats and said, "consumers, software and content providers, and hardware manufacturers would be best served" by a single format combining "the strongest technical features" of both systems.

The companies issued a list of nine objectives for a single-disc system for both video movies and multimedia PC applications: (1) A single interchange standard for entertainment and computer applications. (2) Backward compatibility with existing CDs. (3) Forward compatibility with future recordable CDs. (4) A single file system for all uses and combinations of uses. (5) Costs comparable with existing CD-ROM drives and discs. (6) No caddy, saving costs and paving way for commercial disc changers. (7) Reliable storage and

retrieval with average uncorrectable errors no greater than that of existing CDs. (8) Capability to accommodate future capacity increases such as multiple data layers or blue lasers. (9) High performance for both "sequential" (movies) and "nonsequential" (random access data) files.

The computer industry's insistence on a single standard to accommodate both video and data is a strong indication that the merger of computers and video is now at hand.

Sony enters DSS.



SONY IS ENTERING THE DSS market with its SAS-AD1 system.

Sony will attempt to build upon the success of the RCA brand in selling receivers for the Digital Satellite System (DSS) providing home reception of up to 175 channels via high-powered satellite and requiring a dish only 18 inches in diameter. In less than a single year, RCA's parent Thomson Consumer Electronics sold more than a million DSS systems at \$695 to \$795 plus installation cost. Sony becomes the second manufacturer

Continued on page 21

More Lessons!

More Services!

A Shocking Offer!

Now you don't have to be enrolled at CIE to receive our introductory Electronic and Electricity Lesson Modules. This program is available for a limited time to non-students for the shockingly low price of only \$99.50.

With CIE's patented AUTO-PROGRAMMED method of learning you will quickly learn and then master the basics of electronics and electricity and then move on to... DC/AC circuit theories, fundamentals of bi-polar junction transistors (BJT), field effect transistors (FET), wiring, diagram and schematic readings, component identification, soldering techniques... and much, much, more. This introductory offer includes the first 39 lessons in CIE's Associate in Applied Science in Electronic Engineering Technology Degree.

Your commitment to CIE ends with your payment, but CIE's commitment to your success just begins when you receive your lessons, exams, binder and equip-

ment. This special introductory price includes all the benefits and assistance CIE normally extends to its full time students. You'll be entitled to unlimited access to CIE's faculty and staff to assist you in your studies via a toll free 800 number six days a week, 24-hour turn-around on grading your submitted exams, CIE bookstore privileges, a patented learning method, reference library, access to CIE's electronic bulletin board and a free issue of CIE's school newspaper The Electron.

And best of all, when you decide to continue your electronics education in any of CIE's programs you'll receive full academic credit for successful lessons submitted and a \$100.00 Tuition Credit Certificate.

All this knowledge and support will put you on the road to understanding digital electronics, automotive and industrial electronics, microprocessing principals, computer systems, telecommunications and much, much, more.



All This For Only!

\$99.50

- \$100.00 Tuition Credit
- Academic Credit
- Free issue of The Electron
- Build your personal burglar alarm
- Toll Free Instructor Assistance
- 24-hour grading
- CIE bookstore privileges

- 39 theory and hands-on training lessons and exams.
- Patented learning method
- CIE electronic bulletin board privileges

Yes! Send me CIE's Introductory Electronic and Electricity Lessons and Equipment. A7329

Name: _____
 Street: _____ Apt#: _____
 City: _____
 State: _____ Zip: _____
 Age: _____ Phone: (____) _____

Total Merchandise: _____ \$99.50
 Ohio Residents add 7% Sales Tax: _____
 California Residents add 6 1/2% Sales Tax: _____
 Total This Order: _____
 Shipping and Handling Charge: _____ \$5.00
 Method of Payment/Amount Enclosed: _____ \$
 Personal Check or Money Order
 Master Card Visa Discover

Card Expiration Date: _____

Signature: _____



BOOKSTORE
1776 East 17th Street
Cleveland, Ohio 44114



CHARGE BY PHONE!
9 AM to 4:30 PM Eastern Time;
1-800-321-2155 ext. 7329

August 1995, Electronics Now



Q & A

READER'S QUESTIONS, EDITORS' ANSWERS

VARIABLE DUTY CYCLE

Q I am trying to build a variable duty cycle signal generator to control relays. I'd like the circuit to sweep from full on to full off as linearly as possible. The generator period should be between 30 seconds and a minute. Can you show me a working circuit?—J. Janowski, Skokie, IL

exactly half the time and off for the other half. Frequency refers to the signal's repetition rate, or oscillations, in a given time period. The two waveforms shown in Fig. 1 have the same frequency, but their duty cycles are completely opposite. Figure 2 shows two waveforms with identical duty cycles but with different frequencies. From the details of your letter, I'm

1/1.14 RC. If you use CMOS inverters in the Fig. 3 circuit, the duty cycle will be about 50% because CMOS logic changes state at around half of the supply voltage. There will be some drift from that frequency because of changes in the behavior of the capacitor when it charges and discharges, but that can be ignored for now.

If the oscillator is modified as shown in Fig. 4, the duty cycle can be changed without significantly altering the output frequency. The two diodes allow independent control over the charge and discharge time of the capacitor. By adjusting the trimmer potentiometer, the duty cycle can be varied between nearly always high and nearly always low. The diodes aren't perfect, so you won't be able to obtain the maximum high or low conditions from the circuit.

This same technique for varying a waveform's duty cycle will work with any oscillator, such as a 555 timer IC set up as an oscillator. In the basic 555 circuit shown in Fig. 5, the frequency is determined by the formula $f = 1.44/(R1 + 2 R2)C$. The duty cycle depends on the relative values of the two resistors because the capacitor charges through both R1 and R2 but discharges only through R2.

The 555's duty cycle can be calculated by the formula $R1 + R2/R2$. Varying the resistor values will vary the duty cycle without significantly affecting the frequency. If you want more precise control over the 555's duty cycle, you can use a pair of diodes to isolate the capacitor's charge and discharge times, as was done in the first example

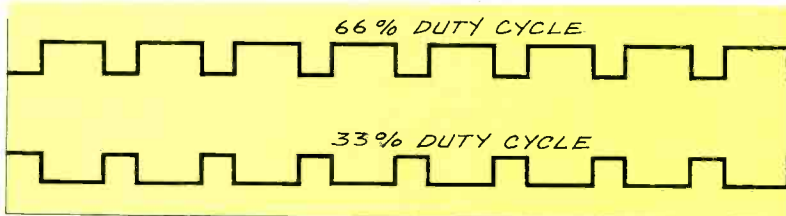

FIG. 1—FREQUENCY REFERS TO HOW OFTEN a signal repeats. These two waveforms have the same frequency, but their duty cycles are opposite.

A You weren't very clear in your letter about the details of the job you have in mind. However, it seems to me that you don't have a clear understanding on what varying the duty cycle really means. Two of the most basic characteristics of any waveform are its frequency and duty cycle. It's possible to vary either one of those without one

guessing that you want to be able to vary both.

At a fundamental level, oscillators generate frequencies by controlling the charging and discharging of a capacitor. When you alter the resistor and capacitor values in the oscillator, you change the frequency, but if you selectively vary the charge and discharge time, you

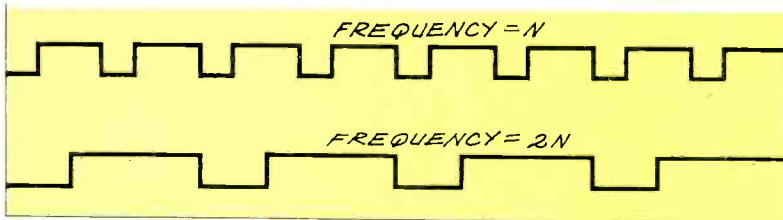

FIG. 2—DUTY CYCLE REFERS TO THE RATIO of how long a signal is on compared to how long it's off. These two waveforms have identical duty cycles but different frequencies.

having an effect on the other.

Duty cycle refers to the ratio of how long a signal is "on" compared to how long it's "off"—a signal with a 50% duty cycle is on for

change the duty cycle. The circuit in Fig. 3 is a simple oscillator that illustrates those basic ideas. The frequency of the circuit (f) is determined by the formula $f =$

Electronics Experimenters' Books



PCP116—Introducing Digital Audio—CD, DAT and Sampling... \$10.00. Digital audio involves methods and circuits that are totally alien to the technician or inquiring amateur who has previously worked with audio circuits. This book is intended to bridge the gap! The principles and methods are explained, but the mathematical background and theory are avoided when practical.



BP325—A Concise User's Guide to Windows 3.1...\$7.95. If you are having trouble with Windows 3.1, then discover how to manipulate Windows screens and how to run Windows and DOS applications under the Windows Graphic User Interface (GUI) environment. There's more: the word processor (Write), Program Manager, File Manager and Print Manager will be mastered by you. The text's scope is enormous.



BP233—Electronic Hobbyists Handbook...\$9.95. A collection of data for the amateur electronics enthusiast. The text includes data on a multitude of topics such as parts color codes, integrated circuit pin-outs, transistor lead-out diagrams and data, basic circuit building blocks, and much more. Where appropriate, detailed background information and explanatory notes are provided.

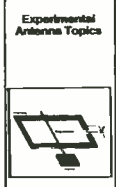

BP278—Experimental Antenna Topic...\$5.95. Contains 28 fascinating sections and includes many unusual practical antenna designs that use such outlandish materials as cardboard, aluminum foil, plastic bottles, cat-food cans, etc., even water!



PCP104—Electronics—Build and Learn...\$9.95. Construction details are given to build a circuit demonstrator that is used throughout the book to introduce common electronic components and how these components are built up to useful circuits.



BP287—A Reference Guide to Practical Electronics Terms...\$8.95. A companion volume to BP286. Covers the more practical and applied aspects of electronics. An essential reference work for the library of all those interested in electronics.



PCP118—MIDI Survival Guide...\$7.75. The book offers practical advice on starting up, setting up, and ending up with a practical MIDI system. Includes over 40 cabling diagrams and tips on connecting synths, sound modules, sequencers, etc.



PCP117—Electronic Projects for Guitar...\$12.95. If you are a guitarist, you'll find this collection of 16 guitar and general-purpose effects projects extremely useful at bargain do-it-yourself prices. Each project has an introduction, an explanation of how it works, complete instruction on stripboard layout and assembly, as well as notes on setting it up and using. Written for the beginner project builder.



BP256—Introduction to Loudspeakers and Enclosure Design...\$5.95. All you need to know about the theory and operation of loudspeakers (drivers) and the various types of enclosures (boxes) into which they should be built. Crossover units are covered. Also includes the complete design and construction details of how to make an inexpensive but high-quality enclosure called the "Kapellmeister."



BP195—An Introduction to Satellite Television...\$9.95. As an introduction to satellite television this book is presented on two levels. For the absolute beginner with no previous knowledge, the story is told as simply as it can be in the main text. For the professional engineer, student or others with technical backgrounds, there are numerous appendices backing up the main text with additional technical and scientific details.



BP275—Simple Shortwave Receiver Construction...\$6.95. Contains practical designs for building a number of simple shortwave receivers. Comprehensive plans include diagrams and full coil-winding details where necessary.



BP251—Computer Hobbyists Handbook...\$8.95. Provides a single, quick reference source to bountiful data and information that the computer hobbyist will find useful. An absolutely essential addition to your bookshelf that will become a reference text.

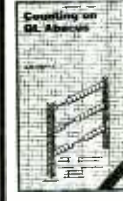

BP162—Counting on QL Abacus...\$4.95. Shows the reader how to get the maximum use from the enormously powerful QL Abacus which is a practical spreadsheet-type of program. Useful for presenting information and data.



BP58—50 Circuits Using 7400 Series IC's...\$5.50. Interesting and useful circuits and applications that cover many different aspects of electronics using this readily freely obtainable, inexpensive and fantastically versatile series of devices.



BP298—A Concise Introduction to the Macintosh System and Finder...\$6.25. If you have one of the popular Macintosh range of computers, this book is designed to help you get the most from it. Although the Mac's WIMP user interface is designed to be easy to use, much of it only becomes clear when it is explained in simple terms. All Macintosh computers are covered including the new "Classic" range.



BP101—HOW TO IDENTIFY UNMARKED IC's...\$2.25. A chart that shows the reader how, with just a multimeter, to go about recording the particular signature of an unmarked IC which should enable the IC to then be identified. By now you are probably wondering what an IC signature is. It is a specially plotted chart produced by measuring the resistances between all terminal pairs of an IC.



PCP114—Advance MIDI User's Guide...\$14.95. Although still regarded by many as nothing more than a way to get one instrument to follow the playing of another, MIDI actually has capabilities that go well beyond the simple slaving arrangement. This splendid book explains all the MIDI messages, routing MIDI in simple to advanced systems, explains how to troubleshoot when things go wrong, and much more.

Bargain Table Best Buys for Experimenters and Computer Buffs

- | | |
|---|---|
| <input type="checkbox"/> BP106—Modern Opamp Projects.....\$5.75 | <input type="checkbox"/> BP195—An Introduction to Satellite Television.....\$6.25 |
| <input type="checkbox"/> BP137—BASIC and FORTRAN in Parallel.....\$3.95 | <input type="checkbox"/> BP198—An Introduction to Antenna Theory.....\$6.95 |
| <input type="checkbox"/> BP138—BASIC and FORTH in Parallel.....\$3.95 | <input type="checkbox"/> BP248—Test Equipment Construction.....\$5.95 |
| <input type="checkbox"/> BP154—An Introduction to MSX BASIC.....\$4.95 | <input type="checkbox"/> BP249—More Advanced Test Equipment Construction.....\$6.95 |
| <input type="checkbox"/> BP169—Hot to Get Your Computer Programs Running.....\$5.95 | <input type="checkbox"/> BP260—A Concise Introduction to OS/2.....\$4.95 |
| <input type="checkbox"/> BP194—Modern Opto Devices Projects.....\$6.25 | <input type="checkbox"/> BP263—A Concise Introduction to dBASE.....\$6.95 |

ELECTRONIC TECHNOLOGY TODAY INC.
P.O. BOX 240, Massapequa, NY 11762-0240

Name _____
Address _____
City _____ State _____ Zip _____
EN3 Allow 6-8 weeks for delivery

SHIPPING CHARGES IN USA AND CANADA
\$0.01 to \$5.00.....\$2.00
\$5.01 to \$10.00.....\$3.00
\$10.01 to 20.00.....\$4.00
\$20.01 to 30.00.....\$5.00
\$30.01 to 40.00.....\$6.00
\$40.01 to 50.00.....\$7.00
\$50.01 and above.....\$8.50

SORRY No orders accepted outside of USA & Canada

Number of books ordered
Total price of merchandise.....\$ _____
Shipping (see chart).....\$ _____
Subtotal.....\$ _____
Sales Tax (NYS only).....\$ _____
Total Enclosed.....\$ _____

All payments must be in U.S. funds!

EARN YOUR B.S. DEGREE IN COMPUTERS OR ELECTRONICS



By Studying at Home

Grantham College of Engineering, now in our 45th year, is highly experienced in "distance education"—teaching by correspondence—through printed materials, computer materials, fax, modem, and phone.

No commuting to class. Study at your own pace, while continuing on your present job. Learn from easy-to-understand but complete and thorough lesson materials, with additional help from our instructors.

Our Engineering Technology B.S. Degree Program is available in either of two options:

- (1) The B.S.E.T. with Major Emphasis in Electronics, OR
- (2) The B.S.E.T. with Major Emphasis in Computers.

Our Computer Science B.S. Degree Program leads to the B.S.C.S.—the Bachelor of Science in Computer Science.

An important part of being prepared to *move up* is holding the right college degree, and the absolutely necessary part is knowing your field. Grantham can help you both ways—to learn more and to earn your degree in the process.

Write or phone for our free catalog. Toll free, 1-800-955-2527, or see mailing address below.

Accredited by
the Accrediting Commission of the
Distance Education and
Training Council

GRANTHAM
College of Engineering
Grantham College Road
Slidell, LA 70460

RISC VS. CISC

Q I've heard about reduced-instruction-set computing (RISC) and complex-instruction-set computing (CISC) microprocessors for the last few years but I still don't understand the difference between the two. According to what I've read, RISC chips are faster than CISC chips. If that's true, why isn't everybody using them? I thought that one of the main goals of computer manufacturers was to achieve maximum speed.—F. Renja, Boston, MA

A As microprocessors developed from the early 1980's on, techniques were refined to squeeze more and more transistors onto the substrate of the device. The more transistors there are in the chip, the more instructions that can be built into the microcode. The result is that successive generations of microprocessors could execute much more complex instructions than their predecessors. For example, Intel's 16-

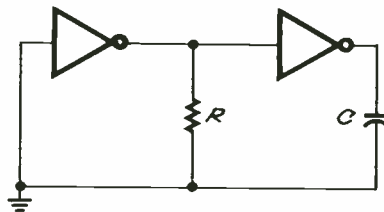

FIG. 3—THE FREQUENCY of this oscillator circuit is equal to $1/1.14 RC$. If CMOS inverters are used, the duty cycle will be about 50%.

bit microprocessors included multiply and divide instructions while the older 8-bit microprocessors could only add and subtract.

Increasing microprocessor complexity simplifies the programmer's job, but whenever multiplication is done with a single operation code, the program is tied to the microcode that makes up the multiply instruction. The more complex the instruction, the more time it takes to complete. The multiply instruction in Intel's 80XXX microprocessor family can take more than 100 machine cycles to execute.

RISC is an alternative to the CISC design philosophy that was just described. Rather than provide the programmer with single-instruction options to perform complex opera-

tions, a RISC microprocessor has a much simpler instruction set with opcodes that require fewer machine

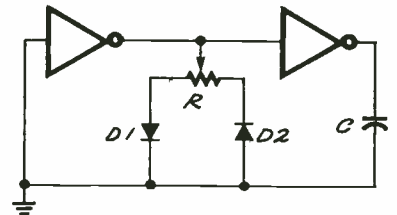

FIG. 4—THE DUTY CYCLE of the oscillator in this circuit can be changed by adjusting the trimmer potentiometer.

cycles to execute (usually no more than one or two). RISC chips contain hardwired instruction sets rather than internal microcode to make the operation even faster. Streamlining permits the RISC chip to complete instructions more quickly, but it puts a heavier burden on the programmer.

A good example of this is in handling interrupts. A CISC chip will respond to an interrupt and automatically save registers, the location of the program counter, and other information that's needed when it is time to return from the interrupt-handling routine. With a RISC chip, all these things must be done by the programmer and that means more code.

Simply put, RISC chips have instructions that execute more quickly than CISC chips, but a RISC chip requires more instructions to do the same job. That's why RISC chips have a lot of internal registers for temporary storage during certain operations. RISC systems usually require more external memory for the same reason.

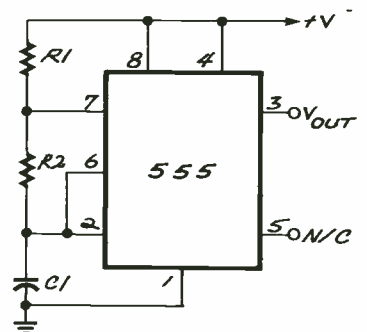

FIG. 5—THE DUTY CYCLE of this 555 timer-based oscillator is equal to $1.44/(R1 + 2 R2)C$.

While it's true that RISC chips, by definition, will outperform CISC chips, raw microprocessor performance isn't the yardstick that the end user should consider. The bottom line is computer performance, and that's measured by how long it takes for a task to be completed when a key is pressed. Real-world program performance is based on a combination of microprocessor performance, programming efficiency, and the subjective judgment of the end user, and the RISC processor does not always offer the best solution.

WALKIE-TALKIE MOD

I have recently put together the 27.145-MHz *1-Com Handi-Talkie* from the October 1992 issue of *Radio-Electronics*. I would like to change the transmitting frequency to 27.195 MHz. Will the 27.145-MHz bandpass filter affect its performance? *Felax G. Chow, St. Petersburg, FL.*

No, the bandpass isn't nearly that narrow. From the rest of your letter I gather you want to transmit on one frequency and receive on the other. That's perfectly OK; just change the transmitting crystal but not the receiving one, and align for best transmitting performance.

The antenna is fed through a bandpass filter because the RF signal is generated by a frequency tripler. The RF starts out at 9.0483 MHz and is tripled to get 27.145 MHz. The tripler also produces a harmonic at 45.2 MHz, among others. The purpose of the bandpass filter is to eliminate everything but the desired 27.145-MHz signal when you transmit. Leave it out, and you'd be transmitting on several frequencies simultaneously, interfering with TV and other radio services. The bandpass filter also prevents interference from out-of-band signals when receiving.

To transmit on 27.195 MHz, just change the transmitter crystal to 9.065 MHz and perform a normal alignment. 27.195 and 27.145 are so close together that the bandpass filter can't tell them apart, nor does it need to.

Measure It All!

The DMM/LCR Meter/ Frequency Counter. All in One.

Troubleshoot down to the component level — any component! Verify poorly marked parts, test for tolerances and damage. Wavetek's new DM27XT is not only a full-function DMM, but also includes complete inductance, capacitance, and frequency measurement capabilities.

- **Wide LCR range:**
10 Ω to 2000 M Ω
10 pF to 2000 μ F
100 pHz to 20 Hz
- **Autoranging frequency meter** 10 Hz to 20 MHz
- **Ac and dc current to 20 A**
- **Logic test, diode test, max reading hold, continuity beeper, input warning beeper, fused input protection, battery saver**

Consolidate your test bench with one meter that does it all — Wavetek's high-performing, full-function XT Series DMM. It's all in one compact, rugged, field-ready package with a big 0.7-inch, 3 $\frac{1}{2}$ -digit display. Insulated probes and alligator clip leads are included, and there is a huge selection of accessories, including current, rf and HV probes, temperature converters, holsters, and cases. Ask for Wavetek DMMs. They're the meters to pick when you have things to fix.



\$119⁹⁵

Other XT Series DMMs from \$89.95

U.S.A.: (619)279-2200
Europe: (44/243) 531323
Asia Pacific: (852)865-1903

©1993 Wavetek Corporation
www.americanradiohistory.com



WAVETEK

CIRCLE 98 ON FREE INFORMATION CARD



LETTERS

SEND YOUR COMMENTS TO THE EDITORS OF ELECTRONICS NOW MAGAZINE

CONCRETE BATTERY DRAIN

On the subject of lead-acid battery drain on concrete floors (Q&A, *Electronics Now*, April 1995), lead-acid batteries are not discharged, but they can be damaged, by placing them on concrete floors in contact with the earth. When a battery rests on concrete or any cold surface, the battery salt precipitates to the bottom of the cells due to the cooling.

If the battery is being charged or is undergoing heavy discharge, this precipitation will be much greater because the electrolyte is warmer and more salt goes into solution. The precipitation of those salts on the bottom of the battery can short the battery plates.

In the past, I have used an insulated, heated-water bath to keep the batteries at a fixed temperature. This increased battery life by more than 300%. I also used only deionized distilled water.

WAYNE EASTWOOD
Long Beach, CA

I'd heard about batteries draining when placed on concrete floors, and here is how it is supposed to happen.

The cold concrete floor, it was said, promotes condensation on the battery, so trace acid salts on the outer surface of the case become damp, creating a conductive path between the terminals, thus causing the battery to discharge.

When I placed an old battery on a piece of newspaper atop a concrete floor, I soon saw those salts accumulating on the newspaper. The paper became moist without any apparent leakage from the battery. The battery also discharged,

but I suspect it was just becoming sulfated from being left inactive. I don't know if the temperature gradient from the top to the bottom of the battery might have promoted sulfation.

From what I've read, one way to store a battery is to (*very carefully*) drain the acid and put it in a separate, suitable container. The battery can then be stored dry. That would solve the annoying problem of the acid salts accumulating on any surface you put it on.

However, draining a battery's sulfuric acid can be dangerous—you can get acid burns on your hands or in your eyes if it splashes. Also the acid will burn holes in your clothing. I once caused a hydrogen explosion while tipping a battery over to drain the acid into a plastic garbage can. I recommend that you either sell (or give) the battery to a scrap dealer or put it into some container that will safely absorb the acid salts and put a trickle charger on it.

I made a simple trickle charger from a 120-volt AC to 12-volt DC, 1 ampere, wall outlet adapter. I wired together (in series starting with its cathode) a silicon 1N4001 diode, an in-line fuse, and a 47-ohm, film-type resistor. I attached the anode of the diode to the

adapter's positive lead and put a battery clip on the other end of the series for the battery's positive terminal. I put a second clip on the ground lead for the negative battery terminal. It kept a battery alive for two years.

P. MIHOK

Markham, Ontario, Canada

SAFETY FIRST

As a product safety engineer with a major safety testing laboratory, I am concerned with the level of precaution expressed in the article "Off-Line Regulators" (*Electronics Now*, April 1995, page 71). I evaluate power supplies that include the components discussed in that article. One of the prime characteristics we look for is isolation from the mains (AC supply) to the output (user-accessible circuits). Otherwise, the circuitry must be made completely inaccessible to the user in the end product. That concept is not mentioned in the article.

In articles describing how to build high-voltage supplies, lasers, or other obviously hazardous projects, you usually place a prominent disclaimer in a box on the first page, separate from the text. In this article, however, your warnings were placed somewhat inconspicuously within the text of the article, where their relative importance is diminished.

The gist of the author's warning is to "... observe proper safety precautions about isolation for the 120-volt AC line ..." and "It is strongly recommended that the builder/user become familiar with safe AC isolation practices and the

Continued on page 17

Write To:

Letters,
Electronics Now Magazine,
500-B Bi-County Blvd.,
Farmingdale, NY 11735

Due to the volume of mail we receive, not all letters can be answered personally. All letters are subject to editing for clarity and length.

Just like these Fully Trained Electronics Professionals



"Thanks to CIE I have tripled my previous salary, and I am now in a challenging and rewarding new field where only the sky is the limit."

Daniel Wade Reynolds
Industrial Electrician
Ore-Ida Foods



"CIE was recommended to me by my boss. It was appealing since I could study at my own pace at home and during business travel."

Dan Parks
Marketing Manager/Consumer Products
Analog Devices, Inc.



"I loved the flexibility CIE offered. It was the only way I could continue both school and my demanding job."

Britt A. Hanks
Director of Engineering
Petroleum Helicopters, Inc.



"I liked the way the school was set up with laboratory assignments to enforce conceptual learning. The thing which impressed me the most about CIE's curriculum is the way they show application for all the theory that is presented."

Daniel N. Parkman
Missile Electro-Mechanical Technician
U.S. Air Force



"Completing the course gave me the ability to efficiently troubleshoot modern microprocessor based audio and video systems and enjoy a sense of job security."

Tony Reynolds
Service Manager/Technician
Threshold Audio & Video

Graduate with an Associate Degree from CIE!

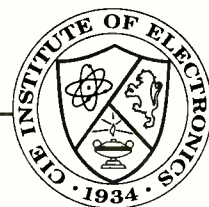

CIE is the best educational value you can receive if you want to learn about electronics, and earn a good income with that knowledge. CIE's reputation as the world leader in home study electronics is based solely on the success of our graduates. And we've earned our reputation with an unconditional commitment to provide our students with the very best electronics training.

Just ask any of the 150,000-plus graduates of the Cleveland Institute of Electronics who are working in high-paying positions with aerospace, computer, medical, automotive and communications firms throughout the world. They'll tell you success didn't come easy...but it did come...thanks to their CIE training. And today, a career in electronics offers more rewards than ever before.

CIE'S COMMITTED TO BEING THE BEST...IN ONE AREA...ELECTRONICS.

CIE isn't another be-everything-to-everyone school. CIE teaches only one subject and we believe we're the best at what we do. Also, CIE is accredited by the National Home Study Council. And with more than 1,000 graduates each year, we're the largest home study school specializing exclusively in electronics. CIE has been training career-minded students for nearly sixty years and we're the best at our subject...
ELECTRONICS... IT'S THE ONLY SUBJECT WE TEACH!

CIE PROVIDES A LEARNING METHOD SO GOOD IT'S PATENTED.

CIE's AUTO-PROGRAMMED® lessons are a proven learning method for building valuable electronics

career skills. Each lesson is designed to take you step-by-step and principle-by-principle. And while all of CIE's lessons are designed for independent study, CIE's instructors are personally available to assist you with just a toll free call. The result is practical training... the kind of experience you can put to work in today's marketplace.

LEARN BY DOING...WITH STATE-OF-THE-ART EQUIPMENT AND TRAINING.

CIE pioneered the first Electronics Laboratory



Course and the first Microprocessor Course. Today, no other home study school can match CIE's state-of-the-art equipment and training. And all your laboratory equipment, books and lessons are included in your tuition. It's all yours to use while you study and for on-the-job after you graduate.

PERSONALIZED TRAINING....TO MATCH YOUR BACKGROUND.

While some of our students have a working knowledge of electronics others are just starting out. That's why CIE has developed twelve career courses and an A.A.S. Degree program to choose from. So, even if you're not sure which electronics career is best for you, CIE can get you started with core lessons applicable to all areas in

electronics. And every CIE Course earns credit towards the completion of your Associate in Applied Science Degree. So you can work toward your degree in stages or as fast as you wish. In fact, CIE is the only school that actually rewards you for fast study, which can save you money.



YES!

I want to get started. Send me my CIE course catalog including details about the Associate Degree Program. (For your convenience, CIE will have a representative contact you - there is no obligation.)

Please Print Clearly

Name _____

Address _____

City _____

State _____ Zip _____ Age _____

Phone No. _____

Check box for G.I. Bill Benefits.

Veteran Active Duty AE77

Cleveland Institute of Electronics, Inc.
1776 East 17th Street
Cleveland, OH 44114

A School of Thousands.
A Class of One. Since 1934.

Send for CIE's FREE Course Catalog and See How We Can Help Your Career Too!



EQUIPMENT REPORTS

CHIP QUIK SMD REMOVAL KIT.

An easy, new way to remove surface-mount components from PC boards

CIRCLE 15 ON FREE INFORMATION CARD

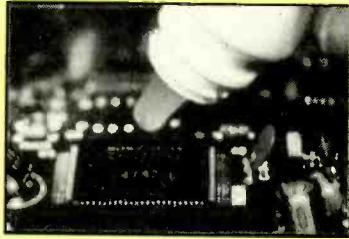

Everyone who is active in electronics, whether as a hobby or as a profession, should be familiar with soldering. Good soldering skills are essential for building a kit or for prototyping a new circuit.

Just as important as soldering is desoldering, or removing parts from a PC board. Unfortunately, desoldering can be quite challenging. And some of the equipment used for desoldering can be prohibitively expensive for casual use.

Desoldering braid is probably the most commonly used solder removal tool at all levels of electronics, from the beginning hobbyist to the experienced engineer. Desoldering braid is placed over a solder joint, and then it and the solder are melted with an iron. The braid acts as a wick that soaks up the solder. There is often a slight solder "residue" left on component leads after desoldering braid is used, but a slight wiggling of the leads with a pair of needle-nose pliers is usually enough to free the part. Desoldering braid is so popular because it is inexpensive, easy-to-use, and it is usually more effective than a cheap plunger-type solder sucker.

However, desoldering braid is much less effective with surface-mount components, especially ICs. When desoldering braid is used to remove surface-mount components, the leftover solder residue cools and

hardens right away, and is enough to hold the part in place—a surface-mount part has no leads to grab and wiggle with a pair of pliers. Any attempt to pry a surface-mount part from a PC board, even after desoldering braid has been used, usually results in damage to the part and perhaps even the PC board.

Surface-mount parts are usually removed by simultaneously melting all solder joints and then lifting the part off the board in a process called solder reflow. Needless to say, the equipment to perform reflow work is usually expensive, often costing thousands of dollars. The concept behind reflow work is simple: lift the part off the board while all the solder holding it down is melted. Short of placing an entire PC board in a very hot oven and then lifting off the suspect part, intricate equipment is required to heat only the leads of the suspect part without excessively heating the rest of the board.

Chip Quik

Can you imagine if—instead of heating the board—you could reduce the melting point of solder so that a bad surface-mount part could be lifted off? That idea isn't as far-fetched as it might seem—it is entirely possible with *Chip Quik*, the SMD removal kit that consists mainly of a very special kind of solder that you *add* to the leads of a surface-mount part.

Chip Quik is a specially designed solder that melts at a very low temperature. When it is heated, it remains in a liquid state much longer than regular solder. This leaves enough time for parts to be "pried" off a PC board before the solder hardens. Regular solder melts at a temperature of 360°F. The Chip Quik alloy melts at 173°F. When the two solders are combined, the resulting alloy melts at about 200°F.

The Chip Quik SMD Removal Kit is sold by Chip Quik (3 Second Street, Framingham, MA 01701, 1-800-836-2447) for \$13 for orders of 1 to 6 kits, \$7 for orders of more than 500 kits, and prices in between for orders in between. Each kit contains enough Chip Quik solder alloy to remove 8 to 10 large surface-mount ICs, solder braid to clean up the board after a part is removed, and a special liquid flux to be used with both the alloy and the braid.

Using Chip Quik

Chip Quik looks very much like regular solder. But if you try to "unroll" a piece of it too quickly it will snap, revealing the brittleness of the alloy. This "weakness" of the alloy also helps in the freeing of soldered parts.

Chip Quik melts much faster than regular solder when held to an iron, especially one at the regular working temperature of 500°F or more. An iron of only 200°F can be used with Chip Quik. A molten drop of this special alloy stays that way for much longer than one might expect. That's what you learn when you mash your finger on a drop of it after what seems like enough time for it to have hardened. Surprisingly,

Continued on page 24

LETTERS

Continued from page 12

principles of double-insulated electrically powered devices, circuits, and appliances." The author advises readers to "provide adequate protection," but did not explain how to do so. Nevertheless, later in his article he suggests providing $1/16$ -inch between traces as "good design practice."

Baloney! Underwriters Laboratories recommends, in its standard UL1012 (which covers general-purpose power supplies) at least $3/8$ -inch over-surface and $1/4$ -inch through-air for potentials between 151 and 300 volts. This, we are to assume, exists because of a rectified line voltage of about 170 volts DC. Then, the article cites examples of typical double-insulated appliances. These include computer monitors and power tools, as if the lay person understands how to double insulate when even manufacturers have trouble doing so.

As a teenager, I developed hands-on skills building projects from *Radio-Electronics*. However, when I think back about how I connected AC lines, or how I selected fuse sizes, it's amazing that I didn't hurt myself or cause damage. I think *Electronics Now* should be more active in promoting the safety aspects of your projects, giving proper importance to the design of safety features into those projects.

For example, the appliances that were cited in the article as having double insulation are products with no user connection to the power supply. The end terminal of an electric drill, for instance, is a mechanical device; all electrical connections start and end in the enclosure which has been carefully evaluated to meet double-insulated requirements.

A hobbyist is not likely to mold a thermoplastic enclosure that meets all of those requirements and, of more importance, use the AC-line-derived DC voltage in some user-accessible application such as a bench power supply or other project. If a fault were to occur in the power supply, mains voltage would appear on accessible components.

More important, the article's

advice to provide $1/16$ -inch of spacing is troublesome to me—it seems almost cavalier. At least the author should go to the trouble of presenting safety rules as advocated by authorities such as UL or CSA that are in the business of developing such requirements.

Perhaps *Electronics Now* should develop guidelines for text to be included in manuscripts for the proper and safe construction of line-powered, or otherwise hazardous, circuits. Those guidelines could be made available to authors and readers.

JONATHAN KALFUS, P.E.

Rego Park, NY

HIGH-TECH CAREERS?

The article "A High-Tech Career for the '90s" (*Electronics Now*, April 1995) is misleading. The future jobs are not in electronics but in such fields as prison security and medicine.

I know of two people who spent two years and a lot of money to earn Associates degrees in electronics engineering technology. It took them a long while to find jobs in a local manufacturing plant—at \$7 an hour, with some minor benefits. The others in that class are still looking for jobs.

My niece took a 90-day prison guard course and had four job offers before she graduated. She was hired starting at \$8.77 an hour plus full benefits. There are good jobs in this field.

I have been trying to find work in the electronics field for over a year since I graduated from college. I have an A.S. in electronics engineering technology, an A.A.S. in avionics, a certificate in computer electronics (2960 hours), and 20 years of electronics experience in the armed forces. I believe I should have spent my time and money studying medicine.

I enjoy reading *Electronics Now* and have for many years. I am a volunteer with a local non-profit organization and use my electronics training to help the organization. Meanwhile, I am still looking for all the good electronics jobs said to be out there.

JAMES M. McLAUGHLIN

Lynn Haven, FL

This will be the last issue in which we will carry an advertisement in this magazine.

We would like to thank those readers who have seen our advertisement during the past year.



FAX: +81+3 3251-3357

Akizuki Denshi Co., Ltd.

1st Floor, Normizu Bldg., 1-8-3 Sotokanda, Chiyoda-ku, Tokyo, Japan 101
CALL: 81-3-3431-6279 FAX: 81-3-3251-3357
Supervisor: Akio Tsumimoto

Be an FCC LICENSED ELECTRONIC TECHNICIAN!



No costly school. No commuting to class. The Original Home-Study course prepares you for the "FCC Commercial Radiotelephone License." This valuable license is your professional "ticket" to thousands of exciting jobs in Communications, Radio-TV, Microwave, Maritime, Radar, Avionics and more...even start your own business! You don't need a college degree to qualify, but you do need an FCC License.

No Need to Quit Your Job or Go To School
This proven course is easy, fast and low cost! **GUARANTEED PASS**—You get your FCC License or money refunded. **Send for FREE facts now. MAIL COUPON TODAY!**
Or, Call 1-800-932-4268 Ext. 90

COMMAND PRODUCTIONS

FCC LICENSE TRAINING, Dept. 90
P.O. Box 2824, San Francisco, CA 94126
Please rush FREE details immediately!

NAME _____
ADDRESS _____
CITY _____ STATE _____ ZIP _____

August 1995, Electronics Now

17



NEW PRODUCTS

USE THE FREE INFORMATION CARD FOR FAST RESPONSE

Digital Cable Tester.

FLUKE HAS INTRODUCED its DSP-100 LAN CableMeter handheld test set for local area network (LAN) testing. The instrument will test installed local area network (LAN) cabling to the forthcoming Category 5 ISO, and IEC standards. The standards apply to cabling for transmitting up to 100 MHz.

The DSP-100 performs a full, one-button, pass/fail autotest for near-end crosstalk (NEXT) and other variables in installed Category 5 cabling in less than 20 seconds.

This is said to be two to seven times faster than analog testers. In that time, the DSP-100 makes NEXT measurements at more than 1000 different frequencies per pair. This is more than the expected standard requirement.

The DSP-100 exceeds the expected +plmi2-dB accuracy specification of the TIA standard. Digital signal processing (DSP) within the unit is said to give it high accuracy in compliance with the proposed standard's Level II requirement. It offers faster test

speed than existing analog testers, and fault identification and the location of crosstalk faults.

The DSP-100 can identify the location of the fault, including near-end crosstalk (NEXT) problems caused by defective components or poor workmanship. It can pinpoint these and other NEXT faults with a graphical representation showing the amount of and distance to a crosstalk fault.

Two classes of instrument performance are defined in the proposed standard. Level I testers will be adequate for diagnostic work, and Level II will give the accuracy needed for certification.

The DSP-100, with a standard remote unit and a rechargeable nickel-cadmium battery is priced at \$3795.00. The DSP-100/SR package, which includes the main unit and a smart remote, is \$4995.00.

FLUKE CORPORATION

P. O. Box 9090

Everett, WA 98206

Phone: 800-44-FLUKE

Fax: 206-356-5116



CIRCLE 20 ON FREE INFORMATION CARD

Color Monitor Pattern Tester.

CHECKER JR. FROM COMPUTER & Monitor Maintenance is a handheld, battery-operated tester for color computer monitors. It measures only 1×3.75×2.4 inches, so it is small enough to fit in a pocket or tool kit. Nevertheless, it can drive most VGA, SVGA, or multi-sync monitors.

With the Checker JR., a field service technician can quickly isolate display problems without having to open the computer case. Most problems can be isolated quickly by connecting the monitor to the tester. There is no need to



CIRCLE 22 ON FREE INFORMATION CARD

swap video cards or monitors.

The tester has an 8x8 test pattern of 64 different color blocks in a white grid. The pattern can be used to evaluate the subjective quality of the monitor. By observing the subtle shades and variations when the brightness and contrast are adjusted, the overall color tracking and balance can be evaluated.

Focus can be evaluated by observing the serrations running down each side of the pattern; they should be sharp and defined. The size, position, convergence, focus, and color balance can be set with the 8x8 color pattern.

Checker JR. is list priced at \$99.95, plus S&H.

COMPUTER & MONITOR MAINTENANCE INC.

6649-N1 Peachtree Industrial Blvd.
Norcross, GA 30092
Phone: 800-466-4411
Fax: 404-840-8814

RF Power Amplifier.

MOTOROLA IS OFFERING THE MRFA2600 broadband, linear pallet Class A RF amplifier for television applications in the 470- to 860-MHz range.

The amplifier module is specified at 26.5 volts with an output power of 25 watts minimum at 1-dB compression and a 10.5-dB minimum small

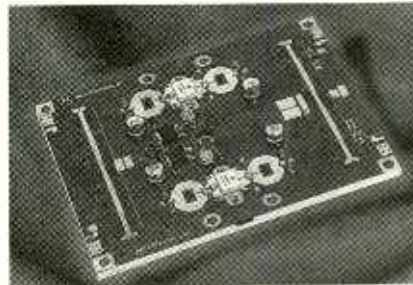

CIRCLE 21 ON FREE INFORMATION CARD

signal gain. However, it can operate at 28-volts.

The MRFA2600 RF amplifier is priced at \$1252.40 in small-quantity purchases.

MOTOROLA INC.

Don Sundby--E 114
5005 East McDowell Road
Phoenix, AZ 85008
Phone: 602-244-6108
Fax: 602-244-4597

Tool Vest.

THE TOOL VEST FROM PAKTEK is a handy vest tool carrier with many pockets for the storage of tools needed for any electronic field-service task. Frequently used tools can be stored in the front pockets--14 are open for easy access and six have flap covers. One large rear pocket is accessible from both sides.

The vest, which has a front zipper, fits easily over street clothing and can be adjusted for different-sized wearers with four expandable, side-release buckles. It is made of black nylon

N.E.W.
National Electronic Wholesalers
CHIPS

Jerrod Compatible
DP5, DPV5....as low as \$5.00
DP7, DPV7 ..as low as \$7.00
R2, V5, CFT modules from \$15.00
Scientific Atlanta
Quick-Boards for:
8550, 8570, 8580, 8590, 8600
all as low as \$14.75

ALSO AVAILABLE FOR TOCOM, PIONEER AND ZENITH

1-800-639-6369

CIRCLE 182 ON FREE INFORMATION CARD

WE PRIDE OURSELVES ON EXCELLENCE IN QUALITY

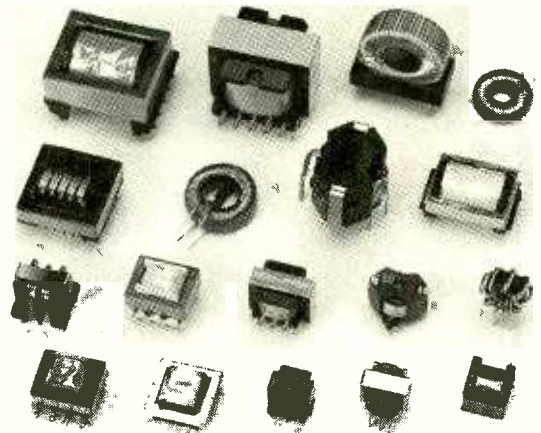

WE SPECIALIZE IN:

- AC/DC ADAPTOR
- AUDIO OUTPUT TRANSFORMER
- CHOKE COIL
- COMMUNICATION TRANSFORMER
- DRIVE TRANSFORMER
- LINEAR POWER TRANSFORMER
- MATCHING TRANSFORMER
- PINCUSHION TRANSFORMER
- PULSE TRANSFORMER
- SWITCHING POWER TRANSFORMER

SEND IN YOUR SPECIFICATIONS FOR QUOTATION TODAY!!



全銘實業有限公司
MAINSTAR INDUSTRIES LIMITED
B10, 16 Floor, Kailey Industrial Centre, 12 Fung Yip Street, Chai Wan, Hong Kong.
TEL : (852) 2558 9319 FAX : (852) 2557 6936



CIRCLE 23 ON FREE INFORMATION CARD

mesh that permits air to circulate around the wearer. The front and back pockets are made of high-visibility red-on-black fabric.

The Tool Vest is priced at \$54.97 plus \$4.75 S&H.

PAKTEK

7307 82nd St. Ct. SW
Tacoma, WA 98498
Phone: 1-800-258-8458
Fax: 206-589-1091

Grounding Plug.

THE MODEL 61038 GROUNDING plug from Contact East provides reliable electrostatic discharge (ESD) protection through a "proven" ground. When it is inserted in a three-wire, 120-volt receptacle, its display lights indicate if the protective circuit is wired properly and that the ground connection is effective. The standard banana-plug receptacle on the Model 61038 will accept the banana-plug ter-

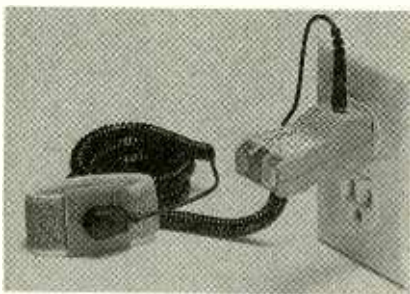

CIRCLE 24 ON FREE INFORMATION CARD

mination of standard ESD-protective wrist straps to give a safe and reliable ground connection. (A wrist strap and grounding cord are not included.)

The Model 61038 grounding plug is priced at \$22.60.

CONTACT EAST

335 Willow Street South
North Andover, MA 01845-5995
Phone: 508-682-2000
Fax: 508-688-7829

8-BIT A/D CARD.

COMPUSCOPE 2125 DATA ACQUISITION cards from Gage Applied Sciences can digitize analog signals at a maximum real-time sampling rate of 250 million samples per second (msps) with a bandwidth of 125 MHz at eight-bit resolution. The card is intended for data acquisition with IBM PC or compatible computers with oscilloscope software.

The card's sampling rate is faster than the speed that can be handled by the ISA bus, so as many as one mil-

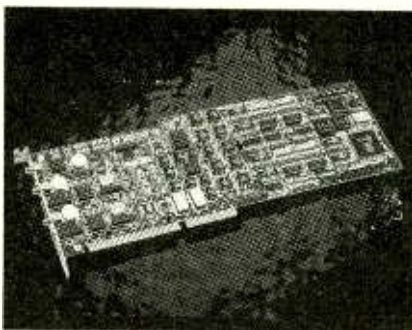

CIRCLE 25 ON FREE INFORMATION CARD

lion samples of A/D data are stored in on-board memory. No GPIB or IEEE 488 interface is required to transfer the data to an IBM PC/AT or compatible. The on-board memory is mapped into the 80x86 processor's memory map and can be transferred to the PC's extended memory with software drivers supplied by Gage.

In the single-channel mode, the 2125 routes the signal connected to channel A to both of its A/D converters and interlaces the clocks so the two converters assign the total memory to channel A. In the dual-channel mode, the A/D converters provide two channels of simultaneous sampling at up to 125 mps for inputs connected to channel A and B.

The IBM PC ISA bus card is sold with GageScope software that allows the card to function like an oscilloscope. There is no need to write a single line of programming code. It also allows the storage analysis and printing of data and it will convert it to an ASCII format for export to spreadsheets and mathematical software packages.

The 2125 provides eight-bit verti-

cal resolution, up to one megasample of memory depth, programmable input gain and input coupling, internal or external trigger capability, software drivers, and an easy-to-use interface. The card can be used for testing computer disk-drives, cellular telephones, radio receivers, radar, and many different test instruments.

The CompuScope 2125 is priced at \$4995.00. Optional drivers in C, Pascal, BASIC, LabWindows for DOS, CVI, and LabVIEW are priced at \$250.00 each. Windows 3.1 DLL has a price of \$250.00

GAGE APPLIED SCIENCES INC.

5465 Vanden Abeele
Montreal, Quebec
Canada H4S 1S1

ESD Control Accessories.

ITT POMONA IS OFFERING two complete electrostatic discharge (ESD) protection field-service kits. The field-service kits include the basic protective accessories for performing field service on ESD-sensitive devices and circuits.

Both include red vinyl static-dissi-

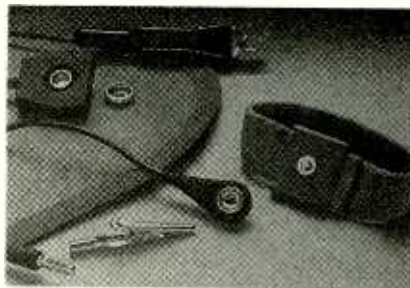

CIRCLE 26 ON FREE INFORMATION CARD

passive mats with snap-type ground wire connection sockets, a common point ground connector cable with two banana-plug sockets, a 15-foot cord terminated with a clip, and an adjustable elastic wrist strap with a 6-foot retractable cord. One kit contains an 18x22-inch mat and the other features a 22x24-inch mat with two storage pockets.

The ESD field service kits are priced at \$46.50 and \$56.00.

ITT POMONA ELECTRONICS

1500 East Ninth Street
Pomona, CA 91766-3835

PROBE ADAPTERS.

HEWLETT-PACKARD IS OFFERING nine general-purpose and micro-processor-specific probe adapters for HP's logic analyzers and oscilloscopes. The adapters are intended for probing surface-mount integrated circuits in 0.5- and 0.65-mm pitch plastic quad flat packs (PQFP) or ceramic quad flat packs (CQFP).

The probe adapters will provide reliable, solderless connections to IC packages with as many as 304 pins. They have a typical bandwidths of up to 600 MHz and typical inter-contact capacitance of 2 picofarads.

Two different mounting techniques ensure a reliable connection and allow quick removal of the adapter. In the first method, a locator base for the adapter is attached to the PC board surface around the IC to be

probed with adhesive supplied. The probe adapter then slides down over the IC package and connects to the base. After installing a flexible or rigid adapter to the probe adapter, measurements can be taken without concern that the adapter might shift position.

The second technique requires that the circuit board have four mounting holes with threaded inserts

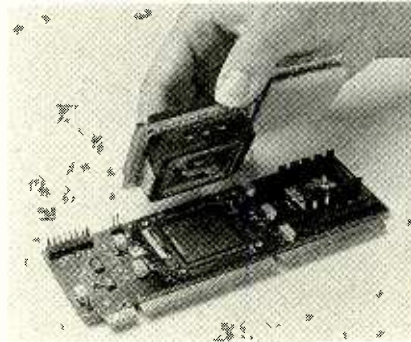

CIRCLE 27 ON FREE INFORMATION CARD

around the package to be probed. A different locator base is then aligned with the IC package. Next, the probe

adapter is installed over the locator base and attached to the PC board with four screws.

In both techniques, the locator base provides fine alignment for the probe adapter for quick, but reliable connections to the IC. A clearance of 0.236 inches is required around the perimeter of the package to be probed by either mounting method.

HP E5316A flexible adapters and HP E5330A rigid adapters for HP logic analyzers or oscilloscopes are available for use with the probe adapters. As many as four adapters can be used with each probe adapter so that all IC pins to be probed simultaneously.

The probe adapter prices range from \$1885.00 to \$2400.00. Flexible adapters are priced at \$350.00 and rigid adapters are priced at \$150.00.

HEWLETT-PACKARD COMPANY

Direct Marketing Organization
P. O. Box 58059, MS51L-S7
Santa Clara, CA 95051-8059

EN

VIDEO NEWS

Continued from page 6

franchised to produce and sell the system, to be followed later by Toshiba, Uniden, and Hughes Electronics. Sony's system will be priced somewhat higher than RCA's, at \$749 and \$949 for basic packages, and will emphasize multi-room capability. Sony's lightweight aluminum antennas feature a signal-seeker LED that lights when it's locked onto the satellite signal to eliminate "wild sprints between the living room and the backyard," as one Sony executive put it.

More ghostbusters.

More than 50% of the nation's television stations are now transmitting the ghost-cancellation reference (GCR) signal developed by Philips Electronics to eliminate ghosting. The signal is intended to be used by home receivers and cable-TV systems. Philips has introduced two Magnavox direct-view and projection

sets in 27- and 32-inch sizes with ghost cancellation built in. An additional 14 Magnavox direct-view and projection sets have back-of-set ports to accommodate ghostbusting set-top box adapters, which are priced at \$150. In addition to the adapters for those special Magnavox sets, Philips is offering another adapter at the same price designed for any TV set, VCR, or cable box.

Digital camcorders on the way.

The new digital videocassette (DVC) format, backed by more than 50 manufacturers worldwide, will first be seen in a camcorder, with prototypes to be displayed at the Consumer Electronics Show next January in Las Vegas. The first company to announce specific plans for a digital camcorder is Korea's Samsung, which says it will have a model on the market in the second half of 1996. The commercialized model is expected to be 33% smaller and 20% lighter than today's compact camcorders.

Samsung says that its prototype model provides pictures with "the quality of a fine photograph," better sound than a CD, and duplication with no loss of quality. The company forecasts annual world demand for digital camcorders at 200,000 in 1997, rising to 8,500,000 by 2005, while digital VCR demand will exceed one million in 1997 and 36,000,000 in 2005.

The appeal of the DVC format for camcorder use lies in its tiny cassette, about the size of a DAT cassette, containing +afl/4-inch tape and capable of recording an hour in standard definition or 30 minutes in HDTV. A somewhat larger cassette will provide 4-1/2 hours of recording in standard formats and half of that in high definition. The 50-member Digital VCR Conference recently finalized specifications for a high-definition version compatible with the U.S. Grand Alliance HDTV system, now under final test. The DVC recorder will require a digital-to-analog converter to play through a standard analog TV set, but will play directly through future digital HDTV receivers.

EN



NEW LITERATURE

USE THE FREE INFORMATION CARD FOR FAST RESPONSE

Repairing PCs: Beyond the Basics

by Michael F. Hordeski.
Windcrest/McGraw-Hill, Blue Ridge Summit, PA 17294-0850
Phone: 1-800-233-1128
Fax: 717-794-2103
\$22.95

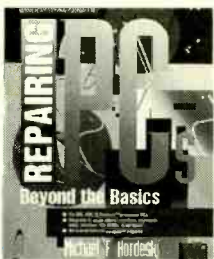

CIRCLE 337 ON FREE INFORMATION CARD

This book gives the reader helpful guidance on how to troubleshoot and repair IBM personal computers and compatibles. These include the IBM XT,

and those computers with Intel, 80286, 80386, 80486 and Pentium microprocessors. The author explains how to troubleshoot and repair personal computers *before* problems occur.

He has written it for non-professionals who would like to maintain and upgrade their computers but are inhibited from doing so because of lack of specialized computer training and experience. This book is clearly written and illustrated to help the reader over the mystery barrier and get him or her to take that important first step--removing the cover from the computer and looking inside.

According to the author, patience and the ability to read and follow simple directions will permit the reader to work on his computer with confidence. He believes readers will enjoy being able to carry out routine repair and maintenance procedures by following the techniques perfected by computer professionals. And they'll reduce downtime, improve

the PC's performance, and save money in the bargain.

Hordeski explains how to test microprocessors and test and repair hard-disk drives, video systems, memory boards, power supplies, CD-ROM drives, networks, mice, computer printers, and scanners. No special tools or equipment are required. The book also explains how readers can extend the lives and upgrade the capabilities of their computers with more advanced replacement microprocessors, memory expansion boards, and larger-capacity disk drives.

The Benchtop Electronics Reference Manual

by Victor F.C. Veley.
Tab Books Inc., Blue Ridge Summit, PA 17294-0850
Phone: 1-800-233-1128
\$54.95

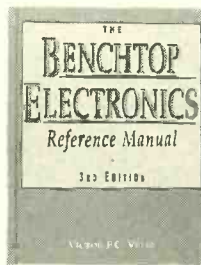

CIRCLE 338 ON FREE INFORMATION CARD

This third edition of a comprehensive electronics reference manual has been expanded, updated, and improved. Intended as a handy, easily

portable source of basic information for technicians, students and hobbyists, it covers more than 240 electronic subjects.

The fundamental topics of direct current, alternating current, solid-state electronics, communications, microwaves, and mathematics for electronics are covered. Each topic is presented in three stages: basic principles, mathematical deriva-

tions, and examples that explain how to use the equations. The helpful practice problems include practical component values.

This third edition includes new sections on differentiation and integration circuits, RF transformers, piezoelectric crystals, directional antennas, the Smith chart, electromagnetic wave propagation, scientific notation, partial derivatives, quadratic equations, matrixes, determinants, and graphical analysis.

1995 Crystals & Oscillators Catalog

Pletronics, Inc.,
19015 36th Avenue West, Suite H,
Lynnwood, WA 98036
Phone: 206-776-1880
Fax: 206-76-2760

Free

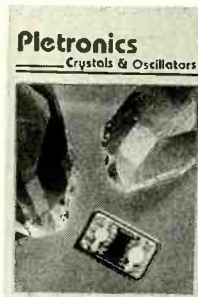

CIRCLE 339 ON FREE INFORMATION CARD

This catalog describes Pletronics' product line of standard and surface-mount quartz crystals and clock oscillators. The selection of packages, frequencies, tolerances, stabilities,

and operating temperatures for the products is included in the catalog. The features, specifications, and dimensions of each device are given.

The catalog has been organized so that each product can be specified by part number. Pletronics' wide ranges of standard frequencies for each product family are listed, and specification guidelines for both modified standard and custom-

made crystals and oscillators are provided.

1995 Catalog

Parts Express, 340 East First Street,
Dayton, OH 45402-1257
Phone: 1-800-338-0531

Free



CIRCLE 340 ON FREE INFORMATION CARD

This Parts Express catalog covers the distributor's lines of electronic parts and accessories that focus on consumer electronics products and electronics hobbyists' projects.

The catalog illustrates and describes audio speakers and accessories for the home and car, audio products for building into the home and office, and professional sound equipment.

Other products offered are cable TV and VCR repair parts, semiconductors, tools, technical books and videos, computer accessories, and supplies for circuit assembly and cleaning.

The Mosaic Navigator:

The Essential Guide to the Internet; by Paul Gilster. John Wiley & Sons, Inc., 605 Third Avenue, New York, NY 10158-0012
Phone: 1-800-CALL-WILEY
\$16.95

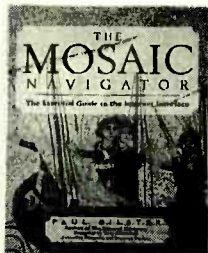

CIRCLE 341 ON FREE INFORMATION CARD

Mosaic, a graphical interface for high-speed computer access, is a program that can make gaining access to the Internet easier for those who are not computer experts. Based on

the click-and-point approach that has made Windows and Macintosh software popular, it allows users to choose icons and explore the Internet without having to learn long command strings in confusing Unix code.

This book explains the capabilities and difficulties encountered in using Mosaic. Instructions are given on how to download, install, explore, and customize Mosaic on a personal computer. Sample sessions and demonstrations explain how to use Mosaic's FTP, Telnet, and Mail tools, and such Internet services as Usenet, WAIS, and gopher. With this background, the reader can create a hotlist of Mosaic menus for instant access to favorite Internet sites.

Gilster's book explains how to customize the program to change home pages, speed up access, and alter how it "sees" FTP directories. Instruction is given on downloading Mosaic at no cost from the National Center for Supercomputing Applications (NCSA), and how to use related programs such as Lview, WHAM, GhostScript, and MPEGPLAY. Also included are a travelogue of World Wide Web sites for Mosaic, and a discussion of the interface's future.

1995 RF Selector Guide & Cross Reference

Motorola Inc., Literature Distribution Center, P. O. Box 20924, Phoenix, AZ 85063

Phone: 1-800-441-2447

Fax: 602-994-6430

Free



CIRCLE 342 ON FREE INFORMATION CARD

Here are two new technical literature offerings from Motorola. The RF Selector Guide & Cross Reference for

1995 (SG46/D Rev 13) has been updated to reflect new and current Motorola products including integrated circuits that operate in the 1.8- and 2.4-GHz frequency ranges. This first issue of the RF Application Reports handbook (HB215/D) includes 92 application notes, article reprints, and engineering bulletins written by Motorola employees. The authors represent the various groups within the Motorola organization whose products relate to radio-frequency transmission and reception.

53,226

ELECTRONIC COMPONENTS

Whether you order 1 part or all 53,226...MOUSER stocks and...ships same day!!

CALL... (800) 992-9943



for your
**FREE
CATALOG**

958 North Main St.
Mansfield, TX 76063

**MOUSER[®]
ELECTRONICS**
Sales & Stocking Locations Nationwide

CIRCLE 117 ON FREE INFORMATION CARD

Earn \$1000

A Week While You Learn High Paying VCR Repair.

**Earn While You Learn . . .
Secrets Revealed . . .**



Train at Home

If you are able to work with small hand tools and possess average mechanical ability, you could earn top dollar part time or full

time. Our learn by doing method teaches you how to work on VCR's without boring unnecessary electronic basics.

For Free Information Package Send Coupon to:
Foley-Belsaw Institute, 6301 Equitable Road,
Kansas City, MO 64120

Check VCR or another High Paying Career Field	(Check One Box Only)
	<input type="checkbox"/> VCR Repair, Dept. 62345
	<input type="checkbox"/> Computer Repair, Dept. 64243
	<input type="checkbox"/> TV/Satellite Dish, Dept. 31126
	<input type="checkbox"/> Advance VCR Repair, Dept. 65046
<input type="checkbox"/> Camcorder Repair, Dept. 66056	
<input type="checkbox"/> Fax Repair, Dept. 67056	
<input type="checkbox"/> Printer Repair, Dept. 68055	
<input type="checkbox"/> Computer Programming, Dept. 35074	
FOLEY BELSAW Since 1926	
Name _____	
Address _____	
City _____	
State _____ Zip _____	

CIRCLE 191 ON FREE INFORMATION CARD

Circuit Protection Catalog

USD Products, Division of Cooper Industries, 7300 West Wilson Avenue, Chicago, IL 60656
Phone: 708-867-4600
Fax: 708-867-2211

Free

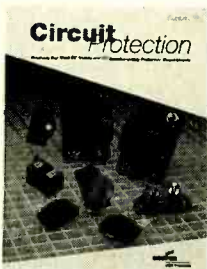

CIRCLE 343 ON FREE INFORMATION CARD

This catalog concentrates on circuit protection products offered by USD Products. It provides specifications, illustrations, and ordering information for products that meet federal and local protection requirements. The circuit protection products are organized into categories for recreational boats, recreational vehicles, multiple power-outlet strips, battery chargers, and other related products.

ucts that meet federal and local protection requirements. The circuit protection products are organized into categories for recreational boats, recreational vehicles, multiple power-outlet strips, battery chargers, and other related products.

Neural Network Computing

by Ramachandran Bharath and James Drosen.

Windcrest/McGraw-Hill, Blue Ridge Summit, PA 17294-0850
Phone: 1-800-233-1128

Fax: 717-794-2103

\$29.95

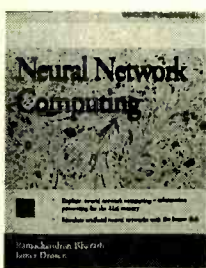

CIRCLE 345 ON FREE INFORMATION CARD

This book and its included computer disk will provide a thorough introduction to neural networking for electronics systems designers, software developers, programmers, and advanced hobbyists. Neural networking is based on parallel distributed processing, in contrast to the sequential computing performed by a computer with a central processing unit (CPU). After explaining in detail the differences between artificial neural networking technology and conventional computer-based computing, the authors cover the basic components of an artificial neural network.

Other topics in the book include multilayer feedforward networks, Hopfield networks, Boltzmann machines, and Kohonen and ART networks (unsupervised learning). The computer disk contains nine ready-to-run programs and complete instructions for using those programs. These permit the reader to gain "hands-on" experience with artificial neural network computing techniques.

Operational Amplifier Circuits: Analysis and Design

by John C.C. Nelson.

Butterworth-Heinemann, 313 Washington Street, Newton, MA 02158-1626

Phone: 617-928-2500

Fax: 617-933-6333

\$22.95

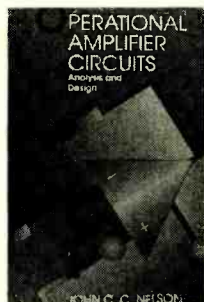

CIRCLE 344 ON FREE INFORMATION CARD

This operational amplifier circuit book will be of special interest to designers who want to make use of widely sourced operational amplifier ICs for many different applications. The author explains that the availability of low-cost, versatile, monolithic operational amplifiers makes possible a modular approach to analog circuit design. He reports that in many cases, a single operational amplifier combined with a small number of passive components might be all that is needed to perform a specific function. By interconnecting several of these subsystems, the required configuration can be built with a minimum of design effort.

Mr. Nelson has used simple, consistent mathematical notation throughout the book, making it comprehensible to designers and technicians with limited experience in circuit analysis. Several computer programs which supplement the text will simplify and speed up the determination of component values and assist in the design of practical operational amplifier circuits.

EQUIPMENT REPORTS

Continued from page 17

mashing your finger on a drop of molten Chip Quik doesn't hurt at all, and only causes it to harden quickly, like wax, leaving a fingerprint in the hardened mass.

To remove a surface-mount part from a PC board, the liquid flux is applied to the component leads and then the Chip Quik alloy is added to the regular solder holding the part in place. This is done by simultaneously heating both the component leads and the alloy, just as if you were soldering the part for the first time. The one exception to regular soldering is that neatness doesn't matter here, as long as surrounding components aren't touched. Only a small amount of the Chip Quik alloy must be added to each pin.

Once every component lead has been treated, the part can be removed. If the part is small enough, it will still be hot enough from adding the Chip Quik for the part to be pried off immediately with a puller or dental pick. If some of the leads have cooled slightly and the part seems stubborn, a quick wipe of the iron across each side of the IC will heat it enough for it to be lifted off the board without causing damage to the part or the board.

After a part has been removed from a board, any solder/alloy mix remaining on the PC-board and its pads must be cleaned up with desoldering braid and some solvent. The board is then ready for a new part. If the removed part might still be good, the leads can be cleaned up with a heat gun and stiff brush or little more desoldering braid.

Chip Quik can be used on any surface-mount part where the soldered leads are accessible. While it can be used on small 2-leaded components, such as resistors and capacitors, these parts can also be removed with tweezers and a regular iron by alternately heating each side. Chip Quik should really be used with surface-mount ICs, which are by far the most difficult components to remove. For these parts, there is no cheaper, simpler, and less-damaging way to remove them than Chip Quik.

EN

EN

Obtain required certification...
 Enhance your career potential...
 Improve your earning power...

Prepare Yourself to Pass The Communications Licensing and Certification Exams!

Give yourself the competitive edge it takes to succeed in the expanding world of communications. For the first time ever, McGraw-Hill offers you the opportunity to thoroughly prepare yourself to pass the difficult tests required for licensing and certification by major sponsoring organizations.

Use Communications Licensing and Certification Examinations The Complete TAB Reference to "prep" yourself in a wide range of electronics subjects and concentrate on the areas where you need to "brush up."

Practice Tests for Communications Licensing and Certification Examinations provides you with full-length practice tests that cover virtually every subject needed to master the actual test. Answers let you focus on your weak points and improve your overall knowledge.

Much more than just a textbook, this set provides a focused review of the material you need to know. Fill out and return the coupon, or call, toll-free **1-800-822-8158** — now — for this extraordinary study reference set.

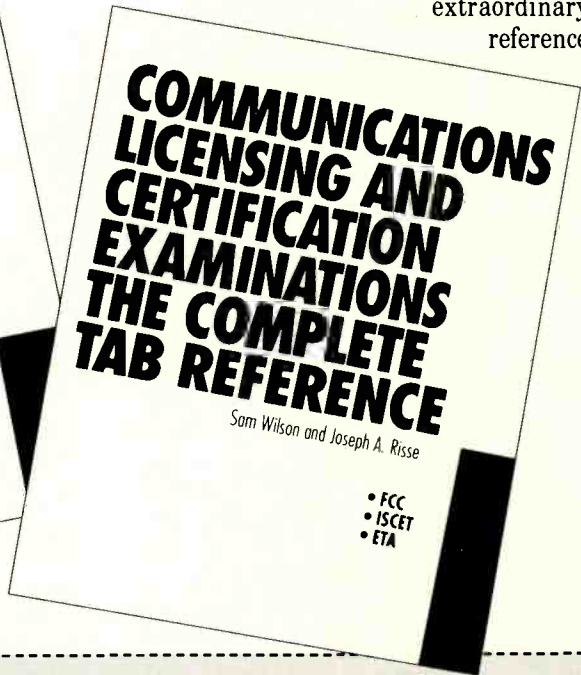
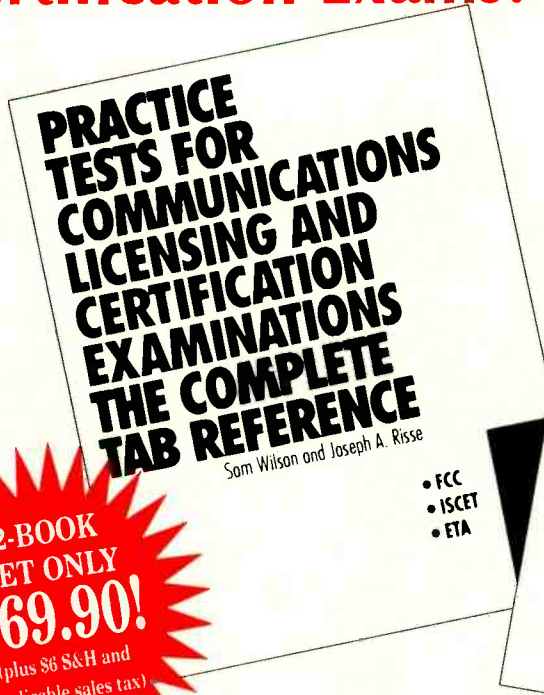

2-BOOK SET ONLY \$69.90!
 (plus \$6 S&H and applicable sales tax)

Get a TAB Electronics brief bag, absolutely free!

Satisfaction Absolutely Guaranteed

We're so sure that you'll be satisfied with your selection, we'll even pay the postage if you decide to return it.

PAYMENT METHOD:

Check or Money Order Enclosed Please charge my credit card:



Account No. _____

Expiration Date _____

Signature _____



TAB Electronics
 P.O. Box 182606
 Columbus, OH 43271-3033

YES! Please rush my 2-volume set (#587064-9). Payment of \$69.90 (plus \$6 S&H and applicable sales tax) is enclosed. I understand that if I purchase this set now, I will receive a TAB Electronics brief bag, absolutely free.

Name _____

Address _____

City _____ State _____

Zip _____ Phone () _____



FOR FASTEST RESPONSE CALL TOLL-FREE, 1 800 822-8158, 24 hours a day!

Key= SP85ENA

Engineering and Compromise.

Windows 95 will not satisfy everyone.

COMPROMISE IS A DIRTY WORD TO MANY. OUR INDIVIDUALISTIC SOCIETY ADMIRES PURITY AND SINGLE-MINDEDNESS. NONETHELESS, COMPROMISE IS NECESSARY FOR SURVIVAL.

Nowhere is our ambivalence toward compromise more apparent than in the computer industry. This month's column describes compromises in operating systems and in systems engineering.

Windows 95 vs. NT

"What constitutes an operating system" is a question I've addressed here more than once. I bring it up once again because of some heat Microsoft has been taking in the computer press recently regarding the stability, or robustness, of the forthcoming Windows 95. It turns out that crashing Windows 95—whether intentionally or not—is easy to do. Therefore, conclude some writers, Windows 95 is a sham, just a pretty new face on the same old crumbling, unstable foundation.

After considering both the technical and marketing issues at some length, I conclude that that attitude is incorrect. To understand why, you have to understand Windows 95's position relative to Microsoft's other major operating systems: Windows 3.11 and Windows NT.

In essence, Windows NT was designed from the ground up as an architecturally solid system, with

considerable protection from system corruption. Windows NT correspondingly carries with it resource requirements that are quite a bit higher than either Windows 3.1 or Windows 95. In addition, in the name of system stability, Windows NT sacrifices both performance and compatibility.

Windows 95, on the other hand, explicitly emphasizes cost, compatibility, and performance. With the

emphasis on those three, something else had to give: namely, architectural robustness.

In the simplest possible terms: *Windows 95 is not Windows NT*. Should it be? Did Microsoft intimate that it would be? Does the market care either way? I'll examine those questions in reverse order.

The only way the mass market will care about the Windows 95 design is if the product proves to be considerably more unstable than its predecessor, Windows 3.1. Obviously, Windows 3.1 is no bedrock of stability. But that hasn't prevented Microsoft from getting 10^8 copies of it into circulation. If, in the worst case, Windows 95 is no worse than Windows 3.1, it will

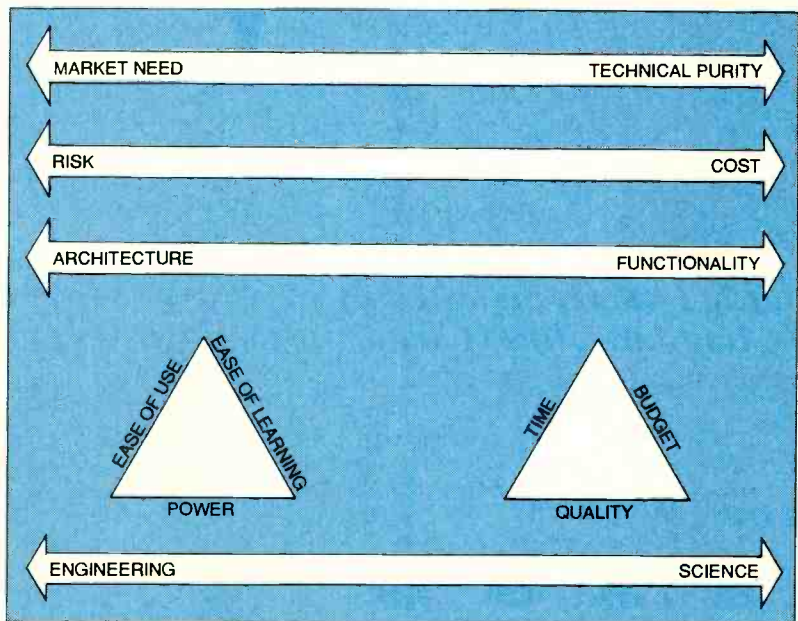

FIG. 1—EVERY DESIGN REVOLVES AROUND A SET OF COMPROMISES among several often mutually exclusive options. Zealous allegiance to a particular option can doom a product.

be successful. So far, it appears to be better.

Microsoft has been vague about the precise relationship between Windows 3.1, Windows 95, and Windows NT. And that is classic Microsoft marketing strategy: Put something out there, get feedback, and tweak it. If it turns out that early (and mind you, we're still talking about the pre-commercial release of the product) adopters demand more stability, Microsoft will add it. Indeed, precisely that process has been at work the past few months. Originally, the company planned to lock only the lowest 4 kilobytes of system memory. Because of the recent brouhaha, Microsoft has now decided to lock the lower 64 kilobytes. That's not a complete, NT-class solution, but it's better than it was, and is less expensive, in terms of both hardware requirements and software overhead, than a robust NT-like solution.

Third, Windows 95 is not and should not be Windows NT. If everyone had 100-MHz Pentiums with 32 megabytes of RAM, the NT architecture might be viable. But given the widespread use of 386 and 486 machines, Windows NT is not viable. Technically, Windows NT may be superior to Windows 95. But the computer industry is littered with the carcasses of technically superior solutions that were out of sync with market reality.

As a consultant and systems integrator, I find aspects of the Windows 95 architecture extremely troublesome. But putting on my marketing cap, I think Microsoft has cut a compromise among cost, compatibility, performance, and robustness that is likely to be wildly successful.

Design as compromise

Step back and consider these issues from a broader perspective. The issues facing Microsoft are no different than those facing any design engineer, regardless of his field, be it electronic hardware, computer operating systems, application software, civil engineering, or any other. Every non-trivial design involves several related groups of tradeoffs and compromises.

Here are some of them:

- Market need and technical purity
- Risk and cost
- Architecture and functionality
- Ease of use, ease of learning, and inherent power
- Quality, time, and budget
- Engineering and science

I'll examine each group in turn.

Market need is first

The primary characteristic of a successful design is that it should meet a market need. Second is that it doesn't violate technical constraints. A purist approach that insists first on conforming to abstract mathematical (or other) principles is guaranteed to fail.

For example, it is possible to build earthquake-proof buildings, but it is almost never done because of the cost. As a society we have collectively weighed risk and cost, and have opted to decrease cost at the expense of increased risk.

The same is true in the computer business. Until now, the PC industry has evolved by opting for lower cost at higher risk. In fact, it couldn't have evolved in any other way. Other parts of the computer industry have made different tradeoffs for the purpose of decreasing risk. Mainframes and minicomputers have been designed for decades with a much greater emphasis on risk avoidance, at consequently higher cost. Now minis and mainframes are on the endangered species list. But that is not because of technical inferiority. It is instead because of manufacturers' inability to respond to emerging new markets and changes in existing markets.

Ironically, the very same technologies used by the mini and mainframe vendors to keep risk low and cost high are the very ones that are now coming into demand in the PC industry. The tightrope that Microsoft has proven so adept at walking involves active ongoing sensitivity to desired risk and acceptable cost to achieve it.

Architecture and functionality

Of course, risk and cost are not the only characteristics that must be balanced in system design. Particularly when it comes to computer software, architecture and functionality are

Electronic Security

2 for 1 SALE!



Mini Long Range FM Voice Transmitter (3 mi) Ultra Sensitive - with fine tune, range control, more! Detects even whispers! FMX1 Kit and Plans.....~~\$49.50~~



Tiny Telephone FM Transmitter (3 mi) - automatically operates when phone is used. Crystal clear clarity with fine tune and range control. TELX-1 Kit and Plans.....~~\$49.50~~

Both Easy-to-Build Kits Above only \$49.50!

Extended Play Telephone Recording System - \$129.50



- Automatic - Crystal Clear - Easy to Use - Connects to Any Phone - Automatically controls and records both sides of the conversation on our extended play recorder. Caution - check local laws as some states require an alerting beeper. TAP20X Ready-to-Use System only \$129.50

FREE CATALOG with order - or send \$1.00 P&H

INFORMATION UNLIMITED MC, VISA, Check, Cash or C.O.D. Send or Fax Orders to: Dept en16 PO Box 719, Amherst, NH 03031 Orders: 800-221-1705 FAX 603-672-5406 Tel 603-673-4730

ATTENTION! ELECTRONICS TECHNICIANS

EARN YOUR **B.S.E.E. DEGREE**



THROUGH HOME STUDY

Our New and Highly Effective Advanced-Placement Program for experienced Electronic Technicians grants credit for previous Schooling and Professional Experience, and can greatly reduce the time required to complete Program and reach graduation. No residence schooling required for qualified Electronic Technicians. Through this Special Program you can pull all of the loose ends of your electronics background together and earn your B.S.E.E. Degree. Upgrade your status and pay to the Engineering Level. Advance Rapidly! Many finish in 12 months or less. Students and graduates in all 50 States and throughout the World. Established Over 40 Years! Write for free Descriptive Literature.

COOK'S INSTITUTE OF ELECTRONICS ENGINEERING

CIE 4251 CYPRESS DRIVE JACKSON, MISSISSIPPI 39212

CIRCLE 58 ON FREE INFORMATION CARD

August 1995, Electronics Now

Two ways to fit a 100 MHz



Bigger hands.



Got huge hands? Then you probably don't mind lugging a benchtop scope around in the field. For the rest of us, there's TekScope™, the revolutionary oscilloscope/DMM from Tektronix. It's the first hand-held to offer true 100 MHz bandwidth and a 500MS/s sample rate on each of its two channels.

benchtop scope in your hand.



TekScope™

That's enough power to capture fast single-shot pulses. Plus it's got the familiar Tek interface and a bright, backlit display—all for just \$2195 MSRP. For the name of your nearest Tektronix distributor, call us at 1-800-479-4490, action code 701. Or visit our Web site at <http://www.tek.com>.

Tektronix

another mutually conflicting pair.

For example, the growth of the PC industry has seen vast increases in functionality in virtually all software applications. But comparatively speaking, there has been no corresponding increase in architecture. That is, the vast majority of applications appear as massive collections of functions that are simply glued together in various ways. The apparent user interface of the particular application typically has a collection of nested menus to present a few of the most commonly used functions. But buried beneath the surface are countless functions that most users never see. They're buried because the industry has failed to find a way of presenting advanced functionality other than with simple laundry lists of functions that make for easy descriptions in comparative magazine reviews.

I firmly believe that it is possible to build solutions that expose the easy 20% of the functions to the 80% who are satisfied with that, and to simultaneously encompass the remaining 80% for the 20% of power users who need it in an organized way. For example, why do all current word processors present different models for different document components? A consistent underlying model would be no more visible to the 80% than current structures, but could be of great use to the 20% willing to make the modest intellectual investment.

Use, learning, and power

This is a complicated and interconnected set of issues. In general, as power increases, ease of use and ease of learning both decrease. But the PC industry has evolved to a model that includes much power, of which only the first 20% is easy to learn and easy to use. Going beyond that requires disproportionate effort because of the lack of underlying architecture, as well as a social disinclination toward understanding anything beyond the level of pushing buttons, not to mention lack of methods for communicating architectural concepts clearly and concisely.

Quality, time, and budget

One axiom of system design is that in any given project, you can achieve

any two of quality, time, or budget, but never all three. So the wise designer considers the issue carefully during the planning stage, and continually reviews it throughout the life of a project, making course corrections as necessary.

Science and engineering

Tradeoff and compromise are concepts that clearly distinguish engineering from science. Science is pure; it does not admit compromise. The problem is that engineering is often taught, hence practiced, as if it were science, as if it owed its primary allegiance to purity of concept, rather than to working out a compromise among both theoretical and real-world constraints.

Conclusions

I started this discussion concerned with the robustness and stability of Microsoft's forthcoming Windows 95. The technical and trade press has recently shown that Windows 95 will be a less stable environment than Microsoft's explicitly designated high-end product, Windows NT. Fair enough; Windows 95 is not Windows NT. Both are commercial products, engineered as a set of compromises. Is the Windows 95 set of compromises unacceptable? Does a "mainstream" operating system require high-end robustness? Will the mainstream pay for that robustness?

In my experience, the answer to each of those questions is a resounding "No!" The mainstream doesn't want it and won't pay for it. There might yet be some tuning (and schedule slipping), but warts and all, Windows 95 is headed for five to ten years of dominance on mainstream PCs.

E-mail

I have been having reliability problems with my E-mail forwarding service, so if you have not received a reply to a message, my sincere apologies for the inconvenience. Your message or my reply may well have been lost. I am working on a solution; in the meantime, you can reach me on CompuServe as 72170,2226, or via the Internet at 72170.2226@CompuServe.com

We Can Think Of 9 Good Reasons To Immunize On Time.

Measles
Mumps
Diphtheria
Tetanus
Hepatitis B
Rubella
Spinal Meningitis
Pertussis
Polio

But You Only Need One.



Immunize On Time.
Your Baby's
Counting On You.
Call 1-800-232-2522



U.S. Department of Health and Human Services

Has **DSS** Been Hacked?

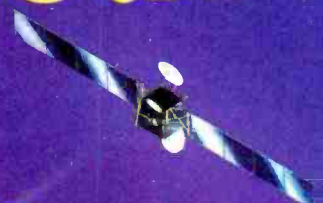

Has the hot new Digital Satellite System fallen victim to signal pirates?

JOHN McCORMAC

THE RCA DIGITAL SATELLITE SYSTEM (DSS) WAS INTRODUCED with much fanfare in mid-1994. The all-digital, direct satellite broadcast system delivers high quality TV signals to satellite dishes only 18 inches in diameter. Modern data-compression technology allows a pair of geostationary satellites co-located above the equator at 101° West longitude to transmit about 150 or more high fidelity programs to the continental U.S. That number might even increase in the future.

Will the piracy that haunted large-dish, C-band satellite program delivery during the late 1980's and early 1990's do the same to the small-dish direct-satellite industry? Perhaps—the system's encryption technology is based on a modified version of the VideoCrypt conditional-access system, which has been in operation in Europe for more than five years and has been repeatedly compromised by hackers and signal pirates.

According to the information we have available, the Digital Satellite System is on the verge of being hacked. Pirate smart cards, which will give the DSS receivers access to programs, are expected to be available by the time you read this.

Signal pirates are planning to make four tiers of pirate cards available. The first tier, which is expected to cost \$150, will provide access to only the basic programs. The second tier card will add the subscription movie channels. The third tier card will provide access to the sports packages. The last card will give access to all services and will include a ceiling of \$500 in pay-per-view (PPV) credit. Pirates are, in essence, forming an alternate access control system that will supplant the official DSS billing system with their own.

The pirate cards will contain features that will prevent them from being pirated, or at least make piracy more difficult. For example, each card will be "married" to an individual receiver or IRD (inte-

grated receiver/descrambler). Pirates in Europe found piracy of their own cards to be a major problem. (More information on the European scrambling situation, and valuable background information on signal piracy is contained in the companion article, "Satellite Piracy: The European Experience," on page 37.)

The majority of the pirate smart cards for the European VideoCrypt system are based on the PIC16C84 microcontroller. Although that microcontroller has a code-protection fuse that normally prevents the contents of the program memory from being read out, pirates were able to "pop" the device and extract the program code of other pirates.

As a result of this, the program for hacking VideoCrypt spread rapidly throughout Europe. A repeat of this situation is the last thing that the DSS pirates want—they want to maintain control over the distribution of pirate cards. Therefore the new smart cards might be based on a more secure processor. Some pirate sources have commented that microcontrollers from Dallas Semiconductor and Zilog were under consideration.

Because of tough anti-piracy laws in the United States, the main pirate operations will be based outside of the country. Canada is rumored to be one site. Other sources have reported that operations will be based on islands in the Caribbean.

How the hack occurred

The most valuable tool for hackers is information. A valuable piece of information came from text printed on the smart card itself: "This card is the property of News Datacom Ltd. and must be returned upon request. Incorporates Videoguard (tm) security system. Provided for reception of authorized 101°W longitude satellite services. Protected by U.S Patent 4,748,668, and others."

That patent referred to on the smart card is the Fiat-Shamir zero-knowledge test. It is an authentication algorithm that the decoder runs to see that the smart card inserted is a genuine smart card. The same authentication algorithm is used in the analog VideoCrypt system in Europe. This may not be the only commonality between the two systems.

In early 1984, the European VideoCrypt system, using the issue 07 card, was hacked. The full source code of the hack had been distributed freely on the Internet and via many computer bulletin board systems (BBSs). The Digital Satellite System was preparing for launch in the USA.

It was a gut-wrenching time for the executives involved in the DSS venture. The common element between Europe and the U.S. was News Datacom. The DSS executives were worried about the security of their new system. Would what happened in Europe happen in the U.S.?

Slowly but surely the favorable press coverage started. The satellite television trade press began to run articles about the new DSS system. The articles were, in hacker terms, content-free. The majority of the articles seemed to be written by clueless people without any knowledge of what really happened in Europe. One article in particular stated that VideoCrypt had been unhacked since its introduction in Europe in 1989—there was no mention of the 500,000 pirate VideoCrypt smart cards and the Omigod emulator programs that were in use. It seemed to be a replay of what had happened in Europe—the puff pieces in the trade press and the inevitable hacks.

Despite the articles, the 500,000 pirate VideoCrypt cards were very real and they forced Sky to issue a new card ten months ahead of schedule. But there was an even greater problem. The 08 card Sky had planned to launch was almost identical to the hacked 07 card. The 08 issue had to be scrap-



THE SMART CARD or access card for the DSS integrated receiver/descrambler (IRD) has drawn the attention of hackers.

ped, and the 09 card issue was released.

There were two major differences between the 09 and the 07 Sky cards: The 09 had a different architecture and a very different algorithm. Sky started to distribute this new card in February 1994 but did not switch over to the card until May 18, 1994. That day is known as Dark Wednesday by European hackers.

The connection between those events and DSS is the timing. It would have been very convenient for News Datacom to draw heavily on the Sky 09 card for the new DSS card. Most of the ROM routines could have been easily adapted for the new system. The main changes would of course have been in the EEPROM, which contains the main cryptographic routines.

The operation to “pop” the 09 Sky card to read its contents took European hackers a few months. The hack required that the smart card be completely reverse engineered. Some preliminary code was sold in June last year at an auction in London, giving hackers a start. It took a further four months before the system was totally compromised. Perhaps the most

important part of the operation was the discovery of a “back door” in the smart card’s code.

When VideoCrypt was developed, the overall structure of the system was simplistic, compared with systems like VideoCipher II. It was also reliable. But the designers may never have expected the system to be required to support over two million subscribers.

As a direct result of this loading, the designer of the system, News Datacom, had to incorporate some new levels of access control into the system. Upgrading the decoders was out of the question—there were too many to track down. Most of the stand-alone decoders had long ago disappeared into mainland Europe.

News Datacom’s solution proved to be both clever and stupid at the same time. The company incorporated a method of programming the card over the air. The over-the-air instructions were included in the standard access control data packets. The instructions looked just like more card identity numbers but they were not. The hackers called them “nanocommands.”

The over-the-air programming scheme was clever in that it gave program suppliers more control over the cards—they could easily implement electronic countermeasures (ECMs) by updating the card’s EEPROM and they could actively change the channel authorization. In effect they could even run a limited form of pay-per-view service.

Of course there is a downside to over-the-air programming: All of the security of this card relied on the hackers not finding out the core algorithm and obtaining a working knowledge of the card addressing. However, the core algorithm had been sold at auction in June 1994. The rest was only a matter of time.

The cracks in the edifice began to show, and by the end of July, VideoCrypt was crumbling. The Phoenix hack had worked. This hack relied on an understanding of how the ac-

cess control data packets were encrypted and structured. (The Phoenix hack allowed hackers to activate or reactivate all channels on Sky cards using a computer and eventually a stand-alone programmer.)

Naturally when Sky tried to retaliate against the Phoenix hack, it used the nanocommands. The hackers were watching. It was true electronic warfare—Sky and News Datacom versus the hackers.

Gradually the function of each nanocommand was ascertained. Even now it is difficult to believe what happened next. One nanocommand was found to read a byte from the EEPROM as the input for a round of the algorithm. Another nanocommands acted like a BREAK command that would dump the current result out as the decryption key.

The hackers had the algorithm and knew the result just prior to the byte from the EEPROM being used. They could dump out the result just after the EEPROM byte had been processed through the algorithm. Since they then had the main components, it was simply a case of starting the algorithm from the first result and stepping through with input bytes from 0 to 255. This hack has become known as the "Vampire Hack".

Of course this attack was not perfect. The resulting data from

the Vampire hack of the 09 Sky card seemed to make no sense. The processor in the smart card was based on the 6805, but the data was definitely not related to the 6805. Eventually the hackers cracked the encryption and made sense out of the data.

The speed of the reported DSS hack strongly indicates that the same card type was used for the DSS system. This would mean that the same techniques that were used to pop the 09 Sky card could be used on the DSS card.

The real test of the pirate cards lies ahead. As with the European VideoCrypt, the DSS smart card may be over-the-air programmable. This would mean that the DSS cards could be updated over the air and new cards would not have to be issued immediately. The pirate cards would, of course, would need to be updated by the pirates.

The main difference between Europe and the U.S. is that the American hacking industry has experience with such upgrading. The same technology was used to hack VideoCipher II (the compromised scrambling system that was used for C-band transmissions). The pirate cards may well come with a modem module to automatically update the card.

How the Vampire Hack works

For all of its digital complex-

ity, the European VideoCrypt system still depends on a 9600-baud data link to a smart card. The smart card is an eight-bit processor based on a 6805. It is not fast enough to run calculation-intensive algorithms such as RSA (Rivest Shamir Adleman). As a result the VideoCrypt encryption algorithms have been register-based hashing algorithms that are designed to be fast and efficient.

In the European VideoCrypt system, two data packets are associated with the decryption process: the 74h packet and the 78h packet. The packet format and structure the DSS system uses is not yet known. However, the smart-card interface conforms to the ISO-7816 specification, so the packet types can be determined by monitoring the data.

For reasons of economy, it is possible that the packet structure that News Datacom used for DSS is similar to that for VideoCrypt. However, the actual algorithms may be slightly different.

Some of the differences between the European and DSS system are expected to be in the pay-per-view (PPV) routines. In the European VideoCrypt system, the main PPV routines were incorporated into the card-decoder interface microcontroller. This chip also held the PPV token reservoir. It is unlikely that such a mistake has been repeated in the DSS system.

In the DSS IRD, a custom microcontroller controls the interface between the card and decoder. The contents of the microcontroller's memory is protected from prying. By contrast, the designers of the European VideoCrypt system made a major mistake by not protecting the microcontroller. Hackers were able to dump out contents of the microcontroller's ROM and were able to attack the system. They rewrote the code and loaded it into a version of the microcontroller that contained EPROM. This modified code looked for the card's identity packet, and ignored the packet. This



THE BOTTOM OF THE SMART CARD shows its contact points. Note News Datacom's patent statement that hackers credit with helping them.

hack, known as the KENTucky Fried Chip, prevented Sky from switching off a smart card.

The card-decoder microcontroller would have been the first chip in the DSS IRD to have been reverse-engineered. The reverse engineering of a customized microcontroller is not, in most cases, as difficult as a smart card. In mass-produced IRDs and decoders, the microcontrollers are typically ROM versions of commonly available microcontrollers. Some of them have simple back doors.

Packets

The 74h message packet is the workhorse of the VideoCrypt system. It carries all of the card turn-on and turn-off codes. The packet contents are also used as the input data for the hashing algorithm that generates the decryption key.

The data in this packet has a 27-4-1 structure. The first 27 bytes contain the decoder flags, the card addressing instructions, the channel identifier and the card addresses affected by the packet. The next four bytes are a hash algorithm checksum.

When the packet is processed by the hash algorithm, part of the results in stages 28, 29, 30, and 31 should equal the checksum bytes. The card will reject packets that do not have a valid checksum. The purpose of the checksum is to prevent a third-party authorization of a smart card.

The final byte is a packet checksum. The value of this byte is that required to bring the sum of the bytes in the packet to a multiple of 256.

Byte 0 in the 74h packet carries the decoder flags. It effectively tells the decoder how to handle the packet. The high nibble (4 bits) identifies the type of scrambling in use. A value of Cxh indicates that the channel is not scrambled. A value of Exh or Fxh indicates that the channel is hard scrambled. The Dxh value may indicate a free-access mode of scrambling. The value x8h as the low nibble indicates that the packet will be used to

generate a new decryption key. The value x0h indicates an information packet that should not be used to generate a new key.

Another important element is the packet-type byte. This byte identifies the packet as being a switch-on, switch-off or ECM packet. The ECM packet carries the nanocommands. Basically speaking, the area of the packet that would normally be occupied by card-identity numbers carry a routine that is loaded into the smart card. This is the back door.

The 78h packet is the eight-byte decryption key generated by the hash algorithm in the smart card. This key is passed to the pseudo-random number generator (PRNG) in the custom integrated circuit in the European VideoCrypt decoder. Only 60 bits of this result is used to seed the PRNG.

There are four requirements for the Vampire hack. The first is a working implementation of the hash algorithm. This is necessary because the state of the answer bytes must be tracked through the whole process. The hash implementation is also required to generate a valid checksum for the packet.

The second requirement is a set of current Phoenix codes or, alternatively, the algorithm for generating these codes. These codes will be exclusive-ored with the packet data before the checksum is generated. Since the KENTucky Fried Chip hack, News Datacom has had to encrypt the information in the 74h packets. In order for the Vampire packets to be accepted and processed by the smart card, they have to be properly encrypted.

The third requirement is a working knowledge of the nanocommands. The basic commands in the Vampire hack are the 09h address loader, the 30h data processor and the 03h break.

It is necessary to know how many hash iterations are effected by each nanocommand. This is where much of the research work will have to be carried out with the DSS. It

would be extremely lucky for the hackers if News Datacom used the same nanocommands in the DSS card.

However, if News Datacom believed that the card and the hashing algorithm could not be popped, then they may well have used similar nanocommands. The nanocommands in the 09 Sky card seem to be based on 6805 microcontroller commands.

The fourth requirement is some sort of recovery routine. This routine will exhaustively search for the data byte used in the 30h command. This is perhaps the most intensive part of the algorithm and some hackers decided to leave this recovery routine until after the results are obtained from the card.

The DSS hack will be carried out in six stages:

- Stage 1: Nanocommand generation. Basically this stage involves setting the address bytes that follow the 09h command.
- Stage 2: Encryption of packet data. This is where the Nanocommand Decrypt Key algorithm is applied to the packet data. It exclusive-ors the output of the encryption algorithm with the nanocommands and other data.
- Stage 3: Checksum generation. The packet presented to the card must have a valid checksum or the card will reject it. Again the working implementation of the hash algorithm is required. In many respects this process is similar to the original Phoenix program.
- Stage 4: Vampire packet sent to card. The circuitry used for this stage of the DSS hack is the same as that used for the Phoenix hack.
- Stage 5: Answer packet (78h) recorded. The answer packet from the card would be recorded in a file along with the address of the recorded data, the nanocommands used, and the state of the answer bytes just prior to the execution of the nanocommands.
- Stage 6: Data recovery. Theoretically this is a simple stage.

Continued on page 92

SATELLITE SIGNAL PIRACY



THE EUROPEAN EXPERIENCE

Hackers have repeatedly compromised the satellite-scrambling system commonly used in Europe.

JOHN McCORMAC

SIGNAL PIRATES ARE THREATENING to break the encryption system used by the RCA Digital Satellite System. Hackers, armed with the knowledge gained by breaking VideoCrypt, Europe's similar encryption scheme, are confident that they are close to a break of DSS. (See "Has DSS Been Hacked?" on page 33.) This article outlines the history of the VideoCrypt hack in Europe.

There are three main encryption systems in European satellite TV. The first and most visible is VideoCrypt, used by BSkyB, the broadcaster of Sky and a number of other channels. (BSkyB is the broadcaster of the Sky Multichannels Package, which carries three movie channels and a few general entertainment channels intended for Ireland and the United Kingdom (UK). An estimated 2.5 million subscribers use VideoCrypt smart cards to gain access to programming.

The second principle system is EuroCrypt-M, used by Canal Plus, TV3, FilmNet, TV1000, and a few other programmers. There may be as many as 400,000 subscribers to channels encoded with the EuroCrypt-M scrambling system. The third scrambling system is Nagra Syster, the only one that is still secure from signal hackers. It is used by Premiere, Canal Plus, and Teleclub. While hackers are now actively working on a viable hack for Nagra Syster, the system has fared well during the past four years.

One major difference between Europe and the United States is the uniformity of American laws and their enforcement. Piracy has been able to thrive in Europe because each nation has its own copyright laws, and generally protects only its own channels. This makes it possible, for example, to legally sell pirate smart cards that allow access to VideoCrypt-encoded channels throughout all of Europe, except in the UK.

The VideoCrypt scrambling system used by the DSS system in the United States differs from the European implementation. European VideoCrypt is a purely analog system that scrambles only the video. DSS is a completely digital system that encrypts the digitally encoded video and audio. However, there are many similarities between DSS and European VideoCrypt, including the use of smart cards.

The VideoCrypt scrambling system, like DSS, is based on a secure detachable processor—a removable smart card holds all of the critical information. The smart cards are both the systems' greatest strength and their greatest weakness. Smart cards permit broadcasters to change or upgrade their conditional-access system. In small quantities, an upgrade can be relatively inexpensive, but when the number of cards that have to be replaced increases, so does the cost. For example, BSkyB paid 21 million pounds

for its last card upgrade. Originally, BSkyB planned to issue new versions of smart cards on a three- to six-month cycle to deter hackers. When the cycle grew longer, hackers had enough time to hack the smart cards.

DSS faces a similar threat today. Since the VideoCrypt system in Europe has been totally compromised, European pirates are setting their sights on DSS. Some sources have reported that the DSS system has, indeed, been hacked already, and that pirate smart cards will be on the market as before this article is published. Even if that proves not to be true, European hackers have an intimate understanding of the VideoCrypt system, and they can transfer that knowledge to the DSS digital encryption system.

What Is VideoCrypt?

The European implementation of VideoCrypt is a video-only scrambling system. The active video section of each line is cut and rotated about one of 256 points. The cutpoint for each line is generated from the output of a pseudo-random number generator or PRNG.

The seed for the PRNG is derived from data that is transmitted over the air along with the video. The decoder passes that data to the smart card, which then runs a built-in seed-generation algorithm and returns the correct seed to the decoder. The decoder itself is essentially "dumb" because the main cryptography takes place inside the smart card.

VideoCrypt decoders contain

a few built-in algorithms to prevent pirate cards from being used. However due to a programming error on many of the original decoders and IRDs (integrated receiver/de-scramblers), the most powerful algorithm, the Fiat-Shamir zero-knowledge test, did not work properly. Although the same authentication algorithm is used in the DSS system, it is doubtful that the same error was made.

The Fall Of VideoCrypt

VideoCrypt was compromised almost immediately because it contained the same fundamental flaw that was common to most of the smart-card-based systems that were designed in the 1980s: The data flow between the card and the decoder could be tapped just like a phone conversation. The data could then be fed to other decoders, and they could all decrypt programming from data produced by the one authorized card. If the data were sent over a radio transmitter, any decoder equipped with an appropriate receiver could be turned on.

This hack, presented in an article written about the security of smart card based scrambling systems, is known as the McCormac Hack. It works and is still in operation in Spain where it feeds an MMDS (multipoint microwave distribution system) network from one smart card.

The ease with which VideoCrypt could be hacked was astounding. Here was this system that was advertised as the most pirate-proof system yet developed—yet it was hacked. It

was only the beginning of the nightmare for Sky and News Datacom.

Infinite-Lives hack. Another major hack on the security of the VideoCrypt system was called the Infinite-Lives hack. At the time, the smart cards were using EPROM technology and needed a supply of 21 volts DC for programming. By limiting the programming supply to 12 volts DC or so, it was possible to prevent Sky from reprogramming or turning off the cards. (This is a variant of the hack on the France Telecom phone cards whereby the programming voltage pad was covered so that the payphone could not overwrite the card.)

The KENTucky Fried Chip hack. The KENTucky Fried Chip hack was named after Ken Crouch, the head of Sky's Security Department. The hackers had modified the program in the IC that controlled the smart-card interface so that it would read the identity of the smart card inserted in the decoder. It would then look to see if there was a kill message addressed to that particular card and, if there was, the modified chip ensured that the kill message would never reach the card. This technique is known as "chipping" in the United States. It was the first incident of this type of hacking in Europe. In the RCA DSS system, the smart-card interface appears to have a custom microcontroller.

The Ho Lee Fook hack. This hack on VideoCrypt reportedly got its name from the exclamations of executives who learned about it—the hack was a direct replacement for a smart card.

The first version was based on the technology of the KENTucky Fried Chip. It modified the same chip so that it contained the same algorithm embedded in an authorized smart card. Thus the first cardless Sky VideoCrypt decoder was born, a feat that News Datacom claimed was impossible. The VideoCrypt developers had integrated the Fiat-Shamir zero-knowledge test into the system for just such an event. Strangely it never worked.

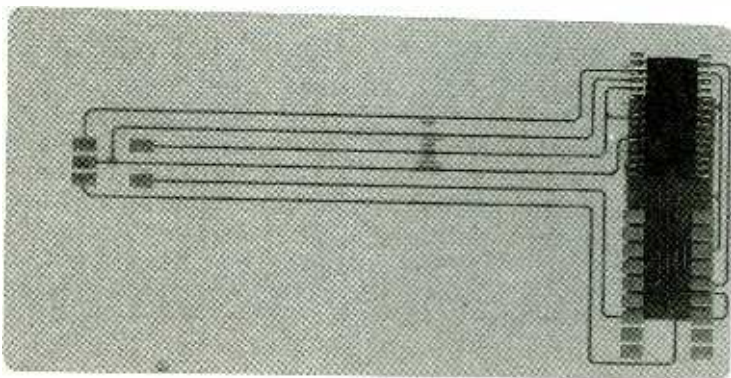

THIS SMART CARD was used to gain access to VideoCrypt programming.

The first version of the Ho Lee Fook hack proved to be both too insecure and too expensive for pirates. Hackers improved the technique by using low cost PIC microcontrollers manufactured by Microchip Technology.

In early June 1993, the first PIC smart card was developed. This was a genuine pirate smart card—the very thing that VideoCrypt brochures claimed was impossible. This situation lasted for the life of that particular Sky card issue. Sky's VideoCrypt remained completely smashed for approximately one year. All of the Sky channels, the new multichannels, the Adult channel, and TV-Asia were available from the pirates. The minor electronic countermeasures (ECMs) that News Datacom implemented were easily dealt with by hackers. Solutions were available from the hackers sometimes within a few minutes of an ECM.

A leap in hacking technology had been made. The newer versions of the pirate cards were reprogrammable. So with a modem, it was possible to serve all the European dealers within a few hours with an update all of their cards.

Because their technical methods had failed to control hacking, Sky and News Datacom sought some help from the law. At first Sky attacked the pirates in the UK but then moved on to Ireland.

A Question of copyright

The laws on piracy are cut and dried in the UK. Fortunately for hackers, Ireland is not part of the UK. A major court precedent was set when Sky tried to pursue David Lyons of Satellite Decoding Systems, an Irish business, through the Irish courts. Sky charged him with copyright infringement of the software in their smart card.

An Irish court granted Sky an Anton Pillar order that allowed company representatives to enter Satellite Decoding Systems' Offaly trading address and seize items or assets that they believed were directly related to the alleged breach of copyright. Sky's intent apparently was to

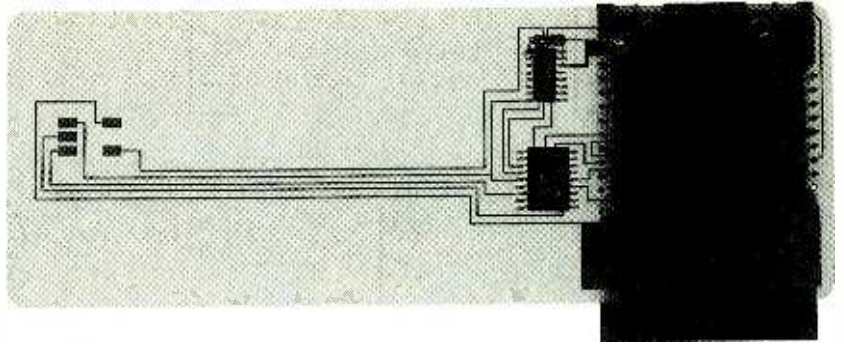

A PHOENIX BLOCKER combines the Phoenix code with a blocker program. The combined program runs on a PIC16C84 microcontroller. The card can turn on all channels on a Sky card and block the kill signal that Sky sends to it.

seize the addresses and identities of people who had purchased the PIC cards from satellite Decoding Systems. However, Satellite Decoding Systems did not maintain such records. After months of legal maneuvering and tactical errors, the courts ruled against Sky.

The TV-Crypt

Perhaps the most significant event of 1994 in the hacking world was the formation of TV-Crypt, a non-commercial group whose interest is to explore scrambling systems. TV-Crypt originated what was called the Season 7 or Omigod hack.

When Sky One was scrambled in September of 1993, many European viewers were cut off watching *Star Trek - The Next Generation*. The seventh and final season of the TV show was to be scrambled and shown on Sky One. Because *Star Trek* was a favorite show of many hackers, what followed was not unexpected—they put all of their efforts behind a hack.

This time, hackers sought to write an emulation program for their personal computers so that the computer could drive the decoder. Some of the existing commercial hacks were examined and, in one case, the code was extracted from one of the Ho Lee Fook chips. The code for the 8052 microprocessor was transformed into the C language. From there it was transformed into the PC program known as Season Seven or Omigod.

The distribution of the

Omigod hack only took a few hours. It was available on all major BBSs and at many Internet sites in Europe. There were even copies floating around at the Cable and Satellite Show in London, one of the biggest trade shows in Europe. Most of the top hackers in Europe were together in the same place at the same time.

Dark Wednesday

The reality of the situation was beginning to tell on Sky. The company could no longer evade the hacker problem and it switched to its new smart cards, issue 09. Although Sky had been sending these cards out since February, it wasn't until May 18th that the pirate cards ceased to operate. The Omigod program stopped working entirely. Sky had, or so they thought, won the war. To the hackers, the fun had only just begun.

The Great Code Auction

Something decidedly strange happened on June 20th when Sky's 09 code was auctioned at London's Dorchester Hotel. The code was legitimate, and Sky's smart card was compromised again.

It is not known how much money changed hands in the auction, but the theory is that it was in the hundreds of thousands of pounds. Pirates and hackers worked day and night to upgrade their cards based on the auctioned code. They were successful, but only for a week. Then Sky and News Datacom implemented their electronic

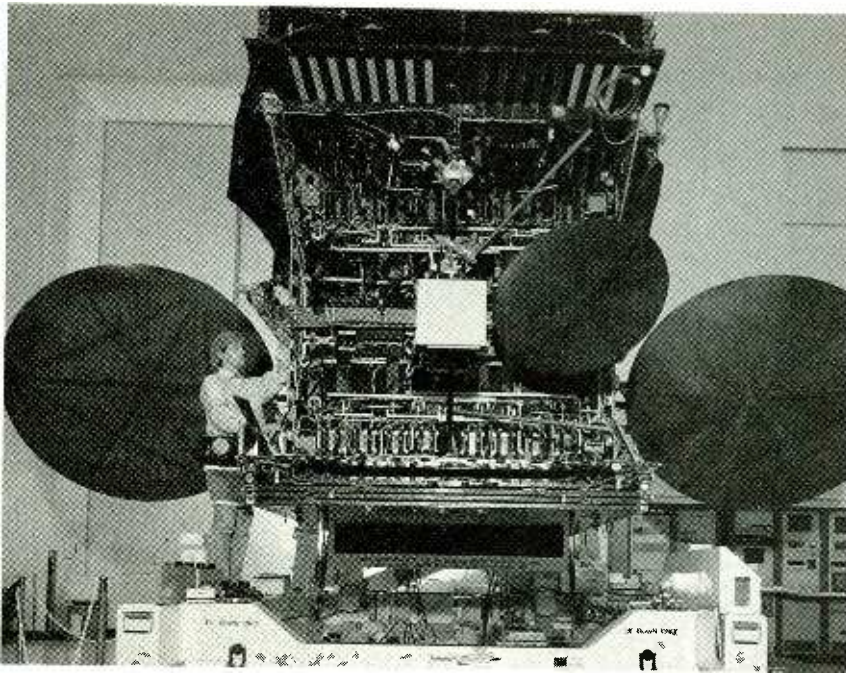

HACKERS HAVE SET THEIR SIGHTS on the Hughes HS601 satellite as their next target.

countermeasures that proved to be difficult for the hackers to solve.

The timing of the event had sown the seeds of uncertainty in pirates' minds. Was the auction of the code and the subsequent countermeasures a "sting" by Sky? Was it a pirate operation? The full story of how and why the code was auctioned has not yet been established. There seemed to be so much lying and deception surrounding the code auction that it was difficult to know who was involved.

What followed was a long summer of false starts and disgruntled customers of signal pirates. It seemed that Sky was winning the battle with pirates, as some customers of the pirates were re-signing with Sky. Others customers decided to switch to other program suppliers and watch other channels. Still others decided to buy smart cards from legal outlets and have the cards authorized for only a few weeks, ensuring that they could watch Sky if they wanted to.

The Phoenix hack

The code that had been auctioned in June made its way to the TV-Crypt group where it was

analyzed. The code was an improvement over the algorithm of the 07 smart-card issue, but there was something else.

TV-Crypt found that the code could be re-written so that a smart card would generate a correct checksum for any packet of data that it received. Therefore, by using a decoder-emulation program, it was possible to have an authorized smart card treat any data packet sent to it as valid.

That was a significant discovery. Sky's VideoCrypt system operated on an over-the-air authorization procedure. Therefore if a data packet with a correct checksum was sent to a card, it would be possible to switch on cards without the intervention of Sky. The card would not be able to tell the difference between a packet from a decoder emulator program and the real decoder.

By phoning Sky and having the company turn on some legitimate cards over the air, it was possible to build up an image of how the authorization scheme worked. After some analysis of the over-the-air data, some patterns became clear. By the first week in August, the Phoenix program was posted.

To the TV-Crypt group, the

Phoenix program was an intellectual exercise to see how the VideoCrypt system worked. There were some pirates, however, who saw it differently and sold the program for, in some cases, thousands of pounds.

The Genesis hack

One of the first commercial hacks based on the Phoenix program was named Genesis, after a Star Trek movie plot. It combined the Phoenix code with a blocker program. The combined program was incorporated in a PIC16C84 microcontroller to create one device that could turn on all channels on a Sky card and block the kill signal that Sky sent to that card.

Sky had totally lost control of its access control system. Even the 09-issue cards that Sky had previously turned off were being reauthorized. Sky and News Datacom were searching desperately for some solution. It seemed that Sky, through its Quick Start scheme, had supplied the pirates with all the genuine Sky cards that they needed. The going price for a Quick Start card in September reached 60 pounds (about \$95).

After what can be described as a war of attrition, News Datacom came up with an ECM that completely killed cards activated by the Genesis blockers. The dead cards could not be reauthorized. However, September 1994 was a very bad month for Sky. From pirate sources, who were monitoring the over-the-air data, it became apparent that Sky was trying to kill every card for which it could not account. In that month alone, Sky killed 569,430 cards. It is not clear how many of these were Quick Start cards, or how many people just gave up watching the Sky channels. In October, Sky killed an additional 220,073 cards.

Legal action in the UK

Sky eliminated its security department in March 1993, even though this internal group had succeeded in stemming the flow of piracy in the UK. After

continued on page 76

HAVE YOU EVER WANTED TO MAKE good use of all those infrared (IR) remote control units from TVs, VCRs, and other stereo equipment that have been piling up over the years? Have you ever wanted to add remote-control operation to your electronic projects? This simple-to-build, low-cost construction project will receive and convert the output of virtually any infrared remote-control transmitter with a 40-kHz carrier to logic levels that can control all your favorite toys, from robots to model railroads.

This basic circuit can also turn just about any appliance in your home on and off. These include lamps, fans, radios, alarms, electric locks, space heaters, and air conditioners. You won't have to leave the comfort of your lounge chair. Anything which operates on electricity can be controlled with \$3.00 remote controls found in abundance at surplus dealers and ham fests.

The remote control receiver has seven individual TTL-level outputs that can be programmed to respond to any button on a remote control. Each output can be set up as a latching output that toggles between high only as long as the button is pressed, or as a momentary output that switches and remains high for as long as the remote's button is pressed. To program the receiver, place the unit in its programming mode, aim your remote-control transmitter at it, and press buttons to let the remote-control receiver "learn" and record the data transmitted by the remote.

Remote control transmitters

A standard infrared remote-control transmitter has a photodiode that transmits in the near-infrared range and is pulsed on and off at 40 kHz. Although some transmitters have a different carrier frequency, 40 kHz is the most common and is therefore the carrier frequency used in this circuit.

The author was unable to find

REMOTE CONTROL ADAPTER



Couch potatoes, sit right where you are—this circuit lets you control virtually anything with any infrared remote control.

a remote that used a different frequency. If, however, you have one that transmits on a different carrier frequency, simply replace the 40-kHz IR module specified in this circuit with one that's tuned to your transmitter's frequency.

The IR signal is pulse-code modulated when it is transmitted in bursts of 40-kHz pulses, as shown in Fig. 1. Data is encoded on the IR signal by varying the length of the bursts or the time between bursts. The different data patterns indicate which button is pressed on the remote. Figure 1-a shows an IR

signal that encodes data on the carrier by alternating the length of the burst, while Fig. 1-b shows one that alternates the time between bursts. A typical infrared remote-control receiver in a host product will decode the logic levels in the data stream by comparing the pattern of bursts with an internal clock operating at the same frequency as the transmitter.

In most cases, each IR command consists of a pattern of anywhere from 12 to 32 bursts at 40 kHz. This pattern is repeated continuously while the transmitter's button is held

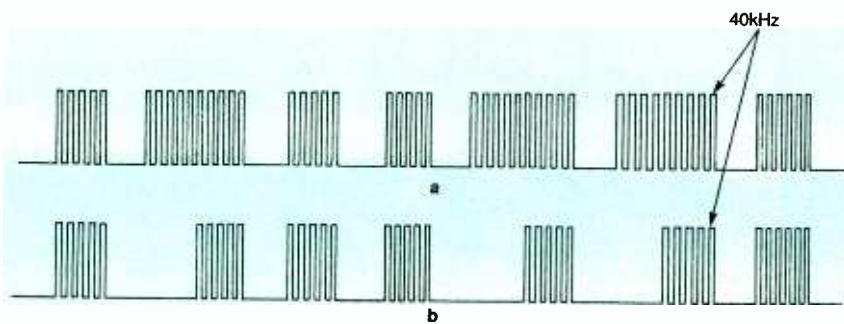

FIG. 1—AN INFRARED SIGNAL is modulated by transmission in bursts. The signal in *a* is modulated by alternating the length of the burst, while the one in *b* is modulated by alternating the time between bursts.

down. The author found one model whose burst pattern was transmitted only upon initial contact with the button, and this pattern was followed by a short burst of the pattern every 100 milliseconds or so until the button was released.

Circuit theory

The circuit is simplified by the use of the self-contained infrared receiver/demodulator MOD1. A block diagram of the IR module is shown in Fig. 2. The modulated IR signal is detected by the photodiode whose peak sensitivity is in the near-infrared range.

After the signal passes through a preamplifier/limiter, the built-in bandpass filter then rejects all signals outside of 40 kHz. This largely eliminates false triggering from other light sources. The resulting signal (Fig. 3-a) is fed through a demodulator, an integrator, and a comparator which outputs a clean TTL-level pulse stream without the carrier (Fig. 3-b). Notice how a positive-going IR burst produces a corresponding low pulse at the output of the IR module.

A schematic diagram of the remote control receiver is shown in Fig. 4. The heart of the circuit is IC1, a PIC16C54 8-bit CMOS microcontroller manufactured by Microchip. The microcontroller has one eight-bit I/O port and one four-bit I/O port. Each I/O pin can be used and configured individually. That makes it possible to simplify the PC board layout so that only a single-sided board is needed.

The microcontroller stores its data in IC2, a 93LC46 1 kilobit serial EEPROM (electrically erasable programmable read only memory) also manufactured by Microchip. In this application the 93LC46 has a three-line interface with the microcontroller. The three lines are CHIP SELECT, CLOCK, and DATA IN/OUT. Because DATA IN and DATA OUT share the same line, a 1 kilobit resistor (R2) limits the current flow during transitions be-

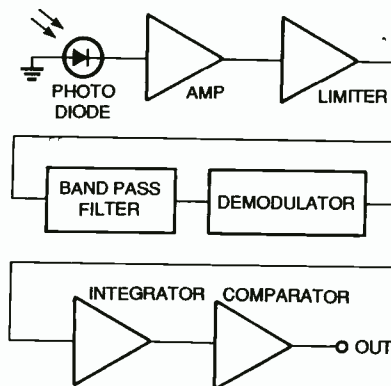

FIG. 2—BLOCK DIAGRAM of the infrared receiver/demodulator module (MOD1).

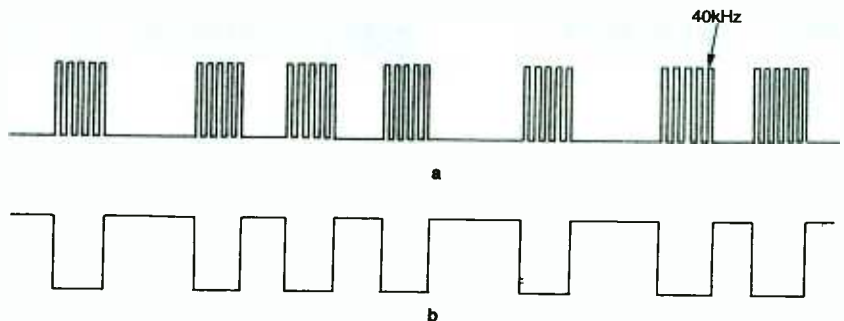

FIG. 3—THE OUTPUT WAVEFORM of the infrared module (*b*) with respect to the 40-kHz IR signal received at its input (*a*).

tween writing and reading when there are conflicting logic levels.

The microcontroller communicates with the 93LC46 by placing a logic high on the CHIP SELECT pin. Data is then transferred serially to and from the 93LC46 on the positive transition of the clock line. Each read or write function is preceded by a start bit, an opcode identifying the function to be performed (read, write, etc.), then a seven-bit address, followed by the eight bits of data which is being written to or read from that address. Immediately preceding and following all write operations, the microcontroller sends instructions to the 93LC46 which enables or disables the write function, thereby protecting the data that has been stored.

In the programming mode, IC1 reads an IR data stream from MOD1 and converts it to data patterns that can be stored in IC2. These data patterns are held for comparison while the unit is in normal operation. More on this later.

Power for the circuit is conditioned by IC3, a 78L05 low-current, 5-volt regulator which will accept any DC input voltage between 7 and 25 volts. Capacitors C1 and C2 stabilize the operation of the regulator. Crystal XTAL1 sets the internal oscillator of IC1 to 4 MHz. Jumper JU1 consists of two closely spaced pads on the PC board that, when momentarily jumpered with a screwdriver or other piece of metal, places IC1 in the programming mode and lights LED1.

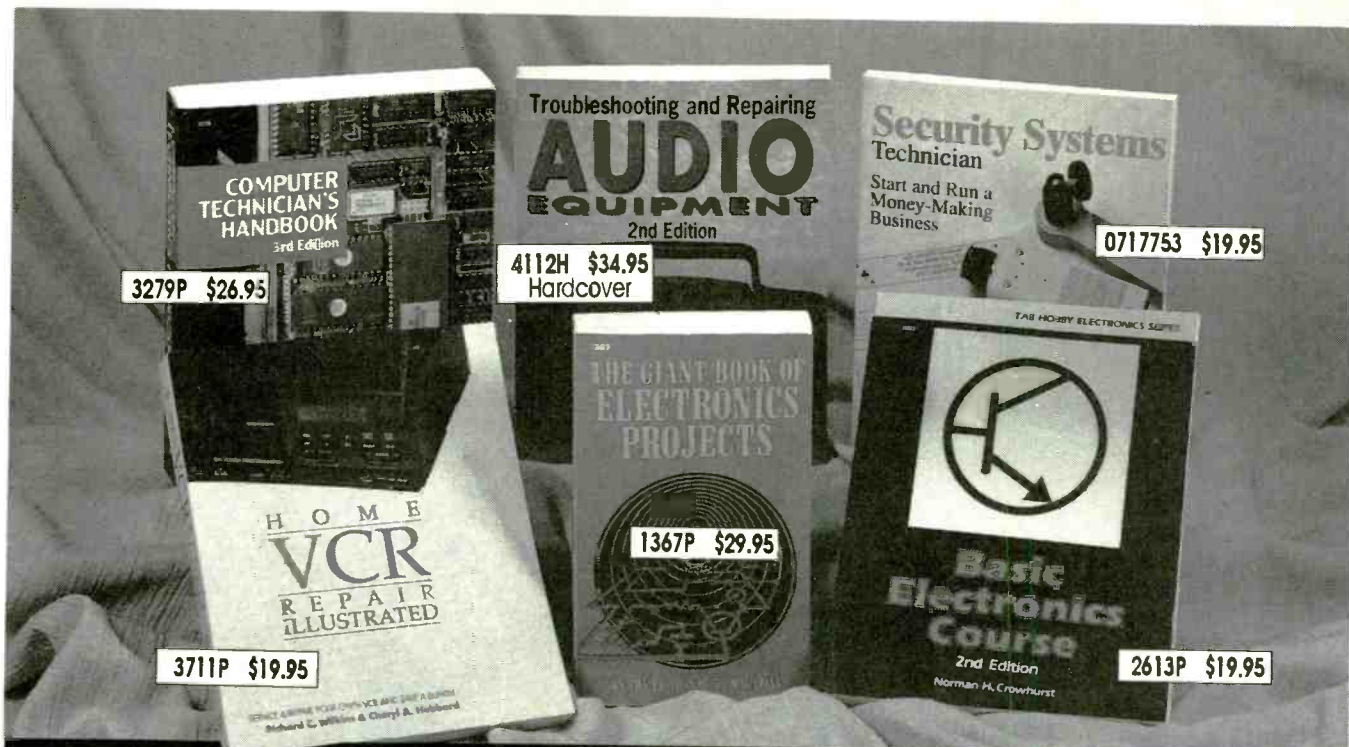

The leading source of information for electronics hobbyists for over 30 years!



2790P \$17.95

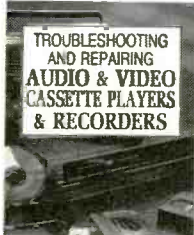

3795P \$19.95

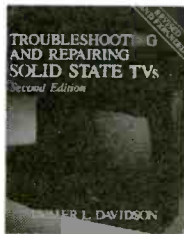

3700H-XX \$36.95
Counts as 2/Hardcover

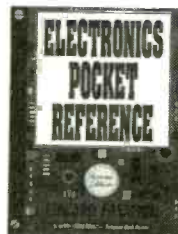

0487375 \$24.95

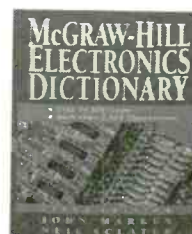

0404348-XX \$49.50
Counts as 2/Hardcover

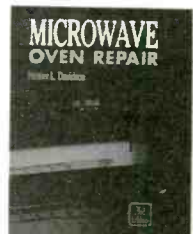

0156778 \$44.95
Hardcover

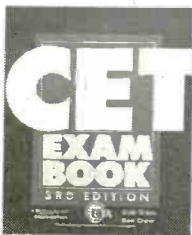

4199H \$29.95
Hardcover

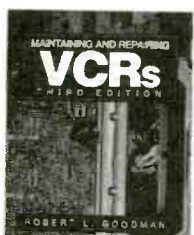

4204H-XX \$39.95
Counts as 2/Hardcover

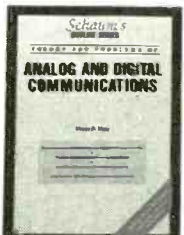

0306362 \$13.95



5851075-XX \$24.95
Counts as 2

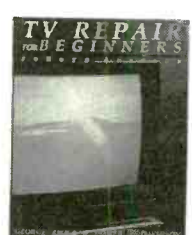

3627P \$19.95



3671P \$18.95

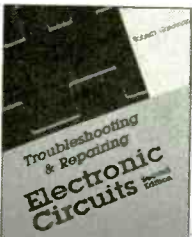

3258P \$19.95



4503P-XX \$36.95
Counts as 2



3475P \$21.95

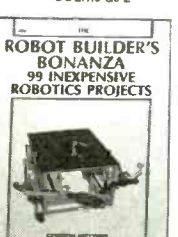

2800P \$17.95

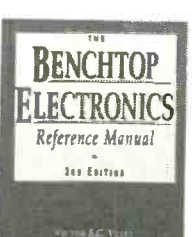

0673764-XX \$54.95
Counts as 2/Hardcover



3621H-XX \$39.95
Counts as 2/Hardcover

As a member of the **ELECTRONICS BOOK CLUB**®... you'll enjoy receiving Club bulletins every 3-4 weeks

containing exciting offers on the latest books in the field at savings of up to 50% off the regular publishers' prices. If you want the Main Selection, do nothing and it will be shipped automatically. If you want another book, or no book at all, simply return the reply form to us by the date specified. You'll have at least 10 days to decide. If you ever receive a book you don't want due to late delivery of the bulletin, you can return it at our expense. Your only obligation is to purchase 3 more books during the next 12 months, after which you may cancel your membership at any time. And you'll be eligible for FREE BOOKS through our Bonus Book Program.

A shipping/handling charge and sales tax will be added to all orders. All books are softcover unless otherwise noted. If you select a book that counts as 2 choices, write the book number in one box and XX in the next. (Publishers' Prices Shown) ©1995 EBC

5 BOOKS FOR ONLY \$4.95

VALUES TO \$192.85

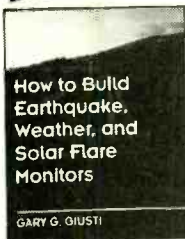

0252092 \$19.95



0410836-XX \$59.50
Counts as 2/Hardcover



4362P \$16.95



0443017-XX \$50.00
Counts as 2/Hardcover



1604P \$17.95

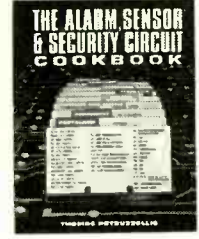

4334H \$29.95
Hardcover



4261P \$24.95

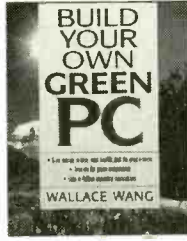

0681562 \$19.95

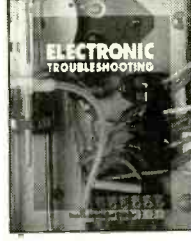

4360H-XX \$34.95
Counts as 2/Hardcover

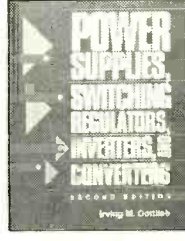

4394H \$35.00
Hardcover



0039615 \$45.00
Hardcover

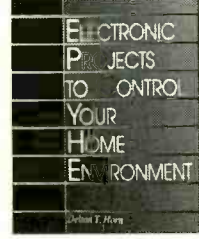

0304165 \$26.95
Hardcover

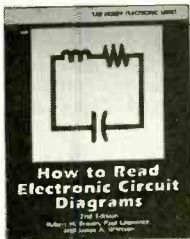

2880P \$15.95



5869284-XX \$46.00
Counts as 2/Hardcover

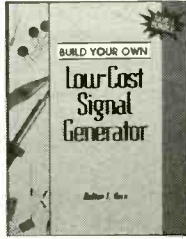

0304289 \$32.95



3632P \$10.95

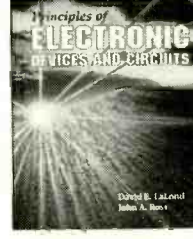

5869314-XX \$59.95
Counts as 2/Hardcover

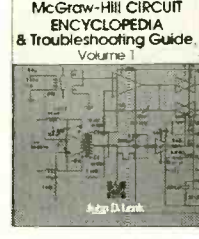

0376034-XX \$59.50
Counts as 2/Hardcover

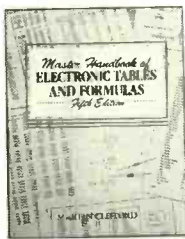

3739P \$24.95

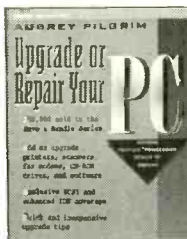

0501149 \$26.95

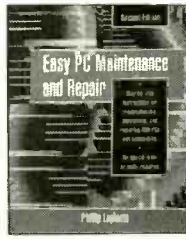

036432X \$27.95
Hardcover



5869349-XX \$44.00
Counts as 2/Hardcover



4179H \$28.95
Hardcover

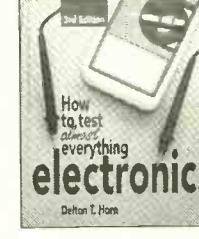

4227P \$15.95

If coupon is missing, write to: Electronics Book Club, A Division of McGraw-Hill, Inc., P.O. Box 549, Blacklick, OH 43004-9918

Electronics Book Club®

A Division of McGraw-Hill, Inc.
P.O. Box 549, Blacklick, OH 43004-9918

YES! Send the 5 books listed below, billing me just \$4.95 plus shipping/handling & tax. Enroll me as a member of the **Electronics Book Club** according to the terms outlined in this ad. If not satisfied, I may return the books within ten days without obligation and have my membership cancelled. A shipping/handling charge and sales tax will be added to all orders.

--	--	--	--

If you select a book that counts as 2 choices, write the book number in one box and XX in the next box.

CHARGE MY: VISA MasterCard AMERICAN EXPRESS DISCOVER ACCT # _____ EXP. DATE _____

BILL ME CHECK OR MONEY ORDER ENCLOSED PAYABLE TO MCGRAW-HILL, INC.

NAME _____ SIGNATURE _____ (required on all credit card orders)

ADDRESS/APT# _____

CITY _____ STATE _____ ZIP _____ PHONE _____

Valid for new members only, subject to acceptance by EBC. Canada must remit in U.S. funds drawn on U.S. banks. Applicants outside the U.S. and Canada will receive special ordering instructions. A shipping/handling charge and sales tax will be added to all orders.

PHONE 1(614)759-3666 • FAX 1(614)759-3749

8:30 a.m. - 5:00 p.m. EST Monday-Friday

24 hours a day, 7 days a week

RE895C 47

August 1995, Electronics Now

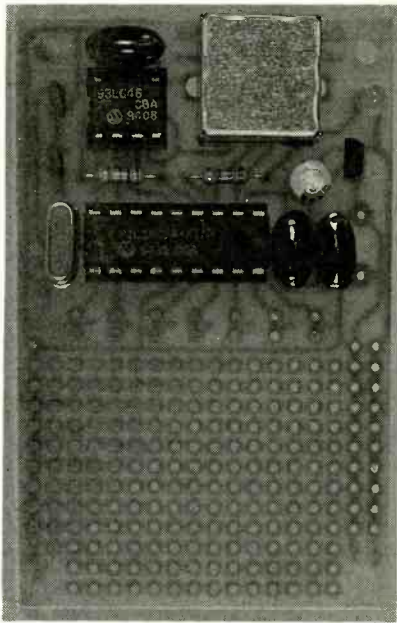

FIG. 6—COMPLETED BOARD. The infrared module greatly reduces the number of parts required.

After IC1 enters its programming mode (when it detects a low on pin 5 of port B), it waits to receive an IR signal from a remote-control transmitter. A set of 32 bursts are sampled from the beginning of the IR signal's data stream, measured, and stored in IC2. The pattern is then assigned to I/O pin 1, and the microcontroller flashes the LED to indicate that the recording process is complete for that button.

If the remote control's button is held down following the flash of the LED, the I/O pin is configured for momentary operation. If the button is released immediately, the I/O pin is configured for toggled operation. The microcontroller then waits for the next button to be pressed on the remote and repeats the same procedure, assigning the next pattern to I/O pin 2, and so on. After seven patterns have been stored, IC1 turns off the LED and returns to normal operation.

During normal operation, IC1 waits for any IR signal to be received, determines its burst pattern in the same way as in the programming mode, and looks for a match in memory. If a match is found, IC1 either toggles the state of the corresponding I/O pin or holds the pin logic

PARTS LIST

All resistors are 1/4-watt, 10%

R1—620 ohms

R2—1000 ohms

Capacitors

C1, C5, C6—0.1 μ F, polyester

C2—10 μ F, 35 volts, electrolytic

C3, C4—15 pF, ceramic disc

Semiconductors

IC1—PIC16C54-XT/P pre-programmed 8-bit microcontroller (Microchip)

IC2—93LC46 serial EEPROM (Microchip)

IC3—78L05 low-power 5-volt regulator

LED1—light-emitting diode, any color

Other components

MOD1—40-kHz infrared remote control receiver module (Digi-Key part No. LT1060-ND or equivalent—Digi-Key also has IR modules tuned to 32 kHz and 36 kHz. Digi-Key can be reached at 800-344-4539.)

XTAL1—4-MHz crystal

Note: The following items are available from Weeder Technologies, PO Box 421, Batavia, OH 45103, 513-752-0279:

- Etched and drilled PC board (WTRCR-B)—\$8.50.

- All board-mounted components including pre-programmed PIC16C54 (WTRCR-C)—\$23.50

- Pre-programmed PIC16C54 only (PIC-RCR)—\$16.00

All orders must include an additional \$3.50 for shipping and handling. Ohio residents must add 6% sales tax.

high until the IR signal ceases, depending on the configuration of the individual I/O pin as was previously defined in the programming mode.

Construction

A foil pattern is provided for those who wish to make their own board, or a prefabricated board can be purchased from the source given in the Parts List. The PC board measures less than 2 x 3-inches, and about half of the board space is a prototyping area reserved for circuitry you might want to add for your particular application, including AC or DC power-control circuits.

Refer to the parts-placement

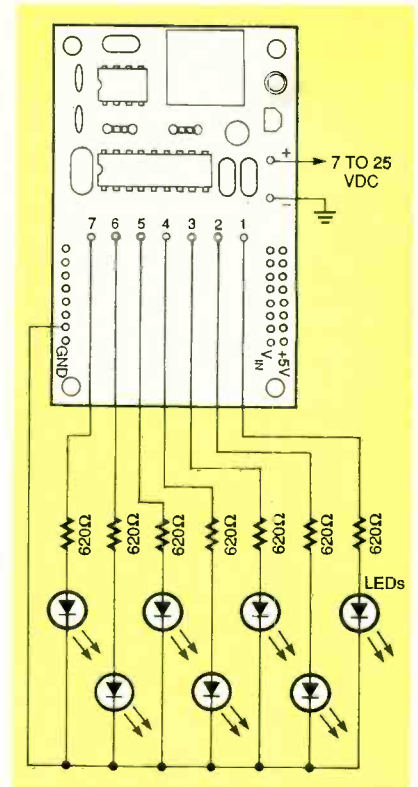

FIG. 7—USE THIS TEST SETUP to check out your finished project. A separate LED indicates when each I/O pin goes high.

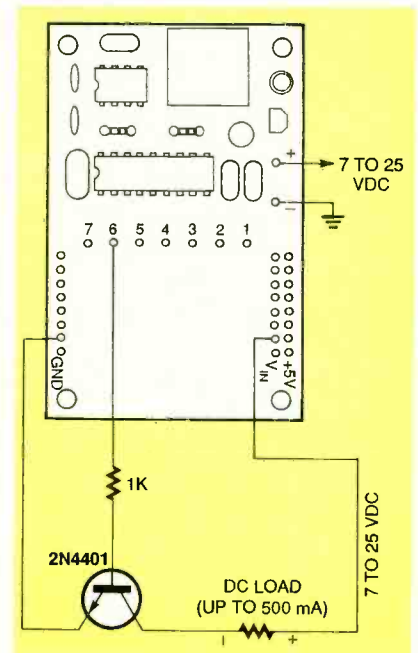

FIG. 8—THIS CIRCUIT can turn on any DC load up to 500 milliamperes.

diagram, Fig. 5, and begin by soldering in the two IC sockets for IC1 and IC2. Next mount all resistors and capacitors, paying particular attention to the orientation of polarized capacitor

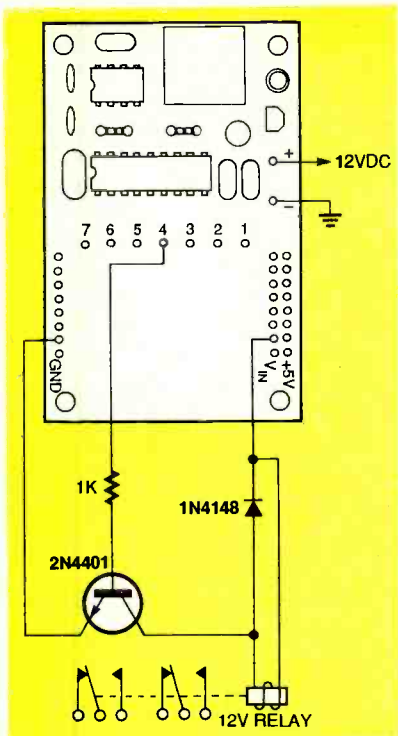

FIG. 9—FOR HEAVIER CURRENT demands, this circuit shows the remote control receiver interfaced to a relay.

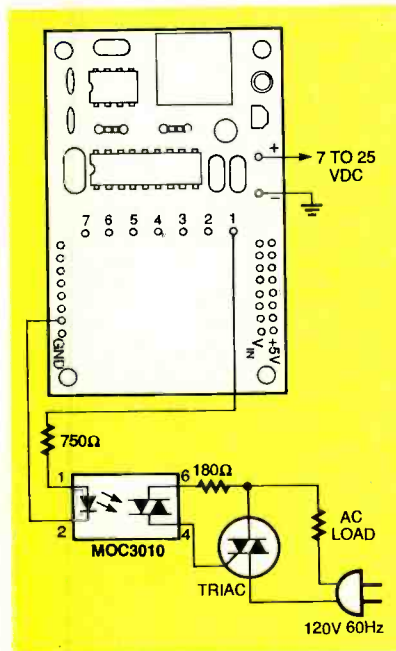

FIG. 10—AC LOADS including lamps, fans, stereos, and more can be controlled with this circuit.

C2. Solder in crystal XTAL1, voltage regulator IC3, and the LED. Finish by mounting the IR module, and be sure to solder the two mounting tabs on its case for making a good ground connection.

After all components have

been mounted, examine the solder side of the board for solder bridges and/or cold solder joints and resolder if necessary. Carefully plug IC1 and IC2 into their sockets following the orientation shown in Fig. 5. Figure 6 shows a photograph of the completed board.

Operation

To test the receiver, set up the board as shown in Fig. 7. This circuit will turn on a separate LED for each I/O pin that goes logic high, letting you study the unit's operation and understand how it works and how it is programmed. Until you have decided on a specific application for the receiver circuit, tem-

porarily solder seven solid-conductor wires to the I/O terminals on the PC board and connect them to a solderless breadboard to be used for your test circuit. The breadboard will allow you to make experimental changes without having to solder and desolder.

Put fresh batteries in your remote control and set up the receiver so that you can aim the transmitter directly at the receiver's IR module at a distance of 2 to 3 feet. Do not hold the transmitter closer than 2 feet or the IR module will be overdriven, and the data being recorded will be unreliable. Make sure that there are no fluorescent lights shining on the IR module, as that light can also cause various programming errors.

Apply power to the receiver. Locate the two square pads directly underneath the IR module and briefly short them together with the tip of a screwdriver; this will cause the LED to light and remain on. Point the transmitter at the receiver and press and hold the button you wish to assign to I/O pin 1. After approximately a half second delay, the LED will flash off then back on. Release the button on the remote immediately if you want I/O pin 1 to be configured for toggled operation. Otherwise, hold the button down until the LED flashes a second time if you want the I/O pin to be configured for momentary operation. Next, select the button you wish to assign to I/O pin 2 and repeat the procedure. Continue until all seven I/O pins have been dedicated to a button on the remote. After the last I/O pin has been programmed, the receiver will automatically halt the programming mode and turn off the LED. Note that you must program all I/O pins before the programming mode will be terminated.

Now point the remote at the receiver and press the buttons that you programmed the receiver to recognize; the appropriate LEDs in the test circuit of Fig. 7 should turn on and off. You can assign more than one

Continued on page 83

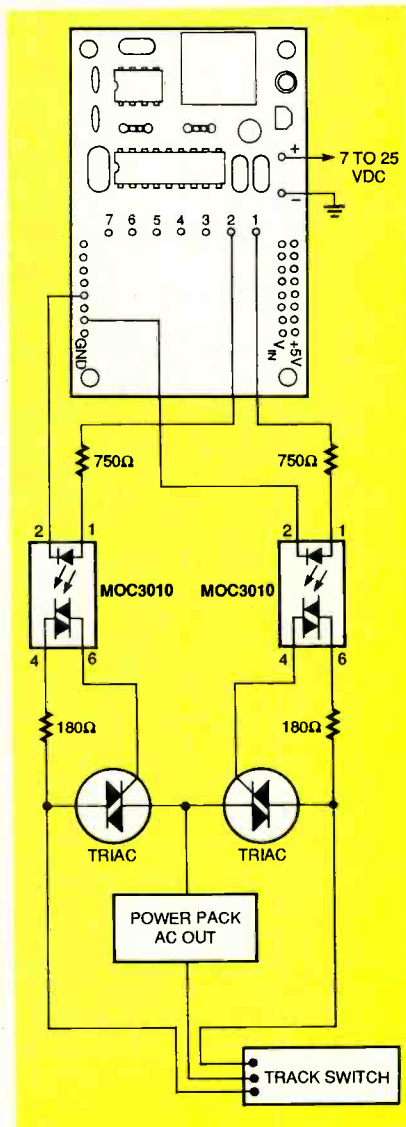
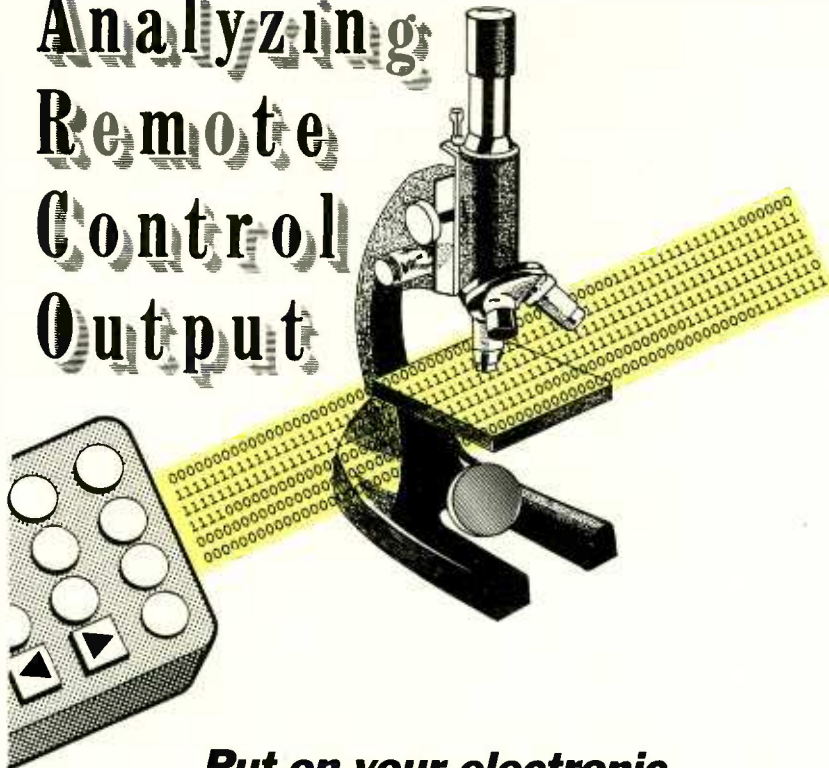

FIG. 11—THIS SETUP can be used on a model railroad to control the track switches.

Analyzing Remote Control Output



**Put on your electronic
Sherlock Holmes hat and investigate
the output of your
infrared remote controls.**

BARRY HAMILTON

THE CONSUMER ELECTRONICS MARKET has become inundated with low-cost pre-programmed infrared (IR) remote controls. These can produce codes to control a variety of appliances, including TVs, stereos, VCRs, and cable boxes.

You can build an infrared receiver with less than \$10.00 of parts, and use any PC with a parallel printer port as a kind of digital storage oscilloscope to examine the pulse train produced by an IR remote. The knowledge you gain will allow you to incorporate remote controls in your next circuit design project.

The receiver

Figure 1 shows a schematic of the IR receiver circuit. The heart of the circuit is MOD1, an infrared detector module that removes the IR carrier frequen-

cy and transmits only the data that is encoded in the received IR signal.

A suitable IR module is available at Radio Shack (No. 276-137) for \$3.59. The IR module needs a clean 5-volt power supply that is provided by IC1, a 7805 regulator. Power is supplied to the regulator by 9-volt

battery B1. The output of the module is wired to a male DB-25 multipin connector.

Most infrared remote controls encode data in the form of long and short pulses of infrared light on a 40-kilohertz carrier frequency. This method is known as pulse-width modulation, or PWM.

The infrared detector module receives a signal, filters it, and removes the 40-kilohertz carrier. The output of the module is a TTL-level signal consisting of long and short pulses. The PC records those voltage levels over time, while the signal is being sent, and stores the data in a file.

The line normally used by the PC's printer port to indicate that the printer is out of paper (pin 12) is used in this project to accept data from the IR module. The I/O port is located at address 0x379. Bit 5 corresponds to input pin 12.

Various software programs are required to let a PC store information input to its printer port. (All of the software is available on the Gernsback BBS—516-293-2283, v.32, v.42bis—contained in a file called IR-TEST.ZIP).

The source code of the first program, IRLOG.EXE, is written in C and shown in Listing 1. The program stores the value it reads from the PC's printer port into an array. When the input line is logic high, the ASCII character "1" is stored in the array. When the input line is logic low, ASCII character "0" is stored.

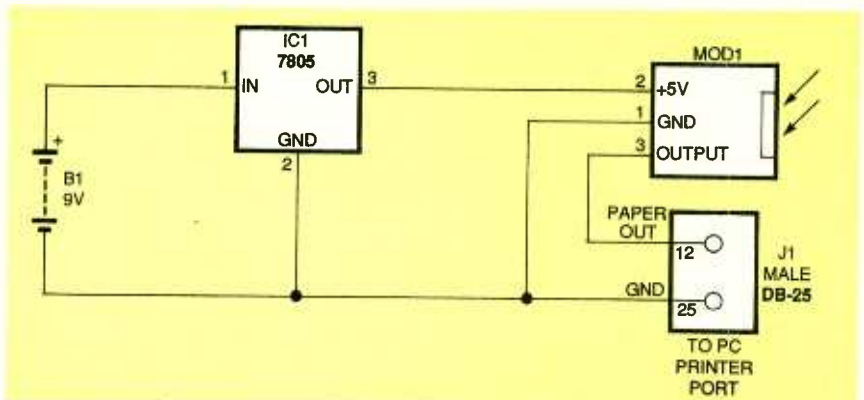

FIG. 1—SCHEMATIC OF THE IR RECEIVER CIRCUIT. The heart of the circuit is MOD1, an infrared detector module that removes the IR carrier frequency and sends only the data encoded in an IR signal.

IRLOG.EXE is a simple loop. The program reads the value of the line, stores it in the array store[], increments the array index X, and then waits a user-defined time delay before repeating itself.

When the array is full (30,000 points), the program dumps the array to a file and then waits for a keypress to take another 30,000 points. Pressing the Escape key terminates the program.

The program does not try to write values to disk while it is sampling the infrared input be-

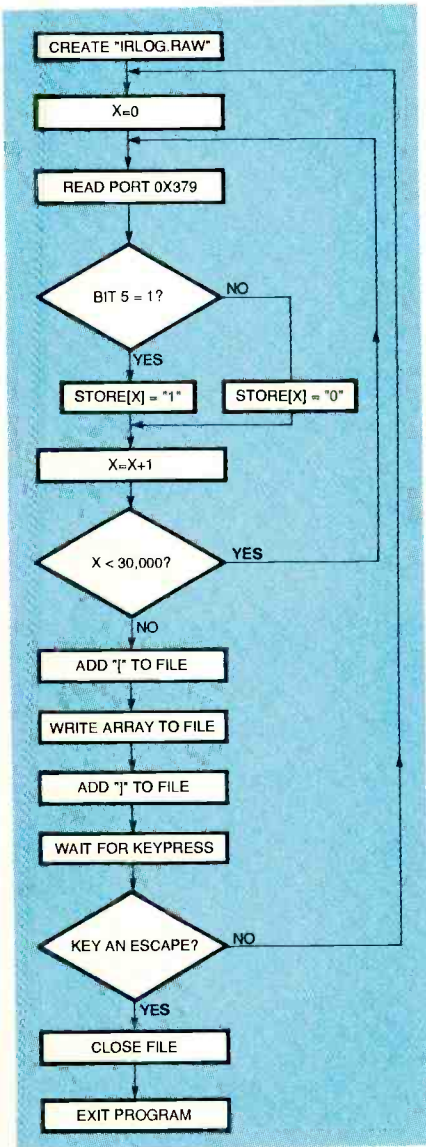

FIG. 2—FLOWCHART OF IRLOG.EXE shows how the program stores raw data in a file filled with 1's when no signal was received and stretches of 1's and 0's during times where the infrared was received.

LISTING 1

```
//This is IRLOG.C - Monitors OUT_OF_PAPER Input, writes to file.
// (C) 1994, Barry Hamilton, M.S.E.E.
```

```
#include <stdio.h>
#include <stdlib.h>
#include <conio.h>
#include <dos.h>
```

```
int main (int argc, char *argv[])
{
    int timeDelay; //User Variable to adjust Part Sampling Rate.
    int loop = 1; //Control For Sampling Loop, Set to 0 by ESCAPE key.
    int key; //To store Keypress.
    int x; //Array Index.
    int z; //Time Delay Counter.
    int cInData; //Store Byte from Part.
    int limit = 30000; //Array Limit.
    int store[30000]; //Array to store Samples.
    FILE *fp; //File Pointer For IRLOG.RAW Output.
```

```
if (argc != 2) {
    printf("IRLOG - Samples Pin 12 of printer part monitoring IR Detector\n");
    printf(" USAGE: IRLOG TIMEDELAY\n");
    printf(" Like: IRLOG 200\n");
    printf("The output file will be called IRLOG.RAW\n");
    exit(1);
}
```

```
clrscr();
timeDelay = atoi(argv[1]); //Note No Checking is done...
```

```
if ((fp = fopen("IRLOG.RAW", "wb")) == NULL) {
    printf("cannot create IRLOG.RAW\n");
    exit(2);
}
```

```
//=====
while (loop == 1) {
    //Record Input Samples into Array...
    for (x=0;x<limit;x++){
```

```
        cInData = inportb(0x379);

        if( (cInData & 0x20) != 0 )
            store[x] = 0x31; //Store an ASCII "1"
        else
            store[x] = 0x30; //Store an ASCII "0"
```

```
        //User Selectable Time Delay between Samples...
        for(z=1;z<timeDelay;z++){
```

```
        }
        //=====
        //Sampling is over, now time to save array...
        fprintf(fp);
```

```
        for (x=0;x<limit;x++){
            fprintf(store[x],fp);
        }
```

```
        fprintf(fp);
        putchar('.'); //Visual Progress For user...
        sound(440); //Beep To denote End of Sampling...
        delay(20);
        nosound();
```

```
        key = getch(); //Hit ESC to Exit Program or any other key to repeat.
        if (key == 0x1B) loop = 0; //ESC exits...
```

```
    } //End of While loop == 1
    //=====
    return(0);
} //<EOF> IRLOG.C
```

cause the time it would take to write to the disk would slow down the sampling process. Therefore the array is filled, sampling is stopped, and then the data is appended to file IRLOG.RAW.

The program places brackets around each array's worth of samples to delineate the begin-

ning and ending of each subsequent sample. The flowchart of IRLOG.EXE, shown in Fig. 2, illustrates this process. The program IRLOG.EXE stores raw data in a file filled with 1's when no signal is received and stretches of 1's and 0's during times when the infrared is received. A sample interval of the

output file IRLOG.RAW is shown in Fig. 3.

To run IRLOG, enter the following form on the command line:

```
IRLOG <TIMEDELAY
```

Where <TIMEDELAY is the value that will be used in the delay loop between samples. The au-

LISTING 2

```
//This is IRGRAPH.C - Produces IRLOG.GPH From IRLOG.RAW
// (C) 1994, Barry Hamilton, M.S.E.E.

#include <stdio.h>
#include <stdlib.h>
#include <conio.h>
#include <dos.h>
#include <string.h>

void main(void)
{
    FILE *fpIn;           //File Pointer for IRLOG.RAW Input File.
    FILE *fpOut;         //File Pointer for IRLOG.GPH Output File.

    int inChar;          //Present Character retrieved from IRLOG.RAW.
    int lastChar;        //Used to compare the Character before with present.
    int totalCnt = 0;    //Character Counter for runs of the same character.
    int nLimit = 80;    //Limit of Graph String.
    char s2[81];         //String of "111" or "000" to be printed to IRLOG.GPH

    char s1[] = "111111111+111111111+111111111+111111111+\
111111111+111111111+111111111+111111111+";

    char s10[] = "000000000+000000000+000000000+000000000+\
000000000+000000000+000000000+000000000+";

    //=====
    if ( (fpIn=fopen("IRLOG.RAW","rb")) == NULL) {
        printf("cannot open IRLOG.RAW\n");
        return;
    }
    if ( (fpOut=fopen("IRLOG.GPH","wb")) == NULL) {
        printf("cannot open IRLOG.GPH\n");
        return;
    }
    //=====
    while ( (inChar = fgetc(fpIn)) != EOF) { //Main Loop...

        if (inChar == '0' && lastChar == '0') {
            totalCnt++;
        }

        if (inChar == '1' && lastChar == '1') {
            totalCnt++;
        }
        //=====
        if (lastChar == '[') { //Resets on Beginning of Sample...
            totalCnt = 1;
        }

        if (lastChar == ']') { //Resets on End of Sample...
            totalCnt = 0;
        }
        //
        //=====
        if (inChar == '0' && lastChar == '1') {
            if (totalCnt < nLimit) {
                strcpy(s2,"");
                strcat(s2,s11,totalCnt);
                fprintf(fpOut,"%s\n",s2); //Print String of "1"s.
            }
            else {
                fprintf(fpOut,"          | %04d 1 \n",totalCnt);
            }
            totalCnt = 1;
        }
        //=====
        if (inChar == '1' && lastChar == '0') {
            if (totalCnt < nLimit) {
                strcpy(s2,"");
                strcat(s2,s10,totalCnt);
                fprintf(fpOut,"%s\n",s2); //Print String of "0"s.
            }
            else {
                fprintf(fpOut,"          | %04d 0 \n",totalCnt);
            }
            totalCnt = 1;
        }
        //=====
        if (inChar == ']' && lastChar == '0') {
            if (totalCnt < nLimit) {
                strcpy(s2,"");
                strcat(s2,s10,totalCnt);
                fprintf(fpOut,"%s\n",s2); //Print String of "0"s and ].
            }
            else {
                fprintf(fpOut,"          | %04d 0] \n",totalCnt);
            }
            totalCnt = 0;
        }
        //=====
        if (inChar == '[' && lastChar == '1') {
            if (totalCnt < nLimit) {
                strcpy(s2,"");
                strcat(s2,s11,totalCnt);
                fprintf(fpOut,"%s\n",s2); //Print String of "1"s and [.
            }
            else {
                fprintf(fpOut,"          | %04d 1] \n",totalCnt);
            }
            totalCnt = 0;
        }
        //=====
        lastChar = inChar; //Always update lastChar...
    } //End of Main Loop...

    fclose(fpOut);
    fclose(fpIn);
} //< EOF > IRGRAPH.C
```

SAMPLE INTERVAL IN IRLOG.RAW

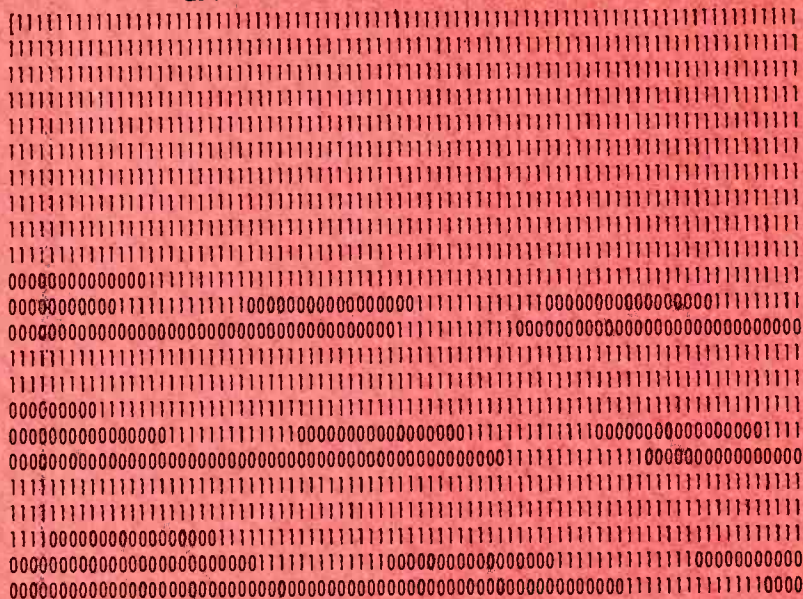

FIG. 3—SAMPLE INTERVAL of the output file IRLOG.RAW.

thor found that a delay value of 200 works well for a computer based on a 50-MHz 486 processor and that a delay of 20 was required for an IBM AT-class computer. Those values will vary with the computer used and the particular pulse train being analyzed. You can observe the output generated by IRGRAPH to adjust the delay value.

The program IRGRAPH.EXE

reduces the data stored by IRLOG.EXE to a more convenient form. It counts how many 1's occur in a row and reduces them to an output of "nnn 1's." The same is true for the number of 0's that occur.

To simplify the visual analysis of the output data, IRGRAPH takes those sequences of 1's and 0's that fall between 1 and 80 and prints a string of 1's or 0's to create a bargraph. The source code for IRGRAPH.EXE is shown in Listing 2, its flowchart is shown in Fig. 4, and its output (IRLOG.GPH) is shown in Fig. 5.

The output in Fig. 5 was obtained from a One For All Universal TV remote set up for manufacturer's code of 1111. The example sampling recorded the remote's power button being pressed.

The output starts with a trigger pulse that is longer than all

other pulses. A series of long and short pulses interspersed with constant-width sync pulses is sent after that. The trigger has an interval of 65, the long pulse corresponding to a "1" has an interval of 34, the short pulse corresponding to a "0" has an interval of 19, and the sync pulses have an interval of 12. There is a repeat time of 649 intervals between the bursts of infrared.

Note that in this example, the sync pulses are sent as intervals when the signal is high. This means the sync pulses use the "mark" state versus the "space" state. The mark state is considered the idle state, i.e., the value output when no infrared signals are received.

The sync pulses can be considered as the rest times between sending data. Knowing whether these rests occur during the period that the signal is logic high or low will allow you to identify the data that would be of the opposite state.

One last program, IRFINAL.EXE, shown in Listing 3, reduces the data to a long pulse corresponding to a 1 and a short pulse corresponding to a 0. IRFINAL.EXE examines the raw data generated by the program IRLOG.EXE.

The flowchart for IRFINAL.EXE is shown in Fig. 6. The program counts the numbers of 1's and 0's. If the count falls within the parameters defined as a long pulse (MAXZERO AND MAXONE) it will output a 1. If the count is less than MAXZERO, it is considered to be a short pulse and it will output a 0. These characters will be sent to the file called IRLOG.FNL, as shown in Fig. 7.

To run the program IRFINAL, enter the following instruction

ANNOTATED OUTPUT FROM IRLOG.FNL

```

Trigger/Address & Data
| 0065 0=101010010000
| 0063 0=101010010000
| 0063 0=101010010000
| 0063 0=101010010000
| 0062 0=101010010000
| 0063 0=101010010000
| 0062 0=101010010000
| 0062 0=101010010000
| 0062 0=101010010000
| 0063 0=101010010000
| 0062 0=101010010000
| 0062 0=101010010000
| 0062 0=101010010000
| 0062 0=101010010000
| 0062 0=101010010000
| 0063 0=101010010000
| 0062 0=101010010000
| 2660 1}
    
```

FIG. 7—IRFINAL.EXE outputs characters to the file called IRLOG.FNL, as shown here.

TABLE 1—OUTPUT DATA

BINARY (MSB FIRST)		BUTTON	HEX	
Address	Data		Address	Data
0000	1001 0000	Channel Up	09	0
0000	1001 0001	Channel Down	09	1
0000	1001 0010	Volume Up	09	2
0000	1001 0011	Volume Down	09	3
0000	1001 0100	Mute	09	4
0000	1001 0101	Power	09	5

LISTING 3

```

//This is IRFINAL.C - Converts Raw Data to actual address/data code.
// (C) 1994, Barry Hamilton, M.S.E.E.

#include <stdio.h>
#include <stdlib.h>
#include <conio.h>
#include <dos.h>
#include <string.h>

#define MARK 1
#define SPACE 0

int main (int argc, char *argv[])
{
    FILE *fpIn;           //File Pointer for IRLOG.RAW Input File.
    FILE *fpOut;          //File Pointer for IRLOG.FNL Output File.

    int inChar;           //Present Character retrieved from IRLOG.RAW.
    int lastChar;         //Used to compare the Character before with present.
    int totalCnt = 0;     //Character Counter for runs of the same character.

    //===== User Adjustable Variables... =====
    int MaxZero; //Greatest relative Time Interval Of Pulse Considered a "0".
    int MaxOne;  //Greatest relative Time Interval Of Pulse Considered a "1".

    int synchState; //MOSTLY SPACE. Check By looking at IRLOG.GPH.
    //=====

    if (argc != 4) {
        printf("IRFINAL - Produces Address and Data Codes from IRLOG.RAW\n");
        printf("  USAGE:  IRFINAL M(ark synch)/S(pace synch) MAXZERO MAXONE\n");
        printf("  Like:  IRFINAL M 25 40\n");
        printf("  The output file will be called IRLOG.FNL\n");
        exit(1);
    }

    if (strcmp(argv[1], "M") == 0) //Note Little Error Checking...
        synchState = MARK;
    else
        synchState = SPACE;

    MaxZero = atoi(argv[2]);
    MaxOne = atoi(argv[3]);

    if ((fpIn = fopen("IRLOG.RAW", "rb")) == NULL) {
        printf("cannot open IRLOG.RAW\n");
        exit(2);
    }

    if ((fpOut = fopen("IRLOG.FNL", "wb")) == NULL) {
        printf("cannot open IRLOG.FNL\n");
        exit(3);
    }

    //=====

    while ((inChar = fgetc(fpIn)) != EOF) {

        if (inChar == '0' && lastChar == '0') {
            totalCnt++;
        }

        if (inChar == '1' && lastChar == '1') {
            totalCnt++;
        }

        //=====

        if (lastChar == '!') { //Resets on Beginning of Sample...
            totalCnt = 1;
        }

        //=====

        if (lastChar == '!') { //Resets on End of Sample...
            totalCnt = 0;
        }

        //=====

        if (inChar == '0' && lastChar == '1') {
            if (synchState == SPACE) { //Count MARK (1) As 1 (Long) and 0 (Short).

                if (totalCnt <= MaxZero) {
                    fprintf(fpOut, "0");
                }

                if (totalCnt > MaxZero && totalCnt < MaxOne) {
                    fprintf(fpOut, "1");
                }

                if (totalCnt >= MaxOne) { //NOTE: MARK is ALWAYS Idle State!
                    fprintf(fpOut, "\n | %04d 1 =", totalCnt);
                }
            }
            totalCnt = 1;
        }

        //=====

        if (inChar == '1' && lastChar == '0') {
            if (synchState == MARK) { //Count SPACE (0) As 1 (Long) and 0 (Short).

                if (totalCnt <= MaxZero) {
                    fprintf(fpOut, "0");
                }

                if (totalCnt > MaxZero && totalCnt < MaxOne) {
                    fprintf(fpOut, "1");
                }

                if (totalCnt >= MaxOne) {
                    fprintf(fpOut, "\n | %04d 0 =", totalCnt);
                }
            }
            totalCnt = 1;
        }

        //=====

        //Shows When Sampling Period Ended...

        if (inChar == '!' && lastChar == '0') {
            fprintf(fpOut, "\n | %04d 0");
            totalCnt = 0;
        }

        if (inChar == '!' && lastChar == '1') {
            fprintf(fpOut, "\n | %04d 1", totalCnt);
            totalCnt = 0;
        }

        lastChar = inChar;
    }

    fclose(fpOut);
    fclose(fpIn);
    return(0);
} //< EOF > IRFINAL.C

```

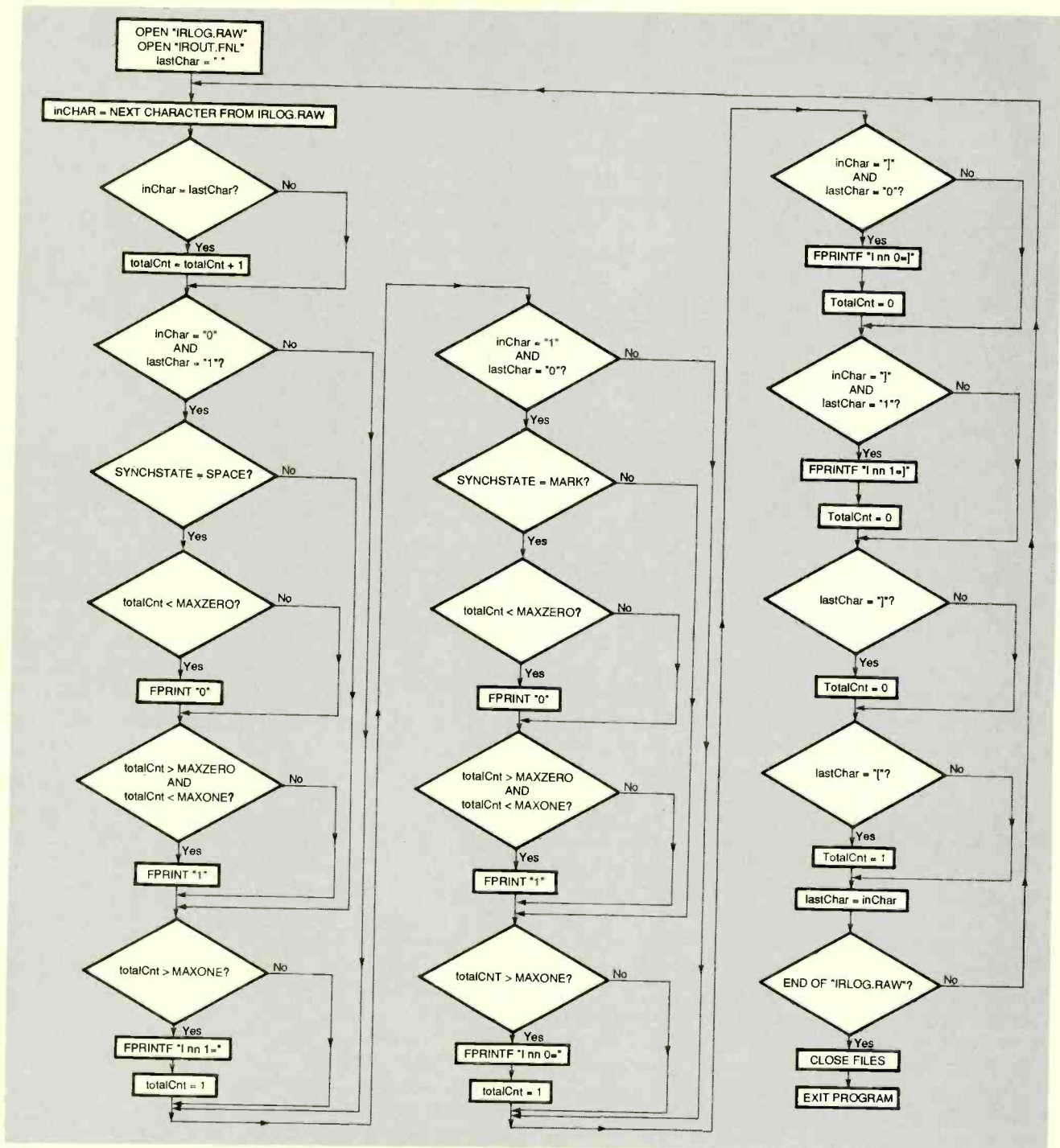



FIG. 6—IRFINAL.EXE FLOWCHART. This program reduces the data to a long pulse corresponding to a 1 and a short pulse corresponding to a 0.

on the command line:

```
IRFINAL M/S MAXZERO
MAXONE
```

where M or S is mark or space sync state, MAXZERO is the maximum data length you want to be a Data 0 value, and MAXONE is the maximum data length you want to be a Data 1 value.

Note in Fig. 7 that since only one key was pressed, the code repeats itself. The example remote control sends 12 bits at a time.

Other remotes typically send 12 to 15 bits. Many manufacturers precede the data code with an address code, and most send the least significant bit first.

Some remotes send the information twice with each key-press, sometimes inverting the repeated data. Some use a checksum for error checking. Many send the pulse train once, and then wait and send a special code meaning "repeat last command." The data in Table 1 was generated for the one for all universal TV remote. Ω

WIND MONITOR

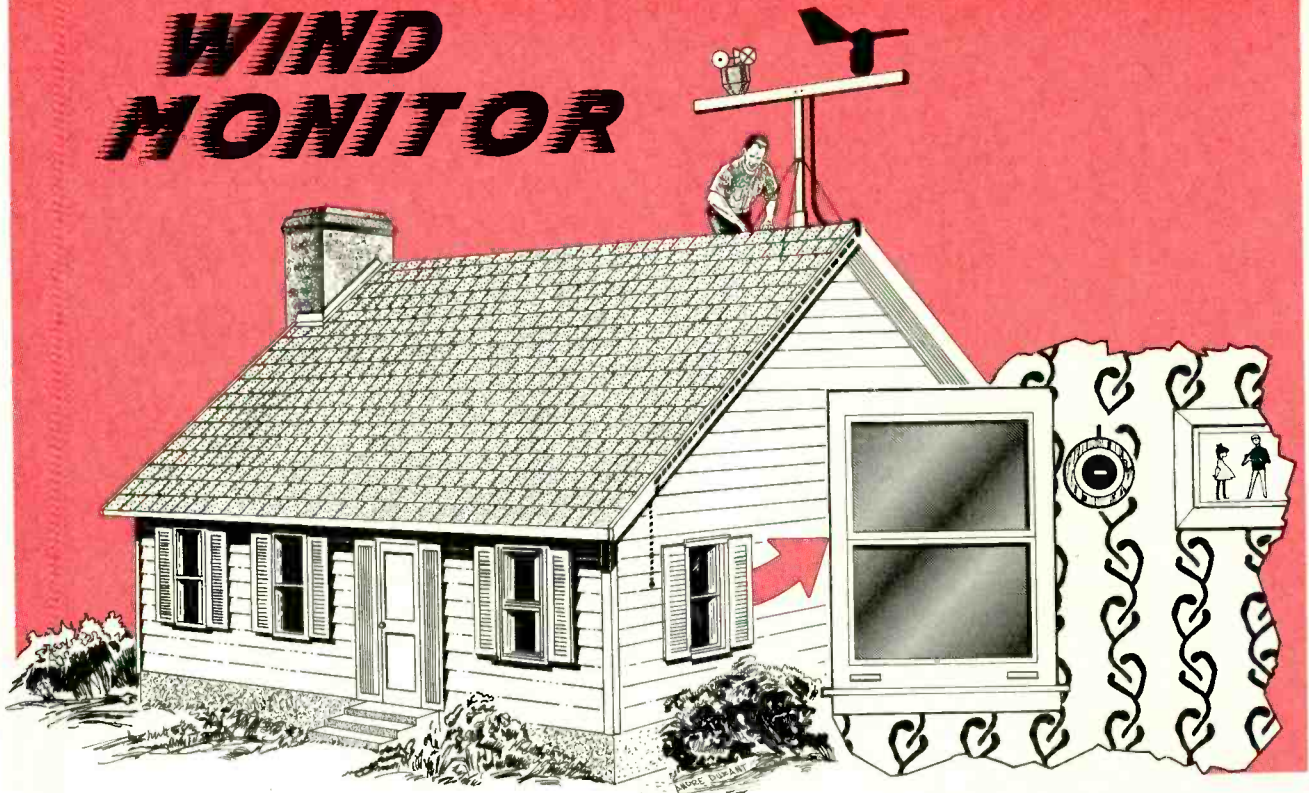

Keep tabs on the weather with this stylish microprocessor-based monitoring system.

TOM LEONIK

WE LIVE IN A WEATHER-CONSCIOUS word. There's even a 24-hour-a-day cable TV station dedicated to nothing but weather. If you're active outdoors, you'll appreciate the convenience of having a wind-monitoring system in your own home. And, if you're interested in custom microprocessor applications, you'll like this project even better.

The finished project measures wind speed and direction. Features include a bright, three-digit LED wind-speed indicator, a 16-point wind-direction display, and pushbutton selection of wind-speed units (MPH or knots) and peak (gust) display. An optical encoder system provides both speed and direction data; an 80C31 CMOS microcontroller interprets and scales the data for meaningful results. A seven-conductor cable connects the sensing unit, which is mounted outdoors in a high

place, to the electronics, which are housed in a highly attractive oak and brass frame that is suitable for mounting in your living room.

Circuit boards and partial and complete parts kits are available; object code for the EPROM is available on the Gernsback BBS (516-293-2283, v.32, v.42bis).

Wind monitoring

There are several methods for measuring wind speed and direction. The most common is the anemometer and wind-vane technique, which is used at airports, on most ships, and at weather stations. An anemometer measures wind speed, and a wind vane measures wind direction. The vane rotates, seeking equilibrium, which occurs when the wind-direction rudder is pointing directly into the wind. Typically, the ane-

nometer and wind vane are mounted on opposite ends of a cross member, which in turn attaches to a vertical mast.

An anemometer usually consists of three aerodynamically shaped cups, mounted 120° apart, and attached via spokes to a central shaft. The cups catch the wind better in one direction than the other, thereby causing the shaft to rotate. Rotation speed is proportional to wind velocity. The vane design is shown in Fig. 1; numbered components are listed in Table 1. Stainless-steel fastening hardware, available at most marine-supply stores, is used to minimize the corrosive effects of weather.

Various types of sensors could be used, including a generator, a variable resistor, or an optical encoder. For best environmental stability, the optical method is used.

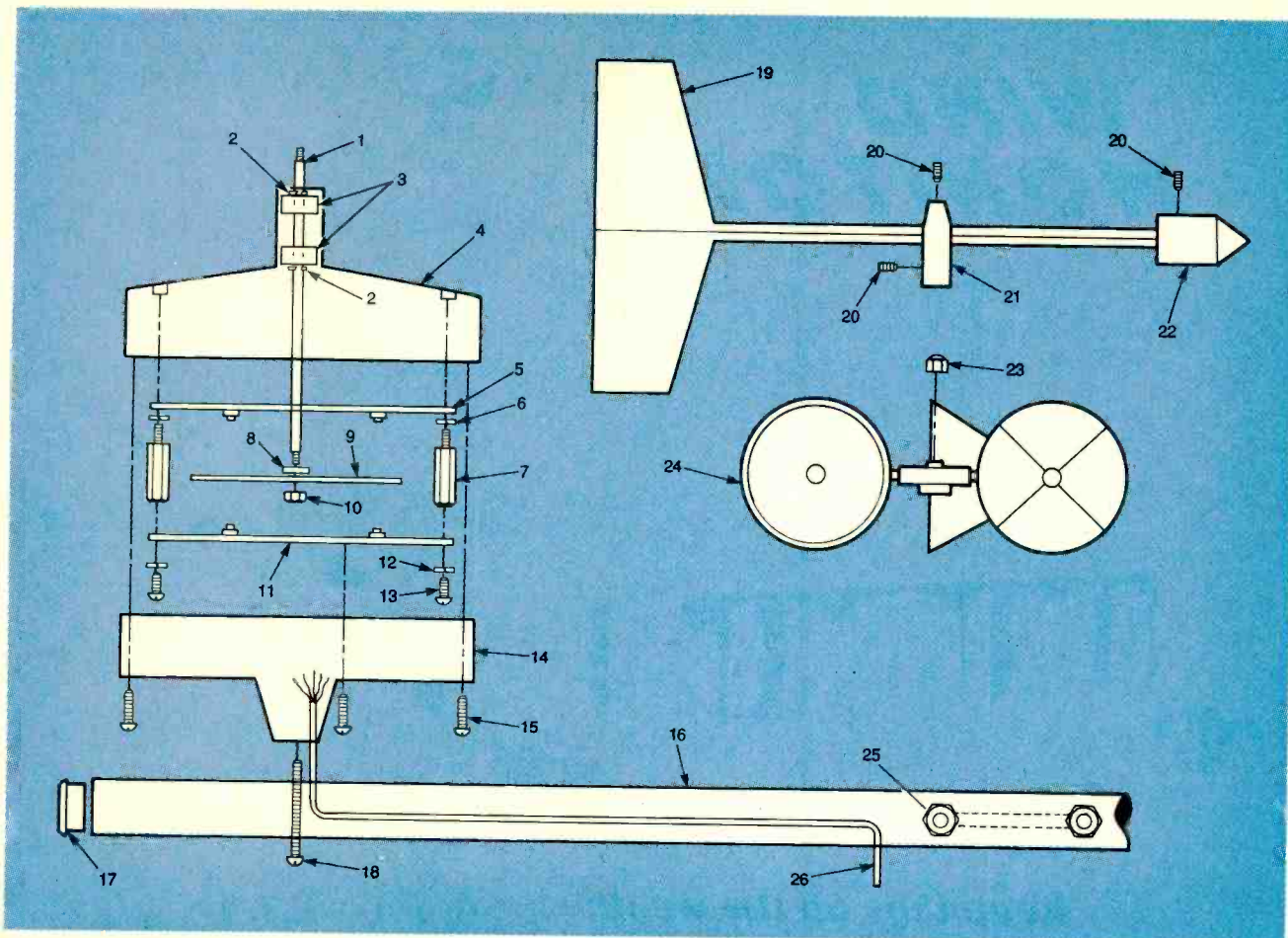

FIG. 1—THE WEATHER VANE ASSEMBLY. Circled numbers correspond to the parts listed in Table 1.

A typical optical encoder consists of a clear, round plastic disk that rotates about its center. The disk has a series of opaque patterns silk-screened onto it. The patterns interrupt the light path between pairs of optical emitter/detectors.

After examining several alternatives, the author decided on a sensor assembly manufactured by the Heath/Zenith Company of Benton Harbor, Michigan (616-982-3571). The company offers various weather-monitoring kits, including some microprocessor-based units with lots of functions. However, their packaging schemes did not meet the author's criteria for style.

On the other hand, the Heath units used just the sort of optical sensing the author had in mind. In addition, the company sells the manuals for its products separately, and at very reasonable prices. The manuals

allow a potential kit builder to examine the complexity of a particular kit before buying it. The manual contains step-by-step assembly instructions, a detailed parts list, and excellent pictorial views of critical assembly steps. That fact alone was a big help, because designing and building an anemometer/wind vane assembly from scratch is difficult. In addition, hard-to-find components, like those in the wind-sensor assembly, are available from Heath/Zenith's parts department.

Sensor boards

Another nice feature of the Heath system is a PC board that can be configured in four ways: as a wind-speed emitter, a wind-speed detector, a wind-direction emitter, and a wind-direction detector. The wind-speed configuration consists of a single emitter/detector pair. The wind-direction configuration con-

tains four emitter/detector pairs, thereby allowing the board to detect wind direction with a resolution of 16 (2^4) points around the compass.

Heath also sells an encoder disk with special patterns that allow it to be used for both speed and direction measurements. The wind-speed pattern, consisting of an alternating set of 32 transparent-opaque sectors, is printed on the outer diameter of the disk. One complete revolution of the disk generates 32 pulses. The wind direction pattern consists of four concentric circles. The pattern is based on a 4-bit Gray code. Gray code is a special binary counting sequence, in which only one bit changes from one number to the next. Gray code prevents the microcontroller from making false readings. For example, using standard binary code, if the value changed from fifteen (1111) to zero (0000), the reading might be ambiguous, since all four bits would change si-

multaneously. Table 2 indicates the Gray code output from the wind-direction sensor as it rotates clockwise around its axis. By default, all outputs are high when the direction is North.

Figure 2 shows the Heath circuits for the wind-speed (a) and wind-direction (b) sensors. Typically, the forward drop across an infrared (IR) LED is 1.6 volts, and the maximum continuous forward current is 50 milliamperes. The circuit biases the IR emitters to provide a continuous current of 20 milliamperes. The IR detectors operate in an open-emitter configuration, in which the detector conducts current provided that the light path from the emitter has not been obstructed by a dark section on the optical disk.

The author modified Heath's sensor circuitry to provide better noise immunity and stability, as shown in Fig. 3. Heath's PC boards were used after drilling several extra holes

and making the connections with wire-wrap wire. The new circuits use the TRW OPL801 Photologic sensor as detectors. The device incorporates a photodiode, a linear amplifier, and a Schmitt trigger in a single package. The Schmitt trigger's hysteresis provides high noise immunity on both the input and the power rails. The OPL801s require regulated 5-volt DC power, so the circuits also include low-power 78L05 regulators.

To determine the proper factor for scaling encoder output into MPH, the author powered the anemometer from an automotive cigarette lighter jack, then drove with the output connected to a frequency counter. Next, holding the sensor outside the car window, he measured the frequency at 5-MPH intervals, ranging from 5 to 65 MPH. This was done on a windless night. After studying the data, the accuracy and the lin-

earity of the sensor was found to be impressive. The scaling factor arrived at is 0.08695, or a divisor of 11.5.

One nautical mile is the length of one minute of longitude at the equator, or 1.1508 statute miles. Therefore, to convert MPH to knots, the speed in MPH must be multiplied by 0.86896.

The best feature of the OPL801 sensors is that they are digital. Once the scaling factor has been determined, no further calibration is required. Even the most extreme variation in temperature will have a negligible effect on the operation of the sensors.

The only required setup involves orienting the wind vane so that it points to compass North. This is accomplished by pointing the vane north and rotating the sensor housing (to which the circuit boards are attached) until the display reads north.

TABLE 1—WIND VANE PARTS

ITEM	QTY/ SENSOR	QTY TOTAL	PART DESCRIPTION	SOURCE
1	1	2	STAINLESS STEEL SHAFT	HEATH/ZENITH PN 453-282
2	2	4	STAINLESS STEEL C-RING	IRR Co. p/n 2000-18 SS2 5612
3	2	4	STAINLESS STEEL SEALED BEARING	NEW HAMPSHIRE PN SR1663PPK58
4	1	2	WIND SENSOR HOUSING ZTOP HALF	HEATH/ZENITH PN 214-208-1
5	1	2	EMITTER CIRCUIT BOARD	HEATH/ZENITH PN 85-1982-1
6	4	8	#6 LOCK WASHER	HARDWARE STORE
7	4	8	CIRCUIT BOARD SPACER	HH SMITH PN8251 OR 4385 (6-32 .625" HEX)
8	1	2	#6 FIBER FELT WASHER	HARDWARE STORE
9	1	2	OPTICAL DISC	HEATH/ZENITH PN 266-1032
10	1	2	6-32 LOCK NUT STAINLESS STL	HARDWARE STORE
11	1	2	DETECTOR CIRCUIT BOARD	HEATH/ZENITH PN 85-1982-1
12	4	8	#6 LOCK WASHER	HARDWARE STORE
13	4	8	6-32 1/4" STAINLESS STEEL SCREW	HARDWARE STORE
14	1	2	WIND SENSOR HOUSING BOTTOM HALF	HEATH/ZENITH PN 214-209-1
15	3	6	#4 BY 1" STAINLESS STEEL SCREW	HARDWARE STORE
16	-	30" LENGTH	1" SQUARE ALUMINUM TUBING 1/8"	HARDWARE STORE
17	1	2	PLASTIC END CAP FP-161	CAPPLUGS OR USE STYROFOAM TO SEAL END
18	1	2	8-32 BY 1 1/2" STAINLESS STEEL	HARDWARE STORE
19	1	1	WIND VANE	HEATH/ZENITH PN 266-930
20	3	1	8-32 SETSCREW STAINLESS	HARDWARE STORE
21	1	1	WIND VANE SHAFT ADAPTER	HEATH/ZENITH PN 266-1200
22	1	1	WIND VANE COUNTER WEIGHT	HEATH/ZENITH PN 266-943
23	1	1	6-32 CAP NUT STAINLESS	HARDWARE STORE
24	1	1	WIND CUPS	HEATH/ZENITH PN 266-939
25	1	1	2" PIPE CLAMP	RADIO SHACK
26	1	1	7 CONDUCTOR CABLE SAXTON 2375	DIGIKEY

Frequency counter design

With the modified sensor circuits, a wind-speed and -direction monitor can be implemented with a frequency counter. The frequency output of the speed-sensor board must be scaled into units of MPH, and a 4-to-16 line decoder (like the CD4514B) can determine wind direction. Although such a system would be functional, the turbulence occurring from wind rushing around the structure would be problematic. Without some sort of filtering, the compass indicator would sweep all over the dial, making it impossible to determine wind direction at a glance. However, because the sensor outputs are digital, an effective filter can be "built" in software controlled by a microcontroller. A CPU also makes it easy to display wind speed in several units (MPH and knots), and some other "tricks."

The wind direction is sampled on a relatively frequent basis. Each sample then indexes into a 16-byte array; the corresponding array position increments each time that value arrives. The microcontroller examines the array on a relatively infrequent basis, and the array position with the highest value wins—i.e., that position indicates the "true" wind direction.

In a similar fashion, the CPU averages wind-speed data over a relatively long period of time. The CPU also maintains a peak or "gust" value, which is simply the highest value read since the unit powered up, or since the user pressed the clear button.

Microcontroller circuit

Figure 4 shows the circuitry required to implement the wind monitor. Signal flow is from left (inputs) to right (outputs), with processing logic in the center. To simplify the software, and to minimize the amount of RF generated by an elaborate multiplexing scheme, the display uses discrete latchable decoders. For similar reasons, the Intel 80C31 single-chip microcontroller with on-board RAM, address decoding, two 16-bit timer/counters, interrupt decoder, input/output ports, serial port, and on-board clock oscillator is used.

All circuit power is supplied by a wall-mount AC-to-DC adapter rated for 9-volts DC at 500 milliamperes. The wind-

monitoring circuit typically draws about 100 milliamperes. A 1N4001 diode (D1) in series with the DC power input protects against accidentally reverse biasing the circuit.

The circuit generates a 2.5-volt reference by dropping the regulated supply voltage across two identical resistors (R1 and R2), filtering it, and feeding it to an op-amp (IC1-a) configured as a voltage follower. The latter simply provides enough drive to supply the op-amps that monitor the sensor outputs.

The remaining op-amps function as comparators. Each input has a Schmitt trigger that provides hysteresis for the sensor outputs; hysteresis is especially important for the standard Heath sensors. Each output is a function of the amount of IR transmitted to the optical detectors. If the optical encoder disk should be at the border between opaque and translucent sections when a reading is taken, it is possible for the output to be at half the supply voltage. A voltage in that range would cause a CMOS-based logic input to be unstable, perhaps to the point of oscillating.

Hysteresis is achieved by positive feedback from the op-amp's output back to its inverting input, and the 2.5-volt reference, via the voltage divider network consisting of 1-megohm and 220-kilohm resistors (e.g., R7 and R8). With the values indicated, the width of the hysteresis loop is approximately 1 volt. This means that once the output of the comparator changes state, the input must move 1 volt in the opposite direction before the comparator will revert to the previous state. Each input is pulled up to +5 volts with a 15-kilohm resistor to prevent the inverted input from floating when sensors are not attached. In addition, another 15-kilohm resistor directly in line with each op-amp's negative input provides overload protection.

The conditioned outputs of the wind-direction sensors (IC2-a, IC2-b, IC3-a, IC3-b) directly drive the low nibble of

TABLE 2—GRAY CODES AND COMPASS POINTS

Gray Code	Compass Point
1111	N
1101	NNE
1100	NE
0100	ENE
0101	E
0111	ESE
0110	SE
0010	SSE
0011	S
0001	SSW
0000	SW
1000	WSW
1001	W
1011	WNW
1010	NW
1110	NNW

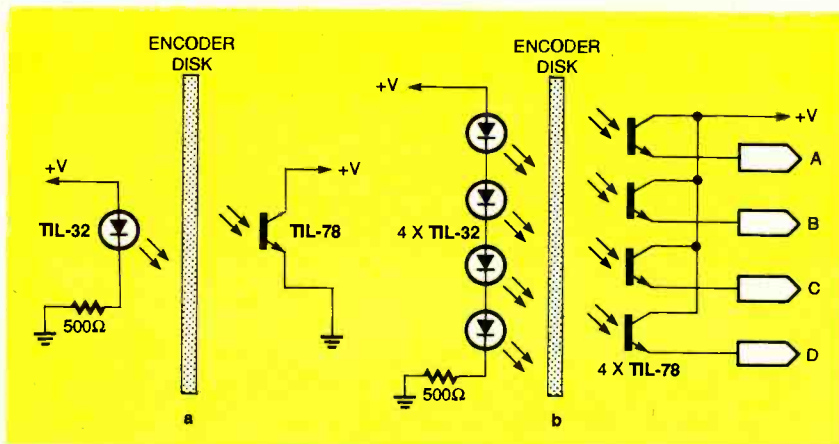

FIG. 2—HEATH'S BASIC SENSOR CIRCUIT works, but leaves something to be desired.

CPU port 1. The conditioned output of the wind-speed sensor drives CPU timer/counter T1 (port 3 bit 5).

Bits 4, 5, and 6 of CPU port 1 act as inputs for the display-mode pushbuttons (S1, S2, and S3). Bit 4 selects display units (MPH or knots); bit 5 selects peak display; and bit 6 clears the peak display value. Since the system does not contain a backup battery, peak wind speed will be cleared by any power loss.

One critical yet frequently overlooked element of good microcontroller design is control of the reset pin. When the reset pin is activated it forces registers to known states and starts program execution at a given location. A reset should occur whenever the microcontroller powers up, whenever the supply voltage drops below a safe operating range, and whenever a significant power glitch occurs. The commonly used RC circuit is not reliable enough. All it takes is a one-bit error on either the data or the address bus to cause the executing program to fall out of sequence and get caught in a continuous loop. This design incorporates a TI TL7705 voltage supervisor IC (IC4), which properly resets the microcontroller when necessary.

When pin 31 of the CPU is pulled low it configures it to use external program memory. The microcontroller does not have enough pins for all the address and data lines; instead, it multiplexes the low-order address lines along with the data bus. Octal noninverting latch IC6 captures the low-order address bits and presents them to the EPROM (IC7) from which the program code executes. The CPU's ALE output goes low when it is time to latch the lower address lines; ALE drives the latch's latch-enable input (\overline{LE}). A 74HC573 was chosen for the octal latch rather than a more-common 74HC373 because the sequential pinout of the device makes it easier to design the PC board artwork, and easier to troubleshoot the circuit. The CPU drives the EPROM's high-

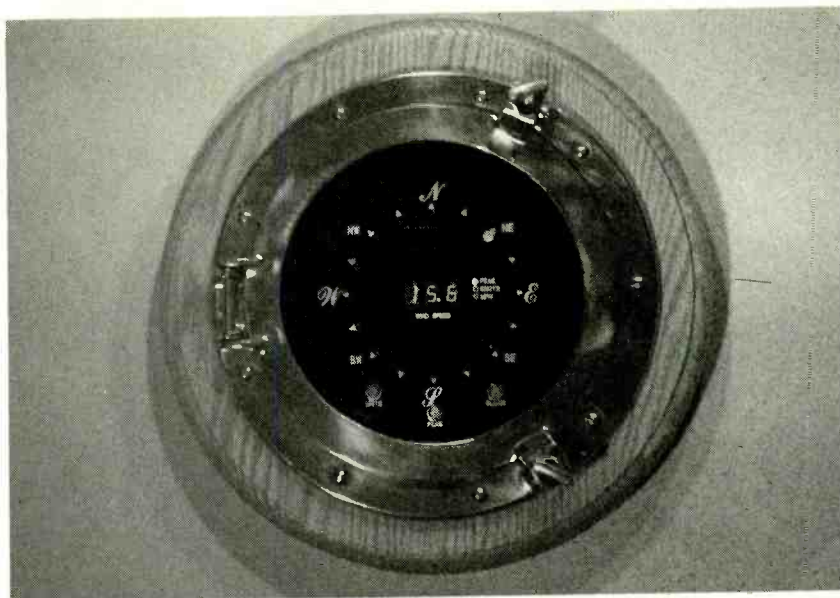

FIG. 5—THE PROTOTYPE looks like this (but the photo doesn't really do it justice).

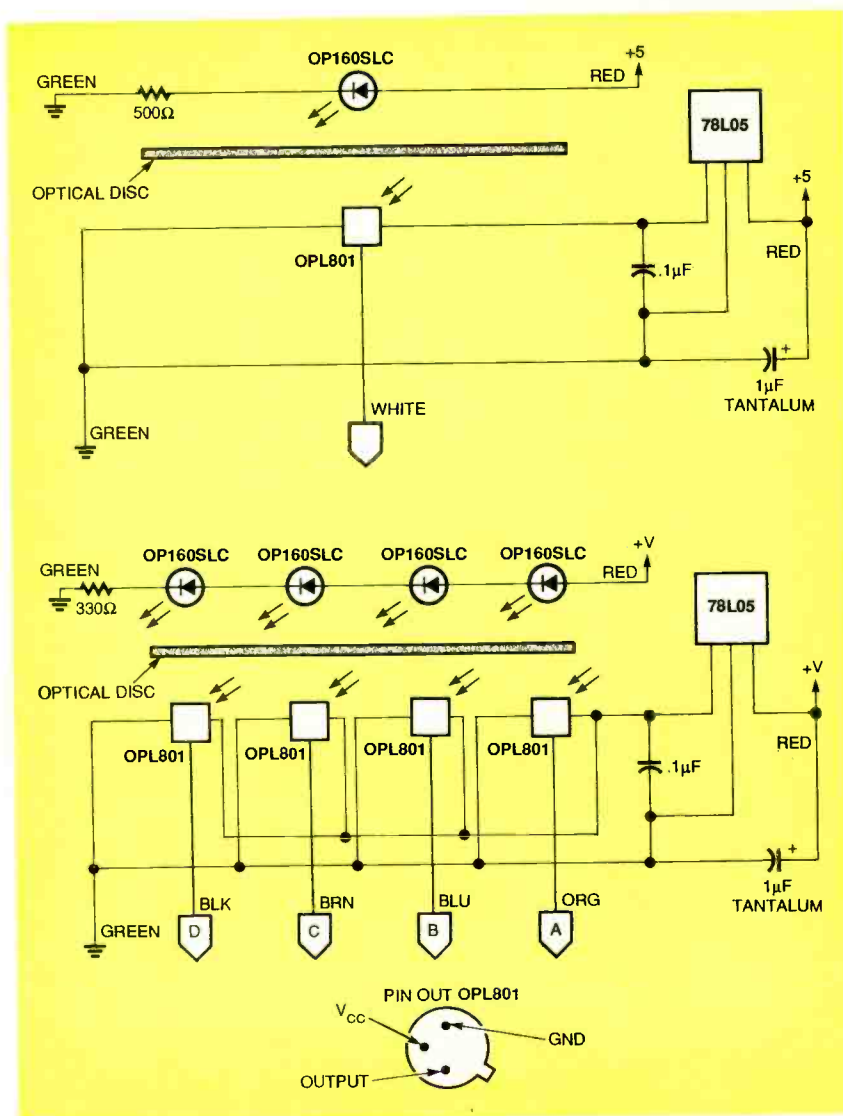
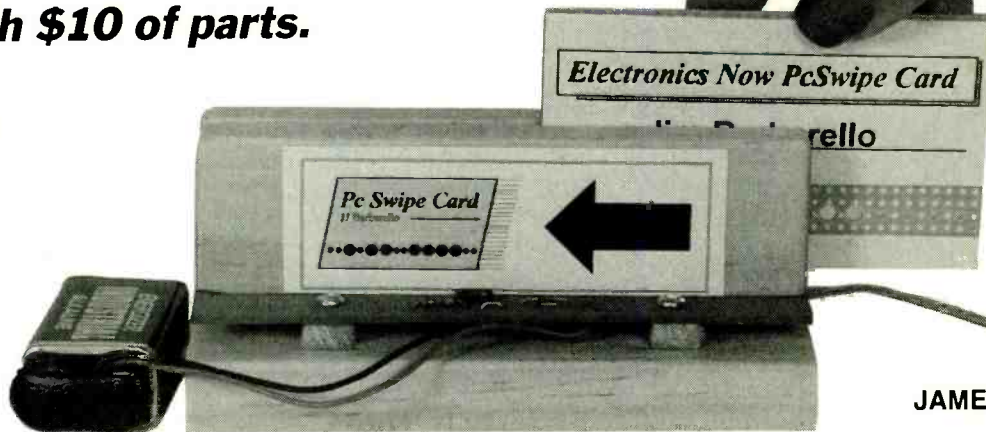

FIG. 3—THIS MODIFIED SENSOR CIRCUIT provides superior noise rejection and hysteresis.

Card Reader For Your PC

**Build this infrared card reader
with \$10 of parts.**



JAMES J. BARBARELLO

HERE'S A NEAT LITTLE PROJECT that consists of only five components and a simple Basic program. Construction time is about an hour, and parts cost less than \$10, and are all readily available. What you end up with is a versatile gadget I call PcSwipe. PcSwipe is a PC-based infrared information reader that can be used in many ways.

For example, assume you're a small-business person looking for a unique way to draw customers into your shop. You send a packet of advertising material to your customers. The packet contains a stiff, thin card that looks like a credit card, but it has a series of holes across the bottom. The packet also contains a note stating, "Here's your invitation to drop by Acme Electronics on Main Street. When you come in, bring your invitation card and run it through our computerized card reader. Who knows? You might be our grand prize winner!"

The customer's interest is piqued, so he makes a trip to your store. On entering, he sees a computer displaying the message, "Welcome! Try your card to see if you've won the grand

prize." The customer runs his card through the reader and . . . you can complete the story.

How it works

PcSwipe works by sensing the presence and size of holes in a card passed by its infrared LED and phototransistor. The detection algorithm implemented in the Basic program is not affected by variations in speed as the card passes through the reader.

The card measures $2 \times 3\frac{3}{8}$ inches and contains a row of 16 holes spaced on 0.2-inch centers located one-half inch up from the bottom. Based on hole size, each hole can represent either a one or a zero. Small holes ($\frac{1}{16}$ inch) represent logic 0; large holes ($\frac{1}{8}$ inch) represent logic 1. Hole 1 functions as a "start" bit; the remaining 15 holes provide 2^{15} or 32,768 combinations.

The card can be fabricated easily from such materials as card stock, plastic, PC board stock, perforated board, or aluminum. The circuit can be powered from any 5–15-volt source, including a 9-volt battery. Further, you can use any PC to run the software.

In the demonstration program, PcSwipe simply displays a message on the screen. Of course, it could do more than just display messages. You could easily modify the program to look up names and other information in a file, print a receipt, or activate a relay. Your imagination is the only limit.

Circuit and components

Figure 1 shows the complete circuit. The LED is a high-output infrared emitter. It receives its power through current-limiting resistor R1. With a 9-volt power supply and a value of 220 ohms for R1, the diode will receive about 25 millamperes of current. (The diode has a forward voltage drop of about 1.2 volts). With a 5-volt supply, R1 should have a value of 150 ohms to keep diode current in the 25-milliampere range.

The LED energizes NPN phototransistor Q1, which is configured as a simple inverting amplifier. As more light shines on Q1, the output voltage at its collector decreases. With a value of 2.2 kilohms for R2, the circuit provides TTL-compatible logic levels.

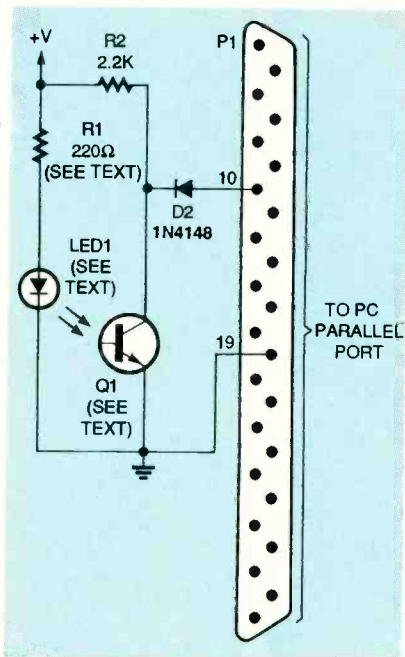

FIG. 1—THE COMPLETE CIRCUIT consists of an LED, a phototransistor, a diode, and two resistors.

The output of Q1 feeds one bit of a PC's parallel port. Diode D2 allows the use of power sources greater than 5 volts, thereby maintaining TTL level compatibility, even with higher supply voltages. If the voltage at the collector of Q1 ever exceeds 5 volts, D2 will block the voltage, thereby protecting the port. On the other hand, when Q1 goes logic low, D2 becomes forward-biased, so the low level can be sensed by the port.

The circuit can be powered by a wide range of supplies, including three series-connected AA cells for a total of 4.5 volts, a 5-volt power supply, a single 9-volt battery, an unregulated 9-volt source, a 100-milliamperere power cube, or a variable power supply set that can supply between 4.5 and 15 volts.

A few notes about the emitter/detector pair: I used readily available Radio Shack parts, but others with similar characteristics can be used. Here's some information about the specified parts to help if you'd like to make substitutions.

The high-output infrared LED is a two-terminal device in a T-1 $\frac{3}{4}$ package. It has a minimum radiant power output of 16 milliwatts when driven with 100 milliamperes of current. At

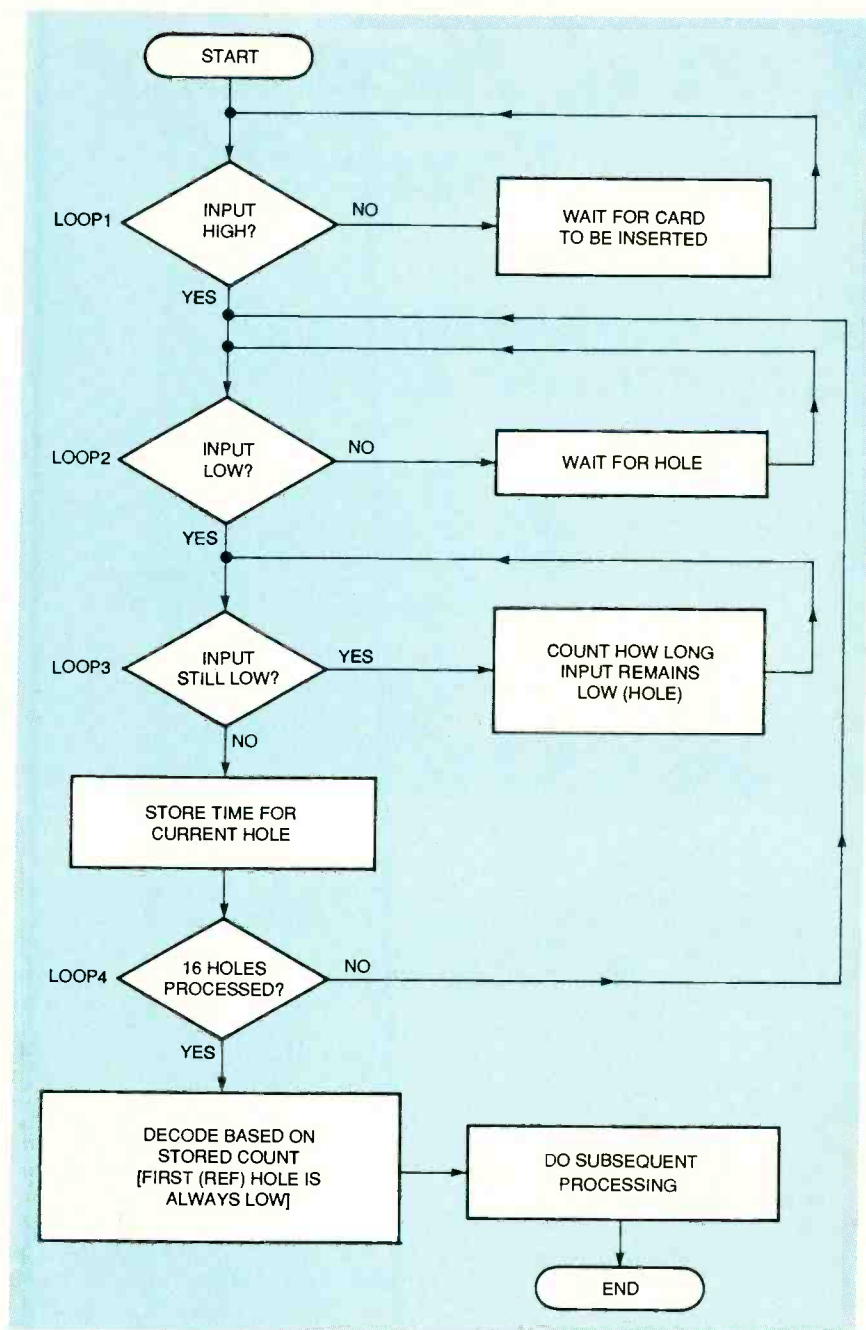

FIG. 2—FLOWCHART OF THE BASIC SOFTWARE. Loop 1 waits for a card to be inserted. Loops 2 and 3 measure a hole, and Loop 4 ensures that all 16 holes are measured. Following loop 4, the software converts the decoded values into a binary number.

20 milliamperes, its forward voltage is a maximum of 1.6 volts. The LED has a viewing angle, at half intensity, of 45°, meaning that it has a wide viewing angle. A flat on the package base indicates the cathode.

The infrared phototransistor is also packaged in a two-terminal, T-1 $\frac{3}{4}$ case. It is an NPN, silicon-transistor, with high speed and high photosensitivity. Rise and fall times are in the 5 to 10

microsecond range, and collector-emitter saturation voltage is between 0.3 and 0.5 volt. A flat on the package base indicates the collector.

Software

To understand how the software senses information, refer to the flow chart, Fig. 2. At the beginning of the program (START), three assumptions are made: 1) The circuit is

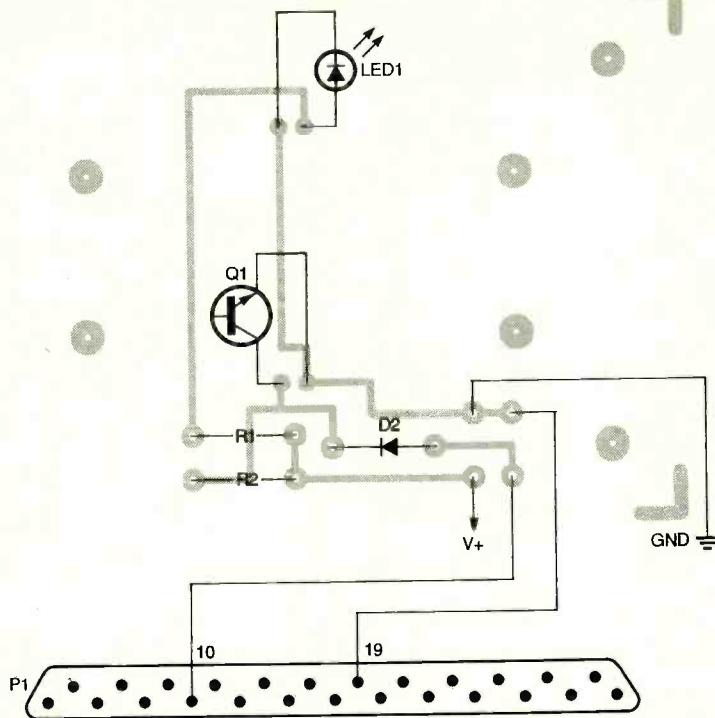

FIG. 3—MOUNT ALL COMPONENTS as shown here.

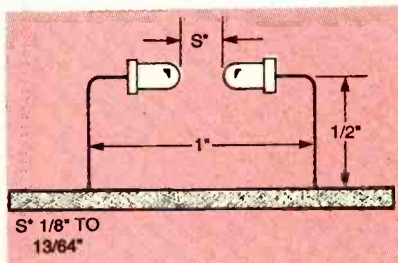

FIG. 4—MOUNT THE LED AND transistor one inch apart, one-half inch above the bottom of the board, and separated by a gap of about one-eighth inch.

powered up. 2) The LED is emitting infrared energy, and 3) The phototransistor is conducting, thus providing a logic low to the PC. The first loop then begins. It waits for the user to insert a card that will cause the transistor to conduct.

Once a card has been inserted, loop 2 looks for a logic low. When the low occurs, the program knows it's at the beginning of a hole. Loop 3 then begins counting to provide a relative measure of the diameter of the hole. Counting continues until the input goes high again, and then the count is saved.

Loop 4 continues the loop 2 and loop 3 process until all 16 holes have been counted. (Note

PARTS LIST

All resistors are 1/4-watt, 5%, unless otherwise noted.

LED1—High-output infrared LED SSS-IR53L (Radio Shack 276-143 or equivalent)

D1—not used

D2—1N4148 switching diode

P1—DB-25 male connector

Q1—Infrared phototransistor SY32PT NPN (Radio Shack 276-145 or equivalent)

R1—150 to 220 ohms (see text)

R2—2200 ohms

Miscellaneous: PC board and construction material (see text), power connector or 9-volt battery snap, swipe card material (punched perboard or equivalent), mounting hardware, wire, solder, etc.

Note: A disk containing several application programs (both source and executable code), as well as instructions on how to use and modify them is available for \$12.00 from JJ Barbarello, 817 Tennent Road, Manalapan, NJ 07726. Specify SWIPE-S when ordering.

that only 15 of the holes contain information. The first hole functions as a "start bit.") After processing all 16 holes, the counts are decoded to determine the binary number represented by the holes.

The decoding scheme is simple but powerful, as it ignores

changes in velocity as the card moves through the slot. The ratio of the large-hole diameters to the small-hole diameters is 2:1. Allowing for some variation in vertical alignment and size, a 1.5:1 factor in the software determines whether the current hole is larger, smaller, or the same as the previous hole. The first hole functions as a refer-

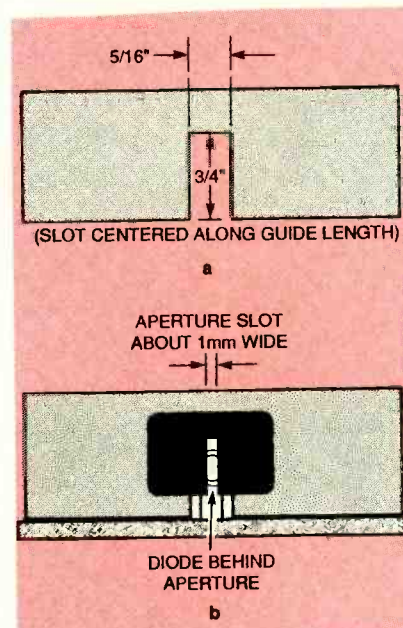

FIG. 5—CUT A SLOT IN EACH GUIDE as shown in (a). Cut a 1 mm slit in a write-protect tab, and center the tab over the guide slot, as shown in (b).

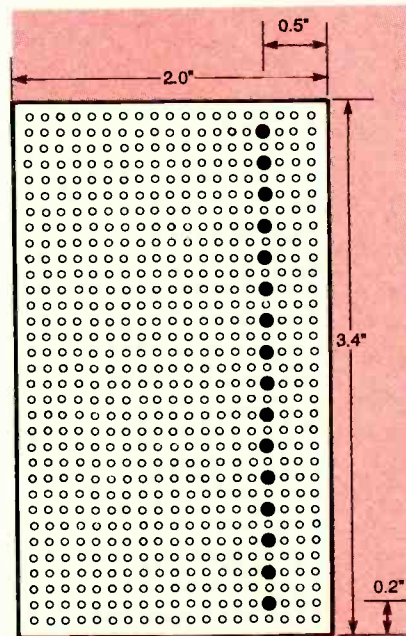

FIG. 6—TO MAKE A SWIPE CARD, cut a piece of perboard as shown here.

LISTING 1—MAIN PROGRAM

```

REM*****
REM** SWIPE.BAS V950121 (c) 1995, JJ Barbarello ****
REM** NOTICE: This is a non-compileable version ****
REM*****
CLEAR : CLS : DEFINT A-X: DEFSTR Y-Z: DIM x(16)
DEF SEG = 64: ON ERROR GOTO errortrap
OPEN "R", 1, "BITPORT.DAT": FIELD 1, 4 AS a$
IF LOF(1) = 0 THEN
a1 = PEEK(8) + 256 * PEEK(9) + 1
ELSE
GET 1, 1: a1 = VAL(a$) + 1
END IF
CLOSE 1
REM***** MAIN PROGRAM LOOP
start1:
GOSUB screenlayout
WHILE (INP(a1) AND 64) = 0
a$ = INKEY$: IF a$ <> "" THEN GOTO readytoend
WEND
x = 0: j = 0: start! = TIMER
readholes:
WHILE (INP(a1) AND 64) = 64: WEND
x = 0: WHILE (INP(a1) AND 64) = 0: x = x + 1: WEND
j = j + 1: x(j) = x
IF x = 0 OR (TIMER - start!) > 2 THEN ERROR 6
IF j < 16 THEN GOTO readholes
done1:
VIEW PRINT 3 TO 24: CLS : VIEW PRINT: BEEP
stat = 0: ttl = 0
FOR i = 2 TO 16
SELECT CASE stat
CASE IS = 0
IF x(i) > 1.5 * x(i - 1) THEN
ttl = ttl + 2 ^ (i - 2): stat = 1
ELSE
stat = 0
END IF
CASE IS = 1
IF x(i) < .667 * x(i - 1) THEN
stat = 0
ELSE
ttl = ttl + 2 ^ (i - 2): stat = 1
END IF
CASE ELSE
ERROR 6
END SELECT
NEXT
LOCATE 14, 3
LOCATE 10, 35: PRINT "ID SENSED:": ttl
GOSUB screenlayout
GOTO start1
readytoend:
IF a$ = CHR$(27) THEN CLS : LOCATE 18, 1, 1: END
BEEP: GOTO readholes
REM**
REM** SCREEN LAYOUT
REM**
screenlayout:
LOCATE 1, 34, 0: PRINT "Pc SWIPE CARD":
LOCATE 2, 1: PRINT STRING$(79, 220)
LOCATE 18, 35: COLOR 23, 0: PRINT "waiting.....":
COLOR 7, 0
LOCATE 21, 33: PRINT "(Press ESC to end)"
RETURN
REM**
REM** ERROR TRAP
REM**
errortrap:
IF ERR = 6 THEN
SOUND 500, 1
CLS : LOCATE 1, 34: PRINT "Pc SWIPE CARD":
LOCATE 2, 1: PRINT STRING$(79, 220): COLOR 0, 7
LOCATE 9, 25: PRINT SPACE$(34)
LOCATE 10, 25: PRINT " Error In Reading Swipe Card. "
LOCATE 11, 25: PRINT " Wait For The Beep and Try Again. "
LOCATE 12, 25: PRINT SPACE$(34): COLOR 7, 0
start! = TIMER
WHILE (TIMER - start!) < 1: WEND: CLS
END IF
BEEP
RESUME start1

```

LISTING 2—TEST PROGRAM

```

REM*****
REM** SWIPEST.BAS 1/20/95 *
REM*****
CLEAR : CLS: DEFINT A-X: DEF SEG = 64
a1 = PEEK(8) + 256 * PEEK(9) + 1
LOCATE 1, 34, 0: PRINT "PcSWIPE TEST"
LOCATE 2, 1: PRINT STRING$(79, 220)
LOCATE 4, 31: PRINT "(Press ESC To End)"
previous = (INP(a1) AND 64) / 64
LOCATE 10, 39
IF previous = 1 THEN PRINT "HI" ELSE PRINT "LO"
loop01:
a = (INP(a1) AND 64) / 64
a$ = INKEY$: IF a$ <> "" THEN GOTO endit
LOCATE 10, 39
IF a = 1 AND previous = 0 THEN
SOUND 600, 1
PRINT "HI"
previous = 1
ELSEIF a = 0 AND previous = 1 THEN
SOUND 100, 1
PRINT "LO"
previous = 0
END IF
GOTO loop01
endit:
END

```

LISTING 3—DECIMAL TO BINARY CONVERSION

```

REM*****
REM** SWIPENOS.BAS 1/20/95 **
REM*****
CLEAR : CLS : DIM n$(14)
LOCATE 1, 23: PRINT "PC SWIPE DECIMAL TO BINARY
CONVERSION"
LOCATE 2, 1: PRINT STRING$(79, 220)
loop1:
LOCATE 6, 23: INPUT "Enter Decimal Number (0 to
32767)..": n
IF n < 0 OR n > 32767 THEN
BEEP
LOCATE 6, 20: PRINT SPACE$(50)
GOTO loop1
END IF
number = n
FOR i = 14 TO 0 STEP -1
bin = 2 ^ i
IF bin <= n THEN n = n - bin: n$(i) = CHR$(79) ELSE
n$(i) = CHR$(248)
NEXT
LOCATE 10, 1
LOCATE 10, 23: PRINT CHR$(218): STRING$(33, 196):
CHR$(191)
FOR i = 11 TO 15
LOCATE i, 23
PRINT CHR$(179): SPACE$(33): CHR$(179)
NEXT i
LOCATE 16, 23: PRINT CHR$(192): STRING$(33, 196):
CHR$(217)
LOCATE 13, 25: PRINT "Ref": : LOCATE 14, 25: PRINT
CHR$(179):
LOCATE 15, 25: PRINT CHR$(248): " "
FOR i = 0 TO 14
PRINT n$(i): " "
NEXT i
LOCATE 12, 35: PRINT USING "ID: ####": number
LOCATE 20, 23: PRINT "Press a key to try again, ESC to
end...":
LOCATE 6, 23: PRINT SPACE$(50)
a$ = INPUT$(1)
IF ASC(a$) = 27 THEN END
LOCATE 20, 23: PRINT SPACE$(50)
GOTO loop1

```

ence for all subsequent possible comparisons.

If a hole is at least 50% larger than its predecessor, it a logic 1. If it is less than 66% of the size of its predecessor, it is a logic 0.

If a hole is neither larger or smaller than its predecessor, it must be the same. Velocity from hole to hole (a distance of about 0.2 inch), remains essentially the same, so speed variations

during the swipe will not affect sensing accuracy. The main program appears in Listing 1. All software listings needed for this project can be downloaded from the Gernsback BBS

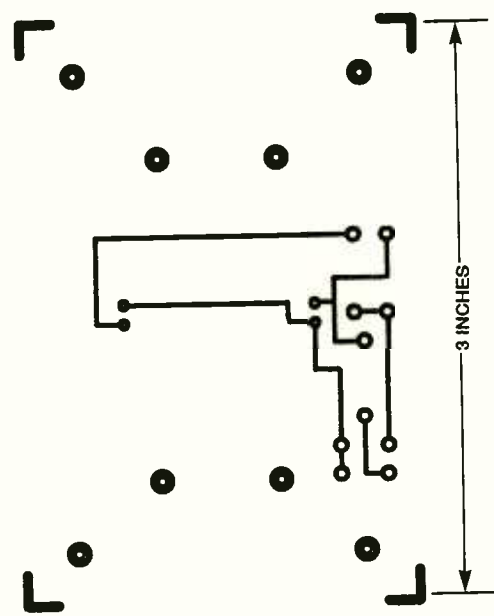
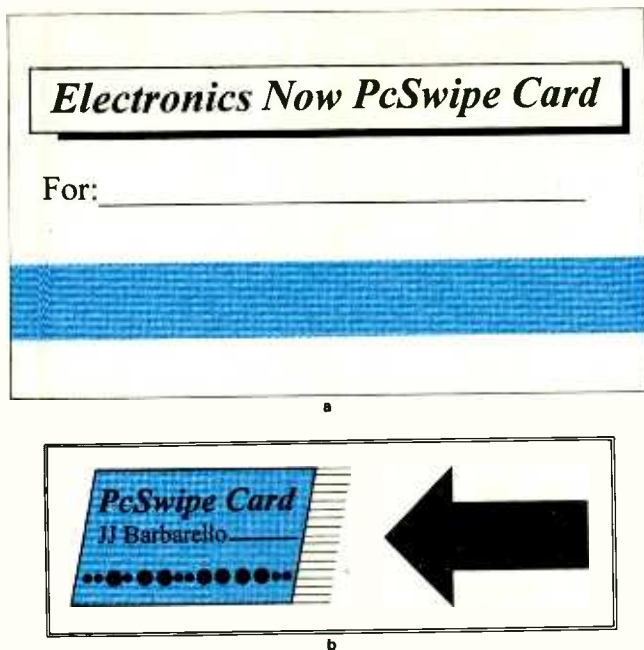

FIG. 7—LABEL THE SWIPE CARD (a). As an option you can add a PcSwipe foil pattern. directional label (b) to the base unit.

(516-293-2283, V.32, V.42bis) as a text file called PCSWIPE.TXT.

Construction

The components can be mounted on a copper-clad perforated board or a PC board. A foil pattern for a suitable board is included in this article; the components should be placed as shown in Fig. 3.

Figure 4 is a side view of the board. Note that Q1 and LED1 are mounted opposite each other, one inch apart. Bend the leads of each device at a 90° angle, allowing a gap of about 1/8-inch between the two devices. The devices should be horizontal, with an imaginary centerline running through both at a point 1/2-inch above the board. Tack-solder each device to the board, check their alignment, then add solder to position them securely. Next mount R1, R2, and D2. Make sure you position all semiconductors with their pins in the correct holes.

Note that there are two sets of four mounting holes shown in the foil pattern and in Fig. 3. The four outer holes are for mounting the PC board to a base. The four inner holes are for the card guides. All eight holes can be drilled with a 1/8-inch diameter drill for a No.

4-40 machine screw or a No. 4 sheet-metal screw.

If you're anxious to try out your PcSwipe now, attach a battery or power supply to the board and the DB-25 connector to the LPT1 port of your PC. Run QBasic, and enter the test program shown in Listing 2. You should see the word LO in the center of the screen. Place a piece of paper between Q1 and LED1. The screen should now display HI, and you should hear a high-pitched beep. If you remove the paper, the word will return to LO, and you'll hear a low-pitched beep.

If you don't get the initial LO, check the power source, connections, and component placement. Correct any errors and try again. When you know the circuit is working, start the mechanical assembly.

Mechanical assembly

The swipe guides are two pieces of pine (or other wood) measuring 1 inch high by 3 inches long by 1/2 inch wide. As shown in Fig. 3, bevel the front inside edges of both guides to ease card insertion. Also, make a slot in each guide as shown in Figure 5-a.

Install one guide over LED1 and secure it from the bottom with appropriate hardware (No.

4 sheet-metal screws work well). Temporarily bend Q1 toward the PC board so that you can access the front of the diode. Obtain a piece of adhesive-backed opaque paper or similar material; a standard floppy-disk write-protect tab works fine. Cut a 1-mm slit in the tab as shown in Figure 5-b; this provides the LED aperture mentioned earlier. Center the tab in front of LED1, bend Q1 back into place, and install the remaining guide. Last, mount the PC board on a suitable base. I used a small pine block measuring about 2 1/2 x 4 1/2 inches.

Making a swipe card

The swipe card needs a row of holes located 1/2-inch up from the bottom. Space the holes 0.2-inch apart. The card material should be relatively rigid and no thicker than 1/8-inch. Form the holes cleanly.

The easiest way to make the card is to cut it from pre-punched perforated board or use it as a guide for drilling holes in other material; the holes on perforated board are spaced 0.1-inch apart. The board is usually 1/16-inch thick, and can be machined easily. Because the holes must be spaced 0.2 inch apart, block every other hole on the board with

Many happy returns.



Give the gift that gives back more than you've given. For as little as \$25, you can give a piece of America to someone you care about. Ask your banker for a gift certificate upon purchase.



Haven't you always wanted a weather station?



The Weather Monitor II makes a state-of-the-art weather monitoring system affordable enough for home use! Includes all the features of a professional weather station for a fraction of the cost.

FEATURES INCLUDE:

- Inside & Outside Temps
- Wind Speed & Direction
- Barometer
- Time & Date
- Inside Humidity
- Wind Chill
- Alarms
- Highs & Lows
- Rainfall Option
- Instant Metric Conversions
- Outside Hum. & Dew Point Option
- Optional PC Interface

Order today:

1-800-678-3669

M-F 7 a.m. to 5:30 p.m. Pacific Time • EN6561
 FAX 1-510-670-0589 • M/C and VISA
 One-year warranty • 30-day money-back guarantee

DAVIS INSTRUMENTS

3485 Diablo Ave., Hayward, CA 94545

some substance opaque to infrared light. Household tub and tile caulking works fine.

Using Fig. 6 as a guide, cut a piece of perforated board to 3.4 inches wide (34 holes) by 2 inches high (20 holes). Make sure one row of holes is exactly 1/2-inch above the bottom edge of the card. Next, spread a small amount of caulking over the surface of the board, filling in all the holes. Remove excess caulking from both sides and let the board dry before continuing.

Starting from the left edge, and in the fifth row up, drill every other hole with a 1/16-inch drill bit, for a total of 16 holes. That provides the logic 0 holes; now drill logic 1 holes (1/8-inch) where desired. Remember that the leftmost hole is the reference; the next hole is 2⁰, the next hole is 2¹, and so on. The program shown in Listing 3 allows you to enter a decimal number 0 to 32767, and it presents a visual indication of the holes to drill.

When all holes have been drilled, lightly sand both faces of the card to remove burrs and caulking residue. Finish the card by attaching an attractive label like that shown in Fig 7-a. Cut out and discard the shaded area before adhering the two remaining pieces of the label, one above and the other below the row of holes.

Enhancements

If you'd like to customize PcSwipe for a particular application, here are a few ideas you can try:

- Increase the guide length to 5 inches or more. The greater length will decrease the possibility that the card will rock in the guides, and it will minimize the possibility of erroneous readings.
- Add a power switch to extend battery life.
- Add a label to the outside of the guide to indicate the preferred direction for swiping. PcSwipe is bi-directional, in that the card can be swiped from either end, as long as the reference hole enters first. The label will help ensure that users insert their cards properly, at

the beveled ends of the guides. A label can also help to minimize wear on both the guides and the card. A sample label suitable for mounting on the card reader is shown in Fig. 7-b.

- Using a separate bit of the parallel port, you can control a device such as a light or door lock. For example, the following QBasic code will energize bit 2 of the parallel port whenever ID 1946 is read:

```
IF TTL = 1946 THEN OUT AD1-1, 1 ELSE OUT AD1-1, 0
```

To use a bit from the parallel port as an output, build a buffer circuit with a transistor and a relay. Don't drive an external device directly.

That floppy-only 8088 PC sitting unused in your basement could serve well in this application. Compile the program so it can run efficiently, then add it to the AUTOEXEC.BAT file. Voila—an instant home-automation controller.

Here are a few rules of thumb if you'd like to vary the design of the cards:

- Absolute hole diameter is not critical.
- The diameter difference between the 0 and 1 holes should be in a ratio of at least 2:1 for the card to work properly.
- Accurate horizontal spacing of holes is not critical, as long as there is sufficient space to differentiate between a hole and a non-hole.
- Slits or other geometric shapes can be cut instead of holes, as long as they meet the 2:1 width ratio.
- The number of holes read by the software can be modified easily.

The software also offers many opportunities for enhancement. The disk offered by the author demonstrates many software enhancements. Here's an idea to get you started. Add a disk file that contains information related to the ID on each card. Each record in the file could contain name, address, and other useful data. The ID could serve as an index to the appropriate record, so that when a particular ID is read, the card holder's information can be displayed or printed. □

FIVE MORE AC CONTROL CIRCUITS will be discussed in this article. These include incandescent light dimmers and motor-speed controllers. Also discussed in this article are the basic principles of DC power control. The last four articles in this series have examined the basics of electrical and electronic power control devices and circuits, and these four articles were illustrated with schematics of semiconductor AC power switching circuits.

Each of the AC power control circuits presented here is based on the triac or silicon controlled rectifier (SCR) as its power switching device. All component values presented here are for switching only 120 volts AC. The reader will have an opportunity to select a triac, SCR, and diac in a rating and package style appropriate for a project or experiment.

AC light-dimming circuits

Triacs can function as efficient incandescent light dimmers because they can control the flow of current in the bulb filaments with phase-triggered power control. The triac is turned on and off once in each power-line half cycle with its duty cycle controlling the current flowing in the filament. These circuits include a simple inductive-capacitive (LC) filter power supply line to minimize radio-frequency interference (RFI).

There are three popular methods for triggering the triac by variable phase-delay methods: bilateral trigger diacs, resistor-capacitor phase-delay networks, and a line-synchronized variable-delay unijunction (UJT) trigger. Figures 1, 2 and 3 are schematics for circuits that can dim incandescent lights.

Figure 1 is the schematic for a diac-triggered incandescent light dimmer. A bilateral trigger diac is a full-wave or bidirectional thyristor. It is triggered from a blocking-to-conduction state for either polarity of applied voltage whenever the amplitude of applied voltage exceeds the breakover rating of the diac.

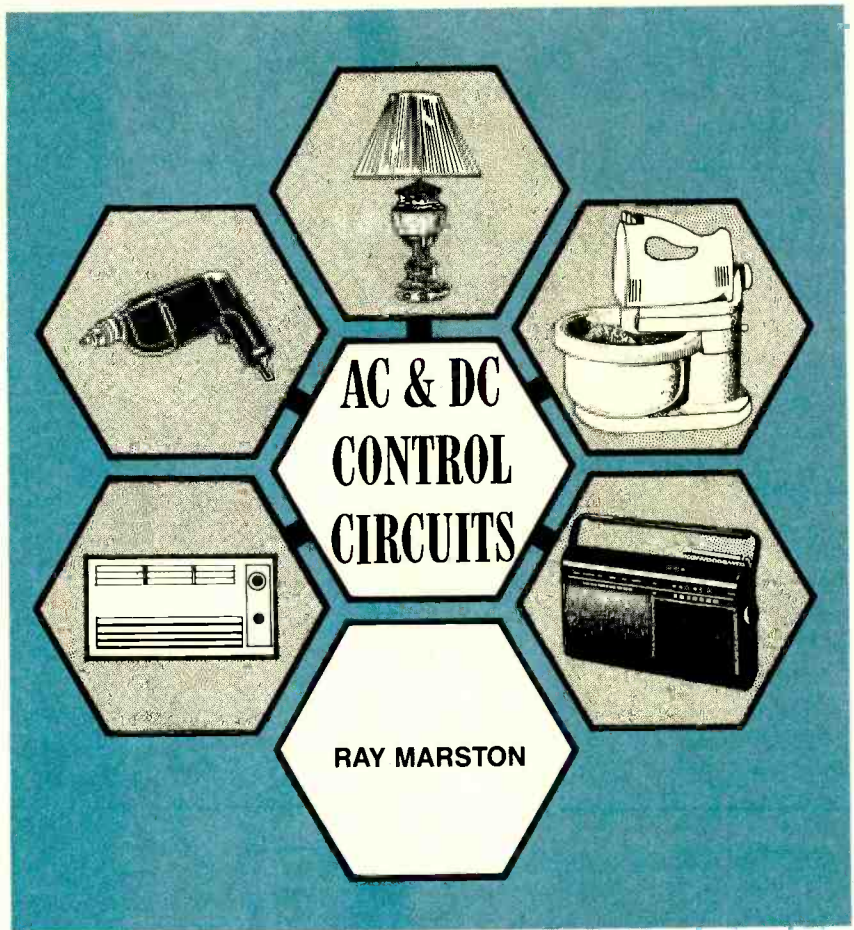

Learn about circuits that will control lights, AC/DC motors, and appliances as well as the fundamentals of DC power control, and put this this knowledge to work.

These devices are widely available in DO-35, axial leaded glass packages with maximum breakover voltages of 37 to 70 volts. Resistor R1, potentiometer R2, and capacitor C1 provide the variable-phase delay. An ON-OFF switch S1 is ganged to potentiometer R2 so that the lamp can be turned fully off when it is not needed.

Unfortunately, the Fig. 1 circuit exhibits control hysteresis or backlash. This can be seen if the light is dimmed almost to the point of turning it off by increasing the value of potentiometer R2 to 470 kilohms. The lamp will not turn on again un-

til R2 is reduced to about 400 kilohms, and it then burns at a high brightness level. This backlash is caused by diac D11 partially discharging capacitor C1 each time the triac triggers. The backlash in Fig. 1 was reduced by placing 47-ohm resistor R1 in series with the diac to reduce its discharge of capacitor C1.

However, an even more effective improvement is to include a *gate-slaving circuit*, as shown in Fig. 2. The diac is triggered from C1, which "follows" the C2 phase-delay voltage but protects C2 from discharging when the diac is triggered.

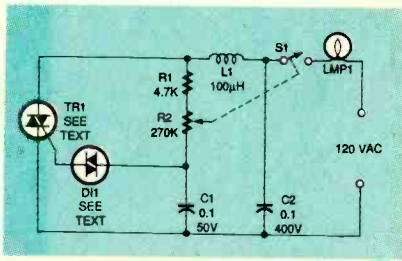

FIG. 1—SIMPLE INCANDESCENT light-dimmer circuit.

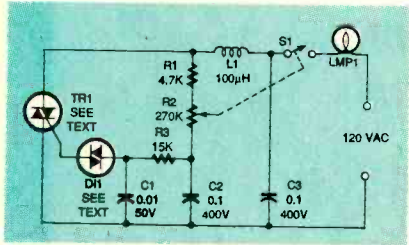

FIG. 2—IMPROVED INCANDESCENT light-dimmer circuit.

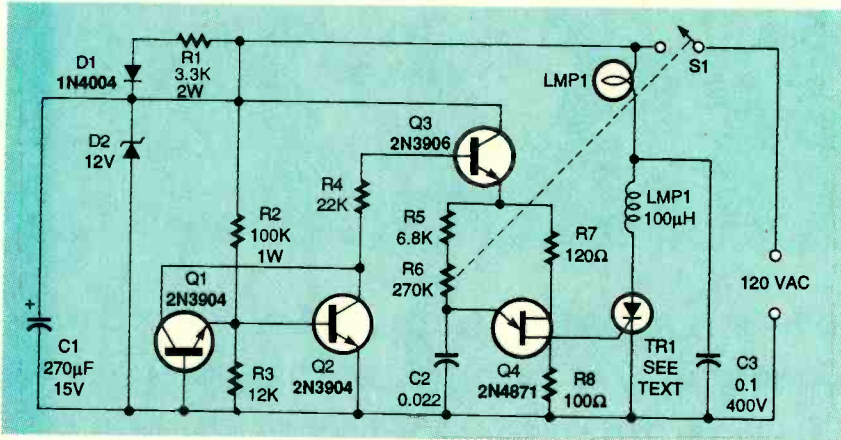

FIG. 3—ZERO-BACKLASH LIGHT dimmer with UJT triggering.

If you want a truly backlash-free circuit, install a unijunction transistor (UJT) as shown in Fig. 3. The UJT in this circuit is a 2N4871 in a TO-92 plastic package. It is powered from 12-volt DC derived from the AC line through resistor R1, diode D1, Zener diode D2, and capacitor C1.

The UJT is synchronized to the AC power line through the zero-crossing detector network consisting of Q1, Q2, and Q3, also in TO-92 plastic cases. The network turns on Q3, and it applies power to UJT Q4 at all times other than when the AC line voltage waveform approaches the zero-crossover points at the end and start of each AC half-cycle.

Thus, shortly after the start of

each half-cycle, power is applied to the UJT Q4 circuit through Q3. After a delay determined by resistor R5, potentiometer R6 and capacitor C2, a trigger pulse is applied to the triac's gate by UJT Q4. UJT Q4 resets at the end of each half-cycle, and a new sequence begins.

Universal motor control

Many consumer appliances such as food mixers and fans as well as light-duty power tools such as electric drills and sanding machines are powered by series-wound, fractional-horsepower, universal electric motors. (They are called universal because they can be powered from either AC or DC supplies). When operating, these motors produce a back electromotive

der conditions of variable load. Thus, a suitable diac with a phase-delay circuit, as shown in Fig. 4, will improve its performance. This circuit is especially useful for controlling appliances such as food mixers and sewing machines that normally operate with light loads.

By contrast, electric drills, and rotary and reciprocal sanding machines, for example, are subject to heavy load variations. Therefore, they are not suitable candidates for the circuit shown in Fig. 4. However, the alternative variable-speed regulator circuit shown in Fig. 5 is suitable. A silicon controlled rectifier (SCR) rated for 4 to 6 amperes at 200 volts is suitable as the control element that feeds half-wave power to the motor. A Motorola MCR704A1 or equivalent in a TO-220-style plastic package is suitable as SCR1.

The penalty paid for this circuit is about a 20% reduction in maximum available speed. In the off half-cycles, the back EMF of the motor is sensed by the SCR, and it provides automatic speed regulation by adjusting the next gating pulse for the SCR automatically.

The network consisting of resistor R1, potentiometer R2, and diode D2 provides only 90° of phase adjustment, so all motor pulses have minimum durations of 90°. At low speeds the circuit goes into a *skip cycling* mode, in which power pulses are delivered intermittently to suit the motor's load conditions. This circuit provides high torque under low-speed conditions.

DC power control

The remainder of this article will discuss DC power control circuits. DC power to essentially resistive loads such as incandescent lights, electric heaters, electromagnetic relay and buzz coils can be controlled by unidirectional semiconductor devices. These include bipolar power transistors, power MOSFETs, and silicon controlled rectifiers. These can be configured to give simple ON or OFF switching control or they

force (EMF) that is proportional to the motor's speed.

The effective voltage applied to universal motors is equal to the true applied voltage minus the motor's back EMF, which is directly proportional to the motor speed. Consequently, universal motors have self-regulating capability because any increase in the motor's load tends to reduce the speed and the back EMF. This, in turn, increases the effective applied voltage and causes the motor speed to increase toward its original value.

Most universal motors are made for single-speed operation. Triac phase-control circuits can provide variable speed control for these motors, but they degrade self-regulation un-

can provide variable power control, as described in earlier articles in this series.

DC power switching

The power transistor is widely used in DC power-switching applications. Figures 6 shows an NPN power transistor configured as a common-emitter amplifier. The load is positioned between the collector of Q1 and the positive power source. Transistor Q1 acts as a current sink.

This means that conventional current flows into the collector through the load. By contrast, the load in Fig. 7 is positioned between the collector of Q1 and the ground. In this schematic, transistor Q1 acts as a current source meaning that current flows from Q1's collector through the load to ground.

Common-emitter configurations offer low saturation or loss voltage (typically 200 to 400 millivolts) Their main disadvantage is that they offer low overall current and power gains (typically 100:1). These gains can be increased to 10,000:1 without increasing the saturation voltage either by cascading several common-emitter stages, as in Fig. 8, or by configuring two transistors in the *super alpha mode*, as shown in Fig. 9.

Power MOSFET can function as fast, effective DC power switches. They offer unusual characteristics and capabilities not available with bipolar power transistors. Because MOSFETs are majority-carrier devices, their switching speeds are inherently faster. Without the minority carrier-stored base charge found in transistors, storage time is eliminated. The high switching speeds allow efficient switching at frequencies above 200 kHz. This reduces the cost, size, and weight of transformers and other inductive components in switch-mode (switching) power supplies and motor controllers.

MOSFET switching speeds depend primarily on the charging and discharging of the device's capacitances, and they are essentially independent of operating temperature. The gate of a power MOSFET is electrically

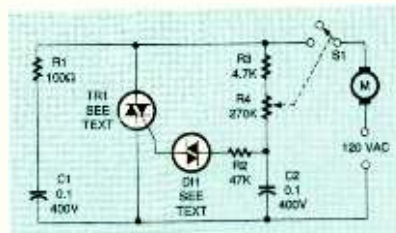

FIG. 4—SPEED CONTROL CIRCUIT for a universal AC/DC electric motor under light load.

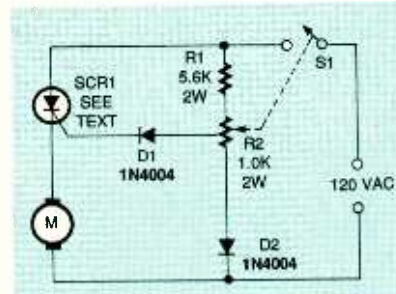

FIG. 5—SELF-REGULATING speed control circuit for a universal electric motor with a heavy load.

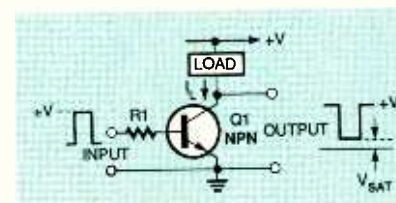

FIG. 6—THIS NPN TRANSISTOR switch circuit acts as a load-current sink.

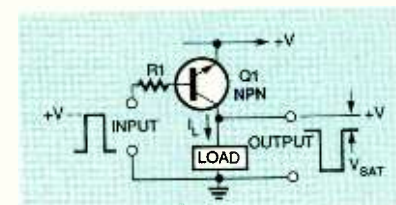

FIG. 7—THIS PNP TRANSISTOR switch circuit acts as a load-current source.

isolated from the source by an oxide layer that gives it a DC resistance greater than 40 megohms. Power MOSFET drive circuits can be relatively simple, and the gate can be driven directly from CMOS and TTL logic ICs to control high-power circuits directly.

Unlike bipolar power transistors, power MOSFETs do not require derating of power handling capability as a function of applied voltage, and destructive second breakdown does not occur if the MOSFET is operated within its specified limits.

Figure 10 is a schematic for a basic MOSFET circuit. The arrow directed toward the gate within the MOSFET schematic symbol indicates the flow of conventional current in an N-channel device and the broken vertical lines represent the source-to-drain channel, indicating that it is an *enhancement mode* or "normally off" device. A protective diode is positioned between its drain and source.

One of the more popular MOSFETs is the N-channel Motorola MTP4N50E TMOS MOSFET. The Motorola designation conveys basic specification information about the device. The first letter "M" indicates that its manufacturer is Motorola, and the "T" indicates that it is a TMOS device, Motorola's trademark for its line of power MOSFETs. The P indicates that it is in a plastic TO-220-style package. (An M, for example, would indicate a metal case, and there are letter designations for other package styles.)

The number "4" in the designation is the MOSFET's current rating in amperes. The "N" stands for channel polarity, meaning that this MOSFET is an N-channel (NPN) device. (A "P" would indicate a P-channel (PNP) device.) The 50 represents

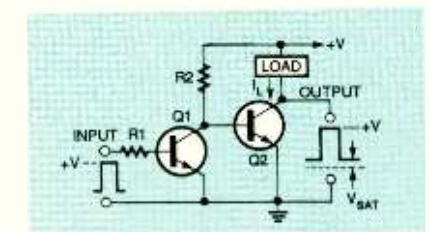

FIG. 8—HIGH-GAIN TRANSISTOR switch circuit with cascaded NPN common-emitter stages.

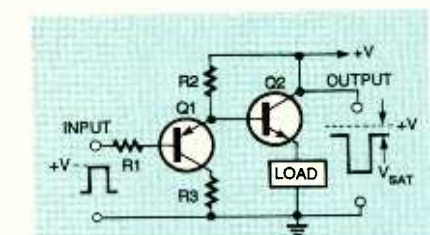

FIG. 9—HIGH-GAIN TRANSISTOR switch circuit with a super-alpha PNP pair.

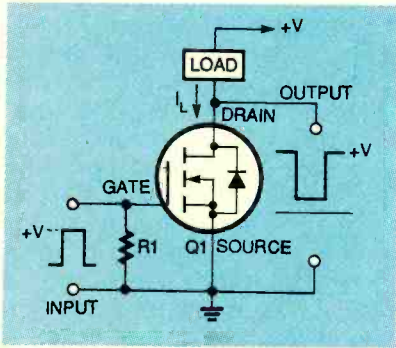

FIG. 10 —POWER MOSFETs offer high-speed switching without destructive second breakdown.

the voltage rating (in volts) divided by 10, and the "E" is Motorola's symbol for its "energy-rated" devices. International Rectifier Corp. offers its equivalent trademarked HEXFET MOSFETs.

The most popular power MOSFETs today are made by the double-diffused vertical DMOS process. This geometry and process has replaced the V-groove or VMOS process widely used 20 years ago. The term "vertical" refers to the flow of current between the drain and source. For more information on these devices, refer to "Power Semiconductors" in the May 1995 *Electronics Now*.

Another effective semiconductor power switching device is the silicon controlled rectifier (SCR). As stated in the May 1995 article, an SCR is fundamentally a rectifier diode with a control element called a *gate*. The SCR is useful in controlling self-interrupting DC loads such as electric bells, buzzers, or sirens. Figure 11 is the schematic for an SCR switching circuit.

A typical load might consist of a solenoid and an activating switch in series to provide an "autoswitching" load. When the solenoid is energized, its plunger, which can be mechanically linked to switch contacts, moves against spring pressure, opening the switch contacts. When the solenoid is deenergized, the plunger is pulled back by the solenoid's internal spring, reclosing the switch contacts.

The SCR circuit of Fig. 11 provides a nonlatching load-driving because the SCR automat-

ically unlatches each time the load self-interrupts. The load and SCR are active only while gate current is applied to the SCR. The circuit can be made fully self-latching, if desired, by shunting the load with resistor R3, shown by the dotted lines to the right of diode D1.

The SCR's anode current does not fall below its minimum holding value as the load self-interrupts. SCRs typically offer gate-to-anode current gains of about 5,000:1, but typical saturation voltage values are about 800 millivolts to 1.5 volts.

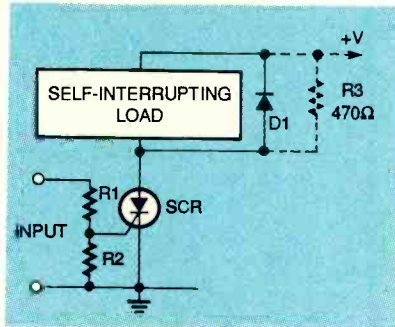

FIG. 11—THIS SCR DC switching circuit offers high power gain.

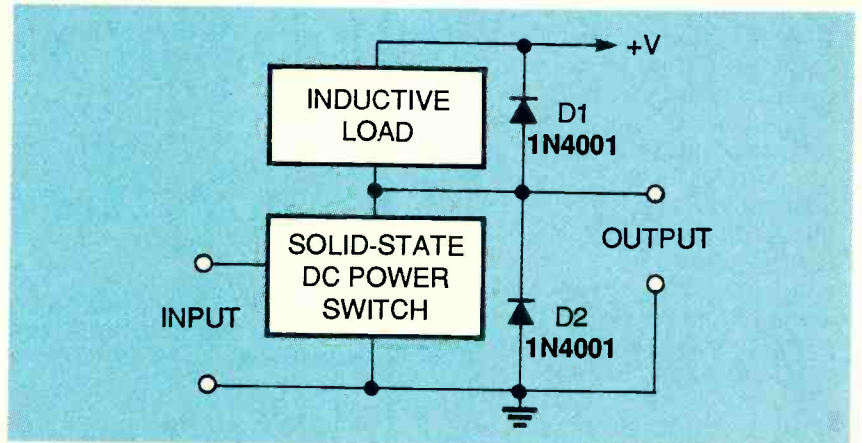

FIG. 12—SEMICONDUCTOR SWITCHING devices should be protected by damping diodes when driving inductive loads.

Handling various loads

When designing DC switching circuits, consideration must be given to the kind of load that is to be controlled and its possible damaging effects on the semiconductor switching circuitry. Here are some important points to keep in mind:

- When controlling incandescent lamps, remember that the tungsten filaments in the bulbs have a low cold resistance. The

value of the cold resistance is typically one-quarter of its value when the lamp is illuminated. Consequently, switch-on currents are typically four times greater than those that flow when the bulb is illuminated. This means that a suitable semiconductor switch for controlling 500-milliamperere lamps must have surge rating of at least 2 amperes.

- When driving inductive loads such as relays, solenoids, speakers, and electric motors, keep in mind that these devices can generate large back EMF values when the current is switched off. Consequently, semiconductor power switches must be protected against damage from back EMF.

Figure 12 is a simplified schematic that shows how to provide circuit protection with a silicon diode that damps the back EMF. Diode D1 prevents the voltage from swinging more than a few hundred millivolts above the positive power supply value, and D2 prevents it from swinging significantly below

ground. In many applications, it might only be necessary to provide partial protection with diode D1, as shown in the SCR circuit of Fig. 11.

When driving loads that are electrically noisy (e.g., buzzers and electric motors), the loads might require damping by low value ceramic capacitors to minimize RFI generation. Also, the power supply might require ripple decoupling. Ω

WIND MONITOR

continued from page 62

order address lines directly. The high bit in Port 2 drives the EPROM's chip-enable input (\overline{CE}).

Display information passes from the CPU to another octal latch (IC8) via the data bus. Data is latched into IC8 via another CPU output, Port 3 bit 6. Subsequently, Port 1 bit 7 and Port 3 bit 4 steer the display data to the appropriate display decoder. Port 1 bit 7 controls the two most significant digits of wind-speed data. Port 3 bit 4 controls the least significant digit of wind-speed data, and

the wind-direction data. Data transfers to the display decoders only when the control bits are high; when they go low, the decoders latch the data.

Several other bits in Port 3 drive status LEDs, which indicate the display units (MPH or knots), peak display mode, and the decimal point position for the current wind speed. Since it is not unusual for the wind to achieve speeds greater than 100 MPH, variable decimal-point positioning was included. If wind speed is less than 99.9 units, it is displayed with a tenth of a unit of accuracy. If speed is greater than that value, it is shown in whole numbers.

WIND MONITOR PARTS LIST

All resistors are 1/4-watt, 5%.

R1, R2, R7, R11, R15, R19, R23—220,000 ohms
R3, R8, R12, R16, R20, R24—1 megohm
R4—5000 ohms
R5, R6, R9, R10, R13, R14, R17, R18, R21, R22—15,000 ohms
R25-R51—150 ohms

Capacitors

C1, C11, C12, C14, C15, C18-C20—0.1 μ F, 50 volts, monolithic
C2—0.22 μ F, 50 volts, monolithic
C3—6.8 μ F, 16 volts, tantalum
C4-C9—0.01 μ F, 50 volts, monolithic
C10, C13—33 μ F, 35 volts, tantalum
C16, C17—27 pF ceramic disc

Semiconductors

D1—1N4001 diode
DISP1-DISP3—MAN4640A bright orange 7-segment display
LED1—T-1 LED (yellow)
LED2—T-1 LED (green)
LED3—T-1 LED (red)
LED4-LED19—T-1 LED (amber)
IC1-IC3—TLC272CP or CA3260 dual op-amp
IC4—TL7705 voltage supervisor (Texas Instruments)
IC5—80C31 microprocessor (Intel)
IC6, IC8—74HC573 octal latch
IC7—27C64 EPROM
IC9-11—74HC4543B latchable seven-segment decoder
IC12—74HC4514 4-TO-16 decoder (0.3" DIP)
IC13—74HC04 hex inverter
IC14—7805 5-volt regulator
Other components
XTAL1—7.3728-MHz crystal
S1-S3—normally open pushbutton switch
TS1—7-position screw-type terminal strip

Note: The following items are available from TL Electronics, 405 East Third Avenue, Mayville, NJ 08210, (609) 465-5291:

- Doubled-sided silk-screened wind-monitor PC board—\$28.50
- Programmed EPROM—\$21.50
- Silk-screened smoked-Plexiglas bezel—\$18.50
- 9-volt, 500-mA AC-to-DC wall outlet adapter—\$8.50
- Infrared emitter-detectors (5 pairs, TRW OP160SLC/OPL801)—\$23.50
- Monitor kit (excluding wood base and brass porthole)—\$135.00
- Monitor kit (with wood base and brass porthole)—\$210.00
- Complete parts kit (includes monitor, wood base, porthole, modified sensors, and 60 feet of cable—does not include mast or mounting hardware)—\$360.00
- Xeltek EPR-01 EPROM Programmer for IBM computers—\$150.00
- Xeltek Universal Programmer for IBM computers (programs EPROMs, EEPROMs, PALs, GALs, and tests ICs)—\$550.00

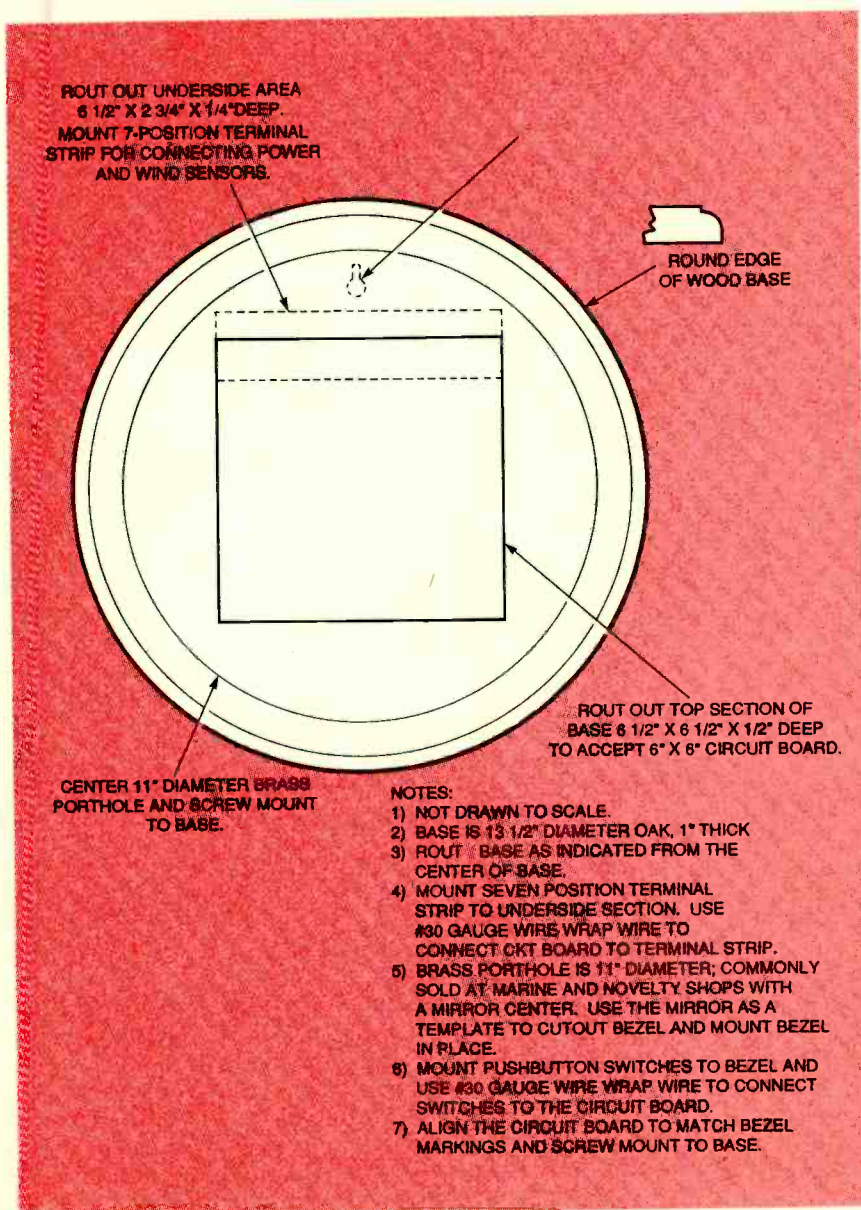

FIG. 6—USE A 13.5-INCH LENGTH OF ROUND OAK STOCK to mount the electronics.

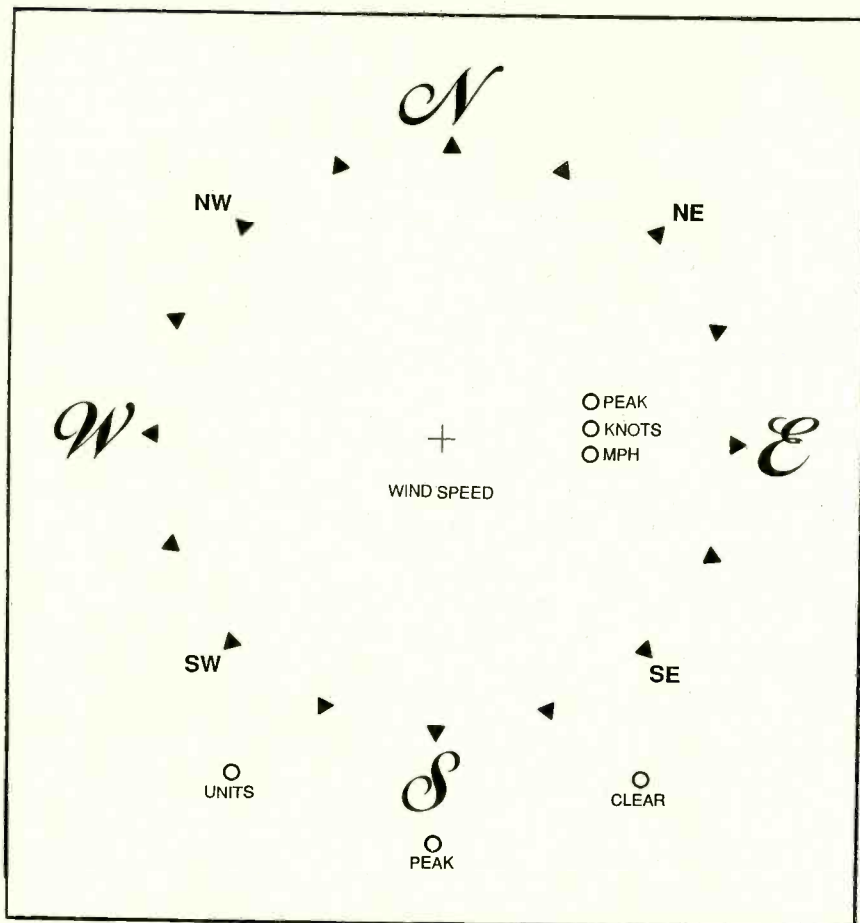

FIG. 7—USE THIS AS A PATTERN for creating your own bezel.

Software

We do not have space to present complete software listings, but the binary object code is available in several common EPROM-programmer formats on the Gernsback BBS (516-293-2283, v.32, v.42bis); look for file WINDMON.ZIP.

Whenever the CPU resets, it verifies that all components are in good working order. To do so, it writes patterns to and reads them back from all RAM locations. It also checks the I/O ports and CPU status registers. If a test fails, a failure code is displayed on the LEDs. In addition, after reset, all LED outputs are cycled at a slow rate. That makes troubleshooting the circuit easy. Assuming that testing completes successfully, current wind speed and peak value are set to zero, and direction is set to North. Default units are MPH.

Software configures timer T0 to generate an interrupt every 10 milliseconds. Each time T0

times out, the software increments a RAM-based counter, measures the wind direction, and increments the appropriate array location. When the RAM counter reaches a value of 100, one second has elapsed, so the software sets a flag that causes the display to update, as follows:

First the software determines wind direction by finding the highest value in the array of previous direction values. Then it clears the array to begin a new cycle. It converts wind speed to units of MPH by multiplication using 3-byte integer math. The collected value is multiplied by 100 then divided by 115. The software then compares the newly computed wind speed to the current peak value; if the new value is greater than the peak value, the peak value is updated.

The processor spends most of its time waiting for the update flag to be set. During that time it also scans (and debounces)

pushbutton switches S1, S2, and S3. The switches set flags that determine speed display units, speed or peak display, and peak value clear. The flags also control LED1, LED2, and LED3.

Construction

For best reliability, the wind sensor circuit boards should be conformally coated with a special varnish after verifying that the circuitry works. The conformal coating hermetically seals all components and connections in order to prevent corrosion, electrical shorts, and leakage that might arise due to the presence of moisture.

Use the seven-conductor cable specified in the Parts List. In the bottom of the wind-sensor cross-member assembly, drill a hole that is large enough to accept the sensor interconnection cable. Make certain that the sides of the hole are smooth so that the cable will not be damaged. Use the color code given in the sensor schematic for the wiring. Strip the PVC jacket from the cable and feed the red, green, orange, blue, brown, and black wires to the wind vane assembly, and the white wire to the wind-speed assembly. Use separate lengths of red and green hookup wire to feed power from the vane assembly to the speed assembly. The best way to do that is to solder separate wires approximately six inches long from each sensor circuit board, then join common wires with wire nuts. Use plastic ties to provide strain relief for the cable and to secure the cable to the vertical mounting member.

Depending on how creative you want to get, there are many different ways of packaging the circuit. Figure 5 illustrates the author's packaging, and Fig. 6 shows the details.

The brass porthole is 11.5 inches in diameter; it is a common item at marine and novelty stores. The bezel labeling shown in Fig. 7 was silk-screened on a piece of smoked Plexiglas. (You might have to enlarge the image to fit properly.)

The interconnection diagram

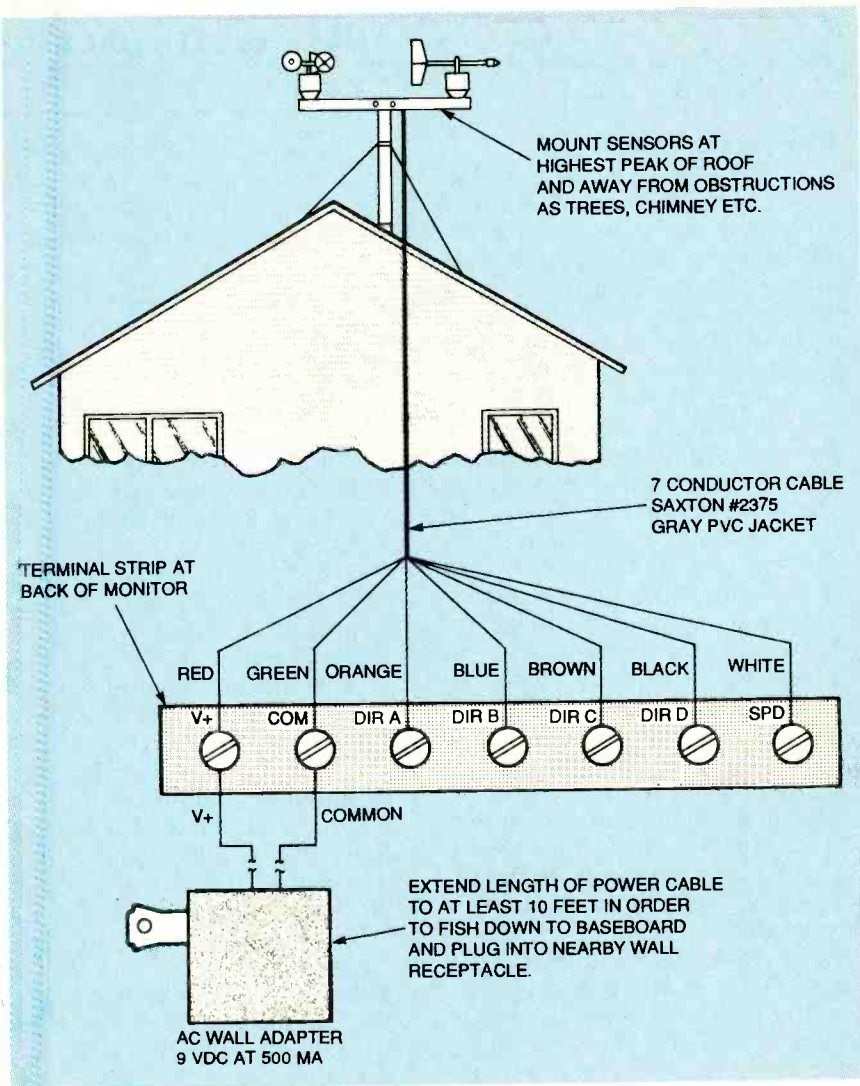

FIG. 8—MOUNT THE WEATHER VANE as shown here.

for the unit appears in Fig. 8. The author found it necessary to extend the lead length of the DC wall adapter to approximately 10 feet. That allowed him to fish the power line down the inside of the wall to the baseboard, and then to the nearest wall socket.

Installation and calibration

The sensor assembly should be mounted four feet above the peak of the house, and as far as possible from objects that might block the sensors or cause turbulence.

The only calibration required is locating compass North. Rotate the vane until the display reads north and mark the sensor housing with a black marker at the tail end of the vane. When mounting on the roof, use

a compass to align the black mark to the tip of the compass needle. If you prefer to have the cross member of the sensor parallel a roof line, rotate the sensor housing until the black mark lines up with compass North. Then tighten the screw that attaches the wind-vane sensor to the cross member.

Mount the display at the desired height on a wall. Drill a hole to feed the sensor cable into the back of the display. Strip the PVC jacket off the cable so that only the discrete wires pass through the wall. These wires are much more flexible than the jacketed cable and will not interfere with flush mounting. Fish the power line up from the baseboard, and plug the AC adapter into a power receptacle. Ω

"YOUR FREE CATALOG KNOCKED MY SOCKS OFF"

We get that sort of comment all the time. People are impressed that our free Consumer Information Catalog lists so many free and low-cost government booklets. There are more than 200 in all, containing a wealth of valuable information.

They tell you how to make money, how to save money and how to invest it wisely. They tell you about federal benefits, housing, jobs, and learning activities for children. They fill you in on nutrition, health and much, much more.

Our free Catalog will very likely impress you, too. But first you have to get it. Just send your name and address to:

**Consumer Information Center
Department KO
Pueblo, Colorado 81009**

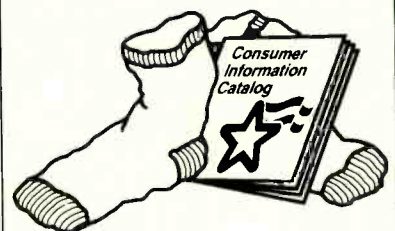

SATELLITE PIRACY

continued from page 40

that, the company began a deluge of legal action in the UK.

Sky essentially prosecuted the "small guys" who did not have the money to defend themselves. Even though the pirates were breaking the law in the UK, Sky's action was a public-relations nightmare. The company created martyrs.

In one incident, for example, Sky drew the media's attention by trying to prove that one defendant was a main dealer of Genesis blockers. However, that defendant had stocked only 300 blockers—he was certainly not one of the larger dealers.

Sky estimated that it lost 50,000 subscribers and 2.25 million pounds (\$3.5 million) to piracy between January 1st and may 18th 1994. However, according to Hack Watch News, a European hacker publication, there were about 300,000 pirate Sky cards in the UK at the beginning of the year.

The 09 issue of cards in February cost Sky approximately 21 million pounds. The next card issue, 0A, that was due in April 1995, probably cost another 21 million pounds.

Another card issue (OB) will probably be necessary in November 1995 if Sky wants to maintain the security of its conditional-access system. The present cycle is not short enough to deter pirates from producing their own cards.

The cloning of VideoCrypt

A sure sign that the VideoCrypt scrambling system was thoroughly defeated was that it was cloned. The clone system, called KoyCrypt, was demonstrated at the London Cable And Satellite Show in April 1994. The company that cloned it, Hi Tech Xtravision, also developed a customized smart card that it claimed would be much more difficult to hack. It seemed to be a case of a poacher turned gamekeeper.

Despite the potential benefits of KoyCrypt, broadcasters that want to use it—and perhaps

have a more secure system—can't. Copyright issues prevent them from doing so.

The present day

At the time of writing, VideoCrypt is still hacked. There are a few programs available for the PC and the Macintosh that actually allow a computer to tie into a decoder and decode all of the VideoCrypt channels. These programs are free—most of the computer bulletin-board systems in Europe have copies. Today when Sky implements an ECM, the modified versions of the programs are posted on the BBSs within a few hours—an embarrassing situation for News Datacom and Sky.

Many of the pirate smart cards on the market now use pirate technology developed in the U.S. One card has a keypad. When there is an ECM, the pirate card user just telephones an answering service to retrieve a set of numbers. He then enters the numbers on the keypad and the pirate card resumes operation. Another card uses a modem.

Things could change over the next few months though if Sky brings out its new OA-issue card. Then the pirates will be defeated—at least for a little while. However, the problem is that nobody is sure how long the new card will remain unhacked. The most important lesson that the DSS programmers could learn from the European experience is that smart cards have to be changed every six months. Otherwise it's certain that they will be hacked. Ω

HAS DSS BEEN HACKED?

continued from page 36

In practice it is complex. The state of the answer bytes prior to the execution of the nanocommands is known. The process used here is an exhaustive search. The 30h and 03h iterations would be executed exhaustively with all values from 00h to FFh being tried as the input in the 30h loop. The potential for errors exists but it is the simplest way, short of reverse-engineering the card, to obtain the contents of the card memory.

On paper, these steps might look simple. In reality they are complex. The main problem hackers had with the European situation was working out how the recovered data mapped back to standard 6805 commands. Eventually, the op-codes were established and the routines began to make sense. The hackers now have a fully disassembled dump of the ROM and EEPROM of the Sky 09 smart card.

It is probable that the DSS hackers have used the Sky 09 data and knowledge to attack the DSS smart card. The problem for the DSS hackers is knowing the extent and power of the nanocommands in the DSS card. DSS may have a trick or two in its cards to send the hackers back to their drawing boards.

One thing is certain, though. If the DSS engineers do not take into account what happened in Europe, a similar series of events is sure to happen here. Ω

—LEARN ALL THE FACTS— MINIATURE 18" DISHES & HACKING

—TWO NEW BOOKS—
by Frank Baylin / John McCormac

- 18" satellite dish technology, players, programming, encryption and more
- The acclaimed hacker's "bible" outlines all the nitty-gritty technical details

CALL 1-800-483-2423
to order or for a catalog

Auth Publications

1905 Mariposa, Boulder, Colorado 80302, USA
Telephone: 303-449-4551 FAX: 303-939-8720



320 pages, 6" x 8.5"
\$50 plus \$4 s/h

MINIATURE SATELLITE DISHES

The New Digital Television
2nd Edition



by Dr. Frank Baylin

176 pages, 6" x 9"
\$20 plus \$4 s/h

Fourier series analysis.

Plus plated-through hole alternates, classic computer resources, a \$290 GPS receiver, and NewTek's Video Toaster.

EVERY TIME THAT I MENTION NICOLA TESLA'S NAME IN PRINT, I GET BUNCHES OF STATIC FROM CARD-CARRYING MEMBERS OF THE CULT OF THE LATTER DAY TESLAITES AND HUNDREDS

of dreary and poorly thought out incoherent pseudoscience drivel. Based on my extensive study and review, here's how I see things:

Yes, Tesla was one of the most brilliant engineers of all time. Tesla's developments of the induction motor, polyphase AC machinery, and the AC transformer remain crucial keys to nearly everything electrical.

Yes, Tesla was treated unfairly by history—grossly so. Some of that treatment was because the U.S. was at war with Tesla's native country of Croatia as well as the blatant propaganda of Edison's humongous PR mill.

No, Tesla was not original in his explorations of fluorescent lighting or radio. He was one of many people working on these topics.

As with any product developer, the way to get a few brilliant ideas is to start off with a lot of lousy ones. Eventually something will stick to the ceiling. For every good idea, there are zillions of bad ones.

There is not one scrap of credible evidence that shows Tesla had any "free" *earth resonance* energy. This was just an uncompleted experiment that was virtually cer-

tain to fail. There was apparently some major confusion between resonant energy buildup and true energy sourcing. This was caused in part by Tesla being a brilliant experimenter but a terrible theoretician. You'll also find strong

This is an example of a repetitive waveform...

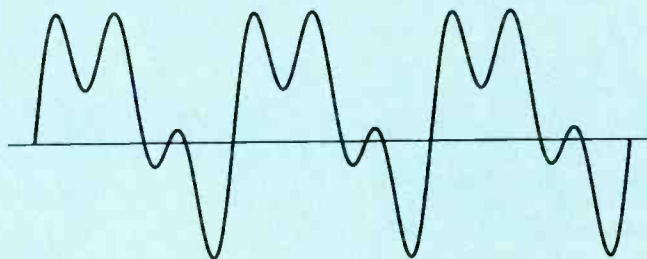

Classic Fourier Series tells us that this waveform consists of...

- A dc level, offset, unbalance, or level shift
– PLUS –
- A fundamental sine wave of some amplitude
– PLUS –
- A fundamental cosine wave of some amplitude
– PLUS –
- A second harmonic sine wave of some amplitude
– PLUS –
- A second harmonic cosine wave of some amplitude
– PLUS –
- A third harmonic sine wave of a specified amplitude
– PLUS –
- A third harmonic cosine wave of some amplitude
– PLUS –
- As many extra sine and cosines of higher harmonics as are required for accuracy.

FIG. 1—THE CLASSIC FOURIER SERIES is an essential tool for waveform analysis and fast Fourier transforms or wavelet work.

evidence that earth resonance was a lab-funding scam.

A piggy bank may have hundreds of dollars in it, but they got there a nickel and a dime at a time. It's the same with resonance. You can build up lots and lots of resonant energy a little bit at a time. And you can remove that energy very quickly. But you'll *never* get back any more than was put in. You most certainly can *not* sustain continuous removal.

Such an energy system would be a blatant violation of the second law of thermodynamics. So far, *all* attempts at second law violation have failed.

If you feel that earth resonant free energy is possible, fine. But note that the only way you'll convince anyone else of it is to come up with a simple and easily duplicated experiment that generates *one net watt* of power. Or publish a peer-reviewed analysis of a credible theory that supports such an unlikely energy source. Also note that your probability of success is zero.

These days, there's great heaping bunches of legitimate emerging electronic opportunities. By all means, do

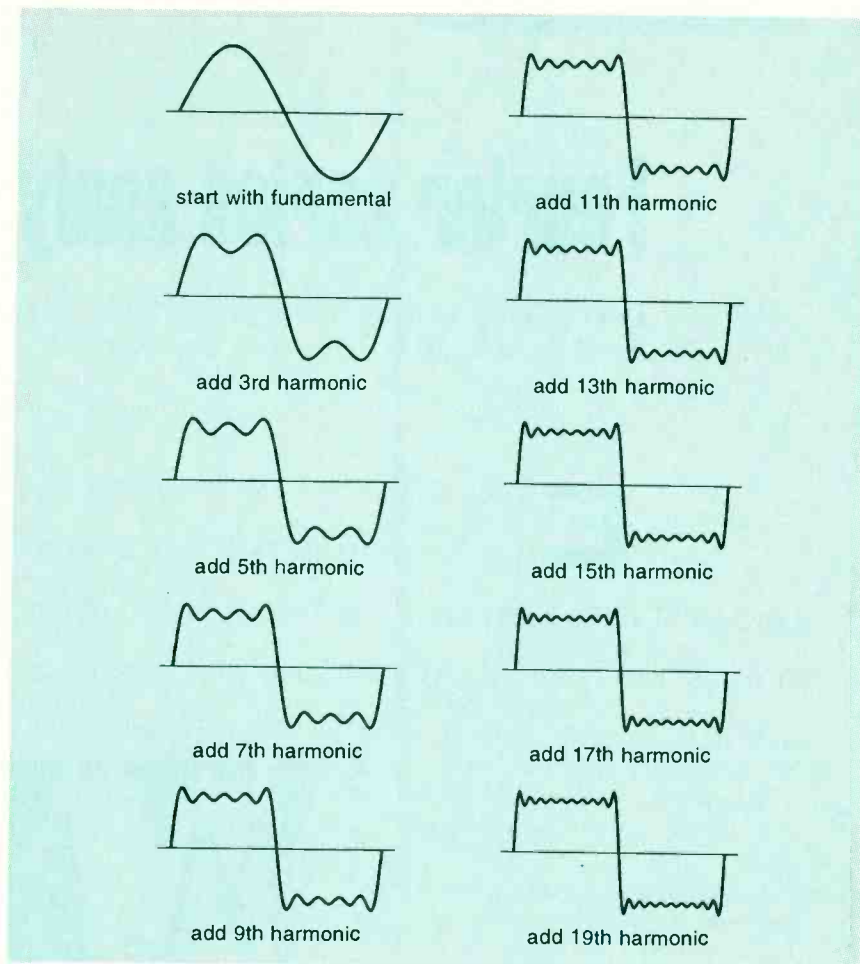

FIG. 2—BUILDING UP A SQUARE WAVE one harmonic at a time.

study Tesla and learn from him. But concentrate your readings on all of the actual historical documents and not on any latter day pseudoscience ramblings. One good source for information on Tesla research is *Lindsay Publications*. A second is the *Tesla Bookstore* service.

Fourier and his series

There are many reasons why you might want to relate time and frequency in physics and electronics. Relating time and frequency is of crucial importance in side-looking radar, spectrum analysis, holography, seismography, geophysics, vibration studies, cardiology, cryptography, data compression, correlation, feature extraction, and picture deblurring.

Jean Baptiste Joseph Fourier (1768 to 1830) was one cool dude—strange but cool. I urge you to look up his biography in the *Britannica Great Books* No. 45 or wherever. While

famous for a theory of heat, his primary contribution to electronics consisted of a math tool that relates time and frequency.

His math tool is called, of all things, the *Classic Fourier Series*. Classic Fourier Series applies to repetitive waveforms. This extends to continuous signals as the *Fourier Transform*. A newer variant is the *Fast Fourier Transform*, which speeds up most digital processing of sampled data dramatically.

One exciting newer replacement tool is called *Wavelet Theory*, which completely blows away Fourier “one size fits all” hassles. But Classic Fourier is the secret to understanding any and all of the newer stuff. Figure 1 shows the concept involved.

Say you have a repetitive waveform you wish to analyze. Fourier tells us that we can represent any waveform as a DC term plus sine and cosine waves of a fundamental frequency.

NEW FROM DON LANCASTER

HARDWARE CLASSICS

Incredible Secret Money Machine II	18.50
The Case Against Patents	28.50
Hardware Hacker Reprints II, III, or IV	24.50
Blatant Opportunist Reprints	24.50
Resource Bin Reprints	24.50
Ask The Guru Reprints I, II or III	24.50
CMOS Cookbook	28.50
TTL Cookbook	28.50
Active Filter Cookbook	28.50
Micro Cookbook I	19.50
Lancaster Classics Library	119.50

POSTSCRIPT STUFF

PostScript Secrets (Ile/Mac/PC)	29.50
Book-on-demand resource kit	39.50
Intro to PostScript VHS Video	29.50
PostScript Beginner Stuff	29.50
PostScript Show & Tell	29.50
PostScript Cookbook (Adobe)	19.50
PostScript Ref. Manual II (Adobe)	32.50
PostScript Program Design (Adobe)	24.50
Type I Font Format (Adobe)	16.50
Acrobat Reference (Adobe)	24.50
LaserWriter Reference (Apple)	19.50
PostScript by Example (McGilton)	29.50
Pgm Display PostScript with X	29.50
PostScript Visual Approach (Smith)	22.50
Thinking in PostScript (Reid)	22.50
Undst PS Pgrmmg (Holtzgang)	29.50
The Whole Works (all PostScript)	379.50

FREE VOICE HELPLINE VISA/MC

SYNERGETICS

Box 809-RE
Thatcher, AZ 85552
(520) 428-4073

Plus sines and cosines of even and odd harmonics.

A square wave is equal to a fundamental frequency plus one-third of the third harmonic, one-fifth of the fifth harmonic, and so on. A square wave also has even harmonics, but these all end up at zero amplitude. Figure 2 shows the "progressive build" quality of Fourier Series when lots of harmonics are added to make a waveform.

Observe that any waveform and its classic Fourier series end up *identical* and *interchangeable*. Thus, you can generate a square wave all at once, or build it up harmonic by harmonic. You can analyze a square wave all at once, or by individual harmonics.

This is also known as *superposition*.

More often than not, only a few key harmonics are of great interest. For instance, a vibration study on a moving piece of machinery might show strong Fourier components at specific frequencies that can instantly pinpoint possible problems.

Each Fourier component can be treated individually because of one remarkable trigonometric property. A *cosine* wave is just a sinewave whose phase is shifted by 90 degrees, or precisely *one-quarter* of the full cycle. These sine and cosine waves are *quadrature* or *orthogonal*.

Here is the neat part: Sines and cosines are largely "invisible" to each other and *fully independent*. And *any*

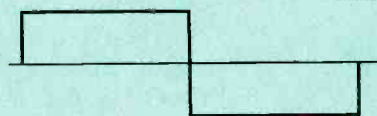

$$y = \sin(x) + 0.333 \sin(3x) + 0.200 \sin(5x) + 0.142 \sin(7x) + \dots$$

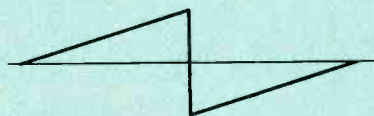

$$y = \sin(x) - 0.500 \sin(2x) + 0.333 \sin(3x) - 0.25 \sin(4x) + \dots$$

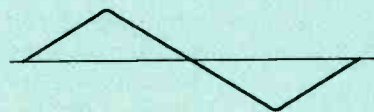

$$y = \sin(x) - 0.111 \sin(3x) + .040 \sin(5x) - 0.020 \sin(7x) + \dots$$

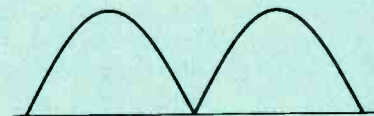

$$y = 0.636 + 0.424 \sin(2x) - 0.085 \sin(4x) + 0.036 \sin(6x) - \dots$$

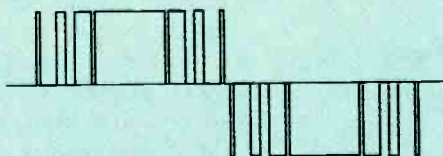

$$y = \sin(x) + 0.011 \sin(11x) + 0.089 \sin(13x) + 0.289 \sin(17x) + \dots$$

FIG. 3—FOURIER SERIES EQUIVALENTS for some useful waveforms.

Electronics NOW mini-ADS

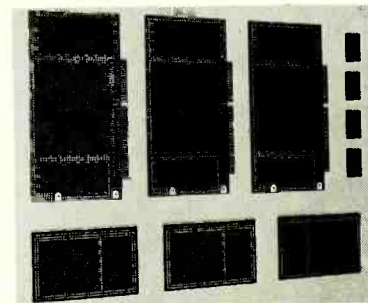

BEST PROTO™ PROTOTYPING BOARDS INCLUDE LOW NOISE POWER AND GROUND PLANES, plated through holes, predefined sites for SMD passives, and signal names silk-screened on both sides. Engineer's kit (pictured) is **\$129.50**, 16-bit ISA card is **\$32.50**. Add \$5 s&h (CA add 7.25% Sales Tax). Distributors wanted. **BEST PROTO, Dept E5, Box 232440, San Diego, CA 92183-2440 (619) 286-9000 ph/fax. Visa/MC.**

CIRCLE 190 ON FREE INFORMATION CARD

Yours for only
\$3.50

Prices includes
shipping!



HAVE A THOUSAND YUCKS FOR ONLY THREE AND A HALF BUCKS! That comes to one-third of a cent per laugh. Electronics Comics is a compilation of over 125 riotous, outrageous and phenomenal cartoons that appeared in **Popular Electronics** and **Electronics Now**. Only **\$3.50**—price includes shipping. **Claggg, Inc., Reprint Bookstore, P.O. Box 4099, Farmingdale, NY 11735-0793**. All payments in U.S. funds. Sorry, no orders outside U.S.A. and Canada. Check or money order only—send no cash. NY state residents add applicable tax. MA04

CALL NOW AND RESERVE YOUR SPACE

- 6 x rate \$1,000.00 each insertion.
- Fast reader service cycle.
- Short lead time for the placement of ads.
- We typeset and layout the ad at no additional charge.

Call **516-293-3000** to reserve space. Ask for Arline Fishman. Limited number of pages available. Mail materials to: mini-ADS, ELECTRONICS NOW, 500-B Bi-County Blvd., Farmingdale, NY 11735.

FAX: 516-293-3115

single-frequency waveform can be created simply by summing its sine and cosine components. Check any trigonometry book for full details.

Why are sines and cosines largely invisible to each other? *Because their cross-product over any cycle is zero!* You can prove this to yourself by sketching out a sine and cosine waveform over a full cycle. Their product is positive in quadrants one and four. But it is negative in quadrants two and three. They cancel each other exactly.

Even more important, *all the cross products between harmonics are also zero!* Thus, a full cycle product of a third harmonic sine and some sixth harmonic cosine will *always* be zero. The same is true for a second harmonic sine and a thirty-seventh harmonic

sine, or cosine against cosine. This "all cross products cancel to zero" ploy is *why* Fourier Series works. All those sines and cosines end up fully independent; they do not interact.

To analyze classic Fourier Series, you first find your *offset* or *DC term*. This is simply how much more is positive than negative during one full cycle. Many waveforms have a zero DC term, especially if they are capacitively coupled in some audio circuit. On the other hand, that DC term is precisely what you are after in a half-wave or full-wave rectifier. The rectifier harmonics are usually undesirable "hum" that get ruthlessly stomped upon.

Next, you'll try different sizes of fundamental sinewaves, finding out

which one removes the most energy from your waveform. Then you try different sizes of fundamental cosine waves, once again removing as much remaining energy as you can. The fundamental amplitude can be shown as sine and cosine values, or can be combined into one magnitude having that usual square-root-of-the-sum-of-the-squares relation.

Next, you step on up to the second harmonic, letting its sine and cosine terms take out as much remaining energy as possible. Continue this for all harmonics of interest.

Waveforms that have an identical positive and negative cycle should guarantee a zero DC term. Waveforms with *halfwave symmetry* guarantee no even harmonics. Waveforms which possess *mirror symmetry* on their half cycles should guarantee zero cosine terms. Other tricks can be played to simplify analysis of the waveform or to force certain harmonic patterns.

Figure 3 shows the Fourier series for a few common waveforms. Note how a full-wave rectifier has no fundamental term. One curious and unusual result: the waveform thus has *infinite* distortion!

Back in the days of the Apple II, I had my students searching for long binary sequences which had powerful third, fourth, and fifth harmonics but little else. This let them play *chords*.

One place where I'd like to do some more Fourier work is on the "hum on the desert" phenomenon. I can assure you that this phenomenon is very real. The hum often sounds like a barely audible generator in places where there are no generators for dozens of miles. The humming noise is also highly intermittent and maddeningly infuriating.

I suspect the hum has multiple and mundane causes, such as distant trains or scads of flying bugs. I also suspect that the acoustic resonance of a van can greatly magnify it.

There's a free *Incredible Secret Money Machine II* book for you if you are able to send me any hard data on this. Surely there is a scientific explanation.

Most college-level circuit theory books cover the Fourier Series. My

CLASSIC COMPUTER RESOURCES

The Calculator Collector

Intl Assn Calculator Collectors
10445 Victoria Ave
Riverside, CA 92503

Collector's Guide to PC's

PO Box 2326
Florence AL 35630
(205) 757-9966

The Computer Journal

PO Box 535
Lincoln CA 95648
(916) 645-1670

Computer Museum

Museum Wharf
Boston MA 02210
(617) 426-2800

Corvatek (Franklin)

561 NW Van Buren Street
Corvallis OR 97330
(503) 752-4833

Dynacomp (Atari)

178 Phillips Road
Webster NY 14580
(800) 828-6772

Forth Interest Group

PO Box 2154
Oakland CA 94621
(510) 89-FORTH

GIMIX/OS-9 (6800/6809)

3223 Arnold Lane
Northbrook IL 60062
(800) 559-0909

Historically Brewed

Historical Computer Society
2962 Park Street #1
Jacksonville FL 32205

Herb Johnson (S-100)

CN 5256 #105
Princeton NJ 08543
(609) 771-1503

Microcomputer Library

4209 France Avenue N
Robbinsdale MN 55422
(612) 533-3226

NOVAOUG (Osborne)

7512 Fairwood Land
Falls Church VA 22046
(703) 534-1186

Oughtred Society

8338 Colombard Ct
San Jose CA 95135
(408) 238-8082

Parts is Parts (Zenith)

137 Barkley Avenue
Clifton NJ 07011
(201) 340-7333

Pre-Owned Electronics

30 Clematis Avenue
Waltham MA 02154
(800) 274-5343

Jay Sabe (Z-Systems)

1435 Centre Street
Newton Centre MA 02159
(617) 965-7259

Shreve Systems

3804 Karen Dr
Bossier City LA 71112
(800) 227-3971

Charles Stafford (Kaypro)

4000 Norris Avenue
Sacramento CA 95821
(916) 483-0312

Stanch 8jj/jj89er (Heath)

PO Box 548
West Branch IA 52358
(319) 643-7136

Sydex (CP/M)

PO Box 5700
Eugene OR 97405
(503) 683-6033

favorite is Skilling's ancient *Electrical Engineering Circuits*, chapters 14 and 15.

I have put together a simple and powerful interactive Fourier Series analyzer. It is written in PostScript, of course. Waveforms can be either mathematically defined or else come from a list of sampled numbers. The code is too long to list here, besides being tedious to hand key. I've posted it as FOURIER.PS to my *GENie* PSRT RoundTable. It is available free for the downloading.

If you do not yet have PostScript available, we've also uploaded the latest versions of the *GhostScript* shareware offerings as files 1162 to 1169. For a detailed application tutorial, also check out MAGSINE.PDF. This one greatly expands upon the magic sinewave stuff I have described in past columns. It is a "must have" if you are at all into electric cars or AC induction motor controls.

NewTek's Toaster for Windows

For those of you that came in late, Commodore Computer was just sold at a yard sale for \$12.95. Well, for \$12 million, actually. It was a bizarre transaction that appears to have thrown out the baby and drank the washwater. It left the *Amiga* as a less than stellar platform to develop any expanding product base upon.

So, *NewTek* has just announced a stunning new addition to its *Video Toaster* product line. It's a *portable*, and optionally *stand alone* small box that fully supports *nonlinear editing*. It interfaces with any computer having a SCSI port. Those PC-compatible computers running *Windows* for openers, and Macs later on.

Even more mind-blowing, you can *eliminate all videotape completely!* Just connect your mid- to high-range home camcorder *directly* to the Toaster. You store the images *directly* to hard disk. Typical camcorder image sensors offer outstanding quality; it is only when the image hits the tape that it degrades dramatically. No more generation loss!

You'll also need one less monitor and one less timebase corrector (TBC), since these insert into the basic box. *NewTek's Toaster* can do routine editing tasks all by itself,

without needing *any* computer connection at all. It is only when you decide to do serious animation rendering, fancy transitions, or other "gee whiz" stuff that a supporting computer becomes extremely handy. Snap-in hard drives can optionally substitute for videotape cartridges. The bare system costs \$2990, less the drives, nonlinears, and display.

I've yet to test this gem and put it through its paces, but this is one product that cannot miss. My original loaner Toaster is now at *Black Range Films*, still doing yeoman duty for everything from videos on straw-bale home construction to cable TV pilots to kivas to UFO grand tours. Stay tuned right here for more details as they unfold. *NewTek* has a free video available. *Video Toaster User* magazine offers outstanding tutorials and help.

A \$290 GPS receiver

Terry Maurel loaned me his new *Garmin* GPS-45 receiver on a recent cave trip. I only had a few minutes to play around with it. This is both (A) utterly amazing, and (B) not quite good enough for me. The street price is a mere \$290 for a unit that is the size of a small handheld scanner. A short, stubby antenna is built in.

The features provided are nothing short of incredible. This system rapidly tells you your exact location anywhere in the world: latitude, longitude, and elevation. After the normal warm-up, it updates itself every second. It works outdoors only, of course, with a clear sky overhead.

A built in multimode liquid crystal display reveals everything from the pattern of satellites and their signal strengths to your current travel path and waypoints. Your speed is limited to 100 miles per hour.

The stand-alone accuracy typically averages plus or minus 300 feet or so. But it can occasionally get gruesomely worse, possibly for hours at a time. The military also has the option of purposely fouling up the signals.

You can dramatically improve the accuracy by using *differential mode* from a second receiver or an FM radio correction service. Differential GPS works by having a second receiver at a known site. The differ-

SALE!

CABLE TV DESCRAMBLERS WE'LL BEAT ANY PRICE! CALL TOLL-FREE 1-800-284-8432

• JERROLD • TOCOM • ZENITH •
• OAK • PIONEER • HAMLIN •
• SCIENTIFIC ATLANTA •

24 HOUR SHIPMENTS!
QUANTITY DISCOUNTS!
30 DAY MONEY BACK GUARANTEE!
FREE CATALOG & INFORMATION



Mastercard • American Express • Visa • C.O.D.
HAVE MAKE AND MODEL NUMBER OF EQUIPMENT USED IN YOUR AREA

1-800-284-8432

FOR ORDERS ONLY
For technical & customer service: 305-749-3122
ALL SHIPPING & HANDLING FEES AT CUSTOMER'S EXPENSE
Anyone implying theft of service will be denied assistance.

CABLE WAREHOUSE

10117 WEST OAKLAND PARK BLVD., SUITE 315, SUNRISE, FL 33351
NO FLORIDA SALES

CIRCLE 186 ON FREE INFORMATION CARD

ELECTRONIC KITS AND MORE!



World's Smallest Crystal
Controlled Transmitter Kit
Up to 1/2 mile range
Uses board mount 3V battery
Transmits at 143.79 MHz
XTL1000 E-Z\$69.95

Micro-Minature FM Transmitter Kit

Up to 1/2 mile range
Uses board mount 3V battery
Transmits from 88 to 108 MHz
XWB1000 E-Z\$49.95



World's Smallest FM
Transmitter kit
Up to 1 mile range
Uses 9V battery/Transmits from
88 to 108 MHz
XST500 E-Z\$44.95

For Catalog and Orders Call 1-800-336-7389
We accept Check, MO, MC/VISA and COD. S&H Extra
Send Mail Orders To:

XANDI ELECTRONICS, INC.
1270 E. Broadway Rd. #113 Tempe, AZ 85282

Invest a stamp... ... Save a bundle

For the price of a stamp, you can get the federal government's free *Consumer Information Catalog*. It lists more than 200 free or low-cost publications. Send your name and address to: Consumer Information Center, Department SB, Pueblo, Colorado 81009

NAMES AND NUMBERS

Closeout News

728 East 8th Street #1
Holland MI 49423
(616) 392-9687

Garmin

9875 Widmer Road
Oenexa KS 66215
(800) 800-1020

GENie

401 N Washington Street
Rockville MD 20850
(800) 638-9636

GPS World

859 Willamette St
Eugene OR 97440
(503) 343-1200

Steve Hansen's Bell Jar

35 Windsor Dr
Amherst NH 03031
(603) 429-0948

Institute of Navigation

1800 Diagonal Road #480
Alexandria VA 22314
(703) 683-7101

Lindsay Publications

PO Box 538
Bradley IL 60915
(815) 935-5353

LPKF Distribution

6840 SW Canyon Drive
Portland OR 97225
(800) 345-LPKF

Switchable Privacy Glass

Marvin Windows
Warroad MN 56763
(800) 346-5128

Navtech Books & Software

2775 S Quincy Street #610
Arlington VA 22206
(800) NAV-0885

NetGuide

600 Community Drive
Manhasset NY 11030
(516) 562-5000

NewTek

1200 SW Executive Drive
Topeka KS 66615
(800) 847-6111

Response TV

201 E Sandpointe Avenue #600
Santa Ana CA 92707
(800) 854-3112

Science/AAAS

1333 H Street NW
Washington DC 20005
(202) 326-6400

Tesla Book Co

Box 121873
Chula Vista CA 91912
(805) 646-3371

Video Toaster User

273 North Matilda Avenue
Sunnyvale CA 94086
(408) 252-0508

VR World

20 Ketchum Street
Westport CT 06880
(203) 226-6967

West Marine

PO Box 50050
Watsonville CA 95077
(800) 538-0775

On the other hand, you might like to collect and restore an early classic computer. Or maybe you are trying to keep your existing one alive for some marginal use which does not justify anything newer. Maybe you just happen to like some earlier machine that does a specific task *exactly* the way you want it to. This column is still being written on an Apple IIe.

Nearly all special-interest computer magazines and user groups have long folded. Most of the experts have gone on to greener pastures, and simply cannot afford supporting stuff which can not pay for their time. This month's resource sidebar lists several remaining places to try for replacement and upgrade parts and information on classic computers.

Foremost here is *The Computer Journal*. Still at their same old stall after all these years. They regularly publish resource directories.

An excellent price directory is the recent *Collectors Guide to Personal Computers*. *Historically Brewed* is a good newsletter.

There is also lots of superb online support. For instance, GENie's A2 and A2.PRO RoundTables still provide the finest in any remaining classic Apple support. And there's bound to be all sorts of Internet nooks and crannies offering specialized help for offbeat computers.

Please let me know if I missed anything major in this listing.

New tech lit

More papers on DNA computing, including new designs that far exceed human brain capacity appear in the April 28, 1995 issue of *Science*. The new *Computation Beyond the Turing Limit* story is no slouch, either.

An alternate to plated-through circuit boards is offered by LPKF. It is a conductive epoxy that is extruded through each hole. After a partial cure, the central hole is blown out, leaving a conductive plastic eyelet, at around ten cents per hole. LPKF also provides snap-off copper tubes in its *Copperset* system.

Large area liquid-crystal panels are now sold for architectural purposes by *Marvin Windows and Doors*. The *Switchable Privacy Glass* costs \$90 per

ence between where it really is and where GPS thinks it is is used to create the correction values for the moving GPS receiver.

There is this failed and long forgotten lumber tramway that is literally in my front yard. It includes an astounding drop of well over *one vertical mile*. I've been doing some historical archaeology on this and I sure could use a GPS system with better than thirty foot accuracy. More details on this fascinating beast in *GRAMTRAM.PDF*.

One distributor for Garmin is *West Marine*. Lots more on GPS in general can be found in *GPS World* magazine, from the *Navtech Bookstore*, and the *Institute of Navigation*.

A review of the Garmin 45 appears as *GARMIN45.TXT*. Or check *HACK48.PDF* for more GPS background.

Classic computer resources

These days, all of the classic early computers are *not* a bargain in any way, shape, or form. You certainly should *not* buy one just because it seems cheap at some hamfest or swap meet. Especially not as a "favor" to a child or someone else who doesn't have a computer.

HELP LINE

Phone or write all your Hardware Hacker questions to:

Don Lancaster
Synergetics
Box 809-EN
Thatcher, AZ, 85552
(520) 428-4073

For fast PSRT access, modem
(800) 638-8369. On prompt, type
JOINENIE. When asked for the
offer code, enter DMD524.

US Internet email access link:
SYNERGETICS@GENIE.GEIS.COM.

square foot. Maximum size is 35 x 84 inches. The response switching time is likely to be way too slow for virtual reality uses.

Speaking of which, *VR World* is a glossy magazine about virtual reality. *NetGuide* is but one of the many new Internet magazines.

Response TV is the primary trade journal of the infomercial industry. *Closeout News* has surplus and distress merchandise in it, including phones and electronics.

One good Internet source for car ignition computer information is: MajorDomo@columb.eng.ohio-state.edu.

An Experimenter's Introduction to Vacuum Technology is the new Steve Hansen booklet. It's mostly reprints from his great *Bell Jar* vacuum news.

We offer excerpts and ongoing support on my *GENie* PSRT.

I've just received fresh stock on the *seventeenth* classic reprinting of my *Active Filter Cookbook*. This is by far the best-selling book on active filters of all time. Check *Synergetics* or PSRT for availability.

My usual reminder that I've arranged ten free *GENie* PSRT hours for Electronics Now readers, per the *Need Help* box. Note that my Internet address can be used to ask technical questions, order products, or request catalogs. US Internet questions get answered directly to Category 1, topic 33 of my *GENie* PSRT. Often in two hours. **EN**



You can Build Gadgets! Here are 3 reasons why!

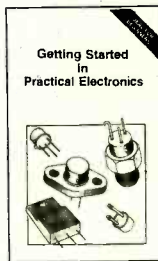

menter should toy with. Printed-circuit board designs are included to give your project a professional appearance.

BP345—GETTING STARTED IN PRACTICAL ELECTRONICS \$5.95

If you are looking into launching an exciting hobby activity, this text provides minimum essentials for the builder and 30 easy-to-build fun projects every exper-

BP349—PRACTICAL OPTO-ELECTRONIC PROJECTS \$5.95

If you shun opto-electronic projects for lack of knowledge, this is the book for you. A bit of introductory theory comes first and then a number of practical projects which utilize a range of opto devices, from a filament bulb to modern infrared sensors and emitters—all are easy to build.

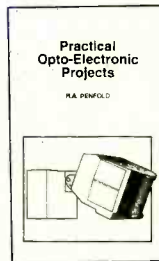

Practical Electronic Music Projects



BP363—PRACTICAL ELECTRONIC MUSIC PROJECTS \$5.95

The text contains a goodly number of practical music projects most often requested by musicians. All the projects are relatively low-in-cost to build and all use standard, readily-available components that you can buy. The project categories are guitar, general music and MIDI.

Mail to:

**Electronic Technology Today, Inc.
P.O. Box 240
Massapequa Park, NY 11762-0240**

Shipping Charges in USA & Canada

\$0.01 to \$5.00.....\$2.00	\$30.01 to \$40.00.....\$6.00
\$5.01 to \$10.00.....\$3.00	\$40.01 to \$50.00.....\$7.00
\$10.01 to \$20.00.....\$4.00	\$50.01 and above.....\$8.50
\$20.01 to \$30.00.....\$5.00	

Sorry, no orders accepted outside of USA and Canada. All payments must be in U.S. funds only.

Number of books ordered.

Total price of books.....\$ _____
Shipping (see chart).....\$ _____
Subtotal.....\$ _____
Sales Tax (NYS only).....\$ _____
Total enclosed.....\$ _____

Name _____
Address _____
City _____ State _____ ZIP _____

Please allow 6-8 weeks for delivery.

REMOTE CONTROL ADAPTER

continued from page 49

I/O pin to a single button on the transmitter. For example, one I/O pin could be set up to toggle between high and low each time the button is pressed, while another (set to momentary) could perform a different function, depending on how long that same button is held down. For example, pressing a button could lower a projection screen, while holding down the same button could dim the lights to a certain level.

Figure 8 shows how an I/O pin can be made to drive a DC load up to 500 milliamperes with the aid of a transistor. This same circuit can be repeated on all I/O pins to control seven different loads. Applications include controlling servos and motors in robotics, or turning any 9-volt battery-powered device on and off. If larger loads with greater current demands must be driven, Fig. 9 shows how to interface a relay to the circuit. Although a 12-volt relay is shown, any relay that operates on a voltage from 7 to 25 volts DC can be substituted by powering the receiver circuit with the same voltage.

For AC applications, an optoisolator and triac can switch line current from a standard 120-volt AC outlet, as shown in Fig. 10. Be careful when working with 120-volt AC power. Most triacs have their metal tabs tied directly to one of their main terminals. You will receive a shock if you touch the tab while power is applied. If heavy AC loads are driven and the triac must have a heatsink, mount the triac to the heatsink with insulating hardware and check for short circuits to ground with an ohmmeter before plugging the circuit into an AC outlet.

Model railroad buffs can control track switches with the circuit in Fig. 11. Two I/O pins are required per switch—one for each direction. The I/O pins must be configured as momentary. The receiver can also control other railroad accessories in the system.

Listening tests.

Sex and the experienced listener

FOR MANY YEARS, I WAS AN AUDIO-PHILE IN A RATHER PRIVILEGED POSITION. IF I WERE INTERESTED IN, SAY, A NEWLY ADVERTISED SPEAKER SYSTEM, I SIMPLY CALLED THE

manufacturer and a pair would be shipped to me forthwith. In fact, speaker manufacturers would frequently call me and ask whether I would like to audition a sample of some new three-way wonder. I should hasten to add that it probably wasn't just my winning personality that prompted all this kowtowing and cooperation, but rather the fact that I was the pre-auditioning "gateway" through which loudspeakers—and a few other product categories—had to go before they could be sent to *Stereo Review's* Hirsch-Houck Laboratories for a full-scale published lab test. I set up this arrangement when it became evident that the lab—which was my editorial responsibility—was wasting time and money handling speakers that were simply not good enough to warrant laboratory testing.

Typically, a speaker manufacturer would call me and we would discuss which model he might like to have a test report on. Not infrequently, I would ask for several different models to be sent to my home; I would connect them all to my built-in volume-equalizing switching system and spend an evening switching among them and my AR-3 reference standard.

The program material was an open-reel tape that I had dubbed with "revealing" sonic segments from a wide variety of pop and classical recordings. (As I remember, the Frank Sinatra/Nelson Riddle recordings, for example, were ideal for showing up midrange irregularities (a.k.a. "nasality") in systems.

It was relatively easy to weed out the really rotten sound reproducers (why couldn't the manufacturer have saved me the trouble?), and I would send the best of a sometimes bad lot off to H-H Labs for measurements and fur-

ther listening. Remember that all this took place during the early 1960s, when the only consistently good speakers came from a few Boston-based companies like AR, KLH, EPI, and ADC—and sometimes even they slipped up. Later, when most manufacturers' speaker systems got substantially better, pre-auditioning was no longer necessary, and my switcher got turned on only for special occasions.

Listening reliability

Long-term readers of "Audio Update" might be wondering whether I've suddenly, in retrospect, started to espouse the sloppy *laissez-faire* listening-test procedures typical of today's tweeko audiophiles and their publications. Although I did carefully match the playing levels of the models being compared, my listening technique was neither double- nor single-



THE PHYSICAL APPEARANCE of a particular speaker system can greatly influence listener's opinions of their sound quality.

blind. I not only knew the brands and models of all the speakers I was comparing, but I frequently had been subjected to manufacturer brainwashing and elegant expense-account lunches. Given all that, to what degree did I hear what I expected to hear? Did my biases pro or con weigh so heavily that my judgments of sound quality were without merit?

Floyd Toole and Sean E. Olive of Harman International discussed such matters and more in a paper presented last November at the 97th Audio Engineering Convention. The preprint (3894 H-6) is titled "Hearing is Believing vs. Believing is Hearing: Blind vs. Sighted Listening Tests, and Other Interesting Things."

Specifically, Toole and Olive set out (1) "to determine the extent to which listeners' opinions about loud-speaker sound quality are affected by not seeing (blind tests) and seeing (sighted tests) the loudspeakers being evaluated, (2) to evaluate the performance of listeners with and without experience in critical listening, and (3) to examine the influence of the sex of the listener."

To start, the authors state unequivocally that many years of carefully controlled listening tests have proven their worth: The results have been repeatable, the relationships between the subjective and objective have been logical, and listeners have been shown to be extremely sensitive to small changes in quality.

The four speaker systems being evaluated were two slightly different-sounding, but impressive-looking products from the upper end of the Harman line, an audiophile favored speaker; and an inexpensive, unimpressive-looking, but good-sounding subwoofer/satellite system. The sound of the systems ranged from very good to excellent.

As a preface to what follows I ask the reader to take as a "given" that all the tests were conducted with full scientific rigor. The AES paper fully documents (to the point of tedium) Toole and Olive's procedures, and both gentlemen have extensive and impressive backgrounds in psychoacoustic research.

The authors first investigated the question: To what degree are listeners' opinions affected by knowing the brand names and specifications of the products being listened to? Incidentally, all 40 listeners were employees of Harman International companies.

In analyzing the blind test comparisons, it became clear that preferences were based more on the locations of the speakers and the effect on their sound than the innate characteristics of the speakers themselves. That was no surprise, because it has been demonstrated repeatedly that in tests involving good, closely rated speakers, room location can be the dominant factor in determining listener ratings.

However, in the sighted tests, the ratings were strongly differentiated and did not change with speaker location. It was clear that the listeners' opinions of sound quality were positively influenced by the appearance of the speakers, including the fact that two of them had the Harman brand name attached.

Surprised? As stage magicians discovered centuries ago, most people's expectations strongly influence their perception of reality. (For reasons that I don't understand, I've always been relatively immune to the effect of expectations in audio and other areas. Perhaps I'm a natural-born skeptic—or cynic.)

Sex and the experienced listener

Toole and Olive next set out to determine the effect of sex and experience on listener evaluations. (Perhaps needless to say, we are not talking about sexual experience, but rather differences in listening evaluations between men and women.) Interestingly, the researchers seemed unable to come up with experienced female listeners, so the comparisons were done using only inexperienced listeners of both sexes.

The testing seemed to reveal that there was no essential difference in the preferences of experienced and novice listeners, or between men and women. I find this puzzling because my experience dealing with novice hi-fi shoppers seems to indicate that on

those rare occasions when they—men or women—could tell good from bad, they frequently preferred bad! Perhaps the test results were affected by the lack of really bad speakers in the four samples evaluated and the fact that playback levels were set low enough to be acceptable to female ears.

On that last point, I would be interested in comparison data on the preferred listening levels of men and woman with normal hearing. I'm not sure of its relevance, but the paper mentioned that a lower percentage of the women in the test group had any hearing loss compared to the men. In any case, in my generation it was almost always the women who wanted the volume level turned down. I wonder if that's still true.

To return to my "opening monologue"—as the late-night comics call it—I stand by my evaluations made in those early days—and later. For perhaps 20 years my subjective evaluations were repeatedly tested and validated against objective tests in the labs and listening rooms of loud-speaker manufacturers here and abroad.

Over the past 12 years my ears have gradually become unreliable as their high-frequency response began to pop in and out accompanied by reduced overall sensitivity. I now decline as gracefully as possible when asked to privately evaluate sound systems, but, thank goodness, my auditory disability has certainly not diminished my appreciation of live or reproduced music. EN



A PC board for the audio router.

THERE'S NOT MUCH WORK LEFT TO BE DONE ON THE AUDIO ROUTER CIRCUIT THAT I'VE BEEN DESCRIBING SINCE THE MARCH 1995 ISSUE. THE CIRCUIT, AS IT EXISTS SO FAR, IS AN EXTR-

emely versatile one. Although I'm using the circuit to control audio, the control signals that it generates can control any other kind of external hardware. I'll talk more about this once I complete the rest of the circuit—but I expect most of the ideas to come from you.

I've used CD4066B analog switches to route the audio on the output side of the circuit. Each chip contains four analog switches, each with its own control line. When you put a logic high on any one of the control lines, its related switch makes a connection between input and output and behaves like a 100-ohm resistor. When you remove the high from the control line, the switch essentially becomes an open circuit. Actually it behaves like a 10-gigohm resistor, which is pretty much the same thing as an open circuit.

The layout of one of the four required 4066 output sections is shown in Fig. 1. Each of the four sections contains four 4066s configured as two independent DPDT switches. The control lines connect to the data outputs of the 4508 at the "end" of the circuit I've already laid out.

Audio is switched by the 4066s

in pairs of left and right. Each individual switch connects a left or right input to a common left or right output. The logic in the rest of the circuit guarantees that only one audio input in each of the four output sections can be routed to the associated output. Note that

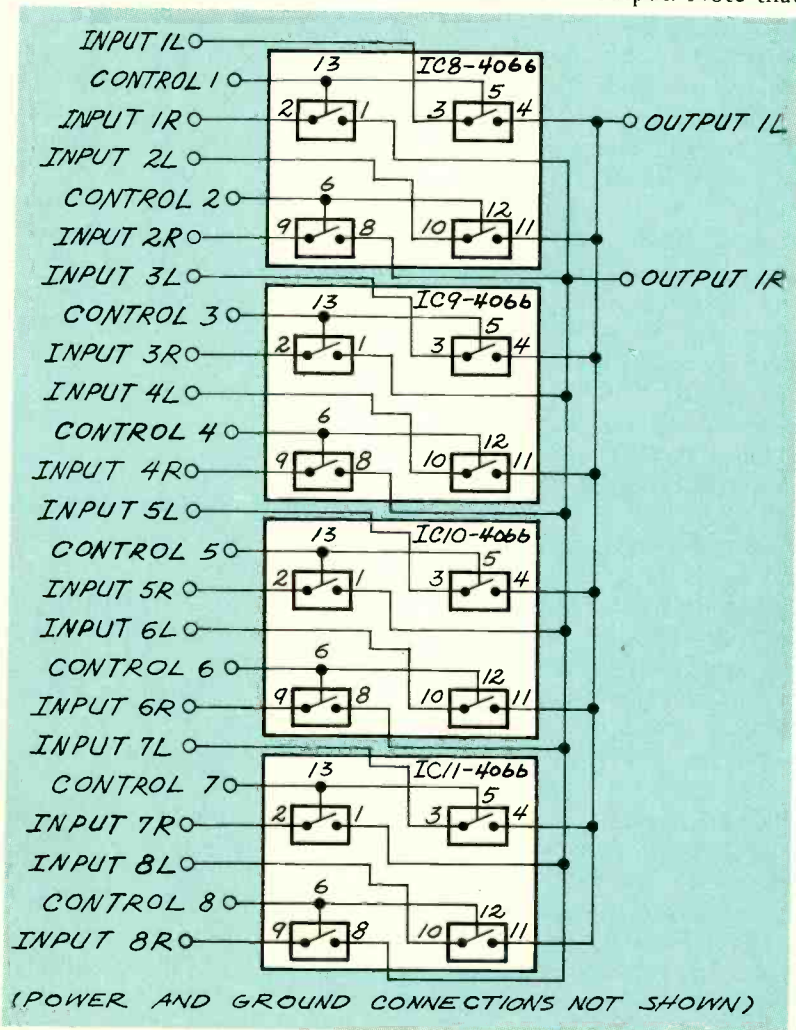

FIG. 1—A 4066 OUTPUT SECTION. One of the four needed output sections.

power and ground connections to the 4066s (pins 14 and 7, respectively) are not shown in Fig. 1--just remember to make those connections when you build the circuit.

Putting together all of the output channels requires 16 CD4066s (four for each channel), so it's a good idea to wire one channel at a time. There are a lot of connections to make, and it's really easy to make one incorrectly.

The easiest way to troubleshoot an output channel is with a resistor and two LEDs. Connect the LEDs to the output channels and connect 5 volts to the left and right audio inputs. Connect the power to each input channel in turn and see if the LEDs light whenever you select that channel on the keyboard. Once you've verified that the connections are correct, try routing some audio through the 4066s and see if the expected signals show up at the expected output channels.

The foil patterns I've made for the double-sided PC board are shown in Figs. 2 (component side) and 3 (solder side). The parts-placement diagram is

shown in Fig. 4. I designed the layout to fit some PC-mountable pushbutton switches that I already had a bunch of. If you can't find switches that fit the pads on the PC board, you'll have to hard-wire them to the board.

Notice that I've added a power-indicator LED and a protection diode at the power input. Although you can eliminate them, it's good design practice to protect a circuit in this way. The current limiting resistor for the LED (R10) should be about 1000 ohms and the protection diode should be rated for at least one ampere (a 1N4001 diode is a perfect choice).

The PC board will hold only the logic circuitry; the output 4066s must be dealt with separately. Each of the four sets of output control signals coming from the 4508s is brought out to a separate pin on the edge of the board. I put them on tenth-of-an-inch spacing because I'm using a row of female headers for each output channel. There are nine pads per output channel because I have a ground available there as well as the control

lines. This was done so that I could couple audio and power ground as easily as possible. On reflection, it would have been a good idea to expand it to ten pads and have power for the 4066s there as well.

I didn't design a PC board for the 4066s because I used a different technique to put them together. This was done because I had to make the switching section as small as possible. For what it's worth, each of my output sections consists of four 4066s glued together, one on top of another, with the pins bent straight out. I then made the connections shown in Fig. 1 by soldering wire directly to the pins. This is an interesting way to make small modules, and if there's enough interest, I'll spend some time describing it in more detail. I've built some portable test equipment this way, and have found it to be a very reliable and rugged method of assembling components. Whenever you have a circuit with a lot of ICs and a minimum amount of other types of components, it's something you should consider.

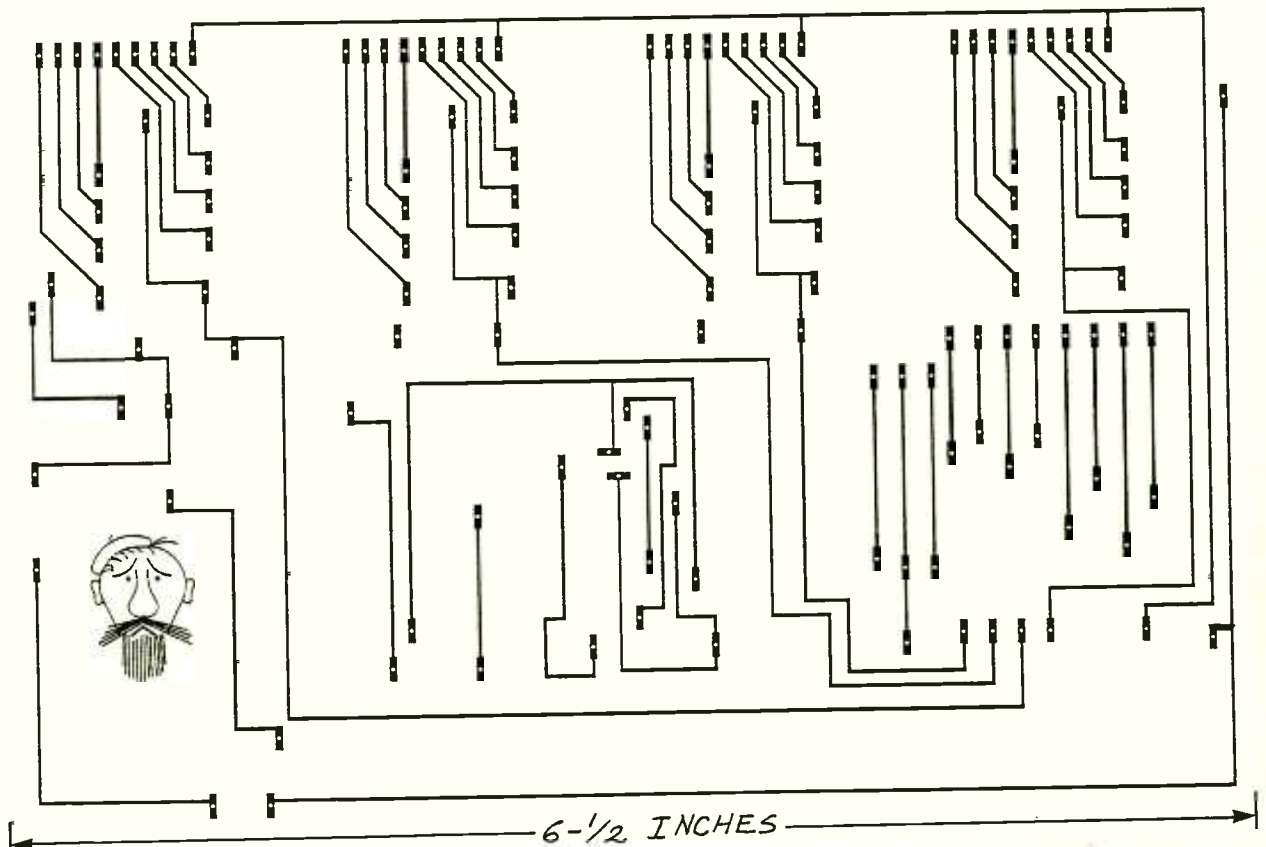

FIG. 2—COMPONENT SIDE FOIL PATTERN.

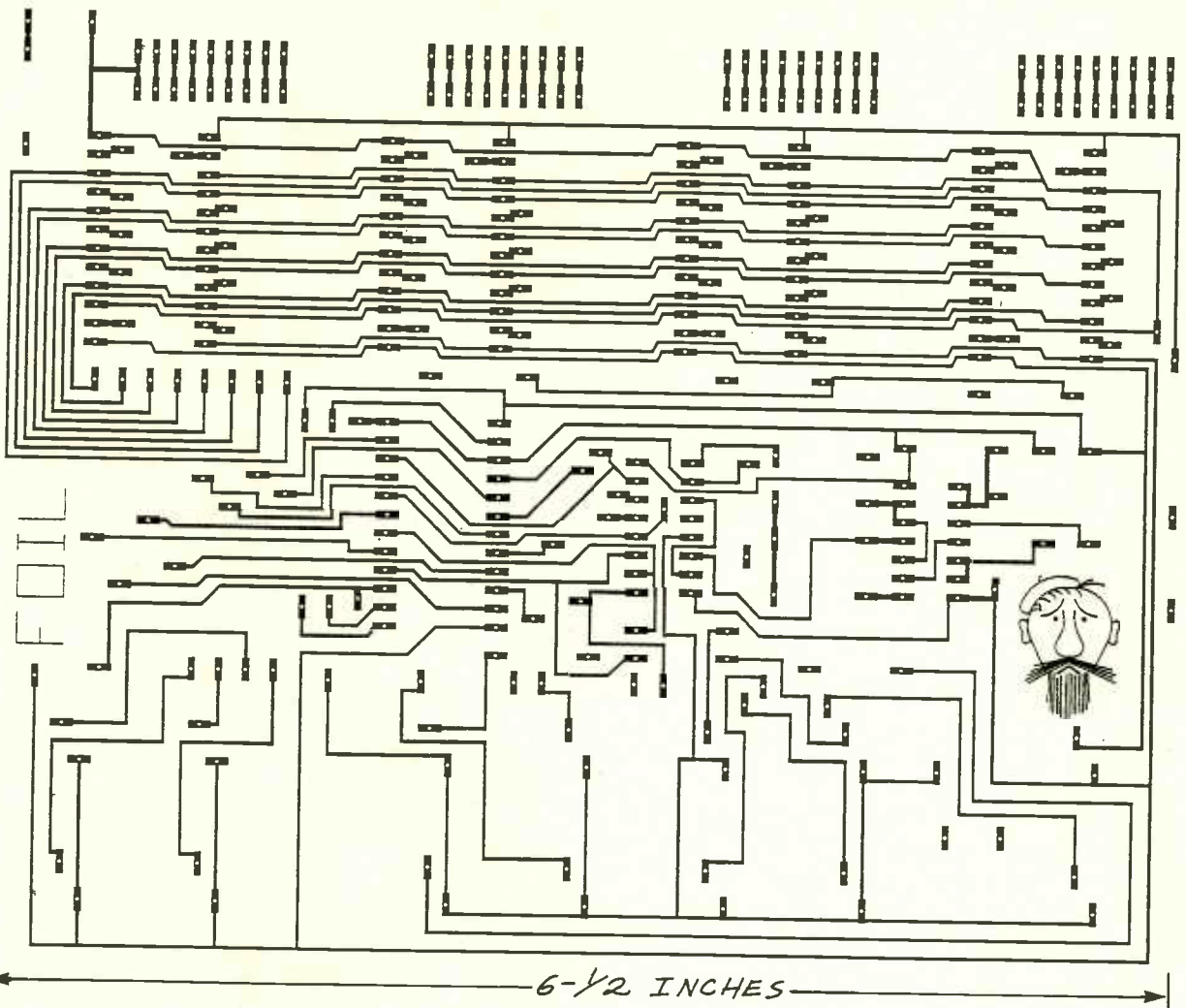

FIG. 3-SOLDER SIDE FOIL PATTERN.

On a different note entirely, I like to prowl around in antique shops, and recently I ran across two books I read when I was a kid about a million years ago. They're from the "Rick Brant Science Adventure Story" series, and the two I found are the first two in the series. The titles are "The Rocket's Shadow" (No. 1), and "The Lost City" (No. 2). There are other books in the series but the only title I remember is "The Caves of Fear." If anyone out there remembers these books, please drop me a note. And if anybody has some of them for sale, I'd be interested in buying them. Because, for reasons I don't understand, I'd like to read the rest of them. Maybe it's midlife crisis.

Once again I'm out of space, so I'll have to postpone the wrapup of this circuit. All that's left to explore is how it can be used, and how a few bells and whistles can be added.

EN

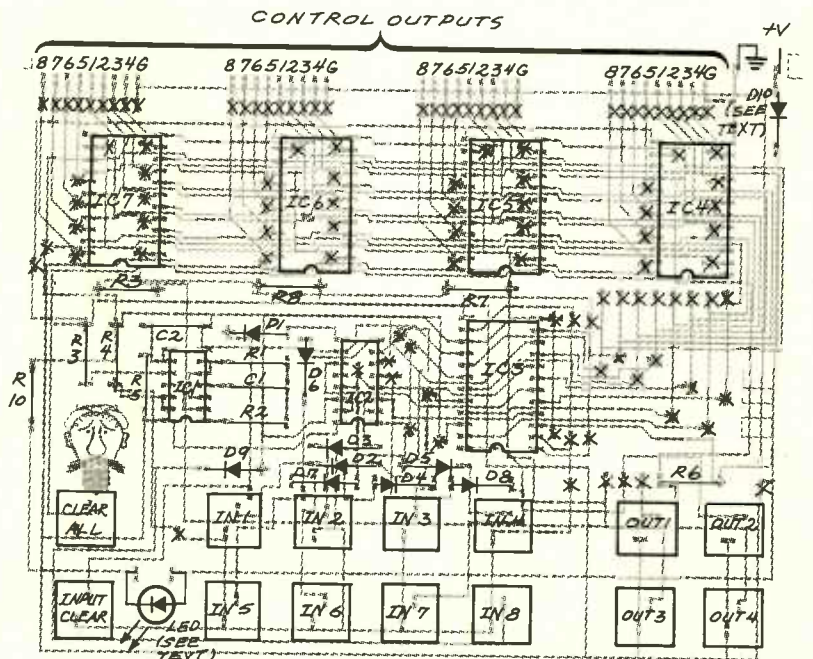

FIG. 4-PARTS-PLACEMENT DIAGRAM. All leads that pass through a foil pad on both sides of the board must be soldered on both sides. Any location marked with an "X" must have a short length of bare wire inserted and soldered on both sides.

BUYER'S MART

FOR SALE

CATV Test Chips as low as \$8.95 for testing converter boxes in full service modes. Jerrold, Tocom, Scientific Atlanta, Pioneer BA5XXX — BA67XX cubes clears E2-E5. **MICRO MAS-TERS, 1 (800) 360-7654.**

TUBES, new, up to 90% off, SASE, KIRBY, 298 West Carmel Drive, Carmel, IN 46032.

CABLE test chips. Jerrold, Tocom, S.A., Zenith. Puts cable boxes into full service model \$29.95 to \$59.95. 1 (800) 452-7090, (310) 902-0841.

TUBES: "oldest", "latest". Parts and schematics. SASE for lists. **STEINMETZ**, 7519 Maplewood Ave. RE, Hammond, IN 46324.

CONVERTER — descramblers: Examples, Zenith Ztac \$225.00, Scientific Atlanta 85XX \$175.00, 8580 compatible \$215.00, 8600 \$335.00, DPV-7212 compatible \$215.00, DP5 \$200.00, Jerrold 400 \$99.00, M35B \$45.00. All **Pioneer test generator** \$150.00. Most makes in stock, COD ok. **MOUNT HOOD ELECTRONICS** (503) 543-7239.

CLASSIFIED AD ORDER FORM

To run your own classified ad, put one word on each of the lines below and send this form along with your check to:

Electronics Now Classified Ads, 500-B Bi-County Boulevard, Farmingdale, NY 11735

PLEASE INDICATE in which category of classified advertising you wish your ad to appear. For special headings, there is a surcharge of \$25.00.

() Plans/Kits () Business Opportunities () For Sale
() Education/Instruction () Wanted () Satellite Television

Special Category: \$25.00

PLEASE PRINT EACH WORD SEPARATELY, IN BLOCK LETTERS.

(No refunds or credits for typesetting errors can be made unless you clearly print or type your copy.) Rates indicated are for standard style classified ads only. See below for additional charges for special ads. **Minimum: 15 words.**

1	2	3	4	5
6	7	8	9	10
11	12	13	14	15 (\$46.50)
16 (\$49.60)	17 (\$52.70)	18 (\$55.80)	19 (\$58.90)	20 (\$62.00)
21 (\$65.10)	22 (\$68.20)	23 (\$71.30)	24 (\$74.40)	25 (\$77.50)
26 (\$80.60)	27 (\$83.70)	28 (\$86.80)	29 (\$89.90)	30 (\$93.00)
31 (\$96.10)	32 (\$99.20)	33 (\$102.30)	34 (\$105.40)	35 (\$108.50)

We accept MasterCard and Visa for payment of orders. If you wish to use your credit card to pay for your ad fill in the following additional information (Sorry, no telephone orders can be accepted.):

Card Number _____ Expiration Date _____

Please Print Name _____

Signature _____

IF YOU USE A BOX NUMBER YOU MUST INCLUDE YOUR PERMANENT ADDRESS AND PHONE NUMBER FOR OUR FILES. ADS SUBMITTED WITHOUT THIS INFORMATION WILL NOT BE ACCEPTED.

CLASSIFIED COMMERCIAL RATE: (for firms or individuals offering commercial products or services) \$3.10 per word prepaid (no charge for zip code)...**MINIMUM 15 WORDS.** 5% discount for same ad in 6 issues; 10% discount for same ad in 12 issues within one year; if prepaid (not applicable on credit card orders). **NON-COMMERCIAL RATE:** (for individuals who want to buy or sell a personal item) \$2.50 per word, prepaid...no minimum. **ONLY FIRST WORD AND NAME** set in bold caps at no extra charge. Additional bold face (not available as all caps) **55¢ per word additional.** Entire ad in boldface, \$3.70 per word. **TINT SCREEN BEHIND ENTIRE AD: \$3.85 per word. TINT SCREEN BEHIND ENTIRE AD PLUS ALL BOLD FACE AD: \$4.50 per word. EXPANDED TYPE AD: \$4.70 per word prepaid.** Entire ad in boldface, \$5.60 per word. **TINT SCREEN BEHIND ENTIRE EXPANDED TYPE AD: \$5.90 per word. TINT SCREEN BEHIND ENTIRE EXPANDED TYPE AD PLUS ALL BOLD FACE AD: \$6.80 per word. DISPLAY ADS:** 1" x 2 1/8"—\$410.00; 2" x 2 1/8"—\$820.00; 3" x 2 1/8"—\$1230.00. **General Information:** Frequency rates and prepayment discounts are available. **ALL COPY SUBJECT TO PUBLISHERS APPROVAL. ADVERTISEMENTS USING P.O. BOX ADDRESS WILL NOT BE ACCEPTED UNTIL ADVERTISER SUPPLIES PUBLISHER WITH PERMANENT ADDRESS AND PHONE NUMBER.** Copy to be in our hands on the 1st of the third month preceding the date of the issue. (i.e., March issue copy must be received by December 1st). When normal closing date falls on Saturday, Sunday or Holiday, issue closes on preceding working day. Send for the classified brochure. Circle Number 49 on the Free Information Card.

Please make checks payable to Gernsback Publications Inc.

CABLE TV CHANNELS
EQUIPMENT *Direct!*
GUARANTEED
SAVE \$1000's
The Nationwide source for cable TV equipment.
BUY WHERE THE DEALERS BUY!
FREE TV Cable Descramblers, Converters and Magic Box Catalog. Open Every Day!
FREE YOUR VCR TAPES CAN PLAY AS CLEAR AS DAY!
Eliminates copy protection on any tape.
STARTING NOW WITH Video Decoder
• Copy any rental/bought tape
• Power Cord and RC Plugs Included
CALL NOW!
Member Better Business Bureau
FREE 30 Day Trial!
MEGA ELECTRONICS
1-800-676-6342 VISA • MC • COD

SECRET cable descramblers! Build your own descrambler for less than \$12.00 in seven easy steps! Radio Shack parts list and free descrambling methods that cost nothing to try, included. Send \$10.00 to: **INFORMATION FACTORY**, PO Box 669, Seabrook, TX 77586. For COD's (713) 922-3512 any time.

300 Experimenters Circuits — Complete in 6 practical books using diodes, relays, FET's, LED's, IC 555's, and IC CA3130's for building blocks. Only \$33.00 plus \$6.00 for shipping. USA and Canada only. US funds. **ETT, INC.**, PO Box 240, Massapequa Park, NY 11762-0240.

Quality Microwave TV Antennas
WIRELESS CABLE - IFTS - MMDS - Amateur TV
Ultra High Gain 50db(+) • Tuneable 1.9 to 2.7 Ghz.
• 55-Channel Dish System \$199.95
• 36-Channel Dish System \$149.95
• 20-Channel Dish System \$124.95
• Optional Commercial Grid Antenna (not shown) Add \$50.00
• Yagi Antennas, Components, Custom Tuning Available
• Call or write (SASE) for "FREE" Catalog
PHILLIPS-TECH ELECTRONICS
P.O. Box 8533 • Scottsdale, AZ 85252
(602) 947-7700 (\$3.00 Credit all phone orders)
MasterCard • Visa • American Express • COD's • Quantity Pricing

RESTRICTED Information: surveillance, schematics, locksmithing, cable, hacking, etc. Send stamp: **MENTOR**, Box 1549-Z, Asbury, NJ 07712.

CABLE TV converters and accessories. Fair prices, quality service, and 14 years experience gives us the advantage. Call 1 (800) 952-3916 V/MC/Amex/Disc/COD. **ADVANTAGE ELECTRONICS, INC.**, 1125 Riverwood Dr., Burnsville, MN 55337. Member of NCCA.

Do-It-Yourself Electronic Kits

Free Catalog Available

Call 213/888-8988 Fax 213/888-6868

Mark V Electronics 8019 E. Slauson Ave.,
Montebello, CA 90640

▲ Beginner ▲ Intermediate ▲ Advanced ▲

Stereo Loudspeaker Protector TY-26 ▲



Kit: \$ 16.75

Super fast acting relay protects speaker against destructive DC voltage. Can connect directly to a power amp. or can use a separate power supply. Has a 3 second turn-on delay to avoid turn-on thumps.

120W MOSFET Power Mono Amp. TA-477 ▲▲



Kit: \$ 70.00

120W into 8 ohms RMS. THD: < 0.007%. Frequency Response: 8 HZ-20 KHZ, +0-0.4 dB. 2.8 HZ-65 KHZ, +0-3 dB. Sensitivity: 1V. Power Requirement: 55V DC @ 3A. May use Mark V Model # 003 or # 012 transformer.

300W High Power Mono Amp. TA-3600 ▲▲▲



Kit: \$ 89.00

300W into 8 ohms RMS. Frequency Response: 10 HZ-20 KHZ. THD: < 0.05%. Sensitivity: 1V rms at 47K. Power Requirements: 60-75V DC at 8A. May use Mark V Model # 007 or # 009 transformer.

30W+30W Pre & Main Stereo Amp. TA-323A ▲



Kit: \$ 32.50

30W into 8 ohms RMS per channel. THD: < 0.1% from 100 HZ-10KHZ. Phono 3mV @ 47K. Tuner, Tape 130mV @ 47K. Power Requirement: 22-36V AC. 3A. May use Mark V Model # 002 transformer.

Metal Cabinets Power Transformers

LG-1273 3X12X7"	\$ 26.50	#001 28/30VX2 6A	\$30.00
LG-1894 4X16X8"	32.50	#002 38VX2 3A	25.00
LG-1924 4X19X11 1/2"	38.25	#003 40VX2 6A	32.00
LG-1925 5X19X11 1/2"	42.00	#004 24VX2 6A	25.00
LG-1983 2 1/2 X 19 X 8"	35.25	#006 28VX2 3A	19.00
		#006 18VX2 5A	19.00
		#007 53VX2 8A	47.00
		#009*48/53VX2 8A	66.00
		#012*24/42VX2 6A	48.00

Minimum order \$20.00 We accept Visa, MasterCard, Money orders and Checks. Please call for shipping charges. Quantity discounts available

ORDER 1-800-521-MARK/1-800-423-FIVE

CIRCLE 93 ON FREE INFORMATION CARD

THE Case Against the Patents. Thoroughly tested and proven alternatives that work in the real world. \$28.50. **SYNERGETICS PRESS**, Box 809-C, Thatcher, AZ 85552. (520) 428-4073. Visa/MC.

CABLE descrambling. New secret manual. Build your own descramblers for cable and subscription TV. Instructions, schematics for SSAVI, gated sync, sinewave, (HBO, Cinemax, Showtime, UHF, Adult) \$12.95, \$2.00 postage. **CABLETRONICS**, Box 30502R, Bethesda, MD 20824.

CABLE TV equipment & accessories. Wholesalers welcome! 30 day moneyback guarantee! Free catalog! **PERFORMANCE ELECTRONICS, INC.**, 1 (800) 815-1512.

DESCRAMBLE cable with simple circuit added to Radio Shack RF modulator and using VCR as tuner. Instructions \$10.00. **TELCOM**, Box 832-E8, Brusly, LA 70719.

CABLE BOX WHOLESALE, INC.

BEST BOXES—BEST PRICES

Immediate Shipping—COD's

Satisfaction Guaranteed

FREE Catalog—Call Now

800-841-7835

SURVEILLANCE

& COUNTERSURVEILLANCE Electronic Devices

Covert Video Cameras • Transmitter Kits • Voice Changers.
Bug and Phone Tap Detectors • Shotgun Mics • Micro Recorders
• Vehicle Tracking • Locksmithing • AND MORE!

16 - Hour Telephone Recorder - silently tapes incoming/outgoing phone calls automatically. **\$199.00**

SDY FOR CATALOG SEND \$5.00 TO... CREDIT CARDS WELCOME
OUTLET P.O. Box 337, Buffalo, NY 14226 (716) 691-3476

TV Notch filters, free brochure, **MICRO THINC.**, Box 63/6025, Margate, FL 33063. (305) 752-9202.

TEST equipment pre-owned now at affordable prices. Signal generators from \$50.00, oscilloscopes from \$50.00. Other equipment including manuals available. Send \$2.00 U.S. for catalog refunded on first order. **J.B. ELECTRONICS**, 3446 Dempster, Skokie, IL 60076. (708) 982-1973.

CABLE descramblers. Bargain headquarters. Below wholesale prices. Absolutely the lowest prices! Money back guarantee. Nobody beats us! **RP ELECTRONICS**, 1 (800) 304-3604.

PRINTED circuit boards — etched, drilled, tin plated. Single sided \$1.25/sq. inch. **CELCO ELECTRONICS**, 61 Water Street, Mayville, NY 14757. 1 (800) 388-8521. Fax (716) 753-3220.

CABLE TV new products designed and supported by the best in the business. External activators for Jerrold, Pioneer, Scientific Atlanta living or dead. Save big. Make lots of money. 1 (800) 375-7022.

PAY TV AND SATELLITE DESCRAMBLING
all new info Volume 6 all new info

Volume 6: Our entire collection of all current cable satellite and wireless turn-ons/Pay TV volumes 1-5 (all different Vol. - basics) Satellite and DBS Handbook (includes Hacker info) Wireless Cable Hacking Hacker Video Complete Wizard (VCI+) Cellular Phone Hacking \$15.95 each or 3/34.95 or 5/52.95. Newsletter \$29.95/12 issues. Catalog #1. All our info \$129.95 (includes sub.)

Scrambling News
3494 Delaware Ave., Buffalo, NY 14217-1230
Voice/FAX 716-874-2088 BBS 716-871-1915

CABLE test-chips as low as \$9.95, for testing cable boxes in full service mode. Jerrold: Starcom VI, VII & R2 V5, Jerrold cubes; Pioneer, clears E2 thru E5; Pioneer cubes: BA-5000 thru BA-6700; Tocom 5503/5507; Scientific Atlanta: 8500 thru 8600; Zenith: all but PZ1; **N.E. ENGINEERING**, 1 (800) 926-4030 sales, (617) 770-3830 tech, (617) 770-2305 fax.

CABLE descrambler! Build with 7 Radio Shack parts for under \$12.00. Complete instructions. \$8.00. **F.A.S.T.**, Box 369-E, Pt. Salerno, FL 34992-0369.

FREE Buy/Sell listing searches. Free 2 month listing. Used/surplus/antique equipment/parts/books. **COMMUNICATIONS/COMPUTER/ELECTRONICS BBS**, Modem: (201) 993-0811 (8/N/1/ANSI) or Suite 111, 103 Washington, Morristown, NJ 07960.

CB Radio Modifications! Frequencies, 10M, sliders, FM, amplifiers, books, kits, repairs, high-performance accessories. The best since 1976! Catalog \$3.00. **CBCI**, Box 31500EN, Phoenix, AZ 85046.

CABLE TV converters & descramblers. Replacements for most models, 30 day trial/1 year warranty, dealer inquiries invited. Visa/MC/DISC/AMEX/COD. For quality price & service call 1 (800) 259-1187, **EAGLE ELECTRONICS INC.**, #1, 1301 Railhead Blvd., Naples, FL 33963. No Florida sales.

FREE samples! Cable, parts, tools, connectors, enclosures. Build your next project totally for free! Call now! 24 hrs. (404) 394-8885 ext. 38.

CABLE TV converters/descramblers. Don't pay retail, buy from the wholesaler. Dealer discounts for single lot purchases. TVT-3G. \$69.95. Stealth..\$79.95. M-80 + ..\$79.95. Piogold..\$99.95. Converter with sleep timer/remote/parental lock. \$79.95. Novavisions from \$239.00. 30 day money back guarantee. No PA sales. **DIRECT CABLE SUPPLY INC.** 1 (800) 808-3356.

BUSINESS OPPORTUNITIES

EASY work! Excellent pay! Assemble products at home. Call toll free 1 (800) 467-5566 Ext. 5192.

START your own technical venture! Don Lancaster's newly updated **Incredible Secret Money Machine II** tells how. We now have autographed copies of the Guru's underground classic for \$18.50. **SYNERGETICS PRESS**, Box 809-C, Thatcher, AZ 85552. (520) 428-4073. Visa/MC.

EDUCATION & INSTRUCTION

ELECTRONIC engineering. 8 volumes complete. \$109.95. No prior knowledge required. Free brochure. **BANNER TECHNICAL BOOKS**, 1203 Grant Avenue, Rockford, IL 61103.

LEARN VCR repair. Great profits. Home study. P.C.D.I., Atlanta, GA. Free literature. 1 (800) 362-7070 Dept. VRJ342.

LEARN PC repair-troubleshooting, servicing. Home study. Free literature. P.C.D.I., Atlanta, GA. 1 (800) 362-7070 Dept. JJJ342.

BECOME an electrician. Approved home study. Free career literature. P.C.D.I., Atlanta, GA 1 (800) 362-7070 Dept. TEJ342.

EARN your computer diploma in networks, programming, multimedia, systems analyst or applications. Earn cells and become certified. Software, videos, textbooks included in tuition. Free catalog. 1 (800) 9-ITS-ITS (home study).

MICROWAVE oven manual, to become a technician. Award winning edition. USA \$42.95, all foreign countries \$69.00. **RANDALL**, Box 2168 R, Van Nuys, CA 91404.

HISTORIC and classic hardware support magazine. *The Computer Journal* provides how-to information on keeping S-100, Kaypro, Z80, 6809, CP/M, and PC/XT systems running. Over ten years of hardware, software projects. 6 issues \$24.00. Free sample. 1 (800) 424-8825. **TCJ**, PO Box 535, Lincoln, CA 95648.

OVER 100 electronic VCR cures in IBM compatible database. Send \$15.00 **RAG SOFTWARE**, Box 272, Station NDG, Mtl. Que H4A3P6.

CABLE TV TURN-ON CHIPS

SUPER Cable TV "Test Chips". Provides full service activation. Excellent! instructions & illustrations. **Jerrold Starcom: DP(V)5.. DP(V)7..DPBB7..CFT-2000 series. Pioneer: BA-5000 thru BA-6700. Scientific Atlanta: 8500 thru 8600. Tocom: 5503-VIP..5507. Zenith: ST-1000 thru ST-5000. Call now! MASTER COMPONENTS.** 1 (800) 233-9570.

PROGRAMMABLE LOGIC

FPGA design kit includes hardware, software, textbook. Low-cost way to learn modern logic design! Call **XESS CORP.**, 1 (800) 549-9377 or dev@vnet.net for details.

MASTERCARD AND VISA are now accepted for payment of your advertising. Simply complete the Classified Ad order form and we will bill you.

BEST BY MAIL

Rates: Write National, Box 5, Sarasota, FL 34230

BUSINESS OPPORTUNITIES

GUARANTEED! BIG MAIL Home Based Businesses And Opportunities. Only \$5.00: J & M SPECIALTIES, 3403-(RE) Cameron Drive, Henderson, NC 27536.

ASTONISHING FORTUNES — TAX-forfeited land!! Complete guide \$12.00: **SOUTHEX**, PO Box 5918, Brandon, MS 39047-5918.

EDUCATION & INSTRUCTION

HIGH SCHOOL DIPLOMA At Home, Accredited, Fast, "Failure-Proof"! 1-800-470-4723, American Academy, 12651 S. Dixie Highway, Miami, FL 33156.

Special Prices for Electronics Now Readers. Please mention VIP #8R5!

Electronic Kits

SALE

Fiber Optics Kit

Use light to transmit and receive information

Discover the intriguing principles of fiber optics data communications. The kit includes separate transmitter and receiver circuit boards, fiber optics cable and all connectors for interfacing cables with the circuit boards. Either a square-wave or TTL signal from 200Hz to 5kHz can be inputted.

- Dimensions: 4.125" L x 1.5" W x 0.25" H
- Requires 9 volt battery • Weight: 0.1 lbs.

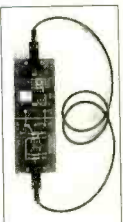

Part No.	Description	1-9	10-24
21135	Fiber optics kit	SALE \$17.95	

Function Generator Kit

Sine, triangle and square wave

Great for prototyping electronic circuits, whether analog or digital! Produces sinusoidal, triangular (saw-tooth), and square wave-forms at frequencies continuously variable from 1Hz to 100kHz. Requires 12VDC or ±6VDC split supply.

- 21 piece kit (chip, components, PC board, hardware) • Recommend power supply P/N 20626 (below) • Weight: 0.2 lbs.
- Dimensions: 4.125" L x 1.5" W

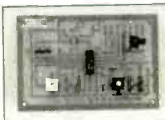

Part No.	Description	1-9	10-24
20685	Function generator	\$19.95	SALE \$17.95

Dual Adjustable Power Supply Kit

± 5VDC to ± 15VDC @ 175mA to 750mA

- 48 piece kit (components/hardware)
- Adjustable positive and negative supplies ±5 to ±15VDC regulated, 175mA - 750mA per supply
- Positive and negative 5VDC to 15VDC
- Power output (each supply): 5VDC @ 750mA, 12VDC @ 500mA, and 15VDC @ 175mA
- 120VAC input • PC board construction
- LED on indicator • Weight: 1.8 lbs.
- Size: 5.062" L x 3.5" W x 2.0" H



Part No.	Description	1-9	10-24
20626	Power supply kit	\$19.95	SALE \$17.95

Triple Voltage Power Supply Kit

+ 5VDC @ 1 Amp, +3 to +12VDC @ 100 mA & -3 to -12 VDC @ 100mA

- 103 piece kit (components/hardware)
- Power output: Fixed +5VDC output @ 1 Amp, adjustable +3 to +12VDC @ 100mA, adjustable -3 to -12VDC @ 100mA
- Input voltage 120VAC @ 50/60Hz
- Fuse protected • PC board construction
- Comes with power cord
- Includes all required hardware
- Size: 5.12" L x 5.12" W x 2.25" H
- Weight: 2.2 lbs.

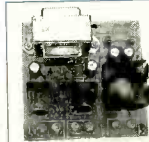

Part No.	Description	1-9	10-24
73613	Power supply kit	\$29.95	SALE \$26.95

Digitalker™ DT1050 Voice Synthesizer Chip Set

- Language translations
- Telecommunications
- Teaching aids
- Automotive • Clocks

Chip Set encoded with 137 separate and useful words. The words have been assigned discrete addresses, making it possible to output single words, phrases or sentences.

Includes: • MM54104N (40-pin) speech processor chip • 74LS04 • MM52164SSR1 (24-pin) and MM52164SSR2 (24-pin) speech ROMs • Master Word List



Part No.	Description	1-9	10-24
16491	Digitalkertm (4 Chips)	SALE \$29.95	

Jameco Analog Display Soldering Station

- Electronic temperature control
- Zero-Voltage thyristor switching protects voltage and current sensitive devices
- LED on and Heater-on Power indicators
- Power consumption: 60 watts
- Includes one 35115, 1/16" tip
- Size: 4.25" W x 6" D x 3.38" H
- Weight: 4.2 lbs. • UL listed



Part No.	Description	1-9	10-24
114569	Analog Station	SALE \$79.95	

Linear Integrated Circuits

Part No.	Product No.	1-9	10-99
23051	LH0002CN	SALE \$6.95	
27852	OP07	SALE 1.75	
24811	MAX232CPE	1.95	1.75
23579	LM317T	.65	.55
23683	LM324N	.39	.35
23721	LM331N	SALE 3.49	
23771	LM336Z	SALE .79	
23851	LM339N	SALE .45	
23966	LM358N	.45	.39
24061	LM381N	6.95	6.49
24109	LM385Z	SALE .99	
24117	LM385Z1.2	SALE .99	
24133	LM386N-3	.49	.39
24301	LM399H	6.95	6.49
27422	NE555V	.35	.29
24328	LM556N	.49	.39
24352	LM565N	1.49	1.29
24539	LM741CN	.35	.29
23157	LM1488N	.45	.39
23181	LM1489N	.45	.39
34972	XR2206	3.49	3.29
39600	26LS32	SALE .79	
23341	LM2917N-14	1.75	1.55
24230	LM3914N	1.95	1.75
27385	NE5532	SALE .75	
51182	78L05	.29	.25
51246	7805K	1.69	1.55
51262	7805T	.45	.39
51334	7812T	.45	.39
25064	MC14490P	4.25	3.95
50964	75176	1.49	1.35
25099	MC145406P	2.95	2.75

3 1/2 Digit Pocket Multimeter

- Measures: AC/DC voltage, DC current, HFE and resistance
- DC Voltage: 200mV, 2V, 20V, 200V, 1000V
- AC Voltage: 200V, 750V
- Resistance: 200Ω, 2 KΩ, 20 KΩ, 200 KΩ, 2M
- DC Current: 200 mA, 2mA, 20mA, 200mA, 10A
- Diode Test • Transistor HFE
- Removeable test leads
- Size: 2.62" W X 1" D X 4.75" H
- Weight: 0.5 lbs. • One-year warranty



Part No.	Description	Special Price
119212	Digital multimeter	\$14.95

Jameco Digital Lab

Includes:

- Solderless Breadboard
- DC Power Supplies
- Two 7-Segment Displays
- Function Generator (5 ranges)
- Digital Voltmeter (DVM) 4 ranges
- Size: 10.625" W x 13.25" D x 5" H
- One-year warranty • Weight: 8.5 lbs.

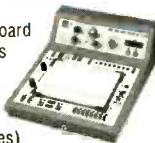

Part No.	Description	1-4	5-9
75838	Digital Lab	\$299.95	SALE \$269.95

Jameco Solderless Breadboards

Our long-lasting breadboards feature screen printed color coordinates and are suitable for many kinds of prototyping and circuit design.

Larger models feature heavy-duty aluminum backing with voltage and grounding posts.

- One-year warranty



Part No.	Terminal Strips	Bus Strips	Contact Points*	1-9	10-49
20343	0	2	200	\$2.95	\$2.59
20600	1	2	400	4.95	4.49
20669	1	0	630	4.49	3.95
20722	1	2	830	SALE 6.25	
20757	2	1	1,360	11.95	10.75
20773	2	4	1,660	16.95	14.95
20790	3	5	2,390	SALE 19.95	
20811	4	7	3,220	29.95	27.95

Jameco Wire Jumper Kit

- 25 each of lengths 0.1 through 5.0 (14 sizes)
- 350 assorted lengths in 13 colors
- Pre-stripped/pre-formed 22 AWG solid wire jumpers
- Handy, durable, clear plastic case



Part No.	Description	1-9	10-49
19289	Wire jumper kit	\$9.95	SALE \$8.95
20079	Refill for 19289	7.95	6.95

286 12MHz Bare-bones System

Includes motherboard, computer case, power supply & keyboard

- Intel 286 12MHz CPU
- 1MB RAM
- 1.2MB (5.25") floppy disk drive
- IDE hard/floppy controller
- Five expansion slots
- Two Serial & one parallel ports



Part No.	Description	Special Price
115705	286 12MHz	\$149.95

14" Paper White Monochrome Monitor & Adapter

- 0.31mm dot pitch
- Supports MDA, Hercules graphics (HGC)
- 720 x 348 • Tilt/swivel base
- Input: DB9-pin (TTL) connector

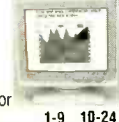

Part No.	Description	1-9	10-24
119482	White monitor	\$109.95	SALE \$99.95
19684	Adapter	SALE 14.95	

40 Piece Tool Kit

- IC extractor
- IC inserter with pin straightener
- Extra long 3-claw parts holder
- Slotted and Phillips screwdriver bits
- Metric nutdriver sockets (6mm-12mm)
- S.A.E. nutdriver sockets (3/16"-1/2")
- Reversible torque screwdriver bits (T10-T25)
- Potentiometer alignment tools
- Adapter bit for sockets • Wire cutters & stripper
- Pocket clip screwdriver • Zipper vinyl case
- Weight: 1.8 lbs. • Size: 9.5" L x 6.8" W x 1.38" H



Part No.	Description	Special Price
119183	40 Piece Tool Kit	\$12.95

Capacitors

Silver Mica, Radial and Axial Electrolytic Capacitors also available.

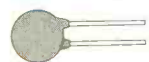

Ceramic Disc (± 20%) 50V

Part No.	Capacitance	Voltage	1	10	100	1000
15405	22pf	50v	\$0.10	\$0.05	\$0.03	\$0.028
15341	100pf	50v	.10	.05	.04	.028
15190	001µf	50v	.10	.05	.03	.028
15229	.01µf	50v	.12	.07	.05	.045
15253	.047µf	50v	.12	.07	.05	.045
15270	.1µf	50v	.15	.12	.07	.06

Mylar (± 10%) 100V

Part No.	Capacitance	Voltage	1	10	100	1000
26884	.01µf	100v	\$1.11	\$0.99	\$0.06	\$0.05
26921	.033µf	100v	.12	.10	.09	.065
26956	.1µf	100v	.19	.15	.12	.10
26972	.22µf	100v	.23	.19	.16	.11
26999	.47µf	100v	.29	.25	.22	.19
27001	1µf	100v	SALE .35	.35	.27	

Dipped Tantalum (± 10%) 35V

Part No.	Capacitance	Voltage	1	10	100	1000
33486	1µf	35v	SALE \$1.11	\$0.99	\$0.06	\$0.05
33662	1µf	35v	.21	.17	.13	.11
33734	2.2µf	35v	.25	.23	.17	.15
33806	4.7µf	35v	.39	.35	.26	.21
33689	10µf	35v	.65	.55	.49	.39
33822	47µf	25v	1.75	1.55	1.39	1.25

Monolithic (± 20%) 50V

Part No.	Capacitance	Voltage	1	10	100	1000
25523	1µf	50v	\$1.19	\$1.15	\$1.11	\$0.99
25507	.01µf	50v	.15	.12	.09	.065
81525	100pf	50v	SALE .09	.09	.065	
25558	.47µf	50v	.23	.19	.15	.12
25540	.22µf	50v	SALE .15	.15	.12	

Carbon Film 1/4 Watt 5% Resistor Assortments



Part No.	Description	Price
10719	5 each 70 values	SALE \$8.95
10663	100 each (27 values)	SALE 19.95



1355 Shoreway Road Belmont, CA 94002-4100
 Call for your FREE catalog
 FAX: 1-800-237-6948 (Domestic)
 FAX: 415-592-2503 (International)

© 1995 Jameco 8/95

No Minimum Order Call for Details

New Hours: 6AM - 5PM PST



Mention V.I.P.# 8R5

Call 1-800-831-4242 to order today!

only about one-fifth the size of those found on the most advanced microcircuits now in production--has been developed.

The equipment development was the result of a joint effort by researchers at Sandia National Laboratories and AT&T Bell Laboratories who worked together to explore the feasibility of using extreme ultraviolet light in the manufacture of ICs. The research was sponsored by the U.S. Department of Energy's National Lithography Program.

The research equipment based on the use of short wavelengths of ultraviolet light includes frictionless magnetic levitation to align the wafer between each process step and it made use of new types of photoresist adapted to the shorter UV wavelengths. Extreme ultraviolet light provides a narrower "paintbrush" for outlining circuit features that are imprinted on a chip in much the same way conventional photolithography.

In the latest production photolithographic equipment, IC patterns are reduced by projecting an image through a series of mirrors. However that scheme will not work at the shorter UV wavelengths of light. Instead, the extreme UV is reflected with extraordinarily precise mirrors coated with special multilayers. The mirrors' average surface precision must be within the range of the diameter of a single atom--no more than five angstroms.

The researchers also working on new photoresists for coating the silicon wafer that are sensitive to extreme UV. When light passes through the IC pattern, it alters the chemical composition of the photoresist, "hardening" some areas so they resist chemical etchants applied in further processing steps. The image formed allows other areas of footrests to be removed. The bare areas of the wafer opened by the removal of footrests become sites for further material deposition.

Integrated circuits are formed by a

series of deposition and re-removal steps, each calling for a separate mask, the applications of photoresist, photoresist removal, and material deposition. As many as 20 masks and etching and deposition steps might be required in the manufacture of a complex integrated circuit.

According to Richard Strulén, manager of Sandia's Material Science & Technology Department, the system is the first one capable of fabricating an IC by making use of extreme ultraviolet. He expects IC manufacturers to be manufacturing production ICs on equipment based on their research by 2007.

The Sandia/AT&T lithography concept is just one of several competing lithography methods in contention for selection to achieve the industry goal of 0.1-micron-wide IC features. One prominent option is X-ray lithography. The Semiconductor Industry Association expects that the contenders will be narrowed by 2001, the winning technology will be selected by 2002, and volume production with the selected equipment will occur by 2007.

"Nanowires" exhibit different properties

ELECTRICAL, MECHANICAL, and other properties of microscopic wires change significantly as their width narrows to nanoscale dimensions (less than 10 atoms wide). This is according to studies that were conducted by scientists at the Georgia Institute of Technology and the Universidad Autonoma de Madrid in Spain.

The experimental and supercomputer-based studies also revealed new information about the fundamental behavior of materials in the nanorealm. Such information is seen as significant because the trend toward more miniaturization of electronic components.

The studies of electronic transport and mechanical elongation in three-dimensional, ultrathin, metallic wires at room temperature uncovered a localization phenomena previously

seen only in one-dimensional "whiskers" at cryogenic temperatures.

Dr. Uzi Landman, director of Georgia Tech's Center for Computational Materials Science said that there are certain effects relating to size that must be considered when designing parts that are smaller than certain size limits. He cautioned that at microscopic scale "the behavior of the system may not be what you would expect on the macroscopic scale."

The researchers discovered that under certain conditions, the ability of the nanowires to conduct electricity degrades until they resemble insulators. Conductance of atomic-scale gold wires depends on their length, lateral dimensions, the state of atomic order, and disorder, and the elongation mechanism of the wires.

Researchers at the Universidad Autonoma de Madrid created formed nanowires between 50 and 400 angstroms long under a scanning-tunneling microscope. (An angstrom is one ten-billionth of a meter, or approximately the diameter of a hydrogen atom.) By precisely measuring electrical conductance, the researchers studied the effect of elongating and eventually breaking the nanowire. The experimental measurements were correlated with predictions obtained from dynamic molecular simulations done by the Georgia Tech group.

The conductance measurements revealed a repeating pattern in which the conductance exhibited dips corresponding to enhanced degrees of disorder in the wires during elongation. The increases in the conductance subsequent to those dips are correlated with a restoration of a higher degree of order in the elongated wire. The repeating pattern showed up as the thickness of the wire was reduced below five to ten atoms.

The researchers observed a nonlinear dependence of the electrical resistance as a function of the voltage across the wire in wires between 50 and 400 angstroms long. As the nanowires' length increased, their conductance decreased, until ultimately the wires acted more like insulators than conductors.

**CABLE TV
DESCRAMBLERS**
1-800-233-9388
FREE CATALOG
GUARANTEED BEST PRICES • IMMEDIATE SHIPPING
APPLE ELECTRONICS
3389 Sheridan St. • Suite 257
Hollywood, FL 33021

WANTED

INVENTIONS, ideas, new products! Presentation to industry/exhibition at national innovation exposition. Patent services. **1 (800) 288-IDEA.**

SATELLITE TV

FREE catalog — Lowest prices worldwide. Satisfaction guarantee on everything sold — systems, upgrades, parts, all major brands factory fresh and warranted. **SKYVISION**, 1012 Frontier, Fergus Falls, MN 56537. **1 (800) 334-6455.** Outside US (218) 739-5231.

VIDEOCYEPHER II descrambling manual. Schematics, video and audio. Explains DES, EPROM, CloneMaster, Pay-per-view (HBO, Cinemax, Showtime, Adult, etc.) \$16.95, \$2.00 postage. Schematics for Videocypher II Plus, \$20.00. Schematics for Videocypher II 032, \$15.00. Software to copy and alter EPROM codes, \$25.00. VCII Plus EPROM, binary and source code, \$30.00. **CABLETRONICS**, Box 30502R, Bethesda, MD 20824.

NEW Product Announcement

Universal Cable TV Descrambler

No Converter Necessary!

Works With All Systems

Call 1-800-664-6999



PLANS AND KITS

60 SOLDERLESS Breadboard Projects in two easy-to-read pocket books. Complete with circuit descriptions, schematics, parts layouts, component listings, etc. Both book (BP107 & BP113) only \$11.90 plus \$4.00 for shipping. USA and Canada only. US funds. **ETT, INC.**, PO Box 240, Massapequa Park, NY 11762-0240.

SURVEILLANCE Transmitter kits, 65 to 305 MHz. **Quick & Easy** Partially assembled units. Five minutes completion. 110-volt duplex receptacle, room battery types, and telephone. Counter-surveillance. Catalog: \$2.00. **SHEFFIELD ELECTRONICS**, PO Box 377940-C, Chicago, IL 60637-7940.

CRYSTAL set Handbook — Visit antiquity by building the radios your grandfather built. Assemble a "Quaker Oats" rig, wind coils that work and make it look like the 1920's! Only \$10.95 plus \$4.00 for shipping and handling. **CLAGGK INC.**, PO Box 4099, Farmingdale, NY 11735. US funds only! USA and Canada — no foreign orders.

SURVEILLANCE/Countersurveillance, bugging/phone tapping detector, telephone/fax encryption, vehicle tracking, covert video, transmitters kit, and more... **A.B. ELECTRONICS**, 1 (800) U-ANTI-BUG.

100 Milliwatt Narrowband (VHF) voice transmitter. Complete plans of this unit that can be built for under \$35.00 in less than one evening! Smaller than a 9V batt. Free info in return for a SASE. This plan has been endorsed by John S. Wilson Jr., America's most famous designer of "electronic surveillance gear". "Read what he has to say about it" in his international newsletter in our free brochure. **D.E. NEWKIRK**, PO Box 17277, N. Little Rock, AR 72117-0277, U.S.A.

**CABLE - TV
NOTCH FILTERS**

- FOR ELIMINATING RF INTERFERENCE
- FOR BLOCKING UNWANTED CHANNELS



- AVAILABLE FOR VHF CHANNELS
Ø THRU 36 AND 95 THRU 99
- PRICING AS LOW AS \$12 EACH

Call or write for a
FREE brochure today!

STAR CIRCUITS

PO. BOX 94917
LAS VEGAS, NV 89193
1-800-535-STAR

CALLER ID!

150 name & number storage; works stand-alone or with your PC via RS232.

Multistation Thermometer Kit: LCD, 4 stations Telephone Dialer Kit: 240 number memory, LCD

Call for kit information! 1-800-772-3945

GENOA Group, 7304 S. Alton Way, Unit A, Englewood CO 80112

**SINGERS! REMOVE
UNLIMITED BACKGROUNDS!**

From Standard Records & CDs with the Thompson Vocal Eliminator™. Call for Free Catalog & Demo Record.
Phone: (404)482-4189 Ext 72
Singer's Supply, Dept RL-1
7987 Hightower Trail
Lithonia, GA 30058
24 Hour Demo/Info Request
Line (404)482-2405 Ext 72
Singer's Supply • We Have Anything & Everything For Singers



LASER light show plans. New, inexpensive, non-computerized. Exotic patterns from music! \$8.95. **TJ TEK**, 9318 S. Steele St., Suite 222, Tacoma, WA 98444.

NIGHT vislon kits complete! US components, easy assembly. Free brochure. **NENVIS**, PO Box 1088, Sturbridge, MA 01566. (508) 347-7238. **Save \$!**

LONG range listening device. Hear sounds one mile away, whispers at 100'. Plans \$3.00, kit \$35.00 includes freight. **D&F CONCEPTS**, 3646 East Ray Rd., #16-42, Phoenix, AZ 85044.

FIBER Optics experimenters parts, supplies and tools: Fiber, cable, connectors, splices, detectors, lasers, kits, plans, newsletter. Send \$2.00 for catalog. **LIGHTLINE ENGINEERING**, PO Box 24, Mullica Hill, NJ 08062.

ALL-IN-ONE CATALOG. AM/FM/HAM/SPY, transmitters, amplifiers, receivers, voice scramblers/disguisers. Audio, TV, Tesla Coils, plans, "secret" books, kits, imports, exports and more. Start your own licensed or unlicensed radio station, 60 full pages for \$1.00. **PAN-COM INTERNATIONAL**, PO Box 130-F8, Paradise, CA 95967.

INVENTIONS

FREE invention package: **DAVISON AND ASSOCIATES** offers customized development, patenting, and licensing of new products and ideas. Proven results: 1 (800) 677-6382.

Parts Express™

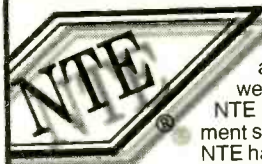

Parts Express is proud to

announce that we now stock the NTE line of replacement semiconductors. NTE has been

supplying the electronics industry with top notch replacement parts for over 15 years. All NTE products meet or exceed industry specifications and offer an exclusive 2 year manufacturer warranty.

We also offer a complete line of parts for the service repair industry. Test equipment, loudspeakers, video and audio heads, magnetrons, belts, idler assemblies, tools, soldering equipment, just to name some of the 12,000 items we stock. Ask about our new dealer program for resellers. Call toll free for a copy of our **FREE 212** page catalog. **Source Code: ENM**



**CALL TOLL FREE
1-800-338-0531**

Parts Express 340 E First St, Dayton, Ohio 45402-1257
Phone: 513-222-0173 Fax: 513-222-4644

CIRCLE 56 ON FREE INFORMATION CARD

CABLE TV DESCRAMBLERS

- Quantity Discounts • 24 Hour Shipping
- Save Money Don't Rent

NOBODY BEATS OUR PRICE

Call Us Last For Best Price

1-800-677-0321

Anyone implying theft of service will be denied service
VCI - NO FLORIDA SALES

ANTIQUE RADIO CLASSIFIED

Free Sample!

Antique Radio's
Largest Circulation Monthly.
Articles, Ads & Classifieds.



6-Month Trial: \$17.95. 1-Yr: \$34.95 (\$51.95-1st Class).

A.R.C., P.O. Box 802-L15, Carlisle, MA 01741

Phone:(508) 371-0512 VISA/MC Fax:(508) 371-7129

ELECTRONICS DESIGN AIDS

Electronic Drawing Design Aids

Over 400 stickers used in schematic diagrams, standard TTL logic devices, resistors, capacitors, semiconductors, and many other electronic symbols.

Circuit Board Design Kits

Learn how you can design and make your own zopper clad circuit boards.

Include \$4.50 Shipping & Handling **\$9.98** per kit, as well as applicable sales tax.

RoboTron mini-tronics Box 73012 #206, 2525

Woodview Dr. SW Calgary, AB Canada T2W-6E4



BUY BONDS

ALL ELECTRONICS

FAST SERVICE • DISCOUNT PRICES

640 X 480 LCD PANELS WITH BUILT-IN DIGITIZ-

Originally designed for laptop computer/note pad. Built-in digitizer to be used with a stylus (not included) for hand written notations. Onboard drivers. Operates on 5 vdc (logic) and 18 vdc (LCD). Full documentation included.

SHARP LM64P90

Built-in CCFT backlight.

Overall dimensions: 10.19" X 7" X 0.35"

Viewing area: 7.88" X 6"

Dot size:

0.27mm X 0.27mm. White dots on black background.

CAT # LCD-31

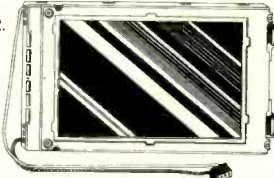

\$40⁰⁰ each

ULTRASONIC TRANSDUCER SET



Murata-Erie # MA40A3R & MA40A3S 40 Khz transmitter and receiver, matched pair. Band width: 4K Hz.+. Ideal for remote control systems, burglar alarms, flow rate detectors, etc.

0.64" diameter X 0.47" high.

CAT# UST-40

\$2⁵⁰ per pair



30" "SNAKE" CABLE

A GREAT DEAL!



Originally made to connect Digital Audio Tape machine to a remote controller, this "snake" cable consists of four separate 9 conductor plus drain wire, foil-shielded cables in one jacket. The conductors are stranded 24 AWG wire. Each end of each smaller cable is terminated with DB-9P connectors. The cable is well-made and quite flexible for its size. Snake cable nominal O.D. is 0.52". Interior cable O.D. is 0.15". The outer jacket can be slit and removed if only the 9 conductor cable is required. DB-9 connectors include thumb-screw hold-downs. If you are using multiconductor shielded cable this is a great deal.

\$5⁵⁰ each

CAT# CBL-3

2 for \$10.00

ORDER TOLL FREE

1-800-826-5432

CHARGE ORDERS to Visa, Mastercard or Discover

TERMS: NO MINIMUM ORDER. Shipping and handling for the 48 continental U.S.A. \$5.00 per order. All others including AK, HI, PR or Canada must pay full shipping. All orders delivered in CALIFORNIA must include local state sales tax. Quantities Limited. NO COD. Prices subject to change without notice.

CALL, WRITE or FAX for a FREE 64 Page CATALOG Outside the U.S.A. send \$2.00 postage.

MAIL ORDERS TO:
ALL ELECTRONICS CORPORATION
P.O. Box 567
Van Nuys, CA 91408
FAX (818)781-2653

ADVERTISING INDEX

Electronics Now does not assume any responsibility for errors that may appear in the index below.

Free Information Number	Page
— Akizuki Denshi Tsusho Ltd.	17
107 All Electronics	94
190 Best Proto	79
109 C&S Sales	CV3
186 Cable Warehouse	81
— CLAGGK Inc.	79
— Cleveland Institute of Elec.	7, 15
— Command Productions	17
58 Cook's Institute of Elec. Eng.	27
193 Davis Instruments	68
— Electronics Tech. Today	9, 83
121 Fluke Corporation	CV2
191 Foley-Belsaw Company	23
— Grantham College	10
— Information Unlimited	27
126 Interactive Image Technologies	1
114 Jameco	91
— Mainstar Industries Ltd.	19
93 Mark V Electronics	90
192 Mini-Circuits	CV4
117 Mouser Electronics	23
182 National Electronic Wholesalers 19	
— NRI Schools	31
56 Parts Express Inc.	93
— Tab Books	25, 44
92 Tektronix, Inc.	5
— Tektronix, Inc.	28
98 Wavetek Corp.	11
— Xandi Electronics	81

Gernsback Publications, Inc.
500-B Bi-County Blvd.
Farmingdale, NY 11735
1-(516) 293-3000
Larry Steckler, EHF/CET
President

Christina Estrada
assistant to the President

For Advertising ONLY
516-293-3000
Fax 1-516-293-3115

Larry Steckler
publisher

Arline Fishman
advertising director

Denise Mullen
advertising assistant

Kelly Twist
credit manager

Subscriber Customer Service
1-800-288-0652

Order Entry for New Subscribers
1-800-999-7139
7:00 AM - 6:00 PM M-F MST

ADVERTISING SALES OFFICES

EAST/SOUTHEAST

Stanley Levitan
Eastern Advertising
1 Overlook Ave.
Great Neck, NY 11021
1-516-487-9357
Fax 1-516-487-8402

MIDWEST/Texas/Arkansas/Okla.

Ralph Bergen
Midwest Advertising
One Northfield Plaza, Suite 300
Northfield, IL 60093-1214
1-708-446-1444
Fax 1-708-559-0562

PACIFIC COAST

Blake Murphy
Pacific Advertising
Hutch Looney & Associates, Inc.
6310 San Vicente Blvd.
Suite 360
Los Angeles, CA 90048
1-213-931-3444
Fax 1-213-931-7309

Electronic Shopper

Joe Shere
National Representative
P.O. Box 169
Idyllwild, CA 92549
1-909-659-9743
Fax 1-909-659-2469

CALL TOLL FREE
1-800-292-7711
1-800-445-3201 (Can)

C&S SALES

EXCELLENCE IN SERVICE

**CALL FOR
FREE CATALOG**



**Line Tracker
MV-963**
\$52.95
(Infra-red Sensor)
The robot follows
a black line
on white paper.
Preassembled PCB



**Dual-Display
LCR Meter
w/ Stat Functions
B+K Model 878**
\$239.95
Auto/manual range
Many features
with Q factor
High Accuracy

Electronic Tool Kit Model TK-1000
A professional organizer tool kit at affordable prices. No student should be without this unique tool kit that holds all the tools you need.

- Including:
Diagonal Cutter
Long Nose Pliers
6" Wire Stripper
Solder 60/40
6" Screwdriver
6" Phillips Driver
Safety Goggles
IC Puller
3pc Nut Drivers
Iron 25W
Iron Stand
Solder Wick
Desoldering Pump
5 pc Solder Ease Kit
6pc Precision Screwdrivers



\$39.95



**Robotic Arm
Y-01**
\$49.95
(Wired Control)
Movement grabs
& releases,
lifts & lowers,
pivots from side to side



**Stereo Cassette Player
Kit
Model
TR-18K**
\$16.95
Headphones
Included



**Digital
Multimeter
EDM-83B**
\$175.00
Almost every
feature available
Bargain of the decade



**Elenco
LCR + DMM
LCM-1950**
\$79
12 Functions
Freq to 4MHz
Inductance
Capacitance



**Digital
Capacitance
Meter
CM-1555**
\$49.95
Measures capacitors
from .1pf to 20,000µf



**Digital
LCR Meter
LCR-680**
\$79.95
3-1/2 Digit
LCD Display
Inductance
1uH to 20MΩ



**Function Generator
GF-8026**
\$239
Int/Ext
Operation
Sine, Square, Triangle, Pulse
Ramp, .2 to 2MHz, Freq Ctr



**3-3/4 Digit Multimeter
BK-390**
\$139.00
0.1% DCV accy
Analog bar graph
Auto/manual ranging
Capacitance meas
Temperature probe



**Digital
Multimeter Kit
w/ Training Course
M-2665K**
\$49.95
Full function 34 ranges
Ideal school project
M-2661 (Assembled) \$55.00



**Frequency Counter
F-1225**
\$225.00
8 Digit LED display
Wide meas range
High sensitivity
Data hold function
Input impedance 1MΩ or 50Ω
10:1 input attenuation function

**Fluke Multimeters
(All Models Available Call)**
Scopemeters
70 Series
Model 97 \$1,795
Model 7011 \$69.95
Model 7311 \$97.50
Model 10 \$62.95
Model 7711 \$149
Model 12 \$84.95
Model 7911 \$175
20 Series
80 Series
Model 2911 \$175
Model 87 \$289



**Triple Power
Supply
XP-620**
By Elenco
\$75.00
3 fully regulated supplies: 1.5-15V @ 1A, -1.5 to -15V @ 1A or 3-30V @ 1A & 5V @ 3A Kit XP-620K \$49.95



**Quad Power
Supply
XP-581**
By Elenco
\$79.95
Four supplies in one unit: 2-20V @ 2.5A, 5V @ 3A, -5V @ 5A and 12V @ 1A. All regulated and short protected



**High Current DC
Power Supply
BK-1686** **\$169.95**
3 to 14 VDC Output
12A @ 13.8V
For servicing high
power car stereos,
camcorders, ham radios, etc.
Connect 2 or more in parallel

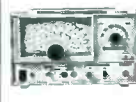

**Wide Band
Signal
Generators
SG-9000**
\$124.95
RF Frequency 100K-450MHz
AM modulation of 1KHz Variable
SG-9500 150MHz \$239.00

**Telephone Kit
PT-223K**
\$14.95



Available
Assembled
PT-223
\$15.95

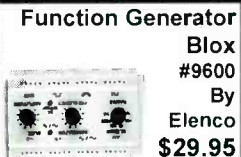

**Function Generator
Blox
#9600**
By
Elenco
\$29.95
Kit \$26.95
Sine, Triangle, Square Wave

**Learn to Build & Program
Computers with this Kit**

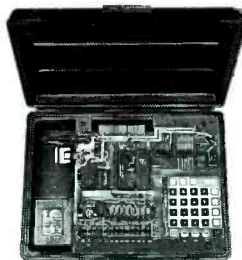

From scratch you build a complete system. Our Micro-Master trainer teaches you to write into RAMs, ROMs and run a 8085 microprocessor, which uses similar machine language as IBM PC.

MM-8000
By Elenco
\$129.00

Digital/Analog Trainer
Complete Mini-Lab For Building,
Testing, Prototyping Analog and Digital



By Elenco
in U.S.A.

XK-525
\$159.95
Kit
XK-525K
\$129.95

**AM/FM Transistor
Radio Kit
with Training Course
Model AM/FM 108**
\$29.95

14 Transistor, 5 Diodes
Easy to build because
schematic is printed on the PCB
Makes a great school project
Model AM-550 AM Only \$17.95



**Telephone Line
Analyzer**
Kit TT-400K \$19.95
Assembled TT-400 \$26.95

WE WILL NOT BE UNDERSOLD
UPS SHIPPING: 48 STATES 5%
IL RES 7.5% TAX (\$3 min \$10 max)
OTHERS CALL

C&S SALES INC.
1245 ROSEWOOD, DEERFIELD, IL 60015
FAX: 708-520-0085 (708) 541-0710



**15 DAY MONEY BACK
GUARANTEE**
FULL FACTORY WARRANTY
PRICES SUBJECT TO CHANGE WITHOUT NOTICE

CIRCLE 109 ON FREE INFORMATION CARD

DC-2000 MHz AMPLIFIERS



99¢

In plastic and ceramic packages, for low-cost solutions to dozens of application requirements, select Mini-Circuits surface mount or flatpack wide-band monolithic amplifiers. For example, cascade three MAR-2 monolithic amplifiers and end up with a 25dB gain, 0.3 to 2000MHz amplifier for less than \$4.50. Design values and circuit board layout available on request.

It's just as easy to create an amplifier that meets other specific needs, whether it be low noise, high gain, or medium power. Select from our wide assortment of models (see chart), sketch a simple interconnect layout, and the design is done. Each model is characterized with S parameter data included in our 740 page RF/IF Designer's Handbook or available from our applications department.

All Mini-Circuits amplifiers feature tight unit-to-unit repeatability, high reliability, a one year guarantee, tape and reel packaging for SMD, off-the-shelf availability, with prices starting at only 99¢.

Mini-Circuits monolithic amplifiers...for innovative do-it-yourself problem solvers.

Mini-Circuits...we're redefining what VALUE is all about!

DESIGNER'S KIT, KH-1 available only \$59.95 includes:
40 AMPLIFIERS* 10 MAR-1, 10 MAR-3, 10 MAR-4, 10 MAR-8
150 CAPACITORS* 50 100pf, 50 1,000pf, 50 10,000pf
740 page RF/IF DESIGNER'S HANDBOOK

MIXERS • POWER SPLITTER/COMBINERS • AMPLIFIERS
 ELECTRONIC ATTENUATORS • I&Q/QPSK MODULATORS
 ATTENUATORS/TERMINATIONS • DIRECTIONAL COUPLERS
 RF TRANSFORMERS • DIGITAL ATTENUATORS
 LIMITERS • PHASE DETECTORS • FILTERS
 SWITCHES/DRIVERS • FREQUENCY DOUBLERS

* Values or models may be substituted without notice, depending on supplies.

Typical Circuit Arrangement

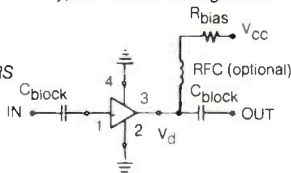

finding new ways...
 setting higher standards

from 99¢ ea. (qty. 50)

MODEL	Freq. (MHz) DC TO	GAIN (Typ. dB) At 100MHz	MAX. Power (@ 1dB Compr.) dBm	NF dB (Typ.)	Price \$ea. (Qty. 50)
MAR	MAR-1	1000	18.5	1.5	.99
	MAR-2	2000	12.5	4.5	1.35
	MAR-3	2000	12.5	10.0	1.45
	MAR-4	1000	8.3	12.5	1.55
MAR SM	MAR-6	2000	20.0	2.0	3.0 1.29
	MAR-7	2000	13.5	5.5	5.0 1.75
	MAR-8	1000	32.5	12.5	3.3 1.70
RAM	RAM-1	1000	19.0	1.5	5.5 *6.40
	RAM-2	2000	12.5	4.5	6.5 *6.40
	RAM-3	2000	12.5	10.0	6.0 *6.40
	RAM-4	1000	8.5	12.5	6.5 *6.40
	RAM-6	2000	20.0	2.0	2.8 *6.40
	RAM-7	2000	13.5	5.5	4.5 *6.40
	RAM-8	1000	32.5	12.5	3.0 *6.40
MAV	MAV-1	1000	18.5	1.5	5.5 1.10
	MAV-2	1500	12.5	4.5	6.5 1.40
	MAV-3	1500	12.5	10.0	6.0 1.50
	MAV-4	1000	8.3	11.5	7.0 1.60
MAV SM	MAV-5SM	50-1500	8.0	18.0	6.5 2.07
	MAV-11	10-1000	12.7	17.5	3.6 2.10
VAM	VAM-3	2000	11.5	9.0	6.0 1.45
	VAM-6	2000	19.5	2.0	3.0 1.29
	VAM-7	2000	13.0	5.5	5.0 1.75

*Qty. 10

MAR & MAV MODELS: Plastic flat pack...for surface mount, add SM suffix to model number and 5¢ to price. Example: MAR-2SM...\$1.40.
 MAV-5SM available plastic surface mount only.

RAM MODELS: Ceramic surface mount.

VAM MODELS: Plastic surface mount.

Mini-Circuits™

P.O. Box 350166, Brooklyn, New York 11235-0003 (718) 934-4500 Fax (718) 332-4661
 WE ACCEPT AMERICAN EXPRESS AND VISA

Distribution Centers / NORTH AMERICA 800-654-7949 • 417-335-5935 Fax 417-335-5945 EUROPE 44-252-835094 Fax 44-252-837010

CIRCLE 192 ON FREE INFORMATION CARD

www.americanradiohistory.com