

# Radio Electronics®

SEPTEMBER 1992

## BUILD THIS DSP VOICE-EFFECTS BOARD

Combined  
with **Electronics  
NOW®**

Use digital  
signal  
processing  
technology  
to change  
your voice  
or create  
fun effects!

## THE SLOPING VEE ANTENNA

The perfect  
home-built  
antenna for hams  
and shortwave  
enthusiasts!

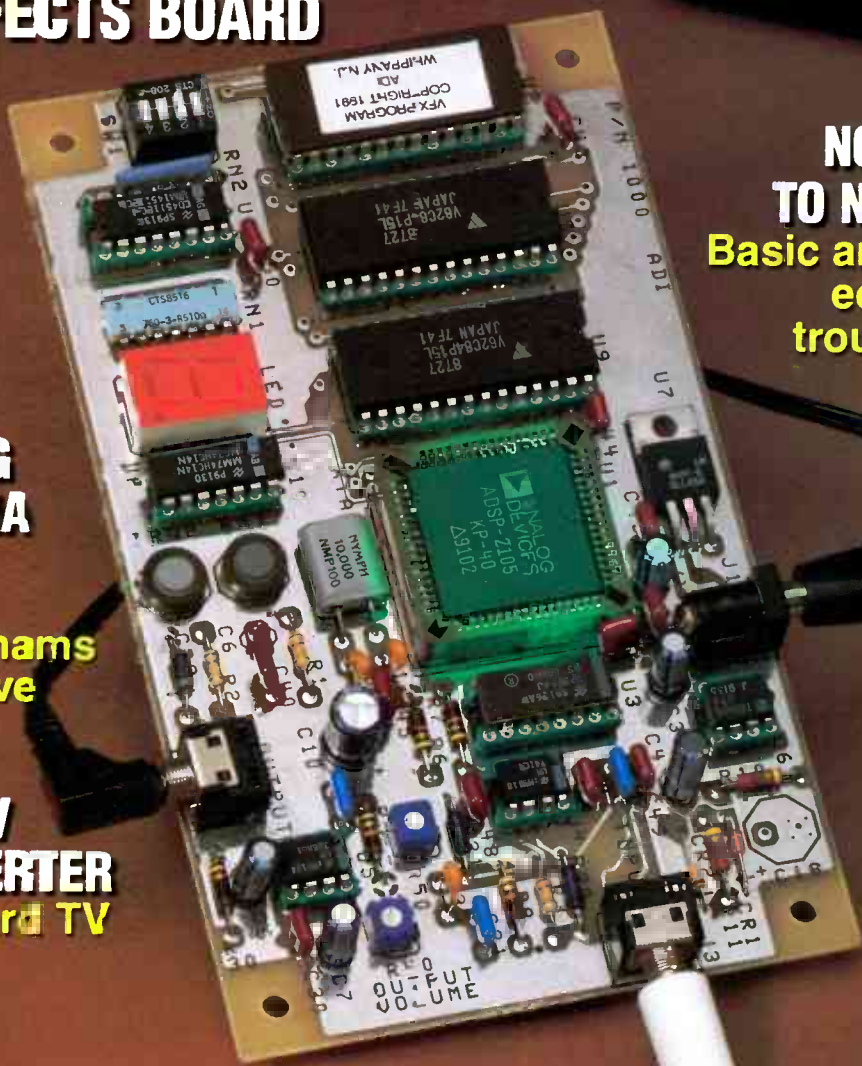
## AMATEUR TV DOWNCONVERTER

Use a standard TV  
to view  
ATV signals

## CIRCUIT COOKBOOK

Learn—or re-learn—how to use  
the 555 timer

**NOT WORKING  
TO NETWORKING**  
Basic and advanced  
equipment for  
troubleshooting  
LAN's



\$3.50 U.S.  
\$3.95 CAN

A  
**GERMSBACK**  
PUBLICATION

\*\*\*\*\* CAR-RT SORT \*\* CR24  
390736DHMD997G093 09 70  
JAN 94  
MR ROBERT DAHM RB  
997 GRAND AV  
AURORA, IL 60506

# We Only Skimped On The Price.

## Introducing The Fluke Series 10—From \$69.<sup>95</sup>

**Fluke quality:** Made in the USA by Fluke, with the same rugged reliability that's made us the world leader in digital multimeters. Count on hard-working high performance—and a two-year warranty to back it up.

**Large, easy-to-read display:** 4000 count digital readout.

**Actual size:** Easy to carry, easy to use.

**New! V Chek™:** For fast accurate checks on power sources and supplies, set your meter on V Chek—and let it do the rest. V Chek will determine continuity/ohms; if voltage is present, it will automatically change modes to measure AC or DC volts, whichever is detected. For most initial troubleshooting checks, here's the only setting you need to make.

**New! Min/Max record with relative time stamp and Continuity Capture™:** Makes intermittent problems easier to find. Records highs and lows—and "time stamps" when they occurred. In continuity mode, opens or shorts as brief as 250  $\mu$ s are captured and displayed.

**Capacitance:** Autoranging from .001  $\mu$ F to 9999  $\mu$ F. No need to carry a dedicated capacitance meter.

**Autoranging with manual option:** Your choice, depending on your situation.

**Sleep Mode:** Shuts itself off if you forget, extending long battery life even further.

**New! Slide switch and a few pushbuttons control all functions:** Designed for true one-hand operation.

**Fast, accurate tests and measurements:** AC and DC voltage measurements to 600 volts, ohms to 40 M $\Omega$ ; audible continuity test; and diode test.

**For high performance at Fluke's lowest price, get your hands on the new Series 10.** Stop by your local Fluke distributor and feel what a powerful difference the right multimeter makes—at the right price. For a free product brochure or the name of your nearest distributor, call 1-800-87-FLUKE.

Fluke 10	Fluke 11	Fluke 12
\$69.95*	\$79.95*	\$89.95*
4000 count digital display	V Chek™	V Chek™
1.5% basic dc volts accuracy	Capacitance, .001 to 9999 $\mu$ F	Min/Max recording with relative time stamp
2.9% basic ac volts accuracy	4000 count digital display	Continuity Capture™
1.5% basic ohms accuracy	0.9% basic dc volts accuracy	Capacitance, .001 to 9999 $\mu$ F
Fast continuity beeper	1.9% basic ac volts accuracy	4000 count digital display
Diode Test	0.9% basic ohms accuracy	0.9% basic dc volts accuracy
Sleep Mode	Fast continuity beeper	1.9% basic ac volts accuracy
Two-year warranty	Diode Test	0.9% basic ohms accuracy
	Sleep Mode	Fast continuity beeper
	Two-year warranty	Diode Test
		Sleep Mode
		Two-year warranty

\* Suggested U.S. list price.

Optional holster with tilt-stand available.



### The New Series 10. A Small Price For A Fluke.

FLUKE AND PHILIPS  
THE T & M ALLIANCE

©1991 John Fluke Mfg. Co., Inc. Prices and specifications subject to change. Ad no. 00130.

# FLUKE®

CIRCLE 121 ON FREE INFORMATION CARD





## ON THE COVER



One of the latest electronic buzzwords is "digital signal processing" or DSP. We're not surprised to hear so much talk about it. DSP is being used in everything from compact disc players, to weather satellites, to the retrieval of photographs from NASA space missions. If you're curious about DSP technology, turn to page 37. Our VFX Digital Processors lets you take a hands-on approach to an exciting new technology, and have some fun while you're at it. The VFX (voice effects) processor uses DSP techniques to alter the pitch of your voice, or to produce reverb and echo effects. It's much less expensive than any commercially available DSP product, and you'll learn about the technology as you build and use it.

## COMING NEXT MONTH

### THE OCTOBER ISSUE GOES ON SALE SEPTEMBER 3.

#### **BUILD A HIGH-EFFICIENCY FM HANDI-TALKIE**

This small, light-weight transceiver is powerful and efficient, offers narrow-band FM modulation and can be designed to operate anywhere from 27 to 32 MHz.

#### **BUILD A 60-Hz POWER INVERTER**

It will provide over 200 watts to your line-powered devices.

#### **DESIGNING HIGH-POWER, LOW-DISTORTION AMPLIFIERS**

Real-world applications from a simple 20-watt composite amplifier to a 70-watt bridge amp.

#### **DIFFERENTIAL TEST PROBES**

How and why to use a differential probe.

As a service to readers, ELECTRONICS NOW publishes available plans or information relating to newsworthy products, techniques and scientific and technological developments. Because of possible variances in the quality and condition of materials and workmanship used by readers, ELECTRONICS NOW disclaims any responsibility for the safe and proper functioning of reader-built projects based upon or from plans or information published in this magazine.

Since some of the equipment and circuitry described in ELECTRONICS NOW may relate to or be covered by U.S. patents, ELECTRONICS NOW disclaims any liability for the infringement of such patents by the making, using, or selling of any such equipment or circuitry, and suggests that anyone interested in such projects consult a patent attorney.

ELECTRONICS NOW, (ISSN 0033-7862) September 1992. Published monthly by Gernsback Publications, Inc., 500-B Bi-County Boulevard, Farmingdale, NY 11735. Second-Class Postage paid at Farmingdale, NY and additional mailing offices. Second-Class mail registration No. R125166280, authorized at Toronto, Canada. One-year subscription rate U.S.A. and possessions \$19.97. Canada \$27.79 (includes G.S.T. Canadian Goods and Services Tax Registration No. R125166280), all other countries \$28.97. All subscription orders payable in U.S.A. funds only, via international postal money order or check drawn on a U.S.A. bank. Single copies \$2.95. © 1992 by Gernsback Publications, Inc. All rights reserved. Printed in U.S.A.

POSTMASTER: Please send address changes to ELECTRONICS NOW, Subscription Dept., Box 55115, Boulder, CO 80321-5115.

A stamped self-addressed envelope must accompany all submitted manuscripts and/or artwork or photographs if their return is desired should they be rejected. We disclaim any responsibility for the loss or damage of manuscripts and/or artwork or photographs while in our possession or otherwise.

# Electronics NOW®

Hugo Gernsback (1884-1967) founder

Larry Steckler, EHF, CET,  
editor-in-chief and publisher

#### EDITORIAL DEPARTMENT

Brian C. Fenton, editor  
Marc Spiwak, associate editor  
Neil Sclater, associate editor  
Tori Scaduto, assistant editor  
Jeffrey K. Holtzman  
computer editor  
Robert Grossblatt, circuits editor  
Larry Klein, audio editor  
David Lachenbruch  
contributing editor  
Don Lancaster  
contributing editor  
Kathy Terenzi, editorial assistant

#### ART DEPARTMENT

Andre Duzant, art director  
Injae Lee, illustrator  
Russell C. Truelson, illustrator

#### PRODUCTION DEPARTMENT

Ruby M. Yee, production director  
Karen S. Brown  
advertising production  
Marcella Amoroso  
production assistant  
Lisa Rachowitz  
editorial production

#### CIRCULATION DEPARTMENT

Jacqueline P. Cheeseboro  
circulation director  
Wendy Alanko  
circulation analyst  
Theresa Lombardo  
circulation assistant  
Michele Torrillo,  
reprint bookstore

Typography by Mates Graphics  
Cover photo by Diversified Photo  
Services

Electronics Now is indexed in  
*Applied Science & Technology Index*  
and *Readers Guide to Periodical Literature*.

Microfilm & Microfiche editions are  
available. Contact circulation department  
for details.

Advertising Sales Offices listed  
on page 102.

Electronics Now Executive and  
Administrative Offices  
1-516-293-3000.

Subscriber Customer Service:  
1-800-288-0652.

Order Entry for New Subscribers:  
1-800-999-7139.

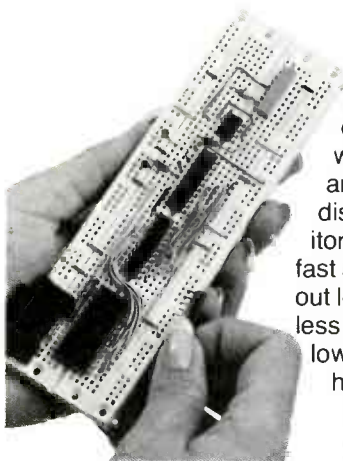


Audit Bureau  
of Circulations  
Member



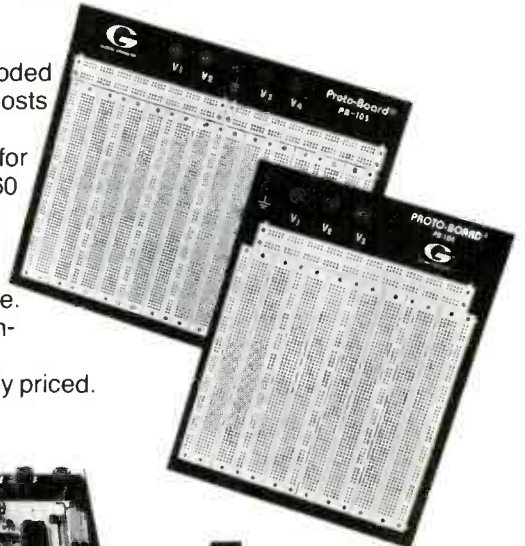


# 5 WAYS TO STOP WASTING TIME IN ELECTRONICS.



**Stop wasting your time soldering.** Save hours of soldering, desoldering, resoldering with Quick Test™ sockets and bus strips. Connect/disconnect resistors, capacitors, transistors, ICs, etc. as fast as you can push in/pull out leads. Interlock for limitless expandability. Priced as low as \$1.60, you'll wonder how you've done without them!

5-color coded binding posts and 17 sockets, for over 4,560 contact points. Lifetime guarantee. American-made. Affordably priced.



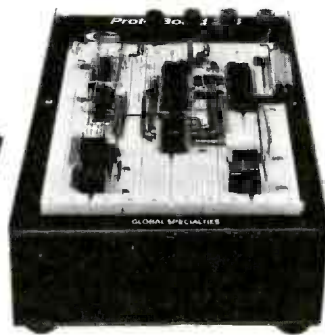
## 2. Stop wasting your time breadboarding.

Here are three popular PROTO BOARD® Brand solderless breadboarding systems that meet any budget or time schedule. First the diminutive PB-10's 840 contact points and 3-color binding posts. PB-102 has 1,240 tie points, accepting up to 12 16-pin ICs. Finally, PB-103, with 2,250 contact points, and up to 24 16-pin capacity. They're affordable, American-made, lifetime guaranteed. You'll soon see why PROTO BOARD Brand is Today's Standard for Quality in Breadboarding.



## 4. Stop wasting your time plugging-in external power.

We've added the power to the breadboard. And, what power! Up to triple voltage power, +5V, +12V, -12V, regulated/current limited and DC. Up to 2,250 tie points, with 24 IC capacity and 14 pin DIPs. Now you can create, test and modify TTL, CMOS, Op-Amps and even microprocessor circuits. Plus, there is the standard Global Lifetime Guarantee on the sockets. And, wait 'til you see the modest prices!



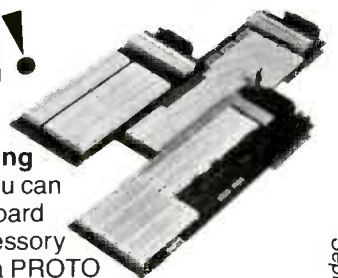
## 3. Stop wasting your time jury-rigging

**large numbers of circuits.** Here are two oversized PROTO BOARDS Brand, with expanded area, tie points, and more to keep your ideas together. PB-104 features 3,060 tie points, which can handle to 32 16-pin ICs with ease. Four color coded binding posts, and roomy 9.2" x 8" metal panel make it big...but simple. The humungous PB-105 lets you load up to 48 16-pin ICs, and much more onto its



## 5. NEW!

**Stop wasting time designing computer circuits.** Now you can use your solderless breadboard concepts for designing accessory circuits. PROTCARD® is a PROTO BOARD Brand which fits any standard slot in your IBM, PC/XT or PC/AT computer. Some modules even include built-in basic decoder circuits for memory and I/O addressing. Breadboard areas up to 3,360 contact points. Buffered versions eliminate loading of pc buses.



Call toll-free for details  
**1-800-572-1028**

**GLOBAL SPECIALTIES**

CIRCLE 188 ON FREE INFORMATION CARD

*Easy does it!™*

Global Specialties. An Interplex Electronics Company.  
70 Fulton Terrace. New Haven, CT 06512.  
Telephone: (203) 624-3103. © Interplex Electronics 1989.  
All Global Specialties breadboarding products made in USA.

# EDITORIAL

## NOW'S THE TIME

*Now*, according to Webster's New World Dictionary, means "at the present time; at this moment." **Electronics Now** is just what its name implies: a compilation of what is happening in electronics at this moment!

**Electronics Now** brings you the latest news, the newest products, the most useful training, the most exciting projects, the newest how-to information. We help you learn how it works, how to keep it working, and, of course, how to make your own. We even show you what may happen tomorrow.

Above all else, we remain *your* electronics magazine. We know that the great majority (89%) of you earn your living in electronics. But you are the engineers and technicians to whom being an electronics professional is more than just a job. In your spare time—your leisure time—your personal time—you still want to know and learn more about electronics.

You want to know how Caller ID works. You want to know how digital audio tape compares to digital compact cassettes. You need to know about cellular telephone services and the personal communication networks of tomorrow. You need to know what microprocessor your next computer will have. You have to know what the next generation IC's will be like.

Bringing you information on those and other subjects is our forte. We work and strive to stay on top, to learn, to explore, and follow late-breaking developments in electronics. And we do it *now!* That's where our new name—**Electronics Now**—comes from. That's what we bring to you —today and tomorrow—  
**Electronics Now!**

Stay with us as we evolve and grow to meet the ever growing challenge of the electronics revolution. Stay with us as we continue our quest for the most exciting, most revolutionary, and most daring developments of today and tomorrow. Become, through our pages, a part of the most important and influential segment of our modern world. Come with us as we become **Electronics Now**.



Larry Steckler, EHF/CET  
Editor-in-Chief and Publisher

# Take this GIANT Handbook for only \$9.95

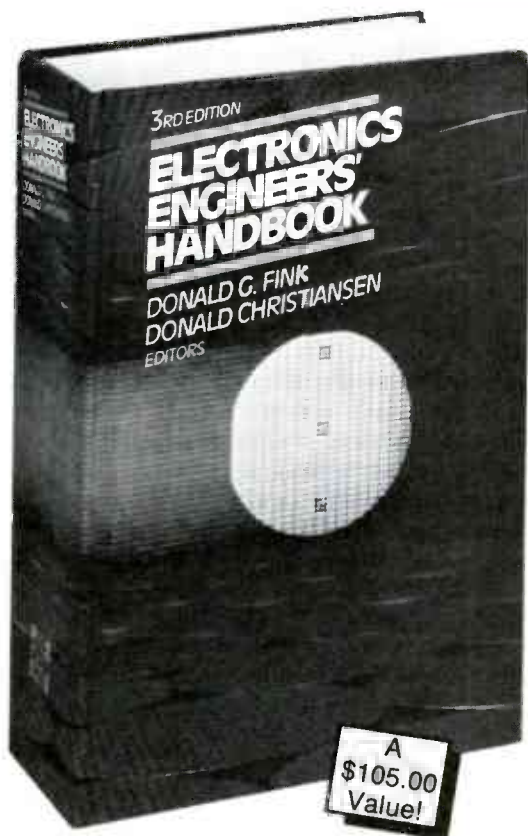
when you join the *Electronics Engineers' Book Club*

## ELECTRONICS ENGINEERS' HANDBOOK, Third Edition

Edited by D.G. Fink  
and D. Christiansen

Completely revised, expanded, and updated, this third edition of the desktop reference is widely considered the definitive work in its field, covering all aspects of today's electronics engineering. Written and compiled by more than 170 experts, this giant handbook shows you how to use the latest design and cost-cutting solutions at work in the industry today. You'll find a wealth of new material on electronic systems design, computer systems and digital recording, telecommunications, process control, laser technology, and CAD of electronic circuits. It deals with the full range of theory and practice, covering essential principles, data, devices, components, assemblies, circuits, functions, and applications.

2,624 pages 1,800 illustrations **Book No. 9255H Hardcover**



If coupon is missing, write to: Electronics Engineers' Book Club, Blue Ridge Summit, PA 17294-0860

### As a member of the Electronics Engineers' Book Club . . .

. . . you'll enjoy receiving Club bulletins every 3-4 weeks containing exciting offers on the latest books in the field at savings of up to 50% off of regular publishers' prices. If you want the Main Selection do nothing and it will be shipped automatically. If you want another book, or no book at all, simply return the reply form to us by the date specified. You'll always have at least 10 days to decide. Your only obligation is to purchase 3 more books during the next 2 years, after which you may cancel your membership at any time.

Publishers' prices shown. ©1992 EEBC

## ELECTRONICS ENGINEERS'

BOOK CLUB

Blue Ridge Summit, PA 17294-0860

**YES!** Please send me *Electronics Engineers' Handbook, 3rd Ed.* (9255H), billing me \$9.95 plus shipping/handling & tax. Enroll me as a member of the **Electronics Engineers' Book Club** according to the terms outlined in this ad. If not satisfied, I may return the book within 10 days and have my membership cancelled. A shipping/handling charge & sales tax will be added to all orders.

Name \_\_\_\_\_

Address \_\_\_\_\_

City/State \_\_\_\_\_

Zip \_\_\_\_\_ Phone \_\_\_\_\_

Valid for new members only, subject to acceptance by EEBC. Canada *must* remit in U.S. funds. Applicants outside the U.S. and Canada will receive special ordering instructions. RPIF992



# WHAT'S NEWS

*A review of the latest happenings in electronics.*

## World's smallest hard-disk drive

Hewlett-Packard Company introduced the world's smallest hard-disk drive in June. Its 1.3-inch Kittyhawk Personal Storage Module can store up to 21.4 megabytes of data (formatted). The introduction of the matchbox-size drive by HP, not known for its expertise in that technology, seems to assure continued life for rotating disk memories. HP's development makes it highly unlikely that disk drives will be driven out of the market by semiconductor memory modules in the foreseeable future.

The drive was developed for palmtop, pen-based and sub notebook-size computers whose manufacturers are continually seeking component size, weight, and power reductions. The disk drive package measures 0.4 inch × 2 inches × 1.44 inches, and it weighs about one ounce. The platters rotate at 5400 rpm, and average seek time is less than 18 milliseconds.

HP says the drive—which will be priced at \$250 in high volume—is far more resistant to shock than the 1.8-inch and 2.4-inch drives now available. In addition to applications in existing products, HP predicts that Kittyhawk will find a place in such future products as printers, fax machines, medical equipment, communications gear, and digital imagers. Company officials even see a place for it in consumer video-game cartridges and as data storage media for cellular telephones and digital copiers.

The sub-mini disk drive was developed in cooperation with several companies including AT&T Microelectronics (Berkeley Heights, NJ) and Citizen Watch Co., Ltd., of Japan. Working with AT&T Microelectronics, HP was able to reduce the 20 to 30 IC's typical of most of today's 1.8- and 2.5-inch drives to just seven.

According to HP, the cost of semiconductor memory equivalent



**HEWLETT-PACKARD'S 1.3-INCH DRIVE shown here actual size.**

to the capacity of the Kittyhawk is about five times the price of the drive—and that is before the learning curve price reductions have taken effect. Twenty megabytes of semiconductor memory now has an OEM price of about \$1000 (\$50 per Mbyte); by comparison, at Kittyhawk's present OEM prices, the cost of memory is \$12 per Mbyte.

The drive module stores data like a standard Winchester drive, and it connects with a Personal Computer Memory Card International Association (PCMCIA) or standard AT interface. The 21.4-Mbyte drive has two platters and three heads. The modules contain a sensor that detects impact and causes them to shift to a self-protective mode to preserve data.

## Advanced MRI technique

Advanced magnetic resonance imaging (MRI) now permits the measurement of the flexibility of blood vessels, a key predictor of heart disease. Scientists at GE Research and Development Center (Schenectady, NY), working closely with researchers from the Imperial College of Science, Technology, and Medicine (London, U.K.), have developed a non-invasive technique

based on MRI technology that simultaneously determines blood-flow velocities at different points along a blood vessel.

The measurements obtained can then be used to calculate the speed at which a pressure pulse travels away from the heart and down a vessel after the heart contracts. Those wave propagation speeds permit the computation of vessel-wall flexibility, a factor in the determination of the presence of diseases such as atherosclerosis.

GE's MRI technique is expected to be able to follow changes in blood-vessel flexibility as people age or as diseases develop. Because it relies on MRI angiography, there is no need to insert a pressure transducer on the end of a catheter that must be snaked through the arteries, a potentially dangerous invasive process.



**A BLOOD-FLOW VELOCITY measurement made with an MRI imaging technique is studied by GE scientists Charles Dumoulin and Robert Darrow.**

In MRI inspection of internal organs and tissues is done with a combination of powerful magnetic field, radio-frequency emissions and computer computation. A superconducting magnet within the barrel-shaped MRI equipment can produce a 1.5 Tesla field within its one-meter bore where the patient is located.

The patient within the bore is  
*continued on page 21*



**48 HOUR SHIPPING**

# ELENCO & HITACHI PRODUCTS AT DISCOUNT PRICES

**TO ORDER CALL TOLL FREE 1-800-292-7711 1-800-445-3201 (Can.)**

## Hitachi RSO Series

- (Portable Real-time Digital Storage Oscilloscopes)
- VC-6023 - 20MHz, 20MS/s \$1,695
  - VC-6024 - 50MHz, 20MS/s \$1,995
  - VC-6025 - 50MHz, 20MS/s \$2,195
  - VC-6045 - 100MHz, 40MS/s Call
  - VC-6145 - 100MHz, 100MS/s Call

RSO's from Hitachi feature roll mode, averaging, save memory, smoothing, interpolation, pretriggering, cursor measurements. These scopes enable more accurate, simpler observation of complex waveforms, in addition to such functions as hardcopy via a plotter interface and waveform transfer via the RS-232C interface. Enjoy the comfort of analog and the power to digital.

## 25MHz Elenco Oscilloscope



**\$349**

**S-1325**

- Dual Trace
- 1mV Sensitivity
- 6" CRT
- X-Y Operation
- TV Sync

• (2) 1x, 10x Probes included

## SPECIAL BUY

**V-212 - 20MHz Scope \$409**

## Hitachi Portable Scopes

**DC to 50MHz, 2-Channel, DC offset function, Alternate magnifier function**

- V-525 - CRT Readout, Cursor Meas. \$995
- V-523 - Delayed Sweep \$975
- V-522 - Basic Model \$875
- V-422 - 40MHz \$775
- V-223 - 20MHz delayed sweep \$695
- V-222 - 20MHz deluxe \$625

## PRICE BREAKTHRU

**20MHz Digital Storage Oscilloscope**

- Analog/Digital Scope
- 2K word per channel memory **DS203**
- 10MS/s sampling rate
- State-of-art technology **\$775**
- Includes probes

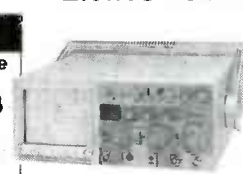
**S-1360 60MHz Delay Sweep \$775**

## HITACHI COMPACT SERIES SCOPES

This series provides many new functions such as CRT Readout, Cursor measurements (V-1085/1065A/665A), Frequency Ctr. (V-1085), Sweetime Autoranging, Delayed sweep and Tripper Lock using a 6-inch CRT. You don't feel the compactness in terms of performance and operation.

- V-660 - 60MHz, Dual Trace \$1,149
- V-665A - 60MHz, DT, w/cursor \$1,345
- V-1060 - 100MHz, Dual Trace \$1,395
- V-1065A - 100MHz, DT, w/cursor \$1,649
- V-1085 - 100MHz, QT, w/cursor \$1,995
- V-1100A - 100MHz, Quad Trace \$2,195
- V-1150 - 150MHz, Quad Trace \$2,695

## Elenco 40MHz Dual Trace



**Good to 50MHz \$495 S-1340**

- High luminance 6" CRT
- 1mV Sensitivity
- 10KV Acceleration Voltage
- 9ns Rise Time
- X-Y Operation

• Includes (2) 1x, 10x Probes

All scopes include probes, schematics, operators manual and 3 year (2 yrs for Elenco scopes) world wide warranty on parts & labor. Many accessories available for all Hitachi scopes. Call or write for complete specifications on these and many other fine oscilloscopes. **1x, 10x Scope Probes: P-1 65MHz \$17.95, P-2 100MHz \$21.95**

## Digital Capacitance Meter



**CM-1550B**

**\$58.95**

- 9 Ranges
- 1pf-20,000ufd
- .5% basic accy.
- Zero control w/ Case
- Big 1" Display

## Digital Multimeter



with Inductance & Capacitance **\$75.00**

**LCM-1850**

Ten Functions

## Multimeter with Capacitance & Transistor Tester



**\$55 CM-1500B**

- Reads Volts, Ohms
- Current, Capacitors, Transistors and Diodes / with case

## FLUKE MULTIMETERS

Scopemeters	(All Models Available Call)
Model 93	\$1,095.00
Model 95	\$1,395.00
Model 97	\$1,695.00
10 Series	
Model 10	\$62.95
Model 12	\$79.95
70 Series	
Model 70II	\$65.00
Model 77II	\$145.00
Model 79II	\$169.00
80 Series	
Model 87	\$289.00

## Quad Power Supply XP-580



**\$69.95**

- 2-20V @ 2A
- 12V @ 1A
- 5V @ 3A
- 5V @ .5A

Fully regulated and short circuit protected

## Digital Triple Power Supply



**XP-765**

**\$289**

- 0-20V @ 1A
- 0-20V @ 1A
- 5V @ 5A

Fully regulated, Short circuit protected with 2 limit control, 3 separate supplies **XP-660 with Analog Meters \$195**

## AM/FM Transistor Radio Kit with Training Course

**Model AM/FM 108**

**\$26.95**

14 Transistors • 5 Diodes  
Makes a great school project

## True RMS 4 1/2 Digit Multimeter



**M-700T**

**\$135**

.05% DC Accuracy  
1% Resistance with Freq. Counter  
Data Hold

## GF-8016 Function Generator with Freq. Counter



**\$249**

- Sine, Square, Triangle
- Pulse, Ramp, .2 to 2MHz
- Freq Counter .1 - 10MHz
- Int/Ext operation

**GF-8015 without Freq. Meter \$179**

## Function Generator Blox



**#9600**

**\$28.95**

Provides sine, triangle, square wave from 1Hz to 1MHz  
AM or FM capability

## Learn to Build and Program Computers with this Kit

Includes: All Parts, Assembly and Lesson Manual

**Model**

**MM-8000**

**\$129.00**



Starting from scratch you build a complete system. Our Micro-Master trainer teaches you to write into RAMs, ROMs and run a 8085 microprocessor, which uses similar machine language as IBM PC.

## Wide Band Signal Generators



**SG-9000 \$129**

RF Freq 100K-450MHz AM Modulation of 1KHz Variable RF output

**SG-9500 w/ Digital Display & 150 MHz built-in Counter \$249**

## XK-500 Digital / Analog Trainer

A complete mini-lab for building, testing, prototyping analog and digital circuits Elenco's Digital/Analog Trainer is specially designed for school projects, with 5 built-in power supplies. Includes a function generator with continuously variable, sine, triangular, square wave forms. All power supplies are regulated and protected against shorts.

### Power Supplies

- Variable Power Supply
- +1.25 to 20VDC @ .5 Amp (+1.25 to 15VDC @ 1 Amp)
- 1.25 to -20VDC @ 5 Amp (-1.25 to -15VDC @ 1 Amp)
- +12VDC @ 1 Amp
- 12VDC @ 1 Amp
- +5VDC @ 1 Amp
- 30VAC Center tapped @ 15VAC at 1 Amp

### Analog - Section

- Function Generator Sine, Triangular, Square wave forms
- Frequency adjustable in five ranges from 1 to 100KHz
- Fine frequency adjust
- Amplitude adjust
- DC offset
- Modulation FM-AM

### Digital - Section

- Eight data switches
- Two no bounce logic switches
- 8 LED readouts TTL buffered
- Clock frequency 1 to 100KHz
- Clock amplitude 5VPP square wave

### Breadboards

- 2 breadboards, each contain: 840 tie points (total 1,680)



**\$149.95 Assembled**

**\$119.95 Kit**

**WE WILL NOT BE UNDERSOLD**

UPS SHIPPING: 48 STATES 5%  
IL RES 7.5% TAX (\$3 min \$10 max)  
OTHERS CALL

**C&S SALES INC.**

1245 ROSEWOOD, DEERFIELD, IL 60015  
FAX: 708-520-0085 • (708) 541-0710



**15 DAY MONEY BACK GUARANTEE**

**2 YEAR WARRANTY**

**WRITE FOR FREE CATALOG**

PRICES SUBJECT TO CHANGE

CIRCLE 109 ON FREE INFORMATION CARD

# VIDEO NEWS

What's new in the fast-changing video industry.

DAVID LACHENBRUCH

• **Flat panels for HDTV.** There's still no substitute for the CRT when it comes to large-screen resolution, but that doesn't mean that developers around the world aren't still trying to find that elusive giant picture on the wall for HDTV. Two promising developments recently surfaced in Japan.

*Flat plasma display.* The prestigious Japan Broadcasting Corporation (NHK), Japan's public-television broadcaster, recently held an impressive progress-report demonstration of a thin glass sandwich HDTV plasma display panel that it says could be commercialized as soon as 1997. The system is being developed as a joint effort with Matsushita (Panasonic), NEC, Oki Electric, and Dai Nippon Printing. Texas Instruments has a contract to develop semiconductors for the system. NHK is now demonstrating a working model HDTV display panel with a 16:9 widescreen aspect ratio. The model is three inches thick and weighs less than 18 pounds.

NHK concedes that there's more work to do, but thinks the answers to the remaining problems are in sight. The screen has 1344 display cells horizontally and 800 vertically, for a resolution of 1,075,000 pixels, but it still falls short of the necessary brightness and life for a consumer display. The final version will have smaller cell size. NHK is promising to show a 55-inch working prototype next year.

*Ferroelectric LCD.* Working with a technology that others have rejected, Canon of Japan believes that it has found the solution to the need for giant thin color screens with no flicker and with a wide display angle for digital HDTV. While others work with the frustratingly difficult problems of active matrix LCD's, Canon has chosen to gamble on ferroelectric LCD (FELCD), a technology known since 1974. Canon is already planning to build several plants to mass-produce consumer HDTV panels.

Canon scientists believe that there is no theoretical limit to the size of FELCD screens. FELCD material differs from active matrix LCD transistors in that it's bi-stable—it can only be switched off or on. Once switched on, an FELCD molecule remains on until turned off, and vice versa. That would make it ideally suited to digital TV transmission if the problem of color rendition and gray scale could be solved. Canon says it has done this by calling on its work in black-and-white and color printers.

Canon says that it will start making computer monitors using the FELCD material next year, moving to color in 1994. The company already has displayed a still color screen with nearly HDTV resolution—four times better than computer VGA color CRT monitors. The planned 15-inch computer display has a resolution of 1280 x 1024 pixels, and the proposed 16:9 HDTV display is scheduled to have 1920 pixels in each of 1152 horizontal lines.

• **Widescreen sets in the U.S.**

Thomson Consumer Electronics continues to dole out information about its widescreen 16:9 aspect ratio TV sets just a little at a time. The first sets, due out late this year under the RCA and ProScan labels, will have 34-inch picture tubes made in Thomson's tube plant in Italy. The company is shooting for a price of \$4000–\$5000 for the first sets, less than the price tags for Thomson widescreen sets that are already available in Europe. However, Thomson plans to start manufacturing widescreen tubes in the U.S. in 1994, and its goal for that time is a 34-inch widescreen set at about the price of today's 35-inch standard aspect ratio (4:3) sets, which now start at less than \$2000. In addition to the 34-inch direct-view set, Thomson plans to offer widescreen projection sets in larger sizes beginning next year.

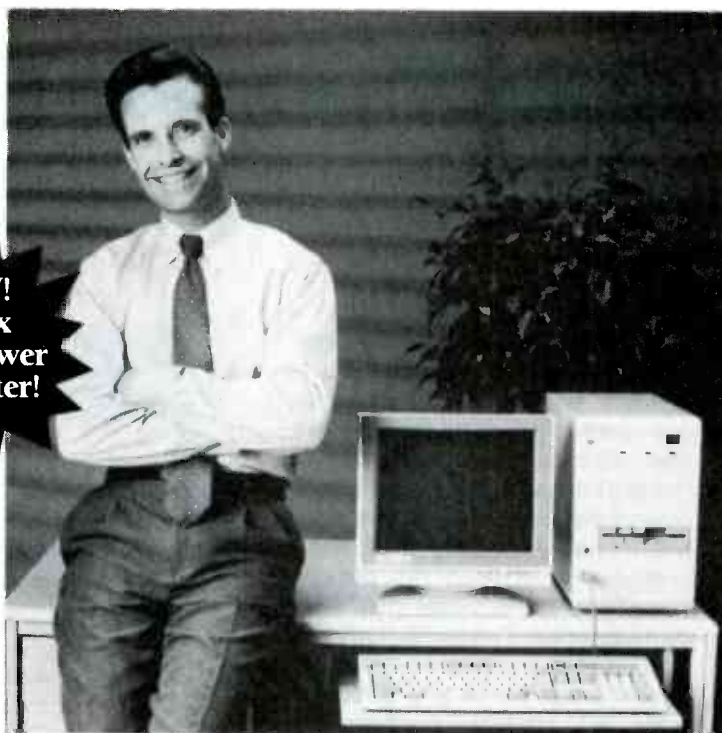
• **Hughes-JVC projection pact.** Hughes Aircraft, which has manufactured multi-million dollar video projectors for the Pentagon, is gearing up for civilian production. Hughes has been seeking a consumer-electronics partner to develop a consumer version of its liquid-crystal lightvalve (LCLV) projection system. It finally found that partner in Japan's JVC. Hughes-JVC Technology Corp., 60% owned by Hughes and 40% by JVC, will develop consumer and commercial versions of LCLV projectors. The system combines a high-resolution CRT for image generation with separate LCD panels and an external light source to provide a very bright picture with high resolution. It is a candidate for future giant-screen HDTV projection sets.

This fall, Hughes-JVC will market professional models already developed by Hughes, priced from \$8000 to more than a million dollars; consumer versions will cost from \$2000 to \$7000. JVC will manufacture consumer projectors and key components in Japan, and will distribute LCLV projectors worldwide through its sales network. Hughes said that HDTV resolution has been achieved with LCLV projectors, and 35mm-film resolution is the next target it will be shooting for.

• **8mm video decks here.** The success of the 8mm video format in camcorders must be followed by decks for showing and editing home videos. Sony was the only source 8mm decks, but two others have appeared. The compact decks with hi-fi stereo sound, which carry the RCA and Samsung brand names, are expected to sell for about \$499. They're both made by Korea's Samsung. In the future is a dual-well 8mm/VHS deck to transfer 8mm videos to VHS cassettes and for editing home videos. Go-Video has already shown a prototype model, due next year. **R-E**



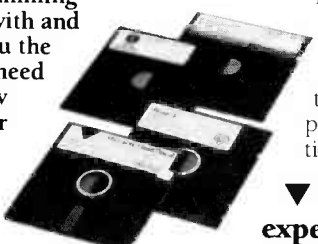
# With NRI hands-on training, you can experience the rewards of a career in computer programming



**NEW!  
386sx  
mini-tower  
computer!**

Now you can get the practical training and experience you need to succeed in computer programming, today's top-growth computer career field.

NRI at-home training gives you real-world programming skills in four of today's hottest computer languages: BASIC, Pascal, C, and COBOL. You get hands-on training that now includes a powerful 386sx/20 MHz mini-tower computer, modem, and programming software ... all yours to train with and keep! Best of all, NRI gives you the programming know-how you need to succeed on the job, in a new career, or in a business of your own.



Job opportunities for the skilled computer programmer will increase by 71.7 percent over the next 10 years according to Bureau of Labor Statistics forecasts. And now, with NRI training, you can be one of the increasing number of computer programmers using their skills to build a top-paying career — even a business of their own — in this professionally and financially rewarding high-tech field.

## ▼ The only programming course that includes a powerful 386sx-based computer system and programming software you keep

Right from the start, NRI training gets you actively involved in the challenge of real-world programming. You learn how to create the kinds of full-featured, powerful programs today's employers and clients demand.

And, unlike any other school, NRI lets you experience first-hand the power of an IBM PC/AT-compatible, 386sx-based computer system, complete with modem, a full megabyte of RAM, disk drive, and monitor — all yours to train with and keep!

Plus you explore the extraordinary capabilities of not one or two but four in-demand computer languages.

You learn to design, code, run, debug, and document programs in BASIC, Pascal, C, and COBOL. In the process you become uniquely prepared for the wide variety of programming opportunities available today.

## ▼ No previous experience necessary

Immediately, you start getting the money-making job skills you need to secure a future in computer programming — no matter what your background. NRI's unique Discovery Learning Method guides you swiftly from computer novice to computer professional with step-by-step lessons covering program design techniques used every day by successful PC programmers.

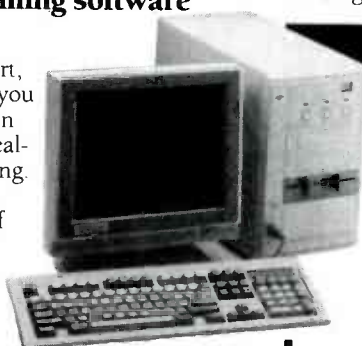
You'll find no heavy textbooks to plow through. No night classes to attend. Instead, NRI's at-home, step-by-step training covers all the bases, guiding you

from the important fundamentals to real-world methods and techniques. Backed up throughout your course by your experienced NRI instructor, you quickly gain the skills you need to handle a wide variety of programming tasks with confidence. You even use your modem to "talk" to your instructor, meet other NRI students, and download programs through NRI's exclusive programmers network, PRONET.

## ▼ Send today for your FREE catalog

Now you can experience the professional and financial rewards of a career in computer programming. See how NRI at-home training gives you the know-how, the computer, and the software you need to get started in this top-paying field. Send today for your FREE catalog!

If the coupon is missing, write to us as the NRI School of Computer Programming, McGraw-Hill Continuing Education Center, 4401 Connecticut Avenue, NW, Washington, DC 20008.



**SEND FOR YOUR FREE NRI CATALOG TODAY!**

## **NRI** Schools

McGraw-Hill Continuing Education Center  
4401 Connecticut Avenue, NW, Washington, DC 20008



### Check one free catalog only

- |   |  |
|---|--|
| <input type="checkbox"/> Computer Programming       | <input type="checkbox"/> Programming in C++ with Windows |
| <input type="checkbox"/> Microcomputer Servicing    | <input type="checkbox"/> Desktop Publishing & Design     |
| <input type="checkbox"/> PC Applications Specialist | <input type="checkbox"/> Bookkeeping and Accounting      |

Name \_\_\_\_\_ Age \_\_\_\_\_  
(please print)

Address \_\_\_\_\_

City \_\_\_\_\_ State \_\_\_\_\_ Zip \_\_\_\_\_

Accredited Member, National Home Study Council

5415-092

## Q & A

Write to Q & A, *Electronics Now*, 500-B Bi-County Blvd., Farmingdale, NY 11735

### DOUBLE AND HIGH DENSITY

**Is there any truth to the rumor I've heard that the only difference between 3½-inch double- and high-density disks is the extra hole in the corner of the plastic package? Just about everybody I know buys the double-density variety and then punches a hole in the plastic case to turn the disks into high-density ones. I've done it myself and can't see any difference between these disks and the ones with "HD" stamped on them.—F. Foeg, Frish, CA**

This is one of those times when I have to say that your guess is as good as mine. I've done the same thing to double-density disks and have never had a problem either. I know people who swear they're different but I've never had a practical example of it.

I remember reading a long description of the chemical difference in the media but it seems to have made little impression on me since all I remember is that the article was long and technical—the details have disappeared completely from my mind.

From a practical point of view, I've had more trouble with "real" high-density 3½-inch disks than with the ones I've punched or drilled into existence. This is just as true for name-brand disks as it is for the generic (and cheaper) variety.

Just about the only piece of hard information I have for you is the fact that some older high-density 3½-inch disk drives don't have the LED and sensor setup to look for the extra hole. Those drives are usually found on the older PS2 computers from IBM.

I know that this letter—and the answer—will spark a host of mail from people who are into disk media chemistry. That may be a good thing because this rumor about 3½-inch disks has been floating around since the high-density variety first



**FIG.1—A SECOND HOLE INDICATES that a disk is high-density.**

came on the market. If people out there really have the answer, and the credentials to back it up, I look forward to hearing from them and I'll be sure to pass the "real" information along.

### THE APPLE FAMILY

**I'm thinking about buying a used Apple IIe for my son since there are some good buys around, but I'm not sure about the difference between these computers and the other members of the Apple family. Also, I'd like to know if I can use my color TV for a monitor or will everything be unreadable?—S. Gibbs, Redondo Beach, CA**

Apple isn't what Apple once was. It's sad but true that while Apple made a lot of money with the Apple II series by saturation selling in the educational market (mostly grade schools), they seemed to have shifted their corporate focus to the Macintosh. While there are some similarities between all the members of the Apple II family, they are a completely different breed from the Macintosh.

Once upon a time, Apple II computers were targeted mostly at the schools and the Macintoshes were aimed at the graphic arts, but this seems to have changed. Apple has reduced the amount of corporate resources devoted to the Apple II and has been touting the Macintosh

as an alternative to IBM compatibles in the business world.

To answer your first question more specifically, there's a big difference between the Apple IIe and the Apple IIgs. The "e" stands for "enhanced" to highlight the difference between it and the older Apple II+ it replaced. The "gs" stands for "graphics/sound" and is a way of emphasizing the difference between it and the older Apple IIe you're thinking of buying.

While the Apple IIgs can run a lot of the software written for the Apple IIe, the reverse isn't true at all. The hardware is very different and so are the capabilities of the two machines. If you have some specific software in mind, a used Apple IIe can be a good buy but, if you're sold on the idea of having one of the Apple II series of computers, spring for the extra bucks and hunt up a used Apple IIgs.

It may interest you to know that friends of mine who teach the computer courses in grade schools tell me that it's getting harder and harder to find new software for the Apple II computers—even for the top of the line Apple IIgs. You should check with people in the schools near you and find out for yourself since even the world's greatest computer isn't worth anything if the larger software companies are withdrawing their support. Remember these people are market driven and they may know something we don't. It's not always wise to rely completely on the advice of the salesmen in the Apple stores. They make their money selling computers, not writing the software that will run on them.

As far as using a TV is concerned, it might be OK for games but if you want to do anything more serious, you'll find it entirely unsuitable. You might save some money by not buying a real monitor but it's a safe bet that all those savings will go into eye exams and new glasses.





Welcome to . . .

# SCIENCE PROBE!®

The Amateur Scientist's Journal

Embark on an irresistible new journey into the realm of mystery, challenge, and exploration! The perfect magazine for the budding scientist, the serious amateur, the professional who would like to relax, and those who simply want to gaze at the stars.

**Science PROBE!** — the *only* magazine devoted entirely to Amateur Scientists! If you are fascinated by science in all its many forms . . . if you can't stay away from a microscope, telescope, calipers, or test tube — we invite you to share the wonders in every issue of **Science PROBE!** You will join a community of Amateur and Student Scientists who enthusiastically seek scientific knowledge or follow scientific pursuits for their own sakes and not merely as a profession.

Obtain your next issue of **Science PROBE!** by visiting a quality Newsstand, Convenience Store, or Supermarket or by reserving your personal copy through the mail by completing the coupon below.

From your very first issue of **Science PROBE!** you will be involved in a world of scientific facts, experiments, and studies pursued by amateur scientists who are university students, investors, academicians, engineers, or office workers, salesmen, farmers—whose *quest* is to probe into the mysteries of science and reveal them to all.

Plan to become a **Science PROBE!** reader!

Articles to appear in upcoming issues of **Science PROBE!** are:

**Inside Internet—A Scientific Computer Network**  
**Make your own Seismometer**  
**Operate a Solar-Powered Weather Station**  
**Assemble a Solid-State Portable Barometer**  
**The Bicycle—A Traveling Scientific Laboratory**

If you're fascinated by science in all its many forms, if you are compelled to experiment and explore, then **Science PROBE!** is your kind of magazine!

**For Faster Service—Call Today:**  
**1-800-777-5489**

**Science PROBE!**  
 500-B Bi-County Boulevard  
 Farmingdale, NY 11735

7RJ29

Please forward my copy of **Science PROBE!** as soon as it comes off the press. I am enclosing \$3.50-U.S.A. (\$4.23-Canada-includes G.S.T.) plus \$1.00 for shipping and handling. Better still, please enroll me as a subscriber and send the next four (4) quarterly issues of **Science Probe**. I am enclosing \$9.95-U.S.A. (Canada: \$16.00—includes G.S.T.)

Next Issue Only       Next Four Issues (1 Year)  
 Offers valid in the U.S.A. and Canada only. No foreign orders.

Name \_\_\_\_\_

Address \_\_\_\_\_

City \_\_\_\_\_ State \_\_\_\_\_ ZIP \_\_\_\_\_

All Orders payable in U.S.A. Funds only.

**ON SALE AT QUALITY NEWSSTANDS, CONVENIENCE STORES AND SUPERMARKETS**  
**GET YOUR COPY TODAY—\$3.50-U.S.A.—\$3.95-Canada**

# Earn Your B.S. Degree in ELECTRONICS or COMPUTERS



## By Studying at Home

Grantham College of Engineering, now in our 42nd year, is highly experienced in "distance education"—teaching by correspondence—through printed materials, computer materials, fax, and phone.

No commuting to class. Study at your own pace, while continuing on your present job. Learn from easy-to-understand but complete and thorough lesson materials, with additional help from our instructors.

Our Computer B.S. Degree Program includes courses in BASIC, PASCAL and C languages — as well as Assembly Language, MS DOS, CADD, Robotics, and much more.

Our Electronics B.S. Degree Program includes courses in Solid-State Circuit Analysis and Design, Control Systems, Analog/Digital Communications, Microwave Engr, and much more.

An important part of being prepared to *move up* is holding the right college degree, and the absolutely necessary part is knowing your field. Grantham can help you both ways—to learn more and to earn your degree in the process.

Write or phone for our free catalog. Toll free, 1-800-955-2527, or see mailing address below.

•  
Accredited by  
the Accrediting Commission of the  
National Home Study Council

•  
**GRANTHAM**  
**College of Engineering**  
Grantham College Road  
Slidell, LA 70460

### VIDEO IC's

I'm interested in building some video devices but I'm having a hard time locating the IC's that are best suited to the circuits I have in mind. Do you have any supplier that specializes in carrying these chips?—**M. Brown, London, UK**

I sympathize with you because I've frequently run into the same problem myself. It's a hard and fast rule that the more specialized the IC, the harder it is to find—especially in single quantities and without having to meet any minimum order.

The best place to begin your hunt for these parts is with the very people who make them—the IC manufacturers. If you're lucky, you'll be able to get some freebie "engineering samples" from them. This is only true if you get the right person on the phone and you identify yourself in such a way as to let them think it's worth their while to send you the stuff you want.

Remember, they're in the business of making chips for sale and if they believe that a small sample now can lead to a large order later on, you'll get what you need.

A second line of approach is to find out who their distributors are in your area and trying the same line with them. Your chances aren't as good with a distributor, but you never know. The salesperson might let you pay for a few parts (and shipping), without having to meet their minimum order quantity.

The last alternative—although you might not like it—is to fill out the minimum order by stocking up on parts you'll be able to use later on. This means stuff that may be needed for something else you have in mind but don't intend to actually start for a while.

Getting anything in single quantities is the hardest thing an experimenter can do. There are, however, suppliers who stock a wide variety of components and low or no minimum orders.

### SPEEDING CURSOR

I recently upgraded from my old XT computer and got a much faster 386SX that runs at 20 MHz. Everything runs much

faster now, but I find that the cursor speed hasn't changed much. Is there anything I can do about this because speeding up the cursor will make my new computer seem to run even faster.—**B. Geoff, Fischer, IN**

Although your expectations haven't quite been met, I guarantee that making such a major change in your computer horsepower has also made a change in the speed of your cursor. The reason you haven't seen as much of a change as you would like is simply that the speed of the cursor is dependent on three separate factors:

- Basic computer speed
  - Basic video speed
  - Basic keyboard speed
- and all you've done is changed one of these factors.

Now that you have a computer that runs at a furious rate of speed, the cursor speed is being limited by the speed of either your video adapter or your keyboard—which-ever is less.

Remember that when the keyboard sends an instruction to move the cursor, the computer tells the video adapter to do it. The computer does its part of the job pretty quickly, but the other two components operate much more slowly—particularly the keyboard.

However, it's a good thing that the keyboard is the slowest component because the keyboard repeat rate can be changed with software. (There isn't much you can do about the speed of your video adapter, short of spending a lot of money for fast video card.)

There are several public domain programs (and some commercial ones as well) for changing the keyboard repeat rate, but all of them have one slight disadvantage: they steal a certain amount, however little, of valuable memory. That can be a really big problem.

The answer is a small public domain program called FAST.COM that cuts the keyboard repeat delay to a bare minimum. I've been using it for several years without any trouble, and I run it automatically every time I turn on my computer. I've put it on the RE-BBS (516-293-2283, 1200/2400, 8N1) so you can download it and see if it works. **R-E**



# Electronics Paperback Books

GREAT PAPERBACKS AT SPECIAL PRICES

□ **BP248—TEST EQUIPMENT CONSTRUCTION** ..... \$5.95. Details construction of simple, inexpensive, but extremely useful test equipment. AF Gen, Test Bench Ampl, Audio Millivoltmeter, Transistor Tester and six more.



□ **BP267—HOW TO USE OSCILLOSCOPES AND OTHER TEST EQUIPMENT** ..... \$6.95. Mastering the oscilloscope is not really too difficult. This book explains all the standard controls and functions. Other equipment is also described.



□ **BP265—MORE ADVANCED USES OF THE MULTIMETER** ..... \$5.95. Use these techniques to test and analyze the performance of a variety of components. Also see how to build add-ons to extend multi-meter capabilities.



□ **BP256—INTRO TO LOUDSPEAKERS AND ENCLOSURE DESIGN** ..... \$5.95. We explore the variety of enclosure and speaker designs in use today so the reader can understand the principles involved.

□ **CMOS1—CMOS POCKET GUIDE 1** ..... \$18.95. Works like the TTL Guides but covers all commonly used CMOS standard devices. Six major sections. The first shows the device schematic. Next is a brief description of the component and is followed by full operating details. The fourth section lists major applications, while the 5th and 6th sections present essential data for that device and a list of the relevant manufacturers. The final two sections are a valuable cross-reference.



□ **BP299—PRACTICAL ELECTRONIC FILTERS** ..... \$6.95. Presents a dozen filter-based practical projects with applications in and around the home or in the constructor's workshop. Complete construction details are included.



□ **BP249—MORE ADVANCED TEST EQUIPMENT CONSTRUCTION** ..... \$6.95. Eleven more test equipment construction projects. They include a digital voltmeter, capacitance meter, current tracer and more.



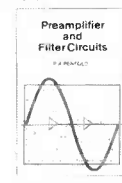
□ **BP245—DIGITAL AUDIO PROJECTS** ..... \$5.95. Practical circuits to build and experiment with. Includes A/D converter, input amplifier, digital delay line, compander, echo effect and more.



□ **BP247—MORE ADVANCED MIDI PROJECTS** ..... \$5.95. Circuits included are a MIDI indicator, THRU box, merge unit, code generator, pedal, programmer, channelizer, and analyzer.



□ **BP257—INTRO TO AMATEUR RADIO** ..... \$6.95. Amateur is a unique and fascinating hobby. This book gives the newcomer a comprehensive and easy to understand guide to the subject.



□ **BP309—PREAMPLIFIER AND FILTER CIRCUITS** ..... \$6.95. Provides circuits and background info for a range of pre-amplifiers, plus tone controls, filters, mixers and more. All are high-performance circuits that can be built at a reasonable cost.

□ **PCP115—ELECTRONIC PROJECTS FOR HOME SECURITY** ..... \$10.00. 25 projects ranging from a single-door protection circuit that can be completed in an hour or two, to a sophisticated multi-channel security system. Each project is described in detail with circuit diagrams, explanations of how it works, instructions for building and testing, and how to adapt circuits to meet special requirements.



□ **BP303—UNDERSTANDING PC SOFTWARE** ..... \$6.95. This book will help you understand the basics of various types of business software in common use. Types of software covered include word processors, spelling checkers, graphics programs, desktop publishing, databases, spreadsheets and utilities.



□ **BP251—COMPUTER HOBBYISTS HANDBOOK** ..... \$8.95. A wrapup of everything the computer hobbyist needs to know in one easy to use volume. Provides a range of useful reference material in a single source.



□ **BP195—INTRODUCTION TO SATELLITE TV** ..... \$9.95. A definitive introduction to the subject written for the professional engineer, electronics enthusiast, or others who want to know more before they buy. 8 x 10 in.

□ **BP190—ADVANCED ELECTRONIC SECURITY PROJECTS** ..... \$5.95. Includes a passive infra-red detector, a fiber-optic loop alarm, computer-based alarms and an unusual form of ultrasonic intruder detector.

□ **BP235—POWER SELECTOR GUIDE** ..... \$10.00. Complete guide to semiconductor power devices. More than 1000 power handling devices are included. They are tabulated in alpha-numeric sequence, by technical specs. Includes power diodes, Thyristors, Triacs, Power Transistors and FETs.

□ **BP234—TRANSISTOR SELECTOR GUIDE** ..... \$10.00. Companion volume to BP235. Book covers more than 1400 JEDEC, JIS, and brand-specific devices. Also contains listing by case type, and electronic parameters. Includes Darlingtons transistors, high-voltage devices, high-current devices, high power devices.

□ **BP99—MINI-MATRIX BOARD PROJECTS** ..... \$5.50. Here are 20 useful circuits that can be built on a mini-matrix board that is just 24 holes by ten copper-foil strips.

□ **BP117—PRACTICAL ELECTRONIC BUILDING BLOCKS—Book 1** ..... \$5.75. Oscillators, Timers, Noise Generators, Rectifiers, Comparators, Triggers and more.

□ **BP184—INTRO TO 68000 ASSEMBLY LANGUAGE** ..... \$6.95. The 68000 is a great new breed of microprocessor. Programming in assembly language increases the running speed of your programs. Here's what you need to know.

□ **BP179—ELECTRONIC CIRCUITS FOR THE COMPUTER CONTROL OF ROBOTS** ..... \$7.50. Data and circuits for interfacing the computer to the robot's motors and sensors.

□ **BP239—GETTING THE MOST FROM YOUR MULTIMETER** ..... \$5.95. Covers basics of analog and digital meters. Methods of component testing includes transistors, thyristors, resistors, capacitors and other active and passive devices.

□ **BP97—IC PROJECTS FOR BEGINNERS** ..... \$5.50. Power supplies, radio and audio circuits, oscillators, timers, switches, and more. If you can use a soldering iron you can build these devices.

□ **BP37—50 PROJECTS USING RELAYS, SCR'S & TRIACS** ..... \$5.50. Build priority indicators, light modulators, warning devices, light dimmers and more.

□ **RADIO—100 RADIO HOOKUPS** ..... \$3.00. Reprint of 1924 booklet presents radio circuits of the era including regenerative, neutrodyne, reflex & more.

□ **BP42—SIMPLE LED CIRCUITS** ..... \$5.50. A large selection of simple applications for this simple electronic component.

□ **BP122—AUDIO AMPLIFIER CONSTRUCTION** ..... \$5.75. Construction details for preamps and power amplifiers up through a 100-watt DC-coupled FED amplifier.

□ **BP92—CRYSTAL SET CONSTRUCTION** ..... \$5.50. Everything you need to know about building crystal radio receivers.

□ **BP255—INTERNATIONAL RADIO STATIONS GUIDE** ..... \$7.95. Provides the casual listener, amateur radio DXer and the professional radio monitor with an essential reference work designed to guide him or her around than ever more complex radio bands.

## CHECK OFF THE BOOKS YOU WANT

**ELECTRONIC TECHNOLOGY TODAY INC.**  
P.O. Box 240, Massapequa Park, NY 11762-0240

**SHIPPING CHARGES IN USA AND CANADA**

**SORRY No orders accepted outside of USA & Canada**

Number of books ordered

Name \_\_\_\_\_  
Address \_\_\_\_\_  
City \_\_\_\_\_ State \_\_\_\_\_ Zip \_\_\_\_\_

\$0.01 to \$5.00	.....	\$1.50
\$5.01 to \$10.00	.....	\$2.50
\$10.01 to 20.00	.....	\$3.50
\$20.01 to 30.00	.....	\$4.50
\$30.01 to 40.00	.....	\$5.50
\$40.01 to 50.00	.....	\$6.50
\$50.01 and above	.....	\$8.00

Total price of merchandise ..... \$ \_\_\_\_\_  
Shipping (see chart) ..... \$ \_\_\_\_\_  
Subtotal ..... \$ \_\_\_\_\_  
Sales Tax (NYS only) ..... \$ \_\_\_\_\_  
Total Enclosed ... \$ \_\_\_\_\_

**All payments must be in U.S. funds**

RE992

# LETTERS

Write to Letters, *Electronics Now*, 500-B Bi-County Blvd., Farmingdale, NY 11735

## SOLID-STATE RELAY UPDATE

Regarding the article, "Solid-State Relay" (**Radio-Electronics**, May 1992), a very important feature is the zero-current switch-off characteristic inherent in the triac.

The interruption of the circuit at the instant the current is zero avoids voltage spikes that could be produced by the stored energy ( $E$ ) in the distributed inductance of the power line and leakage inductance of the mains (line) transformer ( $L$ ) if the current is suddenly interrupted at a non-zero value, as occurs with mechanical contact breakers. As we know,  $E = \frac{1}{2} Li^2$ . At the instant the current crosses zero, the stored energy is also zero.

These voltage transients, which are caused by switching heavy currents, are often the reason for failure of electronic equipment connected to the same line. The solid-state relay prevents such damage.

LEO BATISTA

*Professor of Electric Automation  
University of Sao Paulo  
Sao Paulo, Brazil*

## A REAL HUM-DINGER

I appreciated the response to the 60-hertz hum question that appeared in *Ask R-E* in the June issue of **Radio-Electronics**. I had the same problem with my speaker system. I took your advice, and my problems were solved. Thanks!

JEFF FRUSCELLA

*Kirtland, OH*

## ANOTHER HUM STOPPER

I enjoy reading *Ask R-E* each month. The 60-hertz hum problem described in the June issue could be caused by a ground loop. When components of a stereo system that are connected by patch cords receive their power from different 120-volt receptacles, a ground loop can be formed by a small amount of alternating current flowing in the shield of a shielded patch cord. That

current flow is caused by a small potential difference in the neutral conductor wiring in a building's 120-volt circuits.

There is help for this type of hum problem. Radio Shack has a stereo ground-loop isolator, No. 270-054, which is a patch cord with two audio isolation transformers included. Those transformers break the ground-loop circuit, thereby stopping the current flow that causes the hum.

The ground loop isolator is listed on page 60 of Radio Shack's 1992 catalog in the automotive section. It can be used in line-level circuits of any audio equipment. I have successfully used this device in audio component hookups.

JACK P. SONNEMAN

*Fayetteville, OH*

## ROSICRUCIANS, ALIVE AND WELL

I am writing in response to the item in *Ask R-E* (**Radio-Electronics**, June 1992) about FM antennas that use household wiring. Perhaps they have disappeared, which is fine by me, but Rosicrucians (AMORC) haven't. I subscribe to **Radio-Electronics** and have done so for quite some time. I am also a member of the Rosicrucian Order, AMORC, and have been a member for just as long, if not longer.

Until the time comes when I no longer receive the valued information that I do from both **Radio-Electronics** and AMORC, I will be affiliated with both. Your questions are welcome.

CHARLES R. BAILEY

*2123 Grand St. N.E.  
Minneapolis, MN 55418*

## TURN-SIGNAL AMPLIFIER

Regarding the request from W. Baker in *Ask R-E* (**Radio-Electronics**, April 1992) for a turn-signal amplifier, I have designed a simple, low-cost device that is intended to solve that problem.

The product requires no wiring in any vehicle, be it a bus, truck, or automobile, and operates with a time delay. A 2800-Hz beep is generated after a fixed-time delay and is repeated at this same delay for as long as the turn-signal switch is on. For example, when the turn-signal switch is selected to indicate a turn, 45 seconds later if the selector switch is still on, a 2800-Hz beep is emitted. The beep is repeated 45 seconds later, and will keep occurring at 45-second intervals for as long as the turn signal remains on. The time delay can be designed for any value. Most customers will likely prefer a 60-second delay, but there will be 30-second and 45-second delays available, or any other that the market might desire. Two volumes of sound are selectable by a slide switch.

The product is simply installed in any vehicle in less than two minutes, and will be available from my company for less than \$20 starting in December 1992.

ALBERT P. GREGORY

*A.G. Technologies  
27211 El Pico Lane  
Sun City, CA 92486*

## TURN-SIGNAL AMPLIFIER

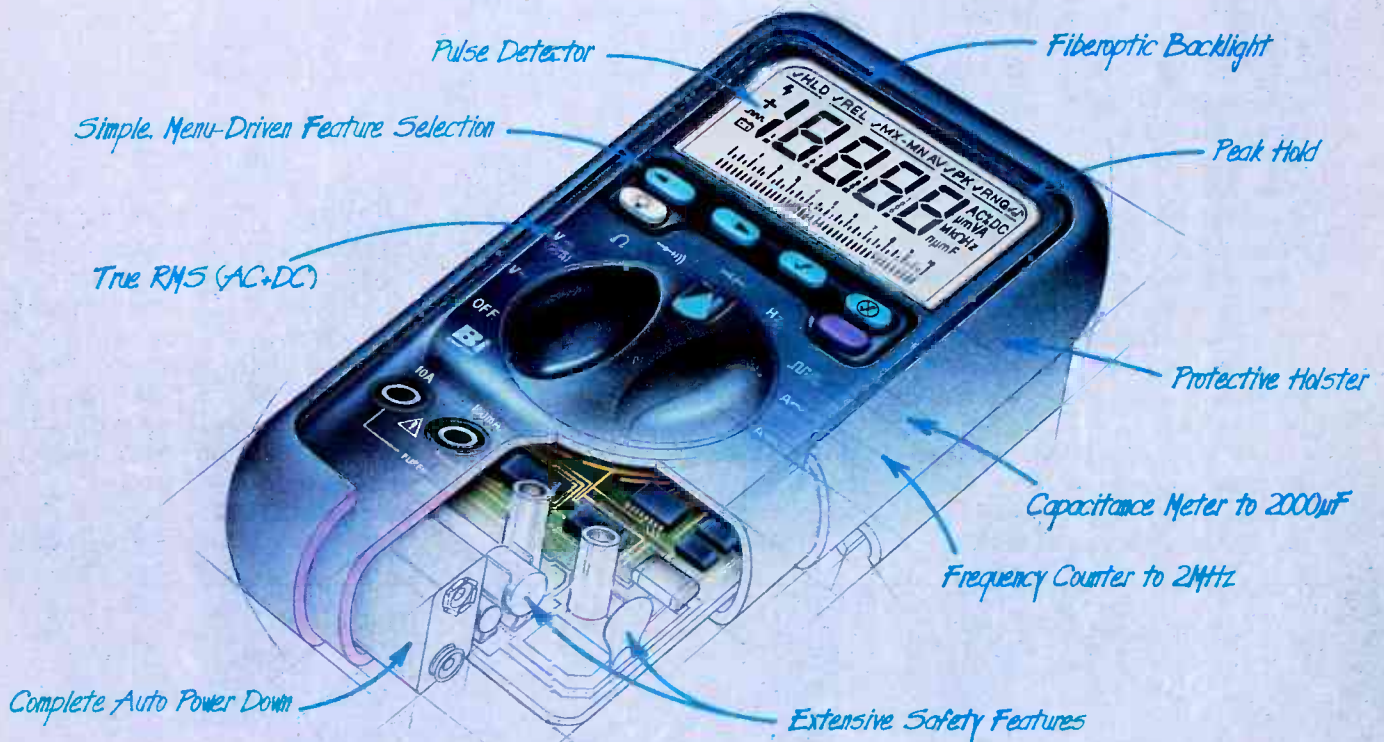
In April's *Ask R-E*, your response to W. Baker's request for a turn signal amplifier—to purchase and add a chime—is expensive and gives an undesirable indication. The "chime" is not something most people want to hear every time their turn-signal lamps flash. Here are two other practical solutions.

Wagner Lighting now markets a fully solid-state, two-terminal automotive flasher. One specification that has been an issue since the project started is the audio output, since there is no bimetallic blade or relay to make the sound. An audio transducer was added to generate the familiar click that drivers associate with flashers.

Because a solid-state flasher re-



# The DMM our customers designed.



Before we built the new generation Beckman Industrial Series 2000 DMMs, we asked people like you what you *really* want.

You want more. More test and measurement capabilities. More troubleshooting features. All in an affordable hand-held DMM. The Series 2000 features the widest range Frequency Counter in any professional DMM, a full-range Capacitance Meter, True RMS measurements, Intermittent Detection, 50ns Pulse Detection, and Peak Measurement capabilities. Plus, the Series 2000 is the only meter to offer autoranging Min/Max recording and relative modes.

You want a DMM that's easier to use. The Series 2000's display is 25% larger, with bigger digits and backlighting for easier reading, even in the worst light. Plus the fast 4 digit display provides the high resolution needed for adjusting power supplies and generators down to 1mV. And only the Series 2000 features a menuing system for fast, simple feature access.



Made in the USA

The Beckman Industrial Series 2000, priced from \$209 to \$279 offers you the best performance for your dollar. Look again at these features:

- 4 Digit, 10,000 Count Resolution
- Basic Accuracy to 0.1%
- True RMS, AC or AC on DC
- 0.01Ω Resolution
- Automatic Reading Hold
- 1ms Peak Hold
- Fully Autoranging Relative and Min Max Modes
- Intermittent Detector
- UL1244, IEC1010 Design
- Three Year Warranty

The Series 2000 offers the most solutions for your everyday test and measurement needs. The only DMMs designed by the people who use them. You.

For more information on these new DMMs call (outside CA) 1-800-854-2708 or (inside CA) 1-800-227-9781. Beckman Industrial Corporation, 3883 Ruffin Rd., San Diego, CA 92123-1898.



**Beckman Industrial™**

An Affiliate of Emerson Electric Co.

Specifications subject to change without notice.  
© 1992 Beckman Industrial Corp.

CIRCLE 98 ON FREE INFORMATION CARD

quires an external audio transducer. Wagner's new flasher has incorporated an attention timer that beeps for eight flashes after a delay of about three minutes. Beeps alert the driver that his turn signal flasher has been left on. Because this flasher has two terminals, it can replace any existing automotive turn-signal flasher.

Another way to get the driver's attention is by making the click louder. A capacitor in series with a speaker across the load and battery terminal of the flasher will create a click at every lamp on/off transition. When the flasher turns the lamps on, a voltage spike will dissipate through the speaker and create a "click." The same thing will happen when the flasher turns the lamps off. The larger the capacitor and speaker, the louder the click. A value of 47 microfarads works well with a 1½-inch speaker.

I've enjoyed **Radio-Electronics** for years and use it to keep my design and practical skills up to date. Keep up the good work.

TIMOTHY W. BROOKS  
*Senior Design Engineer*  
*Wagner Lighting*  
*Sevierville, TN*

#### TV AND X RAYS

I'm writing in regard to the item about TV and X-rays that appeared in *Video News* (**Radio-Electronics**, June 1992). I'm aware that the changes in modern-day TV sets—including solid-state circuitry and redesigned shielded CRT's—probably make them safer to be near than ever.

However, I'm also aware that many manufacturers design their products very close to the product safety guidelines as a matter of cost containment. Many individuals, including office workers, children who play video games, and students may spend considerable time in close proximity to CRT's—either in TV sets or computer terminals. That doesn't even take into account the increasing time that many children spend watching TV.

In the auto industry, we are buying

safety in the form of redesigned car bodies, safety restraints, air bags, safety glass, anti-lock brakes, and making sure that we crash-proof this and that.

I agree that we must not hamper the electronics industry, but at the same time, I believe that we must do more to safeguard people against radiation, which is both invisible and harmful.

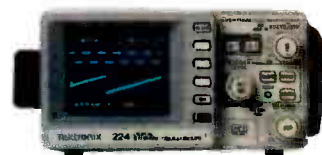
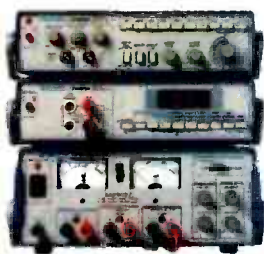
DONALD HANG  
*North Canton, OH*

#### SNOOPER STOPPER SUGGESTION

The article "The Snooper Stopper" (**Radio-Electronics**, April 1992) was very interesting. But if a person is only interested in protecting his cable box from the bullet and ID signal, then why not use an FM-trap, which is available from Radio Shack (Cat. No. 15-577) for \$3.69? That would save about \$20 compared to the cost of your project, and it needs no adjusting.

MATT STANTON  
*Shrewsbury, MA*

**R-E**



If you're in the market for great test and measurement gear, here's some food for thought: Tek makes a bunch of it. All with the same enduring quality that made our scopes famous. We even have catalogs so you can order these



## WHAT'S NEWS

continued from page 6

probed with high-frequency radio signals. Those signals, under the influence of the magnetic field, "excite" the nuclei of the hydrogen atoms concentrated in blood and body organs, causing them to resonate. Those resonance signals are transmitted to a computer which converts them into digital data. Computer software reconstructs the data into a picture of the object being imaged on the computer's monitor.

A flow encoding procedure that distinguishes between resonance signals emitted by moving hydrogen atoms in the bloodstream and those in the stationary organs and structures sets GE's MRI angiography technique apart. Signals emitted by the motionless hydrogen atoms are suppressed while those from the moving atoms are highlighted. The technique can measure and calculate the flexibility of the aorta and

various major arteries as well as most blood vessels.

To explore the clinical relevance of the quantitative measurement technique, GE and Imperial College researchers will examine how various agents such as nicotine and nitroglycerine alter the flow dynamics of blood within a vessel.

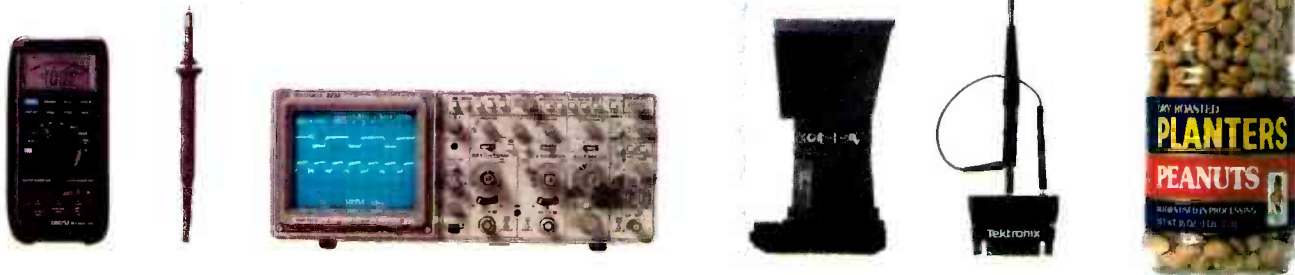
### Military technology for law enforcement

In an effort to shed its type casting as an exclusive defense contractor, the Westinghouse Electronics Systems Group (Baltimore, MD) has unveiled a shopping list of law-enforcement related products that it has developed. They are intended for the war on drugs and are expected to make law enforcement safer and more effective. Among the products and systems are:

- A vehicle equipped with advanced electronics providing an automatic communications link to criminal and motor-vehicle data banks, and still-frame video capture and transmission.

- A multi-sensor surveillance aircraft equipped with advanced sensors, communications, and navigation systems for aerial surveillance.
- A handheld instrument that detects trace amounts of illicit drugs or explosives and displays its findings. The instrument does a chemical analysis of a card that is passed over a suspect container.
- Software for computer-assisted report entry and law enforcement management.

By down-linking the multi-sensor aircraft's infrared and radar image to a ground base, the aircraft can also serve as an airborne command center to direct and coordinate ground activities. The vehicle-integrated payload-elevated reconnaissance (VIPER) system integrates radar, electro-optical, communications, and computer technologies into a mobile target-detection and reporting system intended for border surveillance. These are commercial versions of military systems that the company has developed over the past five decades. **R-E**



affordable products directly, in case you want to do more than just window shop. **TALK TO TEK / 1-800-426-2200 EXT. 78**



**Tektronix**

Test and Measurement

# EQUIPMENT REPORTS

## Beckman Industrial DM10XL Digital Multimeter

*High-quality, innovative meters at a hard-to-beat price.*

CIRCLE 10 ON FREE INFORMATION CARD



**M**ultimeter buyers on a budget have never had it so easy—nor have they ever had it so hard. It used to be difficult to find a low-cost DMM that was full-featured and built with an eye toward safety. These days, it's easier than ever to find such meters, but it's getting more difficult to choose from among them. The latest crop of low-cost high-quality DMM's to hit the market are from Beckman Industrial (Instrumentation Products Division, 3883 Ruffin Road, San Diego, CA 92123.) Beckman's *DM15XL*, *DM10XL*, and *DM5XL* range in price from \$34.95 to \$59.95. The *DM10XL*, which we examined, costs \$44.95.

The first thing we noticed about the *DM10XL* was its 3½-digit (2000-count) LCD readout. The large (0.7-inch) digits are very easy to read. We also noticed the meter's non-traditional color—a charcoal-gray cabinet with green labels and accents. Although we certainly wouldn't buy a DMM because of its color, the people at Beckman say they did a lot of market research that led them to choose the green shade.

The dimensions of the *DM10XL* are roughly 6×3×1¼ inches. The meter's face is dominated by a large rotary function-selector knob roughly in the center. The LCD is above the knob, and a row of 4 input jacks is below it. Along the left front edge is what we regard as the unit's

most innovative feature: A row of LED's give a rough idea of the voltage level at the probes even if the meter's battery is dead! It's a good feature because many DMM users are careless about replacing the battery when the low-battery annunciator indicates that it's time to do just that. (We assume that's because they don't know that a low battery can reduce a meter's accuracy tremendously, which could result in potentially dangerous situations.) Beckman calls the feature the "Safety Tester."

The Safety Tester feature also makes sense for someone who doesn't use a DMM regularly—a home-owner, for example, who occasionally uses a DMM when working on a home-wiring project or when doing some work on his car. Even when he pulls the meter out of his tool box with a dead battery, he'll be able to use it for basic, low-precision measurements, because the Safety Tester is powered by the voltage being measured, not by the DMM's battery.

Seven LED's indicate the voltage being measured: One yellow LED is used to indicate a negative voltage (or, in combination with another LED, an AC voltage.) A row of six red LED's indicates the voltage level; the levels indicated are 6, 12, 24, 50, 110, and 230 volts.

The DMM section of the meter measures AC volts in two ranges; (200 and 740 volts), DC voltage in

five ranges (200 mV, 2, 20, 200, and 1000 volts); and resistance in six ranges (200, 2K, 20K, 200K, 2000K, and 20 megohms). A diode-test/continuity feature is also available.

The *DM10XL* can measure DC current over five ranges (200  $\mu$ A, 2 mA, 20 mA, 200 mA, and 10 A). One test lead must be moved for current measurement to one of two current jacks—one jack handles current levels up to 200 milliamps; the second handles 10 amperes. Beckman has included two important safety features here. First, both current inputs are fused to protect both the user and the meter. Second, the meter will sound a warning tone if you have the test leads set up for current measurement while the function switch is in a voltage-measurement range. That's important because trying to measure a voltage with the test leads set for current could cause an excessively high current to flow.

Along with the fusing, the *DM10XL* also provides good overload protection on all functions and ranges. That's an important safety consideration missing from many low-cost meters.

The accuracy specifications of the *DM10XL* are impressive for a low-cost meter. DC accuracy is rated at  $\pm 0.7\% + 1$  digit; AC accuracy at  $\pm 1\% + 4$  digits. DC current is rated at  $\pm 1\% + 1$  digit for readings in the 200- $\mu$ A to 200-mA ranges, and at  $\pm 2\% + 3$  digits for readings in the 10-amp range.

The lowest-cost meter in the series, the *DM5XL* does not offer the Safety Tester feature and, in general, provides lower accuracy and reduced measurement capabilities. The *DM15XL* also lacks the Safety Tester, but adds AC current measurement and a logic-probe mode.

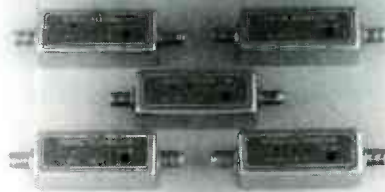
We were impressed by the convenience and safety features built into the \$44.95 *DM10XL*. We recommend it highly. **R-E**





### ELEVEN-PIECE RACHET TOOL KIT

Includes reversible ratchet handle, extension bar, six bits, two precision screwdrivers, and a cutter. Comes in fitted case. Get one for your shop, another for your car, another for your tool kit. To order send \$11.75 USA shipping only. **ELECTRONIC TECHNOLOGY TODAY INC., PO Box 240, Massapequa Park, NY 11762-0240.**



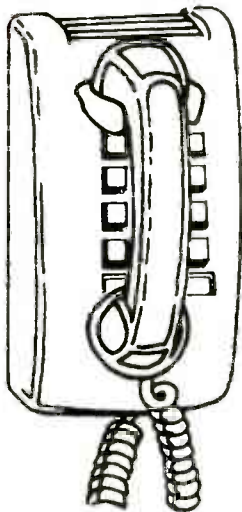
### TUNABLE 50dB NOTCH FILTERS—for TV.

Can be tuned precisely to required frequency. Model 23H-Ch's 2-3 (50-66 Mhz) Model 46FM-Ch's 4-6 plus FM (66-108 Mhz) Model 713-Ch's 7-13 (174-216 Mhz) Model 1417-Ch's 14-17 (120-144 Mhz) Model 1822-Ch's 18-22 (144-174 Mhz) \$30 each, includes shipping. Visa, MC, or check. (C.O.D. \$5 extra). Fast delivery, 30 day money back. Quantity prices to \$16. **STAR CIRCUITS, P.O. Box 94917, Las Vegas, Nevada 89193, 1-800-535-7827.**



**FREE CATALOG! ELECTRONIC TOOLS & TEST EQUIPMENT**—Jensen's new Master Catalog, available free, presents major brand name electronics tools, tool kits, and test instruments, plus unique, hard-to-find products for assembly and repair and custom field service kits available only from Jensen. All fully described and illustrated. Enjoy free technical support and rapid, post-paid delivery anywhere in the Continental USA. **JENSEN TOOLS, INC., 7815 S. 46th St., Phoenix, AZ 85044. Phone: 602-968-6231; FAX 1-800-366-9662.**

**CIRCLE 115 ON FREE INFORMATION CARD**



### TWO TRANSMITTERS IN ONE! 5 MINUTE ASSEMBLY! MONEYBACK GUARANTEE!

New Law Enforcement grade device on a single chip is the most sensitive, powerful, stable room transmitter you can buy. Uses any 3V-12V battery. Or attach to telephone line to monitor all telephone conversations over 1 mile away without batteries! 100mW output! 80-130MHZ. Receive on any FM radio or wideband scanner. VT-75 microtransmitter. \$49.95 + 1.50 S&H. VISA, MC, MO. COD's add \$4.00. **DECO INDUSTRIES, Box 607, Bedford Hills, NY 10507. 1-800-759-5553.**

**CIRCLE 127 ON FREE INFORMATION CARD**



### \$495 FOR A PROGRAMMABLE DC POWER SUPPLY IS NOW A REALITY!

• GPIB Interface Standard • Output Voltage/Current Programming & Readback • Local & Remote GPIB Operations • Remote Sense Function • Programmable Overvoltage and Overcurrent Protection • Software Calibration • Superior Line/Load Regulation • Output Enable/Disable • 3 Year Warranty. FREE Orientation Video available. For details, call: **AMERICAN RELIANCE INC. 800-654-9838 FAX: 818-575-0801.**

**CIRCLE 176 ON FREE INFORMATION CARD**

## CALL NOW AND RESERVE YOUR SPACE

- 6 x rate \$940.00 per each insertion.
- Fast reader service cycle.
- Short lead time for the placement of ads.
- We typeset and layout the ad at no additional charge.

Call 516-293-3000 to reserve space. Ask for Arline Fishman. Limited number of pages available. Mail materials to: mini-ADS, ELECTRONICS NOW, 500-B Bi-County Blvd., Farmingdale, NY 11735.

FAX: 516-293-3115



**APPLIANCE REPAIR HANDBOOKS**—13 volumes by service experts; easy-to-understand diagrams, illustrations. For major appliances (air conditioners, refrigerators, washers, dryers, microwaves, etc.), elec. housewares, personal-care appliances. Basics of solid state, setting up shop, test instruments. \$2.65 to \$5.90 each. Free brochure. **APPLIANCE SERVICE, PO Box 789, Lombard, IL 60148. 1-708-932-9550.**

**CIRCLE 84 ON FREE INFORMATION CARD**



**CABLE TV CONVERTERS AND DE-SCRAMBLERS** SB-3, TRI-BI, MLD, M35B, DRZ-DIC. Call for catalog and price list. Special combos available. We ship COD. Quantity discounts. Call for pricing on other products. Dealers wanted. **FREE CATALOG.** We stand behind our products where others fail. One year warranty. **ACE PRODUCTS, 1-800-234-0726.**

**CIRCLE 75 ON FREE INFORMATION CARD**

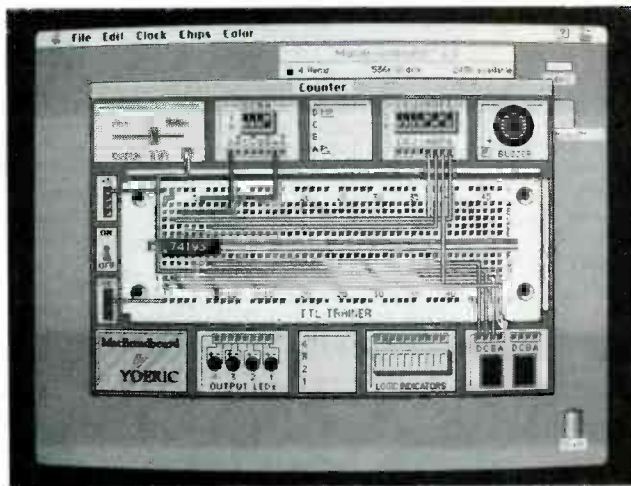
# NEW PRODUCTS

Use the Free Information Card for more details on these products.

## MACINTOSH DIGITAL-CIRCUITS TRAINER.

Owners and users of a Macintosh computer (512ke with System 4.1 or greater) who want to learn more about digital electronics can do so with *Yoeric Software's MacBreadboard 1.0*. Intended for hobbyists and students, the transistor-transistor logic (TTL) trainer was designed to act like the hardware simulators used in many digital circuit courses. Unlike those simulators which are based on a schematic approach, *MacBreadboard* provides a computer representation of a real-world object; the student manipulates IC chips and conductors, not individual gates.

Students select a TTL device by number (i.e. 7400) from a menu, place it on the representation of a PC board on the MAC computer's screen, and "draw" conductors to connect the power supply, resistors, capacitors, switches and other components just as they would in putting together a lab breadboard. According to Yoeric, the program permits students to simulate their laboratory



CIRCLE 16 ON FREE INFORMATION CARD

assignments before actually doing them. The program is said to be able to supplement or be an alternative to a formal course on digital circuits.

*MacBreadboard* permits the student to select from among over 30 two-state devices, breadboard, power supply, wires, LED's, buzzer, seven-segment displays, switches, and a logic probe. Timing diagrams of circuits that have been simulated can be displayed and printed out. A "snapshot" of the breadboard can also be printed. Integrated circuit sche-

matics can be displayed by double-clicking on the symbol of a device. The program runs in color, gray scale, and black-and-white. In the color mode, the traces can be colored by length or node, or the user can specify the color desired. A 50-page manual with diagrams of sample circuits that can be simulated is included.

*MacBreadboard 1.0* costs \$59.95; educational discounts are available.—**Yoeric Software**, 600 South Churton #24, Hillsborough, NC 27278; Phone: 919-644-1620.

terprises's Digicom/64 public software (MFJ-1293).

The MFJ-1271 costs \$49.95.—**MFJ Enterprises, Inc.**, P.O. Box 494, Mississippi State, MS 39762; Phone: 601-323-5869 (for orders: 1-800-647-1800); Fax: 601-323-6551.

## GENERAL-PURPOSE CUTTER.

Cable TV and computer network installers, and technicians working with different kinds of coaxial cable and wire need sharp, general purpose cutters. GC Electronics



CIRCLE 18 ON FREE INFORMATION CARD

says it meets this need with its No.12-457 5-inch cutter. The tool is said to cut through all sizes of coaxial cable cleanly and crisply, without crushing the cable. It is also capable of cutting other kinds of wire used in electrical and electronic work.

The No. 12-457 cutter sells for \$3.50.—**GC Electronics**, 1801 Morgan Street, Rockford, IL 61102.

## AUDIO REFERENCE GENERATORS.

The ARG-440 and ARG-1000 audio reference generators from *Tobin Cinema Systems* are said to generate pure, accurate 440-Hz (A4 to musicians) and 1000-Hz tones. The generators also provide precision "pink" and

## PACKET MODEM/TERMINAL MODE CONTROLLER

A Commodore 64/128 computer and a handheld VHF or HF single-sideband transceiver with the MFJ-1271 are your tickets for admission to packet communication. MFJ's modem/terminal mode controller plugs into your Commodore's rear cassette port. It works both



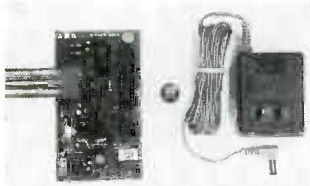
CIRCLE 17 ON FREE INFORMATION CARD

VHF packet at 1200 baud and HF packet at 300 baud. A data carrier detected circuit and adjustable threshold control reduces noise

susceptibility and increases the chances of making QSO connections—especially on HF bands.

A DCD circuit with a LED indicates when you are receiving signals properly. The device also features remote packet operation, mailbox-like message forwarding, and Net/ROM emulation. It uses MFJ En-





CIRCLE 19 ON FREE INFORMATION CARD

"white" noise for audio tests.

A 440-Hz frequency standard is used in tuning musical instruments and even whole orchestras. The frequency can also verify that tape speed is correct and that 0 VU reference levels are set. A frequency of 1000 Hz is the traditional reference level. Both models of audio reference generator have stated accuracies of 10 parts per million, 3 ppm (0.0003%) typical.

Pink noise applied to tape heads after the reference tone permit playback

equalization to be precisely set when used with a real-time analyzer. That noise can also be used for room equalization. Moreover, pink and white noise can be mixed to simulate the sound of rain, a waterfall, surf, or various hissing noises.

The outputs of the audio reference generators are electronically balanced at 600 ohms and deliver 0 dBm. They can also be unterminated at +6 dBu, unbalanced at 0 dBu, or loaded for a lower signal level. Each generator set includes a calibrated circuit board, color-coded detachable 16-wire cable, a wall-outlet AC to DC converter, and a mating DC power plug. Both can be operated from any +12- to +35-volt DC source.

ARG-440 and ARG-1000 audio reference

generators are priced at \$150.—**Tobin Cinema Systems**, 3227 49th Avenue SW, Seattle, WA 98116; Phone: 206-932-7280.

**ALLIGATOR CLIPS.** A family of five alligator clips from *ITT Pomona* permits the safe electrical testing of components and systems carrying up to 250 volts. The clips are available in a range of sizes: large heavy duty, large, medium, miniature, and disposable. All alligator clips are coated with durable plastic insulation to prevent shock hazard, shorting, or grounding to conductive surfaces.

Tinned copper-alloy jaws firmly grasp wires or leads and receptacles with connectors accept 2- to 4-mm (0.087- to 0.157-inch) lead wires. The miniature and disposable clips are intended for tests on densely pop-

ulated circuit boards in restricted locations. They are also useful in such medical applications as electrocardiogram testing. The larger clips are suitable for testing for high-current withstand capability and electrostatic-control products.



CIRCLE 20 ON FREE INFORMATION CARD

The large, heavy-duty *Model 5785* grips objects up to 9.5-mm (0.37 inch) in diameter. It has an overall length of 81 mm (3.19-inch), and it accepts a sheathed banana plug. It will protect against 250 volts. The large *Model 5786* clip grips objects up



## EVEN AT \$39, THE BLUES CAN LAST A LONG, LONG TIME.

Conventional wisdom says if you spend less than forty bucks on a probe, it won't be long until the thrill is gone. But **Duraprobes™** start at \$39, live practically forever, and work with almost any scope around, so it won't surprise us if you pick up a whole case. After all, some folks were just born to have the blues.

### Duraprobe

63W-188581-1

Brownell / Carolton-Bates / CMI-Metermaster / Contact East / ENTEST / INOTEK  
ITC / Jensen Tools, Inc. / Joseph Electronics / Marshall Industries  
Radar Electric / R.S. Electronics / Zack Electronics

CIRCLE 92 ON FREE INFORMATION CARD

# HAMEG® Instruments

**Top engineering  
needs top equipment**

Our line of high quality measuring instruments offers a full range of outstanding features and unbeatable price/performance standards.



Call toll free  
800.247.1241

## HAMEG INC.

1939 Plaza Real  
OCEANSIDE, CA 92056  
Phone (619) 630-4080  
Telefax (619) 630-6507

20 Lumber Road BLDG. # 2  
ROSLYN, NEW YORK 11576  
Phone (516) 484-7121  
Telefax (516) 484-7170

to 10 mm (0.39 inch) in diameter. It includes a screw connection for lead wires up to 18 AWG (2.4 mm). Its overall length is 80.5 mm (3.17 inches).

The *Model 5787*, 56-mm (2.20-inches) long medium clip, connects to a standard 4-mm banana jack. The *Model 5788* miniature clip has a miniature banana jack and an overall length of 40 mm (1.57 inches). The disposable *Model 5791* clip, with an overall length of 53 mm (2.09 inches), has a button fix/release for lead retention and a standard banana jack.

The alligator clips are priced from \$.98 to \$3.45 each.—**ITT Pomona Electronics**, Customer Service, 1500 East Ninth Street, P.O. Box 2767, Pomona, CA 91769; Phone: 714-469-2900; Fax: 714-629-3317.

### INTEGRATED SURFACE MOUNT WORKSTATION.

Manufacturers who perform paste and place surface-mount component assembly in small volume can improve their yields and their productivity with the *SMT-6000* pick/place/dispose system from **OK Industries**.

The mechanically assisted, solder-paste dispensing and component placement system is designed to achieve placement rates of up to 600 components per hour. It integrates a solder-paste dispenser and vacuum pick-up head onto a single arm assembly. That arm can be moved in the X-Y-Z-0 axes while the operator's hand is stabilized on a movable hand rest.

Needle positioning for paste dispensing, is said to be precise and repeatable, reducing placement location error by as much as 67%. According to **OK In-**



**CIRCLE 21 ON FREE  
INFORMATION CARD**

dustries, the mechanical assistance of arm assembly provides a three-fold increase in production over manual pick-and-place methods. For prototyping and batch production, a board can be pasted and populated in one workstation while secured in the adjustable, locking PC board holder. Movement is minimized because the board remains fixed during both the pasting and populating operations.

The *SMT-6000* is sold complete with a 45-compartment carousel, 12-inch and 15-inch PC board holders, a self-contained vacuum source for pick-and-place operations, time/pressure controls for dispensing, a hand rest, and a pick/place nozzle kit. Optional accessories such as stick and reel component feeders, a light/magnifier, interchangeable spare carousels, and a feeder-mounting bracket are also available.

The *SMT-6000* SMT workstation sells for \$3750.—**OK Industries, Inc.**, 4 Executive Plaza, Yonkers, NY 10701; Phone: 914-969-6800; Fax: 914-969-6650.

### TRANSDUCER POWER SUPPLY.

The *Model 4130* encapsulated power supply from **Calex** offers adjustable voltage output for powering transducers, strain gages, and many kinds of laboratory equipment. The power supply provides 4 to 15 volts DC at up to 1590 milliamperes, enough power for three



**WHOS SHHH!**  
**THE FASTEST, EASIEST CROSS-REFERENCING  
 OF ORIGINAL DEVICES TO NTE  
 REPLACEMENT PARTS!**



**NTE'S NEW SOFTWARE**

# QUICK Cross

"QUICK Cross" is the industry's first PC-based software cross-reference to NTE's highly successful line of semiconductors and relays!

Just type in any one quarter of a million industry device numbers — U.S., Japanese, and European — and you'll get the deal replacement from over 4,750 NTE devices in about one second.

All NTE parts carry a two-year warranty and most are available off the shelf.

"QUICK Cross" 5 1/4" and 3 1/2" floppy diskette MS-DOS versions are available direct from NTE or through your local NTE distributor. For your nearest one, call NTE toll free 1-800-637-1250 (including Canada) or (201) 748-5083.

FAX: (201) 748-6224



**NTE ELECTRONICS, INC.**

A WORLDWIDE REPUTATION FOR QUALITY, SERVICE AND VALUE

YES, PLEASE SEND ME THE FOLLOWING NUMBER OF COPIES OF "QUICK Cross" SOFTWARE ON FLOPPY DISKETTES

\_\_\_ 5 1/4" (1.2M) \$5.00 ea.     \_\_\_ 3 1/2" (720K) \$6.00 ea.  
 \_\_\_ 5 1/4" (360K) \$7.50 ea.

Enclosed please find my check or money order for \$\_\_\_\_\_ (U.S. funds only.)

Name \_\_\_\_\_  
 Company \_\_\_\_\_  
 Address \_\_\_\_\_  
 City \_\_\_\_\_ State \_\_\_\_\_ Zip \_\_\_\_\_

Attach this coupon to your letterhead and mail to:  
 NTE, 44 Farrant St., Bloomfield, NJ 07003 RE992

"QUICK Cross" software runs in MS-DOS on any IBM PC or compatible with 640K of RAM, a small hard drive, and a 5 1/4" or a 3 1/2" floppy drive. NTE's database occupies only 2.1 Mbytes of hard disk space when loaded. It is a public domain release. MS-DOS is a registered trademark of Microsoft Corporation. IBM is a registered trademark of International Business Machines.

CIRCLE 18 ON FREE INFORMATION CARD



# If You're Serious About a Future in Electronics, Ensure that Future with the Best Educational Training Available.

## FREE!

SEND FOR YOUR CIE HOME STUDY COURSE CATALOG AND RECEIVE A FREE 24 PAGE CIE ELECTRONICS SYMBOL HANDBOOK!

Includes hundreds of the most frequently used electronic symbols. Published by CIE exclusively for our students and alumni. Yours free when you request a CIE Course Catalog.

### Procedure

Figure 16 shows the circuit diagram for this experiment. You will need the IC pin numbers for the IC given; included on the diagram. For those numbers refer to Fig. 17, which shows pertinent 74151A data. For the 10K resistors you'll use an eight pole DIP switch in conjunction with 10K resistors. For the Select and Strobe lines, finally, you'll use the 74151A data sheet.

1. With the power off, mount the 74151A IC, and the DIP switch on the breadboard.
2. Connect the eight 10K resistors to the DIP switch as shown in Fig. 16. Connect the opposite end of each of these resistors to the positive supply. The common terminal of each switch is to be connected to the negative ground.
3. Connect the IC  $V_{CC}$  pin to a +5V; connect the GND pin to the negative ground.
4. Next, connect the three data switches to the Select and Strobe lines on the IC using Fig. 17 as a guide. Initially, set SW1 through SW3 to the 0 position.
5. Connect the single LED to the H output, and connect the other end of the LED to the H output.
6. Switch each line of the DIP switch to 0. The logic diagram in Fig. 16 shows the connections. Connect the

Fig. 16 Circuit for Experiment 2

Fig. 17 Pin diagram for 74151A

7. Turn the power on. The LED in your circuit should be off and the H LED should be on. If you don't observe these conditions, turn off the power and check your connections.
8. From the present input conditions on the inputs, you can see that the input will be enabled.
9. Set the appropriate DIP switch H (input), and verify your prediction. Record your results in terms of the selected input D, where n is the number of the selected data line in the appropriate space in the truth table in Fig. 18.



If you want to learn about electronics, and earn a good income with that knowledge then CIE is your best educational value.

CIE's reputation as the world leader in home study electronics is based solely on the success of our graduates. And we've earned that reputation with an unconditional commitment to provide our students with the very best electronics training.

Just ask any of the 150,000-plus graduates of the Cleveland Institute of Electronics who are working in high-paying positions with aerospace, computer, medical, automotive and communication firms throughout the world.



They'll tell you success didn't come easy...but, it did come....thanks to CIE. And today, a career in electronics offers more opportunities and greater rewards than ever before.

### CIE'S COMMITTED TO BEING THE BEST....IN ONE AREA....ELECTRONICS.

CIE isn't another be-everything-to-everybody school. We teach only one subject and we believe we're the best at what we do. Also, CIE is accredited by the National Home Study Council. And with more than a 1,000 graduates each year, we're the largest home study school specializing exclusively in electronics. CIE has been training career-minded students like yourself for nearly 60 years and we're the best at our subject ....  
ELECTRONICS ... BECAUSE IT'S THE ONLY SUBJECT WE TEACH!

### CIE PROVIDES YOU WITH A LEARNING METHOD SO GOOD, IT'S PATENTED.

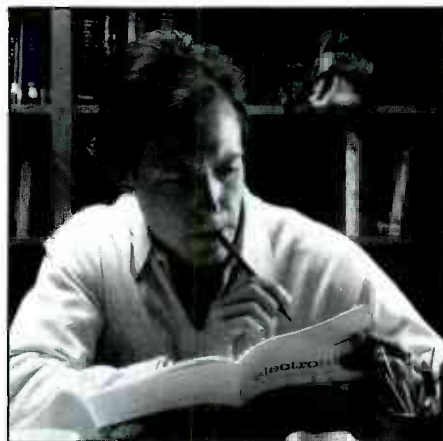
CIE's Auto-programmed lessons are a proven learning method for building valuable electronics career skills. Each lesson is designed to take you step-by-step and principle-by-principle. And while all CIE lessons are designed for independent study, CIE's instructors are personally available to assist you with just a toll-free call. The result is practical training... the kind of experience you can put to work in today's marketplace.

### LEARN BY DOING...WITH STATE-OF-THE-ART FACILITIES AND EQUIPMENT.

In 1969, CIE pioneered the first Electronics Laboratory course and in 1984, the first Microprocessor Laboratory course. Today, no other home study school can match CIE's state-of-the-art equipment and training. And all your laboratory equipment, books, and lessons are included in your tuition. It's all yours to use while you study at home and for on-the-job after graduation.

### PERSONALIZED TRAINING....TO MATCH YOUR BACKGROUND.

While some of our students have a working knowledge of electronics others are just starting out. That's why we've developed twelve career courses and an A.A.S. Degree program to choose from. So, even if your not sure which electronics career is best for you, CIE can get you started with



core lessons applicable to all areas of electronics. And every CIE course you take earns you credit towards completion of your Associate in Applied Science Degree. So you can work toward your degree in stages or as fast as you wish. In fact, CIE is the only school that actually rewards you for fast study, which can save you thousands of dollars.

SEND TODAY FOR YOUR CIE COURSE CATALOG AND WE'LL SEND YOU A FREE 24 PAGE CIE ELECTRONICS SYMBOL HANDBOOK!

#### WHY CHOOSE CIE FOR YOUR TRAINING?

- 150,000 successful graduates from every country around the world.
- Only CIE rewards you for fast study. CIE offers an Associate Degree program based on actual study time used. The faster you complete your degree the less your overall tuition.
- State-of-the-art laboratory equipment is yours to keep and it comes assembled, ready for hands-on experiments.
- Approved for educational benefits under the G.I. Bill for veterans and other eligible persons.
- Upon graduation, CIE offers free preparation to pass the Certified Electronics Technician Exams.

**YES!** I want to get started.  
Send me my CIE school catalog including details about the Associate Degree Program. (For your convenience, CIE will have a representative contact you - there is no obligation.)

AE42

Name: \_\_\_\_\_

Address: \_\_\_\_\_

City: \_\_\_\_\_ State: \_\_\_\_\_

Zip: \_\_\_\_\_ Age: \_\_\_\_\_

Phone No. ( \_\_\_\_\_ ) \_\_\_\_\_

Check box for G.I. Bulletin Benefits

Veteran  Active Duty

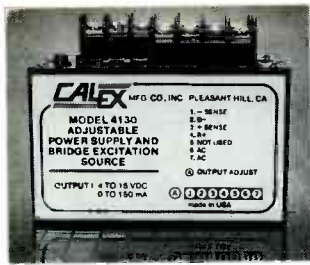


**CLEVELAND INSTITUTE OF ELECTRONICS**

1776 East 17th Street  
Cleveland, Ohio 44114  
(216) 781-9400



A school of thousands.  
A class of one.  
Since 1934.



**CIRCLE 22 ON FREE INFORMATION CARD**

350-ohm gages or transducers that require 10-volt excitation.

Voltage can be adjusted with a built-in potentiometer. Line and load regulation are 0.05%. Ripple and noise are less than 0.5 millivolt rms. The power supply has built-in remote sensing, it is short-circuit protected, and it has an internal thermal shutdown switch. The Model 4130 can operate at full load to temperatures of 70°C. It measures 3.75 x 2 x 2.87 inches and weighs only 18 ounces. The case has two molded-in mounting holes, and mounting bolts are provided with the supply.

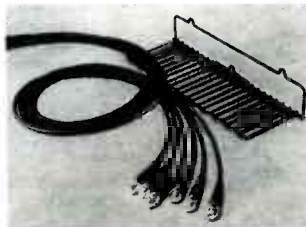
Options for input voltages for the Model 4130 are 110, 115, 220, 230, or 240 volts AC. Prices start at \$122.—**Calex Mfg. Co., Inc.**, 2401 Stanwell Drive, Concord, CA 94520-4841; Phone: 800-542-3355; Fax: 510-687-3333.

### COAXIAL ADAPTER CABLE KIT AND CONNECTOR KIT.

Test Probes' universal coaxial adapter cable kit, TPI-5010, is intended for use with the company's TPI-3000A connector kit. Each of the six adapter cables in the kit accepts all combinations of BNC, TNC, SMA, N, UHF, Mini-UHF, F, and RCA connectors.

According to the manufacturer, any combination of two connectors from the 24 available in the TPI-3000A kit can be at-

tached to the ends of one of the six universal cables in the TPI-5010 kit. Because no crimping or soldering is required, the cables can be used repeatedly and in different configurations. The six RG-58 cables in the kit are double-braid shielded, 48 inches long, and have soft poly-



**CIRCLE 23 ON FREE INFORMATION CARD**

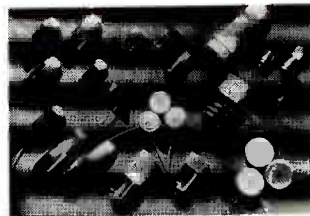
vinyl chloride (PVC) jackets.

The TPI-3000A connector kit include two male and two female connectors for BNC, N, UHF, and TNC adapters and one male and one female connector for the SMA, Mini-UHF, F, and RCA adapters along with six universal interfaces.

All connectors have silver-plated machined brass shells and gold-plated contacts. Both kits are said to be convenient for servicing communications equipment and local-area networks in the field, and interfacing or connecting for various RF systems and test equipment.

The TPI-5010 kit containing six cables and a plastic-coated wall rack is priced at \$98. The TPI-3000A connector kit with 24 connectors sells for \$150.—**Test Probes, Inc.**, 9178 Brown Deer Road, San Diego, CA 92121; Phone: 800-368-5719.

**BRIGHT LED LAMPS.** The light-emitting diode lamps in this new family from Lumex Opto/Components are intended as replace-



**CIRCLE 24 ON FREE INFORMATION CARD**

ments for incandescent lamps in existing products. McLED's are made with from two to eight LED dies to obtain light output comparable to that of the incandescent bulb it replaces. The multi-LED lamps are offered with wire ends or standard incandescent lamp bases. They are said to run cooler and save the time and cost of frequent filament lamp replacement in the field.

The lamps are being sold as replacements for miniature and sub-miniature incandescent lamps with ratings from 2 to 20 volts AC or DC. The AC lamp replacements include miniature rectifier bridges to permit them to operate from AC sources. (Individual LED dies draw currents of 2 to 25 milliamperes at 1.5 to 2.8 volts DC.) The DC lamp replacements can be mounted directly on PC boards or front panels. Lumex obtains a near-white light output for its lamps by mixing LED dies that emit different colors on the same lamp header.

The prices of McLED's vary from \$1.00 to \$10 each, depending on order quantity, color, and package.—**Lumex Opto/Components Inc.**, 292 East Hellen Road, Palatine, IL 60067; Phone: 708-359-2790; Fax: 708-359-8904.

**DIFFERENTIAL OSCILLOSCOPE PROBE.** Two different signals can be measured on one oscilloscope channel with this active differential os-

cilloscope probe, and there is no need for a ground reference to make the measurement. The model ADF15, from Test Probes, Inc. was designed to permit the oscilloscope to be grounded for safety while measurements are made without isolation ampli-



**CIRCLE 25 ON FREE INFORMATION CARD**

fiers. This feature is said to eliminate errors caused by the voltage differences between two amplifiers and two probes.

The ADF15 is intended for making high voltage differential measurements in switching power supplies, motor controllers that include thyristors, and power MOSFET's. It can also make accurate measurements of small signal differences in the presence of high common-mode voltage. The probe's bandwidth covers the range of DC to 15 MHz and it has a switchable x20 to x200 attenuation mode.

The probe is powered by four AA batteries or an external 6-volt DC converter (not supplied). The price includes standard probes, alligator clips, and spring-tip probes with banana-plug leads.

The ADF15 probe is priced at \$375.—**Test Probes, Inc.**, 9178 Brown Deer Road, San Diego, CA 92121; Phone: 619-535-9292.

**R-E**



# NEW LIT

Use The Free Information Card for fast response.

## USING ONLINE SCIENTIFIC & ENGINEERING DATABASES; by Harley Bjelland. Windcrest/McGraw-Hill, Blue Ridge Summit, PA 17294-0850; \$26.95.

Engineers, technicians, scientists, hobbyists, and technical writers always seem to be hungry for facts, and they might spend hours searching for just the right information before they start or complete a project. But we are now undergoing an information explosion, and it seems that the leading edge of scientific and engineering knowledge always seems to elude our ability to keep up. Books, maga-



CIRCLE 26 ON FREE INFORMATION CARD

zines, technical papers and other printed materials are no longer the only sources of technical data; on-line computer databases are helping out by providing current information that is easily accessible through your modem-equipped PC.

This book explains how to conduct successful on-line scientific and engineer-

ing database search with a minimum investment of time, effort, and expense. It describes the required computer hardware and software and explains the advantages and disadvantages of each database service. Step-by-step, illustrated instructions tell you how to tap into the power of on-line databases, and sample searches show exactly what you'll see as you work your way through specific database menus. Also explained are ways to save money by using command-line searches and other shortcuts.

Descriptions are given for major technical and con-

sumer on-line databases including EasyNet, Dialog, BRS, MEAD, STN, ORBIT, Dow Jones, and EPIC. Techniques are presented for evaluating information obtained through on-line systems and putting it to profitable use.

**1992 CATALOG; from Jim-Pak Electronic Components, 1355 Shoreway Road, Belmont, CA 94002; free.**

This 30-page free brochure from Jim-Pak contains listings and illustrations of over 600 of its products for electronic hobbyists and professionals. For example, you'll find listings of the company's

# Train at HOME to be an Electronics Technician!

As the demand for computers and microprocessors in business, manufacturing and communications continues to grow, so does the need for qualified technicians. It's not unusual for experienced technicians to earn from \$30,000 to more than \$40,000 a year.\* Now through Peoples College of Independent Studies you can train for this exciting field without interrupting your job or home life.

### Choose From Five Programs of Study

- Electronics & Microprocessor Technology
- Industrial Electronics & Microprocessor Technology
- Communications Electronics with Microprocessor Technology
- Computer Servicing & Electronics Technology
- Specialized Associate Degree In Electronics Technology

### Professional Equipment Is Included

Depending on the program you select, you'll perfect your skills using this advanced equipment, included in the price of tuition:

- IBM-Compatible Personal Computer
- Digital Multimeter
- Digital Logic Probe
- Elenco Oscilloscope
- Portable Cellular Telephone

(\* Source: U.S. Bureau of Labor Statistics)



### Exclusive Extras That Enhance Your Training

Peoples College introduces some training firsts to make your learning experience more complete:

- Accelerated Learning System — a scientifically proven study system that helps you learn faster and easier than ever before.
- Video Tutor Training Tapes — give you a permanent, visual record of informative lectures and close-up demonstrations.
- Experience Labs — professionally designed experiments that give you hands-on "bench" experience.
- Industry Certification Training Guide — provided with four of our programs. Prepares you for examinations you may take for your professional license or certification.

### Easy Payment Plans — No Finance Charges

To help you get started on your education, Peoples College has reduced tuition rates and offers low monthly payment plans with no finance fees. So don't delay, call or write for more information today!

### For COLOR CATALOG Mail Coupon or Call TOLL FREE 1-800-765-7247

Programs offered only in United States, Canada, Puerto Rico and Virgin Islands. No Obligation. No sales person will call.

Our programs are accredited by the Accrediting Commission of the National Home Study Council

✂

**YES! I would like to know more about your training programs. Send a catalog to:**

Name \_\_\_\_\_

Address \_\_\_\_\_

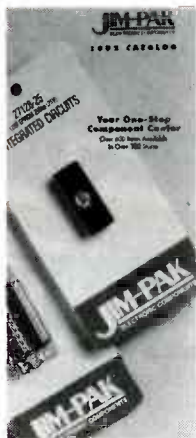
City \_\_\_\_\_

State \_\_\_\_\_ Zip \_\_\_\_\_

Phone # \_\_\_\_\_

**PEOPLES COLLEGE**  
OF INDEPENDENT STUDIES  
233 Academy Drive • P.O. Box 421768  
Kissimmee, FL 34742-1768  
Member, D.I. Peoples Group RE0992

CIRCLE 187 ON FREE INFORMATION CARD



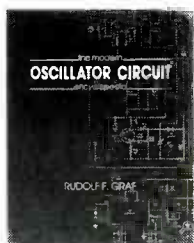
**CIRCLE 27 ON FREE INFORMATION CARD**

offerings in resistors, capacitors, trimmers, and potentiometers. You'll also be able to find active devices from diodes and LED lamps to digital and linear integrated circuits, microprocessors, and memories. Packaging products being offered include breadboards, enclosures, connectors, fans, heat sinks and power supplies. Manufacturing equipment from Jim-Pak includes soldering irons and hand tools. Reference and text books of interest to the electronics community are also listed in the catalog. A state-by-state listing of over 300 of Jim-Pak's stores is included.

**THE MODERN OSCILLATOR CIRCUIT ENCYCLOPEDIA; by Rudolf F. Graf. TAB Books, Division of McGraw-Hill Inc., Blue Ridge Summit, PA 17294-0850; Tel. 1-800-822-8138; \$12.95.**

This circuit encyclopedia is a handy reference for those who want instant access to more than 250 proven, practical oscillator circuit designs. Some of the circuits contain late-model ICs that simplify their construction and reduce the number of components needed. Needless to say, they add to the versatility and reliability of the resulting oscillator.

Mr. Graf's encyclopedia includes schematics for virtually every type of oscillator circuit that has ever been designed—some that are very familiar and others that are obscure—even to experts. The names of many of the oscillator circuits are familiar to students and seasoned professionals alike. Their operation is taught in engineering classes as well as vocational and military tech schools. There are, for example, the old familiar Armstrong, Clapp, Colpitts, Franklin, Hartley, Hertz, Miller, Pierce and Wien-bridge oscillators as well as audio, blocking, crystal, multivibrator and electron-coupled versions.



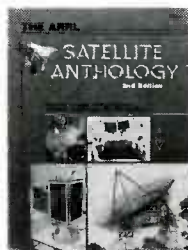
**CIRCLE 28 ON FREE INFORMATION CARD**

The schematics and descriptions are organized by application for easy reference. The circuit schematics and descriptive text have been reproduced in the same form in which they were originally published in such sources as **Radio-Electronics**. This was done by Mr. Graf to prevent transcription errors and make them instantly recognizable to readers who might have seen them in the past. The original source for each circuit is listed in a section at the back of the encyclopedia. That permits readers to refer back to the source publications for additional information on construction and application.

**THE ARRL SATELLITE ANTHOLOGY: 2nd Edition; from**

**The American Radio Relay League, 225 Main Street, Newington, CT 06111; \$8.00.**

In the 30 years since the first amateur-radio satellite was launched, satellite technology has become increasingly sophisticated. Nevertheless, communication with satellites has become easier. This collection of articles from ARRL's *QST* magazine is intended to help amateur radio operators participate in satellite communications; they dispel the myth that satellite operating is expensive and difficult.



**CIRCLE 29 ON FREE INFORMATION CARD**

Amateurs can access satellites with equipment they already own. The informative articles discuss active amateur satellites, their operating features, and how to access them. Several articles, whose content is still valid today, were retained from the first edition. Subjects include satellite tracking and conversing with other operators in other countries. More recent articles discuss presently operating satellites such as AMSAT-OSCAR 13, and look at the next generation of OSCAR satellites.

**TROUBLESHOOTING & REPAIRING ELECTRONIC MUSIC SYNTHESIZERS; by Delton T. Horn. TAB Books, Division of McGraw-Hill Inc., Blue Ridge Summit, PA 17294-0850; Tel. 1-800-822-8138; \$16.95.**

As music synthesizers become more popular,

there is an increasing demand for instruction material on their maintenance and repair. This book was written for musicians who want to repair their own equipment as well as electronic hobbyists and technicians who need a reliable source of information on synthesizer troubleshooting and repair. Mr. Horn's book gives complete, step-by-step instructions for servicing synthesizers and replacing their components. Both the older analog and more modern digital instruments are covered.

The first half of the book is devoted to locating and repairing problems that commonly occur in analog synthesizers. Those include nonexistent, weak, or noisy output signals. Also described are methods for repairing voltage sources, function generators and keyboards.

The book's second half covers digital synthesizers. It gives instructions for re-



**CIRCLE 30 ON FREE INFORMATION CARD**

pairing digital oscillators, amplifiers, and their power supplies. Topics discussed include logic probes and logic pulsers. One whole chapter is devoted to MIDI with discussion of cabling, channels and circuitry. Instructions are given on what to do if your synthesizer fails to respond to MIDI commands. In addition, the book offers advice on how to restore old or unusable synthesizers as well as how to modify and expand existing units.



# Countersurveillance

**Never before has so much professional information on the art of detecting and eliminating electronic snooping devices—and how to defend against experienced information thieves—been placed in one VHS video. If you are a Fortune 500 CEO, an executive in any hi-tech industry, or a novice seeking entry into an honorable, rewarding field of work in countersurveillance, you must view this video presentation again and again.**

*Wake up!* You may be the victim of stolen words—precious ideas that would have made you very wealthy! Yes, professionals, even rank amateurs, may be listening to your most private conversations.

*Wake up!* If you are not the victim, then you are surrounded by countless victims who need your help if you know how to discover telephone taps, locate bugs, or "sweep" a room clean.

There is a thriving professional service steeped in high-tech techniques that you can become a part of! But first, you must know and understand Countersurveillance Technology. Your very first insight into this highly rewarding field is made possible by a video VHS presentation that you cannot view on broadcast television, satellite, or cable. It presents an informative program prepared by professionals in the field who know their industry, its techniques, kinks and loopholes. Men who can tell you more in 45 minutes in a straightforward, exclusive talk than was ever attempted before.

## Foiling Information Thieves

Discover the targets professional snoopers seek out! The prey are stock brokers, arbitrage firms, manufacturers, high-tech companies, any competitive industry, or even small businesses in the same community. The valuable information they filch may be marketing strategies, customer lists, product formulas, manufacturing techniques, even advertising plans. Information thieves eavesdrop on court decisions, bidding information, financial data. The list is unlimited in the mind of man—especially if he is a thief!

You know that the Russians secretly installed countless microphones in the concrete work of the American Embassy building in Moscow. They converted



**CALL NOW!**

**1-516-293-3751**

**HAVE YOUR VISA or MC CARD AVAILABLE**

what was to be an embassy and private residence into the most sophisticated recording studio the world had ever known. The building had to be torn down in order to remove all the bugs.

## Stolen Information

The open taps from where the information pours out may be from FAX's, computer communications, telephone calls, and everyday business meetings and lunchtime encounters. Businessmen need counselling on how to eliminate this information drain. Basic telephone use coupled with the user's understanding that someone may be listening or recording vital data and information greatly reduces the opportunity for others to purloin meaningful information.

The professional discussions seen on the TV screen in your home reveals how to detect and disable wiretaps, midget radio-frequency transmitters, and other bugs, plus when to use disinformation to confuse the unwanted listener, and the technique of voice scrambling telephone communications. In fact, do you know how to look for a bug, where to look for a bug, and what to do when you find it?

Bugs of a very small size are easy to build and they can be placed quickly in a matter of seconds, in any object or room. Today you may have used a telephone handset that was bugged. It probably contained three bugs. One was a phony bug to fool you into believing you found a bug and secured the telephone. The second bug placates the investigator when he finds the real thing! And the third bug is found only by the professional, who continued to search just in case there were more bugs.

The professional is not without his tools. Special equipment has been designed so that the professional can sweep a room so that he can detect voice-activated (VOX) and remote-activated bugs. Some of this equipment can be operated by novices, others require a trained countersurveillance professional.

The professionals viewed on your television screen reveal information on the latest technological advances like laser-beam snoopers that are installed hundreds of feet away from the room they snoop on. The professionals disclose that computers yield information too easily.

This advertisement was not written by a countersurveillance professional, but by a beginner whose only experience came from viewing the video tape in the privacy of his home. After you review the video carefully and understand its contents, you have taken the first important step in either acquiring professional help with your surveillance problems, or you may very well consider a career as a countersurveillance professional.

## The Dollars You Save

To obtain the information contained in the video VHS cassette, you would attend a professional seminar costing \$350-750 and possibly pay hundreds of dollars more if you had to travel to a distant city to attend. Now, for only \$49.95 (plus \$4.00 P&H) you can view *Countersurveillance Techniques* at home and take refresher views often. To obtain your coupon, complete the coupon or call.

**RE**

**CLAGGK INC.**  
**P.O. Box 4099 • Farmingdale, NY 11735**

Please rush my copy of the Countersurveillance Techniques Video VHS Cassette for a total cost of \$53.95 each (which includes \$4.00 postage and handling)

No. of Cassettes ordered \_\_\_\_\_

Amount of payment \$ \_\_\_\_\_

Sales tax (N.Y.S. only) \_\_\_\_\_

Total enclosed \_\_\_\_\_

Bill my  VISA  MasterCard

Card No. \_\_\_\_\_

Expire Date \_\_\_\_/\_\_\_\_/\_\_\_\_

Signature \_\_\_\_\_

Name \_\_\_\_\_

Address \_\_\_\_\_

City \_\_\_\_\_ State \_\_\_\_\_ ZIP \_\_\_\_\_

All payments in U.S.A. funds. Canadians add \$4.00 per VHS cassette. No foreign orders.

# GET THE LATEST ADVANCES IN ELECTRONICS

WITH A SUBSCRIPTION TO

# Electronics

Radio Combined with  
**Electronics**<sup>®</sup> **NOW**<sup>®</sup>



Electronics Now gives you exciting articles like:

- Buyer's Guide to Digital Oscilloscopes
- Build A Scanner Converter
- Single-Chip Voice Recorder
- Build A MIDI Interface for your PC
- Troubleshoot Microprocessor Circuits
- Build A High-Power Amplifier for your Car
- Add Music On Hold to your Phone
- All About Binaural Recording
- VGA-to-NTSC Converter

ENJOY THE WORLD OF ELECTRONICS EACH MONTH!

Subscribe to the best electronics magazine—the one that brings you the latest high-tech construction projects, feature articles on new technology, practical troubleshooting techniques, circuit design fundamentals, and much more.

Electronics Now looks to the future and shows you what new video, audio and computer products are on the horizon. What's more you'll find helpful, monthly departments such as Video News, Equipment Reports, Hardware Hacker, Audio Update, Drawing Board, Computer Connections, New Products, and more. All designed to give you instruction, tips, and fun.



FOR FASTER SERVICE CALL TODAY

**1-800-999-7139**

# DON'T DELAY SUBSCRIBE TODAY!

Just fill out the order card in this magazine and mail it in today.

5REJ9



# VFX

## DIGITAL SIGNAL PROCESSOR

WOULD YOU LIKE TO CHANGE THE pitch of your voice or create such special audio effects as echo or reverb? We will show you how to build a voice effects processor (or VFX processor, for short) that can generate such unusual effects. We'll explain the basic algorithms used to perform these DSP (digital signal processing) techniques, and examine the heart of the VFX hardware, the Analog Devices-2105 digital signal processing microcomputer. If you're on a tight budget, you'll appreciate that this project costs much less than any commercial single-effect generator.

Before we describe the details of the hardware and software, let's look at what the VFX processor does. The VFX processor accepts audio signals, digitally processes the information in one of three user-selected modes, and amplifies the signal for listening with a speaker or a pair of headphones. All you need besides the VFX processor is a microphone, a pair of headphones, and a 9-volt DC power source—all of which are available from the source given in the Parts List.

### Basic operation

The VFX block diagram is shown in Fig. 1. A four-position DIP switch (of which only three are used) puts the VFX into one of four operating modes: harmonizer, echo, reverb, and test. Table 1 shows the DIP switch

positions for each mode. The harmonizer voice effect raises or lowers the pitch of your voice. A high pitch makes you sound as if you're breathing helium, and a low pitch makes you sound like a baritone singer. In this mode, a single-digit LED readout indicates the pitch change level; 0 is the maximum down shift (8% of  $\omega$  Hz) and 9 is

the maximum upshift (+305 Hz). The VFX board powers up in level 4, which is no shift at all. A SHIFT button lets you step through the range of pitch shifts; after 9 the processor returns to 0. Each pitch shift increment is approximately 51 Hz; we'll explain why later.

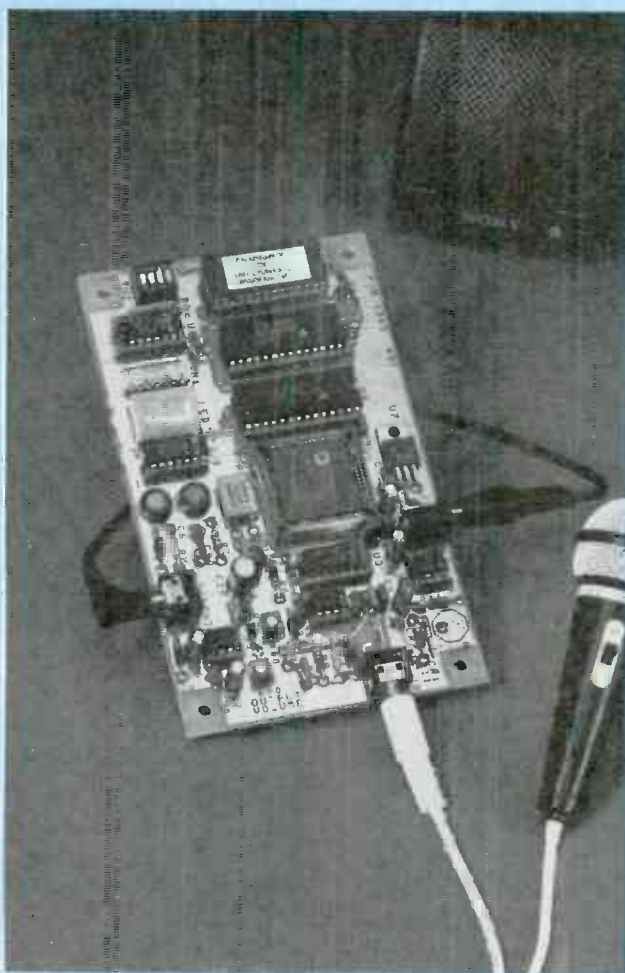
The echo effect has an adjustable delay; you can decrease the echo delay time by pressing the SHIFT button. In this mode the LED displays a number from 9 to 0 indicating a delay time of 0.63 to 0 seconds. Each press of the SHIFT button decreases the time delay by 70 milliseconds.

The reverb effect is similar to the echo effect, except that the delay time is fixed at 78 milliseconds and the amplitude of the feedback signal is adjustable from 0.5 to 0 with the SHIFT button. The effect is more subtle than the echo effect and simulates the acoustics of a large room.

The test mode helps troubleshoot the VFX board. The test mode will be discussed in greater detail later on.

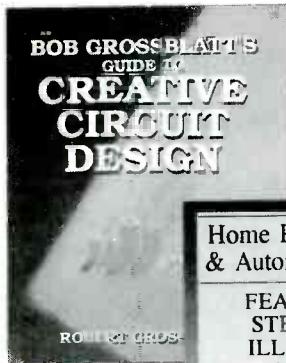
### The basic circuit

As shown in the block diagram (Fig. 1), the VFX processor consists of a microphone input circuit that uses a National Semiconductor TP3054 CODEC (coder-decoder), an Analog Devices ADSP-2105 DSP (digital signal processor), an 8K  $\times$  8 EPROM (erasable program-



***A little DSP goes a long way  
in generating unusual  
sound effects.***

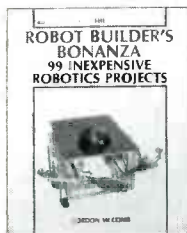
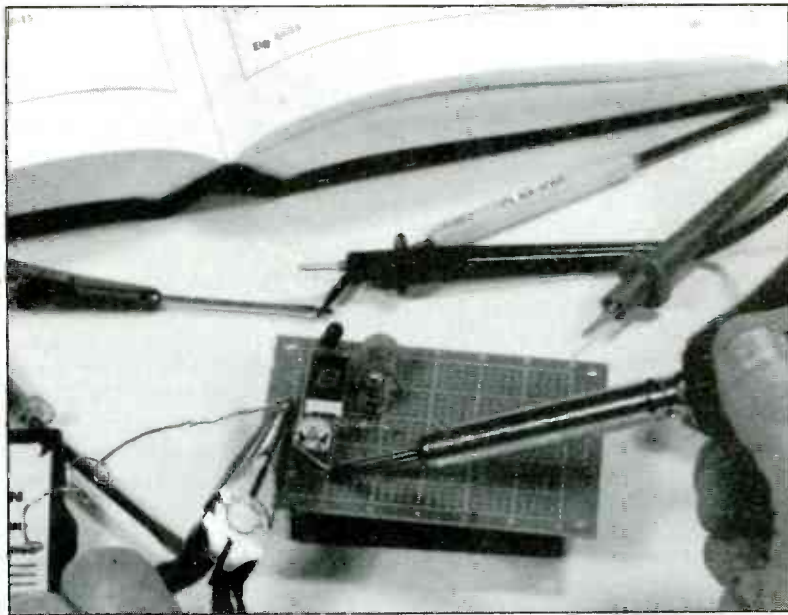
CRAIG BORAX and DAVID BECK



3610 \$28.95



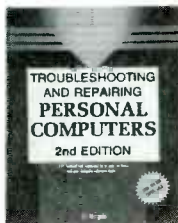
3765 \$29.95



2800P \$16.95  
Softcover



3374P \$16.95  
Softcover



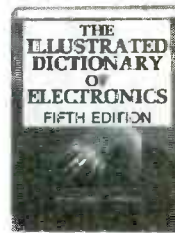
3677-XX \$34.95  
Counts as 2



2883P \$18.95  
Softcover



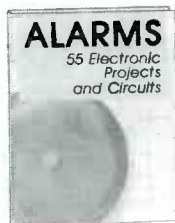
1604P \$17.95  
Softcover



3345P \$24.95  
Softcover



2613P \$17.95  
Softcover



2996P \$14.95  
Softcover



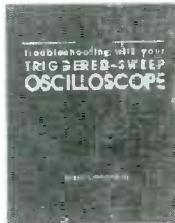
1001B \$39.95



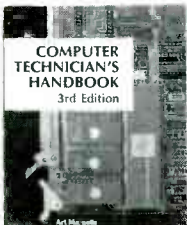
1367P \$29.95  
Softcover



3922 \$26.95



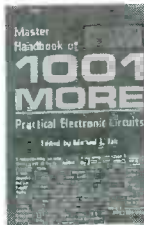
3669 \$27.95



3279-XX \$36.95  
Counts as 2



586023-XX \$26.95  
Counts as 2



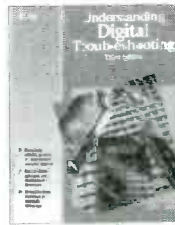
804P-XX \$21.95  
Counts as 2/Softcover



3550-XX \$34.95  
Counts as 2



3107P \$18.95  
Softcover



9457P \$24.95  
Softcover



3825 \$26.95



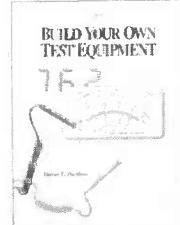
585885 \$29.95



3804P-XX \$19.95  
Counts as 2/Softcover



3778 \$26.95



3475 \$27.95

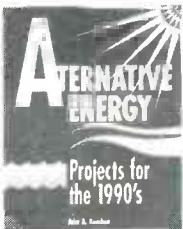


3627P \$19.95  
Softcover

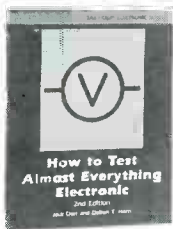


# Select any 5 books for only \$4<sup>95</sup>

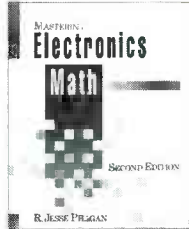
when you join the Electronics Book Club<sup>SM</sup> (values up to \$169.75)



3835 \$24.95



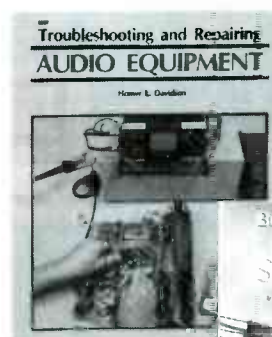
2925P \$10.95  
Softcover



3589 \$27.95



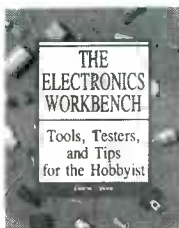
3540 \$26.95



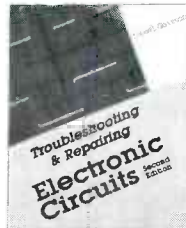
2867P \$18.95  
Softcover



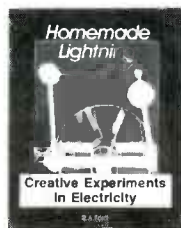
10016 \$39.95



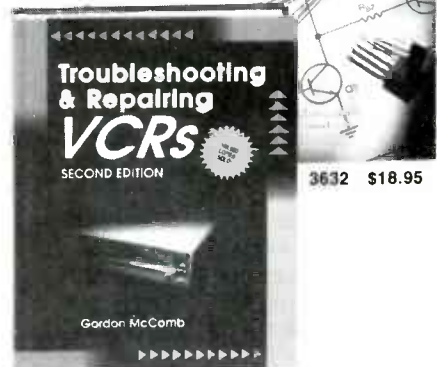
3672P \$18.95  
Softcover



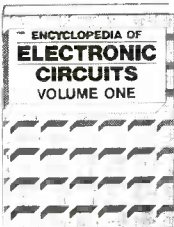
3258 \$28.95



3576P \$14.95  
Softcover



3632 \$18.95



1938-XXX \$60.00  
Counts as 3



2980P \$19.95  
Softcover



3457 \$29.95



9370-XX \$38.60  
Counts as 2

## As a member of the Electronics Book Club . . .

. . . you'll enjoy receiving Club bulletins every 3-4 weeks containing exciting offers on the latest books in the field at savings of up to 50% off of regular publishers' prices. If you want the Main Selection do nothing and it will be shipped automatically. If you want another book, or no book at all, simply return the Reply Form to us by the date specified. You'll have at least 10 days to decide. Your only obligation is to purchase 3 more books during the next 12 months, after which you may cancel your membership at any time. (Publishers' Prices Shown)

All books are hardcover unless otherwise noted. ©1992 EBC

**Your most complete and comprehensive source for the finest electronics books**

## ELECTRONICS BOOK CLUB<sup>SM</sup>

Blue Ridge Summit, PA 17294-0810

**YES!** Send the 5 volumes listed below, billing me just \$4.95 plus shipping/handling & tax. Enroll me as a member of the **Electronics Book Club** according to the terms outlined in this ad. If not satisfied, I may return the books within ten days and have my membership cancelled. A shipping/handling charge and sales tax will be added to all orders.

--	--	--	--

If you select a book that counts as 2 choices, write the book number in one box and XX in the next. If you select a Counts as 3 book, write the book number in one box and XXX in the next 2 boxes.

Name \_\_\_\_\_

Address \_\_\_\_\_

City \_\_\_\_\_ State \_\_\_\_\_

Zip \_\_\_\_\_ Phone \_\_\_\_\_

Valid for new members only, subject to acceptance by EBC. U.S. orders are shipped 4th Class Book Post. Canada must remit in U.S. funds. Applicants outside the U.S. and Canada will receive special ordering instructions.

RE992

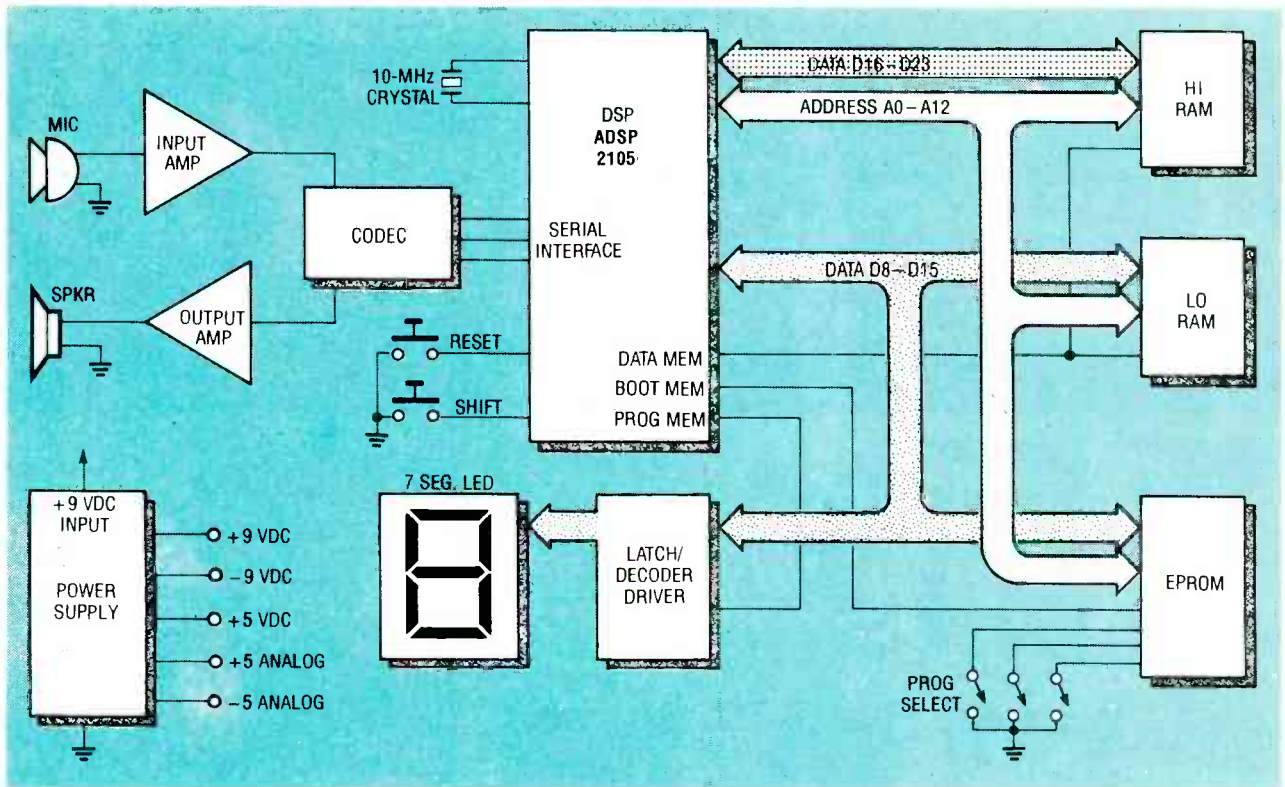


FIG. 1—VFX BLOCK DIAGRAM. The VFX has a microphone input, a CODEC, a DSP, EPROM, SRAM, power-supply circuitry, and audio conditioning.

mable read-only memory), two  $8K \times 8$  SRAM's (static-random access memory), power-supply circuitry, and audio conditioning. The CODEC incorporates an input anti-aliasing filter, an A/D converter, a D/A converter, an output filter, and control circuitry. The SRAM's provide  $8K \times 16$ -bit words of data storage to supplement the 2105's internal 512 words. The DSP can access external memory in 100 nanoseconds but has an internal wait-state generator to allow the use of slower devices. The VFX processor has three wait states programmed for external data memory access.

The VFX processor performs four functions: the theory of operation for each implemented in hardware is virtually identical. The software makes the hardware perform these multiple

effects. The EPROM hex code will be posted on the RE-BBS (516-293-2283, 1200/2400, 8N1), as a file called VFX.HEX. Let's look at the algorithms used for each effect.

### Algorithms

The harmonizer shifts the pitch of an audio signal, such as music or speech, up or down. One of the most widely known uses of this technique is seen in the novelty musical group, the Chipmunks. Recorded in the early 60's, the Chipmunks' up-pitch effect was made simply by playing back audio tapes at a higher speed. Today, the high-tech approach is to use digital signal processing.

The principal algorithms performed by the DSP hardware for the harmonizer are the fast Fourier transform (FFT) and the inverse FFT (IFFT). Those al-

gorithms convert the audio signal in the time domain to the frequency domain, and then back again. Figure 2 shows an original audio signal and the data at each stage in the process as it is spectrum-shifted. Figure 2-a plots the audio input versus time. Figure 2-b shows the frequency spectrum of the audio signal in 2-a. Figure 2-c shows the original spectrum at the top and the up-shifted spectrum at the bottom. Figure 2-d shows the original audio signal on top with the processed audio signal, which contains higher-frequency components, at the bottom.

The timing of the algorithm of the harmonizer is shown in Fig.

### THE FFT

The Fourier series and its related transforms and algorithms are widely used in electronics. The Fourier transform (FT) is a mathematical method for converting a signal from the time domain to the frequency domain, or simply a way of expressing a continuous waveform as a series of sine waves. The fast Fourier transform (FFT) is an algorithm enhanced for computer computation of a discrete Fourier transform (DFT), which is the digital equivalent of the Fourier transform. **R-E**

TABLE 1—DIP SWITCH SETTINGS

	S1-a	S1-b	S1-c	S1-d
Harmonizer	X	ON	ON	ON
Echo	X	OFF	ON	ON
Reverb	X	ON	OFF	ON
Test Mode	X	OFF	OFF	ON



3. and its block diagram is shown in Fig. 4. In Fig. 3, the input signal from the microphone is sampled at a 6.5-kHz rate. At that rate buffer #1 is filled in 19.7 milliseconds with 128 samples. (That determines the pitch resolution because the resolution in the frequency domain is the inverse of the sampling period, or 50.7 Hz.) Then the next 128 samples are stored in buffer #2. (The double-throw switch in Fig. 4 is there to suggest the toggling from one buffer to the other.) While buffer #2 is being filled, the VFX processor begins the harmonizing effect by processing buffer #1 through a 128-point FFT, then comes the shift, and then the IFFT. The entire FFT/Shift/IFFT algorithm takes approximately 6 milliseconds so that all processing is finished before the next buffer is filled. That allows real-time processing with a minimal two-buffer delay of 39.3 milliseconds between the time the microphone input arrives at the VFX processor and when it is output to the speaker.

The echo-effect algorithm uses a digital implementation of an adjustable-length analog delay line as shown in Fig. 5. The input signal from the microphone is sampled at a 6.5-kHz rate. It is then summed with the delayed signal received  $n \times 455$  periods ago (where  $n$  is a number from zero to nine as shown on the VFX's LED display). The delay line is implemented in 4K of external SRAM. The software allows the adjustment of the delay from 0.63 to 0 milliseconds.

The reverb effect is very similar to the echo effect (see Fig. 6) except that the length of the delay line is fixed at 78 milliseconds, and the reflection factor is adjustable from 0% to 50% with the SHIFT button. The reflection factor determines the attenuation of the signal before it is stored in the delay line and simulates the reflection factor of a room.

The test mode can be used during hardware checkout to isolate problems with your VFX board. We'll discuss how to use the test mode later.

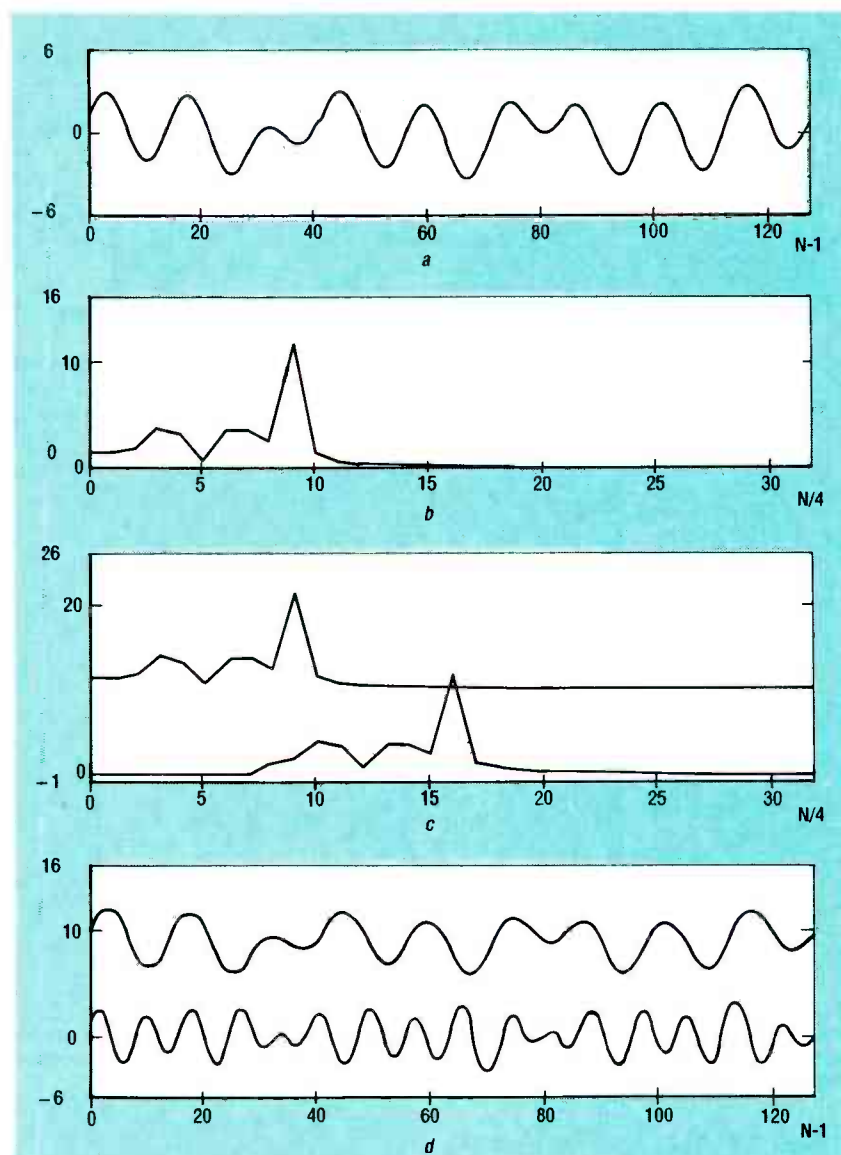


FIG. 2—HARMONIZER ALGORITHM. In *a* you see the audio input vs. time, *b* shows the frequency spectrum of the audio signal, *c* shows the original spectrum at the top and the up-shifted spectrum at the bottom, and *d* shows the original audio signal on top with the processed audio signal at the bottom.

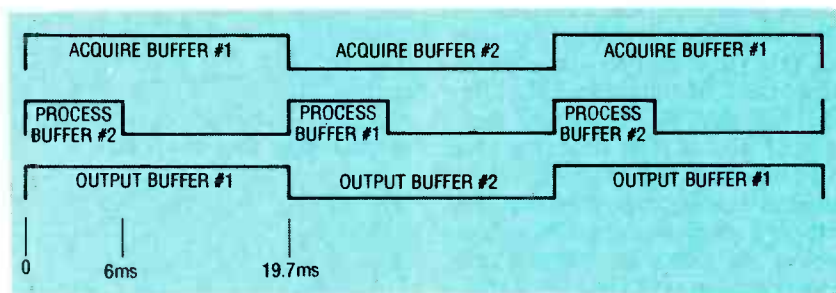
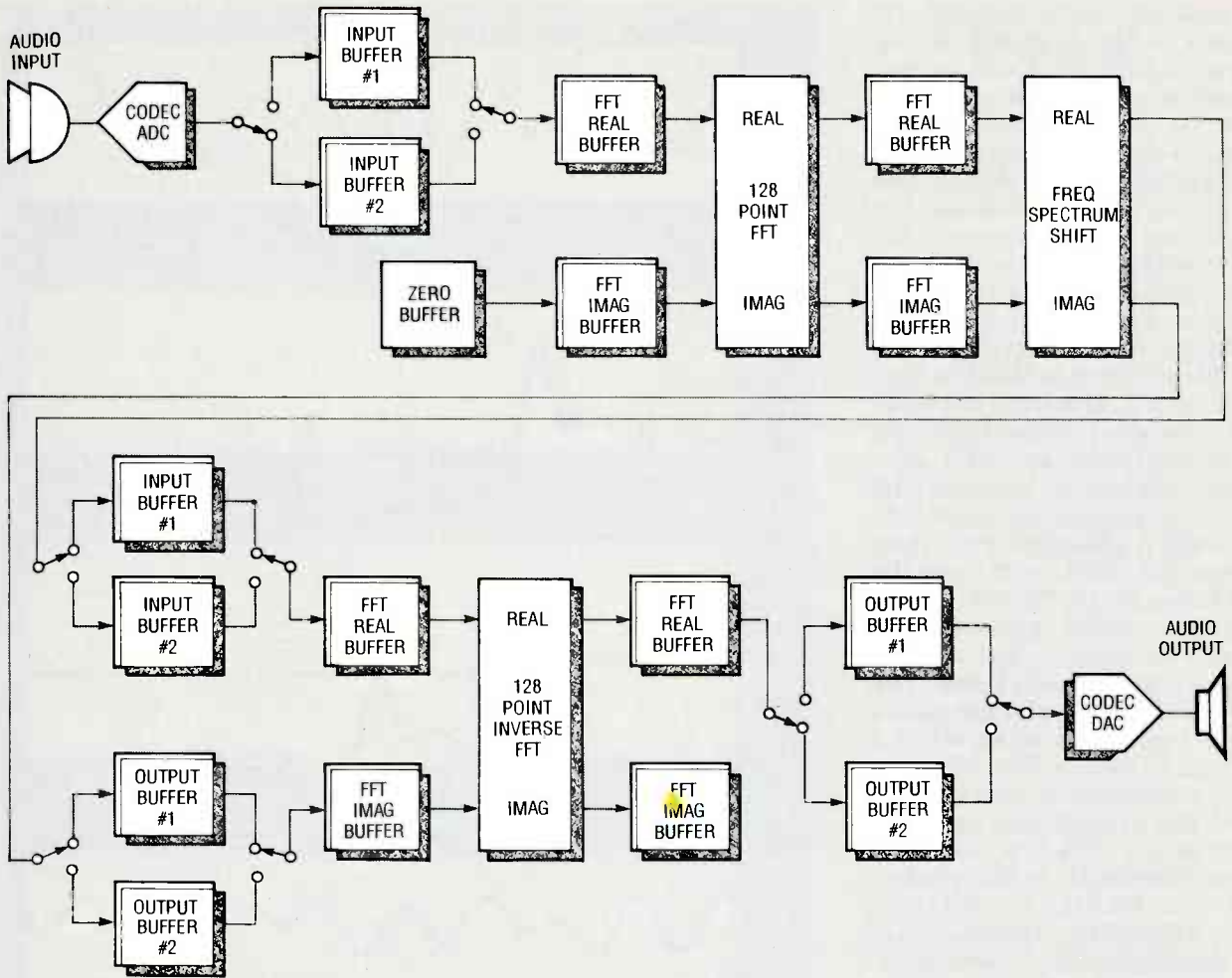


FIG. 3—HARMONIZER TIMING DIAGRAM. The input signal is sampled at a 6.5-kHz rate and fills buffer #1 in 19.7 milliseconds with 128 samples. The next 128 samples are stored in buffer #2.

### Circuitry

The schematic diagram for the VFX processor is shown in Fig. 7. The ADSP-2105 DSP mi-

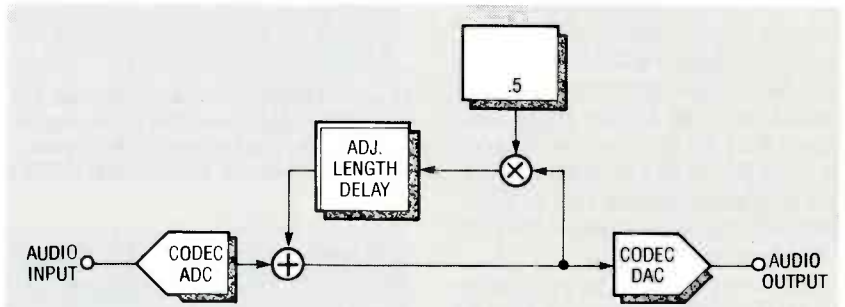
croprocessor, IC1, has  $1K \times 24$ -bit words of fast program memory (PM) on chip. An on-chip oscillator requires a 10-MHz



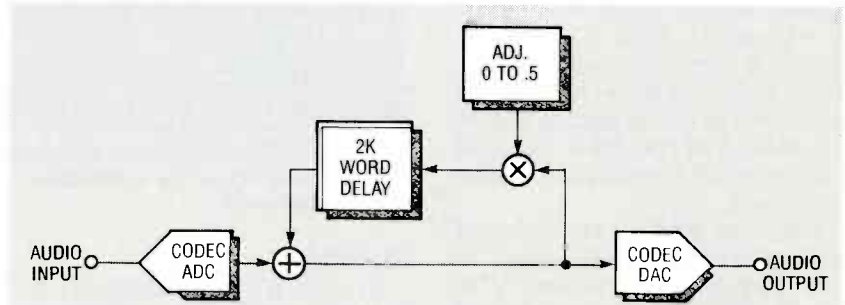
**FIG. 4—HARMONIZER BLOCK DIAGRAM.** The double-throw switches indicate the toggling from one buffer to the other. While buffer #2 is being filled, the VFX processor begins processing buffer #1.

crystal (XTAL1) and two small capacitors (C1 and C2). On power-up and after a reset, the 2105 boots the program from the EPROM (IC2) into the on-board memory. The boot function is built into the 2105 and it allows a slower and inexpensive EPROM (250 ns) to supply the 1K words (3K bytes) of PM. The BOOT MEMORY SELECT (BMS) output of the 2105 selects the EPROM, and the addressing is automatically generated on the external address bus. The selection of the program booted can be programmed by the 2105, but to simplify the VFX hardware and software, the program is selected by setting the three most-significant bits (MSB's) of the EPROM's address with DIP switch S1.

In addition to the on-board PM, there is 0.5K × 16-bit words

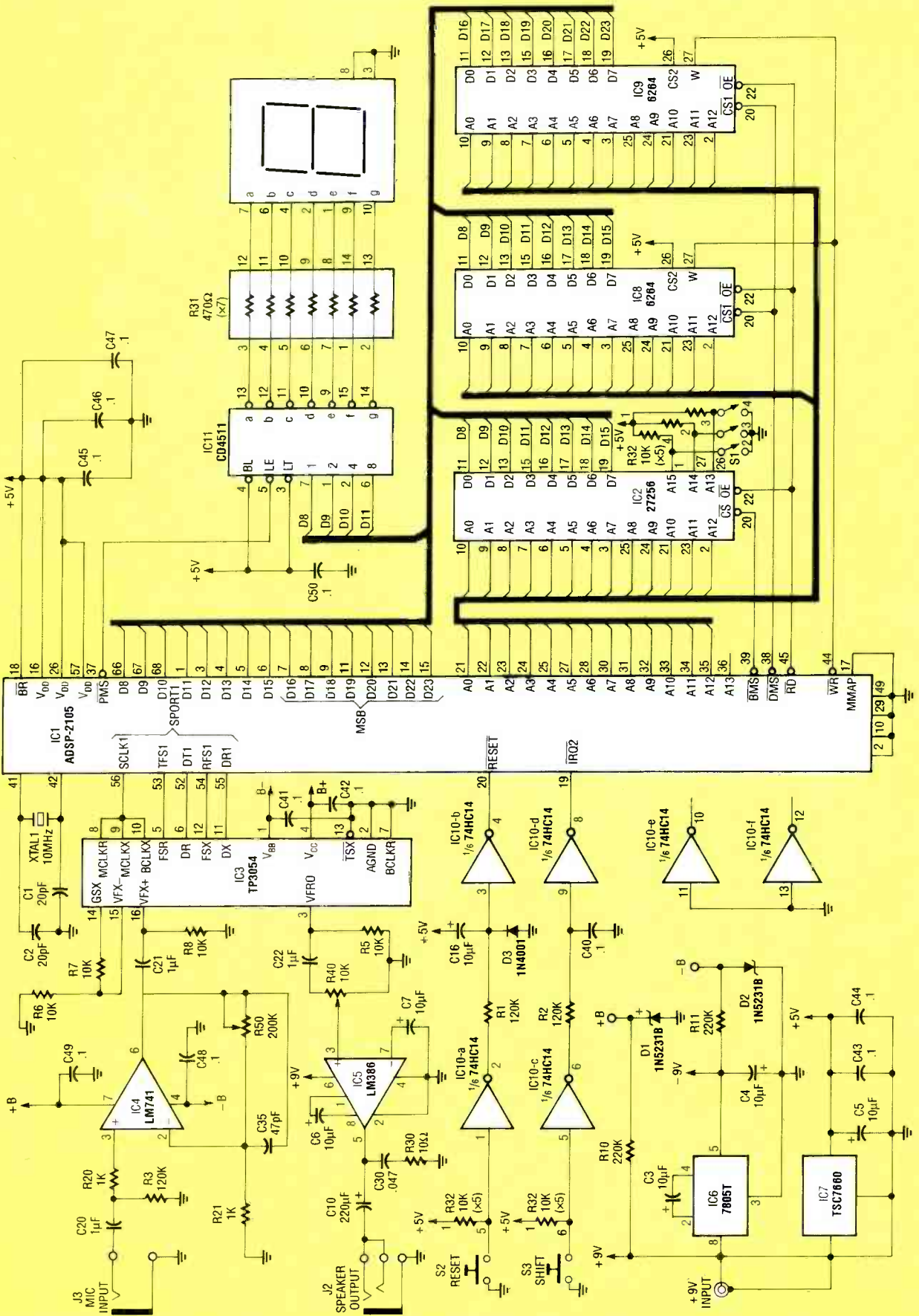


**FIG. 5—ECHO-EFFECT BLOCK DIAGRAM.** A digital implementation of an adjustable-length analog delay line is used.



**FIG. 6—REVERB EFFECT BLOCK DIAGRAM.** The length of the delay line is fixed at 78 milliseconds, and the reflection factor is adjustable from 0% to 50%.





**FIG. 7—VFX SCHEMATIC.** The DSP microprocessor (IC1) has  $1K \times 24$ -bit words of fast program memory (PM) on chip. On power-up, the 2105 boots the program from the EPROM IC2 into the on-board memory.

## THE ADSP-2105

The Analog Devices ADSP-2105 is the engine of the VFX processor. The ADSP-2105 is a second-generation digital signal processing (DSP) microcomputer based on the earlier ADSP-2100. It has significant architectural improvements over earlier generations (see block diagram in Fig. 10). The 2105 has built-in data memory RAM (0.5K × 16 bits) and program memory RAM (1K × 24 bits) so it really is a DSP microcomputer and not a microprocessor. Both of those memory banks are expandable with off-chip fast static RAM. That allows the program memory to be loaded, using the resident boot memory loader, from a slow PROM or EPROM (250 nanosecond access) and keeps high-speed data transfer inside the chip to reduce EMI and board-layout requirements.

The program and data memory can be easily expanded off-chip—as has been done with the VFX processor—when the internal data memory is not sufficient for the algorithms. The chip has resources built-in to simplify external memory hardware interfacing. They include separate selects for program memory, data memory, and boot memory, and a programmable wait-state generator to allow for slow external memories.

The 2105 incorporates several peripheral

devices and their associated interrupts. There is a built-in 16-bit interval timer with programmable prescaler and interrupts. A high-speed synchronous serial interface (SPORT1) can interface to  $\mu$ -law and A-law CODEC's using hardware companding as well as digital audio-oriented D/A and A/D converters. Additionally, the serial port can connect multiple 2105's together in parallel processing applications.

The ADSP-2105 also offers high performance by virtue of its instruction set. With a 100-nanosecond cycle time, multiple operations per cycle, and zero-overhead looping, the numerical performance of the chip is respectable. In addition, the 1-micron low-power CMOS processing holds power dissipation to

less than 1 watt; a powerdown mode reduces the power consumption to a mere 80 milliwatts.

The ADSP-2105 incorporates three execution units:

- Barrel shifter
- Arithmetic Logic Unit (ALU)
- Multiplier Accumulator (MAC)

The three units are optimized for their specific function, and are, therefore, very fast, completing any instruction in one cycle. Access to the three execution units is made via registers associated with each execution unit. For example, the ALU has the following 16-bit registers:

AX0, AX1, AY0, AY1, AR, and AF

The MAC has:

MX0, MX1, MY0, MY1, MR0, MR1, MR2,

### LISTING 1

```

START:
      I0=buffer#1;           {Address of buffer#1 in DMD}
      M0=1;                 {Post modify value}
      I4=buffer#2;         {Address of buffer#2 in PMD}
      M0=1;                 {Post modify value}
      CNTR=2048;           {Number of words in buffer}
DO MOVE_BUFFER UNTIL CE;   {Do loop}
      AR=PM(I4,M4);
      DM(I0,M0)=AR;
      MOV_BUFFER:          {End of the loop}
  
```

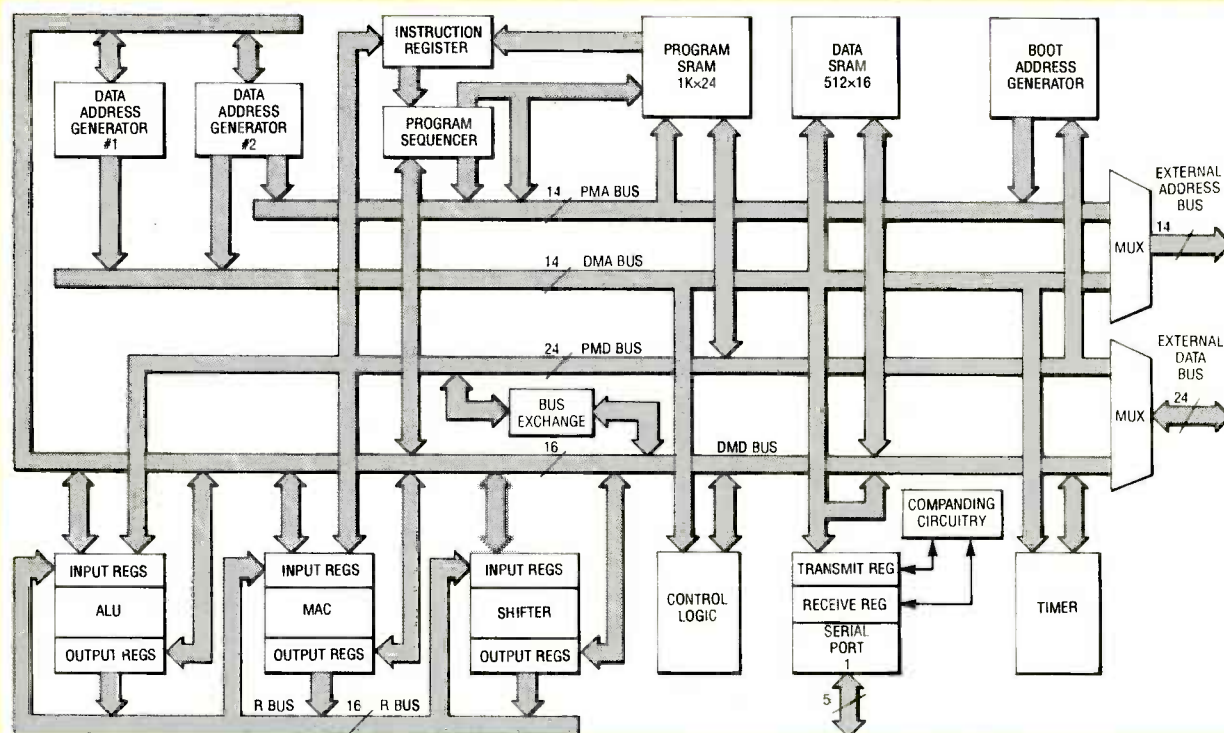


FIG. 10—ADSP-2105 BLOCK DIAGRAM. The 2105 has built-in data memory and program memory implemented in fast SRAM. That keeps high-speed data transfer inside the chip.



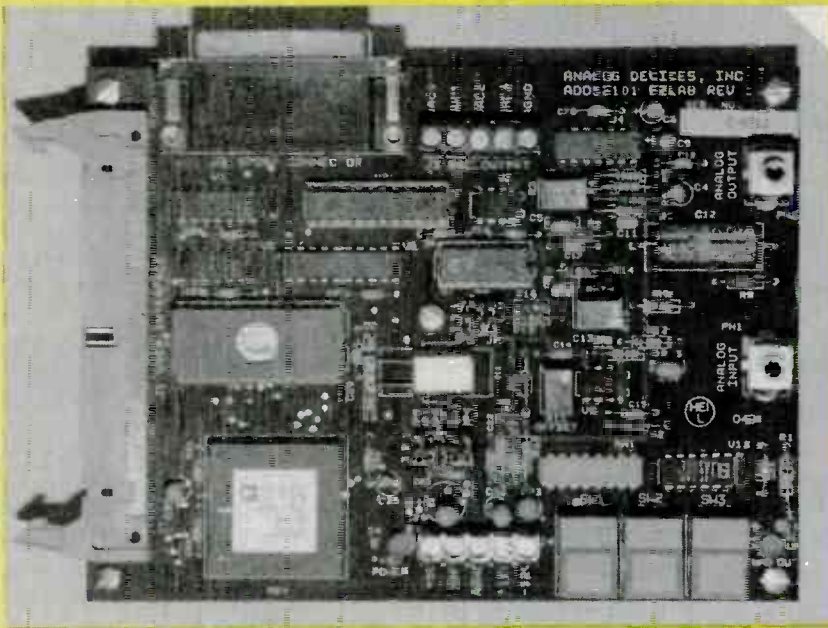


FIG. 11—THE EZ-LAB KIT includes a demo board, an ADSP-2105 family assembler, linker, and other miscellaneous development software. You can design and debug software for certain applications at minimal cost.

and MF

The barrel shifter has:  
SB, SI, SE, SP1 and SR0

In addition, the ADSP-2105 incorporates two data address generators (DAG's), one of which can perform the bit reversing that is required for certain FFT algorithms. One DAG accesses program-memory data (PMD) and the other accesses data-memory data (DMD). The DAG's use a set of three registers to control indirect addressing and circular buffers. Those are the index registers (I0 to I7), the modify registers (M0 to M7), and the length registers (L0 to L7). For example, by setting up the registers so that I0 has the starting address, M0 has a value of 1, and L0 is zero, blocks of data can be moved from one buffer to another with very little programming (see Listing 1).

To be successful, any microcomputer, including a digital signal processor, must have readily available low-cost software tools. Analog Devices has supplied the ADSP-2105 with quality software tools at a reasonable price. The assembly language is algebraic and straightforward. Included is a powerful personal computer-based software simulator that allows software debugging without an expensive in-circuit emulator (ICE).

The ADSP-2105 has the same kind of interrupt handling capabilities as other microcomputers. The interrupts can be individually masked or enabled, edge-triggered or level sensitive. Interrupts are vectored to the program memory lo-

#### LISTING 2

IRQ2	0004h
SPORT0 (Transmit)	0008h
SPORT0 (Receive)	000Ch
SPORT1 (Transmit)	0010h
SPORT2 (Receive)	0014h
TIMER	0018h

cations shown in Listing 2. A second mirror set of Data registers can be enabled to facilitate fast context switching during its interrupt servicing. The device has on-chip clock generation circuitry and is packaged in a 68-lead plastic leaded chip carrier (PLCC).

The VFX processor described in this article was developed with Analog Devices' ADSP-2101 EZ-Lab Kit (see Fig. 11). The Analog Devices EZ-Lab kit includes an EZ-LAB demonstration board, an ADSP-2101/5 family assembler, linker and other miscellaneous development software, including the essential simulator. With this package one can design and debug software for certain applications with excellent results at minimal cost. Of course, an in-circuit emulator (ICE) will speed up the development process, although, of course, at a much higher price: the EZ-Lab kit sells for less than \$500 dollars, and an emulator costs more than \$2000 dollars. For people with limited capital resources and small to medium complexity algorithms, the kit is great. R-E

of on-board data memory (DM). Since that is not enough to perform the 128-point FFT and IFFT, two external static RAMs are also attached to the data bus, one for the high byte (IC9), and one for the low byte (IC8) of the memory. That 2×8K bytes of SRAM addressed by the 2105 is accessed when the DATA MEMORY SELECT (DMS) strobe is active.

The seven-segment LED display adds to the interactivity of the VFX processor, and is written to as if it was external program memory. The PROGRAM MEMORY SELECT (PMS) signal from the 2105 is activated to latch data from the bus into IC11 (the seven-segment BCD latch/decoder/driver), which then drives the seven segment display. No decoding is required for the selection of IC11 because there is no external program memory in the system.

The VFX processor uses a CODEC to digitize the audio input and convert it into a serial data stream. The CODEC interfaces directly with the 2105's synchronous serial port SPORT1, which includes pins 52–56. SPORT1 is configured for 8-bit synchronous data transfer with word-framing sync pulses and  $\mu$ -law companding. The 2105 generates a 1.66-MHz serial clock (SCLK1) and 6.5-kHz framing pulses on TRANSMIT FRAME SYNC (TFS1) and RECEIVE FRAME SYNC (RFS1) to synchronize the data transfer.

The CODEC implements  $\mu$ -law companding, which improves the dynamic range of the conversion by taking advantage of human perception of sound; that is, that the ear is much more sensitive to noise in low-level (volume) signals than in high-level signals. The CODEC receives and transmits 8 bits of data, and the digital signal processor has built-in companding hardware to convert it into a 14-bit number.

The other components of the VFX processor are the power supply and analog components. The VFX board accepts +9 volts DC and generates -9, +5, +5.1, and -5.1 volts DC. Voltage converter IC7 (a TSC7660)

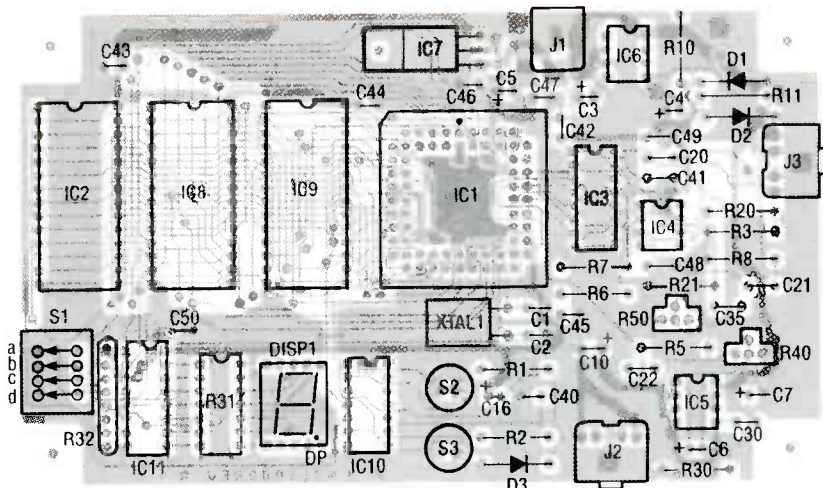


FIG. 8—PARTS-PLACEMENT DIAGRAM. Make sure that you install the mono jack at J1 and the stereo jack at J2.

### PARTS LIST

All resistors are 1/4-watt, 5%, unless otherwise noted.

- R1-R3—120,000 ohms
- R4, R9, R12-R19, R22-R29, R33-R39, R41-R49—not used
- R5-R8—10,000 ohms
- R10, R11—220,000 ohms
- R20, R21—1000 ohms
- R30—10 ohms
- R31—470 ohms ( $\times 7$ ), 14-pin DIP
- R32—10,000 ohms ( $\times 5$ ), 6-pin SIP
- R40—10,000 ohms, multiterm potentiometer
- R50—200,000 ohms, multiterm potentiometer

#### Capacitors

- C1, C2—20 pF, 100 volts, ceramic
- C3-C7—10  $\mu$ F, 35 volts, electrolytic
- C8, C9, C11-C15, C17-C19, C23-C29, C31-C34, C36-C39—not used
- C10—220  $\mu$ F, 25 volts, electrolytic
- C16—10  $\mu$ F, 6.3 volts, Tantalum electrolytic
- C20-C22—1  $\mu$ F, 50 volts, ceramic
- C30—0.047  $\mu$ F, 100 volts, ceramic
- C35—47 pF, 100 volts, ceramic
- C40-C50—0.1  $\mu$ F, 100 volts, ceramic

#### Semiconductors

- IC1—ADSP-2105KP40 DSP processor
- IC2—27256-25 32K  $\times$  8 EPROM (256K)
- IC3—TP3054J CODEC
- IC4—LM741N op-amp
- IC5—LM386N-3 audio amplifier
- IC6—7660SCPA voltage converter

- IC7—7805T 5-volt regulator
- IC8, IC9—6264-15 SRAM, 150 ns
- IC10—74HC14N hex Schmitt trigger inverter
- IC11—CD4511 7-segment decoder/driver

- D1, D2—1N5231B 5.1-volt Zener diode
- D3—1N4001 diode
- DISP1—LTS6780R 7-segment common cathode LED

#### Other components

- XTAL1—10-MHz crystal
- S1—4-position DIP switch
- S2, S3—momentary pushbutton, N.O.
- J1—2mm DC power jack
- J2—mini stereo jack
- J3—mini mono jack

**Miscellaneous:** IC sockets, 9-volt DC wall transformer, microphone, headphones, PC board, solder, etc.

**Note:** The following items are available from American Distributors, Inc., 9 Whippany Road, Whippany, NJ 07981 (800) 877-0510:

- VFX kit (includes PC board and all PC-mounted components)—\$105
  - (plated through holes, solder masked and silkscreened)
  - 9-volt wall transformer—\$12
  - Headphones—\$15
  - Microphone—\$16
- Add \$5 shipping and handling. Check, MasterCard, or Visa.

generates the negative supply from the positive supply. A 5-volt DC regulator (IC7, a 7805) supplies +5 volts DC to the 2105 and all logic IC's, and two Zener regulators (D1 and D2)

generate the analog voltages of plus and minus 5.1 volts DC. Op-amp IC4 and audio amplifier IC5 condition and amplify the audio input and output, respectively.

### Construction

The VFX processor is easy to build. All the necessary components including a double-sided PC board, all IC's, semiconductors, and passive components are available from the source given in the Parts List. A microphone, DC wall outlet transformer, and headphones are also available if you don't already have them. We've provided foil patterns in case you want to make your own PC board.

Following Fig. 8 as a guide, mount the components beginning with the resistors. Next install the capacitors, the crystal, switches, jacks, voltage regulator (IC7), and then all of the IC sockets. Make sure you don't install the input and output jacks in the wrong locations. The output jack has three terminals so that if you use headphones you'll hear sound from both sides. Be sure to orient the polarized capacitors correctly. Do not install the IC's yet and don't remove them from their packaging just yet either. When you've completed the soldering, carefully double check parts placement and look for solder splashes and bridging. The completed VFX card is shown in Fig. 9.

### Hardware checkout

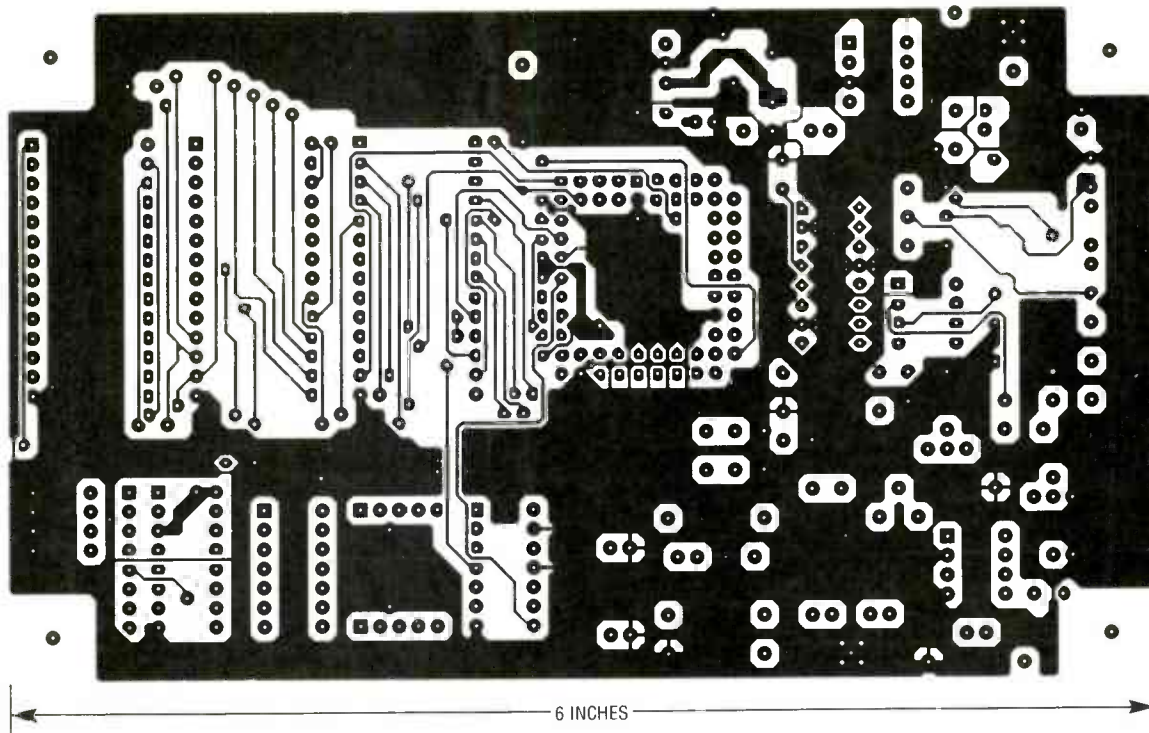
Now we will perform a hardware checkout, one IC at a time. Precautions against static discharge should be followed when handling the IC's. Electrostatic discharge can cause very subtle damage in the IC that can be hard to find—the kind that is

### FILTER DESIGN SOFTWARE

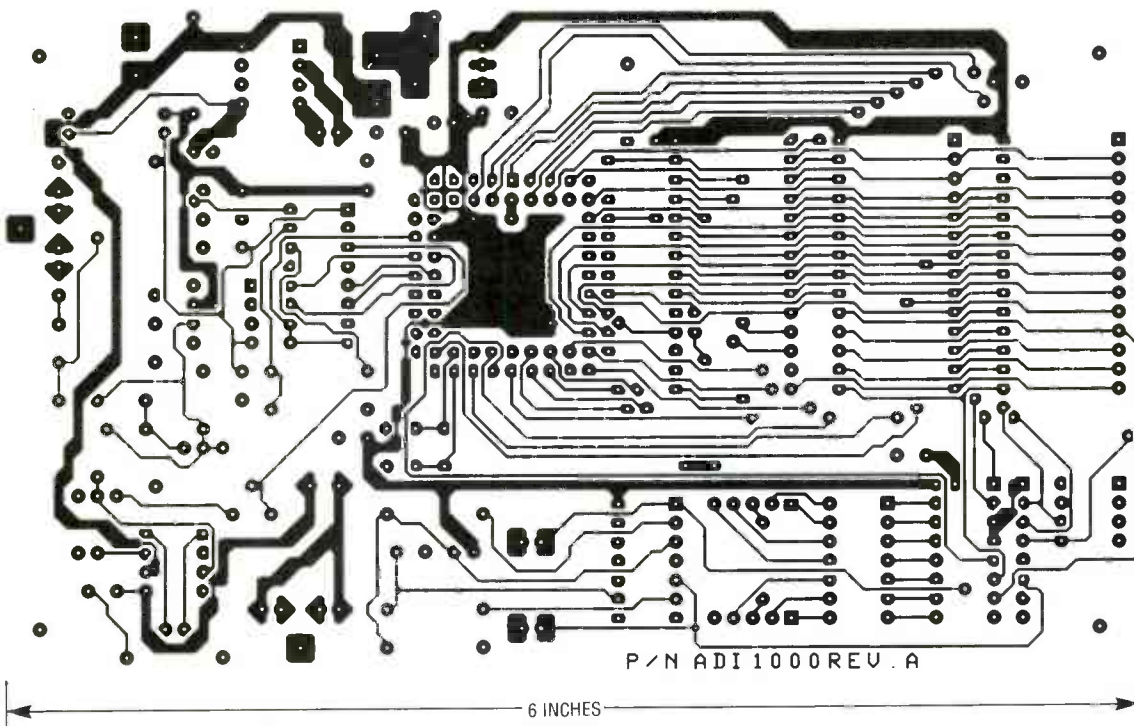
The digital filter used in the echo and reverb effect was designed with the filter and digital analysis software (FDAS) from Momentum Data Systems software. The software was used to implement a finite impulse response (FIR) filter. The optional code generator wrote the source code for the filter, given its characteristics. The package also runs on the ADSP-2101 processor and other family members. The FDAS software can also implement other kinds of digital filters than FIR, including infinite impulse response (IIR) and some analog equivalents.

R-E





COMPONENT SIDE of the VFX board.



SOLDER SIDE of the VFX board.

worth avoiding.

First apply 9-volt DC power to J1 and verify that there is 5 volts on the power pins of each IC socket. When verified, remove power from the board and plug in IC6, the negative-supply gen-

erator. Now reapply 9-volts DC to J1 and measure pin 5 of IC6; the voltage should be the negative of the voltage on IC6 pin 8 or -12 volts (whichever is less).

Next, check pins 1 and 4 of IC3 for -5 volts  $\pm$  0.2 volt and +5.0  $\pm$  0.2 volt, respectively.

Install IC1, IC2, IC10, and IC11 in their respective sockets. For the RAM test, set all the S1 DIP switches to the "on" position and apply power to the board. The LED display should show the number "6." Press the SHIFT continued on page 94

# 47st. Photo<sup>®</sup>

The latest in electronics is only a phone call away! **1-800-221-7774**

In N.Y. or if busy call: 1-718-722-4750. Please mention code ES892.



**NEW!**  
**AIWA CSD-EX1**  
**PORTABLE LCD**  
**RADIO CASSETTE CD PLAYER**  
 • High power output  
 • Power saving switch plus auto stop  
 • 20-selection random programmable memory CD  
 • AM wide/FM stereo tuner  
 (AIW-427)  
 Sugg. Retail \$179.95 **Our Price \$139.95**



**NEW!**  
**AIWA NSX-330**  
**30W/ch HI-FI MINI COMPONENT**  
**SYSTEM WITH SURROUND SOUND**  
 • Super T-bass  
 includes:  
 • 3-preset graphic equalizer  
 • 5-band spectrum analyzer  
 • Wireless remote  
 • FM/AM tuner with 32-station random preset  
 • Dual auto reverse cass. w/Dolby B NR  
 • Optical digital output terminal  
 • 3-way speaker  
 (AIW-424)  
 Sugg. Retail \$560.00 **Our Price \$399.95**



**NEW!**  
**AIWA XP-7**  
**PORTABLE CD PLAYER**  
**WITH IN CAR USE**  
 • 1-bit dual D/A converter  
 • 8-times oversampling digital filter  
 • Optical digital output terminal  
 • 24-random programmable memory  
 • Heat-resistant for in car use  
 • Random play with 3-way repeat  
 includes: Rechargeable battery BP-50 stereo headphones with remote control, AC adaptor, recharger, and connection cord  
 (AIW-420)  
 Sugg. Retail \$280.00 **Our Price \$249.95**



**BONUS!**  
 Free case with purchase of E-63  
**\$59 Value!**  
**CANON E-63**  
**8mm CAMCORDER WITH**  
**8:1 POWER ZOOM**  
 • High speed shutter  
 • 180° FlexiGrip  
 • 2-lux low light  
 • Sports finder  
 • Wireless Remote (CAN-6300)

**Super Value!**



**NEW!**  
**PANASONIC RQ-S35V**  
**AM/FM STEREO CASSETTE**  
**PLAYER WITH AUTO REVERSE**  
 • Ultra compact size  
 • Digital synthesizer tuner with 7AM/7FM presets  
 • S-XBS & Dolby NR  
 • LCD tape/radio display  
 • Dual clock/alarm functions  
 • One button wired remote  
 Includes:  
 Rechargeable battery and charger.  
 (PAN-275A)  
 Sugg. Retail \$209.95 **Our Price \$169.95**



**NEW!**  
**SONY WM-WX50**  
**WALKMAN®**  
**STEREO CASSETTE**  
**PLAYER**  
**WIRELESS HEADSET!**  
 • Broadcasts up to 9 ft.  
 • Auto reverse Mega Bass 2x sound system with variable control  
 • Dolby NR  
 (SON-3483)  
 Sugg. Retail \$249.95 **Our Price \$179.95**



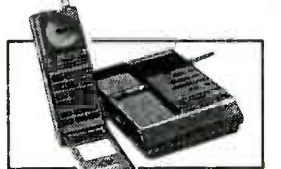
**SHARP IQ-8400**  
**ELECTRONIC ORGANIZER**  
 • 256 KB memory  
 • Typewriter style keyboard  
 • Hi-contrast 40 char. by 8 line screen  
 • Month/week & day calendar  
 • 3 phone directories  
 • Business Card function  
 (SHA-8400)  
 Sugg. Retail \$499.95 **Our Price \$319.95**



**SONY XVT-600**  
**ADD PRO STYLE SUPERIMPOSED**  
**TITLES TO YOUR VIDEOS!**  
 • 15 color picture computer superimposes picture title or background to video  
 • Draw lines, add color—endless possibilities!  
 (SON-409)  
 Sugg. Retail \$600 **SALE! \$109.95**



**PANASONIC KX-T4300**  
**CORDLESSPHONE WITH**  
**ANSWERING MACHINE**  
 • 10 channel access • Rubber antenna  
 • Tone/pulse • 2-way paging  
 • 10-number speed dial • Message alert  
 • LED readout  
 • 11-function tone remote  
 • Auto logic operation.  
 (PAN-4300)  
 Sugg. Retail \$199.95 **Our Price \$159.95**



**PANASONIC KX-T9000**  
**900MHz POCKET-SIZED FOLDING**  
**CORDLESSPHONE**  
 • Operates on 902/928MHz  
 • Sound Charger technology  
 • 30ch auto scan • Auto Intercom  
 • 2 interchangeable batteries  
 • 2-way paging & auto Intercom  
 • 10, 20 digit no. auto dial  
 • Handset Auto switch to talk mode  
 (PAN-9000)  
 Sugg. Retail \$499.95 **Our Price \$399.95**



**NEW!**  
**CASIO BP-100**  
**BLOOD PRESSURE**  
**MONITOR WATCH**  
 • Water resistant to 50 meter  
 • 12/24-hour formats  
 • 3 multi-function alarms  
 • Altimeter, Depth meter & Barometer  
 • Countdown alarm  
 • 1/100 stopwatch  
 (CAS-826)  
 Sugg. Retail \$169.95 **Our Price \$129.95**



**PANASONIC CTP-2066S**  
**20" STEREO MONITOR-RECEIVER**  
**WITH S-VHS INPUT (Over 500**  
**lines horizontal resolution)**  
 • Audio/Video input jacks  
 • Unified TV/VCR remote  
 • Clock, Sleep-timer & on-timer  
 (PAN-2796)  
 Sugg. Retail \$499.95 **SALE! \$357.95**

- Cameras
- Darkroom Supplies
- Video Equipment
- Televisions
- Hi-Fi Stereo Equipment
- Portable/Personal Audio
- Telephones
- Cellular Phones
- Computer Equipment
- Business Machines
- Calculators/Organizers
- Electronic Games
- Watches/Sunglasses
- Small Home Appliances
- Jewelry

Visit our superstores at:  
**67 West 47th Street** **115 West 45th Street**  
 Bet. 5th & 6th, NYC CA. LIC. #800189-691860 Bet. 6th & B'way, NYC CA. LIC. #800191-81628

**1-212-921-1287**

Sun. 10:00-5:00, Mon-Thurs. 9:30-6:00, Fri. 9:30-2:00, Closed Saturday

**A New York Landmark for over 26 years!**

Toll-free line is open  
 SUN. 10-5, DAILY 8-7, FRI. 8-2  
 Local lines are open  
 SUN. 10-5, DAILY 9:30-6, FRI. 9:30-2

**OVERNIGHT DELIVERY**  
 to any point in the  
 continental USA  
 AVAILABLE  
 at additional cost

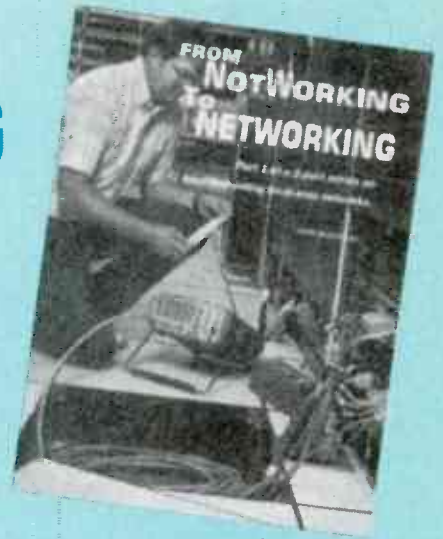
Mall Order Dept.:  
 455 Smith Street, Brooklyn, N.Y. 11231

ES AUG. 92



# FROM NotWorking To NETWORKING

**Learn about basic and advanced equipment for troubleshooting LAN's.**



**GARY McCLELLAN**

THIS IS PART 2 OF A THREE-PART SERIES on troubleshooting local-area networks (LAN's). In Part 1 we presented technical background on network technologies including cable types, topologies, signal schemes, and access protocols. This time we introduce the tools and test equipment necessary to service LAN's quickly and effectively. Next time we'll put our knowledge to work in diagnosing and solving easy and difficult network problems.

Experts say that cable faults cause more than 70% of all network failures. Cable faults may sound simple in theory but, in practice, diagnosing and locating them can bring strong men to tears. However, common sense, good test equipment, and intelligent substitution techniques can take you a long way toward rapid, inexpensive repair.

Common sense helps you localize the problem to avoid wasting time performing irrelevant tests. Good test instruments are your eyes and ears into the LAN; equipment can be as simple as a \$20 digital multimeter (DMM) or as complex as a time-domain reflectometer (TDR) costing thousands of dollars. (A TDR uses radar-like techniques to measure the distance to a cable fault. Typically a test instrument transmits a signal and measures the time it

takes for its reflection to return to the source.)

Gone are the days of mindlessly swapping computers, boards, and cables. Instead we use intelligent swapping to localize a problem, and then use appropriate test equipment to find the suspect part. Next we install a substitute, and if the LAN comes to life, that part remains. Otherwise, we will repeat the process until the fault disappears and the LAN comes on-line.

Some training firms claim that only a screwdriver is required to service a LAN. We won't go that far—but with the techniques discussed here, we'll come close.

## **Hand tools**

Common hand tools are useful in servicing LAN's. Table 1 describes the basic requirements; you'll probably add other, more specialized tools to the list as time goes on.

One quick and easy way to get the tools you need is to buy a Jensen tool kit. For example, the reasonably priced JTK-5 tool kit contains all the essentials for servicing Ethernet LAN's. Also check with Jensen for tools and tool kits suitable for twisted-pair and Token Ring LAN's.

Probably the most common problem in LAN service is connectors. Sooner or later, you'll

have to replace a bad one. The best way to learn the proper techniques is to work with someone already skilled in the art. Failing that, there are other resources. Try a local electronic parts distributor for manufacturer's literature on connector installation. Or locate a copy of the *Radio Amateur's Handbook*, published by the American Radio Relay League. The Construction Practices chapter of that handbook describes the proper way to install BNC-type coaxial connectors. You might also contact AMP and other manufacturers to request assembly information on their crimp-on coax and RJ-xx series connectors. The sidebar lists several sources of information.

## **The DMM**

No service technician in his right mind would be caught dead without a DMM; it is literally indispensable. You can use it to service LAN's, and also to check building AC-line power and repair electronic equipment of all types. DMM's are available with a dazzling variety of features. If you are shopping for a DMM, choose a 3½-digit unit, like the one shown in Fig. 1, that is easy to use, has the features you really need, and has a low price. Minimum LAN-specific requirements for a DMM include a 0 to 200 ohms range, a continuity beeper, a 0



FIG. 1—A BASIC DMM, like the Fluke Model 70, is an indispensable tool for LAN troubleshooting.

to 20-volts DC range, and a 0 to 200-volts AC range. Most DMM's sold today meet those minimum specifications.

Let's discuss briefly how you can use a DMM for LAN servicing. Resistance and continuity are probably the most used functions in LAN servicing. Use the ohms function to measure the resistance of cables and terminator resistors, and to locate shorts or opens in cables and connectors. A low-end range of 0 to 200 ohms is important because coaxial cables typically measure less than 5.0 ohms end-to-end, and twisted pair less than 20.0 ohms. To make this type of measurement, first power down the network to avoid affecting LAN operation. Disconnect questionable cables before making measurements.

High-resistance cables can have partially severed wires or bad connectors. Test all terminators (connector bodies containing 50-, 91-, or 100-ohm

resistors) to ensure proper resistance. Use the continuity function to locate shorts and opens in cables and connectors. Audible beeps are especially useful when working in dark or tight places like plenums (dropped ceilings).

The DC function is useful as well. Ethernet LAN's carry 5-volt power and data to the transceivers attached to the backbone cable. Use the DMM to verify that power is present at the transceiver if it does not have a Power Good indicator. You can also use the DC volts function to verify voltages in emergency lights and uninterruptible power supplies (UPS's).

Last but not least, use the AC volts function to measure AC power outlets and noise levels on the LAN cables. It is not uncommon for power problems to cause trouble on a LAN, particularly when the file server or hub computer is affected. Then

the whole network may crash. Just check the outlet voltage with a DMM, and if it is outside the 105 to 125-volt AC operating range of most computers, call an electrician!

Noise problems can be a big headache, especially on LAN's with unshielded twisted-pair (UTP) cable. Noise causes random data errors and, in serious cases, can crash the network. Measure noise with a DMM by connecting it to one end of the cable, making sure the other end is terminated properly. The DMM reading for a good UTP cable can be in the range of 5 millivolts or less. A high reading can uncover unusual faults such as a coil of excess cable or cable routed too close to EMI sources such as fluorescent lighting fixtures. In fact, the author once determined that a 50-foot coil of excess UTP left on top of a light fixture by an installer was causing intermittent problems on a newly installed LAN. The problem drove everyone crazy for months! Using a DMM as a noise meter has limited utility because DMM's measure voltage in the kHz range, not in the 4 to 16-MHz range typical of most networks protocols.

Worse, DMM's don't measure impulse noise, which is especially disruptive to LAN operation. For that type of measurement, we must go to more specialized equipment such as that described in the following sections.

#### Microtest cable scanner

Microtest was the first company to provide specialized, all-in-one LAN test equipment such as the Microtest Cable Scanner. This handheld instrument contains everything you need to troubleshoot LAN cables, including ohmmeter, noise meter, time domain reflectometer (TDR), Ethernet activity monitor, and cable tracer. Best of all, the Cable Scanner is reasonably priced and readily available. Figure 2 shows the Cable Scanner and several other similar models.

Although optimized for Ethernet LAN's, the Cable Scanner also tests unshielded twisted





**FIG. 2—MICROTEST'S HANDHELD LAN TESTERS** combine most-needed features in easy-to-use, hand-held packages. Clockwise from upper left are the Cable Scanner, the Ring Scanner, the Pair Scanner, and the Quick Scanner.

pair (UTP), shielded twisted pair (STP), Token Ring, and RS-232 cables with simple adapters. In addition, Microtest offers specialized scanners specifically for testing unique features of other cable.

Key features of the Cable Scanner include resistance and continuity functions, a basic noise meter, and a TDR. The noise meter is a simple AC voltmeter that reads millivolt noise in the 1-kHz range; it has no capability for measuring impulse noise. Due to the shielding nature of coaxial cable, noise problems are less common in Ethernet systems—but

they do happen. The Cable Scanner is adept at sensing 60-Hz power-line noise that often appears in problematic coaxial cable systems.

The TDR function can locate shorts and opens in LAN cables. Operating it is as simple as pushing a button. The device then injects pulses into the cable where they travel until they strike a fault, and subsequently bounce back to the instrument. The Cable Scanner measures the travel time, calculates distance to the fault, and then displays the distance. All you have to do is inspect the cable at that distance and repair the fault.

Remember that for a TDR to work properly, all equipment must be turned off. Otherwise, data on the line could cause false distance readings—not to mention what it would do to on-line computers! You should also know that all TDR's have a blind spot, or dead zone, from where the instrument connects to some distance down the cable. The Cable Scanner cannot detect faults occurring within the first 25 feet of cable. If you suspect a fault in that section, inspect the cable manually, or make another measurement from the other end of the cable.

The Cable Scanner's Ethernet activity monitor is useful for spotting bad transceivers and other cases of network overload. Recall from Part 1 of this series that Ethernet works on a first-come, first-served basis, somewhat like an old-fashioned telephone party line. Whoever speaks first gets the line. Should something go wrong—for example, a transceiver that "jabbers" or talks all the time—traffic could soar to 100% usage. That, in turn, would prevent other computers on the network from exchanging data because their collision sense multiple access (CSMA) circuitry would force them to wait continually. The result is that LAN operation would come to a grinding halt.

The activity monitor counts the number of data packets (messages) sent between computers on the network over a set time period (for example, one second or one minute). Then it calculates percent usage. You then look up that value on a chart to determine whether there are problems. If so, you must troubleshoot to locate the cause of the fault.

The Cable Scanner also has an optional cable tracer that allows you to trace a specific cable as it runs through the building alongside others. This is a handy feature because LAN cables look alike, making it easy to waste time tracing the wrong cable. To operate the cable tracer, you must also purchase a cigarette-pack-size receiver. In operation, the Cable Scanner

sends a special signal over the cable under test. Then you hold the receiver next to each cable in turn; the one that produces a warble tone is the one you want.

Microtest also sells more specialized instruments for testing other kinds of cables. For UTP/STP cables there is the Pair Scanner, which addresses major twisted-pair concerns including impulse noise and signal loss through the cable. The Pair Scanner also has switching capabilities for selecting different transmit/receive pairs, as well as a hub computer test function. For Token Ring cabling there is the Ring Scanner, which isolates faulty multistation access units (MAU's), determines whether the ring maintains continuity, and monitors network traffic. Interestingly, it can simulate network faults, so you can perform "fire drills" on a good LAN and get a feel for symptoms before they occur. All Microtest products provide a serial output for logging data or printing hard copy reports.

### Paladin Patch Check

Growing popularity of UTP-based LAN's has created a market for special test tools. One good example is a simple, low-cost cable tester from Paladin Corporation called Patch Check. Patch Check, shown in Fig. 3, identifies the most common faults in UTP systems, namely bad connectors, shorts, and opens.

Patch Check tests the full range of UTP systems, from single- to four-pair cables terminated in RJ-11 or RJ-45 connectors. Operation is simply a matter of snapping both ends of the cable into the unit, pushing the Test button, and watching the indicators. Bad connections or opens appear as one or more unilluminated LED's; shorts appear as multiple simultaneously lit indicators. Paladin also offers a remote indicator for situations where you can't get at both ends of the cable.

Patch Check can save lots of time. For example, in resolving one problem described in Part 3 of this series, the author check-

ed a cable with Patch Check in ten seconds, vs. five minutes on a DMM!



FIG. 3—PALADIN'S PATCH CHECK provides instant go/no-go testing of RJ-11 and RJ-45 telephone-style connectors, used for shielded and unshielded twisted-pair wiring.

### Tektronix 1502C TDR

Of all the equipment discussed in these articles, the Tektronix 1502C TDR is oldest and best established. For finding tough problems it can't be beat. It can identify badly crimped connectors, crushed coaxial cables, wiring chewed by rodents, and more. It is sensitive enough to locate problems to within inches on the cable. The 1502C is a state-of-the-art version of a line of analog TDR's that goes back several decades.

The 1502C looks much like a benchtop oscilloscope, as shown in Fig. 4. However, instead of the usual cathode ray tube (CRT), the 1502C has a liquid crystal display (LCD) to reduce power consumption and weight. A removable reticle fits over the display, which shows cable impedance vs. distance. The operating controls are simple, and there are less of them than on an oscilloscope. An excellent operator's manual helps new or infrequent users operate the device.

Key features of the 1502C include a negative-going output pulse, which shuts down live

Ethernet transceivers, and a zoom feature that allows you to examine tiny faults which show up as impedance spikes on the display. Zoom helps you find problems like rusty connectors or bad crimps. In Part III we will show how we found an unauthorized cable tap using these features.

One important feature is the propagation-rate control. It's important because it determines the distance accuracy of the TDR. As you might recall from physics class, electrons travel at the speed of light in a vacuum. But in the real world of copper cabling, signals travel much slower. The speed reduction is due to insulation quality and conductor diameter. The propagation-rate control calibrates the equipment to compensate for the slower conduction in the cable, thereby providing correct distance indications.

### RESOURCES

Following are addresses of manufacturers whose products were discussed in this article. Contact them for current pricing and more information.

- Paladin Corporation, 3543 Old Conejo Rd., Newbury Park, CA 92123, (800) 272-8665.
- Jensen Tools, Inc., 7815 S. 46th Street, Phoenix, AZ, 85044, (602) 968-6231.
- MicroTest, Inc., 3519 E. Shea Blvd. Suite 134, Phoenix, AZ 85028, (800) 526-9675.
- Radio Amateur's Handbook, American Radio Relay League, Newington, CT 06111.
- Tektronix, Inc., Redmond Division, 625 S. E. Salmon Dr., Redmond, OR 97756, (800) 833-9200.
- AMP, Inc., P.O. Box 3608, Harrisburg, PA 17105, (717) 561-6168.

Typically you set the propagation rate by consulting a chart published by the cable manufacturer or LAN equipment vendor. Values are usually expressed as a percentage of the speed of light, *c*. The higher the percentage, the faster the signals travel through the cable. Typical Ethernet backbone cable has a propagation rate of 0.76*c*. Some sources refer to propagation rate as the numer-



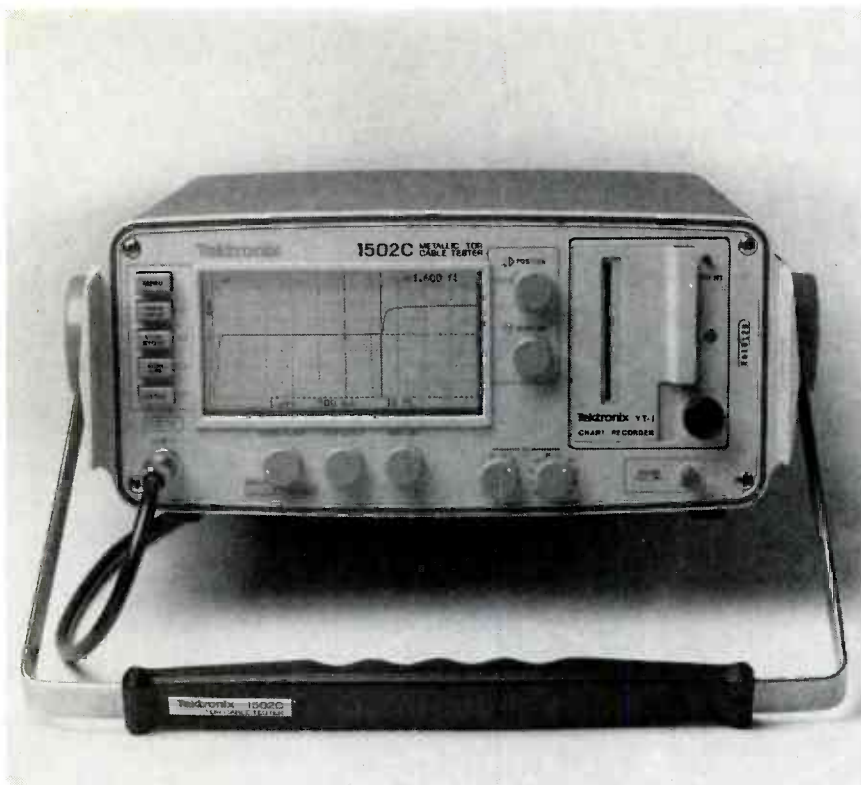


FIG. 4—TEKTRONIX' 1502C TIME DOMAIN REFLECTOMETER provides analog display of distance versus impedance. A knowledgeable technician can interpret the display to locate subtle LAN cable faults.

ical value of propagation (NVP) or velocity factor (VF). The terms all mean the same thing. Regardless of name, it is important to set the propagation rate control of your TDR if you want it to display meaningful, accurate readings.

Operating the 1502C is straightforward. You begin by powering down the LAN equipment on the questionable cable segment and removing any terminator resistors. (Terminators can trick a TDR into displaying fantastic cable lengths.) Then connect the TDR to the cable through an impedance adapter, install the correct display reticle, and apply power. Then adjust the controls, and you'll receive a visual indication of cable quality.

Tektronix makes several other TDR's. The 1503C analog TDR accommodates cables as long as 50,000 feet, and has an Ethernet option. The 1503C looks like a good choice for cable TV or aircraft carrier applications. Tektronix also makes the TMA-802, a moderately priced digital TDR and Ethernet ac-

tivity monitor.

#### Analog vs. digital

In this article, we have described two types of TDR's: digital (Microtest) and analog (Tektronix). Each type of TDR has its own advantages and disadvantages; both instruments are widely used in LAN servicing.

The major differences between the two are in information display and sensitivity to minor faults. Push a button on a digital TDR, and you'll read something like *Short 40 Ft* on the display. Digital TDR's are great for novice users because they make it easy to understand results. Their drawback, however, is that they report only major faults, missing minor ones that often cause the most frustrating problems.

Turn on an analog TDR and you'll see a oscilloscope-style wavy line over a black reticle calibrated in impedance vs. distance. Clearly the analog TDR is intended for more experienced users who can disregard the dead zone, interpret impedance

changes, and read distance from the reticle. Analog TDR's also have an amazing sensitivity to rusty contacts in connectors, water-logged cables, and other faults that can go undetected with less-sensitive instruments.

#### Network certification

Another issue is network certification, which is becoming increasingly important as corporations continue the downsizing trend. Downsizing involves using networks of PC's to perform mission-critical applications formerly run on mainframes. *Mission-critical* means that the health and competitiveness of the company depend critically on the computer systems that support the company. Without a reliable network, workers can't do their jobs, so goods and services are delivered to customers late. If customer dissatisfaction increases, the company suffers, and so do jobs. Clearly, we all have a vested interest in keeping our LAN networks running reliably.

In the past, LAN cables were often pulled by electrical or telephone wiring contractors who might not have had proper tools and expertise. As a result, Ethernet cables may exceed recommended lengths, excess UTP cable may be left coiled in plenums over fluorescent fixtures, and so on. Those problems decrease LAN performance and, even worse, can serve to reduce reliability.

In response, major LAN vendors have devised performance tests to help ensure that LAN's meet standards for noise level, cable length, attenuation, and other factors that affect performance and robustness.

Without thinking out the problem the fanciest TDR in the world will be useless. Develop your ability to identify a problem and logically work your way through possible causes until it is solved.

Be sure to join us in Part III when we will roll up our sleeves and troubleshoot actual LAN's with the equipment and tools described here.

# The 555

## A Versatile Timer

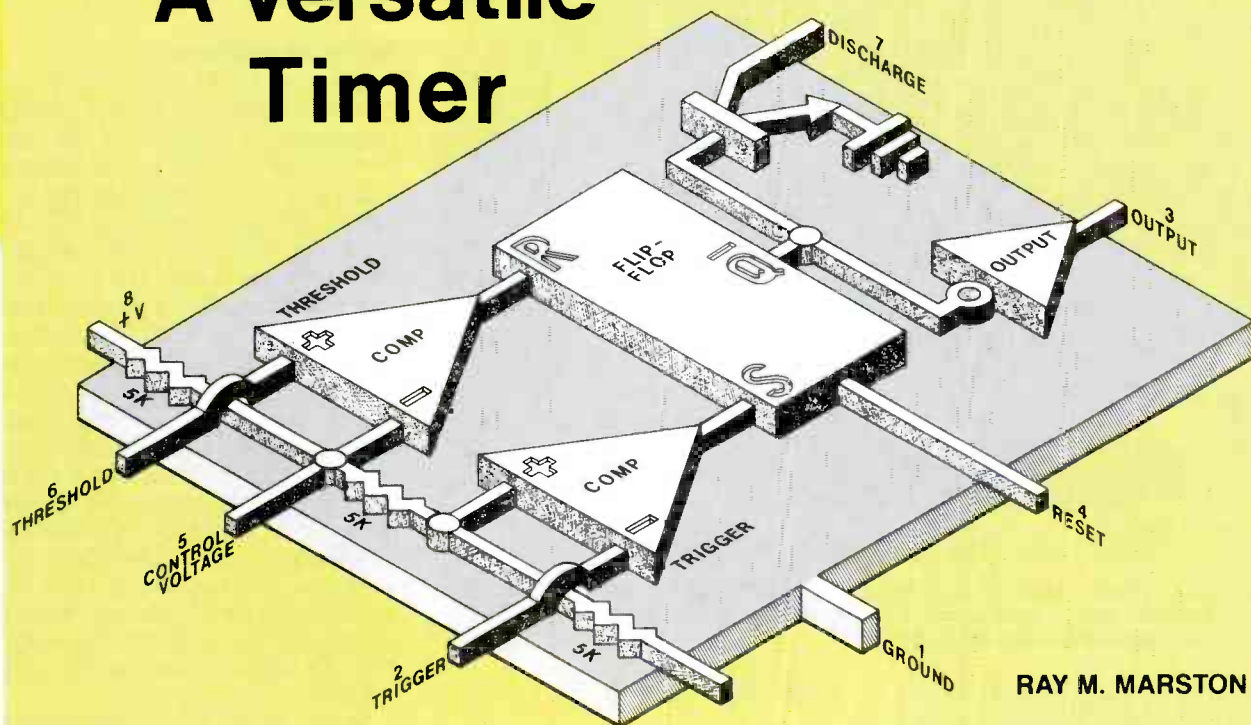


FIG. 1—FUNCTIONAL BLOCKS OF THE 555 TIMER with its pinout identified.

### **Learn to use the 555 and 556 timer IC in practical circuits to obtain accurate time delays and square waves**

IN ANY ASSOCIATION TEST FOR those who know integrated circuits, the three digits 555 will summon up the instant response "timer IC." It's the short form generic designation for progeny of the NE555, a popular monolithic timer/oscillator IC first introduced by Signetics many years ago. Still widely second-sourced because of its versatility, the 555 ranks as a standard "building block."

The 555 and its derivatives can be found in thousands of different circuits, and its possibilities for further applications appear limitless. Although classed as a linear IC, it is often used in digital or "quasi-digital" applications because its inputs and outputs are essentially square waves

rather than sine or other complex waveforms. This article explains how the 555 works and shows you how to apply the IC in various practical control circuits.

#### **A 555/556 overview**

Figure 1 is a simplified block diagram of the 555 showing its principal functional blocks: threshold comparator, trigger comparator, R-S flip-flop, low-power complementary output stage, slave discharge transistor, and a voltage-reference potential divider. Both halves of a dual version of the 555 (two 555's on a single chip), the 556, have identical electrical characteristics. The 555/556 will run from 4.5 to 16 volts DC, although a typical

supply will be +12 volts DC or less.

The outstanding features of the 555/556 include:

- Timing adjustable from microseconds to hours
- Duty cycle adjustable
- Ability of output to source (supply) or sink (dissipate) 200-milliampere current
- Output can drive TTL logic circuits
- Temperature stability exceeds 0.005%/°C
- Normally "on" and normally "off" output

The 555 and 556 were designed for precision timing applications, with the timing interval controlled by an external resistor and capacitor (RC) network. The devices contain voltage dividers consisting of



three 5000-ohm resistors in series between the supply voltage and ground so that one-third of the supply voltage is developed across each resistor. The internal flip-flop circuit provides a definite "on" or "off" response. Its timing intervals are independent of the supply voltage.

The 555 has two basic operating modes: *monostable* (one-shot—a single pulse is emitted), and *astable* (a stream of output pulses is generated). In the monostable mode when functioning as timers, time is precisely controlled by the external RC network. In that mode the 555 produces output pulses with rise and fall times measured in microseconds.

In the astable mode, the 555 can be an oscillator. It can maintain an accurately controlled free-running frequency and duty cycle with only two external resistors and one capacitor. In either monostable or astable modes, timing accuracy is essentially independent of variations in supply voltage or ambient temperature. The device can be triggered and reset on falling waveforms.

Typical applications for the 555 include precision and sequential timing, pulse generation, pulse-width and pulse-position modulation, and linear ramp generation. Moreover, it can directly drive loads such as relays, solenoids, low-power lamps, and high-impedance speakers.

The 555 is packaged in plas-

tic and metal DIP's and 8-pin metal cans for operation in the commercial temperature range of 0 °C to +70°C. Some plastic DIPs can operate in the -40°C to +85°C extended temperature range.

Alternate-sourced 555's can usually be identified by the inclusion of the numbers 55 or 555 in their designations. Examples include Harris' CA555, Motorola's MC1455, and National Semiconductors' LM555C. Other sources include Exar, Goldstar, Raytheon, Samsung, SGS-Thomson, and Sharp Electronics. CMOS versions of the 555, such as Texas Instruments' TLC555 are also available. In addition to their low power consumption compared to standard 555's, their outputs are compatible with CMOS as well as TTL.

Table 1 presents some basic electrical characteristics for the 555. The 556 is housed in a 14-pin DIP package but the block diagram of each circuit is identical to that of the 555 shown in Fig. 1. The 556 is also alternate-sourced by many of the same firms that offer the 555. Examples are Motorola's MC3556 and Texas Instruments' TLC7556.

#### How the 555 works.

Figure 2 is a representative circuit schematic for the 555. It contains 21 transistors, 4 diodes, and 15 resistors. The voltage divider consisting of three 5000-ohm resistors (shown in Fig. 1) appears to the right of

Q10 in the trigger comparator. It applies one-third of the supply voltage to the non-inverting input terminal of the trigger comparator and two-thirds of the supply voltage to the inverting input of the IC's threshold comparator.

The output of the two comparators controls the R-S flip-flop, which in turn controls the states of the complementary output stage and the slave transistor Q6. The flip-flop's state can also be set by signals at RESET pin 4.

When organized as a monostable timer, the TRIGGER pin 2 is held high by external resistor  $R_T$  in series with the DC supply voltage. Under that condition, Q6 is saturated, shorting external timing capacitor  $C_D$  to ground, and OUTPUT pin 3 is driven low. Timer action is started by applying a negative-going trigger pulse to pin 2. As this pulse falls below one-third of the DC supply voltage, the output of the trigger comparator changes state. That causes the R-S flip-flop to switch, turning Q6 off, and driving OUTPUT pin 3 high.

As Q6 turns off, the short is removed from the external capacitor  $C_D$ . The capacitor charges through the external resistor  $R_D$  until the voltage across  $C_D$  rises to two-thirds of the supply voltage. Then the threshold comparator changes state and switches the R-S flip-flop back to its original state, turning Q6 "on" and rapidly discharging  $C_D$ . At the same time, OUTPUT pin 3 reverts to its low state. The *timing cycle* is then complete.

A characteristic of the 555 is that, once triggered, it cannot respond to additional triggering until the timing sequence is complete. However, the sequence can be aborted at any time by feeding a negative-going pulse to RESET pin 4.

The output pulse is a square wave whose duration (time delay) depends on the values of R and C. The formula for this is:  $t_D$  (time delay) = 1.1 (value of R × value of C)

Simply stated, time delay is directly proportional to the

TABLE 1—ELECTRICAL CHARACTERISTICS

Characteristics	Symbol	Min.	Typ.	Max.	Unit
DC Supply Voltage	$V_{CC}$	4.5	—	16	V
DC Supply Current ( $V+ = 5V$ )	$I_{CC}$	—	3	6	mA
		—	10	15	mA
Power Dissipation		—	—	600	mW
Threshold Voltage	$V_{th}$	—	$\frac{2}{3}$	—	V
Trigger Voltage ( $V+ = 5V$ )	$V_T$	—	1.67	—	V
		—	5	—	V
Reset Voltage	$V_R$	0.4	0.7	1.0	V
Reset Current	$I_R$	—	0.1	—	mA
Timing Error (Monostable)		—	1	—	%
Frequency Drift with Temperature		—	50	—	ppm/°C
Drift with Supply Voltage		—	0.1	—	%/V
Output Rise Time	$t_r$	—	100	—	ns
Output Fall Time	$t_f$	—	100	—	ns

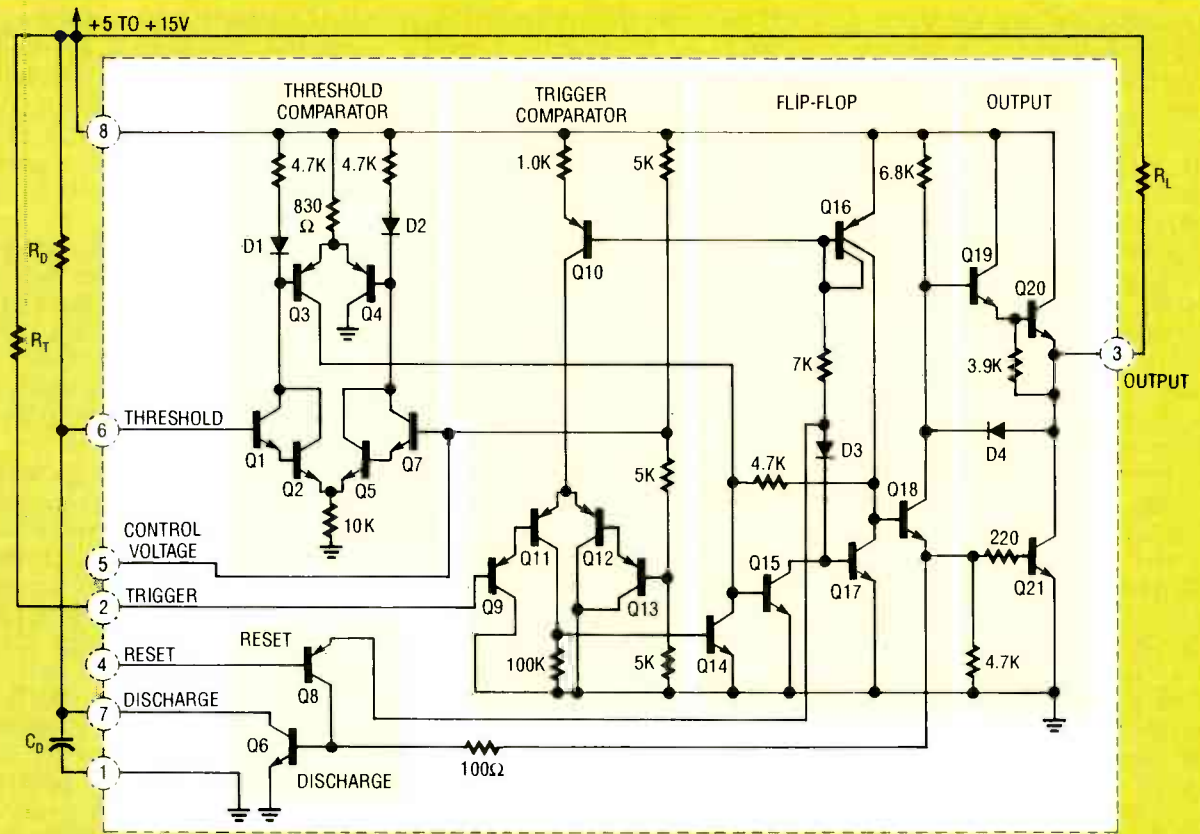


FIG. 2—REPRESENTATIVE CIRCUIT SCHEMATIC FOR A 555 timer with external resistive and capacitive components.



FIG. 3—COMBINATIONS OF RESISTANCE AND CAPACITANCE yield a range of time delays. The trigger pulse width must be less than the timing period.

product of  $R$  and  $C$ . Figure 3 is a plot of time delay vs. resistance and capacitance based upon the time-delay formula where  $t_D$  is in milliseconds,  $R$  is in thousands of ohms, and  $C$  is in microfarads. Figure 3 gives a

family of time delay curves with variations in  $R_T$  and  $C_T$ . Delays from 10 microseconds to 100 seconds can be obtained by selecting suitable values of low-leakage capacitors from 0.001  $\mu\text{F}$  to 100  $\mu\text{F}$  and resistors from

1 thousand ohms to 10 megohms.

Figure 4-a is a simple fixed-period (approximately 50-second) manually-triggered time delay circuit, and Fig. 4-b shows the waveforms as they would appear on an oscilloscope. The sequence of events in Fig. 4-b is initiated by grounding TRIGGER pin 2 with momentary START switch S1. The CONTROL VOLTAGE pin 5 is decoupled by C2, and the output state can be determined by observing whether LED1 is illuminated or not. A square output pulse (whose fixed-period is determined by  $R_1$  and  $C_1$ ) appears at OUTPUT pin 3, while an exponential sawtooth (with the same period as the square wave) appears at DISCHARGE pin 7.

The fixed-period output of the circuit in Fig. 4 can vary from 1.1 to 120 seconds by making the changes shown in Fig. 5. Resistor  $R_1$  is replaced with a 10K fixed resistor and 1-megohm potentiometer  $R_5$  in series, as shown. A reset feature can be added by installing RESET switch S2, permitting



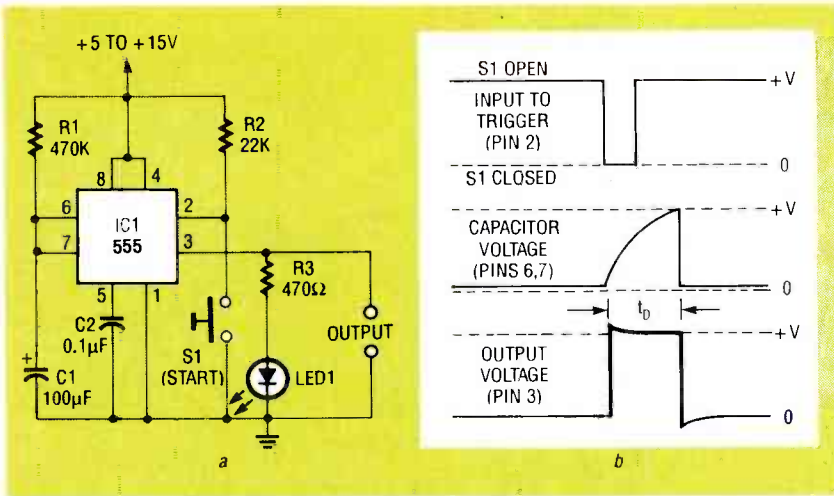


FIG. 4—FIXED-PERIOD TIMER produces a .50-second time delay (a). The waveforms at three pins are shown (b + a).

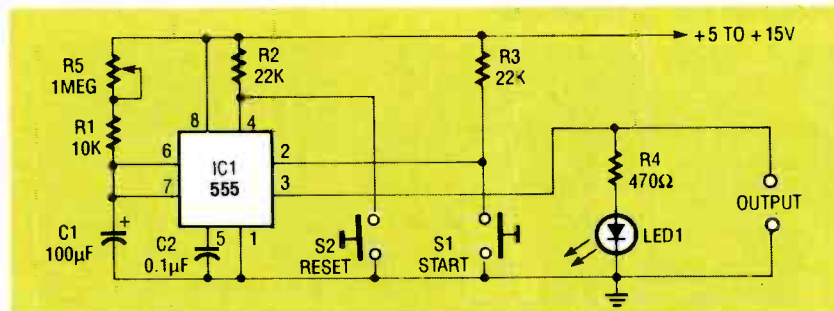


FIG. 5—VARIABLE-PERIOD TIMER CIRCUIT with reset capability produces time delays from 1.1 to 120 seconds.

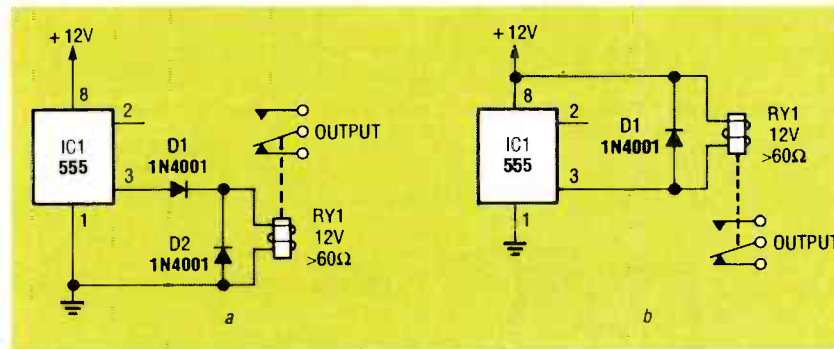


FIG. 6—ALTERNATE METHODS FOR ENERGIZING a relay from the output of a 555.

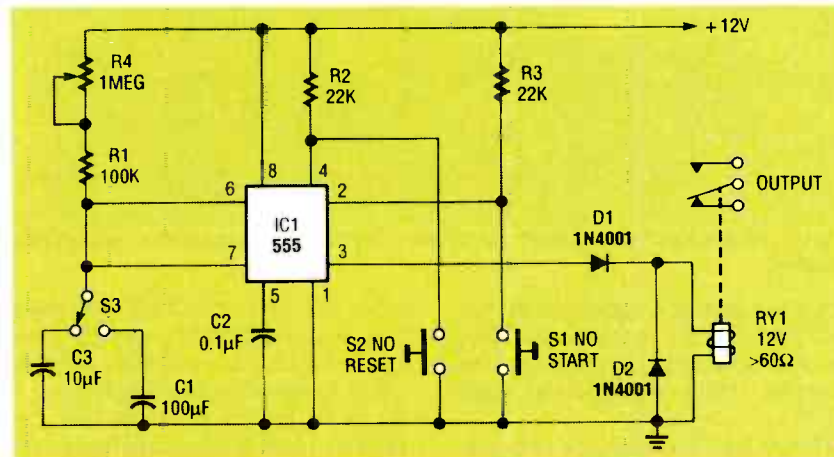


FIG. 7—TIMER WITH A RELAY OUTPUT provides time delays of 1.1 to 120 seconds.

premature termination of the timing period.

The 555 timer can drive non-inductive loads directly from pin 3 with currents as large as 200 milliamperes. However, if the circuit contains an inductive relay load, either of the schematics shown in Fig. 6 apply. In Fig. 6-a, the relay RY1 is normally off, but it goes on only when output pin 3 goes high during the timing interval; in Fig. 6-b, RY1 is normally on, but it turns off during the timing interval. Diode D1 in both circuits protects the 555 against inductive-switching damage. The contacts of relay RY1 can control external circuits.

Figure 7 shows how a relay and a 555 can form a simple 1.1- to 120-second timer in two switch-selected decades. However, the general-purpose circuit has several drawbacks. First, it draws current continuously, even when the timer is off. Second, because of the wide tolerance variations in the electrolytic timing capacitors C1 and C2, potentiometer R4 needs two custom calibrated scales.

The schematic in Fig. 8 shows how to overcome these drawbacks. The RESET switch S2 and the set of relay contacts in parallel with the START switch S1, which are both normally open (N.O.) keep the circuit off so there is no current drain. The timing cycle is started by pressing momentary pushbutton switch S1, which connects power to the 555. At the instant of S1 closure, C3 is fully discharged. It therefore sends a start pulse to TRIGGER pin 2 through R4 and initiates a timing cycle.

As the timing cycle starts, RY1 is energized. The contacts in parallel with S1 close and keep the 555 powered even when S2 is released. At the end of the timing cycle RY1 is de-energized and its contacts re-open, disconnecting power from the 555.

The timing of the circuit in Fig. 8 is principally controlled by the values of resistor R1 and potentiometer R5, and either C1 or C2, which are switch-selected by S3-a. Note, however,

that timing is also influenced by the setting of potentiometers R6 and R7. They are selected with switch S3-b and connected to CONTROL voltage pin 5 of the IC. Those potentiometers effectively shunt the internal voltage of the 555, thereby altering timing periods.

That feature allows the circuit to produce precise timing periods even when capacitors with loose-tolerance values are in the circuit. It also allows a single calibrated timing scale to cover the two switch-selected timing ranges.

To set up the Fig. 8 circuit, first set potentiometer R5 to its maximum value, set switch S3 to position 1 and push START button S1. Then adjust potentiometer R6 for a precise period of 10 seconds. Next, set 3 to position 2, push START switch S1, and adjust potentiometer R7 for a precise period of 100 seconds. With those adjustments complete, the timing scale can be calibrated over its full 100-second range.

### Timers for car lights

Figure 9 is a circuit that automatically delays the turn-off of an automobile's headlights, permitting them to function as safety lights at night after the ignition switch is turned off. It is a useful circuit if you want your car's headlights to remain on for 50 seconds after you have parked, turned off the ignition, locked the doors, and walked away. The headlights will stay on long enough to illuminate your route until you can reach the safety of your home. The circuit does not interfere with normal headlight operation.

When the car's ignition switch S2 is turned "on," RY1 is energized (through diode D3) closing its contacts and connecting the 12-volt battery to the 555 and headlights switch S1. In this state the headlights operate normally. However, because both sides of capacitor C2 are connected to the positive supply, it is fully discharged.

When S2 is turned "off," the voltage across R3 goes to zero, de-energizing the relay. However, at that time C3 applies a

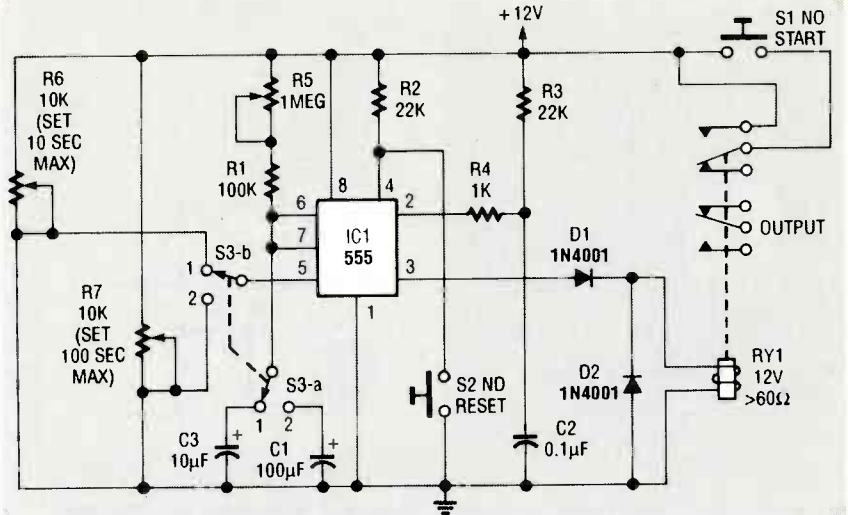


FIG. 8—PRECISION (COMPENSATED) TIMER with a relay output has two ranges: 0.9 to 10 seconds and 9 to 100 seconds.

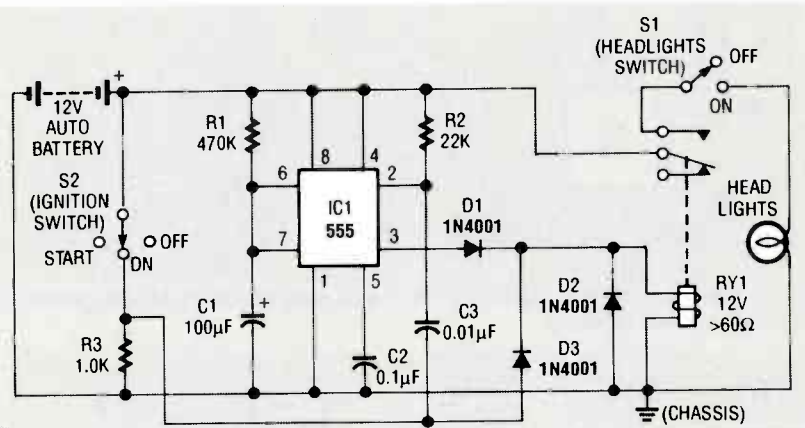


FIG. 9—HEADLIGHT TURNOFF CONTROL with automatic delay for automobiles.

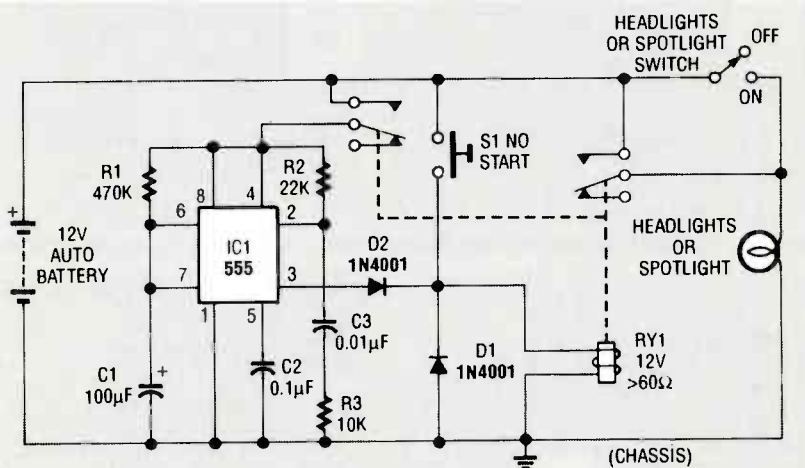


FIG. 10—HEADLIGHT/SPOTLIGHT TURNOFF CONTROL for automobiles is manually actuated.

negative-going trigger pulse to TRIGGER pin 2, initiating a 50-second timing cycle that applies current to the relay coil through D1.

Relay RY1's contacts remain closed for about 50 seconds

after S2 is turned off, keeping the positive battery supply connected to S1 during this period. That keeps the headlights on if S1 is in its ON position. At the end of that 50-second time delay, RY1 de-energizes, its con-



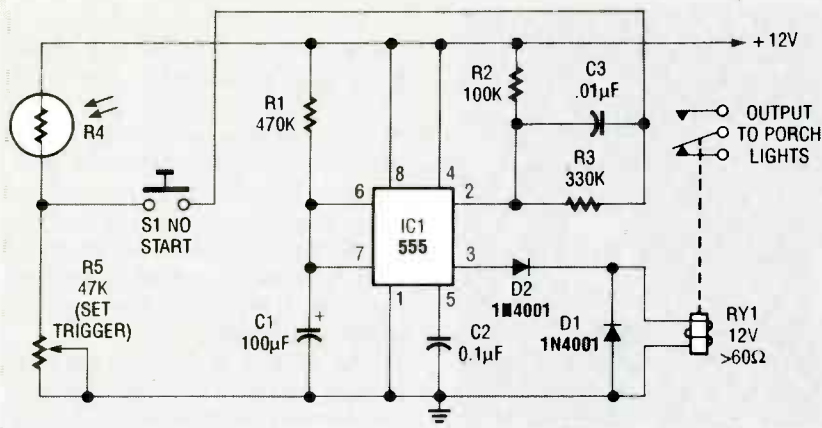


FIG. 11—PORCH LIGHT CONTROL automatically turns on a light for a preset period only when triggered at night.

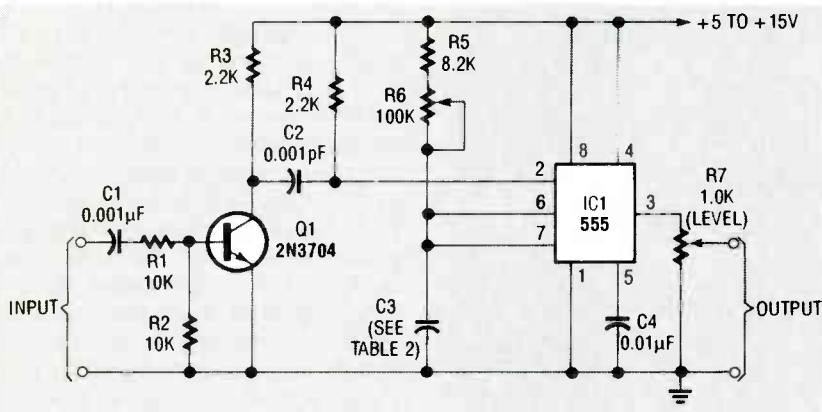


FIG. 12—ADD-ON PULSE GENERATOR can supplement a stand-alone pulse generator. It is triggered by rectangular input signals. Table 1 gives output pulse widths for various values of C3.

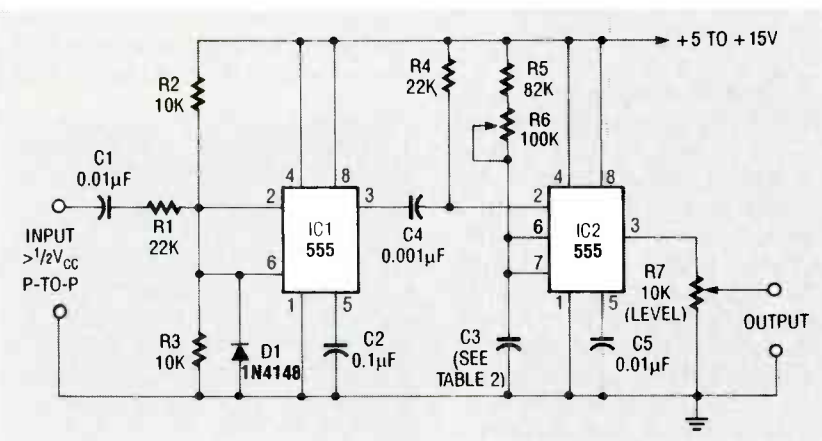


FIG. 13—MODIFIED ADD-ON PULSE GENERATOR can be triggered by any kind of input waveform including sine waves.

tacts open, and battery supply is disconnected from the 555 and S1.

The circuit in Fig. 9 is compatible with modern practice for powering the headlights switch S1 with ignition switch S2 so that headlights work only when the ignition switch is on. How-

ever, the circuit shown in Fig. 10 is applicable to older vehicles whose headlights or spotlight are independent of the ignition switch. The circuit illustrates a manual delayed turn-off light control.

That circuit works if the vehicle is parked with its lights off.

They will be turned on for a preset 50-second period as soon as momentary pushbutton START switch S1 is pressed. When the delay period times out, the lights will be turned off again automatically.

The Fig. 10 circuit includes relay RY1 with two sets of normally-open contacts. The timing sequence is started with the momentary closure of pushbutton switch S1. Normally, both S1 and the relay contacts are open, so the timer circuit is not powered and the lights are off. Capacitor C3 is discharged under this condition.

When S1 is momentarily closed, RY1's coil is energized. That action closes its first set of contacts, applying power to the car's lights while also closing its second set of contacts, applying power to the 555. However, TRIGGER pin 2 of the IC is briefly grounded through C2, so a negative trigger pulse is fed to it, and a timing cycle is begun.

Consequently, OUTPUT pin 3 of the 555 switches high when the relay contacts close, locking the relay into its "on" state (regardless of the subsequent state of S1), keeping the lights on for 50 seconds. At the end of the timing cycle, pin 3 of the IC switches to its low state, de-energizing RY1. Then both sets of relay contacts open, disconnecting power from the 555 and the lights.

### Automatic porch light

Figure 11 is an automatic control circuit for a porch light. It will turn a porch light on automatically for a preset 50-second period when its sensor detects the presence of a person. However, it performs that function only at night or under conditions of reduced visibility such as might occur during a storm. The circuit is activated with switch S1, which can be a microswitch triggered by a porch gate. It might also be a pressure-switch hidden under a porch mat and triggered by a person weighing perhaps 50 pounds or more.

Circuit operation depends on a negative-going pulse that falls below the internally controlled

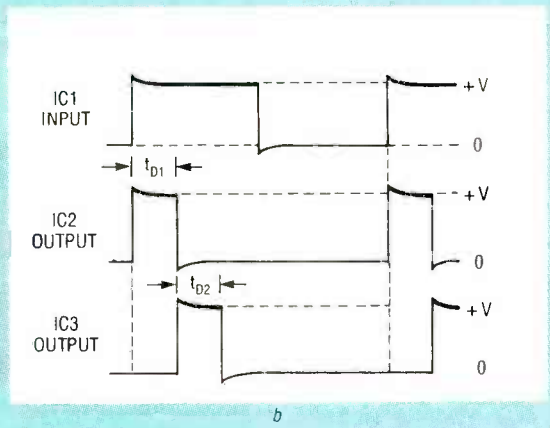
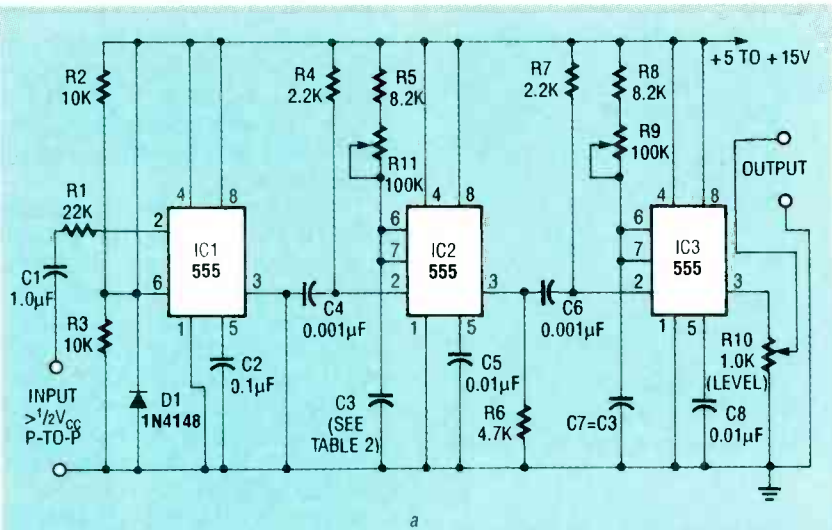


FIG. 14—ADD-ON DELAYED PULSE GENERATOR can be triggered by any input waveform (a). Waveforms at input to IC1 and those at the outputs of IC2 and IC3 based on different values of R and C (b).

one-third supply voltage being fed to TRIGGER pin 2 of the 555. If the trigger pulse does not fall below that value, the timing cycles cannot be initiated.

In Fig. 11, the photocell (resistor R4) and potentiometer R5 are in series as a light-dependent voltage divider. One side of S1 is connected to the junction between R4 and R5, and the other side is connected to pin 2 through a network of C2 and R3. In normal daylight the photocell's resistance is low, so a high voltage appears at the junction of R4 and R5. As a result, closing S1 sends a voltage pulse to pin 2 whose value is too low to pull pin 2 below one-third of the supply voltage. Thus, the timer cannot be triggered with S1 under those conditions.

However, the photocell's resistance value increases at night or

under reduced visibility, causing a low voltage to appear at the R4-R5 junction. Under that condition, closing S1 generates a voltage pulse that pulls pin 2 below the one-third supply voltage value, triggering the timer.

The cadmium-sulphide (CdS) photocell (resistor R4) should have a resistance of 1000 to 47,000 ohms under "dark" turn-on conditions. Potentiometer R5 can be adjusted to preset the minimum "dark" level for circuit triggering. The trigger signal is fed to pin 2 of the 555 through the C3 and R3, a network that shapes the trigger pulse and effectively isolates the DC component of the photocell-potentiometer network from pin 2.

### Pulse generators

In all of the circuits presented

so far, the 555 functions as a monostable (one-shot) pulse generator. Suitable trigger signals are fed to TRIGGER pin 2 and output pulses are taken from OUTPUT pin 3. The 555 can generate well formed output pulses with periods from 5 microseconds to hundreds of seconds. The maximum usable pulse repetition frequency is approximately 100 kHz.

The signal reaching TRIGGER pin 2 must be a carefully shaped negative-going pulse. Its amplitude must switch from an "off" value greater than two-thirds of the supply voltage to an "on" value less than one-third of the supply voltage. (Triggering actually occurs as pin 2 drops through the one-third supply voltage value.) Trigger pulse width must be greater than 100 nanoseconds but less than that of the desired output pulse. That condition assures trigger pulse removal by the time the monostable period times out.

Suitable trigger signals for the 555 in the monostable mode can be formed by converting the input signal to a good square wave that switches between the full positive supply voltage and ground. The square wave is then coupled to pin 2 with a resistor-capacitor differentiating network having a short time constant. That network con-

TABLE 2—CAPACITOR VALUES FOR PULSE-WIDTHS

Capacitors C3 (Microfarads)	Pulse Width Range (Time in Seconds)
10.0	90 ms - 1.2
1.0	9 ms - 120 ms
0.1	900 $\mu$ s - 12 ms
0.01	90 $\mu$ s - 1.2 ms
0.001	9 $\mu$ s - 120 $\mu$ s

verts the leading or trailing edges of the square wave into suitable trigger pulses.

Figure 12 shows a timing circuit that accepts input signals already in the form of square waves or pulses. Transistor Q1 converts a rectangular input signal into a form that switches between the positive supply and ground. The output signal is



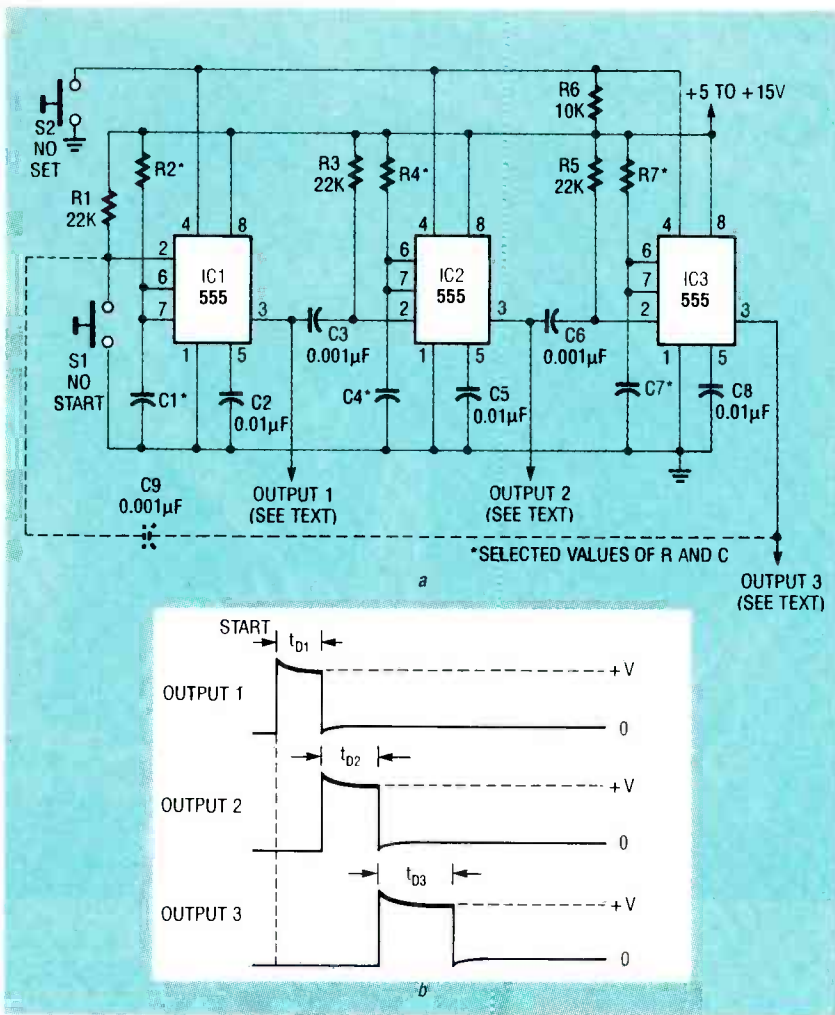


FIG. 15—THREE-STAGE SEQUENTIAL TIMER or pulse generator (a) and waveforms at three different output pins (b).

then fed to TRIGGER pin 2 through differentiating network C2-R4. The circuit can become an add-on pulse generator in combination with a separate square-wave or pulse generator. Variable-amplitude output pulses can be obtained from potentiometer R7.

The output pulse widths of the Fig. 12 circuit can be varied over more than a decade range with potentiometer R6, and they can be switched in overlapping decade ranges with the values of C3 listed in Table 2. With the component values shown, output pulse width is variable from 9 microseconds to 1.2 seconds. Capacitor C4 decouples CONTROL VOLTAGE pin 5 to improve circuit stability.

Figure 13 shows a modification of the circuit in Fig. 12 that can be triggered by any kind of input waveform, including sine

waves. Here the first 555 (IC1) is configured as a Schmitt trigger to convert all input signals into square-wave output signals. Those square waves trigger the second 555 (IC2) in the monostable mode in the same way as described earlier. The circuit can also become an add-on pulse generator in combination with any kind of stand-alone waveform generator that produces output signals with peak-to-peak amplitudes greater than one-half the IC's supply voltage.

Figure 14-a shows how two monostable circuits can be connected in series to make a delayed-pulse generator. As in Fig. 13, the first 555 (IC1) is configured as a Schmitt trigger. The second 555 (IC2) controls time delay width, while the third 555 (IC3) determines the output pulse width.

As shown in Fig. 14-b, the output pulse at pin 3 of IC3 appears at a time interval after the initial application of the trigger signal. This time delay width  $T_{D1}$  is determined by the product of the value of capacitor C3 and the sum of the values of resistor R5 and potentiometer R6, in accordance with the time delay formula given earlier. Similarly, output pulse width  $t_{D2}$  is determined with the values of C7, and R8 and R9.

This circuit can become part of a stand-alone pulse delay generator by building it into a square-wave generator case. The square-wave generator will provide the initial trigger signals needed.

A number of monostable pulse generators can be placed in series to operate in sequential form. Figure 15-a, for example, shows a three-stage sequential generator circuit. It can control lamps or relays in a pre-programmed time sequence after pushbutton switch S1 is pressed to give the START command. Note that the RESET pins (pin 4) of all three 555's are shorted together and positively biased by R6. Those pins can be shorted to ground with SET switch S2. When power is applied, S1 should be closed, ensuring that none of the 555's in the circuit are falsely triggered.

Figure 14-b shows the waveforms from the output pins of all three 555's (IC1 to IC3). The time delay  $t_{D1}$  is determined by the values of C1 and R2.  $t_{D2}$  is determined by the value of C4 and R4 and  $t_{D3}$  is determined by the values of C7 and R7 when inserted in the time delay formula given earlier.

Finally, three or more monostable circuits can be connected with capacitor C9 (shown in a dashed connection line) between S1 and pin 3 of the third 555 (IC3). This loop feeds a signal back from the OUTPUT pin of IC3 to the input TRIGGER pin of IC1, permitting infinite repetition of pulse sequence. The circuit can drive LED's and digital logic. The circuit also has the reset capability provided by S2 that clears the circuit when power is first applied.



**W**here will it be? Hawaii? Las Vegas? Mexico? The Bahamas? It's up to you. We're going to send you a free coupon for up to six days and five nights of free lodging at the destination of your choice. Now did we get your attention?

Here's how it works: We sell books, and instead of advertising our program on TV (at great expense) we decided to pass the savings along to you.

When you decide to participate in our program, we'll send you a booklet of 40 coupons and a catalog listing our current book offerings. Purchase one book and include one of the coupons for your second book. In all, you'll get 40 books for your \$19.95 investment.

When we receive your fifth coupon, there's a bonus for you in the form of a free membership in the Grocery Savers of America. This will entitle you to save up to \$50 or more on your monthly grocery bill. And on receipt of your 15th coupon, you automatically get a free membership in The Great American Traveler, entitling you to receive a 50% savings on hotels, motels and car rentals. On receipt of your 20th coupon, Bingo! You get that big free lodging for six days and five nights at your choice of Hawaii, Mexico, Las Vegas or the Bahamas.

You're going to be very impressed with the book selections as well. These are not all paperbacks, but the same, high-quality volumes you see in bookstores at many times your own purchase price. Frankly, there just isn't enough room on this page

to outline all of the details, but don't pass this up! Send us your name, address and \$19.95 so we can send you all of the information, including your catalog and 40-coupon book today. MasterCharge and Visa are accepted.

**THE GREAT TWO FOR ONE**

**Readers Club of America**

**GIVE AWAY**

UP TO \$1,000 RETAIL VALUE

"If you find the same book or publication for less within 10 days Readers Club will refund double the difference"

**FREQUENT USER PROGRAM**

**RECEIVE FREE GIFTS**

MEMBERSHIP NO. **1007850**

The coupon redeemable for one book/publication in the Readers Club Catalog when purchasing another book/publication from that catalog of equal or greater value.

NO EXPIRY DATE

MEMBERSHIP NO. 000000

Author: **Stephen King**  
Title: **The Eyes of the Dragon**  
Item No. 7-0131 Price 18.95

Author 2  
Title: **COMPLETE DESTROY PUBLISHING**  
Item No. 2-0093-P Price 21.95

Author 3  
Title: **MILL VANDER HANDBASE**  
Item No. 7-0193 Price 18.95

NAME: **JOHN SMITH**  
Address: **123 MAIN ST.**  
City: **ANYTOWN**  
State: **NJ** Zip: **08001**

FL Ret. Add 6% Sales Tax \$3.50  
Ship. (Htg. Acc. on Date) .95  
Insured (Owner's Add. on Coupon) .95  
Act 15% of Contributor Funds  
TOTAL ENCLOSED **26.40**

**CIAGGK Inc.**  
P.O. Box 4099  
Farmingdale, New York 11735

Gentlemen: I've enclosed \$19.95 in full payment. Please send my "The Great Two for One Give Away" booklet of 40 coupons and catalog.

Check Enclosed       Visa       MasterCard

Name \_\_\_\_\_

Address \_\_\_\_\_

City \_\_\_\_\_ State \_\_\_\_\_ ZIP \_\_\_\_\_

Credit Card No. \_\_\_\_\_ Exp. Date \_\_\_\_\_

Signature \_\_\_\_\_

*(Clip coupon and mail today! Do not send cash through the mail.)*



**Set up a versatile sloping-vee antenna for your shortwave receiver or ham rig to improve your transmission and reception at low cost.**

# SLOPING V ANTENNA

RICHARD A. FORMATO

THE SLOPING-VEE ANTENNA IS ONE of the most versatile broadband antenna designs available to amateur radio enthusiasts and shortwave listeners. It is structurally simple, inexpensive, easy-to-build, and easy to set up in the field if you want to take your rig with you on vacation. The sloping vee can achieve moderate and occasionally even high gain over a frequency span of 5 to 1, 10 to 1, or more. The antenna is functional over the high-frequency (HF) into ultra-high-frequency (UHF)-range from about 3 MHz to about 800 MHz.

The most common configuration for the sloping-vee antenna is shown in Fig. 1. It consists of two sloping, radiating elements (wires) fed by a radio-frequency source at their vertex. The source is located at a height  $H$  above the ground, and the elements are terminated by two equal resistors,  $R$ , located at or

near the Earth's surface. Technically it is an *inverted-vee* sloping antenna.

The *true* sloping-vee antenna has a vertex height,  $H$ , that is actually less than the height of its terminations. The radiating elements slope up from the ground, not down as shown in Fig. 1, making this configuration more difficult and expensive to build because two masts are required. However, both forms are called sloping vee's because they resemble a tilted letter "V."

This article presents a systematic design procedure that takes into account the unique characteristics of this antenna. A typical design for an HF/VHF 10- to 60-MHz sloping-vee antenna is discussed in detail, and measured performance data for the actual antenna is given. A frequently overlooked feature of the sloping-vee antenna at HF and a major advantage is that it combines the features of horizontal and vertical antennas, which results in virtual polarization diversity.

In a careful design, the characteristics of the communi-

cation links to be supported by the antenna must be considered. For example, the take-off angles at which the antenna must have adequate gain are determined by the transmitter-to-receiver distance and by the virtual ionospheric reflection height.

Another design constraint is the antenna's required bandwidth which is determined by the operating frequencies. For some amateur radio operators, only the HF band (3 to 30 MHz) is of concern; others want to cover the upper HF range and the 6-meter (50 kHz) band as well. High-gain antennas such as Yagis exhibit a bandwidth of a few percent of the center frequency. A well designed sloping vee, by contrast, will cover the entire HF spectrum and even exceed it.

Antenna siting is another important consideration in the design of a sloping vee. From HF well into the VHF range, the Earth's electrical characteristics (ground conductivity and dielectric constant) have a dramatic effect on antenna performance. Ground effects are especially important at low take-off angles (close to the horizon).

Shallow take-off angles are necessary for long-range transmission. For very long distances, the take-off angle could

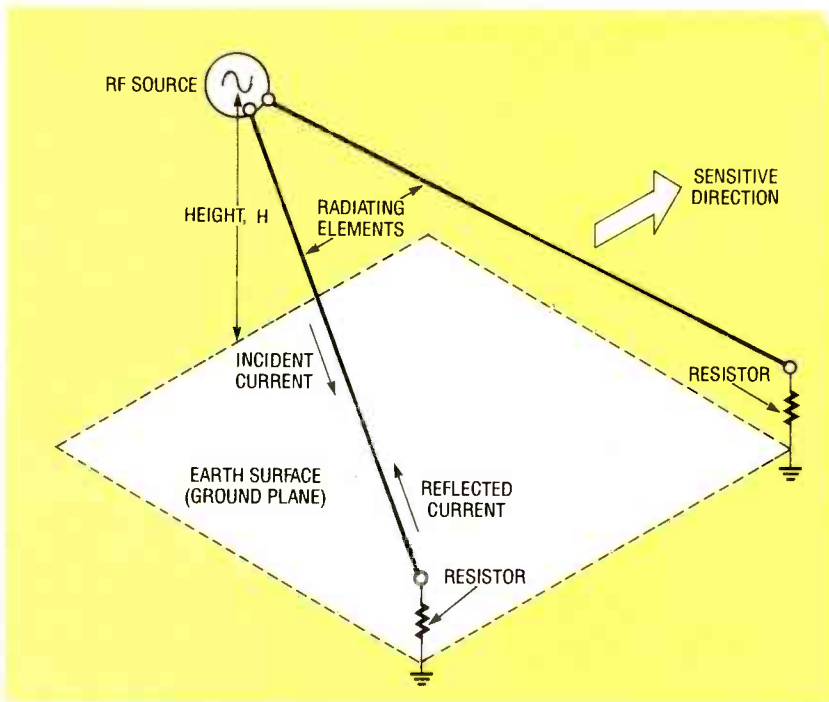


FIG. 1—A SLOPING-VEE ANTENNA is simple, inexpensive to build and erect, and provides excellent broadband performance from HF well into VHF.

be so low that mountains or other terrain features block signal transmission. Those obstructions limit the minimum take-off angle which, in turn, limits the range.

### Sloping-vee operation

As shown in Fig. 1, the RF source excites current waves on the vee's radiating elements. The total current consists of two components: an incident wave propagating from the source toward the end of the element, and a reflected wave propagating from the terminating resistor back toward the source. In an ideal vee, the reflected component is zero because the terminating resistor absorbs any incident energy that would otherwise be reflected. In practice, there is only a slight reflected component. The incident and reflected waves combine point-by-point along the element length to form a weak standing-wave pattern. An unterminated antenna, such as a center-fed, half-wave dipole, propagates a reflected wave with a large amplitude that creates a strong standing-wave pattern.

The half-wave dipole is a resonant, narrow band, standing-wave antenna. By contrast, a

properly designed vee is a non-resonant, broadband, traveling-wave antenna. Broadband operation is obtained from the vee antenna by eliminating as much of the reflected current wave as possible. The terminating resistors are capable of absorbing most of the incident energy that is not radiated from the elements. If the terminating resistor is conjugate-matched to the characteristic impedance of the radiating element, there is no reflected signal because all of the power is absorbed.

This situation is the same as the maximum power transfer condition for a transmission line feeding a load. The load absorbs maximum power when its internal impedance is equal to the complex conjugate of the transmission line's characteristic impedance  $Z_0$ . Because  $Z_0$  for well-designed transmission lines is nearly a pure resistance, the matched load is a resistance of equal value. The most common coaxial cable impedance is 50 ohms, and the corresponding matched load is a resistive 50 ohms. The load could be a 50-ohm dummy (essentially a resistor), or it could be an antenna with an input impedance of  $50 + j0$  ohms.

The frequencies at which the vee exhibits near traveling-wave behavior determine its useful bandwidth. The precise definition of *impedance bandwidth* is the range of frequencies at which antenna input voltage standing-wave ratio (VSWR) is less than or equal to some threshold value, typically 2 to 2.5:1 for transmitters and up to 5:1 for receivers. There are different thresholds because transmitter circuits cannot tolerate high VSWR without reducing output power or shutting down; by contrast, a receiver is not limited by VSWR.

For receive-only operation, increased antenna VSWR causes higher mismatch loss into the receiver front-end, which reduces the available signal level. There is a point at which the mismatch loss is so high that receiver sensitivity (minimum detectable signal) becomes unacceptable low. Figure 2 is a plot of mismatch loss as a function of VSWR with one end of the transmission line matched. At a VSWR of 5:1, receiver sensitivity is reduced by only 2.5 dB; but at 21:1, the reduction approaches 8 dB.

An objective for the design of a vee antenna is to maximize the range of frequencies in which VSWR is less than 2.5:1 for transmission and less than 5:1 for reception. An antenna meeting the transmission criterion between 3.5 and 30 MHz, for example, could be loaded directly on all bands from 80 to 10 meters without a tuner or matching network! The same antenna could receive over an even wider bandwidth.

### Design procedure

The design of a good vee involves three steps. The first is to evaluate the kinds of communication links for which the antenna is intended. The designer must answer the following questions: What are the distances and operating frequencies involved, and what is the propagation mode? The second step calls for the selection of the vee's apex angle based upon the intended operating frequency and antenna size. The third



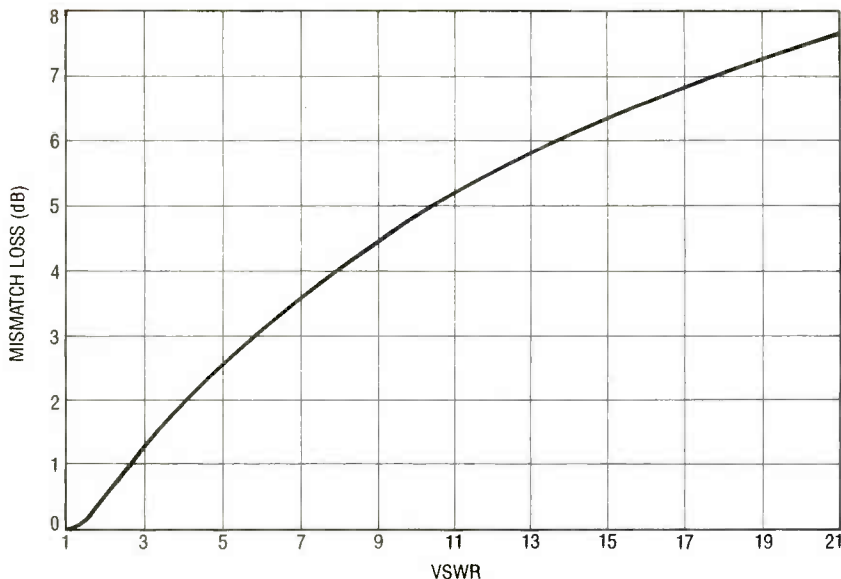


FIG. 2—PLOT OF MISMATCH LOSS in decibels vs. VSWR with one end of the transmission-line matched.

step is the computation of the antenna radiation patterns for the desired distances.

The assumed specifications for the design of a vee antenna are:

- Frequency range—15 to 50 MHz (continuous)
- Propagation mode—meteor trails at 100 kilometers
- Link distances—400 to 1200 kilometers (250 to 750 miles)
- Antenna siting—limited to an area 100 × 100 feet and a height 25 feet
- Main lobe gain—0 dBi, minimum value

**Step 1—Link evaluation**

Three transmission-path factors influence vee design: distance between transmitter and receiver (determines antenna take-off angles); operating frequencies (determines required bandwidth); and propagation mode (determines take-off angles). Each of those factors must be known or estimated to design an antenna matched to the path.

Signals propagating between points on the Earth's surface are bent by the ionosphere or other scattering mechanism such as a meteor reflection. The most common (but not the only) propagation mode at HF is the skywave. The transmitted signal is bent back toward the Earth's surface by the ionosphere's

changing refractive index. This process is equivalent to a specular reflection from a virtual reflection point. The simplest

model of HF skywave propagation is a straight-line signal ray from the transmitter to a location near the reflection point where it is bent back as another straight line ray from the reflection point to the receiver as shown in Fig. 3.

The attainable distance in a communication path depends, in part, on the reflection height, with higher reflections providing greater distances. HF skywave propagation is caused by reflections from the ionosphere's layers: D layer (about 50 kilometers high), E layer (about 120 kilometer high) and F layer (200 to 500 kilometers high). Meteor-trail reflections are of growing interest because of the increased availability of high-speed packet data equipment. Those reflections occur at altitudes of about 100 kilometers.

The path geometry (reflection height and transmitter-to-re-

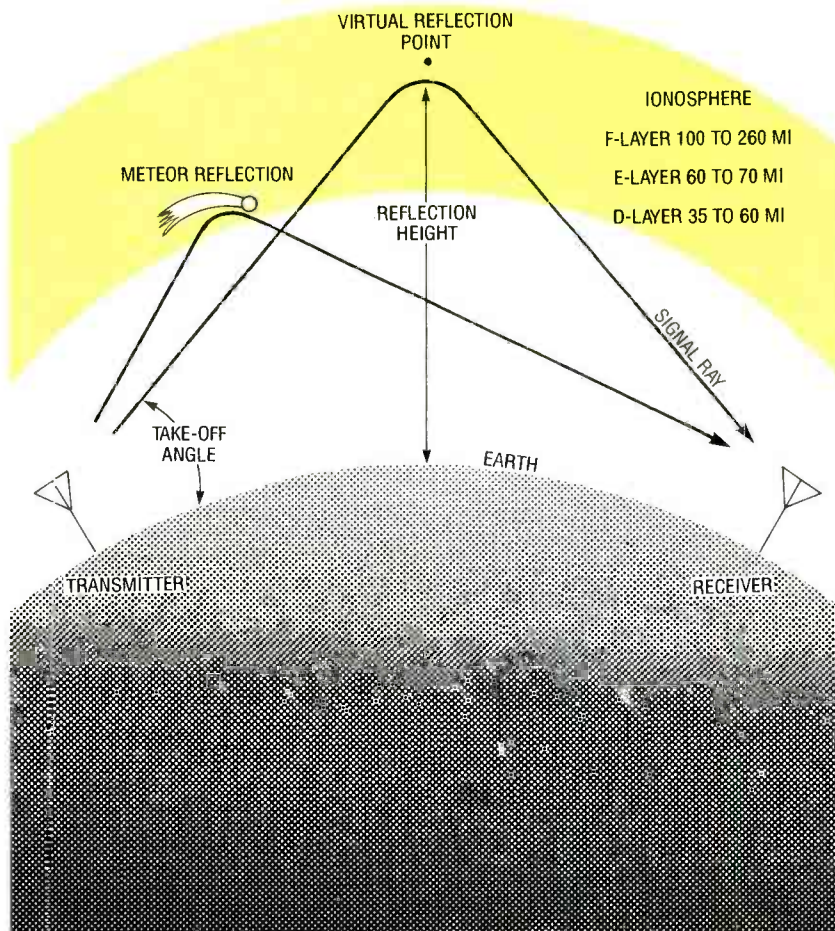


FIG. 3—DIAGRAM SHOWING RELATIONS between take-off angle, virtual reflection point, and signal range.

veiver distance) determines the range of required take-off angles for the antenna. Signal rays transmitted at too high an angle fall short of the receiver, while those transmitted at too shallow an angle can overshoot the receiver.

Figure 3 shows two important angles in vee design. The take-off (or elevation) angle is measured upward from the earth's surface to the ray direction. The polar (or zenith) angle is measured down from the vertical to the ray direction. Both angles are important because path requirements are usually described in terms of the take-off angle, but antenna performance is usually referred to a coordinate system based on the polar angle. The sum of the polar angle and the take-off angle is 90°, so the polar angle can always be determined by subtracting the take-off angle from 90° and the take-off angle can be found by subtracting the polar angle from 90°.

Figure 4 is a communication-range plot. The left vertical axis is the maximum range in kilometers for a specific take-off angle in degrees, while the right vertical axis is the maximum obstruction height in feet vs. take-off angle. Three range vs. take-off angle curves are plotted for different reflection heights, and each curve is labeled with the height (100, 300, and 500 kilometers). These curves were computed for an Earth spherical radius of 6371 kilometers. A "1/3-Earth" correction factor (Earth radius increased by 1/3) is sometimes used at HF. Applying that correction would modify the curves shown somewhat.

Either the maximum path distance for a given take-off angle or the appropriate take-off angle for a specified distance can be determined from Fig. 5. At a take-off angle of 20°, for example, the maximum range is about 2100 kilometers (1300 miles) for 500-kilometer reflections in the F2 region. The range increases to 4000 kilometers (2500 miles) at about a 5° take-off angle.

If the path length were 3200 kilometers, the appropriate

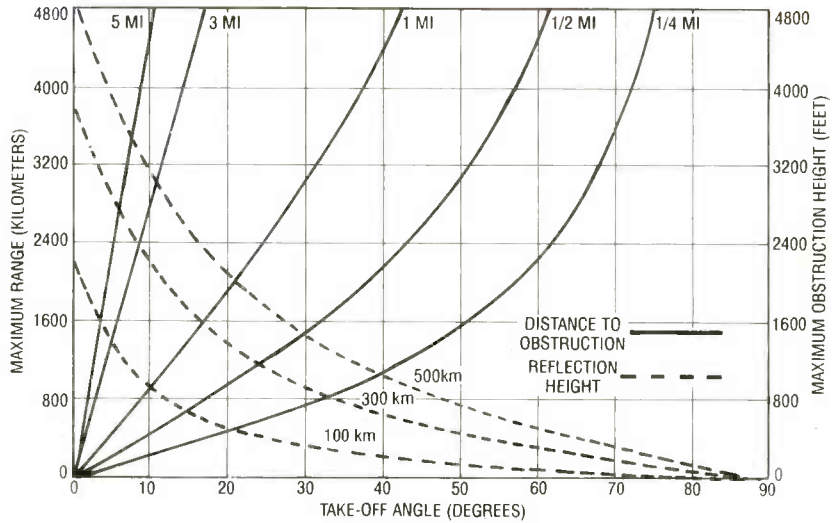


FIG. 4—COMMUNICATION RANGE PLOT: maximum range and maximum obstruction height vs. take-off angle

take-off angle for 500-kilometer reflections is about 10°, and it's about 3° for 300-kilometer reflections. Also plotted in Fig. 5 is a family of five obstruction height curves. They are important in antenna siting, especially for very shallow take-off angles (long paths).

Figure 5 shows the transmitted-ray geometry for a signal obscured by a hill or mountain. The obstruction with height  $H$  is located at a distance  $R$  from the antenna. The minimum take-off angle corresponds to the ray that just grazes the obstruction as shown. Transmitted or received signals at smaller take-off angles are blocked by the obstruction.

The curves related to the right vertical axis in Fig. 4 show the maximum allowable obstruction height in feet vs. the take-off angle. For example, if the path requires a take-off angle of

20°, a land-mass or structural obstruction 1/4 mile away must be less than 500 feet high if the ray is to pass without being blocked. A 500-foot hill 1/4 mile away would obscure all signals with take-off angles below 20°. Higher obstructions can be tolerated if they are further away. At a distance of 1/2 mile, for example, the obstruction could be as high as 1000 feet before obscuring a ray with a 20° take-off angle.

The curves in Fig. 4 also show maximum range in kilometers vs. take-off angles in degrees for the vee. For 100-kilometer reflections, the most effective angles are between about 8° and 25°. The objective in designing a vee antenna is the placement of this lobe in this angular range. The 8° minimum take-off angle requires that the antenna be carefully sited to avoid lobe blockage by a nearby

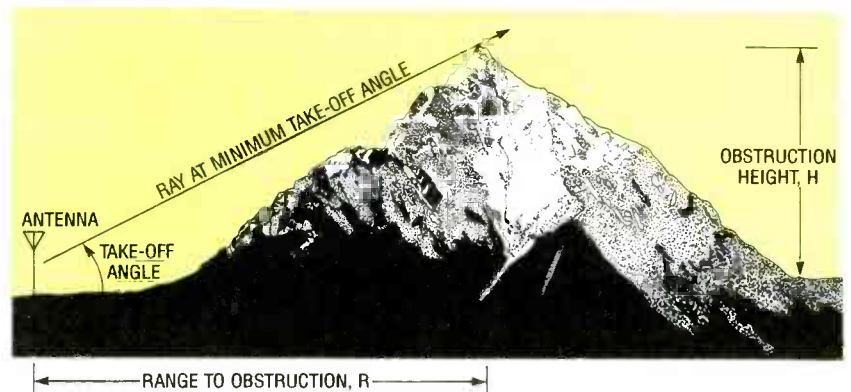


FIG. 5—DIAGRAM SHOWING MINIMUM TAKE-OFF angle to avoid a nearby signal-blocking obstruction.



hill or structure. The maximum height of that obstruction can be only about 200 feet if the antenna is to be located ¼ mile away. This requirement might easily be exceeded in hilly terrain or near tall buildings.

### Step 2—The apex angle

Figures 6 and 7 plot the optimum vee apex angle in degrees as it changes with frequency and antenna element (radiator) length. The apex angle is inversely related to both frequency and element length. Thus, short elements at low frequencies must have wide apex angles while long elements at high frequencies can have small angles. The curves in Fig. 6 are for frequencies of 10, 30, and 50 MHz with respect to element lengths in meters, while those in Fig. 7 are for element lengths of 20, 40 and 60 meters with respect to frequency. Our example vee must operate over a wide frequency range (15 to 50 MHz).

It turns out that a given apex angle is optimum at only one frequency, not over a range of frequencies. Therefore, the selection of an optimum apex angle calls for both judgment and compromise. The objective is to select an angle that provides good performance at all frequencies over the stated range.

The design example calls for a vee antenna that will fit in a 100 × 100 foot square plot. Therefore, 40- or 60-meter elements are too long; only the 20-meter length will fit. By referring to both Figs. 6 and 7, it can be seen that for a 20-meter element the optimum apex angle at 10 MHz is 116°, but at 50 MHz it is 54°. It can also be seen that a good compromise for apex angle with a 20-meter element over the 15- to 50-MHz band can be reached by finding the apex angle for 30 MHz—69°. That angle will now become the trial value, and it will be retained unless the gain or pattern fails to meet the design objectives. In that case, the selection process must be repeated with another choice for the apex angle.

Now look at the vee input resistance at the design apex angle. Figure 8 is a plot of input

resistance in ohms ( $R_{in}$ ) vs. frequency for apex angles of 40°, 70°, and 100°. The input resistance value for a 70° apex angle at 30 MHz is about 690 ohms. (The vee is generally considered to be a 600-ohm antenna, so this is close to a match). The value of input resistance increases to 780 ohms at 15 MHz but drops to 630 ohms at 50 MHz. For design purposes, 690 ohms can be selected as a representative average value of  $R_{in}$  over the 15- to 50-MHz band.

The value of  $R_{in}$  is needed to specify the vee input balun. Because the vee is a balanced radiating system, feeding it with an

unbalanced coaxial cable requires a balun (a *balanced to unbalanced transformer*). Matching a 50-ohm transmitter to 690 ohms requires a 14:1 balun, which can be made by winding magnet wire on a ferrite core or purchasing the component complete.

A value for  $R_{in}$  is also needed in the specification of each terminating resistor. Those values are  $R_{in}/2$  (345 ohms for the design example). Select the standard value closest to 345 ohms. That value is not critical because  $R_{in}$  changes with frequency.

The tentative geometry for the

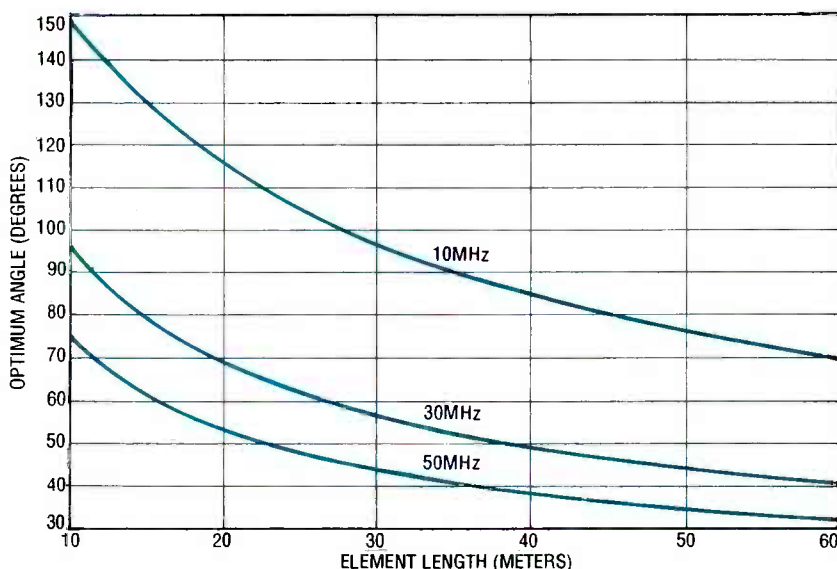


FIG. 6—OPTIMUM APEX ANGLE for sloping-vee antenna: plot of optimum angle vs. element length at three different frequencies.

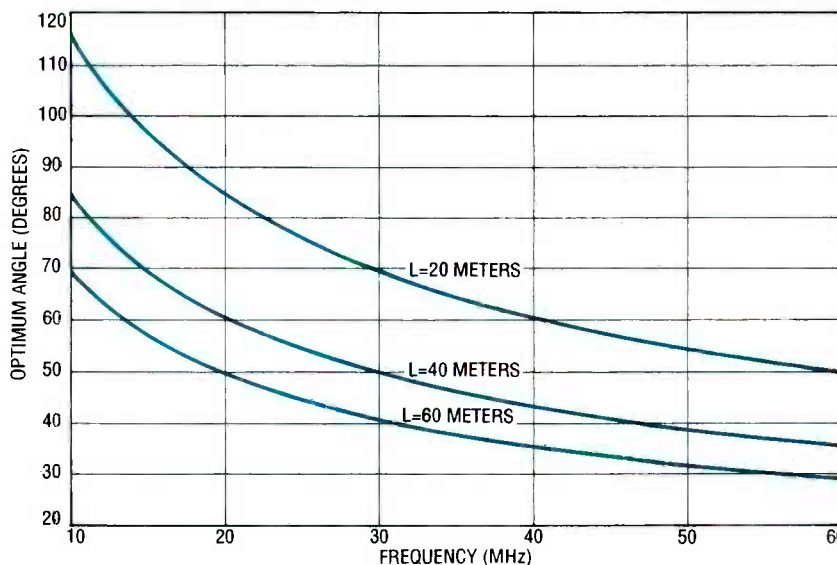


FIG. 7—OPTIMUM APEX ANGLE for sloping-vee antenna: plot of optimum angle vs. frequency for three different element lengths.

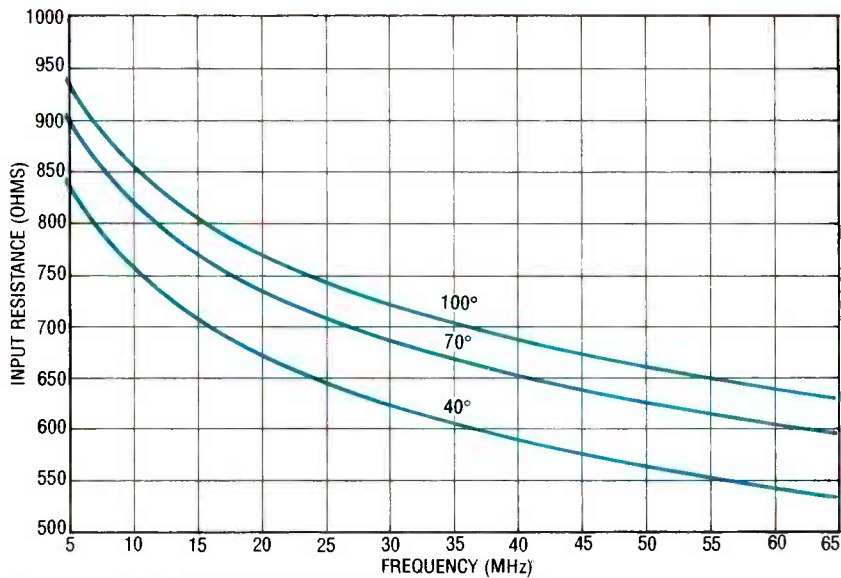


FIG. 8—PLOT OF INPUT RESISTANCE vs. frequency for a sloping-vee antenna.

15- to 50-MHz vee is shown in Fig. 9. Each radiating element is 62 feet (20 meters) long, and the apex angle is 69°. The required separation at the ends of the elements can be calculated with trigonometry or plotted to scale on paper with a protractor. For the 69°-apex angle, the ends of the elements must be 72.5 feet apart.

**Step 3—Radiation Patterns**

An antenna is efficient only if it radiates signals with adequate gain in the desired direction. The final step in the design of the vee is to compute its radiation patterns to verify that they meet the gain requirements. Software compatible with personal computers is available for this purpose from the source listed in Sources of Materials.

Certain parameters such as feed-point height, termination height, and element length should be varied before writing a final antenna specification. Changing any of those parameters will modify the radiation patterns. The design process is complete when the antenna radiates acceptable patterns. If a specific design doesn't meet requirements, the process should be repeated with new design values until they are met. A repetitive approach ensures a good design, and also gives the designer insight into how an antenna's performance changes with parameter differences.

For the design example, an element length of 20 meters was determined from the siting criterion. Missing are the design heights for the feed point and terminating resistors. Because the maximum height cannot exceed 25 feet, it is convenient to start by assuming a feed-point height of 6 meters (19.5 feet) and a termination height at ground level. The effectiveness of those choices will become clear as the radiation patterns are studied.

Radiation patterns were calculated every 5 MHz from 15 to 50 MHz, the intended operating range, with the tentative design

values and element lengths of 20, 40 and 60 meters. Although only the 20-meter element meets the 100 × 100 foot site limit, it's instructive to see how the pattern changes with longer elements. Figures 11, 12, and 13 show the patterns at 15, 30, and 50 MHz. Those frequencies mark the endpoints and mid portion of the desired band. In all three figures the mast height is 6 meters, the apex angle is 69°, the diameter of the element is 1/8 inch and the termination is 689 ohms.

Results at intermediate frequencies are not included here. The patterns were computed with the sloping-vee antenna located on rocky ground with a conductivity of 0.001 siemens/meter and a dielectric constant of 4. The patterns change if different ground constants are assumed, so sensitivity to ground constants was also examined, although those results are not included here.

Figure 10 shows the pattern at 15 MHz. The left vertical axis is the antenna power gain in dBi (decibels relative to an isotropic radiator, an antenna that radiates in all directions). The horizontal axis is the polar angle in degrees. Note that the polar angle, not the take-off angle, is used on the horizontal scale. A polar angle of zero is a vertical with respect to the Earth

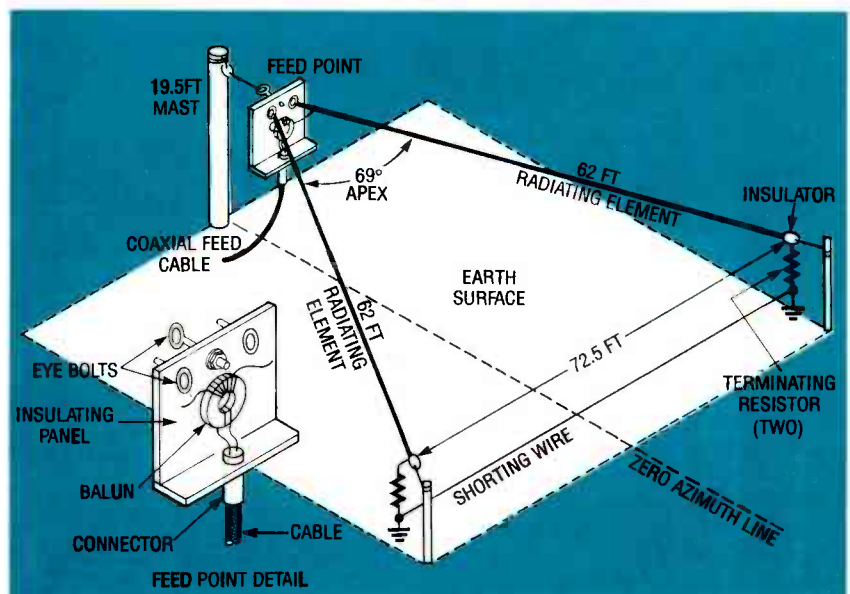


FIG. 9—FINAL DIMENSIONED DESIGN for a sloping-vee antenna that can be set up on a 100 × 100 foot plot.



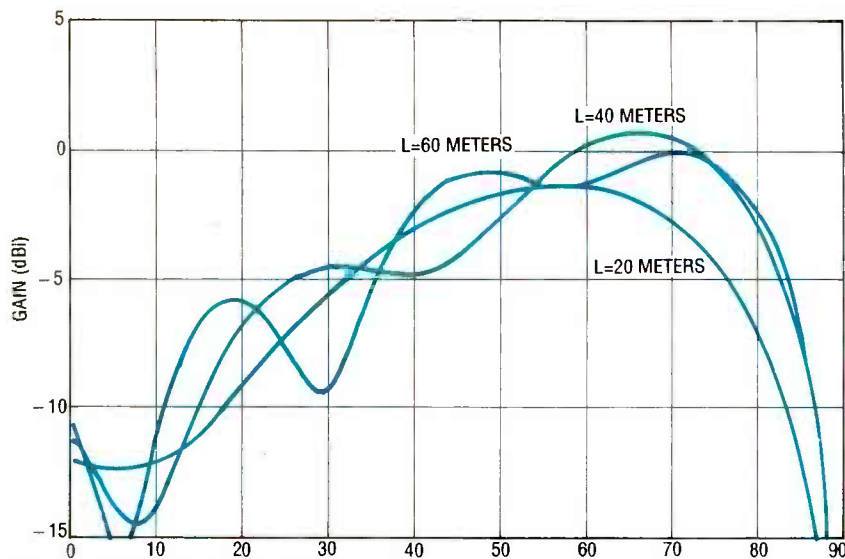


FIG. 10—GAIN VS. POLAR ANGLE for a sloping-vee antenna above rocky ground at a frequency of 15 MHz for various element lengths.

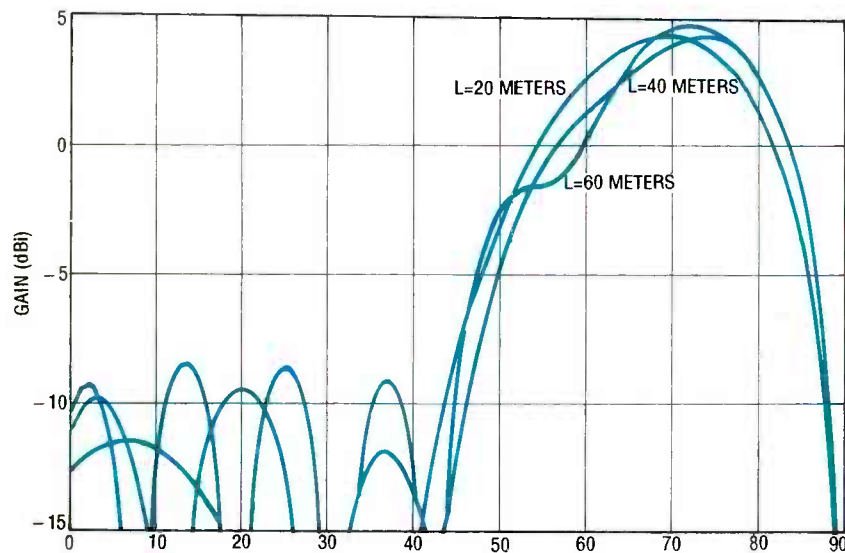


FIG. 11—GAIN VS. POLAR ANGLE for sloping-vee antenna above rocky ground at a frequency of 30 MHz for various element lengths.

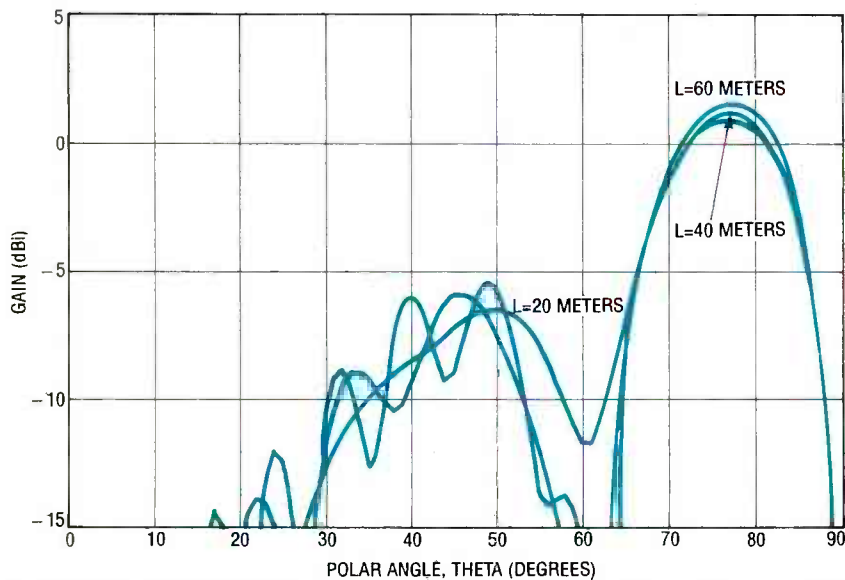


FIG. 12—GAIN VS. POLAR ANGLE for sloping-vee antenna above rocky ground at a frequency of 50 MHz for various element lengths.

(zenith), while  $90^\circ$  is parallel to the Earth's surface (horizon). Take-off angles of interest,  $8^\circ$  to  $25^\circ$ , correspond to polar angles of  $82^\circ$  to  $65^\circ$  in the figure. The design objective is to obtain at least 0 dBi gain in a main lobe propagating generally between polar angles of  $65^\circ$  to  $82^\circ$ .

The main lobe maximum gain at 15 MHz is -1.5 dBi at  $57^\circ$  for the 20-meter element. The lobe is broad, and the gain rolls off slowly on either side of the maximum. The -3 dB points are at about  $32^\circ$  and  $74^\circ$ . The highest gain, 1.5 dBi, is obtained with the 40-meter element in a broad main lobe that shows minor scalloping (sidelobing) near  $40^\circ$ . The pattern for the 60-meter element shows signs of breaking up—a significant secondary lobe is forming near  $18^\circ$ .

The 30-MHz pattern (Fig. 11) is interesting because all three elements produce a maximum gain of about 4 dBi, and their main lobe structures are very similar. The lobes are broad and smooth between  $40^\circ$  and  $88^\circ$  and the -3 dB points are near  $55^\circ$  and  $82^\circ$ . The 40- and 60-meter elements show considerable pattern scalloping between  $0^\circ$  and  $40^\circ$ , but the 20-meter element is electrically too short to develop a highly structured pattern.

Scalloping is due to constructive and destructive interference between direct rays from the antenna and rays reflected from the Earth's surface. Electrically long antennas (measured in wavelengths) are more susceptible to scalloping than shorter ones. Sidelobes waste energy by radiating it in undesired directions. Good antenna designs, therefore, minimize sidelobes as much as possible.

The 50-MHz vee pattern is shown in Fig. 12. The main lobe is again similar for the three element lengths. Maximum gain is about 6.5 dBi near  $77^\circ$  ( $13^\circ$  take-off), and the -3 dB points are at approximately  $70^\circ$  and  $83^\circ$ . The main lobes are smooth and narrower than they are at the lower frequencies. The 20-meter element is beginning to show some scalloping. It has a peak sidelobe gain of -2 dBi at  $50^\circ$ .

However, the 40- and 60-meter antenna elements show more scalloping and even higher side-lobe gains.

An assessment of the patterns supports the conclusion that a vee antenna with 20-meter elements fed at a 6-meter height with a 69° apex angle and ground-level terminating resistors meets the objectives. Gain could be improved at the low end of the band with a longer radiating element, but that could violate the site limit.

The actual dimensions selected for the vee antenna are those of Fig. 9. A shorting wire connects the terminating resistors (which might or might not be connected to actual Earth ground). That wire, a current path between the resistors, is very important. In an ideal vee, the resistors are connected to a perfect ground plane that provides the current path. Omitting the shorting wire in a vee mounted on poorly conducting ground degrades performance significantly.

### Antenna Construction and Measured VSWR

The antenna shown in Fig. 9 was built and tested on rocky ground in New England. It was fed through a 14:1 balun wound with 18 AWG magnet wire on a 2-inch outside diameter toroidal ferrite core. The turns ratio is the square root of the impedance ratio (in this case 3.75:1). The balun was wound with 2 turns in its primary and 7.5 turns in its secondary. If the sloping-vee is to transmit, the balun should be tested for power handling by operating at full power for several hours. Any problems that might develop

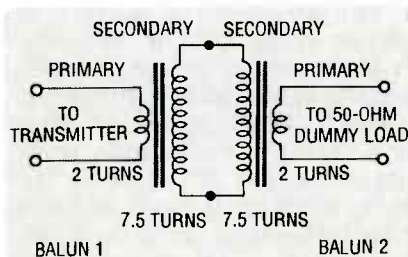


FIG. 13—BACK-TO-BACK INSERTION LOSS TEST of baluns for sloping-vee antenna.

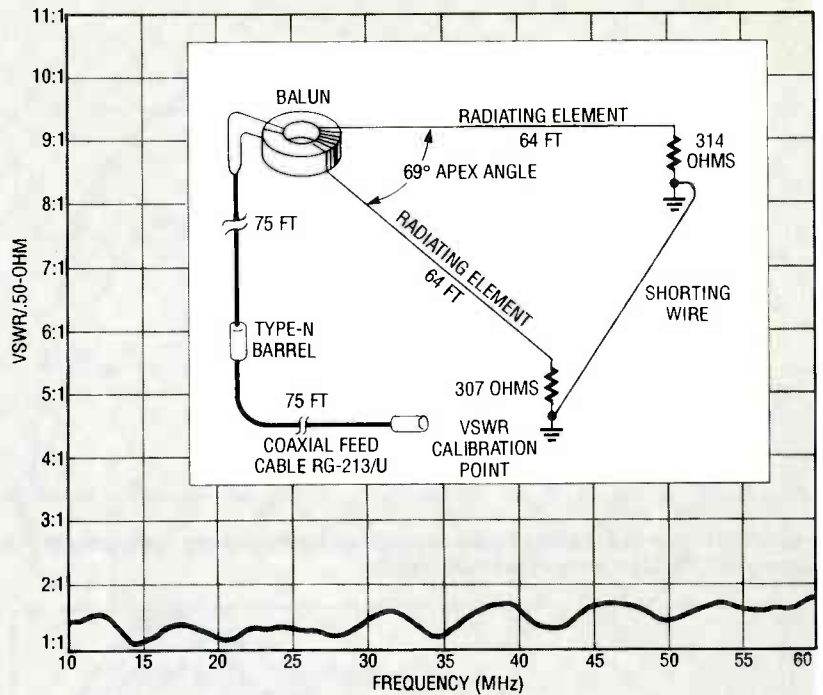


FIG. 14—PLOT OF VSWR VS. FREQUENCY for sloping-vee antenna with characteristics shown.

### SOURCES OF MATERIALS

The following companies are sources for materials and computer software for this project:

- Toroidal ferrite cores (Part No. FT240-43)—Radio Kit, Inc., P.O. Box 973, Pelham, NH 03076, (603) 635-2235
- Film power resistors—Power Film Systems, Inc., Yellville, AR 72687, (501) 449-4091
- Antenna design software—Phadean Engineering Co., Inc., P.O. Box 611, Shrewsbury, MA 01545, (508) 869-6077
- Phosphor-bronze wire—Astro Industries, Inc., Dayton, OH 43432, (800) 543-5810
- Fiberglass tubing—J. T. Ryerson Co., P. O. Box 1111, Boston, MA 02103, (617) 782-6900

such as transmitter overheating and arcing will show up.

The simplest way to test a balun is to build two and connect them back-to-back as in Fig. 13. One balun is connected to the transmitter and the other is connected to a 50-ohm dummy load. This setup can also test for insertion loss by measuring the input and output power. The insertion loss in decibels for one balun is  $5 \log_{10}$  (output power/input power). The measured insertion loss of the balun in this vee was a low 1.5 dB.

The 6-meter antenna mast was a single 20-foot section of round 2-inch diameter Extren 500 fiberglass tubing with 1/4-inch wall thickness. This material is strong, durable, and easy to machine. Extren 500 is available as round and square tubing, right-angle stock, flat stock, and I-beams in various sizes. A suitable base for a self-supporting mast can be made from those materials.

Alternatively, the fiberglass mast can be guyed at several points. The balun, eye-hook strain reliefs for the vee radiating elements, and the input coaxial connector were mounted as shown in Fig. 9. If fiberglass tubing for the mast is not readily available or it costs more than you want to spend (about \$4 per foot), other suitable insulating materials such as thick-wall polyvinyl chloride (PVC) tubing is a good substitute.

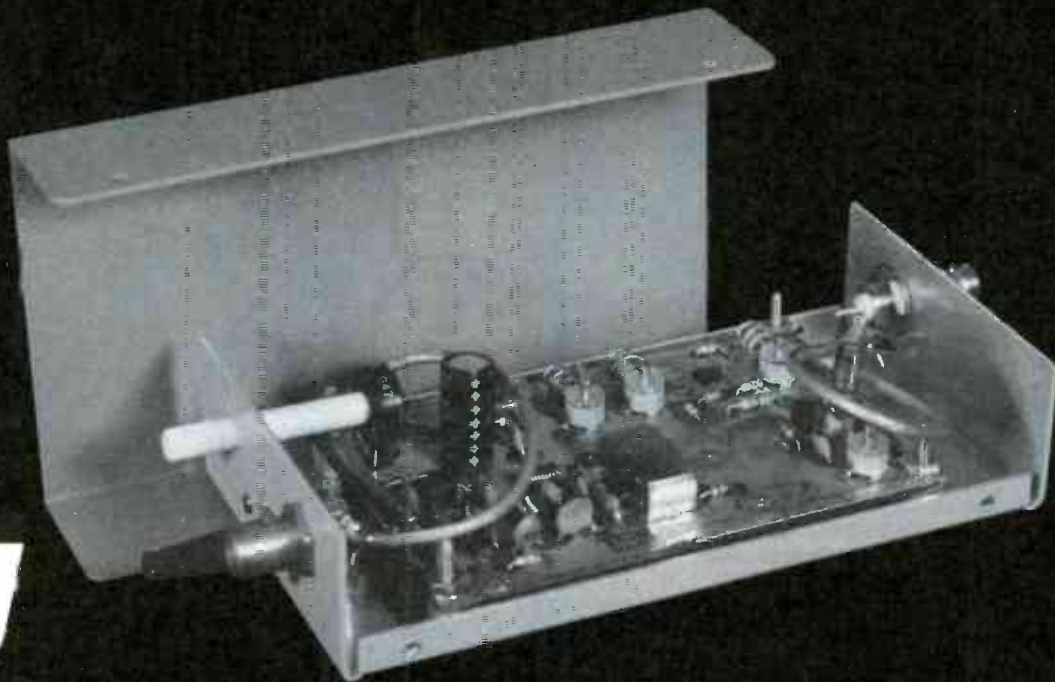
Other less expensive mast alternatives include wood beams or even living trees.

The antenna radiating elements were 62-foot lengths of uninsulated 7 × 19 stranded phosphor-bronze wire with a diameter of 1/8-inch. Stranded

*continued on page 100*



**Receive amateur TV signals on a standard TV with our low-noise downconverter.**



# ATV Downconverter

WILLIAM SHEETS and RUDOLF F. GRAF

YOU CAN RECEIVE AMATEUR TV signals on a standard TV receiver with our inexpensive ATV downconverter. The downconverter converts the 420–450 MHz ATV band, which is several channels below the lower limit of the UHF band, to channel 3 or 4 for viewing on virtually any TV. The downconverter has a low-noise preamplifier stage and a double-balanced passive mixer for good performance and a wide dynamic range. That is necessary with today's crowded UHF bands. The converter draws about 27 milliamperes from a 13.2-volt DC source, so it can be used in portable and mobile applications. An extra IF stage gives an overall gain of about 25 dB.

## Circuitry

Figure 1 is a block diagram of the downconverter. It consists

of three active stages and a passive diode double-balanced mixer. The input signal is first filtered so that only signals centered around 430 MHz are fed to Q1, an RF amplifier with a 20-dB gain and a noise figure of 1.5 dB. Q1 is an NEC 25137 gallium-arsenide field-effect transistor, or GaAsFET. The amplified signal in the 420–450 MHz range is fed to a double-tuned bandpass filter. The overall bandwidth of the RF stage is about 12 MHz, which is sufficient to cover the most frequently used part of the ATV band (426–439 MHz) without retuning. For operation over the entire 420–450 MHz band, you may have to repeak the filters to tune in weak signals.

The amplified signals are mixed by a diode double-balanced mixer with an oscillator signal (generated by Q2) that is

nominally 60–70 MHz lower than the received frequency. A 2-dB pad is used between the oscillator and mixer to reduce interaction. The IF output from the mixer is fed to a low-pass filter that cuts off at about 100 MHz. That reduces UHF signal feedthrough. Amplifier Q3 boosts the IF signal at 60 or 66 MHz (channel 3 or 4) by about +15 dB. The output of Q3 is fed to the TV receiver being used as an IF amplifier.

Figure 2 shows the schematic of the downconverter. The input signal from J1 is applied to a tap on L1, the input (antenna) coil. L1 is nominally a 3-turn coil and the tap is at  $\frac{3}{4}$  turn so that the voltage applied from J1 is stepped up four times. Capacitor C1 tunes L1 to resonance, and is also connected to gate 1 of Q1.

Capacitors C3 and C4 provide



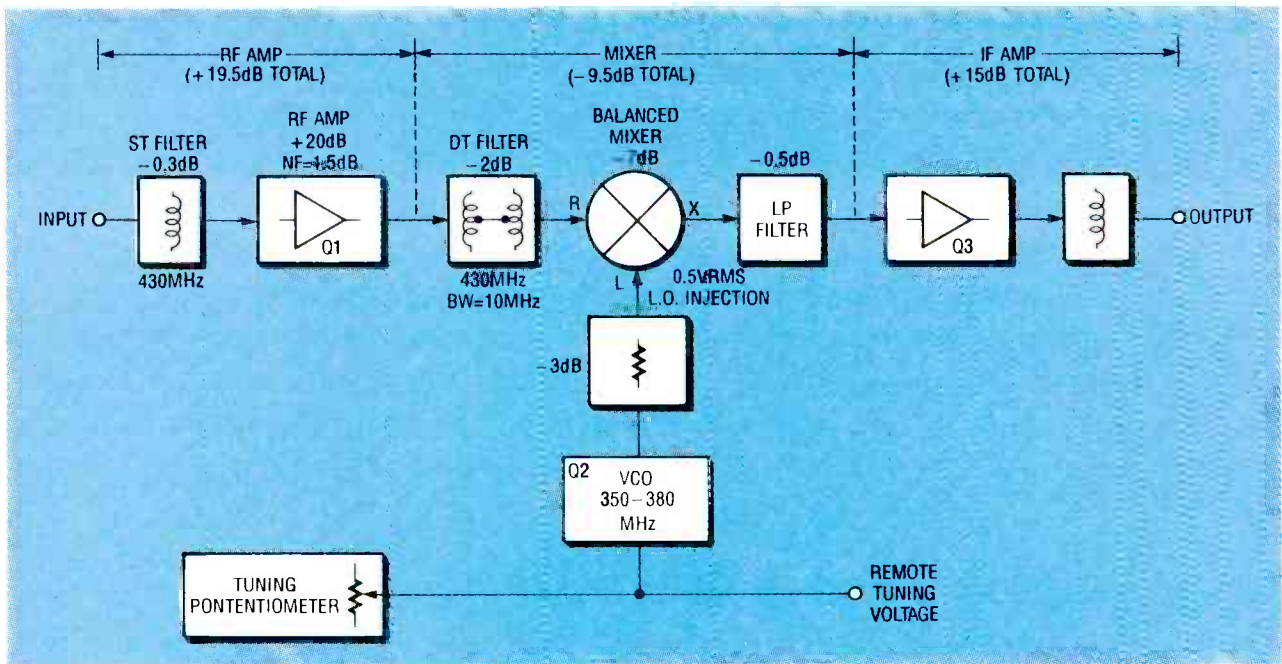


FIG. 1—DOWNCONVERTER BLOCK DIAGRAM. It consists of three active stages and a passive diode double-balanced mixer.

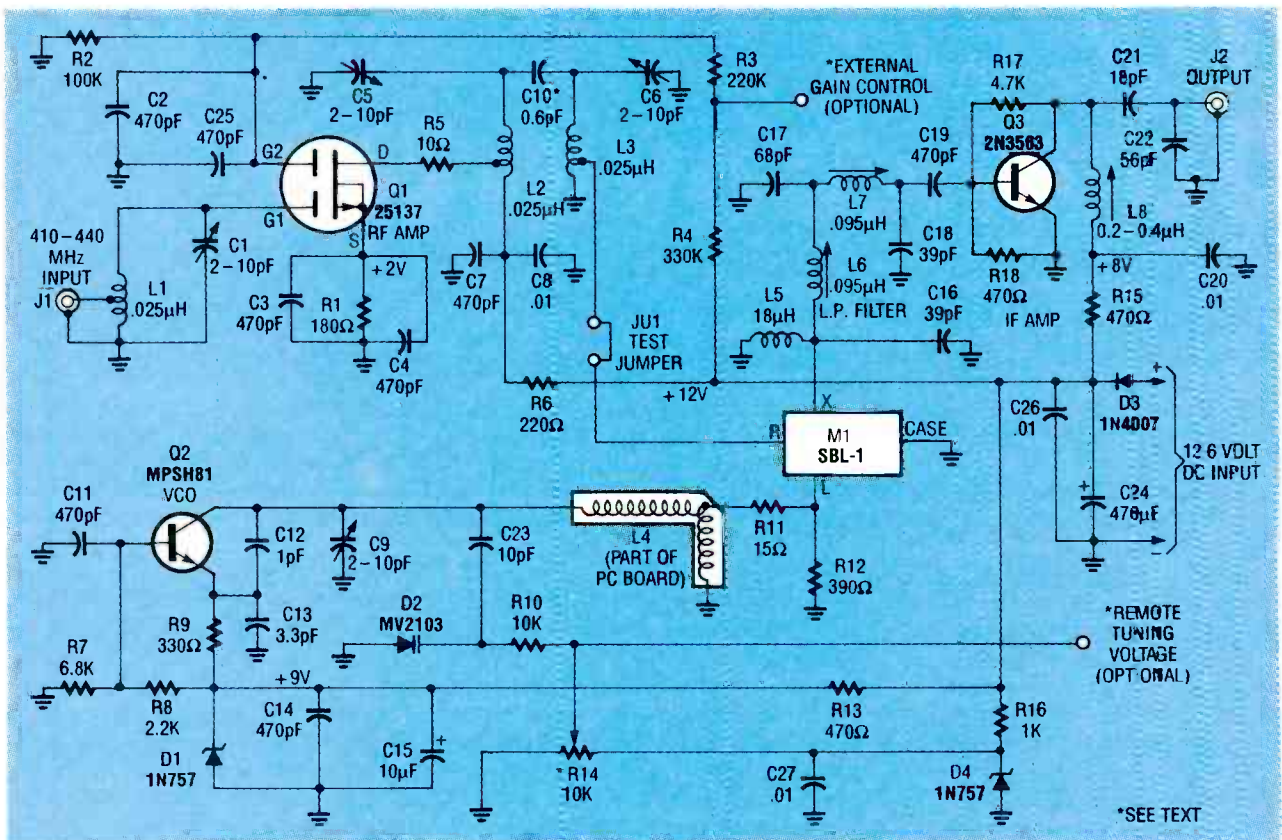


FIG. 2—DOWNCONVERTER SCHEMATIC. The input signal from J1 is applied to a tap on L1. Capacitor C1 tunes L1 to resonance and passes the signal to Q1, an NEC 25137 GaAsFET.

RF bypassing for the source of Q1, and R1 provides self-bias for Q1. Gate 2 of Q1 is biased by network R2, R3 and R4. An external gain-control signal

(which is usually not required) can be applied to the junction of R3 and R4 if it becomes necessary to reduce the gain of the converter on very strong sig-

nals. A DC voltage of +6 volts will cause full gain, and -6 volts will cause nearly a -40-dB reduction in gain. The voltage can be derived from an AGC circuit, if necessary, but a potentiometer can also be used. Capacitor C2 provides RF



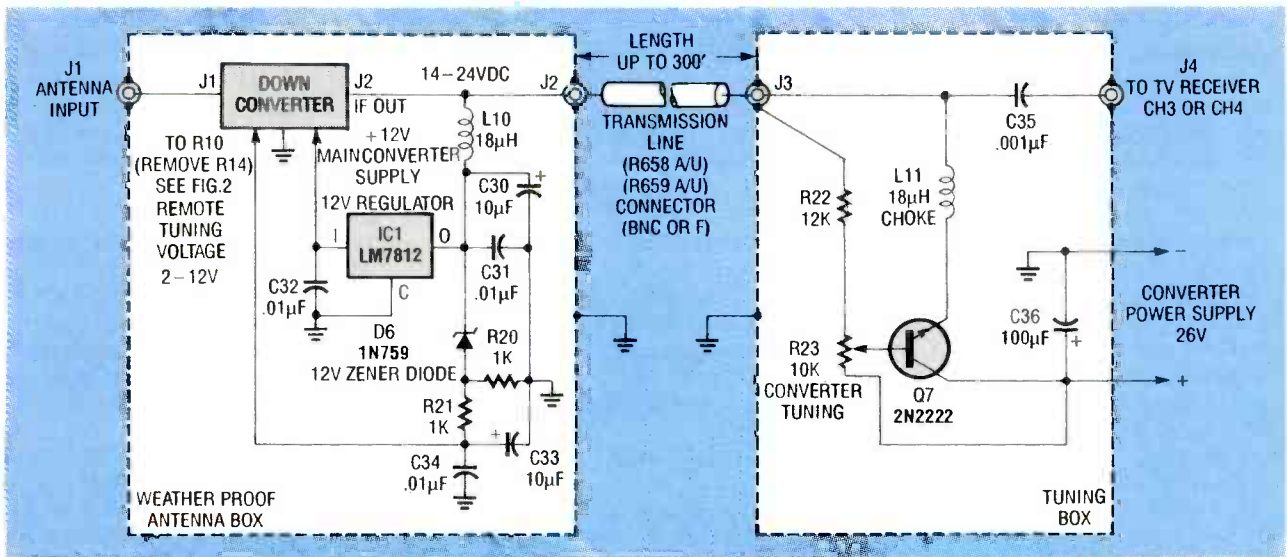


FIG. 3—THE DOWNCONVERTER can be supplied with an external DC voltage for remote-control tuning.

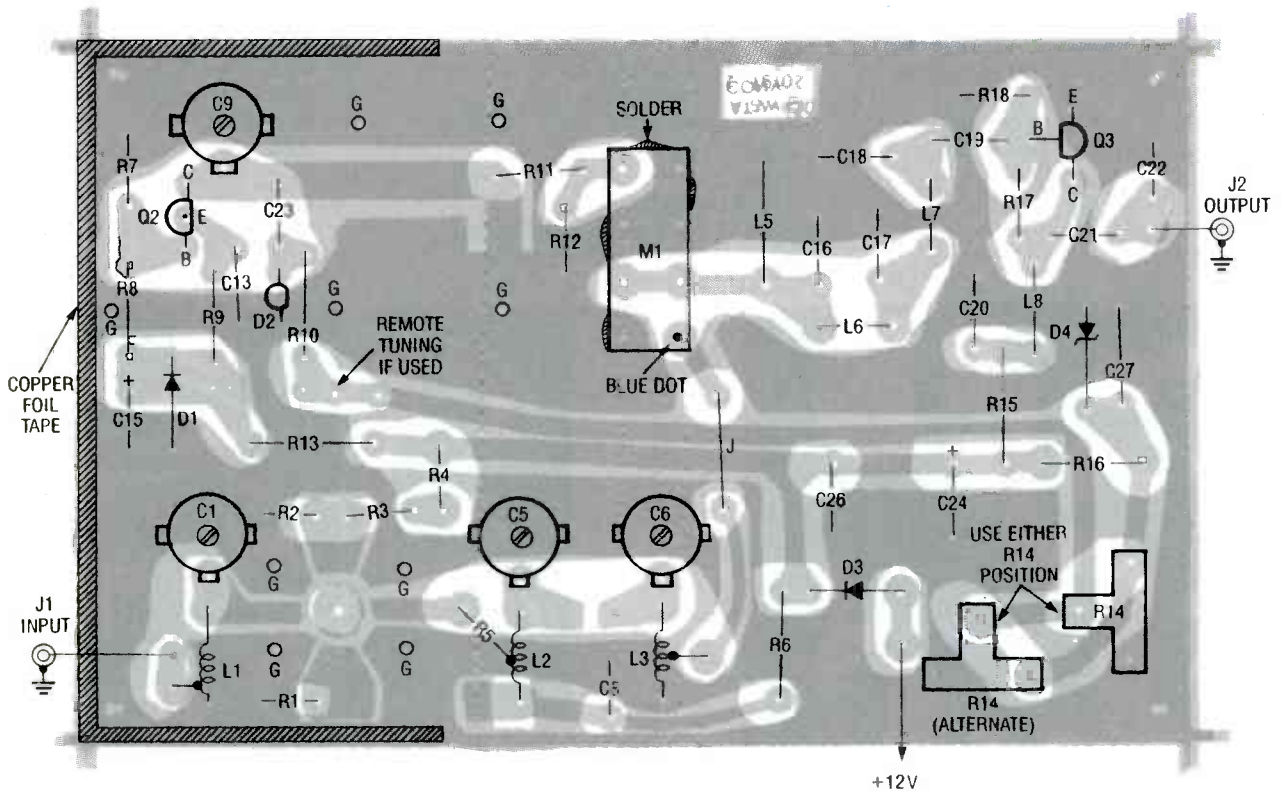


FIG. 4—PARTS-PLACEMENT DIAGRAM. This layout must be followed exactly to duplicate the performance of the downconverter. Some components mount on the solder side of the board as shown in Fig. 6.

grounding for gate 2 of Q1, and R5 reduces any UHF parasitic oscillations. The drain of Q1 is connected to a tap on L2, which is part of the bandpass filter network. Capacitors C7 and C8 provide RF grounding for the cold end of L2. DC bias is fed through R6. Under normal conditions, the drain pin of Q1 will be at +10 to +11 volts DC.

Capacitor C10 couples the signal from the first tuned circuit (C5-L2) to the second tuned circuit (C6-L3). The value of C10 is very small (0.6 pF); it determines the degree of coupling between L2 and L3. It is made from a small piece of PC board material and is mounted on the bottom of the main board. A signal from a tap on L3 is fed via

test jumper JU1 to mixer M1. The local oscillator (L.O.) signal from Q2 is also fed to the mixer.

Transistor Q2 is the local oscillator, for which R13, D1, C14, and C16 provide a stabilized 9 volts DC. Because Q2 is a PNP transistor, it allows the collector to be DC grounded, which is an advantage in this type of oscillator circuit. Resistors R7 and R8 provide base bias for Q2, C11 provides a solid RF ground

## PARTS LIST

All resistors are 1/8-watt, 5%, unless otherwise noted.

R1—180 ohms  
 R2—100,000 ohms  
 R3, R4—220,000 ohms  
 R5—10 ohms  
 R6—220 ohms  
 R7—6800 ohms  
 R8—2200 ohms  
 R9—330 ohms  
 R10—10,000 ohms  
 R11—15 ohms  
 R12—390 ohms  
 R13, R15—470 ohms, 1/4-watt  
 R14—10,000 ohms, potentiometer with shaft  
 R16—1000 ohms  
 R17—4700 ohms  
 R18—470 ohms

### Capacitors

C1, C5, C6, C9—2–10 pF trimmer  
 C2—C4, C7, C11, C14, C25—470 pF, chip  
 C8, C20, C26, C27—0.01  $\mu$ F, disc  
 C10—0.6 pF (must be handmade, see text)  
 C12—1 pF, NPO disc or chip  
 C13—3.3 pF, NPO disc or chip  
 C15—10  $\mu$ F, 16 volts, electrolytic  
 C16, C18—39 pF, NPO disc  
 C17—68 pF, NPO disc  
 C19—470 pF, disc

C21—18 pF, NPO disc  
 C22—56 pF, NPO disc  
 C23—10 pF, NPO disc  
 C24—470  $\mu$ F, 16 volts, electrolytic

### Semiconductors

D1, D4—1N757A Zener diode  
 D2—MV2103 varactor diode  
 D3—1N4007 diode  
 Q1—25137 GaAsFET (NEC)  
 Q2—MPSH81 NPN transistor  
 Q3—2N3563 NPN transistor

### Other components

L1—L3—3 turns of 20 AWG tinned wire (approx. 0.025  $\mu$ H, see Fig. 5)  
 L4—part of PC board etching, see text  
 L5—18  $\mu$ H RF choke  
 L6, L7—8 turns of 22 AWG enameled wire wound on No. 8 screw (approx. 0.095  $\mu$ H, see Fig. 5)  
 L8—9 1/2 turns of 22 AWG enameled wire wound on No. 8 screw, with ferrite slug (see Fig. 5)  
 M1—MCL SBL-1 mixer  
 J1, J2—F connector

**Miscellaneous:** PC board, 3/16-inch copper-foil tape, coaxial cable, project case, 12.6-volt DC power supply, solder, etc.

**Note:** The following items are available from North Country

Radio, P.O. Box 53, Wykagyl Station, New Rochelle, New York 10804:

- A kit of parts to build the downconverter (includes PC board and all parts that mount on it, J1 and J2, and wire to wind all inductors (metal case and power supply not included)—\$59.50 + \$3.50 S&H (Note that none of the parts shown in Fig. 3 are included with the downconverter kit.)

- Metal case as shown—\$12.50

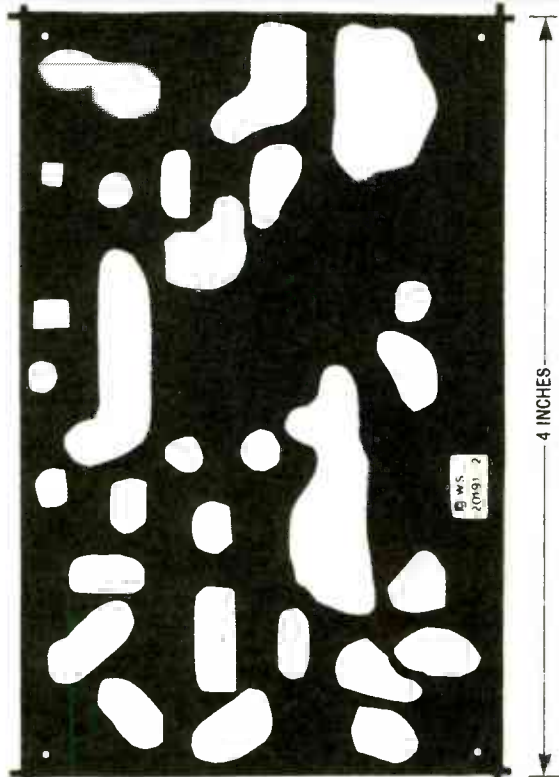
- 2-watt ATV transmitter kit with a 439.25-MHz crystal (see Radio-Electronics, June and July 1989)—\$110 + \$3.50 S&H

- A 0.5-watt, 9-volt transmitter kit with a 439.25-MHz crystal—\$112 + \$3.50 S&H

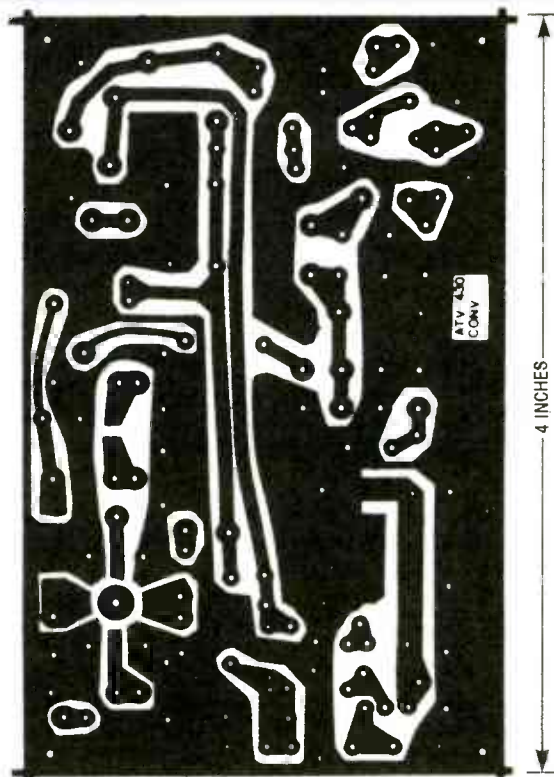
- Linear amplifier kit to boost the output of ATV transmitter to 15 watts (see Radio-Electronics, August 1992)—\$79.50 + \$3.50 S&H

- Crystals for channels 14, 15, 16, 17, or 18 (for test purposes only)—\$7.50 each

New York residents must add sales tax.



COMPONENT SIDE FOIL PATTERN.



SOLDER SIDE FOIL PATTERN.

for the base of Q2, and R9 provides emitter bias. Nominal current through Q2 is about 5 to 6

milliamperes. Capacitors C12 and C13 provide a feedback network for Q2.

Components C9 and L4 (a length of microstrip line etched on the PC board), together with



C23 and varactor diode D2, form a circuit that can be tuned via the bias on D2 over the range of 350 to 390 MHz, depending on the setting of C9. Therefore, Q2 will oscillate over that frequency range, because positive feedback is provided by C12 and C13, and Q2 acts as a grounded-base amplifier. Oscillator output is taken through R17 and R12 to mixer M1. The level at terminal L of the mixer is about 0.3 volt RMS. Resistor R11 is connected to a tap on L4, which also provides bias return for the collector of Q2, because it is at DC ground.

The output from mixer M1 at 60 to 70 MHz (the difference frequency between received signal and L.O. frequency) appears at mixer terminal X. There is about a 7-dB loss in the mixer. Coil L5 provides a DC return for the mixer IF port. A low-pass filter made up of C16, L6, C17, L7, and C18 eliminates any remaining UHF signal components appearing at terminal X. Transistor Q3 is an IF amplifier stage, which is biased by R13, R14, and R15 to a  $V_{CE}$  of 8 volts and a collector current of about 8 mA. Tuned circuit L8, C21, and C22 can be tuned to either channel 3 or 4. The signal from the low-pass filter is coupled to Q3's base via C19. Transistor Q3 provides about a 15-dB gain; its output signal appears at J2. Power for the downconverter is supplied through D3, which protects against reverse voltages, and C24 and C26, which bypass RF and noise.

Resistor R10 couples DC bias to D2 supplied from tuning-potentiometer R14. Components R16, D4, and C25 provide 9-volts DC for that purpose. If desired, R10 can be supplied with external DC for remote-control tuning, or to allow the downconverter to be mounted close to the antenna. That is commonly done to reduce transmission-line losses between the antenna and converter—losses run high at 450 MHz unless very expensive transmission line, such as 1/2-inch hard line, is used. If you are planning on remote-controlling the converter, install R14 so it's easy to move.

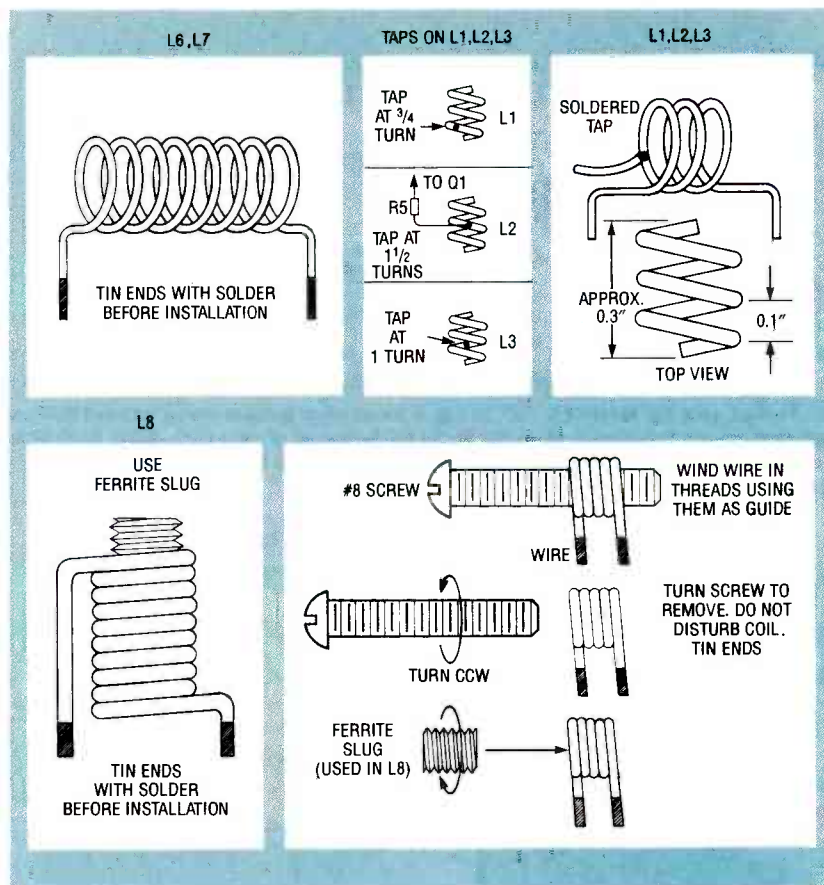


FIG. 5—COILS L1, L2, AND L3 are three turns each of 20 AWG tinned wire wound around a No. 8 screw and stretched to 0.3 inch. The lead from J1 has its center conductor soldered to L1 at 3/4 turn from the grounded end. Resistor R5 is soldered 1/2 turns from the end of L2 that connects to R6, C7, and C8. Coil L3 is tapped at 1 turn from the grounded end. Coils L6 and L7 are 8 turns each of 22 AWG enamelled wire wound on a No. 8 screw. Coil L8 is 9 1/2 turns of 22 AWG enamelled wire wound on a No. 8 screw with a ferrite tuning slug added.

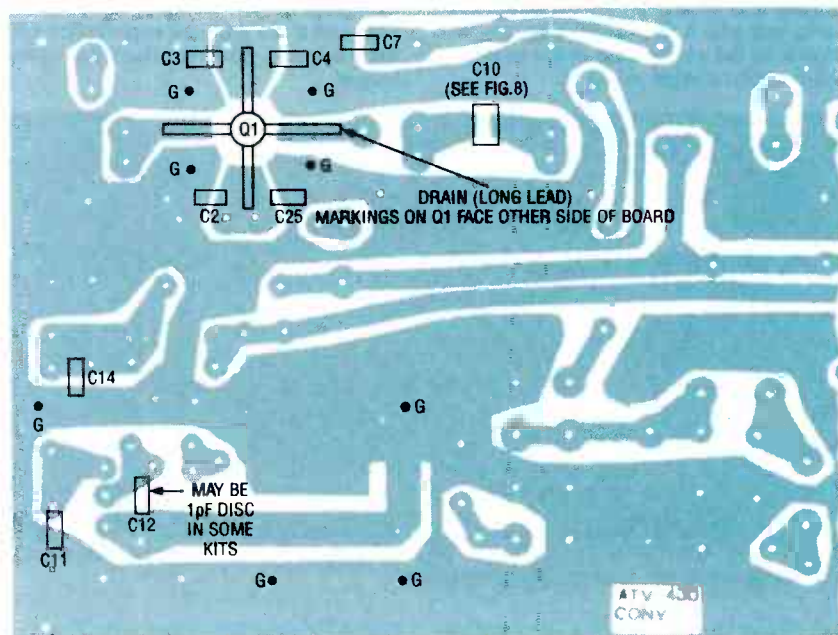
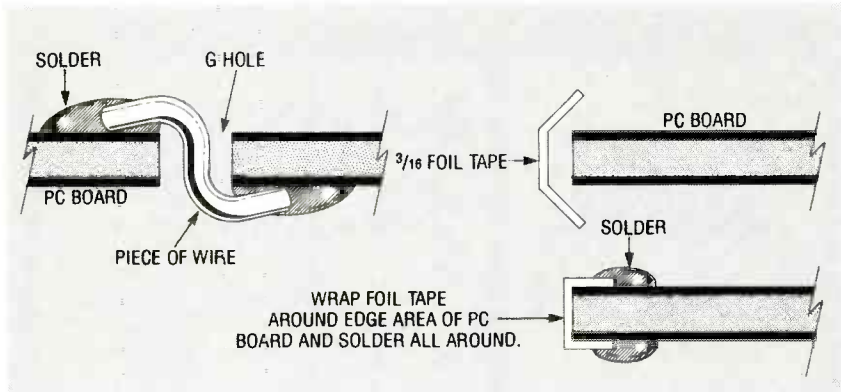
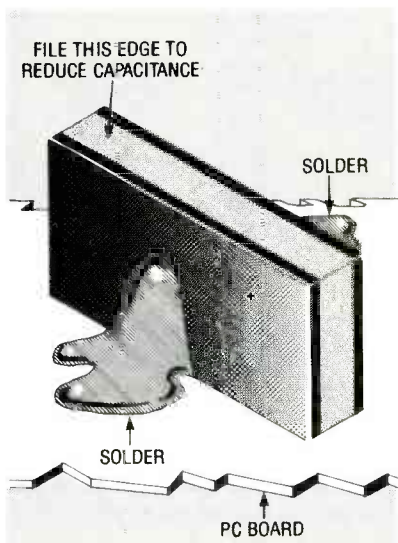


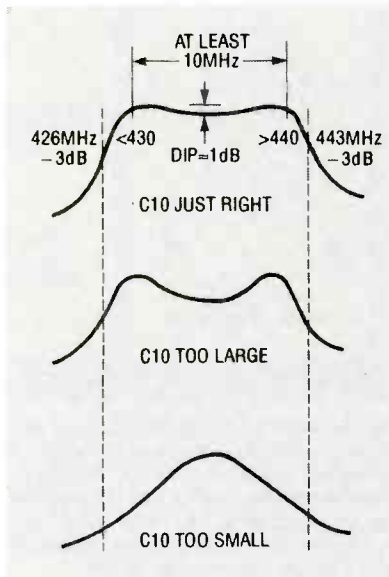
FIG. 6—ALL CHIP CAPACITORS, C10 (see Fig. 8), and Q1 mount on the solder side of the board. The markings on Q1 face the component side of the board.



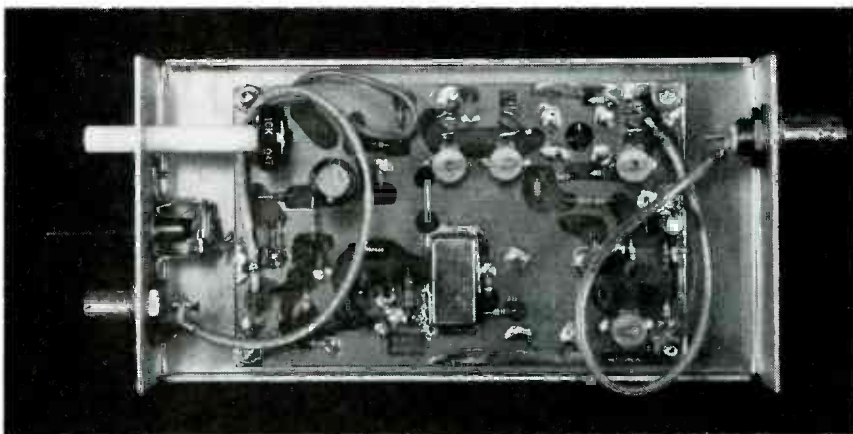
**FIG. 7**—ALL HOLES MARKED "G" in Fig. 4 must have jumper wires passed through them that are soldered on both sides of the PC board as shown here. Also, both sides of the board must be grounded together with copper-foil tape as shown.



**FIG. 8**—TO MAKE C10, take a small square of G-10, 0.062-inch PC board material and trim it to a 3/16-inch square. Install it on the solder side of the board in the location shown in Fig. 6.



**FIG. 10**—PEAK THE CONVERTER for a response as shown here. By trimming C10 with a file you can experiment with the coupling and resultant bandpass shape.



**FIG. 9**—THE AUTHOR'S PROTOTYPE. The converter should be mounted in a metal box, weatherproof if outdoor use is intended.

age. The DC voltage is impressed on the cable as follows: A nominal 26-volt power source at the ATV receiver station is connected to Q7, a 2N2222 NPN transistor used as an emitter-follower. Resistors R22 and R23 produce a variable voltage of 14 to 26 volts at the base of Q7, whose emitter will follow the voltage. Power is supplied to the cable through L11, and by varying potentiometer R23, the voltage applied via R22 to the cable at J3 can be adjusted between 14 and 24 volts. Capacitor C35 prevents any DC voltage from appearing at J4.

The DC voltage is taken off the cable via the 18 $\mu$ H RF choke L10. Capacitors C30 and C31 remove noise from the DC voltage and provide an RF ground. Positive voltage is fed to the downconverter via the cable's center conductor and the outer shield serves as the negative supply lead; it is grounded to the case and ground foil.

The DC input is fed to D6, a 12-volt Zener diode (a 1N759 can be used). Capacitors C33 and C34 filter any noise from the voltage which will be 12 volts less than the voltage on the coaxial transmission line (+14 to +24 volts), or +2 to +12 volts DC. That is fed to R10, which feeds the tuning voltage to the downconverter varactor. By varying the DC voltage on the transmission line between +14 and +24 volts, not only can the downconverter be powered, but it can be remotely tuned to a desired frequency as well.

Note that the components shown in Fig. 3 are not part of the downconverter board, and they are used only if remote operation is required.

### Construction

The PC board material (G-10, 0.062 inch thick glass epoxy) and layout must be followed exactly to duplicate the performance of the downconverter. The stray capacitance, coupling between elements, and L4 are all integrated into the design of the board. Any layout deviations can change those specifications. The foil patterns are

*continued on page 109*

Figure 3 shows how J2 can be connected to a long coaxial transmission line that runs to

the ATV receiver station. The cable is isolated from ground and can therefore carry a DC volt-



# HARDWARE HACKER

Apple's PhotoGrade, electronic halftones, consultants network, marketing your ideas, and two great new books.

DON LANCASTER

Oh, the times, they are a-changing. We seem to have a mix of really bad and really awesome stuff coming down lately. Let's start off with some of the sadder vibes...

*Heathkit* has recently discontinued production on most of its electronic kits. It's the end of an era for sure.

But a funky little outfit called *Musty Manuals* is setting out to stock and make available all of those older Heath assembly books and instruction manuals. And lots of exciting hacker kits are being made available from such outfits as *PAIA*, *Old Colony*, and *Micro Mint*. Plus, of course, through several of the advertisers in this magazine.

The technical paperback book field (especially the non-computer titles) is clearly not well. *Sams* is essentially gone, bought out by Macmillan and triaged into an ethereal shadow of what once was the most respected and diversified technical book publishers in the world. *TAB* has been purchased by McGraw-Hill and become a subsidiary. I have been getting plenty of helpline complaints about several sources that offer dated and inaccurate titles. Believe it or not, your IRS is now paying publishers to shred books, especially old technical paperbacks, through an obscure inventory ruling that has totally decimated long-term back lists and older technical titles.

But—an incredibly exciting new opportunity called *Book-on-demand* publishing is emerging in which you can produce first-quality paperback and hardback books literally on your kitchen table when and as they are ordered. With a "forever" backlist, no IRS inventory penalties, and no lower limit to the total number of sellable volumes needed. And it also includes such

exciting possibilities as a 90-percent author's royalty and rapid CD-ROM distribution. Much more on this on *GENie* PSRT.

Very alarmingly, some community colleges are cutting back on or outright eliminating their electronics departments. And many electronic service and repair trade journals have vanished without a trace.

But—we now have got the richest and most incredible variety of cheap new chips to play with. Anywhere. Ever. We have major breakthroughs in hacker direct-toner printed circuits. We have a brand-new **Electronics Now** format with new features and fresh ideas that continues the oldest ongoing electronics magazine publishing house. And we are something like a scant eight years away from hardware that can surpass the human brain in logic and analysis capabilities.

Right now is certainly the greatest time ever to be getting into hardware hacking in a very big way.

## Electronic halftones

I've recently been playing around with the new *LaserWriter G* and am very impressed with its new ability to print medium- to high-quality photo halftones. So, I thought we might review what is involved in the laser printing of photos in general, and see just why Apple's neat *PhotoGrade* process seems to beat out brute-force methods—and how we can do even better.

Many of those previous-generation laser printers were 300-DPI devices, capable of placing or not placing 300 whole dots per inch uniformly along any one selected laser scan line. That translates to 90,000 dots per square inch, or a tad over 8 million dots on a standard page. If a dot is only black or white, it can usually be represented on the *page bitmap* or in your *frame device* as a single bit. Thus, around a megabyte worth of memory must be reserved for your full-page bitmap at 300-DPI resolution.

The obvious big dilemma in raising your laser-printer resolution is this: As you go from 300 DPI to 1200 DPI, you could end up requiring *sixteen* times the memory! And your page makeup times could end up *sixteen times* as long! Yet "more" resolution is perceived to be a big user need. Or is it?

Actually, laser-printing resolution is pretty near as highly overrated as *Peterbilt* trucks or teenage sex. But that's another story for another time. I strongly feel that higher resolution is not worth losing genuine Adobe Level II PostScript, duplex printing options, low per-page printing costs, mainstream technology, good third-party supply sources, local hard-disk support, or any sleep.

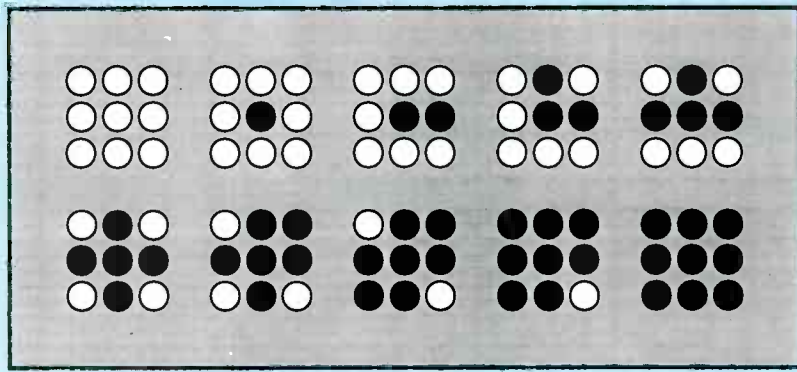
A poorly scanned photo (or one that's not properly *histogram equalized*) will end up looking even worse on the premium machines.

One zero-cost way to increase your printer's resolution when you'd like "camera ready" art for conventional printing: Just work oversize and then photoreduce. Most of my *Hardware Hacker* figures are printed at 133 percent normal size and are then reduced here for an effective resolution of a scant 400 DPI. Yet I feel they look as good as most of the other technical figures.

An easy way of making a 300-DPI

## NEED HELP?

Phone or write your **Hardware Hacker** questions directly to:  
Don Lancaster  
Synergetics  
Box 809  
Thatcher, AZ 85552  
(602) 428-4073



**FIG. 1—A LASER PRINTER can fake a halftone by grouping dots into a larger "cell." In this example, a 3 × 3 pixel array forms a cell that can have ten gray levels, including black and white. On a 300-DPI printer, this would form a "100 line, 0 degree" halftone screen.**

printer look better is to do a plain old smoothing job. That concept was pioneered by *Hewlett-Packard* as *Resolution Enhancement Technology*.

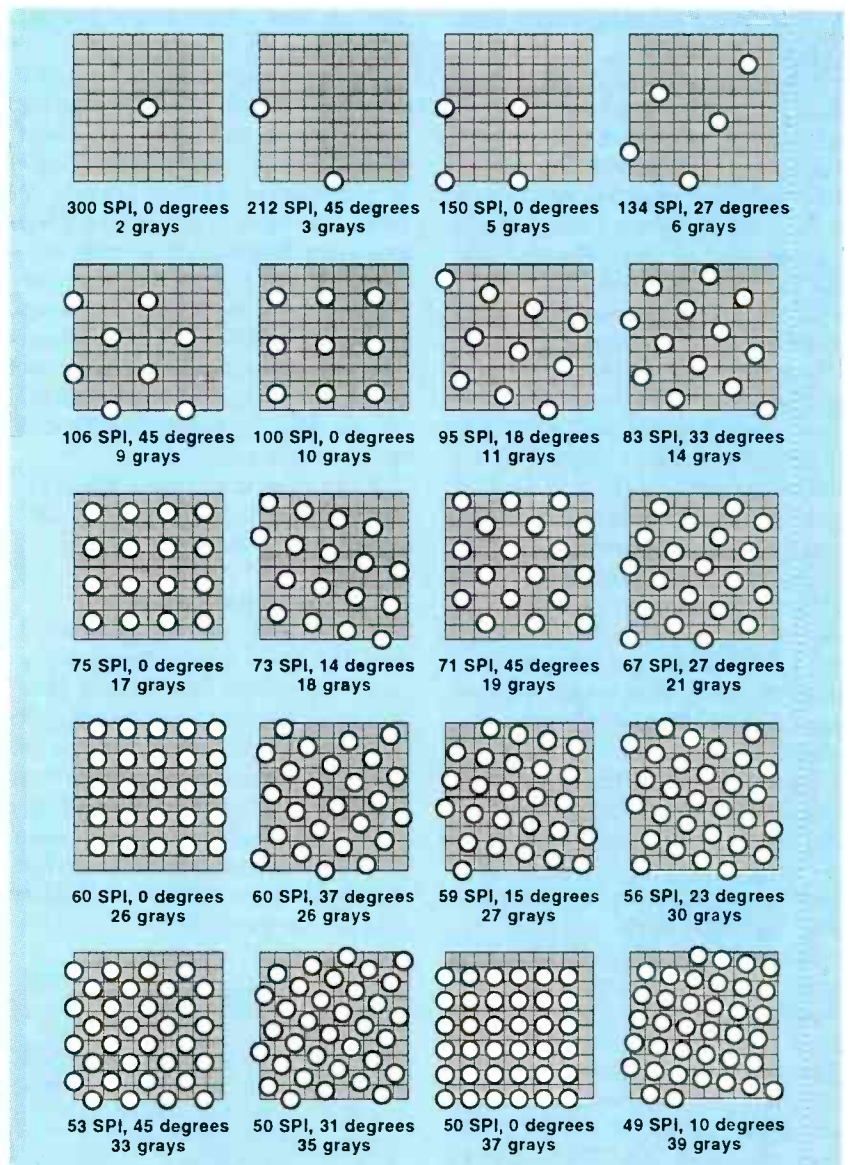
Apple (and many also-rans) have copied this idea. On the LaserWriter G, Apple calls it *FinePrint*.

The smoothing is done by a custom integrated circuit that inter-

cepts and stores a few of the scan lines on their final way out to the laser scanner. By analyzing a matrix formed from the nearby dots on earlier and later lines, certain dot positions are delayed by one-half a dot, following a smoothing algorithm. The result is a really big improvement in most typography and some graphics, especially for reproducing slanted lines.

Despite all the hype, the circuitry involved is simple and cheap. And it can end up totally independent of the imaging model or language in use.

But plain old smoothing can't help halftone photos, and it may even



**FIG. 2—THE AVAILABLE SPOT PATTERNS for a typical 300-DPI PostScript printer. Note that these are the ONLY dense patterns available. You'll get one of these regardless of what you ask for. Note the perfect tiling.**

**NEW FROM DON LANCASTER**

**HARDWARE HACKER STUFF**

- Hardware Hacker Reprints II or III 24.50
- Midnight Engineering Reprints 16.50
- Incredible Secret Money Machine 18.50
- CMOS Cookbook 24.50
- TTL Cookbook 24.50
- Active Filter Cookbook 19.50
- Micro Cookbook vol I or II 19.50
- Lancaster Classics Library 119.50
- AppleWriter Cookbook 19.50

**POSTSCRIPT STUFF**

- Ask The Guru Reprints I, II or III 24.50
- LaserWriter Secrets (Ile/Mac/PC) 29.50
- PostScript Show & Tell 39.50
- Intro to PostScript VHS Video 39.50
- PostScript Beginner Stuff 39.50
- PostScript Cookbook (Adobe) 16.50
- PostScript Ref. Manual II (Adobe) 28.50
- PostScript Program Design (Adobe) 22.50
- Type I Font Format (Adobe) 15.50
- LaserWriter Reference (Apple) 19.50
- Real World Postscript (Roth) 22.50
- PostScript Visual Approach (Smith) 22.50
- Thinking in PostScript (Reid) 22.50
- Undst PS Pgrmmg (Holtzgang) 29.50
- The Whole Works (all PostScript) 349.50

**BOOK-ON-DEMAND STUFF**

- Book-on-demand resource kit 39.50
- GENie PSRT sampler (Ile/Mac/PC) 39.50

FREE VOICE HELPLINE VISA/MC

**SYNERGETICS**

Box 809-RE  
Thatcher, AZ 85552  
(602) 428-4073



hurt. Let's look further at...

### The halftone process

There is only one method to print something that is truly gray on the page. And that is to use gray ink. And each *different* shade of true gray will need a *different* gray ink and another pass through the printing press. Since this is clearly not good, printers have long used a *halftone* process instead.

The halftone process consists of printing lots of different-sized *black* dots very near to each other. The dots are carefully spaced to be less than the eye's angular resolution. Instead of seeing the individual dots, your eye averages out the black dots and the white background and perceives an average gray level. The higher the ratio of white to black, the lighter the gray, and vice versa. Let's try it out. Look at a gray portion of any black and white photograph or tint box in this magazine. While it looks gray with the naked eye, under a magnifying glass you'll see all the little dots that make up the *halftone*. The dots are all black.

To print any photograph, a special screen is used on the litho camera to convert gray values into collections of black dots of varying size.

Traditional printers will spec their *screen size* as the number of halftone spots per inch. Some popular ones include 85 spots per inch for tabloid news and the 120 spots per inch for most magazines of **Electronics Now** quality.

Even higher spot densities are used on premium magazines. But they require special inks, coated papers, and extreme attention to detail. *Note that even the highest spot densities used are nowhere near 300 spots per inch!*

A second halftone parameter is called the *screen angle*. It turns out that the human eye is very good at picking out horizontal and vertical lines, but rather poor on resolving diagonals. Since the halftone process introduces *visual artifacts*, it is often best to set your black-and-white screens on a 45-degree angle. In color printing, the halftone screen angles become even more critical if they are to eliminate objectionable *Moire* patterns.

Several methods can be used to fake halftone screens on laser printers. One method is to group all the possible laser dot positions into larger spots that I'll call a *cell*. Figure 1 shows you how a 300-DPI printer can use nine dots to make cells of 100 spots per inch. This particular cell has a screen angle of zero. As you can see, there are ten possible gray levels here, including black and white.

We can immediately see that we could use 36 dots to form 50-spot-per-inch cells. And those cells would give us 37 possible grays. Clearly, we have a tradeoff between the number of cells per inch and the number of available grays. Use too few cells per inch, and you'll end up with the "Sunday Funnies" effect with very grainy dots. Use too few grays, and you will *solarize* with obvious (and often objectionable) steps between each possible gray level.

The gray-level resolution of your eye depends on context and con-

trast, but a number slightly over 256 gray levels is possible. But, because of the stupendous costs of exceeding 256 grays, most experts agree that eight bits of gray scale resolution is enough even for premium images. Television sometimes might get by with as few as six bits, good for a mere 64 gray levels.

The obvious next question is "How good can our halftones image at an unenhanced resolution of 300 DPI?" Ignoring the obvious answer of "Not good enough," we'll then go on to ask "What can we do about it?"

### PostScript to the rescue

I have found that the *PostScript* general-purpose computer language has some really great approaches to electronic halftones. Those involve their *setscreen* and *image* operators, among many others. *PostScript* uses some imaging *tiles* that determine the screen angles and frequencies. Since these screen tiles must all abut

NO COMPLICATED ELECTRONICS, NO EXPENSIVE INSTRUMENTS:

## Home study course shows you how to make good money in VCR repair.

An amazing fact: you can do more than four out of five VCR repairs with ordinary tools and basic fix-it procedures. Our home study program shows you how.

Learn all of the systems, mechanisms, and parts of almost all brands of VCRs. With *no* expensive instruments. *No* complicated electronics. *No* fancy workshop. The step-by-step texts and close personal attention from your instructor make learning easy.

Texts, course materials, and tool kit are sent to your home. Graduate ready to make up to \$50.00 or more per hour in your own spare-time or full-time business.

**Send today for your free career booklet. Or call 800-223-4542**



Name \_\_\_\_\_  
Address \_\_\_\_\_  
City \_\_\_\_\_ State \_\_\_\_\_ Zip \_\_\_\_\_

### The School of VCR Repair

2245 Perimeter Park, Dept. VK342, Atlanta, Georgia 30341

CIRCLE 181 ON FREE INFORMATION CARD

each other perfectly and still must obey integer (whole numbers only) math, there are very definite limits to which 300-DPI tiles are and are not possible. If you ask for some halftone cell angle or frequency that is simply not physically possible, PostScript will substitute the nearest handy one.

Figure 2 shows you the available denser halftone cells as used on most popular 300-DPI PostScript printers. Figure 3 shows you the *secret gray map* for all of the "hidden" PostScript grays.

Typical PostScript users and most applications packages blindly insist on using the *seventeenth* most putrid PostScript gray available. While this is often incorrectly called a 60-DPI screen, its effective resolution is only 53 dots per inch. There are 33 grays with this default screen.

That sort of explains the "Sunday Funnies" effect of most poorly done PostScript screens. And one of the biggest reasons why people feel

they need "more" resolution. When in fact, their grays can all get instantly and dramatically improved by using a few dozen keystrokes!

For instance, the best PostScript 300 DPI halftone screen for typical graphics is a 106 DPI, 45-degree one which gives you absolutely beautiful grays. Sadly, you'll only get ten of those grays, but the lightest ones are very good for graphics.

Two other quite useful 300 DPI secret PostScript grays of interest are the 85-line and 35-degree "reprogray" useful for oversize cam-

era-ready art, and the 135-line, 25-degree "india ink wash" gray. The latter gives you only six gray levels and requires a careful selection of toner and paper. But the results are stunning.

One way to do a best PostScript gray is to enter these keystrokes as PostScript commands...

```
106 45 dup mul exch dup mul
add 1.0 exch sub setscreen
```

The first number is your cell frequency; the second is your angle. The details of where and how you enter these code lines depend on

## GREAT MONEY IN VCR REPAIR

*Start your own highly profitable cash business from your home!*



◆◆ **Earn up to \$1,000 Per week** ◆◆

Start your own VCR repair business with video home study course

◆ **Big Money Making Opportunity** ◆

Millions of VCR's are sold each year. There is a **serious shortage** of trained VCR technicians. Learn to service and repair the most popular appliance in America. No complicated electronics. No expensive instruments. No fancy workshop

**LEARN VCR REPAIR** with easy **step-by-step** video instruction. Video training allows you to **learn faster** with **higher retention**.

VCR Repair Technician  
 Computer Repair Technician  
 Electronic Security Technician

CALL TOLL FREE: 24 HRS • 7 DAYS

**1-800-824-7761**, ext. V16

or write to:

**SJD VIDEO LEARNING CENTER**  
4031 Palos Verdes Drive South  
Rancho Palos Verdes, CA 90274

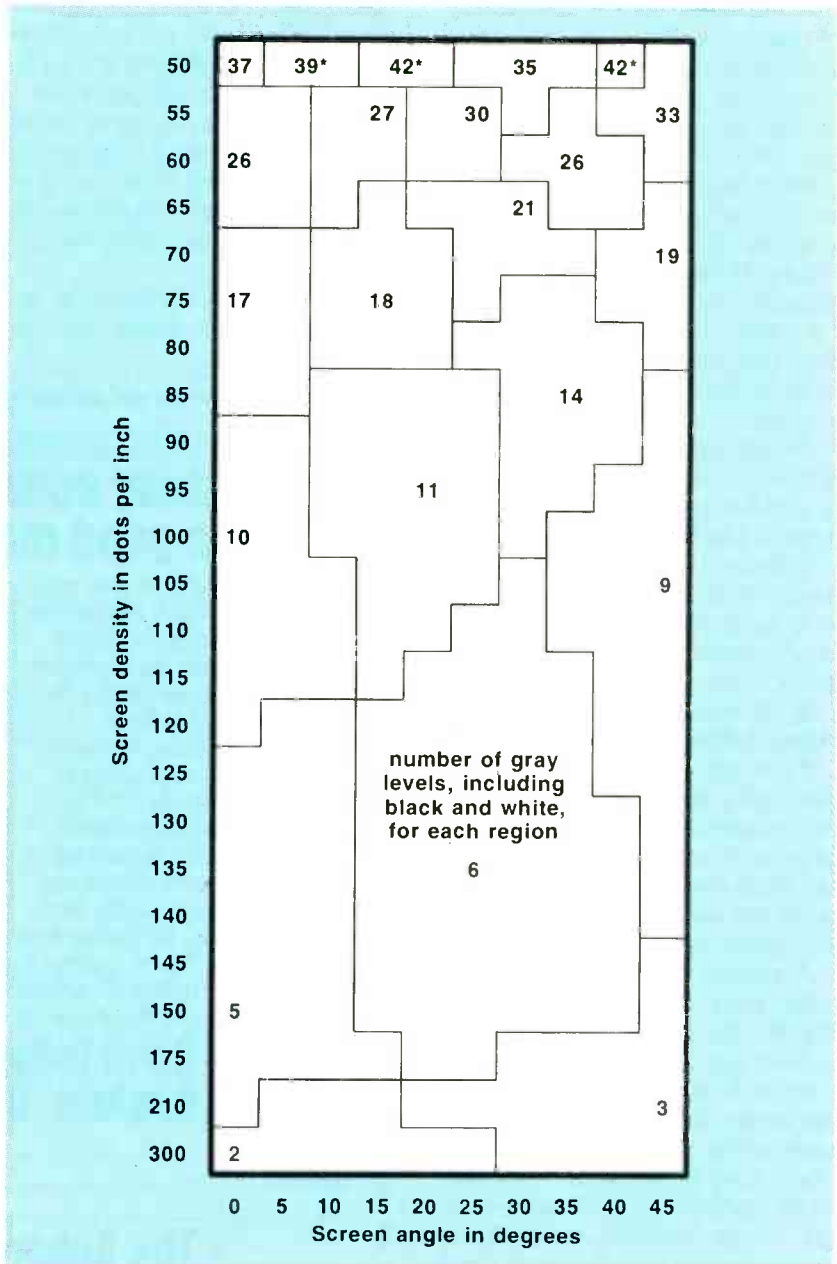


FIG. 3—THE TOP SECRET GRAY MAP for a 300-DPI PostScript printer. Most users and most application packages insist on using the seventeenth most putrid of the available grays. The best graphics gray is 106 DPI at 45 degrees.



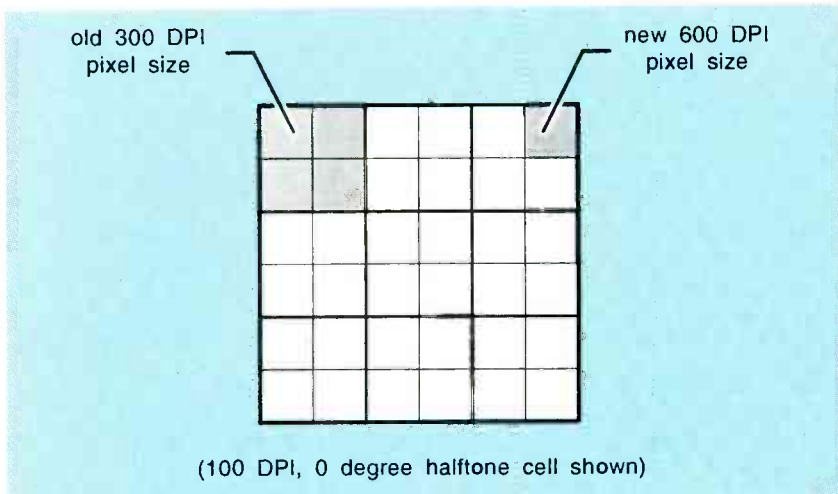


FIG. 4—BOTH QMS AND IBM/LEXMARK chose the "brute force" 600-DPI method to improve their PostScript photo halftones. The original 100-DPI spots allowed 10 gray levels; the new ones allow 37. There is a 4× speed and 4× memory penalty for the modest (but certainly welcome) improvement.

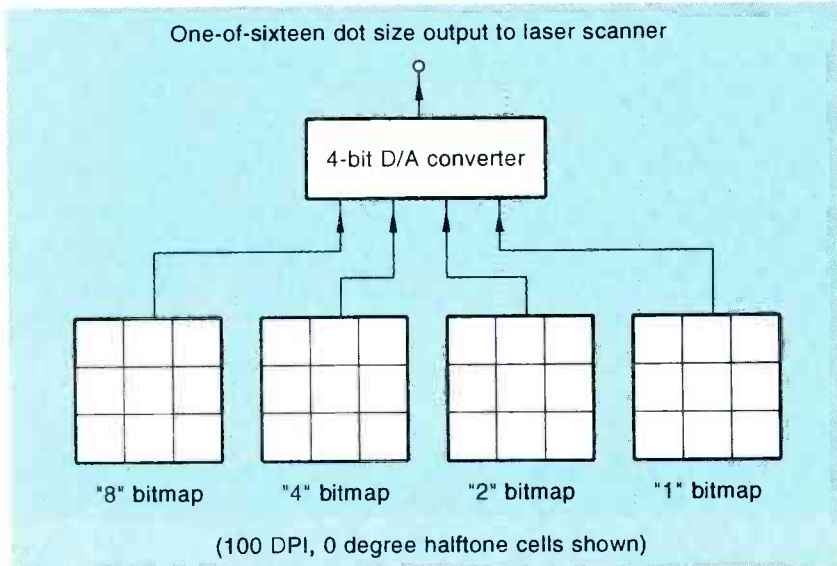


FIG. 5—THE APPLE LASERWRITER G remains at 300 DPI, but it uses four bitmap memory planes that allow one of sixteen pixel dot sizes. That permits 144 gray levels at 100 DPI for good- to better-grade photo halftones. Or 128 gray levels at the more popular 106 DPI and 45 degree screen.

your PostScript programming style or the applications package you have. Call me if you need any further help on this.

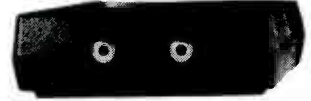
No, none of those screens can give you any high-quality halftone photos. But the 75-line screen can give you a recognizable "auto shopper" quality photograph. Especially if the scanned image has been properly histogram-equalized.

Three key points: The halftone dots used in everyday printing are much coarser than 300 DPI. Some excellent graphic PostScript grays are available at 300 DPI. They need

only a few dozen simple keystrokes for their activation. And our halftone photo quality, when given any properly image processed input, doesn't miss by that much.

So we can potentially add only a little to 300 DPI and gain enormously on halftone photo quality. Both QMS and IBM/Lexmark picked the brute force method. As Fig. 4 shows us, they switched to a 600-DPI double resolution and then swallowed the 4:1 speed and memory penalties. At 100 cells per inch, you now have 37 gray levels. Or 50 gray levels at an 85-cells-per-inch

## DIGITAL VIDEO STABILIZER ELIMINATES ALL VIDEO COPYGUARDS



While watching rental movies, you will notice annoying periodic color darkening, color shift, unwanted lines, flashing or jagged edges. This is caused by the copy protection jamming signals embedded in the video tape, such as Macrovision copy protection. THE DIGITAL VIDEO STABILIZER: RXII COMPLETELY ELIMINATES ALL COPY PROTECTIONS AND JAMMING SIGNALS AND BRINGS YOU CRYSTAL CLEAR PICTURES.

### FEATURES

- Easy to use and a snap to install
- State-of-the-art Microchip technology
- 100% automatic
- Compatible to all types of VCRs and TVs
- The best and most exciting Video Stabilizer in the market
- Light weight (8 ounces) and compact (1x3.5x5")
- Uses a standard 9 Volt battery (last 1-2 years)
- Fast UPS delivery
- Air shipping available
- UNCONDITIONAL 30 day money back guarantee
- 1 year warranty

### WARNING

THE DIGITAL VIDEO STABILIZER IS INTENDED FOR PRIVATE HOME USE ONLY. IT IS NOT INTENDED TO COPY RENTAL MOVIES OR COPYRIGHTED VIDEO TAPES THAT MAY CONSTITUTE COPYRIGHT INFRINGEMENT.

(Dealers Welcome)  
**FREE 20P Catalog**

To Order: \$59.95 ea + \$4 for p & h  
Visa, M/C, COD Mon-Fri: 9-6 EST

**1-800-445-9285**

ZENTEK CORP. DEPT. CRE9

3670-12 WEST OCEANSIDE RD. OCEANSIDE, NY 11572

CIRCLE 182 ON FREE INFORMATION CARD

## CABLE TV DESCRAMBLERS

How You Can Save Money on  
Cable Rental Fees

### Bullet Proof



1 Unit 5+

BEST Super Tri-Bi Auto/  
Var. Gain Adjustment \$119.95...\$85  
Jerrold Super Tri-Bi... \$109.95...\$79  
Scientific Atlanta... \$109...\$79  
Pioneer... \$109...\$79  
Panasonic TZPC145... \$99.95...\$79  
Stargate Converter... \$95...\$69  
Digital Video Stabilizer... \$59.95...\$29  
Wireless Video Sender... \$59.95...\$49.95

US Cable'll Beat  
Anyone's Price  
Advertised in  
this Magazine!

**30 Day Money Back Guarantee**  
FREE 20 page Catalog

Visa, M/C, COD or send money order to:

**U.S. Cable TV Inc. Dept. KRE9**  
4100 N. Powerline Rd., Bldg. F-4  
Pompano Beach, FL 33073

**1-800-772-6244**

### For Our Record

I, the undersigned, do hereby declare under penalty of perjury that all products purchased, now and in the future, will only be used on Cable TV systems with proper authorization from local officials or cable company officials in accordance with all applicable federal and state laws. FEDERAL AND VARIOUS STATE LAWS PROVIDE FOR SUBSTANTIAL CRIMINAL AND CIVIL PENALTIES FOR UNAUTHORIZED USE.

Date: \_\_\_\_\_

Signed: \_\_\_\_\_

**No Florida Sales!**

CIRCLE 183 ON FREE INFORMATION CARD

# Be an FCC LICENSED ELECTRONIC TECHNICIAN!



No costly school. No commuting to class. The Original Home-Study course prepares you for the "FCC Commercial Radiotelephone License." This valuable license is your professional "ticket" to thousands of exciting jobs in Communications, Radio-TV, Microwave, Maritime, Radar, Avionics and more... even start your own business! You don't need a college degree to qualify, but you do need an FCC License.

**No Need to Quit Your Job or Go To School**  
This proven course is easy, fast and low cost! **GUARANTEED PASS**—You get your FCC License or money refunded. **Send for FREE facts now. MAIL COUPON TODAY!**

## COMMAND PRODUCTIONS

FCC LICENSE TRAINING, Dept. 90  
P.O. Box 2824, San Francisco, CA 94126  
Please rush FREE details immediately!

NAME \_\_\_\_\_  
ADDRESS \_\_\_\_\_  
CITY \_\_\_\_\_ STATE \_\_\_\_\_ ZIP \_\_\_\_\_

## ADVANCE YOUR ELECTRONIC INTERESTS



### WITH A NEW SUBSCRIPTION TO: THE SPEC-COM JOURNAL!

Getting your FCC Amateur Radio License is easier than ever before (NO-CODE requirement - see R.E. April 91 issue, pages 27-28). SCJ is an 80-page per issue HAM RADIO magazine that covers ALL the specialized modes. Modes like HAM-TV, Radioteletype, Satellites, WXFAX and Computer Data Transmissions. Current issue - just \$3.75 ppd.

Annual Subscriptions (6 issues):  
\$20 USA \$25 Canada/Mexico  
\$30 Foreign (Surface)

**The SPEC-COM Journal**  
P.O. Box 1002,  
Dubuque, IA 52004-1002  
(319) 557-8791  
BBS (319) 582-3235

## NAMES AND NUMBERS

### Addison-Wesley

Jacob Way  
Reading, MA 01867  
(617) 944-3700  
CIRCLE 316 ON FREE INFORMATION CARD

### Apple Computer

20525 Mariani Avenue  
Cupertino, CA 95014  
(408) 996-1010  
CIRCLE 317 ON FREE INFORMATION CARD

### Fistell's Microelectronics

7023 East Colfax  
Denver, CO 80220  
(303) 393-6000  
CIRCLE 318 ON FREE INFORMATION CARD

### Hewlett-Packard Company

PO Box 10301  
Palo Alto, CA 94303  
(415) 857-1501  
CIRCLE 319 ON FREE INFORMATION CARD

### IBM/Lexmark

1221 Alverser Drive  
Midlothian, VA 23113  
(800) 438-2468  
CIRCLE 320 ON FREE INFORMATION CARD

### Keyboard Systems

3637 East 7800 South  
Salt Lake City, UT 84121  
(801) 943-7888  
CIRCLE 321 ON FREE INFORMATION CARD

### Magazine of Service Management

PO Box 12901  
Overland Park, KS 66282  
(913) 341-1300  
CIRCLE 322 ON FREE INFORMATION CARD

### Musty Manuals

645 Wheeling Road  
Wheeling, IL 60090  
(708) 634-6467  
CIRCLE 323 ON FREE INFORMATION CARD

### Navtech Information Service

2775 South Quincy St #610  
Arlington, VA 22206  
(800) NAV-0885  
CIRCLE 324 ON FREE INFORMATION CARD

### Old Colony Audio

PO Box 243  
Peterborough, NH 03458  
(603) 924-6371  
CIRCLE 325 ON FREE INFORMATION CARD

### QMS

PO Box 81250  
Mobile, AL 36689  
(205) 633-4300  
CIRCLE 326 ON FREE INFORMATION CARD

### Spread Spectrum Scene

PO Box 2199  
El Granada, CA 94018  
(510) 278-3157  
CIRCLE 327 ON FREE INFORMATION CARD

### Texas Instruments

PO Box 809066  
Dallas, TX 75380  
(800) 336-5236  
CIRCLE 328 ON FREE INFORMATION CARD

### Vox Humania Press

150 Locust Street  
Macungie, PA 18062  
(215) 966-2200  
CIRCLE 329 ON FREE INFORMATION CARD

density. That could make the difference between lousy and not half bad photo halftones. Especially given a proper digital image processing.

Apple has chosen the more elegant *PhotoGrade* method shown in Fig. 5. They remained at 300 DPI, but added three extra bitmap memory planes for a total of four. Then they modulated their laser dot size to one of sixteen values. You now can have *sixteen* times as many potential gray levels as you did at 300 DPI with only a single memory plane. At 106 DPI, you now have a much better 129 gray levels available. That is equal to a brute force resolution of 1200 DPI!

There is only a negligible speed penalty, since all four memory planes are written in parallel by

custom-designed LSI chips. And while you retain the same  $4 \times$  memory penalty as a brute force  $600 \times 600$ , you'll get *four times* the effective resolution!

The result? Good to better photo halftones out of any plain old 300-DPI laser-printer engine. Especially with premium toner and properly scanned image processing. The *PhotoGrade* is also upgradable on older NT and NTX printers with a simple plug-in board.

### Can we do better?

I think we can. At least in theory. For any 100-spot-per-inch tile at plain old 300 DPI, we are using *nine* bits to call out only 10 different spot values. Since nine bits could represent 512 different state values, the *memory use efficiency* is a tad un-



## PRODUCT MARKETING RESOURCES

### DesignTech International

7401 Fullerton Road  
Springfield, VA 22153  
(703) 866-2000  
CIRCLE 330 ON FREE INFORMATION CARD

### Encyclopedia of Associations

835 Penobscot Building  
Detroit, MI 48226  
(313) 961-2242  
CIRCLE 331 ON FREE INFORMATION CARD

### GENie

401 North Washington Street  
Rockville, MD 20850  
(800) 638-9636  
CIRCLE 332 ON FREE INFORMATION CARD

### Inventor-Entrepreneur Network

1683 Plymouth Road  
Ann Arbor, MI 48105  
(313) 663-8000  
CIRCLE 333 ON FREE INFORMATION CARD

### Micro-Mint

4 Park Street, Suite 20  
Vernon, CT 06066  
(203) 875-2751  
CIRCLE 334 ON FREE INFORMATION CARD

### Midnight Engineering

111 E Drake Road Suite 7041  
Ft Collins, CO 80525  
(303) 491-9092  
CIRCLE 335 ON FREE INFORMATION CARD

### PAIA Electronics

3200 Teakwood Lane  
Edmond, OK 73013  
(405) 340-6300  
CIRCLE 336 ON FREE INFORMATION CARD

### Redmond Cable

17371-A1 NE 67th Court  
Redmond, WA 98052  
(206) 882-2009  
CIRCLE 337 ON FREE INFORMATION CARD

### Synergetics Consultants Network

Box 809  
Thatcher, AZ 85552  
(602) 428-4073  
CIRCLE 338 ON FREE INFORMATION CARD

### Whole Earth Review

27 Gate Five Road  
Sausalito, CA 94965  
(415) 332-1716  
CIRCLE 339 ON FREE INFORMATION CARD

der two percent. Wowie gee!

The *PhotoGrade* does ridiculously worse. Here we are asking 36 bits to call out a mere 144 different gray levels. Since thirty-six

bits can yield us up to 68,719,476,736 different states, our memory use efficiency is essentially zero! Thus, *virtually all of that Apple PhotoGrade memory bitmap is totally wasted!*

Instead, let's go back to, say, 100 spots per inch at a plain old 300 DPI. Once in the *center* of every desired halftone spot, put out a *single* laser dot having 512 possible size values. Presto. A mind-blowing total of 512 grays at 100 DPI! Or a *perfect* 256 grays up at the usual 106 DPI! This is for photo halftone dots only; you would still be able to do special screens and weird spot functions the old way. Patterns, too.

For us to make full use of what seems theoretically designable, you would need some special automatic mode sensing for the halftone areas. And a diamond-shaped laser beam whose diameter could be controlled over a 25-decibel or 16:1 range. Down from a maximum slightly under three times *larger* than is now used. None of those

needs seems a really big deal.

Thus, it should be theoretically possible to build a 300-DPI PostScript laser printer with outstanding photo halftones. A 1697-DPI equivalent. At zero speed or memory penalties. Hmmmm...

I have posted lots of halftone and secret gray study examples to GENie PSRT, especially my files 129, 141, 144, 179, 180, 231, and 239. I've also uploaded some high-quality images that you can play with, either inside or outside PostScript. In particular, check out LENA.PS, MANDRILL.PS, and my enhanced LENA.HIST.PS.

### Marketing your products

I was pleasantly surprised to find that the leading invention marketing firms are now publishing their track records—up front in their initial mailings. One of the oldest and largest discloses: Of the ideas submitted and contracted, the odds of getting a royalty license are 100:1 against,

*continued on page 93*

# JAN Crystals

*your reliable source for  
a world of crystal clear  
communication*



- Commercial Two-Way
- MicroProcessors
- Amateur/Experimental
- Scanners/Monitors/Pagers
- Satellite-Telemetry
- Plus custom applications

**EXPEDITED ORDER SERVICE!**  
FOR FREE CATALOG,  
CALL OR WRITE:  
**JAN CRYSTALS**  
P.O. Box 06017  
Ft. Myers, FL 33906  
(813) 936-2397

**TOLL FREE 1-800-526-9825**  
FAX ORDERS: 1-813-936-3750

VISA  
MasterCard

CIRCLE 104 ON FREE INFORMATION CARD

# ATTENTION! ELECTRONICS TECHNICIANS




## EARN YOUR B.S.E.E. DEGREE

### THROUGH HOME STUDY

Our New and Highly Effective Advanced-Placement Program for experienced Electronic Technicians grants credit for previous Schooling and Professional Experience, and can greatly reduce the time required to complete Program and reach graduation. No residence schooling required for qualified Electronic Technicians. Through this Special Program you can pull all of the loose ends of your electronics background together and earn your B.S.E.E. Degree. Upgrade your status and pay to the Engineering Level. Advance Rapidly! Many finish in 12 months or less. Students and graduates in all 50 States and throughout the World. Established Over 40 Years! Write for free Descriptive Literature.

## COOK'S INSTITUTE OF ELECTRONICS ENGINEERING

 4251 CYPRESS DRIVE  
JACKSON, MISSISSIPPI 39212

CIRCLE 58 ON FREE INFORMATION CARD

# AUDIO UPDATE

## Format future shock

LARRY KLEIN

**A**re we lost in a forest of new audio formats? Is there a future for DAT, DCC, and the mini disc—not to mention recordable CD's?

I have always considered myself relatively immune to the effects of "Future Shock." As you may recall, the dreaded FS Syndrome describes the disturbed and disoriented behavior of those suffering input overload brought on by too many life changes happening too fast.

Students of sociology are aware that the organization of any society roughly reflects the way that the people in it make their living. And the kind of work that people do, in turn, derives from the technological level of the society. Since technology is cumulative, it follows that change, for better or worse, is inevitable. (I could cite historical data for all this, but for the sake of argument, just take my word for it). It has been suggested in other contexts that the way to deal with the inevitable is to relax and, if possible, enjoy it. But for many audiophiles, their fun is threatened by the proliferation and confusion of many competing formats.

All this is by way of a psycho-historical introduction to the present state of home audio electronics. In past articles I've looked at the question of new formats and examined the factors that make them into hits or misses. As I see it, the majority of audio consumers are most interested in a format's convenience and only secondarily in its fidelity. Although I certainly don't discount the very low distortion and noise-free qualities of the CD format, its obvious attractions—for the average consumer—mostly reside in its durability and convenient handling. My evidence for all this is the fact

that several years ago the compact, convenient-to-use, and relatively rugged prerecorded cassette started to outsell LP's despite the LP's superior sound quality and lower price. For the same reasons, the latest figures show that CD's are now outselling cassettes in dollar volume. Next year's figures will probably show superior sales in absolute numbers as well.

What does all this tell us about the relatively sudden proliferation of new audio formats—and consumer reactions to them in the past several years? Are the Japanese (and others) engaging in a strange rite of mutual commercial throat-cutting? For example, no sooner did the CD format establish itself than digital audio tape (DAT) was introduced. Although the two formats were not really competitors any more than LP's and open-reel tapes were, consumer confusion was rampant. And consumers stayed away from the DAT format in droves!

Then, in 1986, the word was out that various companies were working on a recordable CD. About four years ago one company held a press conference during which it was claimed that their digital recorder/player would be on the market in about two years—and would cost less than \$500! It didn't happen then, but recently Carver and Philips announced the imminent release of a new breed of compact-disc recorders. A clue to the target market for the machine is given in the Carver press release: "Professional user net price of the PDR-10 is under \$8,000." In truth, I don't have a feel for the professional in the recording industry, but audio consumers are not likely to be waiting in line to invest so heavily in an unproven product with (for them) somewhat obscure advantages.

### Planned obsolescence?

Over the years, I've occasionally defended the hi-fi industry against the recurrent charge of engaging in "planned obsolescence." The conversion from 78's to LP's, tubes to transistors, mono FM and records to stereo all struck me as worthwhile advances in the audio art rather than nefarious plots to sell new products. With today's technologies I'm not so sure.

Is Japan so filled with technologically obsessed marketers that they compulsively create new audio formats oblivious to consumer needs and reactions? Is their guiding philosophy something like the classic advertising agency approach, "Let's run it up the flagpole and see if anyone salutes."? If so, it's an expensive and frequently self-defeating way to run an industry.

Several years ago, the consumer-electronics trade publication *Twice* ran an interview with Hiroki Shimizu, general manager of JVC's Personal Audio Products Division. Mr. Shimizu's comments were so startlingly different from the usual self-serving presentations heard at new-product press conferences that they are worth quoting. Shimizu was troubled by what he called the ethical (!) aspects of today's proliferation of formats. He suggested that the industry was coming out with too many products too fast without considering the interest—or best interests—of the consumer. DAT technology, according to Mr. Shimizu, came too fast and the application came later; as a result the market has not taken off. The application should come first, he said. In his view the most important thing is how the new product will fit into the market.

Other voices of discontent are heard in the land. A writer in *The*





**PHILIPS' DCC900 will be one of the first Digital Compact Cassette decks on the market.**

*New York Times* suggested that the proliferation of competing formats is part of a conspiracy involving Sony (CBS Records), Matsushita (MCA Records), and Philips to somehow protect their record-company royalties from the predations of rabid home recordists. (If the recording machines don't sell because of consumer confusion, they won't be used to copy copyrighted material.) However, it seems improbable to me that the music and audio-product divisions of a company would play those sort of internal games with so much cash and prestige on the line.

### Future formats

Do I have any advice to offer those seeking to keep their heads above water in the flood of new audio products? For one thing, read the articles extolling the virtues of this or that new format with a critical eye. Remember that most writers and editors believe that readers are automatically turned on by the *New!* Experience has shown, however, that large numbers of excited words devoted to the advent of a new audio format don't reliably predict its success.

Given the snowballing of technology, it's hard to make predictions, but certain developments seem inevitable. In a science-fiction story I wrote in 1977, I predicted that the turn of the century would see a fiber-optic cable that linked most homes in America. Among its many services would be the ability to call up any musical composition, pop or classical, from the world's recorded library. Separate musical software as such would be obsolete, as would, of course, the players that deliver it. I think such a development is inevitable, and it would finally put an end to all the format shenanigans. Or would it? **R-E**

## HARDWARE HACKER

*continued from page 91*

and the odds of any positive cash flow that exceed costs are 600:1 against!

Those figures sound about right to me. Sometimes I've done almost that well on my own. And sometimes not. Selling an idea is a real rough row to hoe. One that could become a near impossibility if you are not a fully trained and well experienced insider knowledgeable about what is going on in trade journals, politics, economics, and the tech literature of the target field.

An invention-marketing firm is just a hired gun, similar to an ad agency or a resume-typing service. You pay them for their time and effort for such services as patent searches, listings in product newsletters, and participation in invention fairs—cash up front.

As we've seen a number of times in the past, the core problem lies in the absurd mythology surrounding today's patent system. Very simply, patents have little or nothing at all to do with the selling or marketing of an idea. For most individuals and most small-scale technical startups, *any involvement whatsoever with the patent system is virtually certain to end up as a net loss of time, energy, money, and sanity.*

Just about all hackers will tend to grossly overvalue a new idea. At one time way back in the golden age of inventing, ideas were occasionally worth as much as a dime a dozen. Today, they are worth less than ten cents a bale in ten-bale lots. Ideas gain value *only* when you can clearly demonstrate your end users actually getting off on them. And then *only* when those ideas are *already* in some saleable, competitive, promotable, and distributable form.

The key secret to selling an idea is very simple: *The buyer must come to you.* For our special resource sidebar this month, I have gathered together some ideas that can help you to profit from your ideas.

Two essential magazines are that *Midnight Engineering* and the *continued on page 108*



**NEW!**

**NO-CODE  
HAM  
LICENSES ARE  
HERE!**

*All About Ham Radio* by Harry Helms, AA6FW, tells how to get your *code-free* ham license and talk to the world. In over 300 pages, you'll learn about:

- packet (computer-to-computer) radio
- ham television
- using ham radio satellites
- contacting stations in foreign countries

and many other exciting topics explained in a friendly, humorous style without a lot of math and/or technical jargon. If you've been wanting a ham license, this is the book you've been waiting for!

Only \$19.95 at bookstores and radio equipment dealers. Or order direct from HighText! Add \$3 shipping (\$4 to Canada, \$5 elsewhere). CA please add sales tax. U.S. funds only please.

**HighText**  
publications Inc.

7128 Miramar Rd., Suite 15L  
San Diego, CA 92121

Get hands-on training  
in today's fastest-growing  
computer career field...

**386DX  
COMPUTER  
INCLUDED WITH  
COURSE**

## Be a PC Repair Technician!

**386DX 32-bit/25MHz computer system included with course!**

Now you can cash in on the billion-dollar personal computer boom! Learn PC repair at home in your spare time. Experts guide you step by step in hands-on training that teaches you every facet of PC troubleshooting and repair. You receive all the professional tools and equipment shown at right and more—including a 386DX personal computer—to use during your training and keep for your career.

**PC repair...a high-paying, high-growth field!**

The U.S. Department of Labor states that the average annual salary of highly-qualified computer repair technicians is over \$30,000! And the number of jobs available is expected to nearly double in the next ten years. So you can see there's plenty of money and plenty of opportunity waiting for you!



Send for **FREE FACTS** that explain everything about our revolutionary home-study course in PC repair.

MAIL COUPON TODAY!

**ICS School of Computer Training**

SINCE 1890 Dept. ADE082S, 925 Oak Street, Scranton, PA 18515  
Send me free facts on how I can learn PC repair at home in my spare time. No obligation. No salesman will visit.

Name \_\_\_\_\_ Age \_\_\_\_\_  
Address \_\_\_\_\_ Apt. # \_\_\_\_\_  
City/State \_\_\_\_\_ Zip \_\_\_\_\_  
Phone ( ) \_\_\_\_\_

September 1992, Electronics Now

## VFX

continued from page 52

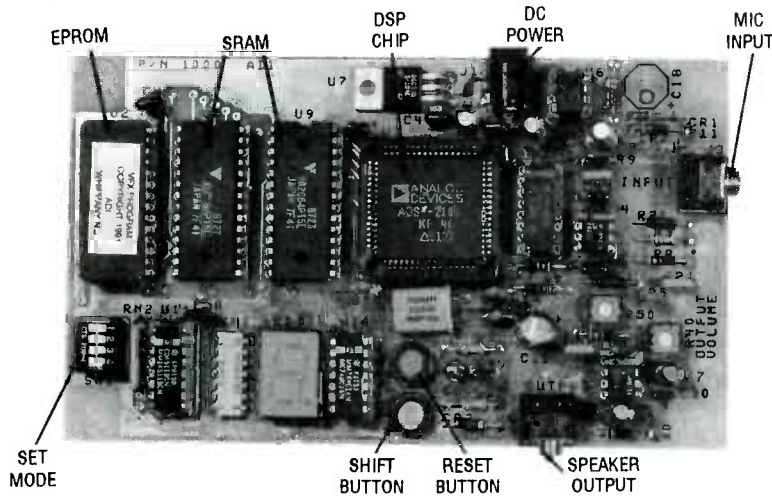


FIG. 9—THE VFX PROTOTYPE. Carefully check the board for solder splashes and bridging before applying power.

button and the LED display should count fast enough so that all the segments (an "8") appear dimly lit.

Remove power from the board and install the two RAMs (IC8 and IC9). Apply power to the board. The LED should again display "6." Press the SHIFT button and the LED should display "0." If any RAM errors occur, they will cause the LED display to increment.

Next install IC3 and IC5. Connect your speaker or headphones to J2 and reapply power. Press the SHIFT button twice and a tone should be heard in the headphones or speaker. Install IC4 and connect a microphone to J3. Apply power and press the SHIFT button three times. Then speak into the microphone and your voice should be heard through the headphones. Adjust potentiometers R50 and R40 for minimum distortion. Now that your VFX board is working, you can change the DIP switches according to Table 1 for the other three effects.

As mentioned before, there is a test mode that can help troubleshoot the VFX processor. It is activated by setting the DIP switches as shown in Table 1

and pressing the reset button. The test mode individually tests the system RAM, the CODEC, and the LED display.

In the test mode the external SRAM is constantly written to and read, and the number of errors are displayed on the LED. If the LED display is blank and all the power supplies are normal, there is something wrong with the LED or the driver. If the LED has a number other than zero, there might be a problem with the SRAM.

The CODEC data is received and immediately retransmitted, so the microphone input is echoed back the headphones. If there is no output or if the output doesn't sound like the input, there is a problem. If there are no other fault indications and the microphone and speaker are working, there might be a problem with the CODEC. If nothing happens and the power supplies are normal, there might be a problem with the digital signal processing chip or the EPROM.

### Where to go from here

The VFX processor is intended to demonstrate in, an enjoyable way, the capabilities of

digital signal processing. The four applications programmed into the VFX board are just four out of many possible applications. The VFX processor hardware is capable of being reprogrammed to perform other functions as well. Some of the possibilities are speech recognition, active noise cancellation, voice compression/recording, and a spectrum-shifting hearing aid.

For example, the VFX processor could easily recognize the numbers from 0 to 9 and display them on the LED indicator. That requires that the speech be converted into the frequency domain and the spectral peaks of the sound be compared with pre-stored templates. The closest matching sound is selected and displayed on the LED. The processor could then generate the DTMF signals for that number to make a voice-activated telephone dialer.

A voice compressor/recorder converts an audio input into the frequency domain, picks out the most prominent spectral energies, and stores them in data memory as frequency and amplitude. The technique can reduce the amount of data that must be stored compared to that from conventional digitizing processes from 6.5K words per second to 650 to 300 words per second. The VFX board with 8K words can record approximately 12 to 25 seconds of compressed speech.

Active noise cancellation is being developed for applications ranging from muffling the sound of automobile engines and industrial machines to eliminating the background hissing noise in fighter-aircraft intercom-system headphones. Similar applications for the VFX board are being developed. Let us know if you have any other applications you would like programmed into the VFX processor. If you are interested in programming your own applications, look into the EZ-LAB system sold by Analog Devices that has been referenced in this article. It is an affordable way to implement small- to medium-sized algorithms. R-E



# DRAWING BOARD

## Video scrambling.

ROBERT GROSSBLATT

Looking at a line of video on an oscilloscope or waveform monitor can be a real eye opener. As we discuss the various factors involved in video scrambling, you'll need a good understanding of video to follow along. You'll also need some equipment to view the waveform, other than on a TV set. For a good background on video, get your hands on the series of Drawing Board columns I did on video from January to November 1990. You'll probably be able to find them in your library if you don't have the back issues.

The starting point for any would-be unscrambler (hereinafter referred to as "us") is that scramblers (hereinafter referred to as "them") start out with a signal that's exactly the one we want to wind up with. Video originates in the clear, gets messed up one way or another by them, and is sent to us. Our job is simply to undo what they've spent a lot of money doing.

You don't have to be a rocket scientist to mess up video—that is true both aesthetically and scientifically. The hard part is to do it in such a way that you can put it back together again. This means that there has to be a rigorous approach—almost a mathematical one—to tearing the signal apart.

Take a look at—and get intimately familiar with—the typical line of video shown in Fig. 1. While most of the time on the line is devoted to the picture area, it's the control area where the real work is done. The signal in the picture area determines what you'll be seeing on the screen but the stuff in the control area is what tells your TV where to put the picture and how it's supposed to appear.

The control area is blown up in Fig. 2, and the information in it is a graphed function of time and voltage. By the way, most video people

like to talk about "units of video" rather than voltage for the same reason that audio people like to talk about decibels rather than voltage.

When the NTSC video standard was established, the two most basic decisions made were that it would range from 0 to 1 volt peak-to-peak, and that one voltage range would be reserved for picture and one would be reserved for control. As we go through our discussion on scrambled video, I'll talk sometimes about video in terms of IRE units and other times about voltage. The

two are directly related as shown on the Y axis of Fig. 2.

The bottom line of the picture is 0 IRE units which is about 0.3 volts  $\uparrow$  on the IRE scale. That point is important because it's both the defined level for black video (no picture on the screen) and the upper limit for any control signals. (There's a slight ambiguity here when you examine the colorburst but we'll get to that later.) For the moment, we can consider everything above 0.3 volts as picture and everything below that as non-picture.

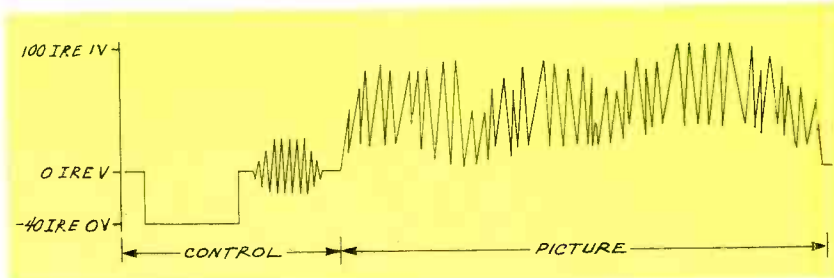


FIG. 1—TYPICAL LINE OF VIDEO. Most of the line is devoted to the picture area, but it's the control area that we're interested in.

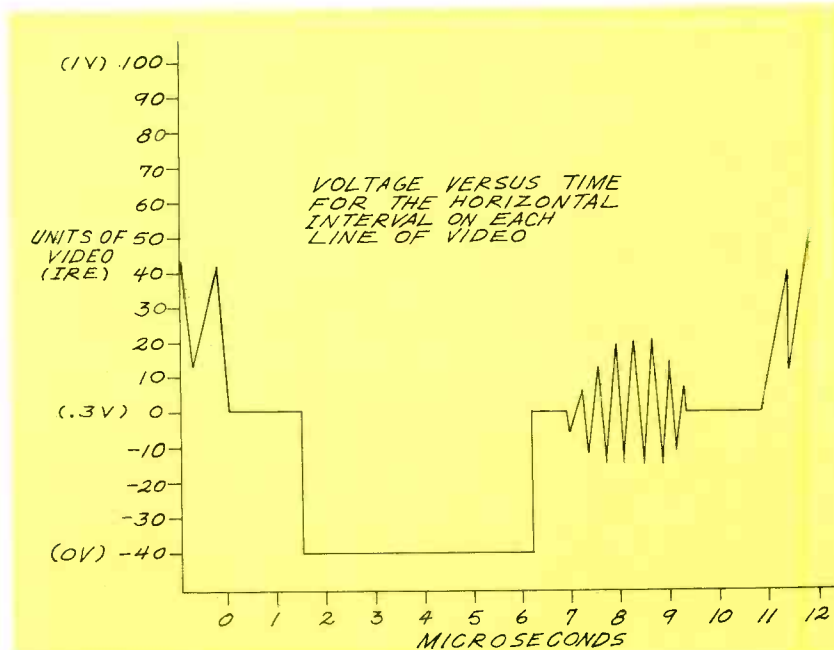


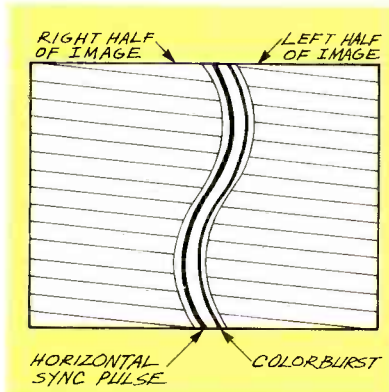
FIG. 2—THE CONTROL AREA. The NTSC video standard says that the signal can range from 0 to 1 volt peak-to-peak.

That signal definition is the basis for most of the hardware in every NTSC-compatible TV ever made. Your TV contains circuitry that expects control information to be below 0.3 volts and picture information from 0.3 to 1 volt. That's important because it is the starting point for scramblers; when you get rid of some of the control information, a standard TV can't display the picture. Remember that the horizontal sync pulse defines the end (or, depending on your point of view, the beginning) of a line of video. If the TV doesn't see it, it won't know how to display the line on the screen, and the result will be that the TV will end one line and start another one at some random point on the screen.

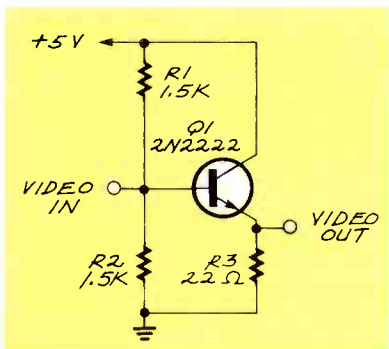
The freewheeling retrace frequency of the TV will come close to the one sent by the broadcaster, but it won't match exactly. What you'll see on the screen will be something like Fig. 3. The curved line running down the center of the screen is the horizontal interval sent by the broadcaster.

Three things are happening in Fig. 3. The first is that the line is curved because the horizontal circuitry in your TV runs at a frequency that's not exactly the same as the broadcast horizontal frequency. The TV can accept a certain amount of drift in the horizontal frequency. Once upon a time a horizontal control was built into on the TV so you could hand tune the TV to the received signal. Although that control isn't around any longer (except sometimes as a trimmer on a circuit board inside the TV), the tolerance is still there. Modern TV's can automatically lock onto the broadcast horizontal frequency so there's no reason for the horizontal control to be accessible.

The second thing that's happening is that the line is in the center of your screen. The reason for that is simple. The TV's horizontal circuit uses the received horizontal pulse as an instruction to move the beam back to the left side of the screen. Because the scrambled signal has anything but a recognizable horizontal sync pulse, the TV zips the line back to the left side of the screen whenever it reaches the right side.



**FIG. 3—A FREEWHEELING RETRACE won't match the frequency sent by the broadcaster. The curved line running down the center of the screen is the horizontal interval sent by the broadcaster.**



**FIG. 4—A VIDEO BUFFER isolates one stage of hardware from another. The transistor is set up as a buffer and the level of the video can be controlled by the value of R2.**

Because that has nothing to do with the signal it's receiving, the line usually shows up at some random spot on the screen. The TV's freewheeling frequency is close to the broadcast horizontal frequency, so the TV will start a new line at about the same point in the broadcast line. That means you'll see the broadcast horizontal interval on each line at more or less the same horizontal location on the screen. The result is a curved line down the screen.

The third thing happening on the TV screen is that the colors are messed up. Because the horizontal sync is missing, the TV circuitry isn't seeing the colorburst in the right place, so there's no reference for either the intensity or color of the picture. The TV then uses whatever it sees in the colorburst location as a reference for both the intensity and color of the image.

You can see now that by simply getting rid of horizontal sync, the

resulting video signal will be completely messed up. The best way to appreciate that, and a good way to get into video hardware, is to build something to demonstrate how all this stuff really happens. That's right, our first piece of hardware is going to be something that will let you scramble video. And, as far as the law is concerned, I'm pretty sure that nobody's going to become very upset.

We'll need a source of real video. That can be anything from an NTSC generator to a line-level video signal from the back of a VCR. You'll also need a scope to look at the video waveform and a TV to look at the picture. You can do without the latter but the former is a must. I'm not going to beat you up any more about getting a scope, but if you don't have one, get one. If you don't get one, this series of columns, while informative, will be somewhat less than useful from a practical point of view.

To get started, because we're building circuitry that is going to use an external signal, the first thing we have to do is buffer it. That is done for two reasons. The first is that we have to be able to control the level seen by our video circuitry, and the second is so that a wiring error on the breadboard isn't going to send unpleasant voltages back to the signal generator or VCR. The results could be a bit nasty.

Video buffers are just like any other buffer—they're simple circuits that isolate one stage of hardware from another. Think of it as being like an electronic fuse. The easiest way to build a buffer is with a single transistor as shown in Fig. 4. The transistor is set up as a buffer, and the level of the video can be controlled by the value of R2. You can also put a potentiometer in series on the line feeding the video to the base of the transistor and trim the level that way.

Although the NTSC video standard calls for a signal that's 1-volt peak-to-peak, most VCR manufacturers don't strictly follow that standard when it comes to a video output signal. If you put the signal on a scope, you'll probably find that it's a bit higher than that. If that's the

*continued on page 109*



# COMPUTER CONNECTIONS

## The Cheshire Cat, multimedia, and vision.

JEFF HOLTZMAN

**V**ision, according to the American Heritage Electronic Dictionary, can be defined in five ways: 1. The faculty of sight. 2. Unusual foresight. 3. A mental image produced by the imagination. 4. Something, as a supernatural sight, perceived through unusual means. 5. One of extraordinary beauty.

In the business world, definition 2 is what people usually think of. Actually, definition 3 is most important. Persons with unusual foresight help bridge short-term gaps between today and tomorrow. Persons with imagination set long-term goals and directions, and inspire others to try to move in those directions to achieve those goals. Companies are typically founded by Type-3 people, and run by Type-2's.

Starting about 250 years ago during the dawn of the industrial revolution, technical vision and imagination in the western world focused on building tangible items to ease the time involved in producing, transporting, and defending necessities. After about 200 years of widespread social effort, most of those problems were solved, so persons with visionary imagination shifted focus to a different set of problems. From these origins was born the computer industry.

Early work in that field centered on doing the same kinds of activities people had been doing—e.g., accounting and typing—only faster. Things started to get interesting when Ted Nelson, Doug Englebart, and others realized that the computer had created a whole new world, a "virtual" world. Again the American Heritage, this time on virtual image: *An image from which rays of reflected or refracted light appear to diverge, as from an image seen in a plane mirror.*

There is a virtual world behind the CRT, from which *imaginary* light rays are diverging, rays that until recently

were visible only to mathematicians, computer scientists, and software engineers. Now, thanks to Nelson and company, and more recently to video games and the Macintosh (and let's not forget Microsoft Windows), that Cheshire cat image is becoming accessible to more and more people.

Graphics editors let artists reach in and take hold of some of that virtual Play-Dough a proprietary term. On-line references let writers and researchers tap into the knowledge of the world. Three-D CAD programs let architects and product designers "build" prototypes without cutting wood or metal. Medical imaging devices let medical technicians and researchers non-intrusively create images of body parts. Serious and popular composers use synthesizers to create new musical forms.

Computer technology has penetrated many disciplines, but it still has a long way to go. Take video editing for one. The traditional method for editing videotape and film is to do a lot of physical fast-forwarding and rewinding. The efficient way to do the job is via random access, instantly jumping from any frame to any other. Due to the immense storage required for video information, effective random access completely dwarfs the storage and bandwidth capabilities of today's most powerful personal computers and low-cost networks.

### Multimedia

This is where Type-3 vision comes in. That vision centers around a topic of growing public interest: multimedia. Don't be misled by popular computer, video, and games magazines. Multimedia is not just putting a sound board in a PC, or adding a CD-ROM drive to a Nintendo. The real promise behind multimedia is twofold: 1) To bring the whole world into that virtual image

behind the CRT, and 2) To connect your virtual image to mine and everyone else's.

The requirements for rich multimedia are simple: 16-bit audio, full-screen 30-frame-per-second video, 24-bit (photographic-quality) imaging, fast access to lots of textual and numeric data—all of which must be available on-demand, synchronously, instantaneously, at any time, and (eventually) anywhere in the world.

It would take a powerful mainframe to provide that kind of capability today. On the other hand, a run-of-the-mill 486 today exceeds the computational power of a mainframe of a decade ago. Assume then that within the next decade, "computers" that meet those requirements become available. Those "computers" will have built-in general-purpose digital signal processors (DSP's) for compressing and decompressing audio and video data, and for doing fax and modem chores as well. Semiconductor memory will be measured in the gigabytes, and permanent storage will be measured in the terabytes (on *personal* computers; mainframes will have even more). Optical storage may finally, after decades of promise, become cost effective.

Tomorrow's computers will have built-in connectivity to office systems, commercial databases, entertainment banks, and interactive educational courseware. Transmission speeds of these new networks will make Ethernet and Token Ring look like box turtles.

Those systems will have built-in docking technology (both hardware and software) for portable notepad/planner systems based on today's fledgling pen-input technology. They will have lightweight, flat, high-resolution, true-color displays—and printers—and will accept keyboard and pen input indiscriminately. They will communicate via a universal dig-

ital communications system that will probably come about as some sort of joint venture between AT&T, the cable TV companies, the independent networks (CNN, FNN, Fox), media giants like Time-Warner, and major computer companies.

There will be gobs and gobs of data flowing around, and lots of confusion about who owns rights to what. New kinds of copyright issues will keep lawyers busy for the next century. Students and researchers will have unprecedented opportunities to cheat. Illegal data tapping and decoding (akin to today's cable TV descramblers) will provide a data underground and new forms of law enforcement (the Data Police).

That technology will not replace today's TV, VCR, stereo system, video game, fax, telephone, or computer. However, those technologies will come to be seen as modular, interoperable pieces of a larger system in which all the pieces can plug and play—for those who want to.

From this perspective, multimedia begins to look like *everything* connected with computers, consumer electronics, and entertainment. Grandiose? Maybe. But ask yourself why IBM is contemplating a half-billion dollar deal with Time-Warner, why IBM and AT&T are both working like crazy to get fiber-optic data rates to work over copper cabling, and why Apple is partnering with Sharp and Microsoft with Sony.

Personal computers revolutionized typing, accounting, and publishing in the 80's. The 90's will see even more radical and pervasive changes.

That's the vision. Question: How will you participate?

### Product watch

For years the phrase "reasonably priced tape backup" was a contradiction in terms, but that is no longer the case. Figure 1 shows one of the best deals around: the Jumbo 250 from Colorado Memory Systems. It's a high-quality 250-megabyte QIC-80 tape drive that can fit in a 3.5 inch or 5.25 inch bay, and it runs off a standard floppy-disk controller.

The Jumbo 250 includes a special cable adapter that runs from the drive to the floppy controller; the cable from the floppy drive(s) plugs



FIG. 1—COLORADO'S JUMBO 250 packs 250 megabytes of data on a \$20 tape cartridge in less than two hours.

into the Jumbo's cable. Other than mounting the drive and copying software to your hard disk, that's the extent of installation.

Backup software included with the drive runs in both menu-driven and command-line modes; the latter allows unattended backup via scheduled batch files. If hard-disk capacity exceeds that of a tape, the software will store additional data on additional tapes. In addition, the software has several options, including password protection, the ability to back up and restore Novell NetWare bindery (user access rights) files, and several types of software-based data compression. Using compression is faster than not using it; I have no trouble backing up about 170 megabytes of data on a single tape in less than an hour.

You can use the menu-driven mode to create a tag list, or list of files to back up, and then use the command-line mode to back up the files on the list. One nice feature is its ability to append multiple backup volumes to the same tape, which gives you the ability to perform daily backups simply and quickly. My main complaint with the software is that it forces you to restore files to their original locations. Sometimes, especially in a networked environment, it's helpful to be able to restore files elsewhere.

Many installation options are available, including a case for external mounting, numerous special cable and connector arrangements for special PC's (such as PS/2's), and several dedicated tape-controller boards that provide increased

speed and hardware data compression. Colorado also sells software to control the drive under several varieties of Unix (SCO, Interactive, AT&T, and Intel).

The drive includes a one-year warranty, toll-free technical support, and access to a BBS. If you shop around, you can pick one up for \$250 mail order. By way of comparison, just a few years ago my trusty 80-megabyte Irwin backup unit cost three or four times that amount. For small offices and Windows power users, this is a must-have item.

For more power and flexibility in tape backup software, check out Sytos Plus. It has several nice features, including the ability to work with multiple devices, including the Colorado, numerous digital audio tape (DAT) and 8mm formats, IBM's optical read/write disk, and hard and floppy disks; others are being added all the time.

Sytos also supports OS/2, whereas Colorado does not (yet). Sytos is routinely bundled with numerous high-capacity tape drives; the company claims more than a million users.

Probably the nicest feature is Sytos' more integrated way of creating backup sets. Whereas Colorado's TAPE.EXE forces you to create tag lists and then manually create batch files with numerous parameters, Sytos allows you (in the menu mode) to create "procedures" containing both tag list and configuration options, and then run various procedures from the command line.

Sytos also has more extensive



documentation than Colorado. It covers different kinds of backups, and methods for creating backup schedules.

Sytos will allow you to restore files from tape to new locations with new names; the only feature it lacks (and that Colorado supplies) is a gauge that indicates progress in formatting a tape.

### News bits

What's larger than a calculator and smaller than a notebook PC? Better yet, what's the size and weight of a paperback book, has a 32-bit RISC processor, a multitasking, object-oriented operating system, and a 6- x 3-inch LCD screen for pen input and visual display? Easy: Apple's Newton, the first handheld device for jotting, sketching, scribbling, figuring, doodling, making lists, and subsequently moving that data to a larger computer or another user via fax, modem, or network. Initial specs include flash EPROM, 1 to 20 megabytes of RAM, PCMCIA expansion cards, sound output, an infrared data link to other Newtons and desktop Macintoshes, and wired links to both Macs and PC's. In addition to the text and graphics doodle pad, Newton will have an address book, scheduler, and an intelligent assistant that will understand and act on commands like "fax this story to Brian." Newton is scheduled for release around January of 93, and reportedly will cost \$500-\$1000. There are also rumors of another Apple-developed handheld, this one called Sweet Pea, with CD-ROM and the ability to play QuickTime scripts. It sounds a lot like the device Microsoft is developing with Sony.

IBM has publicly demonstrated FDDI running on copper shielded twisted pair (STP) cabling, thus paving the way for a potential ten-fold increase in bandwidth to desktop computers—and other devices. Not to be outdone, AT&T Paradyne has announced a similar technology, with claims that it could spur the nascent multimedia industry by delivering on-demand and interactive video services.

Nintendo and Sega are going at it neck and neck, and in the process,

### PRODUCTS DISCUSSED

- Jumbo 250, Colorado Memory Systems, 800 South Taft Ave., Coveland, CO 80537, (303) 669-8000.
- Sytos Plus, Sytron Corporation, 124 Flanders Road, P.O. Box 5025, Westboro, MA 01581-5025. (508) 898-0100.

taking a pot-shot at the computer industry. Sega plans to introduce two places by Thanksgiving a \$300 CD-based game that delivers quality audio and live-action video; Nintendo plans to introduce a similar \$200 unit early next year. Sega is working with Sony to produce games related to movies, e.g., Spielberg's *Jurassic Park*. Early reports indicate that Sega's device will include only half-speed, quarter-screen animation, whereas the Nintendo unit will do a full 30 frames per second.

R-E

## BIG PROFITS IN VIDEO REPAIR!

WORK FROM HOME-EARN \$85 HR!

With the tens of millions of VCRs and Camcorders in use, there currently is a **serious shortage** of trained techs to perform cleaning and repair jobs on these popular devices...

Learn how you can start your own **highly profitable, Home-Based** video servicing business...

And since up to 95% of all VCR and Camcorder malfunctions

are due to a simple **mechanical or electro-mechanical**

failure, you need not spend months or even years of complicated study before starting **paid, professional service work!**

Let Viejo's Training Program show you how!

**1-800-537-0589**

or mail coupon today!

CALL TOLL-FREE

Train at Home in your Spare Time!

### VIEJO PUBLICATIONS, INC.

4470-107 Sunset Blvd., Suite 600  
Dept. VK Los Angeles, CA 90027

Yes! **Rush** me your **FREE OPPORTUNITY KIT** today!  
(Check appropriate box)

- VCR Repair
- Camcorder Repair
- Advanced VCR Repair
- Fax Machine Repair

Name \_\_\_\_\_

Address \_\_\_\_\_

City/State \_\_\_\_\_

Zip \_\_\_\_\_

Dept. RL \_\_\_\_\_

CIRCLE 179 ON FREE INFORMATION CARD

Try the

## Electronics NOW<sup>®</sup>

bulletin board system

(RE-BBS)

516-293-2283

The more you use it the more useful it becomes.

We support 1200 and 2400 baud operation.

Parameters: 8N1 (8 data bits, no parity, 1 stop bit) or 7E1 (7 data bits, even parity, 1 stop bit).

Add yourself to our user files to increase your access.

Communicate with other R-E readers.

Leave your comments on R-E with the SYSOP.

RE-BBS  
516-293-2283

## SUPER LONG PLAY TAPE RECORDERS

12 Hour Model —  
USES 120 TAPE  
\$119.00\*

Modified Panasonic Slimline, high quality AC-DC provide 6 continuous hours of quality recording & playback on each side of cassette for 12 hours total. Includes • Voice level control • Digital counter, etc. TDK - 120 Cassette Furnished.



### PHONE RECORDING ADAPTER

Records calls automatically. All Solid state connects to your telephone jack and tape recorder. Starts recording when phone is lifted. Stops when you hang up.

\$28.50\*  
FCC APPROVED

### VOX VOICE ACTIVATED CONTROL SWITCH

Solid state. Self contained. Adjustable sensitivity. Voices or other sounds automatically activate and control recorder. Uses either recorder or remote mike.

\$28.50\*

\* Add for ship. & handling Phone Adapter & Vox \$2.00 each  
Recorders \$5.00 each. Calif. Res. add tax. Mail order. VISA, MIC, COD's OK. Money Back Guarantee. Quantity discounts available. Dealer inquiries invited. Free data

AMC SALES INC. Dept. A 9335 Lubec Street  
Box 928, Downey, CA 90241  
Phones (310) 869-8519 1-800-926-2488  
FAX (310) 923-1478  
Mon-Fri 8-5 PAC TIME

CIRCLE 108 ON FREE INFORMATION CARD

## SLOPING VEE ANTENNA

continued from page 78

phosphor-bronze wire is preferred over stranded copper or aluminum wire because its spring qualities avoid kinks. It is almost impossible to tangle this kind of wire, especially important if you want a field-transportable antenna system. Nevertheless, if phosphor-bronze wire is too expensive (about \$2 per foot) or difficult for you to obtain stranded copper or aluminum wire can be substituted. The shorting wire was 16 AWG bare, stranded-copper wire.

Solder all connections if the antenna installation is permanent. But if you plan to set up and take down the antenna frequently, be sure that there are clean metal-to-metal mechanical connections between all conductive components.

The terminating resistors

must be capable of handling a significant amount of power if the antenna is to be used for transmission. Non-inductive carbon-film power resistors, rated for 300 ohms  $\pm 10\%$ , were specified for the test antenna. They had measured DC resistances of 307 and 314 ohms. As a general rule, the resistor power dissipation rating should be 10 to 20% of the maximum transmitter output power. Check the termination resistors for overheating.

For receiver-only applications, almost any low-power dissipating resistor with the correct resistance value will be satisfactory. The test sloping-vee antenna showed good VSWR performance and reception with 300-ohm, 1/4-watt carbon resistors.

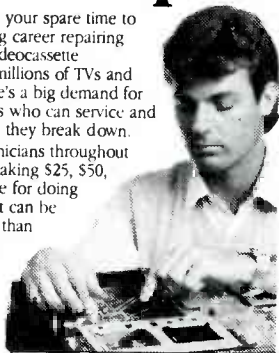
The measured impedance bandwidth of the 15 to 50 MHz vee is shown in Fig. 14. A network analyzer measured the input VSWR of about 150 feet of

RG-213/U coaxial cable and it was below 2:1 at all frequencies between 10 and 60 MHz; it was particularly good between 14 and 30 MHz. The undulations in the VSWR curve shown in Fig. 14 were caused by the transmission line's frequency-dependent transformer action acting on the sloping vee-input impedance.

VSWR measured directly at the antenna input is slightly higher because cable loss lowers VSWR. This measurement was made, and the VSWR was just over 2:1 in the following bands: 38 to 40 MHz; 44 to 47 MHz; and 52 to 57 MHz. At all frequencies below 58 MHz, the sloping vee's input VSWR was less than 2.5:1. The test antenna easily exceeded the bandwidth design objective, and it provides very good broadband performance. In field tests the slope vee performed well as a transmitter antenna down to frequencies of about 4 MHz. R-E

## Make Money in TV/VCR Repair!

Train at home in your spare time to start a high-paying career repairing televisions and videocassette recorders. With millions of TVs and VCRs in use, there's a big demand for skilled technicians who can service and repair them when they break down. TV and VCR technicians throughout the country are making \$25, \$50, even \$100 or more for doing simple repairs that can be completed in less than an hour and often cost very little in parts and equipment. These include replacing TV tuners, power supplies & tubes and replacing VCR drive belts, pinch rollers & motors. We show you how to do all of these and much more.



MAIL COUPON TODAY FOR FREE INFORMATION!

You get practical, hands-on training with special tools that are included with your course. Everything is explained in easy-to-understand language so that even someone with no previous experience can master TV/VCR repair. Send for FREE facts about the exciting opportunities in TV/VCR repair and find out how you can start making money in this great career.



### School of TV/VCR Repair

925 Oak Street, Scranton, PA 18515, Dept. ADE082S

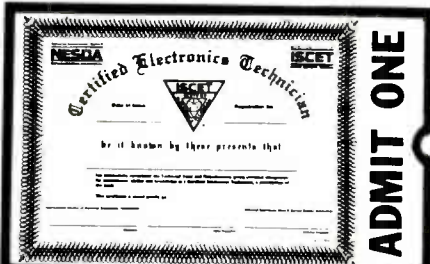
Please send me free facts on how I can learn TV/VCR repair at home in my spare time. I understand there is no obligation and no salesman will visit me.

Name \_\_\_\_\_ Age \_\_\_\_\_

Address \_\_\_\_\_ Apt. # \_\_\_\_\_

City/State/Zip \_\_\_\_\_

Phone ( \_\_\_\_\_ ) \_\_\_\_\_



## Your Ticket To

# SUCCESS

Over 28,000 technicians have gained admittance worldwide as certified professionals. Let your ticket start opening doors for you.

ISCET offers Journeyman certification in Consumer Electronics, Industrial, Medical, Communications, Radar, Computer and Video. For more information, contact the International Society of Certified Electronics Technicians, 2708 West Berry Street, Fort Worth, TX 76109; (817) 921-9101.

Name \_\_\_\_\_

Address \_\_\_\_\_

City \_\_\_\_\_

State \_\_\_\_\_ Zip \_\_\_\_\_

Send material about ISCET and becoming certified.

Send one "Study Guide for the Associate Level CET Test." Enclosed is \$10 (inc. postage).

## Cable TV Article Parts

We stock the exact Parts & PC Board for an article published in Radio Electronics Magazine on building a Snooper Stopper.

Snooper Stopper Kit.....\$19.95  
Includes all the original Parts & Etched, Drilled Silk-Screened PC Board.

Snooper Stopper.....\$39.00  
This is an assembled and tested fixed frequency 106.5Mhz. Snooper Stopper for most Jemold systems.

Protect yourself from descrambler detection and stop the Bullet with one of our Snooper Stoppers.

Macrovision..now you see it, now you don't.

Macrovision Kit.....\$29.00  
Includes all the original Parts & Etched, Drill Silk-Screened PC Board. Originally Published in Radio Electronics Magazine.

Call Toll Free 1-800-886-8699

Visa, MasterCard or COD

Northeast Electronics, Inc.  
PO Box 3310  
N. Attleboro, Ma. 02761

CIRCLE 186 ON FREE INFORMATION CARD



# BUYER'S MART

## FOR SALE

**CABLE Stealth:** protect yourself from descrambler detection and stop the "bullet". Preset/ tested, only \$24.99, \$4.00 S&H, **BALDWIN ELECTRONICS**, Box 9291, Baltimore, MD 21222-0291.

**CABLE TV converters:** Jerrold, Oak, Scientific Atlantic, Zenith & many others. "New MTS" stereo add-on: mute & volume. Ideal for 400 and 450 owners! 1 (800) 826-7623, Amex, Visa, M/C accepted. **B & B INC.**, 4030 Beau-D-Rue Drive, Eagan, MN 55122.

**TUBES**, new, up to 90% off, SASE, **KIRBY**, 298 West Carmel Drive, Carmel, IN 46032.

**T.V. notch filters**, phone recording equipment, brochure \$1.00. **MICRO THinc**, Box 63/6025, Margate, FL 33063. (305) 752-9202.

**SPEAKER repair.** All makes — models. Stereo & professional. Kits available. Refoaming \$18.00 **ATLANTA AUDIO LABS**, 1 (800) 568-6971.

**ENGINEERING software and hardware**, PC/MSDOS. Circuit design and drawing, PCB layout, FFT analysis, mathematics, circuit analysis, etc. Data acquisition, generation, I/O PCB's, etc. Call or write for free catalog. (614) 491-0832, **BSOFT SOFTWARE, INC.**, 444 Colton Rd., Columbus, OH 43207.

**CABLE TV Equipment.** Most type available. Special: Oak M35B \$39.95. No catalog. COD orders only. 1 (800) 822-9955.

## CLASSIFIED AD ORDER FORM

To run your own classified ad, put one word on each of the lines below and send this form along with your check to:

**Electronics Now Classified Ads**, 500-B Bi-County Boulevard, Farmingdale, NY 11735

**PLEASE INDICATE** in which category of classified advertising you wish your ad to appear. For special headings, there is a surcharge of \$25.00.

( ) Plans/Kits ( ) Business Opportunities ( ) For Sale  
( ) Education/Instruction ( ) Wanted ( ) Satellite Television  
( ) \_\_\_\_\_

Special Category: \$25.00

**PLEASE PRINT EACH WORD SEPARATELY, IN BLOCK LETTERS.**

(No refunds or credits for typesetting errors can be made unless you clearly print or type your copy.) Rates indicated are for standard style classified ads only. See below for additional charges for special ads. **Minimum: 15 words.**

1	2	3	4	5
6	7	8	9	10
11	12	13	14	15 (\$46.50)
16 (\$49.60)	17 (\$52.70)	18 (\$55.80)	19 (\$58.90)	20 (\$62.00)
21 (\$65.10)	22 (\$68.20)	23 (\$71.30)	24 (\$74.40)	25 (\$77.50)
26 (\$80.60)	27 (\$83.70)	28 (\$86.80)	29 (\$89.90)	30 (\$93.00)
31 (\$96.10)	32 (\$99.20)	33 (\$102.30)	34 (\$105.40)	35 (\$108.50)

We accept MasterCard and Visa for payment of orders. If you wish to use your credit card to pay for your ad fill in the following additional information (Sorry, no telephone orders can be accepted.):

Card Number \_\_\_\_\_

Expiration Date \_\_\_\_\_

Please Print Name \_\_\_\_\_

Signature \_\_\_\_\_

**IF YOU USE A BOX NUMBER YOU MUST INCLUDE YOUR PERMANENT ADDRESS AND PHONE NUMBER FOR OUR FILES. ADS SUBMITTED WITHOUT THIS INFORMATION WILL NOT BE ACCEPTED.**

**CLASSIFIED COMMERCIAL RATE:** (for firms or individuals offering commercial products or services) \$3.10 per word prepaid (no charge for zip code). **MINIMUM 15 WORDS.** 5% discount for same ad in 6 issues; 10% discount for same ad in 12 issues within one year; if prepaid. **NON-COMMERCIAL RATE:** (for individuals who want to buy or sell a personal item) \$2.50 per word, prepaid...no minimum. **ONLY FIRST WORD AND NAME** set in bold caps at no extra charge. Additional bold face (not available as all caps) 55¢ per word additional. Entire ad in boldface, \$3.70 per word. **TINT SCREEN BEHIND ENTIRE AD: \$3.85 per word. TINT SCREEN BEHIND ENTIRE AD PLUS ALL BOLD FACE AD: \$4.50 per word. EXPANDED TYPE AD: \$4.70 per word prepaid.** Entire ad in boldface, \$5.60 per word. **TINT SCREEN BEHIND ENTIRE AD PLUS ALL BOLD FACE AD: \$6.80 per word. DISPLAY ADS:** 1" x 2 1/4"—\$410.00; 2" x 2 1/4"—\$820.00; 3" x 2 1/4"—\$1230.00. **General Information:** Frequency rates and prepayment discounts are available. **ALL COPY SUBJECT TO PUBLISHERS APPROVAL. ADVERTISEMENTS USING P.O. BOX ADDRESS WILL NOT BE ACCEPTED UNTIL ADVERTISER SUPPLIES PUBLISHER WITH PERMANENT ADDRESS AND PHONE NUMBER.** Copy to be in our hands on the 5th of the third month preceding the date of the issue. (i.e., Aug. issue copy must be received by May 5th). When normal closing date falls on Saturday, Sunday or Holiday, issue closes on preceding working day. Send for the classified brochure. Circle Number 49 on the Free Information Card.

★★★★ PRESENTING ★★★★★

## CABLE TV DESCRAMBLERS

★★★★ STARRING ★★★★★

### JERROLD, HAMLIN, OAK

AND OTHER FAMOUS MANUFACTURERS

- FINEST WARRANTY PROGRAM AVAILABLE
- LOWEST RETAIL / WHOLESALE PRICES IN U.S.
- ORDERS SHIPPED FROM STOCK WITHIN 24 HRS
- ALL MAJOR CREDIT CARDS ACCEPTED

**FOR ALL INFORMATION**  
1-800-345-8927

**PACIFIC CABLE CO., INC.**  
7325 1/2 Reseda Blvd., Dept. 2118  
Reseda, CA 91335

**80C52-Basic microcontroller board.** Basic interpreter, 32K RAM, 16K Eprom, Eprom programmer, RS232, expansion connector. Bare board with manual, schematics \$22.95. **80C52-Basic microprocessor chip \$25.95.** Assembled and tested \$124.95. **PROLOGIC DESIGNS**, PO Box 19026, Baltimore, MD 21204.

**JERROLD, Tocom and Zenith "test" chips.** Fully activates unit. \$50.00. Cable descramblers from \$40.00. Orders 1 (800) 452-7090. Information (310) 867-0081.

**TOCOM-Jerrold Impulse-Scientific Atlanta Converters,** two year warranties, also test modules for your converters. Contact **NATIONAL CABLE**, (219) 935-4128 full details.

**Quality Microwave TV Antennas**

WIRELESS CABLE - IFTS - MMDS - Amateur TV  
Ultra High Gain 50db(+) • Tuneable 1.9 to 2.7 Ghz.

- 55-Channel Dish System \$199.95
- 36-Channel Dish System \$149.95
- 20-Channel Dish System \$124.95
- Optional Commercial Grid Antenna (not shown) Add \$50.00
- Yagi Antennas, Components, Custom Tuning Available
- Call or write (SASE) for "FREE" Catalog

**PHILLIPS-TECH ELECTRONICS**  
P.O. Box 8533 • Scottsdale, AZ 85252  
(602) 947-7700 (\$3.00 Credit all phone orders)

LIFETIME WARRANTY MasterCard • Visa • American Express • COD's • Quantity Pricing

**PROTECT** yourself and equipment from electrical shocks. Complete unit \$98.95. **SAFETY-UNLIMITED**, 1743 Baldwin Road, Yorktown, NY 10598. S/H \$5.00.

**SCIENTIFIC Atlanta 8500 series** as low as \$129.00, Starcom 6 as low as \$149.00. All makes in stock. **S.A.C.** 1 (800) 622-3799.

## CB RADIO OWNERS!

We specialize in a wide variety of technical information, parts and services for CB radios. 10-Meter and FM conversion kits, repair books, plans, high-performance accessories. Thousands of satisfied customers since 1976! Catalog \$2.

### CBC INTERNATIONAL

P.O. BOX 31500RE, PHOENIX, AZ 85046

**TEST-Aids** for testing units in full service mode. Starcom VII, \$40.00; Starcom VI, \$30.00; Starcom DPBB, \$50.00; Pioneer, \$75.00; Tocom VIP 5503/5507, \$25.00; S.A. call; Zenith, \$25.00; N.E. ENGINEERING, (617) 770-3830.

**CABLE test chips** S-A 8550, S-A 8500 — 310, 311, 320, 321 (specify) — \$33.95. S-A 8580/338 — \$69.95. Tocom 5503/07 VIP — \$33.95. Starcom 6 — \$33.95. Starcom 7 — \$49.95. **TELECODE**, PO Box 6426-RE, Yuma, AZ 85366-6426.

**OSCILLOSCOPE** 50 MHz, Hewlett-Packard, solid state calibrated, manual \$290.00. 1 (800) 835-8335 X-159.

**SECRET cable descramblers!** Build your own descrambler for less than \$12.00 in seven easy steps. Complete instructions \$10.00. Radio Shack parts list and free descrambling methods that cost nothing to try included. **HARRYWHITE**, PO Box 1790D, Baytown, TX 77520.

## WIRELESS CABLE RECEIVERS 1.9 TO 2.7 GHz



VISA/MC/AMEX

30 CH PARABOLIC DISH SYSTEM \$173.90  
30 CH ROD ANTENNA SYSTEM \$193.90  
30 CH CRYSTAL CONTROLLED SYSTEM \$294.95  
SUN MICROWAVE INT'L. INC. SEND \$1.00 FOR  
P.O. BOX #34522 CATALOG ON THESE  
PHOENIX, AZ. 85067 AND OTHER FINE  
(602) 230-1245 VIDEO PRODUCTS  
QUANTITY DISCOUNTS  
ORDERS ONLY 1-800-484-4190 CODE 9793

**CABLE converters**, retail at wholesale prices. Overstock reduction sale. Example RTC-56 \$79.00 ea. Starcom 6 as low as \$149.00. All makes available. **MT. HOOD ELECTRONICS** (206) 260-0107.

**PREVENT** descrambler damage. Don't bite the bullet! Snooper stopper data blocker \$29.95. **VIDEO CONNECTIONS**, 1 (800) 933-3038.

**STARCOM 6**, Tocom, Oak, Pioneer, Scientific Atlanta, Zenith, as low as \$39.00. **KABLE CONNECTION** (702) 433-6959.



## RECEIVING TUBES

**OVER 3000 TYPES IN STOCK!**

Also hard-to-find transformers, capacitors and parts for tube equipment. Send \$2.00 for our 32 page catalog.

## ANTIQUE ELECTRONIC SUPPLY

6221 S. Maple Ave. • Tempe, AZ 85283 • 602-820-5411

**CABLE TV**, Zenith, Jerrod, Oak, Scientific Atlanta, Hamlin, Tocom, wholesale to all. **ULTIMATE CABLE PRODUCTS**, (702) 646-6952.

**PCB:** Printed circuit board art work made to your specifications plotted on transparency. Multi layer and surface component capable. Circuit board production available, free estimate send schematic to **NEGRON ENGINEERING**, 159 Garfield Place, Brooklynn, NY 11215. Fax (718) 768-4028.

**CABLE TV descramblers!** Absolutely the lowest prices! All major brands. Nobody beats our prices! **CABLE PRICE CLUB**, 1 (800) 377-9742.

**NO 800#** — no catalog — no bull! Just the best prices on Zenith and SA descramblers. Also available — turn-on kits, call (305) 425-4378.

**PRINTED** circuit boards. Plated, etched and machined to your design. Small runs OK. Call or write: **SHORE PRINTED CIRCUITS**, 36 Fairview Avenue, Little Silver, NJ 07739. (908) 747-6300, 1 (800) 752-1574, Fax (908) 747-6301.

**POWER** inverter 100% portable 115V AC 12V DC 100W from built in rechargeable battery 13 lbs \$185.00 plus \$10.00 S/H. Circuit and brochure only \$10.00 (Refundable when ordering inverter). **PROGRESS TECH**, 13222 Carolyn St., Cerritos, CA 90701.

**PC boards:** Professional quality, 30 day guarantee, beat all prices. **A & D**, PO Box 311, Auburn, MI 48611. (517) 662-6633.

**PLATED** thru hole printed circuits. \$25.00 minimum. Fast turnaround. For more information call **AP CIRCUITS**, (403) 250-3406 or BBS (403) 291-9342 (8,n,1).

## FREE CATALOG

**FAMOUS "FIRESTIK" BRAND CB ANTENNAS AND ACCESSORIES. QUALITY PRODUCTS FOR THE SERIOUS CB'er. SINCE 1962**

**FIRESTIK ANTENNA COMPANY**  
2614 EAST ADAMS  
PHOENIX, ARIZONA 85034

**TUBES:** "oldest," "latest." Parts and schematics. SASE for lists. **STEINMETZ**, 7519 Maplewood Ave., R.E., Hammond, IN 46324.

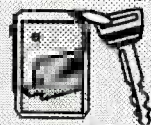
**RESTRICTED** technical information: Electronic surveillance, schematics, locksmithing, covert sciences, hacking, etc. **Huge selection. Free brochures.** **MENTOR-Z**, Drawer 1549, Asbury Park, NJ 07712.

## PLANS AND KITS

**FASCINATING** electronic devices! Dazers! Lasers! Transmitters! Detectors! Free energy! Tesla! Kits/Assembled! Catalog \$4.00 (refundable). **QUANTUM RESEARCH**, 17919-77 Ave., Edmonton, AB. T5T 2S1.

**HOBBY/broadcasting/HAM/CB/surveillance** transmitters, amplifiers, cable TV, science, bugs, other great projects! Catalog \$1.00. **PANAXIS**, Box 130-F9, Paradise, CA 95967.

## REMOTE CONTROL KEYCHAIN



Complete w/minic-transmitter and .5 vdc RF receiver Fully assembled including plans to build your own auto alarm! Check Visa or M/C  
**\$24.95** Add \$3 shipping  
5 @ \$19.95, 10 @ \$14.95

Visitect Inc. Box 14156, Fremont, Ca. 94539  
(510) 651-1425 Fax (510) 651-8454

**DESCRAMBLER** kits. Complete cable kit \$44.95. Complete satellite kit \$49.95. Add \$5.00 shipping. Free brochure. No New York sales. **SUMMIT RE**, Box 489, Bronx, NY 10465.

**VIDEOCIPHER II/satellite/scanner/cable/ amateur/cellular/repair manuals, modification books, software.** Catalog — \$3.00. **TELECODE**, PO Box 6426-RE, Yuma, AZ 85366-6426.

**KENWOOD & ICOM** service bulletins. 175+ pages covering all models. \$39.95. Catalog — \$3.00. CODs (602) 782-2316 / FAX (602) 343-2141. **TELECODE**, Box 6426-RE, Yuma, AZ 85366-6426.

**FREE!** Fabulous catalog of sensational kits. **LNS TECHNOLOGIES**, 20993 Foothill Blvd., Suite 307R, Hayward, CA 94541-1511.

**SURVEILLANCE, counter-surveillance, security devices.** Room and phone monitors, bug detectors, alarms, stunguns, etc. Send \$3.00 for catalog. **HOME VU MERCHANDISE**, Box 38371, Detroit, MI 48238.

**ROBOTICS**, Build-it-Yourself! Hobby, personal, & service robot types — designs, parts and plans. Catalog \$1.00, directory \$10.00. **IPC**, Suite 251RE, 1019-A Old Monrovia Rd., Huntsville, AL 35806.

## REMOVE LEAD VOCALS

From  
Records & CD's  
513-444-2276

Build this kit which removes lead vocals from standard stereo records, CD's, tapes or FM broadcasts. Sing along with the background music. Use with any home component stereo. Additional kit adds reverb to your voice, then mixes it with music. **Pre-assembled boards** also available. Call or write for free info. **Weeder Technologies**, 14773 Lindsey Rd., Mt. Orab, Ohio 45154.

**SURVEILLANCE** transmitter kits tune from 65 to 305 MHz. Mains powered duplex, telephone, room, combination telephone/room. Catalog with **Popular Communications, Popular Electronics and Radio-Electronics** book reviews of "Electronic Eavesdropping Equipment Design," \$2.00. **SHEFFIELD ELECTRONICS**, PO Box 377785-C, Chicago, IL 60637-7785.

**CELLULAR** hackers bible. Theory — hacks — modifications — \$53.95. **TELECODE**, PO Box 6426-RE, Yuma, AZ 85366-6426.

## SATELLITE TV

**FREE** catalog — Lowest prices worldwide. **SKYVISION**, 1012 Frontier, Fergus Falls, MN 56537. 1 (800) 334-6455. See full page ad the Shopper section.

**SATELLITE TV** — Do it yourself — major brands discounted, we'll beat everyone's price. Call **LARRY** (609) 596-0656.

## CABLE TV DESCRAMBLER LIQUIDATION!

**FREE CATALOG!**  
Hamlin Combos \$44, Oak M35B \$60 (min. 5), etc.  
**WEST COAST ELECTRONICS**

For information: 818-709-1758  
Catalogs & Orders: 800-628-9656

## BUSINESS OPPORTUNITIES

**YOUR** own radio station! Licensed/unlicensed AM, FM, TV, cable. Information \$1.00. **BROADCASTING**, Box 130-F9, Paradise, CA 95967.

**LET** the government finance your small business. Grants/loans to \$500,000. Free recorded message: (707) 449-8600. (KS1).

**MAKE** \$75,000.00 to \$250,000.00 yearly or more fixing IBM color monitors. No investment, start doing it from your home (a telephone required). Information, USA, Canada \$2.00 cash for brochure, other countries \$10.00 US funds. **RANDALL DISPLAY**, Box 2168-R, Van Nuys, CA 91404 USA. FAX (818) 990-7803.

**CONTINGENCY** patent licensing. No fees anytime. Three decades experience: law, technology, negotiations. **PROPAT INTERNATIONAL CORPORATION**, 441 Summer Street, Stamford, CT 06901. (203) 325-3344.

## BEST BY MAIL

Rates: Write National, Box 5, Sarasota, FL 34230

### OF INTEREST TO ALL

**RETIRE EARLY** 1-900-776-3348 CODE AB 5180 Mention Code (\$6.95).

**BURGLAR ALARMS! WHOLESALE.** Send \$5.00 For Amazing Catalogue. Global Security, 672 Oldmill Road, Suite 320, DPT(A), Millersville, MD 21108.

### BOOKS - CATALOGS - MAGAZINES

**UNLIMITED 2nd CREDIT FILE!** VISA  
CALL: 614-239-8284, Ext. 1

WRITE: 4th LIMITED • BOX 32431-RE • COL. OH 43232

**FAST CASH GUARANTEED!**  
WELCOME  
VETERANS - SELF-EMPLOYED  
ADP  
VISA



# Start a money-making career in video/audio servicing!

Only NRI gets you started fast with real-world training designed around state-of-the-art equipment you keep!

NRI's newly expanded training covers all the latest advances in home entertainment electronics, then takes you inside today's high-tech equipment as you learn to troubleshoot, diagnose, and service the complete home entertainment system included in your course: 13" color TV, programmable VCR, and integrated audio rack system. Only NRI makes it so easy to start a new career, earn part-time income, even start a video/audio servicing business of your own!

**Billions of dollars of video/audio equipment means big opportunity for you**

There's never been a better time to get involved in home entertainment electronics. Experts predict that consumers of video/audio equipment will spend over \$26 billion by 1995 as product manufacturers race to fill the demand for increasingly sophisticated technology.

This explosive acceleration of new product innovation means new opportunities for you in video/audio servicing. And NRI prepares you to take advantage of those opportunities by giving you the skills to troubleshoot and service a full range of TV, video, and audio equipment.

**The most advanced, most complete video/audio training ever offered!**

You start with lessons that give you a strong foundation in electronics fundamentals, mastering the basic circuits and components at the heart of today's video/audio equipment.

Then you build on that foundation as you explore the high technology of digital controls, CDs and digital audio tape players, advanced TV systems, cable TV, VCRs and camcorders, even microprocessors.

Best of all, you're prepared for the technology of today and tomorrow with hands-on training designed to give you invaluable practical experience.

Hands-on training with this incredible array of home entertainment equipment gives you the skills you need for success.



**State-of-the-art equipment included in your training makes theory come to life**

Only NRI gives you so much real-world equipment ... all yours to train with and keep! Get hands-on experience as you work with a complete, high-tech home entertainment system: a 13" color TV with remote, a programmable VCR, and an integrated remote-controlled audio system including AM/FM tuner, 100 watt amplifier, CD player, dual cassette player, turntable, speakers, and audio rack cabinet.

Theory comes to life as you learn to perform component-level diagnosis and service on advanced technology audio equipment ... conduct in-set demonstrations of TV circuits and components ... and discover first-hand how to maintain and service today's commercial VCRs.

Plus, NRI custom-produced videos

show you in close-up detail how to test, troubleshoot, and service TVs and VCRs like a pro.

**No experience necessary ... NRI builds it in**

You need no previous experience in electronics to succeed with NRI. Step by step, you accumulate the knowledge and practical experience that will make you uniquely qualified for today's opportunities in home entertainment electronics.

You learn at your own pace and on your own time. And all throughout your training, you have the full support of your personal NRI instructor and the entire NRI technical staff.

**FREE catalog tells more**

If the coupon is missing, write to NRI Schools, McGraw-Hill Continuing Education Center, 4401 Connecticut Avenue, NW, Washington, DC 20008.

## SEND TODAY FOR FREE NRI CATALOG

**NRI Schools**

McGraw-Hill Continuing Education Center  
4401 Connecticut Avenue, NW, Washington, DC 20008

For Career Opportunities approved under GI Bill  
 check for details



Check one FREE catalog only

- TV/Video/Audio Servicing
- Microcomputer Servicing
- Computer Programming
- Telecommunications
- PC Applications Specialist
- Programming in C++ with Windows

- Desktop Publishing & Design
- Electronic Music Technology
- Home Inspection
- Automotive Servicing
- Basic Electronics
- Bookkeeping & Accounting

Name \_\_\_\_\_ (Please print) \_\_\_\_\_ Age \_\_\_\_\_

Address \_\_\_\_\_

City \_\_\_\_\_ State \_\_\_\_\_ Zip \_\_\_\_\_

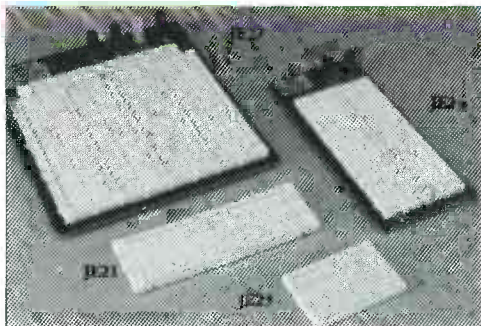


September 1992, Electronics Now

# A Monumental Selection

## Test/Measurement and Prototype Equipment

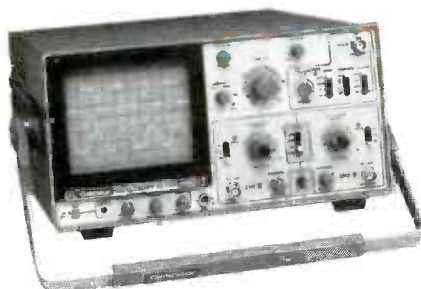
### Jameco Solderless Breadboards



Jameco's long-lasting breadboards feature screen-printed color coordinates and are suitable for many kinds of prototyping and circuit design. Larger models feature a heavy-duty aluminum backing with voltage and grounding posts.

Part No.	Dim. L" x W"	Contact Points	Binding Posts	Price	Part No.	Dim. L" x W"	Contact Points	Binding Posts	Price
JE21	3.25 x 2.125	400	0	\$4.95	JE25	6.500 x 4.25	1,660	3	\$17.95
JE23	6.50 x 2.125	830	0	6.95	JE26	6.875 x 5.75	2,390	4	24.95
JE24	6.50 x 3.125	1,360	2	12.95	JE27	7.250 x 7.50	3,220	4	32.95

### GoldStar 20MHz Dual Trace Oscilloscope



The perfect unit for today's testing and measurement needs! Features include a 6" CRT display, and bandwidth from DC to 20 MHz. The GoldStar oscilloscope comes with two 40MHz probes, two fuses, power cord, operation manual, schematics and block and wiring diagram. It's lightweight and portable with a two-year warranty.

GS7020.....\$399.95

### Additional GoldStar Oscilloscopes

GS904RD	40Mhz 2 channel oscilloscope.....	\$799.95
GS8100	100Mhz 3 channel oscilloscope .....	1349.95

Call for additional Goldstar test equipment



24 Hour Toll-Free Order Hotline  
**1-800-831-4242**



Please refer to Mail Key 002 when ordering



### National and Intel Databooks



400026	National General Purpose Linear Devices Databook ...	\$19.95
400039	National Logic Databook .....	19.95
400015	National Data Acquisition Linear Devices Databook .....	11.95
400104	National Special Purpose Linear Devices Databook .....	11.95
400044	National LS/S/TTL Databook .....	14.95
230843	Intel Memory Databook .....	24.95
270645	Intel Embedded Controller Processors Databook .....	24.95

Additional databooks available!

### Metex Digital Multimeters

- Handheld, high accuracy • Measures AC/DC voltage, AC/DC current, resistance, diodes, continuity, and transistor current gain (except M3900)
- Manual ranging w/overload protection
- Comes with probes, batteries, case and manual

M3650 & M4650 only:

M3800	3.5 Digit Multimeter .....	\$39.95
M3610	3.5 Digit Multimeter .....	\$59.95
M3900	3.5 Digit Multimeter with tach/dwell .....	\$59.95
M3650	3.5 Digit Multimeter w/frequency & capacitance .....	\$74.95
M4650	4.5 Digit w/frequency & capacitance & data hold switch .....	\$99.95



24 Hour Toll-Free Order Hotline!  
**1-800-831-4242**

### Jameco IC Test Clip Series



- Test Clips are designed for temporary connections to DIP components
- Heavy-duty spring loaded hinge provides positive contact

Part No.	Description	Price
JTC16	16-pin (for 8, 14 & 16-pin ICs) ..	\$5.95
JTC20	20-pin (for 18 & 20-pin ICs).....	6.95
JTC24	24-pin .....	7.95
JTC28	28-pin .....	8.95
JTC40	40-pin .....	11.95

### EPROMs - for your programming needs

Part No.	Price	Part No.	Price	Part No.	Price
TMS2516 .....	\$4.25	2764A-25 .....	\$3.49	27C256-12 .....	\$6.49
TMS2564 .....	5.95	27C64-15 .....	3.95	27C256-15 .....	5.95
TMS2716 .....	5.95	27C64-25 .....	3.49	27C256-20 .....	5.49
1702A .....	3.95	27C64-45 .....	2.95	27C256-25 .....	4.95
2708 .....	4.95	27128OTP .....	2.49	27512OTP .....	4.95
2716 .....	3.95	27128-20 .....	7.95	27512-20 .....	6.75
2716-1 .....	4.25	27128-25 .....	7.75	27512-25 .....	5.95
27C16 .....	4.25	27128A-15 .....	4.95	27C512-12 .....	7.49
2732 .....	4.95	27128A-20 .....	4.75	27C512-15 .....	6.95
2732A-20 .....	4.49	27128A-25 .....	3.75	27C512-20 .....	6.49
2732A-25 .....	3.49	27C128-15 .....	5.75	27C512-25 .....	5.95
2732A-45 .....	2.95	27C128-25 .....	7.95	27C010-15 .....	9.95
27C32 .....	4.95	27256OTP .....	4.19	27C020-15 .....	17.95
2764-20 .....	3.95	27256-15 .....	5.49	27C020-20 .....	15.95
2764-25 .....	3.75	27256-20 .....	5.29	68766-35 .....	4.95
2764A-20 .....	3.75	27256-25 .....	4.89		

### A.R.T. EPROM Programmer



- Programs all current EPROMs in the 2716 to 27512 range plus the X2864 EEPROM
- RS232 port • Software included

EPP.....\$199.95

### UVP EPROM Eraser



- Erases all EPROM's • Erases 1 chip in 15 minutes and 8 chips in 21 min
- UV intensity: 6800 UW/CM<sup>2</sup>

DE4.....\$89.95

• **Partial Listing • Over 4000 Electronic and Computer Components in Stock! • Call for quantity discounts.**



# at Competitive Prices

## Computer Upgrade Products and Electronic Components

Upgrade your existing computer system! Jameco will help you upgrade easily and economically.

### 101-Key Enhanced Keyboard



This keyboard features 12 function keys, separate cursor and numeric keys.

- IBM PC/XT/AT and compatible computers
- Automatically switches between XT or AT
- LED Indicators for Num, Caps, and Scroll lock keys.

K101.....\$49.95

### Toshiba 1.44MB 3.5" Internal Floppy Disk Drive

- IBM PC/XT/AT and compatibles
- Compatible with DOS versions 3.3 or higher
- Includes all necessary installation hardware
- 1.44MB formatted high density mode
- 720KB formatted low density mode
- Size: 1"H x 4"W x 5.9"D (actual drive size)
- One-year manufacturer's warranty



356KU.....\$99.95

Many more upgrade products available!

### Jameco 80386SX Motherboard



- 16MHz processing speed
- Baby motherboard (8.5"x13")
- Zero or one wait state operation
- Supports up to 16MB of RAM
- Intel 80387SX/compatible math coprocessor socket
- AMI BIOS
- Six 16-bit and two 8-bit expansion bus slots
- One-year warranty

JE3616SN.....\$249.95

### Jameco IBM Compatible Power Supplies

#### JE1030:

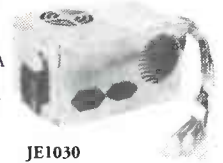
- Output: +5V @ 15A, -5V @ 0.5A, +12V @ 5.5A, -12V @ 0.5A
- 150 watts output power
- Switchable between 110/220V
- Built-in fan
- Size: 9.5"L x 5.5"W x 4.625"H
- One-year warranty
- CSA approved

JE1030 150 watt PC/XT power supply .....\$69.95

JE1036 200 watt AT power supply.....\$89.95

#### JE1036:

- Output: +5V @ 20A, -5V @ 0.5A, +12V @ 8A, -12V @ 0.5A
- 200 watts output power
- Switchable between 110/220V
- Built-in fan
- Size: 6.5"L x 5.88"W x 6"H
- One-year warranty
- CSA approved



JE1030

Additional power supplies available!

### Integrated Circuits\*

Part No.	1-9
74LS00	.....\$ .25
74LS02	......25
74LS04	......25
74LS08	......29
74LS14	......39
74LS30	......25
74LS32	......25
74LS74	......29
74LS76	......49
74LS86	......25
74LS112	......25
74LS123	......39
74LS138	......39
74LS175	......35
74LS193	......59
74LS244	......69
74LS245	......69
74LS373	......69
74LS374	......69

### Linear ICs\*

Part No.	1-9
TL082CP	.....\$ .59
LM317T	......59
LM324N	......35
LM336Z	.....1.09
LM339N	......45
NE555V	......29
LM556N	......49
LM723CN	......49
LM741CN	......29
LM1458N	......39
LM1488N	......45
LM1489N	......45
ULN2003A	......69
LM3914N	.....2.49
NE5532	.....1.19
7805T	......45
7812T	......45

\* Call for a complete listing of ICs

### Memory

Part No.	Function	Price
41256-120	256K DIP 120ns.....	\$1.69
41256-150	256K DIP 150ns.....	1.59
511000P-80	1MB DIP 80ns.....	5.99
511000P-10	1MB DIP 100ns.....	5.49
41256A9B-80	256K SIMM 80ns.....	16.95
421000A9A-80	1MB SIPP 80ns.....	54.95
421000A9B-60	1MB SIMM 60ns.....	64.95
421000A9B-70	1MB SIMM 70ns.....	59.95
421000A9B-80	1MB SIMM 80ns.....	54.95

### Miscellaneous Components\*

#### Potentiometers

Values available (insert ohms into space marked "XX"):

500Ω, 1K, 5K, 10K, 20K, 50K, 100K, 1MEG

43PXX 3/4 watt, 15 turn..... \$ .99

63PXX 1/2 watt, 1 turn ..... .89

#### Transistors And Diodes

Part No.	Price	Part No.	Price
PN2222	\$.12	1N751	\$.15
PN2907	.12	C106B1	.65
1N4004	.10	2N4401	.15
2N2222A	.25	1N4148	.07
1N4735	.25	2N3055	.69
2N3904	.12	1N270	.25

#### Switches

JMT123	SPDT, on-on (toggle)	\$1.15
206-8	SPST, 16-pin (DIP)	1.09
MPC121	SPDT, on-off-on (toggle)	1.19
MS102	SPST, momentary (push-button)	.39

\*Additional components available

### Connectors

Part No.	Description	Price
DB25P	Male, 25-pin	\$.65
DB25S	Female, 25-pin	.75
DB25H	Hood	.39
DB25MH	Metal Hood	1.35

**LEDs**

XC209R	T1, (Red)	\$.14
XC556G	T1 3/4, (Green)	.16
XC556R	T1 3/4, (Red)	.12
XC556Y	T1 3/4, (Yellow)	.16

### IC Sockets

Low Profile Part No.	Price	Wire Wrap(Gold) Part No.	Level #2 Price
8LP	\$.10	8WW	\$.54
14LP	.11	14WW	.79
16LP	.12	16WW	.89
24LP	.19	24WW	1.39
28LP	.22	28WW	1.69
40LP	.28	40WW	1.89

Call or write for your  
**FREE Summer Catalog:**  
1-800-637-8471



Mention Mail Key 002

24-Hour Toll-Free Order Hotline:  
**1-800-831-4242**

**JAMECO**<sup>®</sup>  
ELECTRONIC COMPONENTS  
COMPUTER PRODUCTS  
1355 Shoreway Road  
Belmont, CA 94002

\$30.00 Minimum Order

FAX: 1-800-237-6948 (Domestic)  
FAX: 415-592-2503 (International)

Jameco ServiceLine™:

1-800-831-8020 (Computer Repair)

Technical Support: 1-800-831-0084

BBS Support: 415-637-9025

For International Sales, Customer Service, Credit Department and all other inquiries: Call 415-592-8097 between 7AM-5PM P.S.T.

CA Residents please add applicable sales tax.  
Shipping, handling and insurance are additional.

Terms: Prices subject to change without notice. Items subject to availability and prior sale. Complete list of terms/warranties is available upon request.

© 1992 Jameco 9/92 All trademarks are registered trademarks of their respective companies.

**EASY** work! Excellent pay! Assemble products at home. Call toll free 1 (800) 467-5566 Ext. 5192.

**HOME** assembly work available! Guaranteed easy money! Free details! **HOMEWORK-R**, Box 520, Danville, NH 03819.

**MONEYMAKERS!** Easy! One man CRT rebuilding machinery. \$6,900.00 rebuilt. \$15,900.00 new. CRT, 1909 Louise, Crystalake, IL 60014. (815) 477-8655. FAX (815) 477-7013.

### EDUCATION & INSTRUCTION

**F.C.C. Commercial General Radiotelephone license.** Electronics home study. Fast, inexpensive! "Free" details. **COMMAND**, D-176, Box 2824, San Francisco, CA 94126.

**ELECTRONIC engineering.** 8 volumes complete. \$109.95. No prior knowledge required. Free brochure. **BANNER TECHNICAL BOOKS**, 1203 Grant Avenue, Rockford, IL 61103.

**BIOMEDICAL** newsletter explains ultrasound, cardiac computers, lasers, etc. Four postpaid issues \$20.00. **PNP**, Box 70, Brooklyn, NY 11204. (718) 837-9349 ext. 33.

### ANTIQUE RADIO CLASSIFIED

**Free Sample!**

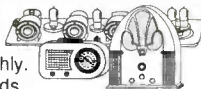
Antique Radio's

Largest Circulation Monthly.

Articles, Ads & Classifieds.

6-Month Trial: \$15. 1-Yr: \$27 (\$40-1st Class).

A.R.C., P.O. Box 802-L9, Carlisle, MA 01741



### WANTED

**INVENTIONS!** new products/ideas wanted: call **TLCI** for free information/inventors newsletter. 1 (800) 468-7200 24 hours/day - USA/Canada.

**INVENTORS:** We submit ideas to industry. Find out what we can do for you. 1 (800) 288-IDEA.

### CABLE TV DESCRAMBLERS

**BEST BUYS BEST SERVICE**

BULLET PROOF TV TESTED

WANT TO BUY:

TOCOM, SA 8590, DPV7212

Must be reasonable price.

**FREE Catalog**

Dealers Wanted

Multi-Vision (402)331-3228 **800-835-2330**

Electronica™ 2730 SO.123rd Ct.#126 Omaha, NE 68144



### INVENTORS

**INVENTORS!** Can you patent and profit from your idea? Call **AMERICAN INVENTORS CORP.** for free information. Serving inventors since 1975. 1 (800) 338-5656.

### SINGERS! REMOVE VOCALS! Unlimited Backgrounds™

From Standard Records & CD's with the Thompson Vocal Eliminator™ Call for Free Catalog & Demo Record.  
Phone: (404)482-4189 Ext 72  
Singer's Supply, Dept RL-1  
7987 Hightower Trail  
Lithonia, GA 30058  
24 Hour Demo/Info Request  
Line (404)482-2485 Ext 72  
Singer's Supply - We Have Anything & Everything For Singers



# BUY BONDS

**FREE CATALOG!**  
**1-800-648-7938**

**JERROLD HAMLIN OAK ETC**  
**CABLE TV**  
**DESCRAMBLERS**

- Special Dealer Prices!
- Compare our Low Retail Prices!
- Guaranteed Prices & Warranties!
- Orders Shipped Immediately!

**REPUBLIC CABLE PRODUCTS, INC.**

4080 Paradise Rd. #15, Dept RE992  
Las Vegas, NV 89109  
For all other information (702) 362-9026

**CABLE TV DESCRAMBLERS**  
**★ CONVERTERS ★**  
and ACCESSORIES.

**SAVE MONEY.**  
**DON'T RENT!**

PANASONIC, JERROLD, OAK,  
PIONEER, SCIENTIFIC ATLANTA  
AND MORE. LOWEST PRICES. FREE CATALOG.  
**CABLE READY COMPANY (800) 234-1006**

**PAY TV AND SATELLITE DESCRAMBLING**

**ALL NEW 1992 EDITION ALL NEW**

1992 Edition updates latest Circuits, Turn-ons, Bypasses, Bullets, Bags, Black-ciphers, VCI Plus and B-Mac Fixes. Only \$15.95. VCI Wizard Hacker's Bible includes Plus, Tells All, \$15.95. Pay TV and Satellite Descrambling Vol. 1 (Basics), 1989, 1991 Editions are all different. \$14.95 each. MDS Handbook \$9.95. Satellite Systems under \$600. \$12.95 (52). Any 3/\$29.95 or 5/\$49.95. Scrambling News Monthly will keep you up to date on Plus breaks. \$24.95/yr. special. Everything we have including video, \$10.95. New Catalog \$1.

Scrambling News, 1552 Hertel Ave.,  
Buffalo, NY, 14216. Voice/Fax (716) 874-2088  
COD'S ARE OK. ADD \$6

### ELECTECH

**CABLE T.V. DESCRAMBLERS**

- All quality brand names •
- All fully guaranteed • All the time •
- Knowledgeable Sales Service Department
- FOR FREE CATALOG 800-253-0099**

MC / COD / VISA

NO FLORIDA SALES

**CABLE TV DESCRAMBLERS**

**WORLDWIDE CABLE**

- BASE BAND
- TOCOM
- SCIENTIFIC ATLANTA
- JERROLD
- PIONEER
- ZENITH
- OAK
- HAMLIN

**1 800-772-3233**

1291 A POWERLINE ROAD, SUITE 109  
POMPAND BEACH, FL 33069

Courteous Service • Discount Prices • Fast Shipping

**ALL ELECTRONICS CORP.**

Mail Order Electronic Parts And Supplies

P.O. Box 567 • Van Nuys, CA 91408

### Car Lighter Coil Cord



Automotive cigar lighter plug with replaceable 5 amp fuse. Quality, retractable coil cord extends to approximately 6 feet. Terminates with a 5 pin DIN plug which can be cut-off. Ideal for battery charger or running 12 Volt devices from a car battery.

CAT# CLP-18  
10 for \$12.50

**\$1.50**  
each

**VERY SPECIAL DEAL - 17 VDC**  
**210 MA WALL TRANSFORMERS**

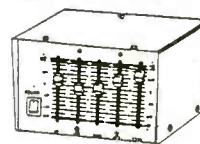
New 17 Vdc, 210 ma wall transformers. 6 ft. cord. Unusual co-axial device on end of cord can be cut off and used for another application.

Large quantity available.  
CAT# DCTX-1721  
100 for \$1.25 each  
1000 for \$1.00 each



**\$1.50**  
each

### Monoral Graphic Equalizer



Five band monoral graphic equalizer. Allows use of one source for background music and music-on-hold. Allows you to equalize and adjust the volume of one without changing the other. Useful in any application where equalization of a monoral source is desirable. RCA jack inputs and outputs. Removable metal control cover to prevent tampering. 6.75" X 5.75" X 3.125" h.

CAT# EQ-1

**\$15.00**  
each

**LCD DISPLAY**  
**40 Character X 2 Line**



Opretex # DMC40218 or Hitachi # LM018L  
Built-in controller and drivers. 4 or 8 bit operation. 5 Vdc power. Display size: 6.05" X 0.7" Module size: 7.12" X 1.34". Character size: (5 X 7 dots) 3.2mm X 4.85 mm. Data sheets and instructions available.

CAT# LCD-3

**\$15.00**  
each

### INVERTER

ERG, Inc. "Smart Force"™  
# LPS15-1-3. Input: 15-25 Vdc  
Output: 80-100 Vac@ 400 Hz. 4.1 ma.

Designed to power electroluminescent lamps and glow-strips. Can be used in any application where low current, high frequency AC is desired. 1.25" X 0.85" X 0.95". CAT# INV-3  
10 for \$20.00



**\$2.50**  
each

**TOLL FREE ORDER LINES**

**1-800-826-5432**

CHARGE ORDERS to Visa, MasterCard or Discover

TERMS: Minimum order \$10.00. Shipping and handling for the 48 continental U.S.A. \$3.50 per order. All others including AK, HI, PR or Canada must pay full shipping. All orders delivered in CALIFORNIA must include state sales tax (7.25%, 7.5%, 7.75%, 8.25% 8.5%). Quantities Limited. NO C.O.D. Prices subject to change w/out notice.

Call or Write For Our

**FREE 64 Page Catalog**

(Outside The U.S.A. Send \$2.00 Postage)

**ALL ELECTRONICS CORP.**

P.O. Box 567 • Van Nuys, CA • 91408

CIRCLE 107 ON FREE INFORMATION CARD



**WHY RENT?  
SAVE! SAVE!**

**CABLE TV  
DESCRAMBLERS**

JERROLD • OAK • HAMLIN • ZENITH  
PIONEER • SCIENTIFIC ATLANTA

**READY-TO-SHIP!**

6 MONTH WARRANTY! ABSOLUTELY  
LOWEST WHOLESALE/RETAIL PRICES!

MASTERCARD • VISA • AMEX • C.O.D.

**FREE COLOR CATALOG!**

**1 (800) 950-9145**



1470 OLD COUNTRY ROAD  
SUITE 315-PE  
PLAINVIEW, NY 11803  
NO NY SALES

**FREE CATALOG**

- CABLE T.V. BOXES - ALL TYPES •
- LOW PRICES - DEALER PRICES •

**ACE PRODUCTS**

1-800-234-0726

**DESCRAMBLERS**

MAKE THE CONNECTION

NU-TEK ELECTRONICS

CABLE TV EQUIPMENT



**ORDER TOLL FREE**

**1-800-228-7404**

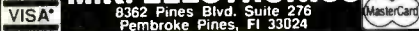
DON'T FORGET TO ASK ABOUT OUR  
**FREE** CATALOG WITH BUYING GUIDE  
FRIENDLY, PROFESSIONAL SERVICE  
30 DAY MONEY BACK GUARANTEE  
BEST PRICE - BEST SERVICE



FOR MORE INFORMATION **NU-TEK ELECTRONICS**  
1-512-250-5031 5114 BALCONES WOOD DR.  
#307 DEP. 298 AUSTIN TEXAS 78759

**CABLE TV  
DESCRAMBLERS  
1-800-582-1114**

**FREE CATALOG**  
GUARANTEED BEST PRICES • IMMEDIATE SHIPPING  
**M.K. ELECTRONICS**



**CABLETRONICS**

**CONVERTERS**

1-4Units 5 Units 10 Units

PANASONIC TZP 145	\$88.00	\$75.00	\$70.00
STARGATE 2000	\$79.00	\$69.00	\$65.00
*HAMLIN MCC 3000	\$25.00	\$19.00	\$15.00

**ADD-ON DECODERS**

SB-3 (NEW)	\$50.00	\$45.00	\$43.00
*SB-3 FACTORY	\$45.00	\$39.00	\$35.00
SA-3	\$56.00	\$50.00	\$45.00
DTB-3	\$65.00	\$55.00	\$50.00
KN12A-2 or 3	\$49.00	\$45.00	\$40.00
*HAMLIN MLD 1200-3	\$49.00	\$40.00	\$35.00
*ZENITH SSAVI	\$165.00	\$149.00	\$125.00
SA-DF	\$159.00	\$139.00	\$125.00

**COMBOS**

JERROLD DPV7	\$299.00	\$149.00	\$239.00
JERROLD DPBB	\$319.00	\$259.00	\$249.00
SA8580 COMBO	\$299.00	\$225.00	\$215.00
*JERROLD DRX-3-DIC	\$165.00	\$105.00	\$89.00
JERROLD DRZ-3-DIC	\$175.00	\$115.00	\$99.00
*OAK M35B	\$45.00	\$35.00	\$30.00
HAMLIN SPC 4000 3M	\$50.00	\$44.00	\$44.00

ADD \$10.00 FOR VARISYNCH

\*Refurbished as New

QTY	ITEM	OUTPUT CHANNEL	PRICE EACH	TOTAL PRICE

California Penal Code #593-D Forbids us from shipping any cable descrambling unit to anyone residing in the state of California. Prices subject to change without notice.

<b>SUB TOTAL</b>	
Shipping Add	5.00 Per unit
COD/CreditCard	Add 5%
<b>TOTAL</b>	

**Please Print**

Name \_\_\_\_\_  
Address \_\_\_\_\_ City \_\_\_\_\_  
State \_\_\_\_\_ Zip \_\_\_\_\_ Tel: ( ) \_\_\_\_\_  
 Cashier's Check     Money order     COD  
 Visa     MC    CC# \_\_\_\_\_ Exp. Date \_\_\_\_\_

DECLARATION OF AUTHORIZED USE- I, the undersigned, do hereby declare under penalty of perjury that all products purchased, now and in the future, will only be used on TV systems with all applicable federal and state laws. FEDERAL AND VARIOUS STATE LAWS PROVIDE FOR SUBSTANTIAL CRIMINAL AND CIVIL PENALTIES FOR UNAUTHORIZED USE.

Date \_\_\_\_\_ Signed \_\_\_\_\_

**Cabletronics**

9800 D Topanga Canyon Blvd., Suite 323,  
Chatsworth, CA 91311  
For Free Catalog, or to place an order call  
(800) 433-2011 • FAX (818) 709-7565

## HARDWARE HACKER

continued from page 93

This fire is out.



Or is it?



driving. Dave slowed  
n even more till wera  
continued on page 34

g through these hills, see,  
e air was as clean and as  
ain stream, and the sun  
ot thundering through  
the fir and birch  
ad, turning  
ers and  
rusted

ga  
is a  
bur



Only you can prevent forest fires.



A Public Service of the USDA Forest Service  
and your State Forester.

*Whole Earth Review*. There are bunches of independent and non-profit inventor's organizations out there. One I can heartily recommend is Ed Zimmer's *Inventor-Entrepreneur Network*. For other regional sources, check out the *Encyclopedia of Associations* that you will probably find at your local library.

No, I just do not know of anyone anywhere who is dumb enough to buy raw, unproven, or undeveloped ideas. But I do know of several someones who sometimes might be interested in looking at tightly targeted products *if those products are now in their pre-production prototype stage and currently under active end-user beta testing*.

For instance, Mark Gottlieb of *Design Tech International* is looking for innovative approaches to low-end consumer electronics, especially for those items that can be blister packed and need no consumer smarts to use.

Dennis Carper of *Redmond Cable* is seeking tested and proven interconnect and adaptor products that clearly solve obvious and well-defined problems.

John Simonton of *PAIA* (and a frequent author in **Electronics Now**) sometimes seeks out items with kit possibilities, especially if they are related to MIDI or electronic music.

And Steve Ciarcia of his *Micro Mint* is occasionally interested in any embedded processor applications—if they are unique.

Besides my own PSRT RoundTable on *GENie*, you might also want to check out their HOSB, short for *Home Office and Small Business*. I've also formed my loosely knit *Synergetics Consultants Network* that centers on our voice helpline. Give me a call if you need more information.

### New tech lit

From *Texas Instruments*, seven pounds of revised linear data books. Volume I is on op-amps; volume II is on A/D, DSP, and video; and volume III is on voltage regulators and

really oddball stuff.

A pair of very readable new books: *The Triumphs and Trials of an Organ Builder*, by Jerome Markowitz, CEO of *Allen Organ*, and published by the *Vox Humana Press*. Among the other things, it reveals how trivially easy it is to have any technically solid and perfectly valid patent busted in court. Just because some epsilon minus does not happen to like you.

Plus *Accidental Empires* by the pseudonym *Robert X. Cringley*, newly published by *Addison Wesley*. Subtitled *How the boys of Silicon Valley make all their millions, battle foreign competition, and still can't get a date*. This book has a double handful of very funny one-liners in it. But otherwise it reads like something that Cringley would write.

I've found very few trade journals devoted to electronic servicing. One useful new one, though, is *MSM, the Magazine of Service Management*. The magazine puts a big emphasis on computer service and identification of sources for printer and disk-drive replacement parts and assemblies.

A great collection of navigation books, GPS (global positioning satellites) and otherwise, is offered by the *Navtech Information Service*. And a new *Spread Spectrum Scene* labor-of-love newsletter has recently started publication.

Two firms apparently still offer top octave generators and other classic electronic organ chips. The first is *Fistell Microelectronics* and the other is *Keyboard Systems*. The latter also builds workaround replacement modules for chips that are truly unavailable.

Turning to some of my own products, yet another obvious and major product selling resource is my recently improved *Incredible Secret Money Machine II*. The autographed copies are available per my nearby *Synergetics* ad.

As usual, I have gathered many of the resources mentioned together into the *Names & Numbers* or the *Product Marketing Resources* sidebars. Be sure to check those out *before* you use our no-charge tech helpline or call for a free hacker secrets brochure.

R-E



## ATV DOWNCONVERTER

*continued from page 84*

provided for you to make your own board, and the parts-placement diagram is shown in Fig. 4.

First install resistors R1–R13, and R15–R17. Next, install all capacitors except the chip capacitors and C10. Install mixer M1, and then wind and install coils L1, L2, L3, L5, L6, L7, L8.

Coils L1, L2, and L3 are three turns each of 20 AWG tinned wire wound around a No. 8 screw as a form (see Fig. 5) and then stretched to a length of 0.3 inch with the turn spacing evenly maintained. All three of those coils must be tapped as shown in Fig. 5. The lead from J1 (which can be coaxial 50-ohm line) has its center conductor soldered to L1 at  $\frac{3}{4}$  turn from the grounded end. Resistor R5 is soldered  $1\frac{1}{2}$  turns from the end of L2 that connects to R6, C7, and C8. Coil L3 is tapped at 1 turn from the grounded end.

Coils L6 and L7 are 8 turns each of 22 AWG enamelled wire wound on a No. 8 screw. The screw is removed after winding the coil. Coil L8 is  $9\frac{1}{2}$  turns of 22 AWG enamelled wire, wound the same way as L6 and L7. However, after winding, the No. 8 screw is removed and a ferrite tuning slug is screwed into the winding as shown in Fig. 5. RF choke L5 is installed as if were a resistor.

Install Q2, Q3, D1, D2, and D3. Now install the chip capacitors. Chip capacitors require special installation procedures—and they all mount on the solder side of the PC board. Figure 6 shows where all of the chip capacitors, C10 (which we'll get to in a moment), and Q1 are mounted on the solder side of the board. As for the chip capacitors, first tin the area on the PC board where a chip is to be installed. Then hold the chip in place with the tip of a small screwdriver or tweezers and tack solder one side. After it's tacked in place, fully solder both sides of the chip.

Now install Q1, whose long lead is the drain. Make sure you

use a grounded iron and work in a static-free area. Treat Q1 as you would a delicate CMOS IC. The tuning potentiometer (R14) can be mounted in different positions for added flexibility; it can be mounted off the board for remote tuning purposes.

Make sure all holes marked "G" in Fig. 4 have jumper wires passed through them and soldered on both sides of the PC board as shown in Fig. 7. Also, both sides of the board must be grounded together with copper foil tape, also as shown in Fig. 7. Once the tape is in place, solder both sides.

Next make capacitor C10. Take a small square of G-10, 0.062 material (the same as the PC board material) and trim it to a  $\frac{3}{16}$ -inch square. Install it on the solder side of the board as shown in Fig. 8. Connect coaxial 50-ohm cables to J1 and J2, and DC power leads to D3 and ground. Set trimmer capacitors C1, C5, and C6 to about 20% of maximum, and set C9 to about 80% of maximum. If you use R14, it can be set halfway. If R14 is not used, R10 should be temporarily connected to a supply of about +8 volts. Figure 9 shows the author's prototype.

### Tune up

Tuning consists of peaking the tuned circuits for best reception. Using a frequency counter connected across R12, adjust C9 for a nominal frequency of 370 to 375 MHz. If installed, R14 should vary that by about  $\pm 15$  MHz. If R14 is not installed, 0 to +12 volts applied to R10 should do the same. The oscillator might stop if less than 2 volts is applied to R10—which is acceptable as long as you can obtain a frequency range of 30 MHz.

Connect the converter to a TV set tuned to channel 3 and to an external antenna for ATV reception. Find a signal and peak L1, L2, and L3 for the best picture. You can also use an RF signal generator tuned to 435 MHz if no on-the-air signal is available. As a last resort, you can also peak L1, L2, and L3 on noise.

It is also possible to experimentally peak the converter on

UHF channels 14, 15, or 16 if no other signals are available. Set C9 for a L.O. frequency of around 410 to 420 MHz. Note: This is only to see if everything works if there's no other way to obtain an ATV signal and you have no access to a signal generator. You will later have to re-peak the converter to 420 to 450 MHz.

If a sweep generator is available, simply peak the converter for a response as shown in Fig. 10. By trimming C10 (use a file on the edge of it) you can also experiment with the coupling and resultant bandpass shape. You can also do this with a calibrated RF signal generator and a receiver and/or RF voltmeter, but this will take more time.

The converter should be mounted in a weatherproof metal box, if outdoor use is intended. A metal box reduces stray signal pickup, and also protects the converter from damage.

If you will be remote-tuning the converter (as was shown in Fig. 3), the converter should be mounted right at the antenna or very close to it. That permits a short cable from J1 to the antenna, reducing signal losses. The converter can then be mounted as far as 300 feet from the TV monitor. **R-E**

## DRAWING BOARD

*continued from page 96*

case, you should trim the level because the circuits we'll be building expect a 1-volt signal.

The only other thing to notice here—there just isn't much to the circuit at all—is that the video signal being fed to the base of the transistor is related to both positive voltage and ground through R1 and R2. The circuit is going to run on a regulated 5-volt supply; it must be steady because the level of the supply voltage is going to have an effect on the level of the video. Wire up the circuit shown in Fig. 4 and get the video source in place. When we get together next time we'll start designing some kind of circuit to screw up the signal. **R-E**

# THE ELECTRONIC GOLDMINE

The Electronic Goldmine has one of the greatest selections of unique electronic kits available in the world! We have over 65 kits and over 1,400 unique, bargain priced, components in our catalog!

**FREE CATALOG**  
With OVER 1400 DIFFERENT ITEMS INCLUDING 60 KITS! REQUEST YOUR COPY TODAY!

## INFRARED DETECTOR KIT

Great for testing and verification of infrared output. 9V battery not included.  
**C6441 \$5.95**



## LCD WATCH MODULE

These were the heart of a high quality LCD watch. They are brand new and are shipped with a good battery. You must remove a tiny screw (with a jeweler's screwdriver) to remove the protective plastic covering the battery compartment. These can display date, time, and even have an alarm, but if you wish to make use of the alarm feature you have to connect any 2 lead piezo (you supply the piezo) to the tiny gold springs on the back of the module. Size 1 1/2" diameter. Complete ready to use - but no case.  
**G2741 \$1.25**



## INEXPENSIVE GEIGER COUNTER KIT

Detects both Beta and Gamma Rays. 9V battery not included.  
**C6447 \$39.95**



## MUSIC MODULE

Tiny flat music module made for a greeting card company. These are brand new and play a pleasant tune each time activated. The song is "Let me call you Sweetheart". Features large flat piezo disk, actuator lever, music IC and battery holder all on a small "PC board". Battery not included but operates from any 1.5V dry hearing aid cell. (You can just about choose any cell and it will work.)  
**G2744 89c**



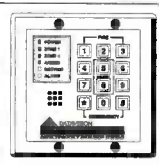
## PRECISION HIGH SPEED MOTOR

Great for Robots, mini-ature fans, etc. Size 1 1/8" x 9/16". Operates from 1.0VDC up to 9VDC.  
**G2846 1.00 ea 10.8.00**



## BURGLAR/FIRE ALARM KEYBOARD CONTROL PANEL

These are actual late model control panels made for use on home/business, burglar/fire alarms. They contain 6 bright LEDs, a 12-key control keypad with 2' cable and connector. These are brand new and the LEDs can be lighted with just the addition of a 9V battery to several points on the connector (we show you which ones) to provide you with the most realistic looking "take" burglar alarm. The average burglar is going to think that you have a very sophisticated alarm system installed! Size 4 9/16" square - 1/2" thick with 3 model standoffs under panel. These are a great flea market item that can be sold for \$10.00 or more! Order fast to avoid disappointment!  
**10 For \$25.00 100 For \$230.00**



MINIMUM ORDER: \$10.00 plus \$3.50 shipping and handling. We accept MC, Visa and Money Orders.  
SEND ORDERS TO: The Electronic Goldmine  
P.O. Box 5408 Scottsdale, AZ 85261  
PHONE ORDERS (602) 451-7454 FAX ORDERS (602) 451-9495

CIRCLE 177 ON FREE INFORMATION CARD

# CABLE DESCRAMBLERS

Converters, Remote Controls, Descramblers, more



All major brands carried

- \*JERROLD, \*TOCOM, \*ZENITH
- \*GENERAL INSTRUMENTS
- \*SCIENTIFIC ATLANTA, \*OAK
- \*HAMLIN, \*EAGLE, \*PIONEER

7th Year in business. Thank You  
Member of Omaha Chamber of Commerce  
1 Year warranty on new equipment  
30 Day money back guarantee  
Orders shipped from stock within 24 hours

CALL TODAY FOR A FREE CATALOG  
**1-800-624-1150**



C.O.D.

**M.D. ELECTRONICS**

875 SO. 72nd St.  
Omaha, NE 68114

CIRCLE 53 ON FREE INFORMATION CARD

# ADVERTISING INDEX

Electronics Now does not assume any responsibility for errors that may appear in the index below.

Free Information Number	Page	Free Information Number	Page	
108	AMC Sales .....	99	— Star Circuits .....	23
75	Ace Products .....	23	92, 185 Tektronix .....	18, 25
107	All Electronics .....	106	— The SPEC-COM Journal .....	90
176	American Reliance Inc. ....	23	181 The School Of VCR Repair ....	87
84	Appliance Service .....	23	183 U.S. Cable .....	89
98	Beckman Industrial .....	17	179 Viejo Publications .....	99
109	C & S Sales .....	7	182 Zentek Corp. ....	89
—	CIE .....	28		
—	CLAGGK, Inc. ....	70		
—	Claggk Video Offer .....	35		
—	Cabletronics .....	107		
—	Command Productions .....	90		
58	Cook's Institute .....	91		
127	Deco Industries .....	23		
177	Electronic Goldmine .....	110		
—	Electronics Tech. Today .....	15		
—	Electronics Book Club .....	5, 38		
121	Fluke Manufacturing .....	CV2		
188	Global Specialties .....	3		
—	Grantham College .....	14		
189	HAMEG Instruments .....	26		
178	Hewlett Packard .....	CV4		
—	HighText Publications, Inc. ....	93		
—	ICS Computer Training .....	93, 100		
—	ISCET .....	100		
114	Jameco .....	104		
104	Jan Crystals .....	91		
115	Jensen Tools .....	23		
53	MD Electronics .....	110		
—	NRI Schools .....	11, 103		
180	NTE Electronics .....	27		
186	Northeast Electronics .....	100		
184	Optoelectronics .....	CV3		
187	People's College .....	33		
—	Science Probe .....	13		
190	Sea Jay Development .....	88		

## ADVERTISING SALES OFFICE

**Gernsback Publications, Inc.**  
500-B Bi-County Blvd.  
Farmingdale, NY 11735  
1-(516) 293-3000  
President: Larry Steckler  
**For Advertising ONLY**  
516-293-3000  
Fax 1-516-293-3115

**Larry Steckler**  
publisher  
**Christina Estrada**  
assistant to the President  
**Arline Fishman**  
advertising director  
**Denise Mullen**  
advertising assistant  
**Kelly McQuade**  
credit manager

**Subscriber Customer Service**  
1-800-288-0652  
**Order Entry for New Subscribers**  
1-800-999-7139  
7:00 AM - 6:00 PM M-F MST

## ADVERTISING SALES OFFICES

**EAST/SOUTHEAST**  
**Stanley Levitan**, Eastern Advertising Sales Manager  
Electronics Now  
1 Overlook Ave.  
Great Neck, NY 11021  
1-516-487-9357, 1-516-293-3000  
Fax 1-516-487-8402

**MIDWEST/Texas/Arkansas/Okla.**  
**Ralph Bergen**, Midwest Advertising Sales Manager  
Electronics Now  
One Northfield Plaza, Suite 300  
Northfield, IL 60093-1214  
1-708-446-1444  
Fax 1-708-559-0562

**PACIFIC COAST/Mountain States**  
**Marvin Green**, Pacific Advertising Sales Manager  
Electronics Now  
5430 Van Nuys Blvd. Suite 316  
Van Nuys, CA 91401  
1-818-986-2001  
Fax 1-818-986-2009

**EN Shopper**  
**Joe Shere**, National Representative  
P.O. Box 169  
Idyllwild, CA 92549  
1-714-659-9743  
Fax 1-714-659-2469



# NO PROBLEMO

You want a bargraph & a full range counter – Optoelectronics can deliver!

**\$199.**

Don't Wait,  
This Offer Can't Last!  
No discounts, No trade-ins.

Now for a limited time only, \$160. off the list price. for our Full Range Model 2810 with bargraph – plus:

- Full range -10Hz to 3GHz.
- LCD display (daylight visibility).
- True state-of-the-art technology with the high speed ASIC.
- NiCads & Charger included.
- Ultra-high sensitivity.
- 4 fast gate times.
- Extruded metal case.
- Compatible with MFJ207.

#### Suggested options

##### TA100S:

Telescoping Whip Antenna..... \$ 12.

##### CC30

Vinyl Carry Case..... \$ 15.

##### BL28:

EL Backlight for use in roomlight and low light..... \$ 45.

##### TCXO 30:

Precision  $\pm 0.2$ ppm 20 to 40°C temp. compensated time base ..... \$100.

Universal  
Handi-Counter™  
Model 3000, \$375. and  
Bench Model 8030, \$579.  
Both offer frequency,  
period, ratio and time  
interval.

5821 NE 14th Ave. • Ft. Lauderdale, FL 33334  
5% Ship/Handling (Max. \$10) U.S. & Canada.  
15% outside continental U.S.A.  
Visa and Master Card accepted.

CIRCLE 184 ON FREE INFORMATION CARD

## OPTOELECTRONICS

Call for free catalog - Factory Direct Order Line:

**1-800-327-5912**

FL (305)771-2050 • FAX (305)771-2052

Made in  
the USA



OPTOELECTRONICS  
HANDI-COUNTER  
MODEL 2810  
10Hz-3GHz

FREQUENCY

146.0095590 MHz

GATE

PWR

ON

Range

200MHz

800MHz

3000MHz

OFF

HOLD

INPUT

A/B

GATE

CAL

9-12VDC

# Within budget. Without compromise.



**Get more of what you want in a 6½ digit DMM for just \$995.**

The HP 34401A gives you more performance than any other DMM for the price. More resolution. Better accuracy. The highest reading speed. Fastest throughput. And widest AC bandwidth..

It has more standard features. Like HP-IB, RS-232 and built-in SCPI commands for more system flexibility. Plus ten extended functions including continuity, diode test, limit test, reading hold, dB and null to give you greater flexibility on the bench.

What more could you want? The HP 34401A also comes with a 3-year warranty, standard.

**☎ For more information, or same-day shipment from HP DIRECT, call 1-800-452-4844\*\*. Ask for Ext. TB26. And we'll send you a data sheet.**

HP 34401A Digital Multimeter	
DC Accuracy (1 year)	0.0035%
AC Accuracy (1 year)	0.06%
Maximum input	1000 Vdc
Reading speed	1000/sec
Resolution	100 nV, 10 nA, 100 μΩ

\* U.S. list price

\*\* In Canada call 1-800-387-3867, Dept. 434

There is a better way.

