

BUILD A VOCAL EFFECTS MIXER FOR HOME RECORDINGS

# Radio **Electronics**®

OCTOBER 1991

TECHNOLOGY - VIDEO - STEREO - COMPUTERS - SERVICE

Put PC power in your home videos with this  
**VGA-TO-NTSC CONVERTER**



Build R-E's  
**DIRECT DIGITAL SYNTHESIZER**  
and generate sinewaves  
digitally



An in-depth look at  
**MAGNETIC FIELDS**

Troubleshoot microprocessor-based systems with our



**MICRO MONITOR**

A look at how  
**BINAURAL RECORDING**  
re-creates realistic sound

Build Call-Alert and  
**ADD SELECTIVE CALLING**  
to your ham or CB rig



\$2.95 U.S.  
\$3.75 CAN

A  
**GERNSBACK**  
PUBLICATION

\*\*\*\*\* 5-DIGIT 60506  
39073604MD9976093 10 79  
JAN 92  
RE  
MR ROBERT DAHM  
897 GRAND AV  
AURORA, IL 60506

**FLUKE**®



**PHILIPS**



70 SERIES II

# 8 New Meters. 8 Old-Fashioned Values.

**Introducing Fluke's 70 Series II, next-generation multimeters that meet the increasing demands of your job and your budget.**

Consider. At the top of the line, the new Fluke 79 and 29 deliver more high-performance features – capacitance, frequency, a fast 63-segment bar graph, Lo-Ohms range, Smoothing™, faster ranges – than DMMs costing much more.

At the entry level, the new model 70, Fluke's lowest-priced DMM ever, delivers unparalleled Fluke quality at a price comparable to "disposable" meters.

And in between are all the models that have made the 70 Series the most popular DMM family in the world – updated, refined and delivering even more value than ever.

**"BASICS" REDEFINED**

No matter which 70 Series II you choose, you get simple, one-handed operation. High resolution. And built-in, go anywhere reliability.

Automatic Touch Hold® – standard on every model – locks the reading on the display and signals you with a beep, automatically updating for each new measurement without a reset. Leaving you free to concentrate on your work, not on your meter.

**YOUR BEST CHOICE**

Best of all, every 70 Series II is a Fluke, backed by a worldwide service network and an industry-leading 3 year warranty.

So the next time you're in the market for a new meter, ask for the one that guarantees old-fashioned value. Fluke 70 Series II. For more information call **1-800-6789-LIT**. Or call 1-800-44-FLUKE, ext 33 for the name of your nearest Fluke distributor.

CIRCLE 121 ON FREE INFORMATION CARD

**Fluke 79 Series II & 29 Series II**

- \$185\*
- 4000 Count Digital Display (9999 in Hz &  $\pm$ )
- 63 segment Analog Bar Graph
- 0.3% Basic DC Voltage Accuracy
- Automatic Touch Hold\*
- Diode Test, Audible Continuity Beeper
- Autorangeing, Manual Ranging
- Holster with Flex Stand™
- Frequency Counter to over 20 kHz
- Capacitance 10 pF to 9999µF
- Lo-Ohms Range with Zero Calibration
- Smoothing™
- 700 Hours Battery Life (alkaline)
- 3 year Warranty

79/77/75/73/70 for measurements to 4800 V-A  
29/23/21 for higher energy measurements.

\*Fluke 70 Series II suggested U.S. list prices range from \$69 to \$185.

John Fluke Mfg. Co., Inc. P.O. Box 9090 M/S 250E Everett, WA 98206 U.S. 206-356-5400  
Canada 416-890-7600 Other Countries 206-356-5500 © Copyright 1991 John Fluke Mfg. Co., Inc. All rights reserved. Ad no. 00091 Prices and specifications subject to change without notice.

**FLUKE**®



## BUILD THIS

### 33 PC-TO-TV CONVERTER

Our VGA to NTSC television adapter is your computer's link to the outside video world.

**Anthony Stevens**

### 39 VOCAL EFFECTS/MIXER

Use it to create a multiple-echo effect and to mix audio from various sources.

**Terry Weeder**

### 43 DIGITAL SINEWAVE SYNTHESIZER

Generate low-distortion waves digitally.

**Steven D. Swift**

### 60 R-E's CALL ALERT

It eliminates the chatter on your favorite channel or repeater.

**Rodney A. Kreuter and David Plant**

### 67 MICRO MONITOR

This inexpensive logic-analyzer kit simplifies microprocessor design

**Jim Cooke**

## TECHNOLOGY

### 51 BINAURAL BASICS

A look at the technique that makes recordings come alive.

**John Sunier**

### 53 AN INTUITIVE LOOK AT ELECTROMAGNETIC THEORY

A look at magnetic charges and "B" fields.

**William P. Rice**

## DEPARTMENTS

### 6 VIDEO NEWS

What's new in this fast-changing field.

**David Lachenbruch**

### 22 EQUIPMENT REPORTS

Units + Conversion Factors.

### 72 HARDWARE HACKER

Tesla coils, high-energy resources, and more.

**Don Lancaster**

### 74 AUDIO UPDATE

Reader letters.

**Larry Klein**

### 85 DRAWING BOARD

Let's build an oscilloscope!

**Robert Grossblatt**

### 94 COMPUTER

CONNECTIONS

History in the making.

**Jeff Holtzman**



**DIGITAL SINEWAVE SYNTHESIZER**

Build this direct digital synthesizer and generate low-distortion sine waves digitally.

**STEVEN D. SWIFT**

Build this direct digital synthesizer and generate low-distortion sine waves digitally. The circuit uses a microcontroller to generate a digital sine wave, which is then converted to an analog signal by a DAC. The resulting sine wave is filtered and amplified to produce a clean, low-distortion output. This project is ideal for anyone interested in digital signal processing and audio synthesis.

PAGE 43



**VOCAL EFFECTS/MIXER**

Build this vocal effects mixer and get studio-quality sound "reverberations" in your recordings.

**TERRY WEEDER**

Build this vocal effects mixer and get studio-quality sound "reverberations" in your recordings. This project allows you to create a professional-sounding vocal recording by adding multiple echoes and reverb to your voice. The circuit uses a microcontroller to generate a series of delayed copies of the input signal, which are then mixed together to create a rich, multi-dimensional sound.

PAGE 39

## AND MORE

108 Advertising and Sales Offices

108 Advertising Index

8 Ask R-E

14 Letters

97 Market Center

27 New Lit

24 New Products

4 What's News

## ON THE COVER



One of the latest "buzzwords" in consumer electronics is "multimedia"—and there's no reason for your computer to be left out. By converting the PC's VGA signal to NTSC, you can display the computer's video pictures on a VCR. You can get a jump on the multimedia trend, and connect your computer to the outside video world, by using our VGA to NTSC video conversion board, a VCR, and animation software. That combination will allow you to create your own TV video productions, insert-edit titles on home videos, or even play video games on a huge projection-TV screen. To find out how to get started, turn to page 33.

## COMING NEXT MONTH

### THE NOVEMBER ISSUE GOES ON SALE OCTOBER 3

#### BUYER'S GUIDE TO DSO'S

We concentrate on digital storage oscilloscopes with bandwidths from 20–200 MHz.

#### MICRO MONITOR

Construction details for the logic analyzer kit.

#### MUSIC ON HOLD

Add this high-tech feature to your telephone.

#### DOPPLER-ULTRASOUND HEART MONITOR

Listen to your heartbeat with this device.

As a service to readers, RADIO-ELECTRONICS publishes available plans or information relating to newsworthy products, techniques and scientific and technological developments. Because of possible variances in the quality and condition of materials and workmanship used by readers, RADIO-ELECTRONICS disclaims any responsibility for the safe and proper functioning of reader-built projects based upon or from plans or information published in this magazine.

Since some of the equipment and circuitry described in RADIO-ELECTRONICS may relate to or be covered by U.S. patents, RADIO-ELECTRONICS disclaims any liability for the infringement of such patents by the making, using, or selling of any such equipment or circuitry, and suggests that anyone interested in such projects consult a patent attorney.

RADIO-ELECTRONICS, (ISSN 0033-7862) October 1991. Published monthly by Gernsback Publications, Inc., 500-B Bi-County Boulevard, Farmingdale, NY 11735 Second-Class Postage paid at Farmingdale, NY and additional mailing offices. Second-Class mail registration No. R125166280, authorized at Toronto, Canada. One-year subscription rate U.S.A. and possessions \$17.97, Canada \$25.65 (includes G.S.T. Canadian Goods and Services Tax Registration No. R125166280), all other countries \$26.97. All subscription orders payable in U.S.A. funds only, via international postal money order or check drawn on a U.S.A. bank. Single copies \$2.95. © 1991 by Gernsback Publications, Inc. All rights reserved. Printed in U.S.A.

**POSTMASTER:** Please send address changes to RADIO-ELECTRONICS, Subscription Dept., Box 55115, Boulder, CO 80321-5115.

A stamped self-addressed envelope must accompany all submitted manuscripts and/or artwork or photographs if their return is desired should they be rejected. We disclaim any responsibility for the loss or damage of manuscripts and/or artwork or photographs while in our possession or otherwise.

# Radio Electronics®

Hugo Gernsback (1884-1967) founder

Larry Steckler, EHF, CET,  
editor-in-chief and publisher

#### EDITORIAL DEPARTMENT

Brian C. Fenton, editor

Marc Spiwak, associate editor

Kim Dunleavy,  
assistant technical editor

Teri Scaduto, assistant editor

Jeffrey K. Holtzman  
computer editor

Robert Grossblatt, circuits editor

Larry Klein, audio editor

David Lachenbruch  
contributing editor

Don Lancaster  
contributing editor

Kathy Terenzi, editorial assistant

#### ART DEPARTMENT

Andre Duzant, art director

Injae Lee, illustrator

Russell C. Truelson, illustrator

#### PRODUCTION DEPARTMENT

Ruby M. Yee, production director

Janice Box,  
editorial production

Karen S. Brown  
advertising production

Marcella Amoroso  
production assistant

#### CIRCULATION DEPARTMENT

Jacqueline P. Cheeseboro  
circulation director

Wendy Alanko  
circulation analyst

Theresa Lombardo  
circulation assistant

Michele Torrillo, reprint bookstore

Typography by Mates Graphics  
Cover photo by Diversified Photo  
Services

Radio-Electronics is indexed in  
*Applied Science & Technology Index*  
and *Readers Guide to Periodical Literature*.

Microfilm & Microfiche editions are  
available. Contact circulation department  
for details.

Advertising Sales Offices listed  
on page 94.

Radio-Electronics Executive and  
Administrative Offices  
1-516-293-3000.

Subscriber Customer Service:  
1-800-288-0652.

Order Entry for New Subscribers:  
1-800-999-7139.

The  
Audit  
Bureau  
of Circulation





# TEST FOR LESS WITH FORDHAM

**Model DVM-636**

**Now Only \$59<sup>95</sup>**

*Rugged & Reliable!*  
•8 Functions  
•37 Ranges

**SCOPE Hand Held Digital Multimeters**

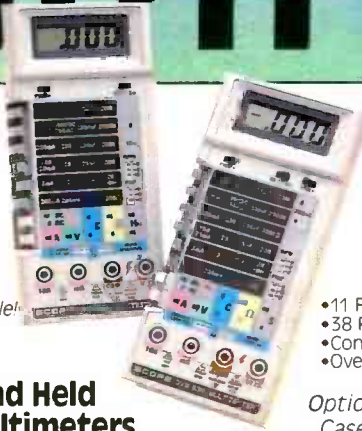

**Model DVM-638**

**Now Only \$69<sup>95</sup>**

•11 Functions  
•38 Ranges  
•Continuity Beeper  
•Overload Protection

Optional Carrying Case CA-92 **\$9.95**

## Special Bonus with any order



**RD-2110 Radar Detector**

*Yours for only \$49<sup>95</sup>* Reg. 109.95



*Feature Packed! Contemporary Look!*

*with your order of any item on this page.*

### SCOPE 3 1/2 Digit LCR Meter

*Ideal for field applications!*

•Light weight •Portable •Hand Held  
•Overload Protection •Test Leads

**Model LCR-680**  
**SALE \$119<sup>95</sup>**

Optional Carrying Case CA-92 **\$9.95**



### SCOPE 3 1/2 Digit LCD Meter

•0.5% Accuracy • DC/AC Voltage, DC Current  
•Diode & Battery Test •Overload Protection

DC 500V, AC 350V, Ohms 250V DC/AC

**Model DVM-630**  
**SALE \$32<sup>50</sup>**

Reg. \$50.00  
Optional Deluxe Carrying Case CC-30 **\$4.50**



### Sweep Function Generator

**Sale! Now \$198<sup>00</sup>**

Reg. \$319.95

**Model FG-801**

•Selectable Wave & TTL Pulse  
•7 Freq. Ranges (0.2 Hz to 2M-Hz)  
•Sweep Ratio 100:1



### SCOPE Analog Lab

**Sale! Now \$198<sup>00</sup>**

Reg. \$225.00

**Model SC-6000**

•5 Freq. Ranges  
•Variable Positive Power  
•Potentiometer



### Proto-Board Station

**Special! \$298<sup>00</sup>**

**Model SC-9000A**

•3 Wire AC Line Input  
•Function Generator  
•Triple Power Supply  
•8 Logic LED's



**Feature Packed! HITACHI Oscilloscope**

**Now \$425<sup>00</sup> Save \$190<sup>00</sup>**

Reg. \$615.00

**Model V-212 Dual Trace**

•DC to 20 MHz, 1mV/div  
•6" Rectangular Screen  
**PROBES INCLUDED!**

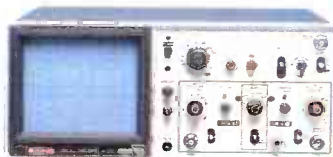

**HITACHI Dual Trace Oscilloscope**

**Now \$598<sup>00</sup>**

**Best Value!**

**Model V-355**

•19 Calibrated Sweeps  
•6" CRT •Auto Focus  
**PROBES INCLUDED!**



# Fordham

260 Motor Parkway, Hauppauge, New York 11783

ASK FOR YOUR FREE CATALOG

**TOLL FREE 800-695-4848**

**Service & Shipping Charge Schedule Continental U.S.A.**

FOR ORDERS	ADD	FOR ORDERS	ADD
\$0-25	\$4.50	\$501-750	\$16.00
\$26-50	\$6.00	\$751-1,000	\$18.00
\$51-100	\$7.50	\$1,001-1,250	\$20.00
\$101-200	\$9.00	\$1,251-1,500	\$22.00
\$201-300	\$10.00	\$1,501-2,000	\$27.50
\$301-400	\$12.00	\$2,001 and up	\$35.00
\$401-500	\$14.00		



Money orders, checks accepted  
C.O.D.'s require 25% deposit

# WHAT'S NEWS

*A review of the latest happenings in electronics.*

## **Commercial solar-electric power plants**

The next generation of solar electric plants are being heavily promoted in the Sunbelt states by solar engineers at Sandia National Laboratories (Albuquerque, NM). Unlike earlier plants, which suffered from power-output and efficiency limitations due to the use of steam, the new solar plants will use molten salt to transfer heat and store energy in the system. The engineers have been trying to sell utilities, regulatory agencies, and environmental groups on the benefits—in terms of cost, environmental safety, and efficiency—of building a molten-salt central receiver power plant that would be capable of producing 100 megawatts or more of electricity.

Central receiver power plants, such as Solar One in the Mojave Desert near Barstow, CA, consist of a field of sun-tracking mirrors that concentrate sunlight onto a receiver that absorbs the energy and transfers it to a heat-transport fluid. The fluid is heated to more than 540°C (1000°F), and the resultant energy is either used to drive a turbine to produce electric power or is stored for later use. Molten salt presents an attractive alternative to steam because of its lower cost, high heat-transfer capabilities, and increased safety. The development of molten-salt systems began in the late 1970's, and national laboratories, private industries, and universities have been working together since then to develop and test the system components. Recent Sandia experiments—many performed at the scale of an operating plant—have proved the feasibility of such a commercial solar power plant and demonstrated the reliability of major components.

Solar One used a receiver in which water was boiled by concentrated sunlight to produce steam, which passed directly to a turbine to produce electric power. It is difficult, however, to store energy in the form of high-pressure steam, so the plant lacked an efficient energy-storage

system. That caused operational problems—particularly during cloudy weather—which had the effect of lowering electricity production.

The use of molten salt eliminates most of those problems. Because the hot salt is stored at atmospheric pressure, the energy-storage system design is simplified. In addition, the molten-salt central-receiver systems do not produce hazardous waste or emit gases linked with acid rain or global warming and could reduce our dependence on foreign oil.

One of the most attractive benefits of the technology is the plant's load-shifting capability, or the ability to deliver electricity to consumers when demand is highest. Its highly efficient energy-storage system also allows a molten-salt plant to operate cost effectively more than 60% of the year without using fossil fuel as a backup.

A 200-megawatt second-generation solar-power plant could produce electricity at a cost competitive with power from a fossil fuel facility. For instance, the cost of electricity from a molten-salt solar-power plant is just one to two cents per kilowatt hour higher than from a similar-sized coal plant, and the price is likely to go down as the technology is improved. The key to getting the costs down lies in reducing the cost of the field of mirrors—which could be achieved with mass production. Other benefits are that the new solar plants would be

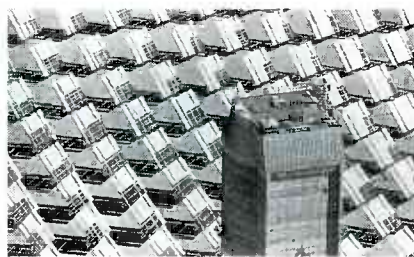

**TESTS AT SANDIA'S NATIONAL SOLAR Thermal Test Facility have proved the viability of a commercial, utility-scale, solar thermal-power plant using molten salt for efficient heat transfer and energy storage. Such a facility, using a field of sun-tracking mirrors as pictured here, could produce electricity at a cost competitive with coal-fired plants.**

able to deliver electricity on demand, even at night; produce electricity much cheaper than any other utility-size solar power plant; store energy inexpensively; and reduce our dependence on foreign oil.

## **Radio signals via fax?**

Fax-Max Services, a Montauk, NY-based communications company, has petitioned the FCC to create a new service in which radio signals could be broadcast to facsimile machines. If the advertiser-supporter service was approved by the FCC, it could allow fax machines to function like radios that provide a printout of their broadcasts. News updates, weather maps, sports scores, stock-market reports, and public-service announcements could be transmitted on a regular basis, at much less cost than transmitting data over telephone lines.

The petition asks the FCC to make legal a new class of broadcasting services to be known as the Public Facsimile Broadcast Service (PFBS). PFBS would use at least three radio channels at about the 930-MHz band. Fax-Max plans to begin experimental services in the New York area by October 1, and has initiated patent proceedings for a radio receiver that accepts signals transmitted to fax machines. About the size of a cigarette pack, the receiver is intended to be attached to a fax and plugged into the phone line. According to current plans, advertisers and other companies transmitting data would pay a per-page fee to Fax-Max. Recipients would buy the receiver, but would receive broadcasts at no charge. They could select both their broadcasts and the channels, as well as the subject categories. Information would be transmitted at regular intervals; for examples, news updates could be sent every 30 minutes. Fax-Max envisions the transmission of a broad range of services, from general hourly newspapers to specialized services like civil-service alerts or wanted poster to law-enforcement agencies.

**R-E**



# MAXIMUM RANGE MAXIMIZED SENSITIVITY

We've Carefully balanced the amount of gain used in our input amplifiers - too much or too little results in poor performance. **OPTOELECTRONICS' HANDI-COUNTERS™** with maximized sensitivity give you the maximum range for antenna pick-up.

Made in the USA



**MODEL 3000**  
Multi-function Counter  
1Hz-z-3GHz, 10 Digit LCD with  
frequency, period, ratio, interval  
& signal level bargraph...\$375.



**Maximum Security Device.**  
Increase your frequency finding™ by 10 times the distance or more.  
**Tunable Preselector APS-104 \$995.**  
Counter Sold separately



**MODEL 8030**  
With all the features of the 3000 plus enhanced input signal conditioning and enhanced TCXO time base **\$579.**

# OPTOELECTRONICS

**\$199.**



**Model 2210A**  
10Hz-2.4GHz Full range counter. Price includes Nicads & AC charger/adapter.

## The Original Pocket-Sized LED Handi-Counter™

All of **OPTOELECTRONICS'** LED Handi-Counters™ will:

- Count frequencies above 2.4GHz.
- Have display saving Power Switch (avoids premature LED burn-out, leading cause of counter failure.)

**Accept no substitutes - Look for the OPTOELECTRONICS name on the label!**

**Only OPTOELECTRONICS offers you MAXIMIZED SENSITIVITY.**

Factory Direct Order Line **1-800-327-5912**  
FL(305)771-2050 • FAX(305)771-2052  
5821 NE 14th Ave. • Ft. Lauderdale, FL33334 • 5% Ship/Handling (Max. \$10)  
U.S. & Canada. 15% outside continental U.S.A.  
Visa and Master Card accepted.

**\$99.**



**Model 2300 - 1MHz-2.4GHz**  
Available with NiCads and AC Charger Adapter. Complete Package only....\$128.

# VIDEO NEWS

*What's new in the fast-changing video industry.*

**DAVID LACHENBRUCH**

●  **Wooing Nintendo.** Sony and Philips, which jointly developed the Compact Disc, appear to be going in different directions in CD-ROM multimedia systems for the consumer market. Both of them have deals with Nintendo involving different—and incompatible—CD-ROM game systems. Sony will introduce a CD-ROM-based home-entertainment system called Play Station, which will also have a port for Nintendo's new 16-bit video-game cartridges. However, the CD-ROM's for Play Station will all be original Sony titles, not adaptations of Nintendo games, and Nintendo has announced that it won't support Play Station with any CD games.

Instead, Nintendo is casting its lot with Philips' CD-I approach, and announced at the Consumer Electronics Show in Chicago that it will develop CD-ROM games for that format. Both Sony and Philips consider Nintendo to be a major asset because of the widespread popularity of its games. At our deadline, Sony and Nintendo were involved in discussions which could result in a closer alliance. It's known that Philips' announcement of Nintendo CD-ROM games took Sony by surprise in view of the fact that Sony apparently thought it had an exclusive CD-ROM deal with the game company.

Additional video-game—CD alliances: JVC and Sega have formed a partnership for sophisticated video motion CD-ROM games, incompatible with both CD-I and Play Station.

● **JVC goes widescreen.** JVC may be the first brand to bring widescreen TV sets with a 16:9 ratio picture tube to the United States. The company is introducing a set with a 34-inch wide-ratio tube in Japan this fall and says it will bring the same set to the U.S. shortly thereafter. Thus it could well beat Thomson, which is selling a widescreen set in Europe, to the U.S. market. JVC's set is designed for standard NTSC pictures, but can accommodate letterboxed

videos full-screen, convert normal ratio (4:3) pictures to 16:9 by eliminating part of the top and bottom, or show standard pictures on the screen with space left over at one side for three small pictures (a "picture-outside-of-picture" version of picture-in-picture).

● **8mm Snapshots.** Electronic digital video still cameras flopped on the consumer market—probably because they were too expensive. Now the Japanese manufacturers have a better idea: Why not let video camcorders make digital snapshots as well? The first such camcorder to embrace this idea was shown in prototype form recently by Hitachi. A high-band 8mm (Hi8) model, it can record a high-resolution digital still picture at the same time it's making a moving analog video. The still pictures are recorded in pulse code modulation on the audio track at the rate of one every 12 seconds. The PCM digital audio track can't be used while stills are being recorded, but the hi-fi AFM analog stereo track can.

● **Philips' LCD Projector.** Philips will soon introduce a unique LCD projector in the U.S. under its Magnavox label. Using three 2.8-inch LCD panels, it can project a 660,000-pixel picture on a screen up to about 100 inches in diagonal measurement. It uses a 2000-hour metal-halide lamp developed by Philips' lighting division. An on-screen countdown can be accessed by the remote control unit to tell how many hours of life the lamp has left. Unlike Sharp's somewhat similar LCD projector (Sharp supplies the LCD's to Philips), the Magnavox unit has a TV tuner. It has a "convenience speaker" in the projector and two outboard speakers as well, for placement at either side of the screen. The picture can be reversed or turned upside down so the same projector may be used in rear projection as well as front projection systems. The price will be in the \$5000–\$7000 range, according to

Philips. Although the first model is rather large (but still fairly portable), Philips says it's aiming at a future version about the size of a VCR.

● **Hail to the King.** Japan is agog over a new TV picture tube, used in high-end Matsushita TV sets, that goes under the name of "Gao." Loosely translated, that means "king of pictures." Having conquered Japan, the King is coming to the United States. The Gao tube (which, of course, will be called something else here) is notable for its almost (but not quite) flat faceplate and its high-contrast picture. The contrast is obtained by the use of a very dark faceplate with a light transmission of only 33% to 36% (depending on tube size). The tube can be driven at very high voltage and has a new gun and shadow-mask system to provide the required brightness even at the extremely high-contrast level. In addition to the high contrast and flat front surface, Matsushita says a multifocus cathode results in an improved focus.

In Japan, Gao comes in three sizes, none of them cheap—25-inch sets start at about \$1265, two 27-inch versions cost up to \$1825 and two 31-inchers go as high as \$3500. In the U.S., it's expected that 27- and 31-inch versions will show up in Panasonic's Prism line next year.

● **VHS-C compatibility.** Speaking of JVC, that company has a goal of across-the-board compatibility of its full line of VHS decks with VHS-C cassettes by 1993. The company currently has two decks—at \$500 and \$1600 suggested list prices—which can play the small VHS-C cassettes without an adaptor. JVC currently is developing a second-generation system to accommodate compact- and standard-size VHS cassettes in the same loading mechanism but at a much lower cost than the current compatible loading-drawer system. Its goal is a loading system that costs no more than the current full-size-only tape slot. **R-E**



# Afford. Ability.

## In a dc power supply.

Now, put a dependable, 30-watt dc power supply on your bench for just **\$300\***. You'll get the low noise your work demands (200  $\mu$ V rms). Constant-voltage or constant-current operation. And built-in reliability ensured by conservative design margins and rigorous environmental testing.

Outstanding value in a dc power supply. It's just one in a full line of basic instruments developed by HP to give you uncompromising performance at an affordable price.

 To order, call **HP DIRECT, 1-800-538-8787, Ext. TW13.**

We'll ship your order the day it's received. Instruments come with a sixty-day, money-back guarantee.

All you need is a company purchase order or credit card.



HP 30-watt power supplies		E3610A	E3611A
Output	Range 1	8V, 3A	20V, 1.50A
	Range 2	15V, 2A	35V, 0.85A
Load or line regulation	0.01% + 2 mV		
Ripple and noise (10 Hz-10 MHz)	200 $\mu$ V rms/2 mV p-p		

\* U.S. list price

There is a better way.



© 1991 Hewlett-Packard Co. TMNJ1105/RE

CIRCLE 180 ON FREE INFORMATION CARD

# ASK R-E

Write to Ask R-E, Radio-Electronics, 500-B Bi-County Blvd., Farmingdale, NY 11735

## SLOWER RECORDING

**I would like to modify my cassette tape recorder so it can play and record at  $1\frac{5}{16}$  inches per second instead of the standard speed of  $1\frac{7}{8}$  inches per second. Doing this will let me get 180 minutes of recording time from a standard C-90 cassette. I've seen ads in various magazines for machines that have been modified like this but I'd like to do it to my own machine. Do you know of any articles or information I can get that will show me how it's done?—M. Couch, Warren, MI**

I read a lot of magazines every month but I can't remember ever having seen an article on this subject. I wouldn't be surprised if some of our readers have better memories (or different reading lists), but I'm willing to bet that, even if you find an article on the subject, it won't be much use to you.

The only way to be able to modify the speed (and, ideally, make it switch-selectable with the standard speed) is to know how your machine works. The most valuable information you can get is the service manual for your cassette recorder—it will give you a head start in modifying the circuit. Otherwise, you'll first have to figure out how your recorder works before you can attempt any changes.

In actual fact though, what you want to do is not terribly difficult, since the method of controlling the speed of the tape on most cassette recorders is fairly simple. The details of the designs will vary from machine to machine but there are really only two basic ways to do the job.

Inexpensive recorders usually have a variable-speed (voltage-dependent) motor, and the speed is maintained by regulating the voltage sent to the motor. The regulation can be as simple as a pair of resistors (not common since there would be a lot of wasted power), or a Zener-based regulator circuit. If you have a recorder like that, you can change the speed by replacing the Zener with one that provides a lower voltage.

There are two important things to watch out for if you decide to do this. The first is that you have to be sure you've identified the right Zener diode on the circuit board and you've verified the voltage by actually measuring the voltage at the motor. The second is that you have to verify that the motor will work reliably at the reduced voltage. Some motors, particularly those in cheap recorders, don't develop a lot of torque and, if you slow them down by reducing the voltage, they'll stop running at a constant speed, or may pack it in completely—and there's a good chance it will eat some of your tape before it decides to die.

More expensive cassette recorders usually have circuitry that monitors the speed of the motor and constantly adjusts the voltage as the power starts to drop. These machines have a tachometer on the shaft of the motor that sends a signal to a frequency-to-voltage converter where it's compared to a reference voltage. The error voltage generated is used to ensure that the motor is always being fed with the proper voltage for the right speed.

If your cassette recorder has a tach-driven motor, you'll usually find there's a potentiometer you can tweak to adjust the speed. Mark the current setting with a pen before you start fooling around with it since you may want to put it back to the original position some time in the future. You'll also need some way to monitor the speed of the machine while you're adjusting it. The standard way of doing that is to use an alignment tape and a frequency counter but, if you've got the mind to mess around with this stuff in the first place, you can more than likely come up with some other creative ways to do it.

While it's possible to modify the speed of just about any cassette recorder in existence, the only ones that are usually used are the more expensive machines with tach-driven motors. Those machines are the ones that you've seen advertised. There's no reason why you can't

modify your own cassette recorder, but trying to do it without the service manual is kind of like doing an appendectomy on a Neptunian. The procedure is fairly simple but you have to know where the appendix is before you start cutting.

## INTEL 8052

**I built a single-board computer based on Intel's 8052AH-BASIC chip which has an onboard 8K ROM containing the Basic Interpreter. I've successfully copied the language to an EPROM but I haven't been able to get the EPROM to work with the standard 8052-AH. This less-expensive version of the 8052AH-BASIC chip is identical in every respect except that it doesn't have BASIC in the internal EPROM. Do you know of any way to make the 8052AH read the EPROM from the moment it's turned on as if it were its own ROM? I don't have a 8052AH simulator so any solution will have to be in BASIC.—D. Nikolaidis, Melbourne, FL**

I've done quite a bit of designing around Intel's 803X, 804X, and 805X family of microcontrollers but haven't had a lot of experience with the BASIC versions of the chip. The first thing you should do is get your hands on any information on the 8052 that you can, since the more information you have in front of you, the less risk there is for brain damage at the bench.

You didn't send any schematics with your letter, but let me tell you right off that the 8052AH and the 8052AH-BASIC are not, as you said, identical in every respect. There are differences between them, and it may be that these differences are causing your problems in the first place.

The pinouts of both chips are shown in Fig. 1 and you can see that, while the chips are similar in function, the differences in their internal organization has resulted in different assignments to the pin functions. I'd strongly suggest that you call Intel's literature department



# Why take chances in today's job market?

## Graduate as a fully trained electronics professional.

To get ahead and stay ahead in today's economy, you need the electronics training CIE has been providing its 150,000-plus successful graduates with for nearly 60 years.

### **Meet the Electronics Specialists.**

When you pick an electronics school, you're getting ready to invest time and money. And your whole future depends on the education you receive in return. That's why it makes so much sense to go with number one... with the specialists... with CIE!

### **There's no such thing as a bargain education.**

If you talk to some of our graduates, and we recommend you do, chances are you'd find a lot of them shopped around for their training. Not for the lowest priced, but for the best training available. They pretty much knew what was available when they picked CIE as number one.

### **Because we're specialists we have to stay ahead.**

At CIE we have a position of leadership to maintain. Here are just a few of the ways we hang onto it...

### **Programmed Learning.**

That's exactly what happens with CIE's Auto-Programmed Lessons®. Each lesson uses famous "programmed learning" methods to teach you important electronics principles. You explore them, master them completely, before you start to apply them. You thoroughly understand each step before you go on to the next. You learn at your own pace.

And, beyond theory, some courses come fully equipped with electronics equipment to actually let you perform hundreds of hands-on experiments.

### **Experienced specialists work closely with you.**

Even though you study at home, CIE's faculty and staff stand ready to assist via CIE's toll free number. And, each time you return a completed exam you can

be sure it will be reviewed, graded and returned with the appropriate instructional help, you get it fast and in writing from the faculty technical specialist best qualified to answer your question in terms you can understand.

### **Pick the pace that's right for you.**

CIE understands people need to learn at their own pace. There's no pressure to keep up...no slow learners hold you back. If you're a beginner, you start with the basics. If you already know some electronics, you move ahead to your own level.

### **"Same Day" grading cycle.**

When we receive your lesson, we grade it and mail it back the same day. You find out quickly how well you're doing!

### **State-of-the-art laboratory equipment.**

Some courses feature the CIE Microprocessor

Training Laboratory. An integral part of computers, microprocessor technology is used in many phases of business, including service and manufacturing industries. The MTL gives you the opportunity to program it and interface it with LED displays, memory devices and switches. You'll gain all the experience

needed to work with state-of-the-art equipment of today and tomorrow.

### **New Courses!**

CIE now offers two new career courses: Automotive Electronics and Computer Operation and Programming.

### **CIE offers you an Associate Degree.**

One of the best credentials you can have in electronics — or any other career field — is a college degree. That's why CIE offers an Associate in Applied Science in Electronics Engineering Technology. And all CIE career courses earn credit toward your degrees.

### **Which CIE training fits you?**

Beginner? Intermediate? Advanced? CIE home study courses are designed for ambitious people at all entry levels. People who have: No previous electronics knowledge, but do have an interest in it, Some basic knowledge or experience in electronics, In-depth working experience or prior training in electronics.

At CIE you start where you fit and feel comfortable where you start, then go on from there to your Diploma, Associate Degree and career!

### **Today is the day. Send now.**

Fill in and return the postage-paid card attached. If some ambitious person has already removed it, cut out and mail the coupon below. You'll get a FREE CIE school catalog, plus complete information on independent home study. Mail in the coupon below or, if you prefer, call toll-free 1-800-321-2155 (in Ohio, 1-800-523-9109).



AE27

**YES!** I want to get started. Send me my CIE school catalog including details about the Associate Degree program. (For your convenience, CIE will have a representative contact you — there is no obligation.)

Print Name \_\_\_\_\_

Address \_\_\_\_\_ Apt. \_\_\_\_\_

City \_\_\_\_\_ State \_\_\_\_\_ Zip \_\_\_\_\_

Age \_\_\_\_\_ Area Code/Phone No. (\_\_\_\_) \_\_\_\_\_

Check box for G.I. Bulletin on Educational Benefits  Veteran  Active Duty

 **CLEVELAND INSTITUTE OF ELECTRONICS, INC.**  
1776 East 17th Street • Cleveland, Ohio 44114 • (216) 781-9400

 A school of thousands.  
A class of one.  
Since 1934.

# Which symbol represents a variable inductor?

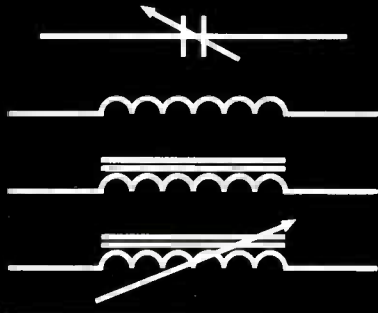

What is the principal disadvantage of neon lights?

What are out-of-phase signals?

## Heath Video Courses speed your learning curve!

Learn basic electronics at home at your own pace with four, 60-minute video tapes. Know the variable inductor symbol. Recognize a PN junction. Understand oscillator fundamentals. Clearly SEE what most basic electronic books can only describe.

**DC ELECTRONICS.** Covers electron movement to troubleshooting and repairing a simple electronic circuit. **EV-3101-A.**

**AC ELECTRONICS.** Follow-up to DC Electronics. Covers the principles of AC, voltage and electrical measurement. Includes motors, generators and test instrument meter movements. **EV-3102-A.**

**SEMICONDUCTORS.** Complete the DC/AC videos and you're ready to learn how semiconductor devices are made, plus the principles of discrete devices, integrated circuits & optoelectronic devices. **EV-3103-A.**

**ELECTRONIC CIRCUITS.** Complete the basic course with amplifier configurations, biasing, coupling, audio amplifiers, closed-loop vs. open-loop operation and more. **EV-3104-A.**

An activity-filled workbook and explanation of how to solve each problem comes with each tape so you learn three ways — video, workbook and hands-on!

Order today!  
Call Toll free,  
24-hours a day.  
1-800-253-0570.

We accept VISA, MasterCard, American Express and Heath Revolving Charge card. Use Order Code 601-060

VIDEO TAPES  
**\$44.95**  
EACH

# Heath®

Benton Harbor, MI

Call for a FREE catalog 1-800-44HEATH.

Price does not include shipping and handling ED-238-R2 or applicable sales tax.

CIRCLE 86 ON FREE INFORMATION CARD

1	(T2) P1.0	Vcc	40
2	(T2(EX)) P1.1	P0.0 (AD0)	39
3	P1.2	P0.1 (AD1)	38
4	P1.3	P0.2 (AD2)	37
5	P1.4	P0.3 (AD3)	36
6	P1.5	P0.4 (AD4)	35
7	P1.6	P0.5 (AD5)	34
8	P1.7	P0.6 (AD6)	33
9	RESET	P0.7 (AD7)	32
10	(RXD) P3.0	EA	31
11	(TXD) P3.1	ALE	30
12	(INT0) P3.2	PSEN	29
13	(INT1) P3.3	P2.7 (A15)	28
14	(T0) P3.4	P2.6 (A14)	27
15	(T1) P3.5	P2.5 (A13)	26
16	(WR) P3.6	P2.4 (A12)	25
17	(RD) P3.7	P2.3 (A11)	24
18	XTAL 2	P2.2 (A10)	23
19	XTAL 1	P2.1 (A9)	22
20	GROUND	P2.0 (A8)	21

1	(T2) P1.0	Vcc	40
2	(T2(EX)) P1.1	AD0	39
3	(PWM OUT) P1.2	AD1	38
4	(CALE DISABLE) P1.3	AD2	37
5	(PROGRAM PULSE) P1.4	AD3	36
6	(PROGRAM ENABLE) P1.5	AD4	35
7	(DMA ACKNOWLEDGE) P1.6	AD5	34
8	(LINE PRINTER OUT) P1.7	AD6	33
9	RESET	AD7	32
10	CONSOLE SERIAL IN	+5V	31
11	CONSOLE SERIAL OUT	ALE	30
12	(INT0) DMA REQUEST	PSEN	29
13	INT1	A15	28
14	T0	A14	27
15	T1	A13	26
16	WR	A12	25
17	RD	A11	24
18	XTAL 2	A10	23
19	XTAL 1	A9	22
20	GROUND	A8	21

FIG. 1—THE 8052AH AND THE 8052AH-BASIC. Differences in their internal organization has resulted in different assignments to the pin functions.

(1-800-538-4725) and get a copy of their Microcontroller Handbook. It

has all the information you need and several interesting article reprints as well.

## LEARN VCR

### CLEANING/MAINTENANCE/REPAIR

**EARN UP TO \$1000 A WEEK, WORKING PART TIME FROM YOUR OWN HOME!**



Secrets Revealed!

NO Special Tools or Equipment Needed.

**EARN UP TO \$60 AN HOUR AND MORE!**

#### THE MONEY MAKING OPPORTUNITY OF THE 1990'S

IF you are able to work with common small hand tools, and are familiar with basic electronics (i.e. able to use voltmeter, understand DC electronics) . . .

IF you possess average mechanical ability, and have a VCR on which to practice and learn. . . then we can teach YOU VCR maintenance and repair!

**FACT:** up to 90% of ALL VCR malfunctions are due to simple MECHANICAL or ELECTRO-MECHANICAL breakdowns!

**FACT:** over 77 million VCRs in use today nationwide! Average VCR needs service or repair every 12 to 18 months!

Viejo's 400 PAGE TRAINING MANUAL (over 500 photos and illustrations) and AWARD-WINNING VIDEO TRAINING TAPE reveals the SECRETS of VCR maintenance and repair—"real world" information that is NOT available elsewhere!

Also includes all the info you'll need regarding the BUSINESS-SIDE of running a successful service operation!

**FREE INFORMATION**  
CALL TOLL-FREE 1-800-537-0589

Or write to: Viejo Publications Inc.  
5329 Fountain Ave.  
Los Angeles, CA 90029 Dept. RE

In general, the two main differences between the chips are that the 8052AH-BASIC requires external memory to operate, and it doesn't have as many I/O ports as the 8052AH. The remaining I/O port lines on the 8052AH-BASIC also have to do double duty to support some features of the Basic Interpreter.

It may very well be that the reason you're having trouble is that you're not properly handling the differences in the pin assignments. If you're really lucky, however, the only reason you're stuck is because you're not properly using pin 31. Even though it's not so evident by looking at Intel's official listing for this pin on both chips, they're identical.

If you tie pin 31 high on either chip, the IC will look for code in its internal EPROM. By making pin 31 low, both chips will expect the program code to be found in an external device such as an EPROM. This means that a low on pin 31 will cause the 8052AH-BASIC to behave very much like a regular 8052AH microcontroller chip since it won't be able to address its own internal EPROM.

*continued on page 87*



INTRODUCING PROTO LAB™ RELEASE 3.0,  
NOW WITH MORE ADVANCED FEATURES AND COLOR!

# PROTO LAB™

**BONUS OFFER!**  
DETAILS BELOW

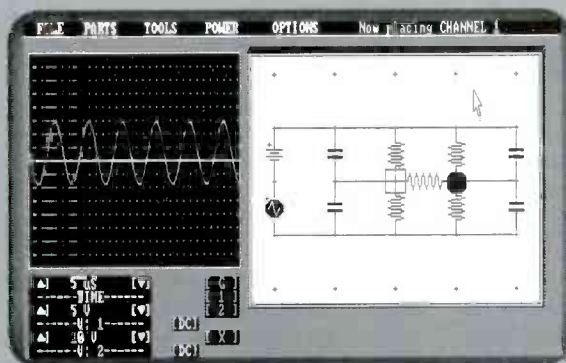

RELEASE 2.2

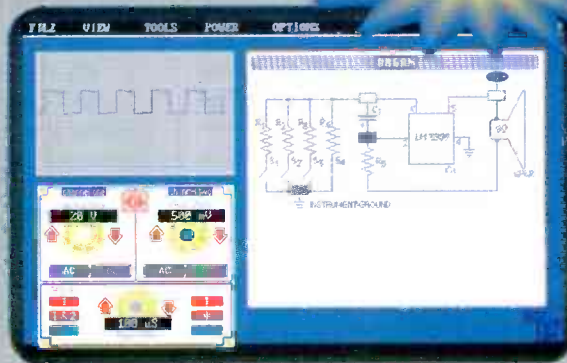

(Example of PROTOWARE™ "Electronic Organ")

RELEASE 3.0

## A total computer simulated electronics laboratory including Free built-in Instruments and Components to build and test circuits

New, PROTO LAB™ 3.0, a state of the art electronics lab for your PC, upgraded with the most requested enhancements. With Release 3.0 you still build, experiment and test actual circuits choosing from an unlimited number of passive components, just as the original Release. Then analyze your circuit with the built-in multimeter, oscilloscope or signal generator, but in a more advanced way.

PROTO LAB™ 3.0 includes color EGA/VGA graphics, quick function key menu selection, and on-line help, plus user preferences which customize your program! Most importantly, Release 3.0 supports advanced components available with PROTOWARE™ circuit modules.

PROTOWARE™ circuit modules expand your lab into the world of diodes, transistors, and special function linear circuits. Each PROTOWARE™ disk, sold separately, covers a particular topic, such as transistor amplifiers. Circuits are presented in a "cook-book" format making it easy to learn and understand. Change component values, and analyze the circuit in the same way as always. Or "play" the Electronic Organ while you study it's operation. Plus, view the circuit in schematic or pictorial presentation. Imagine a PROTOBOARD® layout to follow right on your computer screen!

In the future, your fun will continue as new PROTOWARE™ modules are introduced taking you into more advanced topics. Where else could you find thousands of dollars worth of parts and instruments for the one, low price of \$129.95? Order now for a limited time,

and get three PROTOWARE™ modules included for just \$20 extra. That's a savings of nearly \$40!

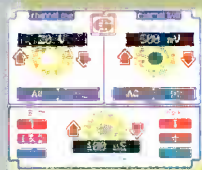

Oscilloscope

**PROTO LAB™ Release 3.0\* \$129.95**

\* Requires IBMPC, 512K RAM, EGA/VGA Video, & mouse.

### BONUS OFFER

**3 PROTOWARE™ MODULES \$19.95**  
(Diodes, Transistors & Electronic Organ)

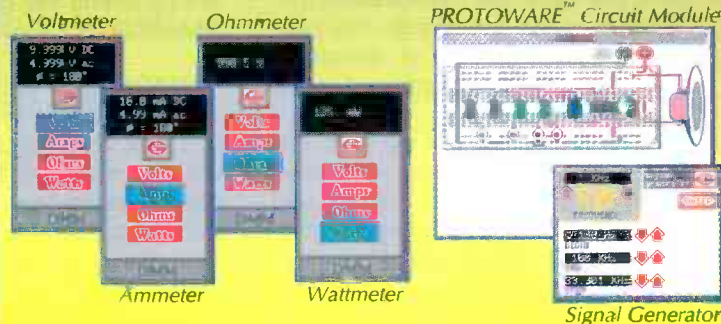

Voltmeter

Ohmmeter

PROTOWARE™ Circuit Module

Ammeter

Wattmeter

Signal Generator

an  
**Interplex  
Industries**  
company

Global Specialties®  
70 Fulton Terrace, New Haven, CT 06512  
©1991 Interplex Electronics A030

  
**GLOBAL  
SPECIALTIES®**



Can't wait? Call  
**1-800-572-1028**

CIRCLE 194 ON FREE INFORMATION CARD

# LETTERS

Write to Letters, Radio-Electronics, 500-B Bi-County Blvd., Farmingdale, NY 11735

## CHROMINANCE CLARIFICATION

Regarding the project "Color Bar Generator" (**Radio-Electronics**, July 1991), there were a couple of statements relating to chrominance that were incorrect. It was stated that "A 3.58-MHz subcarrier is *sent by the transmitter* and used in the receiver to restore the original color information." It also stated that "the colorburst signal is used as a reference to synchronize the phase and *amplitude* of the color subcarrier," and that "the colorburst also determines the tint and *saturation* of the color that is displayed." (The italics were added to pinpoint errors.)

At the transmitter, the R-Y and B-Y signals are each applied to separate modulators. Each of these also receives a 3.58-MHz carrier. The carriers are 90° out of phase with each other. The two resulting amplitude-modulated carriers are applied to a balanced modulator that *suppresses the 3.58-MHz subcarrier*, leaving only the sidebands containing the chroma information for transmission.

At the receiver, a 3.58-MHz subcarrier is generated and reinserted to enable the extraction of the original R-Y and B-Y signals on their respective carriers. The colorburst, which has the phase and *frequency* (not amplitude) of the original 3.58-MHz carrier, is used as a reference to lock the new one. The colorburst, however, does not contain the information relating to hue or saturation. This information is contained in the color sidebands.

To understand how the hue and saturation is determined, try to view the R-Y and B-Y and their respective carriers as two phasors that differ by 90°. The phase angle of the resultant determines the hue (or color) while the amplitude of the resultant determines the saturation. If proper lock between the colorburst and the 3.58-MHz subcarrier generated in the receiver isn't maintained, improper tint will result.

I have presented this additional information because I believe it fills a

gap in an otherwise reasonably thorough discussion of the NTSC method of luma/chroma transmission.

S.J. BABBERT  
Worthington, OH

## PSUEDO TUBE AMPLIFIER

I read Larry Klein's *Audio Update* column about making a transistor amplifier sound like a tube amplifier by adding resistance to the speaker line (**Radio-Electronics**, April 1991), and I tried his method. I own an old tube Dynaco and a transistorized, later model Technics set. I know how the Technics should sound because the 70-watt Dynaco is practically the best any amplifier could sound.

I tried it and it works! It really sounds much better. Larry Klein is a very creative thinker to come up with such a simple and effective approach. It saved me a couple hundred dollars.  
KARL G. MAEDER  
Hemet, CA

## SATISFIED SUBSCRIBER

Bravo! for the "PC-Based Test Equipment" articles by James Barbaro (**Radio-Electronics**, May, June, and July 1991). Those pieces make me glad that I renewed my subscription to **Radio-Electronics**, which I had considered canceling. Well done, guys. You've allowed me to renew my work on a long-term project by letting me get inside my PC.  
AMBROSE C. CAMPBELL

## MAGNETIC-FIELD EXPOSURE

After reading the concerns and opinions expressed in the Letters section of the July 1991 issue of **Radio-Electronics**, I thought the position of the American Conference of Governmental Industrial Hygienists (ACGIH) concerning exposures to magnetic fields should be expressed.

First, a definition is in order. The standard of measure used by the ACGIH is the Threshold Limit Value (TLV), which represents "conditions under which it is believed that nearly all workers may be repeatedly exposed day after day without adverse

health effects." Second, a distinction is made between "Static Magnetic Fields" and "Sub-Radiofrequency Magnetic Fields." the ACGIH (1990-91) recommended exposure limits are as follows:

*Static Magnetic Fields:* Routine occupational exposures should not exceed 60 milliTeslas (mT)—equivalent to 600 Gauss—over the whole body or 600 mT (6000 Gauss) to the extremities on a daily, time-weighted average basis. A flux density of 2 Teslas is recommended as a ceiling value. Safety hazards from the mechanical forces exerted by the magnetic field upon ferromagnetic tools and medical implants may exist. Workers having implanted cardiac pacemakers should not be exposed above 1.0 mT (10 Gauss). Perceptible or adverse effects may also be produced at higher flux densities resulting from forces upon other implanted ferromagnetic medical devices, e.g., suture staples, aneurism clips, prostheses, etc.

*Sub-Radiofrequency Magnetic Fields (30 kHz and below):* These TLV's refer to the amplitude of the magnetic flux density (B) of sub-radiofrequency magnetic fields in the frequency range of 30 kHz and below, to which it is believed that nearly all workers may be exposed repeatedly without adverse health effects. The magnetic field strengths in these TLV's are root-mean-square (RMS) values. Those values should be used as guides in the control of exposure to sub-radiofrequency magnetic fields and should not be regarded as a fine line between safe and dangerous levels. Routine occupational exposure should not exceed  $B_{TLV} = 60 \text{ mT}/f$ , where  $f$  is the frequency in Hz. At frequencies below 1 Hz, the TLV is 60 mT (600 Gauss). The permissible magnetic flux density of  $60 \text{ mT}/f(\text{Hz})$  at 60 Hz corresponds to a maximum permissible flux density of 1.0 mT. At 30 kHz, the TLV is  $2 \mu\text{T}$ , which corresponds to a magnetic field strength of 1.6 A/m. For workers wearing cardiac pacemakers, the TLV may not protect



# Learn to Use Your Computer's Full Potential.

**New Career Course from CIE!**

If you've been hesitating about upgrading your computer skills because you couldn't find the time or locate the right program to teach you everything you need to know to be successful in today's world of computers, you'll be happy to hear that CIE's new career course can provide you with the computer technology curriculum you seek in an independent study program you can afford to invest your time in.

CIE's COMPUTER OPERATION and PROGRAMMING course was designed and developed by CIE to provide a complete overall understanding of the unlimited potential today's computers offer, once you learn and discover their full capabilities, in today's high tech environment. CIE's new computer course quickly provides you with the electronics fundamentals essential to fully understand and master the computer's technological potentials for your personal and professional advancement. Upon mastering the fundamentals you will move into high level language programming such as BASIC and C-Language and then use that programming in order to relate the interfacing of electronic hardware circuitry to programming software. As a graduate of the Computer Operation and Programming course, you will be able to successfully understand, analyze, install, troubleshoot, program and maintain the various types of electronic equipment used in business, manufacturing, and service industries.

Since 1934, CIE has been the world leader in home study electronics by providing our 150,000-plus graduates with the curriculum and hands-on training they've needed to become successful in



today's highly competitive and computer oriented society. As a CIE student you'll receive a first rate education from a faculty and staff with only one desire. Your future success!

We encourage you to look, but you won't find a more comprehensive computer course anywhere!

And it's a course designed to fit around your lifestyle and commitments today, so you can be assured of professional successes and financial gains tomorrow.

Please, do yourself a favor and send the attached card or fill out and mail the coupon below for more information about CIE's

**Computer Operation and Programming course. Do It Today!**

**Computer not included with course**



**YES!** I want to get started. Send me my CIE school catalog including details about the Associate Degree program (for your convenience, CIE will have a representative contact you - there is no obligation).

Print Name \_\_\_\_\_

Address \_\_\_\_\_ Apt. \_\_\_\_\_

City \_\_\_\_\_ State \_\_\_\_\_ Zip \_\_\_\_\_

Age \_\_\_\_\_ Area Code/Phone No. \_\_\_\_\_

Check box for G.I. Bulletin on Educational Benefits  Veteran  Active Duty

**CIE CLEVELAND INSTITUTE OF ELECTRONICS, INC.**

1776 East 17th Street • Cleveland, Ohio 44114 • (216) 781-9400



*A school of thousands.  
A class of one.  
Since 1934.*

AE26

## Shortwave Listening Guidebook

by Harry Helms

The world is talking on shortwave radio, and here's the book that tells you how to listen in! In direct, nontechnical language, Harry explains how to get the most from your shortwave radio. Its 320 heavily illustrated pages are filled with practical advice on:

- antennas
- when and where to tune
- selecting the right radio for you
- accessories
- reception techniques



Learn how to hear the BBC, Radio Moscow, ham radio operators, ships at sea, even Air Force One! Includes hundreds of frequencies for stations around the world and the times you can hear them.

Only \$16.95 plus \$3.00 shipping (CA residents please include sales tax).

**HighText**  
Publications, Inc.  
7128 Miramar Road  
Suite 15L, San Diego, CA 92121

## Be an FCC LICENSED ELECTRONIC TECHNICIAN!



No costly school. No commuting to class. The Original Home-Study course prepares you for the "FCC Commercial Radiotelephone License." This valuable license is your professional "ticket" to thousands of exciting jobs in Communications, Radio-TV, Microwave, Maritime, Radar, Avionics and more...even start your own business! You don't need a college degree to qualify, but you do need an FCC License.

**No Need to Quit Your Job or Go To School**  
This proven course is easy, fast and low cost! **GUARANTEED PASS**—You get your FCC License or money refunded. **Send for FREE facts now. MAIL COUPON TODAY!**

### COMMAND PRODUCTIONS

FCC LICENSE TRAINING, Dept. 90  
P.O. Box 2824, San Francisco, CA 94126  
Please rush FREE details immediately!

NAME \_\_\_\_\_  
ADDRESS \_\_\_\_\_  
CITY \_\_\_\_\_ STATE \_\_\_\_\_ ZIP \_\_\_\_\_

against electromagnetic interference with the pacemaker function. The TLV for pacemaker wearers should be reduced by a safety factor of ten.

Of course, there currently is not a clear understanding of the health effects resulting from exposure to magnetic fields (especially low-intensity, low-frequency ones). I hope that this information will help to clarify what is considered safe exposure to magnetic fields.

JACK G. ELLIS  
McKinney, TX

### LONGER-LIVED BATTERIES

In the *Ask R-E* column in the June 1991 issue of **Radio-Electronics**, the answer to the letter under the heading "Safe Charging" was an interesting and timely discussion of Ni-Cd battery problems, but L. Shedler (who didn't mention Ni-Cd's) was asking about gel cell or lead-acid 12-volt batteries. The tip-off for me was his statement that he is using a transformer to charge them.

I use 12-volt motorcycle batteries—lead-acid, 6.5 AH—with my 8mm Sony camcorder. I use an electronic voltage controller (and voltage reducer) and get fine results. But the question is: When is my lead-acid battery truly, fully charged? I use a digital voltmeter for accuracy, but the basic question is still unanswered. I also use a wall-plug transformer charger.

If you hadn't played with this problem, you might well feel that the simple thing to do is to use 6-volt (approximately 10 AH) motorcycle batteries for the 8mm video 6-volt requirement. The problem is that there is an extremely narrow spread of voltage (available usage) between a fully charged 6-volt battery and the automatic low-voltage shutoff point of the camcorder. (These systems should really be called 7.5-or-so-volt, not 6-volt, systems.) After the shutoff point is reached, an extremely high percentage of the battery power remains unused and unavailable to the operator.

Some camcorder users might wonder if this discussion is relevant. The reason it is relevant is that Ni-Cd batteries available for 8mm camcorders have a far shorter usage between charges than the manufacturers state, and are quite expensive. If you require a couple of hours of use

between charges you must have a number of batteries available, particularly if you are using automatic focus. The "H" series batteries, such as 77H, are improved, but the facts still remain.

GEORGE H. WESSLER  
Santa Fe, NM

### PC POWER SUPPLIES

My compliments to **Radio-Electronics** for running the two installments of the article on PC power supplies ("Inside Switching Power Supplies," April and May 1991). I have to repair those buggers and before reading the article, I understood only about half of what lived inside them. I really appreciate it!

MATT McCULLAR

### TUNING UP

#### THE SHORTWAVE RECEIVER

Rodney A. Kreuter's article, "Tune in the World With R-E's Shortwave Receiver" (**Radio-Electronics**, January 1991), was informative and challenging, not to mention well written. I have enjoyed many years of well-written and -researched articles from **Radio-Electronics**. Thank you.

With regard to the shortwave-receiver project, I used ferrite toroids in place of the micro metal toroids. I also replaced the output amplifier (MC34119) with an LM386 0.4-watt amplifier. I changed to the LM386 amplifier because it required less components and cost less, without losing any audio quality. The PC board foil pattern was well done except for one component (R22). The resistor was shown connected to R10 instead of  $V_{CC}$  (+9.0 volts). That might cause an impedance drop on the collector of transistor Q3 (ZN3904) and could reduce the effectiveness of Q4, which is connected to R22, the AGC of the output.

The receiver operates quite well. I have several high-power AM radio repeating towers nearby, and not one of those stations is heard on my receiver. I receive the BBC, the Voice of America, and a commercial station from Canada, along with all kinds of continuous-wave transmissions. Thanks for the inexpensive shortwave-receiver project. I really enjoyed it. Keep them coming!

JEFF LEMAY  
Carol Stream, IL

R-E



# SELECT 5 BOOKS for only \$4.95 (values to \$112.75)

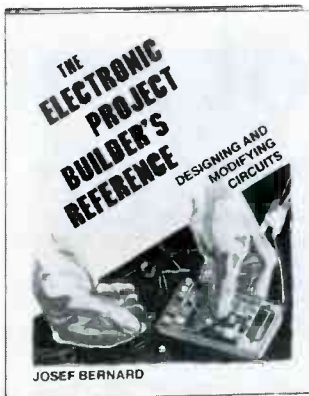
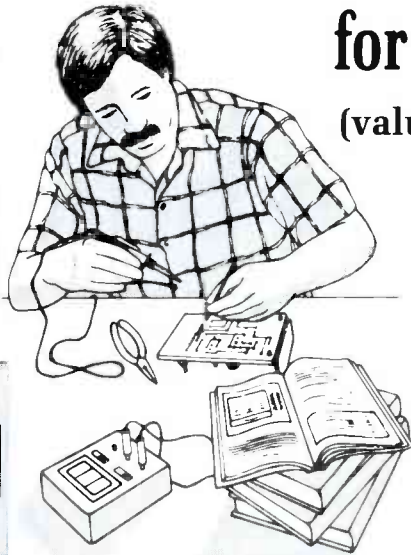

3260P \$14.95

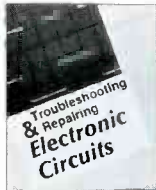

3258 \$27.95  
Counts as 2



3321P \$16.95

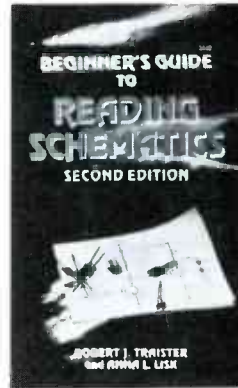

3632 \$18.95



3329 \$29.95  
Counts as 2



2867P \$18.95

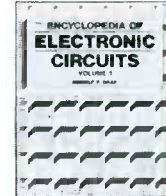

1938 \$60.00  
Counts as 3



2925P \$9.95

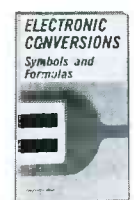

2855P \$14.95



3627 \$29.95  
Counts as 2

Your most complete source for electronics books for over 25 years.



3241P \$16.95



3279 \$36.95  
Counts as 2

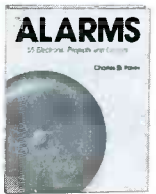

2996P \$14.95

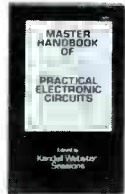

2980P \$19.95



3414 \$39.95  
Counts as 2

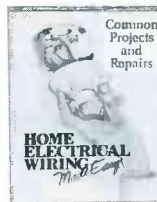

3072P \$16.95



3374P \$16.95



3628 \$26.95  
Counts as 2

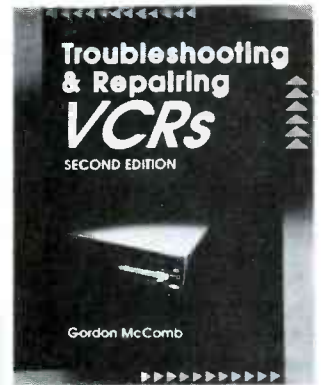

3777 \$32.95  
Counts as 2



2790P \$14.95



3485 \$27.95  
Counts as 2

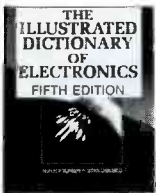

3345 \$39.95  
Counts as 2



2883P \$18.95



2800P \$16.95



2613P \$17.95

**Membership Benefits • Big Savings.** In addition to this introductory offer, you keep saving substantially with members' prices of up to 50% off the publishers' prices. • **Bonus Books.** Starting immediately, you will be eligible for our Bonus Book Plan, with savings of up to 80% off publishers' prices. • **Club News Bulletins.** 15 times per year you will receive the Book Club News, describing all the current selections—mains, alternates, extras—plus bonus offers and special sales, with scores of titles to choose from. • **Automatic Order.** If you want the Main Selection, do nothing and it will be sent to you automatically. If you prefer another selection, or no book at all, simply indicate your choice on the reply form provided. You will have at least 10 days to decide. As a member, you agree to purchase at least 3 books within the next 12 months and may resign at any time thereafter. • **Ironclad No-Risk Guarantee.** If not satisfied with your books, return them within 10 days without obligation! • **Exceptional Quality.** All books are quality publishers' editions especially selected by our Editorial Board. (Publishers' Prices Shown)



**ELECTRONICS BOOK CLUB<sup>SM</sup>**  
Blue Ridge Summit, PA 17294-0810

Please accept my membership in the Electronics Book Club and send the 5 volumes listed below, billing me \$4.95. If not satisfied, I may return the books within ten days without obligation and have my membership cancelled. I agree to purchase at least 3 books at regular Club prices during the next 12 months and may resign any time thereafter. A shipping/handling charge and sales tax will be added to all orders.

--	--	--	--	--	--

Name \_\_\_\_\_  
Address \_\_\_\_\_  
City \_\_\_\_\_  
State \_\_\_\_\_ Zip \_\_\_\_\_ Phone \_\_\_\_\_  
Signature \_\_\_\_\_

Valid for new members only. Foreign applicants will receive special ordering instructions. Canada must remit in U.S. currency. This order subject to acceptance by the Electronics Book Club. RPIE1091



1367P \$24.95  
Counts as 2



3275 \$22.95

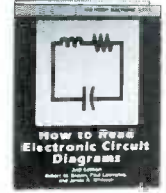

2880P \$14.95

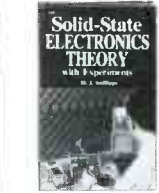

2926 \$25.95



3343 \$29.95  
Counts as 2



3475 \$27.95  
Counts as 2

All books are hardcover unless number is followed by a "P" for paperback.

©1991 ELECTRONICS BOOK CLUB  
Blue Ridge Summit, PA 17294-0810

# Learn to troubleshoot and service today's computer systems as you build a 386sx/20 MHz mini tower computer!

*Train the NRI way—and learn to service today's computers as you build your own 386sx computer system, now with 1 meg RAM, 40 meg IDE hard drive, and exciting new diagnostic hardware and software!*

Jobs for computer service technicians will almost double in the next 10 years according to Department of Labor statistics, making computer service one of the top growth fields in the nation.

Now you can cash in on this exciting opportunity—either as a full-time industry technician or in a money-making computer service business of your own—once you've mastered electronics and computers the NRI way.

NRI's practical combination of "reason-why" theory and hands-on building skills starts you with the fundamentals of electronics, then guides you through more sophisticated circuitry all the way up to the latest advances in computer technology.

**Train with and keep a powerful 386sx/20 MHz computer system plus popular Microsoft® Works software!**

Only NRI gives you hands-on training with the finest example of state-of-the-art technology: the powerful new West Coast 386sx/20 MHz mini tower computer. As you assemble this 1 meg RAM, 32-bit CPU computer from the keyboard up, you actually see for yourself how each section of your computer works.

You assemble and test your computer's "intelligent" keyboard, install the power supply and 1.2 meg, high-density floppy disk drive, then interface the high-resolution monitor.

Your hands-on training continues as you install a powerful new 40 meg IDE hard disk drive—now included in your course to dramatically increase the data storage capacity of your computer while giving you lightning-quick data access.

**NEW!**  
**386sx/20 MHz**  
**Mini Tower**  
**Computer**



Plus you now go on to work with today's most popular integrated software package, Microsoft Works, learning to use its word processing, spreadsheet, database, and communications utilities for your own personal and professional applications. But that's not all.

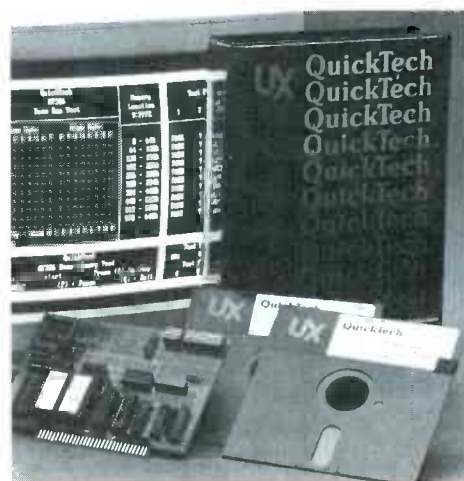

*Only NRI gives you hands-on training with the remarkable R.A.C.E.R. plug-in diagnostic card and QuickTech diagnostic software from Ultra-X—professional, state-of-the-art diagnostic tools that make computer troubleshooting fast and accurate.*



**Your NRI computer training includes all this:** • NRI's unique *Discovery Lab*® for circuit design and testing • Hand-held digital multimeter with "talk-you-through" instructions on audio cassette • Digital logic probe that lets you visually examine computer circuits • The new West Coast 386sx/20 MHz computer system, featuring a high-speed 80386sx CPU, 1 meg RAM, 101-key "intelligent" keyboard, 1.2 meg high-density floppy drive, and high-resolution monitor • 40 meg IDE hard drive • MS-DOS, GW-BASIC, and Microsoft Works software • R.A.C.E.R. plug-in diagnostic card and QuickTech menu-driven diagnostic software • Reference manuals with guidelines and schematics

printer ports, serial communications ports, video display memory, floppy drives, and hard disk drives.

Only NRI gives you such confidence-building, real-world experience. Only NRI gives you both the knowledge and the professional tools to succeed as today's in-demand computer service technician.

### No experience needed ... NRI builds it in

NRI training gives you practical, hands-on experience that makes you uniquely prepared to take advantage of today's opportunities in computer service.

You learn at your own convenience in your own home. No classroom pressures, no night school, no need to quit your present job until you're ready to make your move. NRI starts you with the basics, building on that foundation step by step until you have the knowledge and skills you need for success.

And all throughout your training you've got the full support of your personal NRI instructor and the entire NRI technical staff, always ready to answer your questions and help you achieve your training goals.

### FREE catalog tells more. Send today!

Send today for NRI's big, free catalog that describes every aspect of NRI's innovative computer training, as well as hands-on training in other growing high-tech career fields.

If the coupon is missing, write to:  
NRI School of Electronics, McGraw-Hill

Continuing Education Center, 4401 Connecticut Avenue, NW, Washington, DC 20008.

IBM is a registered trademark of International Business Machines Corp. R.A.C.E.R. and QuickTech are registered trademarks of Ultra-X, Inc.

### NOW! Training now includes Ultra-X diagnostic hardware and software for quick, accurate troubleshooting!

Now you train with and keep the latest in diagnostic hardware and software: the extraordinary R.A.C.E.R. plug-in diagnostic card and QuickTech diagnostic software, both from Ultra-X. Using these state-of-the-art tools, you learn to quickly identify and service virtually any computer problem on XT, AT 80286/80386, and compatible machines.

You discover how to use the R.A.C.E.R. diagnostic card to identify individual defective RAM chips, locate interfacing problems, and pinpoint defective support chips. Plus you learn to use your QuickTech diagnostic software to test the system RAM and such peripheral adapters as parallel

**NEW!**  
**386sx**



## SEND TODAY FOR FREE CATALOG

**NRI** Schools

McGraw-Hill Continuing Education Center  
4401 Connecticut Avenue, NW  
Washington, DC 20008



Check one FREE catalog only

- MICROCOMPUTER SERVICING
- TV/Video/Audio Servicing
- Telecommunications
- Industrial Electronics
- Security Electronics
- Electronic Music Technology
- Basic Electronics
- Automotive Servicing

For career courses approved under GI Bill

check for details.

- Computer Programming
- PC Software Engineering Using C
- Desktop Publishing
- Word Processing Home Business
- Paralegal
- Building Construction
- Bookkeeping & Accounting

Name (please print) \_\_\_\_\_ Age \_\_\_\_\_

Address \_\_\_\_\_

City/State/Zip \_\_\_\_\_ Accredited Member, National Home Study Council \_\_\_\_\_ 3-101

# EQUIPMENT REPORTS

## Units + Conversion Factors Unit-Conversion Software

Know your coulombs from your amp-hours.

CIRCLE 10 ON FREE INFORMATION CARD



Without common units, we would never be able to get anything done. Although the engineering and scientific communities use metric units as a matter of course, the U.S. still is insistent on keeping English units for everyday use. Even people who are not involved in technology or engineering can relate to the problems that incompatible units can cause. Some of us, for example, think of parcels of land in terms of their dimensions and in square feet. Others are more comfortable thinking and working with acres, an area of about 43,560 square feet. Boaters think in terms of fathoms and knots, instead of miles and miles per hour. It's said by some that the tower of Babel was doomed not by differences in language, but by differences of units.

In electronics and engineering, problems with units still exist. In the U.S., for example, we talk of capacitance in units of microfarads and picofarads. Our European counterparts, however, are equally comfortable using nanofarads. Although few things are simpler than shifting a decimal point three places in one direction or the other, it can still cause frustration and confusion.

A greater problem can result when engineers in different disciplines try to communicate. One may be used to thinking of magnetic flux density in units of webers/m<sup>2</sup> or tesla, and the other in units of kilogauss. Convert-

ing between units is never an unsurmountable problem, but it can cause headaches and, occasionally, an error.

We recently found an \$89.95 software package for IBM PC's and compatible computers that takes all the work out of moving from one unit to another: *Units + Conversion Factors* from David F. Taylor, Jr. (P.O. Box 562, Commerce, TX 75429). To run *Units*, your system requires a minimum of 512K memory, one floppy-disk and one hard-disk drive, and either CGA or EGA graphics compatibility. A mouse, though not

required, is supported.

The working screen of *Units* contains six major sections or windows: "Options," "Units of," "Original Number and Units," "New Number and Units," a "Dimensions window," and a command-menu bar.

To convert a given quantity and unit, you click on the "Units of" window and enter, or scroll to, the type of unit you want to use from "acceleration" to "wave number." If you wanted to convert from cubic meters, for example, you would scroll to "Volume."

You would then go to the "Original Number" window and enter the quantity, and then scroll to call up the given original unit (m<sup>3</sup>). Moving down to the "New Units" window, you can then enter the units you're converting to, or scroll through the available list until you get to the one you want. We, for example, were curious how many teaspoons were in a cubic meter. The answer, which we arrived at easily enough, is slightly more than 202,884.

If you need to find out more about a compound unit, you can "dissect" it and examine the nature of its component parts. You can then "transplant" it  
(Continued on page 102)

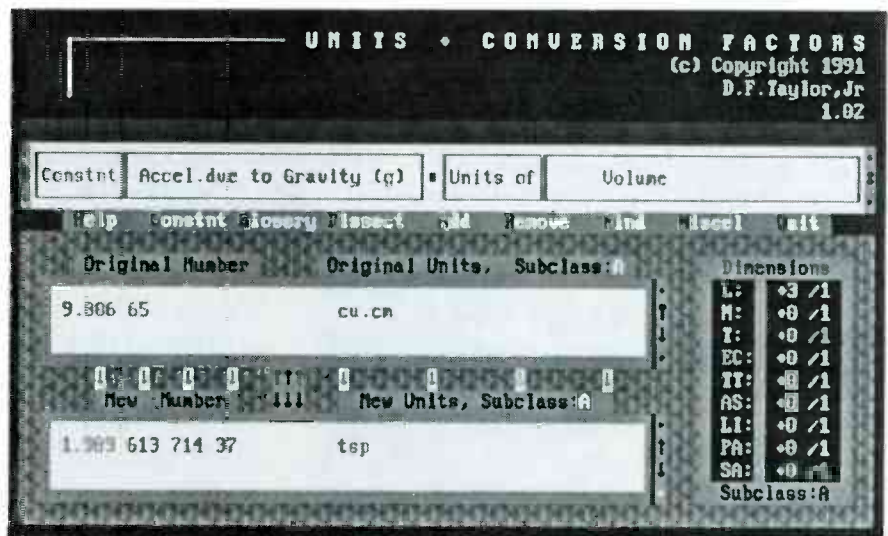

THE MAIN SCREEN OF *UNITS*. Note the "Dimension" window in the lower right corner. Since we're working with units of volume, it shows the basic SI unit of length being raised to the third power.



**Now, You Can Eavesdrop On The World.** Introducing the new Drake R8 Communications Receiver. It's world class, world band radio, made in the U.S.A. From Perth to the Persian Gulf, Moscow to Mozambique, local or global, you hear events *as they happen* with amazing clarity. Since 1943, Drake



has been setting the standards in electronic communications . . . and then raising them. Today, there's no better shortwave receiver than the Drake R8. **Out-Of-This-World Performance.** The new Drake R8 has more standard features than other shortwave radios. You get wide frequency range (100 KHz to 30,000 KHz), coverage of all world and local bands, and excellent dynamic range. But you also get important features you won't find on receivers costing hundreds of dollars more. A multi-voltage power supply. Pre-amp and attenuator. Five filter bandwidths and synchronous detector. Dual mode noise blanker and passband offset. Non-volatile 100 channel memory. All designed to give you the best reception with the least distortion. **Down-To-Earth Design.** The ergonomic design of the R8 gives you real ease of operation. You have convenient keypad entry, with large, legible controls. The face is bold. Uncluttered. And the liquid crystal display (LCD) is backlit for easy reading. **Try The R8 . . . At Our Risk.** If you're not impressed by Drake's quality, performance and ease of operation, return the R8 Receiver within 15 days and we'll refund your money in full, less our original shipping charge. For more information, or to order, call **TOLL-FREE, 1-800-9-DRAKE-1.** Telephone orders may be placed on a major credit card. \$979.00 (Shipping and handling \$10 in continental U.S. Ohio residents add 6½% tax.) Call **TOLL-FREE, 1-800-9-DRAKE-1** today. You can't lose.

**DRAKE**

*In touch with the world.*

R.L. Drake Company • P.O. Box 3006 • Miamisburg, Ohio 45342 U.S.A.  
CIRCLE 197 ON FREE INFORMATION CARD

# NEW PRODUCTS

Use the Free Information Card for more details on these products.

## PC BOARD DIAGNOSTIC SYSTEM.

Automated printed-circuit board tests were not within the budgets of low-volume users, either because the board volumes were too low or too varied, or because the company lacked the technical capability to maintain an automated test system. Other deterrents included concerns about obsolescence, operational complexity, and the difficulties in obtaining the schematic documentation usually required for programming. A cost-effective, in-circuit and out-of-circuit PC-board diagnostic system from *B&K-Precision* solves those problems and fills the gap between expensive ATE systems and service instruments. Designed for use in bench-top production testing, depot repair and testing, SRO's, and independent or third-party service organizations, the *Pro-Line Model PL 5000* will troubleshoot complex boards in-circuit or out of circuit.

The user can define all test routines and voltage thresholds for compatibility with a wide variety of semiconductor technologies and component types. In-circuit configurations are "learned" and tested from a resident library that contains more than 2000 device types, including LSI devices. In addition to TTL, CMOS, and ECL devices, the *Pro-Line PL 5000* system tests analog devices. Test graphics and an historical-fault database guide the user to the failure.

The on-line networkable system is capable of gener-



CIRCLE 16 ON FREE INFORMATION CARD

ating productivity and process management reports, including reports based on fault symptom, component types, or board serial number. A resident software tool for developing custom IC libraries is also included. Programming is simplified with menu-driven software to guide the process of inputting PC-board characteristics, component designations, types, and x-y coordinates for the component locations. The *PL 5000* then automatically learns the circuit configuration by prompting a "walk" from IC to IC using the test clip, until the entire board is learned.

The system's standard capability is 48 channels including six guard points, but it can test up to 64 channels with expansion options. "Clip-on" testing provides easy interfacing to the device under test. To eliminate contact errors,

probe-contact-sensing circuitry assures proper connection to the device under test and automatically initiates the test sequence.

The *Pro-Line PL 5000* uses an 80286-based, IBM-compatible computer with 1 MB of standard memory (expandable to 4 MB) and two expansion slots. The package includes one 40-MB hard drive and a 1.2-MB 5¼-inch floppy drive, a 13-inch EGA monitor, and an AT-style keyboard. Complete software is supplied, including debug tools, a security utility, and diagnostic routines that verify operation of the test unit.

The *Pro-Line PL 5000* PC-board diagnostic system costs \$14,950.—**B&K-Precision**, Division of Maxtec International Corporation, 6470 West Cortland Street, Chicago, IL 60635; Phone: 312-889-1448.

## NTSC/PAL/FILM SYNC GENERATOR.

*MicroKey/Genlock*, an add-on for *Video Associates' MicroKey/A* system, is an NTSC/PAL film synchronization generator that allows a computer to be treated as a standard broadcast video source, eliminating the need for an expensive frame synchronizer. The device is unique in its ability to handle not only PAL and NTSC signals, but also the 24-frame-per-second film speed. The film genlock mode eliminates frame shutter bars on final film products.

The *MicroKey/A* features digital audio and high-resolution VGA graphics output to a video system. Its digital-audio capability allows ADPCM-encoded 12-bit audio to be appended to an image source for message insertion and cueing. *MicroKey/Genlock* provides synchronization of *MicroKey/A's* 15-kHz VGA to an external reference for film, PAL, or NTSC with 24-, 25-, and

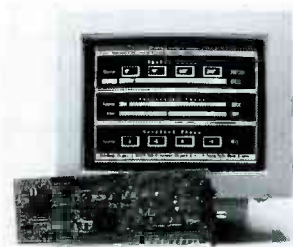

CIRCLE 17 ON FREE INFORMATION CARD

30-frame-per-second display rates, respectively. Two BNC input connectors allow loop-through of external reference black burst or video. Chromalock features include NTSC comb filtering and PAL chroma



separation. The composite input signal is one volt, peak-to-peak. Video overlay is provided by an optional keyer (*MicroKey/Link*). On the *MicroKey/Genlock* board, control of the computer's power-up timing is managed by card-edge adjustments for the horizontal phase and system subcarrier phase. The included software can set and store multiple timing assignments. Pulse assignments quickly change timing for multiple designations. The package includes one board, software, a 20-pin ribbon cable, and a looping terminator.

*MicroKey/A*, *MicroKey/Genlock* (shown), and *MicroKey/Link* have suggested retail prices of \$1495, \$695, and \$195, respectively.—**Video Associates**, 4926 Spicewood Springs Road, Austin, TX 78759; Phone: 512-346-5781.

**WIDEBAND ANTENNA.** Intended to improve the performance of many types of VHF/UHF communications equipment, the compact model *DA-301* wideband transmit and receive antenna from *Ace Communications* covers the 100-kHz to 1.3-GHz frequency range. The 51-inch-tall, Discone-type antenna features eight horizontal radials, eight diagonal radials,

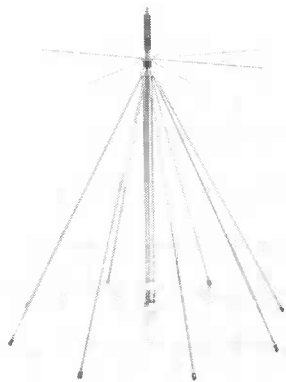

CIRCLE 18 ON FREE INFORMATION CARD

and a single, vertical top whip element. Transmit and receive characteristics are flat within 2 dB over the entire 25–1300-MHz range. The antenna has an input power rating of 200 watts and 50-ohm impedance. The *DA-301* comes with N-type and BNC connectors along with 50 feet of coaxial cable.

The *DA-301* wideband antenna has a suggested retail price of \$99.50.—**Ace Communications**, Monitor Division, 10707 East 106th Street, Indianapolis, IN 46256; Phone: 317-842-7115; Fax: 317-849-8794.

**AMATEUR-RADIO HEADSET.**

The noise-canceling microphone on the *Contester* amateur-radio headset favors the 100–8000-Hz human-voice range for maximum speech intelligibility. The microphone



CIRCLE 19 ON FREE INFORMATION CARD

boom rotates, so that it can be worn on the right or left side of the head, and automatically shuts off the mic when placed upright. To take full advantage of the noise-canceling feature, the microphone should be placed almost touching the user's lips toward one corner of the mouth. According to *Telex Communications*, the *Contester* has the same rugged construction as the headsets the company makes for commercial broadcasters, pilots, and professional football coaches. The

**CRAMOLIN® DeOxidizer**  
**IMPROVES CONDUCTIVITY**

DEOXIDIZES • CLEANS • PRESERVES • LUBRICATES  
For All Metals, Including Gold!

CRAMOLIN® DeOxidizer improves conductivity by dissolving oxides that form on metal connector and contact surfaces, eliminating unwanted resistance that impedes electrical performance.

CRAMOLIN® is an active ingredient that does not rely on solvents for performance. Due to the excellent migration properties, CRAMOLIN® coats the entire metal surface and protects it from future oxidation.

CRAMOLIN® continues to be the most effective and economical product for improving and maintaining electrical component reliability.

**FOR MANUFACTURE, MAINTENANCE AND SERVICE OF:**

- Switches & Relays • Cable Connectors & Adaptors
- Edge Connectors • Terminal Strips • Plugs & Sockets
- Gold Plated Connectors • Potentiometers • Battery Contacts

**USED BY THOSE WHO DEMAND THE BEST:**

- Bell & Howell • Capitol Records • Dolby Laboratories
- Hewlett Packard • John Fluke Mfg. • McIntosh Labs
- MCI (Sony) • Motorola • NASA • Nakamichi
- RCA • Switchcraft • and Many More.

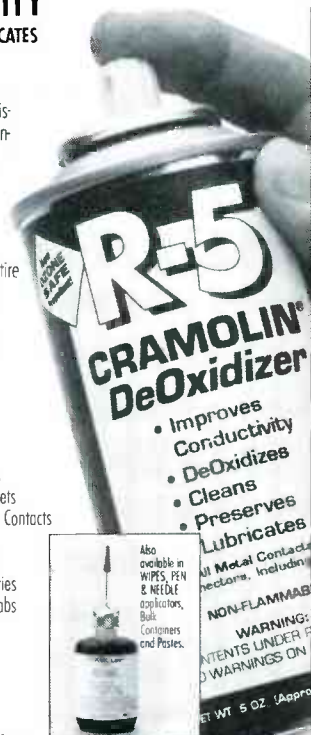

Since 1956



P.O. Box 1  
Escondido, CA 92033-3679  
(619) 743-7143  
FAX: (619) 743-2460

CIRCLE 50 ON FREE INFORMATION CARD

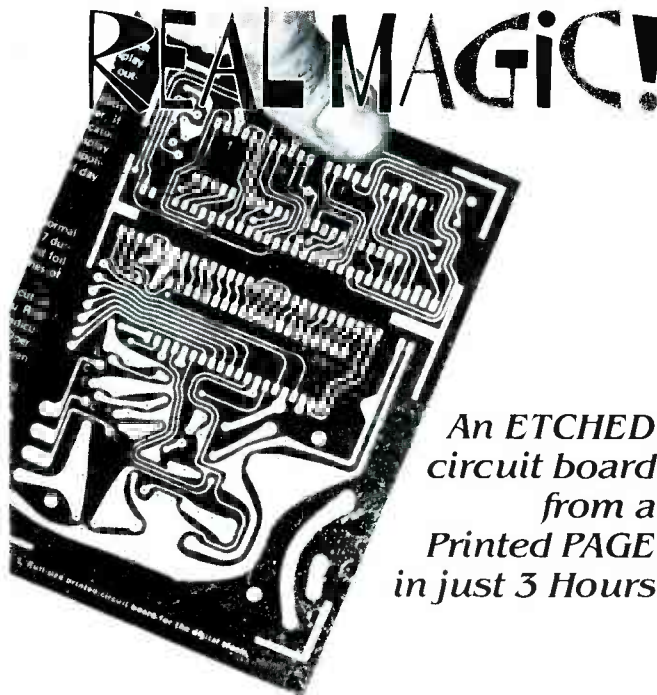

An ETCHED circuit board from a Printed PAGE in just 3 Hours

The ER-4 PHOTO ETCH KIT gives you the tools, materials and chemicals to make your own printed circuit boards. The patented Pos-Neg™ process copies artwork from magazines like this one without damaging the page. Use the circuit patterns, tapes and drafting film to make your own 1X artwork. Or try the Direct Etch™ system (also included), to make single circuit boards without artwork. The ER-4 is stocked by many electronic distributors, or order direct. Add \$3.50 for handling and shipping. **ER-4 PHOTO ETCH KIT** (NV and CA residents add sales tax) . . . \$38.00 **DATAK'S COMPLETE CATALOG** lists hundreds of printed circuit products and art patterns. Also contains dry transfer letter sheets and electronic title sets for professional looking control panels. **WRITE FOR IT NOW!**

**DATAK Corporation • 55 Freeport Blvd. • Sparks, NV 89431**

CIRCLE 177 ON FREE INFORMATION CARD

headset's dynamic receivers have a 50–15,000-Hz frequency response and impedance compatible with amateur transceivers. The five-foot headset cord is unterminated to accept any connector suitable for the user's transceiver. Washable cotton covers come with the headset and slip over the foam-filled ear cushions for long-term comfort.

The *Contester* headset has a suggested list price of \$102—**Telex Communications, Inc.**, 9600 Aldrich Avenue South, Minneapolis, MN 55420. Phone: 612-884-4051; Fax: 612-884-0043.

**HAM RADIO SWR/POWER METER.** Designed to help amateur-radio operators optimize antenna settings for handheld transceivers as well as mobile or fixed ham radios, *Radio Shack's*



**CIRCLE 20 ON FREE INFORMATION CARD**

*Micronta SWR/Power Meter* (catalog number 19-320) is intended for use on two popular amateur-radio bands: 2-meter (144 MHz) and 70cm (440 MHz). The SWR/power meter features low insertion loss, which enables it to remain connected at all times. Its wide accuracy range lets the user measure power up to 60 watts. The rugged, compact device is encased in a sealed die-cast aluminum enclosure and measures approximately 2½ × 2¼ × ¾ inches.

The *Micronta SWR/Power Meter* retails for \$39.95 at **Radio Shack** stores nationwide.—**Radio Shack**, 700 One Tandy Center, Fort Worth, TX 76102; Phone: 817-390-3300.

**SCREEN-MOUNTED SCOPE CAMERA.** To allow users of oscilloscopes and other measuring instruments to take high-resolution photos of screen images in areas where printers and plotters are impractical—even in clean-room environments—*Tektronix's C-9* camera offers Autofilm ca-



**CIRCLE 21 ON FREE INFORMATION CARD**

pabilities. With Polaroid's Autofilm, the C-9 camera can automatically advance, eject, and develop film into a clean, dry print. The camera also offers an optional chamber to hold and protect the photos as they are ejected and developed. The remote shutter actuator is also useful in clean-room and medical environments, where film handling might cause contamination. The C-9 can be used with screen-based instruments including small video monitors, logic analyzers, and medical-imaging equipments. With an optional pistol grip, the C-9 can be used with instruments lacking camera attachments. Also available optionally is a variable-intensity flash unit.

The C-9 camera costs \$490.—**Tektronix, Inc.**, P.O. Box 19638, Portland, OR 97219-0638; Phone: 800-426-2200. **R-E**

## FCC NO-CODE AMATEUR RADIO LICENSE

The FCC recently passed Docket 90-55 which for the first time allows a new codeless entry ham radio license of technician grade. Privileges 30 MHz and above — All modes! (See R.E. article in April 1991 issue).

Get all the no-code license details, study & testing information plus a one-year subscription to one of ham radio's longest running specialty mode publications that will teach you all about the new modes you will be able to operate!

*F5TV S5TV FAX RTTY PACKET  
AMTOR OSCAR FM REPEATERS  
MICROWAVE AND LOTS MORE!*

SEND  
\$25  
CHECK  
OR  
MONEY  
ORDER



The SPEC-COM Journal  
P.O. Box 1002,  
Dubuque, IA 52004  
(319) 557-8791

OUR  
24TH  
YEAR  
SINCE  
1967!



MC/VISA (5% added)



## ATTENTION! ELECTRONICS TECHNICIANS

EARN YOUR  
**B.S.E.E.  
DEGREE**  
THROUGH HOME STUDY

Our New and Highly Effective Advanced-Placement Program for experienced Electronic Technicians grants credit for previous Schooling and Professional Experience, and can greatly reduce the time required to complete Program and reach graduation. No residence schooling required for qualified Electronic Technicians. Through this Special Program you can pull all of the loose ends of your electronics background together and earn your B.S.E.E. Degree. Upgrade your status and pay to the Engineering Level. Advance Rapidly! Many finish in 12 months or less. Students and graduates in all 50 States and throughout the World. Established Over 40 Years! Write for free Descriptive Literature.

**COOK'S INSTITUTE**  
OF ELECTRONICS ENGINEERING



4251 CYPRESS DRIVE  
JACKSON, MISSISSIPPI 39212

**CIRCLE 58 ON FREE INFORMATION CARD**

**PRE CHRISTMAS SALE!**

Save on cable rental fees!

**CABLE TV  
DESCRAMBLERS  
WE'LL BEAT  
ANY PRICE**

**JERROLD-TOCOM-ZENITH  
HAMLIN-OAK-PIONEER  
SCIENTIFIC ATLANTA**

- 24 HOUR SHIPMENTS!
- MONEY BACK GUARANTEE!
- QUANTITY DISCOUNTS!

MASTER CARD / AMEX / VISA / C.O.D.

Have make and model number of equipment used in you area ready.

**CALL TOLL-FREE  
1-800-284-8432**

**CABLE WAREHOUSE**  
10117 West Oakland Park Blvd.,  
Suite 515, Sunrise, FL 33351  
NO FLORIDA SALES

**CIRCLE 187 ON FREE INFORMATION CARD**



# NEW LIT

Use The Free Information Card for fast response.

**1991 ELECTRONIC MARKET DATA BOOK;** from Electronic Industries Association, Publications, EIA Marketing Services Department, 2001 Pennsylvania Avenue, N.W., Washington, DC 20006-1813; Phone: 202-457-4955; \$100.

If you're involved in any area of the electronics industry, this edition of the EIA's annual encyclopedia of the U.S. electronic industries is a valuable business tool. Electronics manufacturers, market research firms, financial institutions, schools, and libraries keep the book on hand for up-to-the-minute information on consumer electronics, communications equipment, computer and industrial electronics, electronic components, government electronics, international trade, employment, and research and development. It covers new and upcoming developments in consumer electronics, such as DAT, CEBus, and HDTV; outlines the government's fiscal year 1992 budget (and budgets for NASA and the Departments of Energy and Transportation), the Strategic Defense Initiative, and a ten-year forecast for military electronics; reports on the average annual employment and earnings and the



CIRCLE 22 ON FREE INFORMATION CARD

job market outlook; and provides a full-industry summary. The book includes illustrative charts, graphs, and tables, along with a glossary of terms. One chapter is devoted to electronic-related products and services, such as automotive electronics and home-office products, and extensive coverage of key technological developments are included.

**PLL DESIGN CHART;** from RF Prototype Systems, 9393 Activity Road, Suite C, San Diego, CA 92126; Phone: 800-874-8037 or 619-689-9715 (in CA); Fax: 619-689-9733; free.

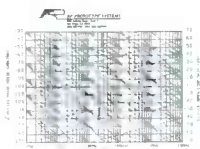

CIRCLE 23 ON FREE INFORMATION CARD

Of particular interest to synthesizer and PLL designers, this reusable PLL design chart can also be used as a general Bode-plotting tool. The chart features key decade slope lines to aid in plotting the open-loop response of a second- or third-order PLL, phase noise floor data for commonly used phase detectors, and a procedure for predicting phase noise at the synthesizer output. The chart, designed for use with only water-based erasable pens, can be easily wiped clean for repeated use. Step-by-step instructions are included.

**1991-1992 EQUIPMENT, TOOLS & SUPPLIES CATALOG;** from Print Products In-

ternational Inc., 8931 Brookville Road, Silver Spring, MD 20910; Phone: 800-638-2020 (301-587-7824 in MD); Fax: 800-545-0058 (301-585-5402 in MD); \$2.00.

This 62-page catalog is filled with electronic maintenance and service products from major manufacturers. Highlighted in the



CIRCLE 24 ON FREE INFORMATION CARD

1991-1992 version are Pace desoldering/soldering and surface-mount rework and repair systems; test equipment from Leader, Hitachi, B&K, Kenwood, Simpson, Beckman, Triplett, Global, and Viz; Print's own line of tool kits and cases; and tools from Cooper, Crescent, Weller, and Xcelite. Also included are computer accessories and supplies, including RAM testers, EPROM programmers, troubleshooting supplies, and diagnostic disks.

**TOTAL HARMONIC DISTORTION; CARTOONS FROM STEREO REVIEW;** by Charles Rodrigues. Published by Perfectbound Press, 1120 Avenue of the Americas, Suite 4118, New York, NY 10036; \$7.95.

Do you take your audio/video gear very seriously? If so, this collection of cartoons is sure to make you



CIRCLE 25 ON FREE INFORMATION CARD

laugh—at the consumer-electronics industry, at the high-end manufacturers and distributors, at the family and friends who must live with your obsession, and at yourself.

**EQUIPMENT CATALOG;** from Optoelectronics Inc., 5821 NE 14th Avenue, Fort Lauderdale, FL 33334; Phone: 800-327-5912 or 305-771-2050; free.

Aimed at two-way radio users, monitoring hobbyists, cellular phone technicians, law-enforcement and security personnel, TV and radio-station engineers, and others involved



CIRCLE 26 ON FREE INFORMATION CARD

with radio broadcasting and reception from sub-audio to 3 GHz, this 16-page catalog describes Optoelectronics newest handheld and bench-top instruments. Included are descriptions, technical data, tips on how to use frequency-finding handi-counters, universal counter-timers for lab and field, and PC-based counters. **R-E**

# The two most comprehensive electronics

# Take any 3 books for only \$9<sup>95</sup>

as your introduction to the *new* ELECTRONICS ENGINEERS' BOOK CLUB

Values to \$107.40



**3258**      **\$27.95**  
This book offers up-to-date instructions for troubleshooting and repairing all major brands of equipment, with hundreds of diagrams, specs, and schematics. Covers TVs, VCRs, CD players, and much more. 310 pp.



**10010P**      **\$19.95**  
More do-it-yourself circuits from the master—Steve Ciarcia. Step-by-step guidance on projects ranging from a gray-scale video digitizer to parallel interfacing. 256 pp.



**9255**      **\$97.50**  
"Outstanding, extensive reference to current technology of electronics. Covers everything from principles to applications."  
—Computer Book Review  
2,528 pp., 1,800 illus.  
*Counts as 3*

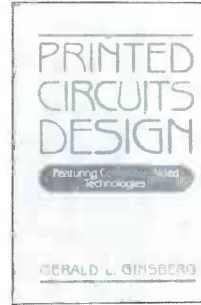

**10016**      **\$39.95**  
Design tighter, more complex circuits, on time and on budget with this book, one of the first to provide a thorough coverage of all aspects of PCB design, including CAD. 320 pp. *Counts as 2*



**3540**      **\$26.95**  
This guide brings you up-to-date on today's most advanced power supply circuits, components, and measurement procedures. Covers switching rates up to 3-MHz and higher as well as the 20-kHz standard. 176 pp.

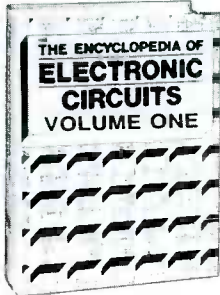

**1938**      **\$60.00**  
For quick-reference and on-the-job use, this sourcebook puts over 1,300 state-of-the-art designs at your fingertips. From A (alarm circuits) to Z (zero crossing detector circuits) this compendium excels in content, scope, and design. 768 pp. *Counts as 2*

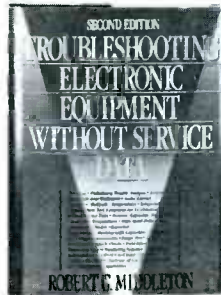

**9290**      **\$36.00**  
This guide provides a practical approach to pinpointing symptoms and causes, and effectively troubleshooting malfunctions. Provides many never-before-published techniques and case histories. 315 pp. *Counts as 2*

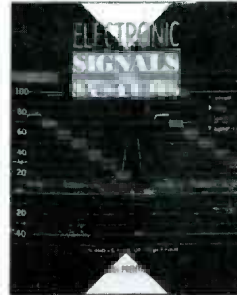

**3557**      **\$29.95**  
A detailed study of signal analysis as it applies to the operation and signal-generating capabilities of today's devices. Explains the composition and use of test instruments, transmission media, satellite systems, broadcast and reception facilities, and more. 272 pp.

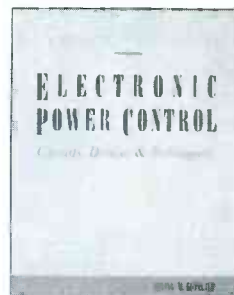

**3837**      **\$27.95**  
Focuses on the specific digital circuits used in electronic power applications. Presents state-of-the-art approaches to analysis, troubleshooting, and implementation of new solid-state devices. 272 pp.

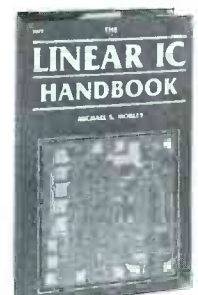

**2672**      **\$49.50**  
A one-stop sourcebook for the data needed on how linear ICs are fabricated, how they work, what types are available, and techniques for designing IC circuits. 624 pp.

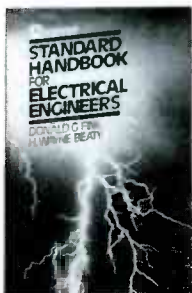

**020975-8**      **\$99.50**  
The essential reference for all electrical engineers. Completely revised and updated, this classic handbook covers the generation, transmission, distribution, control, conservation, and application of electrical power. 2,416 pp., 1,388 illus., 430 tables. *Counts as 3*

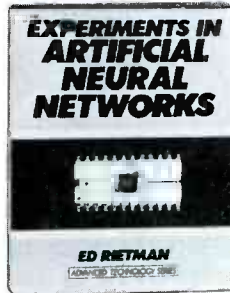

**3037**      **\$24.95**  
This is a practical introduction to artificial neural networks—complete with 11 circuits readers can build, using the schematics and software provided in the book. Also covers theory, hardware, mathematics, and the future of neural computing. 160 pp.

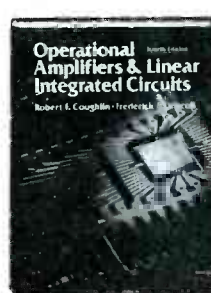

**9373**      **\$46.00**  
This completely updated edition helps electronics professionals discover the wide variety of applications possible using op-amps. Covers signal generation, instrumentation, and filter and control circuits. 516 pp. *Counts as 2*



**003957-7**      **\$49.95**  
Written for technical personnel, engineers, managers, and operators, this is a practical guide to design, implementation, and maintenance of cable TV systems, includes an overall introduction to standard NTSC and HDTV systems. 400 pp. *Counts as 2*

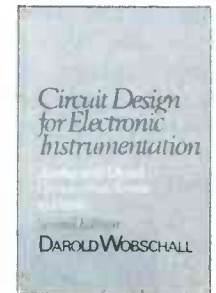

**071231-X**      **\$54.95**  
A wealth of information on both analog and digital devices. Covers many types of sensors, semiconductor devices and basic circuits, signal amplification and processing, data switching, control and readout, and much more. 377 pp. *Counts as 2*



# engineering clubs have joined forces...



**053570-1**      **\$64.95**  
 Everything you need to design or work with communications receivers such as: shortwave, broadcast, radar, military, marine, and more.  
 608 pp., 402 illus. *Counts as 2*

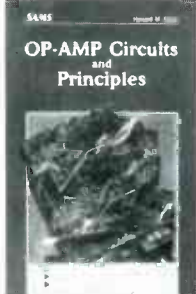

**9401P**      **\$19.95**  
 A step-by-step guide to op-amp circuit operation for technicians, engineers, and scientists. Explore fundamental circuits using bipolar, JFET-input, CMOS, and Norton-type op-amps. 250 pp.

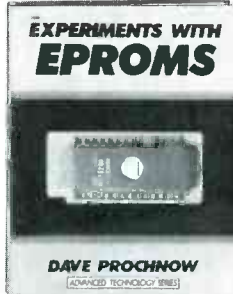

**2962P**      **\$17.95**  
 This complete EPROM instruction manual provides a detailed explanation of underlying theory, plus 15 different projects, including programmers, erasers, and EPROM-based circuits. 240 pp.

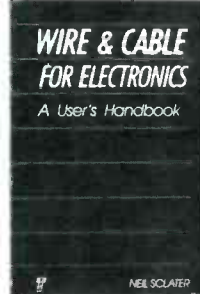

**3787**      **\$29.95**  
 The most current information available on the properties of conductors and insulation, system design and assembly techniques, and guidelines on using the latest equipment. 256 pp.



**10037**      **\$44.95**  
 The most up-to-date guide on CMOS and BiCMOS. Gain practical engineering solutions to designing and building reliable, cost-effective digital systems. 320 pp. *Counts as 2*



**3279**      **\$36.95**  
 Perform routine maintenance, and diagnose and repair any kind of computerized device. This popular reference covers large dynamic RAMs, 32-Bit processors, 80286, 80386, and Z8001-Z8002 processors. 570 pp. *Counts as 2*



**15041P**      **\$19.95**  
 Explore memory capacity, architecture, page-based virtual memory, input/output, and pipelining. Learn about the 80386 registers, real mode and protected mode operation, special fields, and more. 458 pp.

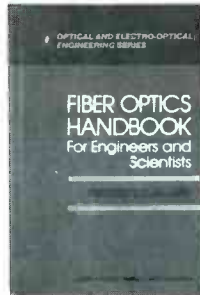

**001013-7**      **\$69.95**  
 A comprehensive review of all elements of applied fiber optic information transfer. It covers operational principles at the system and component levels, comparative data on components, and more. 608 pp. *Counts as 2*

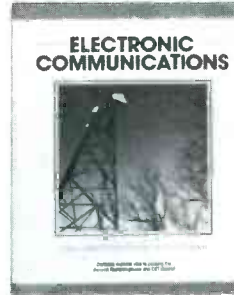

**3365**      **\$34.95**  
 Use this broad study to prepare you for your FCC General Radiotelephone Operator License or CET exam, then keep it on your desk as a handy working reference. 704 pp. *Counts as 2*



**033550 1**      **\$27.95**  
 Gives technicians, engineers, scientists, and students the precise data they need to solve day-to-day problems. Provides instant access to specifics on components, circuits, power supplies, op-amps, and more. 608 pp. *Counts as 2*

## How the Club Works:

The Electronics Engineers and Designers Book Club and the Electronics and Control Engineers' Book Club have joined forces to bring you *all* the best titles from the most prominent electronics publishers.

**YOUR BENEFITS:** You get 3 books for \$9.95 plus shipping and handling when you join. You keep on saving with discounts of up to 50% off as a member.

**YOUR PROFESSIONAL BOOKSTORE BY MAIL:** Every 3-4 weeks, you will receive the Electronics Engineers Book Club News describing the Main Selection and Alternates, as well as bonus offers and special sales, with scores of titles to choose from.

**CLUB CONVENIENCE & EASY RISK-FREE TERMS:** If you want the Main Selection, do nothing and it will be sent to you automatically. If you prefer another selection, or no selection at all, simply indicate your choice on the reply form provided. You will have at least 10 days to decide. As a member, you agree to purchase at least 3 books within the next 2 years and may resign at any time thereafter. If not satisfied with your books, return them within 10 days without obligation!

**BONUS BOOKS:** Starting immediately, you will be eligible for our *Bonus Book Plan*, with savings of up to 80% off publishers' prices.

**EXCEPTIONAL QUALITY:** All books are top-quality editions from ALL the publishers in the field especially selected by our Editorial Board to ensure the information provided is reliable and specific enough to meet your needs.

All books are hardcover unless number is followed by a "P" for paperback. (Publishers' Prices Shown) ©1991 EEBC, Blue Ridge Summit, PA 17294-0860

...to bring you the largest selection of titles available anywhere—at savings of up to 50% off publishers' prices!

### ELECTRONICS ENGINEERS' BOOK CLUB

Blue Ridge Summit, PA 17294-0860

YES! Please accept my membership in the ELECTRONICS ENGINEERS' BOOK CLUB and send my 3 volumes listed below billing me \$9.95. If not satisfied, I may return the books within 10 days and have my membership cancelled. I agree to purchase 3 or more books at regular Club Prices during the next 2 years, and may resign any time thereafter. A shipping/handling charge and sales tax will be added to all orders.

--	--	--

Name \_\_\_\_\_

Address \_\_\_\_\_

City \_\_\_\_\_

State \_\_\_\_\_ Zip \_\_\_\_\_ Phone \_\_\_\_\_

Valid for new members only. Foreign applicants will receive special ordering instructions. Canada must remit in U.S. currency. This order subject to acceptance by the Electronics Engineers Book Club. DRE:1091

OCTOBER 1991

# PARTS PLACE<sup>SM</sup>

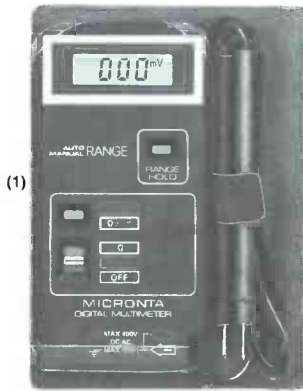

(1)

**(1) NEW! "Shirt Pocket" Multimeter.** Take it along! Features LCD display, autoranging with manual override, continuity sounder. Measures to 400 volts AC/DC and resistance. With fold-up vinyl case, manual and replaceable batteries. #22-169 ..... **27.95**

**(2) NEW! Building Power Supplies.** Easy-to-understand, 96-page book explains linear and switching supplies. Includes complete plans for building five useful supplies with Radio Shack parts. #276-5025 ..... **4.95**

**(3) Mini Audio Amplifier.** Great for computer voice/music synthesis, signal tracing and more. Has a built-in speaker, 1/8" headphone jack, 1/8" input jack and volume control. Put one on your bench today! #277-1008 ..... **11.95**

**(4) Digital Logic Probe.** LEDs and tone outputs reveal logic states instantly. It's the fast way to check operation and pinpoint problems in all types of digital circuits. #22-303 ..... **16.95**

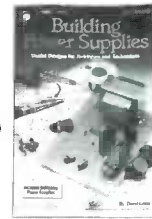

(2)



(4)



(3)

**Parts Special-Order Hotline.** Your local Radio Shack store stocks over 1000 popular electronic components. Plus, we can special-order over 10,000 items from our warehouse—linear and digital ICs, transistors and diodes, vacuum tubes, crystals, phono cartridges and styli, even SAMS<sup>®</sup> service manuals. Your order is sent directly to your Radio Shack store and we notify you when it arrives. Delivery time for most items is one week and there are no postage charges or minimum order requirements.

**(1) Shielded RS-232 Jumper Box.** Top-quality inline D-sub 25 adapter. Wire the included jumper wires and board to suit your need. #276-1403 ..... **9.95**

**(2) Computer RS-232 Tester.** Dual-color LEDs monitor seven data/control lines to help you spot problems quickly. D-sub 25. Connects inline. #276-1401 ..... **14.95**

**(3) Grounded-Tip Soldering Iron.** 15W. #64-2051 ..... **7.49**

**(4) Vacuum-Type Desoldering Tool.** #64-2120 ..... **6.95**

**(5) Locking Forceps.** 6" long. Stainless. #64-1866 ..... **4.95**

**(6) Rosin Soldering Paste Flux.** 1 oz. #64-021 ..... **1.79**

**(7) Lead-Free Solder.** 96% tin, 4% silver. 0.25 oz. #64-025 ..... **1.99**

**(8) 10-Amp Microwave Oven Fuses.** #270-1256 ..... Pkg. of 2/1.29

**(9) 2-Amp Fast-Acting Fuses.** #270-1275 ..... Pkg. of 3/79c

**(10) 5-Amp "Blade" Vehicle Fuses.** #270-1205 ..... Pkg. of 2/89c

**Computer/Printer/Business Machine AC Power Cords.** 6 feet long.

**(11) Extension.** Just plug in to lengthen existing cord. #278-1259 ..... **4.99**

**(12) With Space-Saving 90° CEE Connector.** #278-1260 ..... **5.99**

**(13) With Straight CEE Connector.** #278-1257 ..... **3.99**

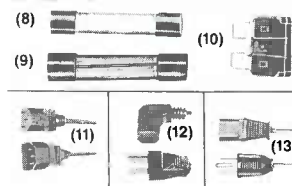
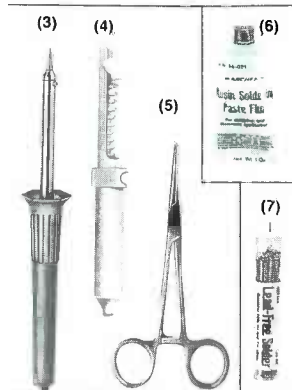
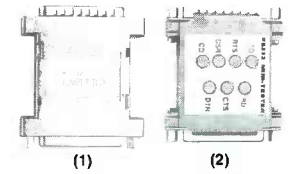

(1)

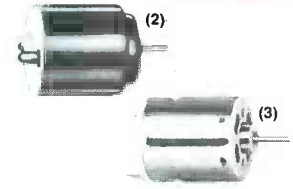

(2)

(3)

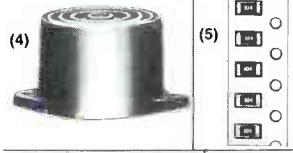

(4)

(5)



(6)

(10)



(7)

(11)

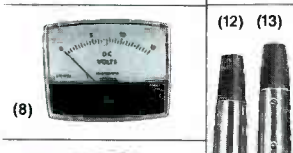

(8)

(12) (13)



(9)

(14)

**(1) Voltage Regulator ICs.** Feature built-in overload protection and thermal shutdown. Great for custom projects. Maximum input: 35VDC. 7805. 5V. #276-1770 ..... **1.19**  
7812. 12V. #276-1771 ..... **1.19**

**(2) Low-Voltage Motor.** Just the thing for science projects, robotics and solar power demos. Operates from 1 1/2 to 3VDC. About 1 1/2" long. #273-223 ..... **99c**

**(3) High-Speed 12VDC Motor.** Up to 15,200 RPM, no load. About 2" long. #273-255 ..... **2.99**

**(4) "Ding-Dong" Chime.** This IC and mini-speaker combo is ideal for a customer-entry alert or doorbell. Produces 80 dB sound pressure at 12VDC. Operates from 6 to 18VDC. #273-071 ..... **8.99**

**(5) Surface-Mount Resistors.** 200-piece assortment of 15 popular values. Rated 1/8 watt, 5%. #271-313 ..... **Set 4.99**

**(6) Metal Project Cabinet.** An attractive, easy-to-drill housing at a low price. 3 x 5 1/4 x 5 7/8". #270-253 ..... **6.79**

**(7) Power Supply Project Case.** Vented 2 1/2 x 4 5/8 x 3 1/4" molded case. #270-287 ..... **3.99**

**(8) 0 to 15 DC Voltmeter.** Quality jeweled movement. #270-1754 ..... **7.95**

**(9) Box/Board Combo.** Molded enclosure plus predrilled 2 x 3 1/8" board, labels and more. #270-291 ..... **4.99**

**(10) Eight-Position Audio Phono Jack Board.** #274-370 ..... **1.69**

**(11) 1:1 Audio Transformer.** Z: 600-900Ω. #273-1374 ..... **3.59**

**(12) Three-Pin XLR Mike Plug.** Metal body. #274-010 ..... **2.99**

**(13) Three-Pin XLR Inline Socket.** #274-011 ..... **2.99**

**(14) Three-Pin XLR Panel Socket.** #274-013 ..... **3.69**



# PC-TO-TV CONVERTER

ANTHONY STEVENS

**Put PC  
power into  
home videos  
with this  
VGA to NTSC  
television  
adapter.**



WITH OUR VGA TO NTSC VIDEO CONVERTER, you can have video production right at your fingertips. A part of multimedia is connecting your computer to the outside video world. In the past, \$100,000 computer-controlled video consoles were required to produce many video effects you see today. Now with animation software, a video tape recorder, and this video converter board we present here, it's possible to turn your PC into a home video production studio!

You don't even need the latest equipment. If you have a VCR and a PC that's compatible with a video graphics array (VGA) video card, you're on your way. Creating your own TV video productions, insert-editing titles on home videos, or playing computer games over a projection TV are

just some of the many exciting possibilities that await you if you build our video converter.

Displaying a computer video picture on a VCR requires a VGA-to-NTSC signal converter. The converter board mounts in the computer and is connected in line with the computer's VGA monitor cable. A memory-resident software program monitors the VGA board, and with a key stroke on the computer, it can be turned on or off.

When conversion is off, the computer monitor displays normal VGA video. When conversion is on, the board converts the VGA monitor display and outputs NTSC broadcast-quality signals for recording. The conversion is in real time and is fast enough to display full-action computer games.

## Computer video

In the early days of personal computers, video monitoring suffered because the circuit designs had to use low-density, high-cost memory components. Various innovative display formats were developed in order to store video text and video graphics with less memory. That need for efficiency started the computer graphics monitor design down a path of noncompatibility with standard broadcast video.

Lately, the VGA standard has become widely accepted. With VGA, a picture is displayed on a video monitor in a serial fashion. Figure 1-a shows how the picture is painted one line at a time. The picture starts at the top of the screen and traces, line by line, until reaching the bottom of the picture. That is repeated fast

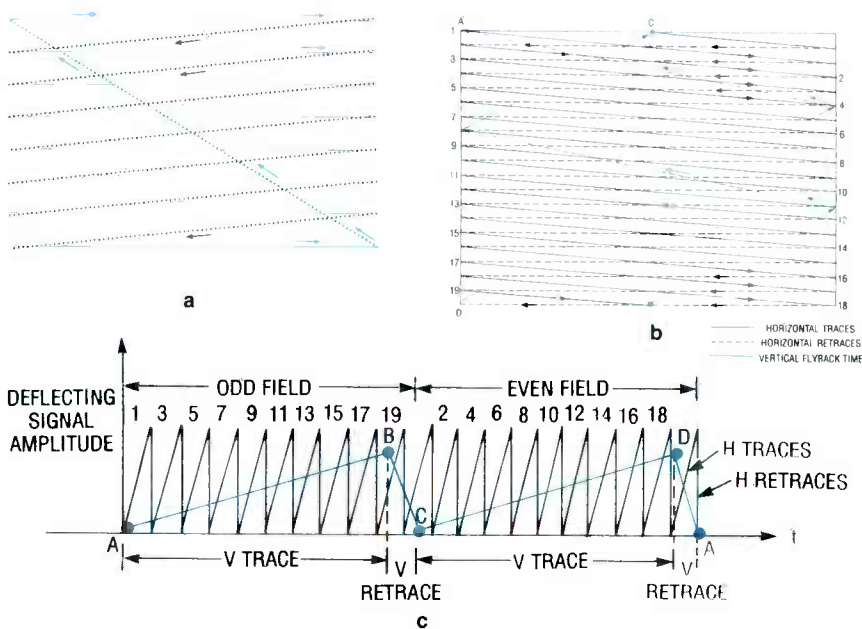

**FIG. 1—DOT SCANNING OF THE PICTURE TUBE** creates the image that you see. VGA uses a noninterlaced technique which scans once to make a complete picture (a), NTSC uses an interlaced method to scan twice to make a complete picture (+hbib+hb). The amplitude of the deflected signal versus time is shown in c.

enough so the eye sees a continuous picture without flicker. Control, or sync signals are also sent to the monitor to align the picture properly on the screen. An NTSC signal scans twice in an interlaced mode to make a complete picture (Fig. 1-b).

The difference in the control and sync signals between VGA

and NTSC makes it impossible to display a VGA picture on standard television without a format converter. Conversion from VGA to NTSC is not an easy task. Let's see how those systems work.

**VGA versus NTSC standards**

VGA boards have become very popular in recent years. The VGA

standard has several modes of operation for compatibility with existing software. Those different modes define the control signals that generate the horizontal, vertical, and pixel clocking rates. The horizontal rate is the time it takes to paint one line from left to right across the face of the video monitor. The pixel clock sets the dots of resolution for each horizontal line. The vertical timing sets how many horizontal lines that make up the whole picture from the top to the bottom of the display.

PC video standards and operating frequencies can differ greatly, depending on the type of monitor used. For instance, a 640×X400 mono/color VGA monitor has a video bandwidth (dot rate) of 25.175 MHz with a horizontal scan rate of 31.5 kHz, while a 640×X350 EGA monitor has a 16.257-MHz bandwidth with a 21.85-kHz horizontal scan rate. Other mono and color monitors, such as CGA, MDA, HGC, and MCGA also have different video bandwidths and horizontal and vertical scan rates. The VGA signaling to the computer monitor consists of multiple signal lines. Figure 2 shows that three independent signal lines carry the actual analog video in a red, green, and blue (RGB) format, one color per line. One other line carries the horizontal sync pulses, and another line carries the vertical sync pulses. Some of the various VGA modes are indicated by the polarity of the two sync signals. Table 1 shows the relationship between sync polarity and the VGA mode. As we will see, VGA technology differs greatly from the NTSC broadcast standard.

NTSC is the standard used by television broadcasters in the United States. Video cassette recorders (VCR's) and cameras/camcorders also use that same standard. The NTSC signal is a composite of all the signals necessary to generate a broadcast quality picture. The three analog color signals are combined together with the horizontal and vertical sync signals and color subcarrier to make up the total NTSC signal.

The NTSC sync signals and color subcarrier are fixed in their frequencies; the horizontal scanning frequency is 15,734.26 Hz,

**TABLE 1—SYNC POLARITY AND VGA MODE RELATIONSHIP**

Fixed-Frequency Monitor				
Display Mode	Horizontal Sync Frequency	Polarity	Vertical Sync Frequency	Polarity
350 lines	31.5 kHz	+	70.1 Hz	-
200 lines	31.5 kHz	-	70.1 Hz	+
400 lines	31.5 kHz	-	70.1 Hz	+
480 lines	31.5 kHz	-	59.9 Hz	-
132 columns	31.5 kHz	-	70.0 Hz	+
Multi-Frequency Monitor				
350 lines	31.5 kHz	+	62.3 Hz	-
200 lines	31.5 kHz	-	62.3 Hz	+
400 lines	28.0 kHz	-	62.3 Hz	+
480 lines	31.5 kHz	-	59.9 Hz	-
132 columns	27.6 kHz	-	61.5 Hz	+
600**	35.2 kHz	-	56.2 Hz	-
768†	35.5 kHz	+	86.9 Hz	+

\*\*800×600 Graphics  
† 1024×768 interlaced graphics

**Video Signals**

Black level = 0V  
Full intensity level = +0.7V



VGA MONITOR CABLE PIN OUTS

PIN	FUNCTION	SIGNAL
1	RED VIDEO	[Red, Green, and Blue video signal waveforms]
2	GREEN VIDEO	
3	BLUE VIDEO	
5	} GROUND	[Horizontal sync signal waveform]
6		
7		
8		
10	} HORIZONTAL SYNC	[Vertical sync signal waveform]
13		
14	VERTICAL SYNC	

FIG. 2—THESE ARE THE PINOUTS OF A VGA MONITOR CABLE, with their corresponding signals. Note that pin 15 is not used.

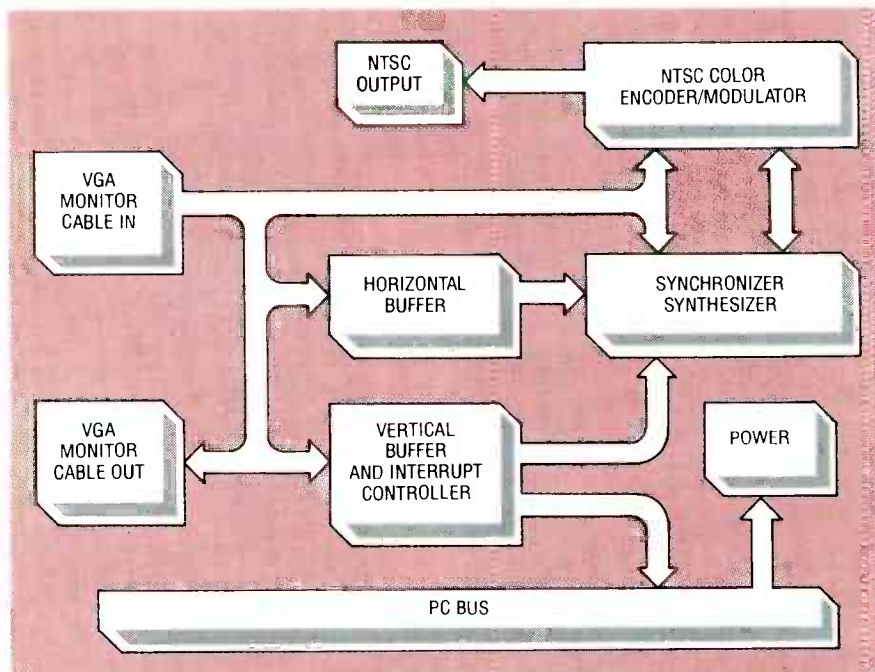

FIG. 3—BLOCK DIAGRAM OF THE BROADCAST VIDEO CONVERTER. The unit consists of two main sections; an NTSC color encoder/modulator and an NTSC synchronizer synthesizer.

the vertical scanning frequency is 59.94 Hz, and the color subcarrier frequency is 3.579545 MHz. By contrast, the different VGA modes have different horizontal and vertical timing rates, depending on the video mode chosen.

Another difference between VGA and NTSC is the field scanning. NTSC uses interlacing, which scans the picture tube twice per picture (Fig. 1-b). There is one scan for the even lines and another scan to fill in between

the evens with the odd numbered lines, making one complete picture. Most modes in VGA, on the other hand, use noninterlaced scanning, where the complete picture is painted in only one pass over the face of the picture tube.

The challenge of converting from VGA to NTSC standards involves stripping off the VGA horizontal and vertical control signals, changing the video timing, and recombining properly generated NTSC horizontal and ver-

tical sync. The three color signals are then mixed and added to the color subcarrier, finishing the job.

**About the circuit**

The video converter's power and software-interrupt control signals are supplied directly from the PC bus. The video signals from the VGA board are connected to the converter using the VGA monitor cable. The computer monitor is then plugged into the converter board by another VGA monitor cable. An RCA jack on the converter board is used to supply the NTSC video signal output.

Figure 3 shows a block diagram of the video converter, and the schematic is shown in Fig. 4. The circuit consists of two main parts: an NTSC color encoder/modulator, IC1, and the NTSC sync generator, IC2. Horizontal and vertical VGA sync signals from the VGA connector (pins 4 and 5 of P1) are buffered by R32, R33, IC3-a, -b, and -d before driving IC2. The vertical sync is also conditioned by R10, R11, C12, and IC3-c. Those conditioned signals are narrow pulses, which drive Q2. The collector of Q2 and R17 are wired ORED to the PC bus interrupt request input (IRQ2), which tells the computer when conversion begins.

Two input clocks are required by IC2: The 14.31818-MHz crystal, XTAL1, and components R19-R21, C21-C23, and D1 make up a phase-locked oscillator clock that's generates the color subcarrier and runs the internal workings of IC2. Components L4, C25-C28, R24-R26, and D2 make up the second clock oscillator, which is used to combine all the necessary sync signals together.

The output of IC2 is the composite NTSC synchronizing signal (pin 21) and the color subcarrier (pin 27). The subcarrier signal is buffered by R31 and IC3-e. Components R12, C16, and C33 reduce the subcarrier amplitude to match IC1's input. The NTSC composite sync and color subcarrier signals are then applied to the NTSC color encoder/modulator.

Motorola's MC1377 is used for the NTSC modulator, IC1. The VGA RGB signals are applied

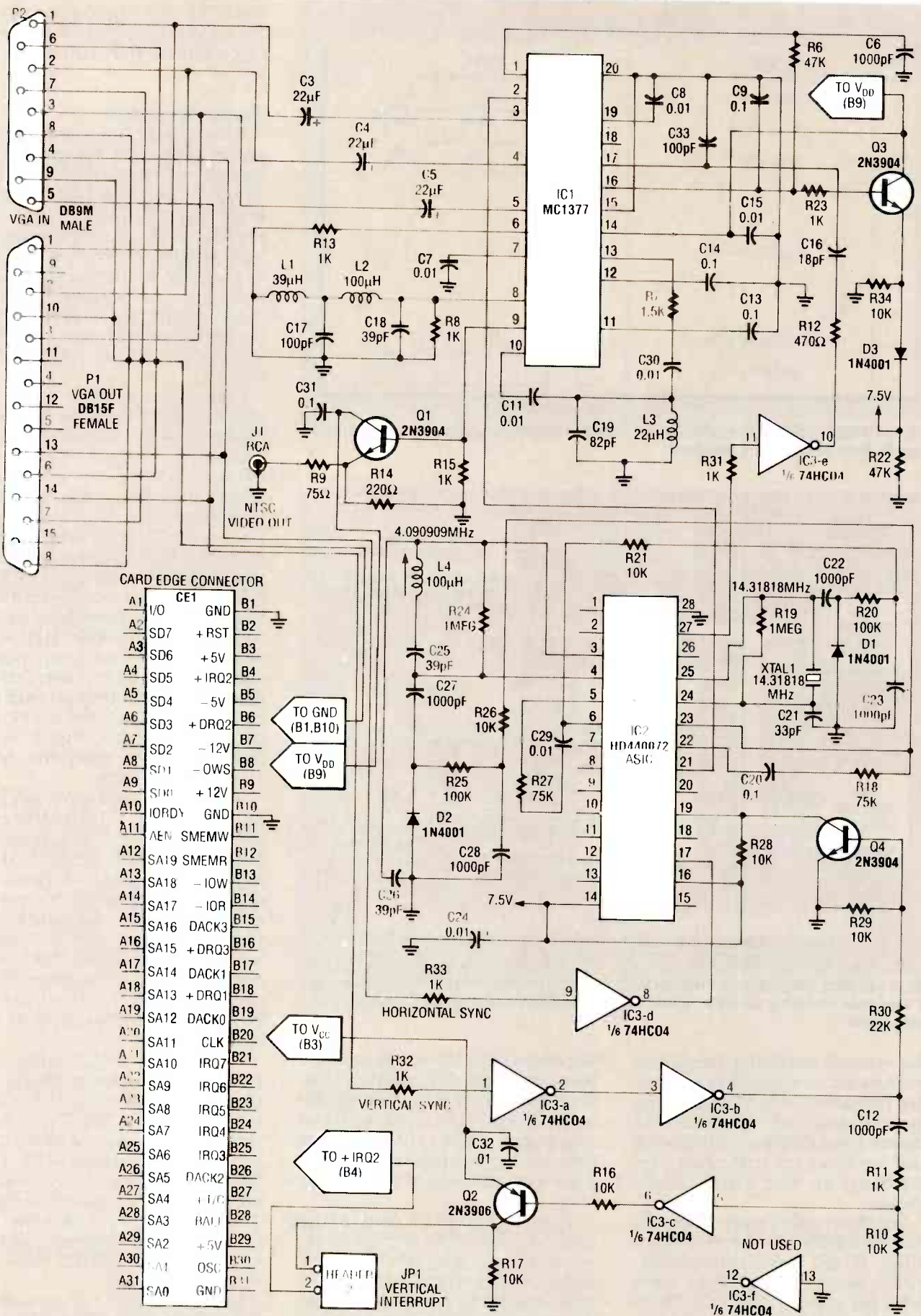

FIG. 4--THE SCHEMATIC OF THE VIDEO CONVERTER. IC2 is used for computer control, as an NTSC signal synthesizer, and for NTSC composite sync and subcarrier output. IC1 is an NTSC modulator; a 200  $\mu$ s-delay circuit is used to align the luminance part of the picture with the chrominance part.



## PARTS LIST

All resistors are 1/4-watt, 5%, unless otherwise indicated.

R1-R5—not used  
 R6, R22—47,000 ohms  
 R7—1500 ohms  
 R8, R11, R13, R15, R23, R31-R33—1000 ohms  
 R9—75 ohms  
 R10, R16, R17, R21, R26, R28, R29, R34—10,000 ohms  
 R12—470 ohms  
 R14—220 ohms  
 R18, R27—75,000 ohms  
 R19, R24—1 megohm  
 R20, R25—100,000 ohms  
 R30—22,000 ohms

### Capacitors

C1, C2, C10—not used  
 C3, C4, C5—22  $\mu$ F, 16 volts, electrolytic  
 C6, C12, C22, C23, C27, C28—1000 pF, 100 volts, disc  
 C7, C8, C11, C15, C24, C29, C30, C32—0.01  $\mu$ F, 100 volts, disc  
 C9, C13, C14, C20, C31—0.1  $\mu$ F, Mylar  
 C16—18 pF, 100 volts, disc  
 C17, C33—100 pF, 100 volts, disc  
 C18, C25, C26—39 pF, 100 volts, disc  
 C19—82 pF, 100 volts, disc  
 C21—33 pF, 100 volts, disc

### Semiconductors

IC1—MC1377 RGB/NTSC encoder, Motorola  
 IC2—HD440072 sync generator, Hitachi  
 IC3—74HC04 CMOS hex-inverter buffer  
 Q1, Q3, Q4—2N3904 NPN transistor  
 Q2—2N3906 PNP transistor  
 D1-D3—1N4001 diode

### Other components

XTAL1—14.31818 MHz resonator (HC-49U)  
 L1—39  $\mu$ H epoxy choke, 5%  
 L2, L4—100  $\mu$ H epoxy choke, 5%  
 L3—22  $\mu$ H epoxy choke, 5%

### Connectors

P1—15-pin female DB15F connector  
 P2—9-pin male DM9M connector  
 CE1—card edge connector in PC  
 J1—RCA phono jack  
 JP1—2-pin header

**Note:** The following items are available from Video Control, 3314 "H" St., Vancouver, WA 98663, (206) 693-3834:

- A complete kit including PC board, D-connectors, mounting hardware, all parts and converter software package—\$164.
- An etched, drilled, and plated through PC board with IC2 and conversion software—\$125.

Please specify 5 1/4 or 3 1/2 inch floppy disk for software, add \$5.50 for shipping and handling; bank cards and checks are accepted. Allow 4 to 6 weeks for delivery.

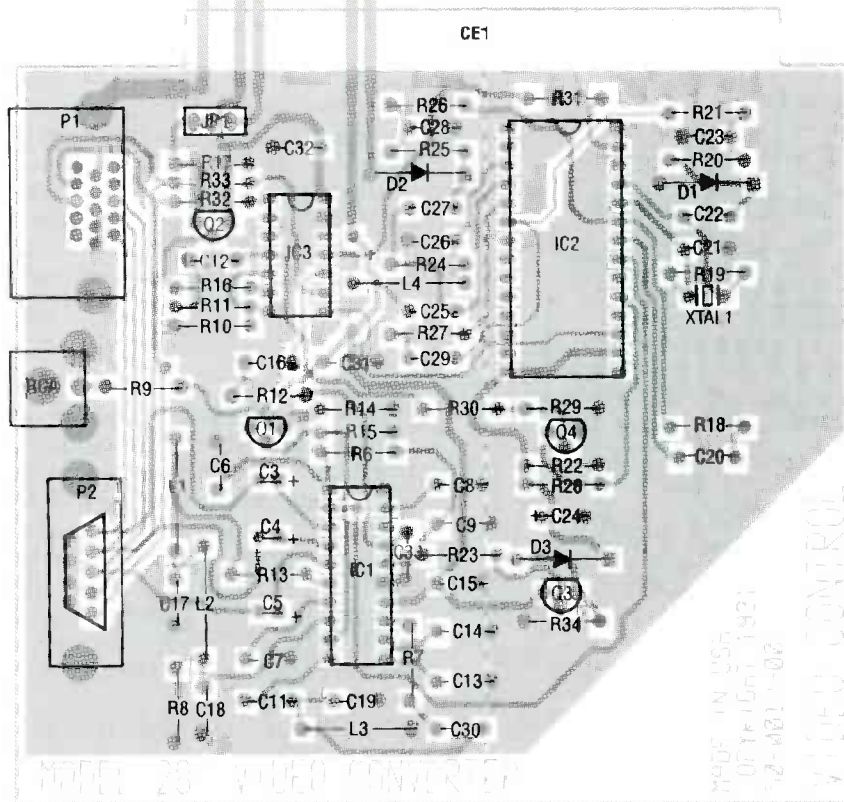

FIG. 5—PARTS PLACEMENT DIAGRAM. The square pads on the PC board indicate the positive leads for polarized capacitors, the cathode of diodes, and pin 1 of the IC's.

through the VGA connector pins 1-3. Components C3-C5 block any DC on the video. A chrominance bandpass filter consisting of R7, C11, C19, C30, and L3 reduces mixing harmonics. That filter introduces a 200- $\mu$ s delay

the color image. A 200- $\mu$ s delay circuit consisting of R8, R13, C17, C18, L1, and L2 was added in the luminance path to match the delay of the chrominance circuit, which makes the black and white part of the picture line up

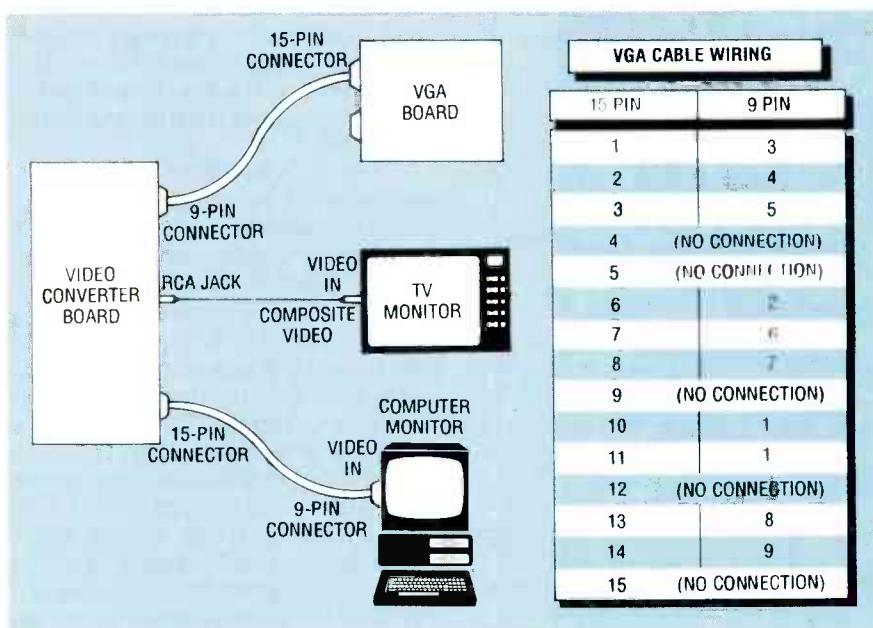
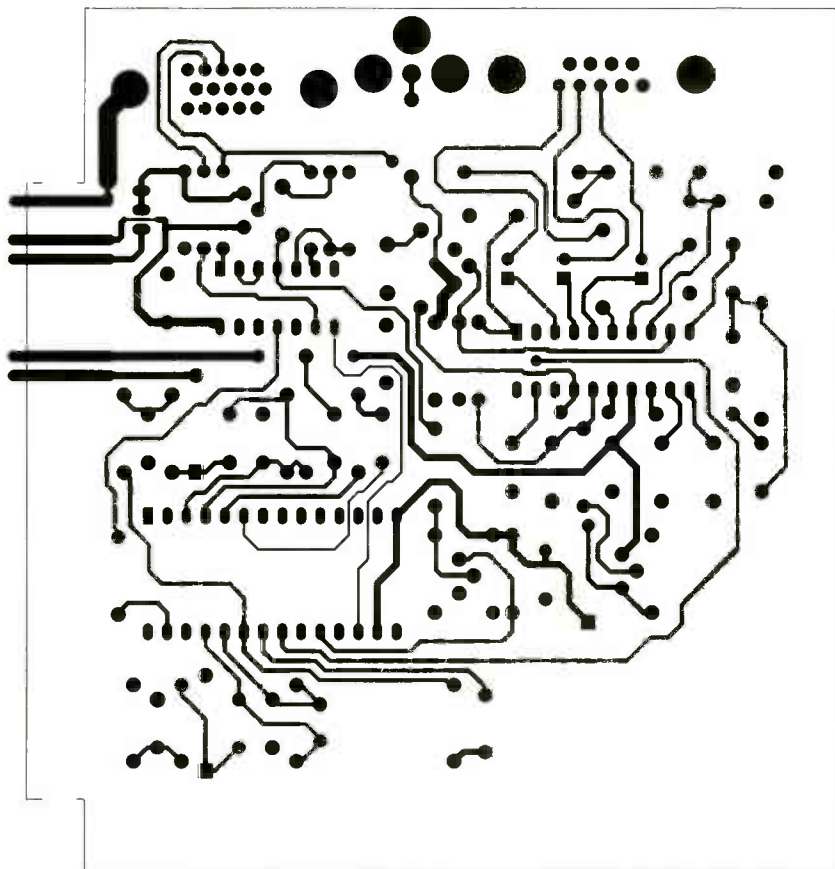
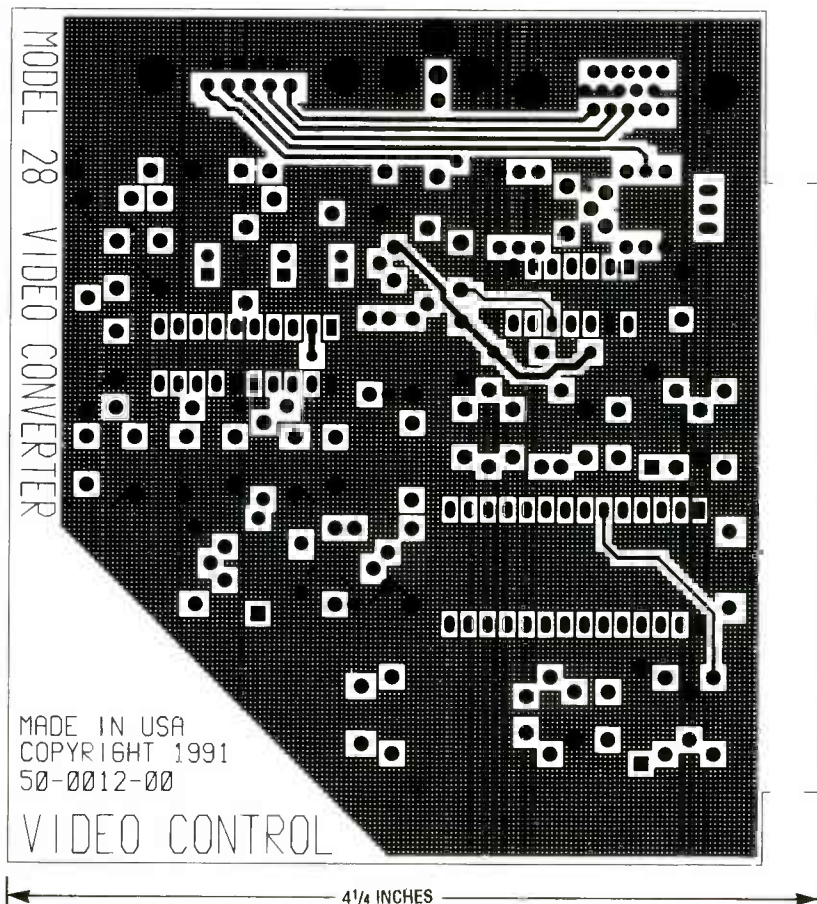

FIG. 6—HERE IS THE HOOKUP DIAGRAM for the video converter.



THIS IS THE FOIL PATTERN of the component side of the PC board.



HERE IS THE FOIL PATTERN of the solder side of the PC board.

with the color part. The pass-band of the delay circuit is 4 MHz to ensure the sharpest possible picture.

The composite NTSC video signal from IC1 pin 9 is buffered by R14, R15, and Q1. A 75-ohm output impedance required to drive a video cable is provided by R9. Components R22, R23, R34, Q3, and D3 make up IC2's power regulator. Now let's build the video converter.

### Construction

The entire video converter circuit is located on one double-sided PC board. The foil patterns of the component side and solder side are provided if you wish to make the board yourself. The PC board is a card-edge type, designed to fit into a short slot directly into a PC motherboard. A parts-placement diagram is shown in Fig 5.

Assembly of the unit is straightforward, just make sure the orientation of the transistors, diodes, electrolytic capacitors, and IC's is correct. The positive (+) leads for polarized capacitors, the cathode of diodes, and pin 1 of the IC's are identified by a square pad on the board. After soldering, visually inspect it to make sure there are no solder bridges between closely spaced traces.

To test the board, hook it up as shown in Fig. 6. A test program is available on the **Radio-Electronics** BBS (516-293-2283, 1200/2400, 8N1) as VGA.ZIP, and will give you a go/no-go indication of proper operation. The complete software is available from the source mentioned in the parts list.

This VGA to TV broadcast converter is an excellent, easy to use multimedia tool. To record the computer's video on your VCR, plug a cable from the VCR's video input into the converter board's NTSC output. With two VCR's and a switch box you can insert-edit text or graphics from your computer using the pause controls. (A time-base corrector is required if you want to overlay the computer images onto your videos.) Now you can create your own video productions, record computer graphic images on VCR's, or play video games on projection TV.

R-E





# VOCAL EFFECTS/MIXER



**Build this vocal effects mixer and get studio-quality sound "reverberations" in your recordings.**

TERRY WEEDER

IF YOU ENJOY EXPERIMENTING WITH home recordings, you'll be interested in our vocal effects mixer. With a few evenings' work and a cost of \$50, you'll be able to shape your voice with tone controls and create a "multiple-echo" effect while mixing in audio from a tape, CD, or other stereo source. The effects mixer can also be used with the lead vocal filter (**Radio-Electronics**, September 1990), to mix your own voice with vocal-less music. Let's see how your stereo's channels are mixed together and delayed to produce the reverberation effects.

### How it works

The effects mixer takes the line-level output from your stereo's RECORD jacks and applies it to two mixers—one for each channel (left and right). Figure 1 shows a block diagram of how the circuit works. The signal from a

microphone is amplified by a pre-amp and is then sent to an equalization stage where bass and treble levels can be adjusted independently. That signal is fed to an 8-ms delay circuit whose output is remixed with the original to simulate an echo. The delayed signal is attenuated and fed back to the input of the delay circuit, to generate the effects of multiple echoes.

Finally, the vocal signal and its echoes are fed to two mixers, where they combine with the music program being received from the stereo system. The output of those mixers are then fed to the stereo amplifier, via its PLAY input jacks.

### Circuitry

The schematic of the effects mixer is shown in Fig. 2. The stereo input signal is coupled via C1 and C2 to the two mixers, IC1-

c and IC1-d. The signal from the microphone is coupled via C13 to IC4-c, which amplifies it 30 times to a line level of approximately 200 mV. The impedance seen by the mike is set by R24, while C14 and R25 filter out frequencies above the voice spectrum.

The output of IC4-c passes through tone controls R28 and R30 (with the associated capacitors) and is applied to the non-inverting input of IC4-b. The gain of IC4 is set by R33 and R34 at 12, which makes up for the loss occurring in the tone-control stage.

The signal then goes through IC1-b to IC2 (an RD5106 256-sample bucket brigade by EG&G Reticon), which delays the signal about 8 milliseconds. An oscillator made up of IC3 and its associated components generates a clock pulse for IC2, which determines the delay time and

can be calculated by  

$$512/f_c = \text{total delay,}$$
 where  $f_c$  represents the clock frequency. A low-pass filter is formed by IC1-a, which smooths out the sample steps caused by

the delay chip. The output of IC1-a is then fed through FEEDBACK potentiometer R9 back to the input of the delay stage, via mixer IC1-b.

The output of IC1-a is also fed

to mixer IC4-a through EFFECTS-LEVEL potentiometer R15. IC4-a combines that signal with the original signal coming from IC4-b. The volume level is adjusted using R41 together with IC4-d. From there the signal is sent to IC1-c and IC1-d where it mixes with the signal coming from the stereo.

### Construction

The author's finished prototype is shown in Fig. 3. The main circuit is mounted on a single-sided PC board, while the power supply (Fig. 4) is wired on a perforated construction board. An etched and drilled PC board is available from the source mentioned in the parts list, or you can build your own using the foil pattern provided. Mount the components according to the parts placement diagram shown in Fig. 5. Note that R24 sets the input impedance at the mike input. The value of that resistor should be 300 ohms when using a low-impedance microphone, or 10K with a high-impedance mike.

A 1/4-inch phone jack can be mounted on the front panel for use with a high-impedance microphone, or an XLR 3-pin jack can be used for a low-impedance mike.

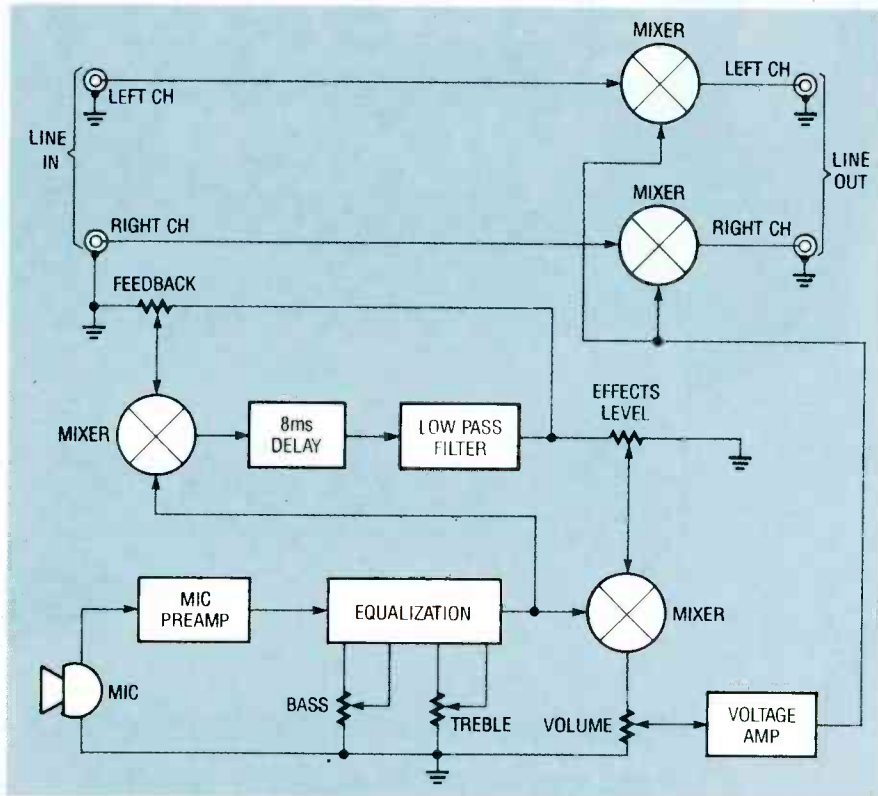

FIG. 1—BLOCK DIAGRAM. The mike signal is adjusted with bass and treble controls. Echo is produced by delaying the signal 8 milliseconds then remixing with the original signal. Feeding the output of the delay circuit to its input causes multiple decaying echoes. The mike signal with echoes are mixed with the stereo signal.

### PARTS LIST

#### All resistors are 1/4-watt.

R1, R2, R5—150,000 ohms  
 R3, R13, R16—R18, R21—R23, R40—47,000 ohms  
 R4—100,000 ohms  
 R6—1 megohm  
 R7, R27—33,000 ohms  
 R8—10 ohms  
 R9, R15, R28, R30, R41—100,000 ohms, potentiometer  
 R10, R12—10,000 ohms  
 R11—43,000 ohms  
 R14, R19, R20, R37—15,000 ohms  
 R24—300 ohms or 10,000 ohms (see text)  
 R25, R29—20,000 ohms  
 R26—1000 ohms  
 R31—3000 ohms  
 R32—2200 ohms  
 R33—5100 ohms  
 R34—56,000 ohms  
 R35, R36, R38, R39—39,000 ohms  
 R42—130,000 ohms

#### Capacitors

C1, C2—2.2  $\mu$ F, tantalum  
 C3, C5, C6, C19—0.1  $\mu$ F, mylar

C4—1  $\mu$ F, tantalum  
 C7—0.15  $\mu$ F, tantalum  
 C8—200 pF, ceramic disc  
 C9—0.002  $\mu$ F, ceramic disc  
 C10—270 pF, ceramic disc  
 C11, C12—4.7  $\mu$ F, tantalum  
 C13—10  $\mu$ F, electrolytic  
 C14—39 pF, ceramic disc  
 C15—0.005  $\mu$ F, mylar  
 C16—0.033  $\mu$ F, mylar  
 C17—0.01  $\mu$ F, mylar  
 C18—0.068  $\mu$ F, mylar

#### Semiconductors

IC1, IC4—LM324 quad op-amp  
 IC2—RD5106 256-sample bucket-brigade analog delay line, EG&G Reticon  
 IC3—4011 quad two-input NAND gate  
**Power-supply parts**  
 F1—0.5 amp fuse and fuseholder  
 T1—24 VAC center-tapped transformer, 100 mA  
 BR1—1.5-amp bridge rectifier, 100 PIV  
 C1, C2—1000  $\mu$ F, 25 volts, electrolytic

C3, C4—10  $\mu$ F, 16 volts, electrolytic  
 C5, C6—0.1  $\mu$ F, ceramic disc  
 D1, D2—12-volt Zener diode  
 R1, R2—220 ohms  
 R3—1000 ohms  
 S1—SPST switch, 1 amp  
 LED1—light emitting diode, any color  
**Miscellaneous:** PC board, stand-offs, hardware, wire, shielded cable, power-supply cord, strain relief, four RCA jacks, XLR jack or 1/4-inch phone jack, five knobs, and enclosure.

**NOTE:** The following are available from Weeder Technologies, 14773 Lindsey Rd., Mt. Orab, Ohio 45154: An etched, drilled, and plated through PC board, \$10.00; all board-mounted components, \$19.00; power-supply components (not including the perforated construction board, fuse, fuseholder, and switch), \$12.50. Include \$2.00 for shipping and handling. Ohio residents add 5.5% sales tax.



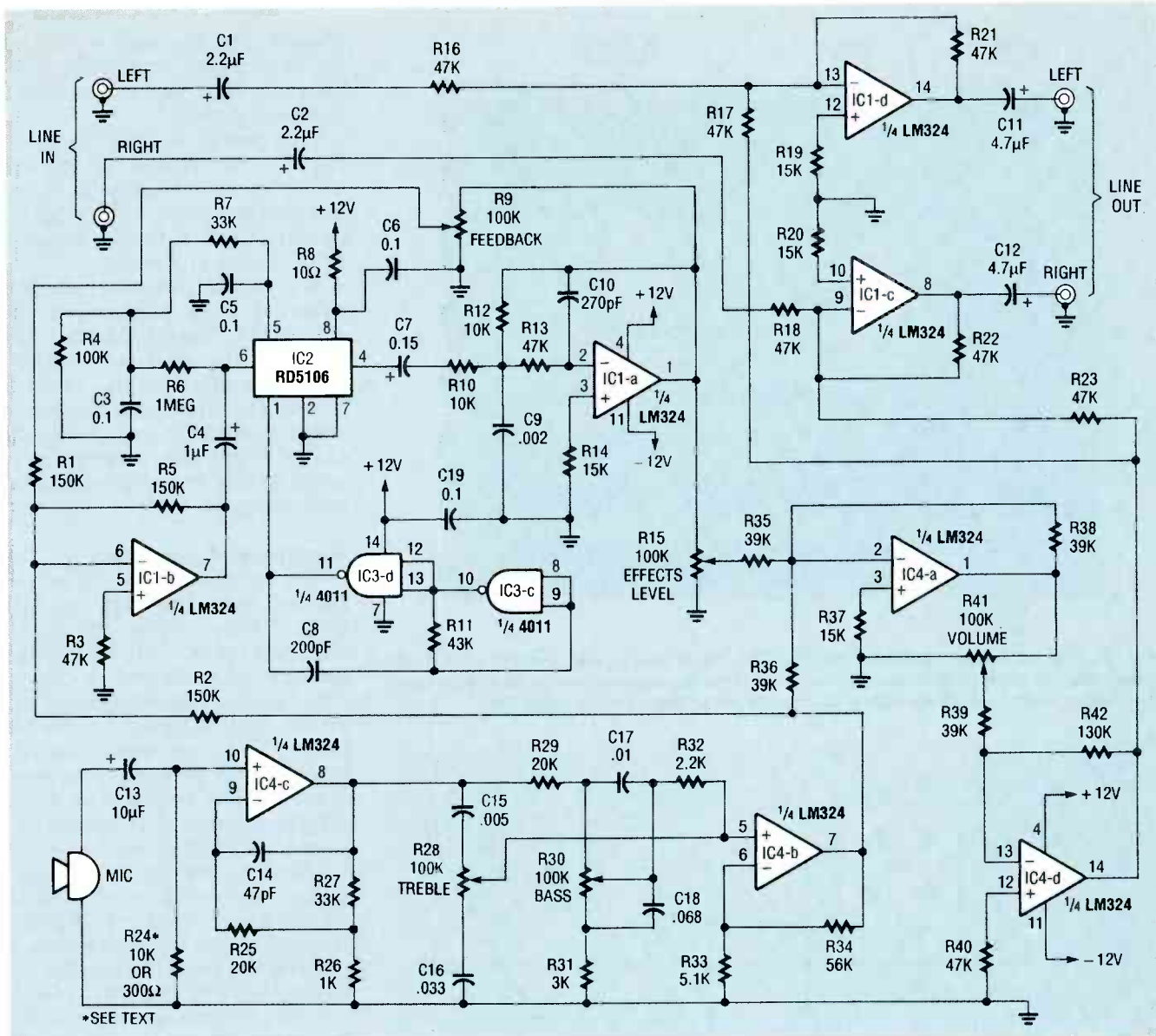
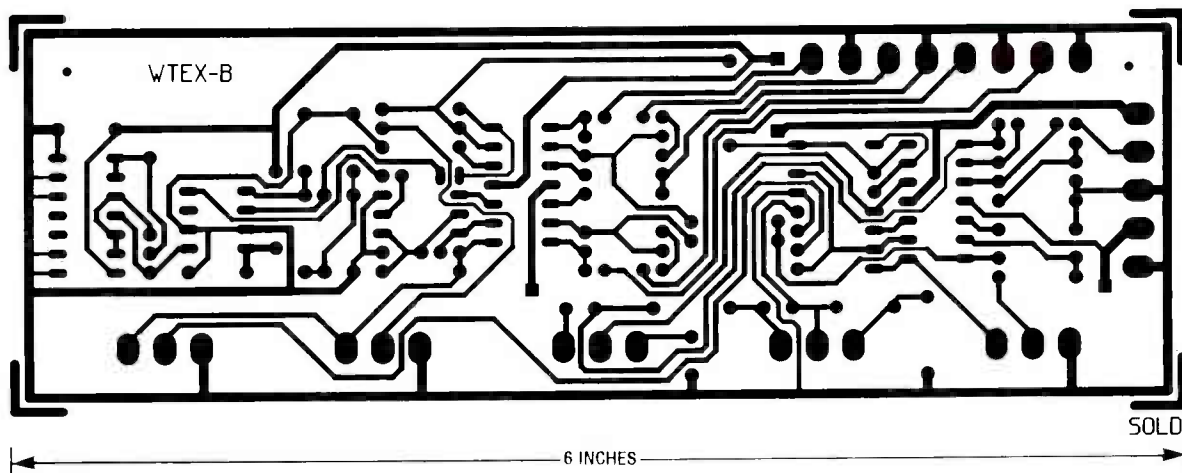
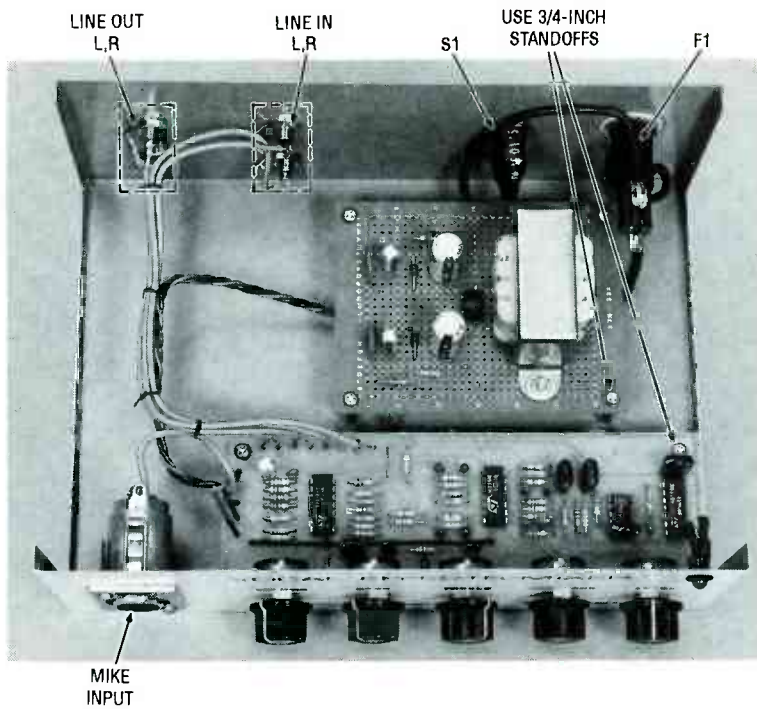

FIG. 2—SCHEMATIC OF THE EFFECTS MIXER. The output from the stereo's RECORD jacks are fed to mixers IC1-c and -d. The mike signal is amplified by preamp IC4-c, IC4-b corrects for signal attenuation in the tone-control stage. IC2 delays the signal 8 milliseconds and IC1-a smooths out the sample steps. The delayed signal combines with the original in the IC4-a mixer, then passes through volume control amp IC4-d to mixers IC1-c and -d where it combines with stereo music. The output is then fed back to stereo via the PLAY jacks.



THIS IS THE SOLDER SIDE of the PC board.



**FIG. 3—THE AUTHORS FINISHED PROTOTYPE.** Both boards are mounted on 3/4-inch standoffs. The left and right channel line IN/OUT jacks are mounted on the rear enclosure. The author used heat-shrink tubing to insulate the primary switch terminals.

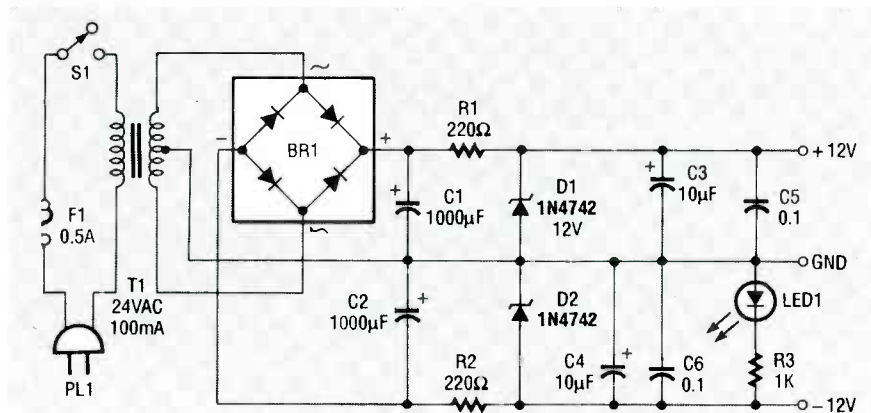

**FIG. 4—POWER SUPPLY SCHEMATIC** for the effects mixer circuit. Note that this is a dual supply.

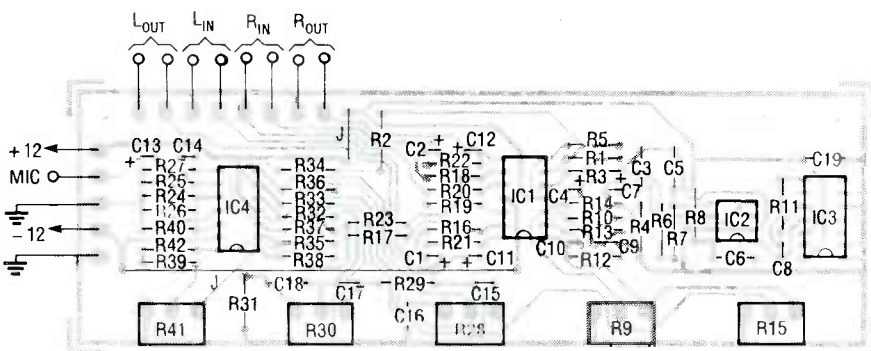

**FIG. 5—PARTS PLACEMENT DIAGRAM.** Remember to connect the two jumpers. Use shielded cables for all inputs and outputs, and make sure the capacitors are installed with correct polarities.

Use shielded wire to connect the jack to the mike input on the board. When using an XLR jack,

pins 1 and 3 should be connected to the shield and pin 2 to the center conductor. Shielded wire

should also be used to connect the line IN/OUT terminals on the board to RCA jacks mounted on the back panel.

The power supply shown in Fig. 4 is the same as the one used in the vocal filter project. In fact, one power supply can be shared by both units if they're mounted in the same enclosure.

Mount the power-supply components on a perforated construction board. Mount that board in the enclosure opposite the mike input of the main PC board. The high-gain mike input stage should be kept some distance from the power-supply transformer to reduce noise and hum pickup.

### Hookup and operation

The effects mixer can be connected into the tape-monitor loop of your stereo system. Use shielded cable with phono connectors on each end to connect inputs to the record jacks on your stereo, and outputs to the play jacks. You can now mix your voice in with the program material selected by your stereo (for example phono, CD player, FM broadcast, and so on).

There are a number of ways of using the vocal filter and the effects mixer together to replace the lead vocals with your own. By placing the vocal filter in the stereo/tape deck record path, you can produce recordings of your favorite songs, minus the lead vocals. Then by placing the effects mixer in the tape deck/stereo playback path, you can dub in your own voice live, or record the music and your voice together with a second tape deck.

You can also remove the lead vocals and add your own simultaneously simply by hooking the input of the vocal filter to the stereo's RECORD jacks, the output to the input of the effects mixer and the output of the effects mixer to the stereo's PLAY jacks. (Keep in mind that your stereo's RECORD jack is an output, and PLAY is an input. For your tape deck, RECORD is an input, and PLAY is an output.)

Once you have the effects mixer connected, plug in a microphone and set the mike volume slightly less than 12 o'clock and the effects controls at their mini-

*continued on page 88*



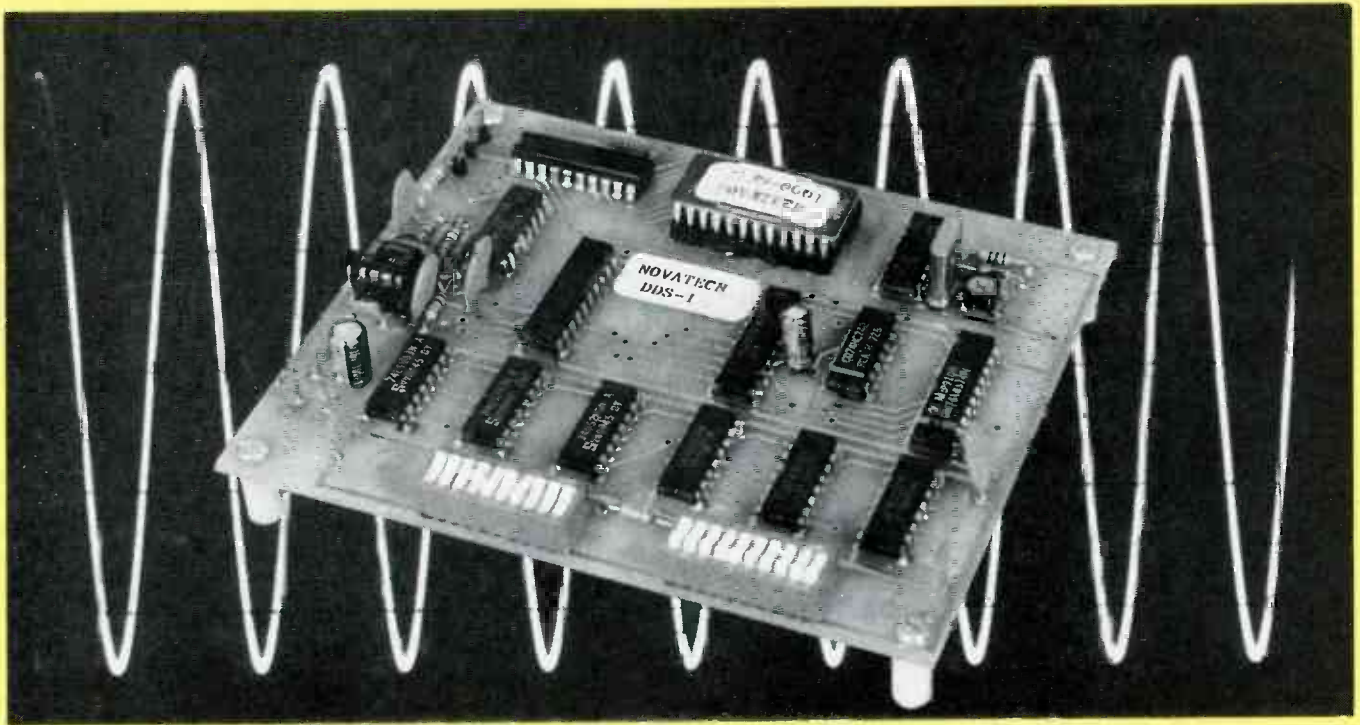

STEVEN D. SWIFT

# DIGITAL SINEWAVE SYNTHESIZER

*Build this direct digital synthesizer,  
and generate low-distortion sine waves digitally.*

HOW OFTEN HAVE YOU WISHED YOU had one of those fancy frequency generators that let you set your frequency accurately without having to fiddle with the uncalibrated tuning knob? Without a high-quality frequency counter and without nearly infinite patience, it is impossible to keep your audio oscillator on frequency without constant tweaking. If you eliminate the expensive extras, while retaining resolution and stability, you'll end up with the synthesizer project presented in this article.

While this synthesizer doesn't have the features of some very expensive products, it does provide 1-Hz resolution at over 500 kHz with crystal-controlled precision, all for less than \$70. Once you add a suitable enclosure and power supply, you'll have a digital

frequency synthesizer small enough to fit on even the messiest workbench. And it's perfect for providing that odd-ball frequency that your new project needs.

## Direct digital synthesis

As the name implies, direct digital synthesis (DDS) is a method of frequency generation that uses digital methods rather than the traditional analog oscillator, phase-locked loop, or bank of crystals. The availability of fast digital circuits and D/A converters make this technology available to the average electronics enthusiast.

A review of trigonometry is important to the understanding of DDS before delving into the details of the electronics. Figure 1 shows a circle with a radius

whose length is arbitrarily set to one. The radial line labelled R is allowed to rotate about the circle through an angle P, which will be referred to as the phase. Drawing a horizontal line from the tip of R until it intersects with the vertical axis defines the length S shown in the figure. As the radius, R, is allowed to make a complete rotation around the circle, the length of S takes on all values between +1 and -1, while P varies from 0 to 360 degrees. The length S is precisely the sine function of P,  $\sin(P)$ , shown in Fig. 2-a.

If, rather than allowing R to rotate smoothly around the circle, we make 8 equal steps around the circle, then the values of S form the stepwise approximation shown in Fig. 2-b. As the number of steps are increased, the ap-

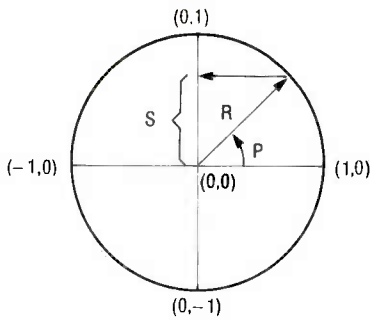

**FIG. 1—THIS CIRCLE HAS A RADIUS whose length is arbitrarily set to one. As R rotates around the circle, S takes on all values between +1 and -1.**

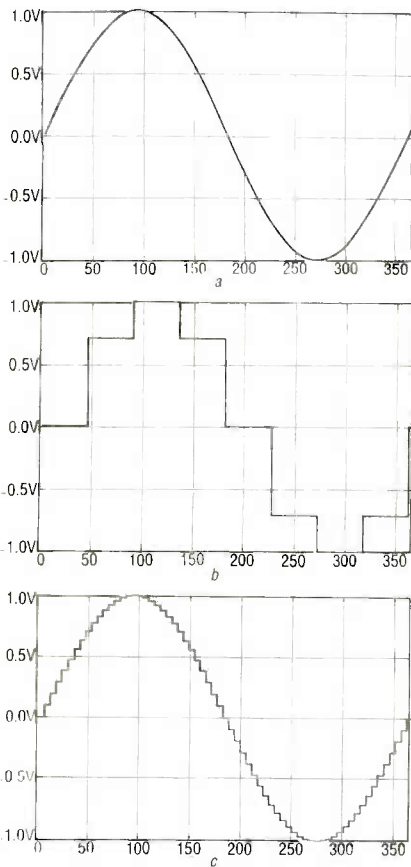

**FIG. 2—THE LENGTH S, AS R ROTATES, is the sine function of P (a). If we make 8 equal steps around the circle, then we get the stepwise approximation shown in b. If we make 64 steps, the approximation becomes closer to the actual sine function (c).**

proximation becomes closer to the actual sine function, with Fig. 2-c showing the approximation for 64 steps. In practice, analog filtering is used to smooth out the steps, as we'll see in a minute.

From this simplified discussion, a method for generating a varying frequency can be derived. Assume that each step occurs at a precisely determined

instant, then by varying the step size the number of steps around the circle can be varied. The fewer the steps, the faster the complete circle is covered, hence the higher the frequency of the sine-wave approximation. Note that fewer steps means a coarser approximation to the actual sine function, with the output eventually reducing to a square wave, which points out one of the limits of this technique. All we need now is a circuit that will synchronize the variable-phase steps to a precision clock.

Figure 3-a shows a block diagram of the system. The block labelled Phase Accumulator repetitively adds the value set by the Step Size Programmer to the sum performing the function of stepping the radius (R) about the circle in equal phase increments. The phase accumulator behaves like a simple counter, except that

rather than incrementing its output by one on each clock pulse, the output advances by the value set by the step size programmer on each clock pulse. The block labelled SIN(P) converts the value stored in the phase accumulator to a sine amplitude approximation. The step size programmer is simply a bank of DIP switches, the phase accumulator is a series of cascaded 4-bit adders, and the SIN(P) block is a sine look-up table contained in an EPROM.

The digital data present at the output of the SIN(P) block must be converted to an analog voltage in order to be useful. A method for doing this is shown in Fig. 3-b, which consists of a D/A converter, filter, and output amplifier. The filter helps to smooth out the jagged steps in the sine approximation, while the output amplifier buffers the output of the D/A converter. In the actual

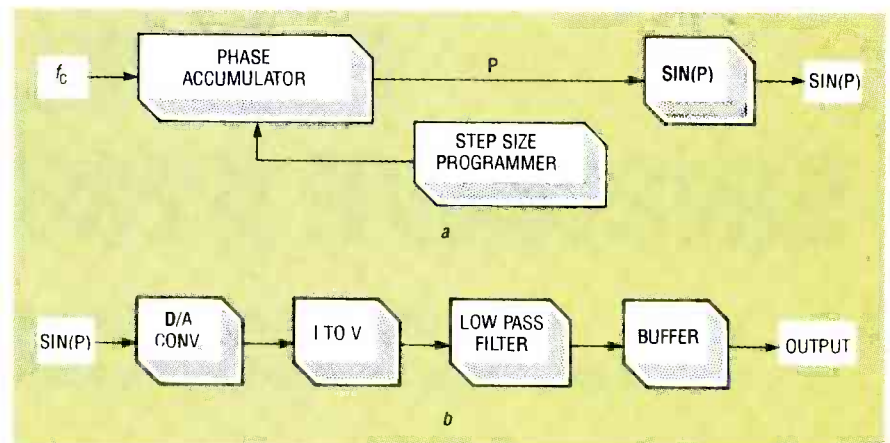

**FIG. 3—BLOCK DIAGRAM of the phase accumulator and phase-to-sine converter (a), and the block diagram of the digital-to-analog converter and output stage (b).**

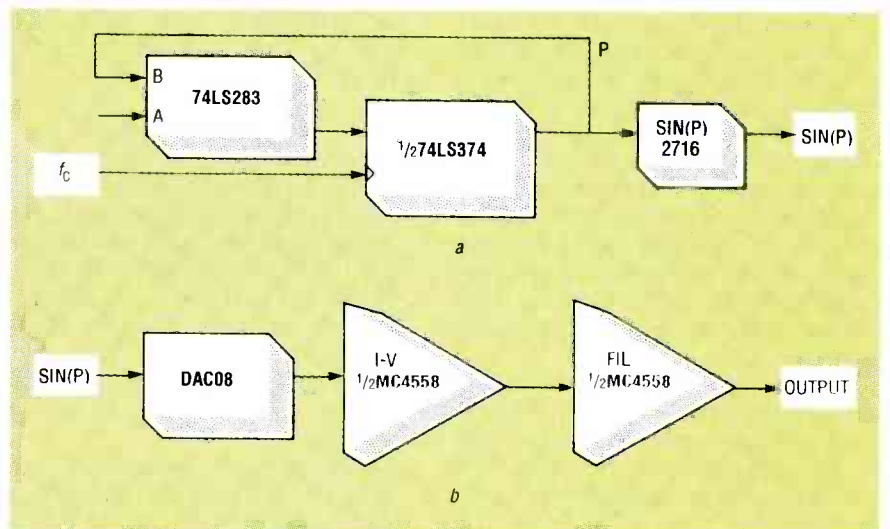

**FIG. 4—PARTIAL SCHEMATIC of the phase accumulator (a) and the converter and output stage (b).**



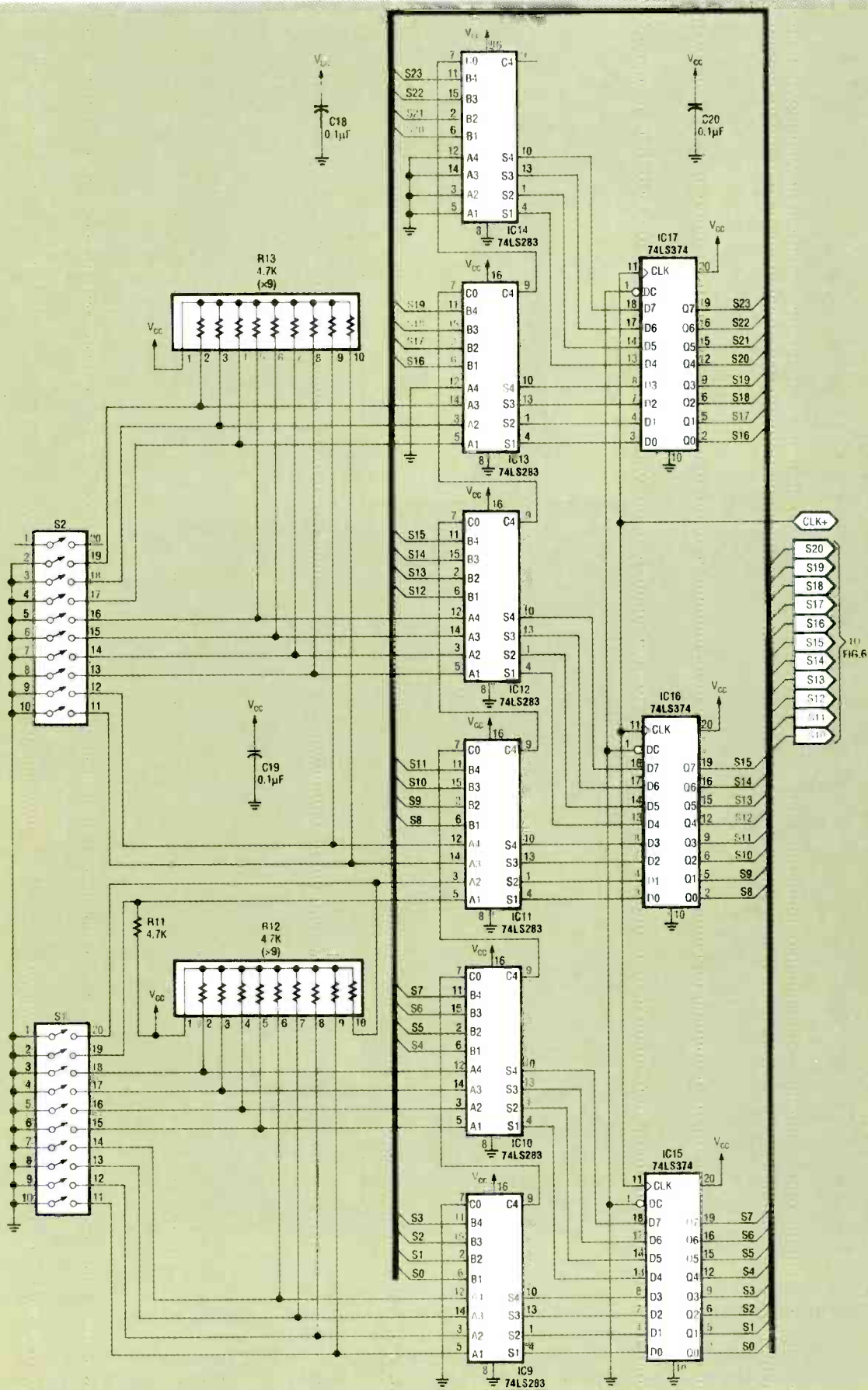

FIG. 5—HERE'S THE COMPLETE SCHEMATIC for the phase-accumulator circuitry.

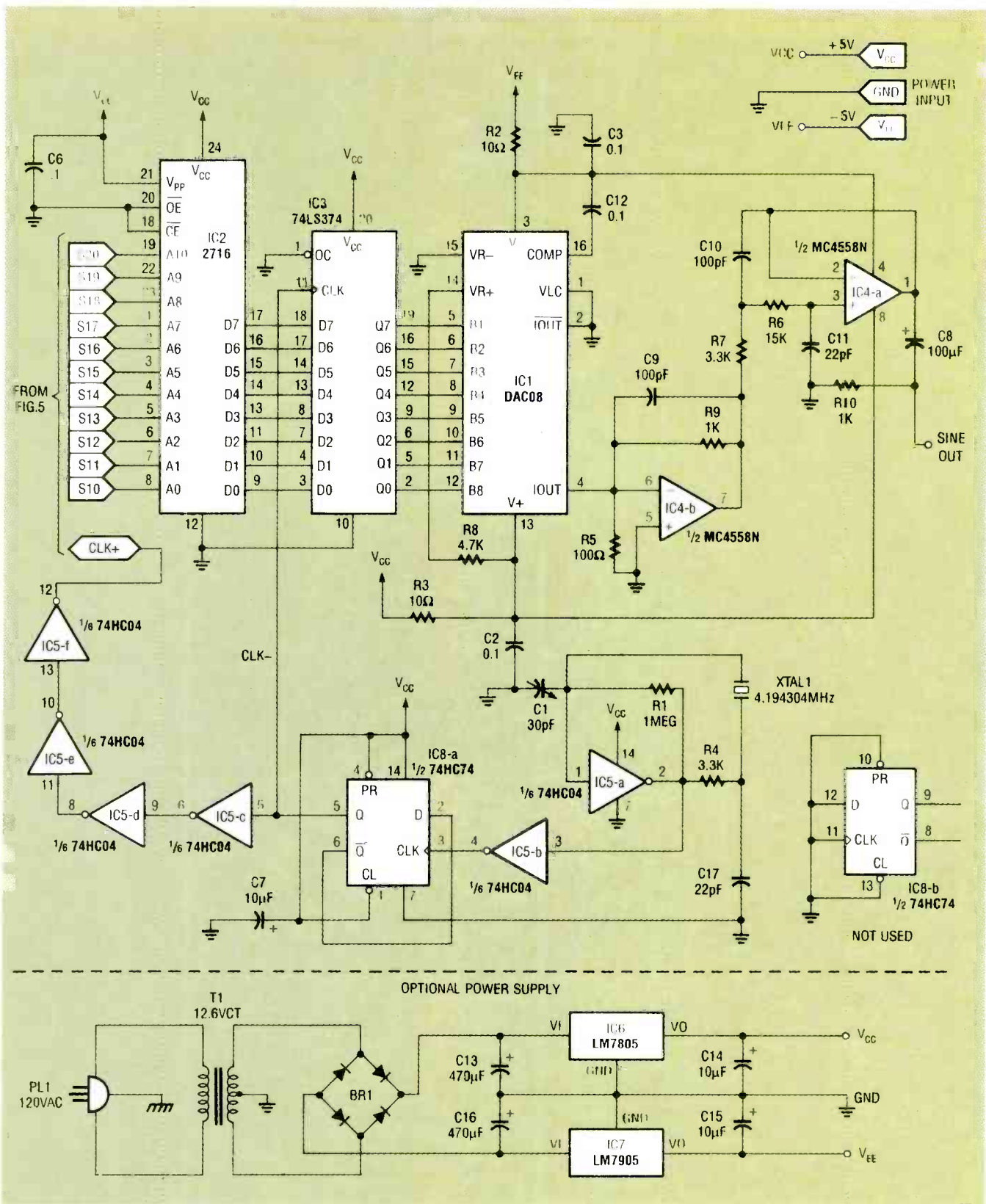

FIG. 6—THE SCHEMATIC for the analog section.

implementation, the buffering and the filtering functions are combined.

The frequency resolution of a DDS system is set by the master clock frequency,  $f_c$ , and the number of bits,  $N$ , in the phase

accumulator. For the binary accumulator that we have here, the resolution is then  $f_c/2^N$ . If the step size programmer is set to a binary value,  $M$ , then the output frequency is  $M \times f_c/2^N$ . The design presented here keeps  $M$  less

than  $N/4$  to minimize distortion at the output.

### Circuitry

There are several manufacturers of complete integrated circuits that can perform the digital



portion of the block diagram, but these parts are expensive and not readily available. Figure 4-a shows a partial schematic of the phase accumulator using components that are inexpensive and easy to get.

The complete phase accumulator consists of six 74LS283 4-bit adders, with their outputs latched by three 74LS374 octal D flip-flops. The outputs of the 74LS374's are fed back to the B inputs of the 74LS283, which forces the sum stored in the latches to be added to the value set by the switches on the A inputs. Since the 74LS374 stores data only at the positive edge of its clock input, the fact that the data presented to its inputs will be changing shortly after the clock causes no errors. The delay through the latch and adder guarantee glitch-free operation. At each clock pulse a new sum is present at the output of the latch. The output of each adder then stabilizes with the new sum allowing the cycle to repeat continuously. This sum represents the value P in the theoretical discussion, while the value set by the DIP switch represents the size of each phase step.

The sine-wave lookup table is contained within a single 2716 EPROM providing phase-to-amplitude conversion. Although 24 bits are available in the phase accumulator as implemented here, only 21 bits are used to maintain compatibility with readily available crystals. For those who wish to program their own EPROM, both a hex dump of the contents of the EPROM and an S-Record formatted hex dump for use with PROM programmers can be downloaded from the R-E BBS (516-293-2283, 1200, 2400, 8N1) in a file named DIGSYN.HEX. A programmed EPROM is available from the source shown in the parts list.

The data in the EPROM represents the values generated by the mathematical function  $127.5(\sin(2\pi P/2048 - \pi/2))$  truncated to 8-bits, with P taking on values from 0 to 2047, that is, the addresses of the EPROM. The formula offsets the sine function so that its value ranges from 0 to 255 as P ranges from 0 to 2047 and avoids negative values which would complicate the next stage.

That matches the function to the 2716 EPROM with its 11-bit address space and with its 8-bit output range. A C-program used to generate the values in the table is shown in Listing 1. Since the EPROM has only 11 address lines, only 11 lines from the accumulator are used in this application. The 8 bits at the output of the EPROM are a digital representation of the amplitude of the sine wave and must be converted to an analog voltage before being filtered and buffered.

Since simplicity and low-cost were design goals, the output of the EPROM is latched by another 74LS374, which allows the full clock period for the EPROM output to settle, permitting the use of inexpensive slow EPROM's. The latch also guarantees a glitch-free input to the D/A converter section.

Figure 4-b shows the D/A converter circuitry. The D/A conversion is accomplished using a DAC08 8-bit D/A converter (an MC1408 can be substituted with some loss in performance). The output of the converter is a cur-

rent proportional to the digital value present on its 8-bit parallel input. The current is set by R8 to a maximum of 1.06 mA. The digital word presented to the D/A varies from 0 to 255, forcing the current output to vary from 0 to  $(255/256) \times 1.06$  mA. The current is then fed to op-amp IC4-b which converts it to a voltage that varies from 0 to approximately 1.0 volt. The complete schematic for the phase accumulator circuit is shown in Fig. 5, and the schematic for the analog section is shown in Fig. 6.

First-order filtering is accomplished by C9 in this conversion stage. Op-amp IC4-a provides additional filtering to further smooth out the steps in the sine approximation. The output of this two-pole filter is AC-coupled to the output connection. Figure 7 shows the relative response of the filtering provided in the output stage. The corner frequency of the filter is set by the formula

$$f_o = 1/(2\pi\sqrt{R7 \times C10 \times R6 \times C11})$$

which, for the values shown, is equal to 482 kHz. A high-speed

#### LISTING 1

```

/* This program calculates the value of the sine function
   offset so that the 4th and 1st quadrants cause a code
   from 0 to 255. Code is generated to fill a 2048 byte prom
   (2716 or equivalent) for a full circle of 2*pi radians.
   Other size memory may be used by changing the value of
   bytes in the declaration table. */

#include <stdio.h>
#include <math.h>

main()
{
    double p=0; /* phase input to sin fcn */
    double S=0; /* output value of true sin fcn */
    int s; /* amplitude truncated to 8 bits */
    double sin(); /* true sin fcn */
    double pi=3.141592654;
    int addr=0; /* address of EPROM */
    int bytes=2048; /* size of EPROM in bytes */

    printf("      0  1  2  3  4  5  6  7  8");
    printf("  9  a  b  c  d  e  f \n");
    while (addr < bytes )
    {
        if ( addr % 16 == 0 )
            printf("\n%4x ", addr);
        p = 2.0*pi*( (double) addr )/((double) bytes );
        S = 127.5*(1.0+sin(p - pi/2.0)); /* gives 0 at -90 deg */
        s = ( int) S ); /* convert to an integer */
        if ( S - ( (double) s ) >= 0.5 ) /* rounds if necessary */
            s++;
        printf("  %2x",s);
        addr++; /* increment address */
    }
}

```

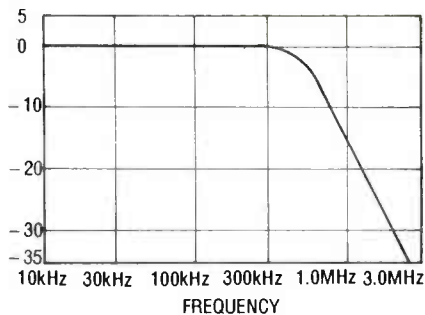

FIG. 7—THE RELATIVE RESPONSE of the filtering in the output stage. The corner frequency is equal to 482 kHz. A high-speed op-amp is required to effectively filter the waveform.

op-amp is required in this stage to filter the waveform effectively. The 4558 op-amp we used is a good compromise between performance and cost.

The clock for all functions is provided by a crystal oscillator running at 4.194304 MHz, which happens to be exactly the 22nd power of two. The clock is divided by two to provide the phase-accumulator clock and EPROM latch clock. Additional inverters are used as delay elements to ensure that the latches are clocked at precisely the right instant to prevent glitches. With the clock and timing as such, EPROM's with access times as slow as 475 ns can be used.

With 21 bits of the phase accumulator used and a clock frequency of  $4.194304/2$  MHz ( $f_c$ ), the output resolution is precisely 1 Hz. Since 19 bits are presented as the input to the phase accumulator by the DIP switch, the maximum output frequency is:

$$2^{19} \times f_c / 2^{21} = f_c / 4 = 524.288 \text{ kHz}$$

While a DDS system can approach  $f_c/2$ ,  $f_c/4$  was chosen as a maximum to limit the total distortion in the output waveform. The top frequency is actually 1 Hz less than that because the maximum setting is  $2^{19} - 1$  for a 19-bit binary input. The filter rolloff shown in Fig. 7 attenuates clock-related distortion by over 30 to 1.

### Construction

A double-sided PC board is available from the source shown in the parts list, and we've also provided the foil patterns in case you want to make your own board. If you're using the PC board, follow the parts-place-

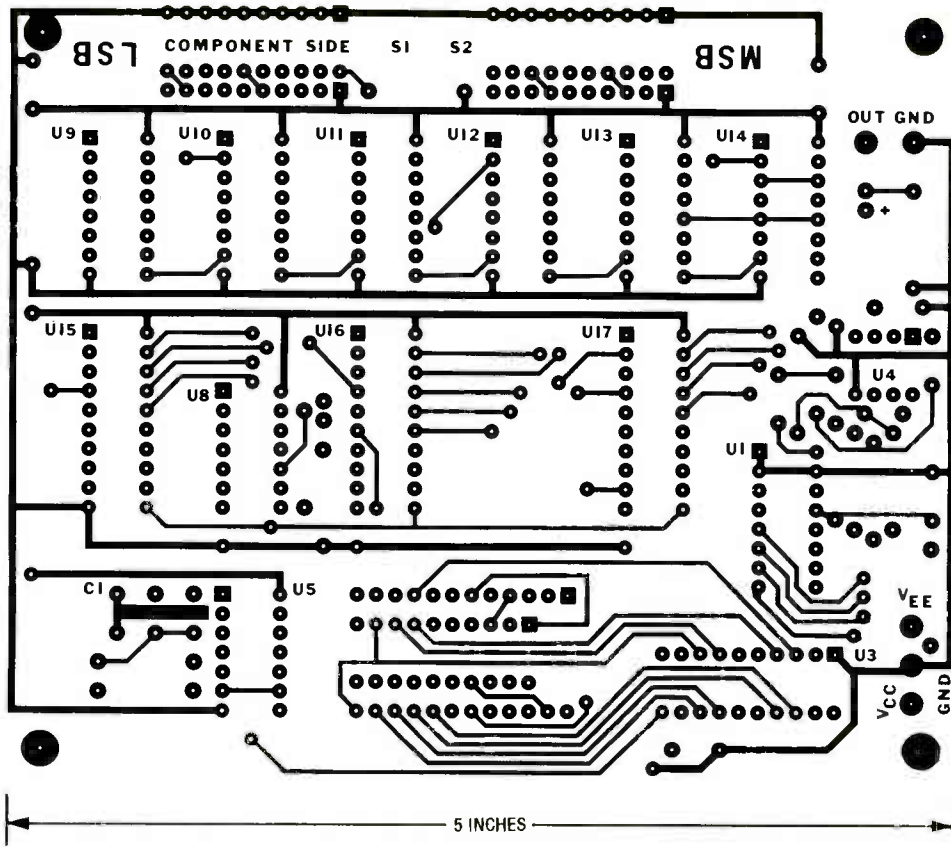

FOIL PATTERN for the component side of the digital synthesizer.

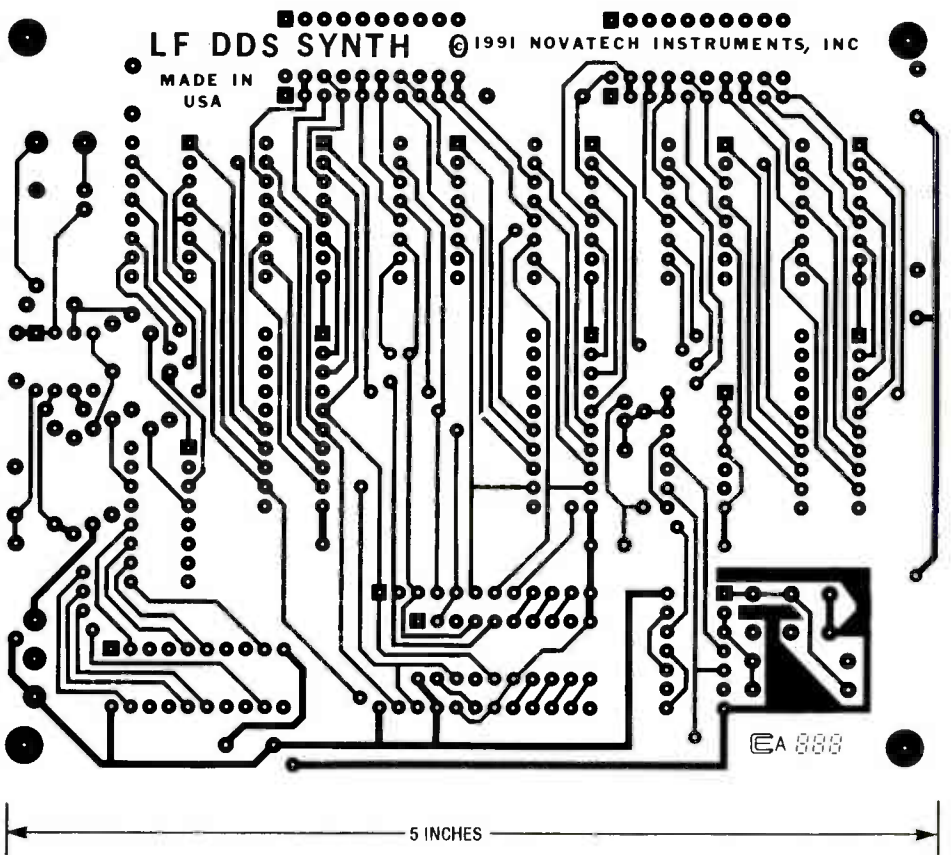

FOIL PATTERN for the solder side of the digital synthesizer.

ment diagram shown in Fig. 8. Note that IC5 and IC8 are high-speed CMOS and must therefore be handled carefully to prevent



## PARTS LIST

All resistors are 1/4-watt, 5%.

- R1—1 megohm
- R2, R3—10 ohms
- R4, R7—3300 ohms
- R5—100 ohms
- R6—15,000 ohms
- R8, R11—4700 ohms
- R9, R10—1000 ohms
- R12, R13—4700 ohms × 9, 10-pin SIP resistor

### Capacitors

- C1—5–30 pF trimmer
- C2, C3, C6, C12, C18–C20—0.1 μF, ceramic disc
- C4, C5—not used
- C7, C14, C15—10 μF, 35 volts, electrolytic
- C8—100 μF, 16 volts, electrolytic
- C9, C10—100 pF, ceramic disc
- C11, C17—22 pF, ceramic disc
- C13, C16—470 μF, 16 volts, electrolytic (optional for power supply)

### Semiconductors

- IC1—DAC08CN 8-bit D/A converter
- IC2—2716 2K × 8-bit EPROM
- IC3, IC15–IC17—DM74LS374N octal latch
- IC4—MC4558CN dual op-amp
- IC5—MM74HC04N hex CMOS inverter
- IC6—LM7805 +5-volt regulator (optional for power supply)
- IC7—LM7905 -5-volt regulator (optional for power supply)
- IC8—MM74HC74AN dual D-type CMOS flip-flop
- IC9–IC14—DM74LS283N 4-bit adder
- BR1—1-amp bridge rectifier (optional for power supply)

### Other components

- XTAL1—4.194304 MHz crystal
- S1, S2—10-position DIP switch
- PL1—AC line cord (optional for power supply)
- T1—120VAC/12.6VAC transformer (optional for power supply)

**Miscellaneous:** PC board, solder, case, mounting hardware, etc.

**Note:** The following items are available from NOVATECH INSTRUMENTS, INC., 1530 Eastlake Ave. E, Suite 303, Seattle, WA 98102 (206) 328-6902:

- Programmed 2716 EPROM—\$10.00
- Double-sided PC board—\$15.00
- Complete kit of parts (except a case and the optional power-supply parts)—\$69.95

Please add \$5.00 shipping and handling. Washington State residents must add 8.2% sales tax.

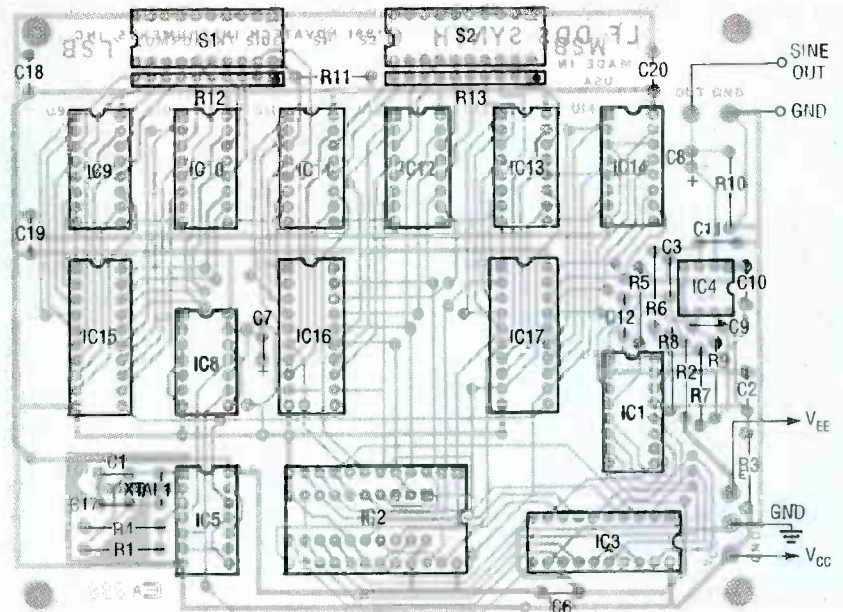

**FIG. 8—PARTS-PLACEMENT DIAGRAM.** Follow this diagram if you're using a PC board. The smaller IC outline beneath IC2 is for experimenting with a faster EPROM such as a 74S472 (see test).

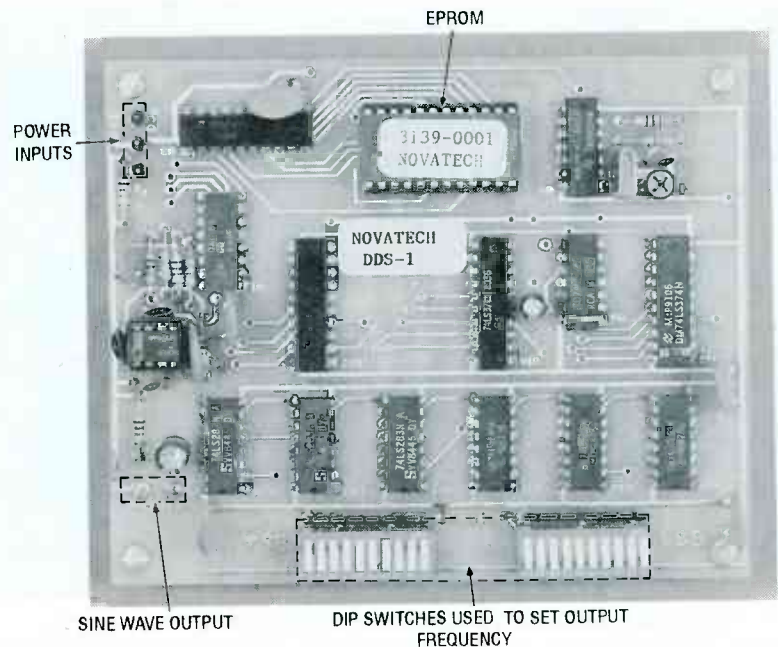

**FIG. 9—THE COMPLETED UNIT.** This compact PC board can easily be installed in almost any kind of project case.

damaging them. Use a grounded-tip soldering iron (if you've got access to one) and ground yourself before picking up the board or an IC. Space for the optional power supply (shown in Fig. 6) is not provided on the PC board, but it can be made on any kind of board. The power-supply circuit is not critical, but be careful due to the line voltages present. Figure 9 shows the completed unit.

Since the majority of the circuit is digital, simple wiring techniques can be used. The author's original prototype was

built using wire-wrap methods for the digital section and point-to-point for the analog section. If you're wire-wrapping the circuit, some care must be applied to the analog section to prevent digital switching noise from getting into the output. The ground returns for all of the analog section must connect to the power supply separately from the digital section and the analog bypass capacitors must be connected as close as possible to the analog integrated circuits. The oscillator, consisting of IC5-a, R1, R4, C1 and

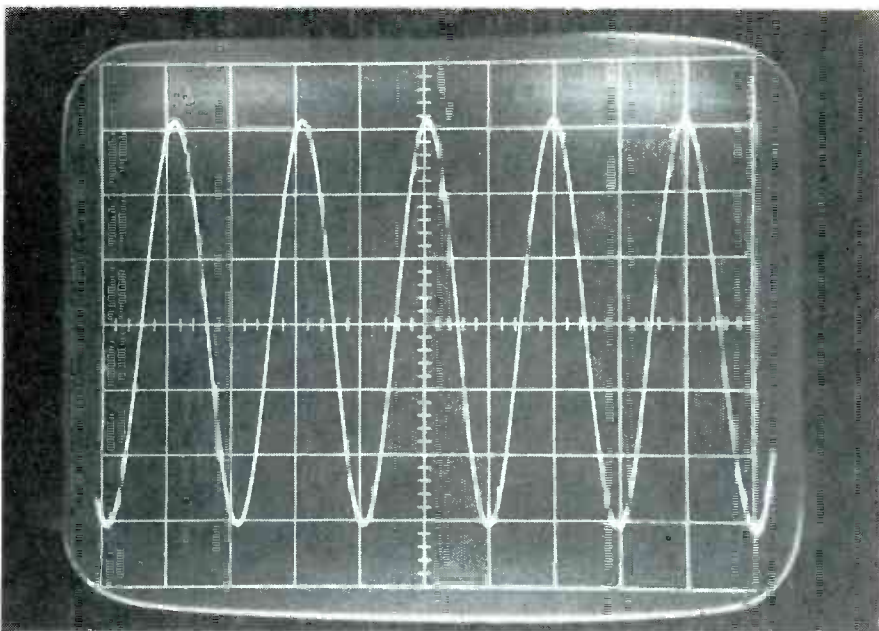

FIG. 10—OUTPUT OF THE AUTHOR'S PROTOTYPE at 100 kHz (5 $\mu$ s/div. horizontal, 0.2V/div. vertical).

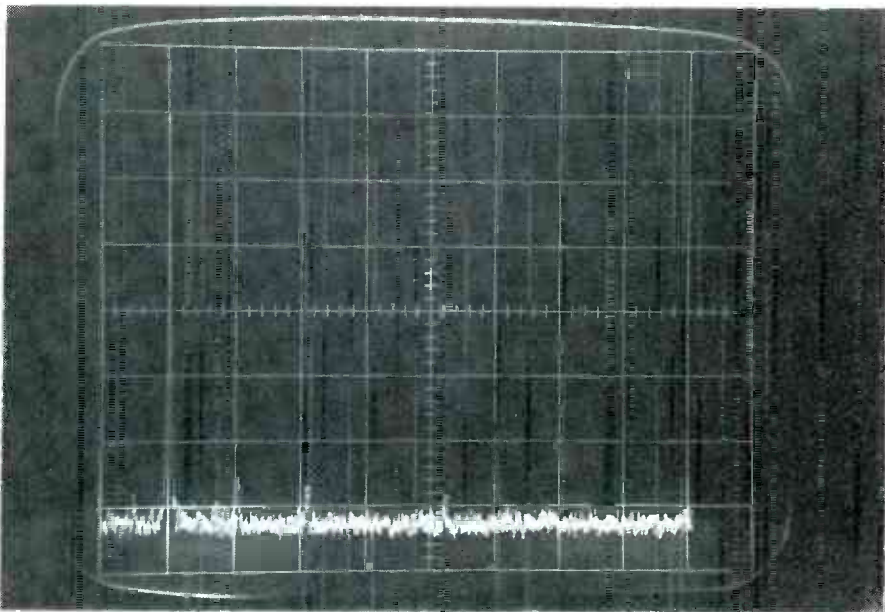

FIG. 11—SPECTRUM ANALYZER PHOTOGRAPH of the 100-kHz output. (100 kHz/div. horizontal, 10dB/div. vertical, 500 kHz center frequency, 10 kHz resolution bandwidth)

TABLE 1—SPECIFICATIONS

Frequency Range:	1 Hz to 524.287 kHz
Resolution:	1 Hz over complete range
Accuracy:	Depends on crystal, typ. 0.005%
Output:	Low distortion sine wave
Output amplitude:	Approx. 1 volt peak-to-peak, decreases at top end
Power requirements:	+5V at approx. 250 mA -5V at approx. 50 mA

XTAL1, must be tightly wired. The author's original prototype had the discrete components soldered directly to the wirewrap-socket pins of IC5. A board with an existing ground plane is ideal for wire-wrap construction.

### Operation

Before turning on the power, carefully inspect the board for shorts, solder bridges, wiring errors, etc. Set the DIP switch to any non-zero value. If you have a frequency counter available, con-

nect it to pin 5 of IC8-a. If you don't have a counter, adjust C1 to mid-range; with the crystal specified, your error should be no more than about 0.02%. Apply power and, using an insulated adjustment tool, adjust C1 to exactly 2.097152 MHz if you have a counter connected. With an oscilloscope connected to the output, vary the DIP switch setting; you will see the frequency change. For higher and higher frequencies the distortion will increase with the maximum distortion at the highest setting.

The frequency output is equal to the binary value set by the DIP switches, with a logical 1 corresponding to an "off" position. For a switch setting of 001,1000,0110,1010,0000 (100 kHz), the author's prototype gave the waveform shown in Fig. 10. A spectrum-analyzer display of the 100-kHz output is shown in Fig. 11. Note that the harmonics are at least 40 dB down, corresponding to about 1% distortion. Varying the least-significant DIP switch will change the frequency output by 1 Hz. Since the frequency is set by the DIP switch and the accuracy of the crystal oscillator, the output will be the same even after a power-down, power-up cycle. Table 1 summarizes the specifications for the completed digital synthesizer.

### Experiments

If the digital parts are changed from 74LS to 74F, the EPROM changed to a bipolar PROM (such as a 74S472 which is accommodated on the circuit board), and the clock oscillator replaced by a faster one, the output frequency can be increased at the expense of resolution. The author has successfully operated the circuit up to a 5.0-MHz output frequency, providing 10 Hz resolution. The circuit is simple and compact enough that several units can be built to provide fixed calibration frequencies needed on your bench. High-speed CMOS logic may be substituted for the low-power TTL devices for lower-power operation. If you decide to change to CMOS, IC3 must be a 74HCT374 as the output of the EPROM is TTL-compatible. Advanced CMOS, 74AC or 74ACT, should not be used because of noise induced by its fast edge rates. R-E



# BINAURAL BASICS

***Binaural recordings  
will add a new  
dimension to  
your audio world.***

JOHN SUNIER

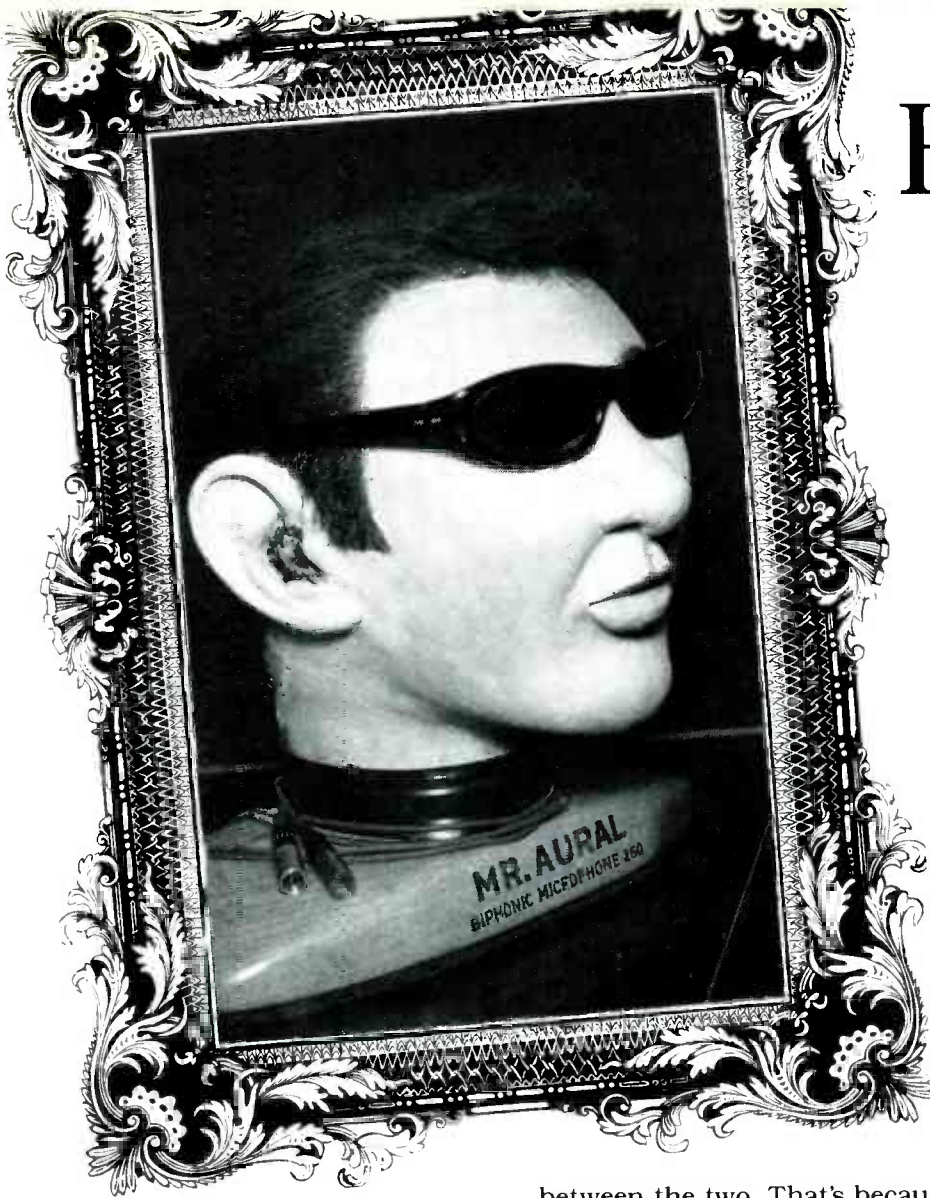

ALTHOUGH MOST AUDIOPHILES ARE familiar with the term binaural, there's still quite a bit of confusion about it. Early in stereo history the terms binaural and stereo were used interchangeably, even though the two recording methods are totally different. Recording pioneer Emory Cook caused some of that confusion by calling his early 50's twin-grooved stereo LP's binaural when they were actually stereo.

Binaural recordings can open up a whole new realm to your listening enjoyment. We'll look at the history behind binaural sound and how it is made as well as present some high-quality binaural products.

## **The binaural difference**

If you listen to a stereo source from stereo headphones compared to the same source listened to from loudspeakers, you'll notice a much different sound

between the two. That's because most source material isn't designed for headphone listening. An unnaturally exaggerated effect is created with headphones, as though half an orchestra is on one side of your head and the other half on the other side, with a hole in the middle. Also, the music sounds as if it's happening inside your head rather than out in the room. No serious record producer would ever monitor a recording session solely on headphones; a proper setup of the highest quality monitor loudspeakers is required to get a feeling for proper balance in the mix.

## **Binaural background**

True binaural uses only two microphones, usually small electret condensers either set into the outer ears of an artificial human head, or at least spaced the same distance apart as an average pair of ears, and mounted on either side of a small baffle. The two

mikes feed two channels which are kept entirely separated from the source all the way to the final listener, whether live, a recording, or a broadcast. The listener wears stereo headphones and the original left ear signal must be routed properly to the left ear and the right to the right or the effect is compromised. The final result is for the listener to be sonically transported to where the sounds originated, rather than attempting to bring the sounds into the listener's room as with speakers. The left speaker signal is prevented from feeding into the listener's right ear, and vice versa, with binaural playback on stereo headphones. Figure 1-a-d shows various types of sound reproductions, including binaural.

With binaural recording, spatial placement within a 360-degree sphere is so realistic that even vertical placement is perceived. Reproduction of the ambience or reflected sounds in a hall is so correct that acoustical engineers can listen to such tapes and identify in which hall they were recorded. The only areas of location that are sometimes problematic are on a line directly in front of and to the rear

of the listener. That is dependent on several factors, including how our hearing mechanism works, differences in headphones, and individual differences as well as learned responses.

### Binaural history

The first use of binaural sound occurred in 1881 in Paris. Inventor Clement Ader mounted a series of primitive carbon telephone transmitters along the front of the stage of the Paris Opera House. The transmitters were grouped in pairs the same distance apart as human ears, with several pairs across. The leftmost of each pair were mixed together and fed to one telephone line, which listeners in their homes directed to their left ears using the ordinary phone earpiece. The rightmost of each pair were also mixed together and fed to a second phone line, which each listener had to have installed in their home. The result was that as opera singers moved about the stage, home listeners could "see" their movement while hearing the music with much greater fidelity than a single phone line could possibly provide. The original patent says "This double listening to sound... produces the same effects on the ear that the stereoscope produces on the eye." It's fortunate that a wide frequency response is not the most important parameter for conveying the binaural effect; phase accuracy and correct balance between the two channels is more important.

A similar project was carried out with an improved version of the Ader experiment in Berlin in 1925. During that same year more than one radio station in the U.S. did experimental binaural broadcasts using two different frequencies. Listeners needed two crystal sets, each feeding a separate earphone. The mikes in the studio were kept about seven inches apart, and therefore listeners with only one radio still heard a normal signal.

During the last 40 years there has been sporadic interest in binaural reproduction around the world, centered primarily in Europe and Japan. In 1970, *Stereo Review* issued a binaural demonstration LP of music and sound effects using the "Blue Max"

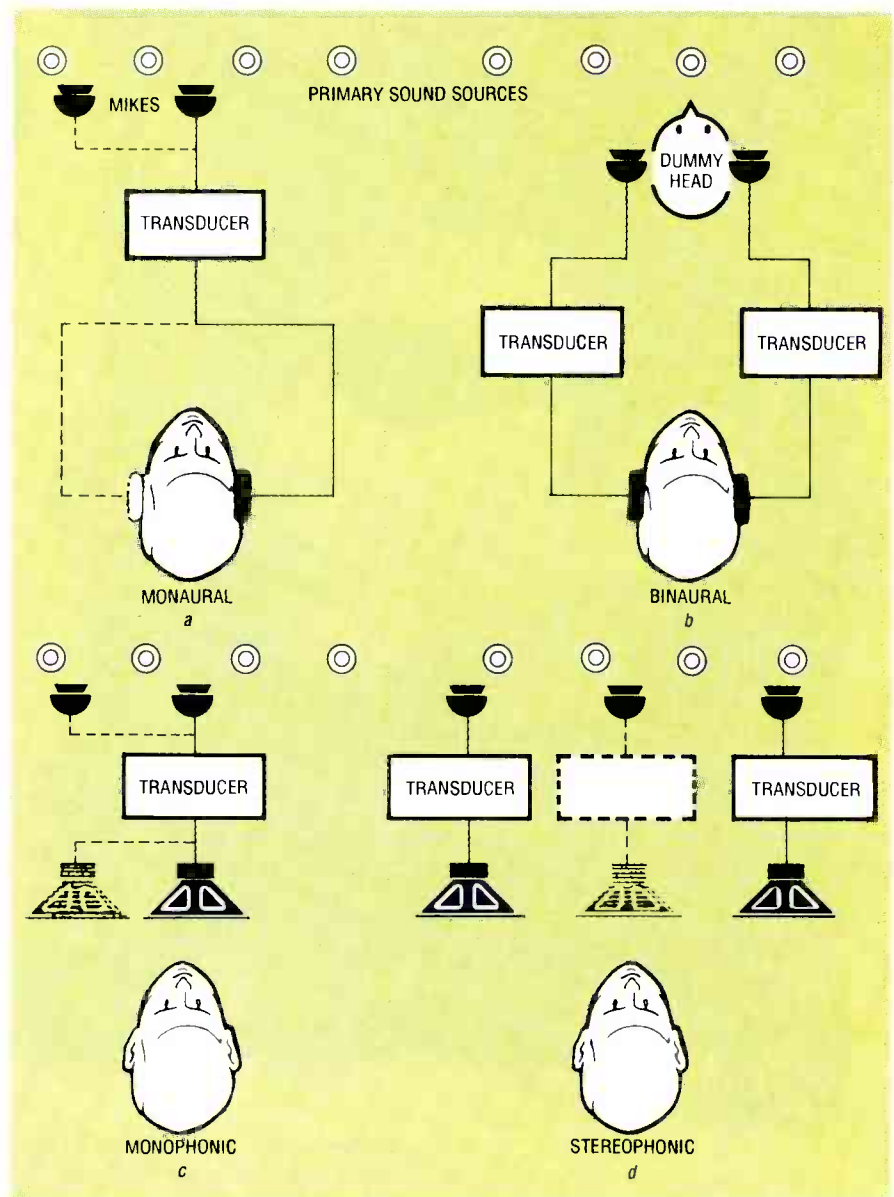

FIG. 1—SOUND REPRODUCTION SYSTEMS; monaural (a), binaural (b), monophonic (c), and stereophonic (d).

dummy head, which was handmade for the project. Music excerpts from it are still currently available on a pre-recorded cassette. The Sennheiser microphone/headphone people in Germany issued a series of 45-rpm binaural demo recordings (long out of print now), which were well done and designed to promote their open-air phones and special binaural mike system. Diagrams of the placement of musicians and sounds around the listener aided in evaluating how precise the effects were.

One demo in particular was interesting. It featured a woman arriving on a train and being met by a man at the station. Placed among all the sound effects of the train, people, and station en-

vironment were the voices of the woman, speaking English, and the man, greeting her in German. Eventually they meet in front of the listener. All the while you can easily focus on either the German or the English and understand perfectly without serious distraction from the other voice, as would occur with stereo sound and certainly with mono reproduction.

This very functional use of binaural is currently being applied to military aircraft communication by researchers at the NASA-Ames Research Center. They use a powerful computer known as the Convolvotron to process mono speech and signals from several sources, such as control

*continued on page 84*



# An Intuitive Look At Electromagnetic Theory

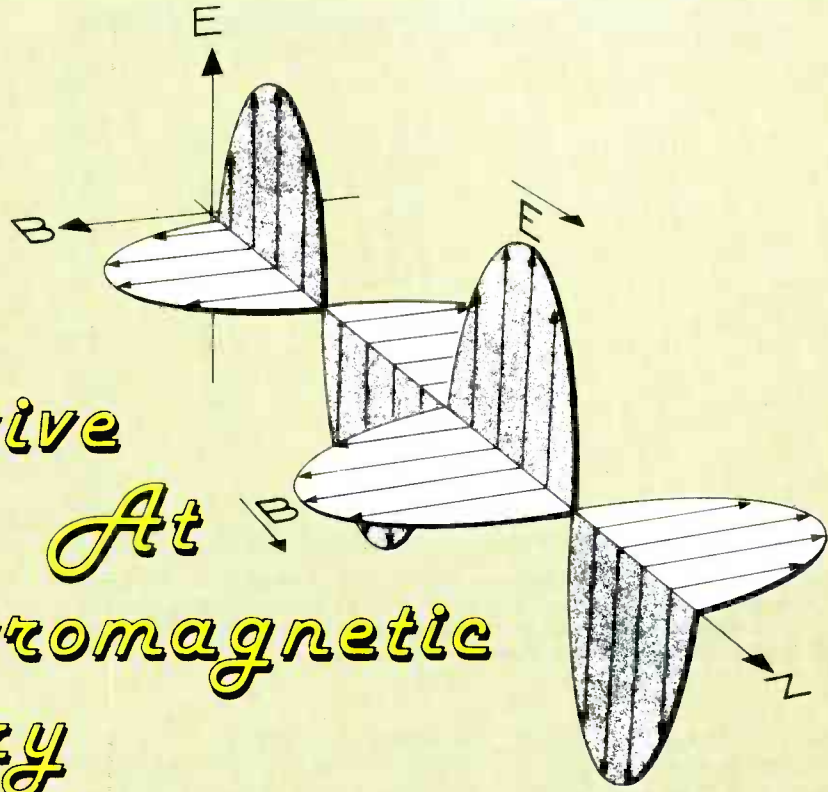

**Learn the meaning behind magnetic charges and "B" fields.**

IN OUR LAST ARTICLE, WE DISCUSSED the general concepts of an electric field and how they applied to forces between static electric charges. We'll now develop an intuitive picture of how charges moving with a constant velocity produce an additional force, and how that force leads to the concept of a magnetic field.

## Magnetic "charges"

Early experiments showed that if two permanent magnets were near each other, each experienced a force. In each magnet there appears to be two regions, called the north and south poles, that contain the source of the force. A pole of one magnet attracts the opposite pole of the other magnet but repels the other pole, thereby creating a torque. Apparently, a magnet produces something similar, but not identical, to that produced by an electric-charge distribution. A basic difference is that electric charge distribution can be separated into two distinct regions of positive and negative charge, while experiments show that cutting a magnet into smaller and

WILLIAM P. RICE

smaller pieces simply result in more magnets, each having two poles. No matter how small a piece is taken, there's always an equal amount of north and south magnetic "charge." Experiments have shown that there's no such thing as an isolated single magnetic charge, or a magnetic monopole, only magnetic dipoles.

Hans Christian Oersted conducted experiments which showed that a permanent magnet near a conductor carrying a constant electric current  $I_1$  experienced a similar force as shown in Fig. 1-a. Experiments by French physicist Andre Marie Ampere showed that when a conductor carries a constant current  $I$  along an infinitesimal length  $dl$  and another conductor carries a constant current  $I_1$  along an infinitesimal length  $dl_1$ , the length  $dl$  experiences an infinitesimal force in newtons

$$dF_m = k_m \frac{I dl \times (I_1 dl_1 \times r_1)}{r_1^2}$$

as shown in Fig. 1-b.  $r_1$  is a unit vector directed from  $dl_1$  to  $dl$  and  $r_1$  is the separation distance. In the mks units,  $k_m$  is equal to

$$k_m = \mu_0 / 4\pi \text{ (webers)/(ampere} \times \text{meter).}$$

$I dl$  and  $I_1 dl_1$ , in units of  $m \cdot C / s = A \cdot m$ , are infinitesimal lengths of positive current in the direction of  $dl$  and  $dl_1$ . In conductors, there are equal distributions of positive and negative electric charges even though the negative charges are moving. The  $E$  fields from the charges must sum to zero, so the  $dF_m$  must be distinct from the Coulomb force  $F_c$ .

The infinitesimal force equation mentioned above is more complicated than for the static electric force since the direction of charge motion must be taken into account by vector multiplication, also known as the cross product  $\times$ . The direction of  $I_1 dl_1 \times r_1$  is defined by the right hand rule: curl the fingers of the right hand through the smallest angle from the vector  $I_1 dl_1$  to the vector  $r_1$ ; the extended thumb points in the direction of  $I_1 dl_1 \times r_1$ . The magnitude of  $I_1 dl_1 \times r_1$  is the area of a paral-

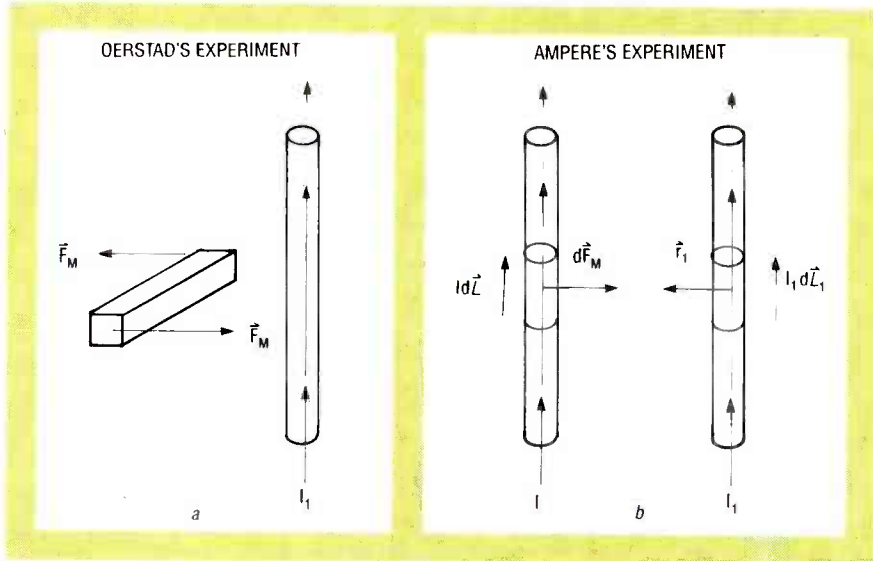

FIG. 1—A MAGNETIC FORCE  $F_m$  is produced by a constant electric current  $I_1$  in a conductor. A permanent magnet experiences a torque due to the force on each pole (a). In (b) a small current segment  $I dl$  of another conductor experiences a force due to the segment  $I_1 dl_1$ .  $I_1 dl_1$  experiences an equal and opposite force.

lelogram with sides  $I_1 dl_1$  and  $r_1$ . That is similar to scalar multiplication where  $A$  times  $B$  gives the area of the rectangle with sides  $A$  and  $B$ . The direction of  $dF_m$  is that of the extended right hand thumb with the fingers wrapped through the smallest angle from  $I dl$  to  $I_1 dl_1 \times r_1$ .

In Fig. 1-b, the current segment  $I dl$  experiences a force towards  $I_1 dl_1$ .  $I_1 dl_1$  experiences an equal and opposite force towards  $I dl$ . For other current segments, the force on an  $I dl$  is not equal and opposite to that on an  $I_1 dl_1$ . That may appear to be a violation of Newton's third law, however the actual constant currents exist only in closed loops or circuits as dictated by charge conservation. The  $I dl$  and  $I_1 dl_1$  are only a part of each loop. The total force is found by summing up all the infinitesimal contributions around each closed loop. We must sum twice by integration, first to find the forces of all the  $I_1 dl_1$ 's on an  $I dl$ , and then to sum the forces on each  $I dl$

$$F_m = \frac{\mu_0}{4\pi} \oint \oint \frac{I dI \times (I_1 dl_1 \times r_1)}{r_1^2}$$

The force on the entire loop composed of  $I dl$  is always equal and opposite to that on the entire loop composed of  $I_1 dl_1$ .

Ampere went on to suggest that in a permanent magnet, the force  $F_m$  is produced by some sort of closed current loops that exist in the material.

### The magnetic field B

Figure 2 shows that the space around a constant current segment  $I_1 dl_1$  can be explored using a very small constant current loop obtained by adding all its  $I dl$  contributions and symbolized by  $\oint I dl$ . Since each  $I dl$  will experience a force due to the presence of  $I_1 dl_1$  even though nothing material connects them, one has the impression that the condition of space itself is affected by the presence of the  $I_1 dl_1$ . We can say that a constant current gives space the propensity to exert a force on another constant current, if it were present, according to Ampere's force law.

To find that propensity, we remove  $I dl$  from the force law to obtain the definition of the magnetic field (also called magnetic flux density) in units of webers/meter<sup>2</sup>, which equals the tesla

$$dB = \frac{\mu_0}{4\pi} \frac{I_1 dl_1 \times r_1}{r_1^2}$$

This is called the Biot-Savart law. The force on each  $I dl$  is  $dF_m$ , which equals  $I dl \times B$ . Opposite sides of the loop will experience forces in the opposite direction since the  $dI$ 's are in opposite directions. The loop will, therefore, experience a torque. Since  $I_1 dl_1$  exists only as a part of a closed loop, the total  $B$  at any point in space is

$$B = \frac{\mu_0}{4\pi} \oint \frac{I_1 dl_1 \times r_1}{r_1^2}$$

Any current loop is called a magnetic dipole because it results in a  $B$  field.

The magnetic-field test instrument must be a very small magnetic dipole, just as a very small positive charge  $+q$  is the electric-field test instrument. The distinction is that  $\oint I dl$  is a sum of all the vectors for which magnitudes and directions must be taken into account, whereas  $+q$  has only a magnitude.

If a current  $I$  is considered as just an individual electric charge  $q$ , moving with constant velocity through a point, the magnetic force it would experience in the  $B$  field at that point is

$$F_m = qv \times B.$$

If an electric field is also present,  $q$  would experience an additional electric force  $F_e$ , and the total force would be

$$F = F_e + F_m = qE + qv \times B = q[E + (v \times B)].$$

This equation is known as the Lorentz force law.

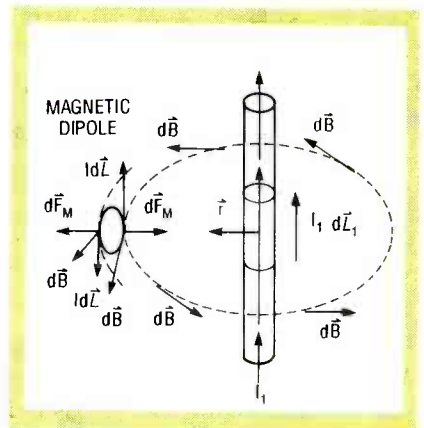

FIG. 2—A SMALL MAGNETIC DIPOLE, composed of current segments  $I dl$ , near a current-carrying conductor experiences a torque due to opposite forces  $dF_m$  on opposite sides. Since nothing material is pushing the dipole, the concept of the  $B$  field is used to account for the forces.

### B field characteristics

The apparent flow of the  $B$  field from an infinitesimal volume about a point can be found by the same method used to find the electric flux. Imagine a Gaussian surface around a current loop composed of an infinite number of current segments  $I dl$  each producing a  $dB$  field as shown in Fig. 3-a. Divide the surface into an



infinite number of infinitesimal  $ds$  areas. Through each  $ds$  there are an infinite number of  $d\mathbf{B}$ 's. The total  $\mathbf{B}$  field at each  $ds$  is  $\mathbf{B} = \int d\mathbf{B}$  by linear superposition. Taking  $\mathbf{B} \cdot ds$  gives the magnitude of  $\mathbf{B}$  times the magnitude of the effective area parallel to  $\mathbf{B}$ . That is the apparent flow of  $\mathbf{B}$  through  $ds$ . Summing those factors by integration over the entire surface gives the total apparent flow, or magnetic flux

$$\phi = \int \mathbf{B} \cdot ds \text{ (webers).}$$

Imagine moving over the surface, adding up the  $d\mathbf{B} \cdot ds$  contributions from each  $I d\mathbf{l}$ . At each  $ds$ ,  $\mathbf{r}$  points from  $I d\mathbf{l}$  towards  $ds$ . Since  $d\mathbf{B}$  is perpendicular to  $\mathbf{r}$ , the only place  $d\mathbf{B} \cdot ds$  is non-zero is where  $ds$  is not directed along  $\mathbf{r}$ . That is where  $ds$  moves away from or toward  $I d\mathbf{l}$ . Since the surface is closed, for each place we move away from  $I d\mathbf{l}$  by a certain amount and direction, there must be another place that we move back in towards  $I d\mathbf{l}$  by the same amount and in opposite direction. Whatever  $\mathbf{B} \cdot ds$  contribution is found over some of the surface is canceled by a  $-\mathbf{B} \cdot ds$  contribution over another part of the surface, therefore we can say that

$$\phi = 0.$$

As in electric flux, any  $\mathbf{B}$  produced by currents outside the surface will not contribute to the total.

If the original Gaussian surface is shrunk so the volume enclosed approaches zero, the ratio of the change in flux to the change in volume would reach a limiting value even if the flux were not zero. That is the divergence of  $\mathbf{B}$ , and since  $\phi = 0$  for any Gaussian surface

$$\nabla \cdot \mathbf{B} = 0 \text{ (T/m}^3\text{)}.$$

That is the unnamed Maxwell equation. It simply says that the total spreading out, or divergence, of the  $\mathbf{B}$  field through an infinitesimal closed surface about any point is zero. Whatever  $\mathbf{B}$  field appears to leave from a particular point must return to that same point. Magnetic monopoles, therefore, cannot exist. That relationship allows magnetic dipoles, which produce equal amounts of outward and inward magnetic flux from a point. If a number of our  $\mathbf{B}$ -field instruments were scattered about the

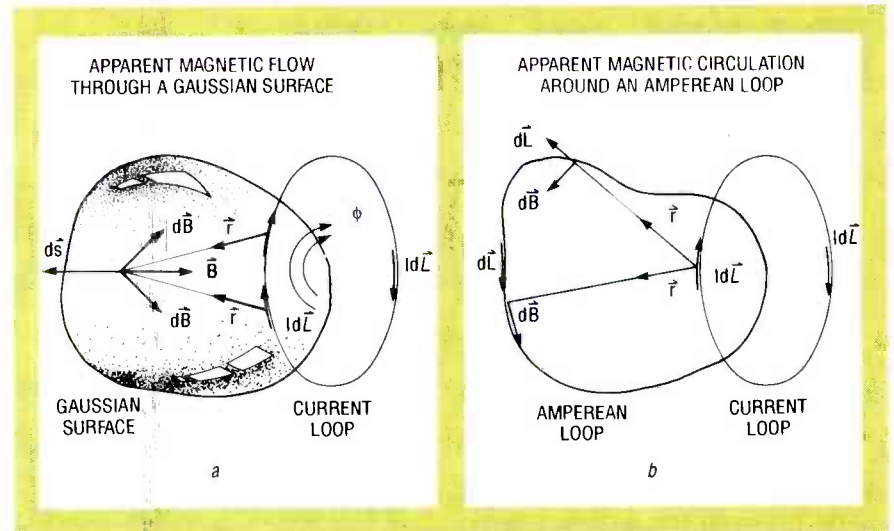

FIG. 3—CHARACTERISTICS OF A  $\mathbf{B}$  FIELD. In (a), a Gaussian surface composed of an infinite number of infinitesimal  $ds$  areas surrounding part of a current loop. The total apparent flow of  $\mathbf{B}$ , the magnetic flux  $\int \mathbf{B} \cdot ds$ , through the surface is zero. Flux from currents outside the surface does not contribute since whatever flux "flows" in through the surface also flows back out. In (b), an amperian loop composed of an infinite number of infinitesimal  $d\mathbf{L}$  lengths encircles a current segment. The magnetic circulation around the loop  $\int \mathbf{B} \cdot d\mathbf{L}$  is proportional to the current encircled. For currents not encircled,  $\int \mathbf{B} \cdot d\mathbf{L}$  is zero.

point, they would not spread out.

The apparent rotation of the  $\mathbf{B}$  field around an infinitesimal area containing a point can be found by imagining an amperian loop about some current loop as shown in Fig. 3-b. Divide the amperian loop into an infinite number of infinitesimal lengths  $d\mathbf{L}$ . The  $\mathbf{B}$  field at each  $d\mathbf{L}$  is again just the sum of each of the infinitesimal  $d\mathbf{B}$  contributions from each  $I d\mathbf{l}$ , where  $\mathbf{B} = \int d\mathbf{B}$ . The magnetic circulation around the loop is proportional to the current encircled.

If you take  $\mathbf{B} \cdot d\mathbf{L}$  you get the magnitude of  $\mathbf{B}$  times the magnitude of the effective length parallel to  $\mathbf{B}$ , which is the apparent flow along  $d\mathbf{L}$ . The direction of  $d\mathbf{L}$  is taken as the direction of the curled fingers of the right hand with the extended thumb pointing in the direction of  $I d\mathbf{l}$ . The total apparent rotation, also called the magnetic circulation, around the amperian loop is found by adding those parts by integration over the entire closed loop  $\int \mathbf{B} \cdot d\mathbf{L}$ .

Imagine moving along the loop, in the direction of  $d\mathbf{L}$ , adding up the  $d\mathbf{B} \cdot d\mathbf{L}$ 's.  $\mathbf{r}$  points from  $I d\mathbf{l}$  to  $d\mathbf{L}$ . When we move at right angles to  $d\mathbf{B}$ , that is along  $\mathbf{r}$  or  $I d\mathbf{l}$ , where  $d\mathbf{B} \cdot d\mathbf{L}$  is zero. At all other places there will be a non-negative contribution since we are always travel-

ing in one direction around the loop. The contributions are proportional to the current  $I$  through the loop since  $\mathbf{B} = \int d\mathbf{B}$  is proportional to that current. The proportionality constant is  $\mu_0$ , so

$$\int \mathbf{B} \cdot d\mathbf{L} = \mu_0 I \text{ (T} \cdot \text{m)}.$$

If the amperian loop is shrunk so the area enclosed approaches zero, the ratio of the change in circulation to the change in area reaches a limiting value. That is the curl of  $\mathbf{B}$ , which must be proportional to the current per unit area  $\mathbf{J}$  through the loop, therefore

$$\nabla \times \mathbf{B} = \mu_0 \mathbf{J} \text{ (T/m}^3\text{)}.$$

That relationship is called Ampere's law for constant currents. It simply says that the total apparent rotation, or curl of  $\mathbf{B}$ , around any point is proportional to the constant current density at that point. The right hand rule gives the direction of apparent rotation. If a number of the  $\mathbf{B}$ -field instruments were scattered about a point, they would rotate.

Next time, we'll discuss some magnetic phenomena and how inductance is related to the magnetic field. The concept of a magnetic circuit will be developed based on an analogy to the electric circuit. We'll see that in matter, the magnetic field can be considered as the linear superposition of two fields, similar to what was shown with the electric field.

# BUILD R-E's CALL-ALERT

RODNEY A. KREUTER  
and DAVID PLANT

*Eliminate the constant chatter  
on your favorite channel or  
repeater with the Call Alert.*

MOST PEOPLE DON'T SEE MANY PARALLELS between the amateur radio service and the citizen's band, but there are similarities. CB channel 9 has helped thousands of stranded motorists, and Hams have provided communication when all else has failed during a disaster such as an earthquake.

However, because of all the activity that may be on your favorite CB channel or two-meter repeater, it is often tempting to turn off the rig or advance the squelch to the point where only the next-door neighbor can get through. In the case of CB, this greatly reduces your range, and with amateur radio it works only with simplex operation. The end result of all this is that you may miss a call from a friend or an emergency call from someone in trouble. The solution to this problem is a selective call system whereby your receiver or transceiver is always on, but does not pass audio until the correct *Touch-Tone* sequence is detected. Then you (and your entire team, if the system is used for club or emergency use) hear the call.

## The Call-Alert

Call-Alert consists of two components, an encoder and a decoder. The encoder is a pocket-sized battery-powered device that produces the *Touch Tones*; it is held next to the transmitting microphone to provide acoustic coupling. The decoder, or monitor, is coupled to the receiver by plugging it into the external speaker jack. It can be powered from either an AC or DC source, for home or mobile use. Note that no modifications to your existing station are required to use either the encoder or the decoder. The Call-Alert simply

acts as a switch between the receiver output and the listener. The system contains an indicator light to let you know that a call has been received, a switch to bypass the device when originating a transmission, a reset switch, and a built-in speaker and volume control.

As shown in the decoder block diagram in Fig. 1, the input from the receiver takes two paths. The lower path goes straight to an audio amplifier (IC7) through volume-control R25. The amplifier is held inoperative by flip-flop IC6-b until the upper logic path is satisfied. The audio stage can

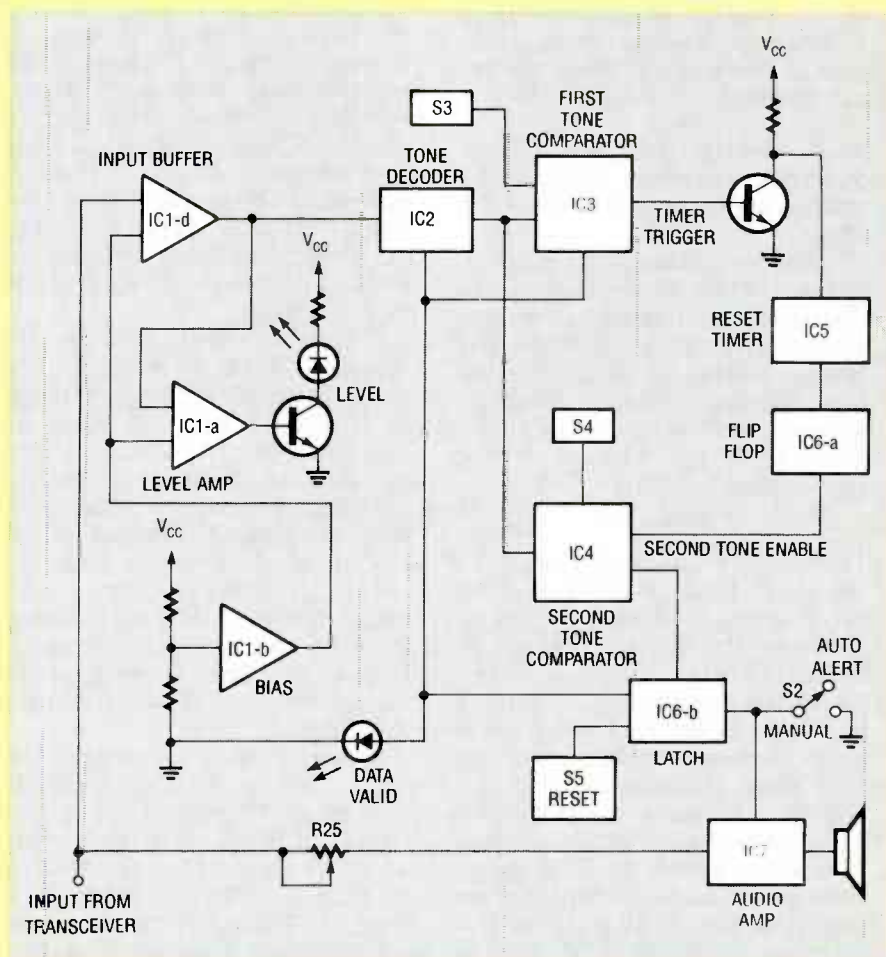

FIG. 1—DECODER BLOCK DIAGRAM. The lower input path goes straight to an audio amplifier (IC7), which is held inoperative until the upper logic path is satisfied.





also be turned on manually via switch S2.

In the upper path, IC1-d is an input buffer for the tone decoder, IC2. Buffering is necessary because the tone decoder can be damaged by high input-signal levels; the buffer limits levels to under 5 volts. The buffer is biased by IC1-b, which also biases IC1-a, the level-indicator amplifier. Driven by its buffer, the tone decoder provides two outputs. The first output indicates which DTMF tone is received. The data is sent to the two comparators that compare the decoder's output with the user-selected switch settings. More about the switches later. The decoder also puts out a DATA VALID signal (DV) that goes high when any valid tone is received, which keys timing logic later in the circuit.

The first tone comparator, IC3, triggers IC5 when the tone and switch inputs coincide and the timer runs for 4 seconds. The timer resets everything after that time period to prevent "hacking" a system entry, and it also provides the signaling to set and reset flip-flop IC6-a. The flip flop enables the second comparator to listen for the second tone. When IC4 validates the second tone, it triggers a latch, IC6-b, which enables the audio stage and turns on the call-alert light. Reset switch S5 unlocks IC6-b, thus preparing the monitor for the next call.

### Circuitry

The schematic for the decoder section is shown in Fig. 2. The

whole system runs on 5 volts (with the exception of the audio stage), so the output of IC1-d will swing up to just under  $V_{CC}$ , thereby protecting the tone decoder's input (IC2). At high audio input levels, however, IC1-d's output will clip, preventing the decoder from functioning. Otherwise, at normal receiver output levels, the decoder works fine. There are LEVEL-SET and DATA-VALID indicators (LED1 and LED2, respectively) on the board that we'll discuss in detail later on. Pin 5 of IC1-b is set to  $\frac{1}{2} V_{CC}$  so the outputs of all three op-amps idle at 2.5 volts. The level amp (IC1-a) is set up to drive LED1 at proper audio input.

The 74HC85's (IC3 and IC4) are 4-bit magnitude comparators that compare two 4-bit "words," and indicate whether one word is larger, smaller, or equal to the other. Inputs A0-A3 are tied to the 4-position DIP switches S3 and S4, and the decoder outputs are tied to comparator inputs B0-B3. When both words match (the words can be binary, BCD, or hexadecimal, which is the case with the decoder as there are 16 DTMF tones) the comparator output at pin 6 will go logic high.

Because the comparator's enable line (pin 3) has to be high to operate, IC3 will respond first, as its enable is brought high by the DV (data valid) output at pin 12 of the decoder. When that happens, flip-flop IC6-a is toggled by a 4-second input from the 555 timer (IC5) and the second tone DV

signal. That allows IC4 to listen for the second valid tone. The timer resets the flip-flop and the device waits for the next input. If the second valid tone arrives within 4 seconds, IC6-b latches on, which turns on audio amplifier IC7 and lights LED4. Reset switch S5 will clear IC6-b.

The audio amplifier, IC7, is a Motorola MC34119. That part was chosen because it can be powered from up to 18 volts and, at rest, it draws virtually no current which makes it totally silent. Keep in mind, though, that neither speaker lead can be grounded, so if you plan to add an external speaker jack, isolate it if you are using a metal case.

The decoder will work from 6 to 12 volts AC, or 9 to 15 volts DC. Although the bridge rectifier will work with either input polarity, it is a good idea to ground the negative with a DC input in case you share a power supply with other equipment—in a mobile environment, for example. For home or office use, a 9-volt DC adapter works perfectly.

### The encoder

The encoder schematic is shown in Fig. 3. The circuit consists of a tone encoder, a switch to go from the first tone to the second, and an amplifier to drive the speaker. The heart of the unit is the TCM5089 tone encoder, manufactured by Texas Instruments, that will generate all 16

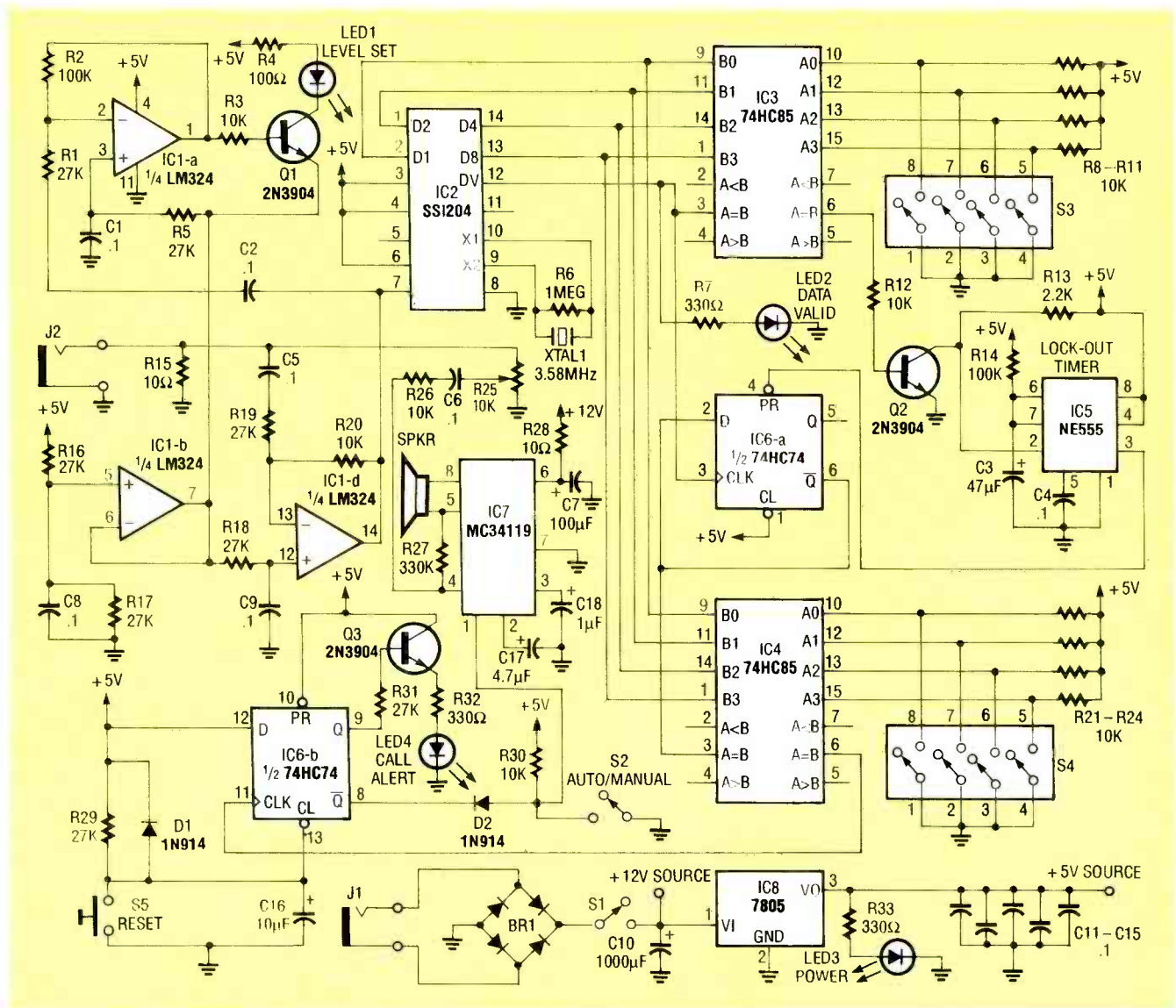

FIG. 2—SCHEMATIC FOR THE DECODER. Everything but the audio stage runs at 5 volts so the output of IC1-d will swing up to just under  $V_{CC}$ .

*Touch Tones* by returning a row pin and a column pin to  $V_{SS}$  or, in our case, ground. (Although most *Touch-Tone* keypads have

only 3 columns and 4 rows, there is a fourth column available for use, or four additional tones called A–D, for a total of 16 tones.)

The encoder uses two 8-position DIP switches, one for each tone. As there are four columns and four rows, and one of each is

#### PARTS LIST—DECODER

All resistors are ¼-watt, 5%

- R1, R5, R16–R19, R29, R31—27,000 ohms
- R2, R14—100,000 ohms
- R3, R8–R12, R20–R24, R26, R30—10,000 ohms
- R4—100 ohms
- R6—1 megohm
- R7, R32, R33—330 ohms
- R13—2200 ohms
- R15, R28—10 ohms
- R25—10,000 ohms, audio taper potentiometer with SPST switch (S1)
- R27—330,000 ohms
- Capacitors**
- C1, C2, C4–C6, C8, C9, C11–C15—0.1  $\mu$ F, ceramic disk
- C3—47  $\mu$ F, 16-volt electrolytic

- C7—100  $\mu$ F, 16-volt electrolytic
- C10—1000  $\mu$ F, 16-volt electrolytic
- C16—10  $\mu$ F, 16-volt electrolytic
- C17—4.7  $\mu$ F, 16-volt electrolytic
- C18—1  $\mu$ F, 16-volt electrolytic
- Semiconductors**
- IC1—LM324 quad op-amp
- IC2—SSI204 *Touch Tone* decoder
- IC3, IC4—74HC85 4-bit magnitude comparator
- IC5—NE555 timer
- IC6—dual D-type flip-flop
- IC7—MC34119 power amp with enable
- IC8—7805 5-volt regulator
- D1, D2—1N914 switching diode
- Q1–Q3—2N3904 NPN transistor
- BR1—50-volt bridge rectifier

- LED1, LED2—miniature red light-emitting diode
- LED3—green panel-mount light-emitting diode
- LED4—red panel-mount light-emitting diode
- Other components**
- XTAL1—3.58-MHz crystal
- S1—SPST switch (mounted on R25)
- S2—SPST toggle switch
- S3, S4—4-position DIP switch
- S5—momentary pushbutton switch
- J1, J2—audio and power input jacks (use whatever best suits your needs)
- Miscellaneous:** PC board, project case, speaker, control knob, labeling, hardware, wire, solder, etc.



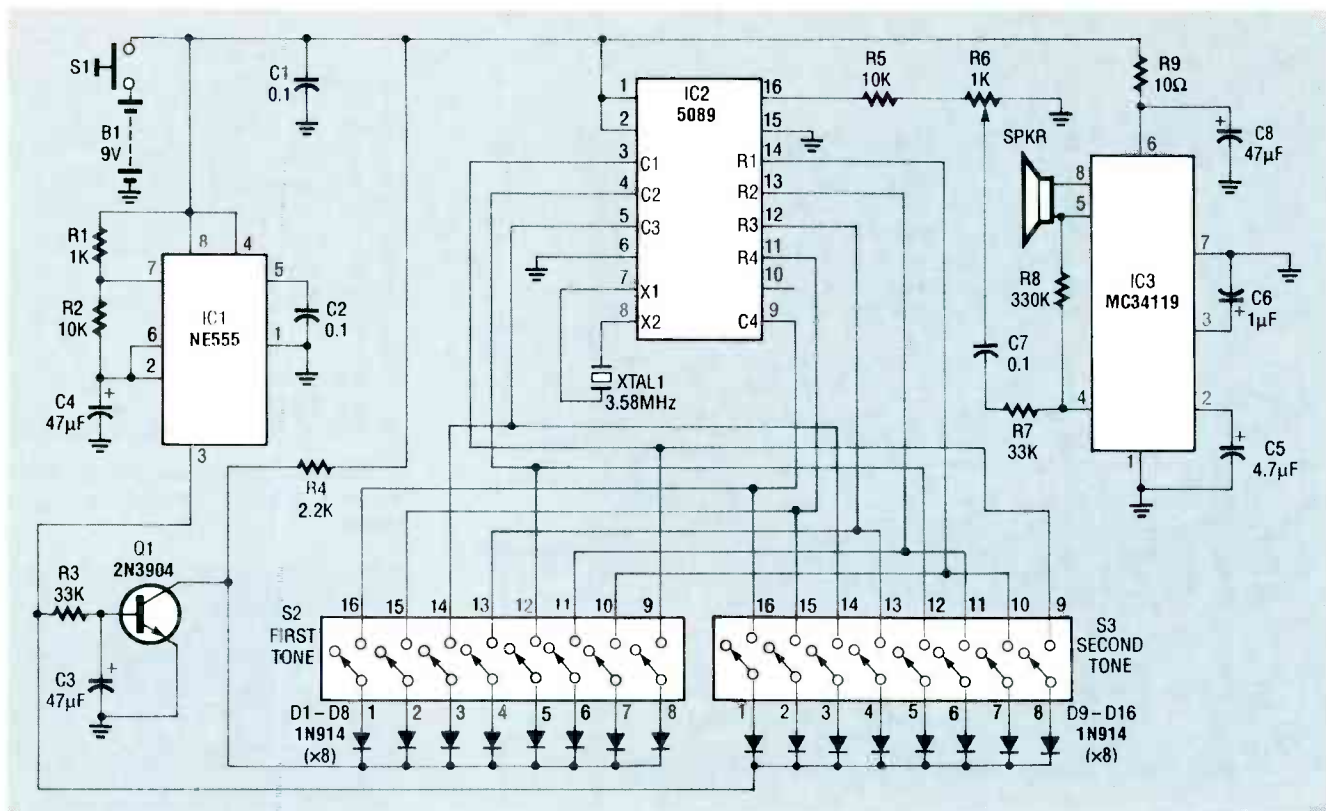

FIG. 3—ENCODER SCHEMATIC. The heart of the unit is the TCM5089 tone encoder that will generate all 16 *Touch Tones*.

required to determine a particular DTMF tone, two on positions are required per DIP. This is also the derivation of the expression "2 of 8" coding. The two DIP switches, S2 and S3, are controlled sequentially by IC1, a 555 timer running in its astable mode to generate a square wave. When first turned on by pushbutton switch S1, the output at pin 3 goes high and is inverted by Q1 which triggers S2 to key in the first tone. After a half second, IC1's pin 3 goes low to enable S3, generating the second tone. The

RC network of C3-R3 at the base of Q1 creates a delay between the two tones; otherwise a combination of two of the same tones would be read as a single tone. The diodes in series with the switches isolate the row and column programming for each tone. The 300 milliwatt output from IC2 is attenuated and fed to IC3.

### Decoder construction

With the exception of the controls and indicators, all parts for the decoder mount on the PC board. A pre-made PC board is

available as part of a kit (see the parts list), and a foil pattern for the board is provided here if you want to make your own. Perforated construction board and point-to-point wiring can also be used. If you're using a PC board, follow the parts layout shown in Fig. 4.

The authors used jacks for J1 and J2 (for power and audio inputs, respectively) that mounted directly on the PC board. However, the jacks are not provided with the kit because each builder will have his own idea regarding

### PARTS LIST—ENCODER

All resistors are 1/4-watt, 5%

- R1—1000 ohms
- R2, R5—10,000 ohms
- R3, R7—33,000 ohms
- R4—2200 ohms
- R6—1000 ohms, miniature PC-mount potentiometer
- R8—330,000 ohms
- R9—10 ohms

#### Capacitors

- C1, C2, C7—0.1  $\mu$ F, ceramic disk
- C3, C4, C8—47  $\mu$ F, 16-volt electrolytic
- C5—4.7  $\mu$ F, 16-volt electrolytic
- C6—1  $\mu$ F, 16-volt electrolytic

#### Semiconductors

- IC1—NE555 timer

IC2—TCM5089N *Touch Tone* encoder

IC3—MC34119 audio amplifier

D1—D16—1N914 switching diode

Q1—2N3904 NPN transistor

#### Other components

- XTAL1—3.58 MHz crystal
- S1—momentary pushbutton switch
- S2, S3—8 position DIP switch

**Miscellaneous:** 1-inch speaker, PC board, project case, 9-volt battery clip, foam rubber, wire, solder, etc.

**Note:** The following items are available from Project-Mate, Ste. 207, 2727 W. Manor Pl., Seattle, WA 98199 (206) 283-4700:

- A decoder kit containing a PC board and all PC-mounted components (except J1 and J2)—\$48.50 + \$2.50 S&H

- An encoder kit containing a PC board, battery clip, and all PC-mounted components—\$22.50 + \$2.50 S&H (Orders may be combined for the same \$2.50 S&H fee)

- A 1-inch speaker—\$4.50 post paid There is a 10% discount on a second kit, and a 15% discount on 5 or more by radio clubs.

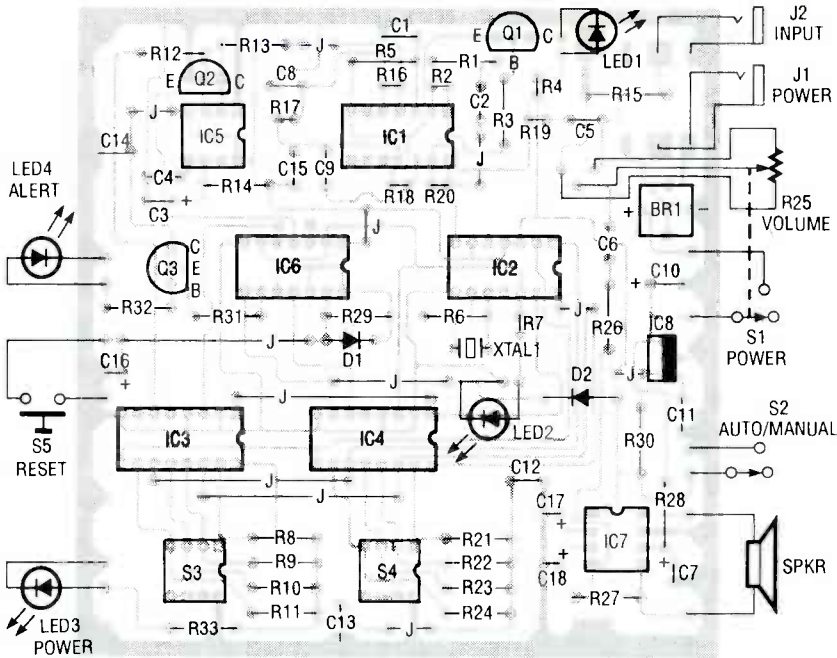

**FIG. 4—DECODER PARTS-PLACEMENT DIAGRAM.** With the exception of the controls and indicators, all parts for the decoder mount on the PC board.

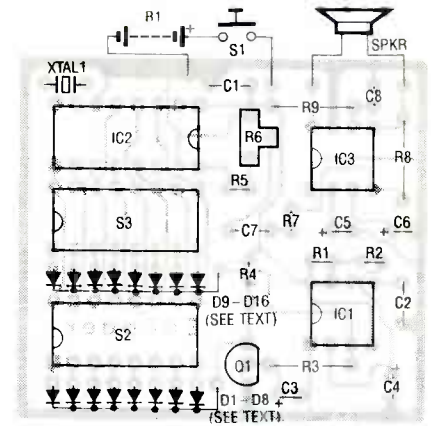

**FIG. 6—ENCODER PARTS-PLACEMENT diagram.** See Fig. 7 before stuffing this board.

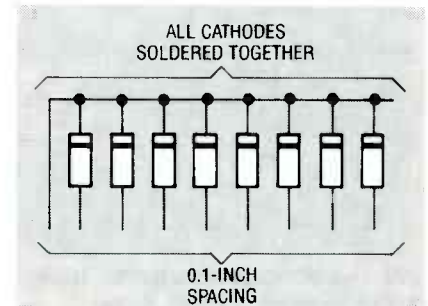

**FIG. 7—THE TWO DIODE ARRAYS** consist of eight 1N914 diodes spaced 0.1-inch apart with the cathodes all soldered to a common bus. A spare piece of perforated construction board can be used as a 0.1-inch spacing guide.

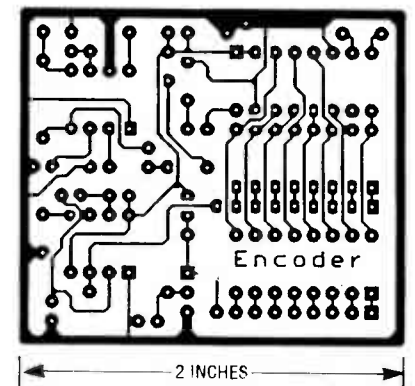

**FOIL PATTERN FOR THE ENCODER.**

sembled. Each array consists of eight 1N914 diodes spaced 0.1 inch apart with the cathodes all soldered to a common bus. Figure 7 shows how you should assemble the arrays, and a spare piece of perforated construction board can be used as a 0.1-inch spacing guide.

Position DIP switches S2 and S3 with the number-1 position on the outer edge of the board. (The prototype has the switches backward, although it doesn't af-

jack selection. By hardwiring the input connections, the jacks can be eliminated entirely.

The finished decoder board, shown in Fig. 5, measures 4×4 inches, with a loaded height of 1 inch. It can easily be installed inside any suitable enclosure. The prototype has the speaker mounted on the top side of the case; for mounting the unit under an automobile dashboard, you may want to mount the speaker on the bottom of the case for better sound quality. Keep in mind that all front-panel controls return to ground, so a single wire can connect all of them to the board.

**Encoder construction**

The encoder is assembled on its own PC board, which is also available from the source mentioned in the parts list or can be made from the foil pattern we've provided. Figure 6 shows the parts-placement diagram for the encoder.

Before you can build the encoder board, the two diode arrays (D1–D8 and D9–D16) must be as-

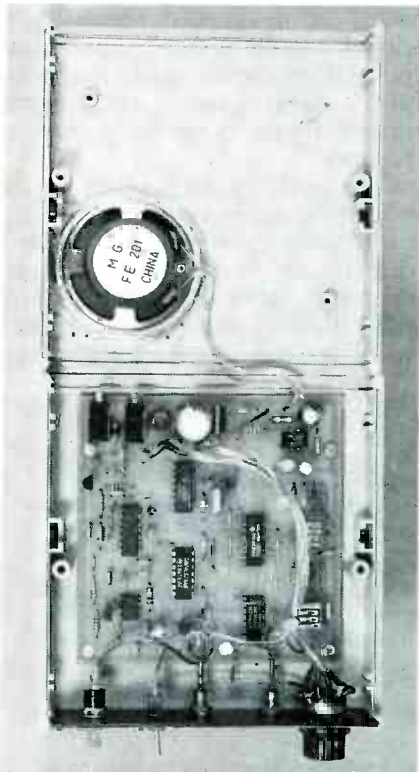

**FIG. 5—THE FINISHED DECODER board** can easily be installed inside any suitable enclosure. All front-panel controls return to ground, so a single wire can connect all of them to the board.



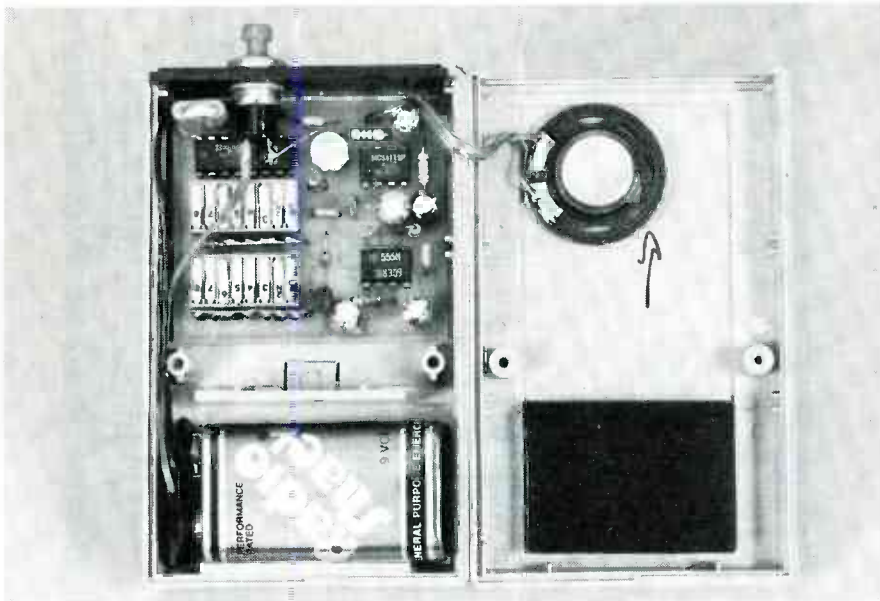

**FIG. 8—THE POCKET-SIZED ENCODER CASE** used for the prototype has a built-in compartment for a 9-volt battery, although you should secure a piece of foam rubber in the bottom of the battery compartment to hold the battery in place.

fect the operation.) The authors drilled a hole in the PC board underneath potentiometer R6 and a matching hole in the back of the case so that the level adjustment could be set with the case closed: this, however, is not necessary.

The pocket-sized case used for the prototype has a built-in compartment for a 9-volt battery, although you can use any case you like. The PC board is held inside the case with double-sided foam tape. Pushbutton switch S1, the battery-clip leads, and a 1-inch Mylar speaker are wired to the circuit board, and the switch and speaker are mounted on the front and top panels of the case, respectively. A 5/8-inch hole is drilled on the top of the enclosure for the speaker, which was secured to the case with some instant glue. We suggest that a bead of glue be placed completely around the speaker for a good acoustic seal. When you position the holes for the speaker and S1, make sure they do not interfere with the circuit board. When the case is assembled, the final step is to secure a piece of foam rubber in the bottom of the battery compartment to hold the battery in place. Figure 8 shows the completed encoder.

#### Preliminary setup

The first step is to pick an arbitrary two-bit code (two tones) and set both units to the same code. Legal codes are from 0-0 to D-D

(0-0, 0-1, 0-2, etc.), including the "#," "\*" and A-D tones. The prototype units were set to code 3-6, so we'll use that combination to demonstrate setting the DIP switches.

The decoder is hexadecimal, so two 4-position DIP switches are used to set the code—one DIP switch per tone. Because the 10K pull-up resistors in the decoder are connected to ground when a DIP switch is closed, an "on" switch position provides a low and an "off" switch position provides a high. Figure 9 shows the DIP-switch settings for S3 and S4 depending on which digit, or code, you have selected. For the 3-6 code, DIP-switch S3 must have switches 1 and 2 in the "on" position and 3 and 4 "off," and S4 must have switches 1 and 4 "on" and 2 and 3 "off."

The encoder requires the setting of two 8-position DIP switches, S2 and S3 (one DIP switch per tone), to generate the two-tone code. Figure 10 shows the DIP-switch settings for S2 and S3. From Fig. 10 we can see that, to generate the first tone (3 in this example), that DIP-switch S2 should have switches 3 and 7 closed. For the second tone (6 in this example), S3 should have switches 3 and 6 closed. At this point, when pressing S1 (with a good battery installed), the encoder should produce a two tone warble, and potentiometer R6 sets the volume.

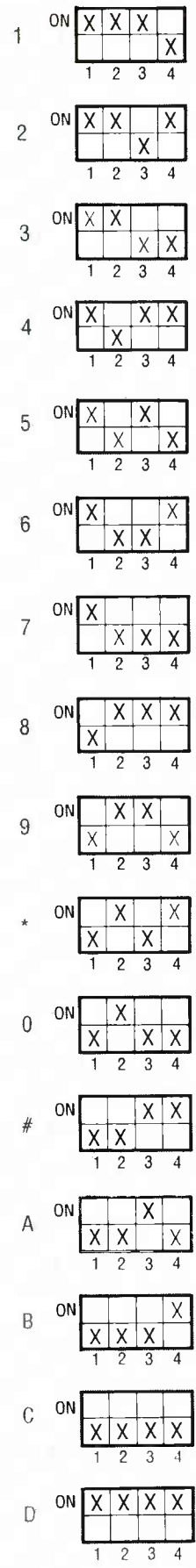

**FIG. 9—THE DECODER** has two 4-position DIP switches used to set the code. Here they're set for the 3-6 code.

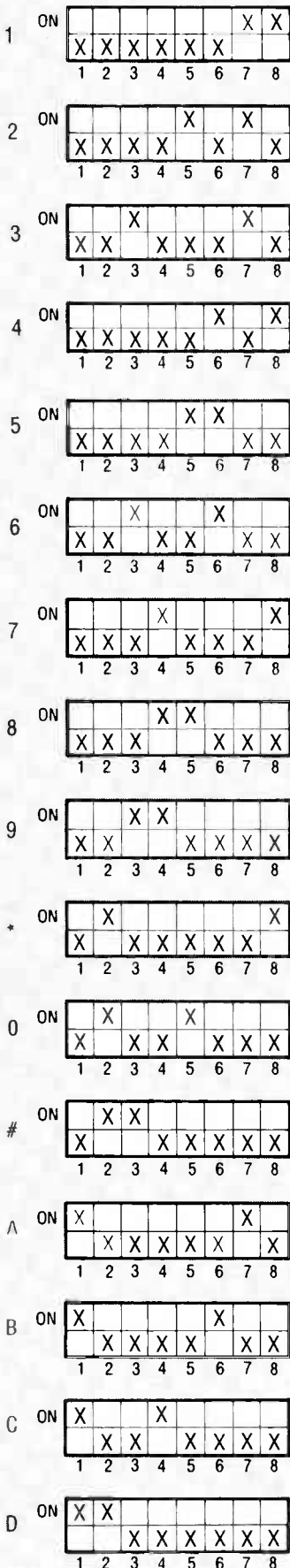
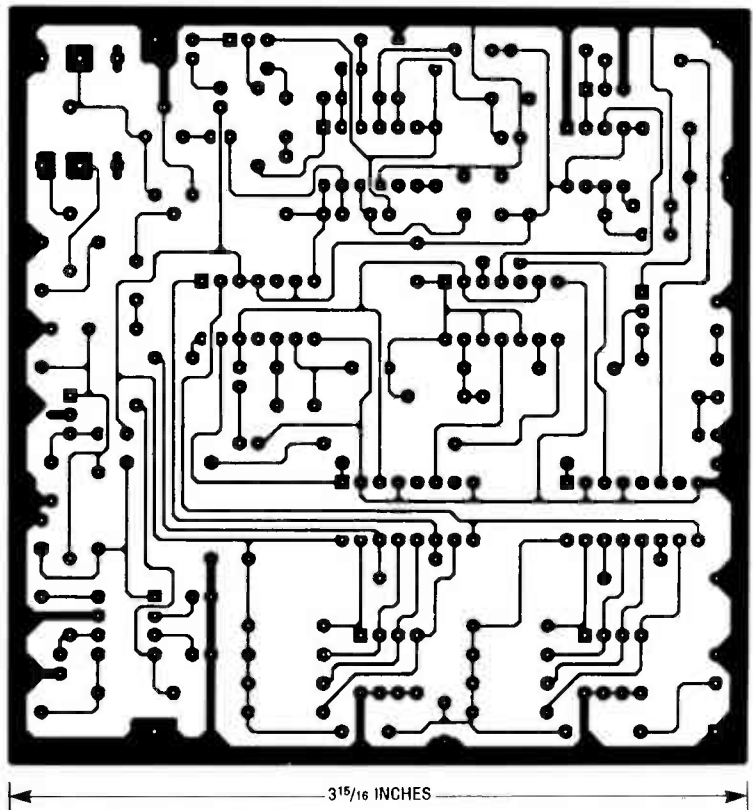

FIG. 10—THE ENCODER has two 8-position DIP switches, S2 and S3, that must be set to generate the two-tone code.



FOIL PATTERN FOR THE DECODER.

**System test**

The first test of the decoder is to apply power and see if LED2 (DATA VALID) flashes briefly. This indicates that the decoder, IC2, is functioning. Now, with a receiver supplying audio, adjust its volume using LED1 to set the level. With an FM receiver, and the squelch off on a quiet channel, the LED should show about 1/3 brightness. On a busy channel it should flicker following voice peaks. CB is somewhat different because the background noise is quieter, and here we adjust to an active channel. A weak glow following voice peaks is the correct setting. At this point the LED2 should remain off until a valid code ID received.

For two-meter testing, a scanner, set to the experimental portion of the band, can be used as the receiver and a hand-held used as the transmitter. Using the built-in *Touch-Tone* pad, pressing any *Touch-Tone* digit should cause LED2 to light, and code 3-6 will trigger the decoder on and you will hear your transmitter. The ALERT lamp, LED4, will stay lit after transmitting, and the RESET button will turn it off.

The next step is to set the encoder level by using it to key the

decoder. Note that if the encoder is held directly against the mike, the audio may become distorted. Try holding the encoder a quarter of an inch from the mike element. Get it to the point where the receiving station hears clean *Touch Tones* at approximately the same level as voice. You will find that it takes very little audio from the encoder when it's placed close to the microphone.

For CB you can use a rig with a 50-ohm dummy load for the transmitter and another transceiver (a walkie-talkie) as the receive source. Set the encoder output level to work best with the transmitter, then set receiver audio. For an on-the-air test, set the levels and drive around with the encoder making various calls throughout the day. The system should work well and it will be a pleasure to have the rig quiet between calls. Another test procedure is to attach the encoder speaker to the decoder input with clip leads and fire up the system. The proper encoder output should be close to that for on-the-air use.

You can probably think of other applications. For example, the output of the ALERT lamp (LED4) can be used to control other devices in your shack. **R-E**



DEVELOPMENT AND DEBUGGING tools have improved tremendously since the introduction of the microprocessor. Logic analyzers and development systems, widely used by hardware and software developers alike, make child's play of otherwise tough debugging chores. There are several problems with these tools, however: They're processor-dependent, hard to use, and costly to purchase.

It doesn't have to be like that, however. We've designed a universal, easy-to-use, low-cost, yet professional-quality logic analyzer with separate LED displays for sixteen address lines and sixteen data lines, single- and auto-stepping operation, the ability to work with both 8- and 16-bit systems, and more. A complete kit of parts with attractive silk-screened panel is available for well under \$200—a fraction of the cost of comparable commercial units. Partial kits as well as a PC board all by itself are also available.

#### **MICRO-MON features**

MICRO-MON attaches to any

***Ease  
microprocessor  
design chores  
with our  
under-\$200  
logic-analyzer kit.***

standard ROM or EPROM on the target system via an IC clip. MICRO-MON works with both 8-bit and 16-bit parts with capacities ranging from  $2K \times 8$  to  $64K \times 16$ , in 24-, 28-, 32-, and 40-pin packages. Two conveniently located connectors accept the interface cables. Connector pinout was designed to use standard ribbon cables and standard IC clips.

Each address and data line has its own dedicated LED, so it's easy to identify shorted lines. In addition, MICRO-MON will blink the corresponding LED of any floating or open address or data line.

By attaching a single lead to the target's WAIT OR READY line, you can single step or continuously step through microprocessor instructions with the press of a switch. For the stepping function to work, the target system must be static—that means that the WAIT OR READY line must be able to stall the microprocessor without adversely affecting system operation.

Continuous stepping works like auto-repeat on a keyboard:

# MICRO MONITOR

JIM COOKE

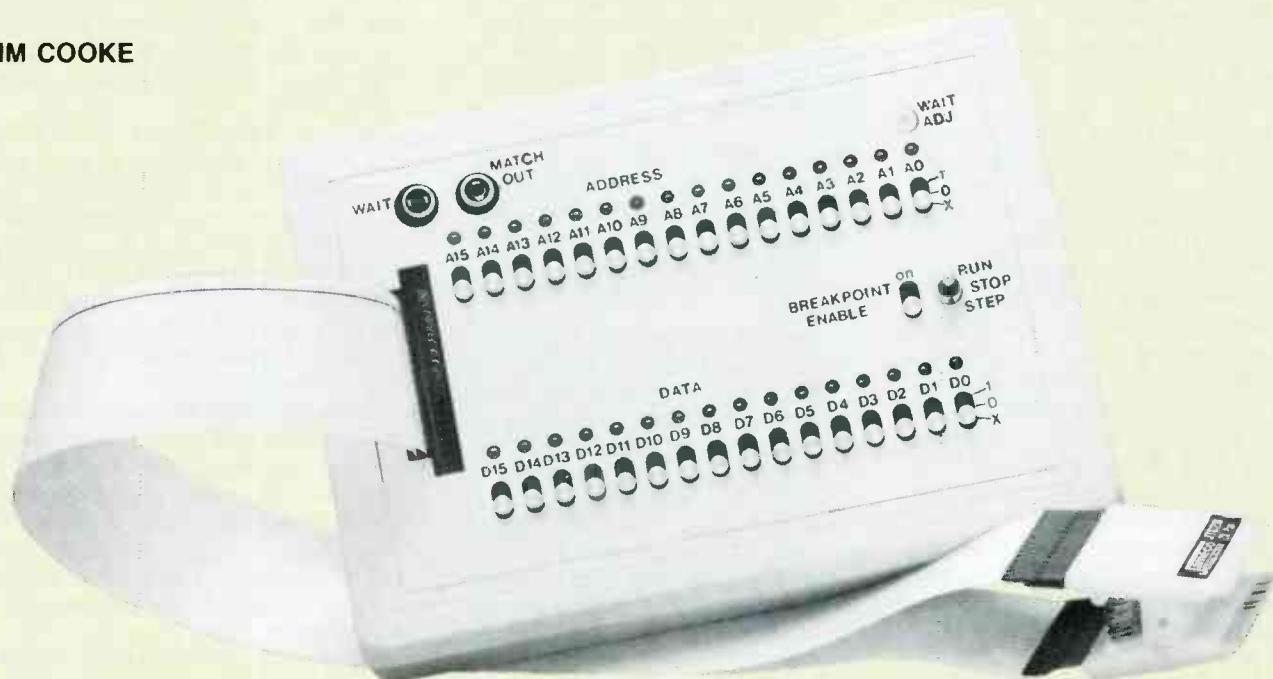

MICRO-MON steps the target system twice per second as long as the Step switch remains depressed. This powerful feature allows you to observe all bus activity, thereby enabling you to easily debug both hardware and firmware.

Another feature allows you to stop the target system on a specific address pattern, data pattern, or combination thereof. MICRO-MON has a three-position switch for each address and data bit, so each bit can be programmed to match on a high, low, or don't care. An external connector carries the MATCH signal, which can be used to trigger a scope or other device. MICRO-MON has its own power supply, so it does not consume power from the target system. Also, to reduce cost, or if the match capability is not required, the unit can be depopulated for 8-bit-only operation.

### Theory of operation

MICRO-MON consists of three major circuits that we'll discuss separately: Display, Single-step, and Match.

**Display Circuit.** The display circuit, shown in Fig. 1, consists of inverting buffers IC1-IC4. Address and data lines from the target system feed the buffers via the IC clip. The buffers feed address and data buses used by the rest of the system. In addition, the output of each buffer drives the cathodes of the display LED's via 470-ohm current-limiting resistors (those resistors are contained in resistor networks RN1-RN4).

A unique feature of the display circuit is the Floating Line Indicator, which identifies open and floating lines by blinking the associated LED. Blinking is accomplished by connecting the input side of each buffer to a 2-Hz oscillator via a 47K resistor (contained in resistor networks RN5-RN8). The inputs of HCT buffers IC1-IC4 are high-impedance types, so open or floating inputs will easily allow the 47K resistors to couple the 2-Hz signal into the circuit. On the other hand, if an input is not floating or open, but is high or low, the logic level will override the 2-Hz signal, clamp the buffer either high or low, and display the corre-

### PARTS LIST

All resistors are 1/4-watt, 5%, unless otherwise noted

R1—150,000 ohms  
 R2—100,000 ohms  
 R3—200,000-ohm PC-mount potentiometer  
 R4—1000 ohms  
 R5, R10—10,000 ohms  
 R6—10 ohms  
 R7—2.2 megohms  
 R8, R9—47,000 ohms  
 RN1-RN4—470 ohms × 9 resistor network, pin 1 common  
 RN5-RN12—47,000 ohms × 9 resistor network, pin 1 common

#### Capacitors

C1—2.2 μF, 25 volts, tantalum  
 C2—0.1 μF, 25 volts, tantalum  
 C3—1 μF, 25 volts, tantalum  
 C4—33 pF, ceramic disc, with socket (see text)  
 C6-C15—0.1 μF, ceramic

#### Semiconductors

IC1-IC4—74HCT240, octal three-state inverting buffer  
 IC5—74HCT221, dual monostable multivibrator  
 IC6—74HCT14, hex Schmitt trigger  
 IC7—74HCT00, quad NAND gate  
 IC8—74HCT32, quad OR gate  
 IC9-IC12—74HCT688, eight-bit magnitude comparator  
 IC13—7805 +5-volt regulator  
 Q1—2N2222 NPN transistor  
 D1—1N914 diode  
 LED1-LED32—red LED (T1-3/4 package)

#### Other components

J1-a—16 × 2 0.1" header  
 J1-b—20 × 2 0.1" header  
 J2—3.5mm coaxial jack  
 J3-J4—RCA PC-mount phono jack  
 JU1, JU2, JU4—3-pin 0.1" header  
 JU3, JU5—2-pin 0.1" header  
 S1—SPDT toggle, center off, one side momentary (Alcoswitch MTA-106H-PC or equiv.)  
 SW2—SW33—SPDT slide, middle NC  
 SW34—SPST slide

**Miscellaneous:** 6-volt, 300-mA DC adaptor, front panel, enclosure (Hammond P/N A9086265), cables for 28-, 32- and 40-pin ROM's, cable for WAIT line, assembly hardware.

**Note:** The following items are available from Jim Cooke, P.O. BOX 834, Pelham, NH 03076 (603) 882-4460: Complete kit, \$189; PC board only, \$29; PC board kit and all components, \$99; enclosure with silkscreened front panel, \$49; cable assembly with 28-pin chip clip, \$49. New Hampshire residents add appropriate sales tax; all orders add 5% for shipping. MC and Visa accepted.

sponding state in the appropriate LED.

**Single-step Circuit.** This circuit consists of the logic shown in Fig. 2. Switch S1 selects one of four stepping functions (Run, Stop, Step, Autostep), all of which are executed by controlling the WAIT or READY line of the target microprocessor. Switch S1 is special: It is an SPDT type with a center "off" position, and a spring return on only one side (Step).

Here are the four stepping functions: *Run*—With S1 in the "run" position, the WAIT line is unaffected by MICRO-MON, so the target microprocessor runs at full speed. *Stop*—With S1 in the center "off" position, the WAIT line is asserted, so the target microprocessor halts. In this state, MICRO-MON displays current address and data lines. *Step*—By moving S1 into the "step" position and releasing it, one-shot IC5-a fires once, thus allowing the microprocessor to execute a single operation. The time constant of the one-shot is adjustable and must be set for the particular microprocessor and clock rate. The combination of IC6-a, R2, and C2 form a filter that prevents switch bounce from falsely triggering IC5-a. *Autostep*—If S1 remains depressed, the delay generated by R7 and C3 expires, which in turn allows the 2-Hz oscillator signal (generated by IC6-d, R1, and C1) to feed into the one-shot via IC7-c and IC6-e. Thus the one-shot will be retrigged twice per second as long as step-switch S1 remains depressed.

**Match circuit.** As shown in Fig. 3, four cascaded octal comparators (IC9-IC12) generate the MATCH signal, which is enabled or disabled by S34, MATCH ENABLE. Each address and data line has a corresponding three-position switch (S2-S33) that is used to specify a match on 0, 1, or X (don't care).

Let's see how the comparators work. Each address or data line is always connected to one leg of a comparator; a switch determines the connection to the other leg of the comparator. For the "don't care" position (down), the two comparator inputs are shorted together, forcing a match. For a match on 1, the switch grounds



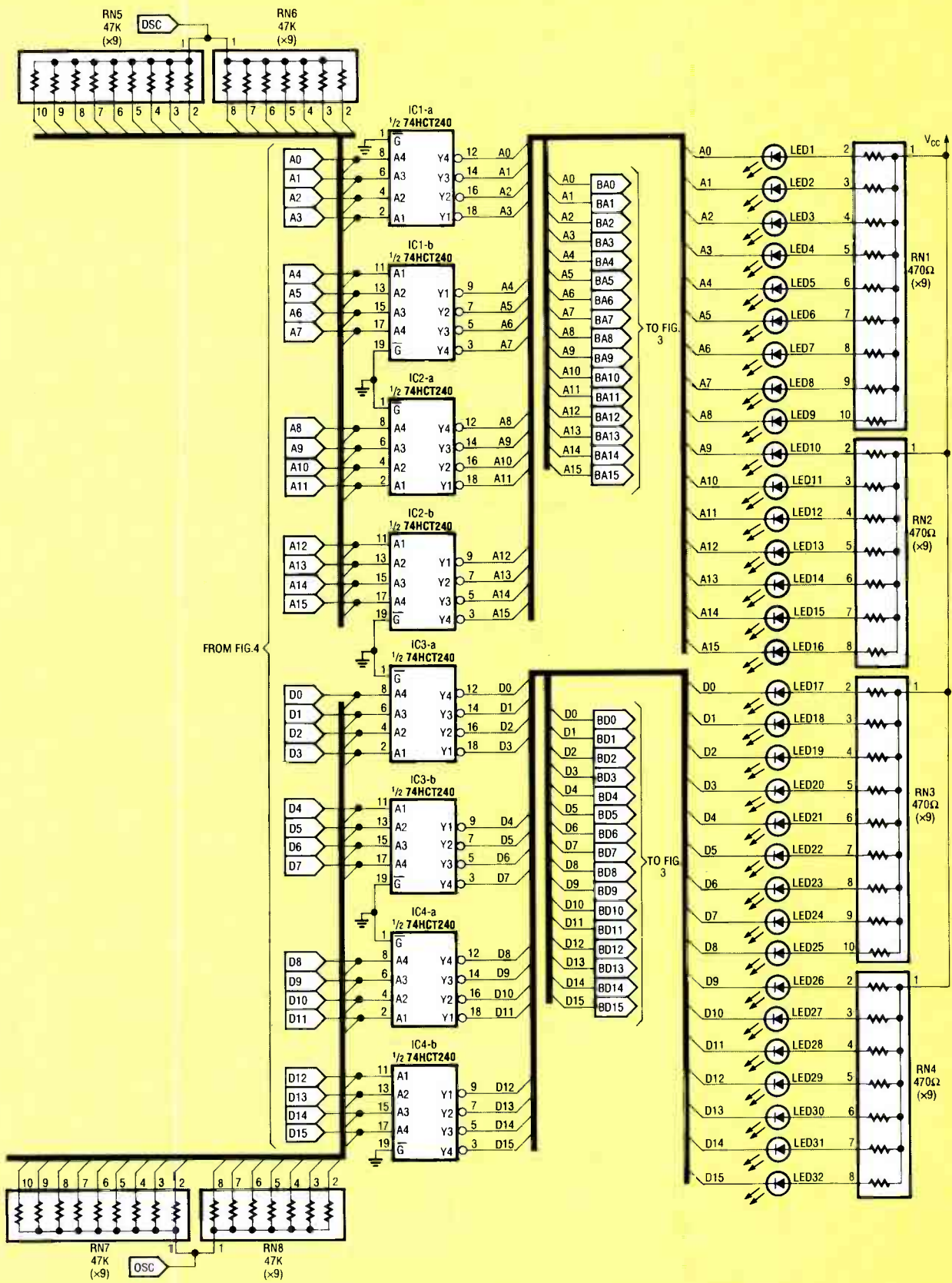

FIG. 1—THE DISPLAY CIRCUIT consists of several octal inverting buffers that drive discrete LED's to display 16 address lines and 16 data lines.

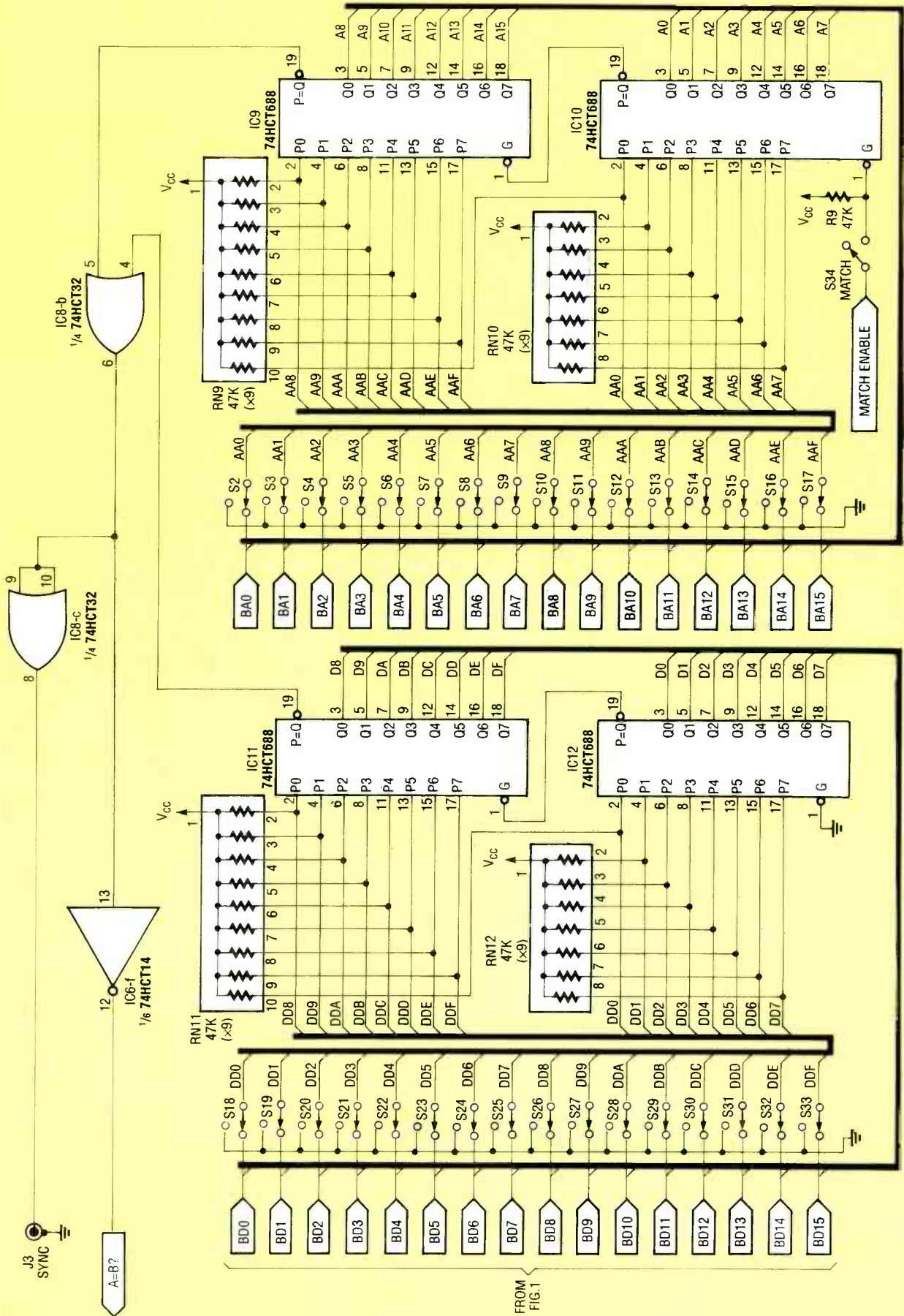

FIG. 3—THE MATCH CIRCUIT compares all address and data lines to the values set on switches S2-S33. If there is a match, IC6-f goes low, and a pulse appears at J3.

FROM FIG. 1



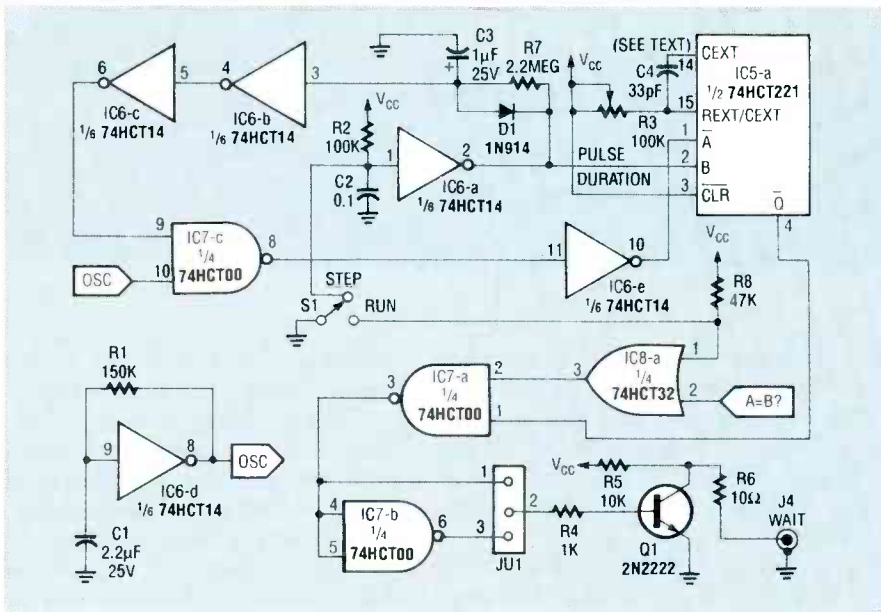

FIG. 2—THE SINGLE-STEP CIRCUIT provides four modes: Run, Stop, Step, and Autostep.

the corresponding input. For a match on 0, the switch is not connected at all, so the input is pulled up through a 47K resistor (contained in RN9–RN12). (Remember, the buffered data is inverted, which explains the negative logic.)

The output of the cascaded match logic feeds into the single-step circuit (shown back in Fig. 1) and, when enabled by S34, can be used to stop the micro-processor on a specific pattern. Note also that the MATCH signal is buffered by IC8-c and delivered to J3 for use as a sync or trigger signal.

That completes the description

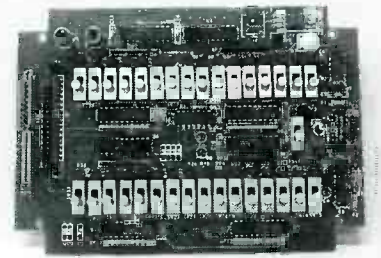

FIG. 5—THE FINISHED BOARD will look something like this. We'll start building the Micro Monitor next month.

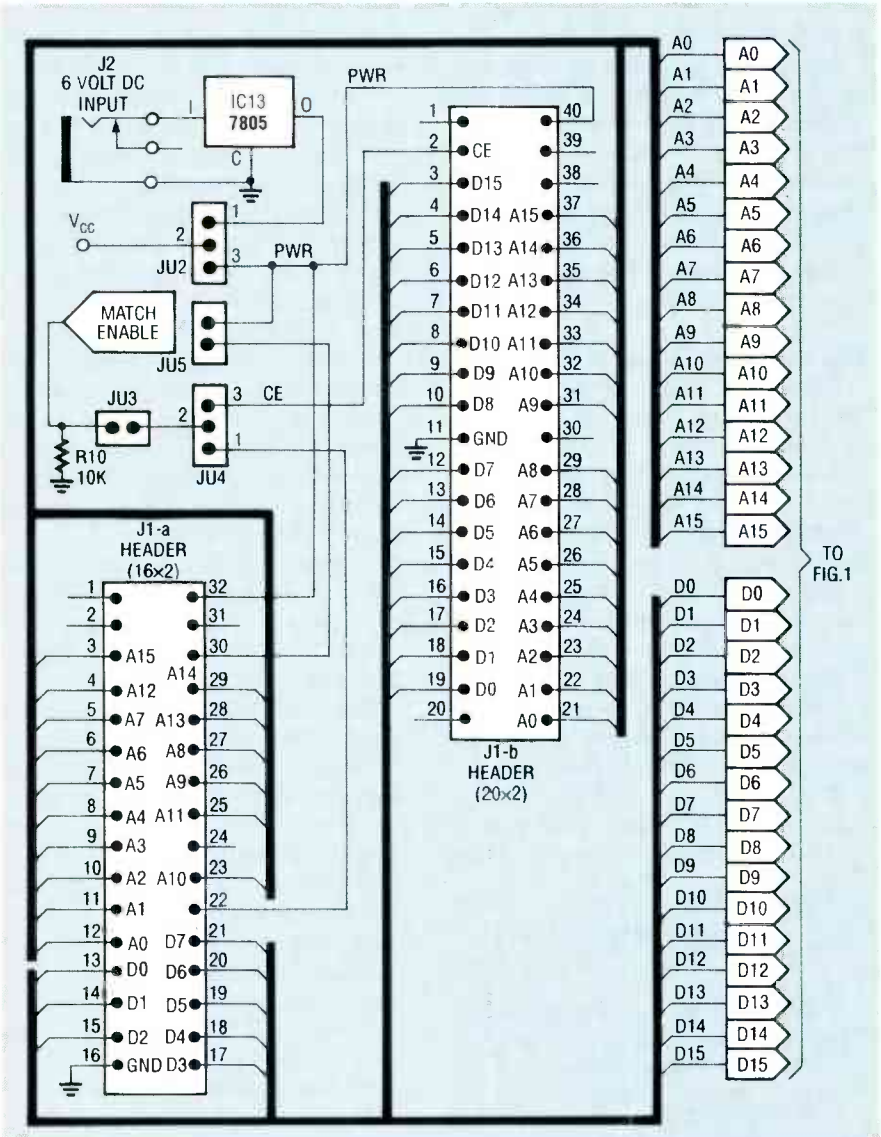

FIG. 4—CABLE AND CONNECTOR WIRING diagram; J1-a accepts 8-bit devices, J1-b accepts 16-bit devices.

of the logic portion of the circuit. Figure 4 shows wiring details for the power supply and the test connectors. The power supply consists of a 6-volt DC wall transformer feeding a 7805 regulator. Header J1-a is a dual-row 32-pin connector for 28- and 32-pin IC's, and J1-b is a 40-pin unit for 40-pin IC's.

### Next month

Unfortunately we've run out of space. Therefore the rest of this story is going to have to wait until next month. We have finished our discussion on how the circuitry works, so next month we'll start right in with building the Micro Monitor. (By the way, a photo of what the finished board looks like is shown in Fig. 5.) In the meantime, we've given you the parts list and a source for the parts and PC boards. So if you're anxious to be building the Micro Monitor, we recommend that you start gathering together all of the parts and a PC board. We'll provide foil patterns for the double-sided board next month if you want to make your own. R-E

# HARDWARE HACKER

Curve fitting fuzzy data, meeting FCC regulations, Tesla Coils and high-energy resources, flashlight-battery supplies, and some thoughts on E-field machines.

DON LANCASTER

Here are several updates to our previous columns: One historic key "horses mouth" paper for doing your own induction-motor speed controls is *Pulse Width Modulated Inverters for AC Motor Drives*, by B. Mokrytzki. IEEE Transactions IGA-3, number 6. Nov-Dec 67, pages 493-503.

Another pair of power electronics resources are the new *Motortechnics* and *Powertechnics* trade journals.

## Meeting FCC specs

I sure do get a lot of helpline calls asking about meeting those *Federal Communications Commission* rules and regulations. Contrary to common belief, these regulations are very easy to find and are not really all that expensive. Most federal regulations appear in a humongous set of paperback volumes known as the CFR, and short for their *Code of Federal Regulations*. Each government bureaucracy has their own *title* in the CFR series.

For instance, their *title 14* is for Aeronautics and Space and *title 37* is the Patent and Trademark office. Of our interest here, *title 47* is the FCC regulations that govern any use of radio spectrum space, intentional or otherwise.

You can view most CFR volumes in most any large library that has a government documents section. The volumes are also now conveniently available from the *US Government Bookstore*. Yes, VISA and MC are accepted, with one week delivery.

The FCC regulations are organized into a hundred separate *parts*. Figure 1 shows you the more popular parts for topics of any hardware-hacking interest. For instance, computers and peripherals have to follow part 15. Telephone interconnection has to obey part 68. Citizens band is part 95, and amateur radio is part 97. And those new direct-broadcasting satellites are now part 100.

There are five volumes in the title 47 series, whose costs range from \$10 to \$20 each. These are arranged as parts 0-19, parts 20-39, parts 40-69, parts 70-79, and parts 80-102. Each volume is a tad over an inch thick.

Typical charges for a registration, certification, or a type approval are usually in the \$300 to \$1500 range, depending on whether any testing is needed. More details on fees appear in parts zero and one.

Meeting FCC specs on your own can be monumentally frustrating and horrendously expensive. Besides taking forever. There are specialists who are willing to help you for a fee. The foremost trade journal for this is called *Compliance Engineering*, and is free to qualified individuals on a letterhead request.

## High-energy resources

Nikola Tesla was certainly one of the greatest hardware hackers of all time. To this day, his developments in the areas of polyphase power distribution and the AC induction motor remain the crucial center to traditional electrical engineering.

Despite these stunning achievements, Tesla is probably more famous today for his work with *Tesla Coils*. Basically a higher frequency transformer used to generate spectacularly high voltages. Voltages that can literally stand people's hair on end.

On the other hand, Tesla was a lousy theoretician, and most of his

explanations of *why* his devices worked often ended up as flat out wrong. Particularly when it came to recognizing the obvious differences between resonant energy *storage* and actual net power *generation*.

Sadly, there have been heaping bunches of mythology and plenty of outright hogwash that seems to have built up around Tesla. After years of careful reading, I have yet to find even the slightest credible shred of evidence that (A) Tesla was an extraterrestrial alien, (B) Tesla invented a unique free-energy perpetual-motion machine, or that (C) All Tesla's *real* inventions got suppressed by a paranoid government conspiracy.

For our resource sidebar this month, I've tried to gather together some of the more useful sources of accurate materials and information on both Tesla and Tesla Coils.

Try the *Tesla Book Company* for a well-done collection on books and publications on and by Tesla that range the gamut from historical fact on down through some utterly absurd few-chips-shy-of-a-full-board fantasy that isn't even wrong.

*Lindsay Publications* also stocks some of the better and more factual titles, as does *Industrial Micro*. Occasional Tesla stories also appear in *Science Probe*.

One leading supplier for museum-quality Tesla systems is *Resonance Research*. Their *Modern Resonance Transformer Design Theory* book is a classic, and they do offer interesting design software and videos.

Good sources for Tesla Coil parts include *Edmund Scientific*, *JerryCo* (now renamed *American Science and Surplus*), and *Surplus Traders*. One newsletter that has lots of hands-on low-end Tesla info in it is *Tec-Spec*. One interesting hacker club is that *Tesla Coil Builder's Association*.

At one time before the personal-computer revolution, building a Tesla coil for a Science Fair was a required rite of passage for any Hardware

## NEED HELP?

Phone or write your **Hardware Hacker** questions directly to:  
Don Lancaster  
**Synergetics**  
Box 809  
Thatcher, AZ 85552  
(602) 428-4073





**KELVIN** Electronics

UP TO **50% OFF**

**LED CENTER**

**PROJECT PARTS**

Kelvin Meters backed by a 2 Yr Warranty - Parts & Labor

**KELVIN DIGITAL MULTIMETERS**

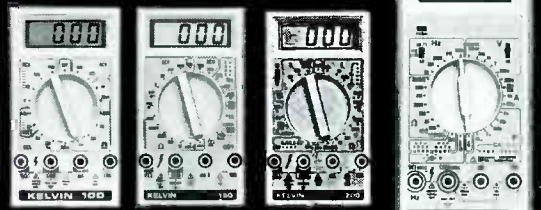

100 Basic	150 Basic+	200 Advanced	PRO 400 with 20MHz Freq Counter
DC VOLTAGE AC VOLTAGE DC CURRENT RESISTANCE CONTINUITY Test - Buzzer DIODE TEST BATTERY TEST 3 1/2 Digit LCD LOW BATTERY ACCURACY ±0.5% RDG <b>KELVIN</b> 100 Basic \$19.95	DC VOLTAGE AC VOLTAGE DC CURRENT RESISTANCE CONTINUITY Test - Buzzer DIODE TEST TRANSISTOR HFE BATTERY TEST 3 1/2 Digit LCD LOW BATTERY ACCURACY ±0.5% RDG <b>KELVIN</b> 150 Basic+ \$29.95	DC VOLTAGE AC VOLTAGE DC CURRENT RESISTANCE CAPACITANCE CONTINUITY Test - Buzzer DIODE TEST TRANSISTOR HFE BATTERY TEST 3 1/2 Digit LCD LOW BATTERY ACCURACY ±0.5% RDG <b>KELVIN</b> 200 Advanced \$39.95	FREQUENCY COUNTER TO 20MHZ IDEAL FOR TROUBLE SHOOTING AC/DC VOLTAGE RANGES AC/DC CURRENT RANGES 5 FREQUENCY RANGES 5 CAPACITANCE RANGES LOGIC TEST CONTINUITY TESTER BUZZER DIODE CHECK TRANSISTOR HFE TEST LED TEST VERIFY GOOD BAD DISPLAY - 3 1/2 DIGIT LCD ACCURACY - 0.5% IMPEDANCE - 10 Mega Ohm <b>KELVIN PRO 400</b> \$69.95

Protective Cases For Models 100, 150, 200 ..... \$4.95 Case For Model Pro 400 .... \$9.95

**DIGITAL TRAINER**

Trainer Manual (100 Pgs) gives detailed instructions. An excellent training tool covering topics for High School (Beginner/Advanced), Trade School (Beginner/Intermediate) & College

A PERFECT FIT WITHIN ANY DIGITAL CURRICULUM & YOUR CLASSROOM TEXTBOOK

**THE KELVIN LDT™ Laptop Digital Trainer**

ONLY **\$99.95**

Stock No. 840460

FREE COMPREHENSIVE TEACHER/STUDENT LAB MANUAL

MADE WITH PRIDE IN THE USA

FEATURES:  
 ■ ONE DIGIT TRUE HEXADECIMAL DISPLAY WITH BUILT IN LOGIC (MEMORY, DECODER, DRIVERS) FULL ALPHA CHARACTERS  
 ■ TWO INDEPENDENT CLOCKS - USER ADJUSTABLE FREQUENCY & DUTY CYCLES  
 ■ BREADBOARD 500 PT PROTO-TYPE AREA  
 ■ TWO POWER DISTRIBUTION BUSES (GND, VCC)  
 ■ 4 DATA BIT SWITCHES  
 ■ MOMENTARY PUSH BUTTON SWITCH (SPDT)  
 ■ 4 LED DISPLAYS w/IC DRIVERS  
 ■ POWER SUPPLY: WALL PLUG-IN TYPE, U.L. LISTED  
 ■ VOLTAGE REG: ±5 VOLTS, SHORT CIR. OVERLOAD PROTECT  
 ■ HOOK-UP WIRES  
 ■ COMPACT CARRYING CASE  
 ■ INSTRUCTION MANUAL FOR BEGINNER TO ADVANCED USERS

**FLUKE 87**

AUTHORIZED DEALER

**FLUKE 70 Series II**

**FLUKE 3 YEAR WARRANTY**

BEST BUY ..... NEW Series II

FLUKE 70 Series II	DISCOUNTED PRICE
FLUKE 70	\$63
FLUKE 73	\$89
FLUKE 75	\$127
FLUKE 77	\$149
FLUKE 79	\$169
FLUKE 83	\$199
FLUKE 85	\$229
FLUKE 87	\$269
FLUKE 86	\$367
FLUKE 88	\$423
FLUKE 8062A	\$329
FLUKE 8060A	\$395
FLUKE 8010A	\$329
FLUKE 8012A	\$359
FLUKE 8050A	\$439
FLUKE 37	\$249
FLUKE 45	\$579

**SCOPES**

20 MHz SCOPE ..... \$345  
Dual Trace 2 Yr Warranty-Parts & Labor



**SCOPE PROBES**

60 MHz, X1 & X10 SPECIAL	
700072	\$18.95
150 MHz, X10	
700073	\$39.95

**BATTERIES**

Duracell / Eveready  
9V Alkaline Battery  
\$1.95 ea  
\$1.75 ea/10+

9V Battery SNAP & HOLDER  
Snap \$.15 ea \$.10 ea/100+  
Holder \$.20 ea \$.10 ea/100+  
HEAVY DUTY NI-CAD RECHARGEABLE BATTERIES

STOCK NO.	TYPE	YOUR COST
220039	AAA	\$3.30 ea
220025	AA	\$2.85 ea
220027	C	\$6.00 ea
220037	D	\$6.00 ea
220038	9V	\$8.90 ea

NI-CAD BATTERY CHARGER  
4 Cell Charger for AAA, AA, C, D or 9V  
STOCK NO. YOUR COST  
220035 SPECIAL \$9.95 ea

**RED LED As Low As 5¢ ea/1000+ Qty**

**JUMBO LED**  
TYPE - T 1 3/4, 5mm  
STOCK NO. YOUR COST 1000+ Qty  
260020 Red \$.06 ea/100+ \$.05 ea  
260027 Green \$.08 ea/100+ \$.07 ea  
260026 Yellow \$.08 ea/100+ \$.07 ea

**LED HOLDER**  
for T 1 3/4 SIZE, BLACK  
Stock No. 250019  
\$.10 ea/100+ Qty  
\$.06 ea/1000+ Qty

**0.37" 7 SEGMENT LED READOUT**  
STOCK NO. TYPE COST 20+ Qty  
260022 Anode \$.95 ea \$.75 ea  
260090 Cathode \$1.25 ea \$.99 ea

**0.6" 7 SEGMENT LED READOUT**  
STOCK NO. Anode Jumbo COST 20+ Qty  
260021 \$1.15 ea \$.99 ea

**RED LED DISPLAY Bar Graph**  
STOCK NO. Color YOUR COST 10+ Qty  
260058 Red \$1.99 ea \$1.79 ea  
260088 Green \$1.99 ea \$1.79 ea  
260089 Yellow \$1.99 ea \$1.79 ea

**MOVING SIGN DISPLAY**  
for Fabricating Your Own Moving Sign Display  
50 mm STOCK NO. 260091  
\$5.95 ea  
\$5.45 ea/20+

**TEST ACCESSORIES**

**IC CLIPS**  
SOLDER TYPE SPRING LOADED  
Stock No. COLOR COST 25+ Qty  
990104 BLACK \$.65 ea \$.50 ea  
990105 RED \$.65 ea \$.50 ea

**IC TEST LEAD SET**  
5 COLOR CODED 18" LEADS WITH MINIATURE HOOK-ON PROD. AT BOTH ENDS  
STOCK NO. YOUR COST 3+ Qty  
990108 \$8.95 ea \$8.25 ea

**DOUBLE BANANA JACK**  
Stock No. YOUR COST 3+ Qty  
600056 \$2.30 ea \$2.07 ea

**FEMALE BNC TO DUAL BANANA PLUG**  
Stock No. YOUR COST 3+ Qty  
990103 \$2.95 ea \$2.75 ea

**DUAL BANANA BINDING POST TO MALE BNC PLUG**  
Stock No. YOUR COST 3+ Qty  
600058 \$5.95 ea \$4.95 ea

**BNC TEST CABLES 3 FT.**  
MALE TO MALE  
Stock No. YOUR COST 3+ Qty  
990101 \$3.45 ea \$2.95 ea

**Soldering IRON**  
with STAND, BLUE LONG LIFE TIP  
Stock No. 990098  
\$4.50 ea

**Project Speaker**  
2" 8 Ohm, 1 Watt  
Stock No. 350009  
59¢

**Project BUZZER**  
3 - 9 Volt DC, 80 db  
Stock No. 680089  
\$1.59 ea  
\$1.39 ea/10+ Qty

**HORN ALARM**  
Loud Penetrating Sound  
Stock No. 640001  
\$.75 ea 9V DC  
\$.69 ea/10+ Qty

**DC MOTOR**  
for SOLAR/ROBOTIC  
Stock No. 852211  
\$.50 ea 1.5 to 6VDC  
\$.45 ea/20+ Qty

**XENON STROBE TUBE**  
Stock No. 260050  
\$2.95 ea  
\$2.50 ea/20+ Qty

**TRIGGER COIL**  
for Xenon Strobe Tube  
Stock No. 320037  
\$1.25 ea  
\$.89 ea/20+ Qty

**INFRARED LED**  
IR Pair, LED infrared transmitter and receiver  
Stock No. 260061  
\$2.79 ea

**NEON LAMP**  
NE2, Long Leads  
Stock No. 260003  
\$.15 ea  
\$.12 ea/100+ Qty

**PHOTO CELL**  
CADMIUM SELENIDE  
Stock No. 260017  
\$.99 ea  
**PHOTO CELL**  
SULPHIDE  
Stock No. 260018  
\$.99 ea

**PUSH-BUTTON SWITCH**  
PUSH-ON, PUSH-OFF  
Stock No. 270021  
\$.55 ea  
\$.49 ea/100+ Qty

**SUB-MINIATURE MOMENTARY SWITCH**  
Stock No. 990002  
\$.35 ea  
\$.28 ea/100+ Qty

**MINIATURE TOGGLE SWITCH**  
Stock No. 270034  
\$.90 ea Type - SPST  
\$.79 ea/50+ Qty

**WALL TRANSFORMERS**

**WALL TRANSFORMER**  
STOCK NO. TYPE - Female  
220069 9V DC/500 mA ..... \$3.95 ea  
220068 12V DC/500 mA ..... \$4.25 ea

**MALE JACK**  
STOCK NO. TYPE  
370048 2.1 mm Male  
\$.49 ea ..... \$.39/10+

**BREADBOARDS**

Stock No.	TYPE	Contacts	your cost
680093	0	500	\$ 4.25
680097	0	840	\$ 5.95
680098	2	1380	\$11.75
680100	4	2390	\$22.95

**WIRE JUMPER KIT**  
Pre-cut, Pre-Stripped  
330289 140 Piece Set ... \$ 4.75  
330290 350 Piece Set ... \$ 7.75

**COMPONENTS**

Stock No.	TYPE	YOUR COST
600021	555 TIMER	\$.20 EA
600029	556 DUAL TIMER	\$.40 EA
600039	LM566 PLL FUNCTION GENERATOR	\$.60 EA
600018	741C OP-AMP INTERNALLY COMPENSATED	\$.30 EA
600026	1458 OP-AMP DUAL 741C OP-AMP DIP	\$.35 EA
630041	2N2222	\$.18 EA
630383	PN2222	\$.08 EA
600023	7805 VOLTAGE REG	\$.36 EA
SILICON CONTROLLED RECTIFIER (Similar to GE C106C1) 4.0 AMP, 100 PIV		
600014		\$.89 EA \$ .79 EA/50+

**KELVIN ELECTRONICS**

CIRCLE RESPONSE CARD or WRITE for our CATALOG full of WHOLESALE PRICED ITEMS.

OVER 10,000 ITEMS IN STOCK

ELECTRONIC COMPONENTS & TECHNOLOGY ACTIVITIES  
VISA & MASTERCARD ACCEPTED \$20 MINIMUM ORDER MINIMUM FREIGHT \$5

**KELVIN** Electronics

Call: 1 (800) 645-9212  
1 (516) 349-7620  
FAX: 1 (516) 349-7830

7 Fairchild Avenue, Plainview, NY 11803

Hacker. Although these induction coils can still be spectacular and lots of fun, they are really nothing but an oversize auto ignition coil or a TV flyback transformer.

For smaller demos, it makes far more sense to hang a voltage multiplier on a color-TV flyback than it does to build a Tesla coil from scratch.

Outside of the science museums, induction coils just aren't that big a deal any more. Not to mention the incredible radio and television interference that a sloppily done Tesla coil generates. Or all of the very real X-ray dangers.

Is there any point in hacking ultra-high voltages? Most electrical (or "E") fields have a magnetic (or "H") field associated with them. In theory, you could build up your motors and generators using only the electric field, using only the magnetic field, or using any combination of the two. But look around you, and you'll find just about every common motor or generator is a magnetic one that uses the H field nearly exclusively. The only ob-

Part 0	Structure and organization of the FCC.
Part 1	Rules, fees, certification, type approval.
Part 2	Frequency spectrum allocations.
Part 5	Experimental radio services.
Part 13	Commercial radio operations.
Part 15	Radio frequency devices (includes computers, peripherals).
Part 18	Industrial and medical equipment.
Part 21	Public service fixed communications.
Part 22	Public service mobile communications.
Part 23	Shortwave broadcasting.
Part 25	Satellite communications.
Part 68	Telephone terminal equipment.
Part 73	AM and FM broadcasting.
Part 74	Auxiliary AM and FM broadcasting links.
Part 78	CATV cable television.
Part 80	Maritime and shipping communications.
Part 87	Aviation communications.
Part 90	Private mobile services.
Part 94	Microwave relay.
Part 95	Personal and CB citizens bands.
Part 97	Amateur radio.
Part 99	Disaster and emergencies.
Part 100	DBS Direct broadcast satellites.

FIG. 1—FEDERAL COMMUNICATIONS COMMISSION regulations are presented in title 47 of the Code of Federal Regulations. Here are how the more useful and popular parts are arranged.

vious exceptions that prove the rule are such nanopower niche items as piezo fans.

Most previous hackers who have explored the E field have now found electric field machinery to be extremely large in size, besides having unacceptably low power densities and even lower efficiencies. To this day, creating the insulation materials, the surface treatments, and the vacuum needed to support ultra strong E fields remains a very difficult problem to solve.

On the other hand, for free energy, all you need is an insulated stationary vertical antenna several miles high to tap the Earth's 100-volts-per-meter calm-day E field. Then you hack up some sort of efficient DC-DC down-converter at the bottom.

Uh Huh. Sure.

### 5 volts from a AA cell

Fortunately, a lot more genuine progress has been made by going the other way, stepping up the voltage of one or two AA cells into the + 5 volts needed by most of today's digital logic projects.

Maxim has a new MAX-655 chip and a handy 655-EV evaluation kit that goes for \$25. The kit includes the printed circuit board and all the parts you'll need to step a pair of AA cells up to a regulated +5-volts DC at currents of 170 mA or less.

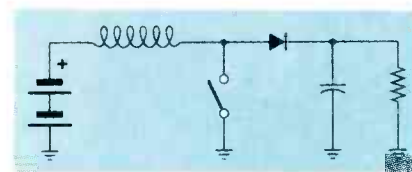

FIG. 2—A SWITCHING MODE step-up converter. Briefly but repetitively closing the switch causes the current in the inductor to ramp up to a high value. On release, the high current is transferred to the load resistor, appearing as a voltage that is always higher than the input. The switching duty cycle sets the amount of voltage step-up you will get.

Figure 2 shows you a type of switching-mode power supply called a *step-up* converter. If you do not close the switch, the output voltage will equal the battery voltage, minus the voltage drop across the diode. If you *briefly* close the switch, the current in the inductor will start increasing at a linear rate.

When you open the switch, the higher current in the inductor will be forced into the load and stored by the output capacitance. By carefully changing your on-off duty cycle, you can provide any output voltage that is *higher* than the input battery voltage.

There is one problem with this classic circuit when it comes to low input voltages. A MOSFET switch likes to have ten or more volts on its gate to give you an acceptably low turn-on resistance. To beat this, the MAX655

## NEW FROM DON LANCASTER

### HARDWARE HACKER STUFF

Hardware Hacker Reprints II or III	24.50
Midnight Engineering Reprints	16.50
Incredible Secret Money Machine	15.50
CMOS Cookbook	24.50
TTL Cookbook	19.50
Active Filter Cookbook	19.50
Micro Cookbook vol I or II	19.50
Lancaster Classics Library	119.50
Enhancing your Apple I or II	17.50
AppleWriter Cookbook	19.50
Enhance I or II Companion Disk	19.50
AppleWriter CB or Assy CB Disk	24.50
Bakerizing film (25 sheets)	14.50

### POSTSCRIPT STUFF

Ask The Guru Reprints I, II or III	24.50
LaserWriter Secrets (IIe/Mac/PC)	29.50
PostScript Show & Tell	39.50
Intro to PostScript VHS Video	39.50
PostScript Beginner Stuff	39.50
PostScript Cookbook (Adobe)	16.50
PostScript Ref. Manual II (Adobe)	28.50
PostScript Program Design (Adobe)	22.50
Type I Font Format (Adobe)	15.50
LaserWriter Reference (Apple)	19.50
Real World Postscript (Roth)	22.50
PostScript Visual Approach (Smith)	22.50
Thinking in PostScript (Reid)	22.50
The Whole Works (all PostScript)	299.50

FREE VOICE HELPLINE

VISA/MC

## SYNERGETICS

Box 809-RE  
Thatcher, AZ 85552  
(602) 428-4073



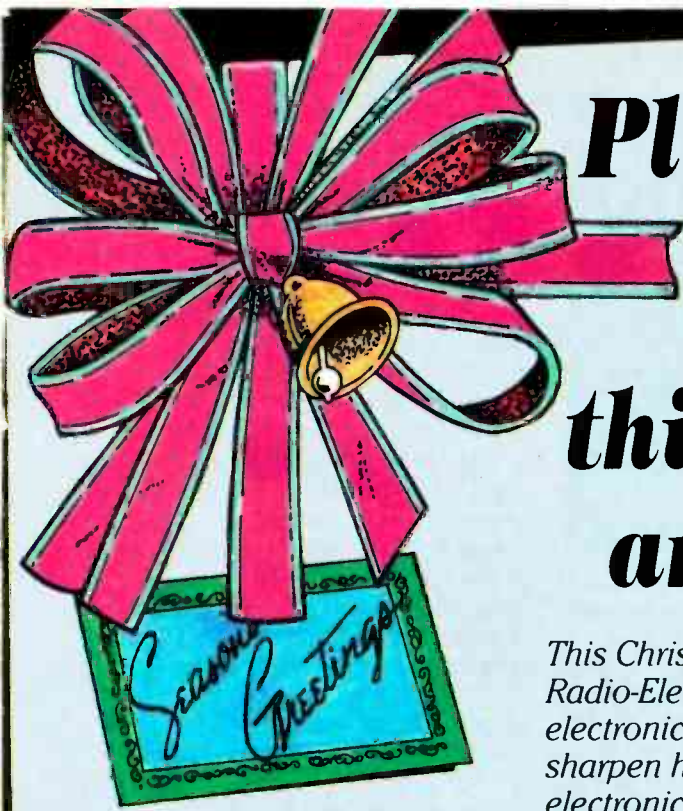

# Plug a Friend into **Radio Electronics®** this Christmas ... and Save \$19.43!

*This Christmas give an electrifying gift ... plug a friend into Radio-Electronics and brighten his whole new year! Whether electronics is his livelihood or his hobby, your gift will sharpen his focus and illuminate the whole spectrum of electronics throughout the coming year.*

Radio-Electronics will keep him informed and up-to-date with new ideas and innovations in all areas of electronic technology ... computers, video, radio, stereo, solid state technology, satellite TV, industrial and medical electronics, communications, robotics, and much, much more.

He'll get great plans and printed circuit patterns for great electronic projects. In just the last year, Radio-Electronics has presented voice scramblers, video switchers, frequency standards, wireless audio links, radiation monitors, function generators, and much more.

In coming issues, Radio-Electronics will present practical, educational, and money-saving projects like: a helium-neon laser ... a lighting controller ... a video timebase corrector ... a video noise processor ... a light-beam communicator ... an antenna amplifier ... and many others!

PLUS ... equipment troubleshooting techniques ... circuit design ... reports on new technology and new products ... equipment test reports ... in-depth coverage on computers, video, audio, shortwave radio ... and lots more exciting features and articles.

SAVE \$19.43\* ... OR EVEN \$38.86\* ... For each gift of Radio-Electronics you give this Christmas, you save a full \$19.43\* off the newsstand price. And as an R-E gift donor, you're entitled to start or extend your own subscription at the same Special Holiday Gift Rate —you save an additional \$19.43\*!

No need to send money ... if you prefer, we'll hold the bill till January, 1992. But you must rush the attached Gift Certificate to us to allow time to process your order and send a handsome gift announcement card, signed with your name, in time for Christmas.

So do it now ... take just a moment to fill in the names of a friend or two and mail the Gift Certificate to us in its attached, postage-paid reply envelope. That's all it takes to plug your friends into a whole year of exciting projects and new ideas in Radio-Electronics!

\*Basic sub rate — 1 yr/\$17.97 2 yrs/\$34.97

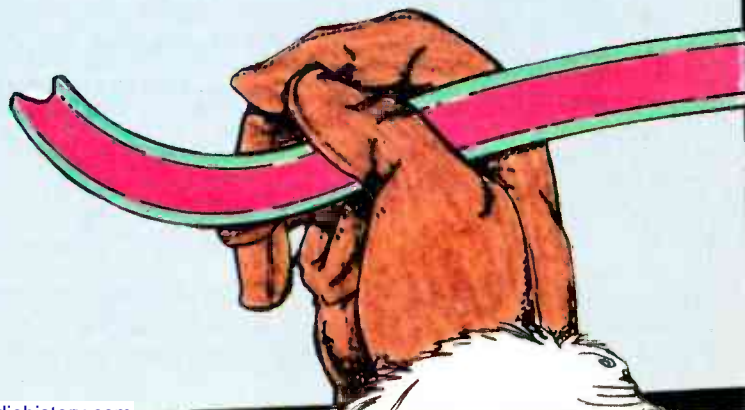

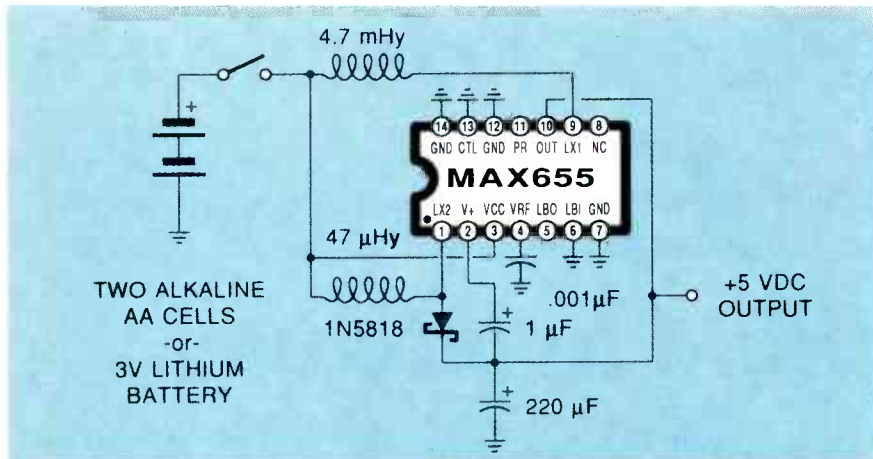

**FIG. 3—THIS MAXIM POWER-SUPPLY KIT gives you a tightly regulated +5 volts DC at 170 milliamps or less from a pair of ordinary alkaline AA cells. The secret is a second internal switching regulator that gets used to raise the efficiency of the main one. Do not substitute the recommended inductors or the Schottky diode.**

has two step-up converters in it. The first one generates a low current and high voltage that gives the switch in the main converter a low enough turn-on resistance.

Take a look at the circuit in Fig. 3. This is what a model hobbyist would call a *shake-the-box* kit. Just drop the parts in place, being careful to watch the polarity, solder it up, and away you

go. Assembly time should be around nine minutes. I suggest adding your own 14-pin IC socket, rather than actually soldering the regulator in place. This is an ideal first hardware hacking project.

One warning: The two inductors and the Schottky diode are critical. If you do not choose *exactly* the parts supplied by *Maxim* or their *exact* rec-

ommended substitutes, your circuit can end up either inefficient or not work at all. Random junkbox inductors tend to have too high a DC resistance and often saturate far too easily to be useful.

Fortunately, all three of them are cheap parts. In quantity, the entire supply can cost well under \$6.

*Maxim* also offers a MAX654 that runs on a *single* AA cell and can start at an incredibly low 1.15 volts.

By the way, AA flashlight cells provide considerably more energy at lower costs in less volume than by using a 9-volt battery. Except when you need ultra-low currents for a very long time. Which gives the 9-volt approach a slight edge. More on this in the free *Maxim Design News*.

As the first of our two contests this month, just tell me what you'd do with an AA-cell-to-+5-VDC converter.

### Smoothing fuzzy data

Every once in a while, I like to take time out and play with pure math. I do this by just shoving some numbers into a computer or laser printer and seeing where it can lead. In the past, this has gotten me into such useful wonderments as the pseudorandom sequences, equally tempered music, *Fourier* synthesis, fractal ferns, stock market analysis, quadrature art, non-linear transforms, Bézier secrets, phase plane plots, wavelets, and, of course, the avuncular sleezoids.

I overwhelmingly prefer to use the *PostScript* language for this. Besides the absolutely unbeatable graphics, *PostScript* is a totally general-purpose computer language that can do most anything that *Basic* or *C* can. And often do so in a simpler and far more obvious manner—besides being lots of fun and very easy to understand.

One fairly common hardware-hacking problem is taking a bunch of sloppy data points and drawing a smooth curve through them. You might want to do this for a lab report, to produce an engineering data curve, or to try and convert some noisy bitmap, scanned, or hand-coded input into smooth outline typography.

Some samples of smoothed data points are shown in Fig. 4, while the hairy-looking equations appear in Fig. 5. You can get the documented *PostScript* code all ready to run as my file #294 FUZZYFIT.PS on *GENIE* PSRT. Typical downloading costs

NO COMPLICATED ELECTRONICS, NO EXPENSIVE INSTRUMENTS:

## Home study course shows you how to make good money in VCR repair.

An amazing fact: you can do more than four out of five VCR repairs with ordinary tools and basic fix-it procedures. Our home study program shows you how.

Learn all of the systems, mechanisms, and parts of almost all brands of VCRs. With *no* expensive instruments. *No* complicated electronics. *No* fancy workshop. The step-by-step texts and close personal attention from your instructor make learning easy.



Texts, course materials, and tool kit are sent to your home. Graduate ready to make up to \$50.00 or more per hour in your own spare-time or full-time business.

**Send today for your free career booklet. Or call 800-223-4542**

Name \_\_\_\_\_  
 Address \_\_\_\_\_  
 City \_\_\_\_\_ State \_\_\_\_\_ Zip \_\_\_\_\_

### The School of VCR Repair

2245 Perimeter Park, Dept. VL342, Atlanta, Georgia 30341



**48 HOUR SHIPPING**

# ELENCO & HITACHI PRODUCTS AT DISCOUNT PRICES

**48 HOUR SHIPPING**

## Hitachi RSO Series

(Portable Real-time Digital Storage Oscilloscopes)

VC-6023 - 20MHz, 20MS/s	\$99/mo*
VC-6024 - 50MHz, 20MS/s	\$120/mo*
VC-6025 - 50MHz, 20MS/s	\$135/mo*
VC-6045 - 100MHz, 40MS/s	\$125/mo*
VC-6145 - 100MHz, 100MS/s	\$200/mo*

RSOs from Hitachi feature roll mode, averaging, save memory, smoothing, interpolation, pretriggering, cursor measurements. These scopes enable more accurate, simpler observation of complex waveforms, in addition to such functions as hardcopy via a plotter interface and waveform transfer via the RS-232C interface. Enjoy the comfort of analog and the power to digital.

## 20MHz Elenco Oscilloscope

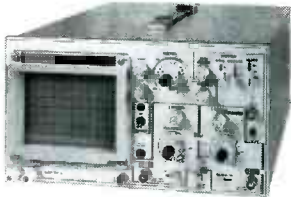

**\$375**  
MO-1251

- Dual Trace Component Tester
- 6" CRT
- X-Y Operation
- TV Sync
- 2 P-1 Probes

## LEASING AVAILABLE

For all Hitachi Scopes - Call for details

\* Based on 24 months except V-1150, VC-6045, VC-6145 (36 months)

## Hitachi Portable Scopes

DC to 50MHz, 2-Channel, DC offset function, Alternate magnifier function

V-525 - CRT Readout, Cursor Meas.	\$1,025
V-523 - Delayed Sweep	\$995
V-522 - Basic Model	\$895
V-422 - 40MHz	\$795
V-223 - 20MHz delayed sweep	\$695
V-212 - 20MHz	\$425

## HITACHI COMPACT SERIES SCOPES

This series provides many new functions such as CRT Readout, Cursor measurements (V-1085/1065/665), Frequency Ctr (V-1085), Sweeptime Autoranging, Delayed sweep and Tripper Lock using a 6-inch CRT. You don't feel the compactness in terms of performance and operation.

V-660 - 60MHz, Dual Trace	\$1,195
V-665 - 60MHz, DT, w/cursor	\$1,345
V-1060 - 100MHz, Dual Trace	\$1,425
V-1065 - 100MHz, DT, w/cursor	\$1,055/mo*
V-1085 - 100MHz, QT, w/cursor	\$125/mo*
V-1100A - 100MHz, Quad Trace	\$125/mo*
V-1150 - 150MHz, Quad Trace	\$115/mo*

## Elenco 35MHz Dual Trace

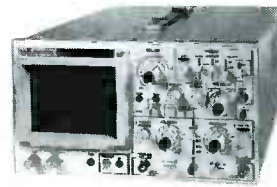

Good to **\$495**  
50MHz  
MO-1252

- High luminance 6" CRT
- 1mV Sensitivity
- 6KV Acceleration Voltage
- 10ns Rise Time
- X-Y Operation • Z Axis
- Delayed Triggering Sweep
- Includes 2 P-1 Probes

## FREE DMM with purchase of ANY SCOPE

**SCOPE PROBES**  
P-1 65MHz, 1x, 10x \$19.95  
P-2 100MHz, 1x, 10x \$26.95

All scopes include probes, schematics, operators manual and 3 year (2 yrs for Elenco scopes) world wide warranty on parts & labor. Many accessories available for all Hitachi scopes. Call or write for complete specifications on these and many other line oscilloscopes.

## Beckman TEST EQUIPMENT

All Models Available

### Digital Capacitance Meter



CM-1550B  
**\$58.95**  
9 Ranges  
.1pf-20,000ufd  
5% basic accy.  
Zero control w/ Case  
Big 1" Display

### Digital LCR Meter



LC-1801  
**\$125**  
Measures:  
Coils 1uH-200H  
Caps .1pf-200uf  
Res .01-20M



Multimeter with Capacitance & Transistor Tester  
**\$55** CM-1500B  
Reads Volts, Ohms  
Current, Capacitors,  
Transistors and  
Diodes / with case

## FLUKE MULTIMETERS

All Models Available

### Quad Power Supply



XP-580  
**\$59.95**  
2-20V @ 2A  
12V @ 1A  
5V @ 3A  
-5V @ .5A

Fully regulated and short circuit protected

### Triple Power Supply



XP-620  
Assembled \$69  
Kit \$45  
2 to 15V @ 1A,  
-2 to -15V @ 1A  
(or 4 to 30V @ 1A  
and 5V @ 3A)

All the desired features for doing experiments. Features short circuit protection, all supplies

### AM/FM Transistor Radio Kit with Training Course

Model AM/FM 108  
**\$26.95**

14 Transistors • 5 Diodes  
Makes a great school project



True RMS 4 1/2 Digit Multimeter  
M-7000  
**\$135**  
.05% DC Accuracy  
.1% Resistance  
with Freq. Counter  
and Deluxe Case

### GF-8016 Function Generator with Freq. Counter



**\$249**

Sine, Square, Triangle  
Pulse, Ramp, 2 to 2MHz  
Freq Counter .1 - 10MHz

GF-8015 without Freq. Meter \$179

### Function Generator Blox

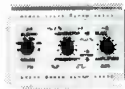

#9600  
**\$28.95**

Provides sine, triangle, square wave from 1Hz to 1MHz  
AM or FM capability

## MOVIT EDUCATIONAL ELECTRONIC ROBOT KITS

The MOVIT line is a series of computerized (and logic controlled) battery robot kits that can teach the basic principles of robotic sensing and locomotion. Each of the kits features pre-assembled PC boards, hardware and mechanical-drive systems that can be handled by almost anyone from ages 10 and up. Only basic hand tools are required for assembly. These fascinating robots allow you to experience and learn any one of the following features: sound sensor, remote control, infra-red sensor, wired control and / or programmable memory. The MOVIT line has provided the future with an innovative electronic educational kit. They are affordable robots that can entertain as well as educate. Now meet the family!



MV-912 Avoider Infra-red	\$45.95	MV-939 Medusa Sound Sensor	\$29.95
MV-915 Piper mouse Sound Sensor	\$45.95	MV-963 Line Tracker Infra-red	\$45.95
MV-916 Peppy Sound Touch	\$25.95	MV-966 Manta Sound/Touch	\$29.95
MV-931 Mr. Bootsman Wire Control	\$35.95	Y-01 Robotic Arm Robotic Control	\$45.95
MV-932 Catrat Remote Control	\$45.95	BT-802 Grand Piano Electronic Piano	\$29.95
MV-936 S-Cargo Sound Sensor	\$45.95	BT-805 Roulette Digital Wheel	\$35.95

### Learn to Build and Program Computers with this Kit

Includes: All Parts, Assembly and Lesson Manual



Model  
MM-8000  
**\$129.00**

Starting from scratch you build a complete system. Our Micro-Master trainer teaches you to write into RAMs, ROMs and run a 8085 microprocessor, which uses similar machine language as IBM PC

Robotics Kit for above (MM8010) 71.95

### Wide Band Signal Generators



SG-9000 \$129  
RF Freq 100K-450MHz AM Modulation of 1KHz Variable RF output  
SG-9500 w/ Digital Display & 150MHz built-in Counter \$249

WE WILL NOT BE UNDERSOLD!

UPS Shipping: 48 States 5%  
(\$3 Min \$10 Max) Shipping  
IL Res., 7% Tax FAX: 708-520-0085

**C & S SALES INC.**  
1245 Rosewood, Deerfield, IL 60015  
(800) 292-7711 (708) 541-0710



**15 Day Money Back Guarantee**  
**2 Year Warranty** Prices Subject to Change  
**WRITE FOR FREE CATALOG**

CIRCLE 109 ON FREE INFORMATION CARD

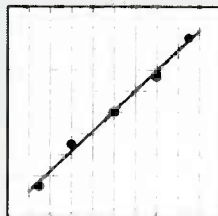

LINEAR  
(first order)

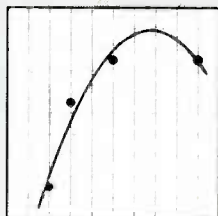

QUADRATIC  
(second order)

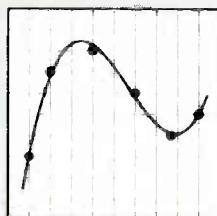

CUBIC  
(third order)

FIG. 4—SMOOTH CURVES CAN be quickly and drawn through fuzzy or noisy engineering data by using the PostScript language and the least squares fitting method. Here are three popular types of curves which can give good fits to many hardware hacking problems.

(A) The **LINEAR** or **FIRST ORDER** least squares fit uses an equation of...

$$y = a_1x + a_0$$

Here are the two linear equations in two unknowns that you need to solve to get the best fit for your data...

$$(\text{sum}x^1)a_1 + (\#\text{pts})a_0 = (\text{sum}y)$$

$$(\text{sum}x^2)a_1 + (\text{sum}x^1)a_0 = (\text{sum}x^1y)$$

(B) The **QUADRATIC** or **SECOND ORDER** fit uses an equation of...

$$y = a_2x^2 + a_1x + a_0$$

Here are the three linear equations in three unknowns that you need to solve to get the best fit for your data...

$$(\text{sum}x^2)a_2 + (\text{sum}x^1)a_1 + (\#\text{pts})a_0 = (\text{sum}y)$$

$$(\text{sum}x^3)a_2 + (\text{sum}x^2)a_1 + (\text{sum}x^1)a_0 = (\text{sum}x^1y)$$

$$(\text{sum}x^4)a_2 + (\text{sum}x^3)a_1 + (\text{sum}x^2)a_0 = (\text{sum}x^2y)$$

(C) The **CUBIC** or **THIRD ORDER** least squares fit uses an equation of...

$$y = a_3x^3 + a_2x^2 + a_1x + a_0$$

Here are the four linear equations in four unknowns that you need to solve to get the best fit for your data...

$$(\text{sum}x^3)a_3 + (\text{sum}x^2)a_2 + (\text{sum}x^1)a_1 + (\#\text{pts})a_0 = (\text{sum}y)$$

$$(\text{sum}x^4)a_3 + (\text{sum}x^3)a_2 + (\text{sum}x^2)a_1 + (\text{sum}x^1)a_0 = (\text{sum}x^1y)$$

$$(\text{sum}x^5)a_3 + (\text{sum}x^4)a_2 + (\text{sum}x^3)a_1 + (\text{sum}x^2)a_0 = (\text{sum}x^2y)$$

$$(\text{sum}x^6)a_3 + (\text{sum}x^5)a_2 + (\text{sum}x^4)a_1 + (\text{sum}x^3)a_0 = (\text{sum}x^3y)$$

(D) For **QUARTIC** or **HIGHER ORDER** least square polynomial fits, just extend the math in the obvious direction for  $n$  linear equations in  $n$  unknowns. Solve for the coefficients. Little is usually gained by going beyond a third order polynomial. Especially in two dimensions.

(E) For least square fits to **OTHER EQUATIONS**, write out the least squares error equation. Then take partial derivatives with respect to each coefficient and set them to zero. This again leads to  $n$  linear equations in  $n$  unknowns.

FIG. 5—HERE IS THE "MAGIC" MATH behind least squares curve fitting. My FUZZYFIT.PS PostScript program on GENIE PSRT does it all for you quickly and painlessly. Just shove in the raw fuzzy data and out pops a smooth curve.

should be around twenty cents.

The best curve for any noisy data usually uses what is called a *least squares* fit. All that means is that you

try to spread the errors out as evenly as you can. Your main reason for squaring is to make all the errors positive, even if the data point lies

## HIGH-ENERGY RESOURCES

### American Science & Surplus

601 Linden Place  
Evanston, IL 60202  
(708) 475-8440  
CIRCLE 301 ON FREE INFORMATION CARD

### Edmund Scientific

101 East Gloucester Pike  
Barrington, NJ 08007  
(609) 573-6250  
CIRCLE 302 ON FREE INFORMATION CARD

### Industrial Micro

Box 596  
Logan, UT 84321  
(800) 359-0466  
CIRCLE 303 ON FREE INFORMATION CARD

### Lindsay Publications

PO Box 12  
Bradley, IL 60915  
(815) 935-5353  
CIRCLE 304 ON FREE INFORMATION CARD

### Resonance Research

E11870 Shady Lane Road  
Baraboo, WI 53913  
(608) 356-3647  
CIRCLE 305 ON FREE INFORMATION CARD

### Science Probe

500-B Bi-County Blvd  
Farmingdale, NY 11735  
(516) 293-0467  
CIRCLE 306 ON FREE INFORMATION CARD

### Surplus Traders

Winters Lane, Box 276  
Alburg, VT 05440  
(514) 739-9328  
CIRCLE 307 ON FREE INFORMATION CARD

### TecSpec

3 Mine Mountain Road  
Cornwall Bridge, CT 06754  
(203) 672-0123  
CIRCLE 308 ON FREE INFORMATION CARD

### Tesla Book Co

Box 121873  
Chula Vista, CA 91912  
(805) 646-3371  
CIRCLE 309 ON FREE INFORMATION CARD

### Tesla Coil Builder's Assoc

3 Amy Lane  
Queensbury, NY 12804  
(518) 792-1003  
CIRCLE 310 ON FREE INFORMATION CARD

below the curve you are fitting.

You have lots of choices of what type of curve to fit to your data.

One class of curves that make good fits to typical engineering graphs and most typography are usually called *polynomials*. These sometimes will also go by the name of a *Power Series Approximation*.





**THE MODEL WTT-20 IS ONLY THE SIZE OF A DIME**, yet transmits both sides of a telephone conversation to any FM radio with crystal clarity. Telephone line powered - never needs a battery! Up to ¼ mile range. Adjustable from 70-130 MHz. Complete kit **\$29.95 + \$1.50 S+H**. Free Shipping on 2 or more! COD add \$4. Call or send VISA, MC, MO. **DECO INDUSTRIES, Box 607, Bedford Hills, NY 10507. (914) 232-3878.**

CIRCLE 127 ON FREE INFORMATION CARD

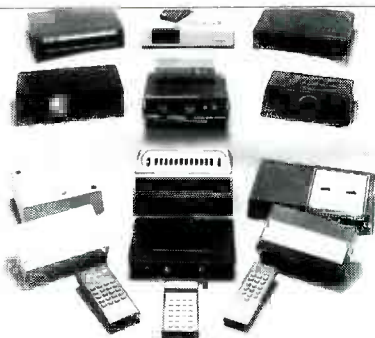

**CABLE TV CONVERTERS AND DE-SCRAMBLERS** SB-3 **\$79.00** TRI-BI **\$95.00** MLD-**\$79.00** M35B **\$69.00** DRZ-DIC **\$149.00**. Special combos available. We ship COD. Quantity discounts. Call for pricing on other products. Dealers wanted. **FREE CATALOG**. We stand behind our products where others fail. One year warranty. **ACE PRODUCTS, P.O. Box 582, Saco, ME 04072 1 (800) 234-0726.**

CIRCLE 75 ON FREE INFORMATION CARD



**FREE CATALOG OF TEST INSTRUMENTS & TOOLS** is packed with thousands of products for testing, repairing, and assembling electronic equipment. Featured are brand name instruments such as Fluke, Tektronix, Leader, Weller, 3M plus many more. Also included are DMM's, hand tools, power supplies, tool kits, test equipment, static supplies plus many other new products. Orders placed by 4 PM are shipped before we go home! **CONTACT EAST, 335 Willow St., No. Andover, MA 01845. (508) 682-2000, Fax: (508) 688-7829.**

CIRCLE 55 ON FREE INFORMATION CARD



**GET YOUR RECHARGE CATALOG FREE...EARN BIG \$\$ IN YOUR SPARE TIME**—All supplies and Do-It-Yourself kits with complete instructions available. Supplies cost from **\$9.95** in qty and you can sell recharged toner cartridges for **\$40.00** to **\$55.00** each. Printers include HP LaserJet and Series II, Apple LaserWriter, QMS, etc. Canon PC-25 Copier also. **CHENESKO PRODUCTS, 2221 Fifth Ave., Suite #4, Ronkonkoma, NY 11779, 516-467-3205.**

CIRCLE 192 ON FREE INFORMATION CARD

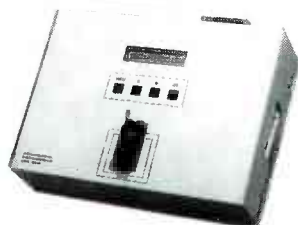

**9850/9850UV PERSONAL E/EEPROM PROGRAMMERS**—Simple function key operations. Programs 2716 to 27513 EPROMs and 2804 to 28256 EEPROMs. Stand-alone or PC remote operation. Programming algorithms: Standard, Intelligent, Interactive and Quick Pulse. Data file formats: INTEL Hex, Binary, Motorola S, and Tektronix Hex. Programming functions: Read, Program, Auto, Blank Check and Verify. Model 9850UV contains built-in UV Eraser. (9850UV). 9850(**\$395**); 9850UV(**\$445**). **AMERICAN RELIANCE INC.—9952 E. Baldwin Place, El Monte, CA 91731. (800) 654-9838.**

CIRCLE 176 ON FREE INFORMATION CARD

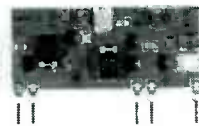

**5 MINUTE ASSEMBLY! MONEYBACK GUARANTEE!** Attach the VT-75 chip to any 3V-12V battery and you have the most powerful miniature transmitter you can buy *anywhere*. Tiny Law Enforcement grade device allows you to hear every sound—even footsteps—over 1 mile away on any FM radio or wideband scanner. 80-130MHz. 100mW output! VT-75 microtransmitter complete **\$49.95 + \$1.50 S & H**. Visa, MC, MO. COD's add \$4.00. **DECO INDUSTRIES, Box 607, Bedford Hills, NY 10507. 1-800-759-5553.**

CIRCLE 127 ON FREE INFORMATION CARD

## CALL NOW AND RESERVE YOUR SPACE

- 6 × rate \$940.00 per each insertion.
- Fast reader service cycle.
- Short lead time for the placement of ads.
- We typeset and layout the ad at no additional charge.

Call **516-293-3000** to reserve space. Ask for Arline Fishman. Limited number of pages available. Mail materials to: mini-ADS, RADIO-ELECTRONICS, 500-B Bi-County Blvd., Farmingdale, NY 11735.

FAX: 516-293-3315

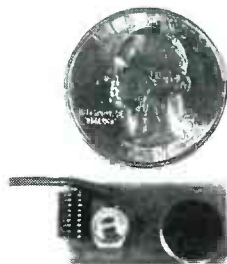

**NEW XST500 SUPER-MINIATURE FM** transmitter uses Surface Mount Technology (SMT)! Own the smallest high performance FM transmitter available. Transmits whispers to any FM receiver up to a mile away. Uses 9V battery. Complete, easy to assemble kit, with SMT components already assembled to circuit board. **\$39.95** Cash, VISA, MC. COD add \$5. **XANDI ELECTRONICS, 201 E. Southern Ave., Suite 114, Tempe, AZ 85282. 1-602-829-8152, (1-800-336-7389 orders only).**

CIRCLE 183 ON FREE INFORMATION CARD

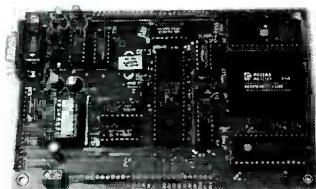

**CREATE INTELLIGENT PROJECTS WITH THE VERSATILE Z8 PROGRAMMABLE MICROCOMPUTER.** This powerful computer was designed for flexibility and can be used for various electronic projects. I/O Intensive. Up to 20MHz operation. Download programs or run EPROM code. Special hardware features included. Prices from **\$125.00**. Battery-backed RAM, X-assembler, and other options available. **CALL FOR FREE BROCHURE. MJS DESIGNS, INC., 1438 W. Broadway Rd., Suite B185, Tempe, AZ 85282. (602) 966-8618.**

CIRCLE 196 ON FREE INFORMATION CARD

## NAMES AND NUMBERS

### Compliance Engineering

629 Massachusetts Avenue  
Boxborough, MA 01719  
(508) 264-4208  
CIRCLE 311 ON FREE INFORMATION CARD

### Cypress Semiconductor

3901 North First Street  
San Jose, CA 95134  
(408) 943-2600  
CIRCLE 312 ON FREE INFORMATION CARD

### Fisher-Klosterman

PO Box 11190  
Louisville, KY 40251  
(502) 776-1505  
CIRCLE 313 ON FREE INFORMATION CARD

### GENie

401 North Washington Street  
Rockville, MD 20850  
(800) 638-9636  
CIRCLE 314 ON FREE INFORMATION CARD

### IC Sensors

1701 McCarthy Blvd  
Milpitas, CA 95035  
(408) 432-1800  
CIRCLE 315 ON FREE INFORMATION CARD

### Maxim

120 San Gabriel Drive  
Sunnyvale, CA 94086  
(408) 737-7600  
CIRCLE 316 ON FREE INFORMATION CARD

### Motortronics

120 South Chaparral, Court #200  
Anaheim, CA 92808  
(714) 283-1123  
CIRCLE 317 ON FREE INFORMATION CARD

### Motorola

5005 East McDowell Road  
Phoenix, AZ 85008  
(800) 521-6274  
CIRCLE 318 ON FREE INFORMATION CARD

### Nova Sensor

1055 Mission Court  
Fremont, CA 94539  
(415) 490-9100  
CIRCLE 319 ON FREE INFORMATION CARD

### NTE Electronics

44 Farrand Street  
Bloomfield, NJ 07003  
(201) 748-5089  
CIRCLE 320 ON FREE INFORMATION CARD

### PMI

1500 Space Park Drive  
Santa Clara, CA 95052  
(800) 843-1515  
CIRCLE 321 ON FREE INFORMATION CARD

### Powertechnics

120 South Chaparral Court #200  
Anaheim, CA 92808  
(714) 283-1123  
CIRCLE 322 ON FREE INFORMATION CARD

### Printed Circuit Design

2000 Powers Ferry Center, S450  
Marietta, GA 30067  
(404) 952-1303  
CIRCLE 323 ON FREE INFORMATION CARD

### SenSym

1255 Reamwood Avenue  
Sunnyvale, CA 94089  
(408) 744-1500  
CIRCLE 324 ON FREE INFORMATION CARD

### Signetics/Phillips

811 East Arques Avenue  
Sunnyvale, CA 94088  
(408) 991-2000  
CIRCLE 325 ON FREE INFORMATION CARD

### Synergetics

Box 809-RE  
Thatcher, AZ 85552  
(602) 428-4073  
CIRCLE 326 ON FREE INFORMATION CARD

### US Government Bookstore

720 North Main Street  
Pueblo CO 81003  
(719) 544-3142  
CIRCLE 327 ON FREE INFORMATION CARD

### Zilog

210 East Hacienda Avenue  
Campbell, CA 95008  
(408) 370-8000  
CIRCLE 328 ON FREE INFORMATION CARD

will immediately recognize this minimization process as taking the *partial derivatives* with respect to each coefficient and setting them to zero. Which results in a humongous mess known as *n linear equations in n unknowns*. You then solve the mess as best you can and out pops your coefficients needed to plot your best fitting curve.

I personally use an old method involving *determinants*. The needed tools appear in FUZZYFIT.PS, while the tools and a detailed background tutorial is separately available as GENie PSRT file #289 LINEAREQ.PS. Incredibly, *only one single pass is needed to find the best possible curve, no matter how many terms in your polynomial or the number of points involved!*

Figure 5 shows you the equations to use for a linear slope, a quadratic, and a cubic fit. These are the ones you would be most likely to use. I'm sure I've just horrified all the genuine math freaks in our audience with my really weird notation here. But all (sumx<sup>3</sup>) means is to take your first x data value and cube it. Then take the second data value and cube it and add it to the first one, and so on for all the data. By (sumx<sup>3</sup>), I simply mean the sum of the cubes of each individual noisy x data value.

#pts is simply equal to your total number of noisy x,y data point *pairs* that you are trying to put your smooth curve through. The (sumxy) expression means to multiply the first x value by the first y value. Then you multiply the second x value by your second y value and sum them. And so on.

Fortunately, PostScript does all of your grunge work for you—quickly, invisibly, and automatically. It takes around half a second to do the whole job.

Say you have five noisy data points and want to put the smoothest and most accurate possible cubic curve through them. All you do is...

```
[2 4 4 11 6 14 12 16 16 12]
  findcubicfit
```

That's all there is to it! In this specific instance, your first data point is at x = 2 and y = 4. Your second data point is at x = 4 and y = 11, and so on. The *findcubicfit* operator then will automatically generate your needed magic a<sub>0</sub>, a<sub>1</sub>, a<sub>2</sub>, and a<sub>3</sub> best-fit coefficients for you.

Here is a typical polynomial:

$$y = a_0 + a_1x + a_2x^2 + a_3x^3 + \dots$$

You pick as many terms for your polynomial as you think you need. For instance, a single a<sub>0</sub> term would give you a horizontal line with half the points above and half below. Dual a<sub>0</sub> + a<sub>1</sub>x terms give you a slanted line, again splitting the points half above and half below.

Three terms gives you a *quadratic* or *parabolic* approximation. And four

terms for a cubic. While you can go beyond a cubic, you'll usually gain surprisingly little extra in doing so.

One way to derive a least squares algorithm is to write out an equation for the total error for a given number of terms. Then you try to minimize the error by finding out how to separately minimize the error created by each individual term.

To find a minimum in an equation or on a curve, you find the *slope* of your curve and set it to zero. Math freaks



Among the other handy PostScript routines in my new FUZZYFIT.PS are *plotxyvalues*, which automatically draws the actual data points on the graph, and *ploteqn*, which sketches the smoothest possible curve through your points.

There's no sane limit to the number of data points allowed. Much of your typical engineering data gives a good fit to a cubic polynomial. Especially stuff that is only slightly nonlinear. Note that, roughly speaking, your  $a_0$  coefficient is strongest at the low valued end of all the data. Your  $a_1$  coefficient sets the initial slope of your data. Your  $a_2$  coefficient works best in the middle, while your  $a_3$  coefficient has by far the strongest influence at the high value end.

You can easily go beyond a simple cubic fit. If you know the underlying physical laws to your lab data, you can try and make your least squares fit the expected math. Other fuzzyfit curves of engineering interest include exponentials, sine waves, statistical distributions, hyperbolas, circles, and ellipses. Your same "set the partial slopes of the error equation to zero" idea works well with these.

For graphics and typography, you can step up to a fancier method of curve fitting that permits loops and cusps. This goes by the name of *cubic splines*, or *Bezier Curves*. PSRT has lots more on this exciting topic.

I'd sure like to have some good hardware hacking examples involving curve fitting for fuzzy data. For the second contest for this month, just send me an example of fuzzy data smoothing or else some data that needs to be smoothed. Preferably using PostScript. There'll be a dozen or so of our brand new second edition *Incredible Secret Money Machine* books, with an all-expense-paid (FOB Thatcher, AZ) tinaja quest for two going to the best of all. As usual, be sure to send your written entries directly to me here at *Synergetics* and not to **Radio-Electronics** editorial.

### New tech lit

From PMI, a new *Audio Handbook*, volume one, that covers the older SSM analog electronic musician products. Included are nineteen excellent application notes on synthesizer ideas. From *Cypress Semiconductor*, a new *MOS Databook* on their memory and programmable log-

ic products. And from *Signetics/Philips*, a new *Master Product Catalog* on all of their analog and digital integrated circuits. Included are such oddball goodies as cellular radio chip sets.

*Motorola* has a new free booklet on *Pressure Sensors* available, along with a literature packet on several of their transducers. But by far your best sources for very low cost pressure transducers still remain *SensSym*, *IC Sensors*, and *Novasensor*.

*Zilog* has the new *Shortform 91* catalog on microcontrollers, microperipherals, and telecomm stuff. A new *Technical Guide and Cross Reference* on replacement semiconductors is available from *NTE*. The cost is \$3.25.

*Printed Circuit Design* is a new trade journal that is heavy on PC layout tools and software. And an interesting *Gas Density Calculator* slide rule is available from the folks at *Fisher-Klosterman*.

Let's see. I've just reprinted my *Incredible Secret Money Machine*, along with a new intro and update section. And for more on PostScript, I stock the best books and software by the best authors in my bargain-priced *The Whole Works* package.

The usual reminder about my new BBS up as *GENIE PSRT*. Besides all of the PostScript and desktop publishing stuff, you'll find all sorts of ongoing *Hardware Hacker* and our *Midnight Engineering* resources here. Finally, I do have a pair of new and free mailers for you. One now includes dozens of insider hardware hacking secret resources, while the second covers PostScript and Desktop Publishing. Write or call for info.

As usual, most of the items mentioned here appear in the *Names and Numbers* or the *Tesla Coils & High Energy Resources* sidebars. **R-E**



"You feel inferior to your software? Say, you do have a problem!"

## Earn Your B.S. Degree in ELECTRONICS or COMPUTERS



### By Studying at Home

Grantham College of Engineering, now in our 41st year, is highly experienced in "distance education"—teaching by correspondence—through printed materials, computer materials, fax, and phone.

No commuting to class. Study at your own pace, while continuing on your present job. Learn from easy-to-understand but complete and thorough lesson materials, with additional help from our instructors.

Our Computer B.S. Degree Program includes courses in BASIC, PASCAL and C languages — as well as Assembly Language, MSDOS, CADD, Robotics, and much more.

Our Electronics B.S. Degree Program includes courses in Solid-State Circuit Analysis and Design, Control Systems, Analog/Digital Communications, Microwave Engnr, and much more.

An important part of being prepared to *move up* is holding the right college degree, and the absolutely necessary part is knowing your field. Grantham can help you both ways—to learn more and to earn your degree in the process.

Write or phone for our free catalog. Toll free, 1-800-955-2527, or see mailing address below.

Accredited by  
the Accrediting Commission of the  
National Home Study Council

**GRANTHAM**  
*College of Engineering*  
Grantham College Road  
Slidell, LA 70460

## Reader letters: some bouquets and brickbats

LARRY KLEIN

I'm sure sure that I'm not the only writer who identifies with the little boy who "shot an arrow into the air—it fell to earth he knew not where." Each month I shoot off my arrow (or my mouth) and wonder what, if any, response it's going to provoke.

Some readers apparently see me as a universal hi-fi maven, with an encyclopedic knowledge of all things audio, whose data can be tapped for the price of a postage stamp. (Speaking of stamps, a letter with a stamped return envelope enclosed is a lot more likely to get a response than one without, but there's no guarantee either way.) I am always pleased to receive mail from my readers, but, unfortunately, I have neither the resources nor time to research and answer complicated or lengthy questions.

### Controversies

As a columnist, rather than a reporter, I get to express my views—pro and con—on the goings on in the audio world. Because I believe that controversy is frequently enlightening, I sometimes deliberately rattle cages to provoke responses. As steady readers of this column know, I've been regularly sniping at the belief systems of the audio-astrology crowd who believe that all amplifiers, wires, capacitors, etc., sound different from each other in subtle and mysterious ways.

I anticipated outraged reactions from the dedicated audiophiles among **Radio-Electronics'** readers, but I've been disappointed. With one or two exceptions, the letters that I have received so far have cheered on my efforts to keep audio rational.

My first thought was that the strong engineering background of **Radio-Electronics'** readership kept them from buying into the hype. But then I remembered that engineering competence doesn't necessarily inhibit audio craziness. For example, I know that many of the Japanese manufacturers suffer from advanced audiophilia, but the effects are significantly tempered by their rational marketing analysis. They may put shock-absorbing feet on their amplifiers, but they are not about to try to push tube equipment on their overseas markets.

In the mainstream press, *Audio* (U.S.) and *Hi-Fi* (U.K.) are two publications that print equipment reviews by qualified engineers who nevertheless regularly report hearing a variety of sonic artifacts not audible to ordinary mortal ears. Need I say once again

# Train at HOME to be an Electronics Technician!

As the demand for computers and microprocessors in business, manufacturing and communications continues to grow, so does the need for qualified technicians. It's not unusual for experienced technicians to earn from \$30,000 to more than \$40,000 a year.\* Now through Peoples College of Independent Studies you can train for this exciting field without interrupting your job or home life.

### Choose From Five Programs of Study

- Electronics & Microprocessor Technology
- Industrial Electronics & Microprocessor Technology
- Communications Electronics with Microprocessor Technology
- Computer Servicing & Electronics Technology
- Specialized Associate Degree In Electronics Technology

### Professional Equipment Is Included

Depending on the program you select, you'll perfect your skills using this advanced equipment, included in the price of tuition:

- IBM-Compatible Personal Computer
- Digital Multimeter
- Digital Logic Probe
- Elenco Oscilloscope
- Portable Cellular Telephone

(\* Source: U.S. Bureau of Labor Statistics)



### Exclusive Extras That Enhance Your Training

Peoples College introduces some training firsts to make your learning experience more complete:

- Accelerated Learning System — a scientifically proven study system that helps you learn faster and easier than ever before.
- Video Tutor Training Tapes — give you a permanent, visual record of informative lectures and close-up demonstrations.
- Experience Labs — professionally designed experiments that give you hands-on "bench" experience.
- Industry Certification Training Guide — provided with four of our programs. Prepares you for examinations you may take for your professional license or certification.

### Easy Payment Plans — No Finance Charges

To help you get started on your education, Peoples College has reduced tuition rates and offers low monthly payment plans with no finance fees. So don't delay, call or write for more information today!

### For COLOR CATALOG Mail Coupon or Call TOLL FREE 1-800-765-7247

Programs offered only in United States, Canada, Puerto Rico and Virgin Islands. No Obligation. No sales person will call.

Our programs are accredited by the Accrediting Commission of the National Home Study Council

YES! I would like to know more about your training programs. Send a catalog to:

Name \_\_\_\_\_

Address \_\_\_\_\_

City \_\_\_\_\_

State \_\_\_\_\_ Zip \_\_\_\_\_

Phone # \_\_\_\_\_

**PEOPLES COLLEGE**  
OF INDEPENDENT STUDIES  
233 Academy Drive • P.O. Box 421768  
Kissimmee, FL 34742-1768

Member, D.I. Peoples Group R 1091



that their ability to hear such phenomena vanishes where subjected to controlled situations?

### Reader Q's and A's

The mail coming to me at my previous publications was heavily weighted toward requests for equipment-buying advice. Our standard response was that if we hadn't done a test report on the product(s) in question, we had no opinion to offer. Today, the best advice I can offer is to check the test reports in the back issues of *Consumer Reports*. I haven't always agreed with *Consumer Reports'* judgments, but I think that their reports are about as good as you are going to find for unbiased evaluations. If you are looking specifically for car audio evaluations, try *Car Audio & Electronics*. Their test lab, run by my friend Joel Cohen (note the personal-involvement disclosure), does a first-rate job.

My two-part piece on distortion (**Radio-Electronics**, June and July 1991) provoked some interesting mail. A mathematics professor from an East Coast University wrote to extend and elaborate on some of my points—and rapidly lost me in his equations. He obviously knew more about the subject than I did!

Another reader thought my distortion discussion was just dandy—and then asked a few questions that showed that he hadn't a clue as to what I was trying to say. Yet another letter-writer took issue with the term "transient intermodulation distortion" because he felt that it reflected "an epidemic of subliteracy." He apparently missed my point that TIM wasn't imaginary; it was just not relevant to the performance of today's equipment.

### Tube defenders

A long letter from a Mr. Richard Carysforth from Lenexa, KS, which appeared in the August **Radio-Electronics Letters** column, attacked my views on tube equipment and the audible differences among amplifiers. He stated that he's "a working audio professional" and that, from his perspective, "Larry Klein (and other scientific audio authorities) simply doesn't know what he's talking about." Mr. Carysforth goes on to write that he works mainly with midwestern pop, country, and jazz recording artists. They, and the

recording studio owners, mostly prefer older, simpler gear, frequently using tubes, over modern stuff sporting superior measurements. And so forth.

Mr. Carysforth raises several points worth discussing. Several years ago I did a one-day tour (courtesy of Revox) of several popular Nashville recording studios of the sort that he is referring to. Although I had expected otherwise, I was left with the strong impression that no two studios agreed on the best amplifiers, microphones, monitors, etc. And, in any case, none tried to support their choices with objective test data. In short, I found what seemed to be the pro-studio equivalent of audiophile subjectivism!

It may seem strange for me to say so, but there is some justification for audio subjectivism among studio engineers and musicians, although most, like Mr. Carysforth, are too philosophically confused to argue the issue coherently. In a nutshell: It is the job of the musician (and to some degree, the engineer) to produce sound. The home music listener uses his equipment to reproduce the sound captured on the disc or tape by the engineers. If the studio musician gets the sounds he wants from a highly distorted amplifier, or if the recording engineer prefers the subtle harmonic structures or overload characteristic of certain tube amplifiers, that's their privilege, assuming the result is satisfactory to other parties involved in the process.

But unlike the situation with studio electronics, where tastes can legitimately vary, all studio monitor speakers should be wide-range and provide a reasonably flat frequency response in the control room. The reason is easy to understand, although it took the recording industry and the designers of studio monitors years to clean up their act in that regard.

Let's say that a pair of studio monitor loudspeakers has a 4–5-dB peak at, say, 8 kHz. Flat master tapes played through that set of speakers are likely to sound overly sizzly on tamborines and top hats. Their solution: Equalize the master tape until it sounds right on the monitors. Unfortunately, if that's the way the tape goes to the disc-cutting lab, the consumer with a reasonably flat audio system will end up with a rather dull sounding performance. The reverse

## LEARN to CLEAN/MAINTAIN/REPAIR CAMCORDERS



EARN \$85 AN HOUR!

### HUGE EXPANDING MARKET!

Work from your home – part-time or full-time! No prior experience needed – Average mechanical ability only requirement for your success! Over 15 million camcorders in use – Over 5 million expected to be sold in 1991 alone!

It is a fact that the vast majority of camcorder malfunctions (just like VCR's) are due to simple mechanical failure... We can show you how to easily fix those breakdowns and earn an average of \$85.00/Hr. while working at home!

**Get In Now** – Soon camcorders will be like VCRs, i.e., one in almost every home.

For a camcorder cleaning job you can earn \$65.00 for less than 30 minutes work.

For a camcorder repair job you can earn over \$100.00.

**FREE INFORMATION PACKAGE** call or write:  
Toll-Free 1-800-537-0589  
Viejo Publications, Inc.  
5329 Fountain Ave., Dept. REC  
Los Angeles, CA 90029

CIRCLE 190 ON FREE INFORMATION CARD

## SUPER LONG PLAY TAPE RECORDERS

12 Hour Model — USES 120 TAPE

\$119.00\*

Modified Panasonic Slimline, high quality AC-DC provide 6 continuous hours of quality recording & playback on each side of cassette for 12 hours total. Includes • Voice level control • Digital counter, etc. TDK — 120 Cassette Furnished.



### PHONE RECORDING ADAPTER

Records calls automatically. All Solid state connects to your telephone jack and tape recorder. Starts recording when phone is lifted. Stops when you hang up. **\$28.50\*** FCC APPROVED

**VOX VOICE ACTIVATED CONTROL SWITCH**  
Solid state. Self contained. Adjustable sensitivity. Voices or other sounds automatically activate and control recorder. Uses either recorder or remote mike. **\$28.50\***

\* Add for ship. & handling. Phone Adapter & Vox \$2.00 each. Recorders \$5.00 each. Calif. Res. add tax. Mail order, VISA, M/C, COD's OK. Money Back Guarantee. Quantity discounts available. Dealer Inquiries invited. Free data.  
**AMC SALES INC.** Dept. A 9335 Lubec Street  
Box 928, Downey, CA 90241  
Phones (213) 869-8519 1-800-926-2488  
FAX (213) 923-1478  
Mon-Fri 8-5 PAC. TIME

CIRCLE 108 ON FREE INFORMATION CARD

# R-E Engineering Admart

Rates: Ads are 2 1/4" x 2 7/8". One insertion \$995 each. Six insertions \$950 each. Twelve insertions \$925 each. Closing date same as regular rate card. Send order with remittance to Engineering Admart, Radio-Electronics Magazine, 500-B Bi-County Blvd., Farmingdale, NY 11735. Direct telephone inquiries to Arline Fishman, area code-1-516-293-3000. FAX 1-516-293-3115. Only 100% Engineering ads are accepted for this Admart.

## FCC LICENSE PREPARATION

The FCC has revised and updated the commercial license exam. The NEW EXAM covers updated marine and aviation rules and regulations, transistor and digital circuitry. THE GENERAL RADIOTELEPHONE OPERATOR LICENSE - STUDY GUIDE contains vital information. VIDEO SEMINAR KITS ARE NOW AVAILABLE.

WPT PUBLICATIONS  
979 Young Street, Suite E  
Woodburn, Oregon 97071  
Phone (503) 981-5159 Dept. 50

CIRCLE 181 ON FREE INFORMATION CARD



Big Plans . . .

Small Budget??

## 6805 Microcomputer Development System

TECI's MCPM-1 system allows your IBM PC and Compatibles to be used as a complete development system for the Motorola 6805 family of single chip microcomputers. Many time saving features at an affordable price.

MCPM-1 Programmer for Motorola MC68705P3, P5, U3, U5, R3, R5

MCPM-1 w/driver, assembler, simulator/debugger \$449  
MCPM-1 w/driver program only \$349

Also available—Programmer for 68HC05, in-circuit emulators and many software tools to help you. Call for a complete catalog and let us help you select your tools



The Engineers Collaborative, Inc.  
Rt. #3 Box 8C Barton, VT 05860 USA

TEL: (802) 525-3458 FAX: (802) 525-3451 Call Toll Free (800) 336-8321

CIRCLE 195 ON FREE INFORMATION CARD

## Surface Mount Chip Component Prototyping Kits—

Only \$49.95



CC-1 Capacitor Kit contains 365 pieces, 5 ea. of every 10% value from 1pf to 33µ. CR-1 Resistor Kit contains 1540 pieces, 10 ea. of every 5% value from 10Ω to 10 megΩ. Sizes are 0805 and 1206. Each kit is ONLY \$49.95 and available for immediate One Day Delivery!

Order by toll-free phone, FAX, or mail. We accept VISA, MC, AMEX, COD, or Pre-paid orders. Company P.O.'s accepted with approved credit. Call for free detailed brochure.



Entire USA 1-800-854-0547

CIRCLE 182 ON FREE INFORMATION CARD

is just as likely to happen when monitors with droopy high-frequency response are used. Many years ago, I remember reading about a technical survey of the speakers used in sound studios and how appalling their frequency performance was.

Frankly, experience has shown that there's no reason to trust the hearing acuity or good judgement of those responsible for the sound of our musical software. True, things are a lot better than in the early 1960's, when I first started looking into the problem

of why some records sounded so bad. But we need look back no further than the hundreds of shrill-sounding CD's released when the format was new to realize that incompetent engineering is not a rare phenomena in the record business. **R-E**

★ ★ ANNOUNCING ★ ★

EXHIBITOR PARTY  
FRI. OCT. 26  
6:00 / 8:00 PM

# 133rd SMPTE

OPEN TO ALL REGISTERED GUESTS

## Technical Conference and Equipment Exhibit

The Conference That Defines Motion Picture and Television Technologies

October 26 - 29, 1991 Los Angeles Convention Center

**S**eminars  
**M**eetings  
**P**apers  
**T**utorials  
**E**xhibits

Friday .....	Tutorial
Weekend .....	Workshops
Daily .....	Technical Papers
Daily .....	Equipment Exhibits
Daily .....	Social Events



### Who Will Attend?

- Presidents, CEOs Owners
- Cameramen
- Chief Engineers
- TV Maintenance Supervisors
- Sales & Marketing VPs
- Designers
- A/V Technicians
- Graphic Artists
- Consultants
- Producers
- Systems Engineers
- Tape Editors
- Directors of Operations
- Marketing Managers
- Technical Supervisors
- Video Editors
- Students
- Publishers
- Production Managers
- Digital Effects Designers

For More Information, Mail To:

Society of Motion Picture and Television Engineers  
595 W. Hartsdale Ave.,  
White Plains, NY 10607

(914) 761-1100 • Fax # 914-761-3115

PLEASE RUSH THE FOLLOWING INFORMATION:

- Exhibitor  Full Conference Registration  
Exhibit Only  Tutorial  Seminar Workshop

REM.

Name \_\_\_\_\_ Title \_\_\_\_\_

Co. \_\_\_\_\_

Street \_\_\_\_\_ City \_\_\_\_\_

State \_\_\_\_\_ Zip \_\_\_\_\_ Country \_\_\_\_\_

Tel. \_\_\_\_\_ Fax \_\_\_\_\_

continued on page 86

## BINAURAL BASICS

continued from page 52

towers and other aircraft, and assign them places in a 360-degree sphere so that pilots wearing stereo headphones can "steer" their binaural hearing to the voice they need to hear and ignore the rest. A demo tape mixed those artificial binaural voices into a loud background of helicopter noise and contrasted the very intelligible result with the same signals in both mono and stereo.

Much research is currently being done on the human hearing mechanism and the broad field known as psychoacoustics. Product approaches being promoted, such as Hughes SRS and Q Sound, are an outgrowth of that work. Those systems attempt to offer a binaural-like surround localization with loudspeakers rather than stereo headphones, and only a pair of them at that. With proper source material, mixing, and proper

continued on page 86



## Let's build an oscilloscope!

There's no such thing as too much test equipment. If you spend enough time at the bench, sooner or later you're going to wind up using not only everything you own, but other stuff as well. If you design for a living, you want the best test gear you can get—clients don't want to hear that you couldn't try something because you had no way to do it at the bench.

You can divide up all test equipment into stuff you absolutely have to have and stuff that's just nice to have. The most important piece of gear—an essential "must have"—is an oscilloscope. These used to be real bank breakers but, as things stand now, you can get a good 30-MHz scope for well under four hundred dollars. There's nothing stopping you from building one, but to come up with a serious, as well as reliable, design you need an oscilloscope. A kind of chicken and egg problem, depending on how you look at it.

We're going to look into building a scope, but before we get started it's important to understand what we can do and what we can't do. The controls on a modern scope—even an inexpensive one—give you a wide range of operating parameters and there's just no way we can duplicate all of them in a home-built os-

cilloscope given the limited amount of space there is in this column and the available time.

What we *can* do is go through the fundamentals of scope design, examine the basic circuitry, and come up with a working demonstration circuit. This isn't as limited as it sounds since, by the time we finish, you'll have a good idea of how the unit works and what you have to do to refine it. That means adding some of the features found on commercial units, upping the bandwidth, and so on.

Enough talk.

The basic layout of a typical oscilloscope is shown in Fig. 1. You can see that, if you don't get into the bells and whistles found on commercial units, a scope is a pretty simple and straightforward unit—in principle anyway. An oscilloscope is like a vector scope that has to deal with an input signal that varies over a period of time.

A lot of what the scope circuits have to do depends on what kind of display is being used. For our purposes, let's assume that the display we're going to use is a matrix of LED's, LCD's, or anything made up of a series of discreet points that can be addressed by specifying a pair of x and y coordinates. Since the scope

we're building is going to use a row-and-column display system, it's easier to understand what each of the elements in the block diagram has to do.

The horizontal circuit is going to control the enabling of the row drivers. That means we're going to be scanning across the rows in the matrix and enabling one row at a time. That also means we need a clock capable of driving the horizontal circuit at a bunch of accurate frequencies. How fast those frequencies have to be depends on how fast a signal we're going to want the scope to handle. This isn't a trivial decision since the maximum signal frequency will also determine how we have to go about designing the circuitry that's going to be used in the rest of the scope as well.

There's no point in having a horizontal circuit that can scan or, to use the officially correct phrase, sweep at a rate of 10 MHz if the rest of the circuitry takes a nose dive when the incoming signal gets above 1 MHz. Scope design, just like any other project, has to be planned carefully from the beginning. All of the details have to be worked out before you get to the bench or a lot of time will be wasted at the bench.

The other major section of a stan-

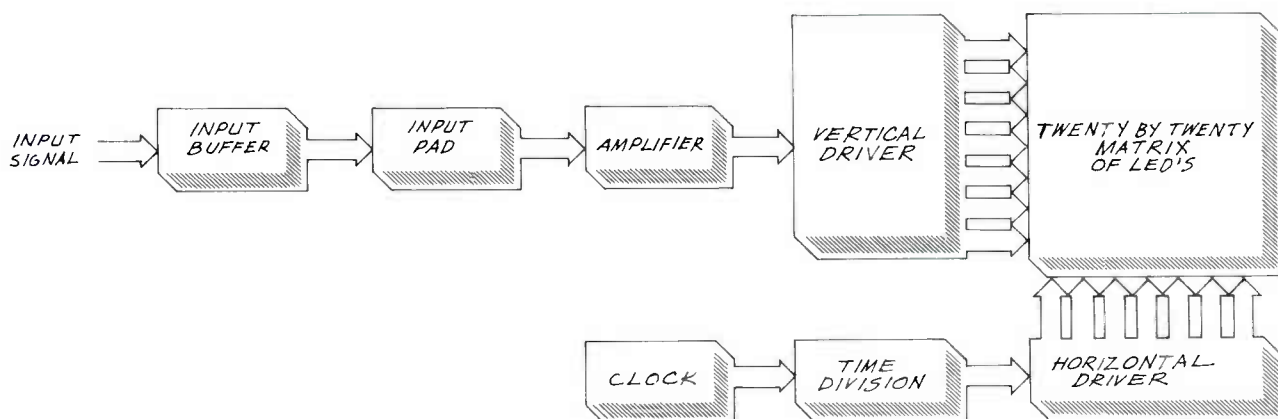

FIG. 1—BASIC OSCILLOSCOPE LAYOUT. Without a lot of bells and whistles, a scope is a pretty simple and straightforward device.

ard oscilloscope is the vertical circuitry. Although there are special considerations, this is really nothing more than an amplifier designed to have a response that's as flat as possible over the rated bandwidth of the scope. Remember that we're using the output of the amp to display changes in the input signal, and we don't want the amplifier to add its own two cents to either the shape or level of the input signal. The point of using a scope, after all, is to display unknowns in a signal, not add to them.

Just as the horizontal section should have several accurate sweep speeds, the vertical section should have several accurate settings for the gain. When you look at the display matrix, going one element to the right should represent a definite amount of time and going up one element should represent a definite amount of voltage increase. Even if you've never used a scope, you've probably heard people talking about the number of volts per division when they're referring to scope measurements. In the scope we're going to build, the equivalent would be to refer to volts per display element.

These three sections—horizontal, vertical, and display—together form the basis of every oscilloscope there is. Before we can even think about including some of the features found on commercial scopes—or even clearly understand what they do—we have to get the basics out of the way. The best way to handle this is to design a basic scope and then, once we have that stuff under control, we'll be in able to think about things like triggered sweep and other bells and whistles found on commercial scopes.

By this time you should know that the first step in any design job is to draw up a list of design criteria to formalize the project you have in mind. In this case the list isn't too long because the scope will be pretty simple—at least in the beginning. Here's our list:

1. The scope will have a maximum bandwidth of 1 MHz.
2. There will be eight selectable sweep speeds.
3. There will be eight selectable gain levels.
4. There will be a variable gain control.
5. The display will be in a twenty-by-twenty matrix.

You can change any of the criteria you want but, for the moment, it's a good idea to leave them all as they are. Once we get into the specifics of the design, you'll find it relatively easy to modify some of the features to adapt to any particular requirements you might have.

Before we start the actual design, we have to talk a bit about the display. Elementary arithmetic tells you that a twenty-by-twenty matrix calls for four hundred LED's and, even though you can get LED's in bulk quantities from mail-order houses at extremely low prices, you still have to do a lot of wiring to get them set together in the kind of matrix we need. Let's face it, it's a real pain in the neck to wire four hundred LED's.

When we get the scope designed, we'll investigate some alternatives to using LED's for the display elements—LCD screens are a perfect choice. I've seen pre-made LED matrix displays that come in various sizes and I'm currently going through my parts books and mail-order house catalogs to see what's available and who has them for sale at reasonable prices. If any of you know where these can be gotten, drop me a line and I'll put it, along with appropriate thanks, in the magazine.

I have a working version of the scope on my bench at the moment and I used four hundred LED's wired into a twenty-by-twenty matrix. It took a bit of time to get it wired but, from personal experience, I can tell you that it's not too bad and certainly not the worst thing I've ever had to do. It was, however, pretty high on my list of unpleasant experiences.

As we develop the circuitry for the scope, I'll base the display on the same sort of LED matrix I wired up on my bench but, between all of us, we should be able to come up with a more attractive alternative that still uses LED's. It's a mechanical problem, not an electronic one.

Once everything is done and we have the circuit working, we'll take a look at LCD panels. These have become readily available and you can find them at reasonable prices. We won't be doing this right at the beginning because the circuitry needed to drive them and the memory needed to hold the display is a separate topic in itself. First things first.

Next time we'll move into hardware design. **R-E**

## BINAURAL BASICS

*continued from page 84*

placement of the listener in the "sweet spot," those approaches can be quite convincing. When optimum criteria are not met, they can also sound worse than poor mono, and even at their best, they don't equal a good true binaural recording on good headphones.

There is one highly successful speaker approach that can be used with any binaural recording. It is the Binaural Panorama circuit included with the normal ambience, reverb, and Dolby Surround features of the Lexicon CP-1 and CP-3 Digital Audio Environment Processors. Correction of the "trans-aural" signals of the left speaker sounds reaching the right ear and the right speaker sounds reaching the left ear are at the heart of this speak-

### THE BINAURAL SOURCE

For a free binaural catalog, write to The Binaural Source, Box 1727RE, Ross, CA 94957 (415) 457-9052 PST.

For a schedule, program listings, and station network information on **AUDIOPHILE AUDITION** write to Box 1621, Ross, CA 94957. Enclose a number-10 self-addressed stamped envelope plus \$1 or four 20-cent stamps for postage and handling.

If you would like to know more about local radio stations carrying **AUDIOPHILE AUDITION**, call John Sunier at (415) 457-2741 PST.

er system. An adjustable delay line sends the properly correlated cancellation signals to each ear, something like Carver's Sonic Holography or Polk's SDS, but is more sophisticated and freer of the "phaseyness" of those approaches. One does have to sit in quite an exact sweet spot. Although it works well with only a pair of speakers, the addition of another matching pair in the rear, being fed a simple L-R signal improves the effect even further. With practice (some of this is a learned response too) the listener can even clearly image sounds to the rear and far sides, as well as vertically.

The crux of the matter is that just as some people have trouble



SINE-WAVE GENERATOR

I do a lot of audio work and build a good deal of the gear myself. I frequently have to send signals to tape machines and other devices and have been using a small square-wave generator. I would prefer to be able to send something a bit smoother so I'd like a simple circuit for generating a sine wave. It doesn't have to be perfect and size is more important than a classic waveshape. Can you help?—G. Fischer, Benjamin, NY

There are several different ways to do sine-wave generation, but all of them really produce "sine-like" waves.

If all you're interested in is something to produce signals that are a bit easier on the ears than the hard edges of a square wave, you can use the circuit shown in Fig. 2. Any op-amp can be used since the work is being done by the Twin-T network in the feedback loop. Use closely matched components in the Twin-T network, and feed the output of the op-amp to a high-impedance input.

The frequency of the signal can be gotten by plugging the component values into the formula  $f = 1/(2\pi RC)$ .

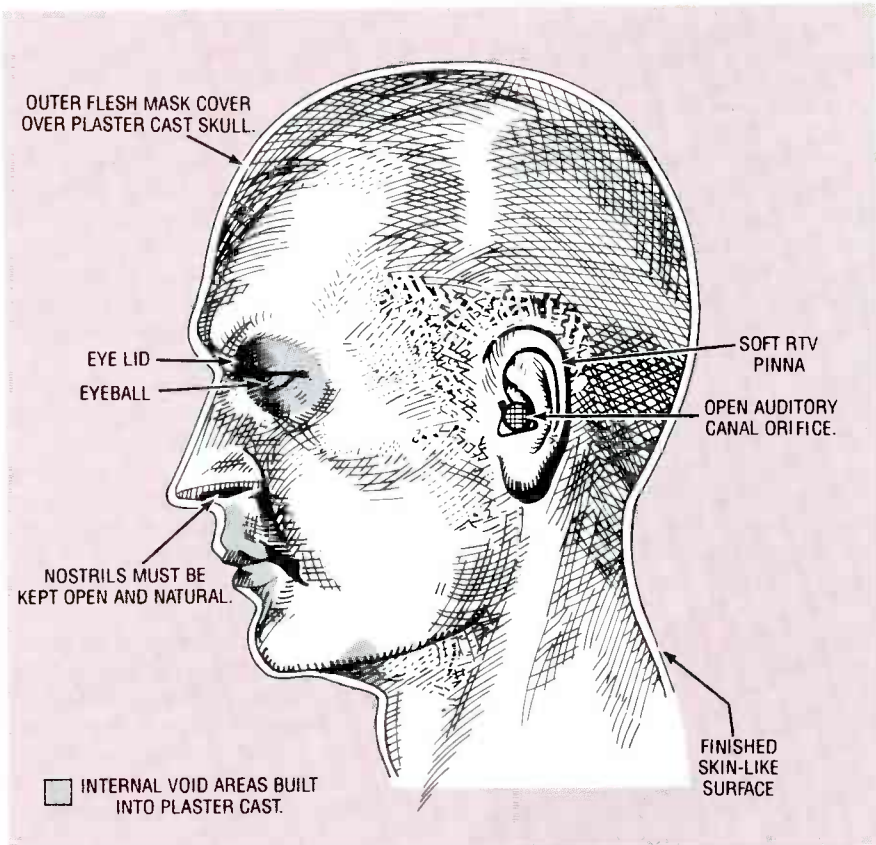

FIG. 2—THIS BINAURAL DUMMY HEAD shows the various human anatomical features that affect sound perception. The mikes are fitted into the auditory canal. All parts shown, including the cranial cavities, ocular structures, nose, skin, and teeth are constructed simulate the human head as closely as possible.

seeing depth when looking at 3D images, some also have trouble experiencing the full binaural effect of being transported to where the sounds originated, rather than attempting to have them brought into your listening room. The pinna, or outer ears, are a vitally important part of the hearing mechanism. A number of researchers have shown how the shapes, bumps, and grooves in the ears control human location of sounds in space.

**Binaural dummies**

When designing binaural heads for recording, the problem of differing widths between people's ears must be considered. Women's ears, for example, are generally closer together than men's. Therefore, a median distance for the mikes on the dummy head must be chosen and it is not totally accurate for many people. If the mikes are too close together, there will be a reduced binaural realism; if they are too far apart it will be exaggerated or more likely to increase the normal difficulty of imaging sounds directly in front and in

back.

One binaural developer, Ron Cole, improved the weak frontal location often experienced with binaural by designing his "Biophonic" dummy heads with exaggerated features on the front of their faces. He also experimented with using real human skulls (obtained from a medical supply house). However, he found that great variations in the shape of real skulls were a problem and switched to plastic and plaster materials. Figure 2 shows one such dummy head, revealing physical characteristics that affect sound reproduction.

There are two professional standard dummy heads used for most commercial binaural recordings available today, and others used primarily in research. The best known is the Neumann KU-81i, which is made of hard dark gray rubber and has condenser mikes sunk into the head. The other is the more complex and even more expensive Aachen Head, also like the Neumann developed in Germany. It comes in two models: one with more detailed features than the

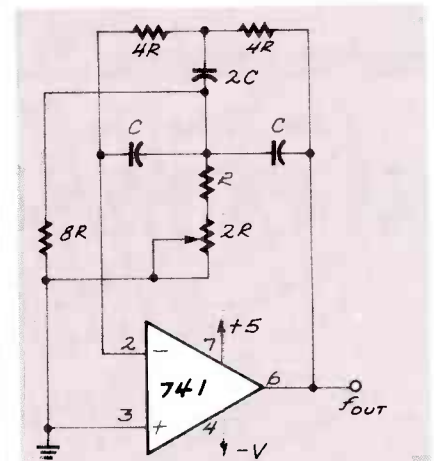

FIG. 2—YOU CAN PRODUCE SINE WAVES with this simple circuit.

Keep the resistor values between 1K and 10K, and use 0.01µf–1µF as the capacitor limits. It's also a good idea to build the circuit with a dual op-amp chip and use the second half as a buffer to avoid overloading the output of the generator. **R-E**

## VOCAL EFFECTS MIXER

*continued from page 42*

mum (counter clockwise) position. Make sure the volume level of your stereo is at its minimum, then turn it on and switch the selector to a source other than the tuner so that you can adjust the mike controls without hearing any music. Now turn up the stereo volume so that your voice can be heard and adjust the BASS and TREBLE controls (R28 and R30) for the desired coloration.

Next, adjust the EFFECTS LEVEL and FEEDBACK controls for the amount of echo desired. The volume of the initial echo is adjusted with the EFFECTS-LEVEL potentiometer (R15), while the amount that each succeeding echo is attenuated is controlled by the FEEDBACK potentiometer (R9).

Now tune in an FM broadcast or put on a record or CD and adjust the mike volume (R41) to match the level of your voice with that of the music. Have fun! **R-E**

## BINAURAL BASICS

*continued from page 87*

other—in fact patterned closely on the actual ears of its inventor, and the head of another person. Complex equalization circuits attempt to achieve the most exact binaural localization with headphones while retaining compatibility for loudspeaker playback.

The "i" upgrade of the Neumann dummy head also was designed for speaker compatibility. Both of those mikes are often used in a manner similar to coincident normal mikes for recordings to be released as ordinary

wearer's own ears, similar to airline earphones, and achieves excellent results. There are no headphones, and thus no compromising the bass end to avoid feedback, but also there is no monitoring. One must also be careful not to move one's head when recording a concert, or in playback at that point or the entire orchestra will seem to shuffle off the stage in the opposite direction from the listener!

Sennheiser also thoughtfully provides a simple dummy head for mike stand mounting, on which to clip the mikes for prolonged recording. With a portable DAT or Sony Pro-Walkman and metal tape, the results can be little short of astounding! Others construct their own binaural mikes to fit into their outer ears, using inexpensive mini-electret capsules with a foam and fabric jacket, powered either from the portable recorder or by a separate 9-volt battery. Another option is attaching the mikes to the headband of a pair of earmuffs. There are also two commercially available mike sets that clip to the temples of one's glasses. You should be aware, however, that although these approaches make use of the baffle effect of both the head and even the shoulders, neither includes the effect of the pinna of your ears, so the final results will not have the full binaural realism.

To the problems of individual hearing differences must be added the tremendous variety in specifications of stereo headphones. Headphones that sound fine for stereo will not necessarily achieve the best binaural effect. No headphones on the market at the moment are equalized to perfectly match the average listener's hearing, or for that matter, the equalization of the particular dummy head used for recording or broadcasting. The Stax Lambda Pro and Signature electrostatic headphones have been used by many researchers because their frequency response and phase accuracy is the closest to the ideal available. In fact, an additional optional equalizer box (priced at \$800) is offered by Stax, to match even more closely the parameters of the specific headphones to binaural recording reproduction. Stax calls their



**FIG. 3—PHOTO OF THE SENNHEISER MKE 2002 stereo head microphone.**

stereo. Sometimes they are used in conjunction with other non-binaural mikes in multi-mike pickups. Of course the speaker playback of compatible binaural recordings will not have the binaural effect (except for the Lexicon circuit mentioned above), but some recording engineers feel that even for stereo playback the Neumann or Aachen heads produce a more natural pickup than any other type of purist mike approach.

Although Sony, JVC, and some other manufacturers have had inexpensive binaural headphone/mike combination units for home recording, those are no longer available. Sennheiser, however, still manufactures their MKE 2002 binaural mike set, shown in Fig. 3, which sells for about \$500. It clips onto the

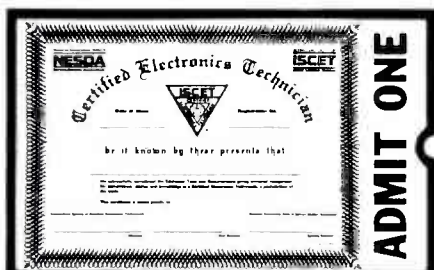

Your Ticket To

# SUCCESS

Over 28,000 technicians have gained admittance worldwide as certified professionals. Let your ticket start opening doors for you.

ISCET offers Journeyman certification in Consumer Electronics, Industrial, Medical, Communications, Radar, Computer and Video. For more information, contact the International Society of Certified Electronics Technicians, 2708 West Berry Street, Fort Worth, TX 76109; (817) 921-9101.

Name \_\_\_\_\_

Address \_\_\_\_\_

City \_\_\_\_\_

State \_\_\_\_\_ Zip \_\_\_\_\_

Send material about ISCET and becoming certified.

Send one "Study Guide for the Associate Level CET Test." Enclosed is \$10 (inc. postage).



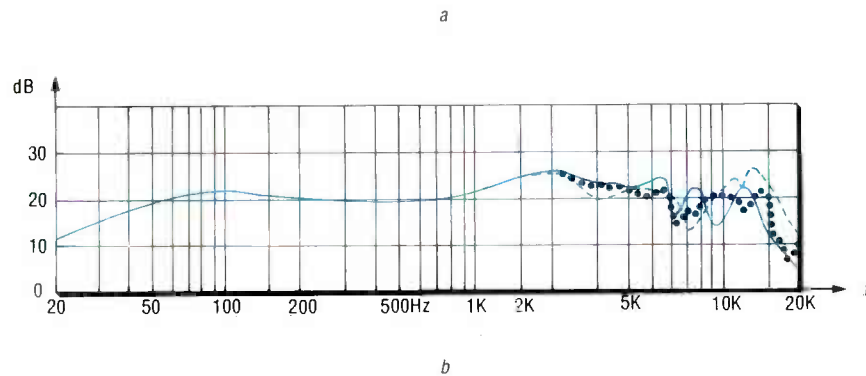
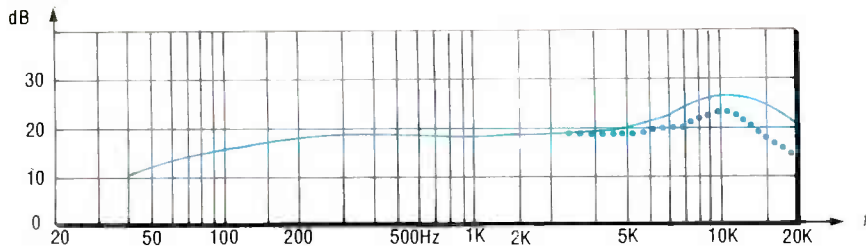

FIG. 4—REPRODUCED SOUND PRESSURE at the ears of various test persons; the MKE 2002 is shown in the free-sound field (a), with the open headset HD 424, measured at a reference point with a probe microphone Bruel & Kjaer 4138. Continuous lines indicate a 0-degree reference, dashed lines represent a 90-degree reference.

phones Semi-Panoramic Sound Electrostatic Earspeakers. The idea is to take the sound field out of confinement to the inside of the listener's head and make the sounds appear realistically out in space. Some peoples' ear-brain interface does a better job of this than others, but the headphone design is definitely a factor. Figure 4-a shows the frequency response of the Sennheiser MKE 2002 microphone compared to the response of a Bruel & Kjaer 4138 (Fig. 4-b). As you can see, the latter microphone produces higher sensitivities in the ears of test persons in the range of 5 Hz to 15 kHz.

Don't think that the electrostatic principle in headphones is inherently superior for binaural listening. Some expensive headphones—both electrostatic and dynamic—compromise the effect. One of the worst is the Consumer Reports-recommended Sony MDR-V6 dynamic. Yet a number of other Sony phones (they are frequently changing models) in the \$100 area are excellent for binaural. If you can find a used MDR-M77 you will have a terrific dynamic phone for binaural for about \$40.

The earspeaker idea is taken all the way by the headphones from Jecklin and AKG's new K 1000.

They position small earspeakers on your head without even touching your ears, and thus make use of the natural pinna so that your own unique direction-locating system can function to its fullest, working on the signals that come in from the headphones.

The Jecklins are available in both electrostatic and dynamic versions. Those two manufacturers considered binaural reproduction seriously in the design of their phones. (Most of the German manufacturers do.) In the author's personal experience, the K 1000's are the most natural-sounding phones for binaural reproduction.

A wonderful side benefit of this is that ordinary stereo's hole-in-the-middle when heard on headphones is seamlessly filled in. Just as with large loudspeakers, some of the delayed left channel signal comes around one's head to the right ear, and vice versa with the left ear receiving the delayed right channel signal. More muscle than a headphone jack provides is needed to power the elements of those phones; a separate power amp should be used and AKG even urges it be a Class A circuit; a bit extreme. The other drawbacks of both the AKG's and Jecklins' is that any-

## DIGITAL VIDEO STABILIZER ELIMINATES ALL VIDEO COPY PROTECTIONS



While watching rental movies, you will notice annoying periodic color darkening, color shift, unwanted lines, flashing or jagged edges. This is caused by the copy protection jamming signals embedded in the video tape, such as Macrovision copy protection. Digital Video Stabilizer: RXII completely eliminates all copy protections and jamming signals and brings you crystal clear pictures.

- FEATURES:**
- Easy to use and a snap to install
  - State-of-the-art integrated circuit technology
  - 100% automatic - no need for any troublesome adjustments
  - Compatible to all types of VCRs and TVs
  - The best and most exciting Video Stabilizer in the market
  - Light weight (8 ounces) and Compact (1x3.5x5")
  - Beautiful deluxe gift box
  - Uses a standard 9 Volt battery which will last 1-2 years.

**WARNING :**  
SCO Electronics and RXII dealers do not encourage people to use the Digital Video Stabilizer to duplicate rental movies or copyrighted video tapes. RXII is intended to stabilize and restore crystal clear picture quality for private home use only.

(Dealers Welcome)

To Order: \$59.95 ea + \$4 for FAST UPS SHIPPING  
**1-800-445-9285** or **516-568-9850**  
 Visa, M/C, COD M-F: 9-6 (battery not included)  
 SCO ELECTRONICS INC.  
 Dept. CRE101 581 W. Merrick Rd. Valley Stream NY 11580  
 Unconditional 30 days Money Back Guarantee

CIRCLE 199 ON FREE INFORMATION CARD

## CABLE TV DESCRAMBLERS

How You Can Save Money on  
Cable Rental Fees

### Bullet Proof

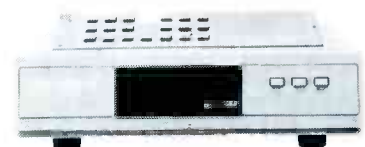

1 Unit 5+

BEST Super Tri-Bi Auto/ Var. Gain Adjustment	\$119.95...\$85	US Cable'll Beat Anyone's Price Advertised in this Magazine!
Jerrold Super Tri-Bi	\$109.95...\$79	
Scientific Atlanta	\$109...\$79	
Pioneer	\$109...\$79	
Panasonic TZPC145	\$99.95...\$79	
Stargate Converter	\$95...\$69	
Digital Video Stabilizer	\$59.95...\$29	
Wireless Video Sender	\$59.95...\$49.95	

**30 Day Money Back Guarantee**  
**FREE 20 page Catalog**

Visa, M/C, COD or send money order to:

**U.S. Cable TV Inc.** Dept. KRE101  
 4100 N. Powerline Rd., Bldg. F-4  
 Pompano Beach, FL 33073

**1-800-772-6244**

**For Our Record**

I, the undersigned, do hereby declare under penalty of perjury that all products purchased, now and in the future, will only be used on Cable TV systems with proper authorization from local officials or cable company officials in accordance with all applicable federal and state laws. FEDERAL AND VARIOUS STATE LAWS PROVIDE FOR SUBSTANTIAL CRIMINAL AND CIVIL PENALTIES FOR UNAUTHORIZED USE.

Date: \_\_\_\_\_

Signed: \_\_\_\_\_

**No Florida Sales!**

CIRCLE 200 ON FREE INFORMATION CARD

one else in your vicinity can still hear the sounds.

In more conventional dynamic headphones, the top-of-the-line Sennheiser models HD 560 and 540 are excellent for binaural, as are the top-of-the-line Beyer phones. Joseph Grado has a new handmade high-end Signature headphone, which is also highly successful in preserving accurate binaural localization.

The easiest and least expensive way to get your own startling binaural demo tape is to walk into most any chain bookstore and head for the "talking books" section. Stephen King's *The Mist*, provides one of the most astonishing introductions to binaural that is available anywhere. It features 35 actors and is one of the most detailed radio dramas ever produced. Monsters were created by putting various live animal sounds into a sampling synthesizer and playing them on the keyboard. When heard on headphones in a comfortable chair in the proper setting, such as at night with the lights out, the results can be even scarier

than a Stephen King movie. The production is from ZBS Foundation, who formerly distributed a public radio binaural drama series. The 80-minute binaural cassette is available as a Simon & Schuster audio book for under \$10.

An even more accessible source of true binaural sound (except for those areas where local stations do not yet carry it) is the syndicated radio program, *AUDIO-PHILE AUDITION*, for audio buffs hosted by the author. He began regular all-binaural broadcasts in the San Francisco area almost ten years ago and continues them on a twice-annual basis nationally. An hour-long weekly program is carried on 185 stations, both public radio and eight commercial classical stations. The majority of stations carry its mix of classical, jazz, and interviews with personalities in the audio field "live" directly off the National Public Radio satellite Sundays at 2 PM Eastern Standard Time. (See box on page 86 for details on obtaining more information.)

The author's binaural specials

feature a variety of music and sound environments recorded in binaural. Even the interview portion of the most recent broadcast was in binaural, though the interview guest was on the opposite coast and for an interesting comparison, each of us was using a different type of dummy head, the guest wore the Aachen and the author wore the Sennheiser.

The good response led to the author's assembling all the worthwhile hard-to-find binaural recordings available in the U.S. and Germany that is aired on the program, and offering them in an exclusive mail order service that is called *THE BINAURAL SOURCE*. Nearly 50 albums in all three formats (CD, cassette, and LP) are available and more are in production from several different record labels. Radio dramas, sound environment recordings, and a variety of music are featured, including the author's own Binaural Audition one-hour sampler cassette, which provides a useful introduction to this whole new sonic universe. **R-E**

# CABLE - TV

## TUNABLE NOTCH FILTERS

- FOR ELIMINATION OF SEVERE INTERFERENCE
- FOR "CENSORING" OF ADULT BROADCASTS



- 45 dB AT CENTER FREQUENCY
- 5 dB AT 2 MHZ FROM CENTER
- 2 dB INSERTION LOSS

MODEL	TUNES TO CHANNEL	PRICE	SHIPPING
23H	2 OR 3 (or 6 meter ham)	\$30	NO
46FM	4, 5, OR 6 (or any FM station)	\$30	SHIPPING
713	7, 8, 9, 10, 11, 12, OR 13	\$30	OR
1417	14(A), 15(B), 16(C), OR 17 (D)	\$30	C.O.D.
1822	18(E), 19(F), 20(G), 21(H), OR 22(I)	\$30	CHARGES

**3 for \$75 - 10 for \$200 - Mix or Match**  
**30 DAY MONEY BACK GUARANTEE (3 FILTER LIMIT)**

**FAST DELIVERY**  
**CALL TOLL FREE FOR C.O.D. OR SEND CHECK TO ORDER**

## STAR CIRCUITS

P.O. BOX 94917  
 LAS VEGAS, NV 89193  
**1-800-433-6319**

**BEFORE BLOOD PRESSURE  
 MEDICATION CAN WORK,  
 IT HAS TO GET PAST  
 A MAJOR OBSTACLE.**



Next time you forget to take your blood pressure pills, remember this: heart attack and stroke are much harder pills to swallow. To learn more, contact the American Heart Association, 7320 Greenville Ave., Box 21, Dallas, TX 75231.

*You can help prevent heart disease. We can tell you how.*

American Heart Association 

This space provided as a public service.



# Now with NRI's new training you can enjoy the rewards of a career in computer programming

A top-paying career in computer programming is no longer out of your reach. Now you can get the practical training and experience you need to succeed in this top-growth field.

It's training that gives you real-world programming skills in four of today's hottest computer languages: BASIC, Pascal, C, and COBOL. Hands-on training that includes a powerful IBM AT-compatible computer, modem, and programming software you train with and keep. Comprehensive, at-home training that gives you the competitive edge to succeed in one of today's leading industries. The kind of experience-based training only NRI can provide.

As a trained computer programmer of the '90's, you can enjoy long-term career success. In fact, the Bureau of Labor Statistics forecasts that during the next 10 years job opportunities will increase by 71.7 percent for the skilled computer programmer. With NRI training you can be one of the increasing number of computer programmers using their skills to build a top-paying career—even a business of their own—in this professionally and financially rewarding high-tech field.

## ▼ The only programming course that includes a powerful AT-compatible computer system and programming software you keep

Right from the start, NRI training gets you actively involved in the challenge of real-world computer programming. You learn how to create the kinds of full-featured, powerful programs today's employers and clients demand. And, unlike any other school, NRI lets you experience first-hand the power of an IBM PC/AT-compatible computer system with modem, a full megabyte of RAM, disk drive, and monitor—all yours to train with and keep.

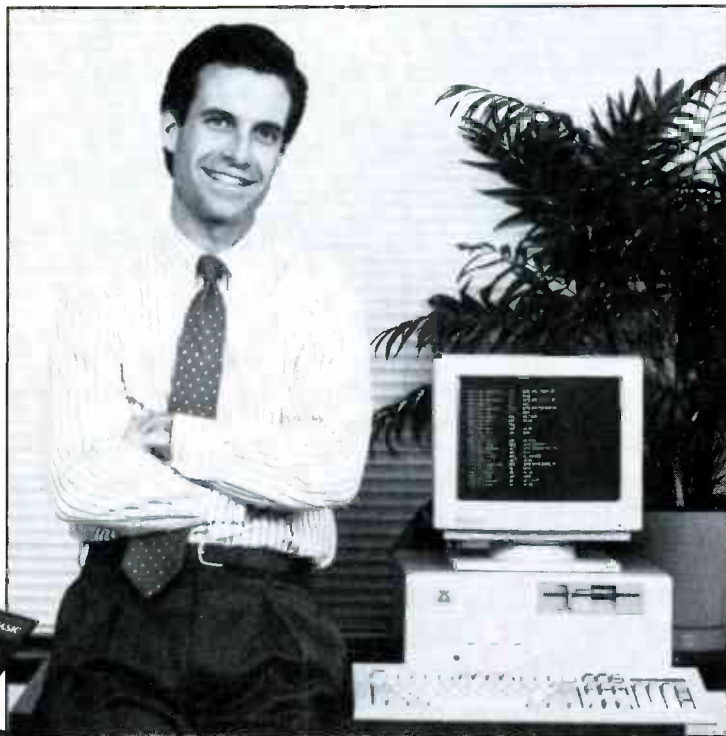
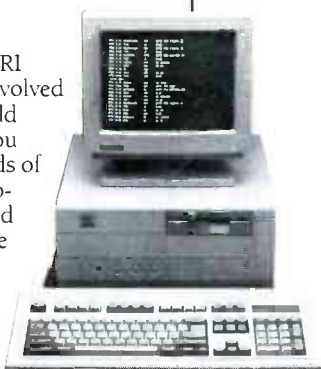

Plus you explore the extraordinary capabilities of not one or two but four in-demand computer languages. You learn to design, code, run, debug, and document programs in BASIC, Pascal, C, and COBOL. In the process you become uniquely prepared for the wide variety of programming opportunities available today.

## ▼ No previous experience necessary

Immediately, you start getting the money-making job skills you need to secure a future in computer programming—no matter what your background. With NRI training you move easily from computer novice to computer professional with step-by-step lessons covering program design techniques used every day by successful micro and mainframe programmers.

You'll find no heavy textbooks to plow through. No night classes to attend. Instead, NRI's at-home, step-by-step training covers all the bases, guiding you from the impor-

tant fundamentals to real-world methods and techniques. With the help of your NRI instructor—offering one-on-one, personal guidance throughout your course—you quickly gain the skills you need to handle with confidence a wide variety of programming applications. You even use your modem to "talk" to your instructor, meet other NRI students, and download programs through NRI's exclusive programmers network, PRONET.

## ▼ Send today for your FREE catalog

Now you can have the professional and financial rewards of a career in computer programming. See how NRI at-home training gives you the experience, the know-how, the computer, and the software you need to get started in this top-paying field. Send today for your FREE catalog.

If the coupon is missing, write to us at the NRI School of Computer Programming, McGraw-Hill Continuing Education Center, 4401 Connecticut Avenue, NW, Washington, DC 20008.

## NRI Schools

McGraw-Hill Continuing Education Center  
4401 Connecticut Avenue, NW, Washington, DC 20008



### Check one free catalog only

- |  |  |
|--|--|
| <input type="checkbox"/> Computer Programming            | <input type="checkbox"/> Microcomputer Servicing       |
| <input type="checkbox"/> PC Systems Analysis             | <input type="checkbox"/> Desktop Publishing and Design |
| <input type="checkbox"/> PC Software Engineering Using C | <input type="checkbox"/> Word Processing Home Business |

Name \_\_\_\_\_ Age \_\_\_\_\_  
(please print)

Address \_\_\_\_\_

City \_\_\_\_\_ State \_\_\_\_\_ Zip \_\_\_\_\_

Accredited Member, National Home Study Council

5415-101

## History in the making

JEFF HOLTZMAN

IBM and Apple recently signed an accord that may be the most elaborate smoke screen ever perpetrated on the PC industry. On the other hand, it may mark the beginning of the end of Microsoft's domination in operating system software for PC's.

Details are still to be worked out, but highlights of the agreement include the following:

- The two companies will set up an independent company, funded by both parents, that will develop a new object-oriented, platform-independent system-software foundation that will run on Intel (80X86), Motorola (680X0), and IBM's own proprietary RS/6000 CPU's, and that will be backward compatible with AIX (IBM's version of UNIX), OS/2, and the Macintosh operating system. Of course, compatibility with OS/2 implies compatibility with DOS and Windows as well. There is also talk that IBM will develop a version of AIX that will offer both Macintosh and OSF/Motif interfaces.
- IBM will license RS/6000 CPU manufacturing rights to Motorola; providing a second source will help legitimize the chip as a platform other vendors (Apple, for instance) might want to support.
- The two companies will develop networking products that will allow easy integration of Macs into IBM-based corporate networks.
- The two companies will try to develop platform-independent standards for multimedia data.

Given the recent sparring between IBM and Microsoft, it seems clear that the operating system issue is most important. But what does it mean?

To answer that question, it's necessary to first examine several subsidiary questions. What does Apple have that IBM wants? Assuming IBM could get its hands on it, what could it do with it, and would that be sufficient to have any market impact, given the

assured fact that Microsoft is not going to roll over and play dead?

### Look and feel

What Apple has is that Macintosh look and feel. And rightly or wrongly, the courts so far seem content to allow Apple to maintain intellectual ownership of the Mac interface.

IBM on the other hand has developed an operating system kernel for OS/2 2.0 that by all accounts is a robust and stable environment for building advanced applications software. Problem is that it's missing a shell—a user interface—not to mention significant applications—not to mention credibility. A Macintosh-like look and feel would solve the first of those problems. Near-perfect compatibility with present-day applications would solve the second. The third, though least technical, may be most difficult to overcome.

IBM has several other OS cards up its sleeve. There's AIX, which powers the RS/6000 line. There's also OSF/1, the Esperanto of UNIX-like dialects, which is being developed by the Open Software Foundation, and to which IBM has made major contributions. Could one of those serve as the underlying foundation for a new world order in operating systems?

Perhaps. But keep in mind that IBM also belongs to several other key consortia, in addition to OSF. First is Patriot Partners, which IBM and Metaphor systems co-founded about a year ago to develop . . . an operating system-independent, object-oriented software layer that would allow the same application to run on multiple platforms, regardless of underlying file and graphics systems.

Then there's the Object Management Group (OMG), whose focus is the development of a set of API's for managing objects in a distributed computing (network) environment.

Confused? Excellent! (And we haven't even mentioned mainframe operating systems!)

### A little help from your friends

Suppose there is a method to the madness. Suppose you're a huge company, with products ranging from PC's to mainframes, segregated into four distinct and totally incompatible product lines (PS/2, RS/6000, AS/400, mainframe), which for several years you've been trying to integrate through an ambitious undertaking called Systems Application Architecture (SAA).

Suppose that even though you have trouble adapting to rapidly changing market conditions, you have a great deal of influence and a clear vision of how you think your industry's technology should and will evolve over the next ten to twenty years. How can you make your vision reality, knowing you can't do it all by yourself? One way is to make some friends and try to get by with a little help from them—and in the meantime, reduce your dependence on proprietary (expensive) underlying technologies.

For example, join an operating system consortium (OSF), make enough contributions to make the other members feel secure enough to make contributions of their own, take the results back to your labs, enhance the technology for your customers, begin weaving it into the half dozen or so operating systems you presently support, and gradually phase them out. Eventually what you get is a single, unified OS that runs on multiple platforms and that supports a high degree of applications portability across all of them.

The world is changing to a distributed (networked) computing model. OK, fine. Develop some stuff internally (Distributed Application Environment or DAE) in the meantime, and join another consortium (OMG) just in case they come up with anything interesting.

Oh, yeah—graphics environments are inevitably slow, so buy some third-party technology (Micrografx) to



# R-E Computer Admart

Rates: Ads are 2 1/4" x 2 7/8". One insertion \$995 each. Six insertions \$950 each. Twelve insertions \$925 each. Closing date same as regular rate card. Send order with remittance to Computer Admart, Radio-Electronics Magazine, 500-B Bi-County Blvd., Farmingdale, NY 11735. Direct telephone inquiries to Arline Fishman, area code-1-516-293-3000. FAX 1-516-293-3115. Only 100% Computer ads are accepted for this Admart.

## A CONCISE INTRODUCTION TO THE MACINTOSH SYSTEM AND FINDER



**BP298**—This introduction for those new to the Mac, this book also serves as a quick refresher for those experienced owners that have not used the machine in some time. To order your copy send \$6.25 plus \$2.50 for shipping in the U.S. to Electronic Technology Today Inc., P.O. Box 240, Massapequa Park, NY 11762-0240.

## HOW TO EXPAND, MODERNIZE AND REPAIR PCs AND COMPATIBLES

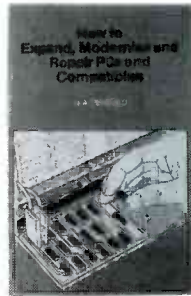

**BF271**—Includes PC overview, memory upgrades, adding a hard disc, adding floppy drives, display adapters and monitors, installing a co-processor, preventive maintenance, repairs, do it yourself PCs and more. To order your copy send \$7.75 plus \$2.50 for shipping in the U.S. to Electronic Technology Today Inc., P.O. Box 240, Massapequa Park, NY 11762-0240.

**PCB and SCHEMATIC C.A.D.**

**EASY-PC** **\$195** **EASY-PC**

- Runs on PC/XT/AT/286/386 with Hercules, CGA, EGA, VGA.
- Design Single sided, Double sided and Multilayer boards
- Provides Surface Mount support
- Standard output includes Dot Matrix / Laser / Inkjet Printer, Pen Plotter, Photo-plotter and N.C. Drill
- Award Winning EASY-PC is now in use in over 9000 Installations in 50 Countries World-wide.
- SUPERBLY EASY TO LEARN AND USE.
- Not Copy Protected.
- Dealers Wanted.

Options - 1000 piece symbol library \$75.00  
Gerber Import facility \$195.00

For full info, write, fax, call or use inquiry # **1**

**Number One Systems Ltd.**

REF: REUS, HARDING WAY, STJVES, HUNTINGDON, CAMBS, ENGLAND, PE17 4WR.

Telephone: USA: 011-44-480-61778 USA: 011-44-480-494042 AMEX, VISA, Intl: +44-480-61778 Intl: +44-480-494042 MasterCard UK: 0480 61778 UK: 0480 494042 Welcome

CIRCLE 188 ON FREE INFORMATION CARD

speed things up. While you're at it, get the premier networking company (Novell) to port its wares to your proprietary systems (e.g., AS/400) and resell it under your own label.

One important thing—don't forget the developers who will be building the great new things your users will use. Pamper those developers, get them slick tools, an integrated development environment. Team up with a class act (Borland), and sell your tools for 10% of what the competition charges.

All of the above have happened. Now last but certainly not least, don't forget your users this time. They want something sexy, something fun, something productive. License some of the flowery stuff from the artsy guys out on the west coast (Apple, NeXT). Build in a set of basic applications that will wet users' whistles. Make it compatible with their old software. Make it easy to install and upgrade. Sell it inexpensively. Make it reliable, reliable, reliable and you'll have it all. (There are more pieces to the puzzle, but you get the idea.)

The problem is that, when you start thinking about it, the pieces don't exactly fit. One seems too big, another too small, another dangles out in space . . . True, but so what? Don't worry about it. If you get enough chunks out on the table, you know that eventually you'll find a way of fitting enough of them together that overall you'll have a coherent system. Sure, you'll throw away a few bucks

on R&D, but you're a big company; in the long term it'll be worth it. In the mean time, keep pushing on all fronts, knowing that some pieces are already starting to fit, and believing that others will come on-line soon.

Next thing you know you've got something that sticks together when you throw it against the wall.

But what do you call it? Be careful of the stigma attached to similar efforts in the past.

### So what?

IBM makes yet another strategic alliance. Ho hum. To produce an operating system? Yuk, yuk, yuk. Takes three, four, maybe five years to do that type of job right, and the company's track record in that field isn't good.

Yeah, but they're not starting from scratch; many of the pieces are in place already.

Look at the basic facts. IBM

- Doesn't want to depend on Microsoft.
- Wants to integrate its vast product line.
- Has a big stake in object-oriented technology.
- Has done lots of development on core OS technology.
- Needs help with look and feel in the PC market, including product operation, packaging, and marketing.

The latest alliance may give Big Blue the shove it needs to crest the operating system hill currently dominated by Microsoft in the PC arena,

and by various vendors in others.

I think we're going to see a new king of the OS hill—and a lot sooner than most people expect.

### OS/2 and you

A coherent picture of **OS/2 2.0** has started to emerge:

- Multiboot allows booting DOS, OS/2, or other operating system without running FDISK.
- A high-performance 32-bit version of the traditional DOS file system.
- A Mac-like desktop for launching programs and managing files.
- Bundled applications including a useful graphics/charting package from Micrografx.
- Reduced prices (\$100-\$150).
- Friendly installation.
- The ability to run multiple DOS sessions simultaneously with as much space as provided by DOS 5.0.
- The ability to run Windows 3.0, DOS, 16-bit OS/2, and 32-bit OS/2 applications simultaneously. Rumor has it that Windows compatibility is still shaky and may not be fully developed in time for the year-end release. I hope IBM can work out the technical details; I'm getting awfully tired of UAE's (Unrecoverable Application Errors) under Win3.

### News bits

Not only do we have to worry about which operating system we're going to run, but also about which CPU it will run on. Intel recently released sketchy details on the architecture.

She's  
waiting  
at her  
home...



for  
you to  
open  
the door  
to yours.

Hundreds of foreign exchange students will be unable to study in America unless you become an OPEN DOOR host family. Without you they can't enrich their own and our understanding of other cultures. Our local high schools won't benefit from their fresh, global perspective. Give your family a unique opportunity to learn personally about and make life-long friendships with visiting students from around the world. Only you can open the door. Help us make the connection.



For a free Host Family Brochure, call: 1-800-366-OPEN (6736), or write:



**OPEN DOOR STUDENT EXCHANGE**  
250 Fulton Street  
P.O. Box 71  
Hempstead, NY 11551



Please send me a Host Family brochure.

Name: \_\_\_\_\_  
Address: \_\_\_\_\_  
City: \_\_\_\_\_ State: \_\_\_\_\_ Zip: \_\_\_\_\_  
Phone: (\_\_\_\_) \_\_\_\_\_

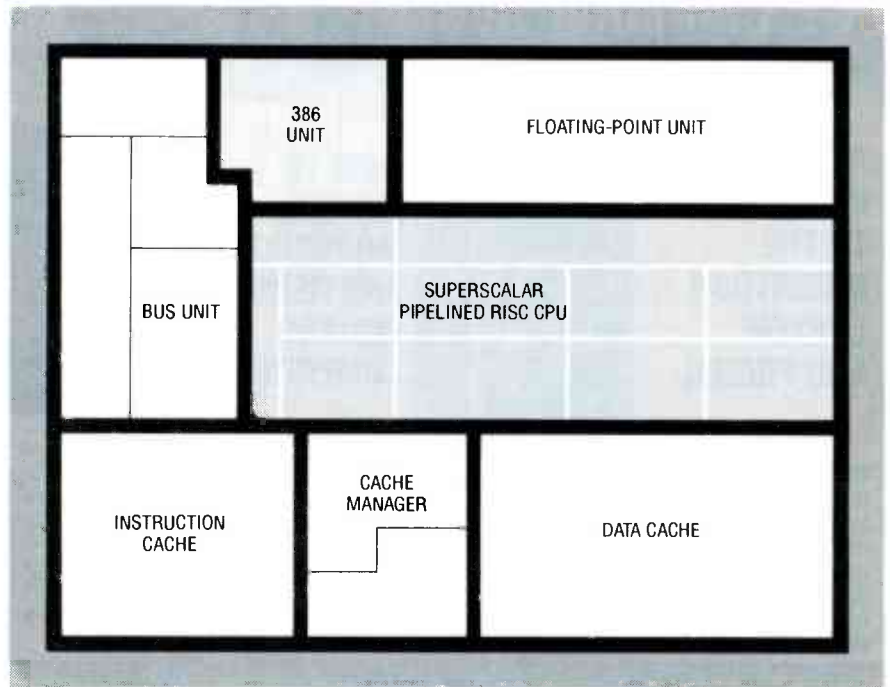

**FIG. 1—INTEL'S UPCOMING P5 (AKA 80586) uses three million transistors to power three separate execution units, separate data and instruction caches, and a sophisticated multiprocessing bus interface unit.**

shown in Fig. 1, of the **586** (aka "P5"), a simulation of which is already said to be running in Intel's design labs. Samples are due in about a year, with systems scheduled for delivery in late 1992.

The P5 consists of more than three million transistors powering three execution units, including a 386 compatibility unit, a floating-point unit, and the new star of the show, a 100 MIPS RISC-based execution unit that will handle basic x86 instructions at a rate of two per clock cycle. (The 386 unit will execute more complex 386 instructions at a slower rate.)

Meanwhile, in response to competitive threats by AMD and others, Intel has been barraging the market with more variations on the 486 than you can count on one hand. There are 25-, 33-, and the recently introduced 50-MHz 486DX, along with a 66-MHz version promised for sometime in 1992. In addition, there is the 20-MHz 486SX, with a 25-MHz version also promised for '92.

Nearly all PC's come with a socket for a math coprocessor. That socket has all the address, data, and control lines necessary to take complete control of the computer. Who says that socket is only good for a math coprocessor? Suppose you installed some other type of device—for example, a next generation CPU? Intel has publicly stated plans for such de-

vices, first implemented in the 487SX math coprocessor, which is really a full-blown 486DX with support logic to disable the "main" 486SX and take control of the system.

In addition, after months of rumors, Intel finally announced plans to release double-speed CPU's that externally appear to run at standard speeds, but that internally run at twice the bus rate. Imagine dropping a 50-MHz 486 into that "old" 33-MHz 386.

**Claris** is a subsidiary of Apple. A couple of years ago, Apple relinquished control of Claris, but about a year ago, regained control. Recently, the Claris has been going through organizational upheaval, and has advertised in national trade journals for programmers experienced in OS/2 and Windows development. There are some speculators out there who think that, like Novell, Apple wants to get out of the hardware business altogether.

On the semiconductor side of the house, **IBM and Siemens** have announced plans to pool resources in manufacturing the next generation of DRAM's—16 megabits. Think about it: Nine of those would provide almost as much memory as hard disks of only five years ago. The companies are also expected to jointly develop the follow-up, 64-megabit chips, due around 1995.

**R-E**



# MARKET CENTER

## FOR SALE

**OSCILLOSCOPE** 50 MHz, dual channel, solid state calibrated, manual \$250 1 (800) 835-8335.

**TOCOM and Zenith "test" chips. Fully activates unit. \$50.00. Cable descramblers from \$40.00. Orders 1 (800) 452-7090. Information (213) 867-0081.**

**COMPUTERS AT/XT** compatible systems and components at discount prices. Catalog \$2.00, refund with first order. **MPS ENTERPRISES**, Box 1048, Lemon Grove, CA 91946.

**WANTED;** old, Western Electric, McIntosh, Aitec, Marantz, Jensen, JBL, EMT, Electrovoice, RCA, Telefunken, Westrex, Fairchild, Fisher, Dynaco; tubes, speakers, amplifiers. (713) 728-4343. **MAURY CORB**, 12325 Ashcroft, Houston, TX 77035.

## CLASSIFIED AD ORDER FORM

To run your own classified ad, put one word on each of the lines below and send this form along with your check to:

**Radio-Electronics Classified Ads**, 500-B Bi-County Boulevard, Farmingdale, NY 11735

**PLEASE INDICATE** in which category of classified advertising you wish your ad to appear. For special headings, there is a surcharge of **\$25.00**.

( ) Plans/Kits ( ) Business Opportunities ( ) For Sale  
( ) Education/Instruction ( ) Wanted ( ) Satellite Television  
( ) \_\_\_\_\_

Special Category: \$25.00

### PLEASE PRINT EACH WORD SEPARATELY, IN BLOCK LETTERS.

(No refunds or credits for typesetting errors can be made unless you clearly print or type your copy.) Rates indicated are for standard style classified ads only. See below for additional charges for special ads. **Minimum: 15 words.**

1	2	3	4	5
6	7	8	9	10
11	12	13	14	15 (\$46.50)
16 (\$49.60)	17 (\$52.70)	18 (\$55.80)	19 (\$58.90)	20 (\$62.00)
21 (\$65.10)	22 (\$68.20)	23 (\$71.30)	24 (\$74.40)	25 (\$77.50)
26 (\$80.60)	27 (\$83.70)	28 (\$86.80)	29 (\$89.90)	30 (\$93.00)
31 (\$96.10)	32 (\$99.20)	33 (\$102.30)	34 (\$105.40)	35 (\$108.50)

We accept MasterCard and Visa for payment of orders. If you wish to use your credit card to pay for your ad fill in the following additional information (Sorry, no telephone orders can be accepted.):

Card Number \_\_\_\_\_

Expiration Date \_\_\_\_\_

Please Print Name \_\_\_\_\_

Signature \_\_\_\_\_

**IF YOU USE A BOX NUMBER YOU MUST INCLUDE YOUR PERMANENT ADDRESS AND PHONE NUMBER FOR OUR FILES. ADS SUBMITTED WITHOUT THIS INFORMATION WILL NOT BE ACCEPTED.**

**CLASSIFIED COMMERCIAL RATE:** (for firms or individuals offering commercial products or services) \$3.10 per word prepaid (no charge for zip code)...**MINIMUM 15 WORDS**. 5% discount for same ad in 6 issues; 10% discount for same ad in 12 issues within one year, if prepaid. **NON-COMMERCIAL RATE:** (for individuals who want to buy or sell a personal item) \$2.50 per word, prepaid...no minimum. **ONLY FIRST WORD AND NAME** set in bold caps at no extra charge. Additional bold face (not available as all caps) **55¢ per word additional**. Entire ad in boldface, \$3.70 per word. **TINT SCREEN BEHIND ENTIRE AD: \$3.85 per word. TINT SCREEN BEHIND ENTIRE AD PLUS ALL BOLD FACE AD: \$4.50 per word. EXPANDED TYPE AD: \$4.70 per word prepaid.** Entire ad in boldface, \$5.60 per word. **TINT SCREEN BEHIND ENTIRE EXPANDED TYPE AD: \$5.90 per word. TINT SCREEN BEHIND ENTIRE EXPANDED TYPE AD PLUS ALL BOLD FACE AD: \$6.80 per word. DISPLAY ADS:** 1" x 2 1/4"—\$410.00; 2" x 2 1/4"—\$820.00; 3" x 2 1/4"—\$1230.00. **General Information:** Frequency rates and prepayment discounts are available. **ALL COPY SUBJECT TO PUBLISHERS APPROVAL. ADVERTISEMENTS USING P.O. BOX ADDRESS WILL NOT BE ACCEPTED UNTIL ADVERTISER SUPPLIES PUBLISHER WITH PERMANENT ADDRESS AND PHONE NUMBER.** Copy to be in our hands on the 5th of the third month preceding the date of the issue. (i.e., Aug. issue copy must be received by May 5th). When normal closing date falls on Saturday, Sunday or Holiday, issue closes on preceding working day. Send for the classified brochure. Circle Number 49 on the Free Information Card.

## CB RADIO OWNERS!

We specialize in a wide variety of technical information, parts and services for CB radios. 10-Meter and FM conversion kits, repair books, plans, high-performance accessories. Thousands of satisfied customers since 1976! Catalog \$2.

**CBC INTERNATIONAL**  
P.O. BOX 31500RE, PHOENIX, AZ 85046

**TEST EQUIPMENT** pre-owned now at affordable prices. Signal generators from \$50.00, oscilloscopes from \$50.00, other equipment, including manuals available. Send \$2.00 U.S. for catalog, refunded on 1st order. **J.B. ELECTRONICS**, 3446 Dempster, Skokie, IL 60076. (708) 982-1973.

**OUR** monthly picture flyer lists quality surplus parts at low prices. You'll like it. **STAR-TRONICS**, Box 683, McMinnville, OR 97128.

**CRIBSHEET laminated**, of commonly used electronic formulas and symbols. \$3.00 to **HUMEX**, 16365 Rhyolite Circle, Reno, NV 89511.

**TUBES:** "oldest," "latest." Parts and schematics. SASE for lists. **STEINMETZ**, 7519 Maplewood Ave., RE, Hammond, IN 46324.

## WIRELESS CABLE RECEIVERS 1.9 TO 2.7 GHz



VISA/MC/AMEX

30 CH PARABOLIC DISH SYSTEM \$173.90  
30 CH ROD ANTENNA SYSTEM \$193.90  
30 CH CRYSTAL CONTROLLED SYSTEM \$294.95

**SUN MICROWAVE INT'L. INC.** SEND \$1.00 FOR  
P.O. BOX #34522 CATALOG ON THESE  
PHOENIX, AZ 85067 AND OTHER FINE  
(602) 230-1245 VIDEO PRODUCTS  
QUANTITY DISCOUNTS

ORDERS ONLY 1-800-484-4190 CODE 9793

**CABLE TV descramblers. Absolutely the lowest prices!** All major brands. Money Back guarantee. **Call us last! ADVANCE ELECTRONICS**, 2140 Shattuck #2082, Berkeley, CA 94704. 1 (800) 659-3018.

**"C.B. radio repair specialist."** All makes and models. Modifications, sales, etc. **LOU'S C.B. SHOP**, (508) 866-3226.

**GOV'T** seized surplus vehicles available from \$100.00! Call for immediate information. (504) 649-5745 ext. S-5192.

## FREE CATALOG

**FAMOUS "FIRESTIK" BRAND CB ANTENNAS AND ACCESSORIES. QUALITY PRODUCTS FOR THE SERIOUS CB'er. SINCE 1962**  
**FIRESTIK ANTENNA COMPANY**  
2614 EAST ADAMS  
PHOENIX, ARIZONA 85034

**PEANUT** Butter oatmeal cookie recipe \$2.00 + SASE 1042 E. Fort Union #374, Midvale, UT 84047.

**DESCRAMBLERS:** Oak Sigma, Varisync, Hamlin, Scientific Atlanta, Jerrold, Pioneer, Sylvania. Catalog \$5.00 moneyorder (credited first order), service manuals, schematics, **SURPLUS ELECTRONICS**, PO Box 10009, Colorado Springs, CO 80932.

**Quality Microwave TV Antennas**

WIRELESS CABLE - IFTS - MMDS - Amateur TV  
Ultra High Gain 50db(+) - Tuneable 1.9 to 2.7 Ghz.

- 36-Channel System Complete \$149.95
- 12-Channel System Complete \$114.95
- Call or write (SASE) for "FREE" Catalog

**PHILLIPS-TECH ELECTRONICS**  
P.O. Box 8533 • Scottsdale, AZ 85252  
(602) 947-7700 (\$3.00 Credit all phone orders)  
MasterCard • Visa • COD's • Quantity Pricing

LIFETIME WARRANTY

**ENGINEERING** software, PC/MSDOS. Circuit design and drawing, PCB layout, Logic simulation, FFT analysis, Mathematics, Circuit analysis. Call or write for free catalog. 1 (800) 728-3805, **BSOFT SOFTWARE, INC.**, 444 Colton Rd., Columbus, OH 43207.

**RESTRICTED** technical information: Electronic surveillance, schematics, locksmithing, covert sciences, hacking, etc. **Huge selection. Free brochures.** MENTOR-Z, Drawer 1549, Asbury Park, NJ 07712.

**CABLE TV** converters: Jerrold, Oak, Scientific Atlantic, Zenith & many others. "New MTS" stereo add-on: mute & volume. Ideal for 400 and 450 owners! 1 (800) 826-7623, Amex, Visa, M/C accepted. **B & B INC.**, 4030 Beau-D-Rue Drive, Eagan, MN 55122.

**TUBES**, new, up to 90% off, SASE, **KIRBY**, 298 West Carmel Drive, Carmel, IN 46032.

**CABLE TV converters and descramblers.** We sell only the best. Low prices. **SB-3 \$79.00.** We ship C.O.D. Free catalog. **ACE PRODUCTS**, PO Box 582, Dept. E, Saco, ME 04072. 1 (800) 234-0726.

T.V. notch filters, phone recording equipment, brochure \$1.00. **MICRO THinc**, Box 63/6025, Margate, FL 33063. (305) 752-9202.

**PHOTOFACT** folders under #1400 \$5.00. Others \$7.00. Postpaid. **LOEB**, 414 Chestnut Lane, East Meadow, NY 11554. (516) 481-4380.

**CABLE CONVERTERS** all major brands info + orders 1 (800) 782-0552 **FREEWAY INC.** s.m.p., PO 5036, Burnsville, MN 55337.

**CIRCUIT Center** — Complete circuit fabrication from single piece single sided to production multi-layer. Also — Laminate \$5.50/sq. ft., etch \$3.50/qt. Thru hole plating available too. **CIRCUIT CENTER**, Dept. 001, PO Box 128, Addison, IL 60101. (708) 543-0671.

**PREVENT** descrambler detection! Order Tech-Block today! Simple in-line connection. Only \$19.95 P.P.D. **THE STAGE DOOR VIDEO**, PO Box 518, Belleview, FL 32620. For C.O.D.'s 1(800) 395-4557.

**CABLE TV  
DESCRAMBLER LIQUIDATION!**

**FREE CATALOG!**  
Hamlin Combos \$44, Oak M35B \$60 (min. 5), etc.  
**WEST COAST ELECTRONICS**  
For Information: 818-709-1758  
Catalogs & Orders: 800-628-9656

**EXOTIC** miniature electronic devices, catalog \$5.00, refundable. **F & P ENTERPRISES**, Box 51272, Palo Alto, CA 94303-L.

**TOCOM-Jerrold Impulse-Scientific Atlanta 8580 & 8590** converters with two yr. warranties, also test modules for Star Comm 6 & 7s, all Tocoms, and Scientific Atlanta. Full details. (219) 935-4128.

**DESCRAMBLERS** cable TV converters, lowest prices, guaranteed, best quality, special Sacramento units, **CNC CONCEPTS, INC.**, Box 34503, Minneapolis, MN 55434. 1 (800) 535-1843.

**ELECTECH**

**CABLE T.V. DESCRAMBLERS**

- All quality brand names •
- All fully guaranteed • All the time •

Knowledgeable Sales Service Department  
**FOR FREE CATALOG 800-253-0099**

**PLANS AND KITS**

**DAZER** personal protectors! Lasers! AM/FM/Infrared transmitters! Detectors! More! Kits/assembled. Catalog \$2.00. **QUANTUM RESEARCH**, 16645-113 Avenue, Edmonton, Alberta T5M 2X2.

**SURVEILLANCE** — Audio/video/infra-red/laser equipment. Industrial or private. 500 item catalog \$7.00. **SECURITY SYSTEMS**, 3017G Hudson Pl., New Orleans, LA 70131.

**DESCRAMBLING**, new secret manual. Build your own descramblers for **cable and subscription TV**. Instructions, schematics for SSAVI, gated sync, sinewave, (HBO, Cinemax, Showtime, UHF, adult) \$12.95, \$2.00 postage. **CABLETRONICS**, Box 30502R, Bethesda, MD 20824.

**REMOVE LEAD VOCALS**

Build this kit for under \$60 which removes lead vocals from standard stereo records, CD's, tapes or FM broadcasts. Easily connects to any home component stereo. Perform live with the backgrounds. You can be the lead singer of your favorite band. Detailed Plans \$4.95  
**Weeder Technologies**  
14773 Lindsey Rd.  
Mt. Orab, Ohio 45154

From Records & CD's

**TELEPHONE caller identifiers.** Displays incoming caller's telephone number, kit \$49.95 postpaid, **SURVEILLANCE** catalog \$5.00, **EDE**, POB 337, Buffalo, NY 14226.

**DESCRAMBLER** kits. Complete cable kit \$44.95. Complete satellite kit \$49.95. Add \$5.00 shipping. Free brochure. No New York sales. **SUMMIT RE**, Box 489, Bronx, NY 10465.

**REMOTE CONTROL KEYCHAIN**

Complete w/mini-transmitter and +5 vdc RF receiver  
Fully assembled including plans to build your own auto alarm  
Quantity discounts available

**\$24.95** Check, Visa or M/C Add \$3 shipping

**VISITECT INC.** Box 14156, Fremont, Ca. 94539  
(415) 531-8425 Fax (415) 531-8442

**HYPNOTIZE** or **Relax** electronically! Alpha/meditation goggles. Complete kit \$53.00. Free information. **MARK WORLEY**, Box 261113, San Diego, CA 92196.

**SURVEILLANCE** transmitter kits tune from 65 to 305 MHz. Mains powered duplex, telephone, room, combination telephone/room. Catalog with **Popular Communications, Popular Electronics and Radio-Electronics** book reviews of "Electronic Eavesdropping Equipment Design," \$2.00. **SHEFFIELD ELECTRONICS**, 7223 Stony Island Ave., Chicago, IL 60649-2806.

**FREE** cable and satellite descrambler plans. Send self addressed stamped envelope. **MJM INDUSTRY**, Box 531, Bronx, NY 10461-0208.

**HOBBY/broadcasting/HAM/CB/surveillance** transmitters, amplifiers, cable TV, science, bugs, other great projects! Catalog \$1.00. **PANAXIS**, Box 130-F10, Paradise, CA 95967.

**CABLE DESCRAMBLERS  
OAK M35B COMBO \$39.95**

Jerrold, Zenith, Hamlin, Sci. Atlanta, Pioneer & MORE! OUR PRICES ARE BELOW WHOLESALE!

**CABLE+PLUS**  
14417 Chase St. #481-A Panorama City, CA 91402  
1-800-822-9955 • Other Info. 1-818-785-4500  
NO CALIF. SALES — DEALERS WANTED

**BUILD** from simple materials, over 100 miles per gallon carburetor. Detailed plans, five versions. Good science project. \$20.00 Visa welcome. (902) 467-3577 **VALLEY MICROWAVE**, Station C, Bear River, N.S., Canada B0S 1B0.

**INVESTIGATORS**, experimenters — Quality new plans. Micro and restricted devices. Free catalog. Self addressed stamped envelope required. **KELLEY SECURITY, INC.** Suite 90, 2531 Sawtelle Blvd., Los Angeles, CA 90064.

**PCB** and schematic CAD. \$195.00 IBM EGA CGA Multilayer, rubberband, autovia, NC drill, laser, dot matrix, plotter, library, Gerber, **AUTOSCENE**, 10565 Bluebird St., Minneapolis, MN 55433. (612) 757-8584 free demo disk.

**VIDEOCIPHER II/scanner/cable/satellite** modifications books. Catalog \$3.00. **TELECODE**, PO Box 6426-RE, Yuma, AZ 85366-6426.

**ANTIQUE RADIO CLASSIFIED**

Free Sample!  
Antique Radio's  
Largest Circulation Monthly.  
Articles, Ads & Classifieds.

6-Month Trial: \$15. 1-Yr: \$27 (\$40-1st Class).  
A.R.C., P.O. Box 802-L9, Carlisle, MA 01741

**DIGITAL recorder.** Digitally record any audio source with special effects. Microprocessor controlled device. Detailed plans, \$9.75: **T. ZURAW**, Box 341, Dearborn Hts, MI 48127.

**REMOVE** VCR copy protection, PCB PAL instructions \$16.50 w/P&H, **LOGICAL CHOICE**, Box 1256, Lomita, CA 90717.

**POWER:** 900 watt amplifier for less than \$100.00! SASE for information. Plans \$10.00 **E.D.S.**, N90 W20756 Scenic Drive, Menomonee Falls, WI 53051.

**SCANNER** antenna plans multi frequency indoor outdoor easy designs \$5.00. **SCANTENNA**, 729-B North Golden State Blvd., Turlock, CA 95380.

**Worldwide Cable**

WE HAVE THE MOST ADVANCED TECHNOLOGY IN CABLE EQUIPMENT:

- BASE BAND
- PIONEER
- HAMLIN
- SCIENTIFIC ATLANTA
- JERROLD
- TOCOM
- ZENITH
- OAK

For out of this world prices call  
**WORLDWIDE CABLE**  
**1800-772-3233**  
FREE CATALOG AVAILABLE

7491 C-5 N. FEDERAL HWY., SUITE 142  
BOCA RATON, FL 33487

MasterCard / COD / VISA NO FLORIDA SALES



**PROTECT** your home for pennies. Alarm kit. Assembles in one night. Thousands already installed. Also receive booklet "How to Install an Alarm System in Your Home." \$24.95: **NOBLE ELECTRONICS**, 17 Farmington Avenue, Suite 169, Plainville, CT 06062-1726.

**ROBOTICS-** powerful, compact, inexpensive, microcomputer, perfect for robotic/microprocessor control applications. Plans/application notes \$5.50, **ACS**, 6220 Shallowford Rd. #152, Chattanooga, TN 37421.

**BEST BY MAIL**  
Rates: Write National, Box 5, Sarasota, FL 34230

**FINANCIAL**  
1% INTEREST LOANS; No Limit! No Refusal Guarantee! Write: JEF, Box 2342-(RE), Ada, OK 74820.  
**LOANS AVAILABLE!** Business - Personal. No front fees. Easy qualify. (619)693-0498.

**HEALTH & BEAUTY**  
**LOSE WEIGHT WHILE** Sleeping! Revolutionary! No Dieting/Exercise! Free Hawaiian Vacation For Trying. 1-800-937-3096X121.

### SATELLITE TV

**FREE** catalog — Lowest prices worldwide. Save 40 — 60%. Systems, upgrades, parts, all major brands factory fresh and warrantied. **SKYVISION**, 2009 Collegeway, Fergus Falls, MN 56537. 1 (800) 334-6455.

**VIDEOCYpher II** descrambling manual. Schematics, video and audio. Explains DES, Eprom, Clonemaster, 3Musketeer, Pay-per-view (HBO, Cinemax, Showtime, adult, etc.) \$16.95, \$2.00 postage. Schematics for Videocypher Plus, \$20.00. Schematics for Videocypher 032, \$15.00. Collection of software to copy and alter Eprom codes, \$25.00. **CABLETRONICS**, Box 30502R, Bethesda, MD 20824.

**CABLE TV** Secrets — the outlaw publication the cable companies tried to ban. HBO, Movie Channel, Showtime, descramblers, converters, etc. Suppliers list included. \$9.95. **CABLE FACTS**, Box 711-R, Pataskala, OH 43062.

\*\*\*\*\*PRESENTING\*\*\*\*\*  
**CABLE TV  
DESCRAMBLERS**  
\*\*\*\*\*STARRING\*\*\*\*\*  
**JERROLD, HAMLIN, OAK**  
AND OTHER FAMOUS MANUFACTURERS

- FINEST WARRANTY PROGRAM AVAILABLE
- LOWEST RETAIL / WHOLESALE PRICES IN U.S.
- ORDERS SHIPPED FROM STOCK WITHIN 24 HRS.
- ALL MAJOR CREDIT CARDS ACCEPTED

FOR FREE CATALOG ONLY 1-800-345-8927  
FOR ALL INFORMATION 1-818-709-9937

**PACIFIC CABLE CO., INC.**  
7325 1/2 Reseda Blvd., Dept. 2107  
Reseda, CA 91335

**SATELLITE TV — Do it yourself** — Systems. Upgrades. Parts. Major brands discounted 40% — 60%. We'll beat everyone's price. L.J.H. Inc., call **LARRY** (609) 596-0656.

**FREE catalog** — Compare our prices for new systems and upgrades. Latest receivers and dishes — all top brands. **ALPHA SATELLITE DIST.**, PO Box 197A, Hawthorne, NJ 07507-0197. 1 (800) 535-ALPHA.

**SATELLITE TV** descrambler. Build your own. Easy to follow instructions, parts list. Circuit board, wiring diagram. \$9.95 **ABG ENTERPRISES**, 27081A, Halifax, NS B3H-4M8.

**SATELLITE TV** and cable descrambling secrets. Surveillance transmitter plans. Send stamp for free catalog. **COMMUNICATIONS ENGINEERING**, 76 Boulevard, Hudson Falls, NY 12839.

## Cable Descramblers

New Auto Tri-Bi guaranteed no flashing \$165.00

SB-3.....	\$99.00	ZENTH SUPER	
TRIMODE.....	\$109.00	SAAVL.....	\$199.00
HAMLIN.....	\$99.00	TOCOM.....	\$319.00
SCIENTIFIC.....		EAGLE.....	\$119.00
ATLANTA.....	\$119.00	COPY GUARD.....	\$59.95
OAK M35B....	\$99.00	STARGATE 2000...	\$88.00
ZENTH.....	\$175.00		

**M.D. Electronics** will match or beat any advertised wholesale or retail price.

**Your best buys and warranties for cable converters and descramblers start with a FREE catalog from MD**

For Information Call

**402-554-0417**

To order or request a free catalog

**1-800-624-1150**



**M.D. ELECTRONICS**

875 SO. 72nd St.  
Omaha, NE 68114

**CIRCLE 53 ON FREE INFORMATION CARD**

## EXCELLERATOR™ Series

### CABLE CONVERTERS

#### WHEN QUALITY COUNTS



New Dynatrack™ fine tuning provides unmatched picture quality  
550 Mhz tuner provides 83 channel capacity  
Sleep timer for automatic shut off within 15-90 minutes  
2/3 switchable HRC / IRC / Standard Switchable  
2 Year warranty, Last channel recall, Favorite channel select, Scan  
Double vented high efficiency transformer for cool performance  
Stargate-2001 \$99.00

Stargate-550XL \$119.00 With Volume Control

**Don't settle for anything less.**



C.O.D.

BY ORDERING CABLE TV EQUIPMENT FROM M.D. ELECTRONICS THE PURCHASER AGREES TO COMPLY WITH ALL STATE AND FEDERAL LAWS REGARDING PRIVATE OWNERSHIP OF CABLE TV EQUIPMENT. IF YOU ARE UNSURE OF THESE LAWS CHECK WITH YOUR LOCAL OFFICIALS.

## BUSINESS OPPORTUNITIES

**MAKE \$50/hr** working evenings or weekends in your own electronics business. Send for free facts. **MJME INDUSTRY**, Box 531, Bronx, NY 10461-0208.

**YOUR** own radio station! Licensed/unlicensed AM, FM, TV, cable. Information \$1.00. **BROADCASTING**, Box 130-F10, Paradise, CA 95967.

**LET** the government finance your small business. Grants/loans to \$500,000. Free recorded message: (707) 449-8600. (KS1).

**BIG PROFITS** **ELECTRONIC ASSEMBLY BUSINESS**

Start home spare time. Investment knowledge or experience unnecessary. **BIG DEMAND** assembling electronic devices. Sales handled by professionals. Unusual business opportunity.

**FREE: Complete illustrated literature**  
BARTA RE 00 Box 248  
Walnut Creek, Calif. 94597

**MAKE \$75,000 to \$250,000** yearly or more fixing IBM color monitors (and most brands). No investment. Start doing it from your home. (A telephone required.) Information, USA, Canada \$1.00 cash. US funds. other countries \$8.00 **RANDALL DISPLAY**, Box 2168-R, Van Nuys, CA 91404 USA. Fax (818) 990-7803.

**EASY** work! Excellent pay! Assemble products at home. Call for information (504) 641-8003 Ext. 5192.

**MAKE \$\$\$!** Become an American electronics dealer! Profit opportunities since 1965. Call **SCOTT PRUETT**, 1 (800) 872-1373.

**HOME** assembly work available! Guaranteed easy money! Free details! **HOMEWORK-R**, Box 520, Danville, NH 03819.

**MONEYMAKERS!** Easy! One man CRT rebuilding machinery. \$6,900.00 rebuilt. \$15,900.00 new. **CRT**, 1909 Louise, Crystalake, IL 60014. (815) 459-0666. Fax (815) 477-7013.

## EDUCATION & INSTRUCTION

**F.C.C. Commercial General Radiotelephone license.** Electronics home study. Fast, inexpensive! "Free" details. **COMMAND**, D-176, Box 2824, San Francisco, CA 94126.

**LEARN** color television in 2hrs **VHS-tape** workbook **NTSC** \$37.00 + \$3.50 guaranteed. **WILLIAMSON LABS**, 6613 Lyndale Dr., Raleigh, NC 27612. (919) 848-8955.

## Be a TV/VCR Repair Specialist

**N**ow you can train at home in spare time for a money-making career as a TV/VCR Repair Specialist. No previous experience necessary. No need to quit your job or school. Everything is explained in easy-to-understand language with plenty of drawings, diagrams and photos. We show you how to troubleshoot and repair video-cassette recorders and TV sets, how to handle house calls and shop repairs for almost any make of television or VCR. Tools are included with your course so you can get "hands-on" practice as you follow your lessons step by step. Send for free facts about the exciting opportunities in TV/VCR Repair and find out how you can start making money in this great career. **MAIL COUPON TODAY** K03C

**ICS SCHOOL OF TV/VCR REPAIR**, Dept. ADE091S  
SINCE 1890 925 Oak Street, Scranton, PA 18515

Please send me full information and color brochure on how I can learn TV/VCR Repair at home in my spare time. I understand there is no obligation and no salesman will visit me.

Name \_\_\_\_\_ Age \_\_\_\_\_  
Address \_\_\_\_\_ Apt. # \_\_\_\_\_  
City/State \_\_\_\_\_ Zip \_\_\_\_\_  
Phone (\_\_\_\_) \_\_\_\_\_

OCTOBER 1991

# AMAZING SCIENTIFIC & ELECTRONIC PRODUCTS

## LASERS AND SCIENTIFIC DEVICES

VRL2K	3mw Vis Red Laser Diode System Kit	\$159.50
LLIS1K	Laser Beam "Bounce" Listener Kit	\$199.50
LHC2K	Visible Simulated 3 Color Laser Kit	\$44.50
LC7	40 Watt Burning Cutting Laser Plans	\$20.00
RUB4	Hi Powered Pulsed Drilling Laser Plans	\$20.00
LGU40	1 to 2mw HeNe Vis Red Laser Gun Assembled	\$199.00
LLS1	Laser Lite Show - 3 Methods Plans	\$20.00
SD5K	See in the Dark Kit	\$299.50
EML1K	Electromagnetic Coil Gun Kit	\$69.50
MCP1	Hi Velocity Coil Gun Plans	\$15.00
LEV1	Levitating Device Plans	\$10.00
EH1	Electronic Hypnotism Techniques Plans	\$10.00

## HIGH VOLTAGE AND PLASMA DISPLAY DEVICES

HVM7K	75,000 Volt DC Variable Output Lab Source Kit	\$149.50
I0G3K	Ion Ray Gun Kit, project energy without wires	\$69.50
NIG9K	12V/115 VAC Hi Out Neg Ion Generator Kit	\$34.50
EMA1K	Telekinetic Enhancer/Electric Man Assembled	\$99.50
LG5K	Lightning Display Globe Kit	\$54.50
BTC1K	Worlds Smallest Tesla Coil Kit	\$49.50
BTC3K	250KV Table Top Tesla Coil Kit	\$249.50
BTC5	1.5 Million Volts Tesla Coil Plans	\$20.00
JL3	Jacobs Ladder - 3 Models Plans	\$15.00
GRA1	Anli Gravity Generator Plans	\$10.00
PFS20	Plasma Fire Saber Assembled	\$69.50
DPL20	Dancing Plasma to Music and Sounds Assembled	\$79.50

## SECURITY AND PROTECTION DEVICES

ITM10	100,000 Volt Intimidator up to 20' Assembled	\$129.50
IPG70	Invisible Pain Field Blast Wave Gun Assembled	\$74.50
PSPAK	Phasor Sonic Blast Wave Pistol Kit	\$59.50
L1ST10	Infinity Xmtr, Listen in Via Phone Assembled	\$199.50
TAT30	Automatic Tel Recording Device Assembled	\$24.50
VWPM7K	3 Mi. FM Auto Tel Transmitter Kit	\$49.50
FMV1K	3 Mi. FM Voice Transmitter Kit	\$39.50
HDD1K	Homng/Tracking Beeper Transmitter Kit	\$49.50

EASY ORDERING PROCEDURE TOLL FREE 1-800-221-1705  
or 24 HRS ON 1-603-673-4730 or FAX IT TO 1-603-672-5406  
VISA, MC, CHECK, MO IN US FUNDS. INCLUDE 10% SHIPPING. ORDERS  
\$100.00 & UP ONLY ADD \$10.00. CATALOG \$1.00 OR FREE WITH ORDER.

**INFORMATION UNLIMITED**  
P.O. BOX 716, DEPT. R3, AMHERST, NH 03031

## THE ELECTRONIC GOLDMINE

**The Electronic Goldmine** has one of the greatest selections of unique electronic kits available in the world! We have over 65 kits and over 1,400 unique, bargain priced, components in our catalog!

**FREE CATALOG**  
with OVER 1400 DIFFERENT ITEMS INCLUDING 100 KITS! REQUEST YOUR COPY TODAY!

**12VAC ADAPTER**  
Puts out 125VAC at up to 265 ma. Brand new, has small 2 prong female connector and long flexible cord. For standard 120 VAC.  
G950 \$1.39 10/\$12 100/\$105

**FISH CALLER KIT**  
This kit produces a clicking sound which is said to attract fish. We have had customers who have reported excellent results! Features very tiny circuit board and small crystal sound element which can be placed in a water tight jar and lowered into the water. Operates from a 9V battery (not included).  
C4566 \$4.50

**METAL LOCATOR KIT**  
Detect coins, rings, buried treasure, etc. with the simple to build kit. Transistorized circuit uses unique detection coil, which is wound directly on top of PC board. The Metal Locator Kit detects metal with a shift in tone which is transmitted to a standard portable AM radio (you supply). Operates from a 9V battery (not included).  
C4515 \$5.95

**MICRO MINI HIGH VOLTAGE POWER SUPPLY**  
Miniature power supply puts out 1000V with only 5VDC in. Draws only 85 milliamps. 1-3/4" x 1-3/16"  
G991 \$6.00

**INVERTER TRANSFORMER**  
Small 4 lead transformer for use with 555 IC to convert 120DC to 250V for strobe/fluorescent tubes with schematic.  
N1703 \$2.00 EACH 10 for \$18.00

**TINY RECTANGULAR SPEAKER**  
The tiny speaker features 400 ohm impedance and high quality metal case. Great for miniature applications. Size 1/2" x 1/16" x 3/8"  
G989 \$1.00 100/\$80

**ULTRAVIOLET SENSOR SUN EXPOSURE METER**  
Small electronic device detects UV energy from the sun and sounds a signal when you've had enough exposure. Has 2 dials for skin type and sun screen rating (SPF). Uses IC circuitry and special UV sensor. Assembled and ready to use, this new surplus item is now available at a fraction of the original cost. (Requires 9V battery, not included.)  
G934 \$8.95

MINIMUM ORDER: \$10.00 plus \$3.50 shipping and handling.  
We accept MC, Visa and Money Orders.  
SEND ORDERS TO: The Electronic Goldmine  
P.O. Box 5408 Scottsdale, AZ 85261  
PHONE ORDERS (602) 451-7454 FAX ORDERS (602) 451-9495

## IMPROVE YOUR DESIGNS

Save power, board space, and fabrication time. The **PAL Compiler** program lets you combine the functions of several ICs into a single PAL, GAL, or PEEL device. Use either truth-table or logic equations as input. Standard JEDEC file is output. Quick logic term minimization is included.

**\$69.95 + shipping/handling/tax**  
Call to order, or for free information.  
(916)674-1626

## TIMELY SOFTWARE, INC.

1747 Live Oak Blvd. #J-210, Yuba City, CA 95991

**PRACTICE troubleshooting on your IBM PC.** 32 circuits including diodes, transistors, FETs and op amps. Hundreds of troubles. Visa, MC \$49.95. 3.5" or 5.25" Demo \$5.00. **MALVINO INC.**, 229 Polaris Ave., Mt. View, CA 94043.

## WANTED

**INVENTIONS/** new products/ideas wanted: call **TLCI** for free information 1 (800) 468-7200 24 hours/day - USA/Canada.

**INVENTORS:** We submit ideas to industry. Find out what we can do for you. 1 (800) 288-IDEA.

**INVENTORS!** Your first step is important. For free advice, call **ADVANCED PATENT SERVICES**, Washington, DC, 1 (800) 458-0352.

**TRAVEL!** High income! Radio officers wanted for shipboard employment. Must have FCC second telegraph license. Rae Echols, **AMERICAN RADIO ASSOCIATION**, 5700 Hammonds Ferry, Linthicum, MD 21090.

## CONVENTIONS

**THE Greater Louisville Hamfest and Computer Convention.** Saturday, September 28, and Sunday September 29, 1991. New and used equipment, forums and testing. For additional information write Post Office Box 34444-R, Louisville, KY 40232-4444 or call (502) 964-1132.

## BIOMEDICAL ELECTRONICS

**BIOMEDICAL letter covers medical electronics, anatomy, equipment functions, electrical safety, troubleshooting.** PNP PUBLISHING, Box 333, Brooklyn, NY 11204. (718) 837-9349 extention 55.

**THIS IS A BOLDFACE EXPANDED AD with a tint background.** . If you like this format, request it. Your cost is \$6.80 per word.

## INVENTORS

**INVENTORS!** Can you patent and profit from your idea? Call **AMERICAN INVENTORS CORP.** for free information. Serving inventors since 1975. 1 (800) 338-5656

## ALARM SECURITY

**LOW cost burglar alarm systems for your home, business, auto, computer, and personal.** We carry all lines of security and electronics supplies. Full information package send \$5.00: **APS**, Box 1074, Moorhead, MN 56561-1074. Inquiry (218) 236-6426.

**FREE CATALOG!**  
**1-800-648-7938**  
**JERROLD HAMLIN OAK ETC**  
**CABLE TV**  
**DESCRAMBLERS**

- Special Dealer Prices!
- Compare our Low Retail Prices!
- Guaranteed Prices & Warranties!
- Orders Shipped Immediately!

**REPUBLIC CABLE PRODUCTS, INC.**  
4080 Paradise Rd. #15, Dept RE 1091  
Las Vegas, NV 89109  
For all other information (702) 362-9026

**CABLE TV DESCRAMBLERS**  
**★ CONVERTERS ★**  
**and ACCESSORIES.**

**SAVE MONEY. DON'T RENT!**

PANASONIC, JERROLD, OAK, PIONEER, SCIENTIFIC ATLANTA AND MORE. LOWEST PRICES. FREE CATALOG.

**CABLE READY COMPANY (800) 234-1006**

**RADON.**  
**THE HEALTH HAZARD IN YOUR HOME THAT HAS A SIMPLE SOLUTION.**

Call  
**1-800-SOS-RADON**  
to get your Radon test information.

**BUY BONDS**





# CABLE TV "BOXES"

**Converters-Descramblers  
Remote Controls-Accessories**

- ★ Guaranteed Best Prices ★
- ★ 1 Year Warranty - C.O.D.'s ★
- ★ Immediate Shipping ★
- ★ FREE CATALOG ★

Call or Write  
**NAS/TRANS-WORLD CABLE CO.**  
3958 North Lake Blvd. • Suite 255  
Lake Park, Florida 33403  
1-800-442-9333  
1-800-848-3997

# DESCRAMBLERS

## CABLE TV EQUIPMENT



**CALL TOLL FREE  
1-800-228-7404**

**FREE CATALOG**

**30 DAY MONEY BACK GUARANTEE**

**OUR PRODUCTS ARE BULLET PROOF**

**YOU WON'T FIND ANY HOLES IN OUR WARRANTIES**

**WE CARRY ALL MAJOR BRANDS  
BEST PRICE BEST SERVICE**

**MAKE THE CONNECTION**

**NU-TEK ELECTRONICS**

FOR MORE INFORMATION  
CALL OR WRITE  
**1-512-250-5031**

**NU-TEK ELECTRONICS**  
8114 BALCONES WOOD DR.  
#507 DEP. 296 AUSTIN TEXAS 78769

# ANNOUNCING:

## AN END TO HIGH MONTHLY CABLE FEES!



All Jerrold, Oak, Hamlin, Zenith, Scientific Atlanta, Magnavox and all specialized cable equipment available for shipment within 24 hours. For fast service MC/VISA or C.O.D. telephone orders accepted. 60 Day Guarantee (Quantity Discounts). Send self-addressed Stamped envelope.

**1-800-232-5017**

**C.O.D. ORDERS ACCEPTED**

**CABLE-TRONICS, INC.**

1304 E. Algonquin Road Suite 501  
Algonquin, Illinois 60102

**"Plant a tree today for all the world to share"**

You can make life better for your children and for the future. Join me and plant a tree today for all the world to share.

For your free brochure, write:  
Trees for America, The National Arbor Day Foundation, Nebraska City, NE 68410.



John Denver for  
**The National Arbor Day Foundation**

**THIS IS A BOLDFACE EXPANDED AD. If you like this format the cost is \$5.65 per word.**

**MASTERCARD AND VISA are now accepted for payment of your advertising. Simply complete the form on the first page of the Market Center and we will bill.**

**PAY TV AND SATELLITE DESCRAMBLING ALL NEW 1991 EDITION**

Our best yet! The very latest in descrambling circuits, bypasses, turn-ons for cable, wireless and satellite. Only \$14.95. Other pay TV editions, Vol. 1 (Basics of All Systems) \$14.95. 1989 Edition \$14.95. Build satellite systems under \$600 \$12.95. Wireless Cable Handbook \$9.95. Any 3/\$29.95 or 5/\$44.95. Scrambling News Monthly has all info on the new "Plain Vanilla" descramblers which emulate B-Mac, VCI, Plus, Orion. \$19.95/yr. New catalog \$1. Special this month. Everything including video and subscription for \$84.95.

**Scrambling News, 1552A Heriel Ave., Buffalo, NY, 14216. For COD'S (716) 874-2088**  
VoiceFax

# MARK V ELECTRONICS, INC.

## Competitive Pricing \* Fast Shipping Since 1985

**ORDER IN CALIFORNIA 800-521-MARK  
ORDER OUTSIDE CA 800-423-FIVE  
FREE CATALOG & INFORMATION (213) 888-8988  
FAX (213) 888-6868**

▲ indicates the level of difficulty in the assembling of our Products. ▲ Beginner ▲▲ Intermediate ▲▲▲ Advanced ★ Fully Assembled

Amplifier + Metal Cabinet + Transformer	TA-3600 LG-1925 #007	TA-477 LG-1925 #003	TA-802 LG-1924 #001	TA-1000A LG-1924 #001	TA-1500 LG-1925 #001
Kit Set	\$155.61	\$125.21	\$100.45	\$113.52	\$130.00
Assmb. Set	\$179.36	\$141.36	\$113.54	\$133.36	\$150.00

• Due to this special offer & low price, we can only exchange or repair any of these units (TA-3600, TA-477, TA-802 & TA-1000A) within 15 days of your receipt.  
• The above prices are for the complete sets. For separate unit price, please see below.

AMPLIFIERS		KIT ASSEMB.	
MODEL	DESCRIPTION		
TA-28MK2	Digital Voice Memo ▲▲	\$ 50.00	
TA-50A / B	Multi-Purpose Melody Generator ▲	12.84	17.20
TA-50C	Multi-Purpose Melody (Happy Birthday, Wedding March, etc.) Generator ▲	13.65	18.71
TA-120MK2	35W Class "A" Main Power Mono Amp ▲▲	31.50	42.80
TA-300	30W Multi-Purpose Single Channel Amp ▲	20.00	29.00
SM-302	60W + 60W Stereo Power Amplifier (with Mic. Input)▲▲	67.00	78.00
TA-323A	30W X 2 Stereo Pre-main Amp ▲	31.50	42.80
TA-377A	State of the Art Full Complementary Symmetrical FET Pre-Amp ▲▲▲	59.95	75.00
TA-400	40W Solid State Mono Amp ▲	28.00	34.93
TA-477	120W Mosfet Power Mono Amp ▲▲	68.00	85.00
TA-800MK2	120W + 120W Low Tim Pre-Main Stereo Power Amp ▲▲	63.92	
TA-802	80W + 80W Pure DC Stereo Main Power Amp ▲▲	45.94	59.72
TA-1000A	100W Dynamic Class "A" Main Power Mono Amp ▲▲	99.69	80.58
TA-1500	100W X 2 Class "A" DC Stereo Pre-Main Amp ▲▲▲	73.70	95.81
TA-2200	DC Fet Super Class "A" DC Pre-Amp ▲▲▲	47.70	58.24
TA-2400A	Electronic Echo & Reverberation Amp ▲		96.00
TA-2500	Hi-Fi Pre-Amp w/10 band graphic equalizer ★		68.80
TA-2800	Bi-FET Hi-Fi Pre-Amp w/3 way tone control ▲▲	48.90	63.57
TA-3000	Stereo Simulator (For Mono TV or Any Mono Source) ▲▲	27.00	38.50
TA-3600	300W HQ Hi-Fi Power Mono Amp ▲▲	85.00	110.00
SM-222	7 Band Hi-Fi Graphic Equalizer ▲▲	26.80	38.80
SM-328	4 Channel Professional Color Light Controller ★		145.00
SM-333	Audio/Video Surround Sound Processor ▲▲▲	65.00	75.00
SM-666	Dynamic Noise Reduction ▲	26.00	34.00
SM-888	Universal Audio/Video KARAOKE Mixer, Pre-Amp. ★		225.00

DIGITAL METERS AND COUNTER		KIT ASSEMB.	
MODEL	DESCRIPTION		
SM-43	3 1/2" Multi-Functional Led D.P.M. (w/ABS plastic case)▲▲	\$ 34.50	\$ 43.00
SM-48	4 1/2" Hi-Precision D.P.M.▲▲	38.00	48.00
SM-48A	4 1/2" Hi-Precision D.P.M. (w/ABS plastic case)▲▲▲	41.20	52.00
SM-49	3 1/2" Multi-Functional LCD D.P.M. (w/Hi-oid Function)▲	36.00	44.50
SM-100	150MC Digital Frequency Counter▲▲▲	79.00	90.00
FC-1000A	1 GHz Frequency Counter ★		179.00

MISCELLANEOUS		KIT ASSEMB.	
MODEL	DESCRIPTION		
TY-23B	3 Channel Color Light Controller ★	\$	\$ 65.00
TY-25	Stereo Loudspeaker Protector ▲	14.85	20.85
TY-35	FM Wireless Microphone ▲	11.25	
TY-36	AC/DC Quartz Digital Clock ▲	19.00	26.20
TY-38	Sound / Touch Control Switch ▲	12.00	
TY-41MK V	Infrared Remote Control Unit (w/Case)▲▲▲	22.00	35.00
TY-42	Bar / Dot Level Meter ▲	24.15	33.81
TY-43	3 1/2" Digital Panel Meter ▲	29.00	38.00
TY-45	20 Steps Bar / Dot Audio Level Display ▲▲	38.45	46.14
TY-47	Superior Electronic Roulette ▲▲	19.46	27.24
10,000uF	80V Capacitor (Suggested for TA-3600, TA-477, TA-1000A & TA-802)		23.00

REGULATORS		KIT ASSEMB.	
TR-355A	0-15V 5A Regulated DC Power Supply (no case & x former) ▲	\$15.65	\$ 21.76
TR-355B	0-30V 3A Regulated DC Power Supply (no case & x former) ▲	15.65	21.76
TR-503	0-50V 3A Regulated DC Power Supply (no case & x former) ▲	16.75	23.65

METAL CABINETS WITH ALUMINUM PANEL			
MODEL	H" x W" x D"	MATCHING	PRICE
LG-1273	3" 12" 7"	TA-2800, TA-377A, TA-2200	\$ 22.95
LG-1684	4" 16" 8"	TA-323A, TA-377A, TA-2200	27.50
LG-1924	4" 19" 11 1/2"	TA-802, TA-1500, TA-120MK2, TA-800 MK2, TA-1000A	32.80
LG-1925	5" 19" 11 1/2"	TA-477, TA-800, MK2, TA-1500, TA-1000A, TA-3600	35.80
LG-1983	2 3/4" 19" 8"	TA-377A, TA-2800, TA-2200, TA-120MK2	29.25

POWER TRANSFORMERS			
MODEL	DESCRIPTION	MATCHING	PRICE
001	28V x 2.6A to 30V x 2.6A	TA-800 MK2, TA-802, TA-820A, TA-1000A, TA-1500	\$ 27.00
002	36V x 2.3A	TR-503, TA-323A, TA-400, TA-300, TA-377A	22.00
003	40V x 2.6A	TA-477	28.00
004	24V x 2.6A	TA-120 MK 2	22.00
005	26V x 2.3A	TR-355B	16.00
006	18V x 2.5A	TR-355A	15.50
007	53V x 2.8A	TA-3600	43.00

We accept major Credit Cards, Money Orders, Checks and C.O.D. Orders. C.O.D. fee is \$5.00. Minimum order is \$20.00. • We ship by UPS ground inside US (min. \$3.00) and ship by US mail Business & Showroom hours: (Pacific Time) outside US. Please call our sales department for orders over 2 lbs. or foreign orders. • All assembled units have a 30 days warranty. Quality or Volume discount available upon request. • Residents of CA please add sales tax 6.75%. • All merchandise checks are subject to prior sale. Prices are subject to change without prior notice. We are not responsible for typographical errors.

**MARK V ELECTRONICS, INC. - 8019 E. Slauson Ave, Montebello, CA 90640**

Mon. thru Fri. 9:30 am to 5:00 pm  
Sat. 10:00 am to 5:00 pm

OCTOBER 1991

CIRCLE 93 ON FREE INFORMATION CARD

www.americanradiohistory.com

## EQUIPMENT REPORTS

continued from page 22

other units into a dissected compound unit. You could dissect "mile" from 60 miles/hour, and replace "mile" with "fathom." You would then be able to determine that 60 miles per hour was equivalent to 13 fathoms per hour.

A library of constants, from "Acceleration due to Gravity" to "Stefan-Boltzman Constant" is available. You can place a constant in the "Original" window with the click of the mouse button. You can then manipulate the number just as you would a number you had input yourself.

The "Dimensions" window shows how given units are related to the seven base quantities of the SI (Système International) of length, mass, time, electric current, thermodynamic temperature, amount of substance, luminous intensity, and the two supplementary quantities, plane angle and solid angle. A unit of time, which is itself a base quantity, would have the base unit time to the first power, with the rest occurring to

the zeroth power. A unit of speed (miles/hour, for example) would show the base quantity length to the first power, and time to the -1 power.

*Units and Conversion Factors* is not a complicated program to use, but it's not as easy as it could be. For example, when scrolling through the windows, you have to click on the up arrow to scroll down alphabetically through a list. A graphical user interface is supposed to make a program's operation intuitive. But we had to refer to the manual often.

Part of the problem is our familiarity with Windows and other look-alike programs. They weren't all too intuitive the first time they were used, either. But now that their conventions are firmly established, why fight them by designing a new user interface that will just confuse people? Ease of use mustn't have been very high on the list of design priorities for *Units*, which can be seen from the fact that the software is copy protected—something we abhor. Nonetheless, *Units* will find itself a "must-have" tool for anyone who regularly must make sense out of jumbles of incompatible specifications. **R-E**

Try the  
**Radio Electronics®**

bulletin board  
system

(RE-BBS)  
516-293-2283

The more you use it the more  
useful it becomes.

We support 1200 and 2400 baud  
operation.

Parameters: 8N1 (8 data bits, no  
parity, 1 stop bit) or 7E1 (7 data  
bits, even parity, 1 stop bit).

Add yourself to our user files to  
increase your access.

Communicate with other R-E  
readers.

Leave your comments on R-E with  
the SYSOP.

RE-BBS  
516-293-2283

### Ferro Fluid

Pro-Tech ferro fluid is commonly used on voice coils to substantially improve frequency response, increase transient and continuous power handling capabilities and reduce second and third order harmonic distortion. It reduces the Q and lowers the impedance peak at resonance without a significant reduction in SPL. Ferro fluid can effectively increase power handling capability of a driver by 200-300%. General purpose fluid for tweeters and midranges only. 10cc bottle (enough for 75-100 tweeters).



#RM-340-430

**\$19<sup>95</sup>**  
Each

### Light Oak Speaker Cabinet

Premium ported speaker cabinet made of acoustical grade particle board and covered with a light oak vinyl laminate. Pre-cut with an 11-1/4" hole for use with most 12" woofers. The baffle board has no tweeter or midrange holes for design flexibility. The 3/4" thick particle board ensures low panel resonance. Dimensions: 11" x 15" x 27". Volume: 2.5 cu ft. Grill and terminal included. Sold individually.



#RM-262-100

**\$49<sup>00</sup>**  
Each

**\$45<sup>50</sup>**  
(2-up)

### 12 Gauge Neon Wire

The competition in today's auto sound contests is so fierce that good sound alone is not enough to win. More and more installers are striving to make their installation more pleasing to the eye. Parts Express now stocks 12 gauge speaker wire in vibrant neon colors. This wire is the same high quality, made in the U.S. wire you have used before, but now it has flashy, neon colored insulating jackets. Available in neon pink, neon green, and neon orange. Sold by the foot on or 50 ft. spools.



#RM-100-162 (Neon pink)

#RM-100-166 (Neon orange) **49¢/Ft.**

#RM-100-170 (Neon green)

### Tuned Port Tubes

These attractive, preformed tuned ports allow the back pressure radiated from the rear of the woofer to reinforce the sound level in front. Made of black plastic.



Part #	Length	Dia.	(1-9)	(10-up)
#RM-260-320	2"	1-7/8"	1.40	.95
#RM-260-321	4"	1-7/8"	1.60	1.20
#RM-260-322	5"	2"	1.65	1.30
#RM-260-323	1"	2-7/8"	1.40	.95
#RM-260-324	5"	2-7/8"	1.85	1.50
#RM-260-326	3"	2-7/8"	1.65	1.30
#RM-260-327	2-1/2"	3-7/8"	1.85	1.50
#RM-260-328	5"	3-7/8"	1.95	1.60

No mixing for quantity pricing.

### Famous Maker 3-1/2" Speaker Pair

Dual cone 3-1/2" speaker pair for upgrading stock dash speakers. Graphite fiber composite woofer cone provides a smooth extended response at all power levels. The high frequency radiator (whizzer) takes over from the woofer at 6,000 Hz and greatly extends the response past 20 KHz. Strontium ferrite magnet. 3/4" high temperature voice coil. Impedance: 4 ohm. Power handling capability: 25 watts continuous, 70 watts peak. Frequency response: 120-21,000 Hz. Equipped with dust screen. Made in the U.S. by a company with over 40 years experience in the auto sound market.



#RM-265-275

**\$29<sup>95</sup>**  
Pair

### Subwoofer Input/Output Terminal

This recessed terminal panel has inputs for right and left channels as well as outputs for right and left channels to route to your satellite speakers. Greatly simplifies subwoofer hook-up. Outside dimensions: 3-7/8" x 5-3/8".

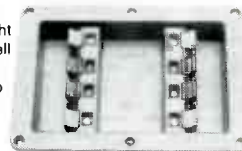

#RM-260-308

**\$3<sup>95</sup>**  
(1-9)

**\$3<sup>50</sup>**  
(10-up)



**Parts Express**  
International Inc.

340 E. First St., Dayton, Ohio 45402  
Local: 1-513-222-0173  
FAX: 513-222-4644

• 15 day money back guarantee • \$15.00 minimum order •  
We accept Mastercard, Visa, Discover, and C.O.D. orders. •  
24 hour shipping • Shipping charge = UPS chart rate + \$1.00  
(\$3.00 minimum charge) • Hours 8:30 am - 7:00 pm EST,  
Monday - Friday • 9:00 am - 2:00 pm Saturday. Mail order customers,  
please call for shipping estimate on orders exceeding 5 lbs. Foreign  
destination customers please send \$5.00 U.S. funds for catalog postage.

CALL TOLL FREE

1-800-338-0531

FREE  
CATALOG



We Have **QUALITY PARTS** • We Have **DISCOUNT PRICES** • We **SHIP FAST**

# ALL ELECTRONICS CORP.

## Highest Quality Metal Cassettes (Erased)

Premium quality metal tape in C-60 and C-90 cassettes (30 or 45 min. per side). One of the finest "brand-name" tapes on the market, in durable, clear plastic transport mechanisms. Recorded and bulk erased, the record-protect tabs have been removed and therefore, need to be taped over to re-record. Audiophiles will appreciate the wide dynamic range of this tape. If your cassette deck has a "metal" setting you will hear the difference. A real bargain! 60 min. tape - **CAT# C-60M** \$1.25 each • 10 for \$10.00  
90 min. tape - **CAT# C-90M** \$1.65 each • 10 for \$15.00

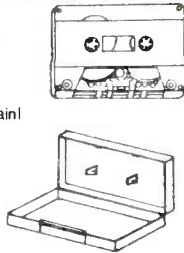

### CASSETTE STORAGE CASE

Black, unbreakable plastic audio cassette storage case.  
**CAT# CBOX** 5 for \$1.00 • 100 for \$15.00

## INFRARED SECURITY LIGHT (AS-IS)

Elektriko # SIL-101 - Experiment with infrared sensors with these outdoor security lights. Contain lots of interesting components, an IR detector, photoresistor, relay, transformer, IC's, voltage regulator, capacitors, trimpots and other goodies. Returned to the distributor for variety of reasons, we've found that most of them work to some extent. We don't want to test them and would prefer to sell them "as-is" at a greatly reduced price. Mounts to any standard electrical junction box. Infrared sensor detects movement up to 65 feet and turns on lights. Sensor can be adjusted for sensitivity and duration of lighting. The position of the sockets and the infrared sensor can be easily adjusted. Will handle two 150 watt PAR 38 lamps. Suitable for wet locations. Bulbs not included. **CAT# IL-101** \$7.50 each

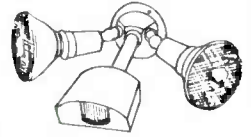

## TOUCH DIMMER

The "brain" part of the "LITE TOUCH" touch dimmer, when connected to any lamp, will turn it on and off and change the brightness level when any metal part is touched. We don't have the wiring harness that originally connected this to the lamp, but we can provide a simple hook-up diagram and instruction sheet. The solid-state circuitry is contained in a thermoplastic box 1.91" X 3.11" X 0.835".  
**CAT# DMR-1** \$3.50 each



## L.E.D.'s

**Standard JUMBO**  
Diffused T 1-3/4 size (5mm)

**RED CAT# LED-1**  
10 for \$1.50 • 100 for \$13.00

**GREEN CAT# LED-2**  
10 for \$2.00 • 100 for \$17.00

**YELLOW CAT# LED-3**  
10 for \$2.00 • 100 for \$17.00



**FLASHING LED**  
W/ built in flashing circuit  
5 volt operation. T 1-3/4 (5mm)



**RED** \$1.00 each  
**CAT# LED-4** 10 for \$9.50

**GREEN** \$1.00 each  
**CAT# LED-4G** 10 for \$9.50

**YELLOW** \$1.00 each  
**CAT# LED-4Y** 10 for \$9.50

### LED HOLDER

Two piece holder.  
**CAT# HLED** 10 for 65¢



## TELEPHONE KEYPAD

12 button telephone keypad. Ivory finish. 2.83" x 2.2" x 0.58" thick. Matrix encoded. Ideal for telephone or security keypad.  
**CAT# KPT-1** \$1.00 each • 10 for \$9.00



## OPTO-SENSOR

TRW/Optron # OPB5447-2 IR emitter/sensor pair in Rectangular package with 28" color coded leads.  
**CAT# OSR-4** 2 for \$1.00



## ULTRASONIC CERAMIC MICROPHONE/TRANSDUCER

Panasonic (Matsushita) # EFR RCBK40K54 An ultrasonic microphone consisting of a bimorph type piezoelectric ceramic vibrator. Ideal for burglar alarms, auto door openers, flow rate detectors and remote control systems. Nom. Freq. 40kHz. Max input volts: 20 Volts. 15/16" dia. X 3/8" high. 5/8" long leads.  
**CAT# UST-1** \$1.00 each



## AUDIO SLIDE POT

Dual 1K audio. 3 1/2" long, 2 1/2" slide  
**CAT# ASP-1KD**  
Reduced to 50¢ each  
100 for \$40.00



## 24 PIN ZERO INSERTION FORCE SOCKET

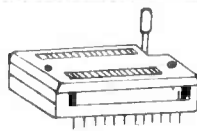

Textool # 224-3344. Protect 24 pin dip IC's from damage during test, burn-in or programming. Lever-operated mechanism locks part securely in place and releases it with no damage to component leads.  
**CAT# ZF-24** \$4.50 each

## FLASH ASSEMBLY

New compact flash assembly from a U.S. manufacturer of cameras. Operates on 3 Vdc and measures 2 1/2" x 1 1/4". Ideal for use as a strobe, warning light or attention getter. Includes hook-up diagram.  
**CAT# FSH-1** \$3.75 each  
10 for \$35.00 • 100 for \$325.00

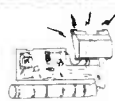

## HALL EFFECT SENSORS

Microswitch #SS41 Tiny, solid state switch reacts instantly to proximity of magnetic field. Operates at extremely high speeds, up to 100 khz. Case size: 0.12" X 0.17" X 0.06" thick. 4.5 Vdc to 24 Vdc supply voltage. 10 ma. sink type digital output. Operating gauss - 15 to 40. P.C. leads.  
**CAT# HESW-2** 75¢ each • 10 for \$6.50  
100 for \$60.00 • 1000 for \$500.00



Sprague # UGN3075LT Operates on 4.5 - 24 Volts Can sink 10 ma. With suitable output pull up, can be used directly with bipolar or CMOS logic circuits. Especially suited for electronic commutation in brushless D.C. motors using multiple ring magnets. Very tiny surface mount package 0.175" X 0.09" X 0.06" thick.  
**CAT# HESW-5** 2 for \$1.00  
100 for \$45.00 Large quantities available



## SWITCHES

**Miniature Toggles**  
Rated: 3 amps @ 120 Vac

**S.P.D.T. (ON-ON)**  
solder lugs  
**CAT# MTS-4**  
\$1.35 each  
10 for \$12.50  
100 for \$110.00



**S.P.D.T. (ON-ON)**  
P.C. mount  
**CAT# MTS-4PC** \$1.00 each  
10 for \$9.00 • 100 for \$80.00

**D.P.D.T. (ON-ON)**  
solder lugs  
**CAT# MTS-8** \$1.75 ea.  
10 for \$15.00



**D.P.D.T. (ON-ON)**  
P.C. mount  
**CAT# MTS-8PC** \$2.00 ea.  
10 for \$17.50

### Pushbutton Switch

SMK Manufacturing 0.47" square black pushbutton. SPST normally open. 4 p.c. pins for mounting. Ideal for low current switching applications.  
**CAT# PB-29**  
5 for \$1.00 • 100 for \$15.00



## PHOTOFLASH CAPACITOR

Rubicon CE 210 Mfd 330 Volt photoflash capacitor. 0.79" dia. X 1.1" high. These are new capacitors that have been prepped with 1.4" black and red wire leads soldered to the terminals.  
**CAT# PPC-210**  
\$1.25 each • 10 for \$11.00  
100 for \$100.00  
Large quantities available. Call for pricing.



## KITS

### L.E.D. FLASHER KIT

Two L.E.D.'s flash in unison when a 9 volt battery is attached. This kit includes a p.c. board, all the parts and instructions to make a simple flasher circuit. A quick and easy project for anyone with basic soldering skills.  
**CAT# LEDKIT** \$1.75 per kit



### L.E.D. CHASER KIT

Build this variable speed led chaser. 10 leds flash sequentially at whatever speed you set them for. Easy to build kit includes pc board, parts and instructions. Ideal for special lighting effects, costumes, etc. Operates on 3 to 9 volts. PC board is 5" X 2.25". A great one hour project.  
**CAT# AEC** \$6.50 each

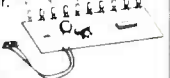

### STEPPING MOTOR CONTROLLER KIT

Learn about stepping motors while building this simple circuit. Includes circuit board, stepping motor and all parts except 12 Vdc power supply. **CAT# SMKIT** \$18.00 each



### METRONOME KIT

This simple device can be set to click from 20 to 1,000 beats per minute. Easy to build, includes circuit board, all components and instructions. Operates on a 9 volt battery (not included).  
**CAT# METRO** \$3.75 each



### PHOTO RESISTOR

1,000 ohms bright light. 16K ohms dark. 0.182" dia. X .08" high. 0.18" long leads.  
**CAT# PRE-7** 2 for \$1.00  
100 for \$45.00 • 1000 for \$400.00



# ORDER TOLL FREE 1-800-826-5432

FAX (818) 781-2653 • INFORMATION (818) 904-0524

Call Or Write For Our **Free 64 Page Catalog**  
Outside the U.S.A. send \$2.00 postage for a catalog.

Minimum Order \$10.00 • All Orders Can Be Charged To Visa, Mastercard Or Discovercard • Checks and Money Orders Accepted By Mail • California, Add Sales Tax • Shipping And Handling \$3.50 for the 48 Continental United States - All Others Including Alaska, Hawaii, P.R. And Canada Must Pay Full Shipping • Quantities Limited • No C.O.D. • Prices Subject to change without notice.



MAIL ORDERS TO: ALL ELECTRONICS CORP. • P.O. BOX 567 • VAN NUYS, CA 91408

CIRCLE 107 ON FREE INFORMATION CARD

www.americanradiohistory.com



# UNICORN ELECTRONICS

10010 Canoga Ave., Unit B-8  
Chatsworth, CA 91311

SINCE 1983 — YOUR I.C. SOURCE — AND MUCH MORE!!  
NO SHIPPING CHARGES ON PRE-PAID ORDERS!\*  
NO CREDIT CARD SURCHARGE!  
SCHOOL P.O.'s WELCOME!

## LASER DIODES

STOCK #	MFG.	WAVE-LENGTH	OUTPUT POWER	OPER. CURR.	OPER. VOLT.	PRICE
LS9220	TOSHIBA	660 nm	3 mW	85 mA	2.5v	129.99
LS9200	TOSHIBA	670 nm	3 mW	85 mA	2.3v	49.99
LS9201	TOSHIBA	670 nm	5 mW	80 mA	2.4v	59.99
LS9211	TOSHIBA	670 nm	5 mW	50 mA	2.3v	69.99
LS9215	TOSHIBA	670 nm	10 mW	45 mA	2.4v	109.99
LS3200	NEC	670 nm	3 mW	85 mA	2.2v	79.99
LS022	SHARP	780 nm	5 mW	65 mA	1.75v	19.99

## LASER TUBES

STOCK #	WAVELENGTH	OUTPUT POWER (MIN.)	OUTPUT POWER (MAX.)	BEAM DIAM.	BEAM DIVERG.	POLARIZATION	OPERATING VOLTAGE	OPER. CURR.	FIRING VOLT.	MIN. SERIES RES.	SIZE D X L (IN MM)	WT. (GM.)	BRH CL.	PRICE 1-9	10+
LT7770	543nm (Green)	0.5mW	1.0mW	0.71mm	≤ 1.2 mrad	random	1750v ± 110v	6.5 mA	≤ 8 kV	81k Ω	37 x 350	200	II	799.99	749.99
LT7650	632.8nm (Red)	0.5mW	2.0mW	0.49mm	≤ 1.7 mrad	>100:1	1000v ± 100v	3.5 mA	< 7 kV	68k Ω	25 x 146	70	IIa	529.99	479.99
LT7656	632.8nm (Red)	0.5mW	2.0mW	0.34mm	≤ 2.4 mrad	random	1050v ± 100v	2.8 mA	≤ 8 kV	82k Ω	22.5 x 118	60	IIa	134.99	124.99
LT7655	632.8nm (Red)	0.5mW	2.0mW	0.49mm	≤ 1.7 mrad	random	1000v ± 100v	3.5 mA	≤ 7 kV	68k Ω	25 x 150	70	IIa	144.99	134.99
LT7655S	632.8nm (Red)	1.0mW	2.0mW	0.49mm	≤ 1.7 mrad	random	1000v ± 100v	3.5 mA	≤ 7 kV	68k Ω	25 x 150	70	IIa	159.99	144.99
LT7632	632.8nm (Red)	1.2mW	3.0mW	0.61mm	≤ 3.0 mrad	random	1300v ± 100v	3.5 mA	≤ 7 kV	81k Ω	20 x 210	70	IIa	249.99	229.99
LT7621S	632.8nm (Red)	2.0mW	5.0mW	0.75mm	≤ 1.2 mrad	random	1300v ± 100v	5.0 mA	≤ 7 kV	68k Ω	30 x 255	140	IIa	204.99	191.99
LT7634	632.8nm (Red)	2.0mW	5.0mW	0.75mm	≤ 1.2 mrad	>500:1	1300v ± 100v	5.0 mA	≤ 7 kV	68k Ω	30 x 255	140	IIa	209.99	194.99
LT7621MM	632.8nm (Red)	5.0mW	15mW	1.0mm	≤ 2.5 mrad	random	1250v ± 100v	6.5 mA	≤ 7 kV	68k Ω	30 x 255	140	IIb	359.99	334.99
LT7627	632.8nm (Red)	5.0mW	15mW	0.80mm	≤ 1.1 mrad	random	1900v ± 100v	6.5 mA	≤ 8 kV	81k Ω	37 x 350	200	IIb	369.99	344.99
LT7628	632.8nm (Red)	5.0mW	15mW	0.80mm	≤ 1.1 mrad	>500:1	1900v ± 100v	6.5 mA	≤ 8 kV	81k Ω	37 x 350	200	IIb	389.99	364.99
LT7627MM	632.8nm (Red)	10mW	30mW	1.2mm	≤ 4.0 mrad	random	1750v ± 100v	6.5 mA	≤ 8 kV	81k Ω	37 x 350	200	IIb	479.99	444.99

## Dynamic RAMS

STOCK #	DESC.	SPEED	1-24	25-99	100+
41256-60	256K x 1	60 ns	2.59	2.46	2.21
41256-80	256K x 1	80 ns	2.19	2.08	1.87
41256-100	256K x 1	100 ns	1.99	1.89	1.70
41256-120	256K x 1	120 ns	1.89	1.80	1.62
41256-150	256K x 1	150 ns	1.79	1.70	1.53
511000-70	1 meg x 1	70 ns	5.49	5.22	4.70
511000-80	1 meg x 1	80 ns	5.29	5.03	4.53
511000-10	1 meg x 1	100 ns	5.09	4.84	4.36
514256-70	256K x 4	70 ns	6.49	6.17	5.55
514256-80	256K x 4	80 ns	6.09	5.79	5.21
514256-10	256K x 4	100 ns	5.69	5.41	4.87
541000-80	4 meg x 1	80 ns	26.99	25.64	23.08
544256-80	1 meg x 4	80 ns	31.99	30.39	27.35

## EPROMS

STOCK #	SPEED	1-24	25-99	100+
2716	450 ns	3.29	3.13	2.82
2732	450 ns	4.19	3.98	3.58
2732A	250 ns	3.29	3.13	2.82
2764	250 ns	3.49	3.32	2.99
2764A	250 ns	3.09	2.94	2.65
27128	250 ns	4.79	4.55	4.10
27C128	250 ns	4.79	4.55	4.10
27256	250 ns	4.59	4.36	3.92
27C256	250 ns	4.29	4.08	3.67
27512	250 ns	5.49	5.22	4.70
27C512	250 ns	5.49	5.22	4.70
27C1024	200 ns	10.99	10.44	9.40
27C2048	200 ns	21.99	20.89	18.80

### Laser Pointer



- Output: 3.5 mW
- Wavelength: 670NM
- Power Supply: 2xAAA Batteries (included)
- Beam: Approx. 3" @ 100 yards

Quantity Discounts Available  
**STOCK #**      **PRICE**  
**LSPOINT**      **\$199.99**

### Power Supply



- Input: 115/230V
- Output: +5v @ 3.75A  
+12v @ 1.5A  
-12v @ .4A
- Size: 7" L x 5 1/4" W x 2 1/2" H

**STOCK #**      **PRICE**  
**PS1003**      **\$19.99**

### Collimator Pen



- Output: 2.5 mW (max.)
- Current: 90-150 mA
- Op. Volt.: 2.2-2.5V
- Wavelength: 820NM
- Data Sheet inc.

**STOCK #**      **PRICE**  
**SB1052**      **\$39.99**

### Disc Drive & Computer Cleaning Kit



Not just a drive cleaner-but a complete computer cleaning kit. Includes swabs, head cleaning fluid, anti-static cleaner, screen wipes and cleaning diskette

**STOCK #**      **PRICE**  
**SB1099** 3 1/2" Kit      **\$6.99**  
**SB1100** 5 1/4" Kit      **\$6.99**

### Disc Drive Head-Cleaning Kit



Includes cleaning fluid and head-cleaning diskette

**STOCK #**      **PRICE**  
**SB1105** 3 1/2" Drive Kit      **\$1.99**  
**SB1106** 5 1/4" Drive Kit      **\$1.99**

### Anti-Static Screen Wipes



For static-sensitive applications. Dispenser packs, individually wrapped.

**STOCK #**      **PRICE**  
**SB1104** Dispenser pack of 25 wipes      **\$1.99**  
**SB1107** Dispenser pack of 100 wipes      **\$4.99**

### Robotic Arm Kit



Robots were once confined to science fiction movies. Today, whether they're performing dangerous tasks or putting together complex products, robotics are finding their way into more and more industries. The Robotic Arm Kit is an educational kit that teaches basic robotic arm fundamentals as well as testing your own motor skills. Command it to perform simple tasks

**STOCK #**      **PRICE**  
**YO1**      **\$49.99**

### Avoider Robot Kit



An intelligent robot that knows how to avoid hitting walls. This robot emits an infra-red beam which detects an obstacle in front and then automatically turns left and continues on.

**STOCK #**      **PRICE**  
**MV912**      **\$49.99**

ORDER LINE — (800) 824-3432

INTERNATIONAL ORDERS — (818) 341-8833

FAX ORDERS — (818) 998-7975

TECHNICAL SUPPORT — (818) 341-8833



- 15.00 MINIMUM ORDER
- UPS BLUE, RED & FEDERAL EXPRESS SHIPPING AVAILABLE
- OPEN MON-FRI 9:00 AM - 6:00 PM, SAT 10:00 AM - 3:00 PM PDT
- CA RESIDENTS ADD 7% SALES TAX
- CALL FOR QUANTITY DISCOUNTS
- CALL FOR FREE CATALOG (FOR 1ST CLASS DELIVERY OR CATALOGS DELIVERED OUTSIDE THE U.S. — SEND \$2.00)
- WE CARRY A COMPLETE LINE OF ELECTRONIC COMPONENTS



\*NO SHIPPING CHARGES ON PRE-PAID ORDERS DELIVERED IN THE CONTINENTAL U.S.

CIRCLE 201 ON FREE INFORMATION CARD



**FAX DIRECT**  
**1-800-582-1255**

# EASYTECH

THE ELECTRONICS SOURCE

**ORDER DIRECT**  
**1-800-582-4044**

## TRIPP LITE — PRECISION REGULATED DC POWER SUPPLIES

Complete Line of DC Power Supplies to Convert 120VAc to 13.8Vdc ±0.5Vdc.

### Standard Features Include:

- Solid state integrated circuit provides excellent regulation
- Output voltage maintained up to 95% of no load value
- High quality filtering for low noise operation
- Heavy duty power transformer for complete line isolation
- On/off indicator light and rugged on/off switch on faceplate
- 3 conductor grounded cord on 10 Amp and larger models
- Current limiting electronic foldback for auto overcurrent protection
- 2 year warranty



PR4.5

Tripp Lite DC Power Supplies Are Designed For Reliability and Superior Performance.

Order #	Price	ICS* (amps)	Continuous Duty (amps)	Fusing	Ripple Voltage	HxWxD (Inches)	Weight
PR4.5	32.95	4.5	3	Internal	0.1 Volt Max.	3.125 x 4.75 x 8.25	5 lbs.
PR7	44.95	7	5	Chassis Mount	0.15 Volt Max.	3.75 x 6.5 x 7.5	7 lbs.
PR10	64.95	10	7.5	Chassis Mount	0.15 Volt Max.	4.5 x 6.625 x 7.625	10 lbs.
PR15	89.95	15	12	Chassis Mount	0.15 Volt Max.	4.75 x 7.5 x 8.25	13 lbs.
PR25	126.95	25	20	Chassis Mount	0.15 Volt Max.	5.125 x 12.5 x 10.5	20 lbs.
PR40	179.95	40	32	Chassis Mount	0.15 Volt Max.	7.25 x 12.5 x 10	26 lbs.
PR60	249.95	60	48	Chassis Mount	0.15 Volt Max.	8.5 x 12.5 x 10	29 lbs.

\*Intermittent Communications Duty (50% Duty Cycle)

## SOLDERLESS PROTOTYPING BOARDS

### Features

- Color coordinates for easy recognition
- Insertion wire: 20-29 AWG (0.3 – 0.8 mm)
- Over 10,000 insertion cycles
- Accepts all standard components

SB830



SB1660



SB2390



SB3220

Order #	Price 1-9	Price 10+	Dimensions (in.) L x W x H	Dist. Strips	Dist. Points	Terminal Strips	Terminal Points	Binding Posts
SB200	2.99	2.49	6.5 x 0.37 x 0.4	2	100 x 2	0	0	0
SB400	4.89	4.39	3.3 x 2.2 x 0.4	2	100	1	300	0
SB630	5.45	4.95	6.5 x 1.4 x 0.4	0	0	1	630	0
SB830	6.49	5.99	6.5 x 2.2 x 0.4	2	200	1	630	0
SB1360	12.49	11.99	8.5 x 3.9 x 1.2	1	100	2	1,260	2
SB1660	17.45	16.95	8.5 x 5.1 x 1.2	4	400	2	1,260	3
SB2390	22.49	21.49	9.1 x 6.9 x 1.2	5	500	3	1,890	4
SB3220	31.49	30.49	9.5 x 8.3 x 1.2	7	700	4	2,520	4

## DATABOOKS

### Motorola RF Device Data – Volumes 1 & 2

This two volume set contains over 2200 pages of data on RF Power TMOS FETs, RF Power Bipolar Transistors, RF Small Signal Transistors, Tuning and Switching Diodes, and RF Amplifiers. Also included are drawings, diagrams, dimensions and pin-outs on all packages. Weight: 4.25 lbs.

Order # DL110 ..... 14.95

### Motorola Memory Data

Over 500 pages on Dynamic RAMS, General and Fast Static RAMS, MOS EEPROM, MECL Memories, etc. Weight: 1.25 lbs.

Order # DL113 ..... 8.95

### Motorola MPU/MCU/Peripheral Data – Volumes 1 & 2

Over 2800 pages on Motorola's Microcontroller and Microprocessor families such as the MC6800, MC6802, MC6821, MC6845, MC146818, MC68701, MC68705, etc. Weight: 4.0 lbs.

Order # DL139 ..... 16.95

### National General Purpose Devices Linear Databook

Over 1600 pages on voltage regulators, operational amplifiers, buffers, voltage comparators and instrumentation amplifiers. Weight: 3 lbs.

Order # 400026 ..... 19.95

### National Programmable Logic Devices Databook

Over 400 pages including data sheets, designing with PLDs, methodology and developmental tools. Also included is an introductory tutorial section. Weight: 1.0 lb.

Order # 400082 ..... 12.95

## ACTIVE COMPONENTS

MICROS		DRAMS		
Order #	Price	Order #	Price	Desc.
6821	1.75	MK4027N2	.75	4x1
6845	2.45	4116-20	.85	16x1
8080A	2.75	4416-12	2.25	16x4
8085A	2.95	4164-10	1.95	64x1
8086	4.45	4164-15	1.55	64x1
8088	4.25	4164-20	1.25	64x1
8237A5	4.15	41464-12	2.75	64x4
8250	5.75	41256-80	2.15	256x1
8251A	2.25	41256-12	1.85	256x1
8253-5	2.25	514256-10	6.95	256x4
8255A5	2.75	511000-80	7.25	1Mx1
8275	18.95	511000-10	6.95	1Mx1

STATIC RAMS		EPROMS		
Order #	Price	Order #	Price	Prog.
2101	1.65	2708	4.75	25V
2114L25	1.15	2716	3.45	25V
2147-3	3.75	2732	3.95	25V
6116LP3	2.75	2732A25	3.45	21V
6116-3	2.25	2732B45	4.25	12.5V
6264LP10	4.95	2764-25	3.75	21V
6264LP15	3.95	2764A25	3.25	12.5V
6264-10	4.75	27128A25	3.95	12.5V
6264-15	3.75	27256-25	4.75	12.5V
62256LP10	6.75	27256-30	3.45	12.5V
62256LP15	6.25	27C512-15	6.95	12.5V

## MEMORY MODULES—SIMMS

Order #	Price	Organization	Speed
256x9-80	19.95	262,144x9	80ns
1x9-80	64.95	1,048,576x9	80ns

## SURFACE MOUNT ICs

Order #	Price	Description	Pins
27C64FP25	3.95	64K PROM	PLCC 32
27C256FP25	4.95	256K PROM	PLCC 32
41256-12FL	2.45	256x1 DRAM	PLCC 18
41464FP15	3.45	64x4 DRAM	PLCC 18
6116FP12	2.45	2Kx8 SRAM	SOP 24
6264LFP10	4.25	8Kx8 SRAM	SOP 28
62256LFP10	6.95	32Kx8 SRAM	SOP 28
74ALS32FP	.55	Gate	SOP 14
74F240FP	1.15	Octal Driver	SOP 20
74LS374FP	1.05	Octal Flip Flop	SOP 20

# EASYTECH

THE ELECTRONICS SOURCE

VISA

2917 Bayview Drive  
 Fremont, CA 94538



**Order Direct: 1-800-582-4044**  
**Fax Direct: 1-800-582-1255**  
**Customer Service: 1-415-770-2345**

Monday-Friday, 7am - 5pm (PST)/10am-8pm (EST)

- COD-No personal checks, US funds (\$5.00 Surcharge)
- USPS
- UPS
- Federal Express
- Airborne

Add 5% of total for shipping UPS Ground (\$3.00 min.).  
 Actual shipping charges based on weight.

**Call or write today for your free copy of our 1991 catalog.**

California residents, add appropriate sales tax.  
 12 month warranty on all EasyTech products.  
 30 day money back guarantee.

We reserve the right to substitute manufacturers.  
 Prices subject to change without notice.

CIRCLE 178 ON FREE INFORMATION CARD

# Winning Products at

## Test/Measurement and Prototype Equipment

### 51-Piece Electronic Tool Kit

#### Tools Included in Kit:

- 10' measuring tape
- 5.25" needle nose pliers
- Electric tape
- Utility components box
- 6 piece precision screwdriver set
- 6" long tweezers
- 8 piece hex key wrench set
- 7" brush and scraper
- Digital Multimeter
- Brush
- 7" fine point probe
- Round needle file
- 10 piece screwdriver set: 6 Slotted & 4 Phillips
- 7" slotted probe
- Flat needle file
- 4.5" diagonal cutting pliers



- 6" adjustable wrench
- 30 Watt soldering iron
- 5.5" Stainless steel scissors
- Soldering stand
- Rosin core solder
- 5.25" Flat nose pliers
- Utility knife with extra blade
- Desoldering pump
- 5.25" Bent needle nose pliers
- Carrying case: 17.63"W x 12.5"D x 3.5"H

**24 Hour  
Order Hotline  
(415) 592-8097**

**MS305 ..... \$119.95**

### Global Specialties Protoboard® Design

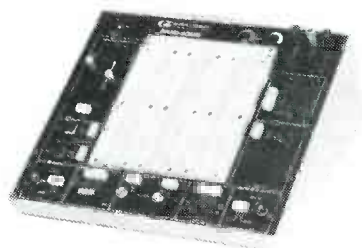

#### Features:

- Ideal for analog, digital and microprocessor circuits
- Triple DC regulated power supplies, +5V, +15V, -15V
- 8 logic indicators
- Function generator with sine, square, triangle and TTL waveforms
- Two debounced push-button switches
- Two SPDT slide switches, all leads available and uncommitted
- A total of 2520 uncommitted tie-points
- Potentiometers: one 1KΩ and one 10KΩ
- Includes power supply, instrumentation and breadboarding

**PB503..... \$299.95**

### Jameco Logic Pulser



- Compatible with TTL, DTL, RTL, HTL, HNIL, MOS and CMOS ICs • 1MΩ Sync input impedance • Pulser mode output current: 10mA • Square wave current output: 5mA • Audible tone

**LP540.....\$16.95**

### Jameco Logic Probe

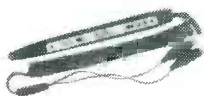

- Max Frequency 80MHz • Minimum detectable pulse: 10ns • 120KΩ input impedance • Max. supply voltage: -25V • TTL threshold: (Lo)-0.8V +0.1V (Hi) -2.3V -0.2V • CMOS threshold: (Lo) 30% VCC +10% (Hi) 70%VCC +10%

**MS104.....\$24.95**

### Weller Soldering and Desoldering Stations

- Temperature adjustable from 350° to 850°F
- Zero voltage circuit protects sensitive components from damage
- Lighted on/off switch

**WCC100 Soldering Station ..... \$89.95**

- 50 Watt Temperature Controlled Desoldering Station
- Desoldering head is temperature controlled to 800°F
- Low maintenance vacuum system

**DS600 Desoldering Station ..... \$549.95**

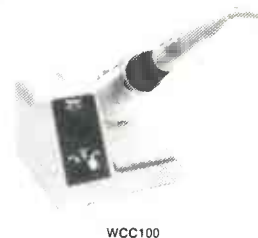

WCC100

### Prototype Products Jameco Solderless Breadboards

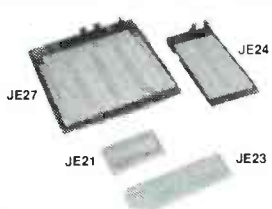

Part No.	Dim. L" x W"	Contact Points	Binding Posts Price	Price
JE21	3.25 x 2.125	400	0	\$4.95
JE23	6.5 x 2.125	830	0	\$6.95
JE24	6.5 x 3.125	1,360	2	\$12.95
JE25	6.5 x 4.25	1,660	3	\$17.95
JE26	6.875 x 5.75	2,390	4	\$22.95
JE27	7.25 x 7.5	3,220	4	\$32.95

### Metex Digital Multimeters

- General Specs:**
- Handheld, high accuracy • AC/DC voltage, AC/DC current, resistance, diodes, continuity, transistor hFE
  - Manual ranging w/ overload protection



- M3650 & M4650 only:**
- Also measure frequency and capacitance

- M4650 only:**
- Data hold switch • 4.5 digit

**M3610 3.5 Digit Multimeter .....\$59.95**

**M3650 3.5 Digit Multimeter w/Frequency & Capacitance .....\$74.95**

**M4650 4.5 Digit w/Frequency, Capacitance and Data Hold Switch .....\$99.95**

### Handheld Multimeter



- 3.5 digit LCD with automatic polarity indication
- AC/DC voltage measurement up to 500 volts
- AC/DC current measurement up to 200mA
- Resistance measurement up to 20MΩ • Continuity checker with audible tone • Diode and logic tester • Auto/manual range and data hold functions • All range protection and function indications

**DMM905.....\$39.95**

### A.R.T. EPROM Programmer



- Programs all current EPROMs in the 2716 to 27512 range plus the X2864 EEPROM
- RS232 port • Software included

**EPP.....\$199.95**

### UVP EPROM Eraser



- Erases all EPROM's • Erases 1 chip in 15 minutes and 8 chips in 21 min
- UV intensity: 6800 UW/CM<sup>2</sup>

**DE4.....\$89.95**

### EPROMs - for your programming needs

Part No.	Price	Part No.	Price	Part No.	Price
TMS2516	\$4.25	2764-20	\$3.95	27256OTP	\$3.75
TMS2532-35	8.95	2764-25	3.75	27256-15	5.49
TMS2532A	6.95	2764-45	3.49	27256-20	4.95
TMS2564	5.95	2764A-20	3.75	27256-25	4.49
TMS2716	5.95	2764A-25	3.19	27C256-15	5.95
1702A	3.95	27C64-15	3.95	27C256-20	4.95
2708	4.75	27C64-25	3.25	27C256-25	4.25
2716	3.39	27128OTP	3.49	27512OTP	4.95
2716-1	3.75	27128-20	7.95	27512-20	6.75
27C16	4.25	27128-25	7.75	27512-25	5.95
2732	4.95	27128A-15	4.95	27C512-15	6.75
2732A-20	4.49	27128A-20	4.49	27C512-20	6.49
2732A-25	3.49	27128A-25	3.75	27C512-25	5.95
2732A-45	2.95	27C128-15	5.75	27C010-15	9.95
27C32	4.75	27C128-25	7.95	68766-35	9.95

# JAMECO®

**24 Hour Order Hotline  
(415) 592-8097**



Please refer to **Mail Key 2** when ordering

• Partial Listing • Over 4000 Electronic and Computer Components in Stock!

CIRCLE 114 ON FREE INFORMATION CARD

[www.americanradiohistory.com](http://www.americanradiohistory.com)



# Competitive Prices

## Computer Products and Electronic Components

### Assemble Your own Computer Kit!

#### Jameco 16MHz 80386SX Desktop Computer Kit

- Building your own computer provides you with a better understanding of components and their functions
- In-depth assembly instructions included
- Have your new computer assembled and running in an evening, using common tools
- Software included
- Purchase computer kits configured by Jameco or design your own

**\$799.95**  
JE3816  
monitor/adaptor extra

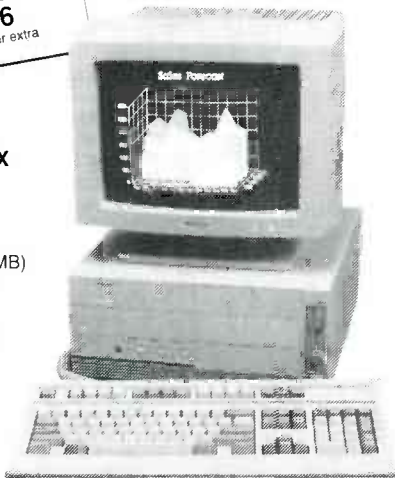

#### Jameco 16MHz 80386SX Desktop Computer Kit

- Includes:
- 80386SX Motherboard with 2MB RAM (expandable to 8MB)
  - 101-key enhanced keyboard
  - Multi I/O Card
  - Toshiba 1.44MB, 3.5" DSHD floppy disk drive
  - Baby sized desktop case
  - 200 Watt power supply
  - DR DOS 5.0 by Digital Research and AMI diagnostic software

Call for latest pricing!

## JAMECO®

ELECTRONIC COMPONENTS  
COMPUTER PRODUCTS

24 Hour Order Hotline (415) 592-8097

#### Relisys 14" VGA Color Monitor



Call for latest pricing!

- Max resolution: 720 x 480
- Bandwidth: 30MHz
- Input: DB15-pin (analog)

RE9513.....\$399.95

#### Jameco 16-bit Super VGA Card



- Emulates VGA, EGA, CGA, MDA and Hercules modes • Comes with 512KB video RAM upgradable to 1MB (Four 514256-80) • Capable of 1024 x 768 with 256 colors (1MB video RAM required)

JE1058S.....\$229.95

#### Hard Drives



#### Conner (16-bit IDE)

CP3044 40MB 3.5" Low Profile.....\$399.95  
CP3184 80MB 3.5"HH.....\$599.95  
CP3104 100MB 3.5"HH.....\$649.95

Call for latest pricing!

ADP20 Host Adaptor.....\$29.95

### Look to Jameco.....

- Wide selection of integrated circuits and components
- Quality prototype and test equipment
- Computer kits and accessories

#### Additional items that Jameco offers:

- Tools
- Cables
- Connectors
- Data Books
- Motherboards
- Memory
- Math Coprocessors
- Computer Accessories
- Power Protection Equipment
- Much, much more !

Let us show you what we have to offer; call or write for the latest Jameco catalog!

#### \$50.00 Minimum Order

Data Sheets - 50c each

Call for a FREE 90-Page catalog!

© 1991 Jameco Electronics 10/91

#### CA Residents Add

7.25% 7.75% or 8.25% Sales Tax  
Shipping, handling and insurance are additional.  
(Costs may vary according to weight and shipping method)  
Terms: Prices subject to change without notice.  
Items subject to availability and prior sale.  
Complete list of terms/warranties is available upon request.

## JAMECO®

ELECTRONIC COMPONENTS  
COMPUTER PRODUCTS

FAX: (415) 592-2503

(415) 595-2664

1355 Shoreway Road  
Belmont, CA 94002

### Integrated Circuits\*

Part No.	1-9	10+	Part No.	1-9	10+
7400	\$.29	\$.19	7472	\$.19	\$1.09
7402	.29	.19	7473	.49	.39
7404	.29	.19	7474	.39	.29
7405	.35	.25	7475	.49	.39
7406	.35	.25	7476	.45	.35
7407	.35	.25	7483	.69	.59
7408	.35	.25	7486	.45	.35
7410	.29	.19	7489	2.95	2.75
7411	.29	.19	7490	.49	.39
7414	.35	.25	7493	.45	.35
7417	.35	.25	74116	1.29	1.19
7420	.29	.19	74121	.49	.39
7427	.35	.25	74123	.49	.39
7430	.29	.19	74125	.45	.35
7432	.35	.25	74151	.39	.29
7438	.45	.35	74160	.59	.49
7442	.49	.39	74161	.69	.59
7445	.75	.65	74192	.79	.69
7446	.99	.89	74193	.79	.69
7447	.89	.79	74194	1.19	1.09

### Dynamic RAMs

4164-100	100ns, 64K x 1	\$1.89	41256-100	100ns, 256K x 1	\$1.95
4164-120	120ns, 64K x 1	1.69	41256-120	120ns, 256K x 1	1.79
4164-150	150ns, 64K x 1	1.49	41256-150	150ns, 256K x 1	1.69
41256-60	60ns, 256K x 1	2.49	511000P-80	80ns, 1MB x 1	7.25
41256-80	80ns, 256K x 1	2.19	511000P-10	100ns, 1MB x 1	6.75

\* Call for a complete listing of IC's

### Miscellaneous Components

#### Potentiometers

Values available (insert ohms into space marked "XX"):  
500Ω, 1K, 5K, 10K, 20K, 50K, 100K, 1MEG

43PXX 3/4 Watt, 15 Turn .....\$ .99  
63PXX 1/2 Watt, 1 Turn .....\$ .89

#### Transistors And Diodes

PN2222.....\$ .12 1N4735.....\$ .25 2N4401.....\$ .15  
PN2907.....\$ .12 2N3904.....\$ .12 1N4148.....\$ .07  
1N4004.....\$ .10 1N751.....\$ .15 2N3055.....\$ .69  
2N2222A.....\$ .25 C106B1.....\$ .59 1N270.....\$ .25

#### Switches

JMT123 SPDT, On-On (Toggle) .....\$1.25  
206-8 SPST, 16-pin (DIP).....\$1.09  
MPC121 SPDT, On-Off-On (Toggle).....\$1.19  
MS102 SPST, Momentary (Push-Button).....\$ .39

#### Connectors

DB25P Male, 25-pin...\$ .65 DB25H Hood.....\$ .39  
DB25S Female, 25-pin...\$ .75 DB25MH Metal Hood.....\$ 1.35

#### LEDs

XC209R T1, (Red).....\$ .14 XC556R T1 3/4, (Red) ...\$ .12  
XC556G T1 3/4, (Green) ...\$ .16 XC556Y T1 3/4, (Yellow) ...\$ .16

#### IC Sockets

Low Profile Wire Wrap (Gold) Level #2  
8LP.....\$ .11 8WW.....\$ .49  
14LP.....\$ .12 14WW.....\$ .69  
16LP.....\$ .13 16WW.....\$ .79  
24LP.....\$ .19 24WW.....\$ 1.15  
28LP.....\$ .22 28WW.....\$ 1.39  
40LP.....\$ .28 40WW.....\$ 1.89  
Solder-tail Standard & Header Plug Sockets Also Available

• Customer Service • Technical Assistance • Credit Department • All Other Inquiries • (415) 592-8097 • 7AM - 4PM P.S.T.

CIRCLE 114 ON FREE INFORMATION CARD

www.americanradiohistory.com

# ADVERTISING INDEX

RADIO-ELECTRONICS does not assume any responsibility for errors that may appear in the index below.

## FUN WITH ELECTRONICS

Coil Design and Construction Manual

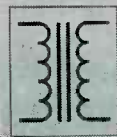

◀ □ **160—COIL DESIGN & CONSTRUCTION MANUAL** ... \$5.95. How to make RF, IF, audio and power coils; chokes and transformers. Practically every possible type is discussed.

□ **PCP113—THE PC MUSIC HANDBOOK** ... \$13.95. Learn the basics of computer music systems. For the professional musician, gifted amateur or just plain curious.



Loudspeakers for Musicians



◀ □ **BP297—LOUDSPEAKERS FOR MUSICIANS** ... \$6.25. Loudspeaker design from the musician's point of view! All you need to know, and you should be able to design your own after reading this.

□ **BP277—HIGH POWER AUDIO AMPLIFIER CONSTRUCTION** ... \$6.25. Here's background and practical design information on high power audio amplifiers capable of 300-400 watts r.m.s. You'll find MOSFET and bipolar output transistors in inverting and non-inverting circuits.



◀ □ **BP302—A CONCISE USER'S GUIDE TO LOTUS 1-2-3 RELEASE 3.1** ... \$6.25. If you are a PC user and want to upgrade to Lotus 1-2-3 release 3.1, this book can teach you how to do that in the shortest and most effective way.

□ **BP298—A CONCISE INTRODUCTION TO THE MACINTOSH SYSTEM AND FINDER** ... \$6.25. This introduction for those new to the Mac, this book also serves as a quick refresher for experienced owners that have not used the machine in some time.



MAIL TO: Electronic Technology Today, Inc.  
P.O. Box 240  
Massapequa Park, NY 11762-0240

### SHIPPING CHARGES IN USA AND CANADA

\$0.01 to \$5.00	\$1.50	\$30.01 to \$40.00	\$5.50
\$5.01 to \$10.00	\$2.50	\$40.01 to \$50.00	\$6.50
\$10.01 to \$20.00	\$3.50	\$50.01 and above	\$8.00
\$20.01 to \$30.00	\$4.50		

**SORRY, No orders accepted outside of USA and Canada**

Total price of merchandise	\$	
Shipping (see chart)	\$	
Subtotal	\$	
Sales Tax (NYS only)	\$	
Total Enclosed	\$	

Name \_\_\_\_\_  
Address \_\_\_\_\_  
City \_\_\_\_\_ State \_\_\_\_\_ Zip \_\_\_\_\_

Free Information Number	Page		Page	
108	AMC Sales	83	78 Radio Shack	32
75	Ace Products	79	199 SCO Electronics	89
107	All Electronics	103	184 Sencore	CV4
—	Amazing Concepts	100	— SMPTEC	84
176	American Reliance Inc.	79	— Star Circuits	90
109	C & S Sales	77	195 TECI	84
—	CIE	11, 15	— The SPEC-COM Journal	26
—	Cable Ready Company	100	185 The School of VCR Repair	76
187	Cable Warehouse	26	201 Unicorn	104
50	Caig Laboratories	25	200 US Cable	89
192	Cheneko Products	79	189,190 Viejo Publications	12, 83
—	Command Productions	16	181 WPT Publications	84
182	Communications Specialists	84	202 Worldwide Cable	98
55	Contact East	79	183 Xandi Electronics	79
58	Cook's Institute	26		
177	Datak Corporation	25		
127	Deco Industries	79		
178	EasyTech	105		
179	Electronic Goldmine	100		
—	Electronic Technology Today	108		
—	Electronics Book Club	17		
—	Electronics Engineers B.C.	28		
121	Fluke Manufacturing	CV2		
—	Fordham	3		
194	Global Specialties	13		
—	Grantham College	81		
86	Heathkit	12		
180	Hewlett Packard	7		
—	HighText Publications, Inc.	16		
—	ISCET	88		
114	Jameco	106, 107		
186	Kelvin	73		
53	MD Electronics	99		
196	MJS Design	79		
93	Mark V. Electronics	101		
—	NRI Schools	18, 93		
71	NTE Electronics	CV3		
188	Number One Systems Ltd.	95		
193	Optoelectronics	5		
56	Parts Express	102		
198	People's College of Indep. Study	82		
197	R.L. Drake Co.	23		

### ADVERTISING SALES OFFICE

**Gernsback Publications, Inc.**  
500-B Bi-County Blvd.  
Farmingdale, NY 11735  
1-(516) 293-3000  
President: **Larry Steckler**

**For Advertising ONLY**  
516-293-3000  
Fax 1-516-293-3115  
**Larry Steckler**  
publisher

**Christina Estrada**  
assistant to the President  
**Arline Fishman**  
advertising director

**Denise Haven**  
advertising assistant  
**Kelly McQuade**  
credit manager

**Subscriber Customer Service**  
1-800-288-0652

**Order Entry for New Subscribers**  
1-800-999-7139  
7:00 AM - 6:00 PM M-F MST

**SALES OFFICES EAST/SOUTHEAST**  
**Stanley Levitan**, Eastern Sales Manager  
Radio-Electronics  
1 Overlook Ave.  
Great Neck, NY 11021  
1-516-487-9357, 1-516-293-3000  
Fax 1-516-487-8402

**MIDWEST/Texas/Arkansas/Okla.**  
**Ralph Bergen**, Midwest Sales Manager  
Radio-Electronics  
One Northfield Plaza, Suite 300  
Northfield, IL 60093-1214  
1-708-446-1444  
Fax 1-708-559-0562

**PACIFIC COAST/Mountain States**  
**Marvin Green**, Pacific Sales Manager  
Radio-Electronics  
5430 Van Nuys Blvd. Suite 316  
Van Nuys, CA 91401  
1-818-986-2001  
Fax 1-818-986-2009

**RE Shopper**  
**Joe Shere**, National Representative  
P.O. Box 169  
Idyllwild, CA 92549  
1-714-659-9743  
Fax 1-714-659-2469



# NTE KEEPS YOU UP AND RUNNING.

NTE specializes in "replacitivity," the science of getting things up and running again—fast! After all, downtime is costly, so no one can wait weeks on end for an OEM part to come in. With NTE, no one has to! One call gives you access to 3,550 top of the line universal replacement semiconductors that are cross-referenced to more than 240,000 original devices! Included in the NTE line are: bipolar transistors, integrated circuits, rectifiers, diodes, thyristors, optoelectronic devices, varistors, resistors, capacitors, and much, much more. All are backed by NTE's exclusive two-year warranty.

For your copy of the NTE Technical Guide contact your local NTE distributor, or simply fill in the coupon below and send it to us today with a check or money order for \$3.25 each.



## NTE ELECTRONICS, INC.

A WORLDWIDE REPUTATION FOR QUALITY, SERVICE AND VALUE

Please rush me \_\_\_\_\_ copies of the NTE Technical Guide and Cross Reference manual at \$3.25 each. I have enclosed my check or money order for a total of \$ \_\_\_\_\_

Name \_\_\_\_\_

Company \_\_\_\_\_

Address \_\_\_\_\_

City \_\_\_\_\_

State \_\_\_\_\_ Zip \_\_\_\_\_

Mail to: NTE, 44-T Farrand St., Bloomfield, NJ 07003



For the name of your nearest NTE distributor, call NTE: Toll Free: 1-800-631-250 (incl. Canada)

Tel: (201) 748-5089 - FAX: (201) 748-6224

CIRCLE 71 ON FREE INFORMATION CARD



# Introducing The Only Complete Solution For All Your Monitor Servicing Needs!



**New!**

**CM2000 Computer Monitor Analyzer**  
Patented - A Sencore Exclusive!

**Completely Test And Troubleshoot  
All High Resolution And Multi-Scan  
Computer Monitors From The  
Input Connector To The CRT...  
Guaranteed!**

*The Only Analyzer  
That Helps You  
Pinpoint Defects In  
All Computer  
Monitors!*



Here's What The CM2000 Offers You:

- Complete High Resolution Computer Monitor Analyzing
- Fully Programmable Scan Rate And Pixel Resolution
- Innovative Performance Testing Patterns
- Special Sync-Locked Substitution Signals
- Patented "Ringer" Test To Dynamically Analyze All:
  - Yokes
  - IHVTs/Flybacks
  - Switching Transformers
- Integrated 2,000 DCV And P-P Meter
- Exclusive "Hook-up" Adapters Available For All Popular Monitors
- Portable Troubleshooting For All Your Field Service Needs

**Call 1-800-SENCORE ext. 708**  
(736-2673)

**SENCORE**

3200 Sencore Drive, Sioux Falls, South Dakota 57107

CIRCLE 184 ON FREE INFORMATION CARD

[www.americanradiohistory.com](http://www.americanradiohistory.com)