

Radio - SURROUND SOUND DE-MYSTIFIED

JUNE 1990

Electronics®

TECHNOLOGY - VIDEO - STEREO - COMPUTERS - SERVICE

BUILD THE LAWN RANGER

Take it easy this summer with the world's first practical robotic lawn mower!

BUILD A UNIVERSAL GENERIC LINEAR POWER SUPPLY

A single PC board design can be used to power dozens of projects!

ADD A DISPLAY TO YOUR NEXT PROJECT

Step-by-step guide to using LCD display modules

EXPERIMENT WITH I/O INTERFACING

How to build an experimenter's card for the PC expansion bus

SINGLE-CHIP XTAL OSCILLATOR

Build a mini crystal-controlled frequency standard and pulse generator



- Plus: ★ Hardware Hacker
★ Audio Update
★ Video News
★ And lots more!



\$2.50 U.S.
\$2.95 CAN

A
GERMSBACK
PUBLICATION

FLUKE



PHILIPS

High Resolution Digital Meter:
4000 count digital readout, 20,000 count mode (Fluke 87) for 4 1/2 digit resolution

Backlit display: Makes it easy to read the DMM in dark, cramped quarters. Automatically shuts off after 68 seconds to save the battery

Recorder: records minimums and maximums, plus true arithmetic average, audible Min Max Alert, selectable response times — 1 second and 100 ms (all models) plus 1 ms Peak Min Max (Fluke 87)

Holster with Flex Stand™: Protects meter and provides test lead storage. Flexible leg allows meter to be hung from peg, bent around a pipe, or used almost anywhere.

Analog Meter: High-speed analog display updates 40 times/second — as fast as the eye can follow. X10 Zoom bargraph mode (Fluke 83 and 85) makes high resolution offset measurements a snap.

Frequency counter: Accurate down to 0.5 Hz; also measures duty cycle

Capacitance meter: Autoranging, with manual ranging at the touch of a button

FLUKE 83	FLUKE 85	FLUKE 87
Volts, ohms, amps, diode test, audible continuity, frequency and duty cycle, capacitance, Touch Hold™ relative protective holster with Flex Stand™	Volts, ohms, amps, diode test, audible continuity, frequency and duty cycle, capacitance, Touch Hold™ relative protective holster with Flex Stand™	Volts, ohms, amps, diode test, audible continuity, frequency and duty cycle, capacitance, Touch Hold™ relative protective holster with Flex Stand™
\$199*	\$229*	\$289*
0.3% basic dc accuracy	0.1% basic dc accuracy	0.1% basic dc accuracy
5 kHz acV	20 kHz acV	20 kHz acV
Analog bargraph and zoom	Analog bargraph and zoom	High resolution analog pointer
Three year warranty	Three year warranty	True-rms ac
		1 ms PEAK MIN MAX
		4 1/2 digit mode
		Backlit display
		Three year warranty

*Suggested U.S. list price

Multi-Meter

Meet the meter that brings an entire test bench to your job. The versatile Fluke 80 Series do-just-about-everything "Multi" Meter.

It offers everything you'd expect from an advanced handheld DMM, plus a lot you'd find only in dedicated instruments. Plus Fluke-exclusive features you can't buy anywhere else. All built with the most advanced surface mount design and single-chip ASIC technology for a thinner, tougher, more reliable package.

There's a fully annunciated display for clear operation. Duty cycle function. High-speed analog indicator. A protective holster with innovative Flex-Stand™ for easy, adaptable operation. Audible Input Alert™ to reduce the risk of damage to the meter, the user and the unit being tested. Plus the strongest warranty in the business.

All good reasons to move up to the truly multi-Fluke 80 Series today. You'll find 80 Series DMMs at your Fluke distributor. For immediate, off-the-shelf delivery. Call

1-800-44-FLUKE, ext. 33 for the name of your nearest distributor.

John Fluke Mfg. Co., Inc. P.O. Box 9090 M/S 250C, Everett, WA 98206 U.S. (206) 347-5400 CANADA, 416-890-7600 OTHER COUNTRIES (206) 356-5500

© Copyright 1989, John Fluke Mfg. Co., Inc. All rights reserved. Prices and specifications subject to change without notice. Ad no. 0102-F80

FROM THE WORLD LEADER IN DIGITAL MULTIMETERS.

FLUKE

CIRCLE 121 ON FREE INFORMATION CARD

BUILD THIS

- 31 THE LAWN RANGER**
Sit back and watch this robotic lawnmower cut the grass for you.
Raymond Rafaelis
- 41 GENERIC LINEAR POWER SUPPLY BOARD**
Build one PC board to fit all your power-supply needs.
John Wannamaker
- 47 PROGRAMMABLE CRYSTAL-CONTROLLED PULSE GENERATOR**
This single chip pulse generator uses a programmable crystal oscillator IC.
Peter A. Lovelock

TECHNOLOGY

- 51 ALL ABOUT SURROUND SOUND**
A straightforward look at surround sound systems for homes and for theaters.
Josef Bernard

CIRCUITS

- 59 ADD A DISPLAY TO YOUR PROJECT**
An easy and inexpensive alpha-numeric display could enhance your next project.
Steven Avritch

COMPUTERS

- 73 BUILD THIS EXPERIMENTER'S CARD**
Our experimenter's card for the PC expansion bus is easy to set up and use with simple BASIC programs.
Mark Hanslip

DEPARTMENTS

- 6 VIDEO NEWS**
What's new in this fast-changing field.
David Lachenbruch
- 18 EQUIPMENT REPORTS**
Huntron DC Line Sentry, and NCI Model PA480 PC-Based Logic Analyzer.
- 63 HARDWARE HACKER**
Low-cost memory.
Don Lancaster
- 69 DRAWING BOARD**
Finally, a video signal!
Robert Grossblatt
- 72 AUDIO UPDATE**
Receivers vs. separate components.
Larry Klein
- 73 EDITOR'S WORKBENCH**
68000 update, system analyzers, and more.
Jeff Holtzman

COMPUTER DIGEST



EDITOR'S
WORK-
BENCH

A new PC expansion card that allows you to use a single PC board to fit all your power-supply needs. This is a generic linear power supply board that can be used to power a variety of PC boards. It's designed to be easy to use and to fit into a standard PC expansion slot. The board is built around a single IC and a few other components. It's a great way to save space and money in your PC system.

Workbench is a collection of tools and techniques for working with computers. It includes articles on hardware, software, and system management. It's a great resource for anyone who's interested in computers and wants to learn more about them. The workbench is designed to be easy to use and to provide a wealth of information in a concise format.

PAGE 73

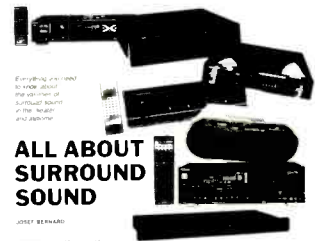

ALL ABOUT
SURROUND
SOUND

Josef Bernard discusses the latest in surround sound technology. He explains how surround sound systems work and how to choose the right system for your home or theater. He also provides tips on how to set up a surround sound system and how to troubleshoot common problems. This is a comprehensive guide to the world of surround sound.

PAGE 51

AND MORE

- 94 Advertising and Sales Offices**
- 94 Advertising Index**
- 8 Ask R-E**
- 95 Free Information Card**
- 12 Letters**
- 80 Market Center**
- 22 New Products**
- 69 PC Service**
- 4 What's News**

ON THE COVER



If you can think of better things to do with your summer weekends than mowing your lawn—and who can't?—get busy building the Lawn Ranger right now. This battery-powered robot is not remote controlled. Its infra-red sensors can actually "see" the grass, and direct its two cutting motors to mow just where its needed. Meanwhile you can lounge in your hammock with a cool drink. Turn to page 31 to get started.

COMING NEXT MONTH

THE JULY ISSUE GOES ON SALE JUNE 5.

BUILD R-E'S DIGITAL DASHBOARD

Bring high-tech monitoring to any car.

THE LAWN RANGER: PART II

A look at the motor control board.

BUILD A SUPERDIRECTIONAL MICROPHONE

Our unusual design uses a horn instead of a parabolic reflector to concentrate sounds.

ROCK, RELIGION, AND RHETORIC

A look at U.S.-based shortwave stations.

SECURITY SYSTEM COOKBOOK

An array of security circuits for your home and car.

COMPUTER DIGEST

Build a solid-state disk drive.

As a service to readers, RADIO-ELECTRONICS publishes available plans or information relating to newsworthy products, techniques and scientific and technological developments. Because of possible variances in the quality and condition of materials and workmanship used by readers, RADIO-ELECTRONICS disclaims any responsibility for the safe and proper functioning of reader-built projects based upon or from plans or information published in this magazine.

Since some of the equipment and circuitry described in RADIO-ELECTRONICS may relate to or be covered by U.S. patents, RADIO-ELECTRONICS disclaims any liability for the infringement of such patents by the making, using, or selling of any such equipment or circuitry, and suggests that anyone interested in such projects consult a patent attorney.

RADIO-ELECTRONICS, (ISSN 0033-7862) June 1990. Published monthly by Gernsback Publications, Inc., 500-B Bi-County Boulevard, Farmingdale, NY 11735 Second-Class Postage paid at Farmingdale, NY and additional mailing offices. Second-Class mail registration No. 9242 authorized at Toronto, Canada. One-year subscription rate U.S.A. and possessions \$17.97, Canada \$23.97, all other countries \$26.97. All subscription orders payable in U.S.A. funds only, via international postal money order or check drawn on a U.S.A. bank. Single copies \$2.50. © 1990 by Gernsback Publications, Inc. All rights reserved. Printed in U.S.A.

POSTMASTER: Please send address changes to RADIO-ELECTRONICS, Subscription Dept., Box 55115, Boulder, CO 80321-5115.

A stamped self-addressed envelope must accompany all submitted manuscripts and/or artwork or photographs if their return is desired should they be rejected. We disclaim any responsibility for the loss or damage of manuscripts and/or artwork or photographs while in our possession or otherwise.

Radio Electronics®

Hugo Gernsback (1884-1967) founder
M. Harvey Gernsback,
editor-in-chief, emeritus

Larry Steckler, EHF, CET,
editor-in-chief and publisher

EDITORIAL DEPARTMENT

Brian C. Fenton, editor

Marc Spiwak, associate editor

Daniel Goodman, technical editor

Teri Scaduto, assistant editor

Jeffrey K. Holtzman
computer editor

Robert Grossblatt, circuits editor

Larry Klein, audio editor

David Lachenbruch
contributing editor

Don Lancaster
contributing editor

Richard D. Fitch
contributing editor

Kathy Campbell, editorial assistant

ART DEPARTMENT

Andre Duzant, art director

Injae Lee, illustrator

Russell C. Truelson, illustrator

PRODUCTION DEPARTMENT

Ruby M. Yee, production director

Janice Box,
editorial production

Karen S. Tucker
advertising production

Marcella Amoroso
production assistant

CIRCULATION DEPARTMENT

Jacqueline P. Cheeseboro
circulation director

Wendy Alanko
circulation analyst

Theresa Lombardo
circulation assistant

Michele Torriello, reprint bookstore

Typography by Mates Graphics

Radio-Electronics is indexed in
Applied Science & Technology Index
and *Readers Guide to Periodical Literature*.

Microfilm & Microfiche editions are
available. Contact circulation department
for details.

**Advertising Sales Offices listed
on page 94.**

Radio-Electronics Executive and
Administrative Offices:
1-516-293-3000.

Subscriber Customer Service:
1-800-288-0652.

Order Entry for New Subscribers:
1-800-999-7139.



The
Audit
Bureau
of Circulation

Clips For Chips.

73 Time Saving Solutions For Faster IC Testing. Think of the time you'll save testing those fine-pitch ICs by having the right Pomona IC Clips, Pin Breakouts or Socket interfaces at your finger tips. You'll do the job quicker and more dependably than ever before.

They're available now. Your choice of DIP styles, SOIC, PGA, PLCC, LCC, or even our newest ultra fine-pitch PQFP (Plastic Quad Flat Pack) series, to make testing faster, more dependable.

Pomona Charts Quality First. Only the finest quality materials are used: beryllium copper for best contact force, gold plating for lowest contact resistance, abrasive contact coating for best oxide penetration, glass-filled Nylon bodies for dimensional stability and rigidity, and stainless steel hinges, pins and springs.

And, to make your job even easier, Pomona also offers a great complement of test accessories, like our SMD Dog-Leg Microtip Test Probe, SMD Test Tweezers, Grabber® and Minipincer™ Clips, jumpers, test leads and cable assemblies to make your IC testing faster and less expensive.

So, if you want to save time and reliability is a must, check-out the chart and pick your clips.

See your nearest Authorized Pomona Distributor or contact POMONA ELECTRONICS, 1500 E. Ninth St., P.O. Box 27267, Pomona, CA 91769 (714) 623-3463 FAX (714) 629-3317



FREE 1990 POMONA CATALOG!
Receive this new, 138-page edition. FREE on request. Contains IC Test Clip Chart and thousands of test solutions

CLIPS FOR BOARD MOUNTED IC'S		ADAPTERS FOR SOCKET MOUNTED IC'S	
Package	No. of Pins	Model No.	Pin I
DIP Dual In-Line Package (.100 Pin Spacing, Thru Hole)	8	5108 ⁺ , 5208 ⁺ , 5649 ⁺	40 48 64
	14	5014 ⁺ , 5114 ⁺ , 5214 ⁺ , 5314 ⁺ , 5650 ⁺	
	16	3916A ⁺ , 4236A ⁺ , 5116 ⁺ , 5216 ⁺ , 5692 ⁺	
	20	5120 ⁺ , 5220 ⁺ , 5693 ⁺	
SOIC Small Outline IC (.050 Pin Spacing, Surface Mnt)	24	4124A ⁺ , 4324A ⁺	5442 5443 5444
	40	5124 ⁺ , 5224 ⁺ , 5694 ⁺ 4140A ⁺ , 4340A ⁺ , 5140 ⁺ , 5240 ⁺ , 5695 ⁺	
	8	5250	
	14	5251, 5413 ⁺	
	16	5252	
PLCC Plastic Leadless Chip Carrier (.050 Pin Spacing, Surface Mnt)	20	5253	5279 5280 5281 5312 5401 5402
	28	5254	
	44	5437	
	52		
	68		
PGA Pin Grid Array (.050 Pin Spacing, Thru Hole)	84		5643 5644 5645
	20	5279	
	28	5280	
	44	5281	
PQFP Plastic Quad Flat Pack (.025 to .0315 Pin Spacing)	120	EIAJ 100 (20X30)	5643 5644 5645
	160	120 (30X30)	
		160 (40X40)	

Pomona's 5640 Series PQFP (Plastic Quad Flat Pack) IC Test Clip is available in three EIAJ models for 0.025"-0.0315" pin spacing. Also available in 8 JEDEC Breakout and Socket Interface styles.

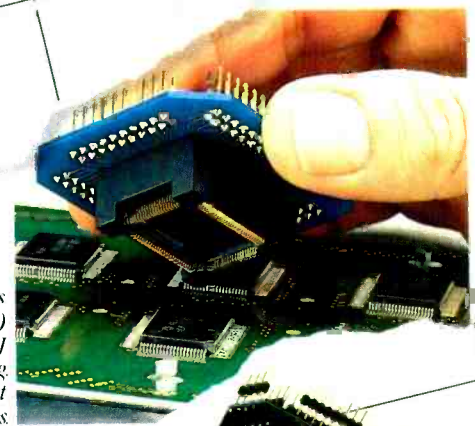

Nylon is a registered trademark of DuPont

CIRCLE 101 ON FREE INFORMATION CARD

ITT Pomona
AN ITT EMC WORLDWIDE COMPANY
Discover our strengths.

WHAT'S NEWS

Radalert reaches Russia

As part of *perestroika*, and in light of the lingering problems created by fallout from Chernobyl, the Soviet government has decided to encourage the production and distribution of radiation detectors for Soviet citizens. The Radalert nuclear radiation monitor (featured in **Radio-Electronics'** June and July 1988 and June 1989 issues) won a recent government-sponsored design competition in the Soviet Union, surpassing 45 other contestants. That resulted in the signing of a Protocol of Intention for Joint Venture by a Soviet group and International Medcom (Sebastopol, CA), the manufacturers of the Radalert. Under the terms of the proposed venture, the Radalert and similar radiation detection instruments will be mass-produced in the Soviet Union under a licensing agreement with International Medcom.

A Radalert monitor was used to measure the radiation level at the Chernobyl plant in April 1989. Three years after the accident, a radiation level of 4067 CPM—about 250 times the normal background radiation level here at **Radio-Electronics'** offices—was recorded.

International Medcom has been



TOM COCHRAN OF THE NATURAL RESOURCES DEFENSE COUNCIL holds a Radalert monitor on the grounds of the Chernobyl nuclear facility in the Soviet Union. The radiation level displayed (4067 CPM) is approximately 250 times higher than normal, three years after the accident occurred there.

active in the United States as well. The company's RMS-2 monitor and detection system was displayed to the Energy Committee of the Massachusetts Legislature last spring, for possible use in monitoring emissions at the Pilgrim and Yankee Rowe nuclear plants in that state. That system, as well as the Radalert, also will be used by environmental groups to keep tabs on radioactivity levels that are near nuclear plants and test sites.

New solid-state laser puts out 1,000 watts

In a feat they compare to breaking the four-minute mile in running, scientists at General Electric Research and Development Labs in Schenectady, NY, have developed a solid-state laser that has achieved one-thousand watts average output. The new laser is a neodymium-doped yttrium-aluminum-garnet (Nd:YAG) face-pumped laser, which happens to be a direct descendant of a device patented by GE physicists 17 years ago, which put out only 10 watts of power.

According to Joseph P. Chernoch,

who invented the original device in 1972 and who led the team that demonstrated the new device, the face-pumped laser is second to none for industrial cutting and drilling because of its combination of high power and good beam quality (a measure of how much the beam spreads out). In addition, it generates light of a one-micron wavelength that is particularly well absorbed by metals. The device can readily cut or drill through more than two inches of nickel-based superalloys, far beyond the reach of other known lasers.

GE's new laser compensates for

distortions introduced by other types by using a slab, rather than a rod, of lasing material and by using a highly effective cooling approach. The slab is a precision-machined Nd:YAG crystal that measures about $1 \times \frac{1}{4} \times 8$ inches. Light is pumped into the faces of the crystal (hence



GE R&D CENTER ENGINEER ANGEL L. ORTIZ, JR puts the face-pumped laser to work drilling holes in a $\frac{1}{2}$ -inch thick plate of superalloy; in other tests it's managed to drill through more than two inches of superalloy. The solid-state laser's average power output of 1,000 watts from a single laser head opens the door to development of industrial laser systems that can cut and drill space-age metals and alloys with unprecedented speed and precision.

the name "face-pumped laser") by a pair of ultra-high-intensity flashlamps that are energized by the system's 17,000-watt power supply. High beam quality is maintained by directing the laser beam through the slab along a zigzag path (the beam reflects internally off the slab's highly polished faces) that enables the beam to "see" a uniform averaged selection of stressed material, which eliminates the thermal distortion.

R-E

It's no fluke.



Made in the U.S.A.

Feature	Fluke Model 77	Beckman Industrial RMS225
Digits	3-1/2 Digits	4 Digits
Resolution	3,200 Counts	10,000 Counts
Accuracy	0.3%	0.25%
Automatic Reading Hold	Touch Hold [®]	Probe Hold [™]
Analog Bar Graph	31 Segments	41 Segments
Battery Life	2,000 Hrs	500 Hrs
10A Range	✓ (Fused)	✓ (Unfused)
Protective Holster	✓	✓
3 Year Warranty	✓	✓
True RMS		✓
Auto Max Min [™]		✓
Relative Mode		✓
Self-Resetting Fuse		✓ (40mA Input)
Price	\$159*	\$149

* Touch Hold is a registered trademark of the John Fluke Mfg. Co., Inc. * 1990 Fluke and Philips Catalog

Your best auto-ranging multimeter for the money. It doesn't happen by accident. It takes expertise, painstaking R&D, and a solid commitment to provide you with the features you've asked for at a price you can afford. When you add it all up, the new Beckman Industrial RMS225 simply outperforms any meter in its class. And like all the



other multimeters we've built over the years, it's designed for long lasting and trouble-free use. So, go visit your local distributor today and check out the new RMS225 digital multimeter. Once you compare it to the others, the choice will be obvious.

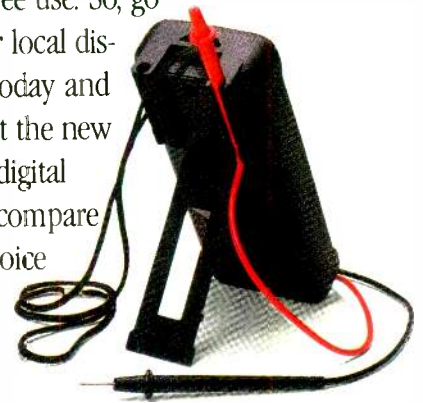

Beckman Industrial[™]

An Affiliate of Emerson Electric Co.

Instrumentation Products Division
 3883 Ruffin Road, San Diego, CA 92123-1898
 (619) 495-3200 • FAX (619) 268-0172 • TLX 249031
 Outside California 1-800-854-2708 Within California 1-800-227-9781

VIDEO NEWS



DAVID LACHENBRUCH,
CONTRIBUTING EDITOR

● **20,000,000 stereo TV's.** At least 20,000,000 TV sets equipped for Multichannel Television Sound (MTS) stereo and second audio channel reception have now been sold, indicating that at least one American home in every five can receive television programs in stereo. Last year was MTS stereo's biggest year, when more than 6,000,000 stereo-equipped sets were sold, representing 27.8% of all color TV set sales. That is an increase of almost a million sets over the 5,100,000 stereo sets sold in 1988, which represented 25.2% of that year's sales. In addition, about 1,800,000 VCR's sold in 1989 were able to receive MTS stereo broadcasts, up from 1,400,000 in 1988.

● **Welcome back, Majestic.** Old-timers will soon see another familiar old brand back in television stores. That is Majestic, which is being revived as a label sold to independent retailers through distributors. The revival of Majestic follows the similar reincarnation of the Crosley brand (**Radio-Electronics**, August, 1989). Like the new Crosley brand, the new Majestic is no relation to its namesake. The new Majestic brand is being made for a distributor organization by another old TV name—Wells-Gardner of Chicago, one of the oldest private-label TV manufacturers—from chassis and subassemblies understood to be made by Zenith. The new Crosley, as we reported earlier, is made by North American Philips. Other pioneer brands which have been revived by new parents include Capehart, Dumont, Emerson, and Symphonic.

● **Exit CD Video.** Speaking of names, one that never caught on has been dropped. Philips and its affiliated record label, PolyGram, have abandoned their effort to promote "CD Video" as the new name for the optical videodisc. They adopted the name back in 1986, when the laser videodisc's fortunes were at a low ebb, in hopes that the magic of the audio CD would rub off onto the videodisc. One added attraction of CD Video was a new 5-inch version that contained up to 6 minutes of video and 20 minutes of digital audio. The 5-incher never caught on, but combination CD and videodisc players brought a revival of the

videodisc, which is becoming increasingly popular. Now Philips and other manufacturers have agreed on a single name: "Laserdisc."

● **Sky Cable.** Activity on the direct satellite broadcasting front indicates that a television revolution will soon be under way. Two groups have announced plans for new satellite ventures. U.S. Satellite Broadcasting signed an agreement with GE Astrospace to acquire a three-channel satellite to broadcast directly to home antennas, with Nationwide Insurance as a partner.

A second announcement stirred up much more publicity. A consortium consisting of NBC, Cablevision Systems, and Rupert Murdoch's News Corporation said they will launch a high-powered direct satellite service in 1993 with up to 108 channels. Using three satellites in the same orbital slot as US. Satellite Broadcasting's bird, "Sky Cable" will provide as many as 128 channels. The Sky Cable consortium said the 200-watt power of its transponders will make it possible for homes to use small flat antennas measuring about 12 inches square. Transmission from the earth to the satellite will be digital, but the satellite will send out analog video signals. It was estimated that receiving antennas plus receivers for the satellite will cost \$200 to \$300.

It's called "Sky Cable" because the sponsors hope to make it available through local cable operators for a monthly fee, but if consumers wish to purchase the equipment and pay the satellite broadcaster directly they may do so as well.

Both NBC and the News Corp. (Fox Broadcasting) insisted that none of their network programs would be broadcast on the satellite, and Cablevision said the system would be a supplement to cable and not a replacement. But it was difficult to see what function terrestrial broadcasting or cable would serve when 128 channels could be picked up from satellites with a small investment on the part of the public, and there was some feeling that investments in the billion-dollar project by its network and cable sponsors was a defensive maneuver—just on the chance that direct satellite broadcasting might make broadcasting and cable obsolete.

R-E

HIGH PLACES

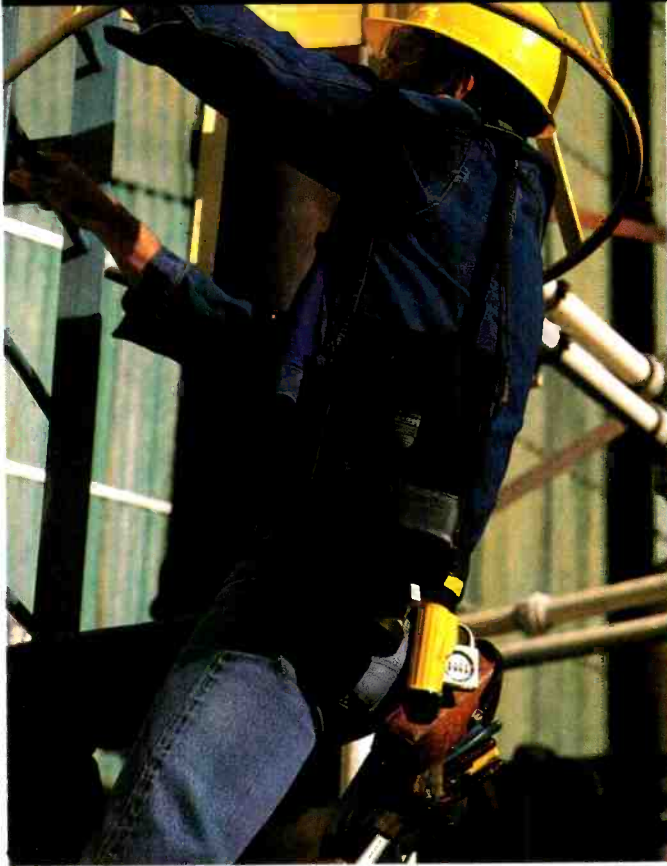

TIGHT SPACES



No matter where you go, Tek's new 222 is a perfect fit.

Introducing Tek's new 222 Digital Oscilloscope. Weighing in at under 4.5 pounds, the new Tek 222 is an ultra-portable, 10-MHz digital storage scope that's perfect for service applications. So tough, rugged, and totally self-contained, it can go just about anywhere. And it's incredibly easy to use—even in extreme conditions.

Extraordinary capability and reliability at a great price. The 222 is a dual-channel scope that can measure a wide variety of electronic instrumentation and circuitry. It has rechargeable on-board batteries with a floating ground to 400 volts, and meets tough environmental standards.

Plus, the 222 lets you pre-define front-panel setups, and call them up with a single button in the field. You can also save waveforms in the scope's memory, then transfer them to a PC for analysis and hard-copy output when you get back to the shop.

Best of all, the 222 is yours for only \$2350. And that includes Tek's remarkable three-year warranty on parts, labor, and CRT.

Get one to go! Pack a handful of power with you wherever you go. To order your 222, or for a free brochure, contact your local Tek representative or authorized distributor.

In a hurry? Call
1-800-426-2200.



ASK R-E

WRITE TO:

ASK R-E
Radio-Electronics
500-B Bi-County Blvd.
Farmingdale, NY 11735

LINES OF RESOLUTION

Please tell me something about the horizontal resolution of the NTSC system. According to the standard, there are 525 horizontal lines per frame, but my VCR only puts out 230 lines. Is that lines per field or lines per frame? Sony ED Beta machines claim to have more than 500 lines and some studio cameras are rated at above 600 lines—more than the NTSC standard. How can a TV display more than 525 lines? And could you explain what difference there is between a “composite video output” and a “video output?”—M. Hart, Burbank, CA

I can understand your confusion but you shouldn't feel too bad because the whole issue of video resolution is confusing. Even some friends of mine who use the video business to pay the rent don't have a clear understanding of exactly what the numbers mean. Let's start with a bit of history.

The whole idea of using numbers of lines to measure resolution had its beginnings in the lens business. As lens making progressed from broken bottle bottoms to fluoride coating and lasers, a standard was developed to measure the amount of detail a lens could transmit. As you've probably guessed, the unit that was chosen was the number of lines per millimeter.

A “line of resolution” is defined as an equal amount of white and black area as shown in Fig. 1. A typical resolution chart would have a series of lines that get thinner and more closely packed as you move across the chart. In practice, the lens would be pointed at the chart and the projected image would be examined to see at what point it became impossible to see individual lines. That point would be designated as the resolving power of the lens.

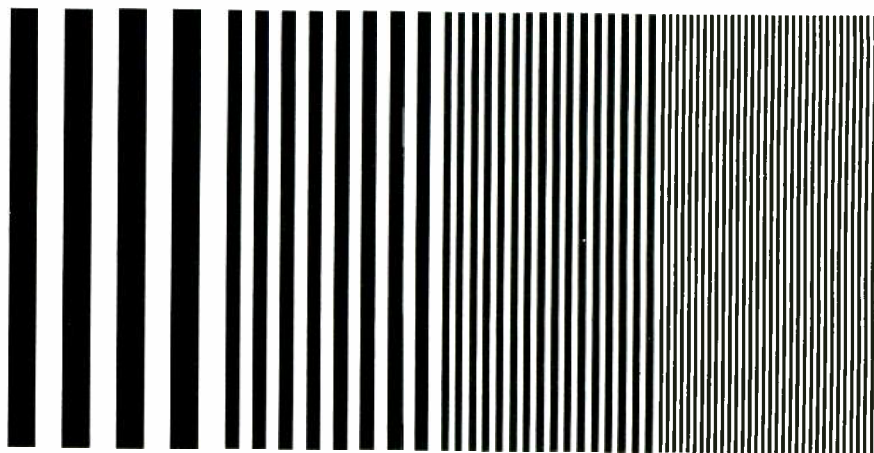

FIG. 1

It should be obvious to you that there's a problem with this method since lenses don't have equal resolving power at every point on the glass. That is due, in part, to theoretical consequences of the optical paths of the light, and also with practical considerations of grinding glass; a lens is usually much sharper at the center than it is at the edges. That's why the published resolution of a lens is specified for a particular point on the lens—usually the center where the image is the sharpest.

The lines-of-resolution method of measuring the sharpness of a lens was carried over to most of the industries that were involved in the business of reproducing images. That includes printing, film, and video. Each industry is concerned with the amount of detail that they can reproduce, but they also have characteristics that differ from the lens business. So, while they all refer to lines when they talk about resolution, they aren't all talking about the same thing. In short, the video industry has made too much use of the word “line.”

You're correct in saying that the NTSC standard calls for 525 lines per frame, but you didn't go far enough. Standard NTSC video doesn't just call for 525 lines per frame, it's that way by definition. Each field contains 262.5 lines, and two fields make one frame of video. A video signal that puts out anything other than that just isn't conforming to the NTSC standard. The signal timing may be such that you can display it on an NTSC-standard monitor, but that means that it's really only “NTSC compatible.”

Now, with that out of the way, exactly what does it mean to say that some video device puts out 200, 300, 500, or 600 lines? What it means is that there are two different kinds of lines: the first is a line of video and the second is a line of resolution. And what, you may well ask, do they have to do with each other? Absolutely nothing!

The way to understand how the lines of resolution in video relate to the lines of resolution used in optics is to realize that video resolution deals with the number of dots on

Train for a High-Paying Career as a Computer Service Technician

Only NRI teaches you to service all computers as you build your own fully AT-compatible micro—now with 1 meg RAM and 20 meg hard drive!

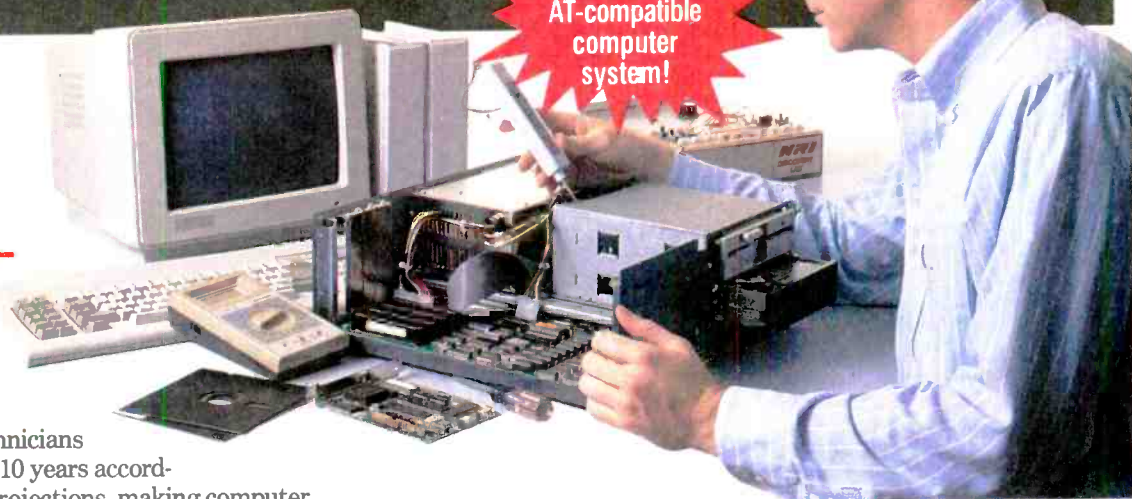

Jobs for computer service technicians will almost double in the next 10 years according to Department of Labor projections, making computer service one of the top 10 growth fields in the nation.

Now you can cash in on this opportunity—either as a full-time industry technician or in a computer service business of your own—once you've mastered electronics and computers the NRI way.

Get inside the powerful, fully AT-compatible West Coast computer system

To give you hands-on training with the absolute in state-of-the-art computer technology, NRI includes the powerful new West Coast 1010 ES computer as the centerpiece of your training. You build this 1 meg RAM, fully IBM AT-compatible computer from the keyboard up, plus you now go on to install a 20 megabyte hard disk drive to complete your total computer system.

Understanding you get only through experience

You need no previous background in electronics to succeed with NRI. You start with the basics, rapidly building on the fundamentals of electronics with bite-size lessons. You perform hands-on experiments with your NRI Discovery Lab® and then move on to master such advanced concepts as digital logic, microprocessors, and computer memories.

Learn at home in your spare time

With NRI, you learn at your own convenience in your own home. No classroom pressures, no night school, no need to quit your present job until you're ready to make your move. And all throughout your training you've got the full support of your personal NRI instructor and the entire NRI technical and support staff. They're always ready to answer your questions and help you whenever you need it.

Get all the facts from NRI's free 100-page catalog. Send today!

Your incomparable hands-on training includes all this:

NRI's unique Discovery Lab® lets you design and modify circuits, diagnose and repair faults • Hand-held digital multimeter, complete with "talk-you-through" instructions on audio cassette • Digital logic probe lets you visually examine computer circuits • The latest West Coast 1010 ES AT-compatible computer with 101-key, "intelligent" keyboard and 1.2 megabyte, 5¼" floppy disk drive • 20 megabyte hard disk drive you install internally • 64K ROM, 1 meg RAM • MS-DOS, GW-BASIC, and exclusive word processing, database, and spreadsheet software • Reference manuals, programming guidelines, and schematics.

See other side for highlights of NRI "hands-on" computer training →

SEND CARD TODAY FOR FREE NRI CATALOG

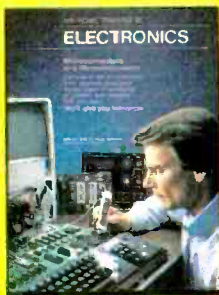

COMPUTERS AND MICROPROCESSORS

This training prepares you to service all computers as you build your own fully IBM AT-compatible computer. Total systems training includes 1.2 meg, 5¼" floppy disk drive, 20 meg hard disk drive, monitor, test equipment, software, and the NRI Discovery Lab®.

Check one FREE catalog only.

- | | |
|--|--|
| <input type="checkbox"/> Computers and Microprocessors | <input type="checkbox"/> Security Electronics |
| <input type="checkbox"/> TV/Video/Audio Servicing | <input type="checkbox"/> Electronic Music Technology |
| <input type="checkbox"/> Robotics | <input type="checkbox"/> Telecommunications Technology |
| <input type="checkbox"/> Computer Programming | <input type="checkbox"/> Basic Electronics |

Name	(Please print)	Age
Address		
City	State	Zip

For career courses approved under GI Bill check for details.

Accredited by the Accrediting Commission of the National Home Study Council

Get In-Demand Computer Servicing Skills With NRI "Hands-On" Training

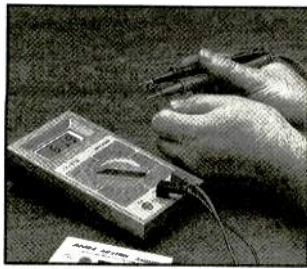

Using NRI's unique Action Audio Cassette, you're talked through the operation and practical applications of your hand-held digital multimeter—the basic, indispensable tool for the computer specialist.

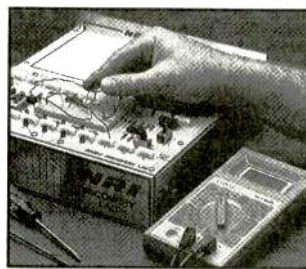

You set up and perform electronics experiments and demonstrations using your NRI Discovery Lab®. You even interface the lab with your computer to "see" keyboard-generated data.



After you build this digital logic probe, you explore the operation of the West Coast 101-key, detached "intelligent" keyboard and its dedicated microprocessor.



You install the 1.2 meg, 5¼" floppy disk drive, learning disk drive operation and adjustment. Later, you improve your data storage capacity dramatically by installing this powerful 20 meg hard drive.

Total Computer Systems Training, Only From NRI

No computer stands alone... it's part of a total system. So if you want to learn to service and repair computers, you have to understand today's computer systems. And only NRI builds meaningful training around just such a powerful computer system—the new West Coast 1010 ES Series Computer, complete with monitor, floppy disk drive, hard disk drive, and valuable software—all yours to train with and keep.

The 1010 ES features full IBM AT compatibility, the breakneck speed of an advanced 80286 CPU, and big-system raw power: 1 meg RAM and full expandability for future system growth.

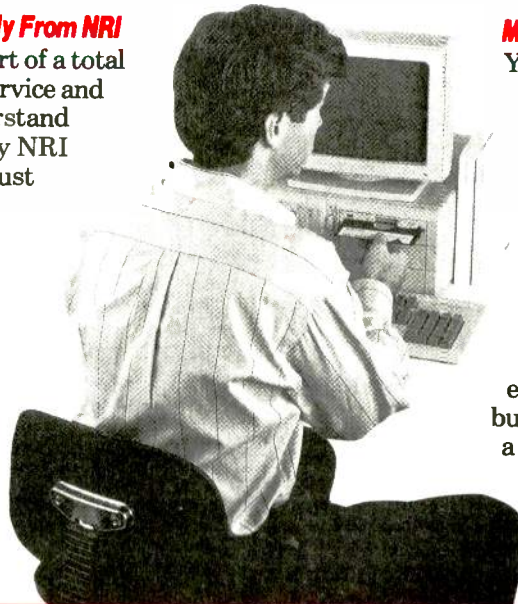

Mastery Is "Built-In"

You assemble the West Coast 101-key "intelligent" keyboard, install the power supply and 1.2 meg, 5¼" floppy disk drive, and attach the high-resolution monitor. You then go on to install a powerful 20 meg hard drive—today's most wanted computer peripheral—now included as part of your NRI hands-on training.

The many demonstrations and experiments you perform as you build your computer system give you a total mastery of computer operation, based on a thorough knowledge of the intricacies of computer theory.

SEND CARD TODAY FOR FREE NRI CATALOG



NO POSTAGE
NECESSARY
IF MAILED
IN THE
UNITED STATES

BUSINESS REPLY MAIL

FIRST CLASS MAIL PERMIT NO. 10008 WASHINGTON, DC

POSTAGE WILL BE PAID BY ADDRESSEE

NRI School of
Electronics

McGraw-Hill Continuing Education Center
4401 Connecticut Avenue, NW
Washington, DC 20077-3543

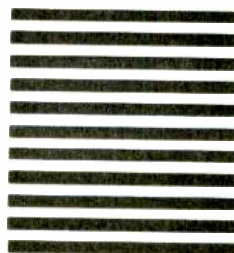

100-Page Free Catalog Tells More... Send Today!

Send the postage-paid card today for NRI's free 100-page catalog that gives all the facts about NRI computer training, plus career training in robotics, TV/video/audio servicing, electronic music technology, and many other fields. If the card is missing, write to NRI at the address below.

IBM is a registered trademark of International Business Machines Corp.

NRI School of
Electronics

McGraw-Hill Continuing
Education Center
4401 Connecticut Avenue, NW
Washington, DC 20008



each individual horizontal line of video. Your VCR can put out 230 lines of resolution, but what that really means is that it can display up to 230 individual dots on each line. Imagine that, using a video camera and a resolution chart similar to the one in Fig. 1, you made a tape showing a few seconds of 200 vertical lines, then 201, 202, 203, etc., on up to and past 230. When shown on a TV, the image would look like vertical lines, but it would really be a series of dots. As soon as the number of lines passed 230, the image from your VCR would become a gray blur rather than a series of individual lines.

To get electronic about things, the resolution of a video device is a direct function of the bandwidth—the more quickly it can turn dots on and off, the higher the bandwidth and the better the resolution on each line. As a rule of thumb, you can say that there about are eighty lines of resolution per megahertz of bandwidth. Sony's ED Beta VCR claims to have more than 500 lines of resolution (we know that really means 500 individually distinguishable dots per horizontal line) at about 9.3 MHz...and that brings out another point worth mentioning.

Our 80-line-per-megahertz rule doesn't seem to work with the Sony because we haven't talked about all the other parts of the signal. A portion of the bandwidth has to be used for the various subcarriers, IF, color, and so on. And don't forget that not all of the horizontal line of video is used for picture—more than 16% of each line is reserved for the horizontal interval where you'll find such goodies as burst and horizontal sync. Another factor to consider is the capability of the recording media. Metal tape can handle a higher bandwidth (which is another way of saying it has a higher frequency response), but even the best tape in the world just can't handle the maximum resolution deliverable by the ED Beta machine.

As far as what the difference is between the "video" and "composite video" outputs, I think we're dealing with a lack of standard. Composite video is a single signal containing both picture information and sync, while a plain video signal may just contain only the picture information. R-E

Cable TV Descrambler Article Parts

We stock the exact parts, PC Board and AC Adaptor for two articles published in Radio-Electronics magazine on building your own CABLE TV DESCRAMBLER

February 1984 issue

#701 Parts.....19.00
Includes all original parts.

#702 PC Board.....7.95
Original 3x4 etched, drilled and silk-screened pc board.

#704 AC Adaptor.....7.95
Original 18 Volt DC @ 200ma.

#701, 702 & 704.....29.00

February 1987 issue

#301 Parts.....29.00
Includes all original parts.

#302 PC Board.....7.95
Original 5x8 etched, drilled and silk-screened pc board.

#304 AC Adaptor.....7.95
Original 18 Volt DC @ 200ma.

#301, 302 & 304.....39.00

Free article reprint with purchase.

Snooper Stopper.....39.00

Cable TV descramblers can be detected, protect your privacy with the Snooper Stopper. Free article on Cable Snooping.

Macrovision Kit.....29.00

Macrovision..now you see it, now you don't with our macroscrubber kit. Article was published in Radio Electronics 1987 issue

CALL TOLL FREE 1-800-332-3557

Out side USA 1-508-699-6935

Visa, Master Card and C.O.D.

Add \$3.50 S & H. \$6.00 outside USA.

Visa

MC

D & D Electronics, Inc., PO Box 3310, N Attleboro, Ma. 02761

CIRCLE 197 ON FREE INFORMATION CARD

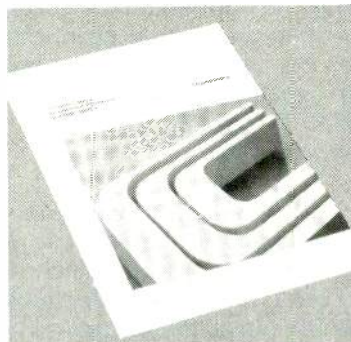

CHEMICAL SOLUTIONS

FREE CHEMTRONICS CATALOG!

Comprehensive new source for over 200 products used in electronic manufacturing and field service. E-Series products are CO₂ propelled for ozone safety. Precision cleaning agents, flux removers, bulk solvents, circuit refrigerants, precision dusters, non-residual wipers, premoistened pads/swabs, antistatic compounds, conformal coatings, lubricants, adhesives, desoldering braids and soldering products. Complete with technical specifications and application guide.

 Chemtronics Inc.
8125 Cobb Centre Drive
Kennesaw, GA 30144
1-800-645-5244
in GA 404-424-4888

CIRCLE 54 ON FREE INFORMATION CARD

JAN CRYSTAL CATALOG NO. 33 - 1990



YOUR RELIABLE SOURCE FOR A WORLD OF CRYSTAL-CLEAR COMMUNICATION

THE ONLY SOURCE YOU'LL EVER NEED!

SATISFACTION GUARANTEED

QUICK SHIPMENT

RELIABILITY • LOW COST

FOR FREE CATALOG, CALL OR WRITE:

JAN CRYSTALS

PO. BOX 06017
FORT MYERS, FL 33906
(813) 936-2397



SINCE 1965

TOLL-FREE: 1-800-JAN-XTAL
(526-9825)

FAX ORDERS: 1-813-936-3750

CIRCLE 104 ON FREE INFORMATION CARD

LETTERS

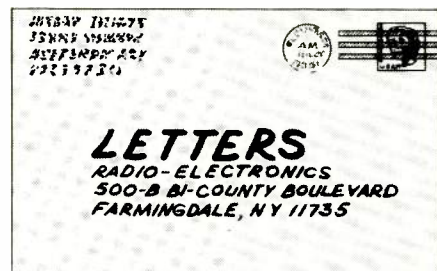

SAP ZAPPED

In his February "Video News" piece on multichannel sound, David Lachenbruch forgot one important thing: The average consumer cannot operate a stereo TV set.

WRC-TV channel 4 (Washington, DC) rebroadcast NOAA weather audio on their SAP channel as a public service. After two days the SAP channel was turned off. The switchboard had been inundated with

calls and the FCC reported that they had several hundred calls complaining of interference on channel 4.

The station then ran an endless tape loop explaining that the SAP channel was selected and the viewer should consult his owner's manual for instructions on how to return to program audio. Again the phone calls poured in. Some viewers even insisted that the station send someone to "fix" their TV sets.

Finally, after three or four weeks, the calls began to taper off. At that point, the station began to broadcast NOAA audio again. The phone calls returned, in increasing numbers each day. After a week, the SAP channel was turned off for good.

I suspect that the SAP channel will never be used for anything other than regular-programming audio.

ROBERT FUTSCHER
Alexandria, VA

THE CORRECT WAVEFORM

I am writing to congratulate you on an excellent article, "Glitches in the Power Line" (*Radio-Electronics*, April 1990). In all the magazines and books I have ever read, only *Radio Engineering* by Terman showed correct waveforms for rectifiers and filters. Now *Radio-Electronics* has become number two, with Fig. 2 in the article. Usually the waveform of part (a) is shown while the filter and load are intact, but in truth that waveform is correct only with no filter and no load or with purely resistive load only, as the article correctly pointed out. The shapes and phasing of parts (b) and (c) are about as nearly correct as the drawing scale would permit. I have pointed out errors shown in respected handbooks to editors who refuse to correct their figures.

The rest of the article is very inter-

esting, and it was obviously written by someone who knows the facts.
KENNETH E. STONE
Cherryvale, KS

COMPARING CD PLAYERS

I must take issue with Dwayne Rosenburgh's letter in the March issue regarding Larry Klein's December "Audio Update" column, which dealt with sonic differences between CD players. Rosenburgh believes that the ABX tests to which Klein refers prove only that there are no significant differences between expensive CD players and that a "\$1500 unit will always sound better than a \$300 model." Rosenburgh is overlooking the fact (mentioned in the column) that two sets of ABX tests were conducted. The second dealt with costly players, but the first set dealt with machines ranging in price from a \$450 Emerson (frequently discounted to \$200) to a \$1400 Meridian. On both occasions the ability of listeners to differentiate between any two CD players to a statistically significant degree, 75% of the time, with music as opposed to test signals, was rare. As a case in point, listeners could distinguish between the Emerson and a \$13000 reference Sony 26 out of 40 times with orchestral music and 21 out of 40 times with jazz. The same listeners could distinguish the Sony from the Meridian 21 out of 40 times with orchestral music and 20 out of 40 times with jazz. The averages were thus 51% and 59% for the Meridian and the Emerson, respectively. A 50% average could be achieved by pure chance. The only conclusion we can reach from those tests is that there are subtle sonic differences between CD players, but the differences between cheap and expensive players are no great-

CORRECTIONS

• R & R Associates was listed as a source for the printed-circuit board in the article entitled "Ion Meter" (*Radio-Electronics*, March 1990). Unfortunately, an error appeared in the address. The correct address is R & R Associates, 3106 Glendon Avenue, Los Angeles, CA 90034—not "31066" as was printed. (Perhaps the extra digit wouldn't make a difference in most places, but we've been informed that on Glendon Avenue—which was once featured in a television-news filler as one of the most confusing streets in Los Angeles—residents have enough problems with even properly addressed mail.) Sorry for the added confusion.

• In our Universal Descrambler story (*Radio-Electronics*, May 1990), the parts list contained a couple of errors. First, the correct part number for IC9 is CD22402E. Also, there were two C39's; the 47 pF NPO is actually C34. In Fig. 3, what's shown as pin 16 of IC4-c is actually pin 14. The unlabeled capacitor above IC4-d is C45. In Fig. 4, polarity switch S3 should go to +5 volts, not ground.



DELUXE TEST LEAD KIT

Users call TPI test leads **The Absolute Best**. The TLS2000 features the highest quality cable in the industry — with spring-loaded safety-sleeved plugs. U.L. listed (file E79581). Kit: \$29. Leads & probes only: \$19. Satisfaction guaranteed. **TEST PROBES INC.** Call toll-free for catalog: 1-800-368-5719.

CIRCLE 208 ON FREE INFORMATION CARD

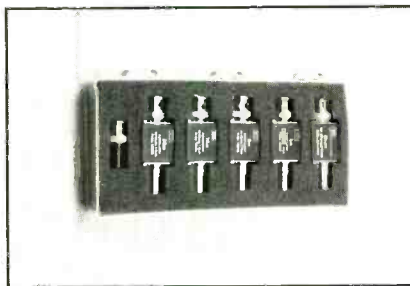

BNC ATTENUATOR KIT

Contains 4 attenuators — 3dB, 6dB, 10dB, 20dB; 1 feedthrough and 1 termination. Thick-film circuitry for low reactances. Rugged design resists shock and lasts longer. Rectangular shape stays put on the bench. **Impedance:** 50Ω **Frequency:** 1GHz. **Maximum Power:** 1kW peak, 1W avg. **VSWR** 1.2:1. Attenuator Accuracy: ±0.2dB. Terminations Resistance Tolerance: ±1%. \$150.

TEST PROBES INC. Call toll-free for catalog: 1-800-368-5719.

CIRCLE 209 ON FREE INFORMATION CARD



ECONOMICAL SILICON RUBBER TEST LEADS

Best value in moderately priced leads. High quality, soft, silicon rubber cable. Banana plug on measuring tip accepts push-on accessories. Plugs have spring-loaded safety sleeves. Model TL1000 \$14. Satisfaction guaranteed. **TEST PROBES INC.** Call toll-free for catalog: 1-800-368-5719.

CIRCLE 210 ON FREE INFORMATION CARD

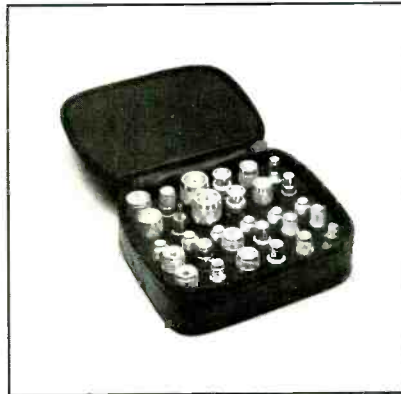

COAX ADAPTER KIT

- Create any adapter in seconds
- Make all combinations of BNC, TNC, SMA, N, UHF, Mini-UHF, F and RCA

The TPI 3000A kit contains male and female connectors of all 8 types, and 6 universal interfaces. Simply screw any combination of 24 connectors to one of the interfaces to create the desired adapter. \$150.

TEST PROBES INC. 9178 Brown Deer, San Diego, California 92121. Call toll-free for catalog: 1-800-368-5719.

CIRCLE 207 ON FREE INFORMATION CARD

New

No Better Probe Ever at This Price!



Shown here
Model SP150
Switchable 1x-10x ... **\$49**

CIRCLE 185 ON FREE INFORMATION CARD

Risetime less than 1.5 nsec.

- **Universal** - works with all oscilloscopes
- **Removable Ground Lead**
- **Excludes External Interference** - even on scope's most sensitive range
- **Rugged** - withstands harsh environments including high temperature and humidity
- **Advanced Strain Relief** - cables last longer
- **Available in 10x, 1x and switchable 1x-10x**

- **10 day return policy** - performance and satisfaction guaranteed

TEST PROBES, INC. TPI

9178 Brown Deer Road
San Diego, CA 92121

Toll Free 1-800-368-5719
1-800-643-8382 in CA

Call for free catalog and Distributor in your area

CIRCLE 123 ON FREE INFORMATION CARD

SERVICING RF PRODUCTS

Signals picked up by the low capacity input of the Spectrum Probe allow rapid evaluation of problems. Simply placing the probe near a component allows judgment of whether it is active. RF failures are easily established.

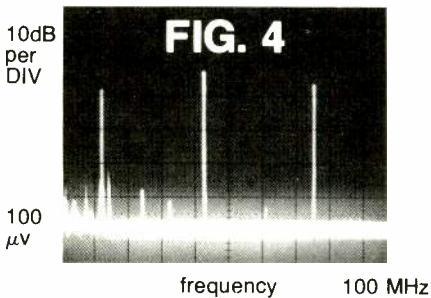

A cordless phone (base station) is probed near its 38.970 crystal in fig. 4. Both 39 MHz and its second harmonic are obvious. The lowest line at 10.245 is also obvious and can be established by probing the adjacent 10.2 crystal, which then shows 10MHz as higher level than 38MHz. We have established receiver RF oscillator/system operation in seconds with no connection, information, schematic, etc.!

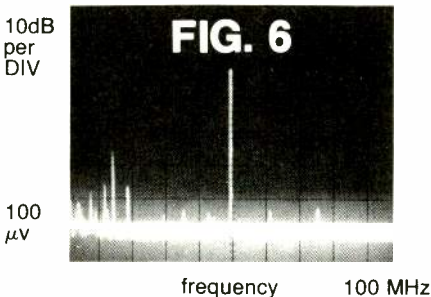
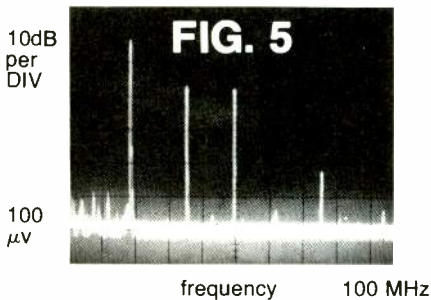

When the transmitter is activated (by pressing CALL), probing near the 15.537 crystal provides fig. 5. Fundamental operation and many harmonics are shown. As the probe is placed near the following stages, the fundamental is decreased, and the third accentuated until the relatively clean output of fig. 6 is obtained near the antenna lead. The transmitter RF is visible in seconds!

107 SPECTRUM PROBE

converts any scope into a 100MHz spectrum analyzer

\$199 direct

Smith Design 1324 Harris Rd.
Dresher, PA 19025 (215) 643-6340

CIRCLE 192 ON FREE INFORMATION CARD

er than the differences between any two expensive players. On the second testing, listeners expressed a subjective preference for a \$750 Denon over a \$2500 Tandberg.

TOM GORDON
Berkeley, CA

TAPE-DECK SPEED

As a long-time audio hobbyist, I've followed Larry Klein's articles for many years. I particularly agree with his contention that there is no discernible audio difference in the sound quality from CD players over a wide range of retail prices. I work with people who contend that my hearing must be hopelessly messed up because I hold that view! They claim that the differences are easily heard, as are the differences between (even new) pre- and power-amplifiers. None of them, however, can agree on precisely what constitutes "the best" or "the most accurate" sound. All they know, they say, is that different pieces of equipment sound "different."

I strongly disagree. I can readily hear pronounced differences be-

tween different brands and models of phono cartridges and loudspeakers, but I find that those whose specifications show their responses to be flatter, with low harmonic and phase distortion over the widest frequency range, sound the most natural. Few, if any, of the mid-to high-priced models produce unpleasant sound reproduction.

The real problem, I believe, is that no sound recording and production system I have ever heard can come close to making me think that there is a live acoustic instrument, voice, or scene being listened to. I can walk into a crowded disco and know instantly if the band is live or recorded. Loud acoustic instruments are absolutely unmistakable even in a high-noise environment. Recorded sound is no more real than a photograph. I know only what the original probably sounded like, just as I can appreciate a picture as a reasonable representation of the original scene. No more, no less.

I fully support the ongoing efforts of all audio researchers in their quest for "real sound." Great strides have been made, and the equipment that is widely available today represents superb value and high reliability. For the same money I spent on a receiver 15 years ago, I can buy one today whose performance and reliability are tremendously improved.

I'd like to suggest a simple method to determine whether a tape deck is running at the wrong speed, or if its speed is varying over the long or short term. I have noticed that few, if any, low- or medium-priced cassette decks include tape-speed accuracy in their specs. Since tape speed determines absolute playback pitch, accuracy is very important. I've recorded a 440-Hz tone on normal tape, using the most expensive cassette deck I could find. I play back the tape on the cassette player to be tested, and check the frequency with a guitar tuner—a relatively cheap device that can be found at any musical instrument store. The indicator (LED or meter needle) quickly shows if the playback machine is running at the same speed as the machine on which my tape was recorded, and if there is any noticeable speed variation on playback. A speed difference or variation of $\pm 0.25\%$ (1 Hz) is readily

Get A Complete Course In

ELECTRONIC ENGINEERING

8 volumes, over 2000 pages, including all necessary math and physics. 29 examinations to help you gauge your personal progress. A truly great learning experience.

Prepare now to take advantage of the growing demand for people able to work at the engineering level.

Ask for our brochure giving complete details of content. Use your free information card number, or write us directly. **\$99.95**, Postage Included. Satisfaction guaranteed or money refunded.

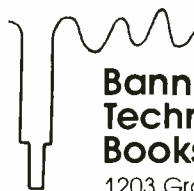

**Banner
Technical
Books, Inc.**

1203 Grant Ave.
Rockford, IL 61103

CIRCLE 67 ON FREE INFORMATION CARD

Discover Your Career Potential In High-Tech Electronics...Call 1-800-366-8989!

CIE Gives You The Training You Need to *Succeed...*
At Your Own Pace...& In Your Own Home!

If you're anxious to get ahead...and build a *real* career...you owe it to yourself to find out about the Cleveland Institute of Electronics!

CIE can help you discover *your* career potential in the fast growing field of high-tech electronics. A career that will challenge and excite you every day...reward you with a powerful feeling of personal accomplishment...and deliver a level of financial security you may have only dreamed of before!

As the leading school in home-study electronics, CIE has helped over 150,000 students in the U.S.A. and over 70 foreign countries get started in this exciting field. To find out how CIE could be helping *you*...read on...then send for a CIE catalog TODAY!

A Growing Need For Trained Professionals!

The career opportunities shown here are only a few of the challenging, high-paying careers you could enjoy as an electronics technician.

You could be the "brains" behind the scenes of an exciting TV broadcast...trouble-shoot life-saving medical equipment...design exotic new aeronautics systems...CIE's job-oriented programs offer you the quickest possible path to the career of your dreams! And CIE also features military and union re-training, to build on what you already know.

Dozens Of Fascinating Careers To Choose From!

Even if you aren't sure which career is best for you, CIE can get you started with core lessons applicable to *all* areas of electronics. As you advance, CIE makes job opportunities available to you through the bimonthly school paper, *The Electron*.



Data Communications



Automotive Electronics



Avionics

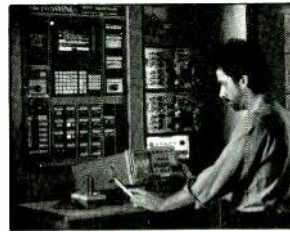

Computer-Assisted Manufacturing



Consumer Electronics



Military Electronics

Personal Training From A Renowned Faculty.

Unlike the impersonal approach of large classroom study, CIE offers you one-on-one instructional help 6 days a week, toll-free. Each CIE lesson is authored by an independent specialist, backed by CIE instructors who work directly with you to answer your questions and provide technical assistance when you need it.

Practical Training... At Your Own Pace.

Through CIE, you can train for your new career while you keep your present job. Each course allows a generous completion time, and there are no limitations on how fast you can study. Should you already have some electronics experience, CIE offers several courses which start at the intermediate level.

"State-Of-The-Art" Facilities & Equipment.

In 1969, CIE pioneered the first electronics laboratory course, and in 1984, the first Microprocessor Laboratory. Today, no other home study school can match CIE's state-of-the-art equipment. And all your laboratory equipment is included in your tuition cost. There is no extra charge—it's yours to use while you study at home and on the job after you complete your course!

Earn Your Degree To Become A Professional In Electronics!

Every CIE course you take earns you credit towards the completion of your Associate in Applied Science Degree, so you can work towards your degree in stages. And CIE is the only school that awards you for fast study, which can save you thousands of dollars in obtaining the same electronics education found in four-year Bachelor's Degree programs! Call or write for details today!

Call TOLL-FREE
1-800-366-8989



CIE World Headquarters

Cleveland Institute of Electronics, Inc.
1776 East 17th St., Cleveland, Ohio 44114

YES! Please send me your independent study catalog (For your convenience, CIE will have a representative contact you—there is no obligation.)

Print Name _____

Address _____ Apt # _____

City/State/Zip _____

Age _____ Area Code/Phone No. _____

Check box for G.I. Bill bulletin on educational benefits: Veteran Active Duty

Mail This Coupon Today! ARE-169

FRIENDLY VIDEOS

'The Pioneer In AT Clone Videos'

COMPUTER HOW-TO VIDEOS



"Video Tape Is A Great Teacher"



"HOW TO BUILD YOUR OWN IBM 286/386 AT CLONE COMPUTER" Easy to do in a couple of evenings of work with just a screwdriver. A real money-saver!
60 MINUTES VHS \$39.95

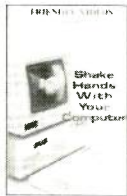

"SHAKE HANDS WITH YOUR PC/XT/AT COMPUTER". A complete new-user's hardware and software learning guide. Everything from powering up, to the directory structure. 60 MINUTES VHS \$29.95

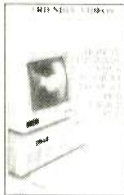

"HOW TO UPGRADE YOUR PC OR XT COMPUTER TO AN AT FOR UNDER \$200". All in one evening with only a screwdriver. Complete step-by-step guide, anyone can do it!
30 MINUTES VHS \$24.95



"HP LASERJET SERIES II PRIMER". The most complete video available on laser printing, featuring the LaserJet II printer, desktop publishing, fonts, hardware and software accessories. 60 MINUTES VHS \$49.95

FREE OFFER!

SAVE \$40 NOW by ordering the complete set of all four titles at the ridiculously LOW PRICE of \$100, and receive, absolutely FREE, "After Hours" - a software program to turn your PC into an unattended Message Center!



TOLL FREE: 1-800-PC-BUYER

Customer Service or CA, Call (714) 898-4055

Friendly Videos

RE06

PO Box 5684
Garden Grove, CA 92645 (714) 898-4055
Please rush me the following VHS format titles:

- "Clone Assy" @ \$39.95 "Shake" @ \$29.95
 "PC Upgrade" @ \$24.95 "LaserJet" @ \$49.95
 Complete Set including FREE software @ \$100
(Add \$1 S&H per video, and sales tax if CA address)

Name _____
Street Address _____
City, State, Zip _____
Telephone _____

seen. Speed adjustments are made as easily as tuning a guitar string (provided the user knows which pot to turn) just by watching the meter and setting it to 0, or 440 Hz.

Is this a recognized method of assessing cassette-tape speed? If so, do you know where I can obtain a pre-recorded tape with the 440-Hz tone at exactly the correct speed?

GEOFF SALE

Burnaby, B.C., Canada

Thanks for your comments and kind words. I agree wholeheartedly with most of your comments. Your technique seems reasonable to me, although I can't be sure without trying it (which I'm not set up to do at this time). For very high quality reference tapes of all types, request a catalog from Magnetic Reference Laboratories, 229 Polaris Avenue, Suite 4, Mountain View, CA 94043 (415-965-8187).—Larry Klein, Audio Editor

THERMOELECTRIC ENTHUSIAST

I am one of those "arcane" engi-

neers who thinks that thermoelectric modules are one of the greatest things to hit the planet in a long time (*Hardware Hacker*, *Radio-Electronics*, January 1990), along with the U.S. space program, the French railways, and the U.S. submarine fleet. For one thing, the hot side of the thermoelectric module can always be kept at an ambient temperature by water cooling its heat sink. (My unit runs at 5°F above ambient with an extremely small "hot" sink and air cooling.) My unit was put into service in 1976 and has an excellent refrigeration record. Also, eliminating compressors, freon, plumbing ammonia, CO₂, and ozone destruction more than compensates for any supposed limitations. And finally, yes, my unit does make ice, at about the same rate and time as my freon refrigerator.

J. LINDNER
San Jose, CA

PCjr DOCUMENTATION

I was pleased to read in Shawn Bobbit's letter (*Letters*, *Radio-Electronics*, February 1990) that he recently purchased an IBM PCjr, and was sorry to learn of his difficulty in obtaining technical information regarding the PCjr. In fact, technical literature is available for all of IBM's Personal Computers, including the PCjr. The "Hardware Technical Reference Manual for the PCjr" is listed in the current directory of technical literature for IBM's PCs. A call to the toll-free number (800-IBM-PCTB) confirmed that the manual is currently available.

I hope this information comes in handy for Mr. Bobbitt and other *Radio-Electronics* readers.

JOHN R. SOMMA
IBM Corporation
White Plains, NY

LEFT-RIGHT IMBALANCE

In regard to Larry Klein's discussion on L-R speaker imbalance, I have found that the problem is often due to the values of the capacitors in the crossover networks; they shift over time. Also, all connections from the amplifier output to the speaker itself must be good. A poor connection anywhere in the line will cause a considerable loss of power to that speaker.

JOHN S. COX
Vancouver, BC

Be an FCC LICENSED ELECTRONIC TECHNICIAN!

Learn at home in spare time.
No previous experience needed!

No costly School. No commuting to class. The Original Home-Study course prepares you for the "FCC Commercial Radiotelephone License". This valuable license is your "ticket" to thousands of exciting jobs in Communications. Radio-TV. Microwave. Computers. Radar. Avionics and more! You don't need a college degree to qualify, but you do need an FCC License. **No Need to Quit Your Job or Go To School** This proven course is easy, fast and low cost! **GUARANTEED PASS**— You get your FCC License or money refunded. **Send for FREE facts now. MAIL COUPON TODAY!**

COMMAND PRODUCTIONS

FCC LICENSE TRAINING, Dept. 90
P.O. Box 2824, San Francisco, CA 94126

Please rush FREE details immediately!

NAME _____
ADDRESS _____
CITY _____ STATE _____ ZIP _____

ONCE YOU'VE GOT IT DESIGNED, YOU'VE GOT IT MADE.

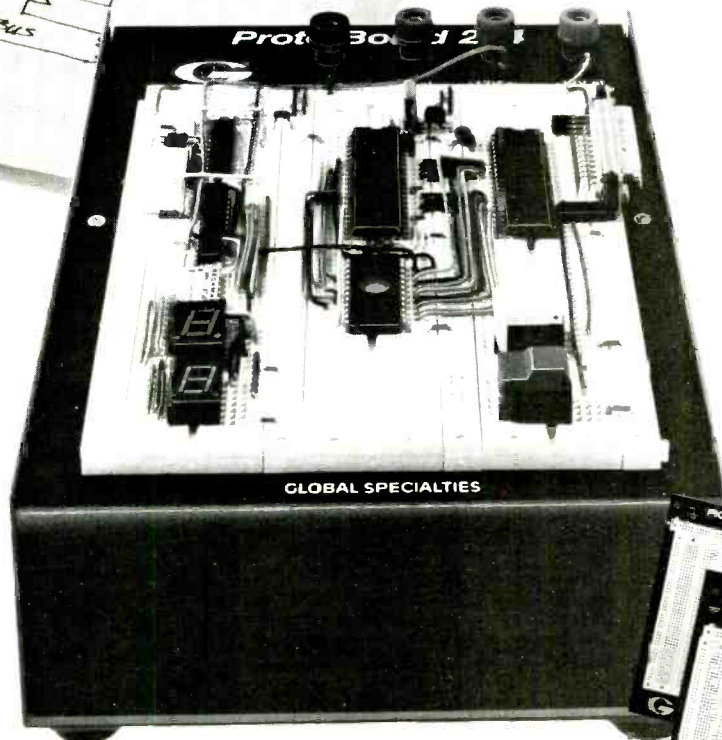
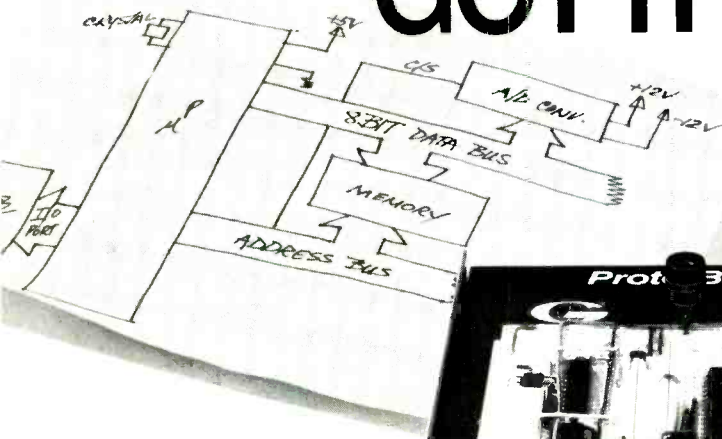

Now you can take those hot, new logic or block design diagrams, and quickly, easily bring them up to reality...in minutes...without solder!

Build circuits as fast as you can think. Test. Modify. Expand. Without burned-out parts or burnt fingers. Save time, money...and prove that you know that you're talking about... before you use your CAD.

Specify PROTO BOARD Brand, Today's recognized Standard for Quality in breadboarding. Here are five expandable breadboards, offering countless arrays of solderless sockets and bus strips that emulate pc board layouts. Pop in components. Pop them out again. Microprocessors. Memory. Large DIPs. Tiny discretes. Makes no difference. The patented aluminum backplane lets you work at

frequencies from DC to half-a-GigaHertz or 500MHz.

Need power? A powered PROTO BOARD Brand offers up to triple voltage power supplies, +5V, +12V, -12V, with regulated/current limited DC power. Over 2,250 tie points with 24 IC capacity and 14 pin DIPs. Super for TTL, CMOS, Op-Amps and microprocessor circuits. And lots more.

Best of all, your hassle-free American-made PROTO BOARD Brand comes with an unlimited lifetime guarantee on all the breadboard sockets. Prices are so modest, you'll wonder why you waited this long to specify PROTO BOARD Brand. Order today.



**GLOBAL
SPECIALTIES**

Easy does it!™



Call toll-free for details
1-800-572-1028

Global Specialties, An Interplex Electronics Company
70 Fulton Terrace, New Haven, CT 06512
Telephone: (203) 624-3103 © Interplex Electronics 1989
All Global Specialties breadboarding products made in USA.

CIRCLE 186 ON FREE INFORMATION CARD

A0010

JUNE 1990

17

Radio Shack Parts Place SM

YOUR ONE-STOP STORE FOR BIG ELECTRONIC VALUES

Build with the Best—Over 1000 Components in Stock!

Parts "Hotline" Service!
Thousands of Items Available

Your Radio Shack store manager can special-order a huge variety of parts and accessories direct from our electronics warehouse—Realistic® Long-Life tubes, linear and digital ICs, microprocessors, support chips, phono cartridges and styli, crystals, special-purpose batteries, diodes, selected modules for TVs and audio equipment, autosound wiring harnesses, accessories, even SAMS Photofacts®. No handling charge, no shipping charge—just speedy delivery to the Radio Shack near you!

Amateur Radio License Guides

495 to 1995

Home Study Courses
For FCC License Tests

Novice Voice Class License
Prep Course. With cassettes.
#62-2402 19.95
Technician Class Manual.
#62-2403 4.95
General Class FCC License
Course. #62-2404 19.95



Brushless Fan



16⁹⁵

Operates
On 12VDC

Tiny, tough and efficient! Rated 150 mA. 1 9/16 x 1 9/16 x 1 3/16" #273-244

IR Detector

349

Module operates on 5VDC, board mountable. 9/8 x 1/2 x 1 9/32". With data. #276-137



Simplifies
IR Design

IC Tool Set

6⁹⁵
Set



Install and remove 6-pin to 40-pin DIPs without damage. Works with LSI, MSI, and DIP devices. Both tools are groundable. #276-1581

Motor and Chime



(1) 1.5-3V DC Motor. For robotics, projects. 1 1/2 x 1 5/16" dia. #273-223
(2) Doorbell Chime. IC/mini-speaker combo. 6-18VDC. 5" leads. #273-071

Diode Rectifiers



3-Amp "Barrel" Type Diodes
200-Amp Surge

Type	Peak Inverse Voltage	Cat. No.	Pkg. of 2
1N5400	50	276-1141	.99
1N5402	200	276-1143	1.19
1N5404	400	276-1144	1.29

Speaker Stuff

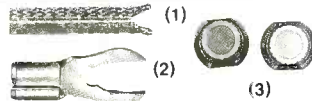

(1) MEGACABLE™. Hi-wattage, 12-gauge. #278-1268 . . . Per Foot 99c
(2) Gold Terminals for MEGACABLE. #64-401 . . . Set of 8/4.99
(3) Terminal Knobs. Screw-down large cable. #274-619 . . . Set 5.95

Dress It Up

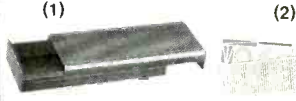

(1) Classy Two-Piece Enclosure. Accepts PC board and 9V battery. 5 9/8 x 2 1/4 x 1 1/16" #270-257 . . . 4.99
(2) Project Labels. Four 7 7/8 x 3" sheets of rub-on letters and symbols. #270-201 . . . Set 2.99

Halogen Lamps

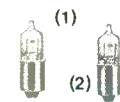

3⁹⁵
Each

(1) HPR50. For 4-cell flashlights and 6-volt lanterns. #272-1189
(2) HPR52. For 2-cell flashlights and 3-volt lanterns. #272-1190

Gold-Plated Plugs and Jacks



(1) Phono Plug. #274-850 . . . 2.49
(2) Chassis-Mount Phono Jack. #274-852 . . . 2-pk./2.49
(3) Straight Inline Phono Jack. #274-854 . . . 2.99
(4) 2-Conductor 1/4" Phone Plug. Monaural. #274-855 . . . 3.49
(5) Three-Conductor (Stereo) 1/4" Phone Plug. #274-856 . . . 3.99
(6) 1/8" Plug. #274-857 . . . 2.79
(7) 3-Conductor. 1/8" Phone Plug. Stereo. #274-858 . . . 3.49
(8) 3-Conductor 1/4" Inline Phone Jack. #274-859 . . . 3.99

Wire Connectors & Accessories

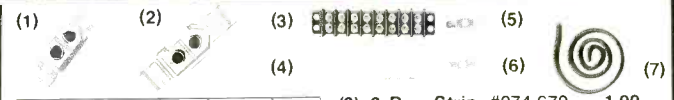

(3) 2-Row Strip. #274-670 . . . 1.99
(4) Jumper. 8-pos. #274-650. 1.59
(5) 45° T-Lugs. #274-645 . . . 4/79c
(6) Dual Solder-Lug Adapters. #274-644 . . . Pkg. of 4/79c
(7) Heavy-Duty Bonded Wire. 25 ft., 2 x 18-gauge. #278-1250 . . . 3.99

Engineering Calculator

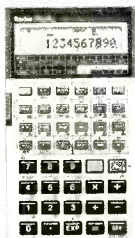

3⁹⁹⁵

Uses Standard
Electronic Symbols

EC-4035 makes design math a snap! Has 110 functions, memory. With case and batteries. #65-983

30-Range Multimeter



7⁹⁹⁵

Tests Capacitors
and Transistors

A great value! Measures to 1000VDC and 750VAC. With 0.5" digital display. Battery extra. #22-194

Panel-Mount Counter



1⁴⁹⁵

Electromechanical — Counts to 99,999

One count per 12VDC pulse, pushbutton reset. Mounts in 1 1/16 x 1" hole. Depth: 1 13/16". With leads and data. #277-222

Over 1000 items in stock! Binding Posts, Books, Breadboards, Buzzers, Capacitors, Chokes, Clips, Coax, Connectors, Fuses, Hardware, ICs, Jacks, Knobs, Lamps, Multitesters, PC Boards, Plugs, Rectifiers, Resistors, Switches, Tools, Transformers, Transistors, Wire, Zeners, More!

Prices apply at participating Radio Shack stores and dealers

Radio Shack
AMERICA'S
TECHNOLOGY
STORE SM

A DIVISION OF TANDY CORPORATION

CIRCLE 78 ON FREE INFORMATION CARD

Put Professional Knowledge and a
COLLEGE DEGREE
 in your Technical Career through
HOME STUDY

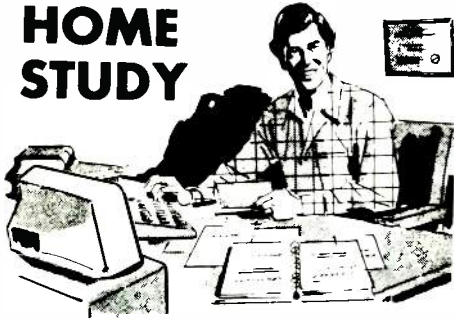

Add prestige and earning power to your technical career by earning your Associate or Bachelor degree through directed home study.

Grantham College of Engineering awards accredited degrees in **electronics and computers.**

An important part of being prepared to *move up* is holding the right college degree, and the absolutely necessary part is knowing your field. Grantham can help you both ways—to learn more and to earn your degree in the process.

Grantham offers two degree programs—one with major emphasis in **electronics**, the other with major emphasis in **computers**. Associate and bachelor degrees are awarded in each program, and both programs are available completely by correspondence.

No commuting to class. Study at your own pace, while continuing on your present job. Learn from easy-to-understand lessons, with help from your Grantham instructors when you need it.

Write for our free catalog (see address below), or phone us at toll-free 1-800-955-2527 (for catalog requests only) and ask for our "degree catalog."

Accredited by
 the Accrediting Commission of the
 National Home Study Council

GRANTHAM
College of Engineering
 10570 Humbolt Street
 Los Alamitos, CA 90720

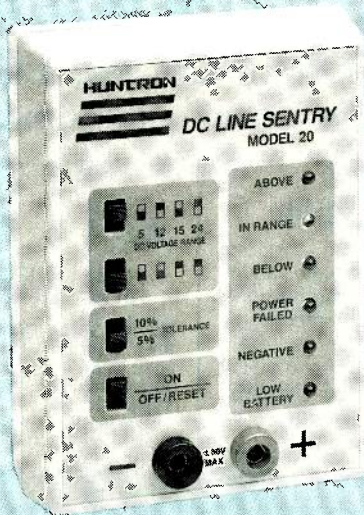

**Huntron DC Line Sentry
 Voltage Monitor**

*Keep tabs on low-voltage
 DC power supplies.*

CIRCLE 11 ON FREE INFORMATION CARD

ONE OF THE MOST DIFFICULT PROBLEMS for the technician to diagnose is the intermittent one. Often, the most effective way to catch the problem is sheer luck. In the absence of luck, expensive test equipment—such as storage scopes or chart recorders—must be called into action.

While intermittent problems can appear anywhere in a circuit, their causes can often be tracked back to the power-supply section. That's the idea behind the *DC Line Sentry* from Huntron Instruments, Inc. (15720 Mill Creek Blvd., Mill Creek, WA 98012). The *DC Line Sentry* lets you keep tabs on a power supply without calling out the "heavy artillery." It's an easy-to-use voltage monitor that can detect and "remember" whether a power supply stays within specified limits during the time it is monitored. If the power supply passes the test, yet an intermittent problem occurs, then you know to look elsewhere for the source of the trouble.

The *DC Line Sentry* is housed in a gray plastic case that measures

roughly 4½ × 3¼ × 1½ inches and weighs about ½ pound. It's powered by a 9-volt alkaline battery. The front panel contains two input banana jacks, four slide switches, and 6 LED indicators.

To use the unit, the supplied test leads are inserted in the input jacks, and are hooked to the supply under test. A pair of switches is used to select one of the four test voltages: +5, +12, +15, and +24 volts. A third switch is used to select either a 5% or 10% tolerance range, and the fourth switch powers up the tester.

When the tester is turned on, the green IN RANGE LED should flash to indicate that everything's OK, and the *DC Line Sentry* is monitoring the voltage. If however, you accidentally hooked up the test leads backward, the red NEGATIVE LED would flash. You would then have to switch the leads and reset the tester with the power switch by turning it off and on.

The *DC Line Sentry* can detect any out-of-range condition with a duration greater than 50 milliseconds. If the supply voltage goes above the set limit, the ABOVE LED will flash. If the voltage then returns to its correct value, both the IN RANGE and ABOVE indicators will flash. As you might expect, an under-voltage condition will start a BELOW LED flashing, and a power failure will flash the POWER FAILED indicator.

A sixth LED is used to indicate battery condition. When the battery gets weak, the LOW BATTERY LED flashes. The indicator remains on steadily when the battery must be replaced. The estimated lifetime for a 9-volt alkaline battery is 2000 hours. That should be long enough to catch all but the most stubborn power-supply intermittent.

Huntron's *DC Line Sentry* is certainly not a revolutionary new piece of test gear. There is other equipment that can duplicate its functionality. Even some high-end digital multimeters can capture slow power-supply glitches.

Yet the *DC Line Sentry* has its advantages: It's extremely easy to use, and it lets the more expensive alternatives be used for more demanding tasks. With a suggested retail price of \$125, it should find many applications in which it can prove its cost-effectiveness.

R-E

LOGIC ANALYZER

continued from page 18

Once the data is acquired, there are several different ways to display it. The **DIAGRAM** command displays the captured data in the form of a timing diagram, as shown in Fig. 2. It should look familiar to anyone who has ever examined a data book or seen a logic analyzer in action.

A pair of cursors (which are barely visible at the left side of the diagram in Fig. 2) help to make measurements easier. Notice the numbers down the right side of the display. They indicate the value of the trace at the cursor position. As the cursor is scrolled through the display, those numbers change, as do the numbers across the top of the screen the indicate the position of the cursors and trigger, and timing differences between them.

The **ASSEMBLY** command displays any data that has been captured as disassembled microprocessor instructions. The command is specific to the pod being used. For example, if you used a 8088 pod, and captured data from the data bus of an operating 8088 microprocessor, you could display those data as the microprocessor's mnemonics.

The **NUMERICAL** command displays the data in a user-chosen numerical format, which is entered from the **FORMAT** menu. The user can divide the data from various channels into eight user-defined fields. For example, 16 channels could be used to examine the address bus of a microprocessor, while another 16 channels gathered data from the data bus. Each grouping of input channels can have an 8-character name, and the data can be displayed in hex, binary, octal, decimal, or ASCII formats.

Switching to the **RECORD** menu allows trace data, numerical data, set-up conditions, and the like to be stored or recalled to or from disk. It is one of the features that become simple on PC-based systems.

The **TRIGGER** menu allows up to 16 trigger words to be entered, while the trigger **SEQUENCE** menu provides a powerful trigger selection and editing menu.

The trigger sequence can have up to 16 levels, and can use a total of 16

continued on page 87



THE MODEL WTT-20 IS ONLY THE SIZE OF A DIME, yet transmits both sides of a telephone conversation to any FM radio with crystal clarity. Telephone line powered - never needs a battery! Up to 1/4 mile range. Adjustable from 70-130 MHz. Complete kit **\$29.95 + \$1.50 S+H**. Free Shipping on 2 or more! COD add \$4. Call or send VISA, MC, MO. **DECO INDUSTRIES, Box 607, Bedford Hills, NY 10507. (914) 232-3878.**

CIRCLE 127 ON FREE INFORMATION CARD



FREE 1990 GENERAL CATALOG OF TOOLS & TEST INSTRUMENTS. Contact East's new 148 page catalog offers products for testing, repairing and assembling electronic equipment. It comes packed with over 10,000 quality products from brand-name manufacturers. Included are DMM's, probes, static supplies, hand tools, tool kits, test equipment and more. Contains full color photos, descriptions and discounted pricing. **CONTACT EAST, 335 Willow St., North Andover, MA 01845 (508) 682-2000.**

CIRCLE 55 ON FREE INFORMATION CARD

CALL NOW AND RESERVE YOUR SPACE

- 6 x rate \$940.00 per each insertion.
- Fast reader service cycle.
- Short lead time for the placement of ads.
- We typeset and layout the ad at no additional charge.

Call **516-293-3000** to reserve space. Ask for Arline Fishman. Limited number of pages available. Mail materials to: mini-ADS, RADIO-ELECTRONICS, 500-B Bi-County Blvd., Farmingdale, NY 11735.

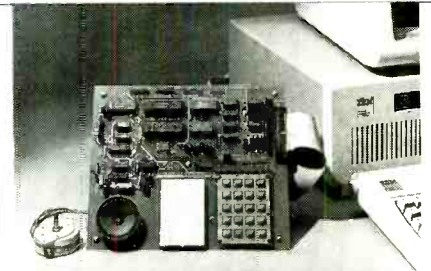

IT-10 INTERFACE TUTOR. Explore computer interfacing with high-quality IBM-PC-compatible hardware. The circuit board with speaker, keypad, A/D, D/A, D/I/O, and stepping motor permits hands-on study of interfacing tasks and custom experiments. Includes manuals and exercises. Product developed by the author of *Hardware and Software Interfacing for IBM PCs* and used in colleges worldwide. **ROYER ASSOCIATES, 206 Santa Margarita Ave., Menlo Park, CA 94025, (415) 326-8079.**

CIRCLE 187 ON FREE INFORMATION CARD

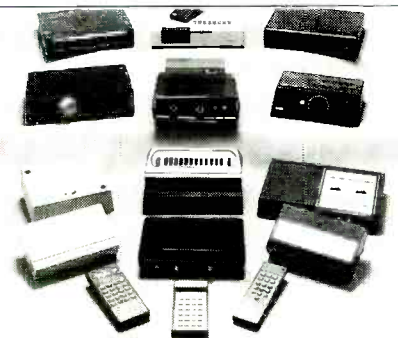

CABLE TV CONVERTERS AND DE-SCRAMBLERS SB-3 \$79.00 TRI-BI \$95.00 MLD-\$79.00 M35B \$69.00 DRZ-DIC \$149.00. Special combos available. We ship COD. Quantity discounts. Call for pricing on other products. Dealers wanted. **FREE CATALOG.** We stand behind our products where others fail. One year warranty. **ACE PRODUCTS, P.O. Box 582, Saco, ME 04072 1 (800) 234-0726.**

CIRCLE 75 ON FREE INFORMATION CARD

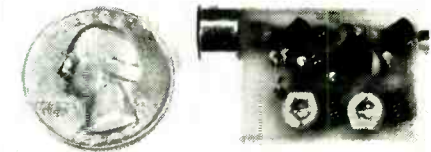

SIMPLY SNAP THE WAT-50 MINIATURE FM TRANSMITTER on top of a 9v battery and hear every sound in an entire house up to 1 mile away! Adjustable from 70-130 MHz. Use with any FM radio. Complete kit **\$29.95 + \$1.50 S+H**. Free shipping on 2 or more! COD add \$4. Call or send VISA, MC, MO. **DECO INDUSTRIES, Box 607, Bedford Hills, NY 10507. (914) 232-3878.**

CIRCLE 127 ON FREE INFORMATION CARD

NEW PRODUCTS

MINIATURE COMPUTER SYSTEM.

Ampro's MiniModule expansion board couples their Little Board/386, /286, or /PC single-board computers to Reflection Technology's Private Eye display (Radio-Electronics, February 1990) to form a complete system that takes up less space than a standard 5¼-inch disk drive. The Private Eye display uses proprietary technology to create an image of a 12-inch monitor in a miniature package that measures just 1.2 × 1.3 × 3.2 inches and weighs about 2 ounces. When held to the eye or mounted on a headset for hands-free viewing, the image appears to float in space in front of the viewer's eye with quality and resolution matching that of a PC display.

The new MiniModule/Private Eye provides the electronics to drive the Private Eye as an IBM CGA-compatible graphics display when used with any PC- or AT-based application software and one of Ampro's Little Board single-board systems. It features rugged, industrial-grade design, a wide operating temperature range (0–70°C), and CMOS con-

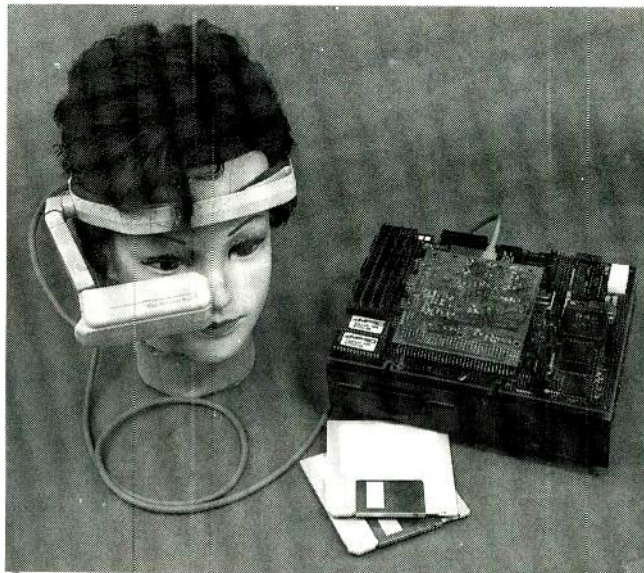

CIRCLE 26 ON FREE INFORMATION CARD

struction for low power consumption (less than 0.5 watts) from the +5-volt supply. Each MiniModule is a 3.5 × 3.8-inch circuit board that attaches directly to a single-board system and interfaces via PC-bus-compatible signals.

The small size and low power consumption open the door for a wide range of portable applications for the MiniModule/Private Eye with single-board systems, in-

cluding telecommunications, portable terminals, mobile data displays, portable data-entry and -retrieval systems, medical electronics, industrial controllers, and maintenance and repair work.

The MiniModule/Private eye is priced at \$250.00 in quantities of 100.—**Ampro Computers Inc.**, 1130 Mountain View/Alviso Road, Sunnyvale, CA 94089; Tel. 408-734-2800.

RS-232 CONNECTOR KIT.

The 272-piece RS-232 Commercial Connector Kit from Jensen Tools is designed to simplify on-site fabrication and maintenance of RS-232 cable connectors. It can be used to make straight null-modem hookups and economical patchcord connections between keyboard and TNC for packet radio, and for many other DB25 patchcord applications. The kit includes 16 plug (male) and 6 receptacle (female) 25-pin connectors, one insertion/

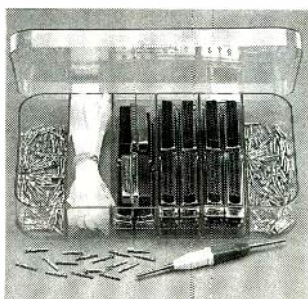

CIRCLE 27 ON FREE INFORMATION CARD

extraction tool, 50 cable ties, and a compact plastic storage box. Connector hoods

are available separately.

The RS-232 Commercial Connector Kit costs \$69.50.—**Jensen Tools Inc.**, 7815 South 46th Street, Phoenix, AZ 85044; Tel. 602-968-6231.

MULTI-BAND RECEIVER.

Providing continuous frequency coverage from 25–550 MHz and from 800–1300 MHz, ACE Communication's MVT-5000 100-channel hand-held receiver allows reception of civil and military aviation bands plus

all public-service bands. AM or narrow FM reception modes are selectable at any frequency. Twenty front-panel keys allow programming of 100 scan memory channels. Pairs of upper and lower limits for bands to be searched can be stored in ten separate search memory locations. RAM memory is backed up by a long-life lithium battery. The MVT-5000 offers an energy-saving "sleep" mode, in which the computer will actually power down all operating circuits and display the word "sleep" on the LCD, and power up only periodically to check for active transmissions.

The compact radio measures 7 × 2½ × 1½ inches and weighs only 13 ounces. It includes a 120–12-volt wall plug adapter/charger, a fused DC cigarette-lighter charger cord, a telescopic antenna, a carrying case, and AA-size rechargeable batteries.

The MVT-5000 hand-held receiver has a suggested retail price of \$499.00.—**ACE Communications**, Monitor Division, 10707 East 106th Street, Indianapolis, IN 46256; Tel. 317-842-7115.



CIRCLE 28 ON FREE INFORMATION CARD

POCKET-SIZE DIGITAL MULTIMETER. A.W. Sperry's DM-4200A 3½-digit, rotary-switch digital multimeter offers pocket-size portability without skimping on features. It incorporates nine functions on 33 ranges. The instrument provides a diode-test function, battery test, and HFE transistor test. It features an instant continuity

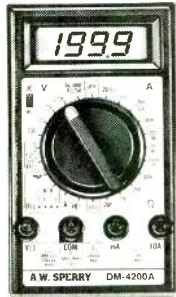

CIRCLE 29 ON FREE INFORMATION CARD

buzzer, a built-in test stand, overload protection, 150-hour battery life, and recessed input terminals designed for safety. The DM-4200A, which comes

with one set of test leads, a battery, and one installed fuse plus a spare, costs \$64.95.—A.W. Sperry Instruments Inc., 245 Marcus Boulevard, Hauppauge, NY 11788; Tel. 516-231-7050.

PROTOCOL ANALYZER SYSTEM. Designed for use in troubleshooting asynchronous serial data-communications systems, Global Specialties' GS500 portable analyzer has extensive diagnostic capabilities to assist you in baud-rate analysis, data word format, ASCII or hex data monitoring, and test-data generation. It can operate in both automatic and manual modes, and is small enough for field-service applications. When it's connected to a standard oscilloscope, it provides a 32-character display.

When combined with the GS501 Display Module and the GS502 Break-out Box, the GS500 is transformed into a complete portable, hand-held system, requiring no oscilloscope. The break-out

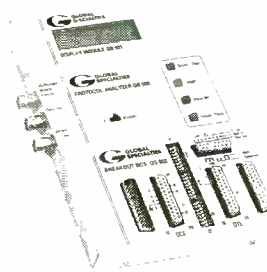

CIRCLE 30 ON FREE INFORMATION CARD

box provides full breaking and patching of 25 lines, plus data monitoring of the analyzer's transmit and receive lines. Using the test-data-generation mode, the system can be used to check the operation of printers, terminals, and other devices when a transmitting device is not available. The battery-powered system will typically operate for 100 hours.

The GS500 analyzer, GS501 display, and GS502 break-out box cost \$179.95, \$99.95, and \$119.95, respectively.—Global Specialties, 70 Fulton Terrace, New Haven, CT 06512; Tel. 203-624-3103.

HAND-HELD UNIVERSAL TIMER/COUNTER. A 10-digit frequency counter from Optoelectronics incorporates high-speed ASIC and custom LCD technology to provide direct-count frequency capability (1-Hz resolution in one second) to over 150 MHz. The model UTC 3000 features switched prescalers to maximize resolution for frequencies to over 2.4 GHz, and multiple preamplifiers for maximum usable sensitivity to allow efficient antenna pickup measurements. A 16-segment bargraph displays input signal level to ensure reliable counting and to aid in RF security sweeps.

Front-panel controls include pushbuttons for gate selection (four gate times), function, and input selection, and also has hold, pre-scale, and direct-count select switches. Calibration and bargraph adjustments are accessible from the front panel, which also features a gate LED and a power switch. In addition to the frequency



Cut Your Video Servicing Time by 54%*



\$3,495
Patented

With The Market Proven VA62A Universal Video Analyzer™

Are you finding it tough to service today's hi-tech VCR and TV circuits? Successful video servicers have told us that, to them, the new technology meant lost profit and troubleshooting grief until they tried the VA62A's time tested, functional analyzing methods. "The VA62A cuts servicing time and increases profits . . ."

You can prove it to yourself, in your shop, absolutely risk free—and share in the profits successful video servicing can bring. Call **1-800-SENCORE (736-2673)** and ask about our exclusive VA62A instrument evaluation program. Tech-Tape Video Preview and FREE full line color catalog are also available.

*Based on a nationwide survey of users who reported an average time savings of 54% compared to their previous test equipment.

SENCORE^(R)
3200 Sencore Drive, Sioux Falls, SD 57107
100% American Made

CIRCLE 177 ON FREE INFORMATION CARD

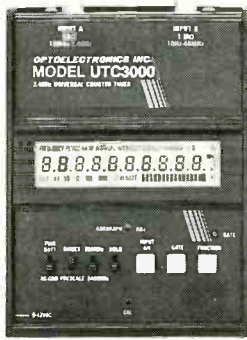

CIRCLE 31 ON FREE INFORMATION CARD

and bargraph display, the custom 120-segment LCD has annunciators for function, gate time, number of cycles averaged, units, and low battery voltage.

The UTC 3000's universal timer-counter functions include period, period average, time interval, time-interval average (0.1-ns resolution), and ratio. Both 50-ohm and 1-megohm input amplifiers are provided. The overall range is 10 Hz to 2.4

GHz. With its field-installable internal Ni-Cd battery pack (providing up to two hours operation) and its compact size (approximately 4 x 5 1/2 x 1 1/2 inches), the unit is highly portable. A 110-volt, 60-Hz wall plug adapter/charger is included. Options include four different antennas, three probes, a precision 0.2-ppm TXCO time base, a carrying case, and a second parallel battery pack to extend portable operation time.

The UTC 3000 hand-held universal counter timer costs \$375.00.—**Optoelectronics, Inc.**, 5821 N.E. 14th Avenue, Fort Lauderdale, FL 33334; Tel. 305-771-2050.

DIGITAL TRANSISTORS. For use in switching circuits, drivers, interface circuits, and inverters, and for interfacing with electromechanical systems, the "KSR" series of transistors from **Samsung** have built-in bias resistors. Eliminating the need for external bias resistors in their application

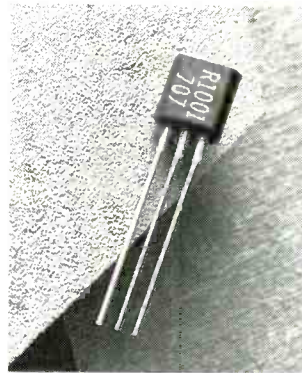

CIRCLE 32 ON FREE INFORMATION CARD

circuits results in a significant saving of space.

There are 28 transistor types—half are NPN devices and half are PNP—available in three different styles of plastic packages. The TO-92 and TO-92S packages have three long parallel leads extending from the bottom. The compact SOT-23 is a plastic surface-mount package with minimal parasitic capacitance and inductance. Its small-outline package has gull-wing-shaped leads for base and emitter on one side

and for the collector on the other side.

Unit prices are 5 cents apiece for the TO-92 and TO-92S packages, and 6 cents apiece for the SOT-23 packages, in quantities between 100 and 999.—**Samsung Semiconductor**, 3725 North First Street, San Jose, CA 95134-1708; Tel. 408-343-5400.

INFRARED DETECTOR. While conversion of infrared light to visible light is not new, most converters require batteries or other power supplies for infrared detection. **ComWay Satellite Systems' IR Detection Card** makes use of a recent technological development to passively detect infrared light. The detector is a business-card-size device that has transmissive phosphor crystals heat-seal laminated at its center. Those crystals emit an orange glow when subjected to infrared light. The cards allow quick checking of remote-control devices for TV's, VCR's, satellite receivers, etc. They also can

VALUE PRICING ON FLUKE INSTRUMENTS FROM Joseph ELECTRONICS

AUTHORIZED FLUKE DISTRIBUTOR

80 SERIES

ANALOG/DIGITAL MULTIMETERS

70 SERIES

Model 87



- 4 1/2 digit mode, 1 ms peak hold
- Min Max Average record mode with Min Max Alert™
- Frequency, duty cycle and capacitance measurements
- 3-3/4 digit, 4000 count display
- Touch Hold® and Relative Modes
- Protective holster with Flex-Stand™
- Protected from 6kV transients on 660V
- UL 1244 listed • Made in USA
- Three-year warranty/One-year calibration

MODEL 87

- Backlit display
- True-rms measurements
- Basic DC accuracy: 0.1%

MODEL 85

- Basic DC accuracy: 0.1%

MODEL 83

- Basic DC accuracy: 0.3%

Reg. \$289
\$249

Reg. \$239
\$209

Reg. \$199
\$179

Call JOSEPH'S For Value Pricing On All Fluke Instruments

- 3 1/2-digit, 3200 count display • 31 segment analog bar graph • Autoranging and automatic polarity selection • Battery-saving "Sleep Mode" power-down display • Protected from 6kV transients on 660V • UL 1244 listed • Made in USA • Three-year warranty/One-year calibration

MODEL 77 • Basic DC accuracy 0.3% • Audible Continuity/Diode Test • Touch Hold® and Range Hold • C70 Holster Included. MODEL 23 • Same specs as Model 77; all inputs protected from high-energy overloads. High-visibility yellow ABS case, safety test leads, C70 holster included.

Reg. \$159
MODEL 77 **\$139**
MODEL 23

Reg. \$119
\$99

Reg. \$79
\$69

Model 77



MODEL 73 • Basic DC accuracy 0.7%

MODEL 75 • Basic DC accuracy 0.5% • Range Hold • Audible Continuity/Diode Test

8060A/8062A 4 1/2 DIGIT HANDHELD DMMs

- 4 1/2-digit, 20,000 count display • True-rms AC voltage and current measurement
- Fast audible-visual continuity tests • Relative reference (offset) • Automatic MΩ Range Selection • Low-power ohms on all resistance ranges • Constant-current diode test mode • Resistance measurements to 300 MΩ • Protected from 6kV transients on 660V • One-year warranty/guaranteed calibration

Reg. \$389
\$349

MODEL 8060A
• Frequency and dB measurements 12Hz to 200kHz+
• Basic DC accuracy: .04%

MODEL 8062A
• Basic DC accuracy: .05%

Reg. \$329
\$289

8060A



CALL TOLL-FREE - SAME-DAY SHIPPING
Joseph 1.800.323.5925
ELECTRONICS

8830 N. Milwaukee Av. Niles, IL 60648 • 708-297-4200 FAX 708-297-6923

Add \$2.50 Shipping and Handling for each unit ordered. IL Residents add 7% Sales Tax.



Call or write for our 528 pg. Catalog. Only \$4.95 - FREE with order.

be used as warning sensors in laser labs, as they will flash if scanned by a laser beam.

The *IR Detection Card* costs \$6.95 for a single sample. Custom printing is available on orders of 500 or more.—**Com/Way Satellite Systems**, P.O. Box 1729, Alamogordo, NM 88310.

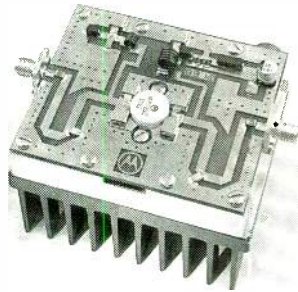

CIRCLE 34 ON FREE INFORMATION CARD

COM/WAY SATELLITE SYSTEMS (505) 437-7575
P.O. Box 1729, Alamogordo, N.M. 88310

INFRARED  DETECTOR
REMOTE CONTROL TESTER

INSTRUCTIONS
EXPOSE ACTIVE AREA TO NORMAL LIGHT BEFORE USE
DETECTOR WILL EMIT AN ORANGE GLOW WHILE BEING
EXPOSED TO IR AND VIEWED IN SUBDUED LIGHT

CIRCLE 33 ON FREE INFORMATION CARD

UHF POWER TRANSISTOR.

Offering outstanding broad-band characteristics and rugged packaging, the *MRF650* UHF power transistor is *Motorola's* first RF device to offer guaranteed gain and efficiency specifications at three frequencies—440, 470, and 512 MHz. Survival is guaranteed for severe load mismatches even when the device is subjected to high supply voltage and input sig-

nals 2 dB above normal. The transistor is packaged in the popular 6-lead flange.

The *MRF650* provides 50 watts of output power, higher than 55% collector efficiency, and more than 5-dB gain while operating from a 12.5-volt power supply. Suggested applications are in 12.5-volt base-station, commercial, and industrial amplifiers, and as a final amplifier in mobile radios.

The *MRF650* UHF power transistor is priced at \$27.75 in quantities of 100 or more.—**Motorola, Inc.**, E-114, 5005 East McDowell Road, Phoenix, AZ 85008. **R-E**

CABLE - TV

SIGNAL REMOVERS

- FOR ELIMINATION OF SEVERE INTERFERENCE
- FOR "CENSORING" OF ADULT BROADCASTS



FOR FULL DESCRIPTION OF USES ask for our free brochure

- ATTENUATION - 45 dB TYPICAL
- BANDWIDTH - 4 MHz AT 5 dB POINTS
- INSERTION LOSS - 2 dB

MODEL	TUNING RANGE	FOR CHANNELS	PASSBAND	PRICE	SHIPPING
23H	50-66 MHz	2,3 (or 6 meter ham)	50-300 MHz	\$30	NO SHIPPING or C.O.D. CHARGES
46FM	66-108 MHz	4,5,6 (or any FM)	50-300 MHz	\$30	
14,7	120-144 MHz	14(A), 15(B), 16(C), 17(D)	50-400 MHz	\$30	
1822	144-174 MHz	18(E), 19(F), 20(G), 21(H), 22(I)	50-400 MHz	\$30	
113	174-216 MHz	7,8,9,10,11,12,13	50-400 MHz	\$30	

3 for \$75 - 10 for \$200 - mix or match

CALL TOLL FREE FOR C.O.D. OR SEND CHECK TO ORDER
FAST DELIVERY
30 DAY MONEY BACK GUARANTEE (3 FILTER LIMIT)

Star Circuits

P. O. Box 94917
Las Vegas, NV 89193-4917

1-800-433-6319

THE HOUSE SITTER THAT DOESN'T NEED A KEY

Use the keyboard to set emergency phone numbers, high and low temperatures, listen-in time and more

ALERT/CANCEL key cancels automatic dial-out, allows you to answer phone

WHAT IS key lets you listen to function settings and dial-out numbers

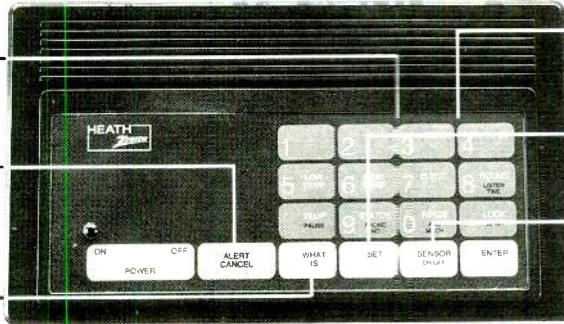

Use the keyboard to ask for information

SET key allows you to change previous settings

SENSOR ON/OFF key chooses the functions to report

ONLY \$129.95

"This is 555-3210. Alert condition is OK. Temperature is 65°. Electricity is on. Sound level is OK." Monitoring your home from work or a vacation spot is made easy with the Heath/Zenith House Sitter Security Monitor/Dialer.

Monitors Your Home

When you call, the House Sitter will report on the AC electric power, the room temperature – comparing it with high and low limits you've already set, loud noises such as burglar alarms and fire alarms, the unit's own battery backup condition, and an additional alert condition. You can even listen to the sounds in the room using the built in microphone.

Dials Out In Alert Conditions

Set the unit to call out to your office, neighbors' and relatives' to announce any alert conditions that are outside preset limits. Up to four numbers can be programmed.

Order Toll Free 1-800-253-0570

The SD-6230 House Sitter is yours for only \$129.95*. To order, call toll-free 1-800-253-0570. VISA, MasterCard, American Express or your Heath Revolving Charge card accepted. Use order code 620-XXX.

See our full line of electronic products for your home in the **Heathkit** catalog – call **1-800-44-HEATH** for your **FREE** copy.

Heath[®]
Benton Harbor, MI

*Price does not include shipping and handling, or applicable sales tax

Join the Electronics and Control Engineers' Book Club®

TROUBLESHOOTING ELECTRONIC EQUIPMENT WITHOUT SERVICE DATA, Second Edition. By R.G. Middleton. 320 pp., illus. This indispensable new edition features all the information that made the first edition so successful, plus the latest developments in digital testing, phase checks, IC troubleshooting, and repair of VCRs, stereos, TVs, tape recorders, and much, much more.
585092-3 Pub. Pr., \$30.00 Club Pr., \$22.50

PRINTED CIRCUITS HANDBOOK, Third Edition. By C.F. Coombs, Jr. 960 pp., 556 illus. Here in one handy volume is all the information you need to design, manufacture, test, and repair printed wiring boards and assemblies. This new edition features ten all-new chapters, including three on SMT.
126/097 Pub. Pr., \$64.95 Club Pr., \$45.50

SOUND SYSTEM ENGINEERING, Second Edition. By D. Davis and C. Davis. 665 pp., illus. The definitive source for all professionals responsible for audio system design, covering everything from concert halls to virtually every oscillator in use today. Packed with proven strategies for solving design and engineering problems and cutting your clients' costs.
584657-8 Pub. Pr., \$39.95 Club Pr., \$31.50

MCGRAW-HILL ENCYCLOPEDIA OF ELECTRONICS AND COMPUTERS, Second Edition. S. Parker, Editor-in-Chief. 1,047 pp., 1,250 illus. Featuring 160 new and revised articles, this new edition treats the entire spectrum of applications, devices, systems, and theory in areas ranging from the flow of electricity to hardware, software, robotics, and IC fabrication.
454/99X Pub. Pr., \$79.50 Club Pr., \$54.95

COMMUNICATIONS RECEIVERS: Principles and Design. By Ulrich L. Rohde and T.T.N. Bucher. 608 pp., 402 illus. Everything you need to know if you design or work with communications receivers, from theory to practical design approaches. Coverage includes all types of receivers: shortwave, broadcast, radar, military, marine, aeronautical, and more.
535/701 Pub. Pr., \$64.95 Club Pr., \$44.50

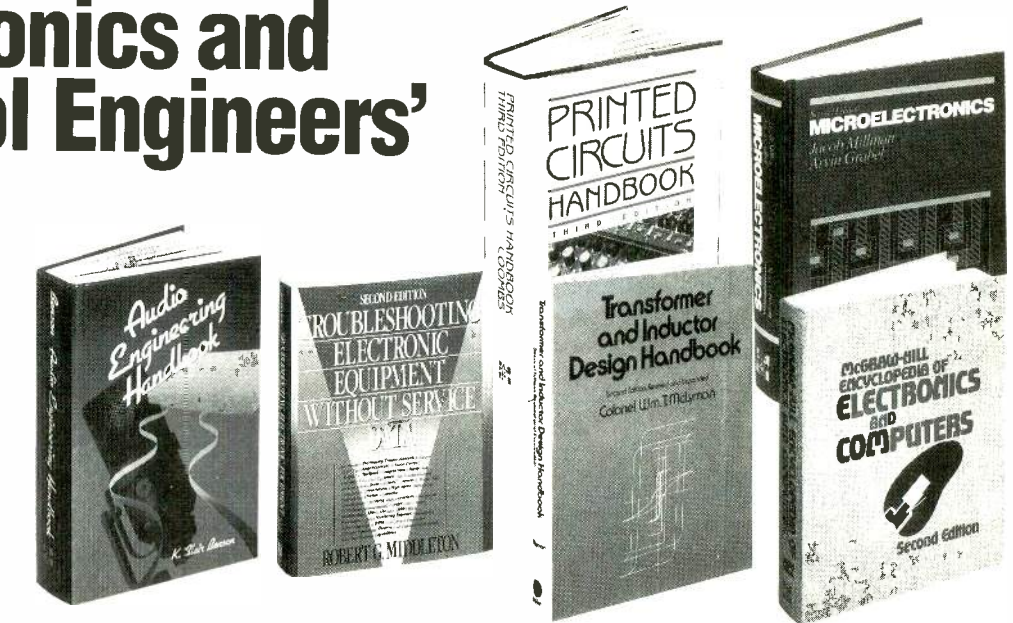

- your one source for engineering books from over 100 different publishers
- the latest and best information in your field
- discounts of up to 40% off publishers' list prices

New Members!
Take any one of these great professional books for only **\$289** as a premium with your first selection!

Spectacular values up to **\$199.50**

ENGINEERING FUNDAMENTALS FOR THE PROFESSIONAL ENGINEERS' EXAM, Third Ed. By L. M. Polentz. 432 pp., 170 illus. Features worked-out solutions and full explanations for all sample problems so you can learn how to solve them. It's a dependable way to prepare for the exam or a perfect on-the-job reference.
503/931 Pub. Pr., \$39.50 Club Pr., \$27.95

AUTOMATIC CONTROL SYSTEMS, Fifth Ed. By B. C. Kuo. 736 pp., illus. Provides an overview of automatic control systems, including in-depth coverage of classical control techniques, optimal control theory, and analog and digital control system design. This up-dated edition discusses the latest ideas on the use of computers to design control systems and as components of such systems.
583706-4 Pub. Pr., \$57.40 Club Pr., \$43.50

CIARCIA'S CIRCUIT CELLAR, Volume VII. By S. Ciarcia. 256 pp., 100 illus., softcover. More do-it-yourself circuits from the master—Steve Ciarcia. Step-by-step guidance on projects ranging from a gray-scale video digitizer and the Circuit Cellar AT Computer to parallel interfacing and the Neighborhood Strategic Defense Initiative.
109/699 Pub. Pr., \$19.95 Club Pr., \$15.95

THE COMPACT DISC: A Handbook of Theory and Use. By K. C. Pohlmann. 288 pp., illus. softcover. The most readable and comprehensive guide to CD technology offers clear descriptions of disc design and manufacturing . . . player circuitry . . . and comparisons of different types of players—all without complicated theoretical or mathematical discussions.
585096-6 Pub. Pr., \$29.95 Club Pr. \$22.50

MOBILE CELLULAR TELECOMMUNICATIONS SYSTEMS. By W.C.Y. Lee. 442 pp., 215 illus. A to Z coverage of state-of-the-art cellular systems, from design to implementation and troubleshooting. Clearly explains spectrum efficiency, propagation models and prediction, interference treatment, and more.
370/303 Pub. Pr., \$62.95 Club Pr., \$44.50

TRANSFORMER AND INDUCTOR DESIGN HANDBOOK, Second Edition. By Col. W.T. McLyman. 440 pp., illus. All the information you need to design today's lighter, smaller transformers and inductors, without relying on out-moded approximation methods. In ready-reference tabular format, this new edition covers the latest equations in transformer and gapped design applications.
584646-2 Pub. Pr., \$55.00 Club Pr., \$38.50

MICROCOMPUTER TROUBLESHOOTING AND REPAIR. By J. G. Stephenson and B. Cahill. 354 pp., illus., softcover. This nuts-and-bolts guide provides expert tips, troubleshooting tools and shortcuts, and practical help on deciding if you really *do* have to bring it in to the shop. It also explains techniques for anticipating and defending against most common computer problems.
585106-7 Pub. Pr., \$24.95 Club Pr., \$18.95

MICROELECTRONICS, Second Ed. By J. Millman and A. Grabel. 1,001 pp., 646 illus. Takes you from the basics of semiconductor properties to an understanding of the operation of solid-state devices, and then to more advanced topics. Its up-to-date coverage, real-life examples, and practical data make this an ideal reference for the working engineer.
423/30X Pub. Pr., \$56.95 Club Pr., \$41.50

ENGINEERING MATHEMATICS HANDBOOK, Third Ed. By J. J. Tuma. 512 pp., illus. This best-selling handbook gives you the essential mathematical tools—formulas, definitions, theorems, tables, and models for computer programming — that you need for your day-to-day engineering calculations.
654/433 Pub. Pr., \$52.50 Club Pr., \$34.50

PORTABLE ELECTRONICS DATA BOOK

360 pp., 6 x 9, illus., softcover 585390-6

A-to-Z coverage of all the essential facts, figures, and formulas you need, in a format that's easy to use and easy to carry. John Douglas-Young has filled this handy on-the-job companion with equations, algorithms, calculus formulas, and BASIC programs in areas ranging from alternating current and amplifiers to transducers and waveguides . . . and they're all yours **ABSOLUTELY FREE!**

A \$19.95 Value — Yours **ABSOLUTELY FREE** when you join!

BASIC TELEVISION AND VIDEO SYSTEMS, Fifth Ed. By B. Grob. 592 pp., illus. Provides the clearest picture of how television and video systems work, and what to do when they don't. Covers television receivers, VCR's, video cameras, and cable systems — all in readable, practical detail.

249/334 Pub. Pr., \$39.95 Club Pr., \$24.95

BUILD YOUR OWN UNIVERSAL COMPUTER INTERFACE. By B. Chubb. 309 pp., illus., softcover. Guiding you from theory to step-by-step assembly instructions, this lively manual shows you how to construct a computer interface and hook it up to virtually any IBM or IBM compatible personal computer, including the XT, XT-286, AT, and System/2 Model 30.

585080-X Pub. Pr., \$19.95 Club Pr., \$15.95

HANDBOOK OF ELECTRICAL NOISE MEASUREMENT AND TECHNOLOGY, Second Ed. By C.A. Verger. 440 pp. 213 illus. Provides answers to all your questions about noise origins, causes, effects. Also shows you how to predict and measure noise, and how to design low-noise circuits.

583947-4 Pub. Pr., \$39.95 Club Pr., \$29.95

SWITCHGEAR AND CONTROL HANDBOOK, Second Ed. Edited by R. W. Smeaton. 1,056 pp., 789 illus. The only handbook that treats all aspects of switchgear control, including design, applications, safety, and maintenance. Updated to reflect the changes brought about by the use of computers, solid-state devices, and programmable controls.

584/494 Pub. Pr., \$83.00 Club Pr., \$56.95

ANTENNA APPLICATIONS REFERENCE GUIDE. Edited by R. C. Johnson and H. Jasiak. 496 pp., 368 illus. and tables. Covers the major applications of antenna technology in all areas of communications and their design methods. Emphasizes important new applications such as earth station, satellite, seeker, aircraft, and microwave-relay antennas.

322/848 Pub. Pr., \$59.95 Club Pr., \$42.50

RADIO HANDBOOK, Twenty-Third Ed. Edited by W. I. Orr. 667 pp., 1,073 illus. and tables. The latest edition of the most complete, current resource on radio technology and its applications. Expert contributors show you how to select, design, build, test and operate all kinds of equipment.

584638-1 Pub. Pr., \$29.95 Club Pr., \$23.95

AUDIO ENGINEERING HANDBOOK. Edited by K. B. Benson. 1056 pp., 722 illus. The ideal on-the-job reference for professionals who design, operate, and service audio equipment. It's a one-volume source of fundamental audio acoustics engineering information and practical how-to source book covering generation, transmission, storage, and reproduction of the audio signal.

047/774 Pub. Pr., \$83.50 Club Pr., \$59.95

Be sure to consider these important titles as well!

BUCHSBAUM'S COMPLETE HANDBOOK OF PRACTICAL ELECTRONIC REFERENCE DATA, Third Ed. By W.H. Buchsbaum. 583880-X Pub. Pr., \$34.95 Club Pr., \$26.50

ON-LINE ELECTRICAL TROUBLE-SHOOTING. By L. Lundquist. 391/106 Pub. Pr., \$34.50 Club Pr., \$26.50

ESSENTIAL CIRCUITS REFERENCE GUIDE. By J. Markus & C. Weston. 404/623 Pub. Pr., \$59.95 Club Pr., \$47.50

INTRODUCING PC-DOS AND MS-DOS, Second Ed. By T. Sheldon. 565/651 Pub. Pr., \$28.95 Club Pr., \$19.95

HANDBOOK OF ELECTRONICS CALCULATIONS FOR ENGINEERS AND TECHNICIANS, Second Ed. Edited by M. Kaufman & A. H. Seidman. 335/281 Pub. Pr., \$49.95 Club Pr., \$37.50

INTRODUCTION TO DIGITAL SIGNAL PROCESSING. By J.G. Proakis and D.G. Manolakis. 584954-2 Pub. Pr., \$50.00 Club Pr., \$37.50

CIRCUIT DESIGN FOR ELECTRONIC INSTRUMENTATION: Analog and Digital Devices from Sensor to Display, Second Ed. By D. Wobschall. 712/31X Pub. Pr., \$52.95 Club Pr., \$36.95

BOB MIDDLETON'S HANDBOOK OF ELECTRONIC TIME-SAVERS AND SHORTCUTS. By R.G. Middleton. 583865-6 Pub. Pr., \$29.95 Club Pr., \$22.50

DIGITAL AND MICROPROCESSOR TECHNOLOGY, Second Ed. By P.J. O'Connor. 585184-9 Pub. Pr., \$42.00 Club Pr., \$33.50

OP-AMP HANDBOOK, Second Ed. By F.W. Hughes. 583651-3 Pub. Pr., \$39.00 Club Pr., \$27.50

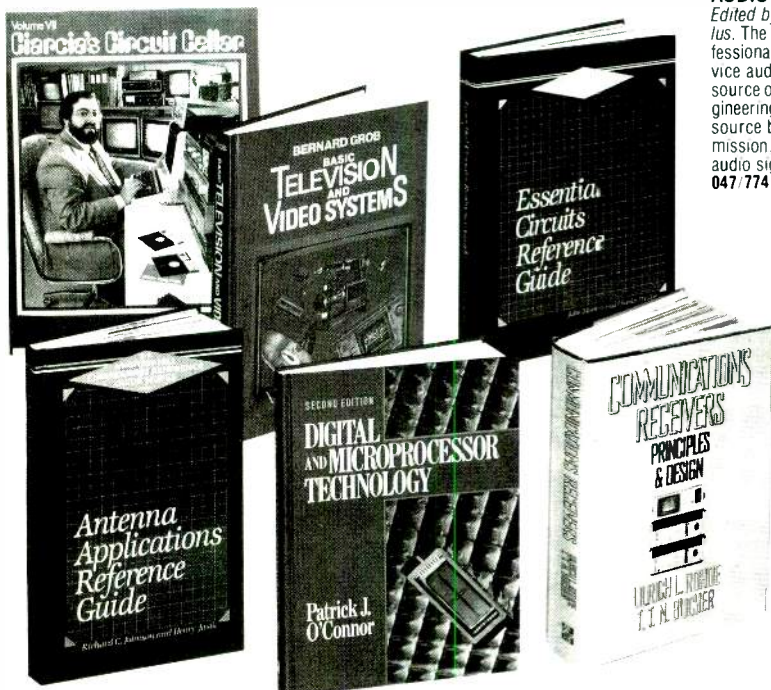

Here's how the Club works to serve YOU:

■ IMPORTANT INFORMATION... WE MAKE IT EASY TO GET!

In our rapidly changing world, those who perform best are those who are best informed. Designed exclusively for the practicing engineer, the Electronics and Control Engineers' Book Club provides you with information that is relevant, reliable, and specific enough to meet your needs. Each Club bulletin comes your way 14-16 times a year and offers you more than 30 books to choose from — the best and newest books from all publishers!

■ DEPENDABLE SERVICE... WE'RE HERE TO HELP!

Whether you want information about a book or have a question about your membership, our qualified staff is here to help. Just call us toll-free or write to our Customer Service. We also make sure you get only the books you want. All you do is simply tell us your choice on the Reply Card and return it to us by the specified date. If you want the Main Selection, do nothing — it will be sent to you automatically. (A small shipping and handling charge is added to each shipment.)

■ CLUB CONVENIENCE... WE DO THE WORK!

Beyond the benefit of timely information, Club membership offers many other benefits. For example, you get a wide choice of books that cannot be matched by any bookstore — anywhere. And all your books are conveniently delivered right to your door. You also get the luxury of 10 full days to decide whether you want the Main Selection. If you should ever receive a Main Selection you don't want because the Club bulletin came late, just return it for credit at our expense.

■ SUBSTANTIAL SAVINGS... AND A BONUS PROGRAM TOO!

In keeping with our goal to provide you with the best information at the greatest possible savings, you will enjoy substantial discounts — up to 40%! — on every book you buy. Plus, you're automatically eligible for our Bonus Book Plan which allows you savings up to 70% on a wide selection of books.

■ EASY MEMBERSHIP TERMS... IT'S WORTHWHILE TO BELONG!

Your only obligation is to purchase one more book — at a handsome discount — during the next 12 months, after which you enjoy the benefits of membership with no further obligation. Either you or the Club may cancel membership anytime thereafter.

FOR FASTER SERVICE IN ENROLLING CALL TOLL-FREE 1-800-2-MCGRAW

MAIL THIS COUPON TODAY

McGraw-Hill Book Clubs Electronics and Control Engineers' Book Club®

P.O. Box 582, Hightstown, NJ 08520-9959

Please enroll me as a member and send me the two books indicated plus the PORTABLE ELECTRONICS DATA BOOK. I am to receive one book for just \$2.89, the other at the discounted member's price, plus local tax, shipping and handling charges. I agree to purchase a minimum of one additional book during my first year of membership as outlined under the Club plan described in this ad. I understand that a shipping and handling charge is added to all shipments.

Your FREE Data Book	
585390-6	
Write Code No. of the \$2.89 selection here	Write Code No. for the First selection here
<input type="text"/>	<input type="text"/>

Signature _____

Name _____

Address Apt. # _____

City _____

State _____ Zip _____

This order subject to acceptance by McGraw-Hill. All prices subject to change without notice. Offer good only to new members. Foreign member acceptance subject to special conditions.

ECGA-037

HITACHI SCOPES AT DISCOUNT PRICES

Digital Storage Scopes



VC-6025 20MS/S
50MHz Bandwidth
2K Word Memory
Capacity
\$2349.00

Advanced storage functions create new dimensions in scopes such as one shot observation, flicker free display, bright display for even high speed event, trace observation for low speed event, hard copy by plotter and data output to computer.

VC-6045 100MHz 40MS/S 4K word Memory cap (call)

All Hitachi scopes include probes, schematics, and Hitachi's 3 year worldwide warranty on parts and labor. Many accessories available for all scopes.



V-212
\$425
List \$595
Save \$170
DC to 20MHz
Dual Channel



V-1060
List \$1595 **\$1,359**

- DC to 100MHz
- Dual Channel
- Delayed Sweep
- CRT Readout
- Sweep Time
- Autoranging
- Trigger Lock
- 2mV Sensitivity

	LIST	PRICE	SAVE
V-422 40MHz D.T., 1mV sens, DC Offset Vert Mode Trigger, Alt Mag	\$940	\$740	\$200
V-423 40MHz D.T., 1mV sens, Delayed Sweep, DC Offset, Alt Mag	\$1,025	\$825	\$200
V-425 40MHz D.T., 1mV sens, DC Offset, CRT Readout, Cursor Meas	\$1,070	\$849	\$221
V-660 60MHz D.T., 2mV sens, Delayed Sweep, CRT Readout	\$1,295	\$1,145	\$150
V-1065 100MHz D.T., 2mV sens, Delayed Sweep, CRT Readout, Cursor Meas	\$1,895	\$1,670	\$225
V-1100A 100MHz Q.T., 1mV sens, Delayed Sweep, CRT Readout, DVM, Counter	\$2,450	\$2,095	\$355
V-1150 150MHz Q.T., 1mV sens, Delayed Sweep, Cursor Meas, DVM, Counter	\$3,100	\$2,675	\$425

ELENCO PRODUCTS AT DISCOUNT PRICES

20MHz Dual Trace Oscilloscope

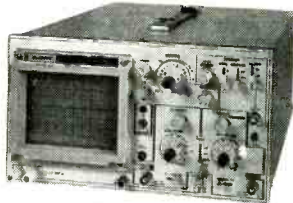

\$375
MO-1251

- 6" CRT
- Built in component tester
- TV Sync

FREE DMM

with purchase of
ANY SCOPE

SCOPE PROBES

P-1 65MHz, 1x, 10x \$19.95
P-2 100MHz, 1x, 10x \$23.95

35MHz Dual Trace Oscilloscope

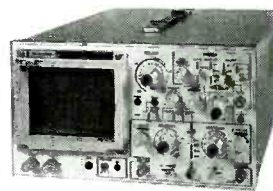

\$495
MO-1252

- High luminance 6" CRT
- 1mV Sensitivity
- 6KV Acceleration Voltage
- 10ns Rise Time
- X-Y Operation • Z Axis
- Delayed Triggering Sweep

Top quality scopes at a very reasonable price. Contains all desired features. Two 1x, 10x probes, diagrams and manual. Two year guarantee.

PRICE BREAKTHRU on Auto Ranging DMMs



3 to choose from:
MDM-1180 **\$24.95**
MDM-1181 **\$27.95**
MDM-1182 **\$29.95**

- 3 1/2 LCD Display
- 27 Functions
- Auto /Manual Ranges
- Audible Continuity
- Data Hold (MDM-1182)
- 1% Accuracy (MDM-1181)



True RMS 4 1/2
Digit Multimeter
\$135 M-7000

.05% DC Accuracy
.1% Resistance
with Freq. Counter
and deluxe case



Multimeter with
Capacitance and
Transistor Tester
\$55 CM-1500

Reads Volts, Ohms,
Current, Capacitors,
Transistors and
Diodes with case



CM-1550
\$58.95

9 Ranges
.1pf-20,000ufd
.5% basic accy
Zero control
with case



LC-1801
\$125

Measures
Coils 1uH-200H
Caps 1pf-200uf
Res .01-20M



Bench DMMs

M-3500 **\$125** 3 1/2 digit
.1% accy
M-4500 **\$175** 4 1/2 digit
.05% accy



AC Current Meter
ST-1010
\$69.95

1000 Amps
Data&Peak Hold
8 Functions
Deluxe Case

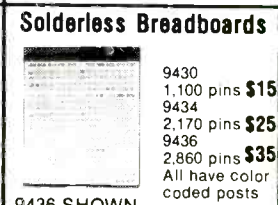

Solderless Breadboards

9430 1,100 pins **\$15**
9434 2,170 pins **\$25**
9436 2,860 pins **\$35**
All have color
coded posts

9436 SHOWN



AC Clamp-On Current Adapter

ST-265
\$25.00

0-1000A AC
Works with
most DMM

Wide Band Signal Generators



SG-9000 **\$129**
RF Freq 100K-450MHz
AM Modulation of 1KHz
Variable RF output

SG-9500 with Digital Display
and 150MHz built-in Freq Ctr **\$249**

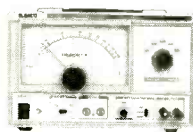

AUDIO GENERATOR
SG-9200
\$129

Low distortion
(<.05%)

10-1MHz Sine/Square Wave
600 ohm Output Impedance, High Output Voltage



Function Generator
Blox
#9600
\$28.95

Provides sine, tri, squ wave
from 1Hz to 1MHz
AM or FM capability



Decade Blox
#9610 or
#9620
\$18.95

#9610 Resistor Blox
47 ohm to 1M & 100K pot
#9620 Capacitor Blox
47pf to 10MFD

Digital Triple Power Supply



XP-765
\$249

0-20V at 1A
0-20V at 1A
5V at 5A

Fully Regulated, Short circuit protected with
2 Limit Cont., 3 Separate supplies

XP-660 with Analog Meters **\$175**

Quad Power Supply



XP-580
\$59.95

2-20V at 2A
12V at 1A
5V at 3A
-5V at .5A

Fully regulated and
short circuit protected

XP-575 without meters **\$39.95**

Four-Function Frequency Counters



F-100 120MH
\$179
F-1000 1.2GH
\$259

Frequency, Period, Totalize,
Self Check with High Stabilized Crystal Oven
Oscillator, 8 digit LED display

GF-8016 Function Generator with Freq. Counter



\$249

Sine, Square, Triangle
Pulse, Ramp, .2 to 2MHz
Freq Counter .1 - 10MHz

GF-8015 without Freq. Meter **\$179**

AM/FM TRANSISTOR RADIO KIT with TRAINING COURSE

Makes a great
school project Model AM/FM-108

14 Transistors • 5 Diodes **\$26.95**

Circuits are laid out in systematic order on an over-sized PC board for easy understanding of the flow of radio signals, from antenna to speaker. Complete course includes all parts, PC board and training manual. When completed you will be proud to display your masterpiece.



7 Transistor AM RADIO KIT **\$16.95**

WE WILL NOT BE UNDERSOLD!
UPS Shipping; 48 States 5%
(\$10 Max) IL Res., 7% Tax



C & S SALES INC.
1245 Rosewood, Deerfield, IL 60015
(800) 292-7711 (708) 541-0710

15 Day Money Back Guarantee
2 Year Warranty Prices subject to change
WRITE FOR FREE CATALOG

PICTURE THIS—YOU'RE SITTING IN A HAMMOCK ON A WARM SUNDAY afternoon listening to your favorite radio station. You watch in amusement as your personal robot completes the last of your weekly chores. Only a dream? Not any longer, because now you can build a personal robot that can perform the world's most dreaded chore—lawn mowing. In the next few issues of *Radio-Electronics*, we will explain how you can build the Lawn Ranger, a patented battery-powered robot that can cut grass automatically while you and your friends watch in amazement.

The Lawn Ranger is *not* a remote-control lawn mower. It is a robot that can actually "see" the grass while it cuts. It may seem hard to believe, but the Lawn Ranger really can cut grass by itself. You may have already seen the Lawn Ranger on television or in periodicals such as the *New York Times*, *USA Today*, *Machine Design*, or others. Now, you can easily build and use the Lawn Ranger for your yard, or even start your own lawn maintenance business.

General description

The design of the Lawn Ranger is surprisingly simple. It consists of an aluminum frame, two electric cutting motors, two electric drive motors, a plastic top, a sensor assembly, two 12-volt batteries, and an electronic control system.

The metal frame provides the basic structure of the robot and is composed of 1/4-inch thick 9091 aluminum. Attached to the frame are two castor wheels located in the front, and two geared drive wheels located in the rear. Each drive wheel is connected to a 24-volt DC gear motor through a spur gear interface. That "direct drive" approach allows the robot to be propelled by a durable drive system that does not rely on chains or belts.

The Lawn Ranger uses four permanent-magnet 24-volt DC motors. The two drive motors come with an internal gear box for speed reduction. The two cutting motors are synchronized by a timing belt to prevent the blades from coming in contact with each other.

The red top is molded from sturdy ABS plastic. For safety, a pressure-sensitive bumper switch is attached to its outer edge. This switch will automatically shut the Lawn Ranger off if it comes in contact with trees or other obstacles. An additional test button shut-off switch is mounted on top of the robot for easy access by the operator.

The sensor assembly consists of 15 infra-red sensors mounted in front of the Lawn Ranger. Those sensors "see" your grass and provide critical

Now you can sit back and watch your lawn mower cut the grass by itself!

Build the Lawn Ranger



Raymond Rafaels

TABLE 1—GRASS SENSOR DATA

Sample #	Byte 1								Byte 2							
	1	2	3	4	5	6	7	8	Sensor #		9	10	11	12	13	14
1	1	1	0	1	0	1	0	1	0	1	0	0	0	0	1	0
2	1	0	1	1	1	1	1	1	0	0	0	0	0	0	0	0
3	0	1	0	0	1	1	1	0	1	0	0	0	1	0	0	
4	1	0	1	0	0	1	1	1	0	0	0	0	0	0	0	
5	0	1	0	1	0	0	1	0	0	0	0	0	0	0	0	

All resistors are 1/4-watt, 5%, unless otherwise indicated.

- R1, R2—1000 ohms
- R3—R7, R12, R15, R17—2200 ohms
- R8—not used
- R9, R10, R19, R20—3300 ohms, SIP
- R11, R18—3300 ohms
- R13—22,000 ohms
- R14—470,000 ohms
- R16—47,000 ohms
- R21—120 ohms

Capacitors

- C1, C12—100 μF, 25 volts, electrolytic
- C2, C3, C5—C9, C11, C13, C15, C16, C18—0.1 μF, ceramic
- C4—56 pF, ceramic
- C10—10 μF, 16 volts, electrolytic
- C14—not used
- C17—1 μF, 35 volts, electrolytic

Semiconductors

- IC1—Z84C00-4PS microprocessor
- IC2—74HCT04 hex inverter
- IC3—74LS08N quad 2-input AND gate
- IC4—74LS00N quad 2-input NAND gate
- IC5—74LS32N quad 2-input OR gate
- IC6—2732A 4K × 8 EPROM (must be purchased from TSI)
- IC7, IC8—2114L-2 1K × 4 RAM
- IC9, IC10—Z84C20-4PS parallel I/O
- D1—1N4148 diode
- Q1—2N3904 NPN transistor

Other components

- XTAL1—2-MHz crystal
- J5—10-pin IDC connector
- S1—7-position DIP switch
- TP1—TP6—individual pins or scraps of component leads

Miscellaneous: IC sockets

Note: The following items can be purchased from Technical Solutions, Inc., P.O. Box 284, Damascus, MD 20872 (301) 253-4933: PC boards for the CPU, motor-controller, power board, and motherboard, \$39 each; programmed EPROM, \$39 (contains computer program and firmware license); grass sensors, \$8.99 each; hand-held manual controller kit, \$39; full CPU-board kit, \$129 (includes EPROM, PC board, and all parts); full kit for motherboard, \$69 (contains PC board and all parts); kit for power board, \$149 (contains PC board and all parts except DC/DC converters); full kit for motor-controller board, \$169 (includes PC board and all parts); Lawn Ranger demo VHS tape, \$19 (refundable for orders of \$100 or more). Please add \$8.00 for S/H (U.S. orders). Maryland residents add sales tax.

ward, the START signal will turn Q1 on and bring the STOP MOVE line low. When the robot shuts down, pin 8 of IC4-c and pin 6 of IC3-d will go low. That deactivates the input power relay.

Input/output

The CPU board uses two Z8420 parallel input/output or PIO chips la-

beled IC9 and IC10. Each chip has two 8-bit I/O ports that are software programmable. Bit 7 of Port B on IC10 is programmed as an output. That output line provides a gating pulse that is used to sample the sensor data. When the line goes high, the sensors are enabled and sensor information is passed to the motor-controller board for amplification. After the sensor data is amplified, it is sent to IC10 on the CPU board.

The bits of Ports A (0-7) and B (0-6) of IC10 are defined as inputs that are used to receive the sensor data. IC10 transfers the information to the Z80 microprocessor over the data bus for processing.

CPU construction and test

It is recommended that you use a PC board for the CPU, and you can either purchase one from TSI (it's a plated-through board that's hard to make—see ordering information), or you can make one from the artwork provided in PC Service. Also, the 2732A EPROM is preprogrammed and is available only from TSI. Using the parts-placement diagram of Fig. 7, first solder the IC sockets to the board, then solder the remaining components. Then, carefully push all the IC's into their respective sockets. And remember, that some of the IC's are CMOS, which must be handled carefully. Figure 8 shows a fully assembled CPU board.

Apply +5 volts to TP4 and ground to TP6. Place a scope probe at pin 34 of IC10; the scope should display a 1-kHz square wave. If you don't have a scope, verify that the voltages on pins 9, 10, 12, 13, 14, and 15 of IC9 read 0-volts DC. Now, as you temporarily ground pin 15 of IC10, recheck IC9 for 5 volts on pins 10, 13, 14, and 15, and 0 volts on pins 9 and 12.

If your board passes those tests, it

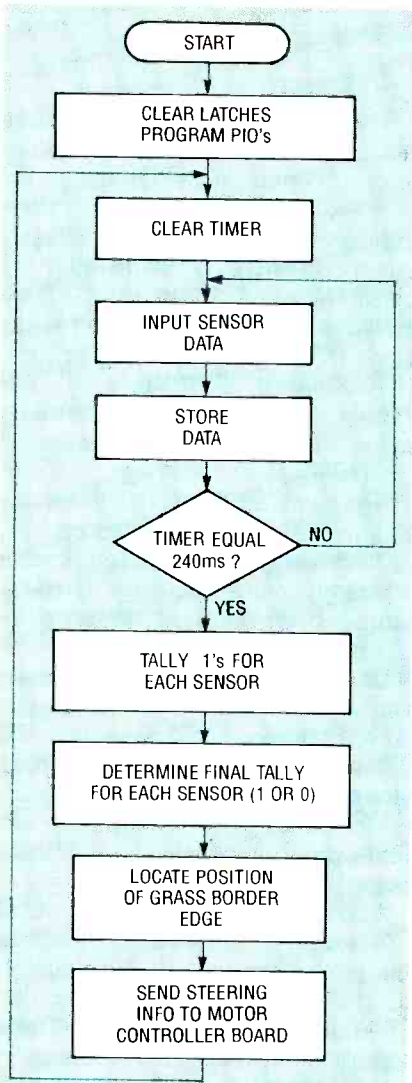

FIG. 5—SIMPLIFIED FLOW CHART of the computer program.

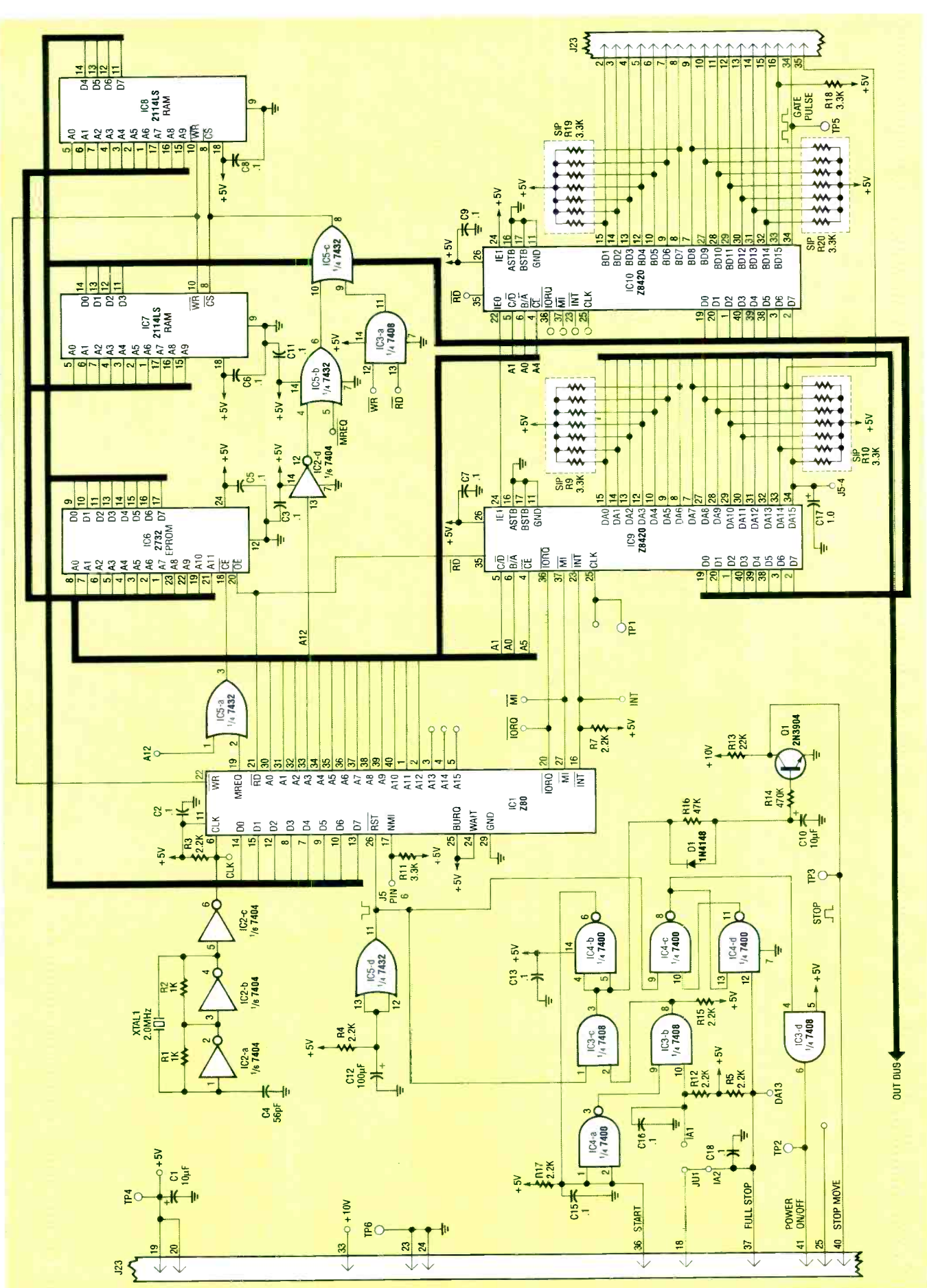

FIG. 6—SCHEMATIC DIAGRAM of the CPU board. Its purpose is to input all sensory information, and then tell the Lawn Ranger where to go.

Electronics Engineers & Designers!

Take 3 books for only \$3.95

(Values to \$168.40)

SHARPEN YOUR SKILLS—With Quality, Affordable Professional Books

COMPUTER SCIENCE

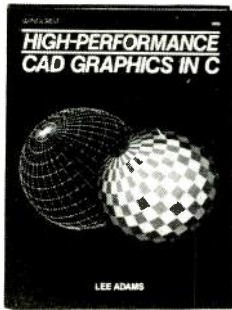

3059 **\$34.95**
Master the art of modeling, rendering, and animating on your IBM® PC. 524 pp. *Counts as 2.*

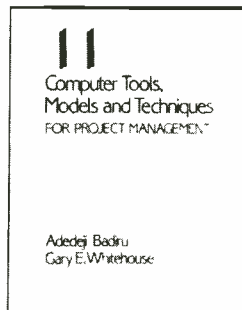

3200 **\$32.95**
Guidelines for enhancing software-driven project management in large or small businesses. 320 pp. *Counts as 2.*

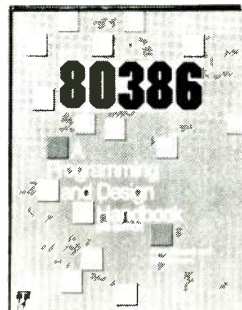

3237P **\$24.95**
This handy guide demonstrates such advanced features as debugging applications and Virtual 8086 Mode. 432 pp.

ENGINEERING MATH

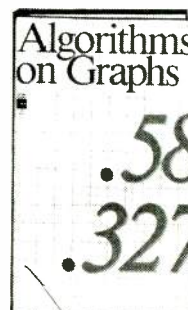

3429 **\$29.95**
Your source for well-developed, ready-to-use computer algorithm codes. 180 pp.

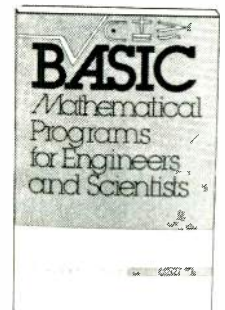

8225P **\$19.95**
Tested programs for most mathematical computing needs. 233 pp.

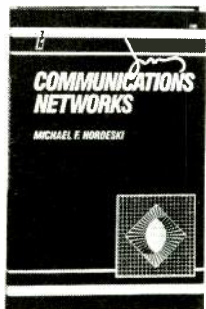

3188 **\$38.95**
A timely, high-level examination of the technical, managerial, and economic issues surrounding communications networks. 300 pp. *Counts as 2.*

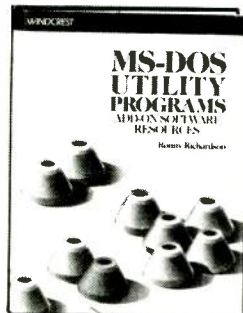

3278 **\$34.95**
The most exhaustive guide available to help DOS users optimize their systems. 665 pp. *Counts as 2.*

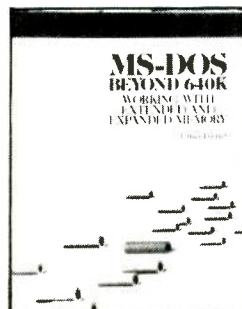

3239 **\$29.95**
Break through the 640K limit and explore a new level of computer power. 240 pp.

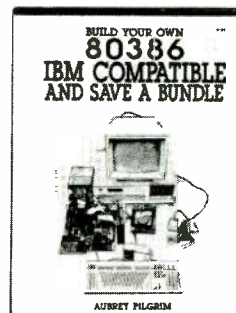

3131 **\$26.95**
Assemble your own powerful microcomputer system... it's easy and inexpensive. 224 pp.

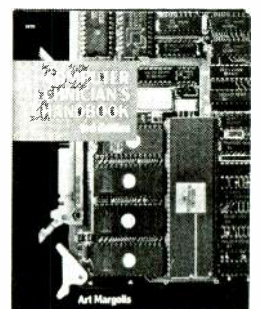

3279 **\$36.95**
Master the proven repair techniques of an expert electronics technician. 570 pp. *Counts as 2.*

ELECTRONIC CIRCUITS

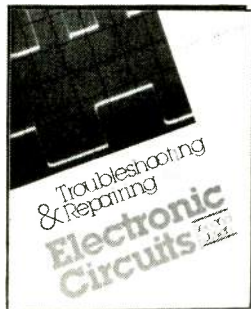

3258 **\$27.95**
Step-by-step instructions for troubleshooting and repairing the latest in electrical equipment. 310 pp.

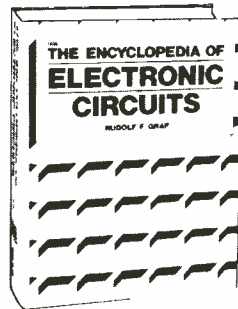

1938P **\$29.95**
Over 1,300 useful and versatile electronic circuit designs. 768 pp.

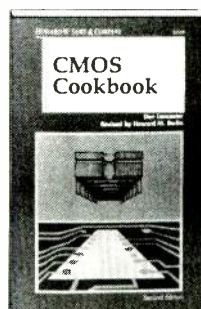

9244P **\$18.95**
This revised and updated edition is both a comprehensive, industry-wide reference, and a valuable collection of project ideas. 512 pp.

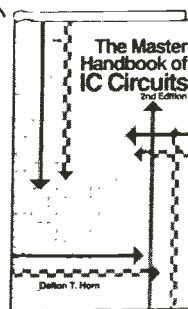

3185 **\$34.95**
Neatly and logically lists over 900 circuits along with schematics and pinout diagrams. 592 pp. *Counts as 2.*

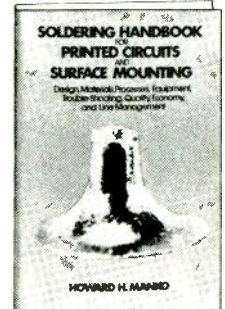

9825 **\$49.95**
A comprehensive manual for soldering and cleaning printed circuit boards. 430 pp.

STATE-OF-THE-ART

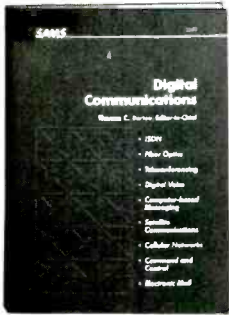

9773 **\$44.95**
Examines the significant advances in communications technology. 406 pp.

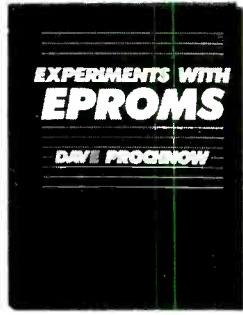

2962P **\$17.95**
Complete schematic diagrams, parts lists, and photos for building a variety of projects. 296 pp.

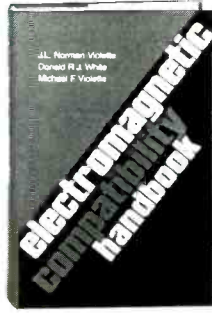

9781 **\$68.95**
Designed to help deal effectively with today's fast-paced EMC technology. 707 pp.

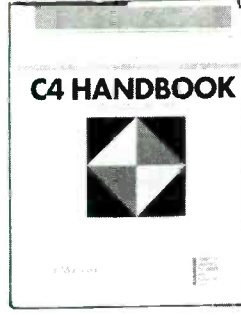

3098 **\$44.50**
A comprehensive overview of CAD/CAM, CAE, and CIM concepts, capabilities and applications. 438 pp. *Counts as 2*

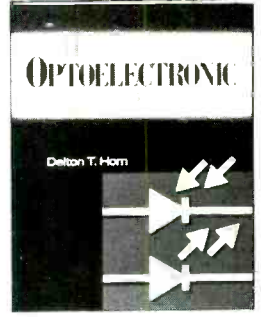

3205 **\$24.95**
Discover the broad range of practical applications for optoelectronic devices. 250 pp.

ELECTRONIC COMPONENTS



3199 **\$52.00**
3199 SMT layout and design guidelines for efficient assembly processing, inspection and repair. 180 pp. *Counts as 2*

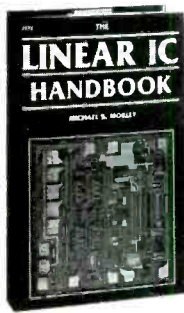

2672 **\$49.50**
2672 Linear integrated circuits—specifications, prices & data. 614 pp.

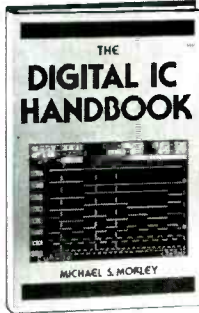

3002 **\$49.50**
3002 Fast, accurate information guaranteed to simplify your search for the right IC. 624 pp.

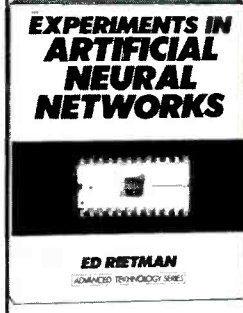

3037 **\$24.95**
3037 Build your own neural networking breadboards—systems that can store and retrieve information like the brain! 160 pp.

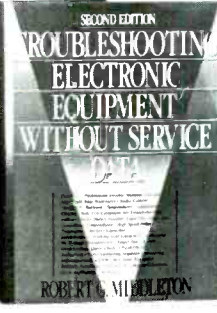

9290 **\$36.00**
9290 Provides many never-before-published troubleshooting techniques and case histories. 315 pp. *Counts as 2*

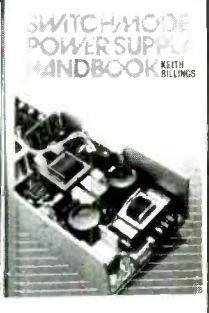

9305 **\$59.50**
9305 The solutions-oriented handbook for practicing engineers at all levels. Contains hundreds of informative illustrations and diagrams demonstrating key principles. 600 pp. *Counts as 2*

How the Club Works:

YOUR BENEFITS: You get 3 books for \$3.95 plus shipping & handling when you join. You keep on saving with discounts of up to 50% as a member.

YOUR PROFESSIONAL BOOKSTORE BY MAIL: Every 3-4 weeks, you will receive the EE&D Book Club News describing the Main Selection and Alternates, as well as bonus offers and special sales, with scores of titles to choose from.

AUTOMATIC ORDER: If you want the Main selection, do nothing and it will be sent to you automatically. If you prefer another selection, or no selection at all, simply indicate your choice on the reply form provided. You will always have at least 10 days to decide. As a member, you agree to purchase at least 3 books within the next 2 years and may resign at any time thereafter.

BONUS BOOKS: Starting immediately you will be eligible for our *Bonus Book Plan* with savings of up to 80% off publishers' prices.

IRONCLAD NO-RISK GUARANTEE: If not satisfied with your books, return them within 10 days without obligation!

EXCEPTIONAL QUALITY: All books are quality publishers' editions especially selected by our Editorial Board.

All books are hardcover unless number is followed by a "P" for paperback. (Publishers' Prices shown)
©1990 EEDBC, Blue Ridge Summit, PA 17294-0860

SEND NO MONEY NOW!

INTRODUCTORY 10-DAY FREE EXAMINATION



ELECTRONICS ENGINEERS & DESIGNERS BOOK CLUBSM

Blue Ridge Summit, PA 17294-0860

YES! Please accept my membership in the *Electronics Engineers & Designers Book Club* and send my 3 volumes listed below billing me \$3.95. If not satisfied, I may return the books within 10 days and have my membership cancelled. I agree to purchase 3 or more books at regular Club prices during the next 2 years, and may resign at any time thereafter. A shipping/handling charge and sales tax will be added to each order.

Name _____

Address _____

City _____

State _____ Zip _____ Phone _____

Signature _____

Valid for new members only. Foreign applicants will receive special ordering instructions. Canada must remit in U.S. funds. This order is subject to acceptance by the *Electronics Engineers & Designers Book Club*. DRE690

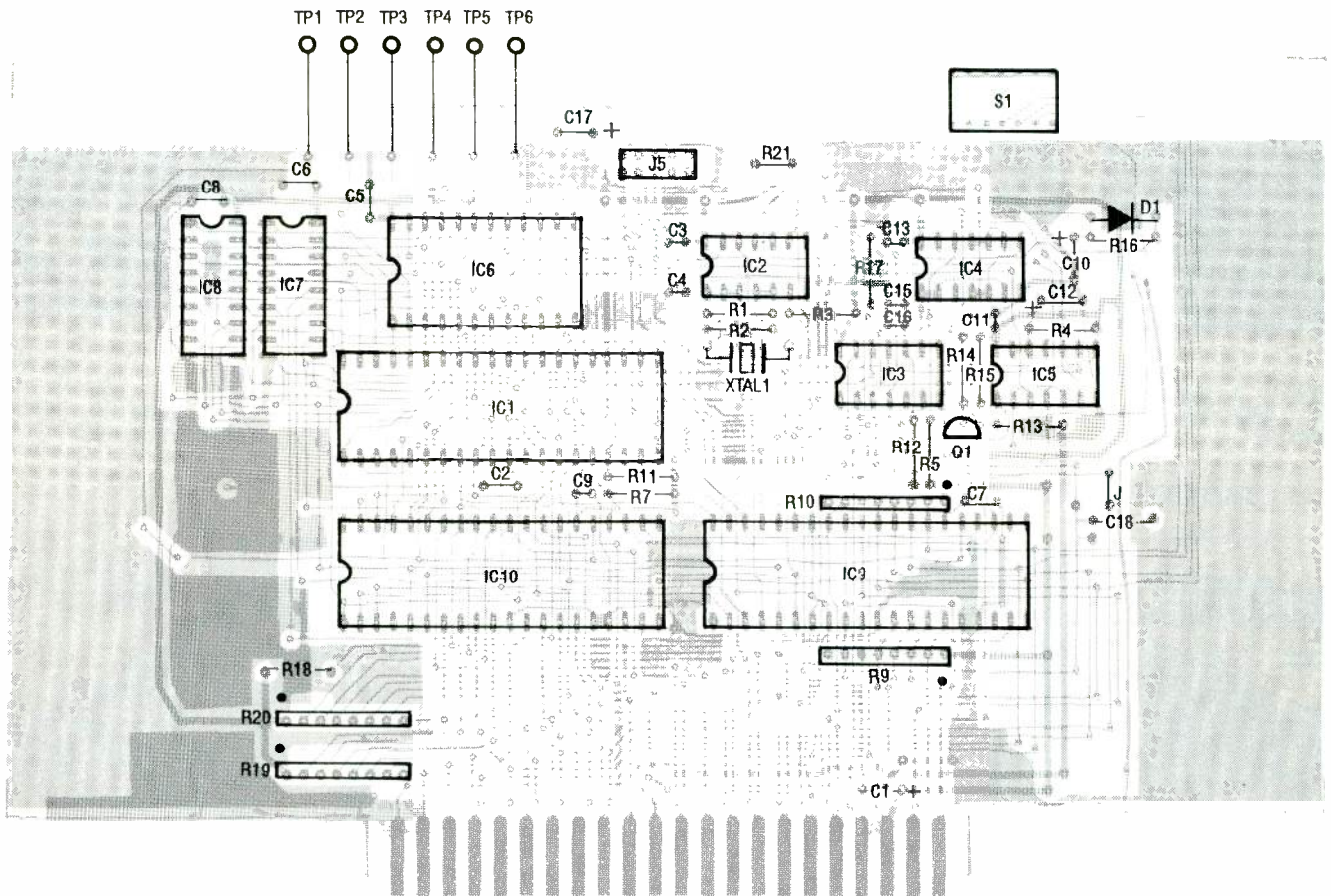

FIG. 7—ASSEMBLE THE COMPONENTS according to this parts-placement diagram.

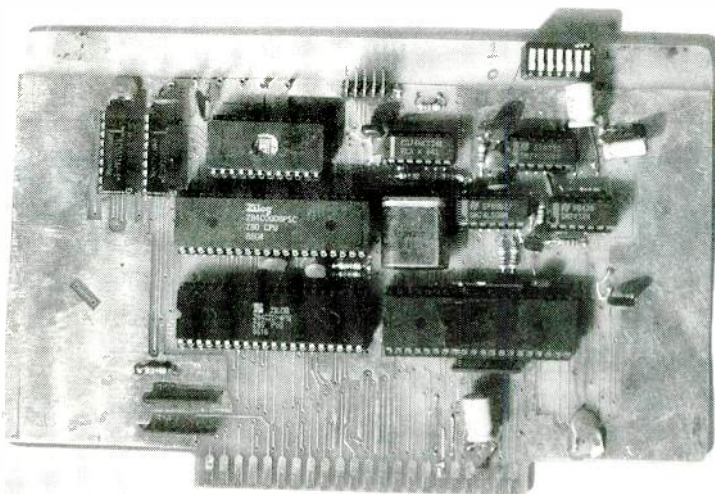

FIG. 8—FULLY ASSEMBLED CPU BOARD.

should be functioning properly. More extensive testing of the CPU can be performed after the motor controller, power board, and motherboard are assembled and tested.

Still to come

In the next couple of issues of **Radio-Electronics** we will explain how

you can finish building the Lawn Ranger. As far as the electronics portion goes, we've still got to build the motor-controller board, the power board, and the motherboard, which holds all of the other boards together. Then we have to build and wire the sensor assembly, put together the mechanical frame, and connect every-

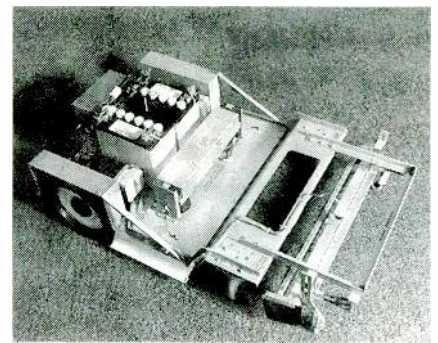

FIG. 9—THE COMPLETE LAWN RANGER unit. We will get to the mechanical assemblies in later issues.

thing together.

By the way, for a sneak preview look "under the hood," of what the Lawn Ranger will eventually look like, Fig. 9 shows the complete mechanical assembly, without the cover. You can see that everything fits together in a nice, compact package.

For those of you who still doubt the Lawn Ranger's capabilities, a VHS demo tape can be purchased, showing the unit in action; it's sure to make you a true believer. The cost of the tape is refundable with an order (see the Parts List for details). **R-E**

BUILD A GENERIC LINEAR POWER SUPPLY BOARD

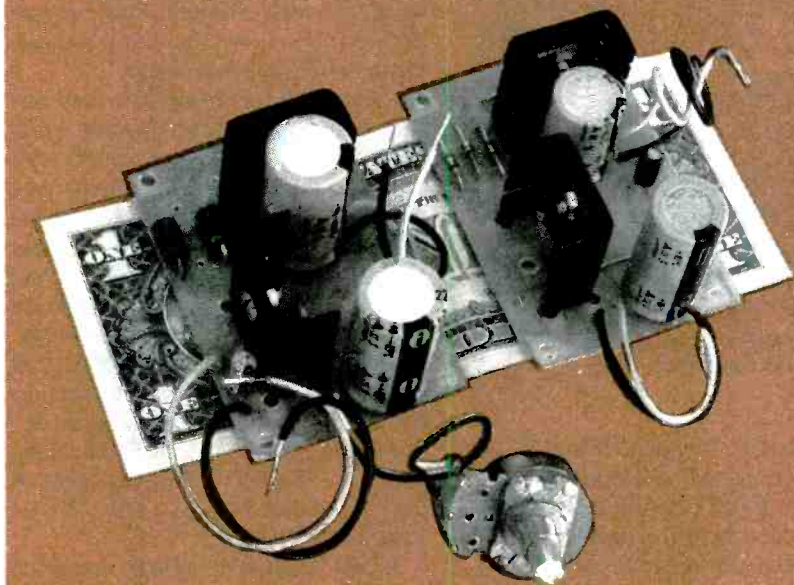

Why go through the trouble of designing a custom power supply every time you build a new project? This single PC board can fill all of your power-supply needs!

JOHN WANNAMAKER

ARE YOU TIRED OF LAYING OUT YET ANOTHER PC board for some special power supply? Here's a possible solution to lessen the trauma: the EZ-DC generic power-supply PC board, designed to give you a choice of one or two linear supplies on a single 2×3-inch PC board. The layout is very versatile, and while one supply produces a fixed-positive voltage, the other can have any value desired. The choices are:

- Two fixed-positive supplies.
- One fixed-positive, and one adjustable-positive supply.
- One fixed-positive, and one fixed-negative supply.
- One fixed-positive, and one adjustable-negative supply.

Of those configurations, the supplies can be either half-wave or full-wave, when a transformer with a center-tapped secondary is used, or you can build a single full-wave bridge of either polarity. You can also make it adjustable or not, as you prefer. Dual isolated grounds are possible. For the TO-220/221A regulators, there are four different 3-terminal pinout configurations, which made the layout of

the EZ-DC quite challenging. Whether or not to rotate the regulator 180° helped reduce the reconfiguration problem to one of selective placement of jumpers.

The EZ-DC is a good basis for a bench supply. With two PC boards, you can build two fixed-positive sources, an adjustable-positive source, and an adjustable-negative source, all with or without isolated grounds. Each supply provides for a millimeter to be inserted at its regulator input. In one supply on each PC board, the meter replaces a jumper. In the other, two adjacent pads are provided for meter leads. The foil connecting the two pads has to be cut with a razor blade or X-acto knife to use the meter; the point is marked by an arrowhead and an "X."

Different power-supply types

● Separate fixed-positive full-wave supplies with common grounds.

Figure 1 shows a dual, full-wave, fixed-positive supply, using a common ground. Fig. 1-a shows the pinouts of the two regulators, Fig. 1-b shows the schematic, and Fig. 1-c shows the parts placement diagram.

Supply #1, on the lower half of the PC board, is always fixed positive. Supply #2, on the upper half of the PC board, can be varied in configuration, and is, in this case, also fixed positive. Since the center-tapped transformer supplies equal voltages to each regulator, the most efficient arrangement is for both IC's to regulate to identical (or nearly so) voltages, such as +12 and +15 volts.

Where the difference is considerable, as between a +5- and a +12-volt supply, the lower voltage regulator must drop 7 volts more than the higher one, and its load current must be limited accordingly. Since the voltage drop across the regulator is multiplied by the load current to determine the regulator power dissipation, the lower the voltage, the more current that's available. The less power consumed by the regulator, the more that's available to the load.

However, there has to be some drop across the regulator or it won't work. This is nominally 2 volts for the 78XX/79XX fixed-voltage series, and about 2.5 volts for the LM317/LM337 adjustable models. Also, the regulator needs a standby current of

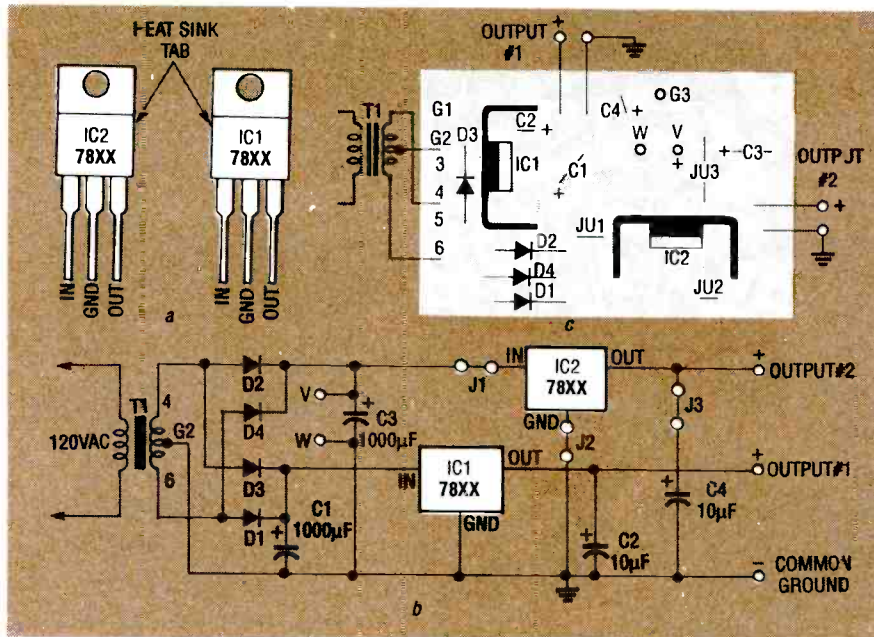

FIG. 1—A DUAL SUPPLY, WITH TWO fixed-positive sources. The pinouts of IC1 and IC2 are shown in (a), the schematic is shown in (b), and the parts placement diagram is shown in (c), with supply #1 on the bottom, and supply #2 on top. This same order of (a)–(c) is used throughout all succeeding figures, except Figs. 4 and 7.

3–10 milliamps, ignored here. Expect any current monitoring at the provided points to reflect this error.

A milliammeter would be inserted in supply #2 in place of jumper JU1, with the negative terminal connected nearest to the heatsink when monitoring a positive supply. In supply #1, connect the meter to the two pads near the right wing of the lower heatsink. Cut the foil between these two pads at point X as already mentioned. The negative meter lead goes to the pad

nearest to IC1. Two pads V and W on both PC board and schematic are used here. Extra filtering capacitance can be added here for supply #2, or these points can provide unregulated voltage for noncritical circuits. Pay attention to the polarity at point V which depends on the polarity of supply #2; point W is ground.

• **Separate fixed-positive and fixed-negative full-wave supplies.** In Fig. 2, supply #1 is fixed-positive as before. The difference is how supply

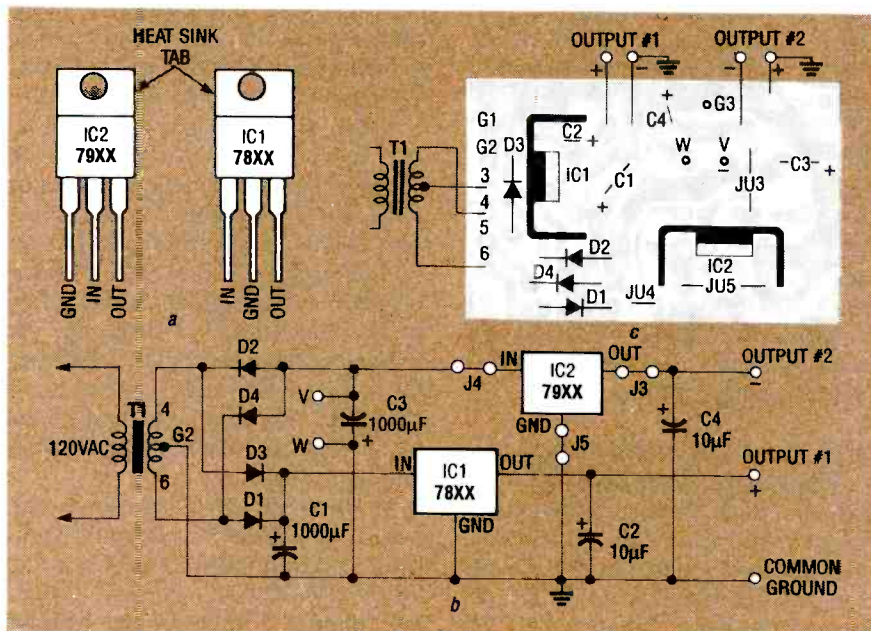

FIG. 2—A DUAL SUPPLY, WITH SEPARATE fixed-negative and fixed-positive sources. The organization of (a)–(c) is that of Fig. 1, but supply #2 has been made negative by reversing D2, D4, C3, and C4, and using a 79XX for IC2 in stead of a 78XX.

#2 is jumpered, to accommodate a fixed-negative regulator, like the 79XX/79MXX series; the “M” denotes medium-power versions, which are harder to find. Since load currents of less than 500 milliamps are suggested to prevent overheating, you should try to find the “M” versions, if possible. Again, due to the transformer’s equal voltage distribution, equal but opposite polarity regulators would be most efficient. Some general information on selecting the transformer will be given later.

• **Separate fixed-positive and adjustable-positive half-wave supplies.** Figure 3 shows supply #2 with an adjustable regulator in a half-wave configuration, where both it and the heatsink are rotated 180° from the fixed regulator position. Don’t use this version in applications where the load current exceeds 200 milliamps. Extra capacitance at V and W will give a smoother input to the regulator, but strains the transformer and diodes due to the higher half-wave charging currents. The accompanying table in Fig. 3-d shows $V_{2(MAX)}$ for different values of R1 and R2.

While current demands could be excessive, the voltage distribution with this arrangement may be advantageous. With one end of the winding grounded, the center tap supplies modest voltage for a low-voltage fixed supply, and the other end provides double that voltage from the adjustable supply. Where higher current is required, the diode and transformer arrangement shown in Fig. 4 is suggested instead.

• **Separate fixed-positive and adjustable-positive full-wave supplies.** The more features you want in any piece of equipment, the more it’s going to cost, and the EZ-DC is no exception. The best transformer arrangement, shown in Fig. 4, uses two transformers with center-tapped secondaries, or a single transformer with dual center-tapped secondaries, if you’re able to find one. The relevant segment of schematic is shown in Fig. 4-a, and the relevant segment of the parts placement diagram is shown in Fig. 4-b.

Supply #1 always has the layout shown in Fig. 1, and you can take the layout for supply #2 from any other version you prefer, in any of the figures. For example, copy the upper part of Fig. 2 for a fixed-negative supply (remember to reverse D2 and D4),

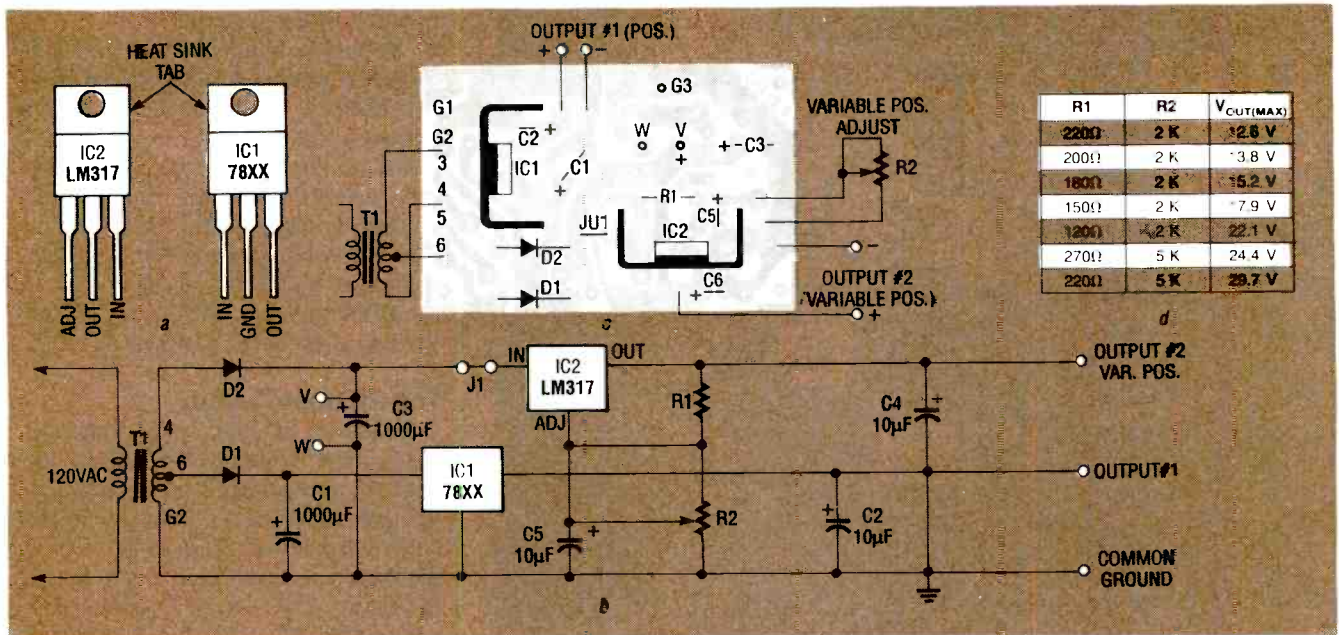

FIG. 3—A DUAL SUPPLY, WITH SEPARATE fixed-positive and adjustable-positive sources. Supply #2 is now made adjustable-positive, changing the jumpers as indicated, changing IC2 to an LM317, adding potentiometer R2, and shifting the other parts as shown. Also, only D1 and D2 are used, and the secondary of T1 is rewired. The accompanying table in (d) shows $V_{2(MAX)}$, for different values of R1 and R2.

other adjustable-negative, is shown in Fig. 5. It's got the same limitations as the version shown in Fig. 3. For the greater current a full-wave supply can provide, use the rectifier arrangement shown in Fig. 4 (reversing D2 and D4), with the layout shown in Fig. 5. If you use a transformer with no center tap, D1 is connected as shown by the dashed lines. In that case, jumper pad 3 to pad 5 with JU7, and remove the connection to pad 6.

The output pad is closer to the heat-sink than you might prefer, but all patterns have multiple output points. Examine the foil pattern and select your own output pad. Always select a ground nearest the filter capacitor's ground connection to minimize hum, and use separate grounds for each supply.

• **Separate fixed-positive full-wave supplies with isolated grounds.** The arrangement for isolating the grounds between full-wave rectifiers is shown in Fig. 6. While this version has dual fixed-positive supplies, that needn't be the case. Use any version for supply #2 you want, but watch the diode polarities. Cut the foil at the "Z" by the ground foil, and then the transformer secondary pads, isolating 3 from 4, and 5 from 6.

Arrowheads on the foil side show the exact points to cut. If you connect the supplies in series, the total output voltage is the sum of both. You can assume both regulators to be passing identical currents, but not necessarily dissipate the same power, since their regulator drops may differ.

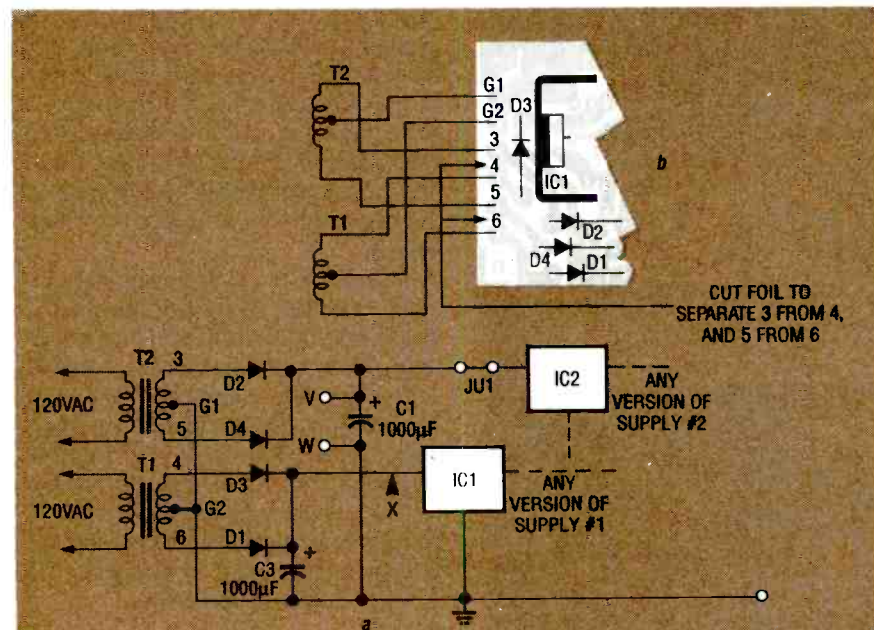

FIG. 4—DUAL FULL-WAVE RECTIFICATION for a fixed-positive supply #1, using either two single-secondary transformers, or a single dual-secondary version; (a) is the relevant segment of schematic, (b) is relevant segment of the parts placement diagram. Only the lower half of the PC board (supply #1) is shown; you can design the upper half (supply #2) as you wish. For example, copy the upper half of Fig. 3 for an adjustable-positive supply, or the upper part of Fig. 5 if you want an adjustable-negative dupply (remember to reverse D2 and D4).

or the upper part of Fig. 3 for an adjustable-positive supply, or. If you'd rather calculate your own values than use those provided in the table accompanying Fig. 3, use the following formula:

$$V_2 = 1.25 \text{ volts} \times [1 + (R2/R1)].$$

For best results, keep: $R1 < 240$ ohms. There's no way to control the minimum output, which should be about 1.25 volts.

• **Separate fixed-positive and adjustable-negative half-wave supplies.** A version with dual half-wave supplies, one fixed-positive and the

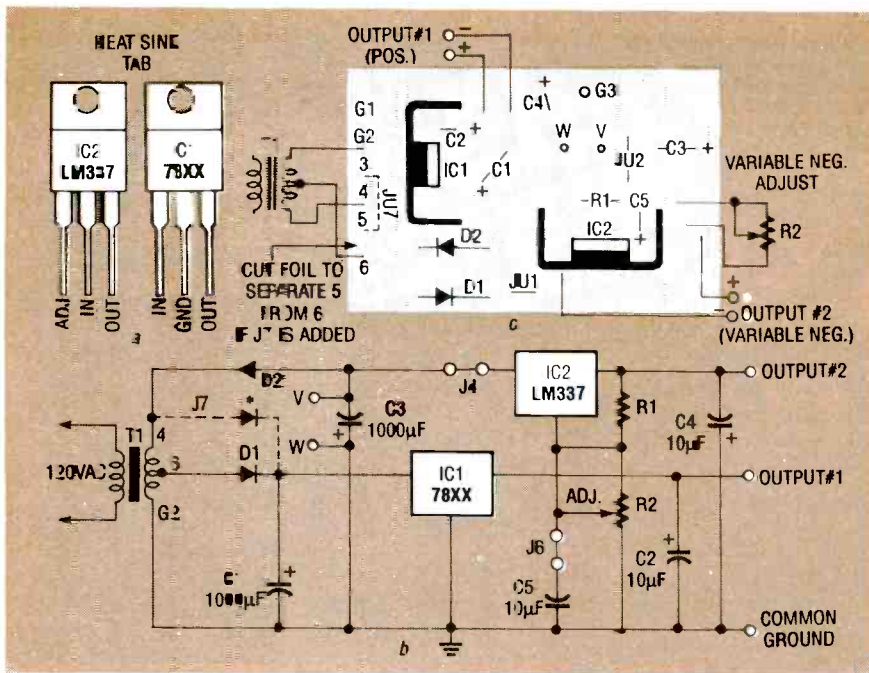

FIG. 5—A DUAL SUPPLY, WITH COMBINED fixed-positive and adjustable-negative sources; it has the same limitations as Fig. 3. For greater current, use the full-wave approach of Fig. 4, with the layout shown here. The D1 shown using dashed lines is connected this way for a transformer with no center tap. In that case, jumper pad 3 to pad 5 with JU7, removing the connection to pad 6.

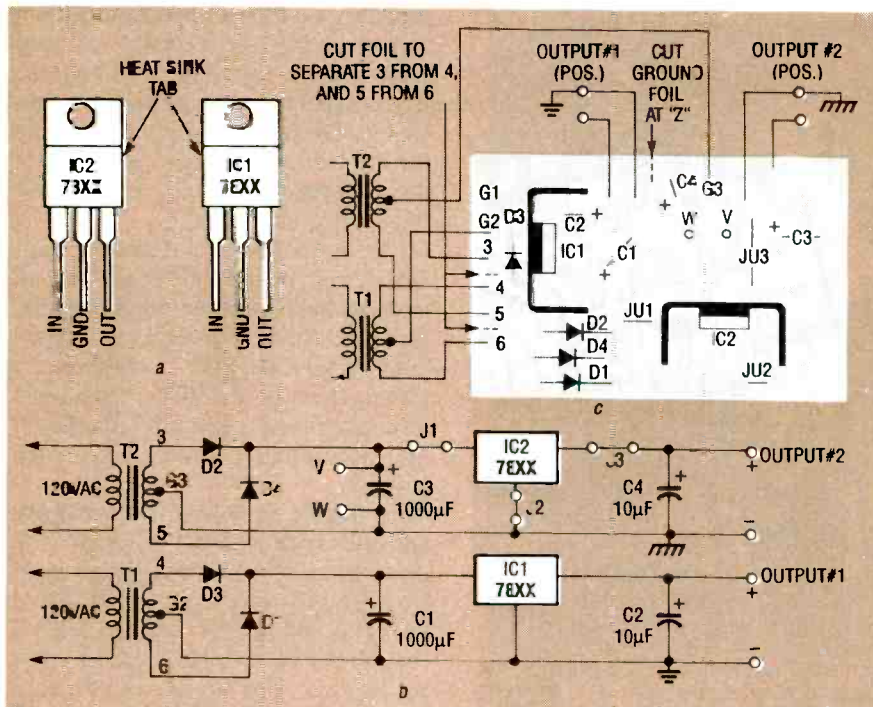

FIG. 6—TWO SPILT-GROUND fixed-positive full-wave supplies. You can use any other version you want for supply #2, but watch the diode polarities. With a razor blade or X-acto knife, cut the ground foil at the "Z." Then, cut the transformer secondary pads at the arrowheads, isolating 3 from 4, and 5 from 6. If you connect the supplies in series, the total output voltage is the sum of both. Assume both regulators pass identical currents, but don't necessarily dissipate identical power, since their regulator drops may differ.

• **A single full-wave bridge supply.** The connections for a full-wave bridge are shown in Fig. 7. Figure 7-a shows the relevant segment of the schematic, and Fig. 7-b shows the relevant segment of the parts place-

ment diagram. Don't forget JU8 where an electrolytic would normally go. Again, use the top of the PC board for any version, whether positive, negative, fixed, or adjustable—but note the the diodes are shown for a

positive supply and must all be reversed if yours is negative.

• **Separate fixed-positive and adjustable-positive supplies from a car battery.** Figure 8 assumes that you use a standard +5-, +6-, or +8-volt regulator for IC1, and an adjustable version for IC2; the output of the second regulator is adjusted by R1 and R2. The accompanying table in Fig. 8-d gives V_2 to within 50 millivolts for different values of R1 and R2, but you can also use the previous formula.

The PC board layout

To ensure that the wide ground foil holds hum to under 1 millivolt, the best soldering layout was sacrificed; you may need to use more heat and solder than usual. Use 4-40 or 6-32 machine screws in the corner holes for mounting. One corner is attached to the ground foil as a metal spacer to electrically connect the PC board to a metal chassis. If you don't want to use it, cut it away.

The heatsinks are electrically connected to the middle pin of each regulator. For a fixed-positive model, it's ground, but it's different in each case; for example, it's the unregulated input in the adjustable-negative model. A little heatsink silicone grease will help transfer about 20% more heat, and can be worthwhile—especially if the regulators are sourcing very high current.

If you use the recommended heatsinks with the three through-the-PC board tabs, be careful you don't bend them underneath and cause a short. Space was left hoping to avoid this, but watch it. The regulators are fairly close to the edges of the PC board to possibly heatsink to a metal cabinet with a screw. Measure the tab's potential, to be sure it's grounded, and use insulation if needed. If you want full 1-A load current, use a fan.

Selecting components

Don't consider the following the last word on how to select power-supply parts. This is an abbreviated method to keep you from going very wrong with practical advice from personal observations. The transformer is a good starting point because they're "ifly," at best. Consider the secondary voltage; for example, a 10-volt secondary. With little or no load, you may measure up to 12 volts. If the line voltage is 5% high, you'll measure 12.6 volts. Isn't that reasonable with

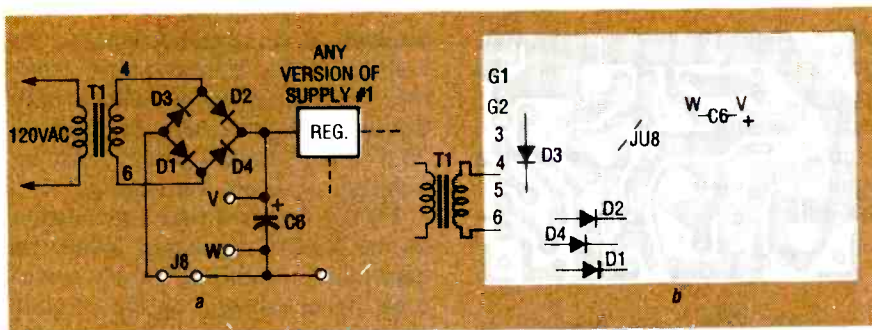

FIG. 7—A FULL-WAVE BRIDGE RECTIFIER as supply #1; (a) is the relevant segment of schematic, (b) is the relevant segment of the parts placement diagram. Remember to reverse D1–D4 for a fixed-negative version. The connections for a full-wave bridge are shown in Fig. 7, and don't forget to add JU8. You can also make supply #2 on top any version, whether positive, negative, fixed, or adjustable.

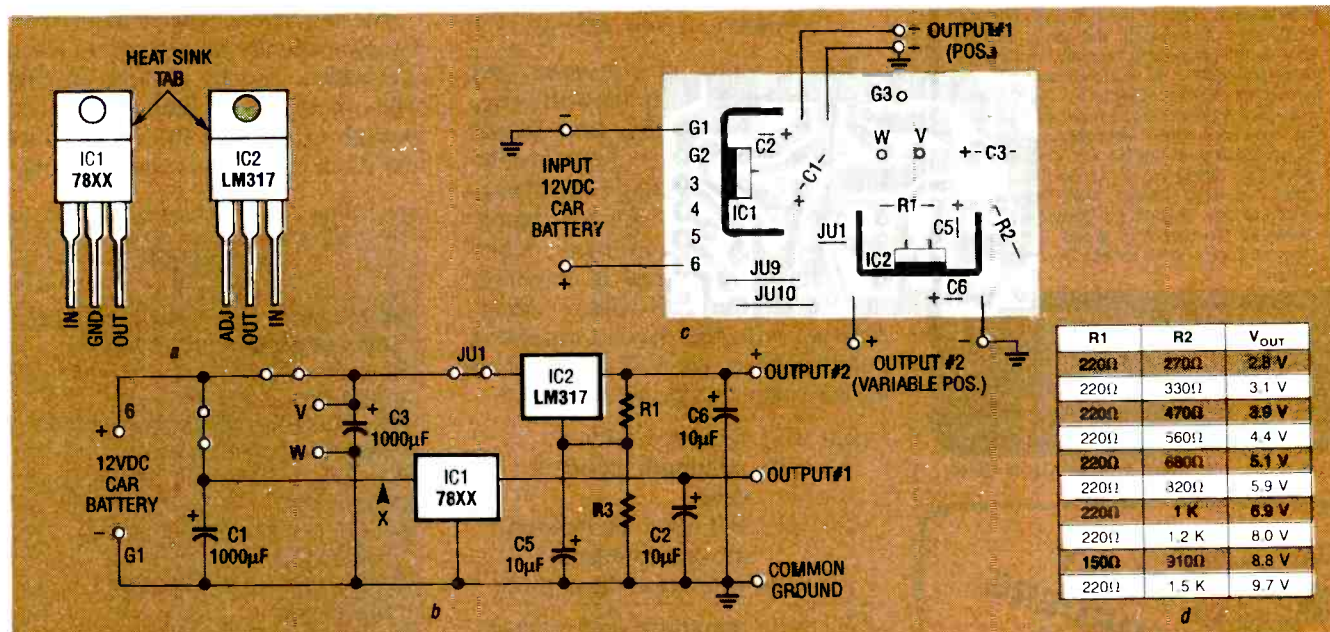

FIG. 8—REGULATING THE VOLTAGE FROM a car battery; the assumption is that IC1 is a standard +5-, +6-, or +8-volt regulator, and that IC2 is adjustable, but set to a non-standard value by R1 and R2. The accompanying table in (d) gives V₂ to within 50 millivolts for different values of R1 and R2, but you can use the formula given in the text.

no load? What's the figure at full load? Try several yourself and see.

In ten transformers sampled, only one was precisely correct at rated load. The average high was 7.56% off, the worst was 12.7%, and these were at the rated 120-volt primary input. Those sampled came from a variety of suppliers, most with a rating of 1 amp or higher. If you order a transformer, you can't be sure what you'll get until you measure it. Since you're dealing with peak value, it may look even worse. What you thought would be merely 14.14 volts may more likely be 15–17.8 volts peak.

The peak value is important, because the electrolytics need to be rated accordingly and the regulator drop is partly dependent on it. Also, a center tap may not always be at the exact electrical center of the second-

ary winding; about 3% error was the worst observed. Assuming a transformer secondary voltage 20% above its rated value is realistic, but don't depend on it. As for RMS current, rate the transformer at 1.2 times the maximum expected load current for full-wave center-tapped, and 1.8 times for a bridge.

The diode voltage ratings should be twice the peak transformer voltage. While you might get by with diodes rated at the maximum load current, you should use ones with *at least* double that limit, for safety, especially for half-wave. The diode will dissipate heat through its leads and the PC board foil, so short leads are best.

The only generalization that can be made about the voltage drop across a diode is that it increases with current under forward bias. Thus, not quite all

the peak transformer voltage is perceived by the electrolytic. Close to rated current, a diode drops about 0.8 volts, and 0.5 volts at low currents. Since the diode normally conducts to recharge the electrolytic, assume a worst-case drop of 1.2 volts. This is the figure to use with either half-wave or full-wave center-tap. With a bridge, two diodes conduct in series, so two drops must be added, for a worst-case of 2.4 volts.

The electrolytic perceives the secondary voltage, minus the diode drop(s). Unless you're right on the

edge of a electrolytic's voltage rating, ignore the diode drop(s) and use electrolytics rated at least equal to peak transformer voltage. In practice, electrolytics are built for safety, so one with a 25-volt rating won't explode if 25.01 volts is used. How much you can get away with depends on the specific electrolytic or individual luck, so don't try it unless desperate. The current into and out of the capacitor causes heating; an electrolytic of large diameter will heat more than two smaller ones with the same capacitance when in parallel, due to less surface area per microfarad.

For an infinitely large capacitor, a constant voltage would be observed at the regulator's input. Most fixed regulators function properly with a 2-volt drop, and 2.5 volts for adjustable versions, so select the electrolytic to get as close to these regulator drops as possible.

Since no electrolytic has infinite capacitance, the regulator voltage

ATTENTION! ELECTRONICS TECHNICIANS

EARN YOUR
**B.S.E.E.
DEGREE**



THROUGH HOME STUDY

Our New and Highly Effective Advanced-Placement Program for experienced Electronic Technicians grants credit for previous Schooling and Professional Experience, and can greatly reduce the time required to complete Program and reach graduation. No residence schooling required for qualified Electronic Technicians. Through this Special Program you can pull all of the loose ends of your electronics background together and earn your B.S.E.E. Degree. Upgrade your status and pay to the Engineering Level. Advance Rapidly! Many finish in 12 months or less. Students and graduates in all 50 States and throughout the World. Established Over 40 Years! Write for free Descriptive Literature.

**COOK'S INSTITUTE
OF ELECTRONICS ENGINEERING**



4251 CYPRESS DRIVE
JACKSON, MISSISSIPPI 39212

CIRCLE 58 ON FREE INFORMATION CARD

NEW SUPER LONG PLAY TAPE RECORDERS

12 Hour Model — \$119.00*
USES D-120 TAPE

Modified Panasonic Slimline, high quality, AC-DC Recorders provide 6 continuous hours of quality recording & playback on each side of cassette for a total of 12 hours.
Built-in features include:
• Voice level control. • Digital counter, etc. TDK DC 120 Cassette Furnished.



PHONE RECORDING ADAPTER

Records calls automatically. All Solid state connects to your telephone jack and tape recorder. Starts recording when phone is lifted. Stops when you hang up. **\$28.50***



VOX VOICE ACTIVATED CONTROL SWITCH
Solid state. Self contained. Adjustable sensitivity. Voices or other sounds automatically activate and control recorder. Uses either recorder or remote mike. **\$28.50***



*Add for ship & hdg. Phone Adapter & Vox \$1.50 ea. Recorders \$4.00 ea. Cal. Res. add tax. Mail order, VISA, M/C, COD's OK. Money Back Guarantee. Qty. disc. avail. Dealer inquiries invited. Free data.
AMC SALES INC. Dept. A9335 Lubec St., Box 928, Downey, CA 90241 Phone (213) 869-8519

CIRCLE 108 ON FREE INFORMATION CARD

isn't constant. The average input voltage varies with load current, and the ripple voltage increases in peak-to-peak value with current. At its lowest value during worst-case ripple, the regulator drop must be at least 2 volts. The following formula for the minimum required electrolytic size in μF is a good approximation:

$$C_{\text{filter}} = 6000 \times I_{\text{load}} / V_{\text{ripple}}$$

For example, if maximum load current is 0.5 amp, and ripple voltage is 2 volts P-P, the minimum electrolytic size is:

$$C_{\text{filt}} = 6000 \times 0.5 / 2 = 1500 \mu\text{F}$$

This is valid for full-wave, but needs to be doubled for half-wave. Now, work backwards, from output back to transformer, to determine the minimum peak voltage the transformer has to deliver. For now, ignore any over-voltage condition, since that's mainly important in determining the electrolytic's voltage rating. Starting with the desired regulated output voltage, say +12 volts, add up all the voltage drops present:

- 12.0 volts regulated output
- 2.0 volts minimum regulator drop
- 2.0 volts P-P ripple (somewhat arbitrarily selected)
- + 1.2 volts worst case diode drop

- 17.2 volts minimum peak voltage from transformer secondary

Multiplying this sum by 0.7071 gives 12.16 volts, the minimum tolerable RMS secondary voltage. This works well with a normal 12.6-volt secondary, but with only a 3% cushion for a low line-voltage condition. With the extra voltage the transformer provides, it should be efficient—for a linear supply. If the figures are too high for a standard transformer, consider using extra capacitance to achieve smaller ripple.

If you can select the transformer from several already on hand, or can afford a little extra cost, a transformer with twice the anticipated current rating could mean an extra volt or more in the secondary voltage. A higher secondary voltage will manifest itself as a higher regulator drop, causing more heating for any given load. This problem is insoluble when using an adjustable regulator to provide from 1.25–25 volts.

A clean 27.5 volts would have to be

available at the regulator input to accommodate the highest output. However, when adjusted downward to only 2 volts, the regulator drop increases to 25.5 volts. Output current must be reduced to prevent overheating.

Finally, here's a little information on the TO-220 regulators. While the adjustable models can handle somewhat higher voltage, consider 35 volts as a maximum for all. This includes the fixed versions from 5–15 volts, inclusive. This same 35-volt figure was kept in mind as a capacitor rating when considering component sizes.

The regulators protect themselves by automatically shutting down when overheated, and by current limiting when shorted. This limit may still be enough to damage the transformer and diodes. You can consider a reg-

PARTS LIST

All resistors are ¼-watt, 5%, unless otherwise indicated.

- R1—150–270 ohms (see Figs. 3 and 8)
- R2—2000- or 5000-ohm cabinet-mounted potentiometer
- R3—270–1500 ohms (see Fig. 8)

Capacitors

- C1, C3, C6—1000 μF , 16 volts, electrolytic
- C2, C4, C5—10 μF , 30 volts, electrolytic

Semiconductors

- D1–D4—1N4004 or 1N5404 silicon rectifier diode or equivalent
- IC1, IC2—78XX, 79XX, LM317, and/or LM337 3-terminal TO-220 voltage regulators (see text)

Miscellaneous: one or more copies of the PC board (see PC Service), suitable cabinet, red and black banana jacks, one or more 3-terminal regulator heatsinks (JAMECO part number 6030B), 1/32-inch and 1/8-inch drill bits, wire, solder.

ulator as a 1.5-watt device with no heatsinking, a 5-watt device with fairly good heatsinking, and a 12-watt device with excellent heatsinking and air circulation.

To get a rough idea of safe operation, let one operate under worst-case conditions for five minutes, and then applying a tiny drop of room-temperature water to the top of the its heat-sink tab. Even if a heatsink is attached, apply the water only to the top of the tab—awkward, but possi-

(Continued on page 58)

BUILD THIS PROGRAMMABLE CRYSTAL-CONTROLLED PULSE GENERATOR

*Build a single-chip
pulse generator using a
programmable crystal oscillator IC.*

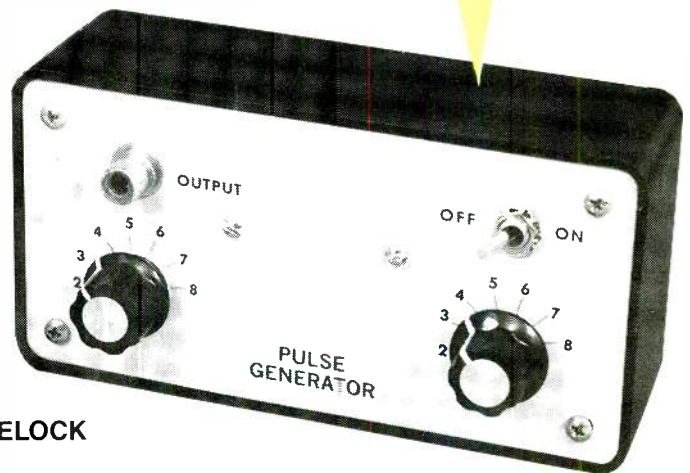

PETER A. LOVELOCK

UNTIL RECENTLY, BUILDING AN INEXPENSIVE, calibrated frequency source has generally involved dividing the output from a crystal oscillator to the specific frequency desired. Figure 1 shows a 1-MHz crystal oscillator feeding a series chain of TTL decade counters to illustrate the technique.

A significant improvement is provided with the recent advent of the Statek Corp. (512 N. Main St., Orange, CA 92668) PXO series of Programmable Crystal Oscillators. These are hybrid IC's with on-board crystal oscillators mounted in 16-pin DIP's, drastically reducing the total PC board space and power required.

All members of the PXO series are identical internally, differing only in the base crystal frequency. The user can select any one of 57 different frequency-divider ratios, using two internal, series frequency counters, each with three TTL-compatible external taps for setting the divider ratios.

Figure 2 is a block diagram of the PXO-1000; it has an 1-MHz internal crystal, and two internal programmable frequency dividers, with ratios available to let the user select output frequencies ranging from 0.0083 Hz–1 MHz. The IC was also made with provision for using an external

source to provide a base frequency that differs from any of the standard manufactured values of the PXO chips.

These IC's also allow either computer control of the frequency selected, by varying the logic levels of the taps, or manual control using either DIP or rotary switches. The PXO-1000 has ± 100 ppm accuracy and $\pm 0.015\%$ stability at room temperature, and consumes only 3.5 milliwatts, or 0.7 milliamps at 5 volts DC. The other standard available base crystal frequencies are 326.68 kHz (the PXO-32768), 600 kHz (the PXO-600), and 768 kHz (the PXO-768).

The PXO-1000

The drawback to the divide-by-N counter shown in Fig. 1 is the need for eight separate counters and a separate crystal oscillator. If 7490 divide-by-10 counters are used, the circuit will take up about 7 square inches on a PC board, and draw 45 milliamps at 5 volts DC for each IC. Thus, the dividers draw $P = I \times E = 8 \times 45 \times 5$ volts DC = 1.8 watts, and the oscillator an additional 0.1 watt, a total of 1.9 watts, a load that makes battery operation impossible.

By contrast, the PXO-1000 shown

in Fig. 2 uses under 1 square inch of PC board real estate, and only 3.5 milliwatts—perfect for battery operation. The output is available on pin 11 (f_{OUT}), and the external clock for special cases can be applied to pin 12 (EXC). Both clocks are fed to the clock-select logic, allowing selection between either one depending on the state of pin 13 (CSEL), the internal clock if low, the external clock if high.

The output of the clock-select logic feeds the two internal programmable counters. They're in series, so the total frequency division factor is the product of the two. The first can be set to divide by 1, 2, 3, 4, 5, 6, 10, or 12, while the second divides by a power of ten, ranging from 1–10⁷, inclusive.

There are eight possible settings for each, since there are three control bits for each and $2^3 = 8$. If all the divider ratios were unique, there'd be 8×8 or 64 distinct frequency divider settings possible. However, since *both* the first and second counter can divide by 1 and 10, seven of those 64 factors will be duplicated.

The PXO-1000 is programmed using pins 2–4 ($P_3P_2P_1$) and pins 5–7 ($P_6P_5P_4$); these are the frequency counter control bits. Setting any of them to V_{CC} constitutes a logic high,

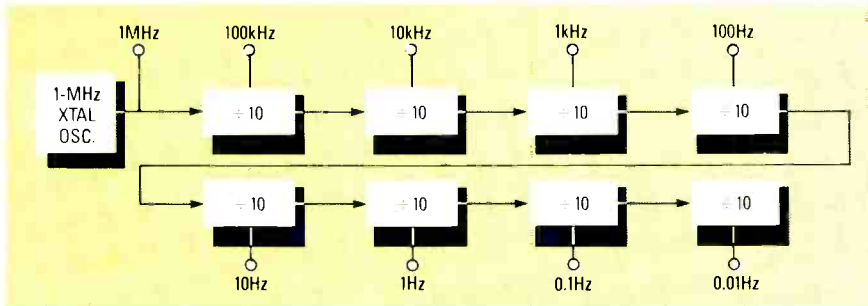

FIG. 1—GENERAL PURPOSE PULSE GENERATOR needs a 1-MHz crystal oscillator driving a chain of high-power TTL decade counters like the 7490 4-bit decade counter.

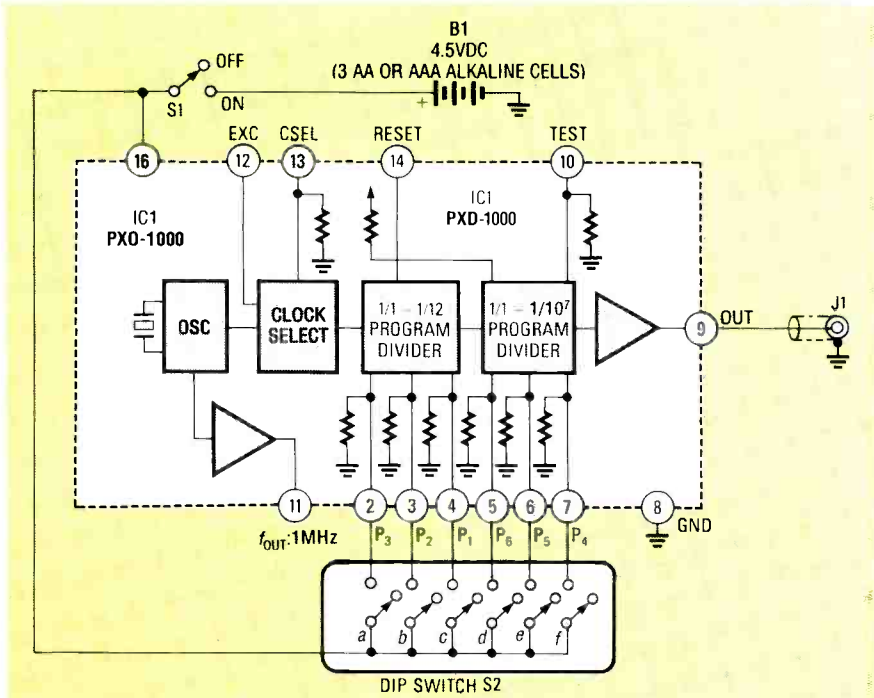

FIG. 2—BLOCK DIAGRAM OF PXO-1000 IC programmable frequency divider with internal 1-MHz quartz crystal oscillator. Frequency division ratios are selected by setting DIP switch S2; 57 distinct frequencies in the range from 0.0083 Hz–1 MHz can be generated. Each of the SPST switches a–f in S2 control a single bit from among pins 2–7 ($P_3P_2P_1$ and $P_6P_5P_4$), the select lines for the two counters. Here, a +4.5-volt DC supply using B1 provides power.

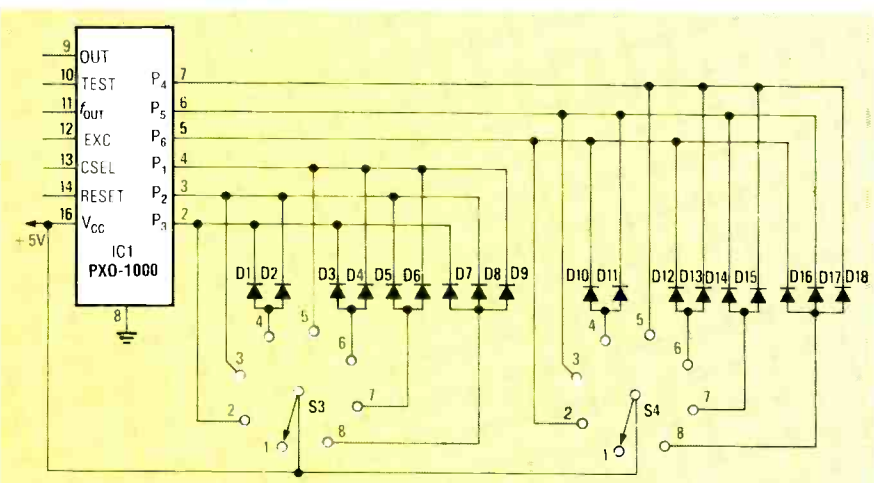

FIG. 3—ROTARY SWITCHES AND DIODE MATRIX D1–D18 set the frequency counters of the PXO-1000, eliminating DIP switch S2 in Fig. 2. D1–D18 act to block incorrect bits from among pins 2–7 ($P_3P_2P_1$ and $P_6P_5P_4$) from being set high. D1–D9 acts with S3 to control $P_1P_2P_3$, while D10–D18 acts with S4 to control $P_4P_5P_6$. S1, the ON/OFF switch, and J1, both present in Fig. 2, have been omitted, but would be needed here.

and ground to a logic low. The frequency division effect of pins 2–7 ($P_3P_2P_1$ and $P_6P_5P_4$) is summarized in Table 1.

The settings of pins 2–4 ($P_3P_2P_1$) aren't in directly ascending order for the first counter. At the low end, the frequency division factor jumps from 1 for a setting of 000 to 10 for 001, and back down to 2 for 010, while at the high end, the factor jumps from 6 for 110, to 12 for 111. However, the settings for pins 5–7 ($P_6P_5P_4$) do go in order, and the binary number corresponding to these three bits is the exponent of the power of 10 for the frequency division factor involved. Thus $P_4P_5P_6 = 100$ is binary for 4, or a division factor of 10^4 .

If the eight possible settings for the two 3-bit groups are arranged as an 8×8 matrix, the output frequencies appear as the 64 entries in Table 2. As mentioned above, seven frequencies are duplicated, so there are only 57 distinct frequencies. In Fig. 2, they are generated by programming the two counters using DIP switch S2. Thus, the entries for row two are shifted one column left from those of row one.

For example, to generate 100 kHz, you can use settings of either $P_1P_2P_3P_4P_5P_6 = 000001$ or 001000 . As a more general example, $P_1P_2P_3P_4P_5P_6 = 100010$ causes division by $4 \times 10^2 = 4 \times 100 = 400$. Since the crystal frequency is 1 MHz, the output frequency is $f_{OUT} = 1 \text{ MHz}/400 = 2.5 \text{ kHz}$.

Figure 3 shows an alternative manual approach using rotary switches S3 and S4 to control diode matrix D1–D18, if you find using a DIP switch awkward. In this case, S3 selects the decade frequencies from 0.1 Hz–1 MHz, while S4 selects the eight output divisions from $1/1$ – $1/12$, determining the final output frequency, as shown in Table 2. Also, you can see that the +4.5 volts DC from battery B1 in Fig. 2 has been replaced in Fig. 3 with +5 volts DC, which is also acceptable.

If you're only interested in 0.1 Hz–1 MHz using the second counter, then exclude S3 and D1–D9, leaving pins 2–4 ($P_3P_2P_1$) open. Likewise, if you're only interested in division by the integer factors provided by the first counter (1, 2, 3, 4, 5, 6, 10, and 12), you can similarly exclude S4 and D10–D18, leaving pins 5–7 ($P_6P_5P_4$) open. The parts placement diagrams

TABLE 1—PXO-1000 FREQUENCY DIVIDER PROGRAMMING CODES

P ₁	P ₂	P ₃	DIVIDER RATIO	P ₄	P ₅	P ₆	DIVIDER RATIO
0	0	0	1/1	0	0	0	1/1
0	0	1	1/10	0	0	1	1/10
0	1	0	1/2	0	1	0	1/10 ²
0	1	1	1/3(*)	0	1	1	1/10 ³
1	0	0	1/4	1	0	0	1/10 ⁴
1	0	1	1/5(**)	1	0	1	1/10 ⁵
1	1	0	1/6	1	1	0	1/10 ⁶
1	1	1	1/12	1	1	1	1/10 ⁷

Notes: (a) 33.3% duty cycle (*);
 (b) 40% duty cycle (**);
 (c) All others 50% duty cycle.

for the PC boards and the part layout for the DIP- and rotary-switch versions of the PXO-1000 are shown in Figs. 4 and 5, respectively. The PC foil patterns for both versions are shown in PC Service.

Note that pins 10–15, the special function pins of the PXO-1000, are

unused. Should you wish to use them, several have already been discussed. Of the remainder, pin 10 (TEST), when set high, multiplies the output frequency by 1000, except when the product of the programmed divider ratios for each counter is under 0.001. Pin 14 (RESET) resets both counters

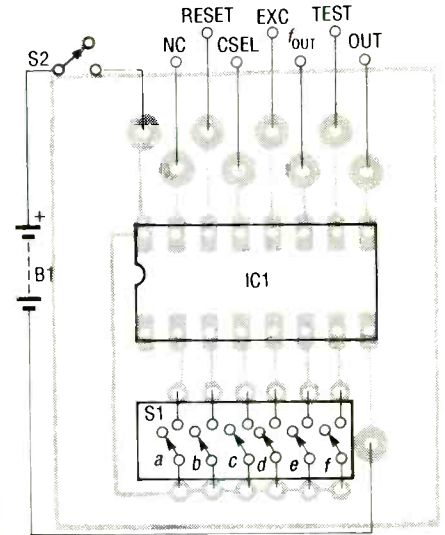

FIG. 4—PARTS-PLACEMENT DIAGRAM for the dip-switch version of the PXO-1000 circuit.

when set low, and sets pin 9 (OUT) low. Also, all inputs except pins 12 (EXC) and 14 (RESET) have internal pull-down resistors, whereas pin 14 (RESET) has an internal pull-up resistor.

Construction

Both the DIP- and rotary-switch versions in Figs. 2 and 3 can be installed in small plastic or metal enclosures with three AA or AAA

TABLE 2—PXO-1000 DIVIDER FREQUENCIES

S ₄				1	2	3	4	5	6	7	8
S ₃	S ₂		P ₄	0	0	0	0	1	1	1	1
			P ₅	0	0	1	1	0	0	1	1
	P ₁	P ₂	P ₃	0	1	0	1	0	1	0	1
1	0	0	0	1 MHz	100 kHz	10 kHz	1 kHz	100 Hz	10 Hz	1 Hz	0.1 Hz
2	0	0	1	100 kHz	10 kHz	1 kHz	100 Hz	10 Hz	1 Hz	0.1 Hz	0.01 Hz
3	0	1	0	500 kHz	50 kHz	5 kHz	500 Hz	50 Hz	5 Hz	0.5 Hz	0.05 Hz
4	0	1	1	333.3 kHz(*)	33.3 kHz	3.33 kHz	333.3 Hz	33.3 Hz	3.33 Hz	0.33 Hz	0.033 Hz
5	1	0	0	250 kHz	25 kHz	2.5 kHz	250 Hz	25 Hz	2.5 Hz	0.25 Hz	0.025 Hz
6	1	0	1	200 kHz(**)	20 kHz	2 kHz	200 Hz	20 Hz	2 Hz	0.2 Hz	0.02 Hz
7	1	1	0	166.67 kHz	16.67 kHz	1.67 kHz	166.67 Hz	16.67 Hz	1.67 Hz	0.167 Hz	0.0167 Hz
8	1	1	1	83.3 kHz	8.3 kHz	833.3 Hz	83.3 Hz	8.3 Hz	0.83 Hz	0.083 Hz	0.0083 Hz

Notes: (a) 33.3% duty cycle (*);
 (b) 40% duty cycle (**);
 (c) All others 50% duty cycle.

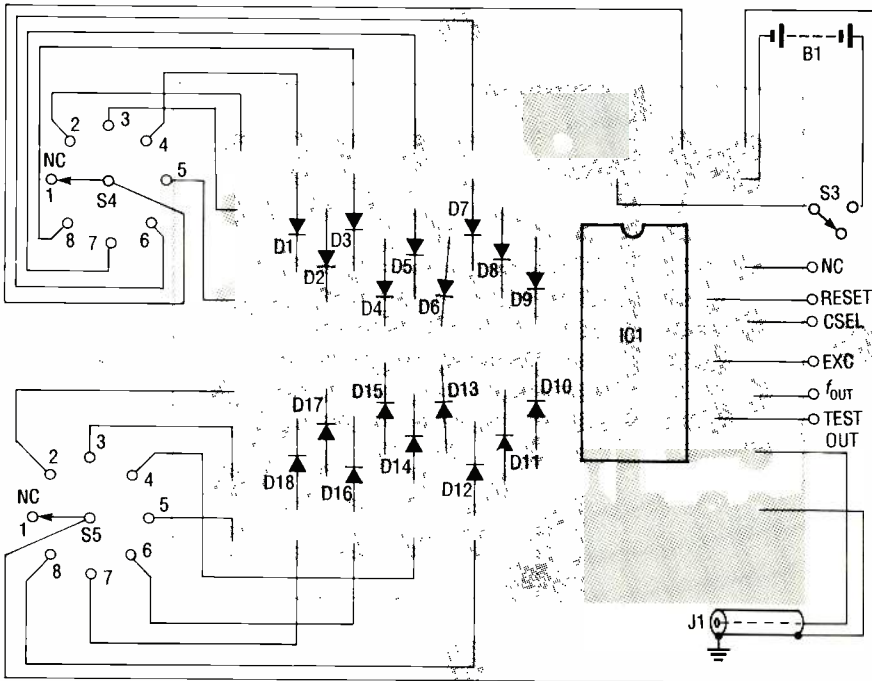

FIG. 5—PARTS-PLACEMENT DIAGRAM FOR THE ROTARY-SWITCH version of the PXO-1000 circuit.

PARTS LIST

Semiconductors:

D1–D18—1N4148, switching diodes
IC1—PXO-1000, programmable crystal oscillator

IC2—7400 quad TTL NAND gate (see text about precision timing application)

Other components:

B1—4.5-volt DC supply using three 1.5-volt DC AA or AAA alkaline cells (optional; a 5-volt DC supply could be used instead)

J1—RCA phono jack (for both the DIP- and rotary-switch versions)

S1—miniature SPST toggle switch (for either the DIP- or rotary- switch versions)

S2—DIP switch with 6 SPST switches (for the DIP-switch version)

S3, S4—SP12T rotary switch (for the rotary-switch version)

Miscellaneous: PC board (see PC Service), 3-cell AA or AAA battery holder, suitable plastic box with aluminum cover (for either the DIP- or rotary-switch versions), wire, solder, knobs (for the rotary-switch version), 1/4-inch spacers, and hardware.

Note: The Statek PXO-1000 is available from Ryno Electronics, 1637 North Brian Street, Orange, CA 92667, (714) 637-0200, for \$12.00 postpaid. An etched and drilled PC board (for the rotary-switch version only) is available from R&R Associates, 3106 Glendon Avenue, Los Angeles, CA 90034, for \$3.00 postpaid. For both items, California residents include appropriate sales tax.

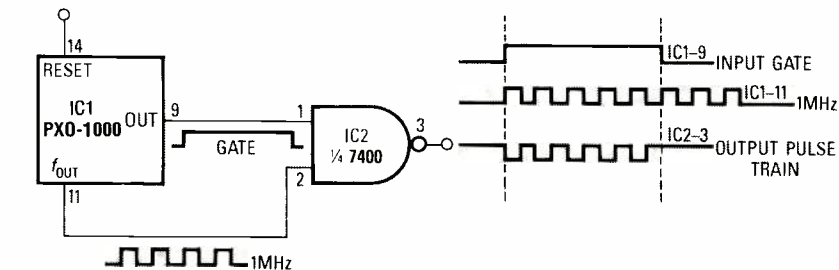

FIG. 6—AN APPLICATION OF PRECISION LOGIC GATE TIMING using the PXO-1000. If you program 10 kHz, NAND-gate IC2 is enabled on each positive half of the output square wave, for a pulse width of 50 μ s. That lets 50 1-MHz square wave pulses from pin 11 (f_{OUT}) of the PXO-1000 pass through IC2 until pin 9 (OUT) goes low on each bottom half of the square wave. In that case, IC2 is disabled, giving a precise gate time. When both inputs go high, the output goes low, inverting the 1-MHz square wave.

alkaline cells. Maximum supply voltage for the PXO-1000 is +6 volts DC. Since the PXO-1000 draws 1 milliamp, three AA cells give hundreds of hours of use.

Mount the PXO-1000 in a low-profile 16-pin DIP socket. Mount both rotary switches and an ON/OFF switch for B1 on the front panel.

The PXO-1000 internal crystal oscillator is available on pin 9 (OUT). It's buffered for TTL or CMOS loads, but you should *never* connect it to a load drawing over 1 milliamp. If you don't know how much current will be used, put a 5K 1/4-watt resistor from pin 9 (OUT) to J1 to limit current. Note that J1 only appears in Fig. 2, not Fig. 3, but you'll need it in both versions.

You may also want a large coupling capacitor from pin 9 (OUT) to the center post of J1, although it'll distort even a low-frequency square-wave output. Use a 3-cell AA or AAA battery holder for B1, a suitable case, and 1/4-inch spacers to keep the board from shorting.

Applications

What can you do with all these frequencies? As mentioned earlier, the range of 0.01 Hz–1 MHz in decade steps can be used for a variety of calibrations, while some other applications may not be as apparent. For example, 5 Hz can drive a clock motor, 1, 25, and 50 Hz are a useful general-purpose time base, 100

Hz–10 kHz are useful for audio, 25 kHz is in the ultrasonic transducer range, 500 kHz–1 MHz is useful for digital applications.

By using period instead of frequency, or $T = 1/f$, you can perform precision logic timing, as shown in Fig. 6. If you program 10 kHz, NAND-gate IC2 is enabled on each positive half of the output square wave, for a pulse width of 50 μ s. That lets 50 1-MHz square wave pulses from pin 11 (f_{OUT}) of the PXO-1000 to pass through IC2 until pin 9 (OUT) goes low on each bottom half of the square wave. In that case, IC2 is disabled, letting you pick a precise gate time. If both inputs go high, the output goes low, inverting the 1-MHz square wave. **R-E**



Everything you need to know about the varieties of surround sound, in the theater and at home.

ALL ABOUT SURROUND SOUND

JOSEF BERNARD

"MOVIES ARE BETTER THAN EVER!" screamed the advertising banners in the middle of the 1950's as theatrical audiences dwindled and stay-at-home TV audiences grew. Hollywood tried everything it could think of to maintain its hold on the vanishing moviegoer: Cinerama, 3-D, CinemaScope, VistaVision, Todd-AO, six-track stereo sound, eight-track stereo sound, Smell-O-Vision (no kidding!), and other schemes now better forgotten. One or two of the concepts and techniques that were introduced during that period proved to have some worth and they or their descendants are with us still today. The stereo and surround sound we enjoy from our audio and video equipment at home are among the benefits that have been derived, at least in part, from the motion picture industry's frantic '50's efforts.

Early attempts

Of the early efforts to provide realistic sound in a theatrical environment, perhaps the best remembered (if it is remembered at all) is Walt

Disney Studios' *Fantastound*, a fourteen-track process that was used for Leopold Stokowski's orchestral accompaniment to 1940's animated *Fantasia*. Each member of an array of microphones spread out before the orchestra picked up the sound emanating from its region. The signal from each mike was recorded on its own soundtrack and during playback was reproduced by a speaker positioned behind the screen in a location corresponding to that of the mike during recording. The effect was a realistic spread of the orchestra before the theatrical audience.

With the cinematic wide-screen spectacles of the '50's came multi-track stereophonic—actually, surround—sound. Mike Todd's wide-screen extravaganza *Around the World in 80 Days* included such effects as a train (with the theatergoer as passenger) crossing a rickety old bridge; you could hear the steam engine in front of you and the clickety-

clack of the wheels on the rails being reflected from the girders of the bridge on either side of you as you passed them. Wow!

At home, in the late '50's and early '60's, record players (there weren't many audiophiles with turntables back then) and a very few tape recorders went stereophonic. By that time it had been realized that a more-or-less convincing soundstage could be recreated in front of the listener from just two channels of sound, one carrying left-ear information and the other carrying that for the right ear. The term "binaural" was sometimes used in place of "stereophonic," but its use soon became reserved for a specific method for stereophonic recording and listening, one with which most people did not wish to become involved because of its inconvenience.

The binaural technique, which enjoys a very limited—but extremely spirited—popularity today requires special recording techniques, and

binaural recordings must properly be auditioned through earphones. Only two microphones are used. The idea is to reproduce as closely as possible the sound of a performance (or environment) as it is perceived by the ear. To this end, binaural recording techniques have used models of the human head (and ear) fitted with microphones (see Fig. 1), and even microphone mounts that were affixed to real, live, human heads. When prepared properly and with care, a binaural recording can provide the listener with a surround sound experience that includes not only front, sides and rear, but up and down as well. Earphones must be used to deliver the sound directly to the ear and preserve the phase relationships of the signal as recorded.

In the late 1970's, home discophiles could have their choice of two systems for four-channel recordings (SQ and QS), with two speakers in front and two behind (see Fig. 2). Both used matrixing systems to encode the quadrasonic (sometimes spelled "quadriphonic") signals on black vinyl records, and required new designs in cartridges and styli to retrieve the signals from the record grooves. The two systems offered to the public were incompatible and that, together with a surfeit of gimmicky recordings similar to the "Ping-Pong Stereo" ones that fortunately disappeared quickly from the two-channel scene, caused the quadrasonic movement to founder and sink with only a few diehard survivors left today. There weren't many people who wanted to listen to the Tijuana Brass while sitting right smack in the middle of the band; maybe just a few frustrated horn players.

Extracting ambience

After the failure of quadraphony, the place and purpose of surround sound were reexamined and it was decided that, for the most part, audio channels in addition to the front two conventionally used for stereo should be subordinate to them. It would be OK to have more than two channels, but the main audio information should come from in front of the listener and the secondary channels used more to provide a feeling of ambience—to recreate the original (or a simulated) recording environment.

In the 1970's, a simple way to recover ambience information from

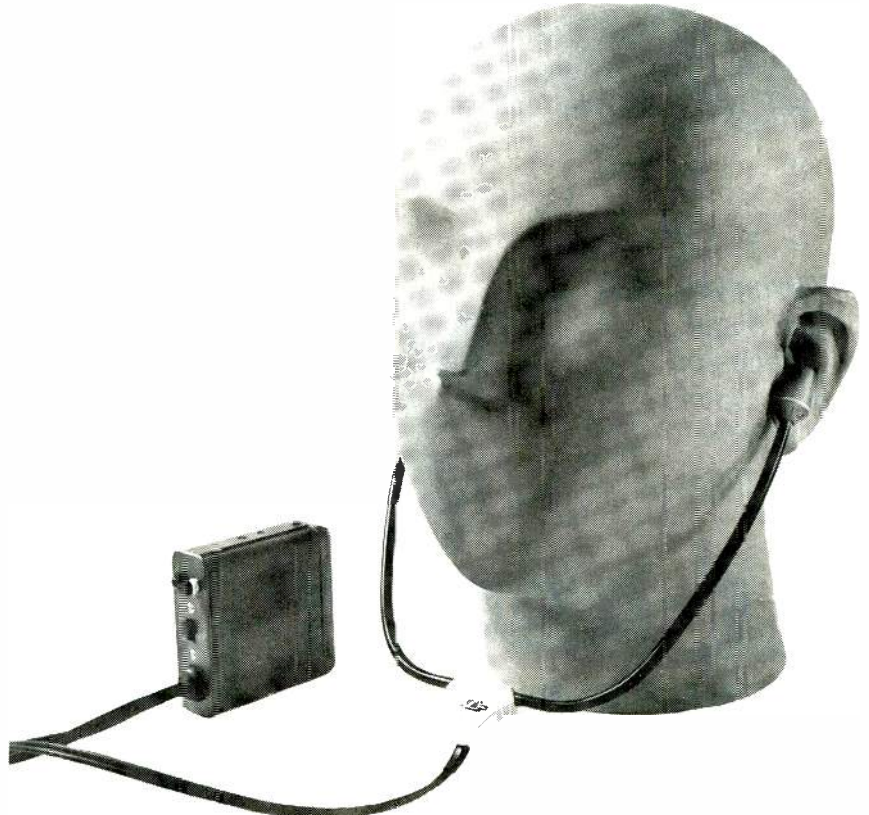

FIG. 1—IN TRUE BINAURAL RECORDING, a mechanical replica of the human head and ears ensures the proper capture of phase relationships. This is the MKE 2002 binaural dummy-head stereo-microphone setup from Sennheiser. To hear the special stereo effects, the recording must be listened to with high-quality headphones.

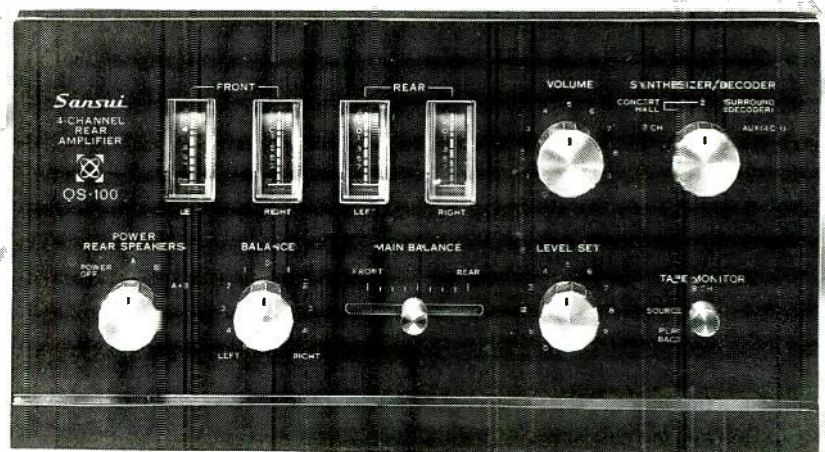

FIG. 2—THE QS-100 4-CHANNEL Converter/Synthesizer/Amplifier from Sansui. This is an example of a quadrasonic amplifier in the QS format.

conventional stereo recordings was proposed. That ambience information—which consists largely of sounds from outside the soundstage located between the stereo microphones (assuming, for the sake of simplicity, that just two are used)—may simply be sound reflected from the walls and ceiling of a concert hall, or it may come from sources such as

instruments positioned intentionally outside the bounds of the soundstage, as illustrated in Fig. 3. One of the ways that the ear pinpoints sound sources is by determining phase relationships. If, for example, the sound waves heard from a pair of speakers by the left and right ears are in phase, the sound source is perceived as being between the two speakers. If the

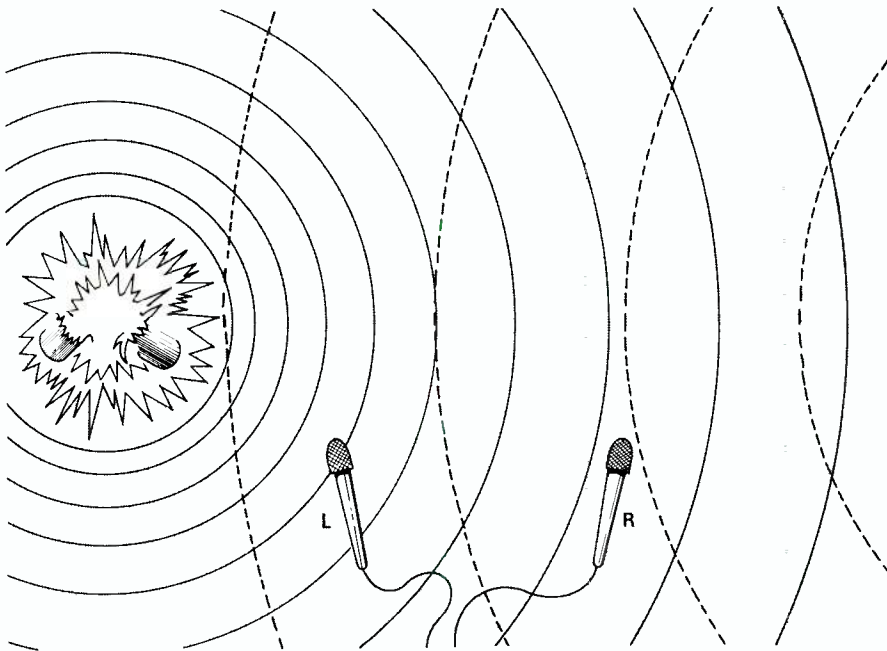

FIG. 3—AMBIENCE INFORMATION recorded as a left-minus-right difference signal can be used to expand a soundstage and even to localize sounds coming from beyond the bounds set by the locations of the microphones or speakers.

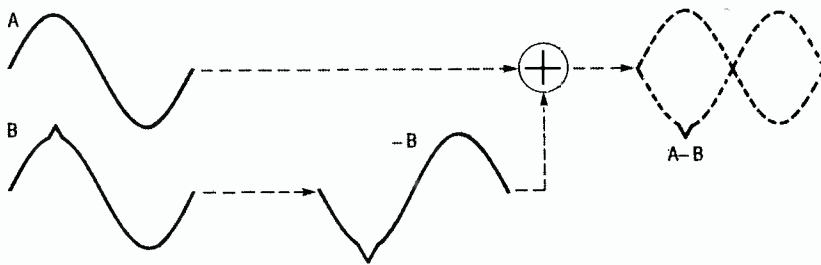

FIG. 4—BY INVERTING THE POLARITY of one of a pair of signals and then summing the two, you can obtain the difference between them.

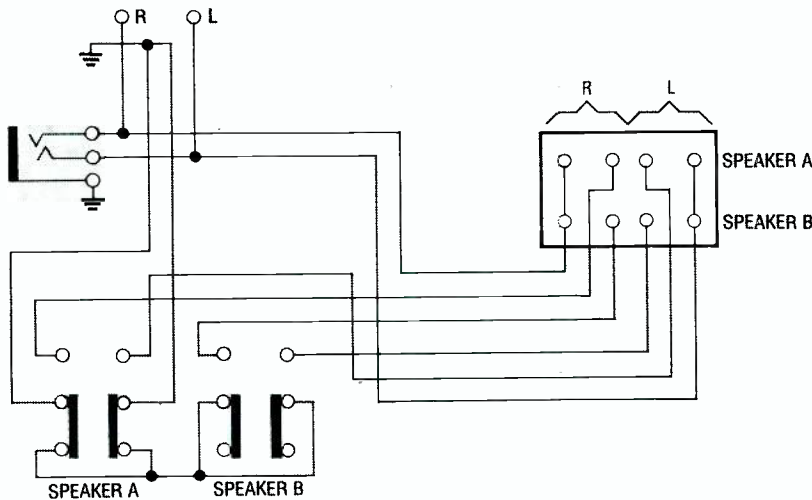

FIG. 5—THE MATRIX SURROUND CIRCUIT used in receivers such as Teac's AG-75 extracts ambience information from a pair of stereo signals by finding the difference between them.

waves are out of phase, the sound seems to come from "beyond" the speakers, and some recordings intentionally include out-of-phase material

to provide special auditory effects.

Out-of-phase information can be described mathematically as the difference between the left and right sig-

nals, or $L - R$. The relationship between an "L" waveform and an "R" one is depicted in Fig. 4. By inverting the phase of the right signal—thereby creating a " $-R$ " one—and adding that signal to the normal "L" one, the " $L - R$ " difference signal representing ambience information is obtained. By connecting a third (ambience channel) speaker between the "hot" speaker terminals of a stereo amplifier, an $L - R$ signal is obtained and reproduced through that speaker. If you place the speaker behind you, and adjust its volume so that it's unobtrusive, recordings that contain a goodly amount of natural ambience material will take on a spaciousness that can make you feel a lot more like you're listening to a performance in a real performance environment rather than your living room.

Matrix surround sound

A number of today's stereo receivers include a feature called "matrix surround sound," or just "matrix surround," the "sound" having disappeared somewhere. The term "matrix" refers to the way the signals are combined to obtain the "surround" signal. The process is a passive one—there is no special encoding or decoding matrixing circuitry used. Figure 5 shows a circuit used in one matrix-surround receiver. When the A SPEAKERS button is engaged, normal stereo sound is heard from the speakers connected to the A terminals; when the B SPEAKERS switch is closed, the output of the amplifier is fed to a second set. When both switches are closed, the A speakers reproduce the normal stereo signal; what goes to the B's speakers, however, is now the difference between the left- and right-channel signals. It turns out that matrix surround is nothing more than a "ready-to-use" version of the "third channel" ambience system described above. Place the B speakers behind you, and you have an ambience synthesizer. You also get a free surprise, which is a subject to which we'll return.

Some sound equipment also boasts a "Hall Surround" mode. While there is definitely a Ray Dolby involved in Dolby Surround (see below), there is no Mr. Hall of the same prominence involved in audio processing. The term "hall" refers simply to a large room (as a concert hall); presumably time delay or reverb effects are added

to the rear channel sound to give a feeling of spaciousness.

Sonic holography

In photography, holography is a process that yields three-dimensional images from a single piece of film without the need for special viewing apparatus (as opposed to the older method that requires a separate picture for each eye—the system used, for example, by View Master reels). Sonic holography produces a sonic image having depth, and a degree of surround effect, using just a pair of stereo speakers.

Sonic Holography, which is a technique patented by Carver Corporation, works on the principle that when we listen to a pair of stereo speakers the phase relationships contained in the recorded or broadcast material are muddled by right-channel sound “leaking” to the left ear, and left-channel sound similarly showing up at the right. What the process does (see Fig. 6) is to inject some degree of out-of-phase right-channel information into the left-channel signal (and vice-versa). If that is done with the right time delay, the out-of-phase right-channel signal mixed with the left-channel one will arrive at the ear at the same time as the right-speaker “leakage” does, and the in-phase and out-of-phase signals will cancel one another. What’s left will be pure left- and right-channel sound as engineered, providing a sense of depth and expanse otherwise impossible in a two-speaker system.

Material that contains a lot of natural or synthetic L – R information can

be astonishing when heard through a sonic-holography system. The soundstage appears to extend far beyond the backs of the speakers—indeed, the speakers almost seem to disappear—and “offstage” sounds often seem to originate from places far beyond the left-right bounds of the conventional stereo soundstage.

The original Carver sonic holography process requires some effort to make it work at its best. Speaker positioning is extremely critical to the effect, and speaker-to-listener distances must be measured extremely carefully, and the corresponding left and right ones matched to within an inch or so of one another. The benefits of sonic holography also are restricted to only one or two listeners at a time. The effect is heard only from a highly sensitive “sweet spot,” and moving just a foot or so out of it destroys the illusion.

In some of its equipment Carver now offers what it calls a Precognition Matrix, which is intended to broaden the sonic-holograph soundstage created from motion picture soundtracks. The precognition circuitry works by detecting the (normally inaudible to the ear) rise in noise-floor level when additional tracks are mixed into the stereo master. By changing the mix of left and minus-right-channel information, the apparent soundstage can be widened dynamically to follow that of the material being reproduced, allowing more listeners to benefit from the sonic holography process. Because the change in noise-floor level occurs several milliseconds before the actual

onset of the new audio material, the processor can respond without missing a note of music or other material.

For those who want everything (or nearly everything), Carver also produces an AM/FM stereo receiver that incorporates both Sonic Holography and Dolby Pro Logic Surround, which will be discussed below.

Other two-speaker systems

There are several other single-ended systems that attempt to recreate a measure of ambience from just the information contained in the two channels of an ordinary stereo signal.

The system that seems to have attracted the most attention of late is the SRS system developed by Hughes Aircraft and licensed by Sony for use in some of its television receivers. Basically, the process extracts the L – R ambience information and processes it through frequency, timing, and phase adjustments to simulate the way the recorded information would have been perceived by the human ear. The effect is an artificial analog of the binaural process described earlier, using loudspeakers instead of earphones. The Hughes SRS system is described in detail in the September 1989 issue of **Radio-Electronics**.

Most “simple” surround systems, though, are just variations—and minor ones, at that—of the L – R matrix process. Sometimes the term “digital” gets thrown in, but the digital portion of these processes often has to do just with creating the out-of-phase L – R signal, and maybe adding some time delay for increased “spaciousness.”

Dolby Stereo

Although it has been in use since 1975, Dolby Stereo, one of a number of audio processes to come from the laboratories headed by Ray Dolby, first came to national cinematic attention with George Lucas’ *Star Wars* in 1977. Anyone who’s seen the full-blown version of that film will never forget the opening scene, where the massive battle cruiser looms onto the screen, appearing—to both eye and ear—to come from behind and above the theatergoer. What an introduction to Dolby Stereo!

Movies with stereo soundtracks—most of them musicals—were not rarities prior to that, but the Dolby process added one or two things to mere lateral directionality. The first

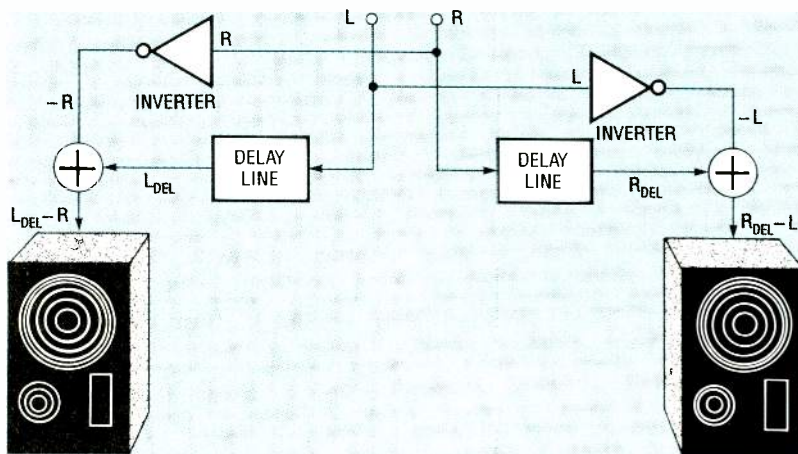
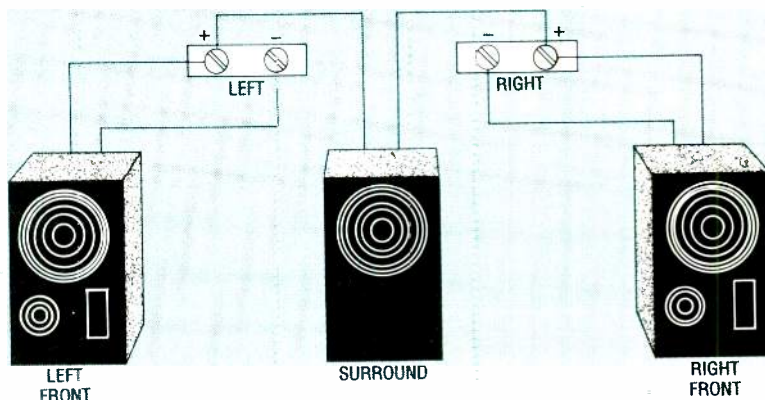

FIG. 6—CARVER'S SONIC HOLOGRAPHY process compensates for signal “muddying” that occurs during ordinary stereo reproduction by using signal cancellation techniques.

was Dolby A noise reduction, which (as you'll know if you ever heard the *Star Wars* soundtrack cranked way up, as it was in most theaters) gave optical-soundtrack sound a much greater dynamic range than it had enjoyed before. The second, and perhaps more significant from an entertainment point of view, benefit of Dolby Stereo was that it added, in a rather elegant and easy-to-achieve manner, *true* stereo. That is, the sound field, which had previously been zero-dimensional (monophonic) or one-dimensional (conventional stereo), now took on another dimension and gained front-to-back depth as well. The word "stereo" derives from the Greek word meaning "solid," and with Dolby Stereo, movie sound fields took on solidity.

Although there is a six-track version of Dolby Stereo, in which each soundtrack carries discrete (non-matrixed) information for a single output channel, the process used for most theatrical releases requires only two tracks. With the Dolby process, those two tracks can provide up to four channels of sound. Figure 7 shows how Dolby Stereo works. The left and right channels contain the usual left- and right-channel information; a movie theater without a Dolby Stereo decoder (or a home videotape viewer using just a stereo VCR) would perceive a nearly-normal left- and right-channel soundtrack. (With only monophonic facilities, the two channels would be mixed to produce a single composite output.) With a Dolby decoder, though, two more channels of sound become available. The first is a front-center channel. This is a mixture of the left- and right-channel signals—a composite mono signal in effect—that fills in the audio "hole" that might be perceived by a moviegoer sitting close to the center of a wide screen.

The really interesting part of a Dolby Stereo soundtrack, though, is the fourth, surround, channel. It is encoded on the stereo tracks as "L-R." "Wait a minute!" you say. "That's the same information that you can extract from ordinary stereo for a matrix-surround rear channel system. What's the big deal?" The big deal, it turns out, is in *what* information is encoded in that difference signal. Matrix surround uses natural, or at least natural-sounding, ambience information. What the Dolby process uses is



DOLBY SURROUND

Once you know how Dolby Surround information is encoded on a stereo soundtrack—namely in the form of an L-R difference signal—it is easy to extract it. While surround decoders bearing the Dolby "double-D" logo contain extra circuitry to provide such things as bandpass filtering and Dolby-B noise-reduction decoding, you can have surround sound—using the Dolby-encoded information—from your stereo VCR or other stereo source such as an over-the-air or cable broadcasts of films containing surround-encoded material for about \$25—including the cost of the speaker!

The easiest method to reproduce the L-R "surround" signal, whether it contains natural ambience information or Dolby Surround programming, is simply to subtract the right-channel signal from the left-channel one at the speaker terminals. You can do that by connecting a speaker, which will become your rear surround speaker, between the two positive ("+") speaker terminals as shown in the figure. Signals common to both channels will not be reproduced (or will be reproduced at a reduced level), but the differences between the two—the L-R information—will. Since that is exactly what the Dolby process uses, the third speaker reproducing that signal will become the surround device.

The process is not perfect (otherwise there would be no market for the more complex and expensive de-

vices being sold as Dolby Surround decoders), but it will give you pretty amazing results from good material at a rock-bottom price.

If you connect the surround speaker directly to your amplifier's usual speaker-output terminals, you should use an L-pad in the line to let you control the level, and thereby the balance, of the surround effect sound. You don't want the effect to be overwhelming; most of the time there should be so little of it that you're not aware it's there, although if you were to eliminate it suddenly you would be struck by its absence as the sound-field collapsed.

Be careful when adding a third speaker to your system in that way. Putting the impedance of the extra speaker across that of the other two will change the impedance of the entire system, and may reduce it below the minimum impedance recommended for your amplifier. At very low output levels that may not matter, but at higher ones it can put an unacceptable strain on the amp.

A slightly more complex way, but one reeking less of brute-force, to obtain surround sound using that method would be to mix the line-level signals from a pair of your amplifier's tape output jacks in the same way you would combine the speaker-output ones—by using the two inner conductors of the TAPE OUT cables—and feed that signal to a separate small mono amp driving the surround speaker.

R-E

much more controlled. However, for the curious, a method for obtaining a surround effect from Dolby-encoded material without the use of a decoder is described in the box above. It's primitive, but effective.

Cinematic sound is an extremely artificial medium—even such a simple effect as the sound of an actor's footsteps as he walks from one side of a scene to the other is much more easily created on an engineering con-

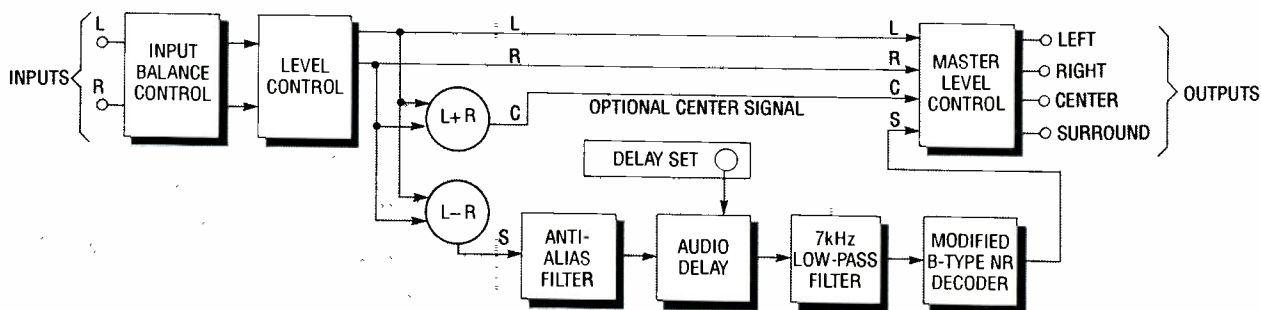

FIG. 7—THEATRICAL DOLBY STEREO encodes four channels of sound on two soundtracks. The Dolby decoder derives a center channel by summing the left and right channels, and surround information by subtracting the right from the left.

sole with a couple of pan pots than on the soundstage during filming. Most of a film's soundtrack is realized in post-production—and that tightly controlled environment makes it relatively easy to put on the surround track exactly what is wanted, without having to rely on natural material.

If you listen carefully to a plain stereo playback of a Dolby Stereo soundtrack, you can frequently detect the presence of the surround effects—they appear to come from outside the speakers' soundstage, the way out-of-phase ambience information may. That is clearly evident in a film such as *Back to the Future*, when the time-travelling DeLorean comes swooshing toward or away from the camera. If all four channels of sound are reproduced, you hear the car moving from front to rear, or vice-versa. In plain-vanilla stereo, though, you can plainly hear the car noises coming from the far-left and far-right—off-stage, as it were.

In creating an L-R surround signal, the Dolby Stereo process does two things. The first is to cut off the rear-channel signal at 7 kHz. That is done for several reasons. The first has to do with eliminating signal leakage and distracting crosstalk from the surround channel. Another big reason has to do with economy. There is no need for high fidelity in a surround channel—most of the time the sound there is for "presence"—that is, you are only unconsciously aware of it. The track is meant to be unobtrusive, not to have you constantly aware of its presence. It's only if the surround channel should suddenly fail that you should become consciously aware of its presence (or absence).

That limited frequency response is the reason behind those cheap-looking, PA-type speakers you may have

noted in movie theaters equipped for Dolby Surround. It's not that the theater-owner is a cheapskate; simply that there is nothing on the surround track to justify the expense of a better speaker. As far as low frequencies go—the rumble of the engines of the Empire spaceship, for example—they are carried as ordinary left and right information. Since your ears cannot determine where frequencies below about 120 Hz originate, they can be reproduced from low-frequency drivers located anywhere. The visual content of the film will cue you as to where the sound is supposed to be coming from.

The second thing that is done to the rear-channel signal is to encode it using a modified form of Dolby B noise reduction. The modification consists of adding only five dB of processing instead of the normal ten dB. The use of Dolby B provides a degree of noise reduction and assists in reducing front-channel signal leakage, while the low level of processing prevents the encoded surround signal from significantly altering the nature of the left- and right-channel signals heard up front.

In the decoding process, a third element is added to Dolby Stereo: time delay. A delay of between 15 and 30 ms is added to the rear-channel signal to take advantage of a phenomenon known as the Haas effect. The Haas effect causes the mind to identify the source of a sound as that from which it is first heard and to ignore the same sound arriving later at the ear. That "first arrival" effect ensures that front-channel sounds are clearly identified as originating from before the viewer, even if they also come from behind him to some extent. Dolby Stereo decoders also make use of steering logic, discussed

below, to add further directionality to the decoded soundtrack.

Before leaving the theatrical Dolby process, we should mention one called "THX." THX is a trademark owned by George Lucas' Lucasfilm (the name has its origin in the title of Lucas' first feature-length work, a science-fiction film called *THX-1138*). All it refers to is a "guaranteed minimum" quality of sound in a particular theater from an ordinary Dolby Stereo soundtrack. THX engineers check and adjust the sound-reproduction equipment in a "THX" theater to meet specific standards of performance. It's just quality control for movie-sound reproduction. Unless you can get a THX engineer to come out to your living room, THX will do nothing for you at home.

Dolby Surround and Pro Logic

Dolby Surround is the name given to one of the two home versions of Dolby Stereo. It starts with the same two stereo soundtracks that are on the film (now on longitudinal or Hi-Fi tracks on a videocassette). And, as is done in theatrical installations, the surround channel is dematrixed, Dolby-B decoded, and time delayed before being amplified and fed to a pair of rear speakers. Only one surround speaker is actually necessary, but two—reproducing the same surround signal—give a "fuller" effect. To derive a monophonic center channel, useful in preventing a center "hole" when the left and right speakers are widely separated, some Dolby Surround decoders mix the left- and right track information. That is not, strictly speaking, necessary, since center information appears equally on both tracks and can be heard appearing from a "phantom" speaker situated

continued on page 58

KIT REPORT: HEATH'S AD-2550 SURROUND SOUND PROCESSOR

If you're looking for a fun way to upgrade your audio/video system to include Dolby Surround, Heath's AD-2550 might be the way to do it. It might also be the perfect way to get yourself back into electronics construction if you've been letting your skills lapse.

The processor is very easy to build. Although we wouldn't recommend it as a first project, anyone with even minimal kit-building experience, or anyone who has ever built a project from plans published in *Radio-Electronics* should have no trouble.

Most of the work involves assembling one large PC board. There's plenty of room to work, and the supplied instructions and silkscreened boards make things as simple as possible. When the board assembly is complete, the final work involves installing it in the metal cabinet and hooking up the power transformer.

Our total assembly time was about six or seven leisurely hours. Alignment takes only a few minutes, and can be accomplished either with or without test equipment. Did it work the first time we turned it on? If you have to ask, you've never build a Heathkit!

Surround features

When you're finished with the assembly work, you're left with a full-featured surround-sound processor. The AD-2550 accepts left- and right-channel inputs and offers a wide assortment of outputs. First, because the processor includes a 20-watt audio amplifier, direct speaker outputs are available for connection to surround speakers. Line-level sur-



MOST OF THE ASSEMBLY work is done on a large PC board.

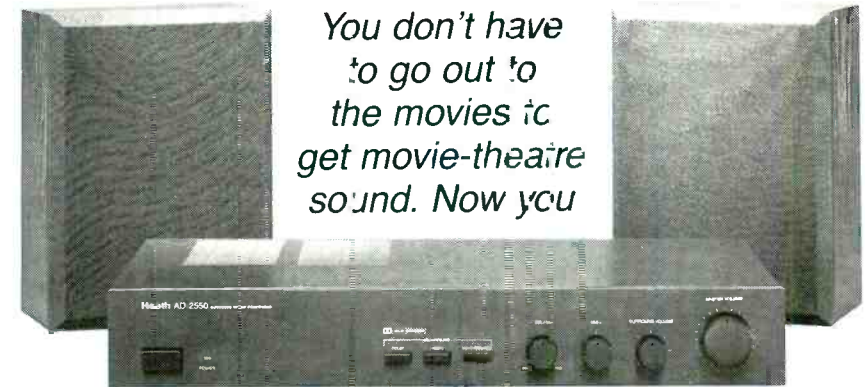

You don't have to go out to the movies to get movie-theatre sound. Now you

can bring it home to your living room!

round-channel outputs are also offered. Line-level outputs for left front and right front are provided for connection to a separate amplifier, or to a stereo TV/monitor. A center-channel output is provided for installations where front-speaker separation produces a sound that is too wide for the

screen. It helps to keep the dialogue of on-screen actors sounding as if it's coming from the screen, not off to the side. A line-level subwoofer output feeds the low-frequency (under 70 Hz) sounds to a separate amplifier for room-rattling effects.

Three different surround modes are provided by the Heath processor. First, of course, is true Dolby Surround. "Music surround" adds synthetic surround effects to stereo audio recordings to give them more depth. A "mono enhance" mode synthesizes stereo-with-surround effects.

Front-panel controls include a power switch, three pushbuttons for choosing the appropriate surround mode, and four rotary potentiometers. First is the DELAY control to set

the amount of time delay between the front and rear speakers to give your room a larger feel, even if you must place the surround speakers close to your listening position. The NULL control balances the left- and right-channel signals that are processed by the surround circuitry. It can compensate for some poorly-encoded material.

Two volume controls—one for the surround output and the other for all outputs—let you perfectly adjust the balance of the front and rear speakers.

Our tests showed that the decoding circuitry performed flawlessly upon completion. But the real test didn't come until we gave it a trial run with some real test material, including *Indiana Jones and the Last Crusade*. Surround sound can make a dramatic difference. The soundstage becomes instantly larger, and, if we're allowed a little exaggeration, even the picture seems bigger!

Movies that are encoded with Dolby surround can, of course, be de-

(Continued on page 88)

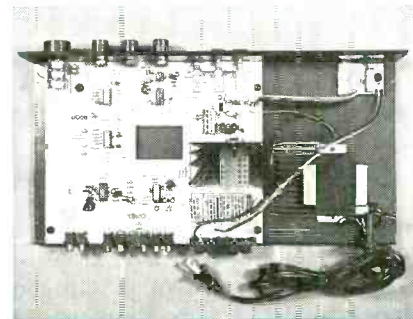

EVERYTHING THAT'S NEEDED to produce professional results is included with the kit.

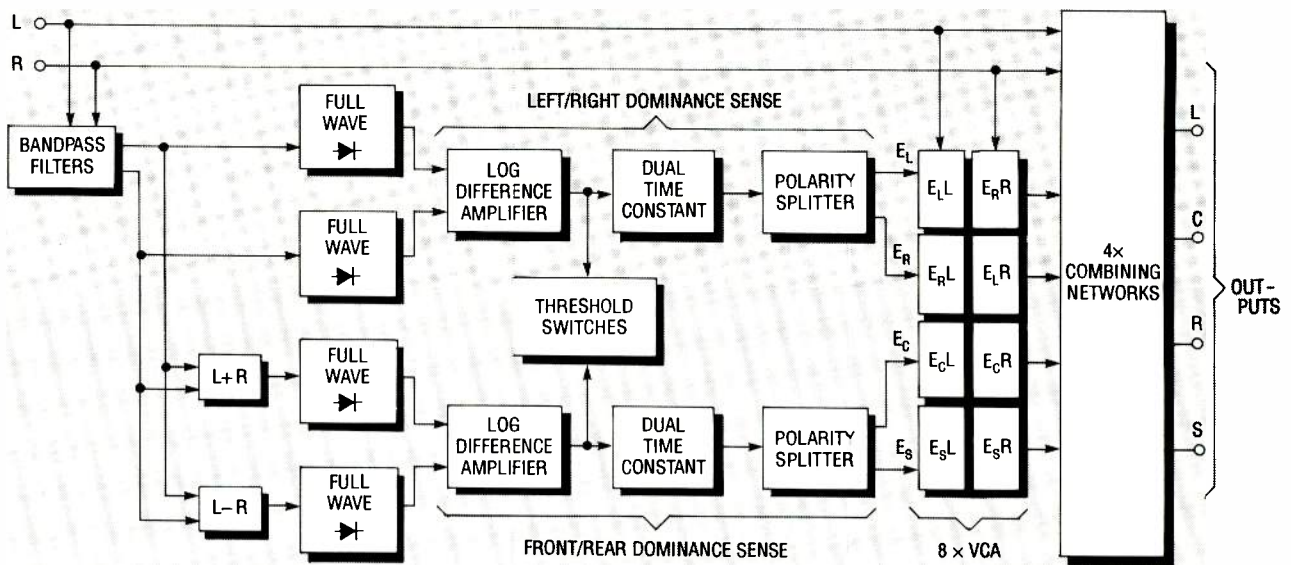

FIG. 8—THE ADAPTIVE MATRIX used in the Dolby Pro Logic Surround process can provide up to 30 dB of separation between opposite or adjacent channels. That affords an extremely high degree of directionality.

between the two front ones. A few Dolby Surround processors can also output a front-and-back mix to side speakers. Finally, most processors on the market also feature a subwoofer output. That has nothing to do with the Dolby process; it's more a convenience than anything else.

Dolby Pro Logic Surround is the ultimate in Dolby Surround processing. While the original Dolby Surround process is primarily a passive one (all the equipment does, essentially, is decode the matrixed information), Pro Logic decoders contain active circuits that provide a surround effect as good as—if not better than—that in the best movie theater. The active addition to a Dolby Pro Logic decoder is known as steering logic.

The purpose of the steering logic circuitry in a Dolby Pro Logic decoder is to sense the direction of soundtrack dominance—that is, to determine from what direction the loudest sound on the track seems to originate—and to generate control signals that increase gain in the appropriate (left, right, center, surround) combination of channels to give a directional vector. Figure 8 illustrates the workings of the adaptive matrix within a Pro Logic decoder. By comparing the left and right and center and surround signal pairs, and taking the logarithms of their values (logarithms are used, in part, because human senses work in a logarithmic rather than linear fashion), a pair of

bipolar control signals is generated, which are used to adjust the gain of eight voltage-controlled amplifiers (four for each input channel). The outputs of those VCA's, together with the original left- and right-channel signals, provide a total of ten control signals. When those signals are applied to the four output channels, a total of forty summed directional components are available. Separation between any pair of channels—adjacent or opposite—is 30 dB, compared to Dolby Surround's 3 dB of adjacent separation, and 40 dB of opposite separation.

Pro Logic decoders are two-speed devices. When only one sound source is dominant, they run in their "slow" mode. But when there are two distinct sound sources (by definition, only one can be "dominant" at a time), the Pro Logic circuitry goes into a "fast,"

time-division multiplexing mode where it gives its attention first to one source, and then to the other. It switches back and forth between the two so quickly that its efforts are unnoticed by the listener.

Dolby Pro Logic decoders include as a matter of course center-channel and subwoofer outputs. As is the case with the surround channel, the center-channel amplifier and speaker need not have the frequency response of the equipment used for the left and right channels. High- and low frequencies will be reproduced by those systems and by the subwoofer, if one is used. With a good-quality hi-fi-soundtrack videotape, and with even a modest array of home sound equipment, you can experience a quality of cinematic sound at home that you would be hard-pressed to find in any theatrical environment. **R-E**

GENERIC POWER SUPPLY

continued from page 46

ble. If the water dries smoothly, from the edges inward, or forms fine bubbles, you're probably safe. However, if the water boils off immediately, there's trouble. It's not a terribly scientific method, but it's free. Check a second time, waiting a full minute after drying for heating recovery.

The 78XX/78MXX versions are fixed-positive models. For example, a

7812 is a positive 12-volt model that can provide at least 1 amp of output current—but only when the regulator drop is low enough to avoid overheating. The suffix "T" specifies a TO-220 case, but catalogs often omit this and specify the case type elsewhere. The 79XX/79MXX versions are fixed-negative models. The LM317/LM317M models are adjustable-positive, and the LM337/LM337M are adjustable-negative. They're all very reliable, and can take considerable abuse. **R-E**



ADD A DISPLAY TO
YOUR PROJECT

The days of LED indicators and segmented displays are numbered. Now you can add an alpha-numeric LCD to your home project easily and inexpensively.

STEVEN AVRITCH

HAVE YOU EVER AVOIDED A PROJECT because it required a display that could handle numbers, letters, and symbols? Have you ever given up on a project because the display had to be at least 10, 20, maybe even 40 characters long?

You can solve all of those problems by using a simple and inexpensive alpha-numeric LCD module which contains a controller chip that does most of the work for you! This article will show you how to use LCD's with a simple microcontroller- or microprocessor-based design. Note that most small LCD modules use the Hitachi HD44780 LCD controller chip (see block diagram in Fig. 1). This article will therefore be limited to a discussion of LCD modules that use, or are compatible with, the HD44780 controller format. Common LCD modules include those manufactured by Optrex, Epson, Hitachi, Amperex, and Densitron.

Multi-character readouts are usually constructed using individually wired, multiplexed display segments. The host microprocessor sequentially flashes the desired character on each digit of the display, one at a time. The microprocessor is fast enough so that the naked eye sees the display as it

should appear. That method of multiplexing the digits of a display is often used because it reduces the amount of external hardware required compared to non-multiplexed systems. However, multiplexing requires the microprocessor to continually update the display, and the amount of external wiring must be increased as additional digits are added (see Fig. 2).

For example, a 10-digit numeric display requires approximately 100 wires and over 20 components. (A 10-digit alpha-numeric display requires even more wires.) The equivalent display (including alpha-numerics) implemented with an LCD module would require only 10 wires and 2 components: the LCD module and a potentiometer for contrast control. Using an LCD module, a designer can add a display containing up to 80 characters with as little as 10 wires, 7 of which connect the display module to the host microcontroller/processor, plus 1 power, 1 ground, and 1 LCD drive wire for contrast control. That's all!

The software interface between the host and the display module is just as simple as the wiring. The display modules automatically handle all refresh and multiplexing functions. The

host needs only to write the data to be displayed and a few control codes (such as display on, display off, scroll left, scroll right, etc.) to the module; the on-board LCD controller chip does the rest.

LCD modules have not been used heavily in the past because of their high costs. However, the cost of the modules has since dropped considerably, and they are now commonly found in many of the popular electronics supply houses. For example, a 32-character display (2 lines, 16 characters per line, 16×2) is available from Digi-Key for approximately \$23. Similar displays can be obtained through surplus houses for approximately \$8-\$10.

Most of the small, inexpensive LCD modules contain a Hitachi HD44780 LCD Controller chip. That means that most of LCD modules follow the same standard format, have the same 14-pin interface, and are therefore compatible and interchangeable. The HD44780 is capable of controlling any size display up to 2 lines long and 40 characters wide with the same hardware interface. Commonly available display sizes include 16×1 , 16×2 , 20×2 , 24×2 , and 40×2 formats. That means that you

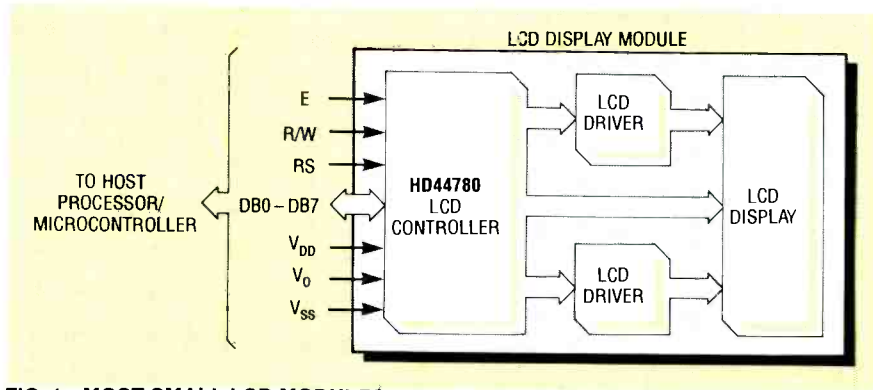

FIG. 1—MOST SMALL LCD MODULES use the Hitachi HD44780 LCD controller chip.

Features of LCD modules

The LCD modules support a variety of display features that can accommodate just about any application. The following is a brief description of their features:

- Display on/off—allows the user to turn the display on and off from the host processor.
- Cursor on/off—user may select to display the cursor or suppress it.
- Cursor blink—the user may select a steady cursor or a blinking cursor. The character above the cursor also

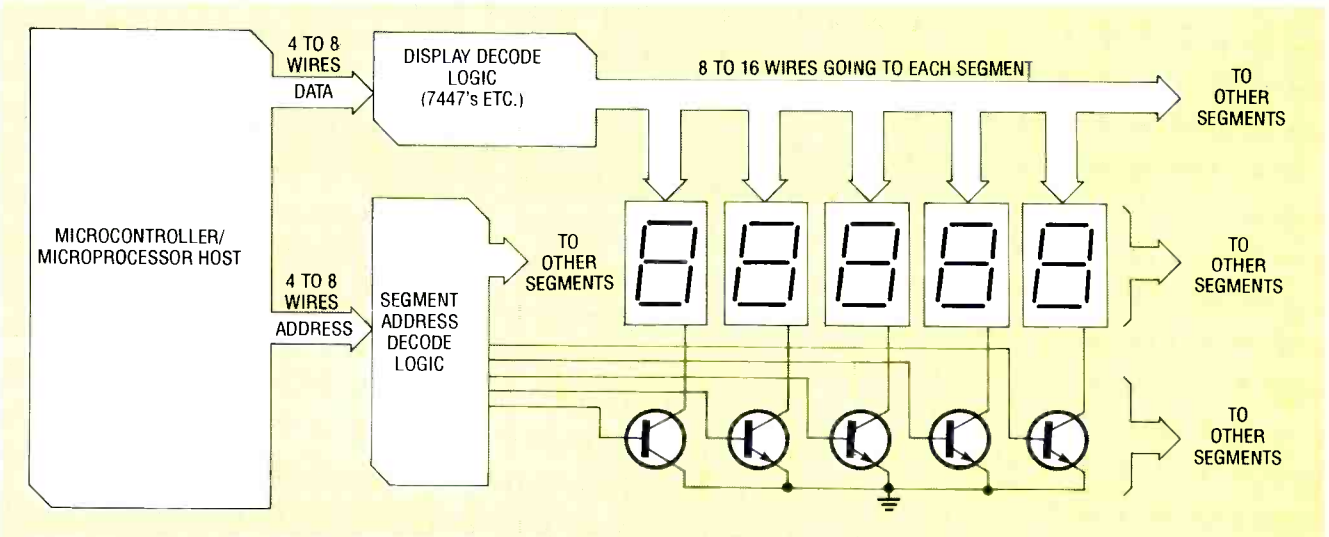

FIG. 2—MULTIPLEXING REQUIRES the microprocessor to continually update the display, and the amount of external wiring must be increased as additional digits are added.

can change the size of your display by simply plugging in a larger module. No other hardware modifications are required; only the software drivers specific to the application would need to change.

The LCD modules recognize standard ASCII code for letters (upper and lower case) and numbers in addition to a variety of symbols including ?, !, \$AK, %, and ` , just to name a few. In all, the LCD module supports 192 alpha-numeric characters and 32 special symbols. The modules also allow you to customize up to 8 user-defined characters of your own. On one home project the author customized three characters that, when displayed together, formed an airplane as can be seen in the photo.

The LCD modules are dot-matrix type displays with each character being formed from a 5-dot-wide by 7-dot-high block (5 × 7 font) or a 5-dot-wide by 10-dot-high block (5 × 10 font). The font is selected by issuing a control command as discussed later in this article.

There is also a cursor line under each character. The 5 × 10 font is better suited for certain lower-case letters such as g, y, and p (i.e. letters with descenders that go below the line that they're written on). Figure 3 shows examples of letters formed using the 5 × 7 and 5 × 10 dot-matrix formats for comparison. It should be noted that the 5 × 10 matrix font limits the display to one line regardless of whether the LCD module is a one-line or two-line display.

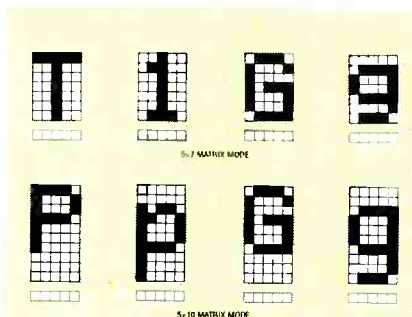

FIG. 3—HERE ARE SOME EXAMPLES of letters formed using the 5 × 7 and 5 × 10 dot-matrix formats.

blinks.

- Scroll left/right—scrolls the data on the display.
- Return home—returns the cursor to the home position (address 0) and returns the display to the original position (if it had been previously scrolled)

Software interface

The software interface between the LCD module and a processor or microcontroller is relatively simple. There are two basic types of software operations: control operations (i.e. display on/off, cursor blink/noblink, etc.) and data operations. The control operations set up the features of the display, while the data operations write the actual data to be displayed to the LCD module.

The LCD module's on-board HD44780 controller chip contains 80 bytes of display RAM and is capable of supporting up to a 40 × 2 display (each byte of display RAM corresponds to a digit of the display). Smaller LCD modules simply do not

display the full 80 bytes of RAM. The display RAM is organized in the following format:

LINE 1:

Character position: 1 2 3 4 5 6 7 8
9...40

RAM address 0 1 2 3 4 5 6 7
8...27(hex)

LINE 2:

Character position: 1 2 3 4 5 6 7 8
9...40

RAM address 40 41 42 43 44 45 46 47
48...67(hex)

Smaller modules simply do not display the upper character positions associated with the upper addresses. For example, a 16×2 display uses addresses 00–0F (hex) for line 1 and 40–4F (hex) for line 2.

The HD44780 also contains 64 bytes of character-generator RAM. That is used to store the character patterns of the 8 user-defined characters (8 bytes per character). Once a user-defined character is set up in character-generator RAM, it may be accessed just as any other regular character. NOTE: in the 5×10 matrix mode, only four user-defined characters are supported, with each character requiring 11 bytes of character-generator RAM.

Software drivers

The host must contain two basic software drivers to support the LCD modules, the Control Write and Data Write drivers. The minimum functions that the software drivers must perform are:

Control Write:

- Sets up DB0–DB7 with the desired control code
- Sets the R/W line to logic zero
- Sets the RS line to logic zero
- Strokes the ENABLE line

Data Write:

- Sets up DB0–DB7 with the desired character
- Sets R/W line to logic zero
- Sets the RS line to logic one
- Strokes the ENABLE line

The user may also read data and control signals from the HD44780. Control Read and Data Read drivers are similar to the write drivers except that the R/W line is set to a logic one. Refer to Table 1 for a complete listing of the control codes and status flags available with the HD44780 LCD controller chip.

Subroutines for the MC68705

The following subroutines show the

```

LISTING 1
DISLET  STX  TEMPX      SAVE INDEX REGISTER
         STA  PORTA     PUT CHARACTER ON BUS
         BCLR 1,PORTB   SET R/W TO WRITE
         BSET 2,PORTB   SET RS TO DATA
         BSET 0,PORTB   TURN ON ENABLE
         BCLR 0,PORTB   TURN OFF ENABLE
         BCLR 2,PORTB   SET RS TO CONTROL
         LDX  #$20
DELAY1  DECX
         BNE  DELAY1
         LDX  TEMPX
         RTS

```

DELAY 120 us
 ASSUMING 1 us
 CLOCK

RESTORE INDEX REGISTER
 RETURN FROM SUBROUTINE

```

LISTING 2
CONTROL STX  TEMPX      SAVE INDEX REGISTER
         STA  PORTA     PUT CONTROL CODE ON BUS
         BCLR 1,PORTB   SET R/W TO WRITE
         BCLR 2,PORTB   SET RS TO CONTROL
         BSET 0,PORTB   TURN ENABLE ON
         BCLR 0,PORTB   TURN ENABLE OFF
         LDX  #$FF
DELAY2  DECX
         BNE  DELAY2
         CMP  #$02
         BHI  DELAY4
DELAY3  JSR  ENDCNTL
         DECX
DELAY4  LDX  TEMPX
ENDCNTL RTS

```

DELAY FOR CONTROL

RESTORE INDEX REGISTER
 RETURN

```

LISTING 3
INIT    LDA  #$01      CLEAR DISPLAY
        JSR  CONTROL
        LDA  #$02      RETURN DISPLAY TO HOME POSITION
        JSR  CONTROL
        LDA  #$38      SET UP FOR 2 LINES, 8 BIT INTERFACE,
                        AND 5X7 MATRIX FORMAT
        JSR  CONTROL
        LDA  #$06      SET UP FOR CURSOR SHIFT WITH DATA WRITE
        JSR  CONTROL
        LDA  #$0C      SET UP FOR DISPLAY ON, CURSOR OFF,
                        AND STEADY CURSOR (NO BLINK)
        JSR  CONTROL
        RTS           RETURN FROM SUBROUTINE

```

```

LISTING 4
CGINIT  LDA  #$40      SET UP FOR WRITES TO CG RAM
        JSR  CONTROL
        CLR  DATCNT    CLEAR BYTE COUNTER
NEXT    LDX  DATCNT    LOAD BYTE COUNTER
        LDA  PLANE,X   LOAD CG RAM DATA INTO ACCUMULATOR
        JSR  DISLET    WRITE BYTE TO CG RAM
        INC  DATCNT    INCREMENT COUNTER FOR NEXT BYTE
        LDA  DATCNT
        CMP  #24
        BNE NEXT
        LDA  #$80      SET UP FOR WRITES TO DD RAM
        JSR  CONTROL
        LDA  #$02      INITIALIZE DISPLAY TO HOME POSITION
        JSR  CONTROL
        RTS           RETURN FROM SUBROUTINE

```

software drivers for data and control writes. The examples shown here are written in Motorola 6800-series assembler code and are targeted for the MC68705 microcontroller. These short routines can be easily translated into other assembly languages that can be used with other microcontrollers/microprocessors.

The Data Write subroutine (Listing 1) displays letters and symbols. The

ASCII code of the letter/symbol to be displayed must be loaded into the Accumulator before calling the Data Write subroutine. Before the Control Write subroutine (Listing 2) can be called, the code of the control operation to be performed (from Table 1) must be loaded into the Accumulator.

Display initialization

The first operation that the software

DIGITAL VIDEO STABILIZER ELIMINATES ALL VIDEO COPY PROTECTIONS



While watching rental movies, you will notice annoying periodic color darkening, color shift, unwanted lines, flashing or jagged edges. This is caused by the copy protection jamming signals embedded in the video tape, such as Macrovision copy protection. Digital Video Stabilizer: RXII completely eliminates all copy protections and jamming signals and brings you crystal clear pictures.

FEATURES:

- Easy to use and a snap to install
- State-of-the-art integrated circuit technology
- 100% automatic - no need for any troublesome adjustments
- Compatible to all types of VCRs and TVs
- The best and most exciting Video Stabilizer in the market
- Light weight (8 ounces) and Compact (1x3.5x5")
- Beautiful deluxe gift box
- Uses a standard 9 Volt battery which will last 1-2 years.

WARNING :
SCO Electronics and RXII dealers do not encourage people to use the Digital Video Stabilizer to duplicate rental movies or copyrighted video tapes. RXII is intended to stabilize and restore crystal clear picture quality for private home use only.

(Dealers Welcome)

To Order: \$49.95 ea + \$4 for FAST UPS SHIPPING

1-800-445-9285 or **516-694-1240**

Visa, M/C, COD M-F: 9-6 (battery not included)

SCO ELECTRONICS INC.

Dept. CBY6 581 W. Merrick Rd. Valley Stream NY 11580
Unconditional 30 days Money Back Guarantee

CIRCLE 194 ON FREE INFORMATION CARD

CABLE TV DESCRAMBLER



- | | | |
|---------------------------|--------|-----------|
| | 1 Unit | 10 + |
| Jerrold S.B. | \$74 |\$55 |
| Jerrold SB w/Trimode..... | \$90 |\$70 |
| Oak N-12 (w/VS)..... | \$89 |\$65 |
| Scientific Atlanta..... | \$109 |\$75 |
| Pioneer..... | \$109 |\$75 |
| Panasonic converter..... | \$98 |\$79 |
| 73 channel converter..... | \$79 |\$59 |

We Beat Anyone's Price!

30 Days Money Back Quaranty

Free Catalog

Visa, M/C, COD or send money order to:

US Cable TV Inc. Dept. KCT6

4100 N.Powerline Rd., Suite F-4

Pompano Beach, FL 33073

1-800-445-9285

Please have make and model number of the equipment used in your area ready.

No Florida Sales!

It's not the intent of US Cable TV Inc. to defraud any pay TV operator and we will not assist any company or individual in doing so.

CIRCLE 195 ON FREE INFORMATION CARD

TABLE 1—CONTROL OPERATIONS

Instruction	RS	R/W	DB7	DB6	DB5	DB4	DB3	DB2	DB1	DB0	Description and execution time
Clear	0	0	0	0	0	0	0	0	0	1	Clears Display Returns cursor to home position (1.64 ms)
Home	0	0	0	0	0	0	0	0	1	X	Return cursor to home position Return shifted display to home position (40 μs)
Mode	0	0	0	0	0	0	0	1	I/D	S	Control automatic RAM address INC/DEC and whether display shifts on writes (40 μs)
Display ON/OFF	0	0	0	0	0	0	1	D	C	B	Controls display ON/OFF Controls cursor ON/OFF Cursor blink ON/OFF (40 μs)
Cursor or display shift	0	0	0	0	0	1	S/C	R/L	X	X	Shifts cursor and/or display without changing display RAM (40 μs)
Function set	0	0	0	0	1	D/L	N	F	X	X	Set interface to 4 or 8 bits Set number of display lines Sets character font (40 μs)
Set CG RAM address	0	0	0	1	Address (CG)					Set address for subsequent writes to character generator. (CG) RAM. (40 μs)	
Set DD RAM address	0	0	1	Address (DD)					Set address for subsequent writes to display (DD) RAM (40 μs)		
Read busy flag & address	0	1	BF	Address Counter					Read status of busy flag (BF) and present address counter value (1 μs)		
Write data to CG or DD RAM	1	0	Data to be written to DD or CG RAM. DD/CG destination based on last "set DD/CG RAM address" control command					Writes data to HD44780 (40μs)			
Read data from CG or DD RAM	1	1	Data read from DD or CG RAM. Source of data (CG or DD) based on last "set DD/CG RAM address" control command					Reads data from HD44780 (40 μs)			

I/D = 1: Increment address pointer on each subsequent read/write
0: Decrement address pointer on each subsequent read/write

DL = 1: 8-bit data-bus interface
0: 4-bit data-bus interface

2 = 1: Shift cursor with display
0: Hold cursor fixed

N = 1: 2-line display
0: 1-line display

S/C = 1: Shift display (without changing DD RAM)
0: Shift cursor only

F = 1: 5 × 10 dot character font
0: 5 × 7 dot character font

R/L = 1: Shift operations occur to the right
0: Shift operations occur to the left

BF = 1: Busy
0: Not busy

must perform is the initialization of the display. Initialization includes clearing the display and issuing the appropriate control commands that set the display up with the desired features. The INIT subroutine (Listing 3) is a sample initialization routine for a 16 × 2 display. The INIT routine sets the display up for 2 line, 5 × 7-font format, 8-bit interface mode, and suppressed cursor. Also, the INIT routine sets up the display to shift the cursor one position to the right on every data write.

Note: The display module requires 10 milliseconds to initialize after power is applied. The host, therefore, must wait at least 10 milliseconds before writing to the display following the power-up of the module.

CG RAM initialization

The CGINIT routine (Listing 4) illustrates the operations required to set up 3 of the 8 user-defined characters. The characters defined in the

LISTING 5

PLANE	FCB	\$00
	FCB	\$00
	FCB	\$00
	FCB	\$1C
	FCB	\$1F
	FCB	\$00
	FCB	\$00
	FCB	\$10
	FCB	\$0C
	FCB	\$06
	FCB	\$1F
	FCB	\$1F
	FCB	\$06
	FCB	\$0C
	FCB	\$10
	FCB	\$18
	FCB	\$18
	FCB	\$18
	FCB	\$1F
	FCB	\$1F
	FCB	\$00
	FCB	\$00
	FCB	\$00

routine form an airplane when displayed together. Table 2 illustrates how each of the three user-definable characters are generated. Listing 5
continued on page 80

HARDWARE HACKER

Electronic Levels
Low Cost Memory
New Form of Matter
Cases and Enclosures
LaserWriter Tech Info

DON LANCASTER

Low-cost memory

SOMEONE AT LONG LAST HAS DONE something right for a change. Hacker friendly too. A giant *Yea Team!* and a sixpack of *attaboys* to all of the folks at *Dallas Semiconductor*, a manufacturer of innovative new integrated circuits.

Dallas has set up a free 24-hour direct-order line with no hassles and no minimums. If you want one or two of their chips at 3:42 in the morning, just whip out your VISA card and give them a call. For next day delivery.

What's really sad is that virtually all of those other "good guy" innovative chip manufacturers invariably use by far the most Neanderthal and the most hacker vicious of the old-line distribution channels.

So here and now, I issue an outright challenge to all the rest of the "good guys"—*Maxim, Sprague, Linear Technology, Samsung, Mitsubishi* (who has far and away the most mesmerizingly awful reps and distributors in the industry, bar none), *Signetics, Reticon, SGS, Statek, Teltone, Rohm, Intersil, Sony, Siemens, Philips*, et. al.

For your own good, please, please, find out why *Dallas* is laughing all the way to the bank. And please set up your own direct order lines that do not go out of their way to kick sand in the collective faces of your most promising future customers. Your present distributors are your worst enemy.

As usual, please observe that all of our referenced sources do appear in either the upcoming *Cases and Enclosures* resource sidebar or in the *Names and Numbers* box. Please do check out the sidebars

before using our free help line. And please do make all your product and your literature requests to anyone listed in either sidebar specific, rather than general.

We return you now to our column already in progress....

LaserWriter information

It appears that *Apple Computer* has gone far out of their way to prevent you from ever getting any useful parts or technical service information on their *LaserWriter* printers. Outside of the limited "white book" *LaserWriter Reference* on all of those connections and the commands (in stock here at *Synergetics*), virtually nothing at all is available from them on their printers. Such stupidity ends up monumentally short-sighted.

Fortunately, *Hewlett-Packard* is as hacker-friendly as *Apple* is hacker-vicious. The *Canon CX* and *SX* engines used by both companies in their printers are nearly identical. Over 95 percent of the mechanical parts are fully interchangeable. And *HP*, like *Dallas Semiconductor*, also has a free VISA order line with overnight express delivery.

HP has a pair of outstanding service and repair manuals that are di-

rectly applicable to the *Apple* printers. Their manual #33440-90920 is for the older *CX* engine as used on the *LaserWriter* and *LaserWriter Plus*. Their manual #33440-90904 is for the newer *SX* engine that is used on the *LaserWriter NT* and *LaserWriter NTX*.

Unfortunately, *HP* sells only the replacement modules, and rarely goes down to the individual component parts level. Thus, you can get a fuser assembly from them, but not a fuser roller. One source I've found useful for any and all *LaserWriter* parts on any level is *Don Thompson*, who also stocks detailed repair literature, low-cost rebuilds, toner supplies, and the handy and useful repair tools. One additional source for a *LaserWriter* schematic is *Bomarc Services*.

As we have seen before, you can easily refill your own *SX* or *CX* toner cartridges in two minutes for \$7.50. The job is much simpler than properly packaging your cartridge for shipping to a commercial refilling service.

Besides *Don Thompson*, another major source of refilling supplies that I personally use is *Arlin Shepard of Lazer Products*. *Arlin* also now offers "infinite life" recoated *SX* drums. One I'm now using is on its 14th refill.

From what I have been able to determine, much of the rest of the toner refilling industry is an outright zoo. We have people selling you shoe polish and calling it drum recoating, others gold plating things that do not need gold plating, and yet others who are making useless

NEED HELP?

Phone or write your **Hardware Hacker** questions to:

Don Lancaster
Synergetics
Box 809-RE
Thatcher, AZ, 85552
(602) 428-4073

"gapping" adjustments that try and compensate for the shoddy quality of the toner.

For a good glimpse into the entire toner refilling industry, check out the highly interesting and informative *Recharger* trade journal. Full details on the toner cartridge reloading appear in previous columns (*Radio-Electronics*, April 1989) and in my *Hardware Hacker II* book-on-demand published reprints.

Low-cost memory

In case you have not met them before, *Dallas Semiconductor* has a mind-boggling array of cheap and innovative new circuits that cry out for hacker use. They are very heavy into such things as clocks, non-volatile memory, supervisory watchdogs, FCC legal "plug-and-go" telephone modules, and the short-range RF remote controls.

One typical example is their DS2222 *EconoRAM*, shown in Fig. 1. This is a 256-bit nanopower memory that is easily made non-volatile with a tiny backup battery. It is intended for intelligent credit cards, public-transit tickets, security-access con-

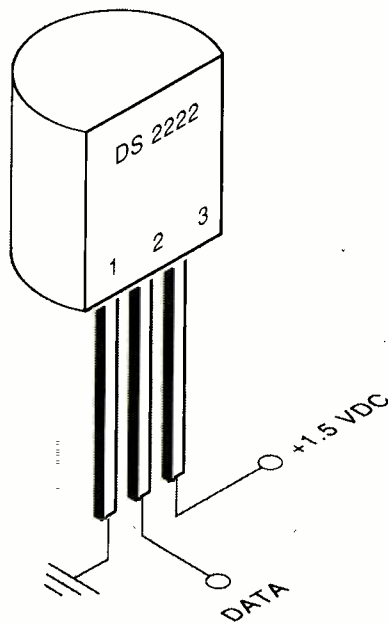

FIG. 1—THE ECONORAM is a micropower memory of 256 bits. These can cost less than a quarter each in quantity. Amazingly, all addressing, data transfers, and all read/write control are done through a single very busy pin!

trol, trade-show customer identification, long-term data acquisition, and user ID keys. Or anywhere else you want to cheaply store a few bits of information that has to be nanopower, compact, and highly portable.

The cost is under a quarter in large enough quantities. Supply voltage is between 1.2 and 4 volts DC. Standby operating current is a mere 100 nanoamperes. Less than one milliamperere is needed for a read or write operation. A typical small coin cell is good for 100 million transactions over several years of operation.

What boggles the mind is that there are only *three* pins on the DS-2222. Power, ground, and a single pin that, believe it or not, performs all of the addressing, data transfer, and control of reading and writing.

You just about have to use a host microprocessor or personal computer to read or write to the chip, since the process is so involved. Here's how it usually works:

To read or write any one bit, all bits must get read or written. Figure 2 shows details. Your host controller provides a high output and then issues a string of 264 pulses. The tim-

ing can be any interval longer than 60 microseconds per pulse.

Each pulse event begins when the output drops from supply to ground. When writing, a logic one must last between 1 and 15 microseconds. A logic zero must last at least 60 microseconds. And so, the *length* of your write pulse determines whether you enter a one or a zero.

When reading, you have your host hold the output low for between 1 and 15 microseconds. The *EconoRAM* should respond by remaining low for another 15 microseconds if a zero is stored, and by immediately going high if a one is stored. Thus, to read, bring the output low for 15 microseconds. Wait 5 microseconds. Then sense the one or zero.

The first 8 bits in your sequence are called the *command word*. The first five are all ones to write, or all zeros to read. That is followed by a pair of zero bits which allow a later memory expansion. The eighth header bit is always a one.

The remaining 256 bits are your data, arranged in a sequentially addressed order, which is much like how a shift register would work. To change a single bit, you first read all of the bits, store them in host memory, and then rewrite all of the bits, changing what you want on the fly.

Obviously, this RAM is best suited for long-term storage applications only occasionally read from or written to. A 5K pull-up resistor is recommended when writing or reading. The output pin is TTL compatible.

Now for the tricky part. To first initialize your *EconoRAM*, you send it 264 write zero states. That automatically resets the internal address counter. After that you send a new sequence to do whatever reading or writing you care to. Remember that you must go completely through a sequence each and every time or the *EconoRAM* will get confused.

Four *EconoRAM*'s are easily used together for a full 1K that should be enough for a complete name, address, and account number. All you do is change the address bits in your command string through 00, 01, 10, or 11. As many as 32 bits could also get permanently factory written in for a positive and genuinely non-volatile message header.

NEW FROM DON LANCASTER

HANDS-ON BOOKS

Hardware Hacker Reprints II	24.50
Ask The Guru Reprints I or II	24.50
CMOS Cookbook	18.50
TTL Cookbook	16.50
Active Filter Cookbook	15.50
Micro Cookbook vol I or II	16.50
Enhancing your Apple I or II	17.50
AppleWriter Cookbook	19.50
Apple Assembly Cookbook	21.50
Incredible Secret Money Machine	10.50
LaserWriter Reference (Apple)	19.50
PostScript Cookbook (Adobe)	16.50
PostScript Ref. Man. (Adobe)	22.50
PostScript Prog. Design (Adobe)	22.50
Real World Postscript (Roth)	22.50

UNLOCKED SOFTWARE

LaserWriter Secrets (Ile/Mac/PC)	29.50
PostScript Show & Tell	39.50
Intro to PostScript VHS Video	39.50
PostScript Beginner Stuff	39.50
PostScript Perspective Draw	39.50
PostScript Technical Illustrations	39.50
PostScript Work in Progress	39.50
PostScript BBS stuff	19.50
Absolute Reset Ile & Iic	19.50
AppleWriter/Laserwriter Utilities	49.50
Enhance I or II Companion Disk	19.50
AppleWriter CB or Assy CB Disk	24.50

FREE VOICE HELPLINE

VISA/MC

SYNERGETICS

Box 809-RE
Thatcher, AZ 85552
(602) 428-4073

CIRCLE 83 ON FREE INFORMATION CARD

Let me know what new hacker uses you might come up with using this innovative new approach to small memory needs.

Cases and enclosures

For this month's resource sidebar, I thought we'd round up some low-cost products and materials that let you design your own electronic cases and enclosures.

Obviously, if you just need a plain old box, your local *Radio Shack* has several bargain priced ones in stock, as does *Mouser Electronics*, as well as nearly all of our other fine **Radio-Electronics** surplus advertisers. The trick is to find something beyond a plain-jane box that looks sharp, makes a clear statement you can relate to, and isn't outrageously expensive.

Let's briefly run down the major case and enclosure manufacturers: *Bud*, of course, who is pricey, very old line and uninspired; *Vero* having a foreign look about them; *Hammond* with a good selection of ABS minicases; *Polycase* who feature the wall-mounted and plug-in stuff; *PacTec* with an incredible variety of sloping small consoles; *Keystone* for built-in battery compartments and standoffs; *Serco* for some fancier, highly styled boxes; and *Vector* who are both low cost and look it.

Want to wrap your own instead? Figure 3 shows you three of my own favorite home-brew packages from way back when. While most of the *Zero Manufacturing* cases are ludicrously expensive, they also offer a line of plain old deep-drawn aluminum boxes (Fig. 3, top) with rounded corners in zillions of sizes that are reasonably priced. These anodize beautifully, and many models have lids which exactly provide an outside or an inside fit. And the photographic dialplate materials from either *Metalphoto* or *Fotofoil* can integrate beautifully with these cases.

For dozens of examples of these, check into the back issues of **Popular Electronics** and **Radio-Electronics** in the 1965-1975 time frame.

Vinyl clad materials are used by all the big folks. Getting them in small quantities can be a real hassle. Instead, you simply go on down to your local *Yellow Front* or an equivalent yuppy pseudo-surplus store,

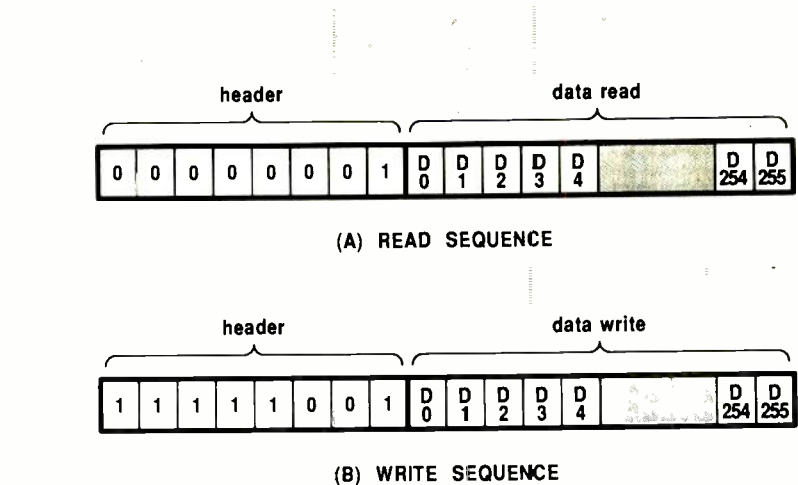
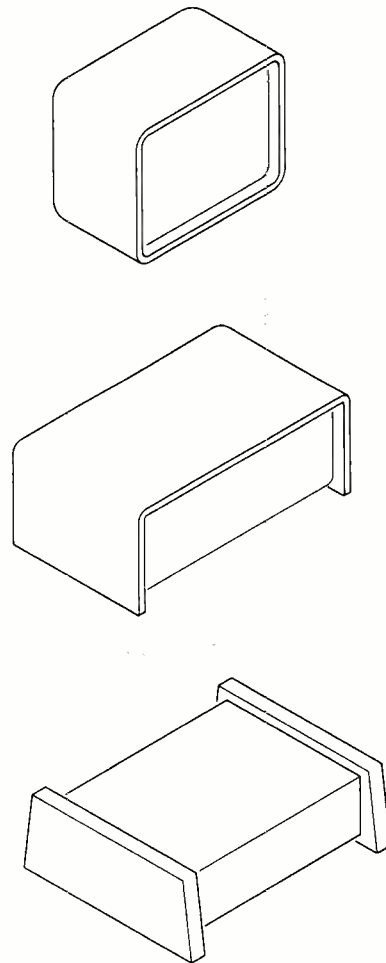

FIG. 2—THE ECONORAM GETS INTERROGATED by use of 264 sequential timing pulses. Once started, the sequence must get completed in its entirety. See the DS2222 data sheet for additional details.



The **ZERO BOX** uses a deep drawn aluminum shell and looks particularly good with a Metalphoto dialplate. Shallow versions can also be used face up. These anodize beautifully.

The **VINYL CLAMSHELL** has a brushed aluminum chassis and a cover coated with glued-on decorator vinyl. Tilting end brackets can also be added, as can ventilation holes.

The **WOODEN END RAIL** play uses exotic wood caps that have suitable grooves routed in them. The chassis itself can be painted aluminum or a polished brass or chrome.

FIG. 3—HOMEBREW CASES FROM the "golden age" of hardware hacking. All of these are easily built, yet can produce outstanding professional results.

buy some fake Naugahyde by the yard, and glue it onto plain old aluminum or steel. The "clamshell" de-

sign (Fig. 3, middle) is easy to do. You can simply sand the bottom half to get a satin finish, and glue vinyl

onto the upper half to get a professional final result.

The *wooden rail* ploy (Fig. 3, bottom) is both easy to hack and looks great. Just get yourself some exotic wood from *EDLCO* or *Constantine* (Cocobolo or Wenge are fine choices), mill some slots in it with a hobby motor tool, slide in a bent

metal frame, and you are home free.

I've found a local blacksmith or sheet-metal shop to be real handy at times, so you'll want to find a good one of these on your own. Better yet, see if you can't find a horse trailer or hitch works. They have the machinery to properly cut and bend the heavier stuff without costing an

arm and a leg. And there's usually enough scrap on the floor under the shear.

Four interesting package support outfits are the *Fomeboards* people which do stock all sorts of beautiful prototyping sheet materials; *Coburn* who is heavy into unusual finishes such as prismatics, glow-in-the-dark, diffraction gratings, foils, etc; instant dust-on flock materials from *DonJer*, and the *Ultra-Suede* from *Red Spot*, a textured urethane finish having a soft fuzzy suede or smooth leather touch.

All the enclosure and packaging people advertise in most of the free electronics trade journals. *Electronic Component News* seems about the best for cases and such. Two other trade journals with useful fit and finish ideas in them include *Electronic Packaging* and *Appliance*.

CASE AND PACKAGING RESOURCES

Appliance

1110 Jorie Blvds, CS 9019
Oak Brook, IL 60522
(708) 990-3484

CIRCLE 225 ON FREE INFORMATION CARD

Coburn

1650 Corporate Road West
Lakewood, NJ 08701
(201) 367-5511

CIRCLE 226 ON FREE INFORMATION CARD

Constantine

2050 Eastchester Road
Bronx, NY 10461
(212) 792-1600

CIRCLE 227 ON FREE INFORMATION CARD

DonJer Products Co

Ilene Court Building 8
Belle Mead, NJ 08502
(800) 336-6537

CIRCLE 228 ON FREE INFORMATION CARD

EDLCO

PO Box 5373
Asheville, NC 28813
(704) 255-8765

CIRCLE 229 ON FREE INFORMATION CARD

Electronic Component News

1 Chilton Way
Radnor, PA 19089
(215) 964-4345

CIRCLE 230 ON FREE INFORMATION CARD

Electronic Packaging

1350 East Touhy Avenue
Des Plaines, IL 60018
(708) 635-8800

CIRCLE 231 ON FREE INFORMATION CARD

Fomeboards

2211 North Elston
Chicago, IL 60614
(312) 278-9200

CIRCLE 232 ON FREE INFORMATION CARD

Fotofoil/Miller Dial

4400 North Temple City Blvd
El Monte, CA 91734
(818) 444-4555

CIRCLE 233 ON FREE INFORMATION CARD

Hammond

1690 Walden Avenue
Buffalo, NY 14225
(716) 894-5710

CIRCLE 234 ON FREE INFORMATION CARD

Keystone Electronics Corp

31-07 20th Road
Astoria, NY 11105
(718) 956-8900

CIRCLE 235 ON FREE INFORMATION CARD

Metalphoto

18531 South Miles Road
Cleveland, OH 44128
(216) 475-0555

CIRCLE 236 ON FREE INFORMATION CARD

Mouser Electronics

11433 Woodside Avenue
Santee, CA 92071
(800) 346-6873

CIRCLE 237 ON FREE INFORMATION CARD

PacTec

Enterprise & Executive Avenues
Philadelphia, PA 19153
(215) 365-8400

CIRCLE 238 ON FREE INFORMATION CARD

Polycase

4726 Superior Avenue
Cleveland, Ohio 44103
(216) 391-0444

CIRCLE 239 ON FREE INFORMATION CARD

Red Spot

PO Box 418
Evansville, IN 47703
(812) 428-9100

CIRCLE 240 ON FREE INFORMATION CARD

Serco

612 Commercial Avenue
Covina, CA 91723
(818) 331-0517

CIRCLE 241 ON FREE INFORMATION CARD

Vector Electronic Co

12460 Gladstone Avenue
Sylmar, CA 91342
(818) 365-9661

CIRCLE 242 ON FREE INFORMATION CARD

Vero

1000 Sherman Avenue
Hamden, CT 06514
(203) 288-8001

CIRCLE 243 ON FREE INFORMATION CARD

Zero Halliburton

PO Box 3339
Pacoima, CA 91333
(818) 897-7777

CIRCLE 244 ON FREE INFORMATION CARD

Electronic inclinometers

The folks at *Wedge Innovations* are now retailing intelligent electronic levels that display your choice of degrees, pitch, slope percent, level & plumb, autocalibration, and even a simulated bubble. The suggested list price is under \$80. Related electronic protractors are being offered by *Lucas Sensing Systems*. I just thought we might take a quick look at some of the principles of electronic level sensing. You can easily build your own level sensor for under \$4.

In general, there are two popular ways of telling which way is up. One quite expensive method is the *vertical gyro*. That is simply a gyroscope that is spun up while level and stays that way when the world around it moves. Two surplus sources of vertical gyros include *Fair Radio Sales* and the folks at *C&H Sales*.

A much simpler method is the *inclinometer*. As Fig. 4 shows us, an inclinometer can be as simple as a plumb bob and a protractor. Your gravity-sensing plumb bob usually points straight down. As the protractor is rotated, its slope angle can be read.

There have been several older attempts at getting an electrical output of an inclinometer. Obviously, you can simply wipe a potentiometer, but stiction, wear, and hysteresis can end up as problems. Other early schemes used mercury, but

NAMES AND NUMBERS

Bomarc Services

Box 113
Casper, WY 82602
(307) 237-3361
CIRCLE 245 ON FREE INFORMATION CARD

C & H Sales

2716 East Colorado Blvd
Pasadena, CA 91107
(213) 681-4925
CIRCLE 246 ON FREE INFORMATION CARD

Dallas Semiconductor

4350 Beltwood Parkway South
Dallas, TX 75244
(214) 450-0400
CIRCLE 247 ON FREE INFORMATION CARD

Don Diers

4276 North 50th Street
Milwaukee, WI 53216
CIRCLE 248 ON FREE INFORMATION CARD

Fair Radio Sales

1016 East Eureka Street
Lima, OH 45802
(419) 227-6573
CIRCLE 249 ON FREE INFORMATION CARD

Genie

401 North Washington Street
Rockville, MD 20850
(800) 638-9636
CIRCLE 250 ON FREE INFORMATION CARD

Hamlin

612 East Lake Street
Lake Mills, WI 53551
(414) 648-5244
CIRCLE 251 ON FREE INFORMATION CARD

Hewlett-Packard

PO Box 10161
Palo Alto, CA 94303
(415) 857-1501
CIRCLE 252 ON FREE INFORMATION CARD

Hoechst Celanese

26 Main Street
Chatham, NJ 07928
(800) 235-2637
CIRCLE 253 ON FREE INFORMATION CARD

Lazer Products

12741 East Caley Ave #130
Englewood, CO 80155
(303) 792-5277
CIRCLE 254 ON FREE INFORMATION CARD

Linear Technology

1630 McCarthy Blvd
Milpitas, CA 95035
(408) 432-1900
CIRCLE 255 ON FREE INFORMATION CARD

Lucas Sensing Systems

21640 North 14th Avenue
Phoenix, AZ 85027
(602) 256-7674
CIRCLE 256 ON FREE INFORMATION CARD

MicroCAD News

PO Box 203550
Austin, TX 78720
(512) 250-1700
CIRCLE 257 ON FREE INFORMATION CARD

Motorola

5005 East McDowell Road
Phoenix, AZ 85508
(602) 244-6900
CIRCLE 258 ON FREE INFORMATION CARD

National Semiconductor

2900 Semiconductor Drive
Santa Clara, CA 95052
(408) 721-5000
CIRCLE 259 ON FREE INFORMATION CARD

Philips

2001 West Blue Heron Blvd
Riviera Beach, FL 33404
(407) 881-3200
CIRCLE 260 ON FREE INFORMATION CARD

PMI

1500 Space Park Drive
Santa Clara, CA 95052
(408) 727-9222
CIRCLE 261 ON FREE INFORMATION CARD

R & D Electronics

1224 Prospect Avenue
Cleveland, OH 44115
(800) 642-1123
CIRCLE 262 ON FREE INFORMATION CARD

Science

1333 H Street NW
Washington, DC 20005
(202) 326-6400
CIRCLE 263 ON FREE INFORMATION CARD

Sharp

Sharp Plaza
Mahwah, NJ 07430
(201) 529-8757
CIRCLE 264 ON FREE INFORMATION CARD

Spectron

595 Old Willets Path
Hauppauge, NY 11788
(516) 582-5671
CIRCLE 265 ON FREE INFORMATION CARD

STANO Components

PO Box 6274
San Bernardino, CA 92412
(714) 882-5789
CIRCLE 266 ON FREE INFORMATION CARD

Synergetics

Box 809
Thatcher, AZ 85552
(602) 428-4073
CIRCLE 267 ON FREE INFORMATION CARD

Texas Instruments

PO Box 1443
Houston, TX 77001
(800) 232-3200
CIRCLE 268 ON FREE INFORMATION CARD

Don Thompson

23072 Lake Center Dr #100
El Toro, CA 92630
(714) 855-3838
CIRCLE 269 ON FREE INFORMATION CARD

Wedge Innovations

532 Mercury Drive
Sunnyvale, CA 94086
(800) 762-7853
CIRCLE 270 ON FREE INFORMATION CARD

that's a hazardous element that's both poisonous and rather low in impedance.

Figure 5 shows you another early attempt at an electronic inclinometer. This one is known as an *electrolytic sensor*. You place three probes in a conductive liquid in a sausage-shaped enclosure. As the sensor tilts from level, the deeper probe's resistance drops, while the shallow one will increase. A simple op-amp bridge circuit can convert the differential resistance into an

output voltage.

One obvious choice for a liquid is bromine, one of those few elements that remain liquid at normal temperatures. Two older sources of the electrolytic level detectors are *Hamlin* and *Spectron*. These devices are both fragile and expensive.

Most of the bets these days, though, are on the *capacitance inclinometer* shown in Fig. 6. That one is simple, cheap, low power, and clean.

Picture an insulated enclosure the

size and shape of a Magician's fake silver dollar. The rear of the enclosure is a grounded metal plate. The front consists of a pair of butterfly-shaped capacitor plates. The case gets filled exactly halfway with a magic liquid that is an inert insulator, has a high dielectric constant, a medium viscosity, is non-wetting, non-corrosive, and has a very high vapor pressure. Propylene is one possible choice.

After filling, your case is sealed. When level, each of those butterfly

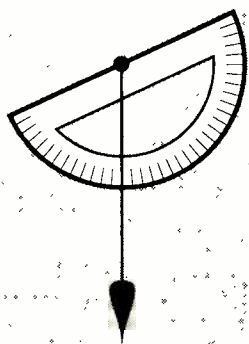

FIG. 4—THIS SIMPLE INCLINOMETER can be created by using nothing but a plumb bob and a protractor. You sight along the base of the protractor base and then read the angle.

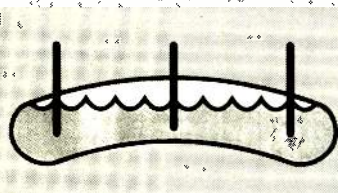

FIG. 5—AN ELECTROLYTIC LEVEL is one older electronic inclinometer. As the device tilts, the bridge resistance between the sensing pins will change. Bromine is one possible liquid.

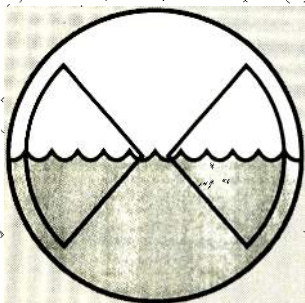

FIG. 6—CAPACITIVE LEVEL SENSOR is the one most often used today for electronic levels and inclinometers. As the device tilts, the high dielectric constant of the liquid will change the differential capacitance on the plates.

plates will be immersed just as deep in the dielectric liquid. As the sensor tilts, one plate goes deeper and the other will become shallower, thus changing the capacitance. The

higher the dielectric constant of the liquid compared to air, the more profound the capacitance change.

To sense, you let each wing of the butterfly set your pulse width of a monostable built out of a pair of 555 timers or one single 556 and measure the time difference between the two to determine the angle.

To get fancier, place a pair of the sensors back-to-back and sharing a common ground. That gives you two big advantages: First, your sensed capacitance change is now doubled, which should give you more accuracy. Better yet, your *cross axis sensitivity* should drop dramatically. That will happen because an unwanted forward or reverse tilt increases the depth on one side and decreases it on the other.

The shape of the plates determines the linearity of the capacitance versus the slope angle. Sometimes, you may like to purposely change the plate shape to get a non-linear response. One use might be to automatically calculate compound miter cut depth on a table saw.

It seems to me that you could easily make up a capacitance sensor using nothing but a pair of printed circuit boards, a spacer and a large O-ring. The bottom board would form the ground plane. The spacer would have a hole in it somewhat larger than the O-ring and would act as a compression stop, setting a fixed width. And the top one would have the butterfly pair on it.

Er, on second thought, why don't you tell me? For this month's contest, either (A) show to me an eminently hackable design for the capacitance inclinometer, or (B) dream up a new use for an electronic angle measuring device. There will be all the usual *Incredible Secret Money Machine* book prizes, with an all-expense-paid (FOB Thatcher, AZ) *tinaja quest* for two going for the best entry of all.

New tech literature

A brand new form of matter known as an *aerogel* got written up in the February 16th, 1990 issue of *Science*, page 807. Aerogels are rigid inorganic solids that have roughly the density of air and look like so much solidified smoke. They transmit light but block heat, electricity, and sound.

You can make aerogels from mine tailings dumps. Important early uses are expected to be brand new types of superinsulation and for the live capture of meteors. Neat stuff.

The new Data books for this month include the *Data Communications Handbook* from National, a *Memory Data Book* from Sharp, and a *Discrete Semiconductor Condensed Catalog* from Philips.

Free samples of their new 75ALS176 differential bus transceivers as well as their new *Widebus* family chips are available from Texas Instruments. The folks at *R&D Electronics* have an interesting new surplus flyer which includes cheap ultrasonic motion detectors and lots of assorted hacker project cases. A wide selection of new and used antique radio vacuum tubes is available through *Don Diers*. And, rebuilt military infrared viewers are available from *Stano Components*.

One of the more popular CAD/CAM circuit-analysis programs for the high-end engineering workstations goes by the name of *SPICE*. For this month's free new software, nearly all of those integrated-circuit houses are crawling all over themselves to see who can get their free *SPICE* macromodule simulation disks out there firstest and fastest. Early entries include *Linear Technology*, *PMI*, and *Motorola*.

The free *Linear Technology* disk includes a simulation and macromodel of their ultra-low-noise op-amp we looked at last month. Additional info on *SPICE* often shows up in the free engineering design trade journals, such as *MicroCAD News*.

A free *Designing With Plastics; The Fundamentals* booklet is obtainable from *Hoechst Celanese*.

Turning to my own products, I am now self publishing nearly a dozen titles using my new *book-on-demand* PostScript technology. Four of them that you might find interesting are the *Hardware Hacker II* reprints, my *Ask The Guru* volumes I and II, and my brand new *LaserWriter Secrets* book-disk combo.

I've also started up a major new PostScript and desktop publishing BBS on *Genie*. Our goal is to have a thousand free downloads very soon. Finally, I've got a new and free mailer for you that includes dozens of insider hardware hacking secret sources. Write or call for a copy. **R-E**

PC SERVICE

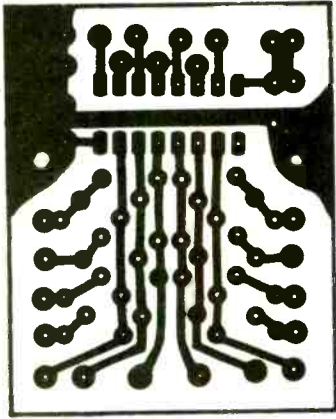

1 11/16 INCHES

PX0-1000 WITH ROTARY-SWITCH programming and a diode matrix.

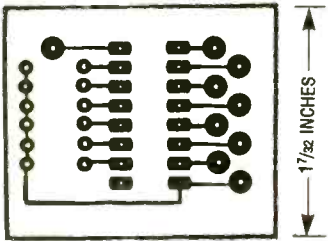

1 7/32 INCHES

PX0-1000 FREQUENCY DIVIDER with DIP-switch programming.

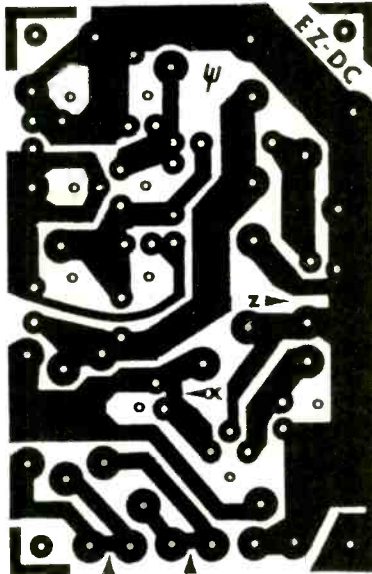

2 INCHES

BUILD A GENERIC POWER SUPPLY using this PC board.



286 AT COMPUTER WITH VGA MONITOR AND SOFTWARE

ONE 5-1/4" ONE 3-1/2" AND 40MB HARD DRIVE!



- 100% IBM compatible.
 - 80286 microprocessor (operates at 12MHz).
 - One 3-1/2" 1.44 MB floppy drive.
 - One 5-1/4" 1.22 MB floppy drive.
 - 40 MB hard drive (IDE hard disc drive).
 - 1 MB RAM on motherboard expandable to 4 MB.
 - 14" VGA .41 dot pitch high resolution color monitor. 256 colors. • VGA color card.
 - Four 16-bit expansion slots open.
 - Two RS232 serial ports • AT compatible.
 - One parallel port. • One mouse port.
 - One half height drive exposed.
 - One half height drive cavity enclosed.
 - 30287 math co-processor socket
 - AT-style 101 keyboard. • Zero wait state.
 - 180 watt switchable power supply.
 - Real time clock/calendar
 - **One Year Parts Warranty!**
 - **120 Day On-Site Servicing Warranty!**
 - **Factory New! Factory Perfect!**
- Software includes:**
- MS-DOS 3.31. • Turbo Pascal 5.0.
 - Borland Quattro. • GW BASIC.
 - PFS Professional Write. • Emerson Menu/Tutorial Program. • Check Free.

Due to a special arrangement, we were able to obtain a large inventory of these 386 computers. As a result, we can now offer them to you at **HUGE SAVINGS!**

Mfr. Sugg. Retail: **\$3,350.00**
DAMARK PRICE:
\$1499.99
 Item No. B-2022-139964
 Insured Ship/Hand: \$40.00

FOR FASTEST SERVICE CALL TOLL FREE 1-800-729-9000



DAMARK INTERNATIONAL, INC.
 6707 Shingle Creek Parkway, Minneapolis, MN 55430
 Customer Service • 612-566-4940

Please rush me: Emerson Computer(s) @ \$1499.99 each, plus \$40.00 s/h each.
 Item No. B-2022-139964
 MN res. add 6% sales tax.

Name _____
 Address _____
 City, State, Zip _____
 Check/MO VISA MasterCard Discover
 Card No. _____
 Exp. Date _____ Ph. # () _____
 Signature _____

DELIVERY TO 48 U.S. STATES ONLY

Do You Know the ABC's of Camcorders?

Memories can last a lifetime when you have a camcorder by your side. Today's camcorders are smaller and lighter than ever before, and have a variety of features that make it easier to preserve such memories as your child's first birthday party or a family reunion. The following quiz will tell you how much you know about camcorders. Score 10 points for each question you answer correctly.

- Which of the following is not a consumer camcorder format?
 (a) Beta
 (b) VHS-C
 (c) 8mm
 (d) VHS
 (e) All of the above are camcorder formats
- Camcorders are becoming more popular every year. How many camcorders were sold in 1989?
 (a) 1,495,889
 (b) 4,290,000
 (c) 6,200,202
 (d) 2,300,000
- The best-selling type of camcorder is
 (a) VHS-C
 (b) 8mm
 (c) Full-size VHS
 (d) Beta
- Which of the following are features found on a camcorder?
 (a) Power zoom
 (b) Automatic focus
 (c) Flying erase heads
 (d) High-speed shutter
 (e) All of the above
- The 8mm format is the fastest growing segment of today's camcorder market. Is it possible to play an 8mm videotape at home if you have a VHS VCR?
 (a) No
 (b) Yes - simply connect your 8mm camcorder to the inputs on your television
- What is the purpose of a flying erase head on a camcorder?
 (a) Faster erasing of tapes
 (b) Smoother transitions between scenes
 (c) Longer recording capability
 (d) Brighter colors
- What does it mean when a camcorder has a low lux rating?
 (a) The camcorder can not be used at excessive heights
 (b) The camcorder's controls are located on the lower half of the unit
 (c) The camcorder can be used in low light situations
 (d) The camcorder can only be used in a very bright situation
- True or false: Headcleaners are not necessary for camcorders
- Camcorders were first demonstrated to consumers in:
 (a) 1955
 (b) 1962
 (c) 1980
 (d) 1978
- A variety of camcorder formats, including Super VHS-C, ED Beta and High Band 8mm, provide consumers with horizontal resolution of between 400 and 500 lines. This means that consumers experience:
 (a) Improved picture quality
 (b) A choice of black and white or color pictures
 (c) Darker pictures
 (d) Better sound



Answers: 1) (e) 2) (b) 3) (c) 4) (e) 5) (b) 6) (b) 7) (c) 8) False 9) (c) 10) a.

DRAWING BOARD



ROBERT GROSSBLATT,
CIRCUITS EDITOR

Finally, a video signal!

ONCE UPON A TIME, YOU COULD GET into electronics without having to spend a lot of money. A pair of pliers, some wire, a busted radio, and a soldering iron, and bingo!—three days later you'd have a variable interositer (and who remembers what that was?). Well, unfortunately, things change. Variable interositers went the way of tubes and Metaluna is as far in the past as it is in the future. A real interest in electronics today means having to dig deeper into your pocket.

Even though the video circuits we've been working on together are only simple ones to demonstrate basic ideas, you really need more than a multimeter and power supply to learn from it. There's often just no way to get by without an oscilloscope. It's particularly valuable when you're doing video stuff because, when something doesn't work properly the first time, you can look directly at the waveform and immediately see where you've got a problem.

Now, I know that "inexpensive" is a relative term, but there are scopes advertised in R/E that can be picked up for under \$300. You may be limited in bandwidth and short some of the bells and whistles found on more expensive models but, unless you're doing some gee-whiz rocket-scientist type stuff, a scope with a 30-MHz bandwidth is more than adequate for a great many applications—including video.

I've made a point of illustrating things step by step so far, but drawings can show only so much—and they can show you only what things look like if everything is working

OK. Since we all know that the chances of that happening first shot out of the box are about as good as finding intelligent life on Pluto, the drawings won't be representative of the waveforms being produced on *your* breadboard. And, if that isn't enough, not having a scope to start with means you don't have any way to tell how close your circuit is to the drawing in the first place. The classic chicken and egg problem—but one that's easily solved by getting a scope.

So where were we?

Believe it or not we're almost finished with our video circuitry. I'm the first one to admit that it's grown to occupy lots of real estate on the breadboard. If you find that upsetting, remember that in the bad old days before IC's, sync generators like the one we're building took up a lot more room, and cost a whole lot more than a handful of IC's.

There are IC's available that can replace most of the hardware we've been assembling. However, as with most special-purpose IC's, the price you pay for using one dedicated IC in place of some MSI stuff is a loss of circuit flexibility.

Since we're designing the timing generators and one-shots, we can set the pulse widths, delays, and scan frequencies to be anything we want. Admittedly, we're after NTSC, but it wouldn't take a lot of modification to generate PAL, EGA, VGA, or any other type of video we want. Also, building a sync generator can show you a lot more than just how video works—it can also show you how to make video not work.

That isn't as screwy as it sounds, since having video not work is exactly what happens when the friendly folks at your local cable company scramble a channel, or when the latest videotape is copy protected in some way. I'm not saying that the circuit we're building will solve those things, but it will help you understand what's going on. And that's the first step to coming up with a solution. More on this intriguing subject later—now it's time to put the finishing touches on the hardware.

Making video

Everything we've done so far has been aimed at generating the two sync pulses that are being produced at the outputs of the 4528. Both the horizontal and vertical pulses are needed to control the deflection circuitry in the TV, but they have to be combined into a composite signal in order to be used to make NTSC-compatible video. And we have to make provisions in the circuitry to be able to add some picture information to the signal, as well.

Even though video is usually thought of as an analog signal, the sync component is essentially digital. After all, it's really nothing more than either high or low. So there are several ways we can combine the separate sync signals, such as resistors and diodes in a home-made Mickey Mouse gate arrangement, standard gates, and others. The choice is really yours.

Even though both of our sync signals are being derived from the master clock, they're being generated by separate circuitry using the two

halves of a 4528 (Radio-Electronics, May 1990). And since we're producing a vertical sync pulse that's three horizontal lines long, the horizontal sync generator is going to keep producing pulses even during the time that the vertical sync pulse is being generated.

In order to avoid potential problems, we can prevent that from happening by putting a low signal on the clear inputs (pins 3 and 13) of the 4528. That prevents the inverted outputs (pins 7 and 9) from going low. (Remember that the sync pulses are active low.)

The simple way to make sure that only one type of sync pulse is generated at any one time is to modify the connections made to the 4528 as shown in Fig. 1. By gating the vertical sync generator with horizontal sync and the horizontal sync generator with vertical sync, there's no possibility of signal conflict. During the period that vertical sync is being produced, the horizontal sync generator is disabled. There's really no

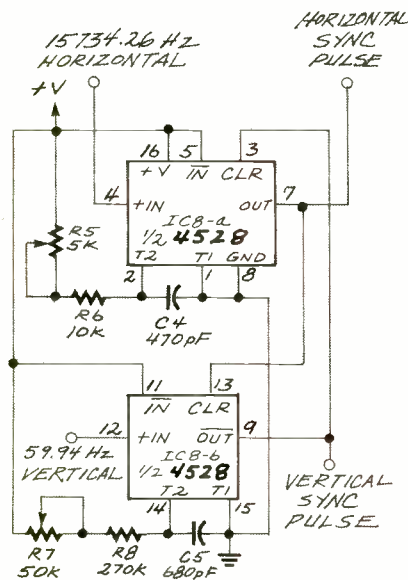

FIG. 1

reason for us to do the same thing to the vertical sync but it can't hurt anything, so we might as well. If you have a scope, you can try it both ways and see how it works.

Since we've eliminated the possibility of having two different sync signals show up at the same time, we can safely produce a composite sync signal. For reasons you'll see in just a second, I like to use gates. The requirements aren't very strict since

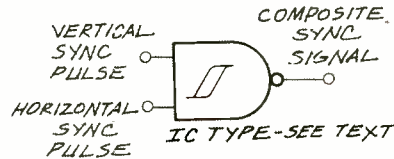

FIG. 2

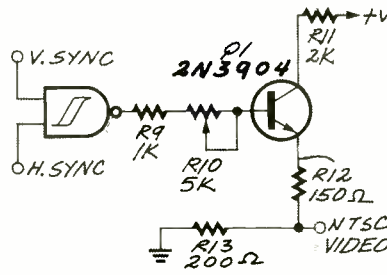

FIG. 3

we've made sure that both signals can't be low at the same time.

We want a low to be produced only when either of the sync signals go low—the rest of the time we want a high. You would think we can use a simple AND gate but, as it turns out, it's easier to first produce an inverted version of sync. That's because the inactive sync level (5-volts) has to be at 0 IRE, or about 0.3-volts DC, and the easiest way to translate levels is with a bunch of resistors and a transistor. And, the transistor will invert the signals applied to the base (since it operates as a switch), so we're better off feeding it with an inverted version of sync.

By the way, there's no reason why you can't use the non-inverting outputs of the 4528 and feed those into an AND gate to combine them. I used the inverting outputs because I prefer to have NAND gates on the board. You never know what you'll be adding to the circuit, and inverting gates are more useful.

Even though Fig. 2 uses a 4093 to combine the sync signals, you can use a 4011, or any other plain NAND gate. The 4093, however, is a Schmitt-trigger part and will produce nice, crisp pulses, even if there's a bit of noise at the inputs. Since noise is always a potential problem on solderless breadboards, it's better to be safe than sorry.

All that's left for us to do is design a circuit to translate the digital signals to NTSC standard. Remember that right now our circuit is making a 5-volt swing, and that is slightly beyond the NTSC-standard 1-volt

range...to put it mildly.

The circuit shown in Fig. 3 will take the composite sync at the output of the 4093 and cut it down to NTSC levels. You can use the trimmer to fine tune the voltage level at the output. Just remember that the high (inactive) part of the signal should be at 0.3-volts DC to meet the NTSC specs.

Now that we're producing a signal that can be fed into any video input, we can start to play around with it. Try putting video on the screen and seeing what can be done to scramble it.

When we finish this off next month, you'll have a really good idea of how to look at broadcast video. In the meantime, try to get your hands on a scope (if you don't have one already), and take a look at what's fed into the back of your TV set. By the way, most scrambling methods aren't really that complicated, and as soon as you see what's been done, you can figure out what you have to do to fix it. Now that really sounds terrific. R-E

LEARN VCR

CLEANING/MAINTENANCE/REPAIR

EARN UP TO \$1000 A WEEK, WORKING PART TIME FROM YOUR OWN HOME!



Secrets Revealed!

NO Special Tools or Equipment Needed.

EARN UP TO \$60 AN HOUR AND MORE!

THE MONEY MAKING OPPORTUNITY OF THE 1990'S

IF you are able to work with common small hand tools, and are familiar with basic electronics (i.e. able to use voltmeter, understand DC electronics). . . . IF you possess average mechanical ability, and have a VCR on which to practice and learn. . . . then we can teach **YOU** VCR maintenance and repair!

FACT: up to 90% of ALL VCR malfunctions are due to simple MECHANICAL or ELECTRO-MECHANICAL breakdowns!

FACT: over 77 million VCRs in use today nationwide! Average VCR needs service or repair every 12 to 18 months!

Viejo's 400 PAGE TRAINING MANUAL (over 500 photos and illustrations) and **AWARD-WINNING VIDEO TRAINING TAPE** reveals the **SECRETS** of VCR maintenance and repair—"real world" information that is **NOT** available elsewhere!

Also includes all the info you'll need regarding the **BUSINESS-SIDE** of running a successful service operation!

FREE INFORMATION

CALL TOLL-FREE 1-800-537-0589

Or write to: Viejo Publications Inc.
3540 Wilshire BL. STE. 310
Los Angeles, CA 90010 Dept. RE

CIRCLE 181 ON FREE INFORMATION CARD

AUDIO UPDATE



LARRY KLEIN,
Audio Editor

Receivers vs. separate components

IN A SENSE, THE RECEIVER IS THE COMPONENT that separates audiophiles from "mere" music listeners. (Or, if you will, the men from the boys.) Music listeners own receivers; audiophiles don't. At one time, the decision to go for separate components (tuner, preamp, and power amplifier) instead of an all-in-one receiver was a rational choice, but time and technology have shifted the parameters of the ballgame somewhat. So for readers shopping for an amplifier and tuner either to upgrade some older equipment or as a first-time buy, here are some historical notes and pros and cons to be used in making the receiver vs. separates decision.

Audio evolution

When hi-fi left the labs and broadcast studios and went public in the early 1950's, the early audiophile could choose dozens of tuners and numerous amplifiers in various configurations. Some power amplifiers had "remote" preamplifiers attached via a powering cable; others were available as integrated amplifiers or as separate power amplifiers with output powers ranging from 8 to 22 watts. However, all-in-one receivers were very rare, possibly reflecting an effort to differentiate the early hi-fi components from the various large, multi-tube radio chassis that were also available for do-it-yourselfers.

By the time stereo records appeared in late 1958, receivers were an established alternative format whose single chassis was easier to install and cheaper to manufacture,

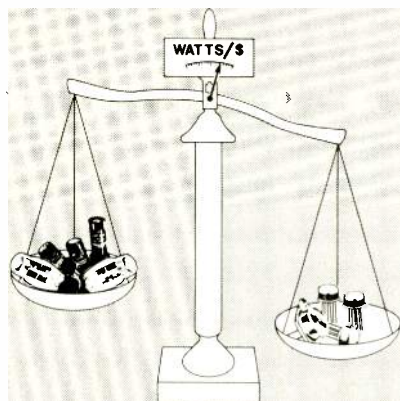

FIG. 1—INTEGRATED CIRCUITS give you a lot more watts for your dollar.

and eliminated the tangle of unreliable interconnecting cables. However, if you wanted appreciable power from both of your stereo channels, the receiver had a problem. Remember that *all* equipment in those days used tubes, and power-output tubes required output transformers. Wide-range, low-distortion output transformers were necessarily large and heavy—as were the power transformers supplying the filaments and the plate currents of the four output tubes. This meant that stereo receivers tended to be large, hot, and heavy. And if you wanted powers higher than about 20 watts, they got significantly larger, hotter, and heavier. I remember one moderately high-powered and expensive Fisher receiver that struck me as an effective advertisement for separate components—it took an incredibly strong man to lift it!

Transistorization

Aside from the other benefits wrought by the transistorization of audio, it brought high-power receivers into the realm of practicality. The low output impedance of the power transistors eliminated the need for the two output transformers. That in turn not only enabled the designers to reduce the cost, weight, and size of their products but also served to improve amplifier bandwidth and stability. The amplifier and tone control stages also benefitted from the low impedance of the solid-state circuitry; the hum and RFI problems that had always plagued high-gain tube circuits were substantially reduced. The net result of all those advantages—plus the cost reduction that resulted from the use of a single chassis and power supply—was that the receiver shortly became the best-selling electronic audio component.

The elements of choice

Given all the factors discussed above, why haven't separate power amplifiers, tuners, and preamplifiers vanished from the marketplace? There are several nonrational reasons why otherwise rational audiophiles (myself included) prefer separates.

A few words about the irrational elements first. It didn't take years on a psychoanalyst's couch for me to realize that there's some snobbery at work in at least two areas of my buying behavior. For example, I've always used the inadequate performance and poor reliability of U.S.

continued on page 79

COMPUTER DIGEST

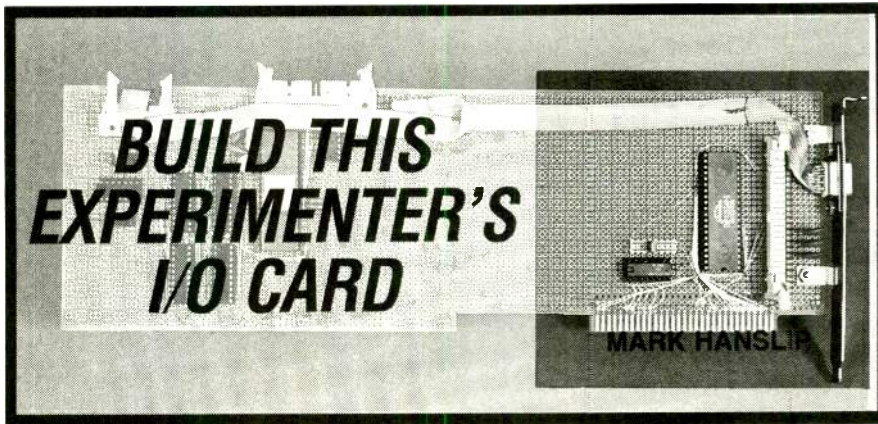

A computer by itself can't do much; it needs some way of communicating with the outside world. It needs to be able to sense external conditions (a switch closure, for example), and it needs to be able to control circuitry (a relay, for example). The principles of interfacing those types of devices are not difficult; we'll show how easy it is by building an experimenter's card for the IBM PC expansion bus.

The card contains three eight-bit parallel ports, but is built from just a few components, thereby making construction simple and inexpensive. We'll describe several circuits for interfacing LED's, switches, and other devices to the card, as well the software required to configure and use the I/O ports. We'll also show you how easy it is to set up and use the card with simple BASIC programs.

The 8255 PPI

The heart of the design is the 8255 Programmable Peripheral Interface, or PPI. The 8255 was originally designed for use with the 8080 microprocessor, but it is also used with 8088 designs including the PC family.

The 8255 has three eight-bit TTL-compatible I/O ports (A-C), and it can operate in three different modes. Depending on the mode, the lines in each port act

differently.

In Mode 0, Ports A and B can operate as either inputs or outputs, and Port C is divided into two four-bit groups, either of which can operate as inputs or outputs.

In Mode 1, Ports A and B can again act as either inputs or outputs. However, the two four-bit ports in Port C are used for handshaking and control purposes in conjunction with Ports A and B. In Mode 1, the Port C lines might be used to strobe data (supplied on either Port A or port B) into a printer, and to detect its "busy" signal.

Last, in Mode 2, Port A is used for eight-bit bidirectional bus I/O, Port C is used for control and status information, and Port B is not used at all. For further details on operating modes, consult Intel's *Microsystem Components Handbook*, Volume 2.

You select among the various modes by writing a value to a special control port; Table 1 shows the control-port values required to achieve various I/O combinations. Our examples all work in Mode 0.

The PC interface

With Intel microprocessors, communications between the CPU and various devices is accomplished through I/O (Input/

(Continued on page 75)

EDITOR'S WORK-BENCH

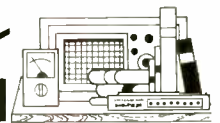

68000 News

I heard from an old friend, Peter Stark, recently. Peter is one of the world's more accomplished 6800/68000 hackers. You may recall his series on building a 68000 computer that uses IBM-PC style display adapters, I/O cards, case, keyboard and power supply. The series ran from May 1987 to September 1988, and PT-68-K2 kits are still available (see Vendor Information below for more information). Peter wrote the operating system that controls the PT-68-K2.

Anyway, it seems that one of the older 68xxx magazines has cut coverage of hobbyist/hacker systems, so Peter is beefing up his own newsletter, trying to take up the slack. If you're interested in 68xxx systems, contact Stark-K Software Systems Corp., P.O. Box 209, Mt. Kisco, NY 10549. Tell 'im I sent you.

System Analyzers

What's inside your home computer? You're probably intimately familiar with it. But what about your office PC? What about your coworker's PC (you know, the cute little blond who's always coming to ask you for advice)? What about the six, twelve, or hundred PC's that you provide service and support for? Maybe you know, maybe you don't. Most of the time you don't care, but when you're installing new hard-

ware or software, you do care, desperately. Several products have come to market recently that purport to provide useful information on PC internals: System Sleuth 2.0 (by DTG) and Manifest (by Quarterdeck Office Systems).

Manifest's main purpose is to help optimize memory usage; System Sleuth provides most of the information that Manifest does, along with a wealth of information on other PC subsystems, as well as several useful utilities.

Manifest can display the contents of just about all types of system memory, including conventional, extended, expanded, and even the CMOS memory in AT's. Of course, the program doesn't just provide raw hex dumps; instead, it provides nicely formatted, organized listings of memory usage, interrupts hooked by various programs, I/O port usage, and more.

The program pops up on-screen in several panels. You move a pointer up and down a list in the left panel to select the type of memory, and left and right in the upper panel to select particular details of that type of memory. You can also make your selections with a mouse.

Manifest's most useful display shows how interrupts are used by programs located in the first megabyte of memory. For example, in Fig. 1, you see the hex segment in the left column, the program located there, and the interrupts it claims last. By pressing F3, the display changes to a sequential listing of interrupt vectors (00-FF), the address in memory where each vector points, and the program that "owns" that vector.

You can load Manifest as either a transient program or as a TSR. In the latter case, the program uses more than 100K of memory, but it could still be useful when trying to track down competition for interrupts among several different programs.

System Sleuth provides a similar display, as shown in Fig. 2. System Sleuth also provides a sequential listing of interrupt vectors, but without addresses and owners.

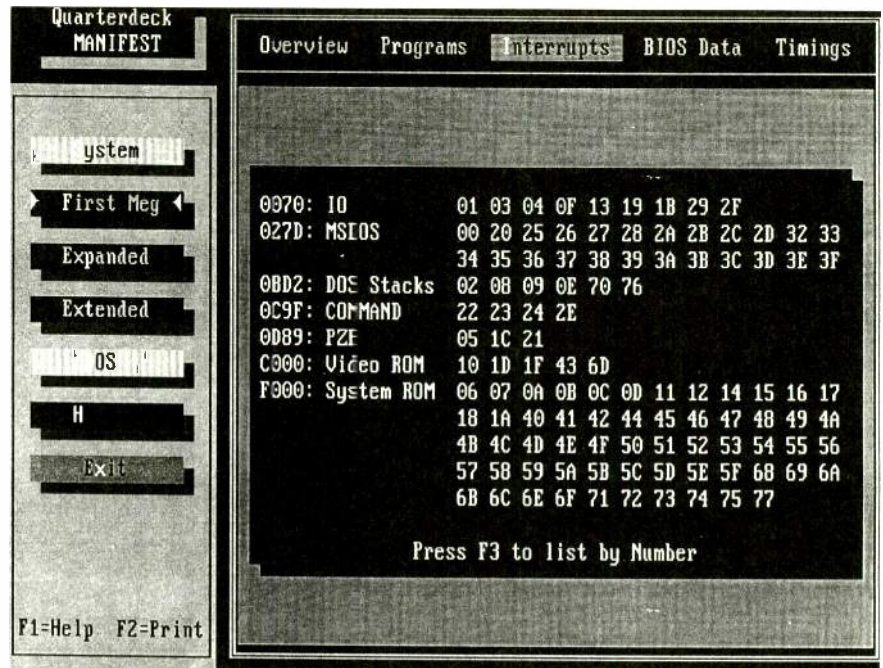

FIG. 1

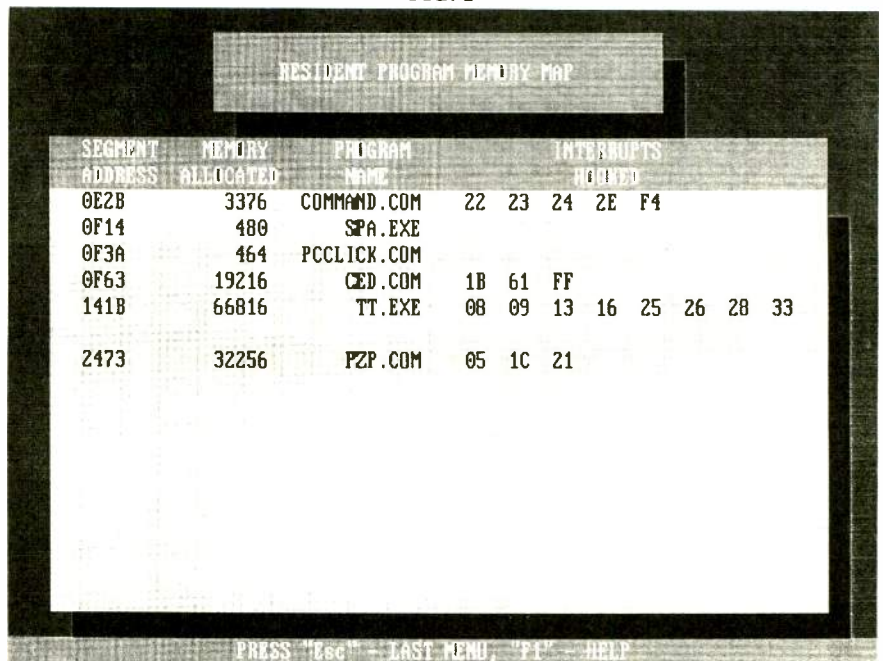

FIG. 2

Manifest provides a nicely formatted display of the BIOS data area (0040:0000); System Sleuth doesn't do that, but it does provide a hex/ASCII display routine that lets you view any area of memory beneath 1 MB. Manifest measures the access speed of various areas of memory (0-640K, video RAM, video ROM, etc.) and reports values relative to a stock PC/XT. System Sleuth has nothing comparable. Manifest also shows each byte in CMOS memory; again, System Sleuth has nothing comparable. All in

all, Manifest has more powerful memory reporting and ratings capabilities.

On the other hand, System Sleuth includes functions for reporting on hard disk drive health. Various menu items provide information on the number of disk drives, and the physical characteristics of each drive (things like bytes/sector, sectors/cluster, sectors/track, etc.). You can view a hex/ASCII dump of a disk file, and even test a disk for bad sectors.

System Sleuth also includes

several external utility programs, including one that finds files across multiple disk drives, another that searches for duplicate file names (also across multiple drives), another that deletes files with certain file names (*.bak, *.tmp, etc.), routines to save and get the data stored in CMOS memory, and an EMS emulator that uses 286 extended memory. The company is adding additional utilities all the time; they tell me a disk cache is next.

I ran Manifest and System Sleuth on several different machines, and had problems with both programs on my AST Premium/286. It has built-in EMS 4.0 hardware that is controlled by AST's EMM driver. I also use a memory manager called Move'em (made by Qualitas, the 386MAX people) to load several device drivers and TSR's into high memory (above the video adapter but below the 1 MB mark). The problem was that I simply could not run either Manifest or System Sleuth on the AST with Move'em installed; the machine crashed every time. That's completely unacceptable; no diagnostic program should ever crash any machine.

However, I had no trouble running either program on several other machines, including a Tandy 1100 FD "notebook" computer, a Dell System 300 (386), and a 33-MHz Intel 386 system. (Both 386's were running 386MAX.) Interestingly, both programs were smart enough to figure out that the CPU in the Tandy is a V20, not an 8088.

I learned a few tricks from Manifest's "Hints" section. One showed me how to map another 32K of EMS memory into an un-

VENDOR INFORMATION

- PT-68-K2 (68000 kit prices start at \$200), Peripheral Technology, 1710 Cumberland Point Drive, No. 8, Marietta, GA 30067. (404) 984-0742.
CIRCLE 271 ON FREE INFORMATION CARD

- System Sleuth 2.0 (\$149.95), DTG, 7439 La Palma Ave., Suite 278, Buena Park, CA 90620-2698. (714) 994-7400.
CIRCLE 272 ON FREE INFORMATION CARD

- Manifest (\$59.95), Quarterdeck Office Systems, 150 Pico Blvd., Santa Monica, CA 90405. (213) 392-9701.
CIRCLE 273 ON FREE INFORMATION CARD

used area of the VGA video adapter range and thereby load a TSR up there. Another saved me about 3K of additional low DOS memory. All in all, I now boot with about 130K of TSR's, but still have 592K of free contiguous DOS memory, all with a VGA adapter that runs graphics just fine.

Reports

Both Manifest and System Sleuth can print partial or comprehensive reports of their findings. You must print System Sleuth's reports via the menus, but you can get them from Manifest either via the menus or in a command line mode. For example, if you start the program like this:

```
CMFT S O
```

you'll get a listing to the screen of the System Overview; similar reports are available for each category and sub-topic, or all categories and sub-topics. The command line mode could be

useful if you wanted to print reports for several PC's. Just create a batch file with the desired command lines and then run it on each machine.

Both programs come with on-line help. Manifest's help system consists of a single screen of information for each topic; System Sleuth includes quite a bit more information, mostly tutorial in nature, that should be useful for those still getting up to speed on device drivers, different kinds of memory, etc. Of course, the information provided is no substitute for an IBM Technical Reference manual.

Manifest comes with a very well written and produced manual that is tutorial in nature. System Sleuth's manual is not so well produced, and it mostly duplicates the information in the help screens. However, if you know a little about DOS, both manuals are superfluous.

All in all, Manifest's strength is information about memory; System Sleuth takes a more systematic approach. Manifest's user interface and documentation is also more polished. But where it counts (resolving interrupt conflicts), both programs deliver.

System Sleuth lists for about \$150, and Manifest for about \$60; I've already seen Manifest discounted via mail order to about \$40.

It may be worth pointing out that neither program will help with the truly tough problems: machines that won't boot, hardware conflicts between adapters trying to use the same interrupts or I/O ports, etc. There you'll be forced to dig out manuals and compare and contrast jumper and DIP switch settings. **CD**

I/O CARD

continued from page 73

Output) ports. Just as each house on a street has its own address, each piece of hardware connected to an Intel processor has its own port address. For example, serial port COM1 is located at address 03F8h. IBM's Technical Reference Manuals list

the specific port addresses associated with specific pieces of hardware.

Our project uses 32 port addresses between 0200h and 02FFh. In order to avoid conflict with other devices, those 32 addresses can start at one of eight locations in that range; you select the desired starting address via a jumper block, as shown in Table 2. Both hex and decimal values

are shown; if you're programming in BASIC, you'll probably find the decimal values useful.

As shown in Fig. 1, the address ranges are decoded by IC2, a 74LS138 demultiplexer. The 74LS138 takes three inputs and decodes the various combinations thereof into eight exclusive outputs. The IC also has one active-high ($\overline{G1}$) and two active-low ($\overline{G2A}$ and $\overline{G2B}$) enable inputs.

TABLE 1—8255 PORT CONFIGURATION

Control Word Hex	Decimal	Port		
		A	B	C
80	128	Out	Out	Out
82	130	Out	In	Out
85	133	Out	Out	In
87	135	Out	In	In
88	136	In	Out	Out
8A	138	In	In	Out
8C	140	In	Out	In
8F	143	In	In	In

TABLE 2—JUMPER POSITIONS AND PORT ADDRESSES

Position	Address	
	Hex	Decimal
1	200	512
2	220	544
3	240	576
4	260	608
5	280	640
6	2A0	672
7	2C0	704
8	2E0	736

Address lines A8 and A9 drive the control inputs, along with AEN (Address Enable), which is low when the microprocessor can access the expansion bus. When A8 and AEN are low and A9 is high, IC2 will decode address lines A5–A7, providing a single active-low output. In that way, the 256-byte page of I/O space beginning at 0200h is divided into eight 32-byte chunks. The eight outputs of IC2 are brought to the jumper block, which passes one enable signal on to the 8255.

The 8255 itself has only 4 ports. Port A is always at the base address, port B is at base + 1, port C is at base + 2, and the control port is at base + 3. Lines A0 and A1 select which port is addressed, and \overline{RD} and \overline{WR} determine whether data is read or written, respectively.

For example, if you short jumper position three, the base address would be 0240h, so you would access Port A at 0240h, Port B at 0241h, Port C at 0242h, and the control port at 0243h.

Construction

The circuit is built on a stan-

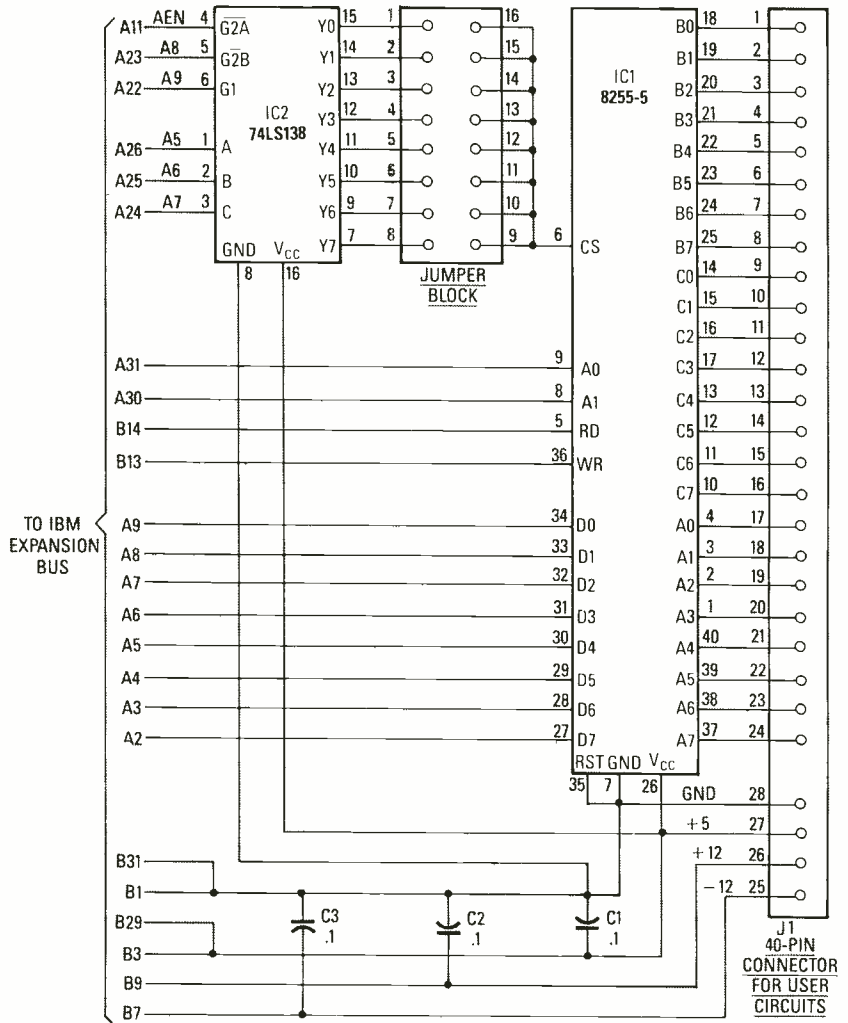

FIG. 1—ADD THREE 8-BIT PARALLEL PORTS for I/O experiments using this simple circuit. The jumper block lets you assign port addresses from 0200h to 02FFh.

dard prototyping card for the 8-bit IBM PC bus. All required parts are standard items that can be obtained from most mail-order

suppliers. Component placement isn't critical, but lead lengths should be minimized. (See Fig. 2). To avoid damage dur-

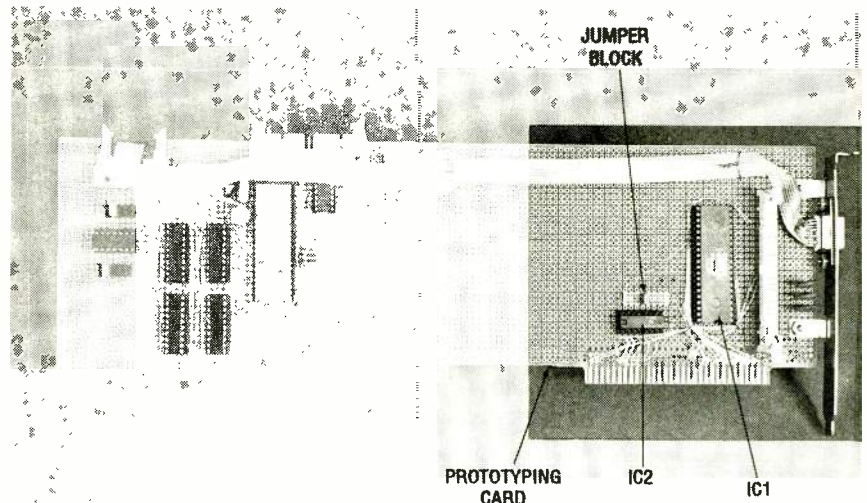

FIG. 2—THE AUTHOR'S PROTOTYPE was used to burn EPROM's, control a model railroad setup, and more.

R-E Computer Admart

Rates: Ads are 2 1/4" x 2 7/8". One insertion \$950. Six insertions \$925 each. Twelve insertions \$895 each. Closing date same as regular rate card. Send order with remittance to Computer Admart, Radio Electronics Magazine, 500-B Bi-County Blvd., Farmingdale, NY 11735. Direct telephone inquiries to Arline Fishman, area code-516-293-3000. Only 100% Computer ads are accepted for this Admart.

GETTING THE MOST FROM YOUR PRINTER

Getting The Most From Your Printer

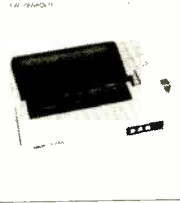

BP181—It is probable that 80% of dot-matrix printer users only ever use 20% of the features offered by their printers. This book will help you unlock the special features and capabilities that you probably don't even know exist. To order your copy send \$6.95 plus \$1.50 for shipping in the U.S. to Electronic Technology Today Inc., P.O. Box 240, Massapequa Park, NY 11762-0240.

SECRETS OF THE COMMODORE 64

Secrets of the COMMODORE 64



BP135—A beginners guide to the Commodore 64 presents masses of useful data and programming tips, as well as describing how to get the best from the powerful sound and graphics facilities. We look at how the memory is organized, random numbers and ways of generating them, graphics-color-and simple animation, and even a chapter on machine code. Get your copy today. Send \$5.00 plus \$1.25 for shipping in the U.S. to Electronic Technology Today Inc., P.O. Box 240, Massapequa Park, NY 11762-0240.

ICs **PROMPT DELIVERY!!!**
 SAME DAY SHIPPING (USUALLY)
 QUANTITY ONE PRICES SHOWN FOR APRIL 1, 1990

OUTSIDE OKLAHOMA NO SALES TAX

DYNAMIC RAM		
1MB	COMP DeskPro 386 20	\$295.00
1SIMM	AST Prem386 33Mhz	225.00
1SIMM	1Mx9 80 ns	95.00
1SIMM	256Kx9 100 ns	38.00
1Mbit	1Mx1 80 ns	9.25
41256	256Kx1 80 ns	4.50
41256	256Kx1 60 ns	4.15
41256	256Kx1 100 ns	3.50
41256	256Kx1 120 ns	2.70
4464	64Kx4 100 ns	3.50
41264*	64Kx4 100 ns	7.50
EPROM		
7C1000	128Kx8 200 ns	\$18.00
7512	64Kx8 200 ns	7.80
7256	32Kx8 150 ns	6.50
7128	16Kx8 250 ns	3.75
STATIC RAM		
2256P-10	32Kx8 100 ns	\$9.50
264P-12	8Kx8 120 ns	4.50
116AP-12	2Kx8 120 ns	4.25

OPEN 6 DAYS, 7:30 AM-10 PM. SHIP VIA FED-EX ON SAT.

SAT DELIVERY INCLUDED ON FED-EX ORDERS RECEIVED BY 11:30 AM. \$2.00 FR. \$1.00

MasterCard VISA or UPS CASH COD
 MICROPROCESSORS UNLIMITED, INC
 24 000 S Peona Ave (918) 267-4961
 BEGGS OK 74421
 No minimum order. Please note prices subject to change.
 Shipping insurance extra. add to \$1 for packing materials.

CIRCLE 61 ON FREE INFORMATION CARD

ing construction, it's best to use sockets for all IC's. Neither IC used in this project is particularly sensitive to static damage, but you can never be too careful. The author found it convenient to use red wires for power and ground connections, white for bus connections, and blue for connections from the 8255 to the output connector.

Start with the 6 wires that run from the bus connector to IC2. (By the way, looking at the component side of your motherboard, the "B" side of each expansion slot is on the left and the "A" side on the right, and the connectors are numbered from 1 to 31 from the rear of the board to the front.) Take your time, and check each solder joint for shorts with adjacent pins.

Then connect the eight wires from IC2 to the jumper block, continue with the eight data-bus wires from the bus connector to the 8255, then the six control wires to the 8255. Then connect the 24 wires from the port outputs of IC1 to J1. The author used a 40-pin header connector for J1 in the prototype. Many projects require a source of +5 volts, so power and ground lines are also brought to J1.

PARTS LIST

- IC1—8255A-5 parallel interface
- IC2—74LS138 3-to-8 line decoder
- C1-C3—0.1 μF
- J1—40-pin header connector
- Jumper block (2 rows, 8 positions)
- PC bus prototyping board
- Sockets, wire, etc.

Programming examples

The following examples assume that the jumper is in position three, so that the 8255 is connected to port 0240h.

When power is first applied, ports A, B, and C are all configured as inputs. To reconfigure the port, you must write the appropriate value to the correct port. For example, by connecting eight LED's to Port A as shown in Fig. 3, you could view the binary counting sequence using this program:

```
10 OUT 579,128
20 A = 0
30 OUT 576,A
40 A = A + 1
50 IF A 255 GOTO 20
60 GOTO 30
```

If one LED doesn't seem to light, run this program:

```
10 OUT 579,128
20 OUT 576,255
```

All of the LEDs should light. If one doesn't, check your wiring.

Reading input values is just as simple. The following program would continually read and display the contents of port B, to which various switches (Fig. 4-a, Fig. 4-b) and sensors (Fig. 4-c) might be connected:

```
10 OUT 579,130
20 A = INP 577
30 IF A
40 GOTO 20
```

That program sets up Port B for input, and then reads the value of the port. If the value is less than 255 (in other words, if at least one line is low), the value is printed.

The 8255's inputs and outputs are TTL compatible, meaning they don't have much current-carrying capacity. To drive heavier-duty devices, use a transistor, as shown in Fig. 5-a, or add a relay, as shown in Fig. 5-b.

More Ideas

Now that you understand the basics, the sky's the limit. What else could you do?

ELECTRONICS PAPERBACKS

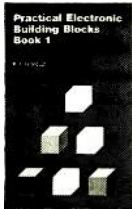

□ **BP117—PRACTICAL ELECTRONIC BUILDING BLOCKS, BK-1** \$5.75. Circuits for a number of useful building blocks are presented. Combine these circuits to build the devices you need.

□ **BP192—MORE ADVANCED POWER SUPPLY PROJECTS** \$5.95. Topics covered include switched-mode power supplies, precision regulators, dual tracking regulators and computer-controlled supplies.

More Advanced Power Supply Projects

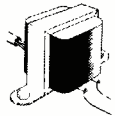

□ **BP190—MORE ADVANCED ELECTRONIC SECURITY PROJECTS** \$5.95. Projects include a passive infra-red detector, a fibre-optic loop alarm, computer-based alarms and an ultrasonic intruder detector.

□ **BP113—30 SOLDERLESS BREADBOARD PROJECTS, BK-2** \$5.95. All projects are based on CMOS logic IC's. Many components are common to several projects. Each project includes a brief circuit description, component layout and parts list.



Electronic Music Projects



□ **BP74—ELECTRONIC MUSIC PROJECTS** \$5.95. Provides a number of circuits for Fuzz Box, Waa-Waa Pedal, Sustain Unit, Reverberation and Phaser Units, Tremolo Generator and more.

□ **BP255—INTERNATIONAL RADIO STATIONS GUIDE** \$7.95. Provides the casual listener, amateur radio DXer and the professional radio monitor with an essential reference work designed to guide him or her around than ever more complex radio bands.



MAIL TO: **Electronic Technology Today, Inc.**
P.O. Box 240
Massapequa Park, NY 11762-0240

SHIPPING CHARGES IN USA AND CANADA

\$0.01 to \$5.00	\$.125	\$30.01 to \$40.00	\$5.00
\$5.01 to \$10.00	\$2.00	\$40.01 to \$50.00	\$6.00
\$10.01 to \$20.00	\$3.00	\$50.01 and above	\$7.50
\$20.01 to \$30.00	\$4.00		

SORRY, No orders accepted outside of USA and Canada

Total price of merchandise	\$	_____
Shipping (see chart)	\$	_____
Subtotal	\$	_____
Sales Tax (NYS only)	\$	_____
Total Enclosed	\$	_____

Name _____
Address _____
City _____ State _____ Zip _____

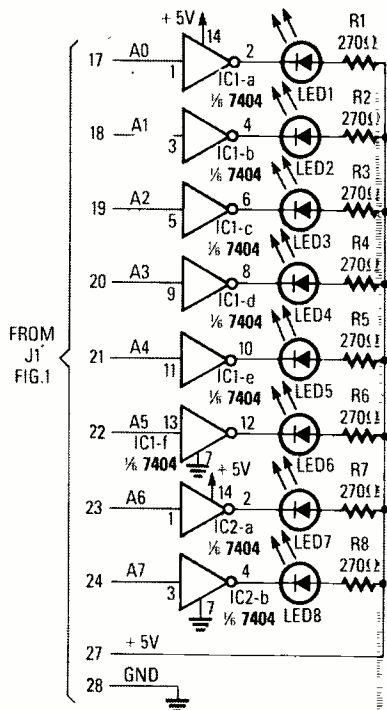

FIG. 3—FOR OUTPUT DISPLAY, add eight LED'S, eight resistors, and two 7404's.

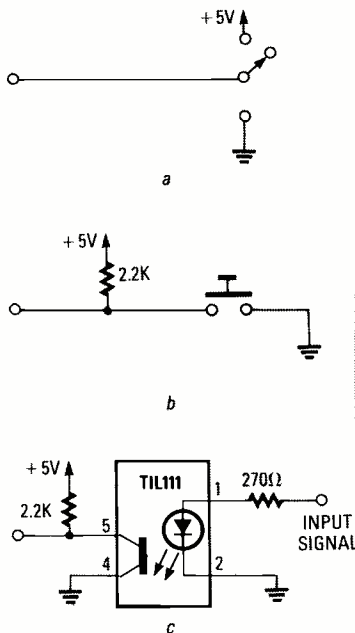

FIG. 4—FOR INPUT, add a toggle switch (a), a pushbutton switch (b), or an opto-isolator (c).

- How about building a robot? Output ports could be configured for motor control, voice synthesis, robotic arm control, etc. Input ports could be used to read bumper sensors, voice recognition, or keypad input.
- Or build a burglar alarm: Input ports would read data from win-

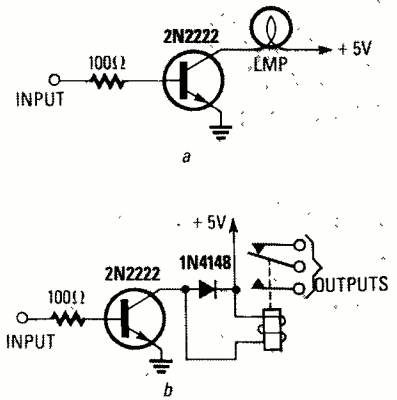

FIG. 5—FOR HIGH-CURRENT OUTPUT, use a transistor to drive a lamp (a) or a relay (b).

dow and door switches, and from motion detectors. Outputs would control lights, a siren, and a telephone dialer.

- Or build a home heating system. One port would be dedicated to motors that would open and close heating vents, control blower motors, etc. Input ports would read thermometers in each room and outside the house. A real-time clock would be used to turn heat on in the morning and off in the evening. You could include a wind speed gauge, controls for a solar hot-water heater, and even calculate your energy savings.
- Or build a scoreboard, a light show, or an IC tester. How about a computer-controlled popcorn popper or a dog food dispenser? The author has used his card to run a plotter, an EPROM programmer, and a model-railroad demonstration.

Another thing you could try building is an automatic home lighting system. Input ports could monitor doorways with pressure-sensitive switches or infra-red beams. The system would sense someone entering or leaving the room, and turn the lights on and off accordingly. The system would have to keep track of how many people were in the room, turning the lights off only after the last person leaves.

For some projects, three ports may not be enough. In that case, just connect a second 8255, wiring all lines except cs in parallel to the second IC1. Connect the cs line of the second 8255 to a different position on the jumper block—and enjoy 48 lines of digital I/O!

R-E Engineering Admart

Rates: Ads are 2 1/4" x 2 7/8". One insertion \$350. Six insertions \$925. each. Twelve insertions \$895. each. Closing date same as regular rate card. Send order with remittance to **Engineering Admart**, Radio Electronics Magazine, 500-B Bi-County Blvd., Farmingdale, NY 11735. Direct telephone inquiries to Arline Fishman, area code 516-293-3000. **Only 100% Engineering ads are accepted for this Admart.**

Surface Mount Chip Component Prototyping Kits—Only \$49.95



CC-1 Capacitor Kit contains 365 pieces, 5 ea. of every 10% value from 1pf to 33µf. CR-1 Resistor Kit contains 1540 pieces, 10 ea. of every 5% value from 10Ω to 10MΩ. Sizes are 0805 and 1206. Each kit is ONLY \$49.95 and available for Immediate One Day Delivery!

Order by toll-free phone, FAX, or mail. We accept VISA, MC, AMEX, COD, or Pre-paid orders. Company P.O.'s accepted with approved credit. Call for free detailed brochure.

COMMUNICATIONS SPECIALISTS, INC.
426 West Taft Ave. • Orange, CA 92665-4296
Local (714) 998-3021 • FAX (714) 974-3420
Entire USA 1-800-854-0547

CIRCLE 178 ON FREE INFORMATION CARD

FCC LICENSE PREPARATION

The FCC has revised and updated the commercial license exam. The **NEW EXAM** covers updated marine and aviation rules and regulations, transistor and digital circuitry. **THE GENERAL RADIOTELEPHONE OPERATOR LICENSE - STUDY GUIDE** contains vital information. **VIDEO SEMINAR KITS ARE NOW AVAILABLE.**

WPT PUBLICATION
979 Young Street, Suite A
Woodburn, Oregon 97071
Phone (503) 981-5159

CIRCLE 182 ON FREE INFORMATION CARD

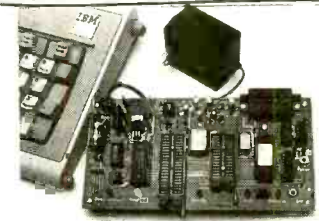

6805 MICROCOMPUTER DEVELOPMENT SYSTEM

The MDCPM-1 system allows the IBM PC and compatibles to be used as a complete development system for the Motorola MC68705P3, P5, U3, U5, R3 and R5 single chip microcomputers. The system includes a cross assembler program, a simulator/debugger program and a programming board that connects to a serial port. Price—\$449.00 VISA and MASTERCARD accepted.

TECI THE ENGINEERS COLLABORATIVE, INC.

RR#3, BOX 8C Barton, Vermont 05822
Phone (802) 525-3458 FAX (802) 525-3451

CIRCLE 188 ON FREE INFORMATION CARD

AUDIO UPDATE

continued from page 72

cars to justify owning foreign-made vehicles. And to tell the truth, I'd be somewhat embarrassed to admit owning a standard U.S. family car. In the same sense, I'd feel that I had blown my credentials as an "Audio Maven" if word got around that I used a receiver in my main system.

But aside from emotional predispositions, what valid reasons are there for choosing separate components? Output power is one. Given the extended dynamic range of compact discs, the advantage of having at least 100 watts per channel of clean power on tap seems inarguable. The sense of ease and openness, and the bass solidity all testify to the sonic virtues of high power.

Today, the top power available in a receiver is about 130 watts per channel. For many people that is probably more than adequate, but for those who want their music very loud and very clean when heard through medium-to-low efficiency speakers, 200 watts is an absolute minimum. That explains why the 1990 stereo buyers' guides list dozens of 300- and 400-watt-per-channel amplifiers. Incidentally, I have clipped a 200-watt-per-channel amplifier trying to reproduce a solo piano at live sound levels, so the desire for ever higher amplifier

New Scanner by AOR

100 Channels
800 MHz

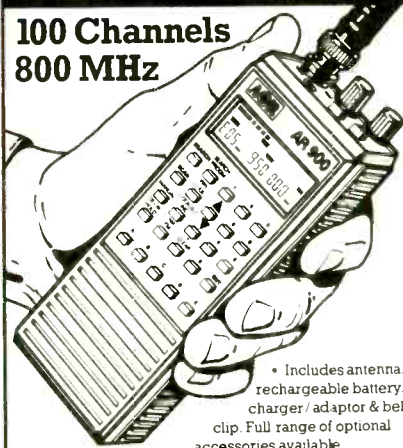

• Includes antenna, rechargeable battery, charger/adaptor & belt clip. Full range of optional accessories available.

• Covers 27-54 MHz, 108-174 MHz, 406-512 MHz, and 800-950 MHz.

• 5 Scan Banks and 5 Search Banks.

• 25 Day Satisfaction Guarantee. Full Refund if not Satisfied.

• No Frequencies cut out.

• Size: 2" x 5 1/4" x 1 1/2" wt: 12 oz.

AR900

Total Price, Freight Prepaid

(Express Shipping Optional)

\$259.00

ACE

COMMUNICATIONS

10707 E. 106th St. Indpls., IN 46256

Toll Free 800-445-7717

Visa and MasterCard

(COD slightly higher)

In Indiana 317-849-2570 Collect FAX (317) 849-8794

CIRCLE 193 ON FREE INFORMATION CARD

power *does* have a genuinely rational basis given certain listening circumstances.

Upgrading

The essence of being a totally

dedicated audiophile (which I am not) is the never-ending pursuit of the holy grail of "perfect" sound reproduction. In practice, that means constant upgrading—or at least replacement—of existing components in hopes of coming ever closer to sonic perfection. The pursuit is encouraged by several small circulation "underground" audio magazines, such as *Stereophile* and *The Absolute Sound*. Their detailed reports on each new high-end (meaning very expensive) pre-amplifier and power amplifier becomes Holy Writ for the dedicated audiophile seeking to determine each product's precise place in the hierarchy of sonic perfection. Page after page will be devoted to what is almost a frequency-by-frequency analysis of each audio product's sound quality.

If the reviewed product appears to offer some real or imagined advantage over his existing equipment—which was the best available only four or five months ago—the dedicated audiophile buys it as soon as his finances permit. Incidentally, some excellent power amplifiers are available for about \$2 a watt, meaning that a 200-watt-per-channel amp can be had for about \$800. One can also spend \$16,000 (!) for a 200-watt-per-channel amplifier, but I think that the joy of owning such a product has little to do with its sound *per se*.

I shouldn't exclude FM tuners

from the upgrading process, although most audiophiles are aware that the broadcast stations are far more responsible for tuner sound quality than any other factor. In any case, it is obvious that owning a receiver makes piecemeal component replacement impractical. Receivers also tend to complicate matters when something goes wrong electronically. If a separate tuner goes bad, the rest of the system is still functional while the tuner is in for repairs. And even a defec-

tive preamp won't stop the music if the power amp has accessible input-level controls.

The bottom line

So, after all of the above, what do I recommend? As I indicated, I think it comes down to how loud you like your music and the efficiency of your speakers. If you want to reproduce music at natural volume levels, then 200+ watts per channel is what you need. But if your taste, you wife, your neighbors, or your

budget doesn't permit such audio extremes, then a high-powered receiver may comfortably fit your requirements.

If possible, listen to the receiver under consideration with the speakers you are going to use it with. Then, listen to the same speakers at the same preferred volume level driven by a significantly higher power amplifier. If the sound quality is about the same, then a receiver is the way to go.

R-E

ADD A DISPLAY

continued from page 62

TABLE 2—USER DEFINABLE CHARACTERS

CHARACTER CODES (DD RAM DATA)								CG RAM ADDRESS								CHARACTER PATTERN (CG RAM DATA)							
7	6	5	4	3	2	1	0	5	4	3	2	1	0	7	6	5	4	3	2	1	0		
0	0	0	0	0	0	0	0	0	0	0	0	0	0	X	X	X	0	0	0	0	0		
0	0	0	0	0	0	0	0	0	0	0	0	0	1	X	X	X	0	0	0	0	0		
0	0	0	0	0	0	0	0	0	0	0	0	1	0	X	X	X	0	0	0	0	0		
0	0	0	0	0	0	0	0	0	0	0	0	1	1	X	X	X	1	1	1	0	0		
0	0	0	0	0	0	0	0	0	0	0	1	0	0	X	X	X	1	1	1	1	1		
0	0	0	0	0	0	0	0	0	0	0	1	0	1	X	X	X	0	0	0	0	0		
0	0	0	0	0	0	0	0	0	0	0	1	1	0	X	X	X	0	0	0	0	0		
0	0	0	0	0	0	0	0	0	0	0	1	1	1	X	X	X	0	0	0	0	0		
0	0	0	0	0	0	0	0	0	0	0	1	1	1	X	X	X	0	0	0	0	0		

NOSE SECTION

CHARACTER CODES (DD RAM DATA)								CG RAM ADDRESS								CHARACTER PATTERN (CG RAM DATA)							
7	6	5	4	3	2	1	0	5	4	3	2	1	0	7	6	5	4	3	2	1	0		
0	0	0	0	0	0	0	0	0	0	1	0	0	0	X	X	X	1	0	0	0	0		
0	0	0	0	0	0	0	0	0	0	1	0	0	1	X	X	X	0	1	1	0	0		
0	0	0	0	0	0	0	0	0	0	1	0	1	0	X	X	X	0	0	1	1	0		
0	0	0	0	0	0	0	0	0	0	1	0	1	1	X	X	X	1	1	1	1	1		
0	0	0	0	0	0	0	0	0	0	1	1	0	0	X	X	X	1	1	1	1	1		
0	0	0	0	0	0	0	0	0	0	1	1	0	1	X	X	X	0	0	1	1	0		
0	0	0	0	0	0	0	0	0	0	1	1	1	0	X	X	X	0	1	1	0	0		
0	0	0	0	0	0	0	0	0	0	1	1	1	1	X	X	X	1	0	0	0	0		

BODY SECTION

CHARACTER CODES (DD RAM DATA)								CG RAM ADDRESS								CHARACTER PATTERN (CG RAM DATA)							
7	6	5	4	3	2	1	0	5	4	3	2	1	0	7	6	5	4	3	2	1	0		
0	0	0	0	0	0	0	0	0	1	0	0	0	0	X	X	X	1	1	0	0	0		
0	0	0	0	0	0	0	0	0	1	0	0	0	1	X	X	X	1	1	0	0	0		
0	0	0	0	0	0	0	0	0	1	0	0	1	0	X	X	X	1	1	0	0	0		
0	0	0	0	0	0	0	0	0	1	0	0	1	1	X	X	X	1	1	1	1	1		
0	0	0	0	0	0	0	0	0	1	0	1	0	0	X	X	X	1	1	1	1	1		
0	0	0	0	0	0	0	0	0	1	0	1	0	1	X	X	X	0	0	0	0	0		
0	0	0	0	0	0	0	0	0	1	0	1	1	0	X	X	X	0	0	0	0	0		
0	0	0	0	0	0	0	0	0	1	0	1	1	1	X	X	X	0	0	0	0	0		

TAIL SECTION



COMPLETE AIRPLANE

ORDERING INFORMATION

The following items are available from Simple Design Implementations (SDI), P.O. Box 9303, Forestville, CT 06010 (203) 582-8526: Experimenter's kit (contains 16x1 OPTREX LCD module, programmed MC68705P3, contrast-control potentiometer, PC board, IC socket, software listings, schematic, and instructions), \$29.95 + \$3 S/H; Same experimenter's kit with 40x1 display, \$39.95 + \$3 S/H; Programmed MC68705P3 and instructions, \$15.95 + \$2.50 S/H.

shows the 24 data bytes that must be written to CG RAM to form the three user-defined characters that form the airplane.

Displaying actual data

Once the display has been properly initialized, displaying data is as simple as writing out the proper ASCII codes with a series of Data Write operations. Remember, the "SET DD RAM ADDRESS" command must precede the data operations to ensure that the data goes to DD RAM and not CG RAM. Similarly, data writes to CG RAM must be preceded by a "SET CG RAM ADDRESS" command. For example, the routine in Listing 6 will display the message "PLANE" (assuming that the user-defined Character Generator RAM is set up as defined in Listing 5).

Next month

Due to space limitations, that's all we have room for this month. Next month we will continue our discussion on LCD modules, and cover some of the different kinds of interfaces, including hardware, microcontroller, and microprocessor. R-E

MARKET CENTER

FOR SALE

GREAT buys! Surplus prices, ICs, linears, transformers, PS, stepping motors, vacuum pump, phototransistor, meters, LSASE, **FERTIK'S**, 5400 Ella, Phila., PA 19120.

DESCRAMBLERS. All brands. Special: Combo Jerrold 400 and SB3 \$165. Complete cable descrambler kit \$39. Complete satellite descrambler kit \$45. Free catalog. **MJM INDUSTRY**, Box 531, Bronx, NY 10461-0531.

T.V. notch filters, surveillance equipment, brochure \$1.00. **D.K. VIDEO**, Box 63/6025, Margate, FL 33063. (305) 752-9202.

MICROWAVE TV RECEIVERS 1.9 to 2.7 GHz



2 CH Compact Dish System - \$77.95
5 CH Dish System - \$93.95
12 CH Yagi (Rod) System - \$123.95
30 CH Dish System - \$163.90 Yagi - \$183.90
SUN MICROWAVE INT'L. INC. Send \$1⁰⁰ for P.O. BOX 34522 PHOENIX, AZ 85067 (602) 230-0640
QUANTITY DISCOUNTS LIFETIME WARRANTY

RESTRICTED technical information: Electronic surveillance, schematics, locksmithing, covert sciences, hacking, etc. **Huge selection. Free brochures.** **MENTOR-Z**, Drawer 1549, Asbury Park, NJ 07712.

RENTAL movie stabilizer. Connect between VCRs or to monitor. Satisfaction guaranteed. \$69.95, \$4.00 handling. 1 (800) 367-7909.

TUBES: "oldest," "latest." Parts and schematics. **SASE** for lists. **STEINMETZ**, 7519 Maplewood Ave., RE, Hammond, IN 46324.

ENGINEERING software, PC/MSDOS. Hobbyists — students — engineers. Circuit design \$59.00, FFT analysis \$69.00, Mathematics \$49.00, Logic Simulation \$49.00, Circuit Analysis \$29.00. Free catalog, (614) 491-0832. **BSOFT SOFTWARE**, 444 Colton Rd., Columbus, OH 43207.

CABLE TV converters and descramblers. We sell only the best. Low prices. **SB-3 \$79.00.** We ship C.O.D. Free catalog. **ACE PRODUCTS**, PO Box 582, Dept. E, Saco, ME 04072. 1 (800) 234-0726.

SAMS closeout sale. #2 to #2600 \$6.00 each postpaid. MC Visa. Call 1 (800) 274-2081. 9-5 CST.

PRINTHEAD repairs — Okidata, Epson, NEC, Toshiba, Digital. Texas Inst., also do board repair — **DATAFIX**, (201) 322-7666.

TUBES Sylvania 6LQ6, 6L6GC, 20L6E etc. Huge discounts. **ARLEN SUPPLY**, 7409 West Chester Pike, Upper Darby, PA 19082. 1 (800) 458-1301.

TJ SERVICES is here to serve you! Our quality products, quick courteous service, knowledgeable sales people and rock bottom prices prove it! Not sure what you need? Call (313) 979-8355 we'll help! We specialize in Jerrold, Hamlin, interference filters and most SA equipment.

FEBRUARY 1984 project. Complete parts with power supply. \$38.00. Postpaid. JIM RHODES, INC., Box 3421, Bristol, TN 37625.

CABLE TV converters: Jerrold, Oak, Scientific Atlantic, Zenith & many others. "New MTS" stereo add-on mute & volume. Ideal for 400 and 450 owners. 1 (800) 826-7623. Amex, Visa, M/C accepted. **B & B INC.**, 4030 Beau-D-Rue Drive, Eagan, MN 55122.

TUBES, new, up to 90% off, **SASE. KIRBY**, 298 West Carmel Drive, Carmel, IN 46032.

CABLE TV DESCRAMBLERS!



BARGAIN HEADQUARTERS!

JERROLD • TOCOM • HAMLIN
SCIENTIFIC ATLANTA • ZENITH

Oak M35B ONLY \$60
6 month warranty! We ship C.O.D.
Lowest retail/wholesale prices!

FREE CATALOG:
Global Cable Network
1032 Irving St. Suite 109
S.F., CA 94122

ORDER TODAY! 800-327-8544

MARK V ELECTRONICS, INC.

QUALITY COMPONENTS * COMPETITIVE PRICES

▲ indicates the level of difficulty in the assembling of our Products. ▲ Beginner ▲▲ Intermediate ▲▲▲ Advanced ★ Fully Assembled

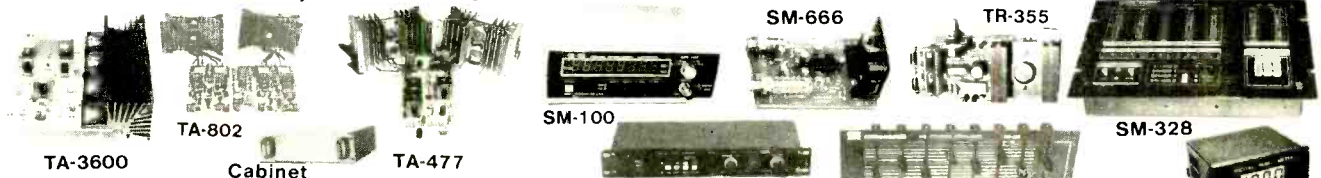

AMPLIFIERS		KIT	ASSMB.	SM-333	SM-222	SM-49
MODEL	DESCRIPTION					
TA-28MK2	Digital Voice Recorder ▲▲	\$ 30.00				
TA-50A/B	Multi-Purpose Melody Generator ▲	11.84	\$ 1658			
TA-50C	Multi-Purpose Melody Generator ▲	12.65				
TA-120MKII	35W Class "A" Main Power Mono Amp ▲	27.16	38.81			
TA-300	30W Multi-Purpose Single Channel Amp ▲	20.00	29.00			
TA-302	60W Stereo Power Booster (w/case) ▲	50.00	70.00			
TA-323A	30Wx2 Stereo Pre-main Amp ▲	29.50	38.35			
TA-377A	Hi-Quality FET Stereo Pre-Amp ▲▲	59.95	75.00			
TA-400	40W Solid State Mono Amp ▲	28.00	34.93			
TA-477	120W Mostel Power Mono Amp ▲	68.00	85.00			
TA-800	80W+80W DC Pre-Main & Power Amp ▲	60.92	79.20			
TA-802	80W+80W DC Stereo Main Power Amp ▲	45.94	59.72			
TA-820A	60W+60W OCL DC Pre-Main Stereo Amp ▲	40.39	49.37			
TA-1000A	100W Dynamic Class "A" Main Power Mono Amp ▲	59.69	80.58			
TA-1500	100Wx2 Class "A" DC Stereo Pre-Main Amp ▲	73.70	95.81			
TA-2200	FET Super class "A" DC Pre-Amp ▲▲	47.70	58.24			
TA-2400A	Electronic Echo & Reverberation Amp ▲▲	116.80				
TA-2500	HQ Pre-Amp. w/10 band graphic equalizer ★		90.80			
TA-2800	Hi-FET IC Pre-Amp. w/3 way tone control ▲	48.90	63.57			
TA-3000	Stereo Simulator (mono TV / any mono source) ▲	30.20	41.38			
TA-3600	300W HQ Hi-Fi Power Mono Amp ▲	79.00	103.00			
POWER SUPPLIES		KIT	ASSMB.	MISCELLANEOUS		
TR-100A	O-15V 2A Regulated DC Power Supply (w/case) ▲	\$ 59.50	\$ 69.50	MODEL	DESCRIPTION	PRICE
TR-355A	O-15V 5A Regulated DC Power Supply ▲	14.55	20.76	TY-23B	3 Channel Color Light Controller ▲▲	\$ 56.04
TR-355B	O-30V 3A Regulated DC Power Supply ▲	14.55	20.76	TY-25	Stereo Loudspeaker Protector ▲	12.65
TR-503	O-50V 3A Regulated DC Power Supply ▲	15.75	22.65	TY-35	FM Wireless Microphone	9.22
INSTRUMENTS		KIT	ASSMB.	TY-36	AC/DC Quartz Digital Clock ▲	18.00
SM-43	3 1/2 Multi-Functional Led D.P.M. (w/ABS plastic case) ▲	\$ 34.50	\$ 43.00	TY-38	Sound/Touch Control Switch ▲	12.00
SM-48	4 1/2 Hi-Precision D.P.M. ▲	38.00	48.00	TY-41MKV	Infrared Remote Control Unit w/case ▲	20.00
SM-48A	4 1/2 Hi-Precision D.P.M. w/ABS plastic case ▲	41.20	52.00	TY-42	Bar/Dot Level Meter ▲	24.15
SM-49	3 1/2 Multi-Functional LCD D.P.M. (w/hold function) ▲	36.00	44.50	TY-43	3 1/2 Digital Panel Meter ▲	29.00
SM-100	150 MC Digital Frequency Counter ▲	79.00	90.00	TY-45	20 Steps Bar/Dot Audio Level Display ▲	38.45
FC-1000A	1 GHz Frequency Counter ★		179.00	TY-47	Superior Electronic Roulette ▲	19.46
				SM-222	7 Band Hi-Fi Graphic Equalizer ▲	26.80
				SM-328	4 Channel Professional Color Light Controller★	150.00
				SM-333	Audio/Video Surround Sound Processor ▲	62.00
				SM-666	Dynamic Noise Reduction ▲	26.00
						34.00
				METAL CABINETS WITH ALUMINUM PANEL		
				MODEL	H" x W" x D"	MATCHING
				LG-1273	3" x 12" x 7"	TA-2800, TA-377A
				LG-1684	4" x 16" x 8"	TA-322, TA-323A, TA-377A
				LG-1924	4" x 19" x 11 1/2"	TA-802, TA-820A, TA-1500, TA-120MKII, TA-800,
				LG-1925	5" x 19" x 11 1/2"	TA-477, TA-800, TA-1500, TA-1000A
				LG-1983	2 1/2" x 19" x 8"	TA-377A, TA-2800, TA-2200, TA-120MKII
						26.50
				POWER TRANSFORMERS		
				MODEL	DESCRIPTION	PRICE
				001	56VCT, 60VCT 6A	TA-800, TA-802, TA-820A, TA-1000A, TA-1500
				002	72VCT 3A	TA-322, TR-503, TA-323A, TA-400
				003	80VCT 6A	TA-477
				004	48VCT 6A	TR-120 HK II
				005	52VCT 3A	TR-355B
				006	36VCT 5A	TR-355A
				007	112VCT 8A	TA-3600

WE ACCEPT MAJOR CREDIT CARDS. MONEY ORDERS AND CHECKS - BUSINESS & SHOWROOM HOURS (PACIFIC TIME, MON-FRI 9:30 A.M. - 5:00 P.M. SAT. 10:00 A.M. - 5:00 P.M. TERMS: 30 DAY MIN. ORDER - 30 MIN. CHARGE CARD ORDER - WE SHIP UPS GROUND - FOR SHIPPING INSIDE USA (MIN \$3.00) FOR SHIPPING OUTSIDE USA ADD 20% (MIN \$5.00) TRANSIT INSURANCE ADD 5% OF TOTAL (OUTSIDE USA ONLY) CA RESIDENTS ADD SALES TAX @ 7.5% ALL MERCHANDISE ARE SUBJECT TO PRIOR SALE. PRICES ARE SUBJECT TO CHANGE WITHOUT PRIOR NOTICE. WE ARE NOT RESPONSIBLE FOR TYPOGRAPHICAL ERRORS.

MARK V ELECTRONICS, INC. - 8019 E. Slauson Ave, Montebello, CA 90640

CIRCLE 93 ON FREE INFORMATION CARD

THE ELECTRONIC GOLDMINE

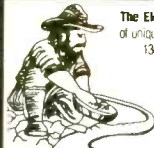

The **Electronic Goldmine** has one of the greatest selections of unique **electronic kits** available in the World! We have over 130 kits and almost 1,000 unique, bargain priced, components in our new 1990 Catalog #211. Request your copy today, or better yet, order and be placed on our Preferred Customer mailing list to be the first to receive new catalogs when they are printed.

☆ MINI GEIGER COUNTER KIT ☆

Everyone knows how fascinating and useful Geiger Counters are, but their price is usually \$100 or more! We've made a tremendous price breakthrough! Not only is our Geiger Counter Kit one of the smallest, it's the most reasonable priced Geiger Counter available anywhere! This ultra-sensitive kit detects Alpha, Beta, Gamma and X-ray radiation and emits clicks in proportion to the intensity of the radiation. Features sensitive alpha window GM tube and IC circuit that operates from standard 9V battery (not included). Detects radiation from radium dials on old watches, lantern mantles, radioactive minerals, background radiation, etc. Note: not for detecting Radon Gas. Size of Board: 3" x 1 9/16". Complete with all parts, PC board and instructions.



SPECIAL ITEM!

C6430
\$59.95

20W + 20W STEREO AMP KIT

Two separate high power amps on one PC board. Each amp has its own level control and puts out an incredible 20 Watts RMS. Features red LED "on" indicator and low distortion circuitry. Great stereo booster amp for your car sound system. Use with any speakers capable of handling at least 20 Watts. Operates on 12VDC. Size of board: 6" x 2 1/2". Complete with all parts, PC board and instructions.



C6442 \$19.95

MINIMUM ORDER: \$10.00 plus \$3.00 shipping and handling. We accept MC, Visa and Money Orders.
SEND ORDERS TO: The Electronic Goldmine
P.O. Box 5408 Scottsdale, AZ 85261
PHONE ORDERS: (602) 451-7454

CIRCLE 179 ON FREE INFORMATION CARD

FREE CATALOG

FAMOUS "FIRESTIK" BRAND CB ANTENNAS AND ACCESSORIES. QUALITY PRODUCTS FOR THE SERIOUS CB'er. SINCE 1962
FIRESTIK ANTENNA COMPANY
2614 EAST ADAMS
PHOENIX, ARIZONA 85034

PROGRAMMABLE stepper motor drive & control for under \$100, IBM PC/XT compatible, Commodore 64, or other with 25 pin parallel port. PCB, interface, & software. Send for detailed literature to: MASE, R.D. #2 Box 166, Mohrsville, PA 19541.

DIGITIZER for IBM compatible PCs 640 by 480 resolution from VCR video camera \$85.00 demonstration disk \$3.00. CODEWARE, Box 3091, Nashua, NH 03061.

COMMUNICATIONS/electronic equipment, sales, service, FCC licensed, free catalog, RAYS, PO Box 14862, Fort Worth, TX 76117-0862.

FREE catalog. Interfaces for IBM compatibles. Digital I/O and analog input. Control relays, motors, lights, measure temperature, voltage. JOHN BELL ENGINEERING, INC., 400 Oxford Way, Belmont, CA 94002. (415) 592-8411.



Quality Microwave TV Antennas

WIRELESS CABLE-1.9 to 2.7 Ghz. 40db Gain (+) 36-Channel System Complete \$149.95
12-Channel System Complete \$114.95
Call or Write for "FREE" Catalog

Phillips-Tech Electronics
P.O. Box 8533 • Scottsdale, AZ 85252

(602) 947-7700 [\$3.00 Credit all phone orders!]
MasterCard • Visa • COO's Quantity Pricing

CABLE descramblers (Jerrold) from \$40.00. Toccm VIP test chip. Fully activates unit. \$50.00 Call (213) 867-0081.

PRINTED circuit boards etched & drilled. Free delivery. **K & F ELECTRONICS, INC.**, 33041 Groesbeck, Fraser, MI 48026. (313) 294-8720.

PHOTOFACT folders, under #1400 \$4.00. Others \$6.00. Postpaid. **LOEB**, 414 Chestnut Lane, East Meadow, NY 11554.

CABLE TV descramblers M35B. Top quality. Tested, guaranteed, vari-sync available. Dealers wanted. \$39.00. 1 (800) 648-4600.

STOP the electronic thieves! Techniques, equipment, laws. Free information. **SVS**, 198 N. 2nd Street, Suite 6, Porterville, CA 93257. (209) 781-2834.

ROBOTICS software, PC/MSDOS. Explore computer vision, sonar sensing. Free brochure. **ROBOTS ETC**, Box 122, Tempe, AZ 85280.

IMPORTANT facts for cable box buyers. Don't make costly mistake when you buy. Fast shipment. Send \$10.00 to: **VESTOR ASSOCIATES**, Suite 205, 25 Forest Street, Attleboro, MA 02703.

CB RADIO OWNERS!

We specialize in a wide variety of technical information, parts and services for CB radios. 10-Meter and FM conversion kits, repair books, plans, high-performance accessories. Thousands of satisfied customers since 1976! Catalog \$2.

CBC INTERNATIONAL

P.O. BOX 31500RE, PHOENIX, AZ 85046

SOFTWARE as low as \$1.99. IBM, Macintosh, Amiga, Apple & C64/128. **CALIFORNIA FREEWARE**, 1747 East Ave Q #C-1, Palmdale, CA 93550. Free Catalog. Call 1 (800) 359-2189.

SOURCES wanted for exciting, quality, proven products of interest to readers of this magazine. **DLJ-A**, 485 Fuhrman, Providence, Utah 84332. Free catalog.

DESCRAMBLERS — for free catalog contact **CABLE CONNECTION**, 1304 E. Chicago Street, Suite 301, Algonquin, IL 60102. (708) 658-2365.

SAMS photofacts from 1964 thru 1972. Sell all - make offer. (818) 353-4603. **KAREN ROBERSON**, Los Angeles, CA.

COMPUTER-aided-living, a new detailed guide shows how to use your computer to control lights and appliances, pay bills, obtain free software, much more! Send \$9.95 (ppd) to: **DANIEL ENGINEERING**, 36437 Spruce, Newark, CA 94560.

CABLE TV

TB-3 (Tri-Bi) or SA-3

Quantity Prices

10	20
\$48.	\$43.
Each	Each
50	100
\$39.	\$35.
Each	Each

Hours open 10:00 am to 4:00 pm Eastern time
Minimum order 5 units 55.00 ea.
Dealers wanted. We ship COD.

King Wholesale

1-800-729-0036

Fax number 6173400053

"No one beats the King's prices!"

DESCRAMBLERS



One tree can make 3,000,000 matches.



One match can burn 3,000,000 trees.



A Public Service of The Magazine & The Advertising Council

CABLE TV "BOXES"

Converters — Descramblers
Remote Controls — Accessories

- ★ Guaranteed Best Prices ★
- ★ 1 Year Warranty — C.O.D.'s ★
- ★ Immediate Shipping ★
- ★ FREE CATALOG ★

Call or Write

TRANS-WORLD CABLE CO.

12062 Southwest 117th Court, Suite 126
Miami, Florida 33186
1-800-442-9333



RADIO tubes, parts. Extensive listings. \$1.00 (refundable). **DIERS**, 4276-E5 North 50th Street, Milwaukee, WI 53216-1313.

SURGE protectors, for all types of electronic equipment, low prices, super protection! Free information. **DATA STAR COMPUTER SERVICE**, 305 Summit Trace Drive, Tucker, GA 30084.

CORDLESS soldering iron! New technology, heats up in seconds. 5 year warranty. \$19.95. Free shipping. **AUTOCOMM**, 4174A S. Parker, #117, Aurora, CO 80014.

REMOTE CONTROL KEYCHAIN



Complete w/mini-transmitter and +5 vdc RF receiver Fully assembled including plans to build your own auto alarm. Quantity discounts available.

\$24.95 Check, Visa or M/C Add \$3 shipping

VISITECT INC./Dept. R (415) 872-0128
PO BOX 5442, SO. SAN FRAN., CA 94080

PLANS AND KITS

BUILD this five-digit panel meter and square-wave generator including an ohms, capacitance and frequency meter. Detailed instructions \$2.50. **BAGNALL ELECTRONICS**, 179 May, Fairfield, CT 06430.

MINIATURE FM transmitters! Tracking transmitters! Voice disguisers! Bug detectors! Phone Devices! More! Available in kits or assembled! Catalog \$2.00! **XANDI ELECTRONICS**, Box 25647, Dept. 60E, Tempe, AZ 85285-5647.

CATALOG: hobby/broadcasting/HAM/CB: Cable TV, transmitters, amplifiers, surveillance devices, computers, more! **PANAXIS**, Box 130-F6, Paradise, CA 95967.

Unlock the Mystery of the Automobile Computer!

Build Your Own Diagnostic Scan Tool!

The Key To Understanding the Modern Electronically Controlled Automobile Engine. Access Stored ECM Data, Read-Out Fault Codes. Challenging **NEW** Electronic Assembly KIT—PLANS—PARTS—ASSEMBLED/TESTED UNITS



Call 1-800-535-3091 or write for complete information
S & M Electro-Tech P.O. Box 34334 Blaine, MN 55434

SURVEILLANCE transmitter kits are available to law enforcement agencies that operate on frequencies they prefer. Four models of each; telephone, room, combination telephone/room transmitters tune from 65 to 305 MHz. Send \$1.00 (overseas airmail \$2.00) for catalog. Included is **Popular Communications** book review of "Now Hear This! **Electronics Eavesdropping Equipment Design!**" by Winston Arrington. Book contains 58 transmitter schematics. **SHEFFIELD ELECTRONICS**, 7223 Stony Island Ave., Chicago, IL 60649-2806.

INVESTIGATORS, experimenters — Quality plans. Micro and restricted devices. Free catalog. Self-addressed stamped envelope required **KELLEY SECURITY INC.**, Suite 90, 2531 Sawtelle Blvd., Los Angeles, CA 90064.

CB Tricks II book. Power amplifier design and theory, UHF CB tune ups. Send \$19.95 **MEDICINE MAN CB**, PO Box 37, Clarksville, AR 72830.

DETECTION — Surveillance, debugging, plans, kits, assembled devices. Latest high-tech catalog \$5. **DETECTION SYSTEMS**, 2515 E. Thomas, #16-864F, Phoenix, AZ 85016.



Computer Kits

They're Fun, Easy to build, IBM Compatible, Educational, Powerful with Wholesale Prices. All Kits include a Free Assembly Manual, Free Software, One Year Warranty and 24 hour Phone Support Line and 24 hour Phone Support Line.

Ask for our **Free Catalog**
(516) 981-9473

General Technics
Quality Computer Systems
P.O. Box 2676
Lake Ronkonkoma, NY 11779

Assembly & Testing Available

BUILD robot from outer space! Plans \$11.95. details free. **ROBOT WORKS**, Box 1979, Colorado Springs, CO 80901.

REMOVE lead vocals from standard stereo records, CDs, tapes, FM broadcasts, so you can be the lead singer of your favorite band. Theory/schematic \$6.95. PCB and parts also available. **WEEDER TECHNOLOGIES**, 14773 Lindsey, Mt. Orab, OH 45154.

BARGAIN plan. Desk top computer stand. Easily built. Personal pride. Send \$4.00, now... **CREATE**, PO Box 440662, Aurora, CO 80044.

CABLE-TV

WE'LL MATCH OR BEAT ANYONE'S ADVERTISED RETAIL OR WHOLESALE PRICES!

BONANZA!

ITEM	1 UNIT	10 OR MORE
HAMLIN MCC 1000 36 CORDED REMOTE CONVERTER (Ch. 3 only)	29 00	18 00
PANASONIC WIRELESS CONVERTER (our best buy)	98 00	79 00
STAR GATE 2000	88 00	69 00
JERROLD 400 COMBO	169 00	119 00
JERROLD 400 HAND REMOTE CONTROL	29 00	18 00
JERROLD 450 COMBO	199 00	139 00
JERROLD 450 HAND REMOTE CONTROL	29 00	18 00
JERROLD SB-ADD-ON	99 00	63 00
JERROLD SB-ADD-ON WITH TRIMODE	109 00	75 00
M-35 B COMBO UNIT (Ch. 3 output only)	99 00	70 00
M-35 B COMBO UNIT WITH VARISYNC	109 00	75 00
MINICODE (N-12)	99 00	62 00
MINICODE (N-12) WITH VARISYNC	109 00	65 00
MINICODE VARISYNC WITH AUTO ON/OFF	145 00	105 00
ECONOCODE (minicode substitute)	69 00	42 00
ECONOCODE WITH VARISYNC	79 00	46 00
MLD 1200 3 (Ch. 3 output)	99 00	62 00
MLD 1200 2 (Ch. 2 output)	99 00	62 00
ZENITH S5AVI CABLE READY	175 00	125 00
INTERFERENCE FILTERS (Ch. 3 only)	24 00	14 00
EAGLE PD-3 DESCRAMBLER (Ch. 3 output only)	119 00	65 00
SCIENTIFIC ATLANTA ADD-ON REPLACEMENT DESCRAMBLER	119 00	85 00

CALL FOR AVAILABILITY

Quantity	Item	Output Channel	Price Each	TOTAL PRICE
California Penal Code #593-D forbids us from shipping any cable descrambling unit to anyone residing in the state of California.			SUBTOTAL	
Prices subject to change without notice.			Shipping Add \$3.00 per unit	
			COD & Credit Cards — Add 5%	
			TOTAL	

PLEASE PRINT

Name _____

Address _____ City _____

State _____ Zip _____ Phone Number () _____

Cashier's Check Money Order COD Visa Mastercard

Acct # _____ Exp Date _____

Signature _____

FOR OUR RECORDS

DECLARATION OF AUTHORIZED USE — I, the undersigned, do hereby declare under penalty of perjury that all products purchased, now and in the future, will only be used on cable TV systems with proper authorization from local officials or cable company officials in accordance with all applicable federal and state laws. **FEDERAL AND VARIOUS STATE LAWS PROVIDE FOR SUBSTANTIAL CRIMINAL AND CIVIL PENALTIES FOR UNAUTHORIZED USE.**

Dated: _____ Signed: _____

Pacific Cable Company, Inc.

7325½ RESEDA BLVD., DEPT. R-6 • RESEDA, CA 91335
(818) 716-5914 • No Collect Calls • (818) 716-5140

IMPORTANT: WHEN CALLING FOR INFORMATION
Please have the make and model # of the equipment used in your area. Thank You

© Copyright 1987 PACIFIC CABLE CO., INC.

UNICORN YOUR I.C. SOURCE

COLLIMATOR PEN (INFRA-RED)

A low power collimator pen containing a MOVPE grown gain guided GaAlAs laser. This collimator pen delivers a maximum CW output power of 2.5 mW at 25°.

These collimated laser sources are designed for industrial applications such as data retrieval, telemetry, alignment, etc.

The non-hermetic stainless steel encapsulation of the pen is specifically designed for easy alignment in an optical read or write system, and consists of a lens and a laser device. The lens system collimates the diverging laser light. The wavefront quality is diffraction limited.

The housing is circular and precision manufactured with a diameter of 11.0 mm and an accuracy between + and - 11µm.

LIST PRICE: \$180.00 OUR PRICE: **\$39.99**

• QUALITY COMPONENTS... LOW PRICES SINCE 1983 •



LASER DIODE (INFRA-RED)

Designed for general industrial low power applications such as reading optical discs, optical memories, barcode scanners, security systems, alignment, etc.

The gain guided laser is constructed on an n-type gallium arsenide substrate with a Metal Organic Vapor Phase Epitaxial process (MOVPE).

The device is mounted in a hermetic SOT148D encapsulation, (diameter 9.0 mm)

The SB1053 is standard equipped with a monitor diode, isolated from the case and optically coupled to the rear-emitting facet of the laser. This fast-responding monitor diode can be used as a sensor to control the laser optical output level.

LIST PRICE: \$38.00 OUR PRICE: **\$9.99**

• WE CARRY A FULL LINE OF COMPONENTS! •

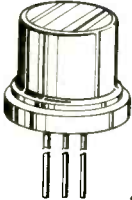

EPROMS

STOCK #	PINS	DESCRIPTION	1-24	25-99	100+
1702	24	256 x 4 1µs	3.99	3.79	3.41
2708	24	1024 x 8 450ns	6.49	6.17	5.55
2798	24	1024 x 8 450ns	3.99	3.79	3.41
2718	24	2048 x 8 450ns (25v)	3.99	3.80	3.24
2716-1	24	2048 x 8 350ns (25v)	3.79	3.60	3.24
TMS2716	24	2048 x 8 450ns	6.29	5.98	5.38
27C16	24	2048 x 8 450ns (25v CMOS)	3.99	3.79	3.41
2732	24	4096 x 8 450ns (25v)	3.79	3.60	3.24
2732A-2	24	4096 x 8 200ns (21v)	3.79	3.60	3.24
2732A	24	4096 x 8 250ns (21v)	3.69	3.51	3.16
2732A-4	24	4096 x 8 450ns (21v)	3.19	3.03	2.73
TMS5332	24	4096 x 8 450ns (25v)	5.79	5.50	4.95
TMS5332	24	4096 x 8 450ns (25v)	1.99	1.89	1.70
27C32	24	4096 x 8 450ns (25v CMOS)	4.19	3.98	3.58
2754-20	28	8192 x 8 200ns (21v)	3.99	3.79	3.41
2764	28	8192 x 8 250ns (21v)	3.79	3.60	3.24
2764A-20	28	8192 x 8 200ns (12.5v)	3.29	3.13	2.82
2764A	28	8192 x 8 250ns (12.5v)	3.29	3.13	2.82
TMS2564	28	8192 x 8 250ns (25v)	6.79	6.45	5.81
27564	28	8192 x 8 250ns (21v CMOS)	4.19	3.98	3.58
27128-20	28	16,384 x 8 200ns (21v)	5.79	5.50	4.95
27128	28	16,384 x 8 250ns (21v)	5.09	4.84	4.35
27128A	28	16,384 x 8 250ns (12.5v)	5.79	5.50	4.95
27C128	28	16,384 x 8 250ns (21v)	5.79	5.50	4.95
27256-20	28	32,768 x 8 200ns (12.5v)	5.29	5.03	4.53
27256	28	32,768 x 8 250ns (12.5v)	4.79	4.55	4.09
27C256	28	32,768 x 8 250ns (12.5v CMOS)	5.29	5.03	4.53
27512-20	28	65,536 x 8 200ns (12.5v)	7.49	7.12	6.41
27512	28	65,536 x 8 250ns (12.5v)	6.99	6.64	5.98
27C512	28	65,536 x 8 250ns (12.5v CMOS)	6.99	6.64	5.98
27C1024	32	131,072 x 8 200ns (12.5v CMOS)	17.99	17.09	15.38
68764	24	8192 x 8 450ns	13.99	13.29	11.96
68766	24	8192 x 8 450ns	14.99	14.24	12.82



• CALL FOR A FREE CATALOG! •



UNICORN ELECTRONICS

10014 Canoga Ave., Unit B-8 • Chatsworth, CA 91311



OUTSIDE CALIFORNIA: (800) 824-3432
IN CALIFORNIA: (818) 341-8833
ORDER BY FAX: (818) 998-7975



NEW HE NE LASER TUBES \$35

Dealer Inquiries Invited.
Free Catalog!

MEREDITH INSTRUMENTS: 6403 N. 59th Ave.
Glendale, AZ 85301 • (602) 934-9387
"The Source for Laser Surplus"

LASERS Build gunsights, pointers, liteshow, nitelite, lab. Blueprints and instructions \$9.00 each, 3 for \$20.00. Free list. **NIGHTWRITER** POB 4418, Phoenix, AZ 85016.

SURVEILLANCE Audio/video equipment — Debugging, industrial or private. 500 item catalog \$7.00. **SECURITY SYSTEMS** 3017G Hudson, New Orleans, LA 70131.

TALKING voltmeter! Microprocessor controlled! No experience necessary with microprocessors. Write to: **DIGITAL DREAMS** Box #4192 Huntington Beach, CA 92605.

SINGERS! Sing With The World's Best Bands!

The Thompson Vocal Eliminator removes lead vocal from standard stereo records & CD's. Unlimited Supply of Background Music! Easily Record or Perform with the Backgrounds. Use Professionally, yet connects easily to home component stereo. Manufactured and Sold Exclusively by LT Sound. For Free Brochure & Demo Record, Call: LT Sound, Dept. RL-1, 7981 LT Parkway, Lithonia, GA 30058 (404)482-4724 24 Hr. Phone Demo/Info Request Line: (404)482-2485

KITS, amplifiers, antenna amplifiers, alarms, power meter, VU meter, motion detector, siren, dimmer, timers, display, counter, chime, doorbell, power supply and many more. Catalog \$1.00. **ARLI ELECTRONICS** 2155 Verdugo Blvd. #22, Montrose, CA 91020.

HOBBYISTS Build this Dual Voltage Power Supply. Includes complete instructions, parts list and circuit board. Specify +/- 5V, +/- 9V, +/- 12V. All 1 A. Only \$19.95 to: **D.WELCH** Box 7221, LaVerne, CA 91750.

DESCRAMBLING, new secret manual. Build your own descramblers for cable and subscription TV. Instructions, schematics for SSAVI, gated sync, sinewave, (HBO, Cinemax, Showtime, UHF, adult) \$8.95, \$2.00 postage. **CABLETRONICS**, Box 30502R, Bethesda, MD 20824.

70 WATT audio amplifier. Simple and easy to build. Plans \$6.00. **T.J.L. ENTERPRISES**, Suite 302RE, 1902 Ridge Road, West Seneca, NY 14224.

FM transmitter 88—108 MHz kit \$12.95; Flyback tester assembled \$95.99; S & H 4% **SIERRA ELECTRONICS** Box 709 Eifers, FL 34680-0709.

CABLE TV DESCRAMBLER LIQUIDATION!

- Major Makes & Models!
- Will match or beat anyone's prices!
- Dealer discounts at 5 units!
- Examples:
HAMLIN COMBOS \$44 ea. (Min. 5)
OAK ADD/ON \$40 ea. (Min. 5)
OAK M35B \$60 ea. (Min. 5)

WEST COAST ELECTRONICS

For Information: 818-709-1758

Catalogs & Orders: 800-628-9656

FM WIRELESS microphone, 3 mile range, plans \$4.00. FM P. O. Box 4383, Bloomington, IL 61701-4383.

VCR amplifier. Transmits to any TV in the house. Complete unit, only \$49.95. Miniature FM transmitter — size of postage stamp, up to 1 mile range, \$29.95. **CAS ELECTRONICS** 1525 Aviation Blvd., Suite 136, Redondo Beach, CA 90278.

SCRAMBLING NEWS MONTHLY. This month "Build a descrambler/cable ready TV interface" to preserve remote control functions with descrambling equipment. This issue \$6.00. Next month a complete B-MAC technical update. This issue \$6.00. One year subscription \$19.95. **Pay TV** and **Satellite Descrambling** series provides system analysis, turn-ons, build-your-own, counter-measures, etc. V1, \$14.95, V1989 \$15.95, V1990 \$14.95. All 3/\$29.00. New indexed catalog \$1.00 or call **SCRAMBLING NEWS**, 1552 Hertel Ave., Buffalo, NY 14216. COD's 716-874-2088.

MULTI CHANNEL MICROWAVE ANTENNAS

- CRYSTAL CONTROLLED MICROWAVE ANTENNAS FOR OVER THE AIR CABLE SYSTEMS (WIRELESS CABLE)
 - CAPABLE OF RECEIVING 30 CHANNELS
 - CONVERTERS AVAILABLE FOR ZENITH SYSTEMS
- CATALOG & INFO: (203) 975-7543

VIDEO-LINK ENTERPRISES

520 GLENBROOK RD., SUITE 202, STAMFORD CT 06906

SATELLITE TV

FREE catalog — Lowest prices worldwide, save 40 — 60%. Systems, upgrades, parts, all major brands factory fresh and warrantied. **SKYVISION, INC.**, 2009 Collegeway, Fergus Falls, MN 56537. 1 (800) 334-6455. MN & International (218) 739-5231.

DESCRAMBLER: Build our low cost video only, satellite TV descrambler for most satellite channels. Uses easy to get, everyday parts. Board & plans \$35.00 US funds. Board, plans & parts \$99.00 US funds. Wired & tested unit \$189.00 US funds. Send check, money order or Visa to: **VALLEY MICROWAVE ELECTRONICS**, Bear River, Nova Scotia, Canada B0S 1B0 or phone (902) 467-3577. 8am to 4pm eastern time. Note: educational project only. Not to be used illegally.

*****PRESENTING*****

CABLE TV DESCRAMBLERS

***** STARRING *****

JERROLD, HAMLIN, OAK AND OTHER FAMOUS MANUFACTURERS

- FINEST WARRANTY PROGRAM AVAILABLE
- LOWEST RETAIL/WHOLESALE PRICES IN U.S.
- ORDERS SHIPPED FROM STOCK WITHIN 24 HOURS

FOR FREE CATALOG ONLY **1-800-345-8927**

FOR ALL INFORMATION 1-818-716-5914

PACIFIC CABLE CO., INC.
7325 W. RESEDA BLVD., DEPT. RE1 09
RESEDA, CA 91335

VIDEOCIPHER II manuals. **Volume 1** — hardware, **Volume 2** — software. Either \$34.95. **Volume 3** — projects/software, **Volume 5** Documentation or **Volume 6** — Experimentation \$44.95 each. **Volume 4** — Repair \$99.95. **Cable Hacker's Bible** — \$34.95. **Clone Hacker's Bible** — \$34.95. Catalog - \$3.00. COD's: (602) 782-2316. **TELECODE**, Box 6426-RE, Yuma, AZ 85366-6426.

CABLE TV secrets — the outlaw publication the cable companies tried to ban. HBO, Movie Channel, Showtime, descramblers, converters, etc. Suppliers list included. \$8.95. **CABLE FACTS**, Box 711-R, Pataskala, OH 43062.

VIDEOCIPHER II descrambling manual. Schematics, video and audio. Explains DES, EPROM, CloneMaster, 3Musketeeer, pay-per-view (HBO, Cinemax, Showtime, adult, etc.) \$13.95, \$2.00 postage. Collection of software to copy and alter EPROM codes, \$25. **CABLETRONICS**, Box 30502R, Bethesda, MD 20824.

TOCOM DESCRAMBLERS

TOCOM Descramblers complete units with remote \$150.00 each. Quantity discounts. **SCIENTIFIC ATLANTA 8500's** \$200.00. Call (213) 478-2506.



	ONE UNIT	10+ UNITS
PANASONIC WIRELESS CONVERTER	85.00	69.00
JERROLD 400 COMBO W/REMOTE (DRX3DIC)	134.00	95.00
JERROLD 400 OR 450 REMOTE HAND UNIT	24.00	15.00
JERROLD JRX 3DIC	84.00	65.00
JERROLD SB ADD ON	74.00	55.00
JERROLD SB ADD ON WITH TRI-BI	95.00	70.00
OAK M-35 COMBO	79.00	50.00
OAK MINICODE (N-12)	84.00	59.00
HAMLIN MLD 1200	64.00	45.00
SCIENTIFIC ATLANTA SA-3 ADD ON	109.00	75.00
INTERFERENCE FILTER (CHANNEL 3 OR 6)	24.00	14.00
NEW SCIENTIFIC ATLANTA COMBO	275.00	215.00
PIONEER DESCRAMBLER	250.00	200.00
TOCOM VIP	200.00	175.00
ZENITH FLASHING	175.00	150.00
ZENITH SSAVI	125.00	90.00
EAGLE PD-3	95.00	75.00

VIDEO-LINK Enterprises, Inc.

520 GLENBROOK RD., SUITE 202 STAMFORD, CT 06906

ORDERS: 1-800-622-9022

CATALOG & INFO: 203-975-7543

MONDAY - FRIDAY 10 AM - 5:30 PM, E.S.T.

IMPORTANT: Have make and model # of the equipment used in your area.

QTY	ITEM	OUTPUT CHANNEL	PRICE EACH	TOTAL PRICE

NO CONNECTICUT SALES. It is not the intent of VIDEO-LINK to defraud any pay television operator and we will not assist any company or individual in doing so.

PLEASE PRINT:
 CASHIER'S CHECK M.O. C.O.D.
 NAME _____
 ADDRESS _____
 CITY/STATE/ZIP _____
 PHONE _____
 SIGNATURE _____

WAIVER. Since I, the undersigned, fully understand that the ownership of a cable decoder does not give the owner of the decoder the right to decode or view premium cable channels without proper authorization from their local cable company, hereby declare under penalty of perjury that all products purchased, at any time, will only be used on cable TV systems with proper authorization from local officials or cable company officers in accordance with all applicable federal and state laws. Federal and various state laws provide for substantial criminal and civil penalties for unauthorized use.

Dated: _____ Signed: _____

CIRCLE 64 ON FREE INFORMATION CARD

DIGITAL V.O.M./D.P.M. SALES—SERVICE—PARTS

FLUKE-BECKMAN-SIMPSON-ETC.

U.S. MADE ONLY. QUOTATION PRIOR TO WORK. FAST SERVICE, 90 DAY WARRANTY. STANDARDS TRACEABLE TO NBS. SINCE 1948. CALIBRATION CERTIFICATE AVAILABLE.
INDUSTRIAL INSTRUMENT WKS. INC.
 5745 SALMEN, HARAHAN, LA 70123 504/733-8355

EARN \$1000's extra as a part-time computer dealer. Where to buy products at big discounts. Who to sell to. Financing without cash. Obtaining free software. Exclusive dealer trade shows. Step-by-step check list. Industry inside knowledge. Written by industry pioneer. Order now, only \$24.95 plus \$4.00 shipping/handling, CA residents add \$1.81 sales tax. **CORNERSTONE PUBLICATIONS**, Dept BB, PO Box 5151, San Jose, CA 95150. Allow 2-4 weeks.

EASY! Moneymaking one man CRT rebuilding machinery. \$6,500.00 - \$11,900.00. **CRT**, 1909 Louise, Crystalake, IL 60014. (815) 459-0666.

NUTS & VOLTS MAGAZINE P.O. Box 1111-E Pleasanton, CA 94670 714-632-7721

GIVE YOURSELF A BREAK—A PRICE BREAK! NUTS & VOLTS WILL SAVE YOU MONEY ON ELECTRONIC PARTS & EQUIPMENT. Plus SHOW YOU WHERE TO FIND UNIQUE, UNUSUAL AND HARD TO FIND ITEMS. **SUBSCRIBE TODAY!** Orders Only 800-783-4624

Subscription Rates: U.S. FUNDS REQUIRED
 3rd Class Mail—USA One Year \$12.00 Two Years \$21.00 Lifetime \$60.00
 1st Class Mail: One Year USA \$20.00 Canada/Mexico \$22.00 Foreign Year \$55.00

A National Publication For The Buying And Selling Of Electronic Equipment

EDUCATION & INSTRUCTION

MAGIC! Four illustrated lessons plus inside information shows you how. We provide almost 50 tricks including equipment for four professional effects. You get a binder to keep the materials in, and a one-year membership in the International Performing Magicians with a plastic membership card that has your name gold-embossed. You get a one-year subscription to our quarterly newsletter "IT'S MAGIC!" Order now! \$29.95 for each course + \$3.50 postage and handling. (New York residents add applicable state and local sales tax). **THE MAGIC COURSE**, 500-B BiCounty Boulevard, Farmingdale, NY 11735.

BE A RECORDING ENGINEER; Train at home for high-paying — Exciting careers. **FREE** information. **AUDIO INSTITUTE** 2174 Union St. Suite 22K, San Francisco, CA 94123

FREE SUBSCRIPTIONS to over 200 major computer and business magazines — Guaranteed. Write for free information: **SEABIRD 4N** Militia Drive, Lexington, MA 02173.

COMPLETE Digital Training course. Comprehensive overview of digital electronics. Super handy desktop reference! Hundreds of pages/illustrations. Free newsletter with order. Send \$10.00 to **VIEJO PUBLICATIONS** 3540 Wilshire Bl. #310 Dept. DG100. LA CA 90010 or call 1 (800) 537-0589.

Be a TV/VCR Repair Specialist

Now you can train at home in spare time for a money-making career as a TV/VCR Repair Specialist. No previous experience necessary. No need to quit your job or school. Everything is explained in easy-to-understand language with plenty of drawings, diagrams and photos. We show you how to troubleshoot and repair video-cassette recorders and TV sets, how to handle house calls and shop repairs for almost any make of television or VCR. Tools are included with your course so you can get "hands-on" practice as you follow your lessons step by step. Send for free facts about the exciting opportunities in TV/VCR Repair and find out how you can start making money in this great career. **MAIL COUPON TODAY** K03C

ICS SCHOOL OF TV/VCR REPAIR, Dept. DE050 (SINCE 1980) 925 Oak Street, Scranton, PA 18515

Please send me full information and color brochure on how I can learn TV/VCR Repair at home in my spare time. I understand there is no obligation and no salesman will visit me.

Name _____ Age _____
 Address _____ Apt. # _____
 City/State _____ Zip _____
 Phone (_____) _____

BASIC video cleaning and maintenance. TV one half hour VCR one hour. \$38.00 each. **JAMES BRADFORD** P.O. Box 38359, Detroit, MI 48238.

EARN \$32,000 to \$58,000 working 6-8 months annually. 6-7 months part time studying required. U.S. or foreign merchant marine radio officer's licenses. Booklet tells how and where to obtain study materials, meet government requirements, exams. Also address list of 100+ government agencies, universities, US, foreign shipping companies, all potential employers. Send \$7.50 to **KNOWLTECH INC.** POB 1070 St. Pete, FL 33731.

ANTIQUE RADIO CLASSIFIED

Free Sample!
 Antique Radio's
 Largest Circulation Monthly.
 Articles, Ads & Classifieds.
6-Month Trial: \$11. 1-Yr: \$20 (\$30-1st Class).
A.R.C., P.O. Box 802-L4, Carlisle, MA 01741

ELECTRONIC Camera Repair: Five day residency and 18 home study lessons. Video aided and 800-number supported. Free brochure. **C & C ASSOCIATES** 300 Highfall Greencastle, IN 46135. (317) 653-3405. Regulated by Commission on Proprietary Education.

BECOME a TV satellite news technician. Home training. Free info. **SPACELINK** P. O. Box 8497, Bridgeport, CT 06606.

CABLE TV EQUIPMENT



Converters, Remote Controls, Descramblers, CD Players.

JERROLD-OAK-SCIENTIFIC ATLANTA-HAMLIN ZENITH MANY MORE CALL TODAY!

√ Only quality products sold √ Easy to use
 √ Satisfaction guaranteed √ Knowledgeable sales staff
 √ Most orders shipped within 24 hours

CALL FOR YOUR FREE CATALOG

MC 1-800-228-7404 VISA

MAKE THE CONNECTION WITH NU-TEK ELECTRONICS
 5114 Balcones Wood Dr.#307 Dept.298 Austin, TX. 78759

WANTED

INVENTORS! Confused? Need help? Call **IMPAC** for free information package. In US and Canada: 1 (800) 225-5800.

INVENTIONS/new products/ideas wanted: Call **TLCI** for free information 1 (800) 468-7200 24 hours/day - USA Canada.

COMPUTER BOOKS

DISCOUNT computer books. All titles available, including recent releases. Please call or write for our latest catalog. **BOOKWARE**, 147 Campville Road, Northfield, CT 06778. 1 (800) 288-5662.

THIS IS A BOLDFACE EXPANDED AD with a tint background. . If you like this format, request it. Your cost is \$6.25 per word.

INVENTORS

INVENTORS! Can you patent and profit from your idea? Call **AMERICAN INVENTORS CORPORATION** for free information. Over a decade of service 1 (800) 338-5656. In Massachusetts or Canada call (413) 568-3753.

BEST BY MAIL

Rates: Write National, Box 5, Sarasota, FL 34230
OF INTEREST TO ALL

GOVERNMENT SEIZED VEHICLES Low as \$100! Amazing recorded message reveals details! (708) 705-2324

INSTANT POSTCARDS!! SAMPLE, send \$.25 stamp. Box 171(RE), Ashland, OR 97520.

BUSINESS OPPORTUNITIES

EARN EXTRA INCOME mailing brochures for national companies! No experience needed! Mail \$1: Finance Publications, Box 1678(RE), Arvada, CO 80001.

MAKE \$2,000 WEEK Recycling Gold! Easy home business! Free booklet! 1(900)246-2323 (\$2/min).

\$250 WEEKLY! IMMEDIATE home income! Photograph data forms! Experience unnecessary. Free details! PHILLIPS(RE), Garrett, PA 15542-0051.

FREE CATALOG!
1-800-648-7938

For all information 1-702-362-9026

JERROLD HAMLIN OAK ETC.

**CABLE TV
DESCRAMBLERS**

• Compare our low Low Retail Prices!

• Guaranteed Prices & Warranties!

• Orders Shipped Immediately!

REPUBLIC CABLE PRODUCTS INC.

4080 Paradise Rd. #15 Dept. RE-90
Las Vegas, NV 89109

LOGIC ANALYZER

continued from page 21

different trigger words. Up to three triggers can be OR-ed together on each level. It is possible to enter some rather complex triggering schemes, with conditional branches, loops, and the like. Trace recording can be turned on and off on any level so that only the data that is of interest—not, for example, a 1,000-count loop—is stored.

The PA480 48-bit x 4096-word, 25 MHz logic analyzer board costs \$1595. Either a general purpose pod or a microprocessor disassembly pod is required for operation. They run from \$495 to \$695.

Because we have limited space in which to describe the analyzer, we have only scratched the surface of its capabilities and features. We were very impressed with its operation, and think it deserves a serious look from anyone contemplating the purchase of a logic analyzer—and a serious look from some of the competition as well. R-E

CONSOLIDATED ELECTRONICS



THE ULTIMATE ELECTRONICS CATALOG

Order your 260 page catalog and price list with over 14,000 money saving electronic parts and equipment! Send \$3.00 in a check or money order, or call 1-800-543-3568 today and use your Mastercard or Visa. Consolidated Electronics, Incorporated, 706 Watervliet Ave., Dayton, Ohio 45420-2599

Name _____
Address _____
City _____ State _____ Zip _____

CIRCLE 70 ON FREE INFORMATION CARD

Parts Express
International Inc.

EMINENCE



MOTOROLA

Polydax

PIONEER

1-800-338-0531

3-WAY 100W CROSSOVER

12 dB/octave rolloff.
800Hz, 5000Hz
crossover points. 8
ohm. 100 watts RMS.



#260-210 **\$12.50** **\$9.95**
(1-9) (10-up)

SPEAKER CONTROL PANEL

Panel with 50 watt L-pads
for tweeter and midrange
and built-in LED power
meter. 5" x 2 1/2" 100
watt version available



#260-235 **\$14.50** **\$12.90**
(1-5) (6-up)

12" POLY WOOFER

Super duty, 40 oz. magnet.
100 watts RMS, 145 watts
max. 4 and 8 ohm compat-
ible (6 ohm). 2" voice coil.
fs = 25 Hz. QTS = .166,
VAS = 10.8 cu ft.
Response: 25-1500 Hz. Net
weight: 9 lbs. Pioneer
#A30GU40-51D



#290-125 **\$36.80** **\$34.50**
(1-3) (4-up)

15" WOOFER

Original Sanyo
woofer. Paper
cone with vented
dust cap and
treated cloth
surround. 12 oz.
magnet. 60 watts
RMS, 85 watts
max. 8 ohm.
Resonance: 26 Hz.
Response: 25-
2,500 Hz.



#291-155 **\$23.90** **\$21.90**
(1-5) (6-up)

PIONEER HORN TWEETER

Mylar dome. 2.93 oz.
barium ferrite magnet. 8
ohm. Response: 1800-
20000 Hz. 35W RMS,
50W max. fs = 2000 Hz,
SPL = 106 dB. Pioneer
#AHE80-51F



#270-050 **\$6.50** **\$5.90**
(1-9) (10-up)

12" SUB WOOFER

Dual voice coil sub woofer.
30 oz. magnet, 2" voice
coils. 100 watts RMS, 145
watts max. fs = 25 Hz. 6 ohm
(4 and 8 ohm compatible).
SPL = 89 dB 1W/1M.
Response: 25 700 Hz.
QTS = .31, VAS = 10.3 cu. ft.
Pioneer #A30GU30-55D.
Net weight: 6 lbs.



#290-145 **\$39.80** **\$36.80**
(1-3) (4-up)

15" THRUSTER WOOFER

Thruster by Eminence.
Made in USA. Poly foam
surround, 56 oz. magnet.
2-1/2", 2 layer voice coil.
150 watts RMS, 210 watts
max. 4 ohm. fs = 23.5
Hz, QTS = .33, VAS = 17.9
cu ft. SPL = 94.8 dB 1W/
1M. Net weight: 15 lbs.



#290-180 **\$43.50** **\$39.80**
(1-3) (4-up)

GRILL FRAME KIT

With this kit you
can make speaker
grill frames up to
30" x 40". Kit
includes 4 corner
pieces, 2 "T"
brackets, and 7
frame bars. Grill
mounting kit
included.



#260-333 **\$8.50** **\$7.80**
(1-9) (10-up)

18" EMINENCE WOOFER

MADE IN USA

100 oz. magnet, 3" voice
coil. 250 watts RMS, 350
watts max. 8 ohm, 30 Hz
resonant frequency. 22-
2700 Hz response.
Efficiency: 95 dB 1W/1M.
Paper cone, treated
accordian surround. Net
weight: 29 lbs.



#290-200 **\$98.90** **\$89.50**
(1-3) (4-up)

TITANIUM COMPOSITE TWEETER

Titanium is deposited on a polymer
dome to combine the advantages of
both hard and soft dome
technologies. 8 ohm. Ferro fluid
cooled voice coil. fs = 1200 Hz,
SPL = 90 dB 1W/1M. 50 watts RMS.
70 watts max. 4" round. Polydax
part #DTW100T125.



#270-047 **\$27.50** **\$24.80**
(1-9) (10-up)

Parts Express
International Inc.

340 E. First St., Dayton, Ohio 45402
Local: 1-513-222-0173
FAX: 513-222-4644

* 15 day money back guarantee * \$15.00 minimum order * We accept
Mastercard, Visa, Discover, and C.O.D. orders * 24 hour shipping
* Shipping charge = UPS chart rate + \$1.00 (\$3.00 minimum charge)
* Hours: 8:30 am-6:00 pm EST, Monday - Friday * Mail order
customers, please call for shipping estimate on orders exceeding
5 lbs.

CIRCLE 56 ON FREE INFORMATION CARD

DESCRAMBLERS

"The Empire Strikes Back"



"We Cut Prices To The Bare Essentials"
There Is NO Competition ANYWHERE !

JERROLD™
TB-3

SCIENTIFIC
ATLANTA
SA-3

HAMLIN
MLD 1200

OAK
M35B
W/ VARI-SYNC

INTELESTAR
CONVERTERS

DF-3/2
FILTERS

FULL
WARRANTY

10% UNDER ANYONES

Quoted or Advertised Prices...Even The **WholeSale**
For Ordering & Info. **(402)331-3228** **Kings!**
Please Call.....

SALES REGULATED BY FEDERAL & STATE LAW ANYONE IMPLYING THEFT OF
SERVICES WILL BE DENIED PURCHASE.

Cable Network Co. 5078 S. 109th St. Ste 121, Omaha, NE 68137

CIRCLE 196 ON FREE INFORMATION CARD

KIT REPORT

continued from page 57

coded from standard stereo TV broadcasts. However, some network TV shows are beginning to incorporate surround techniques as well. Surround sound can even show up where you'd least expect it. Our local public television station supplied the surround channel with music as they conducted a pledge drive in the front speakers.

The AD-2550 is priced at \$199. A pair of surround-channel speakers are also available from Heath for \$49.95. In our opinion, the processor provides *better-than-movie-theater* conditions. We get full control over the sound, and in our living room, the popcorn is *fresh!* **R-E**

BUG ROOM THRU PHONE

Circuit added to your phone always silences 1st ring. When you send secret sequence of "silent rings" - your phone answers itself allowing you to listen in on room while still on the hook! You are not detected! Works like a normal phone all other times. Free hard to find TCM 1506 ring detector chip included with step by step instructions. Send \$13.95 to

LASER BOUNCE, INC.
2020 Pennsylvania Ave. NW Suite 802
Washington, D.C. 20006

If You Are Buying Any of The Following Panasonic® Products Elsewhere, You Are Paying Too Much! Period.

- ★ Series ECQ-E Metallized Polyester Capacitors
- ★ Series ECQ-P(F) Precision Polypropylene Capacitors
- ★ Series X-Y Interference Suppressor AC Capacitors
- ★ Series ECE-Z Low Impedance Aluminum Electrolytic Caps.
- ★ Series TSW Large Aluminum Electrolytic Capacitors
- ★ Series EVN-K0 & EVN-K4 Carbon Trim-Pots.
- ★ Series EVM-31G & EVN-36C Dust-Proof Cermet Trim-Pots
- ★ Series EVM-Q0 & EVM-Q1 Hermetically Sealed Trim Pots
- ★ Series EXBF 2% SIP Resistor Networks
- ★ Series ECQ-M Polyester & Foil Capacitors
- ★ Series ECQ-V Metallized Stacked Film Capacitors
- ★ Series ECE-K Sub-Miniature Aluminum Electrolytic Capacitors
- ★ Series ECE-LS Miniature Aluminum Electrolytic Capacitors
- ★ Series ECS-EF Dipped Solid Tantalum Capacitors
- ★ Series EVM-M0F & EVM-M1F Industrial Cermet Trim-Pots
- ★ Series EVM-S0G Hermetically Sealed Trimmer Potentiometers
- ★ Series EVM-C7G Rectangular 15-Turn Trimmer Potentiometers

12 Months Saving Guarantee

We will refund the first year Membership Fee of any member who has purchased \$300 or more worth of products from Electronic Buyers Club and has not saved an amount greater than the first year Membership Fee, if buying the same items elsewhere.

And these are only 1603 of the more than 10,000 items that we stock and offer to our Members at super low prices. In fact after buying just a few hundred of the above items from Electronic Buyers Club, you will recover the \$35.00 Annual Membership Fee while your saving continues on for the rest of the year. Become a Member today and start paying Less.

30 Days Money Back Guarantee

We will refund the full Membership Fee of any new member of Electronic Buyers Club who within 30 Days after receiving the Membership Binder, returns the Binder to EBC and asks for the cancellation of Membership.

**Electronic
Buyers
Club**

A Division of International Components Corporation

1803 N.W. Lincoln Way • Toledo, OR 97391
PHONE (All 50 States & Canada): 1-800-325-0101
FAX: (503) 336-4400 • Hours: 6:00 AM - 6:00 PM PST



READER HELP READER

• A friend gave NORMAN JUST a Knight color pattern/generator, model KG-685, but the owner's manual, parts list, and schematic were missing. The unit needs some replacement parts and repairs. If you have any information on that model, please send it to 1926 Nocturne Drive, Louisville, KY 40272.

• After subscribing to Radio-Electronics for 25 years, CHARLES BROCKMAN is in need of the schematic for a Teledyne model RA-618 AM/FM receiver. If you have one, or can advise him of a source, please write to him at 2602 Woodlawn, Ennis, TX 75119.

• BRUCE KLIMISCH has an RF generator, EICO model number 369. It's in kit form, with no assembly information. He'd like to receive an instruction manual at 808 MacBeth Circle, Lakeville, MN 55044.

Try the
Radio-Electronics
bulletin board
system

(RE-BBS)
516-293-2283

The more you use it the more
useful it becomes.

We support 300 and 1200 baud
operation.

Parameters: 8N1 (8 data bits, no
parity, 1 stop bit) or 7E1 (7 data
bits, even parity, 1 stop bit).

Add yourself to our user files to
increase your access.

Communicate with other R-E
readers.

Leave your comments on R-E with
the SYSOP.

RE-BBS
516-293-2283

BUY SMART

Here's a sample of just a few great money-saving deals. Be smart, order today.

TURBO XT MOTHERBOARD (12 Mhz.)



Fully 8088 compatible!

- ★ Speed Selectable
- ★ Eight Expansion Slots
- ★ Memory expandable to 640K (0K installed)
- Mfr: ALR, Documentation included. (Customer Upgrades)

Item #25674 Special! \$75.00

9" HI-RESOLUTION TTL MONITOR OPEN FRAME

12 VDC.
GREEN PHOSPHOR
Schematic included.
Mfr — Ball #BCX190
Item #17198

NEW — \$19.95

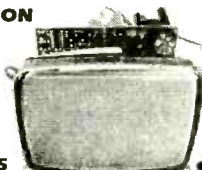

SLIM-LINE — EXTERNAL DISK DRIVE CHASSIS (Disk Drives not included)



Can accommodate:
2 half-height floppy drives, 5-1/4" or 3-1/2" in 5-1/4" frame.
Input: 115/230VAC, 50/60Hz. Orig. designed for Burroughs computer.
Dim.: 11-3/4" L x 9-1/4" H x 5-1/2" D.
Item #24782
RFE — \$59.50

TURBO XT COMPUTER



100% PC/XT Compatible!
16-Bit 8088-10 Turbo Microprocessor
With 12" Monochrome Monitor...
Item #27190
— NEW — \$399.00
With 12" Color Monitor...
Item #27191
— NEW — \$499.00

- Runs at 4.77Mhz or 10 Mhz @ (0+1 wait state)
- Speed switchable by software, keyboard or jumpers
- Includes video support for Hercules & CGA Color
- One 5-1/4" Floppy Drive
- 640K RAM
- 84-Key Keyboard
- Two 8-Bit Expansion Slots

Also Available:
20Mb HARD DISK on a CARD...
Item #27192
— NEW — \$299.00

AMERICAN DESIGN COMPONENTS
815 Fairview Ave.
Fairview, NJ 07022



20Mb HARD DISK DRIVES

HALF HEIGHT
ST225, XT-AT Compatible.
Item #26533
RFE — \$179.00

FULL HEIGHT
AT Compatible, 360 cylinder,
8 head, Item #20060
RFE — \$159.95



5 1/4" FLOPPY DISK DRIVES HALF HEIGHT

360K: DS/DC; 48 TPI; 80 track
Tested Good!
Item #24783 \$69.95

FULL HEIGHT
DS/DD; 43 TPI; 40 track
Tested Good!
Item #7928 \$69.95

SURGE SUPPRESSOR

- Protect your equipment from damaging power surges.
6 AC outlets. UL approved
• 15 A. maximum load
• Lighted ON/OFF switch
• Full 3-line EMI/RF protection
• 6 ft., 14-AWG grounded power cord
Item #27139 NEW — \$12.95



DIGITAL MULTIMETER

3-1/2 Digit LCD Display
Features: DC/AC Volts to 1000V
★ 1% Basic Accuracy (DC Volts)
★ DC/AC Amps to 10A.
★ Continuity Beeper) ★ Diode Test
★ Resistance to 20 Meg.
Includes: Test lead set, 9V battery, and instruction manual.
Item #26596 NEW — \$39.95



115 VAC MUFFIN-TYPE FANS

Super quiet — Can be installed just about anywhere for cooling or exhaust
5 METAL BLADES
NEW — Item #1864 \$9.95
RFE — Item #345 \$5.95



COMPUTER CARRYING CASE ON WHEELS

Fits: IBM PS2, Mac Plus, Mac SE, & SE/30



Opens front & top, or folds down flat for easy loading or unloading. Set of 4 removable casters. Fully padded Cordura nylon case; 4 large interior pockets for all your accessories; exterior keyboard pouch (fits extended keyboards).
Dim.: 15"H x 14"W x 16"D
Item #28359 NEW — \$39.95

(800) 776-3700

BUY SMARTER

With our free catalog you'll get hundreds of sensational bargains to choose from. So — isn't your order in order?



American Design Components

815 Fairview Ave., P.O. Box 220, Fairview, NJ 07022
Thousands more items in our FREE CATALOG!

Please send me one! RE 690

Item # Desc. Qty. Price Total

Item #	Desc.	Qty.	Price	Total

Name _____
Address _____

Phone _____
Visa/MC/Amex _____ Exp. _____

Min. Order \$15.00 — S & H: 10% of order + \$3.00

In NJ (201) 941-5000 • Fax: (201) 939-8918

CIRCLE 106 ON FREE INFORMATION CARD

Math Coprocessors

8088 or 8086 Systems

8087	5MHz	\$89.95
8087-2	8MHz	\$129.95
8087-1	10MHz	\$169.95

80286 or 80C286 Systems

2C87-10	10MHz	\$249.95
2C87-12	12MHz	\$279.95
2C87-20	20MHz	\$299.95

80386 Systems

80387-16	16MHz	\$349.95
80387-20	20MHz	\$399.95
80387-25	25MHz	\$499.95
80387-33	33MHz	\$649.95

SIP Modules

41256A9A-80	80ns, 256Kx9	\$54.95
41256A9A-10	100ns, 256Kx9	\$44.95
421000A9A-70	70ns, 1 Megx9	\$169.95
421000A9A-80	80ns, 1 Megx9	\$124.95
421000A9A-10	100ns, 1 Megx9	\$116.95
94000L-80	80ns, 4 Megx9	\$749.95
94000L-10	100ns, 4 Megx9	\$729.95

SIMM Modules

41256A9B-80	80ns, 256Kx9	\$49.95
41256A9B-10	100ns, 256Kx9	\$39.95
421000A8B-10	100ns, 1 Megx8	\$109.95
421000A9B-70	70ns, 1 Megx9	\$169.95
421000A9B-80	80ns, 1 Megx9	\$119.95
421000A9B-10	100ns, 1 Megx9	\$113.95
94000S-80	80ns, 4 Megx9	\$749.95
94000S-10	100ns, 4 Megx9	\$729.95

NEC V20 & V30 Chips

UPD70108-5	5MHz, V20 Chip	\$5.25
UPD70108-6	8MHz, V20 Chip	\$6.95
UPD70108-10	10MHz, V20 Chip	\$10.95
UPD70116-8	8MHz, V30 Chip	\$7.95
UPD70116-10	10MHz, V30 Chip	\$13.49

Dynamic RAMs

TMS4416-12	120ns, 16Kx4	\$2.75
TMS4416-15	150ns, 16Kx4	\$2.49
4116-12	120ns, 16Kx1	\$1.49
4116-15	150ns, 16Kx1	\$1.09
4116-20	200ns, 16Kx1	\$.89
4164-100	100ns, 64Kx1	\$2.75
4164-120	120ns, 64Kx1	\$2.39
4164-150	150ns, 64Kx1	\$2.15
4164-200	200ns, 64Kx1	\$1.75
41256-60	60ns, 256Kx1	\$5.25
41256-80	80ns, 256Kx1	\$3.75
41256-100	100ns, 256Kx1	\$3.15
41256-120	120ns, 256Kx1	\$2.95
41256-150	150ns, 256Kx1	\$2.59
41464-80	80ns, 64Kx4	\$5.95
41464-10	100ns, 64Kx4	\$4.95
41464-12	120ns, 64Kx4	\$3.95
41464-15	150ns, 64Kx4	\$3.59
511000P-70	70ns, 1 Megx1	\$13.95
511000P-80	80ns, 1 Megx1	\$12.95
511000P-10	100ns, 1 Megx1	\$12.35
514256P-10	100ns, 256Kx4	\$12.95
514256P-80	80ns, 256Kx4	\$13.45

Static RAMs

6116P-3	150ns, 16K (CMOS)	\$2.79
6264LP-10	100ns, 64K (CMOS)	\$6.95
6264LP-15	150ns, 64K (CMOS)	\$6.49
43256-10L	100ns, 256K	\$10.95
43256-15L	150ns, 256K	\$9.95
62256LP-15	150ns, 256K (CMOS)	\$10.95

Prototype Design Stations WM2

WM1 & WM2 Features: • Removable solderless breadboard • Variable and fixed DC power supply • Multi-frequency signal generator • Analog multimeter • 8 bicolor LEDs (red & green) • 8 logic switches • Logic probe • Lighted power switch • Fuse overload protected • Sturdy ruggedized case

WM1 Special Features: • 4 potentiometers • Built-in speaker

WM2 Special Features: • Pulse Generator • Binary coded decimal (BCD) to 7-segment decoder/driver • DB25 connector • Frequency counter (1Hz to 1MHz)

WM1 Analog Prototype Station \$199.95
WM2 Digital Prototype Station \$249.95

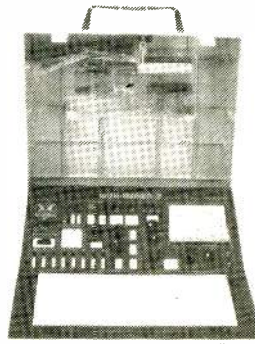

PROTOTYPING PRODUCTS
Jameco Solderless Breadboards

Part No.	Dim. L" x W"	Contact Points	Binding Posts	Price
JE21	3.25 x 2.125	400	0	\$4.95
JE23	6.5 x 2.125	830	0	\$6.95
JE24	6.5 x 3.125	1,360	2	\$12.95
JE25	6.5 x 4.25	1,660	3	\$17.95
JE26	6.875 x 5.75	2,390	4	\$22.95
JE27	7.25 x 7.5	3,220	4	\$32.95

Oscilloscope Probes

• Attenuation: x1 / x10
 • Capacitance (LF180): 180pF / 22pF; (LF210): 40pF / 17pF

LF180	40MHz Oscilloscope Probe	\$19.95
LF210	100MHz Oscilloscope Probe	\$29.95



A.R.T. EPROM Programmer

• Programs all current EPROMs in the 2716 to 27512 range plus the X2864 EEPROM • RS232 port • Software incl.

EPP.....\$179.95



UVP EPROM Eraser

• Erases all EPROM's • Erases 1 chip in 15 Min. and 8 chips in 21 min. • UV intensity: 6800 UW/CM²

DE4.....\$69.95



GoldStar 20MHz Oscilloscope and 1GHz Frequency Counter

GS7020

• Large 6" rectangular display
 • High sensitivity: 1 mV/div

GS7020 Oscilloscope.....\$399.95

• Wide measuring range
 • Measured value hold function

FC7101 Frequency Counter.....\$299.95



Soldering and Desoldering Stations

60 Watt Analog Display Soldering Station • Electronic temperature control from 200 to 878 F • Cartridge heating element for a longer life of the soldering tip

XY1683\$59.95

60 Watt Analog Display Soldering Station • Electronic temperature control from 200 to 878 F • Ceramic heating element for a steady temperature and long life

XY2660\$89.95

60 Watt Digital Display Soldering Station • Electronic temperature control from 200 to 878 F • Temperature displayed on easy to read .560"H 3-digit LED readout • Nichrome heating element

XY960\$99.95

30 Watt Electronic Temperature Controlled Desoldering Station • Electronic temperature control from 212 to 842 F • Self-contained high rotary vacuum pump

XY999\$279.95

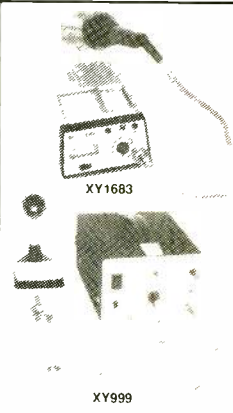

Metex Digital Multimeters

General Specs:
 • Handheld, high accuracy • AC/DC voltage, AC/DC current, resistance, diodes continuity, transistor hFE
 • Manual ranging w/ overload protection

M3650, 3650B & M4650 only:
 • Also measure frequency and capacitance

M4650 only: • Data hold switch • 4 5 digit

M3610	3 5 Digit Multimeter	\$49.95
M3650	3 5 Digit Multimeter w/Frequency & Capacitance	\$69.95
M3650B	Same as M3650 w/Bargraph	\$74.95
M4650	4 5 Digit w/Frequency Capacitance and Data Hold Switch	\$99.95



Multimeter Specials

M80:
 • AC/DC voltage, AC/DC current, resistance, diodes, continuity & frequency • Full auto-ranging on DC voltage • High/low semi-automating for AC/DC current and ohms • Data hold switch • Extra-large display

M80 3 75 Digit Multimeter\$59.95

M3900:
 • AC/DC voltage, AC/DC current, resistance, diodes, continuity, dwell angle and engine RPM • High surge voltage protection

M3900 3 5 Digit Multimeter\$59.95

51-Piece Electronic Tool Kit

The MS305 provides the tools needed for building, repairing and general maintenance of most electronic equipment. A convenient and durable carry-along combination lock case safely protects and secures this 51-piece tool kit. From the digital multimeter to the desoldering pump this kit is the perfect item for technicians and electronic enthusiasts.



Tools Included in Kit

- 10" measuring tape
- Electric tape
- 6" long tweezers
- 7" brush and scraper
- 7" fine point probe
- 7" slotted probe
- Rosin core solder
- 30 watt soldering iron
- Desoldering pump
- Soldering stand
- Stainless steel scissors
- Utility components box
- 8 pcs. hex key wrench
- Digital Multimeter
- Round needle file
- Flat needle file
- 6" adjustable wrench
- Utility knife with extra blade
- Bent needle nose pliers
- Diagonal cutting pliers
- 5.25" needle nose pliers
- 6 piece precision screwdriver set
- Brush
- 10 piece screwdriver set: 5 Slotted & 5 Phillips
- Flat nose pliers
- Carrying case: 17.63"W x 12.5"D x 3.5"

MS305.....\$119.95

Now Available...Jameco's NEW Flyer 142 with 48 pages of Computer Peripherals & More!

Jameco Digitizer Tablet



• AutoCAD 10 template and four-button cursor • Resolution: up to 1016 lines per inch • Accuracy: .025" • Emulates three of the world's most popular formats • EEPROM allows custom configuration

JCAD Digitizer Tablet \$199.95
Stylus Two Button Stylus..... \$39.95

Jameco 20MHz 80386 Desktop Computer Kit

- Fully IBM Compatible
- Free! Concurrent 386 Disk Operating System Software Included
- Free! QAPLUS Diagnostic Software Included!
- Free! WORDSTAR EASY Word Processing Software Included!
- 1Mb RAM Included, Expandable to 8Mb on-board, 16Mb with optional expansion board
- 8/16/20MHz Keyboard Switchable Operation
- AMI BIOS ROMs Included
- Floptop Case w/200 Watt Power Supply
- MiniScribe 3.5" 40Mb RLL Hard Disk Drive
- 1.2Mb Floppy DSHD Disk Drive
- 22.0 Norton SI Rating
- 101-Key (Enhanced) Keyboard



Shown with VGA Option (not included)
JE2057 VGA Monitor and VGA Card... \$559.95
(See Below)

JE3550 20MHz 80386 Compatible Kit..... \$1599.95

Casper Amber & Paper White Monitors

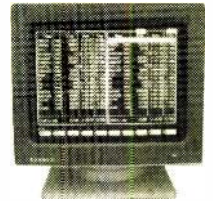

These flat screen 14" monitors feature an anti-glare screen and are ideal for desktop publishing and CAD applications. Resolution: 720 x 348. The GM1468 features four shades of gray and a dual mode option which allows you to use it with CGA or Monochrome adapter cards.

GM1468 Paper White Dual mode ... \$119.95
GM1489 Amber Monochrome..... \$109.95

Logitech ScanMan Plus Scanner



• IBM PC/XT/AT Compatible
• 4" Scanning Window
• 32 Shades of Gray
• Includes Software
• 400DPI

SCANP..... \$219.95

Logitech Mice



MSER Serial Mouse & MouseWare Software \$79.95

MBUS Mouse w/Bus Board and Mouse Ware Software \$89.95

MPS2 PS/2 Mouse & MouseWare Software \$74.95

IBM Compatible Cases and Power Supplies



JE1030 300 watt AT Power Supply \$139.95
JE1010 Flip-Top Standard PC/XT Case \$39.95
JE1011 Side Standard PC/XT Case \$39.95
JE1030 150 watt PC/XT Power Supply \$59.95
JE1032 200 watt Baby AT Power Supply \$89.95
JE1035 300 watt AT Power Supply \$139.95
JE2011 Vertical Case w/300W Pwr. Supply \$249.95
JE2012 Mini Vertical Case w/200W Pwr. Supply \$149.95
JE2014 Flip-Top Baby XT Turbo Case \$69.95
JE2019 Flip-Top Baby AT Case \$69.95

IBM PC/XT/AT Compatible Keyboards



JE2015 84-Key Standard AT Style Layout \$59.95
FKB4700 101-Key Enhanced Layout w/12 Function Keys.. \$69.95

Floppy Disk Drives & Diskettes



Mitsubishi
MF353B 3.5" 720Kb Internal Drive .. \$99.95

Toshiba
356KU 3.5" 1.44Mb Internal Drive \$109.95

TEAC
FD55B 5.25" 360Kb Half Ht \$89.95
FD55G 5.25" 1.2Mb Half Ht \$99.95

3.5" & 5.25" Diskettes (10 per box)
DSDD 5.25" DSDD (360Kb) \$6.95
DSHD 5.25" DSHD (1.2Mb) \$13.95
3DS 3.5" DSDD (720Kb) \$16.95
3HD 3.5" DSHD (1.44Mb) \$34.95

EGA & Multiscan Monitor Packages

Casper 14" EGA monitor and EGA card package (720 x 350 max. resolution)

JE1059 EGA Monitor & EGA Card \$459.95

Relisys 14" Multiscan monitor and EGA card package (800 x 600 max. resolution)

JE2057 Multiscan Monitor & EGA Card \$559.95

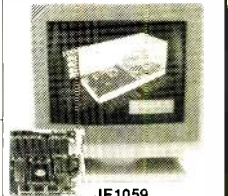

JAMECO IBM PC/XT/AT COMPATIBLE CARDS

JE1043 360K/720K 1.2Mb/1.44Mb Floppy Disk Controller Card (PC/XT/AT) \$49.95
JE1050 Monochrome Graphics Card w/Parallel Printer Port (PC/XT/AT) \$49.95
JE1052 Color Graphics Card w/ Parallel Printer Port (PC/XT/AT)..... \$49.95
JE1055 EGA Card w/ 256K Video RAM (PC/XT/AT) \$139.95
GC1500 Orchid 8 Bit VGA Card w/256K Video RAM (PC/XT/AT)..... \$169.95
JE1057 8/16-Bit VGA Card w/256K Video RAM (PC/XT/AT)..... \$199.95
JE1060 I/O Card w/ Serial, Game, Printer Port & Real Time Clock (PC/XT) \$59.95
JE1062 RS232 Serial Half Card (PC/XT/AT) .. \$29.95
JE1065 I/O Card w/ Serial, Game and Parallel Printer Port (AT) \$59.95
JE1071 Multi I/O Card w/ Controller & Monochrome Graphics (PC/XT) \$119.95
JE1077 Multi I/O Card w/ 360K/720K/1.2Mb/1.44Mb Floppy Controller (AT)..... \$74.95
JE1081 2Mb Expanded or Extended Memory Card (zero-K on-board) (AT)..... \$109.95



MiniScribe Hard Drives & CMS Tape Back-Ups

Part No.	Capacity	Style	Average Speed	Format	Drive Alone	W/8-Bit (XT) Controller	W/16-Bit (AT) Controller
M8425	20Mb	3.5" H	68ms	MFM	\$224.95	-----	-----
M8425XT	20Mb	3.5" H	68ms	MFM	-----	\$269.95	-----
M8425AT	20Mb	3.5" H	68ms	MFM	-----	-----	\$339.95
M8425F	20Mb	3.5" H	40ms	MFM	\$249.95	-----	-----
M8438	30Mb	3.5" H	68ms	RLL	\$249.95	-----	-----
M8438XT	30Mb	3.5" H	68ms	RLL	-----	\$299.95	-----
M8438AT	30Mb	3.5" H	68ms	RLL	-----	-----	\$389.95
M8450	40Mb	3.5" H	46ms	RLL	\$329.95	-----	-----
M8450XT	40Mb	3.5" H	46ms	RLL	-----	\$369.95	-----
M8450AT	40Mb	3.5" H	46ms	RLL	-----	-----	\$429.95
M3085	70Mb	5.25" H	20ms	MFM	\$599.95	-----	-----
M3085AT	70Mb	5.25" H	20ms	MFM	-----	-----	\$699.95

DJ10 40Mb Tape Drive with up to 120Mb capability (includes one TB40 Tape) \$299.95
QFA500 150Mb Tape Drive with up to 500Mb capability (includes one TC150 tape)..... \$1049.95

Hard & Hard/Floppy Disk Controller Cards

Computer Type	MFM Hard		RLL Hard		MFM Hard/Floppy		RLL Hard/Floppy	
	Part No. / Price	Part No. / Price	Part No. / Price	Part No. / Price	Part No. / Price	Part No. / Price	Part No. / Price	
8088 (PC/XT) @ 3:1 Interleave	X1TGN\$79.95	1004A27X\$89.95	JE1044 \$109.95	-----	-----	-----	-----	
80286 (AT)/386 @ 2:1 Interleave	1003VMM1 \$129.95	1003VSR1 \$149.95	1003VMM2 \$149.95	1003VSR2 \$169.95	-----	-----	-----	
80286 (AT)/386 @ 1:1 Interleave	1006VMM1 \$149.95	1006VSR1 \$169.95	1006VMM2 \$169.95	1006VSR2 \$189.95	-----	-----	-----	

MEI 100-Key Microtype Keyboard



• IBM PC/XT/AT/386 Compatible
• Saves an amazing 60% of the desk space used by equivalent standard keyboards

MIRU..... \$129.95

Sony 3.5" 720Kb Disk Drive



• IBM PC/XT/AT Compatible
• Double-sided, double-density
• Documentation included

MPF11 Disk Drive \$69.95
SMK 5.25" Installation Kit for MPF11 \$14.95

1355 Shoreway Road
Belmont, CA 94002
24 Hour Order Hotline (415) 592-8097
FAX's (415) 592-2503 or (415) 595-2564
Telex 176043 - Ans. Back: Jameco Elmt
Data Sheets - 50c each
Send \$2.00 Postage for a FREE 80-Page Catalog
© 1990 Jameco Electronics 6/90
IBM is a registered trademark of International Business Machines



\$50.00 Minimum Order - U.S. Funds Only
CA Residents Add 6.25%, 6.75% or 7.25% Sales Tax
Shipping - Add 5% plus \$1.50 Insurance
(May vary according to weight and shipping method)
Terms: Prices subject to change without notice
We are not responsible for typographical errors.
We reserve the right to substitute manufacturers.
Items subject to availability and prior sale.
Products pictured may only be representative.
Complete list of terms/warranties is available upon request.

24-Hour Order Hotline (415) 592-8097 • The Following Services Are Also Available Through (415) 592-8097 From 7AM - 5PM P.S.T.:
• Customer Service • Technical Assistance • Credit Department • All Other Inquiries

★QUALITY PARTS ★DISCOUNT PRICES ★FAST SHIPPING

ALL ELECTRONICS CORP.

THUMBWHEEL SWITCH

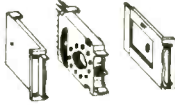

1 pole 10 position decimal encoded switches which interlock to make up desired number or digits. Terminates to 11 pc pins (1 common and 10 poles). Each section measures .31" wide X .20" high X .78" deep. End plates can be added to form a .94" high bezel.

CAT# SWTH-9 \$1.25 each
10 for \$10.00

END PLATES - CAT# SW-9EC
\$1.00 per set

0 - 6 HOUR AUTO SHUT-OFF TIMER

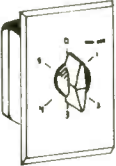

M.H. Rhodes, Inc. Mark-Time# 90007 Wall-box timer fits standard 3" deep wall box. Rated 20 amps @ 125 Vac. Turn knob to desired time. Includes hardware, beige wall plate, and knob. UL and CSA listed.

CAT# TMC-6 \$5.75 each

INSTRUMENT ENCLOSURES



High quality molded ABS instrument enclosures. Integrated PC board standoffs and two sets of vertical mounting slots for front and rear sub panels. All enclosures are 6" wide X 6 1/4" deep. Choice of three heights. Includes non-skid rubber feet and hardware. Available in beige, ivory, black, and blue.

Panel Ht.	CAT#	1-9	10-99
2 1/4"	CAT# MB-A	\$7.50 each	10 for \$65.00
2 5/8"	CAT# MB-B	\$7.75 each	10 for \$65.00
3"	CAT# MB-C	\$8.00 each	10 for \$70.00

Please specify color.

RECHARGEABLE BATTERY PACK (USED)



Four AA nickel cadmium batteries connected in series to make a 4.8 volt pack. Batteries are in a 2 X 2 configuration with a 2 pin connector attached. The four batteries can be separated into single AA size solder tab nickel cadmium batteries or resoldered into other configurations.

SPECIAL SALE PRICE NOW
\$3.00 per pack • 10 packs for \$25.00

CAT# NCB-41AAU

TIL-99 PHOTO TRANSISTOR



TO-18 case with window. For wide-angle viewing applications. Spectrally and mechanically compatible with TIL-31B.

CAT# TIL-99 \$1.00 each • 10 for \$9.00

TIL-31B PHOTO DIODE



TO-18 case with window. Infrared emitting photo diode.

CAT# TIL-31B \$1.00 ea. • 10 for \$9.50

NICKEL-CAD BATTERIES (RECHARGEABLE)



AAA SIZE	\$1.50 each
1.2 volts 180 mA	
CAT# NCB-AAA	
AA SIZE	\$2.00 each
1.25 volts 500 mA	
CAT# NCB-AA	
AA SIZE	\$2.20 each
WITH SOLDER TABS	
CAT# NCB-SAA	
C SIZE	\$4.25 each
1.2 volts 1200 mA	
CAT# NCB-C	
D SIZE	\$4.50 each
1.2 volts 1200 mA	
CAT# NCB-D	

LED CHASER KIT

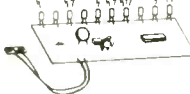

Build this variable speed led chaser. 10 leds flash sequentially at whatever speed you set them for. Easy to build kit includes pc board, parts and instructions. Ideal for special lighting effects, costumes, etc. Operates on 3 to 9 volts. PC board is 5" X 2.25". A great one hour project.

CAT# AEC \$6.50 each

SPECIAL PURCHASE 210 MFD 330 V PHOTOFLASH CAPACITOR



Rubicon CE photoflash capacitor. 0.79" dia. X 1.1" high. These are new capacitors that have been prepped with 1.4" black and red wire leads soldered to the terminals.

CAT# PPC-210 \$2.50 each
10 for \$22.50 • 100 for \$200.00

LED'S

STANDARD JUMBO DIFFUSED T 1-3/4 size

RED	CAT# LED-1	10 for \$1.50 • 100 for \$13.00
GREEN	CAT# LED-2	10 for \$2.00 • 100 for \$17.00
YELLOW	CAT# LED-3	10 for \$2.00 • 100 for \$17.00

FLASHING LED
with built in flashing circuit operates on 5 volts.

RED	\$1.00 each
CAT# LED-4	10 for \$9.50
GREEN	\$1.00 each
CAT# LED-4G	10 for \$9.50

BI-POLAR LED
Lights RED one direction. GREEN the other. Two leads.

CAT# LED-6 2 for \$1.70

LED HOLDER
Two piece holder.

CAT# HLED 10 for 65¢

L.E.D. FLASHER KIT



Two L.E.D.'s flash in unison when a 9 volt battery is attached. This kit includes a p.c. board, all the parts and instructions to make a simple flasher circuit. A quick and easy project for anyone with basic soldering skills.

CAT# LEDKIT \$1.75 per kit

SWITCHES

ITT PUSH BUTTON



ITT MOPL series. 3/4" X 1/2" grey rectangular key cap. S.P.S.T. N.O. Push to close. RATED: 0.1 amp switching, 0.25 amp carry current. P.C. mount.

CAT# PB-8 65¢ each • 10 for \$6.00
100 for \$50.00

SPDT PUSHBUTTON



Marquardt# 1843
Rated 6 amps @ 125/250 Vac. Black plastic pushbutton. Switch body: .92" X .94" X .65".

CAT# PB-18 \$1.65 ea. • 10 for \$15.00

PUSHBUTTON SWITCH



GC/Thomson# 35-420
S.P.S.T. normally open momentary pushbutton switch. Red plastic actuator 0.57" diameter. Chrome bezel 0.68" diameter. Threaded bushing mounts in .50" diameter hole. Rated 3 amp @ 250Vac. Solder loop terminals.

CAT# PB-20 \$1.00 each

XENON TUBE



1" long flashtube with 3 1/2" red and black leads. Ideal for electronic flash or strobe projects.

CAT# FLT-3 2 for \$1.00

22/44 PIN CONNECTOR



.156" pin spacing, 0.200" between double rows, gold contacts, P.C. mounting.

SPECIAL Same as AMP# 2-530655-6
CAT# EBC-1G \$1.00 each • 10 for \$8.00

10 AMP SOLID STATE RELAY



ELECTROL# S2178
CONTROL:
Rated 5.5 to 10 Vdc (will operate on 3-32 Vdc).
LOAD: 10 amp @ 240 Vac
2 1/4" X 1 3/4" X 7/8".

CAT# SSRLY-10B \$9.50 ea.
QUANTITY DISCOUNT
10 for \$85.00 • 25 for \$175.00
50 for \$300.00 • 100 for \$500.00

LOOK WHAT \$1.00 WILL BUY

200 ASSORTED 1/4 WATT RESISTORS



Bent leads, carbon comp. and carbon film.

CAT# GRES \$1.00 per assortment

200 ASSORTED 1/2 WATT RESISTORS



Bent leads, carbon comp. and film.

CAT# GRABRE \$1.00 per assortment

50 ASSORTED DISC CAPACITORS



Most are cut (p.c. leads). Some to 500 volts.

CAT# GRABDC \$1.00 per assortment

15 VALUES OF ELECTROLYTICS



Contains both axial and radial styles from 1 mfd.

CAT# GRABCP \$1.00 per assortment

WALL TRANSFORMERS



ALL PLUG DIRECTLY INTO 120 VAC OUTLET

12 Vdc @ 500 ma.	CAT# DCTX-125	\$4.50
6 Vdc @ 200 ma.	CAT# DCTX-620	\$2.25
9 Vdc @ 1 amp.	CAT# DCTX-951	\$5.00
24 Vdc @ 625 ma.	CAT# ACTX-24B2	\$3.25

RELAYS

5-6 VDC SIP REED RELAY



Electrol
"Blue Boy"®
BBS1A05A10
5-6 Vdc, 500 ohm coil. S.P.S.T. normally open reed relay.

0.5 amp contacts. SIP configuration. 1" X .375" X .3".

CAT# RRLY-SIPS
\$1.10 each • 10 for \$10.00

5 VDC LATCHING RELAY



Aromat# RSL20-5V
Miniature SPDT, dual coil latching relay. 5 Vdc, 170 ohm coils. 1 amp. TTL compatible. UL and CSA recognized. 0.787" X 0.394" X 0.394"

CAT# LRLY-5DC \$2.50 each

ELECTRONIC GAME BOARD

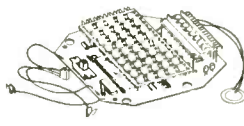

The inner workings of an electronic Scrabble game. Operates on 6 Vdc. 8 digit alpha-numeric readout, 45 button keypad, 14 transistors, 21 C's, 1 piezo element and other goodies. Top and bottom row of keypad buttons are function keys, middle 3 rows are alphabetic.

No instructions available. 6" X 4.45"

CAT# ST-4 \$1.75 each 10 for \$15.00

OPTO SENSOR



U shaped package with mounting ears. 1/8" opening. 3/4" mounting ears.

CAT# OSU-6
50¢ each
10 for \$4.50 • 100 for \$40.00

LOOK WHAT \$2.00 WILL BUY

15 AMP SNAP-ACTION SWITCH



5 pieces of a 15 amp 125,250 Vac normally open switch. Body is 1 3/4" X 5/8" X 5/8". Button extends 3/16" above switch body.

CAT# GRABMS \$2.00 per package

SERVO MOTOR



3 Vdc servo with potentiometer. Ideal for robotics or remote control model experimentation. Rotates approx. 140 degrees. Pot connected to motor varies from either 500 to 3000 ohms. 1.53" X 0.95" X 1.65". 0.87" diameter rubber wheel attached to motor shaft can be used as a capstan or can be easily removed. Prepped with capacitors, chokes and wire leads.

CAT# SVD-2 2 for \$1.00

12 VOLT D.C. COIL S.P.D.T.



Omron# G2E-184P
4 amp contacts, 335 ohm coil. Sugar cube size. .61" X .42" X .44" high. P.C. mount with pins on DIP spacing.

CAT# RLY-787 \$1.50 each

TELEPHONE COUPLING TRANSFORMER



Multi Products International# A18N-HO-10/1
Primary: 600 ohm
Secondary: 600/600 ohm
0.77" X 0.61" X 0.63" high.
8 p.c. pins on 0.187" centers.
Primary Inductance: 300 mH min. at 1kHz, 1 volt.

CAT# CTX-1 \$1.25 each • 10 for \$11.00

A.C. LINE CORDS



Black 6ft., 18/2, SPT-2

NON POLARIZED PLUG
CAT# LCAC 2 for \$1.00
100 for \$45.00

POLARIZED PLUG
CAT# LCP-1 60¢ each
100 for \$50.00

TO-92 TRANSISTORS



20 assorted TO-92 plastic case transistors. Various styles of NPN and PNP. Some house marked, some standard marking.

CAT# GRTRN \$2.00 per assortment

SWITCHES



10 assorted slide, toggle, rotary, pushbutton and rocker switches. Our choice.

CAT# GRABSW \$2.00 per assortment

RADIO-ELECTRONICS

CALL OR WRITE FOR OUR FREE 60 PAGE CATALOG OVER 4000 PARTS!



OUTSIDE THE U.S.A. SEND \$2.00 POSTAGE FOR A CATALOG!!

ORDER TOLL FREE 1-800-826-5432

MAIL ORDERS TO: ALL ELECTRONICS P.O. BOX 567 VAN NUYS, CA 91408

**INFO: (818)904-0524
FAX: (818)781-2653
MINIMUM ORDER \$10.00
QUANTITIES LIMITED
CALIF. ADD SALES TAX
USA: \$3.50 SHIPPING
FOREIGN ORDERS
INCLUDE SUFFICIENT SHIPPING. NO C.O.D.**



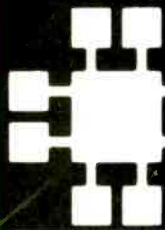

JDR Microdevices

• 30 DAY MONEY BACK GUARANTEE • 1 YEAR WARRANTY ON ALL PRODUCTS • TOLL-FREE TECHNICAL SUPPORT

MMC
MICROCOMPUTER
MARKETING COUNCIL
of the Direct Marketing Association, Inc.

DEVELOPERS' WORLD

JDR caters to the developer with a full line of prototyping & programming products. Request our catalog for the complete line!

MODULAR PROGRAMMING SYSTEM

MODULES USE A COMMON HOST ADAPTOR CARD--1 SLOT PROGRAMS EPROMS, PROMS, PALS, MORE!

HOST ADAPTOR CARD **\$29.95**

- UNIVERSAL INTERFACE FOR ALL PROGRAMMING MODULES!
- SELECTABLE ADDRESSES PREVENTS CONFLICTS
- MOLDED CABLE
- MOD-MAC



UNIVERSAL MODULE **\$499.95**

• PROGRAMS EPROMS, EEPROMS, PALS, BI-POLAR PROMS, 8748 & 8751 SERIES DEVICES, 78V8 AND 20V8 GALS (GENERIC ARRAY LOGIC) FROM LATTICE, NS, SGS • TESTS TTL CMOS, DYNAMIC & STATIC RAMS • I/O DISK, SAVE, DISK EDIT, BLANK CHECK, PROGRAM, AUTO, READ MASTER, VERIFY AND COMPARE • TEXT/OOL SOCKET FOR 3" x 6" W/IC'S (8-40 PINS)

MOD-MUP

MOD-MPL-SOFT CUPL SOFTWARE **\$99.95**

EPROM MODULE **\$119.95**

• PROGRAMS 24-32 PIN EPROMS, CMOS EPROMS & EEPROMS FROM 16K TO 1024K • HEX TO OBJ CONVERTER • AUTO, BLANK CHECK/PROGRAM/VERIFY • VPP 5, 12.5, 12.75, 13, 21 & 25 VOLTS • NORMAL INTELLIGENT, INTERACTIVE & QUICK PULSE PROGRAMMING ALGORITHMS

MOD-MEP

OTHER MODULES: PAL PROGRAMMER, DIGITAL TESTER, BI-POLAR PROGRAMMER, MICROPROCESSOR PROGRAMMER FROM **\$129.95 TO \$259.95** - CALL FOR INFORMATION

EPROM PROGRAMMER **\$129.95**

• PROGRAMS 27XX AND 27XXX EPROMS UP TO 27512
• SUPPORTS VARIOUS PROGRAMMING FORMATS & VOLTAGES
• SPLIT OR COMBINE CONTENTS OF SEVERAL EPROMS OF DIFFERENT SIZES
• READ, WRITE, COPY, BLANK CHECK & VERIFY
• SOFTWARE FOR HEX AND INTEL HEX FORMATS
MOD-EPROM



EPROMS

27128	16384x8	250ns	12.5V	28	4.25
27128A-200	16384x8	200ns	12.5V	28	5.95

PARTIAL LISTINGS ONLY - MANY OTHERS AVAILABLE!

EPROM ERASERS

DATARASE II **\$39.95**
• SHIRT POCKET SIZE!
• ALL SIZES UP TO 4 AT A TIME
• ERASES MOST EPROMS IN 3 MINUTES
DATARASE II



PE-140T SPECTRONICS 9 CHIP ERASER W/TIMER **\$139.95**

PROTOTYPE CARDS

FR-4 EPOXY GLASS LAMINATE WITH GOLD PLATED EDGECARD FINGERS AND SILK SCREENED LEGENDS



FOR XT

JDR-PR1	WITH -5V AND GROUND PLANE	27.95
JDR-PR2	ABOVE WITH I/O DECODING LAYOUT	29.95
JDR-PR2-PK	PARTS KIT FOR JDR-PR2 ABOVE	8.95

FOR AT

JDR-PR10	16 BIT WITH I/O DECODING LAYOUT	34.95
JDR-PR10-PK	PARTS KIT FOR JDR-PR10 ABOVE	12.95

EXTENDER CARDS

SIMPLIFY PROTOTYPING AND TESTING

EXT-8088	8 BIT FOR 8088 MOTHERBOARDS	29.95
EXT-80286	16 BIT FOR 286/386 MOTHERBOARDS	39.95

UPGRADE YOUR OLD SYSTEM! REQUEST OUR NEW FLYER TO LEARN HOW!

ORDER TOLL FREE 800-538-5000 **KEY CODE 12**

CUSTOMER SERVICE TOLL-FREE 800-538-5001 • TECHNICAL SUPPORT TOLL-FREE 800-538-5002

BUILD YOUR OWN 286 SYSTEM FOR UNDER \$650

IT'S A GREAT WAY TO LEARN AND A GREAT WAY TO SAVE! HERE'S JUST ONE OF OUR MOST POPULAR CONFIGURATIONS:

MCT-M286-12	9.10MHZ MINI 286 MOTHERBOARD	\$199.95
MCT-MGP	MONOCHROME GRAPHICS ADAPT	\$49.95
MCT-FDC-HD	360K 1.44MB FLOPPY CONTROLLER	\$49.95
CASE-JR	MINI FLIP-TOP CASE W/150W P.S.	\$149.95
FDD-360	360K 5-1/4" FLOPPY DISK DRIVE	\$69.95
JDR-MONO	MONOCHROME MONITOR (GREEN)	\$69.95
BTC-5060	STANDARD 84 KEY KEYBOARD	\$59.95
TOTAL SYSTEM (OK INSTALLED)		\$649.65

OPTIONAL COMPONENTS

MOTHERBOARDS

MCT-TURBO-10	4.77/10MHZ SINGLE CHIP 8088	\$99.95
MCT-M286-16N	8.15MHZ 286 W/NEAT CHIPSET	\$289.95
MCT-M286-20N	10.20MHZ 286 W/NEAT CHIPSET	\$389.95

Littlefoot™ UPRIGHT CASE **\$249.95**

SPACE SAVING DESIGN HOLDS ALL SIZES OF MOTHERBOARDS AND INCLUDES A 250 WATT POWER SUPPLY

- MOUNTS FOR 3 FLOPPY AND 4 HARD DRIVES
- TURBO & RESET SWITCH
- LED SPEED DISPLAY

CASE-100 CASE-FLIP FLIP TOP CASE FOR 8088 MB'S **\$39.95**

PS-150	150 WATT SUPPLY FOR 8088'S	\$59.95
PS-200X	200 WATT SUPPLY FOR 8088'S	\$89.95
PS-200	200 WATT SUPPLY FOR 286/386'S	\$89.95

KEYBOARDS

BTC-5339	101 KEY ENHANCED KEYBOARD	\$69.95
MAX-5339	101 KEY W/TACTILE FEEDBACK (286)	\$69.95

DRIVE CONTROLLERS

MCT-FDC-HD4	4 FLOPPY DISK CONTROLLER	\$59.95
MCT-HDC	HARD DISK CONTROLLER	\$79.95
MCT-AFH	286/386 FLOPPY/HARD CONTROL	\$149.95

MEMORY/MULTIFUNCTION CARDS

MCT-RAM	516K RAM CARD (OK)	\$49.95
MCT-IO	MULTI I/O CARD	\$59.95

1.44MB FLOPPY DRIVE **\$99.95**

- ULTRA HIGH DENSITY
 - READ/WRITE 720K DISKS TOO
 - BLACK OR BEIGE
- | | | | |
|-----------|---------------------------|-------|---------|
| FDD-1.44X | BLACK FDD-1.44A | BEIGE | |
| FDD-1.2 | 5-1/4" DS/HD 1.2MB FLOPPY | | \$95.95 |

SEAGATE HARD DRIVES

21.4MB KIT **\$249**



32.1MB KIT **\$279**

65MS AVG. ACCESSORY KIT INCLUDES INSTRUCTIONS, XT-COMPATIBLE CONTROLLER AND CABLES. CALL FOR PRICES ON OTHER SEAGATE DRIVES

35MHZ DUAL TRACE OSCILLOSCOPE

\$499⁹⁵

- WIDE BAND WIDTH
 - VARIABLE HOLDOFF
 - 1X/10X PROBES
 - FULL 2 YEAR WARRANTY
- MODEL-3500
MODEL-2000
20MHZ VERSION \$389.95

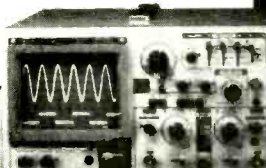

DMM-300	34 RANGES -0.25% TEMP & TRANS TEST	\$79.95
DMM-200	3.5 DIGIT 22 RANGES -0.25% ACCURACY	\$49.95
DMM-100	3.5 DIGIT 1.4 RANGES -0.5% ACCURACY	\$29.95

ALL JDR INSTRUMENTS PRODUCTS WARRANTEED 2 YEARS



VGA COMPATIBLE PACKAGE **\$499.95**

- 720 X 540 MAX RESOLUTION, 640 X 480 IN 16 COLORS, 528 X 480 RESOLUTION IN 256 COLORS
- IBM STYLE MONITOR
- VGA, EGA, CGA, AND MGA COMPATIBLE
- VGA-PKG (INCLUDES VGA CARD AND MONITOR)

JDR-RGB	14" RGB MONITOR	\$239.95
JDR-AMBER	12" TTL MONOCHROME AMBER	\$69.95

16-BIT VGA DISPLAY ADAPTOR **\$199.95**

- 640 X 480 RESOLUTION
- 256K VIDEO RAM EXPANDABLE TO 512K
- 64 LEVELS OF GREY SCALE

MCT-VGA-16		
MCT-EGA	ENHANCED GRAPHICS ADAPTOR	\$149.95
MCT-MGMI/O	MONOGRAPHICS MULTI I/O	\$119.95

2400 BAUD MODEM **\$89.95**

- 2400/1200/300 BAUD HAYES COMPATIBLE
- CONFIGURE AS COM1, 2, 3 OR 4
- BUILT IN SPEAKER • PROCOMM COMMUNICATIONS SOFTWARE

MCT-241		
MCT-121	1200 BAUD INTERNAL MODEM	\$59.95

DYNAMIC RAMS

PART#	SIZE	SPEED	PINS	PRICE
4164-150	55536x1	150ns	16	2.48
41256-150	262144x1	150ns	16	2.59
41256-120	262144x1	120ns	16	2.95
41256-100	262144x1	100ns	16	3.15
41256-80	262144x1	80ns	16	3.75
1 MB-80	1048576x1	80ns	18	12.95



JIM'S BARGAIN HUNTERS CORNER

\$64⁹⁵

Jim Wharton
JDR's VP Sales
LOGITECH HI-REZ BUS MOUSE

- 320 D.P.I. BUS MOUSE
- REQUIRES NO PAD OR POWER SUPPLY
- INTERFACE CARD INCLUDED REQUIRES NO SERIAL PORT
- WORKS WITH MOST SOFTWARE PACKAGES
- INCLUDES DRIVER, TEXT EDITOR, POP-UP MENUS
- COMPLETE DOCUMENTATION

LMOUSE-BH REG \$89.95 EXPIRES 6/15/90

Terms: Minimum order \$10.00. For shipping & handling include \$4.00 for ground and \$5.00 for air. Orders over 1 lb and foreign orders may require additional shipping charges—please contact the sales department for the amount. CA residents must include applicable sales tax. Prices subject to change without notice. We are not responsible for typographical errors. We reserve the right to limit quantities and to substitute manufacturer. All merchandise subject to prior sales. A full copy of our terms is available upon request. Items pictured may only be representative. JDR Microdevices and the JDR Microdevices logo are registered trademarks of JDR Microdevices. IBM, AT, PS-2 are trademarks of International Business Machines.

JDR MICRODEVICES, 2233 BRANHAM LANE, SAN JOSE 95124
LOCAL (408) 559-1200 FAX (408) 559-0250 TELEX 171-110
ALSO ORDER VIA OUR BBS (408) 559-0253

CIRCLE 113 ON FREE INFORMATION CARD
DEALERS CIRCLE 170 ON FREE INFORMATION CARD



ASSEMBLE YOUR OWN COMPUTER FOR LESS

10 MHz 8088 Compatible Kit\$379

- 4.77/10 MHz 8088 Motherboard
- 256KB RAM (640KB max)
- 150W Power Supply
- Floppy Disk Controller
- One 5 1/4" 360KB Drive
- MonoGraphics Card w/ P
- 101 Key Keyboard
- Case (3LED,2Button,Key)
- 12" Amber Mono Monitor
- Installation Guide & Manual



12 MHz 80286 Compatible Kit\$669

- 12 MHz 80286 Motherboard
- 512 KB RAM (4 MB max)
- 200W Power Supply
- Floppy Disk Controller
- One 5 1/4" 1.2 MB Drive
- MonoGraphics Card w/ P
- 101 Key Keyboard
- Case (3LED,2Button,Key)
- 12" Amber Mono Monitor
- Installation Guide & Manual



20 MHz 80386 Compatible Kit\$1399

- All Components Fully Tested Before Ship
- One Year Warranty on All Parts
- Installation Available at No Extra Charge !!!
- VISA & M/C add 3% Amex add 4%
- Price & Quantity subject to change without prior notice
- 15% Restocking Fee on All Non-Defective Items

JINCO COMPUTERS INC.

5122 WALNUT GROVE AVE.

SAN GABRIEL, CA 91776

Tel: (818) 309-1108

Fax: (818) 309-1107

CIRCLE 180 ON FREE INFORMATION CARD

CABLE TV DESCRAMBLERS

	10 Lot
JERROLD™ Tri-Bi Mode	\$105.00 \$85.00
JERROLD™ SB-3 OR 2	\$89.00 \$65.00
Hamlin MLD-1200	\$99.95 \$62.00
Oak N-12 W/V.S.	\$99.95 \$62.00
Oak M-35-B W/V.S.	\$99.00 \$78.00
OAK E-13	\$99.95 \$58.00
Zenith SSAVL	\$185.00 \$145.00
Eagle PD-3	\$120.00 \$85.00
Scientific Atlanta	\$129.95 \$105.00
SA-Combo's	CALL \$Call
Tocom	\$350.00 \$295.00
Oak N-12 W/ Auto	\$140.00 \$105.00
Jerrold Starcom CSV	\$139.95 Call

M.D. ELECTRONICS
WILL MATCH ANY
ADVERTISED PRICE
IN THIS MAGAZINE

*NEW STARGATE 2000 CABLE CONVERTER



1-\$89.00 10-\$69.00 100-Call

Last channel recall-Favorite channel select-75 channel-Channel scan-Manual fine tune-One year warranty-surge protection-HRC & Standard switchable- and much more. **Call Today!**

INFORMATION (402) 554-0417

Orders Call Toll Free

1-800-624-1150

M.D. ELECTRONICS
115 NEW YORK MALL
SUITE 133E
OMAHA, NE. 68114

M.C.
VISA
C.O.D.

CIRCLE 53 ON FREE INFORMATION CARD

ADVERTISING INDEX

RADIO-ELECTRONICS does not assume any responsibility for errors that may appear in the index below.

Free Information Number	Page		Page
108	AMC Sales	46	—
193	Ace Communications	79	192
75	Ace Products	21	74
107	All Electronics	92	—
—	Amazing Concepts	85	83
106	American Design Components	89	188
77	B&K Precision	CV4	92
67	Banner Technical Books	14	123,185
98	Beckman Industrial	5	207-210
109	C & S Sales	30	183
70	CEI	87	195
—	CIE	15	64
196	Cable Network	88	181
54	Chemtronics	11	182
—	Command Productions	16	—
178	Communications Specialists	79	—
55	Contact East	21	—
58	Cook's Institute	46	—
197	D&D Electronics	11	—
—	Damark International	69	—
127	Deco Industries	21	—
179	Electronic Goldmine	82	—
—	Electronics Book Club	36	—
—	Electronic Tech. Today	78	—
121	Fluke Manufacturing	CV2	—
—	Friendly Videos	16	—
186	Global Specialties	17	—
—	Grantham College	20	—
86	Heathkit	25	—
184	International Components Corp.	88	—
113,170	JDR Microdevices	93	—
114	Jameco	90, 91	—
104	Jan Crystals	11	—
180	Jinco Computers	94	—
190	Joseph Electronics	23	—
—	King Wholesale	82	—
53	MD Electronics	94	—
93	Mark V. Electronics	81	—
—	McGraw Hill Book Club	26	—
61	Microprocessors Unltd.	77	—
—	NRI Schools	9	—
191	Optoelectronics	CV3	—
—	Pacific Cable	83	—
56	Parts Express	87	—
101	Pomona Electronics	3	—
78	Radio Shack	19	—
187	Royer Associates	21	—
194	SCO Electronics	62	—
177	Sencore	23	—
—	Short Circuits	18	—
—	Smith Design	14	—
—	Solid State Sales	85	—
—	Star Circuits	25	—
—	Synergetics	64	—
—	TECI	79	—
—	Tektronix	7	—
—	123,185 Test Probes	13	—
—	207-210 Test Probes	13	—
—	183 Unicorn	84	—
—	195 U.S. Cable	62	—
—	64 Video-Link	86	—
—	181 Viejo Publications	71	—
—	182 WPT Publications	79	—

ADVERTISING SALES OFFICE

Gernsback Publications, Inc.
500-B Bi-County Blvd.
Farmingdale, NY 11735
1-(516) 293-3000

President: Larry Steckler
Vice President: Cathy Steckler

For Advertising ONLY

516-293-3000
Fax 1-516-293-3115

Larry Steckler

publisher

Arline Fishman

advertising director

Denise Haven

advertising assistant

Christina Estrada

advertising associate

Lisa Strassman

credit manager

Subscriber Customer Service

1-800-288-0652

Order Entry for New Subscribers

1-800-999-7139

7:00 AM - 6:00 PM M-F MST

SALES OFFICES

EAST/SOUTHEAST

Stanley Levitan

Eastern Sales Manager

Radio-Electronics

259-23 57th Avenue

Little Neck, NY 11362

1-718-428-6037, 1-516-293-3000

MIDWEST/Texas/Arkansas/Okla.

Ralph Bergen

Midwest Sales Manager

Radio-Electronics

540 Frontage Road—Suite 339

Northfield, IL 60093

1-312-446-1444

Fax 1-312-446-8451

PACIFIC COAST/ Mountain States

Marvin Green

Pacific Sales Manager

Radio-Electronics

5430 Van Nuys Blvd. Suite 316

Van Nuys, CA 91401

1-818-986-2001

Fax 1-818-986-2009

OEI OPTOELECTRONICS

The only name in HANDI-COUNTERS

Check These Incredible Features
On The All New UTC3000

- **10Hz to 2.4GHz Range.**
Simply amazing!
 - **10 Digit LCD Display.**
1Hz resolution to over 150 MHz direct.
Readable in bright sunlight.
 - **RF Signal Strength Bargraph.**
16 Segment, Zero, & Full Scale adjustment.
SEE the input signal!
 - **Super Sensitivity.** <1mV 10-200MHz,
<5mV to 2GHz for efficient antenna pickup.
 - **6 Functions.** Frequency, Period, Ratio
Time Interval, Average, & Prescale.
 - **Hold Button.**
"Locks in" your exact Measurement FAST!
 - **Extruded Aluminum Enclosure.**
Designed to fit every hand.
 - **Priced Right! Only \$375.**
Includes Nicads, AC Charger/Adapter.
- Or Select Our Most Popular
HANDI-COUNTER, the model 2210
that set the standard in handheld
frequency counter technology!
Value Priced at only \$219.

Professionals and Hobbyists all over
the world have chosen OEI for 16
years! **Shouldn't YOU?**

HANDI-COUNTERS! ...Only from OEI!
Choose the model that fits your needs...
and your budget! **CALL NOW!**



UTC3000



Period Average Mode



Display Showing All Annunciators

Model	UTC3000	2600H	2210	1300H/A	2400H	CCA	CCB
Function	Freq. Period Ratio, Interval, Avg. Prescale	Frequency	Frequency	Frequency	Frequency	Frequency	RF Indicator
Range	10Hz-2.4GHz	10MHz-2.4GHz	10Hz-2.2GHz	1MHz-1.3GHz	10MHz-2.4GHz	10MHz-550MHz	10MHz-1.8GHz
Display	10 Digit LCD w/Function Annunciators	10 Digit LCD	8 Digit LED	8 Digit LED	8 Digit LED	8 Digit LED	.
RF Signal Strength Indicator	16 Segment Adjustable Bargraph	16 Segment Adjustable Bargraph	.	.	.	LED with Adjustable Threshold	10 Segment Adjustable Bargraph
Price	\$375.	\$325.	\$219.	\$169.	\$189.	\$299.	\$99.

Sensitivity: <1 to <10mV typical. Time Base: ± 1ppm.; ± .5ppm. add \$75 - LED Models; ± 2ppm add \$80. - LCD Models. Nicads & AC charger/adapter included. (9v Alkaline - CCB.) Carry Case, Antennas and Probes extra. One year parts & labor warranty on all products

CIRCLE 191 ON FREE INFORMATION CARD

OEI OPTOELECTRONICS

5821 NE 14th Avenue • Ft. Lauderdale, FL 33334

Toll Free Order Line:
1-800-327-5912

FL(305)771-2050 • FAX(305)771-2052



Visa, MC, C.O.D., Cash, M.O accepted. Personal
Check allow 3 weeks. 5% Shipping, Handling.
(Maximum \$10) U.S. & Canada. 15% outside
continental U.S.A.

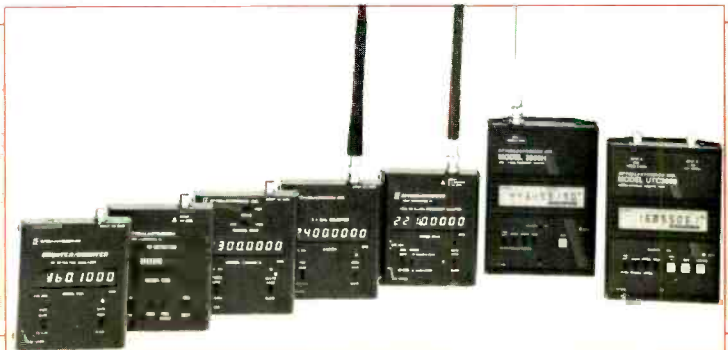

Get the drop on performance with the New Survivor™ DMM

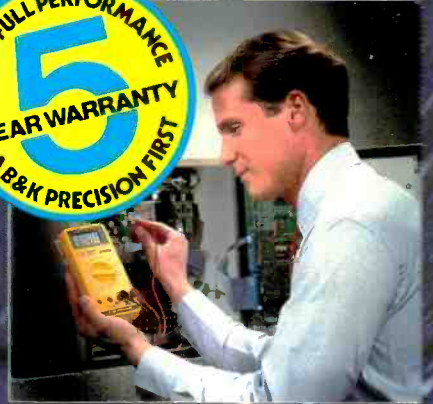

Your performance depends on the reliability of the instruments you use, so you need the New Survivor™ DMM. This high-performance 3½ digit meter is guaranteed to stay on the job without fail for 5 years*—or B&K-PRECISION will repair or replace it free.

The Survivor is built to quality standards you would expect only from more costly instruments. Its ruggedized case is drop resistant to five feet and tightly sealed against water and contaminants. Overload and reverse polarity protection plus high-energy fusing defend its circuitry from electrical mishaps.

Today, many meters look alike, but few perform alike. Demand the Survivor DMM. For detailed specifications or immediate delivery, contact your local distributor.

*5 year warranty covers full instrument performance. Non-transferable. Does not cover abuse.

™ B&K-PRECISION Division, Maxtec International Corp.

- Measures AC/DC voltage and current to 20 amps
- 0.5% basic DC accuracy
- Audible continuity check
- Auto power off saves batteries
- Large 0.8" LCD
- 5 year warranty
- 5 foot drop resistant
- Water resistant

Model 2860 Survivor
\$99⁰⁰



BK PRECISION

MAXTEC INTERNATIONAL CORP.
Domestic and International Sales
6470 W. Cortland St., Chicago, IL 60635
312-889-1448 • FAX: 312-794-9740
Canadian Sales, Atlas Electronics, Ontario

CIRCLE 77 ON FREE INFORMATION CARD