

Radio — HOW TO TRACK DOWN
POWER-LINE GLITCHES

APRIL 1990

Electronics

TECHNOLOGY - VIDEO - STEREO - COMPUTERS - SERVICE

BUILD R-E's MORSE/RTTY DETECTOR

Display Morse code and radioteletype
signals on your computer

BUILD A SOLID STATE WIPER CONTROL
Beat those April showers!

BUILD A CAPACITANCE ADAPTER
Measure capacitance on your DVM

ONE-CHIP FREQUENCY
CONVERTER
Designing with the
versatile NE602

CIRCUIT COOKBOOK
Audio power amp IC's for
automotive applications

COMPUTER DIGEST
Secure your hard-disk data
from unauthorized snooping



\$2.50 U.S.
\$2.95 CAN

A
GERNSBACK
PUBLICATION

***** 5-DIGIT 60506
390736DHMD997GD93 04 07
JAN 91
MR ROBERT DAHM RE
997 GRAND AV
AURORA, IL 60506

FLUKE



PHILIPS



The new 80 Series is a digital meter, an analog meter, a frequency counter, a recorder, a capacitance tester, and a lot more.

It's the first multimeter that can truly be called "multi" ... not only standard features, but special functions usually limited to dedicated instruments.

Plus, innovations only Fluke can bring you. Like duty cycle measurements. Or recording the minimum, maximum and average value of a signal. Or the audible MIN MAX Alert™ that beeps for new highs or lows.

There's even Fluke's exclusive Input Alert™, that warns you of incorrect input connections. And a unique Flex-Stand™ and protective holster, so you can use the 80 Series almost anywhere.

Make sure your next multimeter is truly multi. Call today at 1-800-44-FLUKE, ext 33.

FROM THE WORLD LEADER IN DIGITAL MULTIMETERS.



FLUKE 83	FLUKE 85	FLUKE 87
Volts, ohms, amps, diode test, audible continuity, frequency and duty cycle; capacitance. Touch Hold™.	Volts, ohms, amps, diode test, audible continuity, frequency and duty cycle; capacitance. Touch Hold™. Relative, protective holster with Flex Stand™.	Volts, ohms, amps, diode test, audible continuity, frequency and duty cycle; capacitance. Touch Hold™. Relative, protective holster with Flex Stand™.
\$199*	\$239*	\$289*
0.3% basic dc accuracy	0.1% basic dc accuracy	0.1% basic dc accuracy
5 kHz acV	20 kHz acV	20 kHz acV
Analog bargraph & zoom	Analog bargraph & zoom	High resolution analog pointer
Three year warranty	Three year warranty	True rms ac
		1 ms PEAK MIN MAX
		4 1/2 digit mode
		Back lit display
		Three year warranty

*Suggested U.S. list price

The new Fluke 80 Series shown actual size

John Fluke Mfg. Co., Inc., P.O. Box 9090 M/S 250C, Everett, WA 98206
 U.S.: 206-356-5400 CANADA: 416-890-7600 OTHER COUNTRIES: 206-356-5500
 © Copyright 1990 John Fluke Mfg. Co., Inc. All rights reserved. Art No. 1191-FRM

CIRCLE 121 ON FREE INFORMATION CARD

FLUKE

ON THE COVER



If you're not a radio amateur, Morse code is probably Greek to you. If you find it frustrating to be shut out of the Morse code communications coming across your shortwave radio, our PMX-200 CW/RTTY detector can open the door. Simply hook it up to your computer to display all the morse (CW) and radioteletype (RTTY) transmissions that you've been missing. For the low-down on the high-performance, easy-to-tune Morse code detector, turn to page 33.

COMING NEXT MONTH

THE MAY ISSUE GOES ON SALE APRIL 3

BUILD A "UNIVERSAL" PICTURE STABILIZER
And learn all about video synchronization in the process.

CROSSTALK-CANCELING SPEAKER SYSTEM
Use conventional stereo speakers to simulate binaural listening.

WHY ARE THERE SO MANY TRANSISTORS?
How to pick the right one for a given application.

SECURITY CIRCUIT COOKBOOK
Basic principles and practical circuitry of today's home-security systems.

WAVEFORM PROCESSING USING A PC
Math and computers combine to help you examine electronic wave theory, physics, stock-market cycles, and more.

As a service to readers, RADIO-ELECTRONICS publishes available plans or information relating to newsworthy products, techniques and scientific and technological developments. Because of possible variances in the quality and condition of materials and workmanship used by readers, RADIO-ELECTRONICS disclaims any responsibility for the safe and proper functioning of reader-built projects based upon or from plans or information published in this magazine.

Since some of the equipment and circuitry described in RADIO-ELECTRONICS may relate to or be covered by U.S. patents, RADIO-ELECTRONICS disclaims any liability for the infringement of such patents by the making, using, or selling of any such equipment or circuitry, and suggests that anyone interested in such projects consult a patent attorney.

RADIO-ELECTRONICS, (ISSN 0033-7862) March 1990. Published monthly by Gernsback Publications, Inc., 500-B Bi-County Boulevard, Farmingdale, NY 11735 Second-Class Postage paid at Farmingdale, NY and additional mailing offices. Second-Class mail registration No. 9242 authorized at Toronto, Canada. One-year subscription rate U.S.A. and possessions \$17.97, Canada \$23.97, all other countries \$26.97. All subscription orders payable in U.S.A. funds only, via international postal money order or check drawn on a U.S.A. bank. Single copies \$2.50. © 1990 by Gernsback Publications, Inc. All rights reserved. Printed in U.S.A.

POSTMASTER: Please send address changes to RADIO-ELECTRONICS, Subscription Dept., Box 55115, Boulder, CO 80321-5115.

A stamped self-addressed envelope must accompany all submitted manuscripts and/or artwork or photographs if their return is desired should they be rejected. We disclaim any responsibility for the loss or damage of manuscripts and/or artwork or photographs while in our possession or otherwise.

Radio Electronics®

Hugo Gernsback (1884-1967) founder
M. Harvey Gernsback,
editor-in-chief, emeritus

Larry Steckler, EHF, CET,
editor-in-chief and publisher

EDITORIAL DEPARTMENT

Brian C. Fenton, editor

Marc Spiwak, associate editor

Daniel Goodman, technical editor

Teri Scaduto, assistant editor

Jeffrey K. Holtzman
computer editor

Robert Grossblatt, circuits editor

Larry Klein, audio editor

David Lachenbruch
contributing editor

Don Lancaster
contributing editor

Richard D. Fitch
contributing editor

Kathy Campbell, editorial assistant

ART DEPARTMENT

Andre Duzant, art director

Injae Lee, illustrator

Russell C. Truelson, illustrator

PRODUCTION DEPARTMENT

Ruby M. Yee, production director

Robert A. W. Lowndes,
editorial production

Karen S. Tucker
advertising production

Marcella Amoroso
production assistant

CIRCULATION DEPARTMENT

Jacqueline P. Cheeseboro
circulation director

Wendy Alanko
circulation analyst

Theresa Lombardo
circulation assistant

Michele Torrillo, reprint bookstore

Typography by Mates Graphics

Cover photo by Diversified Photo
Services

Radio-Electronics is indexed in
Applied Science & Technology Index
and *Readers Guide to Periodical Literature*.

Microfilm & Microfiche editions are
available. Contact circulation depart-
ment for details.

**Advertising Sales Offices listed
on page 92.**





DELUXE TEST LEAD KIT

Users call TPI test leads **The Absolute Best**. The TLS2000 features the highest quality cable in the industry — with spring-loaded safety-sleeved plugs. U.L. listed (file E79581). Kit: \$29. Leads & probes only: \$19. Satisfaction guaranteed. **TEST PROBES INC.** Call toll-free for catalog: 1-800-368-5719.

CIRCLE 251 ON FREE INFORMATION CARD

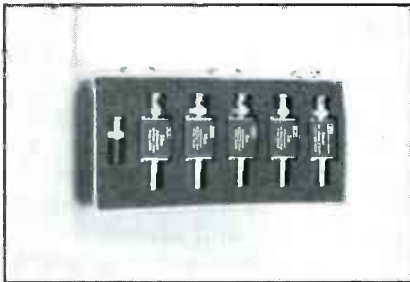

BNC ATTENUATOR KIT

Contains 4 attenuators — 3dB, 6dB, 10dB, 20dB; 1 feedthrough and 1 termination. Thick-film circuitry for low reactances. Rugged design resists shock and lasts longer. Rectangular shape stays put on the bench. **Impedance:** 50Ω **Frequency:** 1GHz. **Maximum Power:** 1kW peak, 1W avg. **VSWR** 1.2:1. Attenuator Accuracy: ±0.2dB. Terminations Resistance Tolerance: ±1%. \$150.

TEST PROBES INC. Call toll-free for catalog: 1-800-368-5719.

CIRCLE 252 ON FREE INFORMATION CARD



ECONOMICAL SILICON RUBBER TEST LEADS

Best value in moderately priced leads. High quality, soft, silicon rubber cable. Banana plug on measuring tip accepts push-on accessories. Plugs have spring-loaded safety sleeves. Model TL1000 \$14. Satisfaction guaranteed.

TEST PROBES INC. Call toll-free for catalog: 1-800-368-5719.

CIRCLE 253 ON FREE INFORMATION CARD



COAX ADAPTER KIT

- Create any adapter in seconds
- Make all combinations of BNC, TNC, SMA, N, UHF, Mini-UHF, F and RCA

The TPI 3000A kit contains male and female connectors of all 8 types, and 6 universal interfaces. Simply screw any combination of 24 connectors to one of the interfaces to create the desired adapter. \$150.

TEST PROBES INC. 9178 Brown Deer, San Diego, California 92121. Call toll-free for catalog: 1-800-368-5719.

CIRCLE 250 ON FREE INFORMATION CARD



No Better Probe Ever at This Price!



Shown here
Model SP150
Switchable 1x-10x ... **\$49**

CIRCLE 186 ON FREE INFORMATION CARD

Risetime less than 1.5 nsec.

- **Universal** - works with all oscilloscopes
- **Removable Ground Lead**
- **Excludes External Interference** - even on scope's most sensitive range
- **Rugged** - withstands harsh environments including high temperature and humidity
- **Advanced Strain Relief** - cables last longer
- **Available in 10x, 1x and switchable 1x-10x**
- **10 day return policy** - performance and satisfaction guaranteed

TEST PROBES, INC. 

9178 Brown Deer Road
San Diego, CA 92121
Toll Free 1-800-368-5719
1-800-643-8382 in CA

Call for free catalog and Distributor in your area

CIRCLE 123 ON FREE INFORMATION CARD

WHAT'S NEWS

Laser radar provides four images per second



MARION SCOTT (LEFT) AND MARK GROHAM INSPECT the optics of the Sandia laser radar.

A laser radar that shows not only the distance to a sighted object, but also an image of it—and updates that image four times a second—has been developed and tested at Sandia National Laboratories (Albuquerque, NM). The new laser combines some of the advantages of conventional radar with those of video imaging, and has capabilities about midway between the two. Its frame rate is fast enough for possible short-range military applications.

The Sandia range-imaging laser uses a small gallium-arsenide semiconductor laser diode that emits continuous near-infrared light that is just beyond the range of the human eye. The signal is amplitude modulated at 4 MHz. The phase of the return signal is mea-



LASER-RADAR RANGE IMAGE OF A POSSIBLE INTRUDER. Different ranges are represented by varying shades of gray or in pseudocolor. A bush, at longer range, can be seen at right. The sky is shown with random shades because it gives no radar return.

sured to obtain the range of the viewed object, and its image is displayed on the video screen as a 64×64 -pixel pseudocolor map. The present maximum range is about 50 meters.

Future plans include efforts to integrate the electronics, replace the present low-power laser with a higher-powered one, and extend the range to the hundreds of meters necessary for a military version of the system.

temperature superconductors they appear only at the natural boundaries between crystal grains or in specially designed structures that are not suitable for device applications. Bellcore's process for fabricating high-temperature superconductor research prototypes offers a means to engineer and control the Josephson properties so that they recur in a highly predictable fashion.

The high-temperature prototype films are composed of three distinct but similar layers, each made of a ceramic material that consists of copper, barium, and oxygen, along with a fourth substance: Yttrium is used in the superconducting first and third layers, while a mix of yttrium and praseodimium results in a non-superconducting middle layer that serves as the critical "weak" electrical link between the others. By substituting some of the yttrium in the layers with praseodimium, the electrical properties of the layers can be significantly varied and controlled. The effect of layering of superconducting and non-superconducting materials was achieved using a process known as pulsed excimer laser deposition.

Because modified semiconductor-processing techniques were employed to make the thin-film prototypes, Bellcore predicts that this approach could be adapted for manufacturing in large quantities with no significant loss in quality. Although this is only the first step toward commercial feasibility, possible applications for the high-temperature superconductors are being considered—including using these materials as extremely sensitive magnetic field detectors for telecommunications systems, and also as integral components in microwave systems. Potential long-range applications include high-speed telecommunications systems and computer logic gates. R-E

Controlled reproduction of superconducting materials.

Researchers at Bellcore (Midletown Township, NJ) have fabricated multi-layered superconducting materials that can be reproduced in a controllable manner, possibly overcoming a critical obstacle to developing high-temperature superconducting devices for commercial use. Bellcore's experimental thin films, when cooled to near liquid-nitrogen

temperatures, display the Josephson effects that are necessary for viable superconductive electronics. A Josephson junction is an electrical connection that allows the flow of low-voltage "super currents" between superconductors. Because the connection is weak, the super current can be easily controlled.

Josephson junctions are present in low-temperature superconducting materials, but in high-

AT \$299.95, NO OTHER DESIGN WORKSTATION GIVES YOU SO MUCH FOR SO LITTLE.

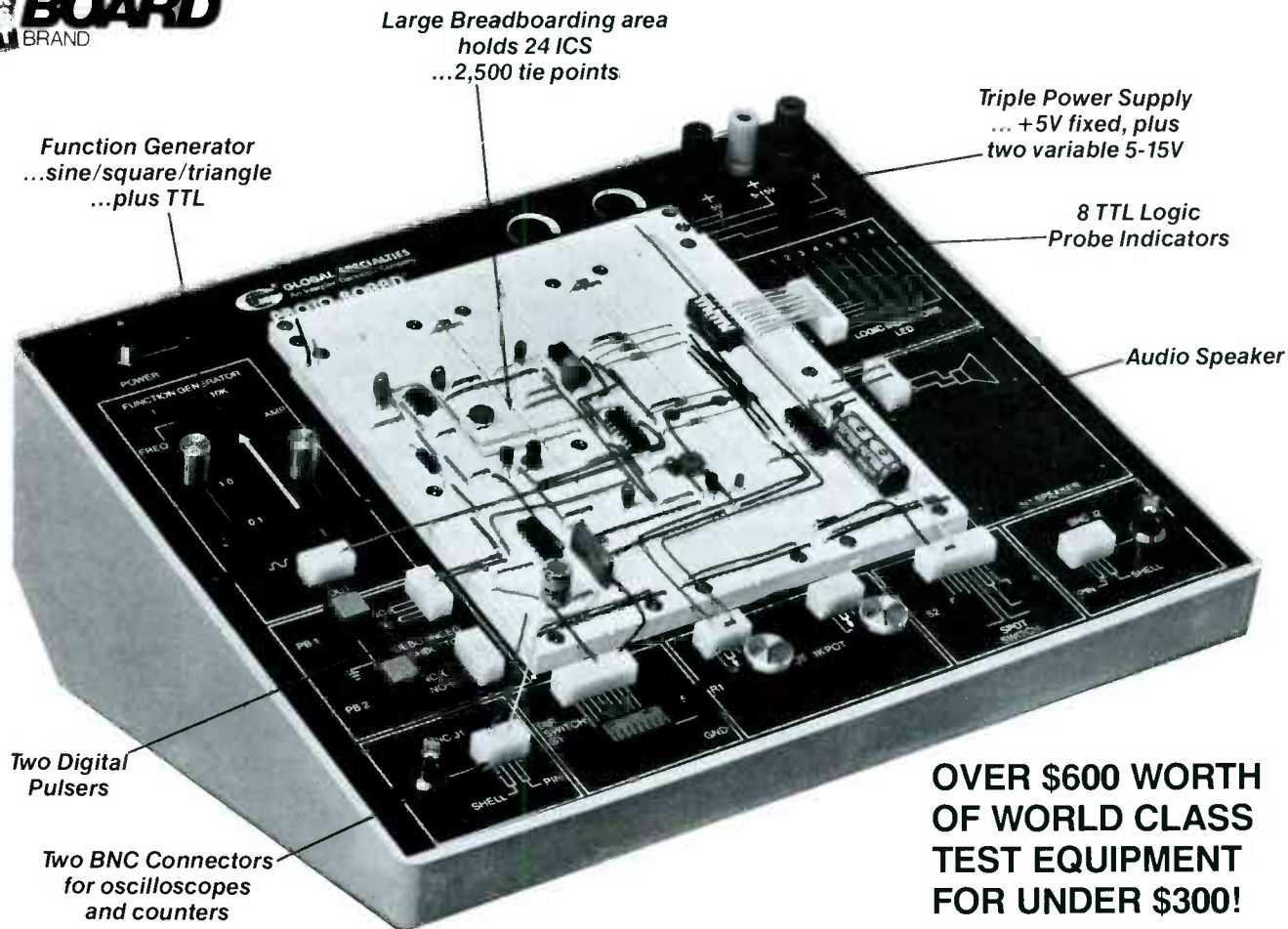

Here's PB-503, the total design workstation. It has everything! **Instrumentation**, including a function generator with continuously variable sine/square/triangle wave forms—plus TTL pulses. **Breadboards** with 8 logic probe circuits.

And a **Triple Power Supply** with fixed 5VDC, plus two variable outputs (+ 5 to 15VDC and - 5 to 15VDC). Throw-in 8 TTL compatible LED indicators, switches, pulsers,

potentiometers, audio experimentation speaker... plus a lifetime guarantee on all breadboarding sockets! You have everything you need right there in front of you! PB-503—one super test station for under \$300! Order yours today!!



Call toll-free for details
1-800-572-1028

**GLOBAL[®]
SPECIALTIES**

CIRCLE 192 ON FREE INFORMATION CARD

Global Specialties,
70 Fulton Terrace, New Haven, CT 06512.
Telephone: (203) 624-3103. © Interplex Electronics, 1990.
All Global Specialties breadboarding products made in USA.
ProtoBoard is a registered trademark of Global Specialties.

A016

an
**Interplex
Industries**
company

VIDEO NEWS



DAVID LACHENBRUCH,
CONTRIBUTING EDITOR

● **Big screens.** The search for a giant, thin replacement for the cathode-ray tube—almost as old as the cathode-ray tube itself—is intensifying. For the first time, color TV sets are being made without picture tubes—the tiny “personal” sets use liquid-crystal displays, or LCD’s. That has encouraged manufacturers to search for ways to build giant LCD’s. Although LCD color-TV displays as large as 14 inches have been built and demonstrated, their cost would be astronomical using present technology.

Japanese manufacturers, joined by their government, have mounted a crash program to develop giant color LCD’s measuring 40 inches or more diagonally. In the United States, several companies have undertaken major projects also intended to lead to giant, thin, wall-mountable color-LCD TV displays. An official of David Sarnoff Research Center in Princeton, NJ (formerly RCA Laboratories) described such a project to a recent conference on flat information displays in Santa Clara, CA. The goal is a wall-hanging HDTV screen measuring 75 inches diagonally and not more than four inches thick, with more than 200 foot-lamberts brightness, and a contrast ratio better than 50-to-1—at a cost of less than \$500. Sarnoff Labs expects to reach this goal in 10 years—but it expects Japan to be there in seven.

● **Another new display.** A completely new type of display for high-resolution television has been proposed by Foresight, Inc., a subsidiary of Summa Medical Corporation of Phoenix, AZ. Although details of the product are still obscure because the company’s patent applications haven’t been granted yet, Japan’s giant trading company Mitsui is planning to form a group of Japanese licensees to manufacture the system.

The heart of the Foresight system is a “material”—unrevealed as yet—which “behaves effectively like an optical semiconductor in that its reaction to light can be modified electronically at very high speeds and with great resolution,” according to the developer. The material, which is used to coat the face of a direct-view or projection-TV tube, is altered by an electrical signal. One of its properties is the ability to

retain its altered state until a new signal changes it. Thus only the changes in a picture need be sent to the tube. Foresight said the result can be an extremely high-definition signal using a standard NTSC signal and computerized line interpolation. The addition of microprocessor picture enhancement could result in a picture with a resolution of more than 4,000,000 pixels.

● **10-Foot rear projection.** The largest rear-projection TV set was demonstrated by Mitsubishi at the Consumer Electronics Show in Las Vegas in a rather large living-room setting. It has a 120-inch diagonal picture and is designed for “home theaters” built into large homes. As displayed in subdued light, the entire wall became an almost theater-sized screen. The cost of this latest step in home-theater television is about \$20,000, not counting installation.

● **TV-VCR combos.** VCR’s with built-in TV’s and TV’s with built-in VCR’s are the latest trend, on the basis of exhibits at the Consumer Electronics Show. Ever since the introduction of the VCR there have been combinations (the first Betamax was built into a television set), but that approach has more adherents than ever today—from tiny 3-inch LCD personal-video combinations with VCR’s to giant-screen televisions with slots for videocassettes.

One of the major exponents of that approach is Panasonic, which introduced six new combinations at the show, each one designed for a different purpose. The smallest is a personal-video combination of VHS recorder and 4-inch LCD monitor. Next is a portable VHS with a 7-inch color TV set, operable on AC or DC. A 20-inch combination is designed to play back videocassettes recorded in European PAL and SECAM color systems as well as NTSC. It can record in NTSC only, however. A second 20-inch combo has two tuners, so it can record one program while displaying another. Panasonic also introduced two 27-inch combinations, one that plays standard VHS cassettes and the other with a built-in Super-VHS recorder and a high-resolution TV set.

R-E

Radio Shack Parts PlaceSM

START SPRING PROJECTS TODAY AT RADIO SHACK

Special-Order "Hotline"

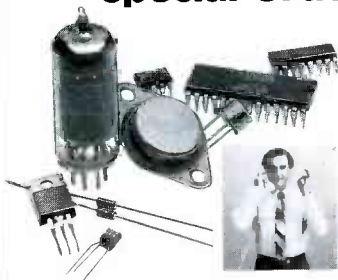

- No Minimum Order
- No Postage Charge

Your Radio Shack store manager can special-order a wide variety of parts and accessories from our warehouse—vacuum tubes, ICs, microprocessors, phono cartridges and styli, crystals, even SAMS Photofacts®. No minimums, no postage charge. Just fast, direct delivery to the Radio Shack store near you.

Electronic Counting Module



Prewired! Heart of a Traffic/Event Counter

16⁹⁵

Counts up to 99,999. Advanced (or reset) by external switch closure or digital circuit. Count rate up to 7 Hz. Features 1/2" LC display, panel-mount escutcheon and holder on back for required "AA" battery. Long battery life—draws only 4µA. 2 1/16 x 1 3/8 x 1 1/8". With data. #277-302

Computer/Peripheral Connectors

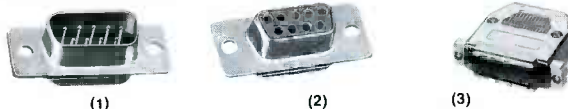

Solder-Type D-Subs. Metal shield plus gold-plated pins and terminals for highest reliability.

Fig.	Description	Cat. No.	Only
1	D-Sub 9 Male	276-1537	.99
2	D-Sub 9 Female	276-1538	1.99
3	Shielded Hood	276-1513	1.49

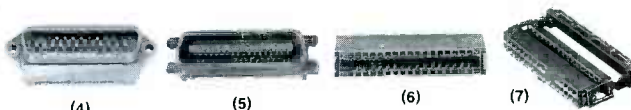

Solderless IDC-Type Connectors

Fig.	Description	Cat. No.	Each
4	D-Sub 25 Male	276-1559	3.99
5	D-Sub 25 Female	276-1565	3.99
6	36-Pos. Male Printer	276-1533	4.99
7	34-Pos. Card-Edge	276-1564	1.99
	34-Pos. Header	276-1525	2.49

Super Adhesive

3⁴⁹

Works When Others Fail

Forms a secure bond to most plastics, metals, ceramics and wood. Twin-plunger dispenser eliminates measuring and waste. #64-2305



Shunt Box



Top-quality, shielded male-to-female RS-232 adapter. Wire included jumpers and board to suit your need. #276-1403 . . . 9.95

Chime & Buzzers



- (1) "Ding-Dong." #273-071 . . . 8.99
- (2) Two-Tone. #273-070 . . . 9.95
- (3) Miniature Electronic Buzzers.

DC Voltage	Cat. No.	Each
1 1/2 to 3	273-053	2.19
6	273-054	2.19
12	273-055	2.19

Strobe Tube



Super Bright! Long Life!

Perfect for photo replacement or hobby projects and experiments. Trigger: 4 kV. Anode: 200V min. With circuit data. #272-1145 . . . 3.29

Shielded Cables



Our Best!

- (1) Oxygen-Free Copper A/V Cable. 6 feet, 6 mm dia. #278-1271 . . . 5.95
- 8 mm Diameter. #278-1272 . . . 7.59
- (2) Dual Mike Cable. For balanced hookups. 30 ft. #278-1281 . . . 19.95
- (3) Super-Flex Mike Cable. Extra-supple. 30 ft. #278-1282 . . . 14.95

Resistor Buys



- (2) Precision Thermistor. Resistance changes in proportion to temperature. -50 to +110° C. #271-110 . . . 1.99
- (2) 15-Turn Trimmer Pots. 3/4 watt. 1k, #271-342. 10k, #271-343. 20k, #271-340 . . . Each 1.49

Tantalum Caps

Low As **59^c** Each

High capacity in a tiny package.

µF	WVDC	Cat. No.	Each
0.1	35	272-1432	.59
0.47	35	272-1433	.59
1.0	35	272-1434	.59
2.2	35	272-1435	.69
10.0	16	272-1436	.79
12.0	16	272-1437	1.19

Service Chems

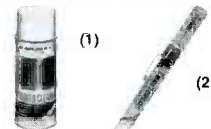

- (1) Color-TV Tuner/Control Cleaner. #64-2320 . . . 3.19
- (2) Precision Lubricator. Needle-tip applicator reduces spills and waste. #64-2301, 1.69

Etch Your Own Boards

9⁹⁵

Extra Etchant and Pens Available



Everything You Need For Two PC Boards

Archer® PC Board Kit includes two 4 1/2 x 3" copper-clad boards, resist-ink pen, solvent, etchant, layout strips/circles, tank, special 1/16" drill bit and instructions. #276-1576

Autoranging Probe DVM

39⁹⁵

Measures to 400 volts AC/DC and resistance. It's really handy for tight spaces. Data hold freezes display and lets you remove tester for easy reading. Has continuity sounder, low-battery indicator. Overload protected. Ready to use with batteries, manual, case. #22-165

"Pro" Soldering Station

39⁹⁵

Solder Better, Faster!



Selectable 15/25-watt power, grounded tip to protect sensitive components. Tip-cleaner pad. Ironclad replacement and surface-mount tips available. UL listed AC. #64-2057

Over 1000 items in stock! Binding Posts, Books, Breadboards, Buzzers, Capacitors, Chokes, Clips, Coax, Connectors, Fuses, Hardware, ICs, Jacks, Knobs, Lamps, Multitesters, PC Boards, Plugs, Rectifiers, Resistors, Switches, Tools, Transformers, Transistors, Wire, Zeners, More!

Prices apply at participating Radio Shack stores and dealers

Radio Shack®

A DIVISION OF TANDY CORPORATION

CIRCLE 78 ON FREE INFORMATION CARD

No other training— anywhere—shows you service computers

Only NRI walks you through the step-by-step assembly of a powerful AT-compatible computer system you keep—giving you the hands-on experience you need to work with, troubleshoot, and service all of today's most widely used computer systems. With NRI at-home training, you get everything you need to start a money-making career, even a computer service business of your own.

NEW!
Now includes
AT-compatible
computer with 1 meg
RAM and 20 meg
hard drive!

No doubt about it. The best way to learn to service computers is to actually *build* a state-of-the-art computer from the keyboard on up. As you put the machine together, performing key tests and demonstrations at each stage of assembly, you see for yourself how each part of it works, what can go wrong, and how you can fix it.

Only NRI, the leader in career-building electronics training for more than 75 years, gives you such practical, real-world computer servicing experience. Indeed, no other training—in school, on the job, *anywhere*—shows you how to troubleshoot and service computers like NRI.

**You get in-demand
computer skills as you
train with your own
AT-compatible computer
system—now with 20 meg
hard drive and 1 meg RAM**

With NRI's exclusive hands-on training, you actually build and keep the powerful new AT-compatible West Coast 1010 ES computer, complete with 1 meg RAM and 20 meg hard disk drive.

You start by assembling and testing the "intelligent" keyboard, move on to test the circuitry on the main logic board, install the power supply and 5-1/4" floppy disk drive,

then interface your high-resolution monitor. But that's not all.

**Only NRI gives you
a top-rated micro
with complete
training built into
the assembly
process**

Your NRI hands-on training continues as you install the powerful 20 megabyte hard disk drive—today's most-wanted computer peripheral—included in your course to dramatically increase your computer's data storage capacity while giving you lightning-quick data access.

Having fully assembled your West Coast 1010 ES, you take it through a complete series of diagnostic tests, mastering professional computer servicing techniques as you take command of the full power of your computer's high-speed 80286 microprocessor.

In no time at all, you have the confidence and the know-how to work with, troubleshoot, and service every computer on the market today. Indeed, you have what it takes to step into a full-time,

HARD DISK DRIVE
20 megabyte hard disk drive you install internally for greater disk storage capacity and data access speed.

**DIGITAL
MULTIMETER**
Professional test instrument for quick and easy circuit measurements.

LESSONS
Clearcut, illustrated texts build your understanding of computers step by step.

SOFTWARE
Including MS-DOS, GW-BASIC, word processing, database, and spreadsheet programs.

**AT-COMPATIBLE
COMPUTER**

80286 CPU (12 MHz clock, 0 wait states), 1 meg RAM (expandable to 4 meg), 1.2 meg high-density floppy disk drive.

money-making career as an industry technician, even start a computer service business of your own.

**Voice synthesis
training adds an
exciting new dimension
to your computer skills**

Now NRI even includes innovative hands-on training in voice synthesis, one of today's most exciting and widely applied new developments in computer technology.

You now train with and keep a full-featured 8-bit D/A converter that attaches in-line with your computer's parallel printer port.

NEW

in school, on the job, how to troubleshoot and like NRI



MONITOR

High-resolution, nonglare, 12" TTL monochrome monitor with tilt and swivel base.

TECHNICAL MANUALS

You get "inside" your Packard Bell computer system with exclusive NRI Training Kit Manuals plus technical specs direct from the manufacturer.

DISCOVERY LAB

Complete breadboarding system to let you design and modify circuits, diagnose and repair faults.

DIGITAL LOGIC PROBE

Gives you first-hand experience analyzing digital circuit operation.

one more way NRI gives you the confidence-building experience you need to feel at home with the latest advances in computer technology.

No experience needed, NRI builds it in

You need no previous experience in computers or electronics to succeed with NRI. You start with the basics, following easy-to-read instructions and diagrams, moving step by step from the fundamentals of electronics to sophisticated computer servicing techniques.

With NRI's unique Discovery Learning Method, you're sure to get the kind of practical hands-on experience that will make you fully prepared to take

advantage of every opportunity in today's top-growth field of computer service.

With NRI, you learn at your own pace in your own home. No classroom pressures, no night school, no need to quit your present job until you're ready to make your move. And all throughout your training, you have the full support of your personal NRI instructor and the NRI technical staff.

Your FREE NRI catalog tells more

Send today for your free full-color catalog describing every aspect of NRI's innovative computer training, as well as hands-on training in robotics, video/audio servicing, telecommunications, electronic music technology, and other growing high-tech career fields.

If the coupon is missing, write to NRI School of Electronics, McGraw-Hill Continuing Education Center, 4401 Connecticut Avenue, NW, Washington, DC 20008.

AT is a registered trademark of International Business Machines Corporation

Using your D/A converter along with the exclusive text-to-speech software also included, you explore the fascinating technology behind both digitized and synthesized computer speech.

You discover how you can use your computer to access and play back a variety of prerecorded sounds . . . you see how to add speech and sound effects to programs written in BASIC, C, Pascal, and others . . . you even learn how to produce high-quality speech directly from your own original printed text.

NRI's exclusive new hands-on training in voice synthesis is just



For career courses approved under GI Bill
 check for details

McGraw-Hill Continuing Education Center
4401 Connecticut Avenue, NW
Washington, DC 20008

CHECK ONE FREE CATALOG ONLY

<input type="checkbox"/> Computers and Microprocessors <input type="checkbox"/> Robotics <input type="checkbox"/> TV/Video/Audio Servicing <input type="checkbox"/> Computer Programming	<input type="checkbox"/> Security Electronics <input type="checkbox"/> Electronic Music Technology <input type="checkbox"/> Basic Electronics <input type="checkbox"/> Telecommunications
---	--

Name _____ (Please Print) _____ Age _____

Address _____

City/State/Zip _____

Accredited Member, National Home Study Council 3-040

ASK R-E

INFO ON LEADING-EDGE PC COMPATIBLE

I have a PC-compatible computer, a Leading Edge model #MP-1676L. I bought it used and, unfortunately, didn't get any manuals with it. It has a hard disk and a memory expansion card that has 384K in 64K RAM chips. The problem is that the switches on the motherboard and the ones on the memory-expansion card got scrambled, and I don't have any idea how to set them. I've written to Leading Edge but haven't gotten any answer from them.—W.D., Brooklyn, NY.

I'm surprised you didn't get any response from Leading Edge since I've never had any trouble with them. Maybe your letter got lost. You can write again but calling would be faster, at (800) 343-6833. You might have trouble getting information since you bought your computer used, and Leading Edge hasn't made them in over six years. Also, Leading Edge made them on an OEM basis for Mitsubishi, and never really sold them under their own name. The "MP" in the serial number stands for "Mitsubishi Product."

If you can't get any help from Leading Edge, try Mitsubishi at (800) 227-3378. Whoever you speak to, try to get an owner's manual. If you don't have any luck, there are two authorized NY area service centers that can help you, Computer Repair Center at (212) 696-1296, and Autotech Computer Systems at (212) 247-2099. Good luck.

POWER SUPPLY IMPROVEMENTS

I have had a 12-volt DC bench-type power supply for several

years. I've never had any trouble with it, but since I'm starting to experiment with digital electronics, I need a 5-volt supply also. I hate to buy another supply because this one works well, and I don't have much bench space. Is there any way to get 5 volts from my present supply? Or, better still, can I make it into a variable supply?—D.P., Los Angeles, CA.

There's good news and bad news. The bad news is that there's no easy way to convert your current supply. You didn't mention this in your letter, but I'll bet the case uses pop rivets or some other method that's difficult to open. And, since you didn't send the schematic, I'm assuming you've never opened it. The good news is that you can build a separate circuit to give you both fixed and variable outputs, and power it with your 12-volt supply.

Since you already have a regulated DC source, you only have to add the circuit shown in Fig. 1 to generate two separate outputs. It's very simple and, if you build it carefully, should be just as reliable as your present supply. Use a plastic case to avoid shorts, and heatsink both reg-

ulators, since you can't tell how much current you'll need, or for how long. In general, bench supplies have to work harder than those built for specific circuits. Both regulators are readily available, and have all the neat features you need, like stable outputs and thermal shutdown.

HARD DISK WOES

I recently bought an ST-238 hard disk for my computer but can't make it work; the controller card is a Western Digital 27X. My computer is a 10-MHz AT clone and works perfectly. I've followed all the steps in the computer manual, but I keep on getting an error every time I try to access the hard disk. Any ideas?—M.M., Chicago, IL.

Several ideas and one really good suspicion. Your letter was rather skimpy on details as to what you've tried, but since you have an AT and a manual (lucky you), I think I know what your problem is.

Although an ST-238 can be used with any IBM clone, the controller you have is an 8-bit device intended for an XT-class machine. If you've followed all the instructions in the manual, you've undoubtedly been told to run the AT setup program, and tell the machine that you have a hard disk as drive one. That is normal procedure for a 16-bit AT controller card. Since you're using an 8-bit controller, you have to tell the computer during setup that you're *not* using a hard disk. That may seem strange, but if you didn't do it, it's the most likely cause of your problem.

The reason has to do with deciding who controls the hard

WRITE TO:

ASK R-E
Radio-Electronics
500-B Bi-County Blvd.
Farmingdale, NY 11735

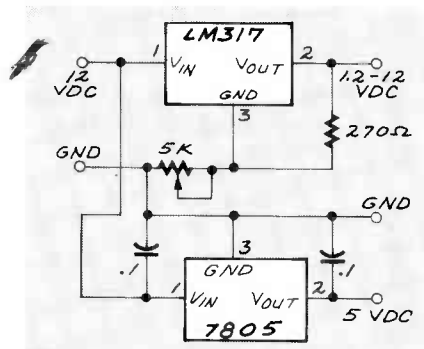
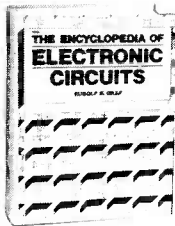

FIG. 1

Take any 3 PROFESSIONAL BOOKS for only \$4.95

when you join the **ELECTRONICS ENGINEERS & DESIGNERS BOOK CLUB** SM

values to \$168.40



1938P \$29.95

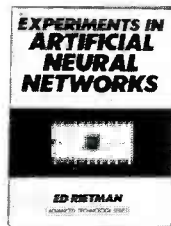

3037 \$24.95



9825 \$49.95



3059 \$34.95
Counts as 2



9808 \$34.95

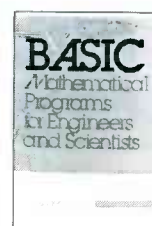

8225P \$19.95



3094 \$42.95
Counts as 2



9821 \$38.95

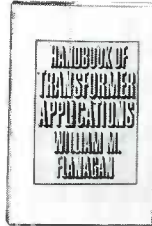

9788 \$49.50



9244P \$18.95



2672 \$49.50

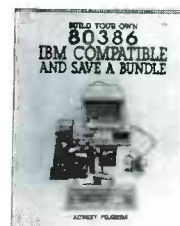

3131 \$24.95



3212 \$34.95
Counts as 2

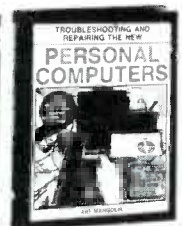

2809 \$27.95



3429 \$29.95

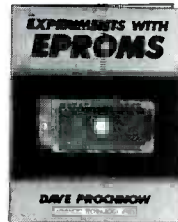

2962P \$17.95

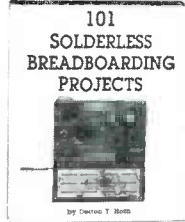

2985 \$24.95



3002 \$49.50

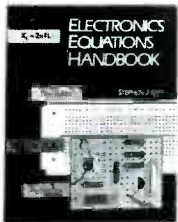

3241 \$24.95



9781 \$68.95



3098 \$44.50
Counts as 2



3199 \$52.00
Counts as 2



2818 \$44.95
Counts as 2



3205 \$24.95



9773 \$44.95

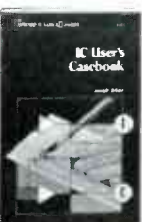

9243P \$12.95

How the Club Works

YOUR BENEFITS: You get 3 books for \$4.95 plus shipping and handling when you join. You keep on saving with discounts up to 50% off as a member.

YOUR PROFESSIONAL BOOKSTORE BY MAIL: Every 3-4 weeks, you will receive the EE&D Book Club News describing the Main Selection and Alternates, as well as bonus offers and special sales, with scores of titles to choose from.

AUTOMATIC ORDER: If you want the Main Selection, do nothing and it will be sent to you automatically. If you prefer another selection, or no selection at all, simply indicate your choice on the reply form provided. As a member, you agree to purchase at least 3 books within the next 2 years and may resign at any time thereafter.

BONUS BOOKS: Starting immediately, you will be eligible for our *Bonus Book Plan*, with savings of up to 80% off publishers' prices.

IRONCLAD NO-RISK GUARANTEE: If not satisfied with your books, return them within 10 days without obligation!

EXCEPTIONAL QUALITY: All books are quality publishers' editions especially selected by our Editorial Board. (Publishers' Prices Shown)

Your source for quality, affordable and timely authoritative engineering books.



ELECTRONICS ENGINEERS & DESIGNERS BOOK CLUB SM
Blue Ridge Summit, PA 17294-0860

YES! Please accept my membership in the *Electronics Engineers & Designers Book Club* SM and send my 3 volumes listed below, billing me \$4.95 plus shipping and handling. If not satisfied, I may return the books within 10 days without obligation and have my membership cancelled. I agree to purchase 3 or more books at regular Club prices during the next 2 years, and may resign at any time thereafter.

--	--	--

Name _____
 Address _____
 City _____
 State _____ Zip _____ Phone _____
 Signature _____

Valid for new members only. Foreign applicants will receive special ordering instructions. Canada must remit in U.S. funds. This order subject to acceptance by the *Electronics Engineers & Designers Book Club*. DRE490

All books are hardcover unless number is followed by a "P" for paperback.
 ©1990 EEDBC, Blue Ridge Summit, PA 17294-0860

CIRCLE 190 ON FREE INFORMATION CARD

NEW SUPER LONG PLAY TAPE RECORDERS

12 Hour Model — \$119.00*
USES D-120 TAPE

Modified Panasonic Slimline, high quality, AC-DC Recorders provide 6 continuous hours of quality recording & playback on each side of cassette for a total of 12 hours.
Built-in features include:
• Voice level control, • Digital counter, etc. TDK DC 120 Cassette Furnished.



PHONE RECORDING ADAPTER

Records calls automatically. All Solid state connects to your telephone jack and tape recorder. Starts recording when phone is lifted. Stops when you hang up.



\$28.50*
FCC APPROVED

VOX VOICE ACTIVATED CONTROL SWITCH

Solid state. Self contained. Adjustable sensitivity. Voices or other sounds automatically activate and control recorder. Uses either recorder or remote mike.



\$28.50*

*Add for ship & hdg. Phone Adapter & Vox \$1.50 ea. Recorders \$4.00 ea. Cal. Res. add tax. Mail order, VISA, M/C, COD's OK. Money Back Guarantee. Qty. disc. avail.. Dealer inquiries invited, Free data.
AMC SALES INC. Dept. A3335 Lubec St., Box 928, Downey, CA 90241 Phone (213) 869-8519

CIRCLE 108 ON FREE INFORMATION CARD

disk, the computer or the controller. Without getting into nit-picky detail, there are two basic steps your computer has to do to talk to the hard disk. It has to know the disk's logical structure (the number of heads and tracks), and second, and how to control the mechanics to move the heads to a specific track and read a sector.

In an XT-class machine, all the hard-disk operations are left to the controller. You tell it what you want, and it translates your request to tracks (cylinders, to be precise), gives the disk the necessary commands to move the heads, and either writes data to the disk or gets the data you're asking for.

By contrast, AT-class machines have the hard-disk translation tables in ROM, and rely on the controller only to operate the drive mechanics—not to do any translations. If you used the setup program and told the computer it had a hard disk connected to it, you'll get an error because the controller is sit-

ting between the ROM-based translation tables and the hard disk itself.

Rerun the setup program, and tell the machine you *don't* have a hard disk attached. Then, format the drive using the controller firmware, just like you would if you were working on an XT. Run DEBUG, and once you're at the dash prompt, type G=C800:5 (no spaces). Follow the screen instructions and, until you get more familiar with the questions, accept all defaults.

The firmware will do a low-level drive formatting, and then you'll have to reboot. Next, run FDISK, and keep pressing RETURN to accept the defaults; that will put a DOS partition on the disk. Both FDISK and DEBUG are on the DOS distribution disks. You can then use the FORMAT program to prepare the hard disk (think of it as a big floppy). If you're not sure about any of this and worried about doing it wrong, get help from someone local who is more familiar with IBM clones.

R-E

Cable TV Descrambler Article Parts

We stock the exact parts, PC Board and AC Adaptor for two articles published in Radio-Electronics magazine on building your own CABLE TV DESCRAMBLER.

February 1984 issue

#701 Parts..... 19.00
Includes all original parts.

#702 PC Board..... 7.95
Original 3x4 etched, drilled and silk-screened pc board.

#704 AC Adaptor..... 7.95
Original 18 Volt DC @ 200ma.

#701, 702 & 704..... 29.00

February 1987 issue

#301 Parts..... 29.00
Includes all original parts.

#302 PC Board..... 7.95
Original 5x8 etched, drilled and silk-screened pc board.

#304 AC Adaptor..... 7.95
Original 18 Volt DC @ 200ma.

#301, 302 & 304..... 39.00

Free article reprint with purchase.

Snooper Stopper..... 39.00

Cable TV descramblers can be detected, protect your privacy with the Snooper Stopper. Free article on Cable Snooping.

Macrovision Kit..... 29.00

Macrovision..now you see it, now you don't with our macroscrubber kit. Article was published in Radio Electronics 1987 issue.

CALL TOLL FREE 1-800-332-3557

Out side USA 1-508-699-6935

Visa, Master Card and C.O.D.

Add \$3.50 S & H. \$6.00 outside USA.

Visa

MC

D & D Electronics, Inc., PO Box 3310, N. Attleboro, Ma. 02761

CIRCLE 200 ON FREE INFORMATION CARD

THIS YEAR, THE IRS WOULD LIKE TO GIVE YOU SOMETHING FOR A CHANGE.

Free help. If you're having a problem doing your taxes, you don't have to do them alone. There are IRS-trained volunteers to help you. So the only number you need to know is on the coupon above. Cut it out and cut down on your tax worries. Call us and we'll direct you to the volunteer site nearest you. The IRS-trained volunteers. They'll make your taxes less taxing.

MAKE YOUR TAXES LESS TAXING.

A Public Service of This Publication &   Internal Revenue Service

Discover Your Career Potential In High-Tech Electronics...Call 1-800-776-2900!

CIE Gives You The Training You Need to *Succeed...*
At Your Own Pace...& In Your Own Home!

If you're anxious to get ahead...and build a *real* career...you owe it to yourself to find out about the Cleveland Institute of Electronics!

CIE can help you discover your career potential in the fast growing field of high-tech electronics. A career that will challenge and excite you every day...reward you with a powerful feeling of personal accomplishment...and deliver a level of financial security you may have only dreamed of before!

As the leading school in home-study electronics, CIE has helped over 150,000 students in the U.S.A. and over 70 foreign countries get started in this exciting field. To find out how CIE could be helping you...read on...then send for a CIE catalog TODAY!

A Growing Need For Trained Professionals!

The career opportunities shown here are only a few of the challenging, high-paying careers you could enjoy as an electronics technician.

You could be the "brains" behind the scenes of an exciting TV broadcast...trouble-shoot life-saving medical equipment...design exotic new aeronautics systems...CIE's job-oriented programs offer you the quickest possible path to the career of your dreams! And CIE also features military and union re-training, to build on what you already know.

Dozens Of Fascinating Careers To Choose From!

Even if you aren't sure which career is best for you, CIE can get you started with core lessons applicable to *all* areas of electronics. As you advance, CIE makes job opportunities available to you through the bimonthly school paper, *The Electron*.



Data Communications

Automotive Electronics

Avionics

Computer-Assisted Manufacturing

Consumer Electronics

Military Electronics

Practical Training... At Your Own Pace.

Through CIE, you can train for your new career while you keep your present job. Each course allows a generous completion time, and there are no limitations on how fast you can study. Should you already have some electronics experience, CIE offers several courses which start at the intermediate level.

"State-Of-The-Art" Facilities & Equipment.

In 1969, CIE pioneered the first electronics laboratory course, and in 1984, the first Microprocessor Laboratory. Today, no other home study school can match CIE's state-of-the-art equipment. And all your laboratory equipment is included in your tuition cost. There is no extra charge—it's yours to use while you study at home and on the job after you complete your course!

Earn Your Degree To Become A Professional In Electronics!

Every CIE course you take earns you credit towards the completion of your Associate in Applied Science Degree, so you can work towards your degree in

Personal Training From A Renowned Faculty.

Unlike the impersonal approach of large classroom study, CIE offers you one-on-one instructional help 6 days a week, toll-free. Each CIE lesson is authored by an independent specialist, backed by CIE instructors who work directly with you to answer your questions and provide technical assistance when you need it.

stages. And CIE is the only school that awards you for fast study, which can save you thousands of dollars in obtaining the same electronics education found in four-year Bachelor's Degree programs! Call or write for details today!

**Call TOLL-FREE
1-800-776-2900!**



CIE World Headquarters

Cleveland Institute of Electronics, Inc.
1776 East 17th St., Cleveland, Ohio 44114

ARE-165

YES! Please send me your independent study catalog (For your convenience, CIE will have a representative contact you—*there is no obligation.*)

Print Name _____

Address _____ Apt # _____

City/State/Zip _____

Age _____ Area Code/Phone No _____

Check box for G.I. Bill bulletin on educational benefits: Veteran Active Duty

Mail This Coupon Today!

LETTERS



SUPER SURROUND SOUND
I must tell you that I've been a subscriber for quite a few years and I will never stop the subscription. I wanted to let you know that I've build the surround-sound decoder from the April 1988 issue of **Radio-Electronics**, and the subwoofer simulator from the May 1988 issue. I also built the width circuit and the center-channel section of the acoustic field generator from the January 1990 issue.

I am so impressed with those designs that I can't stop bragging about my system. It sounds exactly like a theater—or maybe even better. Now I automatically look for a rental tape with the Dolby logo on it, particularly Dolby-Surround. We get popcorn, turn off the lights, and the whole family flips out. It's fantastic!

Thanks for sharing your expertise. You're doing a beautiful job!
RICH CIAFARDINI
Queensbury, NY

NOT-SO-COLD FUSION

Don Lancaster's columns on cold fusion (**Radio-Electronics, August and September 1989**) were most welcome—I've been somewhat out of touch and I'm still trying to come up to date on the subject.

In the early 1950's I met a Dr. Johnson from MIT who claimed to have melted the cathode in a Crookes-tube-type apparatus with very low input energy. He attributed that to fusion of the hydrogen or deuterium in the platinum or palladium cathode (I can't remember precisely which materials he used).

Although I've never been in a position to test Dr. Johnson's claims, it occurs to me that many a hacker might be, and that the idea

should be spread. It would be far better for that principle to be made available in the public domain than to be patented, because the world so urgently needs a good power source.

The prevalent idea now seems to be that Pons made some mistake in his heat measurements, but how about the reported meltings and explosions? Such phenomena would be hard to think of as mere imaginings, and if there is anything a good chemist knows, it is how to make measurements of such phenomena as heat generation.

If there is any question as to why cathodes should explode, I would like to advance the thought that helium formed within the metal would almost surely be slow to escape as compared to the rate at which hydrogen could be absorbed. The resultant pressure could be immense.

For a possible future power application, I would suggest a tube of suitable metal (PD or PT) with a wire anode with ends made of insulating material drawn through its axis. D_2 or H_2 , the gases, would be present at low pressure, characteristic of Crooke's tubes. The tubular cathode could be expected to become very hot, and should be immersed in water, forming a structure similar to a fire-tube boiler. Of course, the entire apparatus should be placed in an underground, or otherwise shielded vault, for protection against possible radiation or explosion.

In the ultimate development the fusion might not be so cold after all. Perhaps the cathode must be allowed to melt, and to form a pool from which the helium could escape readily, eliminating the explosion hazard. A problem of

containment for the high-melting noble metals would then arise; that is the sort of problem any hacker would love.

I have tried to make my own little wet setup, using titanium for the cathode, but have had trouble finding a proper cheap anode. No common metal works, because of oxidation. Silicon should work better, but is not readily available to me.

THOMAS ROSS
Freeland, WA

CUSTOMER SATISFACTION

When I decided to build the 386SX PC from the articles that appeared in the June, July, and August 1989 issues of **Radio-Electronics**, the first thing I did was to contact Peripheral Technology for the parts. The people there are first rate: Whenever I had a question they were helpful and courteous in their responses. I had a few problems along the way (a defective power supply zapped the chips), and the people at Peripheral Technology replaced or repaired the parts and shipped the system back to me at no charge. It works just fine now, and I'm writing commend Peripheral's responsible and honest manner of doing business. I will continue to do business with them as I upgrade the system, and would recommend them to anyone involved with PC's.

CHARLES F. FLAHERTY
Waukegan, IL

TERRIFIC TRANSMITTER

I just wanted to comment on how impressed I was with the "TV Transmitter" article by Rudolf F. Graf and William Sheets that appeared in the June and July 1989 issues. I ordered the kit and re-

ceived it promptly. When I hit a few snags, I called the suppliers and received clear and accurate advise. After the kit was completed, I followed the tuning instructions, and *Voila!* it worked!

The transmitter's design is quite remarkable, using some pretty ordinary electronic components.

Hats off to the authors for providing a reliable, "do-able," mail-order kit, and to Radio-Electronics for making it available to folks like me.

LES MALZMAN
Portland, OR

ETCHANT TANK DESIGN

I am writing about a very small, but potentially disastrous, design oversight in the "Etchant Tank" described in the December 1989 issue of *Radio-Electronics*.

As a tropical-fish owner, I can assure you that if you locate the air pump below the level of the etchant or water in any tank you are inviting trouble. There is a very good chance that if the power fails, or one of the reed or flap valves fails, you will get a siphon

effect—causing a great big mess.

As for the letter from Michael Catudal, which appeared in the same issue, I suggest that he visit a hamfest to get an idea about the real hobbyist world. The 2716 EPROM is far from obsolete. I suppose he has an 80486-based computer that runs at breakneck speed. C'mon, Michael, join the real world!

PHIL CLINE
Indianapolis, IN

CORRECTION

In our "Universal Laboratory Power Supply" construction article (*Radio-Electronics*, March 1990) a couple of errors need correcting:

- In the schematic (Fig. 1), pin 7 of IC2 is shown connected to R14. It should be connected to the output of IC1. The bottom of R14 should instead be connected to pin 2 of IC2.
- The Parts Placement diagram (Fig. 3) shows the incorrect connection for meter M2. Follow the schematic for the proper way to hook up M2 and its corresponding current switch, S2.
- The parts list and ordering information incorrectly identify Q1 and Q2, which are MJ15023 transistors.

A New AOR Scanner

100 Channels Low, Air, High, UHF & 800MHz

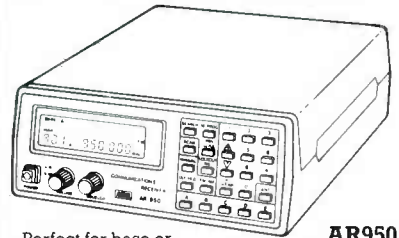

- Perfect for base or mobile. Includes AC and DC power cords, mobile mount hardware and 2 antennas.
- Covers 27-54MHz, 108-174MHz, 406-512MHz and 830-950MHz.
- 5 Scan Banks and 5 Search Banks
- 25 Day Satisfaction Guarantee
- No Frequencies Cut Out.
- Size: 3 1/4" H x 5 5/8" W x 7 1/8" D. Wt.: 2 lb. 10 oz.

AR950
Total Price, Freight Prepaid
(Express Shipping Optional)
\$299.00

ACE
COMMUNICATIONS

10707 E. 106th St. Indpls., IN 46256

Toll Free 800-445-7717

Visa and MasterCard
(COD slightly higher)

In Indiana 317-849-2570 Collect FAX (317) 849-8794

CIRCLE 201 ON FREE INFORMATION CARD

STEP UP TO BK PRECISION

SAVE!

20 MHz DUAL-TRACE OSCILLOSCOPE

1 mV/div sensitivity - 20MHz response at a true -3dB - AUTO/NORM triggered sweep operation with AC, TVH, TVV and Line coupling - Calibrated-18 step timebase with x10 magnifier - X-Y operation - Built-in calibration source - Bright, sharp CRT with P31 phosphor - Tilt stand and soft handle. Includes Probes; 2-year warranty. Model 2120

Reg. \$549
\$397⁵⁰

20 MHz DUAL-TRACE DELAYED SWEEP SCOPE

1 mV/div sensitivity - Delayed sweep in 18 ranges - Built-in component tester for capacitors, inductors, diodes, transistors, zener diodes - 20MHz response at a true -3dB - AUTO/NORM triggered sweep operation with AC, TVH, TVV and Line coupling - Calibrated-20 step timebase with x10 magnifier - X-Y operation - Built-in calibration source - Bright, sharp CRT with P31 phosphor - Tilt stand; soft handle. Probes, 2-yr. warranty incl. Model 2125

Reg. \$646
\$525⁰⁰

60 MHz DUAL-TRACE DUAL TIME BASE SCOPE

1 mV/div sensitivity - sweep to 5 ns/div - 22 calibrated ranges -- main time base - 19 calibrated ranges -- delayed time base - 12kV accelerating voltage - Signal delay line - Beam finder - V mode - Component tester - Channel 1 output, Z axis input - X-Y operation - Single sweep. Probes included. 2 year warranty. Model 2160

Reg. \$1099
\$888⁰⁰

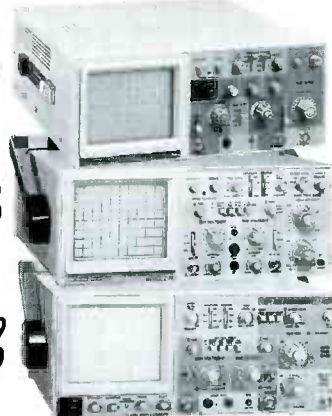

For the Best Values On All Your Test Equipment Needs Look to

JOSEPH ELECTRONICS

BONUS VALUE!
EXTRA UNIVERSAL SWITCHABLE
SCOPE PROBE **\$19⁰⁰**

Only with BK Scope purchases. Limit 2 per scope.

3-position -- 1x, ref, 10x -
Risetime less than 1.5 nsec -
Excludes interference even on
most sensitive ranges - Rugged;
withstands heat, humidity -
Universal for all scopes.

\$39 Value



HAND-HELD 3 1/2 DIGIT LCD 'TEST BENCH' MULTIMETER

41 voltage ranges - Measures AC & DCV with 0.5% DCV accuracy - DC & AC currents 200 uA to 20A - Resistance 0.1 to 2000 MΩ - Frequency 20 kHz to 200 kHz - Capacitance up to 20uF - Logic Level (TTL) - Transistor gain - Diode junction test - Drop-resistant case - Tilt stand. Model 388-HD

OUR BEST PRICE EVER
Reg. \$129
\$108⁵⁰

DUAL TRACE DIGITAL/ANALOG STORAGE SCOPE

20 MHz analog bandwidth - 10MS/s sampling rate - 2k memory per channel - 20MHz equivalent time sampling - Pre-trigger capture. Probes, 2-yr. warranty included.

Model 2522
Reg. \$1495
\$1248⁰⁰

100 MHZ 3-TRACE DELAYED SWEEP SCOPE

1 mV/div sensitivity - Sweeps to 2ns/div - 23 calibrated ranges; 20 on delayed time base - Calibrated delay time multiplier - Signal delay line - 19kV accelerating voltage - V mode triggering - Channel 1 output. Probes, 2-yr. warranty included.

Model 2190
Reg. \$1645
\$1325⁰⁰

0-30V DC 0-3A POWER SUPPLY

Low ripple - Regulated constant volt or current outputs - 2 current ranges - Isolated output - float, ground either polarity - Overload, reverse polarity protection - Parallel, series capability. 1-year warranty.

Model 1630
Reg. \$299
\$248⁰⁰

0-16V DC 0-10A POWER SUPPLY

Continuously variable voltage & current - Constant-voltage & constant-current modes - Voltage & current analog meters - 2A and 10A current range limits. 1-year warranty.

Model 1646
Reg. \$489
\$398⁰⁰

0-150V AC 2A POWER SUPPLY

Variable isolated 0-150 VAC, 2 amp continuous output - Voltage or current display - Isolation transformer eliminates shock hazard. 1-year warranty.

Model 1653
Reg. \$229
\$188⁰⁰

CALL TOLL-FREE - SAME-DAY SHIPPING

Joseph Electronics 1.800.323.5925
8830 N. Milwaukee Av. Niles, IL 60648 • 708-297-4200 FAX 708-297-6923

Add \$7.50 Shipping and Handling for each unit ordered. IL Residents add 7% Sales Tax



Call or write for our 528 pg. Catalog. Only \$4.95 - FREE with order.

CIRCLE 202 ON FREE INFORMATION CARD

LEARN TV/VCR REPAIR



No Previous Experience Necessary

Now you can train at home in your spare time for a money-making career as a TV/VCR Repair Specialist. No need to quit your job or school. We show you how to troubleshoot and repair videocassette recorders and TV sets, how to handle house calls and shop repairs for almost any make of television or VCR. You learn about TV receivers, tuners and antennas, X-ray emission, the characteristics of sound, how electrical impulses are converted into a TV picture, and much, much more. Tools are included with your course so you can get "hands-on" practice as you follow the lessons step by step. Send for free facts about opportunities in TV/VCR Repair and find out how you can start making money in this great career.

Experts show you what to do, how to do it... guide you every step of the way! Everything is explained in easy-to-understand language with plenty of drawings, photos and diagrams. But if there is ever anything in your lessons you don't understand, you can write or phone your instructor and you can count on getting an authoritative answer. Send for free facts and color brochure. No cost. No obligation. No salesman will visit.

MAIL COUPON TODAY

ICS SCHOOL OF TV/VCR REPAIR, Dept. DE030
 SINCE 1980 925 Oak Street, Scranton, PA 18515

Please send me free facts on how I can learn TV/VCR Repair at home in my spare time. No salesman will visit.

Name _____ Age _____
 Address _____ Apt. # _____
 City/State _____ Zip _____
 Phone () _____

A Subsidiary of National Education Corporation

CIRCLE 188 ON FREE INFORMATION CARD

EQUIPMENT REPORTS

Fluke 85 Digital Multimeter

High accuracy with a human touch.



CIRCLE 25 ON FREE INFORMATION CARD

WHEN ENGINEERS AND TECHNICIANS think about high-tech test equipment, multimeters don't usually come to mind. But many of today's digital multimeters are chock-full of high-tech features. A case in point is the *Fluke 85* DMM from the John Fluke Mfg. Co., Inc. (P.O. Box C9090, Everett, WA 98206).

As is becoming common, the meter can measure more than voltage, current, and resistance: Frequency, capacitance, and conductance-measurement capabilities are included in the *Fluke 85*'s features. A host of alternate modes that add "smarts" to the meter, along with numerous human-engineering features, make the *Fluke 85* stand out from a crowded field. Before we get into some of the special features, let's look at the basic specifications.

The *Fluke 85* measures about $7\frac{3}{8} \times 1\frac{1}{4} - 3\frac{3}{8}$ inches and weighs 12½ ounces. Functions are selected using a single rotary switch in the center of the meter's front panel. A $3\frac{3}{4}$ (4000-count) digit LCD, four test-lead input jacks, and 7 push-buttons for feature selection complete the front panel.

Five AC voltage ranges, from 400 millivolts through 1000 volts, offer a worst-case accuracy of $\pm 0.5\% \pm 4$ counts for 60-Hz sine

waves. Accuracy decreases for higher-frequency sinewaves; but even at 20 kHz, the specified accuracy is $\pm 4\% \pm 4$ counts for the highest specified range of 400 volts.

The *Fluke 85* also offers five DC voltage ranges, from 400 millivolts through 1000 volts. The specified accuracy is similarly impressive: $\pm 0.1\% \pm 1$ digit. Six resistance ranges, from 400 ohms through 40 megohms full scale, boast accuracy better than $\pm 0.2\% \pm 1$ count on all but the highest range. A 40-nanosiemens conductance range effectively extends the resistance measurement capability to 100,000 megohms for testing leakage in insulators, diodes, circuit boards, and the like. An impressive accuracy within $\pm 1\% \pm 10$ counts is offered for conductance measurements.

For measuring current, 6 AC and 6 DC ranges, from 400 microamps to 10 amps, provide a worst-case accuracy of $\pm 0.6\% \pm 2$ counts. Capacitance measurements, in four ranges from 5 nanofarads to 5 microfarads, provide an accuracy of $\pm 1\% \pm 2$ counts. Frequency measurements in four ranges from 200 to 200 kHz provide an accuracy of $.005\% \pm 1$ digit.

(Continued on page 20)

A WORLD OF EXPERIENCE GOES INTO EVERY CRYSTAL WE MAKE FOR YOU

Since 1965, we've made crystals for industry, marine, amateur, CB, 2-way, scanners, microprocessors, and radio control.

HIGH QUALITY • LOW PRICE
 QUICK TURNAROUND



FOR FREE CATALOG, CALL OR WRITE:
JAN CRYSTALS
 P.O. BOX 06017
 FORT MYERS, FL 33906
 (813) 936-2397

SINCE 1965



TOLL-FREE: 1-800-JAN-XTAL
 (526-9825)

FAX ORDERS: 1-813-936-3750

CIRCLE 104 ON FREE INFORMATION CARD

Portasol Butane Gas-Powered Soldering Tool Kit

A field-service tech's dream come true!

CIRCLE 26 ON FREE INFORMATION CARD



PORTABLE SOLDERING IRONS ARE MERELY a convenience for most of us. But they're a must for field-service technicians, who can't count on having a source of power available where they need it. A rechargeable battery-operated iron can fill the need nicely—but only if you can get it back to its charging holster between jobs.

If you need a portable soldering iron that you can leave in your tool box indefinitely without it losing its charge, then a butane-gas powered tool is your only sensible choice. While they've been around for a few years, we were reminded of their convenience and versatility when we recently examined the Model *P-1K* butane gas-powered soldering tool kit from Portasol, Inc. (7422 Carmel Executive Park, Charlotte, NC 28226).

The kit, which comes packaged in a rugged plastic storage case, includes the soldering tool, a 2.4 mm ($\frac{3}{32}$ inch) soldering tip, and three other tips that convert the tool into a blow torch, a hot-air blower, and a hot knife. A tip-cleaning sponge, a safety stand, and a cap (that doubles as a flint lighter) complete the kit.

The soldering tool measures about 6½ inches with a tip in place, and less than 7 inches with the cap on. Full of fuel and with a tip in

place, the soldering iron weighs just over 2 ounces. It's certainly light enough to feel at home in a shirt pocket—which is probably why a shirt-pocket clip is included on the cap.

In continuous use, a single filling of butane provides about 90 minutes of use. When that runs out, standard butane cigarette-lighter fuel can be used to refill the Portasol. A catalytic converter in the soldering tip provides heat from a flameless combustion (except, of course, when the blow-torch tip is in place). An adjustable temperature control on the bottom of the tool provides the equivalent of a 10–60-watt soldering iron.

The cap contains a flint lighter which uses standard, replaceable flints. After lighting, it takes the Portasol soldering tool slightly over one half minute to come up to operating temperature. When you're finished, the cap can be replaced immediately. As a safety feature, replacing the cap automatically shuts off the gas on/off control.

While convenience and portability are certainly good reasons to choose the Portasol butane gas-powered soldering tool, there's yet another good reason: There is virtually no risk of leakage current that could damage sensitive circuits.

The Portasol *P-1K* tool kit sells for \$54.95. The soldering iron itself (the model *P-1*) is available for \$29.99, including a $\frac{3}{32}$ -inch tip. It's a bargain for anyone who is looking for cordless convenience. If you find yourself in remote or limited-space situations, then you know that this portable soldering tool will pay for itself virtually the first time you need it. R-E

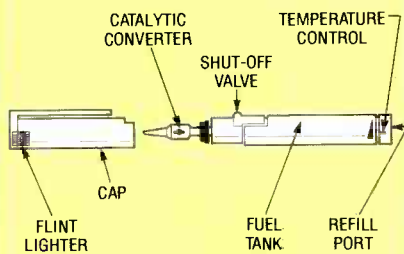

FIG. 1

DIGITAL VIDEO STABILIZER ELIMINATES ALL VIDEO COPY PROTECTIONS



While watching rental movies, you will notice annoying periodic color darkening, color shift, unwanted lines, flashing or jagged edges. This is caused by the copy protection jamming signals embedded in the video tape, such as Macrovision copy protection. Digital Video Stabilizer: RXII completely eliminates all copy protections and jamming signals and brings you crystal clear pictures.

- FEATURES:**
- Easy to use and a snap to install
 - State-of-the-art integrated circuit technology
 - 100% automatic - no need for any troublesome adjustments
 - Compatible to all types of VCRs and TVs
 - The best and most exciting Video Stabilizer in the market
 - Light weight (8 ounces) and Compact (1x3.5x5")
 - Beautiful deluxe gift box
 - Uses a standard 9 Volt battery which will last 1-2 years.

WARNING :
SCO Electronics and RXII dealers do not encourage people to use the Digital Video Stabilizer to duplicate rental movies or copyrighted video tapes. RXII is intended to stabilize and restore crystal clear picture quality for private home use only.

(Dealers Welcome)

To Order: \$49.95 ea + \$4 for FAST UPS SHIPPING
1-800-445-9285 or **516-694-1240**
Visa, M/C, COD M-F: 9-6 (battery not included)
SCO ELECTRONICS INC.
Dept. CBM561 W. Merrick Rd. Valley Stream NY 11580
Unconditional 30 days Money Back Guarantee

CIRCLE 196 ON FREE INFORMATION CARD

CABLE TV DESCRAMBLER



	1 Unit	10 +
Jerrold S.B.	\$74\$55
Jerrold SB w/Trimode.....	\$90\$70
Oak N-12 (w/VS).....	\$89\$65
Scientific Atlanta.....	\$109\$75
Pioneer.....	\$109\$75
Panasonic converter.....	\$98\$79
73 channel converter.....	\$79\$59

We Beat Anyone's Price!

30 Days Money Back Quaranty

Free Catalog

Visa, M/C, COD or send money order to:
US Cable TV Inc. Dept. KAW
4100 N. Powerline Rd., Suite F-4
Pompano Beach, FL 33073

1-800-445-9285

Please have make and model number of the equipment used in your area ready.

No Florida Sales!

It's not the intent of US Cable TV Inc. to defraud any pay TV operator and we will not assist any company or individual in doing so.

CIRCLE 197 ON FREE INFORMATION CARD

Put Professional Knowledge and a
COLLEGE DEGREE
in your Technical Career through
**HOME
STUDY**

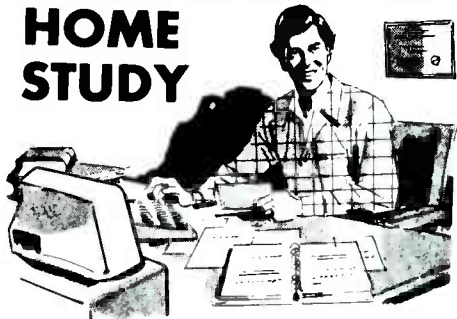

Add prestige and earning power to your technical career by earning your Associate or Bachelor degree through directed home study.

Grantham College of Engineering awards accredited degrees in
electronics and computers.

An important part of being prepared to *move up* is holding the right college degree, and the absolutely necessary part is knowing your field. Grantham can help you both ways—to learn more and to earn your degree in the process.

Grantham offers two degree programs—one with major emphasis in **electronics**, the other with major emphasis in **computers**. Associate and bachelor degrees are awarded in each program, and both programs are available completely by correspondence.

No commuting to class. Study at your own pace, while continuing on your present job. Learn from easy-to-understand lessons, with help from your Grantham instructors when you need it.

Write for our free catalog (see address below), or phone us at toll-free 1-800-955-2527 (for catalog requests only) and ask for our "degree catalog."

Accredited by
the Accrediting Commission of the
National Home Study Council

GRANTHAM
College of Engineering
10570 Humbolt Street
Los Alamitos, CA 90720

EQUIPMENT REPORT

continued from page 18

Features

Although the basic specifications of the *Fluke 85* are, indeed, impressive, they tell only half the story. For example, one of our favorite features is a MIN/MAX recording mode in which the meter stores the lowest and highest readings while also calculating the true average of all the readings taken over a period as long as 24 hours. It's ideal for catching intermittents, or just to take readings while you are operating the equipment under test and can't watch the meter. We used the meter to measure the AC line voltage over a 12-hour period, and found that it ranged from 104.0 volts to 124.4 volts, with an average of 120.6 volts.

Two recording modes, one with a 100-ms response time, the other, a "high-accuracy" mode with a 1-second response time are offered. Every time a new minimum or maximum reading registers, the meter's beeper will sound. MIN/MAX readings are available for voltage, current, resistance, and frequency measurements.

A relative-measurement mode is also available. For relative measurements, a reading is stored in memory. The display shows the difference between the stored value and subsequent readings.

In the relative-measurement mode, the analog bargraph—which acts just like an analog meter needle in most modes—becomes a zero-center meter. In the other modes, the bargraph can make certain measurements much easier than is normally possible with digital meters. Peaking or nulling a signal, for example, can be seen easily with the bargraph, while changing digital displays usually cause confusion.

An alternate frequency-counter mode makes it possible to measure the duty cycle of input signals. Positive- or negative-edge triggering is selectable.

The little things count

The technical specifications and the measurement features of the *Fluke 85* are enough to recom-

mend the meter to anyone who needs to make a wide range of accurate measurements. But it's the "little things" that the meter offers that really show off Fluke's test-equipment experience.

The front-panel knob and push-buttons are clearly marked and easy to use. However, as with just about every other DMM, it's necessary to switch the test leads if you switch from voltage to current measurements. We all know how easy it is to forget to switch the leads. That's why Fluke incorporates a beeper that lets you know that the leads are not inserted correctly for the measurement you want to make. It's sure to greatly reduce the number of blown safety fuses caused by neglecting to switch leads.

A touch-hold feature, which freezes the display, also makes the *Fluke 85* easier to use.

A holster with Fluke's *Flex-Stand* is included with the meter. The bright yellow holster not only makes the meter easy to find, it offers an added degree of protection. The *Flex-Stand* tilt bale can be used to stand the meter up. But because the bale is flexible, it can be used to hang the meter over a convenient protuberance, including your belt. Two test-probe clips hold the probes for storage. The probes can be clipped in the holster in operating position, which allows you to use the meter much as you would a logic probe.

The *Fluke 85* sells for \$239. Two other meters round out Fluke's *80 Series*. The \$199 *Fluke 83* offers the same features of the *Fluke 85*, but with lower accuracy and frequency response. The \$289 *Fluke 87* offers not only greater accuracy, but extra features as well. For example, the *Fluke 87* offers a 4½-digit (20,000 count) display, and backlighting, too. Like the other meters in the series, the *Fluke 87* features a MIN/MAX mode. But it goes one better by adding a PEAK MIN/MAX mode that can capture transients to 1 millisecond or sine-wave peaks to 400 Hz.

If you are in the market for a new multimeter, don't make a decision until you give at least a serious look to Fluke's *80 Series*. They represent the state of the art of digital multimeters.

R-E

Portasol Butane Gas-Powered Soldering Tool Kit

A field-service tech's dream come true!

CIRCLE 26 ON FREE INFORMATION CARD



PORTABLE SOLDERING IRONS ARE MERELY a convenience for most of us. But they're a must for field-service technicians, who can't count on having a source of power available where they need it. A rechargeable battery-operated iron can fill the need nicely—but only if you can get it back to its charging holster between jobs.

If you need a portable soldering iron that you can leave in your tool box indefinitely without it losing its charge, then a butane-gas powered tool is your only sensible choice. While they've been around for a few years, we were reminded of their convenience and versatility when we recently examined the Model P-1K butane gas-powered soldering tool kit from Portasol, Inc. (7422 Carmel Executive Park, Charlotte, NC 28226).

The kit, which comes packaged in a rugged plastic storage case, includes the soldering tool, a 2.4 mm (3/32 inch) soldering tip, and three other tips that convert the tool into a blow torch, a hot-air blower, and a hot knife. A tip-cleaning sponge, a safety stand, and a cap (that doubles as a flint lighter) complete the kit.

The soldering tool measures about 6½ inches with a tip in place, and less than 7 inches with the cap on. Full of fuel and with a tip in

place, the soldering iron weighs just over 2 ounces. It's certainly light enough to feel at home in a shirt pocket—which is probably why a shirt-pocket clip is included on the cap.

In continuous use, a single filling of butane provides about 90 minutes of use. When that runs out, standard butane cigarette-lighter fuel can be used to refill the Portasol. A catalytic converter in the soldering tip provides heat from a flameless combustion (except, of course, when the blow-torch tip is in place). An adjustable temperature control on the bottom of the tool provides the equivalent of a 10–60-watt soldering iron.

The cap contains a flint lighter which uses standard, replaceable flints. After lighting, it takes the Portasol soldering tool slightly over one half minute to come up to operating temperature. When you're finished, the cap can be replaced immediately. As a safety feature, replacing the cap automatically shuts off the gas on/off control.

While convenience and portability are certainly good reasons to choose the Portasol butane gas-powered soldering tool, there's yet another good reason: There is virtually no risk of leakage current that could damage sensitive circuits.

The Portasol P-1K tool kit sells for \$54.95. The soldering iron itself (the model P-1) is available for \$29.99, including a 3/32-inch tip. It's a bargain for anyone who is looking for cordless convenience. If you find yourself in remote or limited-space situations, then you know that this portable soldering tool will pay for itself virtually the first time you need it. R-E

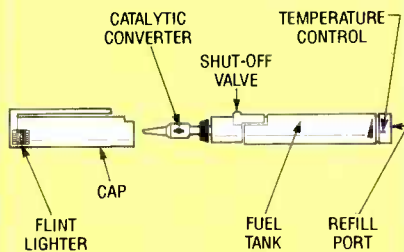

FIG. 1

DIGITAL VIDEO STABILIZER ELIMINATES ALL VIDEO COPY PROTECTIONS



While watching rental movies, you will notice annoying periodic color darkening, color shift, unwanted lines, flashing or jagged edges. This is caused by the copy protection jamming signals embedded in the video tape, such as Macrovision copy protection. Digital Video Stabilizer: RXII completely eliminates all copy protections and jamming signals and brings you crystal clear pictures.

- FEATURES:**
- Easy to use and a snap to install
 - State-of-the-art integrated circuit technology
 - 100% automatic - no need for any troublesome adjustments
 - Compatible to all types of VCRs and TVs
 - The best and most exciting Video Stabilizer in the market
 - Light weight (8 ounces) and Compact (1x3.5x5")
 - Beautiful deluxe gift box
 - Uses a standard 9 Volt battery which will last 1-2 years.

WARNING :
SCO
Electronics and RXII dealers do not encourage people to use the Digital Video Stabilizer to duplicate rental movies or copyrighted video tapes. RXII is intended to stabilize and restore crystal clear picture quality for private home use only.

(Dealers Welcome)

To Order: \$49.95 ea + \$4 for FAST UPS SHIPPING
1-800-445-9285 or **516-694-1240**
Visa, M/C, COD M-F: 9-6 (battery not included)
SCO ELECTRONICS INC.
Dept. CBM581 W. Merrick Rd. Valley Stream NY 11580
Unconditional 30 days Money Back Guarantee

CIRCLE 196 ON FREE INFORMATION CARD

CABLE TV DESCRAMBLER



	1 Unit	10 +
Jerrold S.B.	\$74	\$55
Jerrold SB w/Trimode.....	\$90	\$70
Oak N-12 (w/VS).....	\$89	\$65
Scientific Atlanta.....	\$109	\$75
Pioneer.....	\$109	\$75
Panasonic converter.....	\$98	\$79
73 channel converter.....	\$79	\$59

We Beat Anyone's Price!

30 Days Money Back Quaranty

Free Catalog

Visa, M/C, COD or send money order to:
US Cable TV Inc. Dept. KAW
4100 N. Powerline Rd., Suite F-4
Pompano Beach, FL 33073

1-800-445-9285

Please have make and model number of the equipment used in your area ready.

No Florida Sales!

It's not the intent of US Cable TV Inc. to defraud any pay TV operator and we will not assist any company or individual in doing so.

CIRCLE 197 ON FREE INFORMATION CARD

Put Professional Knowledge and a
COLLEGE DEGREE
in your Technical Career through
**HOME
STUDY**

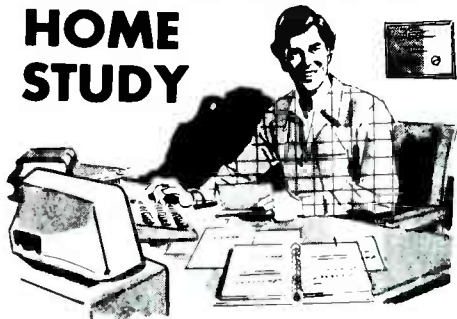

Add prestige and earning power to your technical career by earning your Associate or Bachelor degree through directed home study.

Grantham College of Engineering awards accredited degrees in
electronics and computers.

An important part of being prepared to *move up* is holding the right college degree, and the absolutely necessary part is knowing your field. Grantham can help you both ways—to learn more and to earn your degree in the process.

Grantham offers two degree programs—one with major emphasis in **electronics**, the other with major emphasis in **computers**. Associate and bachelor degrees are awarded in each program, and both programs are available completely by correspondence.

No commuting to class. Study at your own pace, while continuing on your present job. Learn from easy-to-understand lessons, with help from your Grantham instructors when you need it.

Write for our free catalog (see address below), or phone us at toll-free 1-800-955-2527 (for catalog requests only) and ask for our "degree catalog."

Accredited by
the Accrediting Commission of the
National Home Study Council

GRANTHAM
College of Engineering
10570 Humbolt Street
Los Alamitos, CA 90720

EQUIPMENT REPORT

continued from page 18

Features

Although the basic specifications of the *Fluke 85* are, indeed, impressive, they tell only half the story. For example, one of our favorite features is a MIN/MAX recording mode in which the meter stores the lowest and highest readings while also calculating the true average of all the readings taken over a period as long as 24 hours. It's ideal for catching intermittents, or just to take readings while you are operating the equipment under test and can't watch the meter. We used the meter to measure the AC line voltage over a 12-hour period, and found that it ranged from 104.0 volts to 124.4 volts, with an average of 120.6 volts.

Two recording modes, one with a 100-ms response time, the other, a "high-accuracy" mode with a 1-second response time are offered. Every time a new minimum or maximum reading registers, the meter's beeper will sound. MIN/MAX readings are available for voltage, current, resistance, and frequency measurements.

A relative-measurement mode is also available. For relative measurements, a reading is stored in memory. The display shows the difference between the stored value and subsequent readings.

In the relative-measurement mode, the analog bargraph—which acts just like an analog meter needle in most modes—becomes a zero-center meter. In the other modes, the bargraph can make certain measurements much easier than is normally possible with digital meters. Peaking or nulling a signal, for example, can be seen easily with the bargraph, while changing digital displays usually cause confusion.

An alternate frequency-counter mode makes it possible to measure the duty cycle of input signals. Positive- or negative-edge triggering is selectable.

The little things count

The technical specifications and the measurement features of the *Fluke 85* are enough to recom-

mend the meter to anyone who needs to make a wide range of accurate measurements. But it's the "little things" that the meter offers that really show off Fluke's test-equipment experience.

The front-panel knob and push-buttons are clearly marked and easy to use. However, as with just about every other DMM, it's necessary to switch the test leads if you switch from voltage to current measurements. We all know how easy it is to forget to switch the leads. That's why Fluke incorporates a beeper that lets you know that the leads are not inserted correctly for the measurement you want to make. It's sure to greatly reduce the number of blown safety fuses caused by neglecting to switch leads.

A touch-hold feature, which freezes the display, also makes the *Fluke 85* easier to use.

A holster with Fluke's *Flex-Stand* is included with the meter. The bright yellow holster not only makes the meter easy to find, it offers an added degree of protection. The *Flex-Stand* tilt bale can be used to stand the meter up. But because the bale is flexible, it can be used to hang the meter over a convenient protuberance, including your belt. Two test-probe clips hold the probes for storage. The probes can be clipped in the holster in operating position, which allows you to use the meter much as you would a logic probe.

The *Fluke 85* sells for \$239. Two other meters round out Fluke's *80 Series*. The \$199 *Fluke 83* offers the same features of the *Fluke 85*, but with lower accuracy and frequency response. The \$289 *Fluke 87* offers not only greater accuracy, but extra features as well. For example, the *Fluke 87* offers a 4½-digit (20,000 count) display, and back-lighting, too. Like the other meters in the series, the *Fluke 87* features a MIN/MAX mode. But it goes one better by adding a PEAK MIN/MAX mode that can capture transients to 1 millisecond or sine-wave peaks to 400 Hz.

If you are in the market for a new multimeter, don't make a decision until you give at least a serious look to Fluke's *80 Series*. They represent the state of the art of digital multimeters.

R-E

READER HELP READER

● PAUL WHITEMAN has turned to us in desperation. He needs a copy of the schematic or, better yet, the service manual for an AB Systems' power amplifier, model 1201a. He'd gladly pay fair costs and the postage to send it to 404 Dawes Road, Toronto, Ontario, M4B 2E4, Canada.

● When G.H.M. requested the service manual for a Fisher 400 in a previous issue of Radio-Electronics, a few readers were kind enough to respond—and one of them now has a request of his own. MICHAEL WOLIN needs factory-service information on a KLH model 40 tape recorder (the latest, "improved" model). His address is 440 Pratt Street, Longmont, CO 80501.

● A long-time Radio-Electronics reader from across the Atlantic, SAM HOSENBUCUS, would like to correspond with American electronics hobbyists. He is particularly interested in the surveillance field, and would like to exchange information and diagrams. Write to him at 13 Victoria Terrace, Leeds LS3 1BX, W. Yorkshire, England.

● DENNIS BETZ is in the dark without the parts list for his Tigersuarus 210/A power amp, made by Southwest Technical Products of Texas, in the mid-1970's. If you have a copy of the parts list, or can point him in the right direction, write to 125 N. Railroad St., Annville, PA 17003.

● WALDO ARNHOLZ never expected to be writing to Radio-Electronics for help. However, all his efforts to find a complete schematic of the chassis of his Audiophonic stereo receiver, model SR-2150, have left him empty-handed. He'd like to hear from anyone with either the manufacturer's address or the schematic, and he's willing to pay for the schematic copy. Send the information to 1925 Hollow View Drive, Bettendorf, IA 52722.

Radio-Electronics mini-ADS



ELEVEN-PIECE RACHET TOOL KIT

Includes reversible ratchet handle, extension bar, six bits, two precision screwdrivers, and a cutter. Comes in fitted case. Get one for your shop, another for your car, another for your tool kit. To order send \$11.75 USA shipping only. ELECTRONIC TECHNOLOGY TODAY INC., PO Box 240, Massapequa Park, NY 11762-0240.

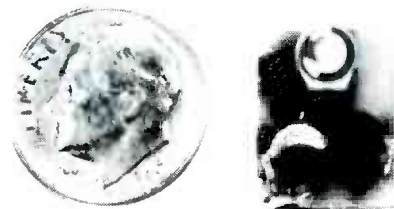

THE MODEL WTT-20 IS ONLY THE SIZE OF A DIME, yet transmits both sides of a telephone conversation to any FM radio with crystal clarity. Telephone line powered - never needs a battery! Up to ¼ mile range. Adjustable from 70-130 MHZ. Complete kit \$29.95 + \$1.50 S + H. Free Shipping on 2 or more! COD add \$4. Call or send VISA, MC, MO. DECO INDUSTRIES, Box 607, Bedford Hills, NY 10507. (914) 232-3878.

CIRCLE 127 ON FREE INFORMATION CARD

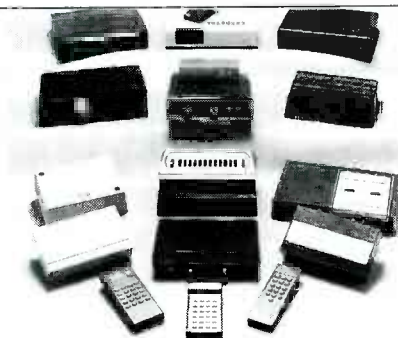
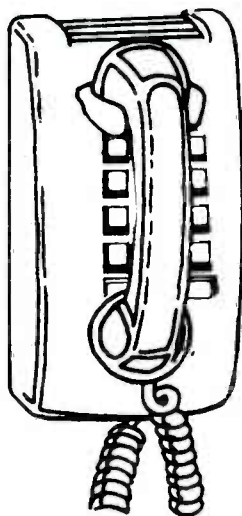

CABLE TV CONVERTERS AND DE-SCRAMBLERS SB-3 \$79.00 TRI-BI \$95.00 MLD-\$85.00 M35B \$89.00 JRX-DIC \$129.00 Special combos available. We ship COD. Quantity discounts. Call for pricing on other products. Dealers wanted. FREE CATALOG. We stand behind our products where others fail. One year warranty. ACE PRODUCTS. P.O. Box 582, Saco, ME 04072 1 (800) 234-0726.

CIRCLE 75 ON FREE INFORMATION CARD

CALL NOW AND RESERVE YOUR SPACE

- 6 x rate \$940.00 per each insertion.
- Fast reader service cycle.
- Short lead time for the placement of ads.
- We typeset and layout the ad at no additional charge.

Call 516-293-3000 to reserve space. Ask for Arline Fishman. Limited number of pages available. Mail materials to: mini-ADS, RADIO-ELECTRONICS, 500-B Bi-County Blvd., Farmingdale, NY 11735.



SIMPLY SNAP THE WAT-50 MINIATURE FM TRANSMITTER on top of a 9v battery and hear every sound in an entire house up to 1 mile away! Adjustable from 70-130 MHZ. Use with any FM radio. Complete kit \$29.95 + \$1.50 S + H. Free shipping on 2 or more! COD add \$4. Call or send VISA, MC, MO. DECO INDUSTRIES, Box 607, Bedford Hills, NY 10507. (914) 232-3878.

CIRCLE 127 ON FREE INFORMATION CARD

NEW PRODUCTS

IEEE-488 BUS ANALYZER.

For detecting and analyzing bus difficulties such as program errors, incomplete device responses, timing errors, incompatible instruments or software, and cable problems, *ICS Electronics* has introduced the *ICS 4811 Analyzer*. The small, self-contained analyzer can be used to monitor bus traffic or as a dedicated data-acquisition system. When set to the HANDSHAKE mode, the 4811 can act like any other IEEE-488 device. With the HANDSHAKE disabled, it can be transparent to the controller and other instruments on the bus. It can be programmed to emulate a device responding to addressed requests for system debugging and, when configured as a pattern generator, the 4811 can provide high-speed data and command output. The versatile device can function as the system controller or as a controller emulator for full-system tests.

Weighing less than eight pounds and requiring no external power supply or computer, the bus analyzer can be carried to any testing site. Its nonvolatile 128K



CIRCLE 35 ON FREE INFORMATION CARD

memory lets the unit store data and analyze it at another location, or send it to a computer. For uploading and downloading to a PC, the 4811 also comes with a standard RS-232 port.

The included software allows optional interactive control and data display of all analyzer functions from any DOS-based instrument, without impacting system operation. The CONFIG function, located on the front-panel membrane keypad, is used to select the function, number base, serial parameters, and other

functional parameters. Those setup parameters can be stored and recalled for subsequent use. The analyzer's 8-line x 40-character LCD shows bus data in either ASCII, octal, hex, binary, decimal, or in disassembled bus mnemonics.

The *ICS 4811 Analyzer* costs \$1995.00; an optional MS-DOS software package, which provides extensive post-processing and analysis of bus data, costs \$500.00.—**ICS Electronics Corporation**, 2185 Old Oakland Road, San Jose, CA 95131.

12-BIT A/D CONVERTER.

Alpha Products' *FA-154* is a high-speed, 12-bit analog-to-digital converter designed for high-speed data acquisition and signal processing. Its conversion speed is only 10µs, and each of its eight input channels will accept 0-5-volt signals. A variable-gain amplifier permits the reading of signals less than 1 LSB (1.2 mV). The *FA-154* runs on all IBM-PC bus machines, Apple II's, Commodores, Tandy, and other computers.

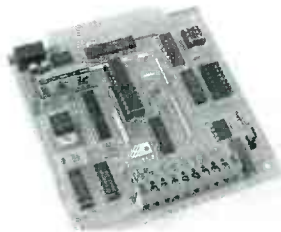

CIRCLE 36 ON FREE INFORMATION CARD

The *FA-154* analog-to-digital converter costs \$179.00.—**Alpha Products**, 242 West Avenue, Darien, CT 96820.

DUAL DATA ANALYZER.

Containing two BERT's, two data-line monitors, and two terminal emulators in one compact package, the *Gemini 1022* from *Telecom Analysis Systems (TAS)* simplifies bench-top testing of data-communications equipment such as modems, ISDN terminal adapters, and DDS sets. It performs bit error-rate, throughput, and polling-performance tests at rates up to 72 kilobytes per second. The tests can be run

simultaneously at both ends of the communications path, cutting in half the amount of equipment needed for an end-to-end test.

A built-in call-setup feature eliminates the need for separate data terminals, line monitors, and A/B switches when testing auto-dial modems, which reduces the cost and complexity of modem-testing arrangements. *Gemini* uses a variety of protocols to communicate with modems, and also monitors and displays modem call-setup commands, as well as command responses.

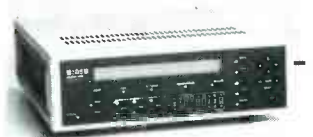

CIRCLE 37 ON FREE INFORMATION CARD

The analyzer can be controlled either through its front-panel keypad and display or through its built-in RS-232 and GPIB interfaces. The simple control-interface commands make it easy to incorporate the unit into automatic modem-test systems. A built-in RS-232-to-GPIB protocol converter allows control of several pieces of GPIB equipment from a single RS-232 port. Its plug-in software cartridge makes it easy to add more features later, and *Gemini* can be combined with other products from *TAS* to make a compact, completely automatic, modem-test system.

The *Gemini 1022* dual data analyzer costs \$5950.00.—**Telecom Analysis Systems, Inc.**, 34 Industrial Way East, Eatontown, NJ 07724.

WRIST-STRAP TESTER. Designed to detect malfunctions or breakage in wrist-strap assemblies, *Plastic Systems' WT-6600* also enhances ESD protection. The device also detects inadequate contact between band and operator.

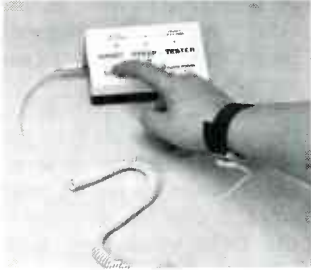

CIRCLE 38 ON FREE INFORMATION CARD

The tester is accurate, portable, and easy to use in electronics and other fields where ESD is a concern. The tester indicates **HAZARD** at readings of less than 470 kilohms, **OK** at less than 10 megohms and higher than 470 kilohms, and **CAUTION** at readings higher than 10 megohms.

The *WT-6600* wrist-strap tester costs \$100.00.—**Plastic Systems, Inc.**, 261 Cedar Hill Street, Marlboro, MA 01752.

MOUNTING KIT. The *MS10* mounting kit is designed to make the *CALEX XW-series "U"-case-size DC-to-DC converters* ready to use. The *CALEX XW DC-to-DC converter series* includes six single- and six dual-output units with up to 30 watts of isolated and highly regulated low-noise output power. Single-output units have input-voltage ranges of 9–36 or 20–72 volts; the dual-output units have 9–18-, 18–36-, or 36–72-volt input ranges.



CIRCLE 39 ON FREE INFORMATION CARD

The *MS-10* converter consists of a PC board, eight single-pin gold-plated sockets, and input/output barrier strips for easy screw-driver connections. The kit is constructed of 1/16-inch glass epoxy and measures 3.25 by 6.3 inches. There are four holes in the board, on 2.75 x 5.5-inch centers, for chassis mounting.

The *MS-10* DC-to-DC converter kit costs \$36.00; the *XW converters* range in price from \$160.00 to \$165.00.—**CALEX Mfg. Co., Inc.**, 3355 Vincent Road, Pleasant Hill, CA 94523.

DIGITAL PANEL METERS. Measuring less than 1 x 2 inches, the *ACCULEX DP-352J* and *DP-352K* thermocouple-input Digital Panel Meters (DPM's) have large 3.5-digit LED displays that can be read in direct sunlight as well as in low-light situations. The high-performance *DP-352J* and *DP-352K* support J- and K-type thermocouples, respectively. They provide



CIRCLE 40 ON FREE INFORMATION CARD

cold junction compensation and display directly in degrees Centigrade. A full-scale display range of 0–200°C is standard. Screw-terminal connectors for both primary operating power and direct signal input allow quick and easy field installation.

The *DP-352J/K's* full differential input and dual-slope integrating A/D converters, combined with common-mode rejection capability of greater than 86 dB, allow precise temperature measurements even under poor environmental and electrical conditions. Their accuracy is rated to 1% full scale (±1 digit) with an operating temperature range of 0–50°C.



Cut Your Video Servicing Time By 54%

With the Market Proven VA62 Universal Video Analyzing System.

Today's VCRs, TVs, and MTS Stereo TVs require a proven method to quickly isolate the defective component. New technology has made simple problem solving a time-consuming and expensive procedure.

A survey of over 1500 Video Analyzer owners has shown that the VA62's unique signal substitution method has reduced their video servicing time by an average of 54%, and increased their servicing profits.

You can join the successful service centers that have cut their video servicing time and increased their profits with the VA62 Universal Video Analyzing System. Call for a brochure on the VA62. Call **1-800-SENCORE** and increase your profits. In Canada also call **1-800-SENCORE**.

SENCORE

3200 Sencore Drive, Sioux Falls, SD 57107

100% American Made

CIRCLE 177 ON FREE INFORMATION CARD

With a low +5 volts DC at 250 mA primary operating power, the DPM's can be used for field/mobile use or as standard temperature monitors for automotive/marine/avionics applications. Other applications include energy management; electronic test and burn-in chambers; marine, automotive, and medical instrumentation; petrochemical processing; and biochemical and biomedical R&D.

The DP-352J and DP-352K thermocouple-input digital panel meters each cost \$119.00.—ACCULEX, A MetraByte Company, 440 Myles Standish Blvd., Taunton, MA 02780.

PIN-FIN HEAT SINK. A cast-aluminum, pin-fin heat sink for cooling 14×14- and 15×15-pin array (PGA) packages is now commercially available from Aavid Engineering. Model 567900 is made in a high-conductivity aluminum alloy cast in a staggered-pin configura-



CIRCLE 41 ON FREE INFORMATION CARD

tion, providing highly efficient cooling for those popular PGA packages.

The advanced aluminum-casting technology used in their manufacture produces a denser, more thermally efficient heat sink than is possible to attain using conventional die casting. Enhanced conductivity, combined with the efficient pin-fin cooling surface, ensures low semiconductor temperatures at high power-output levels.

The heat sink provides rapid heat dissipation for

any high-speed, high-power (greater than 3 watts) PGA package—including bipolar, BICOS, and high-density CMOS. Model 567900 has a thermal resistance of 8°C/W with a load of 5-watts under natural convection. The mounting surface is smooth and flat, with an edge stop for simplified self-fixing and adhesive bonding. The heat sink is available in black-anodized and gold-chromate finishes.

The model 567900 pin-fin heat sink costs \$1.63 in lots of 1000.—Aavid Engineering, Inc., One Kool Path, P.O. Box 400, Laconia, NH 03247.

S-VHS TESTING OPTION.

An optional add-on for several color-TV pattern generators from John Fluke Mfg. Co. provides the capability to test Super-VHS VCR's. The PM 9553 Y/C option provides the separate luminance (Y) and chrominance (C) signals used in S-VHS recording and playback to reduce cross-contamination



CIRCLE 42 ON FREE INFORMATION CARD

between the signals. Its versatility is further enhanced by its standard RGB-output signals.

The PM 9553 Y/C option fits in the PM 5514V, PM 5515, and PM 5518 (pictured here) color pattern generators. It can be installed at the time of purchase or retrofitted to existing pattern generators.

Factory installed, the PM 9553 Y/C option carries a list price of \$600.00.—John Fluke Mfg. Co., Inc., P.O. Box 9090, Everett, WA 98206; Tel. 800-443-5853.

SOLDERING SYSTEM. With its patented "thermal thrust" tip design, the Ungar 9910HC delivers 40% higher thermal capacity than micro irons that use

KENWOOD OSCILLOSCOPES

If you want better measurements, check these figures out.

ANALOG OSCILLOSCOPES W/O READOUT		REGULAR	SALE
CS-1021	20MHz, Dual Channel	519.00	399.95
CS-5135	40MHz 2CH, 4-Trace, Delayed Sweep	895.00	719.95
CS-5155	50MHz 3CH, 6-Trace, Delayed Sweep	995.00	819.95
CS-5165	60MHz 3CH, 6-Trace, Delayed Sweep	1095.00	899.95
CS-2150	150MHz 4CH, 8-Trace, Delayed Sweep	2395.00	1495.95
ANALOG OSCILLOSCOPES W/READOUT/CUSORS			
CS-5130	40MHz 2CH, 4-Trace, Delayed Sweep	1095.00	899.95
CS-5140	Analog 40MHz/100MHz (Equivalent Sampling) 2CH, Readout Cursor	1395.00	999.95
CS-5170	100MHz, 2CH, 4-Trace, Delayed Sweep	1695.00	1399.95
CS-6010	100MHz, 4CH, 10-Trace, Delayed Sweep	1995.00	1699.95
CS-6020	150MHz, 4CH, 10-Trace, Delayed Sweep	2395.00	1999.95
DIGITAL STORAGE OSCILLOSCOPE			
CS-8010	Digital Storage Oscilloscope 2CH, Readout/Cursor 10M Samples/Sec. 20MHz Real Time	1495.00	1299.95



8931 Brookville Rd.
Silver Spring, Md. 20910
(800) 638-2020 (301) 587-7824
Fax (301) 585-5402
Easy Order Fax Line (800) 545-0058

800-638-2020

Kenwood Test Equipment.
From the company you've been listening to for years.



Complete Kenwood Line Available
"Call For Your Price Quotations"

CIRCLE 194 ON FREE INFORMATION CARD

THE ELECTRONIC GOLDMINE

INFRARED DETECTOR KIT
Uses sensitive sensor and electronic circuitry to respond to all types of infrared TV, VCR, etc. remote controllers and LEDs by producing sound and lighting a bright red LED. Great for testing and verification of infrared output—see what you can not see. Small size: 2.5" x 1.4". Operates on 9V battery (not included). Kit comes with all parts and PC board.



C6441 \$5.95

MINI GEIGER COUNTER KIT
This useful kit lets you detect the radiation that you are being exposed to! Use it to detect radium dial, old watches, camping lantern mantles, radioactive minerals, background radiation, etc. Kit detects alpha, beta, gamma and X-ray radiation and features sensitive alpha window GM tube with IC Circuit. (Tinted clock in proportion to intensity of radiation! Size only 1.5" x 3". Operates from one 9V battery (not included). With all parts and PC board.

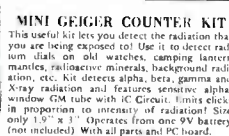

C6430 \$59.95

20W + 20W STEREO AMP KIT

Two separate high power amps on one PC board. Each amp has its own level control and puts out an incredible 20 Watts RMS. Features red LED "on" indicator and low distortion circuitry. Great stereo booster amp for your car sound system. Use with any speakers capable of handling at least 20 watts. Operates on 12VDC. With all parts and pc board.

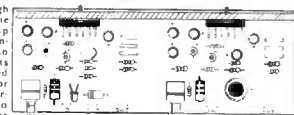

C6442 \$19.95

10W + 10W STEREO AMP KIT

Similar to the amp above only this one puts out 10 watts RMS to each channel. Features one level control that sets level in both channels and red LED "on" indicator. Use this amp with your speakers to boost portable tape players, radios, or CD players to full rich room filling volume. Operates from 12VDC. With all parts and pc board.

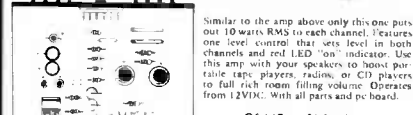

C6443 \$16.95

20 WATT RMS MONO AMP KIT

High power amp for various booster applications. Kit features short circuit and open circuit protection and has very low distortion (1% or less). Amplifier has red LED "on" indicator and will boost any tuner, radio, cassette, CD player to room filling volume out of your speakers! Operates from 12VDC. With all parts and pc board.

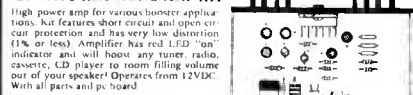

C6444 \$14.95

FREE CATALOG! We include our catalog containing over 130 kits and hundreds of unique components (P&H with each order). We are continually adding new items to our catalog and once you order we will place your name on our preferred customer mailing list to receive it!

MINIMUM ORDER \$10.00 plus 3.00 shipping and handling. We accept M/C, Visa and money orders. COD fee: 2.50 in addition to 3.00 shipping charge.
SEND ORDERS TO: The Electronic Goldmine
P.O. Box 5408 Scottsdale, AZ 85261
PHONE ORDERS: (602) 451-7454

CIRCLE 178 ON FREE INFORMATION CARD



CIRCLE 43 ON FREE INFORMATION CARD

standard tips. Thermal capacity—the iron's ability to minimize and quickly recover from heat loss—determines the system's ability to make repetitive and reliable solder joints. A higher capacity is generally required for soldering larger parts. The *Ungar* system combines the comfort and simplicity of a small iron with the high capacity of a much larger one, so it can be used for high-mass, heavy heat-sink applications as well as for lighter work.

The ESD-protected

9910HC has a closed-loop circuit for temperature stability at idle. It also features zero switching, reliable grounding form tip to plug, a durable ceramic heater, and a cool grip. The 24-volt micro iron can be customized with a choice of three additional, easy-to-connect irons with a variety of tips. The system meets or exceeds government soldering specifications DOD-STD-2000-1B, WS-6536E, MIL-S-47543E, and MIL-STD-2000. If you are looking for an ESD-protected soldering system that's versatile enough to cover all of your soldering needs, than the 9910HC may be exactly what you need.

The 9910HC soldering system has a suggested retail price of \$236.00.—Ungar, Division of Eldon Industries, Inc., 5620 Knott Avenue, Buena Park, CA 90621.

16-BIT D/A CONVERTER. A new family of extended temperature-range, 16-bit digital-to-analog converters

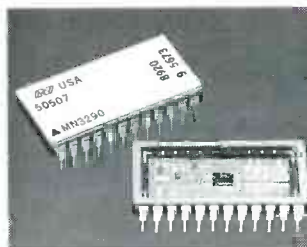

CIRCLE 44 ON FREE INFORMATION CARD

(DAC's) is targeted for demanding military, aerospace, and industrial applications. *Micro Networks'* MN3290 series is exactly pin- and function-compatible with older, industry-standard DAC7172 devices, and is expected to replace many of those older devices in new and existing military programs.

There are 37 different models in the series, including six different voltage- and current-output devices that each offer four different electrical grades to address both commercial (0°C to 70°C) and military (-55°C to +125°C) applications. The extended temperature-

range devices are available screened in accordance with military specifications.

The MN3290 series DAC's are made using a bipolar process. They are TTL compatible and contain an on-chip, low-noise, buried-Zener reference. The devices are packaged in standard, 24-pin, ceramic DIP's. All of them guarantee 14-bit monotonicity at room temperature; the higher grade devices guarantee 14-bit monotonicity and ±0.006%FSR integral linearity over the entire extended temperature range.

The MN3290 commercial and military-standard current-output devices are priced from \$31.00 and from \$75.00, respectively, in quantities of 100. The commercial and military-standard voltage-output devices are priced from \$33.00 and from \$75.00, respectively, also in quantities of 100.—**Micro Networks/Unitrode Corporation**, 324 Clark Street, Worcester, MA 01606.

R-E

MOVIE TIME

CABLE CONVERTERS

NEW!

78 Channel Wireless Remote • Remote Fine Tuning • Parental Control
10 dB Amplifier Favorite Channel Memory • Fine Tune Centering
24 MONTH WARRANTY

<p>(#1) V7800-3 V7800-2</p> <p>15 Lot \$62.95</p> <p>10 Lot \$64.95</p> <p>(3-9) \$69.95 (1-2) \$89.95</p>		<p>(#2) with Volume & Mute Control Last Channel Recall Audio...Output • Decoder Loop</p> <p>10 Lot \$79.95</p> <p>(3-9) \$89.95 (1-2) \$109.95</p>
JERROLD		
<p>(#3) JERROLD - 450 68 Channels Automatic Fine Tune Rebuilt Ch. 3 Only 90 Day Warranty</p> <p>(3-9) \$63.95 (1-2) \$73.95</p>	 <p>10 Lot \$53.95</p>	<p>(#4) JERROLD - JSX 36 Channels Fine Tuning Rebuilt Ch. 3 Only 90 Day Warranty</p> <p>(3-9) \$34.95 (1-2) \$39.95</p>
<p>(#5) HAMLIN - 4000 42 Channels Fine Tuning Wired Remote or Set Top Rebuilt Ch. 2 Only 90 Day Warranty</p> <p>(3-9) \$34.95 (1-2) \$39.95</p>	 <p>10 Lot \$29.95</p>	
<p style="text-align: center;">MOVIE TIME REPLACEMENT HAND UNITS</p> <p>\$14.95 24 Lot</p> <p>Single Lot \$24.95</p> <p>#6 JERROLD-550 #7 JERROLD-450 #9 JERROLD-400 #10 TEXSCAN AND MORE #13-23 \$16.95 (2-12) \$19.95</p>		
<p>ALL OF THE ABOVE CABLE CONVERTERS ARE COMPATIBLE WITH ALL CABLE DECODERS * NONE OF THE ABOVE UNITS ARE CABLE DECODERS</p>		
<p style="text-align: center;">MOVIE TIME</p> <p>20203 N.E. 15th Court • Miami, FL 33179 FAX: (305) 653-8102</p> <p>For More Information Call For Crders Only Call</p> <p>1-305-652-1981 1-800-843-9845</p>		
<p style="text-align: center;">C.O.D.</p> <div style="display: flex; justify-content: center; gap: 20px;">    </div>		

CIRCLE 193 ON FREE INFORMATION CARD

www.americanradiohistory.com

Take any one of these HANDBOOKS ELECTRONICS and CONTROL

- your one source for engineering books from over 100 different publishers
- the latest and best information in your field
- discounts of up to 40% off publishers' list prices

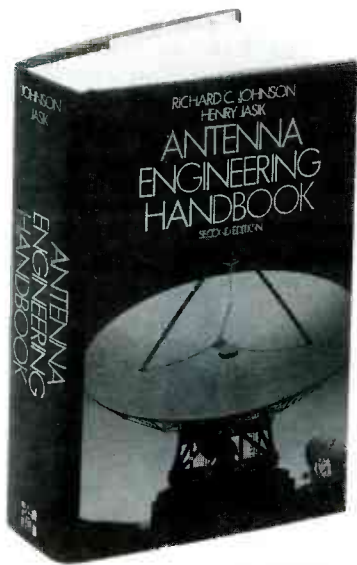

322/910

Publisher's Price \$119.50

ANTENNA ENGINEERING HANDBOOK, Second Edition

Edited by R. C. Johnson and H. Jasik

- 1,408 pages, 946 illustrations
- covers all types of antennas currently in use with a separate chapter devoted to each
- provides detailed data on physical fundamentals, operating principles, design techniques, and performance data
- up-to-the-minute information on antenna applications
- a must for those involved in any phase of antenna engineering

Publisher's Price \$78.00

STANDARD HANDBOOK OF ENGINEERING CALCULATIONS, Second Edition

By T. G. Hicks

- 1,468 pages, 793 illustrations, 499 tables
- puts more than 1,100 specific calculation procedures at your fingertips
- every calculation procedure gives the exact, numbered steps to follow for a quick, accurate solution
- virtually all procedures can be easily programmed on your PC or calculator
- uses USCS and SI units in all calculation procedures

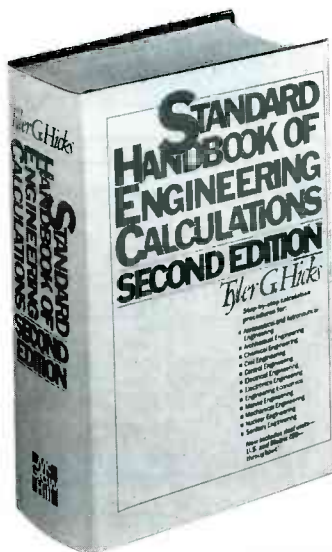

287/35X

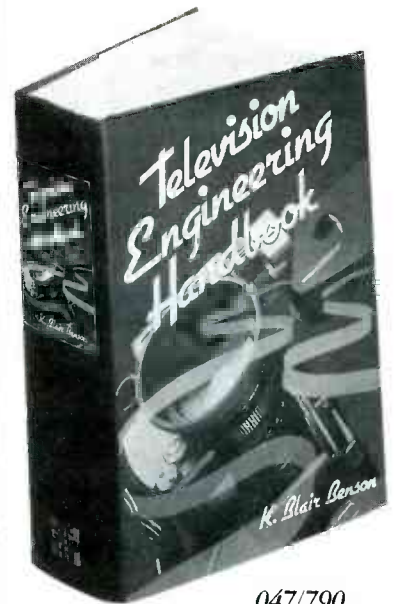

047/790

Publisher's Price \$99.95

TELEVISION ENGINEERING HANDBOOK

Edited by K. B. Benson

- 1,478 pages, 1,091 illustrations
- packed with all the technical information today's engineer needs to design, operate, and maintain every type of television equipment
- extensive coverage of receivers, broadcast equipment, video tape recording, video disc recording, and the latest technological advances
- provides television system and industry standards for the U.S. and other countries
- the most comprehensive book on the subject of television engineering

for only \$14.95 – when you join the ENGINEERS' BOOK CLUB

values up to \$119.50



404/461

Publisher's Price \$94.95

MODERN ELECTRONIC CIRCUITS REFERENCE MANUAL

By J. T. Markus

- 1,264 pages, 3,666 circuit diagrams
- a handy, desktop reference with 103 chapters organized by "family" grouping
- filled with predesigned and use-tested circuits to save you production time and money
- includes concise summaries of all the recent applications notes, journal articles, and reports on each circuit, efficiently organized and indexed for the practicing engineer

Publisher's Price \$92.00

STANDARD HANDBOOK FOR ELECTRICAL ENGINEERS, Twelfth Edition

Edited by D.G. Fink and H.W. Beaty

- 2,416 pages, 1,388 illustrations, 430 tables
- the essential reference for all electrical engineers
- ranges from basic circuits and measurements to advanced topics, such as power distribution and telecommunications
- fully updated to cover all recent advances and developments
- written and compiled by 115 contributors – all experts in their fields

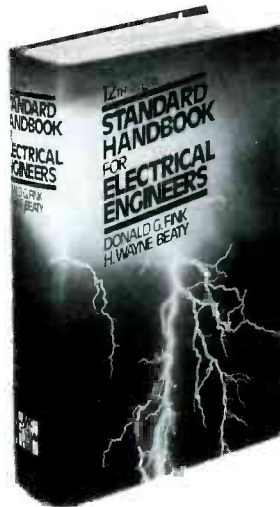

209/758



4 reasons to join today!

1. Best and newest books from ALL publishers! Books are selected from a wide range of publishers by expert editors and consultants to give you continuing access to the best and latest books in your field.

2. Big savings! Build your library and save money, too! Savings range up to 40% off publishers' list prices.

3. Bonus books! You will automatically be eligible to participate in our Bonus Book Plan that allows you savings up to 70% off the publishers' prices of many professional and general interest books!

4. Convenience! 14-16 times a year (about once every 3-4 weeks) you receive the Club Bulletin FREE. It fully describes the Main Selection and alternate selections. A dated Reply Card is included. If you want the Main Selection, you simply do nothing – it will be shipped automatically. If you want an alternate selection – or no book at all – you simply indicate it on the Reply Card and return it by the date specified. You will have at least 10 days to decide. If, because of late delivery of the Bulletin you receive a Main Selection you do not want, you may return it for credit at the Club's expense.

As a Club member you agree only to the purchase of two additional books during your first year of membership. Membership may be discontinued by either you or the Club at any time after you have purchased the two additional books.

FOR FASTER SERVICE IN ENROLLING CALL TOLL FREE 1-800-2-MCGRAW

McGraw-Hill Book Clubs
Electronics and Control Engineers' Book Club®
P.O. Box 582
Hightstown, NJ 08520-9959

Please enroll me as a member of the Electronics and Control Engineers' Book Club® and send me the book I have chosen for only \$14.95 plus local tax, postage and handling. I agree to purchase a minimum of two additional books during my first year as outlined under the Club plan described in this ad. Membership in the club is cancellable by me or McGraw-Hill any time after the two book purchase requirement has been fulfilled. A shipping and handling charge is added to all shipments.

I wish to order the following book:

- ANTENNA ENGINEERING HANDBOOK (322/910)
- MODERN ELECTRONIC CIRCUITS REFERENCE MANUAL (404/461)
- STANDARD HANDBOOK FOR ELECTRICAL ENGINEERS, 12/e (209/758)
- TELEVISION ENGINEERING HANDBOOK (047/790)
- STANDARD HANDBOOK OF ENGINEERING CALCULATIONS (287/35X)

Signature _____

Name _____

Address/Apt. # _____

City/State/Zip _____

This order subject to acceptance by McGraw-Hill. Offer good only to new members. Foreign member acceptance subject to special conditions.

ECGA-031

NEW LIT

INSTRUMENT CATALOG. Wide selections of instruments for test and measurement, plant maintenance, water-quality checks, and monitor/control applications are featured in this 44-page brochure from *Extech*.



CIRCLE 45 ON FREE INFORMATION CARD

Photographs accompany every item listed, and the text includes helpful information on how to choose the right instrument for spe-

cific applications, as well as explanations of the instruments' features. There is no charge for the catalog.—**Extech Instruments**, 150 Bear Hill Road, Waltham, MA 02154; Tel. 617-890-7440.

INTERCONNECTION PARTS. The 1990 edition of *L-com's* catalog includes more than 3,500 items. A full line of components and accessories for the electronic, computer, and communications markets is featured—including an extensive line of more than 1,200 ready-made coaxial and data cables, baluns, IEEE-488 cables and accessories, patch panels, and line testers. To help the user evaluate the products listed, the catalog has full product descriptions,



CIRCLE 46 ON FREE INFORMATION CARD

usage information, and pricing up to moderate quantities. Some of the new products in this edition are modular and IBM token-ring wiring aids, an automatic and manual matrix switch, Wang-type surge protectors, Macintosh networking kits, and a new series of coaxial switches that are specifically made for panel mounting. The catalog is free upon request.—*L-*

com, Inc., 1755 Osgood Street, North Andover, MA 01845; Tel. 508-682-6936.

VCR-PARTS CROSS-REFERENCE. Providing the servicer with a quick reference source of key wear items—belts, motors, pressure rollers, and headwheels—*Thomson Consumer Elec-*

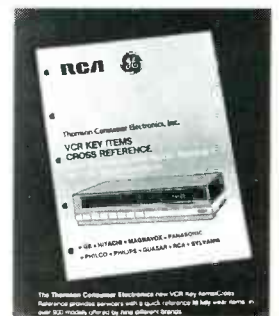

CIRCLE 47 ON FREE INFORMATION CARD

ATTENTION! ELECTRONICS TECHNICIANS

EARN YOUR **B.S.E.E. DEGREE**



THROUGH HOME STUDY

Our New and Highly Effective Advanced-Placement Program for experienced Electronic Technicians grants credit for previous Schooling and Professional Experience, and can greatly reduce the time required to complete Program and reach graduation. No residence schooling required for qualified Electronic Technicians. Through this Special Program you can pull all of the loose ends of your electronics background together and earn your B.S.E.E. Degree. Upgrade your status and pay to the Engineering Level. Advance Rapidly! Many finish in 12 months or less. Students and graduates in all 50 States and throughout the World. Established Over 40 Years! Write for free Descriptive Literature.

COOK'S INSTITUTE OF ELECTRONICS ENGINEERING

4251 CYPRESS DRIVE JACKSON, MISSISSIPPI 39212

CIRCLE 58 ON FREE INFORMATION CARD

CABLE - TV

SIGNAL REMOVERS

- FOR ELIMINATION OF SEVERE INTERFERENCE
- FOR "CENSORING" OF ADULT BROADCASTS



FOR FULL DESCRIPTION OF USES ask for our free brochure

- ATTENUATION - 45 dB TYPICAL
- BANDWIDTH - 4 MHz AT 5 dB POINTS
- INSERTION LOSS - 2 dB

MODEL	TUNING RANGE	FOR CHANNELS	PASSBAND	PRICE	SHIPPING
23H	50-66 MHz	2,3 (or 6 meter ham)	50-300 MHz	\$30	NO SHIPPING OF C.O.D. CHARGES
46FM	66-108 MHz	4,5,6 (or any FM)	50-300 MHz	\$30	
1417	120-144 MHz	14(A) 15(B) 16 (C) 17(D)	50-400 MHz	\$30	
1822	144-174 MHz	18(E) 19(F) 20(G) 21(H) 22(I)	50-400 MHz	\$30	
713	174-216 MHz	7,8,9,10,11,12,13	50-400 MHz	\$30	

3 for \$75 - 10 for \$200 - mix or match

CALL TOLL FREE FOR C.O.D. OR SEND CHECK TO ORDER
FAST DELIVERY
30 DAY MONEY BACK GUARANTEE (3 FILTER LIMIT)

Star Circuits

P. O. Box 94917

Las Vegas, NV 89193-4917

1-800-433-6319



One tree can make 3,000,000 matches.



One match can burn 3,000,000 trees.



A Public Service of The Ad Council
© The Advertising Council

tronics' VCR Key Items Cross Reference lists more than 900 models. The guide contains references to 90% of a servicer's parts needs for nine popular brands: RCA, GE, Hitachi, Magnovox, Panasonic, Philco, Philips, Quasar, and Sylvania. The Thomson stock number, as well as a reference number that corresponds to the number shown on the service-data parts list and on the exploded view diagram of the VCR model listed, is included. When combined with the Thomson cross-reference microfiche, the quick-reference guide provides access the entire VCR replacement parts line.—**Thomson Consumer Electronics**, Service Dealer Parts and Components Merchandising, 2000 Clements Bridge Road, Dextford, NJ 08096-2088.

APPLICATION NOTE. Motorola's Spice Model for TMOS Power MOSFETs (ANI043/D) includes a library of parameters on selected devices that can be used in conjunction with existing simulation programs. The library is available free of charge on 3½- or 5¼-inch disks for IBM-compatible computers (DK301/D and DK103/D, respectively), or on a 3½-inch disk for use with Macintosh PC's (DK202/D). The note also

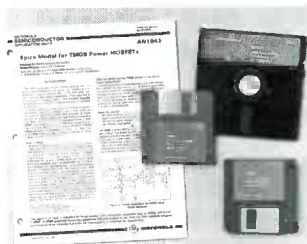

CIRCLE 48 ON FREE INFORMATION CARD

discusses the physics of power MOSFETs, implementation of a model for simulation programs, parameter extraction methods, and a comparison of a simulation with measured results. The application note and the TMOS Library disk are free.—**Motorola Literature Distribution**, P.O. Box 20912, Phoenix, AZ 85036; Tel. 1-800-521-6274.

Extend Your Frequency Counter Range To 1.3GHz Without Extending Your Budget.

FC130A Frequency Counter

- .01Hz to 1.3GHz Frequency Range
- 8-Digit LED Display

- Measures Frequency, Period and Rate per Minute (RPM)
- 10mV Sensitivity (Typical)



\$595

Beckman Industrial™
An Affiliate of Emerson Electric Co

For more information and the location of your nearest authorized Beckman Industrial dealer call 1-800-854-2708 (in California 1-800-227-9781). Instrumentation Products Division, 3883 Ruffin Road, San Diego, CA 92123-1898
© 1989 Beckman Industrial Corporation. Specifications are subject to change without notice.

CIRCLE 98 ON FREE INFORMATION CARD

JN161-01-0490

M O R E T H A N

TIME



Most Accurate Clock by Heathkit®

Discover the world's most accurate time piece plus a large assortment of other electronic products in your **FREE Heathkit Catalog**. It's filled with both kit and ready-to-use home theater components, weather stations and amateur radio products, along with kit

laptop computers and a wide variety of self-study courses for the novice or seasoned electronics enthusiast. Order your **FREE Heathkit Catalog** today. Time's a wasting!

1-800-44-HEATH
(1-800-444-3284)

Send to: Heath Company, Dept. 020-884
Benton Harbor, Michigan 49022

Name _____
Address _____
City _____ State _____ Zip _____

CIRCLE 86 ON FREE INFORMATION CARD

HITACHI SCOPES AT DISCOUNT PRICES

Digital Storage Scopes



VC-6025 20MS/S
50MHz Bandwidth
2K Word Memory
Capacity
\$2349.00

Advanced storage functions create new dimensions in scopes such as one shot observation, flicker free display, bright display for even high speed event, trace observation for low speed event, hard copy by plotter and data output to computer.

VC-6045 100MHz 40MS/S 4K word Memory cap (call)

All Hitachi scopes include probes, schematics, and Hitachi's 3 year worldwide warranty on parts and labor. Many accessories available for all scopes.



V-212
\$435
List \$595
Save \$160
DC to 20MHz
Dual Channel



V-1060
List \$1595 **\$1,359**

- DC to 100MHz
- Dual Channel
- Delayed Sweep
- CRT Readout
- Sweep Time
- Autoranging
- Trigger Lock
- 2mV Sensitivity

	LIST	PRICE	SAVE
V-422 40MHz D.T., 1mV sens, DC Offset Vert Mode Trigger, Alt Mag	\$940	\$740	\$200
V-423 40MHz D.T., 1mV sens, Delayed Sweep, DC Offset, Alt Mag	\$1,025	\$825	\$200
V-425 40MHz D.T., 1mV sens, DC Offset, CRT Readout, Cursor Meas	\$1,070	\$849	\$221
V-660 60MHz D.T., 2mV sens, Delayed Sweep, CRT Readout	\$1,295	\$1,145	\$150
V-1065 100MHz D.T., 2mV sens, Delayed Sweep, CRT Readout, Cursor Meas	\$1,895	\$1,670	\$225
V-1100A 100MHz Q.T., 1mV sens, Delayed Sweep, CRT Readout, DVM, Counter	\$2,450	\$2,095	\$355
V-1150 150MHz Q.T., 1mV sens, Delayed Sweep, Cursor Meas, DVM, Counter	\$3,100	\$2,675	\$425

ELENCO PRODUCTS AT DISCOUNT PRICES

20MHz Dual Trace Oscilloscope

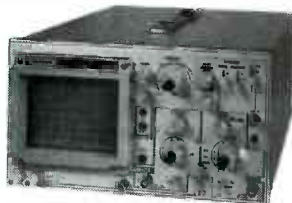

\$375
MO-1251

- 6" CRT
- Built in component tester
- TV Sync

FREE DMM

with purchase of
ANY SCOPE

SCOPE PROBES

P-1 65MHz, 1x, 10x \$19.95
P-2 100MHz, 1x, 10x \$23.95

35MHz Dual Trace Oscilloscope

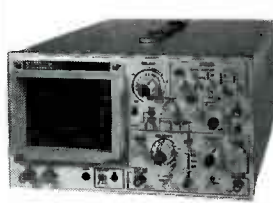

\$495
MO-1252

- High luminance 6" CRT
- 1mV Sensitivity
- 6KV Acceleration Voltage
- 10ns Rise Time
- X-Y Operation • Z Axis
- Delayed Triggering Sweep

Top quality scopes at a very reasonable price. Contains all desired features. Two 1x, 10x probes, diagrams and manual. Two year guarantee.

PRICE BREAKTHRU on Auto Ranging DMMs



3 to choose from:
MDM-1180
\$24.95

MDM-1181
\$27.95

MDM-1182
\$29.95

- 3 1/2 LCD Display
- 27 Functions
- Auto /Manual Ranges
- Audible Continuity
- Data Hold (MDM-1182)
- .1% Accuracy (MDM-1181)



True RMS 4 1/2
Digit Multimeter
\$135 M-7000

.05% DC Accuracy
.1% Resistance
with Freq. Counter
and deluxe case



Multimeter with
Capacitance and
Transistor Tester
\$55 CM-1500

Reads Volts, Ohms,
Current, Capacitors,
Transistors and
Diodes with case

Digital Capacitance Meter



CM-1550
\$58.95

9 Ranges
.1pf-20,000ufd
.5% basic accy
Zero control
with case



LC-1801
\$125

Measures
Coils 1uH-200H
Caps .1pf-200uf
Res .01-20M

Bench DMMS



M-3500
3 1/2 digit
3.1% accy

M-4500
4 1/2 digit
0.5% accy **\$175**



AC Current Meter
ST-1010
\$69.95

1000 Amps
Data & Peak Hold
8 Functions
Deluxe Case

Solderless Breadboards



9430
1,100 pins **\$15**
9434
2,170 pins **\$25**
9436
2,860 pins **\$35**
All have color
coded posts

9436 SHOWN

AC Clamp-On



Current Adapter
ST-265
\$25.00

0-1000A AC
Works with
most DMM

Wide Band Signal Generators

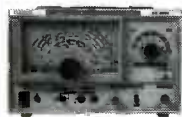

SG-9000 **\$129**

RF Freq 100K-450MHz
AM Modulation of 1KHz
Variable RF output

SG-9500 with Digital Display
and 150MHz built-in Freq Ctr **\$249**

TRIPLE POWER SUPPLY XP-620



Assembled **\$65**
Kit **\$45**

2 to 15V at 1A,
-2 to -15V at 1A
(or 4 to 30V at 1A)
and 5V at 3A

Contains all the desired features for
doing experiments. Features short
circuit protection all supplies

Function Generator



Blox
#9600
\$28.95

Provides sine, tri, squ wave.
from 1Hz to 1MHz
AM or FM capability

Decade Blox



#9610 or
#9620
\$18.95

#9610 Resistor Blox
47 ohm to 1M & 100K pot
#9620 Capacitor Blox
47pf to 10MFD

Digital Triple Power Supply



XP-765
\$249

0-20V at 1A
0-20V at 1A
5V at 5A

Fully Regulated, Short circuit protected with
2 Limit Cont., 3 Separate supplies
XP-660 with Analog Meters **\$175**

Quad Power Supply

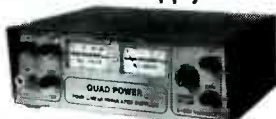

XP-580
\$59.95

2-20V at 2A
12V at 1A
5V at 3A
-5V at 5A

Fully regulated and
short circuit protected
XP-575 without meters **\$39.95**

LEARN TO BUILD AND PROGRAM COMPUTERS WITH THIS KIT!

INCLUDES: All Parts, Assembly and Lesson Manual



MODEL
MM-8000

\$129.00

Starting from scratch you build a complete system. Our Micro-Master trainer teaches you to write into RAMS, ROMS and run a 8085 microprocessor, which uses similar machine language as IBM PC. You will write the initial instructions to tell the 8085 processor to get started and store these instructions in permanent memory in a 2816 EPROM. Teaches you all about input and output ports, computer timers. Build your own keyboard and learn how to scan keyboard and display. No previous computer knowledge required. Simple easy to understand instruction teaches you to write in machine language.

Four-Function Frequency Counters



F-100 120MH
\$179

F-1000 1.2GH
\$259

Frequency, Period, Totalize,
Self Check with High Stabilized Crystal Oven
Oscillator, 8 digit LED display

GF-8016 Function Generator with Freq. Counter



\$249

Sine, Square, Triangle
Pulse, Ramp, .2 to 2MHz
Freq Counter .1 - 10MHz

GF-8015 without Freq. Meter **\$179**

WE WILL NOT BE UNDERSOLD!

UPS Shipping: 48 States 5%

(\$10 Max) IL Res., 7% Tax



C & S SALES INC.
1245 Rosewood, Deerfield, IL 60015
(800) 292-7711 (708) 541-0710

15 Day Money Back Guarantee
2 Year Warranty Prices subject to change

WRITE FOR FREE CATALOG

BUILD THIS

MORSE/RTTY DETECTOR

IF YOU ARE EVEN A CASUAL LISTENER OF shortwave radio, you've undoubtedly heard lots of Morse code (CW) and radioteletype (RTTY) communications. Unless you're a radio amateur, you've probably been frustrated because you can't decipher those signals—that is, until now. Now you can build our PMX-200 CW/RTTY detector, connect it to your computer's serial port, and display all of those messages that have previously been hidden from you.

The impetus for the project's design was the author's frustration with the performance of other Morse and RTTY detectors on the market, specifically their inability to copy weak and noisy signals. Despite the fact that there has been a great deal of effort to improve the software side of communications (like packet), the actual detection schemes have changed little if at all.

The detector's performance plays a critical role in a truly high-quality CW or RTTY system, since any information lost cannot be recovered. The detector presented here circumvents many of the traditional difficulties. Its digital detection scheme takes CW and RTTY performance very nearly to the theoretical limit.

Display system

While most RTTY systems are difficult to tune, the PMX-200 uses a digital detector that makes the proper tuning procedure intuitive even to the inexperienced user. Two rows of LED's allow you to see which way you need to tune even before mistuning causes misprint. In CW mode, only one row is lit, which helps to reduce distraction. In RTTY mode, both rows are used. As a tuning aid, the front-panel shift-select switches are decoded. The display will be properly lit only when the proper RTTY shift has been selected for the incoming signal. Even inexperienced users should have no problem with proper tuning.

*Let your computer decypher Morse code
and radioteletype signals even if you
don't know a dit from a dah!*

LARRY ASHWORTH, K47A-R

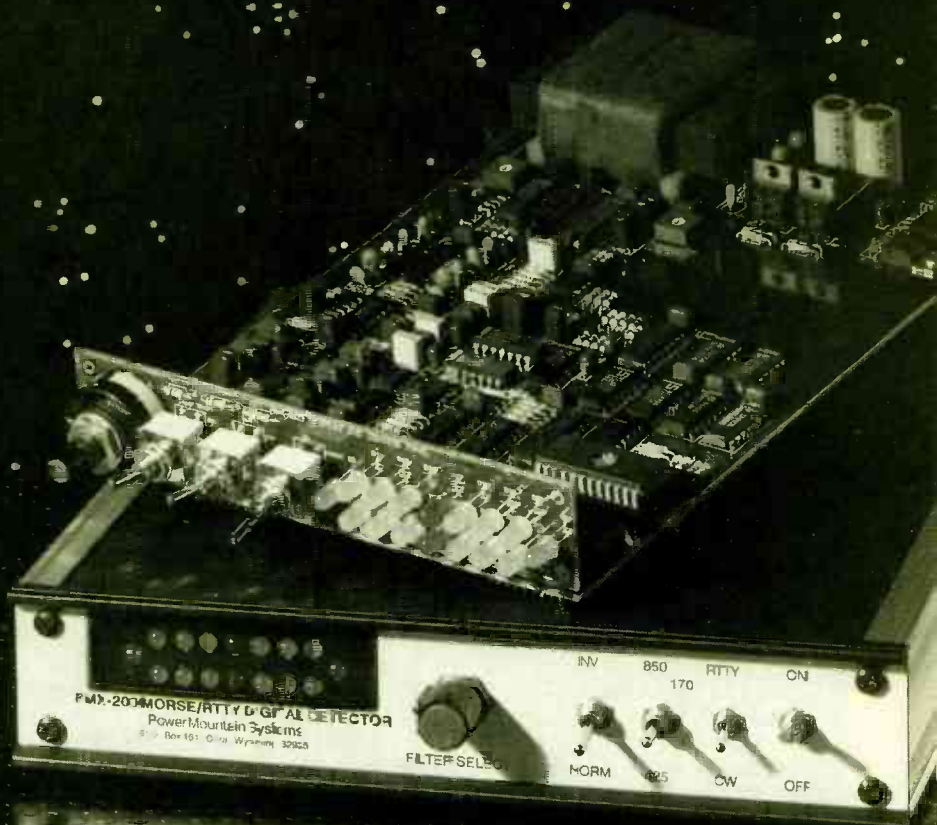

CW modulation

Whenever intelligence is added to a carrier, whether by FM, AM, FSK, SSB, or any other method, there are limitations imposed. The limitations are weighed against their strengths to determine the suitability of a given system for communications. ASCII, as opposed to Baudot, in RTTY is a good example of tradeoffs like that.

ASCII has a larger character set available but, since each character takes nearly twice as long to transmit, it is nearly twice as error prone. For transferring computer programs and lower-case text ASCII is the best, but

for communicating messages and news, Baudot is better. That's why some commercial carriers still use Baudot.

CW takes less bandwidth than any other modulation system but, when conditions are poor, it's less capable than FSK for a given data rate. Some of the advantages of CW are that it is narrow, slow, and has a limited character set. That might not sound like anything positive, but for getting a message through in the worst of conditions, there is nothing better.

Morse code is a series of tone bursts whose relative duration, and

relative absence, carries meaning. That puts a great burden on our receiving system to extract all the information available. Noise immunity is extremely important, and the only thing we know for sure about the tone we are demodulating is the frequency.

Noise by its very nature can appear for an instant to be the frequency we are trying to detect, but will not have a duration long enough to be valid. The faster the detector can detect the correct frequency of the incoming tone, the higher the resolution. That means we can extract greater detail about the signal we are listening to. If we can

PARTS LIST

All resistors are 1/4-watt film except where otherwise indicated.

R1, R3, R6, R12, R43, R45, R49, R55, R81, R82, R89—39,000 ohms
R2, R9, R52, R53—27,000 ohms
R4, R7, R8, R19, R22, R24, R59—R62, R85—47,000 ohms
R5, R13, R86, R87—68,000 ohms
R10, R11, R14, R28—15,000 ohms
R15—R18, R69, R70—33,000 ohms
R21, R51, R76—220,000 ohms
R23, R90—20,000 ohms, 3/8-inch single-turn potentiometer
R25, R26, R34, R74, R77—330 ohms
R27, R30, R31, R78, R79—2200 ohms
R20—270 ohms
R29, R32, R33, R35—R39, R41, R50, R56—R58, R63—R65, R71—R73, R75—1000 ohms
R40—470 ohms
R42, R44, R48—48,000 ohms
R46, R47, R92—10,000 ohms
R54, R88—30,000 ohms
R66, R91, R93, R94—20,000 ohms
R67, R68, R95, R96—20,000 ohms, 10-turn potentiometer
R80—4700 ohms
R83, R84—22,000 ohms
R100—R105—2000 ohms

Capacitors

C1, C2—1000 μ F, electrolytic
C3, C29, C30, C40, C46, C63—10 μ F, electrolytic
C4—C28, C41, C47, C77, C78, C80—C82, C85—0.1 μ F, mylar
C31, C34—C36, C49, C51—0.0047 μ F, mylar
C32, C33—0.0027 μ F, mylar
C37, C38, C43, C44, C59—1 μ F, tantalum
C39, C45—2 μ F, tantalum
C42, C60—30 pF, ceramic
C48, C76, C79—0.22 μ F, mylar
C50, C52—0.002 μ F, mylar
C53, C55—0.003 μ F, mylar
C54, C56—0.0005 μ F, mylar

C57, C58—0.0068 μ F, mylar
C61, C62, C64, C65—0.047 μ F, mylar
C66—C69, C86—C89—0.01 μ F, mylar
C70, C71—0.15 μ F, mylar
C72, C73—0.068 μ F, mylar
C74, C75—0.03 μ F, mylar
C83, C84—0.001 μ F, mylar

Semiconductors

IC1, IC2—LM7805 5-volt regulator
IC3—LM7912 -12-volt regulator
IC4—NE570 compander
IC5, IC26, IC36—LM311 voltage comparator
IC6, IC25—LM324 low-power quad op-amp
IC7, IC8, IC27, IC28—4066 quad bilateral switch
IC9—74LS14 hex low-power Schottky Schmitt-trigger inverter
IC10, IC11, IC14, IC15—74LS161 synchronous binary counter
IC12, IC16—74LS30 8-input NAND gate
IC13, IC17—74LS244 octal tri-state buffer
IC18—74LS10 triple 3-input NAND gate
IC19—2.4576-MHz crystal oscillator
IC20—74LS90 decade counter
IC21, IC24—not used
IC22—2732 EPROM
IC23—74154 4-to-16 line decoder
IC29—7416 hex inverter buffer with high-voltage open-collector outputs
IC30—74LS147 10-line decimal to 4-line BCD encoder
IC31, IC32—LM358N low-power dual op-amp
IC33—1488 quad MDTL line driver
IC34—1489 quad MDTL line receiver
IC35—7414 hex Schmitt-trigger inverter
IC37, IC42—74LS00 quad 2-input NAND gate
IC38, IC39—LM555 timer
IC40—74LS05 open collector hex inverter

IC41—4018 presettable divide-by-N counter
D1—D6—1N4003 rectifier diode
D7—4.3-volt Zener diode
D8—4.7-volt Zener diode
Q1, Q2—TIP42C PNP transistor
LED1, LED16—green light emitting diode
LED5, LED12—red light emitting diode
LED2—LED4, LED6—LED11, LED13—LED16

Other components

T1—FP24-500.....
HDR1, HDR2—18-pin right angle header
HDR3—2-pin jumper header
S1, S4—DPDT PC-mount switch
S2—DPDT PC-mount switch with center off
S3—12-position rotary PC-mount switch
J1—J4—RCA-type jack, chassis mount
J5—DB25 connector
RY1, RY2—16-pin PC-mount relay
PL1—grounded AC line cord
Miscellaneous: case, hardware, wire, solder, etc.

Note: The following items for the **PMX-200 Morse Detector** are available from **Power Mountain Systems, P.O. Box 161, Cora, Wyoming 82925. Double-sided silk-screened PC boards, \$79.95; discrete parts kit (no boards or case), \$159.95; pre-programmed EPROM, \$15.95; detector software package for IBM/compatible, \$19.95; black brushed-aluminum case ready for you to drill, \$79.95; complete kit (contains everything), \$269.95; an assembled, aligned, and tested unit, \$389.95. All prices include UPS Ground, or mailing charges in the USA.**

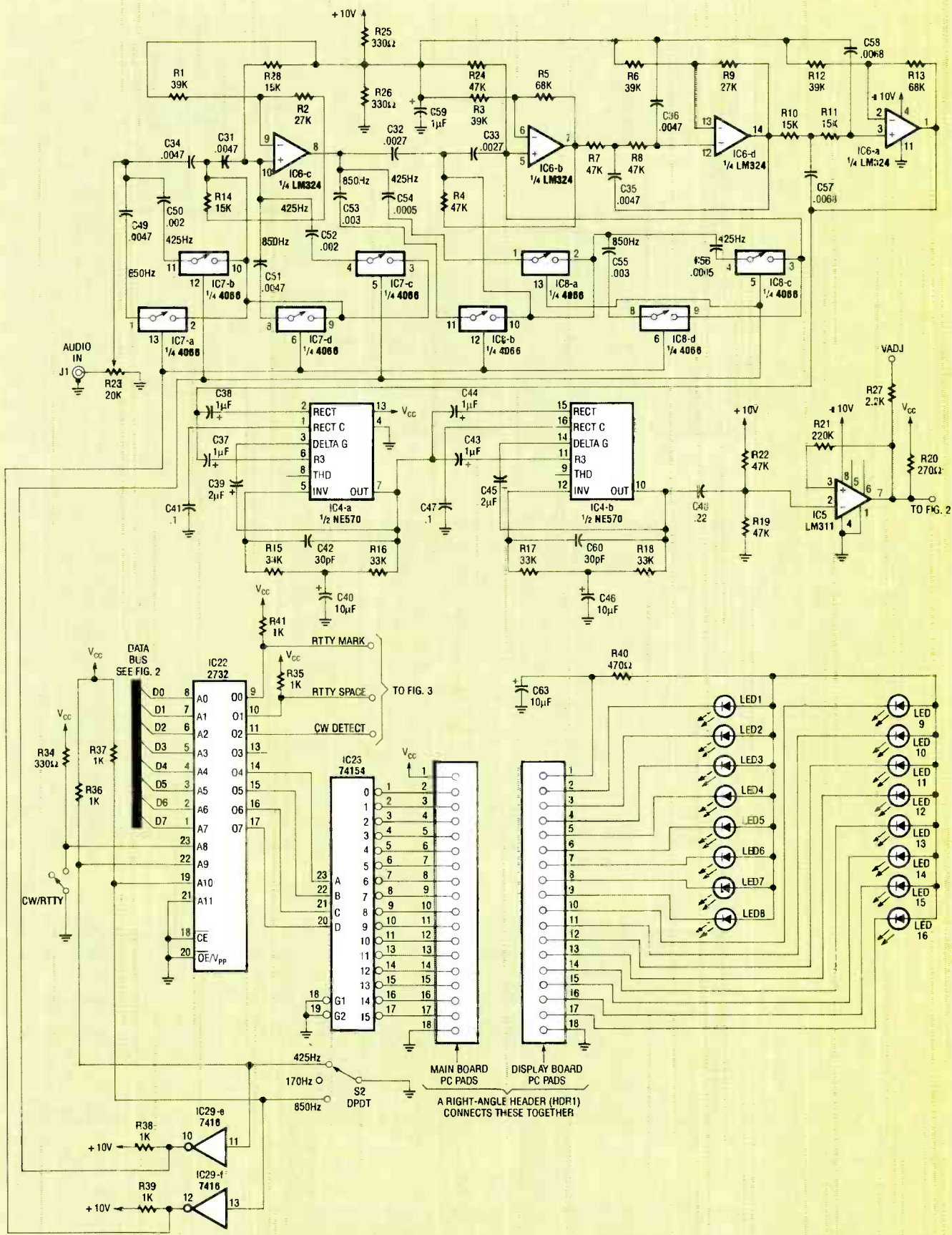

FIG. 1—IN THE FRONT END OF THE PMX-200 there are high- and low-pass, 24-dB-per-octave filters. The low-pass filter is fixed at 1650 Hz, and the high-pass filter is switch selectable (170 Hz, 425 Hz, and 850 Hz) for proper CW and RTTY operation.

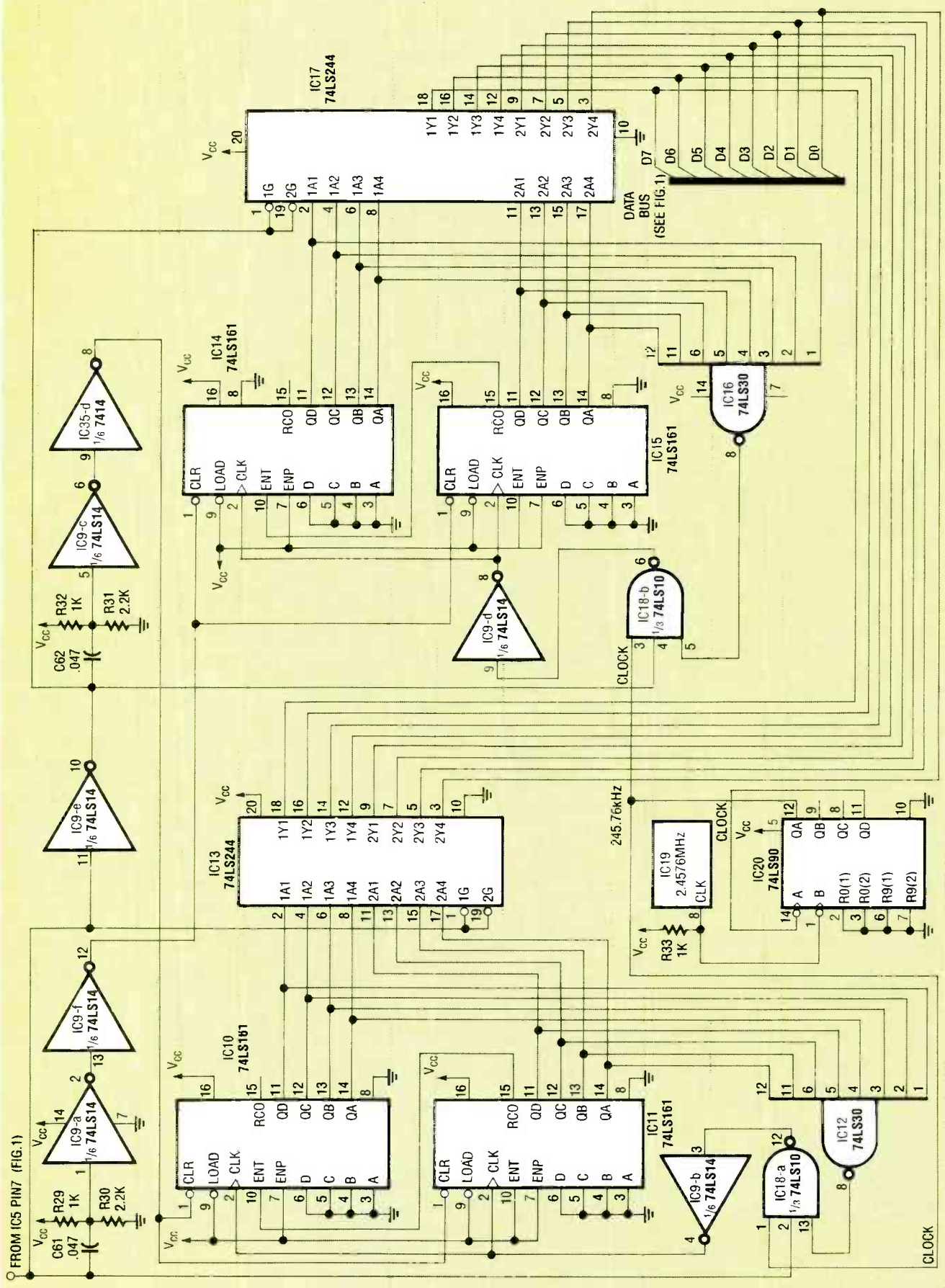

FIG. 2—TWO SEPARATE DETECTORS make up the PMX-200. They each independently measure opposite half cycles.

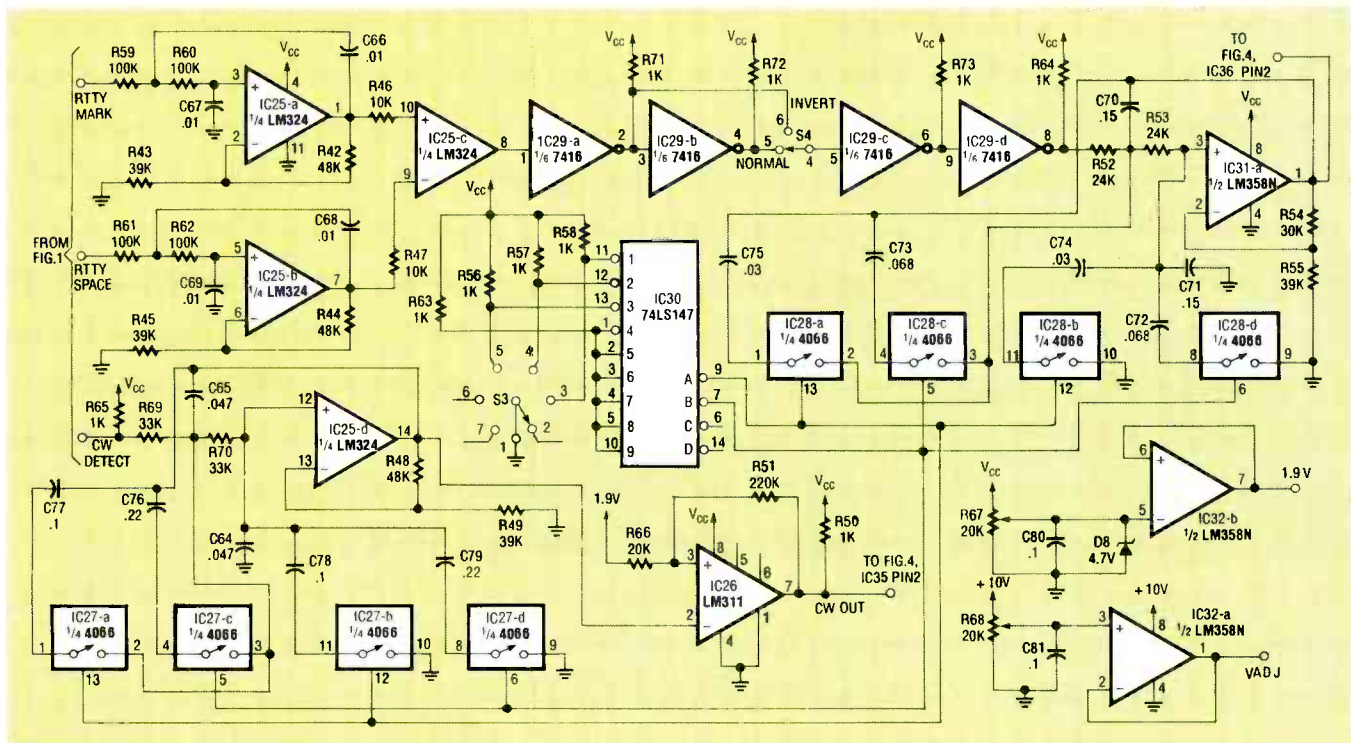

FIG. 3—AFTER ACTUAL DETECTION, analog switches allow us to have four separate low-pass frequencies for CW and four for RTTY to further enhance performance.

detect the proper frequency fast enough, and reject noise fast enough, the detector stops contributing its limitations to the task of detecting the tone and we're left with the constrictions of the modulation system itself.

Devices like the venerable 567 tone decoder have severe limitations for Morse. They can lock on an incoming tone in 10 cycles only 90% of the time. That means that 10% of the time it takes longer. The variation in lock-up time is completely random. If lock is lost for even a half cycle the problem starts all over again. A 567 in this application adds random inconsistency to the problem of decoding Morse code, and that we can do without!

The 567 was never designed for many of the applications for which it is being used—some talented people have managed to do amazing things with it. Unfortunately, it's just not the best way to go.

Phase-lock detectors work well for FSK since they're always locked to a constant carrier, as long as the carrier isn't lost due to noise. They don't do all that well for Morse because the carrier is missing half the time.

Using digital filter techniques, it's possible to measure each half cycle of incoming tone to determine its frequency. That is the reason why the

PMX-200 has such high resolution. In 60 milliseconds we can verify 255 times that the frequency is still present. If there's a signal in there, the detector can see it, *rapidly* and *consistently*.

RTTY data is transmitted at a 22-ms bit rate (45.45 baud or 60 wpm), so there's very little time to detect the proper frequency. At 110 baud, the timing is 9 ms per bit, which makes the problem even more difficult. If the frequency we are detecting is 1500 Hz, there is only an average of 13.5 cycles of tone per bit of information at 110 baud. There are, on average, 33 cycles of tone at 45.45 baud. As the baud rate increases there is less time to make an accurate decision, and fewer cycles to work with. Since we are detecting each half cycle, we can detect the signal 27 times per bit at 110 baud, and 66 times per bit at 45.45 baud.

Morse detector

In the front end of the PMX-200 we are using high- and low-pass, 24-dB-per-octave filters (see Fig. 1). The low-pass filter is fixed at 1650 Hz, and the high-pass filter is switch-selectable (170 Hz, 425 Hz, and 850 Hz) for proper CW and RTTY operation. Switching is greatly simplified through the use of 4066 digitally con-

trolled analog switches.

The filter frequencies were selected so as to be in the upper middle of the audio passband of a typical amateur radio transceiver. High frequencies roll off quickly in this type of equipment above 2200 Hz or so. While it is true that higher frequencies give us more half cycles to detect, that has to be weighed against noise, audio passband, and other considerations.

The input-filter section consists of two separate filter systems. A low-pass filter section with a frequency cutoff set for 1650 Hz sets the upper bandpass frequency limit. The high-pass filters, which set the low-frequency limit, have three different cutoffs depending on the setting of the shift-select switch. The cutoffs are 1200 Hz, 925 Hz, and 500 Hz for 170, 425, and 850 shifts respectively.

The higher the Q of a bandpass filter—Q is equal to the operating frequency divided by the bandwidth—the narrower is its response. As with nearly everything else, you can go too far trying to get a little better signal-to-noise ratio by using a very high-Q filter. The difficulty of narrow bandwidth is that the pulse response of a bandpass filter is equal to 1/(bandwidth in Hz). That means a 1-Hz wide filter would take 1 second to reach 90% of maximum amplitude. A 10-ms response requires at least 100-Hz bandwidth.

	Freq. & Count (10)	Count (Hex)	
	2276 Hz = 108	6C	
	2255 Hz = 109	6D	
	2234 Hz = 110	6E	
	2214 Hz = 111	6F	
	2194 Hz = 112	70	
	2175 Hz = 113	71	
	2156 Hz = 114	72	
Center	2137 Hz = 115	73	detection width 92 Hz
Freq.	2125 Hz		
	2119 Hz = 116	74	
	2101 Hz = 117	75	
	2083 Hz = 118	76	
	2065 Hz = 119	77	
	2048 Hz = 120	78	
	2031 Hz = 121	79	
	2014 Hz = 122	80	
	1998 Hz = 123	81	

In the case of PMX-200, the initial bandpass filter is calculated for 250–300 Hz bandwidth. That was done to allow for minor component variations so that 1% parts weren't required, and also to take advantage of the quick response of the digital detector. As a general rule, it's better to use more filter sections set for a lower Q, than to try using a single filter section at high Q.

After filtering the incoming audio, an NE570 compandor (IC4) is used as a very fast AGC circuit. Both halves of the NE570 are used, and the dynamic range is very large. That means that audio input levels can vary by a wide margin without affecting performance.

An LM311 (IC5) is used as a hysteresis limiter, and converts the incoming sine wave to a square wave that can be used by the TTL-detector system. Hysteresis adds noise immunity to the detector. The voltage adjust (VADJ) provides a voltage to use as a precision crossover point, to guarantee that both halves of the square wave produced are equal.

There are two separate detectors that make up the PMX-200, and they each independently measure opposite half cycles. The TTL-level output from IC5, a LM311 (Fig. 1) is used to gate an internal oscillator to a pair of counters, each counter being made from a pair of 74LS161's. (One counter is formed by IC10 and IC11, and a second is formed by IC14 and IC15—see Fig. 2.) Each pair is wired to act as one 8-bit counter.

The clock input to the counters is disabled—and thus the counting

stops—when the TTL level corresponding to the current half-cycle ends, or when the counter output reaches FF. (The counter output will reach FF only with low-frequency signals that are strong enough to override the high-pass filtering). Since we know the clock frequency, we can determine the frequency of the tone by reading the 8-bit value latched by the counters and the 74LS244 buffers. That 8-bit value is then compared to the values stored in the EPROM, IC22, to determine what tuning LED's should be lit.

The tuning indicator, which is part of Fig. 1, consists of a 4–16 line decoder, IC23, that is under the control of the 2732 EPROM (IC22). There are 16 LED's on the front panel that can be selectively programmed to light, depending on the frequency detected and the switch settings. Three of the four lower output data lines are programmed to provide output for mark, space, and CW.

Here are the formulas for determining the frequency for a given 8-bit detected value, and you can also see how the clock frequency was chosen, where:

$$256 = \text{maximum count}$$

Count = decimal equivalent of the desired frequency

At maximum count, frequency is minimum

$$K = (1/(\text{min. freq.}) \times 2)$$

$$\text{Clock frequency} = 1/(K/256)$$

$$\text{Freq. cutoff} = 1/(2 \times (1/\text{clock}) \times \text{count})$$

As an example, let's use a clock frequency of 491.52 kHz, and a target frequency of 2125 Hz. The calcula-

tions therefore yield the results shown in Table 1. In the EPROM we have programmed a complex lookup table that compares the latched 8-bit value and switch settings to determine what LED should be lit on the display, and whether the corresponding detected frequency is valid.

Table 1 gives a detection bandwidth of 92 Hz, and the center frequency is within 4 Hz of being in the center of the passband. Since the detectors' performance is virtually unrelated to width of detection, you can go as narrow as 18 Hz. Get too narrow though, and you might be retuning your receiver more often and performance could decrease. Noise causes an apparent frequency shift due to slightly shifted zero crossing, making very narrow filter widths impractical.

The minimum width should be more than 1 count, due to aliasing. Aliasing is a counting error at the very edge of detection that causes a miscount. The error is easily worked around by adding one count of extra width to the desired detection bandwidth. You shouldn't try to get super-narrow-width detection, since noise presents a real problem. In fact, you should program for as much width as you can reasonably accept.

Due to the design of the system we can use a push-pull detector system for RTTY. That way we can actually measure the frequency rather than just saying that it is higher or lower than a specific threshold as in a typical discriminator-type detector. That enhances the noise immunity of the system, improving performance. Every little bit can make a difference (no pun intended).

After actual detection we use analog switches to allow us to have four separate low-pass frequencies for CW and four for RTTY to further enhance performance (see Fig. 3). The analog switches also allow us to use a less-expensive single-pole rotary switch, S3, which saves money and eases assembly.

When we continue next month, we'll discuss the circuitry that allows you to interface the detector to your computer. We'll also look at the AFSK generator that allows you to use the detector to transmit RTTY signals. And, of course, we'll show you how to build the detector (will include PC Foil Patterns) and how to tune it so you can put it to work in your radio shack. **R-E**

GLITCHES

IN THE POWER LINE

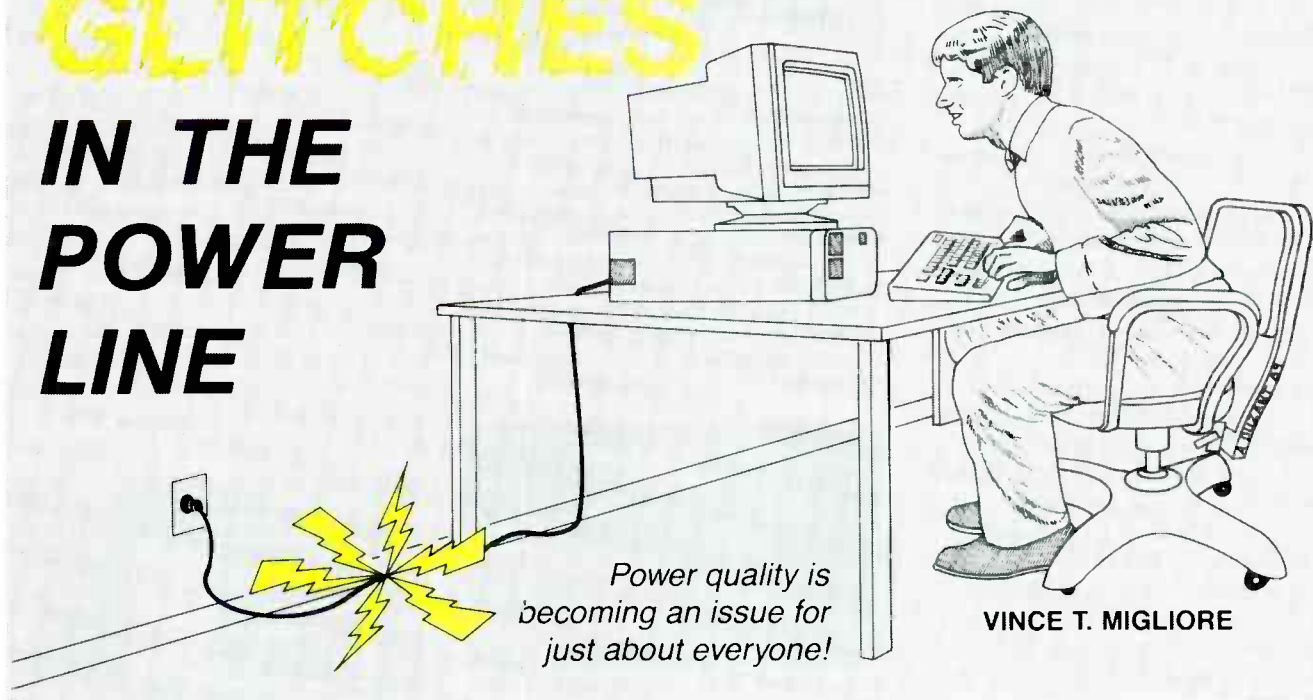

Power quality is becoming an issue for just about everyone!

VINCE T. MIGLIORE

THERE'S A GLITCH IN YOUR POWER LINE and it's going to find you. Imagine that you're right in the middle of saving a file on your PC, or recording a program on your microprocessor-controlled stereo or VCR, and a power-line glitch causes the system to reset. Why? You may never even attempt to find out if it happens only once every month or two, but you should.

In business and industry, the problem becomes more than an inconvenience. Computers, communication devices, sensitive medical instruments, chemical processes, and the like, can succumb to power-line disturbances. A power problem can spell disaster for a small business who can't find a solution.

Power problems can be especially frustrating for the electronics hobbyist. Even you, the solitary electronics buff, can be glitched at home. Your PC boards may burn out for no obvious reason, your PC data may be scrambled, your 10-meter transceiver may run hot, your VCR or stereo may drop dead, and the lights may dim when your refrigerator's compressor turns on. Knowing the causes and cures of power-line disturbances is valuable, technically and financially.

You don't have to be a research scientist or utility engineer to discover glitches and take action against them.

The most common way to clean up the power lines is to rely on surge suppressors. But clean power means more than no impulses. It also means eliminating any voltage sags, outages, impulses, surges, frequency errors, harmonics, grounding problems, high-frequency noise, wave-shape faults, or RF interference.

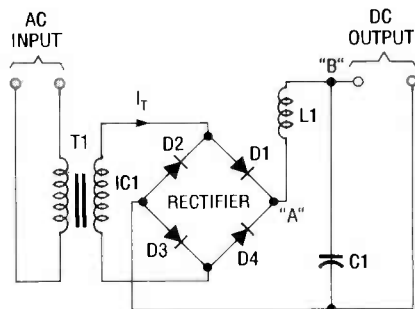

FIG. 1—TYPICAL BRIDGE RECTIFIER, with voltage waveform shaped by an LC filter network. If only a pure resistive network were connected across points A, the waveform shown in Fig. 2-a would be seen with the aid of an oscilloscope.

Causes

Contrary to popular opinion, the vast majority of power problems

aren't caused by power utilities, but by their customers. Occasionally, albeit rarely, utilities are at fault, like when distribution loads are switched, or when large power-factor-correction capacitors kick in. Sometimes lightning or a car can hit a power pole, wreaking havoc with power lines. Such an interruption, if miles away, may not make your lights blink, but the resulting power line hash can blow your PC. Most often, however, transients can travel along a power line from other customers, especially if you're near an industrial area. Major offenders are arc welders or electric-train yards.

However, the above are exceptions, and maybe 95% of disturbances are caused by either home equipment, or faulty or inadequate home wiring. Most utilities bend over backwards to locate problems on their end like low voltages, distribution or switching faults, or line harmonics. Sometimes they'll even attach a monitor or strip-chart recorder to your meter to help find a problem.

Harmonics

One of the most common AC power problems is harmonic distur-

tion, or the unwanted generation of power-line voltage components at frequencies that are multiples of 60 Hz. Linear loads that draw power in proportion to the square of voltage exhibit far fewer problems. With rectifiers, however, strange things start happening to current waveforms. Figure 1 shows a full-wave bridge rectifier, while Fig. 2 shows the relevant voltages and currents.

The voltage across points A and C in Fig. 2-a is a full-wave, rectified sinusoid provided that only a purely resistive load were connected. Across points B and C, the LC filter produces the waveform shown in Fig. 2-b. The current from the bridge rectifier charges capacitor C1 for a small portion of each half cycle as shown in Fig. 2-c, and it supplies power to the load during that brief period. Capacitor C1 provides the power that drives the DC load for the remainder of the half cycle. Inductor L1 smooths the sharp points in the rectified voltage curve at *b*, but its effect on the following discussion is nil.

As the rectifier voltage drops to zero, the charge in C1 drives the DC load. Thus, current flows through transformer T1 for only a small portion of the sinusoid, as shown in Fig. 2-c, driving the DC load and recharging C1, so the energy is concentrated in short pulses. This pulsed current generates harmonics, making a transformer run hotter than it would for a pure 60-Hz sinusoid with RMS power identical to that of the corrupt

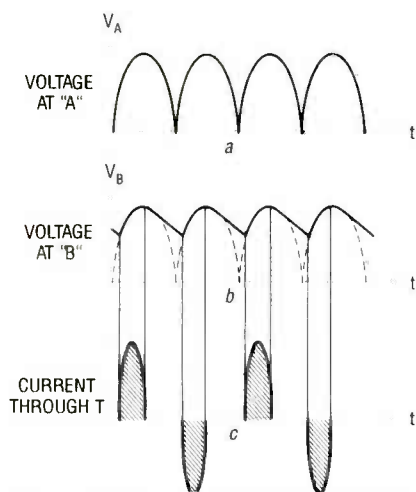

FIG. 2—VOLTAGE AND CURRENT WAVEFORMS at different points in the power supply. At (a) is the voltage exiting the bridge rectifier, presuming either a resistive load or no load at all, instead of the LC filter; at (b) is the voltage exiting the LC filter, and at (c) is the current drawn through the transformer.



FIG. 3—THE BMI 2400 POWERSCOPE power-transient measurement and recording system for single-phase DC, or single- or 3-phase AC. The instrument monitors sags, surges, impulses, waveshape faults, line-frequency variations, and high-frequency noise for single-phase AC or DC, has a built-in RS-232 bus to be used with an external processor to analyze total harmonic distortion and frequency spectral content, and has a full range of available accessories, including temperature and humidity sensors.



FIG. 4—THE BMI 4800 POWERSCOPE. While similar to the BMI 2400 in physical appearance, it has considerably more processing power, with up to four main and eight probe channels.

sinusoid with its harmonics. This is because the magnetic domains reverse polarity more rapidly than for the pure sinusoid, owing to the harmonics, heating the transformer core.

The bridge rectifier shown in Fig. 1 is waning in popularity, although harmonic generation is identical for more recent versions. Most computers and hi-tech gear now use switched-mode power supplies; those varieties are highly nonlinear and a major source of harmonics. If several loads are on one circuit, expect hot motors and transformers. In short, if you're serving up hash, everyone at the table tastes it!

Latest instrumentation

Power-line monitors range from simple beepers or lights that tell you when line voltages and/or currents are out of range, to printing versions that record values numerically and graphically. Two major manufacturers of such gear are Basic Measuring Instruments or BMI (335 Lakeside Drive, Foster City, CA 94404, 415-570-5355), and Dranetz Technologies (1000 New Durham Road,

Edison, NJ 08818, 201-287-3680 or 800-DRAN-TEC).

BMI has three major instruments, the 2400 and 4800 *PowerScopes*, shown in Figs. 3 and 4, respectively, and the 3030 *Power Demand Analyzer* (not covered here). They combine oscilloscopes, strip-chart recorders, and RF interference meters in a single portable cabinet to capture transients varying from a few milliseconds to several hours in duration. Note the calculator keyboard, single-line display, and thermal strip-chart graphic printers on each.

Both versions of the *PowerScope* monitor sags, surges, impulses, waveshape faults, line-frequency variations, and high-frequency noise for single-phase or 3-phase AC or DC power lines, and have a built-in RS-232 bus. They can be combined



FIG. 5—THE DRANETZ SERIES 901 POWER HARMONIC ANALYZER, similar to a BMI 2400. In one printout for an instant in time, the device records line voltage, the current used, total power, power factor, harmonic power, fundamental power, and a breakdown of the power in the individual harmonic frequencies above the fundamental (in other words, its spectral content).

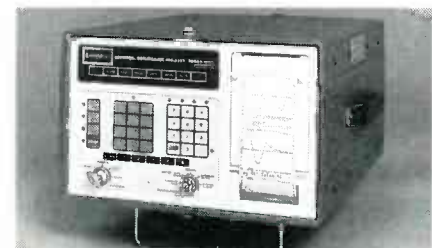

FIG. 6—THE DRANETZ SERIES 626G Universal Disturbance Analyzer, similar to a BMI 4800. This device has several add-on modules that increased the scope of the unit with event monitors.

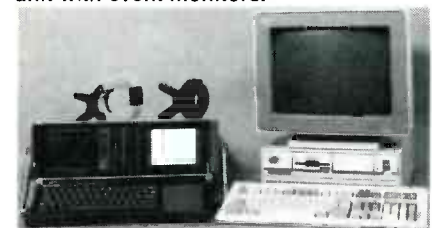

FIG. 7—THE DRANETZ SERIES 656 Disturbance Waveform Analyzer. Note the built-in CRT, full keyboard, dual floppies, and thermal printer.

with the *A-600 Parallel Processor* to analyze total harmonic distortion and frequency spectral content (such as in the *BMI 2460*), and have a full range of accessories, including temperature and humidity sensors.

The *BMI 4800* does everything the *BMI 2400* does, but has more processing power. Whereas the *BMI 2400* has two main and four environmental or probe channels, the *BMI 4800* has up to four main channels and eight probe channels. Both models can be configured to take measurements every 1, 3, 6, 12, or 24 hours, and can do both high-resolution graphics, strip-charts, and text summaries, the sole exception being that the *BMI 2400* can't do high-resolution graphics using the probe channels—only the main ones.

The *Dranetz Technologies* gear is comparable in scope and complexity to that from *BMI*. Their *Series 901 Power Harmonic Analyzer*, shown in Fig. 5, is comparable to the *BMI 2400*, and the *Series 626 Universal Disturbance Analyzer* shown in Fig. 6 and *DRAN-SCAN Multipoint Power Monitoring and Analysis System* (not shown) are comparable to the *BMI 4800*.

The *Dranetz Series 656 Disturbance Waveform Analyzer* shown in Fig. 7 has a built-in CRT and full keyboard, two floppy disk drives, and internal thermal printer. Their *Series 800 Electric Power/Demand Analyzers* (not shown) are also available, and are similar to the *BMI 3030*. Both *BMI* and *Dranetz* also have extensive power analysis software for any external controllers used with their monitoring instruments.

Typical power-line disturbances

The graphs shown in Figs. 8–12 were made using *BMI* gear, and those shown in Figs. 13–16 were made using *Dranetz* gear; they're of similar format. The user selects thresholds and monitors power. Whenever an impulse, voltage sag, or other disturbance occurs, it's graphed as shown in Figs. 8 and 9. Note that the sinusoidal peaks are somewhat flattened where current or voltage reaches a local maximum. If switching loads change a waveshape, that too is recorded. Fortunately, most disturbances have characteristic "signatures." Figure 10 shows a typical motor starting-voltage sag; the in-rush current drops the voltage to 84.5 volts RMS.

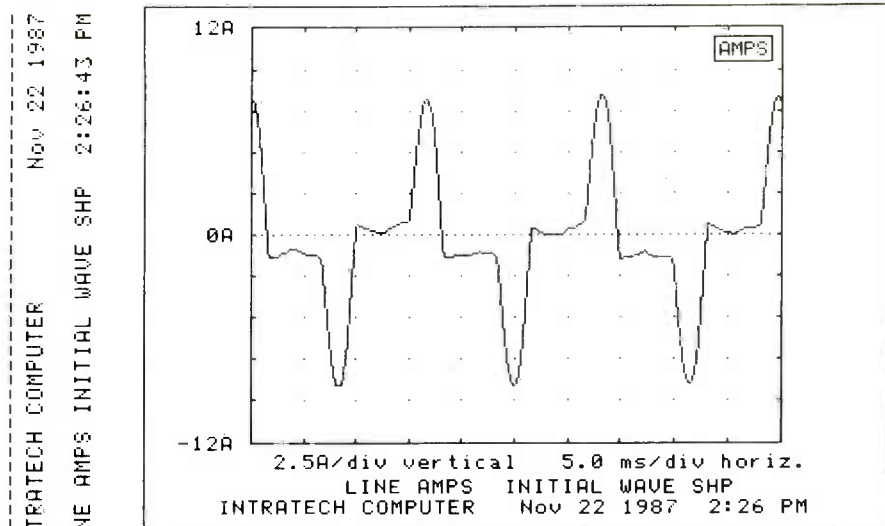

FIG. 8—BMI-GENERATED INITIAL WAVESHAPE REPORT for current for a circuit. Note that the current is drawn in pulses that could seriously compromise the operation of delicate instruments operating on the same or a nearby power line.

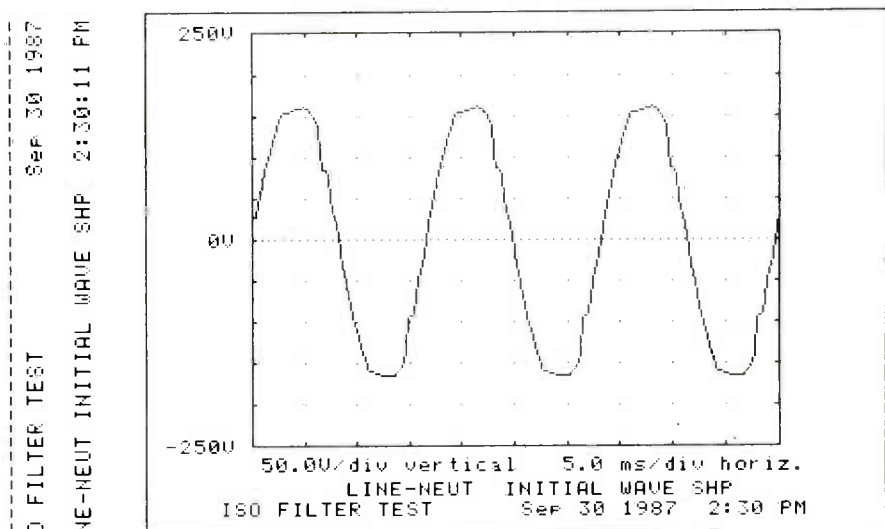

FIG. 9—VOLTAGE WAVEFORM IN A CIRCUIT with harmonics. The voltage sinusoid is distorted at positive and negative peaks, where current flow is maximum.

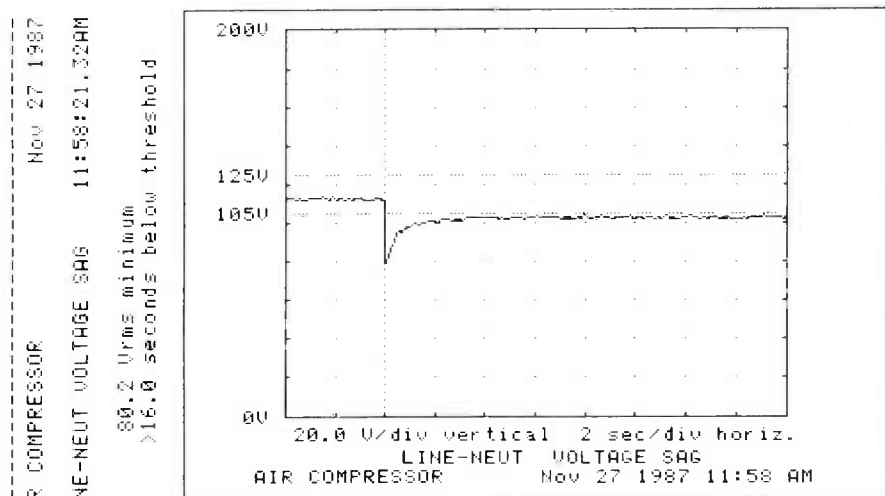

FIG. 10—TYPICAL MOTOR-START SIGNATURE. As the motor stabilizes, voltage returns to normal.

INTRATECH J BOX Sep 27 1987
 LINE-NEUT IMPULSE 12:02:32.54PM

395 V peak
 225° phase position
 2.0 usec rise time
 42 mJoules (50 ohms)

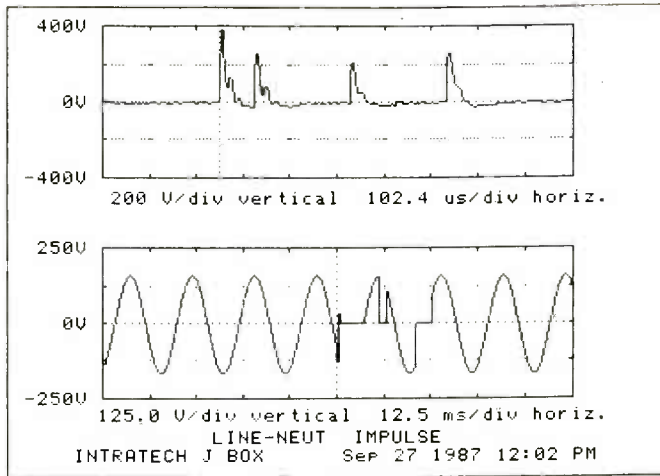

FIG. 11—IMPULSES DUE TO LOOSE WIRING. Sharp-edged dropouts on the sinusoid indicate that the problem is nearby.

INTRATECH GENERATOR Oct 04 1987
 LINE-NEUT HF NOISE SURGE 11:01:31.32AM

10.9 Vpk maximum

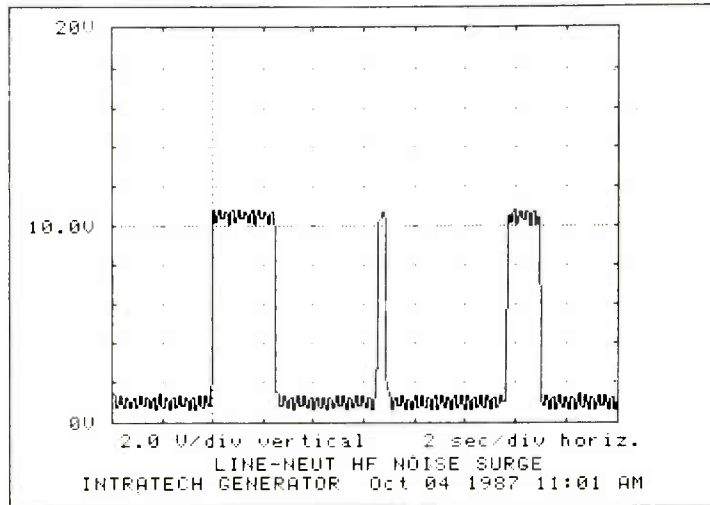

FIG. 12—VOLTAGE SURGES CAUSED BY HIGH-FREQUENCY NOISE. Note the 10-volt peaks that may ride through a power supply to damage memory and program chips in a computer.

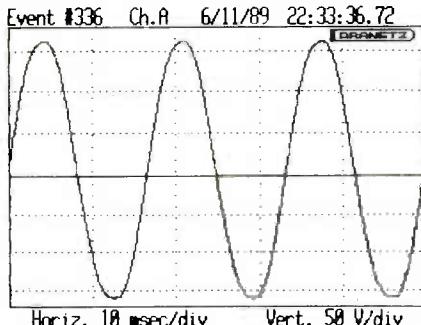

FIG. 13—A NORMAL POWER SINUSOID. The time was 11:33 P.M., when most heavy industrial machinery isn't powered.

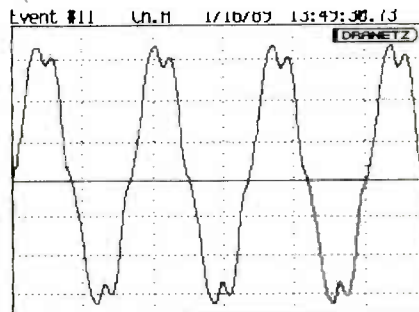

FIG. 14—HARMONIC DISTORTION. This graph was taken at 1:49 P.M. at the same site as that in Fig. 13.

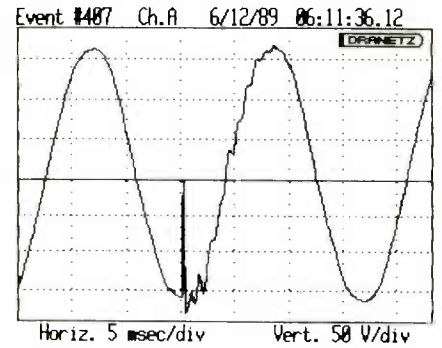

FIG. 15—A POWER GLITCH. Just imagine what the added pulse would do to a counter circuit.

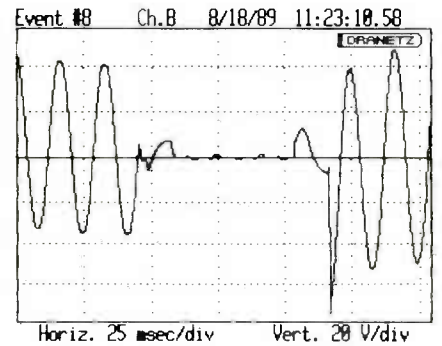

FIG. 16—A BRIEF POWER OUTAGE. Just imagine what this would do to your PC's memory!

over a couple of cycles.

Note the sharp transitions, indicating loose wiring nearby. Had the disturbance occurred farther away, the transitions would've been slower, smoother, and less well-defined, as a result of impedance encountered as the impulse propagated. Power-monitor graphs sometimes need interpretation, but are fairly interesting, and expand your knowledge of power-line problems.

Figure 12 shows bursts of line-to-neutral high-frequency noise, in this case RF interference, while transmitting the letter "K" in Morse code (dah-di-dah) from an amateur radio shack. High-frequency noise is common in such settings, but can also be caused by a CB radio, walkie-talkie, or taxi transmitter. You should check your own transmitter, if you have one, for both neutralization and shielding. The disturbance shown here is only 10 volts, but digital logic circuits work on 5 volts DC. If RF interference can induce 10 volts on a power line, such a level can wreak havoc with even otherwise well-shielded computers or instruments.

Some other waveforms, acquired from Dranetz gear, are shown in Figs.

Continued on page 52

BUILD THIS

CAPACITANCE ADAPTER

Use your digital voltmeter to measure capacitance with this handy adapter.

DOUGLAS A. KOHL



MULTIMETERS OF TODAY CONTAIN A LOT more features than they used to, and perhaps the most useful feature is capacitor checking. It's true that less expensive meters will have only the usual voltage, resistance, and current capabilities but, for a little extra money, you can buy a meter that has capacitance-, frequency-, logic-, and transistor-checking functions. Of course, if you need to measure capacitance, the solution isn't to buy a new multimeter—especially if you already have a meter that you're particularly fond of. But converting your meter with our capacitance adapter may be just what you need.

The adapter converts the value of a capacitor to be tested into a precision analog voltage applied to the input terminals of the digital voltmeter. The adapter covers 5 decades ranging from 100 pF to 1 μ F, full scale.

The accuracy and stability of a typical 3-1/2 digit voltmeter is commonly $\pm 0.25\% + 1$ digit over a one year period. The accuracy of the adapter in combination with a digital voltmeter has been tested to be $\pm 0.4\%$ over a 1400-hour period. Warm-up is 1 digit (0.1%) or less within 30 seconds of turn-on. The thermal stability was found to be $-0.04\%/^{\circ}\text{F}$.

Including a meter movement in the adapter case permits the device to be used as a stand-alone capacitance meter, but with reduced precision. Power for the adapter may be either

from the line or two 9-volt batteries, which will provide about 50 hours of use.

Operation

The outstanding accuracy and stability of the circuit is due to the use of a CMOS version of the 555 timer IC. One is used as an astable pulse generator, that triggers another that is used as a pulse-width modulator. That initiates an R-C exponential rising voltage at J1 and J2 across the capacitor under test, C_x , as shown in the block

diagram of Fig. 1. The modulator output switches high upon receipt of the trigger pulse and switches low when the voltage on C_x reaches an internal reference voltage. See the timing diagrams in Fig. 2.

The average value of the pulse waveform in Fig. 2-a is a DC value such that the area A_1 exactly equals the area A_2 . The duty cycle of the output pulse from the pulse-width modulator is the ratio of the time it is positive to the period, T, or the total time between trigger pulses (P_w/T).

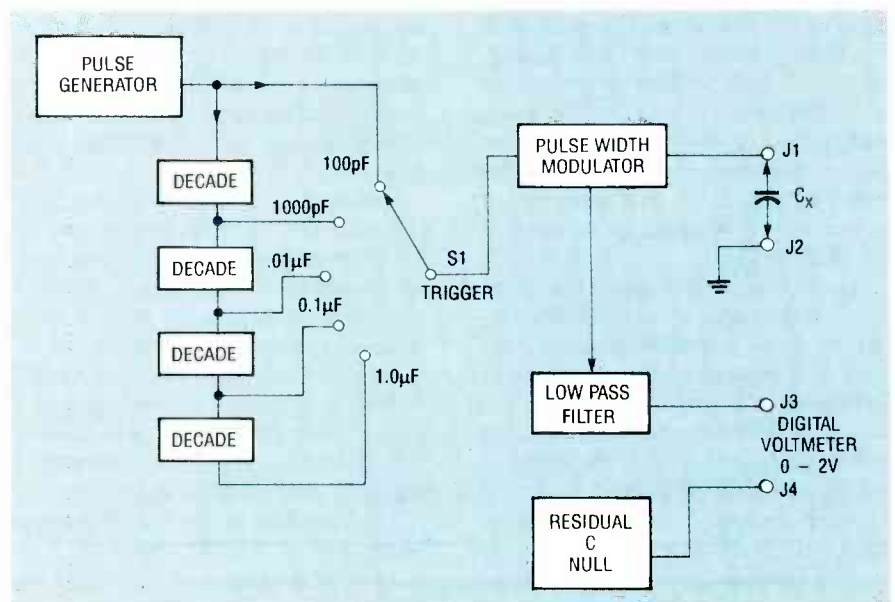

FIG. 1—BLOCK DIAGRAM of the capacitance adapter. It can turn any digital voltmeter into a precision capacitance meter.

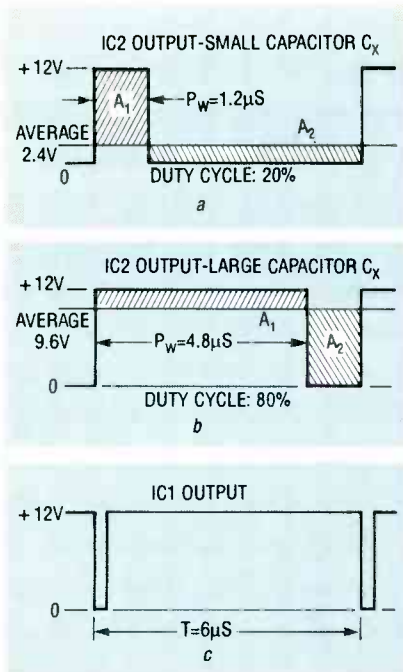

FIG. 2—THE AVERAGE DC VALUE of the pulse waveform in *a* is such that the area A_1 exactly equals the area A_2 , or 2.4 volts. The average voltage equals the duty cycle times the maximum pulse voltage. The average value in *b* is 9.6 volts, which is four times larger than *a* because P_W is four times wider. For larger capacitors, P_W becomes wider than $6\ \mu\text{s}$ (*c*), so it is necessary to increase T in order to generate a new duty cycle.

In the example shown in Fig. 2-*a*, the duty cycle is $1.2\ \mu\text{s}/6\ \mu\text{s} = 0.2$ or 20%. The average voltage equals the duty cycle times the maximum pulse voltage ($0.2 \times 12\text{V} = 2.4\text{VDC}$). The average value is extracted in the circuit by a low-pass filter. The larger the value of C_X , the wider the pulse (see Fig. 2-*b*). The average value in Fig. 2-*b* is 9.6 volts, which is four times larger than in 2-*a* because the pulse width (P_W) is four times wider. For larger capacitors, P_W becomes wider than $6\ \mu\text{s}$ (Fig. 2-*c*), so it is necessary to increase T in order to generate a new duty cycle.

As shown in the block diagram (Fig. 1), the range is switched by factors of 10 by connecting the trigger input of the pulse-width modulator to the output of a decade counter. That has the effect of lengthening the time between trigger pulses by a factor of 10. Even larger capacitors can be measured by switching the trigger to other decade-counter outputs. As an example, on the $1\ \mu\text{F}$ range, the time between trigger pulses is $6\ \mu\text{s} \times (10 \times 10 \times 10 \times 10) = 60,000\ \mu\text{s}$ or 60ms.

On a low range like 100 pF, the capacitance of the wires used to connect the adapter to C_X , will be measured and must be compensated for. A pair of 6-inch long leads an inch apart have a capacitance of about 6 pF which, if not compensated for, would cause a 10-pF capacitor to read 16 pF—a 60% error!

Circuit details

In the schematic of Fig. 3, all integrated circuits are low-power CMOS types. The TLC555 timer, IC1, is connected as an astable that generates narrow negative-going pulses. That's because $C1$'s discharge resistor, R2, is much smaller than R1, which sets the period (T) of the waveform.

The output pulse of IC1 is further narrowed by the differentiator coupling, C3 and R4. It is fed to the trigger input of the pulse-width modulator, IC2, when the 100-pF range (full-scale) is selected. The pulse-width output of IC2 varies with the actual capacitance of the unknown capacitor, C_X .

A low-pass filter for the pulse output of IC2 is formed by R6 and C6. That extracts the average of the pulse waveform which is a DC level that's proportional to the duty cycle of the waveform. Op-amp IC8 is connected as a voltage follower which gives no gain but transforms the high input resistance of the filter to a low value needed to drive the output circuits.

The DC output from IC8 is reduced and fed to the voltmeter terminals, J3 and J4, by a calibration voltage divider consisting of R10 and 10-turn potentiometer R11. The optional 1-mA meter (M1) is included as an analog display, and it can be calibrated via R8 and R9 to set the correct full-scale deflection.

The negative voltmeter terminal (J4) and the negative connection to M1 is floating with a voltage produced by a residual-C-null circuit. Resistor R12 and potentiometer R13 form a variable voltage divider from the + supply and provides an input to IC9 which, as a voltage follower, passes it to J4. When that voltage is increased, it reduces the voltage across J3 and J4 and also reduces M1's deflection.

The range is set by a dual-ganged 5-position switch, S1. Four 4017 divide-by-ten counters (IC3-IC6) are connected in series; IC3 outputs only once for every 10 input pulses from IC1. That lengthens the period be-

tween trigger pulses. S1 is in the output pulse circuit for every 10 input pulses. IC2 when the outputs are different? The form the required negative pulses for IC2.

Another key to stabilizing the adapter's calibration is the regulator, IC10, which must keep supply voltage constant. Two batteries in series can be used to power the circuit until their voltage decrease to 7 volts (see Fig. 4-*a*). The power switch, S2, is part of the re-

PARTS LIST

All resistors are 1/4-watt, 5%, unless otherwise indicated.

- R1, R8, R10—4700 ohms
- R2—220 ohms
- R3—10,000 ohms, 10-turn potentiometer
- R4, R7—3300 ohms
- R5—33,000 ohms
- R6—10 megohms
- R9—10,000 ohms, potentiometer
- R11—1000 ohms, 10-turn potentiometer
- R12—39,000 ohms
- R13—10,000 ohms, potentiometer with on/off switch (S2)

Capacitors

- C1—470 pF, ceramic
- C2—0.001 μF , ceramic
- C3—220 pF, ceramic
- C4—100 pF, ceramic
- C5, C7—0.1 μF , ceramic
- C6—0.05 μF , ceramic
- C8, C9—100 μF , 12 volts, electrolytic

Semiconductors

- IC1, IC2—TLC555 timer
- IC3-IC6—4017 divide-by-ten counter
- IC7—4011 quad 2-input NAND gate
- IC8, IC9—3140 op-amp
- IC10—LM7812 12-volt regulator
- D1, D2—1N4148 diode
- BR1—bridge rectifier, 50 mA or higher

Other components

- M1—1-mA meter, optional
- S1—double pole, 5-position switch
- S2—SPST switch (part of R13)
- J1-J4—banana jack
- B1, B2—9-volt battery, optional
- PL1—AC plug and linecord
- T1—12-volt, 50 mA (or higher) transformer
- F1—1/4-amp fuse

Miscellaneous: two 9-volt-battery clips (optional), hardware, case, solder, etc.

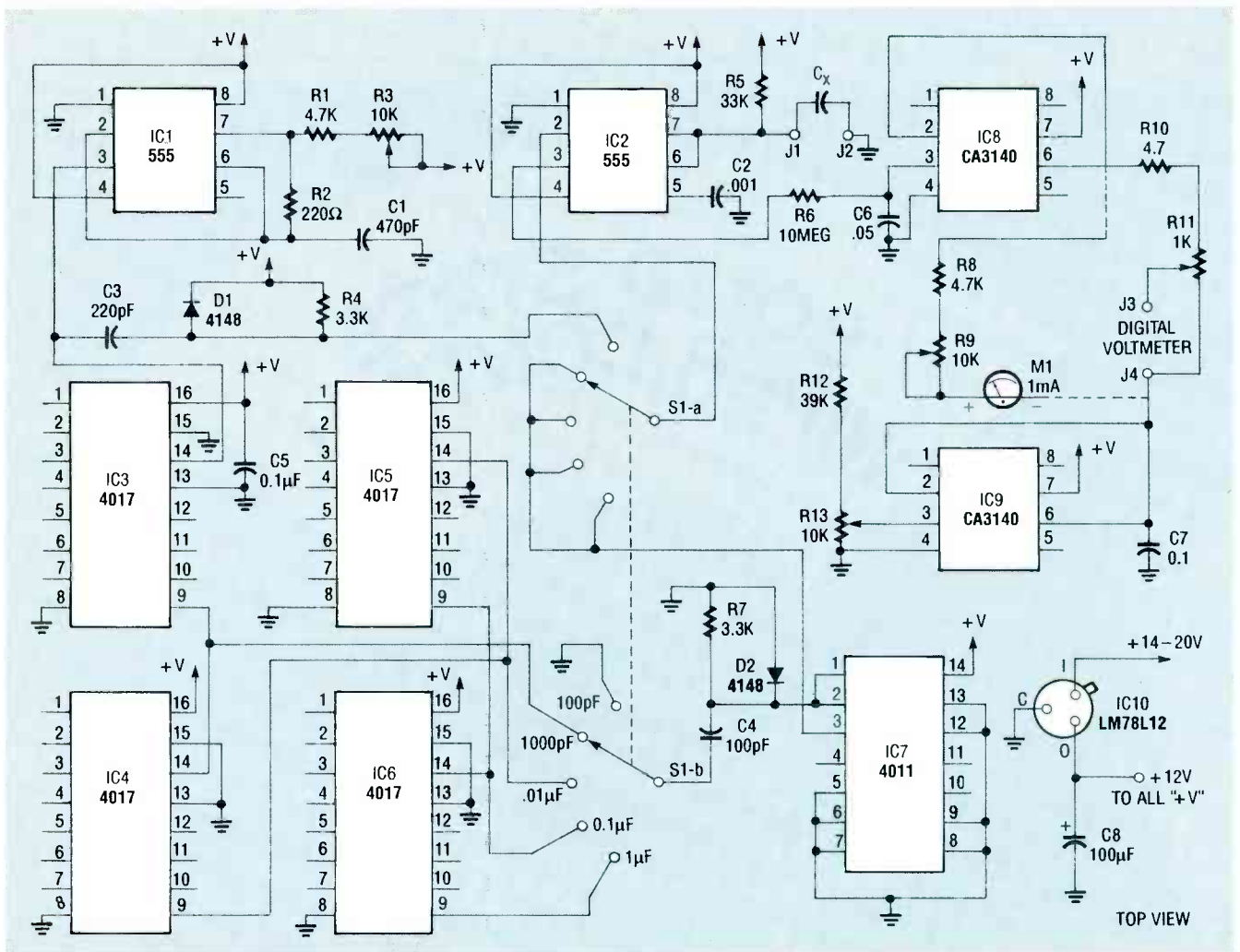

FIG. 3—SCHEMATIC of the capacitance adapter. All IC's are of the CMOS type.

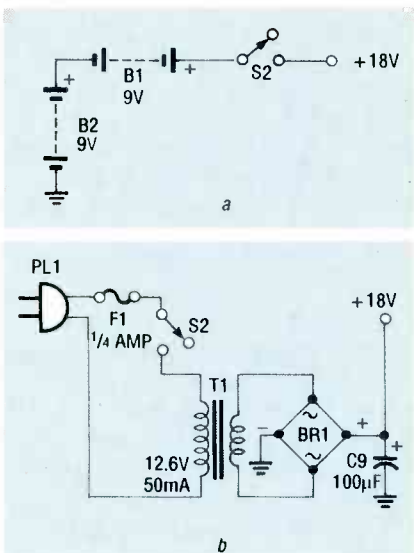

FIG. 4—THE ADAPTER CAN BE POWERED from two 9-volt batteries (a) or an AC supply (b).

signal-C-null potentiometer, R13. If the AC power supply is used in the design (Fig. 4-b), the transformer can

be a small one since the circuit requires only 20 mA—therefore, practically any bridge rectifier can be used for BR1.

Construction

It is recommended that you assemble the circuit on an etched experimenter's board designed for mounting IC's. Component placement is not critical with the exception of IC2; it should be located at the edge of the board and close to the front-panel terminals for C_x . Group the decade counters (IC3–IC6) in a line or cluster and locate the bypass capacitor, C5, in their midst.

Calibration

Before the adapter can make useful measurements, it must first be calibrated. All you have to do is calibrate the unit with one known-value or "standard" capacitor, and all other ranges will automatically be correctly adjusted. Of course, the calibration

will be only as accurate as the capacitor you use. If you must use a low-tolerance capacitor, measure it on a meter that you know to be accurate.

Potentiometer R3 should be adjusted so that a scope connected to pin 3 of IC1 shows $6\mu s$ between pulses. The goal is to set T so that if a capacitor marked with a full-scale value for any range (100 pF, for example) is connected as C_x , the duty cycle observed at pin 3 of IC2 will be about 80%.

Assuming that you have an accurately known capacitor to use for calibration (0.982 μF , for example), connect it to J1 and J2 and, with a digital voltmeter set on the 2-volt scale connected to J3 and J4, adjust R11 until the voltmeter reads 0.982 volts. If an analog meter is used, adjust R9 to give as close to 0.98 as possible. If you use smaller-value capacitors as your "standard," be sure to set the meters to zero with the re-

continued on page 48

SOLID STATE WIPER CONTROL

ROBERT A. HEIL



Build this solid state windshield wiper delay and minimize potentially dangerous driving conditions.

HAVE YOU EVER DRIVEN THROUGH FOG, mist, or light rain and been tempted to turn on your wipers—but didn't because of all the screeching and streaking they make when there's not enough water? One of the more useful features available on today's cars is delayed action and/or manual windshield wiper control. The delay is normally set using either a slide or rotary potentiometer, while the manual control is generally a momentary switch attached to one of the column levers, and flicked with the left hand while holding the steering wheel.

Many drivers with two-speed wiper motors—which are designed for heavy rain—simply don't use their wipers in a light drizzle to avoid the aforementioned screeching and streaking. If you are one of those drivers, you'll surely benefit from the wiper-delay described here. It mounts under the dash, doesn't hinder normal wiper operation, and features a variable 2–18 second delay.

Circuit description

The wiper-delay schematic is shown in Fig. 1. With the ignition on, D1 maintains regulated +12 volts DC. When S1 closes, C1 bypasses transients and passes this +12 volts DC to divider R2-R3, producing a TTL high at pin 3 of IC1, a 4013 CMOS dual leading-edge triggered D-type flip-flop. Filter R4-C3 keeps IC1 from triggering erroneously when the ignition is on. When S1 is pressed, output Q1 (pin 1) of IC1 latches high, turning on Q1, which conducts via R5, turning on IC2; LED1 indicates power, and R6 sets the current. Since IC2 depends on Q1 for power, IC2 stays off until Q1 turns on.

The left half of IC2 is an astable, with its delay set by R7, R8, R11, and C4. The right half of IC2 is a monostable, with its pulse duration set by R9 and C5. With the values used, you might expect R11 to vary the delay from about 15–84 seconds, with a 2.42-second monostable pulse oper-

ating the wiper blades on each cycle. However, the actual delay will range between 2–18 seconds, with a 1-second monostable pulse on each cycle. That discrepancy stems from the fact that IC2 is being fed from the emitter of Q1, rather than directly from the regulated +12-volt supply. Transistor Q1 acts as an active current source, making C4 charge and discharge faster than it ordinarily would.

The astable output (OUT1, or pin 5) is tied to TRIG2 (pin 8). When OUT2 (pin 9) goes high, Q2 is biased via R10 and current flows through RY1, with D2 dissipating back-EMF when RY1 shuts off. If RY1 is an SPDT, then it's connected as in Fig. 1, whereas a DPDT relay is connected as in Fig. 2.

Construction

The foil pattern for the wiper-delay is shown in PC Service, and a source for the PC board is given in the Parts List. Whether you hardwire the wiper-delay or use the PC board, use a

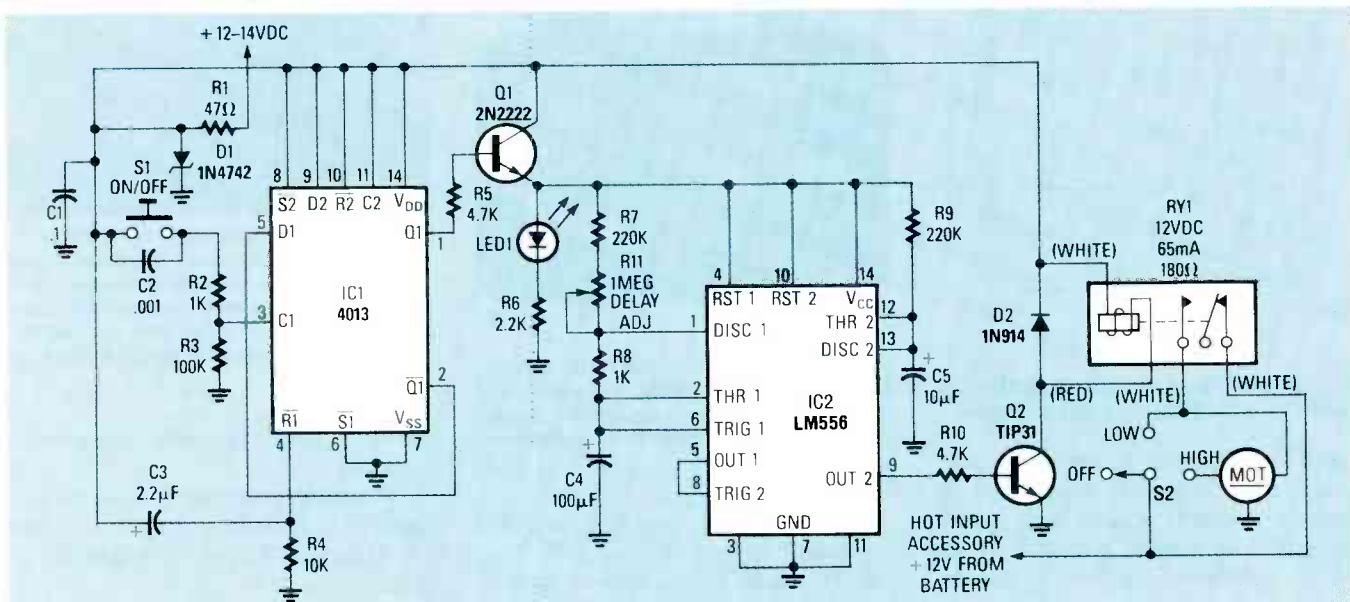

FIG. 1—SCHEMATIC OF THE SOLID-STATE WIPER-DELAY. This is the configuration for older cars without manual pulse delay, using an SPDT wiper switch, where both wires from RY1 are in parallel with the wiper-switch terminals for the low wiper speed.

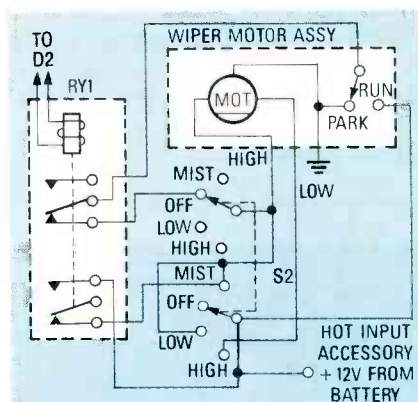

FIG. 2—FOR CARS WITH MANUAL WIPER CONTROL, use either an SPDT or DPDT switch for the wiper motor. For the SPDT switch, connect RY1 in parallel with the manual wiper control switch. For the DPDT switch, a DPDT relay is needed to operate the wiper-delay properly. Pole 1 goes between pole 1 of the switch and the pulse position.

suitable case that fits under the dash. The parts-placement diagram is shown in Fig. 3; S1 is a PC-board mounted, low-profile, SPST push-button ON/OFF keypad switch. The prototype is shown in Fig. 4. With the top of the case facing upwards, drill a hole on the left for S1, on the right for R11, and in the center for LED1. Use super glue to attach LED1 to a washer, then anchor the washer to the case.

After finishing the PC board, use double-sided tape to attach it and RY1 (upside down) behind R11. Drill a hole in the back panel for the four connecting wires, two for RY1 and

- PARTS LIST**
- All resistors are ¼-watt, 5%, unless otherwise indicated.
- R1—47 ohms, ½-watt
 R2, R8—1000 ohms
 R3—100,000 ohms
 R4—10,000 ohms
 R5, R10—4700 ohms
 R6—2200 ohms
 R7, R9—220,000 ohms
 R11—1 megohm, 1-turn, chassis mount potentiometer
- Capacitors**
 C1—0.1 μF, ceramic disc
 C2—0.001 μF, ceramic disc
 C3—2.2 μF, 25 volts, electrolytic
 C4—100 μF, 25 volts, electrolytic
 C5—10 μF, 35 volts, electrolytic
- Semiconductors**
 D1—1N4742 12-volt Zener diode
 D2—1N914 germanium diode
 LED1—green light-emitting diode

two for power. To install the case under the dash as in Fig. 5, use Velcro or double-sided tape. You can also drill completely through all four holes and mount it with four 1.5-inch 4-40 screws. If you use either Velcro or tape, use the lid for the case, whereas for screws, you can discard the lid. Most newer cars have a nonconductive dash, preventing a short.

The prototype in Fig. 4 differs in one minor regard from the parts placement diagram shown in Fig. 3. Figure 3 shows R6 connected to the

- Q1—2N2222 NPN transistor
 Q2—TIP31 NPN transistor
 IC1—4013 dual D-type flip-flop
 IC2—LM555 dual timer
- Other components**
 S1—SPST N.O. momentary push-button switch
 RY1—SPDT relay, 12 volts DC, 180 ohm, 65 mA (see text)
- Miscellaneous:**
 3.25- × 2.125- × 1.125-inch plastic case, 1.25- × 1.5-inch 4-40 hardware (see text), wire (red, white, and black), plastic wire tie, solder, etc.
- NOTE: An etched and drilled PC board is available for \$7.50 and any return postage from R.A.H. Projects, P.O. Box 4715, Irvine, CA 92716-4715. California residents must add sales tax.**

PC board at both ends between LED1 and Q1 at upper right, while Fig. 4 shows R6 just to the right of C7 in the upper middle, with one end going to the PC board and the other end to the cathode of LED1. The PC board corresponding to Fig. 3, and which appears in PC Service, is correct.

Installation

Before installing the wiper-delay, get a schematic of your car's wiring harness from a service manual. Besides having wiring schematics, it's a

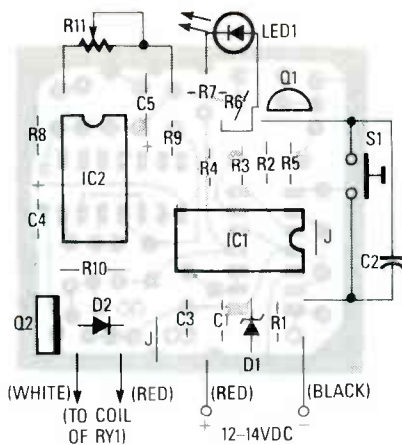

FIG. 3—PARTS-PLACEMENT DIAGRAM FOR THE SOLID-STATE wiper control.

helpful reference for repairs. For older cars with neither wiper delay or manual control, attach both wires from RY1 in parallel with the wiper switch terminals for the low wiper speed, as in Fig. 1.

If your car has both manual and delayed-action wiper control, then you obviously don't need to install the project described here, except either as a spare, or to experiment with how it works. Most cars that have manual wiper control will also have delay capability, but not necessarily all. If

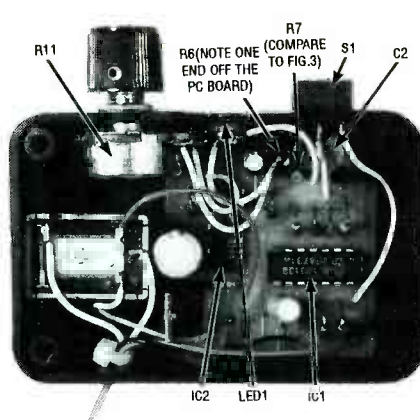

FIG. 4—PROTOTYPE OF THE SOLID-STATE WIPER CONTROL. Note that only one end of R6 goes into the PC board, while its other end goes to the cathode of LED1.

your car falls into that category, it'll generally have either an SPDT or DPDT switch for the wiper motor.

If it has an SPDT switch, connect RY1 in parallel with the manual pulse control switch. For the DPDT switch, a DPDT relay is needed to operate the wiper-delay properly, as in Fig. 2. Pole 1 goes between pole 1 of the switch and the pulse position. If the DPDT relay doesn't fit in the case you're using for your wiper-delay,



FIG. 5—THE INSTALLED SOLID-STATE WIPER CONTROL under the dash. Here, the holes for the lid were drilled out, and 4-40 screws were used to mount the case under the dash. You can also use the lid, and attach the case with Velcro or double-sided tape.

mount it under the dash in a remote location.

To operate, turn the ignition on and push S1; LED1 should light, and you should adjust R11 for the desired delay time.

In rain, use the wipers normally. Since most wipers operate at 2 Hz or faster, the pulse delay shouldn't affect normal operation. If you forget to turn the wiper delay off before shutting off the car, don't worry because it shuts off when you turn off the ignition, and won't turn on again until you start the car and press S1. **R-E**

CAPACITANCE ADAPTER

continued from page 45

residual-C-null control before connecting the capacitor. That completes the calibration.

There are several ways to obtain a "standard" capacitor for calibration. One way is to have a paper, polyester film, or dipped mica capacitor measured on some other accurate capacitance-meter and use that value for the calibration. It is possible to buy polystyrene capacitors with $\pm 2\%$ accuracy. Purchase at least 10 of the same kind and measure each one on the adapter, even though it hasn't been calibrated. Take a numerical average of all the readings and pick the capacitor which comes closest to the average and assume that it has the value marked on the body. Calibrate to that value. The more capacitors used, the more accurate the result will be.

Operation

Using the adapter requires choosing the correct range. A range too low

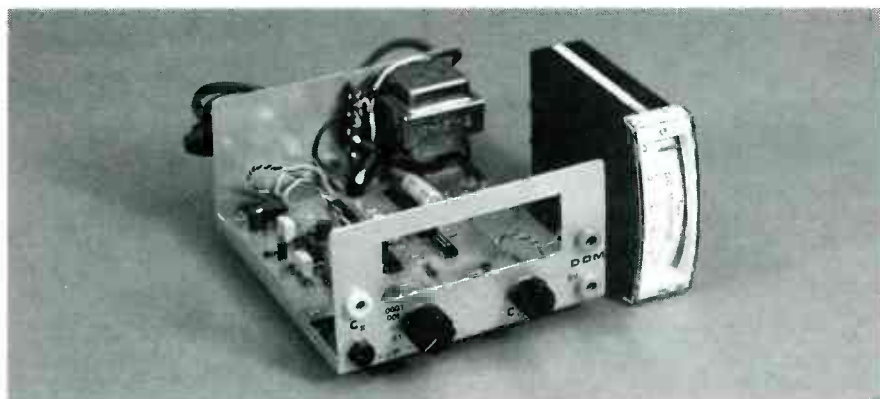

FIG. 5—THE UNIT IS ASSEMBLED on an etched experimenter's board designed for mounting IC's. IC2 should be located at the edge of the board and close to the front-panel terminals for C_x .

for the value of C_x will result in a reading greater than 1 volt, or 1.000 on the voltmeter. A range too high will give readings less than 0.1 volt, or 100, which reduces the accuracy of the readout. For values of C_x less than $.01 \mu\text{F}$, first adjust the meter to zero with the residual-C-null control with the connecting wires in place but not attached to C_x —then connect C_x . Use the digital voltmeter's digits, not as volts, but as a multiplier times the

range-switch full-scale capacitance to arrive at the value of C_x .

A leaky capacitor will give an erroneous high reading. The effect of leakage produces greater errors in the measurement of small capacitors than for larger values. A 470 kilohm leakage in a $0.047\text{-}\mu\text{F}$ capacitor produces a 6% error and a 12% error in a 220-pF size. It is therefore good practice to use an ohmmeter to test C_x before measuring its capacitance. **R-E**

SINGLE-CHIP FREQUENCY CONVERTER

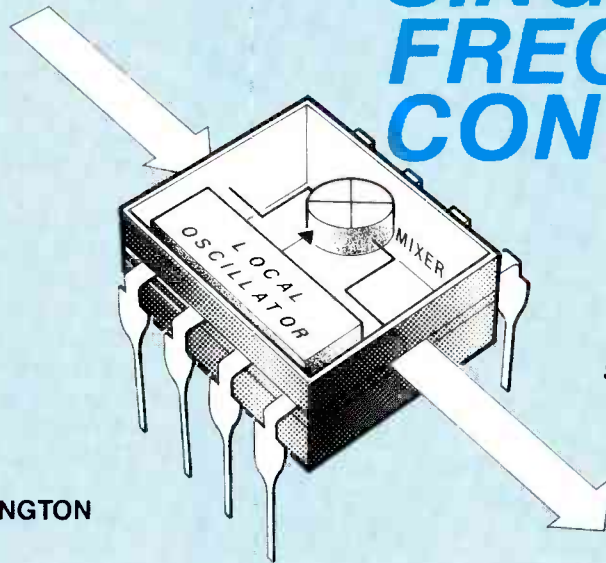

Introducing a general-purpose single-chip frequency converter which should greatly simplify your RF designs.

MICHAEL A. COVINGTON

FREQUENCY CONVERTERS ARE BASIC building blocks of RF equipment. You'll find them wherever there's a need to shift the RF carrier of a signal from one frequency to another, such as in any modern radio receiver.

Frequency conversion, or heterodyning, is the process of mixing an incoming signal with that of a Local Oscillator (LO), as shown in Fig. 1. Two signals result from mixing, their frequencies being the sum and difference of those of the originals. Thus, a 9-MHz input and a 2-MHz LO yield outputs of 7 and 11 MHz.

Building a frequency converter is easier now than it's ever been because of a new IC, the Signetics NE602. The NE602 contains an LO and double-balanced mixer in an 8-pin DIP, as shown in Fig. 2, a block diagram of the IC. The NE602 was originally designed for VHF receiver front ends, since the LO works up to 200 MHz, and the mixer to 500 MHz. However, it has plenty of uses at lower frequencies as well, and this article will explore them.

Circuit description

The NE602 uses a double-balanced mixer, producing only the sum and difference frequencies, not that of the RF input or LO. You can thus connect

the output of an NE602 directly to a receiver without overloading it. With a conventional mixer, you'd have to add a tuned LC circuit to eliminate the LO output. The NE602 LO is also well isolated from its RF input; you can thus connect a receiving antenna directly to the RF input terminals of the IC without worrying about radiating the LO signal back out through the antenna. This is important in direct-conversion receivers, where the LO frequency is so close to that of the input, that the two can't be isolated by a tuned LC circuit.

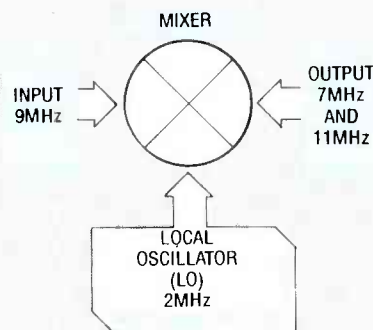

FIG. 1.—FREQUENCY CONVERSION PRODUCES outputs at the sum and difference of input and LO frequencies. In the case of the NE602, since it's double-balanced, both the input and LO signals are absent from the output.

The combination of the differential amplifier and mixer in the NE602 is known as a Gilbert cell. The mixer has on-board voltage regulation, and draws 2.5–3 mA at 4.5–8 volts. For best performance, bypass the power supply with a 0.04- μ F capacitor as close to the IC as possible. The absolute maximum supply voltage is 9.0 volts, but a 9-volt battery often exceeds that, and 9-volt wall transformers often deliver as much as 11 volts. For safety, use 1000-ohm dropping resistor R1 as shown in Fig. 3; using a Zener diode, you can use automotive power supplies up to 18 volts.

The RF input and mixer output can be either single-ended or balanced as shown in Figs. 4 and 5. Using a balanced input reduces harmonics, while a balanced output gives better suppression of the input RF and LO signals. However, even in the simplest single-ended configuration, the NE602 gives much better performance than the one-transistor mixer commonly found in receivers.

The input and output impedances of the NE602 are about 1.5K at low frequencies, and decrease with increasing frequency. The input signal should be weak to prevent harmonics; the third-order intercept point is for a -15 dBm input, but the recommended

level is -25 dBm or below. That corresponds to 68.87 millivolts into 1.5K if you use direct coupling, or 12.82 millivolts into 52 ohms if you use impedance matching. The NE602 works well with microvolt-level signals from antennas.

The input signal is amplified prior to mixing; the voltage gain is about 10. Thus, a receiving converter built with the NE602 can increase a receiver's sensitivity. The NE602 LO is a transistor with connections to its base and emitter, with biasing han-

dled on the chip. That makes it easy to build many different oscillator types with few external components.

Figure 6 shows some of the main versions; there are many others. The NE602 can be used as an oscillator without the mixer. One way is to sample the LO output at pin 7; a better way is to unbalance the mixer and use it to amplify the LO signal, as shown in Fig. 7. The unbalance is created by a 10K resistor from one input pin to ground, which changes the bias voltage slightly. The output level of such an oscillator is about 0.5 VAC P-P.

Basic crystal oscillator

Many frequency converters are crystal-controlled; Fig. 8 shows the most basic version. The low side of XTAL1 and C2 can be returned either to ground or to V_{CC} ; the latter is more compact, because pins 6 and 7 are adjacent to V_{CC} (pin 8). The values of C1 and C2 are important. If C1 is too large, or C2 is too small, there's too much feedback and the oscillator waveform is distorted, with a strong third harmonic. If C1 is too small or C2 is too large, oscillation doesn't occur.

Some suggested values for C1 and C2 are shown in Fig. 6 along with formulae for calculating them. At high frequencies, C1 can be somewhat than the value shown because stray capacitance does some of the work. The values shown are for the best sinusoid. If you want to be sure that a relatively inactive crystal will oscillate and don't mind harmonics, make C1 three times larger. The third harmonic from such a circuit could be used for VHF. There's also a lower frequency limit; the unmodified circuit will oscillate with a 455-kHz ceramic resonator, but not a 100-kHz crystal. Adding 22K from pin 7 to ground will increase the oscillator gain, and improve your chances with low-frequency crystals.

Precise frequency control

A crystal won't necessarily oscillate at its exact rated frequency. There are two kinds, series- and parallel-resonant. They're electrically identical, the only difference being that series-resonant crystals are cut to an exact frequency, whereas parallel-resonant crystals are cut slightly longer, so as to resonate independently slightly below their rated frequency. For that reason, parallel-resonant

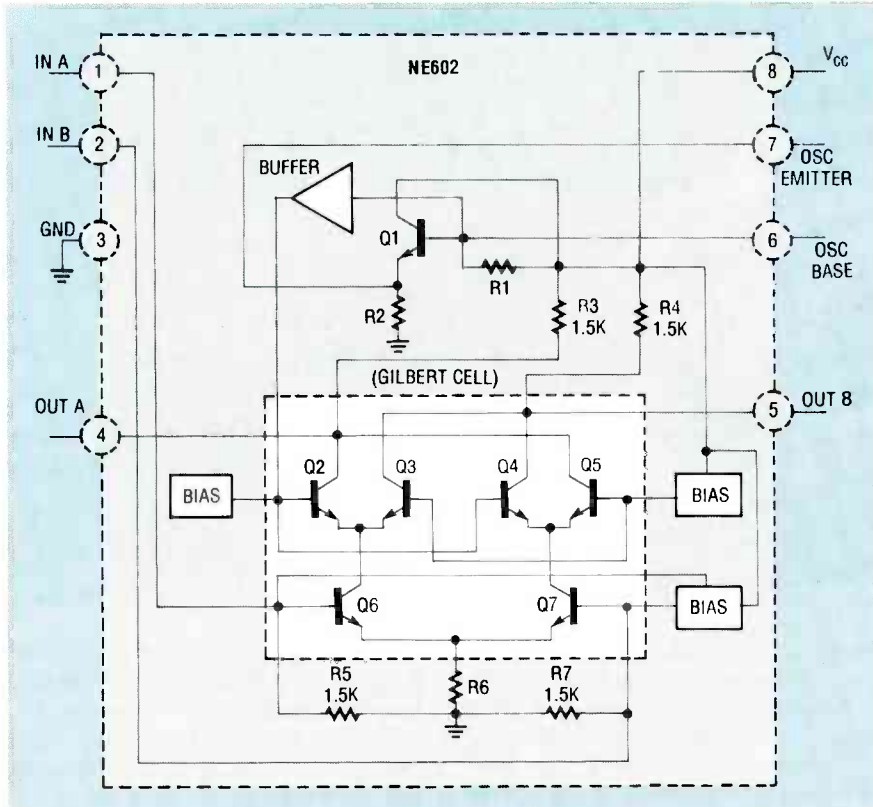

FIG. 2.—NE602 EQUIVALENT CIRCUIT WITH PINOUTS. The combination of differential amplifier Q6-Q7 and mixers Q2-Q3 and Q4-Q5 is called a Gilbert cell.

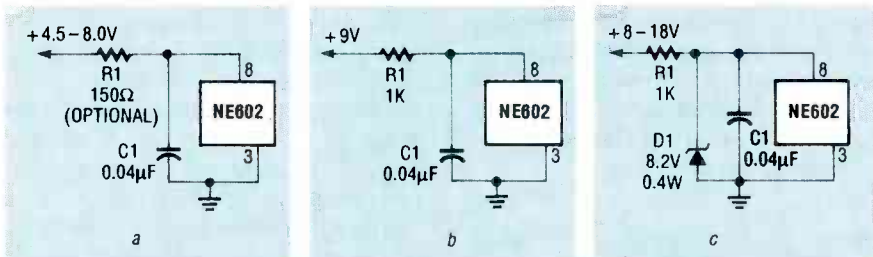

FIG. 3.—NE602 POWER SUPPLY OPTIONS. Here, (a)–(c) show an RC-filter used as both current limiter (R1) and integrator (C1), as well as for isolation. In (a), +4.5–8.0 volts DC is the normal operating range of the NE602. In (b), R1 drops voltage, and is used since a +9-volt battery can go higher, and a +9-volt wall supply can produce up to 11 volts. In (c), an +8–18-volt DC supply is regulated using 8.2-volt Zener D1.

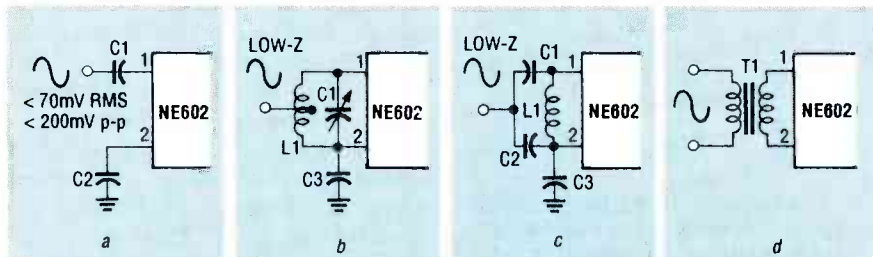

FIG. 4.—MIXER RF INPUT CONFIGURATIONS. Here, (a)–(c) are for single-ended coupling, (a) being for no impedance matching, (b) for inductive matching, (c) for capacitive matching. By contrast, (d) is for a balanced input with reduced second harmonic.

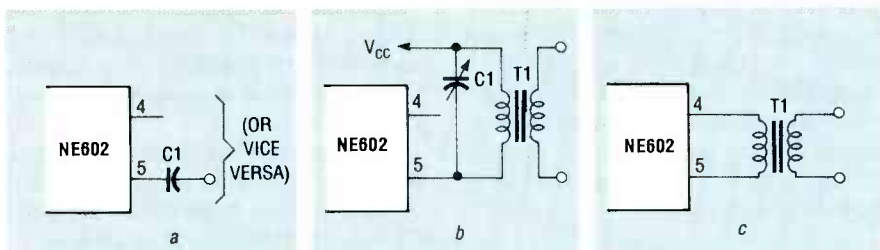

FIG. 5.—OUTPUT CONFIGURATIONS. Here, (a) is the simplest single-ended approach without impedance matching, (b) is a single-ended approach for a tuned LC circuit load, and (c) is for a balanced approach for better suppression of input and LO signals.

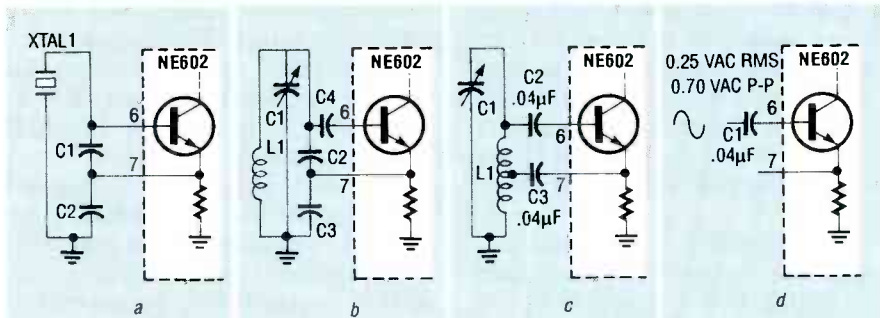

FIG. 6.—BASIC NE602 OSCILLATOR CIRCUITS; (a) is Colpitts crystal-controlled, (b) is Colpitts LC-tank-controlled, (c) is Hartley LC-tank-controlled, and (d) is controlled by an external oscillator. Many other configurations are possible.

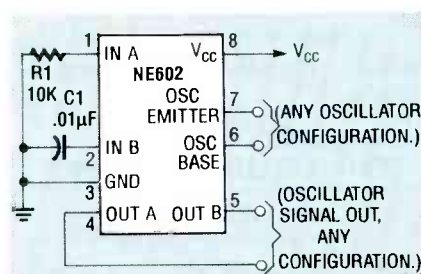

FIG. 7.—THIS IS A GENERAL CONFIGURATION for an NE602. To make an LO signal appear at OUT A (pin 4) and OUT B (pin 5), IN A (pin 1) is grounded through R1.

crystals need external capacitors (usually 32 pF) to increase their actual frequency of oscillation to their rated value. In Fig. 8, C1 is this capacitor, but it's usually larger than 32 pF and has less effect than the one depicted here.

Thus, at 10 MHz, parallel-resonant crystals oscillate about 100 parts per million (ppm) below their rated frequency, while series crystals resonate about 300 ppm above. A parallel-resonant crystal can be pulled up to its rated frequency using a small variable capacitor in series with it, as in Fig. 9, letting you adjust the oscillator as desired. However, even without this capacitor, the frequency error won't be more than 300 ppm (0.03%).

Overtone crystal oscillator

Above 20 MHz, crystals oscillate in overtone mode, and the oscillator

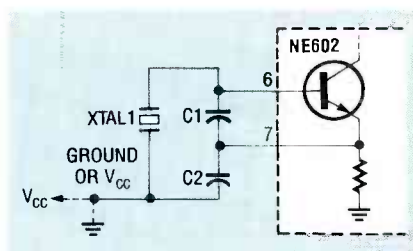

f MHz	C1=100pF/√f	C2=1000pF/f
1	100	1000
2	70	500
4	50	250
10	32	100
20	22	50

FIG. 8.—FUNDAMENTAL COLPITTS CRYSTAL OSCILLATOR. Note that the juncture of XTAL1 and C2 can go to either ground or V_{CC}.

needs a tuned LC circuit to select the desired harmonic. For example, a 27-MHz third-harmonic crystal can resonate at 9 MHz (fundamental) or 45 MHz (fifth harmonic). The NE602

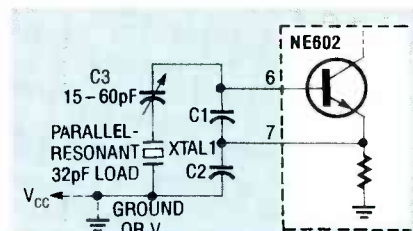

FIG. 9.—A VARIATION ON FIG. 8, including C3 to adjust the frequency of XTAL1 (parallel-resonant), bringing it up to its rated value.

data sheet recommends a modified Colpitts oscillator for overtone crystals, but the Butler oscillator in Fig. 10 gives much better results. Its crystal is series-resonant, and L₁ and C1 are tuned to the crystal frequency.

This circuit is reliable to at least 60 MHz. Just adjust L₁ and C1 until oscillation occurs. By adjusting this tuned LC circuit, you can trim the frequency by about 50 ppm; for greater variation, use a parallel-resonant crystal in series with a variable capacitor for adjustments.

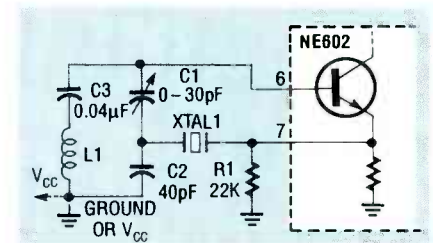

FIG. 10.—BUTLER OVERTONE CRYSTAL OSCILLATOR, with C1 as trimmer. Here: L₁=1300 μH, and both L₁ and C1 have to be tuned to the frequency of XTAL1.

Frequency doubler

Figure 11 shows a crystal-controlled frequency doubler with no tuned LC circuits. That circuit is useful in the 20–40 MHz range, but the same method could be used with overtone crystal oscillators for even higher output frequencies.

The doubling is achieved by feeding the LO from pin 7 into the mixer. The output is 2×f (where f is the oscillator fundamental frequency), while the difference frequency is zero (or DC), disappearing due to capacitive coupling.

The output still contains some energy at the LO frequency and isn't pure, but is good enough for hobbyist purposes. A tuned LC circuit can easily provide pure output. Of the oscillators shown here, this is the only one that can't be used with the mixer, because one mixer input is occupied (although you could feed a signal to the other mixer input).

Figure 12 shows a Colpitts LC oscillator using coils and capacitors. Here, L₁ forms a resonant circuit with C1 and C2 in series, plus C4 in parallel. Also, C3 blocks DC from pin 6 to V_{CC} or ground; it has little effect on the resonant frequency. Figure 12 also gives formulas for component values. At very high frequencies, a 22K resistor from pin 7 to ground (not V_{CC}) will change the bias point and increase gain.

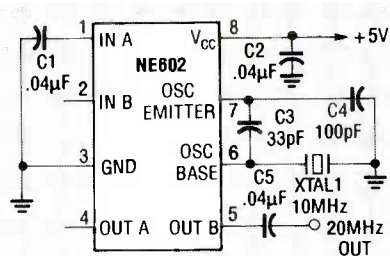

FIG. 11.—THIS FREQUENCY DOUBLER PRODUCES a sine wave at twice the frequency OF XTAL1. Note that output is taken only from OUT B (pin 5), while OUT A (pin 4) is left open.

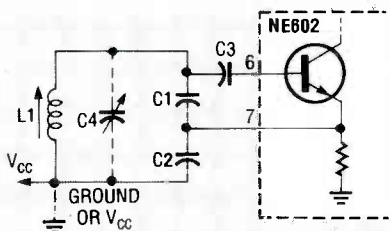

FIG. 12.—COLPITTS LC OSCILLATOR. Here: $L1 \approx 7 \mu\text{H}/f$, $C1 \approx C2 \approx C3 \approx 2400 \text{ pF}/f$, where f is in MHz.

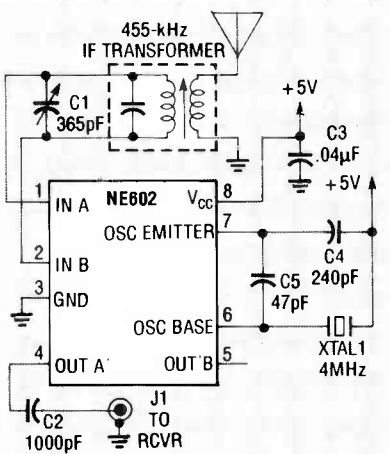

FIG. 13.—THIS CONVERTER DOWN-CONVERTS LONGWAVE signals from 350–500 kHz up to 4.35–4.5 MHz, enabling them to be received via a shortwave receiver plugged into J1.

Longwave receiver converter

Figure 13 shows a frequency converter front end for a shortwave receiver to receive longwave signals (350–500 kHz). It mixes the incoming signal with the 4-MHz signal from the LO. For example, 400 kHz incoming produces 4.4 and 3.6 MHz. The shortwave receiver will receive the signal if tuned to either frequency. The input has a tuned LC circuit to prevent spurious response.

If the receiver is set to 4.4 MHz, then without the tuned LC circuit you'd listen to 400 kHz and 8.4 MHz, because each gives a 4.4-MHz output when mixed with the LO. The tuned

LC circuit at the input selects one and rejects the other. This circuit was attached to a shortwave receiver, and immediately received several long-wave navigational beacons in nearby states. A long wire antenna works, but loops pick up less noise because they are directional.

Direct-conversion receiver

A frequency converter can shift frequencies up or down. However, if you shift an RF signal down to audio, you get an audio signal. This is called direct-conversion reception, and can demodulate Single-Sideband (SSB) and Morse code Continuous-Wave (CW) transmissions. It demodulates AM, but there's a whine if the tuning isn't perfect.

Figure 14 shows such a direct-conversion receiver for the 40 meter band (7.5 MHz), that was able to receive several amateur radio stations using a 3-foot whip antenna. The design could be refined; tuning would be easier with a variable capacitor instead of an adjustable coil.

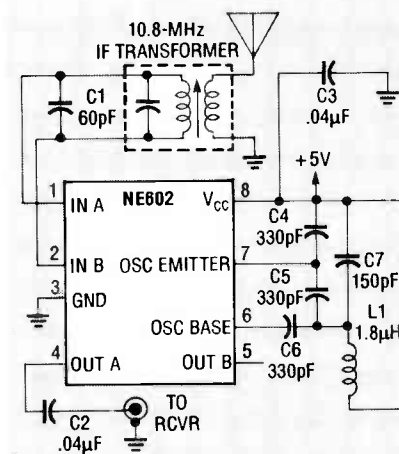

FIG. 14.—DIRECT-CONVERSION RECEIVER for the 40-meter (7-MHz) amateur radio band, where CW is directly down-converted to audio.

Conclusion

There are basically three RF circuit types—amplifiers, oscillators, and frequency converters. The NE602 makes frequency conversion easier than ever. Both it and related IC's will eventually become basic building blocks of RF design. This article has only scratched the surface of the possibilities for the NE602. In an IF section, it makes a good product detector. By mixing audio with RF, it can act as an AM or DSB modulator. By mixing audio with audio, the

NE602 can be the heart of an ultrasonic listener (by down-converting high-frequency audio) or a speech scrambler to add security to telephone conversations.

You can get NE602's at \$2.00 each, plus \$2.50 per order postage and handling per order, from the Small Parts Center, 6818 Meese Drive, Lansing, MI 48911. (517) 882-6447; there's no minimum order. They're also available from Arrow Electronics, Schweber Electronics, and many other Signetics distributors, with \$25.00 typical minimum orders. Be sure to specify whether you want the NE602N (8-pin DIP) or NE602D (surface mount package).

You also may prefer to order the NE602A, which will be replacing the NE602 imminently; it has somewhat improved intercept characteristics, resulting in less harmonic generation and intermodulation distortion. To specify the desired package type, you'd refer to the NE602AN or NE602AD. We would like to thank Phil Anzalone, Ali Fotowat, and Craig Hirtz of Signetics for their invaluable assistance in preparing this article.

R-E

POWER LINE GLITCHES

continued from page 42

13–16. Figure 13 shows a normal power sinusoid, Fig. 14 shows harmonic distortion, Fig. 15 shows a brief glitch, and Fig. 16 shows a brief power outage.

Conclusion

Those graphs shown in Figs. 8–16 show only a few of many possible disturbances. Power glitches are common and readily identified. Most are easily fixed, the culprit often being poor wiring, bad grounding, or load switching—all can be corrected cheaply. The most common, practical countermeasure is to install a separate power line from the circuit-breaker box involved to the device being interfered with, like a PC.

Power monitors make identification easy, but they're generally too expensive, and would be needed too infrequently, to warrant purchase by the average hobbyist. They can, however, be rented for short periods, on an as-needed basis, letting you derive the benefits of their technology without making a major investment.

R-E

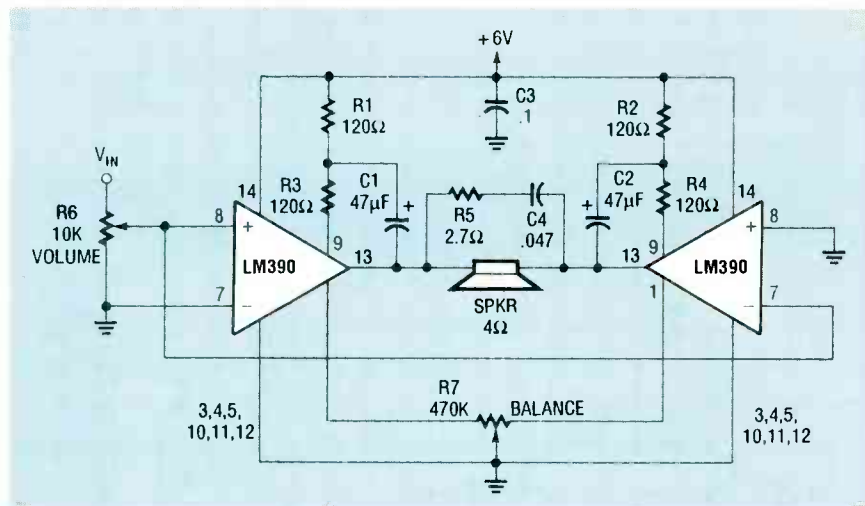

FIG. 4—TWO LM390'S USED AS A BRIDGE AMPLIFIER delivering 2.5 watts into a 4-ohm speaker.

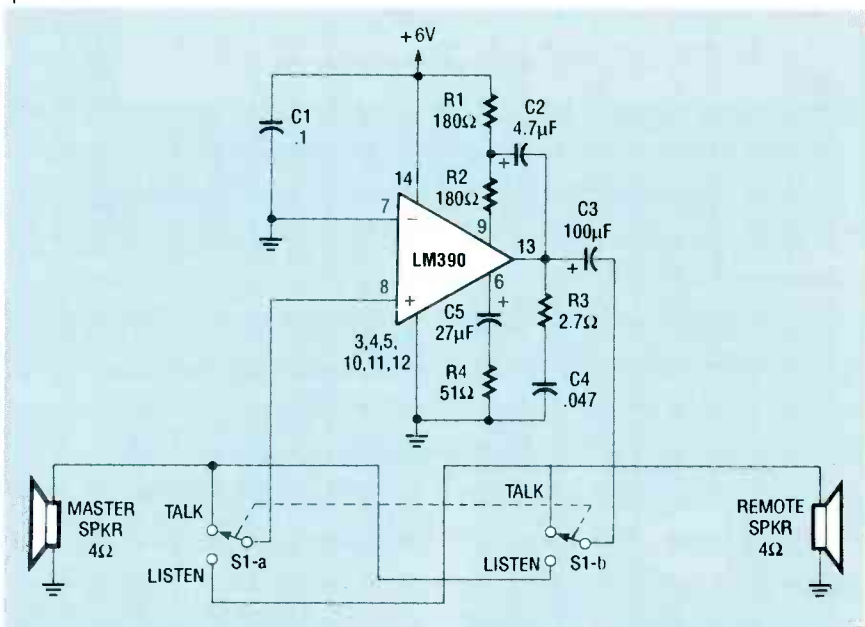

FIG. 5—AN LM390 USED IN AN INTERCOM. Note how S1-a and S1-b interchange speaker and microphone.

TABLE 1—APPROXIMATE PERFORMANCE CHARACTERISTICS OF THE LM377/8/9 AMPLIFIERS

V _{CC} (volts)	Power Limit per Channel (watts)			Maximum Output Power per Channel (watts)	
	LM377	LM378	LM379	8-ohm load	16-ohm load
12	2.5	5.0	6.0	1.6	1.0
16	2.5	5.0	6.0	2.2	1.5
18	2.5	5.0	6.0	3.0	1.8
20	2.5	5.0	6.0	3.8	2.4
22	2.5	5.0	6.0	4.6	2.8
24	—	5.0	6.0	5.4	3.6
26	—	—	6.0	6.0	4.2
28	—	—	6.0	7.0	5.0
30	—	—	6.0	—	5.5

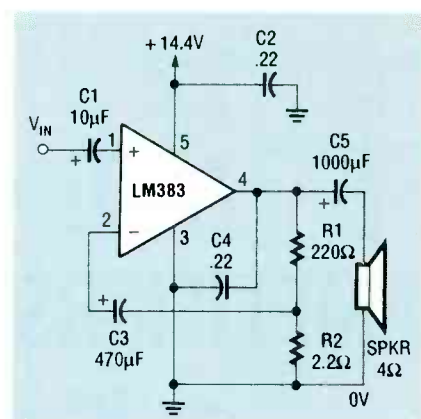

FIG. 6—AN LM383 USED IN A 5.5-WATT AUDIO AMPLIFIER for use in automotive audio applications.

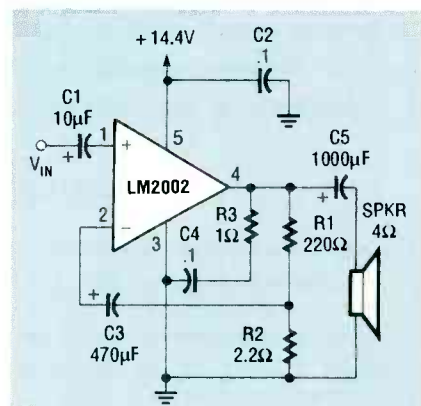

FIG. 7—AN LM2002 USED IN A 5.2-WATT automotive-audio amplifier.

bility; they can be eliminated in some applications.

LM383 circuits

The LM383 is described as an 8-watt audio-power amplifier IC. It's specifically designed for use in automotive audio applications, in which the "running" power supply has a nominal value of 14.4 volts. At that level, the LM383 can typically deliver 5.5 watts into a 4-ohm speaker, or 8.6 watts into a 2-ohm speaker. In reality, the IC can operate using +5–20-volts DC, can deliver peak output currents of 3.5 amps, and has a current-limited and thermally-protected output stage.

The LM383 is housed in a 5-pin TO-220 package, and is very easy to use. Figure 6 shows an application in a 5.5-watt automotive-audio amplifier. Here, the closed-loop gain is 100 via the R1-R2-C3 feedback network, and the LM383 is made non-inverting by feeding the input signal to pin 1 via C1. Also, C2 and C4 ensure high-frequency stability, but C4 *must* be physically close to pins 3 and 4. It is also possible to use LM383's in a bridge configuration for higher power.

LM2002 (TDA2002) circuits

The LM2002 is an 8-watt automotive-audio amplifier IC, equivalent to the TDA2002, and housed in a 5-pin TO-220 package. It can deliver 5.2 watts into a 4-ohm speaker, or 8 watts into a 2-ohm speaker. It uses a +5–20-volt power supply, can deliver peak output currents of 3.5 amps, and has a current-limited and thermally-protected output. It's similar to the LM383, but has a slightly less efficient output, with consequent lower output power into a given load.

Figure 7 shows an application of an LM2002 used in a 5.2-watt automotive-audio amplifier, with a closed-loop gain of 100 set by R1, R2, and C3. Here, R3 and C4 ensure high-frequency stability, and have to be close to pins 3 and 4. Two LM2002's or TDA2002's can be used to form a 16-watt automotive-audio bridge amplifier.

LM377/8/9 circuits

National Semiconductor has a range of dual power-amplifier IC's for mono, stereo, and bridge amplifier applications. The best known are the LM377 2-watt, the LM378 4-watt, and the LM379 6-watt versions. Figure 8 shows the outlines of their DIP's with pinouts, and Table 1 their approximate performance characteristics. They all have high-impedance differential input stages and fully-protected output stages, but differ in voltage, power, and packages. The input stages are DC-biased to $V_{CC}/2$, and a bias generator is built into the IC.

Figure 9 shows a general inverting stereo amplifier using a single-ended power supply. The IC depicted can be any of those in the accompanying table, which lists typical performance. The amplifiers in the IC are biased by connecting each non-inverting input to the bias terminal (pin 1 on the LM377 or LM378, or pin 14 on the LM379), and the closed-loop gain of each is about 50 ($R2/R1$ or $R4/R3$). Figure 10 shows how the above circuit can be used in non-inverting mode using a single-ended power supply, with the gain of each half set at 50 ($R4/R3$ or $R6/R5$), and the non-inverting input terminals of the amplifiers biased internally.

It is possible to power the circuit of Fig. 10 by using a split power supply. In that case, the internal bias generator is ignored, and the non-inverting

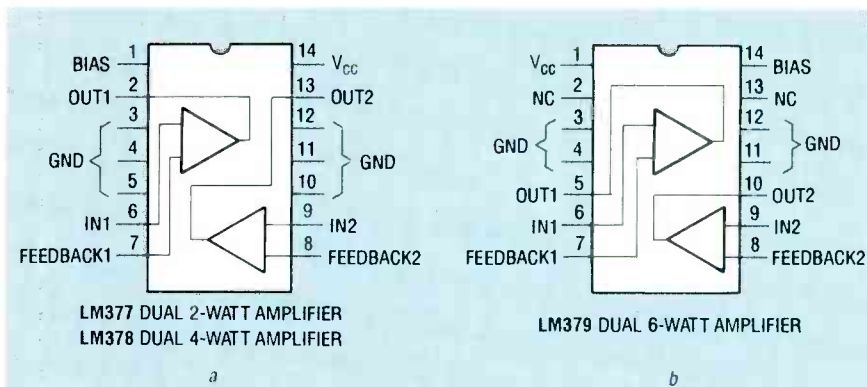

FIG. 8—OUTLINES AND PIN NOTATIONS OF THE popular LM377/8/9 dual amplifiers.

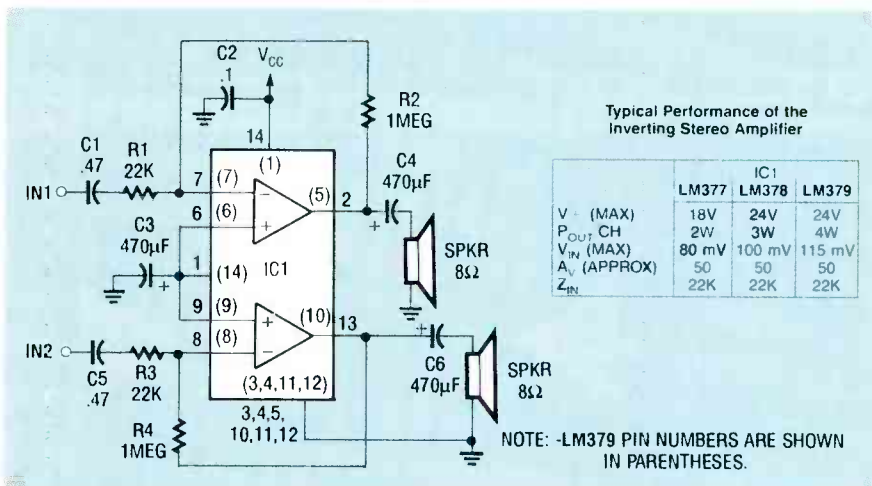

FIG. 9—SIMPLE INVERTING STEREO AMPLIFIER using the LM377/8/9 dual amplifiers.

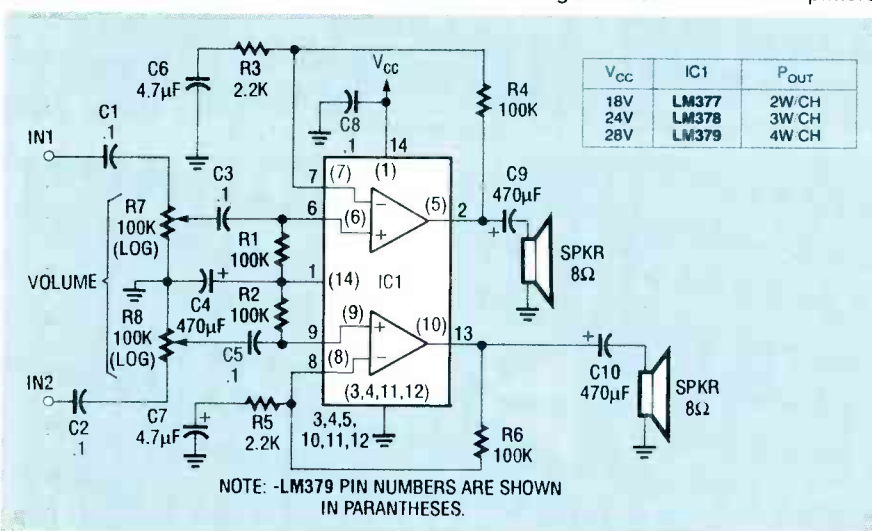

FIG. 10—NON-INVERTING STEREO AMPLIFIER USING a single-ended power supply.

input of each amplifier is DC-coupled to the ground half-supply point via R6 and R7.

Figure 11 illustrates how to boost the available power of one half of an LM378 to 15 watts, while generating only 0.05% Total Harmonic Distortion (THD) at 10 watts. At very low power, Q1 and Q2 are inoperative, and power is fed directly to the speaker via R2.

At high power, Q1 and Q2 form a complementary emitter follower, providing most of the power to the speaker. Also, R2 and Q1-Q2 are wired into the negative feedback loop, generating negligible cross-over distortion. Figure 12 shows an application of both halves of an LM377/8/9 in a mono bridge amplifier feeding high power into a DC-coupled speaker.

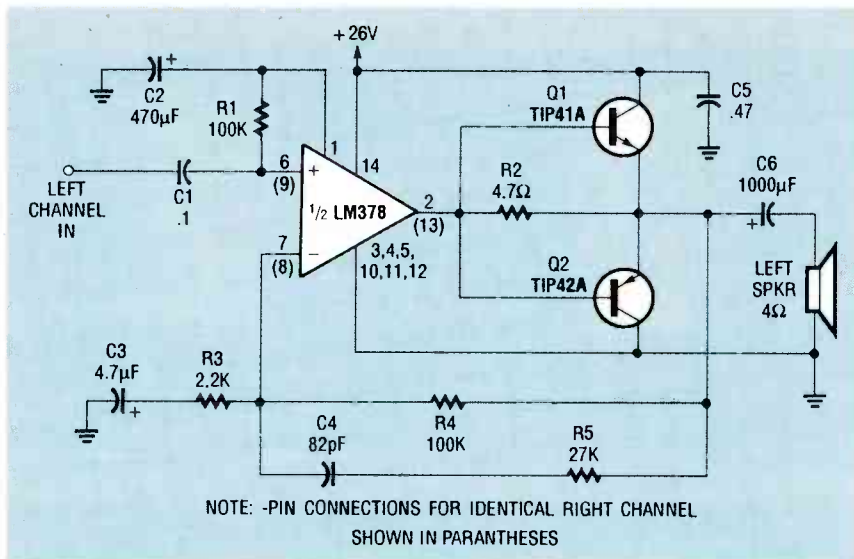

FIG. 11—ONE CHANNEL OF A 15-WATTS-PER-CHANNEL stereo amplifier using a single-ended power supply.

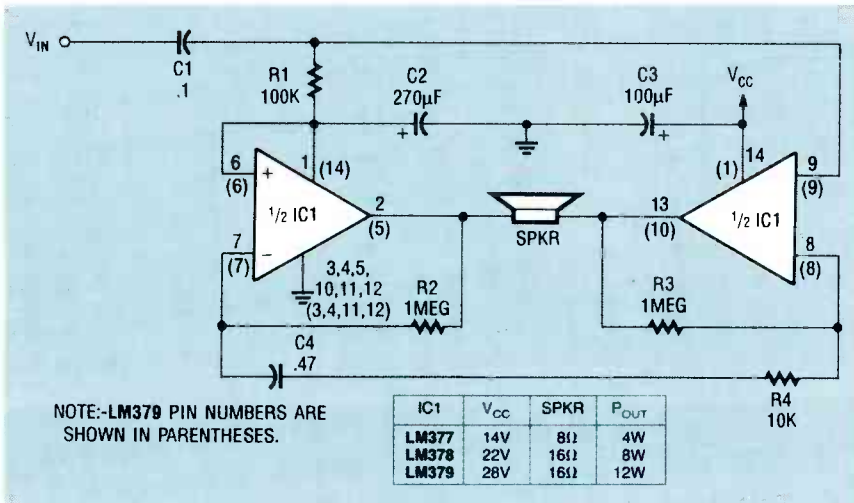

FIG. 12—BRIDGE AMPLIFIER CIRCUIT USING dual-amplifier IC's.

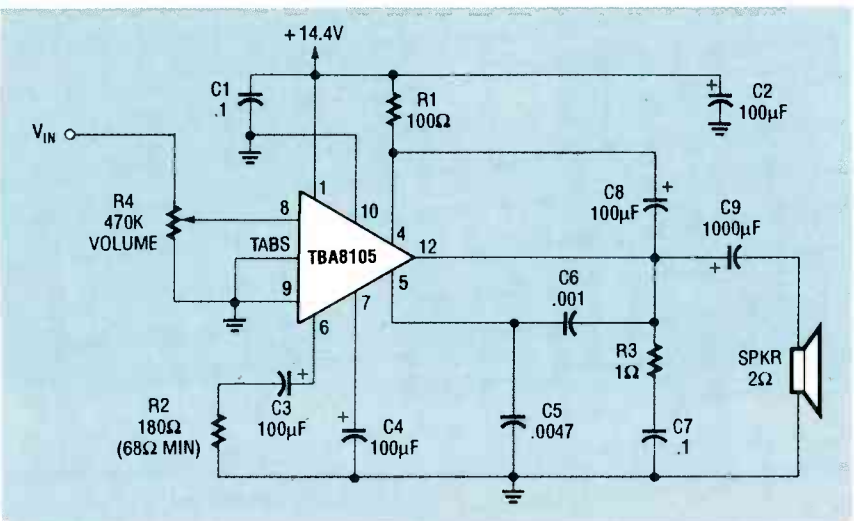

FIG. 13—A TBA8105 USED AS A 7-WATT AUTOMOTIVE-AUDIO amplifier.

The LM1877 IC

The LM1877 dual 2-watt power amplifier IC is an improved pin-for-pin replacement for the LM377, to be used in place of the LM1877 whenever possible. It provides improved

performance in terms of very low cross-over distortion, very high input impedance, and high slew rate, but has slightly worse ripple rejection and higher quiescent current than the LM377.

Assorted amps

The remainder of this discussion will give brief descriptions of a few popular audio-power amplifier IC's, with applications for each. The TBA8105 can deliver several watts for automotive audio applications. It features protection against power supply polarity inversion and high-voltage transients.

Figure 13 shows an application that uses a TBA8105 as a 7-watt automotive-audio amplifier; the gain is determined by R2, while R1 performs output biasing and is bootstrapped via C8, and R3-C7 functions as a Zobel network.

The TBA820M is a low-power amplifier IC capable of delivering a few hundred milliwatts into a 4-16-ohm speaker, and is housed in an 8-pin DIP. It can run on as little as +3 volts, and has low quiescent current, good ripple rejection, and low cross-over distortion.

Figure 14 shows an application of a TBA820M as a low-power audio amplifier, where the gain is determined by R2, and R3-C6 is a Zobel network. It can run on a +16-volt single-ended power supply using a 16-ohm speaker, a +12-volt power supply using an 8-ohm speaker, or a +9-volt power supply using a 4-ohm speaker.

The TDS2005M is a 20-watt automotive audio-power booster IC housed in an 11-pin package, fully output short-protected. It houses two internal bridge-connected power amplifiers, providing high power into a 2-ohm speaker from a +14.4-volt power supply. Figure 15 shows an application as a 20-watt automotive audio-power booster; all electrolytic capacitors should be rated at a minimum of +25 volts.

The TDA2006 and TDA2030 are high-quality amplifiers capable of being used using either split or single-ended power supplies, and generating less than 0.1% distortion when delivering 8 watts into a 4-ohm speaker. They're housed in a 5-pin TO-220 package with an insulated heatsink bolted directly to an external heat sink with no insulating washer.

Figure 16 shows the package and pin connections for both the TDA2006 and TDA2030, and Figure 17 shows an application that uses a TDA2006 in an 8-watt amplifier powered by a split power supply, with the non-inverting input tied to ground via R1. Here, high-frequency roll-off

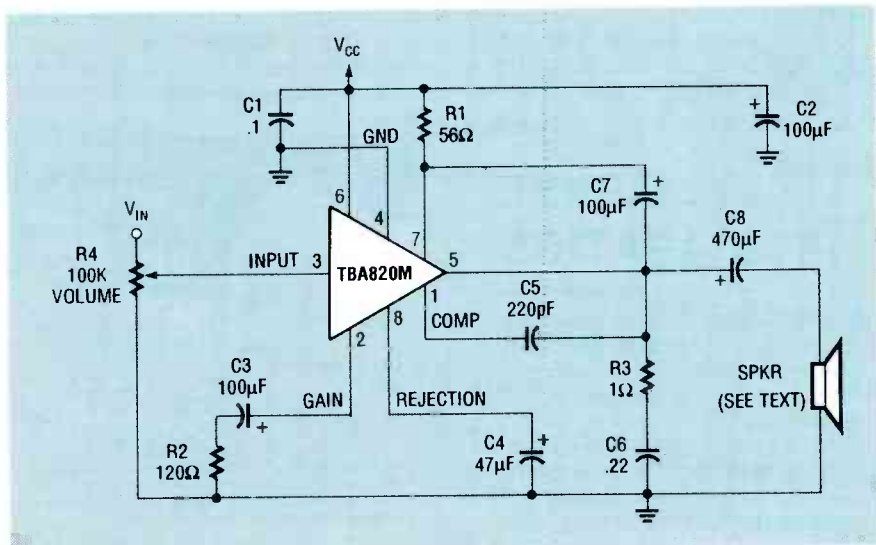

FIG. 14—A TBA820M USED AS A LOW-POWER audio amplifier.

use up to +36 volts in the case of a single-ended power supply, and ± 18 volts in the case of a split power supply. Using a +28-volt single-ended power supply, it delivers 12 watts into a 4-ohm speaker or 8 watts into an 8-ohm speaker, with a THD of 0.05% at 1 kHz and 7 watts out.

Figure 18 shows an application of the TDA2030 as a 15-watt amplifier using a +30-volt single-ended power supply and 4-ohm speaker, with 30 dB gain.

The performance that you can obtain from the circuits presented can be quite impressive. While they form an excellent starting point for an original amplifier design, they can also be used in other projects. For example, with a hand-full of parts and a little bit

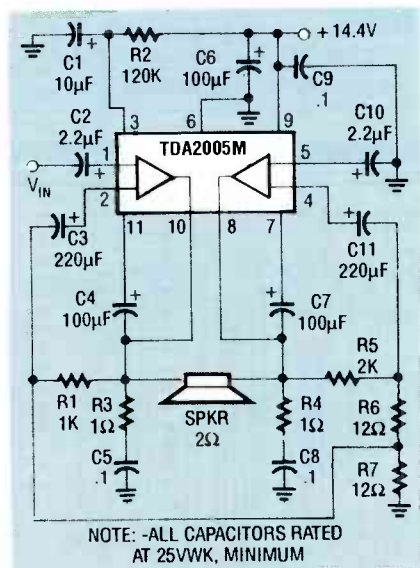

FIG. 15—A TDA2005M USED AS A 20-WATT AUTOMOTIVE audio-power booster.

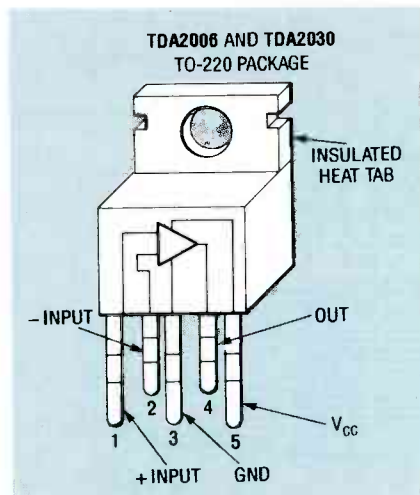

FIG. 16—THE TO-220 OUTLINE AND PIN CONNECTIONS of the TDA2006 and TDA2030.

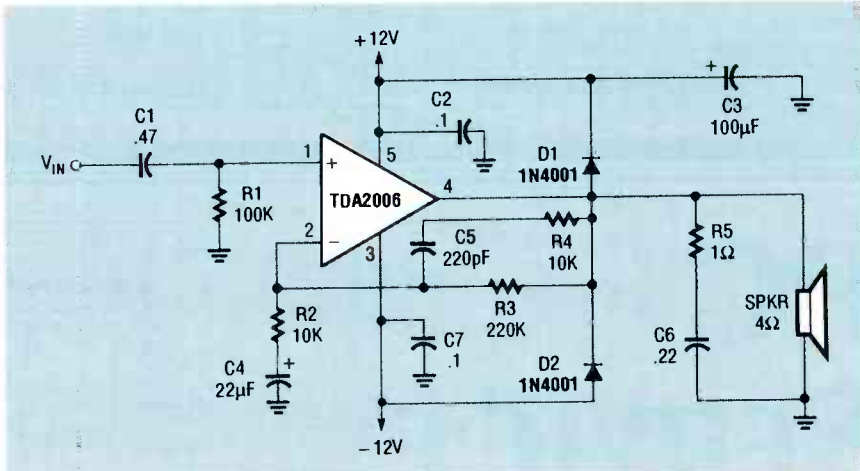

FIG. 17—A TDA2006 USED AS AN 8-WATT AMPLIFIER using a split power supply.

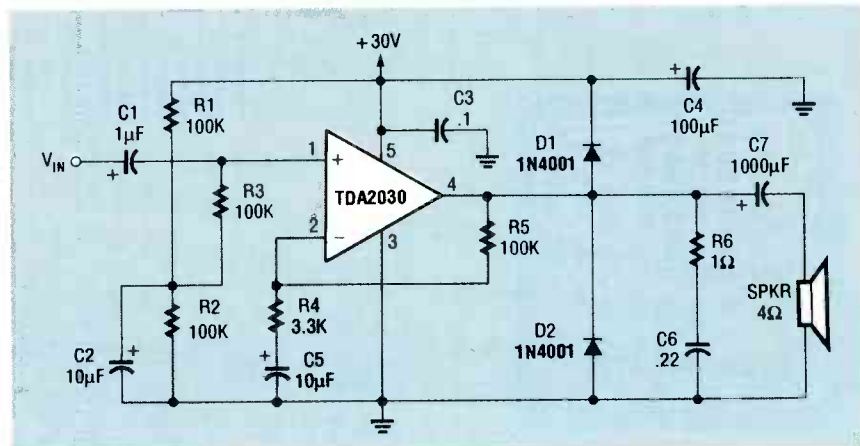

FIG. 18—A TDA2030 USED AS A 15-WATT AMPLIFIER using a single-ended power supply.

is achieved via R4-C5, and the gain is set by R3/R2, or 22. Diode D1 and D2 protect the output against damage from back-EMF from the speaker, and R5 and C6 form a Zobel network.

The TDA2030 is an upgraded TDA2006 housed in a 5-pin TO-220 package with insulated heat tab. It can

of work, you can transform the output of your personal portable stereo into car-filling sound.

If you have an older car stereo (and who doesn't?) with blown final output amplifiers, you might find that many of the circuits we presented will fill the bill nicely.

R-E

R-E Engineering Admart

Rates: Ads are 2 1/4" x 2 7/8". One insertion \$950. Six insertions \$925. each. Twelve insertions \$895. each. Closing date same as regular rate card. Send order with remittance to **Engineering Admart**, Radio Electronics Magazine, 500-B Bi-County Blvd., Farmingdale, NY 11735. Direct telephone inquiries to Arline Fishman, area code-516-293-3000. **Only 100% Engineering ads are accepted for this Admart.**

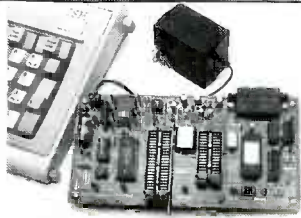

6805 MICROCOMPUTER DEVELOPMENT SYSTEM

The MCPM 1 system allows the IBM PC and compatibles to be used as a complete development system for the Motorola MC68705P3, P5, U3, U5, R3 and R5 single chip microcomputers. The system includes a cross assembler program, a simulator/debugger program and a programming board that connects to a serial port. Price—\$449.00 VISA and MASTERCARD accepted.

TECI THE ENGINEERS COLLABORATIVE, INC.

RR#3, BOX 8C Barton, Vermont 05822
Phone (802) 525-3458 FAX (802) 525-3451

CIRCLE 191 ON FREE INFORMATION CARD

FCC LICENSE PREPARATION

The FCC has revised and updated the commercial license exam. The **NEW EXAM** covers updated marine and aviation rules and regulations, transistor and digital circuitry. **THE GENERAL RADIOTELEPHONE OPERATOR LICENSE - STUDY GUIDE contains vital information. VIDEO SEMINAR KITS ARE NOW AVAILABLE.**

WPT PUBLICATION
979 Young Street, Suite A
Woodburn, Oregon 97071
Phone (503) 981-5159

CIRCLE 185 ON FREE INFORMATION CARD

Surface Mount Chip Component Prototyping Kits— Only \$49.95



CC-1 Capacitor Kit contains 365 pieces, 5 ea. of every 10% value from 1pf to 33µf. CR-1 Resistor Kit contains 1540 pieces; 10 ea. of every 5% value from 10Ω to 10 megΩ. Sizes are 0805 and 1206. Each kit is **ONLY \$49.95** and available for Immediate One Day Delivery!

Order by toll-free phone, FAX, or mail. We accept VISA, MC, AMEX, COD, or Pre-paid orders. Company P.O.'s accepted with approved credit. Call for free detailed brochure.

COMMUNICATIONS SPECIALISTS, INC.
426 West Talt Ave. • Orange, CA 92665-4296
Local (714) 998-3021 • FAX (714) 974-3420

Entire USA 1-800-854-0547

CIRCLE 187 ON FREE INFORMATION CARD

PC SERVICE

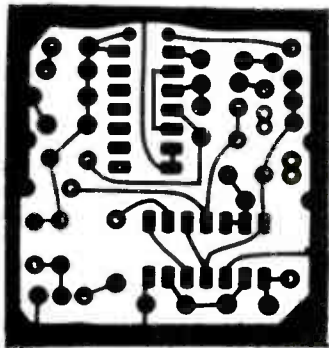

1 1/16 INCHES

FOIL PATTERN for the windshield-wiper delay unit.

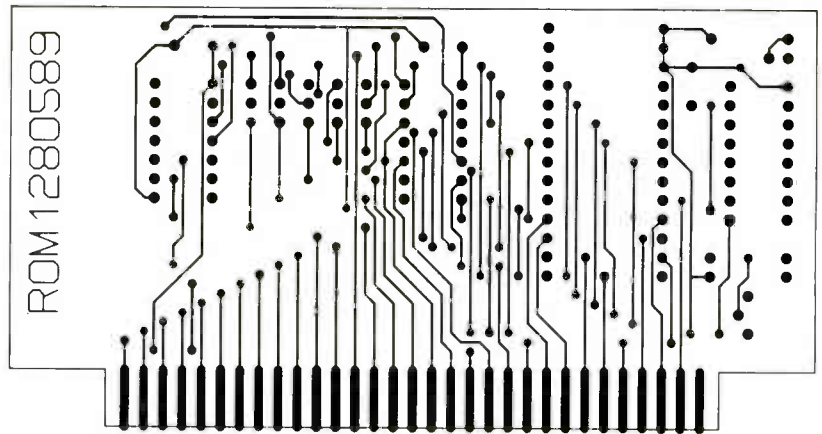

ROM 1280589

4 1/4 INCHES

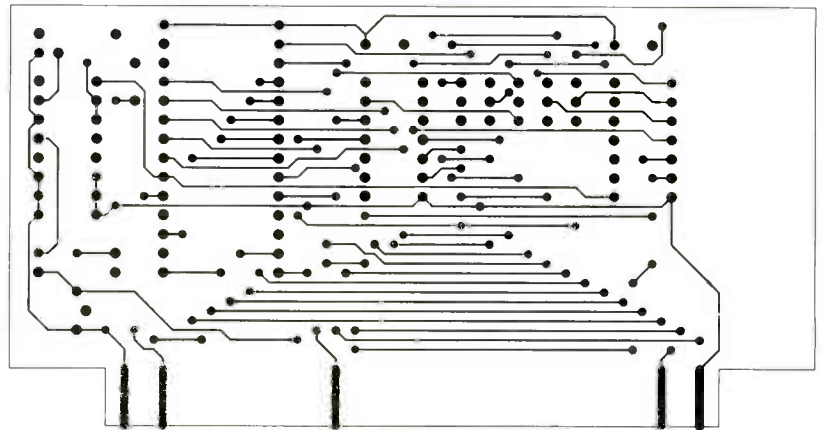

4 1/4 INCHES

ABOVE RIGHT is the component side of the PC Access. At right is the solder side.

HARDWARE HACKER

Organic Vapor Detectors
Low Melting Point Alloys
Alternate Energy Resources
Ultraviolet Flame Detector
Five Band Equalizer Circuit

Alternate-energy resources

DON LANCASTER

WE SEEM TO HAVE A REALLY MIXED BAG of outstanding goodies this month, so let's just jump right in. As usual, please note that all of our referenced sources appear in either the alternate-energy resource sidebar or in the names and numbers box.

Hazardous materials

I've gotten several calls asking how to dispose of any spent printed-circuit etchant. Since I'm part of the Haz-Mat team at our local fire department, I thought we'd look at the big picture first. Back to square one.

We can define a *hazardous material* as any substance that is out to do you in. It might burn, explode, be chemically reactive, be biologically active, poisonous, radioactive, or might interact violently with water or air.

As a hardware hacker, you probably expose yourself to hundreds of hazardous materials. Knowing ahead of time what these nasties are and what they do to you is common sense.

Most industrial chemicals and by-products have to provide a *Materials Safety Data Sheet*. Obviously, you'll want to read and collect them. If you have any employees, you are required by law to make any relevant sheets available to them on request.

Unfortunately, most MSDS listings do a total whitewash job and dwell on stupid trivia. For instance, the sheet on Kapton films goes out of its way to tell you that these films are slippery and you can trip on them if you leave them

on the floor. But they make no obvious mention that Kapton turns from an insulator into a conductor above a certain temperature, totally thrashing any computer or electronic system it is involved with. Always watch for understatement, weasel words, and any misdirection when you are reading the sheets.

One of the best Haz-Mat references is the "yellow" book from DOT, otherwise known as the *Emergency Response Guidebook*. It lists most industrial chemicals and tells competent professionals how to deal with them under emergency conditions. Single copies are obtainable at no charge on request.

LMA-117

Melts at 117 Degrees F.
Contracts slightly on cooling.
About \$7.50 per ounce.

LMA-158

Melts at 158 Degrees F.
Expands slightly on cooling.
About \$1.35 per ounce.

LMA-255

Melts at 255 Degrees F.
Expands slightly on cooling.
About \$1.00 per ounce.

LMA-281

Melts at 281 Degrees F.
Expands slightly on cooling.
About \$2.20 per ounce.

FIG. 1—SOME LOW-TEMPERATURE ALLOYS you can get through Small Parts. Two of these can be melted and cast with boiling water. What hacker uses can you think of?

A second resource is the 24-hour emergency telephone number from *Chemtrek* at (800) 424-9300. It's a free chemical-industry service that can instantly place you in contact with experts on any hazardous material. But note that it's an emergency response number, sort of a nationwide 911. Do not use it for idle chat.

An interesting free trade journal that deals with hazardous materials is *Pollution Equipment News*. That one also exposes you to some real pneumatic and electronic gems that you might not otherwise see.

Naturally, any genuine Haz-Mat incident should be handled by the professionals, usually contacted by your local 911 number. One of the hardest things for the pros to learn is that their preconditioned "Save my Baby!" super-aggressive initial fire-attack strategy is most often dead wrong in a Haz-Mat incident. Doing nothing at all is usually far better than becoming part of the problem.

The quantity of the material and the way you store it will also make a big difference. Common sense is an obvious factor here.

In the case of ammonium-per-sulfate printed-circuit etchant, storage of the dry etchant in small and sealed plastic containers is recommended. *Tupperware* works quite well. Some ammonium-per-sulfate etchants also include a highly poisonous mercury activator. So never work in your kitchen, always be in a well-ventilated area, and always wear safety

WARNING: Extreme shock and "hot chassis" danger in this circuit as shown!

All capacitors are 500 volts.

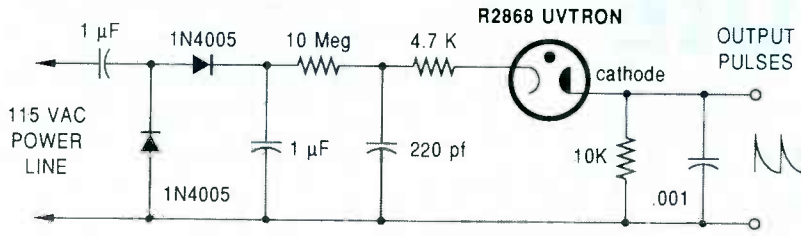

FIG. 2—AN ULTRA-VIOLET FLAME SENSOR. The circuit is basically a neon lamp relaxation oscillator. Its frequency is a few counts per minute in the absence of a flame, and a mid to high audio frequency with a flame present.

Figure 1 sums up their properties.

The melting points for those alloys are set to 117 degrees Fahrenheit, 158 degrees, 255 degrees, and 281 degrees. They are available in quarter- and one-pound sizes, and range in price from \$28 to \$78 per pound. Unfortunately, the 117 degree one is by far the most expensive, since it is around one-fifth irridium, a precious metal.

Those two alloys with the lowest melting point can easily be cast from a "crucible" placed inside boiling water on your stove. Plaster or silicon-rubber molds should work just fine.

While you could, in theory, mix

glasses and plastic gloves.

Note that ammonium persulfate is an oxidizer. If you use a wooden spoon to stir it, and come back a week or two later, the chances are that you'll have nothing but a burned-off spoon handle left. Do avoid all contacts between ammonium persulfate and organic materials.

To dispose of the etchant, contact your local environmental con-

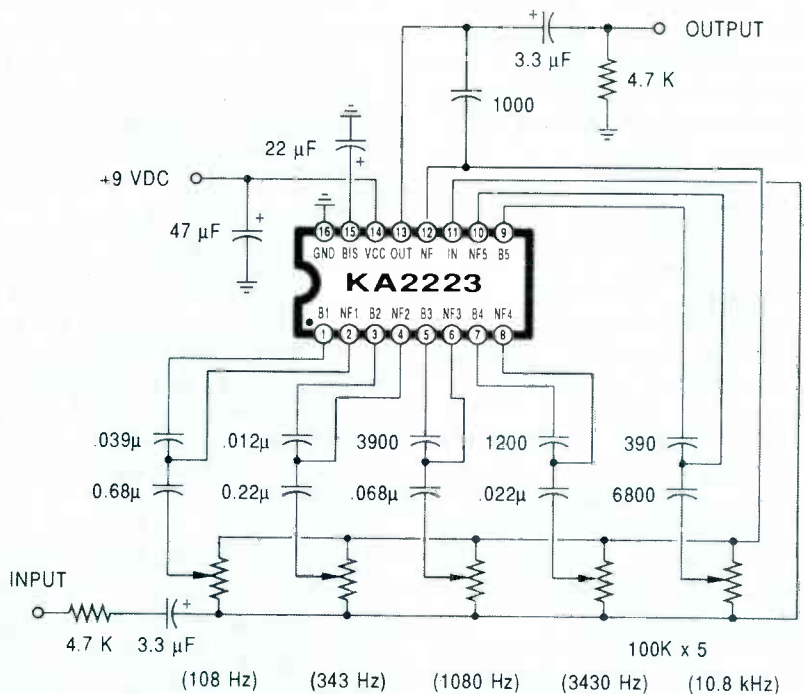

FIG. 3—A 5-BAND GRAPHIC EQUALIZER that uses a single Samsung integrated circuit. A pair of chips can be used for ten bands.

servation agency and ask them for the requirements in your area.

Low-temperature alloys

I just got a new copy of *Catalog #12* from *Small Parts*. As we've seen a time or two in the past, those folks are a great source for everything your hardware store never heard of, besides custom cutting small quantities of metal and plastics for you.

Several of their more interesting products include a series of four low-temperature melting alloys.

the alloys together to get different melting points, it pays to know what you are doing. Otherwise, instead of a free flowing eutectic liquid, you might end up with so much dross. Metallurgy and all.

I can think of all sorts of unusual and off-the-wall uses for them, but why don't you tell me instead? As our contest this month, just dream up a unique application for a low melting point alloy. There'll be all the usual *Incredible Secret Money Machine* book prizes, along with an all-expense paid (FOB Thatcher,

NEW FROM DON LANCASTER

HANDS-ON BOOKS

Hardware Hacker Reprints II	24.50
Ask The Guru Reprints I or II	24.50
CMOS Cookbook	18.50
TTL Cookbook	16.50
Active Filter Cookbook	15.50
Micro Cookbook vol I or II	16.50
Enhancing your Apple I or II	17.50
AppleWriter Cookbook	19.50
Apple Assembly Cookbook	21.50
Incredible Secret Money Machine	10.50
LaserWriter Reference (Apple)	19.50
PostScript Cookbook (Adobe)	16.50
PostScript Ref. Man. (Adobe)	22.50
PostScript Prog. Design (Adobe)	22.50
Real World Postscript (Roth)	22.50

UNLOCKED SOFTWARE

LaserWriter Secrets (Ile/Mac/PC)	29.50
PostScript Show & Tell	39.50
Intro to PostScript VHS Video	39.50
PostScript Beginner Stuff	39.50
PostScript Perspective Draw	39.50
PostScript Technical Illustrations	39.50
PostScript Work in Progress	39.50
PostScript BBS stuff	19.50
Absolute Reset Ile & Iic	19.50
AppleWriter/Laserwriter Utilities	49.50
Enhance I or II Companion Disk	19.50
AppleWriter CB or Assy CB Disk	24.50

FREE VOICE HELPLINE

VISA/MC

SYNERGETICS

Box 809-RE
Thatcher, AZ 85552
(602) 428-4073

CIRCLE 83 ON FREE INFORMATION CARD

NAMES AND NUMBERS

Chemtec

Use this number ONLY for a Haz-Mat emergency.
(800) 424-9300

DonJer

Ilene Court Building 8
Belle Mead, NJ 08502
(800) 336-6537
CIRCLE 239 ON FREE INFORMATION CARD

Figaro Engineering

Box 357
Wilmette, IL 60091
(708) 256-3546
CIRCLE 240 ON FREE INFORMATION CARD

Hamamatsu

PO Box 6910
Bridgewater, NJ 08807
(201) 231-0960
CIRCLE 241 ON FREE INFORMATION CARD

Klockit

PO Box 636
Lake Geneva, WI 53147
(800) 556-2548
CIRCLE 242 ON FREE INFORMATION CARD

Logical Devices

6600 NW 12th Ave., Ste 203
Ft. Lauderdale, FL 33309
(800) 331-7766
CIRCLE 204 ON FREE INFORMATION CARD

Midnight Engineering

PO Box 7041
Fort Collins, CO 80525
(303) 491-9092
CIRCLE 205 ON FREE INFORMATION CARD

NEC

401 Ellis Street
Mountain View, CA 94043
(800) 632-3531/(415) 960-6000
CIRCLE 206 ON FREE INFORMATION CARD

Pollution Equipment News

8650 Babcock Blvd
Pittsburgh, PA 15237
(412) 364-5366
CIRCLE 207 ON FREE INFORMATION CARD

Samsung

3725 North First Street
San Jose, CA 95134
(408) 434-5400
CIRCLE 208 ON FREE INFORMATION CARD

SGS-Thomson

1000 East Bell Road
Phoenix, AZ 85022
(602) 867-6259
CIRCLE 209 ON FREE INFORMATION CARD

Silicon Systems

14351 Myford Road
Tustin, CA 92680
(714) 731-7110
CIRCLE 210 ON FREE INFORMATION CARD

Small Parts

PO Box 381966
Miami, FL 33238
(305) 751-0856
CIRCLE 211 ON FREE INFORMATION CARD

Stock Drive Products

2101 Jericho Turnpike
New Hyde Park, NY 11040
(516) 328-0200
CIRCLE 212 ON FREE INFORMATION CARD

Synergetics

Box 809
Thatcher, AZ 85552
(602) 428-4073
CIRCLE 213 ON FREE INFORMATION CARD

Tektronix

PO Box 500
Beaverton, OR 97077
(800) 835-9433
CIRCLE 214 ON FREE INFORMATION CARD

Texas Instruments

PO Box 1443
Houston, TX 77001
(800) 232-3200
CIRCLE 215 ON FREE INFORMATION CARD

US DOT; ATTN: DHM-50

400 7th St SW, RM 84-20
Washington, DC 20590
(202) 366-0656
CIRCLE 216 ON FREE INFORMATION CARD

CMS-302

Oxygen combustion sensor.
Externally heated to 700-900 C.
12 volt supply.

TGS-100

For fumes and odors in air.
1 volt, 440 milliwatt heater.
100 volt supply.

TGS-109

For natural gas and gasoline.
1 volt 440 milliwatt heater.
100 volt supply.

TGS-203

For carbon monoxide.
0.8 volt, 700 milliwatt heater.
12 volt supply.

TGS-813

For propane and methane.
5 volt, 830 milliwatt heater.
24 volt supply.

TGS-822

For DWI breath alcohol testers.
5 volt, 830 milliwatt heater.
24 volt supply.

TGS-880

For automatic microwave cooking.
5 volt, 830 milliwatt heater.
24 volt supply.

FIG. 4—A FEW VAPOR DETECTORS from Figaro Engineering. Each gets optimized for specific sensing tasks.

Sadly, the good old ten cent neon lamp isn't even on most hacker charts any more, done in by its need for high voltage, and its limited brightness and color range. Sigh.

But the *Hamamatsu* folks have come up with an interesting variation on the traditional neon lamp. It is known as an *UVTRON R2868* flame sensor.

Figure 2 shows you a typical circuit. Any open flame has lots of ultraviolet energy associated with it. The circuit is a simple relaxation oscillator. In the absence of any ultraviolet energy, the oscillator fires only every few seconds or so. When sensing, the oscillator fires as much as 5000 times a second. Thus, you get an audio tone out in the presence of the ultraviolet energy from a flame, and only a few random clicks otherwise.

It's sensitive enough to easily detect a match at 10 feet. While the

AZ) *tinaja quest* for two for the best entry of all. Please be sure to send your written entries directly to me and not over to **Radio-Electronics** editorial.

A flame detector

At one time way back when, far and away the numero uno hacker component was the NE-2 neon

lamp. It was incredible what you could do with them. Panel lamps, night lights, polarity detectors, spike protectors, winking oscillators, tiny disco stars, tone generators for electronic organs, vacuum-tube filament checkers, hot chassis testers, triggers, voltage regulators, and great heaping bunches more.

LEARN VCR CLEANING/MAINTENANCE/REPAIR

EARN UP TO \$1000 A WEEK, WORKING
PART TIME FROM YOUR OWN HOME!



Secrets
Revealed!

NO Special
Tools or
Equipment
Needed.

EARN UP TO \$60
AN HOUR AND
MORE!

THE MONEY MAKING OPPORTUNITY OF THE 1990'S

IF you are able to work with common small hand tools, and are familiar with basic electronics (i.e. able to use voltmeter, understand DC electronics)...

IF you possess average mechanical ability, and have a VCR on which to practice and learn... then we can teach YOU VCR maintenance and repair!

FACT: up to 90% of ALL VCR malfunctions are due to simple MECHANICAL or ELECTRO-MECHANICAL breakdowns!

FACT: over 77 million VCRs in use today nationwide! Average VCR needs service or repair every 12 to 18 months!

Viejo's **400 PAGE TRAINING MANUAL** (over 500 photos and illustrations) and **AWARD-WINNING VIDEO TRAINING TAPE** reveals the **SECRETS** of VCR maintenance and repair—"real world" information that is **NOT** available elsewhere!

Also includes all the info you'll need regarding the **BUSINESS-SIDE** of running a successful service operation!

FREE INFORMATION

CALL TOLL-FREE 1-800-537-0589

Or write to: Viejo Publications Inc.
3540 Wilshire BL, STE. 310
Los Angeles, CA 90010 Dept. RE

CIRCLE 184 ON FREE INFORMATION CARD

Get A Complete Course In

ELECTRONIC ENGINEERING

8 volumes, over 2000 pages, including all necessary math and physics. 29 examinations to help you gauge your personal progress. A truly great learning experience.

Prepare now to take advantage of the growing demand for people able to work at the engineering level.

Ask for our brochure giving complete details of content. Use your free information card number, or write us directly. **\$99.95**, Postage Included. Satisfaction guaranteed or money refunded.



**Banner
Technical
Books, Inc.**

1203 Grant Ave.
Rockford, IL 61103

CIRCLE 67 ON FREE INFORMATION CARD

ALTERNATE ENERGY RESOURCES

Arco Solar
PO Box 6032
Carmarillo, CA 93010
(805) 482-6800
CIRCLE 217 ON FREE INFORMATION CARD

Assoc of Energy Engineers

4025 Pleasantdale S420
Atlanta, GA 30340
(404) 447-5083
CIRCLE 218 ON FREE INFORMATION CARD

Bergey Windpower

2001 Priestley Avenue
Norman, OK 73069
(405) 364-4212
CIRCLE 219 ON FREE INFORMATION CARD

Energy depot

61 Paul Drive
San Rafael, CA 94903
(415) 499-1333
CIRCLE 220 ON FREE INFORMATION CARD

Home Power

PO Box 130
Hornbrook, CA 96044
(916) 475-3179
CIRCLE 221 ON FREE INFORMATION CARD

HVAC Product News

400 N. Michigan Avenue
Chicago, IL 60611
(312) 222-2000
CIRCLE 222 ON FREE INFORMATION CARD

Mother Earth News

PO Box 70
Hendersonville, NC 28793
(704) 693-0211
CIRCLE 223 ON FREE INFORMATION CARD

Photocomm Inc

930 Idaho Maryland Road
Grass Valley, CA 95945
(800) 544-6466
CIRCLE 224 ON FREE INFORMATION CARD

Popular Science

2 Park Avenue
New York, NY 10016
(212) 779-5000
CIRCLE 225 ON FREE INFORMATION CARD

Real Goods

966 Mazzoni Street, #4B
Ukiah, CA 95482
(800) 762-7325
CIRCLE 226 ON FREE INFORMATION CARD

Sandia National Labs

PO Box 5800
Albuquerque, NM 87125
(505) 844-5678
CIRCLE 227 ON FREE INFORMATION CARD

Snow Belt Solar

286 Wilson Street
Amherst, WI 54406
(715) 824-3982
CIRCLE 228 ON FREE INFORMATION CARD

Solar Energy

Maxwell House, Fairview Park
Elmsford, NY 10523
(914) 592-7700
CIRCLE 229 ON FREE INFORMATION CARD

Solar Energy Research Inst

1617 Cole Blvd
Golden, CO 80401
(303) 231-1000
CIRCLE 230 ON FREE INFORMATION CARD

Solar Jack

325 East Main
Safford, AZ 85546
(602) 428-1092
CIRCLE 231 ON FREE INFORMATION CARD

Solarex

1335 Piccard Drive
Rockville, MD 20850
(301) 948-0202
CIRCLE 232 ON FREE INFORMATION CARD

Solec International

12533 Chadron Avenue
Hawthorne, CA 90250
(213) 970-0065
CIRCLE 233 ON FREE INFORMATION CARD

Solronics Solar Systems

1100 West Maple Road
Troy, MI 48084
(313) 362-4170
CIRCLE 234 ON FREE INFORMATION CARD

Southwest Windpower

PO Box 22178
Flagstaff, AZ 86002
(602) 526-0997
CIRCLE 235 ON FREE INFORMATION CARD

Whole Earth Review

27 Gate Five Road
Sausalito, CA 94965
(415) 332-1716
CIRCLE 236 ON FREE INFORMATION CARD

Yellow Jacket Solar

Box 253
Yellow Jacket, CO 81335
(303) 562-4884
CIRCLE 237 ON FREE INFORMATION CARD

Zomeworks

PO Box 25805
Albuquerque, NM 87125
(505) 242-5354
CIRCLE 238 ON FREE INFORMATION CARD

recommended supply voltage should be within ten percent of 325 volts, you can usually work with the simple line-operated voltage doubler shown.

Note that it is a "hot chassis" type of circuit with a severe shock hazard potential. You'll probably want to use an optocoupler on the output in your final circuit, and an input isolation transformer would also be a good idea. The output pulses are normally around eight volts high and about five microseconds wide.

Two use tips: Be sure the anode resistor is physically quite close to your flame sensor. And avoid having two sensors near each other, since they produce ultraviolet in use and could badly interact or even latch.

Hamamatsu also makes small and complete flame-sensor circuit cards ready for use that run off the usual 24-volt AC thermostat transformer. While intended for flame detection in gas heaters and air conditioners, there should be lots of other interesting hacker uses. What can you come up with here?

A great new data book

I've seen some exciting data books before, but this one is way off the scale. It reads like a pulp novel that you literally cannot put down. Each and every page is crammed full of outstanding new low-cost hacker integrated circuits that cry to be used.

I am referring to the new *Linear IC Volume 1* data book by *Samsung*. That beauty is crammed to the gills with audio, video, and remote-control toy radio chips. All sanely priced, and all with detailed application examples.

As a random example, let's drop in on page 178 where we see a single-chip 5-band graphic equalizer. Full details appear in Fig. 3.

While it is a five-band equalizer, you can easily use a pair of chips for a ten-bander, again per their data book. Only a volume control and a pair of capacitors are needed per band.

Other goodies in the book include audio-power amplifiers and preamps, the complete toy R/C vehicle remote drivers, infra-red encoders and pre-amps and bunches more.

FIGARO TGS-822

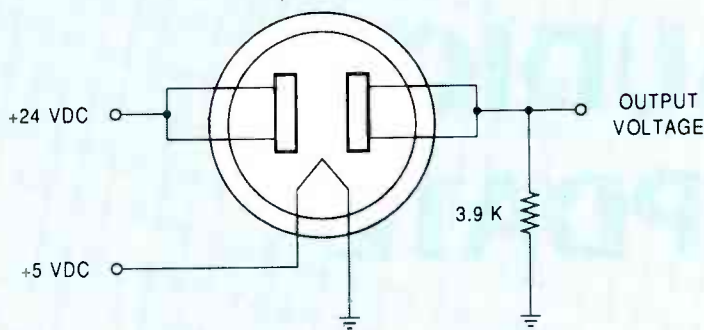

FIG. 5—A DWI BREATH-ALCOHOL TESTER that uses the Figaro TGS-822. The presence of 500 parts per million of grain alcohol lowers the cell resistance by a factor of 10, raising the output voltage.

Fume and vapor detectors

There's lots of reasons why you might like to detect any organic or chemical vapors in the air. In home uses, we have gas-leak detection, fuel vapors, carbon monoxide, "stuffy" air ventilation controls, auto microwave oven "the roast is done" sensing, DWI breath-alcohol testers, the combustion monitoring, odor detection, and oxygen sensing.

Similarly, industrial sensors are sometimes required for ammonia, hydrogen sulfide, organic vapors, for freon, and other organic vapors.

The people at *Figaro Engineering* have dozens of low-cost and easy-to-use sensors, optimized for various substances. Figure 4 summarizes many of their key models. Quantity costs are in the \$5 range.

In general, each sensor consists of a sintered block of tin oxide, with variations that will optimize for any particular sensed vapor. An internal heater is used to raise the surface temperature to the 200- to 400-degree Centigrade range.

Through surface absorption, the resistance of the tin oxide will drop in the presence of an organic vapor. The amount that the resistance drops depends on the vapor and its concentration.

For instance, Fig. 5 shows you how the TGS822 gets used as a breath-alcohol detector. You apply a 5-volt AC or DC heater voltage at a current of 120 milliamperes or so. You apply a main supply voltage of 24 volts AC or DC, and sense an output voltage across a 3.9K load

resistor.

In the presence of 300 parts per million alcohol, the sensor resistance will drop by 10:1. At 3000 parts per million alcohol, the sensor resistance will drop by 50:1. Thus, both the presence and the strength of the organic vapor can be measured. The response time is typically a few seconds.

These sensors are relatively broad-spectrum devices. They may well respond more strongly to certain other vapors than the one you are really looking for. Thus, they will work best in those situations where one and only one vapor or contaminant is expected.

Ads for similar sensors appear in *Pollution Equipment News*. Let me know if you want more details on sensors of that type.

Alternate-energy resources

Bowseretta and I were recently day hiking over at Antelope Springs, a long-abandoned hippie commune. Besides the obligatory rusting VW microbus shells, the ruins of dozens of alternate-energy experiments seemed strewn about. There were octagon earth-sheltered houses, a sauna and hot-tub combo lovingly crafted from the native stone, the broken *Savonius* windmill rotors, countless cracked batteries, and various solar stills.

At least one of those stills must have been a monumental disaster, since the evaporator and the condenser were both designed to operate at the same temperature and

continued on page 72

AUDIO UPDATE



LARRY KLEIN,
AUDIO EDITOR

Is sound quality a matter of taste?

IN MY LAST COLUMN I DISCUSSED some of the strange beliefs that in the past linked sound preferences to the nationality of the listeners. Philosophically, such a position is part of a larger view that holds that any preference for a particular sound balance is simply a matter of taste. Some home listeners like a “rich, mellow sound” with lots of upper-bass emphasis, others prefer a “clear, distinct sound” with the balance tilted toward the upper frequencies, and still others prefer a sound with lots of “presence”—meaning upper-midrange emphasis. And, of course, there are those strange individuals (such as myself) who tend to prefer the sound of systems that during objective tests show a wide and flat frequency response.

You may have noticed that all my comments have related sound quality to frequency response. I don’t mean to imply that frequency response is the only factor that determines a component’s sound quality, but when an amplifier or speaker is not being over-driven (or suffering from some internal fault) frequency response differences *are* responsible for perhaps 95% of the “quality” differences heard between audio products.

Don’t just take my word for it. If you have a 10-band equalizer as part of your system you can demonstrate for yourself how easy it is to add (or subtract) such subjective audio qualities as openness, air, solidity, detail, warmth, body, and so forth. Depending on the frequency bands involved, a

change of only 2 or 3 dB in slider position can have an enormous effect on the “quality” of the sound you’re hearing.

Does everyone hear differently?

It’s true that no two pairs of ears respond identically. But it’s also true that everyone is listening to the same objective sonic reality, and that there is a more-or-less-direct correspondence between the objective world of sound and the impression it makes on our auditory apparatus. For example, if you were to shred this issue’s Reader Service card in an operating electric fan it would create a specific sound. If you were able to make a perfect recording of that sound and play it back through a perfect sound system, everyone would agree that the original and recorded sounds were identical. That agreement should hold despite possible differences in sonic taste—or in the acuity of their ears. In other words, whatever aberrations exist in a person’s hearing, within his limitation he should be able to tell when the sonic properties of two audio systems are alike. And ultimately—by definition—*reproduced* sound should be referenced to some original.

So why do many speaker systems in the same general price range sound different from each other? (Incidentally, the situation has vastly improved during the 35 years or so that I’ve been evaluating speakers. The differences in tonal quality heard among today’s best speaker systems are quite small; similar in nature and ampli-

tude to what you might hear in different seats in a good concert hall.) As I discussed last month, for many years most of the major Japanese designers appeared convinced that speakers should be designed to taste. I thought a breakthrough had occurred in the early 1970’s when I was invited to Japan to see, among other things, a new computer-assisted speaker-evaluation setup.

Computerized Evaluation

Visualize, if you will, a large, acoustically neutral listening room. On a slightly raised dais at the front is a stage with several speaker systems positioned on the periphery of a large, electrically driven “lazy Susan.” One speaker is always at stage-center position. A push of a button rotates the assembly until the next speaker in line is centered. On the arm rest of each of forty audience chairs is a small box with a pilot light and seven pushbuttons labeled, respectively, -3, -2, -1, 0, +1, +2, and +3.

During the evaluations, an acoustically transparent curtain conceals the speakers, and the speaker-positioning button is pressed to bring one of the now-hidden speakers into playing position. After a few moments of light-classical program material, the button is pressed again, a different speaker moves into playing position, and the program material is repeated. The pilot light on our individual response boxes then lights up, and the audience is instructed to push one of the num-

bered buttons to indicate the degree of our preference between the first and the second speakers. Pushing the zero indicates no preference, pushing a plus number indicates how much more you like the second speaker than the first, and pushing a minus number would show how much less you like it.

I must confess that I didn't care for the sound produced by *any* of the speakers, so I was hard pressed in each case to pick the lesser of the two evils. Where did the computer come in? It simply tabulated the results. The push-button data from the audience response boxes was fed to the computer, which provided an instantaneous readout on how many listeners preferred which speakers, to what degree, and—in the full-scale tests—with what kind of music. (Incidentally, my hosts also believed that different speaker sound qualities were desirable depending upon whether one preferred classical, pop, or rock music.)

I asked who normally filled the chairs during an evaluation session, and it was carefully explained to me that since the goal was to design speaker systems that would appeal to a large cross-section of the public, the audience was carefully chosen to be representative of that cross-section. Women from the assembly line, maintenance men, clerical workers, and so forth all had their chance to push buttons. During repeated tests the designs were modified until the sound quality satisfied most of the listeners. I found it paradoxical that this *vox populi* approach to speaker design was backed up by a



LARRY KLEIN IN THE SPEAKER ROOM in the Sato Musen showroom in Akihabara, Tokyo.

laboratory with more and better instrumentation than I had ever seen in any U.S. lab.

The bottom line

Today, it is evident that most U.S., and some Japanese, audio companies reject the notion that speaker design is a matter of taste. Many years ago I was told by the head of the Swedish Broadcasting System that when they set out to reequip all their studios with new monitors, the Yamaha NS-1000's won out over dozens of European and U.S. competitors during blind listening tests. That didn't particularly surprise me, since at the

time I was using a pair of the Yamaha NS-1000's at home. I had chosen them because of their compact size and clean, flat, uncolored response.

Keep in mind that any speaker that has a sonic characteristic of its own will add that quality to whatever material is being reproduced. There are undoubtedly special circumstances when the sonic balance of a given recording might be enhanced by the frequency aberrations of a particular speaker. But most of the time such colorations would serve only to degrade the complex process of high-fidelity reproduction. **R-E**



Ed has yet to find a salesman who knows as much as he does.



Fox

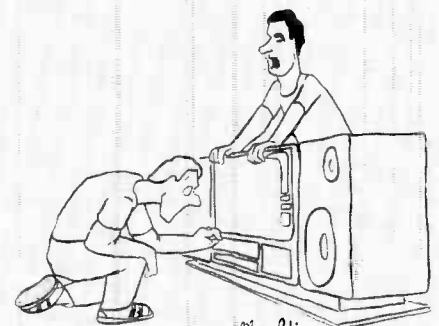

Sure it looks great. Now I've got to build the inside.

DRAWING BOARD

Let's plunge deeper into video



ROBERT GROSSBLATT,
CIRCUITS EDITOR

VIDEO TIMING RELATIONSHIPS

$$\begin{aligned} \text{COLORBURST} &= \text{MASTER FREQUENCY} = 3.579545 \text{ MHz} \\ \text{HORIZONTAL} &= \frac{2 \times (\text{COLORBURST})}{455} = 15,734.26 \text{ Hz} \\ \text{VERTICAL} &= \frac{2 \times (\text{HORIZONTAL})}{525} = 59.94 \text{ Hz} \end{aligned}$$

FIG. 1

THE MORE YOU START MESSING around with video, the more jokes you hear about the NTSC standard...Never Twice the Same Color, and so on ad nauseum. Now, I'm the first to admit that it's far from being ideal, but let's also remember that the National Television Systems Committee designed the color standard more than thirty years ago and, when they did it, they had to make sure it was compatible with the black-and-white standard that came before it.

If you're old enough to remember the introduction of color TV, you might also remember some of the schemes that were proposed. If you do, you should also realize that the guys who came up with NTSC did a pretty good job. One alternative I remember had something to do with a wheel of colored gels that revolved in front of the camera. It was a mechanical nightmare and, fortunately, I've forgotten the rest of it. If any of you know more about that, or any of the other early color proposals, drop me a note and I'll pass them on to everyone.

In any event, however crazy the NTSC system seems, it's a lot better than any of the others that were proposed at the time, and no mat-

ter what else you have to say about it, it works.

The hallmark of the NTSC standard is that all of the individual signals that make up the complete waveform can be derived from one master clock—everything is locked to everything else. Before we get to the arithmetic, however, let's review some video basics and define some terms.

Fields, frames, and interlace

The NTSC standard picture we all watch and love is produced by having the electron beam paint a series of successive lines of video on the face of the TV tube. The electron beam in the tube has to make two passes in order to paint a complete picture, called a "frame," on the screen. The first pass puts out the odd-numbered lines of video and the second pass puts out the even ones. Each of those half images is called a "field." The reason for the system, called "interlace," is to reduce the amount of flicker on the screen. If all the lines were sequentially painted, the top would begin to fade before the screen was completely "painted."

The vertical scan rate is the amount of time it takes the beam

to paint each field (half a frame) of video. In the black-and-white days, the vertical rate was set to match the 60-Hz power-line frequency to minimize interference on the screen. Since each field took 1/60th of a second, a full frame took twice that—or 1/30th of a second. Knowing that, and remembering that each frame of video is made up of 525 horizontal lines, we can begin to understand where the TV-signal frequencies come from.

Since it takes 1/30th of a second to paint 525 lines, the horizontal scanning frequency is $525 \times 30 \text{ Hz} = 15.75 \text{ kHz}$ and each line is painted in $1/15.75 \text{ kHz} = 63.5 \mu\text{sec}$. Those numbers were slightly modified when the NTSC

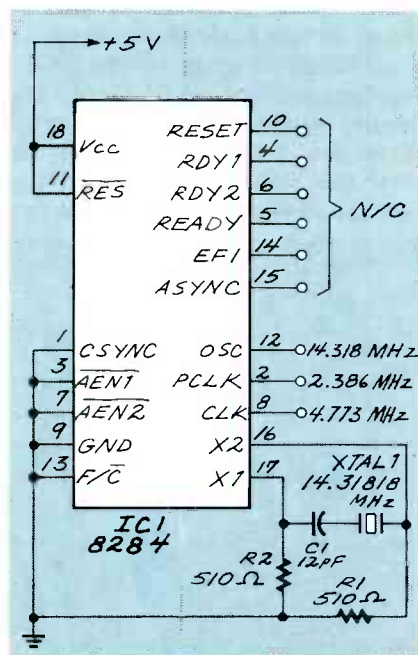

FIG. 2

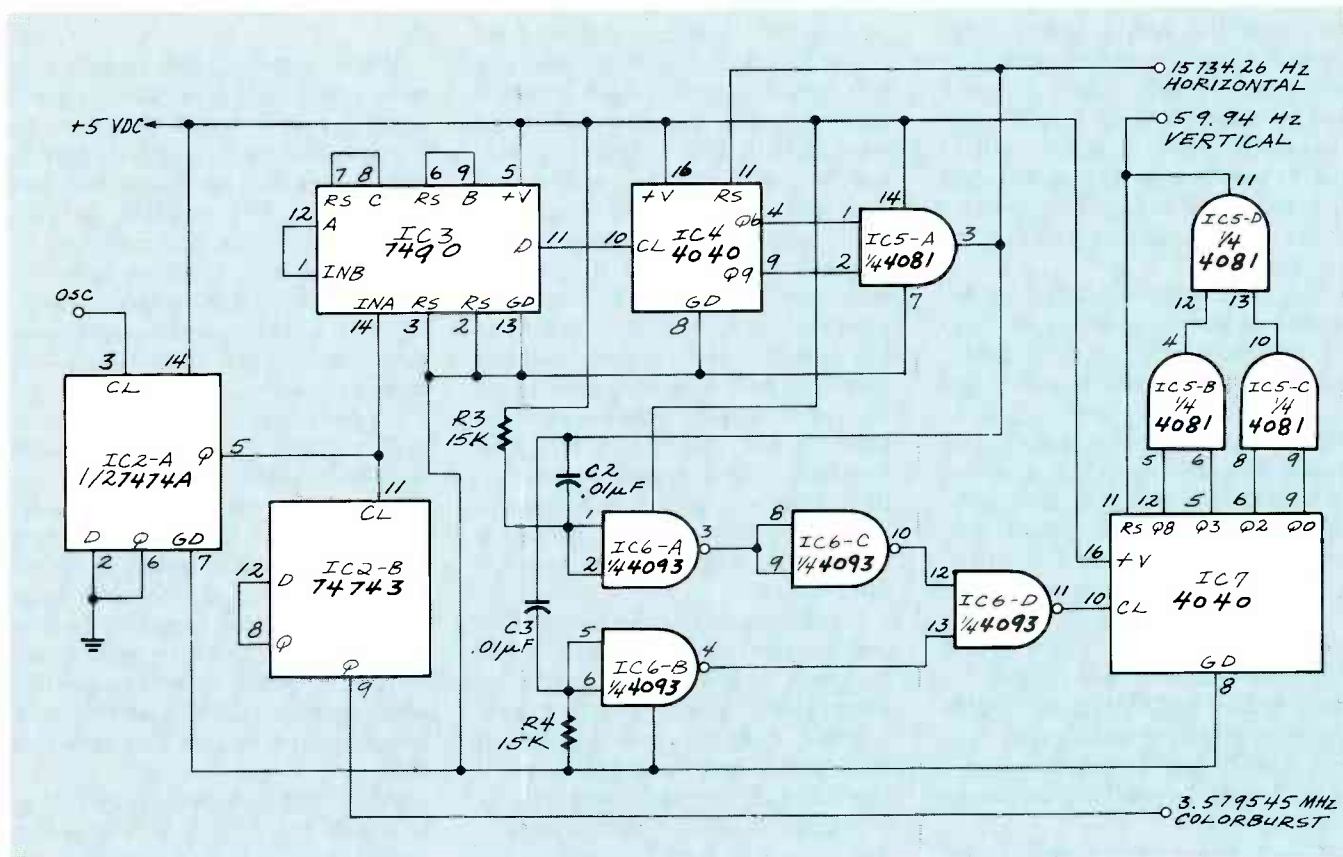

FIG. 3

color standard was developed, but the simple exercise we just went through should help you understand where the numbers came from in the first place.

The master clock for the NTSC color standard was set to be 3.579545 MHz, and all the other signals are derived from it. While the older standard used the power-line frequency and number of scan lines as the basis for the TV picture, the 1953 color standard is built around the burst frequency and a strict arithmetical relationship defined all the other frequencies.

The horizontal scan rate was defined to be the colorburst frequency multiplied by $\frac{2}{455}$ (not exactly obvious), and when you do the arithmetic you'll wind up with 15,734.26 Hz—not as neat as the old 15,750-Hz standard, but close enough to lock the horizontal circuitry in old black-and-white TV sets.

The same sort of "close enough" results show up when you calculate the vertical frequency. Given a horizontal scan rate of 15,734.26 Hz, it follows that each line takes

63.56 microseconds, or just slightly longer than the older standard of 63.50 microseconds. Since the new color standard still contained 525 lines in each frame, the vertical frequency works out to 59.94 Hz. That's close enough to the original 60-Hz to avoid interference and still accommodate black-and-white TV sets.

A lot of you might be wondering what I have in mind when I talk about "older black-and-white TV sets." If you pay a visit to your local TV store, you'll find that it's almost impossible to buy a black-and-white TV set anymore, just as, back in 1953, when the NTSC defined the color standard, it was almost impossible to buy a color TV. Since the majority of existing TV sets were black-and-white, compatibility was the overriding issue. It's not such a big deal now but, back then, when the NBC peacock opened its tail, a lot of viewers were happy to hear the magic words "compatible color."

Generating sync triggers

Now that we've put the historical matters behind us (the

important numbers and the relationships between them are summarized in Fig. 1), our job is to develop some hardware. The only circuitry we have working so far is the 8284 clock circuit shown in Fig. 2, and I've indicated the frequencies that it produces.

Getting colorburst from the circuit is easy since the osc output is a buffered version of the crystal. A bit of simple arithmetic tells us that 14.318 MHz divided by four equals the burst frequency of 3.579 MHz. You can see from Fig. 1 that getting horizontal sync from the burst is going to take some multiplication as well as division. Since that's a real pain in the neck, we'll start our search for horizontal sync with one half osc, rather than the burst. That way we can stick with frequency division and make things somewhat easier.

We all have our own preferences but, if you're a regular reader, you know I like to use CMOS whenever I can. In this case, however, we're going to use some TTL to do the first part of the division since the circuit is operating at 5 volts (because of the 8284). CMOS parts

can certainly operate at 5 volts, but the lower the supply voltage, the lower the maximum frequency the parts can handle. You can solve that by using 74HC or 74HCT parts but, in this case, it really doesn't matter very much. Just remember that the circuit in Fig. 3 is only one of the numerous ways to get the job done.

The frequency available at the output of the first 7474 is half the crystal frequency, or 7.159 MHz. We have to divide that by 455 to get horizontal sync and, at first glance, 455 is a screwy number to deal with—it's much nicer when numbers are readily divisible rather than apparently prime. Well, 455 can be factored into $13 \times 5 \times 7$, so the first thing we'll do is divide the frequency by 7 using what should be an old TTL friend, a 7490 counter. That will produce a frequency of 1.022 MHz, and that is low enough to be handled by regular CMOS parts operating at 5 volts. So we can still use ordinary CMOS parts.

All we need to get horizontal sync is a way to divide the resulting

frequency by 13×5 , or 65. Now, seeing the number 65 should set off an alarm in your head, because it's very close to 64, which is one of the magic numbers of the digital world. And, that being the case, we can handle the rest of the division with a 4040 CMOS binary ripple counter, and a simple two-legged gate. When the count reaches 65 in the 4040, only two pins will be high; the Q0 and the Q6 outputs. The AND gate will decode the two 4040 outputs and go high at exactly the rate we've been looking for; 15,734.26 Hz. The horizontal sync trigger at the output of the AND gate is positive-going so therefore we can also use it to reset the 4040 CMOS binary ripple counter.

We haven't talked much about vertical sync other than to say that it's close to the 60-Hz power-line frequency. Well, as they say, "close" only has meaning with horseshoes and hand grenades. If the vertical rate had been exactly 60 Hz as it was in the pre-color days, it would have been a snap to generate. Just feed a 5369AA with the burst frequency and you'll get 60 Hz out at the other end. As we saw earlier in the column, however, things aren't that simple since vertical sync has to be derived from the signals we've generated so far and the number of lines on the screen.

The NTSC standard calls for a 525-line image, but don't forget that each image is made of two interlaced fields. That means that we are going to need a vertical-sync signal after each field of video—or after every 262.5 lines of video. That's the relationship shown in Fig. 1, and that's also the design job that we have laid out in front of us.

We don't have any handy frequency available to avoid multiplication this time, so we'll have come up with a way to do it electronically, and that's exactly what we're doing with the NAND gate in Fig. 3. The first two gates, A and B, are set up as simple edge detectors. Gate A responds to the negative-going edge and gate B to the positive-going edge. If you work out the truth table on a sheet of paper, you'll see that the frequency at the output of Gate D is twice

the input frequency at Gates A and B.

We're feeding the NAND gates with horizontal sync so that we'll wind up with 31,468.52 Hz at the output. The next (and last) part of the circuit has to divide the frequency by 525, which, as you should know, is the number of lines in a frame. Since we're working with twice the horizontal sync rate, we'll really be generating vertical sync every 262.5 lines—or after each field.

It's possible to factor 525 as $5 \times 5 \times 7 \times 3$ and do the division with simple counters but, just as we saw with producing horizontal sync, you have to keep your mind open when you're trying to figure an easy way to do division by a larger than usual number. In this case, 525 is pretty close to the magic number of 512, so we can use the same ordinary CMOS part that we used earlier in our design—the 4040.

When the number you're trying to divide by is close to one of the powers of 2, a long binary divider becomes a good choice. In our case for example, we're only thirteen away from 512, and that means we only have to decode four of the 4040 outputs (525 decimal is 10000 1101 in binary). The job becomes even simpler since we still have three spare AND gates in the circuit. As with horizontal sync, the vertical-sync trigger is positive-going, so we're also using it to reset the 4040 binary ripple counter IC.

When you put the circuit together and power it up, you should see colorburst (3.579545 MHz), a horizontal-sync trigger at 15,734.26 Hz, and a vertical-sync trigger at 59.94 Hz. Keep in mind that the last two aren't the final signals. They're only the frequencies we need to trigger the one shots that will output pulses of the proper width to work as horizontal and vertical sync for the video that we'll be generating very shortly.

When we get together next time, we'll design the one-shots and put together a circuit that will actually produce video images. We won't be seeing an image of the Mona Lisa on the screen, but what we see will be recognizable. I promise. **R-E**

Be an FCC LICENSED ELECTRONIC TECHNICIAN!

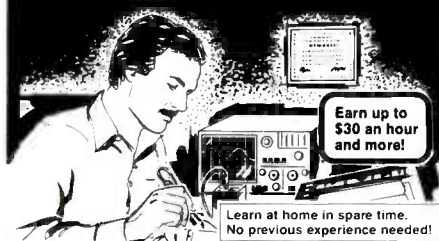

No costly School. No commuting to class. The Original Home-Study course prepares you for the "FCC Commercial Radiotelephone License". This valuable license is your "ticket" to thousands of exciting jobs in Communications, Radio-TV, Microwave, Computers, Radar, Avionics and more! You don't need a college degree to qualify, but you do need an FCC License.

No Need to Quit Your Job or Go To School This proven course is easy, fast and low cost! **GUARANTEED PASS** — You get your FCC License or money refunded. **Send for FREE facts now. MAIL COUPON TODAY!**

COMMAND PRODUCTIONS

FCC LICENSE TRAINING, Dept. 90
P.O. Box 2824, San Francisco, CA 94126

Please rush FREE details immediately!

NAME _____
ADDRESS _____
CITY _____ STATE _____ ZIP _____

COMPUTER DIGEST

SECURE YOUR HARD DISK WITH PC ACCESS

PAUL RENTON

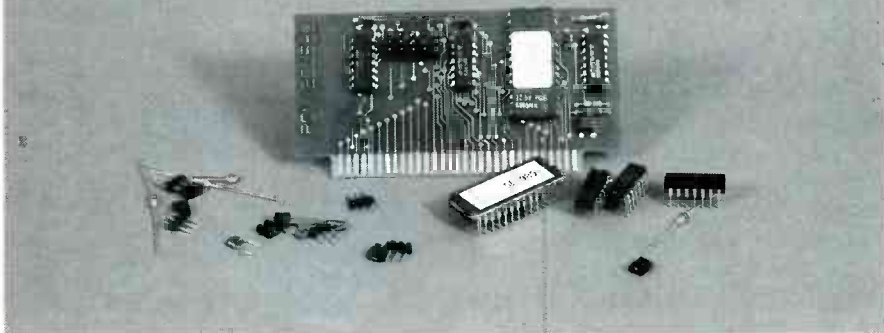

Computer security may seem like a problem only for large corporations or the government. However, small businesses and home computers often contain sensitive information that should be protected. For example, if you have a small business, your payroll records may not seem to be the most sensitive information in the world, but a competitor would certainly love to see them! And you wouldn't want your babysitter to boot your PC and get into your checking-account data!

There are many approaches to PC security, but the one offered here is a combined hardware/software solution. PC Access provides one master password, which enables access to the password list and to other functions, and fifteen user passwords. An EPROM on a small expansion card contains a BIOS extension that hooks PC Access into your PC's boot procedure. The circuit is simple and inexpensive to build; a kit is available for less than \$35.

PC Access provides several extras, including a hold function

that allows the user to suspend computer access by pressing a hotkey. The computer then idles until the correct password is entered. The hotkey combination can be configured for compatibility with various memory-resident programs. In addition, you can maintain an audit trail of who logs onto the system. The audit file is encoded, hence meaningless when viewed with a DOS TYPE command. A program provided with the kit decodes the file into ASCII format.

How it works

PC Access works by altering DOS's normal boot procedure in several ways. First, PC Access forces the system to boot from the hard drive by disabling access to floppy drive A during the boot process. Thus, you can't disable PC Access simply by booting from a floppy.

In addition, a software driver must be loaded via CONFIG.SYS and processed by DOS in the usual manner, otherwise the system will not boot. That means that you can't boot the PC by de-

continued on page 73

EDITOR'S WORK- BENCH

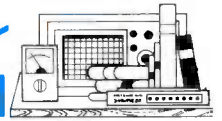

Personal Computers and the Future

I tend to spend most of my time here poking around under the hood. For a change, let's take a step back and look at things from a wider perspective. The occasion? The beginning of a new year and of a new decade. For me it's just past the first of the year, and though you won't read this for a good three months, I hope you'll find it interesting.

It's hard to believe sometimes how much this industry has grown the past decade. In the murky beginnings ten or twelve years ago, hobbyists and technically oriented people were the only ones who used personal computers. Now estimates range as high as 40 million PC users in this country alone, and obviously, the vast majority of them don't know a bit from a byte. That makes us members of a pretty elite group.

Personal computers have caught on faster than just about any other modern invention, and they have altered the way we work (and play) so drastically that, short of catastrophe, it's inconceivable that we might ever return to the way things used to be done.

However, industry growth is slowing, partially because of market saturation, and partially because those 40 million people are having trouble adjusting to what's happened so far. Many industry analysts believe that the

fastest growth during the next few years is not going to be in new systems or new technologies, but in putting what we've already got to better use. In short, service and support industries are the growing segments of the computer business.

To be sure, top-notch programmers and engineers will still be needed in droves. But the strata beneath those very top levels have to be filled out as well. So if you're trying to plan out your career, think about activities like the following:

- **System Integration:** With the proliferation of various hardware and software "standards," people who understand the PC architecture and know how to resolve conflicts between competing hardware adapters have been and will continue to be valuable.

- **Network Support:** Some analysts believe that if the 1980's was the decade in which personal computers brought quality and quantity increases to individual users, the 1990's will be the decade in which those users are linked together. From the support point of view, networks represent an area with much growth potential, both for installation and for maintenance. I've never seen a network with a level of reliability approaching even $\frac{1}{100}$ th that of the PCs on which it is based. From the development point of view, networks offer virtually unlimited growth opportunities. At this point in time many companies are connecting their PC's together physically. But a lot of work still needs to be done to give some intelligence to the way they interact.

- **Applications Support:** Becoming an expert in a core group of applications (including just about any major word processor, spreadsheet, and database manager) will just about guarantee you gainful employment as well as a growth path in any decent company. People like to blame software for being hard to use; I believe that in many categories, the software is sufficiently easy to use (or close to it); it's the users who need to be better educated. Modern software has powerful new ways of doing things; along

with that power comes the responsibility for learning how to use it. Until the time when children start studying word processing and the like on a wide scale at the grade school level, applications support personnel will continue to be necessary.

- **Hardware Service:** This is a negative category; jobs here will shrink. Component-level servicing has always been difficult and time consuming; as the semiconductor industry achieves greater and greater component density, and as labor costs continue to skyrocket, upper-level management will dictate that labor-intensive procedures be eliminated. This is not a new trend, but one that will certainly continue. If you want hands-on contact at the component level, figure on working in an engineering lab, either as an engineer or as a research technician. You'll need almost as much education to be the latter as the former; you'll just get paid less. So stay in school as long as you can.

- **Education:** There is now and will continue to be a crying need for technically competent people to join the ranks of educators. Society as a whole, however, needs to rethink the process of education, take it out of the realm of rote memorization, and bring it into the realm of interactive, self-paced, wide-area-networkable interaction that focuses on mastering processes, not just memorizing facts. Both what we teach and how we teach it are two of society's biggest questions. Education and entertainment must merge to a great extent.

- **Entertainment:** The rise of the video industry (VCR, cable TV, satellite TV, MTV), various technical advancements in the PC industry (the compact disk, high-resolution video, interactive adventure games, graphical operating environments), and the emerging multimedia industry all lead one to realize that people want control over their entertainment, as well as lots of variety. The television networks will never again enjoy the power they once had. Emerging technologies will allow people to buy off-the-

shelf packages combining the forms of entertainment they like. Kind of like buying videotapes, but these new forms will have full motion video, still graphics, high-fidelity sound, and will be fully interactive. The technologies to do this are just now becoming available; there are no standards about how to fit it all together. All the largest computer companies (IBM, Apple, HP, and more) are investing heavily in this area; getting in on the ground floor here is guaranteed to be challenging and exciting.

If you thought the 80's were exciting, just wait. The 90's are going to be even better. ♦CD♦



MathEdit

Word processing has improved enormously the past decade; it's still the most popular PC application. Users have benefited greatly from the feature wars brought on by vendors competing for the huge word processing market. However, support for editing mathematical equations is lacking from all major word processors. In fact, the only package I know of that does have an equation editor is Lotus Manuscript, which although powerful, is geared toward producing long technical documents, and is unsuited for simpler tasks.

K-Talk Communications has a solution: MathEdit. It is a text-mode program that lets you create equations interactively, and then export them in resolution-independent PostScript format, HP PCL (LaserJet), or one of several bit-mapped formats (PIX, TIFF). You can then import the file thus created into a word processor or desktop publishing program just like any other graphic. PageMaker and Ventura

R-E Computer Admart

Rates: Ads are 2 1/4" x 2 7/8". One insertion \$950. Six insertions \$925 each. Twelve insertions \$895 each. Closing date same as regular rate card. Send order with remittance to **Computer Admart**, Radio Electronics Magazine, 500-B Bi-County Blvd., Farmingdale, NY 11735. Direct telephone inquiries to Arline Fishman, area code-516-293-3000. *Only 100% Computer ads are accepted for this Admart.*

GETTING THE MOST FROM YOUR PRINTER

Getting The Most From Your Printer



BP181—It is probable that 80% of dot-matrix printer users only ever use 20% of the features offered by their printers. This book will help you unlock the special features and capabilities that you probably don't even know exist. To order your copy send **\$6.95 plus \$1.50 for shipping** in the U.S. to **Electronic Technology Today Inc., P.O. Box 240, Massapequa Park, NY 11762-0240.**

SECRETS OF THE COMMODORE 64

Secrets of the COMMODORE 64



BP135—A beginners guide to the Commodore 64 presents masses of useful data and programming tips, as well as describing how to get the best from the powerful sound and graphics facilities. We look at how the memory is organized, random numbers and ways of generating them, graphics-color-and simple animation, and even a chapter on machine code. Get your copy today. **Send \$5.00 plus \$1.25 for shipping** in the U.S. to **Electronic Technology Today Inc., P.O. Box 240, Massapequa Park, NY 11762-0240.**

ICs PROMPT DELIVERY!!!

SAME DAY SHIPPING (USUALLY)
QUANTITY ONE PRICES SHOWN FOR JAN. 21 1996

OUTSIDE OKLAHOMA: NO SALES TAX

DYNAMIC RAM		EPROM	
SIMM	AST Prem386 33Mhz	27C1000	128Kx8 200 ns \$18.00
SIMM (1)	256Kx36 80 ns 240.00	27512	64Kx8 200 ns 7.80
SIMM (1)	1Mx9 80 ns 100.00	27256	32Kx8 150 ns 6.50
SIMM (2)	256Kx9 100 ns 35.00	27128	16Kx8 250 ns 3.75
1Mbit	1Mx1 80 ns 9.75	STATIC RAM	
41256	256Kx1 60 ns 4.50	62256P-10	32Kx8 100 ns \$10.40
41256	256Kx1 80 ns 2.95	6264P-12	8Kx8 120 ns 4.50
41256	256Kx1 100 ns 2.25	6116AP-12	2Kx8 120 ns 4.25
41256	256Kx1 120 ns 2.05		
4464	64Kx4 120 ns 2.95		
41264 (3)	64Kx4 100 ns 7.50		

OPEN 6 DAYS, 7:30 AM-10 PM; SHIP VIA FEDEX ON SAT

SAT DELIVERY INCLUDED ON FEDEX ORDERS RECEIVED BY: 12:00 PM EST. No minimum order. Please note: prices subject to change. Shipping insurance extra (up to \$1 for packing materials).

CIRCLE 61 ON FREE INFORMATION CARD

of course can handle that type of file; in addition, modern versions of Word, WordPerfect, and WordStar all have the ability to import such files and display them in a bit-mapped preview mode.

MathEdit comes on four 360K diskettes. You install the program simply by creating a directory on your hard disk and copying all files to it; you'll need about 1.5MB of space. Then you run the program, which takes you to a setup utility in which you specify the output file type and the program into which you'll be importing equations. (Currently, WordPerfect 5.0, Word 5.0, WordStar 5.5, TEX, and Manuscript are supported.) The version of the program that I examined (1.22B) had a lot of confusing information about setting the program up to work with HP LaserJet soft fonts, but if you choose either PostScript or a bit-mapped output format, you can ignore all that. (Also, the company will be dropping support for PCL output in version 2.0, due out about the time you read this.)

As shown in Fig. 1, MathEdit's screen is divided into three windows. System messages are displayed in the bottom window; the cursor and what you type appears in the top window. In the middle window you see a very rough approximation of what

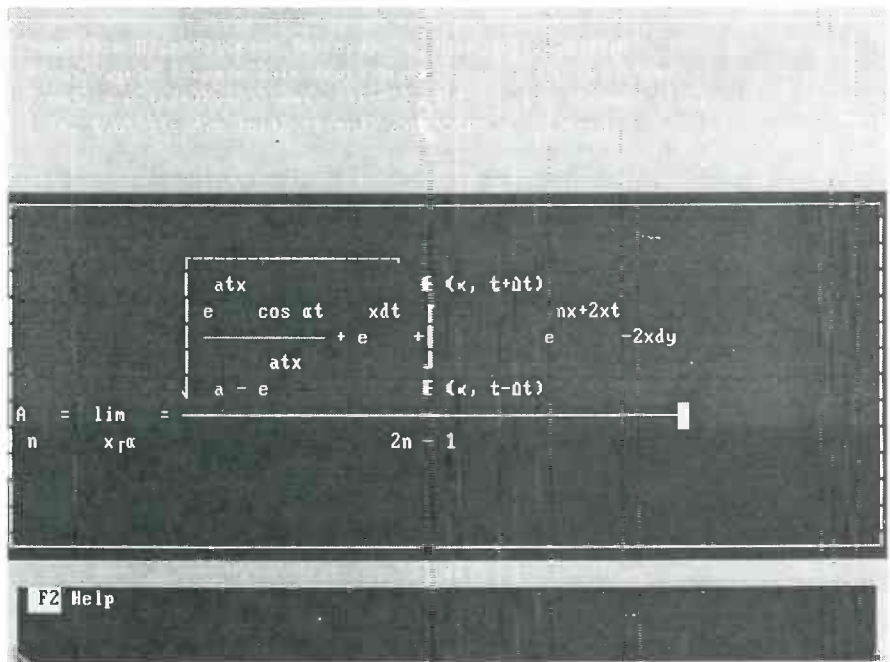

FIG. 1

your equation looks like, or if you press F2 (Help), a list of what the function keys do.

Entering an equation into MathEdit is like typing a formula into a pocket calculator that uses algebraic (not RPN) notation. You type numbers and simple functions (+, -, =, etc.) in directly; you must go through several function-key menus to enter more complicated functions (integrals, summations, roots, fractions, matrix notation, trig and

log functions, vectors, "not" bars, braces, brackets, vertical bars, etc.).

You can move around the editing window using the cursor keys, Home, and End; delete characters with Del and BackSpace; and delete to end of line with Ctrl-End. As you type, the middle window provides a rough approximation of your equation. MathEdit also contains a graphic preview mode that provides a more accurate representation of

HARDWARE HACKER

continued from page 63

pressure. Oh well. I guess an awful lot of dreams died here...somewhere along the way.

On the other hand, the solar-pump factory down the street is bursting at the seams with new activity. It seems a dose of reality has at long last caught up with alternate energy. The old order fadeth.

So, where does that leave us? What are the key hardware-hacker alternate-energy resources for the nineties? This month's resource sidebar gives us a clue or two.

The very core of today's alternate energy appears to be a funky little magazine known as *Home Power*. Besides its no-nonsense shirt-sleeves tech articles, that gem is full of ads from all of the leaders in the field. Cost is around \$6 per year.

Still at the same old stall is the good old *Whole Earth Review*, the ongoing continuation of the original *Whole Earth Catalog* and its progeny. Of the 497 magazines I personally subscribe to, that one is number two, right up there behind *MAD*. Nothing else even comes remotely close. Today the WER folks are heavy into CD ROM distribution and their major alternate-lifestyle BBS system widely known as *The Well*.

While both *Mother Earth News* and *Popular Science* have lots of useful alternate-energy stuff in them, there is a key difference. PS will admit that they have contacted a terminally incurable case of *Yuppus dementus*, while MEN does not.

I've found that *HVAC News*, a free air-conditioning trade journal, also has a surprising amount of the alternate-energy stuff in it.

Although most of the other solar and wind magazines have folded, *Solar Energy* remains as one useful, but highly technical resource.

The feds have bunches of alternate-energy info available, spread over a dozen agencies. The Department of Energy often sponsors seminars and technical-paper presentations. So does the National Bureau of Standards. Try any large

continued on page 76

$$A_n = \lim_{z \rightarrow \alpha} = \frac{\frac{e^{atz} \cos \alpha t}{a - e^{at}} + e^{xdt} + \int_{f(x,t-\Delta t)}^{f(x,t+\Delta t)} e^{nx-2xt-2xy} dx}{2n-1}$$

FIG. 2

the equation. I found that the graphic preview mode didn't always work correctly; the company stated that the bugs won't be fixed in the current version, because 2.0 will operate entirely in a WYSIWYG (what you see is what you get) graphics mode.

After you've got your equation the way you want it, you save it. The program actually saves two versions of the file: one, which contains the master data, has the extension EQU; the other, which contains the desired output format, has the appropriate extension (PIX, TIF, EPS, etc.). If you're set up for PIX output and decide at a later time that you need PostScript (EPS) files—no problem. Just run the setup routine and select the new output format. Then reload and resave the desired equation.

At that point you can fire up your word processor and follow its normal procedure for importing a graphic file. I tested MathEdit with WordStar 5.5, which actually uses Inset for graphics display and printing, and had no problem. If you wanted to get really fancy, you could use Inset to touch up the PIX file created by MathEdit. However, as shown in Fig. 2 (an actual size, unretouched equation printed by WordStar and Inset on an HP LaserJet Series II), you probably won't need to.

To really polish the appearance of your equation, you can enter thin and wide spaces. You can also align a group of equations on a character (the equal sign, for example), and you can number equations. In addition, a number of special characters and symbols are mapped to various Alt- and Ctrl-key combinations. For example, most common Greek characters are mapped to Alt-A-Alt-Z, and many common mathematical symbols are mapped to Ctrl-A-Ctrl-Z. Because of

display limitations, you'll need an EGA, VGA, or Hercules Graphics Card Plus (with RAMfont) to view the symbols in the text-mode screen. You can re-map the special characters to different key combinations, but you can't define your own special symbols. However, version 2.0 is supposed to correct that deficiency.

All in all, MathEdit is darned handy for anyone in school or anyone who has to publish documents with equations. The current version is good; I expect version 2.0 to be great! ♦CD♦

ITEMS DISCUSSED

- MathEdit (\$199.95), K-Talk Communications, 30 West First Avenue, Suite 100, Columbus OH 43201. (614) 294-3535.

CIRCLE 30 ON FREE INFORMATION CARD

Try the

Radio-Electronics

bulletin board system

(RE-BBS)
516-293-2283

The more you use it the more useful it becomes.

We support 300 and 1200 baud operation.

Parameters: 8N1 (8 data bits, no parity, 1 stop bit) or 7E1 (7 data bits, even parity, 1 stop bit).

Add yourself to our user files to increase your access.

Communicate with other R-E readers.

Leave your comments on R-E with the SYSOP.

RE-BBS
516-293-2283

PC ACCESS

continued from page 69

letting the software driver or by changing the contents of CONFIG.SYS. Thus it is impossible to gain access to a secured PC without removing the PC Access card.

Further, PC Access locks out the use of the Ctrl and Alt keys on the PC keyboard, so pressing Ctrl-C or Ctrl-BREAK will not halt the boot process.

Additionally, some computers have monitor or setup functions that can be accessed before DOS has booted. Those setup routines are typically entered by pressing some combination of Ctrl, Alt and some other key. Locking out Ctrl and Alt provides a means to prevent unauthorized access to those functions during boot.

At boot time, PC Access's device driver (SECURITY.BIN) prompts the user for a password and optionally for a user ID as well. The passwords and user ID's are stored in an encoded form inside the device driver. If no valid password is entered in three attempts, access to the computer is denied until it is rebooted. A new password prompt appears each time the computer is rebooted.

After a valid password has been entered, the device driver restores access to drive A, re-enables use of the Ctrl and Alt keys, and returns control to DOS so that it can execute the remaining CONFIG.SYS commands and give user access to the PC.

DOS's boot sequence

When an IBM (or compatible) PC executes its power-up routines, one chore is to search for BIOS extensions. The extensions are located in memory segments C000h through EFFFh. The BIOS searches that area in 2K steps, looking for the two-byte sequence, 55h AAh. If the BIOS finds that "signature," it then assumes that the next byte contains the length (in 512-byte chunks) of the routines contained in the ROM. Next the BIOS computes a checksum on the area described. The checksum must be zero for the extension to be recognized. Once the exten-

sion is recognized, the computer executes a far call to the fourth location in the ROM. That call is provided so that the ROM can perform any required initialization. The initialization routine should exit with a far return. The BIOS then continues searching for other extensions. Once all of the legal addresses have been searched, DOS is booted.

Part of DOS's boot procedure is to load the CONFIG.SYS file that is stored in the root directory, and perform any setup and configuration functions specified in the file. One advantage of using a device driver to request user passwords is that the passwords and user ID's can be stored inside the device driver rather than in the EPROM. Circuit cost and complexity would increase if that information were stored in EEPROM.

The software included in the

PC Access EPROM sets up a new interrupt handler for floppy- and hard-disk access. The new routine allows DOS to boot from the hard drive, but not from drive A. A second interrupt is established that intercepts scan codes from the keyboard and disables the Ctrl and Alt keys.

Circuit details

The PC Access EPROM is mapped into an 8K slot in the PC's address space somewhere between C000H and EFFFH. As shown in Fig. 1, decoding the desired address is accomplished with a 74LS30 eight-input NAND gate (IC1) and a 74LS04 inverter (IC2). When all eight NAND-gate inputs are high, then the output will be low; otherwise, the output will be high. A low output enables the EPROM's chip select (\overline{CS}) input (pin 20).

The address that is actually de-

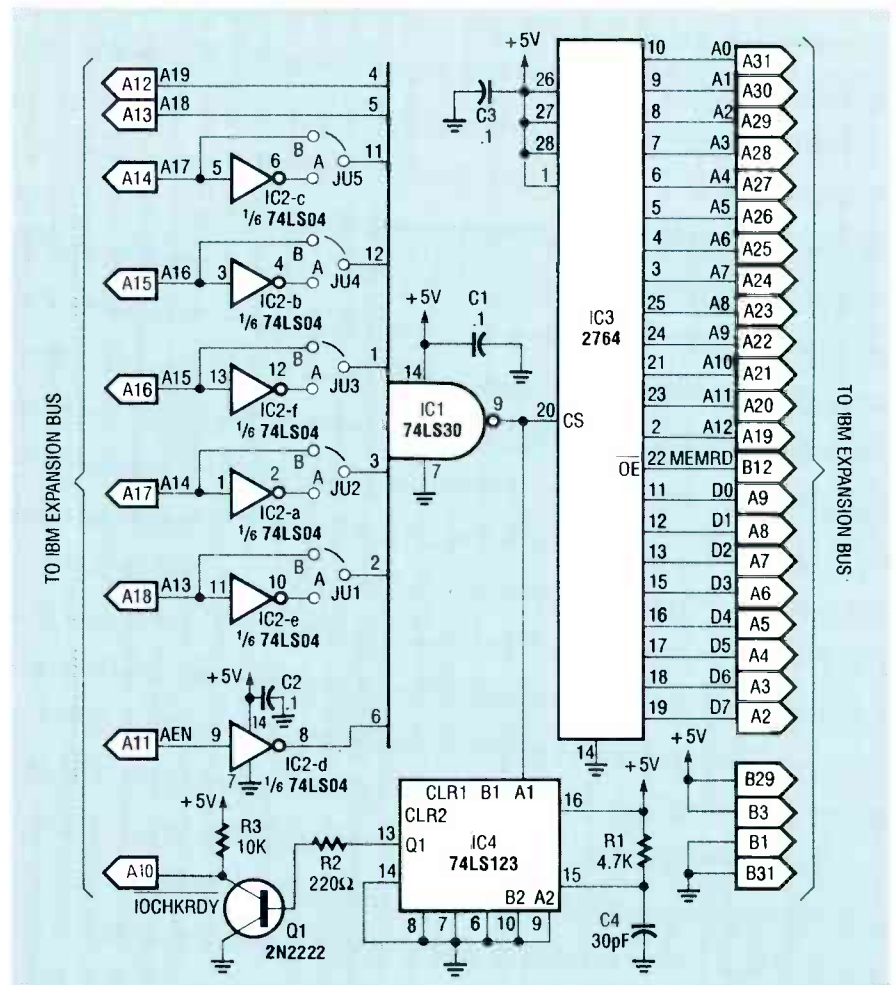

Fig. 1. PC ACCESS SCHEMATIC: IC1 and IC2 decode the 8K block where EPROM IC3 resides. The one-shot (IC4) and associated components extend the memory access cycle, thereby allowing slow EPROM's to be used.

coded is determined by the positions of five address-select jumpers, which are connected to address lines A13–A17. The jumpers determine whether the true or the inverted address lines from the expansion bus are routed to IC1. When a line goes directly to IC1, that line must be a high for the chip-select signal to occur. When the inverted address line is used, it must be a low.

Address lines A18 and A19 drive IC1 directly, because both will be high whenever an address greater than or equal to C0000 is accessed. The A13–A17 lines further decode the address; any available 8K slot from C0000–EE000 may be used. Jumper settings and corresponding addresses are shown in Table 1.

The AEN signal from the expansion bus shows whether the address and data busses are currently being controlled by the microprocessor or by the 8237 direct memory access (DMA) controller. The PC Access EPROM should be enabled only when the microprocessor is controlling the bus, so an inverted version of AEN is routed to IC1.

Data and address lines to the EPROM are connected to the corresponding data and address lines from the expansion bus. The EPROM's output enable (\overline{OE}) is provided by the memory read (\overline{MEMRD}) signal from the bus.

The 74LS123 is a one-shot that provides a 150-ns pulse at its Q1 output (pin 13) each time the EPROM is selected (i.e., each time \overline{CS} goes low). The output of the one-shot drives Q1, a 2N2222 NPN transistor, which pulls low the expansion-bus signal $\overline{TOCHKRDY}$. That signal is used to insert a wait state into the memory access cycle, and is used to allow slow EPROM's to be used on a fast bus. Slow EPROM's (250 ns) are easier to buy and less expensive than fast (150 ns) ones.

Power for the card is obtained directly from the expansion bus.

Construction

The hardest part of construction is fabricating the PC board. If you want to build your own PC board, foil patterns are shown in PC Service. You can also purchase a prefabricated PC board from the source shown in the Parts List. The commercial

PC board has plated-through holes and gold-plated edge connections.

If you make your own board, remember that it's double-sided, so the wires must be soldered on both sides of the board.

After buying or building a board, install the components as shown in Fig. 2. The order of installation is not critical. Just keep polarities straight, and check your work carefully for shorts and opens before installing the board in your PC.

A socket may or may not be necessary for the EPROM. If you

Parts List

Resistors

All resistors are 1/4-watt, 5%, unless otherwise noted.

- R1 4700 ohms
 R2 220 ohms
 R3 10,000 ohms

Capacitors

- C1–C3 0.1 μ F disc or monolithic
 C4 30 pF disc

Semiconductors

- IC1 74LS30 8-input NAND gate
 IC2 74LS04 hex inverter
 IC3 2764 EPROM
 IC4 74LS123 dual retriggerable monostable multivibrator
 Q1 2N2222 NPN transistor

Other components

- JU1–JU5 3-pin header with shunt jumper

Ordering Information

The following are available from
Renton Products
 P.O. BOX 16271
 Seattle, WA 98116
 (206) 682 7341

Etched and drilled PC Board with gold-plated fingers \$14.

Complete kit of parts (including programmed EPROM and software on 5 1/4 inch diskette) \$34.

Assembled and tested units .. \$59.

Please add \$3 S/H to each order.
 WA residents add 8.1% sales tax.

TABLE 1—JUMPER SETTINGS

	JU1	JU2	JU3	JU4	JU5
C000	A	A	A	A	A
C200	B	A	A	A	A
C400	A	B	A	A	A
C600	B	B	A	A	A
C800	A	A	B	A	A
CA00	B	A	B	A	A
CC00	A	B	B	A	A
CE00	B	B	B	A	A
D000	A	A	A	B	A
D200	B	A	A	B	A
D400	A	B	A	B	A
D600	B	B	A	B	A
D800	A	A	B	B	A
DA00	B	A	B	B	A
DC00	A	B	B	B	A
DE00	B	B	B	B	A
E000	A	A	A	A	B
E200	B	A	A	A	B
E400	A	B	A	A	B
E600	B	B	A	A	B
E800	A	A	B	A	B
EA00	B	A	B	A	B
EC00	A	B	B	A	B
EE00	B	B	B	A	B

Note: A refers to an inverted address line and B refers to a non-inverted address line.

just want to use the board for security, you may want to solder the EPROM to the board. But you could use the board to prototype your own ROM BIOS extensions, in which case you'd want to use a socket.

Installation

All of the software for PC Access, including a burned EPROM and a copy of the binary file for burning your own EPROM, comes with the kit of parts. (A hex dump of the EPROM is shown in Listing 1.) The software is also available on the RE-BBS (300/1200 8N1, 516-293-2283) in a self-extracting ZIP file called PCACCESS.EXE. You'll need about 160K of disk space to decompress the file.

The general procedure for installing PC Access is to copy all files to the root directory of the boot drive, add a line to CONFIG.SYS, set the card's address, and then install it.

The easiest way to install the software is to log onto your boot drive (C in most cases), place the distribution diskette in drive A, type A:INSTALL, and then press Enter. Doing so runs a batch file that copies all files into the root directory of drive C, and also makes the needed change to CONFIG.SYS. If you wish to install the software yourself manually, copy SECURITY.BIN and the *.COM files into the root directory. Then add the following line to your CONFIG.SYS file:

```
DEVICE = SECURITY.BIN
```

That must be the first line in CONFIG.SYS: do not put any spaces in the line. In addition, don't rename SECURITY.BIN.

The card has five jumpers that determine the address at which the EPROM resides. The default (factory) setting is D8000h, which should be fine for most systems. If there is a conflict, the computer system may not boot. If there are any problems, remove the card and select a new address using Table 1.

After configuring the jumpers, park your hard drive and turn the computer off. Then install the card in any empty slot.

With the card and the software installed, turn the computer on.

Listing 1--PC ACCESS EPROM CONTENTS

000000	55	AA	03	FA	8C	CA	8E	DA	BA	00	00	8E	C2	BF	FF	01	
000010	B0	EA	26	88	05	BF	4C	00	BE	00	02	26	8B	05	26	89	
000020	04	47	47	46	46	26	8B	05	26	89	04	BF	04	02	B0	01	
000030	26	88	05	BF	4C	00	B8	08	04	26	89	05	47	47	8C	C8	
000040	26	89	05	BF	24	00	BE	10	02	26	8B	05	26	89	04	47	
000050	47	46	46	26	8B	05	26	89	04	BE	0F	02	B0	EA	26	88	
000060	04	BF	24	00	B8	A6	04	26	89	05	47	47	8C	C8	26	89	
000070	05	FB	B8	01	02	BB	00	00	B9	00	30	8E	C1	B9	01	00	
000080	BA	80	00	CD	13	BA	00	30	8E	DA	C7	06	27	10	00	00	
000090	C7	06	29	10	00	00	C7	06	2B	10	00	00	C7	06	39	10	
0000A0	00	00	BF	BE	01	8A	05	3C	80	74	09	8B	C7	05	10	00	
0000B0	8B	F8	EB	F1	47	8A	05	8A	F0	B4	00	A3	00	10	47	8A	
0000C0	05	8A	C8	B4	00	A3	02	10	47	8A	05	8A	E8	B4	00	A3	
0000D0	04	10	B8	01	02	BB	00	30	8E	C3	BB	00	00	B2	80	CD	
0000E0	13	BA	00	30	8E	DA	BF	0B	00	BE	06	10	B9	13	00	8A	
0000F0	05	88	04	47	46	E2	F8	8B	0E	04	10	8B	C1	F7	26	15	
000100	10	8B	D8	8B	0E	00	10	8B	C1	F7	26	13	10	03	C3	8B	
000110	D8	8B	0E	02	10	8B	C1	03	C3	A3	19	10	8A	1E	0B	10	
000120	8A	C3	B4	00	F7	26	11	10	8B	1E	19	10	03	C3	A3	1B	
000130	10	8B	1E	0C	10	8B	C3	D1	E8	D1	E8	D1	E8	D1	E8	25	
000140	FF	0F	8B	1E	1B	10	03	C3	A3	33	10	48	A3	1D	10	8B	
000150	1E	15	10	8B	C3	F7	26	13	10	A3	1F	10	8B	1E	1B	10	
000160	8B	C3	48	A3	31	10	FF	06	31	10	8B	1E	31	10	8B	C3	
000170	3B	06	1D	10	76	03	E9	BC	00	8B	C3	BA	00	00	F7	36	
000180	1F	10	A3	21	10	8B	C2	BA	00	00	C7	36	13	10	A3	23	
000190	10	8B	C2	05	01	00	A3	25	10	8B	1E	25	10	8A	CB	8B	
0001A0	1E	21	10	8A	EB	8B	C3	D1	E8	D1	E8	24	C0	0A	C8	8B	
0001B0	1E	23	10	8A	F3	B2	80	BB	00	30	8E	C3	BB	00	00	8A	
0001C0	01	02	CD	13	BE	00	00	8B	C6	3D	00	02	75	03	EB	62	
0001D0	90	56	BF	D5	03	8C	CB	8E	C3	B9	0B	00	8A	04	26	3A	
0001E0	05	75	1B	46	47	E2	F5	C7	06	27	10	FF	FF	5E	56	8B	
0001F0	C6	05	1A	00	8B	F0	8B	04	2D	02	00	A3	2D	10	5E	56	
000200	BF	E0	03	B9	0B	00	8A	04	26	3A	05	75	1B	46	47	E2	
000210	F5	C7	06	29	10	FF	FF	5E	56	8B	C6	05	1A	00	8B	F0	
000220	8B	04	2D	02	00	A3	35	10	5E	8B	C6	05	20	00	8B	F0	
000230	EB	95	E9	31	FF	90	8A	1E	08	10	8B	C3	B4	00	F7	26	
000240	2D	10	8B	1E	33	10	03	C3	A3	2F	10	8B	D8	BA	00	00	
000250	F7	36	1F	10	A3	21	10	8B	C2	BA	00	00	F7	36	13	10	
000260	A3	23	10	8B	C2	05	01	00	A3	25	10	8B	1E	25	10	8A	
000270	CB	8B	1E	21	10	8A	EB	8B	C3	D1	E8	D1	E8	24	C0	0A	
000280	C8	8B	1E	23	10	8A	F3	B2	80	BB	00	30	8E	C3	BB	00	
000290	00	B8	01	02	CD	13	BE	00	00	BF	EB	03	8C	CB	EB	C3	
0002A0	BB	00	30	8E	DB	B9	15	00	8A	04	3C	61	72	06	3C	7A	
0002B0	77	02	2C	20	26	3A	05	75	0A	46	47	E2	EB	C7	06	2B	
0002C0	10	FF	FF	8A	1E	08	10	8B	C3	B4	00	F7	26	35	10	8B	
0002D0	1E	33	10	03	C3	A3	37	10	8B	D8	BA	00	00	F7	36	1F	
0002E0	10	A3	21	10	8B	C2	BA	00	00	F7	36	13	10	A3	23	10	
0002F0	8B	C2	05	01	00	A3	25	10	8B	1E	25	10	8A	CB	8B	1E	
000300	21	10	8A	EB	8B	C3	D1	E8	D1	E8	24	C0	0A	C8	8B	1E	
000310	23	10	8A	F3	B2	80	BB	00	30	8E	C3	BB	00	00	B8	01	
000320	02	CD	13	B8	00	30	8E	D8	8C	C8	8E	C0	BE	0A	00	BF	
000330	00	04	B9	08	00	8A	04	26	3A	05	75	0A	47	46	E2	F5	
000340	C7	06	39	10	FF	FF	90	8B	1E	27	10	0B	DB	75	03	EB	
000350	23	90	8B	1E	29	10	0B	DB	75	03	EB	18	90	8B	1E	2B	
000360	10	0B	DB	75	03	EB	0D	90	8B	1E	39	10	0B	DB	75	03	
000370	EB	02	90	CB	B4	0F	CD	10	24	7F	B4	00	CD	10	B4	02	
000380	B7	00	BA	00	02	CD	10	8C	CA	8E	DA	BF	A5	03	8A	05	
000390	04	CO	74	0F	57	1E	B4	0E	B7	00	B3	07	CD	10	1F	5F	
0003A0	47	EB	EB	EB	FE	41	43	43	45	53	53	20	44	45	4E	49	
0003B0	45	44	20	2D	2D	2D	20	49	4D	50	52	4F	50	45	52	20	
0003C0	53	59	53	54	45	45	4D	20	43	4F	4E	46	49	47	55	52	41
0003D0	54	49	4F	4E	00	43	4F	4E	46	49	47	20	20	53	59	53	
0003E0	53	45	43	55	52	49	54	59	42	49	4E	44	45	56	49	43	
0003F0	45	3D	53	45	43	55	52	49	54	59	2E	42	49	4E	0D	0A	
000400	50	38	32	58	5A	5A	43	56	80	FC	00	75	25	80	FA	00	
000410	75	20	50	52	1E	57	BA	00	00	8E	DA	BF	04	02	8A	05	
000420	3C	01	74	03	EB	08	90	5F	1F	5A	58	EB	0A	90	5F	1F	
000430	5A	58	EA	FF	01	00	00	50	53	51	52	1E	06	57	56	55	
000440	FB	B4	0F	CD	10	24	7F	B4	00	CD	10	B4	02	B7	00	BA	
000450	00	02	CD	10	BF	8C	04	8C	CA	8E	DA	8A	05	0A	CO	74	
000460	0C	57	B4	0E	BB	00	01	CD	10	5F	47	EB	EA	5D	5E	5F	
000470	07	1F	5A	59	5B	58	57	83	C4	06	8B	FC	36	8B	05	0D	
000480	01	00	36	89	05	83	EC	06	5F	B4	80	CF	44	72	69	76	
000490	65	20	41	20	41	63	63	65	73	73	20	44	65	6E	69	65	
0004A0	64	20	0D	0A	0A	00	1E	52	57	50	BA	00	00	8E	DA	BF	
0004B0	04	02	8A	05	0A	CO	74	09	BF	17	04	8A	05	24	F3	88	
0004C0	05	58	5F	5A	1F	EA	0F	02	00	00	FF	FF	FF	FF	FF	FF	
0004D0	FF	FF	FF	FF	FF	FF	FF	FF	FF	FF	FF	FF	FF	FF	FF	FF	
0004E0	FF	FF	FF	FF	FF	FF	FF	FF	FF	FF	FF	FF	FF	FF	FF	FF	
0004F0	9B	FF	FF	FF	FF	FF	FF	FF	FF	FF	FF	FF	FF	FF	FF	FF	
000500	FF	FF	FF	FF	FF	FF	FF	FF	FF	FF	FF	FF	FF	FF	FF	FF	
...	
...	
...	
001FF0	FF	FF	FF	FF	FF	FF	FF	FF	FF	FF	FF	FF	FF	FF	FF	FF	

The rest of the EPROM consists of FF's

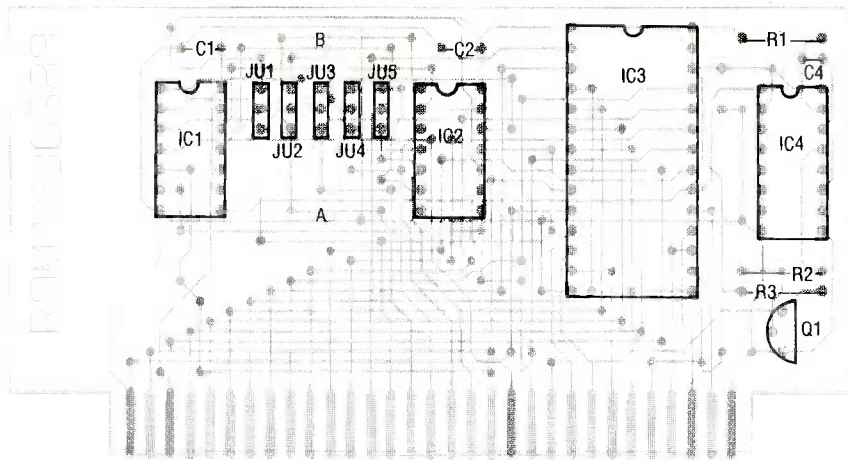

Fig. 2. PARTS AND JUMPER LOCATIONS. Mount all components as shown here. Table 1 shows how to configure the jumpers for various addresses.

If all has gone well, any floppy disk in drive A will be ignored and you will be prompted for a password. The default master password is SECURITY. You can change the master password and the user passwords with LOCK.COM, and individual passwords with CHANGE.COM.

To uninstall the security system, delete the DEVICE = SECURITY.BIN line from CONFIG.SYS, park the hard drive, turn the computer off, and remove the card.

Software

What follows are brief descriptions of the PC Access utility programs. LOCK.COM and CHANGE.COM are provided to establish the passwords and user ID's. A user can alter his or her own password using CHANGE; the system administrator can use LOCK to change the master password, any user ID, and any user password. You can optionally require users to type in both the user ID and the password each time the system boots. But even if you don't require the user ID to be typed in, the audit trail will log it.

HOLD.COM allows a user to suspend computer access until the correct password is entered. HOTKEY establishes what key combination triggers the hold function. HOLDOFF.COM removes HOLD.COM from memory.

The FINDROMS program helps locate a free segment in high memory. It searches for the 55AA

pattern that signifies a BIOS extension, and reports on any that it finds.

TRAIL.COM can be executed by AUTOEXEC.BAT to record user ID, access date, and access time. TRAIL should be one of the first programs in AUTOEXEC.BAT (after running any programs needed to update time and date from a real-time clock).

The audit file (a hidden system file) can be decoded by use of AUDIT.COM, as follows:

AUDIT Filename

After you hit the RETURN key, AUDIT will prompt the user for the master password. After the password is entered correctly, AUDIT will decode audit trail entries from the encoded file and append them to the specified file. If no file exists with the given filename, a new file will be created. The audit trail will then be cleared of entries. This function works even if user ID's are not required for system access.

Conclusion

PC Access is inexpensive, easy to build and install, yet nonetheless provides a significant deterrent to unauthorized access to your hard drive.

Additionally, the PC Access circuit board can be used to develop other ROM extensions. Not only does the PC Access give you an inexpensive way to protect your computer, it also provides an excellent flat form that allows you to learn more about how your computer works. **◆CD◆**

technical library that has a government documents section.

One fed document I've found most useful is the *Stand-Alone Photovoltaic Systems—The Handbook of Recommended Design Practices*. It's available through Sandia National Laboratories.

There are lots of distributors of alternate-energy products. One of the largest is *Real Goods*, who also offer a 320-page alternate-energy sourcebook for \$6.50. Their competitors include *Photocomm Inc*, the *Energy depot*, *Yellowjacket Solar*, and *Snow Belt Solar*. Get their catalogs.

Two establishment associations that have useful resource availability include the *Solar Energy Research Institute* and the *Association of Energy Engineers*. Write for their literature and service lists.

The leading manufacturers of solar panels include *Arco Solar*, *Solarex*, *Solec*, and *Solvonics*. Two windpower sources include *Bergey Windpower* and *Southwest Windpower*.

Finally, two of the alternate-energy "good guys" definitely include Steve Baer of *Zomeworks*, who is heavy into solar trackers and energy management; plus Jim Allen of *SolarJack*, who specializes in higher efficiency solar pumps and controllers.

New tech literature

Texas Instruments has released their three volumes of Linear Circuits data books.

TI also has free samples of all their new OTP (one time programmable) EPROM's. They work like a "real" EPROM, except that they are in a cheaper plastic case and can only get programmed one time. You use them for repeat copies of known-good code.

From *NEC*, the *Digital Signal Processor and Speech Processor* data book. And from *Silicon Systems*, a *Microperipheral Products Data Book* that covers chips used in floppy disks, hard disks, and cassette tapes.

Free software this month in-
continued on page 83

MARKET CENTER

FOR SALE

PHOTOFACT folders, under #1400 \$4.00. Others \$6.00. Postpaid. **LOEB**, 414 Chestnut Lane, East Meadow, NY 11554.

GREAT buys! Surplus prices, ICs, linears, transformers, PS, stepping motors, vacuum pump, phototransistor, meters, LSASE, **FERTIK'S**, 5400 Ella, Phila., PA 19120.

DESCRAMBLERS. All brands. Special: Combo Jerrold 400 and SB3 \$165. Complete cable descrambler kit \$39. Complete satellite descrambler kit \$45. Free catalog. **MJM INDUSTRY**, Box 531, Bronx, NY 10461-0531.

T.V. notch filters, surveillance equipment, brochure \$1.00. **D.K. VIDEO**, Box 63/6025, Margate, FL 33063. (305) 752-9202.

TUBES: "oldest," "latest." Parts and schematics. **SASE** for lists. **STEINMETZ**, 7519 Maplewood Ave., RE, Hammond, IN 46324.

CABLE TV DESCRAMBLERS!



BARGAIN HEADQUARTERS!

• JERROLD • TOCOM • HAMLIN
• SCIENTIFIC ATLANTA • ZENITH

Oak M35B ONLY \$60
6 month warranty! We ship C.O.D!
Lowest retail/wholesale prices!

FREE CATALOG:
Global Cable Network
1032 Irving St. Suite 109
S.F., CA 94122

ORDER TODAY! 800-327-8544

LASER Listener II, other projects. Surveillance, descrambling, false identification, information. Plans, kits, other strange stuff. Informational package \$3.00 refundable. **DIRIJO/BOND ELECTRONICS**, Box 212, Lowell, NC 28098.

ENGINEERING software, PC/MSDOS. Hobbyists — students — engineers. Circuit design \$59.00, FFT analysis \$69.00, Mathematics \$49.00, Logic Simulation \$49.00, Circuit Analysis \$29.00. Free catalog, (614) 491-0832, **BSOFT SOFTWARE**, 444 Colton Rd., Columbus, OH 43207.

RESTRICTED technical information: Electronic surveillance, schematics, locksmithing, covert sciences, hacking, etc. **Huge selection. Free brochures.** **MENTOR-Z**, Drawer 1549, Asbury Park, NJ 07712.

MICROWAVE TV RECEIVERS 1.9 to 2.7 GHz



2 CH Compact Dish System - \$77.95
5 CH Dish System - \$93.95
12 CH Yagi (Rod) System - \$123.95
30 CH Dish System - \$163.90 Yagi - \$183.90

SUN MICROWAVE INT'L. INC. Send \$1⁰⁰ for P.O. BOX 34522 catalog on these and other line (602) 230-0840 video products.

VISA/MC/COD QUANTITY DISCOUNTS LIFETIME WARRANTY

DESIGN and build your own computerized product! New manual makes it easy! Includes introduction to design, choosing the proper CPU, comparison between many CPUs and micro-controllers, component suppliers, sample schematics, programming, debugging, hints, tips, and more! Simple step-by-step details from idea to finished product. \$8.00 complete, satisfaction guaranteed, details free, **TRAVCO**, 107 E. Vallette, Suite 1301A, Elmhurst, IL 60126.

RENTAL movie stabilizer. Connect between VCRs or to monitor. Satisfaction guaranteed. \$69.95, \$4.00 handling. 1 (800) 367-7909.

MEMORY chips, Simms and Sippes: 4164-100 \$2.00, 41256-100 \$2.55, 41464-100 \$3.25. Call **ED/ DATAFIX**, (201) 322-7666.

CLASSIFIED AD ORDER FORM

To run your own classified ad, put one word on each of the lines below and send this form along with your check to:

Radio-Electronics Classified Ads, 500-B Bi-County Boulevard, Farmingdale, NY 11735

PLEASE INDICATE in which category of classified advertising you wish your ad to appear. For special headings, there is a surcharge of **\$25.00**.

() Plans/Kits () Business Opportunities () For Sale
() Education/Instruction () Wanted () Satellite Television
() _____

Special Category: \$25.00

PLEASE PRINT EACH WORD SEPARATELY, IN BLOCK LETTERS.

(No refunds or credits for typesetting errors can be made unless you clearly print or type your copy.) Rates indicated are for standard style classified ads only. See below for additional charges for special ads. **Minimum: 15 words.**

1	2	3	4	5
6	7	8	9	10
11	12	13	14	15 (\$46.50)
16 (\$49.60)	17 (\$52.70)	18 (\$55.80)	19 (\$58.90)	20 (\$62.00)
21 (\$65.10)	22 (\$68.20)	23 (\$71.30)	24 (\$74.40)	25 (\$77.50)
26 (\$80.60)	27 (\$83.70)	28 (\$86.80)	29 (\$89.90)	30 (\$93.00)
31 (\$96.10)	32 (\$99.20)	33 (\$102.30)	34 (\$105.40)	35 (\$108.50)

We accept MasterCard and Visa for payment of orders. If you wish to use your credit card to pay for your ad fill in the following additional information (Sorry, no telephone orders can be accepted.):

Card Number _____

Expiration Date _____

Please Print Name _____

Signature _____

IF YOU USE A BOX NUMBER YOU MUST INCLUDE YOUR PERMANENT ADDRESS AND PHONE NUMBER FOR OUR FILES. ADS SUBMITTED WITHOUT THIS INFORMATION WILL NOT BE ACCEPTED.

CLASSIFIED COMMERCIAL RATE: (for firms or individuals offering commercial products or services) \$3.10 per word prepaid (no charge for zip code)...**MINIMUM 15 WORDS.** 5% discount for same ad in 6 issues; 10% discount for same ad in 12 issues within one year; if prepaid. **NON-COMMERCIAL RATE:** (for individuals who want to buy or sell a personal item) \$2.50 per word, prepaid...no minimum. **ONLY FIRST WORD AND NAME** set in bold caps at no extra charge. Additional bold face (not available as all caps) **55¢ per word additional.** Entire ad in boldface, \$3.70 per word. **TINT SCREEN BEHIND ENTIRE AD: \$3.85 per word. TINT SCREEN BEHIND ENTIRE AD PLUS ALL BOLD FACE AD: \$4.50 per word. EXPANDED TYPE AD: \$4.70 per word prepaid.** Entire ad in boldface, \$5.60 per word. **TINT SCREEN BEHIND ENTIRE EXPANDED TYPE AD: \$5.90 per word. TINT SCREEN BEHIND ENTIRE EXPANDED TYPE AD PLUS ALL BOLD FACE AD: \$6.80 per word. DISPLAY ADS:** 1" x 2 1/4"—\$410.00; 2" x 2 1/4"—\$820.00; 3" x 2 1/4"—\$1230.00. **General Information:** Frequency rates and prepayment discounts are available. **ALL COPY SUBJECT TO PUBLISHERS APPROVAL. ADVERTISEMENTS USING P.O. BOX ADDRESS WILL NOT BE ACCEPTED UNTIL ADVERTISER SUPPLIES PUBLISHER WITH PERMANENT ADDRESS AND PHONE NUMBER.** Copy to be in our hands on the 10th of the third month preceding the date of the issue (i.e., Aug. issue copy must be received by May 10th). When normal closing date falls on Saturday, Sunday or Holiday, issue closes on preceding working day. Send for the classified brochure. Circle Number 49 on the Free Information Card.

ASSEMBLE YOUR OWN COMPUTER FOR LESS

10 MHz 8088 Compatible Kit\$379

- 4.77/10 MHz 8088 Motherboard
- 256KB RAM (840KB max)
- 150W Power Supply
- Floppy Disk Controller
- One 5 1/4" 360KB Drive
- MonoGraphics Card w/ P
- 101 Key Keyboard
- Case (3LED,2Button,Key)
- 12" Amber Mono Monitor
- Installation Guide & Manual



12 MHz 80286 Compatible Kit\$669

- 12 MHz 80286 Motherboard
- 512 KB RAM (4 MB max)
- 200W Power Supply
- Floppy Disk Controller
- One 5 1/4" 1.2 MB Drive
- MonoGraphics Card w/ P
- 101 Key Keyboard
- Case (3LED,2Button,Key)
- 12" Amber Mono Monitor
- Installation Guide & Manual



20 MHz 80386 Compatible Kit\$1399

- All Components Fully Tested Before Ship
- One Year Warranty on All Parts
- Installation Available at No Extra Charge !!!
- VISA & M/C add 3% Amex add 4%
- Price & Quantity subject to change without prior notice
- 15% Restocking Fee on All Non-Defective Items

JINCO COMPUTERS INC.

5122 WALNUT GROVE AVE.
SAN GABRIEL, CA 91776

Tel: (818) 309-1108

Fax: (818) 309-1107

CIRCLE 179 ON FREE INFORMATION CARD

CB RADIO OWNERS!

We specialize in a wide variety of technical information, parts and services for CB radios. 10-Meter and FM conversion kits, repair books, plans, high-performance accessories. Thousands of satisfied customer since 1976! Catalog \$2.

CBC INTERNATIONAL
P.O. BOX 31500RE, PHOENIX, AZ 85046

CABLE TV, best SSAVI's, Tocom's and filters in the business. We build all our own equipment, no middleman. Upgrade your SSAVI to a super SSAVI with our PAL kit. Quantity and dealer pricing. We ship COD — call to get on our mailing list. 1 (800) 426-9063. COPA ELECTRONICS.

COMMUNICATIONS/electronic equipment sales, service, FCC licensed, free catalog, RAYS, PO Box 14862, Fort Worth, TX 76117-0862.

CABLE TV converters and descramblers discount center! Jerrold, Tocom, Hamlin, Oak, Scientific Atlanta, Zenith. Quantity discount, order yours today! 1 (800) 962-6836.

FREE CATALOG

FAMOUS "FIRESTIK" BRAND CB ANTENNAS AND ACCESSORIES. QUALITY PRODUCTS FOR THE SERIOUS CB'er. SINCE 1962
FIRESTIK ANTENNA COMPANY
2614 EAST ADAMS
PHOENIX, ARIZONA 85034

SAM'S photofacts set 1091 — 2660 minimum price \$1500. HENNEPIN TECHNICAL COLLEGE, 9000 Brooklyn Blvd., Brooklyn Park, MN 55445. (612) 425-3800. Ade Olson.

CABLE TV converters: Jerrold, Oak, Scientific Atlantic, Zenith & many others. "New MTS" stereo add-on: mute & volume. Ideal for 400 and 450 owners! 1 (800) 826-7623, Amex, Visa, M/C accepted. B & B INC., 4030 Beau-D-Rue Drive, Eagan, MN 55122.

DESCRAMBLERS, top brands, lowest prices, fast service, best warranty, technical support, COD ok, example, Tocom with remote \$199.00, R.T.C.-56 with remote \$150.00, call now, we have SA-3, Tri-Bi, Hamlin, Pioneer in stock. MOUNT HOOD ELECTRONICS, (206) 896-6837.

TUBES, new, up to 90% off, SASE, KIRBY, 298 West Carmel Drive, Carmel, IN 46032.

CABLE TV converters and descramblers. We sell only the best. Low prices. SB-3 \$79.00. We ship C.O.D. Free catalog. ACE PRODUCTS, PO Box 582, Dept. E, Saco, ME 04072. 1 (800) 234-0726.

SAMS closeout sale. #2 to #2600 \$6.00 each postpaid. MC/Visa. Call 1 (800) 274-2081. 9-5 CST.

General Technics
Quality Computer Systems

(516) 981-9473

Save hundreds of dollars assembling your own IBM XT, AT, or 386 compatible computer

Complete AT Computer System \$675

Amber Monitor, 512k Memory, 101 Enhanced Keyboard, 1.2m Floppy Drive, 12 mhz 80286 Mother Board, Hard/Floppy Controller Card, Instruction Manual

FREE CATALOG

P.O. Box 2676, Lake Ronkonkoma, NY 11779

CABLE converters, descramblers, Tocom-w/r \$199.00, Oak R.T.C.-56-w/r \$150.00, Jerrold-400-w/r \$125.00, Hamlin-6600-w/r \$145.00, Zenith-w/r \$225.00, SA-3 \$99.00, Tri-Bi \$89.00, Pioneer \$135.00, MLD-1200 \$45.00, all in stock with full warranty, COD orders welcome, nobody can beat our quantity prices, full tech support. S.A.C., info (702) 647-3799 orders 1 (800) 622-3799.

FINALLY a digital technology course for everyone! Technicians, supervisors and managers! Free details. TEKKNOWLEDGY SOURCES, RE004, Box 1284, League City, TX 77573.

TJ SERVICES is here to serve you! Our quality products, quick courteous service, knowledgeable sales people and rock bottom prices prove it! Not sure what you need? Call (313) 979-8356 we'll help! We specialize in Jerrold, Hamlin, interference filters and most SA equipment.

CABLE TV descramblers M35B. Top quality. Tested, guaranteed, vari-sync available. Dealers wanted. \$39.00. 1 (800) 648-4600.

ELECTRONIC test equipment and parts. Free illustrated catalog. EF ELECTRONICS, PO Box 326, Aurora, IL 60507.

DESCRAMBLERS. — For free catalog contact CABLE CONNECTION, 1304 E. Chicago Street, Suite 301, Algonquin, IL 60102. (708) 658-2365.

FEBRUARY 1984 complete parts with power supply. \$38.00. Postpaid. JIM RHODES, INC., Box 3421, Bristol, TN 37625.

PROGRAMMABLE stepper motor drive & control for under \$100, IBM PC/XT compatible, Commodore 64, or other with 25 pin parallel port. PCB, interface, & software. Send for detailed literature to: MASE, R.D. #2 Box 166, Mohrsville, PA 19541.

TOCOM converters w/r from \$199.00. Tocom super chips turn on everything \$69.00 each Phone (219) 935-4128.

SURVEILLANCE — Privacy control — debugging — protection. (kits — assembled) large new catalog \$5.00. TRI-TRON, 2209F Lopalco, Harvey, LA 70058.

INTEGRATED circuits data books, business SASE for list. FRAZIER, Box 972, Windermere, FL 34786.

SECRET new hair growing formula you can make. Really works. Free information NATURAL HAIR, PO Box 0963, Paragould, AR 72451-0963.

COMPUTER interconnection products. Free 100 page catalog qualified buyers. L-COM, 1755 Os-good, North Andover, MA 01845.

CABLE TV

TB-3 (Tri-Bi) or SA-3

Quantity Prices

10	20
\$48. Each	\$43. Each
50	100
\$39. Each	\$35. Each

Hours open 10:00 am to 4:00 pm Eastern time
Minimum order 5 units 55.00 ea.
Dealers wanted. We ship COD.

King Wholesale
1-800-729-0036
Fax number 6173400053

"No one beats the King's prices!"

DESCRAMBLERS



One tree can make
3,000,000 matches.



One match can burn
3,000,000 trees.



A Public Service of The Magazine
& The Advertising Council

UNICORN-YOUR I.C. SOURCE

COLLIMATOR PEN



A low power collimator pen containing a MOVPE grown gain guided GaAlAs laser. This collimator pen delivers a maximum CW output power of 2.5 mW at 25°C.

These collimated laser sources are designed for industrial applications such as data retrieval,

telemetry, alignment etc.

The non-hermetic stainless steel encapsulation of the pen is specifically designed for easy alignment in an optical read or write system, and consists of a lens and a laser device. The lens system collimates the diverging laser light. The wavefront quality is diffraction limited.

The housing is circular and precision manufactured with a diameter of 11.0 mm and an accuracy between + and - 11µm.

LIST PRICE ~~\$180.00~~ PRICE **\$39.99**

Quality Components — Low Prices Since 1983

LASER DIODE

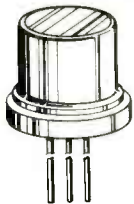

Designed for general industrial low power applications such as reading optical discs, optical memories, bar code scanners, security systems, alignment etc.

The gain guided laser is constructed on a n-type gallium arsenide substrate with a Metal Organic Vapor Phase Epitaxial process (MOVPE).

The device is mounted in an hermetic SOT148D (diameter 9.0 mm) encapsulation.

The SB1053 is standard equipped with a monitor diode, isolated from the case and optically coupled to the rear emitting facet of the laser. This fast responding monitor diode can be used as a sensor to control the laser optical output level.

LIST PRICE ~~\$38.00~~ PRICE **\$9.99**

We Carry A Full Line of Components

CALL FOR FREE CATALOG

EPROMS

STOCK #	PINS	DESCRIPTION	1-24	25-99	100+
1702	24	256 x 4 1ns	3.99	3.79	3.41
2708	24	1024 x 8 450ns	5.79	5.50	4.95
2758	24	1024 x 8 450ns	3.99	3.79	3.41
2716	24	2048 x 8 450ns (25v)	3.19	3.03	2.73
2716-1	24	2048 x 8 350ns (25v)	3.39	3.22	2.90
TMS2716	24	2048 x 8 450ns	6.29	5.98	5.38
27C16	24	2048 x 8 450ns (25v-CMOS)	3.59	3.41	3.07
2732	24	4096 x 8 450ns (25v)	3.79	3.60	3.24
2732A-2	24	4096 x 8 200ns (21v)	3.79	3.60	3.24
2732A	24	4096 x 8 250ns (21v)	3.69	3.51	3.16
2732A-4	24	4096 x 8 450ns (21v)	3.09	2.94	2.65
TMS2532	24	4096 x 8 450ns (25v)	5.79	5.50	4.95
27C32	24	4096 x 8 450ns (25v-CMOS)	4.19	3.98	3.58
2764-20	28	8192 x 8 200ns (21v)	3.99	3.79	3.41
2764	28	8192 x 8 250ns (21v)	3.59	3.41	3.07
2764A-20	28	8192 x 8 200ns (12.5v)	3.99	3.79	3.41
2764A	28	8192 x 8 250ns (12.5v)	3.59	3.41	3.07
TMS2564	28	8192 x 8 250ns (25v)	6.79	6.45	5.81
27128-20	28	16,384 x 8 200ns (21v)	5.79	5.50	4.95
27128	28	16,384 x 8 250ns (21v)	4.79	4.55	4.10
27C128	28	16,384 x 8 250ns (21v)	5.39	5.12	4.61
27256-20	28	32,768 x 8 200ns (12.5v)	5.99	5.69	5.12
27256	28	32,768 x 8 250ns (12.5v)	4.99	4.74	4.27
27C256	28	32,768 x 8 250ns (12.5v-CMOS)	5.99	5.69	5.12
27512-20	28	65,536 x 8 200ns (12.5v)	10.49	9.97	8.97
27512	28	65,536 x 8 250ns (12.5v)	9.49	9.02	8.12
27C512	28	65,536 x 8 250ns (12.5v-CMOS)	9.99	9.49	8.54
27C1024	32	131,072 x 8 200ns (12.5v)	27.99	26.59	23.93
68164	24	8192 x 8 450ns	18.99	18.04	16.24
68166	24	8192 x 8 450ns	15.99	15.19	13.67

UNICORN ELECTRONICS

10010 Canoga Ave., Unit B-8
Chatsworth, CA 91311

ORDER BY PHONE (TOLL FREE)

(800) 824-3432 (OUTSIDE CALIFORNIA)

IN CALIFORNIA (818) 341-8833

ORDER BY FAX (818) 998-7975

CIRCLE 198 ON FREE INFORMATION CARD

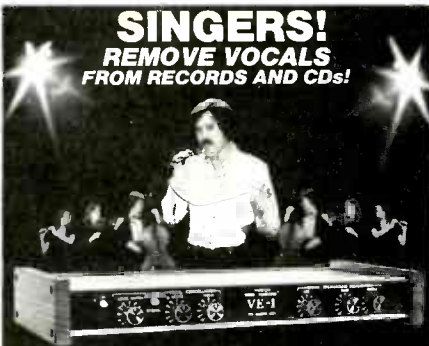

SING WITH THE WORLD'S BEST BANDS!

An Unlimited supply of Backgrounds from standard stereo records! Record with your voice or perform live with the backgrounds. Used in Professional Performance yet connects easily to a home component stereo. This unique product is manufactured and sold Exclusively by LT Sound - Not sold through dealers. Call or write for a Free Brochure and Demo Record.

LT Sound, Dept. R-L-3, 7980 LT Parkway
Lithonia, GA 30058 (404) 482-4724
Manufactured and Sold Exclusively by LT Sound
24 HOUR PHONE DEMO LINE: (404) 482-2485

BUILD remote controlled robot, plans, electronic kits, free details, **ROBOT WORKS**, Box 1979, Colorado Springs, CO 80901.

CATALOG: hobby/broadcasting/HAM/CB: Cable TV, transmitters, amplifiers, surveillance devices, computers, more! PANAXIS, Box 130-F4, Paradise, CA 95967.

SURVEILLANCE transmitter kits are available to professional City, State and Government law enforcement agencies that operate on frequencies they prefer. Our transmitters have proven generally to outperform theirs. Four models of each; telephone, room, combination telephone/room transmitters tune from 65 to 305 MHz. Send \$1.00 (overseas airmail \$2.00) for catalog. Included is **Popular Communications** book review of "Now Hear This! Electronics Eavesdropping Equipment Design" by Winston Arrington. Book contains 58 transmitter schematics. **SHEFFIELD ELECTRONICS**, 7223 Stony Island Ave., Chicago, IL 60649-2806.

**NEW HE NE
LASER TUBES \$35**

*Dealer Inquiries Invited.
Free Catalog!*

MEREDITH INSTRUMENTS: 6403 N. 59th Ave.
Glendale, AZ 85301 • (602) 934-9387
"The Source for Laser Surplus"

SINGERS. At last, build your own vocal filter. Remove lead vocals from standard stereo records, CDs, tapes, FM broadcasts, so you can be the lead singer of your favorite band. Schematic/theory \$6.95. **WEEDER TECHNOLOGIES**, 14773 Lindsey, Mt. Orab, OH 45154.

KITS Preamplifiers, amplifiers, antenna amplifier, alarm, dice, power meter, VU meter, motion detector, siren, chime, door bell, timers and trainers. Catalog: **ARLI ELECTRONICS**, 2155 Verdugo Blvd. #22, Montrose, CA 91020.

STRESSED out? Relaxation technique easily learned with the aid of a simple electronic device. Not hypnosis! Plans \$9.95. **BLUE CHIP ENGINEERING**, Dept. 33, PO Box 1100, Walnut, CA 91789.

SURVEILLANCE schematics. Easy to build. Bug detector \$5.00, FM transmitter \$5.00, phone snoop \$5.00, all three \$12.95, \$1.00 postage. **CABLETRONICS**, Box 30502R, Bethesda, MD 20824.

PROJECT supplies — tools — motors — casting — etc.. Catalog \$1.00 **INVENTORS HARDWARE**, Box 8460-R, Anaheim, CA 92812.

ROBOTS. 44 kits and plans to build. Catalog \$1.00. **MUSEUM OF ROBOTICS STORE**, 4026 MLK JR. Way, Oakland, CA 94609.

CIRCUIT design software: filters, amplifiers, crossovers, oscillators, timers and more! Disk and documentation \$19.95. PC/MSDOS. Info \$1.00. **BRUTECH**, Box 596, Welland, Ontario, Canada L3B 5R3.

RECHARGE toner cartridges used in laser printers and personal copiers. Earn \$50.00 per hour. **1 (800) 221-3516**. 62 N. Coleman Road, Centereach, NY 11720.

TALKING voltmeter! Microprocessor controlled! Build yours under \$20.00. No experience necessary with microprocessors. Send self addressed/stamped envelope to: **DIGITAL DREAMS**, Box #4192, Huntington Beach, CA 92605.

UNIVERSAL IC, component tester! Plans \$5.00 US. Catalog \$1.00 **QUANTUM RESEARCH**, 17919-77 Avenue, Edmonton, Alberta T5T 2S1.

MULTI CHANNEL MICROWAVE ANTENNAS

- CRYSTAL CONTROLLED MICROWAVE ANTENNAS FOR OVER THE AIR CABLE SYSTEMS (WIRELESS CABLE)
 - CAPABLE OF RECEIVING 30 CHANNELS
 - CONVERTERS AVAILABLE FOR ZENITH SYSTEMS
- CATALOG & INFO: (203) 975-7543**

VIDEO-LINK ENTERPRISES

520 GLENBROOK RD., SUITE 202, STAMFORD CT 06906

SATELLITE TV

FREE catalog — Do-it-yourself save 40-60%. Lowest prices worldwide, systems, upgrades, parts, all major brands factory fresh and warrantied. **SKYVISION, INC.**, 2009 Collegeway, Fergus Falls, MN 56537. 1 (800) 334-6455.

DESCRAMBLER: Build our low cost video only, satellite TV descrambler for most satellite channels. Uses easy to get, everyday parts. Board & plans \$35.00 US funds. Board, plans & parts \$99.00 US funds. Wired & tested unit \$189.00 US funds. Send check, money order or Visa to: **VALLEY MICRO-WAVE ELECTRONICS**, Bear River, Nova Scotia, Canada B0S 1B0 or phone (902) 467-3577. 8am to 4pm eastern time. Note: educational project only. Not to be used illegally.

CABLE TV DESCRAMBLER LIQUIDATION!

- Major Makes & Models!
- Will match or beat anyone's prices!
- Dealer discounts at 5 units!
- Examples:
HAMLIN COMBOS . . . \$44 ea. (Min. 5)
OAK ADD/ON \$40 ea. (Min. 5)
OAK M35B \$60 ea. (Min. 5)

WEST COAST ELECTRONICS

For Information: 818-709-1758

Catalogs & Orders: 800-628-9656

VIDEOCYpher II descrambling manual. Schematics, video and audio. Explains DES, EPROM, CloneMaster, 3Musketeeer, pay-per-view (HBO, Cinemax, Showtime, adult, etc.) \$13.95, \$2.00 postage. Collection of Software to copy and alter EPROM codes, \$25. **CABLETRONICS**, Box 30502R, Bethesda, MD 20824.

DESCRAMBLERS for movies, networks, \$175, video only, \$450 complete. Visa, MC accepted. Catalog \$4.00. **SKYWATCH**, 238 Davenport Road, Toronto, Canada, M5R 1J6.

SATELLITE printout for your location \$7.95. **DATABANK RESEARCH**, PO Box 261, Westmont, IL 60559.

PAY TV and satellite descrambling 1990 edition. Our best yet. More descrambling circuits, turn-ons, schematics, countermeasures, counter-counter measures. **only \$14.95.** Scrambling News monthly \$19.95/yr. Sample \$3.00. New indexed catalog \$1.00. COD's are ok (716) 874-2088. **SCRAMBLING NEWS**, 1552 W. Hertel Ave., Buffalo, NY 14216.

VIDEOCIPHER II manuals. Volume 1 — hardware, Volume 2 — software. Either \$32.45. Volume 3 — projects/software — \$42.45. Volume 4 — repair — \$97.45. Volume 5 documentation — \$42.45. **Cable Hacker's Bible** — \$32.45. **Clone Hacker's Bible** — \$32.95 CODs: (602) 782-2316. 220+ Megabytes IBM-PC/XT software — catalog-\$3.00. **TELECODE**, Box 6426-RE, Yuma, AZ 85366-6426.

CABLE TV secrets — the outlaw publication the cable companies tried to ban. HBO, Movie Channel, Showtime, descramblers, converters, etc. Suppliers list included. \$8.95. **CABLE FACTS**, Box 711-R, Pataskala, OH 43062.

ATLANTIC GROUP ENTERPRISES INC. Buy satellite equipment. Dealing directly with the seller. We can show you how. Toll free 1 (800) 446-4039.

*****PRESENTING*****
**CABLE TV
 DESCRAMBLERS**
 *****STARRING*****
JERROLD, HAMLIN, OAK
 AND OTHER FAMOUS MANUFACTURERS

- FINEST WARRANTY PROGRAM AVAILABLE
- LOWEST RETAIL/WHOLESALE PRICES IN U.S.
- ORDERS SHIPPED FROM STOCK WITHIN 24 HOURS

FOR FREE CATALOG ONLY **1-800-345-8927**
 FOR ALL INFORMATION 1-818-716-5914

PACIFIC CABLE CO. INC.
 7325 1/2 RESEDA BLVD., DEPT. RET 89
 RESEDA, CA 91335

SOFTWARE

FREE software for IBM and compatibles! Info \$1.00. **BLUE CHIP ENGINEERING**, Dept. 33, PO Box 1100, Walnut, CA 91789.

FREE CATALOG!
1-800-648-7938
 For all information 1-702-362-9026
JERROLD HAMLIN OAK ETC.
**CABLE TV
 DESCRAMBLERS**
 • Compare our low Low Retail Prices!
 • Guaranteed Prices & Warranties!
 • Orders Shipped Immediately!
REPUBLIC CABLE PRODUCTS INC.
 4080 Paradise Rd. #15 Dept. RE-90
 Las Vegas, NV 89109

EDUCATION & INSTRUCTION

MAGIC! Four illustrated lessons plus inside information shows you how. We provide almost 50 tricks including equipment for four professional effects. You get a binder to keep the materials in, and a one-year membership in the International Performing Magicians with a plastic membership card that has your name gold-embossed. You get a one-year subscription to our quarterly newsletter "IT'S MAGIC!" Order now! \$29.95 for each course + \$3.50 postage and handling. (New York residents add applicable state and local sales tax). **THE MAGIC COURSE**, 500-B BiCounty Boulevard, Farmingdale, NY 11735.

LEARN IBM PC assembly language. 80 sample programs. Disk \$5. Book \$18. **ZIPFAST**, Box 12238, Lexington, KY 40581-2238.

INSTANTANEOUSLY reduce stereo volume. Device mutes stereo while phone in use. PC board, complete instructions only \$14.95. **TRIAD TECHNOLOGIES**, 7184 Manchester, St. Louis, MO 63143-2408.

**CABLE TV
 DESCRAMBLERS**

JERROLD™ Tri-Bi Mode.....	\$105.00	10 Lot	\$85.00
JERROLD™ SB-3 OR 2.....	\$89.00		\$65.00
Hamlin MLD-1200.....	\$99.95		\$62.00
Oak N-12 W/V.S.....	\$99.95		\$62.00
Oak-M-35-B W/V.S.....	\$99.00		\$78.00
OAK E-13.....	\$99.95		\$58.00
Zenith SSAVI.....	\$185.00		\$145.00
Eagle PD-3.....	\$120.00		\$85.00
Scientific Atlanta.....	\$129.95		\$105.00
SA-Combo's.....	CALL		\$Call
Tocom.....	\$350.00		\$295.00
Oak N-12 W/ Auto.....	\$140.00		\$105.00
Jerrold Starcom CSV.....	\$139.95		Call

**M.D. ELECTRONICS
 WILL MATCH ANY
 ADVERTISED PRICE
 IN THIS MAGAZINE**

***NEW STARGATE 2000
 CABLE CONVERTER**



1-\$89.00 10-\$69.00 100-Call
 Last channel recall-Favorite channel select-75 channel-Channel scan-Manual fine tune-One year warranty-surge protection-HRC & Standard switchable- and much more. **Call Today!**

INFORMATION(402)554-0417

Orders Call Toll Free
1-800-624-1150

**M.D. ELECTRONICS
 115 NEW YORK MALL
 SUITE 133E
 OMAHA, NE. 68114**

CIRCLE 53 ON FREE INFORMATION CARD

Parts Express International Inc.

EMINENCE **THRU-MASTER** **MOTOROLA** **Polydax** **PIONEER**

1-800-338-0531

3-WAY 100W CROSSOVER

12 dB/octave rolloff. 800Hz, 5000Hz crossover points. 8 ohm. 100 watts RMS.

#260-210 \$12.50 (1-9) \$9.95 (10-up)

WALNUT SPEAKER CABINET KIT

Super quality, genuine walnut veneer cabinet. Kit includes: routed and mitred top, sides, and bottom in unfinished 3/4" walnut veneer. Cut your own custom holes in the front and rear to match your drivers. 15" x 24" x 11". Volume: 1.9 cubic feet.

#260-350 \$22.50 (1-3) \$19.95 (4-up)

12" SUB WOOFER

Dual voice coil sub woofer. 30 oz. magnet, 2" voice coils. 100 watts RMS, 145 watts max. fs = 25 Hz. 6 ohm (4 and 8 ohm compatible). SPL = 89 dB 1W/1M. Response: 25-700 Hz. QTS = .31, VAS = 10.3 cu. ft. Pioneer # A30GU30-55D. Net weight: 6 lbs.

#290-145 \$39.80 (1-3) \$36.80 (4-up)

18" EMINENCE WOOFER

MADE IN USA
 100 oz. magnet, 3" voice coil. 250 watts RMS, 350 watts max. 8 ohm, 30 Hz resonant frequency. 22-2700 Hz response. Efficiency: 95 dB 1W/1M. Paper cone, treated accordion surround. Net weight: 29 lbs.

#290-200 \$98.90 (1-3) \$89.50 (4-up)

SPEAKER CONTROL PANEL

Panel with 50 watt L-pads for tweeter and midrange and built-in LED power meter. 5" x 2 1/2" 100 watt version available

#260-235 \$14.50 (1-5) \$12.90 (6-up)

12" POLY WOOFER

Super duty, 40 oz. magnet. 100 watts RMS, 145 watts max. 4 and 8 ohm compatible (6 ohm). 2" voice coil. fs = 25 Hz. QTS = .166, VAS = 10.8 cu. ft. Response: 25-1500 Hz. Net weight: 9 lbs. Pioneer # A30GU40-51D

#290-125 \$36.80 (1-3) \$34.50 (4-up)

15" THRUSTER WOOFER

Thruster by Eminence. Made in USA. Poly foam surround, 56 oz. magnet. 2-1/2", 2 layer voice coil. 150 watts RMS, 210 watts max. 4 ohm. fs = 23.5 Hz, QTS = .33, VAS = 17.9 cu. ft. SPL = 94.8 dB 1W/1M. Net weight: 15 lbs.

#290-180 \$43.50 (1-3) \$39.80 (4-up)

TITANIUM COMPOSITE TWEETER

Titanium is deposited on a polymer dome to combine the advantages of both hard and soft dome technologies. 8 ohm Ferro fluid cooled voice coil. fs = 1200 Hz. SPL = 90 dB 1W/1M. 50 watts RMS. 70 watts max. 4" surround. Polydax part #DTW100T125.

#270-047 \$27.50 (1-9) \$24.80 (10-up)

PIONEER HORN TWEETER

Mylar dome. 2.93 oz. barium ferrite magnet. 8 ohm. Response: 1800-20000 Hz. 35W RMS, 50W max. fs = 2000 Hz. SPL = 106 dB. Pioneer # AHE60-51F

#270-050 \$6.50 (1-9) \$5.90 (10-up)

GRILL FRAME KIT

With this kit you can make speaker grill frames up to 30" x 40". Kit includes 4 corner pieces, 2 1/2" brackets, and 7 frame bars. Grill mounting kit included.

#260-333 \$8.50 (1-9) \$7.80 (10-up)

Parts Express International Inc.

1989 CATALOG
 CALL TOLL FREE 1-800-338-0531
FREE CATALOG

Parts Express
 340 E. First St., Dayton, Ohio 45402
 Local: 1-513-222-2173
 FAX: 513-222-4644

* 15 day money back guarantee * \$1500 minimum order * We accept Mastercard, Visa, Discover, and C.O.D. orders * 24 hour shipping * Shipping charge = UPS chart rate * \$1.00 (\$3.00 minimum charge) * Hours: 8:30 am - 6:00 pm EST, Monday - Friday * Mail order customers, please call for shipping estimate on orders exceeding \$5 lbs.

CIRCLE 56 ON FREE INFORMATION CARD

HARDWARE HACKER

continued from page 76

cludes a *Generic Array Logic Demo* through *SGS-Thomson* and a *CUPL* demo disk from *Logical Devices*. Included here is a *My First PAL Design* booklet.

Tektronix has a new and free *Scope Evaluation Kit* available that includes a test circuit board which purposely generates overshoots and hard-to-see glitches. They also have several free oscilloscope videotapes available. Surprisingly cheap (\$3.95) analog hygrometer humidity instruments are available from *Klockit*.

Turning to other mechanical stuff, *Stock Drive Products* has a new data book and master catalog available on such things as gears, belts, couplings, robotics, breadboards, and such.

To improve the appearance of your prototypes, the *Donjer* folks have low-cost "instant suede" applied via liquid glop and a cabbage duster. 28 colors are available, as is a \$52 professional starter kit.

Yet another reminder here that the *Midnight Engineering* is a great new hacker magazine aimed at all of your small-scale hardware and software productions. Free samples are available by special arrangement.

Turning to my own stuff, for the fundamentals of microprocessors and microcomputers, check into my *Micro Cookbooks*, volumes I and II. I also have a new and free mailer for you that includes dozens of insider and top hardware-hacking secret sources. Write or call for a copy. R-E

CABLE TV "BOXES"

Converters — Descramblers
Remote Controls — Accessories

- ★ Guaranteed Best Prices ★
- ★ 1 Year Warranty — C.O.D.'s ★
- ★ Immediate Shipping ★
- ★ FREE CATALOG ★

Call or Write

TRANS-WORLD CABLE CO.

12062 Southwest 117th Court, Suite 126

Miami, Florida 33186

1-800-442-9333



CONSOLIDATED ELECTRONICS

COMPLETE WITH NEW PRICE LIST!

THE ULTIMATE ELECTRONICS CATALOG

Order your 260 page catalog and price list with over 14,000 money saving electronic parts and equipment! Send \$3.00 in a check or money order, or call 1-800-543-3568 today and use your Mastercard or Visa. Consolidated Electronics, Incorporated
705 Watervliet Ave., Dayton, Ohio 45420-2599

Name _____
Address _____
City _____ State _____ Zip _____

CIRCLE 70 ON FREE INFORMATION CARD

MARK V ELECTRONICS, INC.

QUALITY COMPONENTS * COMPETITIVE PRICING

CATALOG & INFORMATION (213) 888-8988

ORDER TOLL FREE 800-423-3483

IN CALIFORNIA 800-521-MARK

FAX (213) 888-6868

▲ indicates the level of difficulty in the assembling of our Products. ▲ Beginner ▲▲ Intermediate ▲▲▲ Advanced ★ Fully Assembled

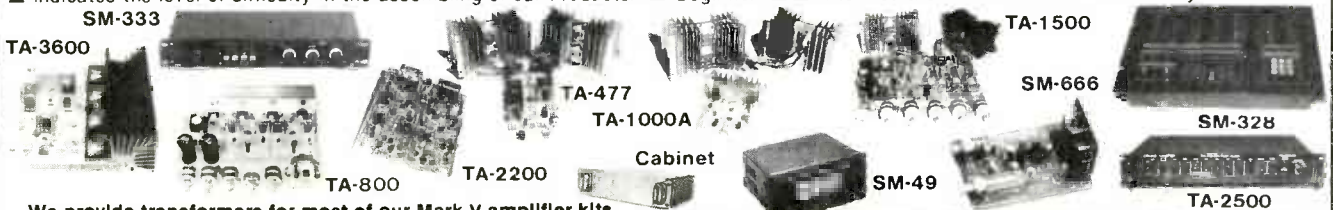

We provide transformers for most of our Mark V amplifier kits.

AMPLIFIERS

MODEL	DESCRIPTION	KIT	ASSEMBLED
TA-28MK2	Digital Voice Recorder ▲▲	30.00	
TA-50A/B	Multi-Purpose Melody Generator ▲	11.84	\$ 16.58
TA-50C	Multi-Purpose Melody Generator ▲	12.63	17.71
TA-120MK2	35W Class "A" Main Power Mono Amp ▲	27.13	38.81
TA-300	30W Multi-Purpose Single Channel Amp ▲	20.00	29.00
TA-302	60W Stereo Power Booster	50.00	70.00
TA-322i	50W+50W IC Stereo Amp. w/led level display ▲	35.50	46.15
TA-323A	30Wx2 Stereo Pre-main Amp. ▲	29.50	38.35
TA-377A	HI-QUALITY FET Stereo Pre-Amp. ▲▲▲	59.95	75.00
TA-400	40W Solid State Mono Amp. ▲	28.00	34.93
TA-477	120W Mosfet Power Mono Amp. ▲▲	68.00	
TA-800	80W+80W DC Pre-Main & Power Amp. ▲▲	68.92	
TA-802	80W+80W DC Stereo Main Power Amp. ▲▲	45.95	
TA-820A	60W+ 60W OCL DC Pre-Main Stereo Amp. ▲▲	40.39	49.37
TA-1000A	100W Dynamic Class "A" Main Power Mono Amp.	59.69	80.58
TA-1500	100W x 2 Class "A" DC Stereo Pre-Main Amp. ▲▲▲	73.70	95.81
TA-2200	FET Super class "A" DC Pre-Amp.	47.70	58.24
TA-2400A	Electronic Echo & Revelation Amp. ▲▲▲★	93.30	116.80
TA-2500	HQ Pre-Amp. w/10 band graphic equalizer★		90.80
TA-2800	BI-FET IC Pre-Amp. w/3 way tone control ▲▲	48.90	
TA-3000	Stereo Simulator (For mono TV or any mono source)	30.20	41.38
TA-3600	300W HQ HI-FI Power Mono Amp. ▲▲	79.00	103.00

POWER SUPPLIES

TR-100A	O-15V 2A Regulated DC Power Supply	59.50	69.50
TR-355A	O-15V 5A Regulated DC Power Supply	14.50	20.76
TR-355B	O-30V 3A Regulated DC Power Supply	14.55	20.76
TR-503	O-50V 3A Regulated DC Power Supply	15.75	22.65

MISCELLANEOUS

MODEL	DESCRIPTION	KIT	ASSEMBLED
TY-23B	3 Channel Color Light Controller ▲▲▲★	\$ 56.04	\$74.50
TY-25	Stereo Loudspeaker Protector ▲	12.85	18.88
TY-35	FM Wireless Microphone ▲	9.22	
TY-36	AC/DC Quartz Digital Clock ▲	18.00	25.20
TY-38	Sound/Touch Control Switch ▲	12.00	
TY-41 MK111	Infrared Remote Control Unit ▲▲	15.00	25.00
TY-41 MKV	Infrared Remote Control Unit ▲▲	20.00	35.00
TY-42	Bar/Dot Level Meter ▲▲	24.15	
TY-43	3 1/2" Digital Panel Meter ▲	29.00	38.00
TY-45	20 Steps Bar/Dot Audio Level Display ▲	38.45	48.14
TY-47	Superior Electronic Roulette ▲	19.48	27.24
SM-328	4 Channel Professional Color Light Controller		150.00
SM-333	Audio/Video Surround Sound Processor ▲▲▲★	62.00	83.00
SM-686	Dynamic Noise Reduction ▲	26.00	34.00

INSTRUMENTS

SM-43	3 1/2" Multi-Functional Led D.P.M.	34.50	43.00
SM-48	4 1/2" Hi-Precision D.P.M.	38.00	48.00
SM-48A	4 1/2" Hi-Precision D.P.M. w/stdndr case	4.20	52.00
SM-49	3 1/2" Multi-Functional LCDD P.M (w/hold function)	34.00	44.50
SM-100	150 MC Digital Frequency Counter	79.00	90.00
FC1000A	1 GHz Frequency Counter		179.00

METAL CABINETS WITH ALUMINUM PANEL:

LG-1273	3" x 12" x 7"	\$20.18
LG-1684	4" x 16" x 8"	24.84
LG-1924	4" x 19" x 1 1/2"	30.00
LG-1925	5" x 19" x 1 1/2"	33.00
LG-1983	2 1/2" x 19" x 8"	29.50

— WE ACCEPT MAJOR CREDIT CARDS, MONEY ORDERS AND CHECKS — BUSINESS & SHOWROOM HOURS: (PACIFIC TIME) MON. - FRI.: 9:30 A.M. - 5:00 P.M. SAT. 10:00 A.M. - 5:00 P.M. TERMS: \$10.00 MIN. ORDER * \$20 MIN. CHARGE CARD ORDER * WE SHIP UPS GROUND * ADD 10% OF TOTAL ORDER (MIN. \$3.00) FOR SHIPPING OUTSIDE USA. ADD 20% (MIN. \$5.00) TRANSIT INSURANCE. ADD 5% OF TOTAL (OUTSIDE USA ONLY). CA RESIDENTS ADD SALES TAX * ALL MERCHANDISE SUBJECT TO PRIOR SALE * PRICES ARE SUBJECT TO CHANGE WITHOUT NOTICE * WE ARE NOT RESPONSIBLE FOR TYPOGRAPHICAL ERRORS.

MARK V ELECTRONICS, INC. — 8019 E. Slauson Ave., Montebello, CA 90640

CIRCLE 93 ON FREE INFORMATION CARD

AMAZING SCIENTIFIC & ELECTRONIC PRODUCTS

PLANS ARE IN STOCK

GRA1 — ANTI GRAVITY GENERATOR	\$10.00
LC7 — 40 WATT BURNING CUTTING LASER	\$20.00
RUB4 — HI POWER PULSED DRILLING LASER	\$20.00
BTC5 — 1 MILLION VOLT TESLA COIL	\$20.00
MCP1 — HI VELOCITY COIL GUN	\$15.00
LLS1 — LASER LIGHT SHOW 3 METHODS	\$20.00
EH1 — ELECTRONIC HYPNOTISM TECHNIQUES	\$8.00
EML1 — LOWER POWERED COIL GUN LAUNCHER	\$8.00
JL3 — JACOB LADDER 3 MODELS	\$10.00
SD5 — SEE IN THE DARK	\$10.00
LEV1 — LEVITATION DEVICE	\$10.00

KITS ASSISTANCE PROGRAM AVAILABLE

FMV1K — 3 MILE FM VOICE TRANSMITTER	\$34.50
PFS1K — HAND CONTROLLED PLASMA FIRE SABER	\$49.50
NIG7K — HI FLUX NEGATIVE ION GENERATOR	\$34.50
PG5K — PLASMA LIGHTNING GLOBE	\$49.50
LHC2K — VISIBLE SIMULATED 3 COLOR LASER	\$44.50
HOD1K — HOMING/TRACKING BEEPER TRANSMITTER	\$44.50
LGU6K — 2.5 MW HAND-HELD VISIBLE LASER GUN	\$249.50
BTC3K — 250,000 VOLT TABLE TOP TESLA COIL	\$249.50
IOG2K — ION RAY GUN, project energy without wires	\$129.95
TKE1K — TELEKINETIC ENHANCER/ELECTRIC MAN	\$79.50
VWPM7K — 3 MILE AUTO TELEPHONE TRANSMITTER	\$49.50

ASSEMBLED IN OUR LABS

LIST10 — INFINITY XMTR Listen in via phone lines	\$199.50
IPG70 — INVISIBLE PAIN FIELD BLAST WAVE GENERATOR	\$74.50
ITM10 — 100,000 VOLT INTIMIDATOR UP TO 20'	\$99.50
TAT30 — AUTOMATIC TELEPHONE RECORDING DEVICE	\$24.50
PSP40 — PHASOR SONIC BLAST WAVE PISTOL	\$89.50
DNE10 — ALL NEW 26" VIVID COLORED NEON STICK	\$74.50
LGU20 — 5 TO 1MW VISIBLE RED HeNe LASER GUN	\$199.50
BLS10 — 100,000 WATT BLASTER DEFENSE WAND	\$89.50

EASY ORDERING PROCEDURE - TOLL FREE 1-800-221-1705 or 24 HRS ON 1-603-673-4730 or FAX IT TO 1-603-672-5406
VISA, MC, CHECK, MO IN US FUNDS. INCLUDE 10% SHIPPING. ORDERS \$100.00 & UP ONLY ADD \$10.00. CATALOG \$1.00 OR FREE WITH ORDER

INFORMATION UNLIMITED
P.O. BOX 716, DEPT. R2, AMHERST, NH 03031

DESCRAMBLERS

"The Empire Strikes Back"



JERROLD™
TB-3

SCIENTIFIC
ATLANTA
SA-3

HAMLIN
MLD 1200

OAK
M35B
W/ VARI-SYNC

INTELESTAR
CONVERTERS

DF-3/2
FILTERS

FULL
WARRANTY

"We Cut Prices To The Bare Essentials"
There Is NO Competition ANYWHERE !

10% UNDER ANYONES

Quoted or Advertised Prices...Even The Whole Sale Kings!
For Ordering & Info. **(402)331-3228**
Please Call.....

SALES REGULATED BY FEDERAL & STATE LAW ANYONE IMPLYING THEFT OF SERVICES WILL BE DENIED PURCHASE.

CIRCLE 203 ON FREE INFORMATION CARD

When You Need Resistors, We Sell You Resistors (And Gravy), But Not Printed Matter!

Resistors are one of the most common of electronic component parts and having a good reliable source for them is a necessity. For years we have been the lowest price leader in this (and many other) areas, and the following price comparison table proves that although we ask for a yearly Membership Fee of \$35.00, you can recover your investment quickly after purchasing just a few thousand resistors, and what you will save on more than 10,000 additional items that we stock, is the so-called 'gravy' part of the whole deal.

Resistor Type	Quantity	Electronic Buyers Club	Digi-Key® (No Discount)	Digi-Key® (Max Discount)	Jameco Electronics®	JDR Microdevices®	Sintec®
1/4 Watt, 5% Carbon- Film (Bulk)	10	--	\$ 0.50	\$ 0.375	\$ 0.50	\$ 0.50	--
	100	\$ 0.77	1.70	1.275	2.50	2.00	\$ 4.00
	1,000	4.76	8.10	8.10	11.95	15.00	12.00
	10,000	43.20	72.00	72.00	99.50	--	--
1/4 Watt, 1%, Metal- Film (Bulk)	10	0.32	1.00	0.75	--	--	--
	100	1.16	3.90	2.925	3.29	--	8.00
	1,000	8.25	20.00	20.00	17.95	--	30.00

12 Months Saving Guarantee

We will refund the first year Membership Fee of any member who has purchased \$300 or more worth of products from Electronic Buyers Club and has not saved an amount greater than the first year Membership Fee, if buying the same items elsewhere.

It is not that these other firms are trying to rip you off, the fact is that advertising in several Trade Magazines each month and printing and mailing hundreds of thousands of virtually the same catalog every few months cost a lot of money and they have to charge more. Call us today and start receiving components for your money instead of printed matter.

30 Days Money Back Guarantee

We will refund the full Membership Fee of any new member of Electronic Buyers Club who within 30 Days after receiving the Membership Binder, returns the Binder to EBC and asks for the cancellation of Membership.

**Electronic
Buyers
Club**

A Division of International Components Corporation

1803 N.W. Lincoln Way • Toledo, OR 97391
PHONE (All 50 States & Canada): 1-800-325-0101
FAX: (503) 336-4400 • Hours: 6:00 AM - 6:00 PM PST



CIRCLE 199 ON FREE INFORMATION CARD

Now Look What Hand Held Frequency Counters Can Do!

New from OPTOELECTRONICS

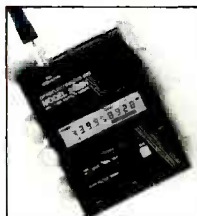

Introducing two advanced hand held frequency counters incorporating many unique features usually found only on laboratory bench counters.

These counters are designed for virtually every measurement application from DC through Microwave including measuring RF transmission frequencies at the maximum possible distance.

The UTC 3000 does all of this and is also the world's first Hand Held universal counter timer with Period, Time Interval, and Ratio measurement capability.

- 10 Digit LCD Display with Gate, Function, and Input Annunciators.
- Direct count (1 Hz resolution in 1 Sec) to over 150 MHz.
- 16 Segment Bargraph displays Input Signal Level. Ensures reliable counting, proven effective in locating concealed transmitters.
- High Accuracy, 1 ppm 10 MHz Crystal Time Base is standard with optional 0.2 ppm TCXO available.
- More usable Sensitivity than in any other counter for efficient on-air pick up measurements.
- Four push button selectable Gate times.
- Ni-Cad battery pack and AC adapter-charger included.

In addition, The Model UTC3000 features:

- In addition to Frequency, additional Functions Include: Period, Ratio, and Time Interval and Average.
- Single Shot Time Interval 100 ns, .1 ns averaged.
- Two input channels with High Impedance and 50 ohm input

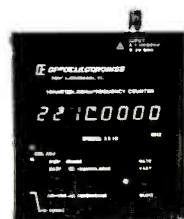

Also Available from Optoelectronics, 8 Digit LED Hand Held Frequency Counters:
 Mode 2200 10 Hz - 2.2 GHz General Purpose Audio to Microwave . . . \$219
 Mode 300H/A 1 MHz - 1.3 GHz RF Counter . . . \$169
 Mode 303 Relative RF Signal Strength Bar Graph Meter With 6 Segment LED Display . . . \$99

Mode 2600H . . . \$325
 Mode UTC 3000 . . . \$375
 Mode TCXO-30 . . . \$80
 Mode TA-005 Telescoping Whip Antenna . . . \$12

OPTOELECTRONICS INC.

5821 N.E. 14th Avenue, Fort Lauderdale, Florida 33304

1-800-327-5912 • FL (305) 771-2050 • FAX (305) 771-2052

CIRCLE 195 ON FREE INFORMATION CARD

SIP & SIMM MODULES

Part No.	Function	Price
512K1T	100ns 256K x 9 SIMM (2 each)	99.95
2MEGKIT	100ns 1MEG x 9 SIMM (2 each)	369.95
41256A9B-80	100ns 256K x 9 SIP (Has Leads)	44.95
421000A8B-10	80ns 1MEG x 8 SIMM	109.95
421000A9B-80	1,048.576x9 80ns 1MEG x 9 SIP (Has Leads)	124.95
421000A9B-80	1,048.576x9 80ns 1MEG x 9 SIMM	119.95

*Upgrade for Models 30, 502 and 60

7400

Part No.	1-9	10+	Part No.	1-9	10+
7400	29	19	7474	39	29
7402	29	19	7475	49	39
7404	29	19	7476	45	35
7405	35	25	7483	59	49
7406	39	29	7485	65	55
7407	39	29	7486	45	35
7408	35	25	7489	2.25	2.15
7410	29	19	7490	49	39
7411	35	25	7493	45	35
7414	49	39	7495	59	49
7416	35	25	74107	39	29
7417	35	25	74121	39	29
7420	29	19	74123	49	39
7427	29	19	74125	49	39
7430	29	19	74147	1.99	1.89
7432	39	29	74150	1.35	1.25
7438	39	29	74151	39	29
7442	49	39	74154	1.35	1.25
7445	75	65	74161	69	59
7446	89	79	74174	59	49
7447	89	79	74175	59	49
7473	39	29	74193	79	69

74LS

Part No.	26	16	74LS139	49	39
74LS00	26	16	74LS151	49	39
74LS03	26	16	74LS153	49	39
74LS04	26	16	74LS154	1.29	1.19
74LS05	26	16	74LS157	45	35
74LS06	59	49	74LS161	49	39
74LS07	59	49	74LS163	49	39
74LS08	26	16	74LS164	59	49
74LS09	26	16	74LS165	75	65
74LS10	26	16	74LS166	89	79
74LS11	29	19	74LS173	45	35
74LS14	49	39	74LS174	39	29
74LS20	26	16	74LS175	39	29
74LS21	29	19	74LS179	59	49
74LS27	35	25	74LS192	69	59
74LS30	26	16	74LS193	69	59
74LS32	26	16	74LS194	69	59
74LS38	35	25	74LS221	69	59
74LS42	49	39	74LS240	59	49
74LS47	65	55	74LS241	59	49
74LS73	39	29	74LS244	79	69
74LS74	35	25	74LS245	79	69
74LS75	39	29	74LS257	49	39
74LS76	39	29	74LS259	49	39
74LS83	55	45	74LS273	89	79
74LS85	55	45	74LS279	49	39
74LS96	29	19	74LS367	49	39
74LS99	49	39	74LS373	79	69
74LS98	49	39	74LS374	79	69
74LS123	49	39	74LS393	89	79
74LS125	49	39	74LS41	1.29	1.19
74LS132	49	39	74LS590	5.95	5.85
74LS138	49	39	74LS660	2.39	2.29

74S/PROMS*

74S00	25	74S188*	1.49
74S04	25	74S189	1.49
74S32	25	74S240	1.39
74S74	25	74S244	99
74S112	25	74S287*	1.49
74S124	1.25	74S288*	1.49
74S138	49	74S370	99
74S153	29	74S374	99
74S163	75	74S387*	1.29
74S174	29	74S472*	2.95
74S175	37	74S571*	2.49

CD-CMOS

CD4001	19	CD4051	59
CD4002	19	CD4052	59
CD4007	19	CD4053	59
CD4011	19	CD4060	65
CD4012	29	CD4066	29
CD4013	29	CD4069	25
CD4015	29	CD4070	29
CD4016	29	CD4071	19
CD4017	49	CD4072	19
CD4018	49	CD4073	19
CD4020	59	CD4081	19
CD4021	49	CD4093	35
CD4024	45	CD4094	89
CD4027	35	CD4284	39
CD4028	49	CD4511	59
CD4029	35	CD4518	75
CD4030	35	CD4520	69
CD4040	65	CD4522	75
CD4042	49	CD4528	69
CD4043	59	CD4538	79
CD4046	65	CD4543	79
CD4049	29	CD4584	69
CD4050	29	CD4585	69

NEC V20 & V30 Chips

Replace the 8086 or 8088 in Your IBM PC and Increase Its Speed by up to 30% Price

UPD70108-5	(5MHz) V20 Chip	5.25
UPD70108-8	(8MHz) V20 Chip	6.95
UPD70108-10	(10MHz) V20 Chip	7.95
UPD70116-8	(8MHz) V30 Chip	7.95
UPD70116-10	(10MHz) V30 Chip	13.49

MICROPROCESSOR COMPONENTS

Z80, Z80A, Z80B, SERIES		8000 SERIES Continued		8000 SERIES Continued	
Part No.	Price	Part No.	Price	Part No.	Price
Z80	1.25	8155 2	3.75	8286	2.29
Z80A	1.29	81C55	4.25	8741	3.49
Z80A-CTC	1.65	8205	9.95	8742	14.95
Z80A-DART	4.95	82C11	6.95	8748 (25V)	7.95
Z80A-PIO	1.89	8212	1.99	8748H (HMOS)(21V)	9.95
Z80A-SIO/IO	3.95	8215	1.39	8749	3.95
Z80B	2.75	8224	1.49	8751H (3.5-12MHz)	34.95
Z80B-CTC	3.95	8228	1.49	8755	13.95
Z80B-PIO	3.95	8237-5	4.25	80286-10 (10MHz)LOC	29.95
Z8400HB1 CPU 8MHz	3.95	8243	1.95	80287-3 (5MHz)	109.95
8000 SERIES					
8031	3.95	8250A	4.95	80287-8 (8MHz)	209.95
80C31	8.95	8250B (For IBM)	1.95	80287-10 (10MHz)	239.95
8035	1.25	8251-A	1.89	80386-16 PGA	259.95
8039	1.59	8253-5	1.95	80387-16 (16MHz)	349.95
8052AHBASIC	24.95	82C53-5	3.95	80387-20 (20MHz)	399.95
8080A	1.95	8254	4.95	80387-25 (25MHz)	499.95
8085A	1.95	8255A-5	2.95	82268 (8MHz)	5.49
8085A-2	1.95	82C55A-5	4.49	82268 (8MHz)	5.95
8086	3.95	8256	1.95	DATA ACQUISITION	
8087 (5MHz)	89.95	8259-5	11.25	ADC0804LNC	3.25
8087-1 (10MHz)	169.95	8272	3.49	ADC0808CCN	5.49
8087-2 (8MHz)	129.95	8274	4.75	ADC0809CCN	3.75
8088 (5MHz)	4.95	8282	2.95	ADC1205CCJ-1	19.95
8088-2 (8MHz)	6.95	8282	2.95	ADC0808LNC	4.49
8155	2.49	8284A	1.95	AY-3-101510	6.95
				AY-5-1013A	2.95

STATIC RAMS

Part No.	Function	Price
2016-12	2048x8 120ns	2.95
2102	1024x1 350ns	89
2112	256x4 450ns MOS	2.49
2114N	1024x4 450ns	1.99
2114N-2L	1024x4 200ns Low Power	4.49
21C14	1024x4 200ns (CMOS)	4.49
5101	256x4 450ns (CMOS)	3.95
6116P-1	2048x8 150ns (16K) CMOS	3.19
6116P-3	2048x8 150ns (16K) CMOS	2.75
6116P-1P	2048x8 150ns (16K) LP CMOS	3.59
6116P-1P-2	2048x8 150ns (16K) LP CMOS	3.09
6254P-10	8192x8 100ns (64K) CMOS	6.75
6254P-15	8192x8 150ns (64K) CMOS	4.95
6264P-10	8192x8 100ns (64K) LP CMOS	6.95
6264P-12	8192x8 120ns (64K) LP CMOS	6.49
6264P-15	8192x8 150ns (64K) LP CMOS	4.95
6514	1024x4 350ns CMOS	3.25
43256-10L	32.768x8 100ns (256K) Low Power	10.95
43256-15L	32.768x8 150ns (256K) Low Power	9.95
62256P-10	32.768x8 100ns (256K) LP CMOS	11.95
62256P-12	32.768x8 120ns (256K) LP CMOS	10.95
62256P-15	32.768x8 150ns (256K) LP CMOS	10.95

DYNAMIC RAMS

TMS4416-12	16.384x4 120ns	5.95
TMS4416-15	16.384x4 150ns	5.49
4116-15	16.384x1 150ns (MM5290N-2)	1.09
4128-15	131.072x1 150ns (Piggyback)	4.49
4164-100	65.536x1 100ns	2.75
4164-120	65.536x1 120ns	2.99
4164-150	65.536x1 150ns	3.15
-1256-60	262.144x1 60ns	2.25
-1256-80	262.144x1 80ns	2.75
-1256-100	262.144x1 100ns	3.15
-1256-120	262.144x1 120ns	2.95
-1256-150	262.144x1 150ns	2.59
41264-12	64Kx4 120ns Video RAM	10.95
41464-60	65.536x4 60ns	3.95
41464-12	65.536x4 120ns	3.95
41464-15	65.536x4 150ns	3.59
51258-10	262.144x1 100ns Static Column	8.95
51100P-80	1,048.576x1 80ns (1 Meg)	12.95
51100P-10	1,048.576x1 100ns (1 Meg)	12.35
514256P-10	262.144x4 100ns (1 Meg)	12.95
514258-10	262.144x4 100ns Static Column	26.95

EPROMS

TMS2516	2048x8 450ns (25V)	4.95
TMS2532	4096x8 450ns (25V)	5.95
TMS2532A	4096x8 450ns (12.5V)	5.25
TMS2564	8192x8 450ns (25V)	6.95
TMS2716	2048x8 450ns (+5V, +5V, +12V)	6.49
1702A	256x8 2K (1µs)	4.25
2708	1024x8 450ns	6.95
2716	2048x8 450ns (25V)	5.95
2716-1P	2048x8 350ns (25V)	3.95
2732	2048x8 450ns (25V) CMOS	4.25
2732-20	4096x8 450ns (25V)	4.95
2732A-20	4096x8 200ns (21V)	3.95
27032	4096x8 450ns (25V) CMOS	4.95
2764-25	8192x8 250ns (21V)	3.25
2764A-20	8192x8 200ns (12.5V)	4.19
2764A-25	8192x8 250ns (12.5V)	3.49
27C64-15	8192x8 150ns (12.5V) CMOS	4.95
27128-20	16.384x8 200ns (21V)	5.95
27128-25	16.384x8 250ns (12.5V)	5.25
27128A-15	16.384x8 150ns (12.5V)	3.9
27128A-20	16.384x8 200ns (12.5V)	4.75
27C128-25	16.384x8 250ns (21V) CMOS	5.95
27256-15	32.768x8 150ns (12.5V)	8.49
27256-20	32.768x8 200ns (12.5V)	8.49
27256-25	32.768x8 250ns (12.5V)	4.95
27C256-15	32.768x8 150ns (12.5V) CMOS	7.25
27C256-20	32.768x8 200ns (12.5V) CMOS	5.99
27512-25	65.536x8 250ns (12.5V)	7.25
27C512-15	65.536x8 150ns (12.5V) CMOS	7.49
27C512-25	65.536x8 250ns (12.5V) CMOS	7.49
27C010-15	131.072x8 150ns (12.5V) CMOS (1 Meg)	19.95
6876A	8192x8 64K 450ns 25V (Chp Enable)	14.95
6876B-35	8192x8 64K 350ns (25V) (Output Enable)	15.95

EEPROMS

2816A-25	2048x8 250ns (9V-15V) 5V Read/Write	5.49
2817A	2048x8 350ns 5V Read/Write	6.99
2864A	8192x8 250ns 5V Read/Write (Pin 1, No RB)	10.95
2865A	8192x8 250ns 5V Read/Write	10.95

MISC. COMPONENTS

TANTALUM CAPACITORS					
TM 1	1µf @ 35V	19	TM 4	7.4µf @ 35V	45
TM 1	1µf @ 35V	19	TM 6	6.7µf @ 35V	59
TM 2	2.2µf @ 35V	25	TM 10	10µf @ 35V	69

Values available (insert ohms into space marked "X")
500k, 1K, 2K, 5K, 10K, 20K, 50K, 100K, 200K, 1MEG

43PXX

Now Available...Jameco's NEW Flyer 142 with 48 pages of Computer Peripherals & More!

Oscilloscope Probes

- Attenuation: x1 / x10
- Capacitance (LF180): 180pF / 22pF; (LF210): 40pF / 17pF



LF180 40MHz Oscilloscope Probe \$19.95
LF210 100MHz Oscilloscope Probe \$29.95

TEST EQUIPMENT

GoldStar 20MHz Oscilloscope and 1GHz Frequency Counter



GS7020 Oscilloscope \$399.95

- Large 6" rectangular display • High sensitivity: 1 mV/div
- Wide measuring range • Measured value hold function

FC7101 Frequency Counter \$299.95

Prometheus 9600 Baud Modem



9600E External 9600 Baud \$699.95
1200B Internal 1200 Baud \$49.95
2400B Internal 2400 Baud \$99.95

Metex Digital Multimeters

Metex General Specs:

- Handheld, high accuracy
- AC/DC Voltage, AC/DC Current, Resistance, Diodes, Continuity, Transistor hFE
- Manual ranging w/overload protection

M4650: Vertical Case w/300W Pwr. Supply \$249.95
M3650, 3650B & M4650 only: Also measure frequency and capacitance
M4650 only: • Data Hold Switch • 4.5 Digit

M3610 3.5 Digit Multimeter \$49.95
M3650 3.5 Digit Multimeter w/Frequency & Capacitance \$69.95
M3650B Same as M3650 w/Bargraph \$74.95
M4650 4.5 Digit w/Frequency, Capacitance and Data Hold Switch \$99.95

PROTOTYPING PRODUCTS

Jameco Solderless Breadboards



Part No.	Dim. L" x W"	Contact Points	Binding Posts	Price
JE21	3.25 x 2.125	400	0	\$4.95
JE23	6.5 x 2.125	830	0	\$6.95
JE24	6.5 x 3.125	1,360	2	\$12.95
JE25	6.5 x 4.25	1,660	3	\$17.95
JE26	6.875 x 5.75	2,390	4	\$22.95
JE27	7.25 x 7.5	3,220	4	\$32.95

Prototype Design Stations

WM2

WM1 & WM2 Features: • Removable solderless breadboard • Variable and fixed DC power supply • Multi-frequency signal generator • Analog multimeter • 8 bicolor LEDs (red & green) • 8 logic switches • Logic probe • Lighted power switch • Fuse overload protected • Sturdy ruggedized case

WM1 Special Features: • 4 potentiometers • Built-in speaker

WM2 Special Features: • Pulse Generator • Binary coded decimal (BCD) to 7-segment decoder/driver • DB25 connector • Frequency counter (1Hz to 1MHz)

WM1 Analog Prototype Station \$199.95
WM2 Digital Prototype Station \$249.95

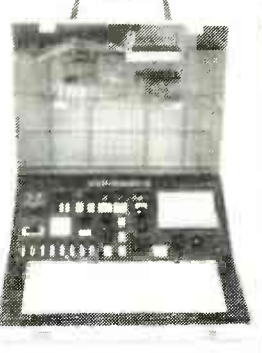

IBM Compatible Cases and Power Supplies

JE2012

JE1030 Flip Top Standard PC/XT Case \$36.95
JE1010 Side Standard PC/XT Case \$39.95
JE1011 150 watt PC/XT Power Supply \$59.95
JE1032 200 watt Baby AT Power Supply \$89.95
JE1035 300 watt AT Power Supply \$139.95
JE2011 Vertical Case w/300W Pwr. Supply \$249.95
JE2012 Min-Vertical Case w/200W Pwr. Supply \$149.95
JE2014 Flip Top Baby XT Turbo Case \$69.95
JE2019 Flip Top Baby AT Case \$69.95



IBM PC/XT/AT Compatible Keyboards



JE2015 84-Key Standard AT Style Layout \$59.95
FKB4700 101-Key Enhanced Layout with 12 Function Keys \$69.95
JE2016 111-Key Enhanced with Solar Powered Calculator \$79.95
JE2017 104-Key Enhanced with Trackball (Microsoft Compatible) \$99.95

3.5" and 5.25" Floppy Disk Drives

MPF11 Pictured

Sony

MPF11 3.5" 720Kb Internal Drive \$49.95
SMK 5.25" Installation Kit w/Faceplate \$14.95

TEAC

FD55B 5.25" 360Kb Half Ht. \$89.95
FD55G 5.25" 1.2Mb Half Ht. \$99.95

Mitsubishi

MF353B 3.5" 720Kb Half Height ... \$99.95
MF355B 3.5" 1.44Mb Half Height \$119.95

MOTHERBOARDS

20MHz 386 Only \$629.95!

• All w/ OK RAM

JE3520 Pictured

JE1001 Jameco 4.77 8MHz 8088 (PC XT) \$89.95
JE3005 Jameco Baby 8 12MHz 80286 (AT) \$199.95
JE3010 Jameco Baby 8 16MHz 80286 (AT) \$299.95
JE3011 Jameco Baby 8 20MHz 80286 (AT) \$389.95
JE3025 AMI Baby 20MHz 80386 \$1199.95
JE3026 AMI Full-Size 25MHz 80386 \$1899.95
JE3028 AMI Full-Size 33MHz 80386 \$2299.95
JE3520 Jameco Baby 20MHz 80386 \$629.95
JE3525 Jameco Baby 25MHz 80386 \$1199.95
JE3533 Jameco Baby 33MHz 80386 \$1699.95



EGA & Multiscan Monitor Packages

Casper 14" EGA monitor and EGA card package (720 x 350 max. resolution)

JE1059 EGA Monitor & EGA Card \$459.95

Relisys 14" Multiscan monitor and EGA card package (800 x 600 max. resolution)

JE2057 Multiscan Monitor & EGA Card \$559.95



A.R.T. EPROM Programmer



• Programs all current EPROMs in the 2716 to 27512 range plus the X2864 EPROM • RS232 port • Software incl.

EPP \$179.95

UVP EPROM Eraser



• Erases all EPROM's • Erases 1 chip in 15 Min. and 8 chips in 21 min. • UV intensity: 6800 UW/CM²

DE4 \$69.95

Soldering and Desoldering Stations

60 Watt Analog Display Soldering Station • Electronic temperature control from 200° to 878°F • Cartridge heating element for a longer life of the soldering tip

XY1683 \$59.95

60 Watt Analog Display Soldering Station • Electronic temperature control from 200° to 878°F • Ceramic heating element for a steady temperature and long life

XY2660 \$89.95

60 Watt Digital Display Soldering Station • Electronic temperature control from 200° to 878°F • Temperature displayed on easy to read .560"H 3-digit LED readout • Nichrome heating element

XY960 \$99.95

30 Watt Electronic Temperature Controlled Desoldering Station • Electronic temperature control from 212° to 842°F • Self-contained high rotary vacuum pump

XY999 \$279.95

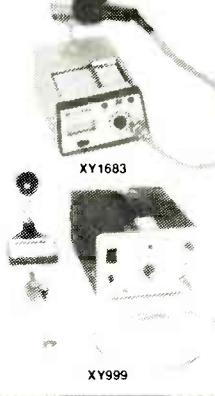

Hard & Hard/Floppy Disk Controller Cards

Computer Type	MFM Hard		RLI Hard		MFM Hard/Floppy		RLI Hard/Floppy	
	Part No. / Price	Part No. / Price	Part No. / Price	Part No. / Price	Part No. / Price	Part No. / Price	Part No. / Price	
8088 (PC/XT) @ 3:1 Interleave	XTGEN \$79.95	1004A27X \$89.95	JE1044 \$109.95					
80286 (AT) @ 2:1 Interleave	1003VMM1 \$129.95	1003VSR1 \$149.95	1003VMM2 \$149.95	1003VSR2 \$169.95				
80286 (AT) @ 1:1 Interleave	1006VMM1 \$149.95	1006VSR1 \$169.95	1006VMM2 \$169.95	1006VSR2 \$189.95				

1355 Shoreway Road
 Belmont, CA 94002
24 Hour Order Hotline (415) 592-8097
 FAX's (415) 592-2503 or (415) 595-2664
 Telex 176043 - Ans. Back: Jameco Bmt
 Data Sheets - 50¢ each
 Send \$2.00 Postage for a FREE 80-Page Catalog
 © 1990 Jameco Electronics 490
 IBM is a registered trademark of International Business Machines



\$50.00 Minimum Order - U.S. Funds Only
 CA Residents Add 6%, 6.5% or 7% Sales Tax
 Shipping - Add 5% plus \$1.50 Insurance
 (May vary according to weight and shipping method)
 Terms: Prices subject to change without notice
 We are not responsible for typographical errors.
 We reserve the right to substitute manufacturers.
 Items subject to availability and prior sale.
 Products pictured may only be representative.
 Complete list of terms/warranties is available upon request.

24-Hour Order Hotline (415) 592-8097 • The Following Services Are Also Available Through (415) 592-8097 From 7AM - 5PM P.S.T.:
 • Customer Service • Technical Assistance • Credit Department • All Other Inquiries

CIRCLE 114 ON FREE INFORMATION CARD

INTEGRATED CIRCUITS

7400 TTL	Part	Price	7400 CMOS	Part	Price
7400	74LS289	80	74HC00	74VHC00	55
7401	74LS289	77	74HC01	74VHC01	55
7402	74LS289	80	74HC02	74VHC02	55
7403	74LS289	80	74HC03	74VHC03	55
7404	74LS289	80	74HC04	74VHC04	55
7405	74LS289	80	74HC05	74VHC05	55
7406	74LS289	80	74HC06	74VHC06	55
7407	74LS289	80	74HC07	74VHC07	55
7408	74LS289	80	74HC08	74VHC08	55
7409	74LS289	80	74HC09	74VHC09	55
7410	74LS289	80	74HC10	74VHC10	55
7411	74LS289	80	74HC11	74VHC11	55
7412	74LS289	80	74HC12	74VHC12	55
7413	74LS289	80	74HC13	74VHC13	55
7414	74LS289	80	74HC14	74VHC14	55
7415	74LS289	80	74HC15	74VHC15	55
7416	74LS289	80	74HC16	74VHC16	55
7417	74LS289	80	74HC17	74VHC17	55
7418	74LS289	80	74HC18	74VHC18	55
7419	74LS289	80	74HC19	74VHC19	55
7420	74LS289	80	74HC20	74VHC20	55
7421	74LS289	80	74HC21	74VHC21	55
7422	74LS289	80	74HC22	74VHC22	55
7423	74LS289	80	74HC23	74VHC23	55
7424	74LS289	80	74HC24	74VHC24	55
7425	74LS289	80	74HC25	74VHC25	55
7426	74LS289	80	74HC26	74VHC26	55
7427	74LS289	80	74HC27	74VHC27	55
7428	74LS289	80	74HC28	74VHC28	55
7429	74LS289	80	74HC29	74VHC29	55
7430	74LS289	80	74HC30	74VHC30	55
7431	74LS289	80	74HC31	74VHC31	55
7432	74LS289	80	74HC32	74VHC32	55
7433	74LS289	80	74HC33	74VHC33	55
7434	74LS289	80	74HC34	74VHC34	55
7435	74LS289	80	74HC35	74VHC35	55
7436	74LS289	80	74HC36	74VHC36	55
7437	74LS289	80	74HC37	74VHC37	55
7438	74LS289	80	74HC38	74VHC38	55
7439	74LS289	80	74HC39	74VHC39	55
7440	74LS289	80	74HC40	74VHC40	55
7441	74LS289	80	74HC41	74VHC41	55
7442	74LS289	80	74HC42	74VHC42	55
7443	74LS289	80	74HC43	74VHC43	55
7444	74LS289	80	74HC44	74VHC44	55
7445	74LS289	80	74HC45	74VHC45	55
7446	74LS289	80	74HC46	74VHC46	55
7447	74LS289	80	74HC47	74VHC47	55
7448	74LS289	80	74HC48	74VHC48	55
7449	74LS289	80	74HC49	74VHC49	55
7450	74LS289	80	74HC50	74VHC50	55
7451	74LS289	80	74HC51	74VHC51	55
7452	74LS289	80	74HC52	74VHC52	55
7453	74LS289	80	74HC53	74VHC53	55
7454	74LS289	80	74HC54	74VHC54	55
7455	74LS289	80	74HC55	74VHC55	55
7456	74LS289	80	74HC56	74VHC56	55
7457	74LS289	80	74HC57	74VHC57	55
7458	74LS289	80	74HC58	74VHC58	55
7459	74LS289	80	74HC59	74VHC59	55
7460	74LS289	80	74HC60	74VHC60	55
7461	74LS289	80	74HC61	74VHC61	55
7462	74LS289	80	74HC62	74VHC62	55
7463	74LS289	80	74HC63	74VHC63	55
7464	74LS289	80	74HC64	74VHC64	55
7465	74LS289	80	74HC65	74VHC65	55
7466	74LS289	80	74HC66	74VHC66	55
7467	74LS289	80	74HC67	74VHC67	55
7468	74LS289	80	74HC68	74VHC68	55
7469	74LS289	80	74HC69	74VHC69	55
7470	74LS289	80	74HC70	74VHC70	55
7471	74LS289	80	74HC71	74VHC71	55
7472	74LS289	80	74HC72	74VHC72	55
7473	74LS289	80	74HC73	74VHC73	55
7474	74LS289	80	74HC74	74VHC74	55
7475	74LS289	80	74HC75	74VHC75	55
7476	74LS289	80	74HC76	74VHC76	55
7477	74LS289	80	74HC77	74VHC77	55
7478	74LS289	80	74HC78	74VHC78	55
7479	74LS289	80	74HC79	74VHC79	55
7480	74LS289	80	74HC80	74VHC80	55
7481	74LS289	80	74HC81	74VHC81	55
7482	74LS289	80	74HC82	74VHC82	55
7483	74LS289	80	74HC83	74VHC83	55
7484	74LS289	80	74HC84	74VHC84	55
7485	74LS289	80	74HC85	74VHC85	55
7486	74LS289	80	74HC86	74VHC86	55
7487	74LS289	80	74HC87	74VHC87	55
7488	74LS289	80	74HC88	74VHC88	55
7489	74LS289	80	74HC89	74VHC89	55
7490	74LS289	80	74HC90	74VHC90	55
7491	74LS289	80	74HC91	74VHC91	55
7492	74LS289	80	74HC92	74VHC92	55
7493	74LS289	80	74HC93	74VHC93	55
7494	74LS289	80	74HC94	74VHC94	55
7495	74LS289	80	74HC95	74VHC95	55
7496	74LS289	80	74HC96	74VHC96	55
7497	74LS289	80	74HC97	74VHC97	55
7498	74LS289	80	74HC98	74VHC98	55
7499	74LS289	80	74HC99	74VHC99	55
7500	74LS289	80	74HC100	74VHC100	55

INTEGRATED CIRCUITS

4000 CMOS	Part	Price	4000 CMOS	Part	Price
4000	4001	55	4000	4001	55
4001	4002	55	4000	4002	55
4002	4003	55	4000	4003	55
4003	4004	55	4000	4004	55
4004	4005	55	4000	4005	55
4005	4006	55	4000	4006	55
4006	4007	55	4000	4007	55
4007	4008	55	4000	4008	55
4008	4009	55	4000	4009	55
4009	4010	55	4000	4010	55
4010	4011	55	4000	4011	55
4011	4012	55	4000	4012	55
4012	4013	55	4000	4013	55
4013	4014	55	4000	4014	55
4014	4015	55	4000	4015	55
4015	4016	55	4000	4016	55
4016	4017	55	4000	4017	55
4017	4018	55	4000	4018	55
4018	4019	55	4000	4019	55
4019	4020	55	4000	4020	55
4020	4021	55	4000	4021	55
4021	4022	55	4000	4022	55
4022	4023	55	4000	4023	55
4023	4024	55	4000	4024	55
4024	4025	55	4000	4025	55
4025	4026	55	4000	4026	55
4026	4027	55	4000	4027	55
4027	4028	55	4000	4028	55
4028	4029	55	4000	4029	55
4029	4030	55	4000	4030	55
4030	4031	55	4000	4031	55
4031	4032	55	4000	4032	55
4032	4033	55	4000	4033	55
4033	4034	55	4000	4034	55
4034	4035	55	4000	4035	55
4035	4036	55	4000	4036	55
4036	4037	55	4000	4037	55
4037	4038	55	4000	4038	55
4038	4039	55	4000	4039	55
4039	4040	55	4000	4040	55
4040	4041	55	4000	4041	55
4041	4042	55	4000	4042	55
4042	4043	55	4000	4043	55
4043	4044	55	4000	4044	55
4044	4045	55	4000	4045	55
4045	4046	55	4000	4046	55
4046	4047	55	4000	4047	55
4047	4048	55	4000	4048	55
4048	4049	55	4000	4049	55
4049	4050	55	4000	4050	55
4050	4051	55	4000	4051	55
4051	4052	55	4000	4052	55
4052	4053	55	4000	4053	55
4053	4054	55	4000	4054	55
4054	4055	55	4000	4055	55
4055	4056	55	4000	4056	55
4056	4057	55	4000	4057	55
4057	4058	55	4000	4058	55
4058	4059	55	4000	4059	55
4059	4060	55	4000	4060	55
4060	4061	55	4000	4061	55
4061	4062	55	4000	4062	55
4062	4063	55	4000	4063	55
4063	4064	55	4000	4064	55
4064	4065	55	4000	4065	55
4065	4066	55	4000	4066	55
4066	4067	55	4000	4067	55
4067	4068	55	4000	4068	55
4068	4069	55	4000	4069	55
4069	4070	55	4000	4070	55
4070	4071	55	4000	4071	55
4071	4072	55	4000	4072	55
4072	4073	55	4000	4073	55
4073	4074	55	4000	4074	55
4074	4075	55	4000	4075	55
4075	4076	55	4000	4076	55
4076	4077	55	4000	4077	55
4077	4078	55	4000	4078	55
4078	4079	55	4000	4079	55
4079	4080	55	4000	4080	55
4080	4081	55	4000	4081</	

★ QUALITY PARTS ★ DISCOUNT PRICES ★ FAST SHIPPING

ALL ELECTRONICS CORP.

12 VOLT DC MINI FAN
Howard Industries# 3-15-810. Operates on 12 Vdc, 0.10 amp, 1.0 watt. Compact plastic housing, 2.35" square X 1.275" thick. 9 blade fan. Two 9" pigtail leads.
CAT# CF-121 \$9.00 each

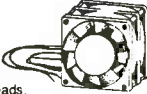

115 VAC COOLING FAN
STANDARD SIZE COOLING FAN.
Features die cast metal housing for strength and durability. IMPEDANCE PROTECTED 4 1/16" square X 1 1/2" deep. Factory new 120 Vac fans. **CF-1N \$9.50 each**



LED CHASER KIT

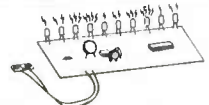

Build this variable speed led chaser. 10 leds flash sequentially at whatever speed you set them for. Easy to build kit includes pc board, parts and instructions. Ideal for special lighting effects, costumes, etc. Operates on 3 to 9 volts. PC board is 5" X 2.25". A great one hour project.
CAT# AEC \$6.50 each

STEPPER MOTOR

Airpax# A82743-M4
Brand new 12 volt dc stepper motor. 35 ohm coil. 7.5 degrees per step. 2.25" diameter, 0.93" long excluding shaft. 0.22" dia. shaft is 0.75" long. 2 hole mounting flange, 2.675" mounting centers. 6 wire leads.
CAT# SMT-5 \$10.00 each



RECHARGEABLE BATTERY PACK (USED)

Four AA nickel cadmium batteries connected in series to make a 4.8 volt pack. Batteries are in a 2 X 2 configuration with a 2 pin connector attached. The four batteries can be separated into single AA size solder tab nickel cadmium batteries or resoldered into other configurations.
SPECIAL SALE PRICE NOW \$3.00 per pack • 10 packs for \$25.00
CAT# NCB-41AAU



TIL-99 PHOTO TRANSISTOR
TO-18 case with window. For wide-angle viewing applications. Spectrally and mechanically compatible with TIL-31B.
CAT# TIL-99 \$1.00 each • 10 for \$9.00

TIL-31B PHOTO DIODE
TO-18 case with window. Infrared emitting photo diode.
CAT# TIL-31B \$1.00 ea. • 10 for \$9.50

NICKEL-CAD BATTERIES (RECHARGEABLE)

AAA SIZE \$1.50 each
1.2 volts 180 mAh
CAT# NCB-AAA
AA SIZE \$2.00 each
1.25 volts 500 mAh
CAT# NCB-AA
AA SIZE \$2.20 each
WITH SOLDER TABS
CAT# NCB-SAA
C SIZE \$4.25 each
1.2 volts 1200 mAh
CAT# NCB-C
D SIZE \$4.50 each
1.2 volts 1200 mAh
CAT# NCB-D



0-30 MINUTE AUTO-SHUTOFF TIMER
Santyo Seiko Mfg.# TMCF35MYB9
120 Vac 60 hz. 10 amp contacts. UL rated. Turn shaft to turn on lights or other electrical devices. Bell rings and circuit breaks after specified amount of time. Ideal for any device that needs to shut off automatically. 2.92" X 1.9" X 2.54" behind face plate. 1/4" half-round shaft.
CAT# TMC-30 \$3.00 each



LED'S

STANDARD JUMBO DIFFUSED T 1-3/4 size
RED CAT# LED-1 10 for \$1.50 • 100 for \$13.00
GREEN CAT# LED-2 10 for \$2.00 • 100 for \$17.00
YELLOW CAT# LED-3 10 for \$2.00 • 100 for \$17.00

FLASHING LED
with built in flashing circuit operates on 5 volts...
RED \$1.00 each
CAT# LED-4 10 for \$9.50
GREEN \$1.00 each
CAT# LED-4G 10 for \$9.50

BI-POLAR LED
Lights RED one direction. GREEN the other. Two leads.
CAT# LED-6 2 for \$1.70

LED HOLDER
Two piece holder.
CAT# HLED 10 for 85¢



L.E.D. FLASHER KIT

Two L.E.D.'s flash in unison when a 9 volt battery is attached. This kit includes a p.c. board, all the parts and instructions to make a simple flasher circuit. A quick and easy project for anyone with basic soldering skills.
CAT# LEDKIT \$1.75 per kit



SWITCHES

ITT PUSH BUTTON
ITT MDPL series. 3/4" X 1/2" grey rectangular key cap. S.P.S.T. N.O. Push to close. RATED: 0.1 amp switching, 0.25 amp carry current. P.C. mount.
CAT# PB-8 65¢ each • 10 for \$6.00
100 for \$50.00



XENON TUBE

1" long flashtube with 3 1/2" red and black leads. Ideal for electronic flash or strobe projects.
CAT# FLT-2 2 for \$1.00



PHOTO FLASH CAPACITOR

Rubycon# FXK
200 mfd. 330 volts.
0.79" diameter X 1.11" high
Solder loop terminals.
CAT# PPC-200 \$3.25 each
10 for \$30.00 • 100 for \$275.00



10 AMP SOLID STATE RELAY

ELECTROL# S2178
CONTROL:
Rated 5.5 to 10 Vdc (will operate on 3-32 Vdc).
LOAD: 10 amp @ 240 Vac
2 1/4" X 1 3/4" X 7/8"
CAT# SSR1Y-10B \$9.50 ea.
QUANTITY DISCOUNT
10 for \$85.00 • 25 for \$175.00
50 for \$300.00 • 100 for \$500.00



LOOK WHAT \$1.00 WILL BUY

200 ASSORTED 1/4 WATT RESISTORS
Bent leads, carbon comp. and carbon film.
CAT# GRES \$1.00 per assortment

200 ASSORTED 1/2 WATT RESISTORS
Bent leads, carbon comp. and film.
CAT# GRABRE \$1.00 per assortment

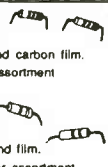

SPDT PUSHBUTTON
Marquardt# 1843
Rated 6 amps @ 125/250 Vac.
Black plastic pushbutton.
Switch body: .92" X .94" X .65".
CAT# PB-18 \$1.65 ea. • 10 for \$15.00 ea.



RELAYS

5-6 VDC SIP REED RELAY
Electrol
"Blue Boy"
BBS1A05A10
5-6 Vdc, 500 ohm coil. S.P.S.T. normally open reed relay.
0.5 amp contacts. SIP configuration.
1" X .375" X .3".
CAT# RRLY-SIPS \$1.10 each • 10 for \$10.00



22/44 PIN CONNECTOR

.156" pin spacing, 0.200" between double rows, gold contacts, P.C. mounting.
SPECIAL. Same as AMP# 2-530655-6.
CAT# EBC-1G \$1.00 each • 10 for \$8.00



OPTO SENSOR

U shaped package with mounting ears.
1/8" opening.
3/4" mounting ears.
CAT# OSU-8 50¢ each
10 for \$4.50 • 100 for \$40.00



LOOK WHAT \$2.00 WILL BUY

15 AMP SNAP-ACTION SWITCH
5 pieces of a 15 amp 125.250 Vac normally open switch. Body is 1 3/4" X 5/8" X 5/8".
Button extends 3/16" above switch body.
CAT# GRABMS \$2.00 per package



PUSHBUTTON SWITCH
GC/Thomsen# 35-420
S.P.S.T. normally open momentary pushbutton switch. Red plastic actuator 0.57" diameter. Chrome bezel 0.68" diameter. Threaded bushing mounts in .50" diameter hole. Rated 3 amp @ 250Vac. Solder loop terminals.
CAT# PB-20 \$1.00 each



5 VDC LATCHING RELAY
Aromat# RSL2D-5V
Miniature SPDT, dual coil latching relay. 5 Vdc, 170 ohm coil. 1 amp. TTL compatible. UL and CSA recognized. 0.787" X 0.394" X 0.394"
CAT# LRLY-5DC \$2.50 each



ELECTRONIC GAME BOARD

The inner workings of an electronic Scrabble game. Operates on 6 Vdc. 8 digit alpha-numeric readout, 45 button keypad, 14 transistors, 2 I.C.'s, 1 piezo element and other goodies. Top and bottom row of keypad buttons are function keys, middle 3 rows are alphabetic. No instructions available. 6" X 4.45".
CAT# ST-4 \$1.75 each • 10 for \$15.00



A.C. LINE CORDS

Black 6ft., 18/2, SPT-2

NON POLARIZED PLUG
CAT# LCAC 2 for \$1.00
100 for \$45.00

POLARIZED PLUG
CAT# LCP-1 60¢ each
100 for \$50.00



TO-92 TRANSISTORS
20 assorted TO-92 plastic case transistors. Various styles of NPN and PNP. Some house marked, some standard marking.
CAT# GRTRN \$2.00 per assortment



WALL TRANSFORMERS

ALL PLUG DIRECTLY INTO 120 VAC OUTLET

12 Vdc @ 500 ma. **CAT# DCTX-125 \$4.50**
6 Vdc @ 200 ma. **CAT# DCTX-620 \$2.25**
9 Vdc @ 1 amp **CAT# DCTX-951 \$5.00**
24 Vac @ 625 ma. **CAT# ACTX-2482 \$3.25**



12 VOLT D.C. COIL S.P.D.T.
Omron# G2E-184P
4 amp contacts.
335 ohm coil.
Sugar cube size.
.81" X .42" X .44" high. P.C. mount with pins on DIP spacing.
CAT# RLY-787 \$1.50 each



TELEPHONE COUPLING TRANSFORMER

Multi Products International# A19N-HO-1D1
Primary: 600 ohm
Secondary: 600/600 ohm
0.77" X 0.61" X 0.63" high.
6 p.c. pins on 0.187" centers.
Primary inductance: 300 mH min., at 1kHz, 1 volt.
CAT# TCTX-1 \$1.25 each • 10 for \$11.00



SERVO MOTOR

3 Vdc servo with potentiometer. Ideal for robotics or remote control model experimentation. Rotates approx. 140 degrees. Pot connected to motor varies from either 500 to 3000 ohms. 1.53" X 0.95" X 1.65". 0.87" diameter rubber wheel attached to motor shaft. Can be used as a capacitor or can be easily removed. Prepped with capacitors, chokes and wire leads.
CAT# SVO-2 2 for \$1.00



5 VDC SERVO MOTOR

3 Vdc servo with potentiometer. Ideal for robotics or remote control model experimentation. Rotates approx. 140 degrees. Pot connected to motor varies from either 500 to 3000 ohms. 1.53" X 0.95" X 1.65". 0.87" diameter rubber wheel attached to motor shaft. Can be used as a capacitor or can be easily removed. Prepped with capacitors, chokes and wire leads.
CAT# SVO-2 2 for \$1.00



CALL OR WRITE FOR OUR FREE 60 PAGE CATALOG OVER 4000 PARTS!

OUTSIDE THE U.S.A. SEND \$2.00 POSTAGE FOR A CATALOG!



ORDER TOLL FREE 1-800-826-5432

**MAIL ORDERS TO:
ALL ELECTRONICS
P.O. BOX 567
VAN NUYS, CA 91408**

**INFO: (818)904-0524
FAX: (818)781-2653**

**MINIMUM ORDER \$10.00
QUANTITIES LIMITED
CALIF. ADD SALES TAX
USA: \$3.50 SHIPPING
FOREIGN ORDERS
INCLUDE SUFFICIENT SHIPPING. NO C.O.D.**



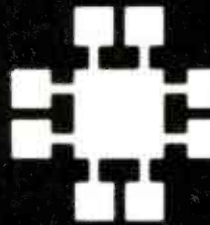

JDR Microdevices

MMC
MICROCOMPUTER
MARKETING COUNCIL
of the Direct Marketing Association, Inc.

30 DAY MONEY BACK GUARANTEE • 1 YEAR WARRANTY ON ALL PRODUCTS • TOLL-FREE TECHNICAL SUPPORT

DYNAMIC RAMS

NEW LOW PRICES!

PART#	SIZE	SPEED	PINS	PRICE
4164-150	65536x1	150ns	16	2.49
4164-120	65536x1	120ns	16	2.89
4164-100	65536x1	100ns	16	3.39
TMS4464-15	65536x4	150ns	16	3.59
TMS4464-12	65536x4	120ns	16	3.95
TMS4464-10	65536x4	100ns	16	4.95
41256-150	262144x1	150ns	16	2.59
41256-120	262144x1	120ns	16	2.95
41256-100	262144x1	100ns	16	3.15
41256-80	262144x1	80ns	16	3.75
41256-60	262144x1	60ns	16	5.25
414256-100	262144x4	100ns	20	12.95
414256-80	262144x4	80ns	20	13.45
1 MB-120	1048576x1	120ns	18	11.95
1 MB-100	1048576x1	100ns	18	12.35
1 MB-80	1048576x1	80ns	18	12.95

SIMM/SIP MODULES

NEW LOW PRICES!

PART#	SIZE	SPEED	TYPE	PRICE
41256A9B-12	256K x 9	120ns	SIMM/PC	36.95
41256A9B-80	256K x 9	80ns	SIMM/PC	49.95
421000A9B-10	1MB x 8	100ns	SIMM MAC	109.95
421000A9B-10	1MB x 9	100ns	SIMM/PC	113.95
421000A9B-80	1MB x 9	80ns	SIMM/PC	119.95
256KX9SIP-80	256K x 9	80ns	SIP/PC	54.95
256KX9SIP-60	256K x 9	60ns	SIP/PC	64.95
1MBX9SIP-80	1MB x 9	80ns	SIP/PC	124.95

STATIC RAMS

NEW LOW PRICES!

PART#	SIZE	SPEED	PINS	PRICE
HM6116L-P-2	2048x8	120ns	24	5.49
HM6264LP-15	8192x8	150ns	28	4.95
HM6264LP-12	8192x8	120ns	28	6.49
HM43256LP-12	32768x8	120ns	28	14.95
HM43256LP-10	32768x8	100ns	28	15.95

MATH COPROCESSORS

8-BIT COPROCESSORS

8087	5 MHz	89.95
8087-2	8 MHz	129.95
8087-1	10 MHz	169.95

16-BIT COPROCESSORS

80287	6 MHz	139.95
80287-8	8 MHz	209.95
80287-10	10 MHz	239.95
80C287	12 MHz	299.95

32-BIT COPROCESSORS

80387-16	16 MHz	359.95
80387-5X	16 MHz	319.95
80387-20	20 MHz	399.95
80387-25	25 MHz	499.95
80387-33	33MHz	649.95

intel 5 YEAR WARRANTY



INCLUDES MANUAL & SOFTWARE GUIDE

74 SERIES LOGIC

7400	.19	74LS32	.18	74LS245	.79
74LS00	.16	74LS73	.29	74LS273	.79
74LS02	.17	7474	.33	74S288	1.69
7404	.19	74LS74	.24	74LS322	3.95
74LS04	.16	74S74	.49	74LS367	.39
74S04	.29	74LS138	.39	74LS373	.79
7406	.29	74LS155	.59	74LS374	.79
7408	.24	74LS163	.39	74LS393	.79
74LS08	.18	74LS240	.69	74LS682	3.20
7432	.29	74LS244	.69	74LS688	2.40

C.P.U.'s

8000

8052AH	BASIC	34.95
8088		5.99
8250		6.95
8251A		1.69
8253-5		1.95
8254		9.95
8255-5		2.49
8741		9.95
8748		7.95
8749		9.95
8755		14.95

6500

65C02		7.95
6522		2.95

V-20

V20		6.95
V20-8		8.95
V20-10		11.95
V30		13.95

MISC

DAC0800	3.29	16L8	2.95
1793	9.95	16R4	2.95
COM8116	8.95	16R6	2.95
MC146818	5.95	16R8	2.95
MMS8167	9.95	20L8	4.95
INS8250	6.95	20R4A	4.95
NS16450	10.95	20R6	4.95
LM317T	6.95	20R8	4.95
NE555	.29	20X8	4.95
LMT41	.29		
7805T	.49		
7812T	.49		
75150	1.95		
75154	1.95		
14411	9.95		

CRYSTAL OSCILLATORS

1.0MHz	5.95
1.8432	5.95
20.0	4.95
24.0	4.95

PALS

16L8	2.95
16R4	2.95
16R6	2.95
16R8	2.95
20L8	4.95
20R4A	4.95
20R6	4.95
20R8	4.95
20X8	4.95

PAL KIT

AN ENTRY-LEVEL COMPLETE PAL DEVELOPMENT KIT FROM CUPL FULL SUPPORT FOR 16L8, 16R4, 16R6, 16R8, 20L8, 20R4, 20R6, 20R8, AND 20X8. MOD-MPL-SOFT \$99.95

Derick's HIGH-TECH SPOTLIGHT



Call our BBS: (408) 559-0253 for more info in SIG file "Hitech"

Choosing a case for your computer is a straightforward task. But, it's not made easier by having so many choices! Nearly any case JDR sells can be used with any of our motherboards. The only exceptions are "full size AT-type" boards which require a case capable of holding a "standard 286/386" board.

How should you select? Begin by deciding how many disk drives you'll be using. Consider such variables as full or half-height drives, 3-1/2" and 5-1/4" slots, and don't forget a tape back-up if it's in your plans.

Next consider your power requirements. A loaded up 8088-based computer ought to have at least 150 watts of power. Consider at least 200W for a moderately loaded 286/386 and 250W for a loaded up 286/386 system. There is nothing more annoying than a computer that overloads on a hot summer afternoon because you decided to save \$20 on a \$1000 system!

Now look at reliability. A tower system will almost always be more reliable because it sits on the floor out of the way and is less likely to be bumped or jostled. It normally runs cooler too, because of better cooling characteristics due to convection. For these reasons it's an especially good choice for busy networks.

If you tinker with the inner workings of your equipment, a flip-top case may be an important consideration. Extension cables for the keyboard & display monitor let you move your computer out of sight or harm's way.

Derick Moore, Director of Engineering

PROTOTYPE CARDS

FR-4 EPOXY GLASS LAMINATE WITH GOLD PLATED EDGE CARD FINGERS AND SILK SCREENED LEGENDS



FOR XT

JDR-PR1	WITH +5V AND GROUND PLANE	27.95
JDR-PR2	ABOVE WITH I/O DECODING LAYOUT	29.95
JDR-PR2-PK	PARTS KIT FOR JDR-PR2 ABOVE	8.95

FOR AT

JDR-PR10	BIT WITH I/O DECODING LAYOUT	34.95
JDR-PR10-PK	PARTS KIT FOR JDR-PR10 ABOVE	12.95

FOR PS/2

JDR-PR32	32 BIT PROTOTYPE CARD	69.95
JDR-PR16	16 BIT WITH I/O DECODING LAYOUT	49.95
JDR-PR16-PK	PARTS KIT FOR JDR-PR16 ABOVE	15.95
JDR-PR16V	16 BIT FOR VIDEO APPLICATIONS	39.95

EXTENDER CARDS

SIMPLIFY PROTOTYPING AND TESTING

EXT-8088	8-BIT FOR 8088 MOTHERBOARDS	29.95
EXT-80286	16-BIT FOR 286/386 MOTHERBOARDS	39.95
EXT-16	MICROCHANNEL 16-BIT	69.95
EXT-32	MICROCHANNEL 32-BIT	99.95

PC BREADBOARD-ON-A-CARD



- 62 BUS LINES
- USE UP TO 24 14-PIN ICs
- 1940 TIE POINTS
- DB25 D-SUB CONNECT.
- PDS-604 \$49.95

SOLDER STATION



- UL APPROVED
- ADJUSTABLE HEAT SETTING
- TIP TEMPERATURE READOUT
- REPLACEMENT TIPS @ \$2.95
- 168-30 \$59.95

IC SOCKETS/DIP CONNECTORS

SOLDERTAIL	WIREWRAP	ZIF SOCKETS			
8 PIN ST	.11	8 PIN WW	.59	ZIF-14	5.95
14 PIN ST	.11	14 PIN WW	.69	ZIF-16	5.95
16 PIN ST	.12	16 PIN WW	.69	ZIF-20	6.95
18 PIN ST	.15	18 PIN WW	.99	ZIF-24	7.95
20 PIN ST	.18	20 PIN WW	1.09	ZIF-28	7.95
24 PIN ST	.20	24 PIN WW	1.49	ZIF-40	10.95
28 PIN ST	.22	28 PIN WW	1.69		
40 PIN ST	.30	40 PIN WW	1.99		

VOLUME DISCOUNTS CALL!

SOLDER-CUP D-SUBS

MALE	FEMALE	IDE20	55		
DB09P	.45	DB09S	.49	IDE34	.89
DB15P	.59	DB15S	.69	IDS20	.65
HDB15P	1.49	HDB15S	1.59	ID534	.75
DB19P	.69	DB19S	.75	IDB09P	1.39
DB25P	.69	DB25S	.75	IDB09S	1.45
DB37P	1.35	DB37S	1.39	IDB25P	2.25
DB50P	1.85	DB50S	2.29	IDB25S	2.35

IDC'S

EPROM ERASERS

DATARASE II \$39.95

- SHIRT POCKET SIZE!
- ALL SIZES UP TO 4 AT A TIME
- ERASES MOST EPROMS IN 3 MINUTES

DATARASE II

SPECTRONICS CORPORATION	Model	Timer	# of Chips	Intensity (uW/Cm ²)	Unit Cost
PE-140	NO	9	8,000	\$ 89.95	
PE-140T	YES	9	8,000	\$139.95	
PE-240T	YES	12	9,600	\$189.95	
PL-265T	YES	30	1,600	\$255.95	



POWER SUPPLIES

135 WATT

- XT-COMPATIBLE • UL APPROVED • 110-220V SWITCH
- +5V @ 15A, +12V @ 4.2A, -5V @ .5A, -12V @ .5A

PS-135 \$59.95

PS-150 150W SUPPLY \$69.95

PS-200X 200W SUPPLY \$89.95



200 WATT

- AT-COMPATIBLE • UL APPROVED • 110-220V SWITCH
- +5V @ 20A, +12V @ 7A, -5V @ .5A, -12V @ .5A

PS-200 \$89.95

PS-250 250W SUPPLY \$129.95



CABLES AND GENDER CHANGERS

MOLDED; GOLD-PLATED CONTACTS; 100% SHIELDED

CBL-PRINTER	6 FT. PC PRINTER CABLE	9.95
CBL-PRNTR-25	25 FT. PC PRINTER CABLE	15.95
CBL-PRNTR-RA	RIGHT ANGLE PRINTER CABLE	15.95
CBL-DB25-MM	DB25 MALE-DB25 MALE 6 FT.	9.95
CBL-DB25-MF	DB25 MALE-DB25 FEMALE 6 FT.	9.95
CBL-9-SERIAL	DB9 FEMALE-DB25 MALE 6 FT.	6.95
CBL-KBD-EXT	5 FT. KEYBOARD EXTENSION	7.95
CBL-CNT-MM	36-PIN CENTRONICS-M/M	14.95
CBL-FDC-EXT	37-PIN EXT. FLOPPY CABLE	9.95
CBL-MNT-9	9-PIN MONITOR EXTENSION	6.95
CBL-MNT-15	15-PIN MONITOR EXTENSION CABLE	9.95
CBL-MODEM	MODEM-DB25-DB25 FEMALE	6.95
GENDER-VGA	DB9-DB15 ADAPTOR	4.95
GENDER-9-25	DB9-DB25 SERIAL ADAPTOR	4.95

PARTIAL LISTINGS ONLY—CALL FOR FREE 100-PG CATALOG!

COPYRIGHT 1989 JDR MICRODEVICES

JDR MICRODEVICES AND THE JDR MICRODEVICES LOGO ARE REGISTERED TRADEMARKS OF JDR MICRODEVICES. IBM, AT, PS/2 ARE TRADEMARKS OF INTERNATIONAL BUSINESS MACHINES.

CIRCLE 113 ON FREE INFORMATION CARD

DEALERS CIRCLE 170 ON FREE INFORMATION CARD

www.americanradiohistory.com

4800/2400 BAUD FAX/DATA MODEM

\$119⁹⁵

- FAX TRANSMISSION ONLY
- 4800 BAUD FAX CAPABILITY TO ANY GROUP III FAX
- 2400 BAUD V.22BIX DATA MODEM
- XT/AT COMPATIBLE HALF CARD
- MENU-DRIVEN SOFTWARE
- MULTIPLE FAX TRANSMISSIONS TO GROUPED ADDRESSES

MCT-FAXM

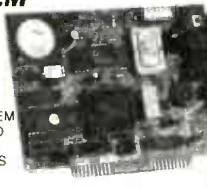

2400 BAUD MODEM

\$89⁹⁵

- 2400/1200/300 BAUD
- FULL HAYES COMPATIBILITY
- CONFIGURE AS COM1, COM2, COM3 OR COM4
- BUILT-IN SPEAKER - AUTO WAIT-FOR-DIAL TONE AND AUTO-REDIAL - PROCOMM COMMUNICATIONS SOFTWARE - MADE IN THE USA

MCT-24I

MCT-121 1200 BAUD INTERNAL MODEM \$59.95



MINI UPRIGHT CASE

\$199⁹⁵

- SMALL FOOTPRINT MINI-UPRIGHT FOR 8088 OR MINI 286/386 MOTHERBOARDS
- ROOM FOR 6 EXPANSION CARDS
- HOLDS 3 5-1/4" & 1 3-1/2" DRIVES (1/2 HT)
- 200 WATT POWER SUPPLY
- 2-DIGIT LED SPEED DISPLAY
- 12" H X 16" L X 8" W

CASE-120



UPRIGHT CASE

\$249⁹⁵

- SPACE SAVING DESIGN HOLDS ALL SIZES OF MOTHERBOARDS AND INCLUDES: 250W POWER SUPPLY
- MOUNTS FOR 3 FLOPPY & 4 HARD DRIVES
- TURBO & RESET SWITCH - LED SPEED DISPLAY - POWER & DISK LED'S
- ALL HARDWARE, FACEPLATES & SPEAKER

CASE-100

- CASE-FLIP FOR 8088 MB'S \$39.95
- CASE-SLIDE FOR 8088 MB'S \$39.95
- CASE-70 FOR 286 MB'S \$89.95
- CASE-50 FOR MINI 286 MB'S \$59.95
- CASE-JR MINI-286 W/150W PS \$149.95

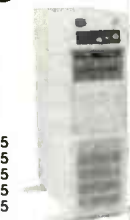

MODULAR PROGRAMMING SYSTEM

MODULES USE A COMMON HOST ADAPTOR CARD-- 1 SLOT PROGRAMS EPROMS, PROMS, PALS, MORE!

HOST ADAPTOR CARD \$29.95

- UNIVERSAL INTERFACE FOR ALL PROGRAMMING MODULES!
- SELECTABLE ADDRESSES PREVENTS CONFLICTS
- MOLDED CABLE

MOD-MAC



UNIVERSAL MODULE

\$499.95

- PROGRAMS EPROMS, EEPROMS, PALS, BI-POLAR PROMS, 8748 & 8751 SERIES DEVICES; 15V8 AND 20V8 GALS (GENERIC ARRAY LOGIC) FROM LATTICE, NS, SGS - TESTS TTL, CMOS, DYNAMIC & STATIC RAMS - LOAD DISK, SAVE DISK, EDIT, BLANK CHECK, PROGRAM, AUTO, READ MASTER, VERIFY AND COMPARE - TEXT TOOL SOCKET FOR 3"-6" W. IC'S (8-40 PINS) MOD-MUP

EPROM MODULE

\$119.95

- PROGRAMS 24-32 PIN EPROMS, CMOS EPROMS & EEPROMS FROM 16K TO 1024K - HEX TO OBJ CONVERTER - AUTO, BLANK CHECK/PROGRAM/VERIFY - VPP 5, 12.5, 12.75, 13, 21 & 25 VOLTS - NORMAL, INTELLIGENT, INTERACTIVE & QUICK PULSE PROGRAMMING ALGORITHMS

OTHER MODULES

- MOD-MPL PAL MODULE \$249.95
- MOD-MIC DIGITAL TESTER MODULE \$129.95
- MOD-MBP BI-POLAR PROGRAMMING MODULE \$259.95
- MOD-MMP MICROPROCESSOR PROG. MODULE \$179.95
- MOD-MPL-SOFT CUPL SOFTWARE \$99.95

VGA COMPATIBLE PACKAGE

\$499⁹⁵

- 720 X 540 MAX RESOLUTION, 640 X 480 INT'L COLORS, 528 X 480 RESOLUTION IN 256 COLORS - IBM STYLE MONITOR
- VGA, EGA, CGA, AND MGA COMPATIBLE

VGA-PKG (INCLUDES VGA CARD AND MONITOR)

VGA MONITOR

\$359.95

- 14" ANALOG VGA - GLARE RESISTANT SCREEN - 720 X 480
- TILT/SWIVEL BASE - FRONT MOUNTED POWER SWITCH

VGA-MONITOR

RELISYS MULTISYNCH \$429.95

- FULL FEATURED MULTISYNCH MONITOR WITH UNLIMITED COLORS - 1024 X 768 RESOLUTION, 14" NON-GLARE DISPLAY
- AUTO SWITCHING - TTL/ANALOG VIDEO INPUT

JDR-MULTI

EGA SPECIAL! CARD & MONITOR--JUST \$479

- EGA-MONITOR 14" RGB MONITOR \$339.95
- NEC-MULTI-3D DIGITAL 1024X768 RESOLUTION \$649.95
- JDR-MONO 12" TTL MONOCHROME-GREEN \$69.95
- JDR-AMBER 12" TTL MONOCHROME-AMBER \$69.95



QUALITY KEYBOARDS

STANDARD KEYBOARDS:

- BTC-5060 AUTOSENSE FOR XT/AT \$59.95
- MAX-5060 WITH TACTILE FEEDBACK \$64.95

ENHANCED KEYBOARDS:

- BTC-5339 AUTOSENSE FOR XT/ AT, AUTOREPEAT \$69.95
- K103-A AUDIBLE "CLICK" STYLE \$84.95
- MAX-5339 MAXI-SWITCH W/TACTILE FEEDBACK \$84.95

MODULAR CIRCUIT TECHNOLOGY

DRIVE CONTROLLERS:

- MCT-FDC FLOPPY DISK CONTROLLER \$29.95
- MCT-FDC-HD 1.44MB FLOPPY CONTROLLER \$49.95
- MCT-HDC HARD DISK CONTROLLER \$79.95
- MCT-RLL RLL CONTROLLER \$89.95
- MCT-FH FLOPPY/HARD CONTROLLER \$139.95
- MCT-AFH 286/386 FLOPPY/HARD \$149.95
- MCT-AFH-RLL 286/386 RLL CONTROLLER \$199.95

DISPLAY ADAPTOR CARDS:

- MCT-MGP MONOCHROME GRAPHICS \$49.95
- MCT-CG COLOR GRAPHICS ADAPTOR \$44.95
- MCT-EGA ENHANCED GRAPHICS ADAPTOR \$149.95
- MCT-VGA-8 8-BIT VGA, ANALOG OUTPUT \$169.95
- MCT-VGA-16 16-BIT VGA, ANALOG OUTPUT \$199.95
- MCT-MGMIO MONOGRAPHS MULTI I/O \$119.75
- MCT-MGAIO 286/386 MONOGRAPHS I/O \$99.95

MULTIFUNCTION CARDS:

- MCT-MIO MULTI I/O FLOPPY CONTROLLER \$79.95
- MCT-IO MULTI I/O CARD \$59.95
- MCT-AMF 286/386 MULTIFUNCTION \$139.95
- MCT-AIO 286/386 MULTI I/O CARD \$59.95

MEMORY CARDS:

- MCT-RAM 576K RAM CARD \$49.95
- MCT-EMS EXPANDED MEMORY CARD \$99.95
- MCT-AEMS 286/386 EMS CARD \$129.95

GeniScan 400 DPI

\$199⁹⁵

- UP TO 400 DPI - 32 LEVELS OF GRAY SCALE - SPEED OF GRAY SCALE - LEED OVER-RUN WARNING LIGHT
- INCLUDES SCANEDIT I AND DR. GENIUS SOFTWARE

GS-4500



EPROM PROGRAMMER \$129.95

- PROGRAMS 27XX AND 27XXX EPROMS UP TO 27512
- SUPPORTS VARIOUS PROGRAMMING FORMATS & VOLTAGES - SPLIT OR COMBINE CONTENTS OF DIFFERENT EPROMS OF DIFFERENT SIZES
- READ, WRITE, COPY, BLANK CHECK & VERIFY
- SOFTWARE FOR HEX AND INTEL HEX FORMATS

MOD-EPROM



HARD DISKS KITS

- 21.4 MB **\$199** 21.4 MB **\$249**
- 32.7 MB **\$219** 32.1 MB **\$279**
- 42.8 MB **\$339**
- 65.5 MB **\$389**
- 80.2 MB **\$569**



SIZE	MODEL	AVG. SPEED	FORM FACTOR ONLY	DRIVE ONLY	XT KIT	AT F/H KIT
21.4MB	ST-225	65 MS	5-1/4"	\$199	\$249	\$309
32.7MB RLL	ST-238	65 MS	5-1/4"	\$219	\$279	\$379
42.8MB	ST-251-1	28 MS	5-1/4"	\$339	\$389	\$449
65.5MB RLL	ST-277-1	28 MS	5-1/4"	\$389	\$449	\$549
80.2MB	ST-4096	28 MS	5-1/4"	\$569	—	\$679
122.7MB RLL	ST-4144A	28 MS	5-1/4"	\$699	\$759	\$859
21.4MB	ST-125	40 MS	3-1/2"	\$259	\$299	\$373
32.1MB RLL	ST-138	40 MS	3-1/2"	\$289	\$339	\$429

157.5MB ESDI DRIVE KIT

\$1049

- 5-1/4" HARD DISK, FLOPPY/HARD CONTROLLER, CABLES, MOUNTING HARDWARE & SOFTWARE. 1355-PKG

1.44MB 3-1/2" DRIVE \$99⁹⁵

- ULTRA HIGH DENSITY
- READ/WRITE 720K DISKS, TOO
- FDD-1.44X BLACK FACEPLATE
- FDD-1.44A BEIGE FACEPLATE
- FDD-1.44A SOFT SOFTWARE DRIVER \$19.95



1/2 HEIGHT FLOPPY DISK DRIVES:

- FD-55B 5-1/4" TEAC DS/DD 360K \$99.95
- FD-55G 5-1/4" TEAC DS/HD 1.2M \$129.95
- FDD-360 5-1/4" DS/DD 360K \$69.95
- FDD-1.2 5-1/4" DS/HD 1.2M \$95.95

MOTHERBOARDS

20MHZ 386 \$629

UPGRADE!

- 16/20 MHZ
- 16 MB RAM CAPACITY - 8MB ON BOARD (OK), 8 MB RAM CARD
- USES 256K OR 1MB SIP RAMS
- 8 SLOTS - 1X32-BIT RAM 2X 8-BIT & 5X 16-BIT
- MEMORY INTERLEAVING
- AMI BIOS - XT-SIZE BOARD

- MCT-M386-20 25MHZ MINI 386 W/CACHE \$1199.00
- MCT-C386-25 8MB RAM CARD (OK) \$99.95
- MCT-M386-M4 10/20MHZ 386 \$799.00
- MCT-386MB20 10/25MHZ 386 \$999.00

10MHZ MINI-286

\$189⁹⁵

- AT COMPATIBLE - KEYBOARD SELECTABLE 6/10MHZ
- EXPANDABLE TO 4MB ON-BOARD WITH 1MB DRAMS (OK)
- SIX 16-BIT, TWO 8-BIT SLOTS - AMI BIOS - LED SUPPORT

- MCT-M286-10 8/12MHZ MINI-286 \$199.95
- MCT-M286-12 8/16MHZ 286 \$289.95
- MCT-M286-16N 10/20MHZ 286 \$389.95
- MCT-M286-20N 10/20MHZ 286 \$389.95
- MCT-XMB STANDARD 4.77MHZ 8088 \$87.95
- MCT-TURBO 4.77/8MHZ 8088 \$89.95
- MCT-TURBO-10 4.77/10MHZ SINGLE CHIP 8088 \$99.95

LOGITECH MICE

- THREE-BUTTON SERIES 9
- 320 DPI RESOLUTION
- SERIAL PS/2 COMPATIBLE
- LOGC9 SERIAL MOUSE \$98.95
- LOGC9-C SERIAL (NOT PS/2 COMPATIBLE) \$79.95
- LOGC9-P SERIAL MOUSE WITH PAINTSHOW \$109.95
- LOGC9-PC SERIAL MOUSE WITH PAINT/CAD \$154.95
- LOGB9 BUS MOUSE \$89.95
- LOGB9-P BUS MOUSE WITH PAINTSHOW \$104.95
- LOGB9-PC BUS MOUSE WITH PAINT/CAD \$149.95



JDR MICRODEVICES, 2233 BRANHAM LANE, SAN JOSE 95124
LOCAL (408) 559-1200 FAX (408) 559-0250 TELEX 171-110

RETAIL STORE: 1256 S. BASCOM AVE., SAN JOSE, CA
(408) 947-8881 HOURS: M-F 9-7 SAT. 9-5 SUN. 12-4



ORDER TOLL FREE 800-538-5000

CUSTOMER SERVICE TOLL-FREE 800-538-5001 • TECHNICAL SUPPORT TOLL-FREE 800-538-5002

CIRCLE 113 ON FREE INFORMATION CARD
DEALERS CIRCLE 170 ON FREE INFORMATION CARD

www.americanradiohistory.com

VALUE-PRICED TEST EQUIPMENT ALL WITH A 2 YEAR WARRANTY!

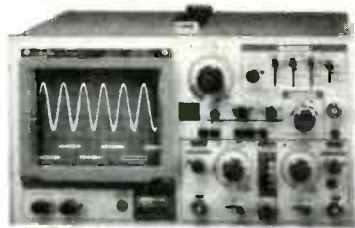

35 MHZ DUAL TRACE OSCILLOSCOPE \$499.95
 • WIDE BAND WIDTH • VARIABLE HOLDOFF
 MODEL-3500 (SHOWN)

20 MHZ DUAL TRACE OSCILLOSCOPE \$389.95
 • TV SYNC FILTER • COMPONENTS TESTER
 MODEL 2000

THE ULTIMATE 3.5 DIGIT DMM \$79.95
 • BASIC DC ACCURACY $\pm 0.25\%$
 • 34 RANGES
 • TEMP. TRANSISTOR & RESISTANCE FEATURES
 DMM-300 (SHOWN)



3.5 DIGIT FULL FUNCTION DMM \$49.95
 • BASIC DC ACCURACY $\pm 0.25\%$
 • 22 RANGES
 DMM-200 \$49.95

3.5 DIGIT POCKET SIZE DMM \$29.95
 • BASIC DC ACCURACY $\pm 0.5\%$ • 14 RANGES
 DMM-100

3.5 DIGIT PROBE TYPE DMM \$54.95
 • AUTORANGING
 • AC/DC 2V - 500V
 • RESISTANCE: 2K-2M
 DPM-1000 (SHOWN)



HIGH/LOW LOGIC PROBE \$17.95
 • DETECTS TTL/CMOS LOGIC STATES
 • MEMORY FUNCTION FREEZES DATA FOR LATER USE
 LP-2800

PULSE PROBE FOR QUICK DEBUGGING \$19.95
 • INJECTS PULSE INTO TEST CIRCUIT-VARIABLE WIDTH
 • TTL, DTL, TRL, HTL, HINIL, MOS, & CMOS COMPATIBLE
 LP-540



Jim Wharton
 JDR's VP Sales

JIM'S BARGAIN HUNTERS CORNER

FACTORY REFURBISHED VGA PACKAGE

\$349.95

IF NEW \$499.95

SAVE \$150 ON THE MONITOR AND 8-BIT CARD!

- HIGH RESOLUTION COLOR ANALOG MONITOR HAS AUTO SWITCHING FOR VGA, EGA, CGA, MDA, HGC
- VGA STANDARD 640 X 480 IN 16 OUT OF 256 COLORS
- 320 X 200 RESOLUTION IN 256 COLORS FROM A PALETTE OF 262,000
- SOFTWARE DRIVERS FOR MICROSOFT WINDOWS, AUTOCAD, LOTUS 1-2-3 & SYMPHONY, DIGITAL RESEARCH GEM AND VENTURA PUBLISHER
- JUMPER AND SWITCH-FREE 8-BIT VGA CARD FOR EASY INSTALLATION
- FULL REGISTER BIOS AND INTERFACE COMPATIBILITY: 256 VIDEO RAM

R/VGA-PKG EXPIRES 4/30/90

JDR Microdevices
 2233 BRANHAM LANE, SAN JOSE, CA 95124

ORDER TOLL-FREE 800-538-5000

LOCAL (408) 559-1200 CUSTOMER SERVICE 800-538-5001
 TECH SUPPORT 800-538-5002 FAX (408) 559-0250

ADVERTISING INDEX

RADIO-ELECTRONICS does not assume any responsibility for errors that may appear in the index below.

Free Information Number	Page	78	Radio Shack	7	
108	AMC Sales	14	196	SCO Electronics	19
201	Ace Communications	17	176,177	Sencore	23, CV3
75	Ace Products	21	—	Star Circuits	30
107	All Electronics	89	83	Synergetics	60
—	Amazing Concepts	84	191	TECI	58
77	B&K Precision	CV4	123,186	Test Probes	3
67	Banner Technical Books	62	250-253	Test Probes	3
98	Beckman Industrial	31	198	Unicorn	80
109	C&S Sales	32	197	U.S. Cable TV	19
70	CEI	83	64	Video-Link	82
—	CIE	15	184	Viejo Publications	62
203	Cable Network	84	185	WPT Publicatons	58
—	Command Productions	68			
187	Communications Specialists	58			
58	Cook's Institute	30			
200	D&D ELECTRONICS	14			
127	Deco Industries	21			
82	Digi-Key	88			
178	Electronic Goldmine	24			
190	Electronics Book Club	13			
121	Fluke Manufacturing	CV2			
192	Global Specialities	5			
—	Grantham College	20			
86	Heathkit	31			
188	ICS Computer Training	18			
199	International Components Corp.	84			
113,170	JDR Microdevices	90-92			
114	Jameco	86			
104	Jan Crystals	18			
179	Jinco Computers	78			
202	Joseph Electronics	17			
—	King Wholesale	78			
53	MD Electronics	81			
93	Mark V. Electronics	83			
—	McGraw Hill Book Club	26			
61	Microprocessors Unitd.	71			
193	Movie Time	25			
—	NRI Schools	8			
195	Optoelectronics	85			
—	Pacific Cable	79			
56	Parts Express	81			
194	Print Products International	24			

Gernsback Publications, Inc.
 500-B Bi-County Blvd.
 Farmingdale, NY 11735
 1-(516) 293-3000
 President: Larry Steckler
 Vice President: Cathy Steckler

For Advertising ONLY
 516-293-3000
 Fax 1-516-293-3115
 Larry Steckler
 publisher

Arline Fishman
 advertising director
Denise Haven
 advertising assistant
Christina Estrada
 advertising associate
Lisa Strassman
 credit manager

SALES OFFICES

EAST/SOUTHEAST
Stanley Levitan
 Eastern Sales Manager
 Radio-Electronics
 259-23 57th Avenue
 Little Neck, NY 11362
 1-718-428-6037, 1-516-293-3000

MIDWEST/Texas/Arkansas/Okla.
Ralph Bergen
 Midwest Sales Manager
 Radio-Electronics
 540 Frontage Road—Suite 339
 Northfield, IL 60093
 1-312-446-1444
 Fax 1-312-446-8451

PACIFIC COAST/ Mountain States
Marvin Green
 Pacific Sales Manager
 Radio-Electronics
 5430 Van Nuys Blvd. Suite 316
 Van Nuys, CA 91401
 1-818-986-2001
 Fax 1-818-986-2009

Introducing The SG80 AM Stereo-FM Stereo Analyzer™

Now For The First Time, A High-Performance AM Stereo (C-QUAM)® - FM Stereo Analyzer Integrated Into One Unit, Allowing You To Performance Test, Troubleshoot, And Align To Manufacturers' Requirements

New



\$3,995
Patented

Licensed Under Motorola Patent No. 4,218,586

- Complete AM Stereo-FM Stereo Analyzer—exceeds manufacturers' requirements.
- Patented FM analyzing signals isolate any FM receiver defect.
- Exclusive integrated AM Stereo C-QUAM analyzer.
- Digitally accurate performance tests meet EIA/IHF requirements.
- Exclusive, tuneable FM-IF Sweep and Markers—aligns all IF stages.
- Expandable FM features for future service needs, plus SCA compatible.
- Twice the capability for less than 1/2 the cost of stand-alone instruments.

C-QUAM is a registered trademark of Motorola, Inc.

IEEE 488
BUS COMPATIBLE

RS232
Compatible

SENCORE

3200 Sencore Drive, Sioux Falls, South Dakota 57107

Call 1-800-SENCORE
(736-2673)

CIRCLE 176 ON FREE INFORMATION CARD

Ask About
A 10 Day
Video Preview

tech tape™

www.americanradiohistory.com

LIVE ACTION

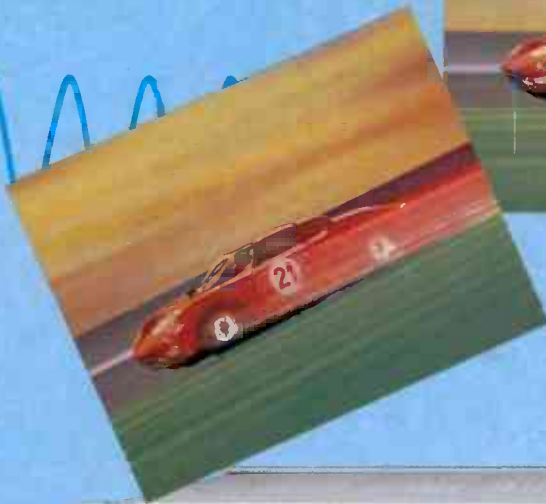

STOP ACTION, INSTANT REPLAY

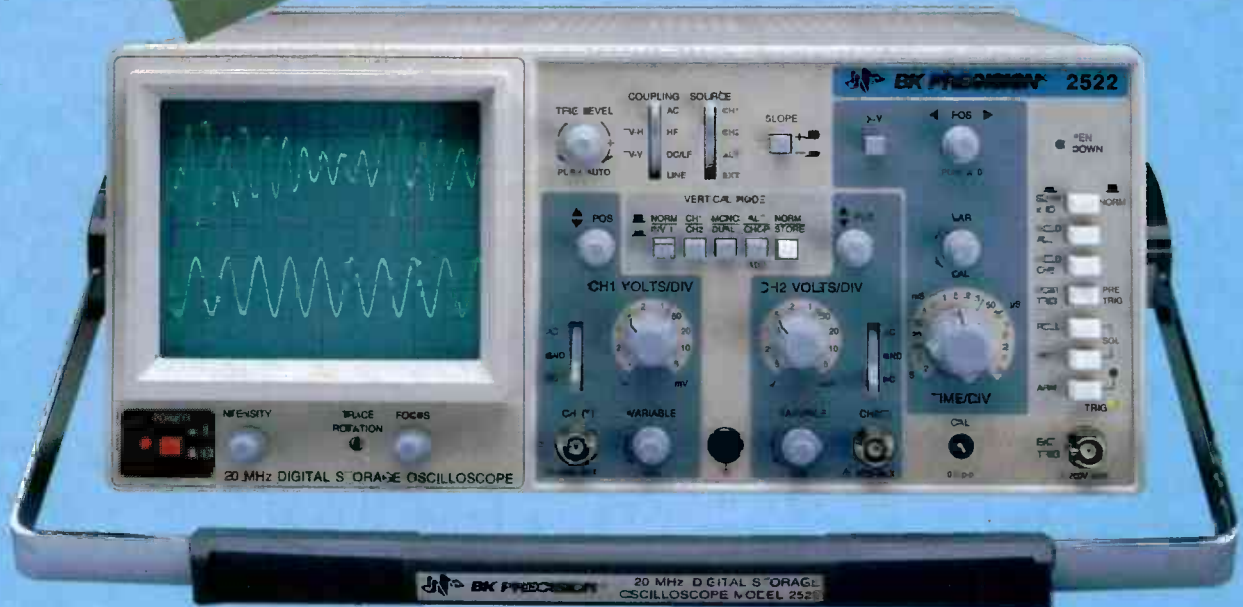

Catch all the action with the new B&K-PRECISION 2522 Digital/Analog oscilloscope.

The new B&K-PRECISION Model 2522 is a full-feature analog scope for live action and a DSO for stop action.

- Full analog and digital operation.
- 20MHz analog operation.
- 10 MS/second sampling rate on 1 or 2 channels.
- Equivalent time sampling to 20MHz.
- 2k memory per channel.
- Pre-trigger capture.

A touch of a button switches the 2522 from analog to digital operation. It's an easy-to-operate scope with the performance you need, at a price you'll like.

Don't let the action pass you by. The 2522 will put you on the fast track for performance and results. For immediate delivery or complete specifications, contact your local B&K-PRECISION distributor.

\$1495



BK PRECISION
MAXTEC INTERNATIONAL CORP.

Domestic and International Sales
6470 W. Cortland St., Chicago, IL 60635
312-889-1448 • FAX: 312-794-9740
Canadian Sales, Atlas Electronics, Ontario

CIRCLE 77 ON FREE INFORMATION CARD