

Radio - **HOLIDAY ELECTRONICS
GIFT GUIDE**

DECEMBER 1989

Electronics®

TECHNOLOGY - VIDEO - STEREO - COMPUTERS - SERVICE

CIRCUIT COOKBOOK

We de-mystify
phase-locked loops
with plenty of
practical examples

BUILD A PC-BOARD ETCHING SYSTEM

A must for making your own
printed-circuit boards at home

WORKING WITH RELAYS

How to select
solid-state relays and
how to design your own

BUILD A VIDEO SCENE SWITCHER

Add professional wipes
and fades to your home
video movies

COMPUTERDIGEST

Build an RGB to
NTSC converter

BUILD THIS PROGRAMMABLE PHASOR PROPERTY GUARD

This high-tech deterrent
produces a painful blast of
disorientating shock waves



\$2.25 U.S.
\$2.75 CAN

A
GERNSBACK
PUBLICATION

Plus: ★ Audio Update
★ Video News
★ Hardware Hacker
★ And Lots More!

FLUKE



PHILIPS

Put a test lab in your tool pouch.



The Fluke 8060A 4½-digit handheld multimeter.

It's the best tool you could add to your tool pouch, because it lets you troubleshoot more ... with less.

This portable, powerful instrument has a unique combination of features not available in any other handheld DMM. It lets you reach beyond traditional DMM applications, tackling jobs that often require more equipment than you can carry.

A simple push of a button on the Fluke 8060A lets you measure frequencies to 200 kHz, make relative offset measurements, convert voltages to direct reading decibels, or conduct audible continuity tests. Plus the 8060A offers wideband True RMS ac measurement capability to 100 kHz.

So say goodbye to your part-time counters, oscilloscopes, continuity testers, calculators and power supplies. And welcome a full-time professional that'll be there when you need it.

You'll find that for troubleshooting everything from motor controls to data communications equipment, the Fluke 8060A is the best multimeter value going.

Find out more by calling our toll-free hot-line **1-800-44-FLUKE, ext. 33.**

FROM THE WORLD LEADER IN DIGITAL MULTIMETERS.

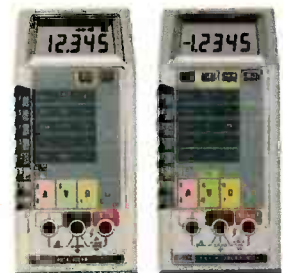

8062A

\$329*
 .05% basic accuracy
 19999 count display
 True-rms ac voltage and current
 Continuity and diode test
 Relative reference
 1-year calibration cycle and warranty

8060A

\$389*
 .04% basic dc accuracy
 19999 count display
 True-rms ac voltage and current
 Continuity and diode test
 Frequency measurements
 dBm, Relative dB
 Relative reference
 1-year calibration cycle and warranty

*Suggested U.S. list price, effective October 1, 1988.

FLUKE

December 1989 **Radio- Electronics**

Vol. 60 No. 12

BUILD THIS

- 37 PROGRAMMABLE PHASOR PROPERTY GUARD**
Keep burglars away with shock waves of sound.
Robert Iannini
- 42 VIDEO SCENE SWITCHER**
Give your videos a professional look.
William Sheets and Rudolf F. Graf
- 45 MAKE YOUR OWN ETCHING TANK**
Home-made etch gives professional results.
Tony Lewis

TECHNOLOGY

- 51 HOLIDAY GIFT GUIDE**
A sampling of electronics gifts for giving—or for receiving!

COMPUTERS

- 81 RGB-TO-NTSC CONVERTER**
Get high-quality computer video on your television!
Robin Bek

CIRCUITS

- 55 CMOS PLL's**
Practical applications for the versatile 4046B micro-power phase-locked loop IC.
Ray Marston
- 59 ALL ABOUT RELAYS**
Put solid-state relays to work in your projects.
Harry L. Trietley

DEPARTMENTS

- 6 VIDEO NEWS**
What's new in this fast-changing field.
David Lachenbruch
- 22 EQUIPMENT REPORTS**
Precision Motion Logic Analyzer and B + K-Precision Model 1249 NTSC Generator.
- 67 AUDIO UPDATE**
The sound of CD: Part II.
Larry Klein
- 68 HARDWARE HACKER**
PC-board breakthrough.
Don Lancaster
- 77 DRAWING BOARD**
PC-board Photography
Robert Grossblatt
- 81 EDITOR'S WORKBENCH**
Software reviews.
Jeff Holtzman

COMPUTER DIGEST

RGB-to-NTSC CONVERTER

high-quality computer video on your TV—for pleasure!

ROBIN BEK

If you have been thinking of getting a color television, you will be pleased to know that you can now get a high-quality computer video on your television. This is made possible by the RGB-to-NTSC converter, which converts the high-quality RGB video from a computer to the NTSC format used by most televisions. The converter is easy to use and provides high-quality video on your television. It is a must-have for anyone who has a computer and a television.

EDITOR'S WORKBENCH

JEFF HOLTZMAN

The Editor's Workbench is a section of the magazine where we review software and hardware products. This section is a must-read for anyone who is interested in the latest in computer technology. We provide detailed reviews of the products and our own opinions on their quality and value.

PAGE 81

1989 ANNUAL INDEX	
Radio Electronics Volume 60 and COMPUTER DIGEST Volume 6	
Advertising	104
Ask R-E	8
Free Information Card	105
Letters	14
Market Center	89
New Literature	35
New Products	28
PC Service	80
What's News	4

The 1989 Annual Index will appear in the January 1990 Issue.

AND MORE

- 104 Advertising and Sales Offices**
- 104 Advertising Index**
- 8 Ask R-E**
- 105 Free Information Card**
- 14 Letters**
- 89 Market Center**
- 35 New Literature**
- 28 New Products**
- 80 PC Service**
- 4 What's News**

ON THE COVER



Have you ever wished for a more effective way to combat thieves? If you worry about your car or your home being burglarized, you can turn to electronics for some peace of mind. While most people are willing to settle for a simple noise maker to scare off a burglar, most burglars work quickly enough so that an alarm is not too much of a threat—but not our alarm.

Our alarm generates painful and disorienting blasts of high-pitched—and even ultrasonic—sound that are sure to send most burglars running. The frequency and range of the sound are user-programmable, and the entire circuit is easy to build. For more details, turn to page 37.

COMING NEXT MONTH

THE JANUARY ISSUE GOES ON SALE DECEMBER 5.

BUILD R-E's ACOUSTICAL FIELD GENERATOR
Turn your living room into an expansive sound environment!

BUILD A PHONE-ACTIVATED AUDIO-MUTING CIRCUIT
Never miss a phone call again—no matter how loud you play your stereo!

BUILD A SIMPLE LOGIC ANALYZER
An easy 3-chip circuit will get you started!

A REVIEW OF THE BERLIN AUDIO FAIR
A sneak preview of what we can expect to see at the Consumer Electronics Show.

COMPUTER DIGEST

Build the Port-A-Matic—a new troubleshooting tool lets you keep track of what ports your computer accesses.

As a service to readers, RADIO-ELECTRONICS publishes available plans or information relating to newsworthy products, techniques and scientific and technological developments. Because of possible variances in the quality and condition of materials and workmanship used by readers, RADIO-ELECTRONICS disclaims any responsibility for the safe and proper functioning of reader-built projects based upon or from plans or information published in this magazine.

Since some of the equipment and circuitry described in RADIO-ELECTRONICS may relate to or be covered by U.S. patents, RADIO-ELECTRONICS disclaims any liability for the infringement of such patents by the making, using, or selling of any such equipment or circuitry, and suggests that anyone interested in such projects consult a patent attorney.

RADIO-ELECTRONICS, (ISSN 0033-7862) December 1989. Published monthly by Gernsback Publications, Inc., 500-B Bi-County Boulevard, Farmingdale, NY 11735 Second-Class Postage paid at Farmingdale, NY and additional mailing offices. Second-Class mail registration No. 9242 authorized at Toronto, Canada. One-year subscription rate U.S.A. and possessions \$17.97, Canada \$23.97, all other countries \$26.97. All subscription orders payable in U.S.A. funds only, via international postal money order or check drawn on a U.S.A. bank. Single copies \$2.25. © 1989 by Gernsback Publications, Inc. All rights reserved. Printed in U.S.A.

POSTMASTER: Please send address changes to RADIO-ELECTRONICS, Subscription Dept., Box 55115, Boulder, CO 80321-5115

A stamped self-addressed envelope must accompany all submitted manuscripts and/or artwork or photographs if their return is desired should they be rejected. We disclaim any responsibility for the loss or damage of manuscripts and/or artwork or photographs while in our possession or otherwise.

Radio Electronics®

Hugo Gernsback (1884-1967) founder
M. Harvey Gernsback,
editor-in-chief, emeritus

Larry Steckler, EHF, CET,
editor-in-chief and publisher

EDITORIAL DEPARTMENT

Brian C. Fenton, editor
Marc Spiwak, associate editor
Daniel Goodman, technical editor
Teri Scaduto, assistant editor
Jeffrey K. Holtzman
computer editor
Robert Grossblatt, circuits editor
Larry Klein, audio editor
David Lachenbruch
contributing editor
Don Lancaster
contributing editor
Richard D. Fitch
contributing editor
Kathy Campbell, editorial assistant

ART DEPARTMENT

Andre Duzant, art director
Injae Lee, illustrator
Russell C. Truelson, illustrator

PRODUCTION DEPARTMENT

Ruby M. Yee, production director
Robert A. W. Lowndes,
editorial production
Karen S. Tucker
advertising production
Marcella Amoroso
production assistant

CIRCULATION DEPARTMENT

Jacqueline P. Cheeseboro
circulation director
Wendy Alanko
circulation analyst
Theresa Lombardo
circulation assistant
Michele Torrillo, reprint bookstore

Typography by Mates Graphics
Cover photo by Diversified Photo
Services

Radio-Electronics is indexed in
Applied Science & Technology Index
and *Readers Guide to Periodical Literature*.

Microfilm & Microfiche editions are
available. Contact circulation department
for details.

Advertising Sales Offices listed
on page 104.



The
Audit
Bureau
of Circulation



READY-TO-USE INSTRUMENTS FROM HEATH

Backed by the expertise that makes our instruments famous

- An engineering department that insists on honest value in every product.
- Rigorous quality assurance inspection.
- Full one year warranty.

- Outstanding manuals with complete specifications, operating instructions, schematics, and more.
- Technical assistance hotline: (616) 982-3315.
- Our own factory service department.

A POWER SUPPLY FOR EVERY WORKBENCH



Here's an excellent value in an all-around bench power supply. Dual meters let you continuously monitor voltage and current, and 0-30 volt 3-amp output fills most common power supply needs. Use the constant current mode to charge rechargeable batteries, limit power to circuits under test, and operate devices that are current dependent.
SP-2762 **\$169.95**

Specifications: Output voltage: 0-30 VDC continuously variable. Coarse and fine controls. Output load: 0-3 A continuous. Output impedance: Typically less than 0.2 Ω to 10 kHz. Ripple: To 10 kHz, less than 5 mV p-p (0.5 mV rms typical). Load regulation: $\pm 0.25\% \pm 3$ mV, 1-100% of rated current. Line regulation: $\pm 0.25\% \pm 2$ mV for $\pm 10\%$ line variation. Current limiting: 0-3 A, variable. Power: 120 VAC/240 VAC, $\pm 10\%$, 50-60 Hz, 180 watts.

HANDY BNC CABLE SET



Our new BNC cable set provides you with 10 handy coax cables for connections to instruments and other equipment. Included are two 3 ft. BNC male/dual E-Z hook connectors, three 1-1/2 ft. BNC male/BNC male connectors, two 2 ft. BNC male/BNC male connectors, and a rack that you can mount on your workshop wall for convenient cable storage. An outstanding value at less than \$3.00 a cable.

HCA-5002 **\$29.95**

PREMIUM QUALITY COAX CONNECTORS



Make different types of coaxial connector adapters with gold plated pins and Teflon insulation. Just screw the required connector onto one of the interfaces — no crimping or soldering is needed. In just seconds, you'll have that special coaxial connection you require. Kit contains male and female N, F, RCA, BNC, UHF, SMA, TNC, and mini UHF connectors. A handsome, padded, zippered case is included with your deluxe kit to protect your connectors and to keep them looking new after years of service.

HCA-3001 **\$79.95**

DELUXE SCOPES ARE A PLEASURE TO USE

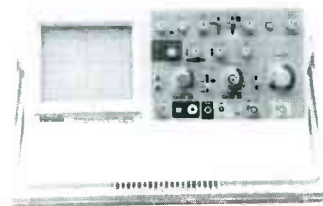

These oscilloscopes offer the measurement capability you need, plus luxury features that make them a joy to own. TV triggers, 1 mV/div sensitivity, differential and X-Y measurements, plus beam finder, component tester, graticule illumination, and other features many manufacturers omit. Enjoy a top-quality 25 or 40 MHz scope backed by a reliable name, full warranty, and complete specifications.

25 MHz: SO-4552 **\$399.95**
40 MHz: SO-4554 **\$599.95**

Specifications: Vertical: 1 mV/div-5 V/div. Bandwidth less at 1 mV/div. Accuracy $\pm 3\%$ at 1 kHz, $\pm 5\%$ at 1 mV/div. Overshoot: less than 5%. Max input: 400 V. Modes: CHA, CHB, dual, add. Horizontal: 2 s - 1 μ s/div, plus X10 magnifier. Trigger: CHA, CHB, Line, Ext, Auto, Norm, TV-V, TV-H, +/- . Power: 90-132/198-264 VAC, 50/60 Hz, 45 W. Weight: 16.7 lbs.

HALF PRICE SPECIAL!



**ONLY
\$12.47**

Order any product from this ad and get our popular shirt pocket miniature DMM, Model SM-2300-A, for only \$12.47 — half our regular price.

Specifications: Autoranging 3-1/2 digit DMM. DC volts: 2000 mV to 450 V, $\pm 1.3\% \pm 4$ counts. Approx. 11 M Ω input resistance. Max input, 450 VDC. AC volts: 2000 mV to 450 V, $\pm 2.3\% \pm 8$ counts, 50 to 400 Hz. Approx. 11 M Ω input resistance. Max input, 450 V. Resistance: 2000 Ω to 2 M Ω $\pm 2\% \pm 4$ counts.

To order, call TOLL FREE 1-800-253-0570

Use order code 217-320



for credit card orders, 24 hours a day

For your free HEATHKIT catalog, call 1-800-44-HEATH

We guarantee every specification we publish on every product we sell.

Heath Instruments
PO Box 8589
Benton Harbor, MI 49022

WHAT'S NEWS

Magnetic resonance images take place of X-rays

Reports on trials of a new experimental approach to imaging three-dimensional areas of the human body without X-rays were made by General Electric scientists at the recent Society of Magnetic Resonance in Medicine (SMRM) conference in the Netherlands.

The new technique, known as "phase contrast magnetic resonance angiography," produces images of flowing blood that outline the veins and arteries through which the blood is flowing. The faster the blood flows, the brighter the image that appears on the Magnetic Resonance (MR) scanner's display screen. Because the image changes due to volume of blood flow, the MR method requires no injections of X-ray-absorbing fluids to highlight the vessels—often an uncomfortable process for the patient.

With the noninvasive GE MR approach, it is possible to acquire data representing all points within a three-dimensional area—commonly termed volume—the head, neck, or whatever. All blood vessels within that area can be seen from any orientation, and the volume can then be rotated to give views from front, back, top, bottom, or oblique angles.

One of the papers presented at the SMRM meeting in the Netherlands dramatized the advantage of MR angiography's 3-D



THIS VIEW SHOWING ALL THE MAJOR blood vessels of the hand was made without X-rays. It used a GE-developed technique known as "phase contrast magnetic resonance angiography." The GE technique—totally noninvasive and painless—enables viewers to see flowing blood and thereby delineate the veins and arteries through which it is flowing. The faster the blood flows, the brighter it appears on the MR scanner's display.

capability. A patient with multiple intercranial aneurysms was evaluated both with X-rays and MR. The resulting MR images clearly showed the aneurysms that were visible on the X-ray screen and also an extra one not discovered by X-rays. The additional aneurysm was found by rotating the 3-D image to an orientation that provided an unobstructed view.

Smart cards will respond to owner's voice

Based on the premise that no two voices are alike, Bellcore has devised a technology for personalized "smart cards" that work with spoken commands. The owner would "train" such a card—which contains integrated circuits and software—to recognize only his or her voice.

Bellcore's recently patented experimental system behind the "speaker-verification" concept could provide increased credit-card security and expedite other transactions involving an access card.

Bellcore's prototype speaker-verification system uses an integrated circuit card to store data about its owner's unique speech

patterns (speech templates) and other pertinent information. Data is loaded into the card when its owner "trains" the speaker-verification software to recognize his or her voice before using the card for the first time.

The system works with special voice-recognition software that could be built into equipment that it's used in, including telephones, or bank terminals equipped with a microphone. The software could also be stored in a centralized computer in a remote location such as a telephone company central office.

A speaker-verification system would be exceptionally easy to use since most commands are simply spoken. Commands range from securing access to the system to dialing pre-programmed telephone numbers.

For example, Once a smart card is programmed with its user's voice, a speaker-verification telephone call could proceed as follows:

The user would first insert the card into any speaker-verification terminal, which would extract the user's name, speech templates, and any special commands and billing information. When prompted, the users would speak the verification password. The password would be translated into digital form, and verified by the computer which would compare the voice against the pre-programmed speech templates.

Once verified as the proper user, you would be able to simply speak a command to initiate a sequence of events. For example, the command "Call Mom" could instruct the phone to generate the call, assuming the command and corresponding telephone number were stored in the smart card.

Bellcore plans to make the technology available for licensing, and believes that it will be quickly developed for many consumer and commercial uses. **R-E**

How to build a high-paying career, even a business of your own, in computer programming.



**CARL BARONE,
NRI PROGRAMMER/ANALYST**

Start with training that gives you hands-on programming experience—at home and at your own pace. Training that begins with BASIC, then continues with Pascal, C, and COBOL—today's hottest computer languages. Training that even includes a powerful IBM-compatible computer, modem, and programming software you keep.

Start with real-world training. The kind of training only NRI provides.

Now with NRI's new at-home training in Computer Programming, you can be one of today's highly paid, creative team of computer wizards who give computers the power to carry out an astonishing range of business, professional, and personal applications. Now, with NRI, you can be a computer programmer, ready to build a high-paying career—even a business of your own—making computers do anything you want them to do.

The only programming course that includes a powerful computer system and software you keep.

Unlike any other school, NRI gives you hands-on programming experience with a powerful IBM-compatible Packard Bell computer system, including 2400



Only NRI gives you an IBM-compatible computer with modem, 512K RAM, disk drive, monitor, and software—BASIC, Pascal, C, and COBOL—all yours to keep!

baud internal modem, 512K RAM, disk drive, monitor, and invaluable programming software—BASIC, Pascal, C, and COBOL—all yours to keep.

You get the experience and the know-how, the computer and the software to get to the heart of every programming problem, design imaginative solutions, then use your choice of four key computer languages to build original, working programs.

No matter what your background, NRI gives you everything you need to succeed in programming, today's top-growth computer career field.

You need no previous experience to build a successful programming career with NRI training. Indeed, your NRI lessons start by walking you step by step through the fundamentals, giving you an expert understanding of the programming design techniques used every day by successful micro and mainframe programmers. And then the fun really begins.

C, and COBOL. Then, rounding out your training, you use your modem to "talk" to your instructor, meet other NRI students, even download programs through NRI's exclusive programmers network, PRONET.

Your career in computer programming begins with your FREE catalog from NRI.

For all the details about NRI's at-home training in Computer Programming, send the coupon today. Soon you'll receive NRI's fascinating, information-packed, full-color catalog.

Open it up and you'll find vivid descriptions of every aspect of your NRI training. You'll see the computer system included in your course up close in a special, poster-sized foldout section. And, best of all, you'll find out how your NRI training will make it easy for you to build that high-paying career—even a business of your own—in computer programming.



You master today's hottest computer languages, gaining the skills you need to build programs for a wide variety of real-world applications.

With your personal NRI instructor on call and ready to help, you use your computer and software to actually design, code, run, debug, and document programs in BASIC, Pascal,

Send for your NRI catalog today. It's yours, free.

If the coupon is missing, write to us at the NRI School of Computer Programming, McGraw-Hill Continuing Education Center, 4401 Connecticut Avenue, NW, Washington, DC 20008.

IBM is a Registered Trademark of the IBM Corporation

NRI School of Computer Programming

McGraw-Hill Continuing Education Center
4401 Connecticut Avenue, NW
Washington, DC 20008



YES! Please rush me my FREE catalog describing NRI's at-home training in Computer Programming.

NAME (please print) AGE

ADDRESS

CITY/STATE/ZIP 5415-129

Accredited by the National Home Study Council

VIDEO NEWS



DAVID LACHENBRUCH,
CONTRIBUTING EDITOR

• **Widescreen TV.** In a major move toward the implementation of high-definition TV, Thomson Consumer Electronics announced at the recent Berlin Audio-Video Fair that it would introduce TV sets with widescreen proportions next fall. Thomson is Europe's second largest manufacturer of TV sets (after Philips). Its brands include Thomson in France; Telefunken, Saba, and Normende in Germany; and Ferguson in England. Thomson also sells RCA and GE TV sets in the United States, but says that its introduction of widescreen sets here will depend upon the American consumers' demand.

Widescreen TV's have an aspect ratio of 16:9, close to the proportions of Cinemascope movies, as compared with 4:3 for standard TV sets. HDTV broadcasting is expected to use widescreen proportions, and the European satellite broadcasts in the extended-definition D2-MAC system are expected to include some widescreen pictures as well as standard-aspect transmissions.

Thomson's first widescreen sets will use a new picture tube, now in pilot production, measuring 34 inches diagonally. In height, the 34-inch tube is the equivalent of a standard 28-inch type. The new set, which will sell for about \$5,000, will be a "multi-format multi-standard" model, which can receive broadcasts in all of the world's TV-transmission standards—those are PAL, SECAM, and NTSC.

In addition, the set will be able to tune directly to D2-MAC satellite programs, displaying widescreen pictures when transmitted, or standard-dimension programs from any source. When tuning regular, standard European broadcasts, it will be capable of doubling the number of fields from 50 to 100, eliminating flicker. At the touch of the remote control, it can enlarge a standard-aspect TV picture to display a "cinema" version, filling the widescreen tube by cutting of a portion of the picture's top and bottom. Alternatively, it can show a standard 4:3 picture at the left of the wide screen, with three smaller pictures from other channels (or a VCR) vertically in the space to the right of the main picture ("picture-outside-picture"). The new set

also can enlarge to full-screen "letterbox" TV transmissions and recordings (which normally have black bands at the top and bottom of the screen to show all of the original movie's dimensions).

Europe's D2-MAC transmissions, which started this year, are designed to be the forerunners of the true HDTV. They achieve improvement in the picture by transmitting brightness and color signals separately. The goal of the combined European "Eureka" project is to start compatible HD-MAC 1,250-line widescreen service in 1992. A preliminary version of HD-MAC was being transmitted from satellite and distributed by fiber optics and cable at the Berlin show for demonstration purposes.

• **Audio-video CD's.** Two interactive audio-video compact-disc formats are racing toward the consumer market, both with products tentatively scheduled for 1990 or 1991. Compact Disc Interactive (*CD-I*), championed by Philips, can squeeze a whole dictionary of audio and still- or limited-action video on a 5-inch CD. Digital Video Interactive (*DVI*), developed by GE and being readied for the market by Intel, claims up to 72 minutes of full-motion digital video, in addition to audio, on the same size disc. Both companies are aiming for \$1,000 players at first, coming down rather quickly to somewhere round the \$500 price level.

Manufacturers are still somewhat vague on what kind of programming they think will become popular, but Philips' subsidiary, American Interactive Media, has released a list of CD-I programs that are under development. Those include "A Visit to Sesame Street," "Children's Bible Stories," "Children's Musical Theater," "Clue," "Gardening," the "Grollier Encyclopedia," "Interactive Golf," "Kaleidoscope Music," "Oldies Juke Box," "Rand-McNally Family Atlas," "Rocket Ranger," "Sargon Chess," "Sinatra, my Father," "Stamps," "Time-Life Photography," and "Treasures of the Smithsonian." That list should give you some idea of what the new medium might be like.

R-E

THINK OF IT AS AN ELECTRONIC SWISS ARMY KNIFE.

CAPACITANCE METER

FREQUENCY COUNTER

This 41 range digital voltmeter, ammeter, ohmmeter, frequency counter, capacitance meter, logic probe, transistor and diode tester features an extra-large LCD display, rugged drop-resistant case and high-energy fusing.

While you won't flip-out forks or knives, you will flip for the versatility of this low-priced wonder. For immediate delivery, see your local B&K-PRECISION distributor.

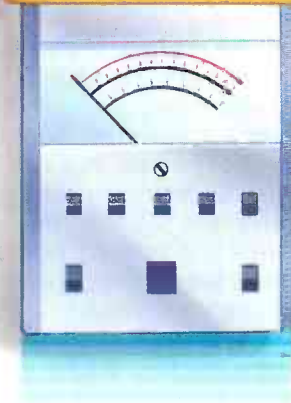

What an idea the Swiss had... a hand-held device combining many different tools in one unit. The same inspiration is behind B&K-PRECISION's new Model 388HD Test Bench. It offers the capabilities of five popular instruments in one hand-held package.

LOGIC PROBE

DIGITAL MULTIMETER

TRANSISTOR TESTER

B&K-PRECISION TEST BENCH

\$129

BK PRECISION
 MAXTEC INTERNATIONAL CORP.
 6470 W. Cortland St. • Chicago, IL • 312-889-1448
 International Sales, 6470 W. Cortland St., Chicago, IL 60635
 Canadian Sales, Atlas Electronics, Ontario.

CIRCLE 77 ON FREE INFORMATION CARD

www.americanradiohistory.com

ASK R-E

WRITE TO:

ASK R-E
Radio-Electronics
500-B Bi-County Blvd.
Farmingdale, NY 11735

BROKEN IC PIN

I bought an 80287 Math Coprocessor for my PC/AT and broke pin 1 flush with the DIP surface while installing it, so there's nothing to connect to. I've written the manufacturer, but no answer. Do you have any ideas?—J. Dunbar, Camden, TN

There's always a way to fix anything; let's talk about repairing IC legs in general, and then we'll deal with your 80287. Some methods will make a manufacturer cringe, some may make them cross the street and walk the other way when they see you, and others may just void your warranty. Putting a crutch on an IC is something that every hardware junkie does eventually. The best way is to replace the IC; however, trying to get a "recommended method" is like asking a car company how to repair a gas tank leak with bubble gum.

One of the staples of any electronics bench should be a collection of dead IC's, since the best replacement for one broken IC leg is another. Break the leg off a dead IC flush with the body of the DIP, and tin the end that was near the DIP. You neither need nor want much solder because the more you have, the more heat you'll need to melt it, and heat is the IC's deadly enemy.

Any electronics bench should have a collection of dead IC's, since the best replacement for one broken IC pin is another. Break off a dead IC pin flush with the package, and tin the package end. Don't use much solder; the more you have, the more heat you'll need, which may damage whatever IC you're trying to fix. Obviously, the best thing to do is

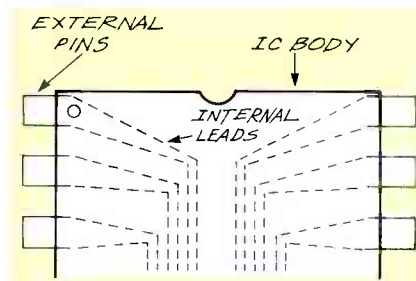

FIG. 1

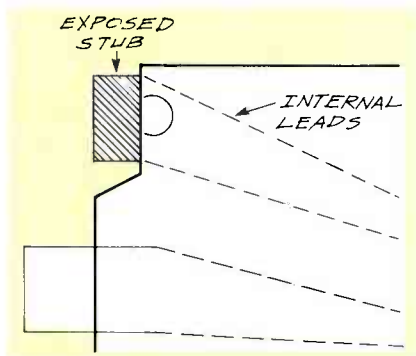

FIG. 2

replace it. Failing that, there are only two instances when you should fix it:

- It's three o'clock in the morning and you need it NOW!
- It's expensive.

If there's a stub left, just tin it and solder the new pin on. This can be tricky, since the new pin is small and will stick to the iron. You'll need a pair of tweezers and steady hands. Don't insist on perfect alignment with the rest of the pins, just get it close enough to fit in a socket. Align it after soldering, to minimize heat.

If the stub is flush with the DIP, first expose more metal; this can be done, but takes great care and very steady hands. Lock the IC *lightly* an alligator clip fixture for PC boards. If you don't have one, use an alligator clip held in a vise. Then, take a Dremel or X-acto

Moto-Tool or similar motorized handtool with a fine, pointed, grinding wheel, and remove some of the case, exposing some of the internal continuation metal, as in Fig. 1. It's not aesthetic, but it works.

Although you can work either on the top or bottom of the DIP, the top presents less risk of damaging other pins. Keep the chip cool with freeze spray or a napkin soaked in ice water. Remember, grinding also generates heat. Limit the area you're grinding to the width of the pin, about 1/16-inch of metal, but *don't* bear down. Whatever the case material, grind a few seconds, and stop to both examine the DIP and cool it off. How much you'll have to do depends on the case.

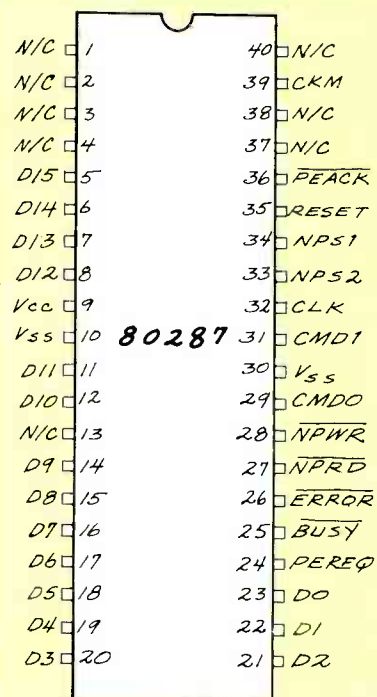
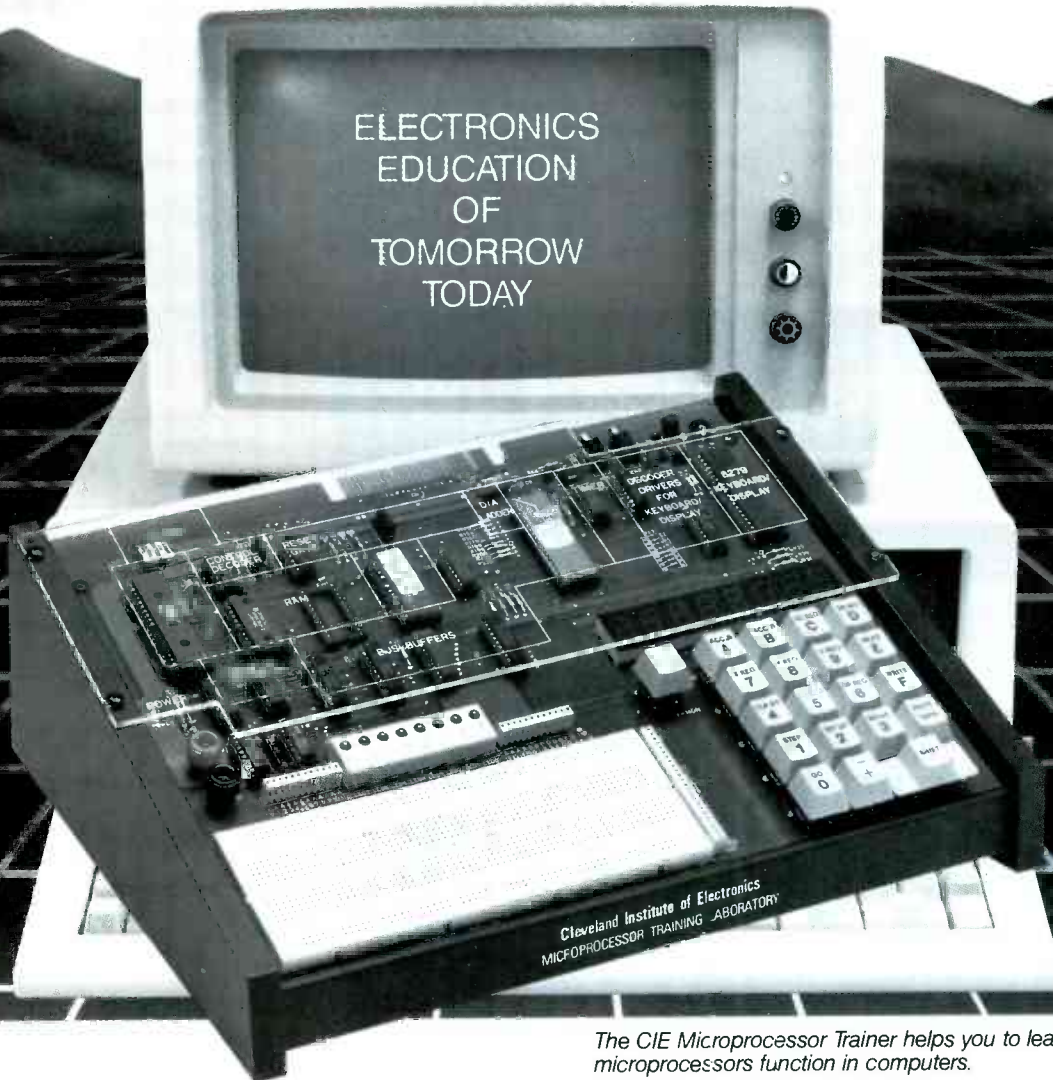

FIG. 3

EXPAND YOUR CAREER HORIZONS...



The CIE Microprocessor Trainer helps you to learn how circuits with microprocessors function in computers.

START WITH CIE.

Microprocessor Technology. Satellite Communications. Robotics. Wherever you want to go in electronics... start first with CIE.

Why CIE? Because we're the leader in teaching electronics through independent study. Consider this. We teach over 25,000 students from all over the United States and in over 70 foreign countries. And we've been doing it for over 50 years, helping thousands of men and women get started in electronics careers.

We offer flexible training to meet your needs. You can start at the beginner level or, if you already know something about electronics, you may want to start at a higher level. But wherever you start, you can go as far as you like. You can even earn your Associate in Applied Science Degree in Electronics.

Let us get you started today. Just call toll-free **1-800-321-2155** (in Ohio, 1-800-362-2105) or mail in

CIRCLE 60 ON FREE INFORMATION CARD

the handy reply coupon or card below to:
Cleveland Institute of Electronics,
1776 East 17th Street, Cleveland, Ohio 44114.

CIE World Headquarters

ARE-152

Cleveland Institute of Electronics, Inc.
1776 East 17th Street • Cleveland, Ohio 44114

Please send your independent study catalog.
For your convenience, CIE will try to have a representative contact you — there is no obligation.

Print Name _____

Address _____ Apt. _____

City _____ State _____ Zip _____

Age _____ Area Code/Phone No. _____

Check box for G.I. Bill bulletin on Educational Benefits

Veteran Active Duty **MAIL TODAY!**

Just call toll-free **1-800-321-2155** (in Ohio, 1-800-362-2105)

Ceramic is more resistant than plastic, but they leave no residue; plastic grinds quickly, but melts. Once you've got the metal exposed as in Fig. 2, tin it and solder to it.

For the 80287, when you break an IC pin, check whether it's used. Those for the 80287 are in Fig. 3, and you're lucky because pin #1 is labelled "N/C" (No Connection), so repairing it is pointless, all the more so since you might very well damage or

overheat it needlessly. Even the slowest 80287 costs over \$150. Since the only benefit is aesthetic, leave it alone. Besides, asymmetry is in vogue.

MIKE INPUT ATTENUATOR

I have a small cassette recorder to listen to tapes at work. I spent the extra money for record as well as play, since I'd like to use it for making the tapes I listen to work. The problem is, the machine only has a mike input, and the copies

are garbled. I've tried using series resistors to cut the level, but they don't. I know there's some way, but I'm out of ideas.—D. Conklin, Princeton, NJ.

You haven't sent in any specs on the recorder, but most have similar inputs. You're having a problem, since a series resistor only cuts current. To match signal line level to input mike level, cut the power of the input by dropping both voltage and current. The mike input needs about 200 μ V at -72 dB, whereas standard outputs deliver about 300 mV, at a 10:1 mismatch. The

POMONA still leads the way in test technology.

For over 35 years POMONA has proven its leadership position on the cutting edge of test technology. For example, we have created innovative solutions to the challenge of advanced ultra-miniaturized electronic components such as surface-mount devices. This sort of inspired dedication is another reason why the industry depends on POMONA.



For your FREE 1989 Catalog, CALL: 714-623-3463 or FAX: 714-629-3317

ITT Pomona Electronics
An ITT ElectroMechanical Components Worldwide Company

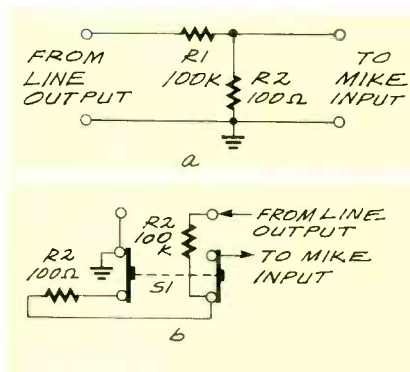

FIG. 4

problem is compounded if you've got low impedance 200-ohm mike inputs, not high impedance 50K inputs. Use one resistor for the signal current, and the other on the mike input voltage. You can use a transformer, but an resistive attenuator pad is easier. It does the same thing and might even fit inside the recorder.

Since I don't have the numbers on your mike input, you'll have to experiment. I used those in Fig. 4 to pad the mike input in my recorder, an old Sony TC-55 with low impedance mike input having 200 μ V sensitivity at -72dB.

If there's enough room, use a DPDT switch as in Fig. 4. With the switch in the "Mike" position, the input is in it's original condition. When you put the switch to "Line," the signal is first routed through R1 and then R2. Mount the resistors on the switch terminals to save space and keep the signal path short. Standard 1/4- or 1/8-watt resistors are fine.

R-E

ONCE YOU'VE GOT IT DESIGNED, YOU'VE GOT IT MADE.

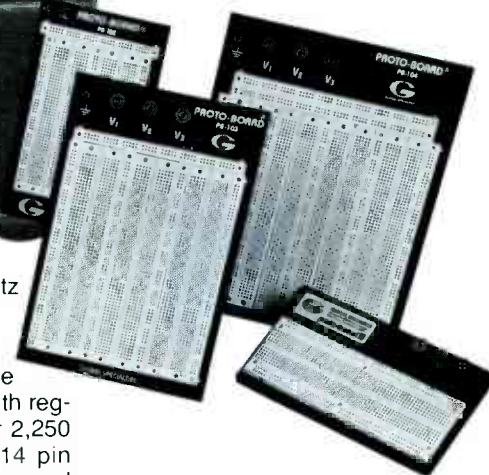
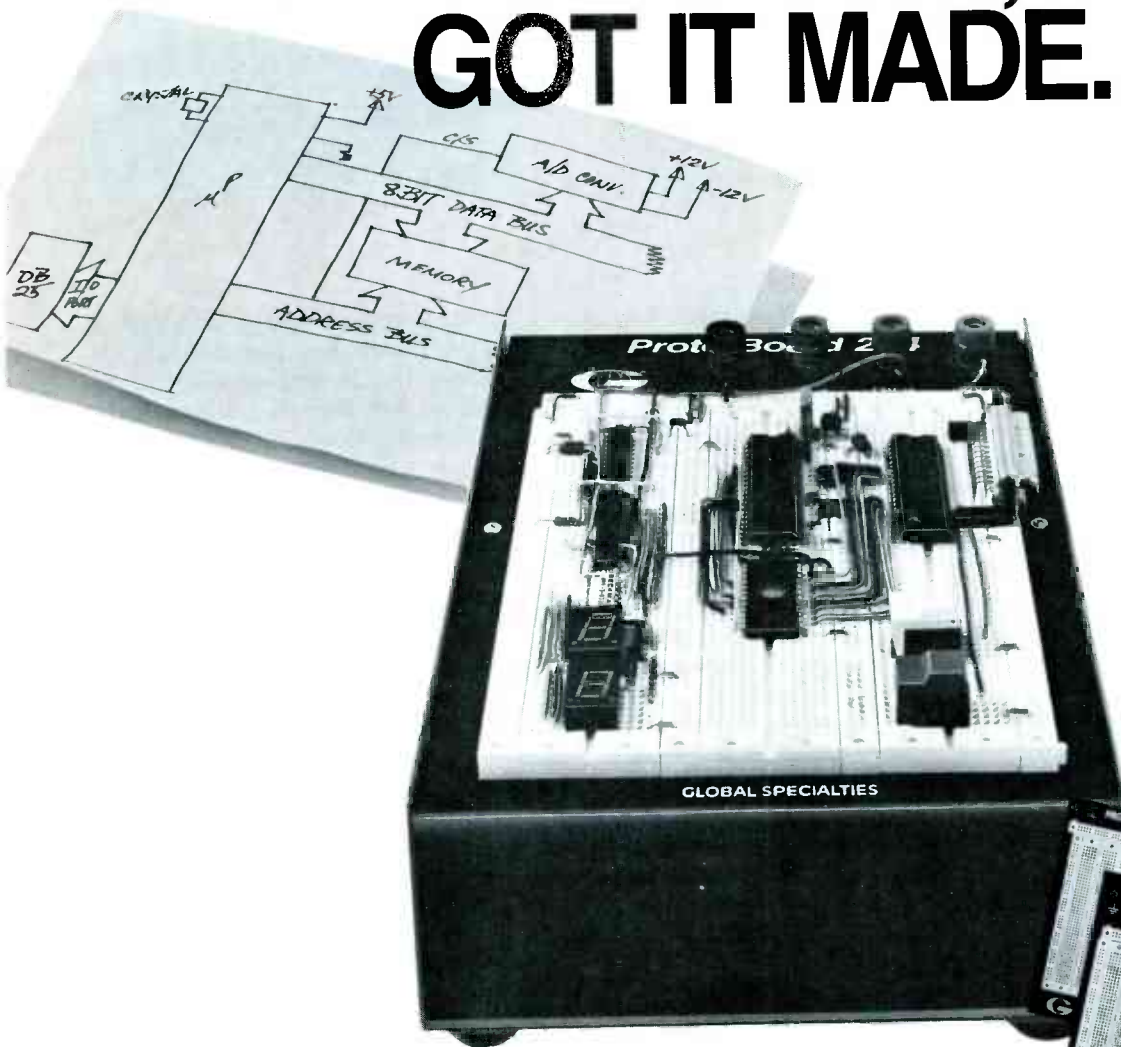

Now you can take those hot, new logic or block design diagrams, and quickly, easily bring them up to reality...in minutes...without solder!

Build circuits as fast as you can think. Test. Modify. Expand. Without burned-out parts or burnt fingers. Save time, money...and prove that you know that you're talking about... before you use your CAD.

Specify PROTO BOARD Brand, Today's recognized Standard for Quality in breadboarding. Here are five expandable breadboards, offering countless arrays of solderless sockets and bus strips that emulate pc board layouts. Pop in components. Pop them out again. Microprocessors. Memory. Large DIPs. Tiny discretes. Makes no difference. The patented aluminum backplane lets you work at

frequencies from DC to half-a-GigaHertz or 500MHz.

Need power? A powered PROTO BOARD Brand offers up to triple voltage power supplies, +5V, +12V, -12V, with regulated/current limited DC power. Over 2,250 tie points with 24 IC capacity and 14 pin DIPs. Super for TTL, CMOS, Op-Amps and microprocessor circuits. And lots more.

Best of all, your hassle-free American-made PROTO BOARD Brand comes with an unlimited lifetime guarantee on all the breadboard sockets. Prices are so modest, you'll wonder why you waited this long to specify PROTO BOARD Brand. Order today.



**GLOBAL
SPECIALTIES**

*Easy does it!*TM



Call toll-free for details
1-800-572-1028

Global Specialties. An Interplex Electronics Company.
70 Fulton Terrace, New Haven, CT 06512.
Telephone: (203) 624-3103. © Interplex Electronics 1989.
All Global Specialties breadboarding products made in USA.

CIRCLE 155 ON FREE INFORMATION CARD

A0010

LETTERS



SPECTRUM MONITOR CORRECTIONS

There are a few corrections and clarifications to "Build this Spectrum Monitor," which appeared in the September and October 1989 issues of **Radio-Electronics**. The tuner is a Zenith part No. 175-02292A. You can buy it from PTS Corp., 5233 S. Hwy 37, Bloomington, IN 47401, (800) 333-7871. Cost from PTS is \$33.45 including shipping and handling.

In the tuner diagram (Fig. 2 in the September issue), some of the nomenclature is not consistent with the schematic: PL5 is incorrectly labeled as PL1, PL6 as PL2, C41 as C1, and L3 as L1. In Fig. 4, the unlabeled electrolytic beneath R20 is C35.

Several performance aspects were unclear: Maximum frequency resolution is about 5 kHz. Rotating the center tune clockwise (CW) increases the center frequency, and vice-versa. The sweep controls horizontal scale; fully CW, it's about 10 MHz/div, if the center frequency isn't near the tuner extremes. Rotating it counterclockwise (CCW) expands the scale to about 5 MHz/div at mid-range, but it's not calibrated. Setting the sweep fully CCW exceeds the monitor's capability.—*Editor*

ASK RE AGAIN

There is a mistake in "Ask RE," **Radio-Electronics**, October, 1989. In the "I Need Values" letter, a schematic was given for a device

that turns on a tape recorder when a telephone handset is taken off-hook. The bridge rectifier, which makes the device polarity-independent, should be "rotated" 90 degrees with respect to the rest of the circuit. In other words, the inputs and outputs of the bridge should be transposed—*Editor*

ONE READER'S OPINION

I would like to respond to your recent request (**Radio-Electronics**, July 1989) for reader's votes on the "PC Service" section, and to voice my opinion on HDTV.

First, I vote to go back to putting artwork for the PC boards on pages with nothing printed on the other side. The way that it is presented now is worthless in most cases. I would also like to comment about your artwork for large (usually digital) PC boards. Because they are so complex and must be reduced to fit the page, they are usually unusable because tracks run together. As an alternative, perhaps you could make full-size, clean artwork available to readers by mail, at a small cost.

Now...HDTV. I think the whole idea of HDTV is a valiant effort for a needless cause. If equipment costs as much as is predicted, I certainly will not buy any. Why do you need more resolution on television, anyway—for sports nuts to see the lines on the football field clearer? I see no need to upset the whole industry for the relatively few who will go to big-screen TV (that, admittedly, requires better resolution). It seems that there is always a desire for companies to make more money, hidden behind so-called better products for the average consumer, and it winds up

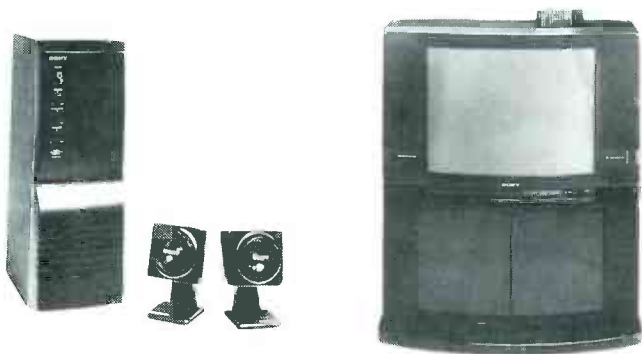

MISTAKEN IDENTITY

In the August 1989 "New Products" column, we featured a television and a speaker system from Sony and mistakenly described both as incorporating Sony's Sound Retrieval System (SRS) technology. Actually, SRS is used only in the Sony XBR line of television sets and in several high-

end Trinitron sets; their SRS speaker systems do not incorporate SRS technology. The SRS-D3K speaker system, shown here and in the original "New Products" column, costs \$299.95; the correct price for the SRS-77G system is \$199.95. Our apologies for the confusion.—*Editor*

Radio Shack Parts PlaceSM

**GET YOUR HOLIDAY PROJECT STARTED TODAY!
VISIT RADIO SHACK FOR ONE-STOP SHOPPING**

Save With Our Hotline Order Service



Over 200,000 Substitutions

Your Radio Shack store manager can phone in a special order for a wide variety of parts and accessories not in our catalog—tubes, linear and digital ICs, diodes, popular TV modules and much more. You can even order any of the SAMS Manuals! No postage or handling charges, no minimum order. We'll call you when your order arrives, in about a week.

New! Special Battery "Hotline"

Your nearby Radio Shack is now your source for everything in consumer batteries—cordless telephone packs, special communications batteries used in police, fire and emergency walkie-talkies and pagers, to name just a few. We will place your order on our phone "Hotline", and your batteries will be shipped directly to your Radio Shack from our main warehouse. We'll notify you when your order arrives. No shipping or handling charges for this convenient service.



High-Quality Cables and Connectors

NEW!

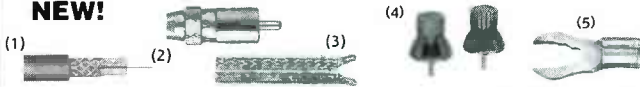

- (1) Oxygen-Free Copper A/V Cable. 6mm dia., 6 ft. #278-1271 ... 5.95
- Oxygen-Free Copper Cable. 8mm dia., 6 ft. #278-1272 ... 7.59
- (2) Phono Plug for 6 mm OF Cable Above. #274-860 ... 4.99
- Phono Plug for 8 mm OF Cable Above. #274-861 ... 5.99
- (3) Speaker MEGACABLE[®]. 12-gauge copper. #278-1268 ... Per Foot 99¢
- (4) Terminal Knobs for MEGACABLE. #274-619 ... Set of 2/5.95
- (5) Crimp Terminals for MEGACABLE. #64-401 ... Set of 8/4.99

Word-Recognizer on a Chip

688
Cut 31%

Reg. 9.95

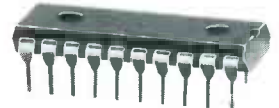

VCP200. Great experimenter's item—control circuits with your voice, or conduct research in robotics and computer technology. Recognizes spoken orders, even when different people give the commands. Five motion and two on/off or yes/no commands. Clipped analog input so A-to-D conversion circuit is not required. Few external parts needed. 20-pin DIP. #276-1308

LED and IR Module

NEW!

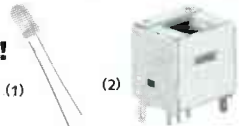

- (1) NEW! Jumbo Bright LED. 5000 mcd! #276-086 ... 4.99
- (2) IR Detector Module. Combines detector, amp, demodulator, limiter filter, integrator, comparator. Requires 5VDC. #276-137 ... 3.49

Jumper and Plugs



- (1) 14" Jumper/Test Cables. Gator clips. #278-1156, Set of 10/3.99
- (2) NEW! Stackable Banana Clips. #274-734 ... Set of 2/1.59
- (3) Multipurpose Posts. 2 red, 2 black. #274-661 ... Set of 4/2.19

Supply Parts

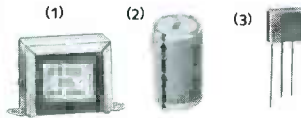

- (1) Power Transformer. Secondary: 18 volts. #273-1515 ... 8.99
- (2) Electrolytic Capacitor. 4700 µF. #272-1022 ... 3.59
- (3) Full-Wave Bridge Rectifier. 400 PIV, 4A. #276-1173 ... 1.99

Builder's Helpers

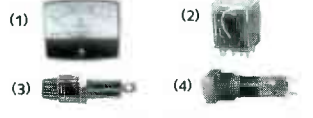

- (1) Panel DC Voltmeter. 0-15VDC. #270-1754 ... 7.95
- (2) 10A Relay. #275-217 ... 5.99
- (3) Fuse Holder. #270-364, 1.29
- (4) SPDT Lighted Switch. 3 amps at 120VAC. #275-676 ... 6.49

Electronics Books

NEW!



- (1) Getting Started in Electronics. #276-4013 ... 2.49
- (2) NEW! Semicon Ref Guide. 1990 edition! Lists over 80,000 types and their Radio Shack equivalents. #276-4013 ... 3.99

Instrument Cases



Deluxe Steel Enclosures.

Size	Cat. No.	Each
3 1/16 x 8 1/4 x 6 1/8	270-274	10.49
1 15/16 x 8 1/4 x 6 1/8	270-272	8.49

Parts-Pourri

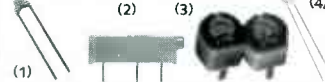

- (1) Thermistor. #271-110 ... 1.99
- (2) 15-Turn Trimmer Pot. PC mount. 3/4W. 1k #271-342, 10k #271-343, 20k #271-340. Each 1.49
- (3) Pkg. 2 Trimmer Caps. 6-50 pF. PC-mount. #272-1340 ... 2/1.59
- (4) Pkg. 50 Picofarad Caps. 1-33 pF. #272-806 ... 6.95

Chime and Buzzer

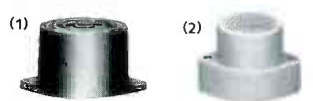

- (1) Doorbell Chime. Produces musical "ding-dong". Rated 6 to 18VDC, 80 dB at 12VDC. #273-071 ... 8.99
- (2) Pulsing Buzzer. Commanding 80 dB output at 2 Hz pulse rate. 12VDC, 20 mA. #273-058 ... 3.49

DVM/Capacitance Meter

NEW!

79⁹⁵



This single time-saving tool combines a 30-range DVM with capacitance and transistor gain meters! Measures to 1000VDC and 750VAC, 10 amps AC/DC, 20 megohms resistance, 20 µF capacitance and transistor DC gain. #22-194

Breadboard & Jumpers



- (1) Universal Solderless Breadboard. Accepts DIPs, components and jumper wires (kit below recommended). #276-169 ... 19.95
- (2) Jumper Wire Kit. 140 insulated, prestripped wires. Case included. #276-173 ... Set 4.95

Electronics Calculator

39⁹⁵



Radio Shack EC-4035. Accepts input and displays output using popular electrical symbols—1000Ω × .5A = 500V. Has 110 functions including trig and statistics. Alphanumeric display with contrast control. Engineering keys. Includes batteries and case. #65-983



Over 1000 items in stock! Binding Posts, Books, Breadboards, Buzzers, Capacitors, Chokes, Clips, Coax, Connectors, Fuses, Hardware, ICs, Jacks, Knobs, Lamps, Multitesters, PC Boards, Plugs, Rectifiers, Resistors, Switches, Tools, Transformers, Wire, Zeners, More!

Prices apply at participating Radio Shack stores and dealers

Radio Shack[®]
The Technology StoreSM

A DIVISION OF TANDY CORPORATION

CIRCLE 78 ON FREE INFORMATION CARD

www.americanradiohistory.com

making all products cost more.

I love **Radio-Electronics**! Keep up the good work.

NORMAN STOBERT
Berrien Springs, MD

WORKING LIKE NEW

Thanks so much for the articles, "New Radios, New Problems, New Solutions," by Gary McClellan (**Radio-Electronics**, July and August 1989). By using some of the suggestions in those articles, I was able to fix a Delco radio that I couldn't find parts for and a Sansui car stereo that had been "butchered" by some other technician. You saved my neck! Let's have more articles like those.

JIM PRIOR
St. Paul, MN

RADIATION RISKS

Like Roy Norman, whose letter appeared in the November issue of **Radio-Electronics**, I was impressed with the series of articles called the "Annals of Radiation" that appeared in three consecutive issues of *The New Yorker* ("Power

Lines," June 12; "Radar," June 19; and "Video Displays," June 26). As an artist who works with electronics, a repair technician, a teacher, and a hobbyist, I found the series to be extremely sobering. I think the material is a "must read" for all of us involved in electronics—as well as those who aren't.

Those articles carefully document research showing at least a doubling of the incidence of leukemia in people living two houses or less from utility-pole-mounted stepdown transformers. The dangers seem to be caused by the magnetic fields and I want very much to build some sort of device that can accurately measure those fields. The important frequencies are 60 Hz, 120 Hz, and 15.7 kHz. I would like the meter to read directly in Milli-Gauss units.

I think that this is also important in light of **Radio-Electronics'** recent articles on brain-wave experimentation both with computers (September, October, and November 1988) and with meditation goggles

(April 1989). *The New Yorker* series discussed research in which cats were exposed to 147-MHz radio waves. They found that unmodulated radio waves of 1 mW/sq. cm. didn't cause any problems, but when they were modulated at brain-wave frequencies, significant electrical disturbances in the cats' brains were observed. The experiment was repeated on chicks and was definitely shown to cause serious calcium-ion and immune-system problems in their brain tissue.

I know that the knee-jerk response to that sort of stuff is to ignore it—after all, it is very harrowing news. But it would be sad if that happened.

FRED WOLFLINK
Brookline, MA 02146

THE GREAT WIRE DEBATE

Concerning the "great wire debate," I conducted experiments similar to those done by Mr. Kiley (**Radio-Electronics**, "Letters," August 1989). In my case, I compared the performance of both 18-SEG

With Just One Probe Connection, You Can Confidently Analyze Any Waveform To 100 MHz, 10 Times Faster, 10 Times More Accurately, Absolutely Error Free, Guaranteed — Or Your Money Back!

SC61 Waveform Analyzer™
Patented
\$3295

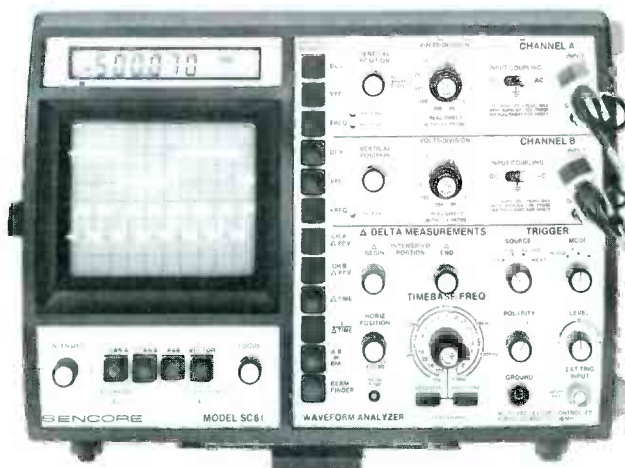

There are other digital readout oscilloscopes, but none of them completely eliminate graticule counting and calculations like the SC61 Waveform Analyzer. The innovative, time-saving AUTO-TRACKING™ digital readout automatically gives you every waveform parameter you need for fast troubleshooting.

The SC61 Waveform Analyzer is a triple patented high performance scope that provides you with a digital LCD read-out of all key waveform parameters (DC volts, peak-to-peak volts, and frequency) at the push of a button, and all with one probe connection.

Other time-saving features include exclusive ECL sync circuits that allow you to lock quickly onto waveforms up to 100 MHz. Plus, with 3000 volts of input protection, you never have to worry about an expensive front end repair job.

Call 1-800-SENCORE to find out more about what the SC61 can do for your service business. In Canada call 1-800-851-8866.

SENCORE

3200 Sencore Drive, Sioux Falls, SD 57107

100% American Made

CIRCLE 151 ON FREE INFORMATION CARD

twin cable and that of standard 5-A PVC line cord 20 feet in length. I also compared performance between working into an actual commercial loudspeaker and a purely resistive load, as well as making direct measurements at the output of the amplifier. Extrapolating for the difference between Mr. Kiley's tests and mine, I arrived at exactly the same conclusions as Mr. Kiley did.

I did, however, find that there was some contact resistance in the speaker connections that far outweighed the resistance of the wire. Checking for the cause I found that, although the external connections to the speaker used standard binding posts, the connections to the driver itself were made via inexpensive slide-on lugs, and that merely jiggling them slightly resulted in variations in the overall resistance of the setup. That was in line with my general experience that poor-quality connectors are far more often the cause of signal degeneration than wire characteristics per se.

No "premium-wire pusher" has ever presented any evidence for his claims, and to my knowledge, no blind group-listening-test results have ever been published (certainly not by the wire pushers!). Fortunately, there are signs that professional audio engineers are increasingly debunking the wire manufacturers' absurd claims.

I would like to express my appreciation for Larry Klein's many contributions to common sense in those matters and for **Radio-Electronics'** consistent objectivity and independent stance in all of the subjects it tackles—which is a tribute to its faithfulness to the principles of its founder, the late Hugo Gernsback. In these days of blatant scams, it is one of the few publications I know that I can always trust.

JOHN COX

Vancouver, B.C., Canada

BEHIND THE TIMES?

I've read **Radio-Electronics** for more than 20 years, and you've had quite a few interesting articles in that time.

Lately quality has gone down,

and I think your magazine should adapt itself to today's and tomorrow's technology and stop looking only at the technology of 5 or 10 years ago. Hobbyists used to be innovators, inventors of new electronic toys. Most hobbyists have only magazines like yours to inform them of new microchips, and you don't seem to do your job very well.

It seems to me, by your articles on microprocessors, that the news takes a long time to reach your magazine. Take the 68705 for instance. I've used that chip for seven years, and first noticed an article on it in your magazine this year. What about the 8096, 8098, TMS370, uPD7810, uPD7810, uPD7811, HD64180, HD647180, HD64180S, V25, H8, HPC, 68701, 68HC11, 8051, 8751, and 8031, to name a few?

The most amusing article I've seen in years is the one on PLC in the September issue. ("Programmable Architectures: The Next Breakthrough?") What are GAL's, PEEL's, or EPLD's, might I ask? It sounds like an article that must have been written in the early 1970's. I can understand that EPLD's are rather new, but I've used them for three years and their EEPROM counterparts for two years, and I've yet to see **Radio-Electronics** write anything about them.

I was rather surprised to see that the EPROM used most often in your articles appears to be the 2716. Don't you know that the 2716 is an obsolete part? The king in the electronic world nowadays is the 27C256. If I were to design anything with a 2716 my boss would think that I was nuts.

MICHAEL CATUDAL

Silver Creek, NY

We try to keep our construction projects buildable. That often precludes using the latest and greatest parts in a project. If a 2716V (which costs about \$4.00) will do the job, why would you use a 27C512 that costs three times as much?

Your point on covering new technology is well taken. We hope that some of the articles we have planned for the coming year answer at least a few of your complaints.—Editor

R-E

Put Professional Knowledge and a COLLEGE DEGREE in your Technical Career through HOME STUDY

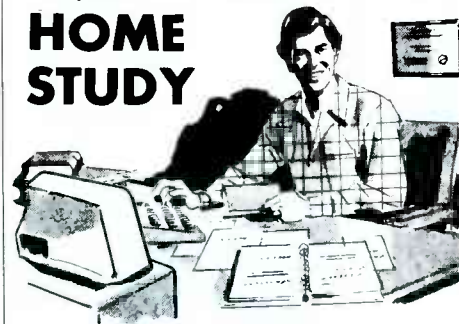

Add prestige and earning power to your technical career by earning your Associate or Bachelor degree through directed home study.

Grantham College of Engineering awards accredited degrees in
electronics and computers.

An important part of being prepared to *move up* is holding the right college degree, and the absolutely necessary part is knowing your field. Grantham can help you both ways—to learn more and to earn your degree in the process.

Grantham offers two degree programs—one with major emphasis in **electronics**, the other with major emphasis in **computers**. Associate and bachelor degrees are awarded in each program, and both programs are available completely by correspondence.

No commuting to class. Study at your own pace, while continuing on your present job. Learn from easy-to-understand lessons, with help from your Grantham instructors when you need it.

Write for our free catalog (see address below), or phone us at toll-free 1-800-955-2527 (for catalog requests only) and ask for our "degree catalog."

Accredited by
the Accrediting Commission of the
National Home Study Council

GRANTHAM
College of Engineering
10570 Humbolt Street
Los Alamitos, CA 90720

BEST FOR LO

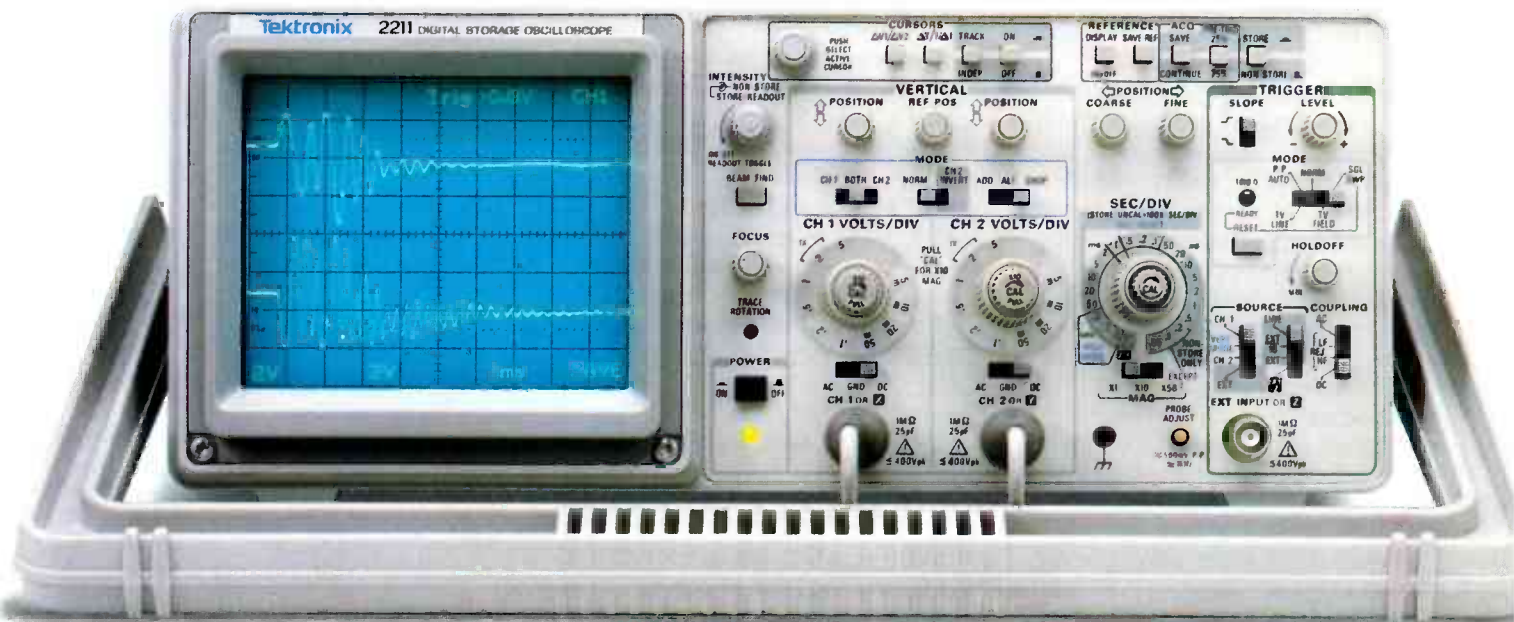

Tek's new 50 MHz 2211 gives you more measurement power for the money than any scope in its class. If you want the performance of an expensive digital scope, but not the cost, our new 2211 is the perfect solution. It represents Tek know-how and quality at its affordable best.

It combines powerful 20 MS/s digital sampling with the familiar operation of an analog scope. In digital storage mode you can capture and display single-shot events, see what happened before a trigger event, or compare newly-acquired signals to a stored waveform.

And if you need to analyze fast or complex signals in real time, simply switch to analog mode with the push of a button.

Productivity-enhancing features are in abundant supply. For instance, all measurements and front-panel scale factors appear on the CRT. Waveform cursors automatically calculate time and voltage. A 4K record length and X50 magnification give you excellent timing resolution, plus analog-quality displays. And trigger levels can be read directly on the screen.



Copyright © Tektronix, Inc. 1989 *Prices subject to change and valid in U.S. only. Educational discounts available on request.

W-COST TEST

There's even a standard hardcopy interface that lets you connect the 2211 to Epson printers or HPGL-compatible plotters, such as the Tek HC100, for convenient automatic 4-color documentation.

Of course, the true indication of why the 2211 is "best for low-cost test" is price: it's only **\$2495**. A sum that includes Tek's remarkable 3-year warranty on all parts and labor — even the CRT.

**Three
value-packed
companions
starting at
\$695.**

Model Number	2211	2201	2225	2205
Bandwidth	50 MHz	20 MHz	50 MHz	20 MHz
Storage Bandwidth	1 MHz	1 MHz	N/A	N/A
Sample Rate	20 MS/s/ch	10 MS/s/ch	N/A	N/A
Vert. Sensitivity	500 μ V/div	5 mV/div	500 μ V/div	5 mV/div
Cursors/Readout	Yes	No	No	No
Hardcopy Interface	Yes	Option	No	No
Record Length	4K/ch	2K/ch	N/A	N/A
Vertical Resolution	8 bit	8 bit	N/A	N/A
Price*	\$2495	\$1495	\$1095	\$695



For low-cost testing from 20 to 50 MHz, Tek has the best line-up in the business.

There's the 50 MHz 2225, which offers superb vertical sensitivity, delay, and horizontal magnification up to X50 for only **\$1095**. The 20 MHz, 10 MS/s 2201 is an economical introduction to digital storage at **\$1495**. And for reliable, ultra low-cost analog measurement, get the 20 MHz 2205 for an incredible **\$695**.

It's easy to get the best. To order your low-cost Tek oscilloscope or get more information, contact your local Tek representative. Or call Tek direct at:



1-800-426-2200

Tektronix
COMMITTED TO EXCELLENCE

EQUIPMENT REPORTS

Precision Motion 20-MHz Logic Analyzer

A 16-channel, 20-MHz logic analyzer that fits in the palm of your hand!

CIRCLE 40 ON FREE INFORMATION CARD



YOU CAN NOW ADD LOGIC ANALYZERS to the list of electronics test equipment that has made the transition from being esoteric and expensive to being rudimentary and relatively inexpensive. As micro-processor-based equipment became ubiquitous, having the proper tools to service them became essential to technicians. Helping to fill that need was a handheld, 16-channel, 20 MHz logic analyzer from Precision Motion (3563 Sueldo Building J, San Luis Obispo, Ca 93401).

Precision Motion's logic analyzer is optimized for—but not limited to—debugging ROM-based hexadecimal code. It features true 20-MHz data acquisition capability, a data-storage memory for 1023 samples both before and

CABLE TV

TB-3 (Tri-Bi) or SA-3

Quantity

10

20

Prices

50

100

\$48.

Each

\$43.

Each

\$39.

Each

\$35.

Each

King Wholesale

1-800-729-0036

"No one beats the King's prices!"

DESCRAMBLERS

WITH CIE, THE WORLD OF ELECTRONICS CAN BE YOUR WORLD, TOO.

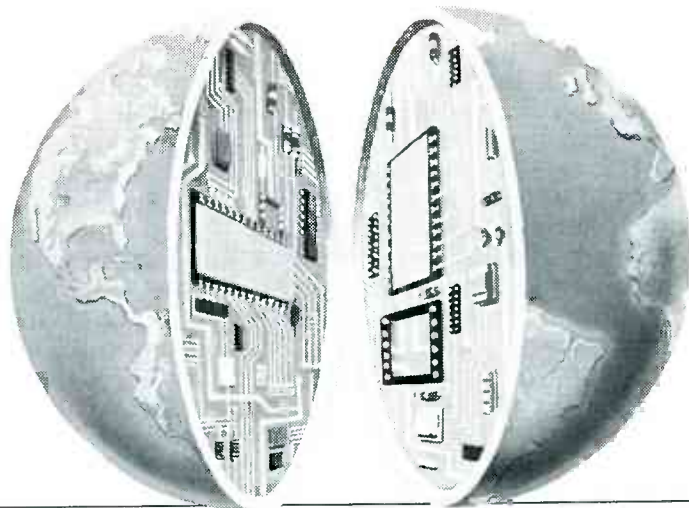

Look at the world as it was 20 years ago and as it is today. Now, try to name another field that's grown faster in those 20 years than electronics. Everywhere you look, you'll find electronics in action. In industry, aerospace, business, medicine, science, government, communications—you name it. And as high technology grows, electronics will grow. Which means few other fields, if any, offer more career opportunities, more job security, more room for advancement—if you have the right skills.

SPECIALISTS NEED SPECIALIZED TRAINING.

It stands to reason that you learn anything best from a specialist, and CIE is the largest independent home study school specializing exclusively in electronics, with a record that speaks for itself. According to a recent survey, 92% of CIE graduates are employed in electronics or a closely related field. When you're investing your time and money, you deserve results like that.

INDEPENDENT STUDY BACKED BY PERSONAL ATTENTION.

We believe in independent study because it puts you in a classroom of one. So you can study where and when you want. At your pace, no somebody else's. And with over 50 years of experience, we've developed proven programs to give you the support

such study demands. Programs that give you the theory you need backed with practical experience using some of the most sophisticated electronics tools available anywhere, including our Microprocessor Training Laboratory with 4K of random access memory. Of course, if you ever have a question or problem, our instructors are only a phone call away.



START WHERE YOU WANT, GO AS FAR AS YOU WANT.

CIE's broad range of entry, intermediate, and advanced level courses in a variety of career areas gives you many options. Start with the Career Course that best suits your talents and interests and go as far as you want—all the way, if you wish, to your Associate in Applied Science Degree in Electronics Engineering Technology. But wherever you start, the time to start is **now**. Simply use the coupon below to send for your FREE CIE catalog and complete package of career information. Or phone us, toll-free, at 1-800-321-2155 (in Ohio, 1-800-523-9109). Don't wait, ask for your free catalog now. After all, there's a whole world of electronics out there waiting for you.

CIE

Cleveland Institute of Electronics, Inc.
1776 East 17th Street, Cleveland, Ohio 44114

Member NHSC
Accredited Member National Home Study Council

ARE-153

CIE **Cleveland Institute of Electronics, Inc.**
1776 East 17th Street, Cleveland, Ohio 44114

YES... I want to learn from the specialists in electronics—CIE. Please send me my FREE CIE school catalog, including details about CIE's Associate Degree program, plus my FREE package of home study information.

Name (print): _____

Address: _____

City: _____ State: _____ Zip: _____

Age: _____ Area Code/Phone No.: _____ / _____

Check box for G.I. Bill bulletin on educational benefits:

Veteran Active Duty

**MAIL
TODAY!**

CIRCLE 60 ON FREE INFORMATION CARD

www.americanradiohistory.com

after the trigger, a Centronics-compatible printer interface, and data-management functions.

The analyzer is housed in a gray plastic case that measures roughly 7×4×1 inches. The front panel is dominated by a 24-key membrane keypad, a 2-line by 16-character LCD readout, and 6 terminals for inputs and outputs. A DB-25 parallel printer port is provided at the side of the analyzer, while the top edge of the unit offers a test-cable connector and power-supply input. A 5-volt regulated wall-transformer power supply is provided with the analyzer.

The 28-pin IC test clip is well suited for connection to either 24- or 28-pin EPROM's. The test clip can connect up to 14 of the EPROM's address lines to the analyzer. The data on those lines (0-13) form the hexadecimal data words that are shown on the display. Two additional inputs are provided on the front panel for lines 14 and 15. Those data are displayed separately, unless specifically appended to the data word. The analyzer directly supports

2758, 2716, 2732, 2764, 27128, and 27256 EPROM's. Some earlier EPROM's, specifically those that use -5 and +12 volts, cannot be hooked up directly to the analyzer.

Once the analyzer is connected to the circuit under test, and the proper ROM is selected and the clock is properly selected, then the analyzer is ready to do its job taking data. Once started, the analyzer continuously loads hexadecimal data words into its memory. The memory will hold the 1023 most recent words, writing over any old data. Once the selected trigger word is stored, the following 1023 data words are stored. The total memory of the analyzer is 2047 words.

Once the data words are stored, they data words can be easily viewed. The analyzer display will start from the trigger position. Left and right arrow keys can be used to scroll through the memory. Shortcuts are provided to move through the memory more quickly, and a search function is provided for finding a particular data word.

Outputting the contents of the

data memory to a printer is simply a matter of setting the cursor to the memory position where you want the output to start, and then issuing the print command. The next 500 hexadecimal data words will be output to a Centronics-compatible printer in a format of 10 columns of 50 words each. A timing-diagram format can also be printed. If that option is chosen, a 16-channel graphic diagram for 101 clock periods will be output. The contents of channels 14 and 15 can be output separately. Turning the analyzer into a handheld two-trace, two state storage scope.

Other features of the analyzer include a hexadecimal/decimal calculator/converter, a pre-trigger arm function, and a stopwatch.

We've only scratched the surface of the capabilities that the Precision Motion logic analyzer delivers. We found the features, the small package, and the \$1495 price of the analyzer impressive, and we're almost looking forward to having a microprocessor-based system break down so we can put it back to work. R-E

When performance & price really count...

CRYSTEK CRYSTALS

The pulse of dependable communications

QUARTZ CRYSTALS FOR Industrial Equipment/Instrumentation

- Micro-processor control
- Computers/Modems
- Test/Measurement
- Medical

General Communications

- Channel element Service (VHF/UHF)
- Land Mobile 2-way
- Marine
- Aircraft
- Telemetry
- Monitors/Scanners/Pagers

Amateurs/2-Meter/General Coverage CB/Hobbyist/Experimenter

For Optimum Stability and Reliability in Frequency Management

Replacement Crystals Catalog

The Pulse of Dependable Communications...

Crystek Crystals offers their new 16 page FREE catalog of crystals and oscillators. Offering state of the art crystal components manufactured by the latest automated technology. Custom designed or "off the shelf," Crystek meets the need, worldwide. Write or call today!

CRYSTEK CORPORATION
DIVISION OF WHITEHALL CORPORATION

2351/2371 Crystal Drive • Ft. Myers, FL 33907
P.O. Box 06135 • Ft. Myers, FL 33906-6135
TOLL FREE 1-800-237-3061
PH 813-936-2109/TWX 510-951-7448/FAX 813-939-4226
TOLL FREE IN THE U.S.A. EXCEPT FLORIDA, ALASKA, HAWAII

ATTENTION! ELECTRONICS TECHNICIANS

**EARN YOUR
B.S.E.E.
DEGREE**

THROUGH HOME STUDY

Our New and Highly Effective Advanced-Placement Program for experienced Electronic Technicians grants credit for previous Schooling and Professional Experience, and can greatly reduce the time required to complete Program and reach graduation. No residence schooling required for qualified Electronic Technicians. Through this Special Program you can pull all of the loose ends of your electronics background together and earn your B.S.E.E. Degree. Upgrade your status and pay to the Engineering Level. Advance Rapidly! Many finish in 12 months or less. Students and graduates in all 50 States and throughout the World. Established Over 40 Years! Write for free Descriptive Literature.

COOK'S INSTITUTE OF ELECTRONICS ENGINEERING

4251 CYPRESS DRIVE
JACKSON, MISSISSIPPI 39212

CIRCLE 58 ON FREE INFORMATION CARD

TELEVISION HAS COME A LONG WAY IN a short time. Somewhere in the past couple of years the television business was transformed into the video industry. And where once screens were only filled with images designed to entertain, today's tubes display everything from Martian invaders at a quarter a pop to stock quotes at considerably higher prices.

The increased sophistication of video monitors has led to the need for more sophisticated diagnostic tools to maintain them. Once upon a time the instruments needed to service televisions were often bigger and more expensive than the televisions themselves. BK Precision (6470 W. Cortland St., Chicago, IL 60635) has always had a line of video test gear and anyone involved in servicing video equipment should certainly be familiar with it.

Their model 1249 is their low-end video-signal generator. Despite a relatively low cost, it can produce just about every signal needed to test, service, and adjust a wide variety of NTSC compatible monitors and television sets. The instrument can generate standard NTSC color bars, split image bars, staircase, and an assortment of line and dot patterns useful for set-ups and convergence.

All the patterns the 1249 can generate are available on several outputs, from composite video, to a 45.75 MHz IF, to modulated RF on either channel three or four. This is a great convenience for tracing problems since the same signal can be injected at different points in the video chain. Being able to single-step your way from the antenna input to the final video amplifier makes it much easier to pinpoint problem areas in tuners and video circuits. Since all the outputs are buffered, they can all be used simultaneously. This means you don't have the hassle of plugging and unplugging cables as you work your way through video circuitry.

To make the instrument as versatile as possible, all the important frequencies are generated from a single master clock and the individual components of the video signal are brought out to separate front panel BNC connectors. This

B + K Precision Model 1249 NTSC Generator

A reliable, easy-to-use servicing tool.

CIRCLE 41 ON FREE INFORMATION CARD



is really convenient if you're using an oscilloscope because, for example, you can trigger off H while

snooping around a suspect monitor and you can be fairly sure of stable traces.

OPTOELECTRONICS



You Have Counted on Us for 15 Years

You have counted on OPTOELECTRONICS Hand Held Frequency Counters to be the best quality, to be affordable and reliable. We have been there for you with Frequency Counters that are compact and ultra sensitive.

And more and more of you are counting on us, technicians, engineers, law enforcement officers, private investigators, two-way radio operators, scanner hobbyists, and amateur radio operators, just to name a few.

Hand Held Series Frequency Counters and Instruments					
MODEL	2210	1300H/A	2400H	CCA	CCB
RANGE: FROM TO	10 Hz 2.2 GHz	1 MHz 1.3 GHz	10 MHz 2.4 GHz	10 MHz 550 MHz	10 MHz 1.8 GHz
APPLICATIONS	General Purpose Audio-Microwave	RF	Microwave	Security	Security
PRICE	\$219	\$169	\$189	\$299	\$99
SENSITIVITY					
1 KHz	< 5 mv	NA	NA	NA	NA
100 MHz	< 3 mv	< 1 mv	< 3 mv	< .5 mv	< 5 mv
450 MHz	< 3 mv	< 5 mv	< 3 mv	< 1 mv	< 5 mv
850 MHz	< 3 mv	< 20 mv	< 5 mv	NA	< 5 mv
1.3 GHz	< 7 mv	< 100 mv	< 7 mv	NA	< 10 mv
2.2 GHz	< 30 mv	NA	< 30 mv	NA	< 30 mv

ACCURACY ALL HAVE +/- 1 PPM TCXO TIME BASE.

All counters have 8 digit red .28" LED displays. Aluminum cabinet is 3.9" H x 3.5" x 1". Internal Ni-Cad batteries provide 2-5 hour portable operation with continuous operation from AC line charger/power supply supplied. Model CCB uses a 9 volt alkaline battery. One year parts and labor guarantee. A full line of probes, antennas, and accessories is available. Orders to U.S. and Canada add 5% to total (\$2 min. \$10 max). Florida residents, add 6% sales tax. COD fee \$3. Foreign orders add 15%. MasterCard and VISA accepted.

Orders to U.S. and Canada add 5% to total (\$2 min. \$10 max) Florida residents, add 6% sales tax. COD fee \$3. Foreign orders add 15%. MasterCard and VISA accepted

OPTOELECTRONICS INC.

5821 N.E. 14th Avenue • Fort Lauderdale, Florida 33334
1-800-327-5912 FL (305) 771-2050 FAX (305) 771-2052

CIRCLE 158 ON FREE INFORMATION CARD

Besides producing NTSC signals, the 1249 also generates a 30 Hz TTL level signal, (useful for servicing VCR's), and a 4.5 MHz signal which is exactly what's needed for locating audio isolation problems in a TV tuner. The 1249 has a DB9 connector on the front panel with pinouts identical to IBM color cards and, since there's a front panel switch to choose either TTL level or .8 volt signals, the instrument can be used to service some computer color monitors.

There are some computers that produce RGB video that's reasonably close to NTSC, so if you service a lot of these monitors, the 1249 can make your bench time more efficient. Even though this instrument is sold as a standard NTSC generator (PAL is a factory option), the fact that someone at B+K decided to add a PC-compatible video output means they had an eye on the field of computer monitors. That's commendable, but if you're looking for an instrument strictly to help service computer monitors, the 1249 is a poor choice.

Most of the computer video being generated today is far from being NTSC compatible. Horizontal scan frequencies vary all over the place and the NTSC standard produced by the 1249 is just too low if you're trying to troubleshoot anything other than a small handful of computer monitors. Even something as common as a PC monochrome monitor needs a signal with a horizontal scan frequency of about 18 kHz and the newer high resolution color monitors are up beyond 35 kHz.

To be fair about it, the 1249 was designed around the NTSC standard so it's hitting below the belt to criticize it for doing only the job it was designed to do. The RGB outputs are a convenience that come in handy for occasional servicing—and, I suppose that if they save you the hassle of having to make a special cable, they're worth the front panel space they occupy.

The documentation that comes with the meter is terrific. Packed in the small instruction booklet is a lot more than just switch details

and setup procedures. Several pages have been devoted to a history of NTSC video, an extremely detailed analysis of the signal itself, and a complete glossary of video terms. The manual has clear instructions on everything from turning the unit on to how to adjust the output by tweaking the trimmers inside the case. You also get an oversized schematic of the unit - something most companies don't provide - and a complete parts list. Just about the only complaint I have with the paperwork is that B+K doesn't put the IC values on the schematic, only the part designations (IC1, IC2, etc.). They are, or course, in the parts list but it's always more convenient to have them right there on the schematic.

The bottom line is that the 1249 is a good value for its \$517 list price. The unit is easy to use, reliable, generates rock steady signals, and you don't need a second mortgage on your home to buy one. If you're in the market for an NTSC generator, the 1249 is well worth taking a look at. **R-E**

M O R E T H A N LOGIC



286 SupersPort Laptop by Heathkit®

Your logical source for quality computer and electronic product needs, the **FREE Heathkit Catalog** is your key to a fun and exciting hobby. The Heathkit Catalog contains powerful kit laptop and desktop computers, test instruments, weather equipment, and home theater components, plus self-study electronics courses. Order your **FREE Heathkit Catalog** today! It's the logical thing to do!

1-800-44-HEATH
(1-800-444-3284)

Send to: Heath Company, Dept. 020-844
Benton Harbor, Michigan 49022

Name _____

Address _____

City _____

State _____

Zip _____

A subsidiary of Zenith Electronics Corporation

CIRCLE 86 ON FREE INFORMATION CARD

LEARN VCR CLEANING/MAINTENANCE/REPAIR EARN UP TO \$1000 A WEEK, WORKING PART TIME FROM YOUR OWN HOME!



Secrets
Revealed!

NO Special
Tools or
Equipment
Needed.

EARN UP TO \$60
AN HOUR AND
MORE!

THE MONEY MAKING OPPORTUNITY OF THE 1990'S

IF you are able to work with common small hand tools, and are familiar with basic electronics (i.e. able to use voltmeter, understand DC electronics) . . .

IF you possess average mechanical ability, and have a VCR on which to practice and learn. . . then we can teach **YOU** VCR maintenance and repair!

FACT: up to 90% of ALL VCR malfunctions are due to simple MECHANICAL or ELECTRO-MECHANICAL breakdowns!

FACT: over 77 million VCRs in use today nationwide! Average VCR needs service or repair every 12 to 18 months!

Viejo's **400 PAGE TRAINING MANUAL** (over 500 photos and illustrations) and **AWARD-WINNING VIDEO TRAINING TAPE** reveals the **SECRETS** of VCR maintenance and repair—"real world" information that is **NOT** available elsewhere!

Also includes all the info you'll need regarding the **BUSINESS-SIDE** of running a successful service operation!

FREE INFORMATION

CALL TOLL-FREE 1-800-537-0589

Or write to: Viejo Publications Inc.

3540 Wilshire BL. STE. 310

Los Angeles, CA 90010 Dept. RE

CIRCLE 139 ON FREE INFORMATION CARD



DELUXE TEST LEAD KIT

Users call TPI test leads **The Absolute Best**. The TLS2000 features the highest quality cable in the industry — with spring-loaded safety-sleeved plugs. U.L. listed (file E79581). Kit: \$29. Leads & probes only: \$19. Satisfaction guaranteed. **TEST PROBES INC.** Call toll-free for catalog: 1-800-368-5719.

CIRCLE 251 ON FREE INFORMATION CARD

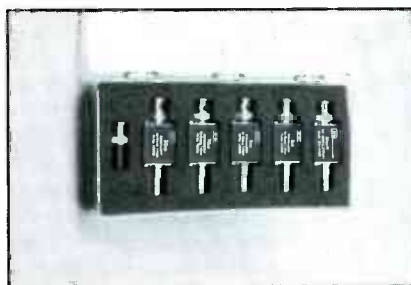

BNC ATTENUATOR KIT

Contains 4 attenuators — 3dB, 6dB, 10dB, 20dB; 1 feedthrough and 1 termination. Thick-film circuitry for low reactances. Rugged design resists shock and lasts longer. Rectangular shape stays put on the bench. **Impedance:** 50Ω **Frequency:** 1GHz. **Maximum Power:** 1kW peak, 1W avg. **VSWR:** 1.2:1. Attenuator Accuracy: ±0.2dB. Terminations Resistance Tolerance: ±1%. \$150.

TEST PROBES INC. Call toll-free for catalog: 1-800-368-5719.

CIRCLE 252 ON FREE INFORMATION CARD

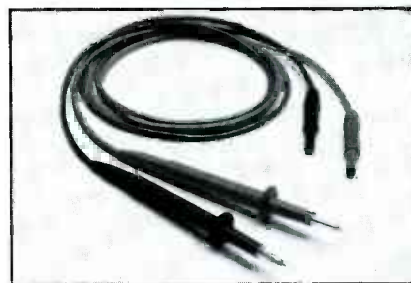

ECONOMICAL SILICON RUBBER TEST LEADS

Best value in moderately priced leads. High quality, soft, silicon rubber cable. Banana plug on measuring tip accepts push-on accessories. Plugs have spring-loaded safety sleeves. Model TL1000 \$14. Satisfaction guaranteed.

TEST PROBES INC. Call toll-free for catalog: 1-800-368-5719.

CIRCLE 253 ON FREE INFORMATION CARD



COAX ADAPTER KIT

- Create any adapter in seconds
- Make all combinations of BNC, TNC, SMA, N, UHF, Mini-UHF, F and RCA

The TPI 3000A kit contains male and female connectors of all 8 types, and 6 universal interfaces. Simply screw any combination of 24 connectors to one of the interfaces to create the desired adapter. \$150.

TEST PROBES INC. 9178 Brown Deer, San Diego, California 92121. Call toll-free for catalog: 1-800-368-5719.

CIRCLE 250 ON FREE INFORMATION CARD



No Better Probe Ever at This Price!



Shown here
Model SP150 \$49
Switchable 1x-10x

CIRCLE 254 ON FREE INFORMATION CARD

Risetime less than 1.5 nsec.

- **Universal** - works with all oscilloscopes
- **Removable Ground Lead**
- **Excludes External Interference** - even on scope's most sensitive range
- **Rugged** - withstands harsh environments including high temperature and humidity
- **Advanced Strain Relief** - cables last longer
- **Available in 10x, 1x and switchable 1x-10x**
- **10 day return policy** - performance and satisfaction guaranteed

TEST PROBES, INC. TPI

9178 Brown Deer Road
San Diego, CA 92121
Toll Free 1-800-368-5719
1-800-643-8382 in CA

Call for free catalog and Distributor in your area

CIRCLE 123 ON FREE INFORMATION CARD

NEW PRODUCTS

PACKAGING SYSTEM. For anyone who's looking for a way to speed up bread-board assembly, or is building a limited-run production device, or simply doesn't have the time or resources for PC boards, the *E-Z Buss* system might provide the solution. The modular electronic-packaging system from *National System, Inc.* offers everything needed to quickly and easily build a reliable, reproducible electronic assembly, including module cards for commonly used analog and digital electronic functions, a mounting connector base, "fill-in-the-blank" documentation forms, and a heavy-duty aluminum enclosure that makes for a professional-looking package.

The module cards can be ordered separately on an "as-needed" basis. They come in three sizes (depending on the size and complexity of your circuit's design). Universal logic and component cards are available, as well as dedicated amplifier, timer, resistor, and power-supply cards. The cards each come with a schematic diagram, top-view layout drawing, and a blank parts list. A connector

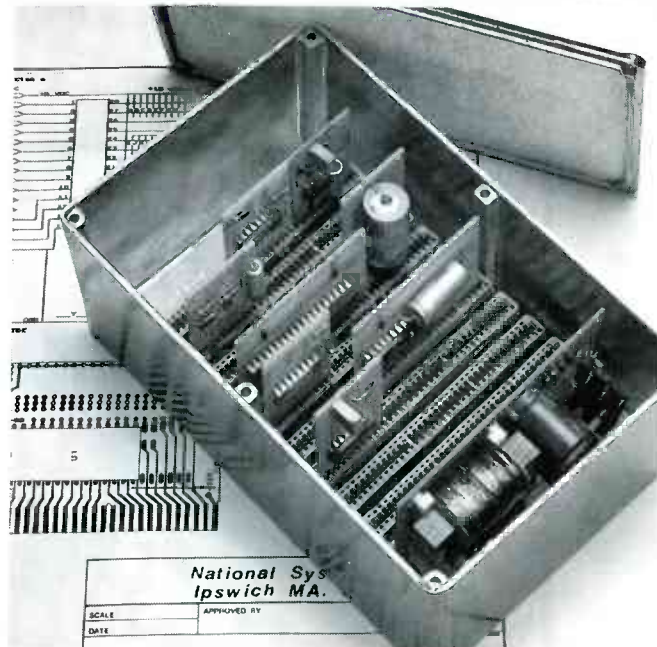

CIRCLE 10 ON FREE INFORMATION CARD

assignment chart and a blank wire-run list simplify base wiring.

The *E-Z Buss* connector base provides a platform on which as many as 30 separate module cards can be installed. The gold-plated module-card connectors have wire-wrap tails that allow up to three wraps per connector. The base itself, which has provisions for input and output block connectors, is clearly num-

bered with tail positions to permit quick and easy inter-connection wiring between modules.

The *E-Z Buss* connector base costs \$150.00, module cards range in price from \$10.00 to 20.00 (including documentation forms), and the enclosure costs \$65.00. Part kits are also available for the power-supply card only.—*National System, Inc.*, 17 Hammatt Street, Ipswich, MA 01938; 508-356-1011.

You are shown how to build a keyboard and to scan a keyboard and display. The kit contains all parts, assembly, and also comes with a lesson manual.

The *Micro Master Trainer* kit costs \$129.00.—*Elenco Electronics, Inc.*, 150 West Carpenter Avenue, Wheeling, IL 60090.

BASE/MOBILE SCANNER. Offering 100 channels and complete public-service-band coverage, *ACE Communications'* model AR950 can be conveniently mounted under an automobile's dashboard with the supplied mounting bracket, or used in a fixed location with its AC wall-plug adapter. The scanning radio pro-



CIRCLE 12 ON FREE INFORMATION CARD

vides coverage of the 27-45-MHz, 108-174-MHz, 406-512-MHz, and 830-950-MHz bands. Those include all of the police, fire, and emergency bands, as well as the new services now available above 800 MHz in 12.5-, 25-, and 30-kHz increments.

The compact (2 7/8 x 5 7/8 x 7 1/4 inches) receiver's 25 front-panel keys can be used to program five banks of 20 channels. Pairs of upper and lower limits for bands to be searched can be stored in five separate search-memory locations. Three permanent memories, which don't lose program information if the power is disconnected, are

MICROPROCESSOR TRAINER KIT. If you've ever considered building a computer from scratch, but weren't quite sure how to go about it, the *Elenco* model MM-8000 *Micro Master Trainer* kit could come in handy. Requiring no prior computer knowledge, the simple, easy-to-understand instructions teach you to write in machine language. The kit demonstrates how

to write into RAM's and ROM's and run an 8085 microprocessor that uses the same machine language as an IBM PC. It teaches you how to write the basic instructions to get the 8085 started, and how to store those instructions in permanent memory in a 2816E2 PROM. The *Micro Master Trainer* explains the workings of input and output ports and computer timers.



CIRCLE 11 ON FREE INFORMATION CARD

One-of-a-kind training lets you explore the technology that's rapidly shrinking our world

Now! Prepare for a money-making new future in telecommunications—today's high-growth electronics career field

With NRI training you build a complete telecommunications system.



Go on line to "talk" to your NRI instructor, take final exam by computer link.



Now you can get a fast start in an exciting career as today's in-demand telecommunications technician with NRI's new at-home training. Experience firsthand the power and excitement of telecommunications electronics as you build your own telecommunications system and become part of NRI's exclusive operating network, interacting with your instructors, fellow students, and even industry experts.

Some of today's hottest jobs in electronics are in telecommunications, where the explosion of new technologies is transforming the worldwide computer and telephone network into a multibillion dollar high-tech hotline for new communications services.

Fax... fiber optics... satellites... microwaves... voice messaging... teleconferencing... electronic mail... these and other futuristic communications services are making it possible for voice, video, and data messages to travel instantly across the country and around the world—and create unlimited opportunity for you as today's trained telecommunications technician.

Now NRI's ready to get you started with hands-on training built around an IBM XT-compatible computer, modem, breakout board, telephone, fiber optics lab, and communications software you train with and keep.

Complete coverage of the latest advances in telecommunications technology prepares you to succeed

Your training starts with an exciting hands-on introduction to the fundamental electronics at the heart of today's telecommunications technology. Using the specially selected equipment and test instruments included with your course, you actually build and experiment with the wide range of analog and digital circuits found in advanced telecommunications systems.

You move on to learn about satellite and cellular technologies, analog and digital switching systems, electronic telephone products and networks, voice, video, and data services, and more. From the ins and outs of a variety of residential telephones to the inner workings of centrex systems and PBX products... from the widespread digital applications of today's local area networks (LANs) to the voice, video, and data services of tomorrow's integrated services digital networks (ISDNs), you cover the complete range of telecommunications technology. But your NRI training doesn't stop there.

Hands-on experience with your own telecommunications system gives you real-world, in-demand skills

At just the right moment in your training, you receive your Packard Bell computer—yours to train with and keep. Step-by-step, through a series of carefully planned

demonstrations and experiments, you transform your computer into a state-of-the-art telecommunications device, complete with modem and dedicated communications software.

You use your system to go on line and "talk" to your instructor, take your final exam via computer link, correspond with other students, and access information services anywhere in the country for on-line

news, weather, sports encyclopedias, newsletters, catalogs, and user groups.

In no time at all, you have a complete understanding of the telecommunications technology that's taking the world by storm. And better yet, you have a head start on a money-making new future as today's fully-trained telecommunications technician.

Send today for your FREE 100-page catalog

NRI's 100-page, full-color catalog describes every aspect of NRI's hands-on training in Telecommunications Technology, as well as at-home training in microcomputers, electronic music, security electronics, robotics, and other high-tech career fields. Send today for your FREE copy!

If the coupon is missing, write to NRI School of Electronics, McGraw-Hill Continuing Education Center, 4401 Connecticut Avenue, NW, Washington, DC 20008.

IBM is a registered trademark of International Business Machines Corporation



McGraw-Hill Continuing Education Center
4401 Connecticut Avenue, NW Washington, DC 20008



CHECK ONE FREE CATALOG ONLY

<input type="checkbox"/> Telecommunications Technology	<input type="checkbox"/> Security Electronics
<input type="checkbox"/> Computers and Microprocessors	<input type="checkbox"/> Cellular Telephone
<input type="checkbox"/> Robotics Technology	<input type="checkbox"/> Computer Programming
<input type="checkbox"/> TV/Video/Audio Servicing	<input type="checkbox"/> Basic Electronics
<input type="checkbox"/> Electronic Music Technology	

Name _____ (please print) Age _____

Address _____

City/State/Zip _____ Accredited Member, National Home Study Council 3-129

used to store all information. The scanner's backlit LCD has 22 prompting annunciators to make it easier to use.

The AR950 also features first-channel priority, keyboard lockout, BNC-antenna connector. Two antennas—a telescopic type and a flexible rubber one optimized for 800 MHz—are included, as are a fused DC power cord, an AC wall-plug adapter, and all mounting hardware.

The AR950 scanning receiver has a suggested retail price of \$299.00.—**ACE Communications**, Monitor Division, 10707 East 106th Street, Indianapolis, IN 46256.

SYNTHESIZED FREQUENCY SOURCE. *Teledata Systems' WAVEBOX 100* frequency source is easy enough to use for educational and production applications, and has exceptionally high accuracy and stability—10-ppm (0.001%) accuracy over



CIRCLE 13 ON FREE INFORMATION CARD

a 1-Hz to 100-kHz frequency range—for an instrument in its price range. Foolproof thumbwheel switches are used to dial up the output frequency directly.

Intended for power, audio, telecommunications, and ultrasonic frequency testing, the *WAVEBOX 100* has 1-Hz resolution over the entire range. The sinewave output is variable up to 20-volts peak-to-peak with a ± 10 -volt offset, and an auxiliary TTL/CMOS-level square-wave output is also provided. Total harmonic and non-harmonic distortion is better than 40 dB.

The *WAVEBOX 100* synthesized frequency source has a suggested retail price

of \$325.00.—**Teledata Systems**, 68 Reservoir Road, New Milford, CT 06776.

COMPUTER TIME STANDARD. Providing reliable, traceable, and accurate time for IBM PC's and compatibles, *Coordinated Time Link's CTS-10* computer time standard decodes time information from WWV/WWVH radio signals from the National Institute of Science and Technology (NIST). Those signals are synchronized to the NIST atomic clock. With the *CTS-10* board installed, any application running on the PC automatically incorporates the correct time.

The time-standard device, which plugs directly into the PC, automatically accommodates daylight-saving time, leap years, leap seconds, and other time anomalies. Menu-driven software provides easy installation of user-defined port addresses and interrupt levels. The *CTS-10* tea-

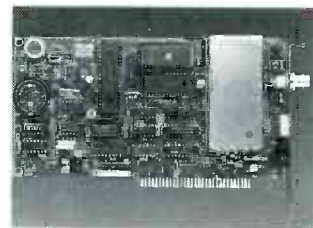

CIRCLE 14 ON FREE INFORMATION CARD

tures time-zone selection, 12-/24-hour selection, adjustable on-screen display, and color selection. The correct time is maintained during power outages by on-board capacitive and battery backup. Remote diagnostics provide convenient evaluation and troubleshooting capabilities.

The *CTS-10*, including software, has a single-unit price of under \$200.00.—**Coordinated Time Link**, 921 Bluebonnet Drive, Sunnyvale, CA 94086.

FREQUENCY COUNTER. Billed as an "affordable, general-purpose instrument with a high frequency

BK PRECISION MAXTEC INTERNATIONAL CORP.

Christmas Specials

MODEL 2160

Oscilloscope, 60MHz, Dual-Trace, with Delayed Sweep
REG. \$1099.00 SALE \$836.95

MODEL 2120

Oscilloscope, 20MHz, Dual Trace
REG. \$549.00 SALE Call for Quote

MODEL 1541A

Oscilloscope, 40MHz, Dual Trace
REG. \$845.00 SALE \$598.00
FREE FREIGHT!

MODEL 560

Programmable In/Out-of-Circuit IC Tester
REG. \$3500.00 SALE \$2940.95
FREE AK560 SOFTWARE!

MODEL CP-1

Clamp-On AC Current Probe
REG. \$65.00 SALE \$29.95

"Great Gift"



MODEL 388-HD

Test Bench
REG. \$129.00
SALE \$108.95



PRINT

Products International
R931 Brookville Rd. 20910
Silver Spring, MD 20910
(800) 638-2020 (301) 587-7824
FAX (301) 585-5407
EASY ORDER FAX LINE (800) 545-0058

800-638-2020

Complete B&K Line Available
"Call for your Price Quotations"

CIRCLE 157 ON FREE INFORMATION CARD

CABLE - TV

band - stop filters

- FOR ELIMINATION OF SEVERE INTERFERENCE
- FOR "CENSORING" OF ADULT BROADCASTS

NEW ADDRESS
↓



- ATTENUATION - 45 dB TYPICAL
- BANDWIDTH - 4 MHz AT 5 dB POINTS
- INSERTION LOSS - 2 dB

MODEL	TUNING RANGE	FOR CHANNELS	PASSBAND	PRICE	SHIPPING/HANDLING
23H	50-66 MHz	2,3 (or 6 meter ham)	50-300 MHz	\$30	FREE
46FM	66-108 MHz	4,5,6 (or any FM)	50-300 MHz	\$10	FREE
1417	120-144 MHz	14(A) 15(B) 16(C) 17(D)	50-400 MHz	\$30	FREE
1822	144-174 MHz	18(E) 19(F) 20(G) 21(H) 22(I)	50-400 MHz	\$30	FREE
713	174-216 MHz	7,8,9,10,11,12,13	50-400 MHz	\$30	FREE

3 for \$72 - 10 for \$180 - mix & match

Call Toll Free For C.O.D. or Send Check To Order
No Shipping Charges

- Shipped Within 3 Days
- 30 Day Money Back Guarantee

FACTORY DIRECT FROM

Star Circuits

P.O. Box 94917
Las Vegas, NV 89193-4917

1-800-433-6319

range," B&K-PRECISION's model 1804 features measurement to 550 MHz, an 8-digit LED display, a low-pass filter, 1- and 0.1-second gates, and an overflow indicator. It has a direct range of 5 Hz to 100 MHz and a prescale range of 10 MHz to 550 MHz. Using the 1.0-second gate, it has resolution of 1 Hz in direct mode and 10 Hz in prescale mode; with the 0.1-second gate, direct and prescale resolutions are 10 and 100 Hz, respectively. Accuracy with the 1.0-second gate is \pm time base accuracy \pm 1 count; with the 0.1-second gate accuracy is \pm time base accuracy \pm 2 counts.

The counter's input impedance in the direct range is 1 megohm, shunted by less than 40 pF. For the prescale range, impedance is 50 ohms to match communications applications. Sinewave sensitivity for the direct range is 30-mV rms for 5 Hz–30 MHz; 50-mV rms for 30–80 MHz; and 100-



CIRCLE 15 ON FREE INFORMATION CARD

mV rms for 80–100 MHz. Prescale-range sensitivity is 50-mV rms for 10–550 MHz. The input filter is a switch-selectable 100-kHz low-pass filter.

The model 1804 frequency counter has a suggested list price of \$295.00.—B&K-PRECISION, Maxtec International Corporation, 6470 West Cortland Avenue, Chicago, IL 60635.

IC REMOVER. Using the *IC Remover* from *Video Repair School*, you can quickly salvage integrated circuits from surplus PC boards. With a little practice, a 40-pin IC can be de-soldered in as little as 8 seconds, and more than 300 IC's can be

de-soldered in an hour.

The *IC Remover* is a set of eight special de-soldering tool bits that screw onto the tip of a *Radio Shack* or *Ungar* soldering iron. The tips fit 8- to 40-pin IC's, and can be used to remove IC's from double-sided and multilayered boards without damaging the board. Because the IC's are heated so briefly, they are not damaged either, and can then be reused in other applications.

The *IC Remover* set of eight IC-desoldering bits (soldering iron not included) costs \$89.95.—Vid-



CIRCLE 16 ON FREE INFORMATION CARD

eo Repair School, P.O. Box 121, Glen, MS 38846.

SWR/WATTMETER. You can monitor SWR, forward, and reflected power at a single glance with the *MFJ-815B* lighted cross-needle SWR/



CIRCLE 17 ON FREE INFORMATION CARD

wattmeter, which provides both peak- and average-reading functions. There are two user-selectable power ranges for forward and reflected power (2000 watts forward/500 watts reflected and 200 watts forward/50 watts reflected). The *MFJ-815B* shows SWR from 1:1 to 8:1, and covers 1.8 to 30 MHz with 10% accuracy. The instrument is

Professional Tool Case

SPECIAL \$49.95
Reg. \$64.95

Makes a Great Holiday Gift!

Model REIM5

- Two removable pallets hold over 60 tools
- Case top has built-in document holder
- Case bottom is partitioned into 3 areas

A handsome black case to organize and transport your valuable tools and instruments. This is the same quality case used by literally thousands of professional field engineers. Case is made of high impact polypropylene, and has snap-action key locks and a padded handle.

Size: 17½" x 12½" x 5".

Tools are not included.

Offer expires January 31, 1990.

To order call:
1-800-225-5370

In MA: (508) 682-2000

Same Day Shipment!
Money Back Guarantee!

Terms: Visa, MC, Amex;
PO's from qualified firms accepted.
Add \$5.50 for packing and delivery



contact east



FREE CONTACT EAST CATALOG

Contains thousands of products for testing, repairing & assembling electronic equipment. To get your free catalog, call (508)682-2000.

CIRCLE 55 ON FREE INFORMATION CARD

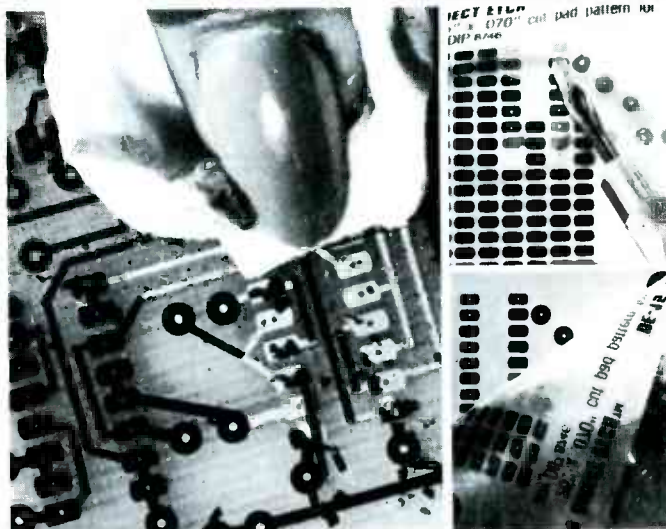

DIRECT ETCH

NO MASTER · NO CAMERA · NO FILM · NO DEVELOPER

DIRECT ETCH dry transfers make quality circuit boards fast without formal artwork. A new Master Assortment includes over 4000 donuts from .050" to .250" and 118 trace lines from .014" to .125". It also contains all sizes of through hole and surface mount devices including DIP, TO, DIN, D and edge card connectors, SO, SOL, PLCC, flatpacks, SOT's, 2 terminal tubular and flat SMD's. The Master Assortment has 69 cut apart dry transfer sheets with complete instructions. Works with all common etchants.

DE-973 Master Assortment (69 pattern sheets) \$34.95
(Add \$2.00 shipping. NJ and CA residents also add sales tax)
DATAK Corp. • 3117 Paterson Plank Rd. • N. Bergen, NJ 07047

CIRCLE 136 ON FREE INFORMATION CARD

covered by MFJ's full one-year "No Matter What" guarantee.

The MFJ-815B SWR/wattmeter costs \$69.95.—MFJ Enterprises, Inc., P.O. Box 494, Mississippi State, MS 39762.

HEX KEY SET. Bondhus' BLX-10 hex-key set contains ten "Balldriver" hex-key L-wrenches in 1/16, 1/64, 1/32, 7/64, 1/8, 3/64, 5/32, 3/16, 7/32, 1/4, 5/16, and 3/8-inch sizes. The patented "Balldriver" design allows angle entry into fasteners to 25°. The set is packed in a case that identifies the tools

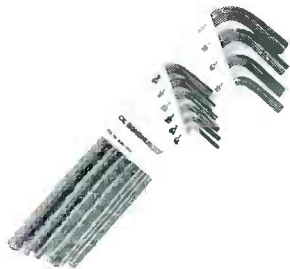

CIRCLE 18 ON FREE INFORMATION CARD

sizes for easy access and use, and locks them into place for quick and easy convenient storage.

The BLX-10 hex-key set (Item No. 10938) has a suggested list price of \$7.99.—Bondhus Corporation, 1400 East Broadway, P.O. Box 660, Monticello, MN 55362.

PROTOTYPING WORKSTATION. Offering flexibility for circuit design, Global Specialties' PB-204 Proto-Board is a complete prototyping workstation housed in a metal case. Designers can quickly make alterations by re-routing connections, and circuit corrections can be performed in seconds.

The PB-204 offers a highly regulated, current-limited, triple-voltage power supply (+5, +12, and -12 volts) to safely handle op-amp, microprocessor, TTL, and CMOS design applications. The large breadboarding area has 2250 tie points, providing space for as many



CIRCLE 19 ON FREE INFORMATION CARD

as 24 14-pin DIP's.

The PB-204 Proto-Board workstation, which is backed by Global's life-guarantee on the breadboard sockets, has a suggested retail price of \$119.95.—Global Specialties, 70 Fulton Terrace, New Haven, CT 06512; 1-800-345-6251 (in CT, 1-800-445-6250).

SOCKET BIT SETS. To eliminate the bulkiness and high costs of individual sockets, Bondhus has introduced SOCKET SAVER interchangeable socket-bit sets.

There are four different sets available, each offering various bit combinations. Each set includes 26 interchangeable socket-bit tools to use with just two standard 1/4 and 3/8-inch-square drive tools. For easy access, all bits and sockets snap-lock into place in a compact but rugged molded case.



CIRCLE 20 ON FREE INFORMATION CARD

The SOCKET SAVER sets have a suggested retail price of \$37.00 each.—Bondhus Corporation, 1400 East Broadway, P.O. Box 660, Monticello, MN 55362. R-E

MOVIE TIME

CABLE CONVERTERS

NEW!

78 Channel Wireless Remote • Remote Fine Tuning • Parental Control
10 dB Amplifier Favorite Channel Memory • Fine Tune Centering
24 MONTH WARRANTY

<p>(#1) V7800-3 V7800-2</p> <p>15 Lot \$62.95</p> <p>10 Lot \$64.95</p> <p>(3-9) \$69.95 (1-2) \$89.95</p>		<p>(#2) with Volume & Mute Control Last Channel Recall Audio...Output • Decoder Loop</p> <p>10 Lot \$79.95</p> <p>(3-9) \$89.95 (1-2) \$109.95</p>
JERROLD		
<p>(#3) JERROLD - 450 68 Channels Automatic Fine Tune Rebuilt Ch. 3 Only 90 Day Warranty</p> <p>10 Lot \$53.95</p> <p>(3-9) \$63.95 (1-2) \$73.95</p>		<p>(#4) JERROLD - JSX 36 Channels Fine Tuning Rebuilt Ch. 3 Only 90 Day Warranty</p> <p>10 Lot \$29.95</p> <p>(3-9) \$34.95 (1-2) \$39.95</p>
<p>MOVIE TIME REPLACEMENT HAND UNITS</p> <p>\$14.95</p> <p>24 Lot</p> <p>Single Lot \$24.95</p> <p>#6 JERROLD-550 #7 JERROLD-450 #9 JERROLD-400 #10 TEXSCAN AND MORE</p> <p>(13-23) \$16.95 (2-12) \$19.95</p>	<p>(#5) HAMLIN - 4000 42 Channels Fine Tuning Wired Remote or Set top Rebuilt Ch. 2 Only 90 Day Warranty</p> <p>10 Lot \$29.95</p> <p>(3-9) \$34.95 (1-2) \$39.95</p>	
<p>ALL OF THE ABOVE CABLE CONVERTERS ARE COMPATIBLE WITH ALL CABLE DECODERS * NONE OF THE ABOVE UNITS ARE CABLE DECODERS</p>		
<p>MOVIE TIME 20203 N.E. 15th Court • Miami, FL 33179 FAX: (305) 653-8102</p> <p>For More Information Call For Orders Only Call</p> <p>1-305-652-1981 1-800-843-9845</p>		<p>Minimum Shipping Charge \$6.50 + \$1.00 for ea. additional converter or .25 for ea. Hand Unit BLUE Label 2nd day air: \$12.50 Min + \$3.50 for additional converter, or .30 for ea. Hand Unit. RED Label 1st day air: \$18.50 Min. + \$3.50 for additional converter, or \$1.00 for ea. Hand Unit. Puerto Rico, Hawaii & Alaska add \$5.00. No COD Orders will be shipped by Air. Shipping Charges are not Refundable.</p> <p>C.O.D. </p>

CIRCLE 154 ON FREE INFORMATION CARD

R-E Engineering Admart

Rates: Ads are 2 1/4" x 2 7/8". One insertion \$950. Six insertions \$925. each. Twelve insertions \$895. each. Closing date same as regular rate card. Send order with remittance to **Engineering Admart**, Radio Electronics Magazine, 500-B Bi-County Blvd., Farmingdale, NY 11735. Direct telephone inquiries to Arline Fishman, area code-516-293-3000. *Only 100% Engineering ads are accepted for this Admart.*

MIDI PROJECTS

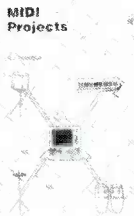

BP182—MIDI interfacing enables any so equipped instruments, regardless of the manufacturer, to be easily connected together and used as a system with easy computer control of these music systems. Combine a computer and some MIDI instruments and you can have what is virtually a programmable orchestra. To get your copy send **\$6.95 plus \$1.25 for shipping** in the U.S. to **Electronic Technology Today Inc.**, P.O. Box 240, Massapequa Park, NY 11762-0240.

Surface Mount Chip Component Prototyping Kits— Only \$49.95

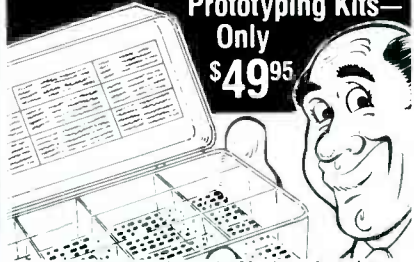

CC-1 Capacitor Kit contains 365 pieces, 5 ea. of every 10% value from 1pf to .33µf. CR-1 Resistor Kit contains 1540 pieces; 10 ea. of every 5% value from 10Ω to 10 megΩ. Sizes are 0805 and 1206. Each kit is **ONLY \$49.95** and available for Immediate One Day Delivery!

Order by toll-free phone, FAX, or mail. We accept VISA, MC, AMEX, COD, or Pre-paid orders. Company P.O.'s accepted with approved credit. Call for free detailed brochure.

COMMUNICATIONS SPECIALISTS, INC.
426 West Taft Ave. • Orange, CA 92665-4296
Local (714) 998-3021 • FAX (714) 974-3420
Entire USA 1-800-854-0547

CIRCLE 141 ON FREE INFORMATION CARD

FCC LICENSE PREPARATION

The FCC has revised and updated the commercial license exam. The **NEW EXAM** covers updated marine and aviation rules and regulations, transistor and digital circuitry. **THE GENERAL RADIOTELEPHONE OPERATOR LICENSE - STUDY GUIDE** contains vital information. **VIDEO SEMINAR KITS ARE NOW AVAILABLE.**

WPT PUBLICATION
979 Young Street, Suite A
Woodburn, Oregon 97071
Phone (503) 981-5159

CIRCLE 140 ON FREE INFORMATION CARD

NEW LIT

1989-1990 MASTER CATALOG. *Jensen Tools'* full-line catalog is full of essentials for electronics technicians, servicemen, and hobbyists—tool kits and cases, power and hand tools, soldering and desoldering equipment, measuring devices, telecommunications

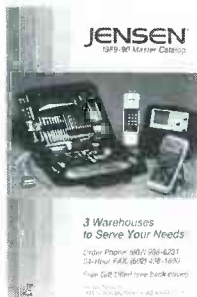

CIRCLE 21 ON FREE INFORMATION CARD

products, computer and test equipment, vacuums and cleaners, and circuit board and static control equipment. The catalog

contains 14 pages of new products. The *Jensen 1989-90 Master Catalog* is free upon request.—**Jensen Tools Inc.**, 7815 South 46th Street, Phoenix, AZ 85044-5399; 602-968-6231.

I/O CONNECTOR CATALOG. The 12-page bulletin (No. EX-10-1) titled *Input/Output Data Communications Connectors* describes *Panduit's* I/O D-sub-miniature and ribbon connectors, which allow reliable mass termination of



CIRCLE 22 ON FREE INFORMATION CARD

0.05-inch centerline spacing flat cable. The connectors, available in PCB or IDC types, are suitable for EIA RS-232-C and RS-449 applications. They are offered in various shell sizes and mounting styles, with either straight or right-angle pins. There is no charge for the catalog.—**Panduit Corp.**, I/O

Group, 17301 Ridgeland Avenue, Tinley Park, IL 60477-0981; 1-800-777-3300.

RF POWER MEASUREMENT. *Bird Electronic's Quality Instruments for RF Power Measurement* is a 60-page,



CIRCLE 23 ON FREE INFORMATION CARD

full-line catalog that includes hundreds of photos along with detailed descriptions, specifications, and ordering information for thousands of products. In addition to their extensive line of wattmeters—including high-accuracy, peak-reading, high- and low-power, multipower-level, and low-frequency models—the brochure presents a wide selection of calorimeters, plug-in elements, line sections, QC-connectors, RF loads, attenuators, switches, directional couplers, and accessories. The catalog is

available at no charge to qualified service establishments, labs, engineers, and buyers.—**Bird Electronic Corp.**, 30303 Aurora Road, Solon, OH 44139; 216-248-1200.

CATALOG OF CATALOGS. *Eaton Corporation's Literature Review* outlines 61 product catalogs and brochures that are being offered for Consolidated Controls, Cutler-Hammer, and MSC Products. Each catalog is described in detail, to simplify selection. They cover relays, sensor instruments, switches, transducers, valves and actuators, and aircraft cockpit

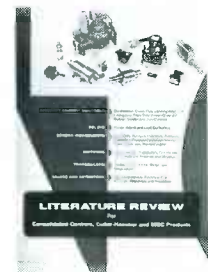

CIRCLE 24 ON FREE INFORMATION CARD

controls. The *Literature Review* is free.—**Eaton Corporation**, Aerospace & Commercial Controls Division, 4201 North 27th Street, Milwaukee, WI 53216; 414-449-7483. **R-E**

HITACHI SCOPES AT DISCOUNT PRICES



V-212
\$425
List \$595
Save \$170



V-425
List \$1,070 **\$849**

- DC to 40MHz
- Dual Channel
- CRT Readout
- Cursor Meas
- DC Offset
- Alt Magnifier
- Compact Size



V-1060
List \$1595 **\$1,359**

- DC to 100MHz
- Dual Channel
- Delayed Sweep
- CRT Readout
- Sweep Time
- Autoranging
- Trigger Lock
- 2mV Sensitivity

20MHz Dual Trace Oscilloscope

All Hitachi scopes include probes, schematics and Hitachi's 3 year warranty on parts and labor. Many accessories available for all scopes.

V-223 20MHz
V-422 40MHz
V-423 40MHz
V-660 60MHz
V-1065 100MHz
V-1100A 100MHz
V-1150 150MHz

D.T., 1mV sens, Delayed Sweep, DC Offset, Vert Mode Trigger
D.T., 1mV sens, DC Offset Vert Mode Trigger, Alt Mag
D.T., 1mV sens, Delayed Sweep, DC Offset, Alt Mag
D.T., 2mV sens, Delayed Sweep, CRT Readout
D.T., 2mV sens, Delayed Sweep, CRT Readout, Cursor Meas
Q.T., 1mV sens, Delayed Sweep, CRT Readout, DVM, Counter
Q.T., 1mV sens, Delayed Sweep, Cursor Meas, DVM, Counter

LIST	PRICE	SAVE
\$825	\$725	\$100
\$940	\$740	\$200
\$1,025	\$825	\$200
\$1,295	\$1,145	\$150
\$1,895	\$1,670	\$225
\$2,450	\$2,095	\$355
\$3,100	\$2,565	\$535

ELENCO PRODUCTS AT DISCOUNT PRICES

20MHz Dual Trace Oscilloscope

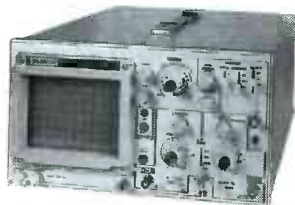

\$375
MO-1251

- 6" CRT
- Built in component tester
- TV Sync

FREE DMM

with purchase of
MO-1251/1252 Scope

SCOPE PROBES

P-1 65MHz, 1x, 10x **\$19.95**
P-2 100MHz, 1x, 10x **\$23.95**

35MHz Dual Trace Oscilloscope

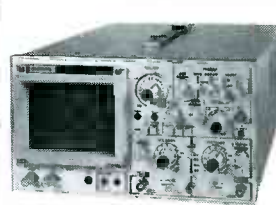

\$495
MO-1252

- High luminance 6" CRT
- 1mV Sensitivity
- 6KV Acceleration Voltage
- 10ns Rise Time
- X-Y Operation • Z Axis
- Delayed Triggering Sweep

Top quality scopes at a very reasonable price. Contains all desired features. Two 1x, 10x probes, diagrams and manual. Two year guarantee.

PRICE BREAKTHRU on Auto Ranging DMMs



3 to choose from:
MDM-1180 \$24.95
MDM-1181 \$27.95
MDM-1182 \$29.95

- 3 1/2 LCD Display
- 27 Functions
- Auto/Manual Ranges
- Audible Continuity
- Data Hold (MDM-1182)
- .1% Accuracy (MDM-1181)

True RMS 4 1/2 Digit Multimeter



\$135 **M-7000**
.05% DC Accuracy
.1% Resistance with Freq. Counter and deluxe case



\$55 **CM-1500A**
Multimeter with Capacitance and Transistor Tester
Reads Volts, Ohms, Current, Capacitors, Transistors and Diodes with case

Digital Capacitance Meter



\$58.95 **CM-1550**
9 Ranges
.1pf-20,000ufd
.5% basic accy
Zero control with case



\$125 **LC-1800**
Digital LCR Meter
Measures Coils 1uH-200H
Caps .1pf-200uf
Res .01-20M

Bench DMMs



\$125 **M-3500**
3 1/2 digit .1% accy

\$175 **M-4500**
4 1/2 digit .05% accy

SOLDERING STATION

Temperature Controlled
\$99 **SL-30**
Digital display
Temp range: 300F-900F
Grounded tip
Overheat protection

Solderless Breadboards



9430 1,100 pins **\$15**
9434 2,170 pins **\$25**
9436 2,860 pins **\$35**
All have color coded posts

AC Clamp-On Current Adapter



\$25 **ST-265**
0-1000A AC
Works with most DMM

Wide Band Signal Generators

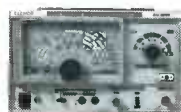

\$129 **SG-9000**
RF Freq 100K-450MHz
AM Modulation of 1KHz
Variable RF output

\$249 **SG-9500 with Digital Display and 150MHz built-in Freq Ctr**

3 1/2 Digit Probe Type DMM



\$39 **M-1900**
Convenient one hand operation with batteries and case
Measures DCV, ACV, Ohms
Audible continuity check, Data hold

Function Generator



\$28.95 **Blox**
#9600
Provides sine, tri, squ wave from 1Hz to 1MHz
AM or FM capability

Decade Blox



\$18.95 **#9610 or #9620**
#9610 Resistor Blox 47 ohm to 1M & 100K pot
#9620 Capacitor Blox 47pf to 10MFD

Digital Triple Power Supply



\$249 **XP-765**
0-20V at 1A
0-20V at 1A
5V at 5A

Fully Regulated, Short circuit protected with 2 Limit Cont., 3 Separate supplies
\$175 **XP-660 with Analog Meters**

Quad Power Supply



\$59.95 **XP-580**
2-20V at 2A
12V at 1A
5V at 3A
-5V at 5A
Fully regulated and short circuit protected

\$39.95 **XP-575 without meters**

10MHz XT 100% IBM® Compatible



\$595 **MODEL PC-1000**
5 Year Warranty

- 150W Power Supply
 - 256K RAM
 - Expandable to 640K
 - Monochrome Monitor
 - Monographic Video Card
 - Parallel Printer Port
- FREE spreadsheet and word processor**
3.XXMS DOS and GW Basic add 75.00

Four-Function Frequency Counters



\$179 **F-100 120MH**
\$259 **F-1000 1.2GH**

Frequency, Period, Totalize, Self Check with High Stabilized Crystal Oven Oscillator, 8 digit LED display

GF-8016 Function Generator with Freq. Counter



\$249
Sine, Square, Triangle Pulse, Ramp, .2 to 2MHz
Freq Counter .1 - 10MHz

\$179 **GF-8015 without Freq. Meter**

WE WILL NOT BE UNDERSOLD!

UPS Shipping: 48 States 5%
(\$10 Max) IL Res., 7% Tax



C & S SALES INC.

1245 Rosewood, Deerfield, IL 60015
(800) 292-7711 (312) 541-0710

15 Day Money Back Guarantee

2 Year Warranty Prices subject to change
WRITE FOR FREE CATALOG

ROBERT IANNINI

LET'S FACE IT. MOST OF US HAVE BEEN THE victim of some form of theft at one time or another. The chances are that either you personally, your house, your car radio, or your whole car has at one time been robbed. And, while a car armed with an ordinary siren-type alarm is better-protected than if it had nothing at all, most people won't even look away from what they're doing when they hear a car alarm go off. And most thieves are not at all frightened by them either. More important, a thief can be out of the car so fast that by the time someone does something about it, it's too late.

That's where the Phasor Property Guard comes in. It's not just an alarm; it emits sound that is actually painful to listen to. It's sound output can be adjusted from an inaudible yet painful ultrasonic level, to an ordinary alarm-type sound, to a level that's so loud and irritating, that not even the world's best car thief could stand to listen to it as he tries to steal your car or car stereo. Be warned, though, that continued exposure to the sound can permanently damage your hearing.

Operation

The Property Guard is intended as a property- or home-protection device. It generates high-pressure ultrasonic sound that is triggered when an unauthorized intrusion is detected. The unit can be triggered by a trip wire or closed system such as taped glass windows and doors, where a break or open triggers the unit. The unit also contains a switch input that can be used with a pressure-sensitive switch activated when someone enters a room or building. A positive voltage from equipment such as an IR intrusion detector, motion detector, sound detector, etc., can also be used to trigger the unit.

The sound produced by the unit can cause certain adverse effects to the intruder. They may be paranoia, severe headaches, disorientation, nausea, cranial pain, upset stomach, or just plain irritating discomfort. Most people are affected in one way or the other, with younger women unfor-

PROGRAMMABLE PHASOR PROPERTY GUARD



*Now you can protect your
valuables by scaring criminals away with an
unbearable ear-piercing sound.*

tunately being the more sensitive. External adjustments allow the user to select clearly audible sounds that serve as an alarm or the higher-frequency energy that produces the discomfort and other effects.

Sound-pressure level is less than 130 dB, and will not produce permanent damage if exposure is kept to a minimum. Therefore, prolonged exposure is not encouraged. A rule of thumb is to keep exposure down to less than 1 hour to any frequency less than 20 kHz at a sound pressure of 105 dB or over.

The system consists of a central control unit that can power up to 6 remotely located transducers, which can be positioned to take advantage of potential entrance and intrusion areas. Be sure to take into considera-

tion that each transducer can produce up to 118 dB at a distance of 1 meter. Sound-pressure levels are logarithmic, so every time the distance from a transducer is doubled, the sound pressure is attenuated by factor of -3 dB.

Circuitry

If you look at Fig. 1, the detection circuits monitor inputs J1, J2, and J3, and, when they sense an intrusion, they energize control-relay RY1 via drive-transistor Q5. Note that the relay controls power (V_{CC}) to the driver stage shown enclosed in the dashed lines. Diodes D2-D6 guarantee full "off" and "on" functions of the circuit while D7 clips the voltage spike produced when the coil of RY1 is turned off. A set of relay contacts are

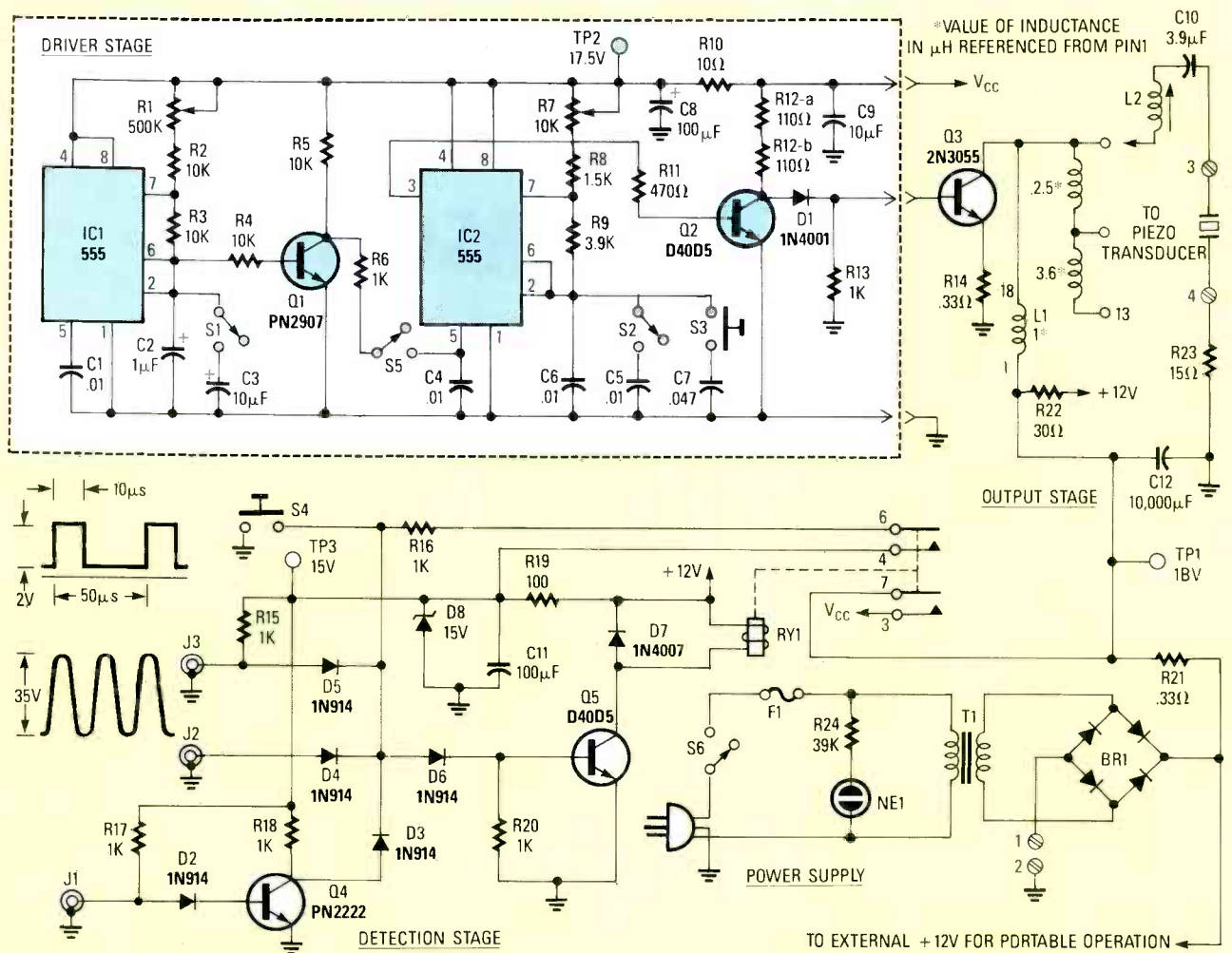

FIG. 1—SCHEMATIC OF THE PHASOR PROPERTY GUARD. Detection circuits sense an intrusion from J1, J2, or J3.

used to “hold on” the circuit once triggered. A pushbutton switch (S4) allows resetting of the circuit by grounding the positive “hold on” voltage at the diode junctions.

As for the driver circuitry (inside the dashed lines), a 555 timer (IC2) is connected as an astable free-running multivibrator whose frequency is externally controlled by potentiometer R7. Resistor R8 selects the range limit of R7, while R9 selects the duty cycle or symmetry of the pulses. Capacitor C6, along with those resistors determines the frequency range of the device. A low-range switch (S2) decreases the frequency by switching C5 into the circuit. A test switch (S3) connects C7 across C6, thus dropping the frequency to approximately 1/5, producing a clearly audible tone for verification and test purposes.

The square-wave output of IC2 pin 3 is resistively coupled to Q2 through R11. The collector of Q2 is DC biased

by R12-a and R12-b. The square-wave output signal is then fed into power amplifier Q3 via D1. The collector of Q3 is DC biased by the choke-coil/transformer combination, L1. Resistor R14 helps stabilize the stage. The amplified square waves are fed to the transducer via resonating-coil L2 and DC-blocking-capacitor C10. The resonating coil is selected to tune out the inherent capacitance of the transducer at the upper frequency limit—usually around 20 kHz. A sinusoidal wave is generated that allows the transducers to operate at a higher peak power level than would the equivalent-voltage square wave because less power is going into the harmonics that would make up the square wave. Resonant peaking of the voltage is also obtained. The transducers, unlike their electromagnetic counterparts, have a tendency to draw high current at higher frequencies. That effect is compensated to an ex-

tent by power-resistor R23. Note the wave shape shown is at a fixed frequency of 20 kHz.

Timer IC1 is similarly connected as an astable running multivibrator, and is used to produce the sweeping voltage necessary for modulating the frequency of IC2. IC1 is activated by S5 (the switch-half of R1/S5), and the sweep repetition rate is controlled by R1 (the potentiometer-half of R1/S5). Resistor R2 limits the range of the repetition time. Resistor R3 selects the duty cycle of the pulse while capacitor C2 sets the sweep time range. A slow sweep range is selected by S1 connecting C3 to the circuit. The ramp-voltage output of IC1 at pins 2 and 6 is resistively coupled via R4 to inverter transistor Q1. The output of Q1 is fed to pin 5 of IC2 and provides the modulation voltage necessary to generate the sweeping frequency action required. Note that the signal is easily disabled via S5, which is a convenience when initially setting or checking the range of IC2, as it elimi-

nates the constant varying frequency.

Power is supplied to the system by a conventional step-down transformer T1, bridge-rectifier BR1 and filter-capacitor C12. Power is controlled by S6, which is part of the frequency-control potentiometer R7. A neon indicator lamp (NE1) tells when the system is energized (R24 is a current-limiter for NE1). A remote-control option is available via pins 1 and 2 of the terminal strip; pins 1 and 2 must be connected for normal operation. A three-wire line cord is shown, but a two-wire cord will suffice as the power supply voltages are under 25 volts.

Construction

The Property Guard consists of a driver board that's assembled on a PC board and a detection board that's assembled on a piece of perfboard. Both are installed inside a metal cabinet with various controls and other hardware mounted to it. A parts-placement diagram for the driver board is shown in Fig. 2. Most of the resistors are vertically mounted. Always leave at least $\frac{1}{16}$ -inch lead between the body of a component and the PC board.

As for the detection board, a sug-

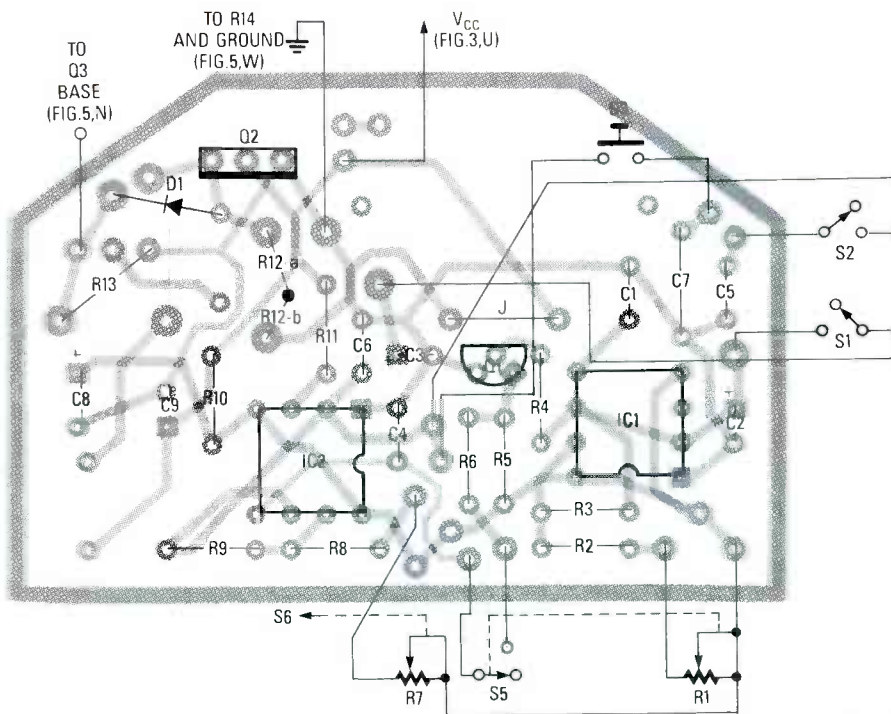

FIG. 2—DRIVER-BOARD PARTS PLACEMENT. Most of the resistors are vertically mounted.

gested layout is shown in Figs. 3 and 4; simply mount the components on the perfboard and hardwire the jumpers as indicated by the dashed lines. Assemble the resonator coil L2 by winding 40 turns of no. 18 enameled

wire in a solenoidal format on a 2-inch long piece of $\frac{5}{8}$ -inch outside-diameter cardboard form. Wrap the coil with tape, or hold the turns together with shellac, varnish, etc. The ferrite core (FER1) included in the kit

PARTS LIST

All resistors are 1/4-watt, 5%, unless otherwise indicated.

- R1—500,000 ohms, potentiometer/switch (S5)
- R2, R3, R4, R5—10,000 ohms
- R6, R13, R15, R16, R17, R18, R20—1000 ohms
- R7—5000–10,000 ohms, potentiometer/switch (S6)
- R8—1500 ohms
- R9—3900 ohms
- R10—10 ohms, 1/2-watt
- R11—470 ohms
- R12-a and R12-b—220 ohms total (2 110-ohm 3-watt resistors connected in series)
- R14, R21—0.33 ohms, 5 watts
- R19—100 ohms
- R22—30 ohms, 2 watts
- R23—15 ohms, 10 watts (see text)
- R24—39,000 ohms

Capacitors

- C1, C4—0.01 μ F, 25 volts, ceramic disc
- C2—1 μ F, 25 volts, electrolytic
- C3, C9—10 μ F, 25 volts, electrolytic
- C5, C6—0.01 μ F, polystyrene (use 0.0068 μ F for higher frequency)
- C7—0.047 μ F, 25 volts, ceramic disc (use lower value for higher frequency)

- C8, C11—100 μ F, 25 volts, electrolytic
- C10—3.9 μ F, 350 volts, paper
- C12—10,000 μ F, 16 volts, electrolytic (larger value acceptable)

Semiconductors

- IC1, IC2—555 timer IC
- D1—IN4001 50-volt diode
- D2, D3, D4, D5, D6—IN914 small signal diode
- D7—IN4007 15-volt diode
- D8—15-volt Zener diode
- Q1—PN2907 PNP transistor
- Q2, Q5—D40D5 NPN power transistor
- Q3—2N3055 NPN power transistor, TO3 package
- Q4—PN2222 NPN transistor
- BR1—5-amp bridge rectifier

Other components

- S1, S2—switch DPDT switch
- S3, S4—momentary pushbutton
- RY1—12-volt DPST relay
- L1—AF choke/transformer (see text)
- L2—resonator (see text)
- T1—12-volt, 2-amp transformer
- F1—1-amp fuse
- J1–J3—RCA-type jack
- NE1—neon lamp
- FER1—3 \times 1/2 ferrite core

- TD1, 2, 3, 4—Piezo directional transducers

Miscellaneous: line cord and retractor bushing, wire nuts, metal cabinet, perfboard (3 1/2 \times 4 1/4 inches), dual TO3 heat sink, TO3 mounting kit (see Fig. 5), tape, neon-lamp holder, small vinyl strap, no. 24 hookup wire, no. 20 hookup wire, hardware, 4-lug screw terminal strip, fuse holder, PC board, etc.

Note: The following items are available from Information Unlimited, PO Box 716, Amherst, NH 03031: assembled and tested driver board (Fig. 2), part no. PPG3A (includes all switches and controls), \$59.50; assembled and tested detection board (Figs. 3 and 4), part no. PPG3B, \$39.50; L1 multitap transformer, \$34.50; L2 resonator, \$19.50; TD1–TD4 Piezo directional transducers, \$12.50 ea. For overseas operation on 220 volts, it is suggested that you use transformer no. STDWTR, or obtain any 220-to-110-volt, 50/60 ohm 50 VA unit.

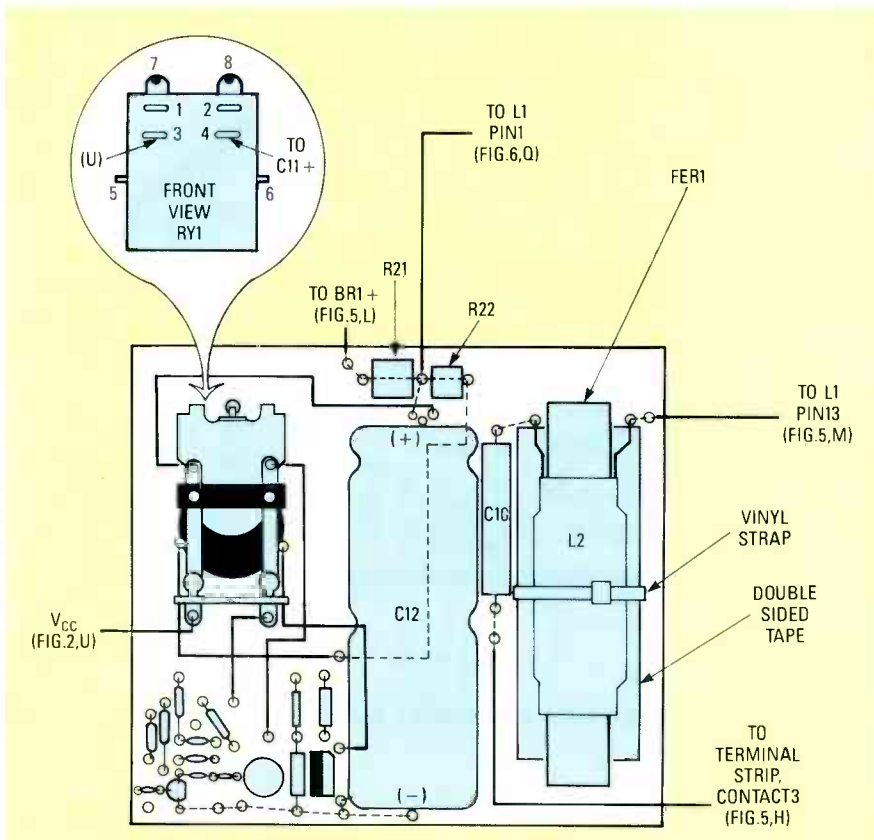

FIG. 3—A SUGGESTED LAYOUT for the detection board. Mount the components on perboard as shown.

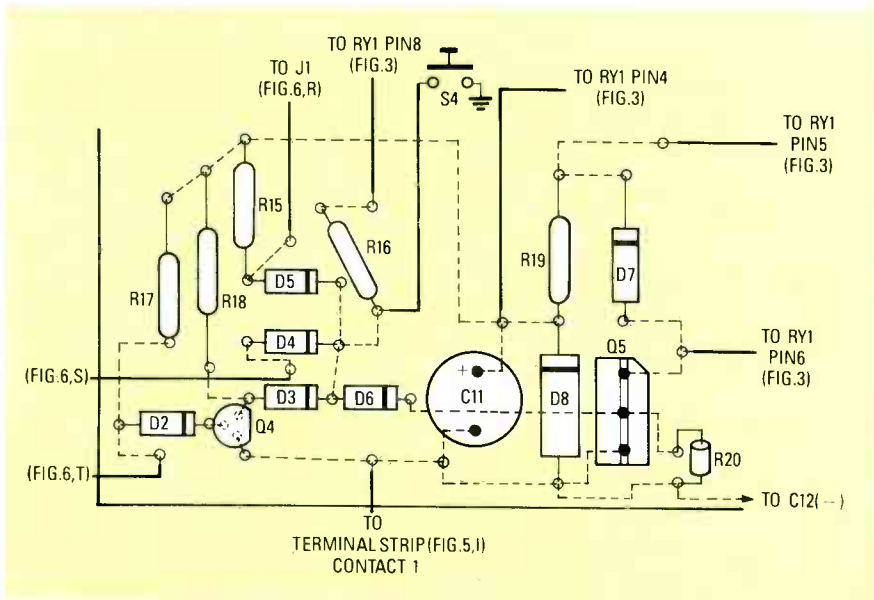

FIG. 4—DETAILED VIEW of the detection board. Hardwire the jumpers as indicated by the dashed lines.

should be inserted inside the cardboard tube. Note that L2 is secured to the perboard by a piece of foam tape and a small nylon strap. Bring the leads out from T2 as shown Fig. 3. Note the wiring of relay RY1. Use appropriate pieces of vinyl-covered no. 22 wire for leads from the relay to the board.

Assemble and wire the cabinet as shown in Figs. 5 and 6. Be careful to allow sufficient clearance for the contacts of the terminal strip. Note that a hole about the size of a half-dollar must be made in the cabinet directly under Q3 for the wires to pass through. Use the drawings as a reference for the location of all holes and

components. It's a good idea to test-position each component before drilling or cutting. Note the mounting of power resistors R14 and R23; R14 must be sealed in RTV or electrical putty to prevent contact of 115V circuits. Do not connect the lead to Q3's base at that point.

Assemble Q3 with its mounting kit as shown in Fig. 5, and mount it on the heatsink. Note that the body of Q3 must be insulated from the heat sink. Check it with a meter to prevent damage to the circuitry.

Assemble the choke-coil/transformer combination L1 by winding 15 turns of no. 18 wire between pin 1 and 18 on the bobbin, 10 turns between 18 and 6, and 5 turns between 6 and 13. Wind all sections in same direction. Those are taps for setting the output level desired. Assemble the ferrite "E" cores with the brass "U" bolt to secure it to the cabinet.

Since the choke is for feeding DC current to Q3 and to maintain a blocking effect to the AC signal, an air gap may be required if more than 4 transducers are powered by the system. It is suggested that you wind 10 more turns on the core and space the ferrite "E" cores with a piece of scotch tape placed one layer thick on each leg of one of the "E" core pieces. Note that the preassembled units do not use an air gap.

Checkout

Check your wiring for accuracy, the quality of solder joints, short circuits, pinched wires, debris, etc. Now place a jumper across contacts 1 and 2 of the terminal strip, and ground J3. Plug the unit into a 120-VAC outlet and turn it on. Check TP1 for 3-4 volts higher than what's shown in Fig. 1 (that's because there's no load on it now). Also check for 15 volts at TP3. Relay RY1 should be deenergized, and TP2 should be at zero volts. Momentarily unground J3 and then reconnect it; RY1 should energize. Measure 15 volts at TP2. Push the reset switch (S4) and make sure TP2 drops to zero.

Momentarily ground J1 and again note RY1 energizing. Measure 15 volts at TP2; push S4 and make sure TP2 drops to zero. Momentarily apply a 5-10-volt level to J2 through a 1K resistor and repeat the previous step. That verifies the detection stage of the device.

Energize the system by removing

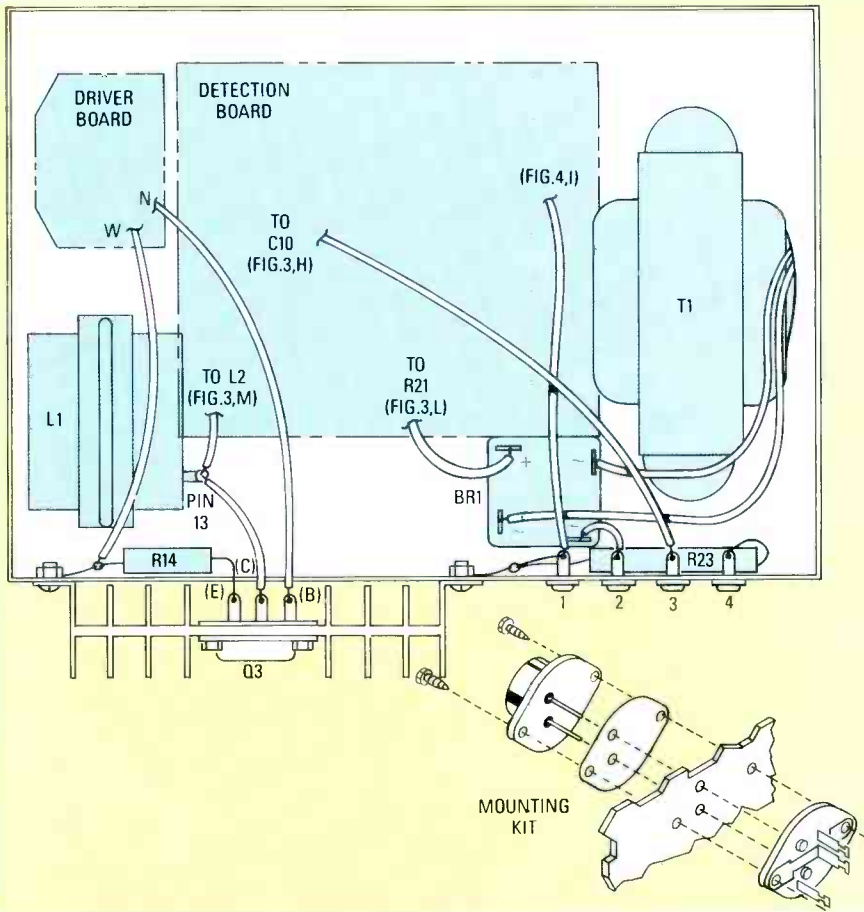

FIG. 5—CABINET WIRING. First make all of these connections, before continuing with Fig. 6.

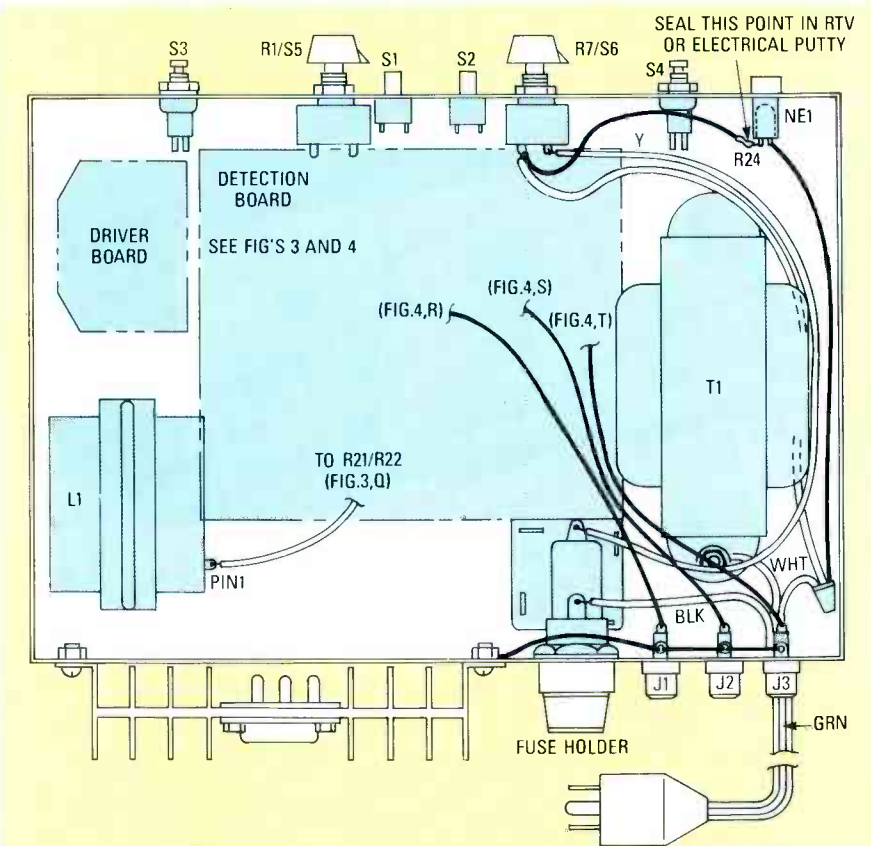

FIG. 6—FINISH THE WIRING as shown here. Be careful to allow sufficient clearance for the contacts of the terminal strip.

the ground connection to J3. Turn S5 to "off," rotate R7 fully clockwise, open up S2, connect a scope to the collector of Q2, and note the approximate wave shape as shown; the voltage will be approximately 15 volts p-p. Those settings should be at the maximum frequency obtainable. If the frequency varies much from 20 kHz, it will be necessary to change the value of R8 or C6; a higher value for lowering the frequency and vice versa.

Rotate R7 fully counter-clockwise and note the frequency dropping from 20 kHz to 10 kHz. Close S2 and note frequency range dropping from approximately 10 kHz to 5 kHz. Check the action of test-switch S3 and make sure that all frequencies decrease by a factor of 4 to 5.

Preset all controls for maximum frequency, and turn on S5 to initiate sweeping action. Close S1 and rotate R1 fully counter-clockwise. Note the frequency sweeping from 20 kHz to approximately 25 kHz. Sweep rate will increase by approximately $\times 10$ when S1 is open. A change will also occur when varying R1. That checks the frequency and sweep ranges of the device. Note that the frequency readings may vary, and can be compensated for, if necessary, by changing circuit values.

Connect the base of Q3 to the driver board via jumper lead (N). Connect up to 4 transducers in parallel to contacts 3 and 4 of the terminal strip. Note that if only 1 or 2 transducers are used, it will be necessary to change R23 from 15 ohms to 40 ohms for output compensation.

Apply power and connect a scope across the transducer(s). The wave shape should be close to a sine-wave. The wave shape deteriorates as the frequency is lowered. Double check the test points with the system in full operation, noting the values given in Fig. 1.

Adjust the ferrite core inside L2 for maximum voltage at maximum frequency and secure it in place. The core may not be needed if four or more transducers are used, as the induction of the coil by itself is usually sufficient.

You will note that L1 is shown with several tap connections intended to produce more output. Tap 18 is the factory setting and is intended for continuous use; the voltage across the

(Continued on page 76)

VIDEO SCENE SWITCHER

WILLIAM SHEETS and RUDOLF F. GRAF

Time to finish this project.

WE LEFT OFF LAST MONTH WITHOUT finishing the discussion on the circuitry operation. So let's finish describing the circuitry, and then get to building and aligning the unit. Before we begin, though, please note that there are a couple of corrections that you'll want to make to last month's article. First, in Fig. 3, pin 13 of IC3 and its corresponding channel-2 component, IC16, should be connected to +5 volts for proper operation. Second, the correct value for R9 and R209 should be 15K. When we left off we were explaining Fig. 5, so would you please refer back to that figure in last month's issue.

Ramp-generator IC12 is used to generate a slowly varying DC voltage for slow fades, wipes, or key-ins. It is fed either positive or negative signals through R44. The speed (rate) of the ramp depends on the setting of the speed control R42. By varying R42, either a slow or fast key transition can be obtained. R47 is used where manual control of key transition is desired. Q3 and Q4 feed either +5 or -5V DC to R42, depending on the logic level at the junction of R37 and R36.

Figure 6 shows the video switching circuits; IC17-IC20 are CMOS analog SPDT switches. Each has three sections that can be switched at over 1-MHz and can handle signals up to 5 MHz with 50 dB isolation. They are controlled by a logic level at the input. All switches are in "up" positions (N.C.) when logic level is zero, and "down" (N.O.) when logic level is high.

Channel-1 video is input to pin 15 of IC17 (IC1 is fed from that point as well), where it is split into video and sync. IC17 is driven by IC2 in the keying section. Sync and video are available separately at J2 and J7. In Fig. 6, an "EF" followed by a letter represents an emitter-follower circuit; one is shown in detail inside dashed lines in Fig. 6. IC18-a selects either input video or effects video (derived externally from video 1). IC18 selects either CH1 or a DC level between -0.5 and +1.5 volts from R115 used in a fadeout; it is blanked during sync intervals so as to not upset sync levels. Transistors Q100-Q102, D100, and

R112-R118 generate the required waveform.

IC18-c and IC20-c are configured as a DPDT switch to switch between CH1 and CH2 for direct fades, wipes, or key-ins (genlock sources are required). Switched video from both channels is fed to fader R125. The output of R125 is taken to summing amplifier IC21, together with sync from IC17-b and IC19-b (sync is selected for the channel in use). Fre-

the PLL on the keyer board (IC5) need be only 50 mA, but it should be well filtered. A suitable power-supply is shown in Fig. 7.

The two PC boards can be constructed using the Parts-Placement diagrams of Figs. 8 and 9. Foil patterns for the two PC boards are provided in PC Service. Just be very careful when soldering, so that you don't create any problems for yourself when you go to calibrate the unit. Check off each part



quency-compensation components R119 and C107 maintain correct burst phase. The output of IC21 is a complete inverted video signal. It's fed to IC22 for re-inversion and then to J9 via termination-resistor R132.

The unit requires ± 5 , and +12-volts DC. The ± 5 -volt supplies must be at least 500 mA. Two IC regulators, an LM7805 for +5 and an LM7905 for -5, together with a 12-volt AC transformer and bridge rectifier can be used. The +12 volts for

as you install it, and inspect your work as you go along to minimize headaches later on.

After you've assembled and checked out the two boards, you must wire them along with the switches, RCA jacks, control potentiometers, and power supply as shown in Fig. 10. There are a lot of connections to be made, so be patient, take your time, and do a careful job.

Any suitable control-panel layout can be used. Just make sure that leads

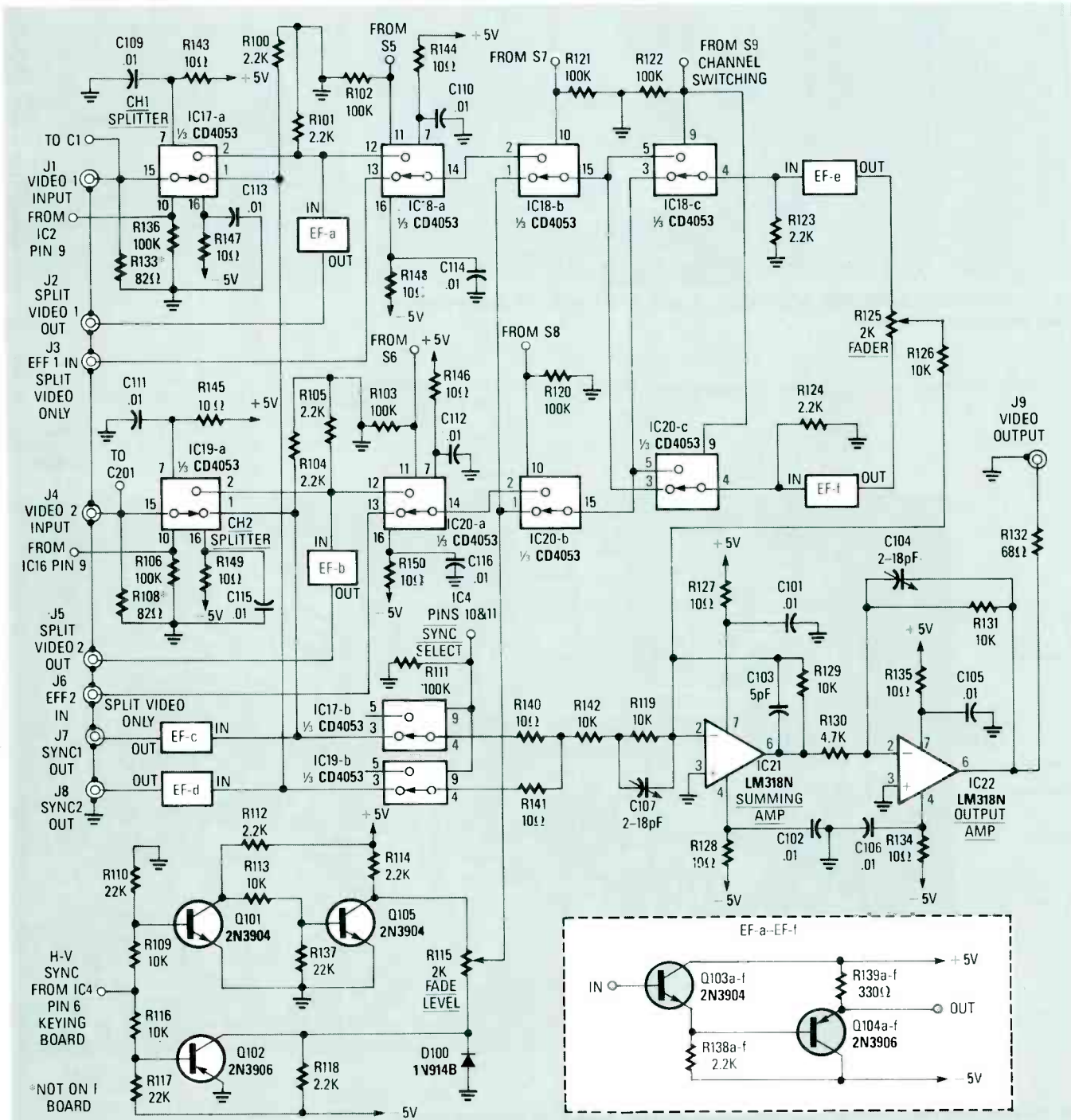

FIG. 6—THE VIDEO SWITCHING CIRCUITS. Each analog switch (a CD4053) has three sections that can be switched at over a 1-MHz rate, controlled by a logic level at the input. An "EF" followed by a letter represents an emitter follower circuit; one is shown in detail inside the dashed lines.

are kept as short as possible and separated from each other to minimize crosstalk. The prototype that you see pictured in this article is mounted inside a metal cabinet. While a metal cabinet is preferred for its shielding, any other kind will do, as long as everything fits inside.

Checkout and alignment

After the unit is all together, and you've inspected the boards for soldering defects, turn the unit on and make sure that none of the IC's get hot. Then check all points for proper voltages—+5, -5, and +12. You will need an oscilloscope for the fol-

lowing checks, and we will go over the procedures for CH1 only, but the procedures are identical for CH1 and CH2.

Apply a 1-volt p-p negative-sync NTSC video signal to J1, and verify negative sync pulses at about 5-volts p-p at IC1 pin 1. Adjust R6 so that IC2

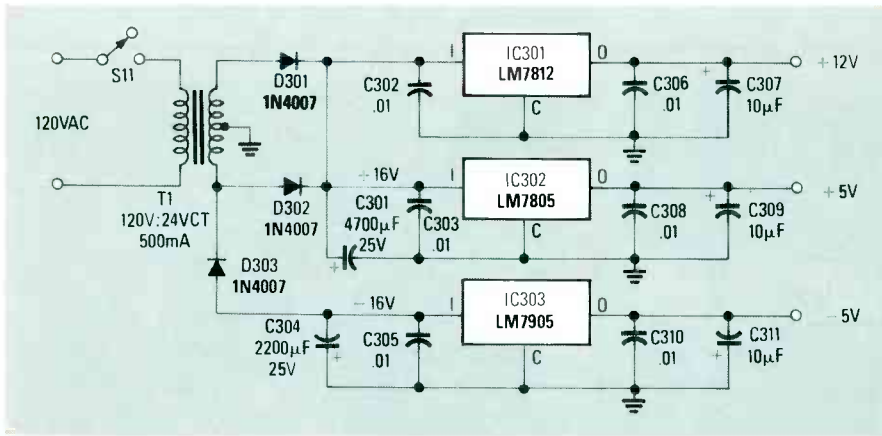

FIG. 7—THE SCENE SWITCHER REQUIRES ± 5 AND $+12$ -VOLTS DC. The prototype's power supply is shown here.

Note: A kit consisting of the two PC boards, the parts that mount on them, and the front-panel potentiometers is available from North Country Radio, PO Box 53, Wykagyl Station, New Rochelle, NY 10804, for \$137.50. The kit does *not* contain other parts that mount off the board, such as the switches, RCA jacks, power supply components, project case, etc. A set of two PC boards is available separately for \$27.50. Add \$2.50 to either order for postage and handling. New York residents must include sales tax.

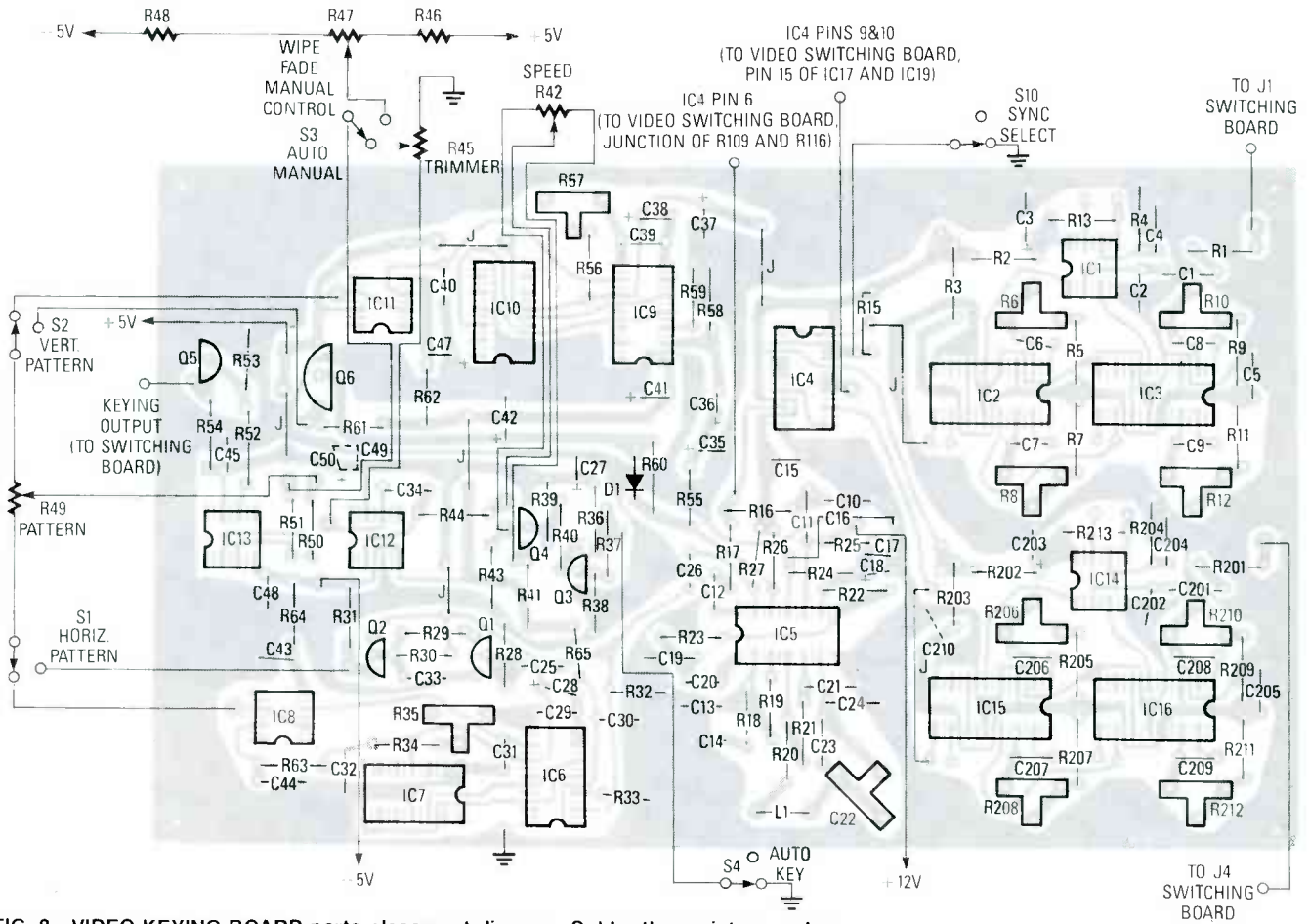

FIG. 8—VIDEO-KEYING BOARD parts-placement diagram. Solder the resistors and capacitors first, and then the IC's.

pin 6 (IC2-a) shows an 8- μ s pulse and adjust R8 so that pin 9 (IC2-b) shows a 53 μ s-pulse. Check for a 60-Hz vertical-sync pulse at IC1 pin 3. Adjust R10 for 0.5–0.6-ms pulses at IC3-a pin 6, and adjust R12 for a 16-ms pulse at IC3-b pin 9. (Start out with R12 at its minimum-resistance setting). Make sure that S10 (SYNC SELECTING) is in the CH1 position, and then check for sync pulses at pin 6 of

IC4. Connect the scope to IC5 pin 13 and, using a non-metallic tool, adjust C22 so that the pulses are synchronized to the video signal. Check for 60-Hz pulses at IC5 pin 12.

Connect the scope to IC8 pin 4, and adjust R35 for a 126-kHz sawtooth wave. Now connect the scope to IC11 pin 6, and adjust R57 for a 480-Hz sawtooth. Verify a 15.7-kHz horizontal sawtooth at the junction of R31 and

the emitter of Q2, and a 60-Hz vertical sawtooth across C42. Now check the waveform at the wiper of R49: it should be a mixture of two of the four previous waveforms, depending on the settings of S1, S2, and R49.

Check for ± 2.5 volts at the wiper of R47, and also for between +4 and -4 volts at IC12 pin 6. When you activate S4, the voltage should slowly

continued on page 54

BUILD THIS

It's easy to build a low-cost, professional-type PC-board etching system.

TONY LEWIS

MAKING A PRINTED-CIRCUIT BOARD by simply plunking the copper-clad board into a bowl of etchant is usually an irritating and time-consuming project, even if you try to speed things up by heating the etchant in a Pyrex bowl on the stove. But build yourself a professional-type etching system that has automatic heater control and air-burst agitation, and your PC boards will be done before you can figure out how to drill or cut the holes. Best of all, the total cost will be about half that of a comparably equipped commercial system.

System design

Etching a printed-circuit board is usually a time-consuming task for even the smallest of boards, because copper etchants require two things to work properly: heat and agitation. Traditional methods of heating the solution include warming its container on a hotplate or stovetop, immersion in a hot-water bath, or even by placing the etchant in a microwave oven. Of course, due to the chemical action of the etching solution, only plastic or glass containers are used—usually large flat bowls with the copper board immersed in the fluid. That is an acceptable method for single-sided boards, but double-sided boards must

be removed frequently and turned over to monitor the etching process. Also, the etchant emits fumes when heated; and although the fumes aren't dangerous, they really don't belong in the kitchen.

Effective etching also requires agitation, which is usually provided by constantly moving the container and the board back and forth while they are being heated. Since the board is probably in the horizontal position, dissolved copper is likely to pile up on the board unless you are very enthusiastic in your agitation. So etching a

typical board may take from 20 to 60 minutes, even if you continuously push the copper-clad board around the bottom of the container of hot etchant. Between the agitation and the heat, it's not a pleasant job.

Build a tank

To minimize the etching time, while also reducing your concentration and effort, you should use an etching system that incorporates its own source of heat and agitation. Systems with heaters and air bubblers (for agitation) sell for about \$60 and

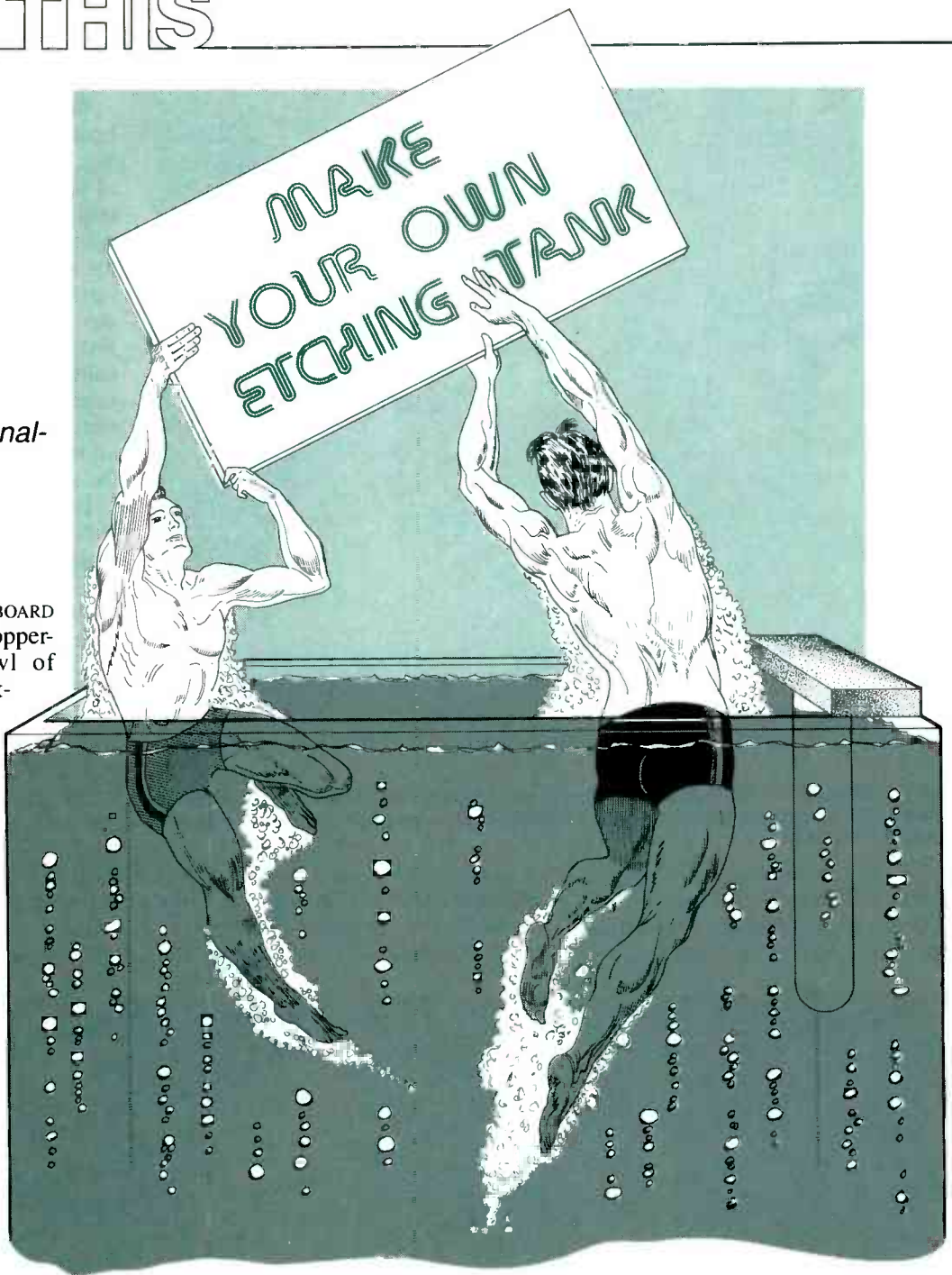

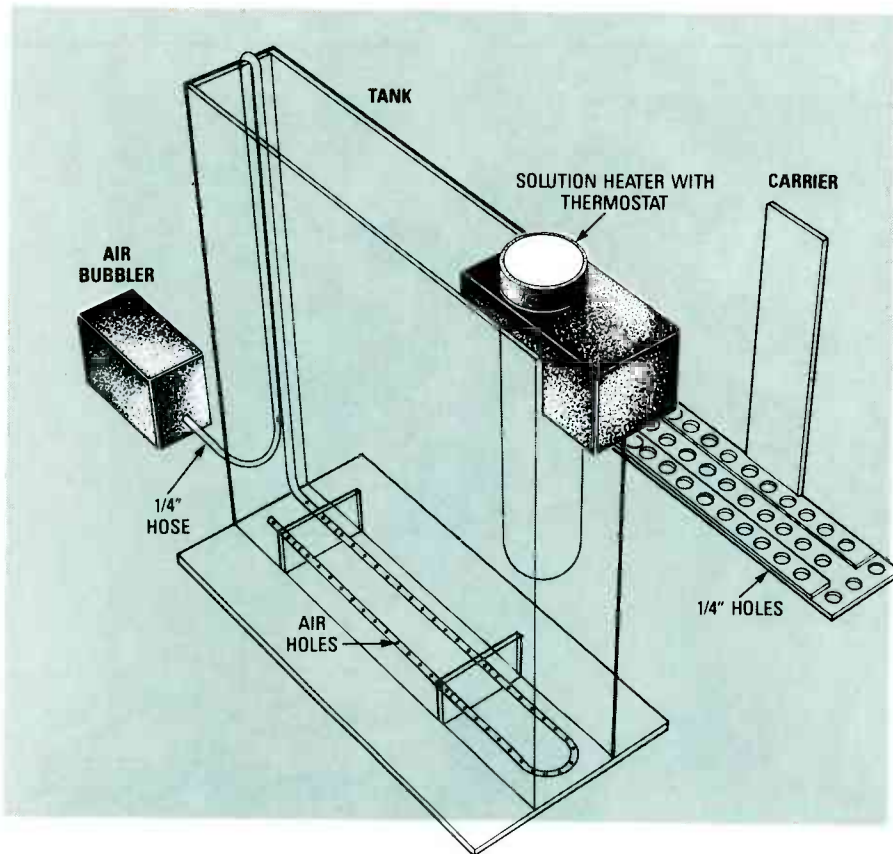

FIG. 1—THESE ARE THE MAIN COMPONENTS of our professional-type PC-board etching system. The air bubbler, the hose, and the solution heater, are available at stores that sell aquarium supplies.

up. As an alternative, we'll show you how to design and build a professional-type etching system, such as the one shown in the photographs, that

uses Plexiglas to form both the etching tank and the PC-board carrier. By constructing the entire system yourself, your total costs should come out

under \$30, and you'll probably avoid an oversized tank by designing the system to fit your individual needs.

The major components of the PC-board etching system are shown in Fig. 1. The individual bits and pieces of plastic that are used to make the tank are shown in Fig. 2. For best control of the etchant's temperature, the solution heater should have an adjustable thermostat. Although heaters are available through mail-order firms, they can also be purchased locally from stores that carry aquarium supplies. Whatever you use, make certain that the heater has a device that allows it to be clipped to the side of the etchant tank.

Depending on the initial temperature of the solution, a 100-watt heater will raise the temperature 100°F in 30 to 45 minutes. If you purchase a heater with a smaller capacity—one with a lower wattage rating—the heat-up time for the solution will be extended proportionally.

The air bubbler and its hose can also be purchased either through the mail or from local aquarium-supply stores. The cost should be under \$10. The air bubbler should be sized for at least a 15-gallon aquarium: The larger the flow capacity, the better the performance. Make sure that you buy enough clear plastic air hose so that it will fit inside the tank and also

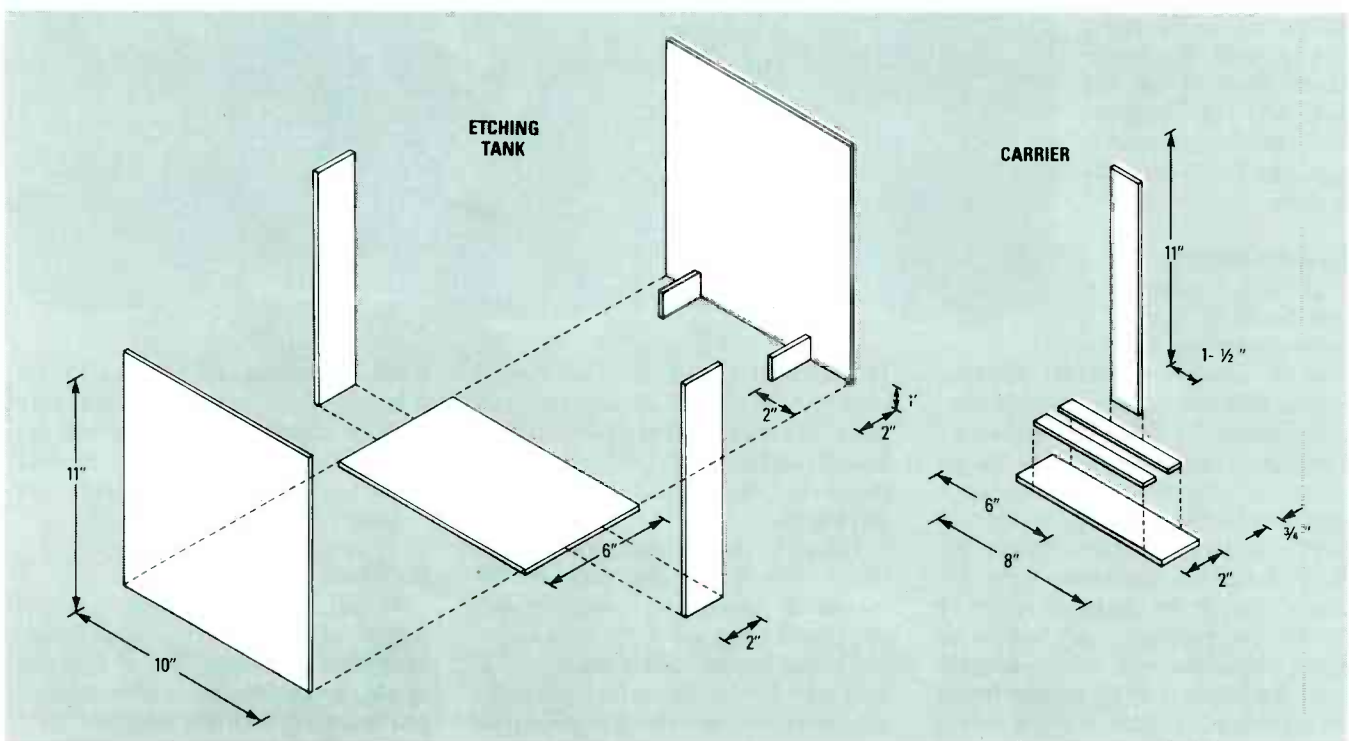

FIG. 2—THESE ARE THE INDIVIDUAL plastic components that are used to make the tank and the carrier.



FIG. 3—A SHEET OF PLEXIGLAS, a cutting tool, adhesive, and some aquarium materials are all that's needed.

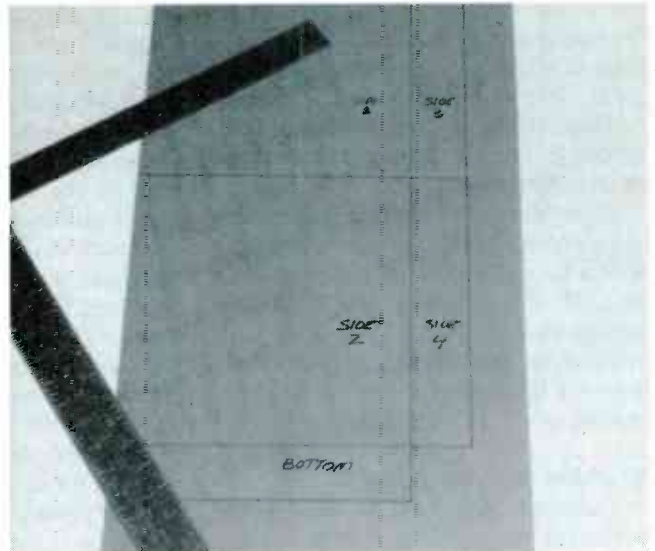

FIG. 4—DRAW YOUR TANK PIECES on a sheet of paper first. Then transfer them to the paper backing of the Plexiglas.



FIG. 5—DON'T TRY TO CUT THE PLEXIGLAS with a saw. Instead, use a straightedge to guide the scoring tool.

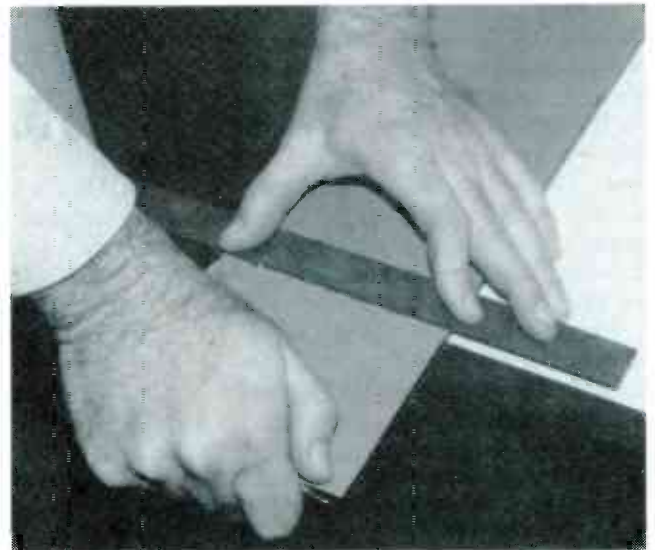

FIG. 6—POSITION THE SCORE LINE on the edge of a table, hold the plastic firmly, and then snap the plastic in two.

allow the bubbler to be placed in a convenient location.

The Plexiglas used for the tank should be $\frac{3}{16}$ — $\frac{5}{16}$ inch thick. Thinner sheets tend to crack too easily, and thicker sheets are harder to work with. You'll need about three square feet of the Plexiglas, preferably in a 1 × 3-foot sheet form. Always buy more Plexiglas than required, to allow for practice and mistakes. Of course, you'll want to use clear Plexiglas so you'll get a good view of the PC board when it's immersed in the etchant. If you live in a metropolitan area, there's probably a local plastics dealer listed in the phone book who can supply the Plexiglas. If not, most hardware stores carry Plexiglas—or can advise you where to get it.

Other items that you'll need in-

clude Plexiglas adhesive and a cutter. To build the tank you'll also need a

PC-BOARD MATERIALS

Active Electronics, PO Box 9100,
Westboro, MA 01581 (800)
343-0874

Data Corporation, 3117 Paterson
Plank Rd., N. Bergen, NJ 07047
(201) 863-7667.

Injectorall, 110 Keyland Court,
Bohemia, NY 11756 (516) 563-3388

Kepto Circuit Systems, 630 Ax-
minister Dr., Fenton, MO
63026-2992 (800) 325-3878

Radio Shack stores

long metal straightedge, a carpenter's or Tee square to draw precise corners, a table or a surface having a sharp edge, and possibly some small C-clamps. A variable-speed drill, assorted drill bits, and sandpaper or a file will also come in handy

Figure 3 shows the the tools and materials that you'll need. The Plexiglas is the "dark" sheet upon which everything else is placed. It's dark because it's supplied with protective paper stuck on both sides to make sure that the Plexiglas doesn't get scratched during construction.

The tank first

The tank should be designed on paper first, then cut and assemble the components from the Plexiglas sheet. Don't hesitate to stop and make a new

part if you make an error while cutting the components, because once Plexiglas is glued together it's glued for good. If you follow the procedures outlined below, you should be able to assemble a leak-tight working system in less than a weekend.

If you use the Plexiglas component sizes shown in Fig. 2, you'll end up with a 10 × 11 × 2-inch tank that sits on a 10 × 6-inch base, and a carrier having an 8 × 2-inch base. The two small strips of Plexiglas on top of the carrier's base form a groove for the bottom of the PC board to rest in.

Working with Plexiglas

Plexiglass isn't hard to work with as long as you're aware of some of the tricks of the trade. The first step, as shown in Fig. 4, is to carefully measure and mark your sheet of Plexiglas. Since the Plexiglas comes with a peel-off paper backing on both sides, simply mark the cutting layout directly on the backing. Because you will be cutting out more than one section at a time, a long straightedge, preferably metal, is necessary. Also, a carpenter's square is invaluable for both drawing the cutting lines and for making perfectly square corners.

Whenever possible, line up the sections having common dimensions; for example, the left and right sides and the base should have a common width. Don't forget to account for the thickness of the Plexiglas when determining the dimensions. Check and double-check all the dimensions, and double-check the corners for squareness. Also check the precut edges and corners of the Plexiglas itself; don't assume that they're cut straight and square at the factory.

Before cutting the sheet of Plexiglas, practice on an extra piece or two just to get the hang of the special cutting technique. Actually, the term "cutting" is a misnomer because you will *score* rather than cut the Plexiglas. If you try to cut the Plexiglas using a conventional saw you will quickly discover one of Plexiglas' annoying characteristics: it melts. If you try to cut or drill the plastic quickly it begins to melt locally in the area of the blade or the drill bit, and will quickly foul the saw or drill. By slowly scoring the surface multiple times, then breaking the Plexiglas on the score line, you can create a smooth edge with very little effort.

Figure 5 shows the tools needed to

cut the Plexiglas: a *plastic knife* (which is not made of plastic, but is designed to cut plastic—available for under \$4), and a metal straight edge to guide the knife as it scores a groove. Draw the knife along the line you marked on the paper in a smooth, slow fashion, without pressing down too much. As a general rule, score the Plexiglas a minimum of 36 times in one direction, then a minimum of 36 times on the same line in the opposite direction. Before stopping, check the edges of the plastic on both ends; the groove should be about one-half the depth of the sheet of Plexiglas.

Next, break the edge. As shown in Fig. 6, position the plastic with the scored line on the edge of a table. Use one hand and a straightedge, or a similar solid object, to hold the plastic down. Using your other hand, press firmly down on the part to be broken off. The Plexiglas will bend slightly, then suddenly snap in two. Inspect the edges. If they're not perfectly smooth, they can be sanded or filed down. Do not leave any ridges on the edge, because they will cause problems when you're trying to seal the tank.

Generally, sections longer than six inches are hard to cut properly the first time when hand-holding the Plexiglas. Clamps and a straightedge, rather than hand pressure, are better for holding long pieces.

Drilling Plexiglas isn't difficult if you use a variable-speed drill and a little patience. Mark the area where the hole is to be drilled, then drill a pilot hole using a small-diameter bit. Note that the faster you drill, the more likely the Plexiglas will be to melt and wrap itself around, and clog the drill bit. After drilling the pilot hole, start drilling slowly with a 1/4-inch bit. Don't press down too hard, or the plastic may crack. For best results, place the Plexiglas on a piece of soft wood when drilling.

As shown in Fig. 7, straighten a length of the plastic air-bubbler hose and drill small-diameter (0.04—0.06-inch) holes spaced about one inch apart. Seal one end of the hose with silicone or RTV sealant and allow it to dry overnight. To ensure that the hose will bubble correctly, connect it to the air bubbler and test the hose underwater in a sink. Drill more holes if there are not enough bubbles, but keep the holes evenly spaced so that the printed-circuit board will not

get too much agitation in one section.

Tank assembly

Remove any ridges from the edges of the Plexiglas pieces before gluing them together. Although it is possible to use epoxy or other adhesives to hold the sections together, we recommend an adhesive that is specifically intended for use on Plexiglas. The stuff is not really an adhesive as much as it is a solvent. Capillary action causes the adhesive to rapidly spread between the two pieces of Plexiglas. The adhesive slightly dissolves both pieces of Plexiglas, which then solidifies into a "weld." A small amount of adhesive will go a long way, so you'll need a convenient dispenser, such as a syringe (hypodermic), which is available from drug stores for about \$1 each. The syringe allows precise dispensing of the amount and location of the adhesive. Once you have the Plexiglas sections aligned, slowly inject the adhesive at the joint without pushing the Plexiglas out of position. The adhesive will flow under the joint and begin to "melt" the plastic slightly, which helps seal the two Plexiglas pieces together watertight—even if they have small imperfections on the edges.

Note: Many states require a doctor's prescription in order to purchase a syringe. If you live in one of those backward-thinking states, purchase a syringe-type fine-oil dispenser, which is really a syringe whose tip has been blunted.

Figure 8 shows a square being used to hold two sections of Plexiglas perpendicular to each other while being glued. Make sure that the two sections are as square as possible, or you'll have trouble fitting the other sections later. After applying the adhesive, press the two sections together and hold them in position for a minute or two. Then allow them to set up undisturbed for at least 15 minutes or longer. When the adhesive dries completely, the joint will be as solid as the Plexiglas itself.

Another reason to use Plexiglas adhesive is that it dries completely clear, which makes for a better appearance of the final product. Once you've applied the adhesive to one side of the joint, go back and apply it to the other side of the joint, and allow it to set up. That will give the joint a better seal and added strength.

Place one of the larger Plexiglas

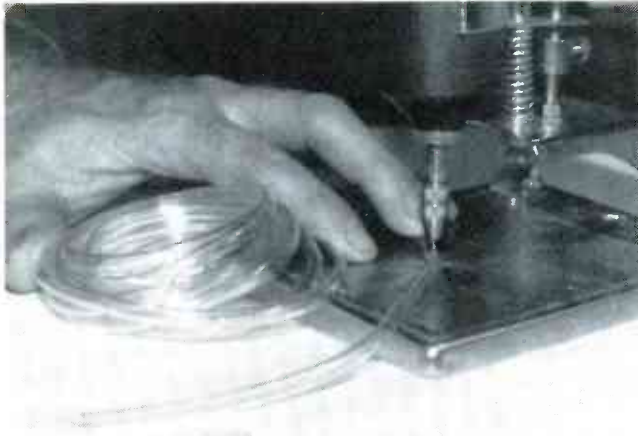

FIG. 7—STRAIGHTEN THE PLASTIC AIR HOSE and drill a series of small holes spaced approximately one inch apart.

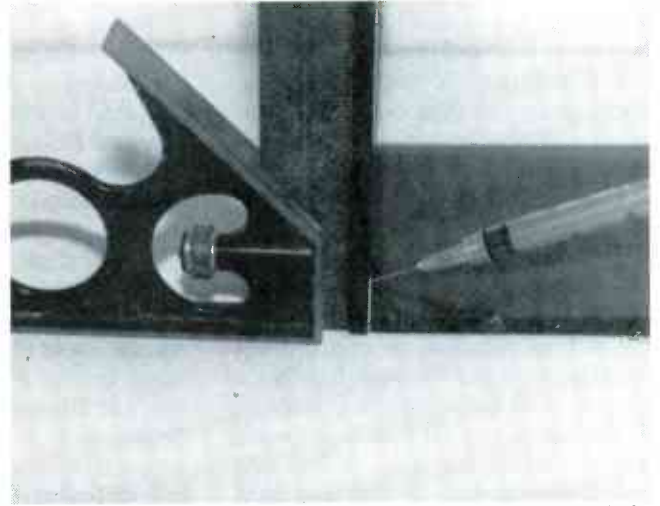

FIG. 8—SQUARE THE PLASTIC SECTIONS using a machinist's square. Then, apply the Plexiglas adhesive.

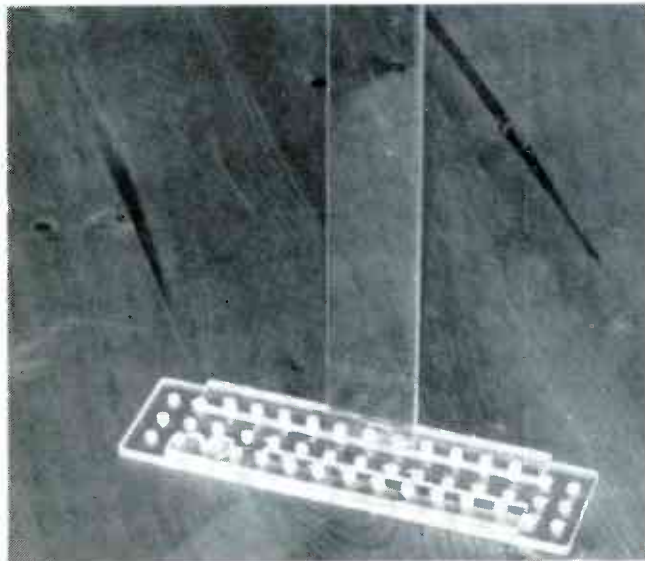

FIG. 9—THE HOLES DRILLED in the bottom of the carrier allow the air bubbles to pass through to the printed-circuit board.



FIG. 10—HANG THE HEATER from the side of the tank, connect the air bubbler, and check for an even bubble distribution.

sides on a flat surface. Using the previous procedures, position one of the smaller sides so that it is perpendicular to the flat piece. Note and correct any ill-fitting edges, and also make certain that the two pieces are of the same height. When you are sure that the pieces have a good fit and are properly supported, slowly begin injecting the Plexiglas adhesive on the inside interface of the two pieces. Note that the adhesive will probably move faster along the interface than you do. When all of the interface has been injected with adhesive, press down lightly on the vertical piece for a minute or two while maintaining its perpendicular position. Release the pressure and recheck for proper position. The adhesive will set up in about 15 minutes, but allow at least 30 minutes before attempting any more

work. After drying, the interface should look clear, with a few minor bubbles. If a bubble appears to run from one side to another, a second injection of adhesive may be necessary. When you're satisfied with the adhesive injection process on one side of the interface, repeat the process for the other side.

With one small side in place, repeat the procedure for the other small side. Your tank should now have three sides, and be capable of standing upright. Position the partially assembled tank over the center of the base section. Once again, make sure there's a tight fit between the Plexiglas pieces before applying adhesive to both sides. Then install the two small supports in the bottom of the tank. But before installing the supports, drill two evenly spaced $\frac{1}{4}$ -inch holes in

each support for the air-bubbler tubing. Temporarily set the supports in the bottom of the tank (using tape to hold them in place) and position the last side on top. Check to make sure that the last side will fit tightly with the base and the two smaller sides, and that the supports do not cause the piece to bulge out. It's too late to correct measuring errors after the supports are glued in place.

When you're satisfied with the fit all around, glue the supports to the base and to the side. (You will not be able to glue them to the last side that's installed.)

Run the bubbler's hose through the holes in the supports—try not to create kinks in the hose. Install the final side of the tank after the hose is properly installed and all the other joints are sealed from both sides.

With the tank in a vertical position, first inject the adhesive to the interface at the base and press down lightly while holding the sides together. Then, place the tank on its side and apply adhesive to the two side interfaces. To ensure a good seal, place a heavy object (about five pounds) on top to apply even pressure.

Checkout

The tank is no good if it can't hold the etching solution, so check it out thoroughly. After the tank has had a chance to set up overnight, place it in a sink and slowly fill it with hot water while watching for leaks. If leaks do occur, drain and dry the tank and reapply Plexiglas adhesive in the areas of the leaks. If necessary, a small amount of adhesive can be poured along the inside corners to enhance sealing from the inside. If you discover that you have a gap between two Plexiglas pieces that the adhesive will not seal, then epoxy or contact cement may have to be applied from the outside to stop the leak. Do not use silicone or RTV sealer, because they may weaken or leak after repeated exposure to the hot etchant.

Another possible way to solve the leaks that the less-than-perfect craftsman is bound to get is to mix some DATAKOAT liquid, or other 100% acrylic coating, with some solvent-type acrylic adhesive. The resulting material should seal even relatively large leaks.

The printed-circuit board carrier, shown in Fig. 9, is easier and less critical to make than the tank. Cut the base, the two top pieces, and the handle. To ensure that the carrier will move in and out of the tank without hitting the walls, the width of the carrier's base is slightly less than the width of the two small sides. As shown, glue the two top strips over the center of the base so that they provide a groove to hold the bottom of the circuit board as it rests in the tank. Carefully drill a series of evenly spaced 1/4-inch holes in the base assembly. Then, glue the handle on top.

Finally, as shown in Fig. 10, install the solution heater and bubbler to test your system. The carrier should be able to move in and out of the tank without hitting the air hose or the heater. With the carrier in place, and the bubbler running, the bubbles should be evenly distributed along the base of the tank.

Custom size

The main advantage to building your own etching system is that you can customize the tank to your needs; it should be customized for your anticipated PC-board sizes. There is no need to oversize the tank because that wastes etchant and takes longer to heat up. If your boards are usually wide and short, or you don't need a tall tank, it is possible to redesign the tank so that the heater is inserted horizontally near the bottom of the tank, above the bubbler hose. An ordinary hole saw from the hardware store will do the trick. In that case, one of the supports will need a corresponding hole drilled to accommodate the heater. However, a horizontal heater assembly is really not advised unless absolutely required because the area around the heater/side joint might be prone to leaks.

Using the system

Two types of etchants are available for hobbyist and technician use: ferric chloride, and sodium or ammonium persulfate. Ferric chloride is generally available and is economical to use. However, it should be used only in a well-ventilated room, and it can stain badly—which can be a problem if the etching tank is upset. The persulfates come in crystal form and have several advantages over ferric chloride in that they will not attack stainless steel, they are totally ineffective when cold, solutions are clear when first used, and they give an indication of their copper absorption by turning blue. Like ferric chloride, the more the persulfate solution is reused, the slower the etching process will become.

Another important advantage of persulfates is that they are not as aggressive as ferric chloride in the etching process, and will not undercut the PC-board's traces. That is especially important if you work with printed-circuit board patterns having line widths of 0.032-inch or smaller, such as computer-memory boards. (Nothing is quite as frustrating as having the etchant dissolve some lines on one side of a board while you were examining the other side.)

For comparison purposes, four 2 × 4-inch single-sided boards having identical patterns were etched in heated ferric chloride and ammonium persulfate, both with and without the bubbler running. For ferric chloride,

the etching time with the bubbler off was 16 minutes; 9 minutes with the bubbler on. For ammonium persulfate, the etching time was 19 minutes with the bubbler off; 11 minutes with the bubbler on. (Etching times will vary, depending upon the board pattern, the number of times the etchant was reused, etc.) Also, monitoring the etching process in the tank was easier using the ammonium persulfate solution, because it is clear.

Note that our test etching times are considerably faster than when agitating a Pyrex dish over a heater or the stove. Often, the bubbler results in a 40% reduction in etching time compared to simple hand agitation. Also, keep in mind that the faster a board is etched, the less likely the chance that the etchant will attack the sensitizer and undercut edges of the traces, thus ruining the board.

If you'd like to use persulfate as an etchant, it is available from Kepro Circuit Systems, and Active Electronics. Other major mail-order firms such as Datak, carry powdered ferric chloride and others carry ferric-chloride solutions.

Those of you who choose to work with ferric chloride will want a way to get rid of the spent etching solution. The best way is to mix it with a solution of lye (sodium hydroxide). The copper and iron will precipitate. The remaining solution is salt water and excess lye. Pour the salt water down the drain. Let the copper and iron hydroxide dry out, and then dispose of with your tin cans, etc.

Our etching system should give years of trouble-free service, while saving you many hours of time spent in etching PC boards. If you want additional information on making PC boards, see the following articles that have appeared in **Radio-Electronics**: "Making Your Own PC Boards" (Feb. 1988); "Designing Double-Sided PC Boards" (Sep.–Oct. 1985); "Etch Your Own PC Boards" (Dec. 1982, Feb. 1983). Also, Bob Grossblatt has been covering PC-board design and production in his "Drawing Board" column since August of this year, and Don Lancaster's "Hardware Hacker" column in this issue looks at a novel approach to PC board design. Now you have no excuse for not putting the PC Service pages to work, or building that design you've been working on and meaning to prototype!

R-E

Radio Electronics **HOLIDAY GIFT GUIDE**

ELECTRONICS HAS CERTAINLY CHANGED THE WAY WE LIVE. IF nothing else, it has made the holiday shopping season a little easier to deal with! The array of consumer products is so great, that you are sure to find something for everyone.

We've compiled a subjective list of what we would buy for our families—or ourselves—from the plethora of products available in the consumer-electronics market. We looked at video and audio products, computer-related products, and electronics for people who take their electronics seriously. We didn't pick products for their price, nor did we pick them because they were the "best." We picked the products because we felt they offered something unique, something fun, or something innovative.

We don't pretend that our list is comprehensive—we're sure that we've neglected to mention some of the products that deserve recognition. Despite that, we hope that this guide proves helpful by, at the very least, giving you some new ideas.

Video products

• Integrated Video System

For those on an unlimited budget, we'd like to suggest the Bang & Olufsen *Video System 5000*, an integrated video system that is capable of multiroom operation. It can be teamed with any Bang & Olufsen audio system to form an interactive audio/video system in anywhere from one to sixteen rooms. The *Video System 5000* integrates a 26-inch TV monitor and a Super-VHS digital VCR with a motorized, remote-controlled stand and an audio/video remote control. As you might expect, the *Video System 5000* doesn't come cheap. But if you're contemplating installing a through-the-house A/V system, that probably doesn't matter much. The entire system, including the motorized stand retails for \$4290.

• LCD projection TV

For those more concerned about picture size than high-tech convenience, Sharp's LCD projection system is the answer. It's quite a change from traditional projection sets. First of all, it's portable. The projector weighs about 30 pounds, and projects a bright, clear picture on either a wall or screen. The unit's magnification can be varied, producing a picture from 25 to 100 inches (measured diagonally). The key to the system's size and performance are three small LCD panels inside the unit. The 3-inch twin TFT (Thin Film Transistor) panels form the red, green, and blue components of the video picture. The projector does not require any convergence adjustment, and it features two video inputs and Super-VHS compatibility. The price for this first-of-its kind TV is \$6500.



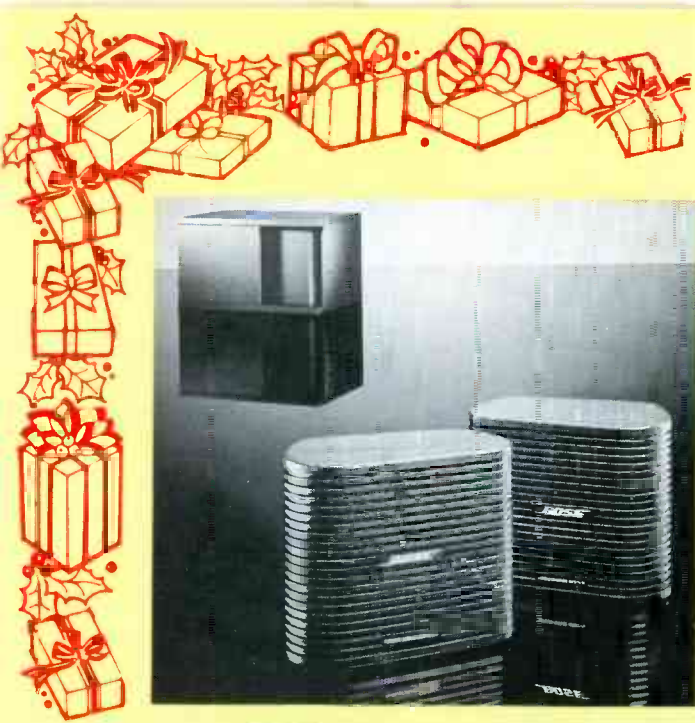

● **Self-Powered Subwoofer**

Perhaps you already have a big-screen TV but you don't feel that you're getting the big-screen feeling. Maybe you've even tried surround sound and still don't feel that you've been successful in creating the home theater experience. Don't give up yet. Audiophiles and videophiles have created a demand for accurate low-frequency sound reproduction. Pioneer Electronics has answered the demand with their *S-W1000* switchable, self-powered subwoofer and center-channel speaker system. The *S-W1000* subwoofer system features a magnetically shielded design and low-distortion 12-inch woofer powered by a built-in switchable power amplifier. An extra amplifier is provided for center-channel Dolby Pro-Logic Surround Sound applications. Switchable roll-off frequency settings of 50, 90, or 140 Hz are available. The subwoofer system is available at a suggested retail price of \$500.

● **Talking Remote Control**

While we hope that no one reading this magazine has trouble programming his VCR, we're sure you've heard family members muttering under their breath as they go through the sometimes frustrating procedure. Until now, you've probably never heard your VCR talk back. But the Optonica *Voice Coach* remote control from Sharp will vocally guide users through the proper programming procedure. The *Voice Coach* comes with the Super-VHS *VC-G990U* VCR. Full remote operation is featured, including remote eject. The *VC-G990U*, with the *Voice Coach*, is available for \$999.95.

● **Videotape Editor**

As camcorder sales have skyrocketed over the last couple of years, the need for an easy-to-use editing system has become evident. *DirectED Plus*, from Videonics, combines the functions of a video editor, titler, special-effects generator, and video librarian. *DirectED* works with just about any VCR that uses an infrared remote control. Both a recording and a playback VCR are required to assemble your finished video production. *DirectED Plus* sells for \$549.95. For professional video producers, *ProED*, a computerized multifunction edit controller is available for less than \$1000.

● **VCR Survival Kit**

VCR maintenance is simple. Simply keep it clean. Unfortunately, not many people follow even that simple advice. You can help them along with the *GE Survival Kit*. The kit includes a head cleaner, a dust cover, and a GE T-120 video tape. While we generally don't recommend head cleaners for VCR's, giving someone this kit might do the favor of stressing the importance of cleanliness for long VCR life. *The GE Survival Kit* retails for \$19.95.

Audio products

● **10th Anniversary Walkman**

The last ten years have seen a lot of changes in audio. Most people would point to the CD player as the most important development of the decade. But we think that the Sony Walkman has done more to bring an appreciation of good

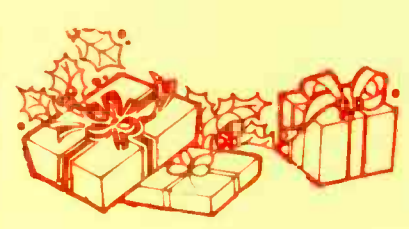
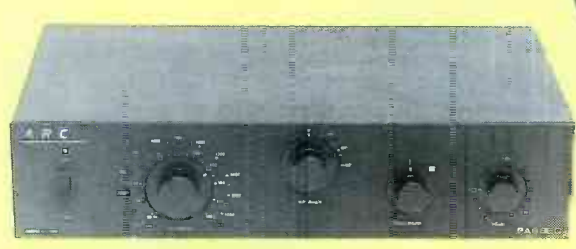



audio to the masses than anything else. In honor of the tenth anniversary of the introduction of the Walkman, Sony has introduced a special edition AM/FM stereo Cassette player, the *WM-F701C*. It features digital synthesized tuning, 14 station presets, remote control, and auto reverse. It all fits in a cassette case-sized package and carries a price that only a Walkman fanatic could love: \$379.95.

● Airplane Headphone.

The Walkman introduced a whole segment of society to good stereo sound. Of course, in doing so, it made people realize how bad some of their audio sources were. Take airplane headphones as an example. They're uncomfortable to begin with, and sound awful, too. Air travelers will be happy to discover *Jetman*, a small audio amplifier with ear-bud style mini stereo headphones. A small microphone module plugs into the headphone jack of a typical airline

seat, filters the sound, and converts it to electronic signals. The signals are amplified by a stereo amplifier and output to stereo headphones. When you can't find any of the airline's music that suits your tastes, you can always plug *Jetman's* earphones into the Walkman that you brought on board. *Jetman* sells for \$34.95

● Big Sound, Small Speakers

The major change in home-stereo systems over the last decade is that they've gotten smaller and less obtrusive. That's to be expected with the electronics portion, and getting big sound from small speakers always proved to be a problem. The Bose *Acoustimass 3*, however, seems to have solved the problem. Acoustimass technology, developed by Dr. Amar Bose, uses two moving air masses (acoustic masses) rather than a moving driver cone to launch low-frequency sound energy into the room. The Acoustimass module can be hidden anywhere in a room, even under furniture. Two curved wedge-shape enclosures, measuring $3\frac{1}{2} \times 4\frac{1}{2} \times 4\frac{1}{2}$ inches, complete the loudspeaker system, which sells for \$599.

● Amplified AM/FM Antenna

When most people think of stereo components, antennas usually don't enter into things. That may change with the *Parsec ARC*, or Amplified Receiving Component. The *ARC* is contains an amplified, directional AM antenna and omnidirectional FM antenna. The amplifier uses GaAsFET circuitry for low-noise, hi-gain operation. The FM section provides a gain of better than 30 dB, AM better than 15 dB. Both AM and FM sections are tunable for optimum performance, and the gain is adjustable. Since most receiver manufacturers pay little attention to the AM sections of their receivers, an antenna that offers a way to improve AM reception is a welcome sight. The suggested retail price of the *ARC* is \$149.95.

● Hi-Fi Phono Plugs

If you're looking for some "stocking stuffers" for the audiophile in your family, you might consider *Pro-Fi* connectors from Neutrick. These connectors incorporate a special retracting ground shell. Thus, the ground makes contact first, and breaks contact last, ensuring a noise-free connection of equipment. Grounding noise is not only annoying, of course, but can also cause speaker damage if the amplifier is operating while the connections are being made. The connectors range in price from \$17.14 to \$24.96, depending on finish.

Computer Products

● Palm-top Computer

It's finally happened: You can buy a PC-compatible computer that fits in your shirt pocket. The Atari *Portfolio*, which the company calls a "palm-top" computer, weighs one pound and is smaller than a VHS video cassette. The keyboard is too small to touch type on, but it's arranged in a standard QWERTY format for quick data entry. The *Portfolio* comes with 128K of RAM standard, and plug-in solid-state RAM cards can add up to 128K of memory. The screen is a 40-line by 8-line liquid-crystal display. A wide variety of add-ons are expected soon, including a parallel interface that will allow for connection to full-sized PC's. A Lotus 1-2-3 work-alike spreadsheet is built in, as are standard pocket-computer functions such as an address book, appointment calendar, editor, and more. This may be the first pocket computer that really makes sense. It sells for \$399.95.

● Tower Computer Case

While small computers make some people happy, others are always looking for more room. For example, we're always playing around with some new card, and always running out of slots or drive bays. We think we've finally found a case for our computer that will help: Jameco Electronics' *JE2010*. It not only accepts all

continued on page 78

SCENE SWITCHER

continued from page 44

change, and R42 should vary the rate of change. Set R45 at the center of its range, and set S3 to manual.

Place the scope at the collector of Q5; you should see the keying waveform. The waveform will disappear if you rotate R49 to its extremes, and you will see either 0 or +5 volts at either extreme.

Place S5–S9 in the “normal” position; you should get video at J9 that

Using the switcher

Switches S5–S9 determine exactly what signal is applied to each side of the fader control. For example, suppose a fade to black is desired. In that case, FADE SELECT (S7) would be set so that CH1 video passes directly to one side of FADER CONTROL (R125). S8 would be placed in the fixed position, which applies a fixed DC level (set via the FADE LEVEL CONTROL) to the opposite side of the FADER CONTROL. By rotating the FADER CONTROL, a mix of CH1 video and the DC fade level is sent to the output amplifier, and man-

swaps CH1 and CH2, reversing the connections to each side of the fader control. If the fader control is set at one extreme, and CH1 is coming through, then moving S9 to the “reverse” position instantly routes CH2 into the output amplifier.

In the “keyed” positions, S5–S9 apply a waveform to electronically switch the video for wipes, transitions, and fades. Switches S1 and S2, in combination with R49 determine the particular pattern. Switch S3 selects the manual fade/key mode where R47 manually controls the effect, or

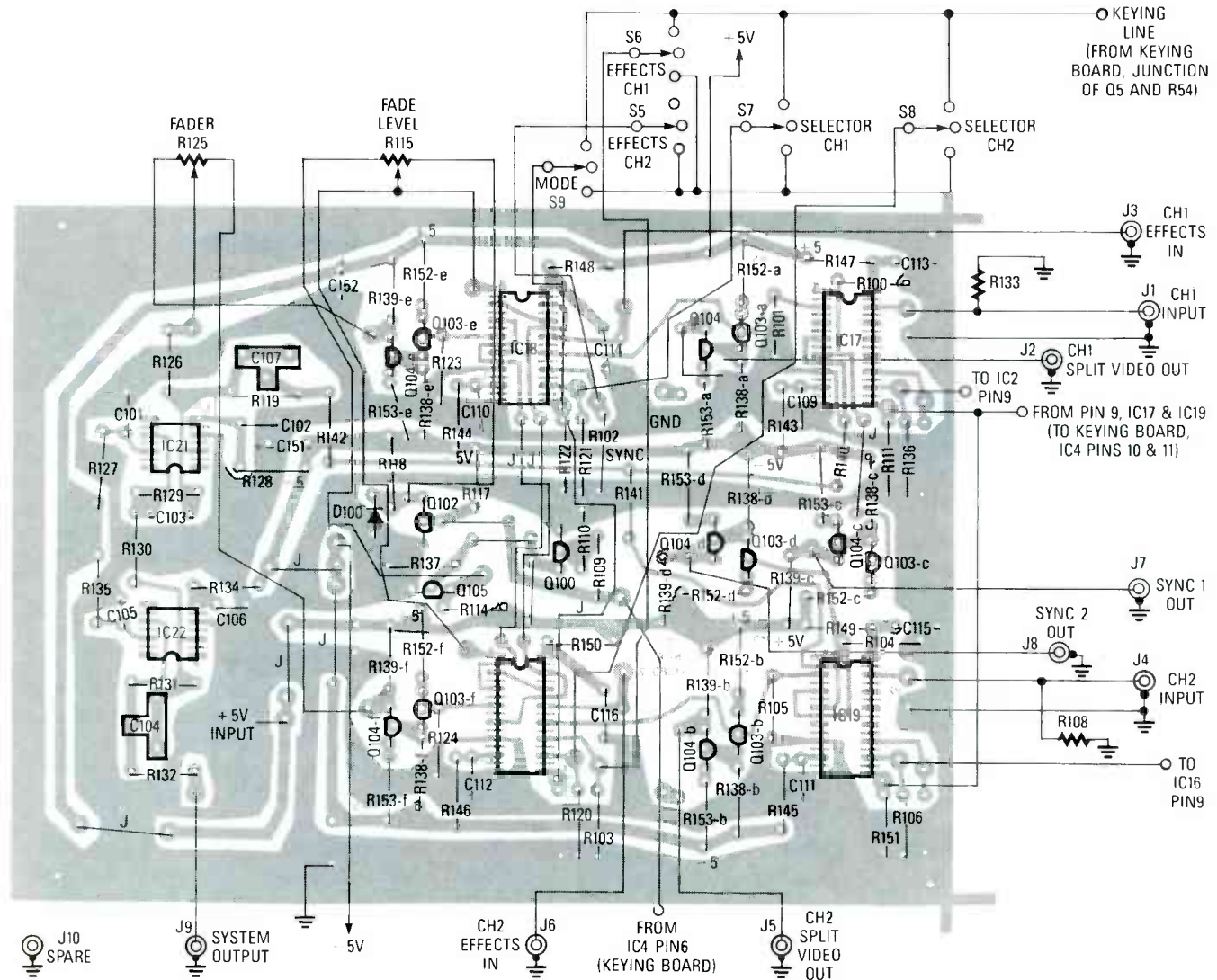

FIG. 9—VIDEO-SWITCHING BOARD parts-placement diagram. Check your work as you go along, to lessen the likelihood of any problems.

you can check with a monitor. Adjust C104 for optimum sharpness. Adjust C107 for correct burst phase, as indicated by proper flesh tones on a video image. Place S8 in the “fixed” position, and vary R125. You should be able to fade to a level set by R115.

ual fading is performed.

If a fade from CH1 to CH2 is desired, both CH1 and CH2 fade selectors must be placed in the normal position. If a fade from CH2 to CH1 is desired, S7 and S8 must be placed in the fixed and normal position. S9

the auto-key mode where the ramp generator produces the effect; S4 initiates the transition or effect, but has no effect in the manual position of S3. Switches S5 and S6 select the effects channel or other video inputs that are synchronized to CH1 or CH2. **R-E**

CMOS PLL'S

R.M. MARSTON

THE 4046B MICRO-POWER PHASE-LOCKED Loop (PLL) is one of the most versatile of all CMOS IC's. PLL's can be used in frequency synthesis, tracking, multiplication, and coherent communication systems. Although the PLL concept has been around for some time using discrete components, the IC was needed to make the idea practical.

The 4046B also has a number of useful, independently accessible elements, very similar to the layout of the 555 IC timer. Its VCO (Voltage-Controlled Oscillator) is the most versatile and cost-effective version available, producing a symmetric square wave with an upper frequency limit over 1 MHz, and capable of being scanned over a 1,000,000:1 frequency range. It can be gated on and off via an INHIBIT terminal, and produces a biphasic output when used with one of the two internal Phase Comparators (PC's). Several practical applications will be covered later.

4046B basics

Figure 1 shows the internal block diagram and pinouts of the 4046B, with two different PC's, a Zener diode, and the VCO. PC1 is a simple XOR gate with good noise rejection, but needs square waves on pins 3 and 14, and has only a narrow capture-frequency range (span). PC2 is an edge-triggered logic/bistable memory version with a tristate output, can be driven by grossly asymmetric waveforms on pins 3 and 14, and has very wide span but somewhat poor noise rejection. The reason is that an XOR gate, being level-triggered, must have a lower frequency response than the edge-triggered/bistable version.

The VCO is wide-range, with a maximum operating frequency over 1 MHz determined by the voltage on

An in-depth look at a particularly versatile CMOS IC, the 4046 micropower CMOS phase-locked loop.

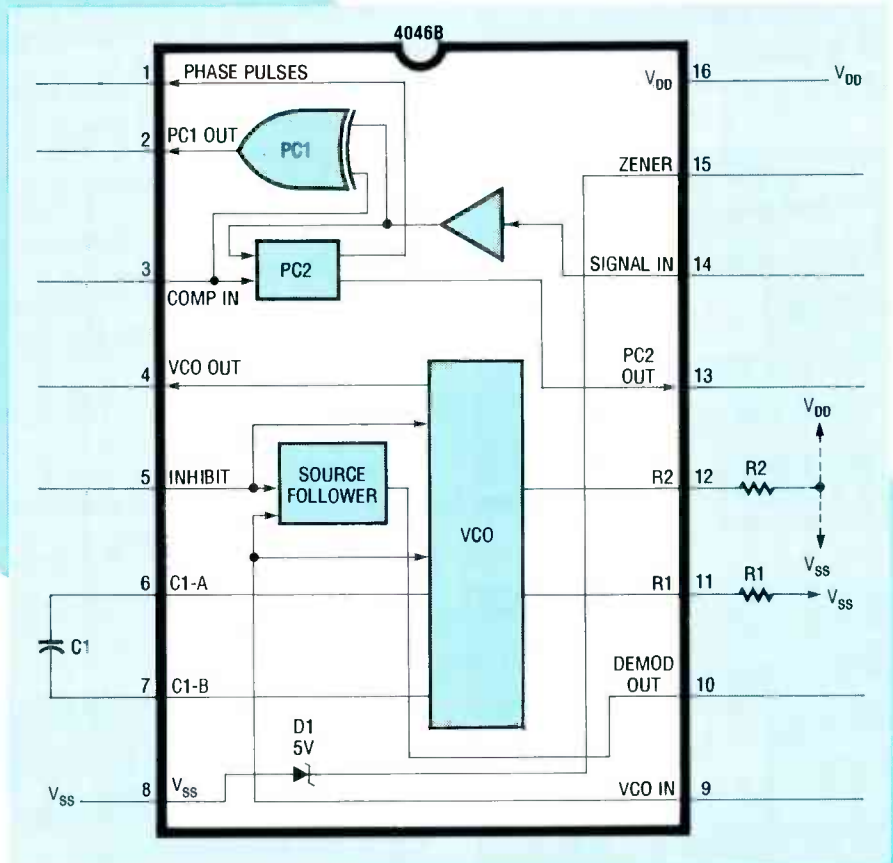

FIG. 1—INTERNAL BLOCK DIAGRAM of the 4046B micro-power CMOS PLL.

pin 9, the capacitor between pins 6 and 7 (50 pF minimum), and R1 and R2. Also, R2 presets the minimum operating frequency, and can be eliminated in many applications. The symmetric square-wave vco OUT appears on pin 4.

The VCO IN, pin 9, has almost infinite input impedance, and is driven from a high-impedance source. The source follower can be externally monitored on pin 10 without loading that source. The INHIBIT terminal, pin 5, is normally tied to V_{SS}, enabling both the VCO and source follower; both are disabled when pin 5 is grounded. The 5-volt Zener provides supply regulation if needed.

PLL basics

Figure 2 shows the basic 4046B PLL configuration, including fre-

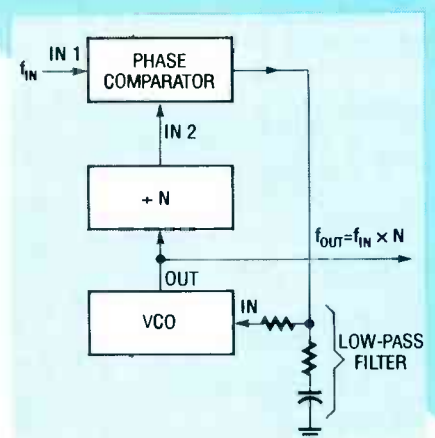

FIG. 2—BASIC PLL, WITH DIVIDE-BY-N COUNTER for frequency synthesis. For N=1 no frequency multiplication occurs, and the action is just that of a PLL.

quency multiplier/synthesizer capability. Each PC has two inputs, IN1

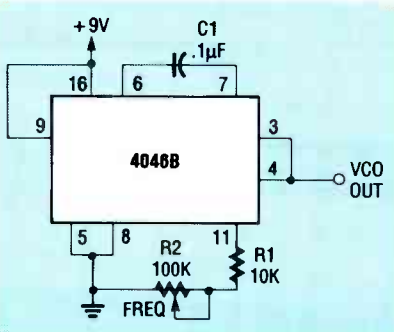

FIG. 3—SIMPLE VARIABLE-FREQUENCY (200 Hz–2 kHz) square-wave generator.

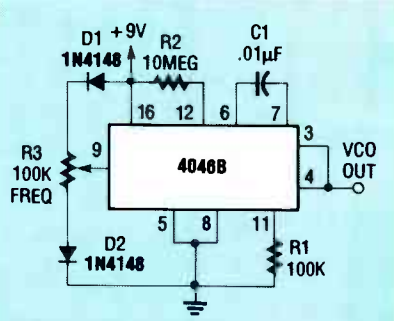

FIG. 4—WIDE-RANGE VCO, fully variable from 0 Hz–1.4 kHz.

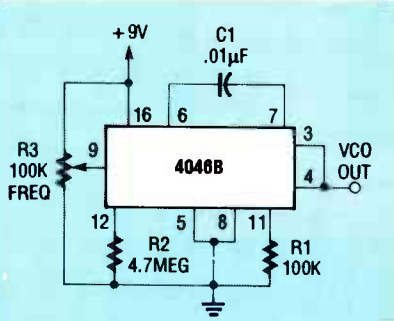

FIG. 5—RESTRICTED-RANGE VCO, variable from 60 Hz–1.4 kHz via R2.

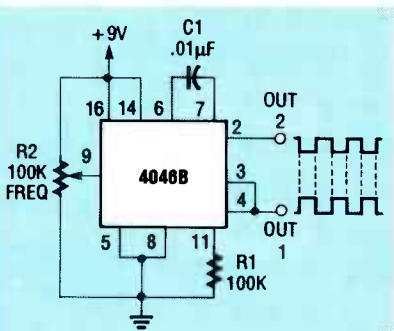

FIG. 6—A BIPHASE WIDE-RANGE VCO.

being fed using an external input, and IN_2 by the VCO output through the divide-by-N counter. Of course, if $N=1$ then no frequency multiplication occurs, and the action is just that

of a PLL alone. The output is directly proportional to the phase difference between IN_1 and IN_2 , smoothed via the Low-Pass Filter (LPF), and fed to IN_2 .

If the VCO frequency is less than that of IN_1 , the PC output goes positive, and the resulting filtered voltage increases the VCO frequency until it tracks IN_1 in frequency and phase. If the VCO frequency is greater than that of the external input, the PC output decreases, causing the VCO output to phase-lock to IN_1 .

That may not seem immediately useful. However, the VCO generates a clean, symmetric output waveform, even if the external input waveform is noisy and asymmetric. Also, because the LPF has a finite time constant, the VCO tracks the *mean* phase and frequency of a rapidly-varying external input. A PLL can track and clean up slowly-varying external inputs, or track the center frequency of an FM signal and provide a demodulated signal at the PC output.

The VCO frequency adjusts so that the divider output frequency matches that of the external input, and the VCO frequency equals $N \times f_{IN}$. If the external input comes from a precision source (a crystal), signals of any fre-

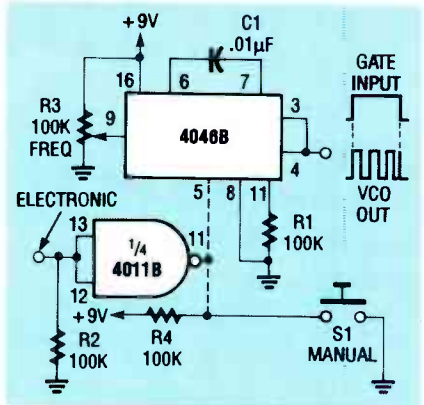

FIG. 7—GATED WIDE-RANGE VCO, using either S1 or an external inverter.

quency can be synthesized with equal precision using the appropriate N value. Some practical versions will be examined later.

VCO circuits

Figure 3 shows the simplest way to use the 4046B VCO. The voltage-control input (pin 9) is tied permanently high and the circuit acts as a basic square-wave oscillator, with variable frequency over a 10:1 range via R2. The VCO output (pin 4) is tied to the PC input (pin 3); if pin 3 is allowed to float, the PC's resonate at

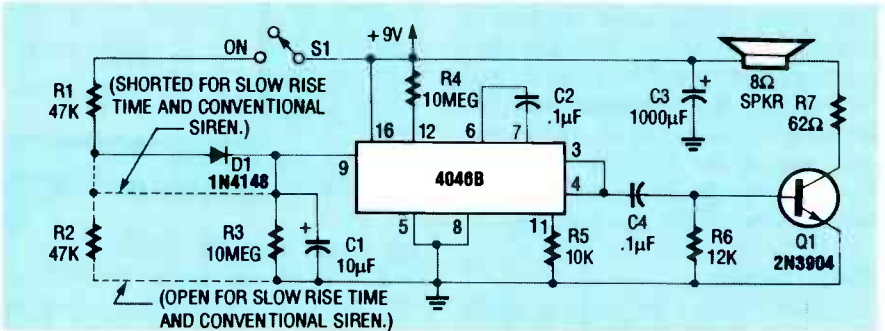

FIG. 8—AN ELECTRONIC SIREN. For normal wailing tone, short D1 and open R2. For fast rise and slow fall in frequency, include D1 and R2.

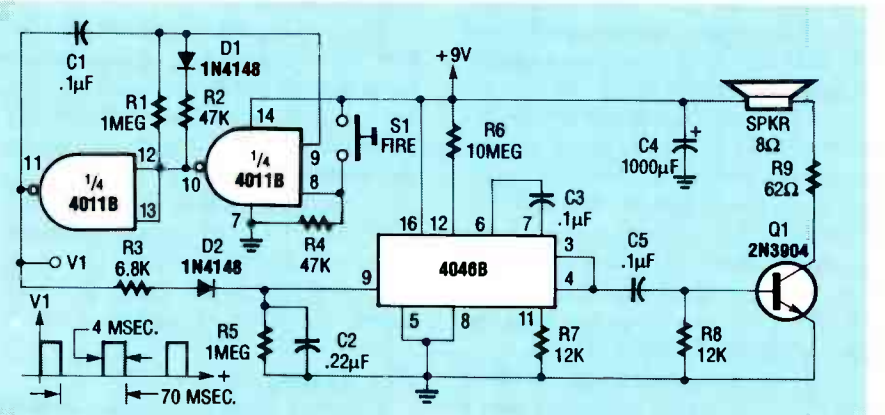

FIG. 9—PHASOR-SOUND GENERATOR CIRCUIT.

about 20 MHz and superimpose a signal on the top part of the VCO output waveform.

Figure 4 shows how to use the 4046B VCO in wide-range mode. Here, R1-C1 determines the maximum frequency obtained, and R2 controls the actual frequency via pin 9. The frequency falls to a few cycles per minute with pin 9 grounded. The effective control range of pin 9 varies from roughly 1 volt above ground to 1 volt below V_{DD} . Also, R2 has a dead range (hysteresis) of several hundred mV at either end of its span, eliminated by D1 and D2. The minimum operating frequency is reduced to zero by R2 on pin 12, in which case the VCO output randomly settles in either logic state.

Figure 5 shows a restricted-range VCO; R2 going to ground determines the minimum operating frequency. Here, f_{MIN} is determined by R2-C1, and f_{MAX} by C1 and R1-R2 in parallel. By suitable selection of R1 and R2, the restricted-range VCO can span any range from 1:1 to near-infinity. The VCO can generate 180 degree out-of-phase square waves by connecting the VCO output to the PCI input, taking the external input (pin 14) high, and taking the anti-phase output from pin 2, as in Fig. 6.

The 4046B VCO can be disabled by taking INHIBIT (pin 5) high. That lets the VCO be gated on and off externally. Figure 7 shows how the VCO can be either manually gated by a pushbutton on pin 5, or by an external inverter from a 4011B NAND gate.

Sirens and sound-effects

Figure 8 shows the 4046B VCO in a siren circuit. For a conventional wailing tone, short D1 and leave out R2. When S1 is closed, C1 charges exponentially via R1, and the VCO frequency rises from zero to a maximum value. When S1 is opened, C1 discharges via R2 and the operating frequency decays to zero. The VCO output is AC-coupled to the speaker via C4 and Q1. For a "quick-start" tone, leave D1 unshorted, and include R2. In that case, C1 charges rapidly to $\frac{1}{2}V_{DD}$ via R1-R2 and D1 when S1 closes, and discharges via R3 when S1 is opened.

Figure 9 shows a "phasor" sound generator. The 4011B astable is gated by S1 to produce 4-millisecond pulses at 70-millisecond intervals. Each pulse rapidly charges C2 via R3-D2,

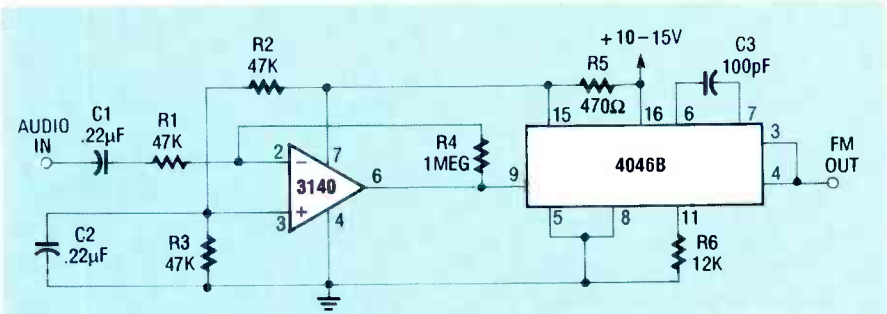

FIG. 10—FM GENERATOR using a 4046B and a 3140 op-amp, at 220 kHz.

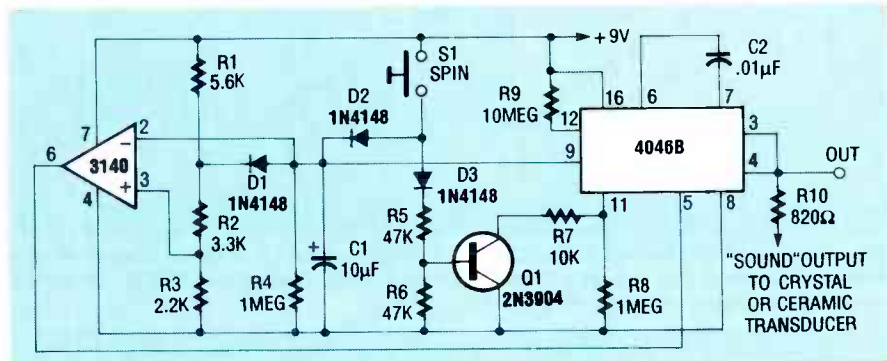

FIG. 11—RUN-DOWN CLOCK/SOUND GENERATOR, for use in dice or roulette games, where the output always settles in logic-0.

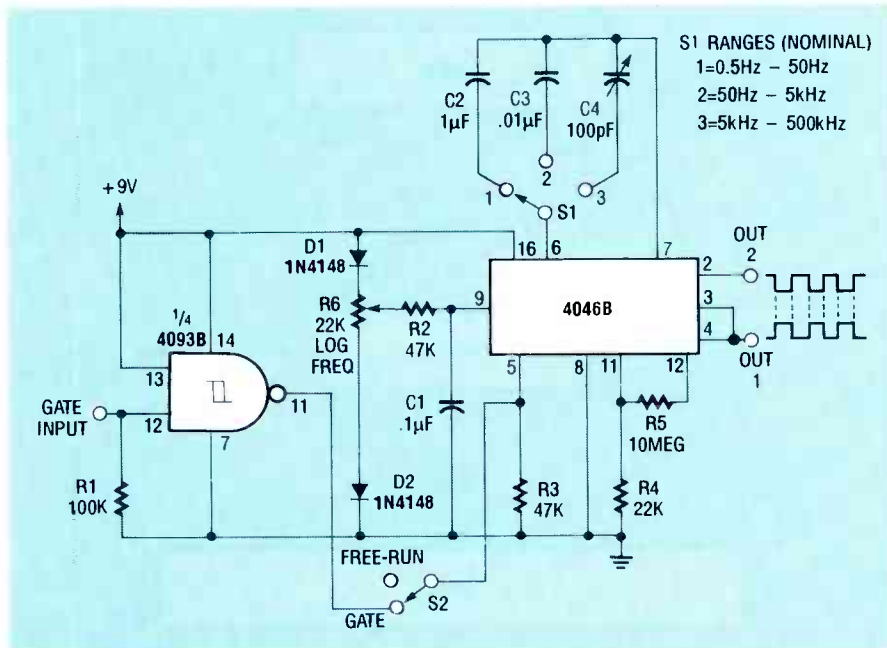

FIG. 12—UNIVERSAL CLOCK/SQUARE-WAVE GENERATOR over 0.5 Hz-500 kHz.

producing a high tone that decays fairly slowly as C2 discharges via R5; the process repeated on the arrival of each pulse.

Miscellaneous VCO circuits

Figure 10 shows a 220-kHz FM generator. The internal Zener on pin 15 of the 4046B provides a stable supply to the 3140 op-amp, biased at about 2 volts via R2-R3; the 2-volt

VCO input on pin 9 of the 4046B is an amplified version ($\times 20$) of the audio input, that modulates the VCO frequency.

Figure 11 shows a "run-down" clock generator used in dice and roulette games. When S1 is pressed, C1 charges via D2, while Q1 is biased on via D3-R5 and effectively connects R7 between pin 11 and ground. The VCO operates in the tens of kHz,

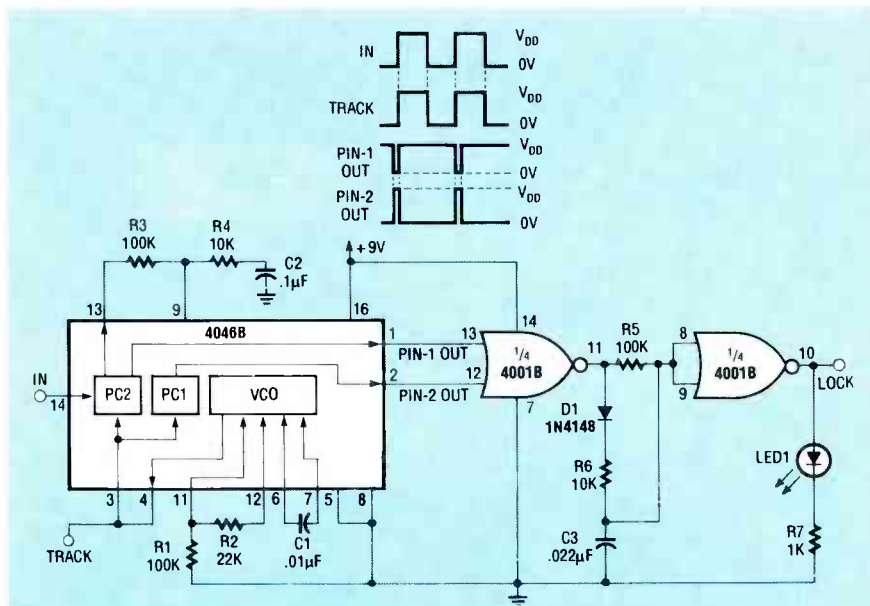

FIG. 13—PRECISION NARROW-BAND TONE SWITCH (about 1.8–2.2 kHz) composed of a 4046B wide-range PLL signal tracker and lock detector using two 4001B NOR gates, showing waveforms obtained with the loop locked.

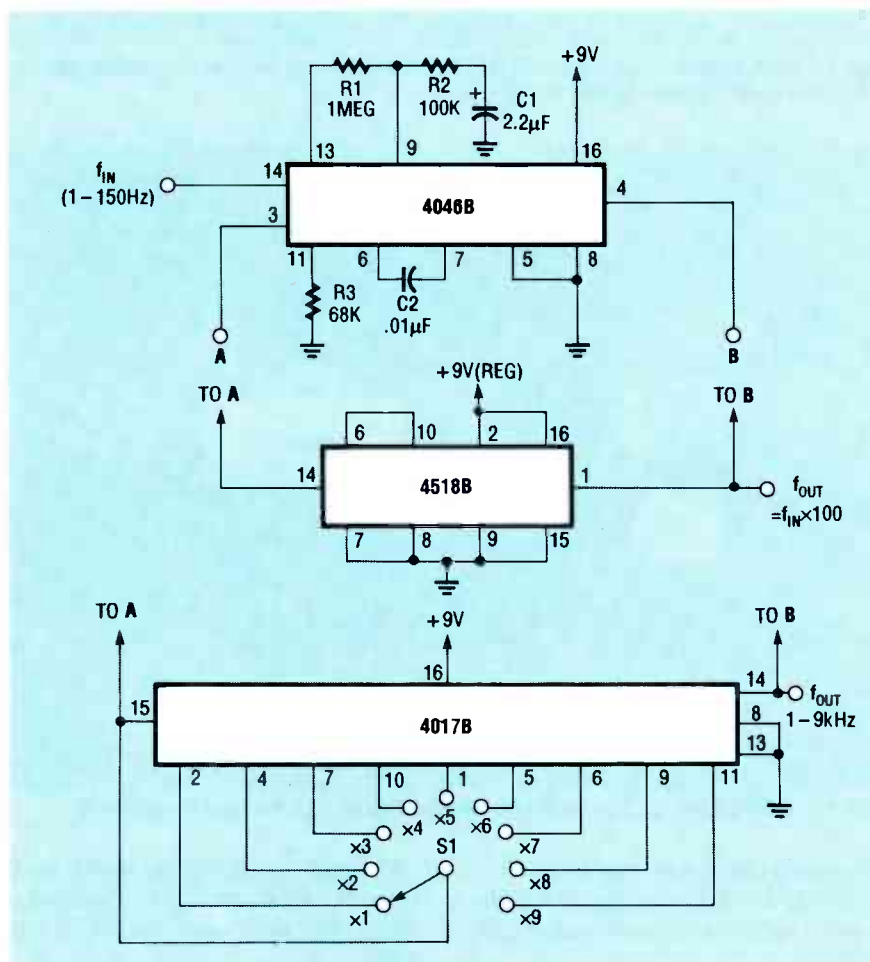

FIG. 14—A 4046B PLL USED WITH EITHER a 4518B dual synchronous up/down counter as a ×100 low-frequency pre-scaler, or a 4017B decade counter as a simple ×1–×9 frequency synthesizer

generating clock pulses until S1 is released. At that point, Q1 turns off and the VCO timing is governed by R8.

while C1 rapidly discharges to 1/2- V_{DD} via R1-R2-R3-D1, making the VCO operate at about 100 Hz. Next,

C1 slowly discharges via R4, and the VCO frequency slowly decays to zero in about 15 seconds.

Figure 12 shows a simple but very useful 4046B VCO “universal” clock or square-wave generator, spanning 0.5 Hz–50 kHz in three switch-selected bands. A biphasic output is provided, along with either free-running or gated modes.

Figure 13 shows a PLL wide-range signal tracker combined with a “lock detector” in a precision narrow-band tone switch. The signal tracker captures and tracks any input within the approximate span 100 Hz–100 kHz, provided the input on pin 14 switches fully between logic-0 and logic-1. The circuit uses PC2, and can lock to any signal within the VCO span due to the wide range it provides.

Filter R3-R4-C2 is a sample-and-hold that determines signal capture, settling, and tracking times. The maximum VCO frequency is determined by $R1 \times C1$, the minimum by $(R1 + R2) \times C1$, and the pin-9 voltage for both. The VCO span, capture, and tracking ranges go from the VCO frequency with pin 9 grounded, to the maximum value with pin 9 at V_{DD} . In the lock detector, each PC output is a series of pulses with widths proportional to the phase difference between the two PC inputs. The PC1 output is low and the PC2 output is high, except for those pulses.

When the PLL is locked, the two PC outputs are almost perfect mirror images, and the output of IC1-a remains low, driving the output of IC1-b high and lighting LED1. If the loop isn't locked, the output of IC1-a is a series of positive-going pulses that rapidly charge C1 via D1-R6, forcing the output of IC1-b low, keeping LED1 off.

Figure 14 shows a 4046B with either a 4518B dual synchronous up/down counter in a ×100 frequency pre-scaler, or a 4017B decade counter as a ×1–×9 frequency multiplier, depending on which counter IC is connected between A and B. The pre-scaler can upconvert 1–150 Hz in to 150 Hz–15 kHz out; the 4518B contains a pair of decade counters configured as a divide-by-100. The frequency multiplier generates an output, the frequency of which is ×1–×9 that of the input. The 4017B is replaceable by a string of programmable decade counters to give a wider 10 Hz–1 MHz range. **R-E**

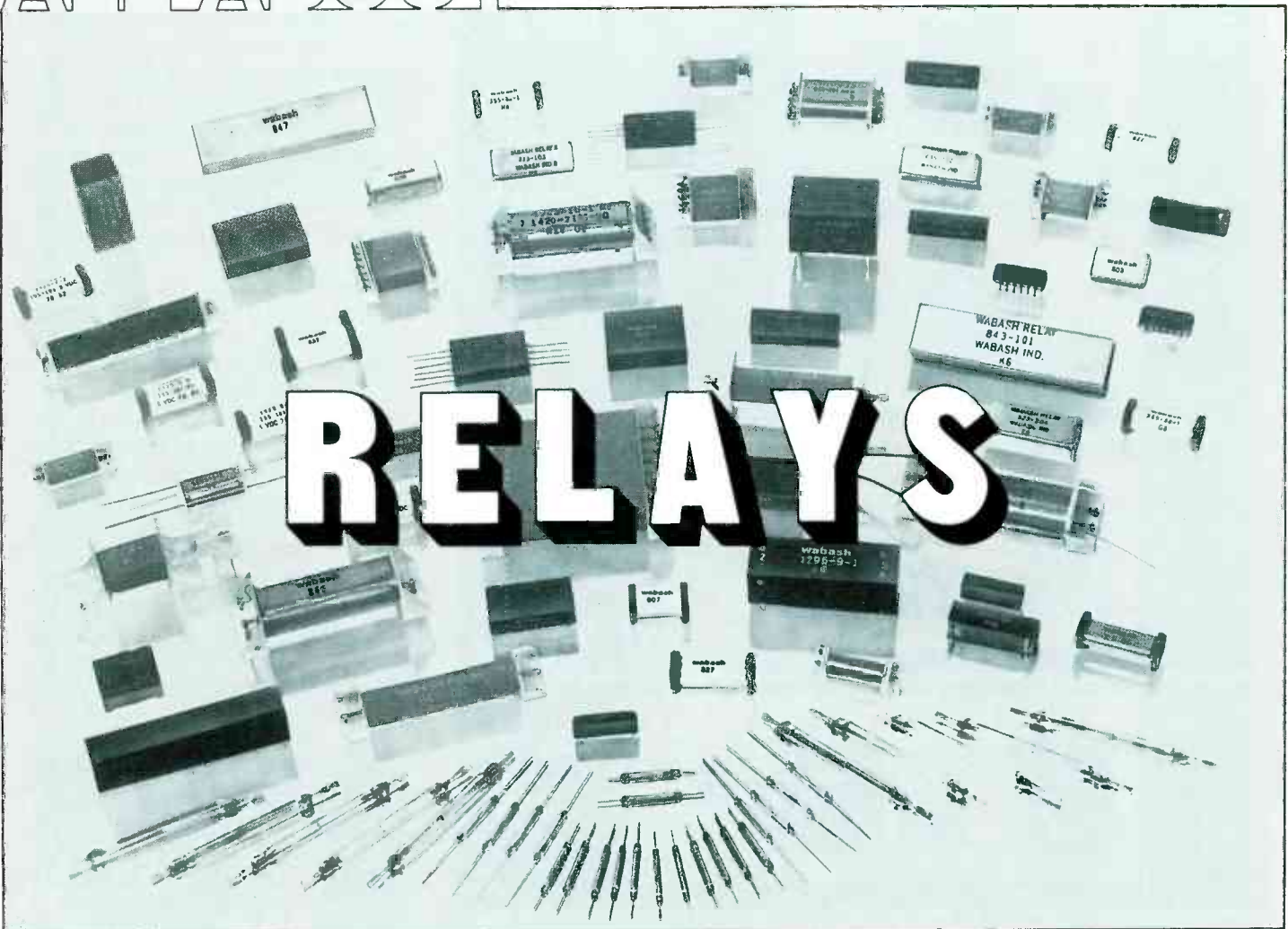

Understanding Relays, Part II: Solid-state versions

HARRY L. TRIETLEY

LAST MONTH, WE EXAMINED ELECTROMECHANICAL relays in depth. This month, we'll examine solid-state versions, including how to build your own. Like the electromechanical variety, solid-state relays use low-level signals to switch isolated loads. However, instead of mechanical contacts, solid-state models use transistors or thyristors (SCR's or triacs) to switch a load.

Control-to-load isolation is provided either by optoisolators or transformers. Solid-state relays are available in AC and DC versions; Fig. 1 shows typical block diagrams. All approaches shown use an optoisolator to separate the control and drive segments. Figures 1-c and 1-d need a rectifier and filter for AC input. Figures 1-a and 1-c use a drive circuit, an NPN

transistor, Zener transient suppression, and reverse-biased inductive load diode for DC output. Figures 1-b and 1-d use a zero voltage switch, an RC snubber filter, and a triac for AC output.

Virtually all solid-state relays are Single-Pole Single-Throw, Normally Open (SPST-NO) devices, where the outputs turn on in response to a control voltage. The majority take operating power from the control I/O, although some require separate DC logic power. The simplest DC input circuits use an LED optoisolator and series current-limiting resistor.

The resistor is usually sized for a 5-volt logic input, and results in a specified "ON" range of 3-6 volts DC. For wider operating ranges (typically 4-32 volts DC), the resistor is re-

placed by a constant-current diode. Then, AC input circuits rectify and filter the control input before applying it to the LED. Typical AC/DC LED currents are 5-20 mA.

AC and DC outputs

The optoisolator photocurrent is amplified and used to drive whatever output device the relay is connected to, whether a transistor for DC outputs, a thyristor for AC, or a power MOSFET for either. The power for the drive circuitry is taken either from the output load or is supplied separately. In some MOSFET designs, the photocurrent is sufficient to drive the output device. Table 1 summarizes typical specifications.

Normally, DC output devices like those in Figs. 1-a and 1-b use an NPN

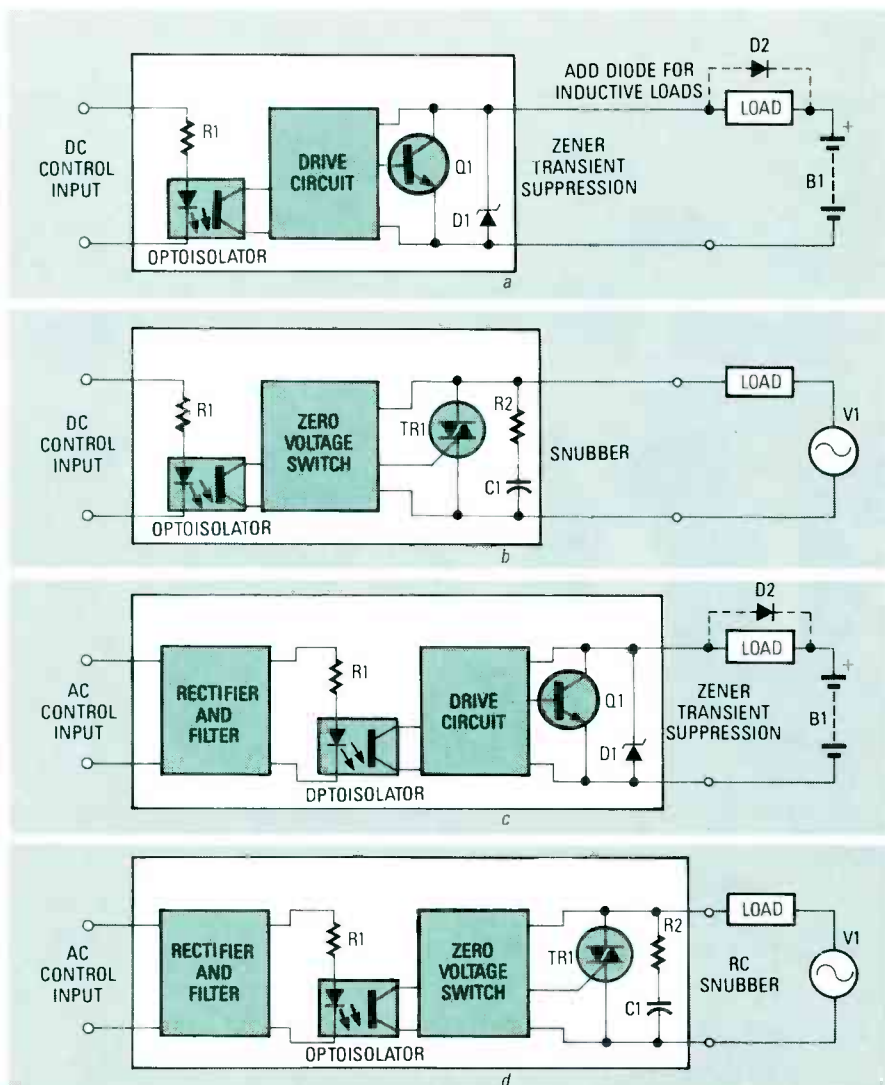

FIG. 1—SOLID-STATE RELAY INPUTS AND OUTPUTS may be designed for AC/DC. All approaches shown use an optoisolator to separate the control and drive segments.

transistor, and may include a Zener diode across the output for transient suppression. The transistor will drop some voltage in the "ON" state, and the drive circuit will need some current to operate. Typical output drop is 1–2 volts at the full rated load current, while the "OFF"-state leakage may range from approximately 10 μA –1 mA.

Most AC output devices include zero-voltage-switching circuitry. Logic detects when the AC load voltage crosses zero (changes polarity) and delays the triac turn-on pulse until then. The triac turns on at the next zero crossing after the input goes high. Once triggered, it remains on until its current goes to zero. Zero-voltage and zero-current switching minimize transients and *ElectroMagnetic Interference* (EMI). The RC snubber in Figs. 1-b and 1-d suppresses rapid voltage changes that can

inadvertently turn on the thyristor.

In some applications, having the output turn on instantly is desirable. Relays referred to as "random turn-on" are designed without zero-voltage switching. Turn-off still occurs at zero current, due to the inherent latching effect of thyristors. As with DC-output relays, the thyristor drops voltage while conducting, while the drive circuitry requires power to operate. In addition, the snubber passes AC leakage in the "OFF" state. Typical "ON"-state voltage is 1.6 volts, while "OFF"-state leakage is 2–10 mA for 60-Hz power.

With recent advances in power MOSFET's, solid-state relays can be designed with lower "ON"-state voltage drops, and greatly reduced "OFF"-state leakage. These MOSFET's offer bidirectional current flow, near-zero gate-drive current, no inherent source-to-drain offset volt-

age, and low "ON"-state resistance and "OFF"-state leakage.

Due to near-zero gate current, power MOSFET's can be driven directly from a series stack of photodiode junctions, as in Fig. 2. The "photovoltaic-generator" stack from International Rectifier shown in Fig. 3 is constructed using IC fabrication techniques, and exposes a series of photodiodes to LED illumination. No operating power is required from the load.

Most FET-output relays are housed in *Dual-Inline Packages* (DIP's). Their main use is as a replacement for reed relays, where low offset and low leakage are important, and for control of low-power AC/DC loads. High-power AC loads are best controlled by thyristors, which are easily controlled for zero-voltage turn-on; they also offer inherent zero-current turnoff, and produce lower output-voltage drop at high currents.

However, FET design involves tradeoffs in voltage, current and resistance specs. In particular, high-voltage FET's have higher "ON"

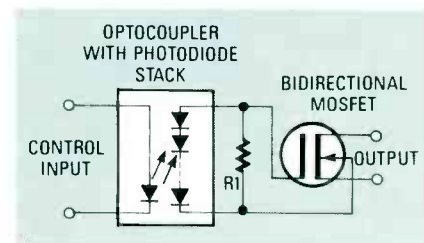

FIG. 2—DUE TO NEAR-ZERO gate current, power MOSFET's can be driven directly by a series stack of photodiode junctions.

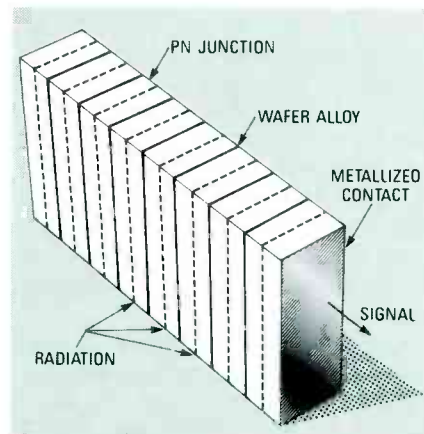

FIG. 3—A PHOTODIODE junction stack, known as a photovoltaic generator, from International Rectifier. It's constructed using IC-fabrication techniques, and exposes a series of photodiodes to LED illumination. No operating power is required from the load.

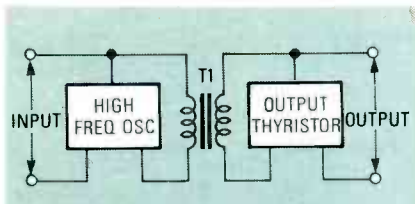

FIG. 4—I/O ISOLATION may be provided by this transformer-coupled AC output oscillator relay. It's powered by a control input which drives a thyristor through a transformer.

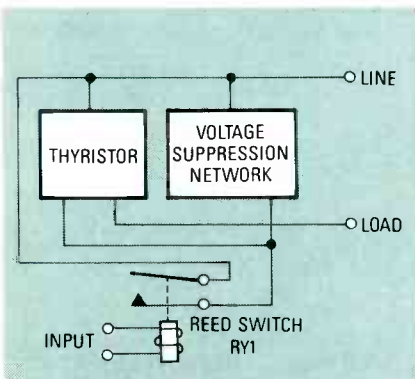

FIG. 5—HYBRID RELAYS marry reed relay input with solid-state power output to control a thyristor. The reed contacts switch low power only, and turn-on time is that of the reed relay; about 1 msec.

resistances, making them unsuitable for switching high-current line-voltage loads. Typical DIP relays have 70–500-mA current ratings, “OFF”-state leakage resistances of 100 Megohms or more, and “ON” resistances from about one ohm for a 60–100-volt rating, to 25–50 ohms for a 300–400-volt rating. Switching times range from 10–100 μ sec.

I/O isolation

The majority of solid-state relays use optoisolators. All offer at least 1.5-kilovolt RMS I/O breakdown, and 2.5- or 4-kilovolt ratings are common. Most of them have been rated, listed, or approved by safety agencies like UL, CSA, and VDE. Transformer coupling is also used to isolate solid-state relays.

Figure 4 shows a transformer-coupled AC-output relay; DC and AC/DC FET relays are also available with transformer coupling. The control input powers an oscillator, the output of which is coupled through a small pulse transformer to trigger the output thyristor. Circuitry of the type shown produces random turn-on operation; transformer-coupled relays generally don't include zero-voltage switching circuitry.

Transformer coupling allows faster switching. The oscillator frequency is typically 1–3 MHz, resulting in switching times as low as 1 μ sec. Optoisolators exhibit slower response, with times for DC versions typically 10–100 μ sec. They can be designed for slightly higher temperatures, being free of LED limitations. However, achieving breakdown voltages above 1.5 kilovolts is easier using optical techniques.

Hybrid relays

Hybrid relays marry reed relays with a solid-state power output. Figure 5 shows a thyristor version; DC outputs are also offered. The hermetically sealed reed contacts switch only low power, and last 10 million operations or longer. The turn-on time is that of the reed relay, about 1 msec. Other hybrid relays are the reverse, using a solid-state input amplifier driving a reed-relay output, the obvious advantage being high input sensitivity. The term “hybrid” sometimes describes construction technique, rather than method of operation. In some catalogs you'll find hybrid solid-state relays with no mechanical components at all.

Self-powered and buffered relays

So far, all the relays that have been discussed until now have been “self-powered,” in that they take operating power from the applied signals. All models, whether optoisolated, transformer coupled, or hybrid, require approximately 5–50 mA at their inputs. Some, notably thyristor-output relays with zero-voltage switching, also take operating power from output loads, although none require separate power connections.

Buffered relays offer improved input sensitivity at the expense of needing separate DC power, and are usually used in systems that already

include DC power supplies (not as stand-alone devices). Figure 6 shows a buffered DC-output relay. The input circuitry and the LED are powered from a separate logic supply, allowing the logic input current to be typically 25–250 μ A.

Package styles

Solid-state relays are generally grouped into DIP's, power relays, and I/O modules. DIP relays are available with transistor (DC), thyristor (AC), or MOSFET (AC/DC) outputs, and with optoisolator or transformer coupling. Most power relays are used to switch AC power, and use thyristor switching with optoisolator coupling. Transistor (DC) outputs and transformer coupling are also available.

I/O modules are always optocoupled, and don't offer MOSFET outputs; Fig. 7-a shows an IC DIP version, Fig. 7-b a power version, and Fig. 7-c an I/O module. The DIP versions have transistor (DC), thyristor (AC), or MOSFET (AC/DC) outputs, and either optoisolator or transformer coupling. Most power types use thyristor switching with optoisolator coupling for AC power; transistor outputs and transformer coupling are available. I/O modules are always optocoupled, and don't offer MOSFET outputs. Their characteristics are summarized in Table 1.

DIP relays look just like IC's; most often, 8- or 14-pin DIP's. Rated load currents are a fraction of an ampere, with voltage ratings from 60–300 volts. Since many can fit on a PC board, they're very handy for interfacing logic signals to the outside world in digital control systems. MOSFET-output relays also make excellent replacements for reed relays in measurement and data-acquisition applications. Edge-mounted SIP (single-inline package) relays also are made. Military-grade relays are pack-

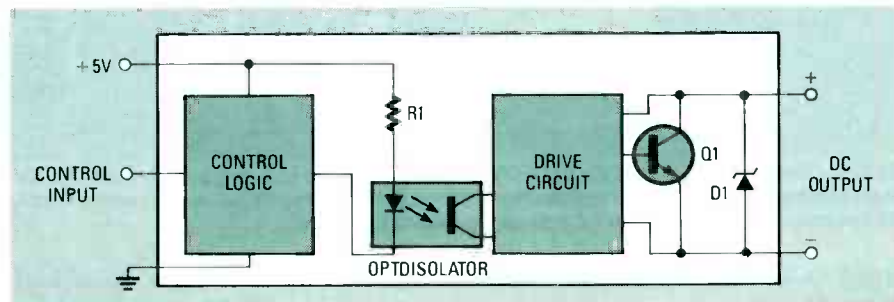

FIG. 6—THE BUFFERED DC-OUTPUT RELAY ADDS externally-powered input circuitry to reduce control current requirements. The input circuitry and the LED are powered from a separate logic supply, letting the logic input current be 25–250 μ A.

TABLE 1—SOLID-STATE RELAY OUTPUT SPECIFICATIONS

Output	AC/DC	Package Style	Max. Load Currents	Max. Load Voltages	Voltage Drop (on) at Rated Load	Leakage Current (off) At 25° C
Bipolar Transistor	DC	Dual Inline (DIP)	500 mA 50 mA	60 VDC 250 VDC	1 to 1.5 V	20 μ A
		Input/Output Module	3.5 A 1 A	60 VDC 200 VDC	1.2 to 1.75 V	10 μ A to 1mA
		Power	2 to 20 A	50 VDC	1.5 to 2V	5 to 15 mA
		Power (High Voltage)	to 5 A	250 VDC	2 V	10 μ A
Thyristor (Triac or SCR)	AC	Dual Inline (DIP)	0.3 to 1 A RMS (to 3 A RMS with heat sink)	140 or 280 V RMS	1.5 V max	10 μ A to 1mA
		Input/Output Module	3.5 A RMS	140 or 280 V RMS	1.5 V max	2 to 5 mA
		Power	10 to 40 A RMS	140 to 480 V RMS	1.5 V max	2 to 15 mA
Power MOSFET	AC/DC	Dual Inline (DIP)	100 to 500 mA (Some to 1 A)	60 to 300 V	Resistance 0.25 to 50 ohms	Resistance typically 100 megohms



FIG. 7—THE THREE most common solid-state relay styles are the (a) IC DIP, (b) power, and (c) I/O module varieties.

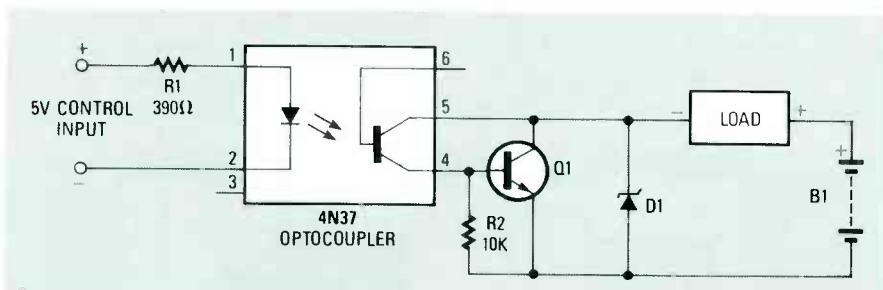

FIG. 8—THIS BASIC DC IN, DC OUT I/O RELAY switches up to 5 amps at 60 volts DC. It's built around a Motorola 4N37 optoisolator, which passes up to 30 mA output with a 10 mA LED current, while providing 1.5 kilovolts peak I/O isolation.

aged in hermetically-sealed TO-5 transistor cans.

Power relays look very similar to the one in Fig. 7, common sizes being

about 2-3 inches on a side. Rated load currents are 10-40 amps, making them suitable for switching all but heavy industrial power loads. Smaller

power relays are also available, including some PC board versions. I/O modules are used primarily in micro-processor-based data acquisition and control systems, although they can be used in other applications where they

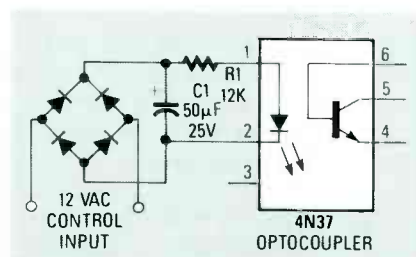

FIG. 9—ADDING A DIODE BRIDGE and filter capacitor converts the control input to AC.



Plug a Friend into Radio-Electronics this Christmas ... and Save \$11!

This Christmas give an electrifying gift ... plug a friend into Radio-Electronics and brighten his whole new year! Whether electronics is his livelihood or his hobby, your gift will sharpen his focus and illuminate the whole spectrum of electronics throughout the coming year.

Radio-Electronics will keep him informed and up-to-date with new ideas and innovations in all areas of electronic technology ... computers, video, radio, stereo, solid state technology, satellite TV, industrial and medical electronics, communications, robotics, and much, much more.

He'll get great plans and printed circuit patterns for great electronic projects. In just the last year, Radio-Electronics has presented voice scramblers, video switchers, frequency standards, wireless audio links, radiation monitors, function generators, and much more.

In coming issues, Radio-Electronics will present practical, educational, and money-saving projects like: a helium-neon laser ... a lighting controller ... a video timebase corrector ... a video noise processor ... a light-beam communicator ... an antenna amplifier ... and many others!

PLUS ... equipment troubleshooting techniques ... circuit design ... reports on new technology and new products ... equipment test reports ... in-depth coverage on computers, video, audio, shortwave radio ... and lots more exciting features and articles.

SAVE \$11 ...OR EVEN \$22 ... For each gift of Radio-Electronics you give this Christmas, you save a full \$11.00 off the newsstand price. And as an R-E gift donor, you're entitled to start or extend your own subscription at the same Special Holiday Gift Rate — you save an additional \$11.00!

No need to send money ... if you prefer, we'll hold the bill till January, 1990. But you must rush the attached Gift Certificate to us to allow time to process your order and send a handsome gift announcement card, signed with your name, in time for Christmas.

So do it now ... take just a moment to fill in the names of a friend or two and mail the Gift Certificate to us in its attached, postage-paid reply envelope. That's all it takes to plug your friends into a whole year of exciting projects and new ideas in Radio-Electronics!



plug into mating multi-channel I/O boards; their normal size is about 1-2 inches on a side.

“Output” modules convert logic signals to AC/DC switched outputs, acting just like the relays examined thus far. They plug into racks of 4, 8 or 16, and can be connected to a computer or microprocessor to control power devices drawing up to 3.5 amps, or to drive power relays for heavier loads. “Input” modules do the reverse.

When to use solid-state relays

The advantages of solid-state relays are fast switching and no mechanical contacts to wear, burn, pit, or corrode, hence clean switching with no contact bounce, and immunity to shock and vibration. Their life should be unlimited, barring electrical surge or overload damage. Their low drive requirements often enable them to be driven directly from logic IC's.

Some have features like noise suppression or overload sensing. The latter shuts the relay off until it's reset, letting it act as a circuit breaker. Their I/O isolation equals that of mechanical versions, and there are no inductive coil surges. AC-output relays with zero-voltage and zero-current switching minimize EMI.

Their major disadvantage is that their outputs are never completely ON/OFF, as shown in Table 1. If the “ON” resistance or “OFF” leakage is of prime importance, use a mechanical device. Also, when switching power, remember that the load is never “OFF.” The several-mA leakage current of AC power relays is a very real shock hazard.

Switching AC loads

AC loads can be switched using either thyristors or power MOSFET's, the latter generally limited to loads under 1 amp. A thyristor is a regenerative, positive-feedback device which, upon triggering, conducts until the current through it goes to zero. When a thyristor is in the “OFF” state, the voltage across it changes rapidly, capacitive coupling within can produce a sufficiently high pulse to cause conduction. The RC snubber in Figs. 1-b and 1-d reduces the effect.

AC relays specify a maximum rate of change of typically 100–200 volts/μsec for power devices, and higher (500–1000 volts/μsec and above) for DIP versions and other

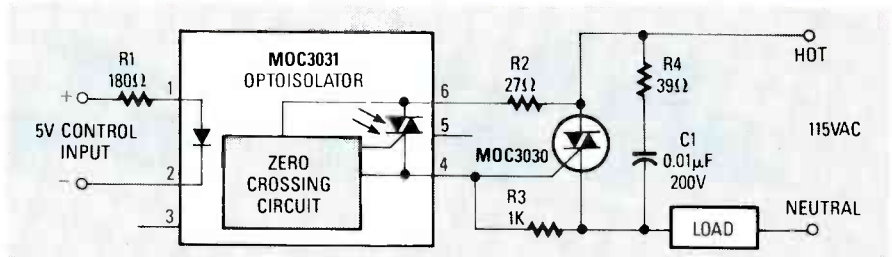

FIG. 10—THE MOTOROLA MOC3031 OPTOISOLATOR WITH built-in zero-voltage switching simplifies design of this solid-state AC output relay. The MOC3031 is optimized for use with 120-volt AC, and provides up to 7.5 kilovolts peak I/O isolation. However, you'll need to keep both input and output well separated.

small models. Normally, 100–200 volts/μsec is adequate for most loads, but inductive loads need special caution. Since a thyristor turns off when its current reaches zero, and an inductor's current lags its voltage, the supply voltage won't be zero when the relay turns off. When the relay opens, the supply voltage will appear across the thyristor, producing a very high rate of change.

Purely inductive loads are a problem for any relay or switch. Fortunately, most real loads such as motors are both inductive and resistive. For highly inductive loads, select a relay with a high rate-of-change rating. Some AC power relays specify maximum motor horsepower or a minimum load power factor.

Incandescent lamps have high initial currents due to the cold filament resistance. Most relays specify peak as well as steady-state surge current. For lamps, a relay should be capable of handling five times the lamp current for 1 sec. Transformers can also draw high initial currents, so you should allow for a one-half cycle surge current equal to the line voltage divided by the resistance of the transformer primary ($I = E/R$). Finally, most thyristor relays are designed for use only at or near 60-Hz.

Building your own

Although solid-state models are readily available at moderate cost, you may want to design your own. That will not only afford greater packaging flexibility, but will let you tailor I/O characteristics. Low-cost optoisolator IC's make designing your own easy. Figure 8 shows a basic DC I/O model built around a Motorola 4N37 optoisolator, which passes up to 30-mA output with a 10-mA LED current, while providing 1.5 kilovolts peak I/O isolation.

The output characteristics depend

mainly on the output transistor; the type you use depends on whether you want high power or minimum leakage current. With the 2N5337 shown, the relay can switch up to 60 volts and 5 amps DC; OFF-state leakage is a few microamps. The Zener protects against voltage transients and inductive turn-off. The input resistor is suited to 10 mA at 5 volts; increase for higher inputs. The LED drops 1.1 V, so:

$$R = (V_{IN} - 1.1 \text{ volts}) / 10 \text{ mA.}$$

The value isn't critical, although operation at lower currents will reduce available output current; the LED can handle up to 60 mA continuously. Figure 9 shows modifications for AC control. Building a zero-voltage-switching AC output relay is almost as easy, as in Fig. 10. The Motorola MOC3031 optoisolator provides built-in zero-voltage switching and triac driver circuitry optimized for 120 volts AC. It also provides up to 7.5 kilovolts peak I/O isolation, but you'll need to keep both the input and output well separated.

Figure 10 is from the Motorola spec sheet; R1 is selected for 20 mA at 5 volts. Or, you can add a bridge and filtering for AC control; R2, R4 and C1 provide “snubbing” of inductive loads. If the load is very inductive then increase R2 to 360 ohms. The breakdown voltage of C1 must be higher than the peak line voltage.

Output voltage and current capabilities depend on the triac used. The circuit shown will switch 120 volts at 15 amps RMS, if the triac is heat-sink mounted. Substitute optoisolator MOC3041 and triac MOC3040 for 240 volts RMS. OFF current through the snubber will be 400 μA at 120 volts. If the OFF leakage is important, and you'll be switching resistive loads like heaters or incandescent lamps, then the snubber can be reduced or eliminated. **R-E**

AUDIO UPDATE



LARRY KLEIN,
AUDIO EDITOR

Are there sonic differences among CD players?

LAST MONTH WE LOOKED AT THE AUDIO community's reactions, pro and con, to the introduction of the digital compact disc. Many dedicated audiophiles and LP collectors complained that, compared to LP's, many—if not most—CD's sounded harsh, constricted, and unmusical. Because the first transistor amplifiers produced the same sort of complaints, I tended to dismiss the critics as simply having emotional or financial vested interests in LP technology. Ultimately, it turned out that many CD's *did* sound bad—not because the music had been chopped into digital bits as the critics claimed, but simply because many recording and record-mastering engineers were unable to adapt to the different demands of the new medium. The many excellent-sounding CD's currently available are sufficient proof that there is nothing inherently wrong with the CD format.

Player problems

One of the claims made in favor of the compact disc is that individual players that conform to the CD standard will all sound essentially alike when working correctly. In other words, a given data stream on a disc will produce from any player a wide-range audio signal with vanishingly low distortion, noise, and wow and flutter.

Leaving aside acknowledged differences in the players' ability to resist external shock and vibration and to ignore varying degrees of disc flaws, do all the machines sound essentially alike, as many of

the more technical critics claim? As you might suspect, dedicated audiophiles claim that each brand and model of player sounds different. Their view is not surprising since those on the outer audio fringes regularly perceive differences that are not only imperceptible to ordinary mortal ears, but also usually defy measurement. But given the release of so many sonically flawed CD's, is it safe to say that the marketplace hasn't been subjected to equally flawed players?

Aside from the regular annual tests run by *Consumer Reports* there have been two fairly rigorous comparative-listening tests conducted by *Stereo Review*, a large mainstream hi-fi publication. The first tests appeared in the January 1986 issue and involved a disparate group of six players ranging in price from an under-\$200 Emerson to a \$1,300 Sony. The second series of comparative-listening tests (in the December 1988 issue) was performed on six pricey (\$750–\$2,500) "state-of-the-art" machines. All tests were carefully controlled, using specially qualified listeners working with the sophisticated ABX test device.

Test techniques

Two players at a time were connected to the ABX test unit's input; its output was connected to a very-high-quality reference audio system. During each trial in the series of listening tests, a logic circuit in the ABX comparator randomly chose one of the two CD players to serve as X. The listener was in-

structed to take as much time as he liked switching between A, B, and X. His task was to decide whether the sound of player A or B was identical to that of the machine-selected X. The ABX's micro-processor kept track of its random choice of X for subsequent comparison with the listeners' written choices. For each listener, every player was compared with every other player for a total of 50 trials.

The beauty of the ABX system is that the listener is not forced to make value judgments, but is asked only to indicate whether he hears a difference between components A, B, and reference X, when X can be either A or B. If the listener can reliably identify A or B as sounding different from (or the same as) X, then it can be said that there is an audible difference between the two components under test. If the choices come out no better than chance, it is evident that the listener is not hearing a difference, even though he might believe he is.

Test results

Since I would rather not drag the reader through a rather dull discussion of the design and statistical mathematics of the ABX double-blind test procedures, let it suffice to say that I have no complaints with either the test techniques or the statistical analysis used in the two series of tests. However, I do have a mild quarrel with some of the article's conclusions.

As with previous tests, the most
continued on page 88

HARDWARE HACKER

Optical reprint sources
Hacker pc breakthrough
Clock and doorbell chip
Faking double-sided boards
Printed circuit resource list

PC-board breakthrough

DON LANCASTER

OUR STUPENDOUSLY MAJOR NEW breakthrough for this month is a brand new way of doing hacker printed-circuit boards that I'll call the *direct toner method*. Believe it or not, all you need is an iron and your favorite word processor.

This new process is ridiculously faster, simpler, and cheaper than any of the old ways. Since it's so new, we sure could use your personal help in further testing and debugging.

But first, let's review some of the older ways of making printed-circuit boards. We might start off by going over some...

Circuit-board fundamentals

Printed circuit boards first became popular in the early 1950's because of their overwhelming advantages over point-to-point wiring. The PC wiring pattern was always the same, virtually eliminating wiring errors. Stray inductance and capacitance were much lower and far more uniform. And the manufacturing could be totally automated. Production times became much shorter, and labor costs dropped sharply. So did size and weight.

A printed-circuit board often will consist of an insulating *substrate* that has one or more layers of conducting patterns placed on or in it. Figure 1 shows some popular forms of printed-circuit boards.

You will find three main substrate materials in use today. They include phenolic, FR-4 (or G-10) glass epoxy, and CEM-1 composite

epoxies. While phenolic is the cheapest, it does chip and shatter easily, and should be heated before punching or drilling. It is often used for single-sided layouts in toys, appliances, and any other high-volume applications. For us hackers, phenolic is nearly useless.

Glass epoxy is pretty near the same stuff that a fiberglass boat is made of. It has great electrical and mechanical properties, and is nearly ideal for any double-sided and multilayer boards. Hacker disadvantages are that glass epoxy costs more and dulls drills at an amazing rate. Carbide drills are just about mandatory for all but the shortest of production runs.

The CEM-1 material has only a pair of fiberglass layers impregnated into an epoxy body. Because it's cheaper and easier to drill than glass epoxy, it's a good choice for hacker use. It also drills and punches well. Glass-epoxy boards are well suited for all but the most precise and exacting needs. They even come in a wide variety of colors.

The simplest variation is a *single-sided* board. The substrate

is most often $\frac{1}{16}$ th of an inch thick, and has a single layer of copper foil laminated to one surface only. Two popular thicknesses of copper are used. *One-ounce* copper is around 0.00135 inches thick; *two-ounce* copper is double that, or around 0.00270 inches thick.

Thus, one-ounce copper is a tad over one mil thick, and two-ounce copper is somewhat over two mils thick. Two-ounce copper is normally reserved for higher-current uses or where extreme reliability is needed.

On a traditional single-sided circuit board, most of the components get mounted on the bare side of the board, giving us a *component side* and a *foil side* to work with. That allows a dip, a reflow, or wave soldering of all the parts at once. The components tend to pull the foil toward the substrate, rather than trying to peel the foil from the board.

Single-sided boards limit both your minimum size and how much you can connect where, unless you go to an unacceptable number of interconnecting jumpers. Because of that, most modern boards are *double-sided*, and have foil on both surfaces. While the most common means of routing connections between the two board sides is with *plated-through holes*, hacker alternatives are eyelets, wire tabs, the component leads by themselves, or individual socket pins. *Mill-Max* is a leading source of low-cost socket pins, and *Stimpson* is a good eyelet source.

A double-sided plate-through

NEED HELP?

Phone or write your **Hardware Hacker** questions directly to:
Don Lancaster
Synergetics
Box 809
Thatcher, AZ 85552
(602) 428-4073

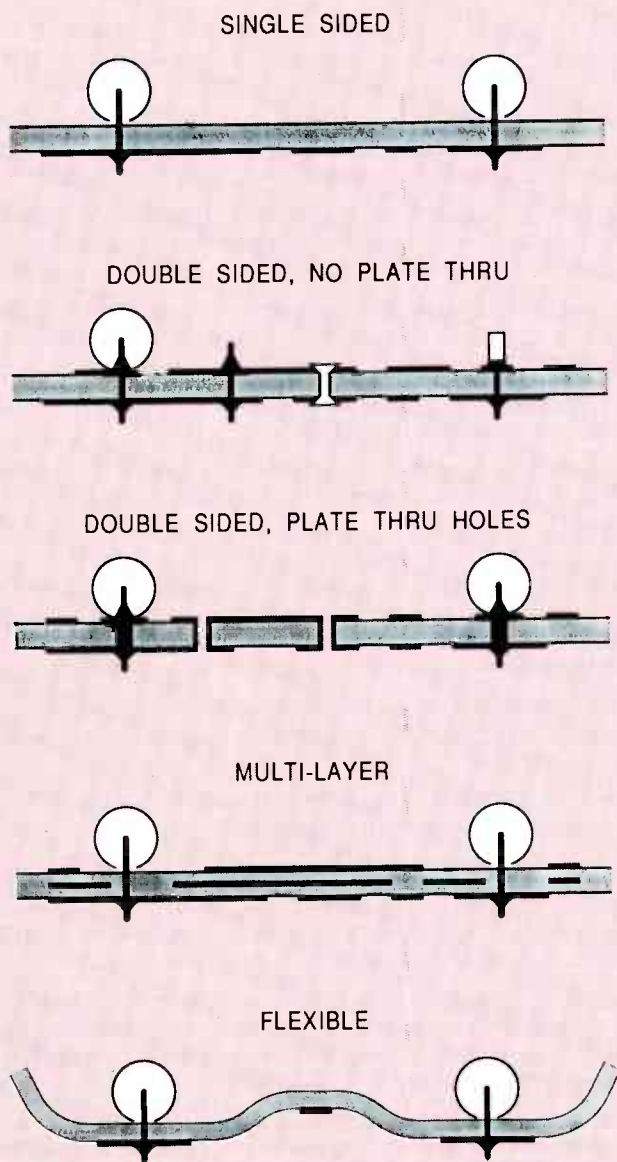

FIG. 1—SEVERAL POPULAR TYPES of printed-circuit boards. Note that a double-sided plate-through board can be hacker-faked by using component leads, eyelets, wire tabs, or low-cost individual pin sockets.

setup is beyond what most hackers would care to attempt. The tanks and such alone can set you back the better part of \$10,000.00. Nasty chemicals are involved that are hard to get in small quantities. Worse yet, it takes a long time and involves several dozen steps, all of which have to function perfectly to ever get any product out at the far end. You could farm out a lot of prototype boards at \$30 to \$60 before you could ever justify the investment.

Fortunately, the latest of the *surface-mount* technology components tend to greatly minimize both the number of holes and the need for plate-through. So jum-

pers, eyelets, or individual socket pins are not really all that bad an alternative for your prototype boards.

The next step beyond double-layer boards are *multi-layer* boards, where circuitry is placed *inside* the substrate, as well as on both surfaces. Typically, there will be four layers. Your horizontal runs will dominate on the top surface, followed by a lower power-supply plane, a ground plane that is lower still, and the vertical runs that dominate the bottom surface.

As you might guess, all four-layer boards are quite expensive and are extremely hard to modify, but they do offer superior shield-

ing and extreme component densities. Multi-layer PC boards as dense as 24 layers have been built. Quite often, the multi-layer PC board will be the most expensive part of an electronic system.

Flexible boards are also becoming popular. They are often thinner and use a *Kapton* substrate. Uses include mounting connectors, and for highly dense or unusual packaging. *Rogers Corp* is a leading source of flexible PC-board supplies.

Creating a printed-circuit

There's a number of good ways to create a final printed-circuit board. In general, those methods that put new conductors on an insulating substrate are *additive*; those that remove unwanted conductors from unneeded areas are *subtractive*. Very often, both additive and subtractive techniques will be used in combination.

Four of the traditional board-production techniques include *direct*, *mechanical*, *silk screen*, and *photographic*.

In the direct method, an etch-resistant pattern is applied by hand to the printed-circuit stock. Most any paint, lacquer, instant transfer, or ink will work, as will the tape and dots intended for initial layout work. So does a fingerprint or spilled root beer. *Bishop Graphics* is a leading supplier of PC tape and dots, and *Datak* is one source for instant-transfer products. There are also some rubber-stamping layout aides being offered.

Actually, the direct method is more hassle than it is worth, and ends up just about totally useless. Some problems here are pattern alignment, preventing fingerprints, tape lifting, a lack of uniformity, and too many defects.

The mechanical methods physically remove unwanted copper, usually by routing, special drills, or by milling. They're another concept that looks much better on paper than in the real world. Several specialized systems are usable for the mechanical PC layouts. Invariably, they are both laughingly and obscenely overpriced.

The silk-screen PC method is quite simple and is widely used commercially, especially for sin-

gle-sided boards of fairly low tolerances. The process is exactly the same as silk screening a T-shirt or a greeting card. Oversize artwork is created, usually at a 2:1 or sometimes a 4:1 scale. A litho negative gets shot from the artwork, which in turn creates a photo master for the screen. High-resolution screens are used, often in a 20XX density.

To print a board, etch-resistant ink is placed on the screen, and a squeegee is used to force the ink through the open portions of the screen. The board is then etched to remove all copper that is *not* covered by the inked image.

The advantages of the silk-screen method are that it is cheap, fast, and relatively low tech. One disadvantage is that the \$30 setup charge per screen gets out of hand when you want only a single prototype board. A second is the inability to do very fine lines or precisely aligned work.

Ulano is one major source of silk-screen films. The screens themselves are available from such

1. Always do your layouts double sized (2X) on a blue gridded mylar sheet, available from any drafting supply house. Always work on a light box. Use only "real" printed circuit tape and dots. *Bishop Graphics* is one source.
2. Watch which side you tape from. Pin one of an integrated circuit is at the *lower left* when viewed from the top as shown in the data book. Pin one will be at the *lower right* when etched from the bottom board foil.
3. Never cut your tape with an X-acto knife! Instead, lay the knife down flat and pull the free end of the tape back against the blade. Always firmly mash the tape in place after routing. A teaspoon is ideal for this.
4. Never do your own photography! A litho negative costs only \$3 at a jiffy printer, ad agency, or lithographers. This is the *only way* to get the proper precision and density.
4. Never coat your own boards! Always use commercially precoated dry film boards, such as those from *Kepro*.
5. Always use dry film photoresist, rather than spray-on or liquid coated KPR types. Otherwise, pinholes, dust, and uniformity will eat you alive.
6. If you must coat your own board, incredible cleanliness is essential. Thoroughly scour the board with ultra fine steel wool and a chlorine activated (*Comet*) cleanser at least three times, spending not less than two minutes per square inch of board. Dry promptly and avoid all finger prints. If possible, follow up with a chemical copper cleaner. Then etch for a few seconds, rinse four times, dry, and use immediately.
7. Note that properly cleaned copper will allow an unbroken film of water to flow over it, and that it will *not* be copper colored at all. Instead, it will be a uniform hot pink.
8. Never print through the negative base! Always have the photo emulsion in direct contact with the dry film photoresist.
9. Never use a ferric chloride etchant! Always use ammonium persulfate.
10. Always etch at an elevated temperature, around 120 degrees Fahrenheit. A warming plate from a yard sale is ideal for this. Agitate the etchant with a gentle sloshing or bubbles from an aquarium pump.
11. Never etch with your foil side up! Support the board vertically, or else *foil side down* at least 1/2 inch above the bottom of the etchant tray. A mirror *under* a glass etchant tray lets you view etching progress. Use only plastic or glass in contact with your etchant.

FIG. 2—SOME REALLY DUMB MISTAKES are often made by hackers who do their own printed-circuit boards the "old way." Here is how to avoid the worst of the pitfalls of the traditional methods. But this is all ancient history, because...

**NEW FROM
DON LANCASTER**

HANDS-ON BOOKS

Hardware Hacker Reprints II	24.50
Ask The Guru Reprints I or II	24.50
CMOS Cookbook	18.50
TTL Cookbook	16.50
Active Filter Cookbook	15.50
Micro Cookbook vol I or II	16.50
Enhancing your Apple I or II	17.50
AppleWriter Cookbook	19.50
Apple Assembly Cookbook	21.50
Incredible Secret Money Machine	10.50
LaserWriter Reference (Apple)	19.50
PostScript Cookbook (Adobe)	16.50
PostScript Ref. Man. (Adobe)	22.50
PostScript Prog. Design (Adobe)	22.50
Real World Postscript (Roth)	22.50

UNLOCKED SOFTWARE

LaserWriter Corner (Ile/Mac/PC)	29.50
PostScript Show & Tell	39.50
Intro to PostScript VHS Video	39.50
PostScript Perspective Draw	39.50
PostScript Beginner Stuff	39.50
PostScript Technical Illustrations	39.50
PostScript Work in Progress	39.50
PostScript BBS stuff	19.50
Absolute Reset Ile & Ilc	19.50
AppleWriter/Laserwriter Utilities	49.50
Enhance I or II Companion Disk	19.50
AppleWriter CB or Assy CB Disk	24.50

FREE VOICE HELPLINE VISA/MC

SYNERGETICS
Box 809-RE
Thatcher, AZ 85552
(602) 428-4073

CIRCLE 83 ON FREE INFORMATION CARD

PRINTED CIRCUIT RESOURCES

Advance Process Supply

400 North Noble Street
Chicago, IL 60622
(312) 829-1400

Bishop Graphics

5210 Lewis Road
Agoura Hills, CA 91376
(818) 991-2600

Black Lightning

RR 1-87 Depot Road
Hartland, VT 05048
(802) 359-2790

Circuits Manufacturing

500 Howard Street
San Francisco, CA 94105
(415) 397-1881

Datak

3117 Paterson Plank Road
North Bergen, NJ 07047
(201) 863-7667

DuPont Riston

3945 Freedom Circle F4
Santa Clara, CA 95054
(408) 562-9300

Electronic Manufacturing

17730 W Peterson Road
Libertyville, IL 60048
(312) 362-8711

Electronic Packaging

1350 E Touhy Avenue
Des Plaines, IL 60018
(312) 635-8800

Kepro Circuit Systems

630 Axminister Drive
Fenton, MO 63026
(314) 343-1630

Kodak

343 State Street
Rochester, NY 14650
(716) 724-4000

sources as *Dick Blick*, *Southern Sign Supply*, and *Advance Screen*. Two trade journals that serve the field are *Screen Printing* and *Signcraft* magazines.

At one time, printed-circuit boards were etched using a ferric chloride solution. Today, ferric chloride is a *very poor* choice of etchant. A much better etchant choice is ammonium persulfate. It is much cleaner, faster, and easier to use. Being a light blue solution, ammonium persulfate also lets you view the board as it is being etched. Etching best takes place at an elevated temperature, typically 120 degrees Fahrenheit. You could easily hit that temperature with a modified aquarium heater, a warming plate from a yard sale, or any of the strip heaters found on the surplus market.

Everything that comes in contact with the etchant must be glass or plastic. PVC is often usable. Ideally, your etchant should be sprayed onto the vertically held boards. Other ways to keep the etchant moving would be a simple manual sloshing or injecting air from an aquarium pump.

One really dumb mistake that most hackers make when etching their first PC boards is to place their board *face up* in the etchant solution. All that does is redeposit sediments and any crud removed from the board back on itself, leading to all sorts of nasty problems.

Instead, always support your boards vertically in the etchant, or else use surface tension to float

1

A thermal transfer toner image is PostScript laser printed onto a treated polyester sheet as a 1:1 reversed positive.

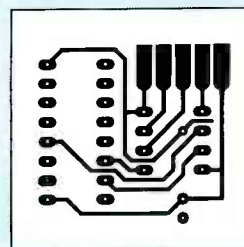

2

Heat and pressure fuse the toner directly to a thoroughly cleaned printed circuit board.

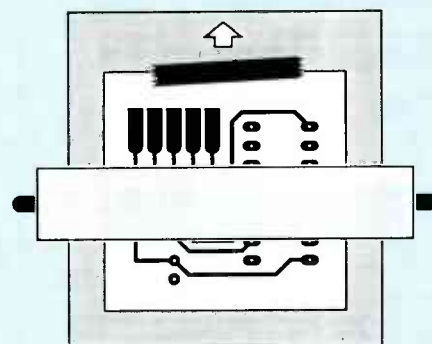

3

The pc board then gets etched in ammonium persulfate in the usual manner.

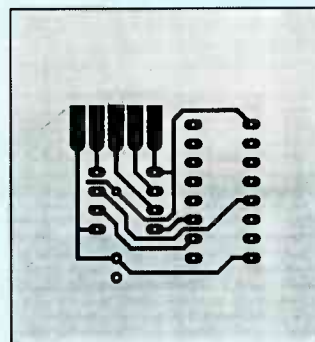

FIG. 3—OUR BRAND NEW DIRECT TONER TRANSFER method can dramatically simplify and speed up making all of your hacker printed-circuits at a cost only of pennies per board. Here are the three key steps in this breakthrough process.

Lazer Products

12741 E. Caley Ave. #130
Englewood, CO 80155
(303) 792-5277

Meadowlake

25 Blanchard Drive
Northport, NY 11768
(516) 757-3385

Miller-Stephenson

Box 950
Danbury, CT 06813
(203) 743-4447

Mill-Max

190 B Pine Hollow Road
Oyster Bay, NY 11771
(516) 922-6000

Rogers Corp

100 S. Roosevelt Avenue
Chandler, AZ 85226

(602) 961-1382

Screen Printing

407 Gilbert Avenue
Cincinnati, OH 45202
(513) 421-2050

Sign Craft

1938 Hill Avenue
Fort Myers, FL 33906
(813) 939-4644

Southern Sign Supply

127 Roesler Road
Glen Burnie, MD 21061
(301) 768-8600

Stimpson

900 Sylvan Avenue
Bayport, NY 11705
(516) 472-2000

Surface Mount Technology

17730 W. Peterson Road

Libertyville, IL 60048

(312) 362-8711

Synergetics

Box 809
Thatcher, AZ 85552
(602) 428-4073

Thiokol Dynachem

2631 Michelle Drive
Tustin, CA 92681
(714) 730-4200

Thompson & Thompson

23072 Lake Center #100
El Toro, CA 92630
(714) 855-3838

Ulano Corp

255 Butler Street
Brooklyn, NY 11217
(718) 622-5200

EXTRAORDINARY PC ADD-ONS

VCR TAPE BACKUP SYSTEM \$197
Store over 300Megabytes on a single
120min VHS tape using your own VCR!
(About 80 cents/40megabytes !!)

PC-OSCILLOSCOPE SYSTEM \$197
Useful BW = 5MHz. 2 channels. Comes
with probes, soft., manual, and expansion
board. (Send \$5.00 for demo package)

PC UPGRADES

MOTHERBOARDS
8MHz XT Motherboard 0K/ram\$85
10MHz XT Motherboard 0K/ram\$95
12MHz AT Motherboard 0K/ram\$245

XT HARD DRIVE KITS
ST238R 30MB, RLL, controller & cables ...\$259
ST250R 40MB, RLL, controller & cables ...289

I/O CARDS
Parallel Port Card for XT/AT\$24
Serial Card for XT/AT\$29

**FOR FREE CATALOG
CALL 1-800-866-7899**

(U.S.A. only)

OR WRITE TO:

CHASE SCIENTIFIC COMPANY
P.O. BOX 1895, APTOS, CA. 95001-1895

- PHONE ORDERS C.O.D. ONLY
- 30 DAY MONEY BACK GUARANTEE

(IBM,XT,AT ARE REGISTERED TRADEMARKS OF
INTERNATIONAL BUSINESS MACHINES INC.)

CIRCLE 147 ON FREE INFORMATION CARD

Get A Complete Course In

ELECTRONIC ENGINEERING

8 volumes, over 2000 pages, including all necessary math and physics. 29 examinations to help you gauge your personal progress. A truly great learning experience.

Prepare now to take advantage of the growing demand for people able to work at the engineering level.

Ask for our brochure giving complete details of content. Use your free information card number, or write us directly. **\$99.95**, Postage Included. Satisfaction guaranteed or money refunded.



**Banner
Technical
Books, Inc.**

1203 Grant Ave.
Rockford, IL 61103

CIRCLE 67 ON FREE INFORMATION CARD

NAMES AND NUMBERS

Adobe PostScript
1585 Charleston Road
Mountain View, CA 94039
(415) 961-4400

All Electronics
PO Box 567
Van Nuys, CA 91408
(800) 826-5432

EG&G Reticon
345 Potrero Avenue
Sunnyvale, CA 94086
(408) 738-4266

Freedom of the Press
900 Tech Park Drive #8
Billerica, MA 01821
(800) 873-4367

Go Script/LaserGo
9235 Trade Place, Ste A
San Diego, CA 92126
(619) 530-2400

Kroy Kolor
14555 N. Hayden Road
Scottsdale, AZ 85260
(800) 521-4997

JKL Components
13343 Paxton Street
Pacoima, CA 91331
(800) 421-7244

Robert A Main & Sons
555 Goffle Rd, Box 159
Wyckoff, NJ 07481
(201) 447-3700

Rohm Corporation
8 Whatney
Irvine, CA 92718
(714) 855-0819

SPIE
PO Box 10
Bellingham, WA 98227
(206) 676-3290

Synergetics
Box 809
Thatcher, AZ 85552
(602) 428-4073

Winzeler Inc
7355 W. Wilson Avenue
Chicago, IL 60656
(312) 867-7971

1. Create a PostScript printed circuit artwork image on disk, using your favorite word processor and the sample routines of figure five and six, the full code found in my *PostScript Show and Tell*, or some suitable third party printed circuit layout package.
2. Run a positive, reversed 1:1 proof on a PostScript speaking laser printer, such as an *Apple LaserWriter IINT*. Many copy shops offer this service. Low cost PostScript printers are available through *Don Thompson*.
3. Optional step: Take a polyester based, laser printable overhead transparency material and lightly coat one side with *Miller-Stephenson* type MS-136 heated mold release agent. Mark the coated side.
4. PostScript laser print a 1:1 positive reversed (black = foil; right = left) onto the coated side of the polyester sheet, using a special thermal transfer (T-shirt) toner from *Black Lightning*, *Don Thompson*, or *Lazer Products*. Other graphic toners might also work; try them and see.
6. Sharpen and smooth the leading edge of an oversize piece of 1/16th inch printed circuit material with a file and steel wool, so that it can be sent through a fake *Kroy Kolor* machine without hurting the rollers. Use a 3/8 to 1/2 inch leading slope.
7. Thoroughly clean this oversize printed circuit board, scouring it three times with fine steel wool and *Comet* cleanser, followed by a chemical cleaner, followed by a brief etch. The board must be a uniform hot pink in color and must allow an unbroken stream of water to flow smoothly over it. Be sure to avoid any and all fingerprints.
8. Tape the leading edge of the polyester sheet *toner side down* to the copper side of the printed circuit board, using a suitable high temperature tape. Make sure the polyester sheet lies flat.
9. Run the board, image side up, through a preheated fake *Kroy Kolor* machine adjusted to a medium temperature. One source of these machines is *Lazer Products*. See the November 88 *Radio Electronics* or my *hardware Hacker II* reprints for details on building your own machine.
10. Optional step: Chill the board suddenly in a freezer before lifting the polyester sheet. Allow to warm to room temperature, then bake for fifteen seconds at 300 degrees F in a kitchen oven.
11. Etch in the usual manner in ammonium persulfate etchant.

FIG. 4—THE STEP-BY-STEP "BASELINE" process for the new toner transfer PC method. An ordinary iron can substituted for the Kroy Kolor machine, but the results may not be as good. Let us know your experiences here.

% Copyright c 1988 by Don Lancaster & Synergetics, Box 809, Thatcher AZ, 85552.
 % (602) 428-4073. All rights reserved. Personal, non-commercial use permitted so long
 % as this header remains both present and intact. Show & Tell disk costs \$39.50.

```
/quadpixel {transform 4 div round 4 mul itransform} def
/setgrid {save /rubbersnap exch def /size exch def quadpixel exch quadpixel exch translate
size dup scale } def
/drawlines {72 300 div lw mul size div setlinewidth /hposs 0 def #hlines gs div 1 add cvi
{hposs 0 moveto 0 #vlines rlineto stroke /hposs hposs gs add def} repeat /vposs 0 def
#vlines gs div 1 add cvi {0 vposs moveto #hlines 0 rlineto stroke /vposs vposs gs add
def} repeat} def
/showgrid{gsave /#vlines exch def /#hlines exch def 106 45 {pop pop 0} setscreen 0.9
setgray /gs 1 def /lw 1 def drawlines grestore} def
/1X {30 72 mul 300 div setgrid} def
/trace20 {6 30 div setlinewidth} def /trace50 {16 30 div setlinewidth} def /trace80 {24
30 div setlinewidth} def
/am {newpath moveto} def
/tdraw {rlineto currentpoint stroke moveto} def
/u {0 exch tdraw} def /r+ {dup tdraw} def
/r {0 tdraw} def /r- {dup neg tdraw} def
/d {0 exch neg tdraw} def /l- {neg dup tdraw} def
/l {neg 0 tdraw} def /l+ {dup neg exch tdraw} def
/black {0 setgray} def /white {1 setgray} def
/xrpt{gsave aload pop /trips exch def /dist exch def /rproc exch def trips { gsave rproc
grestore dist 0 translate } repeat grestore} def
/yrpt{gsave aload pop /trips exch def /dist exch def /rproc exch def trips { gsave
rproc grestore 0 dist translate } repeat grestore} def
/hole {gsave 150 div /dia exch def newpath dia 2 div 0 360 arc white fill grestore} def
/icpad1v {save /psnap exch def trace50 2 copy gsave exch 0.2 sub exch am 0.4 r grestore
20 hole psnap restore} def
/edgeconu {gsave translate 0.4 0 moveto 0 -2 0.4 0 180 arcn 0 2 rlineto closepath fill
grestore} def
/feedpad {save /fpsnap exch def newpath 2 copy black 0.25 0 360 arc fill 18 hole clear
fpsnap restore} def
/circpad2 {save /fpsnap exch def newpath 2 copy black 0.30 0 360 arc fill 22 hole clear
fpsnap restore} def
/dip8v{gsave translate [[0 0 icpad1v] 1 4] yrpt [[3 0 icpad1v] 1 4] yrpt grestore} def
/dip16v{gsave translate [[0 0 icpad1v] 1 8] yrpt [[3 0 icpad1v] 1 8] yrpt grestore} def
1 setlinejoin 1 setlinecap
```

FIG. 5—SOME SAMPLE POSTSCRIPT PC-LAYOUT routines that were excerpted from my PostScript Show & Tell disk. Just shove this listing into your favorite word processor as a prolog to your actual layout.

the board *upside down* on the surface of the etchant. Another ploy is to add nylon spacers to your PC board so the foil faces *down* in your etching solution. Or else throw some nylon hex nuts in the etchant and sit the board upside down on the nuts. Once again, *never etch a PC board face up!*

A second stupid mistake that lots of hackers make is failing to clean the boards properly. It is not possible to clean a circuit board at home without spending at least *two minutes per square inch of board*. Begin by using *Comet* or another chlorine-activated cleanser with a fine steel-wool pad or *Scotchbrite* pad. Rinse thoroughly and wipe on an inner fresh turn of a new roll of paper towels. Repeat that at least three times, avoiding any and all fingerprints.

Note that fairly clean copper will

allow an unbroken stream of water to flow over it without any running or beading. Your key secret is that a genuinely and totally clean copper will not be copper-colored at all. Instead, it will be certainly a uniform hot pink. Commercial copper cleaners, such as CU3 from *Kepra*, are a great help, but are somewhat expensive.

The ultimate final cleanliness step is to place the copper in ammonium persulfate and etch it for ten to fifteen seconds or so. Then thoroughly rinse three times and air dry immediately. If you get a uniform hot pink result, then your copper is clean enough for immediate use.

The photographic methods get rather complicated, but they can be used for arbitrarily fine lines and for all of the precision you will ever need. In fact, the same tech-

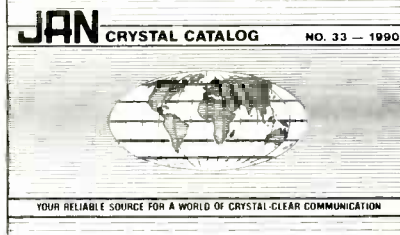

THE ONLY SOURCE YOU'LL EVER NEED!

SATISFACTION GUARANTEED
 QUICK SHIPMENT
 RELIABILITY • LOW COST

FOR FREE CATALOG, CALL OR WRITE:

JAN CRYSTALS
 P.O. BOX 06017
 FORT MYERS, FL 33906
 (813) 936-2397



TOLL-FREE: 1-800-JAN-XTAL
(526-9825)

FAX ORDERS: 1-813-936-3750

CIRCLE 104 ON FREE INFORMATION CARD

A New AOR Scanner

100 Channels Low, Air, High, UHF & 800MHz

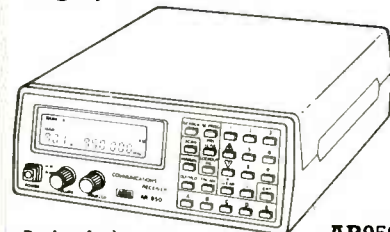

- Perfect for base or mobile. Includes AC and DC power cords, mobile mount hardware and 2 antennas.
- Covers 27-54MHz, 108-174MHz, 406-512MHz and 830-950MHz.
- 5 Scan Banks and 5 Search Banks
- 25 Day Satisfaction Guarantee
- No Frequencies Cut Out.
- Size: 3 1/2" H x 5 5/8" W x 7 1/4" D. Wt.: 2 lb. 10 oz.

AR950

Total Price, Freight Prepaid
 (Express Shipping Optional)

\$299.00



10707 E. 106th St. Indpls., IN 46256

Toll Free 800-445-7717

Visa and MasterCard
 (COD slightly higher)



In Indiana 317-849-2570 Collect FAX (317) 849-8794

CIRCLE 152 ON FREE INFORMATION CARD

niques are used to manufacture integrated circuits to a fraction of a micron accuracy. Note that there are 20 microns in a mil.

With the photo processes, a light-sensitive *etch resist* is placed on the thoroughly cleaned board. The resist is first contact-printed from a photographic negative and then developed. In the most popular *negative-acting* systems, those portions of the resist that receive light harden and remain; those that did not will dissolve out. Etching is done in the usual manner.

Traditionally, the spray-on photoresist was used, such as a KPR product from *Kodak*. These days, though, it is far simpler and far better to use a dry-film photoresist, such as the *Riston* materials by *DuPont*, or any of the *Laminar AX* products from *Thiokol*. Those dry films develop in trisodium phosphate, the garage-floor cleaner found at your local hardware store. They are quite resistant to pinholes, eliminate dust and drying problems, have highly visible images, and are always at the right thickness. Once sensitized, the boards must be kept dry, cool, and in total darkness. They also have a one-year shelf life.

The third most stupid mistake that hackers make is trying to use KPR instead of the new and infinitely better dry films. Mistake number four, of course, is trying to coat their own boards instead of using pre-coated ones. Excellent dry-film pre-coated boards are stocked by *Kepron*.

The cost of the dry-film resist by itself is around a dollar per square foot. Unfortunately, a fancy laminator is needed to bond the resist to the board. I have a hunch that a Kroy Kolor machine or one of its imitators can be substituted here. The required temperature is 234 degrees Fahrenheit. Let me know if you pick up any experience along those lines.

Double-sided plate-through boards often use a combination of processes. Typically, you start with a double-sided board. The holes are first drilled, and then they are plated through by additive techniques. The holes get chemically activated, and then seeded with an

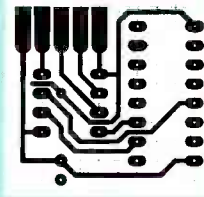

% requires printed circuit sampler code of figure five

```
100 100 1X 11 11 showgrid trace20 10 2 am 1 | 0.75 | 4.5 | 0.75 | 2 | 6 u 10 5 am 0.75 | 1.5 | 1.25 | 0.5 | 2 | 0.5 | 0.75 u 1.25 | 7 4 am 0.75 | 0.5 | 0.75 | 5 5.5 am 1 | 1.5 u 5 4.5 am 2 | 2 u 2 6.5 am 1.5 u 7 3 am 0.5 | 2.75 | 0.75 | 0.5 | 0.5 | 2 3.5 am 1 | 10 9 am 0.75 | 2.75 | 0.5 | 2.75 d 1 | 6 6.5 am 2.15 d 0.35 | 1.15 | 2 | 1 | 5 6.5 am 1.5 u 7 2 dip16v 2 3.5 dip8v [{1 10 edgeconu} 1 5] xrpt 3 2 circpad2 3 1 circpad2 3 5.5 foedpad showpage quit
```

FIG. 6—A TYPICAL PC-TEST LAYOUT. Note how simple and short the code is. Omit the showgrid command to drop out the fine gray viewing grid. Be sure to preface this code with the PostScript routines of Fig. 5.

ultra-thin palladium plating. Electroless copper is then built up on the conductive palladium to a medium thickness, followed by a heavy copper plating up to the final wall thickness needed. The rest of the board is then processed through the usual double-sided photographic steps. Key hacker printed-circuit mistakes are summarized for you in Fig. 2.

Printed-circuit resources

I've gathered some of the major PC-board resources into our first sidebar, as we've done in previous columns for other topics. Most of the products we have mentioned are available directly through those sources.

The best trade journal for printed circuits is *Circuits Manufacturing*. A few others are *Electronic Packaging and Production*, *Surface Mount Technology*, and their sister publication, *Electronic Manufacturing*. Be sure to let me know if there are other resources that you think should be added to the list.

The direct-toner method

There's a new process on the block for hacker printed-circuits which is ridiculously simpler, faster, and far cheaper than any of the above. All you really need is a word processor and an iron. This new scheme is known as the *direct-toner method*. And it is new and undeveloped enough so that you might play a major role in making it work and shaping its future.

Very simply, copier or laser-printer toner is outstanding as an etch resist. Two decades ago, Xerox even had a product that directly printed on your copper PC boards from a 2:1 artwork original. A ways back, a new hacker product known as *Meadowlake* did attempt an iron-on toner system. Early versions of the product didn't turn out reliable enough and lacked stability.

But there is a brand new type of *thermal-transfer toner* now carried by several laser-printer supply houses. While the toner is intended for making iron-on T-shirt images, it transfers to copper beautifully and smudge-free, and is thus a key secret to the direct-toner process. Three sources of a thermal-transfer toner are *Black Lightning*, *Lazer Products*, and *Don Thompson*. *Black Lightning* does offer a free sample. Cost of the toner ranges from \$90 to \$180 per cartridge, which translates to a dime per board. Several of the other new graphics toners should also work well. Your help is needed in pinning down which ones are acceptable and which are not.

Figure 3 summarizes the key toner-transfer steps; that is followed by some detailed instructions in Fig. 4.

The best way I've found to create initial artwork is by using a PostScript speaking laser printer and my word processor. In fact, I have a complete package that does just that for Apple, Mac, and IBM

Radio-Electronics mini-ADS

users. Note that the original image must be a 1:1 reversed positive. That means that left is where right belongs and black is where you want your foil to remain. Naturally, since your image is disk-based, it is easy to change, and super easy to build up from a library of suitable Post-Script dictionary routines.

The image gets printed, again as a 1:1 reversed positive, onto a laser-printable Mylar or polyester overhead projection sheet. Just for luck, I'll previously apply a very thin coating of MS-136 *Heated Mold Release Agent* from *Miller-Stephenson*. That may or may not help, but it sure seems like a good idea, at least for now. It also may be a good idea to anneal or remelt the toner for a few seconds in an oven, after the image is transferred.

Too much reheating, of course, would lower the resolution. Although ten-mil lines on twenty-mil centers should be possible, I'd stick with double that as an initial lower limit.

In theory, you could simply iron the toner directly onto a previously super-cleaned PC board. Instead, I modify the board by *sharpening* its leading edge, and run it through one of the imitation *Kroy Kolor* machines we looked at in *Radio-Electronics*, November, 1988. By the way, an improved and economical do-it-yourself version of that beast is in the works here at *Radio-Electronics*.

The benefits of the new way are obvious. You go from artwork to PC prototype amazingly fast. No cameras, chemistry, screens, or fancy equipment is needed. Without any fuss or bother. Just print and etch. And products such as *GoScript* and *Freedom of the Press* even let you fake PostScript on a dot-matrix printer, so "no printer" is no excuse.

The technique could also revolutionize running hacker PC projects. You show the PostScript code in the magazine and offer it downloadable off your BBS. Now, every hacker can end up with a precisely accurate original, rather than a third-generation copy.

Figure 5 shows some sample PostScript code from my PC layout stuff, while Fig. 6 shows a simple

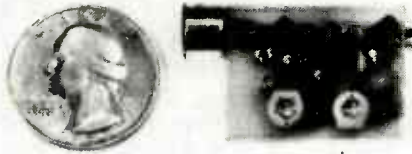

SIMPLY SNAP THE WAT-50 MINIATURE FM TRANSMITTER on top of a 9v battery and hear every sound in an entire house up to 1 mile away! Adjustable from 70-130 MHZ. Use with any FM radio. Complete kit **\$29.95 + \$1.50 S + H**. Free shipping on 2 or more! COD add \$4. Call or send VISA, MC, MO. **DECO INDUSTRIES, Box 607, Bedford Hills, NY 10507. (914) 232-3878.**

CIRCLE 127 ON FREE INFORMATION CARD

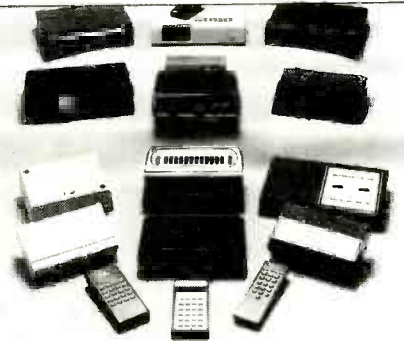

CABLE TV CONVERTERS AND DE-SCRAMBLERS SB-3 \$79.00 TRI-BI \$95.00 MLD-\$85.00 M35B \$89.00 JRX-DIC \$129.00 Special combos available. We ship COD. Quantity discounts. Call for pricing on other products. Dealers wanted. FREE CATALOG. We stand behind our products where others fail. One year warranty. **ACE PRODUCTS, P.O. Box 582, Saco, ME 04072 (207) 967-0726.**

CIRCLE 75 ON FREE INFORMATION CARD

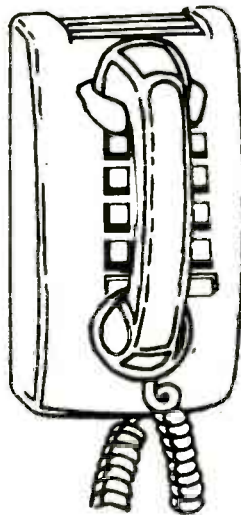

CALL NOW AND RESERVE YOUR SPACE

- 6 x rate \$940.00 per each insertion.
- Fast reader service cycle.
- Short lead time for the placement of ads.
- We typeset and layout the ad at no additional charge.

Call **516-293-3000** to reserve space. Ask for Arline Fishman. Limited number of pages available. Mail materials to: mini-ADS, RADIO-ELECTRONICS, 500-B Bi-County Blvd., Farmingdale, NY 11735.



GET YOUR RECHARGE CATALOG FREE...EARN BIG \$\$ IN YOUR SPARE TIME—All supplies and Do-It-Yourself kits with complete instructions available. Supplies cost from \$9.95 in qty and you can sell recharged toner cartridges for \$40.00 to \$55.00 each. Printers include HP LaserJet and Series II, Apple LaserWriter, QMS, etc. Canon PC-25 Copier also. **CHENESKO PRODUCTS, 62 N Coleman Rd., Centereach, NY 11720, 516-736-7977, 800-221-3516, Fax: 516-732-4650**

CIRCLE 153 ON FREE INFORMATION CARD

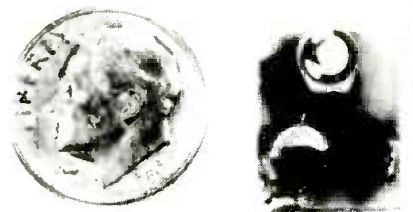

THE MODEL WTT-20 IS ONLY THE SIZE OF A DIME, yet transmits both sides of a telephone conversation to any FM radio with crystal clarity. Telephone line powered - never needs a battery! Up to 1/4 mile range. Adjustable from 70-130 MHZ. Complete kit **\$29.95 + \$1.50 S + H**. Free Shipping on 2 or more! COD add \$4. Call or send VISA, MC, MO. **DECO INDUSTRIES, Box 607, Bedford Hills, NY 10507. (914) 232-3878.**

CIRCLE 127 ON FREE INFORMATION CARD

actual layout that you can use to test out your own version of the direct-toner board method.

As I said before, this is a brand new technique that needs some further experimentation to perfect. So, for our first contest this month, just tell me anything you find out on your own about making a direct-toner PC board. There'll be the usual dozen or so *Incredible Secret Money Machine* books for best entries, along with an all-expense-paid (FOB Thatcher, AZ) *tinaja quest* for the very best of all. Let's hear from you on this hot new topic.

New tech literature

The hacker buy of the month has to be the new \$3.75 speech synthesizer available as stock number ICA from *All Electronics*. It even includes a load-power sensing detector. There is one very tiny gotcha, though—the main thing the synthesizer has to say is "Your ice cream is ready." Oh, well.

The *EG&G Reticon* folks have three brand new data books out. They are their *Image Sensing Products*, *Solid State Cameras*, and the *Analog Signal Processing Integrated Circuits*. The latter covers analog delay lines, switched-capacitor filters, and some very useful ap-notes.

The BU2911 is an interesting new melody chip from *Rohm*. It provides a pair of folk songs and six different chime and siren sound effects. Uses? How about some clocks, doorbells, or alarms? Miniature fluorescent lamps from *JKL* are offered in various colors at very low prices; they also carry EPROM erasing lamps.

The *SPIE* folks have great bunches of reprints involving nearly everything optical, and covering laser scanning, CD ROM, holography, fiber optics, and I-R detection. Get their list number 6.

Turning to mechanical stuff, free molded-gear samples are obtainable from *Winzeler*. And *Robert A.*

Main has a unique catalog of *Hooks, Points, and Teeth*. A sharp outfit for sure. Tellyawhat. Their catalog number twelve is so unusual, that we'll make us a second contest out of it. Just come up with some off-the-wall use for any of the hooks, points, or teeth shown.

If you want to explore our new direct-toner hacker PC process further, or want to draw your own first-quality electronic schematic diagrams, isometric drawings, or architectural perspective sketches (including all lettering!) using nothing but your favorite word processor, check into my *PostScript Show and Tell*, that has scads of working code and detailed examples in it. Available for Apple, Mac, or IBM, it does need a PostScript speaking laser printer (or a software emulator).

As always, this is your column and you can get technical help and off-the-wall networking per the *Need Help?* box. The best calling times are weekdays 8-5, MST. R-E

PROPERTY GUARD

continued from page 40

transducer is approximately 40-volts p-p. Tap 6 may be used for frequencies below 20 kHz with "on" times no more than 20 minutes; voltage is approximately 50-volts p-p. Tap 13 is intended for intermittent use where "on" times are less than 3 minutes and the frequency well below 20 kHz. Those times may be longer when operating at lower frequencies. Never allow the transducers to get excessively warm. That completes the testing and adjustment of the system.

Setup

The Phasor Property Guard is capable of operating in two modes. Mode 1 is at a frequency that is known to produce paranoia, nausea, disorientation, and many other physiological effects. Mode 2 allows using the system as an audible alarm to frighten off intruders or warn the user of an intrusion. Both modes may be used in combination, and are easily controlled by the user. Three separate jacks provide inputs for a broken trip wire or contact foil, a pressure or actuating switch, and a positive voltage pulse from other equipment.

The position of the transducers

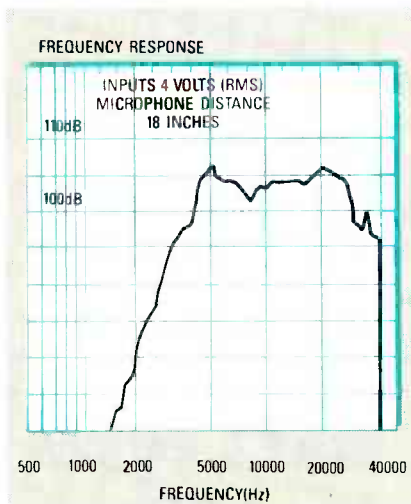

FIG. 7—FREQUENCY RESPONSE of the piezoelectric transducers.

should be such that they direct their energy to the points of intrusion or access. They can be all directed to any target area, or be individually placed for multiple effect.

The transducers used in this system are piezoelectric and are many times more efficient than the electromagnetic-type speaker. Their frequency response is shown in Fig. 7.

Ultrasonics

Ultrasonic is a gray area in many respects when the application in-

volves the control of animals or as an intruder deterrent. It is always best to consult with local municipal and state laws before using this device to protect home or property.

Do not operate at continuous high output at frequencies below 20 kHz. Daily sound pressure exposures in excess of one hour at 105 dB may lead to hearing impairment. When properly used, this device provides a limited liability deterrent. It should not cause permanent damage or trauma.

There have been numerous requests for information on the effect of these devices on people. First of all, an ultrasonic device should not be used unnecessarily on humans, because of the possibility of acoustically sensitive people being highly irritated.

Remember that the Property Guard cannot stop a person with the same effect as a gun, club, or more conventional weapon. It will, however, produce an extremely uncomfortable, irritating, and sometimes painful effect in most people. Although not everyone will experience the effect the same degree. Younger women are much more affected than older men, due to being more acoustically sensitive. The range depends on many variables, but is normally somewhere between 10 and 100 feet. R-E

DRAWING BOARD



ROBERT A. GROSSBLATT

Developing and Etching a PC board.

THE MAIN INGREDIENT IN MAKING good PC boards is consistency. Once you're past the layout phase, you're past the creative part. Converting the graph paper lines to copper foils is as mechanical as filling a gas tank. Just follow the rules, if you know what they are. The only problem is, I've never found them written down anywhere, and believe me, I've looked! Even the Kodak booklet I mentioned last month was vague about the things that were giving me problems.

All the information I've given you so far about PC board production is the result of trial and error. If you follow these steps, you've got a reliable method. The only steps left are developing and etching. While you might think these straightforward, there are some undocumented problems here also.

Developing the board

By the time you're ready to develop, you may be lulled into a false sense of security. After all, it's basically the same process as developing lithographic film. That was easy, but there was so much latitude, you couldn't make a serious mistake without trying really hard. Developing copper, however, has unique problems.

Copper etchant is considerably more caustic than that for film. It may not exactly be aqua-regia, but it'll eat through almost any kind of plastic. Guaranteed, if you pour it into a plastic film tray, the bottom will vanish in 15 seconds, and the floor will be ruined; polyurethane and vinyl flooring are plastic, also.

If you're wearing polyester, the consequences are too horrible to contemplate. So, the first rule for PC board development is: *The trays must be made of glass or metal or else!*



FIG. 1

Properly applied resist is much denser than film emulsion, and development is roughly logarithmic. With film, the image appears fairly quickly, and darkens slowly. The actual rate is irrelevant, since you can watch it happen and pull the film when it's done. With resist, however, you have to remember the chemical reaction rate, because you won't see anything happen on the PC board, making reliable development very difficult. The whole PC board process involves many variables, so a problem can be caused by any preceding steps. If the pattern dissolves, you can't tell why. The list of possible screwups gets longer as you go on. Just as with the earlier parts of the process, I finally doped out a reliable approach.

Put the exposed PC board in the developer *slowly*, and gently rock the tray at one shake per second for 20 secs. Then, remove the PC board at an angle so the excess

developer can run off. Even though the board won't be fully developed, most of the unwanted resist should be loose enough to wash. All the resist, both pattern and excess, should be very soft now, so handle the PC board carefully, or you'll have to scrub the copper clean and start over.

Resist manufacturers all have suggested methods, from a water spray to dabbing with paper towel. The latter was told to me by a spray can manufacturer, and I still have difficulty believing that such stupid advice would be given. There's only one way, which I found after considerable trial and error. Before you start development, fill a sink or tray with *COLD* water, under 70°F (right from a tap), or it won't wash the off the excess. So, the second rule is: *Use only cold water and don't make waves!*

Be careful when washing the PC board; keep it perpendicular to the water as you dunk it and lift it out, and let the water run off momentarily. *DON'T* shake it, and for God's sake, *DON'T* use running water. If you reflect some light off it, you should start to see the pattern appear as the excess is removed. Keep dunking it until you can see the whole foil pattern. The cold water should slowly harden the resist on the board so don't wash the board for more than a minute. If you only see a partial pattern after a minute of washing, the board just needs more development.

Regardless of how the pattern looks after a 1-min cold water wash, develop for about thirty seconds more. Water and developer



GIFT GUIDE

continued from page 53

LIST OF MANUFACTURERS

Bang & Olufsen of America, Inc.
1150 Feehavnille Drive
Mount Prospect, Ill 60056
CIRCLE 25 ON FREE INFORMATION CARD

Sharp Electronics Corporation
Sharp Plaza
Mahwah, NJ 07430-2135
CIRCLE 26 ON FREE INFORMATION CARD

Pioneer Electronics (USA) Inc.
2265E. 220th Street
P.O. Box 1720
Long Beach, CA 90801-1720
CIRCLE 27 ON FREE INFORMATION CARD

Videonics
1129 Dell Avenue
Campbell, CA 85008-661
CIRCLE 28 ON FREE INFORMATION CARD

Thompson Consumer Electronics
2000 Clements Bridge
Deptford, NJ 08096
CIRCLE 29 ON FREE INFORMATION CARD

Sony Corporation of America
9 West 57th Street
New York, New York 10019
CIRCLE 30 ON FREE INFORMATION CARD

Executive Travelware
P.O. Box 59387
Chicago, IL 60659
CIRCLE 31 ON FREE INFORMATION CARD

Bose Corporation
The Mountain
Framingham, Massachusetts 01701
CIRCLE 32 ON FREE INFORMATION CARD

Parsec
400 W. 9th St.
Wilmington, DE 19801
302-651-9189
CIRCLE 33 ON FREE INFORMATION CARD

Neutrik USA
1600 Malone Street
Millville, NJ 08332
CIRCLE 34 ON FREE INFORMATION CARD

Atari (U.S.) Corporation
1196 Borregas Avenue
P.O. Box 3427
Sunnyvale, CA 94088-3427
CIRCLE 35 ON FREE INFORMATION CARD

Jameco Electronics
1355 Shoreway Road
Belmont, California 94002
CIRCLE 36 ON FREE INFORMATION CARD

LaserGo Inc.
9235 Trade Place, Suite A
San Diego, CA 92126
CIRCLE 37 ON FREE INFORMATION CARD

of the popular sizes of motherboards up through new 386 boards, but it has
continued on page 88

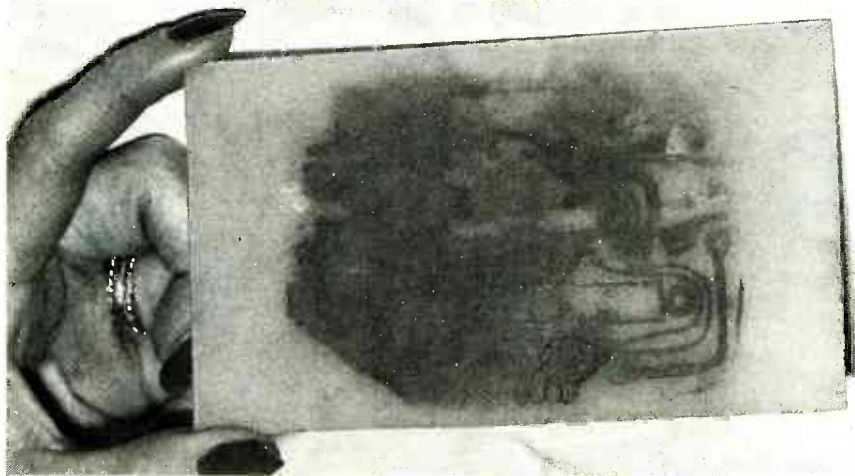

FIG. 2

don't mix, so shake the excess water off the board or just let it air dry thoroughly before you immerse it in the developer a second time. The water should have hardened the resist so should tolerate shaking at this point, it'll probably still be too soft to wipe or touch.

The second immersion in developer should eliminate all unwanted resist, and when the 30 secs is over, repeat the water wash. The pattern should appear much faster now, and be much easier to see, since the copper covered by the pattern should be totally free of resist. Repeat until the pattern is clear. The hardest part is knowing when the copper is free of all excess resist and developer. The difference in appearance between clean and coated copper is fairly evident, as in Fig. 1. Clean copper is reddish, and coated copper whitish. You'll understand when you see it.

Etching the board

Once developing and washing is done, let the resist harden for 15 mins before dumping the PC board in the etchant. The etchant will dissolve metal, as quickly as the developer will plastic. All standard etchants like ferric chloride and ammonium persulfate will dissolve metal. There are some exceptions, like stainless steel, but don't experiment. Remember, the secret to success in this is consistency; find a way that works and keep it. We've now reached the third rule of board making: *Use only plastic or glass trays for the etchant!* It stains just about anything, especially the ferric chlo-

ride variety.

Put the board in a plastic or glass tray, *NOT METAL*, and heat the etchant to 100°F. Pour it on the PC board, wait 15 secs, then take the PC board out wash it. The brief contact with the etchant should start the copper removal. The reason for pulling it out so quickly is to let you examine the resist integrity. This is the time to examine the pattern for any breaks in the foils, excess resist, etc.

The foils can be repaired the same way you laid the pattern out on graph paper. Use drafting tape to cover breaks in the foils, and scrape away excess resist with an X-acto knife. When the pattern is right, put the board back in the etchant and rock the tray gently. *Don't* be violent about it, because you *don't* want to spill that stuff; cleaning it's a *big* job. We're not talking the Exxon Valdiz here, but it'd still be pretty bad.

The time needed depends on the etchant type, the amount, the number of times you've used it before, how much copper is involved, the temperature, and how the board is agitated; however, you shouldn't need over a half hour to finish. You'll have to keep pulling the PC board out to check it for foil breaks and excess resist, repairing with the drafting tape and X-acto knife. Most PC boards need work as they're being etched, but if you get something Fig. 2, it's shot.

Etchant has limited life, since the etched copper combines with the etchant chloride to give cupric chloride. When it gets black, it's saturated and must be dumped. **R-E**

PC SERVICE

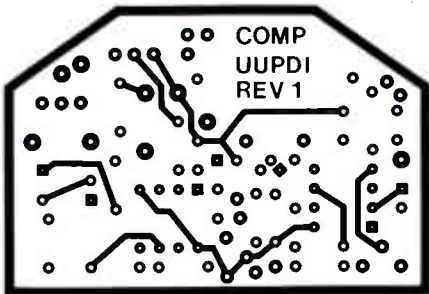

2 1/8 INCHES

DRIVER BOARD, COMPONENT SIDE.

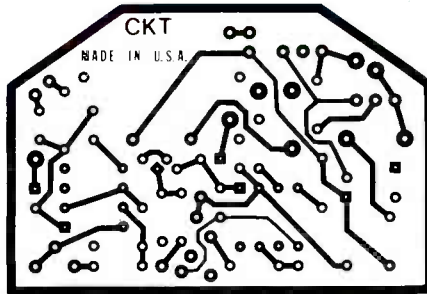

2 1/8 INCHES

DRIVER BOARD, SOLDER SIDE.

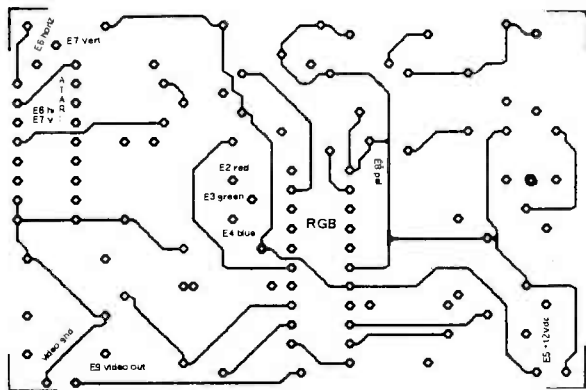

3 INCHES

COLOR CONVERTER COMPONENT SIDE.

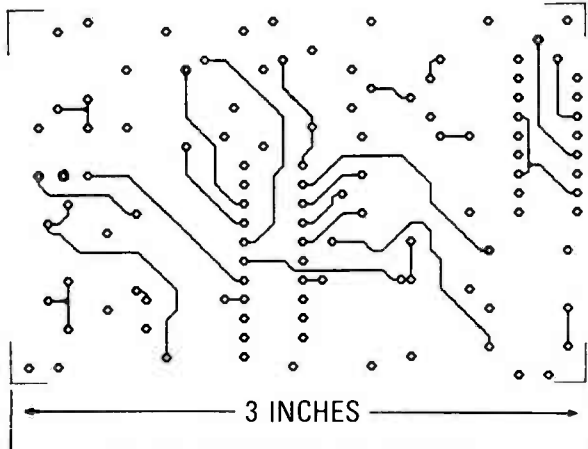

3 INCHES

COLOR CONVERTER SOLDER SIDE.

DIGITAL VIDEO STABILIZER ELIMINATES ALL VIDEO COPY PROTECTIONS



While watching rental movies, you will notice annoying periodic color darkening, color shift, unwanted lines, flashing or jagged edges. This is caused by the copy protection jamming signals embedded in the video tape, such as Macrovision copy protection. Digital Video Stabilizer: RXII completely eliminates all copy protections and jamming signals and brings you crystal clear pictures.

- FEATURES:**
- Easy to use and a snap to install
 - State-of-the-art integrated circuit technology
 - 100% automatic - no need for any troublesome adjustments
 - Compatible to all types of VCRs and TVs
 - The best and most exciting Video Stabilizer in the market
 - Light weight (8 ounces) and Compact (1x3.5x5")
 - Beautiful deluxe gift box
 - Uses a standard 9 Volt battery which will last 1-2 years.

WARNING :
SCO Electronics and RXII dealers do not encourage people to use the Digital Video Stabilizer to duplicate rental movies or copyrighted video tapes. RXII is intended to stabilize and restore crystal clear picture quality for private home use only.

(Dealers Welcome)

To Order: \$49.95 ea + \$4 for FAST UPS SHIPPING

1-800-445-9285 or **516-694-1240**

Visa, M/C, COD M-F: 9-6 (battery not included)
SCO ELECTRONICS INC.

Dept. CR6 581 W. Merrick Rd. Valley Stream NY 11580
Unconditional 30 days Money Back Guarantee

CIRCLE 156 ON FREE INFORMATION CARD

Versatile Lab Power Supply



MODEL 3002A

EXCEPTIONAL
VALUE!

Only **\$125⁰⁰**

- 0-30 VDC at 0-2A
- Excellent Regulation
- Ripple & Noise - 500 uV RMS
- Built-in Short-Circuit and Overload Protection

Model 3002A features continuously adjustable current limiting and precision constant voltage/constant current operation with "automatic crossover." This lab-grade unit can also be used as a current regulated power source. Options: 10-Turn Voltage and Current Controls, \$25.00 ea.

FREE SHIPPING — 48 STATES. Check, Money Order or C.O.D. (add \$3.00). No credit cards. IL residents add 7% tax. 15-Day Money Back Guarantee. Save on Quality Test Equipment & Closeouts. Free Literature.

Salen Enterprises, Ltd.
P.O. Box 915, Morton Grove, IL 60053
Area Code 312-465-1424

CIRCLE 159 ON FREE INFORMATION CARD

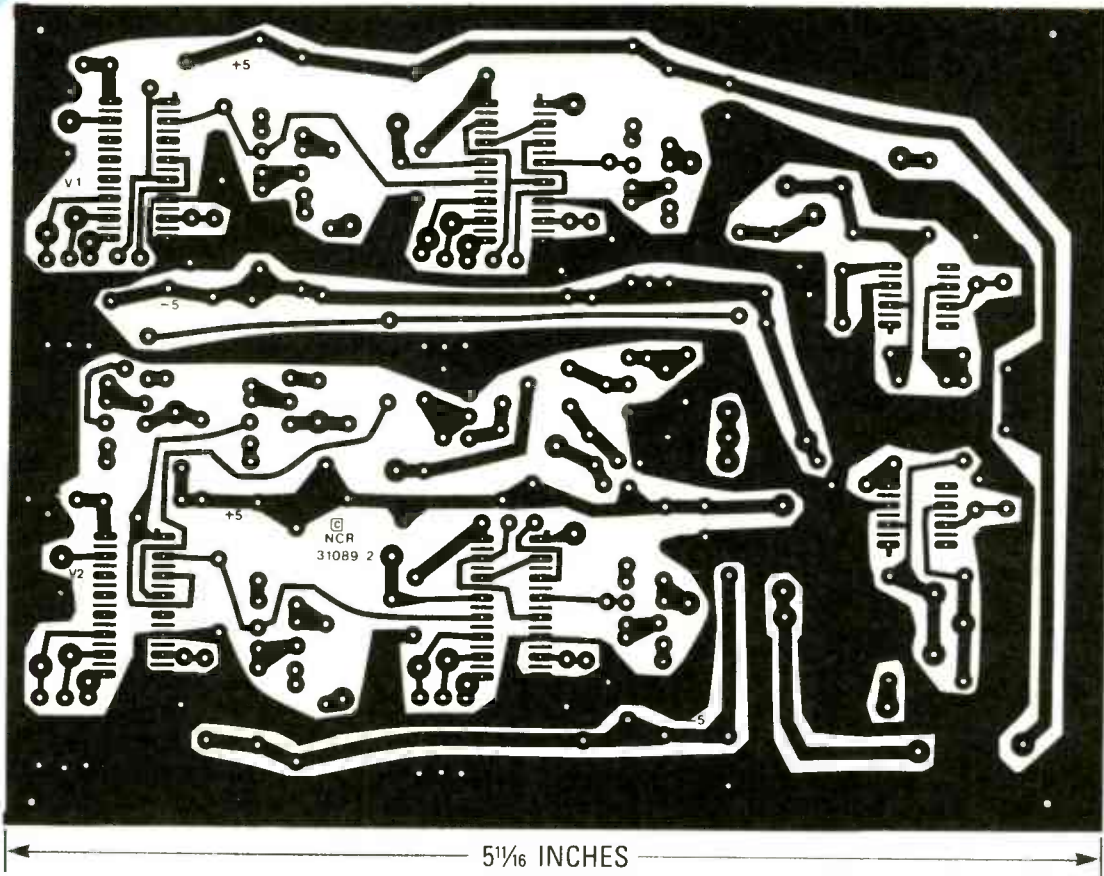

VIDEO SCENE SWITCHER BOARD.

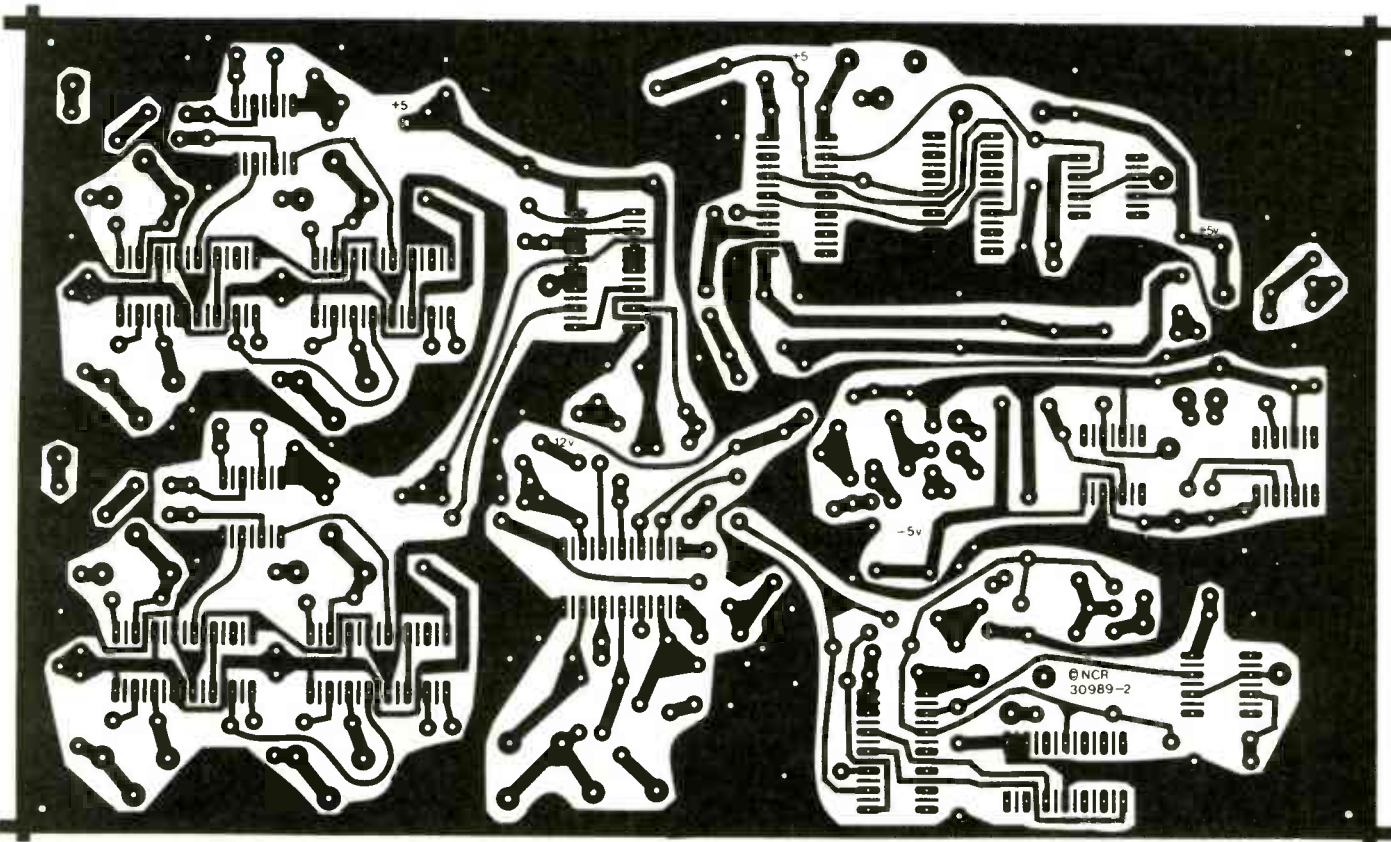

VIDEO SCENE SWITCHER BOARD.

RGB-to-NTSC CONVERTER

High-quality computer video on your TV—for peanuts!

ROBIN BEK

Have you been searching for a low-cost alternative to a \$300 color monitor? Or would you like to run your flight simulator on a big-screen TV? Great idea, but there are problems. Personal computers deliver digital signals that tell the TV when to turn the red, green, and blue guns in the CRT off and on. But TV's expect an analog signal that is a combination of the three color signals, the audio signal, horizontal and vertical sync pulses, and other things as well.

Even so, there's an easy (i.e., inexpensive) way of cutting your cake and eating it too. Our RGB-to-NTSC color converter is easy to build, costs less than \$30, and is easy to tune using only a color TV and a voltmeter. The circuit was designed specifically for the Atari ST, but it could be used with any computer that delivers standard RGB video. Also, the circuit could be adapted to RGB-to-PAL operation for use with European PC's.

Theory of operation

The problem with interfacing a computer to a TV is that the two use two totally different types of video systems. Computers typically deliver RGB video, which is composed of separate digital signals corresponding to the red, green, and blue guns in a color TV tube. In an RGB system, each signal is either on or off. Hence there is a certain number of combinations of on and off signals which correspond to colors rang-

ing from white (all signals on) to black (all signals off). Because there are three signals, and each may assume only two values, there are 2^3 possible combinations, or eight colors.

On the other hand, TV's generally expect a composite NTSC (National Television Standards Committee) video signal, which, as the name suggests, combines the three RGB signals, an audio signal, sync signals (and possibly others as well) into a single *composite* signal.

The advantage of composite video is that instead of using five wires, you use just one. The disadvantage of a single wire is loss of fidelity and increased circuit complexity. Fortunately, though, converting the two radically different signal systems is relatively easy (and inexpensive), thanks to modern technology.

Our circuit is built around Motorola's single-IC solution to the problem, the MC1377. The circuit is easy to build and tune: you really don't even need a scope unless you run into problems. However, you will need a voltmeter to verify the supply voltage and several test points.

How it works

The MC1377 is a 20-pin IC. As shown in Fig. 1, pins 3, 4, and 5 accept the incoming RGB signals, which are separated into chrominance (color) and luminance (intensity) information.

continued on page 85

EDITOR'S WORK- BENCH

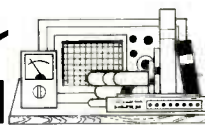

JEFF HOLTZMAN

Wondering about Windows?

The Graphical User Interface (GUI), once relegated to expensive engineering workstations or to toys like the early Macintosh, is gaining wider and wider acceptance from the PC community. There are two complementary reasons for the increasing popularity. First is that hardware has evolved to the point where we can buy computers with enough computing horsepower and memory to handle the greedy demands of GUI's.

Second is that some, but by no means all, of the necessary software is coming to market. The central hub from which those software elements radiate is Microsoft's famous (or infamous) product, Windows, shipments of which have surpassed the two million mark.

On the surface, Windows bears a strong resemblance to environments like that provided by the Mac, by Steve Jobs' NeXT computer, and similar products. That surface resemblance is so strong, in fact, that Apple's legal corps decided to sue Microsoft, even though Apple could no more claim to have invented the GUI than the cheeseburger. Fortunately, common sense seems to be winning out: the presiding judge has dismissed all but a few of Apple's claims.

So what is it about Windows that would make anyone even think of a resemblance between it and the Mac? And why do I say that the resemblance is at best only skin deep?

The points of resemblance are pretty obvious. Both Windows and the Macintosh Finder program present information to the user in a bit-mapped format. The user rolls a mouse about the desktop to select items from menus; those menu items initiate actions such as loading and saving files, etc. In addition, those menu items function pretty much the same from program to program, so that once you learn how to use one, you know them all—in theory, anyway.

The real differences between Windows and the Mac are slightly more subtle. The Mac, on the one hand, was designed around a single coherent philosophy that dictated nearly everything about the system. With the original Macs, software designers didn't have to worry about half a dozen or more video standards, half a dozen or more mouse protocols, and hundreds and hundreds of printers. Originally there was one video standard, one mouse, one keyboard, and one printer. Gradually, more and more options have appeared, but they have been smoothly integrated into an overall architecture.

Windows, on the other hand, was designed from the beginning as a compromise between multiple competing philosophies, and the effects of that compromise show up in Windows' famously laggard performance, difficulty of installation, and difficulty of use (more on that in a moment). When you have to support everything from CGA to one-megabit pixel monitors, it's not surprising that your video drivers aren't optimal.

Why is Windows difficult to use? Doesn't Windows work with a mouse, present bit-mapped graphics, and use drop-down menus, dialogue boxes, and the other hallmarks of the GUI?

Because of the necessity of supporting so many underlying types of hardware, Microsoft never got around to building a slick

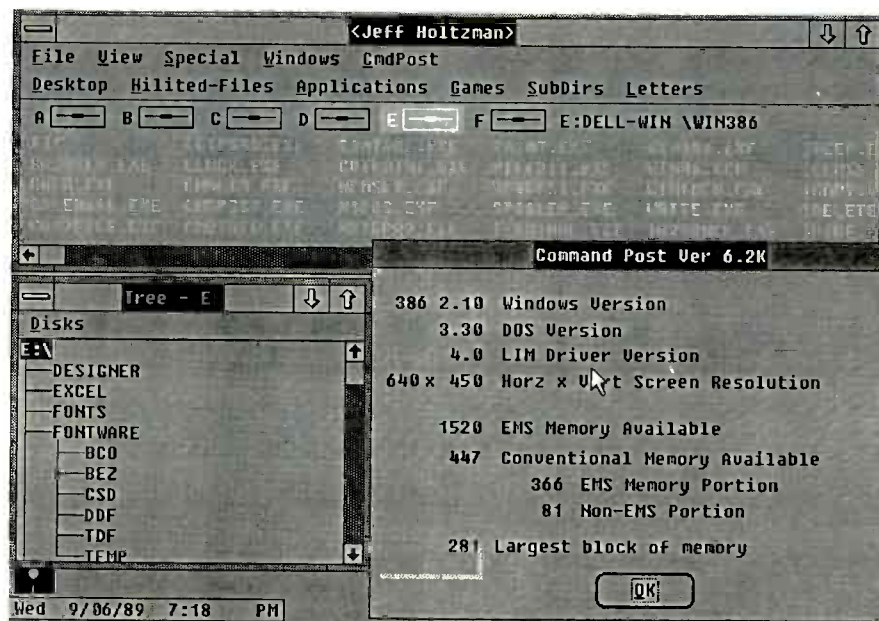

FIG. 1

shell (like what you see for the Mac) for Windows. What you use to work with Windows is something called the MS-DOS Executive, which provides a very crude way of launching programs and maintaining disk files. Comparison with any decent DOS shell (X-tree, Norton Commander, etc.) will show you why I say crude.

At bottom you can think of the Mac as a fine piece of finished furniture, and of Windows as a stain-it-yourself piece from the bare-woods factory. Certainly, with care, you can sand it, stain it, varnish it, and polish it. But in the end you may not end up with the kind of product you really wanted.

To be fair, Microsoft is working on a new version of Windows (3.0) that should be out before the end of the year, and it should add a decent user interface (that, by the way, is rumored to bear a very strong resemblance to the forthcoming version of the OS/2 Presentation Manager). In the four years that have passed since Windows was introduced, however, at least four companies have introduced their own products that attempt to correct that user interface problem, and IBM has even given several of these products semi-official endorsements by including them in sales and educational promotions.

Because they're add-ons, however, these products (all of which I have tested) tend to be buggy and memory hungry. My personal favorite is a \$20 shareware products called Command Post (shown in Fig. 1, and available on the RE-BBS at 516-293-2283, 300/1200, 8N1). With it you can customize your version of Windows, adding your own menus and items to the Windows environment. Command Post won't make a Mac out of your PC, but it does make certain common Windows operations much easier.

Using Windows

Before proceeding, it might be useful to discuss why you'd even want to use Windows. Up until very recently, there were really only three reasons to ever use Windows:

- Designer (Micrografx), a CAD-like drawing program that is simply a joy to use; see Editor's Workbench, March 1989.
- Excel (Microsoft), a spreadsheet that greatly surpassed 1-2-3 in its ability to print nicely, and in its ability to consolidate worksheets.
- PageMaker (Aldus), the original desktop-publishing program.

However, Samna Corporation has introduced a word processor (Ami) for Windows, Crosstalk has likewise introduced a communications program, and Microsoft

R-E Computer Admart

Rates: Ads are 2 1/4" x 2 7/8". One insertion \$950. Six insertions \$925 each. Twelve insertions \$895 each. Closing date same as regular rate card. Send order with remittance to Computer Admart, Radio Electronics Magazine, 500-B Bi-County Blvd., Farmingdale, NY 11735. Direct telephone inquiries to Arline Fishman, area code-516-293-3000. Only 100% Computer ads are accepted for this Admart.

SECRETS OF THE COMMODORE 64

Secrets of the COMMODORE 64

BP135—A beginners guide to the Commodore 64 presents masses of useful data and programming tips, as well as describing how to get the best from the powerful sound and graphics facilities. We look at how the memory is organized, random numbers and ways of generating them, graphics-color and simple animation, and even a chapter on machine code. Get your copy today. **Send \$5.00 plus \$1.25 for shipping in the U.S. to Electronic Technology Today Inc., P.O. Box 240, Massapequa Park, NY 11762-0240.**



GETTING THE MOST FROM YOUR PRINTER

Getting The Most From Your Printer

LESTER WOOD



BP181—It is probable that 80% of dot-matrix printer users only ever use 20% of the features offered by their printers. This book will help you unlock the special features and capabilities that you probably don't even know exist. To order your copy **send \$6.95 plus \$1.50 for shipping in the U.S. to Electronic Technology Today Inc., P.O. Box 240, Massapequa Park, NY 11762-0240.**

ICs PROMPT DELIVERY!!!

SAME DAY SHIPPING (USUALLY)
QUANTITY ONE PRICES SHOWN FOR SEPT. 24, 1989

OUTSIDE OKLAHOMA: NO SALES TAX

DYNAMIC RAM			
SIMM	AST Prem366/33Mhz		\$300.00
SIMM	(1) 256Kx36	80 ns	300.00
SIMM	1Mx9	80 ns	125.00
SIMM	(2) 256Kx9	100 ns	37.50
1MbIt	1Mx1	100 ns	11.25
41256	256Kx1	60 ns	5.75
41256	256Kx1	80 ns	4.40
41256	256Kx1	100 ns	3.15
41256	256Kx1	120 ns	2.65
4464	64Kx4	120 ns	4.40
41264 (3)	64Kx4	100 ns	8.25
EPROM			
27C1000	128Kx8	200 ns	\$22.00
27512	64Kx8	200 ns	7.80
27256	32Kx8	150 ns	6.50
27128	16Kx8	250 ns	4.50
STATIC RAM			
62256P-10	32Kx8	100 ns	\$16.50
6264P-12	8Kx8	120 ns	4.95
6116AP-12	2Kx8	120 ns	4.50

OPEN 6 1/2 DAYS, 7:30 AM-10 PM SHIP VIA FED-EX ON SAT.

SAT DELIVERY MasterCard VISA or UPS CASH COD
INCLUDED ON MICROPROCESSORS UNLIMITED INC.
FED-EX ORDERS 24,000 S. Piquette Ave. (918) 267-4961
RECEIVED BY: BEGGS OK 74421
No minimum order. Please note prices subject to change!
Shipping insurance extra up to \$1 for packing materials.

CIRCLE 61 ON FREE INFORMATION CARD

is readying a version of Word for Windows that is due out by the end of the year. The point is that Windows is rapidly approaching critical mass—even more rapidly than OS/2, to IBM's chagrin.

Even if you're not specifically interested in one of those Windows applications, but are curious about where PC technology is headed, you should get a copy of Windows and play around with it long enough to see what its strengths are—and also its weaknesses.

Problems with Windows

The biggest problem with Windows is the difficulty you have in upgrading hardware. Whenever you change your memory, video setup, or mouse, you must re-install the entire Windows package. When you do, a text file called WIN.INI, which functions like CONFIG.SYS does for DOS, is overwritten by a virgin copy from the installation disk. Consequently, valuable setup information may be lost during a re-installation. A technician on Microsoft's Windows help line told me he includes a line in his AUTOEXEC.BAT file that copies WIN.INI to a safe location every time he boots. I could have saved myself a great deal of heartache on a recent job if I had thought of that trick on my own.

Video hardware is another area that is painful to deal with. On the one hand, you want as much resolution as you can get. On the other, you don't want to wait half an hour each time the screen is redrawn—which means every time *anything* happens. I've worked with Windows on every IBM standard video system (CGA, EGA, and VGA), and none of them are good enough for professional day-to-day work. For professional use, the 800 x 600 Super VGA (SVGA) offers the best compromise between screen resolution, display speed, and cost. On the other hand, for occasional use, Hercules monochrome or monochrome VGA work nicely, especially if your final output is in monochrome.

However, if you're considering a SVGA system for professional use, make sure that it is compatible with your software. Yes, I know that the whole purpose behind Windows is to provide device-independence, so software designers (not to mention end-users!) don't have to worry about the hardware. In practice, however, it doesn't work out that way, particularly in the area of screen fonts.

For example, in setting up a desktop publishing system based on SVGA video and an HP LaserJet II, I had trouble installing

fonts from two different manufacturers, and eventually had to settle for using the system at VGA level. Even at that level, some special symbols appeared on-screen differently than on paper. In addition, some text simply did not print on paper where it appeared on screen, which required several iterations of the "print, inspect, edit, print, inspect, edit" process. And don't even think about getting a decent printout when composing a document for one printer and printing it on another. So much for WYSIWYG.

A related problem is a software package that I use to capture graphics screens and either print them on a LaserJet or include in a desktop publishing file. The program translates screen colors into various shades of gray in a quite attractive manner. The problem is that it supports only standard video modes, not SVGA. Part of the reason is that there is no real standard for SVGA; several manufacturers have implemented bit and color planes in different ways, and small software outfits can't afford to support them all. Meanwhile, an industry group (VESA, headed up by NEC) has begun trying to define an SVGA standard. But what about all the cards sold until the standard emerges—if indeed it does?

Memory woes

Depending on whether you have a 286 or a 386 processor, you buy a different version of Windows. However, in my case, I ended up running the 286 version on a 386, because the SVGA adapter did not come with a 386 software driver—only a 286 version. In addition, after the font fiasco, I ended up running the system in VGA mode anyway, which would have allowed me to use Windows/386—if I felt like installing (and transferring) the setup information in WIN.INI yet again.

In theory, Windows/386 sounds great: it will let you run even ill-behaved standard DOS applications (i.e., most DOS programs of consequence) in separate on-screen windows. However, Windows/386 won't load with 386MAX loaded, because both switch into protected mode to manage memory, and you can run only one protected-mode program at a time. So you can either play tricks loading different CONFIG.SYS files, or stick with Windows/286.

Another complaint regards Microsoft's documentation, especially that "explaining" installation trade-offs (how to allocate memory, for example). Part of the problem is that the documentation hasn't been updated in two or three years; let's hope it is in 3.0!

Given the amount of trouble I had setting up that system, why not stop fighting and switch to a Mac? Hardware cost is one big reason. A 20-MB hard disk for the Mac still costs almost twice what a PC drive costs, and larger capacity drives are even more expensive. There's also the question of selection. With the PC, I've got lots of choices for CPU, memory, video, and printer. And even though I complain about how those choices adversely affect Windows' performance and setup routines, I'd rather be able to make my own decisions.

One standard to watch is the OS/2 Presentation Manager. For a while it seemed that Windows would gradually be phased out as OS/2 PM gained popularity. Now it's not at all clear what will hap-

pen. There are rumors that an upcoming 386-specific version of OS/2 PM will run Windows applications as-is. That's an intriguing possibility, but almost certainly one that will not be realized in the near future. So it seems that DOS, Windows, and OS/2 are each going to have their own market niches.

Ultimately, OS/2 would be the better solution, because it offers built-in support for many problems facing Windows users (memory management and low-level device-driver support). However, as few good Windows applications as we have, there are even fewer for OS/2. Again, though, that's rumored to change during 1990, as versions of Ventura and PageMaker and other programs are released.

At bottom, you've got to look at the problem of system configuration as an ongoing issue that's not likely to settle down in the near future. The point is to find a compromise that seems as though it will remain stable for awhile—a year or two at best. And try not to lock yourself into proprietary solutions that could become obsolete as new standards emerge.

In the ideal world, the Ultimate PC would have unlimited resources, would be extremely powerful, and yet would be easy to operate. That machine doesn't

exist yet, and rather than complain about how far short current systems fall from the goal, we should look back ten years and see how far we've come. An editorial of that time expressed certainty that 16-bit microprocessors would never catch on because most people used personal computers for text processing, and eight bits are enough to adequately represent the necessary information!◆CD◆

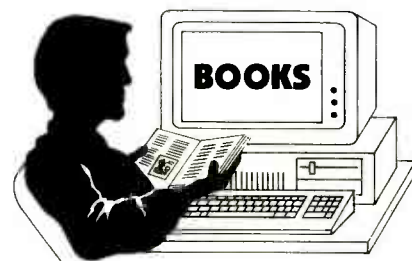

New from Microsoft

C programmers and would-be C programmers will want to check out *Standard C*, by P. J. Plauger and Jim Brodie. This concise, inexpensive (less than \$10) book is a reference for the newly approved ANSI standard for the language. It's not a tutorial but a reference to those *printf* format specifiers you can never remember, as well as the hundreds of other elements of the language. The authors point out that although Standard C is an historical development of the C language, it should be treated as an essentially new language by programmers familiar with previous versions.

Microsoft Mouse Programmer's Reference contains reference information for programmers building menu-based mouse interfaces for text-mode programs, as well as graphics support. The book contains numerous test programs, and two disks containing object code libraries and sample programs in various languages (BASIC, C, Pascal, etc.).

◆CD◆

ITEMS DISCUSSED

- *Standard C* (\$7.95), P. J. Plauger and Jim Brodie, Microsoft Press, 16011 NE 36th Way, Box 97017, Redmond, WA 98073-9717. (206) 882-8080.

CIRCLE 46 ON FREE INFORMATION CARD

- *Microsoft Mouse Programmer's Reference* (\$29.95), Microsoft Press, 16011 NE 36th Way, Box 97017, Redmond, WA 98073-9717. (206) 882-8080.

CIRCLE 47 ON FREE INFORMATION CARD

- *Command Post* (\$20 for license, \$5 for disk, \$10 for printed documentation), Wilson WindowWare, 3377 59th SW, Seattle, WA 98116. (206) 937-9335.

CIRCLE 48 ON FREE INFORMATION CARD

Parts List

Resistors

All resistors are 1/4-watt, 5%, unless otherwise noted.

R1	1000 ohms
R2	5100 ohms
R3	3300 ohms
R4	220 ohms
R5, R6	1200 ohms
R7	51, 100 ohms, metal film, 1%
R8	75 ohms, 1/2-watt
R9	680 ohms

Capacitors

C1, C2	220 pF disc
C3	5-55 pF trimmer
C4	62 pF disc
C5	100 pF disc
C6	.001 μ F disc
C7-C9, C13	0.1 μ F disc
C10, C11, C15, C18	0.01 μ F disc
C12	0.01 μ F polypropylene, 2%
C14	10 μ F, 25-volt electrolytic

C16	2200 μ F, 25-volt electrolytic
C17	1 μ F, 16-volt electrolytic

Semiconductors

IC1	MC1377 RGB to NTSC converter
IC2	DL122401D-1533 delay line (TDK)
IC3	CD4049 inverting hex buffer (optional, see Fig. 7)
IC4	LM7812 12-volt regulator
D1	1N5237 8-volt Zener diode (optional, see Fig. 7)
D2-D5	1N4002 diode
Q1, Q2	2N2222 NPN transistor
LED1	Panel-mount LED

Other components

XTAL1	3.58MHz (for PAL use 4.43 MHz)
T1	.166NMF-10264AG bandpass transformer (TOKO)

T2	120/12-volt AC transformer
S1	SPST power switch (120 VAC)
F1	1/4-amp, 250-volt fuse
J1	Video output connector (see text)
J2	Female MIDI connector (optional 5-pin DIN)

Miscellaneous

PC board, cabinet, 59-ohm cable, line cord, RF modulator (optional), etc.

Note:

The following items are available from RGB, 32 Wilson Ave., Trumbull, CT, 06611, (203) 374-7634, leave a message if no answer: Complete kit of parts including Atari video connector, \$29.95; PC board only, \$10.00. All orders add \$2.50 postage and handling. Connecticut residents please include sales tax.

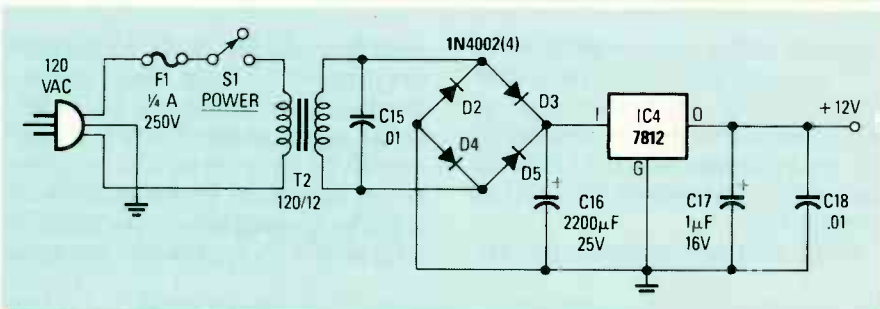

Fig. 3 POWER SUPPLY for the converter.

carefully and correct any mistakes. Then apply power to the circuit, making sure polarity is correct. Upon power-up, LED1 should light. Measure the voltage at pin 9; it should be +3-volts DC, and pin 16 should be +8.2 volts. If the LED doesn't light or those voltages are incorrect, go back and check your connections.

Hooking up

The most difficult part of the project is the hook-up to the computer. And that's not very difficult. Just don't forget to route the audio signal from the computer to the monitor.

The output of the converter should be routed with RG59 coax cable and terminated with a male RCA connector (depending on your television). If your TV doesn't have audio and video inputs, you can feed the video output of the converter into one of those cheap (preferably less than \$5) RF modulators, and connect it to your TV's antenna inputs.

Pinout information for the Atari ST is shown in Fig. 5. To connect the circuit to an IBM CGA circuit, you must invert the sync signals. A simple way to do that is shown in Fig. 6-a; the IBM video pinout is shown in Fig. 6-b.

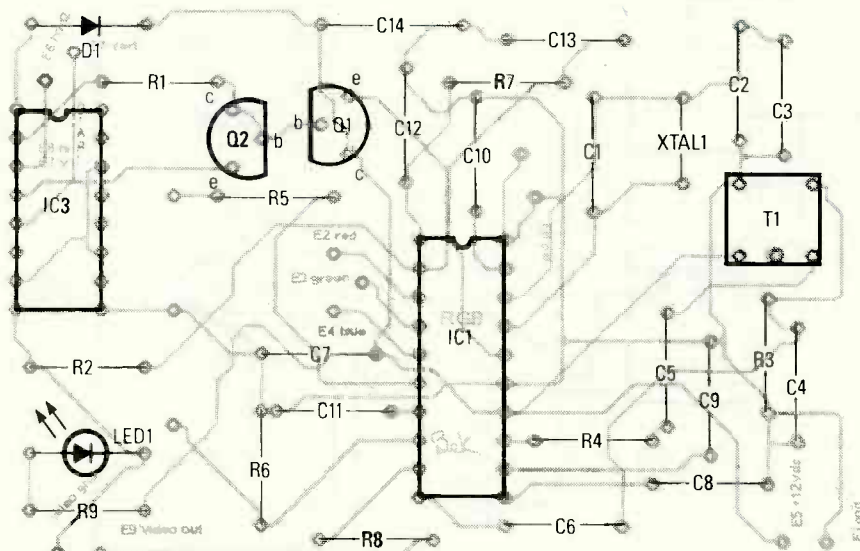

Fig. 4 INSTALL ALL COMPONENTS as shown here.

for R7. If you have access to a scope, you can use a potentiometer in series with R7, an inexpensive capacitor for C13, and tune

the circuit to the correct frequency.

After soldering all components to the board, check your work

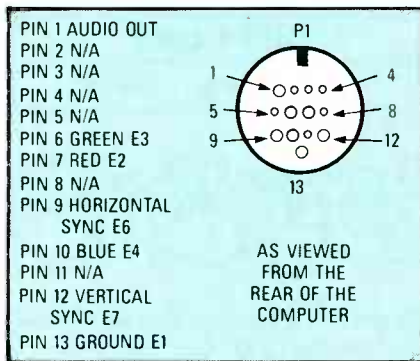

Fig. 5 VIDEO OUTPUT connector of the Atari ST.

17 and adjust C3 until the counter reads 3.579545 MHz. Without a counter, use a computer image of known color. For example, the bootup screen of the Atari is a bright green. Adjust C3 till you obtain that color.

Troubleshooting

There are two things to watch out for:

No image. Check the power supply, Q1, Q2, and connectors. If you have a scope, check pin 2 of

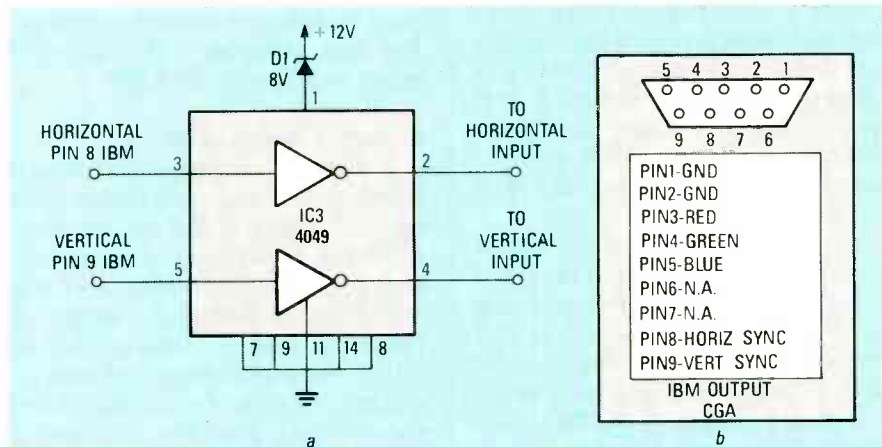

Fig. 6 USE THIS CIRCUIT FOR AN IBM CGA video system. The gates invert the sync lines.

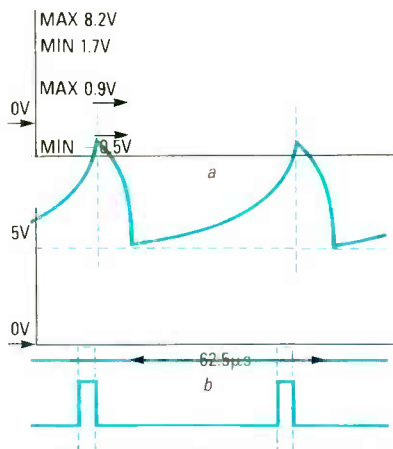

Fig. 7 WAVEFORMS OF A PROPERLY OPERATING CONVERTER. At (a) is the signal at pin 2; at (b), the signal at pin 1.

Turn on your computer and the converter, and place your TV in the monitor mode (or on channel 3 if you're using an RF modulator). You should see a computer image on the screen. If you don't, go back and check your connections again, especially the sync circuit (Q120 and Q2).

There are two ways to adjust the converter. If you have a frequency counter, connect it to pin

IC1 for the waveform shown in Fig. 7-a.

Image but no color. Check pins 3, 4, and 5 of IC1 to make sure that all three of the RGB signals are getting through. Check pin 1 of IC1 for the waveform shown in Fig. 7-b. If adjusting C1 has no effect, then the RC network R7/C13 is out of tolerance. Either replace C13 with a more accurate capacitor or place a trimmer potentiometer in series with R7, and adjust the trimmer until the waveform is correct.

Good luck and enjoy your new computer-TV screen. ♦♦♦

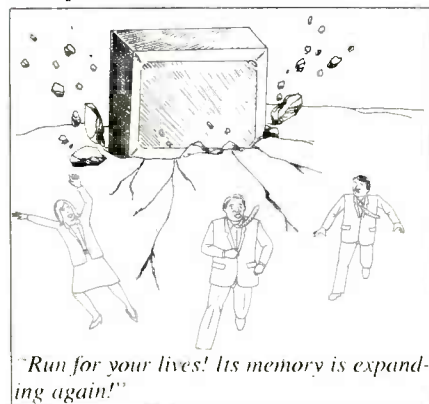

BUILD-IT BOOKS FOR EXPERIMENTERS

Modern Op-Amp Projects



□ **BP106—modern op-amp projects** \$5.75. Wide range of build-it projects that use op-amps. Easy to build board layouts provided for most. A variety of projects of all kinds are included.

□ **RADIO—100 RADIO HOOKUPS** \$3.00. Recent reprint of this 1924 booklet. Presents radio circuits of the era including regenerative, neodyne, reflex and more.



IC 555 Projects



□ **BP44—IC 555 PROJECTS** \$5.95. Included are basic and general timer circuits, automobile and model railroad circuits, alarms and noise makers, as well as a section on 556, 558, and 559 timers.

□ **#17—WIRELESS CATALOG Circa 1916** \$3.00. Historical reprint shows products like the Radioson Detector, Vario Selective Coupler, Sending Helix, Spark Coils and more



Second Book of CMOS IC Projects



□ **BP59—2ND BOOK OF CMOS PROJECTS** \$5.50. Still more ways to use these versatile devices. None of these projects overlap those in book #224. The pair make a wonderful circuit reference set.

□ **BP112—A Z-80 WORKSHOP MANUAL** \$6.95. Hardware details of the Z-80, machine-code and assembly-language programming for those what want to go beyond BASIC.



MAIL TO: Electronic Technology Today, Inc.
 P.O. Box 240
 Massapequa Park, NY 11762-0240

SHIPPING CHARGES IN USA AND CANADA

\$0.01 to \$5.00	... \$1.25	\$30.01 to \$40.00	\$5.00
\$5.01 to 10.00	... \$2.00	\$40.01 to \$50.00	\$6.00
\$10.01 to \$20.00	\$3.00	\$50.01 and above	\$7.50
\$20.01 to \$30.00	\$4.00		

SORRY, No orders accepted outside of USA and Canada

Total price of merchandise \$	_____
Shipping (see chart) \$	_____
Subtotal \$	_____
Sales Tax (NYS only) \$	_____
Total Enclosed \$	_____

Name _____
 Address _____
 City _____ State _____ Zip _____

Be an FCC LICENSED ELECTRONIC TECHNICIAN!



No costly School. No commuting to class. The Original Home-Study course prepares you for the "FCC Commercial Radiotelephone License". This valuable license is your "ticket" to thousands of exciting jobs in Communications, Radio-TV, Microwave, Computers, Radar, Avionics and more! You don't need a college degree to qualify, but you do need an FCC License. **No Need to Quit Your Job or Go To School** This proven course is easy, fast and low cost! **GUARANTEED PASS** — You get your FCC License or money refunded. **Send for FREE facts now. MAIL COUPON TODAY!**

COMMAND PRODUCTIONS

FCC LICENSE TRAINING, Dept.
P.O. Box 2824, San Francisco, CA 94126

Please rush **FREE** details immediately!

NAME _____

ADDRESS _____

CITY _____

STATE _____

ZIP _____

NEW SUPER LONG PLAY TAPE RECORDERS

12 Hour Model — \$119.00*
USES D-120 TAPE

Modified Panasonic Slimline, high quality, AC-DC Recorders provide 6 continuous hours of quality recording & playback on each side of cassette for a total of 12 hours. Built-in features include Voice level control, Digital counter, etc. TDK DC 120 Cassette Furnished.



PHONE RECORDING ADAPTER

Records calls automatically. All solid state connects to your telephone jack and tape recorder. Starts recording when phone is lifted. Stops when you hang up. **\$28.50***

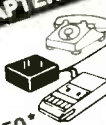

VOX VOICE ACTIVATED CONTROL SWITCH

Solid state. Self contained. Adjustable sensitivity. Voices or other sounds automatically activate and control recorder. Uses either recorder or remote mike. **\$28.50***



*Add for ship & hdg. Phone Adapter & Vox \$1.50 ea. Recorders \$4.00 ea. Cal. Res. add tax. Mail order, VISA, M/C, COD's OK. Money Back Guarantee. Qty. disc. avail.. Dealer inquiries invited, Free data. © **AMC SALES INC.** Dept A9335 Lubec St., Box 928, Downey, CA 90241 Phone (213) 869-8519

AUDIO UPDATE

continued from page 67

recent *Stereo Review* evaluations used both test signals and music. One particular test-disc signal proved particularly revealing: When listening to it, every one of the evaluators was able to distinguish each of the six players from all other players! The signal is on track 20 of the CBS CD-1 test disc, and is a 500-Hz dithered tone that fades from -60 to approximately -120 dB. When reproducing the lowest levels of that signal, and listened to at full gain, the players produced degrees and types of distortion and noise sufficient to allow almost 100% individual identifications during ABX testing.

The dithered 500-Hz test signal was specifically designed to reveal very low-level linearity problems in D/A converters—which it did very effectively. However, I would suggest that there is a sample-to-sample variability in the D/A-converter chips used in even top-of-the-line players that makes it hard to correlate any particular player's price and design with ultimate performance.

The sound of music

For anyone who has worked with both test signals and music in making audio evaluations, it will come as no surprise that the musical part of the listening tests proved to be very difficult. Even those players that were easily identified with the dithered test signal more-or-less sonically merged with the crowd on music tests. The statistical test results indicate that under carefully controlled test conditions using the finest available audio equipment in an acoustically designed listening room, some critical listeners can hear differences on some music some of the time. And even then, I suspect that the perceived differences stem from D/A quality-control problems (or lack of same) rather than from specific design configurations in the player mechanism or circuitry.

So what's the bottom line? In defense of test signals, it's been said

continued on page 95

GIFT GUIDE

continued from page 78



6 available drive bays that are accessible from the front of the case. Now we can have two floppy drives, a tape backup drive, a half-height CD ROM drive, and two hard disks without juggling them in and out of the machine. The case, complete with a 250-watt power supply sells for \$299.

• Math Co-processor

While computer buyers are always interested in speed, most people don't take full advantage of the machines they have. If you know someone who has an empty math co-processor socket, then you might consider a math co-processor such as Intel's 8087 or 80287. For people whose software requires heavy calculations—spreadsheets, graphics, engineering software and the like—no other accessory will have as much impact on their overall computer operation as the addition of a math co-processor. The cost of a co-processor ranges from about \$89 for a slow 8087 up to \$240 for a 10-MHz 80287.

• PostScript Interpreter

When discussing the future of graphics printing, you won't get too many arguments if you suggest that the PostScript language is the way to go. Unfortunately, it doesn't come cheap. But *GoScript*, a new PostScript interpreter, gives PostScript compatibility to a number of common and inexpensive printers. It allows page-makeup and word-processing programs to be used to their full advantage. It's also an excellent way to learn PostScript programming. *GoScript* features up to 35 fonts that can be scaled to any size, and rotated to any angle. *GoScript* certainly can't replace a PostScript-compatible laser printer, but at \$195, it's a good way to get your money's worth out of an inexpensive printer.

R-E



MARKET CENTER

FOR SALE

PHOTOFACT folders, under #1400 \$4.00. Others \$6.00. Postpaid. **LOEB**, 414 Chestnut Lane, East Meadow, NY 11554.

GREAT buys! Surplus prices, ICs, linears, transformers, PS, stepping motors, vacuum pump, phototransistor, meters, LSASE, **FERTIK'S**, 5400 Ella, Phila., PA 19120.

DESCRAMBLERS. All brands. Special: Combo Jerrold 400 and SB3 \$165. Complete cable descrambler kit \$39. Complete satellite descrambler kit \$45. Free catalog. **MJM INDUSTRY**, Box 531, Bronx, NY 10461-0531.

CLASSIFIED AD ORDER FORM

To run your own classified ad, put one word on each of the lines below and send this form along with your check to:

Radio-Electronics Classified Ads, 500-B Bi-County Boulevard, Farmingdale, NY 11735

PLEASE INDICATE in which category of classified advertising you wish your ad to appear. For special headings, there is a surcharge of **\$25.00**.

Plans/Kits Business Opportunities For Sale
 Education/Instruction Wanted Satellite Television

Special Category: \$25.00

PLEASE PRINT EACH WORD SEPARATELY, IN BLOCK LETTERS.

(No refunds or credits for typesetting errors can be made unless you clearly print or type your copy.) Rates indicated are for standard style classified ads only. See below for additional charges for special ads. **Minimum: 15 words.**

1	2	3	4	5
6	7	8	9	10
11	12	13	14	15 (\$46.50)
16 (\$49.60)	17 (\$52.70)	18 (\$55.80)	19 (\$58.90)	20 (\$62.00)
21 (\$65.10)	22 (\$68.20)	23 (\$71.30)	24 (\$74.40)	25 (\$77.50)
26 (\$80.60)	27 (\$83.70)	28 (\$86.80)	29 (\$89.90)	30 (\$93.00)
31 (\$96.10)	32 (\$99.20)	33 (\$102.30)	34 (\$105.40)	35 (\$108.50)

We accept MasterCard and Visa for payment of orders. If you wish to use your credit card to pay for your ad fill in the following additional information (Sorry, no telephone orders can be accepted.):

Card Number _____ Expiration Date _____

Please Print Name _____ Signature _____

IF YOU USE A BOX NUMBER YOU MUST INCLUDE YOUR PERMANENT ADDRESS AND PHONE NUMBER FOR OUR FILES. ADS SUBMITTED WITHOUT THIS INFORMATION WILL NOT BE ACCEPTED.

CLASSIFIED COMMERCIAL RATE: (for firms or individuals offering commercial products or services) \$3.10 per word prepaid (no charge for zip code)...**MINIMUM 15 WORDS.** 5% discount for same ad in 6 issues; 10% discount for same ad in 12 issues within one year; if prepaid. **NON-COMMERCIAL RATE:** (for individuals who want to buy or sell a personal item) \$2.50 per word, prepaid...no minimum. **ONLY FIRST WORD AND NAME** set in bold caps at no extra charge. Additional bold face (not available as all caps) **55¢ per word additional.** Entire ad in boldface, \$3.70 per word. **TINT SCREEN BEHIND ENTIRE AD: \$3.85 per word. TINT SCREEN BEHIND ENTIRE AD PLUS ALL BOLD FACE AD: \$4.50 per word. EXPANDED TYPE AD: \$4.70 per word prepaid.** Entire ad in boldface, \$5.60 per word. **TINT SCREEN BEHIND ENTIRE EXPANDED TYPE AD: \$5.90 per word. TINT SCREEN BEHIND ENTIRE EXPANDED TYPE AD PLUS ALL BOLD FACE AD: \$6.80 per word. DISPLAY ADS:** 1" x 2 1/4"—\$385.00; 2" x 2 1/4"—\$770.00; 3" x 2 1/4"—\$1155.00. **General Information:** Frequency rates and prepayment discounts are available. **ALL COPY SUBJECT TO PUBLISHERS APPROVAL. ADVERTISEMENTS USING P.O. BOX ADDRESS WILL NOT BE ACCEPTED UNTIL ADVERTISER SUPPLIES PUBLISHER WITH PERMANENT ADDRESS AND PHONE NUMBER.** Copy to be in our hands on the 10th of the third month preceding the date of the issue. (i.e., Aug. issue copy must be received by May 10th). When normal closing date falls on Saturday, Sunday or Holiday, issue closes on preceding working day. Send for the classified brochure. Circle Number 49 on the Free Information Card.

ENGINEERING software, PC/MSDOS. Hobbyists — students — engineers. Circuit design, FFT analysis, mathematics, logic simulation, circuit analysis. Free catalog, (614) 491-0832, **BSOFT SOFTWARE**, 444 Colton Rd., Columbus, OH 43207.

CABLE-TV AT ITS BEST

SCIENTIFIC ATLANTA:
Models 8500-8550-8580 ... \$275.00
SA-3 [Add-On Descrambler] ... \$ 99.00

JERROLD:
SB-3 [Inband Gated Sync] ... \$ 74.00
TRI-BI [Trimode/Bistate] ... \$ 95.00

OAK:
M-35B [Combo W/Vari-sync] ... \$ 99.00
N-12 [Add-On W/Vari-sync] ... \$ 89.00

HAMLIN:
MLD-1200 [Add-On] ... \$ 89.00
ZENITH: [Z-TAC Descrambler] \$169.00
CONVERTERS: [80 Channels] \$ 95.00

N.A.S. INTERNATIONAL
(800) 726-4•NAS

DEALER DISCOUNT ON <5> UNITS

DISTRIBUTOR DISCOUNT ON <10> UNITS

CABLE TV DESCRAMBLERS

<p>JERROLD™ Tri-Bi Mode \$105.00 10 Lot \$85.00</p> <p>JERROLD™ SB-3 OR 2 \$89.00 \$65.00</p> <p>Hamlin MLD-1200..... \$99.95 \$62.00</p> <p>Oak N-12 W/V.S..... \$99.95 \$62.00</p> <p>Oak M-35-B W/V.S..... \$99.00 \$78.00</p> <p>OAK E-13..... \$99.95 \$58.00</p> <p>Zenith SSAVI..... \$185.00 \$145.00</p> <p>Eagle PD-3..... \$120.00 \$85.00</p> <p>Scientific Atlanta..... \$129.95 \$105.00</p> <p>SA-Combo's..... CALL \$Call</p> <p>Tocom..... \$350.00 \$295.00</p> <p>Oak N-12 W/ Auto..... \$140.00 \$105.00</p> <p>Jerrold Starcom CSV.... \$139.95 Call</p>	M.D. ELECTRONICS WILL MATCH ANY ADVERTISED PRICE IN THIS MAGAZINE
---	--

***NEW STARGATE 2000
CABLE CONVERTER**



1-\$89.00 10-\$69.00 100-Call

Last channel recall-Favorite channel select-75 channel-Channel scan-Manual fine tune-One year warranty-surge protection-HRC & Standard switchable- and much more. **Call Today!**

INFORMATION(402)554-0417

**Orders Call Toll Free
1-800-624-1150**

**M.D. ELECTRONICS
115 NEW YORK MALL
SUITE 133E
OMAHA, NE. 68114**

M.C.
VISA
C.O.D.

CIRCLE 53 ON FREE INFORMATION CARD

DECEMBER 1989

AMAZING SCIENTIFIC & ELECTRONIC PRODUCTS

PLANS

Build Yourself — All Parts Available in Stock

LC7— BURNING CUTTING CO₂ LASER \$20.00
RUB4— PORTABLE LASER RAY PISTOL \$20.00
TCCT7— 3 SEPARATE TESLA COIL PLANS TO 1.5 MEV \$25.00
IOG2— ION RAY GUN \$10.00
GRA1— GRAVITY GENERATOR \$10.00
EML1— ELECTRO MAGNET COIL GUN/LAUNCHER \$8.00

KITS

With All Necessary Plans

MFT3K— FM VOICE TRANSMITTER 3 MI RANGE \$49.50
WYPM7K— TELEPHONE TRANSMITTER 3 MI RANGE \$39.50
BTC3K— 250,000 VOLT 10-14" SPARK TESLA COIL \$249.50
LHC2K— SIMULATED MULTICOLOR LASER \$44.50
BLSTK— 100,000 WATT BLASTER DEFENSE DEVICE \$69.50
NIG7K— NEGATIVE ION GENERATOR KIT \$34.50
PSPAK— TIME VARIANT SHOCK WAVE PISTOL \$59.50
STATK— ALL NEW SPACE AGE ACTIVE PLASMA SABER \$59.50
SDSK— SEE IN DARK VIEWER KIT \$199.50
PG5K— PLASMA LIGHTNING GLOBE KIT \$49.50

ASSEMBLED

With All Necessary Instructions

BTC10— 50,000 VOLT-WORLD'S SMALLEST TESLA COIL \$54.50
LGI40— 1MW HeNe VISIBLE RED LASER GUN \$249.50
TAT30— AUTO TELEPHONE RECORDING DEVICE \$24.50
ITM10— 100,000 VOLT 20" AFFECTIVE RANGE INTIMIDATOR \$99.50
LIST0— SNOOPER PHONE INFINITY TRANSMITTER \$169.50
IPG70— INVISIBLE PAIN FIELD GENERATOR MUTLI MODE \$74.50

● CATALOG CONTAINING DESCRIPTIONS OF ABOVE PLUS HUNDREDS MORE AVAILABLE FOR \$1.00 OR USE OUR PHONE FOR "ORDERS ONLY" 603-673-4730.

PLEASE INCLUDE \$3.00 PH ON ALL KITS AND PRODUCTS PLANS ARE POSTAGE PAID. SEND CHECK, MO. VISA, MC IN US FUNDS.

INFORMATION UNLIMITED

P.O. BOX 716 DEPT. RE AMHERST, NH 03031

THE ELECTRONIC GOLDMINE



Send for your copy of our 1989 catalog featuring hundreds of electronic components and unique electronic project kits. Each of our project kits include all necessary parts and a glass epoxy etched and drilled PC board - you only need to solder in the parts and provide a battery (on battery operated kits)

Here are two examples of our Unique Kits!

MINIATURE GEIGER COUNTER KIT

Miniature Geiger Counter kit detects alpha, beta, gamma and X-ray radiation. Emits clicks from piezo speaker in proportion to intensity. Features sensitive alpha window GM tube and IC circuit. Operates on 9V battery (not incl.). Size: 1.5" x 3". C6430 \$59.95



LIGHTNING-BOLT STROBE LIGHT KIT

Powerful 120VAC Strobe Kit produces brilliant flashes of light from momentary 3 1/2" long xenon tube. Has control to vary flash rate from 30 to 400 per minute. Caution - this kit is for experienced builders only (due to high voltage). Size: 3.4" x 5". C6431 \$34.95

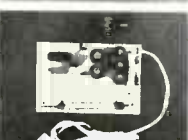

Fabulous Component Values!

SURFACE MOUNT CHIP COMPONENTS

CAPS		RESISTORS		YOUR CHOICE	
2pf	10	270	5K	22K	ANY ONE VALUE OF
3pf	39	270	1.8K	39K	RESISTOR OR
5pf	47	390	2.2K	48K	CAPACITOR IS
10pf	56	470	2.2K	470K	20/\$1.00 or 100/\$4.00
12pf	82	560	2.2K		(NO MIXING)
22pf	120	680	12K		
100pf	180	1.2K	15K		

INVERTER TRANSFORMER

Tiny 4 lead inverter for use with 555 IC to convert 120VDC to over 250V for strobes, fluorescent tubes, etc. Simple schematic included. M703 \$2.00 each 100 for \$20

4KV TRIGGER COIL

3 lead trigger coil to fire most xenon flash tubes. M7700 \$1.25 each 100 for \$20

MINIMUM ORDER \$10.00 plus \$3.00 shipping and handling. We accept M/C, Visa and money orders. COD fee: 2.50 in addition to 3.00 shipping charge. SEND ORDERS TO: The Electronic Goldmine, P.O. Box 5408 Scottsdale, AZ. 85261. PHONE ORDERS: (602) 451-7454

CIRCLE 135 ON FREE INFORMATION CARD

T.V. tunable notch filters. Free brochure. D.K. VIDEO, Box 63/6025, Margate, FL 33063. (305) 752-9202.

SURPLUS ELECTRONICS. New giant wholesale catalog. Hundreds of amazing bargains. \$2. Box 840, Champlain, NY 12919.

TUBES: "oldest," "latest." Parts and schematics. SASE for lists. STEINMETZ, 7519 Maplewood Ave., RE, Hammond, IN 46324.

LASER Listener II, other projects. Surveillance, descrambling, false identification, information. Plans, kits, other strange stuff. Informational package \$3.00 refundable. DIRIJO/BOND ELECTRONICS, Box 212, Lowell, NC 28098.

CB RADIO OWNERS!

We specialize in a wide variety of technical information, parts and services for CB radios. 10-Meter and FM conversion kits, repair books, plans, high-performance accessories. Thousands of satisfied customer since 1976! Catalog \$2.

CBC INTERNATIONAL

P.O. BOX 31500RE, PHOENIX, AZ 85046

RESTRICTED technical information: Electronic surveillance, schematics, locksmithing, covert sciences, hacking, etc. Huge selection. Free brochures. MENTOR-Z, Drawer 1549, Asbury Park, NJ 07712.

CABLE TV converters bargain headquaters: Zenith, Tocom, Scientific Atlanta, Hamlin. Jerrold 400-DRX3DIC w/remote \$135, Oak M35B \$60.00. Quantity discount. Visa-M/C-COD. Order yours today. 1 (800) 327-8544.

CABLE TV converters and descramblers. We sell only the best. Low prices. SB-3 \$79.00. We ship C.O.D. Free catalog. ACE PRODUCTS, PO Box 582, Dept. E, Saco, ME 04072. (207) 967-0726.

STEPPER motor drive & control with Commodore 64. Affordable hardware, interface, & software. Send for detailed literature & prices to: MASE, R.D. #2 Box 166, Mohrsville, PA 19541.

MICROWAVE TV RECEIVERS 1.9 to 2.7 GHz

2 CH Compact Dish System - \$77.95
 5 CH Dish System - \$93.95
 12 CH Yagi (Rod) System - \$123.95
 30 CH Dish System - \$163.90 Yagi - \$183.90

SUN MICROWAVE INT'L. INC. Send \$1⁰⁰ on these catalog on these and other fine video products.
 P.O. BOX 34522 PHOENIX, AZ 85067 (602) 230-0840

VISA/MC/COD QUANTITY DISCOUNTS LIFETIME WARRANTY

FEB 87 Triparts \$59.00. Feb 84 SB parts \$49.00. \$3.50 shipping. OCTE, Box 276, Alburg, VT 05440. (514) 739-9328.

RENTAL movie stabilizer. Connect between VCRs or to monitor. Satisfaction guaranteed. \$69.95, \$4.00 handling. 1 (800) 367-7909.

CABLE TV descramblers. Jerrold, Scientific Atlanta, Zenith, most major brands. Dealer inquiries welcome. Visa-M/C accepted. E & O VIDEO, 9691 E. 265th Street, Elko, MN 55020. 1 (800) 638-6898.

TEST equipment pre-owned now at affordable prices. Signal generators from \$50.00. Oscilloscopes from \$50.00. Other equipment, including manuals available. Send for Catalog. J.B. ELECTRONICS, 3446 Dempster, Skokie, IL 60076. (312) 982-1973.

VIDEOBEAMER links VCR to TV without wires \$99.00. MVS ANTENNAS, 1205 Coplon Ave., Schenectady, NY 12309.

CCTV video cameras: color Sanyo VCC3700 \$395.00, Panasonic B&W \$219.00, others. PC video digitizer \$249.00. SAMPSON ENGINEERING, PO Box 550363, Dallas, TX 75355-0363. (214) 328-2730.

Quality Microwave TV Antennas



Multi-Channel 1.9 to 2.7 GHz. 40dB gain
 30 Channel System complete \$149.95
 12-Channel System complete \$104.95
 3 Channel System complete \$79.95

Phillips-Tech Electronics

P.O. Box 8533 • Scottsdale, AZ 85252
 (602) 947-7700 (\$3.00 Credit all phone orders!)
 MasterCard • Visa • COO's Quantity Pricing

TJ Services is here to serve you! Our quality products, quick courteous service, knowledgeable sales people and rock bottom prices prove it! Not sure what you need? Call (313) 726-0900 we'll help! Prices quoted are 20/10/5/1 lot. Jerrold DRX-3-DIC \$69/\$79/\$89/\$99, DSX-3-DIC \$59 each, DRX-3-auto Tri-Bi-10 \$109/\$119/\$129/\$139, DRZ-3 \$49/\$59/\$69/\$79, SB \$45 each, Tri-Bi-2 or 3 \$69/\$79/\$89/\$109, Oak M35B \$20 each, new original N-12 \$65 each. Scientific Atlanta type SA-3 \$69/\$79/\$89/\$109, Hamlin CRX-6600-3M \$89/\$109/\$129/\$149, MLD-1200-2 or 3 \$29/\$39/\$49/\$59, CRX-6600-2 \$39/\$49/\$59/\$69, Eagle PD-3 original \$59/\$64/\$99/\$109, Interference Filters, we stock all channels \$12/\$15/\$18/\$29, Zenith SSAVI-1 Anti-flashing \$89/\$99/\$109/\$129. Pioneer type PL-3 \$79/\$89/\$109/\$129. Replacement remotes and many accessories in stock. New volume control 78 channel wireless remote converter with parental control and fine tuning capabilities \$79/\$89/\$99/\$109. B.E.L. radar detector 861 close out \$89 each.

TUBES, new, up to 90% off. SASE, KIRBY, 298 West Carmel Drive, Carmel, IN 46032.

2-WAY radio system. Used VHF base stations, portable radios, UHF car radios + many extras. (202) 944-2802 for information.

FREE CATALOG

FAMOUS "FIRESTIK" BRAND CB ANTENNAS AND ACCESSORIES. QUALITY PRODUCTS FOR THE SERIOUS CB'er. SINCE 1962

FIRESTIK ANTENNA COMPANY
 2614 EAST ADAMS
 PHOENIX, ARIZONA 85034

JERROLD 450 module works good, information \$2, module \$55, COD only. BILL, 7014 East Gofflinks #124, Tucson, AZ 85730.

COMMUNICATIONS. Electronic equipment, sales, service, FCC licensed, free catalog. RAYS, PO Box 14862, Fort Worth, TX 76117-0862.

CABLE TV converters: Jerrold, Oak, Scientific Atlantic, Zenith & many others. "New MTS" stereo add-on: mute & volume. Ideal for 400 and 450 owners! 1 (800) 826-7623, Amex, Visa, M/C accepted. B & B INC., 4030 Beau-D-Rue Drive, Eagan, MN 55122.

PC-ECAP, AC circuit analysis software for the IBM-PC, will calculate and display the frequency and phase response of your circuits. Very easy to use. Completely menu driven. Supports CGA, EGA, and Hercules graphics. High resolution plots on IBM/Epson printers. \$99.50 To order or for info, write CIRCUIT SYSTEMS, 418 Church Road, Sicklerville, NJ 08081.

EPROM burners \$79.95, JR PRODUCT DEVELOPMENT CENTER, 5174 Lake Loop Road, Cooper City, FL 33330.

CABLE boxes and electronics. Sharp Fax FO-300 list \$1995.00 our price \$995.00, Oak RTC 56 w/r \$159.00, M35B \$49.95, Jerrold 400 w/r \$129.95, Tocom w/r \$225.00, Hamlin CRX6600 w/r \$179.95, quantity prices on 10 lots, call MOUNT HOOD ELECTRONICS, (206) 896-6837.

PARABOLIC Reflectors. 18" spun metal focuses RF, light, sound; \$25. PJC 2981 Tess Ave., Granger, VT 84119.

MASTERCARD AND VISA are now accepted for payment of your advertising. Simply complete the form on the first page of the Market Center and we will bill.

CABLE TV CONVERTERS & EQUIPMENT



	ONE UNIT	10+ UNITS
SCIENTIFIC ATLANTA W/ TRI-BI	225.00	175.00
PANASONIC WIRELESS CONVERTER 1403N	85.00	74.00
JERROLD 400 COMBO W/ REMOTE (DRX3DIC)	134.00	100.00
JERROLD 400 OR 450 REMOTE HAND UNIT	24.00	15.00
JERROLD JR X 3DIC	84.00	65.00
JERROLD SB ADD ON	74.00	55.00
JERROLD SB ADD ON WITH TRI-BI	95.00	75.00
OAK M-35 COMBO	79.00	50.00
OAK MINICODE (N 12)	84.00	59.00
OAK ECONOCODE (E-13)	64.00	40.00
HAMLIN MLD 1200	64.00	55.00
SCIENTIFIC ATLANTA SA-3 ADD ON	109.00	80.00
INTERFERENCE FILTER (CHANNEL 3 OR 6)	24.00	14.00
SCIENTIFIC ATLANTA 83 CHANNEL CONVERTER	95.00	80.00
PIONEER CONVERTER BA 4500 SERIES	100.00	85.00
TOMCOM VIP	Call for price and availability	
ZENITH FLASHING	Call for price and availability	
ZENITH SSAVI	Call for price and availability	
EAGLE PD-3	Call for price and availability	

VIDEO-LINK Enterprises, Inc.

165 W. PUTNAM AVE.
GREENWICH, CT 06830
(203) 622-4386

MONDAY - FRIDAY 10 AM — 5:30 PM, E.S.T.

IMPORTANT: Have make and model # of the equipment used in your area.

QTY	ITEM	OUTPUT CHANNEL	PRICE EACH	TOTAL PRICE

NO CONNECTICUT SALES. It is not the intent of VIDEO-LINK to defraud any pay television operator and we will not assist any company or individual in doing so.

PLEASE PRINT:

CASHIER'S CHECK M.O. C.O.D.

NAME _____

ADDRESS _____

CITY/STATE/ZIP _____

PHONE _____

SIGNATURE _____

WAIVER. Since I, the undersigned, fully understand that the ownership of a cable decoder does not give the owner of the decoder the right to decode or view premium cable channels without proper authorization from their local cable company, hereby declare under penalty of perjury that all products purchased, at any time, will only be used on cable TV systems with proper authorization from local officials or cable company officers in accordance with all applicable federal and state laws. Federal and various state laws provide for substantial criminal and civil penalties for unauthorized use.

Dated: _____ Signed: _____

CIRCLE 64 ON FREE INFORMATION CARD

SINGERS! REMOVE VOCALS FROM RECORDS AND CDS!



SING WITH THE WORLD'S BEST BANDS!

An Unlimited supply of Backgrounds from standard stereo records! Record with your voice or perform live with the backgrounds. Used in Professional Performance yet connects easily to a home component stereo. This unique product is manufactured and sold Exclusively by LT Sound - Not sold through dealers. Call or write for a Free Brochure and Demo Record.

LT Sound, Dept. RL-3, 7980 LT Parkway
Lithonia, GA 30058 (404) 482-4724
Manufactured and Sold Exclusively by LT Sound
24 HOUR PHONE DEMO LINE: (404) 482-2485

POWER supply — versatile! +1-15V (3A), -1-15V (1.5A) and +5V (1.5A) - with digital display of voltage, current. Includes 60Hz TTL output. Detailed plans US\$4.95. SASE brings information. **CLASSIC DESIGNS**, Box 142, Lachine, Quebec, Canada H8S 4A6.

PRINTED circuit boards solder plated, etched, drilled routed. One week delivery. Solder masking and design available. **SHORE PROTOTYPE CIRCUIT**, 36 Fairview Avenue, Little Silver, NJ 07739. (201) 747-6300.

CABLE TV DESCRAMBLER LIQUIDATION!

- Major Makes & Models!
- Will match or beat anyone's prices!
- Dealer discounts at 5 units!
- Examples:
HAMLIN COMBOS . \$44 ea. (Min. 5)
OAK ADD/ON \$40 ea. (Min. 5)
OAK M35B \$60 ea. (Min. 5)

WEST COAST ELECTRONICS

For Information: 818-709-1758
Catalogs & Orders: 800-628-9656

INVESTIGATORS, experimenters — Quality new plans. Hard to find micro and restricted devices. Free catalog. Self addressed stamped envelope to **KELLEY SECURITY INC.**, Suite 90, 2531 Sawtelle Blvd., Los Angeles, CA 90064.

CB Tricks II book. Power amplifier design and theory, UHF CB tune ups. Send \$19.95 **MEDICINE MAN CB**, PO Box 37, Clarksville, AR 72830.

DAZER protector kit \$44.95! Exciting electronic kits! Catalog \$1.00. **QUANTUM RESEARCH**, 17919-77 Avenue, Edmonton, Alberta T5T 2S1.

SATELLITE TV

CABLE TV secrets — the outlaw publication the cable companies tried to ban. HBO, Movie Channel, Showtime, descramblers, converters, etc. Supplier's list included \$8.95. **CABLE FACTS**, Box 711-R, Pataskala, OH 43062.

VIDEOCIPHER II manuals. **Volume 1** — hardware, **Volume 2** — software. Either \$32.45, **Volume 3** — projects/software — \$42.45, **Volume 4** — repair — \$97.45, **Volume 5** documentation — \$42.45. **Cable Hacker's Bible** — \$32.45. CODs: (602) 782-2316. 0100-032 software — catalog-\$3.00. **TELECODE**, Box 6426-RE, Yuma, AZ 85366-6426.

DESCRAMBLERS for movies, networks, \$175, video only, \$450 complete. Visa, MC accepted. Catalog \$4. **SKYWATCH**, 238 Davenport Road, Toronto, Canada, M5R 1J6.

FREE catalog — Do-it-yourself save 40-60%. **Lowest prices** worldwide, systems, upgrades, parts, all major brands factory fresh and warranted. **SKYVISION**, 2009 Collegeway, Fergus Falls, MN 56537. 1 (800) 334-6455.

DESCRAMBLER: Build our low cost video only, satellite TV descrambler for most satellite channels. Uses easy to get, everyday parts. Boards & plans \$35.00 US funds. Board, plans & parts \$99.00 US funds. Wired & tested unit \$189.00 US funds. Send check, money order or Visa to: **VALLEY MICRO-WAVE ELECTRONICS**, Bear River, Nova Scotia, Canada B0S 1B0 or phone (902) 467-3577. 8am to 4pm eastern time. Note: educational project only. Not to be used illegally.

PAY TV AND SATELLITE DESCRAMBLING NEW... 1989 EDITION... NEW

The newest systems, parameters, turn-ons, harassment and countermeasures being used by and against cable, wireless and satellite operators. New original information \$15.95. Pay TV Vol. 1 \$14.95. Volume 2 \$12.95. Experiences with VC \$12.95. MDS/MMDS Handbook \$9.95. Build Satellite Systems Under \$600. \$12.95. Any 3/\$28 or 6/\$42. Scrambling News Monthly \$24.95/yr. Sample \$3. Scrambling News Year 1 (200) pages \$22.95. Year 2 \$22.95. Catalog \$1 or call. **Scrambling News, 1552 Merter Ave., Buffalo, N.Y. 14216 COD's 716-874-2088**

VIDEOCIPHER II descrambling manual. Schematics, video and audio. Explains DES, EPROM, CloneMaster, 3Musketeer, pay-per-view (HBO, Cinemax, Showtime, adult, etc.) \$13.95, \$2.00 postage. **CABLETRONICS**, Box 30502R, Bethesda, MD 20814.

BUSINESS OPPORTUNITIES

EASY work! Excellent pay! Assemble products at home. Call for information. (504) 641-8003 Ext. 5192.

MAKE \$50/hr working evenings or weekends in your own electronics business. Send for free facts. **INDUSTRY**, Box 531, Bronx, NY 10461.

YOUR own radio station! AM, FM, TV, cable. Licensed/unlicensed. **BROADCASTING**, Box 130-F12, Paradise, CA 95967.

INVENTIONS, ideas, technology wanted for presentation to industry/exhibition at national innovation exposition. Call 1 (800) 288-IDEA.

MAKE \$75,000 to \$250,000 yearly fixing IBM monitors, no investment, start from home, (a telephone required). Information USA, Canada \$1.00, Europe, Middle East \$8.00. **RANDALL DISPLAY**, Box 2168-R, Van Nuys, CA 91404 USA.

NEW HE NE LASER TUBES \$35

Dealer Inquiries Invited.
Free Catalog!

MEREDITH INSTRUMENTS: 6403 N. 59th Ave.
Glendale, AZ 85301 • (602) 934-9387
"The Source for Laser Surplus"

INVENTORS

INVENTORS! Can you patent and profit from your idea? Call **AMERICAN INVENTORS CORPORATION** for free information. Over a decade of service 1 (800) 338-5656. In Massachusetts or Canada call (413) 568-3753.

DIGITAL CAR DASHBOARDS

BUILD yourself complete electronic dashboards. Information package: \$2.00 (refundable). **MODERN LABS**, 2900-F Ruisseau, Saint-Elizabeth, QC, J0K 2J0, Canada.

ASSEMBLE YOUR OWN COMPUTER FOR LE\$\$

IBM XT 10 MHz Compatible Kit.....\$379

- 4.77/10 MHz Motherboard
- 256KB RAM (640KB max)
- 150W Power Supply
- Floppy Disk Controller
- One 5 1/4" 380KB Drive
- MonoGraphics Card w/ P
- 101 Key Keyboard
- Case (3LED,2Button,Key)
- 12" Amber Mono Monitor
- Installation Guide & Manual

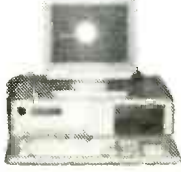

IBM AT 12 MHz Compatible Kit.....\$705

- 8/12 MHz Motherboard
- 512 KB RAM (4 MB max)
- 200W Power Supply
- Floppy Disk Controller
- One 5 1/4" 1.2 MB Drive
- MonoGraphics Card w/ P
- 101 Key Keyboard
- Case (3LED,2Button,Key)
- 12" Amber Mono Monitor
- Installation Guide & Manual



Display Upgrade: CGA Package \$200
EGA Package \$455
VGA Package \$500
MS-DOS with GWBASIC \$75

Hard Drive Option:
20MB w/CTRL XT-\$275 AT-\$315
30MB w/CTRL XT-\$310 AT-\$410
40MB w/CTRL XT-\$390 AT-\$415

All Components Fully Tested Before Ship
VISA & M/C subject to 3% surcharge
Price & Quantity subject to change without prior notice
15% Restocking Fee on All Items

JINCO COMPUTERS INC.
5122 WALNUT GROVE AVE.

SAN GABRIEL, CA 91776

Tel: (818) 309-1108

Fax: (818) 309-1107

IBM, XT, AT are registered trademarks of International Business Machine.

CIRCLE 137 ON FREE INFORMATION CARD

LEARN electronics the practical way. Build your own kit or do tens of experiments with your own self trainer. For free catalog: **ARLI ELECTRONICS**, 2155 Verdugo Blvd. #22, Montrose, CA 91020.

MAGIC! Four illustrated lessons plus inside information shows you how. We provide almost 50 tricks including equipment for four professional effects. You get a binder to keep the materials in, and a one-year membership in the International Performing Magicians with a plastic membership card that has your name gold-embossed. You get a one-year subscription to our quarterly newsletter "IT's MAGIC!" Order now! \$29.95 for each course + \$3.50 postage and handling. (New York residents add applicable state and local sales tax). **THE MAGIC COURSE**, 500-B BiCounty Boulevard, Farmingdale, NY 11735.

CABLE TV "BOXES"

Converters — Descramblers
Remote Controls — Accessories

- ★ Guaranteed Best Prices ★
- ★ 1 Year Warranty — C.O.D.'s ★
- ★ Immediate Shipping ★
- ★ FREE CATALOG ★

Call or Write
TRANS-WORLD CABLE CO.

12062 Southwest 117th Court, Suite 126
Miami, Florida 33186
1-800-442-9333



ATTENTION CABLE BROKERS

SURPLUS CATV converters and descramblers at wholesale prices. Unmodified units only. Oak M35B \$30. (415) 566-9815.

*****PRESENTING*****
CABLE TV DESCRAMBLERS
*****STARRING*****
JERROLD, HAMLIN, OAK
AND OTHER FAMOUS MANUFACTURERS

- FINEST WARRANTY PROGRAM AVAILABLE
- LOWEST RETAIL/WHOLESALE PRICES IN U.S.
- ORDERS SHIPPED FROM STOCK WITHIN 24 HOURS

FOR FREE CATALOG ONLY **1-800-345-8927**
FOR ALL INFORMATION 1-818-716-5914

PACIFIC CABLE CO. INC.
7325 S. RESEDA BLVD., DEPT. RE1 89
RESEDA, CA 91335

PROJECT CABINETS/ ENCLOSURES

RIGID 1/16 aluminum shell, hardwood trim, contemporary styling. Several sizes and styles available. \$10.99 — \$26.99, free brochures. **PYRAMID ELECTRONIC PRODUCTS**, 15020 LaGrange Road, Suite 2100, Orland Park, IL 60462.

MULTI CHANNEL MICROWAVE ANTENNAS

- CRYSTAL CONTROLLED MICROWAVE ANTENNAS FOR OVER THE AIR CABLE SYSTEMS (WIRELESS CABLE)
 - CAPABLE OF RECEIVING 30 CHANNELS
 - CONVERTERS AVAILABLE FOR ZENITH SYSTEMS
- CALL FOR PRICE (203) 622-4386

VIDEO-LINK ENTERPRISES

165 W. PUTNAM AVE. GREENWICH, CT 06830



EMINENCE



MOTOROLA

Polydax

1-800-338-0531

PIONEER

3-WAY 100W CROSSOVER

12 dB/octave rolloff.
800Hz, 5000Hz
crossover points. 8
ohm. 100 watts RMS.



#260-210 **\$12.50** **\$9.95**
(1-9) (10-up)

SPEAKER CONTROL PANEL

Panel with 50 watt L-pads
for tweeter and midrange
and built-in LED power
meter. 5" x 2 1/2" 100
watt version available



#260-235 **\$14.50** **\$12.90**
(1-5) (6-up)

12" POLY WOOFER

Super duty, 40 oz. magnet.
100 watts RMS, 145 watts
max. 4 and 8 ohm compat-
ible (6 ohm). 2" voice coil.
fs = 25 Hz. QTS = .166,
VAS = 10.8 cu ft.
Response: 25-1500 Hz. Net
weight: 9 lbs. Pioneer
#A30GU40-51D



#290-125 **\$36.80** **\$34.50**
(1-3) (4-up)

WALNUT SPEAKER CABINET KIT

Super quality,
genuine walnut
veneer cabinet. Kit
includes: routed and
mitred top, sides,
and bottom in
unfinished 3/4"
walnut veneer. Cut
your own custom
holes in the front
and rear to match
your drivers. 15" x
24" x 11". Volume:
1.9 cubic feet.



#260-350 **\$22.50** **\$19.95**
(1-3) (4-up)

PIONEER HORN TWEETER

Mylar dome. 2.93 oz.
barium ferrite magnet. 8
ohm. Response: 1800-
20000 Hz. 35W RMS,
50W max. fs = 2000 Hz.
SPL = 106 dB. Pioneer
#AHE60-51F



#270-050 **\$6.50** **\$5.90**
(1-9) (10-up)

12" SUB WOOFER

Dual voice coil sub woofer.
30 oz. magnet, 2" voice
coils. 100 watts RMS, 145
watts max. fs = 25 Hz. 6 ohm
(4 and 8 ohm compatible).
SPL = 89 dB 1W/1M.
Response: 25-700 Hz.
QTS = .31, VAS = 10.3 cu. ft.
Pioneer #A30GU30-55D.
Net weight: 6 lbs.



#290-145 **\$39.80** **\$36.80**
(1-3) (4-up)

15" THRUSTER WOOFER

Thruster by Eminence.
Made in USA. Poly foam
surround, 56 oz. magnet.
2-1/2", 2 layer voice coil.
150 watts RMS, 210 watts
max. 4 ohm. fs = 23.5
Hz, QTS = .33, VAS = 17.9
cu ft. SPL = 94.8 dB 1W/
1M. Net weight: 15 lbs.



#290-180 **\$43.50** **\$39.80**
(1-3) (4-up)

GRILL FRAME KIT

With this kit you
can make speaker
grill frames up to
30" x 40". Kit
includes 4 corner
pieces, 2 "T"
brackets, and 7
frame bars. Grill
mounting kit
included.



#260-333 **\$8.50** **\$7.80**
(1-9) (10-up)

18" EMINENCE WOOFER

MADE IN USA

100 oz. magnet, 3" voice
coil. 250 watts RMS, 350
watts max. 8 ohm, 30 Hz
resonant frequency. 22-
2700 Hz response.
Efficiency: 95 dB 1W/1M.
Paper cone, treated
accordion surround. Net
weight: 29 lbs.



#290-200 **\$98.90** **\$89.50**
(1-3) (4-up)

TITANIUM COMPOSITE TWEETER

Titanium is deposited on a polymer
dome to combine the advantages of
both hard and soft dome
technologies. 8 ohm. Ferro fluid
cooled voice coil. fs = 1200 Hz.
SPL = 90 dB 1W/1M. 50 watts RMS,
70 watts max. 4" round. Polydax
part #DTW100T125.



#270-047 **\$27.50** **\$24.80**
(1-9) (10-up)

1989 CATALOG
CALL TOLL FREE 1-800-338-0531
FREE CATALOG

* 15 day money back guarantee * \$15.00 minimum order * We accept
Mastercard, Visa, Discover, and C.O.D. orders * 24 hour shipping
* Shipping charge = UPS chart rate * \$1.00 (\$3.00 minimum charge)
* Hours: 8:30 am - 6:00 pm EST, Monday - Friday * Mail order
customers, please call for shipping estimate on orders exceeding
5 lbs.

AUDIO UPDATE

continued from page 88

that music is the worst kind of signal to use in evaluating components. I would reply that it's always possible to find a test signal that will reveal circuit misbehaviors that, in truth, have no audible consequences.

In any case, the proof of the acoustic pudding is in the listening. Several of the highest-scoring listeners in the group shared the opinion that the audible differences among the tested high-end players were essentially negligible. Based on the tests run by *Consumer Reports*, I would extend that view to include low-end players as well. In other words, once you've selected a player based on its features (and that might not be easy) you need not be concerned about the quality of its sound. *Consumer Reports'* opinion, based on a recent test of 26 models, is that they all sound "splendid." R-E

Try the

Radio Electronics

bulletin board
system

(RE-BBS)
516-293-2283

The more you use it the more
useful it becomes.

We support 300 and 1200 baud
operation.

Parameters: 8N1 (8 data bits, no
parity, 1 stop bit) or 7E1 (7 data
bits, even parity, 1 stop bit).

Add yourself to our user files to
increase your access.

Communicate with other R-E
readers.

Leave your comments on R-E with
the SYSOP.

RE-BBS
516-293-2283

CONSOLIDATED ELECTRONICS

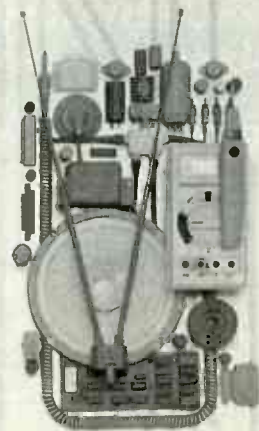

CONSUMER & INDUSTRIAL ELECTRONICS CATALOG • 17TH EDITION

THE ULTIMATE ELECTRONICS CATALOG.

Order your 260 page catalogue packed with over 10,000 money saving electronic parts and equipment. Send \$3.00 check or money order, or call 1-800-543-3568 today and use your Mastercard or Visa.
Consolidated Electronics, Incorporated
705 Watervliet Ave., Dayton, Ohio 45420-2599

NAME _____

ADDRESS _____

CITY _____

STATE _____

ZIP _____

CIRCLE 70 ON FREE INFORMATION CARD

When You Don't Waste Something, You Can Afford To Be Generous With It!

Catalogs are the only way that a Direct Marketing operation can let its current and potential customers be aware of all the items that it carries. Additionally, they should help the firm's customers make an intelligent purchasing decision based on published specifications and operating characteristics. But because most Mail Order Companies send out hundred of thousands of Catalogs every few months to all the people on their mailing list, they become skimpy when it gets to technical information. If there is room on the page, they put in a graph or two and if they are really hurting for space they start printing things so small that you need a magnifying glass to read them. What is worse, they send you the same stale information time after time! We at Electronic Buyers Club have a better idea. All of our Members receive a Large three ring binder and we only replace the pages that have new information when the time comes. And because we don't waste paper and money by sending everyone the same information over and over, we include Original Manufacturers' Spec Sheets and oftentimes their complete Catalogs. Case in point: our competitor lists all the technical information and pricing for Panasonic Type ECQ-E Metallized Polyester Capacitors on one page,

12 Months Saving Guarantee

We will refund the first year Membership Fee of any member who has purchased \$300 or more worth of products from Electronic Buyers Club and has not saved an amount greater than the first year Membership Fee, if buying the same items elsewhere.

but we supply a four page data sheet from Panasonic in addition to 4 pages of pricing information! So you see, by not wasting paper (and money) in sending the same old stuff over and over again we can afford to be generous in supplying complete expanded information to all of our Members.

30 Days Money Back Guarantee

We will refund the full Membership Fee of any new member of Electronic Buyers Club who within 30 Days after receiving the Membership Binder, returns the Binder to EBC and asks for the cancellation of Membership.

**Electronic
Buyers
Club**

A Division of International Components Corporation

1803 N.W. Lincoln Way • Toledo, OR 97391

PHONE (All 50 States & Canada): 1-800-325-0101

FAX: (503) 336-4400 • Hours: 6:00 AM - 6:00 PM PST



CIRCLE 138 ON FREE INFORMATION CARD

www.americanradiohistory.com

NEC V20 & V30 CHIPS

Replace the 8086 or 8088 in Your IBM PC and Increase its Speed by up to 30% Price

Part No.	Price
UPD70108-5 (5MHz) V20 Chip	\$5.25
UPD70108-8 (8MHz) V20 Chip	\$6.95
UPD70108-10 (10MHz) V20 Chip	\$10.95
UPD70116-8 (8MHz) V30 Chip	\$7.95
UPD70116-10 (10MHz) V30 Chip	\$13.49

7400

Part No.	1-9	10+	Part No.	1-9	10+
7400	29	19	7474	39	29
7402	29	19	7475	49	39
7404	29	19	7476	45	35
7405	35	25	7483	59	49
7406	39	29	7485	65	55
7407	39	29	7486	45	35
7408	35	25	7489	2.25	2.15
7410	29	19	7490	49	39
7411	35	25	7493	45	35
7414	49	39	7495	59	49
7416	35	25	74107	29	19
7417	35	25	74121	39	29
7420	29	19	74123	39	29
7427	29	19	74125	49	39
7430	29	19	74147	1.99	1.89
7432	39	29	74150	1.35	1.25
7438	39	29	74151	39	29
7442	49	39	74154	1.35	1.25
7445	75	65	74171	69	59
7446	89	79	74173	79	69
7447	89	79	74174	59	49
7448	1.95	1.85	74175	59	49
7473	39	29	74193	79	69

74LS

Part No.	26	16	74LS139	49	39
74LS02	28	18	74LS151	49	39
74LS03	28	18	74LS153	49	39
74LS04	28	18	74LS154	1.29	1.19
74LS05	28	18	74LS157	49	39
74LS06	59	49	74LS161	49	39
74LS07	59	49	74LS163	49	39
74LS08	28	18	74LS164	59	49
74LS09	28	18	74LS165	75	65
74LS10	26	16	74LS166	89	79
74LS11	29	19	74LS173	45	35
74LS14	49	39	74LS174	39	29
74LS20	28	18	74LS175	39	29
74LS21	29	19	74LS191	59	49
74LS27	35	25	74LS192	69	59
74LS30	28	18	74LS193	69	59
74LS32	28	18	74LS194	69	59
74LS38	35	25	74LS221	69	59
74LS42	49	39	74LS240	59	49
74LS47	85	75	74LS241	59	49
74LS73	39	29	74LS244	59	49
74LS74	35	25	74LS245	79	69
74LS75	39	29	74LS247	49	39
74LS76	39	29	74LS259	99	89
74LS83	55	45	74LS273	89	79
74LS85	55	45	74LS279	49	39
74LS86	29	19	74LS367	49	39
74LS90	49	39	74LS373	79	69
74LS93	49	39	74LS374	79	69
74LS123	49	39	74LS541	1.29	1.19
74LS132	49	39	74LS590	5.95	5.85
74LS138	49	39	74LS688	2.39	2.29

74S/PROMS*

Part No.	25	74S188*	1.49
74S00	25	74S189	1.49
74S04	25	74S240	1.39
74S32	25	74S244	1.39
74S74	25	74S287	1.49
74S112	25	74S287*	1.49
74S124	1.25	74S288*	1.49
74S138	49	74S373	.99
74S153	49	74S374	.99
74S163	.75	74S387*	1.29
74S174	.29	74S472*	2.95
74S175	.39	74S571*	2.49

CD-CMOS

Part No.	19	CD4051	.59
CD4001	19	CD4052	.59
CD4002	19	CD4053	.59
CD4007	19	CD4060	.59
CD4011	19	CD4066	.29
CD4012	25	CD4066	.29
CD4013	29	CD4069	.29
CD4015	29	CD4070	.25
CD4016	29	CD4071	.19
CD4017	49	CD4072	.19
CD4018	49	CD4073	.19
CD4020	59	CD4093	.25
CD4021	59	CD4093	.25
CD4022	59	CD4094	.39
CD4027	35	CD4503	.89
CD4028	35	CD4503	.89
CD4029	69	CD4511	.59
CD4030	69	CD4518	.75
CD4040	65	CD4520	.69
CD4042	65	CD4522	.69
CD4043	59	CD4528	.79
CD4046	65	CD4536	.79
CD4047	65	CD4543	.79
CD4049	29	CD4584	.49
CD4050	29	CD4585	.69

EEPROMS

Part No.	5.25	2816A	2048x8 350ns (9V-15V) 5V Read/Write	5.25
2816A	5.25	2816A-25	2048x8 250ns (9V-15V) 5V Read/Write	5.49
2817A	6.95	2817A	2048x8 350ns 5V Read Write	6.95
2864A	9.95	2864A	8192x8 250ns 5V Read Write (Pin 1, No R/E)	9.95
2864A-30	9.95	2864A-30	8192x8 300ns 5V Read Write (Pin 1, No R/E)	9.95
2865A	10.95	2865A	8192x8 250ns 5V Read Write	10.95
52B13	1.49	52B13	2048x8 350ns (21V) 5V Read Only	1.49

MICROPROCESSOR COMPONENTS

Z80, Z80A, Z80B, SERIES		8000 SERIES Continued		8000 SERIES Continued	
Part No.	Price	Part No.	Price	Part No.	Price
Z80	1.25	8155-2	3.75	8286	2.29
Z80A	1.29	81C55	4.25	8741	9.49
Z80A-CTC	1.65	8205	9.95	8742	14.95
Z80A-DART	4.95	82C11	6.95	8748 (25V)	7.95
Z80A-PIO	1.89	8212	1.99	8748H (HMOS)(21V)	9.95
Z80A-SiO/IO	3.95	8216	1.39	8749	9.95
Z80B	2.75	8224	1.49	8751H (3.5-12MHz)	3.45
Z80B-CTC	3.95	8228	1.49	8755	13.95
Z80B-PIO	3.95	8237-5	4.25	80286-10 (10MHz)CC	29.95
Z8681B1	4.95	8243	1.95	80287-3 (5MHz)	109.95
8000 SERIES		8250A	4.95	80287-8 (8MHz)	209.95
8031	3.95	8250B (For IBM)	5.95	80287-10 (10MHz)	209.95
80C31	8.95	8251A	1.95	80386-16 PCA	259.95
8035	1.25	8253	1.95	80387-16 (16MHz)	349.95
8039	1.59	82C53-5	1.95	80387-20 (20MHz)	399.95
8052AHBASIC	24.95	82C53-5	1.95	80387-25 (25MHz)	439.95
8080A	1.95	8254	4.95	82284 (8MHz)	5.49
8085A	1.95	8255A-5	2.95	82288 (8MHz)	6.95
8085A-2	3.59	82C55A-5	4.49	DATA ACQUISITION	
8086	3.95	8256	1.95	ADC0804CCN	2.99
8087 (5MHz)	3.95	8259-5	2.25	ADC0808CCN	5.35
8087-1 (10MHz)	169.95	8272	3.49	ADC0809CCN	3.69
8087-2 (10MHz)	129.95	8274	4.75	ADC1205CCJ-1	20.95
8088 (5MHz)	4.95	8279-5	2.95	DAC0808CLN	1.75
8088-2 (8MHz)	6.95	8282	2.95	AY-3101SD	4.95
8155	2.49	8284A	1.95	AY-51013A	2.95

STATIC RAMS

Part No.	Function	Price
2016-12	2048x8 120ns	2.95
2102	1024x1 350ns MOS	.89
2112	256x4 450ns MOS	1.49
2114N	1024x4 450ns MOS	.99
2114N-2L	1024x4 200ns Low Power	2.49
21C14	1024x4 200ns (CMOS)	1.49
5101	256x4 450ns (CMOS)	1.95
6116P-1	2048x8 100ns (18K) CMOS	3.19
6116P-3	2048x8 150ns (18K) CMOS	3.59
6116P-1	2048x8 100ns (18K) LP CMOS	3.59
6116LP-3	2048x8 150ns (18K) LP CMOS	3.99
6264P-10	8192x8 100ns (64K) CMOS	6.29
6264P-15	8192x8 150ns (64K) CMOS	6.95
6264LP-12	8192x8 120ns (64K) LP CMOS	6.75
6264LP-15	8192x8 150ns (64K) LP CMOS	6.49
6514	1024x4 350ns CMOS	3.25
43256-10L	32,768x8 100ns (256K) Low Power	15.95
43256-15L	32,768x8 150ns (256K) Low Power	14.95
62256P-P-10	32,768x8 100ns (256K) LP CMOS	16.95
62256P-P-12	32,768x8 120ns (256K) LP CMOS	16.25
62256P-P-15	32,768x8 150ns (256K) LP CMOS	15.95

DYNAMIC RAMS/MODULES

41256A8A-10	262,144x9	100ns 256x9 SIP (Has Leads)	49.95
41256A8B-10	262,144x9	100ns 256x9 SIM	59.95
42100A9A-10	1,048,576x9	100ns 1MEGx9 SIP (Has Leads)	19.95
42100A9B-10	1,048,576x9	100ns 1MEGx9 SIM (Has Leads)	19.95
42100A9A-80	1,048,576x9	80ns 1MEGx9 SIP (Has Leads)	169.95
42100A9B-80	1,048,576x9	80ns 1MEGx9 SIM (Has Leads)	169.95
TMS4416-12	16,384x4	120ns	5.95
TMS4416-15	16,384x4	150ns	5.49
4116-15	16,384x4	150ns (MM5290N-2)	1.75
4128-15	131,072x1	150ns (Puggyback)	4.49
4164-100	65,536x1	100ns	2.09
4164-120	65,536x1	120ns	2.39
4164-150	65,536x1	150ns	2.95
41256-60	262,144x1	60ns	6.95
41256-80	262,144x1	80ns	5.75
41256-100	262,144x1	100ns	3.95
41256-120	262,144x1	120ns	3.59
41256-150	262,144x1	150ns	3.25
41264-12	64Kx4	120ns Video RAM	10.95
41464-10	65,536x4	100ns	6.95
41464-12	65,536x4	120ns	4.49
41464-15	65,536x4	150ns	4.25
51256-100	262,144x1	100ns Static Column	8.95
51100P-10	1,048,576x1	100ns (1 Meg)	13.95
51100P-80	1,048,576x1	80ns (1 Meg)	15.95
514256P-10	262,144x4	100ns (1 Meg)	16.49
514258-10	262,144x4	100ns Static Column	26.95

EPROMS

TMS2516	2048x8	450ns (25V)	4.95
TMS2532	4096x8	450ns (25V)	5.95
TMS2532A	4096x8	450ns (12.5V)	3.25
TMS2564	8192x8	450ns (25V)	6.95
TMS2716	2048x8	450ns (+5V, +12V)	6.49
1702A	256x8	2K (1µs)	4.25
2708	1024x8	450ns	6.95
2716	2048x8	450ns (25V)	3.99
2716-1	2048x8	350ns (25V)	3.49
27C16	2048x8	450ns (25V) CMOS	4.25
27C16-1	4096x8	450ns (25V) CMOS	3.95
2732A-20	4096x8	200ns (21V)	3.95
2732A-25	4096x8	250ns (21V)	4.25
2732A-30	4096x8	300ns (21V) CMOS	3.75
2764-25	8192x8	250ns (21V)	3.95
2764A-20	8192x8	200ns (12.5V)	4.19
2764A-25	8192x8	250ns (12.5V)	3.49
2706A-15	8192x8	150ns (12.5V) CMOS	5.95
27128-20	16,384x8	200ns (21V)	5.95
27128-25	16,384x8	250ns (21V)	5.25
27128A-15	16,384x8	150ns (12.5V)	6.95
27128A-20	16,384x8	200ns (12.5V)	4.75
27128A-25	16,384x8	250ns (12.5V) CMOS	5.95
27256-15	32,768x8	150ns (12.5V)	8.49
27256-20	32,768x8	200ns (12.5V)	5.49
27256-25	32,768x8	250ns (12.5V)	4.95
27256-15	32,768x8	150ns (12.5V) CMOS	7.25
27256-20	32,768x8	200ns (12.5V) CMOS	5.49
27512-25	65,536x8	250ns (12.5V)	7.25
27C512-15	65,536x8	150ns (12.5V) CMOS	9.95
27C512-25	65,536x8	250ns (12.5V) CMOS	7.49
27C512-15	131,072x1	150ns (12.5V) CMOS (1 Meg)	18.95
68784	8192x8	64K 450ns (25V) (Chip Enable)	14.95
68766-35	8192x8	64K 350ns (25V) (Output Enable)	15.95

650

TEST EQUIPMENT

GoldStar 20MHz Oscilloscope

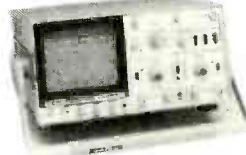

NEW!

- Large 6" rectangular display • High sensitivity: 1 mV/div • High accuracy: ±3% • Stable, low-drift design • Distortion-free waveform measurements
- Special TV sync for quick measurements • Convenient X-Y operation mode

GS7020.....\$399.95

Oscilloscope Probes

- Attenuation: x1 / x10
- Capacitance (LF180): 180pF / 22pF; (LF210): 40pF / 17pF



LF180 Pictured
LF180 40MHz Oscilloscope Probe..... **\$19.95**
LF210 100MHz Oscilloscope Probe..... **\$29.95**

Metex Digital Multimeters

Metex General Specs:

- Handheld, high accuracy
- AC/DC Voltage, AC/DC Current, Resistance, Diodes, Continuity, Transistor hFE • Manual ranging w/overload protection

M3650/B & M4650 only:
• Also measures frequency and capacitance

M4650 only:
• Data Hold Switch
• 4.5 Digit



M4650 Pictured
M3610 3.5 Digit Multimeter..... **\$49.95**
M3650 3.5 Digit w/Freq. & Capacitance **\$69.95**
M3650B Same as M3650 w/Bargraph..... **\$79.95**
M4650 4.5 Dig. w/Freq., Capacitance and Data Hold Switch **\$99.95**

Metex Autoranging Jumbo Readout DMM

- AC/DC Voltage, AC/DC Current, Resistance, Diodes, Continuity and Frequency
- 3.75 Digit (.8" High)
- Ruggedized, Water-resistant case
- Easy-to-use pushbutton switches



M80.....\$59.95

A.R.T. EPROM Programmer

- Programs all current EPROMs in the 2716 to 27512 range plus the X2864 EEPROM • May be operated by any RS232 port w/ terminal emulation • Fully intelligent • ASCII command driven • Menu driven software included



EPP.....\$179.95

SPECIAL! Monochrome Text Card

Sperry Monochrome Display Adapter

- IBM PC/XT Compatible
- Allows for Connection between Computer and Monochrome Monitor
- Use for Text only
- Great for Network Servers and Dedicated Work Stations



TEXT\$12.95

JAMECO IBM PC/XT 8MHz Turbo Compatible Kit With 256K RAM

- Free! WordStar EASY Word Processing and QAPLUS Diagnostic Software Included!
- Free! Now included with DR-DOS (Disk Operating System) Software
- 256K RAM Included, Expandable to 640K
- AMI BIOS ROMs Included
- 4.77 or 8MHz Operation
- Flip-Top Case w/150 Watt Power Supply
- 360K Disk Drive
- Parallel Printer Port
- 84-Key Keyboard
- Monochrome Amber Monitor



SAVE \$88.95!

JE3002 IBM Compatible PC/XT 8MHz Turbo Kit.....\$499.95

IBM COMPATIBLE DISPLAY MONITORS

AMBER	12" Amber Mono.....	\$99.95
HD55H	14" RGB 640x240.....	\$249.95
TM5154	EGA 14" 720x350.....	\$369.95
JE1059	EGA Monitor & Card.....	\$459.95
TM5156	14" VGA 720x480.....	\$399.95
TM5157	14" Multiscan 800x600.....	\$469.95
TM2060	VGA Monitor & VGA Card.....	\$529.95



TM5156 Pictured

JAMECO IBM PC/XT/AT COMPATIBLE CARDS

JE1050	Monochrome Graphics Card w/Parallel Printer Port (PC/XT/AT).....	\$59.95
JE1052	Color Graphics Card w/Parallel Printer Port (PC/XT/AT).....	\$49.95
JE1055	EGA Card w/256K Video RAM (PC/XT/AT).....	\$139.95
JE1071	Multi I/O Card w/Controller & Monochrome Graphics (PC/XT).....	\$119.95
JE1060	I/O Card w/Serial, Game, Printer Port & Real Time Clock (PC/XT).....	\$59.95
JE1062	RS232 Serial Half Card (PC/XT/AT).....	\$29.95
JE1065	I/O Card w/Serial, Game and Parallel Printer Port (AT).....	\$59.95
JE1081	2MB Expanded or Extended Memory Card (zero-K on-board) (AT).....	\$109.95
XTGEN	20/40MB Hard Disk Controller Card (PC/XT).....	\$79.95
JE1043	360K/720K/1.2MB/1.44MB Floppy Disk Controller Card (PC/XT/AT).....	\$49.95
JE1044	360K Floppy/Hard Disk Controller Card (PC/XT).....	\$109.95
1003VMM2	360K/720K/1.2MB/1.44MB Floppy/Hard Disk Controller Card (AT).....	\$149.95

SEAGATE HALF-HEIGHT HARD DISK DRIVES

ST225	20MB Drive only (PC/XT/AT).....	\$224.95
ST225XT	20MB w/Controller (PC/XT).....	\$269.95
ST225AT	20MB w/Controller (AT).....	\$339.95
ST238	30MB Drive only (PC/XT/AT).....	\$249.95
ST238XT	30MB w/Controller (PC/XT).....	\$299.95
ST238AT	30MB w/Controller (AT).....	\$389.95



ST225XT Pictured

Seagate 40MB and 60MB Hard Disk Drives Also Available!

IBM PC/XT/AT COMPATIBLE MOTHERBOARDS

JE1001	4.77/8MHz (PC/XT).....	\$89.95
JE1002	4.77/10MHz (PC/XT).....	\$99.95
JE3005	Baby 8/12MHz (AT).....	\$199.95
JE3010	Baby 8/16MHz NEAT (AT).....	\$299.95
JE3020	Baby 16MHz 80386.....	\$999.95
JE3025	Baby 20MHz 80386.....	\$1199.95
JE3026	Full-Size 25MHz 80386.....	\$1899.95



JE3025 Pictured

IBM PC/XT/AT COMPATIBLE 3.5"/5.25" DISK DRIVES

MF353B	3.5" 720KB (PC/XT/AT).....	\$99.95
356KU	3.5" 1.44MB (PC/XT/AT).....	\$109.95
JE1020	5.25" 360KB (PC/XT/AT) Black	\$89.95
JE1021	5.25" 360KB (PC/XT/AT) Beige	\$89.95
JE1022	5.25" 1.2MB (PC/XT/AT) Beige	\$99.95



JE1022 Pictured

IBM PC/XT/AT COMPATIBLE INTERNAL MODEMS

1200B	1200/300 Baud Internal Modem w/ProComm Comm. Software (PC/XT/AT)....	\$49.95
2400B	2400/1200/300 Baud Internal Modem w/ProComm Comm. Swr. (PC/XT/AT) ..	\$99.95

External Modems and Pocket-Size Modem Also Available!

PROTOTYPING PRODUCTS

Jameco Solderless Breadboards

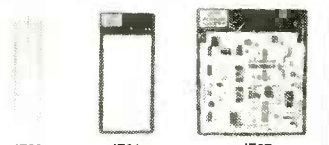

Part No.	Dim. L" x W"	Contact Points	Binding Posts	Price
JE20	6.5 x .75	200	0	\$2.95
JE21	3.25 x 2.125	400	0	\$4.95
JE22	6.5 x 1.325	630	0	\$5.95
JE23	6.5 x 2.125	830	0	\$6.95
JE24	6.5 x 3.125	1,360	2	\$12.95
JE25	6.5 x 4.25	1,660	3	\$17.95
JE26	6.875 x 5.75	2,390	4	\$22.95
JE27	7.25 x 7.5	3,220	4	\$32.95

DATAC Photo Etch PCB Kit

Make your own circuit boards!



The ER4 photo etch kit contains all the chemicals necessary for any hobbyist, engineer or student to create professional circuit boards. Contains: Print frame, photo copy film, resist developer, etch resist, 2 copper circuit boards, concentrated etchant, film developer and flexer, resist patterns and complete instructions. Must be shipped ground (surface).
ER4 Photo Etch PCB Kit.....**\$37.95**

Jameco Prototype PC Boards

Specs: Laminated glass epoxy .062" thick 2 oz. copper clad with solder tin finish. All holes are .042" dia. on 10" x 10" grid pattern.
JE401 Pictured

JE401	4.5"x6.5" 1-sided 3-hole pad pattern.....	\$9.95
JE403	4.5"x6.5" 1-sided pwr & grd busses.....	\$9.95
JE405	4.5"x6.5" 1-sided general purpose.....	\$9.95
JE407	5"x13.25" 2-sided general purpose.....	\$19.95
JE417	4.2"x6.5" PC/XT 1/2 card proto board.....	\$19.95
JE421	4.75"x3.7" IBM PC/XT Card Extender.....	\$19.95

ENGINEERING/DATA BOOKS

21035	Sams TTL Cookbook (88).....	\$14.95
21958	Sams CMOS Cookbook (88).....	\$19.95
22383	Sams Op-Amp Cookbook (88).....	\$21.95
270645	Intel 8-bit Controller Hndbk. (89).....	\$19.95
270646	Intel 16-bit Controller Hndbk. (89).....	\$19.95
270647	Intel 32-bit Controller Hndbk. (89).....	\$19.95
104100	NSC Linear Data Book Vol. 1 (88).....	\$14.95
104200	NSC Linear Data Book Vol. 2 (88).....	\$9.95
104300	NSC Linear Data Book Vol. 3 (88).....	\$9.95
ICM89	1989 IC Master (3 Volume Set).....	\$119.95

EDUCATIONAL KITS

JE310/315:	Fiber optics kits demonstrate the principles of fiber optic system design. Complete step-by-step instructions, theory of operation and tutorial info. incl.	
JE2206:	Function generator kit provides three basic waveforms: sine, triangle and square wave. Frequency range: 1Hz to 100kHz	
JE310	Fiber Optics Experimenter Kit	\$19.95
JE315	Advanced Fiber Optics Kit....	\$29.95
JE2206	Function Generator Kit.....	\$19.95



JE2206 Pictured

1355 Shoreway Road
Belmont, CA 94002
24 Hour Order Hotline (415) 592-8097
FAX's (415) 592-2503 or (415) 595-2664
Telex 176043 - Ans. Back: Jameco Blmt
Data Sheets - 50c each
Send \$2.00 Postage for a FREE 1990 CATALOG
© 1989 Jameco Electronics 12/89
IBM is a registered trademark of International Business Machines



\$25.00 Minimum Order - U.S. Funds Only
CA Residents Add 6%, 6.5% or 7% Sales Tax
Shipping Add 5% plus \$1.50 Insurance
(May vary according to weight and shipping method)
Terms: Prices subject to change without notice.
We are not responsible for typographical errors.
We reserve the right to substitute manufacturers.
Items subject to availability and prior sale.
Products pictured may only be representative.
Complete list of terms/warranties is available upon request.

24-Hour Order Hotline (415) 592-8097 • The Following Phone Lines Are Available From 7AM - 5PM P.S.T.:

• Customer Service (415) 592-8121 • Technical Assistance (415) 592-9990 • Credit Department (415) 592-9983 • All Other Inquiries (415) 592-7108

★ QUALITY PARTS ★ DISCOUNT PRICES ★ FAST SHIPPING

ALL ELECTRONICS CORP.

3 to 6 Vdc MOTOR with GEARBOX

Probably designed for child's toy. Lever selects 2 forward and one reverse speed. 1st gear approx. 120 rpm/6vdc, 2nd gear approx. 300 rpm/6vdc, Reverse approx. 120 rpm/6vdc.

3.35" X 1.75" X 3.25"
CAT# DCM-10 \$6.00

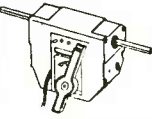

SPECIAL !!! NICKEL CADMIUM BATTERY CHARGER

Rayovac# CH-4
Recharges up to four AA, C, D or two 9 volt nickel cadmium rechargeable batteries. LED charging indicator. CAT# UNCC \$10.00 each • 12 for \$108.00

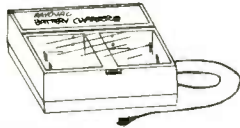

6 VOLT D.C. 9.5 AMP/HOUR GEL-CELL

Elpower# 695
6 volt, 9.5 amp/hour rechargeable gel-cell battery. 4.25" X 2.75" X 5.5". Quick connect terminals.
CAT# GC-695 \$15.00 each



SOLAR CELL

4 inch square silicon solar cell. Produces 0.3-0.45 volts @ 1500 ma in direct sunlight. Solder together in series or parallel for higher voltage or amperage. Ideal for use in solar panels, battery chargers and solar energy products.
CAT# SCEL \$3.50 each
25 for \$75.00



WALL TRANSFORMERS

ALL PLUG DIRECTLY INTO 120 VAC OUTLET

6 Vdc @ 200 ma. CAT# DCTX-620 \$2.25
9 Vdc @ 250 ma. CAT# DCTX-925 \$2.50
12 Vdc @ 900 ma. CAT# ACTX-1293 \$3.50
18 Vdc @ 1 amp. CAT# ACTX-1885 \$3.50



LED'S

STANDARD JUMBO DIFFUSED T-1 3/4 size

RED CAT# LED-1 10 for \$1.50 • 100 for \$13.00
GREEN CAT# LED-2 10 for \$2.00 • 100 for \$17.00
YELLOW CAT# LED-3 10 for \$2.00 • 100 for \$17.00

FLASHING LED with built in flashing circuit operates on 5 volts...

RED \$1.00 each
CAT# LED-4 10 for \$9.50
GREEN \$1.00 each
CAT# LED-4G 10 for \$9.50

BI-POLAR LED Lights RED one direction, GREEN the other. Two leads. CAT# LED-6 2 for \$1.70

LED HOLDER Two piece holder. CAT# HLED 10 for \$5.00



DOOR/WINDOW ALARM

Protects doors and windows from intruders. Opening of door or window pulls pin from alarm module and triggers loud buzzer. Simple installation. Operates on 2 AA batteries (not included). Plastic case is 3.32" X 2.29" X 1.19". Ivory with brushed aluminum face.
CAT# DWA \$2.00 each
5 for \$9.00



PIEZO WARNING DEVICE

Murata Erie # PKB8-440
High pitched audible alarm. Operates on 3 - 20 Vdc @ 20 ma. 1" high x 7/8" dia. P.C. board mount.
CAT# PBZ-84 \$1.75 each



WIDE BAND AMPLIFIER

NEC# UPC1651G. 1200 Mhz @ 3 db. Gain: 19db @ 1-500 hz, 5 volt operation. Small package 4mm dia. X 2.5 mm thick. CAT# UPC-1651 2 for \$1.00
10 for \$4.50 • 100 for \$35.00

N-CHANNEL MOSFET

IRF-511 TO-220 case
CAT# IRF 511 \$1.00 each • 10 for \$9.00
LARGE QUANTITY AVAILABLE



SWITCHES

ITT PUSH BUTTON ITT MDPL series. 3/4" X 1/2" gray rectangular key cap. S.P.S.T. N.O.

Push to close. RATED: 0.1 amp switching, 0.25 amp carry current. P.C. mount. CAT# PB-8 65c each • 10 for \$6.00 • 100 for \$50.00



10 POSITION MINI-ROTARY

Grayhill# 56P36-01-1-10N-C
Mini rotary switch. Non-shorting. 1 deck, 10 positions. .125" dia. shaft X .375" long. .377" behind the panel depth. P.C. pins.
CAT# MRS-10 WAS \$2.50 NOW \$1.50 each



SPDT PUSHBUTTON

Marquardt# 1843
Rated 6 amps @ 125/250 Vac. Black plastic pushbutton. Switch body. .92" X .94" X .65".
CAT# PB-18 \$1.65 each • 10 for \$1.50 each



PUSHBUTTON SWITCH

GC#Thornston# 35 420
S.P.S.T., normally open momentary pushbutton switch. Red plastic actuator. .57" dia. Chrome bezel. .68" diameter. Threaded bushing mounts in .50" diam. chassis hole. Rated 3 amp @ 250 Vac. Solder loop terminals.
CAT# PB-20 \$1.00 each



RELAYS

12 VOLT D.C. COIL S.P.D.T. Omron# G2E-184P 4 Amp contacts 335 ohm coil. Sugar cube size. .61" X .42" X .44" high. P.C. mount with pins on DIP spacing.
CAT# RLY-787 \$1.50 each

5 VOLT DC SIP RELAY Gould, Allied Controls SR-1A 5VDC SPST-normally open SIP relay. 95 ohm coil. 2 amp contacts. .9" X .29" X .39" high. Housing resists fluorocarbon and chlorinated commercial solvents.
CAT# RLY-SIP6 \$1.00 each • 10 for \$8.50



SOUND AND VIDEO MODULATOR

Ti# UM1381-1. Designed for use with T.I. computers. Can be used with video cameras, games or other audiovisual sources. Built in A/B switch enables user to switch from T.V. antenna without disconnection. Operates on channel 3 or 4. Requires 12 Vdc. Hook up diagram included.
CAT# AVMOD \$5.00 each



LIGHT ACTIVATED MOTION SENSOR

This device contains a photo cell which senses sudden change in ambient light. Could be used as a door annunciator or modified to trigger other devices. 5 1/2" X 4" X 1". Operates on 6 Vdc. Requires 4 AA batteries (not included).
CAT# LSMD \$5.75 per unit

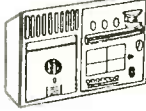

LOOK WHAT \$1.00 WILL BUY

200 ASSORTED 1/4 WATT RESISTORS Bent leads, carbon comp. and carbon film. CAT# GRES \$1.00 per assortment

200 ASSORTED 1/2 WATT RESISTORS Bent leads, carbon comp. and carbon film. CAT# GRABE \$1.00 per assortment

50 ASSORTED DISC CAPACITORS Most are cut (p.c. leads). Some to 500 volts. CAT# GRABDC \$1.00 per assortment

15 VALUES OF ELECTROLYTICS Contains both axial and radial styles from 1 mfd. CAT# GRABCP \$1.00 per assortment

10 AMP SOLID STATE RELAY

ELECTROL# S2181 CONTROL: Rated 5.5 to 10 Vdc (will operate on 3-32 Vdc). LOAD: 10 amp @ 240 Vac. 2 1/4" X 1 3/4" X 7/8"
CAT# SSRLY-10B \$9.50 each
QUANTITY DISCOUNT
10 for \$85.00 • 25 for \$175.00
50 for \$300.00 • 100 for \$500.00



XENON TUBE

1" long flashtube prepped with 3 1/2" red and black leads. Ideal for electronic flash or strobe projects.
CAT# FLT-3 2 for \$1.00



1/4 WATT RESISTOR KIT

Ideal for the workshop, this 1/4 watt resistor kit contains 10 pieces each of 42 of the most popular values (420 pieces total). Includes a divided box and a parts locator.

VALUES in this kit are:
1 ohm, 10 ohm, 39 ohm, 47 ohm, 51 ohm, 68 ohm, 100 ohm, 130 ohm, 150 ohm, 180 ohm, 220 ohm, 330 ohm, 470 ohm, 560 ohm, 680 ohm, 1K, 1.2K, 1.5K, 2K, 2.2K, 2.7K, 3K, 4.7K, 5.1K, 5.6K, 10K, 15K, 22K, 30K, 33K, 39K, 47K, 56K, 68K, 100K, 120K, 150K, 220K, 470K, 1 MEG, 5.1 MEG, 10 MEG

The resistors alone would sell for \$21.00.
Complete kit • CAT# REKIT-14 \$17.00



CALL OR WRITE FOR OUR FREE CATALOG OVER 4000 PARTS!



Now 60 pages!

MAIL ORDERS TO:
ALL ELECTRONICS
P.O. BOX 567
VAN NUYS, CA 91408
TWX-5101010163 (ALL ELECTRONIC)
OUTSIDE THE U.S.A. SEND \$2.00 POSTAGE FOR A CATALOG!!

ORDER TOLL FREE
800-826-5432
INFO: (818)904-0524
FAX: (818)781-2653
MINIMUM ORDER \$10.00
QUANTITIES LIMITED
CALIF. ADD SALES TAX
USA: \$3.00 SHIPPING
FOREIGN ORDERS INCLUDE SUFFICIENT SHIPPING. NO C.O.D.



1-800-3-4539

AK, Puerto Rico - 218-681-6674 Telex - 62827914 FAX - 218-681-3380 TWX - 9103508982 DIGI KEY CORP

INTEGRATED CIRCUITS

Part No.	Price	Part No.	Price	Part No.	Price
7400 TTL		7415288N	60	7415288N	60
7401N	35	7415289N	50	7415289N	50
7402N	35	7415290N	50	7415290N	50
7403N	35	7415291N	50	7415291N	50
7404N	35	7415292N	50	7415292N	50
7405N	35	7415293N	50	7415293N	50
7406N	35	7415294N	50	7415294N	50
7407N	35	7415295N	50	7415295N	50
7408N	35	7415296N	50	7415296N	50
7409N	35	7415297N	50	7415297N	50
7410N	35	7415298N	50	7415298N	50
7411N	35	7415299N	50	7415299N	50
7412N	35	7415300N	50	7415300N	50
7413N	35	7415301N	50	7415301N	50
7414N	35	7415302N	50	7415302N	50
7415N	35	7415303N	50	7415303N	50
7416N	35	7415304N	50	7415304N	50
7417N	35	7415305N	50	7415305N	50
7418N	35	7415306N	50	7415306N	50
7419N	35	7415307N	50	7415307N	50
7420N	35	7415308N	50	7415308N	50
7421N	35	7415309N	50	7415309N	50
7422N	35	7415310N	50	7415310N	50
7423N	35	7415311N	50	7415311N	50
7424N	35	7415312N	50	7415312N	50
7425N	35	7415313N	50	7415313N	50
7426N	35	7415314N	50	7415314N	50
7427N	35	7415315N	50	7415315N	50
7428N	35	7415316N	50	7415316N	50
7429N	35	7415317N	50	7415317N	50
7430N	35	7415318N	50	7415318N	50
7431N	35	7415319N	50	7415319N	50
7432N	35	7415320N	50	7415320N	50
7433N	35	7415321N	50	7415321N	50
7434N	35	7415322N	50	7415322N	50
7435N	35	7415323N	50	7415323N	50
7436N	35	7415324N	50	7415324N	50
7437N	35	7415325N	50	7415325N	50
7438N	35	7415326N	50	7415326N	50
7439N	35	7415327N	50	7415327N	50
7440N	35	7415328N	50	7415328N	50
7441N	35	7415329N	50	7415329N	50
7442N	35	7415330N	50	7415330N	50
7443N	35	7415331N	50	7415331N	50
7444N	35	7415332N	50	7415332N	50
7445N	35	7415333N	50	7415333N	50
7446N	35	7415334N	50	7415334N	50
7447N	35	7415335N	50	7415335N	50
7448N	35	7415336N	50	7415336N	50
7449N	35	7415337N	50	7415337N	50
7450N	35	7415338N	50	7415338N	50
7451N	35	7415339N	50	7415339N	50
7452N	35	7415340N	50	7415340N	50
7453N	35	7415341N	50	7415341N	50
7454N	35	7415342N	50	7415342N	50
7455N	35	7415343N	50	7415343N	50
7456N	35	7415344N	50	7415344N	50
7457N	35	7415345N	50	7415345N	50
7458N	35	7415346N	50	7415346N	50
7459N	35	7415347N	50	7415347N	50
7460N	35	7415348N	50	7415348N	50
7461N	35	7415349N	50	7415349N	50
7462N	35	7415350N	50	7415350N	50
7463N	35	7415351N	50	7415351N	50
7464N	35	7415352N	50	7415352N	50
7465N	35	7415353N	50	7415353N	50
7466N	35	7415354N	50	7415354N	50
7467N	35	7415355N	50	7415355N	50
7468N	35	7415356N	50	7415356N	50
7469N	35	7415357N	50	7415357N	50
7470N	35	7415358N	50	7415358N	50
7471N	35	7415359N	50	7415359N	50
7472N	35	7415360N	50	7415360N	50
7473N	35	7415361N	50	7415361N	50
7474N	35	7415362N	50	7415362N	50
7475N	35	7415363N	50	7415363N	50
7476N	35	7415364N	50	7415364N	50
7477N	35	7415365N	50	7415365N	50
7478N	35	7415366N	50	7415366N	50
7479N	35	7415367N	50	7415367N	50
7480N	35	7415368N	50	7415368N	50
7481N	35	7415369N	50	7415369N	50
7482N	35	7415370N	50	7415370N	50
7483N	35	7415371N	50	7415371N	50
7484N	35	7415372N	50	7415372N	50
7485N	35	7415373N	50	7415373N	50
7486N	35	7415374N	50	7415374N	50
7487N	35	7415375N	50	7415375N	50
7488N	35	7415376N	50	7415376N	50
7489N	35	7415377N	50	7415377N	50
7490N	35	7415378N	50	7415378N	50
7491N	35	7415379N	50	7415379N	50
7492N	35	7415380N	50	7415380N	50
7493N	35	7415381N	50	7415381N	50
7494N	35	7415382N	50	7415382N	50
7495N	35	7415383N	50	7415383N	50
7496N	35	7415384N	50	7415384N	50
7497N	35	7415385N	50	7415385N	50
7498N	35	7415386N	50	7415386N	50
7499N	35	7415387N	50	7415387N	50
7500N	35	7415388N	50	7415388N	50

INTEGRATED CIRCUITS

Part No.	Price	Part No.	Price	Part No.	Price
7400 TTL		7415389N	50	7415389N	50
7401N	35	7415390N	50	7415390N	50
7402N	35	7415391N	50	7415391N	50
7403N	35	7415392N	50	7415392N	50
7404N	35	7415393N	50	7415393N	50
7405N	35	7415394N	50	7415394N	50
7406N	35	7415395N	50	7415395N	50
7407N	35	7415396N	50	7415396N	50
7408N	35	7415397N	50	7415397N	50
7409N	35	7415398N	50	7415398N	50
7410N	35	7415399N	50	7415399N	50
7411N	35	7415400N	50	7415400N	50
7412N	35	7415401N	50	7415401N	50
7413N	35	7415402N	50	7415402N	50
7414N	35	7415403N	50	7415403N	50
7415N	35	7415404N	50	7415404N	50
7416N	35	7415405N	50	7415405N	50
7417N	35	7415406N	50	7415406N	50
7418N	35	7415407N	50	7415407N	50
7419N	35	7415408N	50	7415408N	50
7420N	35	7415409N	50	7415409N	50
7421N	35	7415410N	50	7415410N	50
7422N	35	7415411N	50	7415411N	50
7423N	35	7415412N	50	7415412N	50
7424N	35	7415413N	50	7415413N	50
7425N	35	7415414N	50	7415414N	50
7426N	35	7415415N	50	7415415N	50
7427N	35	7415416N	50	7415416N	50
7428N	35	7415417N	50	7415417N	50
7429N	35	7415418N	50	7415418N	50
7430N	35	7415419N	50	7415419N	50
7431N	35	7415420N	50	7415420N	50
7432N	35	7415421N	50	7415421N	50
7433N	35	7415422N	50	7415422N	50
7434N	35	7415423N	50	7415423N	50
7435N	35	7415424N	50	7415424N	50
7436N	35	7415425N	50	7415425N	50
7437N	35	7415426N	50	7415426N	50
7438N	35	7415427N	50	7415427N	50
7439N	35	7415428N	50	7415428N	50
7440N	35	7415429N	50	7415429N	50
7441N	35	7415430N	50	7415430N	50
7442N	35	7415431N	50	7415431N	50
7443N	35	7415432N	50	7415432N	50
7444N	35	7415433N	50	7415433N	50
7445N	35	7415434N	50	7415434N	50
7446N	35	7415435N	50	7415435N	50
7447N	35	7415436N	50	7415436N	50
7448N	35	7415437N	50	7415437N	50
7449N	35	7415438N	50	7415438N	50
7450N	35	7415439N	50	7415439N	50
7451N	35	7415440N	50	7415440N	50
7452N	35	7415441N	50	7415441N	50
7453N	35	7415442N	50	7415442N	50
7454N	35	7415443N	50	7415443N	50
7455N	35	7415444N	50	7415444N	50
7456N	35	7415445N	50	7415445N	50
7457N	35	7415446N	50	7415446N	50
7458N	35	7415447N	50	7415447N	50
7459N	35	7415448N	50	7415448N	50
7460N	35	7415449N	50	7415449N	50
7461N	35	7415450N	50	7415450N	50
7462N	35	7415451N	50	7415451N	50
7463N	35	7415452N	50	7415452N	50
7464N	35	7415453N	50	7415453N	50
7465N	35	7415454N	50	7415454N	50
7466N	35	7415455N	50	7415455N	50
7467N	35	7415456N	50	7415456N	50
7468N	35	7415457N	50	7415457N	50
7469N	35	7415458N	50	7415458N	



Since
1985

MARK V ELECTRONICS, INC.

▲ indicates the level of difficulty in the assembling of our Products. ▲ Beginner ▲▲ Intermediate ▲▲▲ Advanced ★ Fully Assembled

PROFESSIONAL COLOR LIGHT CONTROLLER SM-328 ★

Assembled & tested \$150.00



The SM-328 professional color light controller is keyboard programmable for ease of use, it allows full control of intensity and flash rate.

It has four separate channels with capacity of 1170 watts per channel. Total wattage capability is 4.68 kilowatts. This is equivalent to bulbs or 9365 watt colored bulbs and is sufficient for the largest halls and auditoriums. ● Independent input signal control ● Professional styled control panel ● 4 independent outputs ● 4 independent dimmer controls ● Chaser speed controls ● Automatic chaser operation ● 4 preset chaser programs ● Clockwise chaser control ● Anti-clockwise chaser control
SPECIFICATIONS: Input sensitivity (music model): 100mV, (music & program): 2V ● Output power: 1170W per channel 4680W total ● Power requirement: 105-120V, 60Hz ● Dimensions: 14.32" wide, 9" high, 3.19" deep

SURROUND SOUND PROCESSOR SM-333 ▲▲

Assembled & tested \$83.00

Completed kit \$62.00



The new SM-333 surround sound processor is a full featured unit

that is designed to provide your system with the ultimate musical realism. It has inputs for VCR, Video Disc and Compact Disc and can also be used with FM tuners, tape decks and LP discs - in fact anything that can be connected to your pre-amplifier. It also has front panel control of dynamic noise reduction, surround level, effect and time delay up to 50 milliseconds. Rear panel outputs for front and rear stereo speaker amplifiers. The unit may be purchased as a kit or fully assembled ready to plug in.

SPECIFICATIONS: Frequency response: 20hz to 20Khz ● Total harmonic distortion: Front channel: 0.05%, Rear channel: Less than 0.25% ● Input signal voltage: 0.1 to 3.5V ● Output: Front channel: 0.1 to 3.5V, Rear channel: 6.6V ● Delay time: 5 to 50 milliseconds ● Input impedance: 47K ● Power requirements: 110/220 VAC, 50/60Hz ● Dimensions: 14.2" wide, 4.82" deep, 2.1" high.

100W DYNAMIC CLASS A MAIN POWER AMPLIFIER TA-1000A▲▲

Assembled & tested \$80.58

Complete kit \$59.69



This well designed and stable amplifier features DC coupling through out and a fully complementary symmetry circuit topology. It operates in class A at low and medium levels and gradually shifts to class AB operation at high levels. A pair of these amplifiers provide 200 watts of super high fidelity sound reproduction.

SPECIFICATIONS: Power output: 100 watts into 8 ohms, 125 watts into 4 ohms ● Frequency response: 10hz to 100Khz ● Total harmonic distortion: Less than 0.008% ● Signal to noise ratio: Better than 80dB ● Sensitivity: 1V ● Power requirements: 35 to 45VDC @ 3amp ● Suggested rack mount cabinet: Mark V LG1924 or LG1925

DIGITAL VOICE MEMO TA-28 MK II ▲▲



Kit / Assembled & tested \$30 / 40

FEATURES: Solid State Record/Play Back ● Power/Record LED Indicator ● 4 Bit ADPCM Algorithm ● 8 Bit AD/DA Converter ● 256K Memory Capacitor ● 8 SEC or 16 SEC Record Time ● Sampling Frequency 8KHz or 4KHz ● Included Condenser Mic & Speaker ● Built in Low Pass Filter ● Low Power Consumption ● Supply Voltage: 5-6 DC ● Dimensions: 3 1/2" x 2 1/2" x 1"

AMPLIFIERS

MODEL	DESCRIPTION	KIT	Assembled
TA-001	1W Mini-Amplifier ▲	\$ 5.07	
TA-006	6W Mini-Amplifier ▲	6.90	
TA-007	12W Mini-Amplifier ▲	11.20	
TA-10	Stereo Pre-Amp. w/magnetic mic amp. ▲	8.20	
TA-28MK2	Digital Voice Recorder ▲	30.00	\$ 40.00
TA-50A/B	Multi-Purpose Melody Generator ▲	11.84	16.58
TA-50C	Multi-Purpose Melody Generator ▲	12.85	17.71
TA-120MK2	Class "A" Main Power Mono Amp. ▲▲	31.25	
TA-300	30W Multi-Purpose Stereo Amp. ▲▲	20.00	
TA-302	60W Stereo Power Booster ▲▲	50.00	70.00
TA-3221	50W ± 50W IC Stereo Amp. w/led level display ▲	35.50	
TA-323A	HQ 30W ± 30W Stereo Amp. ▲	29.50	
TA-377A	FET Stereo Pre-Amp. ▲▲	59.95	75.00
TA-400	40W Solid State Mono Amp. ▲	28.00	
TA-477	120W Mostel Power Mono Amp. ▲▲	68.00	
TA-800	80W ± 80W DC Pre-Main & Power Amp. ▲▲	60.92	
TA-802	80W ± 80W DC Stereo Main Power Amp. ▲▲	45.94	
TA-820A	60W ± 60W DCL DC Pre-Main Stereo Amp. ▲▲	48.00	
TA-1000A	100W Class "A" Main Power Mono Amp. ▲▲	59.59	80.58
TA-1500	100W x 2 Class "A" DC Stereo Pre-Main Amp. ▲▲	73.70	95.81
TA-2400A	Electronic Echo & Revelation Amp. ▲▲	93.30	116.80
TA-2500	HQ Pre-Amp. w/10 band graphic equalizer ▲	33.20	90.00
TA-2800	Hi-Fi Bi-Fet Pre-Amp. w/3 way tone control ▲	48.90	
TA-3000	Stereo Simulator ▲	33.20	43.38
TA-3600	300W HQ Hi-Fi Power Mono Amp. ▲▲	86.00	110.00

MISCELLANEOUS

MODEL	DESCRIPTION	KIT	Assembled
TY-1A	Battery Fluorescent Light Driver ▲	\$ 5.19	
TY-7	Electronic Touch Switch ▲	7.15	
TY-8	Electronic Loto ▲	15.00	
TY-11A	Multi-Functional Control Switch ▲	5.19	
TY-12A	Digital Clock w/Timer ▲	16.93	
TY-13	Color Led Audio Level Meter ▲	20.15	
TY-14	Electronic Shock ▲	6.25	
TY-18	High Precision Sound Control Switch ▲	9.22	
TY-20	V Shape Color Led Level Meter ▲▲	21.45	
TY-23B	3 Channel Color Light Controller ▲▲▲	71.50	\$82.50
TY-25	Stereo Loudspeaker Protector ▲	12.65	
TY-35	FM Wireless Microphone ▲	9.22	
TY-36	AC/DC Quartz Digital Clock ▲	18.00	
TY-38	Sound/Touch Control Switch ▲	12.00	
TY-41MK111	Infrared Remote Control Unit ▲▲	15.00	25.00
TY-41MKV	Infrared Remote Control Unit ▲▲	20.00	35.00
TY-42	Bar/Dot Level Meter ▲	24.15	
TY-43	3 1/2" Digital Panel Meter ▲	33.00	46.20
TY-45	20 Steps Bar/Dot Audio Level Display ▲▲	38.45	
TY-47	Superior Electronic Roulette ▲▲	19.46	
SM-222	7 Bands Graphic Equalizer ▲▲	26.80	38.80
SM-328	4 Channel Professional Color Light Controller ★	150.00	
SM-333	Audio/Video Surround Sound Processor ▲▲	62.00	83.00
SM-666	Dynamic Noise Reduction Unit ▲	26.00	34.00
T-1	LCD Thermometer Clock w/outdoor sensor ★	22.00	
T-2	LCD Thermometer Clock w/ F & C measurement ★	19.80	
# 8501	Parrot Talking Clock ★	12.00	
# 8504	Mynah Talking Clock ★	12.00	

POWER SUPPLIES

MODEL	DESCRIPTION	KIT	Assembled
TR-100A	0-15V 2A Regulated DC Power Supply	59.50	69.50
TR-355A	0-15V 5A Regulated DC Power Supply	12.92	
TR-355B	0-30V 3A Regulated DC Power Supply	12.92	
TR-503	0-50V 3A Regulated DC Power Supply	14.76	

INSTRUMENTS

MODEL	DESCRIPTION	KIT	Assembled
SM-43	3 1/2" Multi-Functional Led O.P.M.	34.50	43.00
SM-48	4 1/2" Hi-Precision D.P.M	38.00	48.00
SM-48A	4 1/2" Hi-Precision D.P.M. w/ stdndr case	41.20	52.00
SM-100	150MC Digital Frequency Counter	90.00	90.00
FC1000A	1 GHz Frequency Counter	192.00	43.00

METAL CABINETS

MODEL	DESCRIPTION	MATCHING	EA SET
LG-1273	3" x 12" x 7"	TA-2800, TA-377A	\$20.16
LG-1684	4" x 16" x 8"	TA-3221, TA-323A, TA-377A	24.64
LG-1924	4" x 19" x 11.5"	TA-802, TA-820A, TA-1500, TA-120, TA-800, TA-1000A	30.00
LG-1925	5" x 19" x 11.5"	TA-477, TA-800, TA-1500, TA-1000A	33.00
LG-1983	2 3/4" x 19" x 8"	TA-377A, TA-2800, TA-2200, TA-120MK II	

TRANSFORMERS

MODEL	DESCRIPTION	MATCHING	PIECE
# 001	56V CT to 60V CT 6A	TA-800, TA-802, TA-820A, TA-1000A, TA-1500	\$25.00
# 002	72V CT 3A	TR-503, TA-3221, TA-323A, TA-400	19.00
# 003	80V CT 6A	TA-477	24.00
# 004	48V CT 6A	TA-120	19.00
# 005	52V CT 3A	TR-355B	19.00
# 006	36V CT 5A	TR-355A	13.60
# 007	112V CT 8A	TA-3600	38.00

8-DIGIT 1 GHZ MULTI-FUNCTION COUNTER FC-1000A ★

Assembled tested

& CAL \$192.00



The FC-1000A is a multi-function 10 hertz to 1ghz dual-range frequency counter. It can measure frequency, period and total events. Readout is a large 0.5" 8-digit, 7-segment LED display. It utilizes two crystal oscillators which can be individually calibrated for maximum long term accuracy against a frequency standard such as WWV transmissions. Additional features include a valuable self-check mode and a two step input attenuator.
SPECIFICATIONS: Frequency range: 10hz to 10mhz, 10mhz to 100mhz, 100mhz to 1000mhz ● Resolution: 1000hz to 0.1hz depending on range ● Accuracy: ±1 digit, ± time base error ● Period measurement: 10hz to 1010mhz ● Period measurement resolution: 10⁻⁷ to 10⁻¹⁰ seconds depending on gate time ● Totalization measurement: 10hz to 10mhz ● Totalization display: 99999999 ● Sensitivity: 153µV 10hz to 0mhz, 30mV 70mhz to 100mhz, 15mV 100mhz to 1000mhz ● Input impedance: 1 megohm 10hz to 100mhz, 50ohms 100mhz to 1000mhz ● Attenuation: X1, X10 ● Power requirements: 110 to 120VAC, 60hz or 220VAC, 50 to 70hz ● Dimension: 9" high, 9.69" wide, 7.87" deep

DYNAMIC NOISE REDUCTION UNIT SM-666 ▲

Complete kit \$26.00

Assembled & tested \$34.00



The SM-666 Dynamic Noise Reduction Unit is designed to reduce noise during playback from cassette tapes, LP records and compact discs, as well as FM radio broadcasts. An National Semi-conductor LM1894 integrated circuit is used to achieve a noise reduction of 10dB. The SM-666 has the great advantage that it can be used with all musical formats on playback whereas existing noise reduction systems such as Dolby B and C operate with magnetic tapes only. The output of the unit is connected directly to the system amplifier input as shown in the schematic. The unit can be switched out or bypassed if desired in order to compare the noise reduction advantage when playing a noise signal.
SPECIFICATIONS: Input signal level: 3.5 V RMS MAX ● 20 K ohm ● Noise reduction: 10dB ● Power supply: 9 to 12V recommended ● Operating current: 27mA MAX

4 1/2" HI-PRECISION D. P. M. SM-48A

Complete kit \$41.20

Assembled & tested & CAL \$52.00



SM-48 Digital Panel Meter employs a high-quality analog-digital converter (ADC) as its main device and employs 14mm high LED display as 4 1/2 digit display. The required external components of SM-48 are very little. Both construction and alignment are so simply. Only need a few resistors that can turn it into a DC voltmeter or ammeter. The range is wide and highly stable. Beside this unit has different usages according to which input circuit you are applied. In order to upset the stability and accuracy, 50ppm/°C temperature compensated voltage reference diode is employed to make this meter working in the best way within 0° to -70°C.

SPECIFICATION: 4 1/2 Digit 14mm red large display with overload flash ● Multi-functions: including BCD, BUSY, STROBE output, suitable for micro computer. ● Memory system can hold the input reading for comparison and monitor. ● Range: DC voltage DC ± 1mV ± 2000V, DC current DC ± 1µA ± 20A ● Accuracy: DC ± 0.025% ± 2 digit ● Power: DC 5-6V at 200mA ● Dimensions: 3 3/4" (W) x 1 1/4" (H) x 4 1/16" (D)

300W HI-FI POWER AMPLIFIER (MONO) TA-3600▲▲

Assembled & tested \$110.00

Complete Kit \$86.00 Transformer \$38.00

10,000 UF 80V E. Cap \$20.00



The TA-3600 is an extremely high power amplifier specifically designed to reproduce the high dynamic range available on compact discs. It has low noise, low distortion, low distortion, extended frequency range and high efficiency in a compact package. Two of these units with appropriate power supply and pre-amplifier are required for stereo reproduction.

SPECIFICATIONS: Power output: 300 watts sine wave 540 watts music power ● Frequency response: Total harmonic distortion: Less than 0.05% ● Sensitivity: 1Vms at 47K ● Power requirements: 60 to 75VDC at 8amp.

— WE ACCEPT MAJOR CREDIT CARDS, MONEY ORDERS AND CHECKS — BUSINESS & SHOWROOM HOURS: (PACIFIC TIME) MON. - FRI. 9:30 A.M. - 5:00 P.M., SAT. 10:00 A.M. - 5:00 P.M. TERMS: \$10.00 MIN. ORDER ● \$20 MIN. CHARGE CARD ORDER ● WE SHIP UPS.GROUND ● ADD 10% OF TOTAL ORDER (MIN. \$3.00) FOR SHIPPING OUTSIDE U.S.A. ADD 20% (MIN. \$5.00) ● TRANSIT INSURANCE: ADD 5% OF TOTAL (OUTSIDE U.S.A ONLY) ● CA RESIDE ADD SALES TAX ● ALL MERCHANDISE SUBJECT TO PRIOR SALE ● PRICES ARE SUBJECT TO CHANGE WITHOUT NOTICE ● WE ARE NOT RESPONSIBLE FOR TYPOGRAPHICAL ERRORS.

CATALOG OR INFORMATION: 213-888-9898 ● PHONE ORDER: 1-800-423-3483 (IN CALIF.) 1-800-521-MARK FAX: 213-888-6868

MARK V ELECTRONIC, INC. — 8019 E. Slauson Ave., Montebello, CA 90640

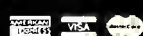

CIRCLE 93 ON FREE INFORMATION CARD

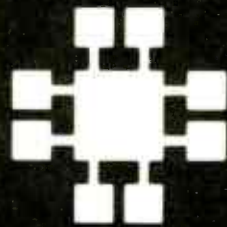

JDR Microdevices®

MMC
MICROCOMPUTER
MARKETING COUNCIL
of the Direct Marketing Association, Inc.

30 DAY MONEY BACK GUARANTEE • 1 YEAR WARRANTY ON ALL PRODUCTS • TOLL-FREE TECHNICAL SUPPORT

MEMORY DYNAMIC RAMS



PART#	SIZE	SPEED	PINS	PRICE
4164-150	65536x1	150ns	16	2.49
4164-120	65536x1	120ns	16	2.89
4164-100	65536x1	100ns	16	3.39
TMS4464-12	65536x4	120ns	16	9.95
41256-150	262144x1	150ns	16	3.99
41256-120	262144x1	120ns	16	4.49
41256-100	262144x1	100ns	16	4.99
41256-80	262144x1	80ns	16	5.49
41256-60	262144x1	60ns	16	7.99
414256-100	262144x4	100ns	20	14.95
414256-80	262144x4	80ns	20	16.95
1 MB-120	1048576x1	120ns	18	13.95
1 MB-100	1048576x1	100ns	18	14.95
1 MB-80	1048576x1	80ns	18	15.95

SIMM/SIP MODULES

PART#	SIZE	SPEED	TYPE	PRICE
41256A9B-12	256K x 9	120ns	SIMM/PC	49.95
41256A9B-80	256K x 9	80ns	SIMM/PC	59.95
421000A8B-10	1MB x 8	100ns	SIMM/MAC	159.95
421000A9B-10	1MB x 9	100ns	SIMM/PC	159.95
421000A9B-80	1MB x 9	80ns	SIMM/PC	169.95
256KX9SIP-80	256K x 9	80ns	SIP/PC	69.95
256KX9SIP-60	256K x 9	60ns	SIP/PC	79.95
1MBX9SIP-80	1MB x 9	80ns	SIP/PC	179.95

STATIC RAMS

PART#	SIZE	SPEED	PINS	PRICE
HM6116L-2	2048x8	120ns	24	4.99
HM6264L-15	8192x8	150ns	28	8.95
HM6264L-12	8192x8	120ns	28	9.95
HM43256L-12	32768x8	120ns	28	21.95
HM43256L-10	32768x8	100ns	28	24.95

MATH COPROCESSORS

8-BIT COPROCESSORS

8087 5 MHz 89.95

8087-2 8 MHz 129.95

8087-1 10 MHz 169.95

16-BIT COPROCESSORS

80287 6 MHz 139.95

80287-8 8 MHz 209.95

80287-10 10 MHz 239.95

80C287 12 MHz 299.95

32-BIT COPROCESSORS

80387-16 16 MHz 359.95

80387-SX 16 MHz 319.95

80387-20 20 MHz 399.95

80387-25 25 MHz 499.95

80387-33 33MHz 649.95

intel 5 YEAR WARRANTY

INCLUDES MANUAL & SOFTWARE GUIDE

74 SERIES LOGIC

7400	.19	74LS32	.18	74LS245	.79
74LS00	.16	74LS73	.29	74LS273	.79
74LS02	.17	7474	.33	74S288	1.69
7404	.16	74LS74	.24	74LS322	3.95
74LS04	.16	74S74	.49	74LS367	.39
74S04	.29	74LS138	.39	74LS373	.79
7406	.29	74LS155	.59	74LS374	.79
7408	.24	74LS163	.39	74LS393	.79
74LS08	.18	74LS240	.69	74LS682	3.20
7432	.29	74LS244	.69	74LS688	2.40

C.P.U.'s

8000	
8052AH	1793
BASIC	34.95
8088	5.99
8250	6.95
8251A	1.69
8253-5	1.95
8254	9.95
8255-5	2.49
8741	9.95
8748	7.95
8749	9.95
8755	14.95
8500	
65C02*	7.95
6522	2.95
V-20	
V20	6.95
V20-8	8.95
V20-10	11.95
V30	13.95

MISC

DAC0800	3.29
1793	9.95
COM8116	8.95
MC146818	5.95
MM58167	9.95
INS8250	6.95
NS16450	10.95
LM317T	.69
NE555	.29
LM741	.29
7805T	.49
7812T	.49
75150	1.95
75154	1.95
14411	9.95
CRYSTAL OSCILLATORS	
1.0MHz	5.95
1.8432	5.95
20.0	4.95
24.0	4.95

PALS

16L8	2.95
16R4	2.95
16R6	2.95
16R8	2.95
20L8	4.95
20R4	4.95
20R6	4.95
20R8	4.95
20X8	4.95
PAL KIT	
AN ENTRY-LEVEL COMPLETE PAL DEVELOPMENT KIT FROM CUPL FULL SUPPORT FOR 16L8, 16R4, 16R6, 16R8, 20L8, 20R4, 20R6, 20R8, AND 20X8. MOD-MPL-SOFT \$99.95	

Derick's HIGH-TECH SPOTLIGHT



Call our BBS: (408) 559-0253 for more info in SIG file "Mitech"

What can you expect from adding a math co-processor? If you run programs that specifically state support from a co-processor, you will realize significant increases in speed from its addition. However, if the program doesn't support a co-processor, then no matter what, the program won't run any faster.

Some programs benefit more than others, in particular, those that make heavy use of Floating Point, Trigonometric, Logarithmic and Exponential calculations show the most improvement. CAD, spreadsheets, some databases, and Mandelbrot programs are frequently written to use a co-processor if it's available.

How much your application will speed up depends on the ratio of time spent on math calculations versus other operations. A 3 to 10 times improvement is not uncommon certain operations are even faster.

The co-processor you need is specific to the type and speed of processor. For 8088/86 and 80386 based machines, the general rule is to use an 8087 or 80387 of the same speed as the processor, i.e. an 80386-25 requires an 80387-25.

80286 based machines frequently use a co-processor running at 2/3rds the processor speed, i.e. an 80286-12 requires an 80287-8.

Derick Moore, Director of Engineering

EPROMS

PART#	SIZE	SPEED	Vpp	PINS	PRICE
2708	1024x8	450ns	25V	24	4.95
2716	2048x8	450ns	25V	24	3.49
2716-1	2048x8	350ns	25V	24	3.95
2732A	4096x8	250ns	21V	24	3.95
2764	8192x8	450ns	12.5V	28	3.49
2764-250	8192x8	250ns	12.5V	28	3.69
2764-200	8192x8	200ns	12.5V	28	4.25
27C64	8192x8	250ns	12.5V	28	4.95
27128	16384x8	250ns	12.5V	28	4.25
27128A-200	16384x8	200ns	12.5V	28	5.95
27256	32768x8	250ns	12.5V	28	5.95
27256-200	32768x8	200ns	12.5V	28	5.95
27C256	32768x8	250ns	12.5V	28	5.95
27S12	65536x8	250ns	12.5V	28	8.95
27C512	65536x8	250ns	12.5V	28	9.95
27C101-20	131072x8	200ns	12.5V	32	29.95

EPROM ERASERS

DATASE II \$39.95

• SHIRT POCKET SIZE!

• ALL SIZES UP TO 4 AT A TIME

• ERASES MOST EPROMS IN 3 MINUTES

DATASE II

SPECTRONICS CORPORATION	Model	Timer	# of Chips	Capacity (K/16K/32K)	Un. Cost
PE-140	NO	9	8,000	\$ 89	
PE-140T	YES	9	8,000	\$139	
PE-240T	YES	12	9,600	\$189	
PL-265T	YES	30	9,600	\$255	

POWER SUPPLIES

135 WATT POWER SUPPLY

• UL APPROVED

• +5V @15A, +12V @ 4.2A, 5V @ 5A, -12V @ 5A

PS-135 \$59.95

PS-150 150W SUPPLY \$69.95

200 WATT POWER SUPPLY

• UL APPROVED

• +5V @ 20A, +12V @ 7A, -5V @ 5A, -12V @ 5A

PS-200 \$89.95

APPLE TYPE SUPPLY

• WITH APPLE CONNECTOR

• +5V @ 6A, +12V @ 3A, -5V @ 1A, -12V @ 1A

PS-A \$59.95

PROTOTYPE CARDS

FR-4 EPOXY GLASS LAMINATE WITH GOLD PLATED EDGECARD FINGERS AND SILK SCREENED LEGENDS



FOR XT

JDR-PR1	WITH +5V AND GROUND PLANE	27.95
JDR-PR2	ABOVE WITH I/O DECODING LAYOUT	29.95
JDR-PR2-PK	PARTS KIT FOR JDR-PR2 ABOVE	8.95

FOR AT

JDR-PR10	BIT WITH I/O DECODING LAYOUT	34.95
JDR-PR10-PK	PARTS KIT FOR JDR-PR10 ABOVE	12.95

FOR PS/2

JDR-PR32	32 BIT PROTOTYPE CARD	69.95
JDR-PR16	16 BIT WITH I/O DECODING LAYOUT	49.95
JDR-PR16-PK	PARTS KIT FOR JDR-PR16 ABOVE	15.95
JDR-PR16V	16 BIT FOR VIDEO APPLICATIONS	39.95

EXTENDER CARDS

SIMPLIFY PROTOTYPING AND TESTING

EXT-8088	8-BIT FOR 8088 MOTHERBOARDS	29.95
EXT-80286	16-BIT FOR 286/386 MOTHERBOARDS	39.95
EXT-16	MICROCHANNEL 16 BIT	69.95
EXT-32	MICROCHANNEL 32-BIT	99.95

PC BREADBOARD-ON-A-CARD

• 62 BUS LINES

• USE UP TO 24 14-PIN IC'S

• 1940 TIE POINTS

• DB25 D-SUB CONNECT.

PDS-604 \$49.95

SOLDER STATION

• UL APPROVED

• ADJUSTABLE HEAT SETTING

• TIP TEMPERATURE READOUT

• REPLACEMENT TIPS @ \$2.95

168-3C \$59.95

IC SOCKETS/DIP CONNECTORS

SOLDERTAIL	WIREWRAPE	ZIF SOCKETS	
8 PIN ST	.11	8 PIN WW .59	ZIF-14 5.95
14 PIN ST	.11	14 PIN WW .69	ZIF-16 5.95
16 PIN ST	.12	16 PIN WW .69	ZIF-20 6.95
18 PIN ST	.15	18 PIN WW .99	ZIF-24 7.95
20 PIN ST	.18	20 PIN WW 1.09	ZIF-28 7.95
24 PIN ST	.20	24 PIN WW 1.49	ZIF-40 10.95
28 PIN ST	.22	28 PIN WW 1.69	
40 PIN ST	.30	40 PIN WW 1.99	

VOLUME DISCOUNTS CALL!

SOLDER-CUP D-SUBS

MALE		FEMALE		IDC'S
DB09P	.45	DB09S	.49	IDE20 .55
DB15P	.59	DB15S	.69	IDE34 .89
HDB15P	1.49	HDB15S	1.59	IDS20 .65
DB19P	.69	DB19S	.75	IDS34 .75
DB25P	.69	DB25S	.75	IDB09P 1.39
DB37P	1.35	DB37S	1.39	IDB09S 1.45
DB50P	1.85	DB50S	2.29	IDB25P 2.25
				IDB25S 2.35

CABLES AND GENDER CHANGERS

MOLDED; GOLD-PLATED CONTACTS; 100% SHIELDED

CBL-PRNTR	6 FT. PC PRINTER CABLE	9.95
CBL-PRNTR-25	25 FT. PC PRINTER CABLE	15.95
CBL-PRNTR-RA	RIGHT ANGLE PRINTER CABLE	15.95
CBL-DB25-MM	DB25 MALE-DB25 MALE 6 FT.	9.95
CBL-DB25-MF	DB25 FEMALE-DB25 FEMALE 6 FT.	9.95
CBL-9-SERIAL	DB9 FEMALE-DB25 MALE 6 FT.	6.95
CBL-KBD-EXT	5 FT. KEYBOARD EXTENSION	7.95
CBL-CNT-MM	36-PIN CENTRONICS-MM	14.95
CBL-FDC-EXT	37-PIN EXT. FLOPPY CABLE	9.95
CBL-MNT-9	9 PIN MONITOR EXTENSION	6.95
CBL-MNT-15	15 PIN MONITOR EXTENSION CABLE	9.95
CBL-MODEM	MODEM-DB25-DB25 FEMALE	6.95
GENDER-VGA	DB9 DB15 ADAPTOR	4.95
GENDER-9-25	DB9-DB25 SERIAL ADAPTOR	4.95

PARTIAL LISTINGS ONLY—CALL FOR FREE CATALOG!

JDR MICRODEVICES AND THE JDR MICRODEVICES LOGO ARE REGISTERED TRADEMARKS OF JDR MICRODEVICES. IBM, AT, PS/2 ARE TRADEMARKS OF INTERNATIONAL BUSINESS MACHINES.

CIRCLE 113 ON FREE INFORMATION CARD
DEALERS CIRCLE 170 ON FREE INFORMATION CARD

www.americanradiohistory.com

4800/2400 BAUD FAX/DATA MODEM

\$119

- FAX TRANSMISSION ONLY
- 4800 BAUD FAX CAPABILITY TO ANY GROUP III FAX
- 2400 BAUD V.22BIX DATA MODEM
- XT/AT COMPATIBLE HALF CARD
- MENU-DRIVEN SOFTWARE
- MULTIPLE FAX TRANSMISSIONS TO GROUPED ADDRESSES

MCT-FAXM

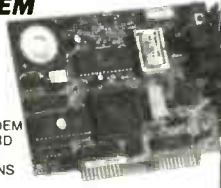

VGA COMPATIBLE PACKAGE

\$499

- 720 X 540 MAX RESOLUTION, 640 X 480 N 16 COLORS, 528 X 480 RESOLUTION IN 256 COLORS
- IBM STYLE MONITOR
- VGA, EGA, CGA, AND MGA COMPATIBLE

VGA MONITOR

- 14" ANALOG VGA - GLARE RESISTANT SCREEN - 720 X 480
- TILT/SWIVEL BASE - FRONT MOUNTED POWER SWITCH

RELISYS MULTISYNCH

- FULL FEATURED MULTISCAN MONITOR WITH UNLIMITED COLORS
- 1024 X 768 RESOLUTION, 14" NON-GLARE DISPLAY
- AUTO SWITCHING - TTL/ANALOG VIDEO INPUT

EGA SPECIAL! CARD & MONITOR—JUST \$479

EGA-MONITOR 14" RGB MONITOR	\$339.00
NEC-MULTI-3D DIGITAL 1024X768 RESOLUTION	\$649.95
JDR-MONO 12" TTL MONOCHROME GREEN	\$69.95
JDR-AMBER 12" TTL MONOCHROME AMBER	\$69.95



HARD DISKS

- 20 MB **\$199**
- 30 MB **\$219**
- 40 MB **\$339**
- 60 MB **\$389**
- 80 MB **\$569**

KITS

- 20 MB **\$249**
- 30 MB **\$279**



SIZE	MODEL	AVG. SPEED	FORM FACTOR	DRIVE ONLY	XT KIT	AT F/H KIT
20MB	ST-225	65 MS	5-1/4"	\$199	\$249	\$309
30MB RLL	ST-238	65 MS	5-1/4"	\$219	\$279	\$379
40MB	ST-251-1	28 MS	5-1/4"	\$339	\$389	\$449
60MB RLL	ST-277-1	28 MS	5-1/4"	\$389	\$449	\$549
80MB	ST-4096	28 MS	5-1/4"	\$569	\$679	\$779
120MBRLL	ST-4144R	28 MS	5-1/4"	\$699	\$759	\$859
20MB	ST-125	40 MS	3-1/2"	\$259	\$299	\$373
30MB RLL	ST-138	40 MS	3-1/2"	\$289	\$339	\$429

DFI HANDY SCANNER 3000 PLUS

\$199⁹⁵

- IMPROVED CLARITY, HIGHER SPEED - SCANS UP TO 4.1" WIDE IMAGES
- 100, 200, 300, 400 DPI BOTH DIRECTIONS
- B&W & 3 HALF-TONE MODES
- 32 LEVELS OF GRAY SCALE
- HERCULES, CGA, EGA AND VGA COMPATIBLE
- HS-3000 WITH HALO DPE & IMAGE EDITOR SOFTWARE
- OCR-SOFT CHARACTER RECOGNITION SOFTWARE \$99.95

NEW LOW PRICE!



MINI UPRIGHT CASE

\$249⁹⁵

- SMALL FOOTPRINT MINI-UPRIGHT FOR 8088 OR MINI 286/386 MOTHERBOARDS
- ROOM FOR 6 EXPANSION CARDS
- HOLDS 3 5-1/4" & 1 3-1/2" DRIVES (1/2 HT)
- 200 WATT POWER SUPPLY
- 2-DIGIT LED SPEED DISPLAY
- 12" H X 16" X 8" W

new!



UPRIGHT CASE

\$299⁹⁵

- SPACE SAVING DESIGN HOLDS ALL SIZES OF MOTHERBOARDS AND INCLUDES
- 250W POWER SUPPLY - MOUNTS FOR 3 FLOPPY & 4 HARD DRIVES
- TURBO & RESET SWITCH - LED SPEED DISPLAY - POWER & DISK LED'S
- ALL HARDWARE, FACEPLATES & SPEAKER

CASE-100		
CASE-FLIP	FOR 8088 MB'S	\$39.95
CASE-SLIDE	FOR 8088 MB'S	\$39.95
CASE-70	FOR 286 MB'S	\$89.95
CASE-50	FOR MINI 286 MB'S	\$59.95
CASE-JR	MINI-286 W/150W PS	\$149.95



QUALITY KEYBOARDS

STANDARD KEYBOARDS:

- BTC-5060 AUTOSENSE FOR XT/AT \$59.95
- MAX-5060 WITH TACTILE FEEDBACK \$64.95

ENHANCED KEYBOARDS:

- BTC-5339 AUTOSENSE FOR XT/AT, AUTOREPEAT \$69.95
- K103-A AUDIBLE "CLICK" STYLE \$84.95
- MAX-5339 MAXI-SWITCH W/TACTILE FEEDBACK \$84.95

MODULAR CIRCUIT TECHNOLOGY

DRIVE CONTROLLERS:

- MCT-FDC FLOPPY DISK CONTROLLER \$29.95
- MCT-FDC-HD 1.44MB FLOPPY CONTROLLER \$49.95
- MCT-HDC HARD DISK CONTROLLER \$79.95
- MCT-RLL RLL CONTROLLER \$89.95
- MCT-FH FLOPPY/HARD CONTROLLER \$139.95
- MCT-AFH 286/386 FLOPPY/HARD \$149.95
- MCT-AFH-RLL 286/386 RLL CONTROLLER \$199.95

DISPLAY ADAPTOR CARDS:

- MCT-MCP MONOCHROME GRAPHICS \$59.95
- MCT-CG COLOR GRAPHICS ADAPTOR \$49.95
- MCT-EGA ENHANCED GRAPHICS ADAPTOR \$149.95
- MCT-VGA-8 8 BIT VGA, ANALOG OUTPUT \$169.95
- MCT-VGA-16 16 BIT VGA, ANALOG OUTPUT \$249.95
- MCT-MGMIO MONOGRAPHICS MULTI I/O \$119.75
- MCT-MGAIO 286/386 MONOGRAPHICS I/O \$99.95

MULTIFUNCTION CARDS:

- MCT-MIO MULTI I/O FLOPPY CONTROLLER \$79.95
- MCT-IO MULTI I/O CARD \$59.95
- MCT-AMF 286/386 MULTIFUNCTION \$139.95
- MCT-AIO 286/386 MULTI I/O CARD \$59.95

MEMORY CARDS:

- MCT-RAM 576K RAM CARD \$59.95
- MCT-EMS EXPANDED MEMORY CARD \$129.95
- MCT-AEMS 286/386 EMS CARD \$139.95

150MB ESDI DRIVE KIT

- 5-1/4" HARD DISK, FLOPPY/HARD CONTROLLER, CABLES, MOUNTING HARDWARE & SOFTWARE 1355-PKG

1.44MB 3-1/2" DRIVE \$99⁹⁵

- ULTRA HIGH DENSITY
- READ/WRITE 720K DISKS, TOO
- FDD-1.44X BLACK FACEPLATE
- FDD-1.44A BEIGE FACEPLATE
- FDD-1.44 SOFT SOFTWARE DRIVER \$19.95

1/2 HEIGHT FLOPPY DISK DRIVES:

- FD-55B 5-1/4" TEAC DS/DD 360K \$99.95
- FD-55G 5-1/4" TEAC DS/HD 1.2M \$129.95
- FDD-360 5-1/4" DS/DD 360K \$69.95
- FDD-1.2 5-1/4" DS/HD 1.2M \$95.95

MOTHERBOARDS

20MHZ 386 \$699

- 16/20 MHZ
- 16 MB RAM CAPACITY - 8MB ON-BOARD(O.K), 8 MB RAM CARD
- USES 256K OR 1MB SIP RAMS
- 8 SLOTS: 1X32-BIT RAM
- 2X 8-BIT & 5X 16-BIT
- MEMORY INTERLEAVING
- AMI BIOS - XT-SIZE BOARD

MCT-M386-20		
MCT-C386-25	25MHZ MINI 386 W/CACHE	\$1499.00
MCT-M386-M	8MB RAM CARD (OK)	\$149.95
MCT-386MB20	10/20MHZ 386	\$799.00
MCT-386MB25	10/25MHZ 386	\$999.00
MCT-386-M	8MB RAM CARD (OK)	\$149.95

10MHZ MINI-286

- AT COMPATIBLE - KEYBOARD SELECTABLE 6/10MHZ
- EXPANDABLE TO 4MB ON-BOARD WITH 1MB DRAMS (OK)
- SIX 16-BIT & TWO 8-BIT SLOTS - AMI BIOS - LED SUPPORT

MCT-M286		
MCT-M286-12	8/12MHZ MINI-286	\$249.95
MCT-M286-16	8/16MHZ 286	\$369.95
MCT-M286-20	10/20MHZ 286	\$429.95
MCT-XMB	STANDARD 4.77MHZ 8088	\$87.95
MCT-TURBO	4.77/8MHZ 8088	\$95.95
MCT-TURBO-10	4.77/10MHZ SINGLE CHIP 8088	\$99.00

EPROM PROGRAMMER \$129⁹⁵

- PROGRAMS 27XX AND 27XXX EPROMS UP TO 27512
- SUPPORTS VARIOUS PROGRAMMING FORMATS & VOLTAGES
- SPLIT OR COMBINE CONTENTS OF SEVERAL EPROMS OF DIFFERENT SIZES
- READ, WRITE, COPY, BLANK CHECK & VERIFY
- SOFTWARE FOR HEX AND INTEL HEX FORMATS



MODULAR PROGRAMMING SYSTEM

INTEGRATED MODULAR SYSTEM EASILY EXPANDS! ALL MODULES USE A COMMON HOST ADAPTOR CARD—USE JUST ONE SLOT TO PROGRAM EPROMS, PROMS, PALS & MORE

HOST ADAPTOR CARD \$29.95

- UNIVERSAL INTERFACE FOR ALL THE PROGRAMMING MODULES!
- SELECTABLE ADDRESSES PREVENTS CONFLICTS
- MOLDED CABLE



UNIVERSAL MODULE \$499.95

- PROGRAMS EPROMS, EEPROMS, PALS, BI-POLAR PROMS, 8748 & 8751 SERIES DEVICES: 16V8 AND 20V8 GALS (GENERIC ARRAY LOGIC) FROM LATTICE, NS, SGS
- TESTS TTL, CMOS, DYNAMIC & STATIC RAMS - LOAD DISK, SAVE DISK, EDIT, BLANK CHECK, PROGRAM, AUTO READ MASTER, VERIFY AND COMPARE
- TEXT/OOL SOCKET FOR 3" TO 6" W. IC'S (8-40 PINS)



EPROM MODULE \$119.95

- PROGRAMS 24-32 PIN EPROMS, CMOS EPROMS & EEPROMS FROM 16K TO 1024K
- HEX TO OBJ CONVERTER - AUTO, BLANK CHECK/PROGRAM/VERIFY - VPP 5, 12.5, 12.75, 13, 21 & 25 VOLTS
- NORMAL, INTELLIGENT, INTERACTIVE & QUICK PULSE PROGRAMMING ALGORITHMS

- MOD-MEP 4 4-EPROM PROGRAMMER \$169.95
- MOD-MEP-8 8-EPROM PROGRAMMER \$259.95
- MOD-MEP-16 16-EPROM PROGRAMMER \$499.95

DIGITAL IC MODULE \$129.95

- TESTS TTL, CMOS, DYNAMIC & STATIC RAM
- AUTO SEARCH FOR UNKNOWN PART NUMBERS
- USER-PROGRAMMABLE TEST PROCEDURES

PAL MODULE \$249.95

- PROGRAMS MMI, NS, TI 20 & TI 24 PIN DEVICES
- BLANK CHECK, PROGRAM, AUTO, READMASTER, VERIFY & SECURITY FUSE BLOW

- MOD-MPL CUPL SOFTWARE—ENTRY-LEVEL PAL DEV. KIT, MOD-MPL-SOFT \$99.95



JDR MICRODEVICES, 2233 BRANHAM LANE, SAN JOSE 95124
 LOCAL (408) 559-1200 FAX (408) 559-0250 TELEX 171-110
 RETAIL STORE: 1256 S. BASCOM AVE., SAN JOSE, CA
 (408) 947-8881 HOURS: M-F 9-7 SAT. 9-5 SUN. 12-4

Terms: Minimum order \$10.00. For shipping & handling include \$3.50 for ground and \$4.50 for air. Orders over 1 lb and foreign orders may require additional shipping charges—please contact the sales department for the amount. CA residents must include applicable sales tax. Prices subject to change without notice. We are not responsible for typographical errors. We reserve the right to limit quantities and to substitute manufacturer. All merchandise subject to prior sales. A full copy of our terms is available upon request. Items pictured may only be representative.

ORDER TOLL FREE 800-538-5000

COPYRIGHT 1989 JDR MICRODEVICES

CIRCLE 113 ON FREE INFORMATION CARD
 DEALERS CIRCLE 170 ON FREE INFORMATION CARD

www.americanradiohistory.com

VALUE-PRICED TEST EQUIPMENT ALL WITH A 2 YEAR WARRANTY!

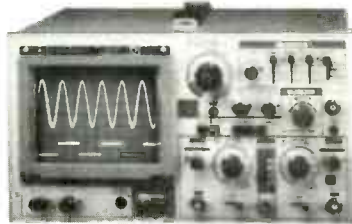

35 MHZ DUAL TRACE OSCILLOSCOPE \$499⁹⁵
 • WIDE BAND WIDTH • VARIABLE HOLDOFF
 MODEL-3500 (SHOWN)

20 MHZ DUAL TRACE OSCILLOSCOPE \$389.95
 • TV SYNC FILTER • COMPONENTS TESTER
 MODEL 2000

THE ULTIMATE 3.5 DIGIT DMM \$79⁹⁵
 • BASIC DC ACCURACY ±0.25%
 • 34 RANGES
 • TEMP. TRANSISTOR & RESISTANCE FEATURES
 DMM-300 (SHOWN)



3.5 DIGIT FULL FUNCTION DMM \$49.95
 • BASIC DC ACCURACY ±0.25%
 • 22 RANGES
 DMM-200 \$49.95

3.5 DIGIT POCKET SIZE DMM \$29.95
 • BASIC DC ACCURACY ±0.5% • 14 RANGES
 DMM-100

3.5 DIGIT PROBE TYPE DMM \$54⁹⁵
 • AUTORANGING
 • AC/DC 2V - 500V
 • RESISTANCE: 2K-2M
 DPM-1000 (SHOWN)



HIGH/LOW LOGIC PROBE \$17.95
 • DETECTS TTL/CMOS LOGIC STATES
 • MEMORY FUNCTION FREEZES DATA FOR LATER USE
 LP-2800

PULSER PROBE FOR QUICK DEBUGGING \$19.95
 • INJECTS PULSE INTO TEST CIRCUIT-VARIABLE WIDTH
 • TTL, DTL, TRL, HTL, HINIL, MOS, & CMOS COMPATIBLE
 LP-540



JIM'S BARGAIN HUNTERS CORNER

Jim Wharton
 JDR's VP Sales

\$219⁹⁵

JT-FAX INTERNAL FAX CARD

REGULARLY \$279.00



THIS FAX BOARD WON'T TIE UP YOUR COMPUTER! ITS MEMORY RESIDENT SOFTWARE WAITS IN THE BACKGROUND TO SEND OR RECEIVE FAXES—LETS YOU USE YOUR COMPUTER UNTIL A FAX IS ACTUALLY SENT OR RECEIVED. COMPATIBLE WITH SEVERAL PAGE SCANNERS—VERY USEFUL WHEN SENDING SCANNED INPUT SUCH AS LOGOS OR SIGNATURES.

- 4800BPS COMMUNICATIONS RATE
- RAM RESIDENT SOFTWARE
- COMPATIBLE WITH PC/XT/AT
- USES FAX, ASCII OR PC PAINT FILES
- HALF CARD SIZE • MENU-DRIVEN SOFTWARE

JT-FAX EXPIRES 11/31/89

JDR Microdevices®
 2233 BRANHAM LANE, SAN JOSE, CA 95124

ORDER TOLL-FREE 800-538-5000

LOCAL (408) 559-1200 FAX (408) 559-0250 TELEX 171-1110

CIRCLE 113 ON FREE INFORMATION CARD
 DEALERS CIRCLE 170 ON FREE INFORMATION CARD

ADVERTISING INDEX

RADIO-ELECTRONICS does not assume any responsibility for errors that may appear in the index below.

Free Information Number	Page		
	157	Print Products Int'l	32
106	85	AMC Sales	78
152	73	Ace Communications	156
75	75	Ace Products	79
107	98	All Electronics	159
—	90	Amazing Concepts	79
106	99	American Design Components	149,151
67	72	Banner Technical Books	16, CV3
77	7	B & K	74
109	36	C & S Sales	74
70	95	CEI	—
60	11, 23	CIE	Star Circuits
147	72	Chase International	32
153	75	Cheneko	83
—	88	Command Productions	Synergetics
141	35	Communications Specialist	—
55	33	Contact East	Tektronix
58	24	Cook's Institute	18
69	24	Crystek	123
136	33	Datak Corp.	Test Probes
127	75	Deco Industries	250-254
82	100	Digi-Key	Test Probes
135	90	Electronic Goldmine	27
—	87	Electronic Tech Today	64
121	CV2	Fluke Manufacturing	Video-Link
—	CV4	Fordham	92
155	13	Global Specialties	139
—	17	Grantham College	26
148	3	Heath Instruments	140
86	26	Heathkit	WPT Publications
138	95	International Components Corp.	35
113,170	102, 103	JDR Microdevices	
113,170	104	JDR Microdevices	
114	96	Jameco	
104	73	Jan Crystals	
137	94	Jinco Computers	
—	22	King Wholesalers	
53	89	MD Electronics	
93	101	Mark V. Electronics	
61	83	Microprocessors Unltd.	
154	34	Movietime	
—	5, 31	NRI Schools	
158	25	Optoelectronics	
—	91	Pacific Cable	
56	94	Parts Express	
101	12	Pomona Electronics	

Gernsback Publications, Inc.
 500-B Bi-County Blvd.
 Farmingdale, NY 11735
 1-516-293-3000
 Fax 1-516-293-3115
 President: **Larry Steckler**
 Vice President: **Cathy Steckler**

For Advertising ONLY
 1-516-293-3000
 Fax 1-516-293-3115
Larry Steckler
 publisher
Arline Fishman
 advertising director
Lisa Strassman
 credit manager
Christina Estrada
 advertising assistant

SALES OFFICES

EAST/SOUTHEAST
Stanley Levitan
 Eastern Sales Manager
 Radio-Electronics
 259-23 57th Avenue
 Little Neck, NY 11362
 1-718-428-6037, 1-516-293-3000

MIDWEST/Texas/Arkansas/Okla.
Ralph Bergen
 Midwest Sales Manager
 Radio-Electronics
 540 Frontage Road—Suite 339
 Northfield, IL 60093
 1-312-446-1444
 Fax 1-312-446-8451

PACIFIC COAST/ Mountain States
Marvin Green
 Pacific Sales Manager
 Radio-Electronics
 5430 Van Nuys Blvd. Suite 316
 Van Nuys, CA 91401
 1-818-986-2001
 Fax 1-818-986-2009



Dynamically Analyze Stereo Audio Power Amplifiers To A Full 500 Watts To IHF/EIA* Specifications In Less Than 1/2 The Time It Now Takes

The PA81 Is Truly The "Missing Link In Audio Servicing"

Introducing the "Missing Link In Audio Servicing," with the NEW PA81 Stereo Power Amplifier Analyzer™ from Sencore Electronics. The PA81 provides everything you need for power amplifier analyzing integrated into one complete package, with:

- **Twin Frequency Compensated Autoranged Wattmeters:** 250 watts per channel (500 watts if paralleled), and listen to audio clarity with built-in volume control.
- **Built-in IHF/EIA Testing Components At Your Fingertips:** 2, 4, 8, 16, and 32 ohm-zero reactance loads, and all specified bandpass audio filters.
- **Measure RMS Volts And dB As You Trace Through Circuits:** Plus, programmable dB to measure stage gain.
- **Test Intermittents To Prevent Amplifier Damage:** Built-in DC balance test, automatically opens loads.
- **Test Audio Line Levels To Make Sure The Driver Input Signal Is Correct:** Check turntables, AM tuners, FM tuners, TV stereo demodulator outputs, CD players, etc. for standard line levels.
- **Monitor Stereo Separation To 126 dB:** Monitor, troubleshoot, or align AM-FM or TV Stereo separation circuits.

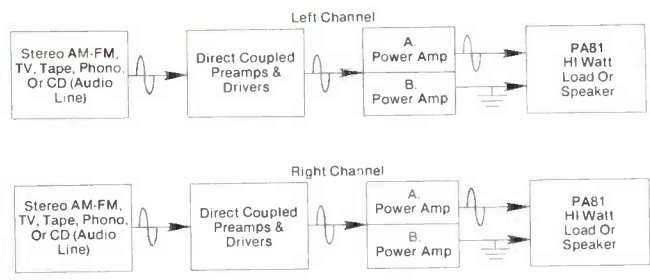

Walk troubles out of any power amplifier stage, step by step, with the PA81.

SENCORE
3200 Sencore Drive, Sioux Falls, South Dakota 57107

Call 1-800-SENCORE
(736-2673)
In Canada Call 1-800-851-8866

Ask About A 10 Day Video Preview



* IHF—Institute Of High Fidelity
EIA—Electronics Industries Association

CIRCLE 149 ON FREE INFORMATION CARD

TROUBLESHOOTERS!

PRECISION HAND-HELD INSTRUMENTS



B & K Precision Test Bench™

- 41 range voltmeter • Ammeter
- Ohmmeter • Frequency counter
- Capacitance meter • Logic probe
- Transistor & diode tester • Extra large LCD display

Model 388-HD
Reg. \$129.95 **\$119⁰⁰**



SCOPE Digital Multimeter

- 11 function, 38 ranges including Logic Level Detector, Audible and Visual Continuity, Capacitance & Conductance measurements

Model DVM-638
Reg. \$87.50 **\$79⁹⁵**



SCOPE 3 1/2 Digit LCD Mini Meter

- 0.5% accuracy • AC/DC Voltage
- DC current • Resistance • Diode test • 300 hrs. battery life
- Overload protection: DC-500V, AC-350V, ohms - 250V DC/AC

Model DVM-630
Reg. \$50.00 **\$32⁵⁰**



SCOPE Hand-Held 3 1/2 Digit LCR Meter

- Measure capacitance, resistance and inductance • Overload protection • Includes test leads, test clips, 9V battery and spare fuse

Model LCR-680
\$119⁹⁵



SCOPE Pocket Size Audio Signal Generator

- Sine/square wave patterns • 20Hz to 150 KHz • Battery operated
- Frequency accuracy ±3% (or less)
- Output 12V rms max (no load)
- Low battery indicator • Test leads & 9V battery included

Model RC-555
Reg. \$69.95 **\$59⁹⁵**

DUAL TRACE OSCILLOSCOPES



A.W. SPERRY 20 MHz OSCILLOSCOPE

- Built-in component checker
- Z-axis input • Low power consumption • TV Video sync filter
- High-sensitivity XY mode
- Front panel trace rotator
- Includes 2 test probes

Model 620C **\$349⁹⁵**

HITACHI 35 MHz OSCILLOSCOPE

- 19 calibrated sweeps • 6" CRT with internal graticule, scale illumination & photographic bezel
- Auto focus
- XY operation • TV sync separation • Includes 2 probes (10:1 and 1:1)

Model V-355 **\$598⁰⁰**
Reg. \$899.95



TRAINERS AND TOOLS

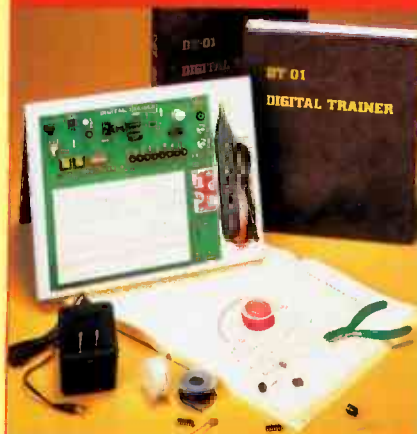

SCOPE DIGITAL TRAINER

- Learn logic circuits and equipment design • Connects to oscilloscopes, signal generators and more • Logic probe included • Solderless breadboard and crib sheets help you build almost any circuit
- Runs off 4 "AA" batteries or AC adapter (included)

Model DT-01
Reg. \$149.95 **\$110⁰⁰**

ALL PURPOSE 92-PC. TOOL CASE

- Complete kit for home, workshop and auto • Includes 52-pc. socket set with extenders
- 2 tool pallets with roomy rear storage compartments
- Attractive, rugged carry case

Model FTK-28
Reg. \$169.95 **\$129⁹⁵**

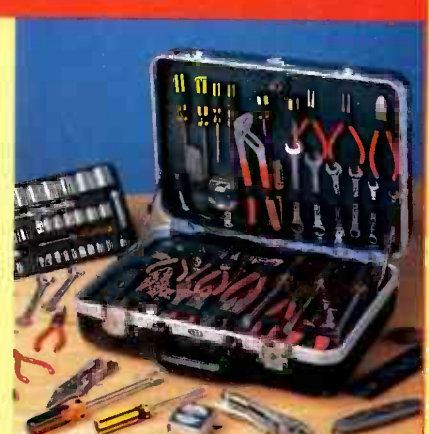

Fordham TOLL FREE 800-645-9518

260 Motor Parkway
Hauppauge, New York 11788

ASK FOR YOUR FREE CATALOG

(In NY State 800-832-1446)



Money orders, checks accepted
C.O.D.'s require 25% deposit.

Service & Shipping Charge Schedule Continental U.S.A.

FOR ORDERS	ADD
\$0-50	\$4.50
\$51-100	\$6.00
\$101-200	\$8.00
\$201-300	\$9.00
\$301-400	\$10.00
\$401-500	\$12.00
\$501-750	\$15.00
\$751-1,000	\$17.50
\$1,001-1,250	\$20.00
\$1,251-1,500	\$25.00
\$1,501-2,000	\$30.00
\$2,001 and Up	\$35.00