

48783 **Radio- HIGH DEFINITION TV
THE LATEST NEWS**

\$2.25 AUGUST 1987
IN CANADA \$2.75

Electronics®

TECHNOLOGY - VIDEO - STEREO - COMPUTERS - SERVICE

BUILD THIS SCA/FM STEREO RECEIVER

Listen to hidden signals
on the FM band

THE ABC's of CET

What it means
to be a Certified
Electronics Technician

BUILD A UNIVERSAL TIMER

For automated
control of your
line-powered devices

TRANSISTOR AMPLIFIERS

A design primer

ROBOT CONTROL LANGUAGE

Software that makes
your robot go!

COMPUTERDIGEST

IBM's new PS/2

A
GERNSBACK
PUBLICATION

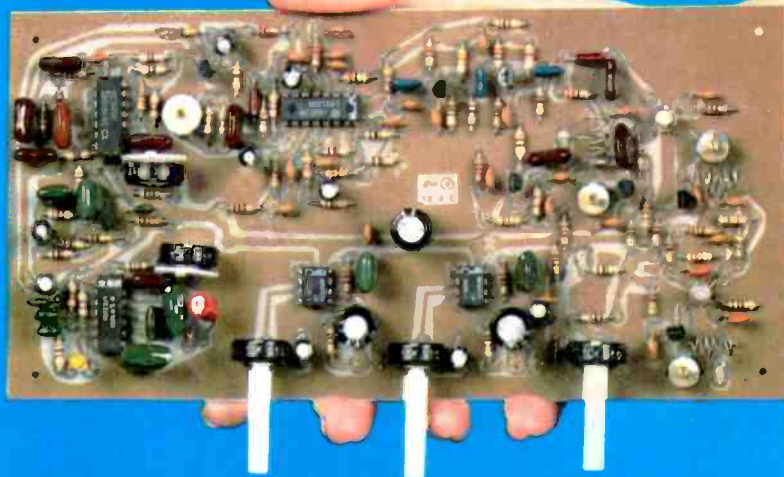

SCA/FM STEREO RECEIVER



VOLUME



PHONES

PLUS:

- ★ Video News
- ★ New Products
- ★ Satellite TV
- ★ Audio Update



NOW GET SCOPE, COUNTER AND DMM INPUT ALL AT ONCE THROUGH ONE PROBE!

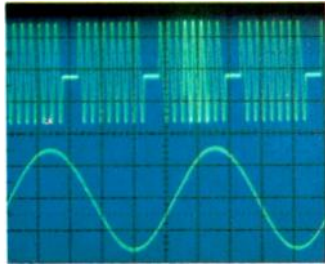

Gated frequency measurement. B sweep triggering during the intensified portion of the A sweep. Intensified portion frequency is measured with the counter/timer/DMM.

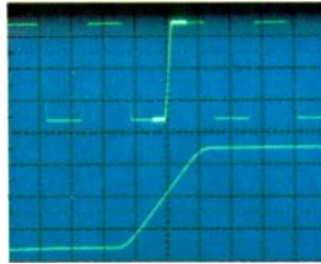

Delay time measurement. Delay time from the start of A sweep to the start of the B sweep is measured with *crystal accuracy*.

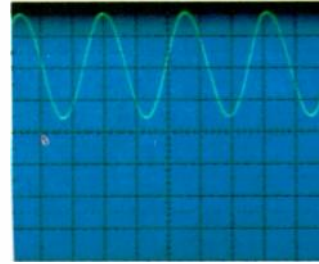

Channel 1 dc volts measurement. The average dc component of a waveform is measured directly through channel 1 with direct digital fluorescent readout.

The Tek 2236 combines 100 MHz, dual timebase scope capability with counter/timer/DMM functions integrated into its vertical, horizontal and trigger systems. For the same effort it takes to display a waveform you can obtain digital readout of frequency, period, width, totalized events, delay time and Δ -time to accuracies of 0.001%.

The same probe is used to provide input for the CRT display and the digital measurement system, resulting in easy set-up, greater measurement confidence and reduced circuit loading. Probe tip volts can also be measured through the Ch 1 input.

Precision measurements at the touch of a button.

Auto-ranging frequency, period, width and gated measurements are push-button-simple. And the 2236 offers an independent floating 5000 count, auto-ranging multimeter with side inputs for DC voltage mea-



Bandwidth	100 MHz
No of Channels	2 + Trig. View
Max. Sweep Speed	5 ns/div
Digital Readout Features	Direct Ch 1 Voltage Meas. 0.5% DC; 2.0% AC RMS Resistance: .01 Ω to 200 Meg Ω Continuity/Temp: Audible/C $^{\circ}$ or F $^{\circ}$ Totalizing Counter: — 1 counts to 8,000,000 Direct Freq. Meas: 100 MHz to 0.001% acc. Period, Width Meas: 10 ns with 10 ps max. resolution
Timing Meas. Accuracy	.001% (delay and Δ -time with readout)
Trigger Modes	P-P Auto, Norm, TV Field, TV Line, Single Sweep
Weight	7.3 kg (16.2 lb)
Price	\$2650
Warranty	3-year including CRT (plus optional service plans to 5 years)

surements to 0.1%.

A built-in, auto-ranging ohmmeter provides resistance measurements from 0.01 Ω to 2G Ω — as well as audible continuity. Automatic diode/junction detection and operator prompts serve to simplify set-up and enhance confidence in your measurements.

The 2236: scope, counter, timer, DMM plus a 3-year warranty — all for just \$2,650.

Contact your nearest distributor or call Tek toll-free. Technical personnel on our direct-line will answer your questions and expedite delivery. Orders include probes, 30-day free trial and service worldwide.

Call Tek direct:

1-800-433-2323 for video tape or literature,

1-800-426-2200 for application assistance or ordering information.

In Oregon, call collect:
1-627-2200

Tektronix
COMMITTED TO EXCELLENCE

BUILD THIS

- 39 SCA RECEIVER**
Hear the hidden signals on the FM band.
Rudolf Graf and William Sheets
- 45 VERSATILE DIGITAL TIMER**
Precisely controls any AC-powered device in your home.
Ross Ortman
- 57 R-E ROBOT**
Part 9. Programming the robot.
Steven E. Sarns
- 75 PC SERVICE**
Direct-etch foil patterns for the digital timer.

TECHNOLOGY

- 48 HIGH DEFINITION TV**
The first major change in television since the addition of color is on its way!
Josef Bernard
- 52 CERTIFICATION FOR ELECTRONICS TECHNICIANS**
The more you learn, the more you can earn.
W. Clem Small, CET

CIRCUITS AND COMPONENTS

- 55 TRANSISTOR AMPLIFIER DESIGN**
A basic design that solves many problems.
Jack Cunkleman

DEPARTMENTS

- 6 VIDEO NEWS**
What's new in this fast-changing field.
David Lachenbruch
- 16 EQUIPMENT REPORTS**
Regency Informant Scanning Receiver
- 26 COMMUNICATIONS CORNER**
Diversity reception and the wireless microphone.
Herb Friedman
- 28 SATELLITE TV**
HDTV standards.
Bob Cooper, Jr.
- 30 DESIGNER'S NOTEBOOK**
Logic family translation.
Robert Grossblatt
- 32 AUDIO UPDATE**
Expert answers.
Larry Klein

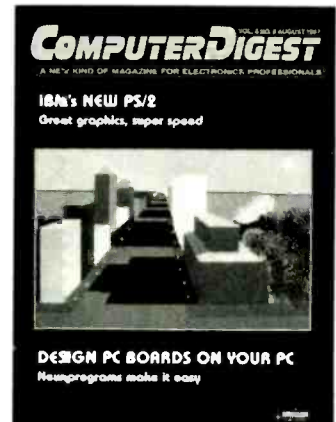

PAGE 61



The most important change in TV technology since it was invented is just about to happen.

JOSEF BERNARD

When you think of television, you probably think of the familiar, boxy sets that have been the mainstay of the living room for decades. But now, a new breed of television is being introduced to the market. High Definition Television (HDTV) is the next major change in television technology since the addition of color. It offers a much sharper, more detailed picture than standard television, and it's set to revolutionize the way we watch TV.

HDTV is a technology that has been in development for years. It uses a different scanning method than standard TV, allowing for a much higher resolution of lines. This results in a picture that is much clearer and more detailed. In fact, HDTV is so sharp that it can be used for medical imaging and scientific research.

While HDTV is still in the early stages of development, it is expected to become a major part of the television market in the near future. As more people become aware of the benefits of HDTV, demand for these sets is expected to rise significantly.

PAGE 48

AND MORE

- 100 Advertising and Sales Offices**
- 100 Advertising Index**
- 8 Ask R-E**
- 101 Free Information Card**
- 12 Letters**
- 82 Market Center**
- 21 New Lit**
- 24 New Products**
- 4 What's News**

ON THE COVER



The FM band abounds with hidden signals. Called SCA broadcasts or transmissions, some carry background music for stores, offices, and restaurants; some carry data for personal and commercial computer users; and some offer special interest programming for the handicapped and other groups. This month, we tell where those hidden signals are, and what makes them possible. Then we'll show you a receiver that will let you tune into the hidden world of FM radio. The story begins on page 39.

COMING NEXT MONTH

THE SEPTEMBER ISSUE IS ON SALE AUGUST 4

BUILD THE VIDEO PALETTE

Add special color effects to a video signal.

BUILD AN UNINTERRUPTABLE POWER SUPPLY

This 40-watt back-up supply kicks in at the first sign of trouble.

CELLULAR TELEPHONE TECHNOLOGY

Learn about the technology that's revolutionized mobile telephones.

R-E ROBOT

Part 10 deals with robot applications.

SCR/TRIAC COOKBOOK

Practical SCR/Triac circuits for your next project.

As a service to readers, RADIO-ELECTRONICS publishes available plans or information relating to newsworthy products, techniques and scientific and technological developments. Because of possible variances in the quality and condition of materials and workmanship used by readers, RADIO-ELECTRONICS disclaims any responsibility for the safe and proper functioning of reader-built projects based upon or from plans or information published in this magazine.

Since some of the equipment and circuitry described in RADIO-ELECTRONICS may relate to or be covered by U.S. patents, RADIO-ELECTRONICS disclaims any liability for the infringement of such patents by the making, using, or selling of any such equipment or circuitry, and suggests that anyone interested in such projects consult a patent attorney.

RADIO-ELECTRONICS, (ISSN 0033-7862) August 1987. Published monthly by Gernsback Publications, Inc., 500-B Bi-County Boulevard, Farmingdale, NY 11735 Second-Class Postage paid at Farmingdale, NY and additional mailing offices. Second-Class mail registration No. 9242 authorized at Toronto, Canada. One-year subscription rate U.S.A. and possessions \$16.97, Canada \$22.97, all other countries \$25.97. All subscription orders payable in U.S.A. funds only, via international postal money order or check drawn on a U.S.A. bank. Single copies \$2.25. © 1987 by Gernsback Publications, Inc. All rights reserved. Printed in U.S.A.

POSTMASTER: Please send address changes to RADIO-ELECTRONICS, Subscription Dept., Box 55115, Boulder, CO 80321-5115

A stamped self-addressed envelope must accompany all submitted manuscripts and/or artwork or photographs if their return is desired should they be rejected. We disclaim any responsibility for the loss or damage of manuscripts and/or artwork or photographs while in our possession or otherwise.

Radio-Electronics

Hugo Gernsback (1884-1967) founder
M. Harvey Gernsback,
editor-in-chief, emeritus

Larry Steckler, EHF, CET,
editor-in-chief
and publisher

EDITORIAL DEPARTMENT

Art Kleiman, editorial director
Brian C. Fenton, managing editor
Carl Laron, WB2SLR, associate editor
Jeffrey K. Holtzman,
assistant technical editor
Robert A. Young, assistant editor
Julian S. Martin, editorial associate
Byron G. Wels, editorial associate
M. Harvey Gernsback,
contributing editor
Jack Darr, CET, service editor
Robert F. Scott,
semiconductor editor
Herb Friedman,
communications editor
Bob Cooper, Jr. satellite-TV editor
Robert Grossblatt, circuits editor
Larry Klein, audio editor
David Lachenbruch,
contributing editor
Richard D. Fitch,
contributing editor
Teri Scaduto, editorial assistant

PRODUCTION DEPARTMENT

Ruby M. Yee, production director
Robert A. W. Lowndes,
editorial production
Andre Duzant, technical illustrator
Karen Tucker, advertising production
Marcella Amoroso, production traffic

CIRCULATION DEPARTMENT

Jacqueline P. Cheeseboro,
circulation director
Wendy Alanko,
circulation analyst
Theresa Lombardo,
circulation assistant

Typography by Mates Graphics

Cover Foto by Bill Peterson,
Design Color Labs

Radio-Electronics is indexed in
Applied Science & Technology Index
and *Readers Guide to Periodical Literature*.

Microfilm & Microfiche editions are
available. Contact circulation department
for details.

Advertising Sales Offices listed
on page 100.



More Functions. Smaller Budget.

Beckman Industrial Circuitmate™ DMMs put hFE, Logic, Capacitance, Frequency and True RMS In Your Hand. For Less.

Get more, for less. It's a simple definition of value. For DMMs, value means finding the combination of capabilities that meets your needs at the right price. Without losing sight of accuracy and reliability. If you want more functions at a low price, Beckman Industrial's Circuitmate™ Digital Multimeters are the best value around.

From the pocket-sized DM20L to the DM850, with true RMS capability and accuracy to 0.05% ± 1 digit, Circuitmate DMMs give you the functions you need.

For instance, the DM20L puts both a Logic Probe, a transistor gain function (hFE), and a full range of DMM functions in the palm of your hand. For only \$69.95.

Then there's the DM25L. Where else does \$89.95 buy you a Logic Probe, capacitance measurement, transistor gain function (hFE), and 24 DMM ranges including resistance to 2000 megohms? Nowhere else.

When high accuracy counts, there's the DM800 with a 4 1/2 digit display. The DM800

DM20L Pocket-Size w/Logic \$69.95*

TTL Logic Probe: 20MHz
Hi/lo/off indications
Detects 25nS pulse widths

hFE (NPN or PNP):
1 range (1000)

DMM: Input Impedance—
10 Megohms
DCA/ACA-5 ranges
(200µA to 2A)

Ohms-8 ranges (200 ohms
to 2000 Megohms)

Continuity beeper

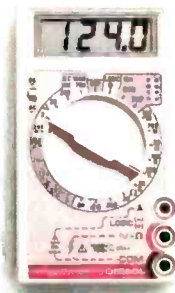

also gives you frequency counting. A full-function DMM, and more, doesn't have to cost over \$169.95. If it's a Circuitmate DM800.

Or, for a few dollars more, get true RMS (AC coupled) to let you accurately measure non-sinusoidal AC waveforms, and all the capability of the DM800, in the DM850.

Of course, there's a whole range of Circuitmate DMMs and service test instruments, including the DM78 autoranger that

DM850 True RMS

4 1/2 digits. DCV accuracy is .05% + 3 digits

True RMS

Frequency counter to 200KHz

Data Hold display capability

Continuity beeper

Built-in bail

Anti-skid pads

Price: DM850 (True RMS) . . . \$219.95*
DM800 (Average) . . . \$169.95*

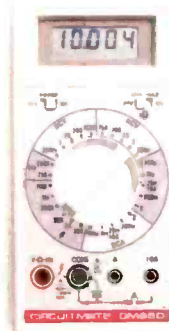

fits in a shirt pocket, yet gives you a full size 3 1/2 digit, 1/2" readout. Not to mention a complete line of accessories like test leads, current clamps, even probes that can extend your DMMs range and sensitivity. All designed to work flawlessly with your Beckman Industrial Circuitmate DMM.



See your Beckman Industrial distributor and discover more DMM performance for less.

*Suggested list price (US\$) with battery, test leads and manual



EMERSON



DM25L Capacitance, Logic, hFE \$89.95*

TTL Logic Probe: 20MHz
Hi/lo/off indications
Detects 25nS pulse widths

Capacitance: 5 ranges
(2nF to 20µF)

hFE (NPN or PNP):
1 range (1000)

Continuity beeper

Built-in bail

Anti-skid pads

Beckman Industrial™

Beckman Industrial Corporation Instrumentation Products Division
A Subsidiary of Emerson Electric Company
9885 Ruffin Rd., San Diego, California 92123-0908
(619) 565-4415 • FAX (619) 268-0172 • TLX 249031

© 1987 Beckman Industrial Corporation

CIRCLE 98 ON FREE INFORMATION CARD

WHAT'S NEWS

New instrument measures tape surface magnetism

A new device that could lead to improved operation of many devices using magnetic tape has been developed by scientists at the Argonne National Laboratory. The instrument, called a polarized-neutron reflectometer, uses neutrons to measure magnetic fields over microscopic depths at the surface of materials.

"The instrument has already been used to measure the response of new recording materials to magnetic fields," says Gian Fletcher of Argonne. "Better infor-

mation in this area could lead to improved magnetic recording technologies."

"The trick," Fletcher said, "was to make the probe as sensitive as possible to magnetic fields at the surface. This was accomplished by sending the neutrons nearly parallel to the surface, so they graze it." The instrument can measure magnetic fields within .0002-inch of the surface of the material. It can detect a magnetic field change over a distance as small as a billionth of an inch.



GIAN P. FLETCHER, ARGONNE NATIONAL LABORATORY scientist, with the polarized-neutron reflectometer that could lead to improvements in magnetic recording.

New infrared systems test gallium-arsenide wafers

The National Bureau of Standards reports two testing systems using polarized infrared light. They are expected to be especially useful in production control of gallium-arsenide (gAs) wafers.

GaAs applications are growing rapidly, but production of the near-perfect crystals needed for best performance is not as advanced as with the older silicon technology. Detecting flaws in GaAs crystals should be easier with the new systems. One can scan an entire wafer; the other uses a 75- to 600- \times microscope to view smaller portions. Both permit digital image storing and the use of false-color graphics to represent variations in characteristics that could point to potential problems.

FCC abandons Consumer Radio Service

The FCC reports that it "has declined to amend its rule to establish a Consumer Radio Service within the 462- and 467-MHz frequency segments now assigned to the General Mobile Radio Service (GMRS)." That marks the end of an FCC-sponsored plan to replace the GMRS with a service that many felt would be of far-less value.

Replies to a request for comments "failed to find any specific needs" for such a service, according to the FCC. Moreover, concern was expressed about the fate of present uses of the GMRS, including safety services provided by volunteer public service teams such as REACT (Radio Emergency Associated Communications Teams).

Consequently, the Commission concluded "that there was no reason to dislocate current GMRS users" and dropped the Consumer Radio Service concept. **R-E**

Where's Your **ELECTRONICS** Career Headed?

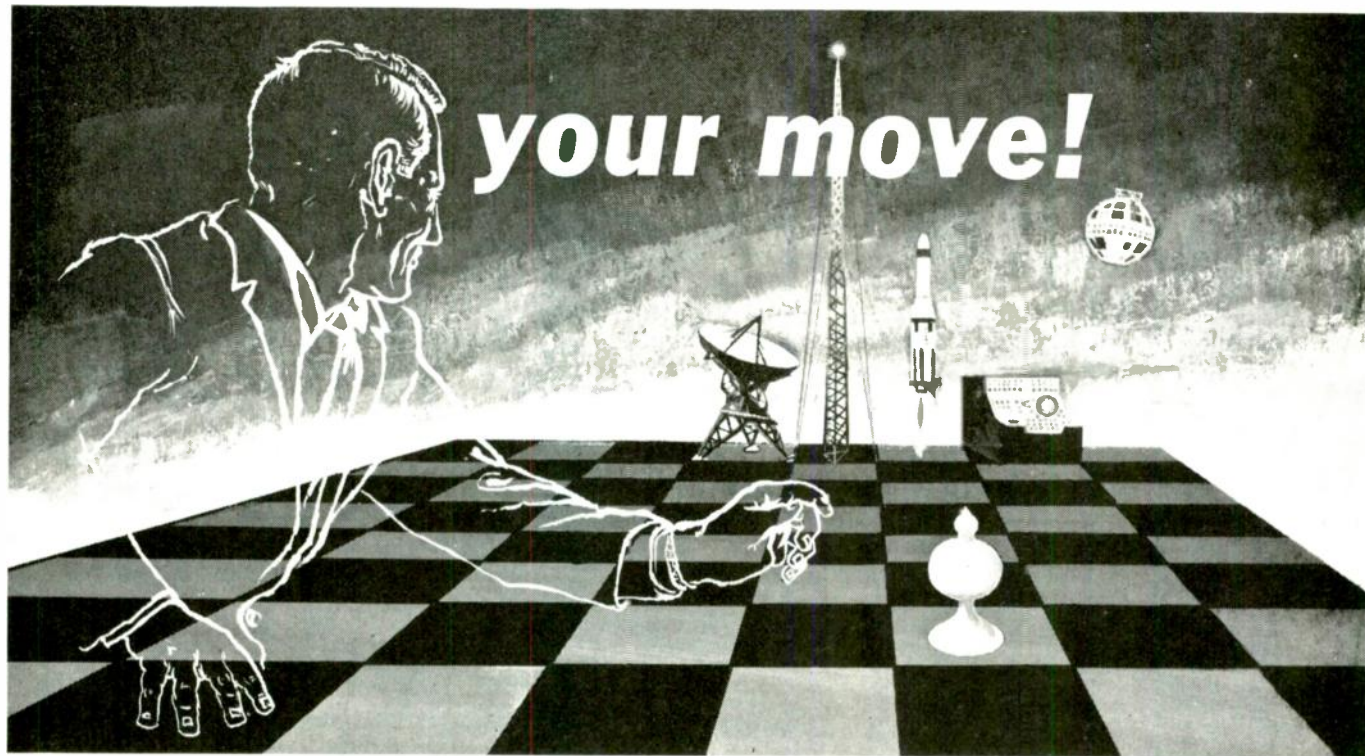

The Move You Make Today Can Shape Your Future

Yes it's your move. Whether on a chess board or in your career, you should plan each move carefully. In **electronics**, you can *move ahead* faster and further with a

B. S. DEGREE

Put professional knowledge and a COLLEGE DEGREE in your electronics career. Earn your degree through independent study at home, with Grantham College of Engineering. No commuting to class. Study at your own pace, while continuing your present job.

The accredited Grantham non-traditional degree program is intended for mature, fully employed workers who want to upgrade their careers . . . and who can successfully study electronics and supporting subjects through

INDEPENDENT STUDY, AT HOME

Free Details Available from:

Grantham College of Engineering
10570 Humbolt Street
Los Alamitos, California 90720

Independent Home Study Can Prepare You

Study materials, carefully written by the Grantham staff for independent study at home, are supplied by the College, and your technical questions related to those materials and the lesson tests are promptly answered by the Grantham teaching staff.

Recognition and Quality Assurance

Grantham College of Engineering is accredited by the Accrediting Commission of the National Home Study Council.

All lessons and other study materials, as well as communications between the college and students, are in the English language. However, we have students in many foreign countries; about 80% of our students live in the United States of America.

Grantham College of Engineering
10570 Humbolt Street, Los Alamitos, CA 90720

R-8-87

Please mail me your free catalog which explains your B.S. Degree independent-study program.

Name _____ Age _____

Address _____

City _____ State _____ Zip _____

VIDEO NEWS



DAVID LACHENBRUCH,
CONTRIBUTING EDITOR

● **TV Sets Large and Small.** TV sets with giant cathode-ray tubes are now included in many manufacturers' lines; at the other end of the spectrum are the first active-matrix LCD color sets. Active-matrix LCD's produce a picture that is vastly superior in terms of resolution and color to the passive-matrix type used in the LCD sets introduced to date.

Panasonic originally showed a sample of its 3-inch "Pocket Watch" LCD TV set almost a year ago, then shelved it because of manufacturing problems. Now it has been introduced in a somewhat different form—including stereo-FM/AM radio (with headphones). Because of the inherent expense of producing the active-matrix LCD's, as well as the high value of the Japanese Yen in relation to the Dollar, Panasonic has put a list price of \$550 on that little TV set. In addition, Toshiba plans to offer a 4-inch active-matrix LCD TV this fall, and has said it is "aiming" at a price of around \$400.

On the large screen front, several manufacturers are introducing sets with screens larger than 26 or 27 inches, but smaller than the 35-inch size produced initially by Mitsubishi, and later adopted by Sanyo, Sharp, Fisher, and Sears.

Panasonic, in its new line, is featuring a 31-inch set, as is North American Philips, which manufactures sets under the Magnavox, Philco, and Sylvania brands. Now Toshiba, the originator of the FST (Flat, Square Tube), has introduced its *FST Magnum*, a tube that measures 30 inches, diagonally, and whose face is virtually flat. The rest of the industry is choosing up sides among the various sizes. Whichever they choose, the new types are luxuries indeed, with prices ranging from \$2,000 and up.

● **Super Camcorder.** The first combination camera-recorder capable of making home movies with higher resolution than broadcast TV or videodisc has been announced by Hitachi. Hitachi says it has developed an MOS camera pickup that can produce 450 lines of horizontal resolution, which it plans to mass-produce starting this summer. Until Hitachi's development became known, it was believed that camera pickups

matching the resolution capability of the new Super-VHS system (**Radio-Electronics**, May, 1987) would be unavailable at a consumer price. Hitachi now says it will deliver a high-resolution Super-VHS camcorder this fall. RCA, whose VCR's and cameras are made by Hitachi, is expected to come out with a similar version.

● **Menu-Driven TV Sets.** Television manufacturers are borrowing from computers in providing what they see as the very latest in tuning convenience—the on-screen menu. That feature is carried to the furthest extreme in the new RCA and Magnavox lines, in which virtually every TV function may be tuned with on-screen indicators and legends. In RCA's *Dimensia* audio-video line even the FM- and AM-radio tuning is done on the TV screen. A typical TV tuning system gives on-screen indication of such functions as mono, stereo, SAP (for Second Audio Program), bass, treble, balance, input, brightness, picture, color, tint, sharpness, cable or broadcast tuning, on-off time setting, channel blackout (for parental control), and so forth. The Magnavox *Total Remote Control* system even has a novel "channel captioning" system. The user can identify each channel by its call letters or broadcast- or cable-network (HBO, CNN, etc.) affiliation, and any time that channel is displayed, the identification also is flashed on the screen.

Double-Tuner TV sets. Another innovation in the new models is the two-tuner TV set. The first digital TV models, you'll recall, had the picture-in-picture feature that superimposes a second picture in a corner of the screen, but required a second picture source, such as a VCR, to use the feature. New color-TV sets from Sony and Hitachi get around that by incorporating two tuners. That allows the viewer to watch any two channels simultaneously, switch them around, halt one to a still picture, and so forth. Interestingly, the new double-tuner picture-in-picture storage system is digital, but other processing circuits are analog. And therein lies another trend in the new models: Use digital technology where necessary to provide a special feature; otherwise stay with tried-and-true analog circuitry.

R-E

TEST EQUIPMENT THAT MEASURES UP TO YOUR SPECIFICATIONS



DMM-300 \$79.95
35 DIGIT DMM / MULTITESTER

Our best model. A highly accurate, full function DMM loaded with many extra features. Audible continuity, capacitance, transistor temperature and conductance all in one hand held meter. Temperature probe, test leads and battery included.

- Basic DC accuracy: plus or minus 0.25%
- DC voltage: 200mv — 1000v, 5 ranges
- AC voltage: 200mv — 750v, 5 ranges
- Resistance: 200 ohms — 20M ohms, 6 ranges
- AC/DC current: 200uA — 10A, 6 ranges
- Capacitance: 2000pf — 20uf, 3 ranges
- Transistor tester: hFE test, NPN, PNP
- Temperature tester: 0° — 2000° F
- Conductance: 200ns
- Fully over-load protected
- Input impedance: 10M ohm



DMM-200 \$49.95
35 DIGIT FULL FUNCTION DMM

High accuracy, 20 amp current capability and many range settings make this model ideal for serious bench or field work. Tilt stand for hands-free operation, 2000 hour battery life with standard 9v cell. Probes and battery included.

- Basic DC accuracy: plus or minus 0.25%
- DC voltage: 200mv — 1000v, 5 ranges
- AC voltage: 200mv — 750v, 5 ranges
- Resistance: 200 ohms — 20M ohms, 6 ranges
- AC/DC current: 200uA — 20A, 6 ranges
- Fully over-load protected
- Input Impedance: 10M ohm
- 180 x 86 x 37mm, weighs 320 grams



DMM-700 \$49.95
35 DIGIT AUTORANGING DMM

Autorange convenience or fully manual operation. Selectable LO OHM mode permits accurate in-circuit resistance measurements involving semi-conductor junctions. MEM mode for measurements relative to a specific reading. Probes and battery included.

- Basic DC accuracy: plus or minus 0.5%
- DC voltage: 200mv — 1000v, autoranging or 5 manual ranges
- AC voltage: 2v — 750v, autoranging or 4 manual ranges
- Resistance: 200 ohms — 20M ohms, autoranging
- AC/DC current: 20mA — 10A, 2 ranges
- Fully over-load protected
- Audible continuity tester
- Input impedance: 10M ohm
- 150 x 75 x 34mm, weighs 230 grams



DMM-100 \$29.95
35 DIGIT POCKET SIZE DMM

Shirt-pocket portability with no compromise in features or accuracy. Large, easy to read 5" LCD display. 2000 hour battery life with standard 9v cell provides over two years of average use. Probes and battery included.

- Basic DC accuracy: plus or minus 0.5%
- DC voltage: 2v — 1000v, 4 ranges
- AC voltage: 200v — 750v, 2 ranges
- Resistance: 2k ohms — 2M ohms, 4 ranges
- DC current: 2mA — 2A, 4 ranges
- Fully over-load protected
- Input impedance: 10M ohm
- 130 x 75 x 28mm, weighs 195 grams

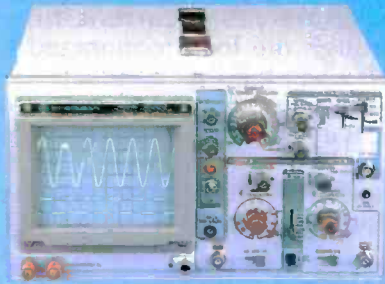

MODEL 2000 \$349.95
20 MHz DUAL TRACE OSCILLOSCOPE

Model 2000 combines useful features and exacting quality. Frequency calculation and phase measurement are quick and easy in the X-Y Mode. Service technicians will appreciate the TV Sync circuitry for viewing TV-V and TV-H as well as accurate synchronization of the Video Signal, Blanking Pedestals, VITS and Vertical/Horizontal sync pulses.

- Lab quality compensated 10X probes included
- Built-in component tester
- 110/220 Volt operation
- X-Y operation • Bright 5" CRT • TV Sync filter



MODEL 3500 \$499.95
35 MHz DUAL TRACE OSCILLOSCOPE

Wide bandwidth and exceptional 1mV/DIV sensitivity make the Model 3500 a powerful diagnostic tool for engineers or technicians. Delayed triggering allows any portion of a waveform to be isolated and expanded for closer inspection. Variable Holdoff makes possible the stable viewing of complex waveforms.

- Lab quality compensated 10X probes included
- Delayed and single sweep modes
- Z Axis intensity modulation
- X-Y operation • Bright 5" CRT • TV Sync filter



DPM-1000 \$54.95
3.5 DIGIT PROBE TYPE DMM

Autorange, pen style design for the ultimate in portability and ease of use. Custom 80 pin LSI chip increases reliability. Audible continuity tester and data hold feature for added convenience. Case, test leads and batteries included.

- Basic DC accuracy: plus or minus 1%
- DC voltage: 2v — 500v, autoranging
- AC voltage: 2v — 500v, autoranging
- Resistance: 2k ohms — 2M ohms, autoranging
- Fully over-load protected
- Input impedance: 11M ohm
- 162 x 28 x 17mm, weighs 75 grams

2 YEAR WARRANTY ON ALL MODELS



JDR INSTRUMENTS

110 Knowles Drive, Los Gatos, CA 95030
(408) 866-6200 • FAX (408) 378-8927 • Telex 171-110

COPYRIGHT 1986 JDR MICRODEVICES
THE JDR INSTRUMENTS LOGO IS A REGISTERED TRADEMARK OF JDR MICRODEVICES
JDR INSTRUMENTS IS A TRADEMARK OF JDR MICRODEVICES.

**ORDER TOLL FREE
800-538-5000**

OR VISIT OUR RETAIL STORE
1256 SOUTH BASCOM AVE.
SAN JOSE, CA. (408) 947-8881
CIRCLE 59 ON FREE INFORMATION CARD

ASK R-E

SUNRISE TO SUNSET SIMULATOR

I need a sunrise/sunset simulator, which is a device that will turn on a lamp slowly to simulate the sun rising and then, after a preset time, slowly dim the light to simulate sunset. Do you have anything in your files?—D.E.R., Notre Dame, IN.

Figure 1 shows a circuit that will fill the bill. The circuit was presented by Jamieson Rowe and Kieth Woodward in the article "An Automatic Lamp Dimmer, Using the Triac AC Switch" in the magazine *Electronics Australia*, De-

ember, 1966, pages 65–75. Because the circuit was designed for 240-volt operation, some circuit values—those marked with an asterisk—will have to be adjusted for operation on 117-volt powerlines.

Current through a lamp or a heater load connected to socket SO1 is controlled by varying the conduction period (angle) through each half-cycle of line voltage applied to the Triac (TR1), which is connected in series with the load across the AC powerline. The conduction period is varied and controlled by the unijunction

transistor (Q3) circuit: a relaxation oscillator that is coupled to Triac TR1's gate through pulse transformer T1. The oscillator's basic frequency depends on R7/C4.

The bridge rectifier develops approximately 165 volts *peak*, which is regulated to approximately 13.5 volts by silicon rectifiers D5 and D6 which are in series with 12-volt Zener diode D8.

Also connected across the 13.5-volt source is Q3's RC timing network, R3/C2. For proper circuit operation, R3 must be adjusted so the voltage across C2 just rises to the conduction point of Q3 at the end of each half-cycle of the line voltage. Under that condition, Q3 delivers a current pulse through T1 to TR1's gate as the instantaneous line voltage drops close to zero. Since the line voltage is near zero, no appreciable current flows through the load (connected to SO1) when the Triac conducts.

The adjustable dimming control R2, is a 10K wirewound potentiometer. The voltage tapped off R2 feeds an RC timing network consisting of R3 and RATE control R4 in series with C3, a 100- μ F, 16-volt electrolytic capacitor. The voltage across C3 is applied to the base of a Darlington amplifier (Q1 and Q2) that uses 2N3565 or similar NPN silicon transistors. The Darlington's emitter output is connected to timing capacitor C4 and to the emitter of Q3.

As C3 charges, its voltage is applied as a "bootstrap" voltage to C4. Since the Triac is normally off, or nearly so, we simply cause it to turn on earlier and earlier in each half-cycle of the supply voltage when we want to increase current through the load that is connected to socket SO1. On the other hand,

WRITE TO:

ASK R-E
Radio-Electronics
500-B Bi-County Blvd.
Farmingdale, NY 11735

Crystek Crystals

FOR OPTIMUM STABILITY
AND RELIABILITY IN
FREQUENCY MANAGEMENT

QUARTZ CRYSTALS FOR

Industrial Equipment/Instrumentation

- Micro-processor control
- Computers/Modems
- Test/Measurement
- Medical



General Communications

- Channel element Service (VHF/UHF)
- Land Mobile 2-way
- Marine
- Aircraft
- Telemetry
- Monitors/Scanners/Pagers



Amateurs/2-Meter/General Coverage CB/Hobbyist/Experimenter

NEW

The Pulse of Dependable Communications

Crystek Crystals offers their new 16 page FREE catalog of crystals and oscillators. Offering state of the art crystal components manufactured by the latest automated technology. Custom designed or "off the shelf," Crystek meets the need, worldwide. Write or call today!



CRYSTEK CORPORATION

DIVISION OF WHITEHALL CORPORATION

2351/2371 Crystal Drive • Ft. Myers, FL 33907
P.O. Box 06135 • Ft. Myers, FL 33906-6135

TOLL FREE 1-800-237-3061

PH 813-936-2109/TWX 510-951-7448/FAX 813-939-4226

TOLL FREE IN THE U.S.A. EXCEPT FLORIDA, ALASKA, HAWAII

CIRCLE 193 ON FREE INFORMATION CARD

The fourth law of robotics

A robot shall make learning fun for man and thereby improve the quality of life for mankind.



A robot is a robot is a robot... was a robot. Until HERO 2000.

HERO 2000 is much more than a robot. It's a walking, talking 16-bit computer. With 64K ROM and 24K RAM expandable to more than half a megabyte. And a fully articulated arm with five axes of motion. Yours to program. Command. Modify and expand. Total system access and solderless experimenter boards provide almost limitless possibilities. Its remote RF console with ASCII keyboard gives total control. Available with three self-study courses. Backed by Heath Company, world leader in electronic kits.

Build your own HERO 2000. Or buy it assembled. Have fun learning skills that translate directly to the world of work.



HERO[®] 2000

the
knowledge
builder

FREE. Send today for latest Heathkit Catalog.



Mail coupon today to receive a **FREE** Heathkit Catalog featuring HERO 2000.

Mail to: Heath Company
Dept. 020-E6E
Benton Harbor, Michigan 49022

Name _____

Address _____

City _____ State _____

Zip _____

RO-141

Heathkit[®]
Heath
Company

A subsidiary of Zenith Electronics Corporation.

CIRCLE 176 ON FREE INFORMATION CARD

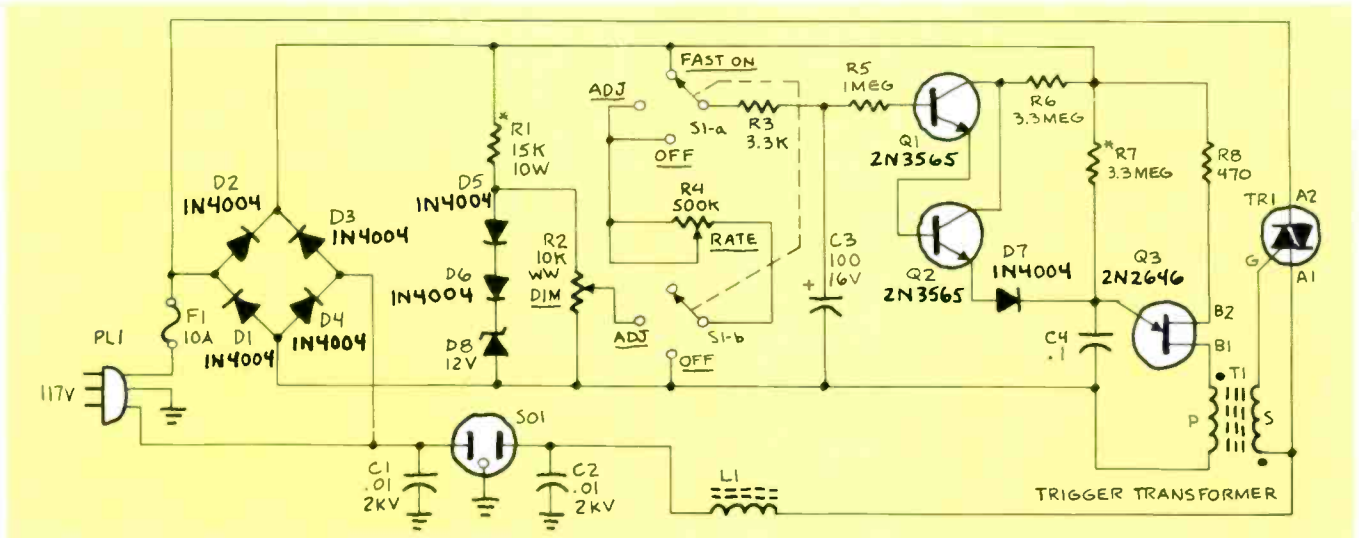

FIG. 1

to reduce current through the load we DIM control R2 to reduce the voltage across C3. That lowers the "bootstrap" voltage available for C4 so Q3 and TR1 begin conducting later and later in each half-cycle of the line voltage.

When RATE control R4 is 500K, the maximum fade-up and fade-

down time is about 1 minute. Changing R4 to 5 megohms increases the control range to about 15 minutes.

Pulse transformer T1 is wound on a 1-inch length of 3/8-inch diameter ferrite rod. Each winding consists of 100 closewound turns of No. 36-40 enameled wire.

Inductor L1 is a hash suppresser made of 50 closewound turns of No. 18 enameled wire on a 2-1/2-inch piece of the same type of rod as used for the core of T1. Insulate the coil with plastic tape.

Resistor R7 may have to be adjusted slightly for correct circuit operation. R-E

TEST INSTRUMENTS

High Quality
Lowest Prices
Off-The-Shelf

New!

MINI-METERS w/MAXI-SPECS

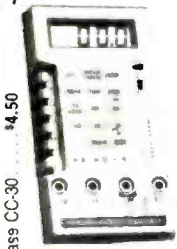

SCOPE 3 1/2 Digit LCD with 8 Full Functions

Model DVM-632 \$4495

Deluxe test leads included • 0.5% accuracy • Transistor gain test • Audible continuity checking & diode test • 10 Amp measurement



SCOPE 3 1/2 Digit LCD Multimeter

Model DVM-630 \$2995

Test leads included • 0.5% accuracy • 6 functions, 19 ranges • Automatic zero adjust • Low battery indication • Measures 5" x 2 3/4" x 7 1/4"



B & K 20 MHz Dual Trace

Model 2120 \$39995

Probes included • 20 and 26 MHz band widths • TVV and TVH • X-Y operation • Trace rotation: adjustable front panel • Channel 1 output



SCOPE 3 1/2 Digit Capacitance

Model DCM-602 \$5500

Test leads included • 8 ranges with full scale values to 2000 µF • LSI circuit • Crystal time base • Frequency range 800 Hz to 8 Hz



SCOPE 3 1/2 Digital Multimeters

Model DVM-638 \$7995

Test leads included • 11 function, 38 ranges • Logic level detector • Audible visual continuity • capacitance and conductance measurement.



Model DVM-634 \$5275

• 7 function, 32 ranges • Transistor measurement

Model DVM-636 \$5875

• 8 function, 37 ranges • Capacitance measurement



SCOPE Pocket Sized Audio Signal Generator

Model RC-555 \$4995

Test leads & 9V battery included • Low distortion sine-wave signal • 46 step selected frequency • x1 range 20 Hz to 1.5 KHz / x100 range 2KHz to 150 KHz

HITACHI 35 MHz Dual Trace Oscilloscope

Model V-355 \$59995

(Reg. \$899.95) Probes included • Thin, lightweight, compact • Large 6" rectangular, internal graticule CRT • Autofocus

FORDHAM Sweep Function Generator

Model FG-801 \$21995

(Reg. \$289.95) Test leads included • 7 frequency ranges, 0.2 Hz to 2 MHz • Accuracy to ±5%

FORDHAM 550 MHz Frequency Counter

Model FM-8 \$16995

(Reg. \$249.95) Completely assembled, pre-tested, precalibrated • High intensity 8-digit LED display



SCOPE 4 1/2 Digit LCD Bench Digital Multimeter

Model DVM-6005 \$19995

Test lead set & 6 "D" size batteries included • 0.4" high characters • Conversion period: 500 milliseconds • Automatic, negative polarity

Phone orders accepted.

Ask for our FREE Catalog

Fordham

260 Motor Parkway, Hauppauge, NY 11788

TOLL FREE 800-645-9518

In New York State 800-832-1446

Service & Shipping Charge Schedule Continental U.S.A.

FOR ORDERS	ADD	FOR ORDERS	ADD
\$25-100	\$4.50	\$751-1,000	\$12.50
\$101-250	\$6.00	\$1,001-1,500	\$16.50
\$251-500	\$8.00	\$1,501-2,000	\$20.00
\$501-750	\$10.50	\$2,001 and up	\$25.00

NRI gives you two unbeatable opportunities for top pay, security, even a business of your own.

Everybody wants to get ahead, but most people want assurance they're making the right job choice. According to the U.S. Department of Labor, jobs for electricians and air conditioning, heating and refrigeration technicians offer high earnings and good job prospects. Now NRI can show you how to go after the high earnings, the steady pay increases, even how to be your own boss in a business of your own. You'll get all the skills to get there. No night school, no need to quit your job until you're ready to make your move. NRI trains you right at home in your spare time.

No Experience Needed.

NRI starts you with the basics, then builds your knowledge and skill a step at a time, all the while adding practical know-how through hands-on training. You even get tools you need on the job or in a business of your own. Over a million and a half students have trained the NRI way since 1914.

Be an Electrician.

Each year, the demand for skilled construction, maintenance, commercial and utility electricians continues to grow. The U.S. Department of Labor estimates that close to 100,000 new jobs will open up in the next ten years - a conservative estimate compared to industry and union predictions.

And few jobs can match the money-making potential of the qualified electrician. You can earn a salary in excess of \$25,000 or be your own boss with your own electrical contracting business.

Only NRI gives you this kind of practical, job-oriented, hands-on training.

You master practical skills like this with the equipment, test instruments, and training materials included in your course...you duplicate on-the-job wiring with your NRI Residential Wiring Practical Lab®...you learn professional troubleshooting using your Volt-Ohmmeter and Clamp-On Ammeter to test the circuits you build up on your NRI Circuit Demonstrator...and, by installing and testing an electronic-programmable thermostat and a microprocessor-controlled remote power control, you come to understand today's electronics as it applies to the latest devices electricians are called on to install and repair.

Training in the latest need-to-know electronics required of today's electrician.

NRI created this new course so you can move from the simplest fundamentals of electricity, through professional wiring and trouble-shooting techniques, all the way up to mastering the practical field skills you need to become today's electronic-smart electrician. Be an electrician. It could be the best and last job choice you'll ever have to make.

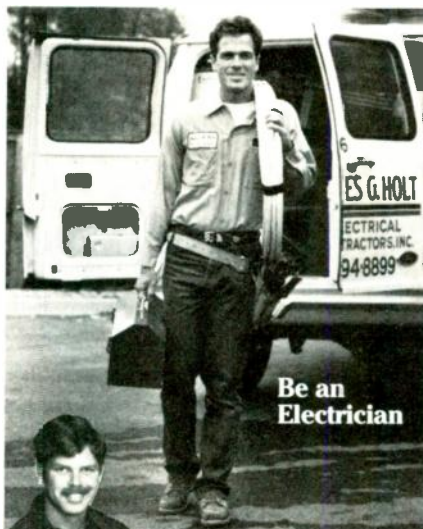

Be an Electrician

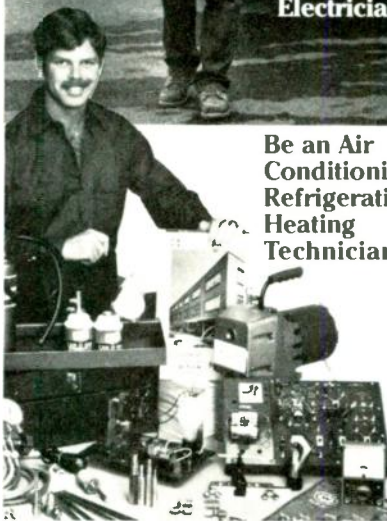

Be an Air Conditioning, Refrigeration, Heating Technician.

Be an Air Conditioning, Refrigeration, Heating Technician.

When it comes to targeting the good paying jobs, regular pay increases, and

the steady demand for your skills in this field, the U.S. Department of Labor scores a solid hit...high earnings and good job prospects attract many individuals... because people in business depend on their air conditioning, heating, and refrigeration systems, the need for skilled technicians to do maintenance work has to be met regardless of swings in the economy. Add millions of window units in older homes requiring maintenance and repair; heat pumps so popular they're now as common as furnaces; commercial refrigeration alone calling for skilled technicians to install and service walk-in coolers, freezers, ice makers, and food cases. Wherever you look, there's tremendous opportunities for the trained air conditioning, refrigeration, and heating technician.

NRI training so complete, professional tools even included.

NRI trains you for this lucrative field, gets you ready to land a good paying job, pick up extra income in your spare time, even start a business of your own. You're ready to jump right in because NRI includes the tools you need: system analyzer, leak detector, tubing and joint tools, a top-quality vacuum pump for purging systems, plus demonstration panel units for hands-on systems training. Graduates of our Master Course also get optional free residential training at the world-famous York Institute in York, PA.

Go after high earnings, pay increases, a business of your own.

Send for NRI's free catalog. Find out what hands-on projects you do, the professional tools you train with, and the future that can be yours. Act today.

SEND COUPON TODAY FOR FREE NRI CATALOG!

NRI SCHOOLS

McGraw-Hill Continuing Education Center
939 Wisconsin Avenue, NW, Washington, DC 20016



We'll give you tomorrow.

For Career course approved under GI Bill
 check for details

✓ CHECK ONE FREE CATALOG ONLY

- | | | |
|---|---|--|
| <input type="checkbox"/> Electrician | <input type="checkbox"/> Automotive Servicing | <input type="checkbox"/> Data Communications |
| <input type="checkbox"/> Air Conditioning Heating & Refrigeration | <input type="checkbox"/> Bookkeeping & Accounting | <input type="checkbox"/> Industrial Electronics |
| <input type="checkbox"/> Small Engine Repair | <input type="checkbox"/> Photography | <input type="checkbox"/> Communication Electronics |
| <input type="checkbox"/> Appliance Servicing | <input type="checkbox"/> Computer Electronics | <input type="checkbox"/> Electronic Design Technology |
| <input type="checkbox"/> Locksmithing & Electronic Security | <input type="checkbox"/> TV/Audio/Video Servicing | <input type="checkbox"/> Telephone Servicing |
| <input type="checkbox"/> Building Construction | <input type="checkbox"/> Satellite Electronics | <input type="checkbox"/> Digital Electronics Servicing |
| | <input type="checkbox"/> Robotics & Industrial Controls | <input type="checkbox"/> Basic Electronics |

Name _____ Age _____

Street _____

City/State/Zip _____

Accredited by the National Home Study Council

4219-087



LETTERS



LEADER DMM/STORAGE OSCILLOSCOPE

I was pleased to see Leader's model LCD-100 DMM/Storage Oscilloscope (see Fig. 1) featured in a Radio-Electronics "Equipment Report" (June, 1987). While the review was informative, the pricing information was incorrect. The actual price is \$850.00, and the unit is currently available.

MARC REINER
Leader Instruments Corp.
380 Oser Ave.
Hauppauge, NY 11788



ON SOLDERING

I enjoyed the article, "Soldering: Old Techniques and New

Technology," by Vaughan D. Martin, in the May 1987 issue of Radio-Electronics. There should be more articles such as that, which give good data to the inexperienced. How else will they be able to learn?

I would like to add two points: One is that we never use any soldering iron that isn't temperature-controlled for electronics soldering. The old "wood-burning" tools are history, but I didn't see any mention of temperature-controlled irons; they really aren't that expensive and are essential to good soldering.

The second point is on technique: The iron must always have an excess of solder in order for the heat to transfer quickly. Get on and get off the joint; otherwise, the heat will travel away from the joint and heat other areas. Understanding heat flow, of course, is what soldering, brazing, and welding are all about. A good rule of thumb would be to apply solder to the tip and joint simultaneously—making contact between the tip and the solder is very important.

Keep up the good work.
GERALD F. DULIN
Torrance, CA

ON PATENT APPLICATIONS

I would like to thank David Pressman for his remarks concerning my article on patents, which appeared in the January, 1987 issue of Radio-Electronics. His corrections to details contained within the text illustrate the need for continuous monitoring of patent requirements, and the wisdom of paying an attorney or an agent to at least review the application.

I agree that the task of applying for a patent is not simple, and that

DOES YOUR DIGITAL CAPACITANCE METER DO THIS?

FULL 4 DIGIT 0.5 INCH LCD DISPLAY COMPLETELY AUTORANGING WITH 10 RANGE MANUAL CAPABILITY

AND THIS
RANGE OF 0.0 pF to 1 FARAD (999.9 mF)
0.5% BASIC ACCURACY UP TO 100 uF

AND THIS
READS DIELECTRIC ABSORPTION

AND THIS
EXTENDED PSEUDO 5 DIGIT
RESOLUTION ON SOME RANGES ONLY

AND THIS
ABILITY TO ZERO LARGE CAPACITANCE
VALUES UP TO 99.99 uF

AND THIS
CALCULATES TRUE CAPACITANCE
IF CAPACITOR IS LEAKY

AND THIS
DIODE CLAMP AND FUSED
PROTECTED INPUT.
DISCHARGE RESISTOR IN OFF
POSITION AT TERMINAL INPUTS.
POWERED BY 9V BATTERY

**ONE YEAR PARTS &
LABOUR WARRANTY**

FOR ONLY THIS



AND THIS
IDENTIFIES TRANSISTORS (NPN, PNP)
AND THEIR LEADS (E, B, C, ETC.)

AND THIS
TESTS ZENER DIODES AND RECTIFIERS.
UP TO 20V ZENER WITH AC ADAPTOR.
ZENER VOLTAGE WITH 9V BATTERY
DEPENDS ON ITS CONDITION

AND THIS
AUTOMATICALLY CALCULATES LENGTHS
OF CABLES IN FEET, METRES, MILES,
KILOMETRES (THEORETICAL RANGE
OF 9.999 MILES)

AND THIS
ABILITY TO SORT CAPACITORS IN
MANY DIFFERENT MODES

AND THIS
ABILITY TO READ LEAKY CAPACITANCE
(INSULATION RESISTANCE OR CURRENT)

AND THIS
CALCULATES TIME CONSTANTS WITH
USER DEFINED RESISTANCE VALUES

AND THIS
HOLD FUNCTION FREEZES DISPLAY

SHIPPING INSTRUCTIONS:

All units shipped out F O B Buffalo NY via United Parcel Service (except Hawaii & Alaska) unless otherwise indicated (in which case shipments will be F O B, Canada)

PLEASE SEND ME		U S FUNDS
_____ (QUANTITY) MC300(S) @	\$169.95	\$ _____
CARRYING CASE	\$ 16.95	\$ _____
AC ADAPTOR	\$ 9.95	\$ _____
SHIPPING AND HANDLING @ \$5.00 PER INSTRUMENT		\$ _____
<input type="checkbox"/> CHECK <input type="checkbox"/> MONEY ORDER		\$ _____
<input type="checkbox"/> VISA <input type="checkbox"/> MASTERCARD	TOTAL	\$ _____
<input type="checkbox"/> CARD NO _____		
EXPIRY DATE _____	SIGNATURE _____	
NAME _____		
ADDRESS _____		
CITY _____ STATE _____	ZIP CODE _____	

\$169.95

MODEL
MC300
Approx. Size
7" x 4" x 1 1/2"
DAETRON
a division of Bergeron Technologies Inc.
7686 KIMBEL STREET, UNIT 5
MISSISSAUGA, ONT., CANADA
L5S 1E9 (416) 676-1600

DEALER ENQUIRIES INVITED

CIRCLE 200 ON FREE INFORMATION CARD

Simpson Electric Co.
Introduces

mercer

The Ultimate in Low-Cost Test Equipment

At last! Here is your opportunity to take your pick from a new test equipment line that has all the features you need and more... and at a price that is unbelievably low.

MODEL 9340
Pocket size, 3½-digit
DMM with 20 megohm
range and 10 megohm
input resistance
\$49⁰⁰

MODEL 9670
Digital capacitance
tester covering 0.1 pF
to 20,000 µF
\$105⁰⁰

MODEL 9101
Compact VOM with 27
ranges, including a
100 megohm range
\$29⁰⁰

MODEL 9301
3½-digit, hand-held
DMM with 0.25%
basic accuracy and
2,000-hour battery life
\$69⁰⁰

MODEL 9120
Analog VOM with 12 A
DC range and output
jack
\$39⁰⁰

MODEL 9401
4½-digit, full function,
hand-held DMM with
.05% accuracy and
data hold
\$129⁰⁰

MODEL 9702
digi-clamp™ compact
AC clamp-on volt-ohm-
ammeter with data hold
\$79⁰⁰

MODEL 9370
3½-digit autoranging
DMM with a memory
mode and 0.5% basic
DC accuracy
\$59⁰⁰

mercer

ELECTRONICS

Division of Simpson Electric Company

859 Dundee Avenue, Elgin, IL 60120-3090
(312) 697-2265 • Telex 72-2416

Mercer Electronics products reflect the design and quality standards established by Simpson Electric Company, an industry leader for over 50 years and known worldwide for its integrity and product excellence.

In Stock... Available Now! Stop in at your nearest distributor and see this new, complete line of Mercer test instruments. For the name of the MERCER distributor in your area, call (312) 697-2265, or send for our new line catalog.

the expression "relatively simple task" (the editor's words, incidentally) could mislead the reader. However, I think that the intent was to introduce the concept that applying for a patent is a finite task comprised of established procedures, standard form, and a structured method of describing the invention.

As to Mr. Arnold's letter concerning the water alarm: Back in 1975, I invented a wetness alarm that used the SCR circuit, and

packaged the alarm in a plastic sandwich box. The alarm worked quite well, even after sitting under a hot-water heater for more than a year. In consideration of patenting the idea, I searched the archives of the Patent and Trademark Office and found numerous patents having to do with sensing water and actuating switches.

In addition, I collected advertising for a number of commercial enterprises marketing both water alarms and wetness-detection sys-

tems for industrial use. Although I did not come across a water alarm that used the SCR circuit, I concluded that a patent for a water alarm would not be profitable. I used the circuit as an example in the patenting article because it satisfied the need for a simple, easy-to-describe circuit, and yet one that exhibited a unique quality.
DAVE SWEENEY

TESTING SEMICONDUCTORS

I was just reading "Testing Semiconductors" in the April 1987 issue of *Radio-Electronics*. I enjoy reading your articles, because they refresh my memory on how various components work.

In the article, you printed an error that is very common in the field. In Fig. 1, you are measuring the reverse current of a diode using a microammeter (the text says milliammeter). The reverse current through the diode should be extremely small as compared to the current used by the voltmeter (M2). With some voltmeters, that current is much higher than with others. It is a good practice, when measuring the properties of any device, to eliminate any external interference that you can. In the present case, simply placing the voltmeter before the current meter would quickly eliminate the problem.

I find that many measurements in the field are inaccurate, due to the technicians involved not knowing how the test equipment affects the circuit that it's being connected to. I once witnessed a technician connecting a meter with a 600-ohm impedance to the input of a transmitter. That was done to measure the audio signal going into the transmitter. However, the meter was connected in parallel to the input, producing a 300-ohm impedance; therefore, the signal level was off by enough to indicate a problem with the transmitter, when, in fact, there was no problem—just an inaccurate measurement.

RICHARD P. MORLEY
APO, NY

PC CLONE

Thanks, *Radio-Electronics*: You finally printed an article, "IBM-continued on page 22

ELENCO PRODUCTS AT DISCOUNT PRICES!

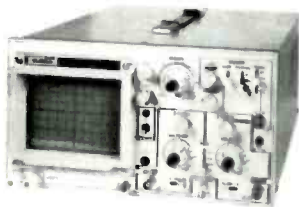

TWO
100MHz
SWITCHABLE
PROBES
INCLUDED



20MHz DUAL TRACE OSCILLOSCOPE
\$359 MO-1251

35MHz DUAL TRACE OSCILLOSCOPE
\$498 MO-1252

Top quality scopes at a very reasonable price. Contains all the desired features. Elenco's 2 year guarantee assures you of continuous service. Two 1x, 10x probes, diagrams and manual included. Write for specs.



MULTIMETER with
CAPACITANCE AND
TRANSISTOR
TESTER
Model
CM-1500A **\$65**
Reads Volts, Ohms,
Current, Capacitors,
Transistors &
Diodes With case.



TRUE RMS 4 1/2
DIGIT MULTIMETER
Model
M-7000 **\$135**
.05% DC Accuracy
1% Resistance
with Freq. Counter
& Deluxe Case



Auto Ranging
plus
Manual Ranging
3 1/2 Digit Meter
28 Functions
Fully protected
M-1180 .7% Acy \$36.95
M-1182 .25% Acy \$39.95
M-1181 .1% Acy \$42.95



GF-8016 FUNCTION GENERATOR
with Freq. Counter
\$239
• Sine, Square, Triangle
• Pulse, Ramp, 2 to 2MHz
• Frequency .1 thru 10MHz
GF-8015 without Freq. Meter \$179



10MHz OSCILLOSCOPE
\$199
Model
S-3000
• 10MHz DC or AC
• Triggered Sweep
• Calibrated Vert & Hor
• Reads Volts & Freq



BREADBOARD
Model
9436
Shown
9430 1,100 pins \$15
9434 2,170 pins \$25
9436 2,860 pins \$35



DIGITAL TRIPLE POWER SUPPLY
Model
XP-765 **\$195**
0-20V @ 1A
0-20V @ 1A
5V @ 5A
Fully Regulated, Short Circuit Protected with 2
Limit Cont. 3 Separate Supplies
XP-660 with Analog Meters \$159.50



DIGITAL LCR METER
\$148
Model
LC-1800
Measures:
Inductors,
Capacitors,
Resistors



50MHz LOGIC PROBE
20 nsec with memory
LP-700
\$23
Logic Pulsar
LP-600 **\$23**



DIGITAL 3 AMP POWER SUPPLY
Model
XP-750 **\$165**
0-40V @ 1.5A
0-20V @ 3A
Fully regulated, short circuit protected current
limit control
XP-650 with Analog Meters \$129.50

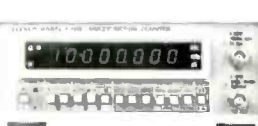

MULTI-FUNCTION COUNTERS
F-1000 **\$245**
1GHz
F-100 **\$169**
100MHz
Frequency, Period, Totalize, Self Check with High-
Stabilized Crystal Oven Oscillator, 8 Digit LED Display

C&S SALES INC., 8744 W. North Ter., Niles, IL 60648 **15 DAY MONEY**
800-292-7711 (312) 459-9040 **ASK FOR CATALOG** **BACK GUARANTEE**

2 Year Limited Guarantee! Add 5% for Postage (\$10 max), IL Res., 7% Tax

CIRCLE 109 ON FREE INFORMATION CARD

Cable TV

DESCRAMBLER ARTICLE PARTS

February 1984 Issue

We stock the parts, PC Board and AC Adaptor for an article on building a cable TV descrambler appearing in *Radio-Electronics*.

#701 Parts Package* \$29.00

Includes all the original resistors, capacitors, diodes, transistors, integrated circuits, coils, IF transformers (Toko BKAN-K5552AXX).

#702 PC Board* \$8.95

Original etched and drilled silk-screened PC Board used in the article.

#704 AC Adaptor \$7.95

Original (14 volts DC @ 285 ma) AC Adaptor used in the article.

FREE reprint with Purchase Above

#708 Toko Coil Set \$6.95

Includes (2) BKAN-K5552AXX, (1) E520HN-300023, (1) 144LY-120K and BFQ-85 Replacement 2SC2369.

February 1987 Issue

We stock the parts, PC Board and AC Adaptor for an article on a tri-mode cable TV descrambler appearing in *Radio-Electronics*.

#301 Parts Package* \$39.00

Includes all the original resistors, capacitors, diodes, potentiometers, transistors, integrated circuits, LED's, Toko coil (E520HN-3000023) and Plessey Saw Filter (SY-323).

#302 PC Board* \$8.95

Original 5 x 8.8 etched and drilled silk-screened PC Board used in the article.

#304 AC Adaptor \$7.95

Original (14 to 18 volt DC @ 200 ma) AC Adaptor used in article.

Free Reprint with Purchase Above

#308 Plessey & Toko Set \$6.95

Includes (1) Plessey SY323 Saw Filter plus (1) Toko E520HN-300023 Coil.

Add \$2.50 Shipping & Handling; \$4.50 Canadian Orders

72-CHANNEL

CABLE CONVERTER

WITH INFRA-RED REMOTE CONTROL



Add \$3.50 Shipping and Handling
\$4.50 on Canadian Orders

- 72-channel capability
- Wireless, Infra-Red remote control
- Channel output 2 or 3 switchable
- Microprocessor controlled PLL operation
- Skip channel memory eliminates unused channels
- Parental control for all channels
- Last channel recall
- Fine tune memory
- UL listed/FCC approved
- Simple installation with any TV
- Includes battery and 3 foot coax cable

MC-702 CONVERTER

\$79.95

ORDER TOLL FREE 1-800-227-8529

Inside MA: 617-695-8699

VISA, MASTERCARD OR C.O.D.



*Not available to Massachusetts residents due to state law

J & W ELECTRONICS, INC.

P.O. BOX 800 • MANSFIELD, MA 02048

©copyright 1987 by J&W Electronics, Inc.

CIRCLE 65 ON FREE INFORMATION CARD

SPECIAL BUY ON VIDEO REWINDERS



**Saves Time
And VCR
Motor
Wear!**

A SOLIDEX® VCR AID!

Free-Up Viewing Time that used to be spent rewinding tapes. And, take the work "load" off your VCR's motor with this factory new VHS Video Cassette Rewinder by Solidex®. Our special arrangement with the manufacturer makes it a great buy at a remarkably **LOW liquidation price!**

3 Big Benefits! This "must" device quickly rewinds video cassette tapes. Extends the life of your VCR's motor. And, helps you avoid costly VCR repairs. Buy NOW! And put this unit to work for you!

- Reduces Costly Wear on VCR Motor.
- Cuts Delays. Lets You Spend More Time Viewing Tapes, and Less Time Waiting on Rewinds.
- Fast, Efficient Operation. Auto Shut-Off. Auto Soft Eject.
- Compact, Space-Saving Size: 2½" H x 5" W x 11½" D. LED "On" Light.

**1-Year Limited Factory
Warranty Parts/Labor.**

Mfr. List **\$29.99**

Liquidation
Priced At

\$19

Item H-2648-7152-291
Ship, handling: \$4.00 ea.

Credit card customers can order by phone, 24 hours a day, 7 days a week.

Toll-Free: 1-800-328-0609

Sales outside the 48 contiguous states are subject to special conditions. Please call or write to inquire.

SEND TO: Item H-2648

GOMO Direct Marketing Corp.
1405 Xenium Lane N/Minneapolis, MN 55441-4494

Send VHS Video Rewinder(s) Item H-2648-7152-291 at \$19 each, plus \$4 each for ship, handling (Minnesota residents add 6% sales tax. Sorry, no C.O.D. orders.)

My check or money order is enclosed (No delays in processing orders paid by check.)

PLEASE CHECK: VISA MasterCard Discover American Express

Acct No _____ Exp. _____

PLEASE PRINT CLEARLY

Name _____

Address _____ Apt # _____

City _____

State _____ ZIP _____

Phone (____) _____

Sign Here _____

EQUIPMENT REPORTS

Regency Informant Scanning Receiver

*An innovation in scanner
technology*



CIRCLE 37 ON FREE INFORMATION CARD

SCANNERS HAVE NEVER BEEN POPULAR with John Q. Public. Potential scanner buffs are often intimidated by the task of programming a scanner's memory with frequencies of interest, or by the need to buy crystals for each frequency to be monitored. But the scanner industry could be in for a big change and huge expansion if it follows the example set by the *Informant INF-1*, a new scanner from Regency Electronics (707 Records Street, Indianapolis, IN 46226).

The *Informant* promises to make just about everyone a scanner enthusiast because it's so easy to use—even first-time listeners will be hooked. The *Informant* is so different from other scanners because it's *pre-programmed* with all frequencies used by state and local police in each of the fifty states. Simply turn the scanner on, switch it to your state, and you're sure to hear lots of action.

The *Informant* is so easy to use that it's almost possible to overlook its second impressive feature: high-speed scanning. Thanks to what Regency calls *TurboScan* technology, the *Informant* offers a scanning rate of 40 channels per second. That's *fast*—most scanners on the market today offer a top scanning speed about one quarter of that.

Using the Informant

How easy is it to use the *Informant*? With only two knobs and three toggle switches on the front panel, you know it can't be too difficult. One of the knobs, of course, is the VOLUME control, which also serves as the power switch. The other is the SQUELCH control.

The HOLD switch is used to lock the scanner on a single frequency of interest. Pressing it once puts the scanner in the HOLD mode; pressing it a second time causes scanning to resume. The HIWAY/CITY switch is used to select either state-police frequencies (HIWAY) or local city- and county-police frequencies (CITY). The third switch is the WX SCAN/STATE selector. When WX SCAN is selected, the *Informant* will scan the frequencies used by the National Weather Service to broadcast weather bulletins. The other position is used to select the state whose frequencies you want the *Informant* to scan.

Rounding out the front panel is a two-digit, vacuum-fluorescent display that indicates the state and the type of signal (state, local, or weather) being monitored, and the scanner's mode.

The *Informant* covers state, city, and county police frequencies from 36–47 MHz (VHF Low),



SATELLITE ELECTRONICS TRAINING FROM NRI!

Now you can move into home satellite TV and commercial satellite communications with NRI's latest breakthrough in electronics training

With NRI training, you'll explore every aspect of satellite transmission and reception as you assemble, install, troubleshoot, and train with the complete TVRO system included in your course. With today's satellite technology, a call to Paris is as clear and as easy to make as a call next door... executives use video conferencing to "meet" without leaving their offices... simultaneously, a billion people witness a single event (a soccer game, an inauguration, a benefit rock concert)... and scientists explore the mysteries of outer space without leaving their labs.

These amazing applications of satellite technology have opened exciting, new opportunities for the technician trained to install, maintain, troubleshoot, and repair satellite communications equipment.

Explosive opportunities in home satellite TV

In suburban backyards, alongside country farmhouses, and atop commercial buildings, satellite TV systems are continuing to expand all across the country.

Already there are over a million TVRO (Television Receive-Only) systems in place in the U.S. alone, and experts predict that the future of home satellite TV looks even brighter.

New jobs, new careers for the trained technician

As an NRI-trained technician, you can concentrate on consumer-oriented TVRO equipment, or use your training to build a career servicing the satellite equipment that has become so vital in commercial and military communications to transmit and receive voice, data, and video signals.

NRI brings satellite technology down to earth

NRI trains you thoroughly in basic electronics, communications, and television principles. Using the remarkable NRI Discovery Lab® and your digital multimeter, you perform critical experiments, tests, and measurements. Then, using your NRI Antenna Applications and Design Lab, you assemble and test various types of antennas and matching sections.

You then concentrate on both commercial and consumer satellite earth station equipment, putting theory to practice as you assemble, install, and test the complete satellite antenna system included in your course.

Building your own home satellite TV system brings theory to life!

Your Drake TVRO system comes complete with 6' parabolic dish antenna system, low-noise amplifier (LNA), down converter, receiver, low-loss coaxial cable, and even a permanent polar mount.



By training with an actual TVRO system, you'll come to understand, first-hand, the function and operation of a satellite earth station. And once completed, your TVRO system will provide the best television entertainment available—direct from the satellite to your home.

Train the uniquely successful NRI way

It's hands-on training, at home... designed around the latest state-of-the-art equipment. You discover by doing... and you do it at your own comfortable pace.

Built into your NRI training is the enormous experience of our development specialists and instructors, whose training skills and personal guidance are available to you on a one-to-one basis.

Make your move into the future today! Send for your FREE NRI catalog

Only NRI can train you at home for an exciting and rewarding career as a satellite electronics technician. And now is the time to act. Send today for your free, 100-page catalog. It details our training methods and materials, and our more than 72 years of successful innovation in hands-on career training. If the coupon is missing, write to: NRI Schools, 3939 Wisconsin Avenue, Washington, D.C. 20016.



Complete TVRO System and electronic test equipment included with your training.

NRI SCHOOLS
 McGraw-Hill Continuing Education Center
 3939 Wisconsin Avenue, Washington, DC 20016

We'll give you tomorrow.

CHECK ONE FREE CATALOG ONLY

<input type="checkbox"/> Satellite Electronics	<input type="checkbox"/> Data Communications	<input type="checkbox"/> Automotive Servicing
<input type="checkbox"/> Computer Electronics with Microcomputers	<input type="checkbox"/> Communications Electronics	<input type="checkbox"/> Air Conditioning, Heating, Refrigeration, & Solar Technology
<input type="checkbox"/> Robotics & Industrial Controls	<input type="checkbox"/> Industrial Electronics	<input type="checkbox"/> Building Construction
<input type="checkbox"/> Video Electronics Servicing	<input type="checkbox"/> Basic Electronics	<input type="checkbox"/> Locksmithing & Electronic Security
<input type="checkbox"/> Electronic Design Technology	<input type="checkbox"/> Telephone Servicing	<input type="checkbox"/> Photography
<input type="checkbox"/> Digital Electronics	<input type="checkbox"/> Small Engine Servicing	<input type="checkbox"/> Bookkeeping
	<input type="checkbox"/> Appliance Servicing	

For Career courses approved under GI bill
 check for details.

Name (Please Print) _____ Age _____

Street _____

City/State/Zip _____ Accredited by the National Home Study Council

10-087

Free Famous hi-tech catalog



A very special computer & electronics guide that shows you what the exciting world of kitbuilding can do for you.

Challenge. Knowledge. Achievement. Enjoyment. All of these things are yours when you build a Heathkit high-quality product. Our colorful, informative catalog reflects the years of experience and technological expertise that make these things happen for you.

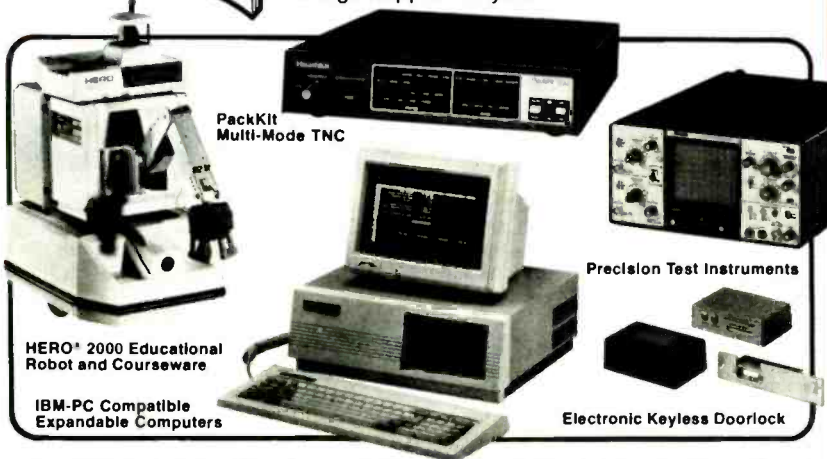

HERO® 2000 Educational Robot and Courseware
IBM-PC Compatible Expandable Computers

PackKit Multi-Mode TNC

Precision Test Instruments

Electronic Keyless Doorlock

In our catalog you'll find over 450 interesting and useful items – from computer hardware and software to robots and test instruments, and from home security systems to color tv's and amateur radio equipment.

But what makes Heath Company unique is that we offer you the confi-

dence and pride that you can only get by building a state-of-the-art product yourself. And you're backed by our promise, "We won't let you fail!"

The Heathkit Catalog is a simple – and FREE – first step toward this excellent opportunity.

Send NOW for your FREE Heathkit Catalog

CIRCLE 86 ON FREE INFORMATION CARD



Yes! I want to see what kitbuilding can do for me. Please send me the latest Heathkit Catalog Free.

**Send to: Heath Company, Dept. 020-562
Benton Harbor, Michigan 49022**

Name _____

Address _____

City _____ State _____

Zip _____

A subsidiary of Zenith Electronics Corporation CL-787R2

Regency		Informant INF-1												
OVERALL PRICE														
EASE OF USE														
INSTRUCTION MANUAL														
PRICE / VALUE														
		1	2	3	4	5	6	7	8	9	10			
		Poor		Fair			Good			Excellent				

150–163 MHz (VHF High), and 450–462 MHz (UHF). It's packaged in a case that will be at home in just about any car (about 1½ x 5 x 6½ inches) and it comes equipped with a mobile mounting bracket. Also included are a DC power cord for permanent installation in a vehicle, and a cigarette-lighter plug for temporary installation.

The *Informant's* simplicity is sure to be a great attraction to people who are unfamiliar with scanners, and to those who want an easy-to-use scanner for mobile use. But simplicity has its disadvantages, too. Regency chose not to include a DELAY switch on the *INF-1*, probably to keep it looking as clean and simple as possible. Without a delay switch, the user has no control over how long the scanner will wait on a single frequency for the response to a transmission. The *Informant* waits less than a second, and in many cases that's just not long enough.

The only other thing missing is a frequency display. In a sense, it's really not needed, but it would be nice to have some way to identify a given channel.

Even though a LOCKOUT switch is not included, it is possible (by using two of the toggle switches in combination) to force the scanner to skip an unwanted channel.

The *Informant INF-1* sells for \$369.95. We can't compare that price to any other scanner on the market because the *Informant* is unique. When its main features—*TurboScan* technology and simple operation—are incorporated in products built for the scanner hobbyist, things will never be the same. Regency is working on doing that now; by the time you read this, they will have introduced new scanners with features you've never even dreamed of. R-E



NEW LIT

ELECTRONICS PRODUCTS CATALOG, includes such items as a color light controller, color LED VU meter, electronic echo and reverbification amplifier, stereo simulator, multi-purpose melody generator, digital clock with two timers, battery fluorescent light, infrared remote-control unit, speaker protection, superior electronic roulette, power supply for microcomputer, and many others. 24 pages. Available on request from **Mark V Electronics, Inc.**, 248 E. Main St., Suite 100, Alhambra, CA 91801.

CIRCLE 38 ON FREE INFORMATION CARD

CONSUMERS'S GUIDE TO PRIMARY BATTERIES, is pocket-size (3½ × 7 inch), six-page guide to the most-commonly used consumer batteries; also some unusual types that are also available in the average supermarket—such as cylindrical, rectangular, and button/coin sizes. The booklet discusses each type and how each should be used to assure the most efficiency and safety. It is available upon request from **National Electrical Manufacturers Association**, 2101 L Street N.W., Washington, DC 20037.

CIRCLE 39 ON FREE INFORMATION CARD

INTRODUCTION TO PACKET RADIO, is an 18-page, letter-sized booklet that explains packet's procedures, operations, and applications in easily-understood terms. It is written in a conversational style, and the contents are organized by the common questions that most potential users ask about packet radio, such as: What is packet radio? Where is it used? What equipment do I need? How do I operate it?—and more. The booklet also includes FCC licensing information. It is available upon request from **Kantronics**, 1202 E. 23rd St., Lawrence, KS 66046. **R-E**

CIRCLE 40 ON FREE INFORMATION CARD

Now test and restore every CRT on the market . . . without ever buying another adaptor socket or coming up embarrassingly short in front of your customer . . . or your money back



with the new improved CR70 "BEAM BUILDER"™
Universal CRT Tester and Restorer
Patented \$995

Have you ever?

Thrown away a good TV CRT, data display CRT, or scope CRT that could have been used for another two or three years because you had no way to test or restore it?

Lost valuable customers because you advised them that they needed a new CRT when another technician came along and restored the CRT for them?

Lost the profitable extra \$35 or more that you could have gotten for restoring a CRT while on the job and locked in the profitable CRT sale later?

Avoided handling profitable trade-ins or rentals because you were afraid you'd have to replace the picture tube when you could have restored it?

Had a real need to test a CRT on the job, but didn't have the right adaptor socket or setup information in your setup book?

If any of these things have happened to you, **CALL TODAY, WATS FREE, 1-800-843-3338**, for a **FREE 15 day Self Demo**.

"BEAM BUILDER" is a trademark of Sencore, Inc.



Call Today Wats Free 1-800-843-3338

SENCORE

3200 Sencore Drive
Sioux Falls, SD 57107
605-339-0100 In SD Only

*innovatively designed
with your time in mind.*

CIRCLE 177 ON FREE INFORMATION CARD

LETTERS

continued from page 14

Compatible Clone Computer," (February 1987 Computer Digest) that I can use and relate to. That one article, to me, is worth the three years or so that I have been carrying a subscription. I want to have a computer soon, and I think the article was my ticket to getting one.

That is not to say that I have

found the electronics articles useless. I subscribe to your magazine because I want to learn more and understand what's going on. I'm a mechanical-engineering student. My only connection to electronics was a sorry two years that I spent learning printed-circuit artwork preparation from the ground up. You know—the "make a mistake and we'll tell you what you did wrong" approach. I made a lot of mistakes.

Anyone who's taped a PC art-

work, made the manufacturing drawing for the boardhouse, and drawn the component layout wants to get a more concrete feeling for electronics. Well, the next step is to stuff boards, get to know actual components, learn how to solder, etc. And *then* get into the theory as a final step.

Radio-Electronics is giving me a library on those things, the "how to," and the advertisers for the parts and the tools.

Again, thanks! And I also think that putting the magazine in a mailing wrapper is great—no more mangled covers.

CURTIS E. VAILLETTE
Madison, WI

ADDITIONAL INFORMATION

In response to the question about operating 117-volt, 60-Hz equipment on 220-volt, 50 Hz power lines that appeared in "Ask R-E" in Radio-Electronics, May 1987, here's some additional information. I was stationed overseas for four years; and as the staff Electronics Officer, I did a lot of modifications of that type.

Most manufacturers have kits that you can buy that compensate for the slower rotation speed of 60-Hz motors when operated on 50-Hz power. A different-size drive wheel is usually available for most turntables and tape recorders. A different-size pulley is usually available for motors that drive washers and dryers.

Clock and timer modifications are available for 50 Hz, but are hardly worth the trouble. Buy a clock in the country where it's to be used. The timers on your washer, dryer, oven, etc. will run a little slower, but they can be set to compensate for that.

The resistive load of oven, stove, iron, toaster, room-heater, and clothes-dryer heating elements will work well on either 60 or 50 Hz. Of course, the voltage must be correct. In a clothes dryer, you can modify the circuit to include a transformer on the drive motor and timer circuit. That will greatly reduce the size of the transformer that is needed.

Forget about operating a TV set built for US video systems and 60 Hz: Rent or buy one in the country

NOW
Hands-on
Electronics
Every Month!



■ YOU CAN HAVE THE NEXT TWELVE ISSUES of **Hands-on Electronics** delivered to your home for only \$18.95 — saving \$11.05 off the single copy price.

■ EVERY ISSUE OF **Hands-on Electronics** will continue to contain a variety of construction articles to suit every taste. In addition, feature articles on electronics fundamentals, test equipment and tools will round out each issue. Of course, **Hands-on Electronics** will continue to provide new product and literature listings to keep you up to date on the latest developments in electronic technology.

■ GET IN ON THE ACTION! Order your next issue of **Hands-on Electronics** today. Use the convenient order coupon below. Be sure to send check or money order—no cash!

■ IF YOU'RE THE KIND OF READER that doesn't want to wait, you can order your next copy of **Hands-on Electronics** now. **Hands-on Electronics** is crammed full of electronic projects that you won't be able to wait to build for yourself. You can expect top-notch digital projects, fun-to-play electronic games, valuable add-on computer projects, BCB and shortwave receivers, photographic/darkroom gadgets, devices to improve your car's performance, test equipment ideas, and more in every issue of **Hands-on Electronics**.

Hands-on Electronics SUBSCRIPTION

I want to be sure I don't miss any issues. Send me ONE FULL YEAR — twelve issues — of **Hands-on Electronics** for \$18.95 (Canada \$23.95 U.S. Funds).

Payment Enclosed Please charge my
 Bill Me Later Visa Mastercard Signature _____
Acct. # _____ Exp. Date _____

Allow 6-8 weeks for the first issue to arrive. Offer valid in U.S. Funds Only.

Please print

(Name) _____

(Street Address) _____

(City) _____

(State) _____

(Zip) _____

Detach and mail today to:
HANDS-ON
ELECTRONICS
SUBSCRIPTION DEPT.
P.O. BOX 338
MOUNT MORRIS, IL
61054

ARE87

that you're in; modifications are too complicated to get into.

Do not buy transformers in the U.S. to take overseas with you. There are always people being transferred back to the States or elsewhere, and who want to get rid of the transformers that they have. You can save a bundle. Even if you buy new ones, buy those wound to operate on 50 Hz; they have more iron in them and will operate cooler for a given load.

Some people have one large transformer for the whole house; others have them for individual appliances. Whichever way you go, watch the load. Add up all the possible loads that you will have and get a transformer that's big enough to handle the job.

If you buy equipment overseas, be sure that the adapters are available to operate it when you get back to the U.S.

Whatever you do for yourself or for somebody else, if you modify the equipment or change the wiring, be sure to document what you have done and what it was like before you started. That will be a great help at some later date, for whomever tries to change it back once again.

I've read your publications since I was age 12, and that was 60 years ago; I've been a subscriber for at least 30 years.

ROY A. NORMAN
Lcdr. USN Ret.
Brunswick, GA

HEADLAMP WARNING

On page 67 of the April 1987 issue of *Radio-Electronics* a circuit is shown that warns of the headlamps of a car being left on. If the voltage from the fuse panel used to power the piezobuzzer and LED is taken after the dimmer control for the panel lights, it is possible that there may not be enough voltage to drive those components.

When I built my own version of a warning circuit a few years ago, I used power from the parking lamps, which are not dimmed. Though it is unlikely that the car's fuse block will come after the dimmer control, if that is the case, my solution is bound to work well.

KEVIN STEBLETON
Royal Oak, MI

R-E

Walk "tough dog" troubles out of any TV & VCR in half the time . . . or your money back

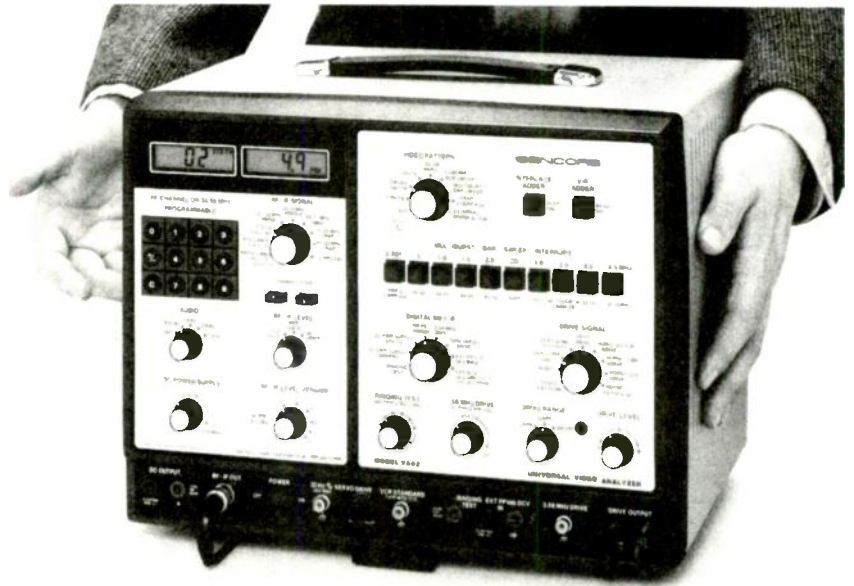

with the exclusive, patented,
VA62 Universal Video Analyzer . . . \$3,295

Would you like to?

Reduce analyzing time: Isolate any problem to one stage in any TV or VCR in minutes, without breaking a circuit connection, using the tried and proven signal substitution method of troubleshooting?

Cut costly callbacks and increase customer referrals by completely performance testing TVs & VCRs before they leave your shop? Own the only analyzer that equips you to check all standard and cable channels with digital accuracy? Check complete, RF, IF, video and chroma response of any chassis in minutes without taking the back off the receiver or removing chassis plus set traps dynamically right on CRT too? Simplify alignment with exclusive multiburst pattern?

Reduce costly inventory from stocking yokes, flybacks, and other coils and transformers, for substitution only, with the patented Ringing Test. Run dynamic proof positive test on any yoke, flyback, and integrated high voltage transformer . . . in- or out-of-circuit?

Protect your future by servicing VCRs for your customers before they go to your competition? Walk out "tough dog" troubles in any VCR chrominance or luminance circuit — stage-by-stage — to isolate problems in minutes? Have proof positive test of the videc record/play heads before you replace the entire mechanism?

Increase your business by meeting all TV and VCR manufacturers' requirements for profitable warranty service work with this one universally recommended analyzer?

To prove it to yourself, CALL TODAY, WATS FREE, 1-800-843-3338, for a FREE Self Demo . . . or learn how the VA62 works first by calling for your free simplified operation and application instruction guide, worth \$10.00.



Call Today Wats Free 1-800-843-3338

SENCORE

3200 Sencore Drive
Sioux Falls, SD 57107
605-339-0100 In SD Only

*innovatively designed
with your time in mind.*

CIRCLE 178 ON FREE INFORMATION CARD

VIDEO TAPE COPY PROTECTION GOT YOU DOWN?

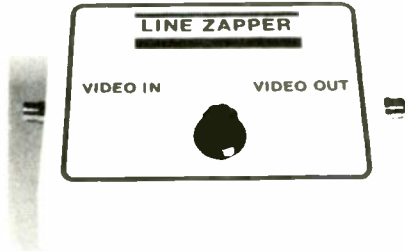

STABILIZE YOUR PICTURE WITH THE NEW, IMPROVED LINE ZAPPER

Bothered by brightness changes, vertical jumping and jittering, and video noise? Tired of renting or buying tapes and being forced to watch an unstable washed out picture? Solve your problems with the Line Zapper.

The Line Zapper accepts direct video from any VCR and monitors the signal, line by video line. When it sees the copy protection signal it Zaps it, giving you a normal, clean signal at the output.

Available in both kit form and fully assembled. The kit is only \$69.95 (Not recommended for the beginner) plus \$3.00 shipping. Assembled, tested units with a 90 day warranty are only \$124.95 plus \$3.00 shipping.

Arizona residents must add 6.7% sales tax. Please allow 6 to 8 weeks for delivery. Dealer inquiries welcome

ELEPHANT ELECTRONICS INC.



BOX 41865-F
PHOENIX, AZ 85080
(602) 581-1973

CIRCLE 120 ON FREE INFORMATION CARD

NEW PRODUCTS

STATIC CONTROL, *Screen Prep* consists of two individual, disposable cloth pads sealed in twin foil packets. The first packet contains a premoistened pad saturated with a combination solvent/anti-static agent that quickly removes dust, dirt, and fingerprint oils. The second packet contains a dry, lint-free pad to wipe the surface clear.



CIRCLE 30 ON FREE INFORMATION CARD

Screen Prep also provides a convenient method for cleaning smudges and stains that result from equipment handling during service calls. It effectively removes CRT screen contaminants that inhibit and destroy vision. Packaged in boxes of 24 dual-packs, *Screen Prep* is priced at \$7.50 per box.—**Chemtronics**, 681 Old Willets Path, Hauppauge, NY 11788.

THERMAL WIRE STRIPPER, the model *G*, features a continuously variable heat control that allows the unit to strip virtually any size or type of plastic-insulated wire. Designed for production-line operation, the device can be used either as a bench-operated tool or it can be held in the hand for use in inaccessible locations.

The stripper uses two parallel-heating elements to sever plastic insulation, and provides a pincers

action to remove the insulation with a slight pull. No sharp cutting edges are used, so there is complete freedom from cut or nicked wires. The light-weight handle is heat-insulated with cork.

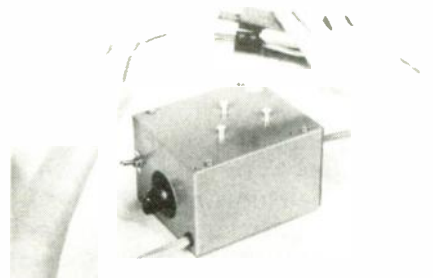

CIRCLE 31 ON FREE INFORMATION CARD

The model *G* strips any size down to the finest stranded #36 AWG wire without adjustment. It is also suited for coaxial cable and will strip Teflon as well materials with a lower melting point, such as vinyl, nylon, dacron, rayon, polyethylene, etc. It is priced at \$139.50.—**Western Electronic Products Co.**, 107 Los Molinos, San Clemente, CA 92672.

POCKET MEGOHM METER, the *Micro-Megger* is a hand-held, battery-powered megohm meter for



CIRCLE 32 ON FREE INFORMATION CARD

testing static dissipative and conductive materials. Featuring a se-

ATTENTION! ELECTRONICS TECHNICIANS

EARN YOUR **B.S.E.E. DEGREE**

THROUGH HOME STUDY

Our New and Highly Effective Advanced-Placement Program for experienced Electronic Technicians grants credit for previous Schooling and Professional Experience, and can greatly reduce the time required to complete Program and reach graduation. No residence schooling required for qualified Electronic Technicians. Through this Special Program you can pull all of the loose ends of your electronics background together and earn your B.S.E.E. Degree. Upgrade your status and pay to the Engineering Level. Advance Rapidly! Many finish in 12 months or less. Students and graduates in all 50 States and throughout the World. Established Over 40 Years! Write for free Descriptive Literature.

COOK'S INSTITUTE OF ELECTRONICS ENGINEERING



347 RAYMOND ROAD
P.O. BOX 20345
JACKSON, MISSISSIPPI 39209

CIRCLE 194 ON FREE INFORMATION CARD

ries of LED's that indicate surface resistivity, the unit performs over 1000 surface measurements on a single charge.

The *Micro-Megger* measures surface electrical resistance in accordance with ASTM D-257; it uses a rechargeable NiCad battery and presents no electrical shock hazard. It is priced at \$249.00.—**Charleswater Products, Inc.**, 93 Border St., West Newton, MA 02165.

ODOMETER DATA COMPUTER, records and stores mileage, date, and time information for up to 60 trips before printing is required; it also keeps a year-to-year mileage total for the current and previous year, and calculates the percentage of auto use for business. It includes a detachable printer.



CIRCLE 33 ON FREE INFORMATION CARD

A simple hookup and command to the printer produces a printed record that can be submitted to the Internal Revenue Service. Each trip's printout includes a purpose section where business activities can be personalized.

The compact computer, which is illuminated for use at night, can be placed anywhere in the vehicle, although the manufacturer recommends that such units be kept off dash due to temperature extremes. The printer, which is powered off the computer, can be stored in the glove box, trunk, briefcase, or the office when not in use. In addition, several people can share a printer.

The *Odometer Data Computer* is priced at \$399.00.—**Mileage Validator, Inc.**, P.O. Box 830650, Richardson, TX 75083. R-E

Exclusive, triple patented dynamic cap and coil analyzing . . . guaranteed to pinpoint your problem every time or your money back



with the all new LC75 "Z METER 2"
Capacitor Inductor Analyzer
Patented \$995

The "Z METER" is the only LC tester that enables you to test all capacitors and coils dynamically — plus, it's now faster, more accurate, and checks Equivalent Series Resistance (ESR) plus small wire high resistance coils.

Eliminate expensive part substitution and time-consuming shotgunning with patented tests that give you results you can trust every time. Test capacitor value, leakage, dielectric absorption, and ESR dynamically; with up to 600 volts applied for guaranteed 100% reliable results — it's exclusive — it's triple patented.

Save time and money with the only 100% reliable, in- or out-of-circuit inductor tester available. Dynamically test inductors for value, shorts, and opens, automatically under "dynamic" circuit conditions.

Reduce costly parts inventory with patented tests you can trust. No more need to stock a large inventory of caps, coils, flybacks, and IHVTs. The "Z METER" eliminates time-consuming and expensive parts substituting with 100% reliable LC analyzing.

Turn chaos into cash by quickly locating transmission line distance to opens and shorts to within feet, in any transmission line.

Test troublesome SCRs & TRIACs easily and automatically without investing in an expensive second tester. The patented "Z METER 2" even tests SCRs, TRIACs, and High-Voltage Diodes dynamically with up to 600 volts applied by adding the new SCR250 SCR and TRIAC Test Accessory for only \$148 or FREE OF CHARGE on Kick Off promotion.

To try the world's only Dynamic LC Tester for yourself, CALL TODAY, WATS FREE, 1-800-843-3338, for a FREE 15 day Self Demo.



Call Today Wats Free 1-800-843-3338

SENCORE

3200 Sencore Drive
Sioux Falls, SD 57107
605-339-0100 In SD Only

*innovatively designed
with your time in mind.*

CIRCLE 179 ON FREE INFORMATION CARD

COMMUNICATIONS CORNER



Diversity microphone transmission

WE HAVE DEVOTED SEVERAL COLUMNS in the past to the subject of diversity reception as it pertains to high-frequency shortwave signals (to 30 MHz); those signals are particularly sensitive to variations in polarization. Although we call the effects of polarization "selective fading," in fact the signal might not vary in strength at all; only its polarity varies. However, the typical receiver sees a change in polarization as being a change in signal strength.

In the usual form of diversity reception, a special receiver switches between horizontal and vertical antennas, always selecting the antenna input that provides the maximum signal strength. Naturally, a broad range of signal level is accepted as "satisfactory" to prevent the antennas from switching back and forth continuously.

But signal polarization isn't the only reception problem that requires diversity reception, nor does diversity reception neces-

sarily require vertical and horizontal receiving antennas. In particular, FM wireless microphones can be seriously affected by signal-phasing problems caused by multipath reception. Although the problem can usually be resolved through diversity reception, the two antennas involved are both vertically polarized.

For those of you unfamiliar with the wireless microphone, it is actually a system consisting of a transmitter and a receiver. The

Pay Less For The Best

WTCPR
Controlled
Output
Soldering
Station
\$76.00

Weller®

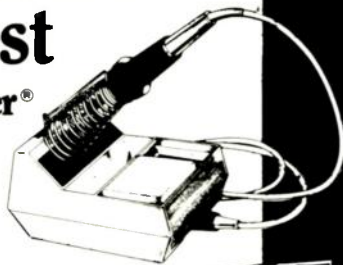

Universal Soldering Kit
List \$28.22 SALE \$22.48

Includes dual heat soldering gun with 3 soldering tips, wrench, flux brush, soldering aid tool & solder in plastic carrying case. 8200PK

Professional Soldering Kit
List \$38.29 SALE \$30.50

Includes soldering gun with pre-tinned heavy copper tip, 2 spare tips, wrench, flux brush, soldering aid tool & solder in plastic carrying case. D550PK

Weller®



Xcelite® Service Master
Roll Kit
List \$95.71 SALE \$76.99

Includes 23 tools in plastic-coated canvas case: 6" long nose plier, 5" diagonal plier, 6" adjustable wrench, regular and stubby handles, 9 regular nutdrivers, 3 stubby nutdrivers, nos. 1 & 2 Phillips screwdrivers, 3/16" & 1/4" slotted screwdrivers, reamers and 7" extension. 99SM

Send now for your
FREE catalog of
electronic tools &
test equipment

W.S. JENKS & Son



1933 Montana Ave. NE
Washington DC 20002

TOLL-FREE 1-800-638-6405

Floppy Drive Repair & Service

Now the company that manufactures floppy drives has set up a repair division.

Complete Floppy Drive service for the following:

IBM	TEAC
Fujitsu	Shugart
Qume	Apple
Mitac	Panasonic

All repairs are warranted!

We also service on IBM and compatible computers.

Call (408) 988-7510 for more information
or bring your service needs to:

First Street Computer Corp.

3385 Viso Ct. • Santa Clara, CA 95054

CIRCLE 188 ON FREE INFORMATION CARD

transmitter might be combined with the microphone into a microphone-shaped device, or the transmitter might be independent of the mike so it can be worn on a belt or concealed under the user's

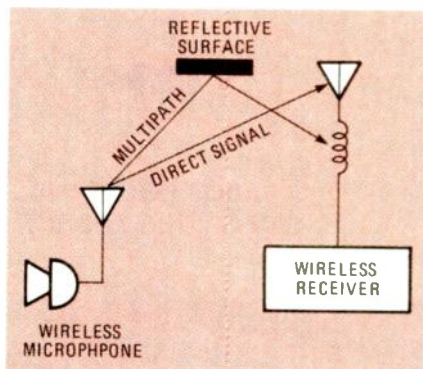

FIG. 1

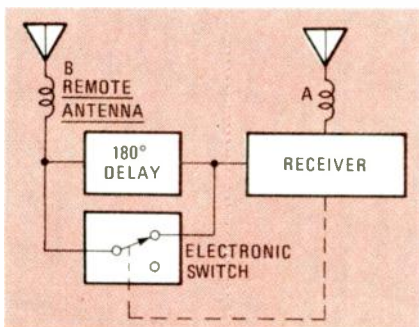

FIG. 2

clothes. Wireless mikes are used by those who prefer to roam unencumbered by the umbilical cord of a conventional microphone. Also, wireless sensors, which are usually wireless-microphone based, are now built into electric instruments such as guitars so that performers can also dispense with the umbilical cord between instrument and amplifier.

In principle, the wireless mikes are much like the inexpensive FM microphone kits you can buy from electronics hobby stores for a few dollars; those, of course, broadcast a signal that can be received by a conventional FM radio. Professional wireless microphones, however, usually pack much more power, have a wider frequency response for high fidelity, and operate on VHF frequencies specifically assigned for stage, radio, and TV communications.

Because they operate on VHF frequencies, they are prone to multipath reflections from by steel
continued on page 31

Analyze defective waveforms faster, more accurately, and more confidently — every time or your money back

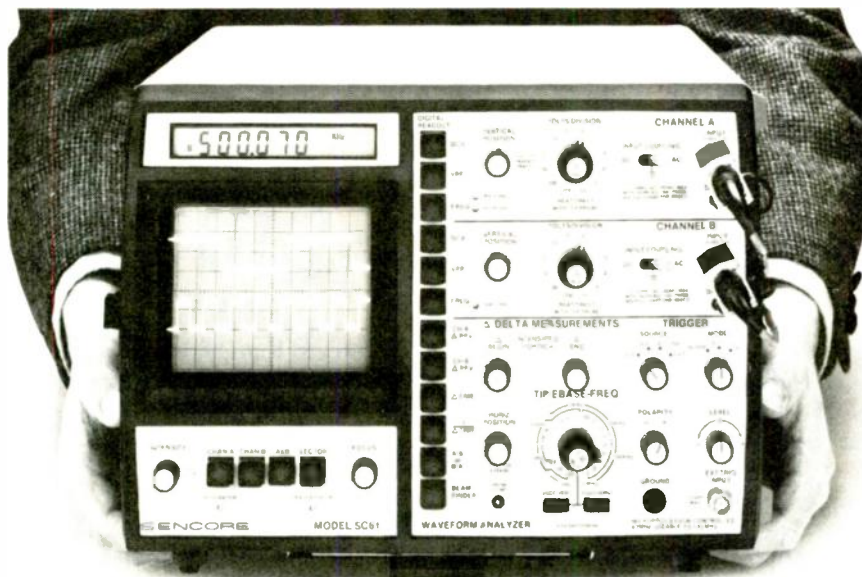

with the SC61 Waveform Analyzer
Patented \$2,995

If you value your precious time, you will really want to check out what the exclusively patented SC61 Waveform Analyzer can do for you. 10 times faster, 10 times more accurate, with zero chance of error.

End frustrating fiddling with confusing controls. Exclusive ultra solid ECL balanced noise cancelling sync amplifiers, simplified controls, and bright blue dual trace CRT help you measure signals to 100 MHz easier than ever.

Accurately and confidently measure waveforms from a tiny 5 mV all the way to a whopping 3,000 V without hesitation with patented 3,000 VPP input protection — eliminates expensive "front end" repairs and costly equipment downtime.

Make only one circuit connection and push one button for each circuit parameter test: You can instantly read out DC volts, peak-to-peak volts and frequency 100% automatically with digital speed and accuracy. It's a real troubleshooting confidence builder.

Confidently analyze complex waveforms fast and easily. Exclusive Delta measurements let you intensify any waveform portion. Analyze glitches, interference signals, rise or fall times or voltage equivalents between levels; direct in frequency or microseconds.

Speed your digital logic circuit testing. Analyzing troublesome divide and multiply stages is quicker and error free — no time-consuming graticule counting or calculations. Simply connect one test lead to any test point, push a button, for test of your choice, for ERROR FREE results.

To see what the SC61 can do for your troubleshooting personal productivity and analyzing confidence, CALL TODAY, WATS FREE, 1-800-843-3338, for a FREE 15 day Self Demo.



Call Today Wats Free 1-800-843-3338

SENCORE
3200 Sencore Drive
Sioux Falls, SD 57107
605-339-0100 In SD Only

*innovatively designed
with your time in mind.*

CIRCLE 180 ON FREE INFORMATION CARD

SATELLITE TV



BOB COOPER, JR.,
SATELLITE TV EDITOR

Is HDTV the key to an international standard?

IN OUR LAST COLUMN WE DISCUSSED A plan to gradually phase out the 525-line NTSC national television standard. Its replacement would be a new wideband, *High Definition TV* (HDTV) system having more than 1,000 scanning lines. What makes the wideband plan feasible is the concept of satellite distribution of television programming, which, perhaps, will ultimately replace terrestrial VHF and UHF transmitters.

The most logical way to produce high-definition video is to double the picture bandwidth. If a 6-MHz bandwidth is required for 525-line NTSC video, a 12-MHz bandwidth will certainly accommodate 1,125-line video. But it's impossible to allow all existing television stations to increase their bandwidth within the existing VHF and UHF television spectrum because the spectrum is essentially filled to capacity already. Also, the FCC has

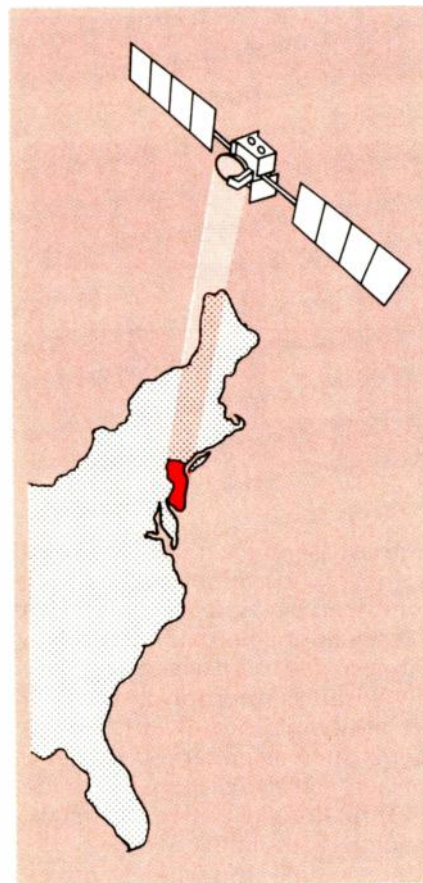

FIG. 1

been chipping away at both the top end (channels 70-82) and the bottom end (channels 14-20) of the UHF band for more than a decade, siphoning off UHF channels for two-way radio and other uses.

Out of spectrum

Spectrum space is, in fact, almost non-existent until the microwave region near 12 GHz. There, perhaps with careful planning, is the means whereby we can fit in the wide bandwidths required for HDTV. CBS would like to see ter-



ELECTRONICS JUBILEE 'N MEMPHIS, TENNESSEE

1987 National Professional Electronics Convention

NESDA (Inc. NATESA), IS CET & TESDA ON THE MISSISSIPPI RIVER

The Peabody • Memphis, TN

August 10-15, 1987



- Social Events • Sponsored Meal Functions • Dances
- Technical Seminars • Business Management Training
- Two-Day National Professional Electronics Trade Show
- Mud Island • Beale Street • The Mississippi River

TENTATIVE SCHEDULE

MONDAY, AUGUST 10

• Golf & tennis outings • Begin 40-hour Instructors Conference and basic VCR servicing course • Get-acquainted party and Mississippi River boat ride (free to early registrants; extra-cost option to others).

TUESDAY, AUGUST 11

• Instructors/VCR school • Business management seminar • Technical seminars • IS CET officer elections • Dinner party.

WEDNESDAY, AUGUST 12

• Instructors/VCR school • NESDA annual House of Representatives and membership meeting/State of the Association • Technical seminars • Dinner party.

THURSDAY, AUGUST 13

• Instructors/VCR school • Trade show • NESDA officer elections • Technical seminars • Country/Western dinner party.

FRIDAY, AUGUST 14

• Instructors/VCR school • Dealer/Mfr. meetings • National Service Conference • CET Exams • Cont. IS CET annual meeting • Professional seminars • Dinner party.

SATURDAY, AUGUST 15

• IS CET breakfast • Instructors/VCR school • Advanced VCR service school • Servicing Digital VCRs • NESDA/IS CET annual awards banquet and officers installation ceremony.

For more information and a registration form, contact NPEC '87,
2708 W. Berry St., Ft. Worth TX 76109; Ph. (817) 921 9061



Try the
**Radio
Electronics**
bulletin board
system
(RE-BBS)
516-293-2283

The more you use it the
more useful it becomes.

We support 300 and 1200
baud operation.

Parameters: 8N1 (8 data
bits, no parity, 1 stop bit) or
7E1 (7 data bits, even parity,
1 stop bit)

Add yourself to our user files
to increase your access.

Communicate with other R-E
readers.

Leave your comments on R-E
with the SYSOP.

RE-BBS
516-293-2283

INTERESTED IN SCRAMBLING?

Bob Cooper's *CSD Magazine* maintains a 24 hour per day *Scramble-Fax-Hotline* telephone service (305/771-0575) which you may call to obtain a 3-minute recorded update on the latest happenings in the satellite scrambling world. *Scramble-Fax Newsletter* is also published to keep you abreast of the latest events in descrambling, including sources for descrambling chips and equipment. For information, write *Scramble Fax*, P.O. Box 100858, Ft. Lauderdale, FL. 33310 or telephone 305-771-0505.

If you have a dish of your own, tune in the Caribbean Super Station (Western 5, transponder 23) Tuesdays at 7 PM eastern for a special weekly Bob Cooper report. Also tune-in *Boresight* at 9 PM Thursday nights (Spacenet 1, transponder 9) for a weekly one-hour report on the activities in the home TVRO field.

restrial delivery of HDTV signals, meaning that the signals originate from a microwave transmitting antenna mounted on a tall tower or a tall building. Virtually nobody else likes that concept because transmission ranges would be short (typically, only direct line of

sight—under 25 miles). Most favor a satellite-to-home approach, using the DBS-assigned 500-MHz bandwidth between 12.2 and 12.7 GHz. A few engineers are looking at the next higher satellite band, Ka, in the 20-GHz region, because precise beam shaping would allow footprint-patterned satellite transmitting antennas to cover irregular shapes (such as the state of New Jersey) with great accuracy.

It's assumed that the U.S. will make the decision to implement HDTV before 1990 because that's the year that the Japanese expect to launch a fully operational three-channel HDTV satellite (in the 12 GHz-band). Already, new satellite receivers, television monitors, and videotape decks have been designed to support their HDTV program. When the Japanese inaugurate the HDTV service they plan to have all of the consumer receiving equipment on store shelves ready for delivery.

The revolution at the receiving end, while spectacular, is hardly the full effort. To produce HDTV

broadcasts, entirely new studio and transmission equipment and programming had to be created, because in addition to the enhanced resolution, the aspect ratio (width to height) was changed as well: from 4×3 to 5×3 . (Sony began delivering 5×3 HDTV cameras and professional tape decks late in 1986, and new production studios using that equipment are already operating in several US cities.)

Back-door standards

Although HDTV addresses itself to a better-quality picture, in actual fact it is interlocked with the concept of a global TV standard, and for many communications people the idea of a global TV standard is more important than whether the TV screen can show greater picture detail. But the idea of a high-resolution picture has more sizzle and snap than technical standards—about which the average user couldn't care two hoots—so we will most probably

continued on page 74

SUPER LONG PLAY TAPE RECORDERS

10 Hour Model — \$95.00*
14 Hour Model — \$159.00*

Modified Panasonic Slimline, high quality, AC-DC Recorders provide 5 or 7 continuous hours of quality recording & playback on each side of cassette for a total of 10 or 14 hours depending on model. Built-in features include: • Voice level control. • Digital counter. etc. TDK DC 180 Cassette Furnished



PHONE RECORDING ADAPTER

Records calls automatically. All Solid state connects to your telephone jack and tape recorder. Starts recording when phone is lifted. Stops when you hang up. **\$24.50*** FCC APPROVED



VOX VOICE ACTIVATED CONTROL SWITCH

Solid state Self contained. Adjustable sensitivity. Voices or other sounds automatically activate and control recorder. Uses either recorder or remote mike. **\$24.95***

*Add for ship & hdg. Phone Adapter & Vox \$1.50 ea. Recorders \$4.00 ea. Cal. Res. add tax. Mail order, VISA, MIC, COD's OK. Money Back Guarantee. Qty. disc. avail. Dealer Inquiries invited. Free data.

AMC SALES, Dept. A 9335 Lubec St., Box 928, Downey, CA (213) 90241 Phone 869 8519

CIRCLE 108 ON FREE INFORMATION CARD

Firestik

CB ANTENNAS & ACCESSORIES

SINCE 1962

THE MOST POPULAR WIRE-WOUND CB ANTENNAS IN THE WORLD

Because...they perform!

FACT

"When CB was legalized in England, 'Firestik' antennas were barred from sale because the emitted signal was too strong. Fortunately, no other country, including the U.S., limits antenna efficiency."

YOU CAN HAVE SECOND BEST OR, 'Firestik'!

Call or Write for **FREE** Catalog
'Firestik' Antenna Company
2614 East Adams
Phoenix, Arizona 85034
(602) 273-7151

MILLIONS OF SATISFIED OWNERS

CIRCLE 100 ON FREE INFORMATION CARD

Be an FCC LICENSED ELECTRONIC TECHNICIAN!



Earn up to \$30 an hour and more!

Learn at home in spare time. No previous experience needed.

No costly school. No commuting to class. The Original Home-Study course prepares you for the "FCC Commercial Radio-telephone License". This valuable license is your "ticket" to thousands of exciting jobs in Communications, Radio-TV, Microwave, Computers, Radar, Avionics and more! You don't need a college degree to qualify, but you do need an FCC License.

No Need to Quit Your Job or Go To School
This proven course is easy, fast and low cost! **GUARANTEED PASS** - You get your FCC License or money refunded. Send for **FREE** facts now. **MAIL COUPON TODAY!**

COMMAND PRODUCTIONS

FCC LICENSE TRAINING, Dept 90
P.O. Box 2223, San Francisco, CA 94126

Please rush **FREE** details immediately!

NAME _____
ADDRESS _____
CITY _____ STATE _____ ZIP _____

DESIGNER'S NOTEBOOK



ROBERT GROSSBLATT,
CIRCUITS EDITOR

Logic-family translation

EVERYBODY HAS HIS FAVORITE LOGIC family. Some like the familiarity of TTL and have never given CMOS a chance since the bad days of the CMOS "A" series devices. On the other hand, some like CMOS and think that anyone hung up on TTL is from the stone age. DTL and RTL users are primarily history.

The truth of the matter is that both TTL and CMOS are going to be around for a while because each has advantages and disadvantages. If you look at enough schematics, you'll see that many circuit designers routinely mix both logic families in the same electronics package.

There are several considerations to keep in mind if you want to do the same thing in your own designs. Mixing logic families requires that you pay attention to the voltage at which they change state. TTL parts have much stricter requirements than CMOS. A TTL low state has a maximum voltage of about 0.8, and a TTL high state has a minimum voltage of 2.4. CMOS, on the other hand, is much more flexible. A low is usually defined as less than half the supply voltage, and a high is more than half the supply voltage.

If you're working with a five-volt-only circuit, mixing TTL and CMOS is simple. As you can see in Fig. 1-a, driving a single TTL input with a CMOS output requires nothing more than connecting the two parts together. Going from TTL to CMOS, however, requires a bit more thought. Assuming a five-volt supply, the TTL high output can be as low as 2.4 volts. That's slightly below the point at which

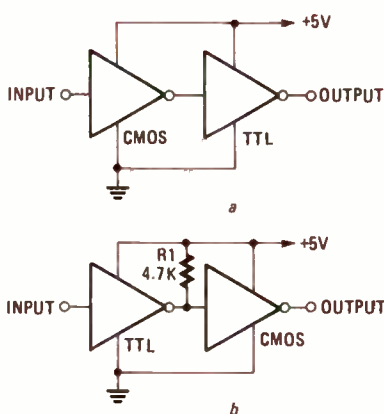

FIG. 1

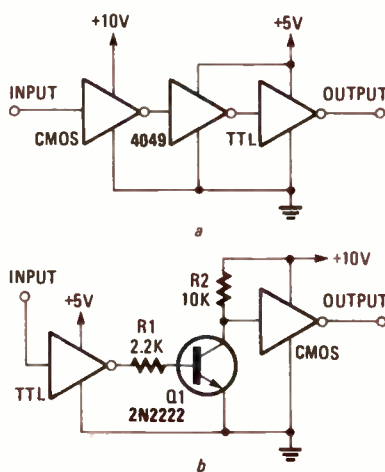

FIG. 2

the CMOS input will change state, so there's no guarantee that the circuit will work correctly. The solution is to add a pull-up resistor of about 4.7K, as shown in Fig. 1-b. The exact value of the resistor depends on the type of TTL you're using (74, 74S, 74LS, etc.), but a value of 4.7K at least will get you in the ballpark.

Different supply voltages

Things get even more tricky if the CMOS and TTL halves of your circuit are powered by different voltages. Two readily available CMOS buffers (the 4049 and the 4050) can translate the higher-voltage CMOS output into something the TTL input can use. A sample circuit is shown in Fig. 2-a. To make the translation without inverting the signal, use a 4050.

Going from TTL at 5 volts to CMOS at, say, 10 volts, requires some voltage translation. We can't always do it the way we did in Fig. 1-b because the TTL output must be isolated from the higher CMOS voltage.

There are many schemes to get the job done, but an easy one is shown in Fig. 2-b. A small-signal NPN transistor is used as a buffering switch between the TTL and the CMOS parts, but keep in mind that the transistor will invert the signal from the TTL output. You can re-invert the signal by using another transistor or a spare CMOS gate.

Fanout

Before we leave the subject of logic-family translation, we must talk about fanout. If you're a regular CMOS user, you're probably used to ignoring fanout limits altogether. The reason is that the input impedance of a typical CMOS part is so high that you can drive as many inputs as you want with a single output. The same is true when driving CMOS with TTL: A typical TTL output has more than enough current-capacity to drive any number of CMOS inputs.

Going the other way, however, is a bit of a problem.

The reason is that most CMOS outputs simply can't deliver much current into a low-impedance TTL input. The number of TTL inputs you can drive with a CMOS output depends on the specific TTL part you're using. As a general rule you can drive more LS inputs than regular or S inputs, but it's usually better to be safe than sorry. So don't drive more than two inputs, regardless of type. As a matter of fact, it's better not to drive more than one, and make it a 7404 or 74S04. You'll have no trouble whatsoever driving the single input and then following the standard rules for TTL-to-TTL fanout.

If you anticipate designing many mixed-family logic circuits, work out each problem on a breadboard and standardize the design. By doing so, any time you're faced with the same problem, you'll have a debugged module you can drop in your circuit and solve the problem. And that will let you go on to more important things. R-E

COMMUNICATIONS CORNER

continued from page 27

beams, stage hardware, and anything else that can reflect radio signals. As shown in Fig. 1, any reflected signals arrive at a wireless-microphone system's receiving antenna after a directly received one; hence, they are usually out of phase with the directly received signal. That phase difference can plunge the received signal level right into the noise level. As a result, at one moment the audience may hear the performer, but at the next only the lips are seen moving. That's because, when the signal strength is too low, the microphone's receiver squelches to prevent the listener's ears from possibly being assaulted by the sound of random noise.

Curing multiphase distortion

Multipath distortion plagued wireless-microphone communications until the introduction of a

diversity antenna/receiver system that Shure (222 Hartrey Ave., Evanston, IL 60202), a manufacturer of high-performance microphone equipment, calls *Diversiphase*.

The wonder of *Diversiphase* is that it wasn't invented earlier. Figure 2 shows how it works. The signal is received by vertical antennas A and B, which feed the receiver in parallel. To ensure that both antennas aren't affected by the same multipath signals, at least one antenna must be remotely located. Usually, 25-foot spacing between the antennas is best; the minimum spacing is 6 feet.

However, note that antenna A feeds the receiver directly, whereas antenna B feeds the receiver through a 180° delay line that is bypassed by an electronic switch. The delay line is a half-wavelength (at the operating frequency) coaxial section.

The signals from the two antennas always add together, so that when they are in-phase, the total signal delivered to the receiver is 3
continued on page 78

Send Purchase Order
Check, Money Order, or C.O.D.
or Call Toll Free
800-223-0826
in N.Y. State (212) 865-5580

#1 IN CABLE BOXES
SPECIAL!

- Volume control
- 68 channels
- Mute control
- Automatic fine tuning
- Instant channel recall
- Programmable to go on at a particular channel and off automatically
- Compatible with descramblers

\$99.95

ANY QUANTITY

JERROLD CORDLESS CABLE TV CONVERTERS

MODEL STARCOM-460



*ADD \$5.00 FOR VISA OR MASTER CARD

JERROLD CORDLESS CABLE TV CONVERTER

MODEL DRX3-105/400

\$69.95

- 58 channels
- Remote channel changing
- Remote on/off switch
- Remote fine tuning



JERROLD CORDLESS CABLE TV CONVERTER

MODEL DRZ/450

- 66 channels
- Automatic fine tuning
- A/B switch option

\$69.95/ 10 lot
\$79.95 ea.



JERROLD CORDED CABLE TV CONVERTER

MODEL JRX3-105

\$34.95/ 10 up

\$39.95/6-9
\$49.95/1-5



"THE RABBIT" VIDEO MULTIPLYING SYSTEM

TR-7000

\$51.95 12 up
\$59.95/6-11
\$69.95/1-5



IT'S LIKE HAVING A VCR IN EVERY ROOM

■ MASTER CARD ■ VISA

OMNITRON ELECTRONICS

770 Amsterdam Ave., New York, NY 10025

SHIPPING CHARGES

For Orders	Add
\$25-100	\$6.50
\$100-500	\$8.50
\$500-750	\$10.50
\$750 and up	\$20.00



CIRCLE 110 ON FREE INFORMATION CARD

AUDIO UPDATE

The audio answerman



LARRY KLEIN,
AUDIO EDITOR

IT OCCURRED TO ME RECENTLY THAT I've been answering consumers' hi-fi questions in various publications for about 30 years! Of course, as times have changed and electronics has advanced, the nature of those questions has also evolved. In 1964, for example, I cautioned a reader that a metal 6L6 tube was not an adequate replacement for a 6L6GC because the glass GC tube was designed to withstand the higher voltages to be encountered in the new audio amplifiers.

Over the years I've handled problems of stereo and then quadraphonic conversion, advised on the pros and cons of switching to transistor equipment, and so forth. Today those questions and their answers are no longer pertinent, but new queries have arisen to take their place, so I've assembled a group of today's recurrent Q's and A's in hope that they will be of some aid and comfort both to the novice and to the technically beleaguered audiophile.

On-off switching

Q. Should audio equipment be left on permanently? Some audiophiles and manufacturers claim that there is less wear on the equipment if it is left on, and that it also sounds better.

A. Several manufacturers of preamps and accessories advise that their equipment be switched on permanently. In fact, some equipment is designed so that its circuits are powered at reduced voltage even when switched off, as long as the AC line cord is plugged in. The purpose in both

cases is simply to prevent audio thumps and other noises as the circuits charge at the moment of turn-on. When dealing with vacuum tubes there's an additional reason not to have the equipment fully off. Tube filaments (like electric light bulbs) tend to suffer stress from turn-on surges. If a tube is always on (with reduced filament voltage), thermal shock is reduced, and the tube's filament life is extended.

Aside from noise and longevity, some manufacturers claim that there is a sonic advantage in having their equipment constantly on. That may be, but my feeling is that any design that needs to be permanently powered to avoid a long warm-up drift needs to be gotten back to the drawing board as quickly as possible! In any case, most manufacturers would advise you to turn off your audio equipment when you don't plan to use it again for several hours.

Separate speakers

Q. I have been told that you should use one type of speaker for classical records and another for rock. Do you agree with that idea?

A. Absolutely not! Every speaker system should deliver an accurate acoustic analog of the electrical signal provided to it by the amplifier. Those pushing the concept of different speakers for different music are saying, in effect, that certain types of music sound best with speakers whose frequency-response curves, dispersion, distortion levels, etc. deviate from the ideal.

It seems to me that if each musical instrument in a band or orchestra has been recorded with a specific loudness level relative to the other instruments in that band or orchestra, you want your speakers to reproduce those levels accurately, no matter what kind of music is involved. For example, if the recording has been engineered so that the brass has an extra "nasal" quality, the bass extra "sock," and the string extra "bite," a speaker with a flat response will deliver those qualities—neither more nor less. In other words, you want a speaker system that is neutral, rather than having a specific built-in tonal quality. When a speaker system injects its own tonal qualities—such as an upper-midrange boost—into the music, some program material may sound "better"—but on most program material the contribution will be inappropriate and will only be heard as coloration.

I can see a situation in which a speaker that does a fine job of reproducing string quartets is not suitable for rock, but only because it lacks the acoustic-output capability to achieve the desired sound-pressure levels. Achieving an adequate loudness level for rock or contemporary electronic music can drive your amplifier, your speakers, or both into distortion. The distortion may be due to (1) inadequate amplifier power, low speaker efficiency, or both, or (2) inadequate power-handling capacity on the part of the speakers. In such a case, other speakers with greater efficiency and power-handling capacity would, of course,

do a better job. However, all other performance criteria in respect to frequency range and smoothness, distortion, dispersion, etc., continue to be valid.

For that reason, a speaker that can deliver the high volume levels desirable for rock reproduction, if it is in truth a high-fidelity reproducer, should do just as good a job reproducing the more moderate levels of a string quartet.

Tape-dub overload

Q. When I dub some of my records onto cassette, sections of the tape (usually at the beginning) suffer from a sort of breakup in the sound every second or so. When I listen to the disks themselves during dubbing or later, they sound fine. What's wrong?

A. The records you are trying to dub are probably warped sufficiently to cause severe vertical deflection of your phono stylus during play. That produces a very strong, very low frequency signal that overloads your tape (or cassette) deck's electronics. The records themselves sound fine when heard through your system probably because the subsonic warp signal is either handled without overload or it is filtered out by components following the tape-output jack in your equipment. You can test my hypothesis by playing the problem disks again and noting whether warps displace the phono stylus toward the cartridge body and whether the warps coincide with the taped overload distortion.

Dubbing Dolby

Q. When copying a Dolby-encoded tape from one deck to another, is it better to decode the tape playing on deck A and re-encode it when recording on deck B, or to record the tape from deck A to deck B without decoding and re-encoding?

A. You'll achieve the best results in duplicating Dolby-processed tapes if you decode the signal during playback and re-encode it while copying. In other words, the Dolby circuits should be switched on in both machines. If you were to copy Dolby-processed audio material with the de-

coding and encoding circuits switched off, the signal is likely to be recorded by the second machine at a different level than on the original tape. That can confuse the Dolby-decoding circuits during playback of the copied tape because the Dolby reference level has been shifted. The result will be less noise reduction and some high-frequency boost (or loss) in playback of low-level signals.

Power and volume loss

Q. Although I have a CD player, I need a record player for my 10-year collection of LP's. I recently replaced my old phono cartridge with a new high-quality unit, but now the power fed to my speakers is much lower on phono than on tape or tuner. Exactly what is the problem?

A. Variations on that question have appeared in my mail at least twice a month for many years. The problem—and it really isn't a problem—is a loss (or a gain) in volume resulting from a change in equipment: phono cartridge, tape deck, CD player, tuner, preamplifier, power amplifier—in fact, any component.

The "problem" arises partially because many audiophiles mistakenly believe that volume control setting correlates directly with amplifier output power. *It does not!* Think of an amplifier's volume control as a handle on a water faucet. If the water pressure (signal voltage) is very high, then a slight twist will deliver a high volume of water (sound); if the pressure is lower, then the faucet has to be opened further to get the same volume of water flowing from it. In the case in point, the new phono cartridge obviously delivers less signal to the preamplifier for a given record-groove velocity than the previous model.

To determine whether the output level of a phono cartridge is adequate, play a record at the loudest volume at which you would ever normally listen to it, and then, without touching the volume control, lift the tone arm with its cue control. Listen for noise from the phono-preamp stages. If you don't hear hum, hiss, or RF buzz, phono gain is within the proper range. **R-E**

"Made in U.S.A."



Since 1965

We've been supplying quality crystals since 1965 — long before the flood of cheap imports.

We're still supplying quality crystals with

- Quick Turnaround
- Low Price
- High Quality

TO SOLVE CRYSTAL PROBLEMS, GET THIS CATALOG



JAN CRYSTALS

P.O. Box 06017

Ft. Myers, FL 33906

(813) 936-2397

VISA

MasterCard

**CALL 1-800-237-3063
FREE (Except Florida)**

CIRCLE 104 ON FREE INFORMATION CARD



CHEMICAL SOLUTIONS

FREE CHEMTRONICS CATALOG!

Comprehensive new source for over 200 products used in electronic manufacturing and field service. Precision cleaning agents, flux removers, bulk solvents, circuit refrigerants, precision dusters, non-residual wipers, foam swabs, premoistened pads/swabs, antistatic compounds, conformal coatings, lubricants, adhesives, desoldering braids, rosin core solder and solder masking agents. Complete with technical specifications and application guide.



Chemtronics Inc.
681 Old Willets Path
Hauppauge, N Y 11788
516-582 3322

CIRCLE 54 ON FREE INFORMATION CARD

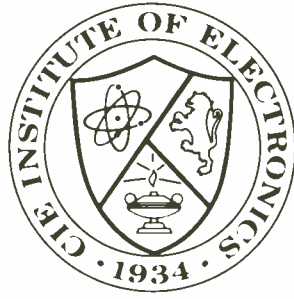

“If you’re going to learn electronics, you might as well learn it right!”

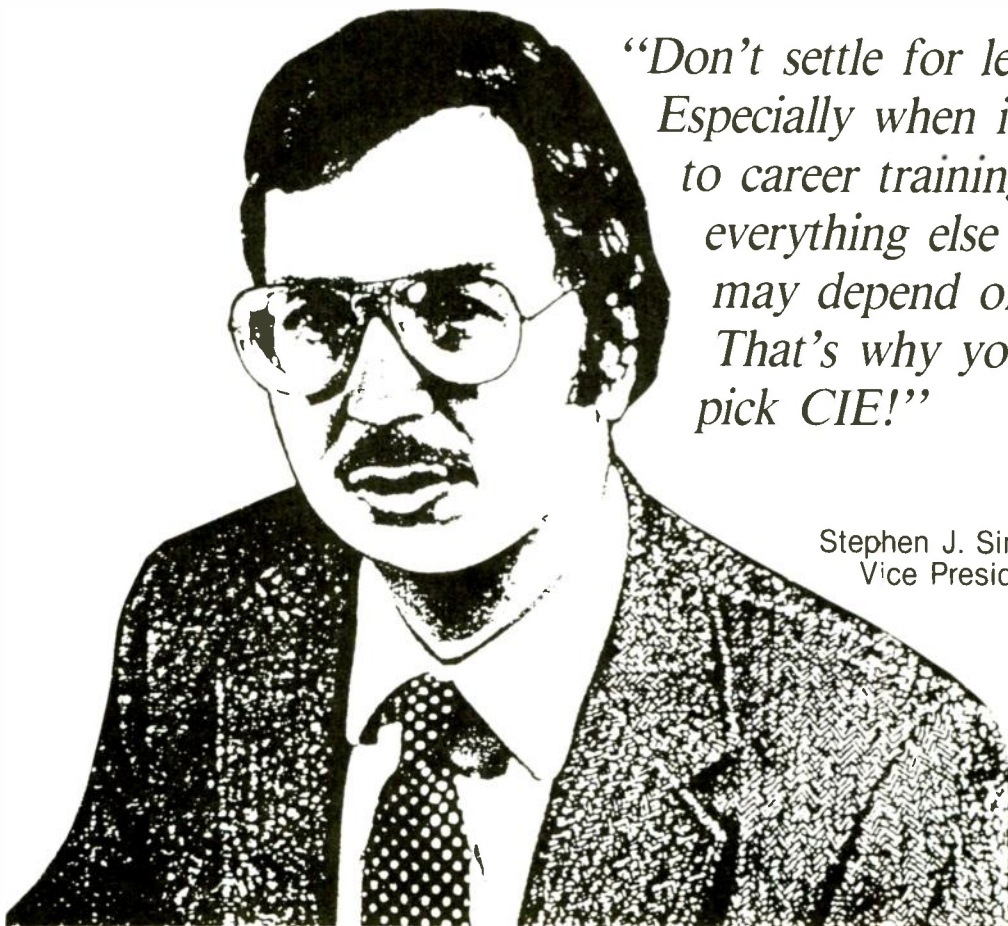

*“Don’t settle for less.
Especially when it comes
to career training...because
everything else in your life
may depend on it.
That’s why you ought to
pick CIE!”*

Stephen J. Simcic
Vice President, Academic Affairs

You've probably seen advertisements from other electronic schools. Maybe you think they're all the same. They're not!

CIE is the largest independent home study school in the world that specializes exclusively in electronics.

Meet the Electronics Specialists.

When you pick an electronics school, you're getting ready to invest some time and money. And your whole future depends on the education you get in return.

That's why it makes so much sense to go with number one . . . with the specialists . . . with CIE!

There's no such thing as bargain education.

If you talk with some of our graduates, chances are you'd find a lot of them shopped around for their training. Not for the lowest priced but for the best. They pretty much knew what was available when they picked CIE as number one.

We don't promise you the moon. We do promise you a proven way to build valuable career skills. The CIE faculty and staff are dedicated to that. When you graduate, your diploma shows employers you know what you're about. Today, it's pretty hard to put a price on that.

Because we're specialists we have to stay ahead.

At CIE, we've got a position of leadership to maintain. Here are some of the ways we hang onto it . . .

Programmed Learning

That's exactly what happens with CIE's Auto-Programmed Lessons. Each lesson uses famous "programmed learning" methods to teach you important principles. You explore them, master them completely, before you start to apply them. You thoroughly understand each step before you go on to the next. You learn at your own pace.

And, beyond theory, some courses come fully equipped with electronics gear (the things you see in technical magazines) to actually let you perform hundreds of "hands-on" experiments.

Experienced specialists work closely with you.

Even though you study at home, you are not alone! Each time you return a completed lesson, you can be sure it will be reviewed, graded, and returned with appropriate instructional help. When you need additional individual help, you get it fast and in writing from the faculty technical specialist best qualified to answer your question in terms you can understand.

Pick the pace that's right for you.

CIE understands people need to learn at their own pace. There's no pressure to keep up . . . no slow learners hold you back. If you're a beginner, you start with the basics. If you already know some electronics, you move ahead to your own level.

Enjoy the promptness of CIE's "same day" grading cycle.

When we receive your lesson before noon Monday through Saturday, we grade it and mail it back the same day. You find out quickly how well you're doing!

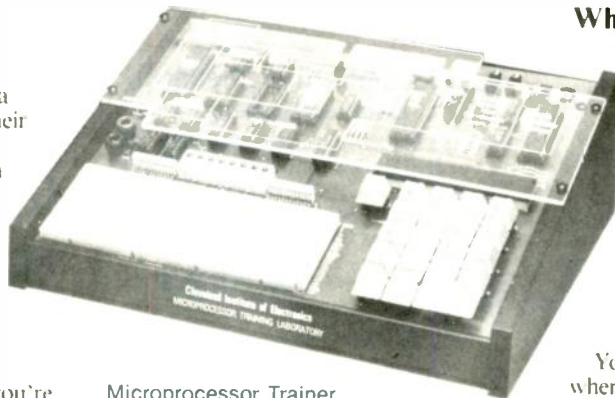

Microprocessor Trainer

State-of-the-art Laboratory Equipment

Some courses feature the CIE Microprocessor Training Laboratory. An integral part of computers, microprocessor technology is used in many phases of business, including service and manufacturing industries.

The MTL gives you the opportunity to program it and interface it with LFD displays, memory devices, and switches. You'll gain all the practical experience needed to work with state-of-the-art equipment of today and tomorrow.

CIE offers you an Associate Degree.

One of the best credentials you can have in electronics — or any other career field — is a college degree.

That's why CIE gives you the opportunity to earn an Associate in Applied Science in Electronics Engineering Technology. Any CIE career course can offer you credit toward the degree — more than half of the number needed in some cases.

"Cleveland Institute of Electronics is the only accredited institution of higher learning offering an Associate Degree program with tuition based on actual study time used. The faster you complete your degree assignments, the less your overall tuition."

Steve Simcic
Vice-President Academic Affairs

Which CIE Training fits you?

Beginner? Intermediate? Advanced? CIE home study courses are designed for ambitious people at all entry levels. People who may have:

1. No previous electronics knowledge, but do have an interest in it;
2. Some basic knowledge or experience in electronics;
3. In-depth working experience or prior training in electronics.

You can start where you fit and fit where you start, then go on from there to your Diploma, Associate Degree, and career.

Today is the day. Send now.

Fill in and return the postage-free card attached. If some ambitious person has removed it, cut out and mail the coupon. You'll get a FREE school catalog plus complete information on independent home study. For your convenience, we'll try to have a CIE representative contact you to answer any questions you may have.

Mail in the coupon below or, if you prefer, call toll-free 1-800-321-2155 (in Ohio, 1-800-523-9109).

CIE Cleveland Institute of Electronics, Inc.
1776 East 17th Street, Cleveland, Ohio 44114

Accredited Member National Home Study Council

YES...I want to learn from the specialists in electronics — CIE. Send me my FREE CIE school catalog...including details about the Associate Degree program... plus my FREE package of home study information.

Print Name _____

Address _____ Apt. _____

City _____ State _____ Zip _____

Age _____ Area Code/Phone No. _____/_____

Check box for G.I. Bill bulletin on Educational Benefits: Veteran Active Duty

MAIL TODAY!

CIRCLE 60 ON FREE INFORMATION CARD

ARE-66

V-1150

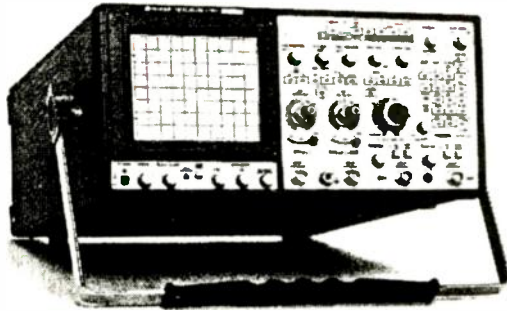

DC TO 150MHz,
Quad Channels,
Delayed Sweep

\$2550.

Save **\$400!**

- CRT Readout Functions: DVM, Freq. Counter, Events Counter, Cursor Readout, Ground Level Indicator, Comments Display, Panel Settings Display.

- CRT: 6" rectangular with 20 kV Potential
- X-Y Operation: (CH1:X, CH2:Y) 3° or less from DC to 1MHz
- Weight: 10kg(22 lb)

VC-6020

\$1750.

Save

\$200!

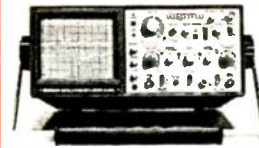

1MHz Sampling, Dual Channels

- Usable as both a conventional oscilloscope and a digital storage scope.
- CRT: 6" rectangular with 2k V Potential
- Vertical Deflection: Ver. Modes: CH1, CH2, DUAL, ADD (DIFF). Bandwidth: DC to 20MHz(-3dB). Sensitivity: 5mV/div to 5V/div. GPIB, IEEE 488
- Digital Storage Functions: Max. Sampling Rate: 1 MHz (for Dual Channels). Ver. Resolution: 8 bit. Max. Storage Freq: 100k Hz(-3dB). Memory Capacity: 1k words/ch. Hor. Resolution: 100 point/div. Sweep Time: 0.1m/div to 1s/div. Pre-trigger: Provided. Data output: Analog.

V-223 **\$695.** Save **\$100!**

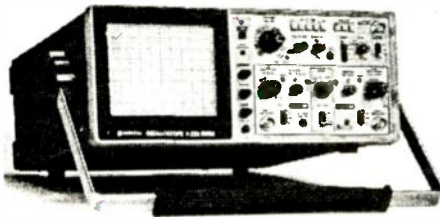

DC to 20MHz, Dual Channels,
Delayed Sweep

- CRT: 6" rectangular with 2k V Potential
- Vertical Deflection: Ver. Modes: CH1, CH2, ALT, CHOP, ADD (DIFF). Bandwidth: DC to 20MHz(-3dB). Sensitivity: 5mV/div to 5V/div. Max Sensitivity: 1mV/div at X5 Mag. Extends.
- X-Y Operation (CH1:X, CH2:Y): 3° or less from DC to 50kHz
- Weight: 7kg (15.5 lb)

POLAROID®

**DS-34
CAMERA**

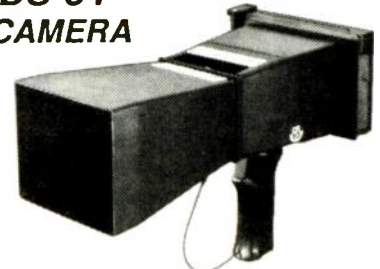

Save **\$135!**

\$280.

- Instant Hard Copy From Oscilloscopes
- 5", 6" and 7" Hoods (Available separately @ \$51 ea. Please Specify size)
- Pistol Grip For Ease of Operation
- Works on Any Make of Oscilloscope
- Three Full Year Warranty

V-209 DC to 20MHz, Dual Channels

- CRT: 6" rectangular with 1.5k V Potential
- Vertical Deflection: Ver. Modes: CH1, CH2, ALT, CHOP, ADD (DIFF) Bandwidth: DC to 20MHz(-3dB). Sensitivity: 5mV/div to 5V/div. Max Sensitivity: 1mV/div at X5 Mag. Extends.
- X-Y Operation (CH1:X, CH2:Y): 3° or less from DC to 100kHz
- Weight: 5kg (11 lb)

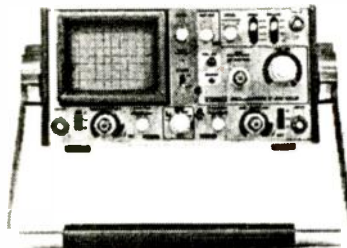

V-212 **\$465.** Save **\$150!**



DC to 20MHz, Dual Channels

- CRT: 6" rectangular with 2k V
- Vertical Deflection: Ver. Modes: CH1, CH2, ALT, CHOP, ADD (DIFF). Bandwidth: DC to 20MHz(-3dB). Sensitivity: 5mV/div to 5V/div. Max Sensitivity: 1mV/div at X5 Mag. Extends.
- X-Y Operation (CH1:X, CH2:Y): 3° or less from DC to 50kHz
- Weight: 6kg (13.3 lb)

\$847. Save **\$150!**



**WM. B. ALLEN
SUPPLY COMPANY**
ALLEN SQUARE

The 300 Block • North Rampart Street
New Orleans • Louisiana 70112-3106

NATIONWIDE 800 535-9593

LOUISIANA 800 - 462 - 9520

NEW ORLEANS (504) 525 - 8222

• American Express • Visa • MasterCard •

V-1100A DC to 100MHz, Quad
Channels, Delayed Sweep

\$2240. Save \$250!

V-680 DC to 60MHz, Triple Channels,
Delayed Sweep **\$1340. Save \$150!**

V-423 DC to 40MHz, Dual Channels,
Single Time Base Delayed Sweep
\$745. Save \$250!

V-1050F DC to 100MHz, Quad
Channels, Delayed Sweep
\$1445. Save \$150!

V-650F DC to 60MHz, Triple Channels,
Delayed Sweep **\$1070. Save \$125!**

V-422 DC to 40MHz, Dual Channels
\$795. Save \$130!

V-509 DC to 50MHz, Dual Channels,
Delayed Sweep **\$1195. Save \$250!**

V-058G DC to 5MHz, Dual Channels
\$838. Save \$100!

V-134 DC to 10MHz, Dual Channels
\$1420. Save \$200!

V-425 DC to 40MHz. Dual Channels
\$845. Save \$150!

V-222

- Same as above, but with CH1 output and DC offset voltage monitor outlet available for external counter or DVM.

\$515. Save \$200!

DID YOU KNOW THAT WITH A STANDARD FM-broadcast receiver you can only hear part of the signals available on that band? The rest, called SCA (Subsidiary Communications Authorization) transmissions, are hidden away on subcarriers and are intended to be received only by certain segments of the public.

SCA originated with the founding of the 88–108-MHz band in the 1940's. It was intended as an income producer to help FM stations financially until the band became economically viable. It has been used for various purposes, such as background music without commercials for restaurants and offices, for medical news, for second-language programming, and for radio reading and news services for the visually handicapped.

In this article we are going to explore the world of SCA. We'll discuss, what it is, what makes it possible, and what types of programs and services make use of it. We'll also show you how to build an FM stereo/SCA receiver that will let you tune in to all of the signals on the FM band.

But before we get too far along, it would be helpful to have an understanding of FM-radio basics. Let's take care of that step first.

FM-radio basics

An FM (Frequency Modulation) signal is simply any RF (Radio Frequency) signal whose instantaneous frequency is determined by the modulation. The deviation of an FM signal is the component of change in carrier frequency that is determined by the amplitude (primarily) and frequency of the modulating signal. In the U.S., FM broadcast stations are permitted ± 75 -kHz deviation, which is defined as 100% modulation. Both a 20-Hz audio signal and a 15-kHz audio signal can produce 75-kHz deviation because it's the combination of the frequency and the amplitude of the modulating signal (program audio) that determines the deviation. If one volt of fixed-frequency audio produced ± 75 -kHz deviation, then one tenth of a volt would produce ± 7.5 -kHz deviation. Although deviation and modulation frequency are independent variables, the ratio of deviation to modulation frequency is called the *modulation index*, or β , where

$$\beta = \text{deviation/modulation frequency}$$

In a typical FM-broadcast situation, with a 1-kHz audio signal at 50% modulation (37.5-kHz deviation), $\beta = 37.5$ (37.5 kHz/1 kHz).

It's noisy

Because the ear is most sensitive to high-frequency noise, and because the

SCA/FM-STEREO RECEIVER

SCA/FM STEREO RECEIVER



Tune into the "hidden" signals on your FM dial with this SCA receiver.

RUDOLF GRAF and WILLIAM SHEETS

FCC wanted FM to have the best possible signal-to-noise ratio, FM broadcasting incorporates a system of preemphasis/deemphasis equalization, whose parameters are based on the fact that the high-frequency energy of the sounds that are commonly part of programming decreases at an almost fixed rate per octave above 1000 Hz. (That was before the era of electronic instruments.) That allows the high frequencies to be preemphasized be-

fore transmission, and mirror-image deemphasized at the receiver. The end product is a "flat audio response"; however noise generated anywhere between the preemphasis and the deemphasis (such as atmospheric noise) is attenuated. Because the equalization reflects nature's own frequency characteristics, it is therefore possible to preemphasize say, a concert orchestra that is reading 100% modulation on a VU

WARNING!

SCA is not a broadcast service, and SCA transmissions are not intended for reception by the general public. As a result, SCA transmissions may be governed by Section 605 of the FCC Rules, which forbid unauthorized individuals from receiving such communications and using them for their own or other's profit, or divulging their contents, intent, or meaning to any other unauthorized individual.

Many for-profit services make use of SCA, and reception of those in most

cases is permitted by paying subscribers, and under certain circumstances, only. Some not-for-profit services do make use of SCA also, however, such as those providing assistance to the blind. It may be possible to receive those without obtaining prior permission or paying a subscription fee, as long as the terms of Section 605 are observed. We advise you to contact the appropriate programmers in your area for more information and to obtain any necessary authorizations.

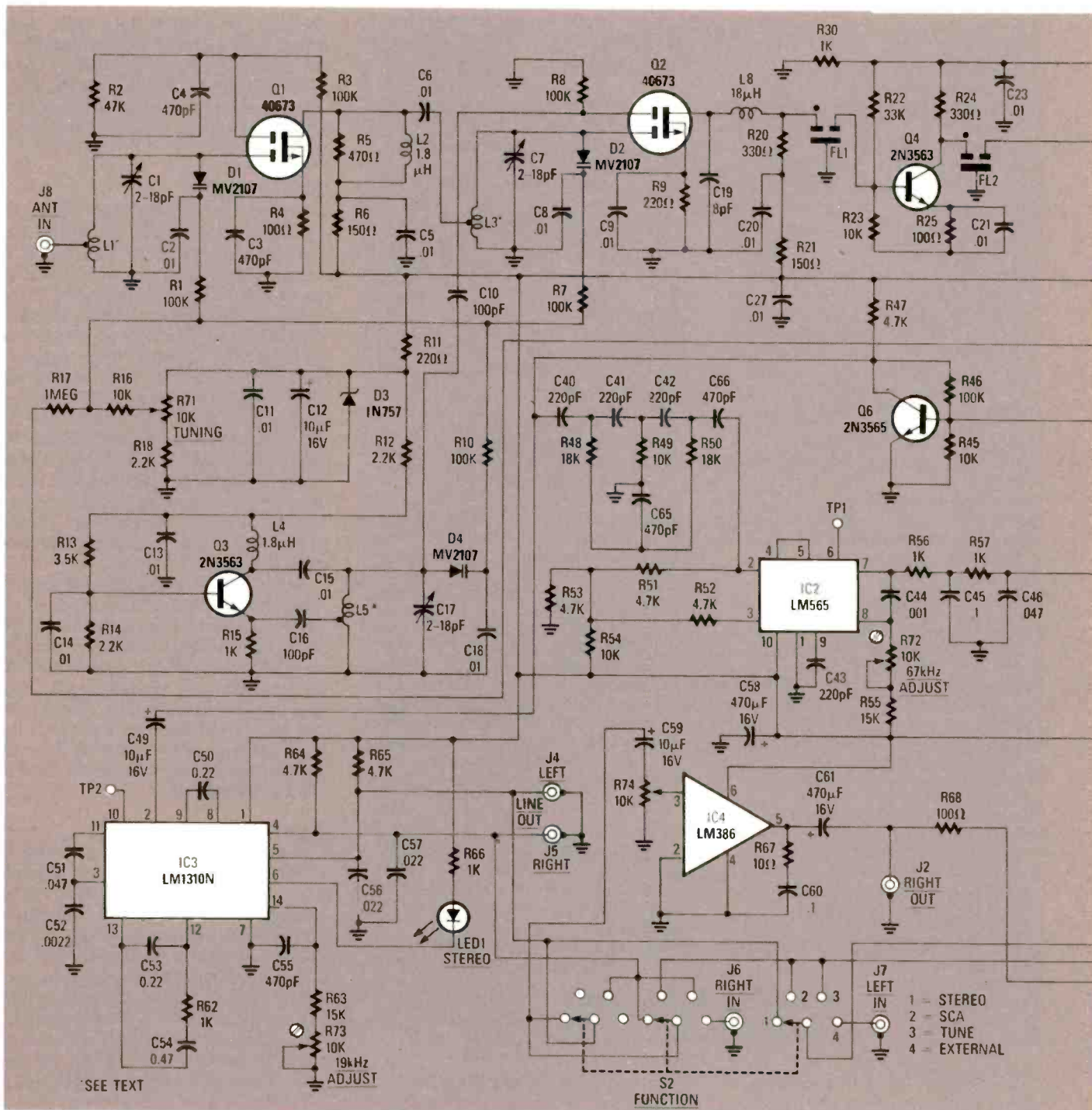

FIG. 2—THREE OF THE INDUCTORS shown in this schematic diagram must be wound by hand. Even so, they are simple to make; complete details will be given in the next installment of the article.

stituted) IC₁. IC₁ performs limiting and quadrature detection of the FM signal, and recovers the original audio baseband. That IC offers high gain, good limiting, and low-distortion detection. It also provides an AFC voltage to correct drift in the local oscillator and to aid in tuning a selected station. Due to the very high gain, layout is *very* critical and we strongly recommend using the PC layout that will be presented next time. Otherwise you may leave yourself open to RF-instability problems.

The audio output of the LM3189N is fed to a 2N3565 audio amplifier, which delivers an output level of about 3-volts p-p. That baseband audio is used to feed the phase-locked-loop SCA detector (an LM565) and the FM-stereo detector (an LM310N).

A high pass and twin-T R-C filter designed to reject frequencies below 50 kHz passes the SCA carrier to the LM565. The output of the IC is the VCO control voltage, which follows instantaneous frequency variations of the 67- or 92-kHz

subcarrier. That output (about 50 to 100 millivolts p-p) is the SCA audio. It is passed through a low-pass de-emphasis R-C network to remove high-frequency noise. An SCA audio amp (a 2N3565) amplifies the signal to about 500-mV p-p, which is sufficient to fully drive the audio power amplifiers.

The LM310N is designed to accept the baseband audio and reproduce the original L and R audio channels. Baseband audio of about 2-3-volts p-p is fed to the LM310N and L and R audio signals ap-

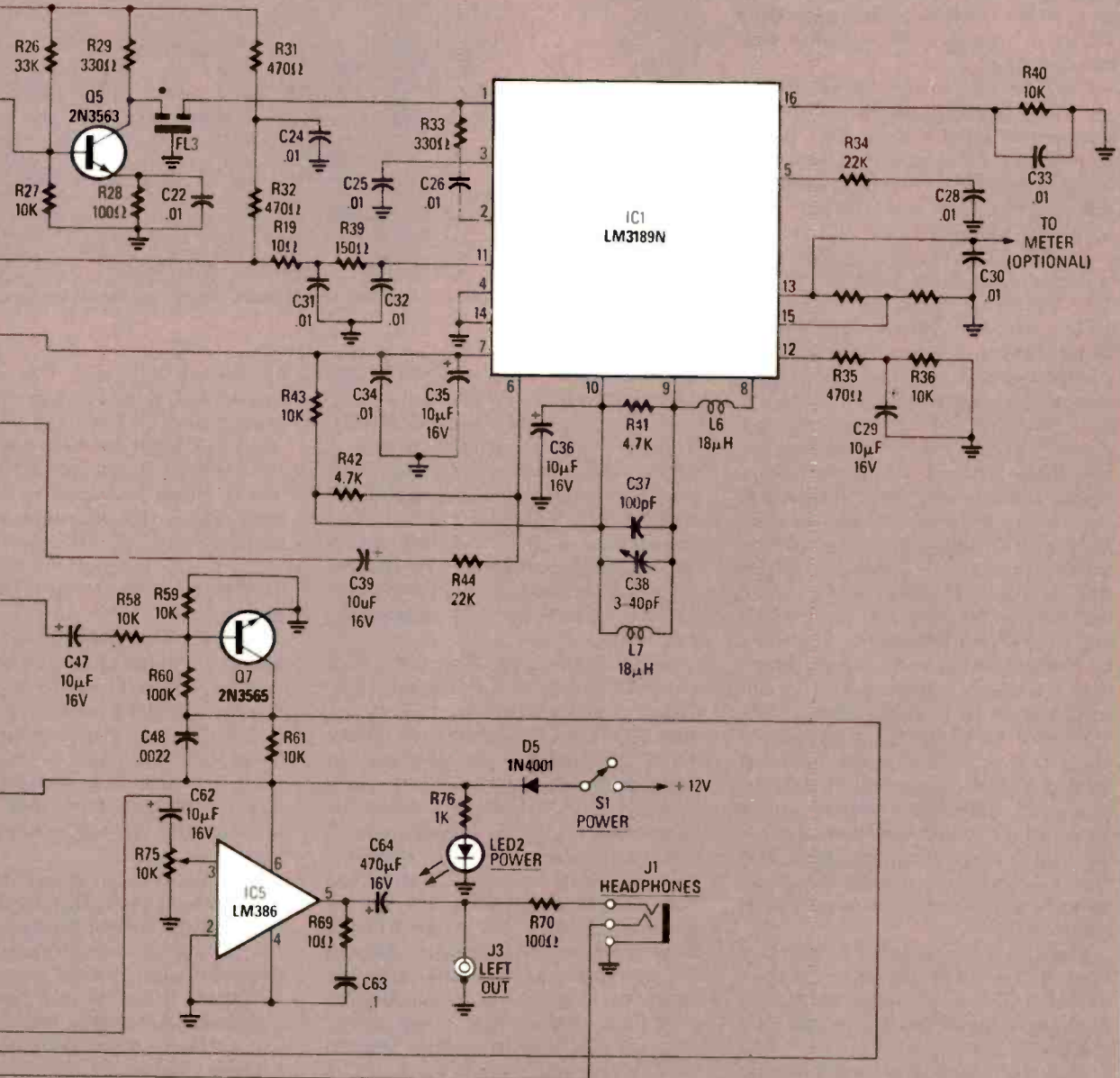

pear at the outputs. Shunt connected capacitors provide de-emphasis. An LED can be connected to the decoder to indicate stereo reception.

A 3P4T (three pole, 4 throw) switch selects among FM (stereo in the case of stereo broadcasts), SCA, tune, and auxiliary positions for input to the dual power amps. In the tune position, FM main channel audio is input to one of the amps while SCA audio is input to the other. That makes tuning in an SCA subcarrier easier; more details will be provided when

we talk about using the receiver. In the auxiliary position the unit becomes a power amp and will accept an external input via its LINE IN jacks.

The dual power amps are identical and are built around a pair of LM386N's. Power output is 1/2 watt (500 mW) per channel. That is sufficient to drive a pair of small speakers, but we recommend using stereo headphones for best results. If desired, the LM386N amps can be omitted and the outputs fed to the line inputs or tuner inputs of an audio system.

About 500 mV into a 10K load is available at the LINE OUT jacks.

More detail

Looking at the circuit in more detail, FM signals from the antenna are applied between the tap on L1, which is the antenna coil, and ground. The antenna coil is tuned by C1 and varactor D1 to the signal frequency. The varactor has a variable back bias of 1.5 to 8 volts across it. That will sweep its capacitance from 15 to 30 pF. When that capacitance is added to the

stray capacitance on the board and the input capacitance of Q1, it yields a tuning range of 87–109 MHz; that is more than sufficient to cover the complete FM broadcast band.

Capacitor C2 provides an RF ground and allows DC bias from the tuning-voltage line to be supplied through R1. It also cleans up any noise present on the tuning voltage line. No DC current flows in R1, and therefore there is no voltage drop across that component.

The tap on L1 is placed so that Q1 sees a high input impedance. Transistor Q1 is a 40673 MOSFET device with a noise figure of 4 dB or less (typically 2–3 dB at FM frequencies); that ensures high sensitivity and there is no base-emitter junction to cause unwanted rectification of strong signals. Resistor R4 and capacitor C3 provide biasing and RF grounding for Q1's source terminal. The G2 terminal is biased at about +4 volts by R2 and R3, and C4 bypasses that terminal to ground. The gain of the stage may be controlled by reducing that bias to –2 volts (cut-off) for AGC purposes. However, AGC was not necessary in the receiver, and was not used. The drain is biased through R6 and L2 to about +11-volts DC. Drain current (which is exactly equal to the source current) is about six to eight milliamperes.

Resistor R5 limits the stage gain to about 6 times. That is the optimum amount of gain to ensure circuit stability; it is quite adequate to override mixer noise, yet not so high as to unnecessarily overload the mixer on strong signals. Further, it allows about a 3-dB margin for mistracking and errors in alignment of the tuned circuits.

Capacitor C6 couples the RF signal to L3, which serves to tune the mixer input. Capacitor C5 is an RF bypass and resistor R6 decouples the RF stage from the +12-volt line.

The mixer-input tuned circuit is tuned by C7 and D2, with stray circuit capacitances once again playing a role. Ideally, total capacitance in the circuit is exactly equal to that in the antenna circuit. However, the operating Q is a little higher (about 30). The overall RF bandwidth is about 2 to 3 MHz, which provides quite adequate image rejection—about –30 dB or better.

The mixer is driven by a signal of about 3–4 volts p-p on G2 of Q2. Since the transconductance of the 40673 is a function of the G2 voltage with respect to the source, the local oscillator (more on that in a moment) signal in effect modulates the transconductance of Q2. That results in the 40673 acting as a mixer. Resistor R8 returns G2 to DC ground. Resistor R9 and capacitor C9 provide about a 0.6-volt bias, which places both gates at about –0.6 volt, with respect to the source terminal. The power gain of the mixer (the ratio of the IF signal at 10.7 MHz to the

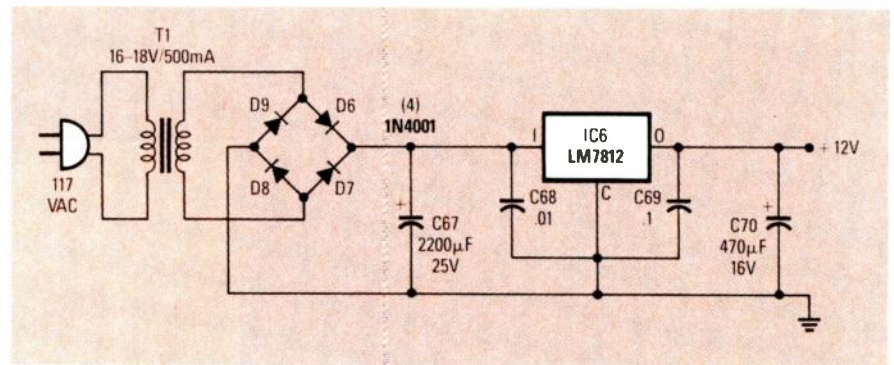

FIG. 3—THE CIRCUIT REQUIRES a regulated 12-volt power supply. The one shown here fills the bill nicely.

RF input signal) is about 12 to 15 dB, depending on local oscillator drive level.

The local oscillator uses a 2N3563 transistor, Q3, whose operating point is 4 volts at 1.5 milliamperes. That operating point is established by the network comprised of R12, R13, R14, and R15. Note that the local oscillator is actually a voltage controlled oscillator set up to be in the common-base mode at RF frequencies. At such frequencies, C14 grounds the base of Q3.

Inductor L4 is an RF choke that is used to feed DC voltage to the collector of Q3. Capacitor C15 couples the tank circuit made up of L5, C17, and D4 to the collector of Q3. That tank circuit is used to determine the oscillator frequency, which should be 10.7 MHz above or below the signal frequency. In this receiver, the local oscillator operates 10.7 MHz above the incoming signal. Therefore, it must tune from about 98 to 120 MHz. The spacing should be 10.7 MHz over the entire tuning range of 87–109 MHz. Resistors R16 and R17 are used to couple the AFC correction voltage to the tuning line, eliminating the need for a separate AFC tuning diode. The value of R16 can be anything from 1K to 100K, depending on how much AFC is desired. We used a 10K unit.

As previously mentioned, L5 and C19 match the mixer to ceramic filter FL1. Those components also help prevent unwanted VHF components from leaking into the IF stages, which could cause spurious responses. A ceramic filter is a piezoelectric device that is the equivalent of an IF transformer. It acts as a double-tuned transformer with a 1-dB bandwidth of 250 kHz, centered at 10.7 MHz. The device's insertion loss is about 6 dB, and its termination impedance is specified as 330 ohms.

The first IF amplifier is built around Q4. That transistor is biased by R22, R23, and R25 to about 2 milliamperes when the collector voltage is 4. Ceramic filter FL2 couples Q4 to Q5, which is biased identically to Q4, using R26, R27, and R28. Capacitors C21 and C22 bypass the emitters of Q4 and Q5 respectively. The IF stages are decoupled from the power-sup-

ply line by R32, R31, C24, and C23. Resistor R30 is used to determine the operating points of Q4 and Q5. It results in a +4.5-volt supply to those stages, forming a voltage divider with R31 and R32. The IF signal is coupled to the limiter/detector stage (IC1 and peripheral components) by FL3. The three ceramic filters shape the IF bandpass of the receiver. They are fixed tuned and no alignment is required.

The gain of Q4 and Q5 is about 26 to 30 dB. That gives a total gain so far, from the antenna, of about 55 to 60 dB, ensuring that the front-end noise will cause limiting in IC1. The maximum output of Q5 is about 0.25 volt, which is the saturation point, no matter how strong a signal is received; IC1 can easily handle that without distortion. No AGC was found necessary in this receiver.

Most the functions of an FM IF system are provided by IC1. That device includes a three-stage limiter, signal-level detectors, a quadrature detector, and an audio amplifier with optional muting circuit (squelch). It has its own internal regulators for DC voltages, and can drive an external tuning meter. While we specified using a National LM3819N, an RCA CA3189E is pin-for-pin compatible with that device and can be used in its place. Use whichever IC is easiest for you to find.

Input signal from FL3 is applied to pin 1 of IC1. R33 is a bias resistor and also terminates FL1. Capacitors C25 and C26 are RF bypass capacitors. The 12-volt supply line is connected to pin 11 of IC1 by R19, C31, R39, and C32; those components provide RF decoupling as well. While they are not used in the receiver, the IC's squelch (mute) circuits must be terminated; R34, C28, C29, R35, and R36 serve that function.

An optional tuning meter can be installed in the receiver. We chose not to do so, but if you do, install it at the junction of C30 and R37 as indicated in Fig. 1. Otherwise, the junction makes a good test point for aligning of the front-end's tuned circuits.

continued on page 81



ROSS ORTMAN

Versatile Digital Timer

You don't need a fancy microprocessor-based timer to turn a device off and on several times a day. This easy-to-build and inexpensive timer will do it with no hassle!

TIMERS CONTROL EVERYTHING FROM security systems to computer systems to coffee makers—the list goes on and on. Timers vary in sophistication from simple mechanical devices to microprocessor-based controllers. But there is a middle ground. A low-cost module allows you to build a high-performance unit that operates like a VCR timer, is inexpensive, and is very easy to build. The timer allows three on/off set points per day, and it can control any device that draws as much as 6 amps of current. If the timer's output capacity is insufficient, you can easily add an output switching device with greater capacity. The timer can be built for about \$60 using all new parts.

How it works

The timer's schematic is shown in Fig. 1. The heart of the timer is the PCIM 2303 LCD timer/clock module, made by PCI (Printed Circuits International, 1145 Sonora Court, Sunnyvale, CA 94086). The 2303 module contains the timer IC, clock crystal, an LCD display, and all support components. It requires only 1.5 volts and draws a maximum of 10 μ A. That low power requirement allows the module to be powered by a single AA battery, which makes it great for use in portable equipment.

The module has a single output that is high during the on period and low during the off period. Because the output is

powered by the module, it cannot deliver any appreciable current. Therefore the control voltage is fed to a transistor switch composed of Q1, Q2, R3, and R4. The switch circuit in turn controls IC1, an MOC3010 optocoupler, which isolates the power-control section from the rest of the circuit.

The power-control section is composed of Triac TR1, current-limiting resistor R5, and an MOV (Metal Oxide Varistor). The latter protects the triac and the optocoupler from power-line spikes and transients caused by highly inductive loads.

The power supply is composed of T1, D1, and C1; it provides nine-volts DC that powers the switch circuitry. It can also be used to trickle-charge a Ni-Cd battery. Although a regular lead-acid or alkaline battery will last for quite some time, a 1.5-volt rechargeable battery will give best results. The 1-mA trickle charge supplied by optional components D2 and R1 should increase battery life indefinitely. If those components are not installed, never apply power to the unit without a battery in place, or damage to the PCIM 2303 module may result.

The specified Triac is rated at 6 amps. If that is inadequate for your application, a larger one can be used. Regardless of which Triac is used, it will generate heat, so provide an adequate heatsink and adequate ventilation to avoid overheating.

Fuse F1 protects not only the transformer and circuitry, but also the Triac. If a device tries to draw more current than the Triac can handle, the fuse will blow, thus saving the Triac from damage. If you use a Triac with a larger current rating, be sure to install a fuse of the proper size.

Other types of power-control circuits are possible; several examples are shown in Fig. 2. An SCR-based circuit is shown in Fig. 2-a, and a relay-based circuit in Fig. 2-b. If you use a different circuit, be sure to isolate the timer module from the voltage being switched. And whether you use a relay, a Triac, an SCR, or some other device, be sure it can handle the maximum current the device you want to control will draw.

Construction

The timer circuit is simple enough to be wired using point-to-point techniques; but for a cleaner layout, PC boards can be used. You can purchase pre-etched and drilled boards from the source mentioned in the Parts List; alternatively, foil patterns for etching your own board are shown in PC Service. As shown in Fig. 3, the display board contains the timer module and S1-S4. The main board, shown in Fig. 4, contains the power supply, the battery, the switching circuit and the output circuit. If you use a different output-switching circuit you can alter the design of that board to fit your application.

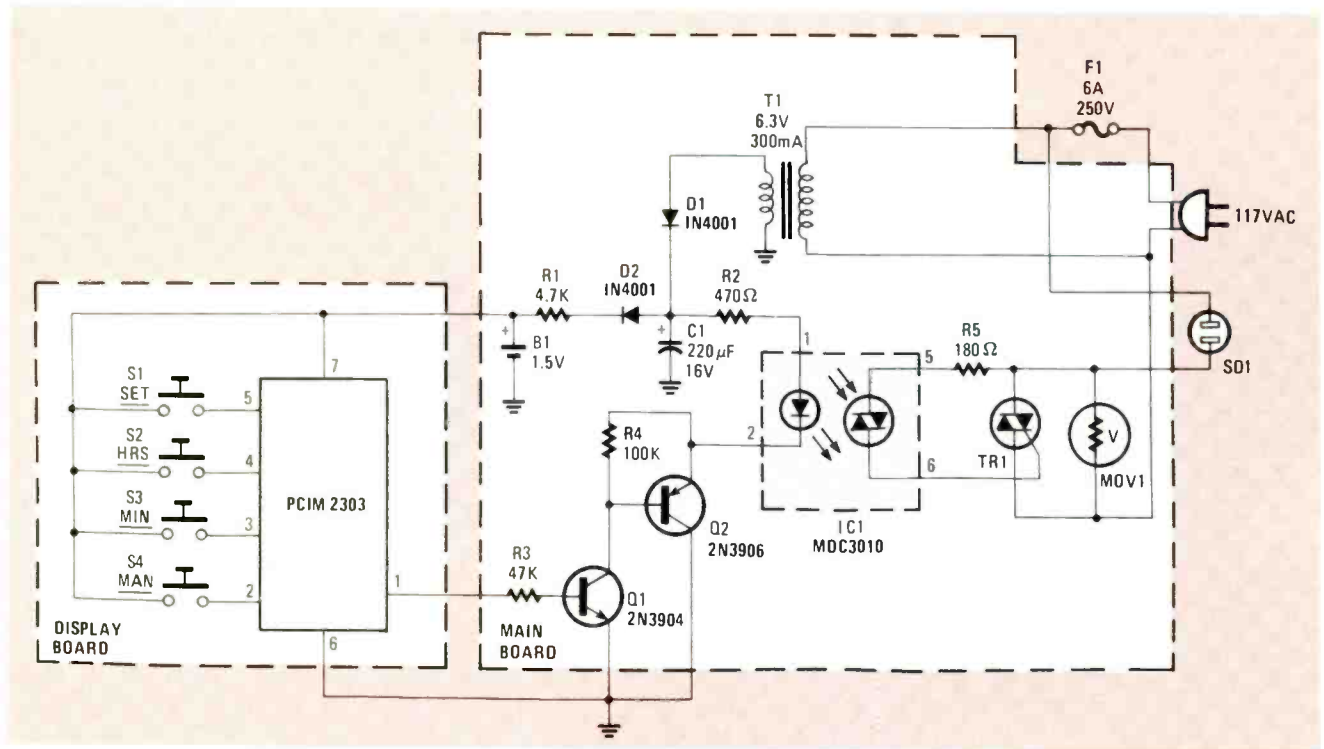

FIG. 1—SCHEMATIC DIAGRAM OF THE TIMER. The PCIM 2303 timer module contains all timing circuits and an LCD display.

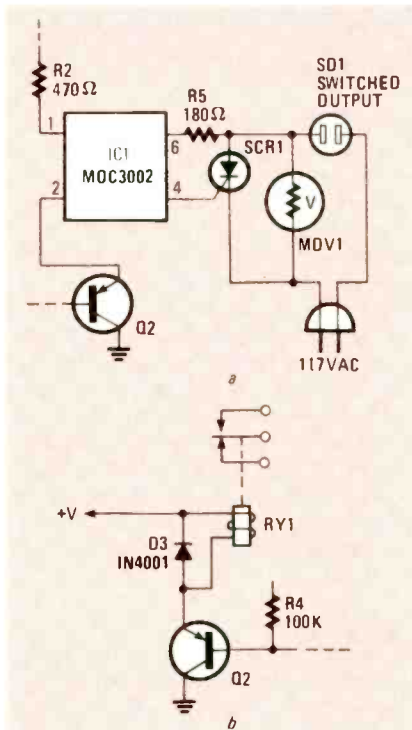

FIG. 2—AN SCR (a) OR RELAY OUTPUT (b) driver can be substituted for the triac output circuit in Fig. 1.

Stuff the boards in the usual manner, starting with the low-profile components, and working up to the larger ones. The timer module contains CMOS circuitry, so handle it with care. Be sure to observe the polarities of capacitor C1 and the semiconductor. Install the transformer last, making sure that it is installed correctly.

An excellent case for the timer is mentioned in the Parts List. If you use the specified case, note the limited clearance between the bottom of the PC board and the case. Be sure to insert a piece of fish-paper (or some other insulator), between the board and the bottom of the case to avoid shorts—and possible shocks.

Note, in Fig. 4 and Fig. 5, the small strip of PC board material glued to the top of the main board behind the display board. That strip reduces stress on the module and prevents the display board from bending when the pushbuttons are pressed. The remainder of construction is straightforward. In our prototype the mod-

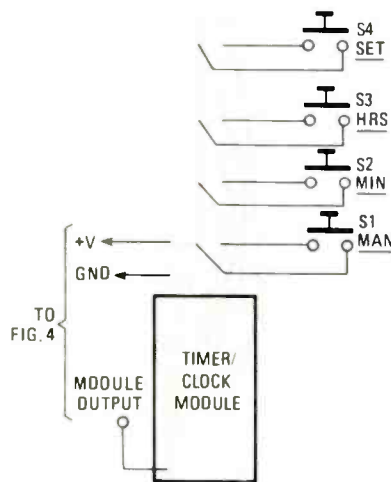

FIG. 3—THE TIMING MODULE and four switches mount on the display board, which connects to the main board via three wires.

ule (and the attached PC board with switches) is glued from behind to an opening in the front panel.

Testing

After mounting all components, inspect your work carefully for open solder joints, solder bridges, etc. Correct any mistakes.

Then insert a battery into the holder, being sure to observe polarity. Now press the SET and MAN buttons simultaneously to reset the module. If the module doesn't display anything, re-check your wiring.

After you get the module to reset, plug the line cord into an AC outlet, and plug a table lamp (or other electrical device) into SD1 and press the MAN button. The light should turn on. If it doesn't, check the module's output pin. It should have about 1.1 volts on it. If it does, make sure that Q1 and Q2 are turning on and enabling the LED in IC1. If the LED is turning on, you should measure about 1.4 volts across it. If the LED does turn on, the problem lies with the AC portion of the circuit. **Be very careful when troubleshooting the AC section, because it has 117-volts AC across it.** Check for wiring errors; otherwise, the triac may be bad.

After you get the circuit working, assemble the case. The timer is now ready to go to work for you in whatever application you see fit.

Operation

Programming the timer is very similar to programming a VCR timer. At initial power-up, the device must be reset. That's

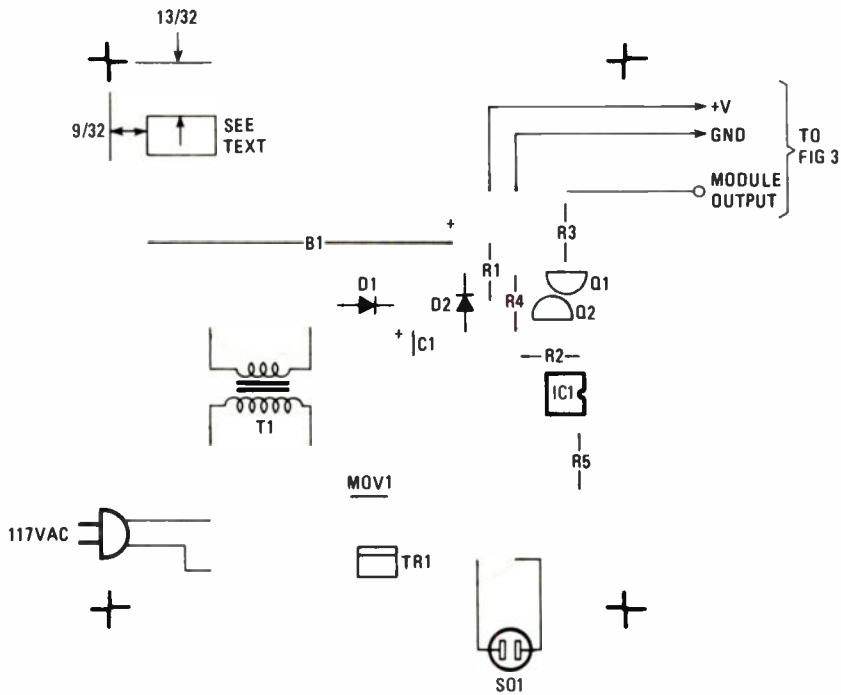

FIG. 4—STUFF THE MAIN BOARD as shown here. Three wires connect to corresponding points on the display board, as shown in Fig. 3.

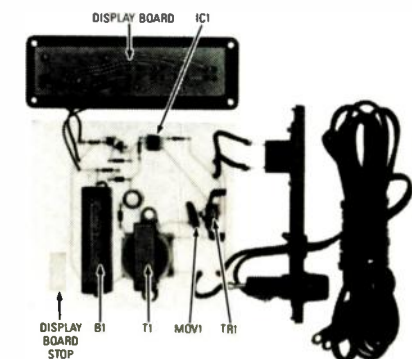

FIG. 5—THE COMPLETE TIMER CIRCUIT appears as shown here. Trim the PC board so that it fits into the case properly, and insert a sheet of insulating paper between the board and the bottom of the case.

accomplished by pressing the SET and MAN buttons simultaneously. Then the correct time must be entered. Press SET once to enter the set mode; a flashing T will be displayed. Now set hours and minutes by pressing the HRS and MIN buttons as appropriate. The displayed hours (or minutes) will advance once for each press of the button; if you keep the button pressed, the display will advance continuously at a rate of about two digits per second.

By pressing the SET button again, the first on time can be set in the same way that time is set. Then press the SET button again to set the first off time. By continuing to press the SET button, the second and third on and off times can be programmed into the unit. After the third off time is set, pressing the SET button once more returns the unit to displaying the

current time, which is indicated by a flashing colon. The programmed timer will now turn the device you connected on and off at the preset times.

The MAN button allows you to override the present state of the timer. If the output is off when the MAN button is pressed, the output will turn on. Conversely, if the output is on, pressing the MAN button will turn the output off. After pressing the MAN button, the state of the output remains constant until the MAN button is pressed again, or until a preset time forces the output of the timer into a different state.

The MAN button controls another important function. It can be used to override the pre-set times. For example, to override the first on time, advance the set mode until the first on time is reached and press the MAN button. An X will appear in the display; it indicates that the first on time has been overridden. The timer will then ignore the locked-out set point until it is "unlocked" by repeating the lock-out sequence.

Applications

The timer is versatile, so its applications are virtually limitless. As a stereo timer, the unit outperforms most commercially available systems. The timer could be programmed to turn your stereo on in the morning, turn it off just after you leave for work or school, turn it on just as you are getting home, and turn it off after you have gone to bed.

The unit could also be used to control house lighting for convenience or security. When used as a security device, a

PARTS LIST

All resistors are 1/4-watt, 5% unless otherwise noted.

R1—4700 ohms

R2—470 ohms

R3—47,000 ohms

R4—100,000 ohms

R5—180 ohms

Capacitors

C1—220 μ F, 16 volts, electrolytic

Semiconductors

IC1—MOC3010 Optocoupler (Radio Shack 276-134 or equivalent)

D1, D2—1N4001 rectifier diode

Q1—2N3904 NPN Transistor

Q2—2N3906 PNP Transistor

TR1—6-amp 400-volt Triac (Radio Shack 276-1000 or equivalent)

Other components

B1—1.5 volts, rechargeable AA battery

F1—6-amp, 250-volt fuse

MOV1—117-volt metal oxide varistor (Radio Shack 276-568 or equivalent)

S1—S4—SPST, momentary, normally open

S01—chassis-mount AC receptacle

T1—6.3-volt 300-mA transformer (Radio Shack 273-1384, or equivalent)

Miscellaneous: PCIM 2303 timer/clock module, chassis-mount fuse holder, battery holder, line cord, case (Radio Shack 270-286).

Note: the following are available from Dakota Digital, R. R. 1, Box 83, Canistota, SD 57012: display PC board, \$3.50; main PC Board, \$9.95; PCIM-2303 module, \$23.95; module and four pushbutton switches, \$26.50. All orders add \$1.50 for shipping and handling. South Dakota residents add appropriate sales tax

house can be made to look "lived in" by turning the lights on in the morning for a preset time and turning them on and off several times during the evening. If several timers were used to control different lights throughout a house, the effect would be even greater.

Other items can be controlled. For example, you could turn your coffee pot on in the morning 10 minutes before you get up. Then you could always have your morning coffee first thing. You could also control your heating system with the timer, heating your house only while you're home and awake, and turning it off during the day while you're gone and at night while you're asleep. The money saved doing that will add up quickly.

During the winter, in cold climates, the timer could be used to turn your car's engine-block heater on in time to warm the block up enough for safe usage.

Of course, the PCIM 2303 can be used in many other applications. It's a versatile device and it can be used in countless applications. Whether you're replacing an existing timer or designing a timer system for a custom application, the PCIM 2303 clock/timer module is the ideal starting point for many designs.

R-E



The most important change in TV technology since it was invented is just over the horizon.

JOSEF BERNARD

CREATED BY NEON LAMPS AND VIEWED through a spinning spiral of holes in a Nipkow disc, the very first TV images were so crude that they barely allowed the viewer to distinguish light from shadow. Today we are much more fortunate—on-screen resolution of several hundred lines, both horizontally and vertically, permits us to read street signs, subtitles, and movie credits on color CRT's or LCD's.

Even so, we're always aware that we're looking at a television picture, that is, a picture displayed on a screen. And when we can not discern the finer details in an image, no matter how hard we strain, the shortcomings of the current system becomes evident. That is true whether the system in question is the NTSC system used in this country, or the slightly higher-resolution PAL and SECAM systems that have been adopted by most of the rest of the world.

But help is on the way. Dramatic improvements are on the horizon in the form

of High-Definition TV (HDTV) systems that will add realism and detail to the images we view for entertainment and information.

HDTV technology exists today; it is used, for example, in Hollywood for special-effects work in TV. By as early as 1990, Japanese broadcaster NHK plans to have an HDTV system in place and operational. And work here, in Europe, and elsewhere is progressing so fast that systems may be in place worldwide shortly thereafter. In this article we'll examine the Japanese HDTV system and others, see how they evolved, and learn about what obstacles remain before they can become adopted for widespread use.

HDTV criteria

One of the goals of HDTV is to create a sense of realism for the viewer that's at least as good as that provided by motion-picture film. How? Tests have shown that, to overcome the "picture-in-a-box" effect

of TV viewing, the image must subtend a viewing angle of at least 30°. To obtain such an angle, one could simply sit closer to the screen. However, at a distance of less than 7 times the image height, scan lines become noticeable and give the image a grainy appearance.

Figure 1 compares the geometries provided by viewing both conventional TV and HDTV screens from the distance at which scan lines are rendered invisible. In a conventional system, the viewing angle is only about 10°, but an HDTV system provides the desired 30° viewing angle.

As shown in the figure, if the number of scan lines is increased to 1000 or more, the minimum viewing distance is reduced to about 3 times the image height. At that distance a 30° viewing angle can be achieved. Further, due to the limited resolution of the human eye, the lines will blend together and give the impression of a smooth image.

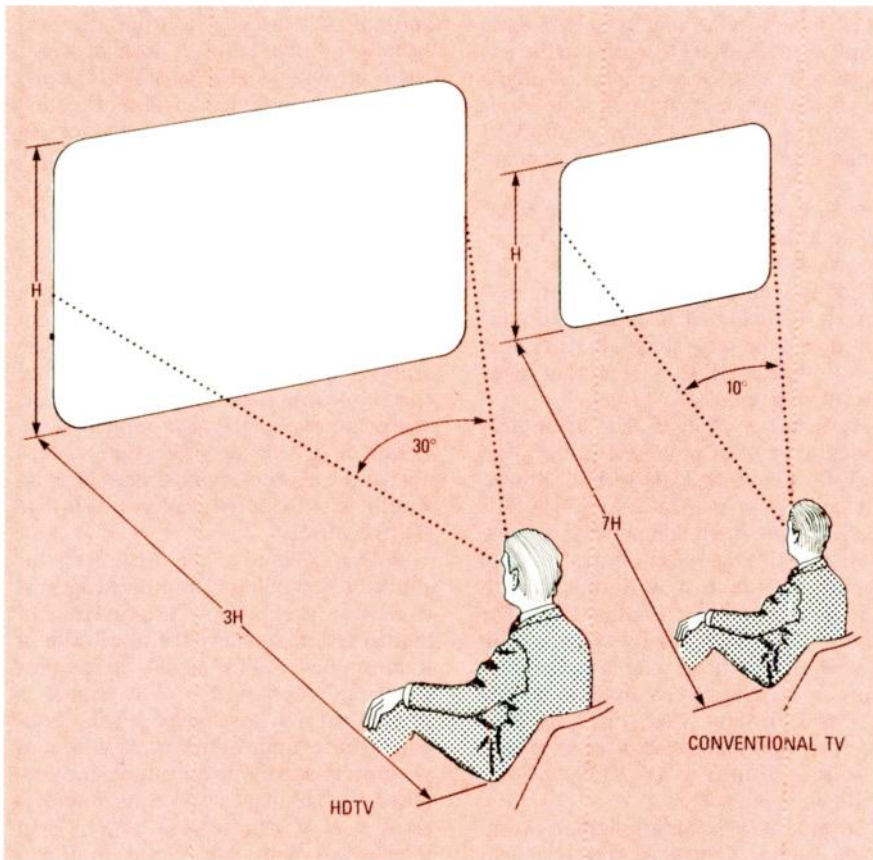

FIG. 1—THE GEOMETRY OF TV VIEWING. With an HDTV image, a viewer can sit closer to the screen to attain a greater viewing angle, thereby improving the sense of realism. Because the signal has approximately twice as many scan lines as a conventional system, those lines are not visible at distances as close as three times the image height.

Another factor adding to the impression of realism offered by HDTV is a change in aspect ratio, the ratio of an image's width to its height. Conventional TV has a 4:3 aspect ratio, which means that the picture is four units wide and three units high. That aspect ratio was adopted originally to conform to what was used at the time for motion-picture photography. These days, most films are shot using the Panavision process, which uses a 1.85:1 (5.55:3) aspect ratio. It is expected that HDTV will use an aspect ratio between the two, with 1.77:1 (16:9) being endorsed by many. See Fig. 2.

The NHK system

As we mentioned earlier, the HDTV system closest to being a practical reality is the one proposed by Japan's NHK. That system uses a signal with 1125 scan lines and a 2:1 interlaced scan rate of 60 fields (30 frames) per second. NHK's HDTV system has already been demonstrated both in Japan and in the U.S.

One problem with all HDTV systems is that they potentially require enormous amounts of bandwidth. For instance, in the system proposed by NHK, a high-definition TV picture contains about five times more luminance (brightness) infor-

mation that does a conventional one, thus requiring a bandwidth at least five times greater than that specified for the NTSC system used by U.S. broadcasters today. That translates to a bandwidth requirement of 30 MHz, compared to the 6 MHz NTSC standard.

To squeeze all of the information required for a HDTV picture into a more manageable bandwidth, NHK developed a system called MUSE (*M*ultiple *S*ub-*N*yquist *S*ampling *E*ncoding). MUSE converts a wideband analog studio signal to digital form, compressing it to slightly more than 8 MHz for transmission. At the receiver, the signal is re-expanded to its original form for display. The MUSE specifications call for:

- Processing of luminance and chrominance information by TCI (*T*ime *C*ompressed *I*ntegration).
- Time-compressed line-sequential processing of chrominance information generating R - Y (red minus luminance) and B - Y (blue minus luminance) color-difference signals.
- Time compression of the chrominance signal by a factor of four.
- Bandwidth reduction of the TCI signal through subsampling.

- A PCM digital audio signal to be multiplexed with the video signal.

MUSE is known as a "motion-compensated subsampling" system. The terms *subsampling* and *sub-Nyquist* refer to the fact that when the video information is processed, fewer samples are extracted from it than would be the case if it were to be processed using conventional methods, where sampling occurs at twice the highest frequency (i. e., the *Nyquist frequency*) involved; the lower sampling rate is the reason why that method is called sub-Nyquist.

The principal trick used by the MUSE system is that it sub-samples the video signal over a four-field sequence prior to transmission; the sampling pattern used is shown in Fig. 3. That technique allows for the 4:1 reduction in required bandwidth.

Reconstruction of the MUSE signal requires an HDTV receiver equipped with a memory capable of storing the four fields. For still (non-moving) parts of an image, the picture can be reconstructed using samples from all four fields since there will be no movement from field to field.

But where there is movement, attempt-

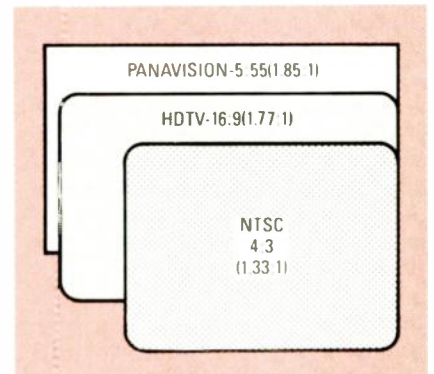

FIG. 2—ASPECT RATIOS. Here, the aspect ratios of conventional-TV, HDTV, and Panavision motion-picture viewing screens are compared.

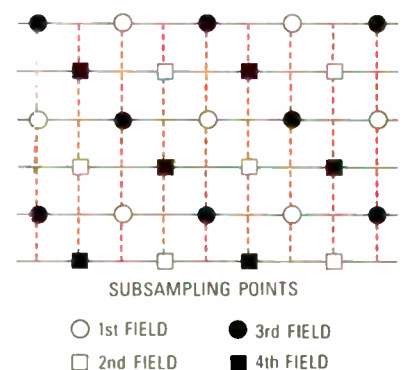

FIG. 3—THE SAMPLING PATTERN used by NHK's MUSE system. Picture information is transmitted over four fields rather than the two of conventional TV.

ing reconstruction using two or more fields will yield a picture with unacceptable blurring. That's because the picture content will be changing from field to field. Therefore, only the information from one field can be used to form the image and a 1:4 loss of resolution occurs.

However, a MUSE receiver also incorporates a motion detector. That stage enables the receiver to integrate the stationary and moving parts of a scene into a single image. (That's where the "motion-compensated" part of the MUSE system comes in.) The result is that stationary parts have maximum resolution while moving parts appear slightly blurred. Such blurring is not considered serious, however, since our perception of sharpness is not reduced by blur in a moving image. We simply accept it as an attribute of the motion.

A special case in the MUSE system occurs when the camera is panned or tilted, causing the entire image to change. When the encoding circuitry detects that type of picture content, a vector representing the motion of a scene is calculated and the information is sent during the vertical-blanking interval. At the receiver, the information is applied to the field memories, causing the position of the sampled picture elements to be shifted as appropriate to the motion. The bottom line is that the moving pictures are processed as if they were stationary ones, with conspicuous blur in uniformly moving regions of the image held to a minimum, subject to the accuracy of the motion vectors. Note however that non-uniform moving regions will unavoidably suffer a loss of resolution. In most instances, however, such loss will be acceptable as a consequence of motion.

Other systems

Although NHK's MUSE system is the one closest to implementation, work on HDTV is also continuing in Europe and the U.S. In this section we will look at some of the more promising systems.

Most of these systems are based on the following standard: 1125 lines, 60 frames per second, 2:1 interlace, 16:9 aspect ratio. The number of lines was chosen as a compromise between the PAL/SECAM and the NTSC camps. It is more than 1000 lines, but not exactly equal to twice either 625 or 525 lines. Also, although 50 frames per second is used in Europe and elsewhere, the NTSC standard of 60 frames per second was accepted because it substantially reduces flicker and allows a higher sampling rate. Interlaced scanning, as opposed to a progressive scanning scheme, is used because of the reduced bandwidth it requires.

Note that those specifications have not been formally accepted as a worldwide standard, however. It was hoped that a standard would be adopted at the Interna-

tional Radio Consultative Committee's 1986 Plenary Assembly. Instead, a decision was postponed until 1990, at the earliest. That postponement has added some confusion to the HDTV world, so there is no guarantee as to what shape, if any, a worldwide specification will take. It is expected, however, that the 1125/60/2:1 standard will become a *de facto* standard in most 60-Hz HDTV studios.

Several of the systems are of the MAC (Multiplexed Analog Components) type. In a MAC signal, the luminance, color difference, and multiple digital sound signals are compressed in time and multiplexed onto the same signal. In particular, most European HDTV systems are based on some type of MAC system.

For instance, Philips, the Dutch electronics giant, has proposed a European HDTV system called HD-MAC. The system is based on the 625-line, 50-Hz PAL standard. The input signal is 1250 lines, 50 Hz, with 2:1 interlace. Vertical filtering is used to make a wide-bandwidth 625/50/2:1 signal for transmission. The bandwidth is reduced by transmitting only alternating horizontal samples; four fields are required to receive a complete HD-MAC picture. That, once again of course, means that the receiver must have a frame memory to display the 1250/50/2:1 picture.

Other MAC systems are similar, except for the numbers involved. For instance, B-MAC is a MAC system that's compatible with the 1125/60/2:1 proposed worldwide standard.

And things have not been quiet in this country, either. Bell Laboratories has proposed a two-channel transmission system in which one channel contains an NTSC

signal that is derived from an HDTV signal of 1050 lines. The second channel contains the high-frequency luminance and color-difference information. According to Bell Labs, a normal NTSC receiver would receive the NTSC channel with only a slight degradation of picture quality. An HDTV receiver would receive both channels and combine them using a frame store. The result is then scan-converted to reproduce the original 1050-line picture.

CBS has proposed another two-channel system. One channel would contain a MAC-like time-multiplexed component signal in a 525-line/60-Hz format. The second channel would contain another time-multiplexed component signal. When the two signals are combined, an HDTV image results. The system does not require a receiver with frame store and would use *Direct-Broadcast Satellite* (DBS) delivery.

William Glenn of the New York Institute of Technology has proposed a system that makes use of the properties of human vision to reduce the bandwidth of a transmitted HDTV signal. In his proposal, an "improved" NTSC signal is transmitted over a standard NTSC channel. (Those improvements could entail pre-combing to eliminate interference between the luminance and color information, use of progressive rather than interleaved scan, etc. Some improvements may require modified NTSC receiving equipment.) That signal, which already will offer somewhat better resolution than standard NTSC, is accompanied by a 3-MHz wide auxiliary signal that contains high-frequency, low temporal-rate information, as well as information

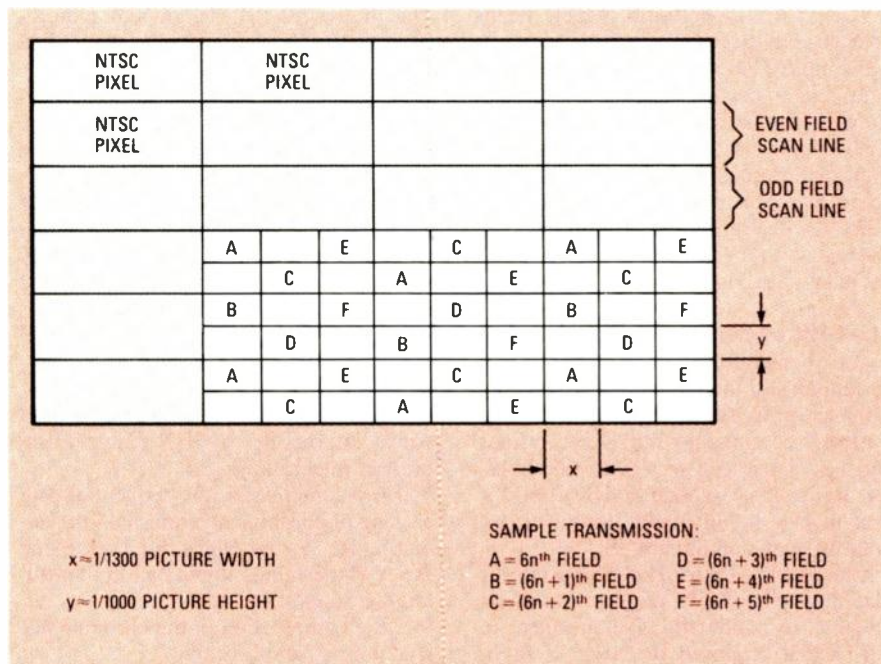

FIG. 4—IN THE DEL RAY HDTV SYSTEM, each NTSC pixel is broken up into six samples for transmission. Picture information is relayed in a sequence of six fields.

required to produce a wide aspect-ratio picture. The two signals would be combined in a frame store to produce an HDTV image.

The Del Ray Group of Marina Del Ray, CA, has proposed a system that uses a single NTSC channel to transmit a 525/60/2:1 HDTV signal. They propose a system in which a single NTSC luminance sample (pixel) is broken up into 6 samples. One sample is transmitted each field until after 6 fields the complete NTSC pixel is sent. The sampling pattern is shown in Fig. 4. At the receiver, a frame store is used to recreate the complete picture. According to the Del Ray Group, such a signal could be displayed on a non-HDTV NTSC receiver with little degradation when compared with a normal NTSC signal.

A wider aspect ratio is achieved in this system by reducing the number of active video lines transmitted by 69. The Del Ray Group contends that due to oversean losses in a typical receiver, the removed lines would not be missed. Further, those 69 lines could then be used to transmit digital sound.

Distribution

After an HDTV specification has been established and agreed upon, the problem remains of how to distribute material produced in that medium to the public waiting for it. So specifications, distribution, and compatibility are HDTV's toughest remaining problems. Let's look at the distribution problem in more detail first; later on we'll delve deeper into compatibility.

As with today's video programming, there are two alternatives: broadcast and pre-recorded material. In the realm of broadcasting, one possibility is, of course, DBS. Satellites could provide a distribution route completely independent of those used for conventional broadcasting, and the compatibility issue could, in a sense, be skirted. It has been suggested that the most economical and practical system for distributing HDTV is by DBS in the 22- and 40-GHz bands. (For more on HDTV and DBS, see *Satellite TV* elsewhere in this issue, as well as in the July issue of *Radio-Electronics*.)

Until recently, most observers had ruled out terrestrial broadcasting as a possible distribution medium. However in a test conducted this past January in the Washington, DC area by the NAB (National Association of Broadcasters) and the MST (Association of Maximum Service Telecasters), two adjacent UHF channel slots were used to transmit a MUSE HDTV signal. At the same time, a 13-GHz terrestrial-microwave relay signal was used as a backup, and to demonstrate the feasibility of using that band in areas where sufficient UHF spectrum was unavailable. On the UHF band the broadcast was made using vestigial sideband AM;



FIG. 5—AN HDTV videotape recorder from Sony was used this past spring to present one designer's spring line in New York.

on 13 GHz, FM was used. In general, the results were satisfactory, although some problems were encountered with the PCM digital audio, which was designed for satellite rather than terrestrial distribution, when the signal was attenuated. That problem will have to be solved to make terrestrial distribution of a MUSE signal practical.

The other way in which HDTV programming could be provided is in pre-recorded form—on videotape and videodiscs. While the wide bandwidths of HDTV are beyond the capabilities of conventional broadcast and consumer equipment, Sony and other manufacturers have developed systems capable of storing HDTV images. See Fig. 5.

Compatibility

High-definition television is certainly practical. Indeed, it already exists. The problem that concerns many, though, is how to get program material produced in that medium to the greatest number of viewers.

In the past, virtually all improvements in broadcasting in the U.S. have been achieved within the framework of the system established in the 1940's by the NTSC; other TV systems have also maintained compatibility with existing equipment as they were improved. Although newer receiving equipment has been required to take full advantage of improvements such as color and stereophonic broadcasts, program material incorporating those improvements has generally been able to be received and enjoyed using equipment already in use.

The ideal, of course, is to develop a system in which a current receiver could accept an HDTV transmission and display it in HDTV form. In all likelihood, that is an unattainable dream. More likely would be a system in which an NTSC receiver would be able to receive an HDTV signal and display it with the same or slightly worse quality as it displays an NTSC signal. Another possibility would be a sys-

tem in which an NTSC receiver could be modified, perhaps through an outboard adapter, to receive HDTV signals. Of course, the cost of such a modification must be relatively low to be practical. If it is too high, most consumers would opt to forgo modification and simply replace their equipment when they decide to upgrade. A final possibility would be that an NTSC receiver simply could not be used to receive and display HDTV signals in any form. In other words, it would be a completely incompatible system.

Of course, compatibility is a desirable goal, but you can not overlook the cost at which it is achieved. At this point in HDTV research, it appears that the higher the compatibility with existing systems, the poorer the high-definition performance. Images will be strikingly better than those provided by a non-HDTV system, but they will not provide maximum possible performance.

On the other hand, the highest performance HDTV system will likely be achieved only if the compatibility problem is completely ignored. In that event, a separate programming distribution system likely will develop that will supply programming to viewers that possess the appropriate equipment.

Ignoring compatibility altogether is not without precedent. When FM radio broadcasting was introduced, that mode was incompatible with the existing AM system. That, however, did not stop people from investing in what then was expensive equipment to take full advantage of the benefits (superior audio quality) offered by that medium.

The newer FM system coexisted with the older AM one, and prospered. Today, it is commonplace to find AM and FM tuners in the same piece of equipment—even small portable receivers. And even now the same program material is sometimes broadcast by a station in both AM and FM, so that those with FM equipment can enjoy the all the benefits of the new technology, and those who are still AM-bound will not be left out.

Similarly, television broadcasters could provide high-quality HDTV programming by satellite or some other means to those equipped to receive it, while performing scan- and media-conversion at their own facilities and simultaneously sending NTSC-format signals containing the same material on their conventional VHF and UHF frequencies for viewers with existing NTSC (or PAL or SECAM) receivers.

Whatever final form politics, policies, and technology dictate for HDTV, it appears that there's no holding that technology back. In just a few short years, Japanese viewers will be enjoying its benefits; it's very likely that shortly thereafter we'll be getting the "big picture" in this country, too!

R-E

ALL ABOUT

EVEN INTO THE EARLY YEARS OF SOLID-state equipment design, the FCC's examination for a *1st Class General Radiotelephone License* which is almost universally known as a "First-Phone," covered most of what there was to know about the electronics of communications. Except for radar, which was an endorsement on the license obtained through a separate examination, the knowledge needed to get a First-Phone was so broad and so thorough that the license was often a prerequisite for general technical employment, even though the license was intended only for technicians whose job involved transmitter adjustments.

The reason why employers placed so much faith in the First-Phone was because it certified a minimum level of knowledge and skill. Even if the job open was repairing home stereo receivers, an employer could be reasonably certain that someone with a First-Phone had an acceptable understanding of both electronics and electric fundamentals.

But suddenly, almost overnight, the general radiotelephone license lost both its value and its need. First, as with all other things, electronics technology became so complex and sophisticated that no one could be expected to be expert, or even merely competent, in more than one or two specialized areas of interest. Because the radio broadcasting services no longer represented a major area of electronics, having a license that certified competence with transmitters and antennas no longer implied competence with the mainstream of electronics equipment.

Second, there was something called "license deregulation." Modern technology had made the stability of radio equipment so reliable that as far as the FCC was concerned, other than for the ship and aircraft services there was really no longer a need for a specially-licensed technician. So the FCC eliminated the requirement that only an FCC-licensed technician could make adjustments and repairs to transmitters: It became the responsibility of the owners and operators of radio-transmitting equipment to ensure proper operation. (Although Congress implied that the FCC could recognize technician "certification" by industry-sponsored private organizations—and that agency has sent out notices about programs available—it officially recognizes no "private" certification of any kind.)

Since an FCC license no longer reflected the major interests of electronics, and since very few positions in the communications industry required an FCC license, how, then, was an employer to evaluate a potential employee's technical knowledge and skill?

CERTIFICATION FOR

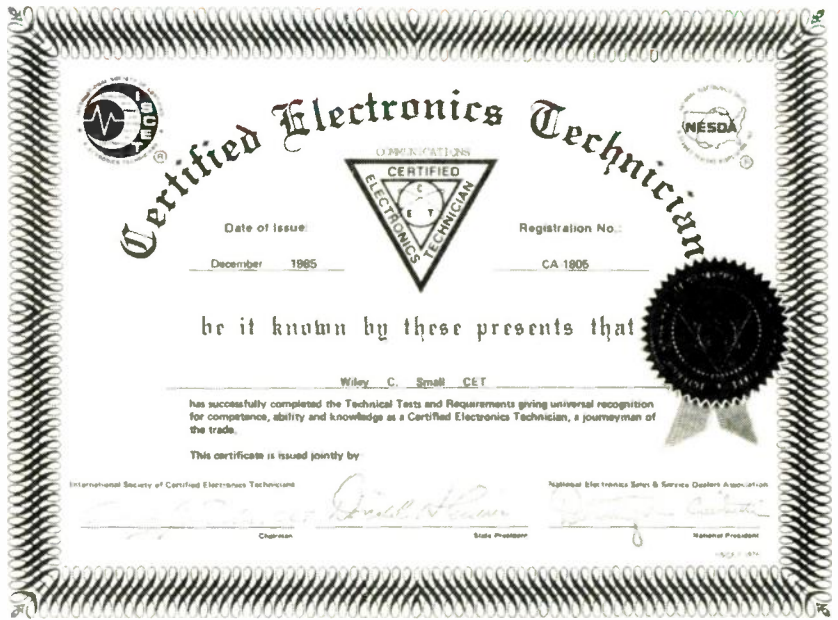

ELECTRONICS TECHNICIANS

*If you really have specialized knowledge and skills—
if you know your stuff—you can become a
certified electronics technician.*

W. CLEM SMALL, CET

For the seasoned technician, past employment records may be all the recommendation that's needed, but for the less experienced person it is usually a different and more complex situation. While it is possible for an employer to ask for transcripts of the applicant's trade-school training, many new technicians who want to work in communications have picked up their knowledge without going to a formal trade school: How are they to establish their knowledge and competence?

Certifications

Often, employers will test job applicants, but if properly done, on-site testing can be a relatively expensive undertaking that often costs more than many small

shops can afford to spend. One effective way to ensure the proper testing and evaluation of potential employees is to use the certification procedures of the various professional organizations that have evolved to serve the communications and electronics industry. In fact, within the broadcast and telecommunications industry, most employers who formerly required the FCC First-Phone now require (or accept) certification by a professional or industry-sponsored organization.

The exact procedure used for the certification of technicians depends on the particular organization. For example, one early approach was to consider a technician's past FCC license level and perhaps his employment under that license. Both

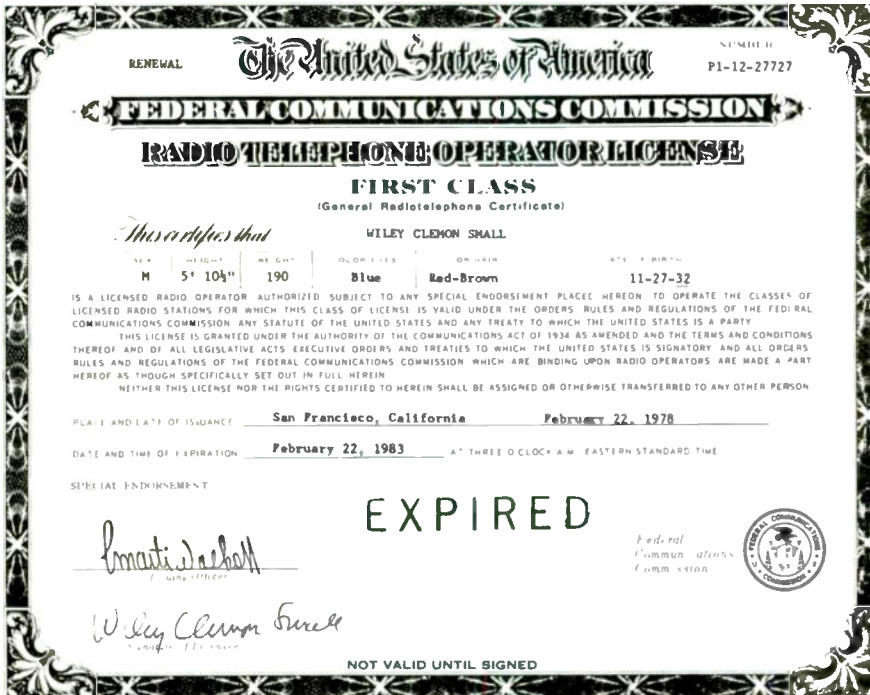

THIS WAS THE LEGENDARY First-Phone FCC license. No longer in existence, it attested to the holder's general technical competence. It was often a "ticket to success" in communications.



SEVERAL PRIVATE CERTIFICATES are similar in appearance or format to the old FCC First-Phone license.

the National Association of Business And Educational Radio (NABER) and the Society of Broadcast Engineers (SBE) have had certification programs that required prior possession of an FCC license as a basic requirement. Upon satisfaction of their requirements, a certificate that resembles the old FCC license is awarded to the applicant. On the other hand, various aspects of existing and emerging radio

technologies such as cellular telephone, as well as the telecommunications skills needed since the breakup (deregulation) of AT&T, requires highly specialized knowledge, which is certified through special exams given by the National Association of Radio And Telecommunication Engineers (NARTE), which certifies on two levels: technician and engineer. Almost without exception, NARTE cer-

tification requires a combination of advanced schooling and extensive experience. For example, their lowest class of engineering certification requires either a two- or four-year engineering degree, or previous high-level technical certification plus two years of engineer level experience. The NARTE's minimum technician certification (Class IV) requires an examination, while the highest (Class I) requires previous certification plus six years verifiable radio or telecommunications experience.

CET

Long before FCC deregulation, electronics professionals recognized the need for certifying electronics technicians in troubleshooting consumer products, in basic logic circuits and industrial controls, and the safety and accuracy of calibration for medical electronic instruments. As early as 1965, the CET test used by the International Society of Certified Electronics Technicians (ISCET) used exams that tested black and white television adjustments, audio speaker enclosures and adjustments, and the use of electronics test equipment. Nearly 20,000 technicians had passed those exams (out of about 70,000) even before the FCC deregulation. Persons passing the appropriate tests may first attain the apprentice electronics-technician certificate, and then one or more advanced journeyman-level certificates.

CERTIFICATION PROGRAMS

Electronic's Technicians Association
604 N. Jackson St.
Greencastle, IN 46135

International Society of Certified Electronics Technicians
2708 West Berry St.
Fort Worth, TX 76109

National Association of Business and Educational Radio
P.O. Box 19164
Washington, DC 20036

National Association of Radio and Telecommunications Engineers
P.O. Box 15029
Salem, OR 97309

National Institute for Certification in Engineering Technologies
1420 King St.
Alexandria, VA 22314

Society of Broadcast Engineers
P.O. Box 50844
Indianapolis, IN 46250

Two organizations that offer a CET or C.E.T. testing program are ISCET and the Electronic Technician's Association (ETA). Options that are available from one or the other of these programs include most major areas within electronics technology.

Within the ETA program are the advanced options of *Senior C.E.T.* and *Master C.E.T.*, which are available to persons with eight or more years of experience in the profession. Higher passing scores in a chosen option are required for the senior level than for the lower levels. The master option requires passing an examination that covers consumer electronics, commercial electronics, communications, industrial electronics, computers, and biomedical electronics.

ISCET has two levels of certification. *Associate CET's* must pass an exam covering basic electronics, circuits, semiconductors, test instruments, and basic troubleshooting. Technicians with four years experience can take the higher-level *Journeyman* exam at the same time. They must be certified at the Journeyman level to use CET after their names. CET's are issued permanent certificates suitable for framing and a plastic wallet card.

Once certified as a CET or C.E.T., technicians are eligible for membership in the parent organization, ISCET or ETA. Members receive books, magazines, reprints, and regular technical material; may attend conventions and technical training programs; and receive discounts on books, tapes, and software. But the real benefit of certification is a growing awareness within the electronics industry that a certified technician is a person who has demonstrated considerable skill, understanding, and competence in his or her tested areas.

The FCC and CET

The FCC has made no official sanction of any private-industry certification program. Public notices have been issued by the FCC to assist technicians in locating certification programs, but those have specifically stated, "The Commission does not approve, endorse, or officially sanction any private sector certification program..." However, in its Report and Order, docket 83-322, 49 Fed. Reg. 20658, the Commission did endorse the *concept* of private sector certification programs as a possible substitute for Commission testing of commercial radio operators.

The right certification

It is reasonable to expect that, as more and more jobs require certification of some kind in lieu of the old First-Phone, we're bound to see a plethora of private organizations offering their own version of private licensing. Bear in mind that certification that isn't specifically recog-

CERTIFIED TECHNICIAN

The National Association of
Business and Educational Radio, Inc.
Certifies that

Wiley Clemon Small

has demonstrated a knowledge of the Federal Communications Commission's Rules and Regulations governing the Land Mobile and Private Fixed Radio Services and has shown a general comprehension of the theories of electronics and radio propagation. This individual is hereby recognized as a NABER Certified Technician through a FEDERAL COMMUNICATIONS COMMISSION endorsed program.



Emmett C. Kitching
PRESIDENT, NABER

AUGUST 1, 1984
DATE OF ISSUANCE

Wiley Clemon Small
SIGNATURE OF TECHNICIAN

AUGUST 31, 1989
DATE OF EXPIRATION

17540

EVEN WHEN THEY DON'T RESEMBLE the First-Phone license, some private certificates such as this one state or imply endorsement by the FCC, although the FCC does not approve, sanction, or endorse any private program.

International Society of Certified Electronics Technicians

Associate Certified Electronics Technician

Expiration Date

Registration No.

be it known by these presents that

I, _____, have successfully completed the Technical Tests and Requirements giving universal recognition for competence, ability and knowledge as an Associate Certified Electronics Technician.

This certificate is issued jointly by:

S. A. T. E.

Secretary

S. A. T. E.

Executive Director

PRIVATE-SECTOR CERTIFICATION attesting to a minimum level of knowledge and skill is available for various areas of electronics. It often serves as a "ticket to success."

nized by employers is worthless. If you want a particular kind of job, say in cellular phone, or even broadcasting, check with some large operations and specifically ask if they recognize or require private certification or licensing and, if so, from whom. If you choose to work in an area that requires private certification, bear in mind that as a general rule the higher the certificate for which you qualify, the greater the potential job opportunities.

For more information on how to get certified in various electronic technologies, you should contact the major private certification organizations listed in the box that can be found elsewhere in this article. Although those organizations are not-for-profit, they do have a reasonable fee for testing and processing. In particular, we suggest you enquire as to what study guides they specifically recommend.

R-E

TRANSISTOR

WE WERE HAVING TROUBLE FINDING AN exact replacement transistor while repairing a piece of equipment recently. Figuring that an *exact* replacement was going to be impossible to find, we began to discuss what to do. And someone pointed out that there were only two kinds of bipolar transistors—NPN and PNP. Of course, values for various characteristics vary widely, even for a specific transistor; but in many circuits, a garden-variety device will work (and did in our case).

Designing and repairing transistorized circuits is much simpler than you might suspect. A well-designed circuit has built-in tolerance, so it's probably not device-sensitive. The most important characteristics to consider when substituting devices or designing a circuit from scratch are operating frequency and power level.

What follows is the design procedure we went through to solve an audio-gain problem. Try it when you need a little extra gain for that next audio project.

An audio amp

This particular project involved injecting the audio from a TV receiver into a stereo system. The audio-output portion of the TV-audio receiver was abandoned because of its poor frequency response and high distortion. Instead, we wanted to come right off the detector into a quality audio amplifier and speaker. So, after picking off the audio at a convenient point in the set (in this case, from a potentiometer), we wanted to feed it to the auxiliary input of the stereo amplifier.

The amplifier we used required an input of 1 volt rms, but a quick check with an AC VTVM indicated that our picked-off audio signal was only 0.1-volt rms. Obviously, an amplifier with a gain of 10 was needed.

Scanning the literature on transistor amplifiers revealed that a common-emitter amplifier with a voltage-divider bias circuit would solve our problem nicely. Such a circuit is shown in Fig. 1. Some of that circuit's characteristics include: moderate input impedance, moderate voltage gain, inverted output, and input/output impedance and gain that depend only slightly on transistor beta.

There are, of course, several rules that must be followed in using a common-emitter amplifier, including:

- With a positive supply use an NPN transistor.
- With a negative supply use a PNP transistor.
- The supply voltage must not exceed the transistor's V_{CE} rating.

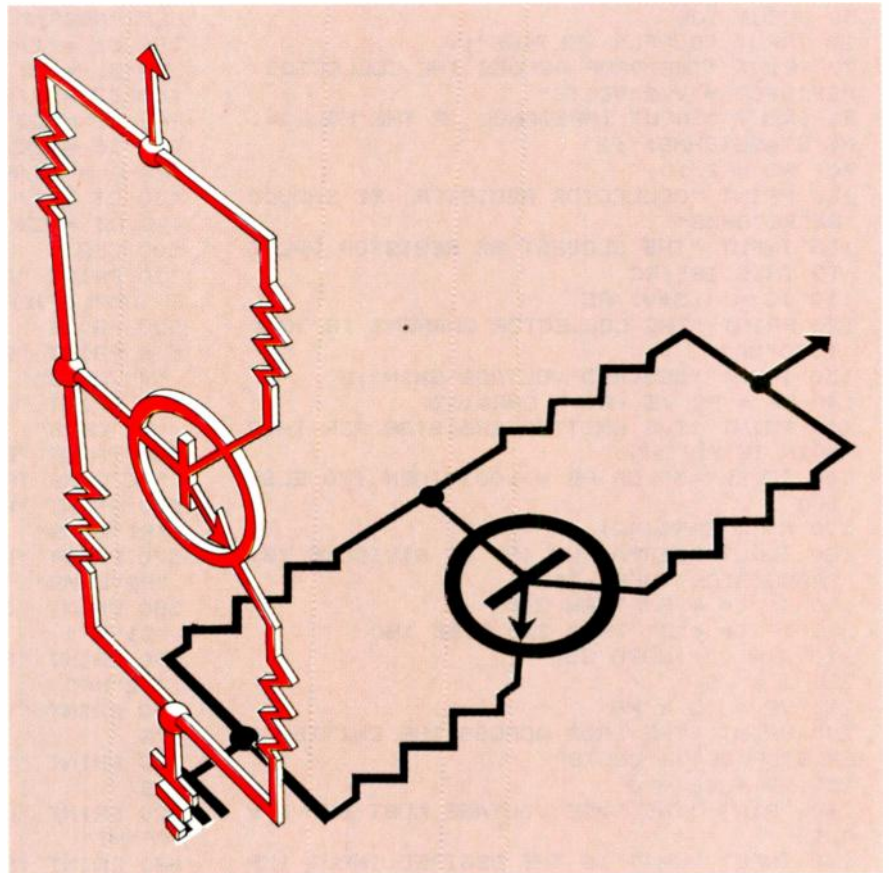

AMPLIFIER DESIGN

JACK CUNKELMAN

It's easy to design a simple transistor amplifier. Here's how.

- The power-dissipation rating of the transistor must not be exceeded.
 - The beta of the transistor should be 100 or higher.
- In our example the following facts are known:
- Our amplifier had a single-ended 12-volt power supply.
 - We need a voltage gain of 10.
 - The input impedance of the amplifier should be about 15K, the same as the potentiometer from which audio was taken.
 - The impedance of the stereo amplifier's auxiliary input is about 50K.

As is the case in most circuit designs, a few facts are known, and the rest must be calculated or picked using a few "rules of

thumb." We will learn how to make the calculations next.

Doing the math

For maximum undistorted output swing, we will make the quiescent collector voltage $\frac{1}{2}$ the supply voltage. See Fig. 2. The drop across R_C must therefore be 6 volts.

The value of R_C , the collector load resistance, is chosen considering output impedance, gain, and collector current. If possible, the output impedance should be lower than the impedance of the circuit we are feeding by a factor of 10 or more. Doing so will avoid circuit loading. So let's make R_C equal to 4700 ohms, which is about 50K/10.

LISTING 1

```

10 CLS
20 REM TRANSISTOR AMPLIFIER CALCULATIONS
30 REM BY JACK CUNKELMAN
40 REM APRIL 1986
50 GOSUB 900
60 INPUT "SUPPLY VOLTAGE";V
70 PRINT "THE DROP ACROSS THE COLLECTOR
RESISTOR ="V/2"VOLTS"
80 INPUT "INPUT IMPEDANCE OF THE FOLLOWI
NG STAGE(OHMS)";Z
90 RC = Z/10
100 PRINT "COLLECTOR RESISTOR, RC SHOULD
BE"RC"OHMS"
105 INPUT "THE CLOSEST 5% RESISTOR VALUE
TO THIS IS";RC
110 IC = (.5*V)/RC
120 PRINT "THE COLLECTOR CURRENT IS"IC *
1000"MA"
130 INPUT "DESIRED VOLTAGE GAIN";G
140 RE = RC /G :R$ = CHR$(32)
150 PRINT "THE EMITTER RESISTOR FOR THIS
GAIN IS"RE"OHMS"
160 IF RE<=39 OR RE =>1001 THEN 170 ELSE
180
170 R$ = CHR$(42)
180 INPUT "GERMANIUM (G) OR SILICONE (S)
TRANSISTOR TYPE";T$
190 IF T$ ="G" THEN 210
200 IF T$ ="S" THEN 220 ELSE 180
210 J = .2 :GOTO 230
220 J = .6
230 VE = IC * RE
240 PRINT "THE DROP ACROSS THE EMITTER R
ESISTOR IS"VE"VOLTS"
250 VB = VE + J
260 PRINT "THE BASE VOLTAGE MUST BE"VB"V
OLTS"
270 INPUT "WHAT IS THE DESIRED INPUT IMP
EDANCE FOR THIS STAGE";IZ
280 R2 = IZ*RE*100/((RE*100)-IZ)
290 PRINT "THE BIAS RESISTOR, R2 IS"R2"O
HMS"
300 INPUT "THE CLOSEST 5% RESISTOR VALUE
TO THIS IS";R2
310 VD = V - VB : I2 = VB / R2
320 IB = IC/B
330 R1 = (V - VB)/(IB + I2)
340 PRINT "THE BIAS RESISTOR, R1 IS"R1"O
HMS"
350 INPUT "THE CLOSEST 5% RESISTOR VALUE
TO THIS IS";R1
360 PRINT "CALCULATION OF THE INPUT AND
OUTPUT CAPACITOR VALUES"
370 INPUT "LOWEST FREQUENCY THIS AMP SHO
ULD PASS";F
380 C1 = 1/(3.2*F*IZ)
390 C1 = C1 * 1E+6
400 C2 = 1/(3.2*20*Z)
405 C2 = C2 * 1E+6
410 IE = VE/RE : RJ = .03/IE
420 A = RC/RJ
430 C3 = 1/(6.2*F*RJ)
440 C3 = C3 * 1E+6
500 CLS
510 PRINT "PARAMETERS FOR A COMMON EMITT
ER AMPLIFIER STAGE"
520 PRINT
530 PRINT "SUPPLY VOLTAGE.....
."V"VOLTS"
540 PRINT "COLLECTOR RESISTOR (RC) .....
."RC"OHMS"
550 PRINT "EMITTER RESISTOR (RE).....
."RE"OHMS "R$"
560 PRINT "BIAS RESISTOR (R1).....
."R1"OHMS"
570 PRINT "BIAS RESISTOR (R2).....
."R2"OHMS"
580 PRINT "INPUT CAPACITOR (C1).....
."C1"MF"
590 PRINT "OUTPUT CAPACITOR (C2).....
."C2"MF"
600 PRINT "VOLTAGE GAIN.....
."G"
610 PRINT "TRANSISTOR BETA.....
."B"
620 PRINT "LOW FREQUENCY LIMIT.....
."F"HZ"
630 PRINT "EMITTER BYPASS = "C3"MF FOR A
GAIN OF ...."A
700 INPUT "RUN AGAIN..Y OR N";R$
710 IF R$ ="Y" THEN 10
720 IF R$ ="N" THEN END ELSE 700
900 PRINT "CALCULATIONS FOR A COMMON EMI
TTER AMPLIFIER STAGE"
910 PRINT
1000 INPUT "TRANSISTOR BETA IF KNOWN (O
IF UNKNOWN)";B
1010 IF B = 0 THEN B = 100
1020 RETURN

```

Collector current, I_C , is equal to $0.5 V_{CC}/R_C$, or $6/4700 = 1.28$ mA. That current is certainly low enough that we will not exceed any collector-current ratings, so let's go on.

To achieve maximum stability, the emitter resistor should be in the range of 40 to 1000 ohms. Voltage gain (A_V) = R_C/R_E , so $R_E = R_C/A_V$. In our case R_E equals $4700/10$, or 470 ohms. That falls within the range of acceptable values.

The current through the emitter resistor consists of the collector current plus the base current. The base current here is significantly smaller than the collector current, so it can be ignored for the next calculation.

The voltage drop across the emitter resistor = $I_C \times R_E$, or 1.28 mA \times 470 ohms = 0.602 volts. The base voltage must exceed the emitter voltage by 0.6 volts for a silicon transistor and by 0.2 volts for a germanium transistor. We'll use a silicon transistor in our circuit, so the base voltage must be $0.6 + 0.602 = 1.202$ volts.

The input impedance of the circuit equals R_2 in parallel with the emitter resistor times beta; input impedance will vary with the transistor's beta. For our example, assume we are using a transistor with a beta of 100. We want the input impedance to be about 15000 ohms. Solving for R_2 , we find:

$$Z_{IN} = (R_2 \times R_E \times \beta) / [R_2 + (R_E \times \beta)]$$

$$R_2 = (Z_{IN} \times R_E \times \beta) / [(R_E \times \beta) - Z_{IN}]$$

$$R_2 = (15000 \times 470 \times 100) / [(470 \times 100) - 15000]$$

$$R_2 = 22,030 \text{ ohms}$$

We can use a 22K resistor. In general, if input impedance is not critical, for maximum stability R_2 can be 10 to 20 times R_E .

The drop across R_2 must be 1.20 volts, so the current through R_2 is $1.20/22,000$, or 0.054 mA. Therefore, R_1 must drop the rest of the supply voltage, which is $12 - 1.20 = 10.8$ volts. The current flowing

continued on page 77

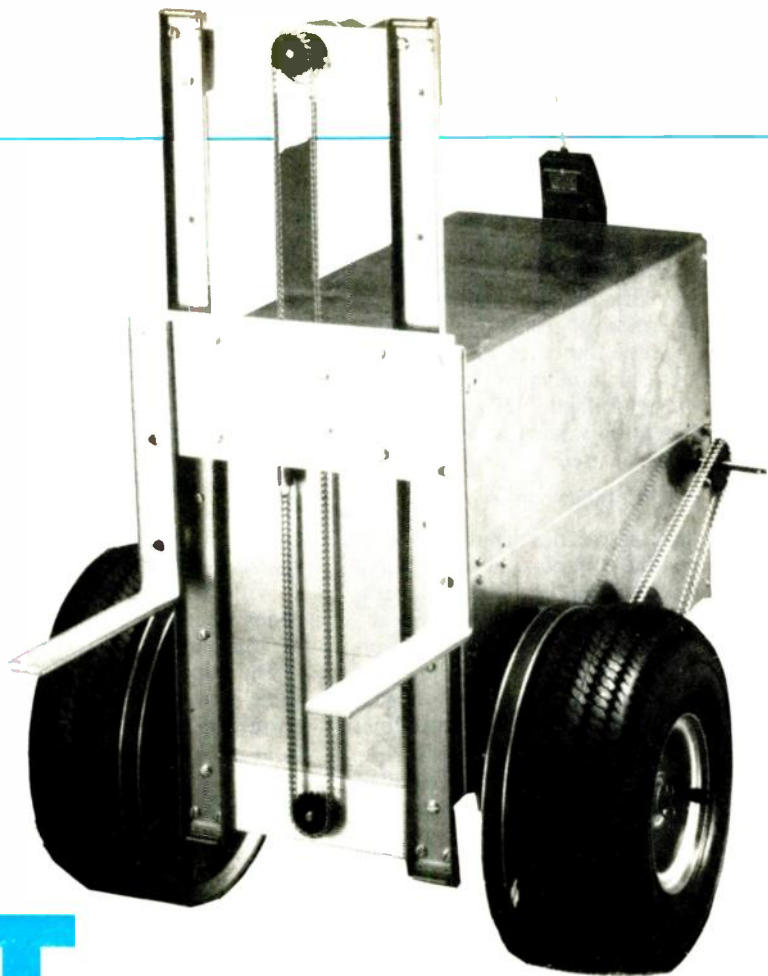

R-E ROBOT

The robot's command language

Part 9 NOW THAT WE'VE ASSEMBLED the robot's hardware, it's time to dig into the software. In this article we'll describe the R-E Robot's command language, RCL (*Robotic Control Language*). It's an easy-to-learn and easy-to-use language written in FORTH. Don't be scared by FORTH; you can use RCL without being an expert at programming in the language. And, as you learn RCL, you'll learn (painlessly) the basics of how FORTH works, so that, if you want to, you can go on and learn the language itself. To give you a chance to see RCL in action, we'll present a robot-based mail-delivery system. You can study our program to learn how RCL works, and you can also use it as the basis of your own program.

How difficult is RCL? Not very. For example, suppose you wanted the robot to move in the forward direction 3.4 feet at a speed of 2 miles per hour. You would simply type in the following code:

```
RERB 2 MPH 3.4 FEET FORWARD
```

RCL includes commands to move the robot forward and backward, to turn left and right, to move its manipulator up and down, and to open and close a gripper.

You can combine a sequence of commands and store them for execution at a later time. In addition, commands can also be executed immediately from the keyboard.

Real-time control

The R-E Robot consists of a computer-controlled set of electromechanical devices. The assembly is broadly known as a *motion-control system*.

Real-time motion control requires real-time sensing and processing. One way to ensure proper sensing and processing is to force the computer to execute a control loop at regular intervals. That control loop will be the computer's highest priority. Everything else the computer does will be secondary, and it will have to do those other things as it finds time.

A simple way to implement the control loop is to have a clock IC generate an interrupt at regular intervals. Each time the clock interrupts the microprocessor, it will execute the control loop, and then it will return to whatever it was doing before the interrupt occurred. The amount of time the computer spends executing the control loop must be less than the time interval between interrupts.

RCL basics

The software that controls the robot is built up layer by layer. The most primitive words must be defined first; more-complex words are defined using the previously defined words; at the top level are the RCL words that make motion control easy. As each word is defined it can be tested and debugged. When it is debugged, the next layer may be defined.

Notice that you are defining words, rather than writing a program, as with most computer languages. That's not just a matter of semantics; it's also a way of looking at a programming problem. The problem can be broken down into a series of smaller problems, and then those problems can be broken down further, and so on, until you have a set of problems that can be programmed. Each little problem becomes a FORTH word, which in turn becomes part of another FORTH word, so that eventually all we have to do is say something like

```
TURN-LEFT
```

The real-time control portion of RCL consists of the hardware interface, interrupt control, following-error monitoring, velocity control, and position control.

Low-level words

The most-primitive words deal with the robot's hardware: turning the motors on and off, setting the direction in which each motor rotates, and enabling the speed-control circuits. To control the hardware, values must be written to and read from various registers on the robot's control board. Those registers are read and written using the microprocessor's I/O statements (IN and OUT). In RCL, to write an eight-bit value to an output port, the word PC! is used:

```
PC! (value port ----)
```

That statement specifies that *value* is to be output to I/O port *port*. A word about notation is in order. The stack diagram, enclosed in parentheses, represents the parameters required by the word PC!. Input parameters appear to the left of the dashes, and output parameters appear to the right. In this case there are no output parameters.

FORTH words in general (and those of RCL in particular) make extensive use of the stack, both for parameters supplied to a word, and those that it may produce. The top of the stack is always the parameter furthest to the right. In the preceding example, the stack diagram shows that the value to be written must be pushed on the stack followed by the port to which it is to be written. The word PC! removes these parameters from the stack, uses them, and leaves nothing on the stack. Other words may leave one or more values on the stack.

Motor-control words

Several words operate the speed-control circuits and the relays. For example, ENABLE and DISABLE write an appropriate value to turn on or off a particular function of the hardware. STOP-LEFT, STOP-RIGHT, and STOP use DISABLE to turn the relays off. FORWARD, REVERSE, CW, and CCW enable the proper relays to allow the motors to turn in the desired direction. CW and CCW allow turns to be made by enabling the wheels to turn opposite to each other. GO and COAST enable and disable the speed-control circuits and the motor-drive current as well.

Speed control

Hardware on the control board is responsible for controlling speed (accelerating and decelerating). The hardware makes the software system much simpler than it would be if the software were required to maintain speed alone. The phase-locked loop on the control board maintains the desired motor speed under varying loads. The software only has to set the speed, and to accelerate and decelerate the base unit.

The speed at which each motor runs is determined by the frequency of a signal that is generated by counter 0 of the 8253

timers. Setting the number of counts in the counter determines the period of a squarewave output. The phase-locked loop circuitry responds to the frequency corresponding to that period.

The frequency of the signal applied to the 8253's on the motor-control board is the 2-MHz system clock divided by 16, or 125 kHz. Therefore a count is generated every 8 microseconds (1/125,000). The 8253 is programmed to generate a squarewave whose period corresponds to the value loaded into the counter. So, if the counter is loaded with the value 125, the total period would be 125×8 microseconds, or 1 millisecond, which corresponds to a frequency of 1000 Hz.

With a 500-count-per-revolution encoder, the motor speed would be $1000/500 = 2$ revolutions per second, or 120 rpm.

The counter can be loaded with any value between 1 and 65,536 (0 actually), corresponding to frequencies ranging from 125 kHz to just under 2 Hz.

Interrupt control

Motor speed must be updated many times per second to produce smooth acceleration and deceleration. The update rate is set by the interrupt-control routines to 100 times per second (i. e., there are 10 ms between interrupts). The 80188 microprocessor has three built-in timers that can generate interrupts. Timer 0 is used by the BIOS and the DOS to maintain a time-of-day clock. The BIOS is set up to generate interrupt 01Ch every time timer 0 counts down to 0. If we change the count value in timer 0 we can use it to generate the motor-control interrupt. However, the time-of-day clock will count in 10-millisecond periods instead of the usual 55-millisecond periods, so a set of time-of-day words will have to be defined for the new rate. In addition, we'll have to install a new BIOS-level interrupt handler to maintain compatibility with MS-DOS.

First of all, we must define the interrupt routine we want to execute. Then we can install that routine so that it is executed each time the interrupt is generated by the timer.

The word INT-OFF disables interrupt generation by the timer so that we can change the interrupt vector, or disable it. INT-ON turns timer-interrupt generation back on. SET-TIMER takes a count that sets the period for the timer. The input frequency to the timer is 2 MHz/3, yielding a period of 1.5 microseconds per count. If the count is set to 6667, the timer will count down to 0 every 10 milliseconds and generate an interrupt.

GET—CS is a special word that is used to return the code segment in which the FORTH system is executing. SET-INT sets the interrupt vector to the word we want to execute each time the interrupt is generated.

INSTALL performs all the tasks neces-

SOFTWARE SOURCES

Micro K Systems (15874 East Hamilton Place, Aurora, CO 80013, 303-693-3413) will provide the following: Commented source code in RE-robot disk format, \$2.00. Printed source-code listing, \$15.00. Two 27128 EPROM's with source screens (and without comments) for the R-E Robot, \$39.00. With EPROM's you won't need a disk drive, but you should also obtain the printed listing to read the comments. The Laxen and Perry F83 Model disk with full source code and metacompiler for customizing F83, in MS-DOS 360K format, for a PC compatible computer, \$25.00. (Very useful for learning FORTH if you already have a PC.) All orders must be prepaid. NO COD's. Include \$3.00 for shipping with each order. Additional source code and applications will be available from Micro K Systems. Contact them for more information.

sary to link a new interrupt handler into the microprocessor's interrupt vector in low RAM. After executing INSTALL the interrupt-control word will be executed every 10 milliseconds, and will continue to do so until the system is turned off, the interrupt is disabled, or a new interrupt routine is installed.

Position-counter words

The hardware position counters must be initialized by the robot's software. In addition, the position counters are only 16 bits wide, so the robot won't move very far before the counters overflow. So it's necessary to extend counter length with software. If we look at the counters often enough, they will not overflow. The software maintains a 32-bit position counter.

Because the counter routines must be executed many times per second, the time required to execute those routines is important. So all counter routines (and several others) have been written as CODE words. To experiment with those words, you'll have to know 80188 assembly-language programming.

The high-level words for reading the counters are ?CNT1 and ?CNT2 to read the positions of motor 1 and motor 2, respectively. The hardware causes the 16-bit counters in the 8253 IC's to decrement for each encoder count that is in the proper direction. The difference between a motor's forward and reverse counts gives the absolute position of the motor.

Following-error words

To detect a problem with the motors, it is necessary to compare actual speed with expected speed. If the two differ by more than a small percentage, an overload condition exists, so the motors could overheat and be destroyed. The following-error words constantly monitor the motors and detect a stalled motor by comparing the

current motor position with the expected position. If the difference is too great the motors are turned off immediately. This also means that if you specify a value of acceleration that is too high, a following-error will be detected, and the motors will be shut down.

Numeric input

FORTH normally works with 16-bit signed integers. Such numbers can range in value from -32768 to +32767. In addition, a decimal point may be included anywhere in a number and FORTH will treat it as a signed double-precision integer with a possible range of -2,147,483,648 to +2,147,483,647. The position of the decimal point is kept in a system variable, DPL. If a number without a decimal point is entered, the system sets DPL to -1. If a number is entered with a decimal point, DPL will contain the position of the decimal point relative to the least significant digit entered. A number may have a maximum of four digits to the right of the decimal point. The FORTH system converts the input number to a signed integer representing the integer part and a signed integer representing the fractional part. The pair of single precision numbers each carries a sign bit; the numbers can be used alone or together.

Table 1 illustrates how various numbers are stored. Keep in mind the fact that the decimal-point position stored in DPL is correct only for the last number entered by the user from the keyboard. Numbers compiled into a definition do not affect the value of DPL after compilation. You must be in the decimal base (base 10) when entering numbers with decimals.

The word FIXED converts the last number input to an integer and a fraction. FIXED gets the value from DPL and puts it on the stack, then it calls (FIXED). We defined the separate word (FIXED) to do the actual conversion, because it can be made more general—it can convert any number, even if it was not entered from the keyboard.

EXTRACT strips the fraction digits from the number one by one until all have been removed. That leaves the integer part of the number on the TOS (Top Of Stack) with the digits beneath it. The digits are reassembled into a single number with BUILD. SCALAR produces a value that is used to adjust the fraction to the proper range. If the unscaled fraction is 9, we need to know whether it is 9000/10,000, 9/10,000, or another value.

The word FRACTION takes a fraction, an integer, and a multiplier and creates a double-precision integer. So the value -932.015 converted by FIXED is a fraction and an integer. Taking these two numbers and a multiplier of 1000 would give us the double precision number -932015 as follows:

TABLE 1—NUMERIC STORAGE

Input	Value	Size	DPL
725	725	16	-1
-1	-1	32	0
1.2	12	32	1
-9.999	-9999	32	3
38.04	3804	32	2

932.015 FIXED 1000 FRACTION.

FRACTION is used by many other words to convert values for internal use.

User-input conversion words

Several words convert user-input values to more basic units the hardware can use for the move commands.

Distances are entered in units of INCHES, FEET, MILES and DEGREES. INCHES takes the value specified and converts it to internal form. The input value and a scale factor are saved for later conversion. FEET takes a distance in feet and MILES takes a distance in miles. The scale factor is set appropriately for each word in terms of the number of inches each word represents. DEGREES calculates how far each motor must move to make the specified turn.

Speed can be entered in miles per hour by using the word MPH, inches per second by IPS, feet per second by FPS, and feet per minute by FPM. Each of those words stores the value and an appropriate scale factor for later conversion.

G converts the input value (in terms of the acceleration due to the earth's gravity, i.e., 32.2 ft/sec/sec) to a count that is used to accelerate or decelerate the motors, if necessary, each time speed is updated by the interrupt routines.

Motion

To move from one point to another, the motors must be accelerated and decelerated.

By allowing the user to set a value for acceleration, deceleration, and maximum speed, the behavior of the robot can be controlled precisely.

Before a move is actually made, the software does a series of calculations to determine the top speed that can be attained, and the positions at which acceleration should end and deceleration should begin in order to attain a trapezoidal velocity curve, as shown in Fig. 1.

Calculated speed may be less than desired speed, but that is not a problem for short moves. Maximum speed will be used for moves that are long enough to allow the motors to accelerate to their maximum velocity. For short moves, acceleration is more important than maximum speed.

To perform a move, breakpoints on the trapezoidal velocity curve must be found. The points where acceleration ends and deceleration begins, as well as the end point position, must be calculated.

The robot is a speed-controlled system, so the acceleration and deceleration breakpoints must be used to calculate what speed will be achieved by accelerating at the specified value of acceleration to the breakpoint position. That new speed is saved with the breakpoint position. The same values of speed and distance are used to calculate the breakpoint where deceleration is to begin.

Trapezoidal velocity control

To perform a move, the robot must be accelerated from a speed of zero to top speed, and then decelerated at the appropriate point to arrive at the desired position. The simplest system would just set the speed of the motors, turn the motors on until the end point was reached, and then turn the motors off. That type of approach assumes instantaneous acceleration and deceleration, but in an actual

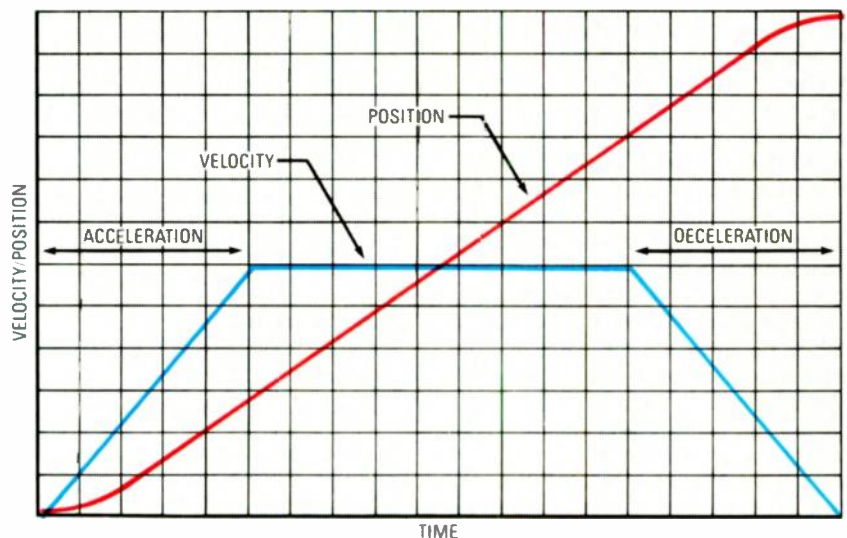

FIG. 1—ACCELERATION AND DECELERATION BREAKPOINTS must be calculated in order to move the robot from one point to another.

system it's not practical. Therefore, we have to take into account the acceleration that actually can be achieved by the system. In practical terms, acceleration might be a fraction of G, or it could be several G's, depending on the size of the motors in relation to the size of the load.

To accelerate and decelerate the robot, velocity actually must be changed many times per second. In general, the robot starts with a velocity of zero and then accelerates at a constant rate to the top speed. Then it must decelerate at a constant rate until it stops at the final position.

The velocity-versus-time profile is also shown in Fig. 1, but superimposed on the velocity trapezoid. Note that the position profile is not simply a straight line. In terms of calculus, position is the integral of speed over time. The basic equations of motion are as follows:

$$V = V_0 + AT$$

$$D = V_0T + \frac{1}{2}AT^2$$

where V stands for velocity, A for acceleration, T for time, and D for distance. V_0 refers to starting velocity.

From the previous equations we can derive an equation that describes the distance required to accelerate from one speed to another:

$$D = (V^2 - V_0^2) / (2A)$$

We can use that equation to compute the distance required to change speeds.

For a short move, the distance required to accelerate to the desired speed and then decelerate to a stop may exceed the distance to move. In such a case, deceleration must begin at some speed less than maximum.

The word DISTANCE takes the original speed and the desired speed (both in rpm) and calculates the distance in inches that will be required to change speeds. The word COUNTS changes the distance from inches to position-encoder counts. The word EXPECTED converts the user-input distance to position-encoder counts. The word SPEED converts the user-input maximum speed into rpm.

The word BREAKPOINTS calculates the positions on the velocity trapezoid to stop accelerating and begin decelerating. The acceleration and deceleration segments can't be more than half the total move distance, so the distance to accelerate from 0 to the input speed is calculated and compared to half the move distance. The minimum of these two values is then used as the acceleration distance. The breakpoint positions are saved in arrays for use during the move.

After the robot starts moving, the breakpoint positions are compared against the current position every time the control loop executes to determine when acceleration should stop and deceleration should begin. If the move distance is long enough, there will be a period during

which the motors run at maximum speed. For a short move, acceleration will stop before maximum speed is attained, and deceleration will start immediately after acceleration stops.

Command language

The RCL includes a simple command set to allow movement of both the base unit and the arm.

The base-movement commands allow forward and backward motion, and left and right turns. Maximum speed, acceleration rates, and move distance may all be altered by user input. After each move is complete, a new move command can be executed. By defining FORTH words we can chain several move commands together in a motion sequence. We'll discuss such a sequence shortly.

The arm commands move the arm up and down, and open and close the jaws.

Command syntax

In general, a command consists of a device name, a speed value, a distance value, and the command:

```
[DEVICE] [n SPEED] [n DISTANCE]
COMMAND
```

where bracketed quantities indicate optional values that will be: the value entered with the command; the last value if a new value is not included; or a default value if this is the first time the particular command is issued. The value of *n* depends on the command. DEVICE may be RERB for the base unit or ARM for the arm unit.

Base commands

The general syntax for the base-movement commands is as follows:

```
[RERB] [n SPEED] [n DISTANCE]
COMMAND
```

COMMAND may be one of the following: FORWARD, BACKWARD, LEFT, or RIGHT. SPEED may be one of the following: MPH, IPS, FPS or FPM. DISTANCE may be one of the following: INCHES, FEET, MILES or DEGREES.

The command G is used to set the acceleration constant used to change speed; the constant is expressed in G's of acceleration. Any acceleration may be specified, up to the maximum acceleration the system can achieve. The acceleration may be specified in a separate command.

Arm Commands

The basic syntax for the arm-movement commands is as follows:

```
[ARM] [n DISTANCE] COMMAND
```

COMMAND may be one of the following: UP, DOWN, OPEN, or CLOSE. DISTANCE may be INCHES or FEET. DISTANCE is the amount specified in the COMMAND direction relative to the current position.

The example program shown in Listing 1 illustrates how you can combine several RCL commands to cause the robot to traverse a square. The sequence first sets the acceleration constant to 0.1 G. Then the RERB device (i. e., the base) is selected to move at 25.5 inches per second. Then it moves 3.5 feet forward and makes a left turn. The latter actions are repeated three times so that the robot ends up where it started.

Here's a short routine that moves the arm down and then back up:

```
ARM 3.1 INCHES DOWN 2 INCHES UP
```

By defining FORTH words we can create macros to perform various functions. For example, Listing 2 shows a macro that will cause the robot to traverse a box of any size.

Example program

Now let's show how the robot could be used to collect and deliver office mail. Figure 2 shows the office layout that we will use in the example program. Trays for incoming and outgoing mail are attached to the robot.

The overall sequence of operations goes like this: The robot starts from a "nest," and travels around the corridors, waiting at several locations for people to retrieve and deposit mail and then returns to the mail room.

We defined several low-level FORTH words for the program. To allow the robot to wait for different time periods, we defined several words to execute time delays. See Listing 3. The first is MS, which waits for the specified number of milliseconds. The next is SECONDS, which

LISTING 1

```
.1G (3.22 ft/sec/sec)
RERB 25.5 IPS
3.5 FEET FORWARD 90 DEGREES LEFT
3.5 FEET FORWARD 90 DEGREES LEFT
3.5 FEET FORWARD 90 DEGREES LEFT
3.5 FEET FORWARD 90 DEGREES LEFT
```

uses MS to delay the specified number of seconds. The last is MINUTES, which uses SECONDS to delay the specified number of minutes.

Next we define several words for convenience and to improve the readability of the source code. The robot will announce its arrival at each place it stops. That is done by sounding a beep. The word ATTENTION generates the beep.

WARNING, sounds several short beeps. It is used to avoid running over anyone when the robot is ready to move.

Since all the turns in our model office are at right angles, it's convenient to define left and right 90° turn words, TURN-LEFT and TURN-RIGHT. When the robot starts its trip it must back out of the

continued on page 80

COMPUTER DIGEST

VOL. 4 NO. 8 AUGUST 1987

A NEW KIND OF MAGAZINE FOR ELECTRONICS PROFESSIONALS

IBM's NEW PS/2

Great graphics, super speed



DESIGN PC BOARDS ON YOUR PC

New programs make it easy

A
GERNSBACK
PUBLICATION

CONTENTS

AUGUST 1987

Vol. 4 No. 8



67 MICRO-FLOPPY RETROFIT

Your PC can read 3½ disks with this simple upgrade.



69 DESIGNING PC BOARDS ON YOUR COMPUTER

Smartwork, AutoBoard, and other PC-based CAD packages.

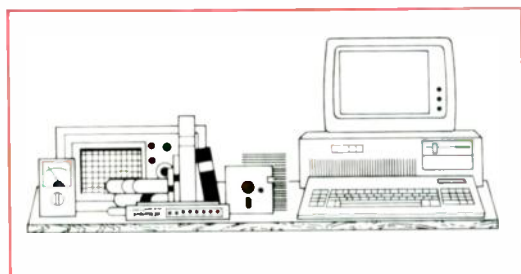

63 EDITOR'S WORKBENCH

Hardware: The new IBM's (Models 30 and 50)

Software: Memory Minder disk drive analyzer
RS-232 network program

COMPUTER DIGEST

Larry Steckler,
EHF, CET: publisher & editor in chief

Art Kleiman,
editorial director
Brian C. Fenton,
managing editor
Jeff Holtzman
technical editor
Byron G. Wels,
associate editor
Carl Laron,
associate editor
Robert A. Young,
assistant editor
Teri Scaduto
editorial assistant
Ruby M. Yee,
production director
Karen Tucker,
production advertising
Robert A. W. Lowndes,
production associate
Marcella Amoroso
production assistant
Andre Duzant,
technical illustrator
Jacqueline P. Cheeseboro
circulation director
Arline R. Fishman,
advertising director

ComputerDigest
Gernsback Publications, Inc.
500-B Bi-County Blvd.
Farmingdale, NY 11735

ADVERTISING SALES 516-293-3000

Larry Steckler
Publisher

NATIONAL SALES

Joe Shere
1507 Bonnie Doone Terrace
Corona Del Mar, CA 92625
714-760-8967

Cover Photo by Jeff Holtzman and
André Duzant

EDITOR'S WORK- BENCH

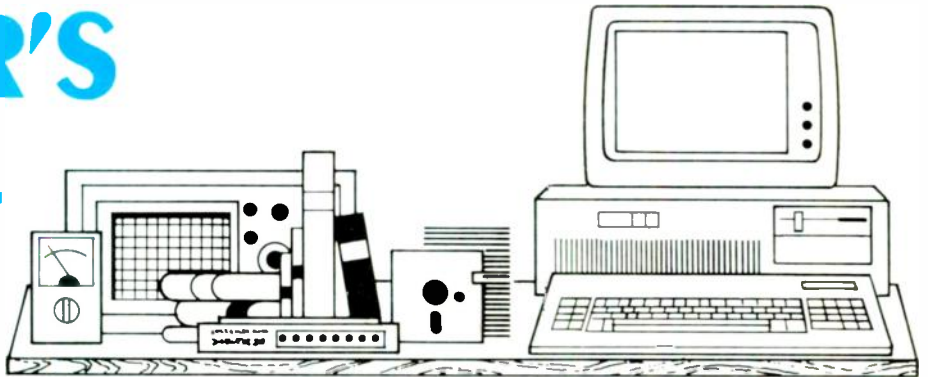

68000 UPDATE

We've just finalized arrangements with Peter Stark, a long-time member of the microcomputing community, to do a series of articles that will be of great interest to anyone interested in Motorola's 68000 family of microprocessors, and to anyone who wants to learn about computer-system design from the ground up. The series will center around a gradually upgradable CPU board that has been custom-designed specially for readers of **ComputerDigest**. A minimal system can be brought up for about \$200; it requires only a serial ASCII terminal or any personal computer and a communications program to operate.

The computer can be populated on-board to include one megabyte of RAM, floppy-disk controller, battery-backed clock, Winchester interface, serial and parallel ports, and more. It will also include 3-5 IBM-compatible expansion slots, in which you can plug a monochrome IBM PC display adapter. In addition, the motherboard will accept an IBM PC keyboard. (Of course, it will also accept low-cost clone components as well.) Using a PC display adapter and keyboard will allow you to easily create a low-cost stand-alone development system.

The bare-bones system will include an EPROM-based monitor program called HUMBUG, which derived its tongue-in-cheek name from a series of different BUG programs, all of which were based on Motorola's original MIKBUG program, which was used in early 6800 (hundred, not thousand!) machines. HUMBUG has a number of commands for examining and displaying memory, etc. In addition, we hope to include a small version of BASIC in EPROM.

The expanded computer will run the SK*DOS operating system, and possibly others. The author of SK*DOS also happens to be the author of the series of articles, so

you'll get a unique first-hand opportunity to learn about operating-system design. SK*DOS includes a 68000 assembler, a line editor, a 6809 emulator, floppy- and hard-disk support, extensive file-manipulation facilities, etc.

As for the MC68000 computer we presented in the March and May issues this year, we should have the promised information packet ready by mid to late summer. In addition, Peter Stark has adapted SK*DOS to run on the MC68000, although no formal system of distribution has been set up. We should point out, however, that the new (and as yet un-christened) machine will have better local support and distribution.

All in all, we're very excited about this project; we hope to begin the series in October or November. For more information, check our BBS (516-293-2283) occasionally, and watch these pages for announcements of progress.



IBM'S NEW MODEL 30 AND MODEL 50 PC'S

In case you missed it, IBM introduced four new personal computers last spring. They go by the name of Personal System/2, although only the three high-end machines (the Models 50, 60, and 80) have the new high-speed (and incompatible) Micro Channel bus, and only they will be able to

take advantage of the new operating system OS/2, which we'll be lucky to see by early next year. However, the low-end machine (the Model 30) is not without merit; we examined one, and a Model 50.

All aboard

The new low-end machine can be viewed as a souped-up PC or XT, depending on whether you get it with two floppy-disk drives or a hard disk and a single floppy. It has a bus that is compatible with the old bus, and it's a fast (8 MHz) 8086-based machine that contains everything on the system board that you normally must add via expansion cards: 640K of RAM, serial and parallel ports, keyboard and mouse connectors, battery-backed clock, and video adapter. See Fig. 1. Other than the compact, lightweight system unit, the only thing you need to get a Model 30 running is DOS 3.30 and a monitor.

The video hardware is downward-compatible with the CGA (contrary to our report last month), and has two new modes of its own, including a stunning 256-color mode that allows you to create images like that shown on this month's cover (page 61). The other new mode provides 640 x 480 resolution in two colors, which should be great for CAD applications. The MCGA (Multi-Color Graphics Array) is not compatible with Hercules or EGA standards, but it may be upgraded (via a plug-in card) to the VGA (Video Graphics Array) video adapter, which we discuss below, that is standard with the other PS/2 machines. The VGA is EGA-compatible.

The Model 30 comes with a disk-based set-up/tutorial program that allows you to set time and date, park the hard-disk heads for moving the system, etc. The tutorial is extremely well-done, both in terms of the information presented and in the way it is presented. The graphics in the tutorial are simply stunning; they drew numerous oohs and aahs from our co-workers. The manual

el; in the high-res mode, each bit represents one pixel.

Model 30 memory mapping

According to the Model 30 *Technical Reference* manual, the BIOS can detect the presence of an alternate video adapter. When it does, it will disable the on-board MCGA and use the alternate adapter. However, the manual does not specify what type of adapter may be used in that way. So we don't know at present whether Hercules, EGA, and other adapters will function in the Model 30. But you can add the IBM PS/2 Display Adapter, which brings VGA-style graphics to the Model 30, as well as to the PC and XT models.

The Model 30's 640K RAM has been implemented as follows. The first 128K consists of four 64K by four-bit and two 64K by two-bit DRAM's, all of which are soldered to the motherboard. The next 512K consists of two 256K by nine-bit plug-in SIP RAM modules. Those modules are mounted on a slant; they're visible at the right side of the system unit in Fig. 2.

A special register (accessible at I/O port 6Bh) allows each 64K segment of memory from 40000h to 90000h to be disabled in case of conflict with memory on an expansion card or hardware error. In addition, a special bit in that register apparently allows one of the upper banks to be re-mapped to the lower 128K segment of memory in case there is a hardware problem there. The BIOS POST (Power-On Self Test) handles those duties automatically.

Model 30 hardware notes

The Model 30 has three horizontally mounted expansion slots; they're visible at the rear left in Fig. 2. The edge connectors for those slots are mounted to a board that in turn plugs into an edge connector on the motherboard. The expansion-slot board also carries the clock/calendar's backup battery; that battery is soldered to the board, and at present IBM only plans to replace that board as a unit when the battery wears out.

The BIOS now supports four serial ports; previous machines officially supported

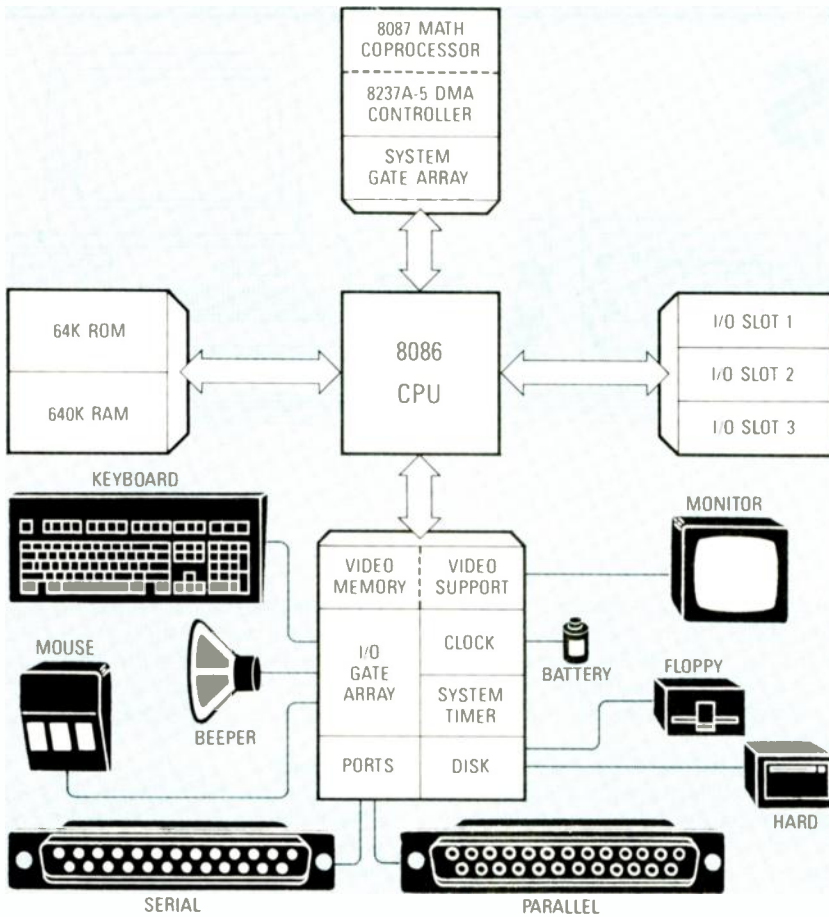

FIG. 1

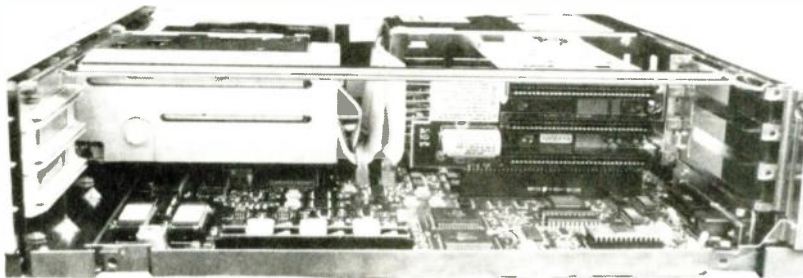

FIG. 2

is a slim booklet that will neither intimidate the novice nor bore the expert

In our tests, we found no hardware or software incompatibilities. Our test unit ran an Ethernet adapter card and a 68000 coprocessor card without a hitch. Tested software includes AutoCad 2.6, WordStar 4.0, Dr Halo II (version 2.15, specially for the PS/2 line), SideKick 1.56b, Direc-Link, Brooklyn Bridge, Best Friend, PCED, and numerous small utilities.

The MCGA

The Model 30's video adapter provides better text quality than the old CGA, because each character is now displayed in an 8 x 16 box, rather than the CGA's 8 x 8 box. However, the screen still flickers when in the text mode. As many as four character

fonts may be stored in the 0A0000h segment of RAM (formerly used by the EGA); one or two active fonts may be loaded and stored in a separate 8K static-RAM character generator. DOS 3.30 uses the new font capability to provide greater support for foreign languages, the new capability should also ease implementing any scientific and engineering word-processing programs. The 0B8000h area of memory is still used as a video buffer, with characters and their attributes occupying alternate bytes of memory.

In graphics modes, 0B8000h is still used for storage in the old CGA-compatible modes, in the new 256-color and 640 x 480 modes (11 and 13, respectively), the video buffer begins at 0A000h. In the 256-color mode, each byte represents one pix-

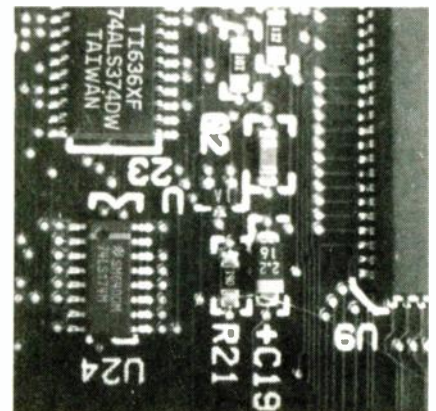

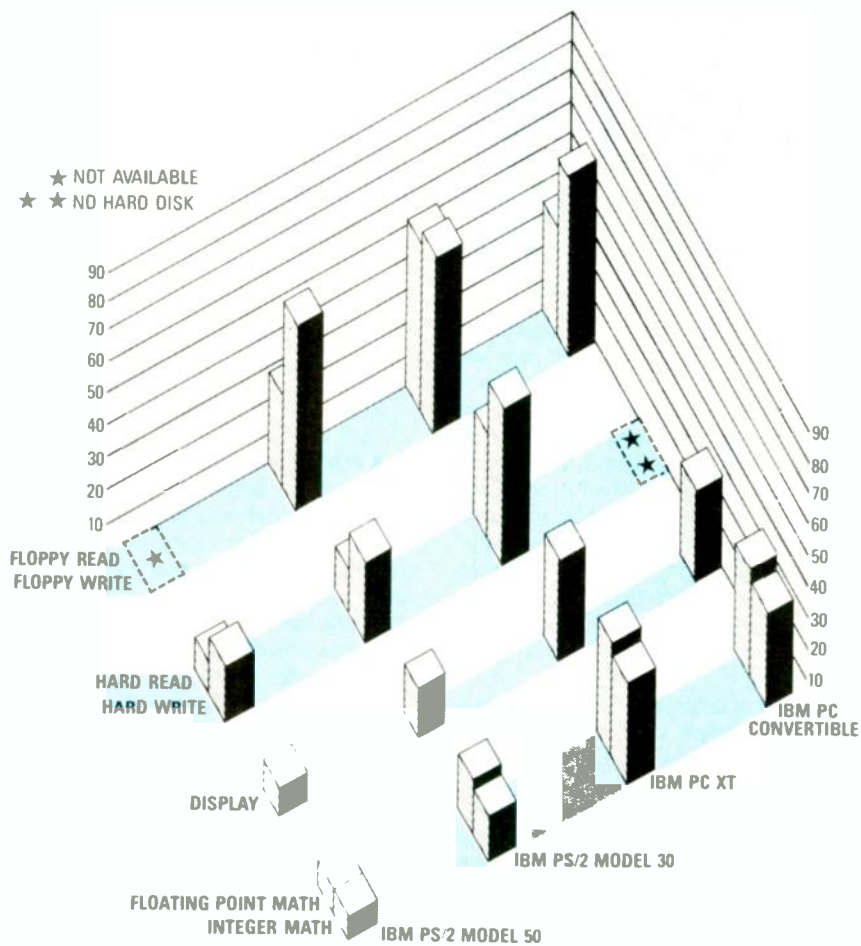

FIG. 4

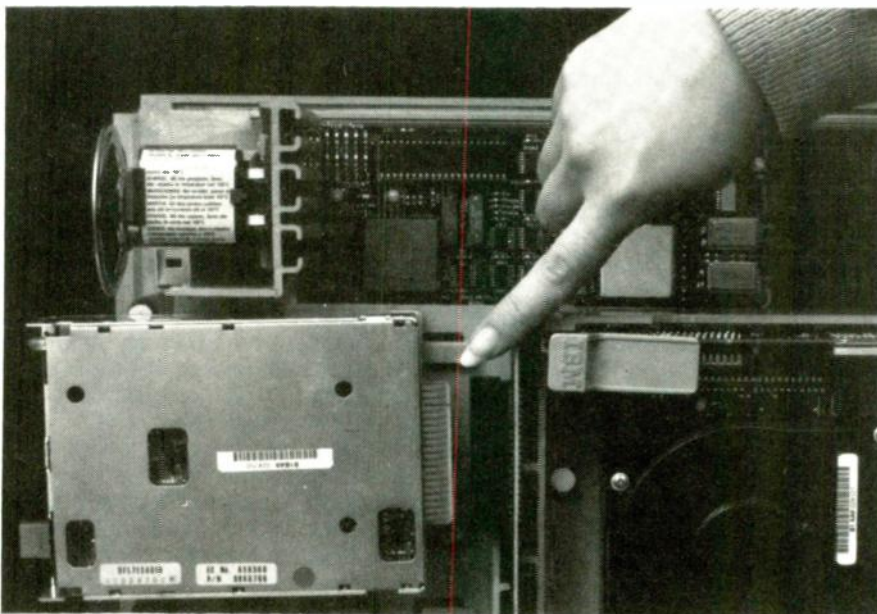

FIG. 5

only two. The parallel port is now bi-directional, so you can connect the parallel ports of two machines together and exchange data between them. In fact, IBM is selling a program/cable combination called the Data Migration Facility (DMF) that allows you

to do exactly that. The DMF could be especially useful in transferring data from an old-style machine.

The keyboard and mouse ports are electrically interchangeable—either keyboard or mouse may be plugged into either port—

the BIOS separates keystroke scan codes from Mouse codes.

All the I/O connectors are soldered to the motherboard. No external disk-controller cards (for hard or floppy disks) are necessary. The disk drive handles 720K 3½" disks, as used in the IBM PC Convertible and many other portables. The power supply is rated at only 70 watts, but that should be sufficient for most users. In addition, surface-mount technology is used extensively, as shown in Fig. 3.

The Model 50

The Model 50 can be viewed as a hybrid of an XT and an AT, with the Micro Channel bus (three slots) and OS/2 compatibility thrown in for good measure. The model 50 has a 10-MHz one-wait-state 80286 microprocessor, which is faster than the AT's microprocessor, but it has a relatively slow, relatively small (20 megabytes) hard-disk drive like the XT.

The floppy-disk drive can read the 720K format used by portables and the Model 30; it also can read and write a new 1.44-megabyte format. You cannot format a 720K diskette for 1.44-megabyte use; special diskettes are required. The Model 50 also includes a megabyte of RAM, and a full complement of I/O ports.

We tested the Model 50 and found it to be quite fast. See Fig. 4 for a speed-comparison chart. The Model 50 ran all the software we tested it with: WordStar 4.0, Dr. Halo II version 2.15, numerous system utilities, including a special communications program that manipulates the serial port directly—and everything we tested worked without a hitch. Of course, we couldn't test any expansion boards, because none are available yet.

The VGA

The Model 50's Video Graphics Array hardware is compatible with all previous IBM display adapters (monochrome, CGA, EGA, and MCGA), and it adds several new display modes of its own, including:

- 340 × 480 graphics in 16 colors (the MCGA provides only two colors at that resolution);
- 720 × 400 alphanumeric in 16 colors or monochrome;
- 360 × 400 alphanumeric in 16 colors.

Of course, the VGA can also run in the 256-color mode of the MCGA. By way of comparison, the EGA provides 640 × 350 in 16 colors in graphics mode. Apparently, the VGA is not compatible with the Hercules monochrome standard.

It's worth pointing out that all supported modes will run on any PS/2 monitor. That differs from most present multi-mode video adapters, which can run in various modes, but only on appropriate monitors (TTL monochrome, color, or enhanced color.) There's much more to say about the VGA, but, unfortunately, no space to do so at this time.

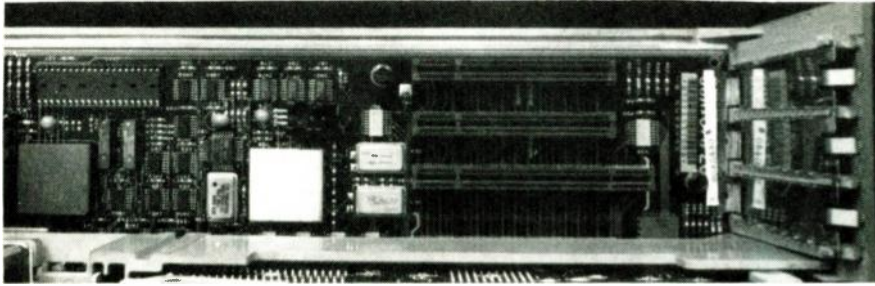

FIG. 6

Model 50 hardware notes

As with the Model 30, surface-mount IC's are used extensively; plug-in cards extend appropriate signals from the motherboard to the floppy- and hard-disk drives. One very interesting feature of the Model 50 is the modular way in which all the sub-sections snap together. For example, as shown in Fig. 5, the floppy-disk drive snaps into place, and the edge connector provides mechanical as well as electrical contact. (A plastic guide system beneath the unit locks it into place.) The hard-disk drive mounts in a similar manner, as do the bus-extender cards, and even the fan.

The Model 50 includes three Micro Channel bus slots (shown in Fig. 6); its sibling, the Model 60 (which we didn't evaluate), provides eight slots and a faster hard disk.

Monitor mania

There are several monitors available for all the new models; two are color displays (8512, 8513) and one is monochrome (8503). They all have the same resolution (720 × 400 in text mode, 640 × 480 in graphics mode); they differ mainly in price and size. Our cover shot was made with the 8512 monitor, a 14-inch model.

The new monitors are analog types, which means that they are incompatible with the previous standards, although NEC has announced that their MultiSync monitor is compatible with the addition of a cable adapter. The new monitors are plug-compatible with each other; the BIOS senses whether a color or a monochrome display is connected and routes signals accordingly. If a monochrome monitor is attached and a color mode is active, the RGB signals are summed and output to the monitor via the DAC (Digital-to-Analog Converter) that controls green.

It's unclear at present whether two monitors can function simultaneously; some CAD programs and debuggers use one screen for menus and control functions, and the other for program output.

New BIOS and DOS

The following discussion refers to the Model 30's BIOS and DOS 3.30. A new BIOS interrupt 10h function call (12h) provides a means of switching various video adapters on and off. Again, it's unclear whether external Hercules, EGA, or other adapters are supported.

Another new BIOS interrupt function (In-

terrupt 15h, function 4fh) allows you to intercept keyboard scan codes as they are generated (via interrupt 9). The new function allows you to change the scan code, or cause it to be ignored altogether. That function will aid remapping keys for foreign-language and technical word processing, but without resorting to illegal interrupt stealing as some word-processing and keyboard-enhancing programs do. Another keyboard function (Interrupt 16h, function 5) allows you to stuff the keyboard buffer with key codes as if those keys had been typed.

A number of other BIOS functions are not clearly documented, but seem to point in the direction of adding multi-tasking capabilities to the machine.

DOS 3.30 is not a major upgrade, but it is not insignificant either. It contains greatly expanded support for foreign-language character display, extended network support, and extended batch-file support, including a CALL command that allows one batch file to call another. (CALLing was possible but awkward in previous versions of DOS.) The new DOS also supports all disk formats, ranging from the single-sided single density (160K) 5¼ format of the original PC to the 1.44 MB format of the models 50, 60, and 80. DOS 3.30 runs on all past and present models of the PC.

Conclusions

All in all, the PS/2 machines represent real technological improvement in the PC family. They are not a radical departure from past systems, nor are they misplaced machines like the PC Jr and the PC Portable. Rather, they represent an incremental step in the evolution of the PC family. They're not the cheapest machines, but they set standards that others will follow. We applaud IBM's leadership efforts, and hope that it will continue in the course it has set itself.

Credits

Media Cybernetics (8484 Georgia Ave., Suite 200, Silver Spring, MD 20910, 800-446-HALO) graciously sent us a beta-test copy of version 2.15 of Dr. Halo, which supports the new video hardware; we used it to create our cover image. And thanks to AutoDesk, Inc. (2320 Marinship Way, Sausalito, CA 94965), for sending a test copy of AutoCAD version 2.6. Thanks to Andre Duzant for cover art, and to Herb Friedman for cover photography. 



MEMORY MINDER, DISK-DRIVE ANALYZER FROM J&M SYSTEMS

Mechanical devices are always the first to go. In particular, disk drives are a primary source of trouble. To help you spot a potential problem before it develops into a catastrophe, you can take your drives to a repair shop for testing. Or you can buy a disk-drive analysis program for about the cost of two trips to the repair shop and run the diagnostics yourself.

One such program is called Memory Minder. It's sold by J & M Systems, Ltd. (15100A Central SE, Albuquerque, NM 87123, 505-292-4182), and it lists for \$114. The package consists of three parts: a manual, a disk containing the control program, and a special test disk. The program disk uses the test disk to check drive speed, head and clamping alignment, and several other factors.

How to run it

First you boot your machine directly from the Memory Minder program disk. It then displays a menu that lets you select parameters and run tests. After booting, the program disk is no longer needed; at that point, you insert the Digital Diagnostic Disk (DDD), manufactured by Dysan, into the desired drive. Disks are available for testing several types of drives.

From the main menu you first run a clamp test (shown in Fig. 2), which tests the accuracy with which a diskette is clamped. If your drive can't pass the clamping test, chances are it can't pass any other tests either. (It's also possible that the DDD has gone bad, in which case it must be replaced for the healthy sum of \$40.)

Then you run a quick test, whose screen appears as shown in Fig. 7). If your drive fails any aspect of the quick test, you can run more-detailed tests. For example, spindle speed may be measured directly in RPM, and, if speed varies from the standard (300 RPM for a 5¼-inch drive) by more than ± 2%, the program tells you so.

Another test checks the drive's head alignment. J & M provides generic instructions for aligning a head, and wisely refers you to the manufacturer's alignment instructions. Other tests check other aspects of the drive's operation, and a special set of rou-

continued on page 72

MICRO-FLOPPY

RETROFIT

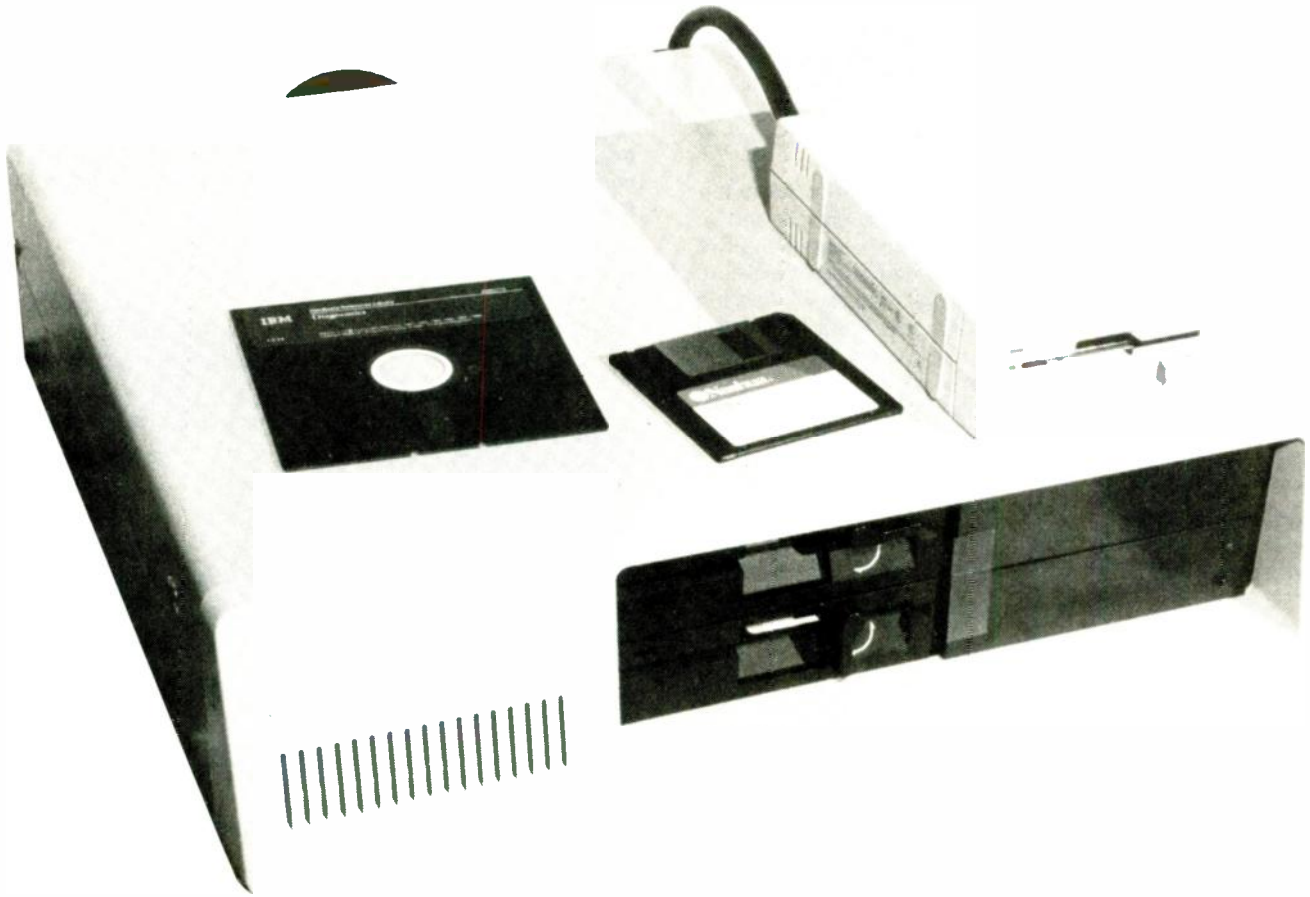

Retrofit your PC or XT with a 3 1/2-inch disk drive.

HERB FRIEDMAN

If you use an IBM PC or clone, you may be underwhelmed by all the fuss being made about 3 1/2-inch disks. However, many portable computers, and all of IBM's new line of PCs, use 3 1/2-inch disks. (See "Editor's Workbench" for reviews of two of the new PCs.) The small diskettes have many advantages over the 5 1/4-inch disk you're used to using, including

- Increased capacity (two to four times that of a standard 360K floppy disk)
- Greater reliability, because each disk is completely enclosed by a hard plastic shell
- Smaller, shirt-pocket size

5 1/4-inch disks are by no means obsolete, but chances are that the industry will move steadily toward use of 3 1/2-inch disks, just as 8-inch disks were gradually supplanted by 5 1/4-inch disks. So in this article we'll show you how to retrofit your computer to use 3 1/2-inch disks. Then you'll be ready to handle the upcoming new wave of software and data. We'll discuss installation of IBM's model 2683190 disk-drive retrofit kit for PC and XT model computers. Similar kits are available from clone manufacturers, but installation may differ, so your drive's instructions carefully.

What it is

The retrofit kit consists of a cabinet-mounted 3 1/2-inch disk drive with attached signal and power cables, a Y-adapter that lets you tap

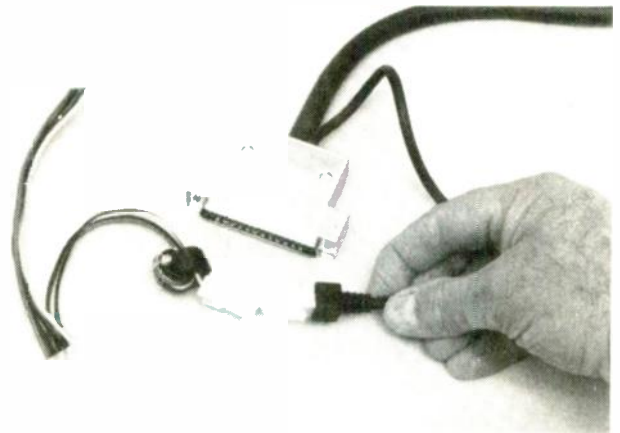

FIG. 1—THE CABLE FROM THE 3 1/2-inch drive has its own power connection take-off that matches the miniature power socket on the supplied Y-adapter. The ring through which the adapter's power wire loops is a toroid choke that help suppress RFI.

power from your computer's internal disk-drive power connector (shown in Fig. 1), and a kit of three pre-punched metal brackets

(shown in Fig. 2) that accept the Y-adapter's connector.

Installation is simple. First you mount the appropriate bracket on the rear apron of your computer. Then you install the Y-adapter in series with one of the existing internal disk-drive power connectors. Next, you push the small power connector through the hole in the bracket. That connector locks in position by means of mounting ears molded on the connector. Finally, you connect the cable from the 3½-inch disk drive to the controller card in your main computer.

With some PC's you won't need to install the power cable in series with the floppy power connector. The reason is that the power supplies in some PC's have four power connectors. So, if you haven't used all four, just connect the Y-adapter to one of the unused connectors.

Use the bracket that causes the least inconvenience. For example, if you use the relatively large standard rear-slot bracket shown in Fig. 2, you must give up an entire slot. Some PC's have only five slots, so it may prove impossible for you to use the large bracket. In that case you could use the smallest bracket, which will mount in the small hole above the cassette port (yes, the original PC included a cassette interface). The medium-size bracket can be used in the extra slot above the keyboard port on an XT.

Clone panel layouts may vary, so you might have to use the full-size bracket and give up a slot. Or you might just cut a hole of your own in which to mount the small bracket.

Standard controller

To use the adapter, you must have an IBM-type floppy-disk controller, the kind with a 37-pin D-connector on the mounting bracket (as shown in Fig. 3), in addition to the regular floppy-disk

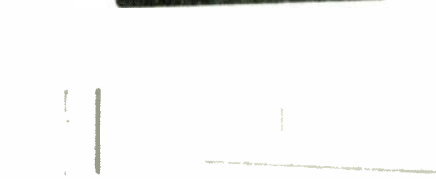
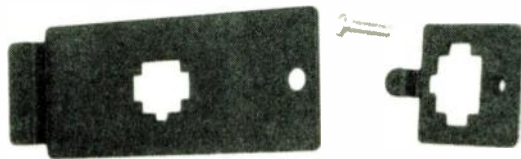

FIG. 2—THE RETROFIT KIT is supplied with three different brackets for the power sockets. Use the one that's most convenient for you, but remember that the standard bracket (the large one) may force you to give up use of one expansion slot.

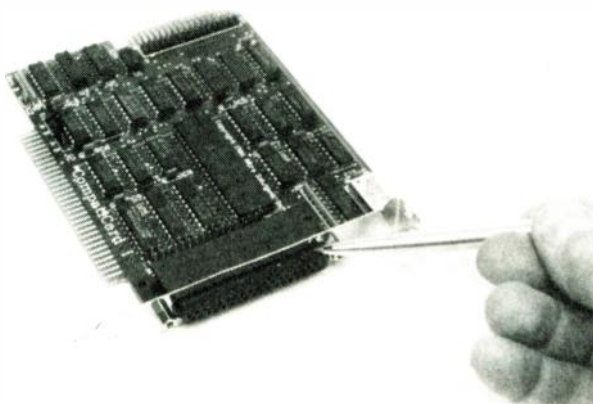

FIG. 3—IBM-TYPE DISK CONTROLLER cards have a 37-pin socket on the rear for external disk drives (C: and D:). The retrofit cable must connect to that socket.

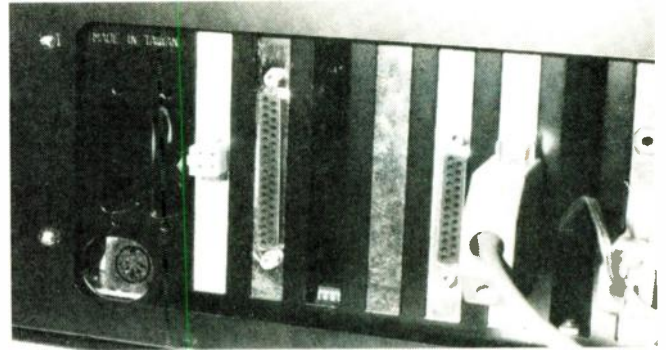

FIG. 4—THIS IS A TYPICAL CLONE INSTALLATION. The disk-controller socket and the 3½-inch drive's power socket are on adjacent brackets.

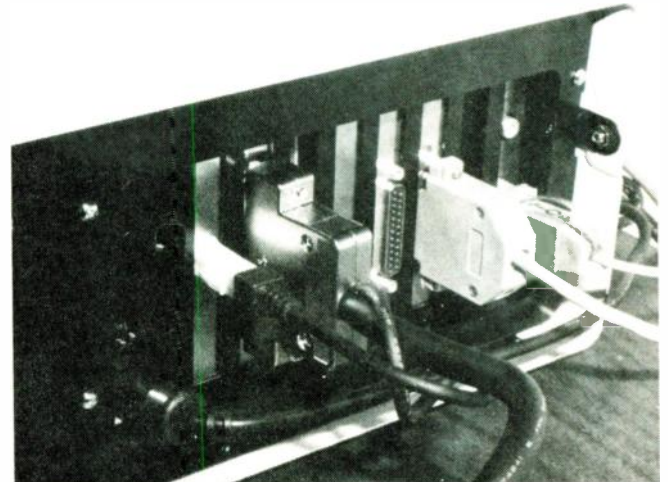

FIG. 5—CONNECTORS IN PLACE AND READY FOR USE. The 37-pin D-connector is a real heavyweight, so be certain that you tighten its mounting screws to ensure reliable operation.

connector. The IBM controller accommodates four floppy-disk drives: two internal and two external drives. Because the retrofit kit connects to the computer via the external 37-pin connector, you cannot use a multi-function disk controller (the kind that combines a disk controller, serial and parallel ports, a joy-stick interface, and a clock), because it has no connector for external floppy-disk drives. The controller itself needn't be an actual IBM device; having the external connector is the important point.

Figure 4 shows an XT clone ready to connect the 3½-inch disk drive. The external disk-drive connector is adjacent to the miniature power connector installed in the slot furthest left.

To install the 3½-inch drive, simply plug the appropriate connectors from the drive in the appropriate jacks, as shown in Fig. 5.

Device driver

Before you can use your new drive you must tell the computer that it's there by adding a device driver to your computer's CONFIG.SYS file, the configuration file that's automatically read when the computer boots. For example, adding the line:

```
DEVICE = DRIVER.SYS /D:2
```

to your CONFIG.SYS file will allow you to access a 3½ inch disk drive as the next available drive (D: on an XT). IBM's device driver comes only with DOS versions 3.20 and 3.30. (Some clone manufacturer's drives are available with drivers that work under DOS 2.11 —*Editor*) The device driver informs your computer that the 3½-inch drive exists, establishes its physical parameters, including number of tracks, sectors per track, number of heads, etc., and sets the drive's logical designation (D:, E:, F:, etc.).

DESIGNING PC BOARDS ON YOUR COMPUTER

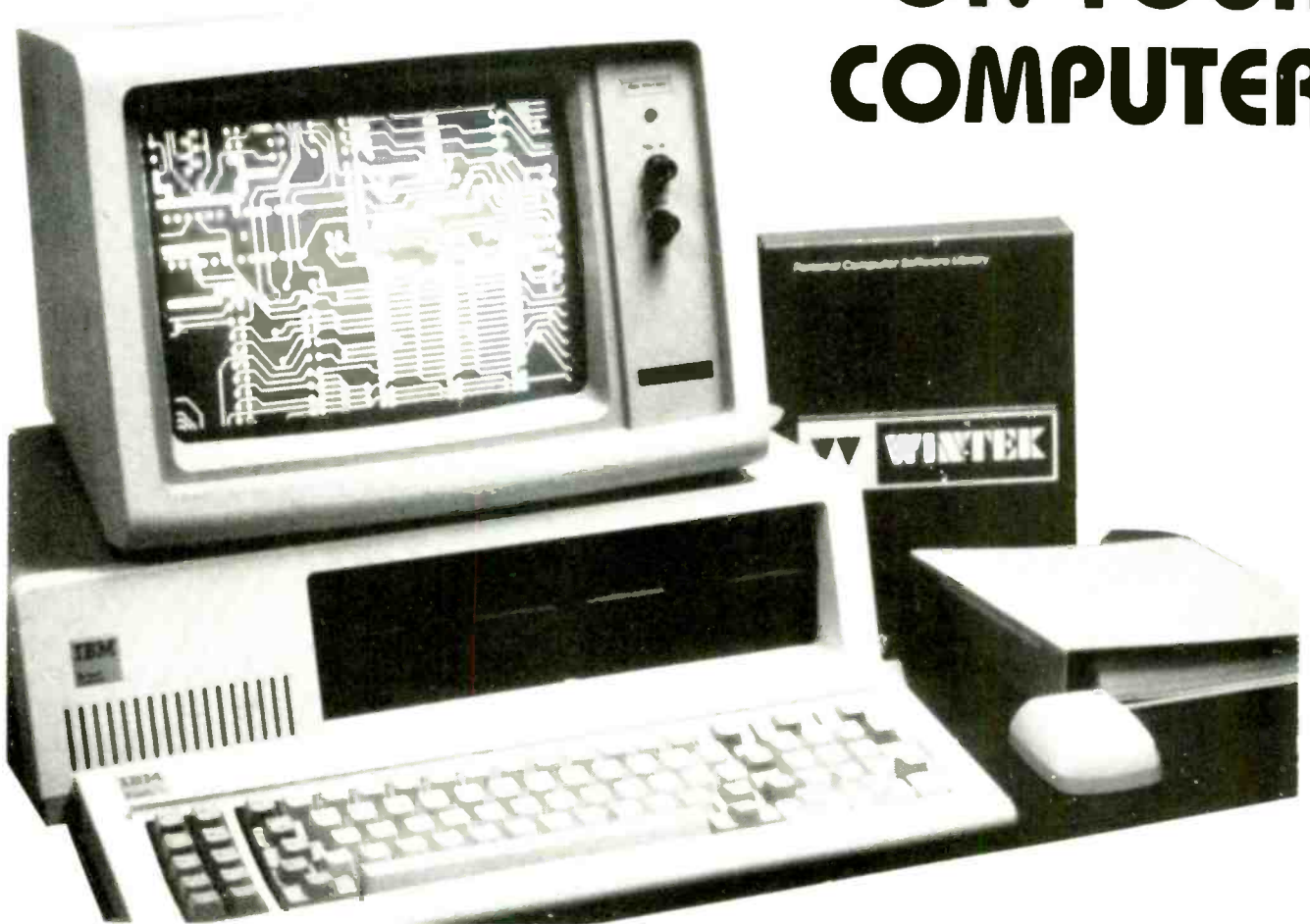

ROBERT GROSSBLATT

Last time, in the June issue, we examined CAD (Computer Aided Design) in a general way, seeing what kinds of things you can do (or should be able to do) with any worthwhile CAD package. This month we'll look at several specific packages, focusing on those that are of special interest to the electronics enthusiast.

There are a number of packages on the market, and both price and performance vary considerably. However, none of the packages we reviewed are inexpensive. As we've seen, a layout program must contain several different but integrated parts, so a complete package represents a substantial investment in development time. In addition, the potential market is small, certainly much smaller than the markets for word-processing and database programs. So development costs and market size translate into relatively high prices.

smARTWORK

The Wintek Corporation markets a package called smARTWORK, which probably is the most popular of the "inexpensive" routing packages. It has a graphics editor, router, and is capable of producing high-quality output. The program is an "interactive" router—what we call a point-to-point router. After you place the components, you can draw traces yourself or tell the router which points

you want connected together. smARTWORK will do its best to lay in the traces.

The Wintek program only does the PC-board layout; there's no way to draw the schematic, generate a netlist, and have the router read the file. So using smARTWORK is in some ways similar to doing a layout by hand on graph paper.

smARTWORK is simple to use. After loading the program and creating a file, you begin your layout by placing the doughnuts and pads. The coordinates of the cursor are always shown on the bottom of the screen; that makes it simple to put a component in a precise location in the workspace. There are a variety of pad shapes available, as well as commands to create various patterns for IC's (SIP and DIP layouts, for example) headers, and so on, automatically.

The finished layout is really the parts-placement diagram for the board you're designing, so it's a good idea to work out a rough idea of where things are to be placed before you start smARTWORK. Doing so will make it easier to avoid going beyond the edge of the board as well as to take into account any of the special placement considerations we've already mentioned. It's easy to make adjustments to the board when you begin routing the traces because smARTWORK's graphics editor has a set of commands to let you move, stretch, delete, and fill.

When you start routing traces, smARTWORK will let you do either a single- or a double-sided board, with an optional silk-screen layer. However, keep in mind the fact that the program can only handle two routing layers. If you want to do multilayer boards, you'll have to use another package. Each layer can contain two trace widths, thin and fat, and although you can choose between three preset thin widths, you can only use one on each layer. The fat width, 50 mils, is the only one available, but you can produce a fatter trace by laying two or more traces near each other.

Routing can be done either by hand or by using the routing algorithm built into the program. However you do it, chances are that you'll want to rearrange traces as the layout develops—and that's where you'll appreciate the power of the graphics editor. It's easy to change anything on the board—it's really as simple as moving text around in a word processor.

When the design is complete, you can get hardcopy from a dot-matrix printer in either actual board size or double size. There are commands to control the intensity, rotation, and size of the printed output. As shown in Fig. 1, a much higher-quality printout can be obtained by using a plotter; smARTWORK supports several. Whichever device you use, smARTWORK will generate camera-ready art for photochemical board fabrication. Wintek can supply you with information about hardware compatibility.

Wintek markets another program called HiWIRE, a graphic schematic-drawing editor, and they're currently working on software that will let the two programs share common data files. Contact them directly at the address shown in the sidebar for more detailed information.

Another company (Creative Electronics) is marketing a program

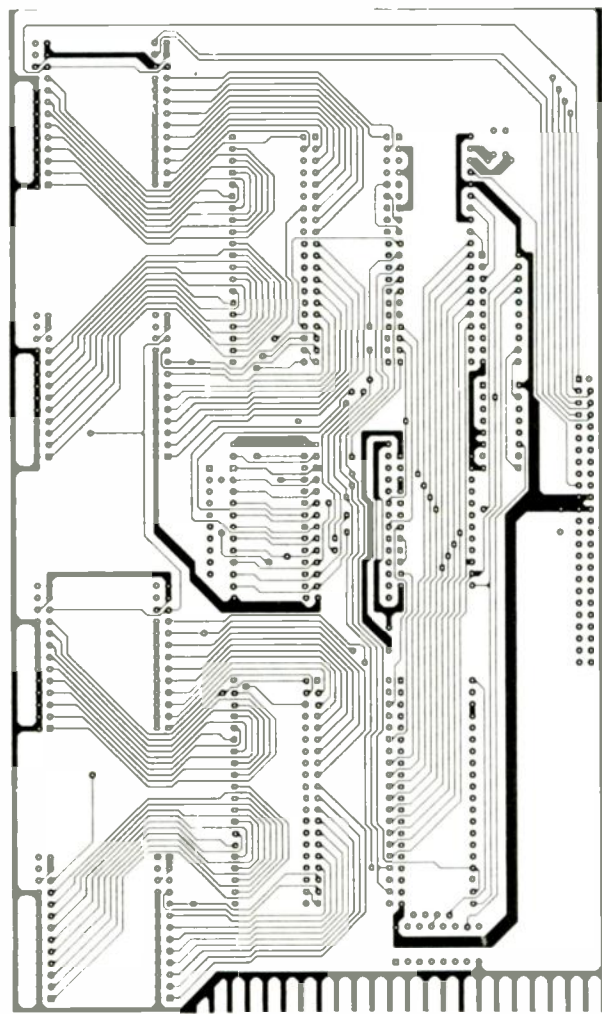

FIG. 1—smARTWORK produces high-quality camera-ready work when used with a good plotter.

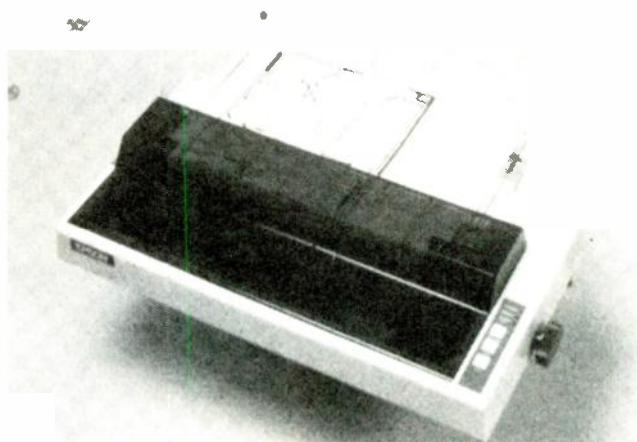

FIG. 2—smARTWORK also produces quality copy on a dot-matrix printer.

(smARTCAD) that converts smARTWORK files into AutoCAD format. (We discuss AutoCAD below.) When you do convert a file, each side of your PC board will be on a separate layer, and you can use any AutoCAD editing command to do things you just can't do with smARTWORK. For example, you can:

- Add text in any size and font.
- Place pads for odd-sized components.
- Increase board size beyond 10 × 16 inches.
- Use a different grid spacing.
- Prepare a solder mask.

Project:PCB

A new low-priced entry is called Project:PCB; it's made by DASOFT Designs, Inc., and it has many features that are missing from smARTWORK, including a means for schematic capture and a true auto-router. The circuit diagram can be entered with a graphics editor; the program can extract the netlist directly from the drawing. You can also enter and edit connections in text form directly from the keyboard. The software comes with a limited component library, but you can use a parts editor to build new parts that can then be called up automatically when you're entering a schematic.

In fact, Project:PCB actively encourages you to create symbols and share them with others; the company has set up a bulletin board (415-486-0862) where users can share custom parts and libraries, and where the company will post information on updates, bug fixes, new versions, etc.

To use Project:PCB, first you create the schematic. When it's finished, you use the layout editor in a graphics mode to define the overall shape of the board and to place the components. Then you're ready to route the board. It can be done automatically with Project:PCB by selecting the Route option on the menu, or you can enter traces manually before turning the router loose on the layout. One of the nicest features of the program is the ability to tell the router to do only a single net and then stop. That means that you can pre-route power and ground lines, for example, before going on to the rest of the board.

The router goes over the board twice. But you can set it up to do only one side of the board and then stop. That gives you the opportunity to try to improve the layout by hand, and then have the router go through that side again. Doing the layout that way can be valuable, because feedthroughs are the inescapable consequences of double-sided boards, and plated-through holes are difficult to do at home and expensive to do commercially.

Project:PCB can deliver hardcopy to a variety of plotters, but printer output is limited to text dumps of the various data files that are generated by the program. If you have one of the plotters supported by the program you'll get beautiful camera-ready artwork that's perfect for board production.

The program has more stringent hardware requirements than smARTWORK. Much of the equipment (mouse and plotter, for example) that is optional with smARTWORK is required to run

Project:PCB. But Project:PCB has a much more extensive graphics package, as well as an auto-router.

Autoboard

At the other end of the price/performance spectrum is a program called Autoboard. It is designed for serious production. It has every feature we've already discussed, and many, many more. In fact, comparing it to the packages we've been discussing is like comparing a Ford to a Ferrari—they're in different leagues altogether. Of course, the added capabilities don't come for nothing.

In order to concentrate all their energy on the routing package, the Great Softwestern Company decided to look elsewhere for the graphics editor. That was a wise decision.

Autoboard, in addition to its auto-router, is a collection of overlays, script files, menus, macros, and drawings to turn AutoCAD into an electronics graphics package. It goes without saying that AutoCAD is one of the most powerful and most supported graphics editors on the market. So one of the great strengths of Autoboard is that it makes full use of AutoCAD. The schematic and board layout are entered in AutoCAD; Autoboard's custom menu system makes it simple to do so.

While building the schematic or the board, you can use any of AutoCAD's awesome range of commands to edit the drawing you're working on. The parts library from Autoboard is extensive, and you can create new parts by building their definitions in a word processor—a straightforward procedure that's described in the manual.

Autoboard is designed for commercial board fabrication, so it has some impressive capabilities:

1. It can route boards up to 16 layers thick.
2. It can handle more than 1000 components on a board.
3. More than 40 buses can be defined.
4. You can have as many IC arrays as you want.
5. More than 1000 pins can be tied together.

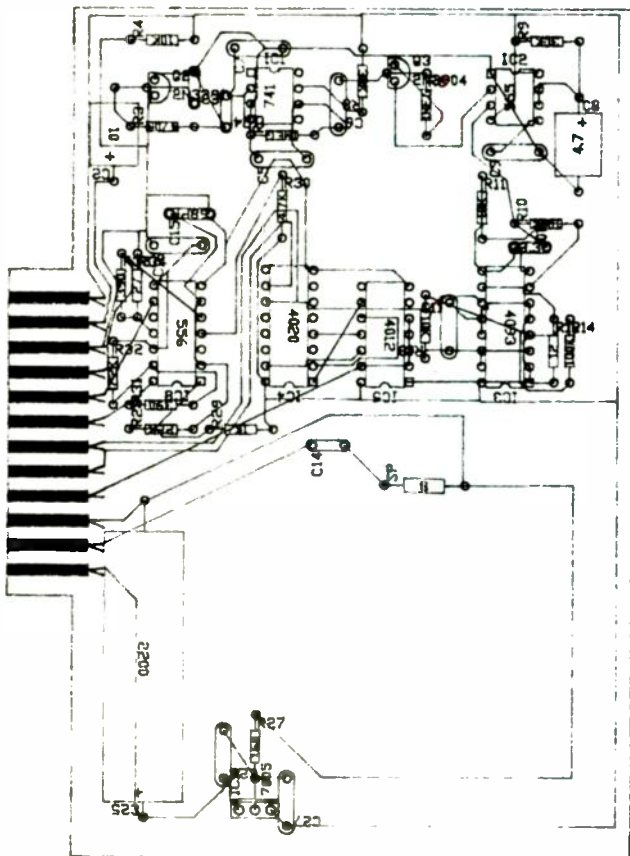

FIG. 3—AUTOBOARD routed this board automatically using a schematic created with AutoCAD.

TABLE 1—PROGRAMS DISCUSSED

smARTWORKS	The Wintek Corporation 1801 South Street Lafayette, Indiana 47904-2993 \$895.00 Copy Protected
Project: PCB	DASOFT Designs Systems, Inc. P.O. Box 8088 Berkeley, California 94707-8088 \$950.00 Hardware Locked
The Autoboard System	The Great Softwestern Company, Inc. 207 W. Hickory St. Suite 309 Denton, Texas 76201 \$2500.00 Requires AutoCAD
AutoCAD	Autodesk, Inc. 2320 Marinship Way Sausalito, California 94965 \$2850.00 (Version 2.5 or above)
smARTCAD	Creative Electronics 925 Fairwin Ave. Nashville, Tennessee 37216 \$395

6. Board dimensions can be up to two feet square

The fourth item in that list deserves a little explanation. Some IC's (memory devices, for example) are put on a board as a block, and the traces that connect them are laid out in a standard fashion. Autoboard has built-in algorithms to generate those traces, and there are routines in the graphics editor to place the IC's on the board with proper spacing.

The best way to indicate how Autoboard works is to describe the process of creating a board. Remember that you must own a copy of AutoCAD (and know how to use it!) in order to use Autoboard.

The first step, as with Project:PCB, is to tell Autoboard about the schematic you're using. There are a series of batch files that do all the setup work for you (open data files, call up AutoCAD, and load a series of custom menus and scripts). Parts are chosen from menus along the right side of the screen; AutoCAD prompts you for orientation and location. As you move the cursor around the screen, the part you're working with drags along until you place it. Next you're asked for the part's number and value. Last, AutoCAD draws the part on the screen along with the other information.

When the parts are all placed and identified, you connect them together using either AutoCAD's Line command or the Line macro in the Autoboard menu. There's a difference. Autoboard's Line command will automatically place the line in the correct layer for the software that reads the drawing file and generates the list of connections. You can switch between layers using the normal AutoCAD commands, but it's simpler to use the macros.

When the drawing is sized, titled, and completed, a special command converts the schematic information to a netlist for use by the rest of the program; it also makes sure you don't have any unconnected components or lines. If it finds any, it lets you know by listing them on the screen as text—but that's not all.

One of the layers that Autoboard defines when it sets up AutoCAD is called the Warning layer. If there are any uncommitted pins, unterminated lines, etc., Autoboard will return you to AutoCAD, and the points in question will have small red circles around them.

R-E Computer Admart

Rates: Ads are 2 1/4" x 2 7/8". One insertion \$825. Six insertions \$800 each. Twelve insertions \$775. each. Closing date same as regular rate card. Send order with remittance to Computer Admart, Radio Electronics Magazine, 500-B Bi-County Blvd., Farmingdale, NY 11735. Direct telephone inquiries to Arline Fishman, area code 516-293-3000. Only 100% Computer ads are accepted for this Admart.

ICs PROMPT DELIVERY!!!

SAME DAY SHIPPING (USUALLY)

QUANTITY ONE PRICES SHOWN FOR MAY 24, 1987

OUTSIDE OKLAHOMA NO SALES TAX

DYNAMIC RAM			
1Mbit	256Kx4	120 ns	\$33.00
1Mbit	1000Kx1	100 ns	28.50
51258	256Kx1	100 ns	6.95
4464	64Kx4	150 ns	3.50
41256	256Kx1	80 ns	5.35
41256	256Kx1	100 ns	4.50
41256	256Kx1	120 ns	3.50
41256	256Kx1	150 ns	3.20
EPROM			
27512	64Kx8	200 ns	\$9.95
27C256	32Kx8	250 ns	5.40
27256	32Kx8	250 ns	5.35
27128	16Kx8	250 ns	4.30
2764	8Kx8	250 ns	4.10
STATIC RAM			
62256	32Kx8	120 ns	\$12.95
6264LP-15	8Kx8	150 ns	3.35

OPEN 6 1/2 DAYS. 7:30 AM-10 PM SHIP VIA FED-EX ON SAT.

SUNDAYS & HOLIDAYS SHIPMENT OR DELIVERY VIA U.S. EXPRESS MAIL

SAT DELIVERY INCLUDED ON FED-EX ORDERS RECEIVED BY 11:30 AM SAT

MasterCard VISA or UPS CASH COOD

Factory New, Prime Parts

MICROPROCESSORS UNLIMITED INC

24 000 S. Peoria Ave

BECKS, OK 74421 (918) 267-4961

No minimum order. Please note that prices are subject to change. Shipping & insurance extra & up to \$1 for packing materials. Orders received by 8 PM EST can usually be delivered the next morning via Federal Express Standard Air at \$4.00 or guaranteed next day Priority One at \$10.50. All parts guaranteed.

COMPUTER ASSEMBLY MANUALS



Eliminate Guesswork!
Build with Confidence!

BIG BLUE SEED for IBM™ BUILDERS
Parts list, placement diagrams & instructions for assembling over 75 IBM-compatible bare cards. Latest version includes guides for 640K, Turbo, & AT MthBds. \$17.95

APPLE SEED II for APPLE™ BUILDERS
Instructions for assembling over 85 Apple-compatible bare cards including II+ & IIe MthBds. For all Apple enthusiasts .. \$14.95

Both for \$30.00! Also bare cards in stock!
Check/money-order, VISA/MasterCard to:

NuScope Associates*, Dept RE
P.O. Box 790 • Lewiston, NY • 14092

*A Division of Kosmic MicroTech Inc

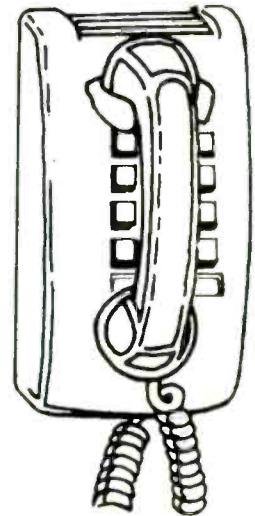

CALL NOW AND RESERVE YOUR SPACE

- 6 x rate \$800.00 per each insertion.
- Reaches 239,312 readers.
- Fast reader service cycle.
- Short lead time for the placement of ads.

Call 516-293-3000 to reserve space. Ask for Arline Fishman. Limited number of pages available. Mail materials to: Computer Admart, RADIO-ELECTRONICS, 500-B Bi-County Blvd., Farmingdale, NY 11735.

CIRCLE 61 ON FREE INFORMATION CARD

Computer Electronics

Super prices, technical support, service:

- complete clone line including 10MHz XT motherboards, 16MHz 80386 motherboards, 3.5" floppies for the XT
- system s/w, how-to books and manuals
- cables, connectors manuals, schematics, diagnostics, test equipment, tools, parts
- desktop publishing components and systems: laser printers, scanners, s/w
- hard disks, int'l & ext., including 3.5"
- specialty interfaces, expansion chassis

Computing Technology

247 Balsam St., Ridgecrest, CA 93555
(619) 375-5744

CIRCLE 203 ON FREE INFORMATION CARD

GETTING THE MOST FROM YOUR PRINTER

Getting The Most From Your Printer



BP181—It is probable that 80% of dot-matrix printer users only ever use 20% of the features offered by their printers. This book will help you unlock the special features and capabilities that you probably don't even know exist. To order your copy send **\$6.95 plus \$1.50 for shipping in the U.S.** to Electronic Technology Today Inc., P.O. Box 240, Massapequa Park, NY 11762-0240.

CIRCLE 202 ON FREE INFORMATION CARD

EDITOR'S WORKBENCH

continued from page 66

tines aid in performing a traditional alignment by allowing you to position the head to any track.

Each test is activated from its own screen from which you can select the drive to test, the head (0 or 1) to test, and the location on the DDD to test. You can print any screen by choosing the appropriate menu item. In addition, a setup screen allows you to establish specific operating characteristics, including disk type, serial-port parameters, main or alternate test tracks, etc. (The alternate tracks on the DDD are provided so that

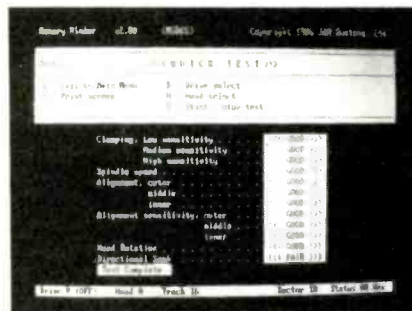

FIG. 7

you can continue to use the disk after the first set wears out.)

Recommendations

Memory Minder is rather expensive for

hobbyist use. However, if you split the cost among several persons, each of whom might use the program two or three times a year, Memory Minder is worthwhile. The manager of a small office with a number of PC's could easily justify the cost of the program, and if he uses it conscientiously, it could prevent valuable data from being lost, and thereby make an employee very happy.

What to do with the information Memory Minder provides is another story. If you have no experience aligning disk drives, it's probably best to leave well enough alone, unless you're willing to experiment and possibly pay the consequences. But as a diagnostic aid, Memory Minder is a well-thought-out, easy-to-use product.

MICRO-FLOPPY DISK DRIVES

continued from page 68

You can access the disk like this: The 3½-inch drive is automatically assigned the next available drive letter (after all floppies and hard disks, if any). For example, if your hard disk is drive C:, the 3½-inch drive becomes drive D:. If you have two hard drives, C: and D:, the 3½-inch drive becomes drive E:. If you have no hard disk, but you do have a RAM disk set up as drive C:, the 3½-inch drive again becomes drive D:.

Logical and physical

You may wonder whether you can copy a file from one 3½-inch diskette to another without going through an intermediary device such as a hard disk, a RAM disk, or even a 5¼-inch floppy disk. You can (using DOS 3.20 or DOS 3.30). What you do is enter the device driver program into the CONFIG.SYS file twice. For example:

```
DEVICE = DRIVER.SYS /D:2  
DEVICE = DRIVER.SYS /D:2
```

The computer is then fooled into thinking that there are two physical 3½-inch drives with different logical designations (D: and E:, for example). DOS will prompt you to switch disks when that is appropriate.

That's not as complicated as it may sound. It's really the same capability we've always had with the IBM, but extended to handle more drives and more types of drives. If you've ever copied a file

from A: to B: on a machine with only a single floppy-disk drive, you know how it works.

For example, assume that you have a single floppy drive and a hard disk. The floppy functions as drives A: and B: and the hard disk functions as drive C:. You can install two device drivers that tell the computer that the 3½-inch drive will function as both D: and E:. Now there's no problem copying files between separate 3½-inch disks via a single drive. The computer will prompt you when to swap disks.

You might prefer to do it this way: Use the motherboard's DIP switch to program four floppies, even if you have only two. The hard disk automatically becomes drive E:. Configure the device driver so the 3½-inch drive is C:. That will leave D: free for use as a RAM disk. Then the entire disk lineup will be A: and B: as 5¼-inch floppies, C: as a 3½-inch floppy, D: as a RAM disk, E: as the hard disk, and F: as the second logical designation for the 3½-inch floppy.

Setting up the device driver can become somewhat complicated, but bear in mind that, when it's over, to interchange data between any combination of disk drives, you can use the normal DOS COPY command.

One final point: There are a number of different 3½-inch disk formats. For example, the Tandy Model 100 disk drive has one format, the Macintosh computers have another, and IBM now has two of its own, both high-density (1.44 megabyte) and low-density (720K). The high-density format is used only in the new Models 50, 60, and 80; the low-density format is used in the new Model 30, IBM's laptop, as well as laptops from a number of manufacturers (including Zenith, Toshiba, etc.) The upgrade described here can read only the low-density IBM format. ♦♦♦

COMPUTER DESIGNED PC BOARDS

continued from page 71

To correct a mistake, you can connect an uncommitted point using the Dot command, which draws a small blue circle there and informs Autoboard that you want a connection. If the pin was left open by design you can just ignore the warning.

The next step is to define the board and place the parts. Once again, Autoboard has a set of files that customize AutoCAD with menus and macros. After the board outline is defined, you can begin laying the parts out in much the same fashion you did when the schematic was drawn. Picking a part from a menu allows you to drag it around the screen and place it exactly where you want it.

It's a tremendous help to use AutoCAD's Zoom command to zero in on a location if you're placing a small part. The drawing of the part you drag around the screen will be enlarged by the same amount, so you'll be able to judge relative placement and size. Once you've picked the insertion point, you'll be asked for the name of the part and its value. They must be consistent with those you used in the schematic entry phase, because Autoboard's router uses those names to identify the parts and also the connections in the netlists.

When you complete the layout, you can hand-route some traces if your circuit has requirements you're afraid won't be properly addressed by the router. Next you'll want to turn the auto-router loose; that's done simply by giving it the name of the board you want routed.

Autoboard is an open system in that all the menus and script files (and many other parts of the program) can be customized to fit your requirements. The same is true, to a lesser extent, of the router. There are a series of "switches" you can set in the router that control things like the number of allowable layers, minimum and maximum pad and trace widths, spacing, time limits, and so on. That is easily done by editing a configuration file with a word processor. The router automatically looks for that file when it starts to run. If it can't find it, it uses its default values.

There's something magical about watching the router in opera-

tion because it constantly reports its progress on the screen. Our example board was one that had already been done by hand (we showed it last time), and it was amazing, to say the least, to watch Autoboard do in 15 minutes what had taken two days to do by hand. The only consolation was that all connections were made in the hand-routed board, but Autoboard missed five (out of a total of 115). That's not a bad percentage, and it's a safe bet that tweaking the configuration file could result in a success rate of 100%.

The last thing the router does is call up AutoCAD, draw the board on the screen, and display all the traces it has finished. It creates a separate "rats-nest" layer for the missed routes and draws them on that layer in a different color. It also creates a text file with a .BAD extension that lists all the connections it missed. By the time reach this point, you're in AutoCAD looking at the routed board with each board layer in a separate AutoCAD layer (including separate ones for the pads and the silkscreen). Now is when you'll appreciate the fact that Autoboard works inside AutoCAD. You can use any AutoCAD command to do anything you want to any layer—you have complete control of the drawing.

When you're happy with the layout, you can use any of AutoCAD's normal output commands. So you can create a text file that describes the board (for conversion to FutureNet, Gerber, etc.), or you can print it, plot it, etc. AutoCAD knows how to talk to virtually every printer and plotter ever made, so you can be confident it will talk to yours. And AutoCAD files are one of the few standards for graphic data. As for input devices, some sort of digitizing tablet is tremendously helpful in drawing both schematics and layouts. And, as with printers and plotters, AutoCAD knows how to talk to just about all of them. The keyboard, of course, can be used alone or in conjunction with a digitizing tablet.

Conclusions

Each of the packages we've been talking about is a well-thought-out piece of software, and each is updated occasionally. All the graphics produced for this article were done on an IBM PC XT with a Sigma Designs Color400 Video Board, an SR-12 monitor from Princeton Graphics, and a Summagraphics mouse from Summagraphics. And a very special bit of thanks must go to Dennis Jump for standing by the phone. ♦♦♦

SATELLITE TV

continued from page 29

end up selling the TV viewers a better picture in order to attain an international standard.

Why an international fuss about the technical nitty-gritty that goes into a TV picture? Because there is a crying need for a universal television standard. High-tech communication systems, such as satellites, can now beam a TV picture from any part of the world to any TV set, so there must be a convenient way for everyone to view programming from any spot on the globe. Since there are three widely-used television standards now in use—NTSC, the North American or US standard; PAL, the basic all-Europe standard; and SECAM, the joint French-Russian standard—the exchange of television programming such as the Olympics, and news feeds, and even family programming, has been a burden because the equipment that converts one TV standard to another is expensive and prone to failure.

While it is possible to manufacture a receiver capable of receiving the three types of TV signals, they are, and are likely to remain, prohibitively expensive. Multi-standard receivers, such as those that are available in small quantities in Europe and the Middle-East, are not cost-effective because a major portion of the circuitry must be duplicated, even triplicated, to accommodate the different transmission standards.

Whose HDTV?

Television formats, as we know them today, originated in the 30's and 40's. (NTSC color was appended to an existing black-and-white standard in the 50's.) Even if we could conveniently and inexpensively interchange the signal formats, all of the systems, NTSC, PAL, and SECAM, realize approximately half of the picture definition that's possible using 1980's technology.

Although present technology makes a 1,000- to 1,200-line video transmission system do-able at consumer prices—European, Jap-

anese, and North American firms all have such systems operating—like the NTSC/PAL/SECAM developments, no two of the presently developed systems share the same standards, so we're back with the same old problem.

Many engineers believe that there is general worldwide acknowledgment that we must avoid entering the era of HDTV with three different "national standards," and that since the present-day transmission standards are

ready to be replaced, a serious effort should be made to adopt new standards it will resolve the 50-year old problems related to multiple, non-compatible systems. Unfortunately, it will require uncommon resolve to push the strong nationalistic instincts into the background in favor of a single, worldwide-technology standard. If it happens, it will be the first time that the world has agreed on an important broadcasting standard.

R-E

Radio-Electronics REPRINT BOOKSTORE

- | | |
|---|---|
| <ul style="list-style-type: none"> <input type="checkbox"/> SP1 Special Projects #1 \$6.00 <input type="checkbox"/> SP4 Special Projects #4 (Summer 1982) . . \$6.00 <input type="checkbox"/> SP5 Special Projects #5 (Winter 1983) . . \$6.00 <input type="checkbox"/> SP6 Special Projects #6 (Spring 1983) . . \$5.00 <input type="checkbox"/> SP7 Special Projects #7 (Summer 1983) . . \$6.00 <input type="checkbox"/> SP8 Special Projects #8 (Fall 1983) . . \$6.00 <input type="checkbox"/> SP9 Special Projects #9 (Winter 1984) . . \$6.00 <input type="checkbox"/> SP10 Special Projects #10 (Spring 1984) . . \$6.00 <input type="checkbox"/> H11 Hands-On Electronics #1 \$5.00 <input type="checkbox"/> H12 Hands-On Electronics #2 \$5.00 <input type="checkbox"/> H13 Hands-On Electronics #3 \$5.00 <input type="checkbox"/> H14 Hands-On Electronics #4 \$5.00 <input type="checkbox"/> H15 Hands-On Electronics #5 \$5.00 <input type="checkbox"/> H15A Hands-On Electronics #6 \$4.00 <input type="checkbox"/> H16A Hands-On Electronics (Jan-Feb '86) . \$4.00 <input type="checkbox"/> H16B Hands-On Electronics (Mar/Apr '86) \$4.00 <input type="checkbox"/> H16C Hands-On Electronics (May/Jun '86) \$4.00 <input type="checkbox"/> H16D Hands-On Electronics (Jul/Aug '86) . \$4.00 <input type="checkbox"/> H16E Hands-On Electronics (Sep/Oct '86) . \$4.00 <input type="checkbox"/> H16K Hands-On Electronics (Nov '86) . . . \$4.00 <input type="checkbox"/> H16L Hands-On Electronics (Dec '86) . . . \$4.00 <input type="checkbox"/> H17 Hands-On Electronics back issues (1987) \$3.50
Write in issues desired _____ <input type="checkbox"/> 150 TV Descrambler \$3.00 <input type="checkbox"/> 151 Build Your Own Robot \$12.00 <input type="checkbox"/> 152 8-Ball Satellite TV Antenna \$5.00 <input type="checkbox"/> 107 Radio-Electronics back issues (1987) \$3.25 <input type="checkbox"/> 106 Radio-Electronics back issues (1986) . \$3.75
Write in issues desired _____ <input type="checkbox"/> 105 Radio-Electronics back issues (1985) . \$4.25
(Jan. 85 not available)
Write in issues desired _____ | <ul style="list-style-type: none"> <input type="checkbox"/> 104 Radio-Electronics back issues (1984) . \$5.25
(December 1984 issue is not available)
Write in issues desired _____ <input type="checkbox"/> 103 Radio-Electronics back issues (1983) . . \$5.75
(Jan., Feb., May are not available)
Write in issues desired _____ <input type="checkbox"/> 102 Radio-Electronics back issues (1982) . \$6.50
(Jan., Feb.) is not available
Write in issues desired _____ <input type="checkbox"/> 101 Radio-Electronics back issues (1981) . . \$7.00
(Issues available: July, Aug. Sept. Nov.)
Write in issues desired _____ <input type="checkbox"/> 153 Etch your own PC boards \$3.00 <input type="checkbox"/> 154 How to Repair VCR's \$3.50 <input type="checkbox"/> 155 IBM Typewriter to Computer \$3.00 <input type="checkbox"/> 125 Radio-Electronics Annual 1985 \$3.50 <input type="checkbox"/> 126 Radio-Electronics Annual 1986 \$2.50 <input type="checkbox"/> 156 How to Make PC Boards \$2.00 <input type="checkbox"/> 157 All About Kits \$2.00 <input type="checkbox"/> 158 Electro Importing Co. Catalog (1918) . \$5.95 <input type="checkbox"/> 159 Low Frequency Receiving Techniques
Building and using VLF Antennas \$6.00 <input type="checkbox"/> 160 New Ideas - 42 Circuits \$3.50 <input type="checkbox"/> 161 Descrambling (Feb., 1984) \$2.00 <input type="checkbox"/> 162 Build Your Own Satellite TV Receiver \$7.00 <input type="checkbox"/> 163 Receiving Satellite TV \$7.00 <input type="checkbox"/> 164 Modern Electrics (April, 1908) \$3.00 <input type="checkbox"/> 165 How to Repair CD Disc Players \$5.00 <input type="checkbox"/> 166 Collected Works of Mohammed Ulyses Fips
(62 pages, April Fools Collection) . . . \$10.00 <input type="checkbox"/> 167 Designing With IC's \$4.00 |
|---|---|

To order any of the items indicated above, check off the ones you want. Complete the order form below, include your payment, check or money order (DO NOT SEND CASH), and mail to Radio-Electronics, Reprint Department, P.O. Box 4079, Farmingdale, NY 11735. Please allow 4-6 weeks for delivery.

If you need a copy of an article that is in an issue we indicate is unavailable you can order it directly from us. We charge 50¢ per page. Indicate the issue (month & year), pages and article desired. Include payment in full, plus shipping and handling charge. Make checks payable to Gernsback Publications, Inc.

ARTICLE

PAGES	MONTH	YEAR
TOTAL PAGES	(at 50¢ each)	TOTAL PRICE

MAIL TO: Radio-Electronics
Reprint Bookstore, P.O. Box 4079, Farmingdale NY 11735

All payments must be in U.S. funds

SHIPPING CHARGES IN USA & CANADA

\$0.01 to \$5.00 \$1.00	\$30.01 to 40.00 \$4.75	OUTSIDE USA & CANADA Multiply Shipping by 2 for sea mail Multiply Shipping by 4 for air mail
\$5.01 to \$10.00 \$1.75	\$40.01 to 50.00 \$5.75	
\$10.01 to 20.00 \$2.75	\$50.01 and above \$7.00	
\$20.01 to 30.00 \$3.75		
Total price of merchandise \$ _____		
Sales Tax (New York State Residents only) \$ _____		
Shipping (see chart) \$ _____		
Name _____	Total Enclosed \$ _____	
Address _____		
City _____ State _____ Zip _____		

PC SERVICE

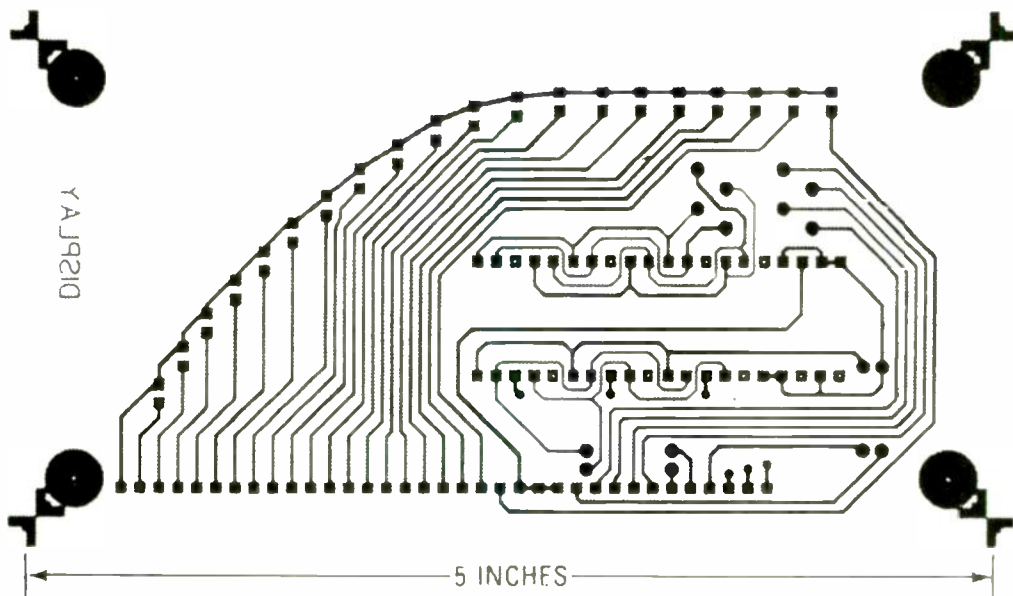

USE THIS BOARD to assemble the digital tachometer's display board. The article appeared in the June 1987 issue.

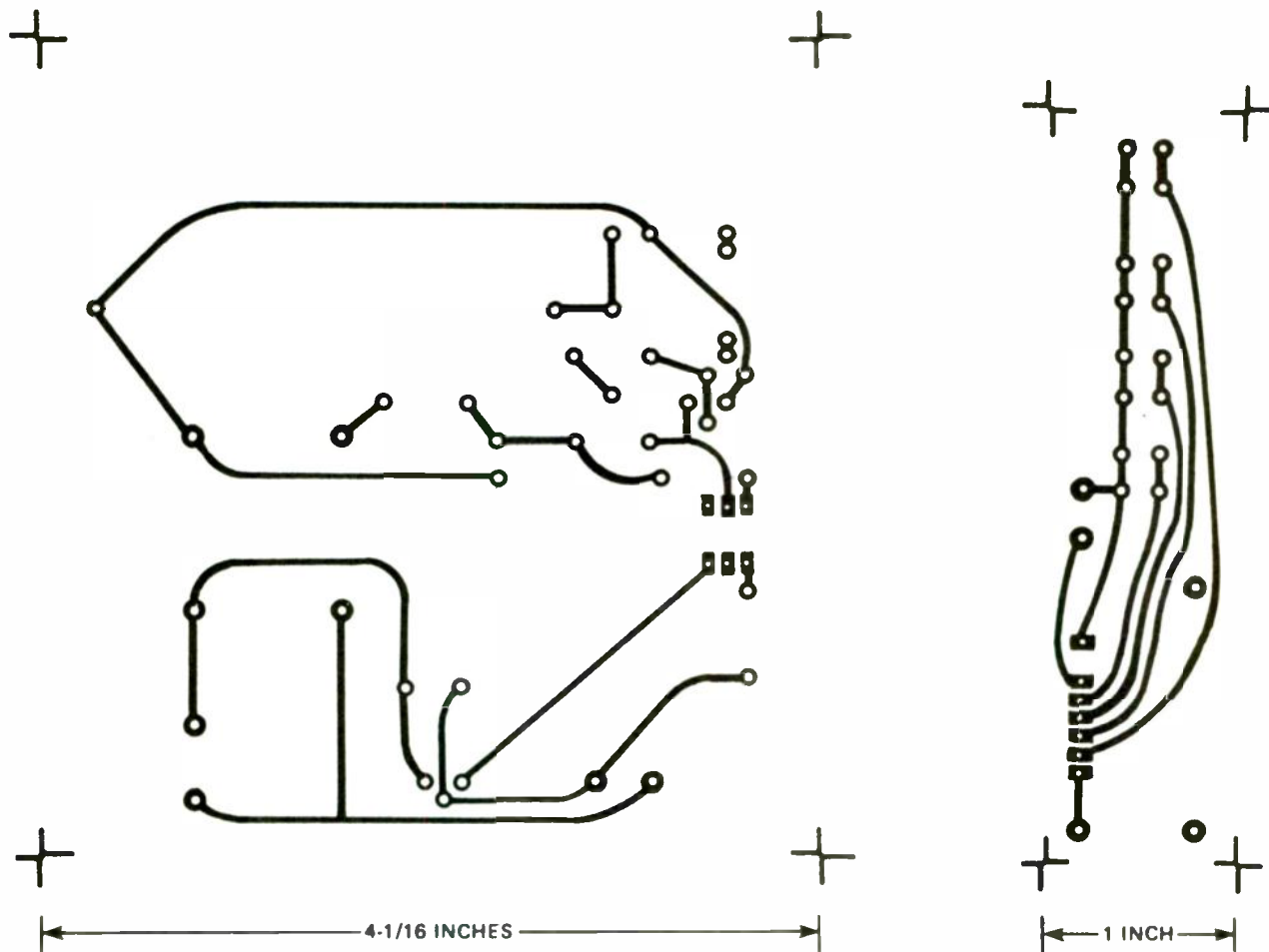

THE MAIN BOARD for the digital timer is shown here. You can find the story beginning on page 45.

THE DISPLAY BOARD for the digital timer is shown here.

PC SERVICE

AMP DESIGN

continued from page 56

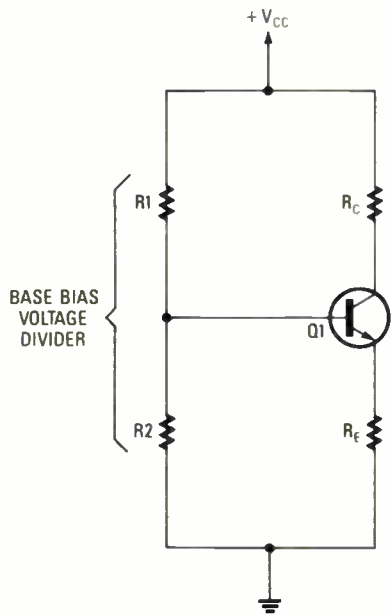

FIG. 1—A COMMON-EMITTER AMPLIFIER was the ideal solution to our design problem.

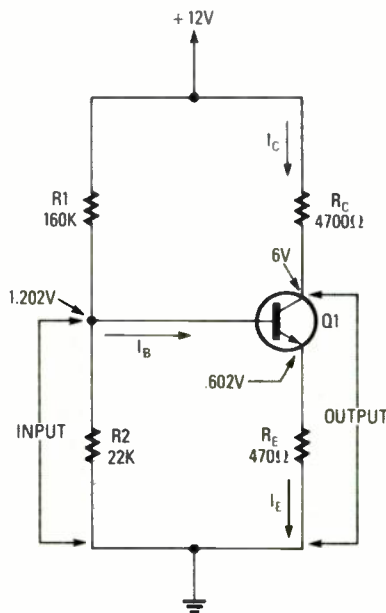

FIG. 2—SIMPLE CALCULATIONS yielded the component values shown here.

through R1 is a combination of the voltage-divider current plus the base current.

The base current is equal to the collector current divided by beta. It is found from:

$$I_B = 1.28/100 = 0.0128 \text{ mA}$$

So the total current through R1 is $0.054 \text{ mA} + 0.0128 \text{ mA} = 0.067 \text{ mA}$, and R1

$$= 10.8/0.067 \text{ mA} = 160,000 \text{ ohms.}$$

Resistor R1 is the most critical resistor in the circuit. To ensure maximum voltage swing, it should bring the quiescent collector voltage to one half the supply voltage = $10.8/0.067 \text{ mA} = 160,000 \text{ ohms}$.

Resistor R1 is the most critical resistor in the circuit. To ensure maximum voltage swing, it should bring the quiescent collector voltage to one half the supply voltage. After building the circuit, the value of R1 may have to be varied slightly to achieve that voltage swing.

We now have a circuit we can test.

Interfacing

Connecting the circuit to the outside world will require capacitor coupling. That serves to isolate the AC signal from any DC bias voltages. Figure 3 shows our complete circuit with input and output coupling capacitors. The values of those capacitors were calculated using $C = 1/(3.2 \times f \times R)$, where C equals the capacitor value in farads, f equals the frequency at which response will be down 1 dB, and R equals the impedance on the load side of the capacitor.

To calculate the value of C1, the amplifier's input impedance (15K) is used for R. To calculate the value of C2, the input impedance of the next stage (50K) is used for R.

The value of C1 can now be calculated for a drop of 1 dB at 20 Hz: $C1 = 1/(3.2 \times 20 \times 15000) = .00000104 \text{ farad} = 1.0 \mu\text{F}$. The value of C2 = $1/(3.2 \times 20 \times 50000) = .00000031 \text{ farad} = 0.33 \mu\text{F}$.

To increase the gain of the stage, you could bypass R_E with a capacitor, as shown in Fig. 4. Nothing comes for free, however. The price you pay for increased gain is lower input impedance, which will vary widely with beta. If that variation is not a problem, a significant gain increase can be realized by adding the bypass capacitor. Our original circuit has a gain of 10; if the emitter is bypassed the gain becomes $R_C/0.03/I_E = 4700/(0.03 / 0.00129) = 4700/23 \approx 200$.

The value of the bypass capacitor in farads is calculated from the formula $C = 1/(6.2 \times f \times R)$. Again f is the low-frequency limit in Hz, and R is the dynamic emitter resistance ($0.03/I_E$). In our example, if we stick to a 20-Hz lower limit we have $C = 1/[6.2 \times 20 \times (0.03/0.00129)] = .000344 \text{ farads} = 344 \mu\text{F}$. A 350- μF unit can be used.

Computerized calculations

It only seems natural to put the computer to work to lessen the drudgery of doing repetitive mathematical calculations. The BASIC program shown in Listing 1 is written to do just that. In addition, it serves as a sort of scratch pad for your designs, and allows you to do several "what-if" calculations easily. The program was written for a Commodore 64.

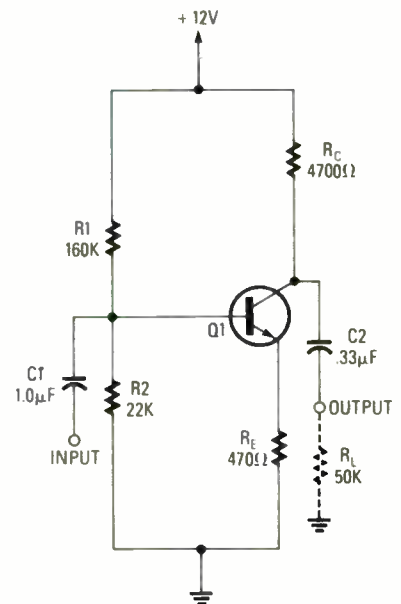

FIG. 3—CAPACITOR COUPLING is required to interface the amplifier to the outside world.

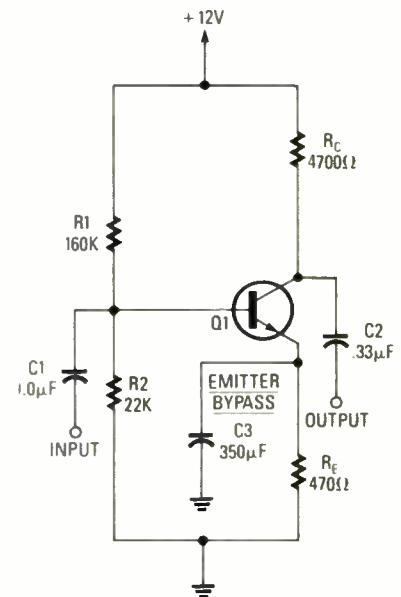

FIG. 4—INCREASE GAIN by bypassing the emitter resistor as shown here.

but it can be modified to run on any other system.

A few thoughts on components before we finish: Using 5% resistors allows closer adherence to the calculated values. Because of their temperature stability and low leakage specifications, silicon rather than germanium transistors are preferable for this type of circuit.

Finally, you've no doubt noticed that we have yet to specify a specific transistor. That's because for this type of application it really doesn't matter! Almost any small-signal device will do fine. **R-E**

COMMUNICATIONS CORNER

continued from page 31

dB greater than the signal received by a single antenna. A special detector samples the signal-to-noise ratio of the received signal on a half-cycle basis. If out-of-phase multipath reception at one antenna causes the signal-to-noise ratio to fall below a minimum value, the detector automatically inserts the delay line by opening the electronic switch, thereby flipping the phase of the signal from antenna B by 180°, which in turn causes the delayed signal to add once again to that of antenna A.

To avoid constant switching back and forth, which might distract the listener, the detector is designed so that it maintains the phasing as long as the received signal is strong enough to be usable. Only if new or changing multipath signals degrade the "out of phase" signal to an unacceptable value will the detector cause the delay line to switch out.

Some of you familiar with selective fading on the high-frequency shortwave bands will wonder what happens to the receiver's volume level when the signal varies within the allowed range (before it falls low enough to activate the delay-line switching). The answer is that nothing happens; there is no change in volume level. On the shortwave frequencies, all signals are AM or single sideband (which, of course, is only a variation of AM), so the volume level from the speaker will vary if the signal level breaks away from control of the AGC (Automatic Gain Control) or the AVC (Automatic Volume Control); that's a condition absolutely bound to occur during selective fading.

But wireless sound equipment uses FM modulation, whose received volume level depends on deviation, not signal strength. Only if the signal falls to an almost-useless level is there any effect on an FM signal's volume level, and the receiver squelch circuits will mute the sound long before the listener hears a change in volume level caused by the received signal strength.

R-E

Radio-Electronics mini-ADS



PANASONIC CABLE CONVERTERS, Wholesale and Retail. Scientific Atlanta and Pioneer Cable Converters in stock. Panasonic model 130N 68 channel converter \$79.95, Panasonic Amplified Video Control Switch Model VCS-1 \$59.95. Scientific Atlanta Brand new Model #8528 550MHZ 80 Channels Converter \$89.95. Video Corrector (MACRO, COPYGUARD, DIGITAL) ENHANCER \$89.95. Write or call BLUE STAR IND., 4712 AVE. N, Dept 105, Brooklyn, NY 11234. Phone 1-718-258-9495.

CIRCLE 85 ON FREE INFORMATION CARD

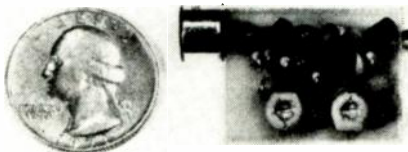

SIMPLY SNAP THE WAT-50 MINIATURE FM TRANSMITTER on top of a 9v battery and hear every sound in an entire house up to 1 mile away! Adjustable from 70-130 MHz. Use with any FM radio. Complete kit \$29.95 + \$1.50 S + H. Free shipping on 2 or more! COD add \$4. Call or send VISA, MC, MO. DECO INDUSTRIES, Box 607, Bedford Hills, NY 10507. (914) 232-3878.

CIRCLE 127 ON FREE INFORMATION CARD

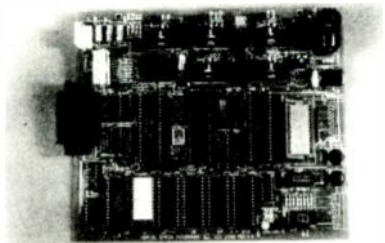

BUILD STEVE CIARCIA'S INTELLIGENT SERIAL EPROM PROGRAMMER. • Use Standalone or with Computer/Terminal; • Programs Standard or Fast Algorithm Mode; • Menu Selectable, No Configuration Jumpers; • Programs All 5V 27XXX EPROMs from 2716 to 27512. Includes CMOS and 12.5V Vpp; • Read, Copy, Verify after Write; • Intel Hex File Upload/Download. Full Programmer Kit \$199.00, Power Supply add \$19.00. S&H \$5 in USA. CCI, 4 Park St., Suite 12, Vernon, CT 06066. (203) 875-2751.

CIRCLE 196 ON FREE INFORMATION CARD

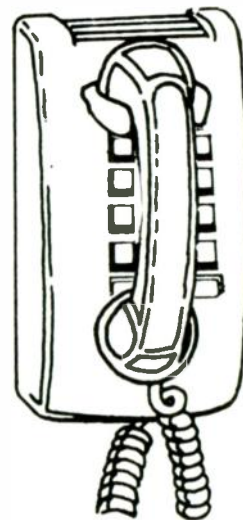

CALL NOW AND RESERVE YOUR SPACE

- 6 x rate \$745.00 per each insertion.
- Reaches 242,400 readers.
- Fast reader service cycle.
- Short lead time for the placement of ads.
- We typeset and layout the ad at no additional charge.

Call 516-293-3000 to reserve space. Ask for Arline Fishman. Limited number of pages available. Mail materials to: mini-ADS, RADIO-ELECTRONICS, 500-B Bi-County Blvd., Farmingdale, NY 11735.



2645T—117 PRACTICAL IC PROJECTS YOU CAN BUILD.....\$10.95. Dozens of fully-tested, ready-to-build circuits you can put together from readily-available, low cost IC's! There are a total of 117 IC circuits ranging from an audio mixer and a signal splitter to a tape-deck amplifier and a top-octave generator organ! From TAB Books. To order your copy send \$10.95 plus \$2.75 shipping to Electronic Technology Today Inc., P.O. Box 240, Massapequa Park, NY 11762-0240

Radio-Electronics mini-ADS



TUNABLE NOTCH FILTER—for elimination of any TV, FM, or VHF signal. Can be tuned precisely to ANY signal within these ranges: *MODEL 26-Ch's. 2-6 plus FM [54-108 Mhz] *MODEL 1422-Ch's. 14(A)-22(I) [120-174 Mhz] *MODEL 713-Ch's. 7-13 [174-216 Mhz] Highly selective 60dB notch. Send \$30 each. Quantity prices as low as \$15. Money back guarantee. **STAR CIRCUITS, P.O. Box 8332, Pembroke Pines, FL. 33084**

CIRCLE 94 ON FREE INFORMATION CARD

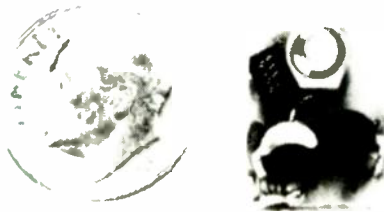

THE MODEL WTT-20 IS ONLY THE SIZE OF A DIME, yet transmits both sides of a telephone conversation to any FM radio with crystal clarity. Telephone line powered - never needs a battery! Up to ¼ mile range. Adjustable from 70-130 MHz. Complete kit \$29.95 + \$1.50 S + H. Free Shipping on 2 or more! COD add \$4. Call or send VISA, MC, MO. **DECO INDUSTRIES, Box 607, Bedford Hills, NY 10507. (914) 232-3878.**

CIRCLE 127 ON FREE INFORMATION CARD

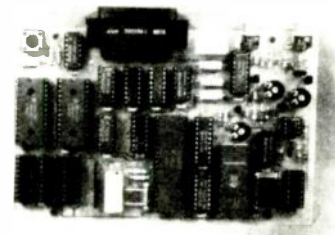

BUILD STEVE CIARCIA'S NEW VIDEO DIGITIZER. • True "Frame Grabber", pic takes 1/60th sec • Not bus Dependent - Standalone digitizer • Serial output, transmits 300bps to 57.6Kbps • Resolution: 256 x 244 x 6 w/64 level grayscale • Accepts any NTSC video input, B&W or Color • Optional Rec/Display makes Video Telephone • Images can be stored & displayed on IBM PC. Full Digitizer/Serial Transmitter Kit - \$249. Call for other options and specs. **CCI, 4 Park St., Suite 12, Vernon, CT 06066. (203) 875-2751.**

CIRCLE 198 ON FREE INFORMATION CARD

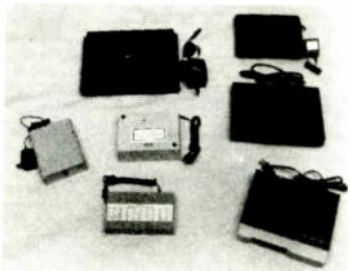

NEW 442 SYNE WAVE DECODER WITH VARI SYNC—Replaces the oak N-12 \$80.00, S.B. add on decoder \$99.00, S.B. Tri-Bi decoder \$100.00, Zenith SSAVI \$185.00, S.B.-S.A. decoder \$140.00, Starcom converter \$139.95. Buy a decoder take off \$(10.00). Guaranteed. (402) 331-4957. Call or write for your free catalog. Many other products & quantity pricing. **M.D. ELECTRONICS, 5078 So. 108th #115A, Omaha, NE 68137**

CIRCLE 204 ON FREE INFORMATION CARD

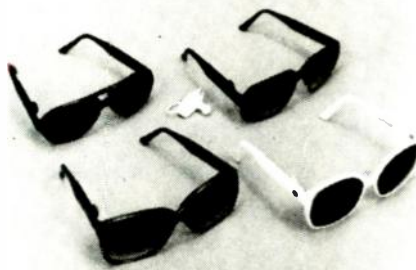

LOOKSOUND FM SUNGLASSES. Super durable sunglasses with that great look. Each one has a state of the art micro FM radio built right in. Great for jogging, bicycling, boating, sports events, etc. \$39.95 plus \$3.00 shipping and handling. Visa, mastercard, and cod. 1-800-522-2636 for orders. (617) 843-1900 for information. **CAMEO ENTERPRISES INC. P.O. Box 63 Accord, MA 02018**

CIRCLE 89 ON FREE INFORMATION CARD



A CAREER START FOR THE 21ST CENTURY. Since 1905, National Technical Schools has helped people build successful careers. Enter the 21st Century through home study courses in Robotics, Computer Technology and Servicing, Microprocessors, Video Technology, Basic Electronics, Transportation Technology, Climate Control Technology or TV and Radio Servicing. For a FREE catalog, call 1-800-B-BETTER. Or write **NTS/INDEPENDENT TRAINING GROUP, 456 West M. L. King Jr. Blvd. L.A., CA 90037.**

CIRCLE 187 ON FREE INFORMATION CARD

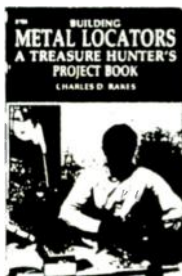

2706T—BUILDING METAL LOCATORS, A Treasure Hunter's Projects Book.....\$9.95. Build your own high-quality metal detector for a fraction of the factory-built cost! The detectors described in this unique project guide will locate anything from coins and jewelry to gold and silver—and can be built quickly and easily! From TAB Books. Get your copy today. Send \$9.95 plus \$1.75 shipping to **Electronic Technology Today Inc., P.O. Box 240, Massapequa Park, NY 11762-0240.**

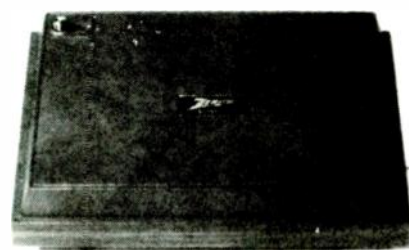

ZENITH SSAVI \$169; Level II \$199. Reconditioned. Surplus Sylvania 4040 Converters-DIC, N-12, MLD 1200, new low quantity prices. Satellite systems, converters, amplifiers, accessories. SSAVI project handbook \$6.50 ppd. Radar speed gun for baseball, car/boat racing, bowling, skiing, etc., from \$275. Professional models used by police. Catalog and coupon \$1.00. **AIS SATELLITE INC., P.O. Box 1226-R, Dublin, PA 18917. (215) 249-9411.**

CIRCLE 81 ON FREE INFORMATION CARD



LONG RANGE NIGHT VIEWER. See over 300' in total darkness. Facial identification to 135'. Developed for industrial & government work. Applications include; animal observation, security surveillance, video recording, laser & fiber optic work, IR astronomy, microscopy & thermal research, document & art examination. 50W halogen, 200,000 CP IR source. 12VDC operation. \$750 delivered. (Dealers Wanted). **OCTE ELECTRONICS, PO Box 276, Alburg, VT 05440. (514) 739-9328. Catalog \$1.**

CIRCLE 191 ON FREE INFORMATION CARD

R-E ROBOT

continued from page 60

LISTING 2

```
: BOX ( feet ---- )
  RERB
  25.5 IPS
  2DUP (FEET) FORWARD
  90 DEGREES RIGHT
  2DUP (FEET) FORWARD
  90 DEGREES RIGHT
  2DUP (FEET) FORWARD
  90 DEGREES RIGHT
  2DUP (FEET) FORWARD
  90 DEGREES RIGHT;
```

LISTING 3

```
: MS ( milliseconds ---- )
  0 ?DO 33 0 DO LOOP LOOP ;

: SECONDS ( seconds ---- )
  0 ?DO 1000 MS LOOP ;

: MINUTES ( minutes ---- )
  0 ?DO 60 SECONDS LOOP ;
```

LISTING 4

```
: ATTENTION ( ---- )
  BEEP BEEP 1 SECONDS ;

: WARNING ( ---- )
  5 0 DO BEEP 1 SECONDS LOOP ;

: TURN-AROUND ( ---- )
  RERB 10 IPS 180 DEGREES
  LEFT ;

: TURN-LEFT ( ---- )
  90 DEGREES LEFT ;

: TURN-RIGHT ( ---- )
  90 DEGREES RIGHT ;

: AHEAD ( feet ---- )
  FEET FORWARD ;

: COLLECT ( minutes ---- )
  ATTENTION MINUTES WARNING ;
```

recharging area and turn around to go forward. The word TURN-AROUND makes a 180° turn. The word AHEAD is shorthand for a forward move. COLLECT combines the ATTENTION, WAITING, and WARNING functions, because we always use them together. The definitions of those words are shown in Listing 4.

A trip consists of backing out of the recharger and exiting the mail room, making a clockwise trip around the office, stopping at several points (including a long stop at the president's office), and finally returning to the mail room. The

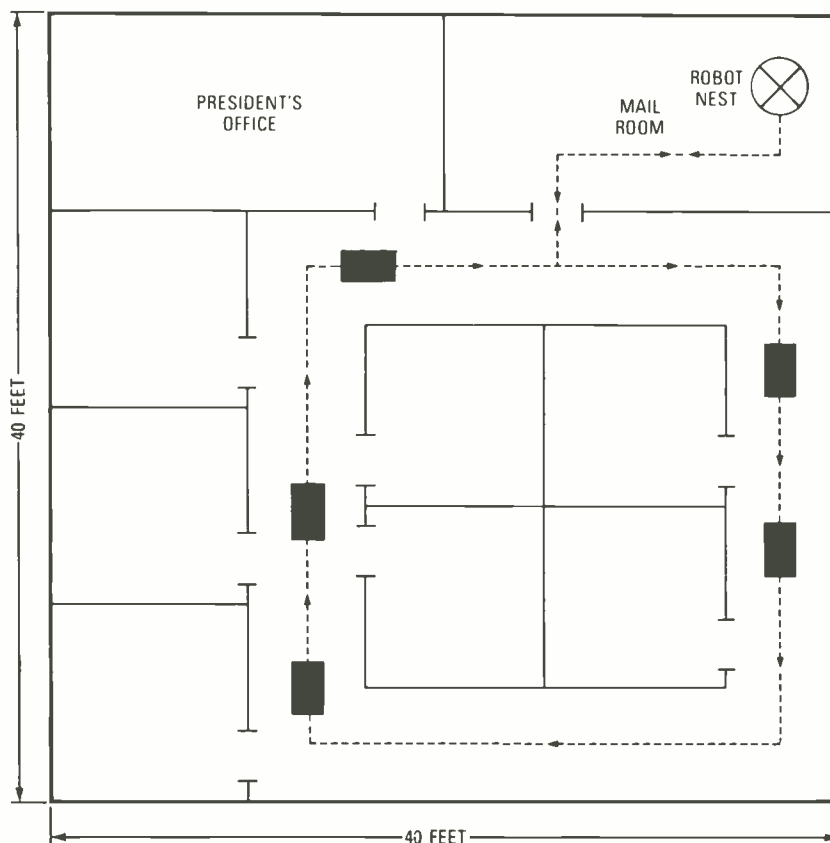

FIG. 2—MODEL OFFICE FOR THE EXPERIMENTAL TRIP program that is shown in Listing 5.

LISTING 5

```
: TRIP ( ---- )
  WARNING          RERB          20 IPS          3 FEET
  BACKWARD        TURN-AROUND  2.5 AHEAD
  TURN-RIGHT      12 AHEAD      TURN-LEFT
  5 AHEAD         TURN-LEFT     36 IPS
  10 AHEAD        TURN-RIGHT    2 COLLECT
  7 AHEAD         2 COLLECT     8 AHEAD
  TURN-RIGHT      25 AHEAD     TURN-RIGHT
  3 AHEAD         2 COLLECT     11.5 AHEAD
  4 COLLECT       11.5 AHEAD    TURN-RIGHT
  ATTENTION       3 COLLECT    ( President)
  14 AHEAD        TURN-LEFT    4.5 AHEAD
  TURN-RIGHT     12 AHEAD     TURN-LEFT
  10 IPS          5.5 AHEAD
```

word TRIP executes the entire program; it is shown in Listing 5.

TRIP only causes the robot to make one excursion around the office, but we want

the robot to make several trips during the day, without having to tell it to do so each time. We can schedule the trips when desired using the words AM, PM, and WAIT-UNTIL. WAIT-UNTIL simply waits in a delay loop until the current time is identical to the desired time. AM and PM set the desired time. Time is specified in hours, so minutes must be expressed as fractional hours. For example, 8.5 AM is 8:30 am. The entire MAILBOT program is shown in Listing 6.

You can extend RCL to deal with additional hardware and to provide greater software flexibility. FORTH gives you the freedom to experiment and add to the capabilities of the system.

R-E

LISTING 6

```
: MAILBOT ( ---- )
  8.5 AM WAIT-UNTIL TRIP
  9.5 AM WAIT-UNTIL TRIP
  10.5 AM WAIT-UNTIL TRIP
  11.5 AM WAIT-UNTIL TRIP
  1.5 PM WAIT-UNTIL TRIP
  2.5 PM WAIT-UNTIL TRIP
  3.5 PM WAIT-UNTIL TRIP
  4.5 PM WAIT-UNTIL TRIP
```

STEREO RECEIVER

continued from page 44

The IC's AGC function was not used in the design. Instead, pin 16 was terminated by R40 and C33.

A 10.7-MHz tuned circuit is formed by L7, C38, and C37. Resistor R41 acts as a swamping resistor to obtain the wide bandwidth of the quadrature circuit. C37, C38, and L7. Drive voltage from pin 8, if out, to pin 9, quadrature detector input, is delivered via L6. The value of that inductor is somewhat critical for proper sleigh-circuit operation. It should be between 18–22 μ H. We had an 18- μ H unit on hand so it was used.

A load for the AFC circuit is provided by R43, and R42 biases the audio circuit in the IC. Capacitor C38 is used to tune the quadrature circuit to 10.7 MHz. It is adjusted for best received audio and zero DC voltage across R43.

Recovered total modulation is present at pin 6. It contains the FM baseband and the SCA signal. The baseband audio is taken off through R44 and C39.

The baseband-audio amplifier is built around Q6, a 2N3565. It is set up for a nominal gain of about 5 (the ratio of R44 to R46 is the approximate gain of this stage). Resistors R45 and R46 bias Q6 to about 6 volts at 1 milliampere. R47 is a load resistor. About 2 volts of baseband audio is present at the collector of Q6.

Audio from Q6 is fed to two separate circuits. One circuit is an SCA demodulator; the other is an FM stereo decoder.

SCA demodulation

Audio from Q6 is fed to an SCA take-off R-C high-pass filter made up of C40, R48, R49, C41, C42, and R65. That filter substantially attenuates audio components below 50 kHz.

The SCA demodulator, IC2, is an LM565 phase-locked loop. It contains a VCO (Voltage Controlled Oscillator) and phase detector comparator. If a signal of sufficient amplitude (about 100 millivolts) is fed into pin 2 or 3 of that device, and its frequency is sufficiently close (say within $\pm 30\%$) to the VCO frequency, the VCO will lock to the input frequency and track it; that is, the voltage that controls the VCO will follow any changes in the frequency of the input signal. The control voltage for the VCO is present at pin 7 and is a linear function of the input-signal frequency. Therefore, the LM565 can function as an FM detector with no external inductive components required. (At the SCA-subcarrier frequencies of 67 or 92 kHz, inductors can become rather large and somewhat costly. It is therefore to our advantage to eliminate those coils, and their alignment.)

The LM565 is biased by external re-

sistors R51, R52, R53, and R54. The VCO frequency is determined by C43 and the resistance of R72 and R55. The setting of R72 is adjusted so that the VCO frequency, which can be measured at pin 4, is near 67 kHz.

Adjustment of R72 is not critical, and simply adjusting it for clearest SCA reception is adequate. (If 92 kHz operation is desired, R55 should be changed to about 6.8K.) Capacitor C44 is used as a loop filter for the phase-locked loop. Audio appears at pin 7 of the LM565. A de-emphasis network made up of R56, C45, R57, and C46 will suppress any 67-kHz components and attenuate high-frequency noise.

An audio-amplifier stage, Q7, brings up the detected audio level to about 500 mV. From the amplifier, the signal is sent to the selector switch, S2, for routing.

FM decoding

Audio from Q6 is also sent, via blocking capacitor C49, to IC3, an LM1310N FM-stereo multiplex decoder. The LM1310N contains a VCO, a phase-locked loop for regenerating the 38-kHz stereo subcarrier, a lock detector used as a stereo-indicator circuit, and a decoder circuit for deriving the left and right audio channels. The internal VCO operates at 76 kHz and the 19-kHz and 38-kHz signals are derived from an internal frequency divider. No indicators are required and alignment consists simply of adjusting R73 for a 19-kHz signal at pin 10.

Getting back to the circuit, C53, R62, and C54 form a compensating network for IC3's internal phase-locked loop. Capacitor C50 is the loop filter for the phase-locked loop. The network made up of C55, R63, and R73 control the center frequency of the internal VCO, which should be 76 kHz. The 19-kHz pilot signal (derived from an internal divider) is available at pin 10 for test purposes. Audio output appears at pins 4 (left) and 5 (right). Resistors R64 and R65 serve as loads for the internal audio amplifiers. FM-audio de-emphasis is provided by C56 and C57. The right and left audio from pins 4 and 5 is fed to S2.

The audio amplifiers in this circuit, IC4 and IC5, are LM1386N's. They each provide about a 0.5-watt output, adequate for driving an eight-ohm speaker. Do not use speakers that present less than an eight-ohm load.

The entire receiver draws about 125 milliamperes at 12-volts (the recommended supply voltage). The supply should be regulated and have good filtering. A suitable power supply is shown in Fig. 3.

Next time

That's all the room we have for now. Next time we'll show you how to build, align, and use the receiver. The PC pattern will be presented at that time. **R-E**

Learn micro-processing with the new MICRO-PROFESSOR 1P

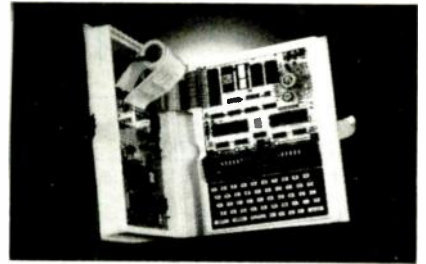

Students, engineers or technicians—upgrade your micro-processing skills with the new Micro-Professor 1P.

The MPF-1P features:

- extensive software support
- more built-in memory
- improved keyboard
- larger display

Three tutorial guides help cover all capabilities. The ideal training tool! MPF-1P will deliver you into the growing world of micro-processing. Invest now!

Plus—FREE GIFT Only \$199.95

Check this box for FREE Z-80 Microprocessor Programming and Interfacing textbook when you order within 7 days. \$16.95 value. (Include \$7.50 postage & handling)

ETRONIX
Dept RE0887
5326 9th Ave. N.E.
Seattle, WA 98105-3617

For immediate action call TOLL FREE:

1-800-426-1044

Full money back guarantee. Priced with optional printer.



CIRCLE 111 ON FREE INFORMATION CARD

LEARN TV/VCR REPAIR



No Previous Experience Necessary

Now you can train at home in spare time for a money-making career as a TV/VCR Repair Specialist. No need to quit your job or school. We show you how to troubleshoot and repair videocassette recorders and TV sets, how to handle house calls and shop repairs for almost any make of television or VCR. You learn about TV receivers, tuners and antennas, x-ray emission, the characteristics of sound, how electrical impulses are converted into a TV picture, and much, much more. Tools are included with your course so you can get "hands-on" practice as you follow the lessons step by step. Send for free facts about opportunities in TV/VCR Repair and find out how you can start making money in this great career.

Experts show you what to do, how to do it...guide you every step of the way!

Everything is explained in easy-to-understand language with plenty of drawings, photos and diagrams. But if there is ever anything in your lessons you don't understand, you can write or phone your instructor and you can count on getting an authoritative answer. Send for free facts and color brochure. No cost. No obligation. No salesman will visit you. MAIL COUPON TODAY!

ICS SCHOOL OF TV/VCR REPAIR, Dept. DE077
(Send no money) Scranton, Pennsylvania 18515

Please send me free facts on how I can learn TV/VCR Repair at home in my spare time. No salesman will visit.

Name _____ Age _____

Address _____

City/State/Zip _____

Phone () _____

MARKET CENTER

FOR SALE

RESTRICTED technical information: Electronic surveillance, schematics, locksmithing, covert sciences, hacking, etc. **Huge selection. Free brochure MENTOR-Z**, 135-53 No. Blvd., Flushing, NY 11354.

TV tunable notch filters, free brochure, **D.K. VIDEO**, Box 63-6025, Margate, FL 33063. (305) 752-9202.

FREE power supply with Assortment #103 (February '84 article, has printed circuit, TOKO coils(4), 2N3904(2), BFO85, 7812, 74123, MC1330, 1N914, 1N5231B. TELE-ASE-MAST ASSORTMENT #301 (October Article) Printed Circuit with all IC's, transistors, diodes. Only \$25.00/each assortment. Five/\$112.50. Shipping \$3.00. 1 (800) 821-5226 Ext. 426. (orders), or write JIM RHODES INC., P.O. Box 3421, Bristol, TN 37625.

DESCRAMBLER catalog all makes. Special combo Jerrold 400 and SB3 \$165. New cable descrambler kit \$39.00 (assemblies in half hour). Send \$1.00. **MJ INDUSTRY**, Box 531, Bronx, NY 10461.

TUBES! 59¢. Year guarantee. Free catalog. Tube tester \$8.95. **CORNELL**, 4215 University, San Diego, CA 92105.

IS it true...Jeeps for \$44 through the government? Call for facts! 1 (312) 742-1142, ext. 4673.

OLDTIME radio programs on high quality tapes. Comedy! Adventure! Music! Free catalog. **CARL F. FROELICH**, Heritage Farm, New Freedom, PA 17349.

LINEAR PARTS—transistors: MRF454 \$15, MRF455 \$12, MRF477 \$11, MRF492 \$16.75, MRF421 \$22.50, SRF2072 \$13, SRF3662 \$25, 3800 \$18.75, 2SC2290 \$19.75, 2SC2879 \$25. **Tubes:** 6KD6 \$10.50, 6LQ6 \$9.75, 6LF6 \$9.75, 8950 \$16.75. Best prices on Palomar road noise mics, Ranger AR3300. New 16-page catalog listing radio/amplifier tricks—channel modification, PLL-sliders, peaking for range, hard-to-find linear parts—mail \$1.00 to: **RFPC**, Box 700, San Marcos, CA 92069. For same day parts shipment, call (619) 744-0728.



TUBES - 2000 TYPES DISCOUNT PRICES!
Early, hard-to-find, and modern tubes. Also transformers, capacitors and parts for tube equipment. *Send \$2.00 for 20 page wholesale catalog.*

ANTIQUE ELECTRONIC SUPPLY
688 W. First St. • Tempe, AZ 85281 • 602/894-9503

CABLE TV converters. Scientific Atlanta, Jerrold, Oak, Zenith, Hamlin. Many others. "New" Video Hopper "The copy killer." VHS-wireless remote \$239.00. Visa, M/C & Amex accepted. Toll free 1-(800) 826-7623. **B & B Inc.**, 10517 Upton Circle, Bloomington, MN 55431.

BUILD your own pro monitors 32 pg. 5 part manual discloses design criteria utilized by major manufacturers of pro monitoring systems. Blueprints included! \$25.00 complete to: **BRIX ENTERPRISES INC.**, 2419 Richmond Road, S.I.N.Y. 10306.

SCANNING disk television. Read all about it! "The Mechanics of Television." (1987) 182 pages \$20.00 postpaid. **TESLA ELECTRONICS**, 835 Bricken, Warson Woods, MO 63122.

LEADER LFC-945 signal level meter \$425.00. (312) 771-4661.

TUBES, name brands, new, 80% off list, **KIRBY**, 298 West Carmel Drive, Carmel, IN 46032

ATTENTION looking for surplus test equipment signal generator voltmeter oscilloscope. **J.B. ELECTRONICS**, 9518 Grand, Franklin Park, IL 60131.

TEST equipment, reconditioned. For sale. \$1.25 for catalog. **WALTER'S**, 2697 Nickel, San Pablo, CA 94806. (415) 724-0587.

OLD radio TV schematics. Send \$1.00, make, model. **RADIO MAPS**, P.O. Box 791, Union City, CA 94587.

ROBOT! kits. Books and Plans! Learn to build your own robots. Free catalogs contain hundreds of affordable robot systems. Explore the world of robotics today. Catalog: **CEARGS-ROBOTS!**, POB 458, Peterborough, NH 03458. (603) 924-3843.

LATEST high-performance op-amps, power mosfets. First quality. Send stamped envelope for list. **ANZA INSTRUMENT CO.**, Box 60907, Palo Alto, CA 94306.

CABLE television converter, descrambler and wireless remote control video equipment accessories catalog free. CABLE DISTRIBUTORS UNLIMITED, 116- Main Road, Washington, AR 71862.

LASERS, components and accessories. Free catalog. **M.J. NEAL COMPANY**, 6672 Mallard Ct., Orient, OH 43146.

CB RADIO OWNERS!

We specialize in a wide variety of technical information, parts and services for CB radios. 10M-FM conversions, repairs, books, plans, kits, high-performance accessories. Our 11th year! Catalog \$2.

CBC INTERNATIONAL, P.O. BOX 31500RE. PHOENIX, AZ 85046

SUPERFAST morse code supereasy. Subliminal cassette. \$10.00 Learn Morse Code in 1 hour; amazing new supereasy technique \$10. Both \$17. Moneyback guarantee. Free catalog: **SASE. BAHR**, 2549-E3 Temple, Palmbay, FL 32905.

TUBES, new, unused. Send self-addressed, stamped envelope for list. **FALA ELECTRONICS**, Box 1376-2, Milwaukee, WI 53201.

TUBES: "Oldest", "latest". Parts and schematics. **SASE** for list. **STEINMETZ**, 7519 Maplewood Ave., RE Hammond, IN 46324.

CABLE-TV converters and descramblers. Low prices, quality merchandise, we ship C.O.D. Send \$2.00 for catalog. **CABLETRONICS UNLIMITED**, P.O. Box 266, South Weymouth, MA 02190. (617) 843-5191.

Upgrade CD players, other equipment with Audio Amateur, world's only audio construction quarterly. \$18/year; \$30/two. Satisfaction guaranteed. MC/VISA (603) 924-9464; checks to Box 576, Dept. E77, Peterborough, NH 03458-0576.

ZENITH SSAVI, ready to go \$100.00 plus shipping, order C.O.D. 1 (305) 752-9202.

FREE sample! Discover Apex screwdriving bits, accessories. Sensational fit, remarkable toughness, amazing durability. Write today! **R. SHOCKEY'S**, 5841 Longford, Dayton, OH 45424.

DECODE nearly any Gated Pulse signal with our new super simple circuit. Works on In-band, AM or FM pilot tone—use with Hamlin, Jerrold, Sylvania. Complete plans and theory only \$13.50 plus \$1.50 P&H. **ELEPHANT ELECTRONICS INC.**, Box 41865-J, Phoenix, AZ 85080. (602) 581-1973.

VIDEO scrambling techniques, the original "secret manual" covers Sinewave, Gatedpulse, and SSAVI systems. 56 pages of solid, useful, legible information, only \$14.95 **ELEPHANT ELECTRONICS INC.**, Box 41865-J, Phoenix, AZ 85080. (602) 581-1973.



WRITE FOR
McGEE'S
SPEAKER & ELECTRONICS CATALOG

1001 BARGAINS IN SPEAKERS

toll free 1-800-346-2433 for ordering only.
1901 MCGEE STREET KANSAS CITY, MO. 64108

WHOLESALE car stereos alarms electronics. Huge selection. Catalog \$1.00. **NORMAN ELECTRONICS**, Box 3579A Ridgewood, NY 11386.

BATTERIES rechargeable, gel-lead, pure lead Nicads send for free complete listing of batteries by amp/hr and voltage. **ENERGY CONTROLS**, 20451 Stephens St., Clair Shores, MI 48080. (313) 775-3492.

RESISTORS: 1/4 watt, 5%, all standard values to 4.7 meg, 20 pieces of one value \$1.00 postpaid. **RAHTEC**, Box 36064, Minneapolis, MN 55435.

PCB volume fabrication from Hong Kong **INTEGRITY TECHNOLOGY**, 105 Serra Way, #230, Milpitas, CA 95035-0604.

SURPLUS computers: Multibus, Versabus, S-100, VME, AMIGA, Atari ST—boards, power supplies, test equipment, terminals, disk drives, complete systems. Free catalog. Trading IBM-compatibles for unwanted systems: buying unwanted equipment. **HIGH-TECH SURPLUS**, (203) 723-5694, 490 Wooster Street, Naugatuck, CT 06770.

TAP complete set volumes 1-84 quality copies \$1.00 ppd **PEI**, P.O. Box 463, Mt. Laurel, NJ 08054.

PHOTOFACT folders, under #1400 \$3.00. Others \$5.00. Postpaid. **LOEB**, 414 Chestnut Lane, East Meadow, NY 11554.

EQUIPMENT liquidation: Surplus remote-control converters, with touch-type remotes, favorite channel programmable, digital PLL synthesized, automatic fine tuning, switched TV outlet, 30 day warranty, \$35.00. Quantity package 25 + units \$15.00(¢), field run, as is (includes service manual). Oak minicode N12 decoders quantity package 25 + units \$20.00(¢), field run, as is. "Beeping", notch filter CH3 decoders, 30-day warranty, \$15.00(¢), quantity 25 + \$10.00(¢), field run, as is, shipped prepaid. All others add \$3.00 unit shipping. Send money order to **ELECTRONICS PRESS**, PO Box 10009, Colorado Springs, CO 80932.

Quality Microwave TV Antennas

Super High Gain System \$99.95 (+ shipping)
AMR High Gain System \$79.95 (+ shipping)
Multi-Channel 1.9 to 2.7 GHz

Dealerships, Qty, Pricing, Replacement Parts

Phillips-Tech Electronics
P.O. Box 8533 • Scottsdale, AZ 85252
(602) 947-7700 (\$3.00 Credit all phone orders!)

MasterCard • Visa • C.O.D.'s

Ti-99/4A software/hardware bargains. Hard to find items. Huge selection. Fast service. Free catalog. **DYNA**, Box 690, Hicksville, NY 11801.

Z-TAC Zenith cable unit only \$175.00. Buy 5 at only \$150.00, or 10 at only \$125.00. These units do not use block converters, we install our own VHF tuner for excellent picture quality. UPS daily, COD accepted. All orders shipped 2nd day air, 90 day warranty on units. Call for information or free catalog or write **AMCOM**, P.O. Box 68391, Virginia Beach, VA 23455. Phone: (804) 456-5505.

FREE "National Semi-Condutor" pocket calculator and catalog of car stereo, C's, radar detectors, alarms, accessories. Dirt cheap! Send \$4.00 for postage and handling. **ELECTROMANIA**, 51B Sunrise Highway, Lynbrook, NY 11563.



DO YOU REALLY GET THE BEST BUY FROM THEM?

Let's face it: There will always be some outfit that can undercut a published price. They do it by having no overhead, and no responsibility to you, the consumer.

"So, you want that Jerrold 450 combo? The one that Pacific Cable Co., Inc. is offering for \$199⁰⁰?

Well, that's a good price, but here's what I'll do..." What may happen is that you may save a

couple of bucks at the time. But suppose

there's a problem (and it happens to the best

of them,) and you call that "Dealer"... This could be what you'll hear:

"No, Steve isn't here. He moved out, the bum! And he owes me \$437⁰⁰ on the phone bill! No, I don't know about any guarantees on your Gerald, who's that? Listen, if you see that creep..." etc.

At Pacific Cable Co., you've got an established company who will be here for you, time after time. We may be tough competitors, but we've got a soft spot for our clients! Try us, and be treated right—and we'll prove it by giving a one-year warranty on everything we sell.

Check our prices on Scientific Atlanta Units!

ITEM	1 UNIT	10 OR MORE	ITEM	1 UNIT	10 OR MORE
RCA 36 Channel Converter (Ch.3 output only)	29.00	18.00	*Minicode (N-12) with Vari Sync	99.00	62.00
Panasonic Wireless Converter (our best buy)	88.00	69.00	*Minicode VariSync with Auto On-Off	145.00	105.00
400 or 450 Converter (manual fine tune)	88.00	69.00	Econocode (minicode substitute)	79.00	52.00
*Jerrold 400 Combo	169.00	119.00	Econocode with VariSync	89.00	56.00
Jerrold 400 Hand Remote Control	29.00	18.00	*MLD-1200-3 (Ch.3 output)	99.00	58.00
Jerrold SB-Add-On	89.00	58.00	*MLD-1200-2 (Ch 2 output)	99.00	58.00
*Jerrold SB-Add-On with Trimode	99.00	70.00	*Zenith SSAVI Cable Ready	175.00	125.00
*M-35 B Combo unit (Ch 3 output only)	99.00	70.00	Interference Filters (Ch 3 only)	24.00	14.00
*M-35 B Combo unit with VariSync	109.00	75.00	*Eagle PD-3 Descrambler (Ch 3 output only)	119.00	65.00
*Minicode (N-12)	89.00	58.00	*Scientific Atlanta Add-on Replacement Descrambler	119.00	75.00

CHECK US OUT—WE'LL MEET OR BEAT THE OTHER'S ADVERTISED WHOLESALE OR RETAIL PRICES!



Pacific Cable Co., Inc.

7325½ Reseda Blvd., Dept. R-08
Reseda, CA 91335
(818) 716-5914 • (818) 716-5140

• NO COLLECT CALLS! •

IMPORTANT • When ordering, please have the make and model number of the equipment used in your area—Thank you!

*Call for availability

Prices subject to change without notice

Jerrold is a registered trademark of General Instruments Corp

Quantity	Item	Output Channel	Price Each	TOTAL PRICE
SUBTOTAL				
Shipping Add \$3.00 per unit				
COD & Credit Cards—Add 5%				
TOTAL				

California Penal Code #593-D forbids us from shipping any cable descrambling unit to anyone residing in the state of California.
Prices subject to change without notice

PLEASE PRINT

Name _____

Address _____ City _____

State _____ Zip _____ Phone Number () _____

Cashier's Check Money Order C O D Visa Mastercard

Acct. # _____ Exp Date _____

Signature _____

FOR OUR RECORDS

DECLARATION OF AUTHORIZED USE — I, the undersigned, do hereby declare under penalty of perjury that all products purchased, now and in the future, will only be used on cable TV systems with proper authorization from local officials or cable company officials in accordance with all applicable federal and state laws.

Dated _____ Signed _____

CABLE-TV DESCRAMBLERS. You name it! You'll get it! Specializing in hard to find equipment. Special: **Scientific Atlanta combination with remote \$229.** C.O.D. anywhere. (916) 541-8461. **NATIONAL CABLE/SO. SHORE INC.,** 1512 Roswell Road # 229, Marietta, Georgia 30067

PLANS AND KITS

BUILD this five-digit panel meter and square-wave generator including an ohms, capacitance and frequency meter. Detailed instructions \$2.50. **BAGNALL ELECTRONICS,** 179 May, Fairfield, CT 06430.

HI-FI speaker systems, kits and speaker components from the world's finest manufacturers. For beginners and audiophiles. Free literature. **A&S SPEAKERS,** Box 7462, Denver, CO 80207. (303) 399-8609.

VOICE disguisers! FM bugs! SWL active antenna! Receivers! More! Catalog \$1.00 (Refundable): **XANDI ELECTRONICS,** Box 25647, Dept. 60P, Tempe, AZ 85282.

PROJECTION TV... Convert your TV to project 7 foot picture. Results comparable to \$2,500 projectors... Total cost less than \$30.00 plans and 8" lens \$21.95... Illustrated information **FREE...** **MACROCOMA-GL,** Washington Crossing, PA 18977. Creditcard orders 24hrs. (215) 736-3979.

CRYSTAL radio sets, plans, parts, kits, catalog \$1.00. **MIDCO,** 660 North Dixie Highway, Hollywood, FL 33020.

CATALOG: hobby/broadcasting/1750 meters/ham/CB: transmitters, antennas, scramblers, bugging devices, more! **PANAXIS,** Box 130-F8, Paradise, CA 95967.

FREE catalog 99-cent kits—audio, video, TV, computer parts. **ALLKIT,** 434 W. 4th St., West Islip, NY 11795.

Cable TV Converters

Why Pay A High Monthly Fee?

Jerrold Products include "New Jerrold Tri-Mode," SB-3, Hamlin, Oak VN-12, M-35-B, Zenith, Magnavox, Scientific Atlanta, and more. (Quantity discounts) 60 day warranty. For fast service C.O.D. orders accepted. Send SASE (60 cents postage) or call for info (312) 658-5320. **Midwest Electronics, Inc., HIGGINS ELECTRONICS,** 5143-R W. Diversey, Chicago, IL 60639. MC/Visa orders accepted. No Illinois orders accepted. Mon.-Fri.-9 A.M.-6 P.M. CST

WIRELESS remote cable converters \$60.00 with purchase of selected video kit. \$50.00 boards and parts for video and hobby projects from magazines and other sources. SA turn on kit \$40.00. Video decoder kit \$75.00. Call or write for list and details. **WIZARD,** 1-(419) 243-7856. 24 East Central, Toledo, OH 43608.

JERROLD gated pulse theory. Twelve information-packed pages covering DI & DIC converter operation. Includes introduction to trimode system. \$6.95 plus \$1.50 postage and handling. **ELEPHANT ELECTRONICS INC.,** Box 41865-J, Phoenix, AZ 85080. (602) 581-1973.

DESCRAMBLE the latest video cassette copy-protection scheme. Our simple line zapper circuit takes the jitter out of your picture. Complete plans and theory only \$13.95 plus \$1.50 postage and handling. PC board and complete kits also available. **ELEPHANT ELECTRONICS INC.,** Box 41865-J, Phoenix, AZ 85080. (602) 581-1973.

MINIATURE electronics devices, like James Bonds. Catalog \$2.00. **F&P ENTERPRISES,** Box 51272, Palo Alto, CA 94303-L.

SUPER Octopus circuit tester; plans and user's guide: \$5.00 to **VIEWPOINT,** 8405 Glencrest, Sun Valley, CA 91352.

ELIMINATE light and dark from copying new video tapes. Schematic \$5.95 circuit board \$5.00. **BLED-SOE,** PO Box 3892, Central Point, OR 97502.

DETECTIVES, experimenters. Exciting new plans. Hard to find micro and restricted devices. Large catalog \$5.00 refundable on 1st order. **WILSON,** P.O. Box 5264, Augusta, GA 30906.

ELECTRONICS surveillance book on eavesdropping investigation surveillance includes civil liberties outlined by congress (Office of Technology Assessment). Also covers infrasonic sound (sound below hearing) send \$17.00 to: **COUNTERMEASURES,** P.O. Box 1021, Rowlett, TX 75088.

RADIO, free power, modern day crystal set. Send for info. **MERIDIAN SYSTEMS,** Box 116, Eliot, ME 03903.

ULTRASONIC ranging system measures distances from 6" to 35'. I/O is TTL compatible, can be connected directly to most computers. Experimenter's kit includes one SN28827 ranging module, one Polaroid 50KHz electrostatic transducer, and user's manual with data sheets. Great for alarms, computer mapping, robotics, etc. \$59.95 + \$2.00 postage. \$2.50 for COD. I.O. **MICRODEVICES,** P.O. Box 2386, Canoga Park, CA 91306. (818) 348-8312.

PAY TV AND SATELLITE DESCRAMBLING NOW 120 PAGES

Schematics, theory bypasses 13 cable 7 satellite systems including Alter Dark Video \$14.95 6 Ed Update Only \$8.95 Experiments With VCR together Latest circuits cloning musketeering data \$12.95 Cable TV Two-way security systems design \$12.95 MD's MM's Handbook For microwave hackers \$9.95 Build Satellite Systems Under \$600. \$12.95 Any 3 \$26 Summer catalog \$1

Shojiki Electronics Corp. 1327A Niagara St., Niagara Falls, NY 14303. COD's 716-284-2163

STRANGE stuff. Plans, kits, new items. Build satellite dish \$69.00. Descramblers, bugs, adult toys. Informational photo package \$3.00 refundable. **DI-RIJO CORPORATION,** Box 212, Lowell, NC 28098.

PAC-TEC enclosure specified in Feb. '87 R-E article on Tri-Mode. Pre-drilled. \$24.95 plus \$2.50 S&H. VISA/MASTERCARD accepted. Call (617) 339-1026 or send to **THE HOBBY HELPER,** P.O. Box 308, Bridgewater, MA. 02324.

ULTRASONIC pest repeller: Exceptional design! Complete quality kit \$25.00, assembled \$30.00. **UFO DETECTING BOOK:** Electronic projects, theories, schematics. \$6.00 (NY + 7.5%). **UFONICS,** Box 1847-R, W. Babylon, NY 11704.

MELODY IC, Piezo element and application sheet only \$3.00. **BELL CERAMIC INDUSTRIES, INC.,** 31 Passmore Avenue, Unit 28, Toronto, Ontario, Canada M1V4T9.

DESCRAMBLING, New secret manual. Build your own descramblers for Cable and Subscription TV. Instructions, schematics for SSAVI, gated sync, sinewave. (HBO, Cinemax, Showtime, etc.) \$8.95 + \$1.00 postage. Catalog \$1.00. **CABLETRONICS,** Box 30502R, Bethesda, MD 20814.

SATELLITE descrambling manual, Video Cypher II. Schematics, thorough explanation of digital audio encoding, EPROM code, DES. (HBO, Cinemax, Showtime.) \$10.95 + \$1.00 postage. Catalog \$1.00. **CABLETRONICS,** Box 30502R, Bethesda, MD 20814.

CABLE television converter, descrambler and wireless remote control video equipment accessories catalog free. **CABLE DISTRIBUTORS UNLIMITED, 116-P Main Road, Washington, AR 71862.**

INVENTORS

INVENTORS! Can you patent and profit from your idea? Call **AMERICAN INVENTORS CORPORATION** for free information. Over a decade of service. 1-(800) 338-5656. In Massachusetts or Canada call (413) 568-3753.



HARDWARE AND ELECTRONICS



MAGNIFIER LAMP
• 4 diopter magnifying lens
• Uses up to a 60 watt bulb (not included) UL listed 117VAC
#350-010 **\$2695**

COPPER CLAD PC BOARD

9" x 8" Double Sided #055-300 **\$150**
18" x 12" Double Sided #055-320 **\$395**

RS-232 DATA SWITCH



• 2 position rotary type • Fully shielded, FCC approved
#130-010 **\$2795**

PIONEER HORN TWEETER



• Frequency response 1800 to 15,000Hz • Power handling capabilities 35W RMS, resonant frequency 2kHz 3 1/2" x 3 1/2"
#270-050 **\$650** **\$590**
(11.95) (10-UP)

12" PIONEER WOOFER



• Power: 65W RMS • 11 oz magnet
• 25 to 2500 Hz response • 1" voice coil
#290-100 **\$1550** **\$1395**
(1.31) (4.10)

TOROIDIAL TRANSFORMER



• 120 volt primary 2-20V 5A secondaries • 4 1/2" round • 4 lbs
#120-150 **\$1250** **\$995**
(1-3) (4-UP)

300 PIECE CAPACITOR KIT



• A great assortment of different values and working voltages Includes electrolytics, ceramics, mylers, and more!
#020-020 **\$495**

FREE CATALOG

Our new 56 page catalog contains thousands of items that you need every day for do-it-yourself projects, product engineering, electronics repair and more. Call us today for your free copy and start saving!



CALL TOLL FREE
1-800-255-3525
In Ohio: 1-800-322-3525
Local: (513) 222-0173

• 15 day money back guarantee. • \$10.00 minimum order. • COD orders accepted. • 24 hour shipping.
• Shipping charge • UPS chart rate (\$2.50 minimum charge). Hours 8:30 a.m. - 6 p.m. EST M-F.

PARTS EXPRESS INT'L INC.
340 East First St
Dayton, Ohio 45402



When someone in your family gets cancer, everyone in your family needs help.

Nobody knows better than we do how much help and understanding is needed. That's why our service and rehabilitation programs emphasize the whole family, not just the cancer patient. Among our regular services we provide information and guidance to patients and families transport patients to and from treatment, supply home care items and assist patients in their return to everyday life. Life is what concerns us. So you can see we are even more than the research organization we are so well known to be. No one faces cancer alone.

AMERICAN CANCER SOCIETY

SATELLITE TV

CABLE TV Secrets—the outlaw publication the cable companies tried to ban. HBO, Movie Channel, Showtime, descramblers, converters, etc. Suppliers list included \$8.95. **CABLE FACTS**, Box 711-R, Pataskala, OH 43062.

SATELLITE TV receiver kits! Instructions! Schematics! Catalog \$1.00 (refundable): **XANDI ELECTRONICS**, Box 25647, Dept. 21S, Tempe, AZ 85282.

DESCRAMBLER build our low cost satellite TV video only descrambler for all major movies and sports. Uses all Radio Shack parts. Order P.C. board and instructions by sending cheque, money order, or Visa for \$35.00 U.S. funds to: **VALLEY MICROVALE ELECTRONICS**, Bear River, Nova Scotia, Canada, BOS-1BO. (902) 467-3577.

Multi-Channel Microwave T.V. Receivers

19.27 GHz Parabolic Dish 40" dB Gain
LIFETIME WARRANTY
Complete System \$89.95 (Shipping Incl.)
Replacement Components & Expert Repairs Available

K & S ELECTRONICS Call now for same
P.O. Box 34522 day shipping!
PHOENIX, AZ 85067 (602) 230-0640

VISA/MC/COD For Dealer Rates Call 602-888-4080

SATELLITE TV equipment. Buyers guide, discount prices. \$3.00 **N.E.C.S. INC.**, Box 22808-R1, Little Rock, AR 72221.

SATELLITE scramble newsletter, non-profit publication, descrambler sources, \$1.00, **MICHAEL THOMPSON**, Box 4508, Dieppe, Canada, E1A-6G1.

59 degree brand name LNAs! LNBs! Ku-Band LNBs! Discount pricing! Catalog \$1.00 (refundable): **LNA-RE**, 201 E. Southern, Suite 100, Tempe, AZ 85282.

NEW!! INSTALLATION and REPAIR of VideoCipher® 2000 and 2100

The Only VCR Instructional Video Program Demonstrating

- Normal & Special Installation
 - Setting External Controls
 - Performing Internal Adjustments
 - Determining and Repairing Common Board Problems
 - Replacing Parts Covered by Epoxy
 - Static Precautions & Special Soldering Techniques
- Using **PROTEC**, the electronic test device for the professional TVRO dealer

Everything you've wanted to know shown for the first time, for only \$59.95

Shipping \$9.50. Send check or add \$9.50 COD (Cash, certified check or MC on COD) No credit card, terms. P.O.s N.Y. add 8% tax

TVRO dealers receive \$10.00 rebate towards 1st purchase of **PROTEC** plus discounts worth more than \$50.00 on soldering equipment and accessories.

TESTRON, Inc.
dept R1, 184 Jericho Turnpike, Floral Park, NY 11001
800-991-1009 ext. 301 24 hrs — 7 days (in NY) 516-358-9414

VIDEOCIPHER data disk, Apple II and PC, dial (011)(52) (451)42268 (Mexico), 4-10 PM. CST. for information.

SCIENTIFIC Atlanta cable users series 8500 8550 get all channels instructions for simple modification costs under \$10.00 to make. Complete instructions. Send \$10.00 no checks to **K.F. SPECIALTIES**, P.O. Box 443, Forked River, NJ 08731.

SATELLITE systems \$295 up. VISA MC available. Catalog \$2. **STARLINK INC.**, 2603- 6E Artie, Huntsville, AL 35805.

10ft Satellite system, remote controlled, tracker and descrambler with 1 yr free subscription to 20 channels. \$1,495 plus UPS. **VISTA VISION**, 1 (602) 458-5482 after 10 a.m.

PRINTED CIRCUIT BOARDS

CIRCUIT boards prepared from layouts or CAD files. Call for price list (301) 987-4623. **PEL**, 1205 Generals Highway, Crownsville, MD 21032.

NUTS & VOLTS MAGAZINE P.O. Box 1111-E Placentia, CA 92670
714-632-7721

Subscription Rates
3rd Class Mail USA
One Year \$10.00
Two Year \$18.00
Lifetime \$50.00
1st Class Mail
One Year \$18.00
Two Year \$32.00
Lifetime \$75.00

DIVL YOURSELF A BREAK — A PRICE BREAK!
NUTS & VOLTS WILL SAVE YOU MONEY ON ELECTRONIC PARTS & EQUIPMENT
WE SHOW YOU WHERE TO FIND UNIQUE, UNUSUAL AND HARD-TO-FIND ITEMS.
SUBSCRIBE TODAY!

A National Publication For The Buying And Selling Of Electronic Equipment

BUSINESS OPPORTUNITIES

MECHANICALLY inclined individuals desiring ownership of small electronics manufacturing business—without investment. Write: **BUSINESSES**, 92-F, Brighton 11th, Brooklyn, NY 11235.

PROJECTION TV..Make \$\$\$s assembling projects...results comparable to \$2,500 projectors. Total cost less than \$30.00. **PLANS, 8 LENS** and dealers information \$20.50. Illustrated information free. **MACROCOMA-GLX**, Washington Crossing, PA 18977. Creditcard orders 24hrs. (215) 736-2880.

BIG PROFITS **ELECTRONIC ASSEMBLY BUSINESS**

Start home spare time. Investment knowledge or experience unnecessary. **BIG DEMAND** assembling electronic devices. Sales handled by professionals. Unusual business opportunity.

FREE: Complete illustrated literature
BARTA RE-O Box 248
Walnut Creek Calif 94597

HOME assembly. Assemble PC boards for video accessories. We supply materials. No experience needed. \$7.50 per hour. Send self-addressed stamped envelope, to: **MICRON-ELECTRONICS**, Box 4716, Akron OH 44310.

EASY, lucrative. One man CRT rebuilding machinery. Free info: (815) 459-0666 **CRT**, 1909 Louise, Crystalake, IL 60014.

GREAT VALUES • FAST SHIPPING • QUANTITY DISCOUNTS

MULTIFUNCTIONAL LED D.P.M. SM 43

LARGE 3 1/2 DIGIT 0.6 LED DISPLAY

MEASUREMENT RANGE
D.C. VOLTAGE 1mV - 1000V
A.C. VOLTAGE 1mV - 1000V
DIGITAL THERMOMETER 0°C - 100°C
D.C. CURRENT 1uA - 2A
CAPACITOR METER 1pF - 2uF

Kit \$30.00
Assembled with tested \$36.00

FREE GOLD-PLATED EDGE CONNECTOR ONLY

80W+80W DC LOW TIM PRE-MAIN AMPLIFIER

BUILD A 160W HI-FI STEREO AMP. YOURSELF

Kit \$55.98
Metal Cabinet X 40MMH \$26 \$16.80

SUPERIOR ELECTRONIC ROULETTE

TY 47

Kit \$16.92

BRING 'LAS VEGAS' HOME ONLY

GET GREAT VALUES ON ALL WITH MARK V

TERMS \$10 min order • \$20 min charge card order • Check, money order or phone order accepted • We ship UPS Ground • Add 10% of total order (min \$2.50) for shipping, outside USA add 20% (min \$5.00) • CA residents add sales tax • All merchandise subject to prior sale • Prices are subject to change without notice • Any goods proved to be defective, MUST BE RETURNED IN ORIGINAL FORM WITH A COPY OF YOUR INVOICE WITHIN 30 DAYS FOR REPLACEMENT

0-15V 2A REGULATED DC POWER SUPPLY

ESSENTIAL FOR FACTORIES, PROFESSIONALS & ENTHUSIASTIC AMATEURS!

Kit \$59.50
Ass. with tested \$69.50

- Output voltage is adjustable from 0.15V DC. Two current limit range size available for selection. 200mA or 2A
- An elaborated protection system is specially designed, a BB' sound and a sparkling light will appear when the output is overloaded
- High stability and reliability is resulted by employing high quality voltage regulated IC
- King size meter makes the reading of voltage and current more clearly and accurately
- A refined case, meter and all accessory are enclosed for both kit and assembled form. It is most suitable for professional or amateur use.

20 STEPS BAR/DOT AUDIO LEVEL DISPLAY KIT TY 45

Kit \$34.95

MAKE YOUR STEREO AMP MORE ATTRACTIVE

HIGH QUALITY PRE-AMPLIFIER WITH 10 BAND EQUALIZER TA-2500

Kit \$34.95

NEW with CD input stage

Ass. with tested \$40.00

INFRARED REMOTE CONTROL UNIT TY 41 MKV

FREE DELUXE CONTROL BOX

Kit \$30
Ass. with Tested \$45

CAN BE SWITCHED ON TO ANY ELECTRICAL APPLIANCES UP TO 200W!

NEW FOR 87

FREE CATALOG

PROFESSIONAL COLOR LIGHT CONTROLLER SM-328

Kit \$150.00

FEATURES
1. FOUR GROUPS OF INDEPENDENT OUTPUT SYSTEM 1000W CH. MAX BOARD 1. PRE 3 INDEPENDENT COLOR CONTROL SYSTEM KEY 2. GROUPS OF INDEPENDENT INPUT SIGNAL ADJUSTMENT 4. 4 QUANT. CHASING PROGRAM B. COMBINATION OF PROGRAM 7. FOUR KINDS OF SPECIAL CHASING EFFECT 9. FORWARD BACKWARD AND STOP AND REVERSE LIGHTING 10. CONTROL SYSTEM FOR CLUB LIGHTING 11. CAPABLE OF PRODUCING LIGHTING EFFECTS BY USING CHASING FOUR GROUPS OF LIGHTS 12. THERE ARE TWO KINDS OF LIGHTING EFFECTS, CW A. AND CW B. FREQUENCY RANGE. FURTHERMORE, EACH GROUP OF LIGHTS IS INCORPORATED IN AN INDEPENDENT SIGNAL ADJUSTMENT. THE SECOND KIND IS COMPOSED OF FOUR CHASING PROGRAMS. 13. THE MAIN PART FOR CREATING A SPECIAL LIGHTING EFFECTS

Dimensions 14.5" x 8.15" x 3.15"
Ass. with tested \$150.00

OFFICE HOURS: (PACIFIC TIME) MON.-FRI. 9:30 to 5:00 SAT. 10:00 to 5:00

MARK V ELECTRONICS INC., 248 EAST MAIN STREET, SUITE 100, ALHAMBRA, CA 91801, TELEX: 3716914 MARK 5

1-800-423-3483 TOLL FREE

Only for orders paid by Master or Viscard

IN CAL.: 1-800-521-MARK

INFORMATION: 1-818-282-1196

MAIL ORDER: P.O. BOX 6610, ALHAMBRA, CA 91802

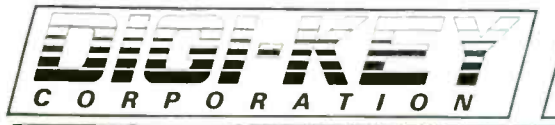

1-800-344-4539 AK, Puerto Rico - 216-681-6674 Telex - 62827914 FAX - 216-681-3380 TWX - 910-558982 DIGI KEY CORP

NATIONAL SEMICONDUCTOR • PANASONIC MACHINE • EWC, INC. • INTERSIL • AD EAC, INC. • J. W. MILLER • AAVID ENGINEER E. F. JOHNSON • ATLANTIC SEMICONDUCTOR

256K (262,144 x 1) DRAM 150NS \$5.70/1; \$39.95/9 Factory Firsts

DIODES • DIAMOND TOOL • UNGAR • ES • CW INDUSTRIES • AMDEK • G.E. JGAR • YAGEO • J. W. MILLER • LUXO 3C CHEMICALS • ARIES • PLESSEY

Table with columns for Part No., Description, Price, and Quantity. Includes sections for 7400 TTL, 74500 TTL, and 7400 CMOS.

SOLDER TAIL DIP SOCKETS. Includes a diagram of a socket and text describing the product.

Carbon Film Resistors. Includes a diagram of a resistor and text describing the product.

DISC CAPACITORS. Includes a diagram of a capacitor and text describing the product.

TANTALUM CAPACITORS. Includes a diagram of a capacitor and text describing the product.

Table with columns for Part No., Description, Price, and Quantity. Includes sections for 74500 TTL and 7400 CMOS.

TI I.C. SOCKETS. Includes a diagram of a socket and text describing the product.

Carbon Film Resistors. Includes a diagram of a resistor and text describing the product.

DISC CAPACITORS. Includes a diagram of a capacitor and text describing the product.

TANTALUM CAPACITORS. Includes a diagram of a capacitor and text describing the product.

Table with columns for Part No., Description, Price, and Quantity. Includes sections for 74500 TTL and 7400 CMOS.

WIRE WRAP DIP SOCKETS. Includes a diagram of a socket and text describing the product.

Carbon Film Resistors. Includes a diagram of a resistor and text describing the product.

DISC CAPACITORS. Includes a diagram of a capacitor and text describing the product.

TANTALUM CAPACITORS. Includes a diagram of a capacitor and text describing the product.

Table with columns for Part No., Description, Price, and Quantity. Includes sections for 74500 TTL and 7400 CMOS.

WIRE WRAP DIP SOCKETS. Includes a diagram of a socket and text describing the product.

Carbon Film Resistors. Includes a diagram of a resistor and text describing the product.

DISC CAPACITORS. Includes a diagram of a capacitor and text describing the product.

TANTALUM CAPACITORS. Includes a diagram of a capacitor and text describing the product.

Table with columns for Part No., Description, Price, and Quantity. Includes sections for 74500 TTL and 7400 CMOS.

WIRE WRAP DIP SOCKETS. Includes a diagram of a socket and text describing the product.

Carbon Film Resistors. Includes a diagram of a resistor and text describing the product.

DISC CAPACITORS. Includes a diagram of a capacitor and text describing the product.

TANTALUM CAPACITORS. Includes a diagram of a capacitor and text describing the product.

When ordering by phone call 1-800-344-4539 (AK, CA 216-681-6674) by MAIL SEND YOUR ORDER TO: DIGI-KEY, P.O. Box 477, Thief River Falls, MN 56701.

WIRE WRAP DIP SOCKETS. Includes a diagram of a socket and text describing the product.

Carbon Film Resistors. Includes a diagram of a resistor and text describing the product.

DISC CAPACITORS. Includes a diagram of a capacitor and text describing the product.

TANTALUM CAPACITORS. Includes a diagram of a capacitor and text describing the product.

The Dig-Key volume discount and service charges are simple to apply. Most items sold by Dig-Key may be combined for a volume discount. Items that are not discountable are identified by the suffix RD following the part number.

WIRE WRAP DIP SOCKETS. Includes a diagram of a socket and text describing the product.

Carbon Film Resistors. Includes a diagram of a resistor and text describing the product.

DISC CAPACITORS. Includes a diagram of a capacitor and text describing the product.

TANTALUM CAPACITORS. Includes a diagram of a capacitor and text describing the product.

WIRE WRAP DIP SOCKETS. Includes a diagram of a socket and text describing the product.

Carbon Film Resistors. Includes a diagram of a resistor and text describing the product.

DISC CAPACITORS. Includes a diagram of a capacitor and text describing the product.

TANTALUM CAPACITORS. Includes a diagram of a capacitor and text describing the product.

WIRE WRAP DIP SOCKETS. Includes a diagram of a socket and text describing the product.

Carbon Film Resistors. Includes a diagram of a resistor and text describing the product.

DISC CAPACITORS. Includes a diagram of a capacitor and text describing the product.

TANTALUM CAPACITORS. Includes a diagram of a capacitor and text describing the product.

WIRE WRAP DIP SOCKETS. Includes a diagram of a socket and text describing the product.

Carbon Film Resistors. Includes a diagram of a resistor and text describing the product.

DISC CAPACITORS. Includes a diagram of a capacitor and text describing the product.

TANTALUM CAPACITORS. Includes a diagram of a capacitor and text describing the product.

WIRE WRAP DIP SOCKETS. Includes a diagram of a socket and text describing the product.

Carbon Film Resistors. Includes a diagram of a resistor and text describing the product.

DISC CAPACITORS. Includes a diagram of a capacitor and text describing the product.

TANTALUM CAPACITORS. Includes a diagram of a capacitor and text describing the product.

WIRE WRAP DIP SOCKETS. Includes a diagram of a socket and text describing the product.

Carbon Film Resistors. Includes a diagram of a resistor and text describing the product.

DISC CAPACITORS. Includes a diagram of a capacitor and text describing the product.

TANTALUM CAPACITORS. Includes a diagram of a capacitor and text describing the product.

WIRE WRAP DIP SOCKETS. Includes a diagram of a socket and text describing the product.

Carbon Film Resistors. Includes a diagram of a resistor and text describing the product.

DISC CAPACITORS. Includes a diagram of a capacitor and text describing the product.

TANTALUM CAPACITORS. Includes a diagram of a capacitor and text describing the product.

WIRE WRAP DIP SOCKETS. Includes a diagram of a socket and text describing the product.

Carbon Film Resistors. Includes a diagram of a resistor and text describing the product.

DISC CAPACITORS. Includes a diagram of a capacitor and text describing the product.

TANTALUM CAPACITORS. Includes a diagram of a capacitor and text describing the product.

WIRE WRAP DIP SOCKETS. Includes a diagram of a socket and text describing the product.

Carbon Film Resistors. Includes a diagram of a resistor and text describing the product.

DISC CAPACITORS. Includes a diagram of a capacitor and text describing the product.

TANTALUM CAPACITORS. Includes a diagram of a capacitor and text describing the product.

WIRE WRAP DIP SOCKETS. Includes a diagram of a socket and text describing the product.

Carbon Film Resistors. Includes a diagram of a resistor and text describing the product.

DISC CAPACITORS. Includes a diagram of a capacitor and text describing the product.

TANTALUM CAPACITORS. Includes a diagram of a capacitor and text describing the product.

WIRE WRAP DIP SOCKETS. Includes a diagram of a socket and text describing the product.

Carbon Film Resistors. Includes a diagram of a resistor and text describing the product.

DISC CAPACITORS. Includes a diagram of a capacitor and text describing the product.

TANTALUM CAPACITORS. Includes a diagram of a capacitor and text describing the product.

WIRE WRAP DIP SOCKETS. Includes a diagram of a socket and text describing the product.

Carbon Film Resistors. Includes a diagram of a resistor and text describing the product.

DISC CAPACITORS. Includes a diagram of a capacitor and text describing the product.

TANTALUM CAPACITORS. Includes a diagram of a capacitor and text describing the product.

WIRE WRAP DIP SOCKETS. Includes a diagram of a socket and text describing the product.

Carbon Film Resistors. Includes a diagram of a resistor and text describing the product.

DISC CAPACITORS. Includes a diagram of a capacitor and text describing the product.

TANTALUM CAPACITORS. Includes a diagram of a capacitor and text describing the product.

WIRE WRAP DIP SOCKETS. Includes a diagram of a socket and text describing the product.

Carbon Film Resistors. Includes a diagram of a resistor and text describing the product.

DISC CAPACITORS. Includes a diagram of a capacitor and text describing the product.

TANTALUM CAPACITORS. Includes a diagram of a capacitor and text describing the product.

WIRE WRAP DIP SOCKETS. Includes a diagram of a socket and text describing the product.

Carbon Film Resistors. Includes a diagram of a resistor and text describing the product.

DISC CAPACITORS. Includes a diagram of a capacitor and text describing the product.

TANTALUM CAPACITORS. Includes a diagram of a capacitor and text describing the product.

WIRE WRAP DIP SOCKETS. Includes a diagram of a socket and text describing the product.

Carbon Film Resistors. Includes a diagram of a resistor and text describing the product.

DISC CAPACITORS. Includes a diagram of a capacitor and text describing the product.

TANTALUM CAPACITORS. Includes a diagram of a capacitor and text describing the product.

Table with columns for Service Charges and Volume Discount. Includes rows for 0.00-8.99, 9.00-25.00, 25.00-49.99, 50.00-99.99, 100.00-499.99, 500.00-999.99, 1000.00 & Up.

CIRCLE 82 ON FREE INFORMATION CARD

Worldwide • Since 1974

• QUALITY COMPONENTS • COMPETITIVE PRICING
• PROMPT DELIVERY

Mail Order Electronics - Worldwide
Jameco
ELECTRONICS

COMMODORE® COMPATIBLE ACCESSORIES



HESWARE 300 Baud Modem
FOR VIC-20 AND C-64
• Connects directly to User Port • Manual Answer/Dial • Function keys defined for convenience
• Includes Midwest Micro Associates communication software.

CM-1 (For VIC-20 and C-64) ~~\$24.95~~ \$19.95

External Power Supplies

CPS-10 (For C-64) \$39.95
CPS-128 (For C-128) \$59.95

RS232 Interface

Allows connection of standard serial devices.
JE232CM (For VIC-20, C-64 & C-128) . . . \$39.95
Operation with the C-128 in 64 mode only

TRS-80/TANDY® COMPATIBLE ACCESSORIES

E-X-P-A-N-D TRS-80 MEMORY

All kits come complete with documentation

TRS-80 MODEL 4, 4P, & 40 64K/128K EXPANSION TRS-64K-2 \$7.95
Expands Model 4 from 16K, 64K or Model 4 (Gate Array Version) 4P and 4D from 64K-128K

TRS-64K-2PAL \$14.95 \$13.95
Expands Model 4 (Non-Gate Array Version) from 64K to 128K

TRS-80 MODEL 100 8K EXPANSION M1008K \$19.95 \$17.95

ZUCKERBERG® TANDY 1000 Expansion Memory Half Card

Expand the memory of your Tandy 1000 (128K Version) to as much as 640K. Also includes DMA controller chip

TAN-EM256K Includes 256K RAM \$ 99.95
TAN-EM512K Includes 512K RAM \$119.95
TAN-C Plug-in Clock option chip (only) \$39.95

NEW! 20Meg Hard Disk NEW!

T20MB 20MB Hard Disk Drive Board for Tandy 1000 . . . \$579.95 \$494.95
SX20MB 20MB Hard Disk Drive Board for Tandy 1000SX \$589.95 \$499.95

TANDY 1000 Multifunction Board with Clock Calendar

Expand the memory on your Tandy 1000 (128K Version) to as much as 640K. Complete with an RS232 port, clock/calendar, RAM Disk Printer Spooler, and on-board DMA controller chip

MTAN-256K Includes 256K RAM \$179.95
MTAN-512K Includes 512K RAM \$199.95

NEW! Multifunction Board for TANDY 1000SX NEW!

M256K Includes 256K RAM \$189.95

UV-EPROM ERASER

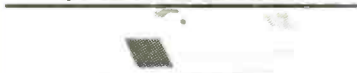

Erases all EPROMs. Erases up to 8 chips within 21 minutes (1 chip in 15 minutes). Maintains constant exposure distance of 1" Special conductive foam liner eliminates static build-up. Built-in safety lock to prevent UV exposure. Compact - 9"00" L x 3"70" W x 2"60" H. Complete with holding tray for 8 chips

DE-4 UV-EPROM Eraser \$69.95
UVS-11EL Replacement Bulb . . . \$19.95
NCF-2 Cond. Foam 12x24x1/2" Hard Blk. \$ 8.95

NOW YOU CAN BUILD AN IBM PC/XT COMPATIBLE!

Jameco's IBM PC/XT Compatible Kit



SAVE \$90.35

- 4164-150 128K RAM (18 Chips) . . . \$20.70
- IBM-FCC Floppy Controller Card . . . \$34.95
- IBM-Case Flip-Top Case \$34.95
- JE1015 XT/AT Style Keyboard . . . \$59.95
- JE1030 150 Watt Power Supply . . . \$69.95
- JE1050 Mono/Graph. Crd. w/Port \$69.95
- JE1020 5 1/4" DSDD Disk Drive . . . \$99.95
- IBM-MON 12" Mono. Green Monitor \$99.95
- IBM-MB XT Motherboard (Zero-K RAM-incl. DTK/ERSO BIOS ROM) \$99.95

FREE! QUICKSOFT PC WRITE WORD PROCESSING SOFTWARE INCLUDED!

Weight: 48 lbs. Regular List \$590.30

JE1004 (Includes 9 items above) \$499.95

ADDITIONAL ADD-ONS AVAILABLE!

- RS232HC RS232 Serial Half Card \$ 29.95
 - EM-100 Expansion Memory Half Card (without RAM) . . \$ 59.95
 - JE1052 Integrated Color Graphics Board \$ 59.95
 - JE1078 Multifunction 0-384K RAM (without RAM) \$ 89.95
 - PM1200B-2 1200/300 Baud Half Card Modem without software . . \$119.95
 - PM1200B-2S 1200/300 Baud Half Card Modem with Mirror Software . . \$149.95
 - JE1055 Enhanced Graphics 256K Video RAM \$199.95
 - TTX-1410 14" RGB Color Monitor \$289.95
 - ST225K 20MB Hard Disk Drive, Controller & Cable . . . \$339.95
- IBM is a registered trademark of IBM Computers

NEW PRODUCTS!

NEW! Logitech Mice SALE!

IBM PC/XT Compatible

- C7BASE C7 Mouse with 3.1 Software \$84.95
- C7PLUS C7 Mouse w/PLUS Pkg. Software \$94.95
- C7BUS C7 Mouse w/Bus Brd. & PLUS Pkg. Sftwr. \$109.95

IBM PC/XT/AT Compatible Keyboard



NEW! AT Style Layout

• Tactile touch keyswitches • AT style layout • Switch selectable between PC/XT or AT • Illuminated Caps Lock, Num Lock and Scroll Lock indicators • Low profile design • 8 1/2' foot cord • Manual included • Size: 18" L x 7 1/2" W x 1 1/2" H

JE1015 \$59.95

IBM PC/XT Compatible Enhanced Keyboard

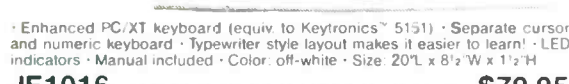

• Enhanced PC/XT keyboard (equiv to Keytronic's™ 5151) • Separate cursor and numeric keyboard • Typewriter style layout makes it easier to learn! • LED indicators • Manual included • Color: off-white • Size: 20" L x 8 1/2" W x 1 1/2" H

JE1016 \$79.95

Turbo 4.77/8MHz Motherboard



IBM PC/XT Compatible

• 75% faster than the IBM PC while in the turbo mode • Turbo Mode selectable through either software or hardware

- Expandable to 640K (comes w/zero-K)
- DTK/ERSO BIOS included

TURBO SALE! . . . \$129.95 \$119.95

APPLE COMPATIBLE ACCESSORIES

Jameco Parallel Printer Card for Apple II, II+ and IIe



- Intelligent interface to most dot matrix graphics printers
- Centronics standard
- Advanced text printing

JE880 Parallel Printer Card \$49.95

JE883 64K Buffer for JE880 \$69.95 \$49.95

JE880J JE880 and JE883 \$99.95 \$89.95

Jameco Extended 80-Column Card for Apple IIe



• 80 Col /64K RAM • Doubles amount of data your Apple IIe can display as well as its memory capacity • Ideal for word processing • Complete with instructions

JE864 \$59.95

Additional Apple Compatible Products Available

Jameco JE310 Fiber Optics Experimenter Kit



NEW! Educational device gives students and engineers hands-on experience with fiber optic technology

- Step by step instructions • Includes transmitter & receiver circuits boards, as well as all nec. IC's, cables & connectors

JE310 Fiber Optic Kit \$19.95

Jameco JE450 Solderless Proto-Type Builder

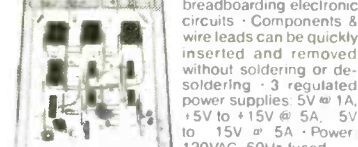

• Provides user with quick and efficient system for breadboarding electronic circuits • Components & wire leads can be quickly inserted and removed without soldering or desoldering • 3 regulated power supplies: 5V @ 1A, +5V to +15V @ 5A, 1V to 15V @ 5A • Power: 120VAC 60Hz fused

NEW! JE450 Solderless Proto-Type Builder . . . \$119.95

IBM Compatible! DISK DRIVES

FD55B Teac 5 1/4" DS 1/2-H (IBM PC/XT) . . . \$109.95
JU-455 Panasonic 5 1/4" DS 1/2-H (IBM PC/XT) \$109.95
JU-475 Panasonic 5 1/4" DS 1/2-H (IBM AT) . . . \$129.95

DATA BOOKS

- 30003 National Linear Data Book (82) \$14.95
- 30009 Intersil Data Book (86) \$ 9.95
- 30013 Zilog Data Book (85) \$14.95
- 30032 National Linear Supplement (84) \$ 6.95
- 210830 Intel Memory Handbook (87) \$17.95
- 23C843 Intel Microsystem Hndbk. Set (87) . . . \$24.95

MUFFIN/SPRITE-STYLE FANS

- MUF60 \$9.95
Torn Industries (4 68" sq. 60 cfm)
- SU2A1 \$8.95
EG&G Rotron (3 125" square, 20 cfm)

\$20 Minimum Order - U.S. Funds Only
Shipping: Add 5% plus \$1.50 Insurance

California Residents: Add 6%, 6 1/2% or 7% Sales Tax
We reserve the right to substitute manufacturers.

Data Sheets - 50¢ each
Prices Subject to Change

Send \$1.00 Postage for a FREE Seasonal Flyer
FAX 415-592-2503
8/87



Send \$1.00 Postage for a FREE 1987 CATALOG
Telex: 176043

© 1987 Jameco Electronics

1355 SHOREWAY RD., BELMONT, CA 94002 • FOR ORDERS ONLY 415-592-8097 • ALL OTHER INQUIRIES 415-592-8121

Computer Power Command Center for only \$39.95!
At this price they won't last long, so order yours today!



This superb monitor stand puts control of your entire system at your fingertips! Our special purchase of these units can put one in your hands at an unbeatable price!

TILT & SWIVEL POWER COMMAND

\$39.95
X-1128

Get rid of that confusing maze of wires and ease operator fatigue with this one fantastic product! The monitor stand swivels 360° and tilts 12.5° to improve line of sight and minimize glare. The electronics built into the base provide EMI filtering and surge & spike protection for five component inputs. You can plug your computer, monitor, printer, and two other devices into the 3-pin sockets in the back of the stand and control them individually with the lighted rocker switches on the front. Or turn the entire system on and off with the master control switch!

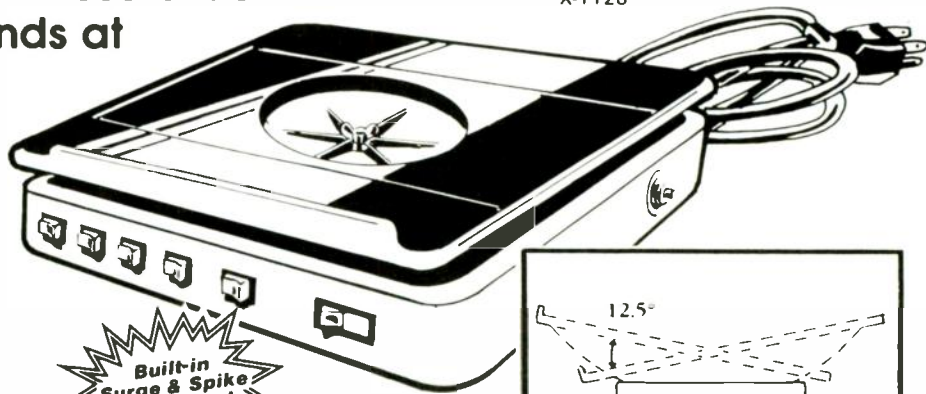

SIZE: 11 1/4" W x 10 1/4" D x 3 1/4" H
 WEIGHT: 4 lbs.
 POWER CORD: 54" 14 AWG x 3C
 CIRCUIT BREAKER: 15 Amp

Compare Our Price!

Dealer Inquiries welcome! Just circle reader service number 189

20MHz Dual Trace Scope Price Breakthrough!

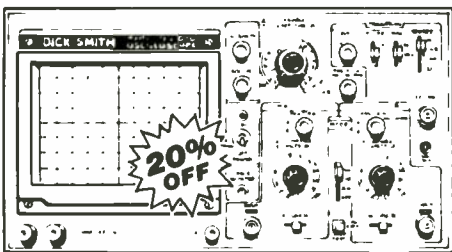

was \$399 - **SAVE \$80 now \$319!**

- Includes quality probes (x1, x10, gnd)
- Built-in component tester
- TV-video sync filter
- X - Y operation
- Z-axis (intensity modulation)
- 1 year warranty

Q-1240

Oscilloscope
SALE

CRT Probe Set



\$29.95
Q-1245

Versatile probe suits virtually any scope. It features built-in x1 x10 switch, 4' of SHIELDED cable with BNC connector and wandering earth lead with alligator clip, insulating shroud.
Specifications: Working voltage - 600V Pk (or 600V DC) • Bandwidth - x1 DC-10MHz/x10 DC-100MHz • Input resistance - x1 1M ohm/x10 10M ohm • Input capacitance - x1 40pF ± CRO input c/x10 10-60pF • REF position - probe grounded via 9M resistor

Please Note: Sale prices are available by MAIL ORDER ONLY. You must mention this ad and quote the prices on the items you wish, offer valid through July 31, 1987 or while supplies last - quantities are limited, so hurry!

SPECIFICATIONS	15 MHz PORTABLE DUAL TRACE	20 MHz DUAL TRACE	35 MHz DUAL TRACE	50 MHz DUAL TRACE
Rise time (usec)	24	<17.5	<10	<7.7
Max input		600V p-p or 300V (DC ± peak AC)		
Input impedance		1M ohms shunted by 20pF ± 3pF for all models		
Chop frequency		200 KHz (approx) for all models		
Channel separation	60dB @ 1 KHz	60dB @ 1 KHz	60dB @ 1 KHz	70dB @ 1 KHz
Time base	.5 usec - .5 sec	.2 usec to .5 sec	.1 usec - .5 sec	2 usec - .5 sec
CRT	95mm	5"	5"	5"
Cat No	Q-1244	Q-1240	Q-1241	Q-1243
NOW SAVINGS	\$349 \$150	\$319 \$80	\$449 \$150	\$649 \$250

All scopes are supplied with schematics

14-Day Satisfaction Guarantee

MAIL ORDERS

DSE, P.O. BOX 8021, Redwood City, CA 94063
 We ship UPS Ground unless otherwise requested. Add 5% of order total (min \$1.50) for shipping. Outside USA add 20% (min \$4). There is an additional \$1.50 handling fee. California residents please add sales tax. VISA and MASTERCARD welcome. Minimum order value \$20.00

Order by Phone
415-368-1066

Mon - Fri 7am - 6pm
 Pacific Time

DICK SMITH ELECTRONICS

Stores in BERKELEY CA (415) 486-0755 REDWOOD CITY CA (415) 368-8844 SAN JOSE CA (408) 241-2266

To receive your copy of our colorful 148 page catalog, circle Reader Service 190

Here is just a sample of what you'll find at MCM Electronics

Tenna 15MHz Dual Trace Portable Oscilloscope

- Dual trace model capable of displaying signals up to 15MHz for up to two hours on a single charge of its internal battery
- Power can be supplied from either a 12VDC or 120/240V 50/60Hz AC source

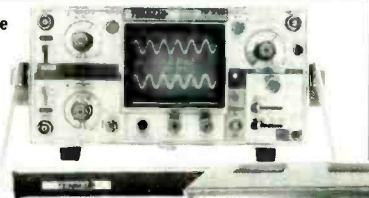

Tenna 10 Amp Regulated Power Supply

- Output: Regulated 13.8VDC ■ Input: 120VAC ■ Fuse protected ■ With easily accessible fuse holder ■ Neon light indicator ■ Heavy duty binding posts ■ Effective heat sinks for more power dissipation ■ Output current: 10 amp one minute on, three minutes off; 7 amp continuous



Tenna LCR Meter

- LCR Meter provides a convenient way to accurately measure inductance, capacitance and resistance (.01ohm resolution) on its 3 1/2 digit LCD display

For more specs and Test Equipment see pages 146-154 of Catalog #15

Anti-Static Work Mat

- A must for the modern service shop.
- Use in conjunction with our #21-660 wrist strap to help eliminate static related problems
- 18" x 26"

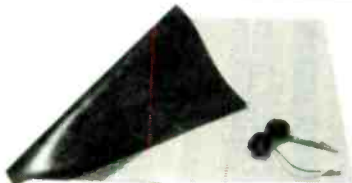

Anti-Static Wrist Strap

- This wrist strap when used with our anti-static work mat, will effectively dissipate static charges
- The five foot coiled, cord with 1Mohm resistor, snaps to wrist strap to give user added mobility
- Cord is terminated with a banana plug and alligator clip



For complete information see page 136 of Catalog #15

Be Sure To Call For Your FREE Catalog! Over 7,000 Items! Call Toll Free 1-800-543-4330

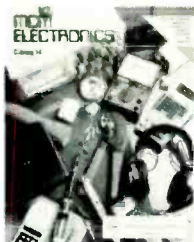

In Ohio 1-800-762-4315
In Alaska and Hawaii 1-800-858-1849

CIRCLE 87 ON FREE INFORMATION CARD

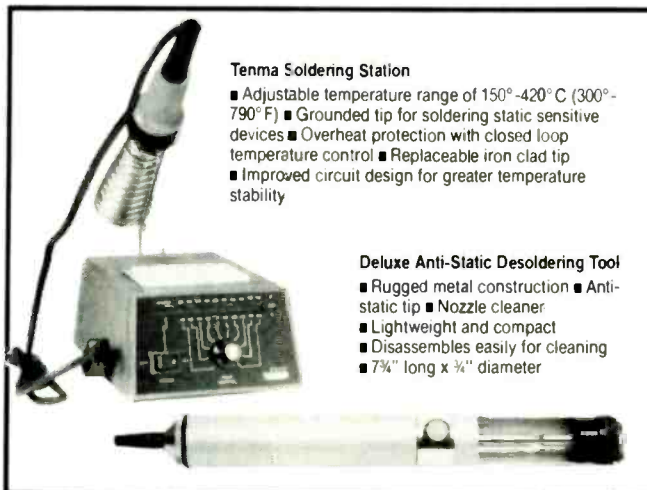

Tenna Soldering Station

- Adjustable temperature range of 150°-420° C (300°-790° F)
- Grounded tip for soldering static sensitive devices
- Overheat protection with closed loop temperature control
- Replaceable iron clad tip
- Improved circuit design for greater temperature stability

Deluxe Anti-Static Desoldering Tool

- Rugged metal construction
- Anti-static tip
- Nozzle cleaner
- Lightweight and compact
- Disassembles easily for cleaning
- 7 1/4" long x 3/4" diameter

Additional Soldering Equipment can be found on pages 137 and 138 of Catalog #15

Super Wash

- Powerful spray cleans intricate electronic assembly without harming plastics
- Dries instantly
- Spray literally blasts dirt and grease away
- 24 oz.



Tuner Cleaner

- Cleans, lubricates, protects
- Cleans and restores dirty and corroded contacts
- Doesn't harm plastics
- 16 oz.



Wire Stripper and Cutter

- Made of tempered steel
- Adjustment can be set for wire sizes 10-24 gauge
- Return spring
- Cushion grip
- 5 1/4" long



For more Chemicals and Tools see pages 128-136 of Catalog #15



Diskette File Box

- Stores up to 70 — 5 1/4" diskettes
- Case made of anti-static ABS plastic with smoked acrylic cover
- Six adjustable index dividers

Deluxe Joystick for Atari and Commodore

- For use with Atari, Commodore and other VCS compatible systems
- Two firing buttons
- 5.5' cord with 9 pin plug

Catalog #15 has other Computer Equipment and Accessories on pages 119-127

© 1987, MCM Electronics



MCM ELECTRONICS
858 E. CONGRESS PARK DR.
CENTERVILLE, OH 45459
A PREMIER Company

SOURCE CODE: RE-35

EGA CARD AND MONITOR NOW ONLY \$569!

DISK DRIVES FOR APPLE COMPUTERS

AP-150
\$99.95



- 1/2 HT. DIRECT DRIVE
- 100% APPLE COMPATIBLE
- SIX MONTH WARRANTY

AP-135
\$129.95

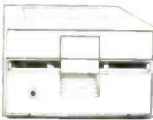

- FULL HT SHUGART MECHANISM
- DIRECT REPLACEMENT FOR APPLE DISK II
- SIX MONTH WARRANTY

DOUBLE SIDED!

MAC535
\$249.95



- 3.5" ADD-ON DISK DRIVE
- 100% MACINTOSH COMPATIBLE
- DOUBLE SIDED 800K BYTE STORAGE
- HIGH RELIABILITY DRIVE
- HAS AUTO-EJECT MECHANISM
- FULL ONE YEAR WARRANTY

AD-3C
\$139.95

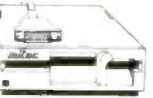

- 100% APPLE IIc COMPATIBLE
- READY TO PLUG IN, W/ SHIELDED CABLE & MOLDED 19 PIN CONNECTOR
- FAST, RELIABLE SLIMLINE DIRECT DRIVE
- SIX MONTH WARRANTY

DISK DRIVE ACCESSORIES

- FDD CONTROLLER CARD \$49.95
 - IIc ADAPTOR CABLE \$19.95
- ADAPTS STANDARD APPLE DRIVES FOR USE WITH APPLE IIc

KB-1000 \$79.95

CASE WITH KEYBOARD FOR APPLE TYPE MOTHERBOARD

- USER DEFINED FUNCTION KEYS
- NUMERIC KEYPAD W/ CURSOR CONTROL
- CAPS LOCK
- AUTO-REPEAT

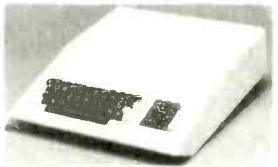

KEYBOARD-AP \$49.95

- REPLACEMENT FOR APPLE II KEYBOARD
- CAPS LOCK KEY, AUTO-REPEAT
- ONE KEY ENTRY OF BASIC OR CP/M COMMANDS

JOYSTICK CB-10 \$19.95

- SET X-Y AXIS FOR AUTO CENTER OR FREE MOVEMENT
- FIRE BUTTON FOR USE WITH GAME SOFTWARE
- ATTRACTIVE, SOLID, PLASTIC CASE
- INCLUDES ADAPTOR CABLE FOR IBM, APPLE II, IIc, IIc, ATARI & VIC 20/64



POWER STRIP \$12.95

- UL APPROVED
- 15A CIRCUIT BREAKER

CRT MONITORS FOR ALL APPLICATIONS



CASPER EGA MONITOR

- EGA & CGA COMPATIBLE
- SCANNING FREQUENCIES: 15.75 - 21.85 KHz
- RES: 640 x 200 - 350
- 31mm DOT PITCH, 25 MHz
- 16 COLORS OUT OF 64
- 14" BLACK MATRIX SCREEN

\$399.95



CASPER RGB MONITOR

- COLOR / GREEN / AMBER SWITCH ON REAR
- DIGITAL RGB-IBM COMPATIBLE
- 14" NON-GLARE SCREEN
- RESOLUTION: 640H x 240V
- 39mm DOT PITCH
- CABLE FOR IBM PC INCLUDED

\$299.95



SAMSUNG MONOCHROME

- IBM COMPATIBLE TTL INPUT
- 12" NON-GLARE AMBER / LOW DISTORTION SCREEN
- RESOLUTION: 720H x 350V
- ATTRACTIVE CASE WITH SWIVEL BASE
- ONE YEAR WARRANTY

\$119.95



FORTRONICS MONOCHROME

- IBM COMPATIBLE TTL INPUT
- 12" NON-GLARE SCREEN
- VERY HIGH RESOLUTION: 1100 LINES (CENTER)
- 25 MHz BANDWIDTH
- CABLE FOR IBM PC INCLUDED

\$99.95

TILT & SWIVEL MONITOR STAND \$129.50

WITH POWER CENTER \$399.95

APPLE COMPATIBLE INTERFACE CARDS



EPROM PROGRAMMER

- DUPLICATE OR BURN ANY 274x SERIES EPROM (2716 TO 27128)
- MENU DRIVEN SOFTWARE
- HIGH SPEED WRITE ALGORITHM

RP-525 \$59.95



16K RAMCARD

- FULL 2 YEAR WARRANTY
- EXPAND YOUR 48K MACHINE TO 2 FULL 64K OF MEMORY
- CAN BE USED IN PLACE OF THE APPLE LANGUAGE CARD

RAM-CARD \$39.95



IC TEST CARD

- QUICKLY TESTS MANY COMMON ICs
- DISPLAYS PASS OR FAIL
- TEST 4000 & 74HC SERIES CMOS: 7400, 74LS, 74H, 74S

IC-TESTER \$129.95

MOLDED INTERFACE CABLES

6 FOOT, 100% SHIELDED, MEETS FCC



- IBM PARALLEL PRINTER CABLE 9.95
- CENTRONICS (MALE TO FEMALE) 15.95
- CENTRONICS (MALE TO MALE) 14.95
- MODEM CABLE (FOR IBM) 7.95
- RS232 SERIAL (MALE TO FEMALE) 9.95
- RS232 SERIAL (MALE TO MALE) 9.95
- KEYBOARD EXTENDER (COILED) 7.95
- APPLE II JOYSTICK EXTENDER 4.95

C. ITOH RITEMAN II PRINTER



- 160 CPS DRAFT, 32 CPS NLQ
- 9 x 9 DOT MATRIX
- SUPPORTS EPSON / IBM GRAPHICS
- FRICTION AND PIN FEEDS
- VARIABLE LINE SPACING AND PITCH

\$219.95

- IBM PRINTER CABLE \$8.95
- REPLACEMENT RIBBON CARTRIDGE \$7.95

SWITCH BOXES

ALL LINES SWITCHED, GOLD PLATED CONNECTORS, QUALITY SWITCHES

2 WAY \$39.95

- CONNECTS 2 PRINTERS TO 1 COMPUTER OR VICE VERSA

AB-P (CENTRONICS PARALLEL)
AB-S (RS232 SERIAL)

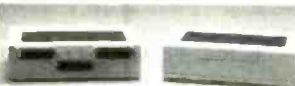

3 WAY \$99.95

- CONNECTS 3 PRINTERS TO 1 COMPUTER OR VICE VERSA

SWITCH-3P (CENTRONICS PARALLEL)
SWITCH-3S (RS232 SERIAL)



300B MODEM \$49.95

FOR APPLE OR IBM

- INCLUDES ASCII PRO-EZ SOFTWARE
- FCC APPROVED
- BELL SYSTEMS 103 COMPATIBLE
- INCLUDES AC ADAPTOR
- AUTO-DIAL DIRECT CONNECT
- CABLE FOR APPLE IIc \$14.95

NASHUA DISKETTES

NASHUA DISKETTES WERE JUDGED TO HAVE THE HIGHEST POLISH AND RECORDED AMPLITUDE OF ANY DISKETTES TESTED (COMPARING FLOPPY DISKS, BYE 9/86)

- N-MD2D DS DD 5" SOFT \$9.95
- N-MD2F DS QUAD 5" SOFT \$19.95
- N-MD2H DS HD 5" FOR A1 \$24.95
- N-FD1 SS DD 8" SOFT \$27.95
- N-FD2D DS DD 8" SOFT \$34.95

BULK DISKETTE SALE

5 1/4" SOFT SECTOR, DS, DD W/ TYVEC SLEEVES & HUB RINGS

\$990 690ea 590ea
BOX OF 10 BULK QTY 50 BULK QTY 250

DISKETTE FILES

- 5 1/4" DISKFILE HOLDS 70 \$8.95
- 3 1/2" DISKFILE HOLDS 40 \$9.95

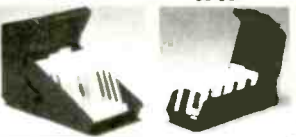

Seagate

5 1/4" HARD DISK DRIVES

- ST-225 HALF HT 20MB 65ms \$275
- ST-238 HALF HT 30MB 65ms (RL) \$299
- ST-251 HALF HT 40MB 40ms \$599
- ST-277 HALF HT 60MB 40ms (RL) CALL
- ST-4038 FULL HT 30MB 40ms \$559
- ST-4096 FULL HT 80MB 28ms \$1195

1/2 HEIGHT FLOPPY DISK DRIVES

- 5 1/4" TEAC FD-55B DS DD \$109.95
- 5 1/4" TEAC FD-55F DS QUAD \$124.95
- 5 1/4" TEAC FD-55GFV DS HD \$154.95
- 5 1/4" MITSUBISHI DS HD \$129.95
- 3 1/2" TOSHIBA KIT DS DD \$149.95

KIT INCLUDES MOUNTING HARDWARE TO FIT 5 1/4" & FACEPLATES FOR AT & XT

DISK DRIVE ACCESSORIES

- TEAC SPECIFICATION MANUAL \$5.00
- TEAC MAINTENANCE MANUAL \$25.00
- 1/2 HT MNTG HARDWARE FOR IBM \$2.95
- MOUNTING RAILS FOR IBM AT \$4.95
- Y POWER CABLE FOR 5 1/4" FDDs \$2.95
- 5 1/4" FDD POWER CONNECTORS \$1.19

DISK DRIVE ENCLOSURES WITH POWER SUPPLIES

- CAB-2SV5 DUAL SLIMLINE 5 1/4" \$49.95
- CAB-1FH5 FULL HT 5 1/4" \$69.95
- CAB-2SV8 DUAL SLIMLINE 8" \$209.95
- CAB-2FH8 DUAL FULL HT 8" \$219.95

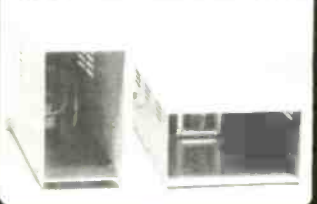

BUILD STEVE GARCIA'S INTELLIGENT EPROM PROGRAMMER

AS SEEN IN BYTE, OCT 86

- STAND-ALONE OR RS-232 SERIAL OPERATION
- MENU SELECTABLE EPROM TYPES
- NO CONFIGURATION JUMPERS
- PROGRAMS ALL 5V 27XXX EPROMS FROM 2716 TO 27512
- READ, COPY OR VERIFY EPROM
- UPLOAD / DOWNLOAD INTEL HEX FILES
- PROGRAMMER DRIVER USER MODIFIABLE

ONLY \$199

KIT INCLUDES PCB AND ALL COMPONENTS EXCEPT CASE & POWER SUPPLY

CALL FOR VOLUME QUOTES

COPYRIGHT 1987 JDR MICRODEVICES

CIRCLE 182 ON FREE INFORMATION CARD

EGA CARD AND MONITOR NOW ONLY \$569!

QUALITY IBM COMPATIBLE MOTHERBOARDS

FROM MODULAR CIRCUIT TECHNOLOGY

TURBO 4.77 / 8 MHZ \$129.95

JDR PART #: MCT-TURBO

- 4.77 OR 8 MHZ OPERATION WITH 8088-2 & OPTIONAL 8087-2 CO-PROCESSOR
- DYNAMICALLY ADJUSTS SPEED DURING DISKETTE OPERATION FOR MAXIMUM THROUGHPUT AND RELIABILITY
- CHOICE OF NORMAL TURBO MODE OR SOFTWARE SELECT PROCESSOR SPEED

STANDARD 4.77 MHZ \$109.95

JDR PART #: MCT-XTMB

- 8088 CPU, OPTIONAL 8087 CO-PROCESSOR
- 8 EXPANSION SLOTS
- EXPANDABLE TO 640K ON-BOARD MEMORY (0K RAM INSTALLED)
- ALL ICs SOCKETED-HIGHEST QUALITY PCB
- ACCEPTS 2764 OR 27128 ROMS

BOTH WITH FREE MCT BIOS!

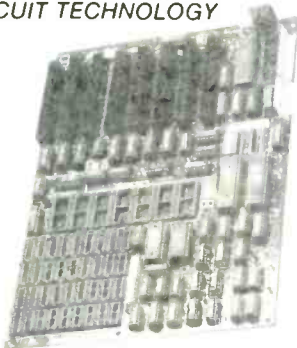

FARADAY FDD CONTROLLER

JDR PART #: FAR-FDD

- SUPPORTS UP TO 4 INTERNALLY MOUNTED FDDs
- IBM COMPATIBLE, INTERFACES TO 360K OR 720K USING DOS 3.20
- INCLUDES CABLE FOR 2 DISK DRIVES

\$24.95

IBM COMPATIBLE FLOPPY DISK DRIVE

JDR PART #: FDD-360

GOOD QUALITY DRIVES BY MAJOR MANUFACTURERS SUCH AS QUME, TANDON & CDC

- 5 1/4" HALF HEIGHT
- 360K STORAGE CAPACITY
- DS, DD
- 48 TPI

\$69.95

IBM STYLE COMPUTER CASE

AN ATTRACTIVE STEEL CASE WITH A HINGED LID. FITS THE POPULAR PC/XT COMPATIBLE MOTHERBOARDS



- SWITCH CUT-OUT ON SIDE FOR PC XT STYLE POWER SUPPLY
- CUT-OUT FOR 8 EXPANSION SLOTS
- ALL HARDWARE INCLUDED

\$34.95

SLIDE TYPE CASE \$39.95

BUILD YOUR OWN 256K XT COMPATIBLE SYSTEM

- XT MOTHERBOARD \$109.95
- PRO-BIOS (A \$20 VALUE) FREE!
- 256K RAM \$28.95
- 130 WATT POWER SUPPLY \$89.95
- FLIP-TOP CASE \$34.95
- KEY TRONIC™ KEYBOARD \$49.95
- 360K DRIVE \$89.95
- FARADAY CONTROLLER \$24.95
- MONOCHROME ADAPTOR \$49.95
- FORTRONICS MONITOR \$99.95

TOTAL: \$536.15

IBM COMPATIBLE KEYBOARDS

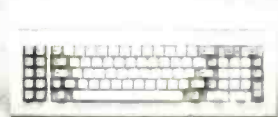

MCT-5150 \$59.95

- "5150" STYLE KEYBOARD
- FULLY IBM COMPATIBLE
- LED STATUS INDICATORS FOR CAPS & NUMBER LOCK
- LARGE, EASY TO REACH SHIFT & RETURN KEYS
- 83 KEY TYPEWRITER LAYOUT



MCT-5151 \$79.95

- REPLACEMENT FOR KEY TRONIC™ KB-5151 KEYBOARD
- SEPARATE CURSOR & NUMERIC KEYPAD
- CAPS LOCK & NUMBER LOCK INDICATORS
- IMPROVED KEYBOARD LAYOUT



MCT-5060 \$59.95

- IBM AT STYLE LAYOUT
- SOFTWARE AUTONSENSE FOR XT OR AT COMPATIBLES
- EXTRA LARGE SHIFT & RETURN KEYS
- LED INDICATORS FOR SCROLL, CAPS & NUMBER LOCK
- AUTO REPEAT FEATURE



MCT-5339 \$89.95

- IBM ENHANCED STYLE LAYOUT
- SOFTWARE AUTONSENSE FOR XT OR AT COMPATIBLES
- 12 FUNCTION KEYS
- EXTRA LARGE SHIFT & RETURN KEYS
- LED INDICATORS FOR SCROLL, CAPS & NUMBER LOCK
- AUTO REPEAT FEATURE
- SEPARATE CURSOR PAD

EASYDATA MODEMS

All models feature auto-dial/answer/redial on busy, Hayes compatible, power up self test, touchtone or pulse dialing, built-in speaker, PC Talk III Communications software, Bell Systems 103 & 212A full or half duplex and more.

INTERNAL
EASYDATA-12H \$99.95
1200 BAUD HALF CARD

EASYDATA-12B \$119.95
1200 BAUD 10" CARD

EASYDATA-24B \$199.95
2400 BAUD FULL CARD

EXTERNAL
NO SOFTWARE INCLUDED
EASYDATA-12D \$119.95
1200 BAUD

EASYDATA-24D \$219.95
2400 BAUD

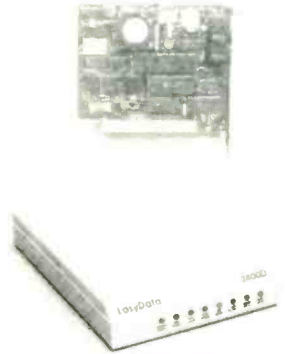

DISPLAY CARDS

FROM MODULAR CIRCUIT TECHNOLOGY

MCT-EGA \$179.95

100% IBM COMPATIBLE, PASSES IBM EGA DIAGNOSTICS

- COMPATIBLE WITH IBM EGA, COLOR GRAPHICS AND MONOCHROME ADAPTORS
- TRIPLE SCANNING FREQUENCY FOR DISPLAY ON EGA, STANDARD RGB OR HIGH RESOLUTION MONOCHROME MONITOR
- FULL 256K OF VIDEO RAM ALLOWS 640 x 350 PIXELS IN 16 OF 64 COLORS
- LIGHT PEN INTERFACE



MCT-CG \$49.95

COMPATIBLE WITH IBM COLOR GRAPHICS STANDARD

- SHORT SLOT CARD USES VLSI CHIPS TO INSURE RELIABILITY
- SUPPORTS RGB, COMPOSITE MONOCHROME & COLOR AND AN RF MODULATOR FOR OUTPUT
- 320 x 200 COLOR GRAPHICS MODE
- 640 x 200 MONOCHROME MODE
- LIGHT PEN INTERFACE



MCT-MGP \$59.95

COMPATIBLE WITH IBM MONOCHROME AND HERCULES GRAPHICS STANDARDS

- SHORT SLOT CARD USES VLSI CHIPS TO INSURE RELIABILITY
- PARALLEL PRINTER PORT, CONFIGURABLE AS LPT1 OR LPT2
- 720 x 348 GRAPHICS MODE
- LOTUS COMPATIBLE
- CAN RUN WITH COLOR GRAPHICS CARD IN THE SAME SYSTEM



MCT-MG \$79.95

COMPATIBLE WITH IBM MONOCHROME AND HERCULES GRAPHICS STANDARDS

- SERIAL PORT OPTION
- PARALLEL PRINTER PORT
- 720 x 348 GRAPHICS MODE
- 80 x 25 TEXT MODE
- LOTUS COMPATIBLE
- SELECTABLE TO RUN ALONG WITH COLOR GRAPHICS CARD IN THE SAME SYSTEM



MG-SERIAL OPTIONAL SERIAL PORT \$19.95

MCT-MONO \$49.95

ANOTHER FANTASTIC VALUE FROM JDR!

- IBM COMPATIBLE TTL INPUT
 - 720 x 348 PIXEL DISPLAY
- PLEASE NOTE: THIS CARD WILL NOT RUN LOTUS GRAPHICS AND DOES NOT INCLUDE A PARALLEL PORT

EPROM PROGRAMMERS

FROM MODULAR CIRCUIT TECHNOLOGY

MCT-EPROM \$129.95

PROGRAMS 27xx AND 27xxx SERIES EPROMS UP TO 27512

- SUPPORTS VARIOUS MANUFACTURERS FORMATS WITH 12.5, 21 AND 25 VOLT PROGRAMMING
- MENU-DRIVEN SOFTWARE ALLOWS EASY MANIPULATION OF DATA FILES
- SPLIT OR COMBINE THE CONTENTS OF SEVERAL EPROMS OF DIFFERENT SIZES
- READ, WRITE, COPY, ERASE CHECK AND VERIFY WITH EASY ONE KEY SELECTION
- INCLUDES SOFTWARE FOR STANDARD HEX AND INTEL HEX FORMATS

4 GANG PROGRAMMER \$189.95

10 GANG PROGRAMMER \$299.95

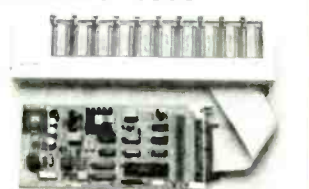

MCT PRODUCTS CARRY A ONE YEAR WARRANTY

© COPYRIGHT 1987 JDR MICRODEVICES

CIRCLE 183 ON FREE INFORMATION CARD

1200B MODEM \$99⁹⁵ FOR IBM W/
SOFTWARE

2400B MODEM \$199⁹⁵

MULTIFUNCTION CARDS

FROM MODULAR CIRCUIT TECHNOLOGY

MCT-MF \$79.95

ALL THE FEATURES OF AST'S SIX PACK PLUS AT HALF THE PRICE!

- 0-348K DYNAMIC RAM USING 4164s
- INCLUDES SERIAL PORT, PARALLEL PRINTER PORT, GAME CONTROLLER PORT AND CLOCK/CALENDAR
- SOFTWARE FOR A RAMDISK, PRINT SPOOLER AND CLOCK/CALENDAR



MCT-ATMF \$139.95

ADDS UP TO 3 MB OF 1 BIT RAM TO THE AT

- USER EXPANDABLE TO 1.5 MB OF ON-BOARD MEMORY (NO MEMORY INSTALLED)
- FLEXIBLE ADDRESS CONFIGURATION
- INCLUDES SERIAL PORT, PARALLEL PORT AND CLOCK/CALENDAR
- OPTIONAL PIGGYBACK BOARD PERMITS EXPANSION TO 3 MB



ATMF-SERIAL 2nd SERIAL PORT \$24⁹⁵

MCT-ATMF-MC \$29⁹⁵
PIGGYBACK BOARD (ZERO K INSTALLED)

MCT-MIO \$79.95

A PERFECT COMPANION FOR OUR MOTHERBOARD

- 2 DRIVE FLOPPY DISK CONTROLLER
- INCLUDES SERIAL PORT, PARALLEL PORT, GAME PORT AND CLOCK/CALENDAR WITH BATTERY BACK-UP
- SOFTWARE FOR A RAMDISK, PRINT SPOOLER AND CLOCK/CALENDAR



MIO-SERIAL 2nd SERIAL PORT \$15⁹⁵

MCT-IO \$59.95

USE WITH MCT-FH FOR A MINIMUM OF SLOTS USED

- SERIAL PORT ADDRESSABLE AS COM1, COM2, COM3 OR COM4
- PARALLEL PRINTER PORT ADDRESSABLE AS LPT1 OR LPT2 (+378 OR +278)
- CLOCK/CALENDAR WITH A BATTERY BACK-UP



IO-SERIAL 2nd SERIAL PORT \$15⁹⁵

MCT-ATIO \$59.95

USE WITH MCT-ATFH FOR A MINIMUM OF SLOTS USED

- SERIAL PORT ADDRESSABLE AS COM1, COM2, COM3 OR COM4
- PARALLEL PRINTER PORT ADDRESSABLE AS LPT1 OR LPT2 (+378 OR +278)
- GAME PORT
- USES 16450 SERIAL SUPPORT CHIPS FOR HIGH SPEED OPERATION IN AN AT



ATIO-SERIAL 2nd SERIAL PORT \$24⁹⁵

RAM CARDS

FROM MODULAR CIRCUIT TECHNOLOGY

MCT-RAM \$69.95

A CONTIGUOUS MEMORY SOLUTION FOR YOUR SHORT OR REGULAR SLOT

- SHORT SLOT, LOW POWER PC COMPATIBLE DESIGN
- CAN OFFER UP TO 576K OF ADDITIONAL MEMORY
- USER SELECTABLE CONFIGURATION AMOUNTS OF 192, 384, 512, 256 & 576K, USING COMBINATIONS OF 64 & 256K RAM



MCT-ATRAM \$149.95

A POWER USER'S DREAM, 4MB OF MEMORY FOR THE AT

- USER EXPANDABLE TO 2MB OF ON-BOARD MEMORY
- USES FULL 16 BIT PARITY CHECKED MEMORY, 64K OR 256K DYNAMIC RAM
- FLEXIBLE STARTING ADDRESS, ROUND OUT CONVENTIONAL MEMORY TO 640K & ADD EXTENDED MEMORY ABOVE 1MB



MCT-ATRAM-MC \$39⁹⁵
2MB PIGGYBACK BOARD (ZERO K INSTALLED)

MCT-EMS \$129.95

2MB OF LOTUS/INTEL/MICROSOFT COMPATIBLE MEMORY FOR THE XT

- CONFORMS TO LOTUS/INTEL EMS
- USER EXPANDABLE TO 2 MB
- USES 64K OR 256K DYNAMIC RAM (NO MEMORY INSTALLED)
- USE AS EXPANDED OR CONVENTIONAL MEMORY, RAMDISK OR SPOOLER
- SOFTWARE INCLUDES EMS DEVICE DRIVERS, PRINT SPOOLER AND RAMDISK

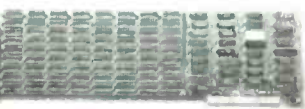

MCT-ATEMS AT VERSION OF THE MCT-EMS \$139⁹⁵

Seagate

HARD DISK SYSTEMS
20 MB 30 MB
\$339 \$399

Systems include half height hard disk drive, hard disk drive controller, cables and instructions. Drives are pre-tested and warranted for one year.

Seagate 40 MB AT DRIVE
FAST 40ms ACCESS TIME



\$599

DISK CONTROLLER CARDS

FROM MODULAR CIRCUIT TECHNOLOGY

MCT-FDC \$34.95

QUALITY DESIGN OFFERS 4 FLOPPY CONTROL IN A SINGLE SLOT

- INTERFACES UP TO 4 FDDs TO AN IBM PC OR COMPATIBLE
- INCLUDES CABLING FOR 2 INTERNAL DRIVES
- USES STANDARD DE37 CONNECTOR FOR EXTERNAL DRIVES
- SUPPORTS BOTH DS-DD AND DS-QD WHEN USED WITH DOS 3.2 OR JFORMAT



MCT-HDC \$89.95

HARD DISK CONTROL FOR WHAT OTHERS CHARGE FOR FLOPPY CONTROL

- IBM XT COMPATIBLE CONTROLLER SUPPORTS 16 DRIVE SIZES INCLUDING 5, 10, 20, 30 & 40MB
- OPTIONS INCLUDE THE ABILITY TO DIVIDE 1 LARGE DRIVE INTO 2 SMALLER, LOGICAL DRIVES
- INCLUDES CABLING FOR 1 INTERNAL DRIVE



MCT-RLI \$119.95

GET UP TO 50% MORE STORAGE SPACE ON YOUR HARD DISK

- INCREASES THE CAPACITY OF PLATED MEDIA DRIVES BY 50%
- ALL 2.7 ENCODING FOR MORE RELIABLE STORAGE
- TRANSFER RATE IS ALSO 5% FASTER, 750K/sec vs 500K/sec
- USE WITH ST-238 DRIVE TO ACHIEVE 30-MB IN A HALF HEIGHT SLOT

NEW!

MCT-FH \$139.95

STARVEL FOR SLOTS? SATISFY IT WITH THIS TIMELY DESIGN

- INTERFACES UP TO 2 FDDs & 2 HDDs
- CABLING FOR 2 FDDs & 1 HDD
- FLOPPY INTERFACE SUPPORTS BOTH DS-DD & DS-QD WHEN USED WITH DOS 3.2 OR JFORMAT
- ALL POPULAR HD SIZES ARE SUPPORTED, INCLUDING 5, 10, 20, 30 & 40MB
- CAN DIVIDE 1 LARGE DRIVE INTO 2 SMALLER, LOGICAL DRIVES



MCT-ATFH \$169.95

FLOPPY AND HARD DISK CONTROL IN A TRUE AT DESIGN

- AT COMPATIBLE, CONTROL UP TO 2 360K/720K OR 2MB FDDs AS WELL AS 2 HDDs USING THE AT STANDARD CONTROL TABLES
- SUPPORTS AT STYLE FRONT PANEL LED TO INDICATE HD ACTIVITY
- 16 BIT BUSS PROVIDES RAPID DATA TRANSFERS
- FULLY SUPPORTED BY ALL BIOS



JDR Microdevices 110 Knowles Drive, Los Gatos, CA 95030
Toll Free 800-538-5000 • (408) 866-6200 • FAX (408) 378-8927 • Telex 171-110

THE JDR MICRODEVICES LOGO IS A REGISTERED TRADEMARK OF JDR MICRODEVICES. JDR INSTRUMENTS AND JDR MICRODEVICES ARE TRADEMARKS OF JDR MICRODEVICES. IBM IS A TRADEMARK OF INTERNATIONAL BUSINESS MACHINES.

1200B MODEM \$99⁹⁵

**FOR IBM W/
SOFTWARE**

2400B MODEM \$199⁹⁵

**BARGAIN HUNTERS CORNER
NEW FROM RIM ELECTRONICS**

**NICKEL EXPRESS \$69⁹⁵
PC/XT SPEED UP KIT**

- * INCREASE THE SPEED OF YOUR PC BY 67% OR MORE!
- * SIMPLE NO-SLOT INSTALLATION
- * SOFTWARE OR HARDWARE SPEED SELECTION
- * 8 MHz V20 PROCESSOR & SOFTWARE INCLUDED
- * SELECT FOR 3 TURBO FREQUENCIES
- * EXTERNAL RESET SWITCH
- * OPTIONAL 8088 8 MHz PROCESSOR AVAILABLE

Certain early PCs may not run at 8 MHz; these machines may be switched to one of the slower speeds.
6.66 MHz=40% 7.37 MHz=56% 8.0 MHz=67%

SPECIAL ENDS 7/31/87

**PAGE WIRE WRAP WIRE
PRECUT ASSORTMENT
IN ASSORTED COLORS \$27.50**

100ea: 5.5", 6.0", 6.5", 7.0"
250ea: 2.5", 4.5", 5.0"
500ea: 3.0", 3.5", 4.0"

SPOOLS

100 feet \$4.30 250 feet \$7.25
500 feet \$13.25 1000 feet \$21.95

Please specify color:
Blue, Black, Yellow or Red

**WIRE WRAP PROTOTYPE CARDS
FR-4 EPOXY GLASS LAMINATE
WITH GOLD-PLATED EDGE-CARD FINGERS**



IBM-PR2

IBM

BOTH CARDS HAVE SILK SCREENED LEGENDS
AND INCLUDES MOUNTING BRACKET

IBM-PR1 WITH -5V AND GROUND PLANE \$27.95
IBM-PR2 AS ABOVE WITH DECODING LAYOUT \$29.95

S-100

P100-1 BARE - NO FOIL PADS \$15.15
P100-2 HORIZONTAL BUS \$21.80
P100-3 VERTICAL BUS \$21.80
P100-4 SINGLE FOIL PADS PER HOLE \$22.75

APPLE

P500-1 BARE - NO FOIL PADS \$15.15
P500-2 HORIZONTAL BUS \$22.75
P500-3 SINGLE FOIL PADS PER HOLE \$21.80
7060-45 FOR APPLE IIc AUX SLOT \$30.00

EXTENDER CARDS

IBM-PC \$29.95
IBM-AT \$39.95



SOCKET-WRAP I.D.™

- * SLIPS OVER WIRE WRAP PINS
- * IDENTIFIES PIN NUMBERS ON WRAP SIDE OF BOARD
- * CAN WRITE ON PLASTIC, SUCH AS IC #

PINS	PART#	PCK. OF	PRICE
8	IDWRAP 08	10	1.95
14	IDWRAP 14	10	1.95
16	IDWRAP 16	10	1.95
18	IDWRAP 18	5	1.95
20	IDWRAP 20	5	1.95
22	IDWRAP 22	5	1.95
24	IDWRAP 24	5	1.95
28	IDWRAP 28	5	1.95
40	IDWRAP 40	5	1.95

PLEASE ORDER BY NUMBER OF PACKAGES (PCK. OF)

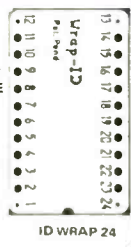

**FRAME STYLE
TRANSFORMERS**

12.6V AC CT	2 AMP	5.95
12.6V AC CT	4 AMP	7.95
12.6V AC CT	8 AMP	10.95
25.2V AC CT	2 AMP	7.95

**25 PIN D-SUB
GENDER
CHANGERS
\$7.95**



SWITCHING POWER SUPPLIES

PS-IBM \$89.95

- * FOR IBM PC-XT COMPATIBLE
- * 135 WATTS
- * -5V @ 15A, -12V @ 4.2A
- * -5V @ 5A, -12V @ 5A
- * ONE YEAR WARRANTY



PS-IBM-150 \$79.95

- * FOR IBM PC-XT COMPATIBLE
- * 150 WATTS
- * -12V @ 5.2A, -5V @ 16A
- * -12V @ 5A, -5V @ 5A
- * ONE YEAR WARRANTY



PS-130 \$99.95

- * 130 WATTS
- * SWITCH ON REAR
- * FOR USE IN OTHER IBM TYPE MACHINES
- * 90 DAY WARRANTY



PS-A \$49.95

- * USE TO POWER APPLE TYPE SYSTEMS, 79.5 WATTS
- * -5V @ 7A, -12V @ 3A
- * -5V @ 5A, -12V @ 5A
- * APPLE POWER CONNECTOR



PS-1558 \$34.95

- * 75 WATTS, UL APPROVED
- * -5V @ 7A, -12V @ 3A
- * -12V @ 250ma, -5V @ 300ma



CAPACITORS

TANTALUM

1.0µf	15V	.35	47µf	35V	.45
6.8	15V	.70	1.0	35V	.45
10	15V	.80	2.2	35V	.65
22	15V	1.35	4.7	35V	.85
.22	35V	.40	10	35V	1.00

DISC

10µf	50V	.05	680	50V	.05
22	50V	.05	001µf	50V	.05
27	50V	.05	0022	50V	.05
33	50V	.05	005	50V	.05
47	50V	.05	.01	50V	.07
68	50V	.05	.02	50V	.07
100	50V	.05	.05	50V	.07
220	50V	.05	1	12V	.10
560	50V	.05	1	50V	.12

MONOLITHIC

.01µf	50V	.14	1µf	50V	.18
.047µf	50V	.15	47µf	50V	.25

ELECTROLYTIC

RADIAL		AXIAL			
1µf	25V	.14	1µf	50V	.14
2.2	35V	.15	10	50V	.16
4.7	50V	.15	22	16V	.14
10	50V	.15	47	50V	.20
47	35V	.18	100	35V	.25
100	16V	.18	220	25V	.30
220	35V	.20	470	50V	.50
470	25V	.30	1000	16V	.60
2200	16V	.70	2200	16V	.70
4700	25V	1.45	4700	16V	1.25

DATASE EPROM ERASER \$34.95

- * ERASES 2 IN 10 MINUTES
- * COMPACT-NO DRAWER
- * THIN METAL SHUTTER
- * PREVENTS UV LIGHT FROM ESCAPING



1/4 WATT RESISTORS

5% CARBON FILM ALL STANDARD VALUES FROM 1 OHM TO 10 MEG. OHM

10 PCS same value	.05	100 PCS same value	.02
50 PCS same value	.025	1000 PCS same value	.015

RESISTOR NETWORKS

SIP	10 PIN	9 RESISTOR	.69
SIP	8 PIN	7 RESISTOR	.59
DIP	16 PIN	8 RESISTOR	1.09
DIP	16 PIN	15 RESISTOR	1.09
DIP	14 PIN	7 RESISTOR	.99
DIP	14 PIN	13 RESISTOR	.99

SPECIALS ON BYPASS CAPACITORS

.01 µf CERAMIC DISC	100/\$5.00
.01 µf MONOLITHIC	100/\$10.00
.1 µf CERAMIC DISC	100/\$6.50
1 µf MONOLITHIC	100/\$12.50

WISH SOLDERLESS BREADBOARDS

PART NUMBER	DIMENSIONS	DISTRIBUTION STRIP(S)	TIE POINTS	TERMINAL STRIP(S)	TIE POINTS	BINDING POSTS	PRICE
WBU-D	3.8 x 6.50"	1	100	---	---	---	2.95
WBU-T	1.38 x 6.50"	---	---	1	630	---	6.95
WBU 204-3	3.94 x 8.45"	1	100	2	1260	2	17.95
WBU 204	5.13 x 8.45"	4	400	2	1260	3	24.95
WBU 206	6.88 x 9.06"	5	500	3	1890	4	29.95
WBU-208	8.25 x 9.45"	7	700	4	2520	4	39.95



**LITHIUM BATTERY
AS USED IN CLOCK CIRCUITS**



3 VOL BATTERY \$3.95
BATTERY HOLDER \$1.49

MUFFIN FANS

3.15" SQ 14.95 3.63" SQ 14.95
3.18" SQUARE 16.95

6' LINE CORDS

2 conductor .39 3 conductor .99
3 conductor w/ female socket 1.49

EMI FILTER \$4.95

**2 VOLUME SET
IC MASTER
THE INDUSTRY STANDARD
\$129.95**

Visit our retail store located at 1256 S. Bascom Ave. in San Jose, (408) 947-8881



JDR Microdevices
110 Knowles Drive, Los Gatos, CA 95030
Toll Free 800-538-5000 • (408) 866-6200
FAX (408) 378-8927 • Telex 171-110

COPYRIGHT 1987 JDR MICRODEVICES

THE JDR MICRODEVICES LOGO IS A REGISTERED TRADEMARK OF JDR MICRODEVICES. JDR INSTRUMENTS AND JDR MICRODEVICES ARE TRADEMARKS OF JDR MICRODEVICES. IBM IS A TRADEMARK OF INTERNATIONAL BUSINESS MACHINES. APPLE IS A TRADEMARK OF APPLE COMPUTER.

PLEASE USE YOUR CUSTOMER NUMBER WHEN ORDERING

TERMS: Minimum order \$10.00. For shipping and handling include \$2.50 for UPS Ground and \$3.50 for UPS Air. Orders over 1 lb. and foreign orders may require additional shipping charges - please contact our sales department for the amount. CA residents must include applicable sales tax. All merchandise is warranted for 90 days unless otherwise stated. Prices are subject to change without notice. We are not responsible for typographical errors. We reserve the right to limit quantities and to substitute manufacturer. All merchandise subject to prior sale.

Radio Shack Parts Place™

THE BUILDER'S STORE! OVER 1000 COMPONENTS IN STOCK

Communications Circuit Book

149

A Must For Project Builders



The latest of the "hands-on" electronic project books by Forrest M. Mims III. Includes projects for wired and wireless voice and code systems, shortwave listening and much more. Contains 48 pages with schematics. #276-5015

Attention-Getting LEDs

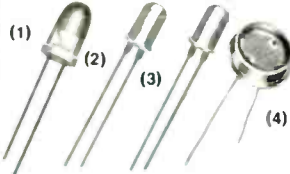

- (1) Super-Bright Red. Outputs 300 mcd, 20 mA. #276-066. 1.19
- (2) Blinking Red. MOS driver and red LED combo. #276-036. 1.29
- (3) Blinking Green. #276-030. 1.29
- (4) CdS Photocell. Rated 200 mW, 170 volts. #276-116. 1.79

Save With Our "Hotline" Order Service

We send your order directly to the Radio Shack near you. We pay the postage. Delivery time on most items is one week.

Your Radio Shack store manager can special-order a variety of parts and accessories not listed in our catalog—tubes, linear and digital ICs, diodes, transistors, crystals, phono cartridges and more. There's no minimum order requirement for this convenient service! Your order will be sent to your nearby Radio Shack store, and we'll notify you when it arrives.

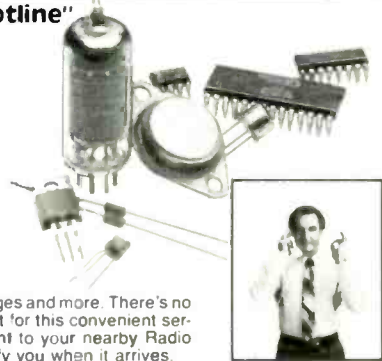

Unusual Buzzers



- (5) Tri-Sound Alarm. Contains an IC, driver circuit and 8-ohm speaker. Three distinctive sounds. 3 VDC. #273-072. 5.95
- (6) Electronic Chime. Melody-synthesizing IC and speaker combo produce a pleasant "ding-dong" sound. Operates 6 to 18 VDC. #273-071. 7.95

Panel Switch Values

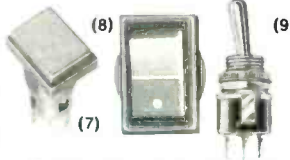

- (7) Lighted SPST Normally Open or Normally Closed. Rated 5 amps at 250 VAC, 12-volt lamp. #275-678. 5.95
- (8) SPST Rocker Switch. Rated 6 amps, 125 VAC. #275-690. 1.89
- DPDT. #275-691. 2.49
- (9) SPDT Mini-Toggle. Rated 5 amps, 125 VAC. #275-603. 1.49

Put These High-Tech ICs to Work

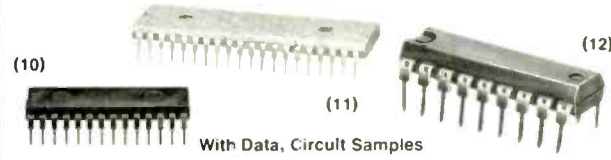

- (10) SPO256-AL2 Speech Synthesizer. MOS/LSI device with built-in program easily interfaces with most computers. Requires 3.12 MHz crystal (special order via "hotline" above). 28-pin DIP. #276-1784. 12.95
- (11) CTS256-AL2 Text-to-Speech IC. Preprogrammed 8-bit processor translates ASCII into control data for figure 10. Requires 10 MHz crystal (special order). 40-pin DIP. #276-1786. 16.95
- (12) SSI 202 Touch-Tone Decoder IC. Easy-to-use DTMF receiver is just right for remote-control applications. Requires a minimum of support parts and is easily interfaced with most microprocessors. #276-1303. 12.95

Deluxe Enclosures



Vented steel tops, easy-to-work aluminum chassis. With protective rubber feet and hardware.

Size	Cat. No.	Each
3 1/4 x 2 1/8 x 4"	270-251	2.99
4 x 2 3/8 x 6"	270-252	3.99
5 1/4 x 3 x 5 7/8"	270-253	4.99

Miniature PC Pots



Rated at 1/8-watt. Sealed against noise-causing contaminants.

Ohms	Cat. No.
1k	271-333
10k	271-335
25k	271-336
100k	271-338

Tantalum Caps



IC pin spacing, 20% tolerance.

F	VWDC	Cat. No.	Each
0.1	35	272-1432	49
0.47	35	272-1433	49
1.0	35	272-1434	49
2.2	35	272-1435	59
10	16	272-1436	69
22	16	272-1437	99

Top-Quality Memory



4164 64K Dynamic RAM. 150 ns access time, low-power design (230 mW, typical). Single 5 VDC supply. #276-2506. 3.95

TMS 4256 256K Dynamic RAM. 150 ns maximum access, low-power 16-pin DIP with specs and pin-out. Single 5 VDC supply. #276-1252. 6.95

Archer® Hand Tools



Professional Quality

- (13) 5 1/4" Long Nose Pliers. Spring return, insulated grips. #64-1812. 5.99
- (14) 4 1/2" Diagonal Cutters. Spring return, long lasting and insulated grips. #64-1813. 5.99
- (15) 6" Locking Forceps. Use as a temporary heat sink and to pick up or hold parts. #64-1866. 4.95

Archer® Coax Cable



Low loss—no more than 4.0 dB per 100 feet at 50 MHz.

RG Type	Ohms	Vel. Fact.	Cat. No.	Price Per Ft.
8"	52	66%	278-1323	.36
8	52	75%	278-1328	.21
58	52	66%	278-1326	.16
59	75	75%	278-1327	.16

*NEW! 95% Shielding.

28-Range FET VOM



Works like a solid-state VTVM! Super-sensitive—10-megohm input impedance. With 28 ranges and "beep" continuity. Includes test leads and spare fuse. Requires one 9V and one "C" battery. #22-220.

Dual-Tracking DC Supply

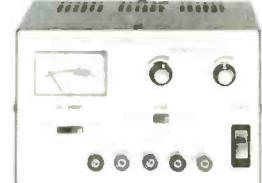

Delivers stable DC with extremely low ripple at precisely the voltage you need. Adjustable from 0 to 15 VDC, or series output provides up to 30 VDC. Selectable independent or slave operation of two voltages. Meter for monitoring voltage or current of either output. UL listed. #22-121. 69.95

Over 1000 items in stock: Binding posts, Books, Breadboards, Buzzers, Capacitors, Chokes, Clips, Connectors, Fuses, Hardware, ICs, Jacks, Knobs, Lamps, Memory Chips, Multitesters, PC Boards, Plugs, Power Supplies, Rectifiers, Relays, Resistors, Switches, Tools, Transformers, Transistors, Wire, Zener Diodes, more!

Radio Shack®

A DIVISION OF TANDY CORPORATION

Prices apply at participating Radio Shack stores and dealers

CIRCLE 78 ON FREE INFORMATION CARD

SEND FOR
FREE
1987 CATALOG...
48 PAGES!

★ QUALITY PARTS ★ DISCOUNT PRICES ★ FAST SHIPPING!

ALL ELECTRONICS CORP.

ALL ELECTRONICS CORP.

SPRING LEVER TERMINALS

Two color coded terminals on a sturdy 2 1/4" x 3 3/4" bakelite plate. Great for speaker enclosures or power supplies.
75c EACH 10 for \$6.00



FUSES

3AG (AGC) SIZE
1 1/2, 2, 2 1/2, 3, 4, 5, 6 AMP
GMA SIZE
1, 2, 3, 4, 5 AMP
5 of any ONE amperage 75c



PHOTO-FLASH CAPACITORS

170 MFD 330 Volt
CAT# PPC-170 75c each
400 MFD 330 Volt
CAT# PPC-400 \$1.00 ea

COMPUTER GRADE CAPACITORS

1,400 mfd. 200 Vdc
3" x 2" dia. \$2.00
6,400 mfd 60 Vdc
4 1/4" x 1 3/8" dia. \$2.50
7,500 mfd 200 Vdc
5 3/4" x 3" dia. \$4.00
12,000 mfd 40 Vdc
4 1/4" x 2" dia. \$2.50
22,000 mfd 25 Vdc
4 3/4" x 2" dia. \$2.50
48,000 mfd 10 Vdc
3" x 2 1/2" dia. \$2.50
66,000 mfd 15 Vdc
3 3/4" x 3" dia. \$3.50
72,000 mfd 15 Vdc
4" x 2" dia. \$3.50
100,000 mfd 10 Vdc
6" x 2 1/2" dia. \$1.00

3rd TAIL LIGHT ?

Sleek high-tech lamp assembly. Could be used as a third auto tail light, emergency warning light, or special-effects lamp. Red reflective lens is 2 3/4" x 5 1/2" is mounted on a 4" high pedestal with up-down swivel adjustment. Includes 12v replaceable bulb.
CAT# TLB \$3.95 each.



LIGHT ACTIVATED MOTION SENSOR

This device contains a photocell which senses sudden changes in ambient light. When an object or person passes within it's field of view (about 5') it beeps for several seconds then resets. Could be used as a door annunciator or modified to trigger other devices. 5 1/2" x 4" x 1. Operates on 6 Vdc. Requires 4 AA batteries (not included).
CAT# LSMD \$5.75 per unit



SOUND EFFECTS BOARD

PC board with 2 1/4" speaker, 2 LEDs, IC, battery snap, other components 2 3/8" x 3". When switch is pushed board beeps and leds light. Operates on 9v battery (not included).
Experimenter's delight*
CAT# ST-3 \$1.25 ea.



COMMODORE PRINTER PLOTTER

4 inch paper
Four color X-Y plotter. Standard VIC serial interface allows easy connection to Commodore 64 computers. Up to 80 characters per line.
CAT # COM-1520 \$49.95 each
EXTRA pen sets \$1.50 per set.

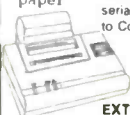

MICRO-CASSETTE MECHANISM

Micro-cassette tape transport for standard MC60 or MC45 micro-cassettes. 3 Vdc operation. Contains: drive motor, belt, head, capstan, pinch wheel and other components. 3 1/2" X 2 1/4" X 5/8"
CAT# MCMEC \$3.00 each 10 for \$27.50



EDGE CONNECTORS

ALL ARE .156" SPACING.
22 EDGE CONNECTOR \$1.25 ea solder lug style 10 for \$11.00
22/44 EDGE CONNECTOR \$2.00 ea PC style 10 for \$18.00
22/44 EDGE CONNECTOR solder lug style \$2.50 each
28/56 EDGE CONNECTOR PC style \$2.50 ea
36/72 EDGE CONNECTOR PC style \$3.00 each
43/86 EDGE CONNECTOR PC style \$4.50 each

WALL TRANSFORMER

11.5 Vdc
1.95 Amp.
INPUT: 120 Vac
SIZE: 120 Vac
3 3/4" X 2 7/8" X 2 5/8"
CAT # DCTX-11519 \$6.50 each

TRANSFORMERS

120 volt primaries
5.6 volts @ 750 ma. \$3.00
6.3 volt @ 600 ma. \$1.75
12 V.C.T. @ 200 ma. \$2.00
12 V.C.T. @ 400 ma. \$3.00
12 V.C.T. @ 1 amp. \$4.00
12 V.C.T. @ 2 amp. \$4.85
12 V.C.T. @ 4 amp. \$7.00
18 volts @ 650 ma. \$2.00
24 V.C.T. @ 200 ma. \$2.50
24 V.C.T. @ 1 amp. \$4.85
24 V.C.T. @ 2 amp. \$6.75
24 V.C.T. @ 3 amp. \$9.50
24 V.C.T. @ 4 amp. \$11.00

TI SWITCHING POWER SUPPLY

Compact, well-regulated switching power supply designed to power Texas Instruments computer equipment.
INPUT: 14 - 25 vac @ 1 amp
OUTPUT: + 12 vdc @ 350 ma
+ 5 vdc @ 1.2 amp
- 5 vdc @ 200 ma.
\$3.50
SIZE: 4 3/4" x 4 1/4" x 1 1/4" high



13.8 VDC REGULATED POWER SUPPLY

These are solid state, fully regulated 13.8 vdc power supplies. Both feature 100% solid state construction, fuse protection, and L.E.D. power indicator. U.L. listed.
2 amp constant, 4 amp surge \$20.00 each
3 amp constant, 5 amp surge \$27.50 each



MINIATURE TOGGLE SWITCHES

ALL ARE RATED 5 AMPS @ 125 VAC

S.P.D.T. (on-on) PC style non-threaded bushing 75c each 10 for \$7.00
S.P.D.T. (on-off-on) Solder lug terminals \$1.00 each 10 for \$9.00 100 for \$80.00
S.P.D.T. (on-off-on) Solder lug terminals \$1.00 each 10 for \$9.00 100 for \$80.00
S.P.D.T. (on-on) PC lugs threaded bushing 75c each 10 for \$7.00
D.P.D.T. (on-on) Solder lug terminals \$2.00 each 10 for \$19.00 100 for \$180.00

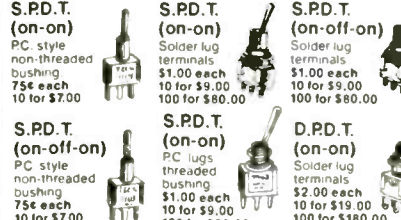

D.P.S.T. LIGHTED ROCKER SWITCH

115 vac lighted rocker. Snap mounts in 1/2" x 1 1/2" hole. Orange lens. 16 amp contact.
\$1.50



MINI-PUSH BUTTON

S.P.S.T. momentary normally open 1/4" bushing. Red button. 35c each 10 for \$3.00



SNAP ACTION SWITCH

Cherry elect. #E-21 N.O. or N.C. 0.1A contacts. Suitable for alarms and other low energy circuits. 1 1/2" lever.
45c EACH 10 FOR \$4.20

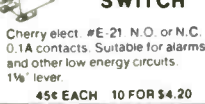

WALL TRANSFORMERS

all plug directly into 120 vac outlet
4 VDC @ 70 ma. \$2.00
6 VDC @ 500 ma. \$3.50
6 VDC @ 750 ma. \$4.50
9 VDC @ 500 ma. \$5.00
12.5 VAC @ 265 ma. \$3.00
18 VAC @ 18 VA and 8.5 VAC @ 1.28 VA \$3.50
24 VAC @ 250 ma. \$3.00
MULTI-VOLTAGE @ 500 ma. 3, 4, 5, 6, 7, 9, or 12 VDC \$7.50



TRANSISTORS

2N705 4 for \$1.00
2N2222A 3 for \$1.00
PN2222A 4 for \$1.00
2N2904 3 for \$1.00
2N2905 3 for \$1.00
MJ2955 \$1.50
2N3055 \$1.00
PMD10K40 \$1.00
TIP 121 75c
TIP 125 75c

LED'S STANDARD JUMBO DIFFUSED T-1-3/4

RED 10 for \$1.50 100 for \$13.00
GREEN 10 for \$2.00 100 for \$17.00
YELLOW 10 for \$2.00 100 for \$17.00

FLASHER LED

5 volt operation red jumbo T-1 1/4 size
CAT# LED-4 \$1.00
NEW GREEN FLASHER
CAT# LED-4G \$1.00



BI-POLAR jumbo T-1 1/4 size

LED HOLDERS
Two piece holder for jumbo LED
10 for 65c 100 for \$5.00

CLEAR CLIPITE LED HOLDER

Make LED a fancy indicator Clear 4 for \$1.00



SP.S.T. TOGGLE SWITCH

CARLING (on-off) RATED: 10 amp @ 125 Vac. All plastic body and toggle.
CAT# STS-1 \$1.00 ea. 10 for \$8.50 100 for \$7.50
LARGE QUANTITIES



XENON FLASH TUBE

3/4" long X 1/8" dia. Flash tube designed for use in compact camera flash units. Ideal for experimenters.
CAT# FLT-1 2 for \$1.00



48 KEY ASSEMBLY FOR COMPUTER OR HOBBYIST

NEW T.I. KEYBOARDS Originally used on computers, these keyboards contain 48 S.P.S.T. mechanical switches. Terminates to 15 pin connector. Frame 4" x 9"
CAT# KP-48 \$3.50 each



WE'VE MOVED

Our Mail Order Operations to serve U better
NEW MAILING ADDRESS
P.O. BOX 567
VAN NUYS, CA 91408



TELEPHONE COUPLING TRANSFORMER

Stancor # TTPC-8
600 ohms c.t. to 600 ohms c.t.
P.C. board mount
3/4" x 5/8" x 3/4"
\$1.25 each



SOUND AND VIDEO MODULATOR

TI#UM1381-1 Designed for use with T.I. computers. Can be used with video cameras, games or other audio/video sources. Built in A/B switch enables user to switch from T.V. antenna without disconnection. Channel 3 or 4 selection. Operates on 12 Vdc. Hook-up diagram included.
CAT# AVMOD \$5.00 each.



RECHARGEABLE NI-CAD BATTERIES

AAA SIZE 1.25V \$1.85
AA SIZE 1.25V 500MAH \$1.85
AA with solder tab \$2.00
C SIZE 1.2V 1200MAH \$3.50
SUB-C SIZE solder tab \$3.50
D SIZE 1.2V 1200MAH \$3.50



NI-CAD CHARGER TESTER

Will charge most every size Ni-cad battery available.
Cat# UNCC-N \$12.50

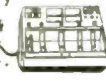

8" 15 WATT SPEAKER

C.T.S Model 8B3079 Full range speaker. 100-10,000Hz. Ideal for PA systems. Mounting holes for line-matching transformer.
CAT#SK-815 \$3.50 ea. Case of 8 pcs. \$25.00 per case



STORES
LOS ANGELES, CA
905 S. Vermont Ave.
213 380-8000
VAN NUYS, CA
6228 Sepulveda Blvd.
818 997-1806



MAIL ORDERS TO:
ALL ELECTRONICS
P.O. BOX 567
91408
TWX - 101010163
ALL ELECTRONIC

QUANTITIES LIMITED
MINIMUM ORDERS \$10.00
CALIF. ADD SALES TAX
USA. \$3.00 SHIPPING
NO C.O.D.I.
FOREIGN ORDERS:
INCLUDE SUFFICIENT SHIPPING

TOLL FREE ORDERS
800-828-5432
INFO • (213) 380-8000
FAX - (213) 389-7073

POLARITY SWITCH

external coaxial relay on a satellite TV system. IDEAL FOR THE EXPERIMENTER AS PARTS Heavy chassis box containing a CA 358 op amp and other parts. Catalog # RDPS
\$1.75 each 10 for \$15.00



SOLID STATE BUZZER

Star #SMB-06L 6vdc TTL compatible.
\$1.00 each 10 for \$9.00



What's New at AMERICAN DESIGN COMPONENTS?

'The Source' of the electro-mechanical components for the hobbyist.

We warehouse 60,000 items at American Design Components — expensive, often hard-to-find components for sale at a fraction of their original cost!

You'll find every part you need — either brand new, or removed from equipment (RFE) in excellent condition. But quantities are limited. Order from this ad, or visit our retail showroom and find exactly what you need from the thousands of items on display.

Open Mon. — Sat., 9—5

THERE'S NO RISK.

With our full 90-day warranty, any purchase can be returned for any reason for full credit or refund.

ADAM COMPUTER... 5 1/2" DISK DRIVE



Gives your Adam fast, reliable data storage and retrieval. Can hold up to 160K bytes of information. Uses industry-standard SS/DD disks. Connects directly to your Adam memory console. Comes with disk drive power supply, Disk Manager disk and owner's manual. Mfr — Coleco, Model 7817

Item #12830 \$199.00 New

PC 8300 HOME COMPUTER

(Advanced version of the Timex 1000)



42-key mechanical keyboard (not membrane). Contains 2K of RAM. Reverse video, Z80A, 6.5MHz processor, ROM 8K BASIC. Graphics capability/sound-music, TV or monitor. Joystick input operates on 115 VAC. Includes: AC adapter, TV cable, and pair of cassette cables. Will run all prerecorded tapes for Sinclair/Timex 1000-ZX81. Mfr — Power 3000. In orig. boxes.

Item #10336 \$29.95 New

Accessories...

★ 16K RAMPACK upgrade Item #10337 \$9.95 New

★ 32K RAMPACK upgrade Item #12148 \$19.95 New

★ COLOR PACK Item #12147 \$19.95 New

12", High Resolution TTL MONITOR



12 VDC/110 VAC (w/built-in power supply). Green phosphor. Mtd. in metal housing. Schematic supplied. Mfr — Capetronic #DS-103D. Item #6811 \$19.95 New

3 1/2", 10Mb HARD DISK DRIVE (IBM® Compatible)

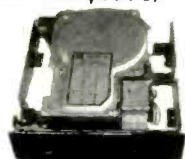

Fits standard 5 1/4" spacing. Shock mounted. High speed, low power. Mfr — Rodime #RO252F. Item #10151 \$159.00 New

Controller Card for above. Item #10150 \$89.00

5 1/4", 1.2 Mb. AT HALF HT. DISK DRIVE



48/96 TPI (IBM® Compatible) Double sided, single/double density; 80 track. Mfr — Panasonic #JU-475

Item #10005 \$119.00 New

15" COMPOSITE VIDEO MONITOR



15", green phosphor, high resolution (12 lines center) and bandwidth from 10Hz to 30Hz ± 3dB. Operating volt.: 120/240VAC. 50/60Hz. 65VA max. Mfr — Motorola — Alpha Series

Item #10044 \$34.95 New

5 1/4" FULL HT. DISK DRIVES



48 TPI (IBM® Compat.) Double sided/double density, full height drive. 48 T.P.I., 80 tracks. Mfr — Tandon TM100-2

Item #7928 \$79.95

2 for \$150.00

96 TPI, DS/Quad Density Mfr — CDC #9409T

Item #1893 \$99.00

5 1/4" 1/2 HT. DISK DRIVE



DOS 3.2 Compatible 96 TPI, DS/QUAD DENSITY

Tandon TM55—4 DS/Quad

Item #1904 \$79.00

2 for \$150.00

Insides of the Commodore Computer



Commodore VIC 20 CPU board & mechanical keyboard. Guaranteed not to work. (For parts only.)

Item #12144 \$14.95 RFE

SWITCHING POWER SUPPLY



115 & 230V, 47—440 Hz. Input: 90—135V/180—27CV

Output: 5VDC @ 5.5A
+12VDC @ 4A
-12VDC @ 3A

Perforated metal case enclosure. Dim.: 9 3/4" L x 3 1/2" W x 2" H. Mfr — General Instrument

Item #7983 \$14.95 New

COMPUTER GRADE POWER SUPPLY



Other uses—runs CS & car radios. Comes ready to plug in!

DC Output: -5V @ 5 amp
+5V @ 3 amp
+12V @ 6 amp

Input 115V/60Hz. Dim.: 9 1/4" W x 3 3/4" H. (Rubber ft. incl.)

Item #9501 \$24.95 New

HI-POWER SWITCHING POWER SUPPLY



Output: +5.15V @ 70A
+12V @ 4A
+12V @ 4A
+5.2V @ 5A

Input: 115/230V nominal, 725KW cont. 47—63Hz. Enclosed in metal housing.

Dim.: 15" W x 2 1/2" H x 6" deep. Mfr — Todd Instrument #4XS8151A

Item #9749 \$29.95 New

ADAM Accessories...

ADAM CDMPTER KIT

(Less printer.) Includes: Keyboard, digital data drive, 2 game controllers, power supply, all memory boards, and one cassette. No wiring necessary; hook-up diagram incl.

Item #7410 \$99.00

COLECOVISION to ADAM EXPANSION KIT

Plugs into your ColecoVision. With printer power supply & one data drive, you'll have a working Adam Computer! Keyboard & one Smart Basic cassette also included.

Item #9918 \$59.50

ADAM PRINTER

Item #8839 \$69.50

DATA DRIVE

Item #6641

LAST CHANCE — \$19.95

PRINTER POWER SUPPLY

Item #6642 \$14.95

ASCII KEYBOARD

Item #6643 \$19.95

CONTROLLERS

(Set of 4) Item #7013 \$9.95

ADAM CASSETTES

(Consisting of Smart Basic, Buck Rogers & blank cassette.)

Item #7786

BAKER'S DOZEN — \$19.95

LOGIC BOARD

(Parts only.) Item #7231 \$9.95

GAME BOARD

(Parts only.) Item #7679 \$6.95

ADAM LINK MODEM

(Software included.) Item #12353 \$29.95

AUTO-DIALER ADDRESS BOOK

Item #12365 \$19.95

PUMPS—COMPRESSORS—BLOWERS—MOTORS—POTENTIOMETERS—COUNTERS TIMERS—RELAYS—VOLTAGE REGULATORS—POWER SUPPLIES

1-PIECE TELEPHONE

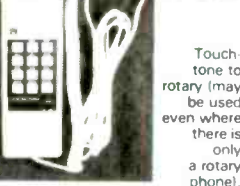

Touch-tone to rotary (may be used even where there is only a rotary phone).

Features: last number redial & mute button. Comes w/15' cord & standard modular plug. Color: Ivory. Mfr — Spectra-phone. Model OP-1. Item #10748 \$6.95, 3 for \$15.00 New

JOYSTICK CONTROLLERS



Fits Atari, Apple, Commodore, and our #10336 PC8300 Computer. Has 4-ft. cord with plug. Dim.: 3 1/2" sq. x 1 1/2" H.

Item #12143 \$5.95 New

12/24 VDC MUZZIN-TYPE FANS



55/100 CFM 8 W. Can be mounted for blowing or exhaust. Aluminum housing, brushless, ball-bearing type.

1" Thin: 5 plastic blades with feathered edges. Mfr — Centaur #CUDCC24K4-601

Item #8541 \$19.95 New

1 1/2" Standard: 5 plastic blades Mfr — Centaur #CNDCC24K4-601

Item #12109 \$14.95 RFE

AT-STYLE COMPUTER CABINET

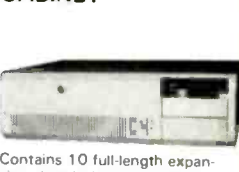

Contains 10 full-length expansion slots (w/guides). With room for an internal 5 1/4" hard disk drive. Has 3 half-height disk drive slots. Rear on/off switch, notched to hold in power supply (not incl.), and security switch w/key.

Item #12266 \$49.95 New

AMERICAN DESIGN COMPONENTS, 62 JOSEPH STREET, MOONACHIE, N.J. 07074

YES! Please send me the following items:

Item No.	How Many?	Description	Price	Total

FREE 1987 CATALOG sent with every order.

Shipping & handling, we ship UPS unless otherwise specified. Add \$3 plus 10% total. Canadian: \$3 plus P.O. cost. Charge only. Sales Tax (N.J. residents only, please add 6% of total)

My check or money order is enclosed.
 Charge my credit card.

Visa Master Card Amex

Card No. _____

Exp. Date _____

Signature _____

Telephone Area Code _____ Number _____

Name _____

Address _____

City _____

State _____ Zip _____

All inquiries and free catalog requests call 201-939-2710.

For all phone orders, call TOLL-FREE 800-524-0809. In New Jersey, 201-939-2710.

CIRCLE 195 ON FREE INFORMATION CARD

AUGUST 1987

THIS 45 SQ. INCH LIGHT PANEL IS .035 INCH THICK PRODUCES NO HEAT COMES IN 3 BOLD COLORS HAS IT'S OWN 12 VOLT POWER SUPPLY AND THATS WHY WE CALL IT THE MAGIC LAMP™



They were developed by the computer industry as hi-tec L.C.D. backlights. You can bend and twist them into almost any shape. The white one turns a brilliant cobalt blue, The pink one turns bright white, The green one, well it looks like the power source from a space ship! A manual explains how they work and the assembly directions are clear. Even the solder is included!

EACH \$39 KIT INCLUDES:

- 1: INSTRUCTION MANUAL WITH THEORY SECTION SEND \$5 (APPLIED TO PURCHASE) FOR THE MANUAL ONLY
- 5: LIGHT PANELS:
 - 1EA 10 INCH BY 4.5 INCH (SPECIFY WHITE OR BLUE)
 - 1EA 9.5 INCH BY 2.5 INCH (PINK THAT TURNS WHITE)
 - 3EA 9.5 INCH BY 2.5 INCH (MELT DOWN GREEN)
- 1: POWER SUPPLY KIT

15 DAY MONEY BACK TRIAL

Call for a copy of 15 day trial agreement. Tax & freight extra. Send check or add 1.90 for COD. Price may change. Store Price may differ. While supplies last. No PO's, terms, or credit cards

Silicon Valley Surplus
 415-261-4506
 4401 OAKPORT OAKLAND CA, 94601

OPEN
 10am-6pm
 CLOSED
 SUN & MON

CALL OUR BBS 415-261-4513

CIRCLE 186 ON FREE INFORMATION CARD

AMAZING SCIENTIFIC & ELECTRONIC PRODUCTS

- PLANS—Build Yourself—All Parts Available In Stock**
- LC7—BURNING CUTTING CO₂ LASER \$ 20.00
 - RUB4—PORTABLE LASER RAY PISTOL 20.00
 - TCC1—3 SEPARATE TESLA COIL 20.00
 - PLANS TO 1.5 MEV
 - IOG1—ION RAY GUN 10.00
 - GRA1—GRAVITY GENERATOR 10.00
 - EML1—ELECTRO MAGNET COIL GUN/LAUNCHER 6.00

- KITS**
- MFT1K—FM VOICE TRANSMITTER 3 MI RANGE 49.50
 - VWPMSK—TELEPHONE TRANSMITTER 3 MI RANGE 39.50
 - BTC3K—250.00 VOLT 10-14" SPARK TESLA COIL 199.50
 - LHC2K—SIMULATED MULTICOLOR LASER 39.50
 - BLS1K—100.000 WATT BLASTER DEFENSE DEVICE 69.50
 - ITM1K—100.000 VOLT 20" AFFECTIVE RANGE INTIMIDATOR 69.50
 - PSP4K—TIME VARIANT SHOCK WAVE PISTOL 59.50
 - PTG1K—SPECTACULAR PLASMA TORNADO GENERATOR 149.50
 - MVPIK SEE IN DARK KIT 169.50

- ASSEMBLED**
- PG70H—MULTICOLORED VARIABLE MODE PLASMA GLOBE 7 425.00
 - BTC10—50.000 VOLT—WORLD'S SMALLEST TESLA COIL 44.50
 - LGU40—1MW HeNe VISIBLE RED LASER GUN 299.50
 - TAT20 AUTO TELEPHONE RECORDING DEVICE 24.50
 - GPV10—SEE IN TOTAL DARKNESS IR VIEWER 299.50
 - LIST10—SNOOPER PHONE INFINITY TRANSMITTER 169.50
 - IPG70—INVISIBLE PAIN FIELD GENERATOR—MULTI MODE 74.50

* CATALOG CONTAINING DESCRIPTIONS OF ABOVE PLUS HUNDREDS MORE AVAILABLE FOR \$1.00 OR INCLUDED FREE WITH ALL ABOVE ORDERS

PLEASE INCLUDE \$3.00 PH ON ALL KITS AND PRODUCTS PLANS ARE POSTAGE PAID SEND CHECK, MO VISA MC IN US FUNDS

INFORMATION UNLIMITED
 P.O. BOX 716 DEPT. RE, AMHERST, NH 03031

ADVERTISING INDEX

RADIO-ELECTRONICS does not assume any responsibility for errors that may appear in the index below.

Free Information Number	Page		
81	A.I.S. Satellite	79	191 OCTE Electronics
108	AMC Sales	29	110 Omnitron
107	All Electronics	98	— Pacific Cable
103	Allen W.B.	38	181 Parts Express
—	Amazing Devices	100	101 Pomona Electronics
195	American Design Components	99	78 Radio Shack
98	Beckman Industrial	3	177, 178 Sencore
85	Blue Star Industries	78	179, 180 Sencore
109	C & S Sales	14	186 Silicon Valley Surplus
—	C.O.M.B.	16	74 Solid State Sales
60	CIE	34	94 Star Circuits
89	Cameo Enterprises	79	92 Tektronix
54	Chemtronics	33	66 W.S. Jenks
196, 198	Circuit Cellar	78, 79	
—	Command Productions	29	
203	Computer Technologies	72	
194	Cook's Institute	24	
193	Crystek	8	
200	Daetron	12	
127	Deco Industries	78, 79	
189, 190	Dick Smith Electronics	90	
82	Digi-Key	87	
—	Electronic Technology Today	78, 79 CV3	
120	Elephant Electronics	24	
111	Etronix	81	
100	Firestik II	29	
188	First Street Computer	26	
—	Fordham Radio	10	
—	Grantham College of Engineering	5	
86, 176	Heath	9, 20	
—	ICS	81	
65	J & W	15	
59	JDR Instruments	7	
113, 182	JDR Microdevices	92, 93	
183, 184	JDR Microdevices	94, 95	
185	JDR Microdevices	96	
114	Jameco	88, 89	
104	Jan Crystals	33	
87	MCM Electronics	91	
204	MD Electronics	79	
93	Mark V. Electronics	85	
205	Mercer	13	
61	Microprocessors Unltd.	72	
—	NRI	11, 17	
187	NTS	79	
—	Nesda	28	
202	NuScope Associates	72	

Gernsback Publications, Inc.
 500-B Bi-County Blvd.
 Farmingdale, NY 11735
 (516) 293-3000
 President: Larry Steckler
 Vice President: Cathy Steckler

For Advertising ONLY
 516-293-3000
Larry Steckler
 publisher
Arline Fishman
 advertising director
Shelli Weinman
 advertising associate
Lisa Strassman
 credit manager
Christina Estrada
 advertising assistant

SALES OFFICES

EAST/SOUTHEAST
Stanley Levitan
 Eastern Sales Manager
 Radio-Electronics
 259-23 57th Avenue
 Little Neck, NY 11362
 718-428-6037, 516-293-3000

MIDWEST/Texas/Arkansas/Okla.
Ralph Bergen
 Midwest Sales Manager
 Radio-Electronics
 540 Frontage Road—Suite 339
 Northfield, IL 60093
 312-446-1444

PACIFIC COAST/ Mountain States
Marvin Green
 Pacific Sales Manager
 Radio-Electronics
 15335 Morrison St.—Suite 227
 Sherman Oaks, CA 91403
 818-986-2001

FOR FREE INFORMATION USE THESE POST-PAID CARDS

- 1 Print your name, address and Zip Code on one of the attached postage-paid cards.
- 2 Circle the number (or numbers) on the card that matches the number at the bottom of each ad or editorial item that you want information on. Advertisers' free information numbers also appear in the ad index on the facing page.

3 Mail the card. It's Postage-Paid.

The bottom free-information card is a BUSINESS/PROFESSIONAL CARD. If you use this card you MUST complete the spaces for Company Name, Title, and Phone Number. If these are not filled in, the card will not be processed.

NOTE:
Use the postcard address for Free Product Information only. Address all editorial inquiries to Editor, Radio-Electronics, 500-B Bi-County Blvd., Farmingdale, NY 11735



Radio Electronics.
Your favorite electronics magazine and still getting better

BUSINESS PROFESSIONAL FREE INFO CARD

Use this card if information requested is for business use. You must fill in company name and phone number.



4-887

Name _____ Title _____
 Company _____
 Dept./MS _____
 Daytime Business Phone _____
 Company Address _____
 City _____ State _____ Zip + 4 _____

Unclear or incomplete mailing info will prevent our processing this request.

- 2 Please send me 12 issues of RADIO-ELECTRONICS for \$16.97 and bill me. (Canada \$22.97 - US Funds only)
- 4 Please send me 12 issues of HANDS-ON ELECTRONICS for \$28.00 and bill me. (Canada \$33.00 - US Funds only)

19 37 55 73 91 109 127 145 163 181 199 217 235 253 271
 20 38 56 74 92 110 128 146 164 182 200 218 236 254 272
 21 39 57 75 93 111 129 147 165 183 201 219 237 255 273
 22 40 58 76 94 112 130 148 166 184 202 220 238 256 274
 23 41 59 77 95 113 131 149 167 185 203 221 239 257 275
 24 42 60 78 96 114 132 150 168 186 204 222 240 258 276
 25 43 61 79 97 115 133 151 169 187 205 223 241 259 277
 26 44 62 80 98 116 134 152 170 188 206 224 242 260 278
 9 27 45 63 81 99 117 135 153 171 189 207 225 243 261 279
 10 28 46 64 82 100 118 136 154 172 190 208 226 244 262 280
 11 29 47 65 83 101 119 137 155 173 191 209 227 245 263 281
 12 30 48 66 84 102 120 138 156 174 192 210 228 246 264 282
 13 31 49 67 85 103 121 139 157 175 193 211 229 247 265 283
 14 32 50 68 86 104 122 140 158 176 194 212 230 248 266 284
 15 33 51 69 87 105 123 141 159 177 195 213 231 249 267 285
 16 34 52 70 88 106 124 142 160 178 196 214 232 250 268 286
 17 35 53 71 89 107 125 143 161 179 197 215 233 251 269 287
 18 36 54 72 90 108 126 144 162 180 198 216 234 252 270 288

FREE INFORMATION CARD

VOID after OCTOBER 31, 1987
 Allow 6-8 weeks for delivery of first issue

POSTAGE-PAID FREE INFORMATION CARD



3-887

Name (please print) _____
 Company Name (if applicable) _____
 Address _____
 City _____ State _____ Zip + 4 _____

Unclear or incomplete mailing info will prevent our processing this request.

- 2 Please send me 12 issues of RADIO-ELECTRONICS for \$16.97 and bill me. (Canada \$22.97 - US Funds only)
- 4 Please send me 12 issues of HANDS-ON ELECTRONICS for \$28.00 and bill me. (Canada \$33.00 - US Funds only)

Is this your personal copy of RADIO-ELECTRONICS?

6 Yes 8 No

19 37 55 73 91 109 127 145 163 181 199 217 235 253 271
 20 38 56 74 92 110 128 146 164 182 200 218 236 254 272
 21 39 57 75 93 111 129 147 165 183 201 219 237 255 273
 22 40 58 76 94 112 130 148 166 184 202 220 238 256 274
 23 41 59 77 95 113 131 149 167 185 203 221 239 257 275
 24 42 60 78 96 114 132 150 168 186 204 222 240 258 276
 25 43 61 79 97 115 133 151 169 187 205 223 241 259 277
 26 44 62 80 98 116 134 152 170 188 206 224 242 260 278
 9 27 45 63 81 99 117 135 153 171 189 207 225 243 261 279
 10 28 46 64 82 100 118 136 154 172 190 208 226 244 262 280
 11 29 47 65 83 101 119 137 155 173 191 209 227 245 263 281
 12 30 48 66 84 102 120 138 156 174 192 210 228 246 264 282
 13 31 49 67 85 103 121 139 157 175 193 211 229 247 265 283
 14 32 50 68 86 104 122 140 158 176 194 212 230 248 266 284
 15 33 51 69 87 105 123 141 159 177 195 213 231 249 267 285
 16 34 52 70 88 106 124 142 160 178 196 214 232 250 268 286
 17 35 53 71 89 107 125 143 161 179 197 215 233 251 269 287
 18 36 54 72 90 108 126 144 162 180 198 216 234 252 270 288

BUSINESS REPLY MAIL

FIRST CLASS PERMIT NO 597 BOULDER, COLORADO



SUBSCRIPTION SERVICE

P.O. Box 51866

BOULDER, COLORADO 80321-1866

NO POSTAGE
 NECESSARY
 IF MAILED
 IN THE
 UNITED STATES



FREE INFORMATION CARD

VOID after OCTOBER 31, 1987
 Allow 6-8 weeks for delivery of first issue



NO POSTAGE
NECESSARY
IF MAILED
IN THE
UNITED STATES

BUSINESS REPLY MAIL
FIRST CLASS PERMIT NO. 132 DALTON, MA

POSTAGE WILL BE PAID BY ADDRESSEE

**Radio-
Electronics**

FREE PRODUCT INFORMATION
P.O. Box 388
DALTON, MA 01226-9990



**For New
Ideas
In Electronics
read Radio-
Electronics
every month.
During the next
12 months**

Radio-Electronics will carry up to the minute articles on:

- Computers • Video
- Solid-state technology
- Outstanding construction projects
- Satellite TV • Telephones
- Radio • Stereo • Equipment Reports
- Test equipment • VCR's
- Servicing
- Industrial electronics



**NEW IDEAS AND INNOVATIONS
IN ELECTRONICS APPEAR IN EVERY
ISSUE OF RADIO-ELECTRONICS**

**KEEP UP TO DATE! DON'T MISS
ANY ISSUES!**

SUBSCRIBE TODAY!

**USE THE ORDER CARD ON YOUR
LEFT!**

**Radio-
Electronics**

4SH79

Subscribe today to the magazine that keeps you up-to-date with the newest ideas and innovations in electronics. (If you already are a subscriber, do a friend a favor and pass this subscription card along to him.)

check offer preferred

- 1 Year—12 issues **ONLY \$16.97** 2 Years (**SAVE MORE**)—24 issues \$32.97
(You save \$10.03 off single copy price) (You save \$21.03 off single copy price)
- Canada—12 issues \$22.97 Canada—24 issues \$44.97

ALL SUBSCRIPTIONS PAYABLE IN U.S. FUNDS ONLY

- Payment enclosed Bill Me Check here if you are extending or renewing your subscription

Name (Please Print) _____
Company Name (If applicable) _____
Address _____
City _____ State _____ Zip _____

Allow 6-8 weeks for delivery of first issue



NO POSTAGE
NECESSARY
IF MAILED
IN THE
UNITED STATES

BUSINESS REPLY MAIL
FIRST CLASS PERMIT NO. 132 DALTON, MA

POSTAGE WILL BE PAID BY ADDRESSEE

**Radio-
Electronics**

FREE PRODUCT INFORMATION
P.O. Box 388
DALTON, MA 01226-9990



**Hands-on
Electronics**
Formerly Special Projects

Delivers construction article after construction article....Exciting columns including Jensen on DXing, Freidman on computers, Test bench tips, Noll with Calling All Hams, New Products and more.



SUBSCRIBE TODAY!

**USE THE REPLY CARDS ON YOUR
LEFT!**

Electronics Paperback Books

EVERY BOOK IN THIS AD \$6 OR LESS!

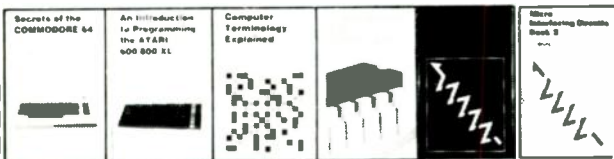

- BP125—25 SIMPLE AMATEUR BAND ANTENNAS.....\$5.00.** All are inexpensive to build, yet perform well. Diodes, beams, triangle and even a mini rhombic.
- BP128—20 PROGRAMS FOR THE ZX SPECTRUM AND 16K ZX82.....\$5.75.** Included with each program is a flow chart and a description of what happens. Notes for converting programs for use on other computers are also included.
- 160—COIL DESIGN & CONSTRUCTION MANUAL.....\$5.95.** How the hobbyist can build RF, IF, audio and power coils, chokes and transformers. Covers AM, FM and TV applications.
- 208—PRACTICAL STEREO & QUADROPHONY HANDBOOK.....\$3.00.** A reference book for all interested in stereo and multichannel sound reproduction.
- BP99—MINI-MATRIX BOARD PROJECTS.....\$5.00.** Here are 20 useful circuits that can be built on a mini-matrix board that is just 24 holes by ten copper-foil strips.
- BP157—HOW TO WRITE ZX SPECTRUM AND SPECTRUM+ GAMES PROGRAMS.....\$5.95.** A crystal-clear step-by-step guide to writing your own graphics games programs.
- BP117—PRACTICAL ELECTRONIC BUILDING BLOCKS—Book 1.....\$5.75.** Oscillators, Timers, Noise Generators, Rectifiers, Comparators, Triggers and more.
- 219—SOLID-STATE NOVELTY PROJECTS.....\$4.95.** Fun projects include the Optomin, a musical instrument that is played by reflecting a light beam with your hand, and many more.
- BP179—ELECTRONIC CIRCUITS FOR THE COMPUTER CONTROL OF ROBOTS.....\$5.00.** Data and circuits for interfacing the computer to the robot's motors and sensors.
- BP126—BASIC & PASCAL IN PARALLEL.....\$4.95.** Takes these two programming languages and develops programs in both languages simultaneously.
- 224—50 CMOS IC PROJECTS.....\$5.25.** Includes sections on multivibrators, amplifiers and oscillators, trigger devices, and special devices.
- 225—A PRACTICAL INTRODUCTION TO DIGITAL IC'S.....\$4.95.** Mainly concerned with TTL devices. Includes several simple projects plus a logic circuit test set and a digital counter timer.
- BP170—INTRODUCTION TO COMPUTER PERIPHERALS.....\$5.95.** Shows how to use a variety of computer add-ons in as non-technical a way as possible.
- 227—BEGINNERS GUIDE TO BUILDING ELECTRONIC PROJECTS.....\$5.00.** How to tackle the practical side of electronics so you can successfully build electronic projects.
- BP169—HOW TO GET YOUR COMPUTER PROGRAMS RUNNING.....\$5.95.** Shows how to identify error in program and what to do about them.
- 123—FIRST BOOK OF PRACTICAL ELECTRONIC PROJECTS.....\$3.75.** Projects include audio distortion meter, super FET receiver, guitar amplifier, metronome and more.
- BP24—52 PROJECTS USING IC 741.....\$5.25.** Lots of projects built around this one available IC.
- BP110—HOW TO GET YOUR ELECTRONIC PROJECTS WORKING.....\$5.00.** How to find and solve the common problems that can occur when building projects.

- BP33—ELECTRONIC CALCULATOR USERS HANDBOOK.....\$5.75.** Invaluable book for all calculator owners. Tells how to get the most out of your calculator.
- BP36—50 CIRCUITS USING GERMANIUM, SILICON & ZENER DIODES.....\$5.00.** A collection of useful circuits you'll want in your library.
- BP37—50 PROJECTS USING RELAYS, SCR'S & TRIACS.....\$5.00.** Build priority indicators, light modulators, warning devices, light dimmers and more.
- BP183—AN INTRODUCTION TO CP/M.....\$5.75.** To run and use programs operating under the CP/M operating system you will find this book extremely useful.
- BP42—SIMPLE LED CIRCUITS.....\$5.00.** A large selection of simple applications for this simple electronic component.
- BP127—HOW TO DESIGN ELECTRONIC PROJECTS.....\$5.75.** Helps the reader to put projects together from standard circuit blocks with a minimum of trial and error.
- BP122—AUDIO AMPLIFIER CONSTRUCTION.....\$5.75.** Construction details for preamps and power amplifiers up through a 100-watt DC-coupled FED amplifier.
- BP92—CRYSTAL SET CONSTRUCTION.....\$5.00.** Everything you need to know about building crystal radio receivers.
- BP45—PROJECTS IN OPTOELECTRONICS.....\$5.00.** Includes infra-red detectors, transmitters, modulated light transmission and photographic applications.
- BP48—ELECTRONIC PROJECTS FOR BEGINNERS.....\$5.00.** A wide range of easily completed projects for the beginner. Includes some no-soldering projects.
- BP49—POPULAR ELECTRONIC PROJECTS.....\$5.50.** Radio, audio, household and test equipment projects are all included.
- BP51—ELECTRONIC MUSIC AND CREATIVE TAPE RECORDING.....\$5.50.** Shows how you can make electronic music at home with the simplest and most inexpensive equipment.
- BP56—ELECTRONIC SECURITY DEVICES.....\$5.00.** Includes both simple and more sophisticated burglar alarm circuits using light, infra-red, and ultrasonics.
- BP59—SECOND BOOK OF CMOS IC PROJECTS.....\$5.00.** More circuits showing CMOS applications. Most are of a fairly simple design.
- BP72—A MICROPROCESSOR PRIMER.....\$5.00.** We start by designing a small computer and show how we can overcome its shortcomings.
- BP74—ELECTRONIC MUSIC PROJECTS.....\$5.95.** Provides the experimenter with a variety of practical circuits including a Fuzz Box, Sustain Unit, Reverberation Unit, Tremolo Generator and more.
- BP91—AN INTRODUCTION TO RADIO DXING.....\$5.00.** How you can tune in on those amateur and commercial broadcasts from around the world in the comfort of your home.
- BP94—ELECTRONIC PROJECTS FOR CARS AND BOATS.....\$5.00.** Fifteen simple projects that you can use with your car or boat. All are designed to operate from 12-volt DC supplies.



ELECTRONIC TECHNOLOGY TODAY INC.
P.O. Box 240, Massapequa Park, NY 11762-0240

Name _____
Address _____
City _____ State _____ Zip _____

SHIPPING CHARGES IN
USA & CANADA
\$0.01 to \$5.00 . . . \$1.00
\$5.01 to \$10.00 . . . \$1.75
\$10.01 to 20.00 . . . \$2.75
\$20.01 to 30.00 . . . \$3.75
\$30.01 to 40.00 . . . \$4.75
\$40.01 to 50.00 . . . \$5.75
\$50.01 and above . . \$7.00

OUTSIDE USA & CANADA

Multiply Shipping by 2 for sea mail
Multiply Shipping by 4 for air mail

Total price of merchandise . . . \$ _____
Sales Tax (New York State Residents only) . . . \$ _____
Shipping (see chart) . . . \$ _____

All payments must
be in U.S. funds

Number of books ordered

Total Enclosed . . . \$ _____

Your Best Source for SMD Test Accessories is POMONA ELECTRONICS

PATCH CORD; SMD GRABBER™
BOTH ENDS: MODEL 5301

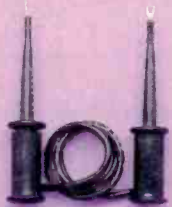

SMD TEST TWEEZER™ TO BNC
MALE: MODEL 5142 (SHOWN).
TO TWO SINGLE STACKING
BANANA PLUGS: MODEL 5143



DO-IT-YOURSELF SMD
GRABBER™: MODEL 5243



SMD MICROTIP™ TEST
PROBE TO SINGLE
STACKING BANANA
PLUG: MODEL 5144



FREE 1987 GENERAL CATALOG

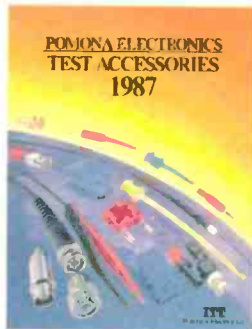

ITT Pomona Electronics
1500 E. Ninth St., Pomona, CA 91766
Tel: (714) 623-3463

PLCC TEST ADAPTORS
FIVE MODELS: 20 PIN, 28 PIN,
44 PIN, 52 PIN, 68 PIN



CABLE ASSEMBLY; SMD
GRABBER™ TEST CLIPS TO
BNC MALE: MODEL 5304



SOIC CLIP™ TEST CLIP: MODEL
5250 (8 PIN); 5251 (14 PIN); 5252
(16 PIN) SHOWN; 5253 (20 PIN);
5254 (24 PIN)

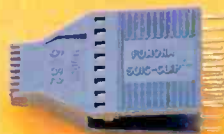

MOLDED BREAKOUT; SMD
GRABBER™ TEST CLIPS TO
FEMALE BNC: MODEL 5305



Our Products are available through your favorite electronics parts distributor.

CIRCLE 101 ON FREE INFORMATION CARD