

48783 **Radio** - BUILD A STEREO-TV DECODER

\$1.95 FEB. 87
IN CANADA \$2.99

Electronics

TECHNOLOGY - VIDEO - STEREO - COMPUTERS - SERVICE

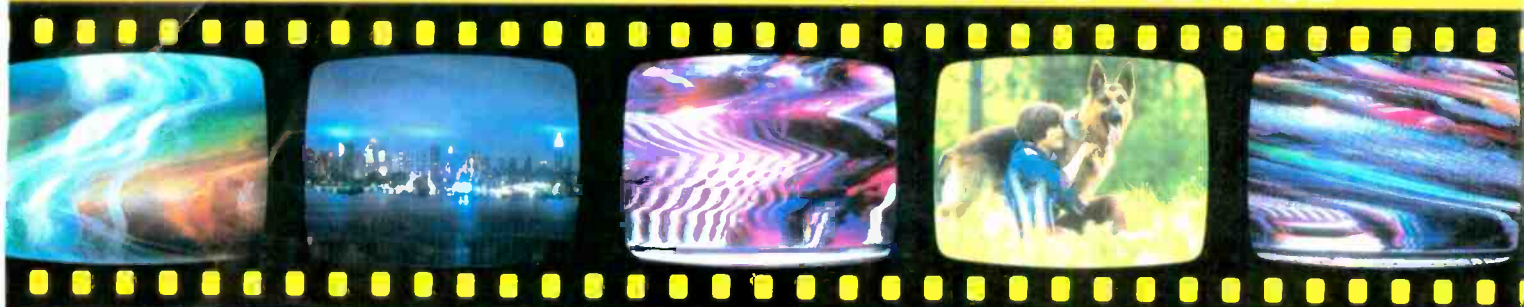

TRI-MODE CABLE-TV DESCRAMBLING

Experimenter's delight!

BUILD THE R-E ROBOT

Designing the base unit.

SEMICONDUCTOR TESTING

Our new back-to-school series

PUSHBUTTON SCOPES

Make measurements easy!

A/D CONVERTERS

Put them to work for you

POLAPULSE BATTERIES

How to use those versatile
power packs



PLUS:

- ★ Video News
- ★ Audio Update
- ★ Ask R-E
- ★ Satellite TV
- ★ Antique Radios
- ★ **COMPUTERDIGEST**



A
GERNSBACK
PUBLICATION

New GPS Series: Tek sets the pace with SmartCursors™ and push-button ease.

Work faster, smarter, with two new general purpose scopes from Tektronix. The four-channel, 100 MHz 2246 and 2245 set the new, fast pace for measurements at the bench or in the field. They're easy to use and afford, by design.

On top: the 2246 with exclusive integrated push-button measurements. Measurements are accessed through easy, pop-up menus and implemented at the touch of a button. Measure peak volts, peak-to-peak, \pm peak, dc volts and gated volts with new hands-off convenience and on-screen readout of values.

SmartCursors™ track voltmeter measurements in the 2246 and visually indicate where ground and trigger levels are located. Or use cursors in the manual mode for immediate, effortless measurement of waveform parameters.

Both scopes build on performance you haven't seen at the bandwidth or prices. Lab grade features include sweep speeds to 2 ns/div. Vertical sensitivity of 2 mV/div at full bandwidth for low-level signal capture. Plus trigger

Features	2246	2245
Bandwidth	100 MHz	100 MHz
No. of Channels	4	4
Scale Factor Readout	Yes	Yes
SmartCursors™	Yes	No
Volts Cursors	Yes	No
Time Cursors	Yes	No
Voltmeter	Yes	No
Vertical Sensitivity	2 mV/div	2 mV/div
Max. Sweep Speed	2 ns/div	2 ns/div
Vert/Hor Accuracy	2%	2%
Trigger Modes	Auto Level, Auto, Norm, TV Field, TV Line, Single Sweep	
Trigger Level Readout	Yes	No
Weight	6.1 kg	6.1 kg
Warranty	3-year on parts and labor including CRT	
Price	\$2400	\$1875

sensitivity to 0.25 div at 50 MHz, to 0.5 div at 150 MHz.

Accuracy is excellent: 2% at vertical, 2% at horizontal. And four-channel capability includes two channels optimized for logic signals.

Best of all, high performance comes with unmatched convenience. You can see it and feel it — in the

responsive controls and simple front-panel design, in extensive on-screen scale factor readouts, and in simplified trigger operation that includes Tek's Auto Level mode for automatic triggering on any signal. Start to finish, the GPS Series saves steps and simplifies tasks.

Get out in front! Call toll-free today to order, to get more details or a videotape demonstration.

1-800-433-2323

In Oregon, call collect 1-627-9000

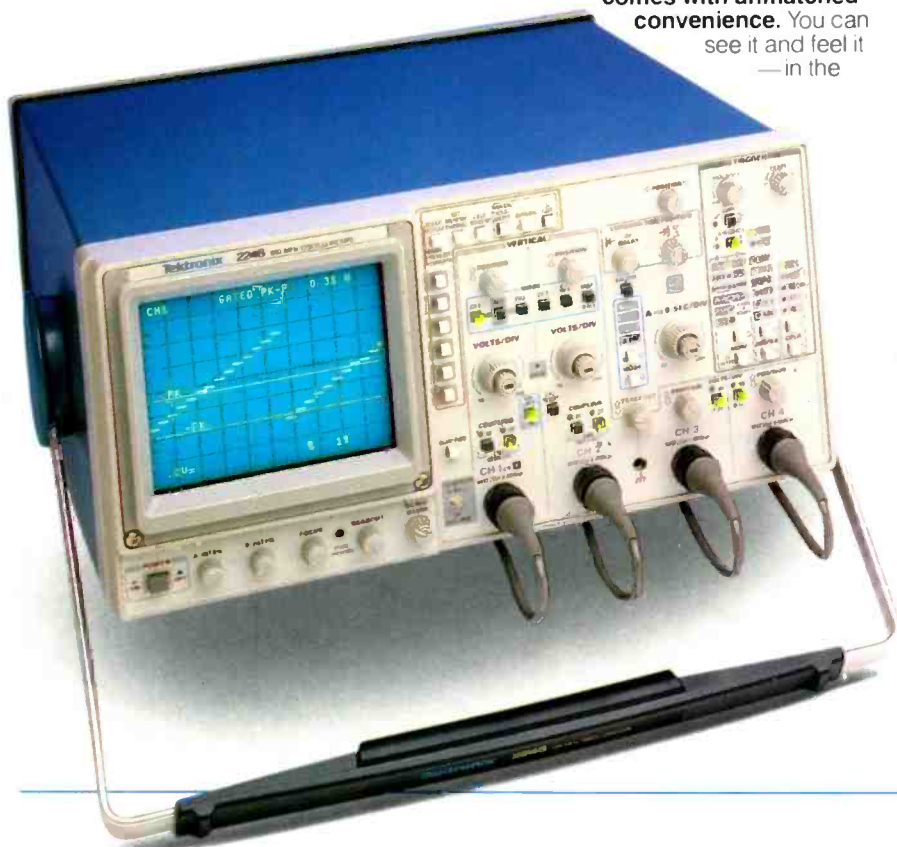

Featuring four channels, flexible triggering, extensive CRT readouts and push-button ease of use, the new Tek 2246 (left) and 2245 (above) bring high-quality, low-cost analysis to diverse applications in digital design, field service and manufacturing.

Tektronix
COMMITTED TO EXCELLENCE

FEBRUARY '87

**Radio-
Electronics**[®]

Electronics publishers since 1908

Vol. 58 No. 2

BUILD THIS	48 R-E ROBOT Part 3. Design considerations for a robot drive system. Steven E. Sarns	RADIO	38 ANTIQUE RADIOS The telegraph. Richard D. Fitch
	51 STEREO TV DECODER Part 2. How to build the decoder and hook it up to any TV set. Tod T. Templin		94 COMMUNICATIONS CORNER Image interference. Herb Friedman
	73 PC SERVICE		
TECHNOLOGY	6 VIDEO NEWS Inside the fast-changing video scene. David Lachenbruch	COMPUTERS	91 COMPUTER DIGEST How to assemble an IBM-compatible clone computer, and more!
	43 TRI-MODE CABLE-TV SCRAMBLING Experimenter's delight! All about the Tri-mode scrambling system and how it can be descrambled. Jimmy Coffell	EQUIPMENT REPORTS	24 Orchid PC Turbo 286e PC Accelerator Card Give your PC or XT the power of an AT.
	55 USING THE NEW GENERATION OSCILLOSCOPES How pushbuttons can make oscilloscope measurements a snap! Calvin Diller		26 Philips Compact Disc Test Set Test discs help find player faults.
	61 USING THE POLAPULSE BATTERY The Polaroid Polapulse batteries are versatile power packs just waiting to be put to use. Fred Blechman	DEPARTMENTS	138 Advertising and Sales Offices
	83 SATELLITE TV Practical notes on Videocipher descrambling. Bob Cooper, Jr.		138 Advertising Index
	85 AUDIO UPDATE The equalizer. Larry Klein		12 Ask R-E
CIRCUITS AND COMPONENTS	36 NEW IDEAS Sequential flasher.		139 Free Information Card
	58 TESTING SEMICONDUCTORS Part 1. Our new back-to-school series. This month, we look at how to test diodes and bipolar transistors. TJ Byers		16 Letters
	71 ALL ABOUT A-TO-D CONVERTERS How they work and how to put them to use. Harry L. Trietley		115 Market Center
	92 STATE OF SOLID STATE A transformerless 5-volt regulator. Robert F. Scott		73 PC Service
	96 DESIGNER'S NOTEBOOK A simple CMOS oscillator. Robert Grossblatt		34 New Products
			4 What's News

RADIO-ELECTRONICS, (ISSN 0033-7862) February 1987. Published monthly by Gernsback Publications, Inc., 500-B Bi-County Boulevard, Farmingdale, NY 11735 Second-Class Postage paid at Farmingdale, NY and additional mailing offices. Second-Class mail registration No. 9242 authorized at Toronto, Canada. One-year subscription rate U.S.A. and possessions \$16.97. Canada \$22.97, all other countries \$25.97. Subscription orders payable in US funds only, international postal money order or check drawn on a U.S.A. bank. Single copies \$1.95. © 1987 by Gernsback Publications, Inc. All rights reserved. Printed in U.S.A.

POSTMASTER: Please send address changes to RADIO-ELECTRONICS, Subscription Dept., Box 55115, Boulder, CO 80321-5115. A stamped self-addressed envelope must accompany all submitted manuscripts and/or artwork or photographs if their return is desired should they be rejected. We disclaim any responsibility for the loss or damage of manuscripts and/or artwork or photographs while in our possession or otherwise.

COVER 1



If you are an experimenter, then there's nothing more fun than attacking a challenging problem. One of the bigger challenges to the electronics experimenter today is cracking the various TV-signal scrambling schemes.

The device shown on the cover is one experimenter's results: a cable-TV Tri-mode descrambler. It was built not to steal cable-TV signals without authorization, but rather in response to the challenge that was offered (because the scrambled signal was there). If you feel the challenge, too, then here's a great circuit which with to experiment. Have fun, and turn to page 43!

NEXT MONTH

THE MARCH ISSUE IS
ON SALE FEBRUARY 3

A BUYER'S GUIDE TO CAMCORDERS
VHS-C Vs. 8mm—what do you buy?

BUILD THE R-E ROBOT
Part 4. Building the robot's chassis.

PIEZOELECTRIC PLASTIC FILM
A versatile material that's fun to experiment with!

SEMICONDUCTOR TESTING
FET DC parameters

CABLE TESTERS
A look at the technology to find cable faults.

VHSIC
New technology for Very High Speed Integrated Circuits

As a service to readers, RADIO-ELECTRONICS publishes available plans or information relating to newsworthy products, techniques and scientific and technological developments. Because of possible variances in the quality and condition of materials and workmanship used by readers, RADIO-ELECTRONICS disclaims any responsibility for the safe and proper functioning of reader-built projects based upon or from plans or information published in this magazine.

Since some of the equipment and circuitry described in RADIO-ELECTRONICS may relate to or be covered by U.S. patents, RADIO-ELECTRONICS disclaims any liability for the infringement of such patents by the making, using, or selling of any such equipment or circuitry, and suggests that anyone interested in such projects consult a patent attorney.

Radio-Electronics

Hugo Gernsback (1884-1967) founder
M. Harvey Gernsback,
editor-in-chief, emeritus

Larry Steckler, EHF, CET, editor-in-chief
and publisher

EDITORIAL DEPARTMENT

Art Kleiman, editorial director
Brian C. Fenton, managing editor
Carl Laron, WB2SLR, associate editor
Jeffrey K. Holtzman,
assistant technical editor
Robert A. Young, assistant editor
Julian S. Martin, editorial associate
Byron G. Wels, editorial associate
M. Harvey Gernsback,
contributing editor
Jack Darr, CET, service editor
Robert F. Scott,
semiconductor editor
Herb Friedman,
communications editor
Bob Cooper, Jr. satellite-TV editor
Robert Grossblatt, circuits editor
Larry Klein, audio editor
David Lachenbruch,
contributing editor
Richard D. Fitch,
contributing editor
Mark J. Robillard, robotics editor
Teri Scaduto, editorial assistant

PRODUCTION DEPARTMENT

Ruby M. Yee, production director
Robert A. W. Lowndes,
editorial production
Andre Duzant, technical illustrator
Karen Tucker, advertising production
Geoffrey S. Weil, production traffic

CIRCULATION DEPARTMENT

Jacqueline P. Cheeseboro,
circulation director
Wendy Alanko,
circulation analyst
Theresa Lombardo,
circulation assistant

Cover photo by Dan Muro

Typography by Mates Graphics

Radio-Electronics, Gernsback Publications, Inc., 500-B Bi-County Blvd., Farmingdale, NY 11735.
516-293-3000

Radio-Electronics is indexed in *Applied Science & Technology Index* and *Readers Guide to Periodical Literature*.

Microfilm & microfiche editions are available. Contact circulation department for details.

Advertising Sales Offices listed
on page 138.



Make your home into something special!

That's exactly what your home will be when you fill it with Heathkit electronic products – products that make your life easier and more enjoyable. Within our diverse line are kit and assembled products sure to enhance each room in your home.



1. Make your entryway more secure and easy to use with the Keyless Doorlock. You'll never again be locked out because of lost or forgotten keys. All it takes is a simple fingertip entry of a four-digit code, and the Keyless Doorlock unlocks your door.

2. Add a new dimension to your living room with your own Computerized Weather Station. This Digital Weather Station displays up-to-the-minute temperature, wind, and barometric pressure readings, along with time and date.



3. Give your kitchen a unique blend of style and efficiency with our Digital Wall Clock. This easy-to-build kit keeps time with quartz-crystal accuracy. And with its simulated oak wood-grain finish cabinet, you'll have a timepiece that fits into almost any decor.



4. Put your den to greater use with this IBM PC AT Compatible Computer. Do word processing, personal accounting and more when you run exciting IBM-compatible software on your fast and powerful HS-241. And you can build it yourself in just a few hours.



5. Bring the latest in digital technology to your bathroom. This Digital Scale lets you closely monitor your weight with electronic precision. And, it's battery operated so it's safe to use right out of the shower.



6. Add a video entertainment center to your bedroom. Our 19"-diagonal stereo TV kit gives you an extra-sharp color-corrected picture with full stereo sound, and convenient viewing that you can control from your bed. Comes in a simulated walnut cabinet that complements your room.



7. Transform your rec room into a haven for hobby fun. Put our Deluxe QRP CW Transceiver in this room and enjoy superb HAM radio operation that excels in performance and features. It offers expandable transmission and reception capabilities.



8. Give your workbench a touch of professionalism with this oscilloscope. Whether you're a service technician or a hobbyist, you'll love the wide range of measurement capability our laboratory-grade Dual Trace 10 MHz Oscilloscope gives you.



9. Add practicality to the utility room and save money, too. Avoid expensive food spoilage with our Freezer Alarm that



warns you when the inside temperature of your freezer rises too high. Prevent water damage with our Food Alarm that warns you of water that's where it shouldn't be.



10. Make your coming and going easier than ever. Your garage door will open with incredible

ease and dependability with our Deluxe Garage Door Opener. Easy to install, this opener is durable and includes a handy security light.

You'll find fun and excitement with every Heathkit product. Whether they're in kit form or already assembled, our products will help you enjoy your home more than you ever dreamed possible.

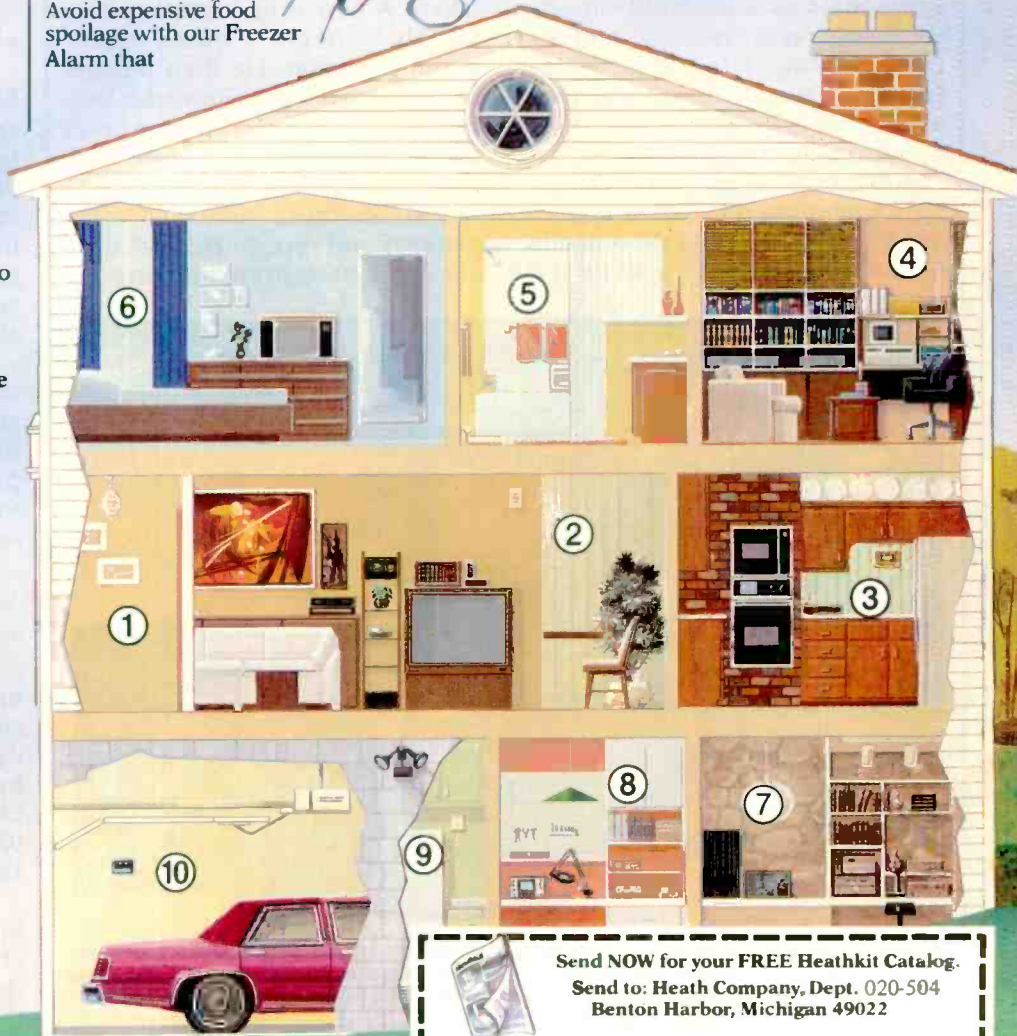

Heathkit
Heath
Company

Send NOW for your FREE Heathkit Catalog.
Send to: Heath Company, Dept. 020-504
Benton Harbor, Michigan 49022

Name _____
Address _____
City _____ State _____ Zip _____
A subsidiary of Zenith Electronics Corporation CL-789A

WHAT'S NEWS

"Car of the future" obeys voice commands

A feature of the recent Paris Auto Show was a special Renault that "obeyed its driver's every command." The demonstration car was a state-of-the-art Renault Model 21 that incorporated the latest in computer-assisted driving aids. The highlight was a Votan voice-recognition system that gave the driver voice control over such accessories as windshield wipers, windows, radio, heating, and air conditioning. The car also featured a navigation system that used a high-resolution graphics monitor with a "touch screen".

According to Renault's safety design engineers, the Votan system allows drivers to keep their hands on the wheel and their eyes on the

road while controlling the many accessories of contemporary cars. No more groping for the windshield wiper controls in a cloud-burst—simply say "Windshield wipers on high!"

The Votan system uses speaker-dependent voice-recognition technology, which requires that "voice-prints" of the driver be taken. A new driver simply hits a switch to begin a quick voice-training session. He then repeats each of two dozen commands into the car's built-in microphone in response to instructions from the graphics monitor. The Votan system stores those individual voice patterns and recognizes that driver's commands from then on.

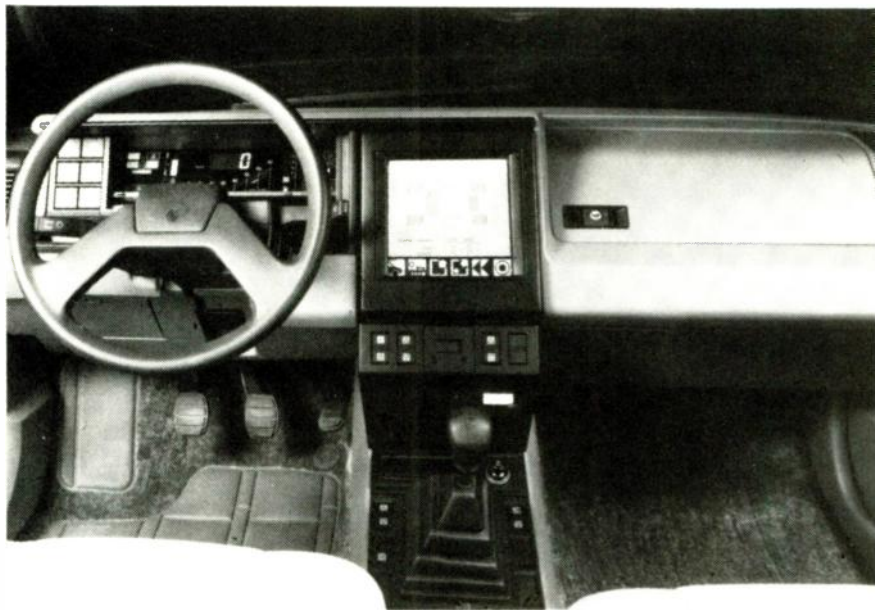

VOTAN-VOICE RECOGNITION TECHNOLOGY enables the Renault to obey "its master's voice." The system allows the driver of the demonstration car to control non-critical accessories, such as windshield wipers, windows, radio, heater, and air conditioner.

Ion-implantation used to toughen metal parts

Ion-beam implantation, widely used in the manufacture of com-

puter IC's, may now be used to toughen bearings, camshafts, and even artificial joints for human beings, says a report from the Uni-

versity of Michigan College of Engineering.

The process requires that ions be accelerated to high energy levels, focused in a beam, and aimed at target material in a vacuum chamber. The ions are embedded in the surface of the material, altering its properties. The new surface shares some of the properties of the ion and the target material, but may be much harder and more wear and corrosion resistant than either of them.

In many instances ion implantation is superior to making an alloy with the desired surface characteristics, because ions are implanted to a depth of only 0.00001 centimeter, and do not affect the bulk of the material. In some cases, alloying might improve the surface of the metal but adversely affect its bulk properties.

In surgical applications the new technique may be especially valuable. Artificial hip joints, for example, are rarely supplied to young patients, since they wear out in 10 to 15 years. With ion implantation, such joints could last a lifetime.

New Optical disk holds 600 megabytes

A new 5.25-inch optical disk, named WORM, and capable of storing 13,000 letter-size pages on its two sides, has been introduced by Maxwell Corp of America (600 Oxford Drive, Moonachie, NJ 07074). WORM is an acronym for Write Once, Read Many times.

The new disk will find applications in record management, archival storage, office automation, data processing, and high-resolution imaging applications. Each disk has 18,624 tracks, with 16 sectors-per-track. Recording density is 24,000 bits-per-inch, and track density is 16,000 turns-per-inch. Rotation speed is 1,800 rpm. R-E

TEST EQUIPMENT THAT MEASURES UP TO YOUR SPECIFICATIONS



DMM-300 \$79.95
3.5 DIGIT DMM / MULTITESTER

Our test model. A highly accurate, full function DMM loaded with many extra features. Audible continuity, capacitance, transistor temperature and conductance all in one handheld meter. Temperature probe, test leads and battery included.

- * Basic DC accuracy: plus or minus 0.25%
- * DC voltage: 200mv — 1000v, 5 ranges
- * AC voltage: 200mv — 750v, 5 ranges
- * Resistance: 200 ohms — 20M ohms, 6 ranges
- * AC/DC current: 200uA — 10A, 6 ranges
- * Capacitance: 2000pF — 20uF, 3 ranges
- * Transistor tester: hFE test, NPN, PNP
- * Temperature tester: C° — 2000° F
- * Conductance: 200ns
- * Fully over-load protected
- * Input impedance: 10M ohm



DMM-200 \$49.95
3.5 DIGIT FULL FUNCTION DMM

High accuracy, 20 amp current capability and many range settings make this model ideal for serious bench or field work. Tilt stand for hands-free operation. 2000 hour battery life with standard 9v cell. Probes and battery included.

- * Basic DC accuracy: plus or minus 0.25%
- * DC voltage: 200mv — 1000v, 5 ranges
- * AC voltage: 200mv — 750v, 5 ranges
- * Resistance: 200 ohms — 20M ohms, 6 ranges
- * AC/DC current: 200uA — 20A, 6 ranges
- * Fully over-load protected
- * Input impedance: 10M ohm
- * 180 x 86 x 37mm, weighs 320 grams



DMM-700 \$49.95
3.5 DIGIT AUTORANGING DMM

Autorange convenience or fully manual operation. Selectable LO OHM mode permits accurate in-circuit resistance measurements involving semi-conductor junctions. MEM mode for measurements relative to a specific reading. Probes and battery included.

- * Basic DC accuracy: plus or minus 0.5%
- * DC voltage: 200mv — 1000v, autoranging or 5 manual ranges
- * AC voltage: 2v — 750v, autoranging or 4 manual ranges
- * Resistance: 200 ohms — 20M ohms, autoranging
- * AC/DC current: 20mA — 10A, 2 ranges
- * Fully over-load protected
- * Audible continuity tester
- * Input impedance: 10M ohm
- * 150 x 75 x 34mm, weighs 230 grams



DMM-100 \$29.95
3.5 DIGIT POCKET SIZE DMM

Shirt-pocket portability with no compromise in features or accuracy. Large, easy to read 5" LCD display. 2000 hour battery life with standard 9v cell provides over two years of average use. Probes and battery included.

- * Basic DC accuracy: plus or minus 0.5%
- * DC voltage: 2v — 1000v, 4 ranges
- * AC voltage: 200v — 750v, 2 ranges
- * Resistance: 2k ohms — 2M ohms, 4 ranges
- * DC current: 2mA — 2A, 4 ranges
- * Fully over-load protected
- * Input impedance: 10M ohm
- * 130 x 75 x 28mm, weighs 195 grams

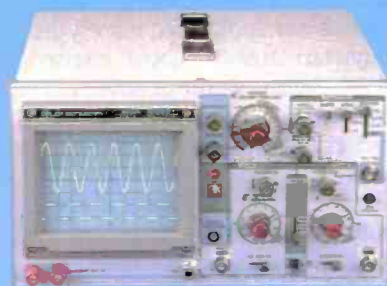

MODEL 2000 \$349.95
20 MHz DUAL TRACE OSCILLOSCOPE

Model 2000 combines useful features and exacting quality. Frequency calculation and phase measurement are quick and easy in the X-Y Mode. Service technicians will appreciate the TV Sync circuitry for viewing TV-V and TV-H as well as accurate synchronization of the Video Signal, Blanking Pedestals, VITS and Vertical/Horizontal sync pulses.

- * Lab quality compensated 10X probes included
- * Built-in component tester
- * 110/220 Volt operation
- * X-Y operation * Bright 5" CRT * TV Sync filter



MODEL 3500 \$499.95
35 MHz DUAL TRACE OSCILLOSCOPE

Wide bandwidth and exceptional 1mV/DIV sensitivity make the Model 3500 a powerful diagnostic tool for engineers or technicians. Delayed triggering allows any portion of a waveform to be isolated and expanded for closer inspection. Variable Holdoff makes possible the stable viewing of complex waveforms.

- * Lab quality compensated 10X probes included
- * Delayed and single sweep modes
- * Z Axis intensity modulation
- * X-Y operation * Bright 5" CRT * TV Sync filter



DPM-1000 \$54.95
3.5 DIGIT PROBE TYPE DMM

Autoranging, pen style design for the ultimate in portability and ease of use. Custom 80 pin LSI chip increases reliability. Audible continuity tester and data hold feature for added convenience. Case, test leads and batteries included.

- * Basic DC accuracy: plus or minus 1%
- * DC voltage: 2v — 500v, autoranging
- * AC voltage: 2v — 500v, autoranging
- * Resistance: 2k ohms — 2M ohms, autoranging
- * Fully over-load protected
- * Input impedance: 11M ohm
- * 162 x 28 x 17mm, weighs 75 grams

2 YEAR WARRANTY ON ALL MODELS

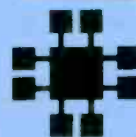

JDR INSTRUMENTS

110 Knowles Drive, Los Gatos, CA 95030

(408) 866-6200 • FAX (408) 378-8927 • Telex 171-110

COPYRIGHT 1986 JDR MICRODEVICES
THE JDR INSTRUMENTS LOGO IS A REGISTERED TRADEMARK OF JDR MICRODEVICES.
JDR INSTRUMENTS IS A TRADEMARK OF JDR MICRODEVICES.

ORDER TOLL FREE 800-538-5000

OR VISIT OUR RETAIL STORE
1256 SOUTH BASCOM AVE.
SAN JOSE, CA. (408) 947-8881
CIRCLE 59 ON FREE INFORMATION CARD

VIDEO NEWS



DAVID LACHENBRUCH,
CONTRIBUTING EDITOR

• **4mm VCR.** As the dispute continues to rage between the proponents of the 8mm and the VHS VCR formats, there's a new dark-horse entry in the field: 4mm. Well, perhaps it is not so dark at that. The new video system doesn't require the development of a special tape or cassette because it uses the tape cassette already developed for DAT (Digital Audio Tape) systems. The DAT system uses metal-particle tape similar to that used in 8mm video recorders.

The 4mm VCR is in a tiny camcorder developed by Samsung of Korea and displayed for the first time at the Korea Electronics Show. It weighs about 2.5 pounds, without battery, and is about 14% lighter and one-third smaller than the smallest previous record-and-play camcorder. But even with its tiny proportions, the 4mm camcorder offers something the others don't have: a built-in 2.5-inch LCD TV set that serves as a viewfinder. That TV set's tuner makes it possible for the camcorder to record off the air. The unit also features autofocus and automatic white balance, and it is expected to go on sale this year in Korea; it is also scheduled for eventual export. The DAT cassette measures about $2 \times 1.3 \times 0.3$ inches and will record up to 80 minutes using the Samsung camcorder.

• **VCR circuits go digital.** The new wave of videorecorders have been dubbed "digital VCR's," but that's really a misleading description since the recording technique itself is still analog. But the new recorders do use digital circuitry for clean still pictures and fast motion. The first of the new units is already on the market in this country, and a wide variety of upcoming versions were shown at the past Japan Electronics Show.

In this column we have already reported on some of the new picture-in-picture VCR's, but soon Japan will send VCR's our way that are capable of filling the screen with nine pictures to provide a slow-scan sample of what's showing on nine different TV channels, or to display a sequence of pictures, frame by frame, with each picture changing every two seconds. A new special effect in some of the digital VCR's is "strobe," which shows a rapid series of still pictures, thereby providing a stroboscopic effect. Also at the show, Matsushita, Japan's biggest

producer of VCR's, introduced several models that use a bar-code reader for programming. When the wireless infrared reader, which resembles a large pen, is drawn across a bar code in a TV listing or an advertisement for a TV program, the VCR is automatically programmed to record the show. The bar codes resemble those used on grocery packages, etc. Matsushita will publish its own program guides containing the bar codes, and will try to convince independent publishers to do the same.

Among the new VCR's shown at the Japan Electronics Show was a tiny 8mm camcorder from Aiwa. The camera/recording portion of the unit weighs about 2.36 pounds. The detachable playback section adds less than 8 ounces when it's clipped on. An accessory is a wired remote control that contains a two-inch *Watchman*-type flat video monitor.

• **More new camcorders.** Not too long ago, Sony's tiny *Handycam* camcorder could record but couldn't play back, while JVC's VHS-C unit could do both. Thanks to competition, now you can buy a Sony *Handycam* that can both record and play back or a JVC VHS-C camcorder that can only record. Sony's new *Auto Handycam* weighs about 3.75 pounds, with battery and cassette, and has a CCD pickup, an electronic viewfinder, autofocus, and a 2.5:1 zoom lens. JVC's record-only VHS-C unit weighs just a little over 2 pounds, with battery and cassette, and has an optical viewfinder and two focus settings. For playback, the VHS-C cassette is placed in an adaptor and then into any standard VHS video recorder.

• **Stereo TV grows.** In the first nine months of 1986, the EIA reported that a total of 2,100,000 color-TV sets with built-in stereo capability were sold. That's 16.6% of the total number of color-TV set sales during the period and compares with 1,500,000 sets sold during all of 1985. The EIA forecasts that some 5,000,000 sets will be sold in 1987. According to one survey, as of last October, 337 stations in the United States, and 15 stations in Canada, were equipped to broadcast stereo sound. Those stations reached about 90% of TV-equipped homes in the United States. **R-E**

Regency "Scanner Answer" Giveaway

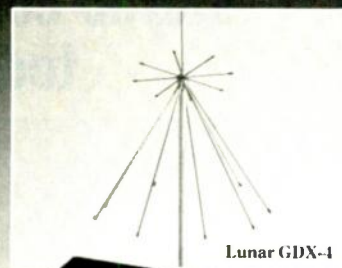

Lunar GDX-4



Here's your chance to win a complete monitoring package from Regency Electronics and Lunar Antennas. 18 scanners in all will be awarded, including a grand prize of the set-up you see above: the Regency HX1500 handheld, the Z60 base station scanner, the R806 mobile unit, and a Lunar GDX-4 Broadband monitoring/reference antenna.

55 Channels to go!

When you're on the go, and you need to stay tuned into the action, take along the Regency HX1500. It's got 55 channels, 4 independent scan banks, a top mounted auxiliary scan control, liquid crystal display, rugged die-cast aluminum chassis, covers ten public service bands including aircraft, and, it's keyboard programmable.

Compact Mobile

With today's smaller cars and limited installation space in mind, Regency has developed a new compact mobile scanner, the R806. It's the world's first microprocessor controlled crystal scanner. In addition, the R806 features 8 channels, programmable priority, dual scan speed, and bright LED channel indicators.

Base Station Plus!

Besides covering all the standard public service bands, the Regency Z60 scanner receives FM broadcast, aircraft transmissions, and has a built-in digital quartz clock with an alarm. Other Z60 features include 60

channels, keyboard programming, priority control, digital display and permanent memory.

Lunar Antenna

Also included in the grand prize is a broadband monitoring/reference antenna from Lunar Electronics. The GDX-4 covers 25 to 1300 MHz, and includes a 6 foot tower.



ELECTRONICS INC.
7707 Records Street
Indianapolis, IN 46226

Grand Prize (1 awarded)

- 1— Regency Z60 Base station scanner
- 1— Regency HX1500 Handheld scanner
- 1— Regency R806 Mobile scanner
- 1— Lunar GDX-4 Antenna

First Prize (5 awarded)

- 1— Regency Z60 Base station scanner
- 1— Regency R806 Mobile scanner

Second Prize (5 awarded)

- 1— Regency HX1500 scanner

Contest rules: Just answer the questions on the coupon, (all answers in the ad copy) fill in your name and address and send the coupon to Regency Electronics, Inc., 7707 Records Street, Indianapolis, IN 46226. Winners will be selected from all correct entries. One entry per person. No purchase necessary. Void where prohibited by law. Contest ends June 30, 1987.

1. The Regency Z60 is
 - a digital alarm clock an FM radio
 - a scanner all of the above
2. The Regency R806 is the world's first _____ controlled crystal scanner.
3. The Regency HX1500 features
 - 55 channels Bank scanning
 - Liquid crystal display all of the above
4. The Lunar GDX-4 antenna covers _____ to _____ MHz.

Name: _____

Address: _____

City: _____ State: _____ Zipcode: _____

I currently own _____ scanners.

Brands owned: _____



Send in a photo (like this one of Mike Nikolich and his Regency monitoring station) and receive a free gift from Regency. Be sure to include your name, address and phone number.

NEW

Only NRI gives you a 27" high-resolution stereo color TV you build to prepare you for today's video servicing careers.



Become one of America's most sought-after technicians . . . put your talents and spare time to work for you in the "explosive-growth" world of home entertainment electronics.

Train in state-of-the-art video/audio servicing and become a fully qualified service professional the uniquely successful NRI way. It's hands-on training, at home . . . designed around the latest electronic equipment you build and keep as part of your training. You start from scratch and "discover by doing." You conduct key experiments . . . perform vital tests . . . build your own systems . . . and do it all at the pace that suits you best.

There's no stopping the incredible boom in consumer electronics. Soaring sales, new and improved video products, entirely new technologies have opened up new opportunities for the trained technician as never before.

Now at \$26 billion in annual sales, the consumer electronics industry is creating a whole new servicing, installation, and repair market. This year, TV sales alone are expected to hit 16.2 million units. Every day, sales of home



VCRs, a product barely conceived of 10 years ago, reach 20,000 units. Every day!

And the revolution has spread to the business sector as tens of thousands of companies are purchasing expensive high-tech video equipment used for employee training, data storage, even video conferencing.

The Video Revolution Is Just Starting

Already, disc players can handle audio CDs and laser video discs. And now there are machines that will accommodate laser computer disks as well. Camcorders are becoming smaller, lighter, and more versatile . . . 8 mm video equipment produces high-resolution pictures and digital audio. By 1990 our TVs will become interactive computer terminals, giving us entertainment, information, and communications in one sophisticated video/computer/audio system.

Join the Future or Be Left Behind

Can you see the opportunity? The servicing and repair market that's there already . . . and the enormous future need created by the millions upon millions of electronic devices yet to come? If you're looking for a high-potential career . . . if you'd like to get started in a field that's still wide open for the independent businessperson . . . even if you'd like to find a way to make extra money part-time, look into NRI at-home training now.

Start Right and There'll Be No Stopping You!

NRI training in video/audio servicing is the perfect way for you to profit from the new explosive growth in consumer electronics. You study at home in your spare time at your own pace. No classroom pressures, no night school grind.

Even if you've never had electronics training, NRI prepares you properly with a thorough grounding in the fundamentals . . . a foundation that you build on to achieve advanced electronics skills. With this kind of understanding and practical bench experience built into NRI's exclusive training methods, you're on your way to take advantage of the new opportunities opening up every day.

Totally Integrated Hands-On Training

Since NRI training is built around "learn by doing," right from the start you conduct important experiments and tests with your professional digital multimeter. You assemble the remarkable NRI Discovery Lab and perform a complete range of demonstrations and experiments in the process.

Hands-On Training As You Build a 27" Stereo TV

In just hours you assemble an exceptional state-of-the-art TV receiver using easy to follow, step-by-step instructions. During this assembly process, you learn to identify and work with components and circuits used in actual commercial circuitry. Then through tests, adjustments, and experiments you quickly master professional troubleshooting and bench techniques.



NRI's commitment to you goes beyond providing you with equipment appropriate to the latest technology. Of equal importance is our dedication to training techniques that let you master TV, video and audio troubleshooting and repair quickly and easily. Best of all, we ensure that in the learning process you acquire the very skills that will make you a professional service technician on the job.

NRI has purposely designed your training around equipment that has the same high-tech circuitry you'll encounter in commercial equipment. That means your training is real-world training. And *that's* unique.

Inside Your TV

This new state-of-the-art Heath/Zenith 27" TV included with your training has all the features that allow you to set up *today* your complete home video center of the future. Flat screen, square corners, and a black matrix to produce dark, rich colors. Cable-compatible tuning, built-in stereo decoder to give you superb reproduction of stereo TV broadcasts . . . even a powerful remote control center that gives you total command of video and audio operating modes.

Your NRI Training Has Another Special Element

Also built into your training is the enormous experience of NRI development specialists and instructors. Their long-proven training skills and enthusiasm come to you on a one-to-one basis. Available for consultation and help whenever you need it, your instructors ensure your success both during your course and after graduation.

Step Into the Future Today

The richest reward you gain from your NRI video/audio training is a firm grip on the future. Your knowledge and know-how provide you with the soundest possible foundation for keeping up with the rapidly evolving, highly innovative video industry.

Send For Free Catalog

Now is the time to act. Send the post-paid card to us today. You'll receive our 100-page catalog free. It's filled with all the facts you'll want to know about our training methods with full details on the equipment you'll use and keep as part of your hands-on training. You'll see how our more than 70 years of experience in uniquely successful at-home career training makes us the leading technical school today. (If someone has already used the card, write to us at the address below.)

NRI School of Electronics
McGraw-Hill Continuing
Education Center
3939 Wisconsin Avenue, NW
Washington, DC 20016

ASK R-E

WRITE TO:

ASK R-E
Radio-Electronics
500-B Bi-County Blvd.
Farmingdale, NY 11735

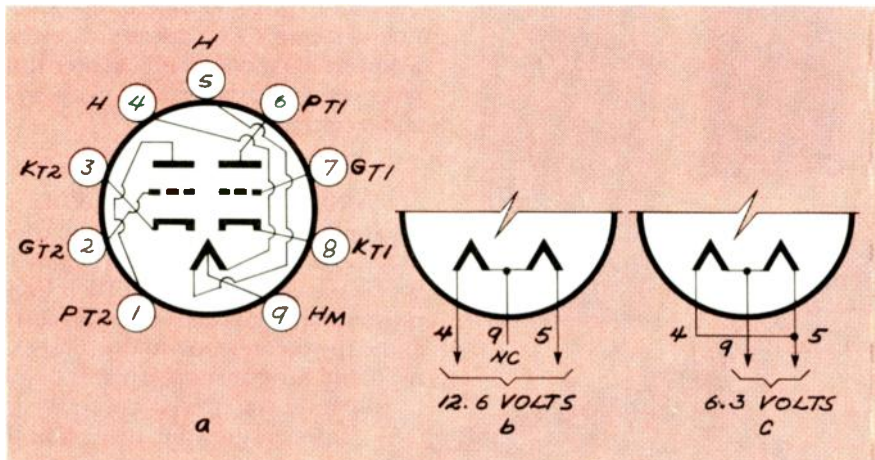

FIG. 1

HELP WANTED

I am restoring an old Fisher Model 400 AM-FM receiver. I have a problem in the right channel. When the set is first turned on, the volume is normal, but then it drops to a very low level. I am a beginning student in electronics and I've mostly studied solid-state electronics. I've checked the four 7868 output tubes, and I don't know where else to look. I don't have a schematic so I'd appreciate any help you can supply.—J. T., Thonotossa, FL.

To begin with, I assume that both speakers are OK. If you're not sure, try swapping them. If the troubled channel works now, and the other doesn't, you've located the problem.

Otherwise, you may want to obtain some service information. A schematic and a wealth of service data on the Model 400-C is available in Sams Photofact Set 432, folder 7. If your set is the 400-T, the service data is in the MHF (Modular Hi Fi) Volume 24. Call Sams at 1-800-428-SAMS for the names of distributors in your area. The service data was published in 1959, so

it may not be in stock. However, it can be ordered. Folder sets are \$9.95, and the MHF manuals are \$11.95.

In the meantime, some "eye-ball" and "seat-of-the-pants" servicing is in order. First, try listening to the AM radio. If both channels deliver the same volume level, the audio amplifier is probably OK. Next, try a stereo record. If one channel drops, there may be a defect in the phono cartridge, the phono input cable, or the phono preamp tube. While the bad channel is still out, switch to a stereo FM broadcast. If the channel is still out, the phono system is probably OK, as is the FM circuit. The problem is probably in the main section of the audio system.

You'll probably find one stage of amplification ahead of the tone controls and one or two stages of amplification between the tone controls and the phase inverter driving the push-pull output tubes.

In most h-fi receivers and amplifiers of the 1950's and 1960's, non-output stages used twin triodes

like the 12AX7/ECC83, the 12AU7/ECC82, the 12AT7/ECC81, and the 7247. In those twin 12-volt triodes, each section has a 6-volt heater. The heaters are brought out to three pins so they can be connected in series for 12-volt heater supplies or in parallel for 6-volt operation. Figure 1-a shows the pin terminals for those tubes; Fig. 1-b shows the series heater connection; and Fig. 1-c shows the parallel heater connection.

I've run across quite a few of those tubes with intermittent heaters; the circuit opened as soon as the tube got hot. If the set has a 12-volt heater circuit, an intermittent open in one section is likely to cause both sections of the heater to go out, so the tube will be completely dark. With a 6-volt heater supply, the heaters are in parallel and only the defective section should go out. So, eye-ball the tubes carefully and see whether one heater is dim or completely out. If you spot a tube whose heater appears to be intermittent, wiggle the tube in its socket. The intermittent may be due to a bad contact between a tube pin and the socket, or possibly a break or a cold-solder joint at the socket terminal pin.

If the heaters and heater circuits appear to be OK, now's the time for one more trick. Swap all tubes between the two channels. If the drop-out moves to the other channel, the problem is one of the tubes. It could be gassy, or it could have some other problem that you can't catch without a good tube tester. Regardless, you can isolate the defective tube by swapping tubes one by one.

Now suppose that you've eliminated the possibility of a defective

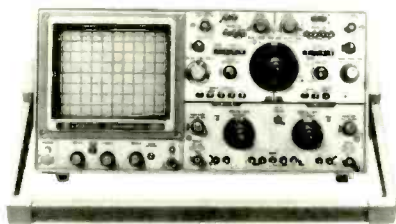

DC-60 MHz 4 Input, 8 Trace, Portable

- Typical Frequency Of From DC To 70 MHz, -3 dB (10 MHz margin over the specified frequency response)
- Reliable Time Difference Between Channels
- Built-In TV Sync Separator
- 3 Year Warranty

SS-5710 — \$1245
 SS-5710C — With Counter \$1799
 SS-5710D — With Counter/DMM \$1995

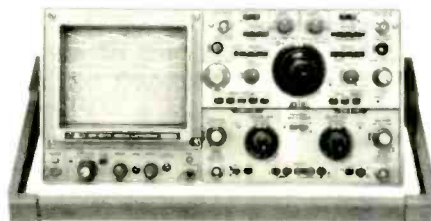

DC-100 MHz 4 Input, 8 Trace, Portable

- Typical Frequency Of From DC To 120 MHz, -3 dB (20 MHz margin over the specified frequency response)
- Reliable Time Difference Between Channels
- Jitterless Circuitry For Stable Triggering
- 3 Year Warranty

SS-5711 — \$1695
 SS-5711C — With Counter \$2295
 SS-5711D — With Counter/DMM \$2495

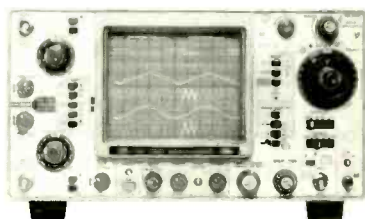

DC-40 MHz

SS-5705 — DC-40 MHz SS-5706 — DC-30 MHz

- 3 Input, 6 Trace (SS5705); 3 Input, 3 Trace (SS5706)
- Versatile Trigger Capability With TV-SYNC
- Jitter-Free Circuitry And Variable Hold-Off
- High Accuracy For V And H ($\pm 2\%$)
- Accurate Calibrator (Amplitude $\pm 1\%$ And Frequency $\pm 1\%$)

SS-5705 — \$899
 SS-5706 — \$749

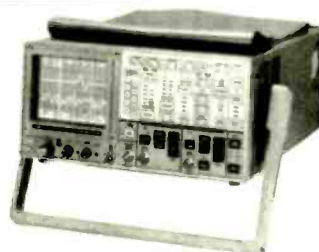

DC-100 MHz Digital Storagecope

- 100 MHz Analog And Digital Bandwidth
- 40 Ms/s Sampling Rate
- Cursor Measurement (Analog And Digital)
- 4 Waveform & 7 Set-Up Memories
- GO/NO GO Judgement

DS-6121 — \$5550
 DS-6121A — With Envelope Mode \$5950

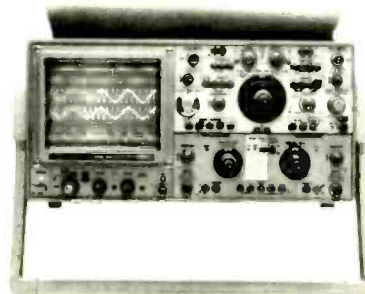

DC-200 MHz 4 Input, 8 Trace, Portable

- Reliable Time Difference Between Channels
- Freerunning Ground Facility
- High-Grade 6 Inch Quadrupole-Lens, Dome Mesh CRT
- Combination Trigger Probe (SS-0071) Optional
- 3 Year Warranty

SS-5712 — \$2999



NEW CRT Readout Oscilloscopes

- Simultaneous Display Of 4 Cursors
- Instant Measurement Of AC, DC Peak and RMS
- Built-In 6 Digit Counter
- 4 Input, 8 Trace Dual Time Base
- 3 Year Warranty

SS-6122 — 100 MHz \$2295.00
 SS-6611 — 60 MHz \$1795.00

OSCILLOSCOPES

Instruments For Your Success

COMB

Authorized Liquidator



Amazing Hearoid™ talks and serves you!

19" tall

Remote Control Unit (Batteries not incl.)

He Obeys Your Commands!

REMOTE CONTROLLED HEAROID™ ROBOT Great Fun For Everyone!

Liquidation due to famous Japanese manufacturer discontinuing this model.

- Loads of fun as Hearoid™ delights the family by serving them, carrying objects in hand or on a removable tray.
- Amaze and impress friends as Hearoid™ serves them and guides them on a talk tour of home (built-in cassette recorder).
- Remote microphone lets you converse with guests through robot.
- Hearoid™ obeys 12 voice commands. Performs programmed routines up to 45 minutes long.
- Switch from voice-activated to push-button control on remote unit.
- Programmable digital alarm clock lets you schedule daily tasks at a set time.
- Rechargeable battery (included) runs up to 3 hours at a time. Recharger incl.
- Factory new, first quality product.

90-Day Limited Factory Warranty.

Mfr. List: \$399.95 **\$149**

Liquidation Price . . .

Item H-2037-7000-862 Ship, handling: \$8.00

Credit card customers can order by phone, 24 hours a day, 7 days a week.



Toll-Free: 1-800-328-0609

Sales outside the 48 contiguous states are subject to special conditions. Please call or write to inquire.

C.O.M.B. Direct Marketing Corp. Item H-2037
1405 Xenium Lane N/Minneapolis, MN 55441-4494

Send ___Hearoid™ Robot(s) Item H-2037-7000-862 at \$149 each plus \$8 each for ship, handling. (Minnesota residents add 6% sales tax. Sorry, no C.O.D. orders.)

My check or money order is enclosed. (No delays in processing orders paid by check.)

Charge: VISA® MasterCard® American Express®

Acct No. _____ Exp. / _____

PLEASE PRINT CLEARLY

Name _____

Address _____

City _____

State _____ ZIP _____

Phone (____) _____

Sign Here _____

COMB Direct Marketing Corp.
Authorized Liquidator
1405 Xenium Lane North
Minneapolis, Minnesota 55441-4494

tube. What next? It's time for signal tracing. You can signal trace with a scope, an audio voltmeter, or even a pair of headphones (2000 ohms or higher, with a 0.005- μ F, 500-volt blocking capacitor in series with each lead).

Apply a signal to both channels. A mono signal is best because you'll want to make point-by-point comparisons of signal levels. Start by checking the signal levels on the grids of the output stage. If those signals are OK, but the signal drop-out is still present, the trouble is in that stage or in the output plate circuit. Measure the DC voltages on the plates of the two output tubes. If they are equal or reasonably close, compare the cathode voltages and the voltages measured between cathode and grid. The corresponding voltages should be equal on both tubes of the push-pull pair. Compare the voltages on the non-functional channel with those of the other.

If the signal drop-out occurred on one of the output grids, move back to the phase inverter, checking signal levels at plate and cathode there. Both should be equal. If they're not, look for an off-value resistor or a leaky capacitor in the circuit with the lowest signal level.

If the phase inverter is OK, move back toward the input, stage by stage, element by element, until you localize the defect. And don't forget the first rule of electronic trouble-shooting: use your eyes, ears, and nose. Look for off-color components, sparks, and whiffs of smoke; listen for "snap, crackle, and pop"; and check for the odor of burned or overheated resistors and other components.

Good luck, and let us know how you make out. Trouble-shooting has been the subject of many books and articles, and we've omitted far more than we've included here.

ELECTRONIC MOTOR CONTROLS

I have a fan with a 117-volt, 60-Hz motor that is rated at 2 amps. I want to reverse the fan but I don't know how. How can I add a reversing switch?—C. S., Ft. Worth, TX.

I have a drill press powered by a ¼-horsepower motor. I'd like to con-

trol motor speed by varying the frequency of the supply voltage. Please publish a circuit that shows how to do that.—J. C., Yuma, TN.

The method of reversing a motor depends on its type and, often, on having certain internal connections readily available. An experienced motor rebuilder and armature rewinder can tell at a glance whether or not a particular motor is easily reversed. If reversing is simple and easy to accomplish, he'll probably do it for a nominal fee. Look in the *Yellow Pages* under "Electric Motors, Dealers, and Repair Service."

It doesn't seem practical to use the variable-frequency method of varying the speed of a drill-press motor. It probably draws about 600 watts, allowing for circuit losses and inefficiency, and will draw considerably more when starting. For a variable-frequency power source, you'd need an adjustable-frequency oscillator covering from about 45 to 65 hertz and a low-frequency amplifier capable of delivering at least 700 watts. The circuitry is relatively simple, but some components are either very expensive or not readily available. A better method of speed control would be to use a variable-speed gear box or a belt and pulleys.

STEREO SPREAD CIRCUIT

A year or so ago, I bought a stereo chassis from a company handling manufacturers' close-outs. I've added 8-track and cassette players, a loudness switch, and a good antenna, but I was never completely satisfied with the unit's performance. I wasn't sure just what I wanted until I listened to a friend's set-up that included a "stereo-wide" circuit. Do you know of a circuit that will produce that effect?—A. S.

I believe you're looking for something to enhance the apparent stereo effect so that the sound source appears to be wider. You can do the trick with Signetics' TDA3810. Signetics calls it a "Spatial, Stereo, and Pseudo-stereo Processor." The device was discussed in "State of Solid State" in the May 1984 issue of this magazine; better yet, obtain a data sheet from Signetics at P. O. Box 3409, Sunnyvale, CA 94088-3409.

R-E

Your Best Source for SMD Test Accessories is POMONA ELECTRONICS

PATCH CORD; SMD GRABBER™
BOTH ENDS: MODEL 5301

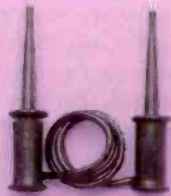

SMD TEST TWEEZER™ TO BNC
MALE: MODEL 5142 (SHOWN).
TO TWO SINGLE STACKING
BANANA PLUGS: MODEL 5143

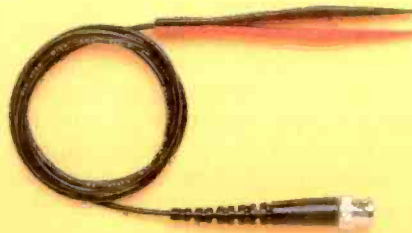

DO-IT-YOURSELF SMD
GRABBER™: MODEL 5243



SMD MICROTIP™ TEST
PROBE TO SINGLE
STACKING BANANA
PLUG: MODEL 5144



FREE 1987 GENERAL CATALOG

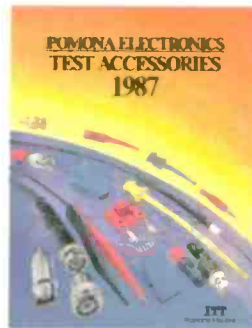

ITT Pomona Electronics
1500 E. Ninth St., Pomona, CA 91766
Tel: (714) 623-3463

68 PIN PLCC QUAD CLIP™
TEST CLIP: MODEL 5060



CABLE ASSEMBLY; SMD
GRABBER™ TEST CLIPS TO
BNC MALE: MODEL 5304



SOIC CLIP™ TEST CLIP: MODEL
5250 (8 PIN); 5251 (14 PIN); 5252
(16 PIN) SHOWN; 5253 (20 PIN);
5254 (24 PIN)



MOLDED BREAKOUT; SMD
GRABBER™ TEST CLIPS TO
FEMALE BNC: MODEL 5305



Our Products are available through your favorite electronics parts distributor.

CIRCLE 101 ON FREE INFORMATION CARD

LETTERS



OLD VACUUM-TUBE DAYS

Your "Antique Radios" department in the November 1986 issue triggered memories of the vacuum-tube business of the 1950's and 1960's. My company manufactured tube testers at the time, and our greatest success was with "user-friendly" tube testers that could be placed in any drug or hardware store for individuals to test their tubes for free. Naturally, new tubes could be purchased on-the-spot.

The new Fall television shows (including football) typically brought streams of males with

brown bags or pockets full of tubes—often the TV set's entire complement. On many week-ends, sleet-covered feet would leave a grand puddle in front of a free tester. And many 12- to 18-dollar service calls were lost forever.

So I was surprised to spot one of those hated "free-testers" in a local TV-repair shop, placed for all comers to use. Old Mel, the proprietor, was a tight old geezer who had been moaning like a wounded cow since the free-testers started showing up nearly everywhere. Still more surprising was the "20% Discount" notice boldly posted in

Mel's window, totally contradicting what I knew to be his skinflint nature.

Only after buying Mel lunch (he loved a free lunch) did he reveal the reasons for such an about-face in the free-testing department. I was already aware that Mel received a much better discount than other retailers, due to a tradition that began when tube manufacturers were backing their distributors in a war for the repairman's business. Yes, that explained the 20% discount.

But the real secret was that Mel had watched a free-tester in action

Small Outlines. No Problem.

With A P Products™ brand SOIC Test Clips.

- Allows safe, convenient, fast and easy testing of normally hard-to-access Small Outline Integrated Circuits (SOICs).
- Eight sizes available for .30" and .15" package sizes.
- Helical compression springs and insulating contact combs ensure contact integrity during testing.
- Permits devices stacked as close as .025" end-to-end to be tested simultaneously.
- Standard .025" square contacts on .10" centers at the probe end of the clip easily accept test probes or single row female socket connectors.
- Steel hinge pin and acetal thermoplastic body provide long service life.
- Available with alloy 764 unplated and gold plated leads.

For immediate response contact a local authorized A P Products Prototype & Test Devices distributor. Or telephone 800-321-9668 or (216) 354-2101 in Ohio for further information.

We Solve Problems.

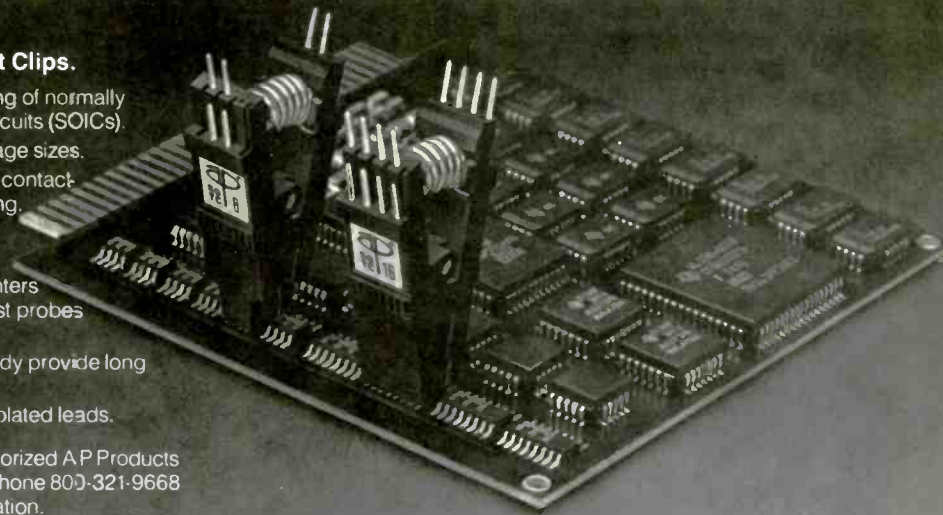

3M

and discovered that the average buyer would often replace any tube that did not nearly peg the meter. Even the best brand of new tubes, depending upon type, might put the needle in the low end of the green-colored "Good" field. Those not-so-smart weekend TV experts would not only replace perfectly good tubes but also would usually leave the "weak" tubes on the counter.

"Hell," Mel told me, "I've sold some of those tubes three times just this week."

ROBERT C. REYNOLDS
Rockford, IL

RELEVANT ERROR

Upon reading part two of the article, "Inside the Telephone," in the November 1986 issue, I noticed a relevant error.

Near the top of page 53 we read: "A USOC RJ11 designation tells you the type of standard jack that the device accepts. A USOC RJ11 designation tells you that the device requires a single line (four conductor) jack; a RJ14 designation tells you that the device requires a two-line (eight-conductor) jack." The latter part of that statement is incorrect.

RJ-11 (four-conductor) jacks, for single-line installations, use only the red and green wires (the first pair tip/ring, in telephone terminology). The same four-conductor jack also can provide two-line service (RJ-14 type jack) by using the black and yellow wires. Additionally, since that "four-conductor" jack can actually accommodate six wires, commonly the white/blue wires are included. That set of wires can accommodate a third line, and the USOC code for that configuration is RJ-25.

The eight-conductor jack mentioned in the article is used primarily for three purposes. First, it is used in connecting special modems and/or data equipment. Second, it will be used as the standard Integrated Services Digital Network (ISDN) connector. And third, it is used for series-connected apparatus (e. g., burglar-alarm dialers, and some others types of automatic dialers that need to disconnect other apparatus). In the latter case, the USOC would be RJ-31X for an alarm dialer that dis-

connects all phones on the line, and the USOC would be RJ-35X for an accessory dialer hooked to a multi-line phone.

On a different note, I must say that I thoroughly enjoy your magazine and look forward to its monthly arrival! Also, I am elated that you didn't change the primary focus of your magazine toward computers, especially since I already receive a specific publication for computers.











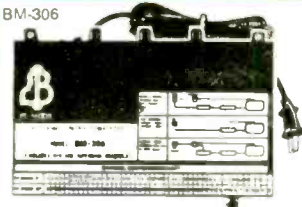

All in all, I do recognize the vast

amount of meticulous work that is necessary to prepare the articles and the magazine for publication, and even being an outstanding magazine, an error is published occasionally.

DAVE WOZNIAK
Farmington Hills, MI

SURFACE-MOUNTED COMPONENTS

I have been in the TV and stereo repair business for many years, and I would like to caution all con-

 <p>75 Ohm A/B Switch Video Switch Box SALE \$1.95 EA MINIMUM 10 BM-307</p>	 <p>3 Pin Computer AC Cable 6 Ft. Cord SALE \$2.75 EA MINIMUM 10 BM-417</p>	
 <p>750 Ohm Grounding Block with Screw SALE 45¢ EA MINIMUM 25 BM-283</p>	 <p>25 Volt Line Transformer SALE \$1.95 EA MINIMUM 5 BM-69</p>	
 <p>20 Amp Alligator Battery Clips SALE \$1.25 pr MIN. 5 BM-467</p>	 <p>46 Channel Block Converter with Fine Tuning Control SALE 19.95 EA</p>	 <p>Replacement For Tetrad Phono Cartridges BM-232 - Red BM-233 - Blue BM-234 - Black BM-235 - Gray BM-236 - Orange BM-237 - Yellow YOUR CHOICE SALE \$2.60 EA MINIMUM 10</p>
 <p>1/4" Stereo 20' Headphone Extension SALE \$2.25 EA MIN. 5 BM-468</p>		 <p>Grain-O-Wheat BM-135 - 6 Volt BM-136 - 12 Volt BOX 10 SALE \$2.00 EA MINIMUM 10</p>
 <p>Exact Replacement for Zenith Dual Antenna SALE \$6.95 EA MINIMUM 5 BM-459</p>	 <p>Stereo Headphones with 6 ft. Cord SALE \$5.99 EA MINIMUM 5 BM-461</p>	
 <p>Exact Replacement for Panasonic Dual Antenna SALE \$2.95 EA MINIMUM 10 BM-219</p>	 <p>F-Type 75 Ohm Terminator Call for a Full Line of Connectors SALE 15¢ EA MINIMUM 25 BM-218</p>	 <p>Female Canon/Switchcraft Type Connector Replaces Switchcraft A3F SALE \$2.25 EA MINIMUM 25 BM-277</p>
<p>ORDER BY PHONE: 800-645-4720 IN NYS CALL: (718) 436-9700</p> <p>ESI Electronic Parts & Accessories a unit of ALPHA-KENCO INC. 3820 14th Avenue, Brooklyn, NY 11218</p> <p>VISA master card</p> <p>CALL FOR OUR MONTHLY SPECIALS</p>		

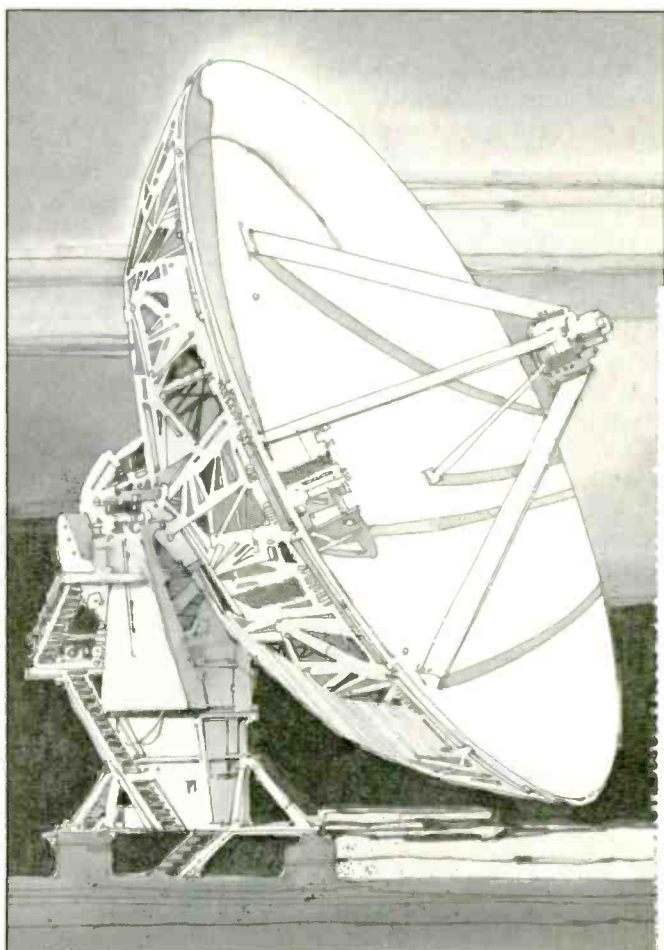
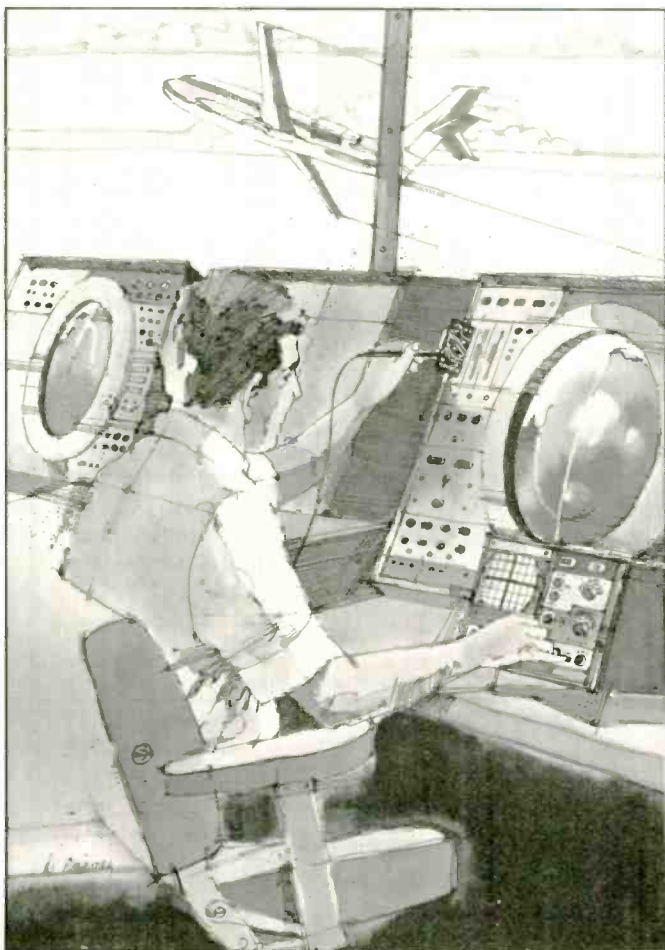
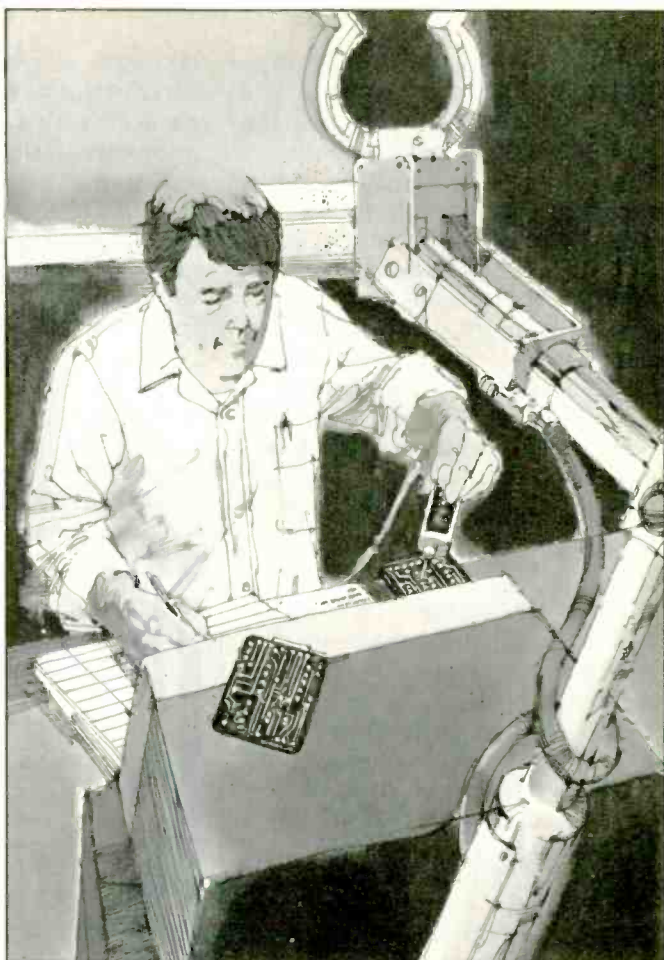

CIE MAKES THE WORLD OF ELECTRONICS YOURS.

Today's world is the world of electronics. To be part of it, you need the right kind of training, the kind you get from Cleveland Institute of Electronics, the kind that can take you to a fast growing career in business, aerospace, medicine, science, government, communications, and more.

Specialized training.

You learn best from a specialist, and that's CIE. We're the leader in teaching electronics through independent study, we teach only electronics and we've been doing it for over 50 years. You can put that experience to work for you just like more than 25,000 CIE students are currently doing all around the world.

Practical training.

You learn best with practical training, so CIE's Auto-Programmed® lessons are designed to take you step-by-step, principle-by-principle. You also get valuable hands-on experience at every stage with sophisticated electronics tools CIE-designed for teaching. Our 4K RAM Microprocessor Training Laboratory, for example, trains you to work with a broad range of computers in a way that working with a single, stock computer simply can't.

Personalized training.

You learn best with flexible training, so we let you choose from a broad range of courses. You start

with what you know, a little or a lot, and you go wherever you want, as far as you want. With CIE, you can even earn your Associate in Applied Science Degree in Electronics Engineering Technology. Of course, you set your own pace, and, if you ever have questions or problems, our instructors are only a toll-free phone call away.

The first step is yours.

To find out more, mail in the coupon below. Or, if you prefer, call toll-free **1-800-321-2155 (in Ohio, 1-800-523-9109)**. We'll send a copy of CIE's school catalog and a complete package of enrollment information. For your convenience, we'll try to have a representative contact you to answer your questions.

CIE Cleveland Institute of Electronics 1776 East 17th St., Cleveland, Ohio 44114

YES! I want to get started. Send me my CIE school catalog including details about the Associate Degree Program. I am most interested in:

- | | |
|--|---|
| <input type="checkbox"/> computer repair | <input type="checkbox"/> television/high fidelity service |
| <input type="checkbox"/> telecommunications | <input type="checkbox"/> medical electronics |
| <input type="checkbox"/> robotics/automation | <input type="checkbox"/> broadcast engineering |
| <input type="checkbox"/> other _____ | |

Print Name _____

Address _____ Apt _____

City _____ State _____ Zip _____

Age _____ Area Code Phone No _____

Check box for G.I. Bulletin on Educational Benefits RE54
 Veteran Active Duty **MAIL TODAY!**

sumers about a grave problem on the horizon. It relates to home-entertainment products. A new trend is emerging, and it is a nightmare: so-called surface-mounted components.

They will cost you more money for repair because of the difficulty in repairing equipment. The situation now is like that when printed-circuit boards were first introduced. At that time customers paid for repairs related to a new breed of problems that rarely ex-

isted in hand-wired chassis. Of course, printed-circuit boards are much cheaper to manufacture, and you do save money on the purchase price. However, I don't think that you will save money on any TV set that uses surface-mounted components.

With ordinary components mounted on a printed-circuit board, the component will yield some, due to circuit-board flexing caused by temperature changes, etc. However, with leadless sur-

face-mounted components, there is no room for slack. It is very difficult to see a broken connection. Those components are much smaller, too.

With that new nightmare coming, I am seriously thinking of getting out of the business. I have a customer now who has paid dearly for that type of repair on a GE TV set. My advice is to buy products, especially TV sets, that do not use surface-mounted components.

JAKE J. AUGUSTINE
Reading, PA

DUAL AUTO BATTERY

Here's another solution, and perhaps an easier one, for G. McC. of Palmetto, SC. (See "Dual Auto Battery" in the "Ask R-E" department, November 1986.)

The average auto or 4 x 4 comes equipped with a 60-amp alternator. Replace it with a 110-amp alternator, and replace your regular voltage regulator with a heavy-duty one to match the alternator. If you can't handle the installation yourself, have an automotive electrician do it for you. Then install the largest car battery you can get your hands on. Your worries are over for at least the next 300,000 miles.

Around here, taxis are set up that way, because they do more idling and slow cruising than anything else. An ordinary alternator and battery constantly lets them down. You might find the setup expensive at first bite, but rarely will a heavy-duty setup, such as I've just described, give up sooner than 300,000 miles. The longest-running one to my knowledge was 320,000 miles on a Malibu. The car played out and the alternator and battery were transferred to a big Dodge, and went on for another 150,000 miles trouble-free. And that rig also powered a communications system, cassette deck, meter, halogen lights, and an ordinary boosted CB set.

B. HARLEY
B. C., Canada

WIRE IS CONTRABAND

I have read the "Antique Radio" department of Radio-Electronics for several years and just want to say that it is excellent and much appreciated.

★ CABLE TV SPECIALS ★

CONVERTERS

JERROLD:	DRZ-3DIC105—66 Channel Wireless	\$199.⁰⁰
	JRX-3 DIC—36 Channel Corded Remote	\$149.⁰⁰
	JSX-3 DIC—36 Channel Set Top	\$129.⁰⁰
	SB-3—'The Real Thing'	\$119.⁰⁰
MAGNAVOX: 6400—60 Channel Wireless w/Parental Lockout for Jerrold systems		\$199.⁰⁰
ZENITH:	Z-TAC Cable Add-On	\$225.⁰⁰
VIEW STAR:	EVSC-2000—60 Channel Wireless— with Parental Lockout	\$ 99.⁰⁰
	EVSC-2000A-B—Same as above with A-B Switch	\$109.⁰⁰
	View Star 1000—60 Channel Wireless— with Volume	\$119.⁰⁰

MISCELLANEOUS

OAK:	N-12 Mini-Code	\$ 89.⁰⁰
	N-12 Mini-Code Vari-Sync	\$109.⁰⁰
	N-12 Mini-Code Vari-Sync Plus Auto On-Off ..	\$165.⁰⁰
JERROLD:	400 & 450 Handheld Transmitters	\$ 29.⁰⁰
HAMLIN:	MLD-1200	\$ 99.⁰⁰
NEW ITEMS:	Standard Components—66 Channel Wireless— with Parental Lockout	\$ 99.⁰⁰
	Scientific Atlanta	Call for Price
	Power Zapper Stun Gun, 46, 000V	\$ 59.⁰⁰
	K-40 Radar Detector—Dash Model	\$199.⁰⁰
	K-40 Radar Detector—Remote	\$229.⁰⁰
	ALL UNITS GUARANTEED. QUANTITY PRICES AVAILABLE.	

UNITED ELECTRONIC SUPPLY

P.O. BOX 1206 • ELGIN, ILLINOIS 60121 • 312-697-0600

I'm a State prisoner in maximum security—even wire is contraband! For years, since I was a child, I have been interested in radio and electronics, especially shortwave. Mr. Fitch's article in the May 1986 issue was very good.

At present, I'm researching communications law and case law for my civil-rights suit against the state's prison system, the Governor, and the Attorney General for the department's policy about multiband receivers. They are banned, and for four years I have tried to get those restrictions lessened; and after writing to no avail, have sued in 1983 civil rights suit #86-0055-L in Lynchburg.

I was wondering if Mr. Fitch (or anyone else) would be so kind as to provide me with an outline of the shortwave spectrum of 1920-1950—experimentation at the beginning, users, as well as the devices that sprang up for reception. In order to claim equal protection, I need to find a prison that allows, or did allow, inmates to receive shortwave radio broadcasts.

I have four long sheets of case law that apply to the censorship, and I have received publicity from the *Times Mirror* and its book about freedom of the press, Radio Israel, Radio Ecuador, the BBC, and I was on "Talknet" with Sarah Jane Raphell—by phone, of course. Though I really do not like much publicity, as I'm not that kind of person, still one man was—and I guess still is—in the "hole" in Belford, PA.

His name is John Demmitt; if you haven't heard of him, all he did was to convert an AM radio to be able to hear the world. I can't write to him, though I tried. He is the reason that, day after day, I continue to try to get my case into the Supreme Court, because the State is under the illusion that that type of radio receiver would be a security risk—or is it to stifle free expression or to prevent exposure of public officials?

In any case, any help you could provide would be appreciated. And since the prison sent me here because I won't be silenced, at least I can take radio and advanced college courses. I still like AM and FM, but it's a simple matter to convert AM-BCB to SW, and that's de-

spite the fact that they took my alignment tools (plastic).
JAMES P. SMITH WDX4JPS
Nottoway C. C, Box 488,
Burkeville, VA

SERVICE TIP

Service technicians, especially in the VCR field, may be interested in a quick and easy way to test the reset function of sequential logic circuits, microprocessors, etc. The common method of viewing that event is using dual-trace or free-

scanning mode. However, that can be tricky to the eye, because reset pins are normally held at a low level until approximately ½ supply has been obtained.

The X-Y or vector mode is ideal for viewing the event. Simply use either input (X or Y) to monitor the supply line. The other input is connected to the reset pin. A characteristic "L" pattern trace will result, due to the reset rise time.

MIKE RAMSEY
Greenville, TX

R-E

NEW Simpson Model 383 Digital Temperature Tester Does It All!



- **Dual Inputs** — measure two temperature sources, switch-selectable
- **Differential and Normal Temperature Modes** — automatically read the difference between two temperatures or each separately. Provides for accurate relative temperature determinations. Ideal for heating and air conditioning service and environmental monitoring.
- **DC Millivolt Range** — quick check of thermocouples, flame rods and other sensors
- **Chart Recorder Output** — provides 1 mV DC per degree F or C output with low source resistance for recording/controlling applications
- **Four Ranges:** -30°F to +200°F and +200°F to +1200°F
 -34°C to +93°C and +93°C to +650°C
- **High Accuracy** — 0.2% of reading + 1°C (1.8°F), from 0°F to +1000°F
- **Switch-Selectable Centigrade or Fahrenheit Readout**
- **Large, High-Contrast, 0.5" Liquid Crystal Display**
- **Single 9 Volt Alkaline Battery**
- **Humidity Kit, Disposable Thermocouples and Other Accessories Available**

Model 383, complete with test lead set, 4' J-type temperature sensor probe, 9 V alkaline battery and operator's manual, Cat. No. 12415

\$195.00

AVAILABLE FROM LEADING ELECTRONICS/ELECTRICAL DISTRIBUTORS



SIMPSON ELECTRIC COMPANY

853 Dundee Avenue, Elgin, Illinois 60120-3090
 (312) 697-2260 • Telex 72-2416 • Cable SIMELCO

CIRCLE 205 ON FREE INFORMATION CARD

Put a
test lab in
your tool pouch.



The Fluke 8060A 4½-digit handheld multimeter.

It's the best tool you could add to your tool pouch, because it lets you troubleshoot more ... with less.

This portable, powerful instrument has a unique combination of features not available in any other handheld DMM.

A simple push of a button on the Fluke 8060A lets you measure frequencies to 200 kHz, make relative offset measurements, convert voltages to direct reading decibels, or conduct audible continuity tests. Plus the 8060A offers wideband True RMS ac measurement capability to 100 kHz.

So say goodbye to your part-time counters, oscilloscopes, continuity testers, calculators and power supplies. And welcome a full-time professional that'll be there when you need it.

You'll find that for troubleshooting everything from motor controls to data communications equipment, the Fluke 8060A is the best multimeter value going.

Find out more by calling our toll-free hotline 1-800-227-3800, ext. 229, day or night. Outside the U.S. call 1-402-496-1350, ext. 229.

FROM THE WORLD LEADER
IN DIGITAL MULTIMETERS.



© 1986 Fluke

CIRCLE 121 ON FREE INFORMATION CARD

EQUIPMENT REPORTS

Orchid PC turbo 286e IBM-PC accelerator card

Two heads are better than one

CIRCLE 9 ON FREE INFORMATION CARD



THE VOLKSWAGON BEETLE IS A GREAT car for day-to-day use, but it's not what you choose to use when performance really counts. Likewise, the IBM-PC is a great machine for simple activities like word processing; but when it comes to heavy-duty number crunching (with, say, a complex spreadsheet, or a design package such as *AutoCAD*), you realize that the poor little PC really has to struggle to keep up. And you can develop a few gray hairs in the process.

What's the solution? You've got two choices: You could trade in that bug for a Mercedes, or you could retro-fit the bug to improve its performance.

The problem is that replacing a PC or an XT with an AT can be an expensive proposition. However, for much less money you can perform the retro-fit. In doing so, you can turn the PC into a machine that runs much faster—five to seven times faster—than it used to. In fact, you may be able to improve its performance so much that it actually can outperform the AT.

The PCturbo 286e

Orchid Technology (47790 Westinghouse Drive, Fremont, CA 94539) designs and manufactures several add-in cards (including ac-

celerator and display boards) for the IBM family of personal computers; the 286e represents their top-of-the-line accelerator card. The board contains an 8-MHz 80286, 1 megabyte of 120-ns no-wait-state RAM, and it has a socket for an 80287 math co-processor and provision for a daughterboard that contains an additional megabyte of RAM. The 286e plugs into a standard expansion slot, and requires about 3.5 amps in its full configuration. There is an additional connector that contains most of the important CPU and bus signals.

What does all that hardware do? Basically, it puts a computer inside your computer. The two computers share resources like keyboard, screen, and disks, but otherwise operate independently. The "host" (the PC) handles all I/O (keyboard, video, disk). Normally, you use one or the other at a time, but Orchid can provide you with experimental multi-tasking software that allows you, for example, to sort a database on the host while calculating a spreadsheet on the 286e.

The RAM on the card cannot be used to expand the host PC's system RAM; it's all dedicated to 286e use. 640K is used as the 286e's

Where's Your **ELECTRONICS** Career Headed?

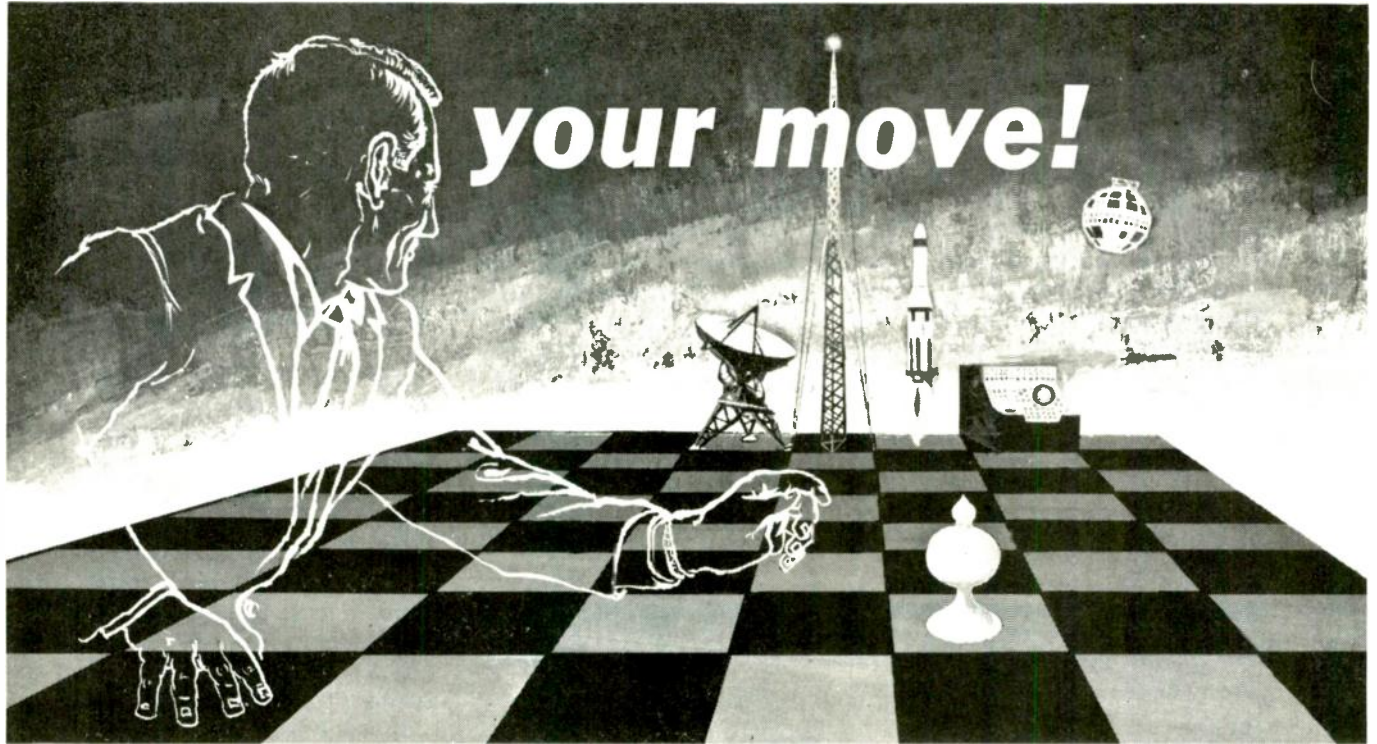

The Move You Make Today Can Shape Your Future

Yes it's your move. Whether on a chess board or in your career, you should plan each move carefully. In **electronics**, you can *move ahead* faster and further with a

B. S. DEGREE

Put professional knowledge and a **COLLEGE DEGREE** in your electronics career. Earn your degree through independent study at home, with Grantham College of Engineering. No commuting to class. Study at your own pace, while continuing your present job.

The accredited Grantham non-traditional degree program is intended for mature, fully employed workers who want to upgrade their careers . . . and who can successfully study electronics and supporting subjects through

INDEPENDENT STUDY, AT HOME

Free Details Available from:

Grantham College of Engineering
10570 Humbolt Street
Los Alamitos, California 90720

Independent Home Study Can Prepare You

Study materials, carefully written by the Grantham staff for independent study at home, are supplied by the College, and your technical questions related to those materials and the lesson tests are promptly answered by the Grantham teaching staff.

Recognition and Quality Assurance

Grantham College of Engineering is accredited by the Accrediting Commission of the National Home Study Council.

All lessons and other study materials, as well as communications between the college and students, are in the English language. However, we have students in many foreign countries; about 80% of our students live in the United States of America.

Grantham College of Engineering R-2-87
10570 Humbolt Street, Los Alamitos, CA 90720

Please mail me your free catalog which explains your B.S. Degree independent-study program.

Name _____ Age _____

Address _____

City _____ State _____ Zip _____

system RAM; an additional 64K is used as a buffer for communicating with the host PC; the remainder is used as EMS (Expanded Memory Specification) RAM. Some applications programs (like Lotus' Symphony, Ashton-Tate's Framework, the Ready! outline processor, and AutoCAD 2.5) use EMS RAM to swap programs and data in and out of system RAM. What if your application cannot make use of EMS RAM? Orchid supplies several software pack-

ages (a RAM disk, a disk cache, and a print spooler) they call "Productivity Software" with the 286e; the RAM disk and the disk cache can be allocated to EMS RAM.

Getting it running

Installation consists of running a program and setting some switches and jumpers on the 286e. The installation program modifies your AUTOEXEC.BAT file and creates two new "boot" files, HOSTEXEC.BAT and TURBEXEC.BAT. It also

Orchid	PC turbo 286e									
OVERALL PRICE	[Bar chart showing 9 out of 10]									
EASE OF USE	[Bar chart showing 8 out of 10]									
INSTRUCTION MANUAL	[Bar chart showing 9 out of 10]									
PRICE/VALUE	[Bar chart showing 9 out of 10]									
	1	2	3	4	5	6	7	8	9	10
	Poor			Fair			Good			Excellent

creates a TURBO.SYS file, the 286e's counterpart to CON FIG.SYS. HOSTEXEC.BAT and TURBEXEC.BAT now load your memory-resident software and start your applications going; HOSTEXEC.BAT loads the host PC, and TURBEXEC.BAT loads the 286e. If you use any of Orchid's Productivity Software, your CON FIG.SYS file will be modified to contain the appropriate driver.

If you have a standard PC or XT with no special add-on hardware, the default hardware and software installation procedures work fine. But if you're running any hardware that uses an IRQ line or I/O ports, you may have to reconfigure either your pre-existing hardware or the 286e. In addition, the 286e cannot be used with an EGA board or a network interface board.

After you've gotten the installation straightened out, using the 286e is simple. To run programs on the 286e, execute the TURBO.COM program. To run programs on the host, execute the UNTURBO.COM program.

If you've ever used an AT, using the 286e will feel more or less the same. But if you're used to a standard PC or XT, you're in for a big surprise, because, in turbo mode, things move *fast*. For example, the disk directory scrolls by so fast that it's nearly unreadable. Block moves and copies in a word processor happen almost instantaneously. Likewise with sorting a database.

Further, regenerating an AutoCAD (2.18) screen takes about one third the time it used to. That saves a tremendous amount of time—as well as frustration. AutoCAD is a powerful program, but it's slow, and you can go crazy waiting for it to catch up. But not with a PCTurbo 286e.

ELENCO PRODUCTS AT DISCOUNT PRICES!

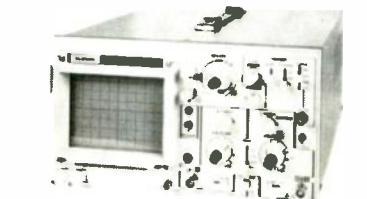

20 MHz DUAL TRACE OSCILLOSCOPE
\$349 MO-1251

TWO
100 MHZ
SWITCHABLE
PROBES
INCLUDED

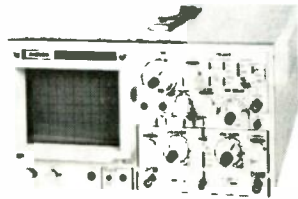

35 MHz DUAL TRACE OSCILLOSCOPE
\$498 MO-1252

Top quality scopes at a very reasonable price. Contains all the desirable features. Elenco's 2 year guarantee assures you of continuous service. Two 1x, 10x probes, diagrams and manual included. Write for specifications.

1500 MULTI METER with CAPACITANCE and transistor tester
\$65 Model CM-1500
Reads Volts, Ohms, Current, Capacitors Transistors & Diodes

TRUE RMS 4 1/2 DIGIT MULTIMETER
\$135 Model M-7000
0.5% DC Accuracy
1% Resistance with Freq. Counter & Deluxe Case

AUTO RANGING plus MANUAL RANGING 3 1/2 DIGIT METER 28 FUNCTIONS FULLY PROTECTED
M-1180 .7% ACY \$38.95
M-1182 .25% ACY \$39.95
M-1181 .1% ACY \$42.95

GF-8016 Function Generator with Freq. Counter
\$219
• Sine, Square, Triangle, Pulse, Ramp, .2 to 2 MHz
• Frequency .1 thru 10 MHz
GF 8015 without Freq. Meter \$169

10 MHz OSCILLOSCOPE
\$190 S-3000
10 MHz DC or AC Triggered Sweep Calibrated Vert & Hor Reads Volts & Freq

BREADBOARD
Shown 9436
9430 1,100 pins \$15
9434 2,170 pins \$25
9436 2,860 pins \$35

Triple Power Supply XP-660
\$14950
0-20V @ 1A
0-20V @ 1A
5V @ 5A
Fully Regulated, Short Circuit Protected with 2 Limit Cont. 3 Separate Supplies.

50 MHz LOGIC PROBE
\$23 LP-700
20 nec with memory

LOGIC PULSER
\$25 LP-600
2 us pulse @ 1A

3 Amp Power Supply XP-650
\$11950
0-40V @ 1.5A
0-20V @ 3A
Fully regulated, short circuit protected current limit control

DIGITAL LCR METER
Model LC-1800 Measures: Inductors Capacitors, Resistors
\$148
Inductors 1µH to 200 H
Capacitor .1pF to 200µF
Resistor .01Ω to 20M Ω
Ranges 6 ind, 7 cap, 7 res

C&S SALES, 8744 W. North Ter. Niles, IL 60648
800-292-7711 (312) 459-9040
15 DAY MONEY BACK GUARANTEE ASK FOR CATALOG
2 Year Limited Guarantee! Add 5% for Postage (\$10 max.), IL Res., 7% Tax
CIRCLE 109 ON FREE INFORMATION CARD

Is it worth it?

If you spend most of your time doing word processing, you don't need a 286e. But if you spend a great deal of time running any compute-intensive (not disk-intensive) program, a 286e is well worth its \$1195 list price. Just make sure that it's compatible with your hardware and software. R-E

Philips Compact Disc Test Set



Compare and test the performance of CD players

CIRCLE 10 ON FREE INFORMATION CARD

WHILE THE COMPACT-DISC PLAYER HAS brought wide dynamic range, superb stereo separation, and low noise levels to the general public, it has also brought some unique problems to audio service technicians. Two compact-disc test sets are now available to help technicians measure the performance of CD players. They come from the co-developer of the Compact Disc standard, Philips (N.A.P. Consumer Electronics Corp., P.O. Box 309, Snapp Ferry Rd., Greeneville, TN 37744-0309).

A two-disc defect-test set evaluates a CD player's ability to play dirty or scratched CD's, and a single audio-frequency test disc supplies signals that allow you to measure the performance of a player. (It also allows the player to be used as a signal source for checking amplifier response, speaker performance, etc.).

Defect test discs

The defect test-disc set (part number 1716550040) is priced at \$89.95 and contains two discs.

ELECTRONIC COMPONENTS



176 PAGE

FREE CATALOG

Manufacturers of Quality Electronic Components

Serving the Nation from Texas and California

- BATTERY HOLDERS & CLIPS • COILS
- CAPACITORS • CONNECTORS • FUSES
- JACKS • KNOBS • LAMPS • PLUGS
- MICROPHONES • POTENTIOMETERS
- RELAYS • RESISTORS • SWITCHES
- TRANSFORMERS • SPEAKERS • LEDS
- SEMICONDUCTORS • RF COILS

OVER 16,000 DIFFERENT ITEMS IN STOCK! CATALOG MAILED OUTSIDE USA SEND \$2.00

MOUSER ELECTRONICS

2401 HWY 287 NORTH MANSFIELD, TX 76063
PHONE 817-483-4422

CIRCLE 117 ON FREE INFORMATION CARD



The Super Converter 8001 Features:

- Listening to 810-912 MHz Band on a UHF Scanner and /or Other Monitor Receivers
- Easy Connections to Your Receiver
- 9 Volts Battery Operation Power Source and Power On Indicator by LED Display
- External Power Jack Size: 79(w) x 30(H) x 100(D)mm

Warranty

- 180 Days From Date of Purchase

Unit Cost

- \$59.94 plus \$4.00 Shipping and Handling Charge

EASY LISTENING

- FOR 810 TO 912 MHz BAND SUPER CONVERTER 8001
- FOR YOUR UHF SCANNING RECEIVER AND OTHERS

A super-converter 8001 has been certified by FCC part 15 regulation.

HOW TO ORDER

Name: _____
 Address: _____
 City: _____ State: _____
 Zip: _____ Phone () _____

Make Check or Money Order payable to GRE AMERICA, INC

Mail to: GRE AMERICA, INC.
 425 Harbor Blvd., Belmont, CA 94002

Unit Cost *(\$59.94)* Qty _____ Total _____
 CA. Residents Add 6.5% Tax
 Shipping & Handling *(\$4.00)*
 Unit Qty Total

PAYMENT METHOD TOTAL ▶

Check Money Order
 Mastercard Visa

Card No _____
 Expiration Date _____

Signature _____

**PHONE ORDER: 800-233-5973
 or 415-591-1400**

Capacitance, logic and more. For less.

Now, a fully-loaded DMM combines a capacitance meter, logic probe, and an hFE meter, all for the price of a DMM.

- TTL Logic Probe: 20 MHz
- Hi/lo/off indications
- Detects 25nS pulse width
- Capacitance: 5 ranges (2nF to 20µF)
- hFE (NPN or PNP): 1 range (1000)
- DMM: DCV-5 ranges (.2V to 1kV)
- ACV-5 ranges (.2V to 750V)
- DCA-4 ranges (200µA to 10A)
- ACA-3 ranges (20mA to 10A)
- Ohms-7 ranges (200 Ohms to 2000 Megohms)
- Continuity beeper
- Diode check
- Built-in bail
- Anti-skid pads

See one now at your local Beckman Industrial distributor.

DM25L... \$89⁹⁵*

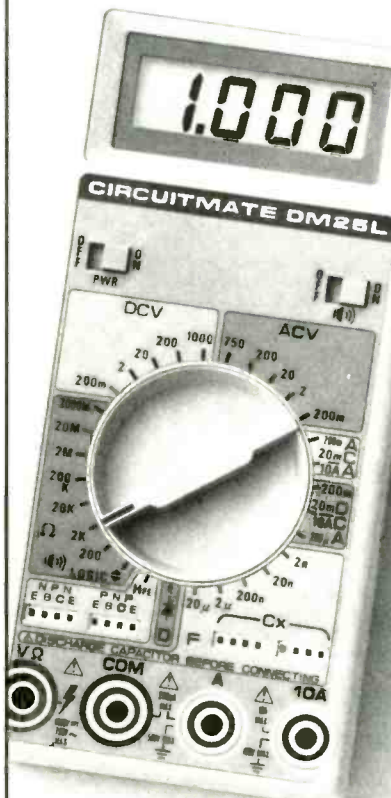

*Suggested list price (\$US) with battery, test leads and manual.

Beckman Industrial

Beckman Industrial Corporation
A Subsidiary of Emerson Electric Company
630 Puente Street, Brea, CA 92621
(714) 671-4800

© Copyright 1985 Beckman Industrial Corporation

One of the discs contains a variety of simulated defects, while the other doesn't. Otherwise, the discs are identical and contain selections that range from excerpts of Beethoven symphonies to swing jazz to a country selection by Teresa Brewer. Despite the defects, both discs should sound the same. A CD player in proper working order should be able to correct the data errors caused by the defects, and it should be able to play back all selections without any audible errors.

Three different defects are simulated: fingerprints, dust, and scratches. The fingerprints are simulated by very fine lines printed on the plastic protective surface of the disc. Dust is represented by black dots, also printed on the plastic surface. The diameter of the dots range from 300 to 800 micrometers (which, by the way, would be a rather large piece of dust).

Scratches are simulated by interruptions in the reflective information layer. The simulated scratch widths range from 400 to 900 mi-

Philips	CD Test Discs									
OVERALL PRICE	[Bar chart showing 8 out of 10]									
EASE OF USE	[Bar chart showing 9 out of 10]									
INSTRUCTION MANUAL	[Bar chart showing 4 out of 10]									
PRICE / VALUE	[Bar chart showing 8 out of 10]									
	1	2	3	4	5	6	7	8	9	10
	Poor			Fair			Good			Excellent

croimeters (which would be a rather severe scratch).

A CD player that is operating properly can cope with all the defects, because the audio information is recorded with extensive error-detection and error-correction coding. Errors are detected with the help of two 32-bit sets of parity bits (for each 588-bit audio frame) and the correction is handled by a system based on a Cross Interleave Reed-Solomon Code or CIRC.

Audio frequency test disc

The audio-frequency test disc (part number 1716550030) contains 20 tracks that range from silence to pink noise, to tonebursts. It is meant to be used primarily to help measure the performance of a CD player to verify that it is operating within specifications. Most CD-player manufacturers publish specifications that include frequency response, dynamic range, signal-to-noise ratio, THD (Total Harmonic Distortion), and channel separation. The test disc provides signals to help make those measurements, and more. Special signals called doubletones can be used to measure intermodulation distortion, and tonebursts can help you determine the phase linearity of the system.

The first track is simply a voice that points out which is the left channel and which is the right. There are tracks for each channel that contain a 1-kHz synchronization tone, followed by a 20-Hz to 20-kHz logarithmic sweep.

For harmonic distortion measurements, there are tracks with tones ranging from 41 Hz to 1999 Hz. (THD is distortion characterized by the appearance of harmonics of the input signal at the output of the system. The "strange" frequencies are prim-

SATELLITE TV The "Magic-Chip"

Special \$250.

**Available for the first time in the U.S.
FOR OAK SYSTEM DESCRAMBLERS**

25 CHANNELS YOU CAN WATCH

MOVIES • SPORTS • NEWS • ENTERTAINMENT

<ul style="list-style-type: none"> • THE SPORTS NETWORK • GLOBAL TV • CHCH (CANADIAN IND) • WDIV (NBC DETROIT) • WXYZ (ABC DETROIT) • TVYT (CANADA IND) • WORD OF FAITH • BAY MEADOWS • NBC SPORTS • MEADOWLANDS • HEALTH INFO • HOSPITAL CHANNEL • CITY (CANADIAN IND) • WTVS (PBS) 	<ul style="list-style-type: none"> • BCTV (CANADIAN IND) • WJBK (CBS DETROIT) • TELEBET • HIALEAH RACING • WOLD RACING • PENN. HOSPITAL ASSN • PHILADELPHIA PARK • SANTA ANITA RACING • SYNSAT • BTN • TUCSON GREYHOUND PARK • MEADOWS RACING • YONKERS-ROOSEVELT • HOLLYWOOD PENN. NAT.
--	--

Doesn't Receive MaCom Scrambled Channels (HBO, CINEMAX)

HOW THE SYSTEM WORKS ?

The "MAGIC CHIP" easily fits into any Oak "P" descrambler box. Receive Canadian Channels that feature Movie, Sports, News and Variety programming. Also four Canadian Superstations, four U.S. Superstations and much more . . .

<p style="text-align: center; font-weight: bold;">Watch Programs from SIX SATELLITES</p> <ul style="list-style-type: none"> • Westar 5 • Galaxy 3 • Spacenet 1 • Anik D • Satcom 4 • Westar 4 	<p style="text-align: center; font-weight: bold;">EASY HOOK-UP</p>
---	--

OAK SYSTEM SALES

RUSH ORDERS OK	P.O. BOX 84208 VANCOUVER, WASH. 98684	ORDERS SENT UPS COD
----------------	--	---------------------

We expressly do not advocate the unauthorized reception of any transmitted signals. It is the purchaser's sole responsibility to pay all subscription fees.

CALL TODAY

1-206-253-4186

DEALERS WANTED

MASTER THE NEW ELECTRONICS WITH MCGRAW-HILL'S

Contemporary Electronics Series

The fast, easy and low cost way to meet the challenges of today's electronic innovations. A unique learning series that's as innovative as the circuitry it explains, as fascinating as the experiments you build and explore.

From digital logic to the latest 32-bit microprocessor, the McGraw-Hill Contemporary Electronics Series puts you into the electronic picture one easy step at a time. Fifteen unique Concept Modules, sent to you one every 4-6 weeks, give you a handle on subjects like optoelectronics, robotics, integrated circuits, lasers, fiber optics and more.

Each Concept Module goes right to the heart of the matter. You waste no time on extraneous material or outdated history. It's a fast, efficient, and lively learning experience...a non-traditional approach to the most modern of subject matter.

Unique Interactive Instruction

With each module, you receive a McGraw-Hill Action Audio Cassette. Each tape is a dynamic discussion that drives home the key facts about the subject. Your learning

With your first module, you get this solderless breadboarding system. You'll use it throughout the series to build electronic circuits and bring concepts to life.

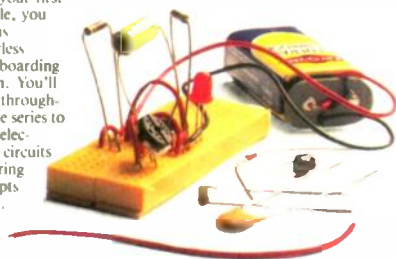

experience is reinforced through interaction with vividly illustrated text, audio cassettes, and actual electronic experiments. Indexed binders preserve backup material, notes, and tapes for convenient referral.



Perform Experiments in Contemporary Electronics

Throughout your series, laboratory experiments reinforce every significant point. This essential experience...dynamic, hands-on demonstrations of theory in practice... will help you master principles that apply all the way up to tomorrow's latest VLSI (Very Large Scale Integrated) circuitry.

In your very first module, you'll use integrated circuits to build a digital oscillator, verifying its operation with a light emitting diode (LED). You'll learn to identify passive and active components, understand concepts common to all electronic circuits.

For Anyone Interested in Electronics

The Contemporary Electronics Series is designed for anyone from hobbyist to professional. It's for you if you're looking for new fields of interest...if you're a teacher who

wants an update in contemporary circuits...a manager or supervisor in an electronics plant...a doctor, an engineer, a chemist who finds electronics playing an increasingly important role in your work. It's even for electronics engineers or technicians who feel their training needs freshening up. It's the quickest, most convenient, probably least expensive way to do it. And the only one that gives you hands-on experience.



15-Day No-Risk Trial

To order your first module without risk, send the card today. Examine it for 15 days under the terms of the order form and see how the Contemporary Electronics Series gets you into today's electronics. If card has been used, write us for ordering information.



McGraw-Hill
Continuing Education Center
3939 Wisconsin Ave.
Washington, D.C. 20016

SEE YOUR DEALER TODAY

FROM



HERE'S A TIP THAT'S PERFECT!

AM/FM AUTO RADIO AND CB

'Firestik' II

GOLDEN SERIES

BARE-HANDS TUNABLE
"NO TOOLS NEEDED"
HIGH PERFORMANCE ANTENNAS

ALSO ANTENNAS FOR
CORDLESS TELEPHONES
MONITOR SCANNERS

Dealer & Distributor Inquiries Invited
SEND FOR FREE CATALOG

'Firestik' Antenna Company
2614 East Adams Phoenix, AZ 85034

Name _____
 Street _____
 City _____
 State _____ Zip _____
 Serving the CB and
 Communications Market Since 1962.

5-YEAR REPLACEMENT WARRANTY

CIRCLE 100 ON FREE INFORMATION CARD

Be an FCC LICENSED ELECTRONIC TECHNICIAN!



Learn at home in spare time.
No previous experience needed.

No costly school. No commuting to class. The Original Home-Study course prepares you for the "FCC Commercial Radiotelephone License". This valuable license is your "ticket" to thousands of exciting jobs in Communications, Radio-TV, Microwave, Computers, Radar, Avionics and more! You don't need a college degree to qualify, but you do need an FCC License.

No Need to Quit Your Job or Go To School This proven course is easy, fast and low cost! **GUARANTEED PASS** - You get your FCC License or money refunded. **Send for FREE facts now. MAIL COUPON TODAY!**

COMMAND PRODUCTIONS

FCC LICENSE TRAINING, Dept 90
P.O. Box 2223, San Francisco, CA 94126

Please rush FREE details immediately!

NAME _____
 ADDRESS _____
 CITY _____ STATE _____ ZIP _____

numbers used to avoid interaction with the CD player's sampling frequency.) The same track is repeated 24 dB and 30 dB down, for both left and right channels.

The other tracks include doubletones, sweeping doubletones, squarewaves, tonebursts, impulses, phase checks, and pink noise. We won't go into detail here on how to use those signals to test CD players, but keep watching for an upcoming article that will tackle the subject in some depth!

Manuals

The instruction pamphlets supplied with both the audio-frequency and the defect-test discs are not very good. They are very skimpy on details, and are obviously translated into English. They are, as a result, difficult to follow. That's unfortunate: all service tools should be supplied with high-quality service literature.

Further, there is no discussion of CD technology. That technology is still new enough that many service professionals are unfamiliar with it. As such, extensive background information would be appropriate and useful. **R-E**

SCOPE PRICE BREAKTHROUGH!

New B&K-PRECISION Dual-Trace 20MHz Scope... \$440!!

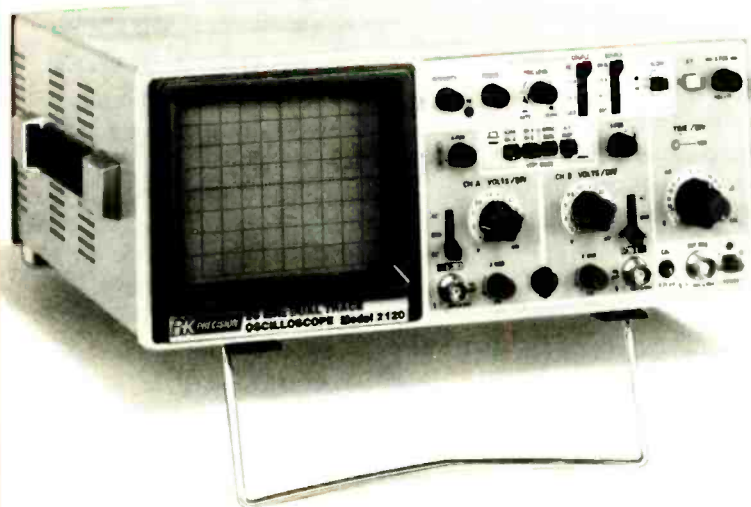

Now you can own a professional quality 20MHz, dual-trace scope for under \$450. Best of all, it's a full featured instrument, from B&K-PRECISION—famous for quality, dependable products.

- Compare these outstanding features, then compare price!
- Dual or single trace operation • 1mV/div sensitivity
 - 20MHz response at a true -3dB • AUTO/NORM triggered sweep operation with AC, TVH, TVV and Line coupling
 - Calibrated 18 step timebase with x10 magnifier • X-Y operation
 - Bright, sharp rectangular CRT with P31 phosphor
 - Front-panel trace rotation control • Tilt stand and soft handle • Selectable +/- slope • Built-in calibration source
 - Compact low-profile design.

For immediate delivery, contact your local B&K-PRECISION distributor or call B&K-PRECISION today.

BK PRECISION DYNASCAN CORPORATION

6460 West Cortland Street • Chicago, Illinois 60635 • 312/889-9087
 International Sales: 6460W Cortland St, Chicago, Illinois 60635 • Canadian Sales: Atlas Electronics, Ontario
 South and Central American Sales: Empire Exporters, Plainville, NY 11803
CIRCLE 77 ON FREE INFORMATION CARD

Radio Electronics mini-ADS

Radio Electronics



INVERTER, remote control video analog free. **CANLIMITED**, 116 AR 71862.

See the exciting new, ten-minute di-

SEE INFORMATION CARD

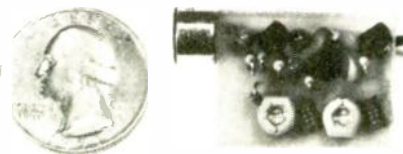

SIMPLY SNAP THE WAT-50 MINIATURE FM TRANSMITTER on top of a 9v battery and hear every sound in an entire house up to 1 mile away! Adjustable from 70-130 MHz. Use with any FM radio. Complete kit **\$29.95 + \$1.50 S + H**. Free shipping on 2 or more! COD add \$4. Call or send VISA, MC, MO. **DECO INDUSTRIES, Box 607, Bedford Hills, NY 10507. (914) 232-3878.**

CIRCLE 127 ON FREE INFORMATION CARD



SCIENTIFIC ATLANTA super Winter sale. Now available Scientific Atlanta 8500 and 8550 cable converters. Perfect reception on all channels. Sale price 8500 or 8550 **\$239.95**. Hand remotes **\$20.00**. Call now to insure your order. Sale ends Feb. 28, 1987. Also, the original CM-04 for 8500 converter. Sale price only **\$69.95**. CM-04 kits **\$39.95!** Dealers welcome. C.O.D. accepted. **V.I.P. ELECTRONICS, P.O. Box 628, Forestdale, R.I. 02824, (617) 755-9778.**

CIRCLE 199 ON FREE INFORMATION CARD

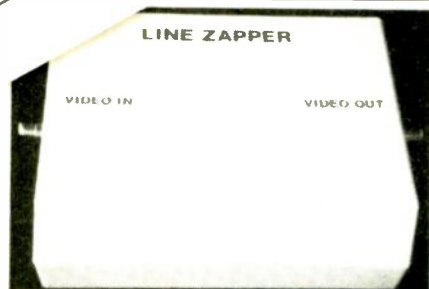

DECODE THE NEW VIDEO TAPE COPY PROTECTION SCHEME. Bothered by brightness changes, vertical jumping and jittering while watching recent movie releases? Stop it with the **LINE ZAPPER**. New kit detects and removes selected lines of video that have been modified and often interfere with normal television operation. Order your KIT today only **\$69.95 plus \$2.00 S & H. ELEPHANT ELECTRONICS, Box 41865-L, Phoenix, AZ 85080. Visa/MC orders (602) 581-1973.** Allow 6 weeks for delivery.

CIRCLE 120 ON FREE INFORMATION CARD

CALL NOW AND RESERVE YOUR SPACE

- 60% rate \$745.00 per each insertion.
- Reaches 239,312 readers.
- Fast reader service cycle.
- Short lead time for the placement of ads.
- We typeset and layout the ad at no additional charge.

Call **516-293-3000** to reserve space. Ask for Arline Fishman. Limited number of pages available. Mail materials to: **mini-ADS, RADIO-ELECTRONICS, 500-B Bi-County Blvd., Farmingdale, NY 11735.**



NEW JERROLD CS 68 CHANNEL CABLE TV CONVERTER with volume control & descrambler loop (Port). Programmable clock turns TV on off & changes channel. Audio mute kills commercials. Programmable channel scan. Instant channel recall. Automatic fine tuning with manual override. Video & audio outputs. Friendly to all descramblers. Specify output. 1 year warranty. **\$129, \$105 ea./case lot of 10.** Free delivery. Dealers wanted. **(514) 739-9328. CROSLY ELECTRONICS, Box 840, Champlain, N.Y. 12919.**

CIRCLE 202 ON FREE INFORMATION CARD



60 dB SIGNAL ELIMINATOR—for removal of undesirable TV FM/VHF signals. Can be tuned precisely to ANY signal within these ranges: *Model 26 - Ch's. 2-6 plus FM (54-108 Mhz) *Model 1422 - Ch's. 14(A) - 22(1) (120-174Mhz) *Model 713 - Ch's. 7-13 (174-216 Mhz). Highly selective notch adjustable strength. Singles **\$30**. Quantity discounts to 60%. **STAR CIRCUITS - P.O. Box 8332 - Pembroke Pines, FL. 33084**

CIRCLE 94 ON FREE INFORMATION CARD

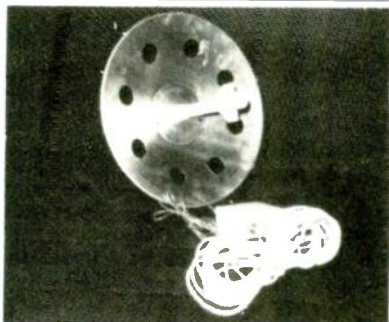

MICROWAVE ANTENNAS \$69.95. Now including shipping and Lifetime warranty. We Repair all types of Downconverters. Cable Converters and equipment available! Panasonic 450 MHz wireless converter **\$79.95 plus shipping.** Coax cable. T.V. parts, accessories, connectors, T.V. amplifiers. Write for free information or call for prices. **BLUE STAR IND., Dept. 105-RE 2-87, 4712 Ave. N, Brooklyn, N.Y. 11234 (718) 338-8318 Ext. 105.**

CIRCLE 85 ON FREE INFORMATION CARD



ZENITH SSAVI \$169 each. Reconditioned original UHF equipment. Sale: UHF gated pulse decoders as is, no warranty, **\$95 each** ppd. Satellite equipment. Surplus TV equipment: N-12, Hamlin 1200, Ztac. Converters, amplifiers, TV accessories. Catalog & Coupon **\$1**. SSAVI modification troubleshooting handbook **\$6.50 ppd.** **AIS SATELLITE, INC., P.O. BOX 1226-R, Dublin, PA, 18917. 215-249-9411.**

CIRCLE 81 ON FREE INFORMATION CARD

NEW PRODUCTS

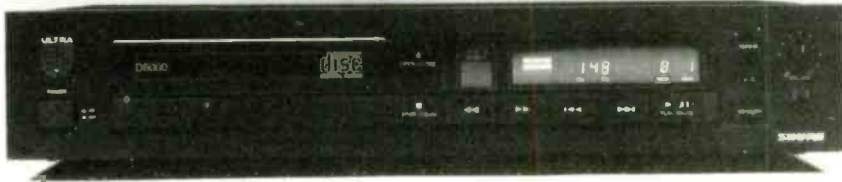

CIRCLE 30 ON FREE INFORMATION CARD

COMPACT DISC PLAYER, the model *D6000*, has a digital filtering system that reduces the negative effects of sampling energy. The sound is further refined by addi-

tional analog filtering and dual high-speed D/A converters, which improve imaging and clarity by reducing interchannel phase shift. There is also a 16-bit processor that

provides the smooth oversampling.

Other features include "longlife" 3-beam state laser-tracking system, key direct-access program and volume control on the less remote control, 2-speed audible scan, and various repeat functions, including disc, memory, and phrase.

The model *D6000* is priced at \$599.00.—**Shure Brothers Incorporated**, 222 Hartrey Avenue, Evanston, IL 60202-3696.

continued on page 37

CONTACTLESS DE-SOLDERING AND SOLDERING WITH THE LEISTER-LABOR "S" HOT AIR TOOL

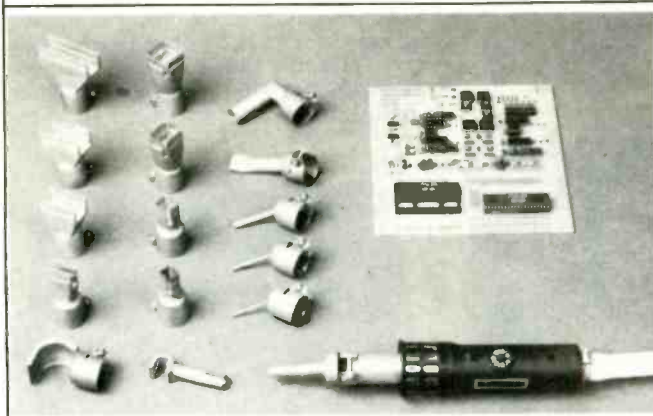

Electronic Temperature Adjustment from 20 to 600°C. Electronical Air Volume Adjustment from 1 to 150 litres per minute. For contactless de-soldering and soldering of SMD- and DP-components in 2-4 seconds.

Ask for brochure UA 19

AIR-TEMP
P.O. Box 148, Mohnton, PA 19540
Tel. (215) 775-5177

ATTENTION! ELECTRONICS TECHNICIANS

EARN YOUR **B.S.E.E. DEGREE**

THROUGH HOME STUDY

Our New and Highly Effective Advanced-Placement Program for experienced Electronic Technicians grants credit for previous Schooling and Professional Experience, and can greatly reduce the time required to complete Program and reach graduation. No residence schooling required for qualified Electronic Technicians. Through this Special Program you can pull all of the loose ends of your electronics background together and earn your B.S.E.E. Degree. Upgrade your status and pay to the Engineering Level. Advance Rapidly! Many finish in 12 months or less. Students and graduates in all 50 States and throughout the World. Established Over 40 Years! Write for free Descriptive Literature.

COOK'S INSTITUTE
OF ELECTRONICS ENGINEERING

347 RAYMOND ROAD
P.O. BOX 20345
JACKSON, MISSISSIPPI 39209

CIRCLE 193 ON FREE INFORMATION CARD

Try the
Radio-Electronics
bulletin board
system
(RE-BBS)
516-293-2283

The more you use it the more useful it becomes.

We support 300 and 1200 baud operation.

Parameters: 8N1 (8 data bits, no parity, 1 stop bit) or 7E1 (7 data bits, even parity, 1 stop bit).

Add yourself to our user files to increase your access.

Communicate with other R-E readers.

Leave your comments on R-E with the SYSOP.

RE-BBS
516-293-2283

HITACHI OSCILLOSCOPES



ALLEN

"The ALLEN INDUSTRIAL ELECTRONICS GROUP highly recommends these fine Industrial Quality

 **Hitachi** Oscilloscopes"

Richard S. Vialton MSEE
Sales Manager
ALLEN
INDUSTRIAL ELECTRONICS GROUP

V-212

20 MHz Dual Channels

Convenient 0, 10, 90 and 100% amplitude markings, vertical mode triggering, 1mV/div. sensitivity & $\pm 3\%$ accuracy, TV sync separation circuit, X-Y mode, low drift.

\$429.

 **HITACHI**
SAVE UP TO \$850.00!



V222

20MHz Dual Channels

Same as above with DC offset to measure signals having DC components, CH1 output and DC offset voltage monitor outlet available for external counter or DVM*, alternate magnify function provides x1 and x10, sweep waveforms to be simultaneously displayed.

\$511.

*The purchase of a Model V222 oscilloscope entitles you to purchase a Revere Model RDMT10 3 1/2 digit, 10 amp. scale digital multi-meter for \$39.95! Regular price is \$49.95. Offer applies only to Hitachi Model V222.

V1100A

100MHz/Quad Channels, 8-trace, delayed sweep, CRT readout, digital measurement.

\$2260.

V1070A

100MHz/Quad Channels, 8-trace, delayed sweep, CRT readout.....

\$1610.

V1050F

100MHz/Quad Channels, 8-trace, delayed sweep.

\$1395.

V650F

60MHz/Triple Channels, delayed sweep.....

\$1057.

V-422

40MHz, Dual Channels.

\$785.

VC6041UG

40MHz, sampling, dual channels, 1mV dual trace, 6" CRT, 4k words per channel, GPIB option.

\$5180.

VC6041UX

40MHz, digital storage, 1mV dual trace, 6" CRT, 4k words per channel.

\$4380.

V509

50MHz, dual channels, mini portable, delayed sweep.

\$1199.

V134

10MHz, dual trace, bi-stable storage.....

\$1395.

V209

20MHz, dual channels, AC-DC, mini portable.....

\$815.



THE 928 PAGE
WM. B. ALLEN
ELECTRONICS CATALOG
A \$15.00 VALUE
FREE!
WITH ANY PURCHASE

WM. B. ALLEN SUPPLY COMPANY, INC.

ALLEN SQUARE

THE 300 BLOCK • NORTH RAMPART STREET

NEW ORLEANS • LOUISIANA 70112-3106

LOUISIANA TOLL FREE 800 462 9520 • NEW ORLEANS (504) 525 8222

CALL NATIONWIDE TOLL FREE

800 535 9593

24 HOURS A DAY!



CIRCLE 103 ON FREE INFORMATION CARD

NEW IDEAS

Sequential flasher

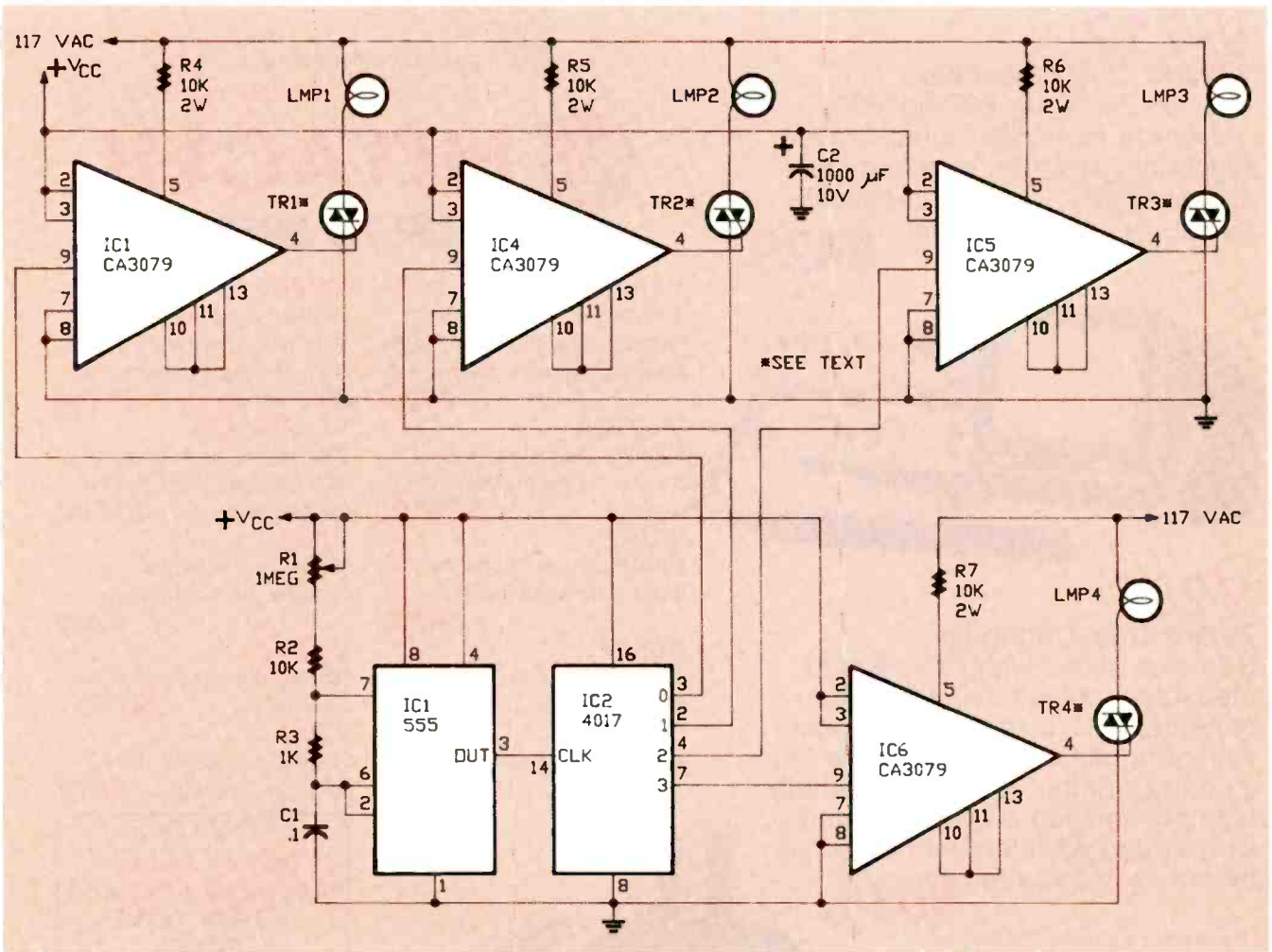

FIG. 1

HERE'S AN EASY AND INEXPENSIVE WAY to liven up a store window, decorate a Christmas tree, or create a do-nothing toy for the kids. As many as ten lightbulbs can be connected to the circuit and arranged in a circle, or in any other pattern. The lights flash sequentially; when the flash rate is about five or six Hz, an optical illusion of a "running dark spot" is produced.

How it works

As shown in Fig. 1, a 555 timer, IC1, drives a 4017 CMOS decade

counter. Each of the 4017's first four outputs drives a CA3079 zero-voltage switch. Pin 9 of the CA3079 is used to inhibit output from pin 4, thereby disabling the string of pulses that IC normally delivers. Those pulses occur every 8.3 ms, i. e., at a rate of 120 Hz. Each pulse has a width of 120 µs.

Due to the action of the CA3079, the lamps connected to the TRI-AC's turn on and off near the zero crossing of the AC waveform. Switching at that point increases lamp life by reducing the inrush of

current that would happen if the lamp were turned on near the high point of the AC waveform. In addition, switching at the zero crossing reduces Radio-Frequency Interference (RFI) considerably.

Construction

CAUTION: The CA3079's are driven directly from the 117-volt AC power line, so use care in building the sequential flasher. Keep lead lengths short, use insulated wire, and mount the entire circuit in a rigid, insulated enclosure.

NEW IDEAS

This column is devoted to new ideas, circuits, device applications, construction techniques, helpful hints, etc.

All published entries, upon publication, will earn \$25. In addition, for U.S. residents only, Panavise will donate their model 333—The Rapid Assembly Circuit Board Holder, having a retail price of \$39.95. It features an eight-position rotating adjustment, indexing at 45-degree increments, and six positive lock positions in the vertical plane, giving you a full ten-inch height adjustment for comfortable working.

I agree to the above terms, and grant **Radio-Electronics Magazine** the right to publish my idea and to subsequently republish my idea in collections or compilations of reprints of similar articles. I declare that the attached idea is my own original material and that its publication does not violate any other copyright. I also declare that this material has not been previously published.

Title of Idea _____

Signature _____

Print Name _____ Date _____

Street _____

City _____ State _____ Zip _____

Mail your idea along with this coupon to: **New Ideas Radio-Electronics, 500-B Bi-County Boulevard Farmingdale, NY 11735**

We didn't specify part numbers for the TRIAC's, because the type will depend on the lamps you will drive. The TRIAC's will almost certainly require heatsinks; the size of the heatsinks will depend on the amount of power the TRIAC's will have to dissipate, and that depends on the lamps you use.

You'll need a low-voltage source (+V_{CC}) to drive the 555, the 4017, and the bias inputs of the CA3079's. One possibility would be to wire up a 7805 regulator circuit and a step-down transformer.

It would also be possible to run the circuit from a 24-volt AC source. Doing so would allow the use of lamps with lower voltage and current ratings. The lower power required by the lamps would also allow use of smaller TRIAC's, smaller heatsinks, and a smaller enclosure. The circuit would also be much safer. See RCA Solid State's *Integrated Circuits for Linear Applications* for more information.—*Michael Ciric*

NEW PRODUCTS

continued from page 34

UNIVERSAL COUNTER/TIMERS, the model 5010 and the model 5110, incorporate frequency, period, period average, time interval, time-interval average, frequency ratio, and totalize-measurement modes. The A and B



CIRCLE 31 ON FREE INFORMATION CARD

inputs of both models have bandwidths of DC to 100 MHz, AC or DC coupling, slope selection, and a $\times 1/\times 10$ attenuator. The model 5110 has an extra input (C) that allows frequency measurements to 1 GHz. Channel A also has an HF filter. Both channels (A and B) have trigger-level controls with 3-state trigger indicators.

The model 5010 (100MHz) costs \$1195.00; the model 5110 (1GHz) costs \$1395.00.—O.K. Electronics Division, 4 Executive Plaza, Yonkers, NY 10701.

SPECTRUM ANALYZER, the model R360, is a fast, totally turnkey spectrum analyzer and digital signal-processing peripheral for the IBM PC, XT, and AT, and compatibles. It is the only PC-based instrument featuring the TI TMS32010 and offering four-channel, real-time spectrum analysis.



CIRCLE 32 ON FREE INFORMATION CARD

Applications include: multi-channel spectrum analysis to 250 kHz, vibration analysis, impact testing, chromatography, ultra-

LEARN TV/VCR REPAIR

No Previous Experience Necessary



Now you can train at home in spare time for a money-making career as a TV/VCR Repair Specialist. No need to quit your job or school. We show you how to troubleshoot and repair videocassette recorders and TV sets, how to handle house calls and shop repairs for almost any make of television or VCR. You learn about TV receivers, tuners and antennas, x-ray emission, the characteristics of sound, how electrical impulses are converted into a TV picture, and much, much more. Tools are included with your course so you can get "hands-on" practice as you follow the lessons step by step. Send for free facts about opportunities in TV/VCR Repair and find out how you can start making money in this great career. Experts show you what to do, how to do it...guide you every step of the way! Everything is explained in easy-to-understand language with plenty of drawings, photos and diagrams.

CALL TOLL-FREE

1-800-228-5300 Dept. DE017

CALL ANYTIME—Operators to take your call 24 hours a day 7 days a week. No cost. No obligation. No salesman will visit you.

OR MAIL COUPON TODAY

ICS SCHOOL OF TV/VCR REPAIR, Dept. DE017
Scranton, Pennsylvania 18515

Please send me free facts on how I can learn TV/VCR Repair at home in my spare time. No salesman will visit.

Name _____ Age _____

Address _____ Apt. # _____

City/State/Zip _____

Phone () _____

A Subsidiary of National Education Corporation

SUPER LONG PLAY TAPE RECORDERS

10 Hour Model — \$95.00*
14 Hour Model — \$159.00*

Modified Panasonic Slimline. high quality, AC-DC Recorders provide 5 or 7 continuous hours of quality recording & playback on each side of 10 or 14 hours depending on model. Built-in features include: • Voice level control, • Digital counter, etc. TDK DC 180 Cassette Furnished.



PHONE RECORDING ADAPTER

Records calls automatically. All Solid state connects to your telephone jack and tape recorder. Starts recording when phone is lifted. Stops when you hang up. **\$24.50*** FCC APPROVED



VOX VOICE ACTIVATED CONTROL SWITCH
Solid state. Self contained. Adjustable sensitivity. Voices or other sounds automatically activate and control recorder. Uses either recorder or remote mike. **\$24.95***



*Add for ship & hdg. Phone Adapter & Vox \$1.50 ea. Recorders \$4.00 ea. Cal. Res. add tax. Mail order, VISA, MIC, COD's OK. Money Back Guarantee. Qty. disc. avail. Dealer inquiries invited. Free data. **AMC SALES, Dept. A 9335 Lube St., Box 928, Downey, CA (213) 90241 Phone 869-8519**

CIRCLE 108 ON FREE INFORMATION CARD

sonic-frequency analysis, power-line monitoring, and audio and speech analysis.

The model R360 is priced at \$2699.00. It is also available with a less expensive data-acquisition module for \$1499.00 (model R340) and alone for development work or OEM at \$999.00 (model R320).—**Rapid Systems, Inc.**, 755 N. Northlake Way, Seattle, WA 98103.

CABLE TIE, *Cables-Away*, is a durable neoprene and velcro strap that stretches to fit any size cable for binding and storage. The bright colors make them easy to spot, and re-useable velcro provides cost and time-saving ease.

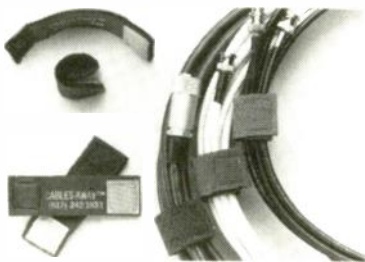

CIRCLE 33 ON FREE INFORMATION CARD

Standard colors are royal blue, red, and orange and the price starts at \$9.00 for a bag of 5. Custom sizes 1" x 2,3,5, or 6", and colors are also available, starting at \$12.15 for a bag of 5.—**Cables Away**, Division of Playback, Inc., 3504 Eighth Street, Boston, MA 02129.

CURING LIGHT, the *Ultracure 100*, is a high-intensity UV (Ultra Violet) curing light, designed to be used with a new generation of UV adhesives. UV adhesives are being used extensively in electronics, automotive, and medical devices, and in fiber-optics industries, and may be used in many assembly procedures where epoxies are presently being used. Once the adhesive is applied to a work area it will remain in a liquid state until exposed to UV light. UV bonding occurs within five seconds.

The *Ultracure 100* provides radiation in the long-wave ultra-violet region with a peak output at 365 nanometers, producing 400 mW/cm² of light intensity. The lamp is a 100-watt DC short-arc mercury-

vapor lamp. An hour meter records accumulated usage of the bulb. A flexible wand is used to guide the UV light precisely to



CIRCLE 34 ON FREE INFORMATION CARD

where it is needed, thus enabling the operator to cure areas otherwise unobtainable with conventional systems. The wand may be used in a fixed position or hand-held for spot curing. The use of a liquid-filled light guide eliminates infrared light; that, combined with a heat-reducing filter and a high-speed fan, allows the unit to be operated continuously.

The *Ultracure 100* is priced at \$3600.00.—**Efos, Inc.**, Stalter Building, 107 Delaware Ave., Suite 1648, Buffalo, NY 14202.

Learn micro-processing with the new **MICRO-PROFESSOR 1P**

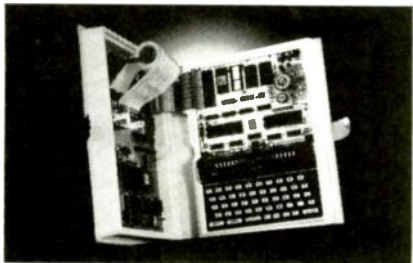

Students, engineers or technicians—upgrade your micro-processing skills with the new Micro-Professor 1P.

The MPF-1P features:

- extensive software support
- more built-in memory
- improved keyboard
- larger display

Three tutorial guides help cover all capabilities. The ideal training tool! MPF-1P will deliver you into the growing world of micro-processing. Invest now!

Plus—FREE GIFT Only **\$199.95**

Check this box for FREE Z-80 Microprocessor Programming and Interfacing textbook when you order within 7 days. \$16.95 value. (Include \$7.50 postage & handling!)

ETRONIX

Dept RE0287
5326 9th Ave. N.E.
Seattle, WA 98105-3617

For immediate action call TOLL FREE:

1-800-426-1044

Full money back guarantee.



CIRCLE 111 ON FREE INFORMATION CARD

SEND FOR THIS
FREE CATALOG NOW



SAVE MONEY
HIGH QUALITY
FAST DELIVERY

We are utilizing the latest equipment and technology to maintain our quality at reasonable prices.

JAN
CRYSTALS
Since 1958

- General Communication
- Industry
- Marine VHF
- Scanners
- Amateur Bands
- CB Standard
- CB Special
- Microprocessor

Call or Write
JAN CRYSTALS
P.O. Box 06017
Fort Myers
FL 33906-6017
(813) 936-2397

CIRCLE 104 ON FREE INFORMATION CARD

Technicians,
Get Serious
About Your
Profession



Being a certified electronics technician lets people know that you are a professional in your field. It tells them that you are serious about your work and can perform up to CET standards.

Now you can order the "Study Guide for the Associate-Level CET Test" from the International Society of Certified Electronics Technicians. It includes material covering the most often missed questions on the Associate CET exam. 8 1/2" x 11", paperback, 60 pages.

For More Information Contact:

IS CET, 2708 W. Berry, Fort Worth, TX 76109; (817) 921-9101

NAME _____
ADDRESS _____
CITY _____ STATE _____
ZIP _____

_____ copies @ \$5 (+ \$1 postage.)

_____ send material about IS CET and becoming certified.

the fourth law of robotics

A robot shall make learning fun for man and thereby improve the quality of life for mankind.



A robot is a robot is a robot... was a robot. Until HERO 2000.

HERO 2000 is much more than a robot. It's a walking, talking 16-bit computer. With 64K ROM and 24K RAM expandable to more than half a megabyte. And a fully articulated arm with five axes of motion. Yours to program. Command. Modify and expand. Total system access and solderless experimenter boards provide almost limitless possibilities. Its remote RF console with ASCII keyboard gives total control. Available with three self-study courses. Backed by Heath Company, world leader in electronic kits.

Build your own HERO 2000 Or buy it assembled. Have fun learning skills that translate directly to the world of work.



HERO[®] 2000

the
knowledge
builder

FREE. Send today for latest Heathkit Catalog.



Mail coupon today to receive a **FREE** Heathkit Catalog featuring HERO 2000.

Mail to: Heath Company
Dept. 020-508
Benton Harbor, Michigan 49022

Name _____

Address _____

City _____ State _____

Zip _____

RO-141

Heathkit[®]
Heath
Company

A subsidiary of Zenith Electronics Corporation.

CIRCLE 86 ON FREE INFORMATION CARD

T S M

1 in EUROPE
SINCE 1966

TSM leader in Europe since 1966. Specialist in quality electronic kits. Will be happy meeting you at the CES in LAS-VEGAS - Booth 4354-Hilton Pavilion Aisle 4300.
 Wide range of products up-dating of applications. Creative in market stimulation.
 Attractive display box looking as video case.
 Realistic distribution policy.
 Advertising team oriented.
 Welcome dealer, inquiries invited.

NEW

MECANORAMA : PCB'S Transfer sheets.
 LA TOLERIE PLASTIQUE : Project Plastic boxes - heavy duty polystyrene.
 SIEBER SCIENTIFIC : New concept double sided solderless bread board for quick experimentation for training and electronic prototype.



Welcome Nationwide Distributors please write

TSM in America INC
 2065 Boston Post Road - Larchmont 10538 NEW YORK

KITS ELECTRONICS

TSM 44 - Audio module 50 watts
 TSM 67 - Audio module 2 X 40 watts
 Come complete with balance, bass, treble controls.
 TSM 73 - Stroboscope 150 Joules ajustable
 TSM 75 - Electronic 8 ways programmables light caterpillar.
 TSM 78 - Universal delayed Alarm for car and home output delayed - Siren - power supply 12 volts.

TSM 150 - Home control Timer 4 Functions 20 programs with quartz Time Base.
 TSM 130 - 24 Tunes Chime 3/4 watts.
 TSM 58 - 2 stations intercom system with speaker.
 TSM 160 - Pseudo stereo decoder.
 TSM 61 - FM Receiver output level 2 watts supply 9/12 volts.
 TSM 158 - FM Receiver output 20 watts supply 9/16 volts.
 TSM 122 - All band FM antenna amplifier 20 db UHF -VHF.

More than 60 kits available

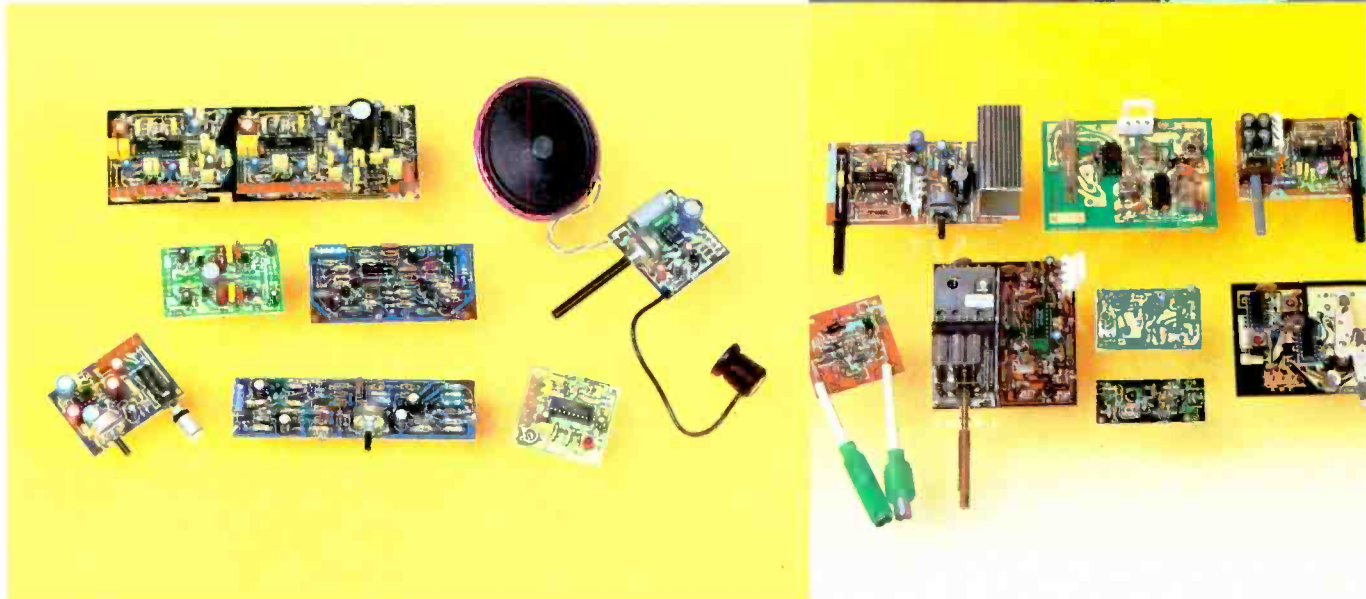
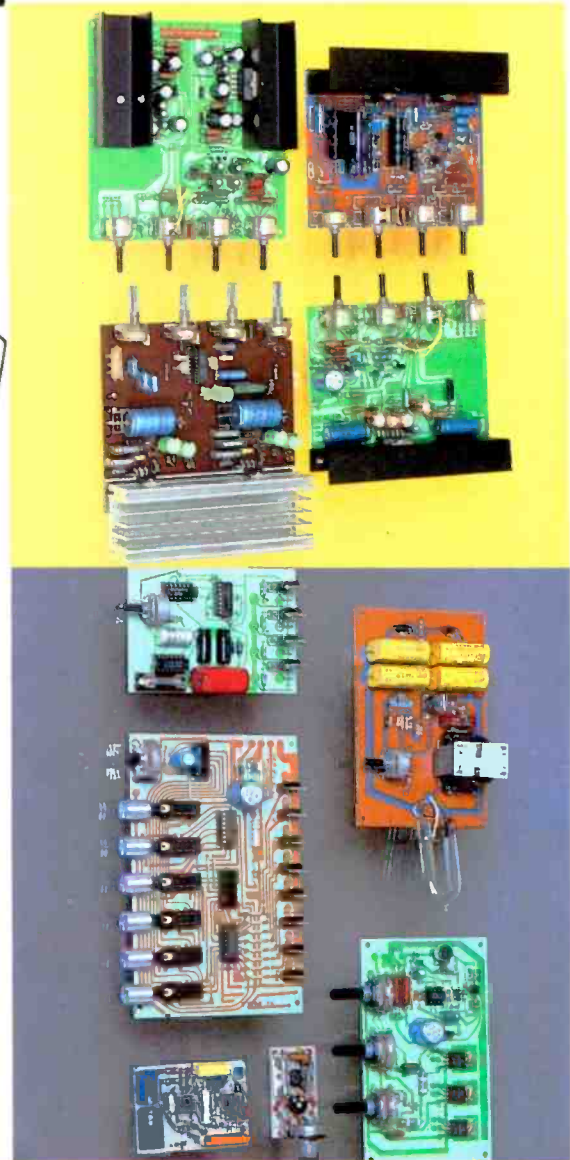

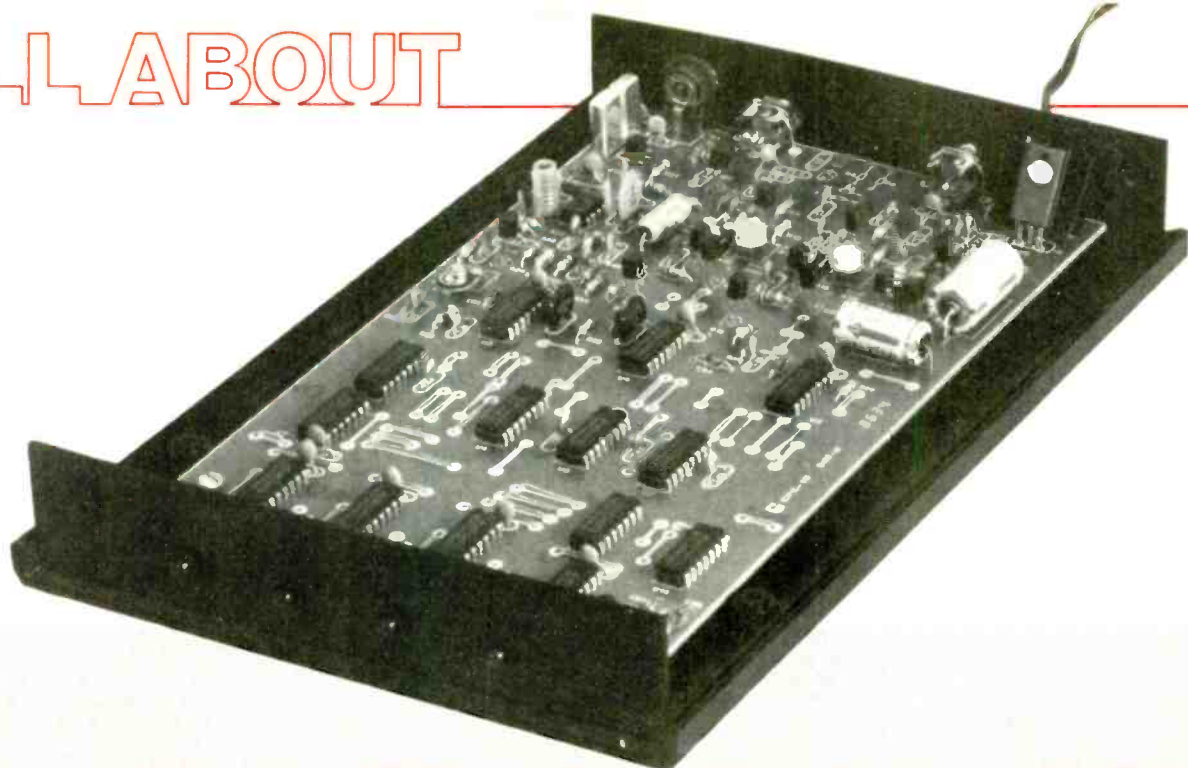

Tri-Mode Cable-TV Scrambling

Learn about one of the more sophisticated cable-TV scrambling techniques in this informative article. Included is an experimental descrambler that can help you gain even more insight.

JIMMY COFFELL

AS MOST OF YOU KNOW, CABLE-TV COMPANIES use scrambling to prevent the viewing of premium channels without the payment of the monthly charges to which they are entitled. To view such signals, an appropriate descrambler is required.

An article published in the February 1984 issue of **Radio-Electronics**, titled "All About Cable TV Descrambling," discussed the in-band gated sync-suppression method of scrambling/descrambling. In that scrambling method, the sync is always suppressed 6 dB. Although that method is still very popular, a new variation has been developed to thwart illegal descramblers. In that scrambling system, referred to as Tri-mode, the sync can be suppressed to one of three different levels. The Tri-mode system can randomly switch between 0-dB, 6-dB, and 10-dB levels of sync suppression.

Tri-mode has become the *de facto* standard because of its high level of security. The system is so popular that it has given rise to a new expression in the cable-TV industry: "multi-vendor compatibility," which means the ability to descramble more than one vendor's scrambling method. For example, both Pioneer and Scien-

tific/Atlanta offer converters that can be used on Jerrold's Tri-mode scrambling system subject to paying the required charges and to compliance with applicable Federal and State law.

In this article we will explain the theory behind the new Tri-mode scrambling/descrambling system. To further help you understand the theory, we will discuss a descrambling circuit that you can experiment with.

First, however, read and understand the following notice:

Please note that the unauthorized reception of cable service is illegal under Federal and State law. Federal law renders illegal both the interception and reception of any communications service offered over a cable system, unless specifically authorized by a cable operator or as may otherwise be specifically authorized by law. Federal law imposes both civil and criminal penalties for violations of the applicable statutes. In addition, most if not all of the states have enacted "theft of cable services" statutes imposing penalties for violations thereof. Thus, the use of the Tri-mode cable-TV descrambler described

in this article should be restricted to educational, scientific, and/or informational purposes. This is not intended to constitute legal advice and readers are advised to obtain independent advice as to the propriety of their use thereof based upon their individual circumstances and jurisdictions.

Tri-mode scrambling

Let's begin by looking at a standard NTSC TV signal. A standard signal contains horizontal and vertical synchronization pulses, which are used to stabilize the picture. Figure 1-a shows part of a standard, demodulated television signal with horizontal-sync (synchronization) pulses. The vertical-synchronization pulses are not shown because they are not altered during scrambling.

Since Tri-mode is a variation of the in-band gated-sync method, a brief review of that method is also in order. In that scrambling method, the level of both the horizontal-sync pulse and the color burst, which are both contained within the horizontal-blanking period, are suppressed 6 dB (see Fig. 1-b). That reduces their level to below that of the peak video. The result

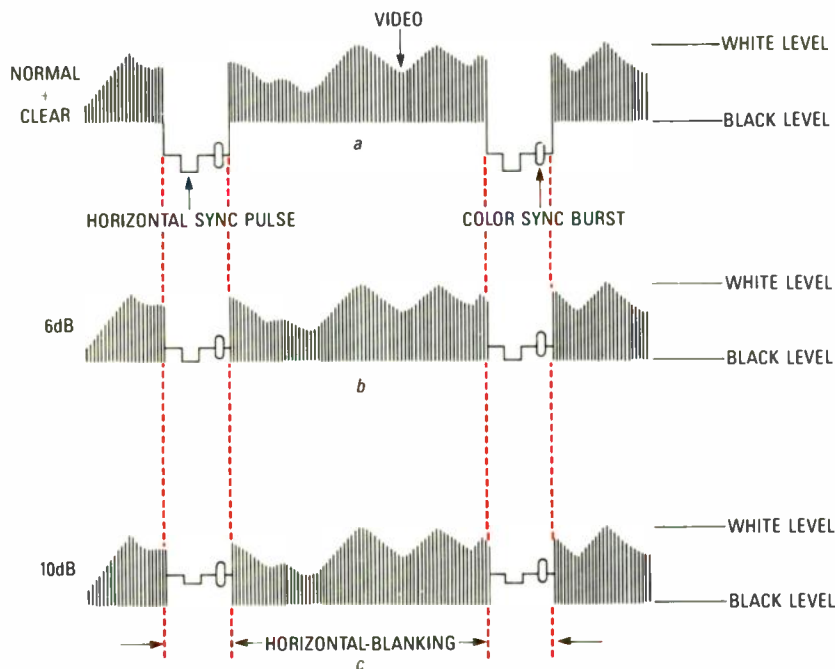

FIG. 1—TRI-MODE'S THREE LEVELS OF SCRAMBLING. The clear or non-scrambled signal is shown in a. A signal with 6 dB of suppression is shown in b. A signal with 10 dB of suppression is shown in c.

is that the TV set's horizontal- and color-sync circuits can not identify the pulses they need to perform their tasks.

In a Tri-mode scrambling system, there is not one level (or mode) of sync suppression; there are three: 0 dB, 6 dB, and 10 dB; and they can be changed randomly. In the 6-dB mode, the sync pulses are suppressed 6 dB (see Fig. 1-b); in the 10-dB mode, the sync pulses are suppressed 10 dB (see Fig. 1-c); in the 0-dB mode, there is no suppression at all (see Fig. 1-a), but a signal is sent to "fool" unauthorized descramblers into thinking that there is. An unsophisticated circuit itself winds up scrambling the signal by trying to introduce sync into a signal that already has it. The 0-dB mode is also called the "clear" mode. The audio is neither scrambled nor relocated in the Tri-mode system.

Descrambling the signal

Obviously, in order to descramble the signal you must restore the sync pulses to their proper levels. As with most scrambling schemes, sync information is hidden elsewhere. To further complicate matters, however, information on the amount of suppression is also hidden. The job of the descrambler then is to find those signals and use them to restore proper sync levels.

Finding the sync information is relatively simple. Just as in the in-band gated-sync system, the sync signal is amplitude modulated onto the sound carrier. Because the sound carrier is 4.5 MHz above the picture carrier, we know where to look for the hidden pulses. For example, Channel 3, whose picture carrier is at 61.25 MHz, has its sound carrier at 65.75 MHz. Therefore, to decode signals from a cable

mine the correct mode by capturing the logic states of data bits 12, 13, and 14 in D latches and then looking at those latches when bits 12 through 15 are all at logic 1.

Once we extract the horizontal-sync pulses and the current mode of scrambling, we can direct the horizontal sync to one of three amplifier stages. For example, when the scrambling mode is 10 dB, the horizontal sync is used to turn on the 10-dB stage during horizontal blanking, which amplifies the sync signal and overcomes the 10-dB suppression. The video portion of the signal is passed through the clear stage, which has no amplification.

When a non-scrambled signal is received, both sync and video are automatically passed through the clear stage.

Circuit description

The schematic of a circuit that will do what we want is shown in Figs. 3 and 4. The 61.25-MHz (Channel 3) input signal is fed to Q2 and Q3. The gain of Q2 is on the order of four to ten. Potentiometer R14 is used to vary the level of signal fed to FL1, a Plessey SY323 SAW filter. Such

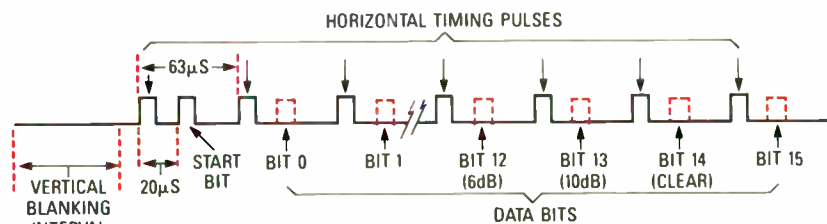

FIG. 2—DATA PULSES that identify the scrambling mode and convey other information are placed in the unused horizontal lines that follow the vertical-blanking interval.

system that uses a Channel-3 output on their converters, you would have to demodulate the horizontal-sync pulses at 65.75 MHz.

In the NTSC system, the first 18–21 lines of video following the vertical-blanking interval are unused. In a Tri-mode-encoded signal, a 17-bit data string is placed within those lines. As shown in Fig. 2, the string begins with a start bit that is a logic 1. Each data bit follows a horizontal sync pulse by 20 μ s.

That data string conveys several pieces of information. Data bits 0 through 7 (8 bits) are used for program authorization codes, and data bits 8 through 15 (8 bits) contain the control codes for the descrambler. Data bits 12 through 15 contain the specific codes that tell the descrambler which of the three scrambling modes is currently being used.

To enhance security, the state of each of those four bits is constantly changing. The scrambling mode is conveyed by the value of the bits in the state immediately prior to the one in which the value is 1111. The 6-dB, 10-dB, and clear modes are identified by a value of 1000, 0100, or 0010, respectively. By using a serial-in, parallel-out shift register, we can deter-

adjustment is needed because the output signal from the cable converter can vary from 20 to 200 mV. The SAW filter passes only 65.75 MHz, which is the sound carrier for Channel 3. Since some of the 65.75-MHz signal is attenuated by the SAW filter, the signal is then amplified by Q10, which also provides an impedance match to the input of IC1. That IC is a low-level video detector that is used here to demodulate the sound-carrier signal that contains the horizontal and data pulses.

Horizontal and data pulses appear at the output of IC1 (pin 5) when coil L1 is adjusted so that L1 and C25 are tuned to the 65.75-MHz sound carrier. Transistor Q14 is used to square up the analog pulses to a 0- to 12-volt digital signal.

That digital signal is fed to pin 1 of NAND gate IC2-a and the scrambled sense circuit, Q15 and Q16. Transistors Q15 and Q16 form a frequency detector that senses the presence or absence of the 15.734-kHz horizontal sync. With the presence of horizontal sync (scrambled), Q16's collector floats high, allowing NAND gate IC2-a to send the horizontal-sync and data pulses to the decode logic.

Horizontal-sync and data pulses from IC2-a's output are delayed and fed back to

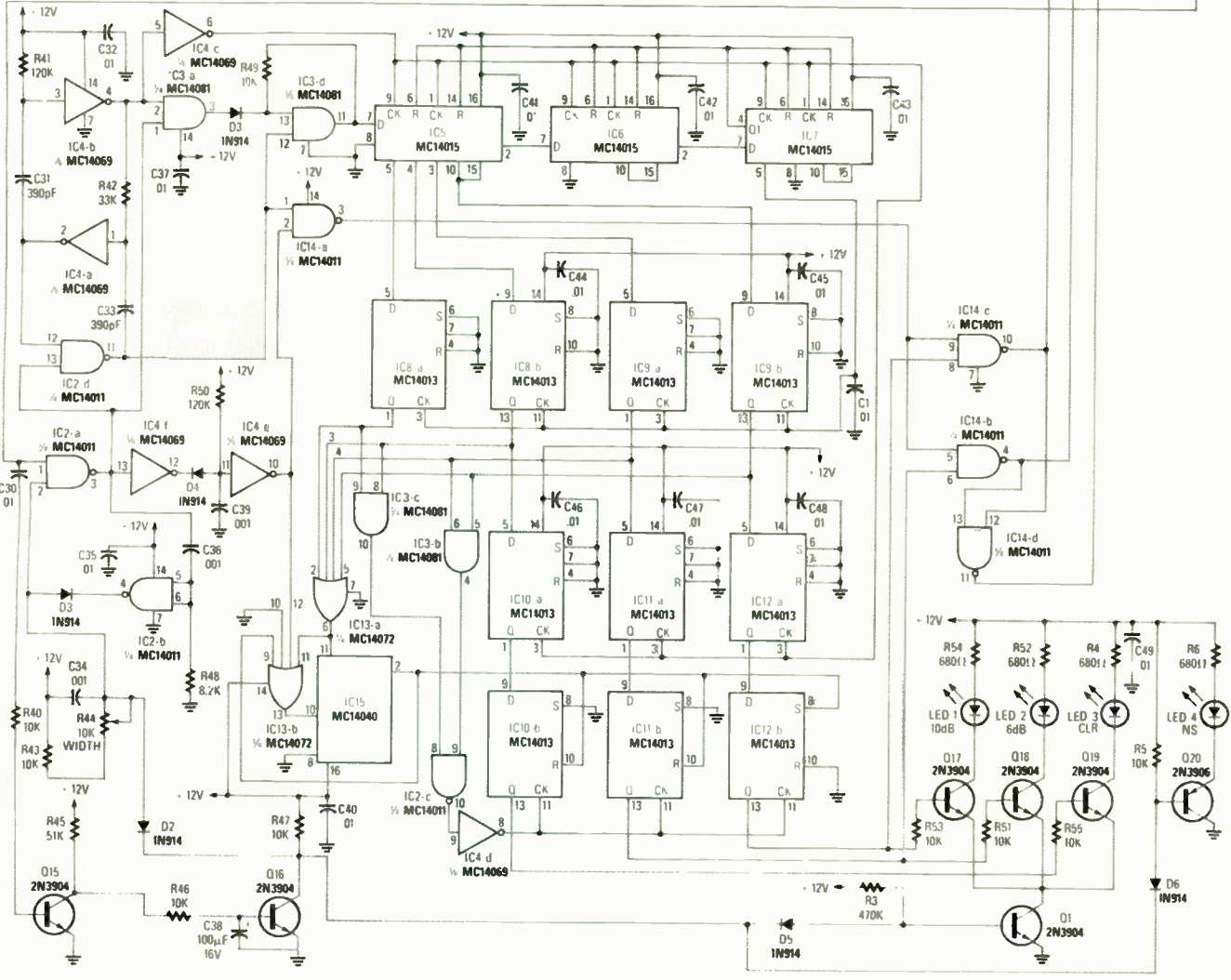
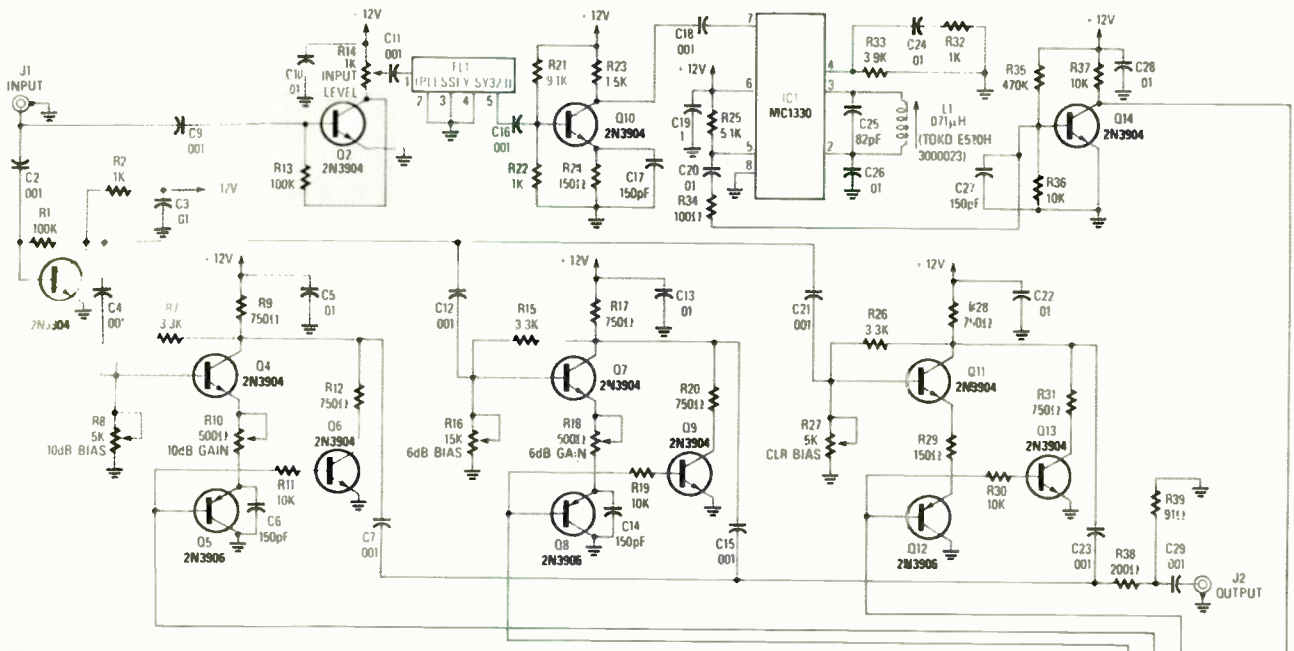

FIG.3—DESCRAMBLING TRI-MODE. All fixed resistors are 1/4-watt, 5% units. Capacitor C25 is an NPO type, capacitors C31 and C33 are mica units, and all polarized capacitors are electrolytics; all other capacitors are ceramic discs.

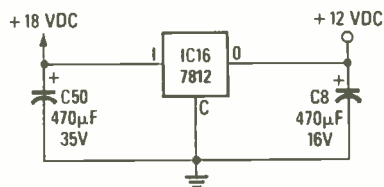

FIG. 4—THIS STANDARD REGULATOR CIRCUIT provides the +12 volts required by the balance of the descrambler. Its 18-volt input is provided by a wall-plug power supply.

its input via IC2-b. That provides horizontal pulse-width control, which is adjusted by potentiometer R44. The signal from IC2-a is also fed into IC2-d, IC4-a, and IC4-b to separate horizontal-sync pulses from data pulses. Horizontal sync appears at IC2-d, pin 11 and is also fed to IC3-d and IC14-a. Pure data pulses are extracted by IC3-a and IC3-d and fed to pin 7 of shift register IC5.

A delayed and inverted version of the horizontal-sync signal from IC4-c is fed to shift registers IC5, IC6, and IC7 as a data clock. Those three IC's are dual 4-bit serial-in shift registers with parallel outputs, configured to output data bits 12 through 15 to D flip-flops IC8 and IC9.

The outputs of IC8 and IC9 are latched to their input levels when the start bit appears at pin 5 of IC7 and at the clock inputs of IC8 and IC9. That occurs 17 data-clock pulses after the VBI (Vertical Blanking Interval), when data bits 12, 13, 14, and 15 are at IC5 output pins 10, 3, 4, and 5, respectively. Data bits 12, 13, and 14 are then loaded into IC12-a, IC11-a, and IC10-a when the D-latches are clocked by the next data-clock pulse. Since data bits 12 through 15 following one VBI have now been stored in the D-latches, shift registers IC5, IC6, and IC7 are reset on the next data clock pulse.

On the data stream following the next VBI, IC8 and IC9 will be updated with new data. As such, we now have the new data stored in IC8 and IC9 and the previous data stored in IC10-a, IC11-a and IC12-a. We have stored both of those states temporarily so that when we detect a value of 1111 on data bits 12 through 15, we have the previous states of data bits 12, 13, and 14, which identifies the current scrambling mode.

The AND function used to detect a 1111 on data bits 12 through 15 is performed by IC3-c, IC3-b, IC2-c, and IC4-d, whose output loads only the true current scrambling mode into IC10-b, IC11-b, and IC12-b. Those D-latches are used to gate the sync pulses to the proper sync-amplifier stage and also to switch transistors Q19, Q18, and Q17, which in turn drive LED indicators for the clear, 10-dB and 6-dB modes, respectively.

An all-0's condition on data bits 12 through 15 is sensed by OR gate IC13-a. That state indicates the presence of a 6-dB sync-suppression signal with no Tri-mode

data (that is, standard in-band gated sync). However an all-0's code is also sent randomly in the Tri-mode system. To eliminate that confusion, binary counter IC15 is used to force IC10-b, IC11-b, and IC12-b into the 6-dB mode only after counting 32 consecutive VBIs that contain no data (all zeros). Operation is returned to Tri-mode by IC13-b if even one non-zero state is detected.

Horizontal sync from IC2-d is combined with the vertical blanking signal, which is derived from the signal at IC2-a by IC4-f and IC4-e, by NAND gate IC14-a. The total sync waveform at IC14-a's output is directed to the proper sync amplifier stage by one of two NAND gates, IC14-b and IC14-c. In the 6-dB mode, IC14-c is turned on by pin 13 of IC12-b, thereby passing the sync pulses to the 6-dB amplifier stage. Similarly, in the 10-dB mode, IC14-b is turned on by pin 13 of IC11-b, thereby passing the sync pulses to the 10-dB amplifier. The outputs of the two NAND gates are now independent 6-dB and 10-dB sync lines that are normally high, with low-going sync pulses. They are NAND-ed by IC14-d to create the clear signal needed for the clear-amplifier stage. The clear line carries an inverted sync waveform in either of the two scrambling modes.

We now have all the signals necessary to return the suppressed sync back to its normal level on the signal. Remember the 61.25-MHz (Channel 3) input signal is fed to transistor Q3, which provides a fixed gain of four to ten. From there, the amplified signal is delivered to three amplifier stages, Q4, Q7, and Q11, which are the 10-dB, 6-dB and clear circuits, respectively. Those circuits are identical with one exception: The clear circuitry has no gain adjust.

Let us study the operation of the 10-dB stage before we try to understand the combined action of all three. In the 10-dB mode, Q4 amplifies the signal only during horizontal-blanking and only when it is turned on by Q5. Transistor Q5 is turned on by the 10-dB sync line from IC14-b. Gain-adjust potentiometer R10 allows you to select the proper amount of amplification to overcome the 10-dB suppression. Transistor Q6 is also driven by the 10-dB sync line and is turned on when Q5 is turned off. That sets the DC level at the collector of Q4 at approximately +6 volts when Q4 is off. Without Q6, the collector of Q4 would float to +12 volts, causing unwanted spikes in the output signal. Bias-adjust potentiometer R8 is used to set the DC level on the collector of Q4 when that transistor is on, so that the level is essentially the same as the level set by Q6, when Q4 is off.

The same process occurs in the 6-dB stage when that stage amplifies the sync pulses that were suppressed in the 6-dB mode. Between sync pulses, during the video portion, both stages are off.

In the clear stage, the reverse process takes place. That stage is controlled by an inverted-sync waveform in either the 6-dB or 10-dB modes. The result is that video is passed, but not the sync signal. In the clear mode, or when a non-scrambled signal is detected, Q12 causes the clear stage to stay on all of the time, so both video and sync are passed. The outputs of the stages, sync from either the 6-dB, 10-dB, or clear stage plus the video from the clear stage, are summed at R38, which is part of a 75-ohm matching network; then they are fed to output jack J2.

When a non-scrambled signal is received, the frequency detector output (the

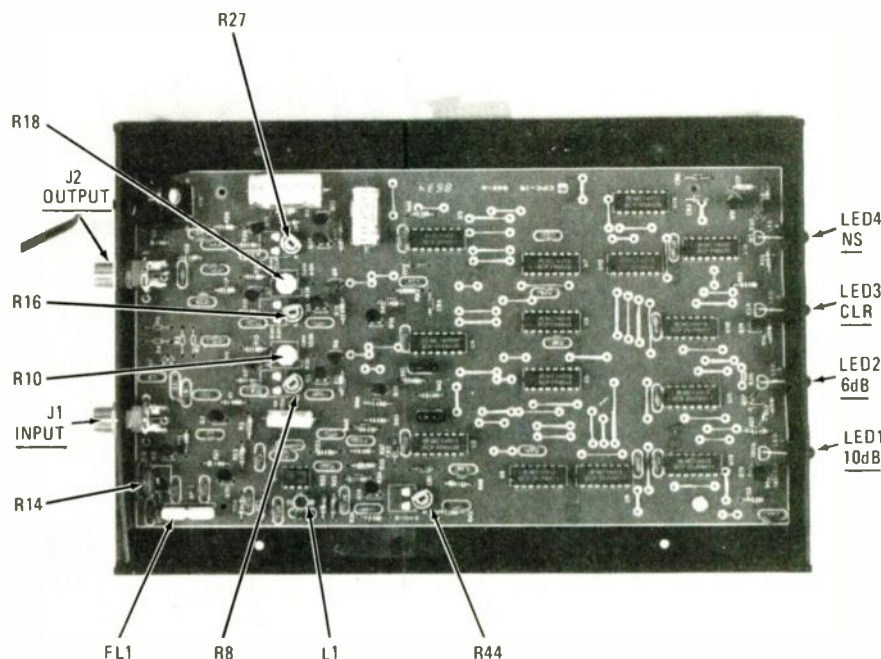

FIG. 5—THE AUTHOR'S PROTOTYPE is shown here. The missing components were eliminated in the final design.

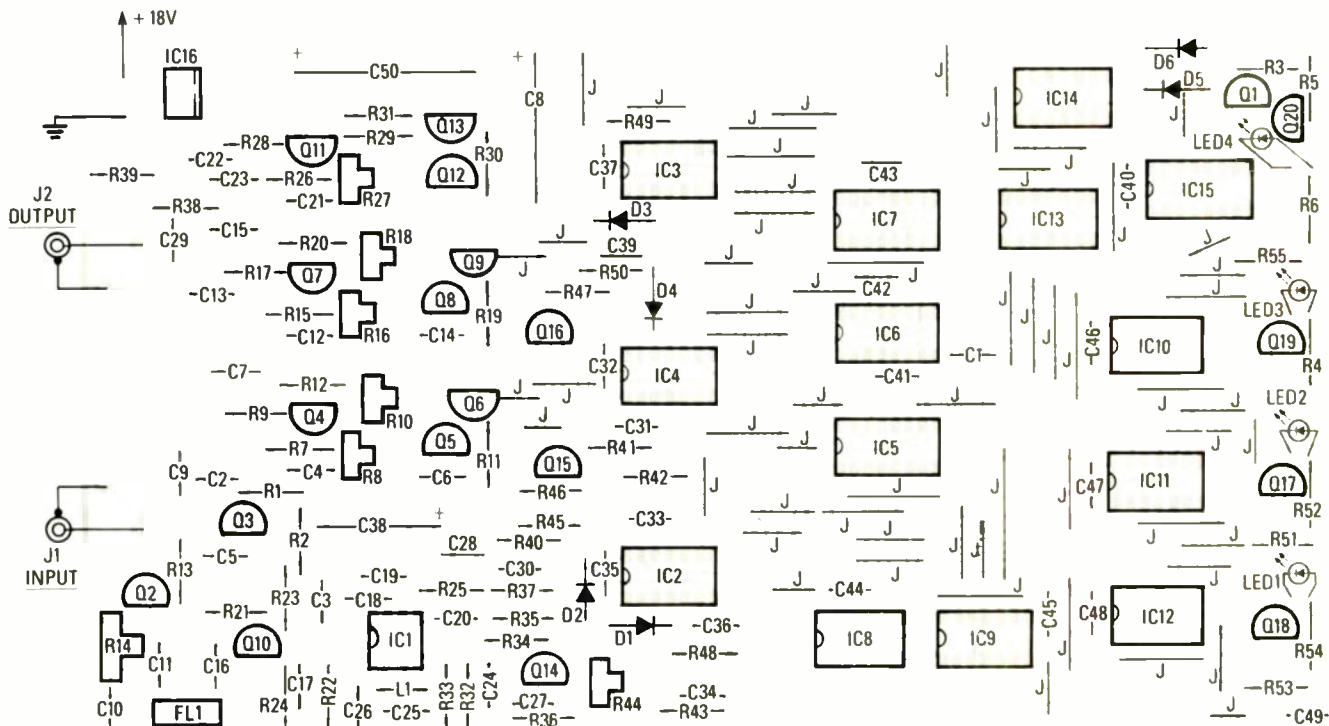

FIG. 6—IF YOU CHOOSE TO BUILD an experimental descrambler, a PC pattern is provided in PC Service. Use this guide when mounting parts on the board.

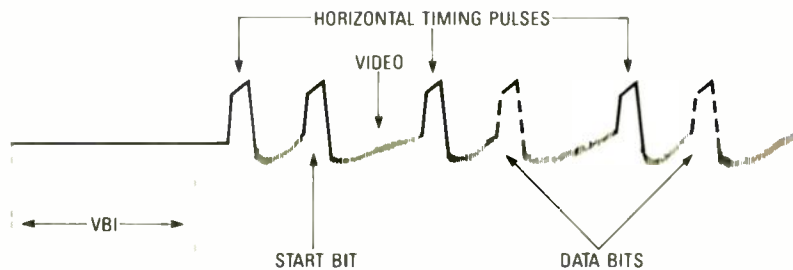

FIG. 7—IF ALL IS WORKING PROPERLY, a signal that resembles the one shown here should be visible on a scope at the base of Q14.

collector of Q16) also drives the non-scrambled (NS) LED indicator via Q20, and removes the ground path from the scrambled-mode LED indicators by shutting off Q1.

On some non-scrambled channels, three bursts of horizontal pulses are sent between frames. That causes some unauthorized descramblers to create three white horizontal bars across an otherwise normal picture. The averaging done by C38 in the frequency-detector circuit ensures that those bursts are ignored.

Building the circuit

A photograph of the author's prototype is shown in Fig. 5. For those of you who want to experiment with the circuit, we have provided a foil pattern in PC Service. The corresponding parts-placement diagram is provided in Fig. 6.

Mount all components as flush with the PC board as possible. We suggest you install the resistors first and use the trimmed leads for the many jumpers (57) required. When installing C38, C50, and C8, be careful to check for proper polarity. The same holds true for the six diodes

and the five LED's. Use good soldering techniques, and a low-wattage (15–30-watts) iron.

Coil L1 must be modified by cutting off the plastic between the leads before it can be installed on the board. Note that IC2–IC15 are CMOS devices. Take the usual precautions to prevent damaging those static-sensitive devices. The 12-volt regulator, IC16, can generate a lot of heat. It must be adequately heat sunk; it is also a good idea to add extra ventilation to the case (by punching some additional holes) in the vicinity of that component. On FL1, the Plessey SY323 SAW filter, pin 1 can be found by locating the part number on the filter's metal can.

Jacks J1 and J2 are PC-mounted F connectors. We mounted ours by laying them on the PC board's component side and strapping a bare wire around them. We then soldered the ends of the wire to the board, in the holes provided, and soldered the bare wire to the connector's body for a good ground. Solder a short piece of wire between the center connector and the appropriate hole on the board. Depending on the AC adapter you use, you can con-

nect the adapter to the board via a plug, or solder the adapter's leads directly to the pads marked +18V and ground. Be sure to observe the proper polarity.

Checkout and alignment

Do not hook up the device unless you are authorized to do so and are otherwise in compliance with Federal and the applicable State law. Note the warning set forth in boldface type at the beginning of this article.

Check the power supply voltage at IC16 at the positive side of C8, for +12 volts. Then check that you have +12 volts to all the IC's in the circuit.

The next step is to tune to a non-scrambled channel and connect the circuit between a cable-TV converter, set to output on Channel 3, and your TV set, tuned to receive Channel 3. However, once again, do not hook up the unit until you have received the required authorizations and are otherwise in compliance with all applicable Federal and State laws. Make sure to fine-tune the cable-TV converter so that the Channel-3 output is correct, because, if it's not, the circuit will not detect the Tri-mode pulses.

Begin alignment by performing the following initial adjustments. The adjustments are designed to provide a starting point that will yield the best and quickest results. Ignore anything that you may see on the TV screen at this time. Set the INPUT LEVEL potentiometer, R14, to the middle of its range. Adjust L1's tuning slug so that it is even with the top of the plastic coil form. Turn WIDTH potentiometer, R44, to the middle of its

continued on page 120

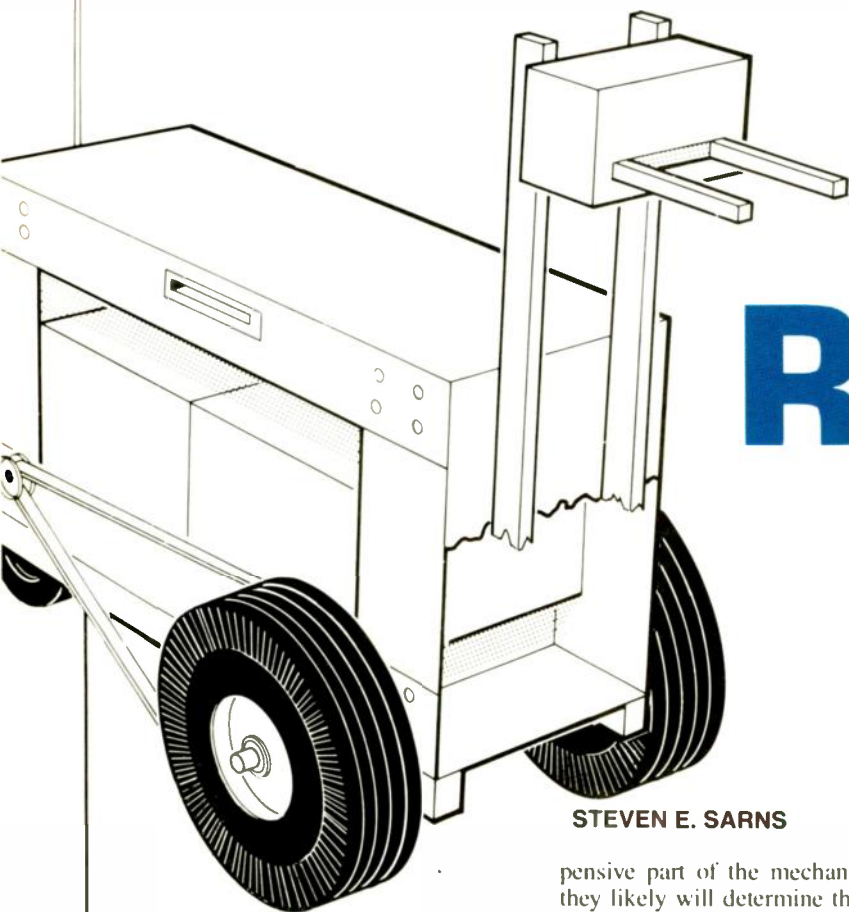

R-E ROBOT

*Follow these guidelines
when designing
your robot's drive system.*

STEVEN E. SARNS

Part 3 LAST MONTH, WE BEGAN to look at the computer system used to control our robot. In a future installment we will look at that computer in depth and present complete construction plans, including PC-board patterns. But for now, let's step back and look at some of the robot's mechanical details.

This month we'll turn our attention to the design and construction of the R-E Robot's base unit. In keeping with this project's emphasis, remember that you are free to build your robot to any size, form, or power that fits your needs or imagination, and that the robot can be designed to use almost any available motor or batteries.

However, that is not to say that the mechanical components can be chosen without care. The components you use will strongly affect the success of your project. Therefore, to help guide you in your design, we will present a step-by-step look at the design of the author's robot base, and the factors that were considered in selecting the motors, batteries, etc.

Motor selection

The first step is to select the motors. Since the motors usually are the most ex-

pensive part of the mechanical system, they likely will determine the configuration of the remainder of the system.

When choosing the motors, a key parameter will be the voltage rating. Motors rated at less than 12-volts DC are rare in the power range we will need. Even if such motors could be located, they would severely tax the current-carrying capacity of our motor-controller board and hookup wires. Motors rated at greater than 48-volts DC could be used, but the battery-pack and motor-control transistors must be selected to withstand that voltage level. The result is unnecessary expense.

We have found that the best choice is a brush-type, permanent-magnet torque motor, rated at 12- to 36-volts DC. Those motors are commonly used in automotive applications as starter motors, windshield-wiper motors, or electric-window actuators.

The power output of the motors is another key specification. The output is expressed in either *HorsePower* (hp) or watts, with one horsepower being equal to 746 watts. The motor's nameplate usually will indicate the power input, such as 12 volts at 10 amps, which translates to a power input of 120 watts. Assuming, for the moment, a 100% conversion efficiency, that yields approximately a 1/6-hp power output (120/746). (We will show you how to calculate the actual power out-

put of the motor later on in this article.) In our prototype, we used 24-volt, 1/10-hp motors.

You should notice that as the motor voltage increases, the current decreases for a given power output. That factor will determine the gauge of the wires used to connect the motors to the controller. If more than 10 amps of current are drawn by the motors, large-gauge wire will be required.

Speed calculations

After selecting the motors for your robot, you must calculate the rotational speed of the tires necessary to achieve a desired speed. Our robot uses 10.5-inch tires, so the following calculations will be for that size tire. Of course, different tire diameters will yield different results.

The first step is to calculate the distance traveled for each tire revolution. That is equal to the tire diameter multiplied by π , or 10.5π . The result is 33 inches, or about 2.75 feet. To find how fast the wheels must turn to achieve a given speed in *Miles-Per-Hour* (mph), we must convert the preceding result to miles-per-revolution. The result is:

$$\frac{2.75 \text{ feet}}{1 \text{ revolution}} \times \frac{1 \text{ mile}}{5280 \text{ feet}} = 0.00052 \frac{\text{miles}}{\text{rev}}$$

That result is then converted to mph as follows:

$$\frac{0.00052 \text{ miles}}{\text{revolution}} \times \frac{1 \text{ revolution}}{\text{second}} \times \frac{60 \text{ seconds}}{\text{minute}} \times \frac{60 \text{ minutes}}{\text{hour}} = \frac{1.872 \text{ miles}}{\text{hour}}$$

In other words, the robot will go about 1.9 mph for every revolution-per-second (rev/sec) of the wheel. For example, if our wheels were turning at 2 rev/sec, the robot would go $1.9 \times 2 = 3.8$ mph. In effect, we select the top speed of the robot, and then calculate the required tire spin.

Motive-power requirements

Our next task is to calculate the amount of power it will take to achieve the desired speed. Calculations of the motive power required to drive the robot are influenced by many factors, such as the final weight of the robot, additional payload, the type of surface the wheels are on, the state of the batteries, and the type of wheels you use. However, we can still roughly determine the necessary amount of power.

The torque required at the wheels is largely a function of the surface the robot is operating on. Obviously, a hardwood floor and a shag rug will require different amounts of torque. In order to get a rough idea of the force required to move the robot, we loaded a mock-up of our robot with 150 pounds, attached a spring scale, and pulled it across the floor. On the shop's concrete floor, the scale showed that three pounds of force were sufficient to move the unit. On a moderate-pile carpet, however, the required force increased to eight pounds. You must remember to make additional allowances for climbing grades, towing, and rough terrain.

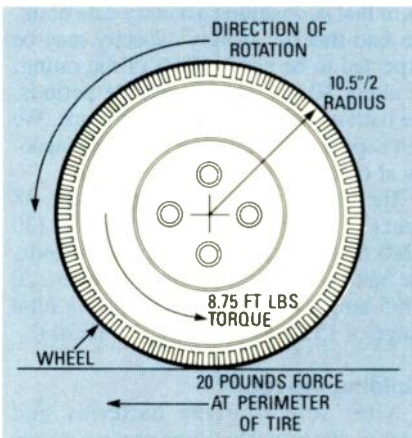

FIG. 1—TO GENERATE A DRIVING FORCE of 20 pounds at a radial distance of 5.25 inches, 8.75 ft-lbs of torque must be supplied to the wheel.

Let's assume that the robot must deliver 20 pounds of force from each wheel. Figure 1 reveals that that force is derived from the rotational force of the wheel and is a torque measured in foot-pounds (ft-lbs).

Therefore, a total of 40 pounds of force is delivered at a radius of 5.25 inches, or 17.5 ft-lbs of torque ($40 \times 5.25/12$). In order to go 3.8 mph, that torque must be delivered at a rate of $2 \text{ rev/sec} \times 2\pi \text{ radians/rev}$, or 220 ft-lbs/sec ($2 \times 6.2832 \times 17.5$). Foot-pounds-per-second (ft-lbs/sec) is a measure of power; 550 ft-lbs/sec is equal to 1 hp. Expressed in horsepower, our robot requires 0.04 hp ($220 \text{ ft-lbs/sec} \div 550 \text{ ft-lbs/hp}$). A handy formula to remember is:

$$\text{hp} = (\text{ft-lbs} \times \text{rpm})/5252.$$

Torque motors

The characteristic curves of a DC permanent-magnet torque motor are derived from two basic phenomena:

- Back emf (ElectroMotive Force) is proportional to motor speed.
- Output torque is proportional to current drain.

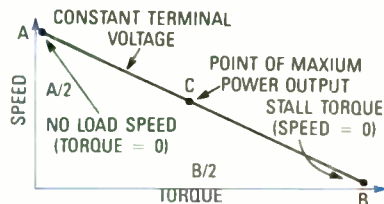

FIG. 2—CHARACTERISTIC CURVE for a DC brush-type torque motor. The no-load speed is the maximum speed the motor can achieve with no external load. The stall torque is the point where the shaft is locked (no motion) by the external load.

If we examine a motor's output speed versus its output torque at a given excitation voltage, the result is a straight line between the no-load speed and the stall torque. See Fig. 2. Basically, an excitation voltage causes the motor to rotate, which produces back emf. The difference between the back emf and excitation voltage causes current to flow in the motor's armature, producing the torque that causes the motor to accelerate. The motor's speed increases until the difference between the excitation voltage and the back emf limits the current to an amount sufficient to meet the torque requirements at the shaft. Therefore, with no load the shaft speed is at maximum, and the torque load is only the motor's internal friction. At stall, the back emf is zero, and maximum current is possible, producing maximum torque.

If the motor is delivering no torque (no-load) or is not moving (stall), the motor's power output is zero. Maximum power is produced at half maximum speed and half maximum torque. Therefore, if we superimposed the power output of our motor on the speed-torque curve, we would get a parabola with maximum power at half speed and half torque. See Fig. 3.

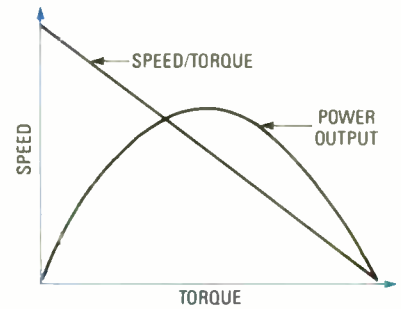

FIG. 3—MAXIMUM POWER is delivered at half speed and half torque, as indicated by the power-output curve.

So, where does all of that lead? We want to determine whether our junkbox motors can deliver the power necessary to drive our robot at the desired speed. Our first task is to determine the stall-torque output of the motor by direct measurement, which is easily accomplished by using a torque wrench. If you do not have a torque wrench, attach a lever arm, such as a pair of vice-grip pliers, to the motor shaft. Then place a spring scale on the lever, one foot away from the shaft and at right angles to the lever. After energizing the motor, note the reading on the scale. That is the number of foot-pounds of torque the motor is producing at stall. Most DC motors operate at between 1500 and 2000 Revolutions-Per-Minute (rpm), so you have all of the information you need to estimate the power output of your motor.

For example, one of our robot's motors produced 3 ft-lbs of stall torque and operated at 60 rev/sec with no load. The maximum power point, which in this case is 45 ft-lbs/sec, is found by multiplying each value by one half. To find the power point in horsepower, the value in ft-lbs/sec is divided by 87.54 ft-lbs/hp. For our example, that yields a power point of 0.51 hp, or about $\frac{1}{2}$ hp.

Overdesigning the torque and underdesigning the speed will pay off. Our analysis is only meant to provide "ball-park" estimates of a motor's torque requirements and horsepower output.

Drive train

If the wheel is rotating at 2 rev/sec, the motor must be operating at a much higher rate. If we assume a speed of 1000 rpm, the motor is operating at about 16 rev/sec. Therefore, a reduction mechanism must be used to convert the high-speed, low-torque output of the motor to the low-speed, high-torque power requirement of the wheel. The reduction ratio required is equal to the ratio of the speed of the motor to the speed of the wheel, which is 16:2, or 8:1.

To get that reduction ratio we used an 8-inch diameter pulley on the wheel and a 1-

Sources

Can you imagine what a robot we could build with a staff of 250,000 (the entire readership of **Radio-Electronics**)? One key to the success of the **R-E Robot** is the collective development capability of that readership. In an effort to encourage the exchange of software, sources of parts, hardware enhancements, and any other items of general interest, **Radio-Electronics** will open a special section of its new remote bulletin-board system (RE-BBS) to builders of the **R-E Robot**. You can reach the bulletin board by calling 516-293-2283.

To help simplify the mechanical aspects of building the robot, Vesta Technology (7100 W. 44th Avenue, Suite 101, Wheatridge, CO 80033, 303-422-8088) will offer an aluminum chassis similar to the one discussed in these articles. Vesta also will offer the RPC, its PC board, and the source code for testing the robot and implementing the RCL. For pricing and availability information, contact Vesta Technology directly. Complete construction details for the RPC, including schematics and PC board patterns, will be presented in a future installment of this series.

A complete description of a drive-train system for the robot, including parts specifications, also will be presented in a future installment. For those that have difficulty finding appropriate drive-train components for the robot, a good source is Stock Drive Products (55 S. Denton Ave, New Hyde Park, NY 11040, 516-328-0200). Contact them directly for pricing and availability information.

Additional sources for various sub-systems and parts for the robot will be provided as appropriate in future installments of this article. **R-E**

inch diameter pulley on the motor shaft. Power was transferred using a 1/2-inch V belt. Of course, there are other convenient power-transfer mechanisms that may be used. Stock Drive Products, whose address is provided in the accompanying Sources box, has a bountiful selection of V-belts, plastic chain drives, and other forms of belt/chain power-transfer mechanisms. Ask for catalog 757. V-belts are not as efficient as other mechanisms, especially when high reduction ratios such as 8:1 are needed, but expediency was an important factor in our choice: V-belts and pulleys are available at most hardware stores.

Thus far we have considered only direct-drive motors. Motors with integral gearheads attached to the motor shaft are also available. Gearheads, of course, are used to reduce the shaft speed. By selecting the proper gearhead motor, you probably will be able to come up with a reduction ratio that is close to 1:1. Low reduction ratios are easier to implement than high reduction and are more economical, too.

Feedback

The robot's torque-motor controls require feedback information for each motor. That information can be obtained at any point in the drive train, including the motor shaft, the drive belt or chain, or the wheel. Of course, we need some way to transform the mechanical motion of the drive system to an electronic signal. That can be done in many ways, but the simplest and most economical way is to use an optical encoder. Typically such an encoder consists of a light source, a light detector, and an encoding mechanism that blocks and passes light in such a way that the signal generated by the light detector can be decoded to provide motor-speed information. Full details on an optical decoder will be provided in a future installment of this series.

When selecting your motor, bear in mind that one in which the drive shaft protrudes from both sides of the housing will afford you an ideal setup for mounting the encoder. But while some motors are built that way, most are not. If you can not locate such a motor, but wish to mount the encoder at the motor anyway, you will have to provide some type of mounting mechanism. The easiest way is to drill a 6-32 tap hole in the capped end of the drive shaft. Once the hole is drilled, tap the hole. Note that since the encoder will impose only a light load on the screw to which it is attached, only a few threads are required.

If you choose to drill a mounting hole, you will need to disassemble the motor. Otherwise, you are likely to break off the tap. Open the motor housing and remove the armature/shaft assembly. Place the armature in a padded vice (soft pine will serve nicely for padding), and then carefully drill the shaft.

Battery selection

As the batteries must power the robot at all times, except during recharging, their selection is an important part of the design process. Two factors must be considered when selecting the batteries: the amount of power that must be supplied, and the length of time that that power must be supplied.

It is important to remember that the robot has two basic modes of operation: moving and non-moving. In our robot, the motors draw five amps during motion. When the robot is stationary, the draw drops to about one amp, at 5-volts DC.

Battery specifications include an Ah (Amp-Hour) rating. That specification tells you how much current can be delivered, multiplied by the length of time (in hours) that the current drain can be maintained. From that, one might expect that a battery with a 100-Ah rating could supply 100 amps for one hour, or one amp for 100 hours. However, the battery's capacity can

be affected by many factors, including temperature, battery-charging history, and the rate of discharge. The rate of discharge is particularly important because the battery's capacity is less at high discharge rates than at low discharge rates. Generally a battery has a current-discharge rating that is equal to 0.1 times the Ah rating, or in our example, $100 \times 0.1 = 10$ amps. So we can expect more than 100 hours of service at one amp, but less than an hour at 100 amps.

When evaluating automotive or motor-cycle batteries, you will find that the automotive industry has developed its own specifications that must be interpreted carefully. The battery's "cranking power" is defined as the number of amps that a fully charged battery can deliver for 30 seconds. That parameter is a measure of the internal resistance of the battery and has little to do with the amount of power stored in the battery. The battery's "reserve capacity" is defined as the number of minutes a fully charged battery can deliver 25 amps while sustaining a cell voltage of 1.75. To convert that figure to Ah, divide the number of minutes specified by 60, and multiply the result by 25.

We decided to power our robot using utility batteries with a rated reserve capacity of 40 minutes. That converts to an Ah rating of 17. The effective Ah capacity that we will derive from the battery will be greater, however, because our current drain is less than 25 amps. Our standby power consumption is about 10 watts. Assuming a DC-DC converter efficiency of 75%, the total power output of the battery will be 15 watts, and the drain on a 24-volt battery will be $I = P/E = 15 \text{ watts}/24 \text{ volts} = 0.625$ amps.

We inferred a capacity of 17 Ah in each utility battery at 25 amps. The actual application will be at a current drain of about 1/40 of that. Consulting a battery data book, we find that our battery capacity may be expected to be about 180% of the rating, or about 30 Ah. During mobile periods, the battery drain will be about 5 amps. We can expect about 120% of the rated capacity at that rate, or about 20 Ah.

Therefore, we can expect about 48 hours of electronics-only operation (30 Ah/0.625 amps). During mobile periods, the batteries will last about four hours (20 Ah/5 amps). That gives the robot a total range of 15 miles (3.8 mph \times 4 hours)!

Building the robot

After selecting the batteries and motors, the actual building process is very straightforward. Basically, the process involves creating and then assembling the chassis, and then mounting the components on it. The operation is simple, but it requires careful attention to innumerable details. We'll begin building the R-E Robot next time by showing you how to fabricate and assemble the chassis. **R-E**



TOD. T. TEMPLIN

STEREO TV DECODER

Now that we know the theory behind MTS transmission and decoding, let's build a decoder!

Part 2 IN THE FIRST PART OF this article we showed the complete set of schematic diagrams (in Fig. 3–Fig. 6) while we discussed the decoder's theory of operation. However, due to a printing error, a line connecting R13, R14, and pin 7 of IC4 was deleted from Fig. 3, the decoder stage schematic. After you go back to your January issue and draw the line in, you'll be ready to start building. But before purchasing any parts, read the section on interfacing below; you may not need the board-mounted demodulator and its associated components, depending on how you interface the decoder with your TV or VCR.

To build the decoder, it's best to use a PC board. If you wish to etch your own, the foil pattern is shown in PC Service. Otherwise you can buy a board from the source mentioned in the Parts List.

However you obtain a board, before beginning construction, inspect it carefully for shorted and open traces, and make sure that the copper is clean. If necessary, rub it with steel wool and then clean it with soap and water.

When the board is in good shape, start stuffing it, as shown in Fig. 7 (which shows all board-mounted components) and Fig. 8 (which shows all off-board components and the three jumpers). First insert the low-profile components, and then work up to the larger components. Be sure to observe the polarity of all semiconductors and electrolytic capacitors—one mistake could be deadly!

When the board is stuffed, clean flux from the foil side and check your work once more. Then mount the board in a case, as shown in Fig. 9.

Interfacing

Before building the decoder, you should determine how you'll interface it

with your TV or VCR. If your TV or VCR has a MPX audio-output jack, then you can simply connect the decoder's MPX input to that jack. In that case, you won't need to buy parts for, or build the 4.5-MHz demodulator. However, few late-model sets include such a jack, so you'll probably have to build and connect a special interface circuit. Doing so may void any warranty that is in effect, so don't undertake any modifications to your set unless you're quite sure you know what you're doing—or are willing to accept the consequences.

We'll present several ideas for interfacing the demodulator; whichever you chose, **be sure you never work on any device while it is plugged into a 117-volt AC power outlet.** Many TV chassis are extremely dangerous because they do not have power transformers to isolate them from the AC power line. Sets that lack such a transformer are said to be hot-chassis types, because there may be a 117 volts between the chassis and ground.

Converted VCR output

This is probably the most difficult option physically, because you must remove the case of your VCR and drill a hole in the rear panel to mount a small SPST switch. You must also locate the 75- μ s audio de-emphasis capacitor in the tuner section, and lift the leg that goes to ground. To find that capacitor, you'll probably need a copy of the schematic diagram for the tuner section of your VCR. Your dealer's service department may have that information, and you may be able to ask a technician there for help in locating the capacitor.

The de-emphasis capacitor is always located close to the audio-demodulator IC. The capacitor forms part of a series RC network; one leg goes to ground, and

the other is connected to a resistor that's in series with the audio path through the circuit. In some sets one IC may perform both audio and video demodulation.

After locating the proper capacitor, remove the grounded leg. Then prepare a piece of shielded cable that is long enough to reach from the capacitor to the rear-panel switch. As shown in Fig. 10-a, solder the shield to the hole from which the capacitor's leg was removed, and the center conductor to the free leg. Connect the other end to the switch.

Now, when the switch is in the STEREO position, the capacitor is disconnected from the circuit. That allows the high-frequency portion of the audio signal that contains the pilot and the L-R signals to pass through the remainder of the circuitry and appear at the VCR's regular audio output jack. Closing the switch returns the recorder to normal MONO operation.

Because we tapped the demodulated audio directly, IC1 and associated components can be eliminated from the decoder's PC board. In addition, **you can use that technique with a TV or a monitor, but only if it is not a hot-chassis type.**

IF output jack

Conversely, the following technique may be used on a TV with a hot chassis. You'll have to build the 4.5-MHz section of the decoder. Before beginning conversion, obtain a copy of the schematic diagram of your set. What you're looking for is a place to pick up the 4.5-MHz audio IF signal *before* it is demodulated.

Locate the audio-demodulator section of the TV set; it should look something like Fig. 10-b. In many cases, the circuit will look similar to the demodulator circuit in the decoder. Older sets will probably use a 4.5-MHz IF transformer

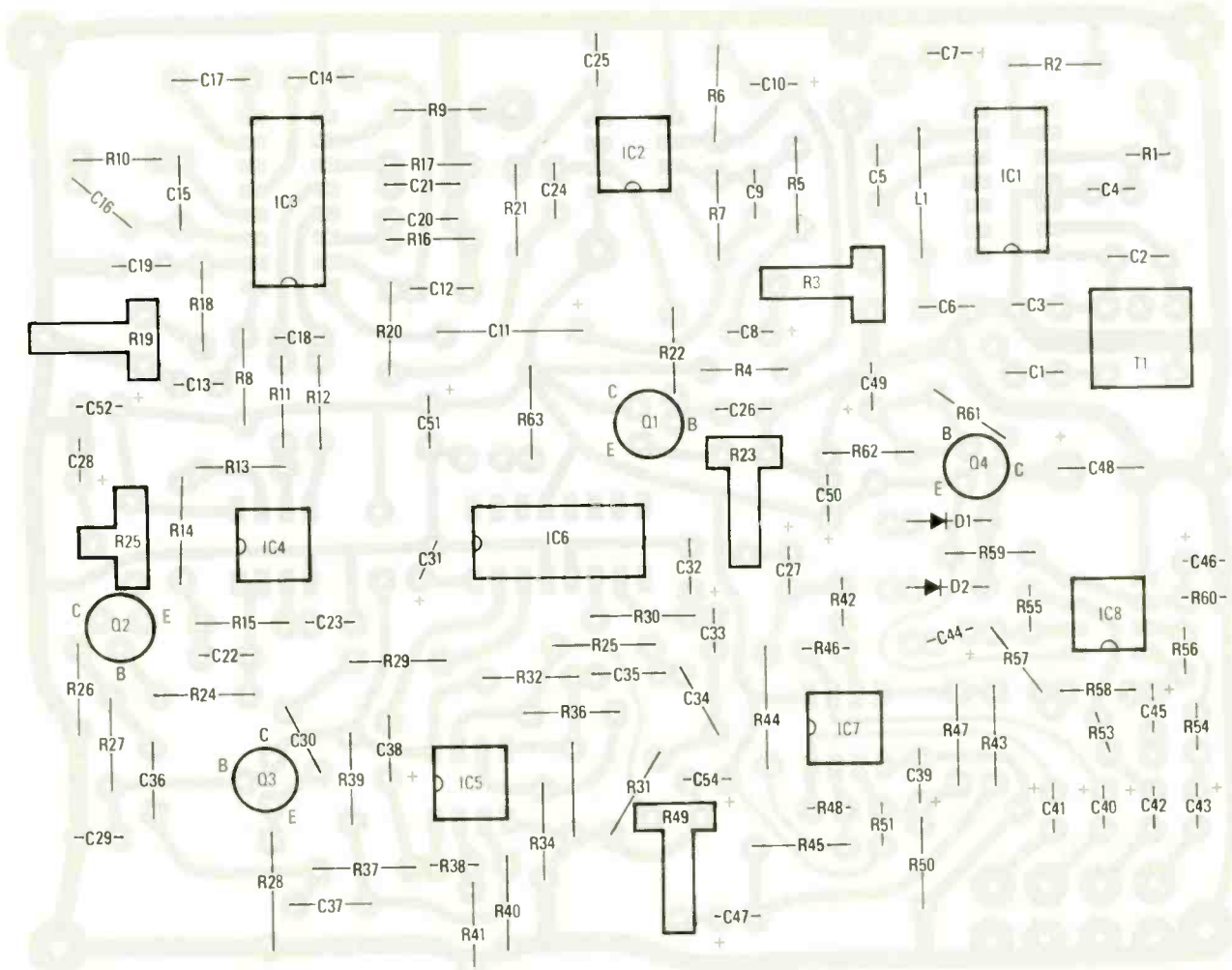

FIG. 7—MOUNT ALL ON-BOARD COMPONENTS on the MTS decoder's PC board as shown here.

PARTS LIST

All resistors are 1/4-watt, 5% unless otherwise noted.

- R1—120 ohms
- R2, R7, R35, R37—10,000 ohms
- R3, R23, R49, R53, R54—10,000 ohms, trimmer potentiometer
- R4, R6, R11, R12, R42, R43, R44, R46, R48, R50, R51, R59, R60—100,000 ohms
- R5—2200 ohms
- R8—10 ohms
- R9, R24, R31, R57, R58, R63—1000 ohms
- R10, R16, R17, R28—3300 ohms
- R13—330,000 ohms
- R14, R15, R21, R62—4700 ohms
- R18—12,000 ohms
- R19—25,000 ohms, trimmer potentiometer
- R20—4300 ohms
- R22, R27—5100 ohms
- R25—5,000 ohms, trimmer potentiometer
- R26—1500 ohms
- R29—30,000 ohms
- R30—18,000 ohms
- R32, R33, R39, R40—20,000 ohms

- R34, R41, R55, R56—39,000 ohms
- R36, R38—22,000 ohms
- R45—68,000 ohms
- R47—470,000 ohms
- R52—100,000 ohms, dual-gang potentiometer
- R61—330 ohms

Capacitors

- C1, C4, C13, C32—0.01 μ F, ceramic disk
- C2, C9, C19—470 pF, ceramic disk
- C3, C14—0.05 μ F, ceramic disk
- C5—5–60 pF, trimmer
- C6—10 pF, ceramic disk
- C7, C8, C10, C11, C27, C38, C47—1 μ F, 50 volts, electrolytic
- C12, C23, C25—0.0022 μ F, ceramic disk
- C15, C30, C34–C37—0.22 μ F, ceramic disk
- C16, C17—0.47 μ F, ceramic disk
- C18—0.0047 μ F, ceramic disk
- C20, C21—0.0015 μ F, ceramic disk
- C22, C24—0.0039 μ F, ceramic disk
- C26, C29—0.015 μ F, ceramic disk
- C28, C31, C39–C46—10 μ F, 50 volts, electrolytic
- C33, C50–C53—2.2 μ F, 50 volts, electrolytic

- C48—2200 μ F, 50 volts, electrolytic
- C49—470 μ F, 50 volts, electrolytic

Semiconductors

- IC1—MC1358 stereo demodulator
- IC2, IC4, IC5, IC7, IC8—LM358 dual op-amp
- IC3—LM1800 stereo decoder
- IC6—NE570 compander
- D1, D1—1N4002 rectifier diode
- LED1, LED2—standard
- Q1, Q3—2N3904 NPN transistor
- Q2—2N3906 PNP transistor
- Q4—2N2222 NPN transistor

Other components

- F1—1/2-amp, 250-volt fuse
- J1–J4—RCA phono jack
- J5—stereo headphone jack
- L1—33 μ H S1—SPDT toggle switch
- S2—SPST toggle switch
- T1—10.7 MHz IF transformer
- T2—25-volt CT power transformer

Note: A drilled, etched, and plated PC board is available from Tod. T. Templin, 5329 N. Navajo Ave., Glendale, WI 53217 for \$9.00.

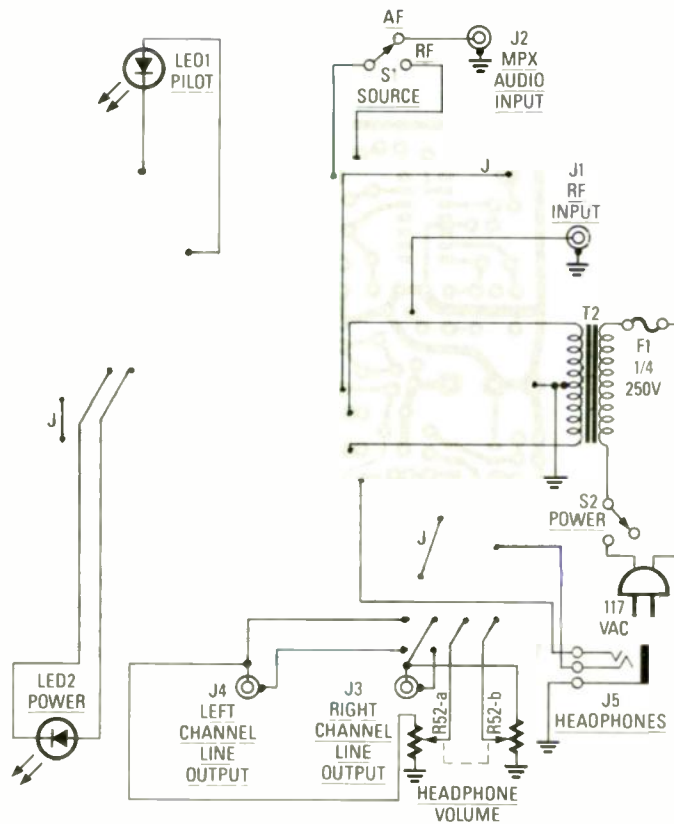

FIG. 8—THREE JUMPERS AND ALL OFF-BOARD components mount as shown here.

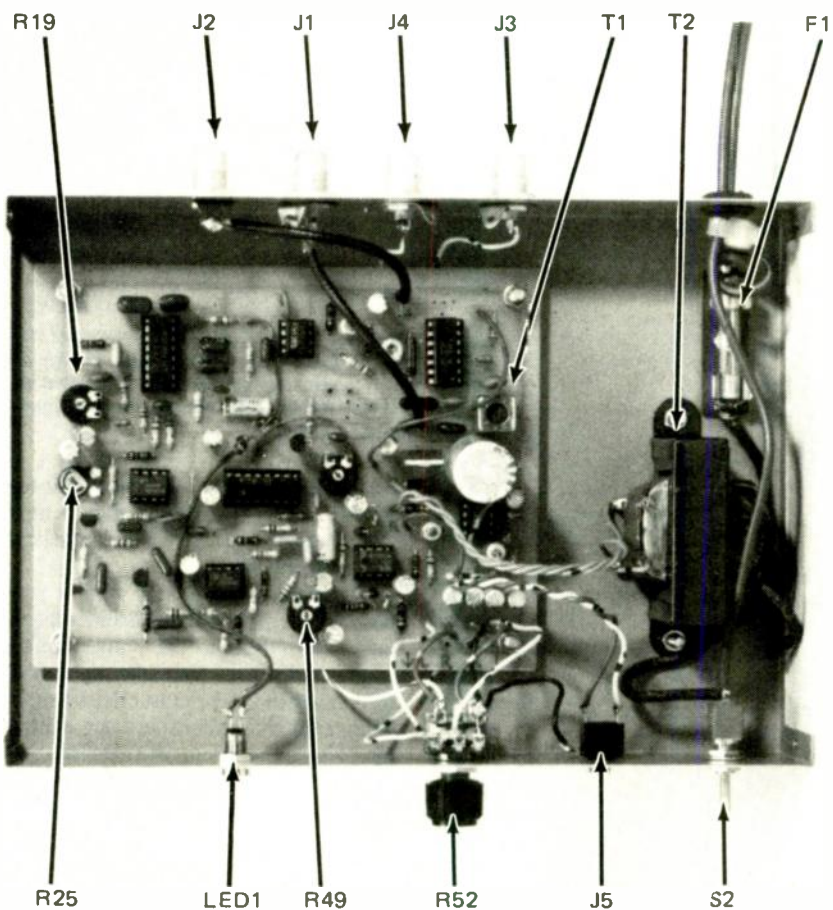

FIG. 9—THE COMPLETED DECODER appears as shown here. The board shown was an early prototype, so it doesn't match the parts-placement diagrams (shown in Fig. 7 and Fig. 8) exactly.

between the video and the audio demodulator sections; newer sets may use a ceramic filter.

In either case, solder one lead of a 100-pF capacitor to the output side of the transformer or filter. Cut a length of shielded cable that is long enough to reach from the capacitor to the rear of the set. Prepare one end by completely removing about one inch of the braid. Cover the part of the cable where the shield ends with tape or heat-shrink tubing. **There must be no possibility of the shield wire's touching any part in the TV.**

Now solder the center lead to the free end of the 100 pF capacitor. Dress the capacitor and the cable so that they don't touch any other parts. Locate a convenient, non-conductive place on the rear cover of the set and mount the RCA jack. **Do not mount the jack on any metal part of the set.** Finish the installation by soldering the 1-megohm resistor and the shielded cable to the jack.

RF probe

The RF probe is probably the best interface to use if you're not familiar with the inner workings of TV's and VCR's. Your set needn't be modified in any way, and you don't have to deal with high voltages. However, you'll almost certainly have to remove the cabinet in order to pick up the RF signal. In addition, you'll have to build the 4.5-MHz demodulator section of the decoder, but in that case, replace 0.01- μ F input capacitor C1 on the decoder board with a wire jumper.

The basic idea is to build a small antenna that is tuned to 4.5 MHz and is placed as close as possible to the TV's audio demodulator. The antenna will pick up the RF signals that are naturally radiated in the set.

The circuit is very simple, as shown in Fig. 10-c. Use several drops of quick-set glue to hold the coil to a stick. Then solder the capacitor close to the body of the coil. Cover the assembly with heat-shrink tubing to help hold it together and to provide insulation. Cut a small hole in the tubing so you can adjust the trimmer capacitor. Then attach a length of shielded cable about six feet long, and terminate it with an RCA plug.

Finding the optimal location for the probe requires that the decoder be operational. On the other hand, you can't make the decoder operational without an input signal from the probe. That leaves you in a bit of a dilemma.

The best solution is to locate the audio demodulator in the television. Then use a rubber band or a piece of tape to secure the probe close to that portion of the circuit. Temporarily remove any shielding, if necessary. Now you should be able to get enough signal to align the decoder, after which you can go back and reposition the probe and adjust the setting of the

trimmer capacitor for maximum signal strength.

In practice we have found that many sets, particularly older models and tube types, radiate so much RF that, after the probe is tuned, it can pick up enough signal to work as far as two feet from the set.

Alignment

The decoder was designed to be easy to align. The values of all components were selected so that by setting each adjustable part to the center of its range, it will be near its optimal setting.

Begin alignment by setting all potentiometers and trimmer capacitors to their center positions. Supply an input signal to the decoder by one of the circuits above. Be sure that you are tuned to a station that is transmitting a stereo signal. Most TV stations leave the pilot on all the time and transmit a synthesized stereo signal during shows that are not true stereo. You'll need to monitor the decoder's outputs via headphones or a stereo amplifier. If everything is working, you should hear some audio from the decoder, although it may be low in volume or highly distorted.

If you're using the on-board 4.5-MHz demodulator, you must adjust it first. Input transformer T1 is broadly tuned, so any adjustment to it will have little effect. Leave it centered, and adjust trimmer capacitor C5 for maximum audio output from the decoder.

If you're using the RF probe for input, you must adjust it while the television is operating, so be **extremely careful not to touch anything inside the TV set**. While carefully holding the probe in a position where you can hear some signal, adjust the probe's trimmer capacitor for maximum output. Then move the probe around to find the point where the signal

level is strongest. Unplug the TV set and attach the probe as close as possible to that point.

Now adjust R3 for maximum signal. Then adjust R19, the stereo PLL adjustment, rotating it through its entire range. At some point the stereo PILOT LED should come on. Set R19 to the point midway between where the LED goes on and off. Re-adjust R3 until the LED goes off, then increase R3 to just beyond the point where it comes back on. Set R19 again. You may need to increase the resistance of potentiometer R3 a little to ensure reliable PLL lock up.

Now you should be hearing a fairly good stereo signal. While listening closely to the program material, adjust R25 to where the sound becomes distorted or noisy. Then reduce it until the sound becomes muffled or dull. Then set it midway between the extremes.

The matrix-input-level controls, R23 and R49, affect overall left/right separation. If everything is working normally, each control should be set to approximately the same position near the center of its range. You may, however, wish to experiment with their settings. While listening to stereo program material, alternately adjust each to obtain the greatest apparent separation.

Another method of adjusting R23, R25, and R49 requires an oscilloscope capable of X-Y display. Connect the right-channel output of the decoder to the X input of the oscilloscope and the left-channel output to the Y input of the oscilloscope. Depending on the signal you're receiving, as separation decreases, the display becomes more of a straight line that tilts one way or the other.

For example, as shown in Fig. 11-a, a mono signal will appear as a straight line at a 45-degree angle. A good stereo signal

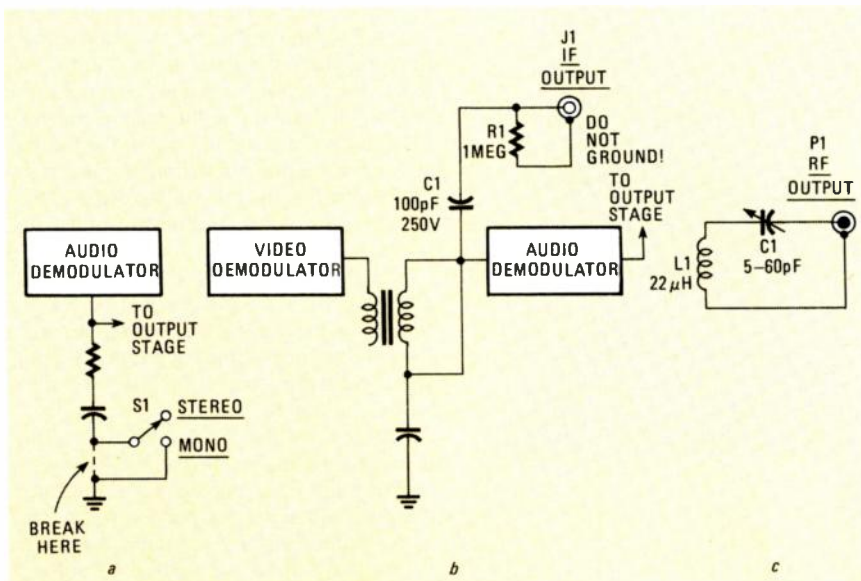

FIG. 10—INTERFACING THE DECODER to a TV or VCR can be accomplished in various ways: via the audio demodulator (a), at the output of the video demodulator (b), or indirectly via an RF probe (c).

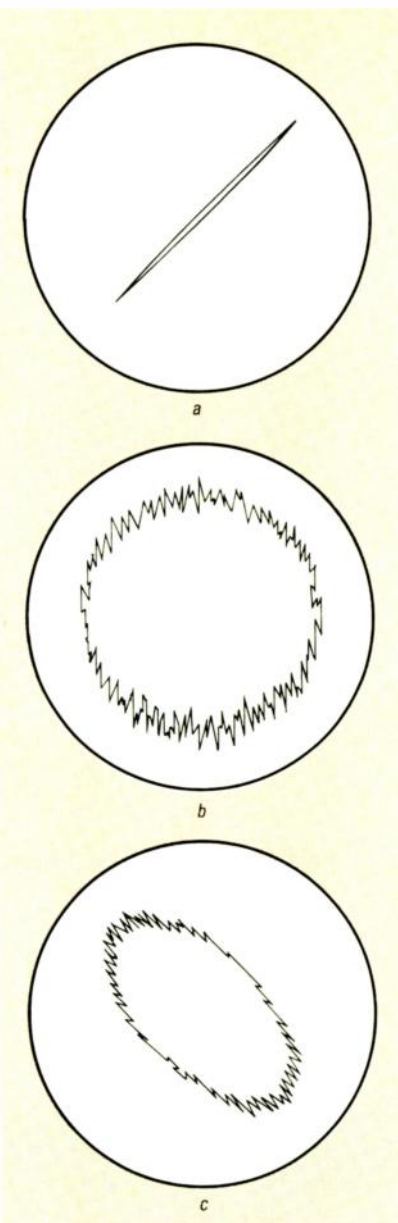
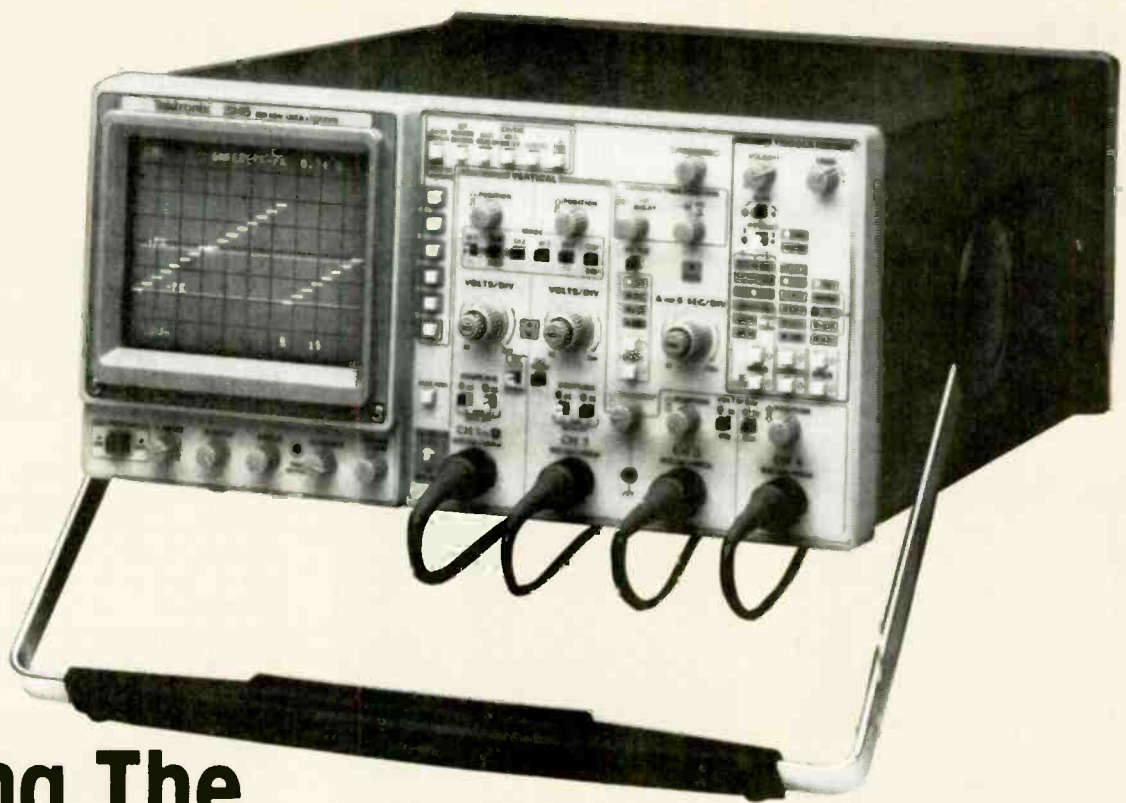

FIG. 11—OSCILLOSCOPE DISPLAYS of the decoder's left and right outputs. Shown in a is a mono signal (L + R); in b is a signal with proper left/right separation; in c is a signal with too much L - R.

fills all four quadrants of the oscilloscope display about equally, as shown in Fig. 11-b. A mostly L - R signal appears as shown in Fig. 11-c.

To adjust the decoder with a scope, observe the pattern and listen to the signal. Adjust R25 to the point where the sound is cleanest. Now alternately adjust R23 and R49 for the most circular display. With patience and experience with different types of program material, you'll quickly learn how the controls affect the sound, and thus find the best setting for each.

When you're satisfied with your adjustments, assemble the decoder and your TV set, sit back, and enjoy the new stereo-TV shows.



Using The New Generation Oscilloscopes

Make complex measurements with just the push of a button.

CALVIN DILLER*

IF YOU HAVEN'T LOOKED AT A NEW OSCILLOSCOPE in a while, the information in this article is going to surprise you. Sure, prices are going down, and bandwidths are going up, but that's to be expected. The real surprise is the ease with which advanced measurement functions can be performed.

For example, on some oscilloscopes you can push a button and see a peak-to-peak waveform displayed on a CRT. Push another button and the average value of the waveform is displayed. It's clean and simple. You don't have to count CRT divisions, and you don't have to do scale-factor multiplications. You just read the values off of the display.

Single-button measurements are just one of many advanced features showing up in low- and medium-cost oscilloscopes. Waveform cursors and gated measurements are other advanced features now found on those units. Those new features provide more waveform information faster and with less chance of error. But to get the most from those features, you'll need to understand some basics of

their operation, as well as where and how they should be used.

Push-button answers

You may have read about push-button oscilloscope measurements in an engineering journal. Or perhaps you've seen them touted in an advertisement.

The idea of being able to push a button to get pulse amplitude, DC offset, or average voltage is attractive, to say the least. It's comparable to moving from a slide rule to a handheld calculator. But there's a problem. Until recently, pushbutton measurements have been available only on the more expensive digital-processing storage oscilloscopes.

Now, however, advanced push-button measurements are becoming available on relatively inexpensive analog oscilloscopes. Those scopes analyze the analog waveform directly, without using expensive waveform digitizing techniques. For example, a DC-average measurement is made by directing a portion of the signal through a 7-Hz filter. Peak and peak-to-peak measurements are done using a peak-detecting microprocessor

feedback system. It amounts to having a specialized "waveform tracking" voltmeter built right into the scope.

The technology behind those oscilloscopes is a topic for another time. Here, what we are interested in is how we can take the maximum advantage of those oscilloscopes' capabilities. To show you how to do that, we'll look at the operation of one oscilloscope in detail. That scope is the Tektronix (Tektronix Industrial Park, P.O. Box 500, Beaverton, OR 97077) model 2246.

Using the 2246

To make an amplitude measurement, you set up the scope as you would any other. Once you get a display of the waveform on the oscilloscope screen, pressing a measurement-menu button causes a menu of available measurement functions to be displayed on the screen; on the 2246 that button is labeled CH1/CH2/VOLTMETER. The measurement menu then appears on the CRT, and the desired item is selected with a push of a second button. See Fig. 1.

If you wished to make a quick check of a digital circuit's voltage parameters, you

*Tektronix, Inc.

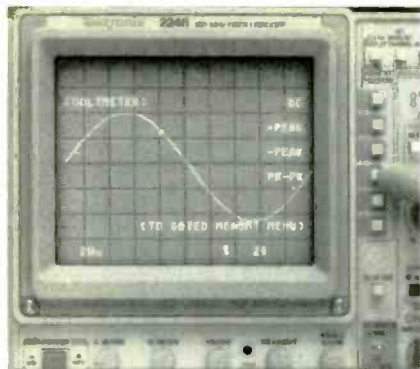

FIG. 1—COMMON AMPLITUDE measurements can now be made at a push of a button on an analog oscilloscope.

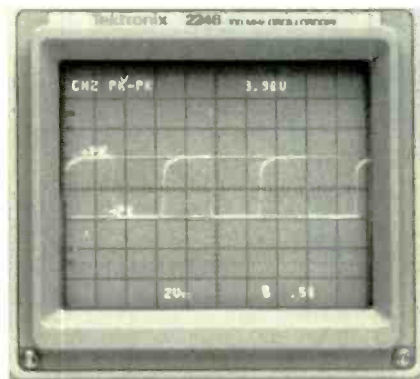

FIG. 2—PEAK-TO-PEAK MEASUREMENT shows the entire 1 to 0 voltage swing of a digital waveform.

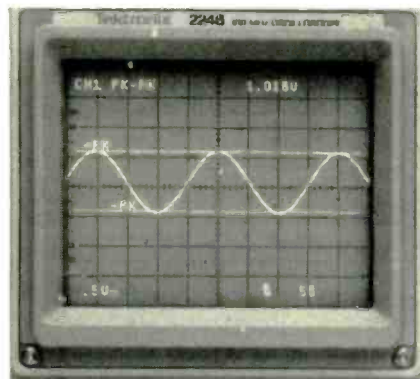

FIG. 3—DIRECT MEASUREMENT of amplifier gain is made by first adjusting the test-signal level for a 1-volt peak-to-peak reading.

ment function and the peak-to-peak value of the input waveform will be displayed on-screen. See Fig. 3.

With the peak-to-peak value of the input displayed, you can adjust the amplifier test signal for a convenient measurement level; 1 volt, for example. Since the display of the peak-to-peak signal is "live" (it tracks the waveform level like a voltmeter), you can use it for precise adjustment of input level. Once the input level is where you want it, switch the scope input selection to channel 2. Now the peak-to-peak reading on the scope will be for the amplifier output waveform. It will also be the amplifier gain if you adjusted the input-test signal level to 1 volt. See Fig. 4.

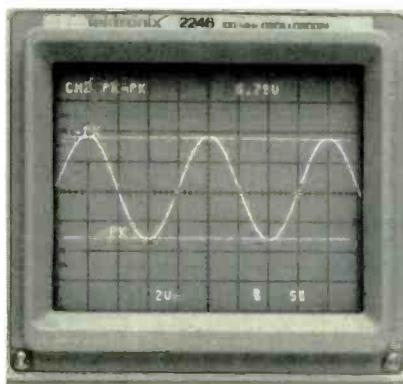

FIG. 4—SWITCHING THE SCOPE to channel 2 yields a direct display of gain, assuming a 1-volt peak-to-peak input to channel 1.

Of course, there are cases where a 1-volt input could overdrive your amplifier. So it might be better to use a 0.1-volt or even 0.01-volt input, depending on your amplifier's operating range. In those cases, the correct gain is obtained by mentally shifting the decimal point to the appropriate place on the scope's channel-2 peak-to-peak reading. If you will be working with low-power circuitry, you will need an oscilloscope with high input-sensitivity. Look for a scope with a minimum sensitivity of at least 2 mV/div.

The + peak or - peak measurement function can also be used to measure gain. However, since + peak or - peak will, by definition, include any DC offset, you'll need to make sure that channels 1 and 2 are both set for AC input-coupling. That will exclude the DC component. On the other hand, you may want to include the DC component. That could be the case, for example, in DC-coupled amplifiers used in some sense and control applications. Then, DC input-coupling on the scope and the + peak or - peak functions would be preferable.

In still another measurement situation involving DC level, you might be working on a solid-state power-control circuit—for a dimmer, a fader, or a motor-speed control. The kinds of waveforms seen there are usually asymmetric. They're rectified, chopped, or otherwise modified versions

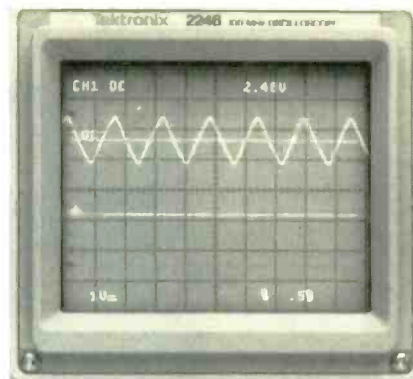

FIG. 5—THE DC AVERAGE of an asymmetric waveform is shown both by a readout and by the location of the measurement cursor.

of sinewaves. Those oddly shaped waveforms can be quite deceiving if you are trying to estimate an average DC value from the oscilloscope display. Unless, of course, your scope features an AC-average measurement function. Then, all you need do is press a button and the correct value will be displayed. See Fig. 5.



FIG. 6—MEASUREMENT CURSORS are positioned by the oscilloscope automatically. They give visual confirmation that the appropriate region of the waveform is being measured.

Voltage and time cursors

In the measurements illustrated by Figs. 2-5, notice the horizontal dashed lines. Those lines are voltage measurement cursors. Whenever a push-button measurement is made with the 2246, those cursors are automatically placed on the waveform by the unit.

That automatic cursor-placement is extremely important and helpful. It gives you visual verification that the correct portion of the waveform is being measured. For example, Fig. 6 shows a + peak measurement of a pulse. The automatic cursor placement shows that + peak includes pulse overshoot.

But you may not want to include overshoot in the measurement. If that is the case, you can switch to cursor mode and move the cursors to the points of interest, the flat top of the pulse for example. The cursor readout is the voltage difference between the two cursor lines. So, by placing the cursors as shown in Fig. 7, you get

would display the waveform on the CRT and select peak-to-peak measurement. The peak-to-peak value, the 1 to 0 swing for a digital waveform, is displayed as shown in Fig. 2. It's as simple as that. Hairsplitting division counts, scale-factor multiplications, and other sources of error are eliminated.

But maybe you're not working on digital circuits. Instead, you need a quick check of amplifier gain. For that, apply a test signal to the amplifier and, using the dual-trace mode of the oscilloscope, hook the channel-1 probe to the amplifier's input and the channel-2 probe to the amplifier's output. Starting with the channel-1 signal, select the peak-to-peak measure-

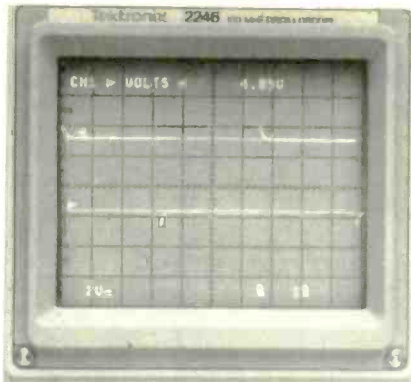

FIG. 7—IF YOU WANT GREATER CONTROL over the region of the waveform to be measured, the measurement cursors can be placed manually. Among other things, that allows you to exclude pulse overshoot from a peak measurement.

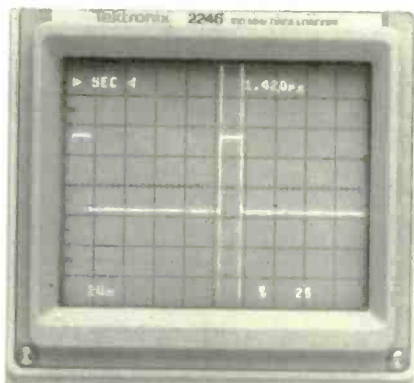

FIG. 8—TIME CURSORS CAN BE POSITIONED for precise timing measurements.

a pulse-amplitude measurement that excludes the overshoot.

Another mode, cursor referenced to ground, brings a single cursor up on screen. The readout for that cursor is voltage-referenced to ground, which is quite useful for checking absolute voltages, logic levels, and voltages in switching devices, among others.

You can also select a time-difference cursor mode. That is indicated by vertical cursor lines (see Fig. 8). Now the cursor readout is the time difference between

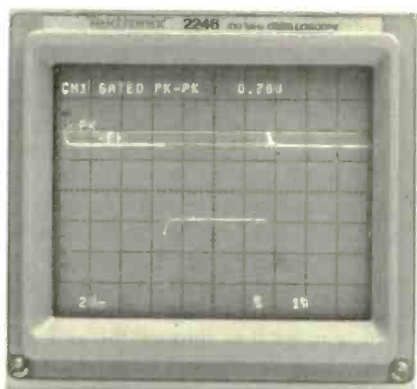

FIG. 9—USING A GATED MODE allows you to measure only specific regions of a waveform, such as pulse overshoot.

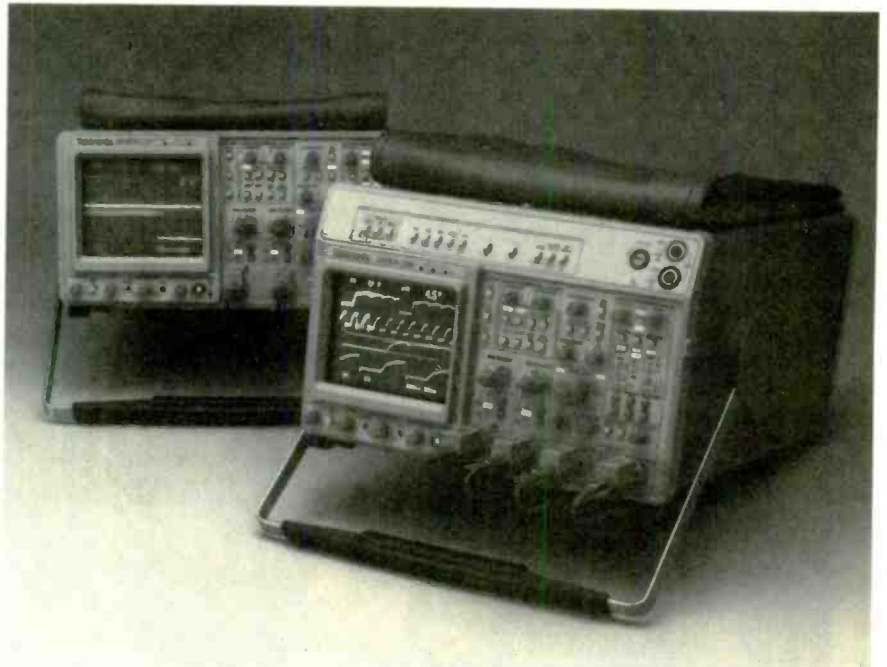

FIG. 10—TEKTRONIX 2245A and 2465A are microprocessor-based scopes with 350 MHz bandwidths. They both offer waveform cursors.

horizontal cursor locations. By positioning the cursors on the transition midpoints of a pulse, you get a pulse-width measurement, as shown in Fig. 8.

Similar cursor placement on alternate sinewave zero crossings would produce a readout of period. Or, in the dual-channel mode, the time cursors can be used to measure propagation delay.

Gated measurements

Between push-button amplitude measurements and cursor time and amplitude measurements, you can simplify the majority of day-to-day oscilloscope measurements. There are, however, additional measurements that can benefit from another new feature of analog oscilloscopes.

Consider again the pulse with overshoot. You can use a gated-measurement function to confine push-button measurements to a selected portion of the waveform. That allows you to measure, for example, pulse overshoot while ignoring the pulse itself.

Such a gated measurement is shown in Fig. 9. The pulse overshoot is isolated by positioning an "intensified zone" on just the overshoot. The intensified zone is the brighter part of the trace and can be positioned anywhere on the trace or made shorter or longer to include just the desired part of the waveform. With the intensified zone on, the pushbutton measurements are made for just the intensified portion of the waveform.

In Fig. 9, for example, the intensified zone confines a + peak measurement to the pulse overshoot. The result is a peak-overshoot measurement. That measurement can then be used with a cursor measurement between pulse top and base to

compute percent overshoot.

There are a number of other cases where gated measurements prove extremely useful. For example, step amplitudes can be quickly isolated and measured on incremental devices such as stepper motors and analog-to-digital converters. Peak-to-peak noise can be monitored on a gated segment of a waveform for determining signal-to-noise ratio. Or you can zero in on the amount of ripple in a power supply.

More for the money

All of the advanced measurement capabilities discussed here can be doubled if the oscilloscope also includes different triggering modes. For example, the 2246 that we've been using as an example has the standard triggering modes offered on most 100-MHz scopes. But it also has TV-field and TV-line triggering. As a result, the pushbutton peak-to-peak, + peak, - peak, DC-average, cursor, and gated measurements can all be used in television applications as well.

The bottom line

That extra measurement capability is nice, even surprising for an analog scope, but is it worth the extra cost? That's the other surprise, and a pleasant one too. Because of engineering and manufacturing advances, those capabilities are basically free extras on scopes from many manufacturers. For instance, the Tektronix 2246 that we've used as an example here, and the 2245 and 2465 scopes shown in Fig. 10, are priced competitively with other analog oscilloscopes that lack many of the advanced features we've discussed.

R-E

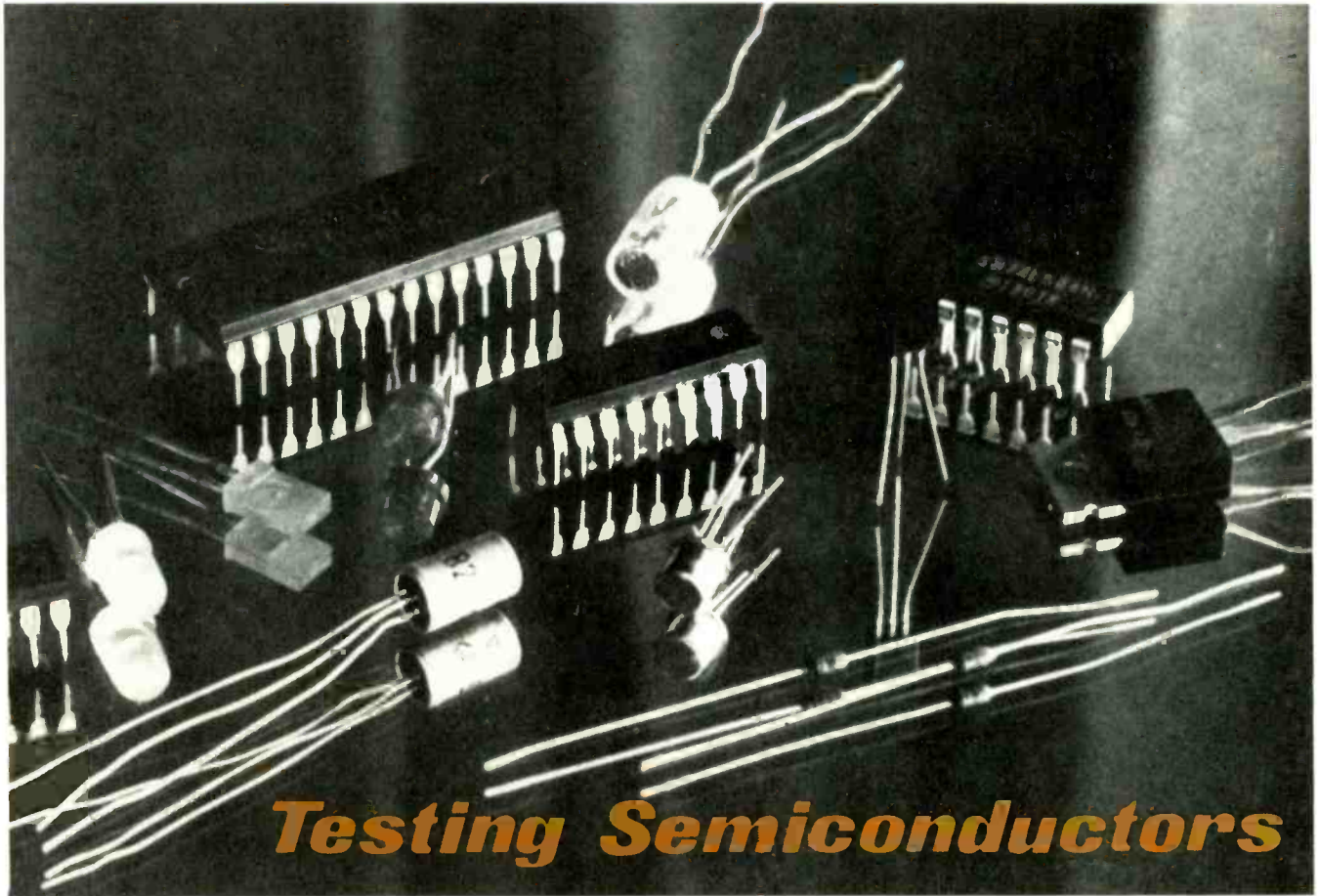

Learn the importance of diode and bipolar-transistor parameters, and how to test them, in the first installment of our new back-to-school series.

TJ BYERS

Part 1 EVEN IF YOU ARE COMFORTABLE using semiconductors in your designs and projects, you may not know how to test those components to ensure correct performance. You may not even realize the importance of such tests. Testing allows you to guarantee performance, improve circuit parameters, and reduce project costs. In addition, it helps you to understand better the nature of semiconductor electronics.

With this article, **Radio-Electronics** begins a new series on semiconductor testing. In the coming months we will examine everything from simple diode leakage to complex environmental testing and burn-in.

Test procedures

Essentially, there are two methods by which semiconductors are tested. The first is called static testing. As the word static implies, the semiconductor device is subjected to a constant voltage or current, as appropriate, and a measurement is made. The relationship between the applied values and the measured values is

then analyzed. Static tests are generally referred to as DC measurements.

The second method is called dynamic testing. In a dynamic test, DC values are again applied to the semiconductor. In addition, however, an AC component, normally in the form of an input signal, is present. The effect of the semiconductor device on the AC signal is then measured and the results interpreted. Not surprisingly, dynamic tests are listed as AC measurements.

As you can imagine, those two test methods yield completely different results, and often both tests are required before we have a complete picture of the semiconductor device. We will begin our survey of semiconductor testing with DC measurements.

Leakage current

The most often specified DC parameters are leakage current and breakdown voltage, both of which normally determine the usefulness of a device within a specific application. Those two parameters have an intimate relationship,

though, and what affects one usually affects the other. Keep that in mind as we examine those two DC parameters.

Let's begin our analysis with the simplest of semiconductor devices: the diode. Basically, a diode is a simple PN junction that acts like an electronic valve. When the diode is forward-biased, it conducts current; when the diode is reverse-biased, it blocks current.

Ideally, a reverse-biased diode passes no current. Unfortunately, no actual device performs like the theoretical "ideal" device. Thermal agitation and impurities in the semiconductor material allow a small but measurable amount of current to escape through the junction. That current is referred to as leakage current and is called I_R (for Reverse) on data sheets.

Leakage current is measured by reverse-biasing a diode with a known voltage, as shown in Fig. 1, and monitoring the current flow through the device. Under those conditions, the semiconductor junction behaves like a bulk resistance. As the voltage across the junction increases, so does the leakage current.

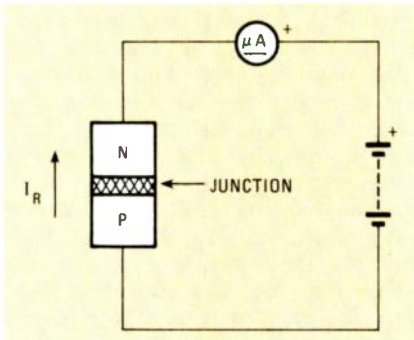

FIG. 1—LEAKAGE CURRENT IS FOUND by reverse-biasing a diode and measuring the current flow through the device.

Breakdown voltage

Breakdown voltage is the voltage at which the semiconductor junction is no longer functional. That is due, in large part, to the strong electric field created within the junction by the applied voltage. As the field increases in intensity, it adds energy to the leakage-current electrons passing through the junction. Those high-energy electrons collide with other electrons in the junction, dislodging them. The freed electrons are accelerated by the strong electric field and, in turn, collide with more electrons.

A voltage is eventually reached where the electric field is so strong that it creates an uncontrolled chain reaction. That process is called avalanche multiplication and results in a rapid rise in leakage current. When avalanche multiplication occurs, the junction has reached its breakdown voltage, and the diode no longer functions as a one-way valve. Sustained avalanche current produces great amounts of heat and literally melts the junction, thus destroying it.

The curve in Fig. 2 shows the relationship between reverse voltage, leakage current, and breakdown voltage (avalanche point). Notice that the curve is fairly linear up to the avalanche point. At the avalanche point, however, the curve takes a sudden turn, and there is very little volt-

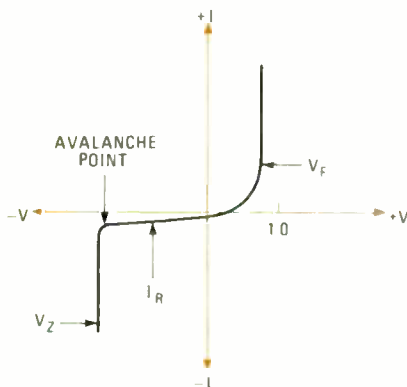

FIG. 2—AT THE AVALANCHE POINT there is very little current increase for a large voltage increase.

age increase for a large current increase. That turn is called the knee of the reverse-operating curve.

There are several methods of measuring breakdown voltage. When working with large numbers of diodes, one simple method of measuring the breakdown voltage is to take advantage of the linear characteristic of the breakdown curve. First, take a representative sampling of the diodes in question and measure the leakage current of each using a standard voltage. Then subject the sample diodes to an increasing reverse voltage until the junction goes into avalanche. Avalanche is monitored by observing the ratio between voltage rise and current increase. When the increase in current no longer corresponds to a change in voltage, the avalanche point has been reached. A current-limiting resistor is normally placed in series with the diode during that phase of the test to prevent the avalanche current from destroying the component. The relationship between leakage current and breakdown voltage is then documented and correlated. It is then possible to predict the breakdown voltage of any diode in the lot by simply measuring the leakage current at the standard voltage and comparing it to the test samples.

Testing transistors

Since the transistor is more complex than a diode, one would assume that it requires more complex testing procedures. But the testing is not different because the transistor also shares many electrical characteristics of the diode.

Basically, you can think of the transistor as two back-to-back diodes, with the base lead connected to the junction between the diodes. Table 1 lists and defines some of the more important transistor parameters.

Let's turn our attention to the leakage parameters. Those are shown in Fig. 3, along with their related voltages. Of the leakage parameters shown, only one is significant for most designs. It is I_{CBO} —the amount of reverse leakage current

TABLE 1

Voltage	Current	Definition
V_{CBO}	I_{CBO}	Collector to base, emitter open
V_{CEO}	I_{CEO}	Collector to emitter, base open
V_{CES}	I_{CES}	Collector to emitter, base shorted to emitter
V_{CER}	I_{CER}	Collector to emitter, base to emitter through a resistance
V_{CEX}	I_{CEX}	Collector to emitter with voltage applied between base and emitter
V_{EBO}	I_{EBO}	Emitter to base, collector open
V_{BE}	I_B	Base to emitter, forward biased; collector, reverse biased
$V_{BE(sat)}$	—	Base to emitter, transistor saturated
$V_{CE(sat)}$	I_C	Collector to emitter, transistor saturated

from Collector to Base with the emitter Open.

throughout the semiconductor industry.

I_{CBO} is commonly measured using the same arrangement as for diodes. A reverse voltage is applied across the collector and base terminals and the leakage current is monitored. It is important to realize, however, that the open emitter lead plays an important part in that measurement.

Leakage and breakdown voltage

As we've already indicated, each leakage configuration also has an associated breakdown voltage. The voltage complement to I_{CBO} , for instance, is V_{CBO} —the breakdown voltage between base and collector. The other two parameters of concern are V_{CEO} and V_{EBO} .

V_{CBO} , which is sometimes listed as BV_{CBO} or $V(BR)_{CBO}$, is the most commonly listed parameter. In a normal design, the base is DC-referenced to ground, making the breakdown voltage from collector to base most critical. If the circuit voltage exceeds V_{CBO} even momentarily, it is a sure bet that the transistor will fail.

V_{CEO} is the maximum voltage the transistor can sustain between its collector and emitter. Typically that value is less than V_{CBO} , and can be as little as half of that parameter.

The reason for that seeming paradox is actually simple. When voltage is applied

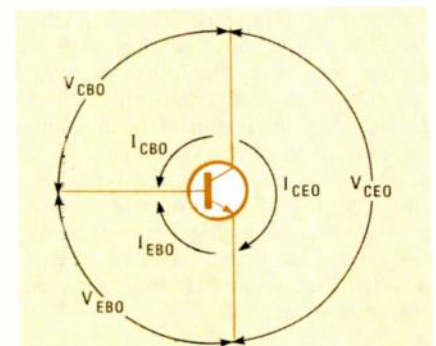

FIG. 3—LEAKAGE CURRENTS, and their associated breakdown voltages, are measured between the indicated terminals of a transistor.

between the collector and the emitter, the collector/base diode becomes reverse-biased. As we have seen, a reverse-biased diode has leakage current. That leakage current flows through the base and into the base-emitter junction in the forward direction. Since any current flowing through the base-emitter junction is amplified by the transistor, be it signal or leakage current, the product of that current appears at the collector, which in turn lowers the voltage drop across the collector and the emitter. The effect the I_{CBO} leakage current has on V_{CEO} is largely determined by the transistor's geometry.

Through prudent use of external resistance, the effects of V_{CEO} can be minimized. While V_{CEO} is an important design consideration, exceeding it doesn't normally damage the transistor, unless V_{CBO} is also exceeded.

The value of V_{EBO} , the breakdown voltage between the emitter and base in the reverse mode, is sometimes important in switching applications, especially when reverse voltage is used to shorten transistor switching times. It is typically a low value, usually 8 volts or less.

Testing breakdown voltage

The procedure for measuring transistor breakdown voltage is slightly different than that for diodes. To properly measure a transistor's breakdown voltage, we must actually subject the transistor to avalanche conditions. In other words, we must apply a voltage that is greater than the breakdown voltage of the device under test.

One popular method is to measure the breakdown voltage using a constant-current source. As you recall, a reverse-biased diode produces a very sharp increase in leakage current at the breakdown voltage. By passing a constant current through the transistor, as shown in Fig. 4, we can force the junction into an avalanche state. Once the junction is in avalanche, we can measure the breakdown voltage with a voltmeter. The technique used to measure V_{CEO} is shown in Fig. 4-a, while the technique used to measure V_{CBO} is shown in Fig. 4-b.

Of course, the current must be precisely controlled. The current must be of sufficient magnitude so that the junction goes into avalanche, yet small enough that it does not destroy the transistor. While the required current varies from device to device, a safe bet is usually the maximum I_{CBO} specified on the data sheet. If, for example, a transistor is listed as having a maximum I_{CBO} leakage current of 1 mA, it is safe to assume that the junction will sustain an avalanche current of 1 mA, from which we can safely measure our breakdown potential.

Impedance multipliers

You should perform voltage measurements across a transistor junction with a

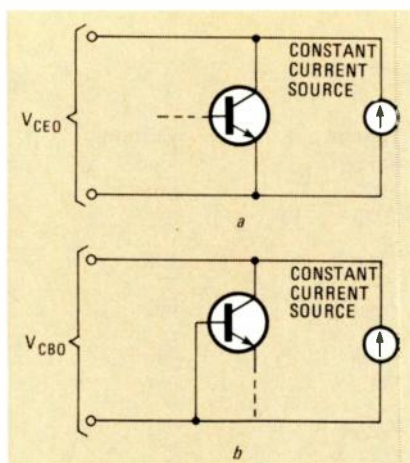

FIG. 4—MEASURING BREAKDOWN VOLTAGE. The technique used to measure V_{CEO} is shown in a; the technique used to measure V_{CBO} is shown in b.

high-impedance meter to avoid loading the circuit. At 100 volts, a meter that presents a resistance of 10,000 megohms will steal 10 nA from the circuit. Often, that current level is greater than I_{CBO} . Consequently, you must take meter resistance into account or the measuring device will have more effect on the meter than the transistor itself.

You can effectively increase a meter's input resistance by using an impedance multiplier, which is a resistance divider that reduces the loading effect of the voltmeter. It does that by scaling the voltage down to a very low value, allowing you to measure the breakdown voltage on a lower voltmeter scale, which has less influence on the circuit.

By using a divider network, like the one shown in Fig. 5, it is possible to increase the effective input impedance by 50 times or more. A 100-megohm voltmeter suddenly becomes a 5000-megohm voltmeter. Just remember that your voltage reading must be scaled up accordingly. In the example of Fig. 5, you must multiply the reading by 100 to arrive at the correct value.

Helpful hints

Just a word about breakdown voltages as listed on a data sheet. The voltages you see on the data sheet are guaranteed minimum values. In other words, if the data sheet specifies 60 volts as a V_{CBO} value, it

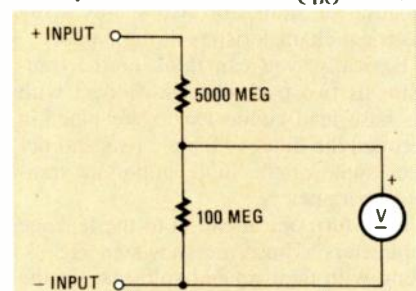

FIG. 5—TO PREVENT EXCESSIVE CURRENT draw during testing, use this impedance multiplier.

means that every transistor shipped will have a V_{CBO} of at least 60 volts.

But the V_{CBO} could be higher. In fact, testing for breakdown voltage could yield a transistor with breakdown characteristics equal to that of a more expensive device. Therefore, testing for V_{CBO} is a good way to reduce project costs without degrading performance.

While we haven't made the distinction yet, transistors come in two types: PNP and NPN. The difference between the two devices is the way the semiconductor materials are arranged. In an NPN transistor, such as we have been discussing so far, the collector is made of N-type material, the base is P-type, and the emitter is N-type; hence, the name NPN. A PNP transistor, on the other hand, is structured with a P-type collector, an N-type base, and a P-type emitter, which is just the opposite of an NPN. All tests outlined here can be performed on a PNP transistor by simply reversing the polarity of the test voltage.

Temperature effects

Leakage current is temperature sensitive. As you're undoubtedly aware, temperature agitates electrons, even to the point where some of them spin free. As temperatures increase, more kinetic energy is assumed by the electrons, and more are liberated.

You can plainly see that the more free electrons you have wandering about, the more likely they will be attracted by beckoning voltages, and the more leakage current that will flow. That is despite the fact that no change has been made in the applied voltage.

Semiconductor leakage currents are specified at 25°C (room temperature), unless otherwise stated, and the measurement is made at V_{CBO} . When measuring leakage at elevated temperatures it is necessary to select a test voltage considerably lower than V_{CBO} .

That is because temperature also affects breakdown voltage. Since I_{CBO} and V_{CBO} are so intimately related, it stands to reason that a shift in one brings on a change in the other. In fact, that is the case. As I_{CBO} increases due to increasing temperature, V_{CBO} decreases. Hence, you must lower test and working voltages when operating at higher temperatures.

Dealing with h_{fe}

Many terms are used to express the gain of a transistor, but none are as familiar as h_{fe} . By definition, h_{fe} is the static value of the forward-current transfer ratio and is equal to I_C/I_B , where I_B is the base current and I_C is the collector current. The values of I_B and I_C , and hence the value of h_{fe} , can be found using the circuit shown in Fig. 6. It must be stressed, however, that h_{fe} is not an absolute value. Instead, its value depends I_C and V_{CE} .

continued on page 120

Using The Polapulse Battery

Ever wonder how to squeeze high power capacity into a very small space? Keep reading—we'll show you how.

FRED BLECHMAN

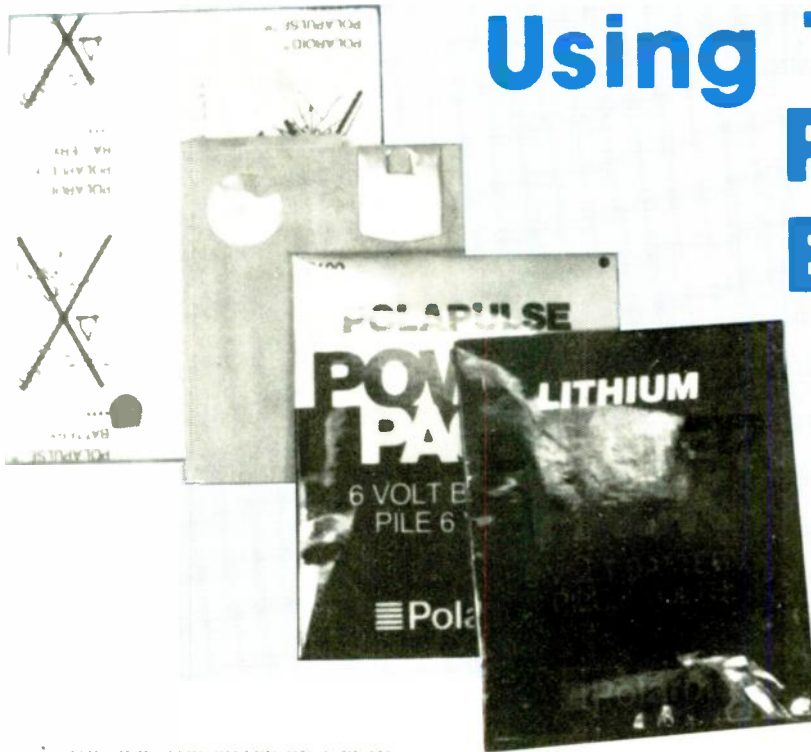

WHAT'S THE SIZE AND SHAPE OF A PLAYING CARD but can supply 100 mA of current for more than 20 hours? Polaroid's *Polapulse* power pack, that's what. It's a flat battery, originally designed for use in Polaroid's instant cameras; but now it's used in everything from computer terminals to portable TV's to stuffed animals. In this article we'll discuss several *Polapulse* batteries: their size and shape, how they work, their performance characteristics, experimental and real-world applications, and where to buy and salvage them.

The mechanics

There are several types of *Polapulse* batteries, all of which are high-capacity versions of the *P70* flat battery that was originally developed in the late 1970's for the Polaroid 600 camera.

The *P80* is a version of the original *P70* that is available only to OEM's; it is used in the type 600 film pack. As shown in Fig. 1, the *P80* is mounted on a card; it powers the camera's electronic flash, the film-advance motor, the shutter, and the sonar-based autofocus unit.

In 1980 Polaroid introduced the *P100*, shown in Fig. 2, a six-volt slim-line battery about the size of a playing card. The *P100* uses Leclanche technology (discussed in the accompanying box.) If you remove the outer covering from a *P100*, you'll find a *P80* inside, with a slightly modified contact mask. Therefore, it's no surprise that the performance of the *P80* and that of the *P100* are identical. In this article, unless otherwise specified, any reference to the *P100* also includes the *P80*.

Later, in 1983, the *P500* was introduced. It has the same size and shape as the *P100*, but a lot more power, because it uses lithium technology (also discussed in the accompanying box). Lithium cells are normally available only in small 3-volt coin or button cells, but Polaroid has flattened the construction and put lithium technology to good use.

In the *P100* and the *P500*, both positive and negative terminals are mounted on one side of the battery. Front and side views of a spring contact suitable for making electrical connections with the battery are shown in Fig. 3-a and Fig. 3-b. The spring may be bent from a scrap of sheet metal; a special copper-nickel alloy contact strip is available from PowerCard Corporation, whose address is given later. A type-600 film pack, and *P80*, *P100*, and *P500* batteries are shown in Fig. 4.

How it works

The *Polapulse* is a primary battery—it's not rechargeable. It's relatively expensive, so it's not practical as a general-purpose substitute for carbon zinc or alkaline batteries. However, the *Polapulse* battery is ideal for special applications where other batteries are too large, too heavy, or simply don't have enough energy capacity.

The *Polapulse* battery has a number of special features, including the following:

- It's very safe (see accompanying box).
- It delivers a great deal of power for its weight. The *P80* weighs a little more than half an ounce, and the *P100* weighs just

under an ounce. The *P500* lithium battery delivers as much as four times the energy of the *P80* and *P100*, but weighs a little more than an ounce.

- Its voltage is very stable under heavy load. The *P100* performs like an alkaline battery in its efficient use of chemical energy at low drain rates. But it's superior to alkaline batteries at a high rate of current drain, because it delivers high current with low internal resistance and fast voltage recovery.

Figure 5 shows a comparison of the voltage that is available from *P100*, alkaline, and carbon/zinc batteries at different load currents. The *P100* is a six-volt battery, so it takes four series-connected AA alkaline or carbon/zinc cells to equal the *P100*'s nominal output. The curves shown in Fig. 5 are based on a load that is drawn for 150 milliseconds every 15 seconds. Note that, at a load current of 1 amp, the *P100* maintains more than six volts, but the alkaline cells drop to about five volts, and the carbon/zinc cells drop to about four volts. With a two-amp load, the *P100* is still above 6 volts, but the alkalines have dropped to four volts, and the carbon/zinc cells to about 1.5 volts! Obviously, then, the *P100* is far superior to the other types where voltage must be maintained at high load currents.

- It's hard to connect a *Polapulse* battery to a circuit incorrectly polarized, because both of the battery's terminals are mounted on the same side of the battery. That built-in polarity protection eliminates the need for protective diodes.
- Every Leclanche-type battery generates gases as part of its electrochemical

LECLANCHE BATTERIES

THE CHEMICAL SYSTEM FOR GENERATING electricity was invented by George Leclanche in 1862; his process is the basis of several types of battery, including the common carbon/zinc dry-cell battery. In the Leclanche system, zinc metal is the anode (the negative electrode), and a chemically inert electrical conductor produces electrical contact with a manganese-dioxide/carbon cathode (the positive electrode). Usually, that electrode is a carbon rod or a sheet of carbon particles with a binder. The nominal output is 1.5 volts.

The carbon is needed as an electrical conductor because manganese by itself is nearly an insulator. The carbon particles (usually "fluffy" acetylene black) also serve as a "sponge" to hold the electrolyte. The latter usually consists of a water solution of ammonium-chloride and zinc-chloride salts. The electrical path is provided by the movement of charged ions in the electrolyte. The grade of manganese dioxide used determines both price and performance of the cell.

The success of the Leclanche cell was due to the low-cost ingredients, stability and good shelf-life, and the portability of the closed-cell design. Further, zinc is a low-cost metal with many non-battery uses, and manganese is the eleventh most abundant element in the earth's crust.

Leclanche cells come in familiar cylindrical forms, and in flat cells used in layers to produce batteries like the popular snap-type nine-volt battery.

The cylindrical design consists of a zinc can coated inside with a thin electrolyte paste. Inside is a separator, usually paper, and then the "black mix" of manganese dioxide, carbon, and electrolyte. At the center is the carbon rod, which serves as the positive terminal.

In a flat cell, the negative terminal is a flat zinc plate that has an electrically conductive but chemically inert film of carbon and a binder that coats the other side. That side makes contact with the positive terminal of the next cell. Each cell has a nominal voltage of 1.5 volts. So, in a typical nine-volt battery, six flat cells are stacked in series and wrapped in a moisture-proof seal. **R-E**

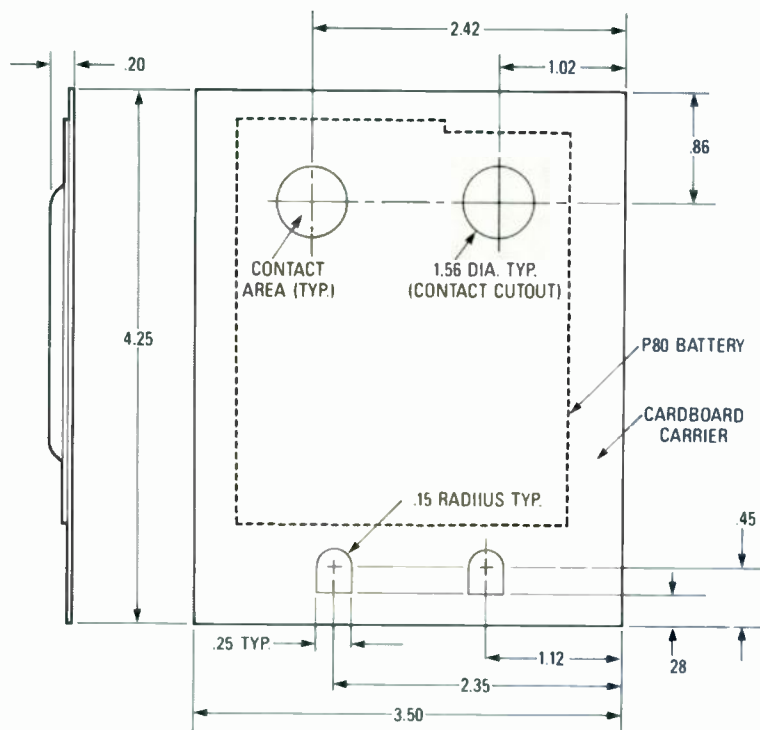

FIG. 1—DIMENSIONS OF POLAROID'S 600 film pack are shown here.

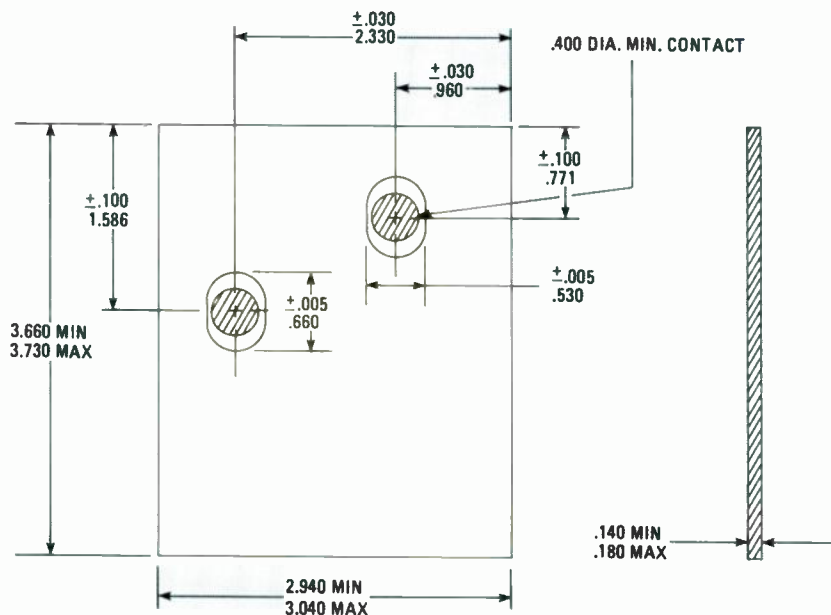

FIG. 2—DIMENSIONS of the P100 and the P500 batteries are shown here.

process. The *Polapulse* has a unique venting system that allows gas to escape via a special membrane that is permeable only to that gas.

• *Polapulse* batteries have high reliability because each one is inspected electrically and visually at assembly, and again after 90 days of controlled aging. The P100 commonly has a three-year shelf life, and the P500, a five-year shelf life.

• The technology is safe: There has been no known damage due to leakage from more than 500 million film packs!

Construction

The internal makeup of the P100 battery is shown in Fig. 6-a. It consists of a laminated stack of zinc and manganese-dioxide cells. The bottom sheet is a paper carrier. It's followed by the anode collec-

tor (the negative contact), and an aluminum sheet lined with zinc-coated conductive plastic. A polymeric separator

LITHIUM-BATTERY TECHNOLOGY

LITHIUM HAS LONG BEEN KNOWN AS A good candidate for use in a high-energy, high-density battery. Recent manufacturing processes allow lithium to be used with manganese dioxide to produce batteries with long storage life and excellent discharge performance.

The most common lithium cell is shaped like a button. The cathode is a mixture of manganese dioxide, a carbon-black conducting agent, and a binder. The electrolyte is a solvent solution of lithium perchlorate in pro-

pylene carbonate with a water content of less than 50 parts per million. The anode of the cell is made of lithium foil pressed into a stainless-steel can.

The nominal output of a lithium cell is 3.0 volts; it has a flat discharge curve; and temperature has little effect on operating characteristics.

The P500 uses a special "duplex" package with the anode and the cathode effectively in series to provide a six-volt output, as shown in Figure 6-b of the accompanying article. R-E

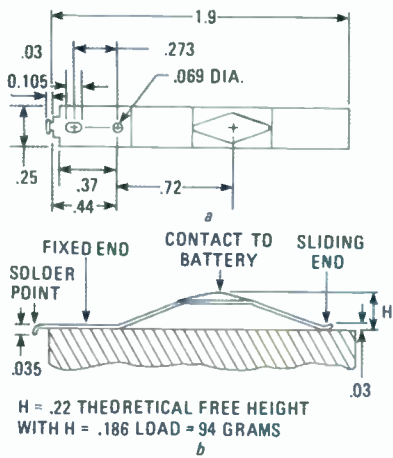

FIG. 3—SPRING TERMINAL CONTACT for the Polapulse battery should be bent as shown here. The front view is shown in a; the side view, in b.



FIG. 4—TYPES OF POLAPULSE BATTERIES are shown here, from left to right: the type-600 film pack, the P80, the P100, and the P500.

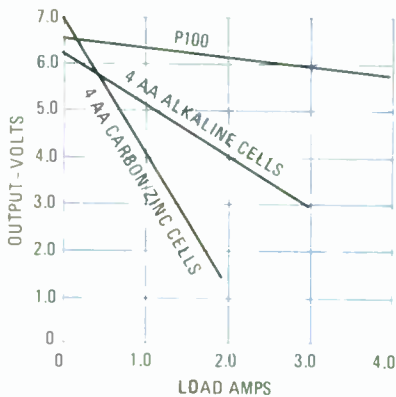

FIG. 5—THE P100 maintains rated output voltage at high drain currents.

isolates the zinc from the cathode mixture containing manganese dioxide and carbon, plus an electrolyte consisting mainly of water, zinc chloride, and ammonium chloride. A zinc-coated conductive plastic "duplex" sheet acts as the cathode collector for the first cell and the anode for the second cell. A plastic frame seals the outside of the cell.

Three cells are stacked on top of the

first cell; each cell delivers a nominal 1.5 volts. The top layer is the cathode collector (the positive contact), another conductive plastic-lined aluminum sheet. A tab, stamped into that sheet, is folded under the battery to allow same-side

mode and cathode contacts. Polaroid's exclusive vent is included in the structure.

Polaroid's "unitized construction" allows stacking four cells, thereby producing a very space-efficient six-volt battery. Because the anode is zinc printed on an

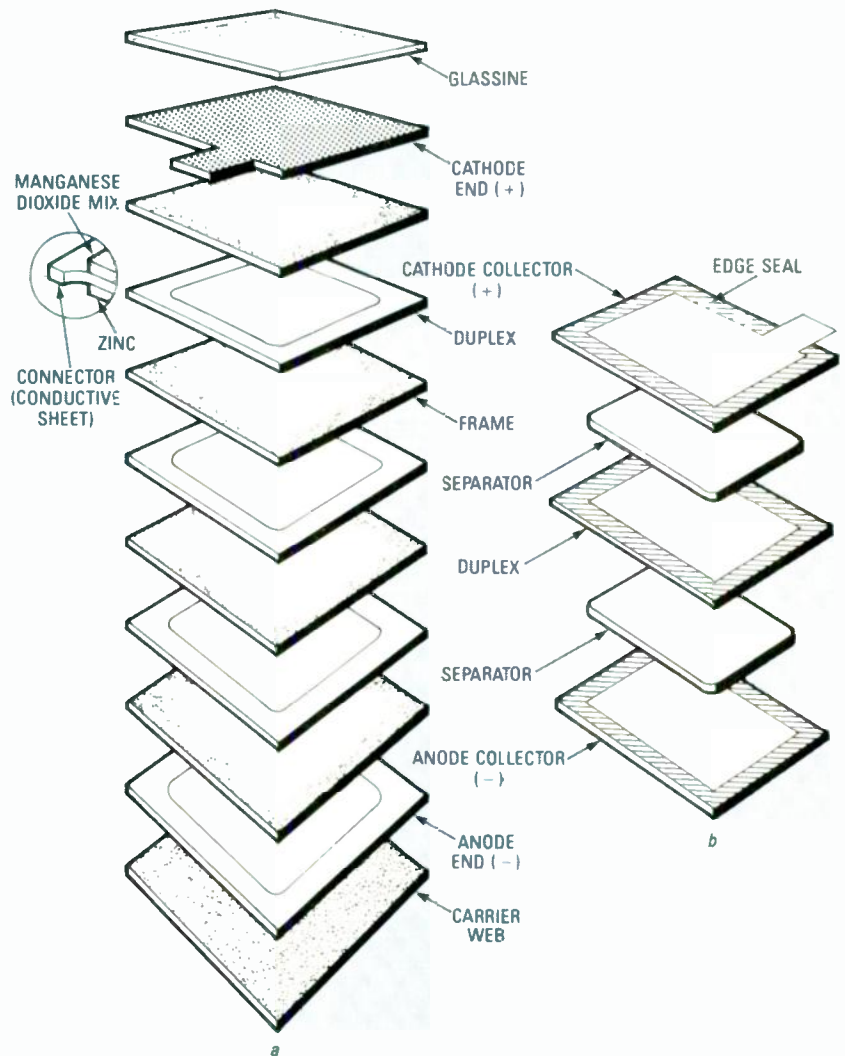
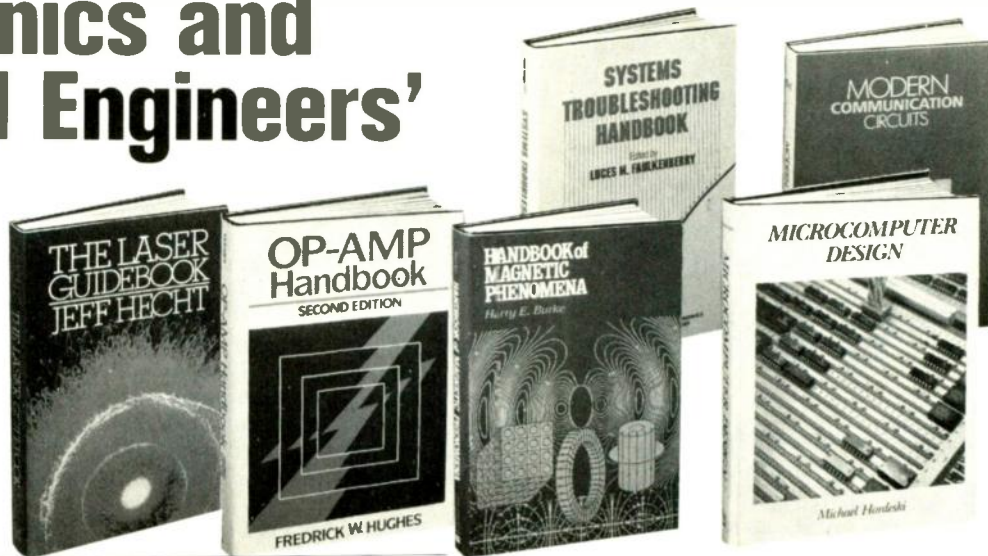

FIG. 6—CONSTRUCTION OF THE P100 is shown in a, and that of the P500 in b.

Join the Electronics and Control Engineers' Book Club®



ELECTRONICS ENGINEERS' HANDBOOK, Second Ed. Edited by D. G. Fink & D. Christiansen. 2,272 pp., 2,189 illus. This updated and enlarged edition covers all the latest knowledge in the field, including new advances in integrated circuits, pulsed and logic circuits, laser technology, telecommunications, and much more.
209/812 Pub. Pr., \$89.00 Club Pr., \$61.50

DESIGNING ELECTRONIC CIRCUITS. By R. G. Middleton. 351 pp., 192 illus. Covers virtually every category of circuits commonly used. This practical manual provides the basic design procedures, tables and formulas vital to effective electronic circuit design. Plus over 60 start-to-finish procedures are featured along with scores of computer programs to help you design and analyze electronic circuits.
583673-4 Pub. Pr., \$36.95 Club Pr., \$27.50

THE LASER GUIDEBOOK. By J. Hecht. 368 pp., 109 illus. This book covers the operating principles, characteristics and applications of all commercially available lasers. It will help you find the specific laser that best meets your requirements.
277/338 Pub. Pr., \$49.50 Club Pr., \$37.50

HANDBOOK OF PRACTICAL ELECTRICAL DESIGN. By J. F. McPartland. 416 pp., 300 illus. This volume provides a step-by-step explanation of designing electrical systems for industrial, commercial, and residential applications.
456/95X Pub. Pr., \$44.50 Club Pr., \$33.50

MICROPROCESSOR HANDBOOK. Edited by J. D. Greenfield. 656 pp., 222 illus. This first-ever handbook helps you select the best microprocessor, enables you to understand the operation of a microprocessor you are now using and provides easily accessed coverage of the most popular 8 and 16-bit microprocessors currently available.
583636-X Pub. Pr., \$44.95 Club Pr., \$28.50

SYSTEMS TROUBLESHOOTING HANDBOOK. Edited by L. M. Faulkenberry. 415 pp., 282 illus. Ten leading experts share their most effective fault-isolation techniques as well as solutions to problems they commonly encounter when troubleshooting microprocessors, robotic control systems, PCs, fiber optics systems and other complex electronic systems and equipment.
583699-8 Pub. Pr., \$44.95 Club Pr., \$33.75

MICROCOMPUTER DESIGN. By M. Hordeski. 406 pp., illus. Emphasizes the most current, cost effective methods for developing, debugging and testing all types of microprocessor products, including software and hardware.
583683-1 Pub. Pr., \$29.95 Club Pr., \$20.95

Get the competitive edge with the newest and the best information in your field . . . with books from all the leading publishers

New members!
Any one of these great professional books for only **\$2⁸⁹** as a premium with your 1st selection!

Spectacular values up to **\$105.00**

ANTENNA ENGINEERING HANDBOOK, Second Ed. Edited by R. C. Johnson and H. Jasik, with contributions by 57 recognized authorities. 1,408 pp., 946 illus. This widely acclaimed Handbook gives you the guidance you need to solve problems in antenna design and application.
372/910 Pub. Pr., \$105.00 Club Pr., \$62.50

CONTEMPORARY ELECTRONIC CIRCUITS DESKBOOK Compiled by H. Helms. 272 pp., 442 circuit diagrams. Packed with clearly reproduced circuit diagrams, all proven-in-action, covering the entire spectrum of electronics technology. Each diagram includes a title, a brief description, type numbers or values for significant components and a citation of the original source.
279/802 Pub. Pr., \$29.95 Club Pr., \$23.50

POWER INTEGRATED CIRCUITS: Physics, Design, and Applications. Edited by P. Antognetti. 544 pp., 410 illus. This comprehensive book offers an exceptionally thorough overview of the state of the art in design and technology—including the latest design advances in voltage regulators, audio amplifiers, power MOS devices, BiMOS power ICs, and improved transistor structures.
021/295 Pub. Pr., \$42.50 Club Pr., \$31.95

AUTOMATIC CONTROL SYSTEMS, Fifth Ed. By B. C. Kuo. 736 pp., illus. Provides an overview of automatic control systems, including in-depth coverage of classical control techniques, optimal control theory, and analog and digital control system design. This updated edition discusses the latest ideas on the use of computers to design control systems and as components of such systems.
583706-4 Pub. Pr., \$44.95 Club Pr., \$33.50

OP-AMP HANDBOOK, Second Ed. By F. W. Hughes. 320 pp., 231 illus. Organized for on-the-job reference, this handbook covers all facets of op-amps, from stability and protection to signal processing using op amps. Includes a collection of over 60 practical circuits for a variety of applications, procedures, and experiments.
583651-3 Pub. Pr., \$31.95 Club Pr., \$23.95

CHOOSING AND USING CMOS. By M. J. Walsh. 304 pp., 155 illus. Offers a comprehensive overview of the semiconductor technology used . . . gives practical advice on circuit techniques to make your job easier. Specifications, characteristics and applications are included.
679/576 Pub. Pr., \$35.50 Club Pr., \$24.95

MCGRAW-HILL CONCISE ENCYCLOPEDIA OF SCIENCE AND TECHNOLOGY. Editor-in-Chief S. P. Parker and the Staff of the McGraw-Hill Encyclopedia of Science and Technology. 2,065 pp., 1,600 illus. This volume serves every need for understanding today's science and technology. Written by over 3,000 of the world's topmost experts, including 19 Nobel Prize winners, it covers 75 disciplines from Acoustics to Zoology.
454/825 Pub. Pr., \$95.00 Club Pr., \$66.50

MICROPROCESSORS IN INSTRUMENTATION AND CONTROL. By S. A. Money. 246 pp., 148 illus. Provides the design procedures and applications data you need to create effective, high quality microprocessor-based systems. There is thorough coverage of programming, arithmetic and logic operations, parallel input-output, serial input-output, hardware design, analog/digital conversion and much more.
427/070 Pub. Pr., \$38.00 Club Pr., \$28.50

MODERN COMMUNICATION CIRCUITS. By J. Smith. 557 pp., 434 illus. Using realistic examples, this book presents time-saving approximation techniques for analyzing and designing virtually every kind of communications circuit imaginable. Includes particularly thorough coverage of the phase-lock loop.
583/302 Pub. Pr., \$43.95 Club Pr., \$32.50

HANDBOOK OF MAGNETIC PHENOMENA. By H. E. Burke. 423 pp., 221 illus. A straightforward guide to over 60 magnetic phenomena. Topics include Ampere's Law, Biot-Savart and toroidal fields, spinning electric charges, magnetic hysteresis, magnetic field measurement, magnetic resonance, galvanomagnetic effects, and more.
583760-9 Pub. Pr., \$49.50 Club Pr., \$37.50

MODERN ELECTRONIC CIRCUITS REFERENCE MANUAL. By J. Markus. 1,264 pp., 3,666 circuit diagrams. Complete with values of components and suggestions for revisions—plus the original source of each circuit in case you want additional performance or construction details.
404/461 Pub. Pr., \$79.50 Club Pr., \$57.95

TELEVISION ENGINEERING HANDBOOK.—By K. B. Benson. 1,478 pp., 1,091 illus. Packed with the technical information and know-how you need to design, operate and maintain every type of TV equipment in current use. 047/790 Pub. Pr., \$89.50 Club Pr., \$62.50

OPERATIONAL AMPLIFIERS AND LINEAR INTEGRATED CIRCUITS, Third Ed. By R. F. Coughlin and F. F. Driscoll. 450 pp., illus. A detailed practical guide to the op amp and its successor, the linear IC. A variety of applications and design procedures are covered. 583754-4 Pub. Pr., \$34.95 Club Pr., \$25.95

THE ENCYCLOPEDIA OF ELECTRONIC CIRCUITS. By R. Graf. 760 pp., 1,256 illus. This large volume provides circuits for virtually every type of application in 98 different categories. Each has a clear and concise explanatory text accompanying it. 583265-8 Pub. Pr., \$50.00 Club Pr., \$39.95

CONTROL SYSTEM DESIGN: An Introduction to State-Space Methods. By B. Friedland. 513 pp., illus. Covers feedback control, dynamics of linear systems, frequency-domain analysis, linear observers, linear, quadratic optimum control, random processes, and many other topics. 224/412 Pub. Pr., \$41.95 Club Pr., \$31.50

INTRODUCTION TO RADAR SYSTEMS. By M. I. Skolnik. 2nd Ed., 698 pp., 244 illus. Covering every radar fundamental and all important changes, this EE text exposes you fully to the systems themselves—and to their applications! Topics include radar equation, CW and frequency modulated radar, MTI, pulse-doppler, tracking radar, receivers, displays, duplexers, noise, and more. 579/091 Pub. Pr., \$49.95 Club Pr., \$35.75

TROUBLESHOOTING ELECTRONIC EQUIPMENT WITHOUT SERVICE DATA By R. G. Middleton. 303 pp., 162 illus., and tables. Packed with charts, diagrams, and case histories, this practical handbook shows you how to pinpoint defective electronic circuitry when no service data is available. 583134-1 Pub. Pr., \$27.95 Club Pr., \$19.95

STANDARD HANDBOOK OF ENGINEERING CALCULATIONS. T. G. Hicks, Editor in Chief. 2nd Ed., 1,463 pp., 1,292 illus. and tables. Now revised, updated, and considerably expanded, this huge handbook provides more than 5,100 step-by-step procedures for solving the kinds of engineering problems you encounter most frequently in your work. 287/35X Pub. Pr., \$59.50 Club Pr., \$44.50

Be sure to consider these important titles as well!

FUNDAMENTALS OF LOGIC DESIGN & SWITCHING THEORY. By A. D. Friedman. 583601-7 Pub. Pr., \$26.95 Club Pr., \$21.50

68000 MICROPROCESSOR: ARCHITECTURE, SOFTWARE & INTERFACE TECHNIQUES. By W. A. Triebel & A. Singh. 583613-0 Pub. Pr., \$34.95 Club Pr., \$26.95

DESIGNING DIGITAL FILTERS. By C. S. Williams. 583627-0 Pub. Pr., \$36.95 Club Pr., \$27.95

APPLICATIONS IN ARTIFICIAL INTELLIGENCE. By S. J. Andriole. 583715-3 Pub. Pr., \$49.95 Club Pr., \$37.50

ILLUSTRATED ENCYCLOPEDIA OF SOLID-STATE CIRCUITS AND APPLICATIONS. By D. R. Mackenroth & L. G. Sands. 583719-6 Pub. Pr., \$34.95 Club Pr., \$26.50

THE FOURIER TRANSFORM AND ITS APPLICATIONS, Second Ed., Revised. By R. N. Bracewell. 070/156 Pub. Pr., \$45.00 Club Pr., \$31.50

DIGITAL FILTERS AND SIGNAL PROCESSING. By L. B. Jackson. 583710-2 Pub. Pr., \$32.95 Club Pr., \$26.50

MICROPROCESSOR SUPPORT CHIPS. By T. J. Byers. 095/183 Pub. Pr., \$43.50 Club Pr., \$35.25

ILLUSTRATED HANDBOOK OF ELECTRONIC TABLES, SYMBOLS, MEASUREMENTS AND VALUES. By R. H. Ludwig. 583705-6 Pub. Pr., \$34.95 Club Pr., \$25.95

INDUSTRIAL ROBOTICS. By M. P. Groover, R. N. Nagel and N. G. Odrey. 249/89X Pub. Pr., \$35.95 Club Pr., \$25.95

THE MCGRAW-HILL COMPUTER HANDBOOK. By H. Helms. 279/721 Pub. Pr., \$84.50 Club Pr., \$52.95



Why YOU should join now!

■ **BEST AND NEWEST BOOKS IN YOUR FIELD**—Books are selected from a wide range of publishers by expert editors and consultants to give you continuing access to the best and latest books in your field.

■ **BIG SAVINGS**—Build your library and save money too! Savings ranging up to 40% or more off publishers' list prices—usually 20% to 30%.

BONUS BOOKS—You will immediately begin to participate in our Bonus Book Plan that allows you savings up to 70% off the publishers' prices of many professional and general interest books!

■ **CONVENIENCE**—12-14 times a year (about once every 3-4 weeks) you receive the Club Bulletin FREE. It fully describes the Main Selection and Alternate Selections. A dated Reply Card is included. If you want the Main Selection, you simply do nothing—it will be shipped automatically. If you want an Alternate Selection—or no book at all—you simply indicate it on the Reply Card and return it by the date specified. You will have at least 10 days to decide. If, because of late delivery of the Bulletin you receive a Main Selection you do not want, you may return it for credit at the Club's expense.

As a Club member you agree only to the purchase of three books (including your first selection) during your first year of membership. Membership may be discontinued by either you or the Club at any time after you have purchased the first selection plus two additional books.

Other McGraw-Hill Book Clubs:
Architects' Book Club • Byte Book Club • Chemical Engineers' Book Club
• Civil Engineers' Book Club • Mechanical Engineers' Book Club

For more information, write to:
McGraw-Hill Book Clubs, P.O. Box 582, Hightstown, New Jersey 08520-9959

MAIL THIS COUPON TODAY

McGraw-Hill Book Clubs
Electronics and Control Engineers'
Book Club®
P.O. Box 582, Hightstown, New Jersey, 08520-9959

Please enroll me as a member and send me the two books indicated—billing me for the \$2.89 premium and my first selection at the discounted member's price, plus local tax, shipping and handling charges. I agree to purchase a minimum of two additional books during my first year of membership as outlined under the Club plan described in this ad. A shipping and handling charge is added to all shipments.

Write Code No. of
\$2.89 selection here

Write Code No. of
first selection here

Signature _____

Name _____

Address/Apt # _____

City _____

State _____ Zip _____

This order subject to acceptance by McGraw-Hill. All prices subject to change without notice. Offer good only to new members.

E33835

electrically conductive plastic sheet, the battery is not subject to the type of corrosion and leakage that is common to old-style cylindrically shaped batteries.

The *P500* lithium battery combines the high energy density and the high voltage of a lithium anode with a safe manganese-dioxide cathode. Fig. 6-*b* shows how the *P500* battery is built. Two three-volt lithium cells are packed into the same space as the *P100*. A unique hermetic seal and careful manufacturing controls result in an expected minimum shelf life of five years for the *P500*.

Temperature variation

Like most Leclanche batteries, the capacity of a *P100* battery is affected by temperature. Capacity is usually rated at 80°F. Figure 7 shows that, with a one-amp drain, capacity drops to a little over 60% at 20°F. At 120°F, there's about 5% "extra." The *P500* lithium battery is not significantly affected by temperature.

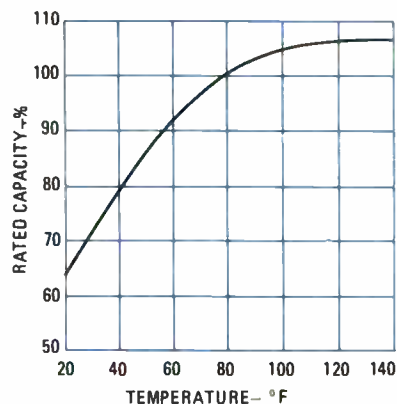

FIG. 7—HIGHER TEMPERATURE increases available capacity from a *P100*.

P100 curves

The performance curves of the *P100* shown here are based on a usage temperature of 80°F. Bear in mind that, if the temperature of your operating environment varies from 80°F, performance will also vary. And keep in mind the fact that some equipment generates heat as it operates; that heat will also affect operation.

The capacity of the *Polapulse* battery is measured in milliampere-hours (mAh) at a particular voltage with a constant current drain. Figure 8 shows the mAh capacity of a *P100* battery at continuous current drains of 1, 10, and 100 mA, and at 1 amp. If you want to know how long a *P100* could deliver ten mA before its output dropped to five volts, follow the ten-mA curve down to where it crosses the five-volt line. Moving straight down, that's about 150 on the mAh scale. Now divide 150 mAh by 10 mA, and you find that the battery should last 15 hours.

Figure 9 provides the same information in another way, but for a cut-off at 3 volts—the point where the *P100* delivers

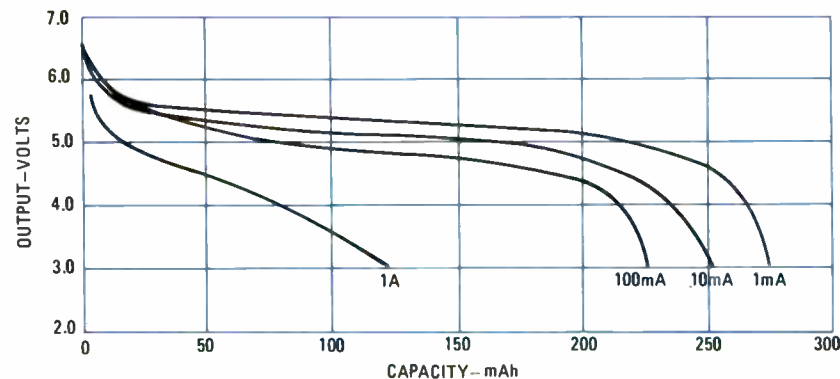

FIG. 8—CAPACITY OF A *P100* at various output voltages and currents.

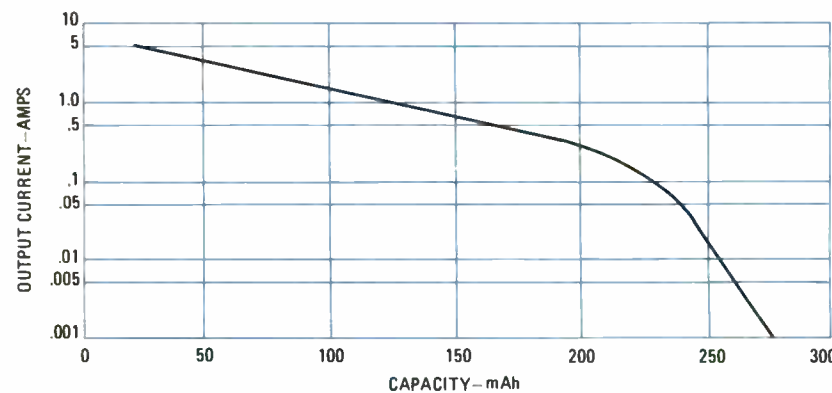

FIG. 9—CAPACITY OF A *P100* when output drops to three volts.

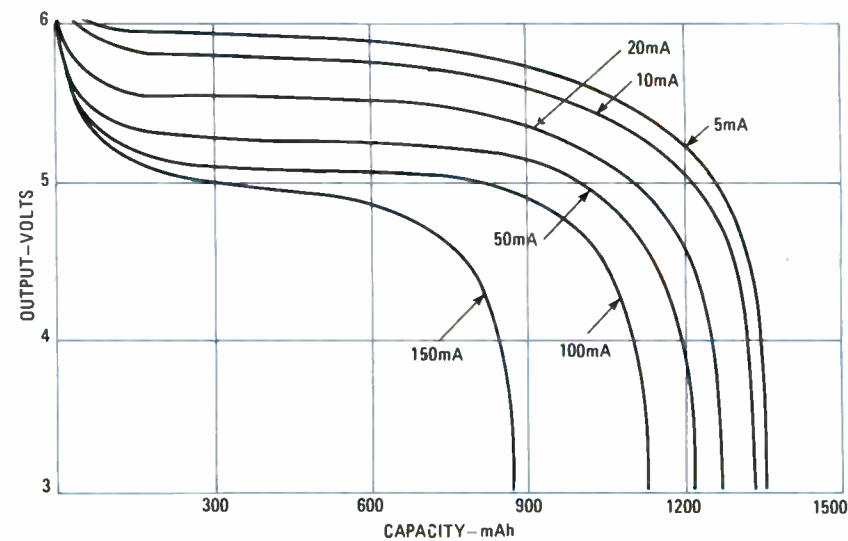

FIG. 10—CAPACITY OF A *P500* at various output voltages and currents.

only three volts at the specified current. For example, at 10 mA the curve shows about 250 mAh of capacity. That's the same value shown at the intersection of the 10-mA curve and the three-volt scale in Fig. 8.

P500 Curves

Figure 10 shows the performance characteristics of the *P500* lithium power

pack. Curves are shown for 5, 10, 20, 50, 100 and 150 mA. For example, at 10 mA, the curve crosses the five-volt line at about 1200 mAh. Dividing 1200 by 10 gives 120, which means the *P500* should provide 120 hours of service at a constant drain of 10 mA before output drops to five volts.

Figure 11 shows the three-volt cutoff point for the *P500*; that curve can be inter-

SAFETY INFORMATION

THE FOLLOWING QUESTIONS AND ANSWERS were provided by Polaroid specifically regarding the *Polapulse P100* battery:

Q: Are the chemicals used in the *P100* toxic?

A: In tests where rats were fed the complete *P100* chemical contents undiluted, no deaths resulted. Subsequent evaluation of internal organs showed no effect. The rats suffered no ill effects at the highest dosage level, which is the equivalent of a 100-pound person's eating 230 grams of the chemical, of which there are only 12 grams in a *P100* battery.

However, all batteries contain material that is severely irritating to the eye. In case of accidental eye contact with the liquid from any battery, flush the eye with water for 15 minutes and contact a physician immediately.

Q: Will it leak or explode?

A: The *P100* battery is nearly identical to the battery used in Polaroid's *SX-70* film packs. Hundreds of millions have been manufactured and used throughout the world with no reported leakage in normal use.

We have subjected the *P100* battery to a variety of tests to simulate customer misuse, and in no case did the *P100* battery leak or rupture explosively as other carbon-zinc batteries have been known to do. Some of those tests include the following:

- Electrical: Dead short for 24 hours; two batteries connected in reverse polarity; charging with a 9-volt dry-

cell charger, and with a 12-volt, 4-amp auto-battery charger; placing across a 110-volt, 60-Hz power line.

- Heat: 48 hours in 190°F oven; placed in paper fire and gasoline fire; grilled in 1200°F flames.

- Mechanical abuse: crushing in trash compactor; stapling; puncture with screw and 1/16" rod; run over with full-size car; pressed between aluminum plates; flexure/torque tests; chewing and biting simulation.

Q: What will happen if I cut the battery with scissors?

A: Our tests show that the chemical contents, which are in the form of a gel, do not leak from the battery. One can force gel out of a cut battery by kneading it. When cutting an unused battery, the scissors will temporarily short the cells; then small sparks and slight heating will occur, and gel will adhere to the scissors.

Q: Can a shorted battery cause a fire or a burn?

A: In the event of a dead short, the surface temperature of the *P100* battery rises to a maximum of about 63°C (145°F) in three minutes. That is too hot to hold comfortably, but not hot enough to burn the skin or ignite a fire. In some of our compaction and shorting tests, we attempted to make the battery light a fire. None occurred. However, deliberate shorting of any powerful 6-volt battery with a conductive combustible material can cause that material to ignite.

Q: Are there any problems with dis-

carded *P100* batteries?

A: Studies on disposal of charged and discharged *P100* batteries show no problems in disposal, including trash compaction or incineration. Disposed of in normal quantities, the *P100* poses no environmental problems and it can be mixed with household rubbish.

Q: How much mercury is in the battery, and is that amount of mercury hazardous?

A: The small quantity of mercury in the *P100* battery creates no environmental or toxicity hazard. Maximum total mercury in the *P100* battery is 50 mg—about a twentieth of a drop. That's about four percent of the amount found in AA alkaline batteries of equivalent voltage. That small quantity is present in the form of an insoluble amalgam, similar to the silver-mercury amalgam used in dental fillings. If incinerated, the mercury will vaporize, but the small amount released is readily diluted in ambient air. The amalgam form impedes leaching of mercury from discarded batteries.

Q: Can I use the *P100* battery in an explosive environment?

A: No six-volt battery capable of short-circuit current greater than 2.5 amperes (including normal lantern batteries and *P100* batteries) is recommended for use in an explosive environment without special safeguards.

R-E

puted just like the corresponding curve for the *P100*.

Consumer applications

Polapulse batteries have found their way into a multitude of products. They can be used in series or in parallel to increase voltage or current capacity. In most cases, the *P100* and the *P500* are interchangeable, but the *P500* provides more than four times the service life of the *P100*.

For example, the *Polapulse* battery has been used in a Hallmark musical greeting card, a Sears safety flasher, and an electronic kitchen scale. Sinclair uses a *P500* in its new flat-screen pocket TV (shown in Fig. 12), where it provides 15 hours of use. A *P100* can be used for about 2 hours.

The Exergen Corporation (307 West Central Street, Natick, MA 01760) makes several hand-held industrial instruments that use ultrasonic and infrared technology for distance and thermal measurements. Those instruments use the *P100* for power.

The *Rangescanner* (shown in Fig. 13) is a high-accuracy ultrasonic tape measure with digital readout; it can provide instant measurements from 1 to 35 feet. The *Microscanner* (shown in Fig. 14) infrared unit instantly measures temperature in either scan or direct mode. The extension lenses can narrow the field of view to as little as 200:1 for long-distance temperature scanning. Exergen makes other devices that use the *P100*.

Melard Technologies, Inc. (5 Westchester Plaza, Elmsford, NY 10523) markets *Access*, a portable personal-computer/terminal that is far smaller (8 1/4 × 3 1/4 × 1 1/8 inches) and more powerful than limited hand-held terminals.

Access has an 8-line × 40-character LCD display that windows a full 80-character by 24-line screen. In addition, *Access* has as much as 120K of memory, a full ASCII keyboard, and a telecommunications package built into the 24-ounce package. Small size, light weight, and dependable operation for extended periods of time were primary design pa-

rameters of *Access*, so it's not surprising that the internal power source is a slip-in *P500* Lithium Power Pack battery, good for 12 hours of continuous use.

IXO, Inc. (5757 Uplander Way, Culver City, CA 90230) offers an even smaller telecomputer. The *TC200*, is shown in Fig. 15. It is designed specially for use as a telex terminal, measures 7 1/4 × 1 1/4 × 4 1/4 inches, and weighs under a pound. The *TC200* includes a *P500* that provides power for one year of normal daily use, or 40 hours of continuous use. It includes a built-in modem and phone dialer, together with enough built-in programming and permanent memory to access any computer or data base from any telephone. The single-line 16-character screen windows an 80-character line; 8000 characters may be retained in memory.

What purrs, growls, shivers, quivers and makes you feel extra special when you just hug it? The *JUST HUGGIT* collection of huggable stuffed toys from AMERTON P. O. Box 10909, Marina Del Rey, CA 90291. Cleverly concealed in each bear,

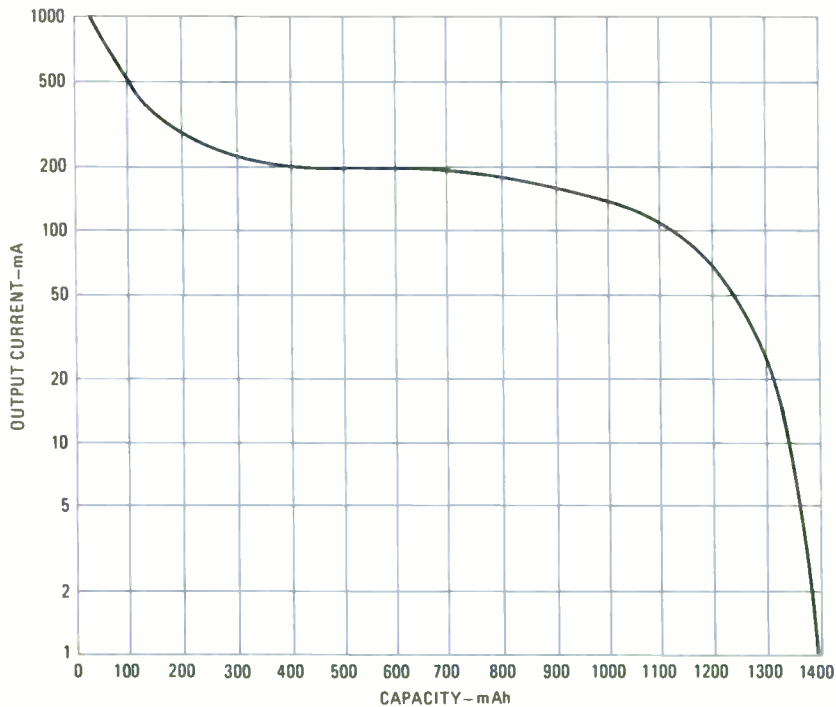

FIG. 11—CAPACITY OF A P500 when output drops to three volts.



FIG. 12—SINCLAIR POCKET TV uses a P500 for power.



FIG. 13—THE ULTRASONIC RANGESCANNER measures distance and uses a Polapulse battery for power.

cardboard holder. The "used" battery often has plenty of power remaining. In general, you can put a "used" P80 in service just about anywhere you need a source of six-volts DC. Any portable de-

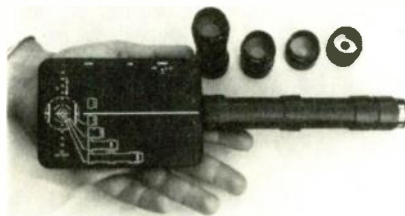

FIG. 14—THE MICROSCANNER can measure temperature from a distance by using special lenses.



FIG. 16—THE TC200 is a portable telecomputer that provides 8K of RAM and a built-in modem. It's powered by a P500.

vice that normally devours carbon/zinc batteries is a candidate for use with a P80.

Figure 16 shows a "power pack" made by mounting a P80 inside a plastic cassette box. Just bring two contact leads out to a snap connector. A piece of foam rub-

ber prevents the battery from flopping around the inside of the box.

You can use the power pack for all sorts of things. For example, the author uses one to operate a portable six-volt cassette

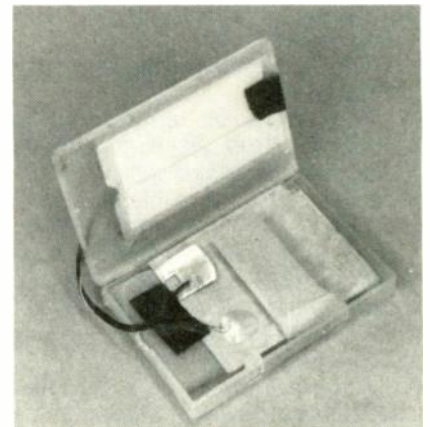

FIG. 18—A USED P100 BATTERY can be mounted in a discarded audio-cassette box.

recorder used to play motivational tapes on early-morning walks. The left-over power in the battery runs the recorder for about two hours.

Also shown in Fig. 16 is how we used a P80 to solve a nagging problem. Some years ago the author paid \$30 for a rechargeable calculator. Some time after purchase, the internal six-volt rechargeable battery pack died and could not be replaced. So we mounted the calculator on a cassette box containing a P80. Two wires are soldered to the battery contacts inside calculator. The P80 saved a good calculator from being discarded.

Battery sources

The PowerCard Corporation (454 Brookline Street, Newton, MA 02159) is the exclusive distributor of Polaroid batteries. They sell the spring contacts mentioned earlier, as well as a series of "Designer Kits."

The P100 Designer kit, Part Number 604155, contains five P100 batteries and a pre-wired plastic battery holder for \$16.75, postpaid. The P500 kit, Part Number 606166 consists of two P500 batteries, two P100 batteries, and a pre-wired plastic battery holder for \$22.50, postpaid.

For single battery needs, your local hobby shop may carry the P100 (for about \$4 each), since it is used in model rocketry. You can also call Polaroid Customer Service at 1-800-225-1384 to purchase small quantities of the P100 (\$3.50 each) or the P500 (\$5.25 each.)

Also, dealers that carry the Sinclair Flat Screen TV also offer three P500's for \$9.95—which is less each than a P100 directly from Polaroid or from your local hobby shop! One source for P500 three-packs is Curry Computer (P.O. Box 5607, Glendale, AZ 85312-5607). One three-pack costs \$10.95, postpaid.

R-E

panda, chimp, dog, puppy, or cartoon character is a patented pressure-sensitive responsive mechanism powered by a P100.

Experimenter applications

The film pack of the Sun 600 camera is a perfect source for a Polapulse battery. The plastic frame of the film pack pulls apart easily; inside the frame is a P80 Polapulse battery neatly packaged in a

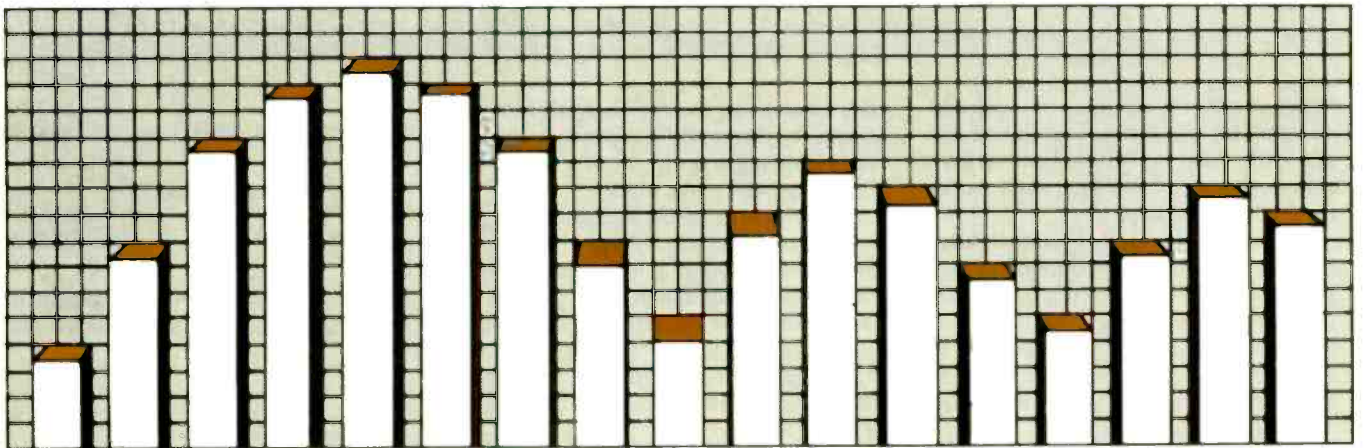
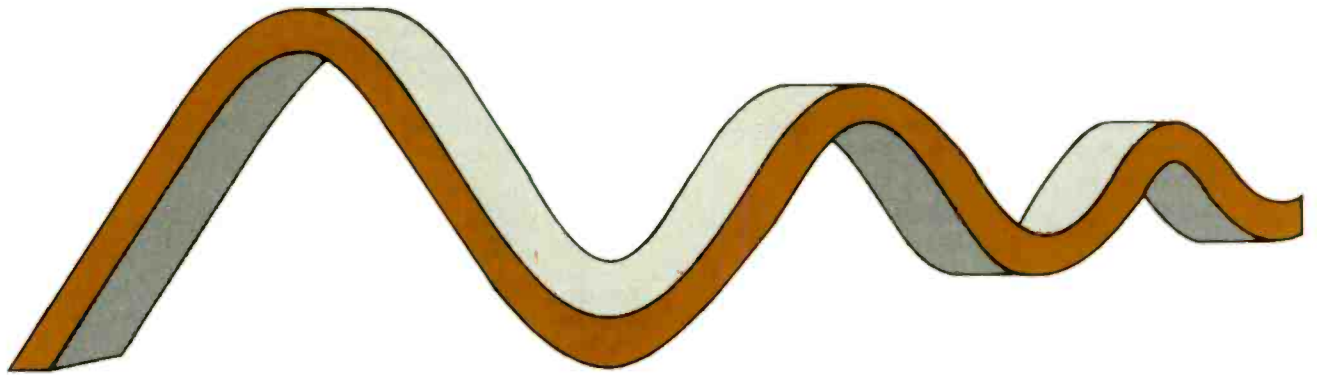

All About A-to-D Converters

There's no mystery about the analog-to-digital converter. In this article we show you how it works and how to connect it to a microprocessor.

HARRY L. TRIETLEY

COMPUTERS HAVE COME A LONG WAY from calculating and accounting machines. Now they control automobiles, refrigerators, and washing machines; measure laboratory data; and guide robots. Many applications these days require real-time input of real-world quantities including temperature, speed, position, and force—and maybe even graphic images.

However, those types of analog quantities must be converted to digital form—a process called *digitization*—in order to be processed by a computer. The basic concepts of analog-to-digital conversion have been known and used for a long time, but today's advances in IC technology have brought tremendous improvements in performance, miniaturization, and cost. In this article we'll learn how the ADC (Analog-to-Digital Converter, also called an A/D converter) works, discuss the different types that are available, and see how to connect an analog-to-digital converter to a microprocessor.

ADC types

There are five types of ADC's in general use: Voltage-to-Frequency (V/F), dual-slope integrating, successive-approximation, tracking, and parallel (or "flash") converters. Table 1 shows some of the strengths and weakness of each type.

Integrating and V/F converters are relatively slow, typically requiring from several milliseconds to a significant fraction of a second to perform a conversion. On the other hand, they're capable of high resolution at moderate cost, and they offer the additional advantage of inherent noise filtering. Dual-slope integrating A/D converters are widely used in digital voltmeters and in other single-input meters and instruments.

Successive-approximation converters are fairly fast, completing a conversion in one to several microseconds. Resolution is typically eight bits, which provides 2^8 or 256 discrete values. Some successive-approximation converters now provide twelve or even sixteen bits of resolution,

which yield 4096 and 65,536 discrete values, respectively. The conversion time of a successive-approximation converter increases as the number of bits increases. Generally available units are fast enough to deal with signals having frequencies into the audio range. They're also good for quickly converting multiplexed, switched inputs often found in data-acquisition and other types of microprocessor applications.

The output of a tracking converter continuously follows its analog input. The tracking converter is slow, but it can follow small changes in input rapidly. It is easily modified to function as a track-and-hold or peak-reading device.

The parallel, or "flash" converter performs essentially instantaneous conversions. It is fast; some operate as fast as 100 MHz. Flash converters are mainly used for high-speed processing of video data in applications including radar, digital oscilloscopes, and digital TV. The disadvantage of the flash converter is that

TABLE 1—A/D CONVERTERS

Type	Speed	Resolution	Comments
Voltage-to-frequency converters	Several kHz to 100 kHz	Depends entirely on number of pulses counted or on resolution of period measurement.	Inexpensive
Integrating converters, including dual-slope integrators	Milliseconds to hundreds of milliseconds.	Typically 3½ to 5½ digits (11 to 18 bits)—higher possible.	Most common for high-accuracy digital meters.
Successive-approximation converters	1 to several microseconds.	Typically 8 to 12 bits, 16 bits available.	Widely used in microprocessor applications.
Tracking converters	1 microsecond or less per step; may be milliseconds for full-scale change.	Typically 8 to 12 bits, 16 bits available.	Good for track-and-hold or peak-reading applications.
Parallel ("flash") converters	Sub-microsecond; up to 10 ⁸ conversions per second.	Typically 4 to 6 bits, 8 bits available.	Expensive. Used for video and other high-speed data.

circuit complexity doubles with each added bit of resolution; hence resolution usually is low. Four to six bits of resolution is typical, although eight-bit units are commercially available.

A/D converters are available commercially in several forms, including integrated circuits, hybrid packages, and circuit-board assemblies. Many include input/output interface circuits such as addressable-analog-input multiplexers, sample-and-hold circuits, and microprocessor interface circuitry.

Now that we've got some idea of what each of the five types of A/D converters can do, let's look at each in detail.

V/F converters

A voltage-to-frequency converter is shown in Fig. 1. In that circuit, R_{IN} , C_{INT} , and the op-amp form an analog integrator. Negative feedback holds the non-inverting input at ground, so the current in R_{IN} is equal to V_{IN}/R_{IN} . Op-amps have high input impedance, so all of R_{IN} 's current

flows into C_{INT} , thereby charging it. As a result, the integrator's output charges linearly (in a negative direction) at a rate that is proportional to the input.

Meanwhile, reference capacitor C_{REF} is charged negatively by V_{REF} . When the integrator's output goes negative, the comparator sends a high to the pulse generator. The pulse generator's output operates switch $S1$, and causes C_{REF} to discharge into the integrator's input. That discharge returns the op-amp's output to a positive level.

The op-amp's non-inverting input remains at ground, due to negative feedback, and that allows C_{REF} to discharge completely. The charge that leaves C_{REF} flows into C_{INT} , causing an output increase equal to:

$$\Delta V = V_{REF} \left(\frac{C_{REF}}{C_{INT}} \right) \quad (\text{EQ. 1})$$

The time required for the output to return to zero comes from this equation:

$$\Delta V = \frac{1}{R_{IN} C_{INT}} (V_{IN} T) \quad (\text{EQ. 2})$$

which may be rearranged as:

$$T = \frac{R_{IN} C_{INT} \Delta V}{V_{IN}} \quad (\text{EQ. 3})$$

Because frequency is the inverse of period, that equation can be written like this:

$$f = \frac{V_{IN}}{R_{IN} C_{INT} \Delta V} \quad (\text{EQ. 4})$$

Then, substituting equation 1 for ΔV , we obtain:

$$f = \frac{V_{IN}}{R_{IN} C_{INT}} \cdot \frac{1}{V_{REF}} \cdot \frac{C_{INT}}{C_{REF}} \quad (\text{EQ. 5})$$

which reduces to:

$$f = V_{IN} \cdot \frac{1}{R_{IN} C_{REF}} \cdot \frac{1}{V_{REF}} \quad (\text{EQ. 6})$$

Note that the circuit's output frequency depends on the input voltage, as well as reference voltage V_{REF} and components C_{REF} and R_{IN} .

The digital representation of the analog input frequency is obtained by counting pulses for a period of time. The length of time depends upon the resolution required; for ten-bit resolution (about 0.1% of full scale), time should be long enough to count 1,024 pulses at the full-scale frequency. Typical frequencies are tens of kHz; a ten-bit conversion at 10 kHz requires just over 10 ms. Each additional bit doubles the time requirement; however, extremely high resolution is possible at low cost. Of course, for best accuracy it is necessary to use high-grade components in the circuit.

When both high resolution and high speed are required, period may be measured, rather than frequency. Measuring period is accomplished by counting the number of pulses from a clock during one

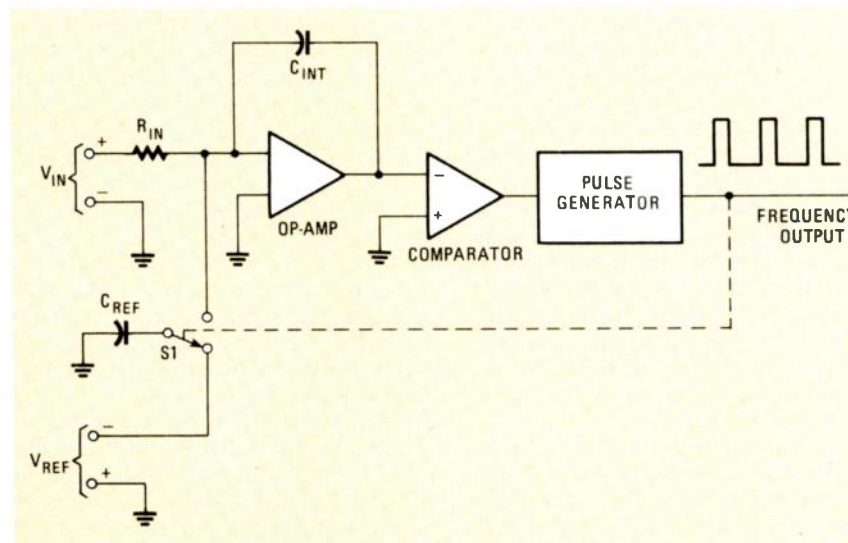

FIG. 1—A VOLTAGE-TO-FREQUENCY A/D CONVERTER charges and discharges C_{INT} at a rate that is proportional to the input voltage.

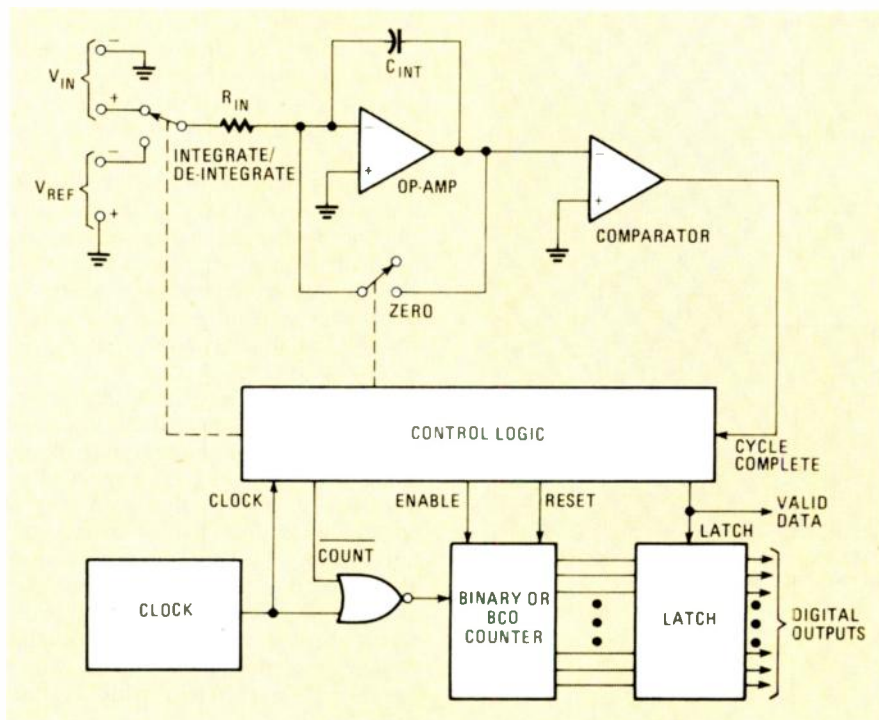

FIG. 2—IN A DUAL-SLOPE INTEGRATING A/D CONVERTER, C_{INT} is charged and then discharged. The discharge time, which is proportional to the input voltage, is counted and latched for output.

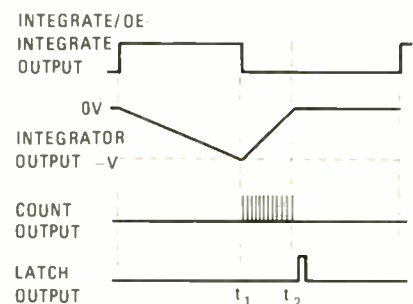

FIG. 3—BY COUNTING THE NUMBER OF PULSES between t_1 and t_2 , a digital representation of the analog input is obtained.

cycle of the converter's frequency output. There are drawbacks to that approach, however. The main drawback is that conversion time increases as V/F output frequency drops. For example, obtaining ten-bit resolution at 10 kHz requires a relatively high clock frequency of 10.24 MHz. Another drawback is the fact that it is necessary to perform division to produce a number that is proportional to V_{IN} .

Dual-slope integration

The conversion accuracy of a dual-slope integrating A/D converter depends primarily on a single reference voltage. Like the V/F converter, a great deal of resolution is possible if long conversion times are acceptable. The block diagram of a typical integrating converter is shown in Fig. 2; its timing diagram is shown in Fig. 3. Refer to both as we discuss how the circuit works.

At the start of conversion C_{INT} is discharged. The integrator is connected to V_{IN} for a fixed time, t_1 , during which the

output of the integrator ramps negatively. The final voltage is determined by:

$$V = \frac{1}{R_{IN} C_{INT}} (V_{IN} t_1) \quad (\text{EQ. 7})$$

At the end of t_1 the integrator's input is switched to V_{REF} , a fixed, negative reference voltage. The integrator discharges, or 'de-integrates,' at a fixed rate until it equals zero (at time t_2) and the comparator stops the cycle. Because the change in voltage equals ΔV , t_2 may be calculated as follows:

$$\Delta V = \frac{1}{R_{IN} C_{INT}} (V_{REF} t_2) \quad (\text{EQ. 8})$$

In terms of time:

$$t_2 = \frac{R_{IN} C_{INT} \Delta V}{V_{REF}} \quad (\text{EQ. 9})$$

Combining equations 7 and 9:

$$t_2 = \frac{V_{IN}}{V_{REF}} (t_1) \quad (\text{EQ. 10})$$

Note that the relationship between t_2 and V_{IN} is affected only by V_{REF} and t_1 . Further, if t_1 and the output count are derived from the same clock, changes in the clock frequency will not affect that relationship.

During the de-integrate time, clock pulses are counted, producing a total that is proportional to V_{IN} . At the end of the cycle the new count is transferred to the output latch, the counter is reset to zero, and C_{INT} is discharged.

Commercially available dual-slope integrating converters include circuit refinements not shown here. Most are able to convert both positive and negative inputs, and include an output line that indicates input polarity. They also contain sophisticated auto-zero circuitry that not only discharges the integrating capacitor but also compensates for input offset voltages of the op-amp and the comparator. Conversion rate depends on clock frequency and required resolution. Normally, a few conversions can be done per second.

Dual-slope integrating converters provide inherent noise filtering, since the input is filtered by the RC integrator. If the integration time (t_1) is equal to a multiple of the power-line frequency, stray pickup is averaged to zero.

The combination of high accuracy, high resolution, and slow speed best suits dual-slope A/D converters to measuring steady or slowly changing quantities. They are most commonly used in instruments such as DVM's, digital thermometers, and digital panel indicators.

Successive-approximation

These are by far the most common A/D converters in computer and data-acquisition applications. They're fast—conversion speeds of 100,000 or more per second are not uncommon—and that makes them ideal for digitizing several multiplexed analog inputs in a short time. IC-packaged devices are available with eight to twelve bits; accuracy ranges from 0.125% to 0.020%. Sixteen-bit hybrid devices are also available.

The theory of operation is straightforward. Figure 4 illustrates the principle, and Fig. 5 shows a typical sequence for a four-bit converter. A comparator compares the analog input signal to the output of a Digital-to-Analog (D/A) converter, which, in turn, is controlled by logic circuitry known as a Successive Approximation Register (SAR).

The circuitry inside a SAR can be quite complex. However, single-IC SAR's are available, so design is simplified. Under clock control, the SAR outputs are set to zero. Assuming the input is positive, the SAR then turns on the first (most significant) bit. If the comparator decides that the D/A's output is less than the input, that bit is left on; otherwise it's turned off. That same process is carried out on each bit in turn, until the least-significant bit has been compared. Then the DATA VALID line from the converter indicates that the conversion is finished.

In the example shown, V_{IN} is about ten volts. First bit eight is turned on and left on, because eight is less than ten. Then bit seven is turned on and then turned back off, because twelve is greater than ten. The process continues until the combination of bits equals the input voltage.

The example circuit can handle only

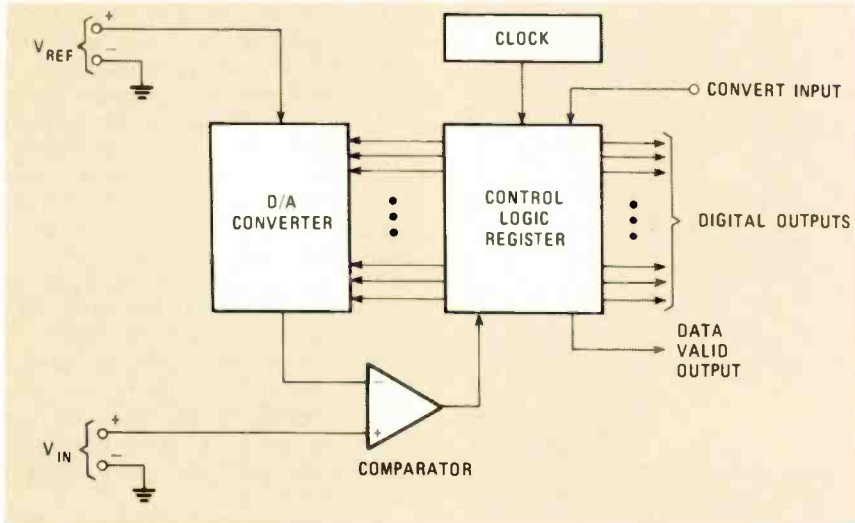

FIG. 4—THE SUCCESSIVE-APPROXIMATION CONVERTER compares the input voltage to voltages generated by the D/A converter until the latter's output matches the input.

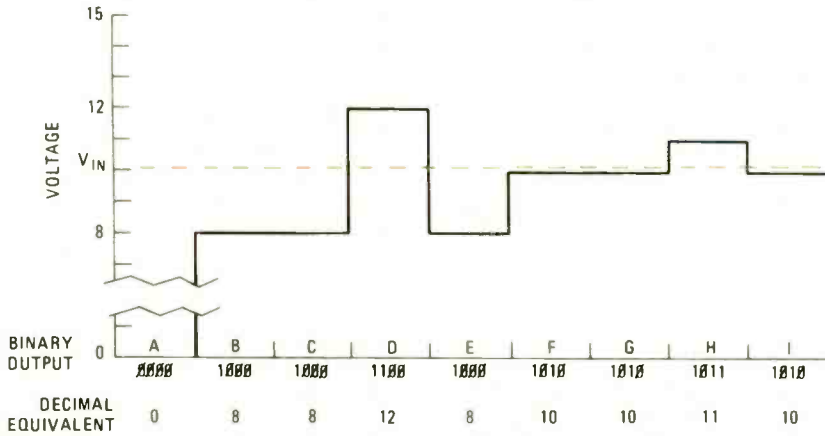

FIG. 5—SUCCESSIVE-APPROXIMATION CONVERTER EXAMPLE: Assume that V_{IN} is ten volts. Various bits from the D/A converter are turned on (from MSB to LSB) until the D/A's output equals V_{IN} .

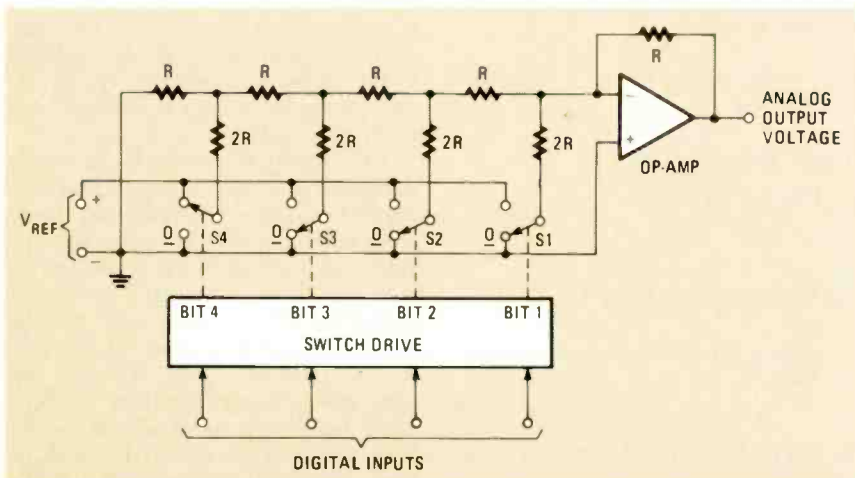

FIG. 6—THE HEART OF MANY D/A CONVERTERS is an R-2R network of resistors. Sixteen discrete output voltages can be generated in this four-bit circuit.

positive inputs. If bipolar operation is required, an offset equal to 50% of full scale must be added to the comparator's reference input. That results in an offset binary code; in our four-bit example, 1000 equals zero, 1111 equals 7, and 0000 equals -8.

We won't go into the workings of the SAR, except to say that it usually consists of a shift register and other logic circuitry. But we will discuss the D/A converter, because those are useful for converting computer outputs into analog signals.

D/A converter

The most common arrangement, shown in Fig. 6, uses a series of solid-state switches and a resistive ladder network (known as an R-2R network, because the 2R resistors have twice the resistance of the R resistors). Each switch, when connected to V_{REF} , increases the amount of current entering the inverting input of the op-amp. The switches are usually weighted according to binary value. (Other weightings, such as binary-coded decimal, are possible, but will not be discussed here.)

To understand how the ladder works, suppose that S4 is connected to V_{REF} and that the others are grounded. Since the op-amp's inverting input is maintained by feedback at ground, the input current comes entirely from the 2R resistor connected to S4. That current equals $V_{REF}/2R$. In addition, that current flows through the op-amp's feedback resistor, which also has a value of R. The output voltage is then equal to $-I \cdot R$, which equals $-(V_{REF}/2R) \cdot R$, which equals $-(V_{REF}/2)$.

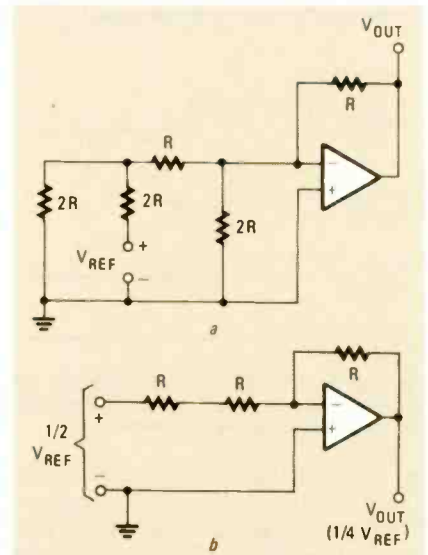

FIG. 7—IF S2 (IN FIG. 6) IS ON, the resistor network is equivalent to that shown in a. That network can be further simplified as shown in b.

Now, imagine instead that only bit 2 is turned on. By combining resistors in parallel and in series, you can see, as shown in Fig. 7-a, that the equivalent resistance of all the resistors to the left of the bit 2 position is 2R. The voltage divider composed of V_{REF} and the 2R resistors can be further simplified to a single resistor, R, and a voltage equal to $1/2 V_{REF}$ as shown in Fig. 7-b. The circuit is thus equivalent to a simple inverting amplifier with a gain of $-1/2$.

Similar (but more complex) analysis shows that bit 3 contributes $-V_{REF}/8$, and bit 4, $-V_{REF}/16$. Furthermore, the individual contributions may be summed together when more than one switch is on.

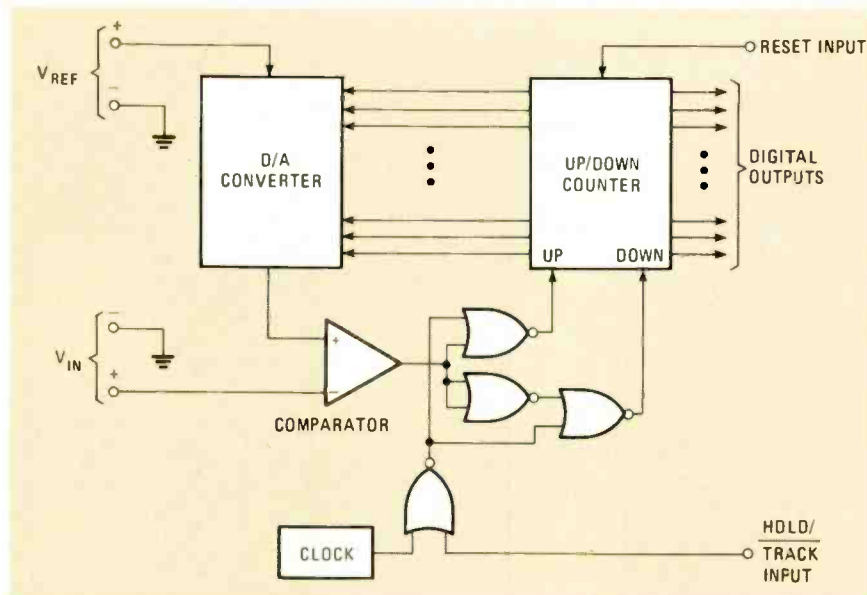

FIG. 8—IN A TRACKING A/D CONVERTER, the comparator controls operation of the up/down counter, which in turn controls a D/A converter. The output of the latter is what is compared to the input signal.

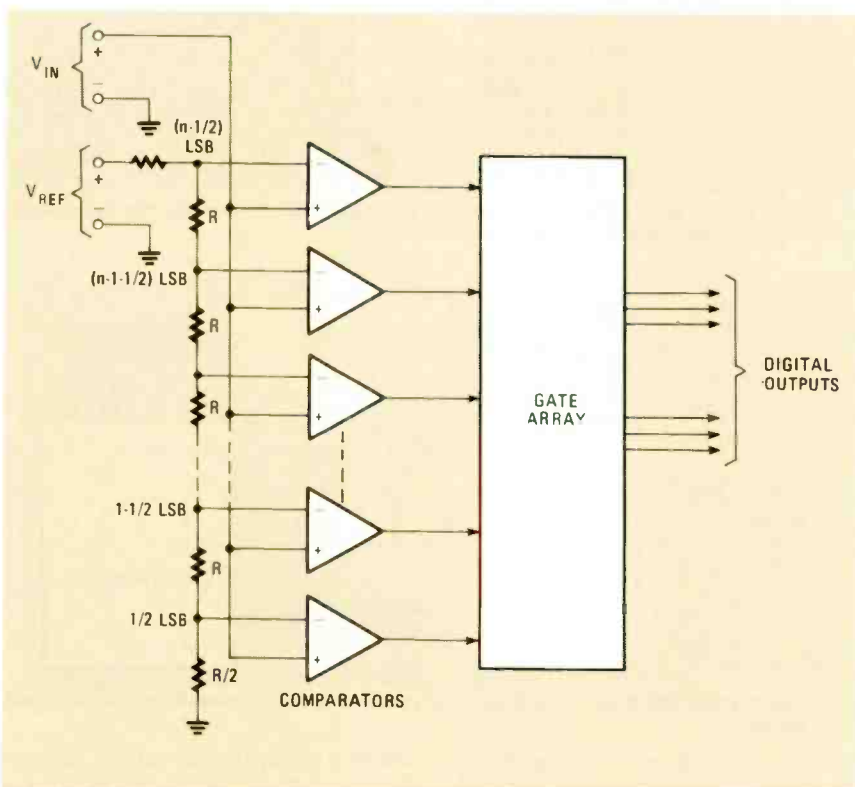

FIG. 9—THE FLASH CONVERTER makes all comparisons at once, so it can operate at extremely high speeds. The disadvantage is circuit complexity.

and switches in the D/A converter double with each added bit. Precision is critical; at no point must an increasing digital signal result in a decreasing analog output signal. The resistor ratios and their temperature tracking must be no worse than ± 1 LSB (Least Significant Bit). In an eight-bit converter, ± 1 LSB equals 0.25%; at twelve bits that becomes 0.025%; and at sixteen bits, less than 0.002%. The "off" leakage and the "on" resistance of the analog switches must be closely matched (or compensated for). High resolution carries a high price tag; the practical limit is about 16 bits. By contrast, dual-slope integration can readily be carried out to an accuracy of one count in a million (20 bits).

Tracking converters

The tracking A/D converter, diagrammed in Fig. 8, provides nearly instantaneous tracking of small input changes. Like the successive-approximation converter, the tracking converter compares the input to a signal fed back from a D/A converter driven by the digital output.

Logic gates controlled by the output of the comparator direct pulses from a clock to an up/down counter, causing the count to increase if the input is greater than the feedback voltage or to decrease if it is less. Unlike the other converters discussed so far, the digital output will track a one-bit change in the output in just one clock cycle. Noise will be followed just as any other input, but will not result in erroneous output codes. Tracking of large changes is slow; a twelve-bit converter requires 4096 clock pulses to go from zero to full scale. The accuracy of components in the D/A converter must be high, as with the successive-approximation converter.

Tracking converters are not often used for conventional data acquisition, but are useful in track-and-hold applications, in which an input signal is followed until the clock is disabled by an external logic input. Tracking converters also make excellent peak-reading devices. By disabling the counter's DOWN input, the converter will follow input increases and hold the highest reading until a new input exceeds it (or until the counter is reset to zero).

Parallel converters

Easy to understand but expensive to build, a parallel converter provides almost instantaneous A/D conversion (hence the nickname *flash* converter). The basic circuit, shown in Fig. 9, uses a precision voltage divider to create a series of equal reference voltage-increments. A bank of comparators compares each of those voltages to the input voltage, and each turns on when the input exceeds its particular reference. If each of the comparators drove a lamp or LED, a bar-graph type display would result.

The total output is an analog voltage that is proportional to the digital value of the 4-bit word.

Keeping the basics of D/A converters in mind, now let's resume our discussion of the successive-approximation converter.

In that type of ADC, a complete conversion takes only a few clock cycles, so conversion can occur in microseconds. Unlike integrating converters, however, it is mandatory that the input remain steady

and noise-free throughout the conversion. If the value of the input changes from one comparison to the next, erroneous comparisons will take place, possibly resulting in erroneous outputs. For that reason, the successive-approximation converter is usually preceded by a sample-and-hold circuit. In fact, some IC and hybrid devices include a built-in sample-and-hold circuit.

The demands on the ladder network

An array of logic gates combines those outputs to form the desired digital output code (binary, BCD, etc.). In the circuit shown no clock is required; however, in most applications it is necessary to clock the output into a digital latch in order to hold the reading steady while it is read by a computer or microprocessor. Sampling rates of 10 or 20 MHz are common, and at least one commercially available IC functions as fast as 100 MHz.

Circuit complexity essentially doubles with each added bit. A one-bit converter requires one comparator, two bits require three comparators, three bits require seven comparators, etc. The complexity of the gate array similarly increases. It is circuit complexity, rather than component accuracy, that limits the size of parallel A/D converters. Six-bit flash converters (which require 63 comparators) are common; eight-bit units (which require 255 comparators) are available.

The number of bits of resolution can be doubled using a "half-flash" or two-step flash converter. As shown in Fig. 10, doubling is done by using separate circuitry for the most and the least significant parts of the analog input. Conversion time is doubled using that approach.

The analog input is applied to the first comparator string to determine the most significant part of the input signal. The output of the first gate array is converted to analog form and subtracted from the input to obtain the least significant part. That signal is applied to a second string of comparators to produce the LSB outputs.

A word of caution: you cannot make an accurate twelve-bit converter from two six-bit flash converters. The first comparator string (and the D/A converter) must provide enough accuracy that the difference signal's error is no more than one LSB. The accuracy requirement makes the two-step flash converter somewhat expensive. But all flash converters are expensive.

Microprocessor interface

A/D converters operate sequentially, periodically updating their outputs, and generally producing incorrect (or no) outputs between conversions. Computers also operate sequentially according to a programmed set of instructions, and may not necessarily be able to receive data when the converter is ready to send it. Therefore, communications must proceed according to a defined sequence. The process is often called handshaking.

Figure 11 shows the basic interface circuit. First the microprocessor must select the A/D converter through its addressing mechanism. Then it sends the ADC a signal (CONVERT) that tells it to start its conversion cycle. Conversion requires some time to complete, so the microprocessor waits for it to finish. When it does, the DATA-READY signal informs the micro-

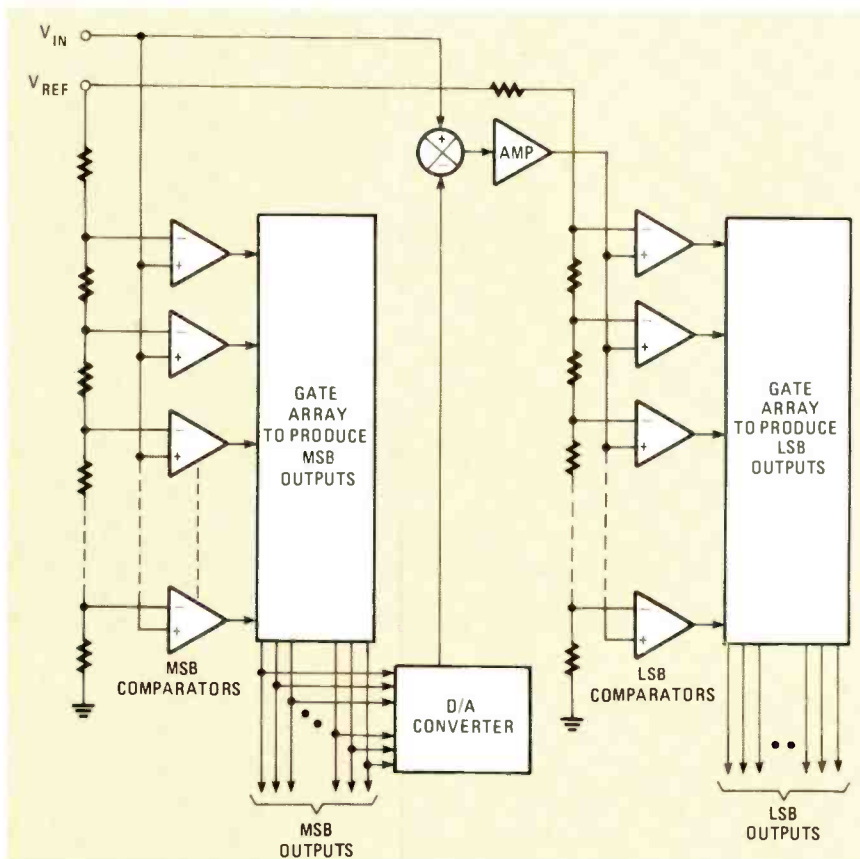

FIG. 10—THE TWO-STEP FLASH CONVERTER makes its conversion in two steps, thereby increasing resolution. Conversion speed is reduced, however.

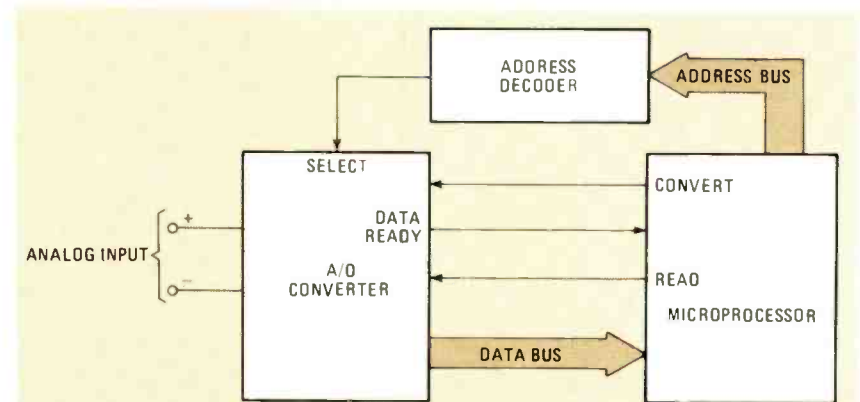

FIG. 11—MICROPROCESSOR INTERFACE for an A/D converter is straightforward, requiring only three control inputs.

processor that conversion is complete, at which time it can re-address the ADC and read its output via the data bus.

The whole process may be interrupt driven. In that case, the DATA-READY line is connected to an interrupt input on the microprocessor. Then, assuming the software is set up to recognize and process the interrupt, any time a conversion is complete, the microprocessor will stop its current task, read the ADC data, store it, and then resume the previous task. The previous task and the data-gathering task may be totally unrelated.

Data-bus width can be a problem. If you use a twelve-bit converter with an eight-bit data bus, two reads will be nec-

essary in order to capture all bits. In fact, a third read may be necessary in order to capture internal status bits and flags.

Control and output lines vary from converter to converter. With some the actual functions vary, and with others, only the name differs.

Control inputs generally include one or more lines (called *chip select* or *chip enable*, for example) to address the IC. Other control pins activate the outputs. Different IC's vary greatly in output control. For example, there may be HIGH-BYTE ENABLE and LOW-BYTE ENABLE pins. But there is not universal agreement about how bits in a twelve-bit converter, for example, should be split. In some, the

R-E Satellite TV Admart

Rates: Ads are 2 1/4" x 2 7/8". One insertion \$825. Six insertions \$800 each. Twelve insertions \$775 each. Closing date same as regular rate card. Send order with remittance to Satellite TV Admart, Radio-Electronics Magazine, 500-B Bi-County Blvd., Farmingdale, NY 11735. Direct telephone inquiries to Arline Fishman, area code-516-293-3000. Only 100% Satellite-TV ads are accepted for this Admart.

TV-DXers HANDBOOK

BP176—A TV-DXERS HANDBOOK \$6.95. Detailed text on the possibilities and problems of receiving television signals over long distances and resolving such pictures with the minimum of distortion on the TV screen. Included is a satellite-TV section that presents a great deal of information for this subject area. To get your copy of this book send \$6.95 plus \$1.75 shipping to Electronic Technology Today Inc., P.O. Box 240, Massapequa Park, NY 11762-0240.

A TV-DXers Handbook



CONTROL YOUR DESTINY KNOWLEDGE IS POWER

- HOME SATELLITE TV INSTALLATION & TROUBLESHOOTING MANUAL (Spanish or English) *The knowledgeable industry home TVRO bible* \$29.95
- HOME SATELLITE TV INSTALLATION VIDEOTAPE *Install & tune up your TVRO* (Spanish or English) \$39.95
- THE HIDDEN SIGNALS ON SATELLITE TV *Your TVRO can detect much more!* \$19.95
- New Book Releases—
- KU-BAND SATELLITE TV—THEORY, INSTALLATION AND REPAIR *The Ku-Band Bible—166 pages* \$19.95
- SATELLITE & CABLE TV SCRAMBLING & DESCRAMBLING *Understand the Videotapher and Clak Clon Decoders* \$19.95



—ORDER NOW—
Send cost plus \$2 shipping for each item to
BAYLINGER PRODUCTIONS
1905 Mariposa — Suite 105
Boulder, CO 80302
TO ORDER ONLY
1-800-634-2255 EXT. 310 (NATIONAL)
1-800-847-4663 EXT. 310 (CALIF.)
FOR ANY OTHER INFORMATION
13031 449-4551
Add \$1 per item when using
VISA/MASTERCARD
©1987 BAYLINGER PRODUCTIONS, INC.

CONFIDENTIAL FREQUENCY LIST

CONFID—CONFIDENTIAL FREQUENCY LIST by Oliver P. Ferrell, Sixth Edition Revised \$15.95. Contains the latest available information on the most interesting communications stations operating on the shortwave bands. The listing represents stations actually in operation and being heard by active monitors. To get your copy send \$15.95 plus \$2.75 shipping to Electronic Technology Today Inc., P.O. Box 240, Massapequa Park, NY 11735-0240.

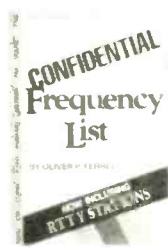

high section includes four bits; in others, the high section includes eight bits. In yet other converters, all twelve bits are available separately for use with a sixteen-bit data bus or with external buffers and latches.

A converter may or may not contain its own clock. Some offer the choice of full twelve-bit conversion, or eight-bit conversion in a shorter period of time. A separate control input allows you to choose.

Other than data outputs, other A/D-converter outputs may include DATA READY (also called STATUS), OVERRANGE, and even POLARITY.

Some A/D converters include addi-

tional functions, such as analog input multiplexers and sample-and-hold circuits.

Such A/D converters, of course, require additional input control lines for those functions.

It is not our purpose in this article to go into detail on designing and programming microprocessor-controlled A/D converters. We will, however, say a few words on how the processor addresses the A/D converter, and on how it chooses among several inputs.

Input selection

Computer-controlled systems can have dozens, or even hundreds, of inputs. For

simplicity, Fig. 12 shows a system with two A/D converters. Addresses 1 and 2 are assigned to A/D-1, and addresses 3 and 4 are assigned to A/D-2.

The converters in the illustration have three inputs: CONVERT, HIGH-BYTE ENABLE, and LOW-BYTE ENABLE. Writing to address 1 strobes the CONVERT input of A/D-1. Writing to address 3 strobes the CONVERT input of A/D-2.

After giving the convert command, the microprocessor can go on about its business. When conversion is complete, the \overline{DR} will strobe the NAND gate, and trigger the microprocessor's interrupt input. What happens next depends on the program, but, for example, the processor might collect A/D-1's high byte by reading address 1, and then the low byte from address 2.

That example showed use of a separate A/D converter for each analog input. That's fine for illustrative purposes, but such a circuit can be very costly to implement where large numbers of converters are involved. Usually it's less expensive to use one converter and multiplex its input. Circuitry to do so would be similar to that shown in Fig. 12, but, rather than addressing individual CONVERT enable lines, analog switches or transistors would connect the A/D converter to the desired input.

Conclusions

The A/D converter is used for scientific data gathering, voice recognition, test instrumentation, and in many other types of applications. We hope that this introduction will provide you with a basic understanding of how those sophisticated systems work, and that it will enable you to start working with A/D converters on your own. If you plan on building the R-E Robot, then you can probably dream up hundreds of applications for analog-to-digital converters.

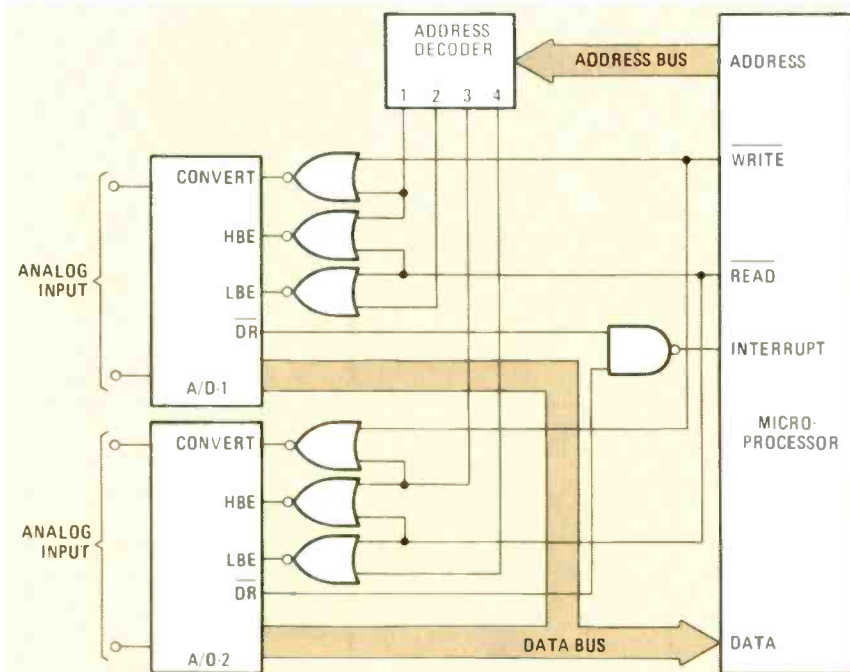

FIG. 12—SEVERAL D/A CONVERTERS may be connected to a single microprocessor as shown here. The circuit could be expanded by providing more decoded addresses.

PC SERVICE

One of the most difficult tasks in building any construction project featured in **Radio-Electronics** is making the PC board using just the foil pattern provided with the article. Well, we're doing something about it.

We've moved all the foil patterns to this new section where they're printed by themselves, full sized, with nothing on the back side of the page. What that means for you is that the printed page can be used directly to produce PC boards!

Note: The patterns provided can be used directly only for *direct positive photoresist methods*.

In order to produce a board directly from the magazine page, remove the page and carefully inspect it under a strong light and/or on a light table. Look for breaks in the traces, bridges between traces, and in general, all the kinds of things you look for

in the final etched board. You can clean up the published artwork the same way you clean up you own artwork. Drafting tape and graphic aids can fix incomplete traces and doughnuts, and you can use a hobby knife to get rid of bridges and dirt.

An optional step, once you're satisfied that the artwork is clean, is to take a little bit of mineral oil and carefully wipe it across the back of the artwork. That helps make the paper translucent. Don't get any on the front side of the paper (the side with the pattern) because you'll contaminate the sensitized surface of the copper blank. After the oil has "dried" a bit—patting with a paper towel will help speed up the process—place the pattern front side down on the sensitized copper blank, and make the exposure. You'll probably have to use a longer exposure time than you are used to.

We can't tell you exactly how long an exposure time you will need as it depends on many factors but, as a starting point, figure that there's a 50 percent increase in exposure time over lithographic film. But you'll have to experiment to find the best method for you. And once you find it, stick with it.

Finally, we would like to hear how you make out using our method. Write and tell us of your successes, and failures, and what techniques work best for you. Address your letters to:

Radio-Electronics
Department PCB
500-B Bi-County Blvd.
Farmingdale, NY 11735

kePRO CIRCUIT MAKER

For art supplies, kits and economical equipment to produce at home professional quality print circuit boards...ask for the pro's - Kepro Circuit Systems, Inc. Kepro has been producing prototype and short run equipment, as well as providing PCB supplies to industrial companies for years. Their specialized experience and knowledge provides the home hobbyist an economical and convenient source of equipment and supplies for a professional, one-of-a-kind, printed circuit board.

Shears, etchers, sensitized and un-sensitized copperclad laminates, art supplies, kits and Keproclad...all you need to make a professional quality printed circuit board at home and at a cost you can afford.

kepro

Kepro Circuit Systems, Inc.

Kepro, your one stop source for at home PCB's.
Write or call Kepro for their catalog and price list:
1-800-325-3878 or 1-314-343-1630 (MO)
630 Axminster Drive, Fenton, MO 63026-2992

ART SUPPLIES

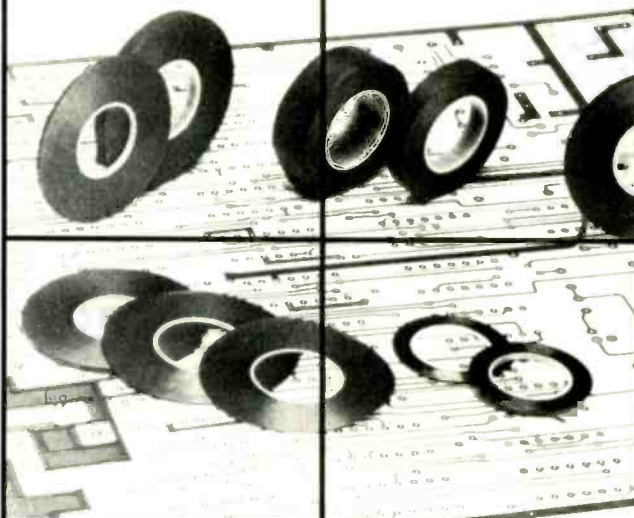

BENCHTOP ETCHER \$765.00



SHEAR \$390.00



ART SUPPLIES from \$2.79



COPPER CLAD LAMINATES

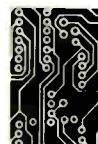

Photosensitized
Pre-cut copper clad
Bulk packaged copper clad
Full sheets
Plate-thru copper clad

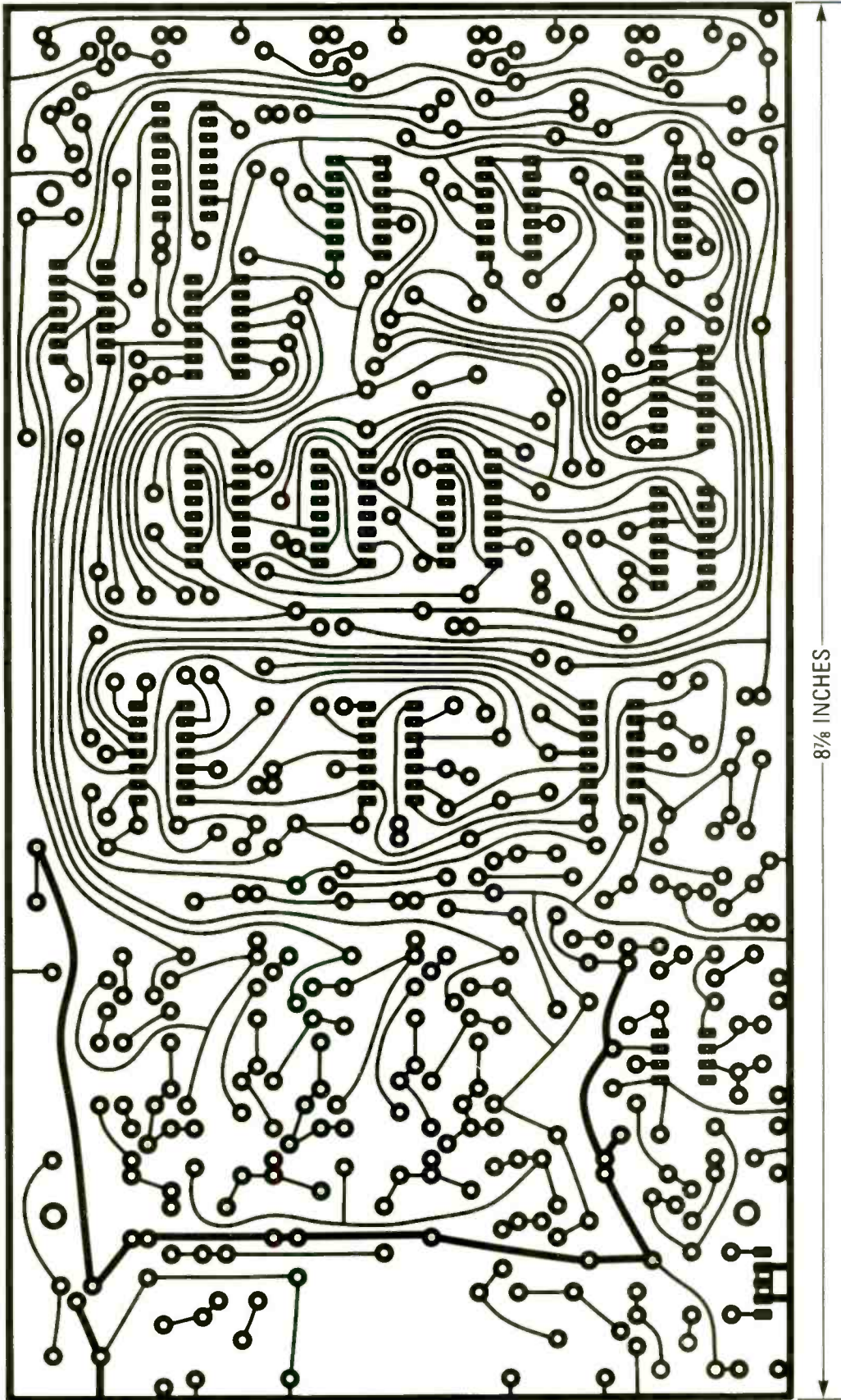

8 7/8 INCHES

DESCRAMBLING TRI-MODE. All components for the Tri-Mode descrambler, which is described beginning on page 43, mount on this board.

**PC
SERVICE**

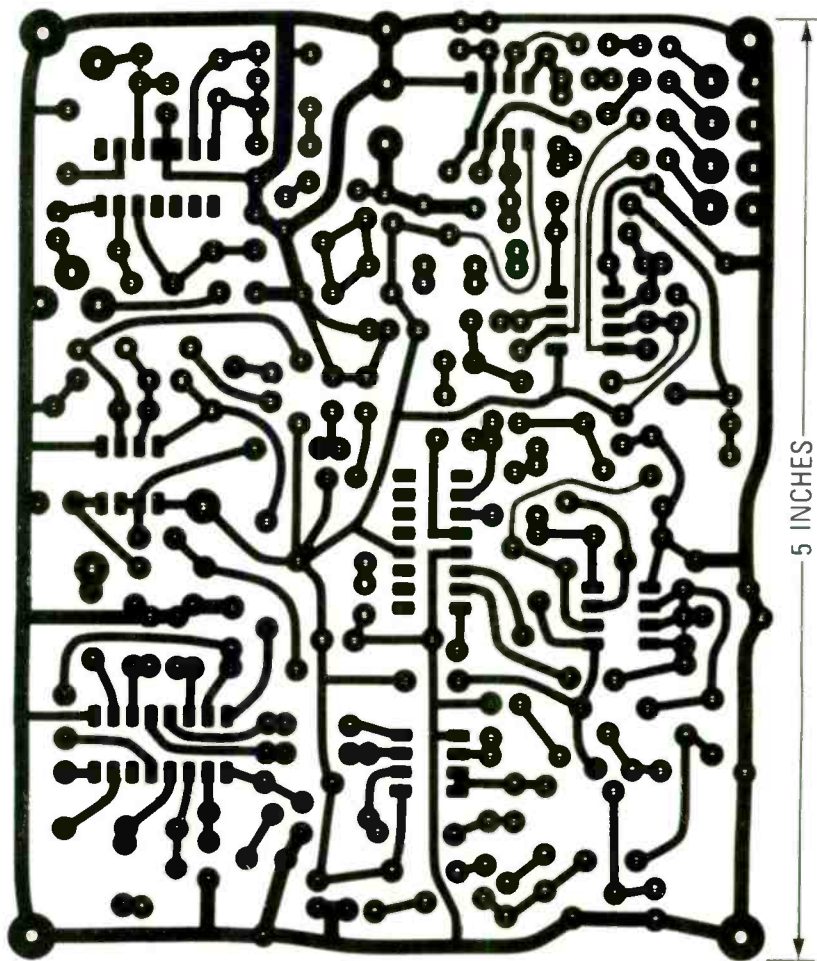

ENJOY THE BENEFITS OF MULTICHANNEL TV SOUND with our stereo-TV decoder. The foil pattern for the PC board is provided here; construction and installation information can be found beginning on page 51.

**PC
SERVICE**

JENSEN® shopper

Tear Out and Save!

JENSEN Means Quality

Jensen's Product Engineering staff pre-tests all products for performance efficiency and our Quality Control department inspects all incoming shipments to make sure they meet our high quality standards.

JENSEN Means Value

Jensen products are professionally-preferred and designed to save you time and money on the job and give you many years of satisfactory service. Many carry a lifetime guarantee of free replacement.

JENSEN Means Service

Because we stock in depth, we can provide you with fast off-the-shelf delivery. Most orders are processed within 24 hours, and we pay the shipping charges in the continental U.S.A.

JENSEN Guarantees Your Satisfaction

If you are not totally satisfied, return your order prepaid within 30 days and you will receive a prompt refund, exchange or credit, whichever you prefer.



***If your Shopper
is missing,
call or write
for a copy
of our latest
catalog.***

**Jensen Tools Inc.
7815 S. 46th Street
Phoenix, AZ 85044
(602) 968-6231**

CIRCLE 115 ON FREE INFORMATION CARD

Free Gift!

With Your Order
Of \$75 Or More
(See back
cover)

JENSEN[®] shopper

Electronics tools for professionals and the serious hobbyist

*Jensen means
quality, value,
and service*



JTK-9™ Personal Computer Service Kit

- ★ **New user friendly kit for PC maintenance**

This compact kit contains the tools necessary to perform user maintenance and service on most personal computer and peripheral equipment.

Provides the tools you need to remove and install unit covers, circuit boards, memory chips, cables, connectors, plus perform many more tasks with ease.

The JTK-9 includes a screwdriver handle with the following interchangeable blades: 1/8" slotted, #1 Phillips screwdrivers; 3/16" and 1/4" nutdrivers. The kit also contains CMOS safe IC insertion/extraction tools (with built-in pin straightener), screwstarter, key cap puller, spudger/DIP switch setter, a disposable penlight and a T-15 Torx key.

The tools are supplied in a deluxe vinyl padded zipper case with rich velvet interior and elastic straps to hold the tools securely. Compact 7 x 7 x 1" size is easily stored near your computer so it's always convenient when needed.

JRE-9 JTK-9 PC Kit With Case . . . \$49.00
JRE-54B109 Case Only . . . 16.00



TELVAC[®] Technician's Field Service Kit

- ★ **Multi-Purpose Tools**
- ★ **Heavy Duty Zipper Case**
- ★ **Optional Digital Multimeter**

A handsome professional looking kit at an economical price. A kit that skimps on price but not on quality or range of tools.

The tool selection includes a variety of screwdrivers to meet most fastening/unfastening needs: a 4-in 1 Pocket Socket with 1/4, 3/16, 3/8, and 7/16" sockets for driving most popular sizes of nuts and bolts; four pair of pliers; lighting/optical aids; soldering/desoldering equipment; 9-piece foldup hex key set, wire stripper, and more (see complete tool listing).

The tools are conveniently positioned in a tough Black vinyl case with oversized zipper and inside meter-sized flapped pocket. The tools are held securely in place with wide loop-stitched elastic straps - Inside dimensions 11 3/4 x 9 3/4 x 1 1/4". The optional meters suggested are the Beckman Model DM10 Digital Multimeter or Model DM73 Probemaster.

JRE-23B460 Kit in Zipper Case . . . \$96.00
JRE-207B075 Zipper Case Only . . . 21.00
JRE-624B010 Beckman DM10 Meter . . . 40.00
JRE-624B073 Beckman DM73 Meter . . . 55.00

These Fine Tools Included in the TELVAC Kit

Birchwood stick
Calculator, decimal/metric
File, needle 6 1/4" *
Hemostat, 3 1/2" *
Hex key set, inch, foldup
Knife, light duty
Mirror, plastic
Penlight, disposable
Pliers, diagonal cutter, 4 1/4"
Pliers, long nose, 4 3/4"
Pliers, groove joint, 6"
Pliers, Vise Grip, 5"
Pocket Socket, 4-in-1

Scissors*
Screwdriver, 4-in-1
Screwdriver, offset, Phillips
Screwdriver, offset, slotted
Screwdriver, pocket clip, Phillips
Screwdriver, pocket clip, slotted
Solder aid
Soldering iron
Solder removal braid
Solder removal tool*
Solder sample
Wire stripper
Vinyl zipper case

* Imported tool

Professional Quality Means More For Your Money!

TELVAC®

Professional-Style Attache Tool Kit

**A lot of kit
for a little price!**

These complete and comprehensive tool kits are designed especially for students, hobbyists, model shops, or in-house service departments.

The Wood/Vinyl case kit has a case with a solid wood frame and pressed composition-board side-panels covered with Black scuff-resistant vinyl. Includes a single removable tool pallet, key lock latches and a document pouch in the lid. Inside dimensions: 17¼ x 12½ x 4".

The tool selection includes most standard tools required for servicing or repairing electronic and electrical equipment, such as: screwdrivers, nutdrivers, pliers, wrenches, wire stripper, soldering equipment, and more. (See complete tool listing). These fine kits will provide years of satisfactory service at a minimum investment. See optional test meter suggestions.

- JRE-23B280** Kit in Wood/Vinyl Case . . . **\$139.00**
- JRE-207B150** Wood/Vinyl Case Only . . . **\$9.00**
- JRE-56B200** Triplett 310 VOM . . . **60.00**
- JRE-317B021** Fluke 8021B DMM . . . **159.00**
- JRE-317B777** Fluke 77 DMM . . . **139.00**



- ★ **Quality Tool Selection**
- ★ **Handsome Wood/Vinyl Case**

These Tools Included in the TELVAC Kits

Birchwood stick	Nutdriver blade, 7/16"	Screwdriver, offset, slotted	Solder removal tool*
Calculator, decimal/metric	Nutdriver blade, 1/2"	Screwdriver, pocket-clip, Phillips	Solder sample
Handle for driver blades, 3 1/8"	Pliers, diagonal cutter, 5 1/4"	Screwdriver, pocket-clip, slotted	Soldering iron
Handle for driver blades, 4 1/8"	Pliers, long nose, 4 3/4"	Screwdriver blade, Phillips #1	Wire stripper/cutter
Hemostat, 3 1/2"*	Pliers, long nose, 6 3/4"	Screwdriver blade, Phillips #2	Wrench, adjustable, 6"*
Knife, light duty	Pliers, slip joint, 6"	Screwdriver blade, slotted, 3/16"	Wrench set, Allen hex
Nutdriver blade, 3/16"	Rule, plastic, 7"	Screwdriver blade, slotted, 1/4"	Attache Style Case
Nutdriver blade, 1/4"	Scissors, thinline, 5"*	Solder aid	
Nutdriver blade, 3/8"	Screwdriver, offset, Phillips	Solder removal braid	* Imported tool

JTK-6™ The Mean Little Kit

★ **Fits Easily In Your Desk Drawer**

This 24-piece kit of electronic tools is ideal for engineers, scientists, technicians, students, executives—anyone who might suddenly be required to dismantle or service electronic equipment. Includes 7 screwdriver sizes, 4" adjustable wrench, 2 pairs of pliers, wire stripper, knife, alignment tool, rule, hex key set, scissors, burnisher, soldering iron, and more. Deluxe padded zipper case, 7 x 9 x 2". An optional Beckman "Probe-Meter" that fits conveniently in the kit is also available.

- JRE-6** JTK-6 Kit in Deluxe Case . . . **\$88.00**
- JRE-54B956** Deluxe Case Only . . . **21.00**
- JRE-624B073** Beckman DM73 Meter . . . **55.00**

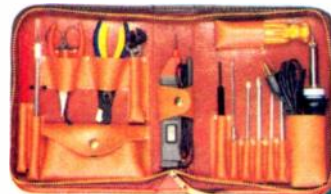

**Order by mail or
call (602) 968-6231**

**JENSEN®
1/4" Drive 14-Piece
Quick-Release
Inch/Metric
Socket Sets**

Fine quality sets of chrome plated steel. 5½" quick release ratchet driver, 6" spinner handle, 3" and 6" extensions. Inch set includes 9 sockets, 3/16 through 1/2", in handy vinyl boot. Metric set includes 9 sockets, 4 through 12mm. Steel box with positive latch with each set.

- JRE-354B105** Inch Socket Set . . . **\$15.95**
- JRE-354B814** Metric Socket Set . . . **15.95**



JENSEN® shopper

**The last screwdrivers, pliers, wrenches you need ever buy.
These quality Jensen® tools carry a lifetime guarantee!***

Precision ground tips, for perfect fit in screw slots.
Break-resistant handles, impervious to most acids and alkalis.



Chrome vanadium steel blades, tempered and nickel-chrome plated for highest finish, lasting durability.

Fluted design handles, beveled edges for comfort—assure perfect thumb and finger grip.

★ **Finest quality**
★ **Complete range of sizes**
★ **Economically priced**

Accurately Aligned Gripping Edges

Solid Orbital Rivet Joint

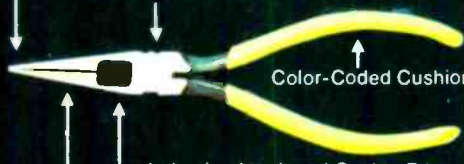

Color-Coded Cushioned Handles

Induction Hardened Cutting Edges

Individually Inspected Hand Finished

JENSEN® Screwdrivers

Jensen screwdrivers are manufactured to precise specifications to assure you of top performance in your work. Tips are accurately ground to fit snugly, securely in screw slots. Handles are shaped to provide a safe, sure grip and to fit the hand comfortably. Blades and handles are balanced over-all for ease of use.



Combination Phillips/Slotted Screwdriver Sets

Top quality screwdriver sets in sturdy vinyl pouches. Ideal for all types of electronic and electrical maintenance. **12 piece set** includes: Six slotted blade drivers in sizes $\frac{3}{32} \times 2"$, $\frac{1}{4} \times 1\frac{1}{4}"$, $\frac{3}{16} \times 3"$, $\frac{1}{4} \times 4"$, $\frac{3}{16} \times 6"$, $\frac{1}{8} \times 8"$; six Phillips blade drivers in sizes #0 x 2", #2 x 1 $\frac{1}{4}"$, #1 x 3", #2 x 4", #1 x 6", #1 x 10". **5 piece set** includes: slotted blade drivers in sizes $\frac{3}{16} \times 3"$, $\frac{1}{4} \times 4"$, pocket-clip style $\frac{1}{8} \times 2"$; Phillips blade drivers #1 x 3", #2 x 4". Chrome vanadium steel blades, precision ground tips, and fluted, break-resistant, handles.

JRE-23B012 Screwdriver Set, 12 piece... \$28.95

JRE-23B006 Screwdriver Set, 5 piece... 11.95

JENSEN® Color-Coded Pliers

With Jensen's color-coded handles you can select the exact pliers you need from tool pouch, tool box or bench, quickly and easily without having to see the working end. You learn to reach for the color and get the right tool every time. But color-coding is only part of the story. These Jensen pliers are manufactured to the most stringent specifications to assure you of top performance on the job.

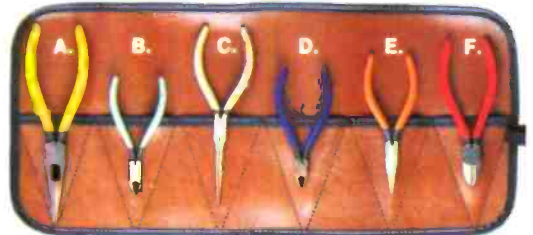

JTK-89™ 6-Piece Pliers Kit

Includes these six pliers in sturdy vinyl roll-pouch with elastic tie strap:

A. Chain Nose with Cutter - yellow

Long nose and strong serrated jaws; sharp side cutter, ideal for a variety of electronic and electrical work. Overall length 6 $\frac{3}{4}"$, nose length 1 $\frac{1}{2}"$. Yellow cushion grips.

B. Thin Nose Diagonal Cutter - turquoise

Flush cutting diagonal cutter with thin pointed nose for reaching into tight areas. Overall length 4 $\frac{1}{4}"$, cut length $\frac{1}{2}"$. Turquoise cushion grips.

C. Thin Needle Nose Pliers - beige

Finely serrated tips and thin needle nose for pulling, bending wire, in confined spaces. Overall length 6 $\frac{1}{4}"$, nose length 2". Beige cushion grips.

D. Miniature Diagonal Cutters - blue

Semi-flush cut for most types of small wire used in electronic work. Overall length 4 $\frac{1}{4}"$, cut length $1\frac{5}{32}"$. Blue cushion grips.

E. Miniature Chain Nose - orange

Narrow tapered, serrated jaws. Hold, bend, loop and pull wires in close quarters. Overall length 4 $\frac{3}{4}"$, nose length 1". Orange cushion grips.

F. Diagonal Cutting Pliers - red

Narrow jaws reach easily into confined areas. Semi-flush cut. For general purpose electronic work. Overall length 5 $\frac{1}{4}"$, cutting length $1\frac{1}{16}"$. Red cushion grips.

JRE-89 JTK-89 Pliers Kit in Roll Pouch... \$57.00

JRE-286B666 Roll Pouch Only... 8.00

JENSEN®

13-Piece Combination Wrench Set

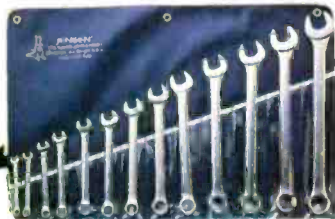

Jensen wrenches are U.S. manufactured to exacting specifications to assure you of total satisfaction with quality, performance and price. These wrenches are hot forged from finest alloy steel, precision machined for accuracy with an open end on one end, box-head on the other, and chrome-plated for beauty and protection.

Includes the full complement of Jensen wrenches from $\frac{1}{4}"$ through 1" in $\frac{1}{16}"$ increments. Supplied in heavy-duty canvas-backed vinyl roll pouch with grommets for wall mounting.

JRE-23B013 13-Piece Combination Wrench Set... \$64.95

* If any Jensen brand screwdriver, pliers or wrench fails to give you complete satisfaction, simply return it to Jensen prepaid, and we will replace it free of charge. This guarantee gives you specific legal rights, and you may also have other rights which vary from state to state.



Computerized order entry system speeds your order on its way

Order By Calling (602) 968-6231 or Use Order Form On Back

Free Gift Offer, See Back Cover

Rugged Duty Case Designed For U.S. Military ★ High Density Polyethylene

- ★ Can be double locked ★ Two Removable Pallets ★ MIL-SPEC Color ★ Heavy Duty Hardware



This uniquely styled case is constructed to withstand the use and abuse encountered in harsh military/industrial environments.

Vacuum molded of extra heavy (.250") high density polyethylene; 20-25% thicker than ordinary tool cases. Permanent olive drab color FED-STD-595 will not fade, chip, or rub off. Withstands temperature extremes from -200°F to +185°F. Hardware is black oxide or epoxy-coated, to provide maximum corrosion protection.

A heavy-duty tongue and groove aluminum valance with a gasket seals out dirt and moisture to protect your tools and equipment in the field. Spring loaded steel handle and low-profile quarter-turn latches resist damage during shipping and handling.

Molded-in stacking lugs provide strength and secure stacking during storage or deployment handling. Combination lock and padlock loops for added security, plus a durable riveted-in document pouch in the lid for TM/TO storage are other features.

This field-proven case is offered with two removable pallets. Inside dimensions: 17¾ x 14½ x 9". Tools not included.

JRE-356B170 Military Case with Pallets . . . \$159.00



Heavy-Duty, Shipping Containers

- ★ Foam "filled" and foam "lined" styles
★ Ideal for transporting sensitive equipment
★ Shipping decals included ★ Padlockable

These lightweight, rugged containers provide a safe, economical way to ship electronic devices, computer peripherals, or other sensitive equipment. Constructed of high-density polyethylene, similar to airline shipping containers. Feature extra-strong male/female closures, and full-length piano hinges. Hardware is clear anodized to resist corrosion. Quarter-turn military style latches are protected by molded in ridges. Steel handles are spring-loaded. A rubber gasket helps seal out dirt and moisture.

These versatile containers are "lined" with 2" of foam on all sides and you can add additional foam to customize them to fit the equipment you are shipping. Permanent white finish won't chip or rub off, is impervious to solvents.

JRE-377B165 Container, 23¾ x 15 x 11" . . . \$179.00

JRE-377B155 Container, 18¾ x 18¾ x 13" . . . 189.00

JRE-377B175 Container, 22¾ x 23¾ x 14" . . . 219.00

Rust-Proof, Dent-Proof Six Drawer Storage Chest Has 47 Compartments



This handsome chest has plenty of room for convenient storage of precision tools, small parts and components. Constructed of tough, durable rust-proof polypropylene to provide years of dependable service. Drawers are easily removable and have tongue and groove rails and fingertip releases. The front cover has padlock tab to secure cabinet when closed, can be used as bottom tray when chest is open. Other features are non-slip rubber feet, twin latches, luggage-style handle. Overall dimensions: 19½ x 10¾ x 15". Color: Mahogany and Birch Tan with Orange drawers.

JRE-352B762 Six Drawer Chest . . . \$79.95

Polyethylene Cases With Diced Foam

Protect your cameras, delicate equipment



Blow-molded double-wall high density polyethylene construction combines strength and toughness with light weight. Multi-layer polyester foam in bottom is cut in checkerboard pattern. Just remove foam cubes to custom-fit your gear. No need for cutting or replacing foam to hold varying size equipment. Simply shift location of foam cubes. Convoluted foam in lid provides additional protection. Other features: luggage style handle, metal latches with key locks, textured Black finish. Four sizes to choose from, inside dimensions given.

JRE-889B860 16½ x 12½ x 5" Case . . . \$49.00

JRE-889B070 18½ x 14½ x 6" Case . . . 59.00

JRE-889B360 21½ x 16½ x 5" Case . . . 69.00

JRE-889B375 21½ x 16½ x 6½" Case . . . 75.00



Most orders shipped within 24 hours of receipt

**Fast, Safe,
Dependable
Self-Igniting
Micro Torch**

The Blazer provides instant push-button ignition every time. Ignites from built-in piezo electronic starter. Two adjustment valves provide precise control of 2500°F flame for pinpoint soldering, brazing, welding, etc. Delivers up to two hours from butane gas cylinder. Can be refilled from a butane cigarette lighter canister. Sturdy brass body with rubber cushioned grip to fit comfortably in the hand. Or you can use it "hands-free" by setting your Blazer upright in the included removable stand. Made in Japan.



JRE-680B201 Blazer Torch . . . \$49.95

**Portasol
Portable Gas
Soldering Iron**

★ **Runs On Ordinary Butane Lighter Fuel**

This lightweight, portable soldering iron can be carried in your pocket like a pen. Delivers power equivalent to a 60-watt electric iron without hookups or trailing cord. Provides adjustable tip temperature of up to 400°C (752°F) for fast, efficient soldering. Patented catalytic convertor provides heating at the tip without flame during soldering. Can be refilled with ordinary butane lighter fuel in seconds and delivers up to 60 minutes of continuous use from one filling. Protective cap includes lighter to start catalytic conversion. Iron comes complete with 2.4mm chisel tip. Made in Ireland.



JRE-149B100 Gas Soldering Iron . . . \$29.95

**JENSEN®
Soldering
Accessory Kit**

★ **Everything you need
in one compact kit**

This handy kit contains the basic accessories most often used during soldering/desoldering operations. The central item in the kit is a low static desoldering tool for safe and efficient solder removal. Also included is a fork/reamer soldering aid, a reverse action tweezer, a lead former, a flux brush, and a 6" hemostat. The tools are contained in an 8½ x 10" vinyl roll pouch which fits easily in tool case or workbench drawer.



JRE-23B350 Soldering Accessory Kit . . . \$19.95

**Precision
Tweezer Kit**

★ **Imported
from Switzerland**

We selected the six most popular stainless steel RUBIS tweezers and packaged them in a velvet-lined, deluxe padded vinyl zipper case for protection and ease of accessibility. This kit is ideal for instrument assembly, watchmaking, laboratory operations and many more microelectronic tasks. Included are the following styles: Style 00, 2A, 3, 6, 7 and 524.

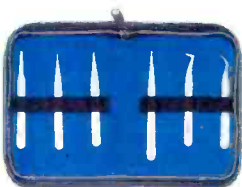

JRE-23B580 Tweezer Kit . . . \$58.00

JRE-54B168 Zipper Case only . . . 10.00



**Master Ultratorch 3 Portable 3-In-1
Soldering/Heat Tool**

This compact, cordless butane gas powered tool is a combination soldering iron, flameless heat tool and torch. Perfect for field service maintenance as no AC current or batteries are required.

The Ultratorch burns ordinary butane lighter fuel to generate infra-red and ultra infra-red heat by means of a unique catalytic combustion system. Fingertip controls let you adjust the temperature from 394 to 932°F for soldering; to 1292°F for heat shrinking; to 2372°F for use as a torch. Operates up to 3 hours at 700°F on a single filling.

Comes complete with soldering/heat ejector, torch ejector, tapered needle soldering tip, heat tip, solder sponge, tip cleaner and spanner wrench. Japanese import.

JRE-10B700 Ultratorch™ 3 . . . \$68.95



JENSEN® 23 Watt Soldering Iron

★ **Fine quality at a low price!**

Finest quality production line soldering iron made for Jensen by a leading U.S. manufacturer. Combines light weight balanced design, fast heating action, comfort grip handle, 3-wire burn proof cord, and long-life plated screw-on tips. The 23-watt heating element and .13" chisel tip are included. All replacement components are interchangeable.

JRE-46B723 Jensen 23-watt iron . . . \$17.50

JENSEN® "D-SOD-R" Tools

- ★ **Fast, efficient
solder removal**
- ★ **Standard and
Micro Models**
- ★ **Regular and Anti-Static Styles**



Now from Jensen, an economical line of precision desoldering tools. Feature evenly balanced all-metal body with one-hand plunger action and easy pushbutton release. Double "O" ring seals assure maximum suction for fast, efficient desoldering. Choose from standard (8") or Micro (6¼") models in regular or anti-static styles. Replacement tips and repair parts are also available. Made in Mexico.

JRE-983B100 Std. tool, Teflon tip . . \$7.95

JRE-983B900 Micro tool, Teflon tip . . 8.95

JRE-983B300 Std. tool, A-S tip . . . 9.95

JRE-983B990 Micro tool, A-S tip . . . 10.95



are welcome!

Charge It On



Pocket Size Static Meter

Shows the intensity and polarity of static charges on surfaces without touching them. Reads directly, in kilovolts, the charge on the test surface. Indispensable in the detection, monitoring and control of potentially harmful

or destructive static charges in work areas where sensitive CMOS electronic devices, explosives or flammables are encountered. Range 0 to ± 5 kilovolts, full scale at 6-inch distance; 0 to ± 10 kilovolts at 12-inches. Accuracy $\pm 10\%$. Powered by two 9V batteries (included). One year repair/replacement warranty. Dimensions: 4 $\frac{1}{2}$ x 2 $\frac{3}{4}$ x 1 $\frac{1}{4}$ ".

JRE-801B121 Static Meter . . . \$295.00

3M Electrically Conductive Field Service Kit

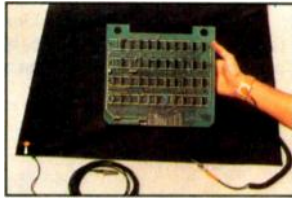

Compact, portable kit provides electrostatic protection of static sensitive components in the field service environment. Includes a 10 mil. 24 x 24" conductive Velostat® workmat with two built-in storage pouches, a 15-foot ground cord (w/1 megohm resistor) terminated with an alligator clip, a Charge-Guard™ wrist strap complete with a 5-foot coiled ground cord (w/1 megohm resistor) and one large and one small wrist band. Kit folds to 8 $\frac{1}{2}$ x 12 x $\frac{1}{2}$ ". Stores easily in case or drawer.

JRE-872B805 Static Control Kit . . . \$48.50



Charge-Guard™ Static Control Wrist Straps

Comfortable wrist straps dissipate the static charge normally found on personnel before static can damage devices. Feature silver-plated mono-filament fibers woven within the elastic band. The result is a highly conductive, corrosion-resistant band which gently conforms to the wrist for reliable contact to ground. Insulative outer surface reduces the chance of accidental injury to personnel. A 5-foot coil type ground cord (w/1 megohm resistor) terminated with a banana plug and alligator clip is included. Three sizes to choose from: Small (gray) 4 $\frac{1}{2}$ -6" circumference wrists; Med. (burgundy) 5 $\frac{1}{2}$ -7 $\frac{1}{4}$ "; Large (blue) greater than 6 $\frac{1}{2}$ ".

JRE-872B266 Small Wrist Strap . . . \$19.95

JRE-872B366 Large Wrist Strap . . . 19.95

JRE-872B300 Med. Wrist Strap . . . 19.95



We pay the shipping charges anywhere in the continental U.S.A.

JTK-33™ Executive Tool Kit



- ★ Compact size
- ★ Padded, leather-like vinyl case
- ★ Complete selection of essential tools

This Executive Tool Kit contains a select assortment of top quality American-made tools designed to perform a wide variety of jobs. Yet the complete kit is no larger than a textbook for easy portability and storage.

The tool selection includes pliers, screwdrivers, tape measure, hex keys, pocket knife, adjustable wrench, 13-piece socket set, AC/DC circuit tester and more (see complete listing).

The compact 9 x 7 x 2" case is constructed of handsome leather-like vinyl with padded sides, heavy-duty zipper and 13 pouches to hold the tools securely. There is also a Velcro® closure pocket for storing the tape measure and hex key set.

JRE-33 JTK-33 Executive Tool Kit . . . \$79.00

JRE-54B132 Tool Case Only . . . 18.00

The Executive Tool Kit includes these fine tools

Adapter, 1/4" Hex—1/4" Sq.
Circuit tester, AC/DC
Hammer/Screwdriver Set, 5-piece
Hex Key Set, 10-piece
Knife, pocket, two blade
Pliers, chain nose, 4 $\frac{1}{4}$ "
Pliers, diagonal cutter, 4 $\frac{1}{4}$ "
Pliers, slip-joint, 5"
Pliers, Vise Grip, 6"
Rule, stainless steel, 6"
Screwdriver, magnetic, 5-in-1

Screwdriver, Phillips, #0, pocket clip
Screwdriver, slotted, 3/32", pocket clip
Screwdriver, stubby, 2-in-1 driver
Socket Set, 13 pc.
Tape measure, inch/metric, 6'
Wrench, adj. 6"
Zipper Tool Case



Anti-Static Circuit Board Cases

Rugged Super-Tough cases made of high density polyethylene with top, bottom and sides covered with pink-poly foam to provide both anti-static and physical protection. Regular size accommodates up to twelve 11 $\frac{1}{2}$ x 9" partitions to divide the case side-to-side or up to nine 15 x 9" partitions to divide the case front-to-back. Overall inside dimensions: 17 $\frac{3}{4}$ x 14 $\frac{1}{2}$ x 10 $\frac{1}{2}$ " (useable, 15 x 11 $\frac{1}{2}$ x 9").

The larger size case uses 15 x 12" partitions to divide the case as illustrated. Overall inside dimensions: 19 x 19 x 13 $\frac{1}{2}$ " (useable, 15 x 15 x 12"). Both cases are lockable. Partitions *not* included with cases. Order separately by catalog number below.

JRE-377B930 Reg. PC Board Case Only . . . \$159.00

JRE-377B950 Large PC Board Case Only . . . 189.00

JRE-377B004 Four, 9 x 11 $\frac{1}{2}$ " partitions . . . 15.00

JRE-377B003 Three, 9 x 15" partitions . . . 15.00

JRE-377B002 Three, 15 x 12" partitions . . . 20.00



The "Blue Box" EIA Interface Monitor and Breakout Panel



Portable, pocket-size test set provides access to all 25 conductors of the EIA RS-232C and CCITT interface between the data terminal and the data modem. Twelve LED's monitor the status at the source of twelve primary signals, and two additional LED's sense either positive or negative voltage levels greater than $\pm 3V$ and may be used to monitor any selected signal. Twenty-four miniature switches allow all interface conductors (except frame ground on pin 1) to be individually interrupted allowing isolated testing and observation of terminal or modem signals. Pins on each side of each switch and small jumper cables are provided to allow cross-patching and monitoring of signals. Power is supplied by two penlite batteries (included). Lifetime factory warranty. Dimensions: 3.75 x 5 x 1.75".
JRE-822B066 Interface Monitor . . . \$159.00



Datacheck I RS-232C Breakout Box



The ideal tool for the installation of computer terminals and printers. Features 25 individually numbered interface switches to quickly and easily isolate any signal. The twelve LED indicators are separated by signal source so you can detect origin of signal - terminal or modem - at a glance. External mark/space monitor provision. Gold-plated recessed pins assure better connections, longer life and extra protection. Datacheck I needs no batteries, operates off the data signal. Patch jumpers and RS-232C cable storage in the back of the rugged molded ABS plastic case. Comes with 5 interface jumpers, a 12" RS-232C cable, operator's manual and case. Size: 4.5 x 3.5 x 1.5". Canadian import.

JRE-875B100 Datacheck I . . . \$99.00



RS-232 Line Tester

★ Easy to read LED signals

A compact, light-weight, communication line monitoring device that may be used either "stand alone" to examine a serial data port or "in-line" for continuous monitoring of data/control lines. Thirteen dual-color LED's indicate the condition of the signal under test. A "Red" signal voltage equates to ≤ -3 volts (marking) and a "Green" signal voltage equates to $\geq +3$ volts (spacing). No light from an LED equates to an indeterminate signal voltage condition ($> -3V$ but $< +3V$). The 50 patch pins and 25 switches allow the device to be used as a breakout box for the various EIA signals. This allows connection of incompatible equipment types over a straight-through EIA interconnect cable. The breakout box may be used to facilitate this interconnection without the recourse of constructing a special cable. Line powered. Dimensions: 3.3 x 5.1 x .8". Comes with 10" male to female ribbon cable, a jumper set (6 straight and one T-Jumper) and padded case.

JRE-862B232 Line Tester . . . \$159.00



RS-232/RS-449 Connector Kit



The answer to on-site fabrication and maintenance of RS-232 and RS-449 cable connectors. This unique kit contains all necessary components needed to repair or fabricate 9 pin, 25 pin and 37 pin connectors to meet RS-232 and RS-449 requirements. The kit includes 6 plugs and 3 receptacles in each configuration (9 pin, 25 pin, 37 pin), 6 each hood assemblies in each configuration (9 pin, 25 pin, 37 pin), 100 each gold-plated #20 DM contact pins and sockets. 50 cable ties and an insertion/extraction tool. Kit is packaged in a 21-compartment meta' box.

JRE-80B249 RS-232/RS-449 Kit . . . \$199.00



RS-232 Smart Cable™



Lets you instantly inter-connect computers, terminals, modems, printers and other RS-232 interfaced devices with just one cable. Just a flick of the switch and the unique on-board computer circuitry looks at the RS-232 interface on both the computer and the peripheral and then correctly connects the interface together. All open outputs are enabled. Monitors hand-shake lines required for bi-directional data transfer. Eliminates the need for breakout boxes, custom cables, etc. The Smart Cable has indicators that point out which device is disabling data transfer when needed. Dimensions: 3½ x 2½ x 2½". Connectors: Dual Male/Female connectors on free end of ribbon cable; Order 970B870 for male connector or 970B875 for female connector on Smart Cable body.

JRE-970B870 Smart Cable, Male . . . \$49.95
JRE-970B875 Smart Cable, Female . . . 49.95
JRE-970B809 Smart Cable, Male, For Apple IIc . . . 39.95
JRE-970B880 Smart Cable, Male, For IBM PC-AT & Jr. . . 39.95

Contact Insertion and Removal Kits



Insert and remove contacts on all types of connectors conforming to MIL-C-26482 and MIL-C-26500: Amphenol, Bendix, Burndy, Cannon, Cinch, Continental, Deutsch, Elco, Flight, Pyle National, etc. Handles properly shaped for gripping with strong durable tool steel probes. Tools color-coded for easy identification of contact sizes. 3-piece kits consist of one each of size 12 (yellow), 16 (blue), 20 (red) tools in zipper case. For front release contacts.

JRE-924B260 Contact Insertion Kit . . . \$70.00
JRE-924B261 Contact Removal Kit . . . 82.00



**Jensen offers
Custom Kit
Service**

Order By Calling (602) 968-6231 or Use Order Form

New!

TEL VAC®

Black Magic™ Zipper Case

Exclusively Ours!

The most versatile case you'll ever own!



★ Lets you change pouches, tool layouts, like magic!

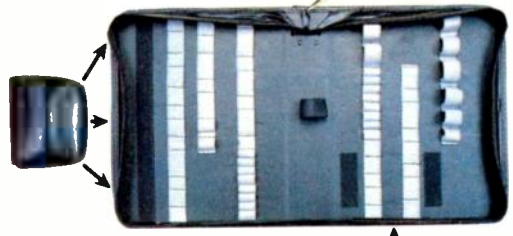

★ Two moveable, removable pouches



Presenting a revolutionary new concept in a highly functional tool case design. Features strategically positioned elastic straps, plus movable and removable pouches on Velcro® strips, to accommodate a wide variety of tools and equipment.

With "Black Magic" you can shift the pouches to the left or right on the Velcro strips to accommodate tools of varying sizes and shapes. Or you can remove one or both pouches from the case, to expose additional elastic straps and increase the tool storage area of the case. The larger removable pouch (7½ x 4½ x 2") is ideal for holding a multimeter or other test equipment.

The smaller pouch (4½ x 4½ x 1") will store test leads or small parts. The 1" wide heavy-duty elastic straps are looped and stitched to hold your tools securely and conveniently.

The case is made of leather-like Black Vinyl with bound edges and full length zipper closure. Overall dimensions: 12½ x 10 x 2¾". Place your order today, as we predict these "Black Magic" cases will disappear fast! (Tools not included.)

JRE-216B088 "Black Magic" Case . . . \$39.00

Free with your merchandise order of \$75.00 or more Mechanics Tool Bag

Offer ends June 1, 1987.

With your order of \$75.00 or more, you'll receive this famous GI bag constructed of O.D. green canvas. Features oversize handles and multiple pockets to hold a variety of tools.



JRE-612B030 Free with order of \$75.00 or more.

VCR Precision Alignment Kit

★ **Specialized tool selection in compact zipper case**

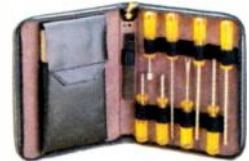

This special kit contains a selection of precision tools manufactured to extremely fine tolerances and designed for critical adjustments of VHS and Beta videocassette recorders.

Includes a base plate reference jig and a height gauge, used together for precision height adjustment of the reel discs, guide posts, tape transport, pinch wheel, audio, synchronization and erase heads.

Also included is an 8-piece driver/wrench set with precisely configured bits for adjusting the tape feed guide, tape tension heads, tape transport, audio and control heads.

The tools are furnished in a padded Gray vinyl zipper case with elastic straps to hold the drivers and height gauge. A Velcro closure pouch holds the base plate reference jig. Case size: 10 x 8 x 1½".

JRE-23B840 VCR Alignment Kit . . . \$166.00
JRE-54B838 Vinyl Case only . . . 19.00



Send for our Free Catalog

Jensen's new catalog features hard-to-find precision tools, tool kits, tool cases, test equipment and computer accessories used by sophisticated hobbyists, scientists, engineers, laboratories and government agencies. Call or write for your free copy today.

JENSEN® Order Form 1987

Mail to: Jensen Tools Inc.
7815 S. 46th Street, Phoenix, AZ 85044
(602) 968-6231

Name _____ (Please Print or Type)

Company _____

Address _____

City/State/Zip _____

Phone _____ **FREE CATALOG**

Bill Company ("Open Account" to customers or D&B rated firms)

P.O. # _____

Check Enclosed VISA MASTERCARD AMEX

Card No. _____ Exp. Date _____

Signature _____

Qty.	Part No.	Description	Price	Total
	<input type="checkbox"/> JRE-612B030	Tool Bag, Free with any order of \$75 or more		

Arizona customers please add 5% sales tax; Maricopa County 5.5% (City of Phoenix 6.7%). Kansas customers add 4% sales tax

Orders under \$25, please add \$5 shipping and handling charge

TOTAL

We pay the shipping charges!
JENSEN® shopper

PRICES SUBJECT TO CHANGE WITHOUT NOTICE!

SATELLITE TV



BOB COOPER, JR.,
SATELLITE-TV EDITOR

Practical descrambling

THE M/A-COM TV-SIGNAL SCRAMBLING system known as *Videocipher* has been breached. As of early November, there are no fewer than six techniques that claim significant or total success in busting *Videocipher*. Information and equipment are being offered in the marketplace, but not in the U. S. as yet. The reason is fear. There are several laws that appear to apply to the marketing of bootleg descramblers, and it is feared that anyone who attempts to market such equipment would be promptly hauled into court.

Of the busting techniques, some are software-oriented, and use an EPROM (Erasable Programmable Read-Only Memory) to re-instruct *Videocipher* what to do and when. Other techniques are hardware solutions designed to work around the encryption process. However, none of the techniques developed so far are foolproof.

Cloning

Let's talk about *Videocipher* hardware. Inside device U7, a TI microprocessor, are several bytes of RAM. In that RAM resides each unit's unique authorization-code number. That number is addressed via the satellite link. When the transmitted address matches the internal, locked-away, and protected address, the *Videocipher* responds to commands that follow the matching of the authorization code.

The microprocessor has a lithium battery to keep its RAM memory intact during power-down, and attempts to go inside and read its data proved fruitless at

first. But then a researcher found a technique for extracting those bytes without penetrating the IC. At that point the code number could be accessed.

The ID-number data stream can be decoded with software to make it usable with other VC2000's. In fact, a technique was created to allow the authorization information from one *Videocipher* to be transferred to another (and another, etc.) *Videocipher*. The process involves taking the authorization information extracted from one device, burning it into an external EPROM, and then using the new EPROM to authorize additional devices. As shown in Fig. 1, the new EPROM clips to the *Videocipher* circuit board.

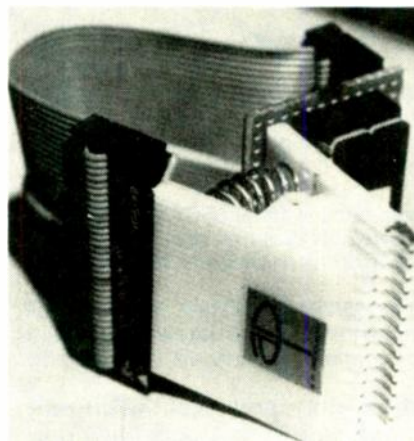

FIG. 1

Using that approach, one VC2000 pays for services (HBO *et al*) and then shares its authorization code with other non-paying units. If you inspected two or more such devices, you would discover they all have the same on-

screen ID number; the reason is that the clones are functionally identical to the original (master) unit. The clone system is now being marketed *outside* the U. S.

Tiering

The same authorization information, extracted from U7 through an indirect route, can also be massaged by software to create "tiering." For example, say the unit in question pays for CNN (\$25 per year). After the authorization information is extracted and re-written, it is reloaded into the same VC2000, but now the VC2000 will decode *all* the scrambled services, not just the paid-for CNN. That approach is being marketed in Latin America.

A variation of those approaches appeared in British Columbia in mid-fall. A customer has his or her VC2000 re-worked so that U30 is replaced with a socket, and an additional socket is mounted on the rear panel of the VC2000. The customer goes to the friendly neighborhood authorization center to have a 2716 EPROM re-authorized on or around the first of each month. Of course, a fee is paid for that bootleg authorization, but the fee is significantly lower than the normal charges of HBO *et al*.

Dangers

At the moment, all the techniques mentioned above seem invulnerable to anything that M/A-Com might do via their satellite data stream. In other words, to ensure against bootleg reception, legitimate decoders currently in the field apparently would require factory modifications.

Cloning and tiering work because some very clever software people have been able to locate holes in the original *Videocipher* software. Any or all of those holes could be sealed if M/A-Com found them. *Videocipher* descramblers already in the field would not be affected, but all future units would be affected, and most likely corrected. In addition, after working out the bugs, M/A-Com could recall all existing devices and change their software as well.

Neither cloning nor tiering leaves a trail. In M/A-Com's hands a recalled device would be indistinguishable from one that was factory stock. However, the Canadian approach is traceable, of course, because of the outboard EPROM socket.

If M/A-Com obtained a unit that was part of a cloning network, it would identify itself with the clone's ID, not the factory-original ID. The number would appear to be genuine, but if there were any

suspicion of unauthorized activities, M/A-Com could shut it down through the uplink authorization center. Of course, any devices sharing that ID would also become de-activated.

Interested in TVRO?

For nearly two years Bob Cooper has provided a no-charge kit of printed materials that describes the challenges of and opportunities in selling TVRO systems today. With the present intense interest in scrambling systems, Coop's *CSD* has made available a new no-charge service.

The SCRAMBLE FAX hotline is a 24-hour-per-day telephone service that provides accurate, detailed, and hard-to-find facts concerning the changeover to scrambling in the satellite communications industry. Information describing satellite receivers tested for scrambling compatibility, sources for authorized descramblers, wholesale rates of scrambling equipment and services—all are provided on the SCRAMBLE FAX hotline. There is no charge for that service, other than your long-distance telephone expenses. Simply dial (305) 771-0575 for a concise and timely three-minute capsule report that covers the latest in scrambling news.

SEND COOP \$20



and HE WILL SEND YOU \$63!

NOPE - not a new fangled 'chain letter'. TVRO pioneer Bob Cooper, Jr. has put together the most useful 'Data-pack' possible to bring you up to full speed on satellite television scrambling. It will cost you \$20 to receive all of the following valuable information:

1) **YOU RECEIVE** the 3 'current issues' of **CSD Magazine**; literally, 'the bible' of the home dish industry. The most complete insider look at the new equipment, scrambling strategies, worldwide satellite explosive growth anyplace. You receive 3 issues starting with the now-current issue. A great introduction to TVRO! This is an **\$18 value**.

2) **YOU RECEIVE** the current plus two recent back issues of **SCRAMBLE-FAX**, the hot-news 'Newsletter' that details the rapid changes taking place in scrambling, who is scrambling, how; who is working to break scrambling, their progress to date. This is a **\$30 value**.

3) **YOU RECEIVE** the special 180 page **COMMEMORATIVE EDITION OF Coop's Satellite Digest**, the full, unabridged history of home satellite television. This is the handiest, one-source reference recording the home dish industry; a **\$15 value**.

YOU RECEIVE all of the facts, all of the history, and all of the current, hard-to-find news about TVRO and scrambling. From Coop; the industry's most authoritative information source. Send your check or money order to the address below, or, with your Visa or MasterCard card handy, call in your order to 305/771-0505 weekdays between 9 AM and 4 PM. Join the Coop team and learn ALL the facts today!

CSD/Coop's Satellite Digest

P.O. Box 100858/Ft. Lauderdale, Fl. 33310
- Telephone 305-771-0505 -

SCRAMBLE-FAX HOTLINE? Call 305-771-0575 for 3 minute update NOW!

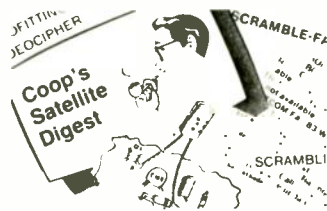

Finances

Cloners typically charge a \$600 fee to extract the authorization number from the master *Videocipher*. Then a per-clone fee is also charged, around \$300 apiece. It costs about \$650 per year to receive HBO, Cinemax, CNN, WGN, WTBS, Showtime, The Movie Channel, and SelecTV. If there are 25 clones sharing the master unit's ID, that makes a total of 26 paying \$25 each per year (\$650/26). If the owner of the master charges \$300 per year for services valued at \$650, he makes a profit of \$275 (\$300 - \$25) per unit per year, and the consumer is getting his services for less than half price, not counting the hardware.

Of course, all that is very upsetting to the firms who manufacture *Videocipher*, and to those who sell programming. Strict U.S. laws appear to forbid marketing descramblers inside the U. S., but in Canada, Latin America, and the Caribbean the laws are much less specific.

Next time, we'll turn our attention to some hardware descrambling techniques. **R-E**

AUDIO UPDATE

The joys of equalization

LAST TIME WE DISCUSSED SIGNAL PROCESSORS and some of the confusions about what they do, how they do it, and why you might want it done. I indicated that the major problems in audio reproduction are noise, dynamic-range limitations, frequency balance, and imaging. We also talked about noise and dynamic range; now let's look at frequency balance and see what an equalizer can do to help.

Balance and equalization

A loudspeaker designer once said to me that, in his experience, differences in frequency balance are 95% of the reasons why audio products sound different. I agree with him, even though I know that many audiophiles, and some engineers, prefer to make other more esoteric factors—such as the crystalline structure of the copper in their cables or the dielectric constants of their amplifier's capacitors—primarily responsible for whatever differences are heard.

In any case, the sonic phenomena that trouble (or enhance) an audio system are mostly dips, peaks, or slopes in frequency response. Those aberrations come about for electrical, acoustic, and psychoacoustic reasons, and they are translated by the ear into a large variety of positive and negative effects, which are heard as colorations, crispness, nasality, openness, glassiness, muddiness, harshness, etc. Anybody who spends time playing with a good ten-band equalizer can prove all that for himself.

Some audiophiles bad-mouth equalizers, claiming that they in-

roduce more audible problems than they solve. That might have been true at one time—how many readers remember the Blonder-Tongue *Audio Baton* from the late 1950's?—but today's better units are clearly free of any audible problems.



FIG. 1

Why would anyone want an equalizer in his system, aside from the pleasure of owning a component with more than twenty control knobs? I've had equalizers in my systems—usually as part of the preamp—since the 1960's, and I would feel lost without one. As I said last time, even in the unlikely event that you are blessed with a perfect-sounding audio system, the program material you are playing in that ideal system is likely to be flawed in a number of ways. An equalizer can help improve the sound of program-source material—and, if needed, loudspeakers and listening-room acoustics.

A typical equalizer, the Technics model *SH-8046*, is shown in Fig. 1. Note the bar-graph display that shows the cut and boost applied.

FM tuners

The FCC requires that a high-frequency equalization boost (called *preemphasis*) be applied during the FM broadcast process. Its purpose is to minimize hiss during FM reception by means of a complementary high-frequency



LARRY KLEIN,
AUDIO EDITOR

deemphasis circuit built into all FM tuners.

Unfortunately, preemphasis makes it difficult to broadcast high-frequency audio at its natural strength without overloading the broadcast transmitter. Therefore, most stations—even classical ones—are forced to cut back on the high-frequency content of their records, tapes, and CD's before broadcast.

A more natural treble level can be restored by boosting the 8- and 16-kHz controls until cymbals, high-hats, harps, and guitars sound natural. The 8-kHz slider will probably need to be raised only slightly; the 16-kHz slider at least half way. (The control bands referred to are typical of those found on most ten-band octave equalizers.) Since stations vary as to how they handle their preemphasis problem, the optimum setting for a system will vary from station to station. But you should be able to find a good compromise that will make most stations sound better.

Record players

The frequency responses of phonograph cartridges vary from unit to unit, as does the capacitance of record-player leads and phono inputs. Most important is the variation, from record to record, in frequency balance. An equalizer can compensate for all those factors simultaneously. Shrillness can be eliminated (or openness and detail restored) with the 8- and 16-kHz controls; bass muddiness can be minimized (or warmth added) with the 125-Hz control; and low bass can be add-

ed (or low-frequency noise can be reduced) with the 32- and 64-Hz controls.

Cassette players

Hiss can usually be reduced by cutting back on the 8- and 16-kHz controls. The trick is to adjust for maximum attenuation of hiss with minimum loss of music. Weak bass is sometimes a problem; it can be helped by boosting the 64-Hz control.

You can usually improve the sound of tapes to be played in your car by recording them with some bass boost at 64 Hz and 125 Hz, and with some treble boost at 8 kHz and above. Trial and error will be necessary to determine what sounds best with a specific type of tape in a specific car.

One potential problem is low-bass block. Some home and car cassette players react badly to recordings with very low bass or with the very low frequencies produced by record warps. If a player "blocks" or distorts on a recording, try redubbing it through an

equalizer with its 32-Hz control set for full cut.

CD players

It's no secret that many CD recordings have been poorly engineered and that they sound shrill or harsh. A slight cut applied by the 8- and 16-kHz controls can help significantly.

Loudspeakers

Speaker systems typically suffer from a variety of frequency-response problems. An equalizer can be of help in many cases. Here are some examples of how boosting or cutting response with a graphic equalizer can cure some common shortcomings;

- If low bass frequencies are lacking, try a moderate boost at 32 Hz.
- Standing waves in a room produce areas of bothersome heavy bass reinforcement, typically in the 40- to 70-Hz range. If there's a standing wave in your chosen listening area, you can reduce its effect by adjusting the setting of one or more of the bottom three

equalizer controls. Note, however, that bass in other areas of the room may be cut more than is desirable as a result.

- Many loudspeaker systems are weak in the upper treble registers. They can be boosted as required by adjusting the settings of the 8- and 16-kHz controls.
- One speaker of a stereo pair might have to be placed in a part of the room that differs acoustically from the rest of the room. That could happen if one speaker is installed in a corner or near sound-absorbing drapes or soft furniture. In that situation, the bass or treble output of one speaker may need adjustment to bring it in line with that of the other. You can make the adjustment by switching your amplifier to mono, and adjusting the equalization of *one* channel until both speakers sound the same as you listen to one and then the other by using your amplifier's balance control. The same frequency performance from both speakers will help maintain good stereo perspective and imaging.

Send Purchase Order
Check, Money Order, or C.O.D.
or Call Toll Free

800-223-0826
in N.Y. State (212) 865-5580

#1 IN CABLE BOXES SPECIAL!

JERROLD CORDLESS CABLE TV CONVERTERS

MODEL STARCOM-460

\$99.95

ANY QUANTITY

- Volume control
- 68 channels
- Mute control
- Automatic fine tuning
- Instant channel recall
- Programmable to go on at a particular channel and off automatically
- Compatible with descramblers

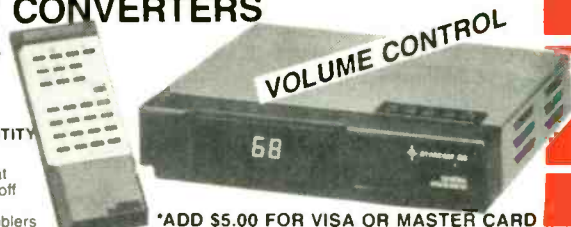

*ADD \$5.00 FOR VISA OR MASTER CARD

JERROLD CORDLESS CABLE TV CONVERTER

MODEL DRX3-105/400

\$69.95

- 58 channels
- Remote channel changing
- Remote on/off switch
- Remote fine tuning



JERROLD CORDLESS CABLE TV CONVERTER

MODEL DRZ/450

- 66 channels
- Automatic fine tuning
- A/B switch option

\$69.95/ 10 lot
\$79.95 ea.



JERROLD CORDED CABLE TV CONVERTER

MODEL JRX3-105

\$49.95

- 36 channels
- push button



"THE RABBIT" VIDEO MULTIPLYING SYSTEM

TR-7000

\$51.95

\$59.95/6-11
\$69.96/1-5

12 up

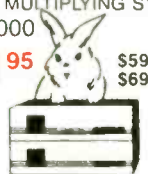

IT'S LIKE HAVING A VCR IN EVERY ROOM

■ MASTER CARD ■ VISA

OMNITRON ELECTRONICS

770 Amsterdam Ave., New York, NY 10025

SHIPPING CHARGES

For Orders	Add
\$25-100	\$6.50
\$100-500	\$8.50
\$500-750	\$10.50
\$750 and up	\$20.00



CIRCLE 110 ON FREE INFORMATION CARD

- To add more "sock" to a disco beat, try some boost at 64 Hz.
- To add body and warmth, try boosting 125 and 250 Hz.
- If male voices sound "boomy," try a slight cut at 125 Hz.
- If voices sound "nasal," try cutting back at 2 kHz and 4 kHz.
- If brushed cymbals and chimes lack "shimmer" and "air," try boosting 16 kHz, and perhaps—to a lesser degree—8 kHz.
- For a more natural balance when listening at background music levels, boost the frequencies at 125 Hz and below.

Ear training

Aside from all the corrective virtues described above, equalizers can be used as wonderful ear-training tools.

As I said earlier, many of the elusive sonic properties, both positive and negative, that are discussed endlessly in various audio publications turn out to be nothing more than minor variations in frequency response.

Those "variations" are translated by the ear into colorations and other sonic artifacts. It is instructive to play a clean recording through a well-balanced system that includes an equalizer, and then to manipulate the equalizer's controls while listening to the frequency bands responsible for steeliness, hollowness, airiness, muddiness, and other sonic properties. For example, the extra "inner detail," "air," and clarity provided by many moving-coil cartridges (and a few audio amplifiers) can be duplicated in large measure by a judicious boost of the two upper-octave controls of almost any ten-band equalizer.

It may be disillusioning to learn that the mysterious special quality of a high-end audio product results from nothing more than a rising high-frequency response—but that's life. It's easy enough to prove it to yourself.

Although ear training may induce a slightly cynical attitude toward the special qualities of some audio products, ultimately it should make you into a more critical listener—one who is better able to appreciate genuine sonic advances when they do actually appear.

R-E

Exclusive, triple patented dynamic cap and coil analyzing . . . guaranteed to pinpoint your problem every time or your money back



with the all new LC75 "Z METER 2"
Capacitor Inductor Analyzer
Patented \$995

The "Z METER" is the only LC tester that enables you to test all capacitors and coils dynamically — plus, it's now faster, more accurate, and checks Equivalent Series Resistance (ESR) plus small wire high resistance coils.

Eliminate expensive part substitution and time-consuming shotgunning with patented tests that give you results you can trust every time. Test capacitor value, leakage, dielectric absorption, and ESR dynamically; with up to 600 volts applied for guaranteed 100% reliable results — it's exclusive — it's triple patented.

Save time and money with the only 100% reliable, in- or out-of-circuit inductor tester available. Dynamically test inductors for value, shorts, and opens, automatically under "dynamic" circuit conditions.

Reduce costly parts inventory with patented tests you can trust. No more need to stock a large inventory of caps, coils, flybacks, and IHVTs. The "Z METER" eliminates time-consuming and expensive parts substituting with 100% reliable LC analyzing.

Turn chaos into cash by quickly locating transmission line distance to opens and shorts to within feet, in any transmission line.

Test troublesome SCRs & TRIACs easily and automatically without investing in an expensive second tester. The patented "Z METER 2" even tests SCRs, TRIACs, and High-Voltage Diodes dynamically with up to 600 volts applied by adding the new SCR250 SCR and TRIAC Test Accessory for only \$148 or FREE OF CHARGE on Kick Off promotion.

To try the world's only Dynamic LC Tester for yourself, CALL TODAY, WATS FREE, 1-800-843-3338, for a FREE 15 day Self Demo.



Call Today Wats Free 1-800-843-3338

SENCORE

3200 Sencore Drive
Sioux Falls, SD 57107
605-339-0100 In SD Only

*innovatively designed
with your time in mind.*

CIRCLE 186 ON FREE INFORMATION CARD

ANTIQUE RADIOS

The telegraph and WWI

FOR ABOUT TWO YEARS NOW WE'VE been discussing many facets of antique radio. This time, let's take a look at some early developments in the field, how World War I affected development, and another closely related technology, the telegraph. In addition, we'll try to nail down the origin of the term radio.

Antique of the month

The U. S. Army Signal Corps Receiver shown in Fig. 1 is a De Forest receiver that belongs to Charles Dold, of Florida. I'd like to thank Mr. Dold for sharing information and the fine photos of his WWI receiver with us.

The date on the lid of the set is July 11, 1918. The radio still operates with the original crystal; it covers what is now the broadcast band.

You can see (in the right side of the cabinet) an added-on single-stage audio amplifier that occupies the space formerly used to store headphones. The amplifier uses a Radiotron V199 tube whose grid circuit is coupled to the emergency telephone connection of the receiver. Volume level is adjusted by a filament rheostat on the added panel. In addition, a battery-powered buzzer is coupled to the antenna circuit; the buzzer provides a broadband signal for finding a sensitive spot on the crystal.

For soldiers in the field who were unfamiliar with servicing or operating the receiver, a diagram and instructions are mounted inside the lid. A transcription of those instructions appears in the text box.



FIG. 1

The telegraph

The telegraph had a 50-year head start on the wireless in practical use, and it wasn't until the very end of that period that the two were in direct competition. Like radio, the telegraph got off to a confusing start in this country.

Actually, the U. S. Government helped build the first telegraph line in 1844. It ran between Baltimore, MD and Washington, DC. The government appropriated \$30,000 for the project, which amounted to about \$1000 per mile. The government operated the line for about two years, but they refused to buy the patent rights. Within five years there were some 50 different telegraph companies operating in the U. S. As with many early radio companies, many of the telegraph companies



RICHARD D. FITCH,
CONTRIBUTING EDITOR

went into receivership and were never heard from again. In addition, there were many patent-rights infringement claims.

Also like wireless, many men contributed to the development of the telegraph. But later it was ruled that Samuel Morse was the inventor of the practical telegraph. It's interesting to note that some historians even credit Morse with inventing wireless.

The reason is that Morse inadvertently performed an experiment in 1842, wherein he made water the medium of radio transmission. He had laid one mile of insulated wire in New York harbor, preparing for a telegraph demonstration. Without warning, a vessel in the harbor weighed anchor and severed the wires. That caused Morse to conduct "wireless" experiments using metal plates in opposite banks of the river, using water as the transmission medium.

Although wireless didn't replace the telegraph, it had many advantages. For one, the Army didn't have to guard miles of telegraph wire to prevent the enemy from cutting it.

The spark gap

Developments in wireless during WWI brought about the end of the spark-gap transmitter. If you're unfamiliar with the term spark-gap transmitter, you should know that it was widely used before WWI, and that a development of it (called the rotary spark-gap transmitter) was widely used ten years before the U. S. entered the war.

In its simplest form, the spark-gap transmitter consists of an an-

SIGNAL-CORPS RECEIVER INSTRUCTIONS

THIS SET IS INDUCTIVELY COUPLED WITH variable inductance in both primary and secondary circuits. With the condenser connected (switch out) the secondary circuit will tune sharply, but with the condenser disconnected (switch on AP) the circuit is not tuned and may be used with close coupling as a "pick up circuit." The detector may be adjusted for any setting by closing the buzzer circuit switch. The buzzer circuit is completed through the first ten turns of the primary inductance and excites the antenna circuit when the buzzer switch is closed.

To tune the set to receive a definite wavelength, proceed as follows. 1. Adjust the detector for its best point. 2. Set the secondary circuit at the desired wavelength by referring to the calibration in the lid. 3. Place coupling indicator on 10 degrees or less. 4. Adjust the primary inductance and capacity until the resonance sound is heard in the secondary. 5. The coupling can now be increased, if desired, and slight variations made in the primary and secondary settings to obtain the best signals from the sending station. The sharpest tuning is obtained by using very loose coupling, as much inductance and as little capacity as possible in both primary and secondary circuits. R-E

tenna, which is connected to a spark gap, a coil, a battery, and a sending key. Most early home-made spark-gap transmitters had limited range. The receiver consisted of an antenna, and a detector that was connected to an earphone. A tuning coil might be, but wasn't always, included in either transmitter or receiver.

Of course, eventually the spark-gap transmitter was replaced by the glowing silent bulb known as a valve or audion, and later as a tube. So, much equipment owned by veterans was obsolete by the time the war ended. Then it was time for the vets to rebuild their stations with all the latest parts and information.

Pre-war radio

Regarding my discussions of tube sets from the 1920's, I thought that few readers would be interested in anything much earlier. How wrong I was. Many readers have personal recollections of experimental wireless equipment pre-dating WWI.

Before 1912, transmitter licensing was handled rather loosely, even though there were many signals traveling through the air. As

Analyze defective waveforms faster, more accurately, and more confidently — every time or your money back

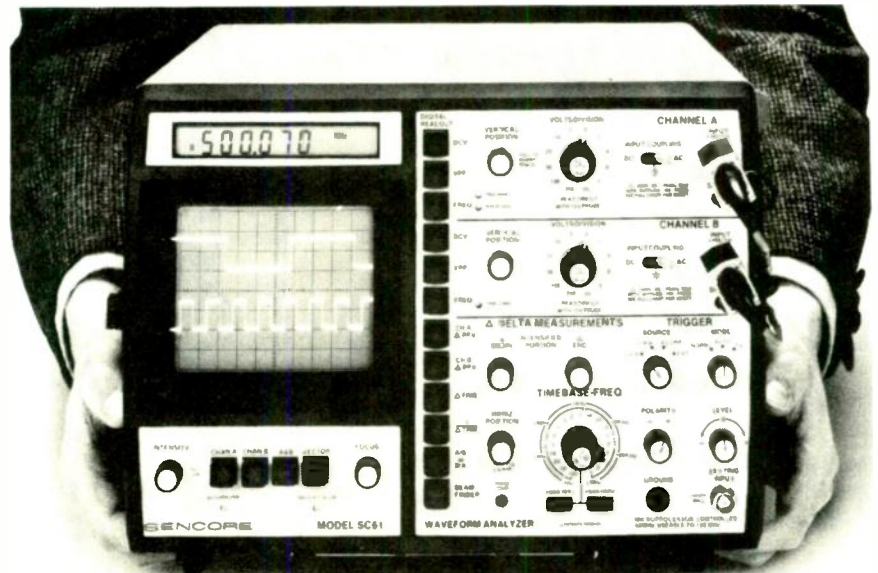

with the SC61 Waveform Analyzer
Patented \$2,995

If you value your precious time, you will really want to check out what the exclusively patented SC61 Waveform Analyzer can do for you. 10 times faster, 10 times more accurate, with zero chance of error.

End frustrating fiddling with confusing controls. Exclusive ultra solid ECL balanced noise cancelling sync amplifiers, simplified controls, and bright blue dual trace CRT help you measure signals to 100 MHz easier than ever.

Accurately and confidently measure waveforms from a tiny 5 mV all the way to a whopping 3,000 V without hesitation with patented 3,000 VPP input protection — eliminates expensive "front end" repairs and costly equipment downtime.

Make only one circuit connection and push one button for each circuit parameter test: You can instantly read out DC volts, peak-to-peak volts and frequency 100% automatically with digital speed and accuracy. It's a real troubleshooting confidence builder.

Confidently analyze complex waveforms fast and easily. Exclusive Delta measurements let you intensify any waveform portion. Analyze glitches, interference signals, rise or fall times or voltage equivalents between levels; direct in frequency or microseconds.

Speed your digital logic circuit testing. Analyzing troublesome divide and multiply stages is quicker and error free — no time-consuming graticule counting or calculations. Simply connect one test lead to any test point, push a button, for test of your choice, for ERROR FREE results.

To see what the SC61 can do for your troubleshooting personal productivity and analyzing confidence, CALL TODAY, WATS FREE, 1-800-843-3338, for a FREE 15 day Self Demo.



Call Today Wats Free 1-800-843-3338

SENCORE

3200 Sencore Drive
Sioux Falls, SD 57107
605-339-0100 In SD Only

*innovatively designed
with your time in mind.*

CIRCLE 187 ON FREE INFORMATION CARD

Radio-Electronics mini-ADS



THE MODEL WTT-20 IS ONLY THE SIZE OF A DIME, yet transmits both sides of a telephone conversation to any FM radio with crystal clarity. Telephone line powered - never needs a battery! Up to ¼ mile range. Adjustable from 70-130 MHZ. Complete kit \$29.95 + \$1.50 S+H. Free Shipping on 2 or more! COD add \$4. Call or send VISA, MC, MO. **DECO INDUSTRIES, Box 607, Bedford Hills, NY 10507. (914)232-3878.**

CIRCLE 127 ON FREE INFORMATION CARD



A CAREER START FOR THE 21ST CENTURY. Since 1905, National Technical Schools has helped people build successful careers. Enter the 21st Century through home study courses in Robotics, Computer Technology and Servicing, Microprocessors, Video Technology, Basic Electronics, Transportation Technology, Climate Control Technology or TV and Radio Servicing. For a FREE catalog, call 1-800-B-BETTER. Or write **NTS/INDEPENDENT TRAINING GROUP, 456 West M. L. King Jr Blvd. L.A., CA 90037.**

CIRCLE 181 ON FREE INFORMATION CARD

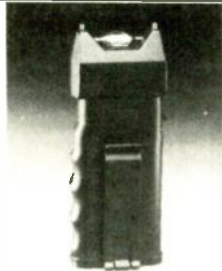

SAFE-LEGAL-EFFECTIVE STUN GUN VIPER II. Instantly immobilizes an attacker up to 15 minutes. Penetrates through leather and thick clothing. Discharges 50,000v from a single 9v NiCad battery. Used by police around the country. 1 Year Guarantee. 1 Viper II \$39.95. With NiCard battery and charger \$49.95. Free belt clip with every VIPER II. Catalog Free. **UNITED IMPORTS & MFG., 684F PACIFIC ST. RE1, OMAHA, NE 68106, (402) 554-0383, TLX: 5106016153, MC, VISA, C.O.D.**

CIRCLE 201 ON FREE INFORMATION CARD

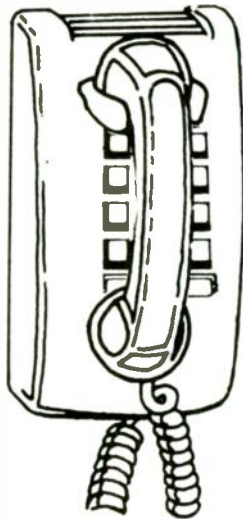

CALL NOW AND RESERVE YOUR SPACE

- 6 x rate \$745.00 per each insertion.
- Reaches 239,312 readers.
- Fast reader service cycle.
- Short lead time for the placement of ads.
- We typeset and layout the ad at no additional charge.

Call 516-293-3000 to reserve space. Ask for Arline Fishman. Limited number of pages available. Mail materials to: **mini-ADS, RADIO-ELECTRONICS, 500-B Bi-County Blvd., Farmingdale, NY 11735.**

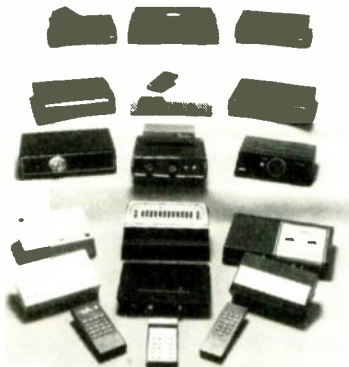

CABLE TV CONVERTERS AND DE-SCRAMBLERS. Large selection of top quality merchandise. Low prices. Quantity discounts. We ship COD. Most orders are shipped within 24 hrs. Send \$2.00 for catalog. **CABLETRONICS UNLIMITED, P.O. Box 266 Dept. R, S. Weymouth, MA 02190 (617) 843-5191**

CIRCLE 203 ON FREE INFORMATION CARD

far back as the 1890's man-made signals were being sent through the air. Government and civilian transmissions cluttered the air waves in some locations.

Even before WWI, armies in the U. S. and in Europe were quick to realize the importance of wireless communications. The war, of course, started in 1914, but the delayed entry of the U. S. in 1917 afforded a grace period that allowed development of better equipment. However, the early field station was a far cry from the field station of later years.

When the U. S. entered WWI, all wireless activity by civilians had to cease (just as it did during WWII). It's hard to say whether that restriction aided or impeded the development of radio. Most of the amateurs and other experimenters who had been deeply involved in wireless were recruited as soldiers, so they had to leave their labs and stations anyway. Of course, those wireless enthusiasts became invaluable to the armed forces. How did the armed forces know who those knowledgeable men were? Even as far back as 1917 they had to be licensed. As a matter of fact, they had to be licensed as far back as 1912, when the Wireless Act was passed.

That's not to say that the war was responsible for advances that wouldn't have been accomplished anyway. I'm sure that those experimenters would have worked just as hard at advancing wireless had they stayed at home, working in their radio shacks.

To be useful to the Army Signal Corps in the field, the entire wireless station had to be mobile. In the pre-WWI era, mobility meant cavalry, and cavalry meant horses. It took at least half-a-dozen horses to carry the entire field station. Yes, the gasoline engine was used, but its sole purpose was to supply power to operate the radio. Like other components, the gasoline engine was carried on a horse fitted with a specially designed saddle. As primitive as it may sound, the horses could be unloaded and the station erected in about 15 minutes.

The technically minded soldier shared his pre-war radio experience, and in return gained knowl-

edge from the Army on the latest advances in wireless. However, when the radiomen returned home, their licenses had expired. Even after the official end of the war in November 1918, the ban on hams and experimenters was not lifted. Most likely the problem was what to do with the 200-meter band. That "useless" band had been delegated to the amateurs when licensing and controls began earlier.

After much effort by returning veterans and organizations like the ARRL, the ban was lifted, and licensing was restored in October of 1919. Even then, however, there was still some debate about whether receivers should be licensed. If, as was the case in some foreign countries, U. S. receivers had to be licensed, it's probable that the development of radio would have occurred much more slowly. Eventually, of course, it was decided that receivers didn't need to be licensed. The easing of restrictions started a whole new hobby for those who wanted to listen to what was on the air, but who didn't want to experiment or to make transmissions of their own.

Restoration

To rebuild the obsolete sets required much technical information—but where would that information and the necessary parts come from? It came from early Gernsback and other publications of the times. The alert magazine editors coordinated readers' needs with mail-order advertisers who could meet those needs. Learned contributors sent in plans, diagrams, schematics, and parts lists for many different types of experimental circuits.

Many of those early home-built sets are still around, and they usually have no identification, except, perhaps, on some parts. Many home-made sets are better made and are of generally higher quality than later commercially produced sets. If you come across one of these unnamed home-made receivers, you'd do well to buy it, if you can get it for a reasonable price. It's as much a part of radio history as any commercially produced product.

R-E

Walk "tough dog" troubles out of any TV & VCR in half the time . . . or your money back



with the exclusive, patented,
VA62 Universal Video Analyzer . . . \$3,295

Would you like to?

Reduce analyzing time: Isolate any problem to one stage in any TV or VCR in minutes, without breaking a circuit connection, using the tried and proven signal substitution method of troubleshooting?

Cut costly callbacks and increase customer referrals by completely performance testing TVs & VCRs before they leave your shop? Own the only analyzer that equips you to check all standard and cable channels with digital accuracy? Check complete, RF, IF, video and chroma response of any chassis in minutes without taking the back off the receiver or removing chassis plus set traps dynamically right on CRT too? Simplify alignment with exclusive multiburst pattern?

Reduce costly inventory from stocking yokes, flybacks, and other coils and transformers, for substitution only, with the patented Ringing Test. Run dynamic proof positive test on any yoke, flyback, and integrated high voltage transformer . . . in- or out-of-circuit?

Protect your future by servicing VCRs for your customers before they go to your competition? Walk out "tough dog" troubles in any VCR chrominance or luminance circuit — stage-by-stage — to isolate problems in minutes? Have proof positive test of the video record/play heads before you replace the entire mechanism?

Increase your business by meeting all TV and VCR manufacturers' requirements for profitable warranty service work with this one universally recommended analyzer?

To prove it to yourself, CALL TODAY, WATS FREE, 1-800-843-3338, for a FREE Self Demo . . . or learn how the VA62 works first by calling for your free simplified operation and application instruction guide, worth \$10.00.



Call Today Wats Free 1-800-843-3338

SENCORE

3200 Sencore Drive
Sioux Falls, SD 57107
605-339-0100 In SD Only

*innovatively designed
with your time in mind.*

CIRCLE 188 ON FREE INFORMATION CARD

STATE OF SOLID STATE

Transformerless 5-volt regulator

A NEW AC-TO-DC CONVERTER AND voltage regulator in an 8-pin DIP IC is a new offering from Maxim Integrated Products. The six devices in the MAX600 series can reduce the cost, simplify the design, and reduce the component count, size, and weight of 5-volt DC, ½-watt power supplies. To create a 5-volt, 100-mA regulated supply, all you must add is a single filter capacitor. In addition, by adding a current-limiting resistor and a capacitor, four devices in the MAX600 series can connect directly to a 117-VAC power line.

The MAX600 and the MAX610 connect directly to the AC power lines and provide a five-volt output using an internal full-wave rectifier. The MAX601 and MAX611 are similar devices with half-wave rectifiers, and the MAX602 and MAX612 convert 8-volts rms to 5 volts DC using full-wave rectifiers. The MAX600, MAX601, and MAX602 have 0 to +50°C temperature ranges, and the MAX610, MAX611, and MAX612 have 0 to +70°C ranges.

Contained in the 8-pin DIP pack-

age is a half-wave rectifier, a 12.4- or 18.6-volt Zener-diode shunt regulator, and a bipolar series-pass regulator. The nominal output voltage of all devices is 5 volts DC $\pm 4\%$; the output of the MAX600, MAX602, MAX610, and MAX612 can be set to any desired value between 1.3- and 15.0-volts DC.

A block diagram of the MAX600 series is shown in Fig. 1. Open-drain pin $\overline{\text{OV}}$ goes low during under- and over-voltage conditions. The under- and over-voltage thresholds are fixed at 4.65 and 5.4 volts, respectively. Those thresholds do not change even if the output voltage is changed via the V_{SET} terminal, explained below.

Output voltage is determined by the state of pin 4, V_{SET} . If pin 4 is grounded, the output voltage will be the preset 5-volts DC. Otherwise pin 4 can be used to set the output to any voltage from 1.3 to 10 (for the MAX600/10) and from 1.3 to 15 (for the MAX602/12) by installing a simple resistive voltage divider. Pin 4 of the MAX601/11 controls a reset delay—the amount of time before pin 3 returns to a high level



ROBERT F. SCOTT,
SEMICONDUCTOR EDITOR

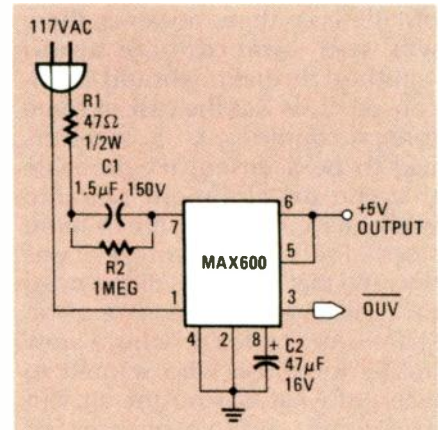

FIG. 2

following an over- or under-voltage condition. The reset delay is directly proportional to the value of an external capacitor connected to pin 3. Each 0.01 μF of capacitance results in a 30-ms delay.

Pin 5 is the current-limit input. The output short-circuit current limit is $0.6\text{V}/R_{\text{SENSE}}$, where R_{SENSE} is a current-limiting resistor connected between pins 5 and 6.

The rectified but unfiltered output of the diode bridge appears at pin 8. The desired filter capacitor should be connected between pins 8 and 2. The output of the regulator appears at pin 6.

Figure 2 shows a MAX600 configured as a 5-volt, 50-mA DC power supply. By substituting a 100 Ω , 1-watt resistor for R1 and a 0.82- μF , 280-volt capacitor for C1, the circuit will run from a 220-volt, 60-Hz AC power line.

When output current demand is less than 10 mA, capacitor C1 can be omitted; the available current will be determined by the value of R1. For 5-volt, 10-mA output, R1 should be 8200 ohms. Power dis-

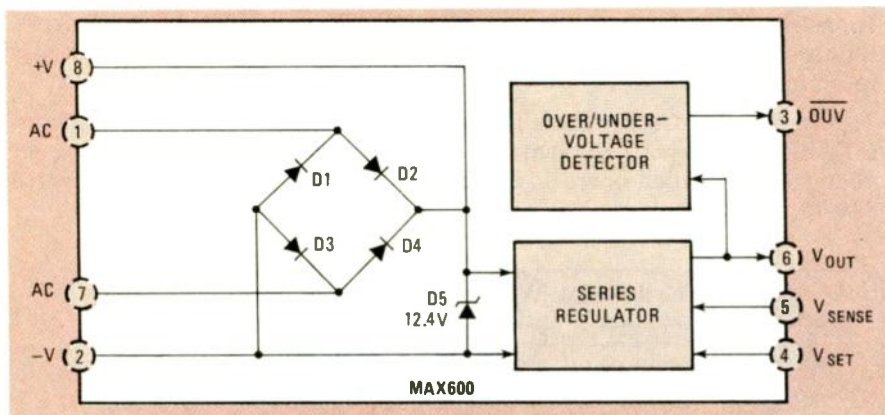

FIG. 1

sipation is about 1.3 watts. For 220-volt AC operation, double the resistance and wattage.

NOTE WELL: The output of power supplies using a MAX600-series regulator is not isolated from the power line unless its input is supplied through an isolation transformer! The MAX600 device, its circuitry, and all components and equipment driven by the 5-volt supply present a shock hazard and should be mounted in a protective enclosure to prevent accidental contact.

Further, when power is removed from a MAX600-based power supply, C1 may contain a charge equal to the peak value of the line voltage, thereby creating a second shock hazard. Therefore R2, the optional 1-megohm resistor, should be included to discharge C1 when power is removed from the circuit.

If the power supply is connected directly to the power line, do not connect the ground of an oscilloscope to the circuit. In addition to creating a shock hazard, doing so could severely damage a solid-state scope, as well as destroy the MAX600 device.

If the power supply must be isolated from the power line, you can use a 1:1 isolation transformer or a step-down transformer and a MAX602 or MAX612. The transformer should deliver 8-volts rms to maintain a regulated 5-volt output. The peak transformer output should not exceed 17 volts unless a series resistor is used to limit current to a safe value.

The maximum power dissipation of the MAX602/612 is approximately $(V_{IN} - V_{OUT}) \times I_{LOAD}$. With an 8-volt rms input, power dissipated in the device limits maximum output current to 100 mA at 25°C and 30 mA at 70°C.

If the 8-volt transformer is replaced by a 6.3-volt unit, maximum output current increases to 150 mA at 25°C, but the line voltage must not be permitted to drop below 100 volts. Otherwise, output voltage regulation will be lost. When using a 6.3-volt transformer, the capacitor connected to the +V terminal must be increased to 220 μ F to help prevent +V from falling below 6.0 volts at any time.

continued on page 97

Now test and restore every CRT on the market . . . without ever buying another adaptor socket or coming up embarrassingly short in front of your customer . . . or your money back



with the new improved CR70 "BEAM BUILDER"™
Universal CRT Tester and Restorer
Patented \$995

Have you ever?

Thrown away a good TV CRT, data display CRT, or scope CRT that could have been used for another two or three years because you had no way to test or restore it?

Lost valuable customers because you advised them that they needed a new CRT when another technician came along and restored the CRT for them?

Lost the profitable extra \$35 or more that you could have gotten for restoring a CRT while on the job and locked in the profitable CRT sale later?

Avoided handling profitable trade-ins or rentals because you were afraid you'd have to replace the picture tube when you could have restored it?

Had a real need to test a CRT on the job, but didn't have the right adaptor socket or setup information in your setup book?

If any of these things have happened to you, **CALL TODAY, WATS FREE, 1-800-843-3338**, for a **FREE 15 day Self Demo**.

"BEAM BUILDER" is a trademark of Sencore, Inc.



Call Today Wats Free 1-800-843-3338

SENCORE

3200 Sencore Drive
Sioux Falls, SD 57107
605-339-0100 In SD Only

*innovatively designed
with your time in mind.*

CIRCLE 189 ON FREE INFORMATION CARD

COMMUNICATIONS CORNER



HERB FRIEDMAN,
COMMUNICATIONS EDITOR

Image interference

MODERN TECHNIQUES OF DESIGN AND manufacture save money and thereby bring more equipment that functions better to more people. However, cost-cutting can have unwanted and unforeseen side effects.

For example, in recent months we've received a rash of complaints about powerful shortwave stations (voice, code, and RTTY) that interfere with standard broadcast-band stations. In fact, that interference often jams even the clear-channel stations. According to some correspondents, the problem is most severe in Boon-docksville, where reception isn't good to begin with, and where outdoor antennas are a fact of life. The way it's told, the longer the antenna, the worse the interference, which sometimes is so bad that it is impossible to listen to the radio.

The problem is *image interference*. If you've had much experience with communications gear, you've probably run across image interference, even if you didn't know what it was. Usually it affects a station or two, or a portion of the band, but it's seldom so bad that it wipes out almost the entire band.

The solution

A letter from reader Wilfred Caron, of Ridgecrest, CA, provided a clue to the nature of the problem. Mr. Caron noticed that several of his radios suffering from severe shortwave interference on the broadcast band had the same problem. He examined their schematics and discovered that each used a similar front end: the composite type shown in Fig. 1. In ad-

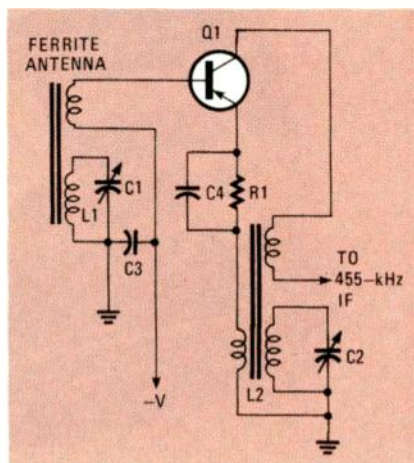

FIG. 1

dition, each radio had an all-plastic cabinet, so neither the front end nor anything else was shielded.

To those of you familiar with the old "All-American Five" vacuum-tube radio, the Fig. 1 circuit should look familiar. It's a solid-state version of the combination RF amplifier/oscillator/mixer stage—what is called a converter. Unfortunately, the transistor version seldom includes the metal shielding common to the tube-type circuit. Also, simple transistor oscillators generate greater odd-order products than vacuum-tube types. Although we would expect the third harmonic of a tube-type converter to be greater than 35 dB down, we have measured third-harmonic products from an equivalent solid-state circuit as little as 10 dB down.

Now let's look at the circuit. For the sake of discussion, assume that no shortwave frequency gets past the tuned-antenna circuit composed of L1 and C1. That circuit is what tunes the broadcast

band. However, the wire that connects the antenna coil and Q1's input is unshielded. That wire functions as an antenna that receives signals from all frequencies and feeds them to Q1's base.

One of Q1's duties is to function as an oscillator whose frequency is tuned by L2 and C2 to 455 kHz above the desired frequency. For example, assume we want to tune in a station at 1100 kHz. Therefore the oscillator is tuned to $1100 + 455 = 1555$ kHz. The third and fifth harmonics of 1555 kHz are 4665 and 7775 kHz. The oscillator's harmonics can *beat* (add and subtract) with any signals fed into Q1's base, so both the additive and the subtractive products will be fed into the 455-kHz IF amplifier.

There will also be *intermodulation products* caused by beating the third and the fifth harmonic products with the IF. So the 4665-kHz harmonic will produce signals at $4665 \pm 455 = 4210$ kHz and 5120 kHz, and the 7775-kHz harmonic will produce output at 7320 and 8239 kHz. The upshot is that any shortwave signal received on any of the product frequencies will be received clearly if it gets into Q1's base. And that type of pickup can happen easily in an unshielded radio.

Bear in mind that, as the radio is tuned to different stations, the oscillator is also tuned. Hence the harmonics also vary—so the radio actually tunes both the broadcast and the shortwave bands.

The problem is compounded because Q1 functions as a regenerative detector, a very-high-gain circuit that is much used in

continued on page 98

KENWOOD

...pacesetter in Amateur radio

NEW

Hear it All!



R-5000

High performance receiver

THE high performance receiver is here from the leader in communications technology—the Kenwood R-5000. This all-band, all mode receiver has superior interference reduction circuits, and has been designed with the highest performance standards in mind. Listen to foreign music, news, and commentary. Tune in local police, fire, aircraft, weather, and other public service channels with the VC-20 VHF converter. All this excitement and more is yours with a Kenwood R-5000 receiver!

- Covers 100 kHz-30 MHz in 30 bands, with additional coverage from 108-174 MHz (with VC-20 converter installed).
- Superior dynamic range. Exclusive Kenwood DynaMix™ system ensures an honest 102 dB dynamic range. (14 MHz, 500 Hz bandwidth, 50 kHz spacing.)

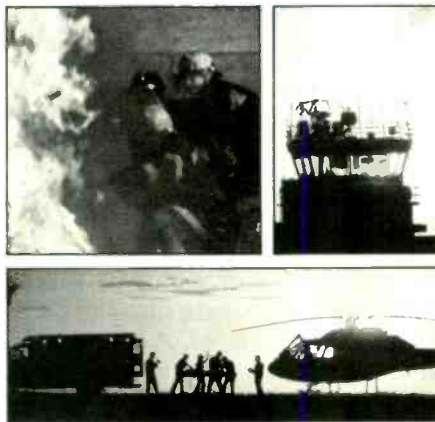

- 100 memory channels. Store mode, frequency, antenna selection.
- Voice synthesizer option.
- Computer control option.
- Extremely stable, dual digital VFOs. Accurate to ± 10 ppm over a wide temperature range.
- Kenwood's superb interference reduction. Optional filters further enhance selectivity. Dual noise blankers built-in.
- Direct keyboard frequency entry.

- Versatile programmable scanning, with center-stop tuning.
- Choice of either high or low impedance antenna connections.
- Kenwood non-volatile operating system. Lithium battery backs up memories; all functions remain intact even after lithium cell expires.
- Power supply built-in. Optional DCK-2 allows DC operation.
- Selectable AGC, RF attenuator, record and headphone jacks, dual 24-hour clocks with timer, muting terminals, 120/220/240 VAC operation.

Optional Accessories:

- VC-20 VHF converter for 108-174 MHz operation
- YK-88A-1 6 kHz AM filter
- YK-88S 2.4 kHz SSB filter
- YK-88SN 1.8 kHz narrow SSB filter
- YK-88C 500 Hz CW filter
- YK-88CN 270 Hz narrow filter
- DCK-2 DC power cable
- HS-5, HS-6, HS-7 headphones
- MB-430 mobile bracket
- SP-430 external speaker
- VS-1 voice synthesizer
- IF-232C/IC-10 computer interface.

More information on the R-5000 and R-2000 is available from Authorized Kenwood Dealers.

KENWOOD

TRIO-KENWOOD COMMUNICATIONS
1111 West Walnut Street
Compton, California 90220

CIRCLE 102 ON FREE INFORMATION CARD

- R-2000** 150 kHz-30 MHz in 30 bands
- All modes • Digital VFOs tune in 50 Hz, 500 Hz, or 5 kHz steps • 10 memory channels
 - Programmable scanning • Dual 24-hour digital clocks, w/ timer • 3 built-in IF filters (CW filter optional) • All mode squelch, noise blanker, RF attenuator, AGC switch, S meter • 100/120/220/240 VAC operation • Record, phone jacks
 - Muting terminals • VC-10 optional VHF converter (118-174 MHz)



Specifications and prices are subject to change without notice or obligation.

DESIGNER'S NOTEBOOK

A simple CMOS oscillator

OSCILLATORS ARE PROBABLY THE MOST popular kind of circuit around. Just about every piece of equipment you can buy has at least one oscillator buried inside it. More than likely there are several, because different kinds of jobs call for different kinds of oscillators.

We've discussed several types of oscillators in this column, but we've never even mentioned the one that's probably the most useful of all: the crystal oscillator. Once upon a time it was anything but simple to design one of those things, but, like many other things, that design difficulty is now a matter of history. These days, a reliable crystal oscillator can be built easily by throwing together a handful of easy-to-find parts.

A simple crystal oscillator

The circuit shown in Fig. 1 is a good example of just how simple it can be to build a crystal-controlled oscillator. To understand how the circuit works, temporarily ignore the crystal and the capacitors. What's left is an inverter set up as a linear amplifier, another circuit we've discussed in this column before. (See, for example, the negative-voltage generator in this column in the March 1986 issue.)

By adding the crystal and the capacitors to the feedback path, we turn the amplifier into an oscillator and force it to oscillate at, or at least very near, the crystal's resonant frequency. The trimmer capacitor (C2) allows you to adjust the actual operating frequency of the circuit. The crystal should be a parallel-resonant type; maximum frequency will depend partly on supply voltage, but you should



ROBERT GROSSBLATT,
CIRCUITS EDITOR

occasionally need out-of-phase clock signals.

If you need other output frequencies that are integrally related to the crystal's frequency (100 kHz, 50 kHz, 10 kHz, etc.), they can be obtained using dividers.

Setting up a home lab

I receive many letters from people asking what basic equipment one needs for doing electronic circuit design at home. That's an easy question to ask, but a difficult one to answer. What you need depends entirely on what you want to do. At the risk of having everyone disagree with me, I'll say that I think a minimum workbench would include a multimeter, a logic probe, a pulse catcher, an RC substitution box, a variable power supply, breadboards, and a good soldering iron. After you acquire those basic items, you can start thinking about oscilloscopes and other more expensive items.

But, as you get more and more involved in circuit design you'll also find that the handiest stuff to have around isn't necessarily what you ordinarily think of as test equipment. No workbench can be considered complete without a slew of debounced switches, digital display circuits, oscillators, variable frequency generators, and other circuits that you can design and build yourself.

If you find yourself using the same sort of circuit over and over on the bench, it's a good idea to take the time to refine it and put it on a PC board. It will make circuit development easier, and you'll find that you can drop the PC layout right into some other circuit. R-E

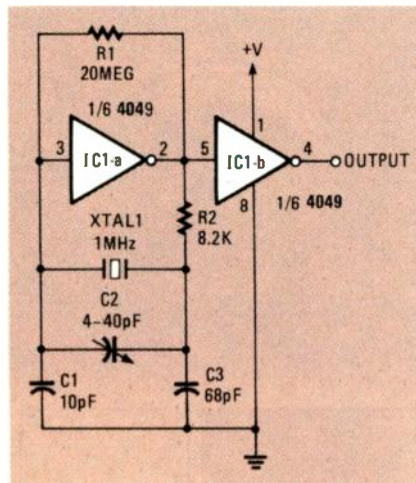

FIG. 1

have no trouble getting at least 1 MHz. Use quality mica capacitors to minimize thermal drift.

The circuit is built from a simple inverter, but you can use just about any CMOS gate that can be set up as an inverter. A TTL gate doesn't behave well when you force it into linear operation. The bandwidth is limited, it sucks up a lot of current, and all sorts of other nasty things can happen.

If you use a two-input NAND or NOR gate instead of an inverter, you can use the other input as a gate to turn the buffer. And, no matter what sort of gate you use, it's a good idea to buffer the output with another gate. Often you can simply use another gate in the same package as the buffer. And if you have more than one gate available, you can feed the buffered output through another inverter. That will give you two outputs that are equal in frequency but 180 degrees out of phase. Micro-processor and other circuits

STATE OF SOLID STATE

continued from page 93

Current-limiting capacitor C1 is critical when used in a 110/220-volt input supply. It should be non-polarized and rated for at least 150-volts rms. Metallized film capacitors are preferred to metal-foil types.

The value of C1 determines the power dissipated in the regulator IC and the maximum output current. It should be the smallest value that will deliver the desired output current at the minimum line voltage, because the power dissipated in the IC increases with the value of C1. For the full-wave MAX600 devices,

$$C1 = \frac{I_{MAX}}{(V_{RMS} - V_{OUT}) \times 4\sqrt{2} \times F_{IN}}$$

where f_{IN} is the input line frequency. For half-wave MAX601/11 devices, the value of C1 is doubled.

Resistor R1 limits maximum peak current to 5 amps. That amount of current could flow if power were connected just as the instantaneous line voltage was at its maximum. With a 117-volt 60-Hz input, dissipation in mW is $1.6 \times C1 \times R1$, where C1 is in microfarads and R1 is in ohms. For a 220-volt input, the constant in that equation is 2.7 instead of 1.6.

The maximum input to the MAX600/10 is 10 volts; those devices can supply outputs from 1.3 to 9 volts. Similarly, the maximum input to the MAX602/12 is 16 volts; those devices can supply outputs from 1.3 to 15 volts—Maxim Integrated Products, 510 N. Pastoria Ave., Sunnyvale, CA 94086.

THIS SPACE CONTRIBUTED AS A PUBLIC SERVICE

You can help us raise the colorectal cancer cure rate.

When detected early the cure rate for colorectal cancer is very high. That's why we urge regular checkups for men and women 50 and over. Warning signs are a change in bowel habits, blood in the stool.

Your doctor can perform the digital and procto exams, and you take care of the stool blood test at home.

Checkup Guidelines for men and women over 50 without symptoms

- digital exam annually
- stool blood test annually
- procto exam every 3 to 5 years after 2 negative tests 1 year apart

No one faces cancer alone.

AMERICAN CANCER SOCIETY



TUBES and IC's
FAST DELIVERY
LOWEST PRICES
call Toll Free (800) 221-5802

In-depth Inventory - Industrial & Receiving Tubes

3-500Z	\$85.00	8122	\$135.00
572B	75.00	813	45.00
811A	15.00	MRF450	12.95
6146B	8.75	MRF454	18.95
M2057	15.00	MRF455	14.95
8950	12.50	MRF492	19.95
4CX250B	75.00	6LF6	8.26
6883B	9.50	6JS6C	7.46
SG613	10.50	6CA7	6.91

CHEMTRONICS CHEMICALS

TUN-O-WASH 24oz.	\$3.89
TUN-O-POWER	3.39
TUNER RENU 6oz.	1.25
FREEZE IT 22oz.	3.39

Major Manufacturers Factory Boxed and Full Line of Sylvania ECG Replacement Semiconductors



Minimum order \$25.00 Allow \$3 UPS charge

TRANSLETERONIC INC.



Box R. 1365 39th Street, Brooklyn, NY 11218
Tel. 718-633 2800/Watts Line 800-221-5802
FAX # (718) 633 4375

CIRCLE 195 ON FREE INFORMATION CARD

HAMEG

Instruments

high quality at low cost

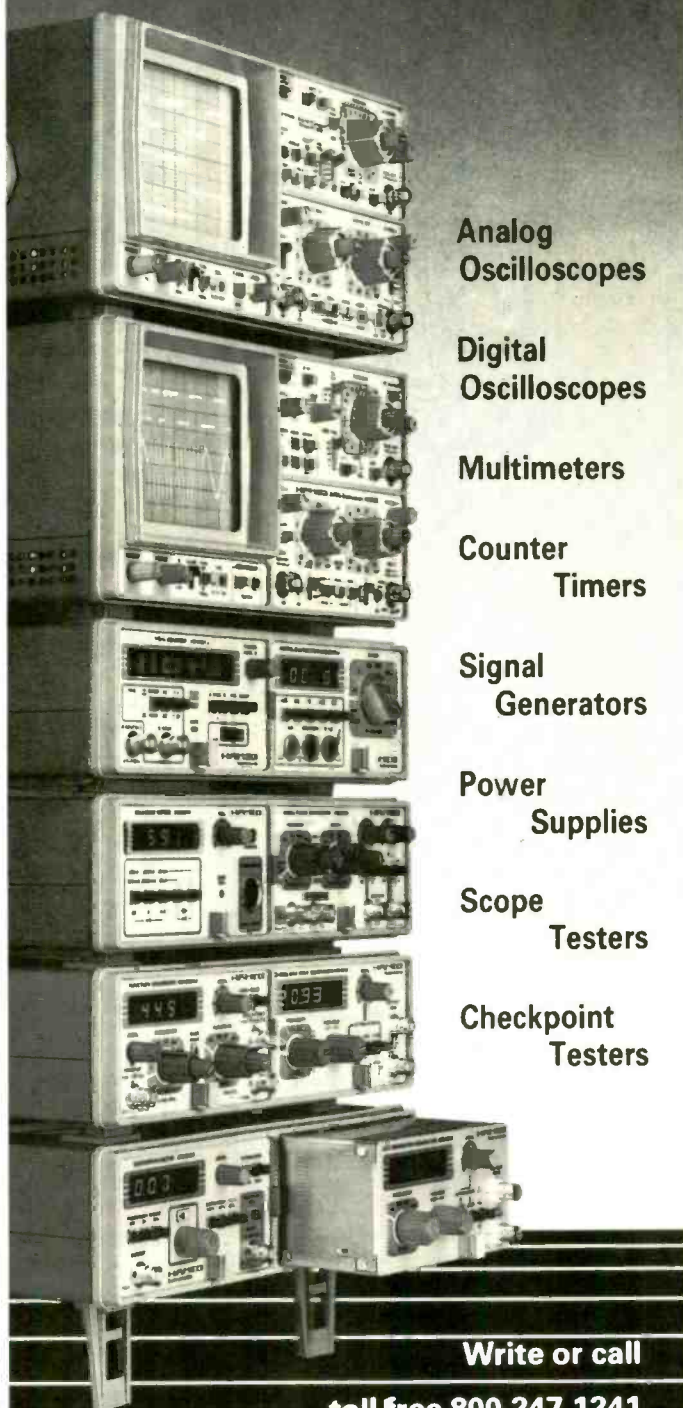

Analog Oscilloscopes

Digital Oscilloscopes

Multimeters

Counter Timers

Signal Generators

Power Supplies

Scope Testers

Checkpoint Testers

Write or call

toll free 800.247.1241

HAMEG, INC.

88-90 Harbor Road · Port Washington N.Y. 11050
Phone (516) 883.3837 TWX (510) 223.0889

FEBRUARY 1987

CIRCLE 62 ON FREE INFORMATION CARD

R-E Engineering Admart

Rates: Ads are 2 1/4" x 2 7/8". One insertion \$825. Six insertions \$800 each. Twelve insertions \$775 each. Closing date same as regular rate card. Send order with remittance to **Engineering Admart**, Radio Electronics Magazine, 500-B Bi-County Blvd., Farmingdale, NY 11735. Direct telephone inquiries to Arline Fishman, area code-516-293-3000. *Only 100% Engineering ads are accepted for this Admart.*

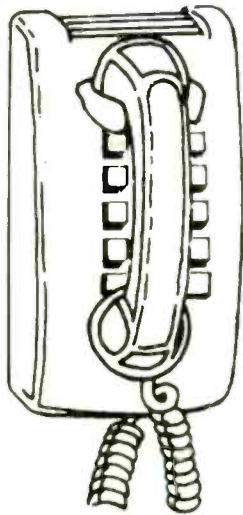

CALL NOW AND RESERVE YOUR SPACE

- 6 x rate \$800.00 per each insertion.
- Reaches 239,312 readers.
- Fast reader service cycle.
- Short lead time for the placement of ads.

Call 516-293-3000 to reserve space. Ask for Arline Fishman. Limited number of pages available. Mail materials to: Engineering Admart, RADIO-ELECTRONICS, 500-B Bi-County Blvd., Farmingdale, NY 11735.

IBM-PC Schematic Design

A professional package enabling you to design, edit, print & plot electronic schematics. Supports "A" through "E" size sheets. over 2000 Unique Library Parts, Part Rotation. Unlimited Hierarchy, Grids, Auto Panning, 5 Zoom Levels, Rubberbanding, Powerful Macros. Hi-Res Color & Monochrome Graphics. Much More! \$495 Includes Everything.

Call or Write for Free Demo Disk.
OrCAD Systems Corporation
1049 S.W. Baseline St. Suite 500
Hillsboro, OR 97123
(503) 640-5007

8051, 8096, 68HC11, 68008 SINGLE BOARD COMPUTERS



We feature a series of single board computers for process control applications. Available as bare boards or assembled and tested. Optional EPROM resident System Monitors and BASIC interpreters are also available.

ALLEN SYSTEMS
2151 Fairfax Road
Columbus, Ohio 43221
614-488-7122

CIRCLE 206 ON FREE INFORMATION CARD

FREE

52 PAGE
CATALOG
AND APPLICATIONS GUIDE

AFFORDABLE
ENGINEERING
SOFTWARE

PDF — Plotter Driver Program
for multi and
single pen plotters \$72.95

XFER — Transfer Function Synthesis
Transfer functions/
Electronic circuits \$72.95

TEKCALC — Scientific Calculator
Program
Scientific
Statistics
Programmable \$72.95

COMCALC — Communications
Design Spreadsheet
communications
circuit simulator \$72.95

RIGHTWRITER — Report
Proofreader Program
version 2.0
200 lines of English \$97.95

ACNAP —
AC Network Analysis \$72.95

DCNAP —
DC Network Analysis \$72.95

SPP —
Signal Processing Program \$72.95

PLOTPRO —
Plotter Design Printing \$72.95

PCPLOT —
High Resolution Plotting \$72.95

LOCIPRO —
Micrologic Analysis \$72.95

ACTEL —
Active Filter Design \$72.95

SIAP —
Sine Program Analysis \$72.95

MATRIC MAGIC —
Matrix Manipulation \$72.95



Engineering

Professional Software (714) 781-0252
201 Business Way, Suite 207, Irvine, CA 92614, USA

CIRCLE 183 ON FREE INFORMATION CARD

LINEAR IC EQUIVALENTS & PIN CONNECTIONS

Linear IC
Equivalents
and Pin
Connections

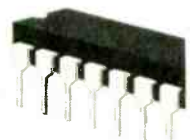

BP141—Shows equivalents & pin connections of a popular user-oriented selection of European, American and Japanese linear IC's 320 pages, 8 x 10 inches. \$12.50 Plus \$2.75 shipping. **ELECTRONIC TECHNOLOGY TODAY INC., PO Box 240, Massapequa Park, New York 11762-0240.**

COMMUNICATIONS CORNER

continued from page 94

non-commercial radios. The detected signal, in the presence of heaven knows how many sum and difference frequencies, ends up modulating one product whose frequency is the 455-kHz IF. So a strong, unwanted signal is fed to the IF amp.

That's the basics of how a simple converter stage can generate shortwave interference to broadcast-band stations. Other means are possible: Intermodulation products could be caused by a strong signal that overdrove Q1's base-emitter junction.

How to get rid of that interference? Change the circuit design to reduce oscillator harmonics, eliminate the possibility of

strong-signal overload, and shield the front-end.

By the way, *direct* harmonic interference of the type we've been discussing—not that caused by intermodulation products—is usually described as second image, third image, etc. What happened to *first image*, you ask? For our 1100-kHz reference signal, the first image would occur at 1100 + 455 + 1100 = 2655 kHz.

R-E

COMPUTER DIGEST

VOL. 5 NO. 2 FEB. 1987

A NEW KIND OF MAGAZINE FOR ELECTRONICS PROFESSIONALS

BUILD AN IBM CLONE

It's cheap, it's easy!



MULTITASKING

True concurrency—or is it just an illusion

VOLTAGE REGULATOR DESIGN

Let your computer pick
the numbers

GERNSBACK
PUBLICATION

CONTENTS

Vol. 4 No. 2

February 1987

104 IBM-Compatible Clone Computer

A PC-compatible computer doesn't have to be expensive. You can assemble your own, complete computer for less than you might think. Best of all, it's easy! **Jack Flack**

110 Computer Regulator Design

Here's another way to put your computer to work. This program will provide a means to help pick the correct values the next time you're designing a regulator. **Jack Cunkelman**

112 Concurrency

Just how many different tasks can you really set your computer to doing at the same time? Despite what the salesmen say, is concurrency just a myth? Our author says "a myth is good as a mile!" **Marc Stern**

101 Editorial

102 Letters

102 Computer Products

103 Software Review



See Page 104

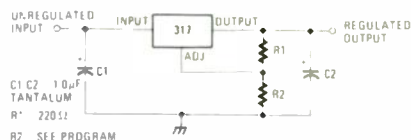

T SUFFIX TO220



1 ADJUST
2 OUTPUT
3 INPUT

K SUFFIX TO 3



1 INPUT
2 ADJUST
3 OUTPUT

See Page 110

ON THE COVER

If you've been thinking about IBM-PC compatibility, now's the time to do something about it. You'll be amazed at how inexpensive it can be if you're willing to do some simple assembly work. The things you learn from assembling your own computer can help you when it comes time to upgrading your system or, heaven forbid, repairing it!

COMING NEXT MONTH

Look for a bang-up issue next month, as we kick off with a really important story about a new way to store and distribute software. And we're going to round out that issue with an important piece on a Protocol Converter that you'll want to clip-and-save. And if you want even-more for your money, check out the article on our Computer Power Control System that will convince even your wife that computers are important! Don't miss our March Issue.



EDITORIAL

Do me a favor...

■...Don't do me any favors!

My computer keyboard has a feature that is being touted as a wonderful development, an advancement that makes it superior to other keyboards. It's called "rollover." And for my money, they can take it and keep it. I don't want it, and don't know how to get rid of this super-wonderful feature that makes computing a pain in the neck.

First, let me explain what rollover is. I suppose it's a blessing for people that touch-type. It has to do with hitting two keys at the same time (or almost the same time). The rollover feature is a super pain-in-the-neck for us hunt-and-peckers (no pun intended) that learned to type on upright manual typewriters before the days of electrics. Now back in my newspaper days everybody typed with two fingers. We called it the "Biblical System." Seek and ye shall find! And before you start putting me down for not touch-typing, let me tell you that I probably go a heck of a lot faster than you do with all ten of your digits!

The problem with rollover is that if I'm *slightly* off with the positioning of my fingers, I have to go back and remove all the wrong letters and characters that (thanks to rollover) I accidentally hit. For instance, usually every time I hit an "O," I'll have to go back and remove a "P" that follows it. And after every "C," there's a "V" that doesn't belong there. After each "B" you'll find an "N" and believe it or not, preceding most of the "T's", you'll find a 5. And why, when I write the word "the" does it come out "tyhe?"

So for my own part, they can remove that rollover feature any time now. I can live without it!



Byron G. Wels
Editor

COMPUTER DIGEST

M. Harvey Gernsback,
editor-in-chief, emeritus

Larry Steckler,
EHF, CET: publisher & editor in chief

Art Kleiman,
editorial director

Byron G. Wels,
editor

Brian C. Fenton,
managing editor

Carl Laron,
associate editor

Robert A. Young,
assistant editor

Jeff Holtzman
technical editor

Teri Scaduto Wilson
editorial assistant

Ruby M. Yee,
production director

Karen Tucker,
production advertising

Robert A. W. Lowndes,
production associate

Geoffrey S. Weil,
production assistant

Andre Duzant,
technical illustrator

Jacqueline P. Cheeseboro
circulation director

Arline R. Fishman,
advertising director

Computer Digest
Gernsback Publications, Inc.

Executive offices
500-B Bi-County Blvd.,
Farmingdale, NY 11735
516-293-3000

President: Larry Steckler
Vice President: Cathy Steckler

ADVERTISING SALES 516-293-3000

Larry Steckler
Publisher

NATIONAL SALES

Joe Shere
1507 Bonnie Doone Terrace
Corona Del Mar, CA 92625
714-760-8967

Computer Digest is published monthly as an insert in Radio-Electronics magazine by Gernsback Publications, Inc. 500-B Bi-County Blvd., Farmingdale, N.Y. 11735. Second-Class Postage Paid at New York, N.Y. and additional mailing offices. Copyright © 1986 Gernsback Publications, Inc. All rights reserved. Printed in U.S.A.

A stamped self-addressed envelope must accompany all submitted manuscripts and/or artwork or photographs if their return is desired should they be rejected. We disclaim any responsibility for the loss or damage of manuscripts and/or artwork or photographs while in our possession or otherwise.

LETTERS

Biofeedback

I wrote the article on the Graphic Biofeedback Monitor and there has apparently been a problem with the software. The program as published is correct. I have run it many times with no failures. However I have discovered what might be a source of error. The machine-language routines are placed in memory close to the end of the BASIC program. If you add lines of your own to the BASIC program you run a chance of interfering with the machine code. Even one or two comment lines added to the start of the program seem to be enough to cause the machine-language routines to load improperly. Enter the code *exactly* as published!—Ron Peterson, Milford, NH.

Thanks for the info Ron. That

should help cut back on some of the mail!

T'anks Pal!

I know you'll probably make some wisecrack about this letter, if it gets into print, but I just wanted to tell you that I really appreciate the way you inform your readers and still keep a good sense of humor.—B.K., Providence, RI.

See the sub-head, above.

In Print

What exactly do I have to do to see my letter in print. I've written to *many* magazines with no success. And this one is wasted too, right?—K.T., Houston, TX.

Right.

No Bets

Okay, now bear with me: If I get all the results of my local state

lottery for the past umpteen years and feed the winning numbers into my computer, can't I get a list of the most-frequently called numbers? And if I bet those numbers, isn't there a good chance that I'll win? R.D., Jersey City, NJ.

One thing for sure, you're letting yourself in for a lot of work! And since most lotteries are random drawings, there are still no guarantees.

Another Fan

One of the first pages I turn to in your magazine, is the Letters Column. I get a real boot out of your good-natured sarcasm. Keep up the good work! K.A., Elko, NV.

Sarcasm? Who, me? I haven't the remotest idea of what you're talking about! Why I'm the nicest, most easy going ...

COMPUTER PRODUCTS

For more details use the free information card inside the back cover

ART SOFTWARE, *Graphics & Symbols 1* and *Artfolio 1*, are part of the Desk Top Art line, each volume of which has more than 300 illustrations, stored on two diskettes as MacPaint documents.

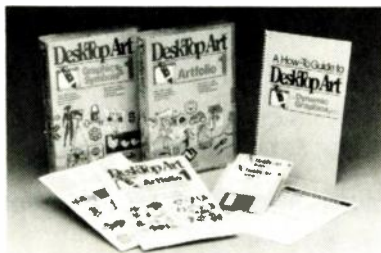

CIRCLE 18 ON FREE INFORMATION CARD

Also included in every package is a 24-page how-to guide, a complete pictorial index to the art, and suggested applications of the art.

Graphics & Symbols 1 is a collection of high-contrast pictograms and

symbols, and sells for \$66.95. *Artfolio 1* is a miscellany of styles and subjects that includes people, familiar objects, and animals. It sells for \$74.95.—

Dynamic Graphics, Inc., 6000 N. Forest Park, PO Box 1901, Peoria, IL 61656-1901

PC X.25 CIRCUIT BOARD, the *DialCard*, allows users of personal computers who have been relying on asynchronous data communications to take full advantage of their equipment's inherent sophistication to utilize the first U.S. X.25 DialSM service. Data communication end users now will have the ability to communicate synchronously over the Telenet[®] public data network simply by dialing into the network through a modem. The software for *DialCard25* uses the same command format as Telenet's assembly/disassembly (PAD) software.

Automatic end-to-end error detec-

tion and retransmission, rates up to 4800 b ts per second, and the ability to perform multiple tasks simulta-



CIRCLE 19 ON FREE INFORMATION CARD

neously, are among the product's leading features. *DialCard* operates at either 1200, 2400 or 4800 bits per second. It offers three virtual circuits, enabling users to talk to three separate computers at one time. It is transparent to the network.

DialCard25 has a retail price of \$595.00—**Western Digital**, 2445 McCabe Way, Irvine, CA 92714.

SOFTWARE REVIEW

Certificate Maker

■How often have you wanted to reward someone for a job well done, a game well played, or maybe just for fun?

Award a certificate—maybe with a gold seal—attesting to someone's prowess, cooking, or proficiency in anything. Even an award to someone for *Eating All Of Your Yucky Vegetables*.

All you need to crank out a customized award on the spur of the moment is your personal computer (almost any well-known brand), almost any well-known matrix printer, and *Certificate Maker*.

Pre-Designed

Certificate Maker lets you create attractive, personalized awards in just minutes, because the hard part is already done for you. It provides more than 200 professionally-designed, partially-completed certificates called *templates*. Some are for special occasions such as academic achievement, sporting triumphs, and the like—with title and appropriate artwork. Other templates are multi-purpose; with no artwork and only a partial title like *Certificate of.....*—you fill in the rest.

In addition to a template, you can select any of 24 pre-designed borders, and any of 5 type styles (fonts): Serif; Sans Serif; Script; Gothic; Art Deco. All fonts can be toggled on a line-by-line basis for medium or large size (there is no "small" size). The screen displays only the maximum number of characters allowed for each particular template line. Although it is possible to enter characters beyond the line width shown on the screen, only the screen characters will be printed on the certificate. If the type size is changed to *large* after entering text—thereby reducing the number of characters that can be accommodated per line—only the displayed characters print.

Six Elements

A certificate contains six specific elements: A pre-designed title; pre-designed graphic; the user-selected border (or no border); open body text and a "name" wildcard area (explained below); open date line; and open signature line.

Menu Driven

Although an operating manual is provided, it really isn't needed because the program is completely menu driven: you need only respond to screen prompts, and the prompts include display of the selected type style and border.

Award for Eating All Of Your Yucky Vegetables



BYRON G. WELS
For eating bland, tasteless
hospital food for three days.
July 30, 1986

The gang at the office

To create a certificate or award, you enter the number of the desired template (all templates are shown in the manual), select a border, and then the type style. The screen will display the maximum number of lines permitted, and you can use some or all of the lines.

A *names mode* allows a continuous file of names to be created and imprinted on the same template, much in the manner of a mailing list that's merged into a form letter. For example, if you prepare a list of club members winning an achievement award, the program will print a series of personalized certificates bearing only one name from the list.

To make the certificates "official," they can contain a *signature line* and date.

Alignment

Because there are two certificate sizes—which can be printed either vertically and horizontally—prior to printing you can call up a *Print Test*, which prints a four-corner test pattern of the certificate; thereby avoiding having to print the certificate to check its alignment. It lets you align or position the paper to center smaller certificates.

The program works with dual floppies and hard disk. Printer selection is done through a *Setup mode*, which lists virtually all commonly-used printers.

While the certificates don't resemble the quality from a press—matrix printing always looks like matrix printing, no matter how good it might be—they are a lot of fun, and a fast way to reward the deserving; or even the undeserving, because a few templates are somewhat biting.

Certificate Maker is available for the Apple II/e/c and the Commodore 64/128 (\$49.95), and the IBM-PC (\$59.95). For more information, write to Springboard Software, Inc., 7808 CreekrIDGE Circle, Minneapolis, MN 55435. ◀▶

CIRCLE 17 ON FREE INFORMATION CARD

BUILD AN IBM-COMPATIBLE CLONE COMPUTER

Now's the time to build your own IBM PC-compatible "clone" computer.

There's no reason to wait any longer!

JACK FLACK

■A lot has happened since we last looked at how to put an IBM PC-compatible clone computer together (**Radio-Electronics**, July and August 1985). If you weren't ready back then, maybe the time is now. The entire computer industry has gone wild with PC's and peripherals. And prices continue to fall as we are bombarded with literally hundreds of quality, compatible motherboards and add-ons ranging from 20-megabyte hard-disk drives to enhanced graphics-adaptor cards.

The PC clone that we assembled to prepare this story was put together from boards and components supplied by JDR Microdevices (110 Knowles Drive, Los Gatos, CA 95030). We would like to thank JDR for their help and cooperation.

Why should you assemble your computer instead of buying a complete unit? First, you can learn about and become familiar with your computer hardware during the assembly process so you'll be better able to deal with hardware problems, should they arise in the future. Also, you'll certainly have more confidence when it's time to expand and upgrade your system with such add-ons as hard disks and expansion cards.

Of course, the reason that most people assemble a clone computer is that it's (relatively) cheap.

Decisions, decisions

Before you can start to put a PC clone together, you have to decide how you want to configure it. Table 1 lists the various items you need to consider. Items marked with an asterisk (*) are necessary in a minimum configuration.

There are many add-on boards and peripherals available for IBM PC's and compatibles, and most can

be added at a later date without retrofitting parts initially installed. For example, you can start out with only one floppy-disk drive and then add up to three more later (depending on your floppy disk controller). Installing a 20-megabyte hard-disk drive is as easy to do later as it is at the beginning. So don't be tempted to get more than you really need at the start. You can always add more later.

However, you should look closely at your requirements for a keyboard and monitor (and monitor-adaptor board). You will use both more than any other system component, and they're not upgradable (though they can be *replaced* easily enough).

Many expansion boards are available that offer serial ports, game ports, parallel printer ports, light pen interfaces, expanded memory, clock/calendars, modems, and more. What do you need?

Some of your choices will be based simply on personal preference. For example, some people find that a clock/calendar board is very convenient, because it can be annoying to set the date and time each time you boot-up. On the other hand, some people never set their computer's clock, and would find a clock/calendar an unnecessary expense.

On the other hand, some of your choices will be based on what type of equipment (such as printers, modems, etc.) you intend on using with your computer.

And now to build

For your convenience, Table 2 is an abbreviated check list of the assembly process. We suggest you read the manufacturer's instructions thoroughly several times and then use Table 2 during assembly. That check list provides for the installation of a moderately



FIG. 1—EVERYTHING YOU NEED to assemble a complete computer system. Turn to page 108 for a description of each component.

TABLE 1 COMMON PC COMPONENTS

Component	Comments	Component	Comments
* Motherboard:	640K RAM capacity on board	Enhanced Graphics Adapter (EGA)	Will emulate mono and CGA boards, EGA mode requires enhanced monitor
Standard			
Turbo	Runs at faster clock speed, switchable, many programs must run at slower speed	Display (monitor):	
* BIOS ROM	Basic Input/Output System	* Monochrome (TTL)	Amber or green phosphor
RAM:		Monochrome (Composite)	Use with the CGA board
* 256K bank	Requires 9 256K x 1 (41256) RAM IC's	Color (Composite)	Use with the CGA board, 40 x 25 text and 320 x 200 color graphics
2nd 256K bank (512K total)	Requires 9 more 41256's	Color (RGBI TTL)	Supports all CGA modes
128K bank (640K total)	Requires 18 64K x 1 (4164) RAM IC's	Enhanced Display (Analog RGB)	21kHz, 28mm dot pitch, use with EGA
* Case	Flip-top lid	* Floppy disk drive	360K double sided, doubled density, half height
* Power supply	130 watts minimum	* Floppy disk controller	Available on multi I/O Floppy card
Keyboard:		Hard disk drive:	With controller
* 5150	standard	10 Megabytes	
5151	deluxe (separate cursor pad)	20 Megabytes	Half-height
Display Adapter:		20 Megabytes (card)	Drive and controller on same card
* Monochrome	Similar to IBM Mono adapter, TTL video	Multi I/O Floppy card	Clock/calendar, serial port, parallel port, floppy disk controller, game port
Monochrome/Hercules	Usually has parallel port, 720 x 348 graphics mode	Modem card	Hayes compatible
Color Graphics Adapter (CGA)	Light-pen interface, mono and color composite video (40 x 25 text on color)	* MS-DOS Software	Similar to PC-DOS but with disk BASIC

**TABLE 2
IBM PC ASSEMBLY CHECK LIST**

STEP	REMARKS	STEP	REMARKS
1. Prepare motherboard a. Insert BIOS ROM b. Insert RAM chips c. Set System switch d. Check for other jumpers and switches	Refer to Figure 1 Bend leads perpendicular, orient pin 1 to rear of board. See Table 3 See Table 3 Refer to manufacturer's documentation	8. Install floppy drive on bracket.	Set jumper to "DS1"
2. Install motherboard in case	Remove drive bracket from case and set aside. Mount board on standoffs loosely first. Align with expansion card(s) installed and then tighten.	9. Ensure drives align with front	Line up in case, adjust as needed.
3. Install Power Supply	Use 4 screws on back of supply. Connect to motherboard with 2 6-pin connectors.	10. Install drives/bracket in case	Reinstall hard drive cover plate.
4. Configure/install display adapter	Assign ports if necessary	11. Install ribbon cable on drives	Connectors are slotted (Fig. 9). Ribbon cable with twist goes on 1st floppy.
5. Test power supply/mother-board/display adapter	Power up system, should see boot sequence, check connections and configuration settings if problems.	12. Connect power supply to drives	4-pin connectors, note polarity.
6. Install speaker	Use outer 2 pins of speaker connector.	13. Install floppy controller card (or Multi I/O card)	34-pin ribbon, middle connector for 2nd floppy drive. If you use Multi I/O set up ports (beware of other cards).
7. Install hard drive on bracket	Bracket removed in step 2. Remove front plate, set jumper on drive to "DS0", DO NOT DROP OR BUMP!	14. Test floppy drive	Power up, watch for drive light and motor after boot, hard drive light should not come on.
		15. Install keyboard	Connector on back of motherboard
		16. Boot up	Insert system disk in floppy drive, all but hard disk should work
		17. Install hard disk controller card	Connect 20 and 34-pin ribbons from drive, neatly stow cables (Fig. 10).
		18. Format hard drive	Instructions in MS-DOS manual.

equipped system with 640K RAM, 1 floppy-disk drive, a 20-megabyte hard-disk drive, monochrome adapter and display, multi I/O floppy card (clock, I/O, floppy disk controller, etc.), and modem card. You can skip over those steps involving parts that you do not have. But pay special attention to the manufacturer's configuration requirements on each expansion card. Your PC will get confused if it sees more than one serial port or parallel port with the same address. It's also a good idea not to get all the parts out before you need them. Some of the cables look very similar and can get mixed up easily.

The motherboard

The motherboard may look intimidating, but when you become familiar with it, you'll realize that it's not as complicated as it appears. To begin, lay the motherboard down on a flat work surface with the 8 card connectors oriented away from you. (See Fig. 1.) You'll have to insert the ROM and RAM IC's and set DIP switches and a jumper before you can install the motherboard in its case.

Leave all the IC's in their conductive foam until you're ready to insert them in the motherboard. Then do so one at a time. It's also a good idea to touch a large metal object to discharge any destructive static electricity.

The RAM and ROM IC's usually come with the pins bent out slightly for use with automatic insertion

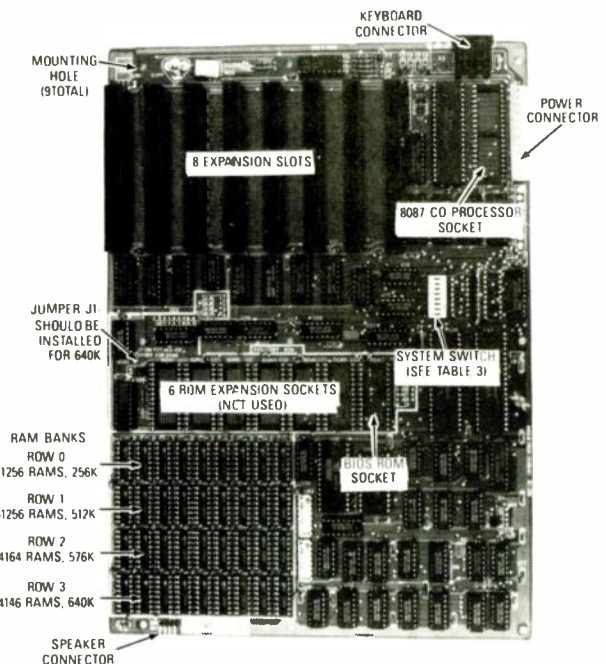

FIG. 2—THE MOTHERBOARD is the heart of the computer. You'll have to become familiar with it.

equipment. Straighten the pins by laying the IC on its side on a flat surface, and gently rocking the chip toward the leads.

When you insert an IC, first place it on top of the

appropriate socket so that all pins make light contact. Inspect all pins to ensure they're headed into the socket and not underneath the IC. Then apply even pressure on the top of the IC with your thumb or two fingers until it seats firmly in the socket. It wouldn't hurt to re-examine each IC after insertion with a good light source. (A bent pin is easier to repair if caught before your heart stops from a system failure!) If a pin gets bent, don't panic! Just remove the IC (pry up the ends with a small screwdriver), straighten the pin, and reinsert it.

Insert the BIOS (Basic Input/Output System) ROM in the "ROM 7" socket on the motherboard. Make sure the notch on the IC is toward the rear of the board. The 16-pin RAM chips are installed in the four rows of nine sockets. If you're using 256k RAM's (41256), the rear two rows (rows 0 & 1) are for those. The front two rows (rows 2 & 3) are for 64k RAM's (4164). The motherboard has a jumper that allows you to install 4164s in all four rows (limiting the total RAM capacity to 256k). In order to install 640k on the motherboard you must use 41256 RAM's in rows 0 and 1. (Never mix 4164s and 41256 on the same row!) Refer to Table 3 for general guidelines for memory configuration.

Next set the DIP switches using Table 3 and verify that the board jumper (J1) is properly in place. Most manufacturers have greatly reduced the number of jumpers and switches on their boards. Take a moment and verify that there are no other switches or jumpers on the motherboard. If others are present, set them according to the manufacturer's specifications.

Installing the motherboard

You're now ready to install the motherboard in the case. Start by removing and setting aside the disk-drive bracket located inside the case on the right. Loosely

TABLE 3
MOTHERBOARD SWITCH SETTINGS

DIP switch settings	Function
General Switches:	
1 = off	Normal Operation
2 = on	Without 8087
2 = off	With 8087
Memory Settings:	
3 = on, 4 = on	256K on-board *
3 = off, 4 = on	512K on-board *
3 = off, 4 = off	640K on-board *
Display Adapter Settings:	
5 = on, 6 = on	No display adapter
5 = off, 6 = on	CGA, 40 x 25 text mode
5 = on, 6 = off	CGA, 80 x 25 text mode
5 = off, 6 = off	Mono
Floppy Drive Settings:	
7 = on, 8 = on	1 drive installed
7 = off, 8 = on	2 drives installed
7 = on, 8 = off	3 drives installed
7 = off, 8 = off	4 drives installed

*These settings are for motherboards with 640K capacity. The 640K jumper (J1) should be installed. Verify that your motherboard has this same jumper and that it is properly installed.

install the nine standoffs in the case. The male portion of the standoff should be up. Next place one insulated flat washer over each of the standoff studs. Carefully place the motherboard over the nine studs with the 8 expansion slots toward the rear of the case. Move the studs until they pass through the holes on the motherboard. Place another insulated flat washer and nut over each stud and hand tighten. Temporarily install a couple of expansion cards to align the motherboard with the back cutouts on the case and then tighten the nuts and screws.



FIG. 3—TO ALIGN THE MOTHERBOARD, temporarily install a couple of expansion cards.

Installing the power supply

Remove and set aside the four screws on the back side of the power supply (the side with the power connector). Position the power supply in the right rear portion of the case with the switch on the right. It should slide back against the back wall. Fasten with the four screws previously removed. (If screws were not present, locate 4 large-head screws in the hardware included with the case.)

Locate two sets of wires with 6-pin connectors. One connector has only five wires and should be inserted in the rear six posts of the power connector on the motherboard with the empty slot toward the rear. The other 6-pin connector should be inserted in the front six posts on the motherboard. When installed properly, four black wires will be grouped together in the middle of the motherboard connector.

If you're installing a speaker, do so now. Refer to the installation guidelines for your case. The speaker wires should be attached to the two outside pins of the 4-pin speaker connector on the motherboard.

Go ahead and install your monitor card in one of the left expansion slots at this time so you can check out your work so far. Connect your monitor and power up the motherboard. You should see memory and I/O checks and the BIOS logo. If not, check all your connections and switch settings, and especially the RAM and ROM IC's.

The disk drives

Hard-disk and floppy-disk drives are both installed on the disk-drive bracket previously removed. The hard

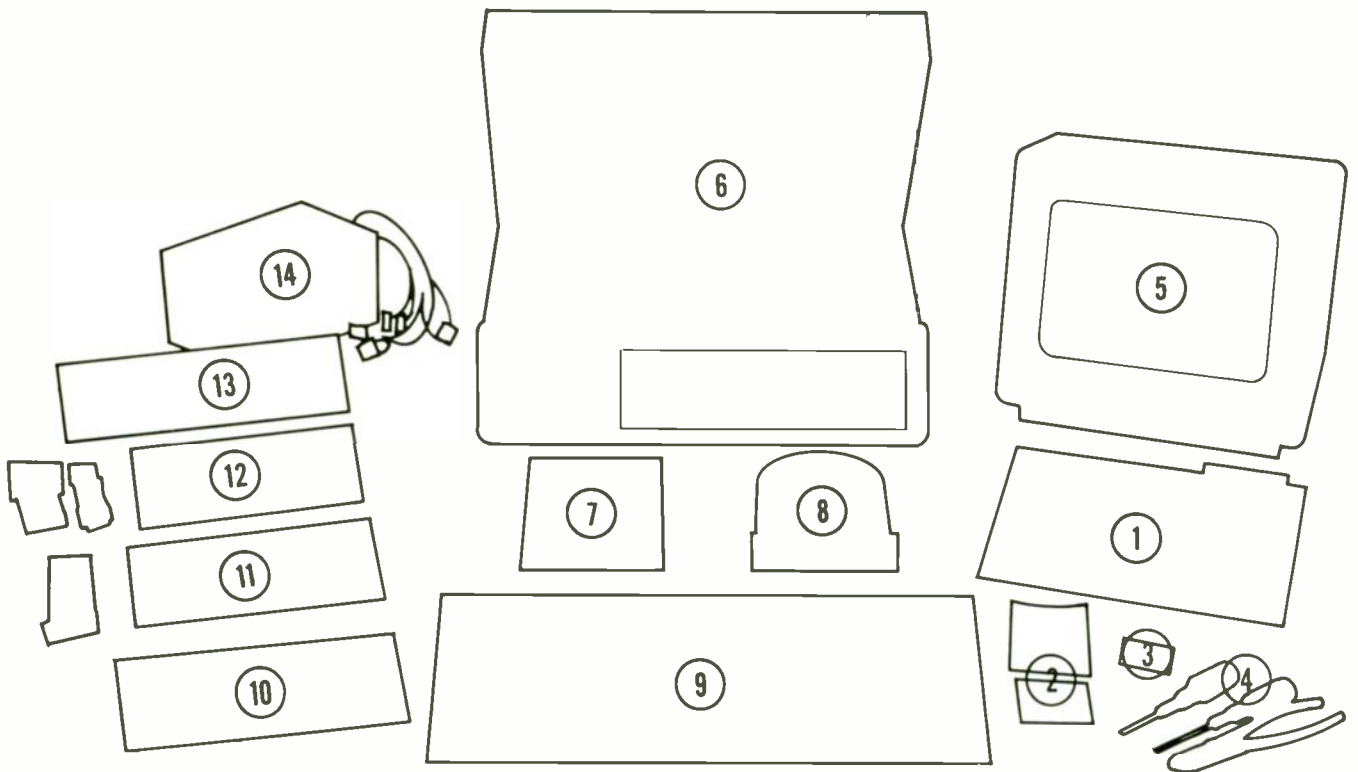

FIG. 4—HERE'S EVERYTHING YOU NEED to assemble a complete, deluxe IBM-compatible clone computer: 1) Motherboard with 640K RAM capacity; 2) 640K RAM IC's; 3) BIOS ROM; 4) Screwdrivers and pliers; 5) TTL monochrome monitor; 6) Flip-top case with side switch cutout; 7) Half-height floppy disk drive; 8) Half-height hard-disk drive; 9) Keyboard; 10) Modem card; 11) Multi I/O floppy controller card; 12) Hard-disk controller card; 13) Enhanced graphics adapter card; 14) 135-watt power supply.

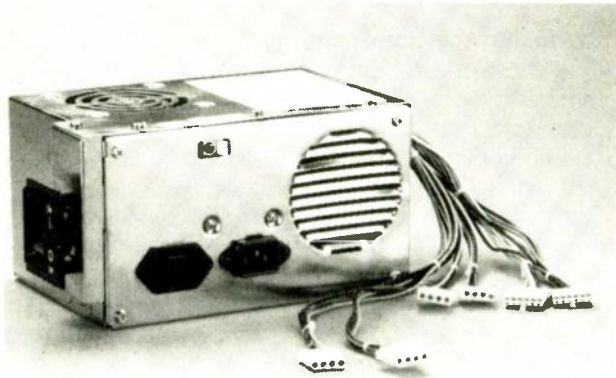

FIG. 5—THE POWER SUPPLY. Note the side-mounted power switch and the numerous power connectors.



FIG. 6—THE COMPUTER'S CASE has a flip-top lid, which makes system expansion a snap!

TABLE 4—GETTING THE PARTS

The clone computer we put together to prepare this article was supplied by JDR Microdevices 1224 S. Bascom Avenue, San Jose, CA 95128). We would like to thank them for their cooperation.

We worked with JDR because we found their prices competitive, and their product line complete. To give you a point of reference, here is a list of the parts that we used, and JDR's prices for those elements. We suggest you contact JDR at 800-538-5000 for more information regarding the manufacturer of the individual products, or for the latest pricing in this constantly changing market.

Hardware	Price
XT-compatible motherboard	\$109.95
BIOS ROM	19.95*
256K RAM	26.55
Power Supply (130 watts)	69.95
Case	39.95
Keyboard(IBM5150)	59.95
floppy disk drive	79.95
floppy disk controller	34.95
Monochrome adapter card	49.95
Monochrome monitor	99.95
20-Megabyte hard disk drive and controller	369.95
Enhanced keyboard 5151	79.95
Modem Card	139.95
Multi I/O floppy controller	89.95
Enhanced graphics adapter	199.95
EGA monitor	479.95

*Note: BIOS ROM is free with purchase of motherboard. EGA monitor and adapter available as a set for \$629.

disk is first. Locate the "select" jumper on the drive and make sure it's set at "DS0." Be very careful not to drop or bump the drive—it's very fragile!

Remove the front cover plate and mount the hard disk loosely on the right side of the bracket. It is usually mounted from below. Place the bracket back in the case where it will be permanently fastened later. Adjust the drive flush with the front of the case, lift the bracket back out and tighten the mounting screws. You may have to repeat that process several times to get proper alignment. Re-install the cover plate and position the bracket and drive back in the case, but do not permanently install it until the floppy drive is attached.

Manufacturers of floppy drives use different mounting techniques and hardware, so refer to the instructions that came with the drive. Set the "select" jumper on the drive to "DS1" and slide it on the bracket through the front of the case. (The floppy drive goes on the left.) As with the hard drive, adjust the floppy drive on the bracket until it is flush with the front of the case. When all looks straight, permanently mount the drive bracket and drives in the case.

Configure the hard disk controller but do not install it yet. Connect the 20-conductor and 34-conductor ribbon cables to the hard drive only. There should be slots cut in the edge connectors to insure proper polarity. The last connection to the hard drive is the power connection. Insert one of the four polarized 4-pin power connectors from the power supply into the hard drive.

Next insert the floppy disk controller card (or Multi I/O Floppy card) into one of the right-hand expansion slots on the motherboard. If you're using the Multi I/O Floppy cards, don't forget to configure the parallel and serial ports so as not to conflict with other cards (if any) with these ports.

Now connect the 34-conductor ribbon between the floppy controller card and the floppy disk drive. The edge connector with the twisted section in the ribbon should be installed on the drive. The other end goes on the controller card and the middle connector is for a second floppy drive. When installing a second drive, be sure and remove the terminating resistor network

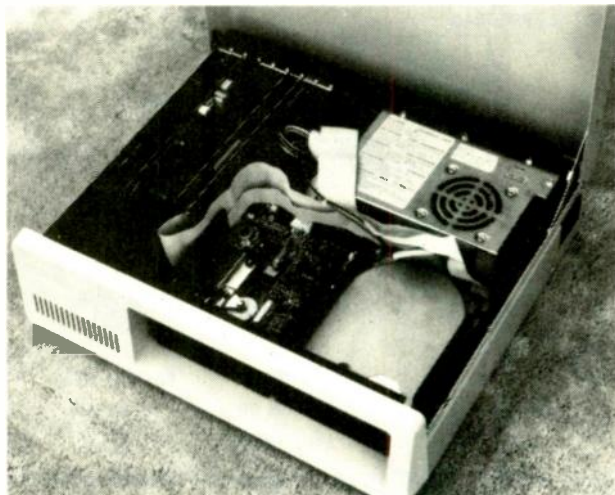

FIG. 7—THE DISK-DRIVE CABLES should be mounted so that they are neat and out of the way of any moving parts.

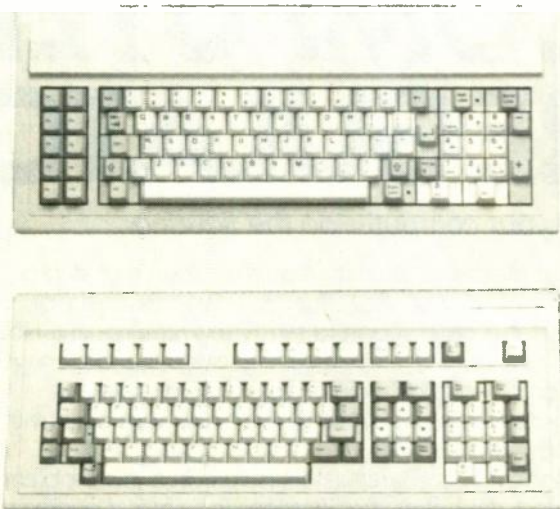

FIG. 8—THE ENHANCED KEYBOARD (bottom) has a separate cursor pad, and the function keys are mounted across the top.

from that drive. (Refer to the drives documentation for the location and description of the terminator chip).

Locate another 4-wire power cord from the power supply and insert it into the floppy drive power connector. Remove the cardboard shipping insert and prepare to power up the system.

Power it up!

Power up the system (without the system diskette installed) and watch and listen for anything unusual. After the BIOS logic appears (30–40 seconds), the floppy-drive light and motor should come on for several seconds. When that happens, all is well and you should insert the system diskette, and re-boot. If you run into problems, check all your connections and the "select" jumper on the floppy drive.

You're now ready to install the hard-disk controller card into one of the right-hand expansion slots and connect it to the 20 and 34-conductor edge connectors previously connected to the hard drive. Neatly stow the excess ribbon cables, making sure they do not interfere with the moving parts of the drive.

Configure and install your modem card in an empty expansion slot, ensuring that the serial port used by the modem doesn't conflict with serial ports (if any) on the other cards in your system.

Finishing touches

A few more steps and your system will be complete. Install the card separators on the inside front left wall of the case. Fasten the cards to the inside back wall of the case with the screws provided with the case. Install one of the metal plates wherever there is an empty slot.

The final step is to hook up the keyboard to the connector on the rear of the motherboard through the opening provided in the rear of the case. Refer to the documentation on the hard disk controller and initialize the drive. ◀▶

COMPUTER-ASSISTED REGULATOR DESIGN

Let your computer do the figuring...

Most electronic circuitry requires a source of stable, low ripple dc voltage to function. The power supply regulator is called upon to satisfy this requirement. Not too many years ago this meant assembling a dozen or so components on a circuit board. Since so many projects required a regulator, this circuit was built over and over again.

Modern IC linear regulators have eased this problem. We now get better specifications in a smaller package. The two types of adjustable linear regulators that have proven to be the most useful in my projects are the 317 series regulators for positive voltages and the 337 series regulators for negative voltages. This program deals with selecting the correct input voltages and resistor values when using these regulators.

The circuit

The output voltage is set by the ratio of R1 and R2 (see Figures 1 and 2). For best stability R1 is kept constant and the value of R2 is varied. The value for R1 in the 317 circuit is 220 ohms and the value for R1 in the 337 circuits is 120 ohms. The input and the output of the regulator should be bypassed with tantalum capacitors to make sure the circuit is unconditionally stable. A value of 1 μ F or so should be used. This value is not critical but the capacitors should be mounted as close to the regulator pins as possible.

Although the junction temperatures of most regulators can get as high as 150 C and still operate, a lower operating temperature is recommended for reliable operation. This would mandate the use of some sort of heat sink. When a heat sink is used, the regulator IC must be electrically isolated from the heat

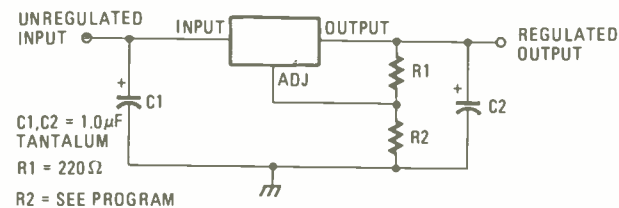

T SUFFIX - TO220

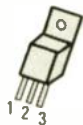

1 = ADJUST
2 = OUTPUT
3 = INPUT

K SUFFIX - TO3



ADJ
IN
OUT
(CASE IS OUTPUT)

H SUFFIX - TD39



1 = INPUT
2 = ADJUST
3 = OUTPUT

FIG. 1—OUTPUT VOLTAGE is set by the ratio of resistors R1 and R2. For stability, R1 is kept constant and R2 is varied. (See text.)

Jack Cunkelman

sink with an insulating washer. Diagrams of the various regulator case types are included in Figures 1 and 2.

The program

Two options are given to you: a screen output or a printer output. On the screen output, once you have answered the prompt as to what voltage you require, the program calculates what value of R2 will give you this voltage. Since this will not likely be a standard resistor value, the closest 5% resistor value is chosen for you. A new output voltage, using this 5% resistor value, is calculated and displayed. This new output voltage will always be within 5% of the target value. This should be more than adequate for most projects.

Two other parameters are also listed on the screen: minimum input voltage and maximum output voltage. Every linear voltage regulator must have a voltage drop across it in order to work properly, (i.e. the input voltage to the regulator must be higher than the output voltage). This minimum, for the chosen output voltage, is listed. The maximum input voltage relates to the amount of power the regulator can dissipate. To be able to draw the maximum output current, the input voltage to the regulator should be at or below this value. If it is above this value the output current will be reduced. In any case, absolute maximum input voltage is 40 volts.

The printer output option produces a table of values for all output voltages from 2 to 37 volts. It includes all values that are available on the screen display.

This program along with the Computer Assisted

C1, C2 = 1.0 μ F
TANTALUM

R1 = 120 Ω

R2 = SEE PROGRAM

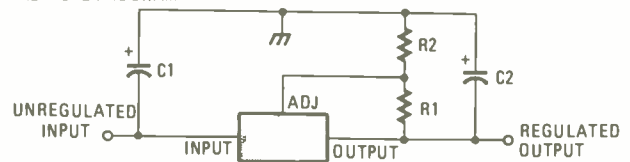

T SUFFIX - TO220



1 = ADJUST
2 = INPUT
3 = OUTPUT

K SUFFIX - TO3

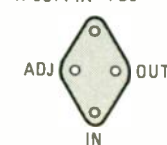

ADJ
IN
OUT
(CASE IS INPUT)

H SUFFIX - TO39



1 = ADJUST
2 = OUTPUT
3 = INPUT

FIG. 2—WHILE FIGURE 1 shows the typical 317 series adjustable positive regulator, the diagram above provides the same information for the 337 series adjustable negative regulator.

PROGRAM: Identify CAD for Regulators

```

10 CLS
20 REM THREE TERMINAL ADJUSTABLE REGULAT
OR APPLICATIONS
30 REM BY JACK CUNKELMAN - SEPT 1985
40 PRINT:PRINT
50 INPUT"SCREEN OUTPUT (S) OR PRINTER OU
TPUT (P)";M$
60 IF M$ = "S" THEN 500 ELSE 70
70 IF M$ = "P" THEN 3000 ELSE 50
500 CLS
610 PRINT "CALCULATIONS FOR USING THE : "
620 PRINT " 317 SERIES POSITIVE REGULATO
RS (1.2 TO 37 VOLTS)"
630 PRINT " 337 SERIES NEGATIVE REGULATO
RS (-1.2 TO -37 VOLTS)"
700 PRINT:PRINT
710 PRINT "SELECT TYPE:"
720 INPUT "POSITIVE (P) OR NEGATIVE (N)
VOLTAGE";T$
730 IF T$ = "P" THEN 750 ELSE 740
740 IF T$ = "N" THEN 900 ELSE 720
750 CLS
760 REM ** 317 CALCULATIONS **
770 INPUT "OUTPUT VOLTAGE DESIRED ( 0 TO
END PGM )";V
773 IF V = 0 THEN END
775 PRINT "MINIMUM INPUT VOLTAGE ="V+2.5
"VOLTS"
776 VM = V + 12
778 IF VM > 40 THEN VM = 40
780 PRINT"MAXIMUM INPUT VOLTAGE FOR MAXI
MUM OUTPUT CURRENT ="VM"VOLTS"
790 R1 = 220 : R2 = ((220*(V-1.25))/1.25
)
800 PRINT"R1 = 220 OHMS          R2 ="R2"
OHMS"
810 GOSUB 2000
820 PRINT "STANDARD 5% VALUE FOR R2 ="RS
"OHMS"
830 V = 1.25 + (1.25 * RS)/220
835 V1 = V*10
838 V2 = INT(V1)/10
840 PRINT "THE VOLTAGE OUTPUT USING"RS"
OHMS IS"V2"VOLTS"
850 PRINT "-----CALCULATIONS FOR
317 SERIES REGULATORS-----"
870 GOTO 770
900 CLS
910 REM ** 377 CALCULATIONS **
920 INPUT" OUTPUT VOLTAGE DESIRED ( 0 TO
END PGM )";V
930 PRINT"MINIMUM INPUT VOLTAGE ="V+2.5"
VOLTS"
932 VM = V + 12
934 IF VM > 40 THEN VM = 40
940 PRINT"MAXIMUM INPUT VOLTAGE FOR MAXI
MUM OUTPUT CURRENT ="VM"VOLTS"
950 R1 = 120: R2 = ((120*(V-1.25))/1.25)
960 PRINT"R1 = 120 OHMS          R2 ="R2"
OHMS"
970 GOSUB 2000
980 PRINT"STANDARD 5% VALUE FOR R2 ="RS"
OHMS"
990 V=1.25 + (1.25 * RS)/120
1000 V1 = V*10
1010 V2 = INT(V1)/10
1020 PRINT "THE OUTPUT VOLTAGE USING"RS"
OHMS IS"V2"VOLTS"
1030 PRINT"-----CALCULATIONS FOR 3
37 SERIES REGULATORS -----"
1050 GOTO 920
2000 RESTORE
2010 READ RX
2020 RZ = R2 - RX
2030 IF SGN(RZ) = -1 THEN 2060
2040 RA = RX
2050 GOTO 2010
2060 RB = RX
2070 E = ABS(RA - R2) : F = ABS(RB - R2)
2080 IF E < F THEN RS = RA ELSE RS = RB
2090 RETURN
2100 DATA 62,68,75,82,91,100,110,120,130
,150,160,180
2200 DATA 200,220,240,270,300,330,360,39
0,430,470,510
2210 DATA 560,620,680,750,820,910,1000,1
100,1200,1300
2220 DATA 1500,1600,1800,2000,2200,2400,
2700,3000,3300
2230 DATA 3600,3900,4300,4700,5100,5600,
6200,6800,7500
3000 CLS
3005 REM ** PRINTER ROUTINES**
3010 PRINT"PRINTED TABLES FOR : "
3020 PRINT"317 SERIES POSITIVE REGULATOR
S (1.2 TO 37 VOLTS)"
3030 PRINT"337 SERIES NEGATIVE REGULATOR
S (-1.2 TO -37 VOLTS)"
3040 PRINT "TABLE FOR : "
3050 INPUT " POSITIVE (P) OR NEGATIVE (
N) VOLTAGE";T$
3060 IF T$ = "P" THEN 3500 ELSE 3070
3070 IF T$ = "N" THEN 3700 ELSE 3050
3510 R1 = 220 : LPRINT:LPRINT:LPRINT
3520 LPRINT TAB(20)"CALCULATIONS FOR THE
317 SERIES REGULATORS"
3530 LPRINT:LPRINT:LPRINT
3540 GOTO 4020
3700 R1 = 120 : LPRINT:LPRINT:LPRINT
3710 LPRINT TAB(20)"CALCULATIONS FOR 337
SERIES REGULATORS"
3715 LPRINT:LPRINT:LPRINT
4020 GOSUB 5000
4030 FOR V = 2 TO 37
4040 VL = V + 2.5
4050 VM = V + 12
4060 IF VM > 40 THEN VM = 40
4070 R2 = ((R1*(V-1.25))/1.25)
4080 GOSUB 2000
4090 VN = 1.25 + (1.25 * RS)/R1
4100 V1 = VN*10
4110 V2 = INT (V1)/10
4120 LPRINT TAB(12);V;TAB(22) R2;TAB(32)
RS;TAB(42) V2;TAB(52) VL;TAB(62) VM
4130 NEXT V
4140 END
5000 LPRINT TAB(10);"OUTPUT";TAB(20)"CAL
CULATED";TAB(34)"5%";TAB(40)"OUTPUT V";T
AB(50)" MIN ";TAB(60)" MAX "
5010 LPRINT TAB(10);" V ";TAB(20)"
R2 ";TAB(34)"R2";TAB(40)" 5% R2 ";TA
B(50)"INPUT V";TAB(60)"INPUT V"
5020 LPRINT
5030 RETURN

```

Power Supply Component Selection program should enable you to provide correct, well-regulated voltages for that next project with a minimum of effort.

This program was written in Microsoft Basic and contains no esoteric Basic functions and should be easily translated into any Basic dialect. ◀▶

CONCURRENCY

You don't get something for nothing...

Marc Stern

■ One of the myths in the microcomputer world is that you can have true concurrency and multitasking—the ability of a microcomputer to handle two applications at once—with an IBM PC or a close clone.

It is fairer to say that all of today's concurrent operating environments present the *illusion* of concurrency, but at a cost in system performance speed. Only those which open a constantly accessed temporary disk file on a high-speed, high-density fixed disk—Quarterdeck Office System's Desqview—have a chance of approaching reasonable operating speed.

The reason, is the 8086/8088 family of microprocessors used in the IBM world. Asking these micros to handle concurrency is like asking a four-cylinder car to pull a 10-ton trailer. You'll get where you're going eventually, but it will take a long time.

(We're not talking about the high-performance, high-powered 80286 or 80386, because it would be like comparing apples and ducks. We're addressing the real world of 8086/8088 machines and there are more than 2.5 million at last check.)

Where the problem lies

You can't expect true concurrency from an 8086/8088 microprocessor because of its architecture. The speed of the unit and the amount of Random Access Memory are secondary.

The 8086/8088 microprocessors use an internal 16-bit architecture. This means that within the microprocessor chip itself everything moves around as 16-bit chunks of data or instructions. This internal architecture allows a marginal measure of concurrency because the 16-bit architecture is more powerful than an 8-bit architecture. But, this isn't the issue. The issue in concurrency is external and on this even the 8086/8088 machines diverge because of external differences.

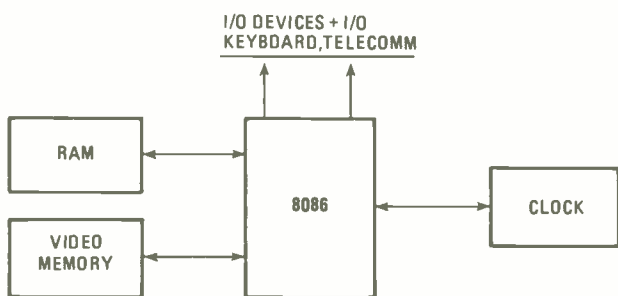

FIG. 1—ALTHOUGH A 16-BIT CHIP, the 8086 still requires support chips for such items as memory management; video management of input-output. They are polled at various points in the clock cycle.

In a strict sense, the 8086 microprocessor, a true 16-bit microprocessor, should handle a reasonable level of concurrency. It can theoretically address more than 1 megabyte of memory directly.

It must have various support chips to handle every input-output or direct memory access function (See Fig. 1). So, in order for this chip to have a measure of concurrency it must poll its support chips for input and when those chips have information it must fetch that information for its internal registers. Once the information is within those registers the 8086 functions as a 16-bit micro but its performance is slowed by the need to poll support chips and fetch the information.

One factor is that everything is handled via a 16-bit data bus so that only one poll and one fetch is needed per machine cycle—roughly every 1/18th of a second. This results in a speed increase over the 8088 because of a difference in architecture between the chips.

Concurrency still pushes the 8086 to its limits because the only way it can be implemented is by time-slicing or devoting some of the microprocessor's clock time to the second application. For several microseconds any first application freezes while the microprocessor handles the chores of the second.

A 16-bit microprocessor which is up to handling one application at reasonable speeds and flexibility slows down to the point of unacceptability when it must handle two or more chores.

So if a microprocessor with a different external architecture and different requirements which can affect performance, the 8088, the 8/16-bit version of the 8086 is a lower cost version, but uses the same instruction set.

The 8088 imposes its own set of constraints on a system because of its data bus. Where the 16-bit 8086 microprocessor has a 16-bit wide data bus, the 8088 has an internal data architecture of 16 bits, but an external data bus of 8 bits (See Fig. 2). Where the 8086 needs only one data fetch and latch, the 8088 must

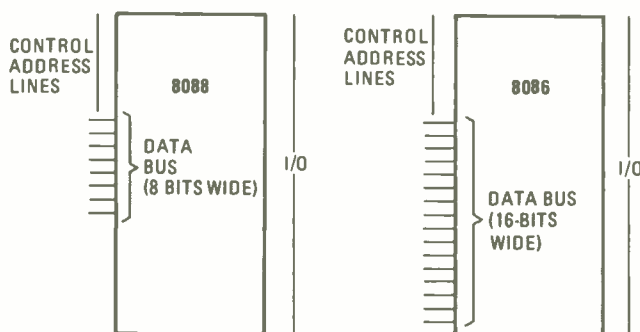

FIG. 2—THE 8088 IS A lower cost version of the 8086. It shares the same internal architecture and instruction set. Where it differs is in its external data bus which is only 8 bits wide.

make two because it is accessing data 8 bits at a time.

So, the 8088 must make two passes on its data bus for every one of the 8086 and this affects the performance of the 8088. Externally, the 8088 appears to be an 8-bit microprocessor in terms of its data bus and this imposes its own limitations on its adaptability to concurrency.

Instead of having to be concerned about time-slicing and fetching 16-bit instructions, which is how the 8086 works in a concurrent system, the 8088 must be concerned with time-slicing, and also the need for two passes at the data bus for complete data. This slows a processor which is already handling a great deal.

Superimpose the need to devote x microseconds to a second application, and the need for two passes at the data bus and true concurrency is impossible on an 8088. What is possible, is pseudo concurrency, where a second application is frozen in the background, while the first application works in the foreground. You switch between the two with a combination of keys and while it looks as if you have concurrent processing, what you actually have is clever memory management. The second function remains alive in RAM and video RAM so when the microprocessor sees a key combination, the environment application program controlling the microcomputer—Topview, Windows, Desqview, for example—switches over to the second application, while freezing the first (See Fig. 3).

The result looks like concurrent processing, but isn't.

And even though pseudo-concurrency is the most efficient way for way for an 8086/8088 machine to be used in this situation, the machine still experiences a slowdown. Its single-task microprocessor is being asked to share some of its resources to keep the second application alive in memory. This requires the resources to refresh the second application, as well as the system resources to monitor I/O so the second application isn't being called for.

There are some applications on the market which have long periods of microprocessor inactivity and you can keep these programs active in the background, instead of suspending their function as you must with most other types of programs that constantly ask for system resources.

These programs usually ask for microprocessor resources on demand—an incoming or outgoing call—and because they can be included in a system where there is a measure of background or concurrent processing. It will only activate when a data call comes in and so can remain active even though handling some foreground task. It works reasonably well even on

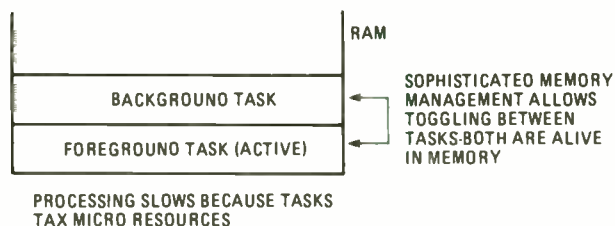

FIG. 3—This is a representation of the relationship of two applications that are used in a concurrent environment.

an 8088 machine. You will notice a slowdown in your first task as you work with it.

The 8086/8088 series of microprocessors is meant for single use. Although their internal architecture makes them marginally capable of concurrent processing, there are too many factors against concurrency.

Clock Speed

Most 16-bit computers run in the 4.7 MHz range, if they are IBM PC compatible, which constrains the capabilities of the microprocessor. The micro itself, is happy at speeds of up to 8 MHz, but is throttled back.

At 4.7 MHz, concurrency is acceptable because the micro must handle all applications installed; housekeeping; input-output; memory access, and video memory refresh. In turn, this cuts the already slow 4.7 MHz clock speed to two-thirds or less so a system which moves along at nearly 5 MHz with one application suddenly runs about 3 MHz with a second and third and slows with more.

If the micro ran at 6 MHz or more, its speed would be more acceptable, on the order of 4 MHz or more so the system works more efficiently.

Random Access Memory

Concurrency requires vast amounts of memory. Imagine trying to run not only the original concurrent environment application program with its own memory requirements, but then installing the operating system and the applications you want to run concurrently with 128K of RAM. It's impossible.

All of these require certain base amounts of memory to run which means your machine will probably need a minimum of 512K of memory installed. And imagine this 512K is only marginally acceptable in most instances. You need 640K and in most cases, performance is only marginally acceptable, especially if

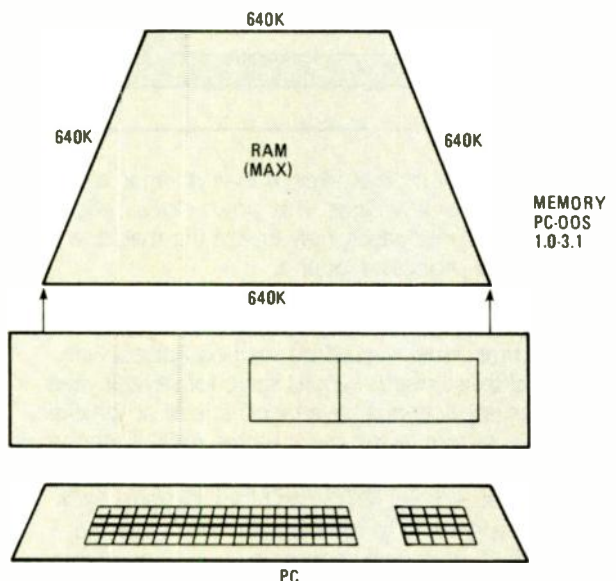
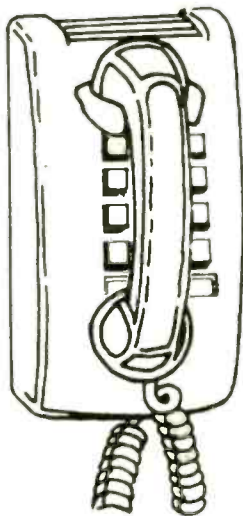

FIG. 4—THE PC'S DISK operating system effectively limits the PC to 640K of memory.

R-E Computer Admart



CALL NOW AND RESERVE YOUR SPACE

- 6 x rate \$800.00 per each insertion.
- Reaches 239,312 readers.
- Fast reader service cycle.
- Short lead time for the placement of ads.

Call 516-293-3000 to reserve space. Ask for Arline Fishman. Limited number of pages available. Mail materials to: Computer Admart, RADIO-ELECTRONICS, 500-B Bi-County Blvd., Farmingdale, NY 11735.

Rates: Ads are 2 1/4" x 2 7/8". One insertion \$825. Six insertions \$800 each. Twelve insertions \$775. each. Closing date same as regular rate card. Send order with remittance to Computer Admart, Radio Electronics Magazine, 500-B Bi-County Blvd., Farmingdale, NY 11735. Direct telephone inquiries to Arline Fishman, area code 516-293-3000. Only 100% Computer ads are accepted for this Admart.*

ICs PROMPT DELIVERY!!!

SAME DAY SHIPPING (USUALLY)

QUANTITY ONE PRICES SHOWN FOR NOV. 30, 1986

OUTSIDE OKLAHOMA NO SALES TAX

DYNAMIC RAM		
1Mbit	1000Kx1	100 ns \$40.00
4464	64Kx4	150 ns 3.75
41256	256Kx1	100 ns 4.85
41256	256Kx1	120 ns 2.95
41256	256Kx1	150 ns 2.55
41128	128Kx1	150 ns 4.99
4164	64Kx1	150 ns 1.35
EPROM		
27512	64Kx8	250 ns \$17.50
27C256	32Kx8	250 ns 5.85
27256	32Kx8	250 ns 5.25
27128	16Kx8	250 ns 3.95
27C64	8Kx8	200 ns 4.75
2764	8Kx8	250 ns 3.75
STATIC RAM		
43256L-12	32Kx8	120 ns \$20.00
6264LP-15	8Kx8	150 ns 2.99

OPEN 6 1/2 DAYS, 7 AM-10 PM SHIP VIA FED-EX ON SAT.

SUNDAYS & HOLIDAYS: SHIPMENT OR DELIVERY VIA U.S. EXPRESS MAIL.

SAT DELIVERY INCLUDED ON FED-EX ORDERS RECEIVED BY:

Fr. 5:45 AM \$6.4 lbs
Fr. 1:00 PM \$13.2 lbs

MasterCard VISA or UPS CASH COD
Factory New, Prime Parts
MICROPROCESSORS UNLIMITED, INC.
24 000 S. Peoria Ave
BEGGS OK 74421
(918) 267-4961

No minimum order!
Cash discount prices shown. Orders received by 9 PM CST can usually be delivered to you the next morning, via Federal Express Standard Air... \$5.00 on Priority One... \$12.00

CIRCLE 61 ON FREE INFORMATION CARD

COMPUTER ASSEMBLY MANUALS



Eliminate Guesswork!
Build with Confidence!

BIG BLUE SEED for IBM™ BUILDERS
Parts list, placement diagrams & instructions for assembling over 75 IBM-compatible bare cards. Latest version includes guides for 640K, Turbo, & AT MthBds. \$17.95

APPLE SEED II for APPLE™ BUILDERS
Instructions for assembling over 85 Apple-compatible bare cards including II+ & IIe MthBds. For all Apple enthusiasts .. \$14.95

Both for \$30.00! Also bare cards in stock!
Check/money-order, VISA/MasterCard to:

NuScope Associates*, Dept RE
P.O. Box 790 • Lewiston, NY • 14092

*A Division of Kosmic MicroTech Inc.

GETTING THE MOST FROM YOUR PRINTER

Getting The Most From Your Printer



BP181—It is probable that 80% of dot-matrix printer users only ever use 20% of the features offered by their printers. This book will help you unlock the special features and capabilities that you probably don't even know exist. To order your copy send \$6.95 plus \$1.50 for shipping in the U.S. to Electronic Technology Today Inc., P.O. Box 240, Massapequa Park, NY 11762-0240.

CIRCLE 197 ON FREE INFORMATION CARD

A Z-80 WORKSHOP MANUAL

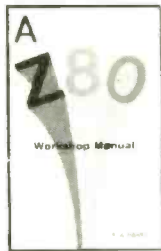

Starting with a review of computer principles, this book describes typical machine-code instructions followed by a detailed description of the Z-80 instruction set. Assembly language programming is also discussed with examples. Z-80 hex machine-code and assembler instructions are given in tabular form, along with in-our connections for the Z-80 and its associated devices.... Order your copy from **Electronic Technology Today Inc., PO Box 240, Massapequa Park, NY 11762. Price is \$6.95 plus \$1.00 for shipping.**

the environment program keeps everything in active memory as Topview does. This slows down reaction time and, in some cases, may freeze the machine because it is processor bound.

The constraining factor is the 640K limit imposed by the disk operating system. When it was designed it was believed machines would be well equipped with 640K and those needs would serve for several years. However, applications have raced ahead of the disk operating system to the point where 640K is becoming average for most PC users and 1.2 megabytes of RAM is actually needed. But, DOS can't look beyond 640K without program help (See Fig. 4). This is the final factor which effectively constrains true concurrency. You don't have enough memory to enable a PC to have as many programs installed in memory as you need.

Quarterdeck's *Desqview* allows you to open five or

more windows with different applications and automatically opens a temporary disk buffer. Only the actual kernel of the program is kept in RAM with the rest residing in the disk file, being called when needed. But the ultimate answer lies in a different breed of microcomputer, the 32-bit chip. These have the power, flexibility and capability of accessing enough memory to make true concurrency possible. Their 32-bit architecture enables this, and they can address over 16 megabytes of memory directly. With this much power and nearly 7 MHz speed available as standard, a micro is capable of handling two or more tasks at once.

While some ads indicate that concurrency is possible, remember it is —on a new 32-bit machine. The standard 16-bit micro is only marginally up to the task and then it takes some sophisticated memory management to pull it off. ◀▶

MARKET CENTER

FOR SALE

TUBES new, unused. Send self-addressed, stamped envelope for list. **FALA ELECTRONICS**, Box 1376-2, Milwaukee, WI 53201.

FREE microprocessors, memory chips, etc. Free electronics magazine subscriptions. Free education in computers. For information write **MICRO-SAT CORPORATION**, 2401 N.E. Cornell, Bldg. 133, Hillsboro, OR 97124.

CHANNEL 3—60dB notch filter, 63.5MHz. \$19.95. All other channels \$29.95. Cable converter and accessory catalog \$1. (514) 739-9328. **CROSLY(A)**, Box 840, Champlain, NY 12919.

CLASSIFIED AD ORDER FORM

To run your own classified ad, put one word on each of the lines below and send this form along with your check to:

Radio-Electronics Classified Ads, 500-B Bi-County Boulevard, Farmingdale, NY 11735

PLEASE INDICATE in which category of classified advertising you wish your ad to appear. For special headings, there is a surcharge of \$23.00.

Plans/Kits Business Opportunities For Sale
 Education/Instruction Wanted Satellite Television

Special Category: \$23.00

PLEASE PRINT EACH WORD SEPARATELY, IN BLOCK LETTERS.

(No refunds or credits for typesetting errors can be made unless you clearly print or type your copy.) Rates indicated are for standard style classified ads only. See below for additional charges for special ads. **Minimum: 15 words.**

1	2	3	4	5
6	7	8	9	10
11	12	13	14	15 (\$42.75)
16 (\$45.60)	17 (\$48.45)	18 (\$51.30)	19 (\$54.15)	20 (\$57.00)
21 (\$59.85)	22 (\$62.70)	23 (\$65.55)	24 (\$68.40)	25 (\$71.25)
26 (\$74.10)	27 (\$76.95)	28 (\$79.80)	29 (\$82.65)	30 (\$85.50)
31 (\$88.35)	32 (\$91.10)	33 (\$94.05)	34 (\$96.90)	35 (\$99.75)

We accept MasterCard and Visa for payment of orders. If you wish to use your credit card to pay for your ad fill in the following additional information (Sorry, no telephone orders can be accepted.):

Card Number

Expiration Date

Please Print Name

Signature

IF YOU USE A BOX NUMBER YOU MUST INCLUDE YOUR PERMANENT ADDRESS AND PHONE NUMBER FOR OUR FILES. ADS SUBMITTED WITHOUT THIS INFORMATION WILL NOT BE ACCEPTED.

CLASSIFIED COMMERCIAL RATE: (for firms or individuals offering commercial products or services) \$2.85 per word prepaid (no charge for zip code)...**MINIMUM 15 WORDS.** 5% discount for same ad in 6 issues; 10% discount for same ad in 12 issues within one year; if prepaid. **NON-COMMERCIAL RATE:** (for individuals who want to buy or sell a personal item) \$2.30 per word, prepaid...no minimum. **ONLY FIRST WORD AND NAME** set in bold caps at no extra charge. Additional bold face (not available as all caps) 50¢ per word additional (20% premium). Entire ad in boldface, add 20% premium to total price. **TINT SCREEN BEHIND ENTIRE AD:** add 25% premium to total price. **TINT SCREEN BEHIND ENTIRE AD PLUS ALL BOLD FACE AD:** add 45% premium to total price. **EXPANDED TYPE AD:** \$4.30 per word prepaid. All other items same as for STANDARD COMMERCIAL RATE. **TINT SCREEN BEHIND ENTIRE EXPANDED TYPE AD:** add 25% premium to total price. **TINT SCREEN BEHIND ENTIRE EXPANDED TYPE AD PLUS ALL BOLD FACE AD:** add 45% premium to total price. **DISPLAY ADS:** 1" x 2 1/4"—\$320.00; 2" x 2 1/4"—\$640.00; 3" x 2 1/4"—\$960.00. General Information: Frequency rates and prepayment discounts are available. **ALL COPY SUBJECT TO PUBLISHERS APPROVAL. ADVERTISEMENTS USING P.O. BOX ADDRESS WILL NOT BE ACCEPTED UNTIL ADVERTISER SUPPLIES PUBLISHER WITH PERMANENT ADDRESS AND PHONE NUMBER.** Copy to be in our hands on the 2th of the third month preceding the date of the issue. (i.e., August issue copy must be received by May 12th). When normal closing date falls on Saturday, Sunday or Holiday, issue closes on preceding working day.

CABLE Dealers—Get your free catalog for the best buys on quality cable equipment. Most prices too low to print. N-12 Mini Code \$100.00. S.B. 2 or 3 \$99.00. Trimodes are the special of the month \$100.00. Hamlin Mid 1200 \$89.00. Extra remotes, cable converters, Pioneer, Jerrold, Viewstar, Starcom, Video Switcher. All products guaranteed 90 days. We accept M.C., VISA, COD's. Call or write for your free catalog today. (402) 331-4957. **M.D. ELECTRONICS**, 5078 South 108th, Suite 115, Omaha, NE 68137.

PICNER—Scientific Atlanta—Jerrold—Panasonic—Hamlin—Wireless converters all new original manufacturers warranted. Try our new converter repair facility we are the best. (718) 459-5088.

Quality Microwave TV Antennas

Multi-Channel 1.9 to 2.7 GHz
40dB Gain True Parabolic 20 Inch Dish
Complete System \$79.95 (plus shipping)
Dealerships, Qty, Pricing, Replacement Parts

Philips-Tech Electronics
P.O. Box 8583 • Scottsdale, AZ 85262
(602) 947-7700 (\$3.00 Credit all phone orders!)

LIFETIME WARRANTY MasterCard • Visa • COD's

RESTRICTED technical information: Electronic surveillance, schematics, locksmithing, covert sciences, hacking, etc. **Huge selection. Free brochure:** MENTOR-Z, 135-53 No. Blvd., Flushing, NY 11354.

TV tunable notch filters, free brochure. D.K. VIDEO, Box 63/6025, Margate, FL 33063 (305) 752-9202.

LASERS, components and accessories. Free catalog. M.J. NEAL COMPANY, 6672 Mallard Ct., Orient, OH 43146.

FREE POWER SUPPLY with Assortment #103 consisting of printed circuit, Toko coils 144LY-120K, 520HN-3000023, BKAN-K555AXX(2); semiconductors 2N3904(2), BFQ85, 7812, 74123, MC1330A1P, 1N914, 1N5231B. Only \$25.00. **Assortment #201** consisting of semiconductors MC1330, LM1458, MC1358, NE565, LM386, 2N3563, MPN3404, IN4002. Only \$10.00. **Assortment #301** consists of printed circuit with all IC's, transistors, and diodes for **Telease-Maast Satellite-TV project** (Oct. 86 article) only \$25.00. **10% discount** for 5 or more. Service charge \$3.00/order. **1 (800) 821-5226 Ext. 426.** MC/VISA, COD, check or M.O. Or write **JIM RHODES INC.**, P.O. Box 3421, Bristol, TN 37625.

TUBES, name brands, new, 80% off list. KIRBY, 298 West Carmel Drive, Carmel, IN 46032.

IS it true...Jeeps for \$44 through the government? Call for facts! 1 (312) 742-1142, ext. 4673.

CB MODIFICATIONS

Increase channels, range, privacy! We specialize in frequency expanders, speech processors, FM converters, PLL & slider tricks, how-to books, plans, kits. Expert mail-in repairs & conversions. 16-page catalog \$2. Our 11th year!

**CBC INTERNATIONAL, P.O. BOX 31500RE,
PHOENIX, AZ 85046**

INDIVIDUAL Photofact-folders #1 to #1400. \$3.00 postpaid. **LOEB**, 414 Chestnut Lane, East Meadow, NY 11554.

WHOLESALE car-radio computer telephone audio video accessories antenna catalog (718) 897-0509 **D&WR**, 68-12 110th St., Flushing, NY 11375.

HIGH gain descramblers, CRT automatic dimmer, SCR tester, plus other unusual electronic devices. Send \$3.00 for info. **RB ELECTRONICS ENGINEERING**, P.O. Box 643, Kalamazoo, MI 49005.

CLONE kits, modems, hard drive kits, disk drives, diskettes and printers, memory, and IC's. Distributor pricing to end users and dealers. For catalog call (800) 833-2600. In Ohio call (513) 531-8866. Free shipping.

DESCRAMBLER info and catalog. Cable and satellite. SB3 \$99.00. Special combination Jerrold 400 and SB3 \$165. Pulse descrambler kit (assembles in half hour) \$69.00, built \$109.00. Satellite descrambler kit \$110.00, built \$170.00. Send \$1.00. **MJ INDUSTRY**, Box 531, Bronx, NY 10461.

TUBES! 59¢. Year guarantee. Free catalog. Tube tester \$8.95. **CORNELL**, 4215 University, San Diego, CA 92105.

TI-99/4A software/hardware bargains. Hard-to-find items. Huge selection. Fast service. Free catalog **DYNA**, Box 690, Hicksville, NY 11801.

VIDEO scrambling techniques. The original "secret manual" covers sinewave, gated pulse, and SSAV systems. 56 pages of solid, useful, legible information. Only \$14.95. **ELEPHANT ELECTRONICS, INC.**, Box 41865-J, Phoenix, AZ 85080. (602) 581-1973.

WIREWRAPE labels. Identify IC's, pins. Easier, error-free wrapping. All DIP's 8-40 pins. Inexpensive, 363 labels \$6.00. **PAUL'S LABELS**, 7320 Embassy, Miramar, FL 33023.

OLDTIME radio programs on high quality tapes. Comedy! Adventure! Music! Free catalog. **CARL F. FROELICH**, Heritage Farm, New Freedom, PA 17349.

THE BEST PLACE to BUY, SELL or TRADE NEW and USED EQUIPMENT
NUTS & VOLTS MAGAZINE
BOX 1111-E • PLACENTIA, CA 92670
(714) 632-7721
Join Thousands of Readers Nationwide Every Month
ONE YEAR U.S. SUBSCRIPTIONS
\$10.00 • 3rd Class • \$15.00 • 1st Class
\$35.00 • Lifetime • 3rd Class

NUTS & VOLTS
HARD GEAR COMPUTERS SOFTWARE SCANNERS • OPTICS TEST EQUIPMENT MICROWAVE SATELLITE AUDIO VISUAL NEW PRODUCTS COMPONENTS • KITS ANTIQUE ELECT PUBLICATIONS PLANS • SERVICES

TRIPLE regulated, metered benchtop power supplies. Fixed $\pm 5VDC$, two variable $\pm 15VDC$, 1 amp maximum. Short and overload protected, current limited. Supplies stackable to $\pm 35VDC$. \$119.95 year warranty. **USI**, Box 332R, Westatogue, CT 06089. (203) 658-4318.

PANASONIC and Scientific Atlanta converters 550-megs brand new full warranty \$89. Panasonic video amp switcher \$99. RGGU belden coay 500 ft \$49. Try our newly opened converter repair facility. **RED-COAT ELECTRONICS**, 104-20 68th Dr., Forest Hills, NY 11375. (718) 459-5088.

LINEAR parts—transistors: MRF454 \$15, MRF455 \$12, MRF477 \$11, MRF492 \$16.75, MRF421 \$22.50, SRF2072 \$13, SRF3662 \$25, 3800 \$18.75, 2SC2290 \$19.75, 2SC2879 \$25. **Tubes:** 6KD6 \$10.50, 6LQ6 \$9.75, 6LF6 \$9.75, 8950 \$16.75. Best prices on Palomar road noise mics, Ranger AR3300. New 16 page catalog listing radio/amplifier tricks—channel modification, PLL-sliders, peaking for range, hard-to-find linear parts—mail \$1.00 to: **RFPC**, Box 700, San Marcos, CA 92069. For same day parts shipment, call (619) 744-0728.

TUBES: "OLDEST", "LATEST". Parts, components, and schematics. **SASE** for list. **Steinmetz**, 7519 Maplewood Ave., RE. Hammond, IN 46324.

OVER \$50 of assorted parts only \$9.95. **B MOORE**, 440 Old Conn Path, Framingham, MA 01701.

CABLE TV converters. Scientific Atlantic, Jerrold, Oak, Zenith, Hamlin. Many others. **Visa & M.C.** accepted. Toll free 1 (800) 826-7623. **B&B INC.**, 10517 Upton Circle, Bloomington, MN 55431.

CABLE TV equipment. All major brands. Specializing in Scientific Atlanta, Jerrold, and Zenith, **Add-ons.** Our units have worked where others have failed. **CODS** accepted. Send \$2.00 for catalog to **K.D. VIDEO**, P.O. Box 29538, Mpls., MN 55429.

PCB, free samples. Low cost Far-East fabrication. **INTEGRITY TECHNOLOGY**, 105 Serra, #230, Milpitas, CA 95035-0604 (408) 262-8640.

QUARTZ crystals HC18 4.896 MHZ \$1.95 ea. add \$1.75 postage. Also 2 pole monos, crystals 1 to 100 MHZ, multipole filters. Send **SASE** for free listing. **QUALITY CRYSTAL SURPLUS**, Box 123, Dodgeville, WI 53533.

WRITE FOR
McGEE'S
SPEAKER & ELECTRONICS CATALOG
1001 BARGAINS IN SPEAKERS
toll free 1-800-346-2433 for ordering only
1901 MCGEE STREET KANSAS CITY, MO. 64108

CABLE television converter, descrambler and wireless remote control video equipment accessories catalog free. **CABLE DISTRIBUTORS UNLIMITED**, 116 Main Road, Washington, AR 71862.

BURGLAR alarms-business booming. Get in now. Information \$2.00. **DYNAMIC SECURITY**, P.O. B.1456-A, Grand Rapids, MI 49501.

PLANS AND KITS

CATALOG: Hobby/broadcasting/1750 meters/Ham/CB: transmitters, amplifiers, antennas, scramblers, bugging devices, more! **PANAXIS**, Box 130-F2, Paradise, CA 95969.

BUILD this five digit panel meter and square wave generator including an ohms, capacitance and frequency meter. Detailed instructions \$2.50. **BAGNALL ELECTRONICS**, 179 May, Fairfield, CT 06430.

CABLE TV converters: Jerrold Products include "New Jerrold Tri-Mode," SB-3, Hamlin, Oak VN-12, M-35-B, Zenith, Magnavox, Scientific Atlanta, and more. (Quantity discounts) 60 day warranty. Service converters sold here. For fast service **C.O.D. orders accepted.** Send **SASE** (60 cents postage) or call for info (312) 658-5320. **Midwest Electronics, Inc./, HIGGINS ELECTRONICS**, 5143-R W. Diversey, Chicago, IL 60039. **MC/Visa orders accepted. No Illinois orders accepted.**

TELEPHONE bug, FM room bug schematics with detailed construction procedures using Radio Shack's numbered parts. Both, \$6.00. Receivers available. **SHEFFIELD ELECTRONICS**, 7223 Stony Island, Chicago, IL 60649.

Multi-Channel Microwave T.V. Receivers
1.9-2.7 GHz Parabolic Dish 40+ dB Gain
LIFETIME WARRANTY
Complete System \$89.95 (Shipping Incl.)
Dealer Rates. Replacement Components & Expert Repairs Available
K & S ELECTRONICS Call now for same day shipping!
P.O. BOX 34522 PHOENIX, AZ 85067 (602) 230-0640
Visa/MC/COD \$2 credit on phone orders!

STRANGE stuff. Plans, kits, new items. Build satellite dish \$69.00. Descramblers, bugs, adult toys. Informational photo package \$3.00 refundable. **DIRIJO CORPORATION**, Box 212, Lowell, NC 28098.

DESCRAMBLE the latest video cassette copy protection scheme. Our simple Line Zapper circuit takes the jitter out of your picture. Complete plans and theory only \$9.95 plus \$1.50 postage and handling. **PC board** and complete kits also available. **ELEPHANT ELECTRONICS, INC.**, Box 41865-J, Phoenix, AZ 85080. (602) 581-1973.

HI-FI speaker systems, kits and speaker components from the world's finest manufacturers. For beginners and audiophiles. Free literature. **A&S SPEAKERS**, Box 7462R, Denver, CO 80207. (303) 399-8609.

VOICE disguisers! FM bugs! SWL active antenna, receivers, more! Send stamped envelope: **XANDI**, Box 25647, Dept. 60H, Tempe, AZ 85282.

JERROLD gated pulse theory. Twelve information-packed pages covering DI & DIC converter operation. Includes introduction to trimode system. \$6.95 plus \$1.50 postage and handling. **ELEPHANT ELECTRONICS, INC.**, Box 41865-J, Phoenix, AZ 85080. (602) 581-1973.

A SINGER'S DREAM!
REMOVES VOCALS FROM RECORDS!
Now You can sing with the world's best bands! The Thompson Vocal Eliminator can remove most or virtually all of a lead vocal from a standard stereo record and leave the background!
Write or call for a free brochure and demo record.
LT Sound, Dept. R-1, P.O. Box 338, Stone Mountain, GA 30086 (404) 493-1258

INFRARED 6032 tubes (tested and guaranteed), infrared kits, complete line of engineering and surveillance viewers. **IR SCIENTIFIC, INC.**, Box 110, Carlisle, MA 01741. (617) 667-7110.

TRANS-AM ELECTRONICS
383 CANAL ST NYC, NY 10013 (212) 226-3893
VISIT OUR RETAIL STORE

BATTERY HOLDER W/ BELT CLIP 1.95
2 'D' cell battery holder with a belt clip like the walkman external power pack. Comes with 1/8" mini plug

SOLID STATE BEEPER 2.95
A 12 vdc beeping tone that can be used as a back-up indicator for a car or any other similar application. Mounting holes are 2" apart

FLASHING BINKY 1.19
Self contained batteries operate this colorful amulet that starts flashing randomly when you touch it and goes off by itself. Specify pink or blue.

PROJECT BOX 3.95
A 4" x 6" x 3" metal box with 4 rca jacks on one end and rubber feet. Comes apart with screws. Very well made.

WALL TRANSFORMERS
All plug directly into 120 vac outlet.
9 vdc @ 200 ma \$1.95
12 vdc @ 300 ma \$2.95
14 vdc @ 500 ma \$3.95

TERMS: \$10 MINIMUM ORDER. ADD \$2.50 FOR UPS AND HANDLING. NYS RESIDENTS ADD 8.25% TAX. SEND ORDER WITH CHECK OR PHONE IN ORDER BETWEEN 11am AND 5pm EST. ALL ITEMS SUBJECT TO PRIOR SALE.

RADIO-ELECTRONICS

CIRCLE 196 ON FREE INFORMATION CARD

SATELLITE TV

CABLE TV Secrets—the outlaw publication the cable companies tried to ban. HBO, Movie Channel, Showtime, descramblers, converters, etc. Suppliers list included \$8.95. **CABLE FACTS**, Box 711-R, Pataskala, OH 43062.

SATELLITE systems \$349.00, catalog \$3.00. Also: KU band, exports. **STARLINK, INC.**, 2603-16R Arlie, Huntsville, AL 35805.

DESCRAMBLER unscramble Videocipher II satellite TV signals with Decipher-Two (video only). Simple low cost circuit using only three timer IC's. P.C. board, instructions \$35.00. **P.P. VALLEY MICRO-WAVE ELECTRONICS**, Bear River, Nova Scotia, Canada BOS-1BO. (902) 467-3577.

SATELLITE TV VIEWERS

Get the most complete weekly listings
Send \$1 for sample copy.

Satellite TV Week

P.O. Box 308E, Fortuna, California 95540
800-358-9997 (U.S.) • 800-556-8787 (Calif.)
707-725-2476 (all others)

SATELLITE TV receiver kits, LNA's, instructions, schematics. Send stamped envelope: **XANDI**, Box 25647, Dept. 21K, Tempe, AZ 85282.

OAK Orion "Turn-On" modifications: "Chip kit" or "Remote keypad." details—\$1.00. **NAS-SAT**, Box 5261, Long Beach, CA 90805. (213) 631-3552.

SATELLITE television uncypfers. American, Canadian, latest technology, plans, kits, complete units, Oak magic chip sets available. Send \$2.00 for informative catalog: **BLACKBEARD**, P.O. Box 737RE, Prudential Center Station, Boston, MA 02199.

RELIABLE sat positioner program for IBMPC & clones. Write to **MIKRODATOR**, Box 96, Lasalle, Quebec H8R 3T7 Canada.

DESCRAMBLE satellite broadcasts! Now watch x-rated, sports, and movies. Assembled and tested descramblers \$179.95. Also: cable descramblers, video accessories, microwave, lasers, plans and more. **ZETA ELECTRONICS**, 22797 Barton Rd., #120, Grand Terrace, CA 92324.

LASERS

HE-NE complete \$129.95, modulated systems available **LES ELECTRONICS**, PO Box 800276, Dallas, TX 75380.

COCO II UPGRADES (PARTS)

COCO II upgrade kits, RGB interface, 256K memory, etc. Electronic parts all types—free catalog. **INVENTIVE SOLUTIONS**, P.O. Box 286, Stan-fordville, NY 12506.

CABLE-TV DESCRAMBLING

CABLE television converter, descrambler, and wireless remote control video equipment accessories catalog. Free. **CABLE DISTRIBUTORS UNLIMITED**, 116-C Main Road, Washington, AR 71862.

EPROM PROGRAMMING

FREE catalog. Your software/data installed in (E)PROM of your choice. Fast, low cost service. Write/call: **ROMULUS MICROCONTROL**, Dept. A, Box 8669, Rockville, MD 20856. (301) 540-8863.

SCIENTIFIC ATLANTA & TOCOM

SCIENTIFIC Atlanta cable converters (original units), models—8500 and 8550, remote control...\$250.00. **TOCOM** and **Zenith** descramblers available, **Guaranteed. N.A.S.**, (213) 631-3552.

EDUCATION & INSTRUCTION

LEARN to be a television studio technician! After only 14 months earn your degree and a great career in video. Financial aid and national placement assistance. Dallas (214) 263-2613 or Long Beach (213) 595-1660. **VIDEO TECHNICAL INSTITUTE**.

CASSETTE recorded home study for new **General Class FCC** license examinations. Also broadcasting and cablevision courses. **BOB JOHNSON TELECOMMUNICATIONS**, 1201 Ninth, Manhattan Beach, CA 90266.

WANTED

INVENTORS! AIM wants—ideas, inventions, new products, improvements on existing products. We present ideas to manufacturers. Confidentiality guaranteed. Call toll free 1 (800) 225-5800 for information kit.

INVENTIONS, ideas, new products wanted! Industry presentation/national exhibition. Call free 1 (800) 528-6050. Canada, 1 (800) 528-6060. X831.

MICROWAVE Info: being hit by a **MICROWAVE DEVICE**, 220 N. San Marino, San Gabriel, CA 91775.

INVENTORS

INVENTORS! Can you patent and profit from your idea? Call **AMERICAN INVENTORS CORPORATION** for free information. Over a decade of service. 1 (800) 338-5656. In Massachusetts or Canada call (413) 568-3753.

MICRO MART

508 Central Ave.
Westfield, N.J. 07090
(201) 654-8008

TOKO COILS FOR FEB 1984 TV PROJECT
Toko #1's BKAN-K5552AXX(2), #E520HN-300023 (071uh) & L-2(12uh) Fixed. 1 Set Of 4 Pcs 6.00, 3 Sets 15.00, 10 Sets 45.00.
Diode Ass 165 Pcs Total-Includes 1N4148, 1N914, 1N4004, 1N4007 1.95
Zener Ass 165 Pcs Total-Includes Minimum 3 Different 1W Devices 1.95
LED Ass 1-Jumbo, Medium, Mini, Red, Green And Amber-25 Pcs 1.95
Resistor Ass 1,000 Pcs 35 Values Minimum. Popular Values (1K, 10K, 100K) Included. Mostly 1/4 & 1/2W. Some 1 & 2W. Lots Of Precisions. Carbon Film. Taped And Reeled For Easy Sorting 9.95
Regulator Ass 1-72 Pcs Includes 7805, 7806, 7812, 7824, 7905, 7912 & LM309K 1.95
LM317T Adjustable Reg (#6630198) 1.01, 25
Mica Insulators For TO-220 Material 20/1.00
Self Adhesive Rubber Stripping-Cut To Any Lengths You Choose (3M-Bumper), 3 Feet/2.00, 10 Feet/5.00, 50 Feet/20.00
Jumper Plugs (Cambion)-Male To Male For Breadboard & Connectors 10/1.25
7400 TTL Ass 1-20 Pcs, Minimum 10 Different Device Types (7410, 32, 42, 74, 92) 2.95
74 LSXX Ass 1-20 Pcs, Minimum 15 Different Device Types (LS02, 04, 05, 10, 14) Etc-2.95
4000 CMOS Ass 1- Minimum 8 Different Device Types (4001/11, 49, 51) Etc-20 Pcs/3.75

LINEAR IC'S
LM324-3/1.00, LM339 — 2/1.00, LM380 (ULN2280) .95, LM386-1.50, NE555-4/1.00, LM555-2/1.00, LM741-4/1.00, MC1330 2/1.00, MC1398-2/1.00, MC1458-4/1.00

TRANSISTORS
PN2222A-10/1.00, 2N2904 (TO-39) 4/1.00, 2N3055 (MOT)-2/1.00, 2N3904-10/1.00, 2N3906-10/1.00 HI Reliability TO-3 Socket (Augur) .95
9VDC Wall Transformer, 500 Ma 2.95
6.3V 1.2A Transformer 1.50
12.6 VCT 1A 3.50
7 (Seven) Amp Tapped Transformer- 7 1/2/15VAC Or 9V/18VAC 6.95
Muffin/Sprite Style Fan #SU2CT (EG & G Rotron), 3 1/2" Sq. 115V 5.95
Jumbo Red LED's 15/1.00, 100/6.00
Jumbo Green LED's 10/1.30, 100/10.00
Jumbo Yellow LED's 10/1.30, 100/11.00
Jumbo Yellow HI Intensity With RT Angle & Black Case Features 10/1.00, 100/12.00
Mini Yellow HI Intensity With Diacrel, Pale Blue Lens/Case Feature 10/1.00, 100/12.00 LED Clips/Rings For Jumbo 15/1.00, 100/6.00
Switch Ass 1-Slides, Rockers, Toggles 10/1.95
Disc Cap Ass 1 (1 Sp1 To .47uF) 50/1.95
Mylar Cap Ass 1/0.01uF To .33uF) 25/1.95
Dip Mica Ass 1 (Approx. 10 Values) 15/1.95
Adjustable Coil/Fixed Choke Ass 1 10/1.95
Triac (400V 6A To-220), TIC216A 2/1.00
SCR (5A 30V To-92), TIC444 2/1.00

74SCXX SERIES IC'S LOW POWER, HIGH SPEED ISO-CMOS (PIN COMPATIBLE TO LSXX & SIMILAR TO HCXX)

74SC137	45	74SC137X	35
74SC138	45	74SC137A	60
74SC139	60	74SC533	50
74SC237	60	74SC534	50
74SC239	60	74SC540	50
74SC240	50	74SC563	1.50
74SC241	60	74SC564	60
74SC244	35	74SC573	2.00
74SC245	35	74SC564	2.00

Data Book For All Above #s 2.50

DIP IC SOCKETS
8 PIN/07, 14 PIN/13, 16 PIN/15, 18 PIN/17, 20 PIN/19, 22 PIN/21, 24 PIN/23, 26 PIN/26, 40 PIN/39
Zero Insertion Test Socket 28 Pin 7.50
MAN6910-Double Digit 7 Segment Display, HI Effi-ency-Rad. 56" Comm Ann 1.25
MM5481-14 Segment Driver Chip 7.50
1.5A 50V Bridge (TO-5) 50
6A 600V Bridge 5/8" Square 1.00
10A 500V Bridge 5/8" Square 1.15
25A 200 Bridge (Solder Lug Type) 2.00
12VDC SPST Reed Relay PC Mount 50
Mini Toggle DPDT (Lock Latch Feature) .75
DPDT "Snap In" Rocker With Bulb Socket .95
Push-Lighted Switch (No Bulb) Off-Mom. 45
Pushbutton DPST On-Mom PC Mount 3/1.00
DPDT Push Button 6A 125V 65
TPDT "Ball" Handle Toggle (On Off On) 1.65
DPDT RT Angle PC Toggle (On Off On) .95
Low Fluid Level Detector Kit-Parts, PC Board & Instructions .495
11 LED Bar Graph Display 2-3/4", Rectangular LED's (Specify Red, Green, Amber) 2.69
Giant Alpha Numeric Display 1-1/2" x 2" x 5 (35 Total) Red LED Matrix .495
Electrolytic Cap Ass 1-Includes 2.2uF, 4.7uF, 10uF, 47uF, 220uF, 470uF, 1,000uF, 3,300uF & Others (Voltages & Lead Configurations Vary) 15.95
Total 1.95
Resistor Networks-High Quality Dip Circuits (Beckman, Dale, Bourns) 6 PC's Values 2.00
Connector/Header Ass 1-Ribbon Cable, Edgecard, "Snap-Off" Headers Etc 10 pcs/2.95
22uF 35V Solid Tantalum (Kemet) 4/1.00
100uF 20V Solid Tantalum (Kemet) 3/1.00
1,000uF 75V Axial .75
3,200uF 50V Twist Lock 1.00
3,300uF 50V Axial Lytic .75
5,000uF 40V Computer Grade (Mallory) 2.50
Monolithic Cap Ass 1 25/1.95
Crystal Clock Oscillator 14.9765 MHz 50
UCN4116B-OSC/Freq Div Clock IC 5/1.00

AM/FM Radio IC W/Data Sheet (#2204)	15/1.00
2N3643 (TO-92 Silicon Gen Pump-NPN)	10/1.00
Slide Pots 1 Each 50K, 100K, 1.2M, 2M, 5M	1.00
ULN2231 (Dipco DM50) Dual Preamp IC	2/1.00
?Mystery? Bag #1 The "OHM" Bag	1.00
?Mystery? Bag #2 The "Volt" Bag	1.00
?Mystery? Bag #3 The "Circuit" Bag	1.00
?Mystery? Bag #4 The "Frequency" Bag	1.00
?Mystery? Bag #5 The "Tolerance" Bag	1.00
No Returns/Exchanges With Mystery Bags	
IC Storage "Bag" Box	2.45
Heavy Duty Alligator Clips (10 Sets)	2.30
Regular Alligator Clips (10 Sets)	1.80
Wire Strippers (Spring Loaded, Adjust.)	2.50
5" Needle Nose Pliers (Spring Loaded)	3.95
4 1/2" Diagonal Cutters (Spring Loaded)	3.95
Nut Driver Set For 3/16", 1/4", 5/16"	32/0.00
Jeweler's Screwdrivers (4 Pcs)	2.65
Desoldering Pump (Solder Sucker)	4.00
Replacement Tips For Solder Sucker	23/0.00
25W Precision Soldering Iron	5.00
Safety Goggles	2.95
De-Soldering Brad (5 Foot Roll)	.69
Solder Aid Tool Kit (4 Pcs)	3.00
Soldering Iron Convenience Stands	5/1.00
Model 810B Logic Probe (Pencil Type)	18.95
Model 620B Logic Pulser (Pencil Type)	18.95
Switch Power Supply-Plus & Minus 5 & 12 Volts	49.00
200W By Converter	12.00
Voltage Mate Switching Regulator Kit	18.95
MRF901 (Hobby-You Test)	10/1.00
Piher PT10V 3/8" Horizontal Mount Trim pots 100 OHM, 1K, 5K, 20K, 50K, 100K, 200K, 500K, 1M, Single Turn	4/1.00
Multi Turn Precision Trim pots (Copal), 100 OHM, 500 OHM, 1K, 10K, 20K, 50K, 100K, 1M, 1.00 Each	
7 Segment Display Ass 1	62/7.50
Zenith TV Replacement IC Special 1.00 Each 221-42, 221-43, 221-48, 221-69, 221-719, 221-87, 221-96, 221-104, 221-105, 221-106, 221-140	
25C1172B (Toshiba-Horiz Output Trans)	2.50
Motion Detector Module (Includes ULN2232 IC & Caps), 2.00 Each, 7/10.00, 25/25.00	
Motion Detect, ULN2232 IC Only 3/2.00, 20/10.00	
Black, Plastic Case For Detector	2.25
Miniature Speaker For Detector	7.95
XN-3 Solid Senses Breadboard-1.360 Tie-Point Matrix, 2 Van Dier Buses	14.95
Model SG-105 Signal Generator-20Hz To 150 MHz, Low Distortion, 46 Step	45.95
40 Pin IDC Ribbon Cable Connector	.40
50 PIN IDC Ribbon Cable Connector	.50
36 PIN RT Angle "Snap Off" Header	.50
14 Pin Header For Ribbon Cable	3/1.00
01uF 100V Mylar Cap	20/1.00
1uF 50V Disc	15/1.00
10uF Disc	40/1.00
.001uF Disc	20/1.00
.0022uF Disc	40/1.00
67uF 16V Disc	30/1.00
9V Battery Snaps	7/1.00
22 Or 27 AWG Wire (Specify)	50/1.00

BLITZ EPROM PROGRAMMER KIT

Attached To The Parallel Printer Port Of An IBM PC, XT, Or Compatible, The Blitz Programs 2716, 2732, 2764, 27128, & 27256 Eproms. Standard & Fast Programming Algorithms Supplied. Voltage Selectable 12.5V, 21V & 25V. Discrete Included Provides Assembly Instructions & Programming Procedures. Kit-669.95. Assembled-99.95

Cypher IV Micro-Controller Kit- \$129.50

* 4 MHz, 8-Bit Microprocessor
(NAT 1N58073)
• Control Basic Interpreter On-Chip
• Auto-Start Operation At Power-On
• Fast 16-Bit Multiply And Divide
• RS-232, Supports CRT & Serial Link
• 24 Bit Directional I/O Lines (8255A)
• RAM Memory-2K Expandable To 16K
• Eprom Memory-Expandable To 16K
• Built In Eprom Programmer
• Port (Centronics) Printer Interface
• Optional Real Time Clock W/Backup

Pay TV Hardware Installation Kit Blow Out

As Low As \$2.95 + \$3.50 Shipping Per Unit
All Kits Contain 5 Feet Connectors, 100 to 75 OHM Balun, 300 OHM Terminal Block 2 Ft 75 OHM Patch Cord 2 Ft 300 OHM Twin Lead, Nylon Cable Ties, And UHF Antenna
Model #4124-\$2.95 Includes All Of The Above Plus 25 Feet Coaxial Cable And Mounting Hardware For Indoor Wall/Ceiling Installation
Model #4880-\$2.95 Includes All Of The Above Plus 25 Feet Coaxial Cable And Attractive Expandable Pole-U-Bolt For Easy Indoor Installation
Model #4845-\$3.95 Includes All Of The Above Plus 65 Feet Coaxial Cable And All Necessary U-Bolt Hardware

MODEL 705 Digital Multimeter

DC Voltage	100uV to 1000V
AC Voltage	100uV to 750V
DC Current	0.1uA to 10A
AC Current	0.1uA to 10A
Hi-Z Resistance	0.3 to 20M
Capacitance	1pF to 20uF
Diode Test	forward voltage testing
Hrc Test	transistor testing

\$51.95

UHF-TV PREAMP

(As featured in Radio Electronics March/ May articles, 1982)
This inexpensive antenna mounted preamp can add more than 25 dB of gain to your system. Lots of satisfied customers and repeat orders for this high quality kit, which includes all component parts. PC BD, Case, Power Supply and Balun \$36.50 Assembled Version \$57.50

Terms: MICRO-MART accepts Visa, MC and telephone CDD's. Minimum order \$10.00 Shipping—U.S. orders, \$2.00. Canada and other countries \$3.50 (minimum) Shipping rate adjusted where applicable. NJ residents add 6% sales tax.
MICRO-MART • 508 CENTRAL AVE., WESTFIELD, NJ 07090 • (201) 654-8008

TESTING SEMICONDUCTOR

continued from page 60

Normally, h_{fe} increases with an increase in collector current. Eventually, however, a point is reached where increas-

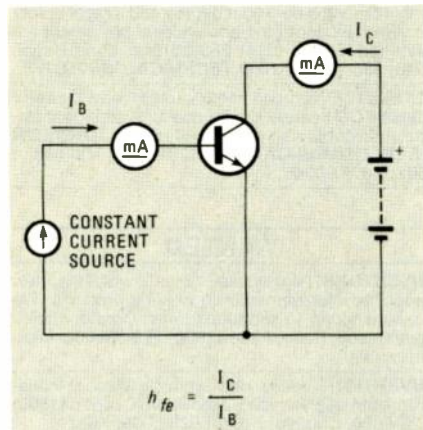

FIG. 6—TO FIND GAIN, h_{fe} measure the values of I_c and I_b as shown here. The transistor's gain is equal to the ratio of those two values.

ing the collector current no longer produces a rise in h_{fe} , and further increases in collector current actually cause the gain to decline. That phenomenon is shown in the curves of Fig. 7. Several reasons are cited

for that peaking of forward gain, but it basically boils down to the construction of the transistor.

The voltage across the transistor, V_{CE} is also responsible for variations in gain. Most of the variations, however, are attributed to the electric field created across the diode junctions. The electric field influences the electrons as they pass through the base region, further complicating the forward-gain pattern. The strength and contour of the electric field at the junctions is determined by the physical geometry of the device.

When trying to draw a correlation between the h_{fe} value specified on the data sheet and the value you have measured, you must know what voltages and currents

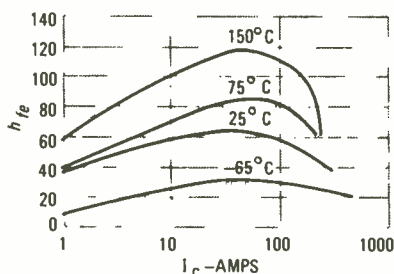

FIG. 7—AMBIENT TEMPERATURE and collector current play significant roles in determining the gain of a device.

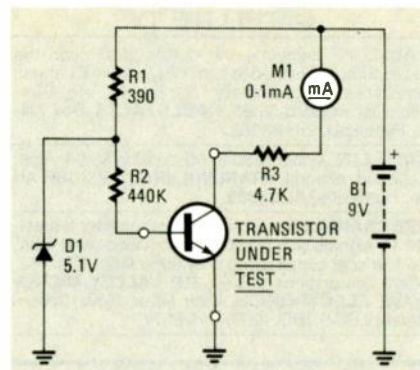

FIG. 8—A SIMPLE h_{fe} tester. Resistor R2 can be formed by connecting two 220K resistors in series.

were used by the manufacturer to obtain the specified h_{fe} . Those values are normally listed on the data sheet.

Let's finish up by showing you a simple circuit for measuring h_{fe} that can be built using a 9-volt battery and a 1-mA meter. See Fig. 8. The base current is fixed so that the meter reads h_{fe} directly on a $\times 100$ scale. A reading of 0.5, for example, translates into an h_{fe} of 50. Reverse the battery and the meter polarities for testing PNP transistors.

In our next installment we will take a look at the important characteristics of another kind of transistor—the FET, or Field-Effect Transistor. **R-E**

TRI-MODE

continued from page 47

range. Set the BIAS potentiometers, R8 and R16, fully clockwise, then back one quarter of their range to about the nine o'clock position. Set the 10-DB and 6-DB GAIN potentiometers, R10 and R18, to the middle of their range. Set the CLEAR BIAS potentiometer R27 fully clockwise.

Select a known-scrambled channel. If the non-scrambled (NS) LED is lit, it indicates that no pulses are being detected by IC1. In that event, turn R14 counterclockwise until the LED goes out, then back clockwise just until it comes on. If the NS LED never goes out, that may indicate a weak signal. If the NS LED is not on, turn R14 clockwise until it just comes on. If the LED never comes on, that may indicate a signal that is too strong. If your signal is too weak, use an adjustable line amplifier; if it is too strong, use an adjustable attenuator (6 to 12 dB). However, proceed to the next step before trying a line amplifier or attenuator.

Slowly turn L1's slug clockwise until the NS LED goes out and one of the other LED's comes on. Depending on the cable system, the modes may be changing, but only one LED should be on at a time. If they are all on and flashing, the circuit is

getting incorrect data. As you continue to turn clockwise, the NS LED will come back on. Now turn the slug counterclockwise until you are halfway between the two points where the NS LED comes on.

At this point, if you have an oscilloscope, you can adjust L1 by looking at the signal on the base of Q14. It should resemble the waveform shown in Fig. 7.

Next, determine the mode by examining the LED indicators. During 10-dB scrambling, adjust only R8 and R10. During 6-dB scrambling, adjust only R16 and R18. Do not make any adjustments during the clear mode.

Coarse adjust the appropriate gain potentiometer to obtain a stable picture. Then tweak the adjustment so that the picture looks normal in color, brightness, and contrast. If you can not obtain a proper picture in one of the modes, adjust the CLEAR BIAS potentiometer, R27, slightly counterclockwise and try again.

Once you have obtained a stable picture in one of the modes, turn WIDTH potentiometer R44 clockwise. You will notice that the picture gets darker, and the colors, if you had any before, fade. Turn R44 counterclockwise and you will notice that the picture gets lighter and the colors get brighter. If you continue turning counterclockwise, the color brightness will level off. If you go a little further, the

picture starts to tear. While watching the picture, adjust back and forth slowly and get a feel for the effect. Then, starting fully clockwise, turn R44 counterclockwise to a point just a hair beyond where the color brightness seems to level off. If you have an oscilloscope, you can adjust R44 more precisely. Set that potentiometer for a 12- μ s pulse width at IC14-a, pin 3.

Final adjustment of the BIAS potentiometers is done by adjusting them so that there is no ripple in the picture. Remember, you can only make the adjustment for the stage that you have already set the gain for, and only when the appropriate LED-mode indicator is on. Once you have completed the gain and bias adjustments for one of the scrambled modes, follow the same procedure for adjusting the gain and bias for the other.

The final step is to check the picture when the scrambling modes change between 6 dB, 10 dB and clear. You can eliminate any shifts in picture level by fine tuning the WIDTH adjustment, R44, and the 6-DB and 10-DB GAIN potentiometers.

Once alignment is complete, you may notice a problem with power-supply noise (60-Hz interference). If you have such a problem, try adding a jumper between the negative side of C50 and the negative side of C8. **R-E**

CrackTheCode

TRI-MODE CABLE TV DESCRAMBLER PARTS

We stock the exact parts, PC board and AC adaptor for *Radio Electronics* February 1987 article on building your own TRI-MODE CABLE TV DESCRAMBLER.

#301 PARTS PACKAGE \$39.⁹⁵

Includes all the original resistors, capacitors, diodes, potentiometers, transistors, integrated circuits, LED's, Toko coil (E520HN-3000023) and Plessey SAW filter (SY323).

#302 PC BOARD \$12.⁹⁵

Original 5 X 8.8 etched & drilled silk-screen PC board used in article.

#304 AC ADAPTOR \$12.⁹⁵

Original (14 to 18 volt DC @ 200ma) AC adaptor used in article.

SPECIALS

Add \$2.50 shipping & handling — \$4.50 for Canadian orders.
We also offer quantity discounts on 5 or more units.

BOTH #301 and #302 \$49.⁰⁰

ALL THREE #301, #302, and #304 \$59.⁰⁰

ORDER TOLL FREE
1-800-227-8529

Inside MA: 617-695-8699
VISA, MASTERCARD OR C.O.D.



J & W
ELECTRONICS, INC.

P.O. BOX 800 • MANSFIELD, MA 02048

Not available to Massachusetts residents due to state law.

CIRCLE 65 ON FREE INFORMATION CARD

7400

Part No.	1-9	10+	Part No.	1-9	10+
7400.	29	19	7485.	65	55
7402.	29	19	7496.	45	35
7404.	35	25	7489.	2.05	1.95
7405.	39	29	7490.	49	39
7406.	39	29	7493.	45	35
7407.	39	29	74121.	45	35
7408.	35	25	74123.	59	49
7410.	35	25	74125.	55	45
7411.	39	29	74126.	75	65
7416.	45	35	74143.	4.05	3.95
7417.	45	35	74150.	1.35	1.25
7420.	35	25	74154.	1.35	1.25
7430.	35	25	74158.	1.59	1.49
7432.	39	29	74173.	85	75
7438.	39	29	74174.	65	55
7442.	55	45	74175.	65	55
7445.	79	69	74176.	99	89
7446.	89	79	74181.	1.95	1.85
7447.	89	79	74189.	2.05	1.95
744R.	2.05	1.95	74193.	79	69
7472.	75	65	74198.	1.85	1.75
7473.	75	65	74221.	99	89
7474.	45	35	74273.	2.05	1.95
7475.	49	39	74365.	69	59
7476.	45	35	74367.	69	59

74LS

Part No.	1-9	10+	Part No.	1-9	10+
74LS00.	29	19	74LS165.	75	65
74LS02.	29	19	74LS166.	99	89
74LS04.	35	25	74LS173.	59	49
74LS05.	35	25	74LS174.	79	69
74LS06.	1.09	99	74LS175.	49	39
74LS07.	1.09	99	74LS189.	4.59	4.49
74LS08.	29	19	74LS191.	59	49
74LS10.	29	19	74LS193.	79	69
74LS14.	49	39	74LS221.	69	59
74LS27.	35	25	74LS240.	79	69
74LS30.	29	19	74LS243.	79	69
74LS32.	35	25	74LS244.	79	69
74LS42.	49	39	74LS245.	89	79
74LS47.	99	89	74LS259.	99	89
74LS73.	39	29	74LS273.	89	79
74LS74.	35	25	74LS279.	49	39
74LS75.	39	29	74LS322.	4.05	3.95
74LS76.	55	45	74LS365.	49	39
74LS85.	59	49	74LS366.	49	39
74LS86.	35	25	74LS367.	49	39
74LS90.	49	39	74LS368.	49	39
74LS93.	49	39	74LS373.	79	69
74LS123.	59	49	74LS374.	79	69
74LS125.	49	39	74LS393.	89	79
74LS138.	49	39	74LS590.	6.05	5.95
74LS139.	49	39	74LS624.	2.05	1.95
74LS154.	1.09	99	74LS629.	2.29	2.19
74LS157.	45	35	74LS640.	1.09	99
74LS158.	45	35	74LS645.	1.09	99
74LS163.	59	49	74LS670.	1.09	99
74LS164.	59	49	74LS688.	2.05	1.95

74S/PROMS*

74S00.	29	74S188*	1.29
74S04.	35	74S189.	1.69
74S08.	35	74S196.	2.49
74S10.	29	74S240.	1.49
74S32.	35	74S244.	1.49
74S74.	39	74S253.	1.49
74S85.	1.79	74S287*	1.49
74S86.	35	74S288*	1.49
74S124.	2.95	74S373.	1.49
74S174.	79	74S374.	1.49
74S175.	79	74S472*	2.95

Part No.	1-9	10+	Part No.	1-9	10+
74ALS00.	35	74ALS138.	89		
74ALS02.	29	74ALS174.	89		
74ALS04.	39	74ALS175.	89		
74ALS08.	39	74ALS240.	1.49		
74ALS10.	39	74ALS244.	1.49		
74ALS27.	39	74ALS245.	1.49		
74ALS30.	39	74ALS373.	1.69		
74ALS32.	39	74ALS374.	1.69		
74ALS38.	49	74ALS573.	1.69		

74F

74F00.	39	74F139.	89
74F04.	39	74F157.	95
74F08.	39	74F193.	3.95
74F10.	39	74F240.	1.39
74F32.	39	74F244.	1.39
74F74.	49	74F253.	2.49
74F86.	59	74F373.	1.39
74F138.	89	74F374.	1.39

CD-CMOS

CD4001.	19	CD4076.	65
CD4008.	89	CD4081.	25
CD4011.	19	CD4082.	35
CD4013.	29	CD4093.	25
CD4016.	35	CD4094.	89
CD4017.	55	CD40103.	2.49
CD4018.	59	CD40107.	69
CD4020.	59	CD4503.	35
CD4024.	49	CD4510.	69
CD4027.	35	CD4511.	69
CD4030.	29	CD4520.	75
CD4040.	65	CD4522.	79
CD4049.	29	CD4538.	79
CD4050.	29	CD4541.	69
CD4051.	59	CD4543.	79
CD4052.	59	CD4553.	4.95
CD4053.	35	CD4555.	79
CD4059.	3.95	CD4560.	2.49
CD4063.	1.95	CD4572 (MC14572).	39
CD4066.	29	CD4583.	89
CD4069.	25	CD4584.	39
CD4070.	25	CD4585.	89
CD4071.	25	MC1311P.	8.95
CD4072.	25	MC14490P.	4.49

COMMODORE CHIPS

Part No.	Price	Part No.	Price	Part No.	Price
WD1770 Disk Cont.	19.95	6545-1 CRTC.	2.49	8701 Clock Chip.	9.95
SI-3052P 5V Pbs Reg 2A	5.95	6551 ACIA.	3.29	*8721 PLA.	14.95
6504A CPU.	1.95	6560 VIC-I.	10.95	8722 MMU.	9.95
6507 CPU.	4.95	6567 VIC-II.	14.95	251104-04 Kernal ROM.	10.95
6508 MPU w/DRAM & I/O.	8.95	6569 VIC PAL.	14.95	*325572-01 Logic Array.	24.95
6510 CPU.	9.95	6572 VIC PAL N.	14.95	*82S100PLA (80614 011)	13.95
6520 PA.	1.75	6581 SID.	14.95	*901225-01 Char ROM.	11.95
6522 VIA.	2.95	8360 Text Editing.	10.95	*901226-01 BASIC ROM.	11.95
6525 TP.	7.95	8501 MPU.	10.95	*901227-03 Kernal ROM.	11.95
6526 CA.	14.95	8502 MPU.	7.95	*901229-05 Upgrad ROM.	15.95
6529 SP.	1.05	8563 CRT Contr.	15.95		
6532 128kB RAM I/O, Tim A.	6.49	8564 VIC.	15.95		

*NOTE: See S100PLA = U17 (C-64)

NEC V20 & V30 CHIPS

Replace the 8086 or 8088 in Your IBM-PC and Increase Its Speed by up to 40%!

Part No.	Price
UPD70108-5 (5MHz) V20 Chip (Replaces the 8088).	\$ 9.95
UPD70108-B (8MHz) V20 Chip (Replaces the 8088-2).	\$11.95
UPD70116-B (8MHz) V30 Chip (Replaces the 8086 or 8086-2).	\$14.95
UPD70116-10 (10MHz) V30 Chip (Replaces the 8086 or 8086-2).	\$34.95

MICROPROCESSOR COMPONENTS

MISCELLANEOUS CHIPS		6500/6800/68000 Cont.		8000 SERIES Cont.	
Part No.	Price	Part No.	Price	Part No.	Price
D765AC	4.49	6840	3.95	8228	2.49
WD1770	19.95	6843	2.95	8237-5	4.95
CDP1800CE	4.95	6845	2.95	8243	2.25
2061-1	5.95	6850	1.49	8250A	6.49
9216	9.95	6852	3.95	8250B (For EM).	5.95
Z80, Z80A, Z80B SERIES		6875	8.95	8251A	1.75
Z80	1.25	68000L8	11.95	8253-5	1.95
Z80-CTC	1.79	68661PEB	5.95	8254	2.95
Z80-DART.	4.95			8255A-5.	1.69
Z80 PIO.	1.79	8031	2.95	8257-5.	2.49
Z80A	1.35	80C31BH	14.95	8259-5.	1.95
Z80A-CTC.	1.49	8035.	1.49	8272.	4.49
Z80A-DART.	4.95	8073.	29.95	8279-5.	2.35
Z80A PIO.	1.49	8080A.	2.49	8741.	10.95
Z80A-SIO/O.	4.95	8085A.	2.29	8748.	7.95
Z80B	2.95	8086	6.95	8749.	7.95
Z80B-CTC	3.49	8086-2.	8.95	8751.	39.95
Z80B PIO.	4.29	8087 (5MHz)	125.00	8755.	14.95
		8087-2 (8MHz)	159.95		
6500/6800/68000 SER.		8088	6.49	DATA ACQUISITION	
6502	2.25	8088-2	8.95	ADC0804LCN.	3.19
65C02 (CMOS)	8.95	8116	4.95	ADC0808CCN.	5.95
6520	1.75	8116	4.95	ADC0809CCN.	3.95
6522	2.35	8155-2.	2.49	ADC0816CCN.	14.95
6532	6.49	8156.	2.49	ADC0817CCN.	8.95
6551.	3.29	8202	9.95	ADC0808LCL.	1.95
6800.	1.75	8202	9.95	ADC1008LCL.	6.49
6802	3.49	8203.	14.95	AY-3-1015D.	4.95
6810.	1.25	8212	1.49	AY-5-1013A.	3.95
6821	1.29	8224.	2.25		

DYNAMIC RAMS

Part No.	Function	Price
4116-15	16,384 x 1 (150ns).	89
4128-20 (Piggyback)	131,072 x 1 (200ns).	4.49
4164-150	65,536 x 1 (150ns).	1.15
4164-200	65,536 x 1 (200ns).	9.95
TMS4416-12	16,384 x 4 (120ns).	4.25
8118	16,384 x 1 (120ns).	69
41256-150	262,144 x 1 (150ns).	2.95
50464-15	65,536 x 4 (150ns) (4464) (41464).	4.95

STATIC RAMS

2016-12	2048 x 8 (120ns).	1.69
2102	1024 x 1 (350ns).	89
2102-2L	1024 x 1 (250ns) Low Power (91L02).	9.95
2114N	1024 x 4 (450ns).	99
2114N-L	1024 x 4 (450ns) Low Power.	1.09
2114N-2	1024 x 4 (200ns).	1.05
2114N-2L	1024 x 4 (200ns) Low Power.	1.49
21C14	1024 x 4 (200ns) (CMOS).	4.49
2145	1024 x 4 (450ns).	1.95
5101	256 x 4 (450ns) CMOS.	4.95
6116LP-2	2048 x 8 (120ns) Low Power CMOS.	2.95
6116P-3	2048 x 8 (150ns) CMOS.	1.89
6116LP-3	2048 x 8 (150ns) Low Power.	1.95
6264P-12	8192 x 8 (120ns) CMOS.	3.89
6264LP-12	8192 x 8 (120ns) Low Power CMOS.	4.25
6264P-15	8192 x 8 (150ns) CMOS.	3.59
6264LP-15	8192 x 8 (150ns) Low Power CMOS.	3.75
6514	1024 x 4 (350ns) CMOS (UPD444C).	4.49
43256-15L	32,768 x 8 (150ns) Low Power.	24.95

PROMS/EPROMS

1702A	256 x 8 (1us)	6.95
TMS2516	2048 x 8 (450ns) 25V.	4.95
TMS2532	4096 x 8 (450ns) 25V.	5.95
TMS2564	8192 x 8 (450ns) 25V.	8.95
2708	1024 x 8 (450ns).	4.95
TMS2716	2048 x 8 (450ns) 3 voltage.	9.95
2716	2048 x 8 (350ns).	3.75
2716-1	2048 x 8 (450ns) 25V.	4.95
27C16	2048 x 8 (450ns) 25V (CMOS).	6.49
2732	4096 x 8 (450ns).	3.95
2732A-20	4096 x 8 (200ns) 21V.	4.25
2732A-25	4096 x 8 (250ns) 21V.	3.95
2732A-45	4096 x 8 (450ns) 21V.	3.75
27C32	4096 x 8 (450ns) 25V (CMOS).	6.49
2764-20	8192 x 8 (200ns) 21V.	4.25
2764-25	8192 x 8 (250ns) 21V.	3.75
2764A-25	8192 x 8 (250ns) 12.5V.	4.25
2764-45	8192 x 8 (450ns) 21V.	3.49
27C64	8192 x 8 (450ns) 21V (CMOS).	5.49
27128-25	16,384 x 8 (250ns) 12.5V.	4.25
27128A-25	16,384 x 8 (250ns) 12.5V.	4.95
27C128-25	16,384 x 8 (250ns) 21V (CMOS).	5.95
27256-25	32,768 x 8 (250ns) 256K (12.5V).	5.95
27C256-25	32,768 x 8 (250ns) 256K (CMOS) (12.5V).	8.95
27512-25	65,536 x 8 (450ns) 25V.	15.95
68764	8192 x 8 (450ns) 25V.	16.95
68766	8192 x 8 (450ns) 25V.	16.95
74S387	256 x 4 PROM O.C.	1.29
74S471	256 x 8 PROM T.S.	4.95
N825123	32 x 8 PROM T.S.	2.49

SATELLITE TV DESCRAMBLER CHIP

The MM5321 is a TV camera sync generator designed to supply the basic sync functions for either color or monochrome 525 line/60Hz interlaced and camera video recorder applications. COLOR BURST GATE & SYNC. ALLOW STABLE COLOR OPERATION

MM5321N. \$11.95

INTERSIL Also Available!

74HCHI-SPEED CMOS

Part No.	Price	Part No.	Price
74HC00	25	74HC175.	69
74HC02	25	74HC221.	99
74HC04	29	74HC240.	79

UPDATE: Our 1987 Product Selection Guide is Here! 94 Pages of Components, Peripherals & More!

Mail Order Electronics - Worldwide
Jameco
 ELECTRONICS

COMMODORE® COMPATIBLE ACCESSORIES



HESWARE 300 Baud Modem For VIC-20 and C-64

• Connects directly to User Port • Manual Answer/Dial • Function keys defined for convenience • Includes Midwest Micro Associates communication software.

CM-1 (For VIC-20 and C-64) \$34.95

RS232 INTERFACE

Allows connection of standard serial devices.
 JE232CM (For VIC-20, C-64 & C-128) \$39.95

External Power Supply

CPS-10 (For C-64) \$39.95

Parallel Printer Interface

2K Buffer, Expandable to 10K!
 MW-350 (For VIC-20, C-64 & C-128) . . . \$54.95

Input/Output Card

16-Channel Analog Multiplexer
 MW-611 (For C-64 and C-128) \$199.95

TRS-80/TANDY® COMPATIBLE ACCESSORIES

E-X-P-A-N-D TRS-80 MEMORY

All kits come complete with documentation

TRS-80 MODEL I, III 16K EXPANSION

TRS-16K3 200ns (Model III) \$5.95

TRS-16K4 250ns (Model I) \$5.49

TRS-80 COLOR AND COLOR II 64K EXPANSION

TRS-64K-2 \$7.95

New models only -

TRS-Co-Co-Incl. 2-50464's (41464's) . . \$10.95

TRS-80 MODEL 4, 4P, & 4D 64K/128K EXPANSION

TRS-64K-2 \$7.95

Expands Model 4 from 16K-64K or Model 4 (Gate Array Version), 4P and 4D from 64K-128K

TRS-64K-2PAL \$14.95

Expands Model 4 (Non-Gate Array Version) from 64K to 128K

TRS-80 MODEL 100 8K EXPANSION

M1008K \$19.95 ea. or 3 for \$54.95

TANDY MODEL 102 8K EXPANSION

M1028K \$9.95

TANDY MODEL 200 24K EXPANSION

M200R \$59.95 ea. or 2 for \$109.95

TANDY 1000 Expansion Memory Half Card

Expand the memory on your Tandy 1000 (128K Version) as much as 640K. Also includes a DMA controller chip.

TAN-EM256K Includes 256K RAM \$ 99.95

TAN-EM512K Includes 512K RAM \$129.95

Options for TAN-EM256K/512K

TAN-C Plug-in Clock option chip (only) \$39.95

TAN-D RAM Disk Printer Spooler Software (only) \$39.95

TANDY 1000 Multifunction Board with Clock Calendar

Expand the memory on your Tandy 1000 (128K Version) to as much as 640K. Complete with an RS232 port, clock/calendar, RAM Disk Printer Spooler and on-board DMA controller chip.

MTAN-256K Includes 256K RAM \$179.95

MTAN-512K Includes 512K RAM \$209.95

UV-EPROM ERASER



Erases all EPROMs. Erases up to 8 chips within 21 minutes (1 chip in 5 minutes). Maintains constant exposure distance of 1". Special conductive foam liner eliminates static build-up. Built-in safety lock to prevent UV exposure. Compact - 9.00" x 3.70" x 2.60". Complete with holding tray for 8 chips.

DE-4 UV-EPROM Eraser \$69.95

UVS-11EL Replacement Bulb \$19.95

NEW PRODUCTS!



ProModem 1200/300 Baud Half-Card Modems

For IBM PC, XT, AT & Compatibles

• Auto-answer/Auto-dial • Extensive diagnostics • Built-in speaker/vol. control • Auto redial on busy • Ability to access Com-port 3 • Hayes compatible • 2-yr. warranty

PM1200B-2 without software . . . \$129.95

PM1200B-2S w/Mirror™ Software . . \$159.95

2 yr. warranty! ZOOM 300 Baud Modem

for Apple II, II+ and IIe



• Auto-dial/Auto-answer • Hayes compatible • Includes call progress monitor, speaker, Zoom Communications software and manual • Made in U.S.A.

ZM300 \$89.95



ProModem 1200/300 for Apple II, II+, IIe and II GS

Fully Compatible with the NEW APPLE II GS!



• NEW, single card version • Built-in software in ROM • Comes with ProCom-A disk based communications software • Hayes compatible • Compatible with ProDOS

• Auto-dial/Auto-answer • Auto redial on busy • Built-in speaker and volume control • 2 phone jacks with exclusion switching • 2-year warranty

PM1200A-2 \$199.95



ProModem 2400/1200/300 Baud Modems

For Any Computer w/RS232 Serial Port

• Hayes command compatible • Call progress tone detection • Auto redial on busy • Internal power supply • Voice/data switching • Second phone jack for voice handset • Auto-answer/Auto-dial • Touch tone and pulse dialing • Speaker with volume control • 8 LED status lights • 1-year warranty



PM1200G (1200/300 baud) \$199.95

PM2400G (2400/1200/300 baud) \$379.95

ProCom-B (Communication Software) . . \$34.95

For IBM PC and Compatibles



1MByte RAM Card for Apple II, II+ and IIe



PLUS-WORKS™ Supports Appleworks!

BIG BOARD comes complete with RAMDISK software for DOS 3.3, ProDOS, Pascal 1.2, and CP/M for Microsoft's SoftCard. A separate driver is available for the AppliCard (StarCard - \$39.95). You can choose the active addressing mode both via a jumper on the BIG BOARD or through software commands

BIG BOARD-1M 1Meg RAM \$299.95

PLUS-WORKS™ XM (Software for Apple II and II+) \$49.95

PLUS-WORKS™ XME (Software for Apple IIe) \$49.95



TTX 14" RGB Color Monitor

for IBM PC, XT and Compatible Computers

• Input: RGB TTL Level • Scanning Freq (Hor) 14.5KHz to 17.8K • Video Bandwidth 18MHz • Resolution 640 x 200 • Connector DB 9-pin (incl.) • Power Consumption 70W • Size 14.6"H x 15.5"W x 13.6"D • Weight 27 lbs. • TTX-1410 is compatible with the IBM-ICB and the IBM-EGA Cards (above, right)

TTX-1410 \$299.95

IBM® COMPATIBLE ACCESSORIES

83-KEY KEYBOARD



• Identical layout as original IBM PC Keyboard • Highly desirable case with palm rest • Complete with cable and data • JUST PLUG IN!

KB83 **SALE** \$29.95

Build an IBM PC/XT™ Compatible!

IBM-64K(2) 64K RAM Chips (18) \$ 19.90

KB83 83-Key Keyboard \$ 29.95

IBM-FCC Floppy Controller Card \$ 39.95

IBM-Case Case \$ 39.95

IBM-MCC Monochrome Card \$ 69.95

IBM-PS Power Supply \$ 69.95

FD55B Disk Drive \$109.95

IBM-MON Monochrome Monitor \$ 99.95

IBM-MB Motherboard \$129.95

Regular List \$609.50

IBM™-Special (Incl. 9 items above) . . . \$549.95

Additional Add-Ons Available!

IBM-KB 83-Key Keyboard \$ 69.95

IBM-ENH Enhanced Keyboard \$ 89.95

IBM-ICB Integrated Color Board \$ 99.95

IBM-EGA Enhd. Graphics 256K RAM \$259.95

IBM-20MBK 20MB Hard Disk Drive \$449.95

IBM is a registered trademark of IBM Computers

Universal 64K/256K Printer Buffer



The UBUFFER Universal Printer Buffer is a hi-speed data buffer that accepts data at a high rate, and then outputs this data to your printer. You save valuable computer time. The UBUFFER can be connected to practically any computer or printer. There are four possible combinations: 1) Serial to Serial 2) Serial to Parallel, 3) Parallel to Parallel, 4) Parallel to Serial. Manual included. Size 9-1/32" L x 4-1/2" W x 1-1/2" H

UB64K \$199.95

UB256K \$239.95

IBM Compatible! DISK DRIVES

Documentation Included

FD55B Teac 5 1/4" DS 1/2"-Height \$109.95

JU-455 Panasonic 5 1/4" DS 1/2"-Height . . . \$109.95

TM100-2 Tandon 5 1/4" DS Full-Height . . . \$119.95

DATA BOOKS

30003 National Linear Data Book (82) \$14.95

30009 Intersil Data Book (85) \$ 9.95

30013 Zilog Data Book (85) \$14.95

30032 National Linear Supplement (84) . . . \$ 6.95

210830 Intel Memory Handbook (86) \$17.95

230843 Intel Microsystem Hndbk. Set (86) . . . \$24.95

MUFFIN/SPRITE-STYLE FANS

MUF60 \$9.95

Torn Industries (4.68" sq. 60 cfm)

SUZ2A1 \$8.95

EGAG Rotron (3.125" square, 20 cfm)

\$20 Minimum Order - U.S. Funds Only
 Shipping: Add 5% plus \$1.50 Insurance

California Residents: Add 6%, 6 1/2% or 7% Sales Tax

Spec. Sheets - 50¢ each
 Prices Subject to Change

Send stamped, self-addressed envelope to receive a Quarterly Sales Flyer - FREE!
 2/87



Send \$1.00 Postage for a FREE 1987 JAMECO CATALOG

© 1986 Jameco Electronics

1355 SHOREWAY ROAD, BELMONT, CA 94002 • PHONE ORDERS WELCOME 415-592-8097 Telex: 176043

Radio Shack Parts Place™

PARTS FOR PROJECTS—NEIGHBORHOOD CLOSE

Top-Quality Capacitors

Tantalums. IC pin spacing. 20% tolerance.

µF	VDC	Cat. No.	Each	µF	VDC	Cat. No.	Each
0.1	35	272-1432	49	2.2	35	272-1435	59
0.47	35	272-1433	49	10	16	272-1436	69
1.0	35	272-1434	49	22	16	272-1437	89

High-"Q" Ceramics. Moistureproof coating.

pF	WVDC	Cat. No.	Pkg. of 2
4.7	50	272-120	39
47	50	272-121	39
100	50	272-123	39
220	50	272-124	39
470	50	272-125	39

µF	WVDC	Cat. No.	Pkg. of 2
.001	500	272-126	49
.0047	500	272-130	49
.01	500	272-131	49
.047	50	272-134	49
.1	50	272-135	49

4000-Series CMOS ICs



With Pin-Out, Specs

Description	Type	Cat. No.	Each
Quad 2-Input NOR Gate	4001	276-2401	79
Quad 2-Input NAND Gate	4011	276-2411	79
Dual Type-D Flip Flop	4013	276-2413	1.19
Decade Counter/Divider	4017	276-2417	1.49
Inverting Hex Buffer	4049	276-2449	99
Quad Bilateral Switch	4066	276-2466	1.19

7400-Series TTL ICs



All Include Pin-Out And Specs

Description	Type	Cat. No.	Each
Quad 2-Input NAND Gate	7400	276-1801	89
Hex Inverter	7404	276-1802	99
Quad 2-Input AND Gate	7408	276-1822	1.29
BCD to 7-Seg. Decoder/Driver	7447	276-1805	1.69
Div. by 2 or 5 BCD Counter	7490	276-1808	1.19

Power Supply Diodes

Micromini 1-Amp. 30-amp surge.

Type	PIV	Cat. No.	Pkg. of 2
1N4001	50	276-1101	49
1N4003	200	276-1102	59
1N4004	400	276-1103	69
1N4005	600	276-1104	79

3-Amp "Barrel". 200-amp surge.

Type	PIV	Cat. No.	Pkg. of 2
1N5400	50	276-1141	79
1N5402	200	276-1143	89
1N5404	400	276-1144	99



Brushless 3" DC Fan

Quiet, Compact, Powerful

Lightweight yet delivers 27 CFM airflow. Ideal for cooling circuitry that's sensitive to hum or AC fields, or mobile equipment. Ball bearings for long life and low noise. Requires 7 to 13.8 VDC.

#273-243 14.95

Breadboarder's "Cookbooks"

Low As **99¢**

Our Mini-Notebooks By Forrest Mims III help you learn to use ICs and other solid-state devices



Mini-Notebook Subject	Pages	Cat. No.	Only
Timer ICs	32	276-5010	.99
Op Amp ICs	48	276-5011	1.49
Optoelectronics	48	276-5012	1.49
Basic Semiconductors	48	276-5013	1.49
Basic Logic Circuits	48	276-5014	1.49

Speech Synthesis Chips



CTS256-AL2 Text-to-Speech IC. 40-pin device translates ASCII from RS-232 into control data for synthesizer below. With data. #276-1786, 16.95
SPO256-AL2 Speech Synthesis IC. 28-pin MOS LSI device uses a stored program to produce natural speech. With detailed data and circuit examples. #276-1784 12.95

Voltage Spike Protectors

Guard Your Valuable Equipment!



Six-Outlet. Features dual MOVs for common and differential mode protection, push-to-reset breaker, bidirectional noise filter with 500 kHz to 5 MHz range, and status indicator lamp. Handles 13 amps. UL listed AC. #61-2786 24.95
One-Outlet. With status indicator. Rated 15 amps. UL listed AC. #61-2791 7.95

Circuit Design Programs

4⁹⁵

Use Your Computer To Select Proper Component Values



This 132-page book contains listings for BASIC programs that help you design electronic circuits. Topics include R-C, R-C-L and filter circuits, transistor circuits and timer circuits using the popular 555 IC. All programs are written in "universal" BASIC and are designed to run on virtually any home computer. #62-1054

Sound Values



(1) **Tri-Sound Siren.** You've never heard a buzzer like this! Contains an IC, driver and speaker in a compact case. Wiring options provide three unique, extra-loud sounds. Requires 3 VDC. #273-072 5.95
 (2) **PC-Mount Piezo Buzzer.** Loud, yet consumes only 12 mA at 12 VDC. #273-065, 2.49

Low-Current Switches



(3) **Mini SPST Momentary.** 0.5 amp at 125 VAC. Normally Open. #275-1547 Pkg. of 5/2.49
 Normally Closed. #275-1548 Pkg. of 5/2.69
 (4) **Slide Switch Kit.** Includes one each: SPDT, DPST, DPDT, plus 3 SPSTs. Rated 0.5 amp at 125 VAC. #275-327 Set of 6/1.79
 (5) **Rotary Switches.** Rated 0.3 amp at 125 VAC. 2-Pole, 6-Position, Non-shorting. #275-1386 1.19
 1-Pole, 12-Position, Shorting type. #275-1385 1.19

Resistor Kit Bargains!



(6) **1/8-Watt Carbon Film.** Set of 100 with 13 popular values from 10 ohms to one megohm. 5% tolerance. #271-311 Set of 100/1.98
 (7) **1/4-Watt Carbon Film.** Jumbo 500-piece set with 54 popular values from 10 ohms to 10 megohms. 5% tolerance. #271-312 Set of 500/7.95

Mini Printed Circuit Pots

1/8-Watt

Only **49¢** Each



Sealed against noise-causing contaminants.

Ohms	Cat. No.	Each
1k	271-333	49
10k	271-335	49
25k	271-336	49
100k	271-338	49

High-Style Enclosures

Superb Looks And Quality



Dress up your project! These deluxe all-metal enclosures feature eggshell white bottoms and black tops. Complete with hardware and rubber feet.

Size	Cat. No.	Each
1 1/16 x 8 1/4 x 6 1/8"	270-272	6.99
3 1/16 x 8 1/4 x 6 1/8"	270-274	8.99

The Relay Corner



(8) **SPST Reed Relays.** Contacts rated 1 amp at 125 VAC. Pins for circuit board mounting. Each, Only 1.49
 5 VDC Coil. #275-232 12 VDC Coil. #275-233
 (9) **Heavy-Duty DPDT Relays.** Contacts rated 10 amps at 125 VAC. Plug in or mount on chassis. Each, 5.49
 12 VDC Coil. #275-218 120 VAC Coil. #275-217
 10-Amp Socket for Above. #275-220 1.59
 (10) **SPDT Mini-Relay.** 6-9 VDC, 500-Ohm Coil. Contacts rated 1 amp at 125 VAC. #275-004 2.99

Over 1000 items in stock: Binding posts, Books, Breadboards, Buzzers, Capacitors, Chokes, Clips, Coax, Connectors, Fuses, Hardware, ICs, Jacks, Knobs, Lamps, Multitesters, PC Boards, Plugs, Rectifiers, Relays, Resistors, Switches, Tools, Transformers, Transistors, Wire, Zeners and more!

Radio Shack®
 A DIVISION OF TANDY CORPORATION

Prices apply at participating Radio Shack stores and dealers

VISA
NATIONAL SEMICONDUCTOR • PANASONIC MACHINE • EWC, INC. • INTERSIL • AD EAC, INC. • J. W. MILLER • AAVID ENGINEER • E. F. JOHNSON • ATLANTIC SEMICONDUCTOR

256K (262,144 x 1) DRAM 150NS \$5.70/1; \$39.95/9
Factory Firsts

DIODES • DIAMOND TOOL • UNGAR • ES • CW INDUSTRIES • AMDEK • G.E. JGAR • YAGO • J. W. MILLER • LUXO 3C CHEMICALS • ARIES • PLESSEY

INTEGRATED CIRCUITS

Part No.	Description	Price
7400 TTL	7400	1.00
7401	7401	1.00
7402	7402	1.00
7403	7403	1.00
7404	7404	1.00
7405	7405	1.00
7406	7406	1.00
7407	7407	1.00
7408	7408	1.00
7409	7409	1.00
7410	7410	1.00
7411	7411	1.00
7412	7412	1.00
7413	7413	1.00
7414	7414	1.00
7415	7415	1.00
7416	7416	1.00
7417	7417	1.00
7418	7418	1.00
7419	7419	1.00
7420	7420	1.00
7421	7421	1.00
7422	7422	1.00
7423	7423	1.00
7424	7424	1.00
7425	7425	1.00
7426	7426	1.00
7427	7427	1.00
7428	7428	1.00
7429	7429	1.00
7430	7430	1.00
7431	7431	1.00
7432	7432	1.00
7433	7433	1.00
7434	7434	1.00
7435	7435	1.00
7436	7436	1.00
7437	7437	1.00
7438	7438	1.00
7439	7439	1.00
7440	7440	1.00
7441	7441	1.00
7442	7442	1.00
7443	7443	1.00
7444	7444	1.00
7445	7445	1.00
7446	7446	1.00
7447	7447	1.00
7448	7448	1.00
7449	7449	1.00
7450	7450	1.00

TI IC SOCKETS

SOLDER TAIL DIP SOCKETS

• Simple Insert
 • Lead Alignment
 • YOUR CHOICE TIN OR GOLD*

TIN PLATED SOLDER TAIL (Min. 98% Tin, 2% Silver)

Part No.	Description	Price
1.16	1.16	1.00
1.17	1.17	1.00
1.18	1.18	1.00
1.19	1.19	1.00
1.20	1.20	1.00
1.21	1.21	1.00
1.22	1.22	1.00
1.23	1.23	1.00
1.24	1.24	1.00
1.25	1.25	1.00
1.26	1.26	1.00
1.27	1.27	1.00
1.28	1.28	1.00
1.29	1.29	1.00
1.30	1.30	1.00
1.31	1.31	1.00
1.32	1.32	1.00
1.33	1.33	1.00
1.34	1.34	1.00
1.35	1.35	1.00
1.36	1.36	1.00
1.37	1.37	1.00
1.38	1.38	1.00
1.39	1.39	1.00
1.40	1.40	1.00

9% Carbon Film Resistors

Standard 1/4W, 1/2W, 1W, 2W, 5W, 10W, 25W, 50W, 100W

• 1/4W
 • 1/2W
 • 1W
 • 2W
 • 5W
 • 10W
 • 25W
 • 50W
 • 100W

• 1/4W
 • 1/2W
 • 1W
 • 2W
 • 5W
 • 10W
 • 25W
 • 50W
 • 100W

• 1/4W
 • 1/2W
 • 1W
 • 2W
 • 5W
 • 10W
 • 25W
 • 50W
 • 100W

OISC CAPACITORS

Part No.	Description	Price
100	100	1.00
101	101	1.00
102	102	1.00
103	103	1.00
104	104	1.00
105	105	1.00
106	106	1.00
107	107	1.00
108	108	1.00
109	109	1.00
110	110	1.00
111	111	1.00
112	112	1.00
113	113	1.00
114	114	1.00
115	115	1.00
116	116	1.00
117	117	1.00
118	118	1.00
119	119	1.00
120	120	1.00

TANTALUM CAPACITORS

Part No.	Description	Price
100	100	1.00
101	101	1.00
102	102	1.00
103	103	1.00
104	104	1.00
105	105	1.00
106	106	1.00
107	107	1.00
108	108	1.00
109	109	1.00
110	110	1.00
111	111	1.00
112	112	1.00
113	113	1.00
114	114	1.00
115	115	1.00
116	116	1.00
117	117	1.00
118	118	1.00
119	119	1.00
120	120	1.00

7400 TTL

Part No.	Description	Price
7400	7400	1.00
7401	7401	1.00
7402	7402	1.00
7403	7403	1.00
7404	7404	1.00
7405	7405	1.00
7406	7406	1.00
7407	7407	1.00
7408	7408	1.00
7409	7409	1.00
7410	7410	1.00
7411	7411	1.00
7412	7412	1.00
7413	7413	1.00
7414	7414	1.00
7415	7415	1.00
7416	7416	1.00
7417	7417	1.00
7418	7418	1.00
7419	7419	1.00
7420	7420	1.00
7421	7421	1.00
7422	7422	1.00
7423	7423	1.00
7424	7424	1.00
7425	7425	1.00
7426	7426	1.00
7427	7427	1.00
7428	7428	1.00
7429	7429	1.00
7430	7430	1.00
7431	7431	1.00
7432	7432	1.00
7433	7433	1.00
7434	7434	1.00
7435	7435	1.00
7436	7436	1.00
7437	7437	1.00
7438	7438	1.00
7439	7439	1.00
7440	7440	1.00

WIRE WRAP DIP SOCKETS

• Standard spacing and packaging capabilities
 • Wire wrap pins in line leads
 • Contact spacings: .027" (1.5mm), .030" (1.27mm), .035" (1.27mm), .040" (1.27mm), .045" (1.27mm), .050" (1.27mm), .055" (1.27mm), .060" (1.27mm), .065" (1.27mm), .070" (1.27mm), .075" (1.27mm), .080" (1.27mm), .085" (1.27mm), .090" (1.27mm), .095" (1.27mm), .100" (1.27mm), .105" (1.27mm), .110" (1.27mm), .115" (1.27mm), .120" (1.27mm), .125" (1.27mm), .130" (1.27mm), .135" (1.27mm), .140" (1.27mm), .145" (1.27mm), .150" (1.27mm), .155" (1.27mm), .160" (1.27mm), .165" (1.27mm), .170" (1.27mm), .175" (1.27mm), .180" (1.27mm), .185" (1.27mm), .190" (1.27mm), .195" (1.27mm), .200" (1.27mm), .205" (1.27mm), .210" (1.27mm), .215" (1.27mm), .220" (1.27mm), .225" (1.27mm), .230" (1.27mm), .235" (1.27mm), .240" (1.27mm), .245" (1.27mm), .250" (1.27mm), .255" (1.27mm), .260" (1.27mm), .265" (1.27mm), .270" (1.27mm), .275" (1.27mm), .280" (1.27mm), .285" (1.27mm), .290" (1.27mm), .295" (1.27mm), .300" (1.27mm), .305" (1.27mm), .310" (1.27mm), .315" (1.27mm), .320" (1.27mm), .325" (1.27mm), .330" (1.27mm), .335" (1.27mm), .340" (1.27mm), .345" (1.27mm), .350" (1.27mm), .355" (1.27mm), .360" (1.27mm), .365" (1.27mm), .370" (1.27mm), .375" (1.27mm), .380" (1.27mm), .385" (1.27mm), .390" (1.27mm), .395" (1.27mm), .400" (1.27mm), .405" (1.27mm), .410" (1.27mm), .415" (1.27mm), .420" (1.27mm), .425" (1.27mm), .430" (1.27mm), .435" (1.27mm), .440" (1.27mm), .445" (1.27mm), .450" (1.27mm), .455" (1.27mm), .460" (1.27mm), .465" (1.27mm), .470" (1.27mm), .475" (1.27mm), .480" (1.27mm), .485" (1.27mm), .490" (1.27mm), .495" (1.27mm), .500" (1.27mm), .505" (1.27mm), .510" (1.27mm), .515" (1.27mm), .520" (1.27mm), .525" (1.27mm), .530" (1.27mm), .535" (1.27mm), .540" (1.27mm), .545" (1.27mm), .550" (1.27mm), .555" (1.27mm), .560" (1.27mm), .565" (1.27mm), .570" (1.27mm), .575" (1.27mm), .580" (1.27mm), .585" (1.27mm), .590" (1.27mm), .595" (1.27mm), .600" (1.27mm), .605" (1.27mm), .610" (1.27mm), .615" (1.27mm), .620" (1.27mm), .625" (1.27mm), .630" (1.27mm), .635" (1.27mm), .640" (1.27mm), .645" (1.27mm), .650" (1.27mm), .655" (1.27mm), .660" (1.27mm), .665" (1.27mm), .670" (1.27mm), .675" (1.27mm), .680" (1.27mm), .685" (1.27mm), .690" (1.27mm), .695" (1.27mm), .700" (1.27mm), .705" (1.27mm), .710" (1.27mm), .715" (1.27mm), .720" (1.27mm), .725" (1.27mm), .730" (1.27mm), .735" (1.27mm), .740" (1.27mm), .745" (1.27mm), .750" (1.27mm), .755" (1.27mm), .760" (1.27mm), .765" (1.27mm), .770" (1.27mm), .775" (1.27mm), .780" (1.27mm), .785" (1.27mm), .790" (1.27mm), .795" (1.27mm), .800" (1.27mm), .805" (1.27mm), .810" (1.27mm), .815" (1.27mm), .820" (1.27mm), .825" (1.27mm), .830" (1.27mm), .835" (1.27mm), .840" (1.27mm), .845" (1.27mm), .850" (1.27mm), .855" (1.27mm), .860" (1.27mm), .865" (1.27mm), .870" (1.27mm), .875" (1.27mm), .880" (1.27mm), .885" (1.27mm), .890" (1.27mm), .895" (1.27mm), .900" (1.27mm), .905" (1.27mm), .910" (1.27mm), .915" (1.27mm), .920" (1.27mm), .925" (1.27mm), .930" (1.27mm), .935" (1.27mm), .940" (1.27mm), .945" (1.27mm), .950" (1.27mm), .955" (1.27mm), .960" (1.27mm), .965" (1.27mm), .970" (1.27mm), .975" (1.27mm), .980" (1.27mm), .985" (1.27mm), .990" (1.27mm), .995" (1.27mm), 1.000" (1.27mm), 1.005" (1.27mm), 1.010" (1.27mm), 1.015" (1.27mm), 1.020" (1.27mm), 1.025" (1.27mm), 1.030" (1.27mm), 1.035" (1.27mm), 1.040" (1.27mm), 1.045" (1.27mm), 1.050" (1.27mm), 1.055" (1.27mm), 1.060" (1.27mm), 1.065" (1.27mm), 1.070" (1.27mm), 1.075" (1.27mm), 1.080" (1.27mm), 1.085" (1.27mm), 1.090" (1.27mm), 1.095" (1.27mm), 1.100" (1.27mm), 1.105" (1.27mm), 1.110" (1.27mm), 1.115" (1.27mm), 1.120" (1.27mm), 1.125" (1.27mm), 1.130" (1.27mm), 1.135" (1.27mm), 1.140" (1.27mm), 1.145" (1.27mm), 1.150" (1.27mm), 1.155" (1.27mm), 1.160" (1.27mm), 1.165" (1.27mm), 1.170" (1.27mm), 1.175" (1.27mm), 1.180" (1.27mm), 1.185" (1.27mm), 1.190" (1.27mm), 1.195" (1.27mm), 1.200" (1.27mm), 1.205" (1.27mm), 1.210" (1.27mm), 1.215" (1.27mm), 1.220" (1.27mm), 1.225" (1.27mm), 1.230" (1.27mm), 1.235" (1.27mm), 1.240" (1.27mm), 1.245" (1.27mm), 1.250" (1.27mm), 1.255" (1.27mm), 1.260" (1.27mm), 1.265" (1.27mm), 1.270" (1.27mm), 1.275" (1.27mm), 1.280" (1.27mm), 1.285" (1.27mm), 1.290" (1.27mm), 1.295" (1.27mm), 1.300" (1.27mm), 1.305" (1.27mm), 1.310" (1.27mm), 1.315" (1.27mm), 1.320" (1.27mm), 1.325" (1.27mm), 1.330" (1.27mm), 1.335" (1.27mm), 1.340" (1.27mm), 1.345" (1.27mm), 1.350" (1.27mm), 1.355" (1.27mm), 1.360" (1.27mm), 1.365" (1.27mm), 1.370" (1.27mm), 1.375" (1.27mm), 1.380" (1.27mm), 1.385" (1.27mm), 1.390" (1.27mm), 1.395" (1.27mm), 1.400" (1.27mm), 1.405" (1.27mm), 1.410" (1.27mm), 1.415" (1.27mm), 1.420" (1.27mm), 1.425" (1.27mm), 1.430" (1.27mm), 1.435" (1.27mm), 1.440" (1.27mm), 1.445" (1.27mm), 1.450" (1.27mm), 1.455" (1.27mm), 1.460" (1.27mm), 1.465" (1.27mm), 1.470" (1.27mm), 1.475" (1.27mm), 1.480" (1.27mm), 1.485" (1.27mm), 1.490" (1.27mm), 1.495" (1.27mm), 1.500" (1.27mm), 1.505" (1.27mm), 1.510" (1.27mm), 1.515" (1.27mm), 1.520" (1.27mm), 1.525" (1.27mm), 1.530" (1.27mm), 1.535" (1.27mm), 1.540" (1.27mm), 1.545" (1.27mm), 1.550" (1.27mm), 1.555" (1.27mm), 1.560" (1.27mm), 1.565" (1.27mm), 1.570" (1.27mm), 1.575" (1.27mm), 1.580" (1.27mm), 1.585" (1.27mm), 1.590" (1.27mm), 1.595" (1.27mm), 1.600" (1.27mm), 1.605" (1.27mm), 1.610" (1.27mm), 1.615" (1.27mm), 1.620" (1.27mm), 1.625" (1.27mm), 1.630" (1.27mm), 1.635" (1.27mm), 1.640" (1.27mm), 1.645" (1.27mm), 1.650" (1.27mm), 1.655" (1.27mm), 1.660" (1.27mm), 1.665" (1.27mm), 1.670" (1.27mm), 1.675" (1.27mm), 1.680" (1.27mm), 1.685" (1.27mm), 1.690" (1.27mm), 1.695" (1.27mm), 1.700" (1.27mm), 1.705" (1.27mm), 1.710" (1.27mm), 1.715" (1.27mm), 1.720" (1.27mm), 1.725" (1.27mm), 1.730" (1.27mm), 1.735" (1.27mm), 1.740" (1.27mm), 1.745" (1.27mm), 1.750" (1.27mm), 1.755" (1.27mm), 1.760" (1.27mm), 1.765" (1.27mm), 1.770" (1.27mm), 1.775" (1.27mm), 1.780" (1.27mm), 1.785" (1.27mm), 1.790" (1.27mm), 1.795" (1.27mm), 1.800" (1.27mm), 1.805" (1.27mm), 1.810" (1.27mm), 1.815" (1.27mm), 1.820" (1.27mm), 1.825" (1.27mm), 1.830" (1.27mm), 1.835" (1.27mm), 1.840" (1.27mm), 1.845" (1.27mm), 1.850" (1.27mm), 1.855" (1.27mm), 1.860" (1.27mm), 1.865" (1.27mm), 1.870" (1.27mm), 1.875" (1.27mm), 1.880" (1.27mm), 1.885" (1.27mm), 1.890" (1.27mm), 1.895" (1.27mm), 1.900" (1.27mm), 1.905" (1.27mm), 1.910" (1.27mm), 1.915" (1.27mm), 1.920" (1.27mm), 1.925" (1.27mm), 1.930" (1.27mm), 1.935" (1.27mm), 1.940" (1.27mm), 1.945" (1.27mm), 1.950" (1.27mm), 1.955" (1.27mm), 1.960" (1.27mm), 1.965" (1.27mm), 1.970" (1.27mm), 1.975" (1.27mm), 1.980" (1.27mm), 1.985" (1.27mm), 1.990" (1.27mm), 1.995" (1.27mm), 2.000" (1.27mm), 2.0

20MB HARD DISK SYSTEM ONLY \$36995!

STATIC RAMS

2101	256x4	(450ns)	1.95
5101	256x4	(450ns)(CMOS)	3.95
2102L-4	1024x1	(450ns)(LP)	.99
2112	256x4	(450ns)	2.99
2114	1024x4	(450ns)	.99
2114L-4	1024x4	(450ns)(LP)	1.09
2114L-2	1024x4	(200ns)(LP)	1.49
2114L-15	1024x4	(150ns)(LP)	1.95
TMS4044-4	4096x1	(450ns)	1.95
TMM2016-150	2048x8	(150ns)	1.49
TMM2016-100	2048x8	(100ns)	1.95
HM6116-4	2048x8	(150ns)(CMOS)	1.95
HM6116-3	2048x8	(200ns)(CMOS)	1.95
HM6116LP-4	2048x8	(200ns)(CMOS)(LP)	1.95
HM6116LP-3	2048x8	(150ns)(CMOS)(LP)	2.05
HM6116LP-2	2048x8	(120ns)(CMOS)(LP)	2.95
HM6264P-15	8192x8	(150ns)(CMOS)	3.89
HM6264LP-15	8192x8	(150ns)(CMOS)(LP)	3.95
HM6264LP-12	8192x8	(120ns)(CMOS)(LP)	4.49

LP=Low power

DYNAMIC RAMS

4116-250	16384x1	(250ns)	.49
4116-200	16384x1	(200ns)	.89
4116-150	16384x1	(150ns)	.99
4116-120	16384x1	(120ns)	1.49
MK432	32768x1	(200ns)	6.95
4164-200	65536x1	(200ns)(5v)	1.19
4164-150	65536x1	(150ns)(5v)	1.29
4164-120	65536x1	(120ns)(5v)	1.95
MCM6665	65536x1	(200ns)(5v)	1.95
TMS4164	65536x1	(150ns)(5v)	1.95
4164-REFRESH	65536x1	(150ns)(5v)(REFRESH)	2.95
TMS4416	16384x4	(150ns)(5v)	4.95
4112B-150	131072x1	(150ns)(5v)	5.95
TMS4464-15	65536x4	(150ns)(5v)	6.95
41256-200	262144x1	(200ns)(5v)	2.95
41256-150	262144x1	(150ns)(5v)	2.95

5v=Single 5 Volt Supply REFRESH=Pin 1 Refresh

★★★★ HIGH-TECH ★★★★★

NEC V20 UPD70108 \$1195

REPLACES 8088 TO SPEED UP IBM PC 10-40%

• HIGH-SPEED ADDRESS CALCULATION IN HARDWARE

• PIN COMPATIBLE WITH 8088

• SUPERSET OF 8088 INSTRUCTION SET

• LOW POWER CMOS

8MHz V20 UPD70108-8 \$13.95

8MHz V30 UPD70116-8 \$19.95

★★★★ SPOTLIGHT ★★★★★

ORDER TOLL FREE 800-538-5000



EPROMS

2708	1024x8	(450ns)	4.95
2716	2048x8	(450ns)(5V)	3.49
2716-1	2048x8	(350ns)(5V)	3.95
TMS2532	4096x8	(450ns)(5V)	5.95
2732	4096x8	(450ns)(5V)	3.95
2732A	4096x8	(250ns)(5V)(21V PGM)	3.95
2732A-2	4096x8	(200ns)(5V)(21V PGM)	4.25
27C64	8192x8	(250ns)(5V)(CMOS)	5.95
2764	8192x8	(450ns)(5V)	3.49
2764-250	8192x8	(250ns)(5V)	3.95
2764-200	8192x8	(200ns)(5V)	4.25
MCM68766	8192x8	(350ns)(5V)(24 PIN)	17.95
27128	16384x8	(250ns)(5V)	4.25
27C256	32768x8	(250ns)(5V)(CMOS)	10.95
27256	32768x8	(250ns)(5V)	7.49

5V=Single 5 Volt Supply 21V PGM=Program at 21 Volts

SPECTRONICS CORPORATION EPROM ERASERS



Model	Timer	Capacity Chp	Intensity (uW Cm ²)	Unit Price
PE 14	NO	9	8,000	\$83.00
PE 14T	YES	9	8,000	\$119.00
PE-24T	YES	12	9,600	\$175.00

8000

8035	1.49
8039	1.95
8080	2.95
8085	2.49
8087-2	169.95
8087	129.00
8088	6.95
8088-2	9.95
8155	2.49
8155-2	3.95
8748	7.95
8755	14.95
80286	129.95
80287	199.95

8200

8203	24.95
8205	3.29
8212	1.49
8216	1.49
8224	2.25
8237	4.95
8237-5	5.49
8250	6.95
8251	1.69
8251A	1.89
8253	1.89
8253-5	1.95
8255	1.69
8255-5	1.89
8259	1.95
8259-5	2.29
8272	4.95
8279	2.49
8279-5	2.95
8282	3.95
8284	2.95
8286	3.95
8288	4.95

Z-80

Z80-CPU 2.5 MHz 1.69

4.0 MHz

Z80A-CPU	1.79
Z80A-PIO	1.89
Z80A-DART	5.95
Z80A-DMA	5.95
Z80A-PIO	1.89
Z80A-SIO/0	5.95
Z80A-SIO/1	5.95
Z80A-SIO/2	5.95

6.0 MHz

Z80B-CPU	3.75
Z80B-CTC	4.25
Z80B-PIO	4.25
Z80B-DART	14.95
Z80B-SIO/0	12.95
Z80B-SIO/2	12.95
Z8671 ZILOG	19.95

CLOCK CIRCUITS

MM5369	1.95
MM5369 EST	1.95
MM58167	12.95
MM58174	11.95
MSM5832	2.95

6500 1.0 MHz

6502	2.69
65C02 (CMOS)	12.95
6507	9.95
6520	1.95
6522	4.95
6526	26.95
6532	6.95
6545	6.95
6551	5.95
6561	19.95
6581	34.95

2.0 MHz

6502A	2.95
6520A	2.95
6522A	5.95
6532A	11.95
6545A	7.95
6551A	6.95

3.0 MHz

6502B	6.95
-------	------

6800 1.0 MHz

6800	1.95
6802	4.95
6803	9.95
6809	5.95
6809E	5.95
6810	1.95
6820	2.95
6821	1.95
6840	6.95
6843	19.95
6844	12.95
6845	4.95
6847	11.95
6850	1.95
6883	22.95

BIT RATE GENERATORS

MC14411	9.95
BR1941	4.95
4702	4.95
COM8116	8.95
MM5307	4.95

UARTS

AY5-1013	3.95
AY3-1015	4.95
TR1602	3.95
2651	4.95
IM6402	6.95
IM6403	9.95
INS8250	6.95

SOUND CHIPS

76477	5.95
76489	8.95
SSI-263	39.95
AY3-8910	12.95
AY3-2376	12.95
SP1000	39.00

GRT CONTROLLERS

6845	4.95
68845	8.95
6847	11.95
HD46505SP	6.95
MC1372	2.95
8275	26.95
7220	19.95
CRT5027	12.95
CRT5037	9.95
TMS9918A	19.95

DISK CONTROLLERS

1771	4.95
1791	9.95
1793	9.95
1795	12.95
1797	12.95
2791	19.95
2793	19.95
2797	29.95
6843	19.95
8272	4.95
UPD765	4.95
MB8876	12.95
MB8877	12.95
1691	6.95
2143	6.95

CRYSTALS

32,768 KHz	.95
1.0 MHz	2.95
1.8432	2.95
2.0	1.95
2.097152	1.95
2.4576	1.95
3.2768	1.95
3.579545	1.95
4.0	1.95
4.032	1.95
5.0	1.95
5.0688	1.95
6.0	1.95
6.144	1.95
6.5536	1.95
8.0	1.95
10.0	1.95
10.738635	1.95
12.0	1.95
14.31818	1.95
15.0	1.95
16.0	1.95
17.430	1.95
18.0	1.95
18.432	1.95
20.0	1.95
22.1184	1.95
24.0	1.95
32.0	1.95

CRYSTAL OSCILLATORS

1.0MHz	5.95
1.8432	5.95
2.0	5.95
2.4576	5.95
2.5	4.95
4.0	4.95
5.0688	4.95
6.0	4.95
6.144	4.95
8.0	4.95
10.0	4.95
12.0	4.95
12.480	4.95
15.0	4.95
16.0	4.95
18.432	4.95
20.0	4.95
24.0	4.95

74LS00

74LS00	.16
74LS01	.18
74LS02	.17
74LS03	.18
74LS04	.16
74LS05	.18
74LS08	.18
74LS09	.18
74LS10	.16
74LS11	.22
74LS12	.22
74LS13	.26
74LS14	.39
74LS15	.26
74LS20	.17
74LS21	.22
74LS22	.22
74LS27	.23
74LS28	.26
74LS30	.17
74LS32	.18
74LS33	.28
74LS37	.26
74LS38	.26
74LS42	.39
74LS47	.79
74LS48	.85
74LS51	.17
74LS73	.29
74LS74	.24
74LS75	.29
74LS76	.29
74LS83	.49
74LS85	.49
74LS86	.22
74LS90	.39
74LS92	.49
74LS93	.39
74LS95	.49
74LS107	.34
74LS109	.36
74LS112	.29
74LS122	.45
74LS123	.49
74LS124	2.75
74LS125	.39
74LS126	.39
74LS132	.39
74LS133	.39
74LS136	.39
74LS138	.39
74LS139	.39
74LS145	.99
74LS147	.99
74LS148	.99
74LS151	.39
74LS153	.39
74LS154	1.49
74LS155	.59
74LS156	.49
74LS157	.35
74LS158	.29
74LS160	.29
74LS161	.39
74LS162	.49
74LS163	.39
74LS164	.49

74LS00

74LS165	.65
74LS166	.95
74LS169	.95
74LS173	.49
74LS174	.39
74LS175	.39
74LS191	.49
74LS192	.69
74LS193	.69
74LS194	.69
74LS195	.69
74LS196	.59
74LS197	.59
74LS221	.59
74LS240	.69
74LS241	.69
74LS242	.69
74LS243	.69
74LS244	.69
74LS245	.69
74LS247	.79
74LS251	.49
74LS253	.49
74LS256	1.79
74LS257	.39
74LS258	.49
74LS259	1.29
74LS260	.49
74LS266	.39
74LS273	.79
74LS279	.39
74LS280	1.98
74LS283	.59
74LS290	.39
74LS293	.89
74LS299	1.49
74LS322	3.95
74LS323	2.49
74LS364	1.95
74LS365	.39
74LS367	.39
74LS368	.39
74LS373	.79
74LS374	.79
74LS375	.95
74LS377	.79
74LS378	1.18
74LS390	1.19
74LS393	.79
74LS413	1.49
74LS414	.99
74LS415	.99
74LS416	1.29
74LS417	.89
74LS418	3.20
74LS419	3.20
74LS420	3.20
74LS421	3.20
74LS422	3.20
74LS423	3.20
74LS424	3.20
74LS425	3.20
74LS426	3.20
74LS427	3.20
74LS428	3.20
74LS429	3.20
74LS430	3.20
74LS431	3.20
74LS432	3.20
74LS433	3.20
74LS434	3.20
74LS435	3.20
74LS436	3.20
74LS437	3.20
74LS438	3.20
74LS439	3.20
74LS440	3

20MB HARD DISK SYSTEM ONLY \$36995!

CMOS		
4001	.19	14419 4.95
4011	.19	14433 14.95
4012	.25	4503 .49
4013	.35	4511 .69
4015	.29	4516 .79
4016	.29	4518 .85
4017	.49	4522 .79
4018	.69	4526 .79
4020	.59	4527 1.95
4021	.69	4528 .79
4024	.49	4529 2.95
4025	.25	4532 1.95
4027	.39	4538 .95
4028	.65	4541 1.29
4035	.69	4553 5.79
4040	.69	4585 .75
4041	.75	4702 12.95
4042	.59	74C00 .29
4043	.85	74C14 .59
4044	.69	74C74 .59
4045	1.98	74C83 1.95
4046	.69	74C85 1.49
4047	.69	74C95 .99
4049	.29	74C150 5.75
4050	.29	74C151 2.25
4051	.69	74C161 .99
4052	.69	74C163 .99
4053	.69	74C164 1.39
4056	2.19	74C192 1.49
4060	.69	74C193 1.49
4066	.29	74C221 2.49
4069	.19	74C240 1.89
4076	.59	74C244 1.89
4077	.29	74C374 1.99
4081	.22	74C905 10.95
4085	.79	74C911 8.95
4086	.89	74C917 12.95
4093	.49	74C922 4.49
4094	2.49	74C923 4.95
14411	9.95	74C926 7.95
14412	6.95	80C97 .95

7400/9000		
7400	.19	74147 2.49
7402	.19	74148 1.20
7404	.19	74150 1.35
7406	.29	74151 .55
7407	.29	74153 .55
7408	.24	74154 1.49
7410	.19	74155 .75
7411	.25	74157 .55
7414	.49	74159 1.65
7416	.25	74161 .69
7417	.25	74163 .69
7420	.19	74164 .85
7423	.29	74165 .85
7430	.19	74166 1.00
7432	.29	74175 .89
7438	.29	74177 .75
7442	.49	74178 1.15
7445	.69	74181 2.25
7447	.89	74182 .75
7470	.35	74184 2.00
7473	.34	74191 1.15
7474	.33	74192 .79
7475	.45	74194 .85
7476	.35	74196 .79
7483	.50	74197 .75
7485	.59	74199 1.35
7486	.35	74221 1.35
7489	2.15	74265 1.35
7490	.39	74247 1.25
7492	.50	74248 1.85
7493	.35	74249 1.95
7495	.55	74251 .75
7497	2.75	74265 1.35
7499	2.29	74273 1.95
74121	.29	74278 3.11
74123	.49	74367 .65
74125	.45	74368 .65
74141	.65	9368 3.95
74143	5.95	9602 1.95
74144	2.95	9637 2.95
74145	.60	96502 1.95

74S00		
74S00	.29	74S163 1.29
74S02	.29	74S168 3.95
74S03	.29	74S174 7.95
74S04	.29	74S175 7.95
74S05	.29	74S188 1.95
74S08	.35	74S189 1.95
74S10	.29	74S195 1.49
74S15	.49	74S196 2.49
74S30	.29	74S197 2.95
74S32	.35	74S226 3.99
74S37	.69	74S240 1.49
74S38	.69	74S241 1.49
74S74	.49	74S244 1.49
74S85	.95	74S257 .79
74S86	.35	74S253 .79
74S112	.50	74S258 .95
74S124	.25	74S280 1.95
74S137	.79	74S287 1.69
74S141	.55	74S288 1.69
74S151	.79	74S299 2.95
74S155	.79	74S373 1.69
74S157	.79	74S374 1.69
74S158	.95	74S471 4.95
74S167	1.29	74S571 2.95

VOLTAGE REGULATORS		
TO-220 CASE		
7805T	.49	7905T .59
7808T	.49	7908T .59
7812T	.49	7912T .59
7815T	.49	7915T .59
TO-3 CASE		
7805K	1.59	7905K 1.69
7812K	1.39	7912K 1.49
TO-93 CASE		
78L05	.49	79L05 .69
78L12	.49	79L12 1.49
OTHER VOLTAGE REGS		
LM323K	5V 3A	TO-3 4.79
LM338K	Adj. 5A	TO-3 6.95
78H12K	12V 5A	TO-3 8.95

LINEAR		
TL066	.99	LM733 .98
TL071	.69	LM741 .29
TL072	1.09	LM747 .69
TL074	1.95	LM748 .59
TL081	.59	MC1330 1.69
TL082	.99	MC1350 1.19
TL084	1.49	MC1372 6.95
LM301	.34	LM1414 1.59
LM309K	1.25	LM1458 .49
LM311	.59	LM1488 .49
LM311H	.89	LM1489 .49
LM317K	3.49	LM1496 .85
LM317T	.95	LM1812 8.25
LM318	1.49	LM1889 1.95
LM319	1.25	ULN2003 .79
LM320	***7900	XR2206 3.95
LM322	1.95	XR2211 2.95
LM323K	4.79	XR2240 1.95
LM324	.49	MPQ2507 1.95
LM331	3.95	LM2917 1.95
LM334	1.19	CA3046 .89
LM335	1.79	CA3081 .99
LM336	1.75	CA3082 .99
LM337K	3.95	CA3086 .80
LM338K	6.95	CA3089 1.95
LM339	.59	CA3130E .99
LM340	***7800	CA3146 1.29
LM350T	4.60	CA3160 1.19
LF351	.59	MC3470 1.95
LF352	.99	MC3480 8.95
LF357	.99	MC3487 2.95
LM358	.59	LM3900 .49
LM380	.89	LM3909 .98
LM383	1.95	LM3911 2.25
LM386	.89	LM3914 2.39
LM393	.45	MC4024 3.49
LM394H	5.95	MC4044 3.99
TL494	4.20	RC4136 1.25
TL497	3.25	RC4558 .69
NE555	.29	LM13600 1.49
NE556	.49	75107 1.49
NE558	1.29	75110 1.95
NE564	1.95	75150 1.95
LM565	.95	75154 1.95
LM566	1.49	75188 1.25
LM567	.79	75189 1.25
NE570	2.95	75451 .39
NE590	2.50	75452 .39
NE592	.98	75453 .39
LM710	.75	75477 1.29
LM723	.49	75492 .79
K-TO-5 CAN. K-TO-3, T-TO-220		

DATA ACQ INTERFACE		
ADC0800	15.55	8T26 1.29
ADC0804	3.49	8T28 1.29
ADC0809	4.49	8T95 .89
ADC0E16	14.95	8T96 .89
ADC0E17	9.95	8T97 .59
ADC0E31	8.95	8T98 .89
DAC0E00	4.49	DM8131 2.95
DAC0E06	1.95	DP8304 2.29
DAC0E08	2.35	DS8833 2.25
DAC1C20	8.25	DS8835 1.99
DAC1C22	5.95	DS8836 .99
MC14C8L8	2.95	DS8837 1.65

IC SOCKETS		
8 PIN ST	1.99	100-
14 PIN ST	.11	10
16 PIN ST	.12	10
18 PIN ST	.15	13
20 PIN ST	.18	15
22 PIN ST	.15	12
24 PIN ST	.20	15
28 PIN ST	.22	16
40 PIN ST	.30	22
64 PIN ST	1.95	149
ST-SOLDERAL		
8 PIN WW	.59	69
14 PIN WW	.69	52
16 PIN WW	.69	58
18 PIN WW	.99	90
20 PIN WW	1.09	98
22 PIN WW	1.39	128
24 PIN WW	1.49	135
28 PIN WW	1.69	149
40 PIN WW	1.99	180
WW-WIREWRAP		
16 PIN ZIF	4.95	CALL
24 PIN ZIF	5.95	CALL
28 PIN ZIF	6.95	CALL
40 PIN ZIF	9.95	CALL
ZIF-TEXTOL (ZERO INSERTION FORCE)		

EDGE CARD CONNECTORS		
100 PIN ST	\$ 100	.125 3.95
100 PIN WW	\$ 100	.125 4.95
62 PIN ST IBM CUP		1.00 1.95
50 PIN ST APPLE		1.00 2.95
44 PIN ST STD		.156 1.95
44 PIN WW STD		.156 4.95

36 PIN CENTRONICS		
IDCEN36	RIBBON CABLE	6.95
CEN36	SOLDER CUP	4.95
FEMALE		
IDCEN36/F	RIBBON CABLE	7.95
CE N36PC	RT ANGLE PC MOUNT	4.95

INTERSIL		
ICL7106	9.95	
ICL7107	12.95	
ICL7660	2.95	
ICL8038	4.95	
ICM7207A	5.95	
ICM7208	15.95	

DIP CONNECTORS										
DESCRIPTION	ORDER BY	CONTACTS								
		8	14	16	18	20	22	24	28	40
HIGH RELIABILITY TOOLED ST IC SOCKETS	AUGATxxST	62	79	89	1.09	1.29	1.39	1.49	1.69	2.49
HIGH RELIABILITY TOOLED WW IC SOCKETS	AUGATxxWW	1.30	1.80	2.10	2.40	2.50	2.90	3.15	3.70	5.40
COMPONENT CARRIES (DIP HEADERS)	ICCxx	.49	.59	.69	.99	.99	.99	.99	1.09	1.49
RIBBON CABLE DIP PLUGS (IDC)	IDPxx95	.95	1.75	...	2.95

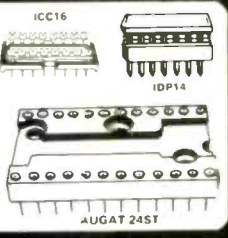

DIODES/OPTO/TRANSISTORS		
1N451	.25	4N28 .69
1N459	.25	4N27 .69
1N4148	25/1.00	4N28 .69
1N4004	10/1.00	4N33 .89
1N4502	.25	4N37 1.19
KEP02	.55	MCT-2 .59
KEU8A	.95	MCT-6 1.29
MBA990-2	.35	TIL-111 .99
N2222	.25	2N3906 .10
PA2222	.10	2N4401 .25
2A2905	.50	2N4402 .25
2A2907	.25	2N4445 .25
2K3055	.79	2N6045 1.75
2K3904	.10	TIP31 .49

D-SUBMINIATURE							
DESCRIPTION	ORDER BY	CONTACTS					
		9	15	19	25	37	50
SOLDER CUP	MALE DBxxP	.82	.90	1.25	1.25	1.80	3.48
	FEMALE DBxxS	.95	1.15	1.50	1.50	2.35	4.32
RIGHT ANGLE PC SOLDER	MALE DBxxPR	1.20	1.49	...	1.95	2.65	...
	FEMALE DBxxSR	1.25	1.55	...	2.00	2.79	...
WIRE WRAP	MALE DBxxPWW	1.69	2.56	...	3.89	5.90	...
	FEMALE DBxxSWW	2.76	4.27	...	6.84	9.95	...
IDC RIBBON CABLE	MALE IDBxxP	2.70	2.95	...	3.98	5.70	...
	FEMALE IDBxxS	2.92	3.20	...	4.33	6.76	...
HOODS	METAL MHOOOxx	1.25	1.25	1.30	1.30
	GREY HOODxx	.65	.6565	.75	.95

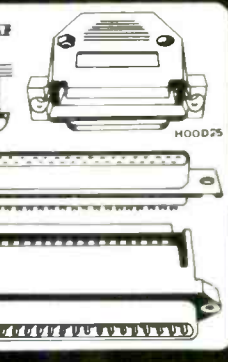

LED DISPLAYS		
FRD-357(359)	COM CATHODE	362" 1.25
FRD-500(503)	COM CATHODE	5" 1.49
FRD-507(510)	COM ANODE	5" 1.49
MAN-72	COM ANODE	3" .99
MAN-74	COM CATHODE	3" .99
MAN-8940	COM CATHODE	8" 1.99
TI-313	COM CATHODE	3" .45
TL-311	4x7 HEX W/LOGIC	270" 9.95
HP5082-7340	4x7 HEX W/LOGIC	290" 7.95

IDC CONNECTORS							
DESCRIPTION	ORDER BY	CONTACTS					
		10	20	26	34	40	50
SOLDER HEADER	IDHxxS	.82	1.29	1.68	2.20	2.58	3.24
RIGHT ANGLE SOLDER HEADER	IDHxxSR	.85	1.35	1.76	2.31	2.72	3.39
WW HEADER	IDHxxW	1.86	2.98	3.84	4.50	5.28	6.63
RIGHT ANGLE WW HEADER	IDHxxWR	2.05	3.28	4.22	4.45	4.80	7.30
RIBBON HEADER SOCKET	IDSxx	.79	.99	1.39	1.59	1.99	2.25
RIBBON HEADER	IDMxx	...	5.50	6.25	7.00	7.50	8.50
RIBBON EDGE CARD	IDExx	1.75	2.25	2.65	2.75	3.80	3.95

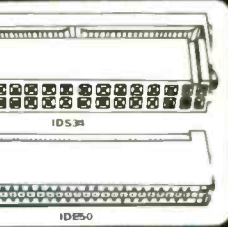

DIFFUSED LEADS		
JUMBO RED	T1 1/4	10 .09
JUMBO		

20MB HARD DISK SYSTEM ONLY \$369⁹⁵!

ENHANCED GRAPHICS ADAPTOR

100% IBM COMPATIBLE—PASSES IBM EGA DIAGNOSTICS

- COMPATIBLE WITH IBM EGA, COLOR GRAPHICS ADAPTOR AND MONOCHROME ADAPTOR
- DISPLAYS 16 COLORS OUT OF 64 COLORS
- COMES WITH 256K OF VIDEO RAM
- DUAL SCANNING FREQUENCIES WORKS WITH STANDARD OR EGA TYPE RGB MONITORS
- LIGHT PEN INTERFACE

NOW ONLY \$199.95

EGA MONITOR

- FULL ONE YEAR WARRANTY
- EGA AND CGA COMPATIBLE
- SCANNING FREQUENCIES: 15.75 KHz / 21.85 KHz
- 14" BLACK MATRIX, NON-GLARE SCREEN
- RESOLUTION: 640 x 200 / 640 x 350
- .31 DOT, 25MHz
- 16 COLORS OUT OF 64



NOW \$479.95

NOW BUY BOTH FOR \$629!

PAGE WIRE WRAP WIRE PRECUT ASSORTMENT

IN ASSORTED COLORS \$27.50
100ea: 5.5", 6.0", 6.5", 7.0"
250ea: 2.5", 4.5", 5.0"
500ea: 3.0", 3.5", 4.0"

SPOOLS

100 feet \$4.30 250 feet \$7.25
500 feet \$13.25 1000 feet \$21.95

Please specify color: Blue, Black, Yellow or Red

EMI FILTER

\$4.95

- MANUFACTURED BY CORCOM
- LOW COST
- FITS LC-HP BELOW
- 6 AMP 120/240 VOLT



6 FOOT LINE CORDS

LC-2 2 CONDUCTOR 39
LC-3 3 CONDUCTOR 99
LC-HP 3 CONDUCTOR W/ STD FEMALE SOCKET 1.49

MUFFIN FANS

3.15" SQ ROTRON 14.95
3.63" SQ ETRI 14.95
3.18" SQ MASUHITA 16.95

WIRE WRAP PROTOTYPE CARDS

FR-4 EPOXY GLASS LAMINATE WITH GOLD-PLATED EDGE-CARD FINGERS



IBM-PR2

IBM

BOTH CARDS HAVE SILK SCREENED LEGENDS AND INCLUDES MOUNTING BRACKET

IBM-PR1 WITH .5V AND GROUND PLANE \$27.95
IBM-PR2 AS ABOVE WITH DECODING LAYOUT \$29.95

S-100

P100-1 BARE - NO FOIL PADS \$15.15
P100-2 HORIZONTAL BUS \$21.80
P100-3 VERTICAL BUS \$21.80
P100-4 SINGLE FOIL PADS PER HOLE \$22.75

APPLE

P500-1 BARE - NO FOIL PADS \$15.15
P500-3 HORIZONTAL BUS \$22.75
P500-4 SINGLE FOIL PADS PER HOLE \$21.80
7060-45 FOR APPLE II⁺ AUX SLOT \$30.00

SOCKET-WRAP I.D.TM

- SLIPS OVER WIRE WRAP PINS
- IDENTIFIES PIN NUMBERS ON WRAP SIDE OF BOARD
- CAN WRITE ON PLASTIC, SUCH AS IC #

PINS	PART#	PK. OF	PRICE
8	IDWRAP 08	10	1.95
14	IDWRAP 14	10	1.95
16	IDWRAP 16	10	1.95
18	IDWRAP 18	5	1.95
20	IDWRAP 20	5	1.95
22	IDWRAP 22	5	1.95
24	IDWRAP 24	5	1.95
28	IDWRAP 28	5	1.95
40	IDWRAP 40	5	1.95

PLEASE ORDER BY NUMBER OF PACKAGES (PK. OF)



ID WRAP 24

FRAME STYLE TRANSFORMERS

12.6V AC CT 2 AMP 5.95
12.6V AC CT 4 AMP 7.95
12.6V AC CT 8 AMP 10.95
25.2V AC CT 2 AMP 7.95

25 PIN D-SUB GENDER CHANGERS

\$7.95



SWITCHING POWER SUPPLIES

PS-IBM \$69.95

- FOR IBM PC-XT COMPATIBLE
- 135 WATTS
- .5V @ 15A, .12V @ 4.2A
- .5V @ 5A, .12V @ 5A
- ONE YEAR WARRANTY



PS-IBM-150 \$79.95

- FOR IBM PC-XT COMPATIBLE
- 150 WATTS
- .12V @ 5.2A, .5V @ 16A
- .12V @ 5A, .5V @ 5A
- ONE YEAR WARRANTY



PS-130 \$99.95

- 130 WATTS
- SWITCH ON REAR
- FOR USE IN OTHER IBM TYPE MACHINES
- 90 DAY WARRANTY



PS-A \$49.95

- USE TO POWER APPLE TYPE SYSTEMS, 79.5 WATTS
- .5V @ 7A, .12V @ 3A
- .5V @ 5A, .12V @ 5A
- APPLE POWER CONNECTOR



PS-SPL200 \$49.95

- .5V @ 25A, .12V @ 3.5A
- .5V @ 1A, .12V @ 1A
- UL APPROVED
- ALUMINUM ENCLOSURE



BOOKS BY STEVE CIARCIA

BUILD YOUR OWN Z80 COMPUTER \$19.95
CIRCUIT CELLAR VOL 1 \$17.95
CIRCUIT CELLAR VOL 2 \$18.95
CIRCUIT CELLAR VOL 3 \$18.95
CIRCUIT CELLAR VOL 4 \$18.95
CIRCUIT CELLAR VOL 5 \$19.95

MICROCOMPUTER HARDWARE HANDBOOK FROM ELCOMP \$14.95

OVER 800 PAGES OF DATA SHEETS ON THE MOST COMMONLY USED ICs. INCLUDES TTL, CMOS, 74LS00, MEMORY, CPUs, MPU SUPPORT, AND MUCH MORE!

CAPACITORS

TANTALUM

1.0µf	15V .35	4.7µf	35V .45
6.8	15V .70	1.0	35V .45
10	15V .80	2.2	35V .65
22	15V 1.35	4.7	35V .85
22	35V .40	10	35V 1.00

DISC

100pf	50V .05	680	50V .05
22	50V .05	001µf	50V .05
27	50V .05	0022	50V .05
33	50V .05	005	50V .05
47	50V .05	.01	50V .07
68	50V .05	.02	50V .07
100	50V .05	.05	50V .07
220	50V .05	.1	12V .10
560	50V .05	.1	50V .12

MONOLITHIC

01µf	50V .14	1µf	50V .18
047µf	50V .15	4.7µf	50V .25

ELECTROLYTIC

	RADIAL	AXIAL		
1µf	25V .14	1µf	50V .14	
2.2	35V .15	10	50V .16	
4.7	50V .15	22	16V .14	
10	50V .15	47	50V .20	
47	35V .18	100	35V .25	
100	16V .18	220	25V .30	
220	35V .20	470	50V .50	
470	25V .30	1000	16V .60	
2200	16V .70	2200	16V .70	
4700	25V 1.45	4700	16V 1.25	

DATABASE EPROM ERASER

\$34.95

- ERASES 2 IN 10 MINUTES
- COMPACT-NO DRAWER
- THIN METAL SHUTTER PREVENTS UV LIGHT FROM ESCAPING



1/4 WATT RESISTORS

5% CARBON FILM ALL STANDARD VALUES FROM 1 OHM TO 10 MEG. OHM
10 PCS same value .05 100 PCS same value .02
50 PCS same value .025 1000 PCS same value .015

RESISTOR NETWORKS

SIP 9 PIN 9 RESISTOR .69
SIP 8 PIN 7 RESISTOR .59
DIP 16 PIN 8 RESISTOR 1.09
DIP 16 PIN 15 RESISTOR 1.09
DIP 14 PIN 7 RESISTOR .99
DIP 14 PIN 13 RESISTOR .99

SPECIALS ON BYPASS CAPACITORS

.01 µf CERAMIC DISC 100/\$5.00
.01 µf MONOLITHIC 100/\$10.00
.1 µf CERAMIC DISC 100/\$6.50
.1 µf MONOLITHIC 100/\$12.50

WISH SOLDERLESS BREADBOARDS

PART NUMBER	DIMENSIONS	DISTRIBUTION STRIP(S)	TIE POINTS	TERMINAL STRIP(S)	TIE POINTS	BINDING POSTS	PRICE
WBU-D	.38 x 6.50"	1	100	---	---	---	2.95
WBU-T	1.38 x 6.50"	---	---	1	630	---	6.95
WBU-204-3	3.94 x 8.45"	1	100	2	1260	2	17.95
WBU-204	5.13 x 8.45"	4	400	2	1260	3	24.95
WBU-206	6.88 x 9.06"	5	500	3	1890	4	29.95
WBU-208	8.25 x 9.45"	7	700	4	2520	4	39.95

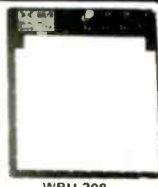

WBU-208

LITHIUM BATTERY

AS USED IN CLOCK CIRCUITS



3 VOLT BATTERY \$3.95
BATTERY HOLDER \$1.49

NEW EDITION!

1986 IC MASTER
THE INDUSTRY STANDARD
\$129.95



Visit our retail store located at 1256 S. Bascom Ave. in San Jose, (408) 947-8881

JDR Microdevices
110 Knowles Drive, Los Gatos, CA 95030
Toll Free 800-538-5000 • (408) 866-6200
FAX (408) 378-8927 • Telex 171-110

© COPYRIGHT 1986 JDR MICRODEVICES

THE JDR MICRODEVICES LOGO IS A REGISTERED TRADEMARK OF JDR MICRODEVICES. JDR INSTRUMENTS AND JDR MICRODEVICES ARE TRADEMARKS OF JDR MICRODEVICES. IBM IS A TRADEMARK OF INTERNATIONAL BUSINESS MACHINES. APPLE IS A TRADEMARK OF APPLE COMPUTER.

PLEASE USE YOUR CUSTOMER NUMBER WHEN ORDERING
TERMS: Minimum order \$10.00. For shipping and handling include \$2.50 for UPS Ground and \$3.50 for UPS Air. Orders over 1 lb. and foreign orders may require additional shipping charges - please contact our sales department for the amount. CA residents must include applicable sales tax. All merchandise is warranted for 90 days unless otherwise stated. Prices are subject to change without notice. We are not responsible for typographical errors. We reserve the right to limit quantities and to substitute manufacturer. All merchandise subject to prior sale.

20MB HARD DISK SYSTEM ONLY \$369⁹⁵!

DISK DRIVES FOR APPLE COMPUTERS

AP-150
\$99.95



- 1/2" HT. DIRECT DRIVE
- 100% APPLE COMPATIBLE
- SIX MONTH WARRANTY

BAL-500
\$129.95

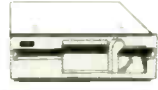

- TEAC MECHANISM DIRECT DRIVE
- 100% APPLE COMPATIBLE
- FULL ONE YEAR WARRANTY

AP-135
\$129.95



- FULL HT SHUGART MECHANISM
- DIRECT REPLACEMENT FOR APPLE DISK II
- SIX MONTH WARRANTY

DOUBLE SIDED!

MAC535
\$249.95

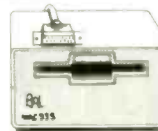

- 3.5" ADD-ON DISK DRIVE
- 100% MACINTOSH COMPATIBLE
- DOUBLE SIDED 800K BYTE STORAGE
- HIGH RELIABILITY DRIVE
- HAS AUTO-EJECT MECHANISM
- FULL ONE YEAR WARRANTY

AD-3C
\$139.95

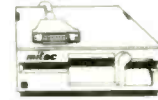

- 100% APPLE IIc COMPATIBLE
- READY TO PLUG IN, W/ SHIELDED CABLE & MOLDED 19 PIN CONNECTOR
- FAST, RELIABLE SLIMLINE DIRECT DRIVE
- SIX MONTH WARRANTY

DISK DRIVE ACCESSORIES
FDD CONTROLLER CARD \$49.95
IIc ADAPTOR CABLE \$19.95
ADAPTS STANDARD APPLE II DRIVES FOR USE WITH APPLE IIc

KB-1000 **\$79.95**

- CASE WITH KEYBOARD FOR APPLE TYPE MOTHERBOARD
- USER DEFINED FUNCTION KEYS
 - NUMERIC KEYPAD WITH CURSOR CONTROL
 - CAPS LOCK • AUTO-REPEAT

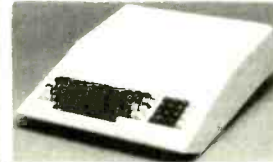

KEYBOARD-AP **\$49.95**

- REPLACEMENT FOR APPLE II KEYBOARD
- CAPS LOCK KEY, AUTO REPEAT
- ONE KEY ENTRY OF BASIC OR CP/M COMMANDS



EXTENDER CARDS

IBM-PC	\$45.00
IBM-AT	\$68.00
APPLE II	\$45.00
APPLE IIc	\$45.00
MULTIBUS	\$86.00

APPLE COMPATIBLE INTERFACE CARDS

EPROM PROGRAMMER \$59.95

MODEL RP525



- DUPLICATE OR BURN ANY STANDARD 27xx SERIES EPROM
- EASY TO USE MENU-DRIVEN SOFTWARE IS INCLUDED
- MENU SELECTION FOR 2716, 2732, 2732A, 2764 AND 27128
- HIGH SPEED WRITE ALGORITHM
- LED INDICATORS FOR ACTIVITY
- NO EXTERNAL POWER SUPPLY NEEDED
- ONE YEAR WARRANTY

16K RAMCARD \$39.95



- FULL TWO YEAR WARRANTY
- EXPAND YOUR 48K APPLE TO 64K
- USE IN PLACE OF APPLE LANGUAGE CARD
- BARE PC CARD W/ INSTRUCTIONS \$9.95

IC TEST CARD \$98.95



- QUICKLY TESTS MANY COMMON ICs
- DISPLAYS PASS OR FAIL
- ONE YEAR WARRANTY
- TESTS: 4000 SERIES CMOS, 74HC SERIES CMOS, 7400, 74LS, 74L, 74H & 74S

300B MODEM \$49.95

- FOR APPLE OR IBM
INCLUDES ASCII PRO-EZ SOFTWARE



- FCC APPROVED
- BELL SYSTEMS 103 COMPATIBLE
- INCLUDES AC ADAPTOR
- AUTO-DIAL
- DIRECT CONNECT
- CABLE FOR APPLE IIc \$14.95

JOYSTICK CR-401 \$7.95

- FOR ATARI 400, 800, 2600,
VIC 20/64 AND APPLE IIc

DISKFILE

HOLDS 70 5 1/4" DISKETTES



3.5" DISKFILE HOLDS 40 \$9⁹⁵

POWER STRIP

- UL APPROVED
- 15A CIRCUIT BREAKER



2 WAY SWITCH BOXES

- AVAILABLE IN SERIAL OR PARALLEL
- CONNECTS 2 PRINTERS TO ONE COMPUTER OR VICE VERSA
- ALL LINES SWITCHES
- PUSH-BUTTON SWITCHES MOUNTED ON PCB
- 3 FEMALE GOLD-PLATED CONNECTORS



AB-P CENTRONICS PARALLEL \$39.95
AB-S RS232 SERIAL \$39.95

MOLDED INTERFACE CABLES

- 6 FOOT, 100% SHIELDED, MEETS FCC
- IBM PARALLEL PRINTER CABLE 9.95
 - CENTRONICS MALE TO FEMALE 15.95
 - CENTRONICS MALE TO MALE 14.95
 - MODEM CABLE FOR IBM 7.95
 - RS232 SERIAL MALE TO FEMALE 9.95
 - RS232 SERIAL MALE TO MALE 9.95
 - KEYBOARD EXTENSION (COILED) 7.95
 - APPLE II JOYSTICK EXTENSION 4.95

C. ITOH RITEMAN II PRINTER



- 160 CPS DRAFT MODE. 32CPS NLQ MODE
- 9 x 9 DOT MATRIX
- SUPPORTS EPSON/IBM GRAPHICS
- FRICTION AND TRACTOR FEEDS
- VARIABLE LINE SPACING AND PITCH

\$219.95

IBM PRINTER CABLE \$9.95
REPLACEMENT RIBBON CARTRIDGE \$7.95

NASHUA DISKETTES DEALS

5 1/4" SOFT SECTOR
DS/DD WITH HUB RINGS

\$9⁹⁰ **69^cea** **59^cea**
BOX OF 10 BULK QTY 50 BULK QTY 250

NASHUA DISKETTES WERE JUDGED TO HAVE THE HIGHEST POLISH AND RECORDED AMPLITUDE OF ANY DISKETTES TESTED ACCORDING TO "COMPARING FLOPPY DISKS", BYTE 9/84

DISKETTES NASHUA 5 1/4"

N-MD2F DS/DD SOFT \$9.90
N-MD2D DS/QUAD SOFT \$19.95
N-MD2H DS/HD FOR AT \$24.95

NASHUA 8"
N-FD1 SS/DD SOFT \$27.95
N-FD2D DS/DD SOFT \$34.95

NASHUA 3.5"
N-3.5SS 3.5" SS/DD FOR MAC \$24.95
VERBATIM 5 1/4"

V-MD1D SS/DD SOFT \$16.95
V-MD2D DS/DD SOFT \$17.95
V-MD110D SS/DD 10 SECTOR HARD \$19.95

BUILD STEVE CIARCIA'S INTELLIGENT EPROM PROGRAMMER

AS SEEN IN BYTE, OCT. 85

- STAND-ALONE OR RS-232 SERIAL OPERATION
- MENU SELECTABLE EPROM TYPES—NO CONFIGURATION JUMPERS
- PROGRAMS ALL 5V 27XXX EPROMS FROM 2716 TO 27512
- READ, COPY OR VERIFY EPROM
- UPLOAD/DOWNLOAD INTEL HEX FILES
- PROGRAMMER DRIVER USER MODIFIABLE

ONLY \$199

KIT INCLUDES PCB AND ALL COMPONENTS EXCEPT CASE AND POWER SUPPLY

5 1/4" FLOPPY DISK DRIVES

TEAC FD-55B 1/2" HT DS/DO (FOR IBM) \$109.95
TEAC FD-55F 1/2" HT DS/QUAD (FOR IBM) \$124.95
TEAC FD-55GFV 1/2" HT DS/HD (FOR IBM AT) \$154.95
TANDON TM100-2 DS/DD (FOR IBM) \$119.00
TANDON TM50-2 1/2" HT DS/DO (FOR IBM) \$79.95
MPI-852 DS/DD (FOR IBM) \$79.95

8" FLOPPY DISK DRIVES

FD 100-8 SS/DD (ISA/801 EQUIV) \$119.00
FD 200-8 DS/DD (ISA/851R EQUIV) \$159.00

DISK DRIVE ACCESSORIES

TEAC SPECIFICATION MANUAL \$5.00
TEAC MAINTENANCE MANUAL \$25.00
1/2" HT MOUNTING HARDWARE \$2.95
MOUNTING RAILS FOR IBM AT \$4.95
POWER CABLE FOR 5 1/4" FDDs \$2.95
5 1/4" FDD POWER CONNECTORS \$1.19

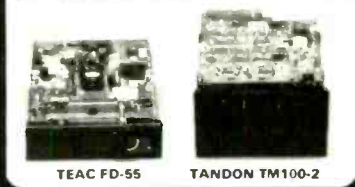

DISK DRIVE ENCLOSURES

CAB-1FH5 \$89.95
FULL HT 5 1/4" BEIGE CABINET W/POWER SUPPLY

CAB-28V5 \$49.95
DUAL SLIMLINE 5 1/4" CABINET W/POWER SUPPLY

CAB-23V8 \$209.95
DUAL SLIMLINE 8" CABINET W/POWER SUPPLY

CAB-2FH8 \$219.95
DUAL FULL HT 8" CABINET W/POWER SUPPLY

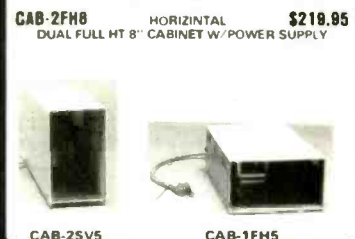

TEST EQUIPMENT FROM JDR INSTRUMENTS

DIGITAL MULTIMETER PEN DPM-1000
AUTO RANGING, POLARITY AND DECIMAL!

\$54.95

- LARGE 3.5 DIGIT DISPLAY
- DATA HOLD SWITCH FREEZES READING
- FAST, AUDIBLE CONTINUITY TEST
- LOW BATTERY INDICATOR
- OVERLOAD PROTECTION



20MHZ DUAL TRACE OSCILLOSCOPE MODEL 2000 \$389.00

35MHZ DUAL TRACE OSCILLOSCOPE MODEL 3500 \$549.00

FOR MORE INFORMATION ON THE OSCILLOSCOPES, CALL US FOR FREE PRODUCT BRIEFS.

CALL FOR VOLUME QUOTES © COPYRIGHT 1986 JDR MICRODEVICES

CIRCLE 178 ON FREE INFORMATION CARD

20 MEGA BYTE HARD DISK SYSTEM ONLY \$369.95!

SEAGATE ST-225 20 MB HARD DISK SYSTEM

INCLUDES HARD DISK CONTROLLER, CABLES AND INSTRUCTIONS. ALL DRIVES ARE PRE-TESTED AND COME WITH A ONE YEAR WARRANTY.

\$369.95

XT COMPATIBLE MOTHERBOARD

\$109.95

- 4.77 MHz 8088 CPU, OPTIONAL 8087 CO-PROCESSOR
- 8 EXPANSION SLOTS
- 0K RAM INSTALLED, EXPANDABLE TO 640K ON-BOARD MEMORY
- ALL ICs SOCKETED-HIGHEST QUALITY PC BOARD
- ACCEPTS 2764 OR 27128 ROMS

FREE PRO-BIOS

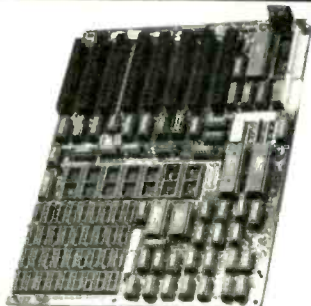

IBM COMPATIBLE INTERFACE CARDS

ALL WITH A ONE YEAR WARRANTY

MULTI I/O FLOPPY CARD

\$89.95

PERFECT FOR THE 640K MOTHERBOARD



- 2 DRIVE FLOPPY DISK CONTROLLER
- 1 RS232 SERIAL PORT; OPTIONAL 2nd SERIAL PORT
- PARALLEL PRINTER PORT
- GAME PORT
- CLOCK / CALENDAR
- SOFTWARE: CLOCK UTILITIES, RAMDISK, SPOOLER
- OPTIONAL SERIAL PORT \$15.95

MULTIFUNCTION CARD

\$84.95

ALL THE FEATURES OF AST'S 6 PACK PLUS AT HALF THE PRICE



- CLOCK / CALENDAR
- 0-384K RAM
- SERIAL PORT
- PARALLEL PORT
- GAME PORT
- SOFTWARE INCLUDED
- PRINTER CABLE \$9.95
- 64K RAM UPGRADE 9/\$11.61

COLOR GRAPHICS ADAPTOR

\$69.95

FULLY COMPATIBLE WITH IBM COLOR CARD



- 4 VIDEO INTERFACES: RGB, COMPOSITE COLOR, HI-RES, COMPOSITE MONOCHROME
- CONNECTOR FOR RF MODULATOR
- COLOR GRAPHICS MODE: 320 x 200
- MONO GRAPHICS MODE: 640 x 200
- LIGHT PEN INTERFACE

MONOCHROME GRAPHICS CARD

\$79.95

FULLY COMPATIBLE W/IBM MONOCHROME ADAPTOR & HERCULES GRAPHICS



- LOTUS COMPATIBLE
- TEXT MODE: 80 x 25
- GRAPHICS MODE: 720 x 348
- PARALLEL PRINTER INTERFACE
- OPTIONAL SERIAL PORT \$19.95

MONOCHROME ADAPTOR

\$49.95

ANOTHER FANTASTIC VALUE FROM JDR!

- IBM COMPATIBLE TTL OUTPUT
- 720 x 350 PIXEL DISPLAY
- PLEASE NOTE: THIS CARD WILL NOT RUN LOTUS GRAPHICS AND DOES NOT INCLUDE A PARALLEL PORT

FLOPPY DISK DRIVE ADAPTOR

\$34.95



- INTERFACES UP TO 4 STANDARD FDDs TO IBM PC OR COMPATIBLES
- INCLUDES CABLE FOR TWO INTERNAL DRIVES
- STANDARD DB37 FOR EXTERNAL DRIVES
- RUNS QUAD DENSITY DRIVES WHEN USED WITH JFORMAT

1200 BAUD MODEMS

HAYES COMPATIBLE, AUTO-DIAL, AUTO-ANSWER, AUTO RE-DIAL ON BUSY, POWER-UP SELF TEST, FULL ONE YEAR WARRANTY

MODEL 1200B*

- INTERNAL DESIGN
- 10 INCH CARD
- SERIAL PORT INCLUDED

\$169.95

MODEL 1200H*

- INTERNAL DESIGN
- HALF LENGTH (5") CARD
- INCLUDES SPEAKER

\$149.95

SMARTTEAM

- EXTERNAL DESIGN
- WITH POWER SUPPLY
- LED STATUS INDICATORS

\$169.95

*FOR IBM, INCLUDES PC TALK III COMMUNICATIONS SOFTWARE

CRT MONITORS FOR ALL APPLICATIONS



HITACHI RGB MONITOR

MODEL 1020

- MADE FOR ERICSSON BY HITACHI
- DIGITAL RGB-IBM COMPATIBLE
- 12" SCREEN
- RESOLUTION: 640H x 200V
- 38mm DOT PITCH
- CABLE FOR IBM PC INCLUDED

\$289.95



SAMSUNG MONOCHROME

MODEL SM-12SF

- IBM COMPATIBLE TTL INPUT
- 12" NON-GLARE AMBER, LOW DISTORTION SCREEN
- RESOLUTION: 720H x 350V
- ATTRACTIVE CASE WITH SWIVEL BASE
- ONE YEAR WARRANTY

\$119.95



CENTER SYSTEMS MONOCHROME

MODEL KLM-1211

- IBM COMPATIBLE TTL INPUT
- 12" NON-GLARE SCREEN
- VERY HIGH RESOLUTION: 1100 LINES (CENTER)
- 25 MHz BANDWIDTH
- CABLE FOR IBM PC INCLUDED
- AMBER OR GREEN AVAILABLE

\$99.95

BUILD YOUR OWN 256K XT COMPATIBLE SYSTEM

- XT MOTHERBOARD **\$109.95**
- PRO-BIOS (A \$20 VALUE) **FREE!**
- 256K RAM **\$28.55**
- 130 WATT POWER SUPPLY **\$68.95**
- FLIP-TOP CASE **\$39.95**
- IBM-5150 KEYBOARD **\$59.95**
- 1/2 HT TANDON DRIVE **\$79.95**
- FLOPPY DISK CONTROLLER **\$34.95**
- MONOCHROME ADAPTOR **\$49.95**
- MONOCHROME MONITOR **\$99.95**

TOTAL: \$571.15

MONITOR STAND



TILTS AND SWIVELS

ONLY \$12.95

IBM PRINTER CABLE



- DB25 TO CENTRONICS
- SHIELDED CABLE **\$9.95**

IBM STYLE COMPUTER CASE

AN ATTRACTIVE STEEL CASE WITH A HINGED LID FITS THE POPULAR PC/XT COMPATIBLE MOTHERBOARDS

- SWITCH CUT-OUT ON SIDE FOR PC/XT STYLE POWER SUPPLY
- CUT-OUT FOR 8 EXPANSION SLOTS
- ALL HARDWARE INCLUDED



\$39.95

IBM COMPATIBLE KEYBOARDS

IBM-5150 **\$59.95**

IBM-5151 **\$79.95**



- "5150" STYLE KEYBOARD
- FULLY IBM COMPATIBLE
- LED STATUS INDICATORS FOR CAPS & NUMBER LOCK
- 83 KEY - SAME LAYOUT AS IBM PC/XT KEYBOARD



- REPLACEMENT FOR KEYTRONICS KB-5151™
- SEPARATE CURSOR & NUMERIC KEYPAD
- CAPS LOCK & NUMBER LOCK INDICATORS
- IMPROVED KEYBOARD LAYOUT

POWER SUPPLY



NOW ONLY \$69.95

- FOR IBM PC-XT COMPATIBLE
- 135 WATTS
- +5V @ 15A, +12V @ 4.2A
- -5V @ .5A, -12V @ .5A

150 WATT MODEL \$79.95

DISK DRIVES TANDON TM50-2

\$79.95

- 1/2 HT DS/DD
- IBM COMPATIBLE
- EXTREMELY QUIET!

TEAC FD-55B	DS/DD	\$109.95
TEAC FD-55F	DS/QUAD	\$124.95
TEAC FD-55B	DS/HD	\$154.95
MOUNTING HARDWARE		\$2.95
AT/RAILS		\$4.95

JDR Microdevices

110 Knowles Drive, Los Gatos, CA 95030
Toll Free 800-538-5000 • (408) 866-6200 • FAX (408) 378-8927 • Telex 171-110

CIRCLE 179 ON FREE INFORMATION CARD

© COPYRIGHT 1986 JDR MICRODEVICES

★ QUALITY PARTS ★ DISCOUNT PRICES ★ FAST SHIPPING!

SEND FOR FREE 1986 CATALOG... 48 PAGES!

ALL ELECTRONICS CORP.

SPECIAL PURCHASE

2K 10 TURN MULTI-TURN POT SPECTROL #MOD 534-7161 \$5.00 EACH

SOLID STATE BUZZER Star # SMB-06L 6 vdc TTL compatible \$1.00 each 10 for \$9.00

EDGE CONNECTORS

ALL ARE 1.56 SPACING.

- 22 EDGE CONNECTOR \$1.25 ea solder lug style 10 for \$11.00
- 22/44 EDGE CONNECTOR \$2.00 ea PC style 10 for \$18.00
- 22/44 EDGE CONNECTOR solder lug style \$2.50 each
- 28/56 EDGE CONNECTOR \$2.50 ea PC style
- 36/72 EDGE CONNECTOR PC style \$3.00 each
- 43/86 EDGE CONNECTOR PC style \$4.50 each

TRANSISTORS

- 2N706 4 for \$1.00
- 2N2222A 3 for \$1.00
- PN2222A 4 for \$1.00
- 2N2904 3 for \$1.00
- 2N2955 3 for \$1.00
- MJ2955 \$1.50
- 2N3055 \$1.00
- PMD 10K40 \$1.00
- TIP-121 75¢
- TIP-125 75¢

TRANSFORMERS

- 120 volt primaries
- 5.6 volts @ 750 ma \$3.00
 - 6.3 volt @ 600 ma \$1.75
 - 12 V.C.T. @ 200 ma \$2.00
 - 12 V.C.T. @ 400 ma \$2.00
 - 12 V.C.T. @ 1 amp \$4.00
 - 12 V.C.T. @ 2 amp \$4.85
 - 12 V.C.T. @ 4 amp \$7.00
 - 18 volts @ 650 ma \$2.00
 - 24 V.C.T. @ 200 ma \$2.50
 - 24 V.C.T. @ 1 amp \$4.85
 - 24 V.C.T. @ 2 amp \$6.75
 - 24 V.C.T. @ 3 amp \$9.50
 - 24 V.C.T. @ 4 amp \$11.00

WALL TRANSFORMERS

- all plug directly into 120 vac outlet
- 4 VDC @ 70 ma \$2.00
 - 6 VDC @ 500 ma \$3.50
 - 6 VDC @ 750 ma \$4.50
 - 9 VDC @ 500 ma \$5.00
 - 12.5 VAC @ 265 ma \$3.00
 - 18 VAC @ 18 VA and 8.5 VAC @ 1.28 VA \$3.50
 - 24 VAC @ 250 ma \$3.00
 - MULTI-VOLTAGE @ 500 ma \$7.50
 - 3.4V, 6.7V, 9 or 12 VDC \$7.50

MINI-BOX

Pomona #2104 \$1.00 EACH Heavy duty black phenolic project box with cover and screws. 2 3/4" X 1 1/2" X 1 1/2"

FUSES

- 3AG (AGC) SIZE 1, 1 1/2, 2, 3, 4, 5, 6 AMP GMA SIZE 1, 2, 3, 4, 5 AMP 5 of any ONE amperage 75¢

COMMODORE PRINTER/PLOTTER

Commodore Model # 1520 Four color X-Y plotter Standard VIC serial interface allows easy connection to Commodore 64 computers. Up to 80 characters per line (upper and lower case) in four sizes.



CAT # COM-1520 \$49.95 each EXTRA pen sets \$1.50 per set.

SPECIALS

1 AMP 50 VOLT DIODES (IN4001) TAPE AND REEL 100 for \$4.50 1000 for \$30.00

SOLDER TAIL I.C. SOCKETS

24 PIN 100 for \$22.00 1000 for \$200.00

SPECIAL PRICE TRANSISTOR

plastic transistor PN3569 TO-92 N P N 100 for \$8.00 1000 for \$60.00 LARGE QUANTITIES AVAILABLE

48 KEY ASSEMBLY FOR COMPUTER OR HOBBYIST

NEW! I.C. KEYBOARDS Originally used on computers, these keyboards contain 48 S.P.S.T. mechanical switches. Terminates to 15 pin connector. Frame 4" x 9" \$3.50 each SPECIAL CAT # KP-48 10 for \$30.00

TI SWITCHING POWER SUPPLY

Compact, well-regulated switching power supply designed to power Texas Instruments computer equipment

INPUT 14-25 vac @ 1 amp
OUTPUT 12 vdc @ 350 ma
5 vdc @ 1.2 amp
5 vdc @ 200 ma

SIZE 4 1/2" x 4 1/4" x 1 1/4" high

SPECIAL PRICE
\$3.50 each

13.8 VDC REGULATED POWER SUPPLY

These are solid state, fully regulated 13.8 vdc power supplies. Both feature 100% solid state construction, fuse protection, and LED power indicator U.L. listed.

2 amp constant, 4 amp surge \$20.00 each
3 amp constant, 5 amp surge \$27.50 each

8 OHMS 15 WATTS

EXTRA SPECIAL VALUE

C.F. S. MODEL 8R1079 8" LOUDSPEAKERS 8 OHMS COIL 3.0 OZ PERMITE MAGNET TYPICAL RESPONSE RANGE 100 - 10,000 Hz POWER RATING 15 WATTS MAX. \$3.50 each

MICRO-CASSETTE MECHANISM

Micro-cassette tape transport for standard MC60 or MC45 micro-cassettes 3 Vdc operation. Contains drive motor, belt, head, capstan, pinch wheel and other components. 3 1/2" X 2 1/4" X 5 8" CAT # MCMEC \$3.00 each 10 for \$27.50

COMPUTER GRADE CAPACITORS

- 2,000 mfd. 200 Vdc 1 3/4" x 5" high \$2.00
- 6,400 mfd. 60 Vdc 1 3/8" x 3 3/4" high \$2.50
- 9,700 mfd. 50 Vdc 1 3/8" x 4 1/2" high \$3.00
- 31,000 mfd. 15 Vdc 1 3/4" x 4" high \$2.50
- 50,000 mfd. 40 Vdc 3" x 5 3/4" high \$4.50
- 60,000 mfd. 40 Vdc 3" x 5" high \$3.50
- 66,000 mfd. 15 Vdc 3" x 3" high \$3.00
- 86,000 mfd. 30 Vdc 3" x 5 1/4" high \$3.50

\$1.00 SPECIALS

- 5,500 mfd. 30 Vdc 1 3/8" x 3 1/2" high \$1.00
- 5,900 mfd. 30 Vdc 1 3/8" x 2 1/4" high \$1.00
- 9,300 mfd. 50 Vdc 2" x 4 1/2" high \$1.00
- 18,000 mfd. 10 Vdc 1 3/8" x 2 5/8" high \$1.00
- 48,000 mfd. 10 Vdc 2 1/2" x 3 1/4" high \$1.00
- 100,000 mfd. 10 Vdc 2 1/2" x 6" high \$1.00
- 185,000 mfd. 6 Vdc 2 1/2" x 4 1/2" high \$1.00

RELAYS

10 AMP SOLID STATE CONTROL 3-32 vdc LOAD 140 vac 10 amp SIZE 2 1/2" x 3/4" x 3/8" \$9.50 EACH 10 FOR \$90.00

ULTRA-MINIATURE 5 VDC RELAY

Fujitsu # FBR211NE D005M20 High sensitivity COIL 120 ohms CONTACTS 1 amp Mounts in 14 on DIP socket \$1.25 each 10 for \$10.00

MINIATURE 6 VDC RELAY

Aromat # RSD-6V Super Small S P D T relay Gold cobalt contacts rated 1 amp @ 30 vdc Highly sensitive. TTL direct or vdc possible 120 ohm coil. Operate from 4.3-6 vdc COIL 120 ohms \$1.50 each 10 for \$13.50

13 VDC RELAY

CONTACTS S P N C 10 amp @ 120 vac Energize coil to open contact COIL 13 vdc 650 ohms SPECIAL PRICE \$1.00 each

4PDT RELAY

14 pin KH style 3 amp contacts USED but fully tested \$1.70 each Specify coil voltage desired Either 24 vdc or 120 vac LARGE QUANTITIES AVAILABLE SOCKETS FOR KH RELAY 75¢ each

RECHARGEABLE NI-CAD BATTERIES

- AAA SIZE 1.25V 500mAh \$1.85
- AA SIZE 1.25V 500mAh \$1.85
- AA with solder tab \$2.00
- C SIZE 1.2V 1200mAh \$3.50
- SUB-C SIZE solder tab \$3.50
- D SIZE 1.2V 1200mAh \$3.50

UNIVERSAL CHARGER

Will charge 4-AA, C, D or AAA ni-cads or one 9 volt ni-cad at one time \$11.00 per charger

PHOTO-FLASH CAPACITORS

- 170 ml 330v 75¢ ea. CAT # PPC-170
- 400 ml 330v CAT # PPC-400 1.00 ea. 800 ml 330v CAT # PPC-800 1.35 ea.

3 1/2" SPEAKER

8 ohm impedance, Full range speaker 8oz magnet 4 diagonal mounting centers \$2.50 each 10 for \$20.00

SPRING LEVER TERMINALS

Two color coded terminal on a sturdy 2 1/2" x 3 3/4" bakelite plate Great for speaker enclosures or power supplies 75¢ EACH 10 for \$6.00

MINIATURE TOGGLE SWITCHES

ALL ARE RATED 5 AMPS @ 125 VAC

S.P.D.T. (on-on) PC style non-threaded bushing 75¢ each 10 for \$7.00

S.P.D.T. (on-on) Solder lug terminals \$1.00 each 10 for \$8.00

S.P.D.T. (on-off-on) PC style non-threaded bushing 75¢ each 10 for \$7.00

S.P.D.T. (on-off-on) Solder lug terminals \$2.00 each 10 for \$19.00

STANDARD JUMBO DIFFUSED T 1-3/4

- RED 10 for \$1.50 100 for \$13.00
- GREEN 10 for \$2.00 100 for \$17.00
- YELLOW 10 for \$2.00 100 for \$17.00

FLASHER LED

5 volt operation red jumbo T 1 1/4 size \$1.00 each NEW GREEN FLASHER CAT # LED-4G \$1.00

BI-POLAR

jumbo T 1 1/4 size 2 for \$1.70

LED HOLDERS

Two piece holder for jumbo LED 10 for 65¢

CLEAR CLIPLITE LED HOLDER

Make LED a fancy indicator Clear 4 for \$1.00

D.P.S.T. LIGHTED ROCKER SWITCH

115 vac lighted rocker snap mounts in 1/2" x 1 1/4" hole Orange lens 16 amp contact \$1.50

MINI-PUSH BUTTON

S P S T momentary normally open 1/4" bushing Red button 35¢ each 10 for \$3.00

SNAP ACTION SWITCH

Cherry elect #E-21 N.O. or N.C. 0.1A contacts Suitable for alarms and other low energy circuits 1 1/2" lever 45¢ EACH 10 FOR \$4.20

220 Vac COOLING FAN

ROTRON # HTX77A3 Mullin XL 220 Vac 4 1/8" square metal frame fan CAT # CF-220 \$6.50 ea 10 for \$60.00 100 for \$500.00 QUANTITIES AVAILABLE

ALL ELECTRONICS CORP. LOS ANGELES, CA STORE 905 S. Vermont Ave. 213 380-8000 VAN NUYS, CA STORE 6228 Sepulveda Blvd. 818 997-1806

MAIL ORDERS TO: P.O. BOX 20406 Los Angeles, CA 90006 TWX - 510101163 ALL ELECTRONIC EASYLINK MBX - 62887748



TOLL FREE ORDERS ONLY 1-800-826-5432 (ORDER ONLY) (IN CALIFORNIA: 1-800-258-6666) ALASKA, HAWAII, OR INFORMATION (213) 380-8000 NO C.O.D.

QUANTITIES LIMITED MINIMUM ORDER \$10.00 USA: \$3.00 SHIPPING; FOREIGN ORDERS: INCLUDING SUFFICIENT SHIPPING CALIF. RES. ADD 6 1/2%

CLEARANCE

Buy merchandise worth \$50 or more from this ad at these incredibly reduced prices, and get a FREE Soldering Iron! Offer valid from January through February 1987 or while supplies last, so hurry!! For details, see below.

BOOKS

- Australia the Beautiful** (288 pp) **\$19.95**
Was \$29.95 **You save 33%!** (8-9900)
- Reference Data for the Radio Engineer** (1196 pp) **\$39.95**
Was \$54.95 **You save 25%** (8-3995)
- Complete Battery Book** (352 pp) **\$14.95**
Was \$16.95 **You save 12%** (8-3624)
- CMOS 74HC00 Data Book** **\$1.95**
Was \$3.00 **You save 33%** (8-3632)
- IC Master** (2 volume set) **\$55.00**
Was \$130.00 **You save 57%!** (8-4000)
- MAGAZINE BINDERS 10 for \$29**
Were \$4.95 ea **You save \$20 on 10!**
Vinyl Binder with metal rods (8-4045)
Open-rib-style vinyl case (8-4046)

COMPUTER ACCESSORIES



Monochrome Monitor for Apple computers **\$79**
Was \$99.95 **You save 20%** (X-1130)

Voyager Modem
Plug-in modem card for IBM & compatibles. 0-300/1200bps RS232C port/modem switch selectable. **\$149**
Was \$169.95 **You save \$20!** (X-1100)

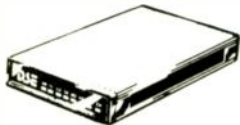

Challenger Modem
0-300/1200bps. Bell & Hayes compatible Auto-answer/dial B external status indicators. **\$169**
Was \$189 **You save \$20!** (X-1102)

Discovery Modem
Incredible features! 0-300/600/1200/2400bps. Voice/data switching. AT command set. Much, much more!
\$379
Was \$399 **You save \$20!** (X-1104)



CARONA GS-220 MHz Preamp **\$49.95**
Was \$59.95 **You save 16%** (D-2954)

50W IDC Flat Ribbon Cable **49¢/ft.**
Was 70¢/ft **You save 28%!** (W-2756)

15-pin "D" socket (Solder Tail) **59¢**
Was \$1.09 **You save 45%** (P-2687)

15-pin "D" plug (Solder Tail) **59¢**
Was 89¢ **You save 33%** (P-2688)

Computer Cassette Tape **59¢**
Was 95¢ **You save 38%** (X-3502)

Keyboard Kit **\$9.95**
60 key QWERTY with individually switched keys & high tactile response. Assembles in minutes. **\$19.95 You save 50%!** (K-3601)

COMPUTER BOOKS

- Introduction to Turbo Pascal** **\$9.95**
Was \$14.95 **You save 33%!** (8-2364) (268 pp)
- From Chips to Systems** **\$12.95**
Was \$15.00 **You save 13%!** (8-2374) (552 pp)
- Micropro/Interface** (456 pp) **\$12.95**
Was \$15.00 **You save 13%!** (8-2375)
- Programming the Macintosh in Assembly Language** **\$13.95**
Was \$16.00 **You save 13%!** (779 pp) (8-7502)

AUDIO/VISUAL ACCESSORIES



Lightweight Stereo Headphones **\$4.95**
Was \$6.95 **You save 29%!** (C-4106)

2 1/4" Mini Speaker (8 Ohm) **59¢**
Was 79¢ **You save 25%!** (C-2222) **10 for \$4.90**

Video Cable Set **\$6.95**
2x6" RCA-RCA leads. 1x6 5 pin DIN leads; 2x6 5 pin DIN-2xRCA. 1x6 6 pin DIN-4xRCA. 2 RCA-BNC adaptors. 2 RCA-UHF adaptors. 2 RCA-F59 adaptors. RCA-Phono adaptor
Was \$9.95 **You save 30%** (W-1287)

CANON-type Audio Connectors

Here are the high quality audio connectors used by musicians & professionals world-wide! Buy now and SAVE!

3-Pin Line Socket (P-1620) **\$1.49**
Was \$2.95 **NOW ONLY You save 49%**

3-Pin Line Panel (P-1622) **\$1.49**
Was \$2.95 **NOW ONLY You save 49%**

3-Pin Line Plug (P-1624) **\$1.75**
Was \$2.95 **NOW ONLY You save 40%**

3-Pin Panel Socket (P-1626) **\$1.95**
Was \$3.95 **NOW ONLY You save 50%!**

We have also specially reduced our high quality "rubberized" audio lead. 1 shield with two center conductors

High Screen Shielding **2 Audio Lines**
Very Flexible Rubberized Outer Sheath
was \$65/roll **NOW ONLY \$29.95/roll**
You save 53%! (W-2037)

PARTS, ETC.



ALUMINUM PROJECT BOXES

- 4" x 2 1/4" x 1 1/2"** (H-2305) **99¢**
Was \$1.80 **You save 44%!**
- 5" x 4" x 3"** (H-2320) **\$1.49**
Was \$2.50 **You save 40%!**
- 5 1/4" x 3" x 2 1/4"** (H-2325) **\$1.39**
Was \$2.25 **You save 38%!**

Printed Stripboard **\$1.95**
Similar to Vero board
0.1" spacing x 3.75 x 12
Was \$2.95 **You save 33%** (H-5112)

Circuit-Fix™ PCB Repair Kit **\$17.50**
Contains spring-loaded clamp & guide, collet knife & blade, 154 assorted copper donuts, 32 sq. in. of copper foil, and instructions
(H-5900) **You save 20%**

Hardware Pack

Get over \$23.00 worth of hardware - popular bits & pieces used in virtually every project! Pack includes: Cord Grip Grommets, Regular Grommets, Cable Ties, Rubber Feet (self adhesive and screw-on), Transistor-mounting kits, PCB Supports, Solder Lugs, Heat-shrink Tubing, and various Connectors

You'll be amazed at the value when you order and receive the clearance E S V Hardware Pack at only \$9.95 (H-0001)

Project Knobs - Prices slashed!

This is a great range of knobs - shiny black surface with white square-dot indicator for positive control.

Small (H-3850) reg 55¢ **19¢ ea.**
43" body x 6" skirt x 6" high

Medium (H-3855) reg 75¢ **When you buy 10 of a kind save up to \$5.60!**

Large (H-3860) reg 90¢ **29¢ ea.**
78" x 1" skirt x 63" high

X-large (H-3865) reg \$1.20 **When you buy 10 of a kind save up to \$9.00!**

16-Pin IC Test Clip (W-4600) \$1.95
Was 3.95 **You save 50%**

Test Clip Pack

Great for technicians & enthusiasts - in the lab, classroom, or at home. Contains 4 red IC test clips (W-4580), 4 black clips (W-4582), 4 red mini IC test clips (W-4584), and 4 black mini clips (W-4586)

A \$1.60 value - Yours for only \$2.95

3-Pin Plug (P-5545) **49¢**
was 95¢ **You save 48%**

3-Pin Socket (P-5547) **99¢**
was \$1.50 **You save 33%**

Rainbow Cable **\$29.95**
12-color-coded strands of 24 AWG insulated conductor in one flat cable
300ft. roll **ROLL (W-2045)**
was \$65/roll **You save 54%!**

Fuse Pack

You'll get at least 100 mixed fuses (generally 5 of each value) At least a \$40 value Yours for only \$15.00

ELECTRONICS

Stepping Motors for Robotics **\$9.95**
Single Shaft (J-0015)
Double Shaft (J-0016) EACH
Was \$14.95 **You save 33%!**

13.2V DC Electric Motor (J-0010) **\$3**
Was 50¢ **Save 40% on 10 or more!**

35V CT, 4A Transformer **\$14.95**
Was \$19.95 **You save 25%!** (M-0145)

Cooling Fan **\$3.95**
110V AC 3 1/4" x 3 1/4" x 1 1/4"
Was \$12.95 **You save 69%** (Y-8505)

Ni-Cad Charger **\$2.95**
2.5mm plug for Ni-Cad packs from 6 to 10 AA cells
Was \$4.95 **You save 40%** (M-9517)

FREE ALARM!

Buy the 2-tone Piezo Audio alarm (L-7027) for \$2.95 and get the Slim Piezo Audio Alarm (L-7024) - a \$1.95 value - FREE! Specify both items & this ad when ordering! **\$2.95**

TOOLS & TEST EQUIPMENT



Signal Injector **\$6.95**
(Q-1270)
Great for troubleshooting radios
Was \$9.95 **You save 30%**



Battery Tester **\$5.95**
(Q-1525)
Save a fortune - test 'em before you trash 'em!
Was \$8.95 **You save 33%**



Wire Stripper **\$5.95**
Was \$7.95 **You save 25%** (T-3620)

Jeweller's Saw

Cut any shape in wood, plastic or metal. It's an unbelievable value by itself, but we need to move them, so take us to the cleaners - with this great deal **\$9.95** (T-4965)

Buy the saw & get 3 sets of blades - FREE!
12 Extra-Fine (80), 12 Fine (82), 12 Medium (86) : (Limited stock available) Regularly \$1.95 per set - **save \$5.85!**

HOME ELECTRONICS

Ultrasonic Home Alarm **\$39**
No wiring required! Complete alarm!
Was \$79 **You save 50%** (L-5108)

Tap-a-Message **\$14.95**
Press a button to record, pick it up for instant playback
Was \$24.95 **You save 40%** (Y-5070)

RAMSEY

RAMSEY ELECTRONICS

QUALITY TEST GEAR YOU CAN COUNT ON

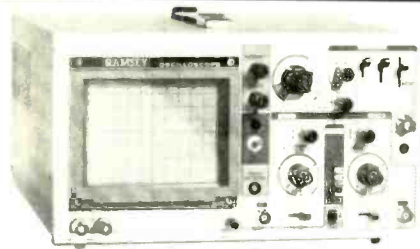

\$369.95*
20 MHz DUAL TRACE

Includes 2 hook-on probes
 Features component testing circuit for resistors, capacitors, digital circuits and diodes—TV sync filter—high sensitivity—Z axis—XY mode—built-in calibrator—5X horizontal magnifier

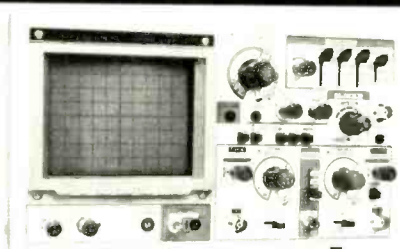

\$499.95*
35 MHz DUAL TRACE

Includes 2 hook-on probes
 wide frequency bandwidth—optimal sensitivity—delayed triggering sweep—hold off—ALT trigger—single sweep TV sync 5X magnification—XY or XYZ operation—HF/LF noise reduction



NEW \$449.95*
15 MHz DUAL TRACE PORTABLE

Field/bench applications—built-in charger and battery pack—up to 2 hours operation per charge—5X horizontal magnification—high brightness CRT—front panel trace rotator

RAMSEY OSCILLOSCOPES

All Ramsey oscilloscopes feature unsurpassed quality at an unbeatable price. Of heavy duty construction, they are suitable for hobby, service and production applications.

*Add an additional \$10.00 for each unit for shipping.

MODEL	BAND WIDTH	# TRACES	CRT SIZE	VERTICAL SENSITIVITY	MAXIMUM TRIG FREQ	USEABLE MAXIMUM BANDWIDTH
2200	20 MHz	(2)	8x10CM	5 mV per div	35 MHz	30 MHz
2500	15 MHz	(2)	3.5 inch	2 mV per div	30 MHz	25 MHz
3500	35 MHz	(2)	8x10CM	1 mV per div	50 MHz	60 MHz

All include high quality 1:1, 10:1 hook on probes, instruction/service manual with schematic and component layout, 1 year warranty.

MINI-100 COUNTER



\$119.95 CHARGER, NICAAD BATTERIES, AC ADAPTER INCLUDED

CT-70 7 DIGIT 525 MHz



\$139.95 WIRED, INCLUDES AC ADAPTER

CT-90 9 DIGIT 600 MHz



\$169.95 WIRED, INCLUDES AC ADAPTER

CT-50 8 DIGIT 600 MHz



\$189.95 WIRED, INCLUDES AC ADAPTER

CT-125 9 DIGIT 1.2 GHz



\$189.95 WIRED, INCLUDES AC ADAPTER

MODEL	FREQ RANGE	SENSITIVITY	ACCURACY	DIGITS	RESOLUTION	PRICE
MINI-100	1-500 MHz	Less than 250mv	1 PPM	7	100 Hz 1 KHz	119.95
CT-70	20 Hz-550 MHz	< 50mv to 150 MHz	1 PPM	7	1Hz, 10Hz, 100Hz	139.95
CT-90	10 Hz-600 MHz	< 10mv to 150 MHz < 150mv to 600 MHz	1 PPM	9	0.1Hz, 1Hz, 10Hz	169.95
CT-50	5 Hz-600 MHz	LESS THAN 25 mv	1 PPM	8	1Hz, 10Hz	189.95
CT-125	10 Hz-1.25 GHz	< 25mv @ 50 MHz < 15mv @ 500 MHz < 100 mv @ 800 MHz	1 PPM	9	0.1Hz, 1Hz, 10Hz	189.95
CT-90 WITH DV-1 OPTION	10 Hz-600 MHz	< 10mv to 150 MHz < 150mv to 600 MHz	0.1 PPM	9	0.1 Hz, 1Hz, 10Hz	229.90

RAMSEY FREQUENCY COUNTERS

Ramsey Electronics has been manufacturing electronic test gear for over 10 years and is recognized for lab quality products at breakthrough prices. Our frequency counters have features and capabilities of counters costing twice as much.



RAMSEY D-4100 COMPACT DIGITAL MULTITESTER
\$2495

Test leads and battery included

NEW

Compact sized reliability and accuracy. This LCD digital multimeter easily fits in your pocket, you can take it anywhere. It features full overload protection • 3 1/2 digit LCD readout • recessed input jacks • safety probes • diode check function • 2000 hours battery life



RAMSEY D-5100 HANDHELD DIGITAL AUTORANGING METER
\$49.95

Includes Probes 1 Year Warranty

Provides distinctive audible chirp after contact has been made and meter reading has stabilized. Has TOUCH-HOLD feature to allow readings to be logged or referred to before making the next reading. Up to 10 AMP current capability and a continuity function which beeps on zero Ohms.



\$4495
 wired includes AC adapter
 PR-2 kit \$39.95



\$6995
 wired
 PS-2 kit \$49.95



\$8995
 wired includes AC adapter

PR-2 COUNTER PREAMP
 The PR-2 is ideal for measuring weak signals from 10 to 1,000 MHz • flat 25 db gain • BNC connectors • great for sniffing RF • ideal receiver/TV preamp

PS-2 AUDIO MULTIPLIER
 The PS-2 is handy for high resolution audio resolution measurements, multiplies up in frequency • great for PL tone measurements • multiplies by 10 or 100 • 0.01 Hz resolution & built-in signal preamp/conditioner

PS-10B 1 GHz PRESCALER
 Extends the range of your present counter to 1 GHz • 2 stage preamp • divide by 1000 circuitry • super sensitive (50 mV typical) • BNC connectors • 1 GHz in, 1 MHz out • drives any counter

MINI KITS—EASY TO ASSEMBLE—FUN TO USE—FOR BEGINNERS, STUDENTS AND PROS

TONE DECODER
 A complete tone decoder on a single PC board. Features 400-5000 Hz adjustable range via 20 turn pot, voltage regulation, 56/1C, useful for touch-tone burst detection, FSK, etc. Can also be used as a stable tone encoder. Runs on 5 to 12 volts.
 Complete kit, 10-1 **\$5.95**

COLOR ORGAN
 See music come alive! 3 different lights flicker with music. One light each for high, mid-range and lows. Each individually adjustable and drives up to 300 W. runs on 110VAC.
 ML-1 Kit, **\$8.95**

VIDEO MODULATOR
 Converts any 14" video monitor. Super stable, tunable over ch 4-6. Runs on 5-15V accepts std video signal. Best unit on the market! Complete kit, V-D-1 **\$7.95**

FM WIRELESS MIKE
 Transmits up to 300 to any FM broadcast radio. Uses any type of mike. Runs on 3 to 9V. Type FM-2 has added sensitive mike preamp stage.
 FM-1 Kit **\$3.95**
 FM-2 Kit **\$4.95**

SUPER SLEUTH
 A super sensitive amplifier which will pick up a pin drop at 15 feet! Great for monitoring baby's room or as general purpose amplifier. Full 2W rms output runs on 6 to 15 volts, uses 8-43 ohm speaker.
 BN-9 Kit **\$5.95**

TELEPHONE TRANSMITTER
 Low cost with professional performance. Features include, self phone line powered, tunable from 76 to 100 MHz, polarity insensitive compact size 1" x 1 1/2", easily installs anywhere on the phone line or inside the instrument itself.
 PB-1 Kit **\$14.95**
 PB-2 Kit **\$5.50**
 PB-6 Assy **\$9.95**

FM RECEIVER
 For built-in applications or hobby experimentation. Full fledged super-heterodyne receiver, microvolt sensitivity, 10.7 MHz IF, integrated circuit detector, 50 mw audio amplifier, 9V external power source operation on standard FM broadcast band as well as large portions on each side, compact (6" square), for bug detection or reception.
 FR-1 Kit **\$14.95**

FM MINI MIKE
 A super high performance FM wireless mike kit! Transmits a stable signal up to 300 yards with exceptional audio quality by means of its built-in electret mike. Kit includes case, mike, on-off switch, antenna, battery and super instructions. This is the latest unit available.
 FM-3 Kit **\$14.95**
 FM-3 Wired and Tested **19.95**

40 WATT 2 mtr PWR AMP
 Simple Class C power amp features 8 times power gain 1 W in for 8 out, 2 W in for 15 out, 5 W in for 40 W out. Max output of 50 W, incredible value, complete with all parts, less case and 1 R relay.
 PA-1, 40 W pwr amp kit **\$22.95**
 TR-1, RF sensed T-R relay kit **6.95**

VOICE ACTIVATED SWITCH
 Voice activated switch kit provides switched output with current capability up to 100 mA. Can drive relays, lights, LED or even a tape recorder motor. Runs on 9VDC.
 VS-1 KIT **\$6.95**

LED BLINKY KIT
 Alternately flashes 2 jumbo LEDs. Use for name badges, buttons, warning panel lights. Runs on 3 to 15 volts.
 BL-1 Kit, **\$2.95**

UNIVERSAL TIMER
 Provides the basic parts and PC board, requires to provide a source of precision timing and pulse generation. Uses 555 timer IC and includes a range of parts for most timing needs.
 UT-5 Kit **\$5.95**

MAD BLASTER
 Produces LOUD ear shattering and attention getting siren like sound. Can supply up to 15 watts of obnoxious audio. Runs on 6-15 VDC.
 MB-1 Kit **\$4.95**

WHISPER LIGHT
 An interesting kit, small mike picks up sounds and converts them to light. The louder the sound, the brighter the light. Includes mike, controls up to 300 W. runs on 110 VAC.
 WL-1 Kit **\$6.95**

ACCESSORIES FOR RAMSEY COUNTERS

- Telescopic whip antenna—BNC plug **\$ 8.95**
- High impedance probe, light loading **16.95**
- Low pass probe, audio use **16.95**
- Direct probe, general purpose use **13.95**
- Tilt bail, for CT-7D, 90, 125 **3.95**



PHONE ORDERS CALL

716-586-3950

TELEX 466735 RAMSEY CI

FAX 716-586-4754

CIRCLE 70 ON FREE INFORMATION CARD

TERMS: • satisfaction guaranteed • examine for 10 days, if not pleased, return in original form for refund • add 6% for shipping and insurance to a maximum of \$10.00 • foreign add 15% for surface mail • CDD add \$2.50 (CDD in USA only) • orders under \$15.00 add \$1.50 • NY residents add 7% sales tax • 90 day parts warranty on all kits • 1 year parts & labor warranty on all wired units.

RAMSEY ELECTRONICS, INC.
 2375 Balrd Rd, Dept. RE
 Penfield, N.Y. 14526

TENMA

THE NAME YOU CAN TRUST IN ELECTRONIC TEST EQUIPMENT

© 1987, MCM Electronics

TENMA Combination Function Generator and Frequency Counter

- Six digit display ■ Output range: 2Hz-2MHz; seven ranges ■ Counter range: .1Hz-10MHz ■ 5-15V TTL and CMOS output
- Wave forms: sine, triangle, square, pulse, and ramp. For detailed specifications call for a complete Tenma catalog.

#72-380

\$21990
(ea.)

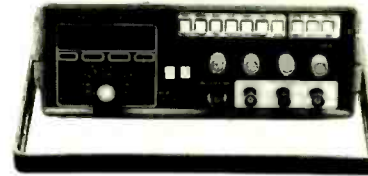

TENMA 30A Power Supply

- Output voltage: 1-15VDC ■ Lighted cross needle meter: Displays voltage, current and power simultaneously ■ Output current: 30A, 24A continuous ■ Fan cooled

#72-035

\$22780
(ea.)



TENMA

3 1/2 Digit Bench Top DMM

- Performs eight functions: DCV, ACV, DCA, ACA, resistance, audible continuity, diode and capacitance test ■ Power: AC adaptor output 7.5VDC ■ Accessories: Test leads, spare fuse (2A), operator's manual and AC adaptor ■ For detailed specifications call for a complete Tenma catalog

#72-410

\$14980
(ea.)

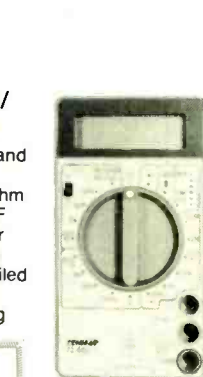

TENMA Compact DMM with Logic Probe

- Measures DCV, ACV, DCA, ACA and resistance
- Audible continuity tester, diode check and transistor hFe ■ Built-in logic tester compatible with DTL/TTL/HTL/CMOS ICs.
- Accessories: Test leads, spare 2A fuse and instruction manual ■ Call for complete specifications

#72-445

\$5980
(ea.)

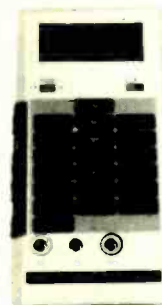

TENMA Digital LCR Meter

- Measures inductance, capacitance and resistance ■ L = 1μH-200H, C = .1pF-200μF, R = .01ohm-20Mohm
- Carrying case included. For detailed specifications call for a complete Tenma catalog.

#72-370

\$14995
(ea.)

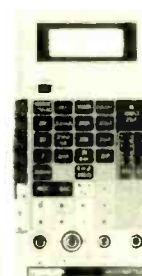

TENMA Combination DMM/Capacitance Meter

- Measures voltage, AC and DC current up to 10A
- Resistance up to 20Mohm
- Capacitance up to 20μF
- Built-in transistor tester
- Test leads and carrying case included ■ For detailed specifications call for a complete Tenma Catalog

#72-045

\$7495
(ea.)

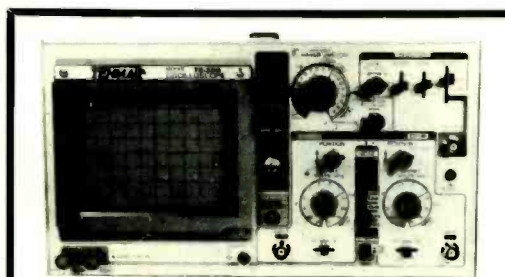

TENMA 20MHz Dual Trace Oscilloscope

- Two high quality 10:1 probes included. For detailed specifications call for a complete Tenma catalog.



#72-320

~~\$38995~~

SPECIAL!
\$34995
(ea.)



TENMA 4 1/2" Digit Multimeter

- True RMS AC voltage and current functions ■ Built-in frequency counter, 20KHz and 200KHz range ■ Data hold feature ■ Measures AC and DC voltage/current, resistance and frequency ■ Carrying case included.

#72-430

\$15980
(ea.)



Be Sure To Call For Your FREE Catalog! Over 6,000 Items!

We also have ... a full line of test equipment, computer accessories, telephone accessories, speakers, television parts, flybacks, yokes, switches, fuses, lamps, capacitors, resistors, cartridges, styli, wire, CATV equipment, the largest selection of original Japanese semiconductors in the country and more.



858 E. CONGRESS PARK DR. • CENTERVILLE, OH 45459
(513) 434-0031



MCM ELECTRONICS

A PREMIER Company

SOURCE NO. RE-28

RADIO-ELECTRONICS

- Terms:**
- \$10 minimum order. \$1.00 charge for orders under \$10.
 - \$20 minimum charge card order.
 - Orders shipped UPS C.O.D.
 - Most orders shipped within 24 hours.
 - Sales office open 8:30 am to 7:00 pm Saturdays 10:00 am to 3 pm EST.
 - For prepaid orders add \$2.75 for shipping and handling.
 - Should shipping and handling charges exceed \$2.75, the balance due will be sent C.O.D.



CALL TOLL FREE 1-800-543-4330

In Ohio 1-800-762-4315 • In Alaska and Hawaii 1-800-858-1849

CIRCLE 87 ON FREE INFORMATION CARD

MARK V ELECTRONICS INC.,

248 EAST MAIN STREET, SUITE 100.
ALHAMBRA, CA 91801.
TELEX: 3716914 MARK 5.

INFORMATION: 1-818-282-1196
MAIL ORDERS: P.O. BOX 6610
ALHAMBRA CA 91802.

1-800-423-3483

TOLL FREE FOR ORDERS PAID
BY MASTER OR VISA CARD
IN CAL.: 1-800-521-MARK

CALL OR WRITE FOR A FREE CATALOG — OVER 60 HOT & WELL-QUALIFIED ITEMS FOR YOUR SELECTION!

SM-43
MULTIFUNCTIONAL
LEDD.P.M.



6 different kinds of usages with only one meter. high accuracy ($\pm 0.1\%$) (± 1 digit), high input impedance, high anti-vibrating ability, the display reset to zero automatically when the inputs QV, and employs 100PPM/C temperature compensating zener diode which improves the accuracy and stationarity of the meter.

MEASUREMENT RANGE:

- D.C. VOLTAGE 1mV - 1000V
- A.C. VOLTAGE 1mV - 1000V
- DIGITAL THERMOMETER 0°C - 100°C
- D.C. CURRENT 1 μ A - 2A
- CAPACITOR METER 1pF - 2uF
- FREQUENCY COUNTER 10Hz - 20KHz
- DIMENSION 3 3/4" x 1 7/8" x 4 1/4"

Kit \$29.23
Assembled with tested \$35.00

TR-100 0-15V 2A REGULATED DC POWER SUPPLY



- * Output voltage is adjustable from 0-15V DC, two current limit range are available for selection: 200mA or 2A.
- * An elaborated protection system is specially designed, a "BB" sound and a sparkle light will appear when the output is overloaded.
- * High stability and reliable resulting from employing high quality voltage regulate IC.
- * Possessing king size meter makes the reading of voltage and current more clearly and accuracy.
- * A refined case, meter and all accessory are enclosed for both kit and assembly form. Most suitable for factory, professional or even amateur.

Kit \$59.50
Ass. with tested \$69.50

YAMATO 3 1/2 DIGITAL MULTIMETER

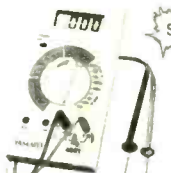

SPECIAL OFFER!

MODEL 4001

The YAMATO 4001 is a 3 1/2 DIGIT COMPACT DIGITAL MULTIMETER, it employs FE type LCD, with large figures. Its ADVANTAGES: High accuracy in measuring. High impedance assures min. measuring error. One rotary switch allows fast & convenient operation. 26 measurement range enable wider application. Over-input indication & low battery life appears on display. LSI-circuit use provides high reliability and durability. Measurement possible even under strong magnetic field.

Not a KIT, assembled with tested \$33.80

150MC Universal Digital Frequency Counter SM-100



FREE AC ADAPTOR
AVAILABLE
UNTIL STOCK LAST.

Frequency Range: 10Hz - 150MHz
Event Counter: 0 to 99999999 counts. (8 Digit)
Input sensitivity: KHz range 10Hz - 10MHz 50mVrms.
MHz range 1MHz - 150MHz 40mVrms.

Response time: 0.2 second.
Hold Function: Hold the last input signal.
Power Supply: DC6V Battery or DC9V 250MA Adaptor.
Dimension: 9 7/8" x 6 1/4" x 2 3/4"

Assembled with tested \$99.00

ELECTRONIC ECHO AND REVERBERATION AMPLIFIER

REMIX records yourself!

TA-2400A

This unit combines the most advanced computer V.L.S.I. technique with high quality Japan made component, so it has the following FEATURES:
It can generate various reflection and reverberation effect such as that in valley and music hall. It has a 3 section effect control which includes reverberation control, delay control and depth control. Special effect can be made in your record tapes by using this model. All kinds of infield sound effect can be obtained by skillful use of this control. It has LED display to show reflection and reverberation.

Ass. with tested \$99.85

TA-1500 100W + 100W NEW CLASS 'A' DC STEREO PRE-MAIN AMPLIFIER



Kit \$67.00

LCD THERMOMETER CLOCK NEW!



Features:
0.34" DIGITAL thermometer with Hi & Low temperature alarm function and 12 hours clock combination.
Measuring range: 0°F to 160°F or -20°C to +70°C.
Resolution reading: $\pm 1.8^\circ$
Dimension: 3.2" x 0.86" x 2.08"

T-1 with In/Out Door sensor \$20.00
T-2 with Fahrenheit/Celsius measuring \$18.00 NOT A KIT!

PROFESSIONAL COLOR LIGHT CONTROLLER SM-328

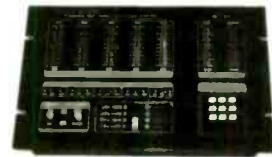

NEW FOR 83

FEATURES:
1. FOUR GROUPS OF INDEPENDENT OUTPUT SYSTEM 100W/CH. MAX. 4600W (100-117V) 2. PROFESSIONAL COLOR CONTROL SYSTEM (KEYBOARD TYPE) 3. INDEPENDENT INPUT SIGNAL ADJUSTMENT & FOUR GROUPS OF INDEPENDENT DIMMER CONTROL 5. SPEED CONTROL CHASER 6. AUTOMATIC CHASING CONTROL SYSTEM 7. FOUR KINDS OF SPECIAL CHASING PROGRAM 8. COMBINATION OF PROGRAM AND MUSIC CHASING EFFECT 9. FORWARD/BACKWARD CHASING CONTROL
SM-328 color light controller is specialized for bedroom, night club, disco and advertisement lighting. It conforms with several color control characteristics, which employ professional color control system and keyboard program selection. Therefore, it is capable of producing lighting effects by using chasing program and fluctuating music signal.

There are two kinds of lighting effects. The first type is controlled by "music" signal. In order to adjust the brightness of four groups of lighting, each music signal will be separated into high, medium low A, and low B frequency range. Furthermore, each group of lightings is incorporated with an independent signal adjustment.

The second kind is composed of electrical circuits and this is the main part for creating a special lighting effect. It has four chasing programs.
DIMENSION: 14 5/16" X 8 15/16" X 3 3/16"

Ass. with tested \$120.00

HIGH QUALITY MULTIPURPOSE PRE-AMPLIFIER

TA-2500
GREAT VALUE



This specially designed pre-amplifier includes a professional GRAPHIC EQUALIZER TONE control system and has a gain of ± 12 dB. Frequency response extends from 5Hz to 20KHz, so as to assure best performance in whatever adverse condition. It can accept input from various magnetic cartridge, record deck, CD player and tuner; its output can be connected to all kinds of power amplifier!

Assembled with tested \$82.00

120W MOSFET POWER AMPLIFIER

TA-477



This amplifier consists of three super low TIM differential stages, and Hitachi 2SJ49/2SK 134 match pair "MOSFET" as output component whose frequency response and transient response is superior to the other power transistor. Therefore this amplifier has high-fidelity and superior analytic power over the entire Audio Spectrum. It is suitable for reproducing classic and modern music. Heavy Duty Heat Sink with 28 radial fins is included!

Kit \$55.00
Metal Cabinet/X-Former (Optional) \$26.00/\$19.88

Model No.	Description	Kit/Assembled	Unit Price	TR-100	0-15V 2A REGULATED DC POWER SUPPLY	Kit/Ass.	\$69.50/89.50
TA-001	1W Mini Amplifier	Kit	\$3.90	TY-7	BATTERY FLUORESCENT LIGHT	Kit	\$3.99
TA-006	6W Mini Amplifier	Kit	\$4.92	TY-11A MK4	ELECTRONIC TOUCH SWITCH	Kit	\$5.90
TA-007	12W Stereo Power Booster	Kit	\$8.00	TY-11A	MULTIFUNCTIONAL CONTROL RELAY	Kit	\$3.99
TA-008	AC/DC SHOULDER AMPLIFIER	Ass.	\$48.00	TY-12	DIGITAL CLOCK WITH TWO TIMER	Kit	\$13.86
TA-10	STEREO PRE-AMPLIFIER WITH MAGNETIC MIC AMP	Kit	\$6.00	TY-13	COLOR LED VU METER	Kit	\$17.50
TA-10A, B	MULTI-PURPOSE MELODY GENERATOR	Kit	\$10.76	TY-14	ELECTRONIC SHOCK	Kit	\$3.00
TA-120	PURE CLASS 'A' MAIN POWER AMPLIFIER	Kit	\$25.00	TY-18	HIGH PRECISION SOUND CONTROL SWITCH	Kit	\$7.98
TA-202	20W AC/DC STEREO AMPLIFIER	Ass.	\$60.00	TY-20	SUPER SENSITIVE COLOR POWER LEVEL INDICATOR	Kit	\$19.50
TA-300	30W Multi-Purpose Single Channel Amp.	Kit	\$11.07	TY-23B	COLOR LIGHT CONTROLLER	Kit/Ass.	\$65.00/75.00
TA-302	60W Stereo Power Booster	Kit/Ass.	\$50.00/60.00	TY-25	SPEAKER PROTECTOR	Kit	\$9.90
TA-322A	High Quality 30W+30W Stereo Amplifier	Kit	\$24.50	TY-35	FM WIRELESS MICROPHONE	Kit	\$7.98
TA-322I	60W IC Stereo Pre-Amplifier & Power Amplifier	Kit	\$29.50	TY-36	AC/DC QUARTZ DIGITAL CLOCK	Kit	\$16.92
TA-400	40W TRANSISTORIZED MONO-AMPLIFIER	Kit	\$13.84	TY-38	SOUND OR TOUCH CONTROL SWITCH	Kit	\$10.00
TA-477	120W MOSFET POWER AMPLIFIER	Kit	\$61.28	TY-41 MKIII	INFRARED REMOTE CONTROL UNIT	Kit/Ass.	\$26.00/30.00
TA-800	80W+80W DC LOW TIM PRE-AMPLIFIER & POWER AMP.	Kit	\$55.38	TY-42	BAR/DOT LEVEL METER	Kit	\$21.00
TA-802	80W+80W PURE DC STEREO POWER AMP. (W/SPEAKER)	Ass.	\$99.85	TY-45	BAR/DOT AUDIO LEVEL DISPLAY	Kit	\$34.95
TA-820A	60W+60W OCL DC PRE-MAIN & STEREO AMPLIFIER	Kit	\$43.00	TY-47	SUPERIOR ELECTRONIC ROULETTE	Kit	\$16.92
TA-1000A	100W DYNAMIC CLASS 'A' MAIN POWER AMP (MONO)	Kit	\$51.95	YAMATO 4001	3 1/2 DIGITAL MULTIMETER	Kit	\$33.80
TA-1500	100W+2 NEW CLASS 'A' DC STEREO PRE-MAIN AMP	Kit	\$67.00	T1	LCD THERMOMETER CLOCK W/IN/OUT DOOR SENSOR	Kit	\$20.00
TA-2400A	ELECTRONIC ECHO AND REVERBERATION AMP	Ass.	\$99.85	T2	LCD THERMOMETER CLOCK W/F °C MEASURING	Kit	\$18.00
TA-2500	HIGH QUALITY MULTI-PURPOSE PRE-AMPLIFIER	Ass.	\$99.00	8504	TALKING CLOCK MYNAH	Kit	\$25.00
TA-2200	DC FET SUPER CLASS 'A' PRE-AMPLIFIER	Kit	\$38.00	NO. 20	TALKING CLOCK COCKATOO	Kit	\$25.00
TA-2800	NF-CR BI-FET PRE-AMP (WITH 3WAY TONE CONTROL)	Kit	\$44.50	NO. 98	CORROLESS SOLDERING IRON RECHARGEABLE	Kit	\$22.80
TA-3000	STEREO SIMULATOR	Kit/Ass.	\$25.00/30.00	NO. 98B	TURBO SCREW DRIVER RECHARGEABLE	Kit	\$30.00
SM-43	3 1/2 MULTI-FUNCTIONAL LED D.P.M.	Kit/Ass.	\$29.23/35.00	MATEL CABINETS WITH ALUMINIUM PANEL			
SM-48	4 1/2 HI-PRECISION D.P.M.	Kit/Ass.	\$38.00/43.00	LG1273	3' x 12' x 7"	Kit	\$18.00
SM-100	8 DIGIT 150MC FREQUENCY COUNTER	Ass.	\$99.00	LG1694	4' x 16' x 8"	Kit	\$22.00
TY-43	3 1/2 DIGITAL PANEL METER	Kit	\$28.00	LG1924	4' x 19' x 11.5"	Kit	\$24.00
TR-355 A, B	3.5A REGULATED DC POWER SUPPLY	Kit	\$6.90	LG1925	5' x 19' x 11.5"	Kit	\$26.00
TR-503	0-15V/2A POWER SUPPLY WITH SHORT CIRCUIT BREAK & OVERLOAD PROTECTOR	Kit	\$10.25	WE CAN SUPPLY HIGH POWER TRANSFORMERS FOR OUR KITS, PLEASE REFER TO OUR CATALOG!			

TERMS: MIN. order \$10.00, MIN. Charge card order \$20.00, No C.O.D.! Check, Money order & phone order accept. CA. residents must include 6.5% sales tax. Prices are subject to change without notice. All merchandise subject to prior sale. Shipping & handling: Inside L.A. 5% of total order (Min. \$1.50). Outside L.A. 10% of total order (Min. \$2.50). Outside U.S.A. 20% of total order (Min. \$5.00). Shipped by UPS ground. HOURS: Mon-Fri 9:30 to 5:00, Sat 9:30 to 1:00 (PACIFIC TIME)

NATION-WIDE DISTRIBUTORS WANTED FOR OUR PRODUCTS, QUANTITY DISCOUNTS AVAILABLE!



CIRCLE 93 ON FREE INFORMATION CARD

ADVERTISING INDEX

RADIO-ELECTRONICS does not assume any responsibility for errors that may appear in the index below.

Free Information Number	Page	197		
—	"2001"	CV3	—	NuScope Associates 114
81	A.I.S. Satellite	33	110	Oak Systems Sales 28
108	AMC Sales	37	182	Omnitron 86
76	AP Products Brand of 3M	16	—	OrCad Systems 95
—	Air-Temp	34	101	Pacific Cable 117
107	All Electronics	131	78	Pomona Electronics 15
206	Allen Systems	95	70	Radio Shack 124
—	Amazing Devices	138	185	Ramsey 134
—	American Design Components	135	186,187	Regency 7
77	B&K Precision	32	188,189	Sencore 87,89
183	BV Engineering	95	180	Sencore 91,93
184	Baylin/Gale Productions	77	205	Silicon Valley Surplus 138
98	Beckman Industrial	28	74	Simpson 23
85	Blue Star Industries	33	94	Solid State Sales 118
109	C & S Sales	26	198	Star Circuits 33
—	C.O.M.B.	14	92	T S M 42
60	CIE	18	196	Tektronix CV2
204	Cable Distributors	33	195	Trans-Am 116
203	Cabletronics	90	102	Transleteronic 97
—	Command Productions	32	190	Trio-Kenwood 95
193	Cook's Institute	34	201	United Electronic Supply 22
—	Coop's Satellite Digest	84	199	United Imports 90
202	Crosley	33	103	VIP Electronics 33
127	Deco Industries	33,90		Wm B. Allen 35
95	Dick Smith Electronics	132,133		
82	Digi-Key	125		
194	ESI	17		
120	Elephant Electronics	33		
111	Etronix	38		
100	Firestik II	32		
121	Fluke Manufacturing	24		
—	Fordham Radio	CV4		
—	GRE America	27		
—	Grantham College of Engineering	25		
62	Hameg	97		
86,191	Heath	3,41		
—	ICS Computer Training	37		
—	ISCET	38		
64	Iwatsu	13		
65	J&W	121		
59	JDR Instruments	5		
113,176	JDR Microdevices	126,127		
177,178	JDR Microdevices	128,129		
179	JDR Microdevices	130		
114	Jameco	122,123		
104	Jan Crystals	38		
115	Jensen Tools	82		
200	Kepro Circuit Systems	78		
87	MCM Electronics	136		
93	Mark V. Electronics	137		
—	McGraw Hill Book Club	64		
—	McGraw Hill Cont. Education Series	29		
—	Micro-Mart	119		
61	Microprocessors Unltd.	114		
117	Mouser	27		
—	NRI	8		
181	NTS	90		

Gernsback Publications, Inc.
500-B Bi-County Blvd.
Farmingdale, NY 11735
(516) 293-3000
President: Larry Steckler
Vice President: Cathy Steckler

For Advertising ONLY 516-293-3000
Larry Steckler
publisher
Arline Fishman
advertising director
Shelli Weinman
advertising associate
Lisa Strassman
credit manager
Christina Estrada
advertising assistant

SALES OFFICES

EAST/SOUTHEAST
Stanley Levitan
Eastern Sales Manager
Radio-Electronics
259-23 57th Avenue
Little Neck, NY 11362
718-428-6037, 516-293-3000

MIDWEST/Texas/Arkansas/Okla.
Ralph Bergen
Midwest Sales Manager
Radio-Electronics
540 Frontage Road—Suite 339
Northfield, IL 60093
312-446-1444

PACIFIC COAST/ Mountain States
Marvin Green
Pacific Sales Manager
Radio-Electronics
15335 Morrison St.—Suite 227
Sherman Oaks, CA 91403
818-986-2001

\$45⁰⁰ MORROW CP/M ENGINE

- Over 15,000 of these single board computers installed.
- Free copy of the "MORROW OWNERS REVIEW". The national magazine devoted just to the MORROW computer. ^{while supplies last}
- We have over 2000 in stock
- 4 mhz Z80A CPU, 64K RAM 16/32K ROM
- 2 RS232 serial ports (300-19.2k baud with db25 connectors installed)
- Centronics printer port
- Power requirements - +12vdc -12vdc +5vdc
- Floppy disk controller (1-4 drives, single/double density single/double side, 40 or 80)
- CP/M bios, Wordstar, and Bazic included
- Schematic, bios.asm, maint manual and users guide included
- Copy program to read/write non morrow formats such as Kaypro, Osborne, Xerox, & etc.
- Optional terminal and keyboard only \$59 with purchase of this board (this is one third off of our regular price)

TERMS: C.O.D. OR PREPAID ONLY. PREPAID-ALLOW 2 WEEKS FOR CHECK TO CLEAR. C.O.D.-CASH OR CERTIFIED CHECK ONLY. ADD \$1.90 OFFER GOOD WHILE SUPPLIES LAST. STORE PRICE MAY DIFFER. PRICES MAY CHANGE.

Silicon Valley Surplus
415-261-4506
10AM-6PM CLOSED SUN & MON
CALL OUR ELECTRONIC CATALOG 415-261-4513
REFEB

CIRCLE 180 ON FREE INFORMATION CARD

AMAZING DEVICES

PHASORS
PLANS—All Parts Available in Stock

- LC5 BURNING CUTTIG CO2 LASER . . . \$20.00
- RUB3 RUBY LASER RAY PISTOL . . . 20.00
- BTC5 1.5 MILLION VOLT TESLA COIL . . . 15.00
- PTG1 PLASMA TORNADO GENERATOR 10.00
- GRA1—GRAVITY GENERATOR . . . 10.00
- MAGNETIC CANNON PROJECTOR . . . 10.00

LASERS
KITS—Includes Plans and Parts

- LHC2K SIMULATED RED/GRN/YEL LIGHT LASER 34.50
- BTC3K 250,000 VOLT TESLA COIL . . . 159.50
- 10G1K ION RAY GUN 109.50
- PSP3K PHASOR SHOCK WAVE PISTOL 49.50
- STG1K—STUN/PARALYZING GUN . . . 39.50
- INF1K INFINITY TRANSMITTER . . . 134.50
- MFT1K 2-3 MILE RANGE FM VOICE XMTR PC BOARD 49.50

SECURITY
ASSEMBLED AND TESTED PRODUCTS

- LGU30 RED 1MW PORTABLE HENE LASER 349.50
- TCL30 SOLID STATE TESLA COIL 35KV 84 50
- IPG50 POCKET PAIN FIELD GENERATOR 64 50
- BLS10 BLASTER DEFENSE WEAPON . . . 89 50
- ITM10—100KV SHOCK AND STUN GUN 99.50
- PPF10 PHASOR PAIN FIELD PORTABLE 249 50
- SNP20 SECURITY PHONE LISTENER . . . 99.50

• CATALOG CONTAINING DESCRIPTIONS OF ABOVE PLUS HUNDREDS MORE AVAILABLE FOR \$1.00 OR INCLUDED FREE WITH ALL ABOVE ORDERS

PLEASE INCLUDE \$3.00 PH ON ALL KITS AND PRODUCTS. PLANS ARE POSTAGE PAID. SEND CHECK, MO, VISA, MC TO:

INFORMATION UNLIMITED
P.O. BOX 716, DEPT. N1 AMHERST, NH 03031

FOR FREE INFORMATION USE THESE POST-PAID CARDS

1 Print your name, address and Zip Code on one of the attached postage-paid cards.

2 Circle the number (or numbers) on the card that matches the number at the bottom of each ad or editorial item that you want information on. Advertisers' free information numbers also appear in the ad index on the facing page.

3 Mail the card. It's Postage-Paid.

The bottom free-information card is a BUSINESS/PROFESSIONAL CARD. If you use this card you MUST complete the spaces for Company Name, Title, and Phone Number. If these are not filled in, the card will not be processed.

NOTE: Use the postcard address for Free Product Information only. Address all editorial inquiries to Editor, Radio-Electronics, 500-B Bi-County Blvd., Farmingdale, NY 11735



Radio Electronics
Your favorite electronics magazine and still getting better

BUSINESS/PROFESSIONAL FREE INFO CARD

Use this card if information requested is for business use. You must fill in company name and phone number.



4-287

Name _____ Title _____
 Company _____ Phone () _____
 Dept./MS _____ Company Address _____
 City _____ State _____ Zip + 4 _____

Unclear or incomplete mailing info will prevent our processing this request.

- Please send me 12 issues of RADIO-ELECTRONICS for \$16.97 and bill me. (Canada \$22.97 - US Funds only)
- Please send me 12 issues of HANDS-ON ELECTRONICS for \$28.00 and bill me. (Canada \$33.00 - US Funds only)

Is this your personal copy of RADIO-ELECTRONICS?
 6 Yes 8 No

19 37 55 73 91 109 127 145 163 181 199 217 235 253 271
 20 38 56 74 92 110 128 146 164 182 200 218 236 254 272
 21 39 57 75 93 111 129 147 165 183 201 219 237 255 273
 22 40 58 76 94 112 130 148 166 184 202 220 238 256 274
 23 41 59 77 95 113 131 149 167 185 203 221 239 257 275
 24 42 60 78 96 114 132 150 168 186 204 222 240 258 276
 25 43 61 79 97 115 133 151 169 187 205 223 241 259 277
 26 44 62 80 98 116 134 152 170 188 206 224 242 260 278
 9 27 45 63 81 99 117 135 153 171 189 207 225 243 261 279
 10 28 46 64 82 100 118 136 154 172 190 208 226 244 262 280
 11 29 47 65 83 101 119 137 155 173 191 209 227 245 263 281
 12 30 48 66 84 102 120 138 156 174 192 210 228 246 264 282
 13 31 49 67 85 103 121 139 157 175 193 211 229 247 265 283
 14 32 50 68 86 104 122 140 158 176 194 212 230 248 266 284
 15 33 51 69 87 105 123 141 159 177 195 213 231 249 267 285
 16 34 52 70 88 106 124 142 160 178 196 214 232 250 268 286
 17 35 53 71 89 107 125 143 161 179 197 215 233 251 269 287
 18 36 54 72 90 108 126 144 162 180 198 216 234 252 270 288

FREE INFORMATION CARD

VOID after APRIL 30, 1987

Allow 6-8 weeks for delivery of first issue

POSTAGE-PAID FREE INFORMATION CARD



3-287

Name (please print) _____
 Company Name (if applicable) _____
 Address _____
 City _____ State _____ Zip + 4 _____

Unclear or incomplete mailing info will prevent our processing this request.

- Please send me 12 issues of RADIO-ELECTRONICS for \$16.97 and bill me. (Canada \$22.97 - US Funds only)
- Please send me 12 issues of HANDS-ON ELECTRONICS for \$28.00 and bill me. (Canada \$33.00 - US Funds only)

Is this your personal copy of RADIO-ELECTRONICS?

6 Yes 8 No

19 37 55 73 91 109 127 145 163 181 199 217 235 253 271
 20 38 56 74 92 110 128 146 164 182 200 218 236 254 272
 21 39 57 75 93 111 129 147 165 183 201 219 237 255 273
 22 40 58 76 94 112 130 148 166 184 202 220 238 256 274
 23 41 59 77 95 113 131 149 167 185 203 221 239 257 275
 24 42 60 78 96 114 132 150 168 186 204 222 240 258 276
 25 43 61 79 97 115 133 151 169 187 205 223 241 259 277
 26 44 62 80 98 116 134 152 170 188 206 224 242 260 278
 9 27 45 63 81 99 117 135 153 171 189 207 225 243 261 279
 10 28 46 64 82 100 118 136 154 172 190 208 226 244 262 280
 11 29 47 65 83 101 119 137 155 173 191 209 227 245 263 281
 12 30 48 66 84 102 120 138 156 174 192 210 228 246 264 282
 13 31 49 67 85 103 121 139 157 175 193 211 229 247 265 283
 14 32 50 68 86 104 122 140 158 176 194 212 230 248 266 284
 15 33 51 69 87 105 123 141 159 177 195 213 231 249 267 285
 16 34 52 70 88 106 124 142 160 178 196 214 232 250 268 286
 17 35 53 71 89 107 125 143 161 179 197 215 233 251 269 287
 18 36 54 72 90 108 126 144 162 180 198 216 234 252 270 288

FREE INFORMATION CARD

VOID after APRIL 30, 1987

Allow 6-8 weeks for delivery of first issue



Radio-Electronics
 SUBSCRIPTION SERVICE
 P.O. Box 51866
 BOULDER, COLORADO 80321-1866





NO POSTAGE
NECESSARY
IF MAILED
IN THE
UNITED STATES

BUSINESS REPLY MAIL

FIRST CLASS PERMIT NO. 132 DALTON, MA

POSTAGE WILL BE PAID BY ADDRESSEE

**Radio-
Electronics**

FREE PRODUCT INFORMATION

**P.O. Box 388
DALTON, MA 01226-9990**



**For New
Ideas
In Electronics
read Radio-
Electronics
every month.**

**During the next
12 months**

Radio-Electronics will carry up to the minute articles on:

- Computers • Video
- Solid-state technology
- Outstanding construction projects
- Satellite TV • Telephones
- Radio • Stereo • Equipment Reports
- Test equipment • VCR's
- Servicing
- Industrial electronics



**NEW IDEAS AND INNOVATIONS
IN ELECTRONICS APPEAR IN EVERY
ISSUE OF RADIO-ELECTRONICS**

**KEEP UP TO DATE! DON'T MISS
ANY ISSUES!**

SUBSCRIBE TODAY!

**USE THE ORDER CARD ON YOUR
LEFT!**

**Hands-on
Electronics**

Formerly Special Projects

**Delivers construction article after
construction article....Exciting col-
umns including Jensen on DXing,
Friedman on computers, Test bench
tips, Noll with Calling All Hams, New
Products and more.**



SUBSCRIBE TODAY!

**USE THE REPLY CARDS ON YOUR
LEFT!**

**Radio-
Electronics**

4SB75

Subscribe today to the magazine that keeps you up-to-date with the newest ideas and innovations in electronics. (If you already are a subscriber, do a friend a favor and pass this subscription card along to him.)

check offer preferred

- | | |
|--|---|
| <input type="checkbox"/> 1 Year—12 issues ONLY \$16.97
(You save \$6.43 off single copy price) | <input type="checkbox"/> 2 Years (SAVE MORE)—24 issues \$32.97
(You save \$13.83 off single copy price) |
| <input type="checkbox"/> Canada—12 issues \$22.97 | <input type="checkbox"/> Canada—12 issues \$44.97 |

ALL SUBSCRIPTIONS PAYABLE IN U.S. FUNDS ONLY

- Payment enclosed Bill Me Check here if you are extending or renewing your subscription

Name (Please Print) _____

Company Name (If applicable) _____

Address _____

City _____ State _____ Zip _____

Allow 6-8 weeks for delivery of first issue



NO POSTAGE
NECESSARY
IF MAILED
IN THE
UNITED STATES

BUSINESS REPLY MAIL

FIRST CLASS PERMIT NO. 132 DALTON, MA

POSTAGE WILL BE PAID BY ADDRESSEE

**Radio-
Electronics**

FREE PRODUCT INFORMATION

**P.O. Box 388
DALTON, MA 01226-9990**

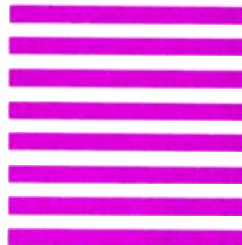

2001 IS COMING IN MAY



An electronics revolution is in the making, but you don't have to wait until 2001 to find out how it will change your life in the 21st century. Radio-Electronics will forecast the coming changes and how they will affect you in the May 1987 issue!

Created by a special editorial task force—two years in preparation—this unique issue, 2001, takes you into the research laboratories of Westinghouse, Texas Instruments, Ford and Bell Labs where the future is being invented today!

You'll get an advance look at what's coming in artificial intelligence... new cars and highways (cleaner, quieter and more efficient)... futuristic energy sources like magneto-hydrodynamic and particle-beam generators... personal communications systems that will give you instant access to anyone anywhere... super computers and teaching breakthroughs that will multiply your capacity to learn!

Arthur Clarke introduces 2001. Isaac Asimov explores the marvels of robotics. But it's not science fiction. Rather it is

emerging technology with a solid foundation in current research and development.

And its impact will be enormous. It will change the way you work... the way you think... the way you live!

2001 is the kind of special publishing event that can only happen once in any magazine's lifetime and it will happen to Radio-Electronics in May, 1987.

With extra features and extra pages, 2001 will bear a premium cover cost, but you can reserve your copy now at less than the regular cover cost by mailing any one of the subscription orders in this issue.

2001 is coming in May. Make sure now that you don't miss it!

**Radio-
Electronics**

SCOPE 3 1/2 Digital Multimeters



Model DVM-638
\$79⁹⁵

- Test leads included
- 11 function, 38 ranges
- Logic level detector
- Audible visual continuity
- Capacitance and conductance measurement

Model DVM-634
\$48⁷⁵

- 7 function, 32 ranges
- Transistor measurement

Model DVM-636
\$62⁷⁵

- 8 function, 37 ranges
- Capacitance measurement

SCOPE 3 1/2 Digit Capacitance Meter



Model DCM-602
\$69⁹⁵

- Test leads included
- 8 ranges with full scale values to 2000 uF
- LSI circuit
- Crystal time base
- Frequency range 800 Hz to 6Hz

SCOPE Pocket Sized Audio Signal Generator



Model RC-555
\$69⁹⁵

- Test leads & 9V battery included
- Low distortion sine-wave signal
- 46 step selected frequency
- x1 range 20 Hz to 1.5 KHz
- x100 range 2 KHz to 150 KHz

SCOPE 4 1/2 Digit LCD Bench Digital Multimeter



Model DVM-6005
\$199⁹⁵

- Test lead set 6, "D" size batteries included
- 0.4" high characters
- Conversion period: 500 milliseconds
- Automatic, negative polarity

Mini-Meters with Maxi-Specs

SCOPE 3 1/2 Digit LCD with 8 Full Functions

Model DVM-632

\$44⁹⁵
OUR PRICE

Measures only 5 3/8" x 2 3/16" x 1 1/4"

- Deluxe test leads included
- 0.5% accuracy
- Transistor gain test
- Audible continuity checking & diode test
- 10 Amp measurement

Zipped Carrying Case CC-30 **\$4⁵⁰**



SCOPE 3 1/2 Digit LCD

Measures only 5" x 2 3/4" x 7/8"



Model DVM-630
\$29⁹⁵

OUR PRICE

- Test leads included
- 0.5% accuracy
- 6 functions, 19 ranges
- Automatic zero adjust
- Low battery indication

Zipped Carrying Case CC-30 **\$4⁵⁰**

ASK FOR FREE CATALOG.

Money orders, checks accepted. C.O.D.'s require 25% deposit.



Fordham

260 Motor Parkway, Hauppauge, NY 11788

Toll Free **800-645-9518**
In NY State 800-832-1446

Service & Shipping Charge Schedule Continental U.S.A.

FOR ORDERS	ADD
\$25-\$100	\$4.50
\$101-\$250	\$6.00
\$251-\$500	\$8.00
\$501-\$750	\$10.50
\$751-\$1,000	\$12.50
\$1,001-\$1,500	\$16.50
\$1,501-\$2,000	\$20.00
\$2,001 and Up	\$25.00