

Radio — BUILD A SATELLITE TV RECEIVER FOR UNDER \$100

Electronics

\$1.95 FEB. 1986
IN CANADA \$2.50

TECHNOLOGY - VIDEO - STEREO - COMPUTERS - SERVICE

BUILD THIS WIRELESS VIDEO-CAMERA LINK

Cut the cables that tie you to your VCR.

BUILD A HUMIDITY MONITOR

Monitor the weather and spot dangerous static conditions.

BUILD A SIMPLE MUSIC SYNTHESIZER

It's easy to build and even easier to play!

TRANSISTOR SWITCHING CIRCUITS

Designing for maximum efficiency.

ELECTROMAGNETIC INTERFERENCE

How to fight EMI in your designs.

HOW TO SERVICE CD PLAYERS

A troubleshooting guide.

➤ PLUS:

- ★ New column: Ask R-E ★ **COMPUTER DIGEST**
- ★ Robotics ★ Service Clinic ★ PC Service
- ★ Antique Radios ★ New Ideas

GERNSBACK PUBLICATION

Now! Tek quality and expert advice are just a free phone call away!

The industry standard in CRT performance. Crisp, easy-to-read, bright CRT; 14kV accelerating potential, provides high writing rate and small spot size. Full size 8x10 cm display for measurement accuracy.

Display controls are flexible and easy to use. Separate intensity controls reduce blooming in alternate sweep mode. Focus tracking minimizes control adjustment and BEAM FIND eliminates confusion.

Vertical system provides measurement assurance. Flat transient response and high accuracy ensures true reproduction of your signals. Fast risetime and high bandwidth is well suited for a variety of measurement.

Perform delayed sweep measurements accurately and easily. Both sweeps can be displayed alternately making differential measurements easy and accurate (1%). An interlocking SEC/DIV control simplifies set-up.

Stable hands-off triggering. P-P AUTO detects signal peaks, then sets the trigger level for you. Display asynchronous signals using VERT MODE triggering. Independent TV field and line selection.

Front panel laid out by function for ease of use. Color coding aids the user in operation. Functions and modes are placed logically. All nomenclature is clearly labeled, and protected behind a scratchless Lexan surface.



Our direct order line gets you the industry's leading price performance portables... and fast answers from experts! The 60 MHz single time base delay 2213A, the 60 MHz dual time base 2215A and the 100 MHz dual time base 2235 offer unprecedented reliability and affordability, plus the industry's first 3-year warranty* on labor and parts, CRT included.

The cost: just \$1275 for the 2213A, \$1525 for the 2215A, \$1750 for the 2235.† Even at these low prices, there's no scrimping on performance. You

have the bandwidth for digital and analog circuits. The sensitivity for low signal measurements. The sweep speeds for fast logic families. And delayed sweep for fast, accurate timing measurements. All scopes are UL Listed and CSA approved.

You can order, or obtain literature, through the Tek National Marketing Center. Technical personnel, expert in scope applications, will answer your questions and expedite delivery. Direct orders include comprehensive 3-year warranty*, operator's

manual, two 10X probes, 15-day return policy and worldwide service backup.

**Order toll free:
1-800-426-2200,
Ask for Rick.**

In Oregon, call collect: (503) 627-9000.
Or write Tektronix, Inc.
P.O. Box 1700
Beaverton, OR 97075

Tektronix
COMMITTED TO EXCELLENCE

FEBRUARY '86

Radio- Electronics

Electronics publishers since 1908

Vol. 57 No. 2

BUILD THIS

- 51 WIRELESS VIDEO-CAMERA LINK**
Who says you need a portable VCR to make great video movies?
William Sheets and Rudolf F. Graf
- 57 \$99 SATELLITE-TV RECEIVER**
Part 2. Here's your chance to get started receiving satellite-TV!
Richard D. Maddox
- 61 HUMIDITY MONITOR**
If you're an electronics hobbyist, you had better be concerned about humidity in the winter months!
Mark C. Worley
- 75 MINI MUSIC SYNTHESIZER**
This is a fun, easy-to-build project that can make anyone a musician.
- 88 PC SERVICE**
Use the direct-etch foil patterns to make circuit boards for your wireless video link, satellite receiver, humidity monitor, and mini music synthesizer!

TECHNOLOGY

- 79 REPAIRING COMPACT DISC PLAYERS**
Part 4. Find out how CD players work—and what to do when they don't.
John D. Lenk
- 94 ROBOTICS**
Brains for your robot.
Mark J. Robillard
- 103 SATELLITE TV**
The Ku band.
Bob Copper, Jr.

CIRCUITS AND COMPONENTS

- 71 CURING ELECTROMAGNETIC INTERFERENCE**
Part 3. How to EMI-proof your designs.
Michael F. Violette
- 83 ALL ABOUT TRANSISTOR SWITCHES**
Good design techniques are often overlooked when designing switching circuits. Here's how to do things the right way. L.B. Cebik
- 112 DRAWING BOARD**
A Z80 demonstration program.
Robert Grossblatt

RADIO

- 96 COMMUNICATIONS CORNER**
All about diversity reception.
Herb Friedman
- 108 ANTIQUE RADIOS**
A history lesson on ancient electronics.
Richard D. Fitch

VIDEO

- 110 SERVICE CLINIC**
Troubleshooting problems with IC's. Jack Darr
- 111 SERVICE QUESTIONS**
Answers to your TV-service questions.

COMPUTERS

- Following page 104 **COMPUTER DIGEST**
Monitors, speaker design, and more

SPECIAL REPORT

- 56 HIGHLIGHTS OF THE NPE CONVENTION**
A report on last year's historic get-together!

EQUIPMENT REPORTS

- 28 Tektronix 318 16-Channel Logic Analyzer**
- 40 Rhoades TE-600 Teledapter Stereo Synthesizer**

DEPARTMENTS

- 138 Advertising and Sales Offices**
- 138 Advertising Index**
- 12 Ask R-E**
- 4 Editorial**
- 139 Free Information Card**
- 16 Letters**
- 115 Market Center**
- 24 New Products**
- 6 What's News**

Radio-Electronics, (ISSN 0033-7862) February 1986. Published monthly by Gernsback Publications, Inc., 200 Park Avenue South, New York, NY 10003. Second-Class Postage paid at New York, NY and additional mailing offices. Second-Class mail registration No. 9242 authorized at Toronto, Canada. One-year subscription rate U.S.A. and possessions \$15.97, Canada \$20.97, all other countries \$23.47. Subscription orders payable in US funds only, international postal money order or check drawn on a U.S.A. bank. Single copies \$1.95. © 1985 by Gernsback Publications, Inc. All rights reserved. Printed in U.S.A.

POSTMASTER: Please send address changes to RADIO-ELECTRONICS, Subscription Dept., Box 2520, Boulder, CO 80322

A stamped self-addressed envelope must accompany all submitted manuscripts and/or artwork or photographs if their return is desired should they be rejected. We disclaim any responsibility for the loss or damage of manuscripts and/or artwork or photographs while in our possession or otherwise.

FEBRUARY 1986

COVER 1



Have you decided that the only way to make the video movies you want is to buy a portable VCR and camera? Well, think again! Our wireless video link will let you transmit video signals from your camera to your VCR over one of the UHF channels! It just might be the ultimate in portability!

Making moves isn't all that our video link will let you do. You can also use it to transmit signals from your VCR in one room to a TV in any other room in the house—all with wireless convenience.

Our thanks to Magnavox for providing the *LoLite* video camera that our model is using with the wireless video link.

NEXT MONTH

THE MARCH ISSUE IS ON SALE FEBRUARY 4

SPECIAL SECTION ON ROBOTICS

Two special articles will bring you up to date on the robotics industry. The first is a buyer's guide to the market. The second tells you what's involved in building your own robot!

BUILD A DELUXE VIDEO TITLER

Due to space restrictions, we were unable to run the final installment this month. In March, we'll finish things up with a look at the software and how to interface the titler to a computer.

BUILD AN AMPLIFIER FOR YOUR WALKMAN

Who says you have to listen to your personal stereo through headphones?

HOW TO AVOID HOT PROJECTS

The second and final installment gives more hints and design considerations.

As a service to readers, Radio-Electronics publishes available plans or information relating to newsworthy products, techniques and scientific and technological developments. Because of possible variances in the quality and condition of materials and workmanship used by readers, Radio-Electronics disclaims any responsibility for the safe and proper functioning of reader-built projects based upon or from plans or information published in this magazine.

Since some of the equipment and circuitry described in RADIO-ELECTRONICS may relate to or be covered by U.S. patents, RADIO-ELECTRONICS disclaims any liability for the infringement of such patents by the making, using, or selling of any such equipment or circuitry, and suggests that anyone interested in such projects consult a patent attorney.

Radio- Electronics

Hugo Gernsback (1884-1967) founder
M. Harvey Gernsback,
editor-in-chief, emeritus

Larry Steckler, BHF, CET, publisher

EDITORIAL DEPARTMENT

Larry Steckler, editor-in-chief

Art Kleinman, editorial director

Brian C. Fenton, managing editor

Carl Laron, WB2SLR, associate editor

Jeffrey K. Holtzman,
assistant technical editor

Robert A. Young, assistant editor

Julian S. Martin, editorial associate

Byron G. Wells, editorial associate

M. Harvey Gernsback,
contributing editor

Jack Darr, CET, service editor

Robert F. Scott,
semiconductor editor

Herb Friedman,
communications editor

Boh Cooper, Jr., satellite-TV editor

Robert Grossblatt, circuits editor

David Lachenbruch,
contributing editor

Richard D. Fitch,
contributing editor

Mark J. Robillard, robotics editor

Bess Isaacson, editorial assistant

PRODUCTION DEPARTMENT

Ruby M. Yee, production director

Robert A. W. Lowndes,
editorial production

Andre Duzant, technical illustrator

Karen Tucker, advertising production

Geoffrey S. Weil, production traffic

CIRCULATION DEPARTMENT

Jacqueline P. Cheeseboro,
circulation director

Rita Sabalis,
assistant circulation director

Jacqueline Allen, circulation assistant

Cover photo by Robert Lewis

Typography by Mates Graphics

Radio-Electronics is indexed in
Applied Science & Technology Index
and *Readers Guide to Periodical Literature*.

Microfilm & Microfiche editions are
available. Contact circulation depart-
ment for details.

Advertising Sales Offices listed
on page 138.



NEW!

Uniden® Bearcat®

Regency®

Scanners

Communications Electronics, the world's largest distributor of radio scanners, introduces new scanners and scanner accessories from J.I.L., Regency and also Uniden/Bearcat. Chances are the police, fire and weather emergencies you'll read about in tomorrow's paper are coming through on a scanner today.

NEW! Regency® MX7000-K

List price \$699.95/CE price \$429.00/SPECIAL
10-Band, 20 Channel • No-Crystal Scanner
Frequency range: 23-550 MHz continuous coverage and 800 MHz to 1.2 GHz continuous coverage
In addition to normal scanner listening, the MX7000 offers CB, VHF, and UHF TV audio, FM Broadcast, all aircraft bands (civil and military), 800 MHz communications, cellular telephone, and when connected to a printer or CRT, satellite weather pictures.

NEW! Regency® MX5000-K

List price \$599.95/CE price \$329.00/SPECIAL
Multi-Band, 20 Channel • No-Crystal Scanner
Search • Lockout • Priority • AC/DC
Selectable AM-FM modes • LCD display
World's first continuous coverage scanner
Frequency range: 23-550 MHz continuous coverage
Never before have so many features come in such a small package. The Regency MX5000 mobile or home scanner has continuous coverage from 25 to 550 MHz. That means you can hear CB, Television audio, FM broadcast stations, all aircraft bands including military and the normal scanner bands, all on your choice of 20 programmable channels.

NEW! Regency® MX4000-K

List price \$629.95/CE price \$299.00/SPECIAL
Multi-Band, 20 Channel • No-Crystal Scanner
Search • Lockout • Priority • AC/DC
Selectable AM-FM modes • LCD display
Bands: 30-50, 118-136, 144-174, 440-512, 800-950 MHz
The Regency MX4000 is gives coverage in the standard VHF and UHF ranges with the important addition of the 800 MHz, and aircraft bands. It features keyboard entry, multifunction liquid crystal display and variable search increments.

NEW! Regency® Z60-K

List price \$379.95/CE price \$216.00/SPECIAL
8-Band, 60 Channel • No-Crystal Scanner
Bands: 30-50, 88-108, 118-136, 144-174, 440-512 MHz
Cover your choice of over 15,000 frequencies on 80 channels at the touch of your finger.

NEW! JIL SX-400-K

List price \$799.95/CE price \$469.00/SPECIAL
Multi-Band, 20 Channel • No-Crystal Scanner
Search • Lockout • Priority • AC/DC
Frequency range: 28-520 MHz continuous coverage
With optionally equipped RF converters 150KHz-3.7 GHz
The JIL SX-400 synthesized scanner is designed for commercial and professional monitor users that demand features not found in ordinary scanners. The SX-400 will cover from 150 KHz to 3.7 GHz, with RF converters. Order the following RF converters for your SX-400 scanner. RF-1030-K at \$259.00 each for frequency range 150 KHz - 30 MHz USB, LSB, CW and AM (CW filter required for CW signal reception). RF-5080-K at \$199.00 each for 500-800 MHz. RF-8014-K at \$199.00 each for 800 MHz - 1.4 GHz. Be sure to also order ACB-300-K at \$99.00 each which is an antenna control box for connection of the RF converters. The RC-4000-K data interface at \$259.00 each gives you control of the SX-400 scanner and RF converters through a computer. Add \$3.00 shipping for each RF converter, data interface or antenna control box. If you need further information on the JIL scanners, contact JIL directly at 213-926-6727 or write JIL at 17120 Edwards Road, Cerritos, California 90701 U.S.A.

SPECIAL! JIL SX-200-K

List price \$499.95/CE special price \$159.00
Multi-Band • 16 Channel • No-Crystal Scanner
Frequency range: 26-88, 108-160, 380-514 MHz
The JIL SX-200 scanner tunes military, F.B.I., Space Satellite, Police and Fire, Drug Enforcement Agencies, Defense Department, Aeronautical AM band, Aero Navigation Band, Fish & Game, Immigration, Paramedics, Amateur Radio, Justice Department, State Department, plus other thousands of radio frequencies most other scanners can't pick up. The SX-200 has selectable AM/FM receiver circuits, 1H-switch squelch settings - signal, audio and signal & audio, outboard AC power supply - DC at 12 volts built-in, quartz clock - bright vacuum fluorescent blue readouts and dimmer, dual level search speeds, tri-level scan delay switches, 16 memory channels in two channels bank, receive fine tune (RIT) ± 2KHz, dual level RF gain settings - 20 db pad, AGC test points for optional signal strength meters.

Regency® HX1000-K

List price \$329.95/CE price \$209.00
6-Band, 30 Channel • No-Crystal Scanner
Search • Lockout • Priority • Scan delay
Sidellit liquid crystal display • Digital Clock
Frequency range: 30-50, 144-174, 440-512 MHz
The new handheld Regency HX1000 scanner is fully keyboard programmable for the ultimate in versatility. You can scan up to 30 channels at the same time. When you activate the Priority control, you automatically override all other calls to listen to your favorite frequency. The LCD display is even sidellit for night use. Order MA-256-K rapid charge drop-in battery charger for \$79.00 plus \$3.00 shipping/handling. Includes wall charger, carrying case, belt clip, flexible antenna and nicad battery. Order now.

NEW! Bearcat® 100XL-K

List price \$349.95/CE price \$229.00
9-Band, 16 Channel • Priority • Scan Delay
Search • Limit • Hold • Lockout • AC/DC
Frequency range: 30-50, 118-174, 406-512 MHz
The world's first no-crystal handheld scanner now has a LCD channel display with backlight for low light use and aircraft band coverage at the same low price. Size is 1 1/2" x 7 1/2" x 2 1/2". The Bearcat 100XL has wide frequency coverage that includes all public service bands (Low, High, UHF and "T" bands), the AM aircraft band, the 2-meter and 70 cm, amateur bands, plus military and federal government frequencies. Wow... what a scanner! Included in our low CE price is a sturdy carrying case, earphone, battery charger/AC adapter, six AA nicad batteries and flexible antenna. Order your scanner now.

NEW! Regency® HX2000-K

The World's First 800 MHz Handheld Scanner
List price \$569.95/CE price \$359.00
7-Band, 20 Channel • No-Crystal Scanner
Priority control • Search/Scan • AC/DC
Sidellit liquid crystal display • Memory backup
Bands: 118-136, 144-174, 440-512, 800-950 MHz
The HX2000 scanner operates on 120V AC of 6 VDC. Scans 15 channels per second. Size 3" x 7" x 1 1/2". Includes wall charger, carrying case, belt clip, flexible antenna and nicad batteries. Selectable AM/FM modes.

NEW! Bearcat® 800XLT-K

List price \$499.95/CE price \$329.00
12-Band, 40 Channel • No-Crystal Scanner
Priority control • Search/Scan • AC/DC
Bands: 29-54, 118-174, 406-512, 806-912 MHz
The Uniden 800XLT receives 40 channels in two banks. Scans 15 channels per second. Size 9 1/2" x 4 1/2" x 1 1/2".

OTHER RADIOS AND ACCESSORIES

Panasonic RF-2800-K Shortwave receiver	\$179.00
Panasonic RF-B300-K Shortwave receiver	\$195.00
RD95-K Uniden Remote Mount Radar Detector	\$139.00
RD55-K Uniden Visor mount Radar Detector	\$119.00
BC 20/20-K Bearcat 40 Channel scanner	\$274.00
BC 210XW-K Bearcat 20 channel scanner	\$219.00
BC-WA-K Bearcat Weather Alert	\$39.00
DX1000-K Bearcat shortwave receiver	\$59.00
PC22-K Uniden remote mount CB transceiver	\$99.00
PC55-K Uniden mobile mount CB transceiver	\$59.00
Z10-K Regency 10 channel scanner	\$139.00
Z30-K Regency 30 channel scanner	\$154.00
Z45-K Regency 45 channel scanner	\$179.00
R1060-K Regency 10 channel scanner	\$98.95
MX3000-K Regency 30 channel scanner	\$189.00
C403-K Regency 4 channel scanner	\$69.00
R106-K Regency 10 channel scanner	\$99.00
RH250B-K Regency 10 channel VHF transceiver	\$329.00
RU150B-K Regency 10 channel UHF transceiver	\$449.00
RPH410-K 10 ch. handheld no-crystal transceiver	\$399.00
BC10-K Battery charger for Regency RPH410	\$79.00
MA256-K Drop-in charger for MX1000 scanner	\$79.95
MA257-K Cigarette lighter cord for MX1000	\$19.95
MA917-K Ni-Cad battery pack for MX1000	\$24.95
EC10-K Programming tool for Regency RPH410	\$20.00
SMRH250-K Service man. for Regency RH250	\$20.00
SMRU150-K Service man. for Regency RU150	\$20.00
SMRPH410-K Service man. for Regency RPH410	\$20.00
SMRX7000-K Svc. man. for MX7000 & MX5000	\$20.00
SMRX3000-K Service man. for Regency MX3000	\$20.00
B-4-K 1.2 V AAA Ni-Cad batteries (set of four)	\$9.00
A-135C-K Crystal certificate	\$3.00
FB-E-K Frequency Directory for Eastern U.S.A.	\$12.00
FB-W-K Frequency Directory for Western U.S.A.	\$12.00
TSG-K "Top Secret" Registry of U.S. Govt. Freq.	\$15.00
TIC-K Techniques for Intercepting Comm.	\$15.00
RRF-K Railroad frequency directory	\$10.00
CIE-K Cover Intelligence, Elect. Eavesdropping	\$15.00
AS0-K Magnet mount mobile scanner antenna	\$35.00
A70-K Base station scanner antenna	\$35.00
USAMM-K Mag mount VHF/UHF ant. w/12' cable	\$39.95
USAK-K 1/2" hole mount VHF/UHF ant. w/17' cable	\$39.95
USATLM-K Trunk ID mount VHF/UHF antenna	\$39.95
Add \$3.00 shipping for all accessories ordered at the same time.	
Add \$12.00 shipping per shortwave receiver.	
Add \$7.00 shipping per scanner and \$3.00 per antenna.	

BUY WITH CONFIDENCE

To get the fastest delivery from CE of any scanner, send or phone your order directly to our Scanner Distribution Center, Michigan residents please add 4% sales tax or supply your tax ID number. Written purchase orders are accepted from approved government agencies and most well rated firms at a 10% surcharge for net 10 billing. All sales are subject to availability, acceptance and verification. All sales on accessories are final. Prices, terms and specifications are subject to change without notice. All prices are in U.S. dollars. Out of stock items will be placed on backorder automatically unless CE is instructed differently. A \$6.00 additional handling fee will be charged for all orders with a merchandise total under \$50.00. Shipments are F.O.B. Ann Arbor, Michigan. No COD's. Most products that we sell have a manufacturer's warranty. Free copies of warranties on these products are available prior to purchase by writing to CE. Non-certified checks require bank clearance.

Mail orders to: Communications Electronics, Box 1045, Ann Arbor, Michigan 48106 U.S.A. Add \$7.00 per scanner for U.P.S. ground shipping and handling in the continental U.S.A. For Canada, Puerto Rico, Hawaii, Alaska, or APO/FPO delivery, shipping charges are three times continental U.S. rates. If you have a Visa or Master Card, you may call and place a credit card order. Order toll-free in the U.S. Dial 800-USA-SCAN. In Canada, order toll-free by calling 800-221-3475. Telex CE anytime, dial 810-223-2422. If you are outside the U.S. or in Michigan dial 313-973-8888. Order today.

Scanner Distribution Center, and CE logos are trademarks of Communications Electronics Inc. Bearcat is a registered trademark of Uniden Corporation. Regency is a federally registered trademark of Regency Electronics Inc. AD #090385-K Copyright © 1985 Communications Electronics

For credit card orders call
1-800-USA-SCAN

**COMMUNICATIONS
ELECTRONICS INC.**

Consumer Products Division
P.O. Box 1045 □ Ann Arbor, Michigan 48106-1045 U.S.A.
Call 800-USA-SCAN or outside U.S.A. 313-973-8888

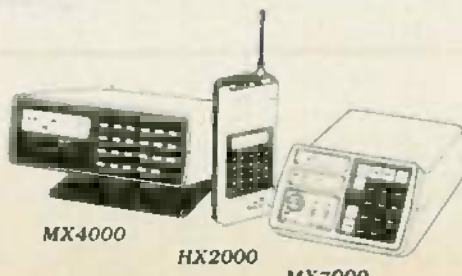
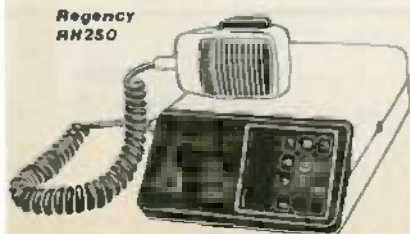

CIRCLE 79 ON FREE INFORMATION CARD

FEBRUARY 1986

Full-featured frequency counter.

The DM850 offers more than any digital multimeter in its price class:

4½ digits. DCV accuracy is .05% + 3 digits

True RMS

Frequency counter to 200KHz

Data Hold display capability

DCV-5 ranges (.2V to 1kV)

ACV-5 ranges (.2V to 750V)

DCA/ACA-6 ranges (.2mA to 10A)

Ohms-6 ranges (200 Ohms to 20 Megohms)

Continuity beeper

Diode check

Built-in bail

Anti-skid pads

Prices: DM850 (True RMS) . . . \$219^{95*}

DM800 (Average RMS) . . . \$169^{95*}

See one now at your local Beckman Industrial distributor.

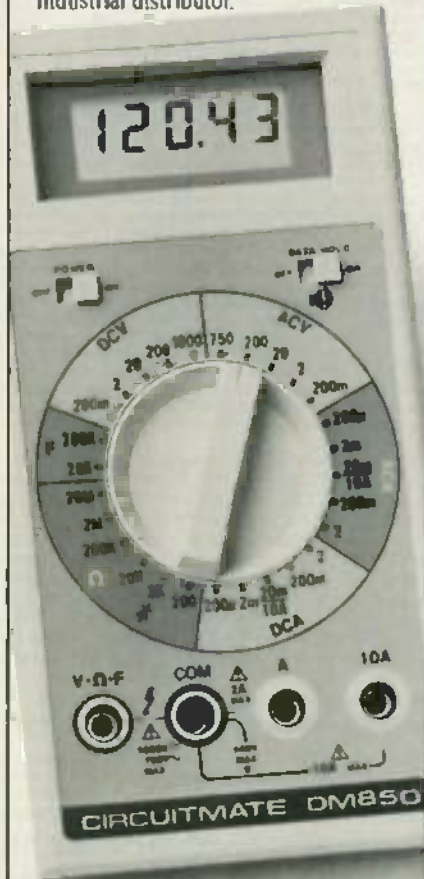

*Suggested list price. Prices subject to change without notice.

Beckman Industrial™

Beckman Industrial Corporation
A Subsidiary of Emerson Electric Company
630 Puente Street, Brea, CA 92621
(714) 671-4800

© Copyright 1985 Beckman Industrial Corporation

EDITORIAL

Radio-Electronics is on the move!

Radio-Electronics is moving! Yes, we're packing our bags and getting set to move out of New York City. We're not taking the move lightly—we've been at our present location for about seventeen years. And we have to admit, we like our Park Avenue South offices...but not as much as we're going to like our new place.

Being thirty miles east of Manhattan does have its advantages. Our new Long Island offices will give us room to think and room to grow.

Don't think that because we're leaving the Big Apple that we'll slow down to an easier pace. We'll be moving faster than ever to keep you up to date and informed. Any changes we make will be for the better. Next month, for example, you'll see a special section on robotics, and a new column devoted to new technology. We intend to stay on the cutting edge—and to keep you there, too.

We also plan to become more responsive to your needs. We started our new *Ask R-E* column to answer your questions. Of course we can't answer everybody, but we'll answer the questions that will be of interest to the largest number of readers. If we can't answer your question, we'll try to steer you to someone who will.

I see that I've strayed from the subject I intended to write about. But that's because I'm more excited about being the new Managing Editor than I am about moving. But I'd be even *more* excited to hear from you. I want to hear your honest opinion about Radio-Electronics. Just write a postcard or short letter and let me know what you think is the best article or column in this issue. Let me know what you think is the worst, too. While you're at it, tell me something about yourself.

I guess I better tell you our new address. It's:

Radio-Electronics
500-B Bi-County Blvd.
Farmingdale, NY 11735

Brian C. Fenton
Managing Editor

RAG ELECTRONICS, INC.

New and Used Electronic Test Equipment
Sales • Service • Rental • Leasing

HITACHI 3.5 Digit DMM *Free* With Scope Purchase



- FEATURES:**
- AC DC voltage
 - AC DC current
 - Resistance
 - Diode test
 - Audible Continuity check
 - Temperature (Type K, 3510 & 3525)
 - Data hold
 - Manual or autoranging
 - Overload protection
 - LCD display
 - Built-in stand
 - Battery included
 - Test leads included

Special!

MODEL	BASIC DC VOLTAGE ACCURACY	QTY 1 PRICE	QTY 3+ PRICE	One With Any Scope Purchased From RAG
3550	±.5% ±2 digits	\$49.00	\$42.00	FREE
3525	±.25% ±2 digits	\$64.00	\$54.00	\$19.95
3510	±.1% ±2 digits	\$79.00	\$67.00	\$29.95

2 year warranty plus carrying case included!

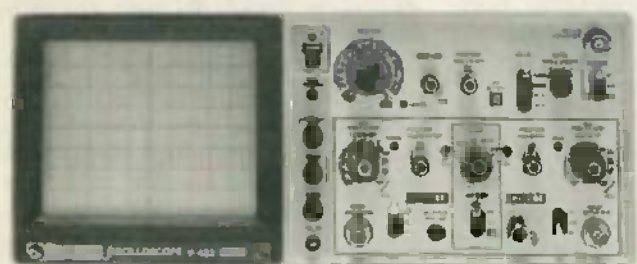

Model V-422 shown

MODEL V-222 **\$536.00**
DC to 20 MHz, 1 mV/div, Dual Trace, D.C. offset for DMM Output, Vertical Mode Trigger, 6" CRT (w/two X1/X10 probes).

MODEL V-422 **\$694.00**
DC to 40 MHz, other features same as V-222 (w/two X1/X10 probe).

MODEL V-1050F **\$1,276.00**
DC to 100 MHz, 5 mV/div, Quad Trace, Delayed Sweep, Full T.V. Triggering, alternate time base (w/two X1/X10 probes).

MODEL V-212 **\$461.00**
DC to 20 MHz, 1 mV/div, Dual Trace, Features 6" Rectangular CRT (w/two X10 probes).

MODEL V-650 **\$956.00**
DC to 60 MHz, 1 mV/div, Triple Trace, Delayed Sweep, Full T.V. Triggering, variable trigger hold-off (w/two X1/X10 Probes).

NEW! 3 year warranty parts and labor on above scopes!
RAG Electronics is a factory authorized Hitachi repair center.

CIRCLE 126 ON FREE INFORMATION CARD

CALL US TOLL FREE
1-800-732-3457
IN CALIFORNIA TOLL FREE
1-800-272-4225

<ul style="list-style-type: none"> • Master Charge • VISA • Money Order • Check 		ADD FOR SHIPPING AND INSURANCE \$0 to \$250.00 \$4.50 \$251.00 to \$500.00 \$8.50 \$501.00 to \$750.00 \$8.50 \$751.00 to \$1000.00 \$12.50 over \$1000.00 \$15.00
---	--	--

Prices subject to change without notice.

RAG ELECTRONICS, INC. / 21418 Parthenia Street / Canoga Park, CA 91304 / 1-818-998-6500

WHAT'S NEWS

Hugo Gernsback honored by antique radio group

The Antique Wireless Association (AWA) declared 1985 "Gernsback Year," and devoted three categories of its annual Old Equipment contest to Electro Importing Co. items, and documentation of Gernsback publications.

The best exhibit, by AWA President Lauren Peckham, was a display of old Electro Importing Co. (EICo) equipment, which included some items rarely seen even by avid collectors. Rarest was a Gernsback Rotary Variable Condenser. Using a patented roller principle, with the foil and dielectric rolling off one roller and onto another, it had a maximum capacitance of .01 μ F. Another exhibit, by Robert Trauterman of Ford City, PA, featured copies of a large number of early Gernsback magazines, plus a collection of his most famous editorials.

Feature of the AWA Annual Banquet was an interview by AWA ex-president Charles Brelsford of Fred Shunaman, long-time managing editor of *Radio-Craft* and *Radio-Electronics*, on Hugo Gernsback as an employer, as an individual, and as an influence on the radio art and the youth of his generation.

The conference was held at Canandaigua, NY, on September 25-29, 1985. Attendance was over 650. Sales at the AWA members' auctions totalled \$18,300, ten per cent of which goes to the Association. During the Conference eight papers were presented and there were three auctions and an amateur seminar.

Discharge rate up 10 times in new solid-state battery

Eveready has just announced



THE EVEREADY 2-VOLT SOLID-STATE CELL

the development of a new battery with a discharge rate ten times greater than that of any earlier solid-state batteries. The new 2-volt lithium cell also operates over a wider temperature range than conventional solid-state cells, and with no loss in shelf life.

The high discharge rate is the result of a patented Isostatic Compression Process. The electroactive materials are assembled in an argon atmosphere, then heat-sealed in a plastic bag and compressed at 80,000 pounds to the square inch in a commercial isostatic press, which applies the compression equally in all directions, using water/water-soluble oil as the pressure transmitting fluid. "The resulting intimate particle-to-particle contact thus achieved reduces the internal battery resistance to enable the higher rate of discharge," says a company spokesman.

The high-temperature performance is possible because the battery itself contains no liquid—it uses vitreous solid electrolytes.

It is expected that samples of the new battery will be available before the end of 1985.

"Fuzzy logic" can make for better military decisions

A new approach being followed by General Electric scientists may enable military field commanders

to make fast, accurate decisions based on quantities of incomplete and/or conflicting reports.

The new approach includes "fuzzy logic." A conventional computer program must have complete and accurate information to make correct decisions. A "fuzzy logic" program resembles more closely the workings of an intelligent human mind—it can make sense of such relative terms as "almost" or "probably."

The new program belongs to the class of "expert systems" that have been developed to simulate a human expert. They are founded on a "knowledge base" which combines all the information obtainable on a given subject—not from one, but from many experts. When confronted with a problem, the computer searches the knowledge base, selects pertinent facts, and applies rules (conditional statements) to them to define the problem. The main difference between that expert system and earlier ones is the use of the fuzzy logic that makes it possible to make decisions even if not all the facts are in place.

Besides that "probabilistic reasoning," the new system has two other parallel approaches: a "dynamic truth-maintenance system" that enables the computer to "think" through various hypotheses and weed out the ones that are not applicable, and a method of reasoning by analogy—of weighing similarities and differences of a current situation compared with a previous one.

The development program is being funded by a two-year, \$1 million contract from the Defense Advanced Research Projects Agency (DARPA) of the U.S. Department of Defense.

R-E

Fluke. First Family of DMMs.



When accuracy, performance and value are important, professionals the world over look to Fluke — the first family of DMMs.

Reliable Fluke-quality 3½- or 4½-digit DMMs fit every need — from design engineering to industrial troubleshooting.

There's the low-cost 70 Series — the most DMM you can get for the money. The tough 20 Series — totally sealed and built to survive the dirtiest, grimmest, roughest jobs. The reliable 8020B Series — made to withstand the rigors of the field service environment. The precise 8060A Series — the most powerful and complete test and measurement system available in a handheld package. And, of course, the versatile Bench/Portables that carry on the Fluke tradition for precision and durability in lab-quality bench instruments.

Fluke comes in first again with the world's largest selection of quality accessories to help extend the capabilities of your DMM even further.

There's no need to look anywhere else. Uncompromising Fluke design and leading edge technology are the reasons why attempts at imitation will never fool the millions of professionals that accept nothing less than a Fluke.

For your nearest distributor or more information, call toll-free
1-800-426-0361.

**FROM THE WORLD LEADER
IN DIGITAL MULTIMETERS.**

FLUKE[®]

800 THE U.S. AND NON-EUROPEAN COUNTRIES: John Fluke Mfg. Co. Inc., P.O. Box C2090, M/S 250C, Everett, WA 98206. Sales (206) 356-5400, Dist. (206) 341-8100.
EUROPEAN HEADQUARTERS: Fluke (Netherlands) B.V., P.O. Box 2259, 5600 CG Eindhoven, The Netherlands. (040) 458045, TLX 51846.
© Copyright 1985 John Fluke Mfg. Co. Inc. All rights reserved. Ad No. 4788-8020/70/20

CIRCLE 266 ON FREE INFORMATION CARD

Train for the Fastest Growing Job Skill in America

Only NRI teaches you to service and repair all computers as you build your own 16-bit IBM-compatible micro

As computers move into offices and homes by the millions, the demand for trained computer service technicians surges forward. The Department of Labor estimates that computer service jobs will actually *double* in the next ten years—a faster growth than any other occupation.

Total System Training

As an NRI student, you'll get total hands-on training as you actually build your own Sanyo MBC-550-2 computer from the keyboard up. Only a person who knows *all* the underlying fundamentals can cope with *all* the significant brands of computers. And as an NRI graduate, you'll possess the up-to-the-minute combination of theory and practical experience that will lead you to success on the job.

You learn at your own convenience, in your own home, at your own comfortable pace. Without classroom pressures, without rigid night-school schedules, without wasted time. Your own personal NRI instructor and NRI's complete technical staff will answer your questions, give you

New from NRI—the only home study course that trains you as you assemble a top-brand computer!



After you construct this digital logic probe, you'll install the "Intelligent" Sanyo detached keyboard, with its dedicated microprocessor.

You next assemble the power supply into the main unit of the computer. Using the digital multimeter, you check all keyboard connections and circuits.

After you install the disk drive and monitor, you'll make a backup copy of the MS-DOS operating disk, explore the 8088 microchip and additional circuits.

guidance and special help whenever you may need it.

The Exciting Sanyo MBC-550-2—Yours To Keep

Critics hail the new Sanyo as the "most intriguing" of all the IBM-PC compatible computers. It uses the same 8088 microprocessor as the IBM-PC and the MS/DOS operating system. So, you'll be able to choose thousands of off-the-shelf software programs to run on your completed Sanyo.

As you build the Sanyo from the keyboard up, you'll perform demonstrations and experiments that will give you a total mastery of computer operations and servicing techniques. You'll do programming in BASIC language. You'll prepare interfaces for peripherals such as printers and joysticks. Using utility programs, you'll check out 8088 functioning. NRI's easy step-by-step instructions will guide you all the way right into one of today's fastest growing fields as a computer



service technician. And the entire system, including all the bundled software and extensive data manuals, is yours to keep as part of your training.

How the pro computer critics rate the Sanyo 550:

"Sanyo BASIC is definitely superior to IBM Microsoft. . . lets you use two or three keystrokes for entering BASIC commands."

—MICROCOMPUTING Magazine

"... compares favorably with the IBM PC, even surpassing it in computational speed. . ."

—COMPUTERS & ELECTRONICS Magazine

Your NRI Course Includes a Sanyo MBC-550-2 Computer with 128K RAM, Monitor, Disk Drive, and "Intelligent" Keyboard; The NRI Discovery Lab[®], Teaching Circuit Design and Operations; a Digital Multimeter; Bundled Spread Sheet and Word Processing Software Worth \$1500 at Retail—and More.

"I went to have a look at the MBC-550. . . what I found made me an owner the next day!"

—Bill Sudbrink,
BYTE Magazine

100-Page Free Catalog Tells More

Send the postage-paid reply card today for NRI's big 100-page color catalog, which gives you all the facts about NRI training in Microcomputers, Robotics, Data

Communications, TV/Video/Audio Servicing, and other growing high-tech career fields. If the card is missing write to NRI at the address below.

NRI SCHOOLS

McGraw-Hill Continuing Education Center
3939 Wisconsin Avenue, NW
Washington, DC 20016

We'll Give You Tomorrow.

IBM is a Registered Trademark of International Business Machine Corporation.



ASK R-E

WRITE TO:

ASK R-E
Radio-Electronics
200 Park Ave South
New York, NY 10003

BUILDING A JOYSTICK

I'm building a robot, and I want to control it with a joystick or ball-type control like the ones used on many video games. I'd like to build my own. Can you help?—H. M., Palmetto, SC.

From your question, we'll assume that you are most interested in the analog types. Those offer a greater degree of control than the switch-closure type (the latter are used primarily by some types of video games), and are simple electrically, but mechanical construction requires a little skill and ingenuity. They are designed so that their motion increases or decreases the resistance of one or

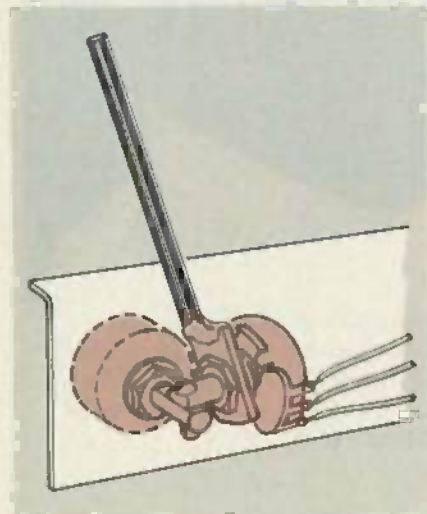

FIG. 1

more potentiometers. Which potentiometers are affected is determined by the direction of the motion.

The mechanical design of a simple joystick is illustrated in Fig. 1. That design originally appeared in the British magazine *Wireless World*. The potentiometer used for side-to-side motion is fixed to

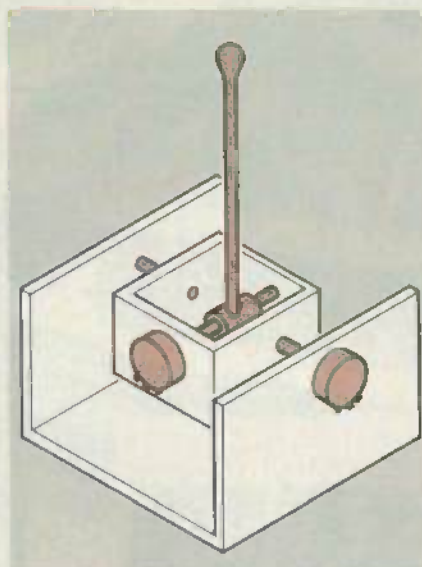

FIG. 2

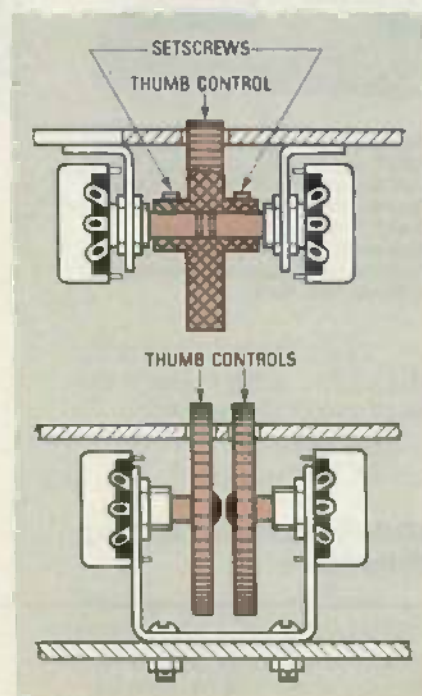

FIG. 3

the chassis or control box. The joystick is fastened to the body of the second potentiometer by its

mounting nut. The shafts of the two potentiometers are drilled and fastened together by a small nut and bolt.

A more elaborate design, from the Argentinian magazine *Revista Telegrafica Electronica*, appears in Fig. 2. A total of four potentiometers are used to vary resistance in two circuits with side-to-side motion, and in two other circuits with fore-and-aft motion.

We can't help you with the construction of a trackball, but you might be able to substitute one of the thumb-operated designs shown in Fig. 3. Those designs are from *Radio* (Czechoslovakia).

Take care in selecting the potentiometers. Most have a rotation of about 270 degrees, but joysticks usually limit motion to about 45 degrees from the neutral or center position. Naturally, you'll want to use linear potentiometers so that equal deviations from the "neutral" position produce equal changes in resistance.

FREQUENCY AND PERIOD

I know what a sinewave is, but I don't understand the difference between frequency and period. How are they related?—N. J. S., Greenboro, NC.

Frequency is the number of cycles that occur per unit of time. A complete cycle is measured between two successive points on the waveform that have the same amplitude and direction. For example: The time between two successive positive peaks, or between two successive positive-going zero crossings, constitutes one cycle. Until about 20 years ago, cycles per second was the unit in which frequency was specified.

But that term has been almost

Name Brands at Lowest Cost

COMPARE BEFORE

OUR PRICES

YOU BUY

A.W. SPERRY 20 MHz DUAL TRACE SCDOPE



- Special built-in Component Checker circuit allows voltage vs. current characteristics of de-energized circuits to be viewed. Saves hours locating defective components.

Model 620-C **\$399⁹⁵**

HITACHI 35 MHz 1MV/DIV DUAL-TRACE PORTABLE SCDOPE

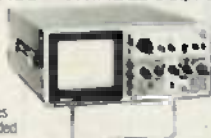

- Thin, light, compact design. • Features large 6" rectangular, internal graticule CRT. • % calibrations. • Autofocus. • Photographic bezel.

Model V-355 **\$599⁹⁵** (Reg. \$899.95)

B&K 60 MHz TRIPLE-TRACE SCDOPE



- 1 mV/div sensitivity. • 22 calibrated sweeps. • Rectangular CRT with internal graticule. • Delayed sweep/dual time base.

Model 1560 **\$899⁹⁵** (Reg. \$1150)

HITACHI 100 MHz QUAD-TRACE DELAYED SWEEP SCDOPE



- Low isolation dome mesh 6" rectangular CRT with internal graticule. • 500 uV/div high sensitivity design. • Delayed sweep function.

Model V-1050F **\$1249⁹⁵** (Reg. \$1980)

FLUKE HANDHELD, 4 1/2 DIGIT MULTIMETER



- RMS measurements for AC signals to 100 kHz. • Frequency to 200 kHz. • Resistance to 300M ohm. • 0.4% Accuracy.

Model 8060A **\$325⁰⁰** (Reg. \$349)

SIMPSON METER AC/DC VOLTS/AMPS RESISTANCE



- 28 time proven ranges. • Direct dial reading. • Multi-purpose test leads with combination probe and alligator clips.

Complete with batteries, test leads, manual.
Model 260-7 **\$109⁹⁵**

XCELITE ATTACHE TOOL KIT



- Contains 53 individual tools, 31 Series 99 interchangeable screwdriver/nutdriver blades and handles, and 2 specialized screwdriver/nutdriver sets and kits. Case (19 1/2" x 13 1/2" x 6 1/4").

(Reg. \$499.95)
Model TCM-100/ST **\$379⁹⁵**

UNGAR HOT VAC DESOLDERING SYSTEM



FREE UNGAR PROBE (\$99.95 value) with purchase of Model 4000-U

- Self-Contained, Super-Quiet Air Pump. • Variable solid-state control adjusts tip temperature from 500° - 1000°F. • Transient spikes fully suppressed for safe desoldering of voltage-sensitive components.

Model 4000-U **\$419⁹⁵** (Reg. \$599.95)

WELLER WTCPR CONTROLLED OUTPUT SOLDERING STATION



- Unique "Closed Loop" method of controlling maximum tip temperature protects temperature sensitive components. • Grounded tip protects voltage and current sensitive components.

Model WTCPR **\$79⁹⁵** each.

SEND FOR OUR LATEST **FREE CATALOG**



WELLER SOLDERING STATION



- Variable tip temperature from 350° to 850°F. • Plug-in soldering irons. • Large digit LED display for accurate setting.

Model EC2000 **\$169⁹⁵**

800-645-9518

In NY State: 800-832-1446

Fordham



(Telephone Orders Accepted)

Service & Shipping Charge Schedule Continental U.S.A.

FOR ORDERS	ADD
\$25-100	\$4.50
\$101-250	\$6.00
\$251-500	\$8.00
\$501-750	\$10.50
\$751-1000	\$12.50
\$1,001-1500	\$16.50
\$1,501-2000	\$20.00
\$2,001 and up	\$25.00

FEBRUARY 1986

universally replaced by *hertz*—a unit equal to one cycle per second. We said *almost* universally because, while most of us use hertz, kilohertz, megahertz, etc., in connection with RF, some still refer to the 60-cycle power line, etc.

Whereas frequency refers to the number of events in a given period of time, the *period* of a signal is simply the amount of time required for one complete event to occur. The symbol for period is *T*, which represents time. Frequency

and period are reciprocals, so the higher the frequency, the shorter the period, and the longer the period, the lower the frequency. Frequency and period are related by these formulas:

$$T \text{ (sec)} = 1 \div f \text{ (Hz)}$$

$$f \text{ (Hz)} = 1 \div T \text{ (sec)}$$

For example, a signal with a frequency of 20 kHz has a period of 1/20,000, or 0.00005 sec. A signal with a period of 12.5 μ s has a frequency of 1/0.000125, or 80 kHz.

WHAT ARE THOSE BANDS?

A friend claims that his police-radar detector is superior to mine because his operates on the K-band, while mine operates on the X-band. What's the story on those bands? Where did they get their names, and what frequencies do they cover?—E. R., Bennettsville, SC.

During World War II, the Allies used various frequencies in the UHF and microwave bands for a variety of secret military applications. For secrecy, each band was identified by a letter. Some of those bands, and the frequencies and wavelengths associated with them, are shown in Table 1.

For years, police radar operated on the S-band. Equipment was expensive, bulky, and heavy (about 250 pounds). Usually, it was installed in a van, a truck, or a specially equipped automobile.

Later, radar was moved to the X-

TABLE 1
VHF AND MICROWAVE BANDS

Band	Frequency	Wavelength
P	225—390 MHz	133.3—76.9 cm
L	390—1500 MHz	76.9—19.3 cm
S	1.5—5.2 GHz	19.3—5.7 cm
C	3.9—6.2 GHz	7.69—4.84 cm
X	5.2—10.9 GHz	5.77—2.75 cm
K	10.9—36 GHz	2.75—0.834 cm
Q	36—46 GHz	0.834—0.652 cm
V	46—56 GHz	0.652—0.365 cm

band. The higher frequency made less expensive, more compact equipment possible. Radar units could be mounted on a tripod, or clamped to the window or rain gutter of a patrol car parked beside the road. Later X-band devices were hand-held. In either case, X-band radar had to be operated from a stationary position; it cannot be used if the operator is in motion.

The next advancement was the development of K-band equipment, which allows the operator to make speed measurements while he is either stationary or in motion. Also, it can be used to measure the speed of both oncoming vehicles and vehicles traveling in the same direction as the operator. Thus, K-band equipment has the advantages of low cost, light weight, and maximum versatility. Because of those reasons, it is used by many city, county, and state police departments. R-E

ELENCO PRODUCTS AT DISCOUNT PRICES!



DIGITAL LCR METER

Measures Inductance, Capacitance and Resistance

At Last! An LCR meter that everyone can afford. Now you can measure coils, transformers, chokes from 1 μ H to 200 H, capacitors from .1 pfd to 200 mfd and resistors from .01 ohms to 20 megohms. All in one handheld instrument.

NEW
MODEL
LC-1800
\$148

SPECIFICATIONS

Capacitors	
Range	• 200 pF, 2 nF, 20 nF, 200 nF, 2 μ F, 20 μ F, 200 μ F
Resolution	• 0.1 pF, 1 pF, 10 pF, 100 pF, 1 nF, 10 nF, 100 nF
Accuracy	• < 0.5 μ F \pm 0.2% \pm 1 digit > 0.5 μ F \pm 0.1% \pm 1 digit
Inductance	
Range	• 2 mH, 20 mH, 200 mH, 2 H, 20 H, 200 H
Resolution	• 1 μ H, 10 μ H, 100 μ H, 1 mH, 10 mH, 100 mH
Accuracy	• < 0.5 H \pm 0.2% \pm 1 digit > 0.5 H \pm 0.1% \pm 1 digit
Resistance	
Range	• 20, 200, 2 k, 20 k, 200 k, 2 M, 20 M Ω
Resolution	• 0.1, 1, 10, 100, 1 k, 10 k Ω
Accuracy	• < 1 M Ω \pm 1% \pm 1 digit

GF-8016 Function Generator with Freq. Counter



\$229

- Sine, Square, Triangle, Pulse, Ramp, 2 to 2 MHz
- Frequency 1 thru 10 MHz

GF 8015 without Freq. Meter *169

20 MHz Dual Trace Oscilloscope



\$329 Model MO-1251

- 2 Year Guarantee
- 2 Probes Included

MO-1252 35 MHz Dual Trace *550⁰⁰

AC Current Meter



\$98 Model ST-1000

- Reads 20, 200, 1000 A
- DC & AC Volts, Resistance
- 3 1/2 LCD Digits
- Deluxe Carry Case

True RMS 4 1/2 Digital Multimeter



\$135 Model M-7000

- .05% DC Accuracy
- .1% on Resistance
- 5% True RMS AC
- .5% Freq. Counter 1-200 kHz
- Deluxe Case Included

AC Current Meter



\$48 Model ST-310

- Reads 300 Amps (5 ranges)
- DC & AC Volts, Resistance
- Case & Leads Included

3 1/2 Digital Multimeter



\$25 Model M-1500

- 1% DC Accuracy
- 1% on Resistance
- 1.5% AC Accuracy
- Reads 10 DC Amps

C&S SALES, 8744 W. North Ter.
Niles, IL 60648 • (312) 459-9040



15 DAY MONEY BACK GUARANTEE

2 Year Limited Guarantee! Add 5% for Postage (*10 Max.), Ill. Res., 7% Tax

CIRCLE 265 ON FREE INFORMATION CARD

PERFORMANCE

THAT IS OUT OF THIS WORLD...



\$389⁰⁰

**MODEL 2000 20MHz
DUAL TRACE**

\$549⁰⁰

**MODEL 3500 35MHz
DUAL TRACE DELAYED SWEEP**

...AT A DOWN TO EARTH PRICE

At last! Truly affordable test equipment with no compromise in design, and features you would expect to find only on oscilloscopes costing hundreds of dollars more! JDR Instruments presents two, new, high-performance models backed by a two year warranty and technical support which is only a phone call away. Perfect for the technician or advanced hobbyist, both models feature Dual Trace capability and a variety of operating and triggering modes, including CH-B Subtract and X-Y operation.

MODEL 2000 has a 20 MHz bandwidth and 20 calibrated sweeps ranging from .2s to .2 μ s. A convenient built-in component tester provides additional diagnostic power.



CIRCLE 261 ON FREE INFORMATION CARD

MODEL 3500 features a 35 MHz bandwidth and exceptional 1mV/DIV sensitivity. Delayed sweep and variable holdoff allow stable viewing of complex waveforms.

**ORDER TOLL FREE
800-538-5000
800-662-6279 (CA)**

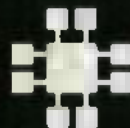

JDR INSTRUMENTS
1224 South Bascom Avenue
San Jose, California 95128 (408) 995-5430

LETTERS

WRITE TO:

LETTERS
Radio-Electronics
200 Park Ave South
New York, NY 10003

PLYWOOD SATELLITE-TV DISH

The article, "A Plywood Satellite-TV Dish," by David J. Sweetnam, which appeared in the October 1985 issue of *Radio-Electronics*, contains several serious errors that affect the design and gain computation of the lens.

The equation for the n th zone radius that is presented as $r_n^2 = nd\lambda$ should be $r_n^2 = nd\lambda + 0.25n^2\lambda^2$. In both equations, d is the focal length and λ is the wavelength. See p. 337 of *Introduction to Electricity and Optics*, by N. H. Frank (published by McGraw Hill),

for the derivation of the equation.

Rearranging things we see that $d = (r_n^2/n\lambda) - 0.25n\lambda$, rather than what was stated in the article, $d = r_n^2/(n\lambda)$. The only explanation I can think of for the difference is that an approximation was used. That approximation is valid for light—where λ is much smaller than d —but not for microwaves.

The amplitude of the signal from each zone is proportional to the zone area (which is not the same for each zone if the radii are computed properly) and inversely proportional to the square of the

distance from the zone to the focal point, or:

$$\frac{A_n}{A_1} = \left(\frac{d}{d + \frac{(2n-1)\lambda}{4}} \right)^2 \left(\frac{1 + \frac{(2n-1)\lambda}{4d}}{1 + \frac{\lambda}{4d}} \right)$$

$$= \frac{1}{\left(1 + \frac{(2n-1)\lambda}{4d} \right) \left(1 + \frac{\lambda}{4d} \right)}$$

It is not true that "gain varies without regard to the diameter of the lens." Given a wavelength and a lens diameter, there is an optimum number of zones. That number may be determined by computing the gain for an increasing number of zones.

continued on page 22

WAVETEK

Our 2 MHz Function Generator has an unlimited range.

Model 20 not only covers the .002 Hz to 2.1 MHz frequency range, it covers the world. With internal NiCad batteries,* you can take Model 20 anywhere and get triggered, gated or continuous waveforms—sines, squares, and triangles up to 20 volts peak to peak. It recharges from wall transformer (included) or external source from 12 to 25 VDC or 10 to 18 VAC. Model 20 also has many of the features you would expect from the industry leader in function generators, including VCG input connector for external sweep or FM, step attenuator to -80dB, and a TTL pulse output. The price is just \$395. For a data sheet or to order, call or write Wavetek San Diego, P.O. Box 85265, 9045 Balboa Ave., San Diego, CA 92138. Phone (619) 279-2200; TWX (910) 335-2007. *Batteries not included.



CIRCLE 267 ON FREE INFORMATION CARD

FLUKE 70 SERIES MULTIMETERS



- 77 • 0.3% Accuracy
- Manual or Autorange
- 10A + mA Range
- Beeper
- "Touch-Hold" Function

Sale.
\$129.95
 75 89.95
 73 69.95

WE CARRY A FULL LINE OF FLUKE MULTI-METERS. IN STOCK NOW

SALE ENDS Feb.28

BECKMAN'S CIRCUITMATE® ALL UNDER \$100

AVAILABLE NOW...



\$64.95

Circuitmate DM-20—3½-digit, pocket-size multimeter; 0.8% Vdc accuracy, diode test, hFE test, conductance, 10 amps AC and DC ranges, auto-polarity, auto-zero, auto-decimal



\$69.95

Circuitmate DM-40—3½-digit multimeter; 0.8% Vdc accuracy, diode test, auto-polarity, auto-zero, auto-decimal



\$79.95

Circuitmate DM-25—3½ digit, pocket-size multimeter; 0.5% Vdc accuracy, diode test, capacitance, continuity beeper, conductance, 10 amps AC and DC ranges, auto-polarity, auto-zero, auto-decimal



\$89.95

Circuitmate DM-45—3½-digit multimeter; 0.5% Vdc accuracy, diode test, continuity beeper, 10 amps AC and DC ranges, auto-zero, auto-polarity, auto-decimal

BK PRECISION DYNASCAN CORPORATION

BREAKS THE PRICE BARRIER WITH THESE HIGH PERFORMANCE OSCILLOSCOPES

100 MHz Dual Trace/
Dual Time Base

- 1 mV/div sensitivity
- 23 calibrated sweeps
- Rectangular CRT with internal graticule and scale illumination
- Signal Delay Line

\$995

Does not include probes (\$60.00 a pair when purchased with scope)

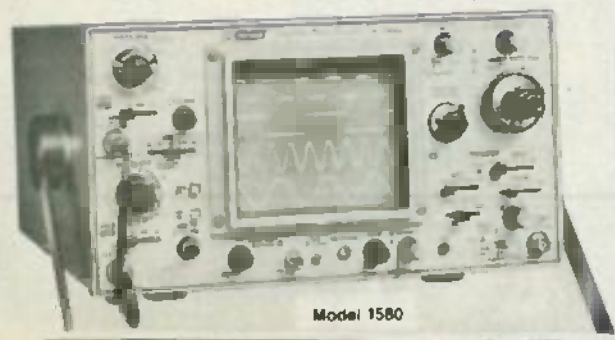

Model 1580

QUANTITIES ARE LIMITED

BK PRECISION



INDUSTRIAL TRANSISTOR TESTER

\$219.95

MODEL 520B

- Now with HI/LO Drive
- Works in-circuit when others won't
- Identifies all three transistor leads
- Random lead connection
- Audibly and visually indicates GOOD transistor

BK PRECISION

100 MHz Dual Time Base SCOPE MODEL 1590

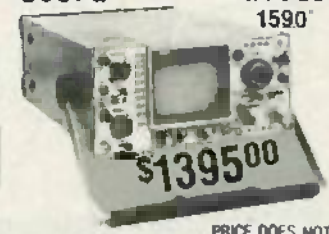

\$1395.00

PRICE DOES NOT INCLUDE PROBES

- 1mV/division sensitivity to 70 MHz
- 500 μV/division cascade sensitivity
- Four-input operation provides trigger view on 4 separate inputs
- Alternate time base operation
- Switching power supply delivers best efficiency and regulation at lowest weight



TOLL FREE HOT LINE
800-223-0474

212-730-7030

ADVANCE ELECTRONICS

26 WEST 46th STREET, NEW YORK, N.Y. 10036

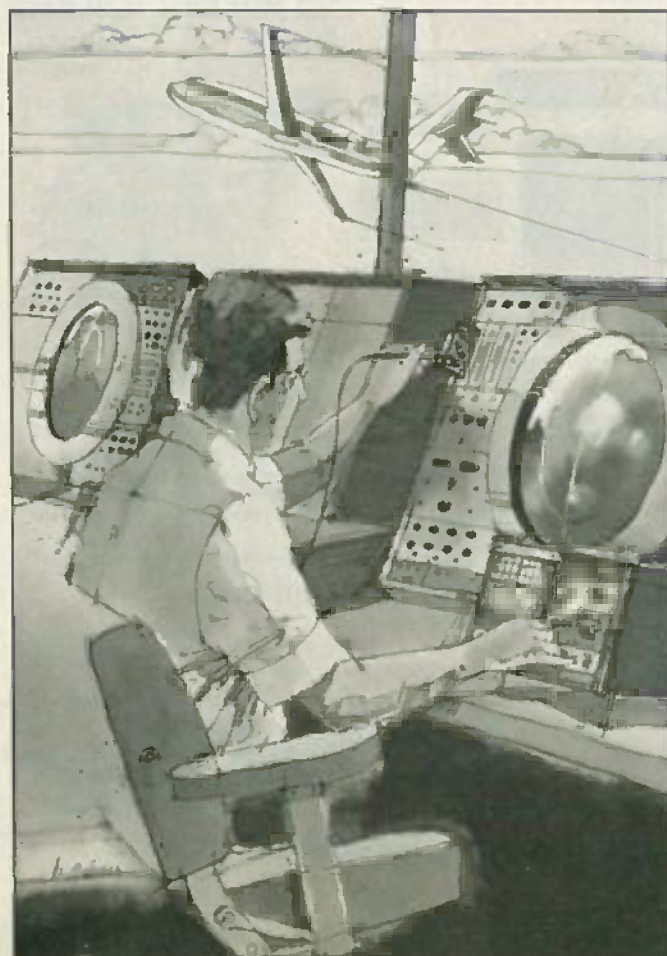
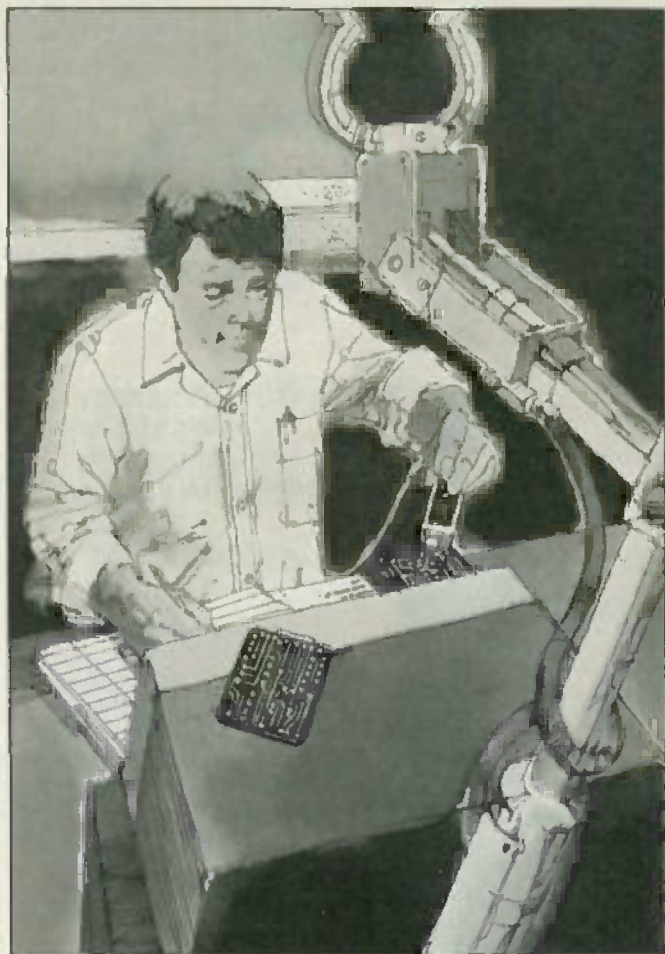

CIE MAKES THE WORLD OF ELECTRONICS YOURS.

Today's world is the world of electronics. To be part of it, you need the right kind of training, the kind you get from Cleveland Institute of Electronics, the kind that can take you to a fast growing career in business, aerospace, medicine, science, government, communications, and more.

Specialized training.

You learn best from a specialist, and that's CIE. We're the leader in teaching electronics through independent study, we teach only electronics and we've been doing it for over 50 years. You can put that experience to work for you just like more than 25,000 CIE students are currently doing all around the world.

Practical training.

You learn best with practical training, so CIE's Auto-Programmed® lessons are designed to take you step-by-step, principle-by-principle. You also get valuable hands-on experience at every stage with sophisticated electronics tools CIE-designed for teaching. Our 4K RAM Microprocessor Training Laboratory, for example, trains you to work with a broad range of computers in a way that working with a single, stock computer simply can't.

Personalized training.

You learn best with flexible training, so we let you choose from a broad range of courses. You start

with what you know, a little or a lot, and you go wherever you want, as far as you want. With CIE, you can even earn your Associate in Applied Science Degree in Electronics Engineering Technology. Of course, you set your own pace, and, if you ever have questions or problems, our instructors are only a toll-free phone call away.

The first step is yours.

To find out more, mail in the coupon below. Or, if you prefer, call toll-free 1-800-321-2155 (in Ohio, 1-800-362-2105). We'll send you a copy of CIE's school catalog and a complete package of enrollment information. For your convenience, we'll try to have a representative contact you to answer your questions.

CIE Cleveland Institute of Electronics
1776 East 17th St., Cleveland, Ohio 44114

YES! I want to get started. Send me my CIE school catalog including details about the Associate Degree program.

Print Name _____

Address _____ Apt _____

City _____ State _____ Zip _____

Age _____ Area Code/Phone No. _____ / _____

Check box for G. I. Bulletin on Educational Benefits

Veteran Active Duty **MAIL TODAY!**

OR CALL TOLL FREE

1-800-321-2155

(In Ohio, 1-800-362-2105)

RE-27

LETTERS

continued from page 16

ing number (by two) of zones until a maximum gain is achieved. The proper technique is, given the diameter, D , and the wavelength, λ , assume n zones, and then compute the focal length:

$$d = ((D/2)^2/n\lambda) - 0.25n\lambda.$$

Note that $r_n = D/2$ in the same units. Then r_i may be computed as $r_i = id\lambda + 0.25i^2\lambda^2$ for $i = 1$ to $n-1$. Gain may then be calculated as $G = 20 \log_{10} \sum A_i$ for $i = 1$ to n .

Gain calculated thus is considerably less than that claimed by the article, as is the focal length. For an 8-foot lens with $\lambda = 8.108$ cm and $n = 20$, d should be 51.12 cm and the gain should be 21.9 dB, rather than 91.83 cm and 26.0 dB.

An 8-foot lens for $\lambda = 8.108$ cm and $d = 91.83$ cm, with zones arranged as suggested in the article, will result in a gain of only 9.1 dB. The reason for that low gain is that the zones do not properly match the phase distribution of the incoming signal at the lens, relative to the focal point. The feedhorn will actually see portions of 15 zones walking progressively in and out of phase with the 20-zone lens. *If zones 7, 9, and 15 of the 20-zone lens are blocked, then the gain should actually increase to 14.6 dB.* The gain for an 8-foot parabolic dish would be about 36.9 dB.

SAM M. STRICKLAND
Bellevue, WA

BEEFED-UP BENCH SUPPLY

I read with interest Mr. Vaughn Martin's bench power-supply article in the October 1985 issue Radio-Electronics. I've been a technician for about seven years, and I would like to build such a supply for my home bench, but with the high-current option Mr. Martin mentions.

I think that, in addition to Mr. Martin's instructions for increasing power output—using a higher-current transformer and higher-current output transistors (Q1, Q3, Q5, Q7)—it might also be necessary to use lower-value, higher-power resistors for R37, R27, R9, R18.

continued on page 104



THE WIRELESS TELEPHONE TRANSMITTER model WTT-20 is only the size of a dime, yet transmits both sides of a telephone conversation with crystal clarity. Completely automatic. Uses power from the telephone line itself. Never needs a battery! Up to ¼ mile range. Use with any FM radio. Complete kit only \$29.95. Tax included. VISA and MasterCard accepted. FREE SHIPPING. DECO INDUSTRIES, Box 607, Bedford Hills, NY 10507. (914) 241-2827.

CIRCLE 127 ON FREE INFORMATION CARD



ZENITH SSAVI DESCRAMBLERS only \$169. Gated Pulse \$189; Sinewave \$199 each. Reconditioned original equipment for UHF chs. 23,27,31,38,51,54,57,68, etc. Quantity discounts. Surplus TV equipment: Oak N-12, Zenith Z-Tac, Hamlin 1200, etc. Catalog \$1. 10 day satisfaction guarantee & 90 day warranty. AIS SATELLITE, P.O. Box 1226-E, Dublin, PA, 18917. 1-800-643-2001 or 215-249-9411.

CIRCLE 268 ON FREE INFORMATION CARD

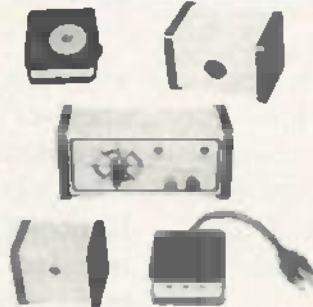

UNIQUE ELECTRONIC KITS—Kits come complete with materials required to build a professional looking product that you will be proud of. Kits also come with attractive enclosures. Some exciting kits offered are: Fiber Optics \$29.95, Touch Control and Switch \$24.95, Wireless Microphone \$19.95, Guard-All Jr. Security Alarm \$19.95, Outlet Tester \$9.95, Power Supply PS-1 \$39.95, and more. ALARMS, KITS & DEVICES, P.O. Box 200, Fredonia, PA 16124. (412) 962-9231.

CIRCLE 271 ON FREE INFORMATION CARD



TVRO RECEIVER ON A BOARD fully tested and assembled. Super reception 7db threshold! Includes weather sealed downconverter \$125.00. In cabinet \$165.00. Quantity discounts. Schematics only \$10.00. C band feeds. Yushica positively the best we've ever seen. Whatever you have, replace it. \$65.00. Private labels welcomed (50 units). 800-448-TVRO, SAUCER CITY. Office B7-B, 931 S. Ridgewood Ave., Edgewater, FL 32032.

CIRCLE 275 ON FREE INFORMATION CARD

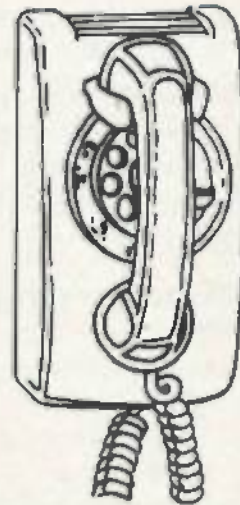

CALL NOW AND RESERVE YOUR SPACE

- 6 x rate \$745.00 per each insertion.
- Reaches 225,379 readers.
- Fast reader service cycle.
- Short lead time for the placement of ads.
- We typeset and layout the ad at no additional charge.

Call 212-777-6400 to reserve space. Ask for Arline Fishman. Limited number of pages available. Mail materials to: mini-ADS, RADIO-ELECTRONICS, 200 Park Ave. South, New York, NY 10003.

Radio-Electronics mini-ADS

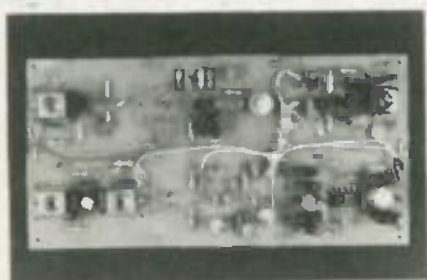

HOBBY KITS THE ERECTOR SET* of linear electronics. Modules from \$4.95 to \$49.95. Build basic circuits: 2 W audio amplifier (AFA-1, \$4.95), tone decoder (PLL-1, \$6.95), to more complex: VHF Converter (using 4 modules, \$27.80), ORP Transceiver (using 6 modules as shown, \$38.70), HF SSB Transceiver (using 14 modules, \$140.30). Add \$2.50 for S&H. SEND \$1.00 for diagrams, \$5.00 for full manual. **MORNING DISTRIBUTING CO., P.O. Box 717, Hialeah, FL 33011 (305) 884-8686.**

CIRCLE 71 ON FREE INFORMATION CARD



R&D SHEET METAL WORKER—New multi-purpose Shear, Brake and Roll now with 6" male dies, removable and removable female dies. A complete in-house shop at 1/3rd the cost. Over 20 years development/sales worldwide in industry, government and education. Free literature or \$2.00 for "Guide to Sheet Metal Working." **PACIFIC ONE CORPORATION, 513 Superior Ave., St. 52, Newport Beach, CA 92663 (714) 645-5962 Telex 4996168.**

CIRCLE 118 ON FREE INFORMATION CARD

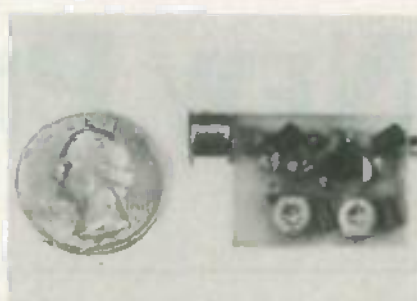

THE MOST EXCITING KIT YOU WILL EVER BUILD The model WAT-50 miniature FM transmitter uses a 4-stage circuit NOT to be confused with a simple wireless microphone. Up to 1 mile range. So sensitive, it will pick-up a whisper 50 feet away! Use with any FM radio. Complete kit only \$29.95 tax incl. VISA and MasterCard accepted. **FREE SHIPPING. DECO INDUSTRIES, Box 607, Bedford Hills, NY 10507. (914) 241-2827.**

CIRCLE 127 ON FREE INFORMATION CARD



ELECTRO IMPORTING CO. CATALOG. This reprint of the historic 176-page catalog No. 20 gives you an accurate look at the state of electronics in 1918. Contains everything from a Zinc Spark Gap to a 1000-Mile Receiving Outfit. You can get your own copy of this modern antique, profusely illustrated, for only \$4.95 plus \$1.00 P&H. Order yours from **R-E BOOKSTORE, Radio-Electronics, 200 Park Avenue South, New York, NY 10003.**

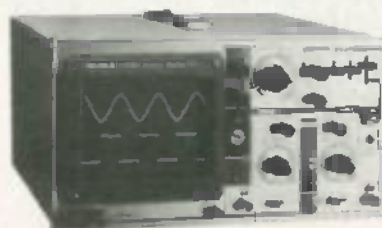

DELTA DUAL TRACE OSCILLOSCOPES WITH PROBES DX5020 20MHz \$379.95. Built in component tester 5MV to 20V DIV 0.2 microsec to 0.5s/OIV. Risetime less than 17ns one year limited warranty. Also available DX5035 35MHz \$527.00 DX5045 45MHz \$789.95 DX5015S 15MHz A C D C \$479.95. CA. residents add 6.5% tax. Shipping \$8.50. Money orders, checks accepted. **DELTA DYNAMIC INC., 20955 E. Lycoming St., Walnut, Calif. 91789. Tel. (714) 594-7131. Telex: 503749 DELTAX.**

CIRCLE 259 ON FREE INFORMATION CARD



CORDLESS TV TRANSMITTER. This unit, a miniature video transmitter, conveniently transmits UHF signals to remote television locations within a 200' range. Signal Inputs from VCR, Video Game, Satellite Receiver, Video Camera, or Micro Computer. When ordering select an open UHF channel for your area. CH 14, 19, 25, or 27. \$89.95 plus \$4.00 S&H. Visa/MasterCard call 1-800-522-2636 orders only, 617-871-5611 for information. **CAMEO ENTERPRISES, INC., P.O. BOX 63, Accord, MA 02018.**

CIRCLE 269 ON FREE INFORMATION CARD



SATELLITE TELEVISION RECEIVER SEMIKIT with dual conversion downconverter. Features infrared remote control tuning, AFC, SAW filter, RF or video output, stereo output. Polarator controls, LED channel & tuning indicators. Install six factory assembled circuit boards to complete. Semikit \$250.00. Completed downconverter add \$75. Completed receiver and downconverter add \$100. **JAMES WALTER SATELLITE RECEIVER, 2697 Nickel, San Pablo, CA 94806. Tel. 415-724-0567.**

CIRCLE 124 ON FREE INFORMATION CARD



SUBSCRIPTION TV MANUAL. This information packed book details the methods used by subscription TV companies to scramble and descramble video signals. Covers the Sinewave, Gated Pulse, SSAVI system, and the methods used by most cable companies. Includes circuit schematics, theory, and trouble shooting hints. Only \$12.95 plus \$2.00 first class P&H. **ELEPHANT ELECTRONICS INC., (formerly Random Access) Box 41770-R, Phoenix, AZ 85080**

CIRCLE 120 ON FREE INFORMATION CARD



SINGLE AND DUAL TRACE Scopes, Analog and Digital Multimeters, Power Supplies, High Voltage and Low Cap Probes, RF and Sine/Square Wave Generators, Digital Capacity Meters. Available at your local distributor **EMCO ELECTRONICS, P.O. Box 327, Plainview, NY 11803.** Send for your free catalog.

CIRCLE 279 ON FREE INFORMATION CARD

NEW PRODUCTS



CIRCLE 21 ON FREE INFORMATION CARD

EARTH-STATION RECEIVERS are available in single (model *ESR 424*, shown in photo) or block (model *ESR 424B*) conversion models.

The model *ESR 424* has infrared remote control for the convenience of armchair viewing, and also offers audio-seek tuning (to locate favorite audio channels automatically), easy-to-read fluorescent display, and a redesigned weatherproof downconverter. It also provides descrambler compatibility through a bottom-panel,

clamped/unclamped video switch. The model *ESR 424* is priced at \$699.00.

The model *ESR 424B* adds multi-channel capability to the model *ESR 424* package. Using a 950-1450 MHz IF output frequency, the block-conversion model features dual input switching to eliminate the need for external relays or switching splitters. It is priced at \$759.00.—**R. L. Drake Company**, PO Box 112, Miamisburg, OH 45342.

SURFACE-MOUNT TEST CLIP is 20-conductor size, with a new design that enables all four sides of the clip to open simultaneously. Its narrow body design allows components to be tested with as little as .100" lead-to-lead spacing. It is side-stackable at .200" lead-to-lead spacing. The clip has a helical compression spring and insulating contact combs, which ensure contact integrity when testing. The probe access points are immediately visible for fast and safe indi-

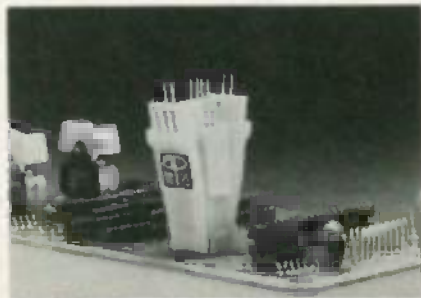

CIRCLE 22 ON FREE INFORMATION CARD

vidual testing. In addition, staggered contact rows on .100"

centers permit easy probe attachment and help prevent accidental shorting of adjacent probes.

The test clip is available in alloy—part number 923670-20, with a suggested retail price of \$19.95, and in gold—part number 923675-20, with a suggested retail price of \$25.90.—**AP Products, Incorporated**, 9325 Progress Parkway, PO Box 540, Mentor, OH 44060.

POWER SUPPLIES, the *XT Series*, are 60-watt linear power supplies, offering six voltage and current ranges in single, dual, triple, and quad configurations. The DC supply series is designed for laboratory, university, service, and other benchtop operations; they may also be used in control systems and ATE applications.

Voltage and current may be displayed simultaneously on front-panel LED readouts. Analog LED



CIRCLE 23 ON FREE INFORMATION CARD

bar-graph displays are also used for easy monitoring of transient changes under varying loads. Other controls include a ten-turn potentiometer for precise setting of output voltage, and a constant-current/current-limiting control that is adjustable from zero to rated output. Output connections are provided by five-way binding posts for dual-banana plugs, with or without safety ground.

The *XT Series* has automatic crossover from current to voltage mode when current exceeds the preset limit. Crossover is identi-

Electricity and water don't mix. At least not in our Heavy Duty Digital Multimeters. Because these Oops Proof™ instruments are protected by a system of seals to ensure contamination-free dependability in even the cruddiest conditions.

Other abuse-proof features include the best mechanical protection ever built into a precision Digital Multimeter. In fact, every one of our Oops Proof multimeters will survive a drop from ten feet onto a concrete surface!

All the Heavy Duty series meters measure up to 1000 volts AC and 1500 volts DC, with full overload protection to those maximum voltages even on the lowest range settings. Overload circuitry also provides transient protection to 6KV on all voltage ranges and up to 600 volts on all resistance ranges.

We also invented a unique, long-life rotary switch for our Digital Multimeters. You can actually feel the difference just by

rotating the function selector knob.

You'll find these features in a full line of Heavy Duty DMMs that offer a 4½ digit readout, 0.05% VDC accuracy, a 10-amp current range, a 2000-hour battery life, diode test, true RMS and temperature measurement. All this and a no-questions, one-year warranty.

You'll want to try one out, of course, so drop into your nearest electronics distributor and drop one.

Our lips are sealed.

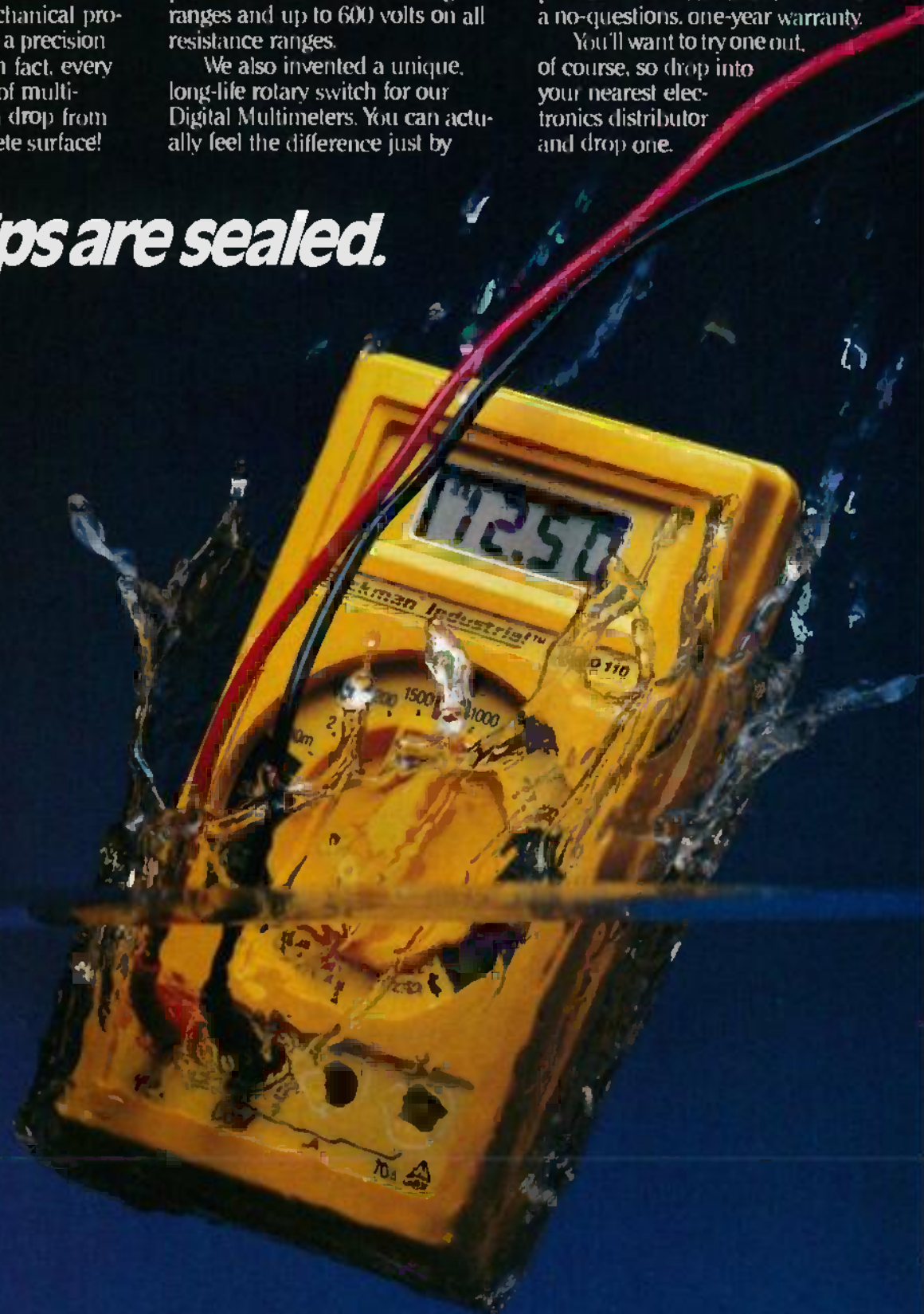

© 1985 Beckman Industrial Corporation, A Subsidiary of Emerson Electric Company,
630 Puente Street, Brea, CA 92621 (714) 671-4800.

Beckman Industrial™

CIRCLE 98 ON FREE INFORMATION CARD

fied by LED indicators and optional audio tone Indicator.

The *XT Series* is priced as follows:

The single-output model *XTS* is priced at \$450.00.

The dual output model *XTD* is priced at \$800.00.

The triple output model *XTT* is priced at \$1175.00.

The quad output model *XTQ* is priced at \$1575.00.—Sorensen Company, 676 Island Pond Road, Manchester, NH 03103.

SCANNER PLUS, the model *Z60*, is not only a sophisticated scanner radio, but a digital alarm clock as well. The scanner monitors 60 channels and 7 public-service bands (including VHF-Aircraft), plus the standard FM broadcast band. When the alarm is activated, listeners can wake up to their favorite FM music program, and then switch to police or fire calls, aircraft communications, amateur radio transmissions, and up-to-the-minute broadcasts from the National Weather Service.

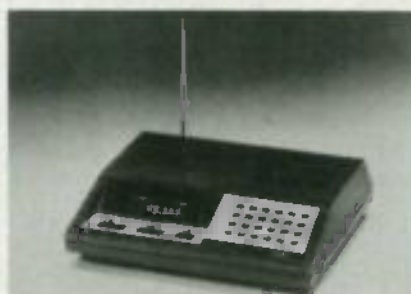

CIRCLE 24 ON FREE INFORMATION CARD

The model *Z60* has a suggested retail price of \$379.95.—Regency Electronics, Inc., 7707 Records Street, Indianapolis, IN 46226.

CAR SPEAKER SYSTEMS, are designed for easy installation by a professional installer or a do-it-



CIRCLE 25 ON FREE INFORMATION CARD

yourself. The *Bass Tank* systems are available in four configurations, variously consisting of a pair of full-range, two-way 6- x 9" CS-18A speakers, or a pair of low-profile, two-way CS-17 speakers in combination with either a 10" CSW-20 or a 12" CSW-21 subwoofer. All systems come complete with crossover filter, mounting hardware, and installation instructions. The sound system features full bass, wide dynamic range, low distortion, and high power-handling capability.

Prices are as follows:

The model *BT 1821: CS-18A* with crossover and 12" subwoofer is priced at \$319.00.

The model *BT 1820: CS-18A* with crossover and 10" subwoofer is priced at \$309.00.

The model *BT 1721: CS-17* with crossover and 12" subwoofer is priced at \$279.00.

The model *BT 1720: CS-17* with crossover and 10" subwoofer is priced at \$269.00.—Cerwin-Vega, 12250 Montague Street, Arletta, CA 91331. R-E

Call us FREE 1-800-626-6343
or write for FREE Flyer.

COPPER ELECTRONICS

4200 PRODUCE ROAD - LOUISVILLE, KENTUCKY 40218

WIRELESS VIDEO

Model J2700 wireless video transmission system that accepts all standard video signals from your VCR, video camera or satellite receiver and converts them to the VHF television band channel 3-6 for wireless relay to the other television in your home.

Retail \$119.95 **59.95**

WESTPORT WCB40

40 CHANNEL CB TRANSCEIVER

Retail \$89.95 **29.95**

AV-261 Permanent Mount
• 1/2" hole mount
26.95

AV-261M Magnet Mount
29.95

AV-261T No-Hole Trunk Mount
26.95

BEARCAT 2020

Retail \$299.95 **\$199.95**

Aircraft, marine and public service—all within pushbutton reach.

uniden Bearcat 300

Retail \$399.95 **269.95**

Limited Quantities

THE LOWEST PRICES IN THE COUNTRY

We have a national factory warranty service on many brands, and we service All CB, Amateur, and Commercial Equipment.

CIRCLE 277 ON FREE INFORMATION CARD

PRINT

Products International Inc.

8928 B. Oakville Road • Silver Spring, Maryland 20910

800-638-2020

Call Our Toll Free Number

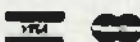

In Maryland Call 301-587-7824

FREE CATALOG

Equipment, Tools & Supplies for Electronic Maintenance & Service.

- Pace Desoldering and Printed Circuit Board Repair Products
- 3M Static Control Products, Work Stations, Shipping Bags
- Huntron Test Instruments
- Lindstrom Hand Tools
- Print Tool Cases
- Cooper Tool Group, Weller, Crescent, Acabit
- Brand Name Tools and Supplies for Repairers in the Field or Shop



HUNTRON INSTRUMENTS

The Art of Trouble Shooting



TRACKER AND SWITCHER

CIRCLE 275 ON FREE INFORMATION CARD



PEAK PERFORMERS!

New Test Instruments from O.K. Industries

- Sweep, Function and Pulse Generators
- Digital Frequency and Universal Counters
- Unique Portable, Battery Operated Miniscope
 - Bench/Portable Digital Multimeters
 - Hand-held Digital Thermometers
- Full Range of Specialized Accessories

Put Them To The Test !



AFFORDABLE EXCELLENCE

OK
Industries
Inc.



3455 Conner Street Bronx, New York, 10475, U.S.A.
Telex 125091 OK NYK Telex 232395 OK NY UR
Phone (212) 998-6600
Fax (212) 994-4786

CIRCLE 274 ON FREE INFORMATION CARD

EQUIPMENT REPORTS

Tektronix 318 16-channel Logic Analyzer

High-powered digital
debugging

CIRCLE 5 ON FREE INFORMATION CARD



EXTREMELY DIFFICULT PROBLEMS CAN crop up when designing and prototyping custom microprocessor

systems. That sort of problem can easily cause you to question whether hardware or software is to

blame. And in many cases, the problem simply can't be tracked down with the usual tools—LED logic probes, single- or dual-channel oscilloscopes, software debuggers, etc. So what do you do when you can't blame either the hardware or the software? Do what professionals do: Use a logic analyzer like Tektronix' model 318 to stamp out those bugs.

Overall specifications

The 318 has a 16-bit parallel data input and a maximum clocking speed of 50 MHz. A serial data-analysis unit is optional; we used it

XMAS SPECIALS!

Jerrold Cordless Cable T.V. Converter (58 CHANNELS)

MODEL LCC-58



SPECIAL!

\$69.95
ANY QUANTITY

TEKNIKA WIRELESS REMOTE CONTROL TV TUNER CABLE CONVERTER

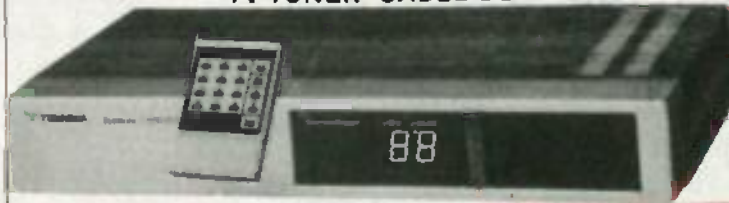

SPECIAL! MODEL-6510
WITH VOLUME CONTROL
140 CHANNEL
\$139.95

RG-59U 75 OHM
Co-Axial Cable
Copper Braided
Shield
White or Black
\$44.99/1000 ft.

CONNECTORS		MATCHING TRANSFORMER	2 WAY-75OHM I/I/V SPLITTER
F-59 separated ferrule 6¢/1000 LOT 11¢/100 LOT	F-59ALM with attached 1/8" grip ring 7¢/1000 LOT 12¢/100 LOT	21¢/1000 LOT	49¢/100 LOT 89¢/50 LOT 99¢/EA.

F-56 AVAILABLE UPON REQUEST

OMNITRON

ELECTRONICS
770 Amsterdam Ave., New York, NY 10025

Write for FREE 136 page Catalog

SHIPPING CHARGES

For Orders	ADD
\$25-100	\$6.50
\$100-\$500	\$8.50
\$500-\$750	\$10.50
\$750 and up	\$15.00

MASTERCARD • VISA

Send Purchase Order, Check, Money Order or C.O.D.

or Call Toll Free

800-223-0826

In N.Y. State (212) 865-5580

CIRCLE 280 ON FREE INFORMATION CARD

RAG

ELECTRONICS, INC.

New and Used Electronic Test Equipment
Sales • Service • Rental • Leasing

LOGICAL

SHOOTER LOW-COST EPROM BLASTER



- ◆ Ideal for Hobbyists or Light Usage
- ◆ 128K RAM Buffer
- ◆ Build-In RS-232 Port
- ◆ Completely Assembled & Tested
- ◆ Programs 2716 through 27256
- ◆ Fast Intelligent Algorithm
- ◆ Works with Any Computer or Dumb Terminal
- ◆ Stand-Alone Mode. Copies and Verifies
- ◆ Upload/Download in Intel/Motorola/Binary Formats
- ◆ 90 Day Warranty Parts & Labor

\$395.00



INDUSTRIAL MODEL WITH TIMER MODEL T8/2T

\$97.50

- ◆ Erases 15 EPROMs in 20-30 Minutes
- ◆ Rugged 60 Minute Auto Shut-Off Timer and Safety Interlock
- ◆ 5" x 8" Tray with Indicator
- ◆ Conductive Pad
- ◆ Attractive Steel Enclosure

MODEL T8/1

\$49.95

This is a Low Cost Unit Designed in a Two Part Plastic Case. This unit erases as many as 8 EPROMs in 15-20 minutes.

LEADER

PORTABLE OSCILLOSCOPE

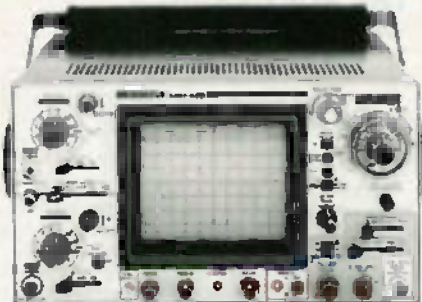

LBO 524L DC to 40 MHz

The LBO-524L is designed to meet a broad range of applications in design, testing and servicing of both analog and digital circuits and equipment. Its large 8x10 cm PDA CRT provides sharp, bright displays even at highest sweep rates. Comprehensive triggering controls including holdoff, alternate triggering and delayed sweep triggered functions permit stable displays for even the most complex signals. With 0.5 millivolt sensitivity, extremely low-level signals can easily be observed. A channel 1 output is available on the rear panel to drive other less sensitive instruments such as a frequency counter with an input level as low as 500 microvolts. The dual time base permits accurate observation and time interval measurements of complex waveforms. Includes probes and 2 year warranty.

\$749.00 Plus free Hitachi DMM. See page 5.

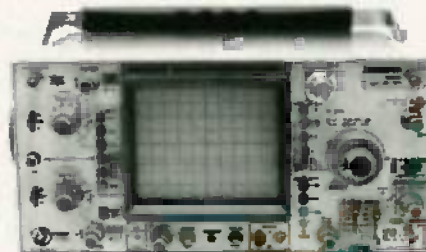

LBO-516 DC to 100 MHz

The LBO-516 is an economical 100-MHz, 3-channel, alternate time base oscilloscope. It has all of the important features that are expected in a 100-MHz oscilloscope such as full front panel operation, alternate triggering for simultaneous view of asynchronous signals and independent or simultaneous display of main and delayed time bases. The bright 20-kV PDA CRT and 0.5mV sensitivity permit sharp, bright displays of even those normally tough to see critical signals. Eight trace capability is possible by displaying main and delayed versions of CH-1, CH-2, CH-3, and CH-1+CH-2. Also included are comprehensive triggering facilities with video sync separators, variable trigger holdoff, excellent trigger sensitivity and more. Includes probes and 2 year warranty.

\$1195.00 Plus free Hitachi DMM. See page 5.



BK PRECISION

FUNCTION GENERATOR

MODEL 3010

\$189.00

- ◆ Sine, square and triangle output
- ◆ Variable and fixed TTL outputs
- ◆ 0.1 Hz to 1 MHz in six ranges
- ◆ Typical distortion under 0.5% from 1 Hz to 100 kHz
- ◆ Variable DC offset
- ◆ VCO Input for sweep tests



ESCORT

3 1/2-Digit Capacitance Meter
Range: 200PF - 20mF

MODEL EOC110A

\$89.00

Accuracy:
20PF-20uF ±(0.5%rdg+1 dgt+0.5PF)
200uF ±(1.0%rdg+1 dgt)
2000uF-20mF ±(2.0% rdg+ 1 dgt)



LICATEK 30 VDC POWER SUPPLY

\$135.00

MODEL 30-3/0-30 VDC/0-3A

NOW OPEN! Saturday, 9:00 a.m.-3:00 p.m.
Monday - Friday, 6:30 a.m.-5:30 p.m.
CIRCLE 255 ON FREE INFORMATION CARD

CALL US TOLL FREE
1-800-732-3457
IN CALIFORNIA TOLL FREE
1-800-272-4225

- ◆ Master Charge
- ◆ VISA
- ◆ COD
- ◆ Money Order
- ◆ Check



ADD FOR SHIPPING AND INSURANCE	
\$0 to \$250.00	\$4.50
\$251.00 to \$500.00	\$6.50
\$501.00 to \$750.00	\$8.50
\$751.00 to \$1000.00	\$12.50
over \$1000.00	\$15.00

Prices subject to change without notice.

RAG ELECTRONICS, INC. / 21418 Parthenia Street/Canoga Park, CA 91304 / 1-818-998-6500

HITACHI 3.5 Digit DMM **FREE** with any Scope purchased from RAG. See page 5 for details.

HITACHI CCTV Cameras & Monitors



MODEL KP-120

Meet the new generation of TV cameras that brim with useful features, thanks to the MOS solid-state imaging devices.

- Compact size and light weight
- Long life and high reliability
- Extreme low-light handling capabilities
- No geometric distortion
- Reduced lag and no sticking
- Excellent immunity to vibration and shock
- No effects of magnetic fields
- Sensitive to near-infrared
- C mount

MODEL KP-120 Camera Head
Lenses available

\$775.00



MODEL HV-720

- Owing to the use of an automatic sensitivity adjusting circuit, the only necessary camera operation is focusing
- A white suppressor circuit ensures faithful reproduction on the video monitor, even for subjects with strong contrast.
- Camera mounting screws are provided at the top and bottom of the camera, facilitating mounting of the camera.
- Switchover to external synchronization takes place automatically when an external drive signal is input, hence no switch operation is necessary.
- Synchronizing System: Line-lock 2:1 interlace.
- Pick-up tube: Vidicon tube.
- Includes 16mm f1.6 lens

MODEL HV-720 \$144.00
***MODEL HV-730 \$199.00**

B&W MONITORS

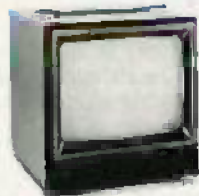

VM-900A	9"/500 line/video loop	\$126.00
VM-910	9"/500 line/video loop/ DC restoration/rack mountable	\$164.00
VM-906	9"/700 line/video loop/ DC restoration/rack mountable	\$210.00
VM-129	12"/700 line/video loop/ DC restoration	\$276.00
VM-173	17"/700 line/video loop/ DC restoration	\$312.00

SOLDERING STATION



SA-3-115 \$84.00

Special lip-mounted sensor and sophisticated control circuitry. Temperature stability within 5% over the range of 100°C to 500°C (200°F to 930°F). For 115 VAC, 50/60 Hz operation; 230 VAC model also available. Lighted power and heater indicators, proportional temperature control and temperature indication meter, iron holder and tip cleaning sponge standard. Rugged, compact enclosure. Supplied with special 24 volt, 48 watt, low-leakage iron and SAT-3-01 (1/32 inch) conical tip.



MULTI-FUNCTION COUNTER



MODEL WD-755 \$248.00

- 5 Hz to 125 MHz
- 6 Digit LED Display
- Period Measurement 5 Hz to 2 MHz
- Totalizes to 99,999,999 Plus Overflow
- Frequency Ratio Mode
- Time Interval Mode
- Switchable Attenuator & Low Pass Filter.

POWER SUPPLY SALE



- Automatic short circuit shutdown
- Ripple 5mV P-P
- 0.075% regulation
- Digital meters V&A
- Measure external 0-99.9 VDC
- Isolated supplies

WP-705A single 0-50VDC, 0-2A
 WP-706A single 0-25VDC, 0-4A
 WP-707A dual 0-25VDC, 0-2A
 WP-708A triple 2 each 0-20VDC, 0-2A and 5V, 4A
 WP-709A single 3.5-6.5VDC or 11.5-14.5VDC, 0-7.5A

WP-705A \$309.00
WP-706A \$318.00
WP-707A \$369.00
WP-708A \$453.00
WP-709A \$326.00



TRIPLE OUTPUT POWER SUPPLY

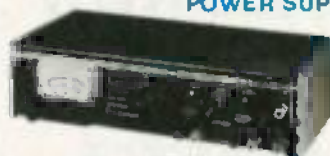

MODEL 1650 \$319.00

- Functions as three separate supplies
- Exclusive tracking circuit
- Fixed output 5 VDC, 5A
- Two 0 to 25 VDC outputs at 0.5A
- Fully automatic, current-limited overload protection
- + and - terminals of each output are fully isolated, in all modes
- All three outputs may be connected in series or parallel for higher voltage or current

CIRCLE 255 ON FREE INFORMATION CARD

R-E Books Admart

Rates: Ads are 2 1/4" x 2 1/4". One insertion \$825. Six insertions \$800. Twelve insertions \$775. each. Closing date same as regular rate card. Send order with remittance to Books Admart, Radio Electronics Magazine, 200 Park Avenue South, New York, New York 10003. Direct telephone inquiries to Arline Fishman, area code-212-777-6400. Only 100% Book ads are accepted for this Admart.

CONFIDENTIAL FREQUENCY LIST, 6th Edition

Latest available information on the most interesting communications stations operating on the short-wave bands. Includes SLB's, Phonetic Alphabet Stations, Numbers Stations, Military, Police, FBI, Government Agencies and more. 304 pages, 6 x 9 inches. Get your own copy for \$13.95 plus \$1 postage in USA. **ELECTRONIC TECHNOLOGY TODAY INC., PO Box 240, Massapequa Park NY 11762-0240.**



CIRCLE 284 ON FREE INFORMATION CARD

IC PROJECTS FOR BEGINNERS



Soft cover; variety of projects built around IC's covering radio and audio projects such as a solar radio and a miniature receiver, plus an audio generator, interval timer, mixer amplifier and more. \$5.00 plus \$1 postage in USA. **ELECTRONIC TECHNOLOGY TODAY INC., PO Box 240, Massapequa Park, NY 11762-0240.**

CIRCLE 284 ON FREE INFORMATION CARD

32 ELECTRONIC POWER SUPPLY PROJECTS

Soft cover; 291 pages of practical DC circuit applications for a wide variety of hobby and experimental purposes! Circuits range from the very simple (like a half-wave supply) to more advanced units (like a 12-volt inverter). \$10.95 plus \$1 postage in USA. **ELECTRONIC TECHNOLOGY TODAY INC., PO Box 240, Massapequa Park, NY 11762-0240.**



CIRCLE 284 ON FREE INFORMATION CARD

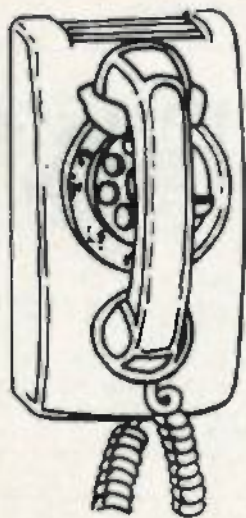

CALL NOW AND RESERVE YOUR SPACE

- 6 x rate \$800.00 per each insertion.
- Reaches 225,379 readers.
- Fast reader service cycle.
- Short lead time for the placement of ads.

Call 212-777-6400 to reserve space. Ask for Arline Fishman. Limited number of pages available. Mail materials to: Books Admart, RADIO-ELECTRONICS, 200 Park Ave. South, New York, NY 10003.

LINEAR IC EQUIVALENTS & PIN CONNECTIONS



Shows equivalents & pin connections of a popular user-oriented selection of European, American and Japanese linear IC's. 320 pages, 8 x 10 inches. \$13.50 postpaid in USA. **ELECTRONIC TECHNOLOGY TODAY INC., PO Box 240, Massapequa Park, New York 11762-0240.**

CIRCLE 284 ON FREE INFORMATION CARD

WHITE'S RADIO LOG



An up-to-date directory of North American AM, FM and TV stations including special section on world-wide shortwave stations. 136 pages, 5 1/2 x 7 1/2 inches, soft cover. \$4.95 plus \$1 postage in USA. **ELECTRONIC TECHNOLOGY TODAY INC., PO Box 240, Massapequa Park, NY 11762-0240.**

CIRCLE 284 ON FREE INFORMATION CARD

DIGITAL IC EQUIVALENTS & PIN CONNECTIONS



Shows equivalents & pin connections of a popular user-oriented selection of European, American and Japanese digital IC's. 256 pages, 8 x 10 inches. \$13.50 postpaid in USA. **ELECTRONIC TECHNOLOGY TODAY INC., PO Box 240, Massapequa Park, New York 11762-0240.**

CIRCLE 284 ON FREE INFORMATION CARD

103 PROJECTS FOR ELECTRONICS EXPERIMENTERS



Soft cover; 308 pages of practical, proven plans for the electronics hobbyist...circuits, converters, amplifiers, synthesizers, optoelectronics, power supplies and more. Written and designed by Forrest M. Mims, III. \$11.50 plus \$1 postage in USA. **ELECTRONIC TECHNOLOGY TODAY INC., PO Box 240, Massapequa Park, NY 11762-0240.**

CIRCLE 284 ON FREE INFORMATION CARD

for most of our tests. All operations are initiated through a 31-key keypad; all data is displayed on a small CRT that measures about 2¼" by 2⅞". The logic analyzer weighs about 11 pounds and measures about 4 × 7.5 × 15 inches. A small leatherette pouch attached to the lid of the machine stores the AC power cord, probes, etc. A snap-on plastic cover protects the unit when it is in transit; the carrying handle rotates smoothly throughout 360 degrees to prop the 318 to a comfortable viewing angle.

On the left side of the instrument (as you face it) are jacks for serial input: a 25-pin "D" connector (DB-25), and a BNC jack to which a low-capacitance oscilloscope-type probe may be connected. A BNC-type composite video jack is also located on the left side. On the right side is space for up to four parallel-input connectors (sub-miniature "D" type), a BNC jack for an external-clock input, and four pin jacks for external trigger input and output, a start output, and ground. The right side of the case also provides access to several important points in the 318's circuit that are used for diagnosing problems with the unit, should they arise.

On power-up, the 318 goes through a series of self tests. The power-up sequence takes only about five seconds, after which the machine is ready ready for use. All operations are accessible through a set of menus (*Setup*, *Threshold*, and *Trigger*); four cursor-control keys, a *select* key, and an *execute* key help you choose the desired item.

The menu displays

Pressing the *setup* key allows you to set the overall operating mode of the 318: serial vs. parallel, local (keyboard) vs. remote operation, etc. If you select the parallel mode, a new menu appears that allows you to set the acquisition mode (see below), and to assign specific data bits to specific display channels. That allows you, for example, to hook your connectors up in just about any convenient manner. You can then let the logic analyzer group data lines, address lines, and control lines together in

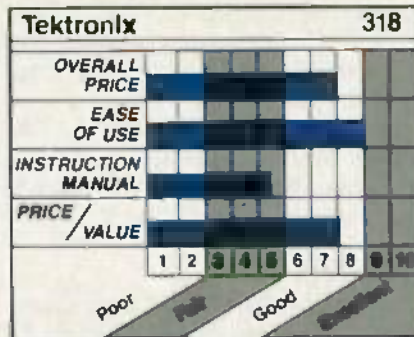

a comprehensible display. In the parallel mode, the 318 has a data memory of 256 bits for each of the 16 input channels; in the serial mode, up to 256 bytes can be stored.

If you select the serial mode from the *setup* menu, a new menu appears that allows you to select the communications parameters (baud rate, sync/async, parity, etc.) and the acquisition mode. In addition, you can set the 318 up to acquire data until a portion of the most recently received data matches—or doesn't match—a designated portion of the 318's optional battery-powered reference memory.

The *Threshold* menu allows you set the voltages the 318 uses to distinguish between different logic states. You can pick standard TTL levels, or any values from -10 to +10 volts, in 0.1-volt increments, to represent the "high" and "low" values used by your system.

The *Trigger* menu allows you to set the event around which the data display centers. In the serial mode, data acquisition can be initiated by an external trigger signal, by receipt of a one- or two-byte data sequence, or either. The trigger byte(s) may be specified in binary, octal, decimal, or hexadecimal. Any bit or digit may be a "don't-care" value. For example, in hex mode, a trigger-byte specification of "FX" would cause any received byte that has a leading digit of "F" to generate a trigger.

The *trigger position* field of this menu allows you to choose seeing the data that precedes the trigger byte, data that follows it, both, or data that follows the trigger, but that is delayed by any number of bytes you specify (up to 65,000).

In the parallel mode, three trigger words are available that may be

NOW, a mini-scope with the features most wanted by field engineers!



B&K-PRECISION MODEL 1420 \$825

This 15MHz dual-trace mini-scope was designed by B&K-PRECISION engineers to respond to the special needs of field engineers... a mini-scope with lab-scope features.

It easily fits into a standard attache case with plenty of storage room for a DMM, tools and accessories. The 1420 can be powered from the AC line, 10-16VDC or an optional internal battery pack.

The rugged 1420 features dual-trace operation and an honest 15MHz response, with useful response beyond 20MHz. An efficient rectangular CRT displays waveforms with good readability under all field service conditions.

There is no sacrifice of features or performance for compact size. The 1420 has 18 sweep ranges from 1 μS/div. to 0.5S/div. in a 1-2-5 sequence; variable between ranges. Sweep magnification is X10, extending the maximum sweep rate to 100nS/div. For use with computer terminals or video circuits, a video sync separator is built in. Automatic selection of chop and alternate sweep modes is provided, as is front-panel X-Y operation.

The Model 1420 measures only 4.5 X 8.5 X 12", weighs 7.75 lbs., with batteries and comes with two 10:1 probes.

For Complete Specifications contact your local distributor or call B&K-PRECISION.

B&K PRECISION

DYNASCAN CORPORATION

6460 West Cortland Street
Chicago, Illinois 60635 • 312/889-9087
International Sales: 6460 W. Cortland St., Chicago, IL 60635
Canadian Sales: Atlas Electronics, Ontario
South and Central American Sales:
Empire Exports, Plainville, NY 11803

CIRCLE 77 ON FREE INFORMATION CARD

FEBRUARY 1986

33

Saratoga Electronics



ORDER TOLL FREE

800-621-0854

ext.245

DYNAMIC RAMS

4164 - 150NS	\$1.00
41256 - 150NS	\$2.45

EPROMS

2716 - 450NS	\$1.95
2732A - 450NS	\$2.25
2764 - 450NS	\$2.50
2764 - 250NS	\$2.00
27256 - 300NS	\$5.95

PC/AT COMPATIBLE SYSTEM BOARD

- * 1 Megabyte Installed
- * Dual Speed Selectable at 6 or 8 MHZ
- * Compatible "AT" System Bios
- * 8-Slot Expansion Capability
- * Complete & Tested w/90 - Day Warranty

\$895

PC/XT COMPATIBLE SYSTEM BOARD

- * 64K Installed - Expandable to 640 KB
- * 4.77 MHZ Speed
- * Compatible "XT" System Bios
- * 8 - Slot (Full) Expansion Capability
- * Complete & Tested w/ 90 - Day Warranty

\$200

\$25 MINIMUM ORDER

12380 SARATOGA - SUNNYVALE ROAD
SARATOGA, CA 95070

(408) 448 - 4949



combined in various ways to trigger data capture. For example, you can specify that a first trigger word must be followed by either a second or a third trigger word. The 318 allows other triggering options in the parallel mode, but we haven't the space to discuss them.

Data display

After operating parameters have been set using the three menus, it's time to press the *data* key. That brings up one of several display screens, depending on the mode. In the serial mode, all data in the 256-byte buffer can be displayed at one time in the character menu display as ASCII (or EBCDIC) characters, or, in the state table display, each location in memory is displayed on a separate line. Each line contains the memory location, the hex (or octal or decimal) value, the binary value, and the ASCII (or EBCDIC) value of that location.

The cursor-control keys allow you to scroll through memory; alternatively, you can enter the location you'd like to view via the data-entry keys in the keypad. You can change some of the communication parameters at the display screens without returning to the *setup* menu. You can flip between the two display screens at will; indeed you can go to most menus at any time to change operating parameters.

To initiate data-capture, the *start* button is pressed, or an external trigger is applied. The message "WAITING TRIG" appears in the lower right corner of the screen; when the trigger-word condition is satisfied, or when you press the *stop* key, an appropriate message is displayed, and you are free to examine the contents of memory. The 318 provides *compare* and *search* functions to aid in that process. The *compare* function compares the current data to a reference memory. A separate function is provided from the *setup* menu that allows you to transfer the contents of the data memory to the reference memory.

You could use the *search* function to search for the "FX" byte (or any other, of course) mentioned above. The 318 locates all matches, highlights them on the

screen, and displays the total number of matches. You can move through memory, using the cursor keys, or you can jump from match to match.

In the parallel mode, a state table that lists received data in the desired number base (2, 8, 10, or 16), and a timing diagram are available. The state table is similar to the serial mode state table, except that no ASCII values are displayed. The timing diagram can display glitches (which are captured whether or not they are displayed), and a portion of the display can be magnified for greater viewing accuracy. *Search* and *compare* functions are also available in the parallel mode.

Conclusions

After you become familiar with the 318, operation is fairly intuitive. The problem is in getting familiar. The operator's manual that is supplied appears to be little more than a polished-up version of the engineering specifications. It contains most of the information you need to know, but the manual's organization is atrocious. Tektronix should have supplied a tutorial introduction for such a complicated machine. However, people who have worked with other brands of logic analyzers shouldn't have much trouble applying their prior experience.

The only other thing we would criticize is the small size of the display screen. Even those with good eyesight reported difficulty reading the screen from a distance greater than about one foot. Evidently, Tektronix was aware of that problem, as they included a composite-video output jack. But it's inconvenient to use a separate monitor; we think the 318 would benefit from a 5" CRT.

As you can see, the 318 logic analyzer has quite a few powerful features—and we've only scratched the surface. Other than the few inconveniences we've mentioned, the 318 should make a useful addition to the professional test bench. The 318 lists for \$5300. The model 338 is similar to the 318, but it has a 32-bit data path, and a 20-MHz maximum clock rate. It lists for \$5800.

R-E

continued on page 40

Build Circuits Faster and Easier With Our \$20 Solderless Breadboard



...and do even
more with our
\$40 breadboard

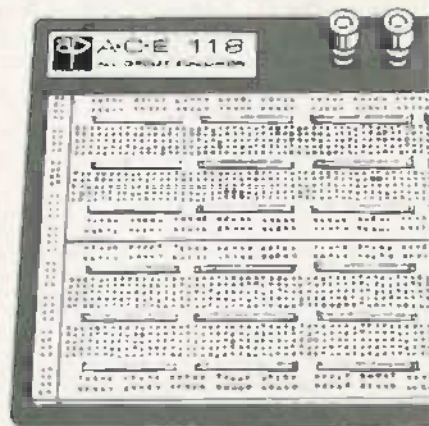

Introducing the plug-in world of AP Product's versatile, low cost breadboards.

Now you can design, build and test prototype circuits just like the professionals...and make changes in seconds. No messy soldering or desoldering. No more twisted leads or damaged devices.

With our ACE 109 and 118 blue breadboards, you simply plug in components and interconnect them with ordinary hook-up wire. All sizes of DIPs and other discrete components up to 22 gauge lead diameters snap right into the 0.1" x 0.1" matrix of the solderless tie points...anywhere on the layout. You don't need expensive sockets or special tools. Buses of spring clip terminals form a distribution network for power, ground and clock lines.

AP Products 100 series breadboards give you all the functions and flexibility of more expensive circuit evaluators. The spring terminals have mechanically independent contact fingers to

accommodate most DIPs and discrete components.

The ACE 109 has two terminals for separate voltages plus a ground connection. The larger ACE 118 offers the same three terminals, plus an additional terminal which can be used for clocking or another voltage. The back-plates are heavy steel to keep the boards stationary.

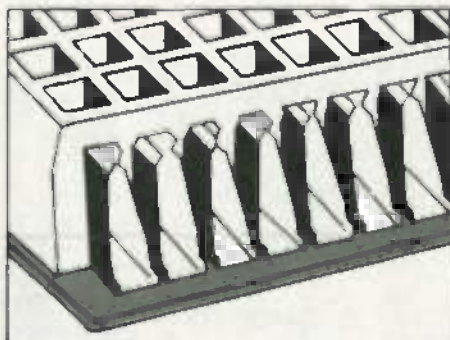

Don't wait. These low prices won't last forever. See your local AP Products dealer today, or send for a list of dealers in your area.

CIRCLE 76 ON FREE INFORMATION CARD



**A P PRODUCTS
INCORPORATED**

9325 Progress Parkway
P.O. Box 540
Mentor, Ohio 44060
800-321-9668
(Ohio, 216/354-2101)

Yes! I'm ready for breadboarding! Send:
 Names of dealers More information
Name: _____
Address: _____
City: _____ State: _____ Zip: _____

IF YOU WANT TO GET YOU HAVE TO GET INTO

Learn PC Servicing By Building Your Own NTS/HEATH HS-15 Desk-Top Computer, Circuit-By-Circuit

NTS Intrinsic Home Training Takes You Below The Surface

NTS gets you right down into the heart of computer circuitry. You learn how microprocessors function, how they are designed, how they operate and are used to solve problems. Your program includes a wide variety of tests and projects, as you assemble your PC. You experience the excitement of seeing your own skills grow, the security of knowing you really understand what makes a computer tick.

A Career in PC Servicing

The world of computers is constantly expanding. Applications have spread from business to manufacturing, from industry to medical and scientific fields. Computer-aided design, engineering, and production have revolutionized drafting, graphics, and prototyping. Computer sales figures point to a continuing need for service technicians as well as installation and maintenance specialists. The type of training you receive will largely determine your ability to take advantage of these opportunities and nothing beats the practical, down-to-earth training you get from NTS.

The NTS/HEATH 16-Bit HS-151

This desk-top PC is the most powerful and versatile ever offered in any home training program. Check the advanced features listed below:

1. 128 KB RAM user memory on board, expandable to 640 KB
2. 16-bit 8088 Microprocessor accepts advanced software, speeds word processing; also allows selection from the huge library of IBM software.
3. 5.25-Inch floppy disk drive, double density, IBM formatted, stores up to 360 KB. (Expandable to dual disk drive, and optional 10.5 MB hard-disk drive.)
4. MS-DOS operating system, IBM compatibility, make a wide choice of software programs available.
5. Four open IBM-compatible slots provide for future expansion, printer, modem, etc. Will accept most peripheral boards designed for IBM-PC.
6. Two video outputs for color or monochrome display monitor. Your NTS course includes a high resolution monitor displaying 80 characters by 25 lines, or graphics.
7. Editing capabilities help you insert or delete characters and lines, erase, jump or smooth scroll, etc.

Your NTS training course will teach you to program on this outstanding PC, using lessons, texts, and diagrams to make full use of its capabilities. Catalog contains complete details.

**IBM
Compatible**



Learning circuitry through the construction of this equipment offers practical training for which there is no substitute. Test equipment is included.

Field servicing is interesting and rewarding. Technicians may work for a service company, manufacturer, or major users.

The NTS/HEATH HS-151 PC completed, incl. monitor and full-function keyboard with cake style keypad, and typewriter format.



NTS TO PC SERVICING A MICROCOMPUTER

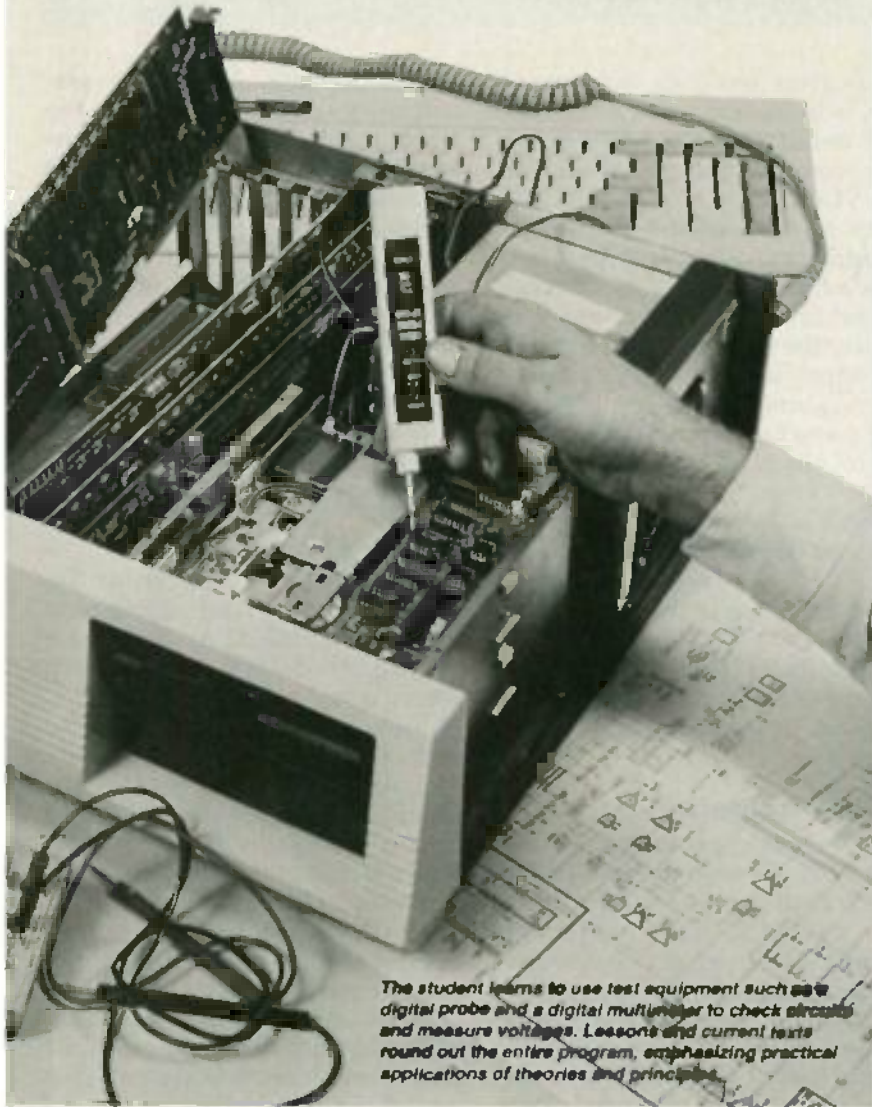

The student learns to use test equipment such as a digital probe and a digital multimeter to check circuits and measure voltages. Lessons and current texts round out the entire program, emphasizing practical applications of theories and principles.

Installing the disk-drive in the PC is one of the final stages in the assembly of the microcomputer. Learning the use of test equipment to check circuits is an integral part of the training which, with field experience, develops invaluable career skills.

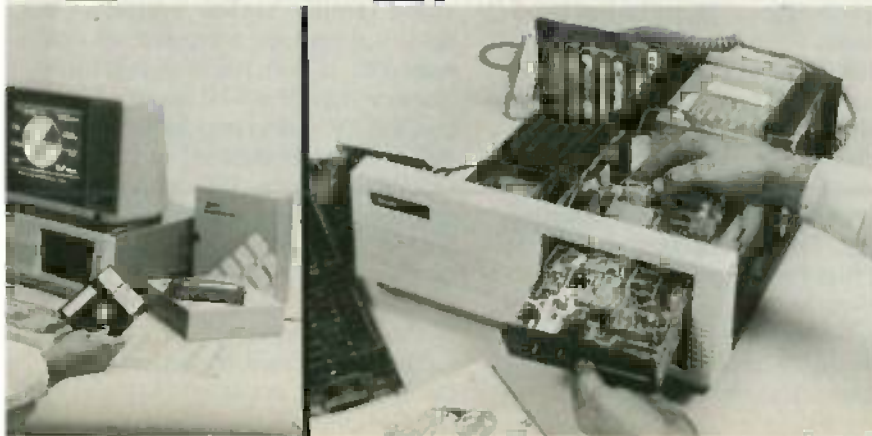

NTS COURSES COVER MANY AREAS OF SPECIALIZATION IN ELECTRONICS:

Robotics: Build the NTS/HEATH Hero 1 Robot as you learn robotic programming. Robot is complete with arm and gripper, voice synthesizer. Robotics is becoming increasingly important in industry as almost daily news features attest.

Video Technology: Build one of the most advanced Color TV sets in America as you learn circuit diagnostics, and the use of digital test instruments. Course covers color TV, video tape recorders, computer fundamentals, solid-state devices.

Industrial and Microprocessor Technology covers circuit analysis, microprocessors and automation applications, lasers, and basic industrial robotics.

TV & Radio Servicing is a specialized course offering an excellent foundation in the use and application of both analog and digital test equipment as applied to the TV servicing field. Learn circuits, adjustments, troubleshooting, and servicing of Color and monochrome monitors.

Digital Electronics offers the student the opportunity to get involved with computer concepts, computer technology fundamentals, and digital equipment by training on the NTS Compu-Trainer.

Basic Electronics is a course designed for those wishing to have an over-view of electronics in many of its aspects including radio receivers, solid state devices, and electronic components.

NTS Intronic training programs include a variety of superb equipment, most of which is classified as field-type, making the training practical and career oriented. Texts and lessons have been tested in our Resident School in Los Angeles to assure home study students their courses of training are easy to understand. NTS, now in its 80th year, continues to be at the leading edge in Electronics home training.

* IBM is a trademark of International Business Machines Corp.
* MS is a trademark of Microsoft Corp.

If card is missing, simply write to the address shown below stating the course you are interested in. A FREE color catalog with all details will be sent to you by return mail.

**NTS NATIONAL
TECHNICAL
SCHOOLS**

TECHNICAL TRADE TRAINING SINCE 1905
Resident and Home-Study Schools

4000 So. Figueroa St., Los Angeles, CA 90037

FEBRUARY 1986

39

LEARN TV/VCR REPAIR



Now you can train at home in spare time for a money-making career as a TV/VCR Repair Specialist. No need to quit your job or school. We show you how to troubleshoot and repair videocassette recorders and TV sets, how to handle house calls and shop repairs for almost any make of television or VCR. You learn about TV receivers, tuners and antennas, x-ray emission, the characteristics of sound, how electrical impulses are converted into a TV picture, and much, much more. Tools are included with your course so you can get "hands-on" practice as you follow the lessons step by step. Send for free facts about opportunities in TV/VCR Repair and find out how you can start making money in this great career.

Experts show you what to do, how to do it...guide you every step of the way!

Everything is explained in easy-to-understand language with plenty of drawings, photos and diagrams. But if there is ever anything in your lessons you don't understand, you can write or phone your instructor and you can count on getting an authoritative answer. Send for free facts and color brochure. No cost. No obligation. No salesman will visit you. MAIL COUPON TODAY!

SCHOOL OF TV/VCR REPAIR, Dept. DE016
Scranton, Pennsylvania 18515

Please send me free facts on how I can learn TV/VCR Repair at home in my spare time. No salesman will visit.

Name _____ Age _____

Address _____

City/State/Zip _____

Phone () _____

STUNGUN



EQUALIZER

- The ultimate non-lethal defense weapon.
- In five seconds can immobilize your attacker, even through heavy clothing.
- Discharges over forty thousand volts of electricity from a nine volt nickel-cadmium battery.
- \$49.95, Mass 5% sales tax, \$3.00 shipping and handling.

1-800-522-2636
FOR ORDERS ONLY
617-871-5611
FOR INFORMATION

Cameo Enterprises, Inc.
P.O. Box 63, Accord, MA 02018

CIRCLE 270 ON FREE INFORMATION CARD

Rhoades TE-600 Teledapter Stereo Synthesizer



CIRCLE 6 ON FREE INFORMATION CARD

Add simulated stereo sound to your video set-up.

THE HOTTEST THING IN VIDEO THESE days is audio. Or, to be more precise, stereo audio. Everywhere you turn, you see the new stereo TV's and VCR's.

But many of us still own mono equipment, and the idea of scrapping an otherwise quite serviceable set-up in favor of a new one just for the sake of stereo often is not appealing. And it is certainly not economical, especially when one considers the high-end price tag of much of that new equipment.

There is an alternative. It is the Rhoades (Highway 99 East, Columbia, TN 48401) TE-600 Teledapter. The primary use of that device is as a stereo synthesizer, but it has other features that help make sure that the unit will not someday join the rest of your system on the scrap heap.

A stereo synthesizer

The primary application of the unit is as a stereo synthesizer. It can accept a mono-audio input from a TV, VCR, etc., and produce a stereo-audio effect. A low-impedance input is provided to accommodate those systems where no audio output is provided. In those cases, the audio can be tapped directly from the TV's speaker terminals and fed to the low-impedance input. An input-level control is provided to set the low-impedance input to the proper level.

The unit uses Rhoades' Stereo-Plex circuit to perform the stereo synthesis. According to the manufacturer, that circuit works by creating a time delay between frequency elements of the original signal. The manufacturer claims that that technique allows the frequency response of the derived stereo channels to be essentially flat from 20- to 20,000-Hz.

In use, the stereo effect that re-

sults is dramatic. A/B testing is facilitated by an IN/OUT switch on the front panel. When stereo synthesis was selected, the sound spread out and filled our listening room. Listening to the same source material in both "natural" stereo and synthesized stereo, it was often difficult to discern between the two.

And a bit more

If the TE-600 stopped there, it would merit a spot at the top of the list for anyone interested in such a product. But there's quite a bit more to that unit.

Rhoades has provided for the day when your video equipment will be upgraded. An ambience circuit that's designed to work with stereo sources has been included in the unit. That circuit detects and reduces common components of the audio from the two stereo channels. The result is widened stereo separation and a concert-hall effect. For instance, when the ambience circuit is used, vocals tend to reverberate and seem to "bounce" off walls, as they would in a live performance.

Finally, the manufacturer has included a National Semiconductor DNR noise-reduction system. That noise-reduction system can be used with either mono or stereo sources. In addition, it is single-ended. That means that, unlike the more familiar Dolby systems, it does not require encoded source material. It will remove high-frequency hiss from all sources, including TV, video and audio tapes, AM and FM broadcast radio, and satellite signals. When properly set, the DNR circuit did an excellent job of removing that high-frequency hiss, without appreciably affecting the frequency response of the input material.

The unit's built-in switching capabilities can accommodate up to

CLEARANCE! TEST EQUIPMENT



Overstocked and discontinued test equipment is being sold by U.S. Instrument Rentals at clearance prices. Equipment is pre-owned, fully tested and warranted. Thousands of models from over 100 manufacturers are represented: HP, Tektronix, Fluke, Intel and others. Special financing is available.

MAKE AN OFFER!

Some overstocked equipment has to move fast! Offers are being accepted for analyzers, scopes and development systems... Products include: HP, Tektronix, Intel, Dolch and more.

SOME EXAMPLES:

BIOMATION

K102D	ANALYZER
K105D	ANALYZER

BIRNIE

TOPPER TERMINAL	
W/MICROCOMPUTER	
DM 83 BURROUGHS	
COMPATIBLE TERMINAL	

CASH (HUSH)

COMEX 4	MODEM
COMEX 8	MODEM
R 114	MODEM

DATA I/O

UNIPAK II	PROGRAMMING PACK
U320A	CONTROL UNIT
29A	PROM PROGRAMMER

DATASOUTH

180	PRINTER
-----	---------

DOLCH

1250A	ANALYZER
-------	----------

GRID

COMPASS	MICROCOMPUTER/ TERMINAL
---------	----------------------------

HEWLETT PACKARD

1610B	ANALYZER
1611A	ANALYZER
TERMINALS	VARIOUS MODELS

INTEL

MDS 225	MD SYSTEM
MDS 225A	MD SYSTEM
MDS 230	MD SYSTEM
MDS 286	MD SYSTEM
MDS 286A	MD SYSTEM

TEKTRONIX

BR 2A	MD SYSTEM
-------	-----------

WANG

OFFICE ASSISTANT	
------------------	--

ACT NOW.

Quantities are limited.
The first reasonable offers
will be accepted.

For our Hot Sheet on the
complete inventory, send in
the reader service card or
call

800-824-2873

for details.

CIRCLE 258 ON FREE INFORMATION CARD

United States
Instrument Rentals, Inc.

US

AUS Leasing Company

2988 Campus Drive
San Mateo, CA 94403

Please write in your work
phone number and address
on the reader service card.

FEBRUARY 1986

41



Happy NEW Year DICK SMITH ELECTRONICS

2 1/2" Mini Speaker
A great value at \$1.50
Cat G-2272 NOW ONLY **50¢**

Measures Transistor Gain!



Pre-Quality, Feature-Packed

MULTIMETER

\$99.05

INCLUDES CASE
Cat Q-1500

More than the usual voltage, current & resistance ranges, it checks capacitors, transistors, diodes & continuity. Includes many other features & incredible specs!

Take It Anywhere!

NEW
Cat Q-1220
\$69

A hand-held oscillator the size of a digital multimeter! 23 ranges of sine & square waves (switchable) between 20 Hz & 1.5kHz plus a x100 range; 48 settings in all. Many other features: 800 ohms output



Hand-Held RC OSCILLATOR

NEW for '86

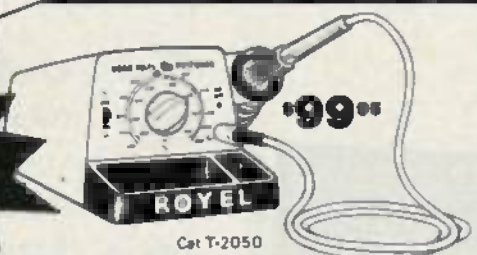

ROYEL SOLDERING STATION

The ideal professional front! It's ultra-light weight, so you can use it comfortably for long periods. Superior design ensures that the temperature at the tip will be precisely the one selected. This is a lasting iron for the production line or workshop.

Top-Quality, Corrosion-free Multicores

SOLDER

Cat N-1619 0.47" (18g) 7oz. was \$5.95 now either **\$3.00** /roll
Cat N-1823 0.31" (21g) 7oz. was \$5.95 now either **\$3.00** /roll

3-4.5-6-7.5-9-12 VDC @ 1 amp



Cat M-9530

\$14.95

Invaluable around the home or workshop, it will give a maximum of 1 amp at 3.4, 5.8, 7.5, 9 and 12 volts DC. Simply plugs into 117 VAC power socket. DC connections via universal socket plug. Ideal for use with alarm systems, intercoms, etc.

HEAVY DUTY SOLID-STATE
13.8V/4A Peak



Cat M-9545

\$19.95

Regulated D.C. Power Supply, 13.8 VDC, 3/5 Amp. For home, lab, service bench, CB Stereo and auto radios, this is an extremely versatile unit. You'll wonder how you managed without it! Input is 117VAC@60Hz/100W, and the output is fully regulated low ripple 13.8VDC to supply 3 Amps continuous and up to 5 amps surge. The unit is fuse and double-short circuit protected with on/off switch and pilot light.

RECHARGEABLE BATTERIES

Cat S-3320 12V 3Ah **\$13.00**
Cat S-3318 12V 1.2Ah **\$7.00**
(Also Available)

SWISS-MADE QUALITY

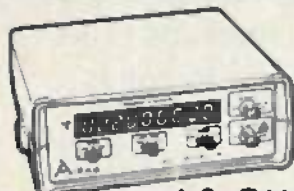

1.2 GHz Frequency Counter

- Range: Switch selectable in 3 ranges
- Coupling AC
- Sensitivity (measured at counter input) INPUT A: 25 Vrms 10Hz to 10MHz INPUT B: 150 Vrms 100MHz to 1GHz
- Input impedance: INPUT A: 1 Mohm/50pF INPUT B: 50ohm nominal
- Max. Input: 250V p-p (decoupling with frequency to 3V p-p)
- Gate Time: 3 switch selectable gate times FAST, MEDIUM, SLOW (0.1, 1, 10)
- Resolution: 1 sec Gate: 0.1Hz to 10MHz range 1Hz to 100MHz range 10Hz to 1GHz range (60 sec Gate time)
- Time Base: 3.90625 AND 10MHz (Crystal Oscillator freq)
- Display: 9 digit, 0.5" 7 segment LED
- Power Req: 12V DC @ 400mA 220/110V AC transformer with wall plug or Ni-Cad C cells. Ni-Cad recharging unit standard
- Size: 8.8" x 7.3" x 3"

Cat Q-1315 **\$249.00** ONLY

SATISFACTION GUARANTEED OR YOUR MONEY BACK

Deluxe Wire Stripper

was \$8.95

NOW \$5.95



Cat T-3620

This is a completely automatic wire stripper. Only one hand is required to complete stripping operation. The multiple sized head strips a range of wire from 6" to .13".

New & UNUSED! 12V DC STEPPING MOTORS

- Choose from Two Models:
- Cat J-0015 - single shaft
 - 1.8° step angle ● 4A drain per phase
 - 2.22" square base
 - Cat J-0016 - Double shaft
 - 1.8° step angle ● 6A drain per phase
 - 2.22" square base

Ideal for Robotics projects - ask for the books we sell on this special Normal WHOLESALE price on these motors is around \$70, but our scoop purchase lowers the price to save you a fortune!

only \$14.00

Choose Either - only \$99.05

SIGNAL GENERATOR

SPECIFICATIONS:
Frequency range: 100kHz to 150MHz in six overlapping ranges
Accuracy: ±1.5%
RF output: 100mV rms approx (up to 35 MHz)
Modulation: 1 kHz internal 50Hz - 20kHz external
Audio output: 1 kHz at 1V rms (fixed)
Crystal Oscillator: 1-15MHz external crystal FT243 holder
Supply voltage: 110V AC

AUDIO GENERATOR

SPECIFICATIONS:
Frequency range: 20Hz-200kHz
Accuracy: ±1.3% - 2Hz
Output impedance: 800 ohms unbalanced
Output Control: High/Low (unbal) (-200dB) and fine adjust
Sine wave output: 20Hz-20kHz, 5V rms max at 1% or less distortion
Square wave output: 20Hz-10V p-p max, 0.5us rise time
Sync: ±1.3% of oscillator frequency per V rms



Cat Q-1312



Cat Q-1310

CO-AX RELAY

reg. \$19.95
JUST \$9.95



Cat S-7402

Mini pcb mounting relay with fully enclosed contacts for coax cable. Coil rated at 12 volts, 80mA. Handles up to 1000 Mhz so its ideal for all HF, VHF and UHF switching applications.

TRANSFORMER

reg. \$7.95
NOW \$4.95



Cat M-6672

AUDIO ALARMS

Two-Tone Piezo
Cat L-7027 reg. \$3.95 NOW **\$2.00**
Slim Piezo Alarm
Cat L-7024 reg. \$2.95 NOW **\$1.00**

PROFESSIONAL SERIES MOSFET AMP KIT

Cat K-3516

POWER OUTPUT One Channel both Channels
4 ohms 184 W 150W
8 ohms 104 W 95W

HARMONIC DISTORTION
Less than 0.2% for all powers up to 100 W into 8 ohm loads
Less than 0.3% for all powers up to 180 W into 4 ohm loads

\$369

40 Pin DIL Socket

Cat P-4250 Reg. 45¢ NOW **25¢**

MOLEX IC Socket Strip

Make your own IC sockets - just cut the required number of pins from the strip & solder them to 100 pin/strip
Cat P-4304 Pack of 100 Reg. \$2.50 NOW **\$1.00**



Buy by the Carton and SAVE!!

Professional quality black instrument case fits standard 19" racks, overall they're 18.75" x 9.8" x 5.5". Supplied flat, assembly takes just a couple of minutes. Heavy gauge (0.12") front panel, top and bottom pre-punched for ventilation.

12 & up
\$29.00 each **\$24.95** ea.

SPEEDY BOXES

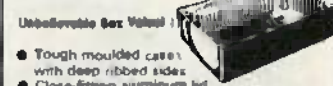

Unbeatable Box Values!

- Tough moulded cases with deep ribbed sides
- Close-fitting aluminium lid
- Screws supplied

Cat H-2755 3" x 2" x 1" only **\$1.25** or 10 for \$5
Cat H-2751 8" x 3.5" x 2" only **\$2.00** or 10 for \$10

DICK SMITH KITS

MK 2 Car Alarm

One of the most sophisticated, yet simple alarms around. It uses a triggering technique which makes it less prone to false alarms - a common problem with many car alarms, yet it will sense a voltage drop anywhere in the electrical system. For example, when a door is opened, or a jumper lead is applied to the starter, etc. It is housed in a virtually waterproof die-cast case to minimize ingress of moisture or fumes, and all connections are made to the terminal strip for easy installation and removal. Cat K-3253

was \$24.95 NOW **\$14.95**

Stereo Preamp

This amazingly versatile unit can be built as a magnetic cartridge preamp (for upgrading your stereo), a tape preamp or an auxiliary preamp with 40, 55 or 80dB gain. It is extremely simple: uses only one special IC and is very small: all parts fit on a PCB less than 2 1/2 square. It does not need a special power supply as any reasonable power supply from 10 to 40V will do. Frequency response is well beyond 20 kHz. Full instructions are supplied. Cat K-3427

was \$9.95 NOW **\$4.95**

Ignition Killer

ingenious but simple circuit based on a 555 timer that literally kills your car ignition and then re-sets itself, making the thief think something is wrong with the engine. The theory is he'll then go and pinch someone else's car instead. Cat K-3255

was \$14.95 NOW **\$9.95**

LCD Panel Meter

A versatile accurate panel meter using a large liquid crystal display for low power consumption. The PCB board design allows for maximum flexibility so cater for varied mounting arrangements. The low cost makes it ideally suited as a readout device on many projects, at both amateur and professional level. Cat K-3450

was \$29.95 NOW **\$19.95**

Don't Buy a Satellite Receiver 'til you compare DICK SMITH prices!

BE AN INFORMED CONSUMER!

\$29.95

HOME SATELLITE TV Installation & Trouble-Shooting Manual

Everything you need to know to understand, select, install, and troubleshoot satellite TV systems. Written in an easy-to-read style, this book is a must for satellite TV dealers and anyone who wants to install their own system!

Cat B-1846

Build the AUSTRALIS I & Save a Fortune

You can put this kit together, in just hours! See the January 1986 issue of *Radio Electronics* for a special feature on the Australis I. As Richard Maddox, author of *Troubleshooting & Repair of Satellite Systems* says:

"The performance rivals commercial receivers costing hundreds of dollars more. The ease of assembly, field proven circuitry is fantastic. The quality... better than expensive commercial units..."

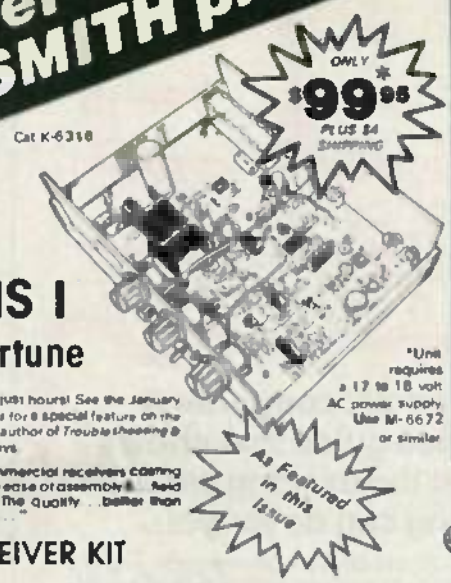

SATELLITE RECEIVER KIT

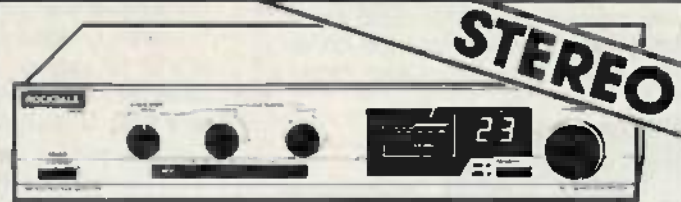

NOW! Get TV Reception for Both Ears!

Once again, Dick Smith Electronics brings you state of the art circuitry with advanced technical standards and you get stereo satellite reception with maximum performance. You'll be amazed at the exciting crisp image - it looks alive! But even more amazing is the incredible Dick Smith price - and this unit is already built! This is a single conversion receiver.

ROCKDALE SATELLITE RECEIVER \$199.00

Never Miss A Show Again!



Move Your Dish Without Leaving the House!

Raining? don't get soaked just because you need to move your satellite dish. With this Actuator (a motor-controlled arm that attaches to dish & mount) and Positioner (the remote control unit that sits under your receiver or TV), you can position your dish in total comfort. This unit is designed to suit most dishes. Install it yourself and save!

FECO SATELLITE POSITIONER & ACTUATOR \$249.00

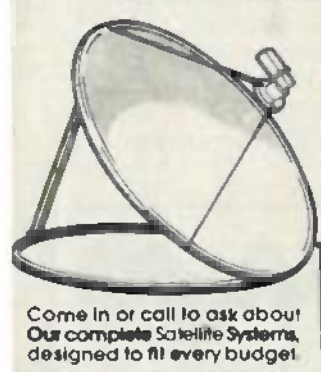

Superb design uses latest IC technology. Low component count makes it very reliable and easy to build. Measures frequency to 500 MHz (with optional pre-scaler) and period both with a 7 digit resolution. Supplied with the exclusive Dick Smith simplified circuit board wiring, step-by-step instructions and a quality pre-punched and silk screened front panel and case.

\$89.95

PreScaler Kit

Increase the range of your K-3439 Frequency Counter to a more professional range of operation... 10.500MHz.

Cat K-3439

TELETEXT IS HERE!



Get More from Your TV!

Right now text & graphics are being transmitted as digital data in the Vertical Blanking Interval on your TV! The latest news, weather, stock & business information, sports scores and a wealth of other features are yours - for free! All you need is a teletext decoder. Our engineers have designed this easy-to-build kit to bring teletext to you at an incredibly low price. (Note: Requires pre-tuned composite video & audio outputs from your VCR, Satellite Receiver, component TV Tuner, some Cable TV decoders, or some newer TV's with composite tuner outputs)

TELETEXT DECODER KIT Cat K-6316

Another Exclusive DICK SMITH KIT



NOW OPEN IN L.A.

CALL, WRITE, OR VISIT OUR RETAIL CENTERS!

- STORES AT:
- BERKELEY: 2474 Shattuck Ave. (415)486-0755
 - REDWOOD CITY: 390 Convention Way (415)368-8844
 - SAN JOSE: 4980 Stevens Creek Blvd (408)241-2266
 - LOS ANGELES: 1830 Westwood Blvd. (213)474-0626
 - HEAD OFFICE: 390 Convention Way, Redwood City, CA 94063

ORDERS ONLY: CALL TOLL FREE 1-800-332-5373 (Mon-Fri. 6am-6pm PACIFIC TIME)

IN CALIFORNIA: 1-415-368-1066

WHERE THE ELECTRONIC ENTHUSIAST IS # 1!

DICK SMITH ELECTRONICS

INCORPORATED IN THE STATE OF CALIFORNIA

MAIL ORDERS

P.O. Box 8024 Redwood City CA 94063

14 DAY Money-Back GUARANTEE



132 pages of products & data includes Bonus Coupons worth \$2 redeemable with your first order. Send only \$1 for postage & handling

FREE CATALOG

NAME _____ ADDRESS _____ CITY _____ STATE _____ ZIP _____

Free

Famous hi-tech catalog



A very special computer & electronics guide that shows you what the exciting world of kitbuilding can do for you.

Challenge. Knowledge. Achievement. Enjoyment. All of these things are yours when you build a Heathkit high-quality product. Our colorful, informative catalog reflects the years of experience and technological expertise that make these things happen for you.



In our catalog you'll find over 450 interesting and useful items – from computer hardware and software to robots and test instruments, and from home security systems to color tv's and amateur radio equipment.

But what makes Heath Company unique is that we offer you the confi-

dence and pride that you can only get by building a state-of-the-art product yourself. And you're backed by our promise. "We won't let you fail."

The Heathkit Catalog is a simple – and FREE – first step toward this excellent opportunity.

Send NOW for your FREE Heathkit Catalog



Yes! I want to see what kitbuilding can do for me. Please send me the latest Heathkit Catalog Free.

Send to: Heath Company, Dept. 020-382
Benton Harbor, Michigan 49022

Name _____

Address _____

City _____ State _____

Zip _____

A subsidiary of Zenith Electronics Corporation CL-787

Heathkit
Heath
Company

Rhoades	TE-600									
OVERALL PRICE										
EASE OF USE										
INSTRUCTION MANUAL										
PRICE/VALUE										
	1	2	3	4	5	6	7	8	9	10
	Poor	Poor	Good	Excellent						

three stereo or four mono inputs. A tape-monitor loop provision allows the unit to be inserted in the tape-monitor loop of any stereo receiver or amplifier. That allows the ambience circuit and/or the DNR circuit to be used with your audio equipment.

Accompanying the unit was a rather rudimentary "manual." That manual, consisting of but a single sheet of paper, provided some basic information about the unit, and how it is used, but little else. On the plus side, a technical-assistance telephone number is provided for those who have trouble hooking up their unit. Considering the sketchiness of some of the information, we'd wager that the manufacturer gets a fair share of calls.

This is a well-made, well-thought out product (with the exception of the manual). It is covered by a two-year limited warranty. The TE-600 is available directly from the manufacturer for \$145.00, plus \$4.00 for postage and handling.

R-E



"The meaning of life? Just a second..."

BUY A SCOPE

GET A DMM FREE!

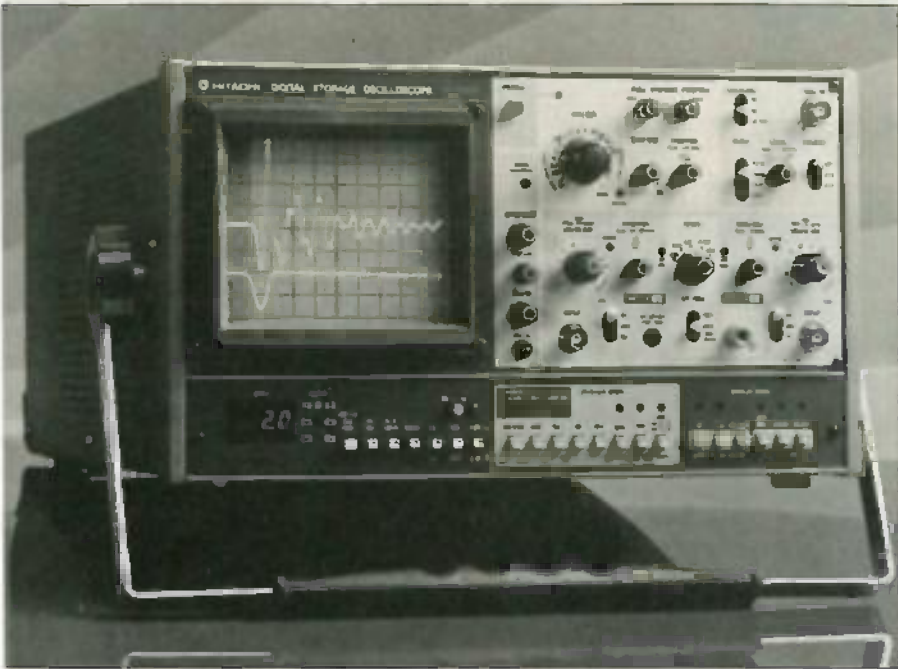

Joseph Electronics give you a free 3½-digit DMM (Regularly: \$79.95) with the purchase of any Hitachi Oscilloscope. For the best value on instrumentation and all your electronic needs CALL JOSEPH ELECTRONICS TODAY!

HITACHI VC-6041 UX Professional 40 MHz Digital Storage Oscilloscope. Features: Repeat Storage of Waveforms at 40 MHz • DC to 40 MHz range • 4000 word memory per channel • Storage of 10 MHz – One time events • Cursor Function • Probes • **Free! Midland DMM** Reg: \$4950 **\$4295**

HITACHI V-1100 A 100 MHz Readout Oscilloscope for fast, easy and precise measuring. Features: Built-in computer • DC to 100 MHz range • Large 6 inch CRT • Quad channel • 8 Trace, delayed sweep • Digital Measurement • 18 Kv accelerating potential • Probes • **Free! Midland DMM** Reg: \$2490 **\$2195**

HITACHI V-222 High performance, lightweight 20 MHz portable oscilloscope: Features: Compact Design • 6 inch CRT with internal graticule • 1 Mv Sensitivity • Dual Trace • Auto Focus • DC to 20 MHz range • Vertical Trigger Mode • DC Offset • Probes • **Free! Midland DMM** Reg: \$715 **\$495**

HITACHI V-422 Same as Hitachi Model V-222 above, with range DC to 40 MHz • **Free! Midland DMM** Reg: \$925 **\$625**

HITACHI V-650F Best-selling Oscilloscope, 60 MHz, dual trace delayed sweep. Features: Large, bright state-of-the-art 6 inch CRT • High sensitivity of 1 MV/div • Dual Trace • Delayed Sweep • Trigger View • Automatic Focus • Probes • **Free! Midland DMM** Reg: \$1195 **\$875**

HITACHI V-1050F Superb 100 MHz, Quad Trace Delayed Sweep Oscilloscope. Features: Large, bright 6 inch CRT • Quad Trace Operation (4 channels) • High Sensitivity • High Accuracy • Alternate Timebase Operation • 20 MHz bandwidth limiter • Full TV Triggering • 10x Magnification • Auto Focus • Probes • **Free! Midland DMM** Reg: \$1595 **\$1150**

Midland DMM 23-215 This pocket-sized DMM features: 3½ digit readout. .5% accuracy. 10 Meg input, and full overload protection to meet UL1244.

Call: 1 (800) 323-5925
In Illinois: (312) 297-4200

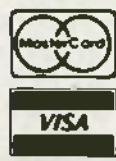

HANDLING CHARGES	
ORDER	ADD
\$0 - 999	\$10
\$1000 - 2499	\$15
\$2500 - up	\$20

Joseph Electronics

8830 N. Milwaukee Ave.,
Niles, IL 60648

Send for our new Joseph's Test Equipment Catalog, featuring 116 pages of tremendous savings on all 25 leading instrumentation lines. This catalog is free, too.

NEW IDEAS

An inexpensive crystal timebase

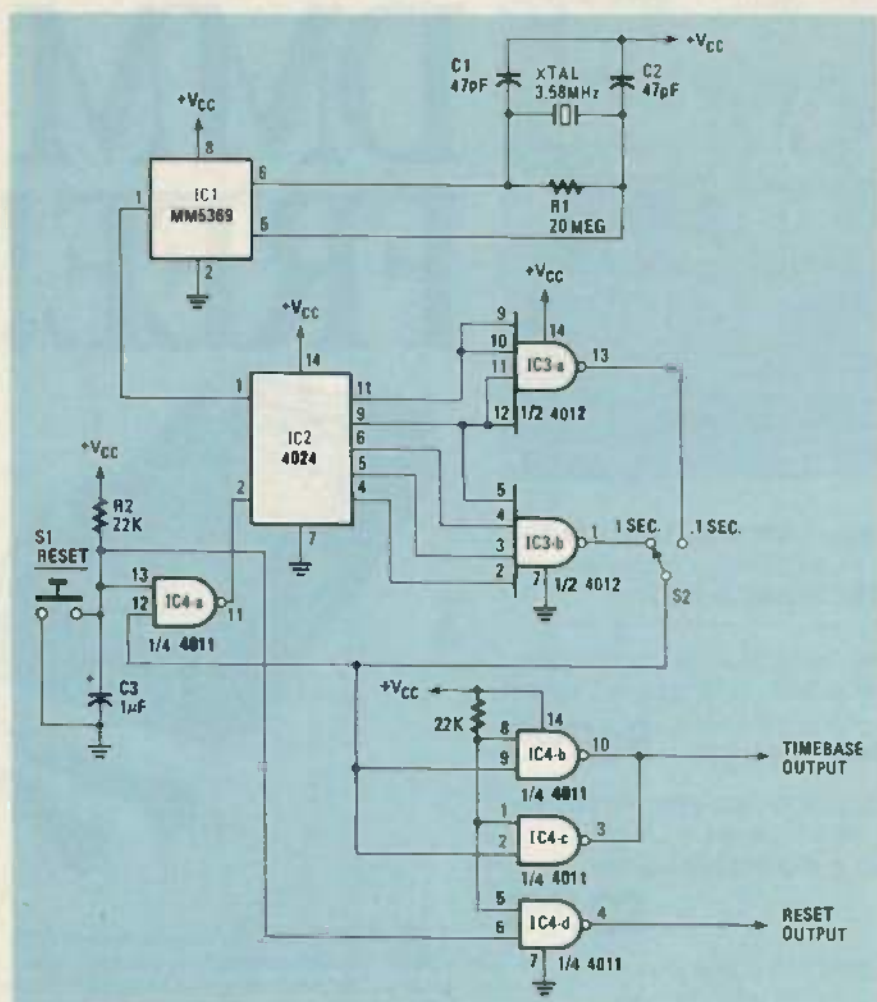

FIG. 1

STOPWATCHES, DIGITAL EVENT COUNTERS, and frequency counters need an accurate and stable source of 1-Hz pulses. Figure 1 shows a way of generating 1-second and 0.1-second pulses, as well as a manual RESET pulse, using an inexpensive TV colorburst crystal, a pushbutton switch and a few common IC's. Since all IC's are CMOS types, the circuit may run from any five- to fifteen-volt power source. The whole circuit, including IC sockets, can be put together for under ten dollars.

Circuit operation

An on-board oscillator and a 17-stage divider compose IC1. By connecting a standard 3.58-MHz television color-burst crystal as shown, an accurate source of 60-Hz squarewaves is generated at the IC's output, pin 1. Those pulses are then fed to IC2, a 4024 seven-stage ripple counter. Its outputs are connected to different gates in IC3, which is a dual four-input NAND gate. Depending on which position PULSE-SELECT switch S2 is in, one of those gates will provide

NEW IDEAS

This column is devoted to new ideas, circuits, device applications, construction techniques, helpful hints, etc.

All published entries, upon publication, will earn \$25. In addition, for U.S. residents only, Panavise will donate their model 333—The Rapid Assembly Circuit Board Holder, having a retail price of \$39.95. It features an eight-position rotating adjustment, indexing at 45-degree increments, and six positive lock positions in the vertical plane, giving you a full ten-inch height adjustment for comfortable working.

I agree to the above terms, and grant Radio-Electronics Magazine the right to publish my idea and to subsequently republish my idea in collections or compilations of reprints of similar articles. I declare that the attached idea is my own original material and that its publication does not violate any other copyright. I also declare that this material has not been previously published.

Title of Idea _____

Signature _____

Print Name _____

Date _____

Street _____

City _____

State _____

Zip _____

Mail your idea along with this coupon to: **New Ideas Radio-Electronics,**
200 Park Ave. South,
New York, NY 10003

an output/reset pulse of the selected width.

First assume that S2 is in the 0.1 SECOND position. The Q2 and the Q3 outputs of IC2 go high after six input pulses have been received. Pin 13 of IC3-a then goes low, so pin 11 of IC4-a goes high, and that resets IC2, so counting starts over. If S2 is in the 1 SECOND position, the reset/output pulse is generated when IC2's Q3-Q6 outputs (pins 2-5) all go high; that is, after 60 input pulses have been received.

The pulse from IC3-a or IC3-b is
continued on page 111

MASTER THE NEW ELECTRONICS WITH MCGRAW-HILL'S

Contemporary Electronics Series

The fast, easy and low cost way to meet the challenges of today's electronic innovations. A unique learning series that's as innovative as the circuitry it explains, as fascinating as the experiments you build and explore.

From digital logic to the latest 32-bit microprocessor, the McGraw-Hill Contemporary Electronics Series puts you into the electronic picture one easy step at a time. Fifteen unique Concept Modules, sent to you one every 4-6 weeks, give you a handle on subjects like optoelectronics, robotics, integrated circuits, lasers, fiber optics and more.

Each Concept Module goes right to the heart of the matter. You waste no time on extraneous material or outdated history. It's a fast, efficient, and lively learning experience... a non-traditional approach to the most modern of subject matter.

Unique Interactive Instruction

With each module, you receive a McGraw-Hill Action Audio Cassette. Each tape is a dynamic discussion that drives home the key facts about the subject. Your learning

With your first module, you get this solderless breadboarding system. You'll use it throughout the series to build electronic circuits and bring concepts to life.



experience is reinforced through interaction with vividly illustrated text, audio cassettes, and actual electronic experiments. Indexed binders preserve backup material, notes, and tapes for convenient referral.

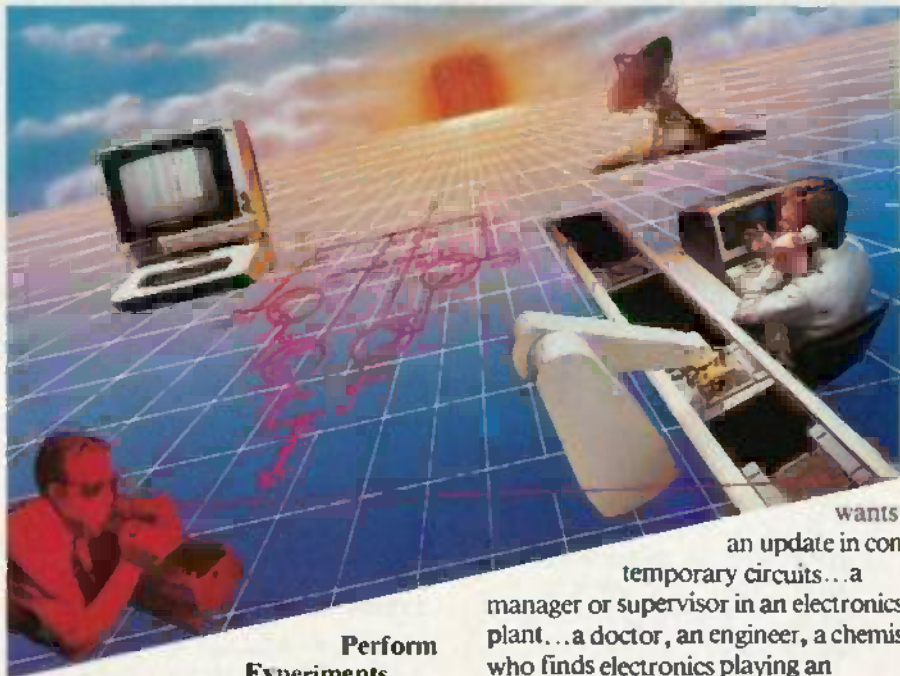

Perform Experiments in Contemporary Electronics

Throughout your series, laboratory experiments reinforce every significant point. This essential experience... dynamic, hands-on demonstrations of theory in practice... will help you master principles that apply all the way up to tomorrow's latest VLSI (Very Large Scale Integrated) circuitry.

In your very first module, you'll use integrated circuits to build a digital oscillator, verifying its operation with a light emitting diode (LED). You'll learn to identify passive and active components, understand concepts common to all electronic circuits.

For Anyone Interested in Electronics

The Contemporary Electronics Series is designed for anyone from hobbyist to professional. It's for you if you're looking for new fields of interest... if you're a teacher who

wants an update in contemporary circuits... a manager or supervisor in an electronics plant... a doctor, an engineer, a chemist who finds electronics playing an increasingly important role in your work. It's even for electronics engineers or technicians who feel their training needs freshening up. It's the quickest, most convenient, probably least expensive way to do it. And the only one that gives you hands-on experience.

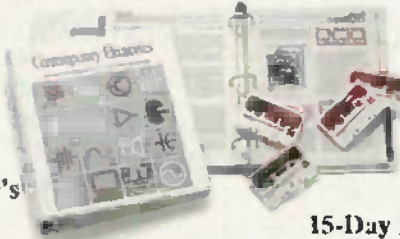

15-Day No-Risk Trial

To order your first module without risk, send the postage-paid card today. Examine it for 15 days under the terms of the order form and see how the Contemporary Electronics Series gets you into today's electronics. If card has been used, write us for ordering information.



McGraw-Hill
Continuing Education Center
3939 Wisconsin Ave.
Washington, D.C. 20016

New
800 MHz models

Regency Scanners

*Bring you the Excitement of Police,
Fire, Emergency Radio, and more.*



MX5000



MX4000

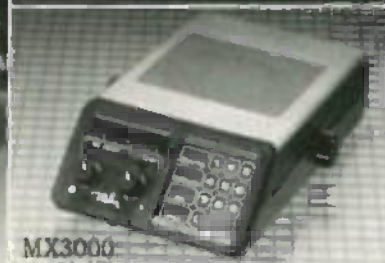

MX3000

Our radios deliver the local news. From bank hold-ups to three alarm fires. It's on-the-scene action. While it's happening from where it's happening . . . in your neighborhood.

You can also listen to weather, business and marine radio calls. Plus radio telephone conversations that offer more real life intrigue than most soap operas. And with our new models, there's even more.

Unique Capabilities

Introducing two all new Regency scanners. First, there's the MX7000, a 20 channel, no-crystal unit that receives continuously from 25 to 550 MHz and 800 MHz to 1.2 GHz. That's right! Continuous coverage that includes VHF and UHF television audio, FM Broadcast, civil and military aircraft bands and 800 MHz communications. Next in line is the new MX4000. It's eight band coverage includes standard VHF and UHF ranges with the important addition of 800 MHz and aircraft bands. Both units feature keyboard entry, a

multifunction liquid crystal display and selectable search frequency increments.

Practical Performance

If you don't need the 800 MHz range coverage, Regency offers two exciting new units. The MX5000 is a 20 channel, no-crystal scanner that receives continuously from 25 to 550 MHz with all the same features as the MX7000. Then there's the 30 channel MX3000. It's digitally synthesized so no crystals are necessary, and the pressure sensitive keyboard makes programming simple. What's



more, it has a full function digital readout, priority, search and scan delay, dual scan speed, and a brightness switch for day or night operation.

At Home Or On The Road

With compact design, easy access front panel and mounting bracket these Regency scanners are ideal for mobile* use. But we also supply each radio with a plug-in transformer and a telescoping antenna so you can stay in touch at home. The MX4000 even has a rechargeable battery pack so it's fully portable.

See your Regency Scanner Authorized Dealer for a free demonstration on these and other new Regency Scanners. Or, write Regency Electronics, 7707 Records Street, Indianapolis, IN 46226.

ELECTRONICS, INC.®
7707 Records Street
Indianapolis, IN 46226-9989

*Mobile use subject to restriction
in certain localities.

CIRCLE 264 ON FREE INFORMATION CARD

Wireless Video Camera Link

Use this high-performance video-camera link to transmit signals from your video camera to your VCR, or from your VCR to TV's all over your home!

WILLIAM SHEETS AND RUDOLF F. GRAF

IF YOU ACHE TO BE FREE OF THE CUMBERSOME "UMBILICAL cord" that connects your video camera to your VCR, then our high-performance wireless video link is just what you need. Its small size and light weight make it a natural for "wireless" video-camera recording. You'll be able to capture all those shots you're missing because your camera cord is just a little too short, or because it restricts your maneuverability in tight places.

Our wireless link can transmit high-quality audio and video to any UHF TV channel. Low power requirements allow the transmitter to run on AA penlight batteries, and the PC board can be mounted easily in a small metal case, complete with batteries and a short antenna. The transmitter is crystal-controlled and it's easy to build and align. In addition, it uses low-cost, easy-to-get components, and it can be built for well under \$100.

Transmitter circuit overview

The block diagram of the wireless video link is shown in Fig. 1. The RF chain is fairly conventional. Its first stage is a crystal-controlled oscillator (Q1) with a frequency of 60 to 65 MHz, which is one-eighth the final output frequency. For example, our prototype used a crystal frequency of 60.40625 MHz, which gives a final output frequency of 483.25 MHz—the video-carrier frequency of UHF channel sixteen.

The oscillator produces a signal of about +6 dBm (4 milliwatts) that drives three stages of frequency doublers. The combined action of those doublers multiplies the input frequency by eight for a final output frequency of (nominally) 500 MHz. Double-tuned circuits are used between each stage to help reduce spurious outputs that might cause unwanted interference.

The video input signal (from your VCR, video camera, etc.) drives a video modulator (Q6 and Q7) that adds the video signal to the +12-volt line supplying power to the final



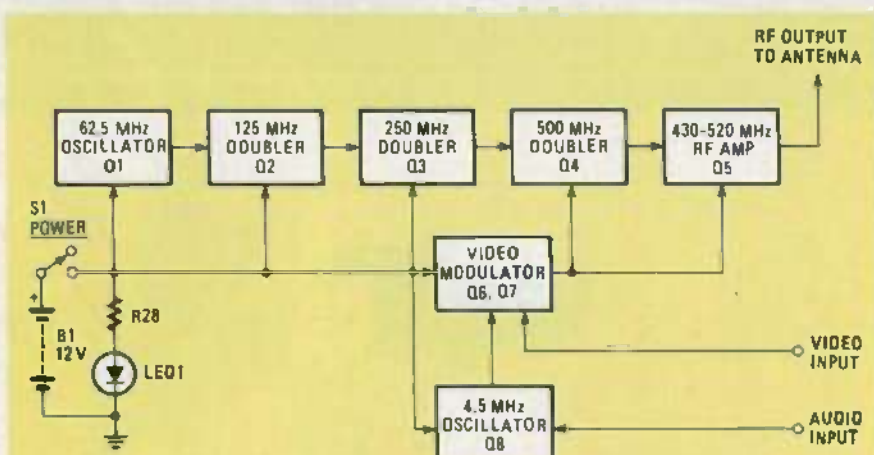

FIG. 1—BLOCK DIAGRAM OF THE TV TRANSMITTER reveals the overall simplicity of the circuit, which is composed of an oscillator, three frequency doublers, and video and audio modulators.

doubler (Q4) and the output amplifier (Q5). That method of modulation is similar to the way a conventional AM-radio transmitter is modulated. The video modulator has a nominal bandwidth of five MHz.

Audio input is applied to Q8, which operates as a VCO (Voltage Controlled Oscillator) running at a nominal frequency of 4.5 MHz to produce the modulated sound carrier. For simplicity, Q8 is a free-running oscillator, since the ± 25 -kHz frequency deviation that is required would be very difficult to produce at that frequency with a crystal-controlled oscillator. Besides, most TV sound systems will accept a ± 10 -kHz error in the sound-carrier frequency without producing undue distortion, and that greatly simplifies the circuitry required.

Calculating maximum range

The following equations may be used to calculate the maximum range you can expect from the wireless video-camera link. All logarithms in this equation (and in those following) are calculated in base 10; frequencies (f) are specified in MHz; and distances (D) are specified in miles.

The average TV receiver has a bandwidth (BW) of 4.0 MHz and a noise factor (NF) of 6 dB. For a snow-free picture, the carrier-to-noise ratio (C/N) should be 40 dB or better. Receiver sensitivity can then be calculated as the Minimum Desired Signal (MDS):

$$MDS = NF + 10 \log (BW) - 174 + C/N$$

Plugging values into that equation, we find that:

$$MDS = 6 + 10 \log (4 \times 10^6) - 174 + 40$$

Therefore, MDS = 62 dBm, or $0.794 \times 10^{-3} \times 273 = 216$ millivolts. So for a transmitter power of +15dBm and 2 isotropic antennas, that allows a Path Loss (PL) of 87 dB.

$$PL = 37 + 20 \log (D) + 20 \log (f)$$

Isolating the distance factor we see that:

$$20 \log (D) = PL - 37 - 20 \log (f)$$

$$20 \log (D) = 87 - 37 - (20 \times 2.7)$$

$$\log (D) = -4/20 = -0.2$$

So the maximum range obtainable should be:

$$D = 10^{-0.2}$$

$$D = 0.6 \text{ mile} = 3100 \text{ feet}$$

However, you wouldn't really be able to get a range of 3100 feet because of reflections, loss from "dead spots," terrain loss, and obstacle shielding. However, a distance of several hundred feet is easily possible using a +12V supply.

Detailed circuit description

The complete schematic of the wireless video link is shown in Fig. 2; we'll discuss each stage in detail. Transistor Q1 is a common-base (or Colpitts) oscillator biased by resistors R1, R2, and R3. Inductor L4 and capacitors C3, C4, C5, and C8 form a circuit that is tuned to the frequency of the crystal.

The crystal is series-resonant at some frequency between 60 and 65 MHz, so it appears as a low impedance (50 ohms or less) at that frequency. Therefore Q1 will have sufficient gain as a common-base amplifier only at the resonant frequency of the crystal. Hence the signal developed at the junction of C4 and C5 will be amplified by Q1 only if that signal is at the same frequency as the crystal. At that frequency, Q1, has sufficient gain to oscillate because the ratio of the voltage initially developed between C4 and C5 to that at Q1's collector is greater than unity.

Capacitors C3 and C8 complete the tuned circuit; they also form a voltage divider that feeds the base of Q2 about one volt of the signal from Q1. Transistor Q2 functions as an overdriven amplifier that distorts its input signal and thereby produces harmonics of the input frequency. The second harmonic (120 MHz) is the

PARTS LIST

All resistors 1/2-watt, 5% unless otherwise noted.

- R1, R5, R11—22,000 ohms
- R2, R6, R12, R16—4,700 ohms
- R3, R7, R13—220 ohms
- R4, R9, R10, R18, R19, R21, R25—100 ohms
- R8, R14, R33—10 ohms
- R15, R26, R35—100,000 ohms
- R17, R28, R30—2200 ohms
- R20, R22—470 ohms
- R23, R27, R34—10,000 ohms
- R24—3300 ohms
- R29—82 ohms
- R31—1000 ohms, linear taper potentiometer
- R32—10,000 ohms, audio taper potentiometer

Capacitors

- C1, C6, C15, C32, C38—0.01 μ F 50 volts, ceramic disc
- C2, C7, C9, C14, C18, C23, C26, C29, C30—470 pF ceramic disc
- C3—33 pF, 5%, mica
- C4, C19—15 pF, 5%, mica
- C5—56 pF, 5%, mica
- C8—82 pF, 5%, mica
- C10—18 pF, 5%, mica
- C11—2 pF, ± 1 pF, mica
- C12—24 pF, 5%, mica
- C13—39 pF, 5%, mica
- C17—8 pF, 5%, mica
- C18, C24—1 pF, ± 1 pF, mica
- C20—12 pF, 5%, mica
- C21, C27—47 pF, 5%, mica
- C22, C25, C28—1-8 pF, polystyrene trimmer
- C31, C33, C39—8.2 μ F, 20 volts, tantalum
- C34—470 pF, 5%, mica
- C35—220 pF, 5%, mica
- C36—5-60 pF, polystyrene trimmer
- C37—100 pF, 5%, mica

Semiconductors

- Q1—Q3, Q6—2N3563
- Q4—2N3564
- Q5, Q7—2N3866
- Q8—MPF102
- Q9—2N3565
- LED1—standard red LED
- D1—1N757 9V Zener
- D2—MV2117 varactor
- D3—1N4002

Other components

- J1—Video camera jack
- J2—BNC jack
- J3—Coaxial power jack
- L1—6.2 μ H (see text)
- L2, L3—0.074 μ H (see text)
- L4—0.15 μ H (see text)
- L5, L6—0.035 μ H (see text)
- L7, L8, L9—0.018 μ H (see text)
- L10, L11—5.6 μ H
- S1—SPST miniature toggle
- XTAL—Crystal (see text)

Miscellaneous: Aluminum project case

AA-penlight cell battery holders
 Note: The following are available from North Country Radio, P. O. Box 53, Wykagil Station, New York 10804: Etched and drilled PC board, ferrite cores for coils L1 and L4, and crystal for Channel 14 or 15, \$32.50. Complete set of all parts that mount on PC board, \$69.95. In either case, be sure to specify channel.

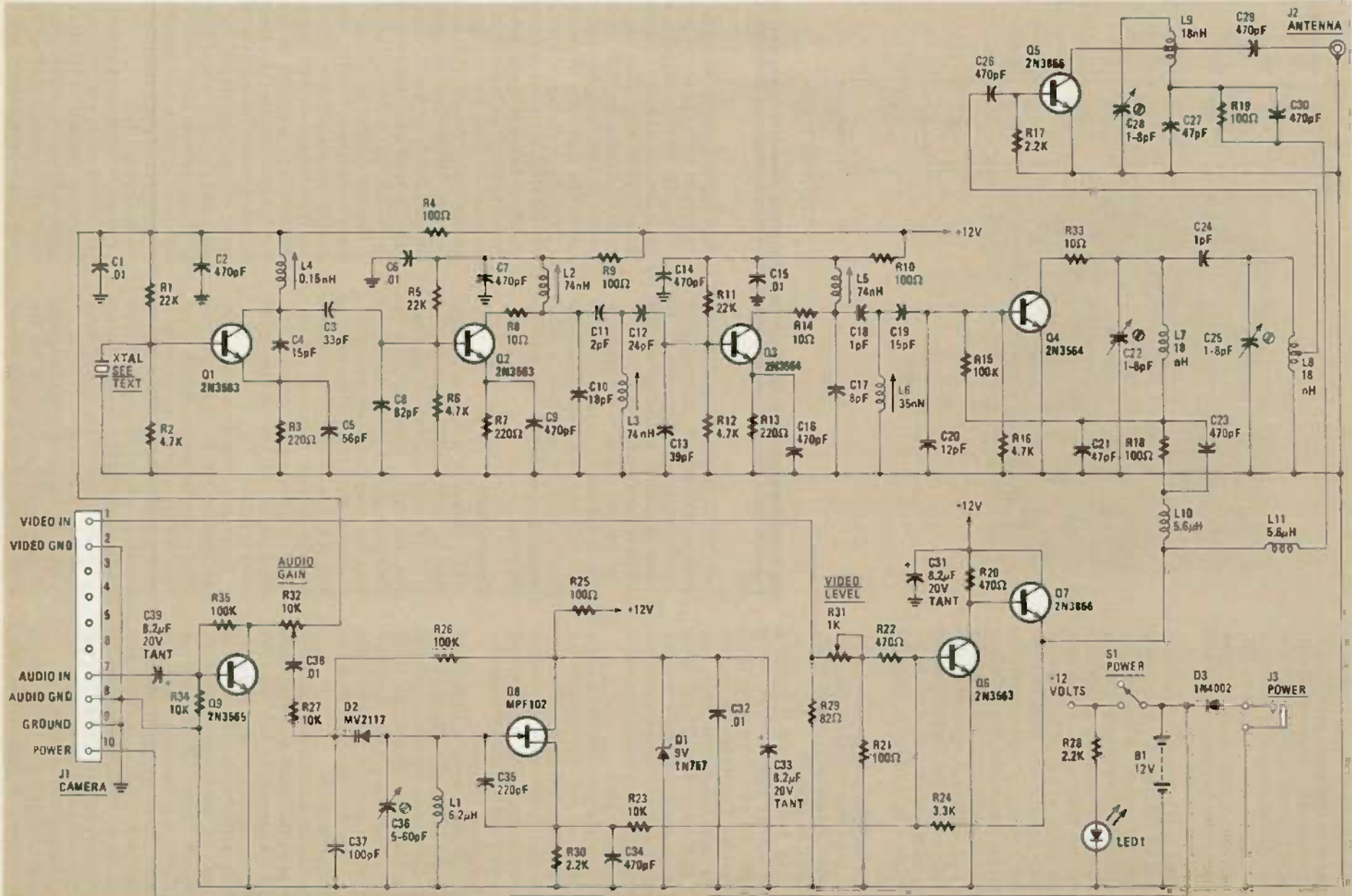

FIG. 2—COMPLETE SCHEMATIC OF THE TV TRANSMITTER is shown here. The circuit is straightforward, but see the text for information on winding coils L1-L9.

frequency we're interested in; L2 and C10 are tuned to that harmonic, and C8 is also series-resonant at that frequency. The additional base current supplied by C8 also improves Q2's efficiency of oscillation. A double-tuned circuit is provided by C11, C12, C13, and L3; those components filter harmonics higher than the second, as well as the 60-MHz fundamental.

Another stage of frequency doubling is provided by Q3, which operates very much like Q2, except that the tuned circuits at its input resonate at approximately 125 MHz, and its output circuits resonate at about 250 MHz. Again, Q4 operates like Q3, taking account of the values of the components in the tuned circuits. However, note that no emitter-bypass capacitor or resistor is used. It is difficult to get good bypassing in the 430–500-MHz range with ordinary components, and it takes only a very small impedance in the emitter to kill the power gain of that stage. Therefore, the emitter is directly grounded.

Power amplification is provided by Q5; it receives its drive from Q4 and the double-tuned VHF circuits composed of L7, L8, C22, C24, and C25.

Both Q4 and Q5 receive their supply voltage from the emitter of Q7, which supplies +4.5 volts with no input signal to Q4 and Q5. That voltage has positive-synch-tip video superimposed on it. The video gain provided by Q6 and Q7 is about eight, and the bandwidth is greater than 10 MHz. Those transistors are capable of driving a 75-ohm load to a level of 10 volts peak-to-peak.

Negative-synch input video from a camera, VCR, etc., is DC-coupled to the junction of R21 and R22. Video bypass is provided by C31. Gain and Q-point are set by R24; potentiometer R31 acts as a video gain control; and R29 keeps the input impedance around 75 ohms.

FET Q8 functions as a Hartley-type VCO with a free-running frequency of 4.5 MHz; C36 is used to fine-tune that frequency. Feedback is provided by C35 and C34; D2 is a varactor (variable-capacitance) diode. It is biased at about nine volts by R25, R26, and Zener diode D1, which also biases Q8.

The varactor (D2) changes capacitance at the audio rate, and that causes the oscillator's frequency to vary. In other words, the varactor provides frequency modulation (FM). Audio is fed to D2 via R27 and C38, and C37 provides RF bypassing at 4.5 MHz. The small value of C38 (0.01 μ F) provides pre-emphasis to the audio. Audio pre-amplification is provided by Q9; R32 is the audio gain control. The 4.5-MHz FM signal from Q8 is summed with the video signal through R23. The sound-level carrier may be varied by changing R23 as necessary.

The power supply is a 12-volt battery pack composed of eight AA alkaline

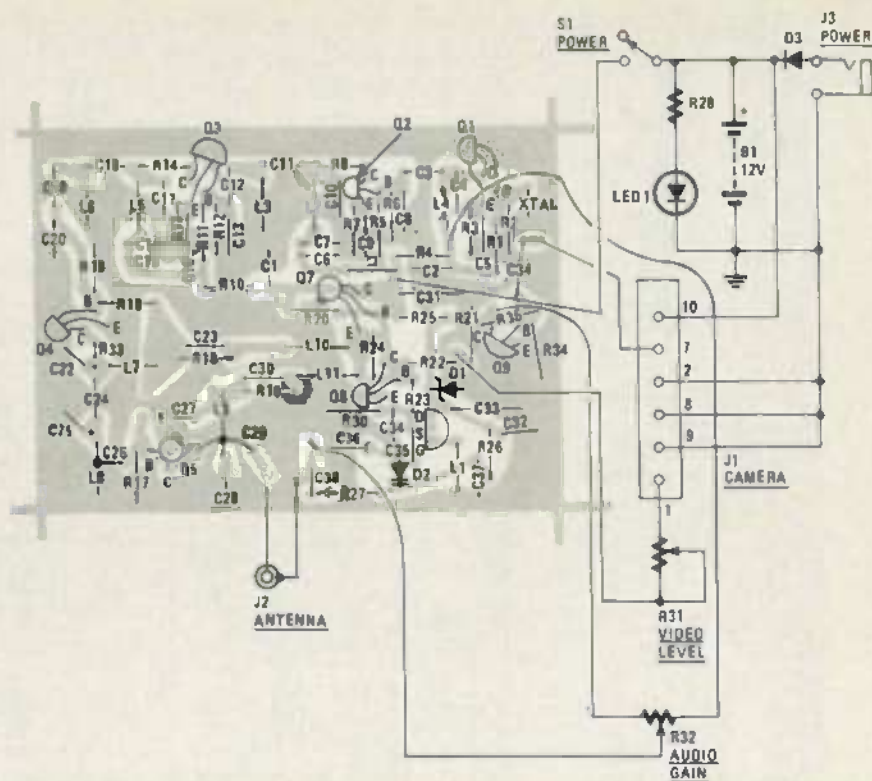

FIG. 3—COMPONENTS ARE MOUNTED ON THE PC BOARD as shown here. Note how R31 dangles from the PC board. We suggest you use a more secure method of mounting that potentiometer than we did.

cells; 10 AA Ni-Cd cells could be used instead. Alternatively, external power may be coupled in through jack J3. The power-on condition is indicated by LED1, which is current-limited by R28.

If, for any reason, video bandwidth must be reduced, simply add a small capacitor across R24. It should have an impedance equal in magnitude to R24's impedance at the highest intended video frequency.

Construction

Our transmitter is built on a single-sided PC board; the foil pattern is shown in "PC Service" elsewhere in this magazine. You may use either 0.8- or 1.6-mm G-10 glass-epoxy PC-board material. For most low-power, solid-state applications, G-10 epoxy is suitable for frequencies at least as high as 1000 MHz. That material has high electrical resistance, low electrical loss, mechanical rigidity, dimensional stability and low water-absorption characteristics.

The majority of construction projects published the past few years have been digital—low frequency—projects. Since many hobbyists have never attempted to build a high-frequency project like our transmitter, a few words about UHF construction techniques are in order. So bear with us for a few moments if what we say below is old hat to you.

First, be careful to select the proper components. For example, at low frequencies (under about 10 MHz), most ce-

ramic bypass capacitors work fairly well. Typical 0.01 and 0.1 μ F bypass capacitors in TTL and CMOS circuits fail to do their job as operating frequency is increased to about 25 or 30 MHz. That may be corrected by reducing the value of those capacitors to 0.001 μ F, and by keeping the lead lengths short—zero, if possible.

As the operating frequency approaches 100–150 MHz, bypassing again becomes a problem. At that point even smaller values (47 to 470 pF) are required, and leads must be very short. At even higher frequencies, up to about 500 MHz, chip capacitors, which have no leads, are soldered directly to the PC board. The moral is: Keep leads very short—do not use 1/4-inch leads on bypass capacitors.

Common electrolytic capacitors generally work well up to 10 MHz, depending on value and physical size. Mica capacitors (DM-15 type) are pretty good up to the VHF range, depending on value, but they can have from 5 to 15 nanohenries of series inductance. That inductance can increase apparent capacitance. For example, a capacitor with a value of 47 pF at 30 MHz may measure 82 pF at 150 MHz. That must be taken into account when designing tuned circuits at the frequencies we are dealing with.

Typical 1/4-watt resistors of 15 to 1000 ohms behave pretty well up to about 250 MHz or so. Values below 15 ohms tend to appear inductive, and values above 1000 ohms tend to appear capacitive. That can cause a shift in impedance, and, there-

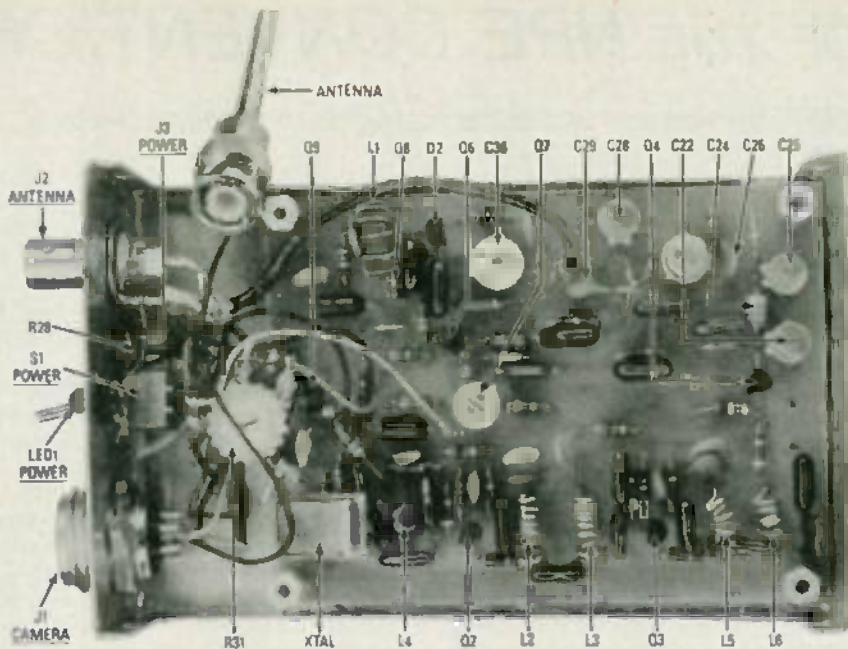

FIG. 4—MOST COMPONENTS ARE STANDARD, but note how C26 and C29 connect to L8 and L9, respectively. Also note the unequal turn-spacing of L2, L3, L5, and L6, which was brought on by tuning those coils. Finally, note the small slug L4 is wound around, and L1's toroidal core.

fore, the resonant frequency, of a tuned circuit. Stray inductive and capacitive reactances cause that shift.

Also, remember that every PC trace has inductance and capacitance. A PC pad may have, depending on size, several pF of capacitance to ground or to another PC pad. A long PC rail may act as an RF transmission line or even as a resonant circuit. It may also appear as an additional turn on a coupling transformer, by which unwanted signals might be radiated to other components or PC traces.

We hope you're not scared by all those cautions. We just want you to be aware of some of the problems involved in RF design and construction. But if you take care to duplicate our prototype exactly, the chances are that you'll have no problem getting your transmitter working. There is no "black magic" involved—only common sense and careful construction. Just be sure to use the same or equivalent parts—be careful!

After you have your components together, check the PC board over for shorts and opens, and make sure that the copper is clean and shiny. Then, referring to the parts-placement diagram in Fig. 3, insert and solder the components, starting with those that have the lowest profile (the resistors and diodes), and working up to the electrolytic and trimmer capacitors. Remember to cut all leads—especially the capacitors' leads—as short as possible. Don't overheat the semiconductors when soldering them to the PC board.

Now you're ready to wind and install the RF coils. Spread the turns of each coil evenly, but don't worry about spacing those turns perfectly, since the coils will

be compressed and expanded later when you tune up your transmitter. You can see in the photo (Fig. 4) how our prototype's coils turned out.

- L1 is eight turns of 22-gauge wire wound on a Ferroxcube 768T188 toroid core made from 4C4 ferrite.

- L2 and L3 are seven turns of 22-gauge wire wound on a #26 drill bit. Of course, remove the drill bit after the coil is completed.

- L4 is wound around a standard 10-32 screw thread. The screw should be removed after the coil is completed. Then L4 should be fitted with a ferrite slug. You may be able to find an appropriate slug in an old TV, radio, or CB radio. Best results will be obtained when the slug is taken from a circuit that operates in the 25–100-MHz range, such as a TV IF circuit, or the front end of an FM radio. But it's not really critical, and almost anything should work (provided it's made of ferrite) as a last resort. If necessary, L4's diameter, and number of turns, could be changed to fit the slug you have.

- L5 and L6 are three turns of 22-gauge wire wound on a #26 drill bit.

- L7, L8, and L9 are merely 1.5 cm loops of wire wound on a 3/8-inch form and sol-

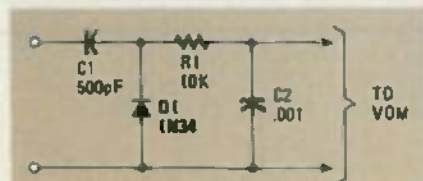

FIG. 5—RF-PROBE may be used with any VOM or DVM that has sensitivity greater than 20K ohms/volt.

dered to the PC board. One end of capacitor C26 is mounted in the normal fashion, and the other end hangs from the approximate mid-point of L8's loop. Similarly, C29 is mounted from the board to the mid-point of L9; the lead then continues to the pad near the collector of Q5.

- L10 and L11 are standard 5.6 μ H, 10%-tolerance chokes obtainable from the J. W. Miller Corporation, etc. They could also be wound from 36-gauge wire on 1/2-watt, 1-megohm carbon resistors if desired.

Last, install the transistors, making sure that they are oriented correctly and that their lead length is minimized.

We use a 10-pin camera jack for J1, but feel free to substitute whatever connectors you need. If no sound carrier is needed, R23, R25, CR2 and all other components associated with Q8 and Q9 can be omitted. Doing that will not affect the operation of the video portion of the transmitter. They can be added at a later date should audio transmission become necessary.

We chose not to leave space on the PC board for the audio- (R32) and video-input (R29, R31) components, since those components were unnecessary in our application. We used fixed-value resistors for R31 and R32, but small potentiometers could be mounted to the case and wires run to the PC board. If no gain control is necessary, R32 should be replaced by a fixed 10K resistor, and C38 should be connected directly to the collector of Q8.

Solder the coils to the PC board now, and solder short interconnecting wires from the board to the chassis components. Before applying power, check over your work; Make sure no solder bridges exist and make sure that all polarized components are correctly oriented.

Testing and alignment

The following equipment is necessary to align the transmitter:

- VOM or DVM having sensitivity of at least 20,000 ohms/volt
- RF probe
- Video source (VCR or camera)
- TV set or monitor
- 50-ohm dummy load

If an RF probe is not available, you can use the circuit shown in Fig. 5 with your voltmeter. If you have no 50-ohm dummy load, you can use a 51-ohm, 1/4-watt resistor. One handy gadget to have is a tuning wand: a plastic rod with a ferrite slug at one end and a brass slug at the other. The inductance of a coil can be increased or decreased by placing the ferrite or the brass slug, respectively, near the coil.

Apply power and check for +12V at R4, R9, R10 and the collector of Q7. Check for +9V at the drain of Q8. Then check for 1.0 to 1.5 volts at the emitters of Q1, Q2, and Q3. Check for +4.5 to

continued on page 114

HIGHLIGHTS OF THE NPE CONVENTION

The unification of NESDA and NATESA was just one of the highlights of the 1985 National Professional Electronics Convention.

WHILE EACH YEAR'S NATIONAL PROFESSIONAL electronics convention (NPEC) is a worthwhile and memorable experience, 1985's session, held in August in Hartford, CT, was particularly significant for the electronics industry. At that meeting a consolidation agreement between the National Electronics Sales and Service Dealers Association (NESDA) and the National Association of Television and Electronic Servicers of America (NATESA) was unanimously approved by NESDA. Later in the month, NATESA, at its convention held in St. Charles, IL, also unanimously approved it.

Joining together

Under the agreement, the Chicago-based NATESA organization will become the NESDA state affiliate in Illinois as of January 1, 1986. At the same time, NESDA will accept and perpetuate the heritage of NATESA as its own. For two years, current NATESA members who reside outside of Illinois may choose to either remain members of the Illinois association or to join the NESDA affiliate in their home state. Current NESDA members residing in Illinois have two years to join the new Illinois affiliate.



GETTING INVOLVED. Murray Barlowe, CET, and Ed Kimmel, CET, participate in the Electronics Instructors Conference, one of the many seminars at the Hartford NPEC.



MAN OF THE YEAR. Larry Steckler, publisher of *Radio-Electronics*, Chairman of the Electronics Industry Hall of Fame, and NESDA's Man of the Year speaks at the Hall of Fame Banquet. Roger Companion, NATESA Vice President, is seated at the right.

Former officers of NATESA will be recognized equally with those of NESDA. The founder of NATESA, the late Frank J. Moch, who, at the convention, was inducted into the Electronics Industry Hall of Fame, will be perpetually honored as the father of both organizations.

The current presidents of both organizations highly praised the new agreement. Said continuing NATESA president Tom Leeny, "We're proud to contribute our part to a vibrant NESDA organization, and this agreement shows that the people in our industry have the ability to work together for the good of all." Dorothy Cicchetti, the newly-elected president of NESDA, added, "With the addition of the diligent and loyal NATESA members, NESDA will become an even more dominant force for good in our profession."

Elections and awards

A spirited contest led to the election of Dorothy Cicchetti, of Flushing, NY, as NESDA president.

The other NESDA officers elected included: Robert Harrell, Johnson City, TN, 1st National Vice President; Clifford A. Shaw, Columbia, VA, Secretary; and Dick Scott, CET, Olympia, WA, Treasurer. Regional Vice Presidents are Art Van Sickle, Hartford, CT; Faust Guarino, CET, Oceanside, NY; Jim Teeters, CET, Norfolk, VA; Gene Dillingham, CET, Louisville, KY; Bob Mesa, CSM, Parma, OH; Floyd Hack, CET, Taft, TX; Gennie Randel, Greensburg, KS; Vince Hostetler, CSM, Grand Junction, CO; Ken Duncan, CSM, Antioch, CA; and Bob Villont, CET, CSM, Tacoma, WA.

The new ISCET (International Society of Certified Electronics Technicians) officers are: Jim Parks, CET, Orlando, FL, Chairman; Don Winchel, CET, Smart-

ville, CA, Vice Chairman; Hal Robbins, CET, Van Nuys, CA, Secretary; and Earl Tickler, CET, Baltimore, MD, Treasurer. Bob Villont will continue as the NESDA representative to the ISCET board of governors.

Turning to the awards, as previously mentioned, the late Frank J. Moch was inducted into the Electronics Industry Hall of Fame. In addition, Larry Steckler, CET, EHF, Publisher, Gernsback Publications (including, of course, *Radio-Electronics*) and Chairman of the Electronics Industry Hall of Fame was named NESDA's Man of the Year; he was also presented with ISCET's Continuous Service Award.

Other major awards included: Ken Duncan, CSM, Officer of the Year; Cliff Shaw and Chic Young, P.E./CSM (tie), Outstanding Committee Chairman; Don Erwin, CSA, Outstanding State President; Ed Erich, CSM, Outstanding Local President; Martin Fleming, CET, Technician of the Year; and Lester Dodd, CET, 1985 Friend of ISCET.

Rounding out the event was an outstanding slate of professional seminars, a trade show, and an unusually rich assortment of memorable social functions. **R-E**



CELEBRATING THE SIGNING of the momentous agreement consolidating NESDA and NATESA are NESDA President Dorothy Cicchetti (left) and NATESA President Tom Leeny.



OUTGOING NESDA PRESIDENT George Bluze (standing left) presents certificates recognizing the industry contributions of Paul Kelley (standing center), Robert Haskins, and Robert Read. Tom Plant, CET (standing right) accepted the certificate for Haskins and Read.



JEROME MOCH, (standing left) son of the late Frank J. Moch, accepts the plaque designating the induction of his father into the Electronics Industry Hall of Fame. Making the presentation is Wallace Harrison, Director of Communications of NESDA/ISCET.

BUILD THIS

\$99

Satellite-TV Receiver



RICHARD MADDOX

OK, TVRO fans, here's your chance to build a high-performance satellite receiver—for peanuts!

Part 2 LAST TIME, WE showed you how our budget satellite receiver works. This month, we give you step-by-step instructions detailing how to build the unit.

Construction

Use of a PC board is strongly recommended; a foil pattern is presented in the "PC Service" section of this magazine.

Use the component-placement diagram in Fig. 3 and the photograph in Fig. 4 to assemble the board. When inserting parts in the PC board, work in numeric sequence, and check off each part as it is installed.

1—Beginning with resistor R1, insert all resistors in numerical order. R96 and R100 are not installed on the PC board.

2—Install the wire jumpers. Insulation should cover the entire exposed length of each jumper.

3—Install the trimmer potentiometers on the board, followed by the trimmer capacitors, and then the other capacitors. Carefully check the value of every part before mounting it. Be sure to orient all polarized capacitors correctly.

4—Install all diodes. Be careful to install them with the correct polarity, and use extra care in bending the leads on glass diodes.

5—Insert all IC sockets, making sure that pin one of every socket is oriented correctly. IC1 and FL1 should both be mounted flush to the board and soldered in. The leads of transistors Q1 and Q2 should be trimmed to a length of 2 mm, and those transistors should be mounted and soldered on the solder side of the board. The other transistors should be inserted from the top and soldered now. Leave 1/4-inch of lead protruding above the board.

6—Voltage regulators IC10 and IC11 need heat sinks. Use heat-sink grease and mount them loosely to the heat sinks before inserting the assembly in the PC board. Align the legs of the regulators and the heat-sink tabs with the corresponding holes in the PC board, solder the regulators and heat sinks to the board, and tighten the screws. Install the 7805 regulator, IC9.

7—Mount POWER switch S3 and AFC switch S2 on the board and solder them.

8—Solder the two type-F connectors, J1 and J5, and the three RCA-type phono jacks, J2, J3 and J4, to the PC board.

9—Mount the RF Modulator on the board. Be sure that all four mounting tabs are flush, and then solder them to the board.

10—Mount and solder the inductors. Note that L4 is mounted vertically on the board. Install FL2 now.

11—Mount green POWER LED3 1/2-inch above the board. It will be bent to fit into the front panel later.

(Editor's note: We recently heard from an experimenter who reported that the following modifications will improve performance: Remove R69 from the board. Replace R64 with a 220-ohm, 1/4-watt unit. Add a 330-ohm, 1/4-watt unit at the base of Q7.)

Front-panel assembly

At this point, all components should be installed except the IC's and the front- and rear-panel components. The front-panel layout is shown in Fig. 5. The wire lengths given below assume that you are using the PC board and case specified in the parts

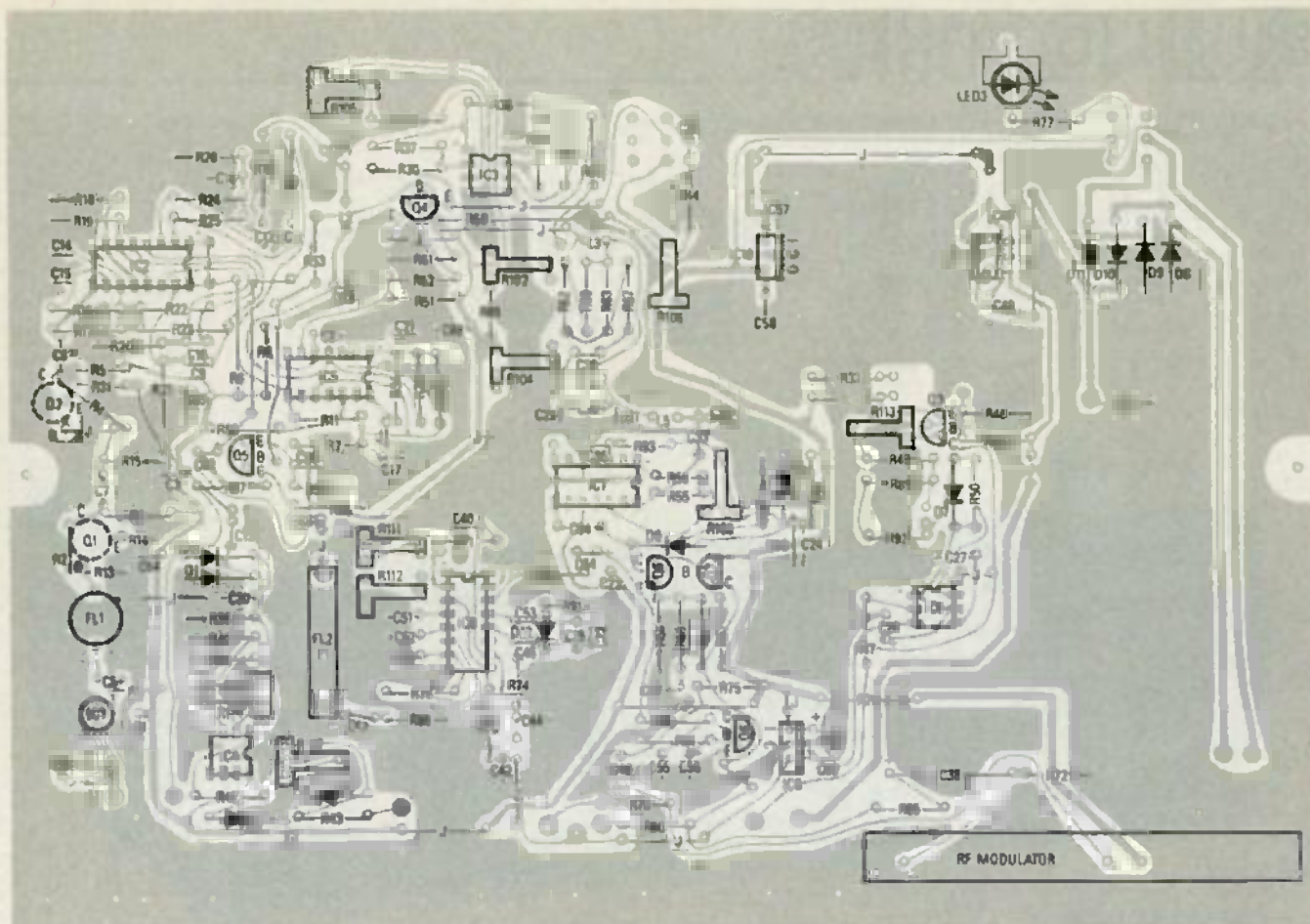

FIG. 3—ON-BOARD COMPONENTS are shown here. Note that transformer Q1 and Q2 are mounted on the underside of the board.

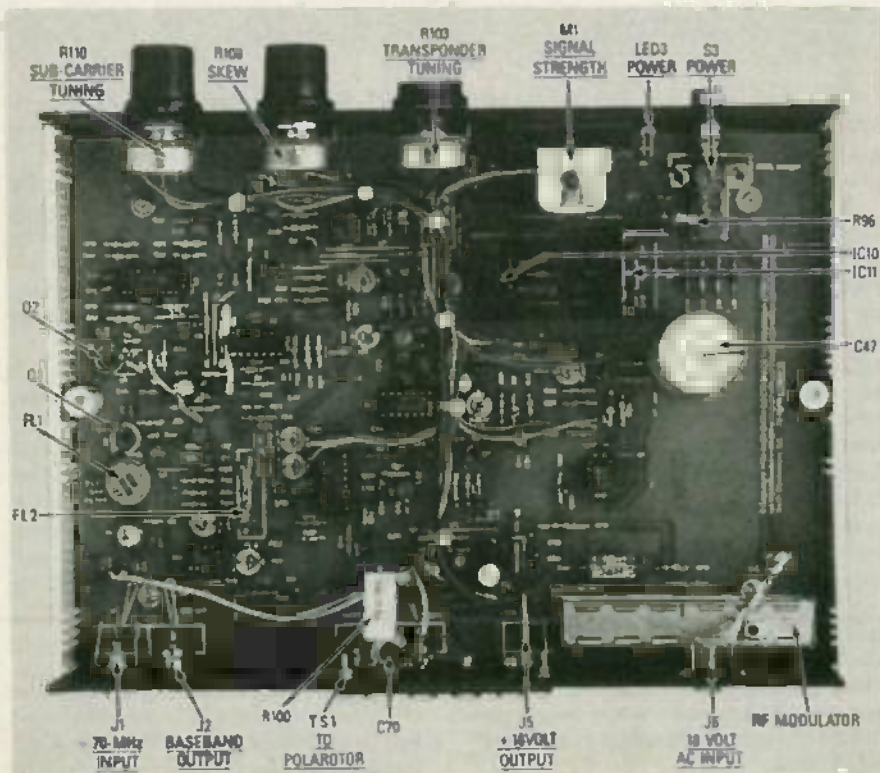

FIG. 4—THE COMPLETED PC BOARD. Be sure to route the interconnecting wires away from the voltage regulators.

list. If you're not, use wires of the appropriate length.

1—Mount potentiometers R103, R108, and R110 to the front panel. Orient all three so that their terminals point down.

2—Viewing the panel from the rear, connect the center and right terminals of R108 together. Solder a seven-inch wire to all terminals except the right terminal of R108.

3—Mount switches S2 and S4. Solder six-inch wires to the three terminals on S4. Solder a seven-inch wire to each center terminal of S2; connect a short jumper between the upper-left and the lower-center terminals.

4—Insert LED1 and LED2 into the appropriate holes in the front panel. Orient them so that their cathodes (the flat sides) are toward polarity-switch S2. Solder each cathode to the nearest lower-end terminal on that switch. Solder a seven-inch wire to each anode.

5—Solder ten inches of wire to each meter terminal. Mount the meter in the front panel.

Rear-panel assembly

The rear-panel layout diagram is shown in Fig. 6.

1—Mount the terminal strip and AC-input jack J6 to the back panel.

PARTS LIST

All resistors 1/4-watt, 5% unless otherwise specified.

R1, R3—270 ohms
 R2—510 ohms
 R4, R5, R32, R33, R77—680 ohms
 R6—150 ohms, 1/2-watt
 R7—1200 ohms
 R8, R30, R44, R46—10,000 ohms
 R9, R10, R26, R53—56 ohms
 R11, R16, R17, R24, R25, R28, R60, R65, R87—75 ohms
 R12, R15, R29, R34, R42, R52, R72, R79, R82, R86, R95—1000 ohms
 R13, R47, R70, R93, R96—100 ohms
 R14—3.9 ohms
 R18—R21, R54, R73—470 ohms
 R22, R23—120 ohms
 R27—820 ohms
 R31, R43, R69—220 ohms
 R35, R37—22,000 ohms
 R36—18,000 ohms
 R38, R74, R94—100,000 ohms
 R39, R40, R45, R92—4700 ohms
 R41—unused
 R48, R64—330 ohms
 R49, R51, R88—2200 ohms
 R50—120,000 ohms
 R55, R56, R58, R62, R63—150 ohms, 1/2-watt
 R57, R75—3300 ohms
 R59, R61, R66, R68, R76—560 ohms
 R87—43 ohms
 R71—12,000 ohms
 R78, R83, R84—0 ohms (jumper)
 R80—47,000 ohms
 R81—1500 ohms
 R85—8200 ohms
 R89, R90—2700 ohms
 R91—68,000 ohms
 R96—180 ohms, 1 watt
 R97—R99, R101—unused
 R100—5.6 ohms, 5 watts
 R102, R104, R105, R107, R111, R112—5000 ohm trimmer potentiometer
 R103—5000 ohm linear potentiometer
 R106, R113—10,000 ohm trimmer potentiometer
 R108—10,000 ohm linear potentiometer
 R109—2000 ohm trimmer potentiometer
 R110—5000 ohm linear potentiometer

R114—100,000 ohm trimmer potentiometer
Capacitors
 C1—C5, C7, C8, C13—C18, C20, C21, C23, C24, C27, C42, C44, C50—C52, C61, C64, C65, C67—0.01 μ F, ceramic disk
 C6, C37, C41, C43, C54, C59, C66—unused
 C9, C10, C63—33 pF, ceramic disk
 C11, C12, C46, C53—0.001 μ F, ceramic disk
 C19—47 pF, silver mica
 C22, C45, C49, C58, C60—10 μ F, 25 volts, tantalum
 C25, C56—47 μ F, 16 volts, tantalum
 C26, C48, C57, C59—0.22 μ F, 30 volts, tantalum
 C28—100 pF, ceramic disk
 C29—56 pF, ceramic disk
 C30—68 pF, ceramic disk
 C31—300 pF, ceramic disk
 C32—220 pF, ceramic disk
 C33, C38, C62—100 μ F, 16 volts, electrolytic
 C34, C68—0.1 μ F, ceramic disk
 C35—470 μ F, 16 volts, electrolytic
 C36—10 pF, ceramic disk
 C39—0.0047 μ F, ceramic disk
 C40—0.047 μ F, ceramic disk
 C47—5600 μ F, 40 volts, electrolytic
 C55—0.0022 μ F, ceramic disk
 C70—220 μ F, 25 volts, electrolytic
 C71—5–70 pF, variable
 C72—2–20 pF, variable
Semiconductors
 IC1—MWA120, hybrid small-signal amplifier
 IC2—MC10116, triple differential line receiver
 IC3, IC4—LM358, dual op-amp
 IC5—MC1496, video detector
 IC6—NE555, timer
 IC7—NE592, video amplifier
 IC8—NE564, phase-lock loop
 IC9—7805, 5-volt regulator
 IC10—7812, 12-volt regulator
 IC11—7818, 18-volt regulator
 Q1, Q2—BFR91
 Q3, Q4, Q6—2N2222
 Q5, Q7—BC328 or 2N3683

Q8—BC548 or ECG548
 D1—D4—1N60
 D5—1N752, 5.6-volt zener diode
 D6—HP 5082-2800 or 1N6263 Schottky diode
 D7—1S2075
 D8—D11—1N4002
 D12—BB119 tuning diode
 LED1—standard green LED
 LED2, LED3—standard red LEDs
Other components
 J1, J5—"F" connector
 J2, J3, J4—RCA phono jack
 J6—coaxial power input jack
 TS1—4-position screw-terminal strip
 L1, L5—10 μ H
 L2—0.33 μ H, six turns on a 1/4-inch form.
 L3—100 μ H
 L4—2.7 μ H
 S1, S4—SPDT, toggle switch
 S2, S3—DPDT, toggle switch
 FL1—BO124 SAW filter
 FL2—5–8 MHz block filter (Dick Smith L-1600)
 M1—200 μ A edge-reading meter
 RF modulator
 T1—18-volt AC power transformer

Note: the following are available from Dick Smith Electronics, Inc., P.O. Box 8021, Redwood City, CA. 94063: Complete kit of parts including case but no power transformer, #K-6316, \$99.95 plus \$4 shipping; SAW filter, #L-1620, \$29.95; Case, #H-2507, \$12.95; PC board, #H-7000, \$29.95; 18-volt transformer, #M6672, \$7.95; BFR91 transistor, #Z-1691, \$1.19; BB119 diode, #Z-3070, \$0.20; MWA120 RF amplifier, #Z-6095, \$12.50; MC10116 ECL IC, #Z-6000, \$0.79; HP5082-2800 Schottky Diode, #Z-3230, \$2.00; 5–8 MHz filter, #L-1600, \$3.95. Other individual parts, and complete satellite systems, are also available from Dick Smith. California residents please add 6.5% sales tax. Orders outside U.S. must include U.S. funds and add 15% of merchandise total for shipping.

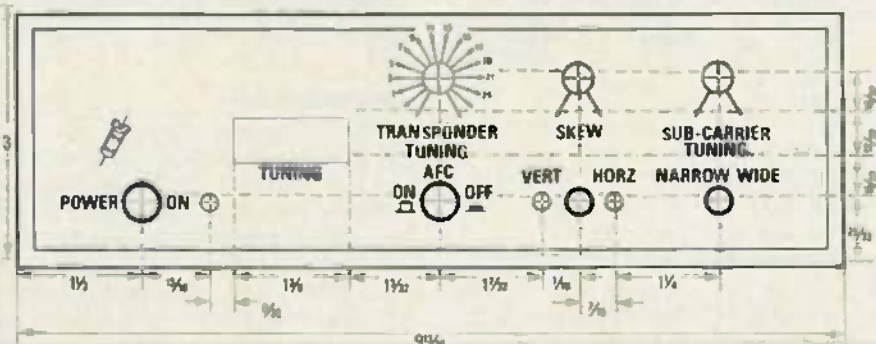

ALL DIMENSIONS IN INCHES

FIG. 5—FRONT-PANEL LAYOUT, with dimensions to fit the controls mounted to the PC board.

2—Solder a jumper wire between the two ground terminals of TS1.

3—Solder R100 and the positive lead of C70 to the +5V terminal. Solder the minus lead of C70 to ground.

4—Solder one four-inch wire to the PULSE output terminal, another to one ground terminal, and another to the other end of R100. Solder a three-inch wire to the two bottom terminals of J6.

Final assembly

The component-placement diagram in Fig. 7 should be consulted while connecting the front- and rear-panel components to the PC board.

1—Insert and solder PC terminal pins (or short pieces of stiff wire) in all holes to which off-board components will be connected. Place the PC board in the cabinet, but do not screw it down yet.

2—Slide the front panel over the two PC-mounted switches, and then insert the front panel into the first slot of the cabinet. Carefully insert the green POWER LED into its hole.

3—Slide the rear panel over the connectors mounted at that end of the board, and then insert the rear panel into the last slot of the cabinet.

4—Insert and tighten the four mounting screws.

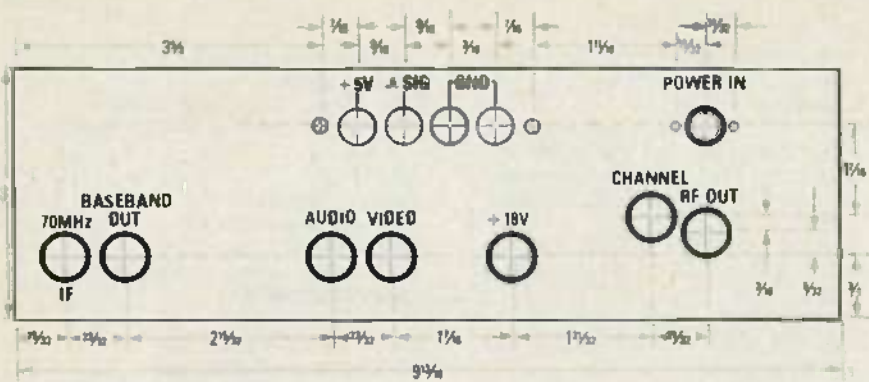

ALL DIMENSIONS IN INCHES
 FIG. 6—REAR-PANEL LAYOUT, with dimensions.

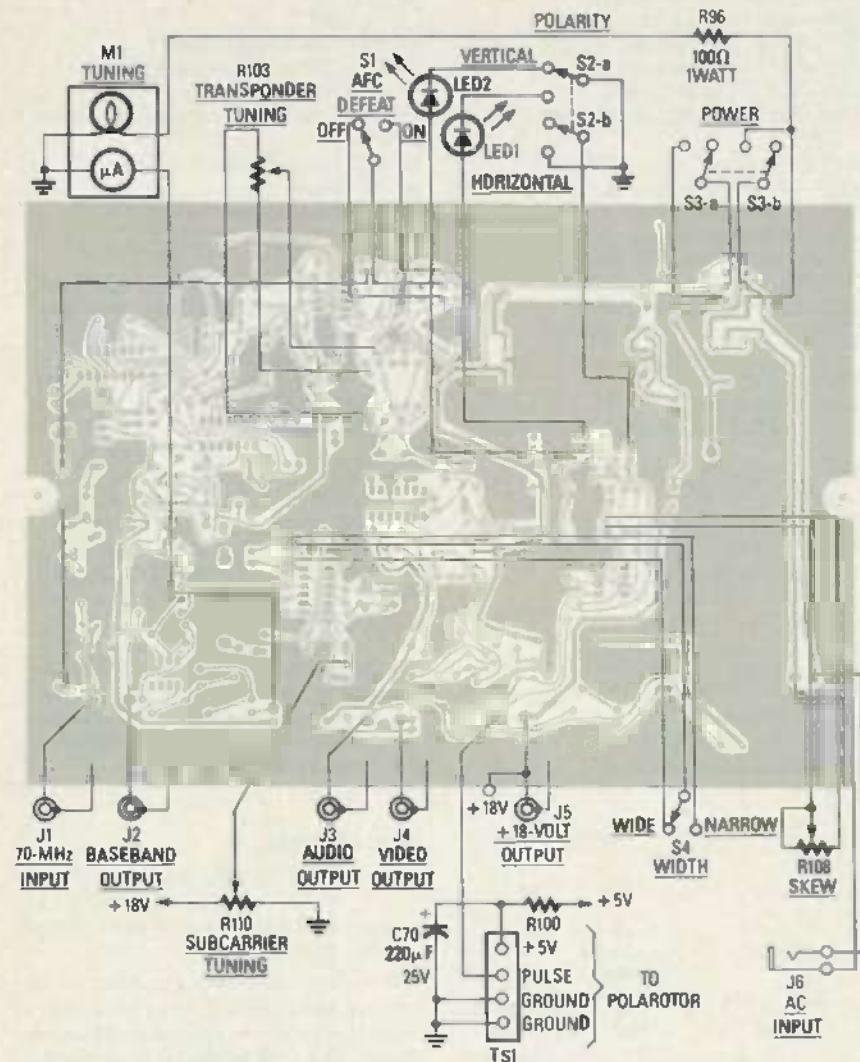

FIG. 7—FRONT- AND REAR-PANEL COMPONENTS are connected to the PC board as shown here.

5—Connect all wires from the off-board components to the appropriate pins on the PC board. Doublecheck all connections.

6—Plug the transformer's output into J6, and then plug it into the wall.

7—Check the output of each regulator (IC9–IC11) for the correct voltage. Also, check the voltages at J5 (the +18V connector), at the +5V terminal strip, and at

pin 8 of IC4 (+12V). The POWER LED and meter lamp should light up, and so should either LED1 or LED2, depending on the position of S2. Flip that switch to verify that the opposite LED lights up.

8—Turn off the receiver and unplug the transformer.

9—Insert all the IC's into their sockets. Be sure to orient them correctly, and make sure all IC's are seated properly.

10—Route all wires down the center of the board. Be sure to leave clearance around the trimmer potentiometers, and route wires away from the regulators' heat sinks. Use wire ties to secure the wires.

11—Set each trimmer to the center of its range using a small screwdriver. Set the two trimmer capacitors so that the adjustment slot is parallel to the side walls of the cabinet.

12—Turn on the receiver and measure the total current drain. It should be about 400 ma.

13—Measure the voltage at J1. The voltage should vary as R103, TRANSPONDER TUNING, is varied.

Aligning the polarizer

A friend or spouse may be helpful in completing the following alignment.

1—Connect the polarizer to the appropriate terminals on TSI. The red wire usually connects to +5V, black connects to ground, and white connects to the pulse output—but make sure your unit follows that convention. Center the SKEW control.

2—Turn on the receiver. Verify that the probe moves as POLARITY switch S2 is toggled. Mark the vertical probe position on the side of the polarizer. Move S2 to HORIZONTAL. Adjust R113 so that the probe is 90 degrees from its former position.

Aligning the tuning control

The adjustments made now will be fine-tuned a little later.

1—Measure the voltage at pin 1 of IC3. Turn AFC on. Adjust R105 for exactly 3.0 volts DC. Turn AFC off. Adjust R106 for the same voltage.

2—Measure the voltage at J1. Set the TRANSPONDER TUNING control to line up with the "Channel 1" label on the front panel. The voltage should be set to the lowest voltage specified by the downconverter manufacturer. That is done by adjusting R104.

3—Set the TRANSPONDER TUNING control to Channel 24. Adjust R102 for the highest voltage needed by the downconverter.

Final check-out

The easiest way to check out and adjust the receiver is to use it on a system that is already working. Ideally, a friend or neighbor will allow you to hook up the receiver and downconverter for final testing. If that is not possible, then first you will have to get your dish aimed precisely at Galaxy 1. Instructions for doing that are usually given in the assembly instructions packed with the dish.

Next, the feedhorn, LNA and downconverter should be installed, and then cable should be run to the receiver. Do not use more than about 250 feet of cable between the downconverter and the receiver.

continued on page 114

BUILD THIS

HUMIDITY MONITOR

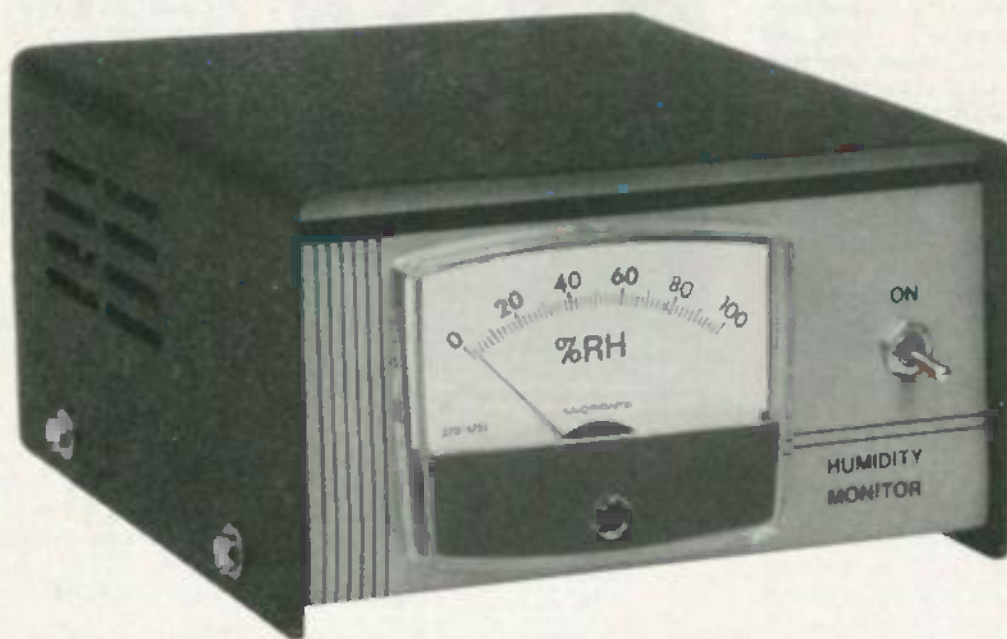

Don't let static zap your costly electronic gear! This electronic humidity monitor lets you spot potentially dangerous conditions.

MARK C. WORLEY

IF YOU'RE LIKE MANY PEOPLE, YOU TEND to downplay—or simply ignore—the importance of humidity. But you shouldn't! The reason is that, after temperature, humidity is the most important environmental condition that affects our comfort level. We're comfortable when the humidity is low in the summer, but that same low humidity can make us feel uncomfortably cool in the winter.

Perhaps more important to the readers of **Radio-Electronics** is the fact that humidity—or the lack of it—can drastically affect the operation of the electronic devices we love so well: computers, TV's, VCR's, stereos, etc. Proper humidity control in the winter months can reduce the static buildup that is so often detrimental to the operation of electronic equipment. For example, a rule of thumb states that you should be careful when the humidity drops below about 50% as the temperature drops below about 70°. You certainly wouldn't want to handle any CMOS IC's in those conditions!

In order to help you bring your humidity problems under control, we will discuss what humidity is, some of its effects, and several historical means of measuring it. Then we'll show you how to build a modern, electronic humidity monitor that features 5% accuracy for about \$50.

What is humidity?

Humidity is usually specified as percent *Relative Humidity*, or RH, for short. Relative humidity is not a *measurement* of the amount of water vapor in the air. Rather, RH is the ratio of the amount of water vapor in the air to the maximum amount of vapor that air can hold. That maximum varies primarily with temperature, although barometric pressure affects it to a lesser degree.

For example, let's assume that a given volume of air at a given temperature can hold one ounce of water vapor. If that air contains half an ounce of water, its relative humidity is 50%. If that same volume of air were cooled, it might be able to hold a maximum of only $\frac{1}{2}$ an ounce of water. So if that air still contained half an ounce of water, the relative humidity would now be $0.5 \div 0.6$, or 83.3%.

On a hot day the relative humidity governs our comfort primarily because it affects the efficiency of our natural cooling system—our sweat glands. If the humidity is high, sweat can't evaporate as readily. That's why a hot, dry day is more comfortable than a warm, humid day. Various "comfort zone" charts have been developed that show which combinations of temperature and humidity are the most comfortable.

The effects of humidity are evident all around us. For example, dew is caused by cooling of the air during the night until it saturates (reaches 100% RH), and it then releases excess moisture onto any cool surface. The temperature at which that saturation occurs is called the *dew point*.

Here's another common effect of humidity: iced drinks that "sweat" on a hot day. That "sweating" is really caused as follows. The outer surface of the glass is cooled by the icy contents of the glass. That surface in turn cools the surrounding air.

When that air reaches the dew point temperature, it releases some of its excess moisture onto the surface of the glass. So in reality that "sweating" is not perspiration from the glass, but condensation from the atmosphere. Hence the reason cold drinks don't "sweat" as much in dry climates as they do in humid ones is that there's very little water in the air to condense on the glass.

Measuring humidity

Temperature is easy to measure using a simple thermometer, or any of a number of solid-state devices. Humidity, on the other hand, is probably the most difficult environmental condition to measure. The search for an accurate, dependable means

of measuring humidity has occupied scientists for centuries. For example, Leonardo Da Vinci noticed in 1550 that a ball of wool weighed more on a rainy day than on a dry day. Ever since then scientists have been refining ways of measuring RH precisely. For example, methods using various organic substances, electro-optical sensors, resistive sensors, and variable-capacitance sensors have been developed. Each method has unique advantages and disadvantages.

Organic sensors like human hair, animal hair, and animal membranes have been in use the longest, and are still in use today. An organic tissue absorbs moisture readily, and, as it does, it will stretch more easily. That stretching can be measured, and that provides an indirect indication of RH. As you might suspect, the primary disadvantage of organic sensors is their tendency to age rapidly, and that requires frequent re-calibration.

Relative humidity can also be calculated by measuring the dew point. The dew-point method is highly accurate, but cumbersome, because of the cleanliness, and the complex, precise circuitry that are required. A mirrored surface is monitored as it cools until moisture begins to form on it. The temperature at which moisture is detected is the dew point, and that is dependent upon relative humidity. The dew-point method is most suitable for laboratory work.

Resistive sensors have their problems, too. The resistance of that sort of sensor usually ranges from the hundred of thousands of ohms to the tens of megohms. That high resistance, plus the non-linear response curves of those sensors, makes them difficult to work with. In addition, they can be damaged by direct contact with moisture, by common airborne contaminants, or by simple DC voltages. Most sensors require an AC excitation voltage, because even a small DC voltage can cause chemical migration within the sensor, and that usually ruins it.

Another humidity sensor is based on variations in capacitance. Sensors of that type weren't commonly used in the past because of their high cost—typically \$100 or more apiece—and because they can be difficult to use due to their small variation in capacitance. However, the sensor shown in Fig. 1, developed by the N. V. Philips Company, and sold in this country by Mepco/Electra (Columbia Road, Morristown, NJ 07869), is inexpensive and easy to work with.

The sensor

Philips' humidity sensor is a capacitor formed from a dime-sized piece of plastic film that is coated on both sides with a very thin layer of gold. Because the dielectric constant of that film varies with changes in RH, so does the sensor's capacitance. On each side of the film the

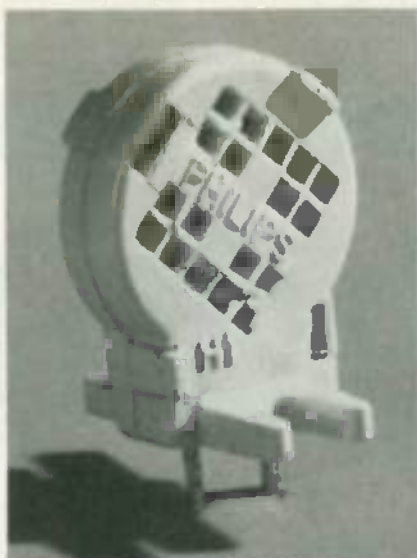

FIG. 1—PHILIPS' HUMIDITY SENSOR provides a 45-pF change in capacitance over the 0-100% humidity range.

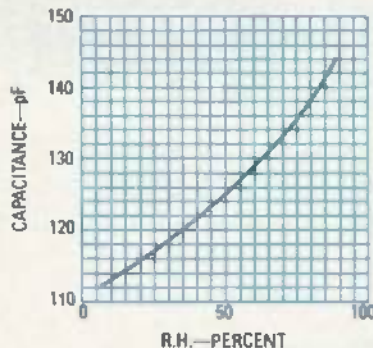

FIG. 2—THE SENSOR'S CAPACITANCE and the relative humidity are related exponentially.

gold functions as one plate of a capacitor; it also provides the electrical contact for the sensor-housing's spring-contact leads. The sensor measures about 0.6" in diameter, and 0.9" high. We list some of the specifications of Philips' sensor in Table 1. For more information, see Mepco's Technical Information Brochure 063, their Technical Note 134, and the data sheet that comes with the sensor.

The curve in Fig. 2 shows how the sensor's capacitance varies with humidity. By

extrapolating a little we see that capacitance varies from about 115 pF at 0.0% RH to about 160 pF at 100% RH. In other words, there is a change in capacitance of 45 pF over the entire RH range. So, in order to measure RH, all we need is a circuit that translates that 45 pF variation in capacitance to a properly scaled variation in voltage.

But before we discuss the details of circuit operation, there are a few other things you should know that affect the accuracy obtainable from our humidity monitor. First, the sensor has a drift of 0.1% per degree Celsius, which translates to an inaccuracy of 1% for a 10°C change in temperature. So, over a range of 40°C, accuracy will drop to about 4%. Given proper calibration, our humidity monitor should be accurate, therefore, to better than 5% RH over a wide temperature range. Just compare that to the typical 25% accuracy—or worse—of the dial-type humidity indicator included with many wall- and desk-top thermometer-barometer-humidity monitors! You should also be aware that the capacitance of the sensor is somewhat dependent upon the frequency applied to it, but to obtain the accuracy we're interested in, we can ignore that variation.

Circuit operation

If we were simply to build an oscillator whose frequency varied in response to changes in the sensor's capacitance, we could measure relative humidity, but we'd have an offset problem, because 0.0% RH corresponds to 115 pF, not 0.0 pF. In other words, we'd have some output even at 0.0% relative humidity. So we use two oscillators in our circuit, and measure the difference between their outputs. That allows us to obtain an output of 1.00 volt for 100% RH.

Our circuit is a modified version of one supplied by Philips. In their circuit, one 4001 CMOS quad-NOR package was used to build the two oscillators, and the gates in a second 4001 were connected in parallel to provide extra drive for the rectifier/filter circuit. We decided to use 7555's for the oscillators because they're only slightly more expensive, but much more

TABLE 1—SENSOR SPECIFICATIONS

Parameter	Value
Humidity range	10-90% RH
Temperature range	0-85°C
Capacitance (25°C, 43% RH, 100 kHz)	122 pF, ± 15%
Frequency range	1-1000 kHz
Temperature dependence	0.1% RH/°C
Response time (max)*	
10-43% RH	3 minutes
43-90% RH	5 minutes
Typical hysteresis	3%
Maximum voltage	15 volts

*To 90% of final value. @ 25°C, in circulating air

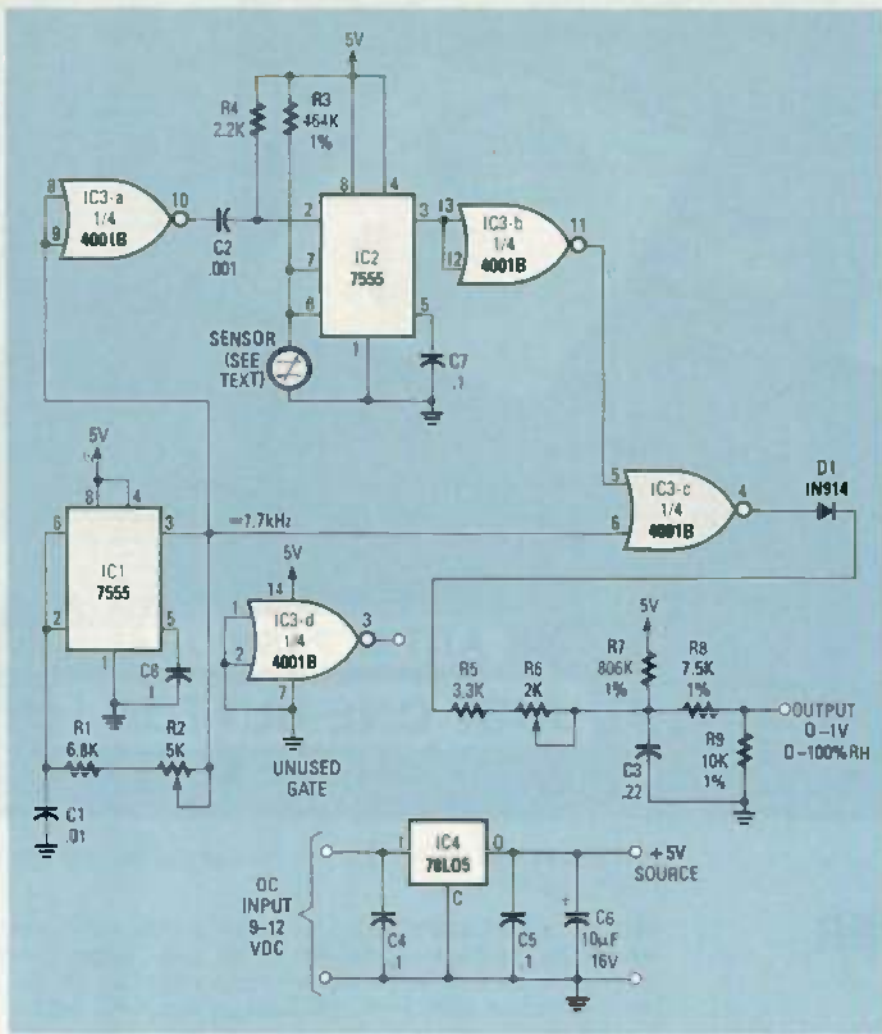

FIG. 3—THE HUMIDITY MONITOR CIRCUIT uses CMOS 555's to keep current drain low.

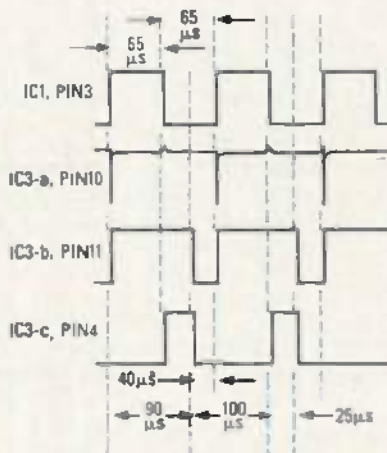

FIG. 4—TIMING RELATIONSHIPS of various points in the humidity monitor's circuit are shown here.

predictable (and repeatable) than oscillators made from CMOS gates. Also, we found that it was unnecessary to use paralleled gates to drive the metering circuit.

As you can see from the schematic in Fig. 3, our humidity monitor is composed

of three CMOS IC's and a low-power voltage regulator. Total current drain is only about 5 mA, so battery operation is entirely feasible. The circuit consists of two oscillators, a few NOR gates, and a detector/filter circuit that helps linearize the output.

A CMOS 7555 is used for IC1, a 7-kHz astable oscillator. A CMOS 7555 is also used for IC2, a one-shot whose pulse width is determined by R3 and the capacitance of the sensor. The master oscillator (IC1) drives IC3-a, which provides the trigger pulse that drives IC2. The relationship of those two signals, and the others to be discussed below, is shown in the timing diagram in Fig. 4.

The output of IC2 is inverted by IC3-b and combined with the master-oscillator signal by IC3-c, which passes only the difference between the two signals to the filter/detector circuit that follows. Trimmer potentiometer R2 is provided to null the circuit out at the low end of the RH scale. On a dual-trace scope the null condition appears as equal-phase, equal-width pulses at pins 5 and 6 of IC3-c. With inputs of that sort, IC3-c gives no output.

The detector circuit is composed of di-

ode D1, resistors R5-R9, and capacitor C3. The pulses from IC3-c are rectified and filtered into a DC voltage that is proportional to relative humidity. Full-scale meter adjustment is provided by R6, and R8 and R9 function as a voltage divider that scales the output to exactly one volt at 100% RH.

Since the sensor's capacitance is exponentially related to RH, something is needed to increase the linearity of the circuit. That something is provided by R7, which supplies extra charging current to C3, which would normally be fed only by the detector. Also, R8 and R9 discharge C3 to further increase linearity. The only drawback to our scheme is that, due to the voltage-divider effect of R7-R9, the out-

PARTS LIST

All resistors 1/4-watt, 5%, metal film (not carbon composition) unless otherwise noted.

- R1—6800 ohms
- R2—5000 ohms, linear potentiometer, PC mount
- R3—464,000 ohms, 1%, 1/4-watt
- R4—2200 ohms
- R5—3300 ohms
- R6—2000 ohms, linear potentiometer, PC mount
- R7—806,000 ohms, 1%, 1/4-watt
- R8—7500 ohms, 1%, 1/4-watt
- R9—10,000 ohms, 1%, 1/4-watt

Capacitors

- C1—0.01 μF, 10%, mylar or polycarbonate
- C2—0.001 μF, 10%, mylar or polycarbonate
- C3—0.22 μF, 10%, mylar or polycarbonate
- C4, C5, C7, C8—0.1 μF, ceramic, monolithic, or disc
- C6—10 μF, 16 volts, electrolytic or tantalum, radial leads

Semiconductors

- IC1, IC2—7555 CMOS 555 timer
- IC3—4001B, CMOS quad dual-input NOR gate
- IC4—78L05, 5-volt, 100-mA voltage regulator
- D1—1N914, 1N4148, or equivalent

Other components

- M1—50 μA, Radio Shack #270-1751
- S1—SPST toggle or momentary switch
- Sensor—Mepco #2322-691-90003
- Sensor socket—Molex part #10-18-2031
- Portable case—Radio Shack #270-1751
- Outdoor case—Keystone part #677 (set of #666 & #685)

Note: The following are available from Mark Worley, 909-B Country Aire, Round Rock, TX 78664: Screened, drilled, and plated PC board, \$7.00; Sensor \$15.00 for 1 or \$25.00 for 2; Calibration capacitors (115 pF and 160 pF, 1% mica), \$2.00 per set; Kit of IC's, sensor, sensor socket, PC board, resistors, and capacitors, \$40.00 (calibration capacitors, meter, enclosure, & hardware not included). Add 10% for shipping, \$3.00 maximum. Most orders shipped within 1 week, but allow up to 30 days for delivery. Send cash or check only.

**F
A
S
T

A
N
D

E
A
S
Y**



**AT THE PUSH OF
JUST ONE BUTTON !**

THE MARK III HV CIRCUIT SCANNER

- ★ Checks the horiz output circuit for open / shorts.
- ★ Checks the flyback, yoke, PC, and HV mult.
- ★ Checks all scan derived B+ sources.
- ★ Checks all circuits that rely on scan derived B+ voltage.
- ★ Checks for open safety capacitor.
- ★ Checks the emitter circuit of the horiz output.

THEN,

- ★ Provided the green normal light is lit, the Mark III will safely power up the TV set so that you can "look" for open circuits by examining the picture on the CRT.
- ★ Circumvents all start up and horiz drive related shut down circuits.

APPLICATIONS: The Mark III will analyze the horiz, flyback, hi-voltage, scan derived B+ sources, yoke, pin cushion, HV multiplier circuits in any TV set that employs either an NPN transistor or a single SCR for its horiz output device. This applies to any age, any model, any chassis, any brand --- including Sony.

In brief, the "test" function scans for shorts, the "run" function permits you to observe any "open" circuits via the symptoms that appear in the CRT screen.

HOOK - UP: Simply remove the set's horiz output device and replace it with the scanner's interface plug. No wires to disconnect, no other connections required (not even a ground connection).

MISTAKE PROOF: No damage will result if an error is made during hook up. The scanner simply won't turn on until the error is corrected.

RED OPEN LIGHT means the emitter circuit of the horiz output stage is open (no ground path).

YELLOW SHORT LIGHT means the flyback primary, HV multiplier, vertical output, horiz driver, and R-B-G color output stages are not shorted. Instead, a circuit that normally draws a small amount of current is shorted (i.e. the tuner, IF, AGC, video chroma, matrix, vertical or horiz oscillator).

RED SHORT LIGHT means either the flyback, the HV multiplier, the vertical output, horiz driver or one of the R-B-G output transistors is shorted.

GREEN NORMAL LIGHT means the TV set's entire flyback circuit is totally free of shorts. It also means that it is safe to power up the TV set with the "run" button so that you can look for open circuits by observing the symptoms on the CRT screen.

FEATURES: All start up circuits and all horiz drive related shut down circuits are automatically circumvented by the Mark III during all test and run functions. During the test function all flyback secondary output is limited to approx 80% of normal. 2nd anode voltage is limited to approx 5 KV.

This means all circuits that are not shorted will have some 80% of their normal B+ voltage during the "test" phase. It also means that any shorted circuit will have zero DC volts on it. This feature makes any short easy to isolate.

The MARK III sells for only \$595⁰⁰

The money you are now spending for unnecessary flybacks alone will easily pay for your Mark III. Why not order yours today!

Visa and Mastercharge Welcome !

Diehl Engineering • 6661 Canyon Drive "F" • Amarillo, TX 79110
Phone: (806) 359-0329 or (806) 359-1824

PUSH THE TEST BUTTON Just one of the four lights will lite.

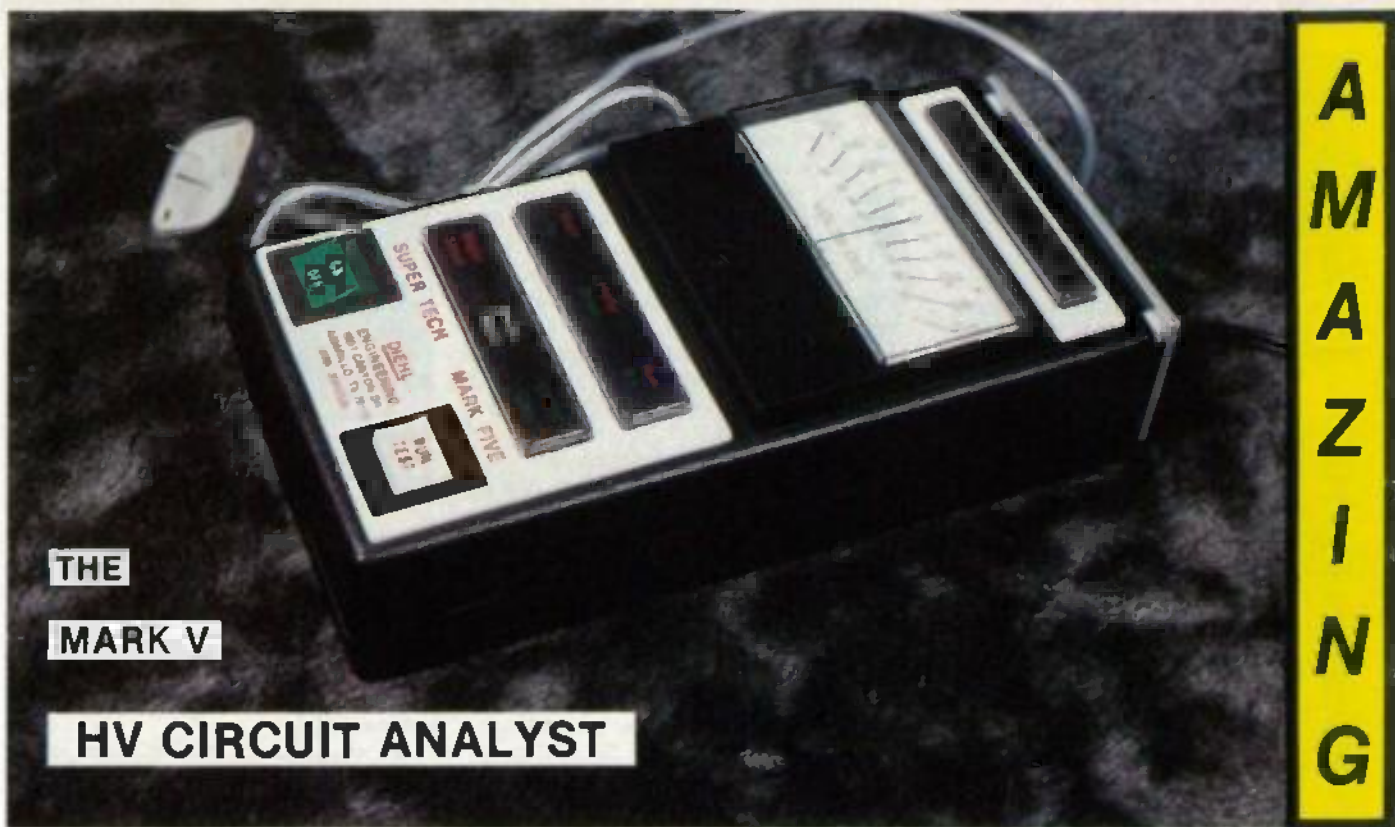

**A
M
A
Z
I
N
G**

**THE
MARK V
HV CIRCUIT ANALYST**

- ★ Checks the horiz output stage for opens / shorts.
- ★ Checks flyback, yoke, PC, and HV mult.
- ★ Checks all scan derived B + sources.
- ★ Checks for open safety capacitors
- ★ Checks for open ground path for horiz output stage
- ★ Checks for open primary LV supply,
- ★ Checks for error in interface connections,
- ★ Checks for proper LV regulation,
- ★ Checks for proper start up circuit operation,
- ★ Checks for shorted horiz driver transistor,
- ★ Checks the operation of the horiz osc / driver circuits,
- ★ Checks B + "run" supply for the horiz osc / driver circuits,
- ★ Checks all circuits in the TV set that rely on scan derived B +.
- ★ Automatically circumvents all start up circuits and horiz drive related shut down circuits.

**READ THE DC VOLTAGE METER THEN,
PUSH THE TEST BUTTON**

If the meter comes up to, or, falls back to, factory specified DC collector voltage, the LV regulator circuit is working. If it fails to do so, it is not working!

RED "B + RUN" LIGHT means that the B + source that normally keeps the horiz osc / driver circuits running after the start up B + pulse has been consumed has become open.

GREEN "B + RUN" LIGHT means that the B + resupply voltage (scan derived) is being provided. All is normal if all three lights are now green.

The scan circuit short detector in the Mark V is identical in all ways to that which is used in the Mark III. Operation is also identical. Both units are virtually indestructible when simple directions are followed. Both units carry a full year's warranty against defects in materials and workmanship (parts and labor). Either unit can be easily repaired by almost any technician in his own shop.

If the green "circuits clear" light is now lit

It is now safe to push the "run" button and examine the symptoms that appear on the CRT screen, for the purpose of isolating any "open" circuits.

Except for hook up and CRT filament warm up time, this test can easily be completed in two to five seconds!

HOOK UP: (Identical to Mark III)

OPERATION: Turn the Mark V on, turn the TV set on, then, simply look at the lights.

RED "HOOK UP" LIGHT means that you have made an error in hook up. No damage has been done, correct the problem then continue.

RED "EMITTER" LIGHT means that the ground path for horiz output stage is open. Correct the problem then continue.

RED "B + OPEN" LIGHT means that the primary LV supply in the TV set is open. Correct the problem then continue.
No "top row lights" equals normal.

Look at the middle row of lights

RED "START UP" LIGHT means that the start up circuit in the TV set is not working (no start up pulse).

GREEN "START UP" LIGHT means the start up circuit in the TV set is working normally. Yes, it is 100% accurate. Even on Zenith's single pulse start up circuit!

RED "HORIZ DRIVE" LIGHT with a green start up light means that the horiz driver transistor in the TV is shorted (E to C).

GREEN HORIZ DRIVE LIGHT means that the horiz oscillator and driver circuits are operational.

The Mark V sells for only \$995⁰⁰

Stop losing money on start up / shut down scan derived B + problems; order your Mark V today!

Visa and Mastercharge Welcome !

Diehl Engineering • 6661 Canyon Drive "F" • Amarillo, TX 79110
Phone (806) 359-0329, or (806) 359-1824

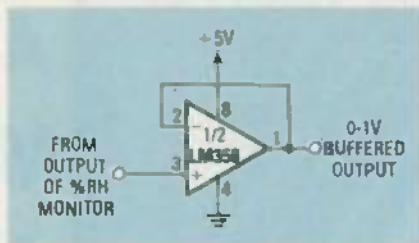

FIG. 5—AN OP-AMP VOLTAGE FOLLOWER may be used to buffer the output of the humidity monitor.

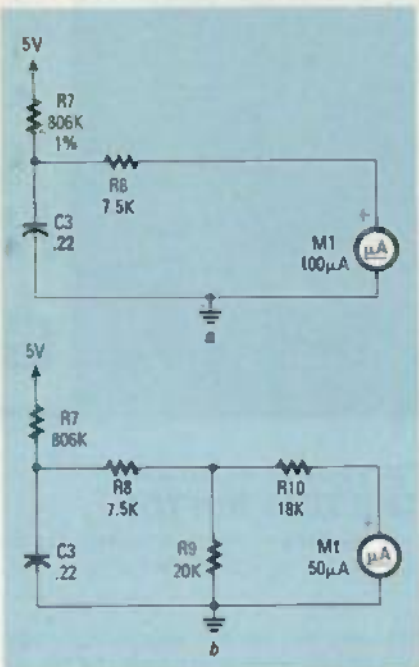

FIG. 6—METERING CIRCUITS for the humidity monitor. Use the circuit shown at a with a 100- μ A meter, and the one at b with a 50- μ A meter.

put cannot fall below 60 mV, which corresponds to 6% RH. So, our monitor can read no lower than 6% RH.

For best accuracy, the output should be monitored with a meter having an input impedance of at least one megohm. Alternatively, the output could be buffered to drive an analog meter or other low-impedance load. The simple op-amp voltage-follower circuit shown in Fig. 5 could be powered by the same (battery) supply that powers the remainder of the circuit. Or you could, if desired, substitute a pre-assembled digital LED- or LCD-meter module.

Another alternative would be to use a 100- μ A moving-coil meter as an indicator. Since a 100- μ A meter with a full-scale reading of one volt has a resistance of 10K, it could replace R9 in the circuit, as shown in Fig. 6-a. But since a 100- μ A meter is slightly difficult to obtain, we used a 50- μ A meter with the voltage divider shown in Fig. 6-b for our prototype.

Current drain

The 78L05 low-power voltage regulator

adds about 4 mA of current drain to the circuit, which would otherwise consume only about 1.5 mA. That 4 mA is the regulator's required operating current, so it can't be eliminated (unless you can obtain one of National's new micro-power voltage regulators). A Zener diode would not alleviate the current-drain problem, since it would require even more operating current. A Zener diode would also have poorer regulation, which could affect accuracy. With no voltage regulator at all, the pulse height from IC3-c would vary with battery voltage, so accuracy would be affected.

For portable or occasional use, a 9-volt battery is the ideal power source, since current drain is low. Alternatively, power could be supplied by an inexpensive wall-mount transformer with an output of 7.5- to 12-volts DC. For permanent outdoor installation, mount the power supply inside the house, not out in the weather.

Construction

Our humidity monitor can be used in a portable mode both indoors and outdoors. However, for permanent outdoor installation more rugged construction techniques will have to be used. We'll present plans for both portable and permanent units, although we'll stress construction of the portable unit.

The circuit should be built on a PC board to minimize stray capacitance that could affect IC1's output frequency and IC2's pulse width. You can purchase a PC board from the source listed in the Parts List, or you can etch and drill your own using the foil patterns shown in the "PC Service" section of this magazine. It's not recommended, but if you assemble the circuit on perf board, use the kind that has a solder pad around every hole (such as OK Industry's #A-PC-02 prototyping board). You may have trouble experimenting with our circuit on a solderless breadboard because that type of breadboard has a large amount of distributed capacitance and a ground plane that can also affect circuit operation.

Use only high-quality, low-temperature-coefficient components to limit the effects of temperature on the circuit's accuracy. Capacitors C1 and C2 should be polystyrene or polycarbonate types. It might be worthwhile experimenting with a positive-temperature-coefficient capacitor for C1 to offset some of the sensor's

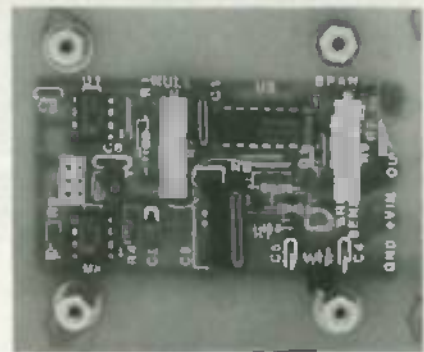

FIG. 8—YOUR COMPLETED PC BOARD for the humidity monitor should appear as shown here. Interconnecting wires attach to the bottom of the board.

temperature drift, especially if the monitor will be used outdoors. The resistors should be metal- or carbon-film types; carbon composition resistors should not be used in our circuit because their values vary widely with temperature and humidity.

When you have a suitable board, use the parts-placement diagram in Fig. 7 and the photo in Fig. 8 to mount and solder all components. Don't use IC sockets since they can contribute to stray capacitance. Solder the 3-pin Molex socket to the board vertically (as shown in the photo) if you want to mount your sensor as it is in our prototype. Also, for proper vertical clearance you may find it necessary to use a small tantalum capacitor for C6, or to mount that capacitor to the foil side of the PC board.

After mounting all components, check your work carefully, looking for solder bridges between adjacent pads, pins and traces. If the board is OK, remove all flux from it. Be careful to keep any solvent—particularly acetone—away from the sensor. Use isopropyl alcohol to remove finger oils, and avoid touching cleaned surfaces.

Use a pair of clipped-off resistor leads to extend the lengths of the sensor's leads. Carefully solder the wires to the sensor, and make sure you don't damage the sensor from too much heat! Then clip the leads to an overall length of 1/4 inch. They will project through the case and into the Molex socket after final assembly.

Now let's turn to mechanical construction. First we'll discuss the portable unit. Drill a mounting hole in each corner

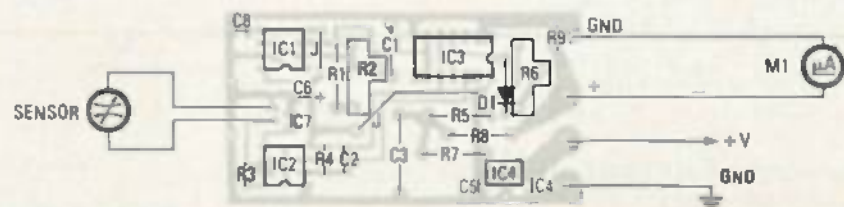

FIG. 7—PARTS-PLACEMENT DIAGRAM reveals the compact size of the humidity monitor.

of the board, and use those holes to mark the locations of the screw holes in the case. Also, drill four holes for the sensor: two for the leads, and two for the mounting tabs. Use an eighth-inch bit (or larger) for the sensor leads to minimize capacitive coupling to the case, as well as to eliminate the possibility of a short. Allow for a little offset in the position of the sensor due to the construction of the Molex socket.

The meter used in our prototype has a resistance of about 2K, so we added an 18K resistor in series with the meter to give it a total resistance of 20K. Then R9 was changed to a 20K resistor, so that the combination of R9, the meter, and R10 would be 10K. That combination gives the meter a full-scale range of one volt.

If you use a 100 μ A meter, pad its resistance to 10K, if necessary. Then remove R9, and use the meter in place of that resistor. If you decide to use a digital meter, you can leave R9 at 10K, since most digital meters have at least 10 megohms input impedance, and the parallel combination of R9 and the DVM will not affect accuracy.

Mounting the sensor at the "rear" of the case might reduce the sensor's ability to respond to current humidity conditions, especially if the monitor is pushed back on a shelf. However, mounting the sensor in that way reduces the possibility that it will be damaged. But feel free to experiment with your own case and mounting methods. We bent a 1/2-inch piece of thin steel strapping into a "U" shape with legs. Holes were drilled through the legs and through the case on either side of the sensor. Then the "U" was bolted to those holes to prevent mechanical damage to the sensor.

Finish assembling the case by installing the power switch, battery holder, and four 1/4-inch standoffs for the PC board. If necessary, carefully remove the face plate of the meter and use rub-on letters to re-label the meter's scale. Assuming you're using a 50- μ A meter, wire the case-mounted components as shown in Fig. 9. If you're using a different metering circuit, substitute the appropriate resistive network. Loose wires and components can move around and cause the outputs of IC1 and IC2 to vary, so mount all components securely, and keep all leads short.

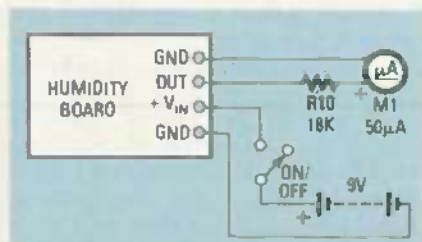

FIG. 9—IF YOU USE A 50- μ A METER with the humidity monitor, it should be wired as shown here.

To complete assembly of the portable unit, mount the board to the case. Then insert the sensor's leads through the case and mount the sensor to the case with two sheet metal screws. Be careful not to crack the sensor by over-tightening those screws.

Building the outdoor monitor

For permanent outdoor use, the sensor must be covered to protect it from direct rain and sunlight. A small louvered or screened box about ten inches on a side should work. Just make sure that air can circulate freely through the enclosure to reach the sensor. Also, avoid placing the assembly in vegetation, near a sprinkler, or in any other location that might tend to exaggerate the actual humidity. A hundred feet of 22-gauge wire between a remotely-mounted sensor and an indoor power supply and display meter should not affect accuracy.

To install the monitor outdoors permanently, the circuit will have to be mounted in a watertight enclosure. We'll discuss how to do that using the Keystone enclosure specified in the Parts List.

First, trim the PC board to fit the case. Then cut four two-inch lengths of 18-gauge wire and insert them into the holes at the end of the board. Bend the leads so that at least 1/4-inch of the wire lies flat against the copper foil, and then solder the leads. The 1/4-inch of contact helps strengthen the support for the board. Slide the free ends of the wires into the octal base of the case. Carefully bend the leads so that the end of the PC board rests against the base. Then clip the leads flush with the end of the plug's pins, and solder the wires inside the hollow pins. The octal

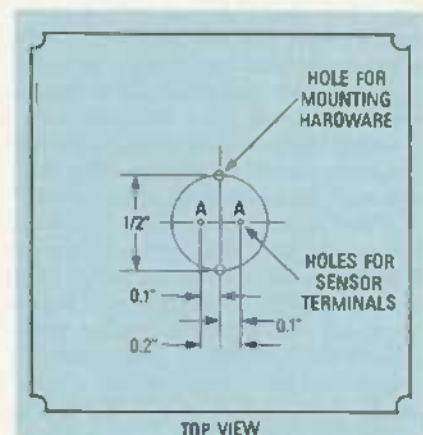

FIG. 10—OUTDOOR INSTALLATION of the humidity monitor requires a watertight case; drill holes for the sensor as shown here.

plug won't fit into its socket if solder leaks through to the outside of the pins, so be careful.

Refer to Fig. 10 to drill the mounting holes for the sensor in the top of the case, and to Fig. 11 to drill the holes in the side of the case that allow access to trimmer

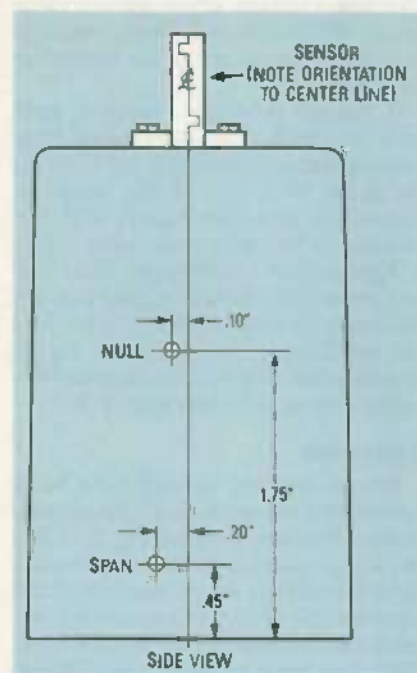

FIG. 11—TWO HOLES MUST BE DRILLED in the side of the waterproof case to allow final calibration.

potentiometers R2 and R6. Those holes must be located precisely as shown to allow proper assembly and adjustment. If you use a small metal punch for the access holes in the side, you may be able to reinsert the punched-out pieces in the holes after calibration; otherwise fill the holes with epoxy, or cover them with electrical tape.

Bend the leads of the Molex connector 90 degrees before mounting it flush against the PC board. Then solder a scrap of wire across the socket to hold it in place firmly; two holes have been provided in the PC board for that support wire. The sensor's leads will have to be extended to a length of 3/8 inch.

To complete assembly, attach the sensor to the case with two sheet metal screws. A thin rubber gasket placed between the sensor and the case will provide additional weatherproofing. Carefully insert the board and the base assembly into the case so that the Molex connector mates with the sensor's extensions. Use four screws to hold the case and the octal base together. The two holes in the side of the case should line up with R2 and R6 so that those potentiometers can be adjusted easily with a small screwdriver.

Final check-out

The check-out is the same for both the portable and the permanent versions of our humidity monitor. Before powering up, carefully check the board once more to make sure that all components have been installed correctly, and that there are no solder bridges between traces, etc. Then plug the sensor into its socket and apply power. You should be able to mea-

sure some voltage across R9 (in other words, M1, if installed, should deflect); that voltage should rise if you breathe on the sensor.

If you get no output, re-check your work, and verify that supply voltage (five volts) appears at pin 8 of IC1, pin 8 of IC2, and at pin 14 of IC3. If that voltage is present, use an oscilloscope to verify the presence of the waveforms shown in Fig. 4. After the board is debugged, allow it to cool down from the heat of soldering before doing the final calibration. Also, isolate the sensor from hand and breath moisture until it stabilizes to ambient humidity—about 5 minutes should do it.

Calibration

For the first step of calibration we'll assume that the sensor's output exactly matches the curve shown in Fig. 2. Doing that allows us to substitute 1% silver-mica capacitors for the sensor. Insert a 115-pF capacitor into the sensor's socket and adjust R2 for a reading of 6% RH (60 mV). Then replace that capacitor with a 160-pF unit and adjust R6 for a reading of 100% RH (1.00 volt).

After assembling the case, you will need to re-adjust R2 so that the output agrees with a secondary humidity standard. That adjustment alters IC1's pulse-width to correspond to the sensor you're using. Remember, the Philips sensors have a tolerance of $\pm 15\%$ at 43% RH. This means that, although there will still be a 45-pF change in capacitance over the entire 0-100% range of RH, the high and low values may be shifted above or below the nominal values. It is R2 that provides compensation for that shift.

Absolute calibration standards

Finding a humidity standard can be difficult, but here are a few ideas that may be useful. The most common method of measuring humidity accurately is with a sling psychrometer. You may be able to borrow one from a science or chemistry lab at a local high-school or college. The sling psychrometer has both dry- and wet-bulb thermometers. The wet-bulb unit has a wick on its bulb that is moistened with distilled water. When the psychrometer is whirled in a circle, the evaporation of the wick cools the thermometer's bulb. The amount it cools depends on the amount of water that evaporates, and that is governed by the amount of moisture in the air—the relative humidity.

The dry-bulb thermometer is unaffected by that procedure since it's not moistened; it simply indicates the temperature of the ambient air. With every psychrometer comes a chart that allows you to determine RH from the readings on the two thermometers.

The accuracy of the sling psychrometer method depends on the accuracy of the two thermometers, the accuracy with

TABLE 2—SATURATED SALT SOLUTIONS

Salt	% RH @ 68°F	% RH @ 77°F
Lithium Chloride Monohydrate	11.3	11.2
Magnesium Chloride Hexahydrate	33.1	32.8
Magnesium Nitrate	54.4	52.9
Sodium Chloride	75.5	75.3
Potassium Chloride	85.1	84.3
Potassium Sulphate	97.6	97.3

which they're read, the cleanliness of the wick and the water, and also upon a sufficient quantity of air blowing across the wick. Small sling psychrometers with one degree increments and short thermometers have an accuracy of only 10%, or worse.

Saturated salt solutions offer better accuracy, but they are more difficult to use because the sensor has to be placed as close as possible to the solution without touching it, and the calibration process must occur inside an airtight container. That can make circuit adjustment awkward. Anyway, the solution maintains an equilibrium of humidity within the sealed container as long as that solution remains saturated. Both salt and water must be pure for best accuracy. We list some commonly-used solutions, and the humidities you can obtain with them, in Table 2.

Caution: Those solutions are poisonous, so handle and store them with care, and keep them out of the reach of children and pets. If you use the lithium chloride solution, don't allow it to fall below a temperature of 18°C (64°F), since the humidity reference of the solution will be permanently altered. Whichever salt you use, stir in crystals a little bit at a time until precipitates begin collecting on the bottom of your container. When you're sure no more salt will dissolve, put the solution and your circuit board in an airtight container, and adjust R2 so that the meter agrees with the value in Table 2.

One problem with the above calibration procedure should be obvious—how does one make the adjustments while the board is within the air-tight container? There are two possibilities. One is to make the adjustment outside the container, then place the board inside to see the result. Repeat as needed until the meter reading agrees with the value in Table 2. A more sensible solution would be to mount only the sensor in the container so that R2 can be adjusted from outside.

If those methods of calibration are impractical for you, you might try tuning in a local weather broadcast on radio or TV, or you could call the National Weather Service in your area. To do the final calibration, whatever standard you have chosen, apply water and then adjust R2 so that the value indicated by the meter agrees with your standard. Construction is now complete.

Final thoughts

Whether or not you actually built our humidity monitor, we hope you learned something about what humidity is and about ways of measuring it. Like many subjects, there is a great deal more that could be said about humidity; we encourage you to do some investigating on your own. In a similar vein, our circuit was not intended to be used as the basis of a precision instrument, but we hope you'll find it fun to build as well as useful.

As you know, indoor humidity drops drastically in the winter. The reason is that cold, dry outside air is further dried by most indoor heating systems. (To be more accurate, hot air can hold more moisture than cool air, so the RH drops as the temperature rises. You may find it interesting to know that office buildings are often built these days with humidity controllers in addition to the systems that control their heating, ventilation, and air-conditioning (HVAC) systems.

You can use our humidity monitor to help maintain humidity levels at your home or office at a comfortable (and safe!) level. Humidity control can help prevent respiratory problems, and it can prolong the life of valuable paintings, books, and electronic devices.

For indoor use, avoid placing the humidity monitor near air-conditioning or heating vents; also, keep the monitor far away from any large potted plants since they can affect accuracy. For desktop use, keep the sensor away from a hot work-light, as heat can also affect the humidity reading.

An RH of less than 20% can easily occur during the winter. And with such low humidity, a large quantity of static electricity can build up, since the conductive moisture usually present in the air isn't available to provide a discharge path for that energy.

Making sparks fly by touching your spouse's nose or a metal surface may be fun, but doing that to your computer (or just about any electronic device) could prove fatal for the machine. Similarly, you're much more likely to damage CMOS and other components while building projects like our humidity monitor. So, an RH of about 50% is low enough for you to be comfortable, and high enough for your electronics to be safe. R-E

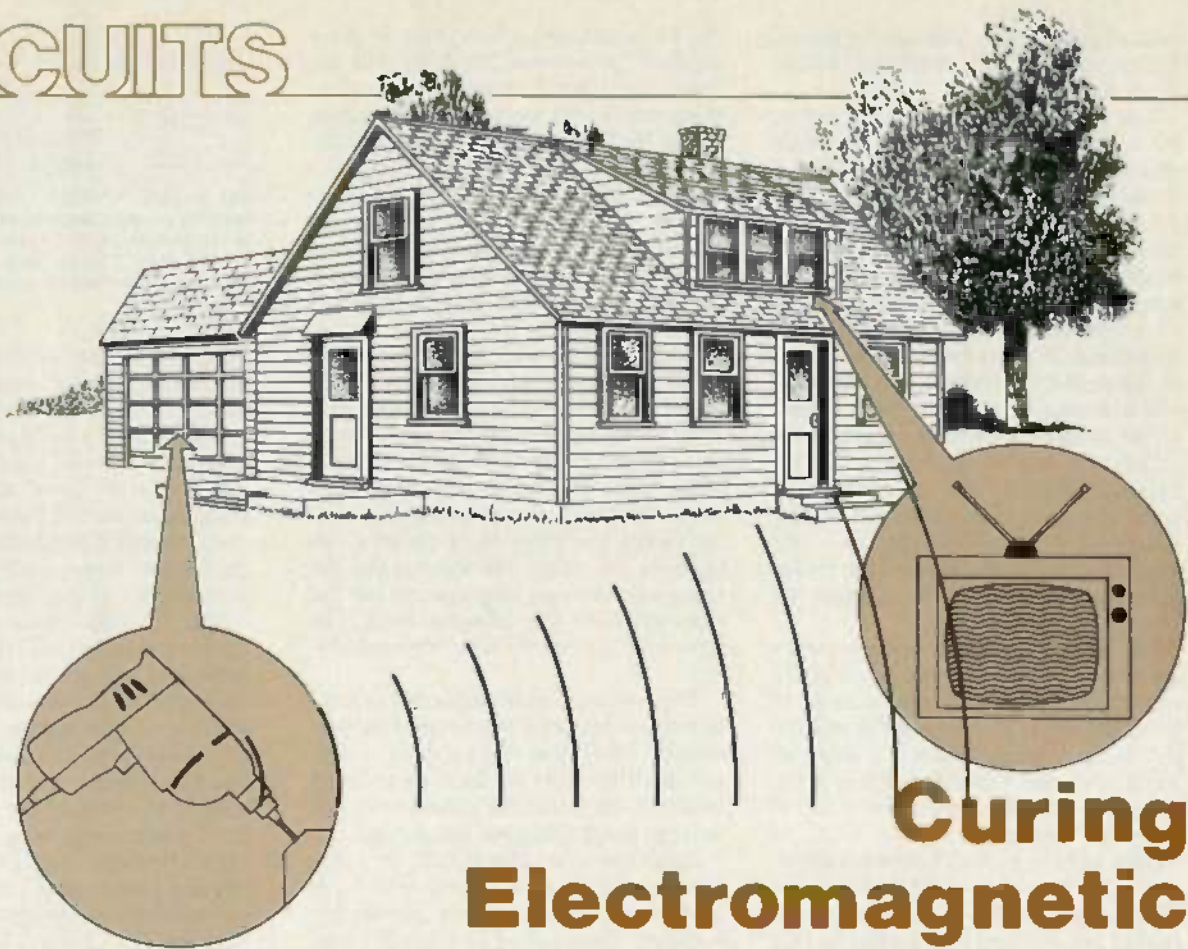

Curing Electromagnetic Interference

MICHAEL F. VIOLETTE

This month, we show you how to head off interference before it enters your electronic equipment. We look at how to deal with power-line transients, too!

Part 3 ELECTROMAGNETIC INTERFERENCE (EMI) can couple into your sensitive equipment in two ways. One of those is via radiation. Last time, we saw some of the techniques that can be used to eliminate that coupling path.

The second way is through conduction. This month, we'll turn our attention to conducted interference and see the various ways that we can combat its harmful effects.

As we saw in Part 1 of this article (see the November 1985 issue of *Radio-Electronics*), there are two forms of conducted interference. In *differential-mode* interference, the interfering signal appears across two conductors, such as a pair of single lines or the hot and neutral sides of a power line. In *common-mode* interference, the interfering signal appears on both conductors, with the reference being a third point (such as a chassis ground). In common-mode interference, the interfering signals on the two conductors may not

be of equal amplitude, but they are in phase.

There are a couple of ways to deal with conducted EMI. One way is to carefully plan out and design any interconnecting cabling. Often, however, you have no control over such cabling (such as in the case of power or telephone lines). In those cases, the only alternative is to install a filter between the line and the equipment.

Cable design

Cables can act like pickup and receiving antennas. When a cable is acting like a pickup antenna, a radiated EMI signal is converted into a conducted EMI signal, which travels on the wires in the cable, through shields, and right into your circuitry. Or, conducted noise (from the commutator in the blower motor of a hair dryer, for instance) finds its way onto the power cord, travels over the AC wiring, and then into the "victim's" circuitry through its power cord. Either way, the result is interference.

Your projects can either radiate or pick-up EMI, or they can do both. In this installment, we will see how to deal with radiation of EMI, but the techniques discussed are also effective against EMI pickup in the vast majority of instances.

Last time, we saw that antennas can be classified by their impedance; of interest here are the low-impedance types. Let's see why.

In many circuits, the operating voltages are relatively low, often ranging between 5 and 24 volts; the impedance of the source of that voltage, the power supply, is generally low. To get an efficient radiator when the EMI antenna is being driven by a low impedance voltage source, the "antenna" must have a relatively low impedance. One type of low-impedance antenna is a simple wire loop. In a circuit or a project, that loop can take many forms. For instance, any loop of wire, such as the power feed and return to a disk drive, or the power supply and ground traces on a PC board can become a surprisingly effi-

cient radiator. Loops can also be formed by any signal-carrying conductors such as the data or clock lines.

Just how much energy is put out by those unintentional antennas? The radiated field strength of a loop is proportional to the product of the current in the loop, the frequency of the signal carried by the loop, and the area of the loop. All three variables play a role in determining how much energy is output. The current in the loop determines how much energy is available to drive the radiator. The area of the loop, and the frequency of the signal that is driving it, determine the efficiency of the radiator. Generally speaking, the greater the area of the loop and/or the frequency of the driving signal, the greater the efficiency of the radiator. The same is true of a "receiving antenna"—the larger the area of the loop and the greater the frequency of the received signal, the more efficient the pickup.

Obviously, the current and frequency are determined by the parameters of the circuit; that means that, in the majority of the cases, their values can not be reduced (or changed in any manner) without affecting the correct operation of the circuit. The area of the loop, however, is an entirely different matter.

That leads us to one of the most important rules for reducing EMI: When designing or laying out cable runs and printed-circuit board traces, keep the area of any potential loops small. Consider the simple circuit shown in Fig. 1. It consists of a signal source, a load, and a ground. The area of the loop is formed by the product of the physical distance separating the source and the load (L), and the physical distance separating the "signal" and "return" (grounded) leads (H).

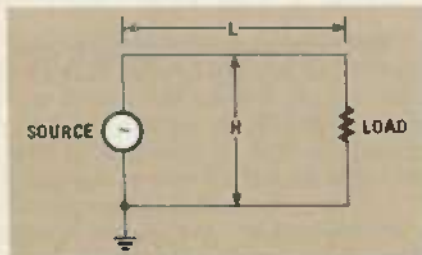

FIG. 1—THE AMOUNT OF INTERFERENCE that a circuit can pick up or cause is largely determined by the physical size of the loop that it forms.

The circuit shown can be realized in a number of ways. For instance, the source could be the output of one gate while the load could be the input of a second gate. The return line could be a common bus or the chassis ground of the project. But no matter what form the circuit takes, under the right circumstances, the whole thing can become a large radiating loop.

The way to minimizing the radiation output by such a loop is to reduce the distance between the source and the load,

run the signal and return leads as close together as possible, or both. For instance, by running a dedicated return line alongside the the signal line, rather than having the return current flow through the chassis ground, the loop area is reduced significantly. With dedicated signal/return cabling, H is effectively reduced to the thickness of the insulation surrounding the two wires. That solution works, and it is much cheaper than using a shielded cable.

When dealing with differential-mode currents, using twisted-wire pairs for the signal line and the return can further help reduce interference. Twisting the wire pair significantly reduces the overall area of the loop. Each twist of the wires does form a small radiating loop, but the twisting causes the loops to be polarized in opposite directions. The result is that the radiation from one loop cancels out the radiation from the adjacent loop. The tighter the twisting the better the cancellation.

The foregoing assumes that the currents in the two lines of a twisted pair are balanced—that is, that they are equal in amplitude. The closer the lines are to being balanced, the better the reduction of differential-mode radiation and pickup.

Balancing also helps the circuit to reject the effects of common-mode currents. Let's assume that we are dealing with two lines feeding two inputs on an unbalanced receiver (a logic gate, etc.). Further, let's assume that the common-mode currents traveling in those lines are equal. Here, unbalanced means that the impedances, "looking" into the receiver, from all lines to ground are unequal. The result is that when the equal common-mode currents encounter the unequal impedances, unequal voltages are generated at the inputs. Those unequal voltages stimulate the inputs to the receiver, just as a normal signal is supposed to, and an undesired output signal can result.

That is a common problem. In fact IC op-amps have a parameter called the Common Mode Rejection Ratio (CMRR). That parameter is a measure of how well the op-amp can reject the effects of a common-mode input. The interference caused by common-mode currents is the reason that balanced line drivers/receivers are used in many cases for long signal-cable runs.

Crosstalk

Crosstalk is caused by the mutual inductance and parasitic capacitance that exists between any two conductors (see Fig. 2). One common example of crosstalk is the phantom conversations that are often overheard when you speak on the telephone.

Though the parasitic capacitance and mutual inductance are shown lumped in Fig. 2, those quantities are distributed

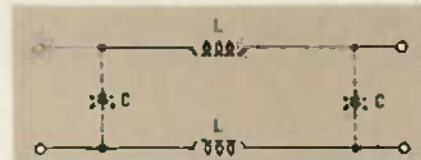

FIG. 2—TWO PARALLEL LINES are electromagnetically coupled because of the mutual inductance and parasitic capacitance that exists between them. That coupling is what causes the phenomenon known as crosstalk.

along the length of the lines. Although there are no physical connections between the lines, the electrical coupling provided by the parasitic capacitance and parasitic inductance provides a path for the current in one wire to "enter" the other. At low frequencies, mutual inductance is the primary coupling mechanism; as the frequency gets higher, parasitic capacitance becomes the primary mechanism.

The closer the cables are together and the longer the parallel runs between the two cables, the greater the coupling. Because of that, the obvious and most inexpensive way to reduce crosstalk is to physically separate conductors that are likely to interfere with each other. Move conductors carrying high voltages (such as AC power cords) away from ones carrying low voltages (such as signal lines). In addition, keep input and output cables isolated from the wiring inside the equipment box. In addition, keep any parallel runs between conductors as short as possible. One way to do that is to make extensive use of twisted-wire pairs. Note that lines that cross at 90° angles have almost no mutual inductance and negligible parasitic capacitance (a couple of picofarads).

Shielded cable design

Using twisted-wire pairs is an effective method of reducing differential-mode interference. To combat common-mode interference, shielded cable is more effective. To combat both types of interference, shielded cables are often made of twisted-wire pairs. In very noisy environments, "double-shielded" cables, in which the individual twisted pairs are also shielded, are used.

The effectiveness of the shielding depends on the nature of its ground. Or, more specifically, whether one end or both ends should be grounded. When dealing with low frequencies, it is usually sufficient to ground the shield at one end only (usually the receiving end). In addition, grounding the shield at both ends can cause a ground loop to be formed. By low frequency we mean that the shield is electrically short when compared with the wavelength of the EMI signal (i.e., the shield is shorter than approximately 1/20 of a wavelength). Under that condition, every point on the shield can be considered to be at ground potential. At higher frequencies, however, both ends must be

grounded. That grounding should be made directly to the chassis ground, and at the point where the cable enters the circuit enclosure.

The wide usage of flat ribbon cables in many types of circuits merits special consideration. When using ribbon cables, and when the circuit is especially sensitive to pickup of radiation (or when the circuit could potentially radiate), a return or ground conductor should be placed be-



FIG. 3—TO ELIMINATE CROSSTALK problems in ribbon cable, alternate conductors should be grounded.



FIG. 4—A SINGLE CAPACITOR, installed as shown, can be used to filter out differential-mode interference. To handle common-mode interference, the capacitor should be installed between each line and ground.

tween each signal line (see Fig. 3).

Often, that is not done. It is common for a flat ribbon cable to have 25 or more conductors, only one of which is a ground. That can lead to high capacitance between signal conductors, resulting in crosstalk problems. The presence of a ground or return line between each signal line will "shield" the signal lines from each other.

Finally, if you want to be totally free from EMI radiation or pickup from cabling, use fiber optics. Made of glass or plastic fibers, such cables neither radiate nor pick up electromagnetic energy. They are coming into wide use in applications where long runs of data cables operate in noisy environments. Telephone companies, for instance, are now making extensive use of fiber-optic cables.

Filters

Even with good cable design and layout, sometimes a filter is needed to reduce conducted EMI. A filter is a circuit that allows certain frequencies to pass unimpeded, but blocks others. Depending on its design, a filter can allow only signals below a cut-off frequency to pass (lowpass filter), only signals above a cut-off frequency to pass (highpass filter), or pass or block signals within a given range or band (bandpass or notch filters, respectively).

A simple filter, consisting of but a sin-

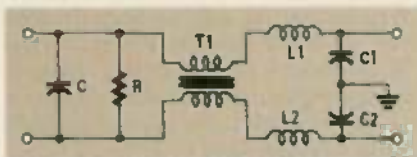

FIG. 5—THIS FILTER NETWORK is effective against both differential-mode and common-mode interference.

gle capacitor, is shown in Fig. 4. At high frequencies, the capacitor looks like a very low impedance to ground. As a result, any high-frequency signals are shorted to ground. At low frequencies, the capacitor is a high impedance, and the signals are unaffected. Thus, the capacitor is acting like a low pass filter. Capacitors are used in that way in a number of applications, such as across the terminals of automotive alternators, electric motors, and on printed-circuit boards (decoupling capacitors).

To use any filter effectively, including the simple capacitor filter, you need to know the nature of the EMI you are dealing with. That's because a filter designed to eliminate common-mode EMI will be largely ineffective against differential-mode interference, and vice-versa.

Let's look at a familiar and common source of EMI and see what kind of interference it creates. An electric razor is one such source. Because the electric motor in the razor is connected between the hot and neutral sides of the power line, the conducted interference it generates is differential mode. That is, the EMI voltage appears between the hot and neutral lines. On the other hand, when an overhead power line acts as a receiving antenna, coupling a broadcast radio signal to the AC power line, for instance, the EMI signal that results is common mode.

To filter differential-mode interference, the capacitor must be installed between the hot and neutral lines. For common-mode interference, capacitors must be installed between each line and ground.

If the interference is both common- and differential-mode, and/or is made up of a variety of frequencies, a more complex filter network is required. Such filter networks are made up of capacitors, inductors, or both. One popular design is shown in Fig. 5. That filter is effective against both common-mode and differential-mode interference. It is installed at the point where the power cord enters the equipment's enclosure.

The transformer in that circuit, T1, is a common-mode choke. As its name implies, its purpose is to block common-mode signals. The transformer is built in such a way that the flux generated by the common-mode signals in one winding opposes the flux generated by the common-mode signals in the other winding. That results in a high impedance to common mode signals, but differential-mode

signals are not affected. That deficiency is taken care of by the series inductors, L1 and L2; those coils present a high impedance to the high-frequency differential-mode signals. The function of the capacitors in the circuit is to shunt differential- and common-mode signals to ground, as previously discussed.

If your interference problem is not severe, or if the victim circuit is not overly sensitive to EMI, you can build a circuit like the one shown in Fig. 6. In that circuit, or in any filter circuit, keep the capacitor leads as short as possible. A capacitor with long leads starts to behave like an inductor as the frequency goes up. Also, use a low-impedance ground connection (the "ground" connection of a

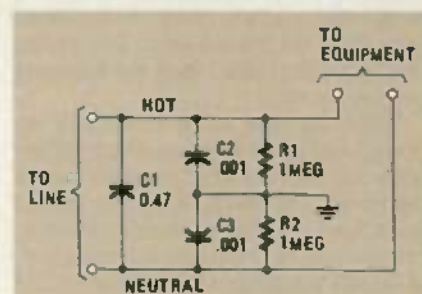

FIG. 6—IF THE EQUIPMENT is not overly sensitive to EMI, or the EMI situation is not severe, here's a practical circuit that will cure the problem.

three-wire power cord is suitable).

One common problem is the unwanted reception of AM radio stations or CB radios by tape decks, audio amplifiers, etc. That type of interference problem occurs when a radio signal is picked up by power or signal cables and causes a common-mode current to flow into the electronics. That type of problem can often be cured by placing a piece of ferrite around the cable as shown in Fig. 7. The effect caused by doing that is similar to the one caused by installing a common-mode choke. That is a quick and easy solution as it entails no soldering—just unplug the

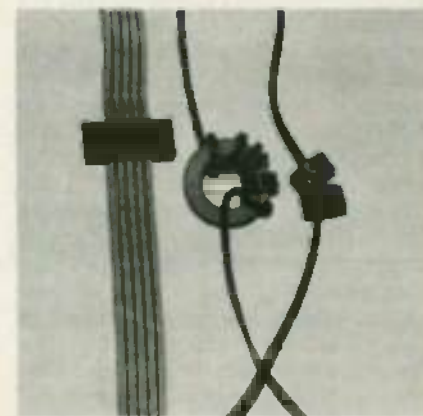

FIG. 7—PLACING A PIECE OF FERRITE around a cable is one simple way to eliminate some types of common-mode EMI.

cable and install the ferrite. (It must be mentioned that that solution will do nothing if the interference is differential mode.)

Interference is filtered from signal lines in much the same way, assuming that the interference signal differs in frequency range from the intended signal. But if the EMI is in the same frequency range as the desired signal, there is little that you can do to reduce the conducted interference with filters. In those cases, the interference must be prevented from getting into the cables by using proper cable design and shielding.

Filter installation

The important thing to remember when installing either a commercial filter or a home-made one is to isolate the unfiltered lines from the filtered ones. In carrying out such installation, keep the following pointers in mind:

Install the filter at the entrance of the power cord to the equipment box; do not allow the AC line cord to penetrate the equipment enclosure. Keep the ground leads from the filter as short as possible. For best results, mount the filter on a metal surface (aluminum foil will do) so that the input connection is made through that metal surface; the surface is then connected to the ground wire of the equipment's AC power cord.

Transient suppression

Anyone who has ever lost a batch of data or has seen his program "crash" when the lights dimmed knows the frustration that power-line transients can cause. Severe transients are capable of causing damage to electronic devices, especially members of the very sensitive MOS logic families. The most common types of transients on the power lines are as follows: sags (the power line voltage drops below the normal value for a short period of time); surges (the line voltage rises above the normal value for a short period of time); dropouts (the line voltage drops to zero for a short period of time); impulses (fast-acting conducted spikes of positive or negative polarity that are superimposed on the normal line voltage), and frequency changes (when the frequency of the line voltage deviates from 60 Hz).

The duration of those types of disturbances, especially the first three, is usually very short, typically lasting for only a few cycles (at 60 Hz, the period of a cycle is approximately 16.7 milliseconds). They have a variety of causes. Some of those include lightning, starting and stopping of heavy machinery, and momentary line faults (short circuits to ground) in the power distribution system. Long term disturbances usually take the form of blackouts or brownouts.

For protection against the long-term

disturbances, the only recourse is some type of uninterruptible power supply. Those devices contain storage batteries and sensing circuits that switch the load to the batteries when the line voltage falls below a certain value.

There are, however, many ways to protect your equipment from the effects of short-term transients. The first step is to recognize that transients can have two very different sets of characteristics. That is, transients can be unidirectional or oscillatory. An oscillatory transient has a fast rise-time and then becomes a decaying sinusoid, oscillating at some frequency until it damps out. The unidirectional wave has a very short rise-time and a comparatively long fall-time. Once the transient drops to zero, it shows no oscillation. Of the two, oscillatory transients are more commonly encountered.

Transients are capable of doing quite a bit of damage; impulse and surge voltages as high as 6000, and currents as high as 200 amperes have been observed. To prevent damage from occurring, the energy must be diverted before it enters sensitive electronics equipment. Power-line EMI filters will help to reduce some of the transient energy, but the amplitude of some transients can overwhelm the filters and cause damage. A device especially designed for transient suppression is needed.

There are a variety of devices that are useful in protecting your equipment from high-energy transients. Many of those are available commercially; you simply buy them and install them between the AC outlet and your equipment. They are generally satisfactory for most applications, if they are installed properly and if a good ground is used.

It is also possible to design and build an effective "home-brew" suppressor. The key components for such a device—gas tubes, varistors, and Silicon Avalanche Suppressors (SAS)—are readily available.

Basically, gas tubes consist of a pair of electrodes that are encased in a non-con-

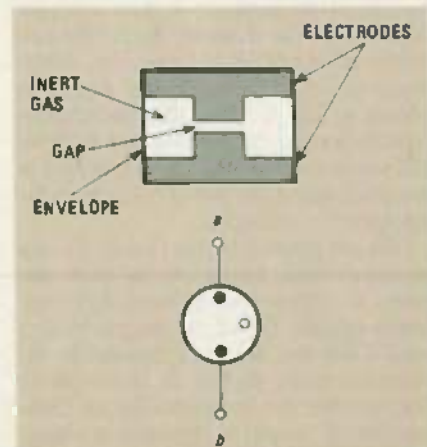

FIG. 8—A CROSS-SECTION of a gas tube is shown in a; its schematic symbol is shown in b.

ductive (usually glass) envelope that contains an inert gas. See Fig. 8-a; the schematic symbol for the gas tube is shown in Fig. 8-b. One of the electrodes is connected to the hot line of the AC power cord, and the other is either grounded or connected to the neutral line. Normally, the presence of a gas tube in the line has no effect, but when a high-energy transient occurs, there is arcing between the two electrodes. That arcing is the dissipation of the transient energy. Lightning arrestors, installed on the utility companies lines, are usually made up of very large gas tubes.

Varistor is short for *VARIABLE RESISTOR*, which essentially describes the action of that device. Varistors have a high resistance at low voltages, but as the voltage increases, the resistance greatly decreases. In the low resistance state, the varistor is capable of handling a large increase of current without a large increase in voltage. Thus, the voltage on the line is "clamped." Varistors are inherently bipolar devices.

The level of the clamping voltage depends on the type of varistor and the energy rating of the device. The varistor, if not properly chosen, can be over-stressed, resulting in damage to the varistor and a lack of protection for your equipment. However, varistors are available in various ratings that can be matched to the job at hand. In addition, varistors react very quickly to transients.

SAS devices are most suitable for use on signal lines, low voltage lines, telephone lines, and at the circuit-board level. SAS's, which are very fast-acting devices, are essentially large area p-n junctions or "beefy" diodes. The device's characteristic curve resembles that of a Zener

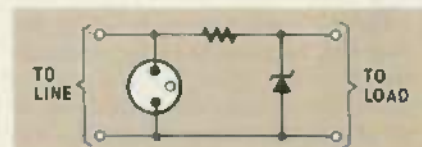

FIG. 9—A HYBRID transient-suppressor circuit allows you to combine the advantages of two or more types of suppressor devices.

diode, but they can handle much more energy. Both bipolar and unipolar devices are available.

It is possible to combine the above devices into a hybrid suppression network. Such hybrid networks are useful because the designer can combine the advantages of two or more suppressor components, such as the energy-handling capability of a gas tube with the speed of an SAS. Such a hybrid network is shown in Figure 9. The isolating impedance is included in the network to limit the transient current into the SAS; it also causes the voltage to build up high enough to trigger the gas tube.

continued on page 114

BUILD THIS



Mini Music Synthesizer

Turn your voice into a versatile musical "instrument" with this fun-to-build mini music synthesizer.

THIS MINI-MUSIC SYNTHESIZER IS NOT TOO complex, but it is a load of fun to build and use. The ingenious little unit samples and holds the frequency of a signal from a microphone or other sound source and outputs that signal as a single note. The input "signal" can be a whistle, hum, or some other sound. The duration and amplitude of the note can be controlled. The frequency of the note can be halved or doubled with a flick of a switch. A vibrato effect can also be applied via a variable tremolo control. To add to all of that, two channels are available to give chorus or stereo effects. Each of those channels has a separate volume control.

The signal source is derived from a low-to medium-impedance microphone. That microphone can be almost any dynamic or electret type. The types used with low-cost cassette recorders will work well.

The synthesizer's output is connected to an external amplifier of some type. A home-stereo system would be suitable; feed the signal to the auxiliary or tuner input. A PA amplifier could also be used.

How it works

The schematic of the synthesizer is shown in Fig. 1. As you can see there, its input section is basically a microphone amplifier and signal shaper with three stages. Twin Voltage Controlled Oscillators (VCO's) each with a Voltage

Controlled Amplifier (VCA) output stage make up the main section. The remaining circuitry is a simple, adjustable low-frequency oscillator that's used as a tremolo-effects generator.

The first stage of the input section is made up of IC1-a and its associated circuitry. That stage has a gain of about 100 at 1 kHz. The op-amp circuit used in that stage is very basic. Note, however the presence of the capacitor in the feedback loop. That capacitor causes a roll-off in gain as the input frequency increases. The output of the amplifier is AC coupled to the next stage by C7.

The second stage consists of IC1-b and its associated circuitry. That stage has a gain of about 20. Like the previous stage, the high frequency response is limited by a capacitor in the feedback loop. That response tailoring has been done to reduce the normally rich harmonic content of the human voice; the only signal we want to process is the fundamental note. The harmonics are low in amplitude and can be partially rejected by the simple approach used in that circuit.

The last stage of the input section is the most significant and needs some explanation. The op-amp there, IC1-c, is configured as a Schmitt trigger with offset. The hysteresis components are R22 and R21. Normally a Schmitt trigger is bistable, and in the quiescent state the output would be either positive or negative depending on the last signal transition. The difference in this case is that the offset volt-

age at the inverting input is greater than the hysteresis voltage at the noninverting input; resistors R20 and R39 establish that offset. The purpose of the offset is to assure that the output at pin 8 of IC1 is always low (negative) when no signal is present. The output will only switch when the input exceeds the sum of the hysteresis and offset voltages. The circuit acts as a gating system to the following phase-locked loop circuits.

The Schmitt trigger is the second stage of the processing that rejects the harmonics and noise in the input signal from the microphone. The input level, set by R41, is adjusted by turning that control until reliable response is achieved from a normal-level input (such as a singing voice). It is not adjusted farther than that minimum amount. In that way, the Schmitt trigger will tend to switch only on the peaks of the fundamental. The levels of the harmonics and noise content of the signal are below the threshold switching points and will be rejected. The purer the voice or note, the more reliable the circuit action. A "gravelly" or "rough" voice thus will tend to prove unreliable as a signal source. The best results will be from a whistle, because that produces a note that is relatively free from harmonics of any amplitude.

From the output of IC1-c, the signal is split and fed to both the right and left channels. Since the circuitry in the two channels is identical, we will look at only one of those: channel 1.

Adapted from a project that originally appeared in Dick Smith's *Funways into Electronics*, volume three.

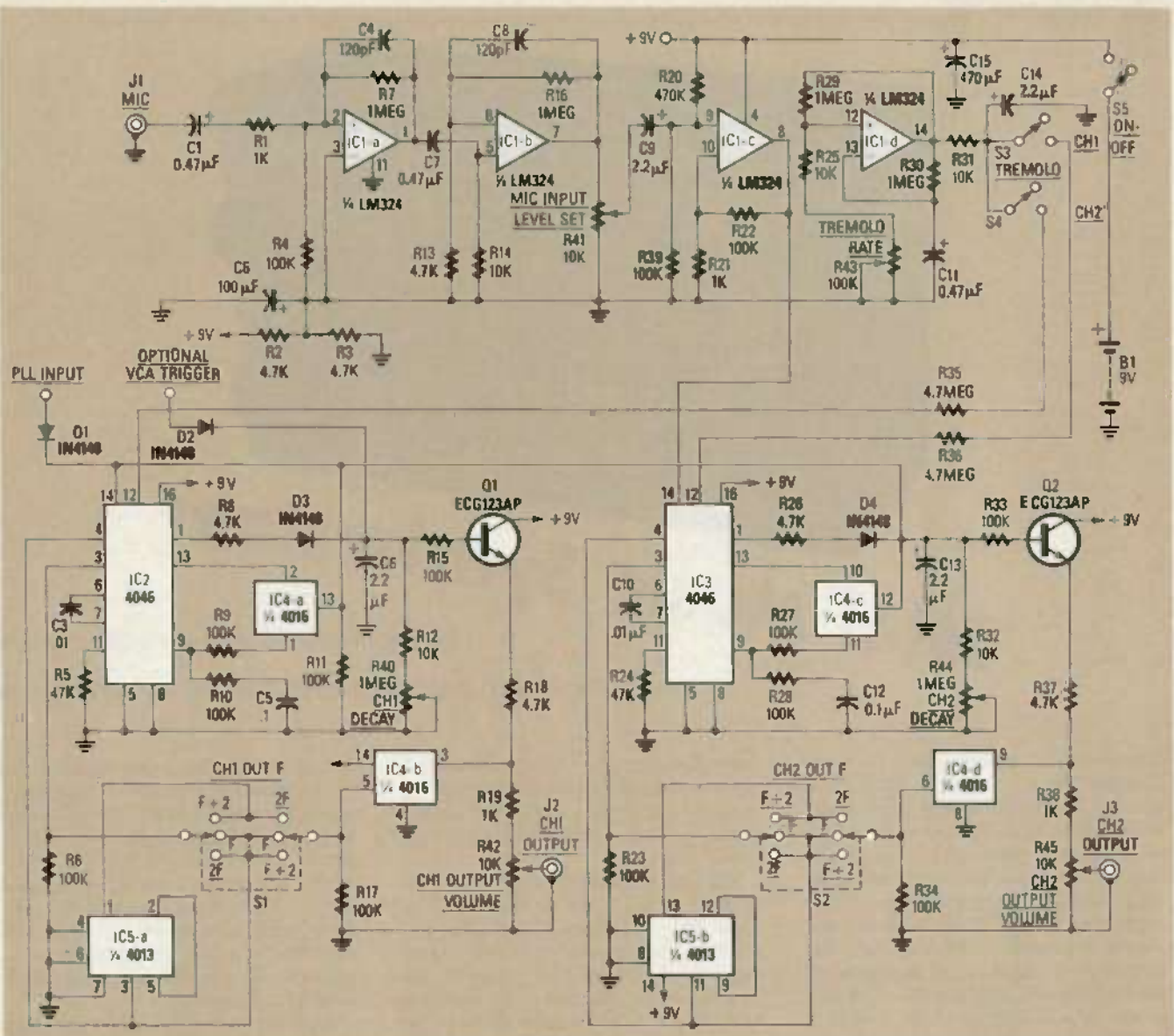

FIG. 1—SCHEMATIC DIAGRAM of the mini synthesizer. The potentiometers can be either panel-mounted or PC-mounted.

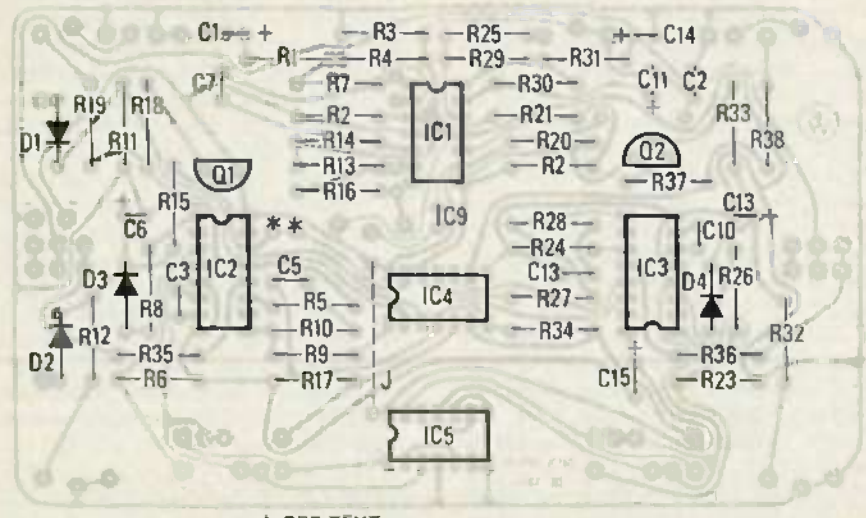

FIG. 2—THE LOCATIONS OF ALL PC-board mounted components are shown here. To disconnect the microphone input stage, cut the trace between the pads marked with an asterisk.

From the Schmitt trigger, the signal is passed to IC2, a 4046 CMOS Phase Locked Loop (PLL). That IC consists of two separate circuits. One is a VCO that runs from subaudio to over 1 MHz. The other is a dual-output phase comparator. By adding just a few external components, a complete PLL can be formed. (For more information on the 4046, see the manufacturer's data sheet.)

Without an input signal, the output of the Schmitt trigger will be low, and therefore pin 13 of IC4-a, a 4016 analog switch, will also be low. That means that the analog switch will be off, and pin 13 (PLL COMPARTOR-OUTPUT 2) of the 4046 will be disconnected from pin 9, the input to the VCO. The voltage present on the lowpass filter capacitor (C5), together with the RC timing components (C3 and R5), will determine the frequency of the

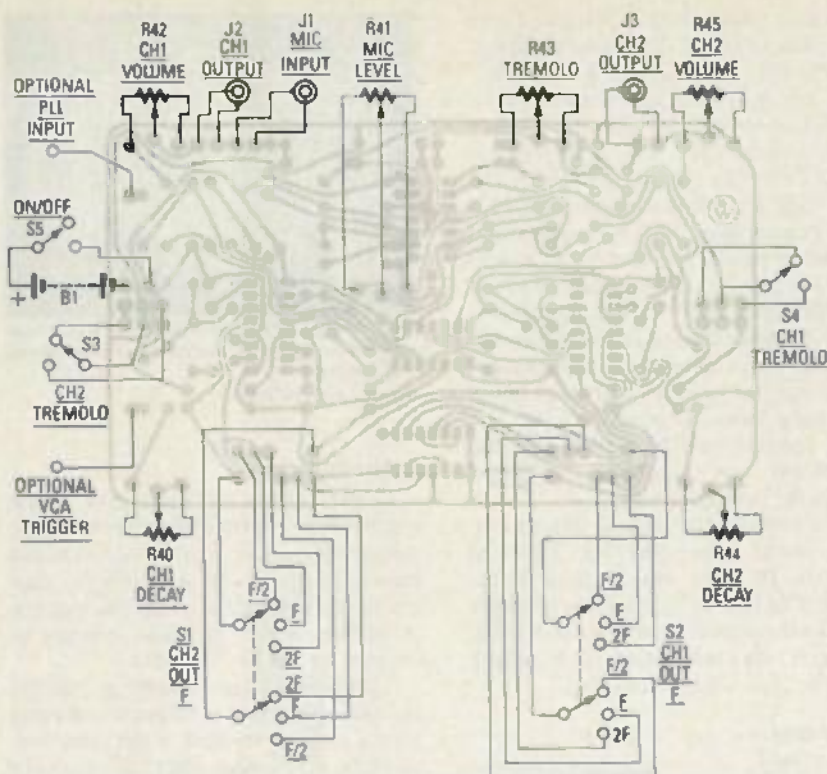

FIG. 3—THE OFF-BOARD COMPONENTS should be connected to the PC board via wires.

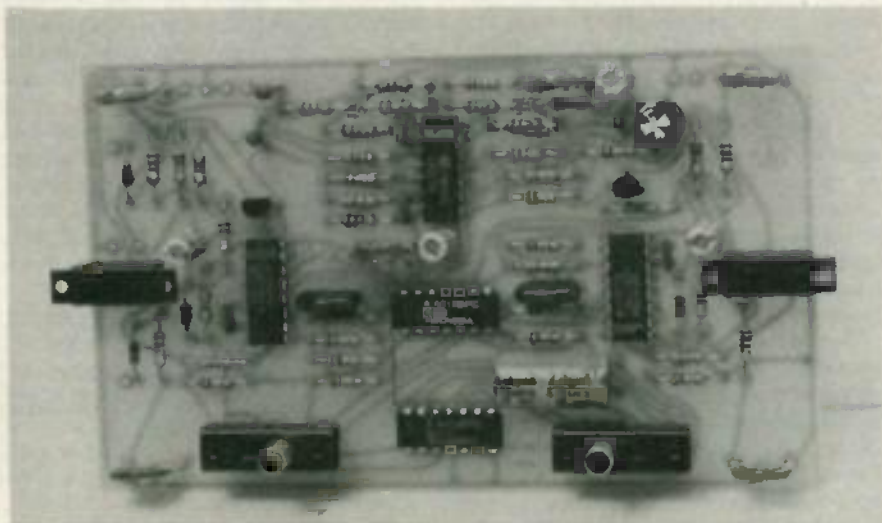

FIG. 4—THE FINISHED PC-BOARD is shown here. Note the use of PC-mounted trimmers in this version.

VCO. The voltage across C5 will not dissipate for a long period of time, because of the very high input impedance at pin 9 of the 4046, and the low-leakage characteristic of that 0.1- μ F polyester capacitor. That, in turn, means that the output frequency of the VCO at pin 4 will remain stable for a long period of time.

Now let us look at what happens when an input signal is present. Pins 13 of the analog switch and 12 of the PLL will go high. The analog switch is then on, and the phase-comparator output of the PLL (IC2, pin 13) will be connected to the VCO (IC2, pin 9) via the lowpass filter (R9, R10, and C5). Provided that the input signal continues at a fixed frequency for a

short period of time, the PLL will lock in and follow any frequency variations. For the most part, in that locked state, the PHASE PULSE output (pin 1) will be high (there will, however, be some narrow negative-going pulses).

With pin 1 of the 4046 high, D3 will be forward-biased via R8, so C6 will charge. The voltage across the capacitor is applied to the base of Q1, which acts as a voltage follower/buffer. That transistor is half of the VCA output stage, the other section being another 4016 analog switch (IC4-b). The control gate (pin 5) of IC4-b is connected directly to the output of the VCO (pin 4 of IC2), or indirectly via the 4013 (a dual D flip-flop), depending on the

PARTS LIST

Resistors

All resistors are 1/4-watt, 5%, unless otherwise noted.

R1, R19, R21, R36—1000 ohms
R2, R3, R8, R18, R26, R37—4700 ohms
R4, R6, R9-R11, R15, R17, R22, R23, R27, R28, R33, R34, R39—100,000 ohms

R5, R13, R24—47,000 ohms
R7, R16, R29, R30—1 megohm
R12, R14, R25, R31, R32—10,000 ohms
R35, R36—4.7 megohms

R40, R44—1 megohm, potentiometer, linear taper

R41, R42, R45—10,000 ohms, potentiometer, audio taper

R43—100,000 ohms, potentiometer, linear taper

Capacitors

C1, C7, C11—0.47 μ F, 10 volts tantalum

C2—100 μ F, 16 volts, electrolytic

C3, C10—0.01 μ F, ceramic disc

C4, C8—120 pF, ceramic disc

C5, C12—0.1 μ F, polyester

C6, C9, C13, C14—2.2 μ F, 16 volts, electrolytic

C15—470 μ F, 16 volts, electrolytic

Semiconductors

IC1—LM324 quad op-amp

IC2, IC3—4046 CMOS PLL

IC4—4016 quad analog switch

IC5—4013 dual D flip-flop

Q1, Q2—ECG123AP NPN transistor

D1-D4—1N4148 silicon diodes

Other Components

S1, S2—DP3T miniature slide switch

S3-S5—DPDT miniature slide switch

J1—miniature phone jack

J2, J3—phono jack

B1—9-volt battery

Miscellaneous: PC board, case, knobs, battery snap wire, etc.

A kit of parts (Catalog Number K-2669) is available from Dick Smith Electronics, PO Box 8021, Redwood City, CA 94063. The kit includes the PC board, but not the case, the battery or the jacks. The price is \$19.95.

setting of S1. The squarewave output from the VCO opens and closes the analog switch. It can be seen that that action directly gates the voltage available to the output terminal via the two current limiting resistors and the potentiometer.

When the input signal disappears, pin 1 of the 4046 returns low. As described previously, the VCO remains running at a frequency determined by the voltage on capacitor C5. The voltage across C6 then begins to discharge via the transistor follower and the two resistors, R12 and R40. Those two resistors control the "decay" rate. If R40 is set to its maximum value (1 megohm) the discharge time will be long (decay will occur slowly). As the discharge is taking place, the continuous output from the VCO switches the analog gate IC1-b on and off to "sink" the decaying voltage on the emitter of Q1 via the load resistor (R18) at the VCO rate.

The frequency of the note reaching the output stage can be changed from that of the original. By using a flip-flop as a divide-by-two element, the output can be halved or doubled depending on where it is coupled into the circuit. With the octave-select switch (S1) in the center position (F), the output frequency will be identical to input. When the $F/2$ position is selected, the 4013 (configured as a clocked flip-flop) divides the output from the VCO (IC2, pin 4) by two (lower octave). In the $2F$ position, the flip-flop is connected between the output of the VCO and the comparator of the PLL. That results in a frequency that is twice that of the input (upper octave) at pin 4 of the VCO.

So far we've only used three sections of the LM324 quad op-amp. The fourth section (IC1-d) is used as a tremolo generator. The op-amp is configured as an astable multivibrator to give a squarewave output. Potentiometer R43 is included to adjust the frequency (tremolo rate). The squarewave is then smoothed somewhat to give a more natural tremolo effect to the output note. That waveform is then applied to the VCO (at pin 12, IC2) via a selector switch and a 4.7 megohm resistor.



ONCE COMPLETED, the circuit should be installed in a case.

Optional Inputs

The VCA of either channel can be triggered from an external source. A positive pulse input via D2 to the VCA will charge C6. If that input is held high, the output from the VCA will also remain high. If the input is a pulse from a sequencer or even a simple switch, the output from the VCA can be triggered without the need for an audio signal at the microphone input. That could be used with rhythm generators, etc., to create different effects. The frequency of the VCO can still be changed by using the microphone input. If you require that the input signal from the microphone-amplifier stage not trigger the VCA, create an open circuit by removing D3 from the board. (The foil pattern for the project is provided in our "PC Service" department; the parts-placement diagrams are shown in Figs. 2 and 3.)

By disconnecting the input stage from the VCO, the PLL can be used separately by providing an external input signal. Isolation is performed by cutting the PC

board trace between the pads marked with an asterisk in Fig. 2. The input is applied via D1. That input should be a square-wave. The peak-to-peak voltage of the input should not be greater than the circuit's supply voltage, and should not be less than 75% of the supply voltage. If the input stage is disconnected from the PLL in the manner described, the circuit could be used to modify the output of an electronically amplified instrument or a sound generator (provided that the input signal meets the requirements of the 4046). For example, the output from a simple monophonic organ can be used to create more interesting tones and sound effects. The decay control could be used to vary the note shape, and the octave switch can change the note frequency.

To reconnect the PLL to the microphone input stage, the link destroyed when the PC trace was cut must be restored. That is done by installing a jumper between the pads marked with an asterisk in Fig. 2; for convenience, that jumper could be replaced by a switch.

Assembly

Assembly is very straightforward if you follow Figs. 2 and 3. Start by mounting all of the low-profile components on the board. Those include the resistors, diodes, and the jumper. Next, install the capacitors. Be sure to observe the polarity of the electrolytics. After that, install the IC's and transistors, taking care to observe the proper orientation. Finally hook up the switches, potentiometers, and other off-board components. Note that the board has been designed to accept PC-mount potentiometers, but you can use panel-mount potentiometers and connect them to the board with wire.

To test the system you will need to use an audio amplifier of some type. Feed the output of the synthesizer to the amp, plug in the microphone and battery, and turn the unit on. Whistle a few times close to, but not directly into the microphone. Turn up the MICROPHONE INPUT LEVEL SET control until some response is heard from the outputs. Set the VOLUME controls of both channels to an appropriate level. Vary the pitch (frequency) of your whistle; the output should vary in kind.

Next, try varying the DECAY controls. With the controls set to maximum, you will hear the outputs change in frequency as the note of your whistle changes. Notes that are wide apart in frequency will take a little longer to lock. Now try changing the setting of the OCTAVE SELECT switches. Also try out the TREMOLO RATE control; be sure that the tremolo section is switched into the circuit when you do that.

If all is working, the completed board (see Fig. 4) can be mounted in a case to complete assembly. If you detect any problems, go over your work carefully to find the cause of the problem.



THE UPPER TRACE is a 3-kHz input signal from a signal generator. The bottom one is the output that results.

(Photo courtesy of Tektronix)

Operation

Connect the microphone and switch the unit on. Now slowly whistle a tune a short distance from the mouthpiece. Do not blow directly into the microphone. Best results are obtained with the microphone at the side of your mouth so that any air currents do not hit it directly.

Turn the input-level control up until you get a reliable response from the unit every time a note is whistled at the same volume. Turn the output-volume controls to a suitable level to avoid feedback. The whistled note should be a short, clean burst. Try changing the DECAY controls so that the generated sound varies from a short staccato to a long, slowly-decreasing tone.

Note that the synthesizer is sensitive to all sound. Thus, when the microphone picks up the output sound of the amplifier, feedback occurs and the system locks up in an uncontrolled state. To avoid that, you must keep the microphone away from the speaker system.

When you find a suitable input level, try the other functions. By changing the OCTAVE SELECT switches, the output frequency can be set to be the same as the input, or one half of the input, or twice the input. By adding tremolo to one or both channels, interesting tonal effects can be achieved.

Try singing or humming into the microphone as the sound source. The system will respond best to pure, clean notes. Rough voices will not be reliable.

By striking different shaped objects next to the microphone, the system will tend to pick up the fundamental resonance of the object and produce an equivalent note.

Musical instruments can also be used as the sound source. A simple recorder, for instance, can produce many and varied sounds. Other instruments, such as a guitar, can produce different notes and sounds. The combinations are endless.

To give greater versatility to the unit, channel one can be controlled from external sources as described above. With a little practice, this mini synthesizer can make you a "one-man band." R-E

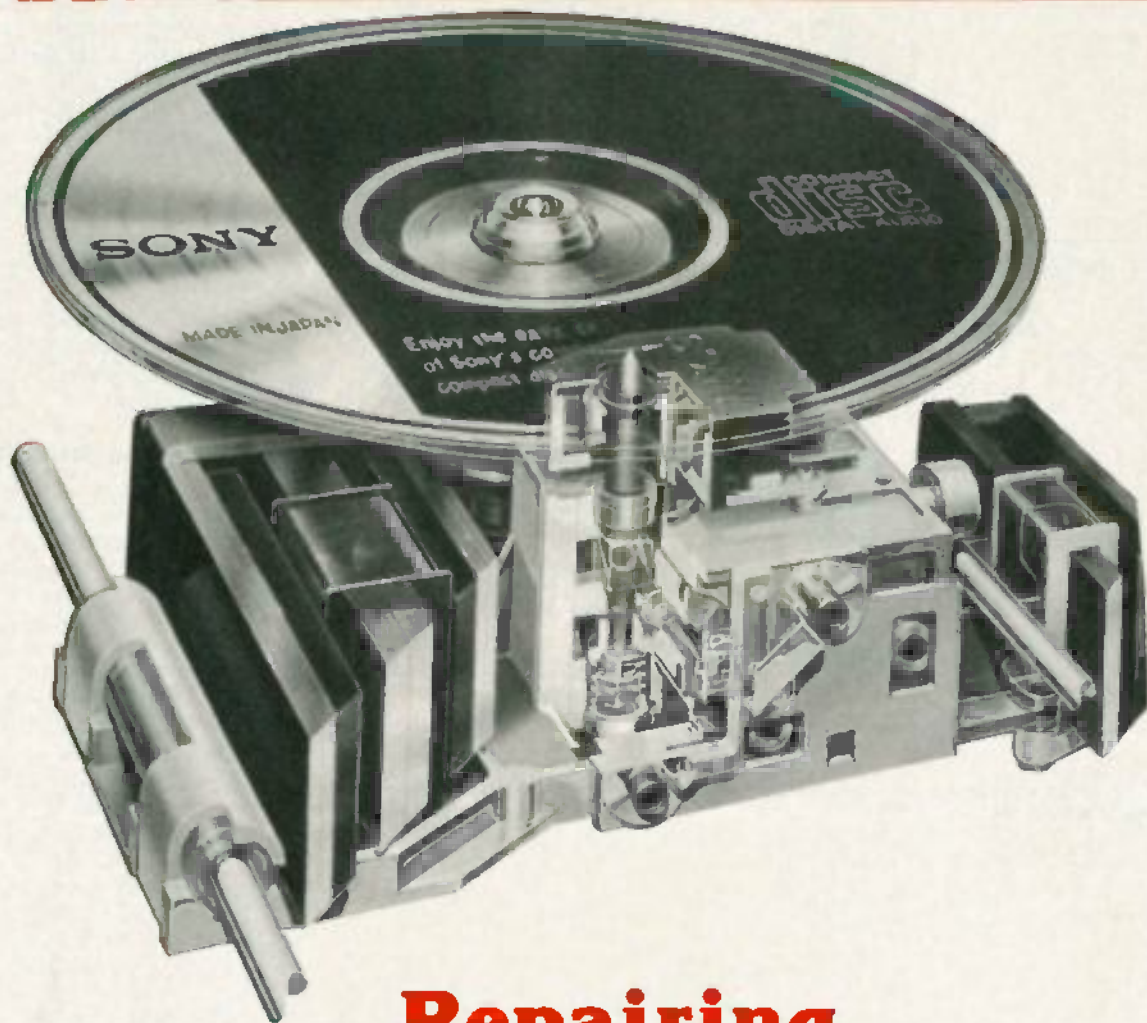

Repairing Compact Disc Players

Compact disc players are the most exciting development in audio in years. In this article we'll show you how those devices work, and how you can repair them when something goes wrong.

Part 4 LAST TIME, WE BEGAN to look at how to adjust CD players. The first adjustment we talked about was the laser output adjustment. Unfortunately, we ran out of room before we could finish that topic, so let's do that now and then move on to the rest of the CD player adjustments.

The simplest way to check laser-diode drive current is to measure the voltage across a resistor in series with the diode, such as R623 in Fig. 20-a, and then calculate the drive current. For example, if the recommended laser diode current is 40 to 70 mA, and the series resistance is 22 ohms, the voltage should be between 0.88 and 1.54. That check can be done before

you adjust the laser diode, and *must be done* after adjustment.

Some literature recommends monitoring the laser with a light meter. However, it is more practical (and much easier) to adjust the laser diode output until you get an EFM (*Eight-to-Fourteen Modulation*) signal of correct amplitude, as we discuss next. Before you make the adjustment, set R629 to minimum, and then increase the setting as required. Also, note that the chuck or CHU switch (S3) must be in the closed (tray in) position before power is applied to Q601 and the laser. (That eliminates the need for separate interlocks.) Of course, you will probably find it necessary to override that interlock (close S3

manually) during adjustment and troubleshooting.

First, connect the oscilloscope as shown in Fig. 20-a. That allows you to monitor the EFM signal (after the photodetector output is preamplified by IC601). As discussed, the EFM signal (at that test point) is applied to the tracking, focus, and pickup motor servos, as well as to the signal processing circuits.

Next, load a disc in the player and select the PLAY mode. The EFM signal should appear on the scope, and produce a waveform similar to that shown in Fig 20-b. Finally, adjust R629 until the EFM signal level is 700 mV (or as specified in the manual, typically 550 to 950 mV).

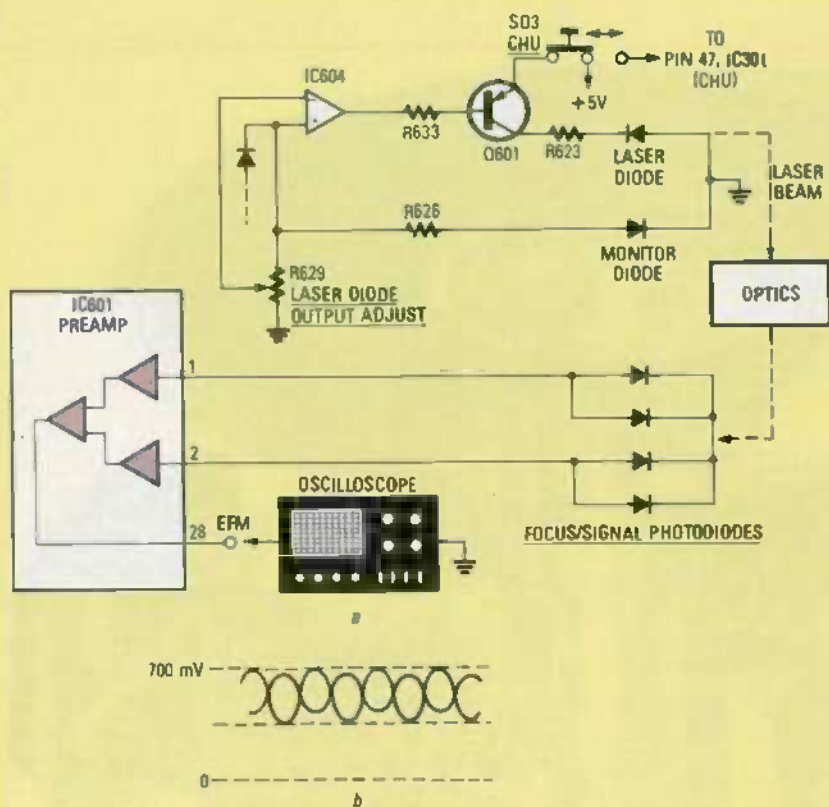

FIG. 20—THE SIMPLEST WAY to check laser diode drive is to measure the voltage across a resistor in series with the diode, such as R623.

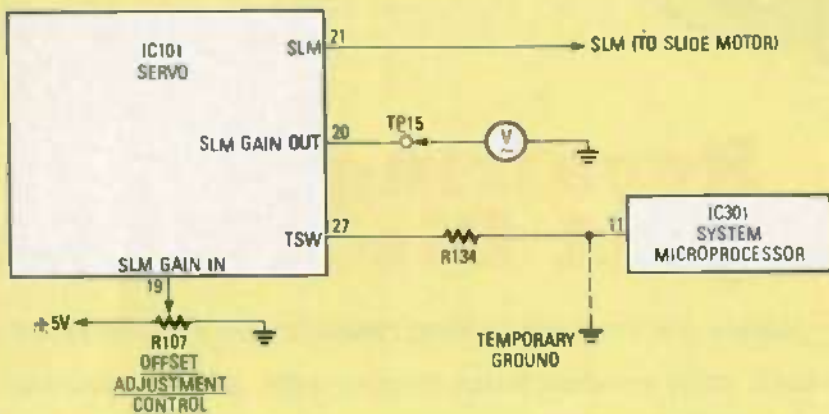

FIG. 21—WHEN THE slide-motor offset adjustment has been completed, be sure to remove the temporary ground.

Slide-motor offset

The slide-motor offset adjustment sets the point where the pickup accesses the beginning of the disc (the disc directory). If the adjustment is not correct, the program information may not be read properly. Note that that adjustment controls the pickup motor servo, and is not to be confused with the inner-limit microswitch, although the two adjustments are interrelated. However, if the microswitch is properly set, you should have no trouble in setting the pickup servo offset, as follows.

First connect a DC voltmeter as shown in Fig. 21. That allows you to monitor the

motor gain output from IC101.

Next, load a disc in the player and select the PLAY mode. While the disc is playing, ground IC301, pin 11 as shown in Fig. 21 to simulate a low tsw signal. (If the tsw line is high, IC301 shuts the system down.) Finally, set the player to stop. After about 10 seconds, measure the DC level at TP15 and adjust R107 so that the reading is 0V (± 50 mV). Adjust R107 in small increments and wait for the voltage level to stabilize before proceeding.

Tracking-servo offset

Figure 22 is the tracking-servo offset adjustment diagram. Here, we are adjust-

ing the optical pickup (through the servo and tracking actuator coil) so that the laser beam is properly centered on the tracks, producing maximum EFM. The EFM signal is monitored via an oscilloscope connected to TP13. Note that R603 sets the offset of the two tracking diodes, but not the four remaining focus/signal diodes.

As before, begin by loading a disc in the player and selecting the PLAY mode. Then adjust R603 until the EFM is of maximum amplitude. That indicates that the laser is properly centered on the tracks. On some players, the display may become erratic and the audio will mute after that adjustment is made. If so, set the player to STOP and then go back to PLAY. That should eliminate the erratic display.

Focus servo offset adjustment

Here, you are again monitoring the EFM signal, but you are now adjusting the optical pickup (through the servo and focus actuator coil) so that the laser beam is properly focused on the tracks. Connect an oscilloscope to TP13 (see Fig. 23) and adjust for the maximum EFM signal. Note that R116 sets the offset of the four focus/signal diodes, but not the two remaining tracking diodes.

The first step is to load a disc in the player and select the PLAY mode. The EFM waveform should appear on a scope connected to TP13.

Next, adjust R116 for the maximum EFM signal (that indicates that the optical pickup is focused on the tracks). Again, if the display becomes erratic after this adjustment, stop and restart the player.

Disc motor Hall gain balance

The adjustment diagram is shown in Fig. 24. In that set up, one channel of a dual-channel scope is connected to TP18, while the other is connected to TP17. That allows you to simultaneously monitor the drive signals to both coils (A and B) of the disc motor (from the motor drive, IC201).

Start by loading a disc in the player and selecting the PLAY mode. Adjust R201 so that the output levels at TP18 (DMCA) and TP17 (DMCB) are equal. Usually, DMCA and DMCB are about 2 volts (p-p).

Sample-and-hold offset adjustment

The adjustment diagram is shown in Fig. 25. Note that this adjustment is not available on all players. Also the circuits shown in Fig. 25 are not to be confused with the sample-and-hold audio circuits. The S/H circuits we are dealing with here are part of the pickup servo, IC101, and control the tracking error or TER signals.

To perform this test, we must create a simulated defect on a disc. The disc is then played and R103 adjusted for minimum audio dropout. The simulated defect is created by placing a strip of black (non-reflective) tape, about 0.5-mm wide, on the mirror side of the disc.

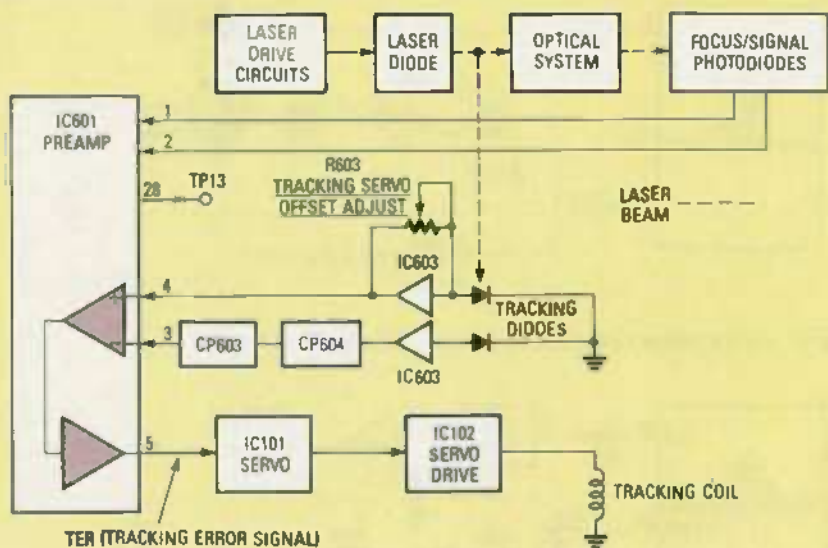

FIG. 22—WHEN THE tracking-servo offset adjustment has been performed correctly, the laser beam is properly centered on the disc tracks and the EFM signal is at a maximum. The EFM signal can be monitored on an oscilloscope connected to TP13.

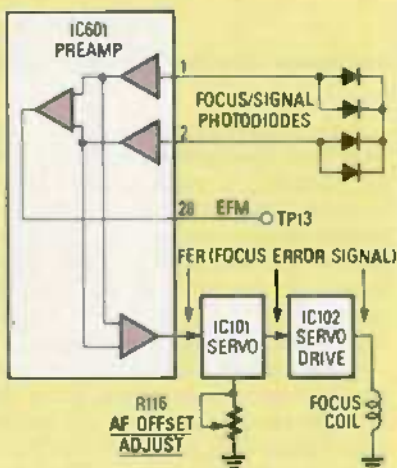

FIG. 23—CONNECT AN OSCILLOSCOPE TO TP13 and adjust R116 for maximum EFM signal.

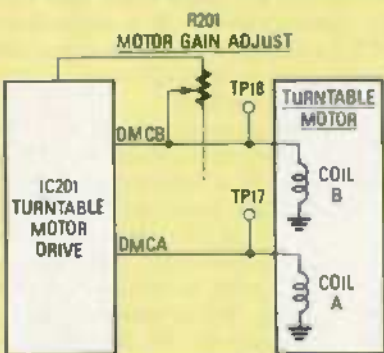

FIG. 24—ADJUST R201 so that the levels of the drive signals to the two coils are equal (about 2-volts p-p).

You can make this adjustment by ear. The simulated defect produces a chattering or ticking in the audio. You simply adjust R103 for minimum noise. Of course, monitoring the EFM signal with a

scope (via TP13), looking at the amount of audio dropout, is generally more accurate. Incidentally, do not turn the volume up with a simulated defect. The noise is unbearable!

If you monitor the EFM on a scope, note that with such a defect, a portion of the EFM display will be cut out (typically a notch or wedge, starting from the top), no

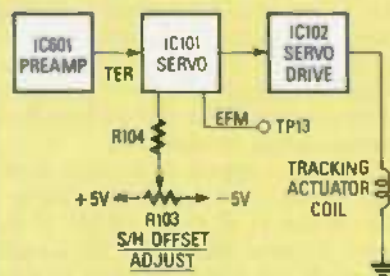

FIG. 25—HERE, you are adjusting the sample-and-hold circuits contained within IC101, not the audio sample-and-hold circuits.

matter how you set R103. However, you should be able to eliminate all (or most) of the audio dropout, as indicated by a cutout at the bottom of the EFM display. If you get considerable dropout at all R103 settings, IC101 may be defective.

Troubleshooting CD players

As with adjustments, troubleshooting procedures found in CD player manuals are limited at best. They give you the usual "troubleshooting tree" with some test points to check, but no hint as to what other components are involved. With the following material, we will attempt to provide you with that important information.

The following sections are a collection of trouble symptoms that match the trou-

bleshooting-tree found in the service manual for a typical CD player. After selecting the symptom that matches that of the player you are servicing, follow the steps in the corresponding troubleshooting procedures.

Preliminary checks

It is always a good idea to make a few preliminary checks before you tear into the player. Here are some examples.

The transit or shipping screw must be removed or loosened before the player can operate normally. Be sure that that has been done.

Cleaning the objective lens should be a routine part of servicing. A dirty objective lens can cause a variety of symptoms (intermittent or poor focus, skipping across the disc, erratic play, and excessive dropouts, to name a few). Also, those same symptoms can be caused by a defective disc. Try a known good disc before starting service.

Do not replace the pickup assembly, or make any adjustments on the pickup, before checking for mechanical problems that can affect the pickup. For example, look for binding at any point in the pickup's travel (indicating that the rails or guides are adjusted too tight.) On the other hand, if you hear a mechanical "chattering" when the pickup is moved, the rails may be too loose.

It is assumed that if you have such obvious symptoms as "none of the front-panel LED's light when the power switch is pressed" you will check the fuses (right after you have checked that the power cord is plugged in). It is also assumed that you will check for bad solder connections, broken foil traces, loose or unseated boards, and the like (cleaning the module and board contacts with a pencil eraser, as necessary). Finally, you should check the various power supply voltages if entire sections (or functions) appear to be inoperative. That means that you must locate the power-supply circuits on the schematic and/or block diagram, and measure the voltages. (If you can not do that, you should not even attempt to service a CD player yourself!)

Now, let's go on to the symptoms, and their cures!

1. Tray does not open or close properly. Figure 26 is the troubleshooting diagram. If the tray will not open or close, first check that the system microprocessor, IC301, is getting signals from the front-panel OPEN/CLOSE switch, S318. If not, suspect S318 and/or the wiring between S318 and IC301. Next, check that the loading motor receives a signal from pin 12 of IC102 when S318 is pressed. If so, suspect the motor; if not, you have a problem between IC301 and the motor (through IC102).

Next check for signals at pins 10 and 11 of IC102 each time S318 is pressed, and

that the signals invert (pin 10 high and 11 low, then vice versa). Check for corresponding inverted signals at pins 33 (OPEN) and 34 (CLOSE) of IC301. If absent, or if the signal does not invert when S318 is pressed, suspect IC301.

If the tray opens, but not fully, check the point where S02 (LIDO) actuates, as indicated by a low-to-high change at pin 48 of IC301. If necessary, adjust S02. First check for any condition that might prevent the tray from opening fully.

If the tray opens fully, but the loading motor does not stop, the problem is almost always an improperly adjusted S02, although IC301 could be at fault.

If the tray closes, but not fully, and the clamp or chuck does not hold the disc in place on the turntable, check the point where the CHU switch, S03, actuates, as indicated by a high-to-low change at pin 47 of IC301. If necessary, adjust S03. First check for mechanical problems.

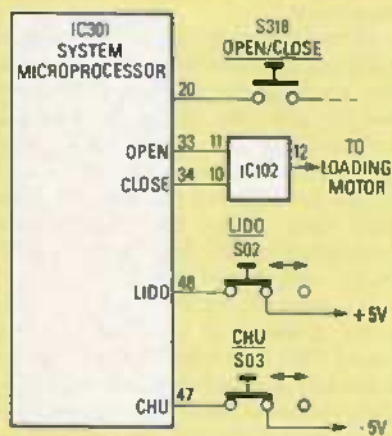

FIG. 26—IF THE TRAY does not open or close properly, use this diagram to help pinpoint the cause.

If the tray closes, and the clamp or chuck goes fully down, but the loading motor does not stop, the problem is likely an improperly adjusted S03, but the problem could be IC301. Look for a high-to-low change at pin 47 of IC301, which should occur when the tray is fully in, and the clamp is down on the disc.

2. Laser-diode problems. Figure 27 is the troubleshooting diagram. CD player operation depends on the laser producing a beam of the correct level. If the beam is absent, there is no EFM signal. If the beam is weak, the EFM signal is weak. If the monitor diode does not monitor the laser diode properly, the beam can shift to an incorrect level (high or low), without that event being sensed by the laser-drive circuits. Any of those conditions can cause improper tracking which, in turn, can produce an even weaker EFM.

So, if you have symptoms with no apparent cause, such as improper tracking that can not be corrected by adjustment, excessive audio dropout with a known good disc, etc., suspect the laser circuits.

If the laser diode appears to be in-

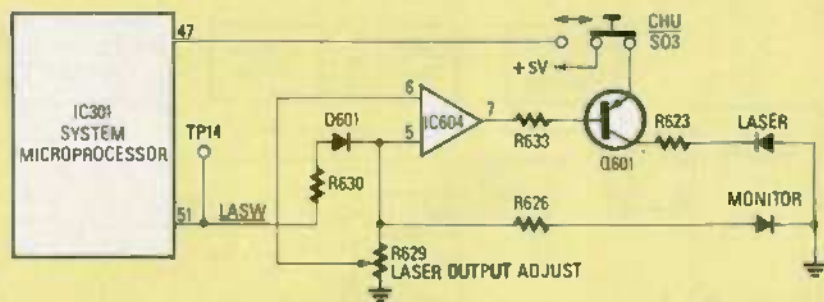

FIG. 27—LASER CIRCUIT PROBLEMS can cause a variety of malfunctions.

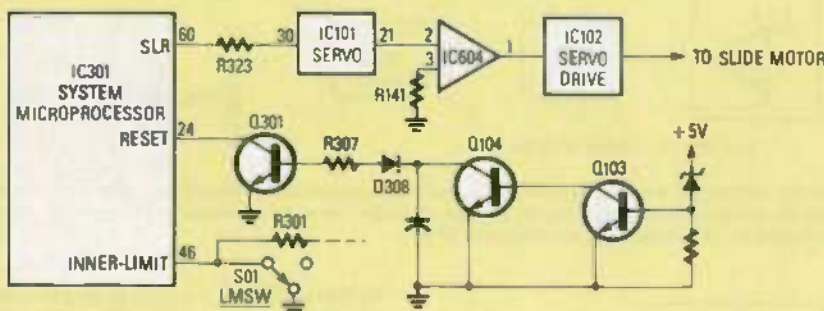

FIG. 28—IF THE PICKUP does not move to the inner limit when power is first applied, this troubleshooting diagram can help pin down the cause.

operative, check if Q601 is getting +5 volts through S03 (CHU). If not, suspect S03 (or the adjustment of S03). When S03 is in the open position, +5 volts is applied to pin 47 of IC301 to show that the tray is open and/or the clamp is not fully down. That disables a number of IC301 system control functions including LASW. When the clamp is fully down, S03 moves to the closed position, and the laser diode receives power through Q601.

If power is applied to the laser diode, look for an LASW signal (indicated by a low) at pin 51 of IC301 (TP14). If that signal is absent (pin 51 of IC301 is high), suspect IC301. If present, check for a signal at IC604 from the monitor diode. If abnormal, suspect the monitor diode and/or R629.

If signals are present at both pins 5 and 6 of IC604, look for drive signal at pin 7 of IC604, and the base of Q601. If absent, suspect IC604. If present, suspect Q601.

3. Pickup does not move to inner limit when power is applied; disc directory is not read properly. Figure 28 is the troubleshooting diagram. When power is first applied, the pickup moves to the inner limit. The system microprocessor applies a temporary SLR (reverse) signal to the pickup servo. In Fig. 28, a reset signal is generated by the circuit made up of Q103, Q104, Q301; it is applied to pin 24 of IC301. That produces a temporary SLR signal at pin 60 of IC301, which is applied to the motor through IC101, IC604, and IC102. That signal causes the pickup to move inward until the inner-limit LMSW switch, S01, is actuated.

If the pickup appears to move to the inner limit when power is applied, but the disc directory is not read properly (for instance, the total playing time, or number of programs on the disc is not given on the front-panel display), try correcting the problem by adjusting the motor offset (as described earlier) before ripping into the motor servo circuits.

If the pickup does not move when power is first applied (you may not be able to see the pickup, but you should hear the motor) check for SLR at pin 60 of IC301. If absent, suspect IC301, or Q301 and the reset circuit. If you get SLR, but the motor does not run, suspect IC101, IC604, IC102, and the motor itself. Also check for motor drive voltage at the output of IC102 and at the motor. If the motor runs, but the pickup does not move, look for mechanical problems.

If the pickup moves, but does not reach the inner limit, check when S01 actuates, as indicated by a high-to-low change at pin 46 of IC301. If necessary, adjust S01. Before adjusting S01, check adjustment of the pickup servo offset. If the offset can be adjusted so that the pickup accesses the disc properly, S01 is probably adjusted correctly. Generally, S01 does not go out of adjustment.

If the pickup reaches the inner limit, but the motor does not stop, the problem is almost always one of an improperly adjusted LMSW switch (unless IC301 is defective).

That's all we have room for now. Next time, we'll finish up the troubleshooting procedures, and this article. R-E

All About TRANSISTOR SWITCHES

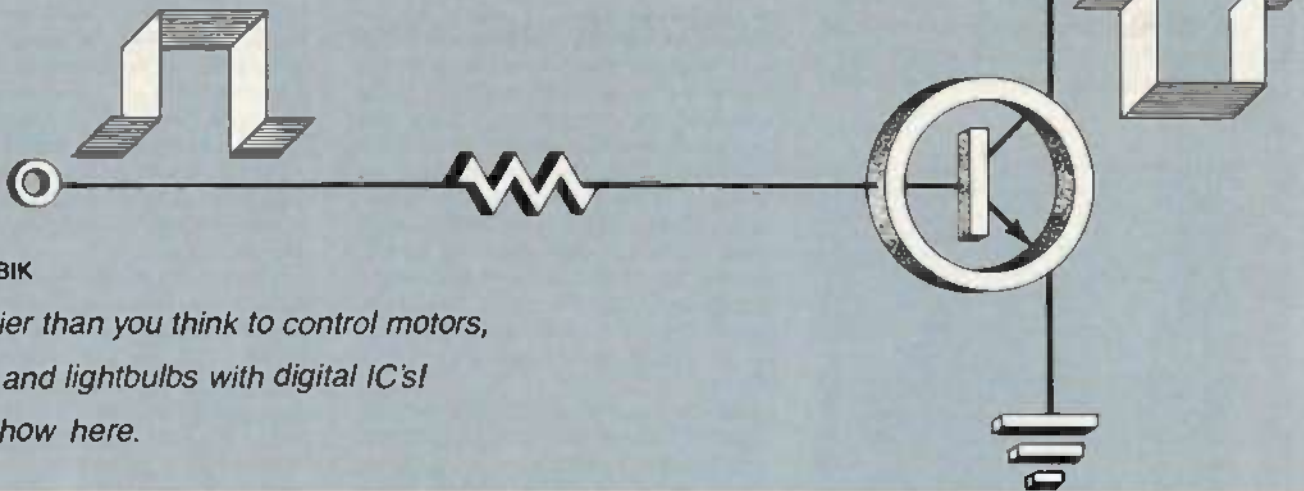

L. B. CEBIK

It's easier than you think to control motors, relays, and lightbulbs with digital IC's! Learn how here.

WITH A LITTLE BACKGROUND IN DIGITAL logic, almost anyone can string together a bunch of logic gates and get a circuit that works. But not everyone can design a circuit that works efficiently and reliably—especially one that requires an interface between digital IC's and non-digital devices like motors, relays, lightbulbs, etc.

It is easy to design one- and two-transistor circuits that allow your digital circuits to control devices like those; in this article we'll show you just how easy it is. If you follow our techniques, your projects that use transistor switches will function much better, and that will allow you to take an extra measure of pride in those projects.

The interface problem

Interfacing digital IC's of one particular family (TTL, CMOS, etc.) to one another is such a standard procedure that consideration of logic alone—apart from any consideration of circuitry—is often sufficient to complete a design. The only *electronic* design involved comes in calculating the value of the pull-up resistors that are necessary to keep logic inputs in a well-defined state.

Problems arise when a digital IC must control a device that is incompatible with the voltage or current ratings of that IC. One way to solve that problem is to use a

discrete transistor or two to link the IC to the incompatible component. Often we simply "lift" a standard circuit from a databook and use it as-is in our design. And why not do that? Most of the time, the technique works. Our lamp lights, or our buzzer buzzes, or our relay energizes, so we're satisfied.

However, by "designing" in such a manner, we'd be lucky if our interface really functioned optimally. For example, an incorrectly-biased switching transistor might itself draw more current than the rest of a CMOS circuit. An additional ten milliamps of current drain from a complex TTL circuit might be insignificant, but such a current drain in a battery-powered CMOS device could rapidly deplete a small battery. In addition, op-amps and comparators—with their bipolar (positive and negative) outputs—impose special design requirements when used with discrete transistor switches.

What we must do, then, is spend a little time designing (*really* designing, that is), and then optimizing a transistor switching circuit. Such design is actually quite simple: We need only a few data sheets, paper and pencil. The little arithmetic we need to do hardly requires a calculator. A breadboard, a few inexpensive components, and a multimeter are all you need to design, test, and optimize the circuits presented below.

Transistor basics

Before we get into the details of switching-circuit design, let's review fundamental transistor operation. The base of a transistor is used to control the current flowing through its emitter and collector. If we block current flow to the transistor's base, collector current will cease. When that happens, we say the device is in *cutoff*.

On the other hand, as we supply more and more current to the base of a transistor, its collector current increases at a corresponding rate. Eventually we reach a point where additional base current causes no corresponding increase in collector current. At that point we say that the transistor is in *saturation*. Between cutoff and saturation is the *linear* operating region.

Circuits using transistors as small-signal amplifiers often try to avoid operating in either cutoff or saturation, although some designs do utilize one or the other extreme (Class-C RF amplifiers, for example). By contrast, transistors used as switches attempt to avoid operating in the linear region. We try to switch a transistor from cutoff to saturation, and from saturation to cutoff, instantaneously. Of course, that is impossible, but if we make the transition period short enough, it will appear to be instantaneous. Overdriving a transistor—that is, forcing it "hard" into

saturation—can adversely affect switching speed by increasing junction capacitance, so we must be careful not to apply too much base current to a switching transistor.

Calculating just the right amount of base current comprises the bulk of the work in switching-transistor circuit design. Let's see how to do that now.

Single-transistor switch

We often make the base current a function of an applied voltage. In Fig. 1-a, resistor R_B is wired in series with transistor Q1's base. As shown in the upper trace of Fig. 1-b, when an appropriate voltage (V_{IN}) is applied to R_B , Q1 will turn on. At that point, as shown in the middle trace, collector current becomes appreciable, and collector voltage drops to (almost) zero, as shown in the bottom trace.

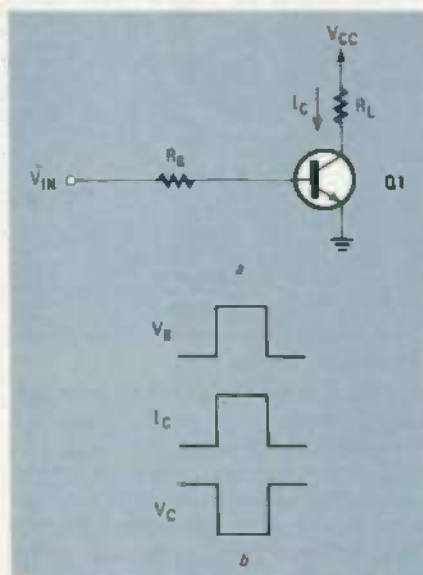

FIG. 1—THE VALUE OF THE BASE RESISTOR in this switching circuit depends on the value of I_C and the gain of the transistor.

We can use Ohm's law to calculate the value of the base resistor: $R_B = V_B / I_B$. Assuming we're working with a standard logic family, we'll know V_B : the output voltage of the IC driving our switch. For example, standard TTL IC's have an output of about 2.4 volts DC. In order to calculate the value of I_B , we need to know the amount of current (I_C) our load (R_L) requires. We can determine that current easily using standard data books, or by "guesstimate," if necessary, and refine our calculated value on the breadboard later. Catalogues often give the current ratings of lamps, buzzers, and other devices. Relays (and other components) may be given only a resistance rating, but, by using Ohm's law, we can easily calculate the load current. So, half the battle is won without a struggle.

We also need the current gain, h_{FE} , of

TABLE 1—COMMON SWITCHING TRANSISTORS

Number	Type	$V_C(\text{MAX})$	$I_C(\text{MAX})$	$H_{FE} @ I_C$
2N2219	NPN	40	500	30 (500)
2N2222	NPN	40	500	30 (500)
2N2907	PNP	60	500	35 (500)
2N3638	PNP	25	500	20 (300)
2N3702	PNP	40	500	60 (300)
2N3704	NPN	30	100	100 (50)
2N3904	NPN	40	100	30 (100)
2N3906	PNP	40	100	30 (100)
2N4400	NPN	40	100	20 (500)
2N4402	PNP	40	500	20 (500)
2N5400	PNP	130	100	40 (50)

the transistor we'll be using; h_{FE} may usually be obtained from a data book. The gain of commonly-available transistors may range anywhere from twenty to two hundred. If you don't know the gain of the transistor you'll be using, or if you use surplus or unmarked transistors, assume that h_{FE} for high-power devices is twenty, and that, for low-power devices, it is forty. Don't worry about being exact; using those values will allow you to get started, and we can optimize resistor values on the breadboard. And since gain ratings are often listed as "typical" or "minimum," we'll probably have to experiment a little anyway.

As long as we've got the data book open, let's check one other rating to ensure that the transistor we're using will be able to do the job. The maximum collector-to-emitter voltage (V_{CEO}) of the transistor is important, because, when it is in cutoff (that is, when no current is flowing through the load), the full supply voltage will appear across the collector and the emitter. A common rule of thumb is that a transistor should be able to withstand at least twice the maximum voltage that will appear across it. In most CMOS and op-amp circuits, the maximum supply voltage will be fifteen volts. It's easy to find thirty-volt transistors, and they'll handle five-volt TTL devices with ease.

Assuming the transistor meets our load's voltage and current requirements, we can use h_{FE} to calculate the base current that we need to turn the transistor on. As you recall, base and collector currents are related by $h_{FE}: I_B = I_C / h_{FE}$. We then plug I_B into our previous equation and calculate R_B . To account for variations among transistors, add about twenty percent to the base current before calculating the value of the base resistor. (Or simply increase the calculated value of R_B by twenty percent.) Now we're just about ready for the breadboard.

However, there's one other thing to check. We must ensure that the (digital or other) device driving our switching circuit can safely supply the calculated base current. Safety is not really a question of burning out the driving IC; rather, we want to ensure that we don't force that IC

to operate unreliably. TTL IC's (and some special IC's like the ubiquitous 555) can usually supply all the current necessary. Regular TTL IC's can supply sixteen mA; low-power TTL IC's can supply twenty mA; and low-power Schottky IC's can supply eight mA. You should treat those values conservatively, but for many applications, there will be more than enough current to drive a simple switch like the one we're discussing.

On the other hand, CMOS IC's and op-amps are voltage-operated devices; they are able to supply very little current. The amount of current CMOS devices can deliver varies with supply voltage; it ranges from about one mA at five volts, to four mA at ten volts. Likewise, op-amps can supply only a milliamp or two. If more current is required, a somewhat more complicated circuit must be used. But more on that in a minute. For now, let's take a look at some real-world transistors and their ratings.

Transistor ratings

To help you choose an appropriate switching transistor, in Table 1 we list maximum voltage and current ratings for several common devices, along with typical current gains at specific collector currents. Manufacturers' data books will contain more specific information, but the information in the Table should be enough to get you started. In general, almost any transistor that can withstand the required voltage and current can be pressed into switching service, but it is wasteful to use a one- or two-dollar transistor when a ten- or twenty-cent device will suffice.

The circuit shown in Fig. 1 is useful when you need to control a device with modest voltage and current requirements, when the driving circuit can supply enough current to reliably turn the switching device on and off, and when you are working with a positive supply voltage. If you were working with a negative supply, all you would need to do in order to make that circuit functional would be to substitute an appropriate PNP transistor for Q1.

In that case, the base-voltage trace in Fig. 1-b would be inverted. For example,

V_B would normally be "high" (zero volts); to turn on the transistor (and thereby the load), a negative voltage would be applied to the base. The collector-voltage trace would normally be low; it would go high when the transistor were turned on. The collector-current diagram would not change, as it indicates the magnitude, not the direction of current flow.

For most of the remainder of this article we will discuss circuits with positive supply voltages, so, if you are designing with a negative supply, just substitute transistors of the opposite type for those shown.

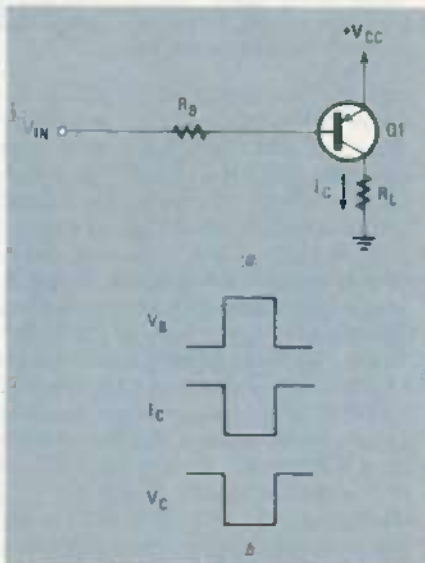

FIG. 2—THIS INVERTED-POLARITY switching circuit applies current to the load when V_{IN} is low. But see the text for precautions on use of this circuit.

Polarity Inversion

Sometimes we want a low from the controlling device to enable current flow, and a high to disable it. The circuit shown in Fig. 2-a will do just that. As the traces in Fig. 2-b reveal, when the base voltage goes high, collector current ceases, and collector voltage drops to zero. There is one precaution to observe when using that circuit: Make sure that the signal driving the switch goes high enough to cut it completely off. Op-amps and some logic devices may have outputs as much as twenty percent below the supply voltage. That may allow the switch to remain on constantly, as V_{BE} will not go below the 0.7 volt difference necessary to place the transistor in cut-off. Only a breadboard test will tell for sure.

Two-transistor switches

Sometimes a single transistor switch just won't meet our design requirements. For example, suppose that the current required by the load exceeds the current that our single-transistor switch can supply. Or perhaps we need to switch a high voltage—or even one of the opposite polarity.

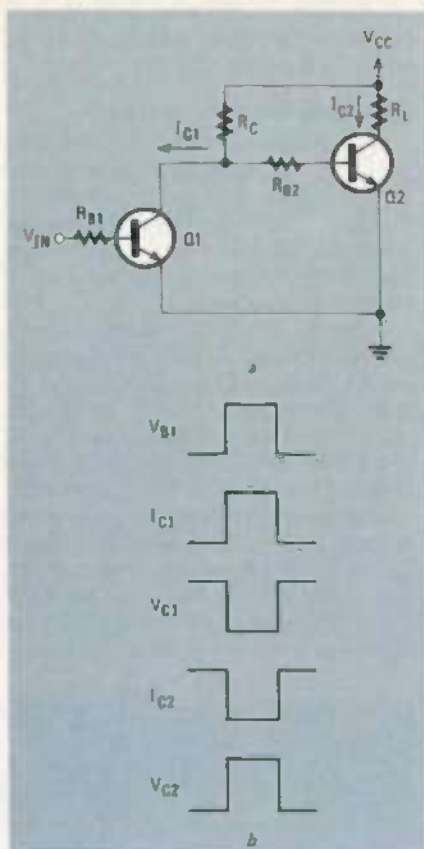

FIG. 3—THIS TWO-TRANSISTOR CIRCUIT can switch heavier loads than the previous circuits.

Perhaps we want to invert the driving signal, and the circuit of Fig. 2-a is just not reliable enough. The solution is to add a second transistor as a kind of "buffer" or "pre-amplifier" for the main switch. There are several ways of doing that.

The circuit shown in Fig. 3-a is an inverting controller. A high at V_{IN} turns Q1 on and Q2 off, and thereby prevents current from reaching the load, R_L . The voltage and current traces in Fig. 3-b illustrate how that works. When Q1 turns on, its collector goes low, and current flows through R_C . However, R_{B2} is also brought low, so Q2 is cut off. Hence its collector goes high, and collector current stops flowing.

To design such a circuit, we work backward from the load. After determining the voltage and current required by the load, we select a transistor for Q2 that can withstand those values. We then determine Q2's required base current using the gain equation listed above. In our one-transistor circuits, that current was supplied by the driving device; now it is supplied by Q1. The base resistor for Q2 is really the series combination of R_C and R_{B2} . However, in applications where Q1 only supplies current to Q2, R_{B2} may be omitted. The driving voltage, V_B , is the supply voltage feeding R_C .

Note that R_C determines the current that flows through Q1 when it is on, and that is one place where many designers

mistakenly allow too much current to flow. Unless you're dealing with very high-powered circuits, a few milliamps will suffice. And if we're using the circuit only to perform "inversion" (not to supply high current or voltage), even less will suffice. The same formula may be used to calculate Q1's base current; using Ohm's law we can calculate the value of R_{B1} . Even with an additional twenty-percent of base current, our driving IC does not have to supply very much current.

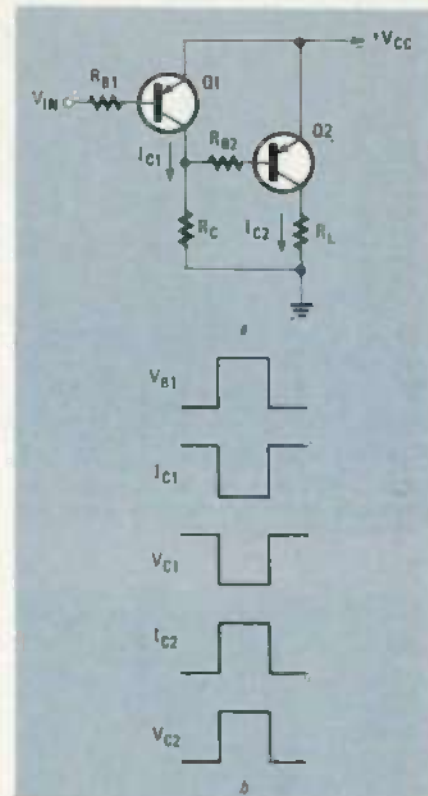

FIG. 4—THIS TWO-TRANSISTOR CIRCUIT can control heavy loads, but, like the circuit shown in Fig. 2, several precautions must be observed.

The circuit shown in Fig. 4-a is an extension of the one shown in Fig. 2, and it is subject to the same caution. In order for Q1 to be cut off completely, the driving voltage must closely approach the supply voltage. However, the lighter load on the driving device provided by the revised circuit may make that possible. As illustrated in Fig. 4-b, when V_{IN} goes high, Q1 is cut off, so no current flows through its collector. The base of Q2 now goes low, so Q2 turns on. Its collector voltage goes high, and collector current flows.

By combining an NPN with a PNP transistor, as shown in Fig. 5, we gain several advantages, including the sensitivity a two-transistor circuit can provide, and an output that follows the input—no inversion. The traces in Fig. 5-b illustrate circuit operation. When V_{IN} goes high, Q1 turns on. Its collector goes low as current flows through the device. That drops Q2's base to ground, so that

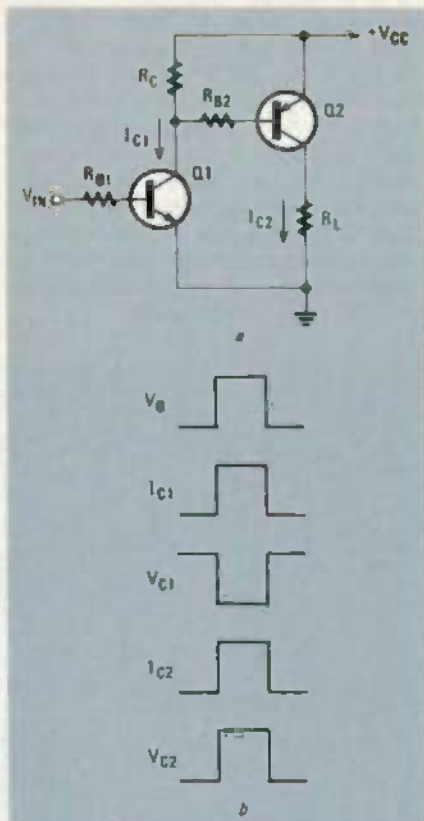

FIG. 5—POSSIBLY THE BEST all-round two-transistor switching circuit, this design does not invert the control signal.

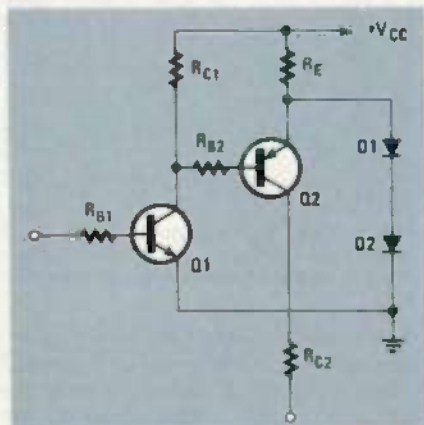

FIG. 6—NEGATIVE VOLTAGES may be switched by this circuit, which is driven from a positive supply.

transistor now turns on. Its collector goes high, and current flows through Q2 and the load.

The two-transistor circuits shown in Fig. 4 and Fig. 5 have an additional advantage. In both cases, the loads are not connected directly to the supply line, but through the collector of the output transistor. That could be useful if you wanted to control a single load with several different switches. Connect the collectors of all the Q2 transistors together, make sure that there can never be more than one switch on simultaneously, and you're ready to go. That configuration is com-

monly referred to as "wired-OR," since a logical OR function is achieved simply by wiring outputs together.

Switching negative voltages

A circuit that switches negative voltages, but that operates from a positive supply, is shown in Fig. 6. It is useful for tasks ranging from switching keying-transmitter lines to providing negative retrace voltages for oscilloscopes. The circuit functions as follows.

When Q1 is off, its collector is high, and so, therefore, is Q2's base, so Q2 is cut off. To turn on Q2, its base must go 0.7 volts more negative than its emitter. Diodes D1 and D2 clamp the emitter at about +1.4 volts, so the base must fall below at least 0.7 volts in order for Q2 to turn on. That provides some insurance against accidental turn-on due to leakage through Q1. In a real-life version of that circuit, RC2 would actually be part of the transmitter keying line. For heavier loads, an additional transistor could be used.

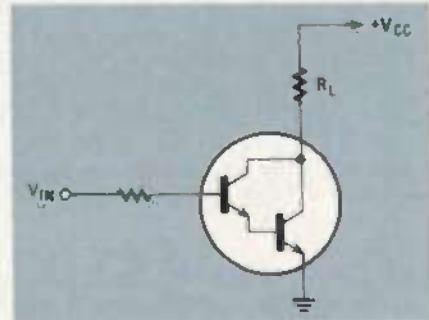

FIG. 7—A DARLINGTON TRANSISTOR may be used to obtain high gain in a single package.

Another way to switch moderate loads is with a Darlington device, such as that shown in Fig. 7. Connecting two transistors in that fashion provides a simple way of attaining very high gain, so that low-power drivers—like CMOS IC's—can drive relatively heavy loads. The 2N6576 and 2N6388 are typical NPN Darlington. To use a Darlington, just make sure that it can supply the required voltage and current, and then calculate the value of RB just as with the simple one-transistor switch of Fig. 1.

There are many variations on the circuits presented above that are used in special applications. But the heritage of most such circuits can be traced to one (or more) of those presented here. So, having mastered the basic theory, you should be able to understand just about any interface circuit you might encounter. And now that you've got the theory down, let's get out our breadboards and learn how to test and refine discrete transistor switching circuits.

Practical considerations

What we'll do now is give step-by-step instructions on how to test and optimize

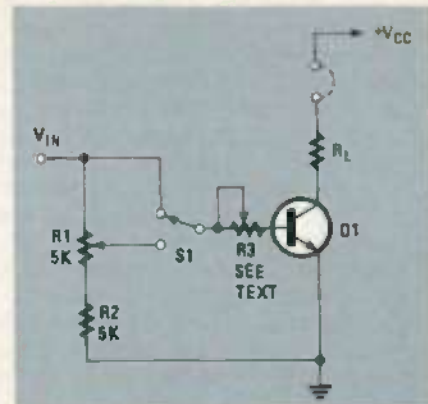

FIG. 8—SWITCHING CIRCUIT OPTIMIZATION is simple with this set-up. The value of the driving voltage is set with R1, and Q1's optimal base current is found by varying R3.

several of the circuits we've already discussed (those shown in Fig. 1 and Fig. 5). Once you understand the processes we describe, you should have no trouble adapting those circuits to the requirements of the devices you are driving.

A single-transistor switching-circuit test set-up is shown in Fig. 8. Switch S1 may actually be a jumper, and R3 is a potentiometer with a value of 25K or 50K ohms; it is used to adjust the current fed to Q1. The voltage divider composed of R1 and R2 gives you a convenient means of simulating the voltage that will actually drive the circuit. The two terminals in Q1's collector circuit (connected by a dashed line in our figure) indicate that you'll need to provide some way of inserting an ammeter. The component designated RL may be the actual device that will be switched, or a resistor that draws the same amount of current.

Our design goal is to find the highest value for RB that provides reliable switching. First calculate the base current that is required, according to the load current and the known (or assumed) gain of the transistor. If the driving source will be a lower voltage than the supply line, set the voltage that appears at the lower terminal of S1 with R1. Now follow these steps:

1. With all components hooked up, and with +VCC applied, gradually increase the value of R3 until the collector current (IC) begins to drop. Some switching transistors have narrow linear ranges and may appear to drop out completely with only a small change in R3.
2. Reduce R3 slightly, to ensure reliable switching, and test through several on-off operations. If the transistor appears to switch reliably, measure and record the value of R3.
3. If the driving voltage may vary, perform steps one and two twice: once with VB set for the upper, and once for the lower, limit of the anticipated driving voltage. When using the R1-R2 voltage divider, recheck the voltage as you approach the switching point, since it may vary a bit as IB changes.

4. Repeat steps one through three using two or three other transistors of the same type.

5. Use the lowest value of R3 measured in all of the tests. That will be the highest

reliable value for the circuit. Note the amount of current drawn from the supply for future reference.

6. Before completing your design, connect the actual load and verify that the circuit operates reliably, and that current drain is within the limits of the transistor you use.

Two-transistor optimization

Optimizing the two-transistor switching circuit shown in Fig. 9 is only a little more complicated. Again, the terminals joined by dashed lines will normally be connected (on your breadboard) by jumpers; the terminals are there to facilitate making current measurements. Now let's see how to determine optimum component values.

1. Calculate the base current needed to turn Q2 on, based on the actual (or calculated) value of load current through R_L.

2. Calculate Q2's required base resistor using the formula $R_2 + R_3 = V_{CC} / I_{B2}$. Note that R3 can be zero, but, in any event, make the value of R2 at least three

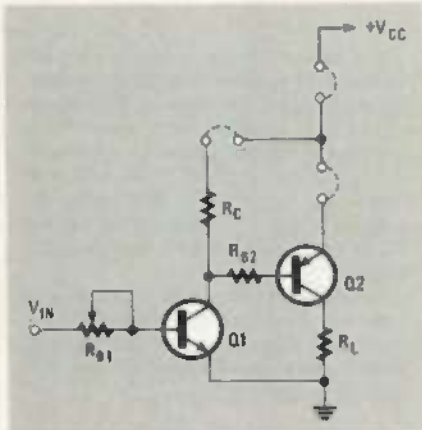

FIG. 9—OPTIMIZING A 2-TRANSISTOR switching circuit is simple with this circuit. The base current of Q1 is set by R_{b1}; the dashed jumpers indicate important points for current measurements.

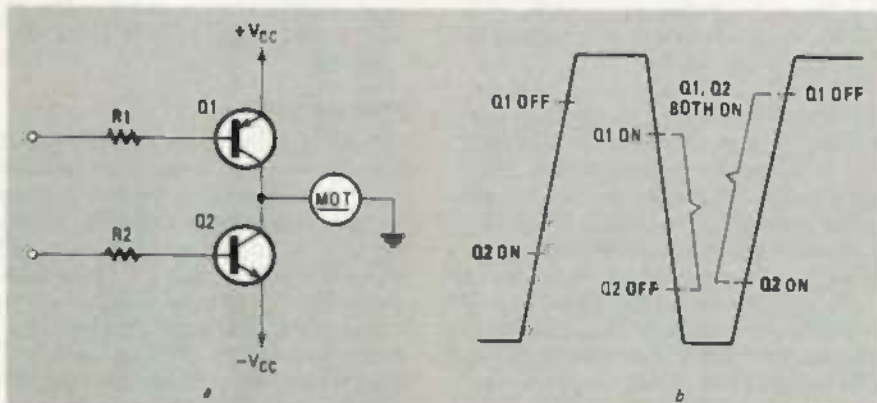

FIG. 10—SWITCHING-SEQUENCE PROBLEMS occur with this motor direction-reversing circuit. As shown at b, Q1 and Q2 could both be on at the same time, and that could result in destruction of both transistors.

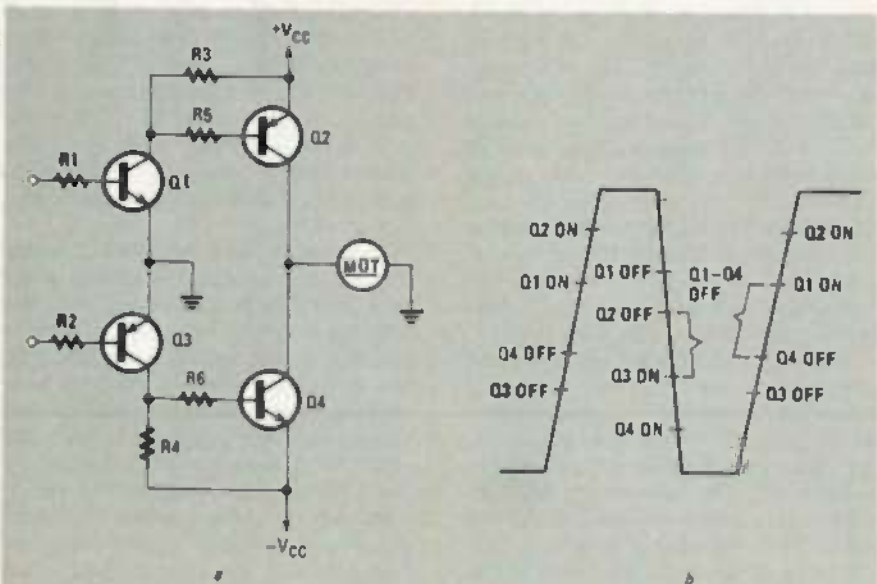

FIG. 11—SWITCHING-SEQUENCE PROBLEMS ARE SOLVED with this motor direction-reversing circuit. Here, Q2 and Q4 could never be on at the same time (barring circuit failure, that is).

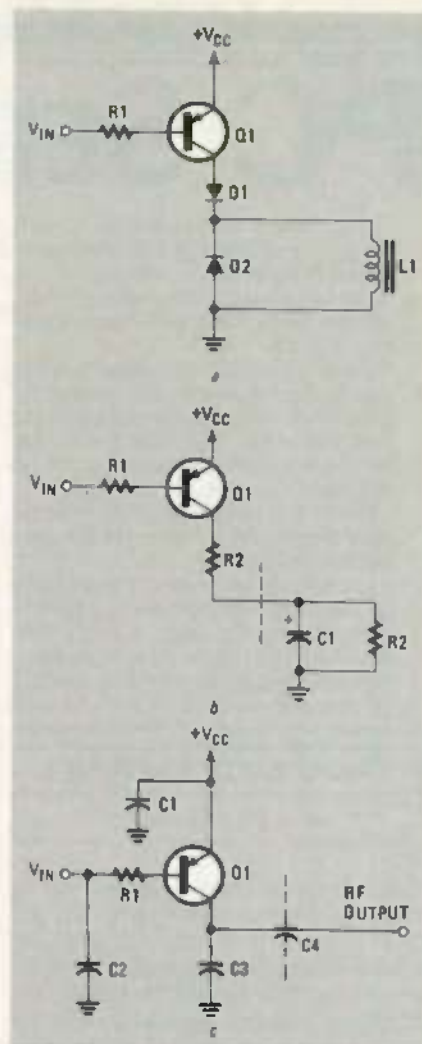

FIG. 12—A FEW SAFEGUARDS MUST BE OBSERVED when switching loads that are not purely resistive.

times that of R3 in order to minimize the current flowing through Q1.

3. Now you can calculate I_{C1} as V_{CC} / R_2 . I_{B1} is I_{C1} / h_{FE} (of Q1). Therefore, $R_1 = V_{IN} / I_{B1}$. If the value of R1 is very high (greater than 50K), lower the value of R2 to a value that permits a collector current through Q1 of at least one mA, and then recalculate all values.

4. Now wire up the circuit using fixed resistors for R2, R3, and R_L, but use a potentiometer for R1. Check the circuit for reliable operation, and if it seems to work well, measure currents I_{B2} (with Q2 on), I_{C1} , and I_{B1} . If any current is excessive, recalculate resistor values, beginning with R3. If either transistor refuses to switch, decrease the value of its base resistor by ten percent and try again. Repeat until switching occurs reliably.

5. Substitute transistors of the same type for Q1 and Q2, and test for reliable operation. Use the lowest value for R1 that permits reliable switching with all transistor combinations. That will be the highest value you can trust. Be sure to record all resistor and current values.

PC SERVICE

One of the most difficult tasks in building any construction project featured in **Radio-Electronics** is making the PC board using just the foil pattern provided with the article. Well, we're doing something about it.

We've moved all the foil patterns to this new section where they're printed by themselves, full sized, with nothing on the back side of the page. What that means for you is that the printed page can be used directly to produce PC boards!

Note: The patterns provided can be used directly only for direct positive photoresist methods.

In order to produce a board directly from the magazine page, remove the page and carefully inspect it under a strong light and/or on a light table. Look for breaks in the traces, bridges between traces, and in general, all the kinds of things you look for

in the final etched board. You can clean up the published artwork the same way you clean up your own artwork. Drafting tape and graphic aids can fix incomplete traces and doughnuts, and you can use a hobby knife to get rid of bridges and dirt.

An optional step, once you're satisfied that the artwork is clean, is to take a little bit of mineral oil and carefully wipe it across the back of the artwork. That helps make the paper translucent. Don't get any on the front side of the paper (the side with the pattern) because you'll contaminate the sensitized surface of the copper blank. After the oil has "dried" a bit—patting with a paper towel will help speed up the process—place the pattern front side down on the sensitized copper blank, and make the exposure. You'll probably have to use a longer exposure time than you are probably used to.

We can't tell you exactly how long an exposure time you will need but, as a starting point, figure that there's a 50 percent increase in exposure time over lithographic film. But you'll have to experiment to find the best method to use with your chemicals. And once you find it, stick with it. Don't forget the "three Cs" of making PC boards—care, cleanliness, and consistency.

Finally, we would like to hear how you make out using our method. Write and tell us of your successes, and failures, and what techniques work best for you. Address your letters to:

Radio-Electronics
Department PCB
200 Park Avenue South
New York, NY 10003

TRANSISTOR SWITCHES

continued from page 87

It takes only about thirty minutes to follow the procedures outlined above, and that's a small price to pay for an optimized circuit. You may be surprised at the values you obtain. For example, I calculated the following values the first time I set up the circuit in Fig. 9: $R1 = 1K$, $R2 = 10K$, $R3 = 1K$. In my final design I used these values: $R1 = 10K$, $R2 = 33K$, $R3 = 10K$. My load must have been much lighter than I originally thought. Only a suspicious nature and a trusty breadboard kept that switch from drawing more current than all the remaining elements of the circuit put together.

Switching sequence

Now that we've got all that under our belt, there is one more topic to consider: switching sequence of bipolar-output circuits, such as the motor direction-reversing circuit shown in Fig. 10-a. With that type of circuit we must ensure that both Q1 and Q2 are never turned on simultaneously. If they were, the $+V_{CC}$ and $-V_{CC}$ supplies would essentially be shorted together through the small "on" resistance provided by the transistors. The resulting current flow would in all likelihood destroy those transistors.

If the unconnected ends of R1 and R2 in Fig. 10-a were connected to the output of an op-amp, we might think that a positive output from the op-amp would turn on Q2, and drive the motor in one direction, and that a negative output would turn on Q1, and drive the motor in the opposite direction. In theory that's correct, but as

the sequencing diagram in Fig. 10-b shows, there is an overlapping time when both transistors are on.

To understand how that could happen, assume the voltage from the op-amp starts off at $-V_{CC}$. At that point, Q1 is on, and Q2 is off. But as the input voltage rises, Q2's base will eventually become 0.7 volt more positive than its emitter, so Q2 will turn on. Both transistors will remain on until the input voltage rises above $+V_{CC} - 0.7$ volt. At that point Q1 will turn off, and it will not turn back on until the input voltage again falls below $+V_{CC} - 0.7$ volt. Therefore, both transistors will remain on until the input again falls below the 0.7 volt threshold needed to keep Q2 on.

One way to solve that problem is to add an additional pair of transistors, as shown in Fig. 11-a. In that circuit, Q4 goes off long before Q2 goes on; Fig. 11-b shows the switching sequence. Assume the input voltage starts at ground. As it approaches -0.7 volts, Q3 turns off, then Q4 turns off as its base is pulled to $-V_{CC}$. As the input voltage continues to rise, Q1 turns on, and that drops Q2's base to ground, so Q2 turns on. Following through the sequence, we see that there is no time when both Q4 and Q2 are on, and there is a short period when all four transistors are off.

Sequence-overlap problems can arise in other ways. For example, in counter circuits, the counter IC can contribute to overlapping "on" times even though the individual switching circuits do not. For example, the data sheet for the 4022 divide-by-eight counter reveals that the rise and fall slopes of successive outputs overlap, and it is doubtful that the switching transistors' internal delays would sufficiently compensate for that overlap. In

such circuits it may be best to create an "off" period with some other device, like a one-shot.

Other precautions

Aside from the problems with bipolar output circuits we've just been discussing, there are several precautions to keep in mind regarding output loading of any transistor switching circuit. Lamps and other (more or less) purely resistive loads require little attention beyond that paid to voltage and current limits. Inductive and capacitive loads, on the other hand, demand special attention. For example, diodes D1 and D2 in Fig. 12-a serve to protect the transistor from inductive spikes generated by L1, which could be an inductor, a relay, a motor, etc.

There are several ways to the limit initial surge current that occurs when switching heavily capacitive loads. For example, we could use a current-limiting resistor, as shown in Fig. 12-b. Finally, for circuits that work in RF or other fields that radiate much potential EMI, filtering and bypassing, as shown in Fig. 12-e, are necessities.

In this article we have discussed several ways to make simple discrete transistor switching circuits operate both more reliably and more efficiently. Given the voltage and current requirements of a load, and given the voltage and current available from a digital IC (or other) driving circuit, we have seen how to calculate, and how to optimize, the values of the gain-determining components of simple transistor switching circuits. The small investment we make in calculating and breadboarding will be well rewarded by projects that work better, that last longer, and that waste less power. **R-E**

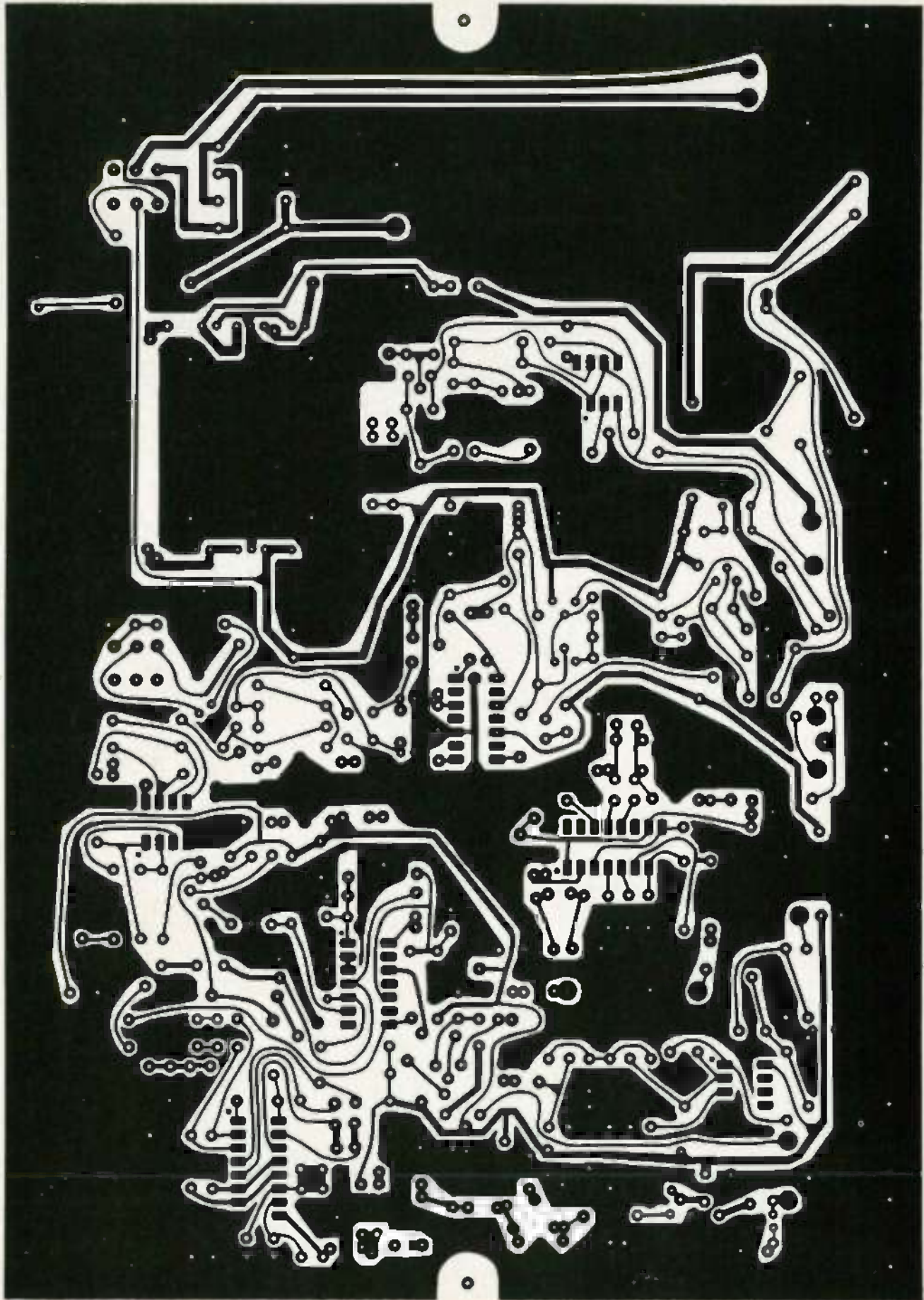

9 9/16 INCHES

FOIL PATTERN for the \$99 Satellite-TV receiver.

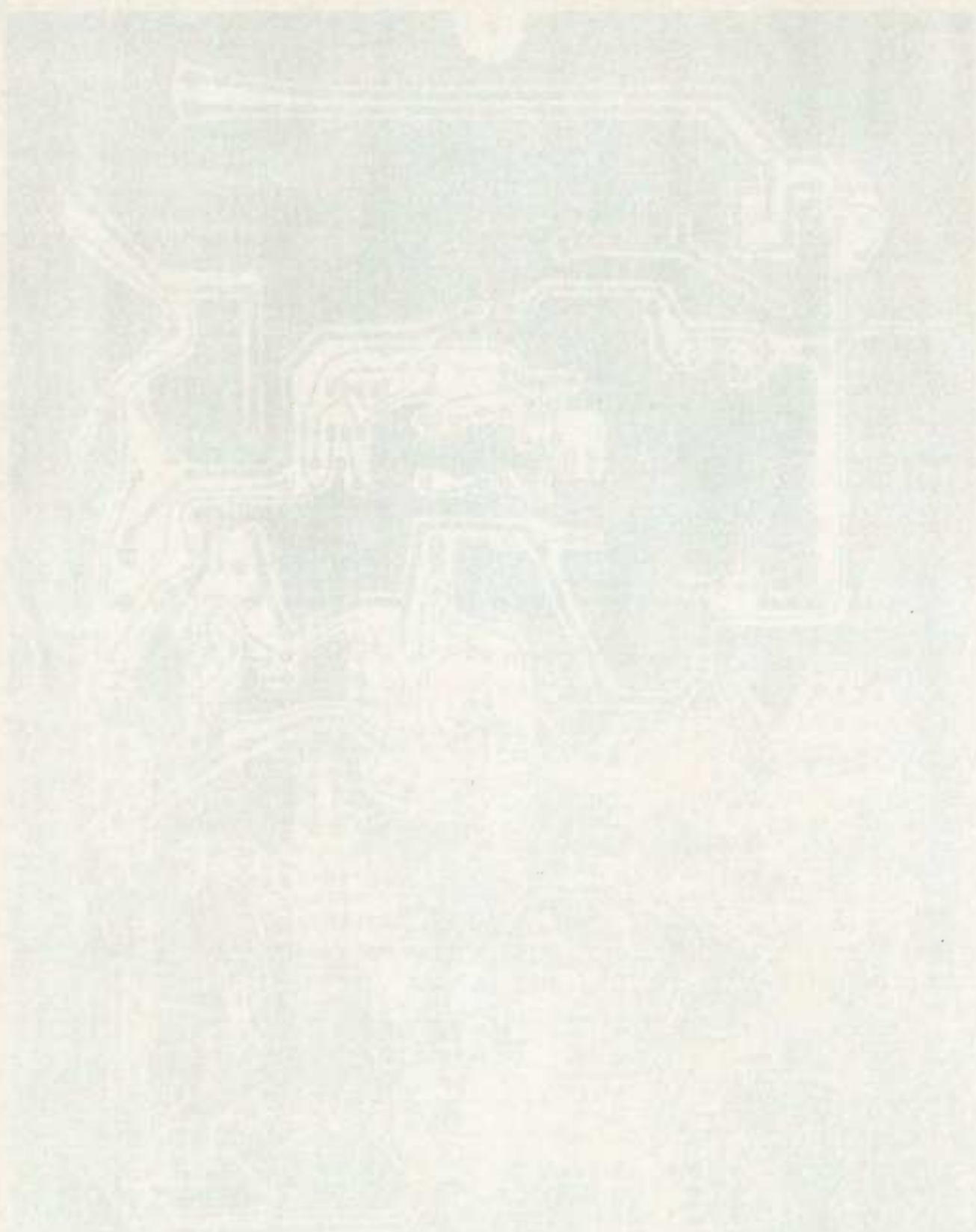

PC SERVICE

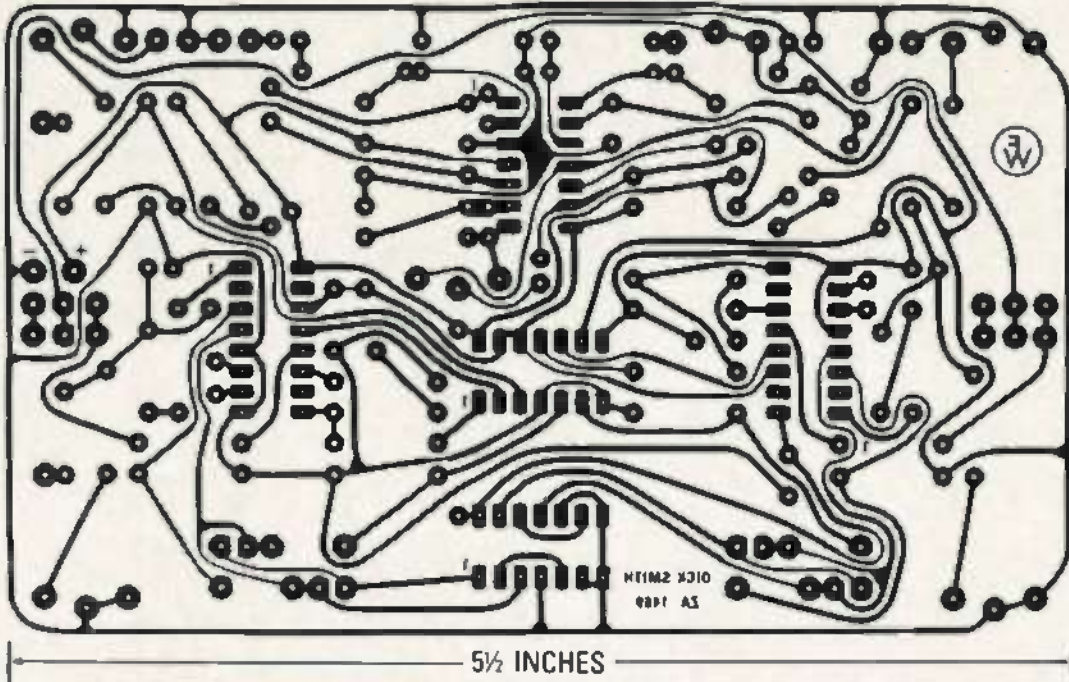

OUR MINI MUSIC SYNTHESIZER can turn anyone into a "one-man-band." The project is fun, and easy-to-build if you use the foil pattern shown here. The story begins on page 75.

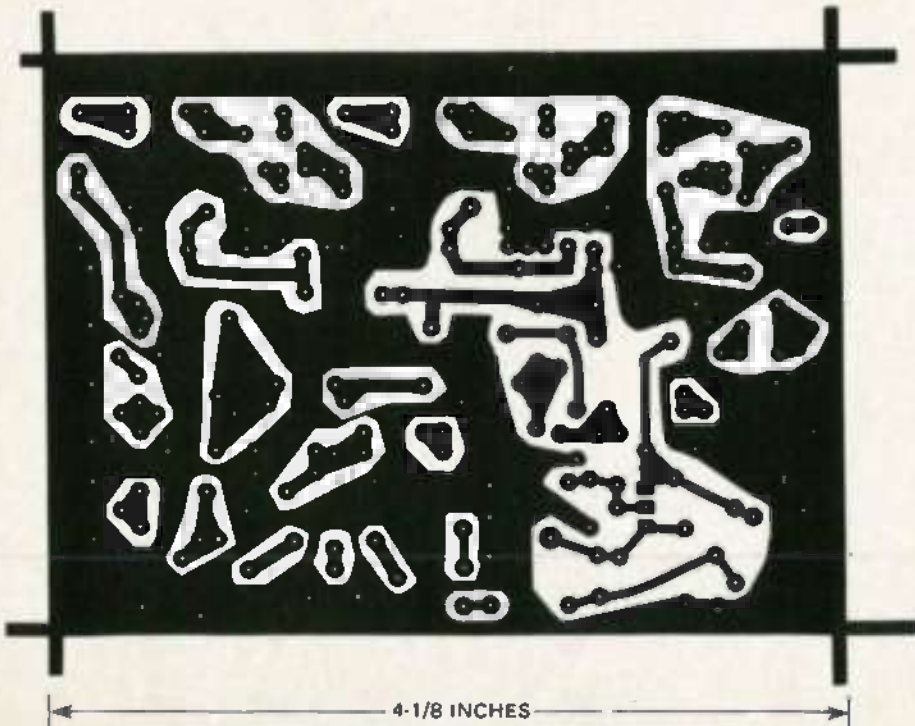

THE PC BOARD for the wireless video link is shown here.

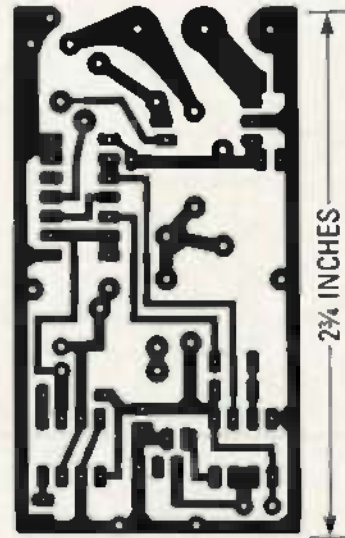

KEEP AN EYE on the humidity with our humidity monitor. The PC board for that project is shown here.

PC SERVICE



Which Way To YOUR Future?

Are you at a crossroads in your career? Have you really thought about it? Are you *planning* for your future, or perhaps refusing to face the subject? Which way will you go — down the same old road? Or are you ready for something else?

In electronics you can't stand still. If you are not moving ahead, then you're falling behind. At the crossroads of your career, various choices are available — and, yes, *decisions* have to be made.

Which road will you take — one that doesn't go where you want to be, or one that leads to hard work *but also* to the better life? Ah, decisions, decisions!

Career decisions are so important that you need all the *input* you can get before locking-in on one of them. Grantham College of Engineering offers you *one* source of input which may help you in making that decision. It's our free catalog.

Ask for our free catalog and you may be surprised to learn how it is easily possible to earn a B.S. degree in electronics without attending traditional classes. Since you are already in electronics (you are, aren't you?), you can complete your B.S. degree work with Grantham while studying at home or at any convenient place.

But don't expect to earn that degree without hard work. Any degree that's worth your effort can't be had without giving effort to the task. And of course it is what you learn in the process, as much as the degree itself, that makes you stand out above the crowd — that places you in an enviable position, prestige-wise and financially.

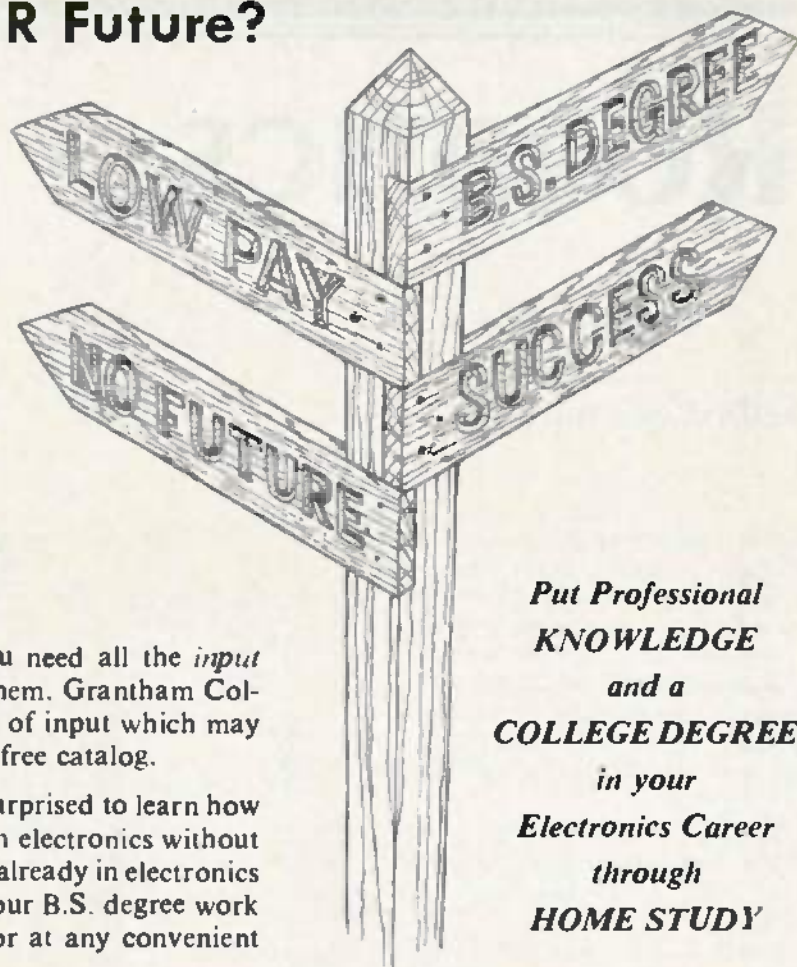

**Put Professional
KNOWLEDGE
and a
COLLEGE DEGREE
in your
Electronics Career
through
HOME STUDY**

Grantham College of Engineering
10570 Humbolt Street
Los Alamitos, California, 90720

Grantham offers this program, complete but without laboratory, to electronics technicians whose objectives are to upgrade their level of technical employment.

Recognition and Quality Assurance

Grantham College of Engineering is accredited by the Accrediting Commission of the National Home Study Council, as a degree-granting institution.

All lessons and other study materials, as well as communications between the college and students, are in the English language. However, we have students in many foreign countries; about 80% of our students live in the United States of America.

**This booklet
FREE!**

This free booklet explains the Grantham B.S. Degree Program, offered by independent study to those who work in electronics.



for
**FREE
Booklet
CLIP
COUPON**
and mail in
envelope or
paste on
postal
card.

Grantham College of Engineering R-02-86
10570 Humbolt Street, Los Alamitos, CA 90720

Please mail me your free catalog which explains your B.S. Degree independent-study program.

Name _____ Age _____

Address _____

City _____ State _____ Zip _____

ROBOTICS



MARK J. ROBILLARD
ROBOTICS EDITOR

Robot brains

WE'VE TALKED ABOUT QUITE A FEW things the past few months, including putting together a robotics lab, robot motion and navigation, and last month we discussed, albeit briefly, the subject of voice recognition. It's time now to start putting those elements together—we need to give our robot some brains.

Perhaps you're asking, "Do I really need a computer to control my robot?" You could build a circuit out of discrete logic components that would allow your robot to perform the task you had in mind. But, as Hamlet said, that's the rub. To change that task, you would have to re-design and re-solder. However, if you implemented the control logic in software, you could change your design simply by keying in new instructions. Given the advantages of a software approach, there are still quite a few hardware questions to be answered. So what would be the composition of a suitable robot-control computer?

Microprocessors

The heart of any home computer is its microprocessor, and there are a number of different microprocessors to choose from. We must pick ours carefully, according to several criteria. The first is power. All devices used in robot-control circuits should be low power, assuming that the robot is to carry its power source (batteries) with it.

There are two chief methods of fabricating microprocessors: NMOS and CMOS. NMOS is the elder of the two, and NMOS al-

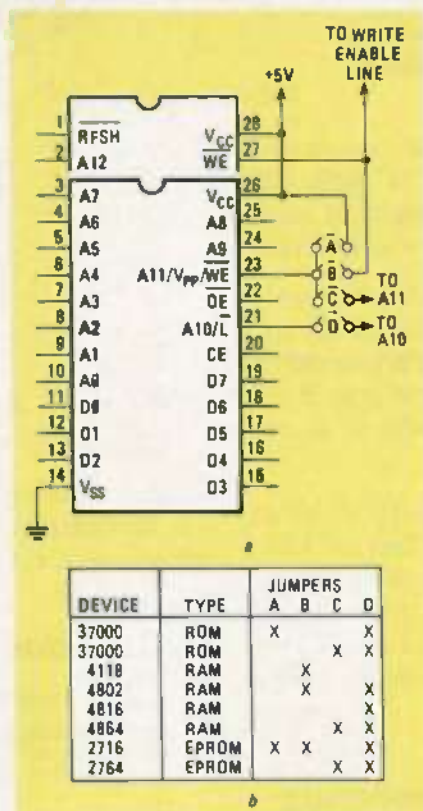

FIG. 1

most invariably draws more power than the newer CMOS types. For example, an NMOS Z80 can draw as much as 150 mA of current at five volts. Most microprocessors (8080, Z80, 6800, 6502) were originally built using NMOS technology, although CMOS versions for many of them were introduced later.

Bearing in mind the fact that the microprocessor must be supported by a bevy of other power-hungry components, before you know it, your computer's brain could easily require 1.5 amps of power. A small motorcycle battery would be necessary to keep a sys-

tem with that sort of current drain operational for an hour! And that doesn't include power for the stepper motors!

It's easy to see why the industry almost universally uses CMOS microprocessors for portable computers. Not all microprocessors are available in CMOS yet, but the Z80, 6809, 8085A, 6502 and 8086/8 types are, and Motorola's 68000 will be soon.

The microprocessors mentioned above lead us to our next design criteria: eight or sixteen bits? (And 32 bits will soon be added to the "equation.") There is no clear-cut choice here. I have seen several robots designed with 16-bit microprocessors that should have been designed with 8-bit devices. Some people automatically assume that a robot requires the larger units, but that is not always the case.

Another consideration is whether the application demands a full-blown multi-IC design. In many cases a single-chip microprocessor will do the job. Single-chip micros typically have 128 bytes of temporary memory and 16 input/output lines. I find single-chip micros most useful as dedicated sensor controllers. For example, you could use one to control your robot's motors and sensors, while the main processor carried out the heavy-duty control logic. Now let's look at the memory question in a bit more detail.

Memory

Once again your application will determine how much RAM (Random Access Memory), ROM (Read

Only Memory) and EPROM (Erasable Programmable Read Only Memory) you'll need to provide. RAM is used for storage of temporary data, and data picked up by sensors; ROM and EPROM are used to store the control program and tables of data.

If you're new to this field, and if you're planning to build a research robot that will not be obsolete before you get done building it, then I suggest designing a "universal" memory system. That type of system is possible because there are, nowadays, RAM's, ROM's, and EPROM's that have almost identical pin-outs.

The circuit depicted in Fig. 1-a shows how a single 28-pin socket can be used to house several different types of memory IC's, and several different devices of each type. The table in Fig. 1-b shows how points A, B, C, and D in the circuit should be jumpered for each type of memory device. If you're interested in learning more about that subject, drop me a line. I'll send you a reprint of an applications note that discusses the subject in depth.

Ins and outs

Robot I/O (Input/Output) is, by far, the most involved decision. Depending on the sensors and motors in your system, I/O circuits can become quite complex. It will simplify matters if you use standard I/O schemes (like RS-232C) for communicating with peripherals or dedicated sensor controllers, like those mentioned above. There are many products on the market that communicate via RS-232C lines, and it's easy to interface your own devices via RS-232C.

Buy or build?

Whether you should buy a pre-assembled control computer or build your own also depends on the application. But if you think there's a chance that a pre-assembled unit will do the job, you'll save yourself a lot of hair-pulling by buying, rather than building.

Based on what I've said above, the specifications of an ideal robot-control computer might include a CMOS microprocessor, plenty of memory, standard I/O

channels, and battery operation. Suppose I told you that you could buy an off-the-shelf device with a CMOS 8085A, 8K of battery-backed-up RAM (which is expandable to 32K), a real-time clock/calendar, an RS-232C port, a Centronics parallel port, a bar-code reader input, a full 60-key alphanumeric keyboard, and a forty-character by eight-line LCD display, all packaged in a case that measures about 8 x 11 inches?

That machine also has, built-in, a special version of Microsoft BASIC that supports all the I/O devices—and interrupts! You can burn your BASIC program into an EPROM and plug it into the ROM expansion socket that is provided. If you have an exotic I/O in mind, the entire system bus is also available.

The complete computer costs less than \$350.00. If you haven't guessed what it is by now, you'll have to wait till next month. I'll have several interesting surprises then for those who choose to use that "mystery" computer for robot development. R-E

Learn micro-processing with the new MICRO-PROFESSOR 1P



Students, engineers or technicians—upgrade your micro-processing skills with the new Micro-Professor 1P.

The MPF-1P features:

- extensive software support
- more built-in memory
- improved keyboard
- larger display

Three tutorial guides help cover all capabilities. The ideal training tool! MPF-1P will deliver you into the growing world of micro-processing. Invest now!

Plus—FREE GIFT Only **\$199.95**

Check this box for FREE Z-80 Microprocessor Programming and Interfacing textbook when you order within 7 days. \$12.95 value. (Include \$5.00 postage & handling)

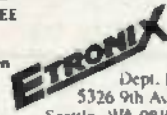

Dept. RE0286
5326 9th Ave. N.E.
Seattle, WA 98105-3617

For immediate action call TOLL FREE:
1-800-426-1044

Full money back guarantee.



CIRCLE 111 ON FREE INFORMATION CARD

It's about JOBS It's about MONEY

The U.S. Labor Department, in their 1984 Occupational Projections and Training Data report, predicts that 589,000 positions will need to be filled by 1995.

Isn't it about TIME

To prepare for an interesting and rewarding career in

COMPUTER TECHNOLOGY
TELECOMMUNICATIONS
OR ROBOTICS?

Isn't it about time to invest in YOU?

We Offer:

- Training that keeps pace with each new advancement
- Facilities that are modern, attractive and comfortable
- Amenities and services to promote your success
- Financial assistance is available
- And once you graduate, placement assistance is also available

Phoenix Institute of Technology

2555 E. University Drive
Phoenix, Arizona 85034
(602) 244-8111

For more information about careers in Electronics Technology, address inquiries to Admissions Department

Name

Address

City

State Zip

Phone ()

CIRCLE 254 ON FREE INFORMATION CARD

COMMUNICATIONS CORNER



HERB FRIEDMAN
COMMUNICATIONS EDITOR

The return of diversity reception

SOMEONE ONCE SAID THAT "HISTORY always repeats itself;" well, the same thing seems to be true of electronics. That is, some idea from a bygone era is brought back and touted as the cutting edge of technology. The latest idea to be reborn is *diversity reception*.

Diversity reception is a means whereby we're able to compensate for the *apparent* loss of signal strength caused by changes in the polarization of an electromagnetic (RF or radio) wave, rather than by loss of the signal itself. Often, because of changes in a signal's polarization, we can't receive the signal even though we're using a decent receiver.

Using such techniques, a wireless microphone, for example, can be received equally well whether its antenna is horizontally or vertically positioned. No longer need reception suffer if a rock star were to literally crawl along the floor at the fringe of a receiver's reception range. While to many the concept is new, diversity reception in non-laboratory equipment goes back a ways.

While diversity reception has been around from at least the late 1920's (AT&T began using it then for their transoceanic circuits), I first came across it in some WWII surplus Navy receivers. But that was during the vacuum tube era, and the hardware necessary for diversity reception was larger than your average office desk. In fact, that diversity receiver could be used as a boat anchor for a small freighter. Today, the whole circuit isn't much larger than your thumb.

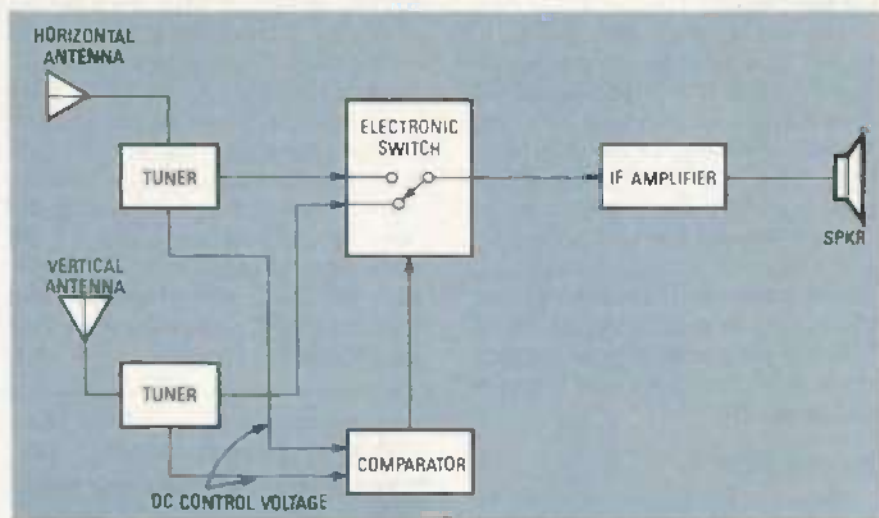

FIG. 1

The importance of polarization

The polarization of an electromagnetic wave starts off in the same plane as the antenna, and maximum energy is obtained when the receiving antenna is in the same plane as the received wave. Unfortunately, many things can affect the polarization of a signal after it leaves the transmitting antenna. And the higher the frequency, the greater the effect on polarization and reception.

Most of us are familiar with signal polarization through experience with antennas for the reception of FM broadcasts. If the FM station's transmitting antenna is one of the older horizontal designs (not circular) and the receiving antenna is rotated from horizontal to vertical, you can actually see the reading on a signal-strength meter decrease as the antenna is adjusted. At 90-degree rotation, you'd lose the signal, or it would be so weakened as to be

useless. In other words, the signal polarity would be wrong for the receiving antenna.

Normally, the forces that affect the polarization of RF after it leaves the antenna are most severe in the HF range between 6 and 30 MHz. Skips and bending can change the polarization of a signal; thus, what started out as horizontal polarization in Europe can arrive here almost vertical.

Depending on the frequency, the time of day, condition of the electrical bands circling the earth, etc., polarization changes can occur over a period of only a few seconds. The signal that you think is fading in and out may really be rock steady in strength, but rotating somewhere between horizontal and vertical polarization.

How it works

A simplified block diagram of how diversity reception works is
continued on page 102

KENWOOD

...pacesetter in Amateur radio

Scan the World



R-2000

All-mode receiver.

- Covers 150 kHz—30 MHz in 30 bands.
- All mode: USB, LSB, CW, AM, FM.
- Digital VFO's, 50-Hz, 500-Hz or 5-kHz steps. F. LOCK switch.
- Ten memories store frequency, band, and mode data. Each memory may be tuned as a VFO.
- Lithium batt. memory back-up.
- Memory scan.
- Programmable band scan.
- Fluorescent tube digital display of frequency (100 Hz resolution) or time.
- Dual 24-hour quartz clocks, with timer.
- Three built-in IF filters with NARROW/WIDE selector switch. (CW filter optional.)
- Squeich circuit, all mode, built-in.
- Noise blanker built-in.
- Large front mounted speaker.
- RF step attenuator. (0-10-20-30 dB.)
- AGC switch. (Slow-Fast.)
- "S" meter, with SINPO scale.
- High and low impedance antenna terminals.
- 100/120/220/240 VAC operation.
- RECORD output jack.
- Timer REMOTE output (not for AC power).
- Muting terminals.



R-1000 High performance receiver • 200 kHz-30 MHz in 30 bands • AM, CW, SSB • 3 IF filters • noise blanker • RF attenuator • S-meter • 120-240 VAC • muting terminals • built-in speaker • digital display/clock/timer

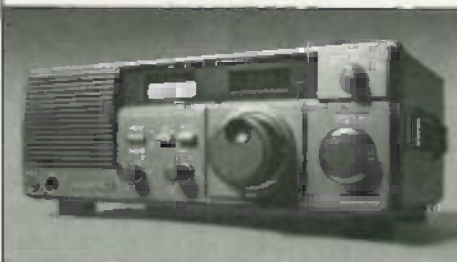

R-600 General Coverage receiver • 150 kHz-30 MHz in 30 bands • AM, CW, SSB • IF filters • noise blanker • RF attenuator • S-meter with SINPO scale • front mounted speaker • 3 antenna inputs • 100-240 VAC operation • record jack • muting terminals • digital display

Optional accessories:

- VC-10 VHF converter for R-2000 covers 118-174 MHz
- YG-455C 500 Hz CW filter for R-2000
- HS-4 Headphones
- HS-5 Deluxe headphones
- HS-6 Lightweight headphones
- HS-7 Micro headphones
- DCK-1 DC cable kit for 13.8 VDC operation
- AL-2 Lightning and static arrester
- Service manuals are available for all receivers and most accessories.

Additional information on Kenwood all-band receivers is available from authorized dealers.

KENWOOD

TRIO-KENWOOD COMMUNICATIONS
1111 West Walnut Street
Compton, California 90220

Specifications and Prices subject to change without notice or obligation.

CIRCLE 102 ON FREE INFORMATION CARD

From McGraw-Hill . . . the professionals' publisher

Join the **Electronics and Control Engineers' Book Club**®



SWITCHED CAPACITOR CIRCUITS
By P. E. Ailen and Edgar Sanchez-Sinencio. 759 pp., 558 illus. and tables. Covering the latest developments in design, analysis, and implementation, this is the first guide to switched capacitor (SC) circuits—an economical way of combining analog sampled data techniques with MOS technology.
583239-8 Pub. Pr., \$56.50 Club Pr., \$39.45

TROUBLESHOOTING ELECTRONIC EQUIPMENT WITHOUT SERVICE DATA By R. G. Middleton. 303 pp., 162 illus. and tables. Packed with charts, diagrams, and case histories, this practical handbook shows you how to pinpoint defective electronic circuitry when no service data is available.
581134-1 Pub. Pr., \$24.95 Club Pr., \$18.50

STANDARD HANDBOOK OF ENGINEERING CALCULATIONS T. G. Hicks, Editor in Chief. 2nd Ed., 1,468 pp., 1,292 illus. and tables. Now revised, updated, and considerably expanded, this huge handbook provides more than 5,100 step-by-step procedures for solving the kinds of engineering problems you encounter most frequently in your work.
78735X Pub. Pr., \$59.50 Club Pr., \$44.50

POWER CONTROL WITH SOLID-STATE DEVICES By Irving M. Gottlieb. 372 pages, 218 illustrations. This comprehensive book discusses every type of solid-state device and circuitry now available for power electronics. It covers both the proven-in-practice power control systems and the avant garde—as well as some promising combinations of the older and newer devices and circuitries.
583240-2 Pub. Pr., \$28.95 Club Pr., \$21.95

CONTROL SYSTEM ENGINEERING By Mohamed E. El-Hawary. 583 pages, 373 illustrations. This up-to-the-minute guide gives you the latest techniques for the design, analysis, and compensation of today's increasingly complex and sophisticated control systems. All the systems covered are closed-loop time-invariant feedback control systems.
583224-0 Pub. Pr., \$32.95 Club Pr., \$24.75

DIGITAL LOGIC DESIGN. By B. Holdsworth. 338 pp., 192 illus. All of the recent advances in digital design techniques are presented here in depth. It's both a text covering basic concepts and a practical guide to design techniques for combinational, clock-driven, and event-driven circuits.
582852-9 Pub. Pr., \$39.95 Club Pr., \$27.50

INTRODUCTION TO RADAR SYSTEMS. By M. I. Skolnik. 2nd Ed., 698 pp., 244 illus. Covering every radar fundamental and all important changes, this EE text exposes you fully to the systems themselves—and to their applications! Topics include radar equation, CW and frequency-modulated radar, MTI, pulse-doppler, tracking radar, receivers, displays, duplexers, noise, and more.
579091 Pub. Pr., \$47.95 Club Pr., \$35.75

Get the competitive edge with the *newest* and the *best* information in your field . . . with books from all the leading publishers

New members!
Any one of these great professional books for only **\$2.89** as a premium with your 1st selection!

Spectacular values up to **\$105.00**

THE ENCYCLOPEDIA OF ELECTRONIC CIRCUITS. By R. Graf. 760 pp., 1,256 illus. This large volume provides circuits for virtually every type of application in 98 different categories. Each has a clear and concise explanatory text accompanying it.
583265-8 Pub. Pr., \$50.00 Club Pr., \$39.95

GATE ARRAYS: Design Techniques and Applications. Edited by J. W. Read. 349 pp., 146 illus. Written by a team of specialists, this book describes the fundamental principles, design techniques, and uses of gate arrays.
512/868 Pub. Pr., \$35.00 Club Pr., \$24.75

ANTENNA ENGINEERING HANDBOOK, 2/e. Edited by R. C. Johnson and H. Jasik, with contributions by 57 recognized authorities. 1,408 pp., 946 illus. This widely acclaimed Handbook gives you the guidance you need to solve problems in antenna design and application.
322/910 Pub. Pr., \$105.00 Club Pr., \$62.50

PRACTICAL DIGITAL DESIGN USING LOGIC IC'S, 2/e. By J. D. Greenfield. 717 pp., 118 illus. This revised and expanded Second Edition of a popular guide shows how to get the most out of a wide range of popular integrated circuits. What's more, it contains the specialized know-how today's designer needs to interleave ICs with microprocessors.
582853-7 Pub. Pr., \$31.95 Club Pr., \$22.95

MCGRAW-HILL CONCISE ENCYCLOPEDIA OF SCIENCE AND TECHNOLOGY. Editor-in-Chief S. P. Parker and the Staff of the McGraw-Hill Encyclopedia of Science and Technology. 2,065 pp., 1,600 illus. This volume serves every need for understanding today's science and technology. Written by over 3,000 of the world's topmost experts, including 19 Nobel Prize winners, it covers 75 disciplines from Acoustics to Zoology.
454/825 Pub. Pr., \$95.00 Club Pr., \$66.50

HANDBOOK OF PRACTICAL ELECTRICAL DESIGN. By J. F. McPartland. 416 pp., 300 illus. This volume provides a step-by-step explanation of designing electrical systems for industrial, commercial, and residential applications.
456/95X Pub. Pr., \$40.95 Club Pr., \$27.50

INTRODUCTION TO MICROWAVE ELECTRONICS. By T.C. Edwards. 76 pp., illus., softbound. Eliminating unnecessary theory and mathematics, this book provides you with a lucid overview of microwave engineering and the devices and circuits being used today.
583038-2 Pub. Pr., \$14.95 Club Pr., \$10.95

ELECTRONICS ENGINEERS' HANDBOOK, 2/e. Edited by D. G. Fink & D. Christiansen. 2,272 pp., 2,189 illus. This updated and enlarged edition covers all the latest knowledge in the field, including new advances in integrated circuits, mixed and logic circuits, laser technology, telecommunications, and much more.
209/012 Pub. Pr., \$83.50 Club Pr., \$63.95

THE MCGRAW-HILL COMPUTER HANDBOOK: Applications, Concepts, Hardware, Software. Edited by H. Helms. 992 pp., 475 illus. Everything you need to know about today's computer science and engineering is here in this massive treasure trove of information.
278/721 Pub. Pr., \$84.50 Club Pr., \$52.95

TRANSDUCERS: Theory and Applications. By J.A. Aliocca and A. Stuart. 497 pp., 328 illus. Thoroughly describes and illustrates the theory and operation of all important transducers used in industrial, communication, medical, and other applications.
582997-5 Pub. Pr., \$29.95 Club Pr., \$24.95

ELECTRONIC COMMUNICATIONS SYSTEMS. By W. D. Stanley. 566 pp., illus. Emphasizing the signal-processing functions of modulation and demodulation operation, this book presents the essentials of electronic communications in a logical, step-by-step sequence.
582834-D Pub. Pr., \$32.95 Club Pr., \$22.50

MICROWAVE SEMICONDUCTOR CIRCUIT DESIGN. By W.A. Davis. 416 pp., heavily illus. Provides in-depth coverage on microwave circuit analysis, passive microwave components, impedance transformers and circuits, broadband directional couplers, mechanical realization of selected transmission lines, CAD, CAM and CAT, characteristics of amplifiers and oscillators, noise, statistical thermodynamics and PN junction theory.
583044-2 Pub. Pr., \$47.50 Club Pr., \$35.50

INTRODUCTION TO RADIO FREQUENCY DESIGN. By W. H. Hayward. 383 pp., illus. This comprehensive volume prepares you to actually design HF, VHF, and UHF equipment and enables you to follow much of the current literature. Structured equation sets make it easy to write programs for small computers or calculators.
582748-4 Pub. Pr., \$32.95 Club Pr., \$27.25

McGraw-Hill Encyclopedia of Electronics and Computers. By S. R. Parker, Editor-in-Chief. 960 pp., 1,266 illus., outsized 8 1/2 x 11 format. It's a single-volume library that covers the entire world of electronics from Edison's pioneering work in electricity right up to optical fiber communications, control systems, lasers, radar, TV receivers, artificial intelligence, and computer storage technology.
454/876 Pub. Pr., \$67.50 Club Pr., \$41.50

ELECTRONICS ENGINEERING FOR PROFESSIONAL ENGINEERS' EXAMINATIONS. By C. R. Hafer. 336 pp., more than 200 illus. Actually two books in one—a quick preparation manual to help you pass your P.E. exams on the first try and a rich source of practical electronics engineering information and know-how.
234/303 Pub. Pr., \$32.50 Club Pr., \$25.50

COMPUTER METHODS FOR CIRCUIT ANALYSIS AND DESIGN. By J. Vlach and K. Singhal. 656 pp., 148 illus. Computational methods have become an integral part of circuit analysis and design. And a solid understanding of the basics of computer-aided design is a must for engineers who want to achieve their career objectives.
582855-3 Pub. Pr., \$42.50 Club Pr., \$33.95

MODERN ELECTRONIC CIRCUITS REFERENCE MANUAL. By J. Markus. 1,264 pp., 3,666 circuit diagrams. Complete with values of components and suggestions for revisions—plus the original source of each circuit in case you want additional performance or construction details.
404/461 Pub. Pr., \$79.50 Club Pr., \$57.95

STANDARD HANDBOOK FOR ELECTRICAL ENGINEERS, 11/e. By D. G. Fink and H. Beaty. 2,448 pp., 1,414 illus. Today's most widely used source of electrical engineering information and data serves you as no other single work when you need detailed, timely, and reliable facts.
209/74A Pub. Pr., \$79.95 Club Pr., \$62.95

Be sure to consider these important titles as well!

DESIGN OF FEEDBACK CONTROL SYSTEMS. By G. H. Hostetter, C. J. Savant, and R. Y. Stefan.
583206-2 Pub. Pr., \$41.95 Club Pr., \$31.45

VLSI SYSTEM DESIGN. By S. Muroga
582823-9 Pub. Pr., \$34.15 Club Pr., \$26.50

MICROPROCESSOR SUPPORT CMPS: Theory, Design, and Applications. By T. J. Byers.
885/183 Pub. Pr., \$43.50 Club Pr., \$35.75

DATA COMPRESSION: Techniques and Applications. By T. J. Lynch
583267-4 Pub. Pr., \$44.50 Club Pr., \$31.25

PRINCIPLES OF ACOUSTIC DEVICES. By V. Ristic.
583248-8 Pub. Pr., \$46.15 Club Pr., \$31.50

ANALYSIS AND DESIGN OF DIGITAL INTEGRATED CIRCUITS. By D. A. Hodges and M. G. Jackson.
291/523 Pub. Pr., \$48.00 Club Pr., \$32.50

HANDBOOK OF OPERATIONAL AMPLIFIER CIRCUIT DESIGN. By D. E. Stout & M. Kaufman.
617/87X Pub. Pr., \$48.50 Club Pr., \$34.95

ENGINEERING MATHEMATICS HANDBOOK, 2/e. By J. J. Tuma.
654/288 Pub. Pr., \$41.50 Club Pr., \$31.00

DIGITAL COMMUNICATIONS. By J. Proakis
589/271 Pub. Pr., \$42.15 Club Pr., \$31.50

CRYSTAL OSCILLATOR CIRCUITS. By R. J. Matthys
583251-1 Pub. Pr., \$37.95 Club Pr., \$26.15

MAINTAINING AND REPAIRING VIDEO CASSETTE RECORDERS. By R. L. Goodman.
582895-2 Pub. Pr., \$15.95 Club Pr., \$12.50



MAIL THIS COUPON TODAY

McGraw-Hill Book Clubs
Electronics and Control Engineers'
Book Club®
P.O. Box 582, Hightstown, New Jersey, 08520-9959

Please enroll me as a member and send me the two books indicated, billing me for the \$2.89 premium and my first selection at the discounted member's price, plus local tax, shipping, and handling charges. I agree to purchase a minimum of two additional books during my first year of membership as outlined under the Club plan described in this ad. A shipping and handling charge is added to all shipments.

Write Code No. of
\$2.89 selection here

Write Code No. of
first selection here

Signature _____

Name _____

Address/Apt. # _____

City _____

State _____ Zip _____

This order subject to acceptance by McGraw-Hill. All prices subject to change without notice. Offer good only to new members.

E33780

Why YOU should join now!

- **BEST AND NEWEST BOOKS IN YOUR FIELD** — Books are selected from a wide range of publishers by expert editors and consultants to give you continuing access to the best and latest books in your field.
- **BIG SAVINGS** — Build your library and save money too! Savings ranging up to 30% or more off publishers' list prices — usually 20% to 25%.

BONUS BOOKS — You will immediately begin to participate in our Bonus Book Plan that allows you savings up to 70% off the publishers' prices of many professional and general interest books!

- **CONVENIENCE** — 12-14 times a year (about once every 3-4 weeks) you receive the Club Bulletin FREE. It fully describes the Main Selection and Alternate Selections. A dated Reply Card is included. If you want the Main Selection, you simply do nothing — it will be shipped automatically. If you want an Alternate Selection — or no book at all — you simply indicate it on the Reply Card and return it by the date specified. You will have at least 10 days to decide. If, because of late delivery of the Bulletin you receive a Main Selection you do not want, you may return it for credit at the Club's expense.

As a Club member you agree only to the purchase of three books (including your first selection) during your first year of membership. Membership may be discontinued by either you or the Club at any time after you have purchased the first selection plus two additional books.

Other McGraw-Hill Book Clubs:
Architects' Book Club • Byte Book Club • Chemical Engineers' Book Club
• Civil Engineers' Book Club • Mechanical Engineers' Book Club

For more information, write to:
McGraw-Hill Book Clubs, P.O. Box 582, Hightstown, New Jersey 08520-9959

COMMUNICATIONS CORNER

continued from page 96

shown in Fig. 1. The idea behind the scheme shown there is to track the polarization of the received signal and automatically switch antennas to maintain the maximum possible signal strength. Basically, as is shown, we have two independent tuners, each having two outputs; an RF output that connects to an electronic switch whose output feeds the receiver's IF amplifier, and a control voltage that is proportional to the received signal strength.

One tuner is connected to a horizontally polarized antenna, the other to a vertically polarized antenna. The control voltages are fed to a comparator that controls the electronic switch. When the received signal from the horizontal tuner is stronger than that of the vertical tuner, the horizontal control voltage is proportionately larger. That forces the electronic

switch to connect the horizontal tuner to the IF amplifier. When the signal from the vertical tuner is the stronger one, the reverse is true.

If anything causes the received signal's polarization to rotate, the signal fades out on the horizontal tuner, causing the control voltage to fall. In the meantime, the signal received by the vertical antenna/tuner increases, thereby, increasing the vertical tuner's control voltage. At some preset level, the control voltage causes the electronic switch to "flip," connecting the vertical tuner to the IF amplifier.

The receiver continuously tracks the control voltages from the tuners, and selects the one that produces the maximum received signal. To prevent flutter caused by rapid and unnecessarily frequent switching between tuners, there's a hysteresis range of control-voltage/signal-strength values within which the receiver will not switch. Of course, if signal fading is caused by an actual reduction in received signal strength regardless

of polarization, the receiver stays with the tuner that produces the higher control voltage.

As you might expect, a lot of hardware goes into diversity reception because it requires what is essentially two receivers, an electronic switch, comparison amplifiers, and lots of "witchcraft" to maintain the adjustments. Vacuum tubes made the system too bulky, expensive, and fussy to be used in consumer and conventional communications equipment.

But solid state is something else. Two limited-range tuners require very little in the way of components, and the whole comparator and switcher can be put on a single integrated circuit. In terms of extra costs, we're talking about pennies instead of hundreds of dollars. And now that a new generation of engineers have re-discovered diversity reception, the question is: Which manufacturer will be the first to produce a mass-marketed, all-band diversity receiver priced at under \$100? R-E

Be an FCC LICENSED ELECTRONIC TECHNICIAN!



Earn up to \$30 an hour and more!

Learn at home in spare time. No previous experience needed.

No costly school. No commuting to class. The Original Home-Study course prepares you for the "FCC Commercial Radio-telephone License". This valuable license is your "ticket" to thousands of exciting jobs in Communications, Radio-TV, Microwave, Computers, Radar, Avionics and more! You don't need a college degree to qualify, but you do need an FCC License.

No Need to Quit Your Job or Go To School
This proven course is easy, fast and low cost! **GUARANTEED PASS** - You get your FCC License or money refunded. Send for **FREE** facts now. **MAIL COUPON TODAY!**

COMMAND PRODUCTIONS

FCC LICENSE TRAINING, Dept 90
P.O. Box 2223, San Francisco, CA 94126

Please rush **FREE** details immediately!

NAME _____
ADDRESS _____
CITY _____ STATE _____ ZIP _____

SAVE MONEY!

CALL FREE



1-800-237-3063

7 A.M. TO 5 P.M. MON-THURS
(IN CONTINENTAL U.S. EXCEPT FL)

FOR ALL YOUR
**CRYSTAL
NEEDS!**

General Communication
Industry • Marine VHF
Amateur • Scanners
CB Standard & Special
Microprocessor

GET YOUR FREE
1986 CATALOG

Call or write:

JAN CRYSTALS

P.O. Box 06017
Fort Myers, FL
33906-6017

(813) 936-2397



SINCE 1965



SUPER LONG PLAY TAPE RECORDERS

10 Hour Model - \$95.00*
14 Hour Model - \$159.00*

Modified Panasonic Slimline.
high quality. AC-DC
Recorders provide 5 or 7
continuous hours of quality
recording & playback on
each side of cassette for a
total of 10 or 14 hours
depending on model. Built-in
features include • Voice
level control • Digital
counter, etc. TDK DC 180
Cassette Furnished



PHONE RECORDING ADAPTER

Records calls automatically. All Solid state connects to your telephone jack and tape recorder. Starts recording when phone is lifted. Stops when you hang up. **\$24.50***
FCC APPROVED

VOX VOICE ACTIVATED CONTROL SWITCH

Solid state. Self contained. Adjustable sensitivity. Voices or other sounds automatically activate and control recorder. Uses either recorder or remote mike. **\$24.95***
*Add for ship & insg. Phone Adapter & Vox \$1.50 ea.
Recorders \$4.00 ea. Cal. Res. add tax. Mail order, VISA avail. COD's OK. Money Back Guarantee. Free data avail. Dealer inquiries invited. Free data
AMC SALES INC. Dept A 9335Lubec St., Box 928, Downey, CA 90421 (213) 888-8519

SATELLITE TV



BOB COOPER, JR.
SATELLITE TV EDITOR

C-band DBS?

LAST MONTH WE LOOKED AT THE REASONING behind the FCC's 1979 decision to create a special DBS, or Direct Broadcast Satellite, TV service on the Ku band. We came to the realization that, for DBS to work with one- to three-foot dishes, high-powered transponders are required.

However, there are difficult technical problems with increasing transmitter power on the Ku band at this time, so those interested in DBS have begun looking elsewhere: the C band. The problem with the C band is that maximum power is limited to about 10 watts. And that maximum is limited by regulation, not by technology. So we are no closer to realizing a worldwide DBS service than we were in 1979, when that service was envisioned.

At present there are about 1.3 million US and Canadian homes equipped with C-band TVRO's. And that number is growing by about 1/2-million per year. So, by 1990, there will be C-band TVRO's serving no less than 5% of all U.S. homes.

However, there are limits to TVRO growth, given current—and foreseeable—technology. And the main thing limiting that growth is dish size. Current 6–10 foot dish antennas are unsightly and impractical. If antennas were smaller—say 2 or 3 feet—a far greater number of homes could receive C-band signals.

You might think that additional performance could be squeezed from another part of the system. But antenna gain and feed efficiency have been maximized for now. Clever receiver circuits that



FIG. 1

trade sensitivity for picture quality (like the so-called "threshold extension systems") have shown that you can improve small-dish systems, but that those improvements are marginal.

In short, for all practical purposes, we're at the state of the

art—on the receiving end. So if antenna size is going to decrease, and if picture quality is going to increase, the transmitting end of the system will have to change. In short, we've got to give our C-band satellites greater power.

C-band power was originally limited in order to prevent interference to terrestrial microwave circuits. The fear, or threat, of such interference may have been justified. But as we saw last month, the possibility that a satellite some 22,000 miles from the earth could interfere with line-of-sight terrestrial telephone communication is miniscule.

C-band DBS

Let's forget regulations for a minute, and ask a technical question: could a 50-watt transmitter do the job on the C band? The Russian *Gorizont* satellite has had 50-watt transmitters for nearly five years. The three-foot dish shown in Fig. 1 operates in Motala, Sweden, and it receives signals from the Russian satellite perfectly.

We need create no new technology to increase our present C-band birds to the 50-watt power level—the technology is here, and it has been proven to work. For example, RCA's Ku1 and Ku2 satellites both have sixteen 45-watt transponders on board. And Sweden has shown us that small dishes function very well with a 50-watt C-band transmitter.

I suggest, and I am hardly alone with this suggestion, that the time is at hand to abolish the 20-year-old engineering constraints that deny us C-band DBS service. That might happen in several ways:

TVRO dealer "Starter Kit" available

Bob Cooper's *CSD Magazine* has arranged with a number of TVRO equipment suppliers to provide a single-package of material that will help introduce you to the world of TVRO dealership. A short booklet written by Bob Cooper describes the start-up pitfalls to be avoided by any would-be TVRO dealer, in addition, product data and pricing sheets from prominent suppliers in the field are included. That package of material is free of charge and is supplied to firms or individuals in the electronics service business as an introduction to the 1984-85 world of selling TVRO systems retail.

You may obtain your *TVRO Dealer Starter Kit* free of charge by writing on company letterhead, or by enclosing a business card with your request. Address your inquiries to: **TVRO STARTER KIT, P.O. Box 100858, Fort Lauderdale, FL 33310**. That kit not available to individuals not involved in some form of electronics sales and service.

• After initial opposition, the terrestrial telephone companies might simply accept the fact that power levels greater than 10 watts won't cause interference to their services.

• Alternatively, present frequency assignments (which, in any case, offset satellite channels from terrestrial channels by 10 MHz) could be modified to eliminate the already-remote possibility of interference.

• Further, the dithering technique that all satellite broadcasters currently use could be further modified to reduce the possibility of interference.

• Last, perhaps only a segment of the sky, say 70 west to 110 west, might be used by high-power C-band birds.

By implementing one or more of the above suggestions, C-band DBS would explode into a service offering dozens, perhaps hundreds, of channels nationwide. If that were to happen, the potential market could increase tenfold, or more!

R-E

LETTERS

continued from page 22

Also, I'm not an experienced designer, but it appears to me that transistors Q2, Q4, Q6, and Q8 are intended to protect the output transistors. With R9, R18, R27, and R37 at 4.7 ohms, as stated in the article, the protection devices will turn on at about 125–150 mA of output current.

As long as the output devices could handle at least that much current, the current-handling capability of the output devices wouldn't have any effect on the turn-on point of the protection devices. According to my calculations, for an output-current of 2 amps, resistors R9, R18, R27, R37 would have to be changed to about 0.3–0.4 ohms at 2 watts.

KARL REEBENACKER
Franklin, MA

Mr. Reebenacker is essentially correct. To increase output current to 2 amps, the transformer's rating

will have to be increased accordingly. The four resistors (R9, R18, R27, R37) should be changed to 0.27Ω at 3 watts. In addition to that, the values of the four output capacitors should be increased to 1000 μF each. Last, you should also replace the 2N3766 with a 2N6057, and the 2N3740 with a 2N6050.—

R-E

No previous experience necessary

LEARN PROGRAMMING



Master computers in your own home at your own pace in your spare time. Learn even before you decide on a computer.

BE YOUR OWN COMPUTER EXPERT

Programming is the best way to learn to use computers and we can show you the best—and most economical—way to learn programming!

Send today for your free information package. No obligation. No salesman will call.

HALIX INSTITUTE
CENTER FOR COMPUTER EDUCATION DEPT. 492
1543 W. OLYMPIC, #226
LOS ANGELES, CA 90015-3894

YES! Send me free information on how I can learn about computers and programming at home!

Name _____

Address _____

City _____

State/Zip _____

PRB ... HAS OVER 10,000 ELECTRONIC COMPONENTS

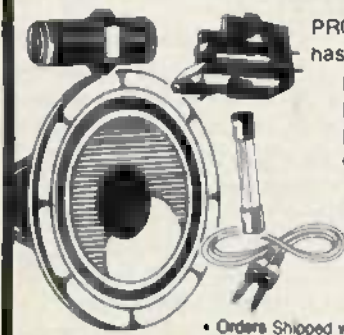

PROJECTOR RECORDER BELT has virtually every electronic component you'll ever need . . . plus . . . the world's most complete inventory of belts (including the hard to find ones).

PRB OFFERS YOU:

- Everyday Low Prices
- FREE Freight (PRB will pay the 1st lb. of UPS-ground only-charge)
- Orders Shipped within 24 Hours
- 100% Guarantee on All Products
- Weekly Specials for Super Savings
- Service You Can Depend On
- FREE - 98 Page Catalog (call for your copy)

SPECIALS

- | | | |
|--|--|--|
| <ul style="list-style-type: none"> ● INDIVIDUAL 5¼" RAINBOW MEMORIES DISKETTES (Bulk) Single Sided #1SBK Just \$1.17 ea. (min. 12) (1-11 \$1.30 Each) Double Sided #2SBK Just \$1.26 ea. (min. 12) (1-11 \$1.40 Each) | <ul style="list-style-type: none"> ● GOOD WASH Spray degreaser/tuner cleaner safe for all plastics #2444 ● 24 OZ. aerosol can Regularly \$3.87 SALE \$2.99 (min. 12) | <ul style="list-style-type: none"> ● VOLTAGE SPIKE PROTECTOR with radio noise filter #445P ● Close-Out Special! Regularly \$6.15 SALE \$1.95 (min. 12) |
|--|--|--|

ORDER TOLL FREE

National 1-800-558-9572 In Wisconsin 1-800-242-9553 TLX: 4994411 PRB USA



PROJECTOR RECORDER BELT
200 Clay Street
Whitewater, WI 53190

SOMEONE YOU KNOW

HAS A RARE DISORDER

- That may be fatal or disabling
- That many doctors don't recognize
- That may have no cure or treatment
- That is one of 5000 disorders with a total of 20 million victims

NORD is a coalition of non-profit agencies, researchers, and individuals that helps by providing information and promoting research. Your membership helps.

NORD



National Organization for Rare Disorders 1182 Broadway, Suite 402
New York, N.Y. 10001
212-686-1057

COMPUTER DIGEST

VOL. 3 NO. 2 February 1986

A NEW KIND OF MAGAZINE FOR ELECTRONICS PROFESSIONALS

SO YOU'RE GOING TO BUY A MONITOR... A State-Of-The-Art Report



GERNSBACK
PUBLICATION

GRAFEX-32

Build This Hi-Res Graphics Adapter
For Your Apple II

SPEAKER ENCLOSURE DESIGN

Let Your Computer Do The Hard Work
Part II. The Conclusion

CONTENTS

Vol. 3 No. 2

February 1986

- 4 So You're Going to Buy A Monitor...**
Read this article *before* you go shopping. Armed with this information you can save a lot of time and money. **Herb Friedman**
- 7 Computer Speaker Enclosure Design**
The conclusion of the story begun last month on using your computer to help design enclosures. **Michael and Robert Raleigh**
- 9 Build The Grafex-32**
This hi-res adapter board for your Apple II will make a big difference. Here's the first of a three-part article. **Ray Dahlby**
- 3 Letters**
- 3 Computer Products**

ON THE COVER

Heath's new Model HVM-122A is a 12-inch amber monochrome monitor with excellent definition for 40 or 80 characters. What's more, you can drop the cost of this unit to well-under \$100 by assembling it yourself from the kit. You'll find that for most non-color applications, such as word processing, you get better definition with a monochrome monitor. So if you're thinking of going monochrome, or changing to amber, take a long, hard look at this unit, and see page 4.

COMING NEXT MONTH

Look for an intriguing application for the Commodore light pen as a frequency counter. If you've got any questions about printers, you'll surely find an answer in the printer tutorial we'll be running next month. We'll also be offering part two of the three-part article on the Grafex-32, begun in this issue.

ComputerDigest is published monthly as an insert in Radio-Electronics magazine by Gernsback Publications, Inc., 200 Park Avenue South, New York, NY 10003. Second-Class Postage Paid at New York, N.Y. and additional mailing offices. Copyright © 1985 Gernsback Publications, Inc. All rights reserved. Printed in U.S.A.

A stamped self-addressed envelope must accompany all submitted manuscripts and/or artwork or photographs if their return is desired should they be rejected. We disclaim any responsibility for the loss or damage of manuscripts and/or artwork or photographs while in our possession or otherwise.

COMPUTER DIGEST

Hugo Gernsback (1884-1967)
founder

M. Harvey Gernsback,
editor-in-chief

Larry Steckler, CET, publisher

Art Kleiman, editorial director

Byron G. Wels, editor

Brian C. Fenton, technical editor

Carl Laron, associate editor

Robert A. Young, assistant editor

Ruby M. Yee, production manager

Robert A. W. Lowndes,

production associate

Karen Tucker,

production assistant

Geoffrey S. Weil,

production assistant

Andre Duzant, Technical Illustrator

Jacqueline P. Cheeseboro

circulation director

Arline R. Fishman,

advertising coordinator

Gernsback Publications, Inc.

200 Park Ave. South

New York, NY 10003

Chairman of the Board:

M. Harvey Gernsback

President: Larry Steckler

ADVERTISING SALES 212-777-6400

Larry Steckler

Publisher

EAST/SOUTHEAST

Stanley Levitan

Radio-Electronics

200 Park Ave. South

New York, NY 10003

212-777-6400

MIDWEST/Texas/Arkansas/Okla.

Ralph Bergen

Radio-Electronics

540 Frontage Road—Suite 325

Northfield, Illinois 60093

312-446-1444

PACIFIC COAST

Mountain States

Marvin Green

Radio-Electronics

15335 Morrison St., Suite 227,

Sherman Oaks, CA 91403

818-986-2001

LETTERS

Glitch!

I built the circuit for the Write-Protect Notch By-Pass article in your July, '85 Issue. I found two small errors in Figure 2, the schematic diagram. Capacitor C4's polarity should be reversed so the positive lead connects to pin 2 of IC1. Also, the lead from the junction of IC1 pin 2 and C1, to one side of S2 should be connected to the junction of IC1 pins 1, 8 and C1 instead. With the corrected circuit, I was able to load the program and saved it to a write-protected diskette.

A. F.,
Somerset, Bermuda.

Thank you. We appreciate your help and hope we didn't cause

you too much trouble.

CP/M vs MS/DOS

When VCR's became popular, I held off until I could see whether Beta or VHS was going to dominate. I've been holding off on buying a computer for the same reasons, waiting to see if I should go with CP/M or MS/DOS, but there doesn't seem to be any resolution. What should I do?

C. D.,
Reno, NV.

Buy. We now have interface devices that can make any system compatible with any other. So stop denying yourself. Remember when Ralph Kramden refused to

buy a TV set because he was waiting for 3-D TV?

Dealer's Choice

I know you select the articles for each issue from those that various authors submit. But if you could have a choice, what would you look for?

S. K.,
Taos, N.M.

Thanks for asking, S.K. Right now we're scrambling for—believe it or not—SHORT articles to fill one or two pages in the magazine! Everything we seem to have now has to be serialized over two or three issues. The subject matter is wide open, but we prefer well-written construction projects. ◀▶

COMPUTER PRODUCTS

For more details use the free information card inside the back cover

INVOICING SYSTEM, the *Supershipper*, integrates all the elements involved: it is capable of handling customer-account lists, and product and price lists, as well as printing invoices, labels, and C.O.D. tags.

The *Supershipper* is available for the Commodore 64. The program retails for \$99.95.—*Progressive Peripherals &*



CIRCLE 11 ON FREE INFORMATION CARD

Software, Inc., 2186 South Holly, Denver, CO 80222.

BAR CODE READER SYSTEM, the model *PSR150*, can be used in either of two basic modes. The on line mode is as a fixed bar code decoder, which will decode bar code information and send it directly to your system. In the storage mode, the unit is a hand-held portable storage device that goes anywhere for collecting data and information at the source, thus eliminating pad and pencil. The stored data can then be transmitted directly to your system, also eliminating the need to key information into the system. Another feature is the scan-pad manual mode. In that mode, individual characters may be scanned from the bar-coded scan pad to form a record. That record can then be sent in the on-line mode or stored in the store mode by scanning the "Enter" bar code on the scan-pad.

The standard unit of the model *PSR150* comes with features such as stainless steel pen, 32-character LCD display, Nicad or alkaline batteries, bar-

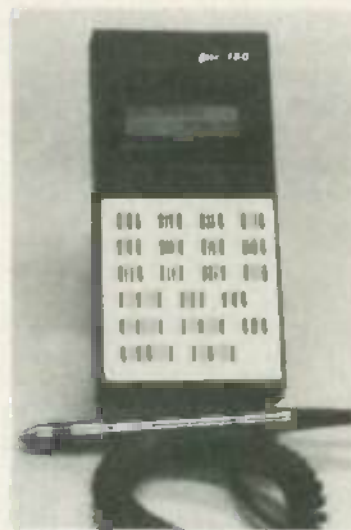

CIRCLE 12 ON FREE INFORMATION CARD

code keyboard, and serial interface, and is priced at under \$500.00. The model *PSR150* is also available with 64KB RAM, at a price of under \$1000.00.—*Digitronics Division, Comtec Information Systems, Inc.*, 53 John Street, Cumberland, RI 02864. ◀▶

SO YOU'RE GOING TO BUY A MONITOR...

What you need to know before you shop.

Herb Friedman

■ There are probably as many reasons for buying a monitor as there are for buying a computer. Maybe you just haven't got one, and have been using a television receiver. The kids want the TV back, and it's either buy them a new TV set or go out and do what you should have done in the first place—Buy a monitor!

Or maybe you've got an old green screen jobbie, and want to try one of the newer easy-on-the-eyes amber screen units. Or maybe when you first shucked out the bucks for your computer, you couldn't see the extra cost for a color monitor and settled for a monochrome—for now—with all that Christmas loot burning a hole in your pocket, maybe "now" is "now."

Whatever you've got in mind for that new monitor, you'd better be armed with some facts when you go shopping. You'd better be prepared for the salesman's jargon, you'd better know what he's talking about when he starts throwing technicalities at you, and you'd also better be prepared for some of the "on-the-spot"

decisions you're probably going to have to make.

The very-worst thing that can happen if you aren't properly pre-educated, is that you're going to make a wrong purchase. We don't want that to happen, and neither do you. We couldn't possibly send one of our experts along with you on your shopping trip, so we did the next best thing. Here it is:

Selecting a computer monitor used to be easy. Most computer stores stocked only monochrome or color. Today, the terms "monochrome" and "color" are meaningless because there are different models within each category, many are mutually exclusive in that they will not function with signals intended for another kind of monitor.

As a general rule, monochrome monitors present few problems other than the signal connection; except for the IBM-type monochrome monitor all employ what is called a composite video input. "Composite" means the video signal contains both the video and sync signals, such as the NTSC waveform shown in Figure 1a; the same kind of signal used for conventional broadcast Black & White TV. Any TV set or composite TV monitor can be used for a computer as long as it can resolve the required detail. Since a composite

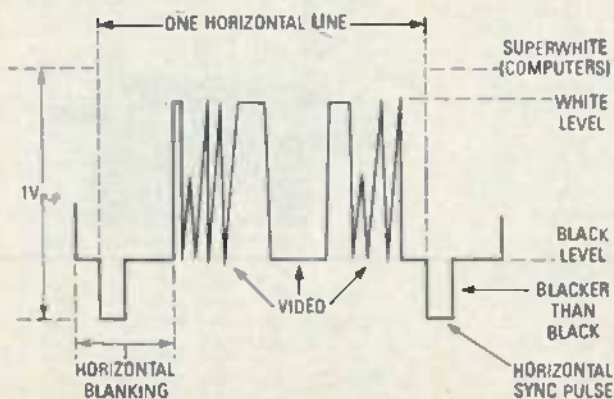

FIG. 1a—THE COMPOSITE VIDEO output from monochrome personal computers uses the same NTSC format used for broadcast TV.

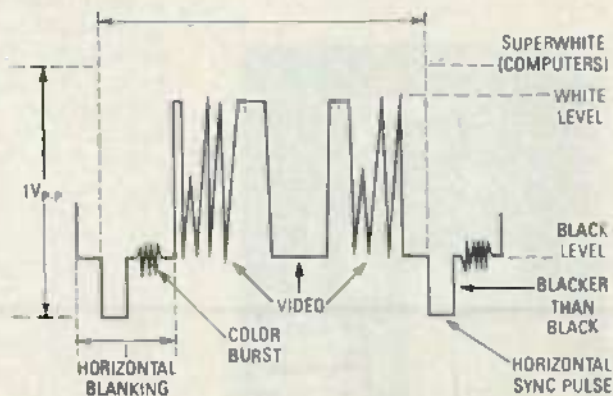

FIG. 1b—COLOR COMPUTERS simply superimpose a color burst on the back porch of the vertical sync. The monitor integrates the color burst with the video signal to create a color display. Without the color burst a color monitor would create a monochrome display.

video signal can be carried on a single shielded wire, the video input connector for those composite monitors specifically intended for personal computers is usually a "phono" jack, though some manufacturers have used unusual connectors which require an expensive "adapter cable." (The more rugged UHF and BNC connectors are generally used on monitors primarily intended for closed circuit TV.)

The resolution of a monochrome monitor is usually not a problem because the frequency response of the monitor serves as an indicator of what to expect. The conventional bandwidth of approximately 6-8 MHz used for closed circuit TV monitors can resolve up to 40 characters per line, possibly 50 characters. A 60 character line requires about 8-12 MHz, a sharp 80 character line takes from 14 to 22 MHz or greater.

Most important, a composite monochrome monitor can be used for both monochrome and composite color signals. It simply ignores the color burst, which, as shown in Figure 1b is the same as the composite monochrome signal shown in Figure 1a.

Until the introduction of the IBM-PC, composite video was the standard signal for personal computers. One of the few attempts to avoid using conventional composite video (especially for monochrome display) was the Osborne computer. Aftermarket vendors immediately introduced composite adapters because non-composite monitors was an idea whose time had not yet come. At its best it was a hindrance to convenient use of the computer.

It was IBM that really created the use of non-composite monitors for personal computers. When the IBM-PC was first introduced considerable sales effort went into convincing the buyer that the composite color output could not be used for monochrome displays. This, of course, was sheer nonsense, meant to sell an expensive monochrome adapter and a special, expensive monitor. Since no one else was selling "IBM-type" monochrome monitors IBM had the market to themselves because no other monochrome monitor would work with IBM's monochrome adapter signals.

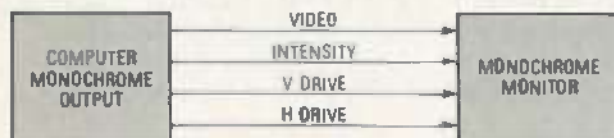

FIG. 2—A COMPUTER WITH an IBM-type monochrome output provides individual TTL signals (non-NTSC) for the video component, intensity, and the vertical and horizontal drive. The monitor integrates the four signals into a screen display.

Figure 2 shows how the IBM-type monochrome computer output differs from conventional single-ended composite video. The multi-terminal IBM-type output connector provides separate TTL signals for video, intensity, and horizontal and vertical drive. The signals are converted into a video display within the monitor. Obviously, the IBM-type monochrome signals cannot be used to drive a conventional composite monitor. But because conventional composite video isn't used it's possible to employ non-NTSC vertical

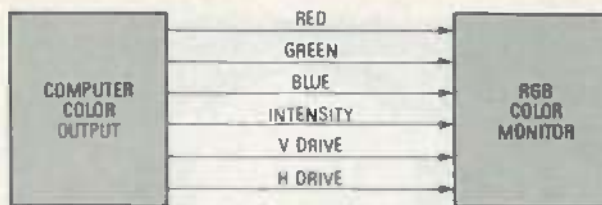

FIG. 3—AN RGB COLOR SIGNAL is also non-NTSC and TTL. Each of the three primary colors is provided as a separate signal along with the intensity and vertical and horizontal drive signals. Like the TTL monochrome monitor, the RGB monitor integrates the separate signals into a complete color display.

and horizontal sweep rates. IBM-type monochrome monitors employ a horizontal sweep of 18 KHz rather than the NTSC rate of 15 KHz, which in combination with a bandwidth of 16MHz results in a display having greater resolution than a conventional monitor.

Color monitors

Color monitors are available in two configurations, known as composite and RGB. In basic terms, the composite produces color displays by processing the composite video and the color burst. (If the color burst is eliminated from the computer's signal the video will be displayed in monochrome on both monochrome and color monitors, for without the color burst from the computer a color monitor cannot create color). As a general rule, almost any hue of any intensity can be displayed by a composite monitor; any limitation on the display of a particular hue is more a function of the computer than the monitor.

Unlike composite video which is an analog signal even if the information it carries is derived digitally, RGB signals are digital representations of the instantaneous color and intensity values of a single picture element. Like the IBM-type monochrome displays, RGB color monitors work with TTL signal levels, only now there are individual digital signals for RED, GREEN, BLUE, INTENSITY, and the vertical and horizontal drive. The signals from the computer, shown in Figure 3, are processed within the RGB monitor to produce a color display capable of the 16 colors shown in Figure 4. Normally, just the three RGB signals can produce the 8 colors indicated with an asterisk; the additional 8 are made possible by integrating the intensity signal with the RGB signals.

RGB COLOR DISPLAY

Basic color	Intensified color
* Black	Dark grey
* Blue	Light blue
* Green	Light green
* Cyan	Light cyan
* Red	Light red
* Magenta	Light magenta
Brown	* Yellow
* White	Intensified (super) white
* Indicates conventional pre IBM-PC basic color rainbow.	

FIG. 4—A MODERN RGB MONITOR that is IBM-compatible will produce 16 colors including brown. Before the introduction of the IBM-PC, RGB monitors produced yellow instead of brown, and some RGB monitors could only produce the eight colors indicated with an asterisk (*)."

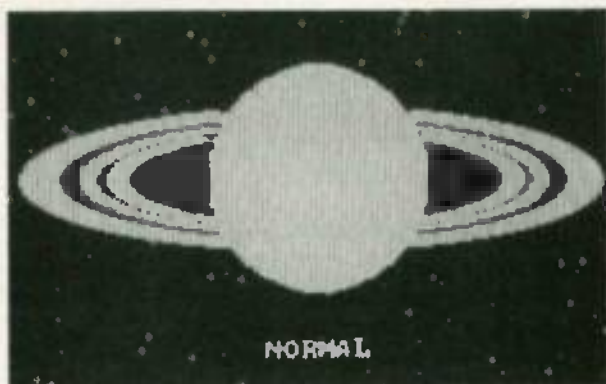

FIG. 5a—USING A MONOCHROME MONITOR with a color signal intended for an RGB monitor usually results in excess "gain" and considerable loss of detail in both the graphics and text characters.

Presently, all conventional RGB monitors create 16 colors from conventional personal computer signals. Unfortunately, some early monitors, a few of which occasionally surface in the surplus market, do not process the intensity signal and provide only 8 colors. It's not that the color table shown in Figure 4 is different from the earlier and conventional RGB colors in that the yellow is not part of the basic 8 colors derived from RED, GREEN and BLUE. In a conventional 8-color rainbow there is no brown: The position occupied by brown in Figure 4 is normally yellow. Unfortunately, although the intensity signal produces lighter versions of seven of the original 8 colors—thereby also producing a legitimate grey and an intense or "super white" (which is actually close to, or equal to the maximum screen brightness)—lighter yellow is still yellow. Also, the lack of brown sharply limits graphic artwork. To make the 16 color rainbow more applicable to "natural" graphics, IBM substituted brown for the basic yellow, and provided yellow in the intensified rainbow. Although brown came into common use with the IBM personal computers, it is now considered "standard" because most personal computer equipment attempts to be IBM-compatible.

Monochrome from RGB

While it is usually possible to use a monochrome



FIG. 5b—BUT WHEN PROCESSED by a Video Enhancer an RGB color signal can look quite good on a monochrome monitor because the device converts each color to an individual shade of grey.

monitor with a composite color output, programs specifically written for an RGB color output often produce little more than "garbage" on a monochrome display even if the monitor's signal source is a composite color video output. For example, in addition to the RGB color output the IBM Color/Graphics Monitor Adapter and its aftermarket clones have a composite video output which can be used to drive both composite color and composite monochrome monitors. If the computer is told to operate in the monochrome mode it will convert a color display to composite video that can be viewed on a monochrome monitor in two shades of monochrome: normal and highlight. If the program is self-booting so that the computer outputs only for RGB the composite video will contain "grainy" characters and missing graphic elements.

By using a device known as a Video Enhancer (Power-R, Inc., 4016 Interlake N., Seattle, WA 981031) the RGB, intensity and H & V drive signals are converted into an "enhanced" composite monochrome output having each of the 16 colors represented by a discernable shade of grey. The Video Enhancer is actually built in a conventional 9-terminal D-connector, the same kind normally used for the RGB connector. It derives its power from the power terminal normally provided on a Color/Monitor Adapter's light pen connector. The output cable of the device is terminated in a conventional phono plug, which can be connected to any conventional composite video monitor.

Figure 5 shows how the Video Enhancer recombines the individual RGB picture elements into a monochromatic grey scale display. Figure 5a, which has not been retouched, shows how the "rings of Saturn" from a Color/Graphics Monitor Adapter's color composite output would appear on a monochrome monitor: There is obviously much detail missing from the graphic art, as well as from the text word "NORMAL." Figure 5b shows how the very same display appears on the same monochrome monitor if taken from the RGB output and processed by the Video Enhancer. Notice that the rings of Saturn are now clearly visible in monochrome. Also, the text word "ENHANCED" is now legible, the way it should really appear on both monochrome and color monitors.

Match the monitor

As you can see, not only are the different types of monitors and their signals mutually exclusive, but the software can also determine the kind of monitor needed. For example, while many users prefer a monochrome monitor for word processing (because the image is sharper), much graphics software and software employing graphics intended for color monitors simply doesn't provide a usable display on monochrome monitors, although monochrome software is almost never a problem when used with a color monitor. The best of both worlds when you cannot afford an RGB color monitor is the Video Enhancer because it provides usable displays from both monochrome and color software. ◀▶

COMPUTER-AIDED DESIGN OF LOUDSPEAKER ENCLOSURES PART II

Michael Raleigh and Robert Raleigh

This article, begun last month, is concluded here.

Figure 8 shows the results of a computer experiment which simulates putting this woofer in a ducted port. The dimensions are provided in the figure. The curve now shows a bump which extends the low-frequency response. The experiment is carried further in Figure 9 which shows the effect of changing the tuning condition of the enclosure by varying the duct length.

On the basis of the results shown in Figure 9 an enclosure was constructed with a .124 cubic meter volume, a .0889 meter port radius, and a .929 meter port length (3.5 inch radius, 9-inch length). The agreement between the computer experiments and the actual experiments was verified by comparing the computed and measured admittances (Figure 10). The measurements were made using the same apparatus, as

FREQ.	POWER	ADMIT.
15	2.31772192E-07	.848189537
20	1.48971818E-06	.8235715442
25	8.41352578E-06	.8434289249
30	3.62626319E-05	.8796287309
35	1.3164318E-04	.12824884
40	3.56285788E-04	.148312447
45	5.43215859E-04	.13413884
50	5.91891887E-04	.8942733154
55	5.55844955E-04	.8583549804
60	5.28822504E-04	.8325588438
65	5.01588831E-04	.8187816434
70	4.93319462E-04	.8215518686
75	4.92873898E-04	.8318286229
80	4.96855885E-04	.8424188523
85	5.0448192E-04	.852152713
90	5.14323653E-04	.8608981319
95	5.25684553E-04	.8687642988
100	5.37789877E-04	.875933387
105	5.50484824E-04	.8824388995
110	5.63422773E-04	.8883621818
115	5.76395798E-04	.89379598
120	5.89259526E-04	.8987899444
125	6.01987884E-04	.903392324
130	6.14264474E-04	.907644855
135	6.26275981E-04	.911588339
140	6.37985841E-04	.91523144
145	6.4913189E-04	.918624554
150	6.59938168E-04	.921782473
155	6.70321592E-04	.924726884
160	6.80281594E-04	.927473777
165	6.89822794E-04	.930041985
170	6.98953111E-04	.932445442
175	7.07682842E-04	.934697483
180	7.16024811E-04	.93688983
185	7.23989816E-04	.938973545
190	7.31594198E-04	.940858362
195	7.3885152E-04	.942413199
200	7.45776388E-04	.943866174
205	7.52383852E-04	.945247
210	7.58686843E-04	.94655535
215	7.64699346E-04	.94784873
220	7.7043653E-04	.94918383
225	7.759188E-04	.950441271
230	7.81134873E-04	.951621814
235	7.86128948E-04	.952733988
240	7.90888783E-04	.953782182
245	7.95423388E-04	.95476623
250	7.99763393E-04	.9556892

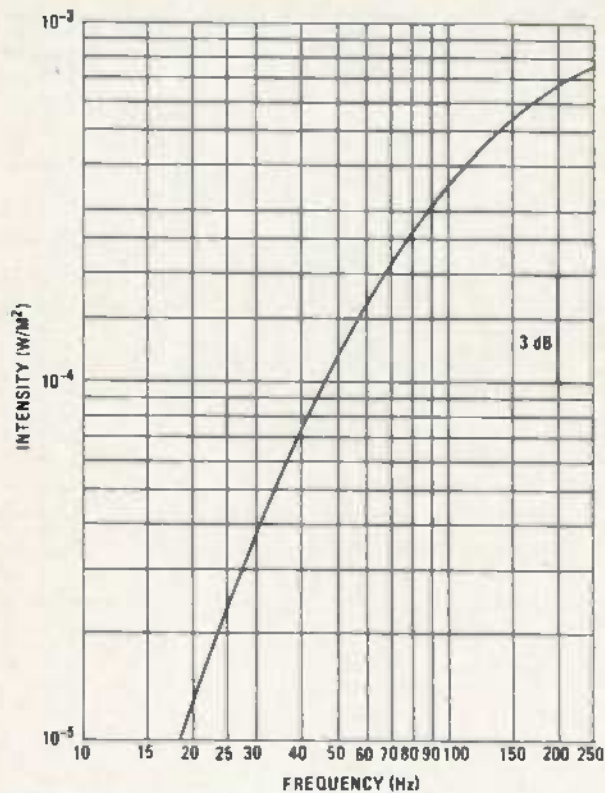

FIG. 7—ACOUSTIC INTENSITY in watts/meter squared versus frequency for a .2 cubic meter infinite baffle enclosure. A 3db difference is indicated for this graph and applies to all subsequent response curves.

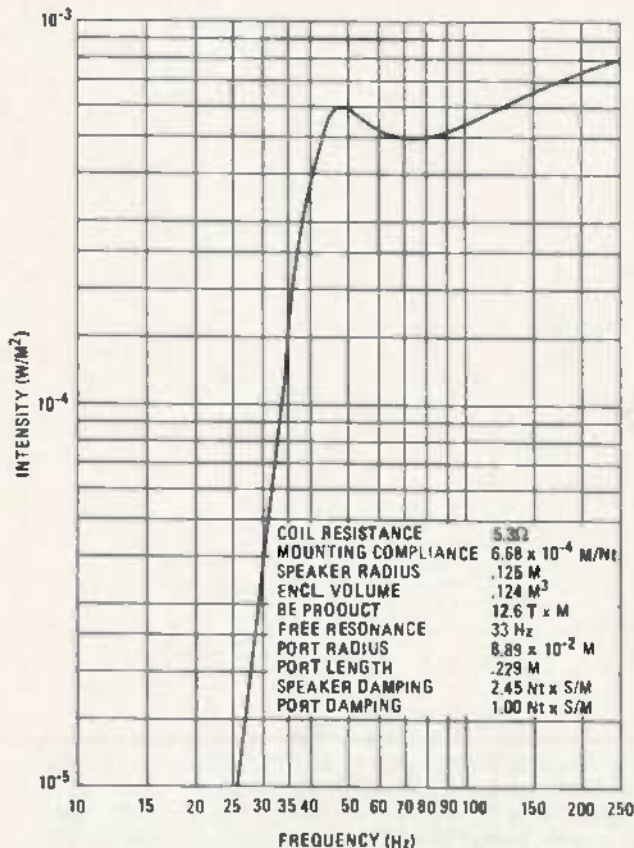

FIG. 8—COMPUTED RESPONSE of ducted port enclosure constructed in design example. Parameters are listed above.

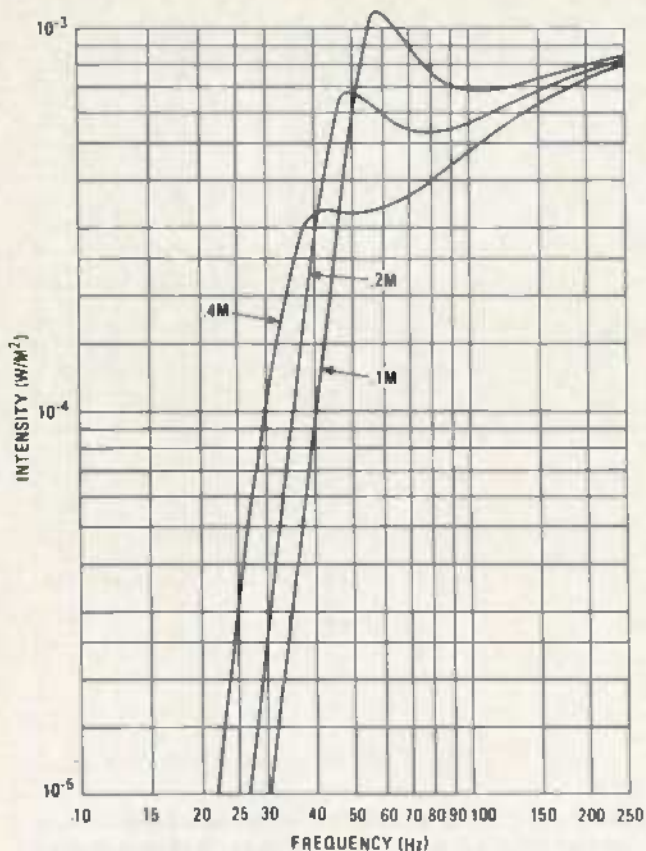

FIG. 9—COMPUTED RESPONSE for design example with various duct lengths. Other parameters same as Figure 8.

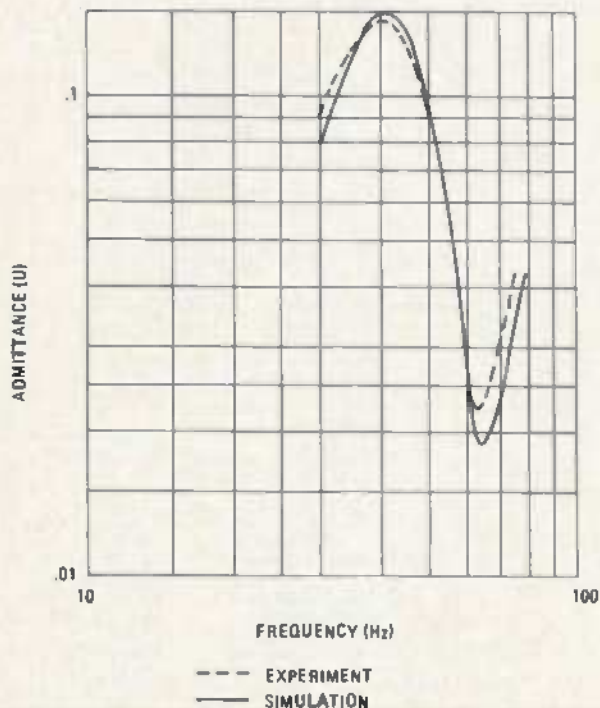

FIG. 10—MEASURED AND COMPUTER SIMULATED admittance of enclosure built as design example, described in Figure 8. Magnitude of the maximum in the admittance which occurs at approximately 40 Hz is sensitive to the amount of damping in the port. Matching measured and simulated maxima provides a means of determining the damping in the port.

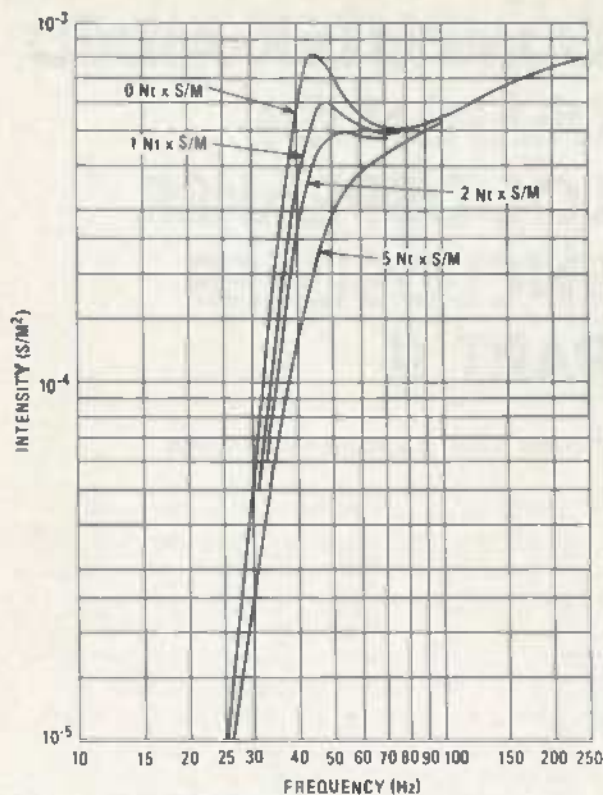

FIG. 11—COMPUTED RESPONSE for the design example with various amounts of damping in the port. Other parameters are as given in Figure 8.

shown in Figure 5, but with the woofer now in the enclosure. To achieve best agreement, a small amount of damping must be assumed in the port.

As a final computer experiment, we investigated the effect of adding additional damping to the port (Figure 11). On the basis of these results, it was decided not to increase the port damping. It is our design philosophy that frequency response takes precedence over transient response. We have therefore made our choice of damping based on this steady-state program result.

Infinite baffle enclosures are simulated by assuming a very long, very narrow duct (.001 meter radius, 1000 meter length). A ported enclosure is simply a ducted port enclosure with a very short duct. In this case, a greater proportion of the effective mass of the duct is due to the motion of air external to the duct. This effect is included in the program however, so that a proper simulation of a ported enclosure results from entering the length of the duct as the thickness of the speaker faceplate. For example, a 1-inch thick faceplate implies a duct length of .00254 meters. If a port or duct is not round in cross section, the radius should be that which gives the same area as the real port or duct.

Conclusion

We have shown but a few examples. The reader is invited to systematically investigate the effects of varying each woofer and enclosure parameter. This program also provides an output—the admittance—whereby the match between the program and the actual loudspeaker may be verified. ◀▶

BUILD THE GRAFEX-32

PART 1

A 640 by 400 graphics adapter for the Apple II.

Ray Dahlby

Dep't. 255
Box C-34069
Seattle, WA 98124-1069

■The Apple II's graphics resolution of 280 by 192 pixels can no longer be considered the "state of the art." The newer Apple *Macintosh* and *Lisa* computers display their bit-mapped images from up to 32K bytes of memory, over four times that used for display on the Apple II.

Recently, the availability of 64K dynamic RAM chips and VLSI graphics controllers at reasonable prices has made it feasible to expand the Apple II's graphics resolution using a simple plug-in circuit board. The Grafex-32 circuit board uses four 16K by 4 bit RAM chips along with a 7220 graphics controller to display 32K bytes of memory as a bit-map of 640 by 400 pixels. The board can be expanded to 128K bytes by plugging in 64K by 4 bit RAM chips and three such boards can be installed in a system to provide the red, green, and blue signals for color graphics displays.

Our design tradeoffs favor circuit simplicity with the option of expansion later, over a complex design incorporating features which might not have been used by everyone. Although the basic circuit consists of just 20 chips, it displays a monochrome resolution of 256,000 pixels on a standard Apple Monitor. Since this baseline performance exceeds the graphics resolution of the Macintosh computer, I decided not to increase the complexity, and thus the cost, of the basic circuit board and thereby provide hardware "hooks" by which the design can be upgraded by those users with higher resolution or color requirements. This design philosophy seems consistent with that of the Apple II itself.

The Apple II

The Apple II/IIe line owes much of its success to the expandability afforded by its expansion slots. In the six or so years that this computer has been on the market, hardware manufacturers have responded to the challenge of filling those slots by developing products to expand the machine and now, with a multitude of

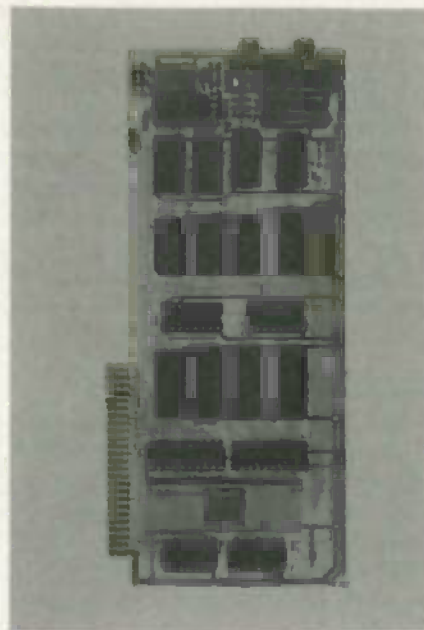

add-on cards available, it is surprising to find an area which has not been adequately served.

One such area seems to be the expansion of the Apple II's graphics resolution. Although a few cards were produced to add sprite-oriented graphics and luminance attributes to the Apple II, these did not significantly increase the number of pixels on the screen. Part of this lapse can probably be attributed to the introduction of the I.B.M. PC which has distracted the focus of third-party hardware manufacturers at a time when VLSI graphics chips and cheap memory make Apple II graphics expansion an easy matter.

The Apple II line can benefit from new graphics technology in other ways than increased screen resolution. The video design used in the Apple II maps the display memory into the 6502 micro-processor's address space in a technique called "memory-mapped video." This was a good choice at the time because it allowed the 6502 full access to the screen memory using all memory reference instructions and addressing modes just as if it were addressing normal system RAM. In fact, if the high resolution screens are not used, the memory space allocated to them can be used for program and data storage. The design of the Apple II limits the graphics resolution for at least two reasons, one being the restricted bandwidth of the home color televisions it was assumed that Apple owners would be using as their display devices. A second reason is limited amount of memory space which can be addressed by the Apple's 6502 microprocessor. This chip has 16 address lines which allows it to address only 65,536 bytes so a memory-mapped video design using half of this precious space just would not have been practical.

Memory-mapped video design is not limited to low resolution graphics as evidenced by the newer Apple *Macintosh* and *Lisa* machines. The 68000 microprocessor used in these computers has a 24-bit address bus and can directly address more than 16M

bytes of system memory. A large graphics RAM mapped into this address space does not represent a significant fraction of the total available for program and data storage.

The answer to improving the Apple II's graphics resolution without using up all of its memory is to keep the graphics RAM separate from the system RAM. The 6502 won't be able to directly access to display RAM but there are new chips optimized for managing large bit-mapped memories. The 6502 actually benefits from the increased program available by not having part of its system RAM allocated to graphics.

The 7220 GDC

The 7220 GDC (Graphics Display Controller) from NEC is designed to handle the repetitive tasks required in figure, line, and character drawing on a raster scan CRT. Unlike previous CRT controller chips such as the Motorola 6845 whose tasks were limited to display refresh and video synchronization. The 7220 has an instruction set which enables it to read, modify, and write data in the display memory. Positioned between the system microprocessor bus and the display memory, it responds to instructions passed to it and draws figures without processor intervention. Since the GDC can handle much of the repetitive pixel drawing and modification tasks, the bandwidth requirement of the microprocessor/display memory path is greatly reduced. Most of the data sent from the

microprocessor during vector and geometric shape drawing will be in the form of commands and parameters sent directly to the GDC which then interprets them into pixel-level operations to be carried out over the high-bandwidth GDC/display memory path. Its pipelined architecture is optimized for such graphics manipulation and it handles these tasks with great speed. For example, a 7220 running at a clock frequency of 5 Mhz can draw a figure at the rate of 800 ns per pixel. This speed is independent of the type of figure being drawn and is much faster than a general purpose microprocessor, such as the 6502, handling the same task.

The 7220 was chosen for this design because its 8 bit uP data bus interfaces nicely with the Apple's 8 bit 6502 and its 16 bit video data bus and 18 bit video address bus allows it to accomodate large bit-mapped display memories without impinging on the limited 16 bit addressing of the 6502. It also handles dynamic RAM refresh and video sync generation. This part is housed in a 40-pin ceramic package and is fabricated in 3um NMOS. It encompasses the equivalent of over 13,000 transistors.

The display memory

The 7220 requires its display memory to be organized in 16-bit words. The most common 64K dynamic RAM chips, such as the 4164, are organized as 65,536 locations of 1 bit each so 16 of these parts are

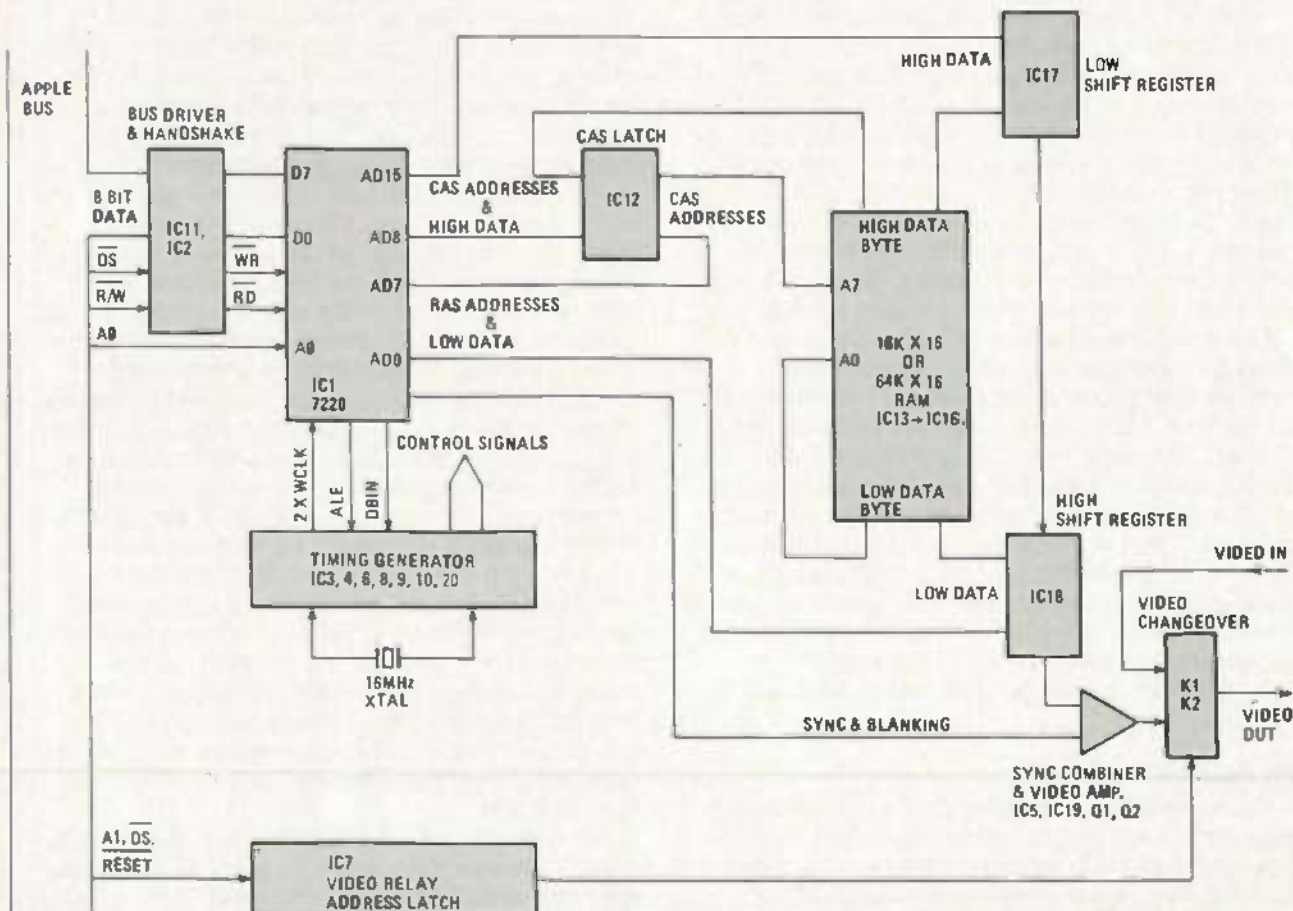

FIG. 1—BLOCK DIAGRAM OF THE GRAFEX-32 should be used along with the schematic diagram to help understand the theory of operation.

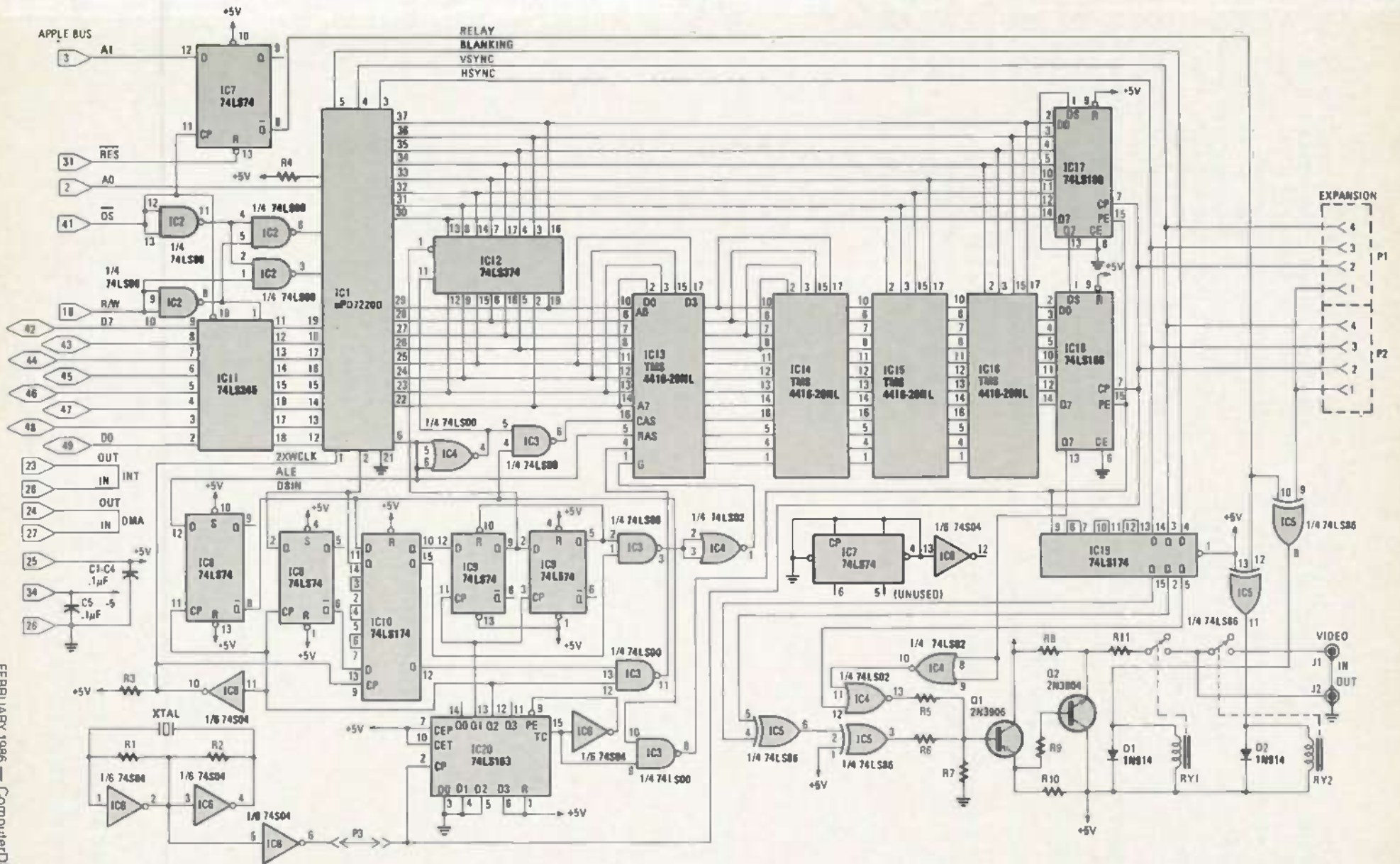

FIG. 2—SCHEMATIC DIAGRAM is not difficult to follow if you take it step-by-step. Refer to this while reading the text and you'll have an almost-immediate grasp of what is going on from Input through output!

required to assemble a 16-bit memory system. There is another 64K RAM chip which is organized as 16,384 locations of 4 bits each. This part, designated the 4416, is available from Texas Instruments, Inmos, and Fujitsu, among others. The 16 bit data bus requirement of a 7220 can be met using just four of these chips, thus reducing power dissipation and printed circuit board complexity. The use of the 4416 actually helps to reduce chip count further as it has a separate output enable pin which can be used to tri-state its data lines. This feature allows very tight coupling between the display memory and the 7220 which helps to simplify PC layout further.

Texas Instruments has recently announced the 4464 and NEC, the 41254, dynamic RAM chips which are organized as 65,536 locations of four bits each. These parts are housed in the same 18-pin package as the 4416 and allow easy system upgrades. The Grafex circuit, for example, has been designed to address the additional memory provided by these parts and expansion of the Grafex circuit from 32 Kbytes to 128 Kbytes is accomplished simply by replacing the 4 display RAM chips.

Circuit description

Referring to the block diagram of Figure 1 and the schematic of Figure 2, it can be seen that the Grafex circuit can be broken down into five sections. These sections are a) the uP bus interface, b) the 7220, c) the display memory, d) the video output circuitry and e) the timing generator.

The 7220, IC1, communicates with the host microprocessor over its eight bidirectional data lines. IC11, A 74LS245 is used to provide buffering and IC2, a 74LS00 is used to convert the Apple's RAW and DS signals into the 8080-type RD and WR signals used by the 7220. The Grafex circuit uses four of the 16 addresses assigned to the peripheral slot in which it is installed in the Apple II. These addresses are used to select the command and parameter registers of the 7220 and to control the video changeover relay latch, IC7. The addresses and their functions are listed in Table 1 which will appear in a subsequent issue. The reset line on the Apple bus is connected to this video relay latch to force a default on power up to the Apple video signal.

The 7220 communicates with the display memory over its 16 multiplexed address/data lines, labelled ADO-AD15 on the block diagram. The CAS latch, IC12, a 74LS374, is used to latch the high order 8 bits of addresses and then to sequence them onto the 8 RAS/CAS address lines of the display memory. This is a tight-coupled design from the standpoint of data and address multiplexing. The low address/data path from the 7220 carries, in sequence, the row addresses, column addresses, and finally, the low byte of display memory data. The high byte of display memory data is carried over a separate path directly to the 7220 AD8-AD15 pins.

The display memory, IC13-IC16, has a multiplexed 8-bit address bus and a 16-bit data I/O with separate output enable. Like other dynamic RAM arrays, the

eight row address bits are first strobed into the on-chip latches, then the eight column address bits are presented on the address lines and finally, these are strobed into the memory. After access time specifications have been met, the data is read during a read cycle or written during a write cycle. The 4416 and 4464 parts have a separate output enable pin which allows data to be read from the selected address location but not presented on the output pins until needed. This "G" pin allows a fast (40 ns) turn-on of the output buffers to supply data to the external circuit when needed later in the read cycle. In this manner, the eight row/column address lines can serve also as the low 8-bit data corridor to and from the 7220 and video shift register without the need for an external tri-state buffer. This kind of coupling facilitates printed circuit board layout and improves reliability by reducing the circuit inter-connections.

The 16 bits of data read from the display memory are presented to two 8-bit parallel in/serial out, shift registers, IC17 and IC18. These 74LS166 shifters serialize the 16-bit data into a video bit stream which is clocked at the 16 MHz dot-clock rate. The blanking, Hsync, and Vsync signals from the 7220 are brought into line with data by means of the 74LS174, IC19. It is loaded by the same load/shift signal as are the shift registers.

The video-bit stream is gated with the 7220 blanking signal by IC4 and then mixed with the composite sync provided by exclusive-or gate IC5. The video amplifier, consisting of Q1 and Q2 provides a standard 1 volt P-P composite video signal into 75 ohms. This composite video signal is routed to the video changeover relay, K1 and K2, which selects either the Grafex video or an external input as the source for the video monitor. When the Grafex board is installed in an Apple II, the external input is normally connected to the Apple's video output connector and the changeover relays output connected to the system video monitor. Alternatively, two monitors could be used to simultaneously display Grafex and Apple video. The video changeover relay is software actuated and defaults on reset to the external input, allowing the Apple system to be operated normally after power up. In this way, unless the Grafex board is specifically addressed, a user need never be aware of its existence.

The timing generator, comprised of the 16 MHz crystal and IC3, IC4, IC6, IC8, IC9, IC10, and IC20 provides the various clock and control signals used in the system. All timing is derived synchronously from the 16 MHz clock. The timing generator has two modes of operation depending on whether the 7220 is executing a display cycle or a RMW (read, modify, write), cycle. These two types of cycles are differentiated by the DBIN pin of the 7220. The 7220, in turn, uses as its master clock, a 2 MHz signal labelled 2Xwc1k. This clock, as its name implies, runs at twice the display word rate and all internal timing of the 7220 is derived from this signal since 16 pixels comprise one 16 bit word of display memory, the 2Xwc1k used in this design is $2 \times 16 \times 65 \text{ ns} = 500 \text{ ns}$ or 2 MHz.

That's all the space for now. We'll continue this article next month.

HOW MUCH DO YOU KNOW ABOUT THIS RCA LV REG. CIRCUIT

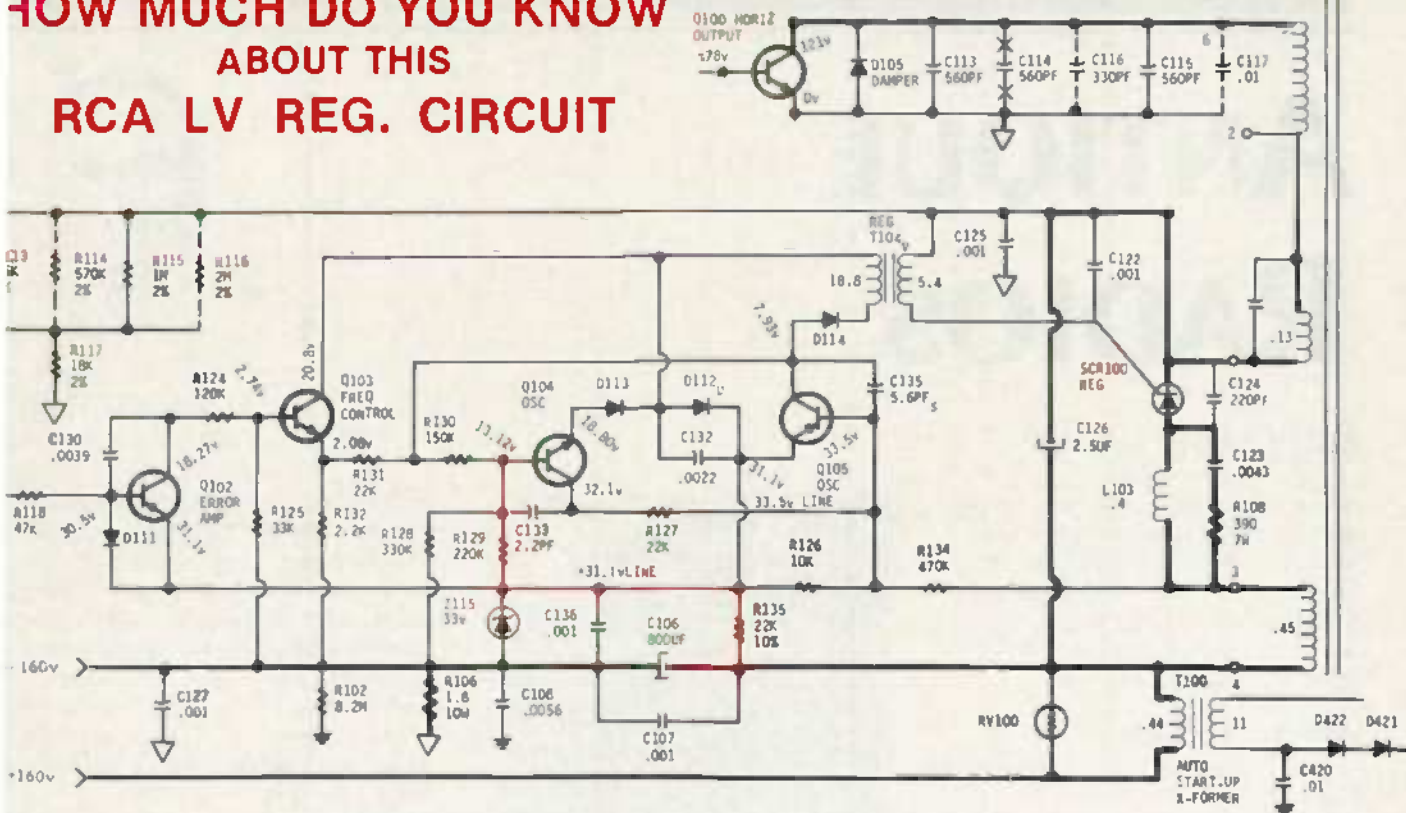

Typical of RCA CTC 85 thru 108 LV Regulator Circuits

Schematic by Diehl Engineering

How many of these questions can you answer?

- 1) Every circuit has a beginning and an ending. Where does this circuit begin?
- 2) Specifically, what is the purpose of this circuit?
- 3) What turns it on? What turns it off, or does it ever really turn off?
- 4) Does this circuit have a shut down feature? If so, which components are involved?
- 5) What would happen if Q103 were to become shorted E to C?
- 6) What purpose does Z115 serve?
- 7) What would happen if D114 became shorted?
- 8) What purpose does C126 serve? What will happen if C126 becomes open?
- 9) Is the winding between terminals 3 and 4 of the flyback a primary or a secondary winding?
- 10) What purpose does C117 serve? Exactly what does it do, and exactly how does it do it?
- 11) Exactly what do resistors R113, 114, 115, 116, and 117 do? What happens if they change value?
- 12) What occurs that causes this circuit to produce an initial start up pulse?
- 13) Why does this entire circuit become shorted and begin to destroy horiz output transistors if the regulator SCR becomes shorted?
- 14) There is exactly one safe and practical method of circumventing this LV regulator circuit for test purposes. This technique does not involve a variac. Instead, you must disconnect one wire then connect a jumper wire from terminal #4 directly to terminal #11. Which wire do you disconnect and where do you connect the other end of your jumper wire?
- 15) If SCR100 is shorted, this circuit will still "eat" horiz output transistors even if you are using a variac. Why?
- 16) Why does this circuit use a floating ground?

We publish a monthly magazine called the Technician / Shop Owners Newsletter. Each month we take a popular circuit and absolutely dissect it.

Using color coded pictorial schematics such as the one above, we "map out" every action in the overall sequence of events that must take place during each and every cycle.

Beginning with the very first "action" in the sequence (which just happens to be depicted in the above schematic) we explain exactly what is taking place. We then explain the function of every component in that portion of the circuit. After explaining the function of each component, we show you how to troubleshoot that particular "action" or function.

After reading our newsletter on this circuit, you could answer all of the above questions as fast as anyone could ask them. In fact, you will then know everything there is to know about this circuit. Including how to troubleshoot it !!

Regardless of whether you work on TV sets, stereos, radios or computers, just having the ability to "dissect" an electronic circuit (any circuit) is worth a fortune. In reality, "dissecting" is exactly what our newsletter is designed to teach you.

Because of the manner in which our newsletter is written, the subject matter that is gained from each monthly issue is so extremely broad that it will "spill over" into your everyday troubleshooting routine, and be applied to totally unrelated circuits.

This entire training program sells for only 119⁰⁰ per year (12 separate issues). Virtually every one of our subscribers agree that no other publication is as informative. By using the attached order card you can purchase the first three of fifteen issues for only 29⁰⁰. Just these three issues alone will vastly improve your knowledge of electronics.

For immediate service call your order into us at (806) 359-0329 or (806) 359-1824.

Diehl Publications, 6661 Canyon Drive Bldg. E, Amarillo, Texas 79110

ANTIQU RADIOS

Early radio history

AFTER DISCUSSING OUR ANTIQUE RADIO of the month, we'll explore some of the history of electricity, magnetism, radio, and related disciplines. It's a long history lesson, so you'll have to wait until next month for its conclusion.

Antique of the month

You'll never guess the make of the antique radio shown in Fig. 1. Actually, it's a composite—it's made up of components that weren't assembled together originally. Composite antiques like that are not unusual. During the lean 1930's, the radio enthusiast often assembled his set from other people's cast-offs. It's possible that your antique is one of those composites—which doesn't make it any less valuable as an antique.

In the 1920's and earlier, all radios were, in a sense, composites. Early radio enthusiasts had complete knowledge of both chassis and cabinet construction. If you've got one of those home-made composites, you've got a real "one-of-a-kind" that may be a valuable link in the evolution of radio.

If you have a chassis and a cabinet left over, feel free to make your own composite, as I did. Take the usual precautions pertaining to exposed high voltages, and provide some means of heat ventilation. Do a good job, and you'll have a fine conversation piece.

My composite has a cabinet made by E. T. Earl. It pre-dates the 1930's, and I got it without the original chassis; so I had to alter the cabinet to accommodate a Zenith chassis I happened to have on hand. The beautifully-worked es-



FIG. 1

cutcheon from that cabinet will go in my collection. The chassis that I used to fill the cabinet is about seven years newer than the cabinet itself. I wanted to mount a *Wave-magnet* antenna (from another Zenith) inside the cabinet as well. Unfortunately, it doesn't fit, so I may have to mount it on the back (or on the top) of the cabinet. In general, you can be a little more creative than usual when "restoring" a composite.

Early radio

In the past, we limited our discussions mostly to radios originally manufactured in the era from the early 1930's to the mid 1940's. But radios from that era were considered modern by some readers who have been involved with radio since the 1920's, or even earlier. They built their chassis from mail-



RICHARD D. FITCH
CONTRIBUTING EDITOR

order parts and instructions in radio magazines like *Modern Electrics* (an early Gernsback publication). Then they built or purchased a cabinet to house that chassis. We haven't talked much about radio before the 1920's, but that's when it really took off in a commercial sense. However, before we talk about the '20's, we'll go back even farther to gain some historical perspective on the development of the radio arts through the ages.

Ancient history

In ancient Greece, around 600 BC, the philosopher Thales noticed that rubbing a piece of amber caused it to attract small bits of material. That's the earliest record of static electricity. In Greek, the word for amber is *elektron*, and that's the root of many words we use every day.

Magnetism, too, was known in ancient times; for example, the Greek playwright Euripides mentioned, in 425 BC, that lodestone attracts iron. The word magnetism comes from the town in Asia Minor, Magnesia, where lodestones are found.

Saint Augustine discussed magnetism and electricity in the late fourth and early fifth centuries, AD, but little else happened throughout the dark and middle ages. In fact, it wasn't until the Renaissance when electrical and magnetic phenomena were again investigated in a scientific manner. William Gilbert, physician to Queen Elizabeth, built a device for detecting electricity that he called an *electroscope*. Gilbert was the first person to use the word *electric* in English. Later in the 17th

century, Sir Isaac Newton did some work with electricity, but things really took off in the 18th century.

Many phenomena were discovered then, including the difference between insulators and conductors, and the difference between "positive" and "negative" electricity. Ben Franklin performed his famous kite experiment, which proved that electricity and lightning are different manifestations of the same phenomenon; the leyden jar was discovered in 1745/6.

The leyden jar

Several investigators simultaneously discovered a device that we now consider to be the first capacitor (or as readers of this column used to say, condenser). The leyden jar is named after the Dutch town of Leyden (also spelled Leiden); leyden jars were used by all early investigators to experiment with static electricity.

The leyden jar is lined, inside and out, with thin, conductive foil; those linings are the "plates" of the capacitor, and they condense, or store, a large quantity of electricity. The leyden jar must be used on a non-conductive table top, and the glass jar must be kept dry. The jar is charged by touching a charged plate to the brass ball on top. The jar is discharged by using a wand to short the ball and the foil-lined outer surface of the jar. The wand has two brass balls connected by stiff wires; the wires extend from an insulated handle held by the experimenter.

Adams, in the late 1700's, and Matteucci, in the 1820's, worked with leyden jars. Their work centered around inducing reactions at a distance of several feet. Riess and Henry also experimented with the Leyden jar, as did Paazlow and Lodge, who worked with huge, oversized Leyden jars. Sir Oliver Lodge, with his *syntonic* (literally, in harmony with, or "tuned with") leyden jars, probably made the most important contributions to the field of radio. Variations on the leyden jar were used in many early electrical appliances.

Other discoveries of the late 1700's included Coulomb's formulas that quantify the attractive

forces of electricity, and magnetism. Galvani discovered a biological phenomenon that was the forerunner of the electrical storage cell, or battery; later that device was refined by Volta.

The 1800's

The nineteenth century was the real Golden Age of electrical discovery and invention. Among the more important discoveries were those of Oersted, who showed that an electrical current could deflect a magnet, and Faraday, who did experiments that eventually led to the electric motor.

The German Georg Simon Ohm discovered the mathematical relationship we now call Ohm's law in 1825. Later, Henry and Faraday independently discovered mutual induction, and shortly thereafter Henry discovered self-induction. Gauss built a rudimentary telegraph, and, in the U. S., Morse made a practical instrument of it. Possibly the most important theoretical breakthrough was that of James Clerk Maxwell, who found a way of mathematically relating light, electricity and magnetism.

Many useful devices were invented in the 19th century, including Alexander Graham Bell's telephone (1876), and Edison's incandescent bulb (1879). Edison also came up with the idea of placing a second element in the light bulb, and that, without a doubt, opened the door for many experimenters. However, the Edison Effect, as it was called, lay dormant for over ten years.

In 1888 Rudolf Hertz provided an experimental verification of Maxwell's theories, and that is what led to practical radio transmission as we know it. A year earlier, Hertz had demonstrated that both sender and receiver had to be tuned to the same frequency for long-distance communication to occur. And Marconi made one of the first long-distance (nine miles!) radio transmissions in 1897.

In the late 1800's the need for standardizing electrical units was recognized. The International Electrical Congress, meeting in Paris, convened a commission to study the matter in 1881.

We'll continue our look back at radio in our next column. R-E

Learn the IBM PC's secrets with the MICROPROFESSOR I/88



Students, engineers, or technicians—
Now you can learn micro-processing and understand the technology which made the IBM PC famous.

The MPF-I/88 features:

- extensive documentation
- 16-bit central processor
- full-size keyboard
- special options

Three tutorial guides cover all capabilities. The ideal training tool! If the IBM PC or micro-processing are in your future, you owe yourself an MPF-I/88. Invest now!

Only \$349.95

Plus—

- Check this box for a 10% discount when you purchase within twelve days.

ETRONIX
Dept. RE 0286
5326 9th Ave. NE
Seattle, WA 98105-3617

For immediate action call TOLL FREE:

1-800-426-1044

Full money back guarantee.

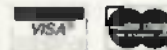

CIRCLE 260 ON FREE INFORMATION CARD

ELECTRONIC SALVAGE PARTS

Below Wholesale
Electronic Prices Slashed!

Condensors	Yokes
Capacitors	Antenna Rods
IC's	Fuses
Transistors	CATV
Diodes	Flyback
Triplers	Video Heads
Controls	Needles
Resistors	Wire
Speakers	Receiving Tubes
Chemicals	and Lots of Goodies!
Remote Control	

You name it, we've got it.
and cheaper

call or write for
free catalogue

E.S.P.

2706 Middle Country Road
Centereach, N.Y. 11720
(516) 467-9852 (800) 645-5030

CIRCLE 278 ON FREE INFORMATION CARD

FEBRUARY 1986

109

SERVICE CLINIC

I see IC's everywhere!

THE FRENCH USED TO CALL A TRANSISTOR "La bête noire avec trois pattes," or, the black beast with three legs. I guess they would call an IC "La bête noire avec quatorze pattes," or, the black beast with fourteen legs. IC's are still somewhat mysterious to many of us, but they needn't be. If you think of them in terms of functional blocks, much of that mystery evaporates with the morning dew.

For example, the ECG742 shown in Fig. 1 is a complete TV sound system with a detector and a two-watt audio output. Every TV set must have some sort of detector, as well as an audio power stage. The IC just combines them in one package, and you should troubleshoot the IC just as you would troubleshoot a circuit made up of discrete components. Using a scope, check the inputs and then the outputs. The signal at the sound detector's input should appear as on any TV set, and so should the output. And the audio stage is even easier to troubleshoot. If you find a good-sized gain, the chances are that that stage of the IC is still in good working order.

But if you're not convinced, check the voltage at each pin; a schematic of the TV you're working on is essential for doing that. If one or more of those voltages are off, chances are that the IC is bad. Otherwise you'll have to check elsewhere. A discrete component connected to the "trouble" pin may have gone bad, for example.

We find very few "weak" IC's (unlike tubes). They're almost always either good or bad, not somewhere in between. The sup-

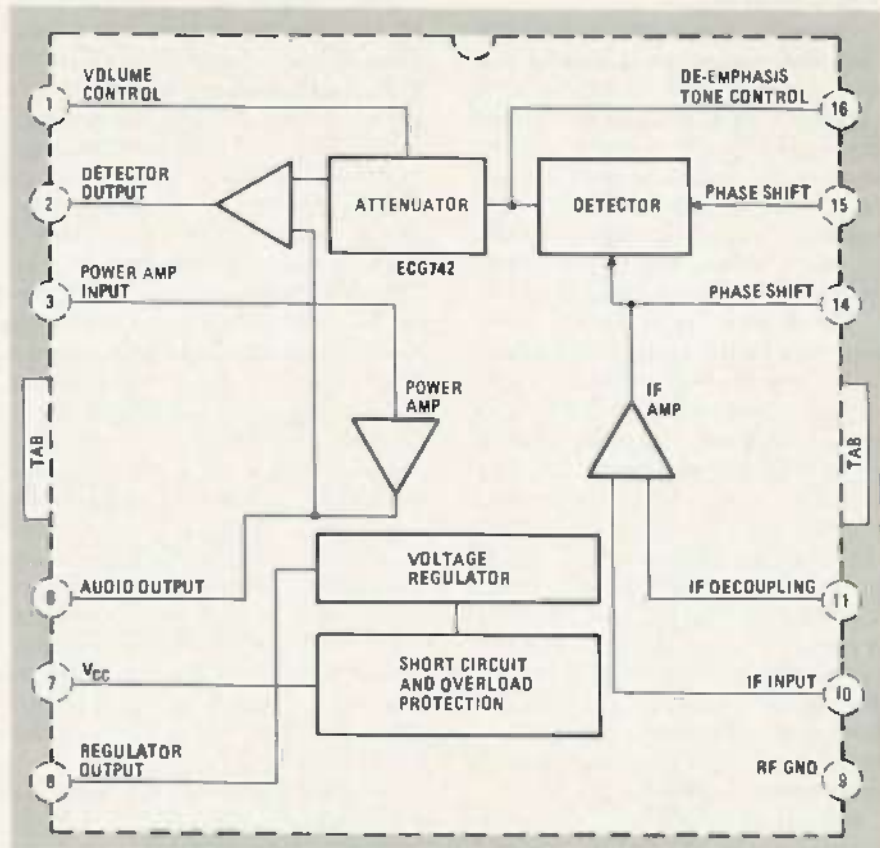

FIG. 1

ply voltage is fed to pin 11 of many—but by no means all—non-digital IC's. Always check the schematic to be sure.

Sometimes you can let your fingers do the checking. Apply a fingertip to the case of an IC you suspect is bad. Most IC's run as cool as a clam. I don't have exact figures on clams' case temperatures, but experience has shown them to be pretty cool. So, if you find a hot one (an IC, not a clam), the chances are that it has an

internal short. Of course, power IC's (as in our example in Fig. 1) may dissipate enough power to run fairly warm, or even hot.

So, the best way to check a suspect IC is with an oscilloscope. By comparing the input and output signals you can tell instantly whether the IC has any gain or not. And most analog IC's have at least some gain. Even sync-separator IC's have some perceptible difference between the input and output signals. It often helps to



JACK DARR
SERVICE EDITOR

use a known input signal (from a sweep generator, for example) for signal tracing. That makes it easier to tell whether an IC is doing the right sort of processing.

IC removal

Finding a bad IC is often the easiest part of a repair job! Removing an IC can be a real pain unless you use the right tools. Probably the best all-round tool for IC removal is the "solder-sucker" type of soldering iron. That tool has a hollow tip and a teflon-lined squeeze-bulb. You must fit the hollow tip around the leg of the IC (or any other component, for that matter) and squeeze the bulb. When the solder melts, simply release the bulb. If everything goes right, all solder from the joint will be sucked up inside the bulb. If you follow that procedure for each IC pin and do a careful job, the IC should just drop out.

But don't get frustrated if it doesn't! If you yank the IC out, you're liable to destroy the little hollow cylinder of plating that connects the top and bottom sides of a double-sided PC board. Or you might rip up some of the copper traces. So be very gentle, and assume that at least one pin, and probably a lot more, will require extra attention before the device can be safely removed.

Another IC remover that comes in handy once in a while works like this: A spring-loaded clamp is attached to the IC from the top side of the board. A soldering iron with a special tip having dual parallel bars is then pressed to the bottom of the board. The bars melt all the joints of all the pins at once, and then the spring pulls the IC out.

In the absence of fancy tools like those, clip all the legs of the IC as near the plastic package as possible. Remove the "body" of the IC, and then use needle-nose pliers to pull the pins one by one from the top of the board, while heating the pad from below with a soldering iron. It's tedious removing an IC that way, but it works. Clamping the PC board in a vertical position will allow easier access to both sides of the board.

So, don't be confused by IC's. Just think of them in terms of the functions they perform, and go on

about your troubleshooting in the usual way. Check the input and output of each stage; and if either is off, check signals at the other pins. If anything differs drastically from what is shown on the schematic, see if any external components (RC networks, for example) could be causing that difference. If not, the IC is probably bad, so replace it carefully. R-E

SERVICE QUESTIONS

B+ TOO LOW

While working on a Teknika, model 3249, I found the B+ adjust not working and the B+ voltage too high. I later found that the regulator transistor was shorted, so I replaced it. With a new one in, B+ is now too low, and I still get no reaction from the B+ adjustment. Please help!—L.W. Baltimore, MD

You have a two-stage regulator in that set, so it couldn't be simpler. The B+ adjust sets up the operating voltages of the error amplifier by altering its base voltage. The emitter, being directly coupled to the base of the regulator, causes shifts in the output voltage. Under the circumstances, I would certainly want to look at the error amp. Needless to say, there are a number of other components that must come under close scrutiny as well: both Zener and standard diodes, and so on.

WHAT KIND OF SCOPE FOR TV?

I want to buy an oscilloscope for TV servicing. What's the best kind?—M. R., Lutherville, MD.

I've always said that it's easy to pick out a wife, a suit of clothes, etc., but you've got to be careful in choosing test equipment. Seriously, there are a lot of good scopes available. Heathkit, B & K, Hickok, Tektronix, and many others all make scopes, and you can't go too far wrong with any of them. I've got six of various makes, and they're all good. My suggestion would be to try the Old Professor's *Famous Test for Whisky*: Pour some in a glass and drink it! In other words, arrange for a demonstration in your shop and try different several models. R-E

NEW IDEAS

continued from page 46

fed to output-buffer gates IC4-b and IC4-c, which are wired in parallel to provide additional drive capability. The width of the output pulse is about 150 microseconds, which should be sufficient for most TTL and CMOS circuits. If you need a longer (or shorter) output pulse, connect a precision monostable between the IC4-b-IC4-c output pins and your external circuit.

There are two other means by which IC2 may be reset. When power is initially applied to the circuit, pin 13 of IC4-a is held low for about 20 milliseconds, as determined by the R2-C3 time constant. During that time pin 11 of IC4-a is high, and that resets IC2. A RESET pulse is also generated each time momentary switch S1 is pressed. Whether it comes from S1's being depressed or from a power-up sequence, the RESET pulse is also buffered by gate IC4-d; that signal may be used to synchronize external circuitry.

The circuit may be built in any convenient manner; just be sure to keep lead lengths short. Mount the crystal near IC1, and use sockets for all IC's. If you need a highly-accurate pulse-source, substitute a 50-pF trimmer capacitor for C2 and adjust it while observing a frequency counter connected to pin 7 of IC1. You should be able to drive several TTL loads with the circuit as shown, but if more drive capability is necessary, connect a 4049 inverter in series with the output.

The MM5369 is available with several different division ratios that provide 50-Hz (MM5369EYR) 60-Hz (MM5369AA) and 100-Hz (MM5369EST) outputs. Make sure you get the correct part!

If you need an oddball reference frequency (2 Hz, 3 Hz, 5 Hz, etc.) you can alter the RESET/OUTPUT pulse rate by NANDing various combinations of IC2's outputs. For example, if you needed a 2-Hz (1/2-second) output, you'd need to count 30 pulses before resetting IC2. To do that you'd need to NAND IC2's Q2, Q3, Q4 and Q5 outputs.

—Chester C. Roher

DRAWING BOARD



ROBERT GROSSBLATT
CIRCUITS EDITOR

Z80 demo program

NOW THAT WE'VE BUILT OUR Z80 SYSTEM, the time has come, as they say in Transylvania, to bring it to life. When the circuit is powered up, the un-enlightened among your friends might get the impression that it's not doing anything. However, we in the know are perfectly well aware that it *is* doing something—it's waiting for us to tell it what to do. When it comes to microprocessors, there's one thing you should always remember: obedience and stupidity are twin virtues.

If you've done your homework and read up on the Z80's Instruction set, and programming techniques in general, you may have come to the realization that our circuit is pretty limited. We've got a fair amount of program storage space in the EPROM, but RAM storage is limited to the Z80's internal registers, and our one-way I/O leaves a lot to be desired. So can we do anything with our circuit that is at all useful?

Let's take things one step at a

time. First we'll write a short demo program to make sure the circuit is working. Then we'll talk about how we can expand the circuit to make it easier to accomplish something really useful. But before we start, I should mention that we're not going to go into the software in any great depth; we simply don't have the space. If you're familiar with any kind of programming at all—even in the BASIC language—you shouldn't have any trouble following our discussion. Otherwise you *will* have trouble; so get out those data books and start reading!

Now for the demo program. Here, and throughout the rest of this column, all numbers will be in hex, unless otherwise specified. Now, since we've got a four-bit port, let's write a program that causes the Z80 to output values from 0 to F to that port.

Software design

Writing software is similar to designing hardware. The first thing

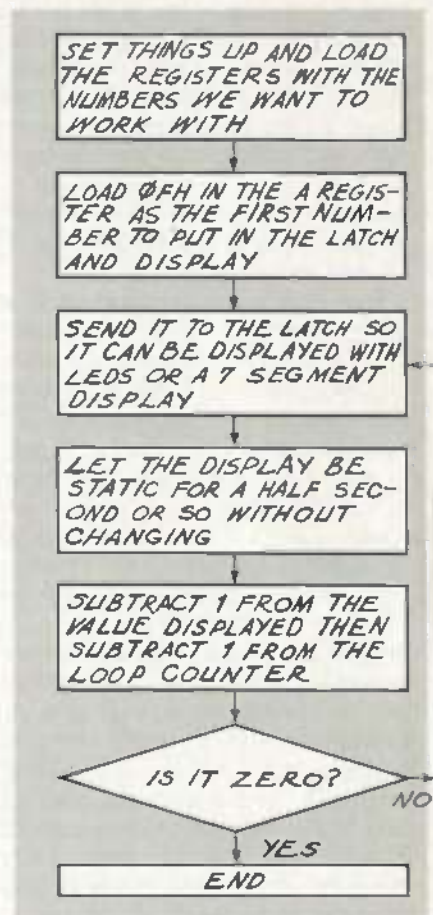

FIG. 1

TABLE 1—EXAMPLE PROGRAM

Line	Address	Op Code	Source Code	Comments
1	0000	AF	XOR A	Zero the Accumulator
2	0001	26 0F	LD H,0F	Set the display number
3	0003	2E A0	LD LA,0	Set the loop counter
4	0005	7C	LD A,H	Load the Accumulator
5	0006	D3 EF	OUT (FF),A	Send it to the latch
6	0008	C3 11 00	JP 0011	Go to delay subroutine
7	000B	25	DEC H	Decrement port count
8	000C	2D	DEC L	Decrement loop counter
9	000D	C2 05 00	JP NZ 0005	Do again if not zero
10	0010	76	HALT	End of the program
11	0011	11 83 8B	LD DE,8B83	Preset the delay loop
12	0014	1B	DEC DE	Decrement the counter
13	0015	C2 14 00	JP NZ 0014	Jump back if not zero
14	0018	C3 0B 00	JP 000B	Return if finished

to do is to get a clear idea of what you want to accomplish. With hardware you draw a block diagram; with software you draw a flowchart, like the one shown in Fig. 1. The flowchart lets you see the way the program is going to operate without getting lost in a maze of low-level details. The flow of a small program like ours is more or less intuitive, but drawing flowcharts is a good habit to get into. Remember Grossblatt's Fourth Law: *You have to know the*

rules to break the rules. In other words, don't look for shortcuts until you know where you're going.

Our flowchart is easy to understand. First we initialize things by loading appropriate values in the registers (which we'll think of as RAM). Then we send the number to be displayed to our latch. We wait for half a second, decrease the display number by one, and then do it all over again. That's repeated over and over until the displayed number is zero.

The actual program listing is shown in Table 1; the Z80 instructions should be self-explanatory now that we understand the flowchart. The final version of the program added one thing not shown in the flowchart: a loop to repeat that whole process ten times and then quit. We use the H register to store the number we want to display, the L register to keep track of the number of times we've gone through the loop, and the DE register pair to keep track of the elapsed delay time.

The first instruction, XOR A, is a neat way to clear the accumulator using only one byte of program memory. What happens is that every bit in the register is XOR-ed with itself. We could get the same result by directly loading the accumulator with zero, but doing it that way takes two bytes.

The more bytes used, the longer the program gets, the more time it takes to run, and the more memory it uses. That's not important in our demo program, but another good habit to develop is that of saving memory, increasing speed, or both, as in the present case, by using "tricks" like that. Also, ANO-ing, OR-ing, and XOR-ing a register with itself is useful for manipulating the Z80's flag bits with a single instruction. Any good book on programming the Z80 should be loaded with tricks like those. If they're not there, it's not a good book.

So, after initializing the registers, line 5 of the program sends the number to be displayed to the latch. If you're wondering why I'm using an OUT (FF), A instruction, you should re-read last month's column. The FF is the address of the port I want the number sent to.

We could actually use any number because our circuit doesn't decode I/O ports, so any our instruction will wind up sending data to the latch. In a more complex system we'd have address-decoding circuitry that would select the proper port. In our circuit, the address lines are used only to load program instructions and data from the EPROM.

Our program now jumps to the delay loop that begins at line 11. We use the delay to slow down the program so you can see the count-down on LED's. Just connect them to the outputs of the latch with 330-ohm resistors. If you're really ambitious you could build a display circuit to have the output appear on a seven-segment readout.

Without the delay loop, the program would cycle so quickly that you wouldn't be able to see any of the individual numbers. I used a full register pair to set up the delay time because the D and E registers together will allow any value up to FFFF.

Calculating the length of the delay isn't difficult. Each Z80 instruction takes one or more clock cycles, called T cycles, to execute. The number of cycles depends partly on the length of the instruction. Each trip through our delay loop takes 14 T cycles. Since we have a 1-Mhz clock, or close to it, each cycle will take 1 microsecond for a total of 14 microseconds. If we want a delay of half a second we have to generate a loop that lasts half a million microseconds. Dividing 500,000 by 14 we get 35,714, or 8B83 hex.

Normally such a delay would be set up as a subroutine, callable by other routines in the program. But since we have no RAM, we can't do a subroutine call, because the Z80 automatically stores—in RAM—the address it is to return to after executing the subroutine. So we'll have to write our program without subroutines. We simply jump to and from the delay "subroutine" using JP, rather than using CALL and RET (GOSUB and RETURN, for you BASIC programmers).

We have a few more things that we need to talk about, but not this month; unfortunately we're out of room. We'll get to those topics the next time.

R-E

SEE YOUR DEALER TODAY

FROM

Firestik
ANTENNAS
ACCESSORIES

HERE'S A TIP
THAT'S PERFECT!

AM/FM AUTO RADIO
AND CB

'Firestik' II

GOLDEN SERIES

BARE-HANDS TUNABLE
"NO TOOLS NEEDED"
HIGH PERFORMANCE ANTENNAS

ALSO ANTENNAS FOR
CORDLESS TELEPHONES
MONITOR SCANNERS

Dealer & Distributor Inquiries invited
SEND FOR FREE CATALOG

Firestik Antenna Company
2614 East Adams-Phoenix, AZ 85034

Name _____

Street _____

City _____

State _____ Zip _____

Serving the CB and
Communications Market Since 1962.

5-YEAR REPLACEMENT WARRANTY

CIRCLE 100 ON FREE INFORMATION CARD

ELECTRONIC COMPONENTS



178 PAGE
FREE CATALOG

Manufacturers of Quality
Electronic Components

- BATTERY HOLDERS & CLIPS • COILS
- CAPACITORS • CONNECTORS • FUSES
- JACKS • KNOBS • LAMPS • PLUGS
- MICROPHONES • POTENTIOMETERS
- RELAYS • RESISTORS • SWITCHES
- TRANSFORMERS • SPEAKERS • LEDS
- SEMICONDUCTORS • RF COILS

OVER 15,000 DIFFERENT ITEMS IN STOCK!

MOUSER ELECTRONICS

11433 WOODSIDE AVE., SANTEE, CA 92071

PHONE (619) 449-2222 TWX 910-331-1175

CIRCLE 117 ON FREE INFORMATION CARD

FEBRUARY 1986

113

VIDEO LINK

continued from page 55

+5.5 volts at the emitter of Q7, and check for +4.5V at the collectors of Q4 and Q5. The emitter of Q7 may show 4-7 volts—that's OK. Also, Q7 will normally run somewhat warm to the touch.

If all DC voltages check out, you can begin alignment. First, check the voltage at the collector of Q5. As you ground the base of Q6, that voltage should increase to over 10 if the modulator is working.

Next, connect the RF probe to the junction of C3 and C8. Tune L4 until Q1 starts to oscillate, as indicated by a reading of 0.5 to 1.0 volts on the VOM. Now connect the RF probe to the base of Q3 and spread or squeeze the turns of both L2 and L3 to obtain maximum voltage. Now connect the RF probe to the base of Q4 and adjust the turn spacing of L5 and L6 for a maximum voltage. Now, re-adjust L2, L3, and L4 to maximize the voltage reading. Connect the voltmeter to the base of Q5 and adjust trimmers C22 and C25 for maximum reading. Re-adjust L5 and L6.

Now connect the dummy load to J2, and connect the RF probe across that load. Adjust C22, C25, C28 and the tap positions on both L8 and L9 until no further increase in output can be observed.

If one stage has no output, the cause may be misalignment of (or circuit trouble in) the preceding stage. It may be necessary in some instances to add or subtract a turn from L2, L3, L5, or L6 if proper adjustment cannot be obtained by adjusting turn spacing. If a coil's turns are spread far apart, and the alignment calls for even more spacing, a turn should be removed. On the other hand, if a coil has to be "crushed" together, add a turn. (But make a new coil rather than splicing on more wire.)

Now tune the TV receiver to the transmitter's output frequency. You should see a blank raster when the transmitter is turned on. Connect a video signal to the input jack (J1) and adjust video level so that a stable picture is obtained. Increase the video level until tearing or rolling develops; that indicates sync-tip compression. Retune the Q4 and Q5 stages for best picture quality without tearing.

Adjust C36 for clearest audio while applying an audio signal to C38. Be careful not to overdeviate or misadjust the 4.5-MHz oscillator frequency. A frequency counter can be helpful for that. Connect it to the emitter of Q7 and adjust C36 for a frequency of 4.500 MHz with no video input (short R21 to ground).

That completes alignment and testing of the wireless video link. A very short antenna (about one inch) connected to a 51 ohm resistor makes a good limited-range antenna. For greater range, a six-inch whip antenna could be used. R-E

CURING EMI

continued from page 74

That isolating impedance is either an inductor (with a value between 50- and 500 μ H) in power-line hybrids, or, as shown in Fig. 9, a resistor (whose value is typically a few tens of ohms) in signal-line applications.

Designing transient suppressors

The most severe source of power-line transients is a lightning stroke. Therefore, most suppressors are primarily designed to protect against lightning. Most of the energy associated with a lightning stroke is in the form of common-mode current and voltage. However, due to unequal wiring parameters and the fact that common-mode suppressors are not perfectly matched (do not suppress equally), some differential-mode energy will also be present. Thus, a lightning-protection network should incorporate both common- and differential-mode protection.

Varistors, which are commonly used as suppressors on household AC power lines (117 volts), are available from a number of electronics suppliers. When selecting a varistor for a particular application, you should consider the nominal operating voltages and currents that the circuit will see, and the maximum surge voltage and current that are likely to be encountered. In addition, the suppressor must be rated to withstand the energy that it will need to dissipate. In the case of 117-volts AC, as stated previously, the most powerful transient that is likely to occur will have a peak voltage of 6000 and a peak current of up to 200 amperes: that's a fairly sizeable wallop. If the suppressor clamped that surge voltage at 500, the amount of energy that the suppressor would need to absorb would be approximately 0.8 joule. Lower clamping voltages will mean that the suppressor will have to absorb more energy.

In addition to power lines, varistors designed to protect low-voltage circuits (as low as 5 volts) are available. The selection of such a varistor follows the same general procedure as above.

Silicon avalanche suppressors also are commonly used to protect low-voltage systems. For instance, to protect sensitive CMOS devices on a PC board, a 5-volt SAS could be connected between the power and ground connections on the board. Data lines similarly could be protected by installing SAS's between the lines and ground.

The suitability of an SAS for a particular application is determined by its power rating. Those power ratings range from 500 watts to several kilowatts. An SAS with a power rating of 1000 watts, that is designed to clamp the voltage at 5, can handle surge currents of up to 200 amperes. R-E

SATELLITE-TV RECEIVER

continued from page 60

At this point you are ready to attach a TV (or a video monitor) and an audio amplifier to the receiver. **CAUTION:** Disconnect the receiver from the AC voltage source while hooking up everything. After everything is hooked up, reconnect the receiver to the AC voltage and follow these steps:

1—Turn on the receiver and adjust the TRANSPONDER TUNING control to receive a picture. Adjust the SKEW control and the POLARITY switch for the best picture.

2—Adjust C71 for maximum contrast in the picture. Gently compress and expand L2's coils slightly while observing the picture on several different channels. Adjust L2 for the best picture.

3—Adjust R109 for the best picture. Video level is controlled by that potentiometer, as is contrast. If it is adjusted to too high a value, a buzzing sound may be heard in the audio when lettering appears on the screen.

4—Set the SUBCARRIER TUNING control to the center position, and set the BANDWIDTH switch to WIDE. If no sound is heard, adjust R112 slightly. If nothing but noise is heard, adjust C72 until the audio comes through. That can be a "touchy" adjustment. Get it close, and then try fine-tuning the front-panel control. Once the sound is heard, readjust R112 for best audio.

5—Aim your dish at Satcom F-3, and tune in the appropriate transponder for either WTBS or WGN. Set the BANDWIDTH switch to NARROW, and then slowly turn the SUBCARRIER control counterclockwise from center. Several FM-radio programs should be heard. Adjust R111 for the best sound.

6—Adjust R107 for full-scale meter deflection when receiving the strongest station in your area.

7—Trimmers R102 and R104 may need to be adjusted slightly in order to make R103 correspond with the markings on the front panel. Set the TRANSPONDER TUNING control to the number of the lowest transponder channel received in your area and adjust R104 for best reception. Then set the panel control to the number of the highest channel in your area and adjust R102. Those adjustments will interact slightly, so go back and forth until both channels come in correctly.

At this point you can sit down and relax: you've got a fully-functional satellite-TV receiver! We have stuck pretty much to the basics in this article, but if you need more information, be sure to consult the manuals that accompany your LNA, down-converter, feedhorn and dish. Also, see "Installing Your TVRO," which appeared in the June and July 1985 issues of *Radio-Electronics*. R-E

MARKET CENTER

FOR SALE

RESISTORS 1/4W, 1/2W 5% C.F. 3 cents, 1% Metal-film, custom wirewounds, capacitors and other components. **JR INDUSTRIES**, 5834-H Swancreek, Toledo, OH 43614.

TUBES new, unused. Send self-addressed, stamped envelope for list. **FALA ELECTRONICS**, Box 1376-2, Milwaukee, WI 53201.

DESCRAMBLERS for downconverters. High gain. Send \$2.00. **RB ELECTRONICS**, P.O. Box 643, Kalamazoo, MI 49005.

ELECTRONICS catalog. Over 4,500 items. Parts & components. Everything needed by the hobbyist or technician. \$2.00 postage & handling (States only), refundable with first \$15.00 order. **T & M ELECTRONICS**, Dept. R, 472 East Main Street, Patchogue, NY 11772. (516) 289-2520.

TV tunable notch filters, free brochure. **D.K. VIDEO**, Box 63-602S, Margate, FL 33063. (305) 752-9202.

BUGGED? Wiretapped? Find out fast. Countermeasures equipment catalog \$1. **CAPRI ELECTRONICS**, Route 1R, Canon, GA 30520.

ASSORTMENT #103—consisting of **TDKO** coils 144LY-120K, 520 HN-3000023, **BKAN-K5552AXX** (2); **PCB**; transistors 2N3904 (2) **BFO85** (sub); IC's 7812, 74123, MC1330A1P; Diodes 1N914, 1N5231B. Only \$25.00. Coils (only) \$8.00/Set. **AC adapter** \$6.00. **Free shipping. MC/VISA/COD.** Toll Free 1-800-821-5226 Ext. 426 (orders). **JIM RHODES, INC.**, 1025 Ramsey Lane, Kingsport, TN 37660.

LASERS and nightvision surplus components. Free catalog. **M. J. NEAL COMPANY**, 6672 Mallard Ct., Onant, OH 43146.

CABLE-TV converters and descramblers. Low prices, quality merchandise. we ship C.O.D.. Send \$2.00 for catalog. **CABLETRONICS UNLIMITED**, P.O. Box 266, South Weymouth, MA 02190.

Quality Microwave TV Antennas

Multi-Channel 1.9 to 2.7 GHz
40dB Gain True Parabolic 20 Inch Dish
Complete System \$84.95 (Shipping Incl.)
Dealerships, Qty. Pricing, Replacement Parts

Philips-Tech Electronics
P.O. Box 34772 • Phoenix, AZ 85067
(802) 847-7700 (3.00 Credit all phone orders)
MasterCard • Visa • COD

LIFETIME WARRANTY

CB'ERS only: antennas, radios, modulators, voice scramblers, frequency expanders, modifications, goody boxes, professional repairs, much more! **free catalog. PRESIDENT CB SALES**, 101 W. Adams-12, Long Beach, CA 90805. (213) 631-3552.

RESTRICTED technical informational: electronic surveillance, schematics, locksmithing, covert sciences, hacking, etc. **Huge selection. Free brochure: MENTOR-Z**, 135-53 No. Blvd., Flushing, NY, 11354.

TUBES, name brands, new, 80% off list. **KIRBY**, 298 West Carmel Drive, Carmel, IN 46032.

ZENITH SSAVI Manual. Original manual used by technicians. Theory of scrambling, schematics, parts list, repair for UHF and cable. For speedy delivery send \$15.00, cash or money order. **BAY STATE ELECTRONICS**, P.O. Box 263, Accord, MA 02018.

FREE importer accessories catalog, video audio, others. With business card write. **17 BANNER COURT**, East Brunswick, NJ 08816.

MASTERCARD AND VISA are now accepted for payment of your advertising. Simply complete the form on the first page of the Market Center and we will bill.

OLDTIME radio programs on high quality tapes. Comedy! Adventure! Music! Free catalogue. **CARL F. FROELICH**, Heritage Farm, New Freedom, PA 17349.

CABLE-TV Secrets—the outlaw publication the cable companies tried to ban. **HBO, Movie Channel, Showtime, descramblers, converters, etc.** Suppliers list included. \$8.95. **CABLE FACTS**, Box 711-R, Pataskala, OH 43062.

ELECTRONICS, exclusives, surplus and more. Send \$1.00 (refundable) for two discount catalogs. Add another \$1.00 and get 15 assorted transistors! **JELKINS**, 311 Shirley Street, Boston, MA 02152.

5-BIT 5 MHz A/D converter priced at \$5.00 per bit—hand selected 0.5% Vishay resistors give 10-bit accuracy. Order DA175, \$25.00 each. 2 1/4" square module. **DIPAC ASSOCIATES**, 645 Executive Ctr. Dr. #204, West Palm Beach, FL 33401.

CLASSIFIED AD ORDER FORM

To run your own classified ad, put one word on each of the lines below and send this form along with your check to:

Radio-Electronics Classified Ads, 200 Park Avenue South, N.Y., N.Y. 10003

PLEASE INDICATE in which category of classified advertising you wish your ad to appear. For special headings, there is a surcharge of \$23.00.

{ } Plans/Kits () Business Opportunities () For Sale
{ } Education/Instruction () Wanted () Satellite Television

Special Category: \$23.00

PLEASE PRINT EACH WORD SEPARATELY, IN BLOCK LETTERS.

(No refunds or credits for typesetting errors can be made unless you clearly print or type your copy.) Rates indicated are for standard style classified ads only. See below for additional charges for special ads. **Minimum: 15 words.**

1	2	3	4	5
6	7	8	9	10
11	12	13	14	15 (\$42.75)
16 (\$45.60)	17 (\$48.45)	18 (\$51.30)	19 (\$54.15)	20 (\$57.00)
21 (\$59.85)	22 (\$62.70)	23 (\$65.55)	24 (\$68.40)	25 (\$71.25)
26 (\$74.10)	27 (\$76.95)	28 (\$79.80)	29 (\$82.65)	30 (\$85.50)
31 (\$88.35)	32 (\$91.10)	33 (\$94.05)	34 (\$96.90)	35 (\$99.75)

We accept MasterCard and Visa for payment of orders. If you wish to use your credit card to pay for your ad fill in the following additional information (Sorry, no telephone orders can be accepted.):

Card Number

Expiration Date

Please Print Name

Signature

IF YOU USE A BOX NUMBER YOU MUST INCLUDE YOUR PERMANENT ADDRESS AND PHONE NUMBER FOR OUR FILES. ADS SUBMITTED WITHOUT THIS INFORMATION WILL NOT BE ACCEPTED.

CLASSIFIED COMMERCIAL RATE: (for firms or individuals offering commercial products or services) \$2.85 per word prepaid (no charge for zip code). **MINIMUM 15 WORDS.** 5% discount for same ad in 6 issues, 10% discount for same ad in 12 issues within one year, if prepaid. **NON-COMMERCIAL RATE:** (for individuals who want to buy or sell a personal item) \$2.30 per word, prepaid... no minimum. **ONLY FIRST WORD AND NAME** set in bold caps at no extra charge. Additional bold face (not available as all caps) 50¢ per word additional (20% premium). Entire ad in boldface, add 20% premium to total price. **TINT SCREEN BEHIND ENTIRE AD:** add 25% premium to total price. **TINT SCREEN BEHIND ENTIRE AD PLUS ALL BOLD FACE AD:** add 45% premium to total price. **EXPANDED TYPE AD:** \$4.30 per word prepaid. All other items same as for STANDARD COMMERCIAL RATE. **TINT SCREEN BEHIND ENTIRE EXPANDED TYPE AD:** add 25% premium to total price. **TINT SCREEN BEHIND ENTIRE EXPANDED TYPE AD PLUS ALL BOLD FACE AD:** add 45% premium to total price. **DISPLAY ADS:** 1" x 2 1/4" — \$310.00; 2" x 2 1/4" — \$620.00; 3" x 2 1/4" — \$930.00. **General Information:** Frequency rates and prepayment discounts are available. **ALL COPY SUBJECT TO PUBLISHERS APPROVAL. ADVERTISEMENTS USING P.O. BOX ADDRESS WILL NOT BE ACCEPTED UNTIL ADVERTISER SUPPLIES PUBLISHER WITH PERMANENT ADDRESS AND PHONE NUMBER.** Copy to be in our hands on the 12th of the third month preceding the date of the issue. (i.e., August issue copy must be received by May 12th). When normal closing date falls on Saturday, Sunday or Holiday, issue closes on preceding working day.

Govt. SURPLUS ELECTRONIC EQUIPMENT CATALOG

New ITEMS . . . New BARGAINS!
FREE SEND TODAY FOR FREE COPY
OF CATALOG WS-85 AND
SUPPLEMENT • ADDRESS: DEPT RE

FAIR RADIO SALES
1016 E. EURIKA • Box 1105 • LIMA, OHIO • 43022

CABLE-TV source book—a complete listing of suppliers for hard-to-find converters, descramblers, technical information, schematics and much more. Full refund if not satisfied. Send \$4.95 to **CABLE**, Box 12505-R, Columbus, OH 43212.

MICROWONDERLAND. Commodore computer's parts! KIM-1 computers, accessories! Thousands IC's by mail! Free 64KORAM sets! Discounts! Catalog—\$3.00! **K. BOUFAL—CONSULTING SERVICES**, Fitzwater, Philadelphia, PA 19147. (215) 925-6469.

TECNICA 140 channel cable converter for fully remote sound and video unit only \$149.00. Jerrold LCC58 converter only \$79.00. Jerrold ORZ450 converter 90 channel auto tuning only \$79.00. All units carry full manufacturer's warranty. Specials while they last. For catalog send \$3.00. Thanks **REDCOAT ELECTRONICS**, P.O. Box 28504, Jamaica, NY 11428. (718) 459-5088.

LINEAR parts, tubes, transistors—MRF454 \$16.00, MRF455 \$12.00, MRF477 \$11.00, MRF492 \$18.00. Catalog, **RFC**, Box 700, San Marcos, CA 92069. (619) 744-0728.

SCHEMATICS: radio receivers 20's/60's. Send brandname, model number, SASE. **EARL SCARAMELLA**, Box 1, Woonsocket, RI 02895-0001.

TEST equipment, reconditioned. For sale, \$1.25 for catalog. **WALTER'S**, 2697 Nickel, San Pablo, CA 94806. (415) 724-0587.

CATALOG TV descramblers, cable converters, microwave converters, satellite systems, many types, kits or built. \$1.00 **MINUTE KITS**, Box 531, West S.O. Bronx, NY 10461.

CABLE-TV converters—All major brands. Wireless remotes with volume, wired remotes. Cable and video accessories. Cablemaster distributor. Lowest prices. Ship C.O.O. Catalogs \$3.00, **SONE ASSOCIATES**, 5 Broadway, Suite 201, Troy, NY 12180. (518) 274-0608.

WRITE FOR **McGEE'S** SPEAKER & ELECTRONICS CATALOG

1001 BARGAINS IN SPEAKERS
toll free 1-800-346-2433 for ordering Only.
1901 MCGEE STREET KANSAS CITY, MO. 64108

100W audio amplifier. Less cabinet and power supply. \$35 assembled. **GIL ELECTRONICS**, Box 1628, Soquel, CA 95073.

PRINTED circuit artwork developed from your schematics & packaging considerations. Professional, reasonable, fast! OEM inquiries invited! **PRINTED CONCEPTS**, (414) 442-4548.

CABLE-TV filters for elimination of undesirable signals (50 dB notch) Channels available: 2 through 8; 14(A) through 20(I). Send \$20.00 each. Money back guarantee. Quantity discounts. **CATV**, Box 17621, Plantation, FL 33318.

ELECTRONICS circuit analysis program Commodore-64. Disk tape only \$27.00. **INFO COMPUTERCATIONS**, Box 79, Farmington, CT 06032.

BREAKING your windows may be burglars' only entrance into your vehicle with this security system. Send \$5.50 for plans **A & A ENTERPRISE**, P.O. Box 6818, Biloxi, MS 39532.

SELL blank video cassettes. Super high grade Olympia VHS T-120. Fully guaranteed. Only \$3.49 your cost. Order in lots of ten. Add \$5.00 shipping & handling each order. **STRANDBERG**, 1001 S. ELM Street, Greensboro, NC 27406. Telephone (919) 274-3775. Check, M.O., VISA or MasterCard account number & expiration date.

RESISTORS—any value/quantity, 1/4 watt \$0.01, 1/2 watt (\$1.00 minimum). Quantity discounts, 1,000 plus. Send wattage(s), value(s), quantity(s), and remittance. **T.O.R.C.C.C. ELECTRONICS**, Box 47148, Chicago, IL 60647. (312) 342-9171.

CABLE and Subscription TV secret manual. Build your own descramblers, converters. Instructions, schematics, for sinewave, inband/outband gated sync, SSAVI—(HBO, Showtime, Cinemax, UHF, etc.) Send \$8.95 to **CABLETRONICS**, Box 30502R, Bethesda, MD 20814.

ADAPT any CRT tester to test all CRT's. Patented kit w/sockets/manual. Money back guarantee. Charge-card/CODs. Phone today for fast shipment. \$59.95. 1-800-331-9658. **DANDY ELECTRONICS**, 2323 Gibson, Muskogee, OK 74403.

GIANT electronics parts grab bag! \$5 postpaid. All new parts. Resistors, ICs, caps, transistors, coils, Zeners, etc. Prime quality components!! Big assortment. Money back guarantee! GE Ni-Cad sticks: 7.2VDC—1.2 AH. New! S6 Motorola full wave bridge: MOA920A7. Mini size. 1.5 amps 600 PIV. Special: 2-\$1 or 10-\$4 Postpaid. Write for new catalog. **ODD BALL ELECTRONICS**, P.O. Box 879, Duncanville, TX 75138.

DESCRAMBLER plans. New design decodes gated sync suppressed signals—newest pilotless method. Circuit boards, most parts from Radio

FREE!



CONSUMER ELECTRONIC PARTS CATALOG

Specializing in
**JAPANESE
SEMI-CONDUCTOR
AND
REPLACEMENT
PARTS**

Call
or Write

EAST COAST TRANSISTOR

2 Marlborough Road • W. Hempstead, N.Y. 11552
TOLL FREE 1-800-645-3516 | IN NEW YORK 1-800-632-3323

CIRCLE 272 ON FREE INFORMATION CARD

Now! A triple output lab power supply for \$149.95.



For \$149.95, this lab quality power supply gives you 3 completely isolated outputs: two variable 1.5-20 VDC at 0.5 amp and a fixed 5 VDC at 1 amp — the same as the \$300 units. The MFJ-4002 is American made and designed for heavy use.

You'll get plenty of voltage and current for your analog and digital circuits. It's ideal for education, circuit design, product development, testing, quality control and production.

You can connect the outputs in series or parallel for higher voltage or current. It's short circuit protected, has excellent line regulation (typically 0.01%/V) and load regulation (typically 0.1%). Two large 3 inch precision meters, monitor voltage and current simultaneously and are lighted for easy reading. It's ruggedly built with heavy gauge aluminum so you'll get many years of trouble free service. 12 x 3 x 6 inches. 110 VAC with 3 wire safety plug.

800-647-1800

Order from MFJ and try it. If not satisfied, return within 30 days for refund (less shipping).

One year unconditional guarantee.
Order today. Call TOLL FREE 800-647-1800. Charge VISA, MC or mail check, money order.

MFJ

MFJ Enterprises, Inc.
921 Louisville Road
Starkville, MS 39759

CIRCLE 105 ON FREE INFORMATION CARD



One tree can make
3,000,000 matches.



One match can burn
3,000,000 trees.



A Public Service of The Ad Council
The Advertising Council

Shack. Detailed theory, drawings, schematics, instructions \$14.95 plus \$2.00 shipping. **DIRIJD CORR.**, Box 212, Lowell, NC 28098.

CIRCUIT boards: Your artwork, quick delivery, reasonable. **ATLAS CIRCUITS**, Dept. A, P.O. Box 892, Lincolnton, NC 28092. (704) 735-3943.

PICTURE flyer lists quality electronic surplus at low prices. Since 1970. Send for the last 3 issues. **STARTRONICS**, Box 683, McMinnville, OR 97128.

CB MODIFICATIONS

Increase channels, range, privacy! We specialize in frequency expanders, speech processors, FM converters, PLL & slider tricks, how-to books, plans, kits. Expert mail-in repairs & conversions. 16-page catalog \$2.

CBC INTERNATIONAL, P.O. Box 31500RE, PHOENIX, AZ 85046 (602) 996-8700

WHOLESALE audio, video, telephone accessories, antennas, cartridges. Free catalog. (718) 897-0509. **D & WR**, 68-12 110 Street, Flushing, NY 11375.

CABLE and satellite equipment. Major brands, wholesale prices. Free catalog. **HMR SALES**, 221 East Camelback, Phoenix, AZ 85012. (602) 993-0398

Ti-99 4A software/hardware bargains. Hard-to-find items. Huge selection. Fast service. Free catalog. **DYNA**, Box 690, Hicksville, NY 11801.

PLANS AND KITS

CATALOG: Hobby/broadcasting/1750 meters Ham CB: transmitters, amplifiers, antennas, scramblers, bugging devices. more! **PANAXIS**, Box 130-F2, Paradise, CA 95969.

CABLE-TV Converters: Jerrold products include "new Jerrold Tri-Mode", SB-3, Hamlin, Oak VN-12, M-35-B, Zenith, and more. UHF Deluxe II kits. (Quantity discounts) 60 day warranty. Repairs of cable converters. For last service C.O.D. orders accepted. Send S.A.S.E. (60 cents postage), or call for info., (312) 637-4408. **HIGGINS ELECTRONICS**, 5143 W. Diversey, Chicago, IL 60639. No Illinois orders accepted.

BUILD this five digit panel meter and squarewave generator including an ohms, capacitance and frequency meter. Detailed instructions \$2.50. Refundable plus 50 cents. **BAGNALL ELECTRONICS**, 179 May, Fairfield, CT 06430.

UHF gated-pulse descrambler plans with simulated stereo output. Watch your favorite movies with the realism of stereo. Booklet contains detailed schematics, instructions & theory. \$12.00 **DEL-PHONE INDUSTRIES**, Box 150, Elmont, NY 11003.

PROJECTION TV...convert your TV to project 7 foot picture...results comparable to \$2,500 projectors...total cost less than \$30.00...plans and 3" lens \$19.95...illustrated information free. **MACROCOMA-GE**, Washington Crossing, PA 18977. Creditcard orders 24 hours (215) 736-3979.

CRYSTAL radio sets, plans, parts, kits. Catalog \$1.00. **MIDCO**, 660 North Dixie Highway, Hollywood, FL 33020.

HI-FI speaker kits, auto speaker systems and speaker components from the world's finest manufacturers. For beginners and audiophiles. Free literature. **A & S SPEAKERS**, Box 7462R, Denver, CO 80207. (303) 399-8690.

UNCYPHERS American and Canadian satellite or cable, latest technology available. Plans & boards. Kits or complete. Send \$5.00 for catalog. Refundable on order to **PILGRIM VIDEO PRODUCTS**, Box 203, Oak Street, Pembroke, MA 02359.

ROBOT control board. Build your own for under \$50.00. Let your computer control 8 lights, motors, or appliances. **ALEX HOCHHAUSL**, 868 Park Ave., Huntington, NY 11743.

MASTERCARD AND VISA are now accepted for payment of your advertising. Simply complete the form on the first page of the Market Center and we will bill.

CABLE-TV

WE'LL MATCH OR BEAT ANYONE'S ADVERTISED RETAIL OR WHOLESALE PRICES!

BONANZA!

ITEM	SINGLE UNIT PRICE	DEALER 10-UNIT PRICE
RCA 36 CHANNEL CONVERTER (CH. 3 OUTPUT ONLY)	29.95	18.00 ea.
PIONEER WIRELESS CONVERTER (OUR BEST BUY)	88.95	72.00 ea.
LCC-58 WIRELESS CONVERTER	92.95	76.00 ea.
JERROLD 450 WIRELESS CONVERTER (CH 3 OUTPUT ONLY)	105.95	90.00 ea.
SB ADD-ON UNIT	109.95	58.00 ea.
BRAND NEW — TRIMODE UNIT FOR JERROLD'S	Call for specifics	
MINICODE (N-12)	109.95	58.00 ea.
MINICODE (N-12) VARISYNC	119.95	62.00 ea.
MINICODE VARISYNC W/AUTO ON-OFF	179.95	115.00 ea.
M-35 B (CH. 3 OUTPUT ONLY)	139.95	70.00 ea.
M-35 B W/AUTO ON-OFF (CALL FOR AVAILABILITY)	199.95	125.00 ea.
MLD-1200-3 (CALL IF CH 2 OUTPUT)	109.95	58.00 ea.
INTERFERENCE FILTERS — CH. 3	24.95	14.00 ea.
JERROLD 400 OR 450 REMOTE CONTROLLER	29.95	18.00 ea.
ZENITH SSAVI CABLE READY (DEALER PRICE BASED ON 5 UNITS)	225.00	185.00 ea.
SPECIFY CHANNEL 2 or 3 OUTPUT Other products available — Please Call		

Quantity	Item	Output Channel	Price Each	TOTAL PRICE
SUBTOTAL				
Shipping Add \$3.00 per unit				
COD & Credit Cards — Add 5%				
TOTAL				

California Penal Code #593-D forbids us from shipping any cable descrambling unit to anyone residing in the state of California.

Prices subject to change without notice.

PLEASE PRINT

Name _____

Address _____ City _____

State _____ Zip _____ Phone Number () _____

Cashier's Check Money Order COD Visa Mastercard

Acct # _____ Exp. Date _____

Signature _____

FOR OUR RECORDS

DECLARATION OF AUTHORIZED USE — I, the undersigned, do hereby declare under penalty of perjury that all products purchased, now and in the future, will only be used on cable TV systems with proper authorization from local officials or cable company officials in accordance with all applicable federal and state laws.

Dated _____ Signed _____

Pacific Cable Company, Inc.

7325 1/2 RESEDA BLVD., DEPT. #10 • RESEDA, CA 91335
(818) 716-5914 • No Collect Calls • (818) 716-5140

IMPORTANT: WHEN CALLING FOR INFORMATION
Please have the make and model # of the equipment used in your area. Thank You

SATELLITE TELEVISION

BUILD your own Satellite-TV receiving system and save! Instruction manuals, schematics, circuit boards, parts kits! Send stamped envelope for complete product listing: XANDI, Box 25647, Dept. 21X, Tempe, AZ 85282.

SATELLITE systems \$449. Name brands. Quantity discounts. Information \$1.00. Catalog \$2.00. **STAR-LINK, INC.,** 2603-16R Artie, Huntsville, AL, 35805.

ENJOY satellite television. Save money with easy, guaranteed, do-it-yourself antenna plans kits. Complete systems also available from Uniden, Raydx & Winegard. Send \$1.00 for catalog or \$8.95 for "Consumer Guide to Satellite Television" GPI-54, Box 9108, Missoula, MT 59807.

DON'T trade in old satellite-TV receiver to get remote control. Channel Wizard™ remotely controls tuning, polarity, and connects from outside satellite receiver. IR version including transmitter, \$69.00 assembled. \$39.00 kit. Wired version \$39.00 assembled. \$24.95 kit. Add \$2.00 shipping. Specify PRI or PRIL. Send M.O. or cashier's check to: **ORANGEBURG TECHNOLOGIES, INC.,** 1830 Five Chop Rd., Orangeburg, SC 29115. Send self-addressed stamped envelope for info.

SATELLITE TV VIEWERS

Get the most complete weekly listings. Send \$1 for sample copy.



P.O. Box 308E, Fortuna, California 95540
800.358.9977 (U.S.) • 800.556.8787 (Call.)
707.725.8476 (all others)

Save hundreds of \$. Install your own satellite system. Complete instruction includes installation and tuning \$9.95. Catalog of satellite systems and accessories. Top brand, low prices. \$5.00 **B & T ELECTRONICS,** Box 3156 Grand Rapids, MI 49501.

MASTERCARD AND VISA are now accepted for payment of your advertising. Simply complete the form on the first page of the Market Center and we will bill.

SUPER LNA kits, dx TV preamps, microwave components, IR detectors. **LSI,** Box 7553, Jackson, MS 39204.

SPECIAL-satellite receivers, Uniden 1000 only \$279.00, owners manual included; great for updating your older system. Certified check money order **LEE'S TV,** Box 234, Syracuse, KS 67878.

THE next generation of satellite systems is here! Popular Echostar system, scramble-ready \$599.00 complete! With installation guide. **VISA-Mastercard 2002 INNOVIA, INC.,** Box 2002, Gardnersville, NV 89410. (800) 626-2828 ext. 519.

THE LNA specialist! Brand name, lowest noise, lowest prices! We will not be undersold! Send for prices: **LNA, 201 E Southern, Suite 100,** Tempe AZ 85282.

E-Z Satellite Kit™. Complete satellite system \$995.00 and \$1995.00 computer print-out of your location \$9.95. **MasterCard/VISA, IN-X-SALES,** Box 45, Tilton, NH 03276. (603) 286-3082

THE BEST PLACE TO BUY, SELL OR TRADE NEW AND USED EQUIPMENT

NUTS & VOLTS MAGAZINE
BOX 11111 E • PLACENTIA, CA 92670
(714) 632-7721

Join Thousands of Readers Nationwide Every Month

ONE YEAR U.S. SUBSCRIPTIONS
\$10.00 - 1st Class • \$11.00 - 1st Class
\$31.00 - Lifetime - 1st Class

MAIL SEND COMPLETE LISTINGS BY PHONE
EXAMINE & OFFICE VISIT EVIDENCE
PUBLICATIONS PLANS - SERVICES

BUSINESS OPPORTUNITIES

MECHANICALLY inclined individuals desiring ownership of small electronics manufacturing business—without investment. Write: **BUSINESSES,** 92-R, Brighton 11th, Brooklyn, NY 11235.

RECOVER pure gold from old circuit boards, computers, electronic junk. Easy method. Send \$5.00 **RECYCLING,** Box 11216R, Reno, NV 89510-1216.

PROJECTION TV..make \$\$\$s assembling projectors...easy...results comparable to \$2,500 projectors...your total cost less than \$200...plans, 6" lens & dealers information \$17.50. Illustrated information free...**MACROMA-GFX** Washington Crossing, PA 18977. Creditcard orders 24 hours (215) 736-2880.

YOUR own radio station! AM, FM, TV, Cable Licensed/unlicensed **BROADCASTING,** Box 130-F2, Paradise, CA 95969.

BIG PROFITS ELECTRONIC ASSEMBLY BUSINESS

Start home spare time investment knowledge or experience unnecessary. **BIG DEMAND** assembling electronic devices. Sales handled by professionals. Unusual business opportunity.

FREE: Complete illustrated literature
BARTA, RE-O Box 248
Wainut Creek, Calif 95197

INVENTORS

INVENTORS can you profit from your idea? Call **AMERICAN INVENTORS CORPORATION** for free information. Over a decade of service. 1-800-338-5656. In Massachusetts call (413) 568-3753.

VIDEOTAPES CONVERSION

OVERSEAS videotapes to American, viceversa. Dual system videos, televisions, discounted. **APPLE,** Box 642, NY 11377. (718) 507-5800.

LOST

LOST! One 24-hour, 24-karat golden day. Each hour studded with 60 diamond minutes. Each minute studded with 60 ruby seconds. But don't bother to look for it. It's gone forever. That wonderful golden day that I lost today.—**DENNIS E. WAITLEY.**

MICRO MART

808 Central Ave.
Westfield, N.J. 07090
(201) 654-8088

- 15 Pin Header & Mating Socket. \$1.00
- Vert. MTPC 5/1.00
- 158 Pin Centers 5/1.00
- Crystal Clock Oscillator 50
- 3.00V 35V AXIAL 1/2" x 38" 2.95
- Cells For Radio Etc's Feb. 84 TV Project, Toko # S T-1, T-2, L-1 (12uM) & L-2 (071uM) Complete Set Of All 4 Cells 6.50
- MC1330—Prime Model 2/1.00
- BFO-85 Transistor 1.50
- Disc Caps .001u 20/1.00
- 74123—Primg (Nap) 3/1.00
- 470uf 35V (Radial) 4/1.00
- 470uf 16V (Lead) 4/1.00
- 2N3904 10/1.00
- 2N3806 10/1.00
- 1N914 40/1.00
- 1N4148 40/1.00
- 1N5211 B 15 1V Zener Diodes 5/1.00
- Voltage Regulators (Prime To 220) 7805 20/1.00
- 7812 7824 7805 7812—Mix of Match 3/1.00
- Micro Isolators For TO-220 Pkg 20/1.00
- Voltage Regs. (Unmarked, 60% Prime) May Include Power Reg. & Adjus. 15/1.00
- 78L08 Voltage Reg (DM105, TO-92) 20/1.00
- PN2222A 20/1.00
- 2N3506 50
- 2N5306 20/1.00
- 18 Cent (1.15) Per IC TTL
- 7403 74126
- 7401 74115
- 7410 74174
- 7437 74176
- 7438 74195
- 7440 74107
- 18 Cent (1.15) Per IC 74LSXX
- 74LS92 74LS32
- 74LS08 74LS154
- 74LS10 74LS27
- 74LS11 74LS257
- 74LS20 74LS273
- 20 Cent (.20) Per IC CMOS
- 4001 B 4011 B 4050B, 4051B
- MC330 (DTL) 10/1.00
- Opto Isolator (H) 1G2-6 Pin IC Specs. 40
- 2716 Eprom 1.45
- 2732 Eprom 1.95
- 2764 Eprom 2.45
- 2716 EPROM 4.95
- 250K Drain 150ns Prime Hitch, Ideal For Mac Upgrades & Expansion Projects 6.95
- 8243 I/O Expander IC W/Specs. 2.95
- UDM 6118 (Display Driver IC) Specs 85
- UDM 6128 95
- UCN 4118B (Char. Pos. Dr. Clock IC) Specs 85
- UCN 4801 16 Chan Bi-Mos Latch/Driver 45
- M339 45
- M380 (ULN220L) 45
- 865 Timers (T) 4/1.00
- NE555 (Dual Timer-Mono) 4/1.00
- 741 Op Amp 41.00
- LM1310 (Unmarked, Tested) 50

- LM1889 95
- LM3900 15
- AM/FM Radio IC (P2204 W/Specs) Hobby 15/1.00
- IC Sockets
- 8 Pin/.07 14 Pin/.13 18 Pin/.16 16 Pin/.17 20 Pin/.19 22 Pin/.21 24 Pin/.22 28 Pin/.24 40 Pin/.39 7 Segment Display 8 Common Cath 15
- 7 Segment Display 8 Common Anode 65
- 16 State LED's 3/1.00
- Jumpo Red LED's Diffused Lens, Primg 100 15
- All 100% Prime-1/5/1, 100%/6, 1000/\$37.50
- LED Mounting Clips & Rings 15/1.00
- Texas Instr #994A Keyboard-Inv Data For Pins Made When Each Key Depressed 4.95
- 27 Switch-12 Position 2/1.00
- 27 Switch-8 Position 4/1.00
- Keyboard Push Button Toss 30/1.00
- Audio Cable 30 Feet/1.00
- 22AWG Wire 50 Feet/1.00
- 27AWG Wire 50 Feet/1.00
- Mini Lubricant & Lubricant 1.00
- Moles Pins (7 Pin) Strip 100/\$2,500.4, 1K/36
- Clock Module-Crystal Controlled, Green Display/12VDC/Time Set Switches/Data-4.95
- Rotary Switch 12 Position 5A 125V/3-1.00
- Quant Alpha Numeric Display 1-1/2" X 2" 7X5 135 Total Red LED Matrix/Specs-4.95
- 11 LED 7 Seg Graph Display-2-3/4" Rect. LED's Specialty Red, Gnt, Ambi Specs 2.59
- Seven Amp (?) Tapped Transformer-Can Be Used For: 6V, 9V, 15V, 18V Reg Cngg 8.95
- Wall Plug Transformer-24V 5/25mA 1.50
- 6.3V 1.2A Transformer 1.20
- 12V Center Tap Transformer 2.50
- BAMP 200V Bridge, Quick Disconnect (Gt) 95
- 1N4007 20/1.00
- 1N4007 (200V 1 Amp) 20/1.00
- 1N5060 1400V 1 Amp 10/1.00
- Zener Diodes-20V 1W 30/1.00
- Zener Diodes-13V 1W Omax 30/1.00
- 250K O/C Crystal 50
- 3.579545 Color Burst Crystal (MC-18) 50
- 1.0 Mhz Crystal 1.95
- 60 Mhz Crystal 1.95
- TO-18 Heat Sinks (Bare) 10/1.00
- TO-18 Heat Sinks (Bare) 10/1.00
- Super Sub-Mini Ceramic Caps (All 100%) 20/1.00
- 001.5uf 100V (1.55) 30/1.00
- 002.2uf 100V (1.55) 30/1.00
- 002.7uf 100V (1.55) 30/1.00
- 003.3uf 100V (1.55) 30/1.00
- 003.9uf 100V (1.55) 30/1.00
- 004.7uf 100V (1.55) 30/1.00
- 008.2uf 100V (1.82) 30/1.00
- 47uf 40V U/C (Radial) 20/1.00
- 47uf 25V U/C (Radial) 10/1.00
- 1000uf 16V Tantal Lock 1.00
- 3200uf 16V Tantal For Power Supplies 1.00
- 5000uf 25V (Comp) Grade 3-5/8" X11-3/16" 1.00
- .01 uf 50V Monolithics 10/1.00
- .01 uf 50V Monolithics 20/1.00

- Chip Caps-Set of 4, 2 Each 2.7 3.3 39p 1.00
- 33uf 100V Dip Mylar 10/1.00
- 1.00K PC Resistor Ass't (30 Values) 1/2W-33 5/1.00
- Pots 1 Meg Linear Taper 6/1.00
- 745C40-Octal Buffer/Line Driver/Inv
- Motion Detector Bids (Inc IC \$2) 7/10.00
- Mot Det IC Conv. ULN2228A 3/32-20/10.00
- Project Box/Lid For Detector 1.95
- Miniature Speaker For Detector65
- Extensive Construction Article For Det. 31 TV Knobs 15/1.00
- Ammeter 10-18 A.C. Amperes 4.95
- Volt/Ohm Meter MVMNT (Dk) Ohm 0-300M 2.95
- 6V Miniature Gear Motor 50
- RF Chokes 1.5uh, 2.2uh, 3.2uh, 22uh-10/1.00
- 40 Pin Flat Cable Socket Connector Hood 40
- 50 Pin Flat Cable Socket Connector Hood 50
- 14 Pin Dip Header Plug Mate (3A) 3/1.00
- Mixed Connector Ass't 10/1.00
- 1.5AMP 50V Bridge (Gt. TO-5 Pkg) 50
- 25AMP 300V Bridge (Solid Lug Term) 1.50
- 28 Pin TV Replacement IC (Spec'd) Each 221-42, 221-43, 221-45, 221-46, 221-69, 221-79, 221-87, 221-96, 221-104, 221-105, 221-106, 221-140
- ZS0900 (Hornz Output W/Dumper Diode)-2.95
- ZS1172B (Toshb-Hornz Output Trans)-.95
- 28 Pin TV Replacement IC (Spec'd) Each 221-42, 221-43, 221-45, 221-46, 221-69, 221-79, 221-87, 221-96, 221-104, 221-105, 221-106, 221-140
- ZS0900 (Hornz Output W/Dumper Diode)-2.95
- ZS1172B (Toshb-Hornz Output Trans)-.95
- 28 Pin TV Replacement IC (Spec'd) Each 221-42, 221-43, 221-45, 221-46, 221-69, 221-79, 221-87, 221-96, 221-104, 221-105, 221-106, 221-140
- IC Storage (Bug Box (Holds) 30 IC's) 1.75
- Precision (Multi-Turn) Trim Pots (Cospa) 100 OHM, 500 OHM, 1K, 2K, 5K, 10K, 20K, 50K, 100K, 200K, 500K, 1M-85 Each-3/\$2
- Pinout For 10V Hrt (Single Turn) Trimmers 100 OHM, 1K, 10K, 25K, 50K, 100K 4.75
- Heat Sensitive Switch/150'C 10/1.00
- Mixed IC Ass't 10/1.00
- Buzzers 3/1.00
- Chip Resistor (.810) 20/1.00
- Chip Resistor (.470R) 20/1.00
- Chip Cap (330p) 20/1.00
- Jumpo Red LED W/Blue in Resistor-30S1 MFR 901 (Hobby Grade-60% Good) 10/1.00
- IC Ass't (Hobby Grade, Some Marked-30/\$1

20 Cent (.20) 74SXX Series Special

- Octal Interface Circuits
- Equivalent To 74LSXX Series
- Low Power 180 CMOS Technology
- Short Propagation Delay
- Improved Noise Margins
- High Current, Sink/Source Capability
- 74S137-1 of 8 Inverted Decoder, Latched
- 74S138-1 of 8 Inverted Decoder
- 74S139-1 of 8 Inverted Decoder
- 74S237-1 of 8 Non-Inverted, Latched
- 74S238-1 of 8 Non-Inverted
- 74S239-1 of 4 Non-Inverted
- 74S240-Octal Buffer/Line Driver/Inv
- 74S241-Octal Buffer/Line Driver/Inv
- 74S244-Octal Buffer/Line Driver/Nul
- 74S245-Octal Bus Transceiver/Nul-1
- 74S245-Octal Bus Transceiver/Nul-1
- 74S247-Transceiver Latch-Nul/Inv

Terms: MICRO-MART accepts Visa, MC and telephone C.O.D's. Minimum order \$10.00. Shipping—US orders \$2.00. Canada and other countries \$3.50 (includes ins.) Shipping rate adjusted where applicable. NJ residents add 6% sales tax.

MICRO-MART • 808 CENTRAL AVE., WESTFIELD, NJ 07090 • (201) 654-8088

- 74S374-D Type Flip-Flop, Non/Inv
- 74S374-D Type Flip-Flop, Non/Inv
- 74S374-D Type Flip-Flop, Inverted
- 74S374-D Type Flip-Flop, Inverted
- 74S374-D Type Flip-Flop, Non/Inv
- 74S374-D Type Flip-Flop, Non/Inv
- 74S374-D Type Flip-Flop, Non/Inv
- 74S374-D Type Flip-Flop, Non/Inv
- 74S374-D Type Flip-Flop, Non/Inv
- 74S374-D Type Flip-Flop, Non/Inv
- Cypher IV Micro-Controller Kit-\$129.50
- 4 MHz, 8 Bit Microprocessor (INAT 1N5807)
- Control Basic Interpreter On-Chip
- Auto-Start Operation At Power-On
- Fast 16 Bit Multiply And Divide
- PS-312 Supports CRT & Serial Link
- 24 Bi-Directional I/O Lines (8255A)
- RAM Memory 2K Expandable To 16K
- Erom Memory Expandable To 16K
- Built In Erom Programmer
- 16 Channel Common Printer Interface
- Optional Real Time Clock W/Backup
- Play TV Hardware Installation Kit Blow Out As Low As \$2.95 + \$3.50 Shipping Per Unit
- All kits contain 5 Pin Connectors, 100 to 75 OHM Balun, 300 OHM Terminal Block 2 F1 75 OHM Patch Cord, 2 F1 300 OHM Twin Lead Nylon Cable Tie, and UHF Antenna
- Model #124-\$2.95 Includes All Of The Above Plus 25 Feet Coaxial Cable And Mounting Hardware For Indoor Wall Ceiling Installation
- Model #450-\$2.95 Includes All Of The Above Plus 25 Feet Coaxial Cable And Attractive Expandable Cover/Box For Easy Indoor Installation
- Model #484-\$3.95 Includes All Of The Above Plus 65 Feet Coaxial Cable And All Necessary U-Box Hardware

MODEL 705 Digital Multimeter

DC Voltage 100V to 1000V
AC Voltage 100V to 750V
DC Current 1.5 to 10A
AC Current 0.1 to 10A
Resistances 8 to 2000 Ohms
Capacitance 1pF to 20uF
Diode Test forward voltage listing
Hertz Test transistor testing

\$51.95

UHF-TV PREAMP

(As featured in Radio Electronics March/April articles, 1982)

This inexpensive antenna mounted preamp can add more than 25 dB of gain to your system. Lots of satisfied customers and repeat orders for this high quality kit, which includes all component parts, PC B.O. Case, Power Supply and Balun \$34.50. Assembled version \$57.50

Radio Shack Parts Place™

OVER 1000 ITEMS IN STOCK AT OUR STORE NEAR YOU!

(1) Plug-In PC Boards (4)

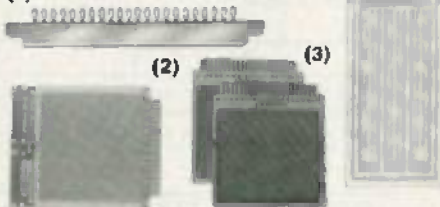

- (1) 44-Position Card-Edge Socket. Accepts plug-in PC boards below. #276-1551 2.99
- (2) Plug-In Board With RS-232 Ports. Ideal for computer projects! Predrilled to accept two PC-type RS-232 connectors (such as RS #276-1521). 4 $\frac{1}{2}$ " x 5 $\frac{1}{2}$ ". Two buses. 1020 holes in DIP pattern. #276-187 3.99
- (3) Multi-Purpose Plug-In Board. 4 $\frac{1}{2}$ " x 4" with 7 $\frac{1}{2}$ " gnds. #276-152 2.99
- Three-Voltage Source Board. Three-bus version of Fig. 3. #276-154 2.99
- (4) Jumbo Two-Bus Board. 4 $\frac{1}{2}$ " x 9 $\frac{1}{2}$ ". Accepts up to 24 16-pin DIP sockets with plenty of room for discrete components. Two buses. #276-190 5.95
- Jumbo IC/Discrete Board. Like Fig. 4 but accepts up to 40 16-pin DIPs. Single bus. #276-191 5.95

New "Hot-Line" Service

Radio Shack Can Replace Almost Any IC or Semiconductor



More Than 200,000 Substitutions

No Minimum Order ■ No Postage Charge

If the IC or semiconductor you need is not part of our regular stock, our store manager will check our new in-store substitution guide and special-order a replacement from our warehouse. Your order will be sent ASAP to your Radio Shack store. We also offer this convenient service on selected tubes, crystals, phono cartridges and styli.

Improve Your Project!

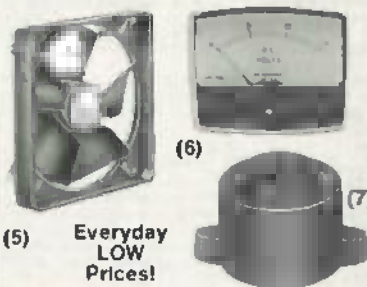

- (5) 120 VAC Cooling Fan. Ideal for computers, hi-fi, Ham equipment. Up to 65 CFM. 11 watts. 4 $\frac{1}{2}$ " x 4 $\frac{1}{2}$ " x 2 $\frac{1}{2}$ ". #273-241 15.95
- (6) Panel Voltmeter. 0-15 VDC. Perfect for monitoring car electrical system or a power supply. 2 $\frac{1}{4}$ " x 2 $\frac{1}{4}$ " x 1 $\frac{1}{4}$ ". #270-1754 7.95
- (7) Two-Tone Piezo Buzzer. 100 dB minimum sound pressure level! 8-16 VDC. 2 $\frac{1}{2}$ " mounting hole centers. #273-070 8.95

Join the Resistance

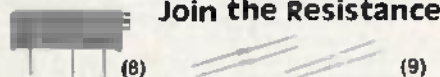

- (8) 15-Turn PC-Mount Potentiometers. $\frac{3}{4}$ -watt, 10% tolerance. For critical fine-control and trimming.

Ohms	Cat. No.	Only
1000	271-342	1.49
10k	271-343	1.49
20k	271-340	1.49

- (9) 50 Metal-Film Resistors. 1% tolerance. $\frac{1}{4}$ -watt. Assortment includes 12 popular values ranging from 10 ohms to one megohm. #271-309 Pkg. of 50, 2.49

Semiconductor Reference And Substitution Guide

New 1986 Edition



Complete data on Radio Shack ICs, SCRs, LEDs, diodes and optos. Plus "sub" listings for over 80,000 semi types. Over 270 pages. #276-4009 3.99

Low-Cost "Insurance"



- (10) Heavy-Duty Metal Oxide Varistor. Diverts power-line voltage "spikes". #276-568 1.69
- (11) Gas Discharge Tube. #270-811 2.49
- (12) Thermal Fuses. Used in coffee-makers and other heating devices. Rated 240 VAC, 10 amps.

Breaks Circuit at	Cat. No.	Each
139° C	270-1320	79
226° C	270-1321	79

Ready-to-Mount LEDs

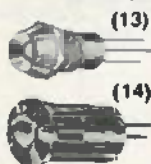

- (13) Two-Color. Provides red and green output. A great mode or status indicator. Mounts in a $\frac{3}{8}$ "-dia. hole. #276-025 1.49
- (14) Snap-Ins. Red output. Mount instantly in $\frac{9}{16}$ " holes. #276-018 Pkg. of 2/1.79

Enclosure and PC Board



Big value in a small, rugged plastic enclosure. 1 $\frac{3}{16}$ " x 3 $\frac{7}{16}$ " x 2 $\frac{1}{16}$ ". Includes PC board with 483 DIP-spaced holes, two labels, hardware, snap-in rubber feet. #270-291 2.99

64K Dynamic RAM

only **3⁹⁵** Each Super Quality

4164. Popular standard memory chip with 150 ns access. Low-power design. Now's the time to upgrade your computer! #276-2506

Capacitor Assortments



- (15) 100 Disc Capacitors. Includes NPOs, Hi-Os, N-750s. Mylar and ceramic types. Popular values, up to 1000 WVDC. #272-801 1.98
- (16) 20 Electrolytic Capacitors. Minis and subminis. Popular values and sizes, up to 50 WVDC. #272-802 1.98

Switch Super-Values



- (17) Lighted SPST Toggle. For 12 VDC use only, rated 5 amps. Mounts in $\frac{7}{16}$ "-dia. hole. #275-680 2.59
- (18) Flatted Lever Switches. Rated 6 amps at 125 VAC. SPDT. #275-635 2.39
DPDT. #275-636 2.69
DPDT Momentary. With spring return to center "off" position. #275-637 2.89

A BONANZA OF SPECIAL-PURCHASE BARGAINS!

DC Hobby Motors

1²⁹

Pkg. of 2

Just right for model-making, solar power and robotics experiments, or rainy day fun for the kids! Require 1.5 to 3 VDC. Approx. 1 $\frac{3}{4}$ " long x $\frac{7}{16}$ " diameter. #273-205



Prewired TV RF Modulator

only **4⁹⁵**

Ideal for use with computers, satellite receivers, ATV, even custom datacom systems and experiments (see 9/85 issue of Modern Electronics, page 53). #277-1015



Prewired Clock Module

4⁹⁵

MA3003D-2. Fluorescent display with $\frac{1}{4}$ "-high digits is easy to read, night or day. Perfect for vehicles or your own custom application—requires 12 VDC. 1 $\frac{3}{8}$ " x 2 $\frac{1}{8}$ " x 1 $\frac{1}{2}$ ". With data. #277-1021



Computer Keyboard

only **5⁹⁵**

Very high-quality full-stroke matrix-output board with standard "QWERTY" layout plus cursor arrows, word processing and numbered functions—total of 75 keys. Originally produced for a computer system. 21-position ribbon cable connector. #277-1020



Over 1000 items in stock: Binding posts, Books, Breadboards, Buzzers, Capacitors, Chokes, Clips, Connectors, Fuses, Hardware, ICs, Jacks, Knobs, Lamps, Multimeters, PC Boards, Plugs, Rectifiers, Relays, Resistors, Switches, Tools, Transformers, Transistors, Wire, Zener Diodes, and more!

Radio Shack
A DIVISION OF TANDY CORPORATION

Prices apply at participating Radio Shack stores and dealers

PLASMA LASERS SECURITY

AMAZING DEVICES

PERSONAL DEFENSE AND PROPERTY PROTECTION UTILIZE SPACE AGE TECHNOLOGY. CAUTION THESE DEVICES CAN BE HAZARDOUS AND MAY SOON BE ILLEGAL.

POCKET PAIN FIELD GENERATOR — IPG50
Assembled \$64.50
IPGS Plans \$9.00 IPGSK Kit/Plans \$44.50

PHASOR PAIN FIELD CROWD CONTROLLER — PPF10
Assembled \$250.00
PPF1 Plans \$15.00 PPF1K Kit/Plans \$175.00

BLASTER — Provides a plasma discharge capable of puncturing a can. Produces a 100,000 WATT PULSE
BLS10 ASSEMBLED \$89.50
BLS1 PLANS \$10.00 BLS1K KIT/PLANS \$69.50

PLASMA STUN GUN — Very intimidating and effective 8 to 10 feet 100,000 VOLTS
ITM10 ASSEMBLED \$39.50
ITM1 PLANS \$10.00 ITM1K KIT/PLANS \$69.50

RUBY LASER RAY GUN — Intense visible red beam burns and welds hardest of metals. **MAY BE HAZARDOUS.**

RUB3 All Parts Available for Completing Device \$20.00
CARBON DIOXIDE BURNING, CUTTING LASER — Produces a continuous beam of high energy. **MAY BE HAZARDOUS, LCS. All Parts Available for Completing Device \$20.00**

VISIBLE LASER LIGHT GUN — produces intense red beam for sighting, spotting, etc. Hand held complete.
LQU3 Plans \$10.00 (Kit & Assembled Units Available)

IR PULSED LASER RIFLE — Produces 15-30 watt infra-red pulses at 200-2000 per sec.
LRG3 All Parts & Diodes Available \$10.00

BEGINNERS LOW POWER VISIBLE LASER — Choice of red, yellow, green — provides an excellent source of monochromatic light.
LHC2 Plans \$5.00 LHC2K Kit \$34.50

SNOOPER PHONE — Allows user to call his premises and listen in without phone ever ringing
SNP20 Assembled \$88.50
SNP2 Plans \$9.00 SNP2K Plans/Kit \$59.50

LONG RANGE WIRELESS MIKE — Miniature device clearly transmits well over one mile. Super sensitive, powerful
MFT1 Plans \$7.00 MFT1K Plans/Kit \$49.50

WIRELESS TELEPHONE TRANSMITTER — Transmits both sides of phone conversation over one mile, shuts off automatically
VWPM5 Plans \$8.00 VWPM5K Plans/Kit \$39.50

PWM5 — LONG RANGE SUPER EAR WITH WIRELESS ATTACHMENT
PWM5 Plans \$10.00 PWM5K Kit \$139.50
PWM50 Assembled and Tested \$169.50

Our phone is open for orders anytime. Technicians are available 9-11 a.m., Mon-Thurs for those needing assistance or information. Send \$1.00 for catalog of hundreds more similar devices. Send check, cash, MO, Visa, MC, COD to: **INFORMATION UNLIMITED**
DEPT RR, P.O. Box 718, Amherst, N.H. 03031 Tel: 603-973-4730

EDUCATION & INSTRUCTION

F.C.C. Commercial General Radiotelephone License. Electronics home study. Fast, inexpensive! "Free" details. **COMMAND, D-176, Box 2223, San Francisco, CA 94126.**

2600 — world's largest Phreak/Hack/telem computer security newsletter. \$12.00/year. \$20.00—overseas. **2600, Box 752, Middle-Isle, NY 11953-0752, \$1.00 for sample.**

Communicate around the world! Get your "HAM" radio license and call sign. Complete novice kit includes actual FCC questions and answers, cassette, manual, etc. \$14.95 **SPI-RO, Box 400-B, Flat Rock, NC 28731.**

FREE EVALUATION and ADVISORY SERVICE



For professional electronic technicians by prestigious non-profit organization. Earn University Degree (Bachelors or Masters) through Home Study! Credit given for previous schooling and professional experience. Upgrade your earning power. Free Details!

CONTINENTAL EDUCATION ASSOCIATES
P.O. Box 1197 · Champlain, NY 12919-1197

A NON PROFIT ORGANIZATION

WANTED

RADIO tubes: 2A3, 45's, 50's, 211, 845, Western Electric tubes, amps, drivers, horns, speakers **DAVID, P.O. Box 832, Monterey Park, CA 91754, Tel: (818) 576-2642.**

INVENTIONS, ideas, new products wanted! Presentation to industry. National exposition. Call **1-800-528-6050, Canada, 1-800-528-6060, X831.**

INVENTORS! AIM wants—ideas, inventions, new products, improvements on existing products. We present ideas to manufacturers. Confidentiality guaranteed. Call Toll Free **1-800-225-5800** for information kit.

PRINTED-CIRCUIT BOARDS

PRINTED-circuit boards. Quick prototypes, production, design, reflow solder. Send print or description for quote to **KIT CIRCUITS, Box 235, Clawson, MI 48017.**

CABLE-TV

DEALERS wanted: Channel 2, 3, and 4 notch filters. **Money back guarantee.** Send \$15.00 for sample and quantity price list. Specify channel(s). **GARY KURTZ, P.O. Box 291394, Davie, FL 33329.**

DO-IT-YOURSELF TV REPAIR

NEW...repair any TV...easy. Anyone can do it. Write, **RESEARCH, Rt 3, Box 601BR, Colville, WA 99114.**

REEL-TO-REEL TAPES

Ampex professional series open reel tape. 1800 or 2400 feet on 7-inch reels, used once. Case of 40, \$45.00. 10 1/2 x 3600 feet and cassettes available. MasterCard/Visa. **VALTECH ELECTRONICS, Box 6-RE, Richboro, PA 18954, (215) 322-4866.**

PRINTED-CIRCUIT BOARDS

CIRCUIT Boards, guaranteed lowest quotes and free twelve hour prototypes. Single and double sided boards. Small through large production quantities. Send specifications—**T.O.R.C.C. ELECTRONICS, Box 47148, Chicago, IL 60647, (312) 342-9171.**





BATTERIES

NICAD batteries and packs for radios, computers, toys, telephones. Major brand distributor and fabricator **S.A.S.E. for flyers, LYNNTRON, 6248 N. 43, Glendale, AZ 85301.**

WM. B. ALLEN SUPPLY COMPANY

OPEN SATURDAYS 8 A.M. TO 1 P.M. WITH 24 HOUR ANSWERING TO TAKE YOUR ORDER ANYTIME

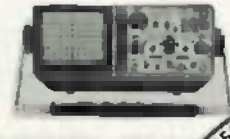
TEST EQUIPMENT SPECIALS

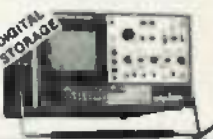
<p>V-650F 60MHz • Dual Trace Delayed Sweep</p>  <p>Reg. \$1195 \$896 <i>SAVE \$299</i></p>	<p>V-222 20MHz • Dual Trace 6" CRT</p>  <p>Reg. \$715 \$500 <i>SAVE \$215</i></p>	<p>VISA MasterCard</p> <p>SAVE ON</p> <p>HITACHI</p> <p>OSCILLOSCOPES</p>		<p>V-1050F 100MHz • Quad Trace Delayed Sweep</p>  <p>Reg. \$1595 \$1196 <i>SAVE \$399</i></p>
<p>V-212 DC-20MHz • Dual Trace</p>  <p>Reg. \$615 \$430 <i>SAVE \$185</i></p>	<p>V-422 DC-40MHz • Dual Trace</p>  <p>Reg. \$925 \$669 <i>SAVE \$256</i></p>	<p>V-1100 100MHz • Quad Trace CRT Readout • 1mV 6" PDA-CRT</p>  <p>Reg. \$2490 \$2260 <i>SAVE \$230</i></p>	<p>V-1070 100MHz • Quad Trace CRT Readout 6" PDA-CRT</p>  <p>Reg. \$2295 \$1532 <i>SAVE \$763</i></p>	<p>V-6041 40MHz/2 Channels • 4000 Words Per Channel</p>  <p>Reg. \$5855 \$5311 <i>SAVE \$544</i></p>

WM. B. ALLEN SUPPLY
ALLEN SQUARE
300 BLOCK NORTH RAMPART, NEW ORLEANS, LA 70112
LOUISIANA TOLL FREE 800 462-9520

800 535-9593
COMPLETE INVENTORY OF MULTIMETERS
AND SCOPES FROM 18 MANUFACTURERS

CIRCLE 103 ON FREE INFORMATION CARD

RADIO-ELECTRONICS

TENMA

THE NAME YOU CAN TRUST IN ELECTRONIC TEST EQUIPMENT

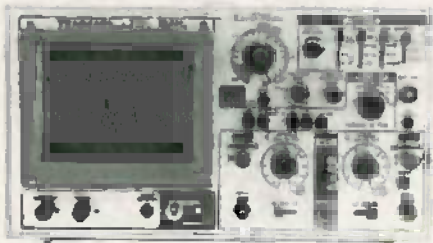

TENMA 35 MHz Dual Trace Oscilloscope

- Two high quality 10:1 probes included
- For additional specifications see MCM Catalog #11

#72-330
\$569⁰⁰ (ea)

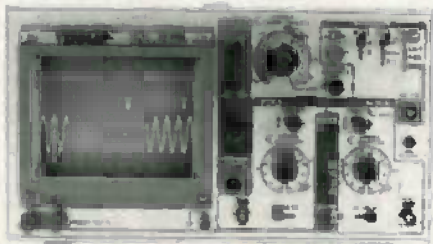

TENMA 20 MHz Dual Trace Oscilloscope

- Two high quality 10:1 probes included
- For additional specifications see MCM Catalog #11

#72-320
\$389⁹⁵ (ea)

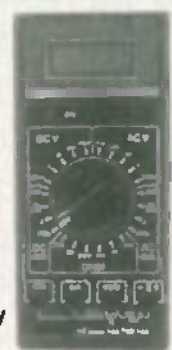

NEW

TENMA Rotary Dial DMM

- 3 1/2 digit LCD display
- Rotary dial for rapid selection of functions and ranges
- 20 amp AC-DC current
- .10hm resolution
- Carrying case included

#72-075 \$44.80 (ea)

\$41⁹⁵ (2-up)



TENMA Autoranging Digital Multimeter

- 3 1/2 digit
- Auto polarity
- Low battery indicator
- 10 amp AC-DC current
- Continuity buzzer
- 2 1/2" x 5 1/2" x 1 1/2"
- Carrying case included

#72-058 \$49.80 (1-4)

\$44⁹⁵ (2-up)



TENMA Drop Proof Digital Multimeter

- DC input impedance 10Mohm
- Shock-mounted LCD display
- Overload protection
- Auto polarity

#72-057
\$29⁹⁵ (ea)



NEW

TENMA Digital LCR Meter

- Measures inductance, capacitance and resistance
- L = 1 micro H to 200H.
- C = .1pF to 200 micro F, R = .01ohm to 20Mohm
- Carrying case included.

#72-370

\$149⁹⁵ (ea)



TENMA Combination Function Generator and Frequency Counter

- 6 digit display
- Output range: .2Hz to 2MHz seven ranges
- Counter range .1Hz to 10MHz
- 5-15 volt TTL and CMOS output
- Wave forms: sine, triangle, square, pulse, and ramp.

#72-380

\$219⁹⁰ (ea)

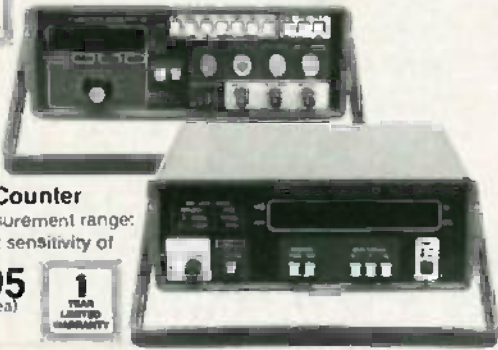

TENMA Frequency Counter

- 8 digit LED display
- Measurement range: .1Hz - 120MHz
- High input sensitivity of 20mV RMS

#72-375 **\$189⁹⁵** (ea)



Be Sure To Call For Your FREE Catalog! Over 6,000 Items!

We also have ... a full line of test equipment, computer accessories, telephone accessories, speakers, television parts, flybacks, yokes, switches, fuses, lamps, capacitors, resistors, cartridges, styli, wire, CATV equipment, the largest selection of original Japanese semiconductors in the country and more.

MCM ELECTRONICS
858 E. Congress Park Dr.
Centerville, Ohio 45459-4072
(513) 434-0031

SOURCE NO. RE-17

Terms:

- \$10 minimum order, \$1.00 charge for orders under \$10.
- \$20 minimum charge card order
- Orders shipped UPS C.O.D.
- Most orders shipped within 24 hours.
- Sales office open 8:30 am to 7:00 pm Saturdays 10:00 am to 3 pm EST.
- For prepaid orders add \$2.75 for shipping and handling.
- Should shipping and handling charges exceed \$2.75, the balance due will be sent C.O.D.

CALL TOLL FREE 1-800-543-4330

In Ohio 1-800-726-4315 • In Alaska and Hawaii 1-800-858-1849

CIRCLE 87 ON FREE INFORMATION CARD

www.americanradiohistory.com

FEBRUARY 1986

CALL FOR QUANTITY DISCOUNTS

Table with columns: Part No., Price, Quantity, Part No., Price, Quantity. Lists various electronic components and their pricing.

Table with columns: Part No., Price, Quantity, Part No., Price, Quantity. Lists various electronic components and their pricing.

Table with columns: Part No., Price, Quantity, Part No., Price, Quantity. Lists various electronic components and their pricing.

Table with columns: Part No., Price, Quantity, Part No., Price, Quantity. Lists various electronic components and their pricing.

SPECIAL!! SPECIAL!! SPECIAL!!

MOTOROLA MC68701 - Microcomputer with EPROM. Features: 2048 bytes of EPROM, 128 bytes of RAM, 16-bit data bus, 24-bit address bus, and a three function Programmable Timer.

CUSTOM COMMODORE CHIPS for VIC-20, C-64 and C-128 Personal Computers. Includes: *5110 CPU, *5120 VCA, *5130 VCA, *5140 VCA, *5150 VCA, *5160 VCA, *5170 VCA, *5180 VCA, *5190 VCA.

MICROPROCESSOR COMPONENTS

Table with columns: Part No., Price, Quantity, Part No., Price, Quantity. Lists various microprocessor components and their pricing.

Table with columns: Part No., Price, Quantity, Part No., Price, Quantity. Lists various microprocessor components and their pricing.

Table with columns: Part No., Price, Quantity, Part No., Price, Quantity. Lists various microprocessor components and their pricing.

Table with columns: Part No., Price, Quantity, Part No., Price, Quantity. Lists various microprocessor components and their pricing.

Table with columns: Part No., Price, Quantity, Part No., Price, Quantity. Lists various microprocessor components and their pricing.

EEPROM

2818A 24 2048x8 16K EPROM 350ns. \$8.95. Features: On-chip Address/Output Drivers, Auto-Sense Data Write, 100ns Read Cycle, 100ns Setup/Hold Times, 100ns Access Time, 100ns Output Delay, 100ns Output Enable Delay, 100ns Output Disable Delay, 100ns Output Enable Delay, 100ns Output Disable Delay.

Digitaliter

DT1050 - 10-bit digital-to-analog converter. Features: 10-bit resolution, 10-bit digital input, 10-bit analog output, 10-bit resolution, 10-bit digital input, 10-bit analog output.

DT1050 Digitaliter \$24.95 ea. MM54104 Processor Chip \$12.95 ea. DT1057 10-bit digital-to-analog converter \$11.95 ea.

INTERISIL

Table with columns: Part No., Price, Quantity, Part No., Price, Quantity. Lists various Interisil components and their pricing.

30009 1985 Interisil Data Book (with key) \$9.95

74HC HIGH SPEED CMOS

Table with columns: Part No., Price, Quantity, Part No., Price, Quantity. Lists various 74HC High Speed CMOS components and their pricing.

74C-C MOS

Table with columns: Part No., Price, Quantity, Part No., Price, Quantity. Lists various 74C-C MOS components and their pricing.

LINEAR

Table with columns: Part No., Price, Quantity, Part No., Price, Quantity. Lists various Linear components and their pricing.

30003 1982 Met. Linear Data Book (with key) \$14.95

MasterCard, Jameco ELECTRONICS, VISA. 1355 SHOREWAY ROAD, BELMONT, CA 94002. 206 PHONE ORDERS WELCOME - (415) 592-8097 - Telex: 176043

Commodore Accessories



RS232 Adapter for VIC-20 and Commodore 64

The JE232CM gives connection of standard serial RS232 printer, modems, etc. to your VIC-20 and C-64. A 4-pole switch allows the inversion of the 4 control lines. Complete installation and operation instructions included.
- Plug into User Port
- Provides Standard RS232 signal levels
- Uses 8 signals (Transmit, Receive, Clear to Send, Request to Send, Data Terminal Ready, Data Set Ready)
JE232CM \$39.95

VOICE SYNTHESIZER FOR COMMODORE VIC-20 AND C-64
Plug-In - Talking in Minutes!
JE520CM \$99.95

300 BAUD AUTO MODEM
Mitey-Mo (For C-64) \$74.95

PARALLEL PRINTER INTERFACE
FREE 2K Buffer Included!
MW350 (For VIC-20 & C-64) \$69.95

TRS-80 Accessories

EXPAND TRS-80 MEMORY

Each kit comes complete with eight 16Kx8 DRAM (M51601M119) 10c Dynamic RAMs and documentation for conversion. Model I kit equipped with Uni-processor interface can be expanded in size with 2 kits. Model II can be expanded four times in size, using 2 kits. Each kit will expand computer by 128K words.

TRS-18K3 200ns (Model III) \$5.95
TRS-18K4 250ns (Model I) \$5.49

TRS-80 COLOR AND COLOR II

Color kit comes complete with 8 each of 16Kx8 DRAM (M51601M119) 10c Dynamic RAMs and documentation for conversion. Complete TRS-80 Color Computers with C.E.I. II and 16C control boards in 2K. Also complete TRS-80 Color Computer II to 16K. Two 500K or 128K or 64K RAM on one computer.

TRS-84K2 \$9.95
TRS-84K3 \$9.95

TRS-80 MODEL 4, 4P

Easy to install kits come complete with TRS-80, 7 pin 16Kx8 DRAM (M51601M119) 10c Dynamic RAMs, TRS-80, 7 pin 16Kx8 DRAM (M51601M119) 10c Dynamic RAMs, TRS-80, 7 pin 16Kx8 DRAM (M51601M119) 10c Dynamic RAMs, TRS-80, 7 pin 16Kx8 DRAM (M51601M119) 10c Dynamic RAMs.

TRS-84K2 \$9.95
TRS-84K3 \$9.95

TRS-80 Model 100 - NEC - Olivetti

Easy to install Modulo page IPI into the sector (Olivetti) motor to the Olivetti. These modules and brackets will convert your Olivetti Commodore with modulator and documentation for conversion.

TRS-80 Model 100 NEC \$37.95
TRS-80 Model 100 Olivetti \$37.95

TANDY 200

Easy to install modems ready to go with the latest modems history at 230, increments. Complete with modulator and documentation for conversion.

M-200R (Ready 200 Expansion) \$99.95

PROMETHEUS MODEMS

Intelligent 1200/300 Baud Modem with Real Time Clock/Calendar

The ProModem™ is a Bell 212A (1200/300) intelligent stand-alone modem. It has a command set compatible with Bell 212A in addition to a extended command set. Shown with alphanumeric display option.

PM1200 RB-232 Stand-Alone Unit \$299.95

OPTIONS FOR ProModem 1200

PM-COM \$79.95
PM-0P512K \$129.95
PM-512K \$84.95
PM-ALP \$79.95

PM-Special #2 \$249.95

DATA BOOKS



30009 Internal Data Book (1986) \$9.95

30010 Zilog Data Book (1986) \$9.95

21830 Intel Memory Components Handbook (1985) \$14.95

22043 Intel Micro-processor Components Handbook (1983/84) \$19.95

30022 National Logic Data Book Set (1984) \$39.95

Muffin-Style & Sprite-Style Fans

MUF60 (MUF-18-242) \$9.95

SU2C7 \$9.95

APPLE COMPATIBLE COMPUTER ACCESSORIES

12" Monochrome Green Monitor for Apple II, II+, IIe and IIc



Also compatible with other computer systems using composite video. Features Composite video output (Red, Green, Blue); High Resolution 70 Line Resolution 600 lines H or 1000 vertical scan lines; Computer with 10/1000 resolution stand; Weight 19 lbs; 14 1/2" x 10 1/2" x 14 1/2" \$99.95

100/200 BAUD INTERNAL MODEM for Apple II, II+, IIe

Also compatible with other computer systems using composite video. Features Composite video output (Red, Green, Blue); High Resolution 70 Line Resolution 600 lines H or 1000 vertical scan lines; Computer with 10/1000 resolution stand; Weight 19 lbs; 14 1/2" x 10 1/2" x 14 1/2" \$99.95

100/200 BAUD STAND-ALONE MODEM for Apple II, II+, IIe

Features Composite video output (Red, Green, Blue); High Resolution 70 Line Resolution 600 lines H or 1000 vertical scan lines; Computer with 10/1000 resolution stand; Weight 19 lbs; 14 1/2" x 10 1/2" x 14 1/2" \$99.95

Apple Keyboard and Case for Apple II and II+

Features Composite video output (Red, Green, Blue); High Resolution 70 Line Resolution 600 lines H or 1000 vertical scan lines; Computer with 10/1000 resolution stand; Weight 19 lbs; 14 1/2" x 10 1/2" x 14 1/2" \$99.95

128K RAM Card for Apple II, II+, IIe

Features Composite video output (Red, Green, Blue); High Resolution 70 Line Resolution 600 lines H or 1000 vertical scan lines; Computer with 10/1000 resolution stand; Weight 19 lbs; 14 1/2" x 10 1/2" x 14 1/2" \$99.95

Apple Diagnostic Disk Controller Card

Features Composite video output (Red, Green, Blue); High Resolution 70 Line Resolution 600 lines H or 1000 vertical scan lines; Computer with 10/1000 resolution stand; Weight 19 lbs; 14 1/2" x 10 1/2" x 14 1/2" \$99.95

Parallel Printer Card for Apple II, II+, IIe

Features Composite video output (Red, Green, Blue); High Resolution 70 Line Resolution 600 lines H or 1000 vertical scan lines; Computer with 10/1000 resolution stand; Weight 19 lbs; 14 1/2" x 10 1/2" x 14 1/2" \$99.95

Parallel/Serial Buffer Card for Apple II, II+, IIe

Features Composite video output (Red, Green, Blue); High Resolution 70 Line Resolution 600 lines H or 1000 vertical scan lines; Computer with 10/1000 resolution stand; Weight 19 lbs; 14 1/2" x 10 1/2" x 14 1/2" \$99.95

VERBACARD for the Apple II, II+, IIe

Features Composite video output (Red, Green, Blue); High Resolution 70 Line Resolution 600 lines H or 1000 vertical scan lines; Computer with 10/1000 resolution stand; Weight 19 lbs; 14 1/2" x 10 1/2" x 14 1/2" \$99.95

Jameco's New 1986 Catalog!

Filled with New Products, Reduced Pricing and Valuable Pin-out Data.

Send \$1 Postage for FREE 1986 Jameco Catalog!

Jameco ELECTRONICS logo and address: 1355 SHOREWAY ROAD, BELMONT, CA 94002. PHONE ORDERS WELCOME - (415) 592-8097 - Telex: 176043

IBM Accessories

IBM PC/XT Compatible Keyboard



IBM-5151 (Equivalent to Keyboard #5151) \$129.95

Additional Add-Ons Available!

MEMORY EXPANSION KITS

IBM PC, PC XT and Compatibles

The IBM PC Kit will increase memory to 64K. IBM XT Kit will increase memory to 128K. IBM PCXT Kit will increase memory to 256K.

IBM64K (Nine 200ns 64K RAMs) \$7.95

IBM PC AT

Eight 16K compatible with new 128K Dynamic RAMs and documentation for conversion.

IBM128K (Nine 200ns 128K RAMs) \$43.95

IBM PCXT Equivalent 130 Watt Power Supply UPGRADE YOUR PC!

Input: 110V @ 60Hz; Output: +5VDC @ 1.5A, -5VDC @ 0.5A, +12VDC @ 0.2A, -12VDC @ 0.5A; Plug compatible connectors - Fits into IBM PC - Weight: 6 lbs.

IBM-PS \$99.95

Prometheus Modems

The ProModem 1200B/300 is a 1200/300 baud modem card which plugs into IBM PC and XT. Provides a third serial port. Two versions available: 1200B (without software) and 1200BS (with software). The PM1200BS is supplied with powerful MTE communications software from Microware Labs. Software available: PC DOS or MS DOS, PM1200B (without software), PM1200BS (with MTE Software).

PM1200B \$239.95

PM1200BS \$274.95

IBM Compatible DISK DRIVES

Documentation included

RFD480 (Rmax 5 1/4" DS full-HI) \$69.95

FD558 (Rmax 5 1/4" DS half-HI) \$99.95

SA455 (Shugart 5 1/4" DS half-HI) \$99.95

TM100-2 (Random 5 1/4" DS full-HI) \$99.95

JMR 5 1/4" DISK DRIVE ENCLOSURES

Complete with power supply, switch, power cord, fuseholder and connectors

DDE-1FH \$69.95

DDE-2FH \$79.95

HDE-1FH \$199.95

General Application Keyboards

Mitsumi 54-Key Unencoded Keyboard

SPBT keyswitches - 20 pin ribbon cable connection - Low profile keys - Features cursor control, control, caps (lock), function, enter and shift keys - Color (keycaps) grey - Weight: 1 lb. - Pinout Intel - Size: 13 1/2" x 4 1/2" x 1 1/2" \$9.95

KB54 \$9.95

74-Key ASCII Cherry Keyboard

7-bit parallel ASCII - Full Upper Case, Full Lower Case (except I, O, N, P) - Cursor keypad - SPST mechanical keyswitches - 26-pin ribbon connector - Color: white - Size: 15 1/2" x 6 1/2" x 1 1/2" - Pinout Intel - Spac included

KB8201 \$14.95

UV-EPROM ERASER

8 Chips - 21 Minutes

1 Chip - 15 Minutes

Erases all EPROMs. Erases up to 8 chips within 21 minutes (1 chip in 15 minutes). Maintains constant exposure distance of one inch. Special conductive light barrier eliminates static build-up. Built-in safety lock to prevent UV exposure. Compact - only 6 1/4" x 3 1/2" x 2 1/4" Complete with holding tray for 8 chips.

DE-4 UV-EPROM Eraser \$74.95

UVS-11EL Replacement Bulb \$17.95

123

RAMSEY

THE FIRST NAME IN ELECTRONIC TEST GEAR

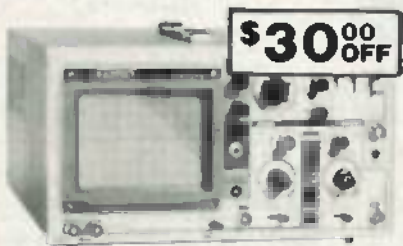

\$30⁰⁰ OFF

Save \$30 on the RAMSEY 20MHz Dual Trace Oscilloscope

Unsurpassed quality at an unbeatable price, the Ramsey oscilloscope compares to others costing hundreds more. Features include a component testing circuit for resistor,

capacitor, digital circuit and diode testing • TV video sync filter • wide bandwidth & high sensitivity • internal graticule • front panel trace rotator • Z axis • high sensitivity x-y mode • regulated power supply • built-in calibrator • rock solid triggering

Was \$399.95 NOW ONLY **\$369⁹⁵** high quality hook on probes included



NEW RAMSEY 1200 VOM MULTITESTER

Check transistors, diodes and LEDs with this professional quality meter. Other features include: decibel scale • 20K volt measuring system • 3 1/4" mirrored scale • polarity switch • 20 measuring ranges • safety probes • high impact plastic case

\$19⁹⁵ test leads and battery included



NEW

RAMSEY D-4100 COMPACT DIGITAL MULTITESTER

Compact sized reliability and accuracy. This LCD digital multimeter, easily fits in your pocket, you can take it anywhere. It features full overload protection • 3 1/2 digit LCD readout • recessed input jacks • safety probes • diode check function • 2000 hours battery life

\$22⁹⁵ test leads and battery included

NEW 35 MHz DUAL TRACE OSCILLOSCOPE



A heavy duty and accurate scope for service as well as production use. Features include • wide frequency bandwidth • optimal sensitivity • extremely bright display • delayed triggering sweep • hold off • ALT trigger • single sweep • TV sync • 5X magnification • XY or XYZ operation • HF/LF noise reduction

3500 Dual Trace Oscilloscope **\$499⁹⁵** includes 2 high quality probes

ALL OSCILLOSCOPES INCLUDE 2 PROBES

NEW 15 MHz DUAL TRACE PORTABLE OSCILLOSCOPE

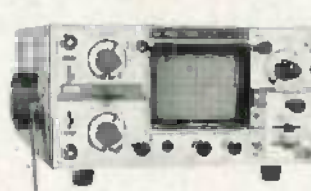

Ideal for field/bench applications, this scope can display up to 15 MHz signals. Internal battery pack allows up to 2 hours operation on a single charge. Features include • built-in battery charger • 5X horizontal magnification • high brightness CRT • front panel trace rotator • internal rechargeable battery pack

2500 Portable Oscilloscope **\$449⁹⁵** includes 2 high quality probes

MINI KITS—EASY TO ASSEMBLE, FUN TO USE BEGINNERS & PROS WILL HAVE A GREAT TIME WITH THESE KITS

FM MINI MIKE



A super high performance FM wireless mike kit. Transmits a stable signal up to 300 yards with exceptional audio quality by means of its built in electrical mike. Kit includes cable, mike, on-off switch, antenna, battery and major instructions. This is the finest unit available.

FM-3 kit \$14.95
FM-3 wired and tested 19.95

Color Organ

See music come alive! 3 different lights flicker with music. One light each for high, mid-range and lows. Each individually adjustable and drives up to 300 W, runs on 110VAC.

Complete kit ML-1 \$8.95

Video Stabilizer Kit
Converts any TV to video monitor. Super stable. Luminance rate CH 4 & 8. Runs on 5-12V acc with the video control. Best unit on the market. Complete kit: VD-1 \$7.95

Super Snoop

A super sensitive amplifier which will pick up a pen drop at 15 feet! Great for monitoring baby's room or as general purpose amplifier. Full 7W rms output, runs on 6 to 15 volts, uses 8-45 ohm speaker. Complete kit: SN-9 \$6.95

CPO-1
Runs on 3-12 Vdc 1 watt out, 1 KHz good for CPO, Alarm, Audio Oscillator. Complete kit \$3.95

FM Wireless Mike Kit

Transmits up to 300 to any FM broadcast radio. Uses any type of mike. Runs on 3 to 9V Type FM-2 has added sensitive mike preamp stage.

FM-1 Kit \$3.95 FM-2 Kit \$4.95

Whisper Light Kit

An interesting kit, small mike picks up sounds and converts them to light. The louder the sound, the brighter the light. Includes mike, controls up to 300 W, runs on 110 VAC.

Complete kit WL-1 \$6.95

Tone Decoder

A complete tone decoder on a single PC board. Features 400-5000 Hz adjustable range and 20 turn pot, voltage regulation. 567 IC. Useful for touch-tone burst detection, FSK, etc. Can also be used as a stable tone encoder. Runs on 5 to 12 volts. Complete kit: TD-1 \$6.95

Siren Kit

Produces upward and downward wail characteristic of a police siren. 5 W peak audio output, runs on 3-15 volts, uses 3-45 ohm speaker. Complete kit: SM-3 \$2.95

50 Hz Tone Beep
Runs on 5-15 VDC, Less than 100mA, 100% accuracy 10 / 7 KHz \$3.95

30 Watt 2 mtr PWR AMP

Simple Class C power amp features 3 times power gain in 1 W in for 3 out, 2 W in for 15 out, 4 W in for 30 out, less output of 35 W, incredible value. Complete with all parts, less case and T-R relay.

PA-1, 30 W per amp kit \$22⁹⁵
PA-1, RF sensed T-R relay kit 6⁹⁵

Power Supply Kit

Complete triple regulated power supply provides variable 0 to 18 volts at 300 mA and 5 at 1 Amp. Excellent load regulation, good filtering and small size. Less transformers, requires 8 3V 1/2 A and 24 VCT. Complete kit: PS-3LT \$6⁹⁵

CT-70 7 DIGIT 525 MHz COUNTER

LED quality at a breakthrough price. Features • 3 frequency ranges each with pre amp • dual selectable gate times • gate activity indicator • 50mV • 150 MHz typical sensitivity • wide frequency range • 1 ppm accuracy

\$119⁹⁵ wired includes AC adapter
CT-70 kit \$99.95
BP-4 nicad pack 8.95

CT-50 8 DIGIT 600 MHz COUNTER

\$169⁹⁵ wired
CT-50 kit \$139.95
RA-1 receiver adapter kit 14.95

CT-90 9 DIGIT 600 MHz COUNTER

The most versatile for less than \$300. Features 3 selectable gate times • 8 digits • gate indicator • display hold • 25mV @ 150 MHz typical sensitivity • 10 MHz timebase for WWV calibration • 1 ppm accuracy

\$149⁹⁵ wired includes AC adapter
CT-90 kit \$129.95
OV-1 0.8 ppm oven timebase 38.95
BP-4 nicad pack 8.95

CT-125 9 DIGIT 1.2 GHz COUNTER

\$169⁹⁵ wired includes AC adapter
BP-4 nicad 38.95

OM-700 DIGITAL MULTIMETER

Professional quality at a hobbyist price. Features include 26 different ranges and 5 functions • 3 1/2 digit 1 inch LED display • automatic decimal placement • automatic polarity

\$119⁹⁵ wired includes AC adapter
OM-700 kit \$99.95
MP-1 probe set 4.95

PR-2 COUNTER PREAMP

The PR-2 is ideal for measuring weak signals from 10 to 1,000 MHz • flat 20 db gain • BNC connectors • great for shifting RF • ideal receiver/TV preamp

\$449⁹⁵ wired includes AC adapter
PR-2 kit \$34.95

PS-2 AUDIO MULTIPLIER

The PS-2 is handy for high resolution audio resolution measurements, multiplies up to frequency • great for PL tone measurements • multiplies by 10 or 100 • 0.01 Hz resolution • built-in signal preamp/conditioner

\$49⁹⁵ wired
PS-2 kit \$38.95

PS-108 1 GHz PRESCALER

Extends the range of your Prescaler counter to 1 GHz • 2 stage preamp • divide by 1000 per circuit • super sensitive (50 mV typical) • BNC connectors • 1 GHz kit, 1 MHz out • drives any counter

\$799⁹⁵ wired includes AC adapter

ACCESSORIES FOR RAMSEY COUNTERS

- Telescopic whip antenna—BNC plug \$ 8.95
- High impedance probe, light loading 16.95
- Low pass probe, audio use 16.95
- Direct probe, general purpose use 13.95
- Tilt ball, for CT-70, 90, 125 3.95



PHONE ORDERS CALL **716-586-3950**

TELEX 466733 RAMSEY CI



RAMSEY ELECTRONICS, INC.
2575 Baird Rd.
Penfield, N.Y. 14626

TERMS • satisfaction guaranteed • shipping for 10 days, if not pleased, return original form for refund • add 6% for shipping and insurance to a maximum of \$10.00 • overseas add 15% for surface mail • COD add \$2.50 (COD in USA only) • orders under \$15.00 add \$1.50 • NY residents add 7% sales tax • 90 day warranty on labor only • 1 year parts & labor warranty on all wired units.

TOLL FREE

800-854-8230

CA Residents 714-558-8813

OUR POLICY

- Surcharge for VISA or Mastercard.
- Volume purchasing agreements available.
- Orders subject to availability.
- Pricing subject to change without notice.
- ACP Retail Store pricing may vary. Not responsible for typos.

CORPORATE BUYERS

CALL
HARRY

MAJOR BRAND PRICE BREAKTHRU



Retail Value \$5000

Save up to 60%

ADVANCED XT

ACP PRICE

NOW ONLY!

\$1695.00

Monochrome Monitor Included
10 Mb Hard Disk

ACP has sold over 2,000 of this system to major customers including Rockwell Int'l, Hughes Aircraft and Emulex Corp. See for yourself why these customers prefer the Advanced XT over the IBM XT.

BASE SYSTEM CONSISTS OF:

- 256K Expandable to 640K on the Motherboard.
- (1) 360K DS/DD Floppy Disk
- Serial & Parallel Ports
- Deluxe Keyboard w/LED's
- Mouse with Software
- LCD, Lightpen & RF Ports
- RGB and Mono Ports
- VLSI Circuit Design
- (3) Expansion Slots
- Ergonomic Design & Packaging
- GEM or PC Works Software
- 90 Day Warranty

SYSTEM A (P/N BDACP100)	Base System (See Left)	\$ 995.00
SYSTEM B (P/N BDACP101)	Base System with additional Floppy Disk Drive	\$1099.00
SYSTEM C (P/N BDACP102)	Base System w/12" Grn Monitor w/Tilt & Swivel base and additional Floppy Drive	\$1295.00
SYSTEM D (P/N BDACP103)	Base System w/RGB Color Monitor w/Tilt & Swivel base and additional Floppy Drive	\$1495.00
SYSTEM E (P/N BDACP104)	Base System w/10Mb Hard Disk and Green Monitor with Tilt & Swivel base	\$1695.00
SYSTEM F (P/N BDACP105)	Base System w/10Mb Hard Disk and RGB Color Monitor with Tilt & Swivel base	\$1985.00

ADVANCED XT ACCESSORIES

- 6 Slot Expansion Chassis (IBM or IBM Compatible)... \$399.00
- LCD Display (80x25) for use with Advanced XT LCD Port... 299.00
- Monochrome Hi-res text card... 69.95
- Monochrome IBM style Monitor... 99.95
- 256K Upgrade (Uninstalled)... 59.95

- PC DOS 2.1... \$65.00
- GW Basic... 75.00
- PC Works 1.15 (Touchstone) Regular \$195... 65.00
- Archive Tape B.U. (ext. 10Mb)... 995.00
- Maintenance Manual... 50.00
- Technical Reference Manual... 50.00

SPECIAL SYSTEM w/Printer

1. System E with Diablo 620 Serial Printer... \$1995.00
2. System F with Diablo 620 Serial Printer... 2285.00
3. Canon LBP-8A1 IBM compatible laser printer. Purchase for a low price of \$2895.00 and we will give you System A FREE!



10 Mb \$399.00

Shugart SA712 w/Controller & Cables. Ready for installation in IBM™ PC and Compatibles. (1 Year Warranty)

Shugart SA712 10Mb HD \$229.00

Seagate ST225 20Mb HD 419.00

PC UPGRADE SPECIAL

\$4.95 SET OF (9) 64K RAMS

\$26.95 SET OF (9) 256K RAMS

\$5.95 4128 PIGGYBACK RAM

1200 Baud Hayes™ Comp. Modem Short Card by U.S. Robotics with Teipac I Software.

List \$499 ACP... **\$179.00**
Buy (6)... **\$159.00**

10Mb Tape Back-up



Archive, #1 in tape back-up technology. High speed 10Mb back-up for only

\$995.00

External Box w/Power Supply

Great for adding Hard Disk to your PC. Same as photo... **\$179.00**

DIABLO 620 DAISYWHEEL PRINTER



The Finest Letter Quality Printer at a Spectacular Price. We have sold 1000's. You can have a spare at this price.

- 620 Serial... List 1495 ACP \$395.00
- 620 API... List 1695 ACP 495.00
- 620 D36... List 1695 ACP 550.00
- F-21 Sheet Feeder... List 895 ACP 249.00
- 620 Tractor... List 395 ACP 99.00
- Cable... ACP 29.00
- Serial to Par. 64K Buffer... ACP 125.00

DELUXE JOYSTICK

\$11.95



Compatible w/Atari 2600, 400, 800, VIC-20/64 and Apple. Apple requires optional cable adaptor. Add \$2.95

APPLE DISK DRIVE

\$115.00



High quality 1/2 high drive for Apple II, II+, IIe or IIc. Apple IIc requires optional cable adaptor. Add \$10.00

CIRCLE 105 ON FREE INFORMATION CARD

★ Advanced Computer Products Inc.

Mail Order: P.O. Box 17829 Irvine, CA 92713

Retail: 1310 B.E. Edinger Santa Ana, CA 92705

cable tv

DESCRAMBLER PARTS!

We stock the exact parts, PC board and AC adaptor for Radio Electronics February 1984 article on building your own Cable TV Descrambler.

- #701 **PARTS PACKAGE**.....\$29.95
Includes all the original resistors, capacitors, diodes, transistors, integrated circuits, coils, IF transformers (toko BKAN-K5552AXX).
- #702 **PC BOARD**.....\$12.95
Original etched & drilled silk-screened PC board used in the article.
- #704 **AC ADAPTOR**.....\$12.95
Original (14 volts DC @ 285ma) ac adaptor used in the article.

S □ P □ E □ C □ I □ A □ L □ S

BOTH #701 & #702..... NOW \$39

ALL THREE #701, #702 & #704..... NOW \$49

FREE

Reprint of Radio Electronics article (February 1984) on Building Your Own CABLE TV DESCRAMBLER with any purchase of above.

AC ADAPTOR
9 VDC @ 500mA \$5.95

PROMS 4k x 8
P2732A (21V) \$3.25

ADD \$2.50 SHIPPING AND HANDLING
\$4.50 FOR CANADIAN ORDERS
WE ALSO OFFER QUANTITY DISCOUNTS
ON 5 OR MORE UNITS



ORDER TOLL FREE

1-800-227-8529

inside MA 617-339-5372
VISA • MASTERCARD OR C.O.D.

Call or write for a free catalog.

J & W ELECTRONICS, INC.

P.O. BOX 800R MANSFIELD, MA 02048

VISA

NATIONAL SEMICONDUCTOR • PANASONIC
DK MACHINE • EVC, INC. • INTER-SIL • AD
EAC, INC. • J. W. MILLER • AAVO ENGINEER
E. F. OHMANN • ATLANTIC SEMI CONDUCT256K (262,144 x 1) DRAM 150NS \$5.70/1; \$39.95/9
Factory FirstsXODES • DIAMOND TOOL • UNGAR
ES • CIM INDUSTRIES • AMER • G. S
IGAR • YAGEO • J. W. MILLER • LUXO
IC CHEMICALS • ARIES • PLESSEY

INTEGRATED CIRCUITS		INTEGRATED CIRCUITS		T. T. C. SOCIETIES	
7400	1	7400	1	7400	1
7401	1	7401	1	7401	1
7402	1	7402	1	7402	1
7403	1	7403	1	7403	1
7404	1	7404	1	7404	1
7405	1	7405	1	7405	1
7406	1	7406	1	7406	1
7407	1	7407	1	7407	1
7408	1	7408	1	7408	1
7409	1	7409	1	7409	1
7410	1	7410	1	7410	1
7411	1	7411	1	7411	1
7412	1	7412	1	7412	1
7413	1	7413	1	7413	1
7414	1	7414	1	7414	1
7415	1	7415	1	7415	1
7416	1	7416	1	7416	1
7417	1	7417	1	7417	1
7418	1	7418	1	7418	1
7419	1	7419	1	7419	1
7420	1	7420	1	7420	1
7421	1	7421	1	7421	1
7422	1	7422	1	7422	1
7423	1	7423	1	7423	1
7424	1	7424	1	7424	1
7425	1	7425	1	7425	1
7426	1	7426	1	7426	1
7427	1	7427	1	7427	1
7428	1	7428	1	7428	1
7429	1	7429	1	7429	1
7430	1	7430	1	7430	1
7431	1	7431	1	7431	1
7432	1	7432	1	7432	1
7433	1	7433	1	7433	1
7434	1	7434	1	7434	1
7435	1	7435	1	7435	1
7436	1	7436	1	7436	1
7437	1	7437	1	7437	1
7438	1	7438	1	7438	1
7439	1	7439	1	7439	1
7440	1	7440	1	7440	1

SOLDER TAIL DIP SOCKETS

3/16" Solid Tail

Part No.	Description	Phosphor	Price
CS100	10 pin	10%	\$1.00
CS105	15 pin	10%	\$1.20
CS110	20 pin	10%	\$1.50
CS115	25 pin	10%	\$1.80
CS120	30 pin	10%	\$2.00
CS125	35 pin	10%	\$2.20
CS130	40 pin	10%	\$2.50
CS135	45 pin	10%	\$2.80
CS140	50 pin	10%	\$3.00
CS145	55 pin	10%	\$3.20
CS150	60 pin	10%	\$3.50

WIRE WRAP DIP SOCKETS

3/16" Solid Tail

Part No.	Description	Phosphor	Price
CS200	10 pin	10%	\$1.00
CS205	15 pin	10%	\$1.20
CS210	20 pin	10%	\$1.50
CS215	25 pin	10%	\$1.80
CS220	30 pin	10%	\$2.00
CS225	35 pin	10%	\$2.20
CS230	40 pin	10%	\$2.50
CS235	45 pin	10%	\$2.80
CS240	50 pin	10%	\$3.00
CS245	55 pin	10%	\$3.20
CS250	60 pin	10%	\$3.50

3/16" Solid Tail DIP SOCKETS

3/16" Solid Tail

Part No.	Description	Phosphor	Price
CS300	10 pin	10%	\$1.00
CS305	15 pin	10%	\$1.20
CS310	20 pin	10%	\$1.50
CS315	25 pin	10%	\$1.80
CS320	30 pin	10%	\$2.00
CS325	35 pin	10%	\$2.20
CS330	40 pin	10%	\$2.50
CS335	45 pin	10%	\$2.80
CS340	50 pin	10%	\$3.00
CS345	55 pin	10%	\$3.20
CS350	60 pin	10%	\$3.50

SILICON TRANSISTORS

Part No.	Description	Price
2N270	100mA, 10V, 50MHz	\$0.08
2N271	200mA, 10V, 50MHz	\$0.08
2N272	300mA, 10V, 50MHz	\$0.08
2N273	400mA, 10V, 50MHz	\$0.08
2N274	500mA, 10V, 50MHz	\$0.08

3/16" Solid Tail DIP SOCKETS

3/16" Solid Tail

Part No.	Description	Phosphor	Price
CS400	10 pin	10%	\$1.00
CS405	15 pin	10%	\$1.20
CS410	20 pin	10%	\$1.50
CS415	25 pin	10%	\$1.80
CS420	30 pin	10%	\$2.00
CS425	35 pin	10%	\$2.20
CS430	40 pin	10%	\$2.50
CS435	45 pin	10%	\$2.80
CS440	50 pin	10%	\$3.00
CS445	55 pin	10%	\$3.20
CS450	60 pin	10%	\$3.50

3/16" Solid Tail DIP SOCKETS

3/16" Solid Tail

Part No.	Description	Phosphor	Price
CS500	10 pin	10%	\$1.00
CS505	15 pin	10%	\$1.20
CS510	20 pin	10%	\$1.50
CS515	25 pin	10%	\$1.80
CS520	30 pin	10%	\$2.00
CS525	35 pin	10%	\$2.20
CS530	40 pin	10%	\$2.50
CS535	45 pin	10%	\$2.80
CS540	50 pin	10%	\$3.00
CS545	55 pin	10%	\$3.20
CS550	60 pin	10%	\$3.50

3/16" Solid Tail DIP SOCKETS

3/16" Solid Tail

Part No.	Description	Phosphor	Price
CS600	10 pin	10%	\$1.00
CS605	15 pin	10%	\$1.20
CS610	20 pin	10%	\$1.50
CS615	25 pin	10%	\$1.80
CS620	30 pin	10%	\$2.00
CS625	35 pin	10%	\$2.20
CS630	40 pin	10%	\$2.50
CS635	45 pin	10%	\$2.80
CS640	50 pin	10%	\$3.00
CS645	55 pin	10%	\$3.20
CS650	60 pin	10%	\$3.50

DISC CAPACITORS

Part No.	Capacitance	Voltage	Price
CD100	0.1	50V	\$0.02
CD105	0.15	50V	\$0.02
CD110	0.2	50V	\$0.02
CD115	0.25	50V	\$0.02
CD120	0.3	50V	\$0.02
CD125	0.35	50V	\$0.02
CD130	0.4	50V	\$0.02
CD135	0.45	50V	\$0.02
CD140	0.5	50V	\$0.02
CD145	0.55	50V	\$0.02
CD150	0.6	50V	\$0.02

3/16" Solid Tail DIP SOCKETS

3/16" Solid Tail

Part No.	Description	Phosphor	Price
CS700	10 pin	10%	\$1.00
CS705	15 pin	10%	\$1.20
CS710	20 pin	10%	\$1.50
CS715	25 pin	10%	\$1.80
CS720	30 pin	10%	\$2.00
CS725	35 pin	10%	\$2.20
CS730	40 pin	10%	\$2.50
CS735	45 pin	10%	\$2.80
CS740	50 pin	10%	\$3.00
CS745	55 pin	10%	\$3.20
CS750	60 pin	10%	\$3.50

3/16" Solid Tail DIP SOCKETS

3/16" Solid Tail

Part No.	Description	Phosphor	Price
CS800	10 pin	10%	\$1.00
CS805	15 pin	10%	\$1.20
CS810	20 pin	10%	\$1.50
CS815	25 pin	10%	\$1.80
CS820	30 pin	10%	\$2.00
CS825	35 pin	10%	\$2.20
CS830	40 pin	10%	\$2.50
CS835	45 pin	10%	\$2.80
CS840	50 pin	10%	\$3.00
CS845	55 pin	10%	\$3.20
CS850	60 pin	10%	\$3.50

3/16" Solid Tail DIP SOCKETS

3/16" Solid Tail

Part No.	Description	Phosphor	Price
CS900	10 pin	10%	\$1.00
CS905	15 pin	10%	\$1.20
CS910	20 pin	10%	\$1.50
CS915	25 pin	10%	\$1.80
CS920	30 pin	10%	\$2.00
CS925	35 pin	10%	\$2.20
CS930	40 pin	10%	\$2.50
CS935	45 pin	10%	\$2.80
CS940	50 pin	10%	\$3.00
CS945	55 pin	10%	\$3.20
CS950	60 pin	10%	\$3.50

3/16" Solid Tail DIP SOCKETS

3/16" Solid Tail

Part No.	Description	Phosphor	Price
CS1000	10 pin	10%	\$1.00
CS1005	15 pin	10%	\$1.20
CS1010	20 pin	10%	\$1.50
CS1015	25 pin	10%	\$1.80
CS1020	30 pin	10%	\$2.00
CS1025	35 pin	10%	\$2.20
CS1030	40 pin	10%	\$2.50
CS1035	45 pin	10%	\$2.80
CS1040	50 pin	10%	\$3.00
CS1045	55 pin	10%	\$3.20
CS1050	60 pin	10%	\$3.50

3/16" Solid Tail DIP SOCKETS

3/16" Solid Tail

Part No.	Description	Phosphor	Price
CS1100	10 pin	10%	\$1.00
CS1105	15 pin	10%	\$1.20
CS1110	20 pin	10%	\$1.50
CS1115	25 pin	10%	\$1.80
CS1120	30 pin	10%	\$2.00
CS1125	35 pin	10%	\$2.20
CS1130	40 pin	10%	\$2.50
CS1135	45 pin	10%	\$2.80
CS1140	50 pin	10%	\$3.00
CS1145	55 pin	10%	\$3.20
CS1150	60 pin	10%	\$3.50

3/16" Solid Tail DIP SOCKETS

3/16" Solid Tail

Part No.	Description	Phosphor	Price
CS1200	10 pin	10%	\$1.00
CS1205	15 pin	10%	\$1.20
CS1210	20 pin	10%	\$1.50
CS1215	25 pin	10%	\$1.80
CS1220	30 pin	10%	\$2.00
CS1225	35 pin	10%	\$2.20
CS1230	40 pin	10%	\$2.50
CS1235	45 pin	10%	\$2.80
CS1240	50 pin	10%	\$3.00
CS1245	55 pin	10%	\$3.20
CS1250	60 pin	10%	\$3.50

TANTALUM CAPACITORS

Part No.	Capacitance	Voltage	Price
TA100	0.1	50V	\$0.05
TA105	0.15	50V	\$0.05
TA110	0.2	50V	\$0.05
TA115	0.25	50V	\$0.05
TA120	0.3	50V	\$0.05
TA125	0.35	50V	\$0.05
TA130	0.4	50V	\$0.05
TA135	0.45	50V	\$0.05
TA140	0.5	50V	\$0.05
TA145	0.55	50V	\$0.05
TA150	0.6	50V	\$0.05

3/16" Solid Tail DIP SOCKETS

3/16" Solid Tail

Part No.	Description	Phosphor	Price
CS1300	10 pin	10%	\$1.00
CS1305	15 pin	10%	\$1.20
CS1310	20 pin	10%	\$1.50
CS1315	25 pin	10%	\$1.80
CS1320	30 pin	10%	\$2.00
CS1325	35 pin	10%	\$2.20
CS1330	40 pin	10%	\$2.50
CS1335	45 pin	10%	\$2.80
CS1340	50 pin	10%	\$3.00
CS1345	55 pin	10%	\$3.20
CS1350	60 pin	10%	\$3.50

3/16" Solid Tail DIP SOCKETS

3/16" Solid Tail

Part No.	Description	Phosphor	Price
CS1400	10 pin	10%	\$1.00
CS1405	15 pin	10%	\$1.20
CS1410	20 pin	10%	\$1.50
CS1415	25 pin	10%	\$1.80
CS1420	30 pin	10%	\$2.00
CS1425	35 pin	10%	\$2.20
CS1430	40 pin	10%	\$2.50
CS1435	45 pin	10%	\$2.80
CS1440	50 pin	10%	\$3.00
CS1445	55 pin	10%	\$3.20
CS1450	60 pin	10%	\$3.50

3/16" Solid Tail DIP SOCKETS

3/16" Solid Tail

Part No.	Description	Phosphor	Price
CS1500	10 pin	10%	\$1.00
CS1505	15 pin	10%	\$1.20
CS1510	20 pin	10%	\$1.50
CS1515	25 pin	10%	\$1.80
CS1520	30 pin	10%	\$2.00
CS1525	35 pin	10%	\$2.20
CS1530	40 pin	10%	\$2.50
CS1535	45 pin	10%	\$2.80
CS1540	50 pin	10%	\$3.00
CS1545	55 pin	10%	\$3.20
CS1550	60 pin	10%	\$3.50

3/16" Solid Tail DIP SOCKETS

3/16" Solid Tail

Part No.	Description	Phosphor	Price
CS1600	10 pin	10%	\$1.00
CS1605	15 pin	10%	\$1.20
CS1610	20 pin	10%	\$1.50
CS1615	25 pin	10%	\$1.80
CS1620	30 pin	10%	\$2.00
CS1625	35 pin	10%	\$2.20
CS1630	40 pin	10%	\$2.50
CS1635	45 pin		

THE MOST POPULAR PRODUCTS IN EUROPE & ASIA ARE COMING NOW! 50 HOT ITEMS FOR YOUR SELECTION. SEND \$1.00 FOR MARK V CATALOG. REFUND UPON ORDER

TY-328 COLOR LIGHT CONTROLLER



As a result of the advanced technology, this unit can control various colored light bulbs, the visual effect of which is most suitable in places like party, disco, electronic game centre and also in lightings for advertisement. Total output power is 3000W (1800W/Ch.) which means that it can control 30 pieces of 100W or 600 pieces of 5W color light which is enough for most usages.

KR \$45.00
As. with tested \$75.00

TR-100 0-12V 2A REGULATED DC POWER SUPPLY



- Output voltage is adjustable from 0-15V DC, two current limit range are available for selection; 200mA or 2A.
- An elaborated protection system is specially designed, a "BB" sound and a spark light will appear when the output is overloaded.
- High stability and reliable resulting from employing high quality voltage regulate IC.
- Possessing ring size meter makes the reading of voltage and current more clearly and accuracy.

A refined case, meter and all accessory are enclosed for both kit and assembly form. Most suitable for factory, professional or even amateur.

KR \$50.50
As. with tested \$65.50

TA-2400A ELECTRONIC ECHO AND REVERBERATION AMPLIFIER

REMIK your record yourself!



This unit combines the most advanced computer VLSI technique with high quality Japan Made component, so it has the following FEATURES:

It can generate various reflection and reverberation effect such as that in valley and music hall. It has a 3 section effect control which includes reverberation control, delay control and depth control. Special effect can be made in your record tapes by using this model. All kinds of infield sound effect can be obtained by skilful use of this control. It has LED display to show reflection and reverberation.

As. with tested \$39.95

TA-2500 HIGH QUALITY MULTIPURPOSE PRE-AMPLIFIER



This specially designed pre-amplifier includes a professional GRAPH EQUALIZER TONE control system and has a gain to 17dB. Frequency response extends from 5Hz to 20KHz, so even in bad listening condition it can improve well. It can accept input from various magnetic cartridge, record deck and tuner, its output can be connected to all kinds of power amplifier. The following combinations are good examples.

Assembled with tested \$30.00

TY-25 SPEAKER PROTECTOR



It includes high sensitive DC output protection circuit and has a LED to indicate the trouble. It is suitable for all kinds of power amplifier. All the OCL and OTL amplifier must have this speaker protection system!

KR \$9.50

150MC UNIVERSAL DIGITAL FREQUENCY COUNTER SM-100



SM-100 is an accurate, easy-operated digital frequency counter. Few pieces of advanced, high technical LSI integrated circuit are used, thus, circuit structure is reliable. SM-100 can give you up to 8 digits of readout for a wide frequency range of 10Hz to 150MHz. Besides, a memorize system is available, the last input digits can be held on the panel, as compare to the other of even observation.

Input sensitivity: KHz range 10Hz - 10MHz 50mVrms
MHz range 1MHz - 150MHz 50mVrms
Response time: 0.2 sec.
Hold: Hold the last input signal
Power supply: DC9V Battery or DC9V 250MA Adaptor
Assembled with Tested \$95.00

TA-477 120W MOSFET POWER AMPLIFIER



This amplifier consists of three super low THD differential stages, and Hitachi 2SJ49 2SK 134 match pair "MOSFET" as output component, whose frequency response and transient response is superior to the other power transistor. Therefore this amplifier sounds clear and high fidelity and has superior analysis over whole Audio spectrum, so it is suitable for reproducing classic and modern music.

KR \$41.20

TA-2000 NF-CR BI-FET IC PRE AMPLIFIER

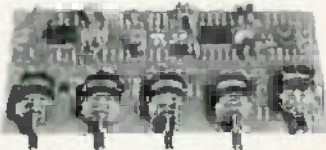

The heart of this Pre-amplifier is TL-984 IC which contains 4 BI-FET operational amplifier and has very good transient response and low distortion. High precision NF-CR MM cartridge amplifier has a superior distortion characteristic (less than 0.005%) and RAA equalization (0.2dB). It reproduces methodical sound. It has 40 steps volume control, separate high, middle and low tone control, tone compensation and tone defeat system. It is compatible with any power amplifiers which are made by our company such as TA-1000A, TA-477, TA-802.

KR \$44.50

TY-45 BAR/DOT AUDIO LEVEL DISPLAY



This unit uses the newly developed display driving IC to drive 20 LEDs/channel, it has two display modes: BAR or DOT. Display range is -57dB to 0dB. It uses green, yellow and red LED, so the display is not only beautiful but also has high readability, it can be used in various power amplifier to display peak power level.

This unit already has a rectifier so only needs an transformer IAC 12V x 2 1A. It can also use 12V CAR BATTERY as power supply. It is simple in construction and easy to build.
Size: 107x68 x 7" x 2 1/2"
KR \$34.95

TURBO SCREW-DRIVER (RECHARGEABLE) No. 998



The most perfect powerful multi-purpose tool for Workshop, Home, Hobby & Outdoor work. Includes UL approval charger, Driver bits: 3 Regular and 2 Philips.
Each set \$30.00

CORDLESS SOLDERING IRON (RECHARGEABLE) No. 620



The most perfect handy, lightweight soldering iron for Workshop, Home, Hobby & Outdoor work. Includes UL approval charger & cleaning sponge. With built-in solder-plate illumination.
Each set \$22.90

TALKING CLOCK

NEW FOR '86'



- Talk: push button for voice announcements of time.
- Read out: twelve hours system display for hour, minute, second by color LED, AM & PM.
- Display: three display modes of time, alarm time & date.
- Alarm: on/off switch with thirty seconds voice alarm.
- Escape: reminder voice alarm of thirty seconds after a minutes of first voice alarm.
- Volume: two level of voice output.
- Language: available English.

Parrot 0601 \$30.00
Mynah 0604 \$28.00 NOT A KIT!

LCD THERMOMETER CLOCK NEW!



Features:
0.34" DIGITAL thermometer with Hi & Low temperature alarm function and 12 hours clock combination.
Measuring range: 0°F to 160°F or -20°C to +70°C.
Resolution reading: ±1.8°F.
Dimension: 3.2" x 0.86" x 2.96".
T-1 with In/Out Clear sensor \$20.00
T-2 with Fahrenheit/Celsius measuring \$18.00 NOT A KIT!

YAMATO 4001 3 1/2 DIGITAL MULTIMETER



SPECIAL OFFER!

The YAMATO 4001 is a 3 1/2 DIGIT COMPACT DIGITAL MULTIMETER. It employs FE type LCD, with large figures. Its ADVANTAGES: High accuracy in measuring. High impedance assures min. measuring error. One rotary switch allows fast & convenient operation. 26 measurement range enable wider application. Over-input indication & low battery life appears on display. LSI-circuit use provides high reliability and durability. Measurement possible even under strong magnetic field.
Net a KIT, as assembled with tested \$23.00

TERMS

Min order: \$10.00
Charge card order: \$20.00
NO C.O.D. Cashier's check, phone orders accept.
Price, Res. Adv (6.5%) Sales Tax.
Orders are subject to change without notice.

All merchandises are subject to prior sale.
Shipping & Handling: Inside L.A. 5% of total order, (Min 1.50). Outside L.A. 10% of total order, (Min 2.50). Outside U.S.A. 20% of total order, (Min 5.00)
Shipped by UPS

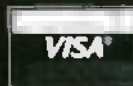

HOURS: MON - FRI 10:00 TO 5:00
SATURDAYS 9:00 TO 12:00

MARK V ELECTRONICS INC.
248 E. Main Street,
Suite 100,
Alhambra, CA 91801
Information (818) 282-1130
Orders, (818) 282-1196
P.O. Box 7422 ALHAMBRA, CA 91802
TELEX 3716014 MARK 5

★ QUALITY PARTS ★ DISCOUNT PRICES ★ FAST SHIPPING!

SEND FOR
FREE
NEW 1986 CATALOG...
48 PAGES!

ALL ELECTRONICS CORP.

EDGE CONNECTORS

ALL ARE 1.56" SPACING

22/44 EDGE CONNECTOR

PC style \$2.00 each
10 for \$18.00

22/44 EDGE CONNECTOR

socket lug style \$2.50 each

28/98 EDGE CONNECTOR

PC style \$2.50 each

34/72 EDGE CONNECTOR

PC style \$3.00 each

43/98 EDGE CONNECTOR

PC style \$4.50 each

TRANSISTORS

2N706	6 for \$1.00
2N2222A	3 for \$1.00
PN2222A	4 for \$1.00
2N2904	3 for \$1.00
2N2904	5 for \$1.00
2N2905	3 for \$1.00
2N2905	5 for \$1.00
MJ2855	\$1.00
2N3055	\$1.00
PNM10440	\$1.00
TIP 121	75¢
TIP 125	75¢

SPECIAL PRICE TRANSISTOR

PN3569 10 92 N P N
Plastic transistor
100 for \$8.00
500 for \$60.00
LARGE QUANTITIES
AVAILABLE

TRANSFORMERS

120 volt	
5.6 volts @ 750 ma	\$3.00
8 volts @ 150 ma	\$1.25
12 volt @ 200 ma	\$2.00
18 volt @ 350 ma	\$3.50
18 volts @ 1 amp	\$4.50
24 volt @ 200 ma	\$2.80
24 volt @ 400 ma	\$3.80
24 volt @ 15 amps	\$28.00
30 volt @ 2 amps	\$5.00

WALL TRANSFORMERS

4 VDC @ 20 ma	\$2.00
6 VDC @ 500 ma	\$3.50
6 VDC @ 750 ma	\$5.50
8 VDC @ 500 ma	\$3.00
12 VDC @ 285 ma	\$3.80
24 VDC @ 250 ma	\$3.80
MULTI-VOLTAGE @ 500 ma 5.4v, 6.7v, or 12 VDC	\$7.50

MINI-BOX

Heavy-duty black phenolic project box with cover and screws. 2 1/4" x 1 1/2" x 1 1/2"
\$1.00 EACH

FUSES

3AG (AGC) SIZE 1 1/2, 2, 2 1/2, 3, 4, 5, 6 AMP GMAA SIZE 1, 2, 3, 4, 5 AMP 5 of any ONE amperage 75¢
--

SOUND AND VIDEO MODULATOR FOR T.I. COMPUTER



T.I. # UM138-1. Designed for use with T.I. computers. Can be used with video sources. Built-in A/B switch. Channel 3 or 4 selection switch. Operates on 12 vdc. Hook-up diagram included.
\$10.00 EACH

SLIM LINE COOLING FAN



En. # 99 x 11/2 low noise fan. Measures 3 1/4" square x 1 1/2" deep. 21 Cfm. 23 db. 1700 rpm.
SPECIAL PRICE ... \$2.50 each

SOLID STATE BUZZER



Star # SSB 06.
8 vdc
TTL compatible
\$1.00 each
10 for \$9.00

2K 10 TURN

MULTI-TURN POT
SPECTROL
#M00 534 7161
\$5.00 EACH

± 12 Vdc or 24Vdc POWER SUPPLY

DELTRON MODEL DDZ/IS-1.7
Dual plus and minus 12Vdc open frame power supply. Can be used as 24Vdc @ 1.5 amp. I/P: either 115 Vac or 730 Vac.
Fully regulated computer grade supply.
7" x 4 1/4" x 2 1/4"
\$12.50 each 10 for \$110.00



SPECIALS OF THE MONTH

ALL 1/4 WATT RESISTORS
1000 pcs of one value \$7.80

ALL 1/2 WATT RESISTORS
1000 pcs of one value \$9.50

1 AMP 50 VOLT DIODES
1N4001 TAPE AND REEL
100 for \$4.50
1000 for \$30.00

D STYLE CONNECTORS
DB25 PLUS 10 for \$11.00
100 for \$100.00

DB25 SOCKET 10 for \$12.50
100 for \$110.00

SOLDER TAIL I.C. SOCKETS
24 PIN 10 for \$2.50
100 for \$22.00
1000 for \$200.00

8" P.A. SPEAKER

C.T.S. Model 8B3079
8 ohms coil
3.0 oz ferrite magnet
Typical response range
100 - 10,000 Hz
Power rating 15 watts max.
Dried to mount line matching transformers
\$5.00 each
CASE OF 8 SPEAKERS \$32.00



LINE CORDS

TWO WIRE
6' 16/2 SPT-1 flat 3 for \$1.00
6' 16/2 SPT-2 flat 3 for \$1.00
6' 16/2 SPT round 3 for \$1.25 each
THREE WIRE
6' 18/3 flat 1 for \$1.50 each
6' 18/3 round 1 for \$2.00 each
6' 18/3 round 2 for \$4.00 each

RELAYS

10 AMP SOLID STATE
CONTROL: 3-32 vdc
LOAD: 140 vac 10 amp
SIZES: 2 1/2" x 1 1/4" x 1 1/8"
\$9.50 EACH 10 FOR \$90.00

ULTRA-MINIATURE 5 VDC RELAY

Futaba # FBR21-1NE0005M20
High sensitivity
COIL: 120 ohms
CONTACTS: 1 amp
Mounts in 14 pin DIP socket
\$1.25 each 10 for \$10.00

MINIATURE 6 VDC RELAY

Aromat # R50.6V
Super Small
S.P.D.T. relay
GOLD contact
contacts rated
1 amp @ 30 vdc. Highly sensitive.
TTL direct drive possible. 120 ohm coil.
Operate from 4.3 - 8 vdc
COIL: 120 ohms
17/8" x 1 1/2" x 3/8"
\$1.50 each
10 for \$11.50

13 VDC RELAY

CONTACTS: 5 PIN C
10 amp @ 120 vac
Energize coil to open contacts
COIL: 13 vdc 650 ohms
SPECIAL PRICE \$1.00 each

4PDT RELAY

14 pin DIP style
3 amp contacts
USED But fully tested
\$1.70 each
Specify coil voltage desired
Either 24 vdc or 120 vac
LARGE QUANTITIES AVAILABLE
SOCKETS FOR R RELAY
75¢ each

RECHARGEABLE NI-CAD BATTERIES

AAA SIZE 1.25V 500MAH	\$1.85
AA SIZE 1.25V 500MAH	\$3.85
AA with solder tab	\$2.00
C SIZE 1.2V 1200MAH	\$3.50
D SIZE 1.2V 1200MAH	\$3.50

UNIVERSAL CHARGER

Will charge 4-AA, C, D, or AAA Ni-cads, or one 9 volt Ni-cad at one time.
\$11.00 per charger

SPECIAL PRICE DUAL L.E.D. DISPLAYS

580 high 7 segment L.E.D. read-outs. Mount in 24 pin DIP sockets.
MAN-6840 orange c.f. 75¢ each
FND-5148 red c.c. 75¢ each
DL-522 red c.a. 75¢ each

CASSETTE MECHANISM

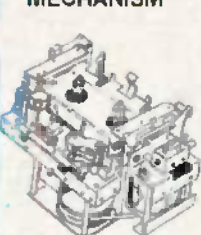

New stereo cassette mechanism includes record/playback and erase heads. 2-12VDC motor drive belts, pulleys, 3-12VDC solenoids, pinch wheels and other mechanical parts. These parts used on other current model decks. Adults cost several times our selling price if purchased separately. Build your own audio or data recorder or use for spare parts. 8 1/2" x 3 1/2" x 3 1/2"
\$750 EACH 2 FOR \$12.50

3 1/2" SPEAKER

8 ohm impedance.
Full range speaker
8 oz magnet
4" diagonal mounting corners
\$2.50 each 10 for \$25.00

SPRING LEVER TERMINALS

Two color coded terminals on a sturdy 2 1/4" x 3 1/8" Bakelite plate.
Great for speaker enclosures or power supplies.
75¢ EACH 10 for \$6.00

MINIATURE TOGGLE SWITCHES

ALL ARE RATED 5 AMPS @ 125 VDC

S.P.D.T. (on-on) PC style non-maleaded bushing \$1.00 each 10 for \$9.00
S.P.D.T. (on-off-on) PC style maleaded bushing \$1.00 each 10 for \$9.00
D.P.D.T. (on-on) PC style maleaded bushing \$1.00 each 10 for \$9.00
S.P.D.T. (on-off-on) PC style maleaded bushing \$1.00 each 10 for \$9.00
D.P.D.T. (on-on) PC style maleaded bushing \$1.00 each 10 for \$9.00

STANDARD JUMBO DIFFUSED T 1 1/2

RED	10 for \$1.00 100 for \$13.00
GREEN	10 for \$2.00 100 for \$17.00
YELLOW	10 for \$2.00 100 for \$17.00

D.R.S.T. LIGHTED ROCKER SWITCH

115 vac lighted rocker switch mounts in 1 1/2" x 1 1/2" hole.
Orange lens 16 amp contact
\$1.50

MINI-PUSH BUTTON

5 PS Y momentary normally open 1/8" bushing.
Red button
25¢ each
10 for \$3.00

FLASHER LED

8 volt operation red jumbo T 1 1/2 size
\$1.00 each

BI-POLAR jumbo T 1 1/2 size

3 for \$1.70

SNAP ACTION SWITCH

Cherry elect. #E-21 N.O. or N.C.
0.1A contact. Suitable for alarms and other low energy circuits.
1 1/4" lever
45¢ EACH 10 FOR \$4.50

LED HOLDERS

Two piece holder for jumbo LED
10 for \$5.00

ROTARY ACTION MICRO

Omron #C-5G3-C41
Dial action micro used in coin-operated mechanisms and low torque operations.
RATED: 5 amps @ 125 Vac
\$1.25 each 10 for \$12.00
LARGE QUANTITIES AVAILABLE

TI SWITCHING POWER SUPPLY

Compact, well regulated switching power supply designed to power Texas Instruments computer equipment.
INPUT: 110-250 vac @ 1 amp
OUTPUT: +12 vdc @ 350 ma
 +5 vdc @ 1.2 amp
 -5 vdc @ 200 ma
SIZE 4 1/2" x 4 1/4" x 1 1/4" high
\$5.00 each

13.8 VDC REGULATED POWER SUPPLY

These are solid state fully regulated 13.8 vdc power supplies. Both feature 100% solid state construction, fuse protection, and L.E.D. power indicator M.L.L. listed.
2 amp constant, 4 amp surge \$18.00 each
3 amp constant, 5 amp surge \$25.00 each

D.C. CONVERTER

Designed to provide a steady 5 vdc @ 240 ma. from a battery supply of 3.5 to 6.25 volts.
2 1/4" x 1 1/2" x 1 1/2"
\$1.50 each

7 CONDUCTOR RIBBON CABLE

Spectra-strip red marker strip.
28 ga. stranded wire.
\$5.00 per 100 roll

ALL ELECTRONICS CORP.
LOS ANGELES, CA STORE
905 S. Vermont Ave
213 380 8000
VAN NUYS, CA STORE
6228 Sepulveda Blvd
818 997 1806

MAIL ORDERS TO
R.O. BOX 20406
Los Angeles, CA 90006
TWX - 51010163 ALL ELECTRONIC
EASLINK MBX - 6288748

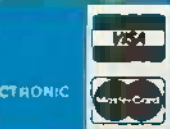

TOLL FREE ORDERS ONLY
1 800 828 5433
(ORDER ONLY)
IN CALIFORNIA: 1 800 258 6666
ALASKA, HAWAII
OR INFORMATION
(213) 380 8000 NO C.O.D.'S

QUANTITIES LIMITED
MINIMUM ORDER \$10.00
USA: \$3.00 SHIPPING
FOREIGN ORDERS
INCLUDING SUFFICIENT
SHIPPING
CALIF RES. ADD 6 1/2%

8 FEBRUARY 1986

BUILD YOUR OWN XT COMPATIBLE SYSTEM

640K XT COMPATIBLE MOTHERBOARD

- ★ 4.77 MHz 8088 CPU, OPTIONAL 8087 CO-PROCESSOR
- ★ 8 EXPANSION SLOTS
- ★ 0K RAM INSTALLED, EXPANDABLE TO 640K ON-BOARD MEMORY
- ★ ALL ICs SOCKETED—HIGHEST QUALITY PC BOARD
- ★ ACCEPTS 2764 OR 27128 ROMS

ONLY \$169

Compatible with all IBM-PC/XT hardware and software. Use with our flip-top case, power supply and other accessories to build a complete XT compatible system.

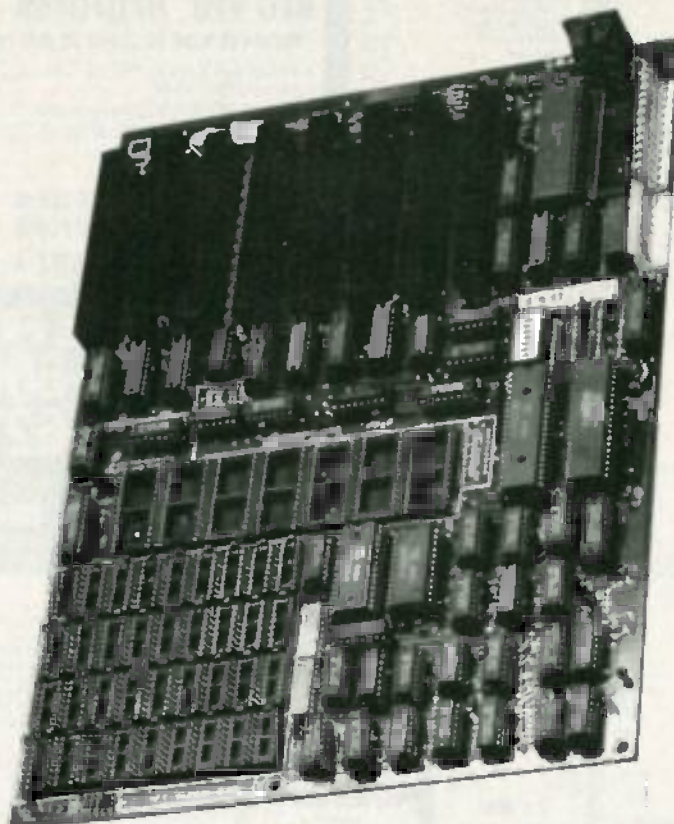

PRO-BIOS \$29⁹⁵

IBM XT Compatible BIOS runs virtually all IBM software, even Sidekick!

EXTRA FEATURES: Control colors from DOS

Park heads on the hard disk with Control-Alternate-Break

HARD DISK SYSTEMS

MINISCRIBE/SHUGART
10 MEGABYTE HALF HEIGHT **\$395**

SEAGATE ST-225
20 MEGABYTE HALF HEIGHT **\$525**

Includes short slot HD controller, cables, mounting hardware and instructions. All drives are pre-tested. One year warranty.

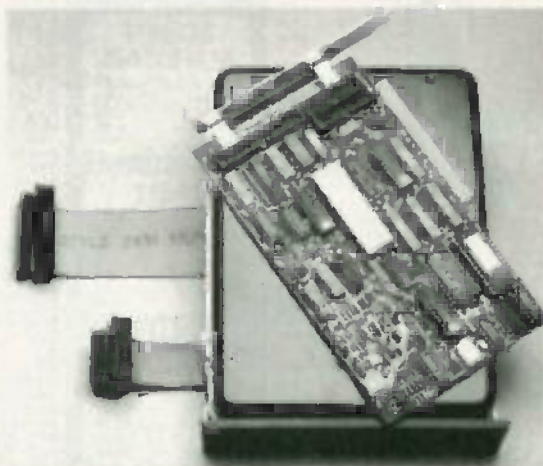

VISIT OUR RETAIL STORE LOCATED AT 1256 SOUTH BASCOM AVENUE IN SAN JOSE

 **JDR Microdevices**

1224 S. Bascom Avenue, San Jose, CA 95128
800-538-5000 • 800-662-6279 (CA) • (408) 995-5430
FAX (408) 275-8415 • Telex 171-110

HOURS: M-W-F, 9-5 TU-TH, 9-9 SAT, 10-3
PLEASE USE YOUR CUSTOMER NUMBER WHEN ORDERING

TERMS: Minimum order \$10.00. For shipping and handling include \$2.50 for UPS Ground and \$3.50 for UPS Air. Orders over 1 lb. and foreign orders may require additional shipping charges - please contact our sales department for the amount. CA residents must include applicable sales tax. All merchandise is warranted for 90 days unless otherwise stated. Prices are subject to change without notice. We are not responsible for typographical errors. We reserve the right to limit quantities and to substitute manufacturers. All merchandise subject to prior sale.

© Copyright 1985 JDR Microdevices

CIRCLE 282 ON FREE INFORMATION CARD

www.americanradiohistory.com

FEBRUARY 1986

131

4164 200ns 69¢

41256 150ns \$2.95

STATIC RAMS

Table listing static RAM models (e.g., 2101, 2102L-4) and their specifications.

DYNAMIC RAMS

Table listing dynamic RAM models (e.g., 4116-250, 4116-200) and their specifications.

★★★HIGH-TECH★★★

NEC V20 UPD70108 \$20.95

REPLACES 8088 TO SPEED UP IBM PC 10-40%

- HIGH-SPEED ADDRESS CALCULATION IN HARDWARE
• PIN COMPATIBLE WITH 8088
• SUPERSET OF 8086/8088 INSTRUCTION SET
• LOW POWER CMOS

8 MHz V20 UPD70108-8 \$24.95
8 MHz V30 UPD70118-8 \$28.95

★★★SPOTLIGHT★★★

ORDER TOLL FREE
800-538-5000
800-662-6279 (CA)



EPROMS

Table listing EPROM models (e.g., 2708, 2716-8) and their specifications.

SPECTRONICS CORPORATION EPROM ERASERS

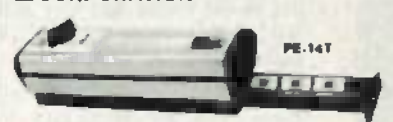

Table listing EPROM eraser models (e.g., PE-14, PE-14T) and their specifications.

8000

Table listing 8000 series RAM models and prices.

6500

Table listing 6500 series RAM models and prices.

CRT CONTROLLERS

Table listing CRT controller models and prices.

CRYSTALS

Table listing crystal models and prices.

74LS00

Table listing 74LS00 series logic chips and prices.

HIGH SPEED CMOS

A new family of high speed CMOS logic featuring the speed of low power Schottky (beta typical gate propagation delay), combined with the advantages of CMOS: very low power consumption, superior noise immunity, and improved output drive.

74HC00

Table listing 74HC00 series logic chips and prices.

74HC100

Table listing 74HC100 series logic chips and prices.

8200

Table listing 8200 series RAM models and prices.

2.0 MHz

Table listing 2.0 MHz RAM models and prices.

DISK CONTROLLERS

Table listing disk controller models and prices.

CRYSTAL OSCILLATORS

Table listing crystal oscillator models and prices.

74LS00

Table listing 74LS00 series logic chips and prices.

BIT RATE GENERATORS

Table listing bit rate generator models and prices.

6800

Table listing 6800 series RAM models and prices.

UARTS

Table listing UART models and prices.

Z-80

Table listing Z-80 series RAM models and prices.

2.0 MHz

Table listing 2.0 MHz RAM models and prices.

MISC.

Table listing miscellaneous components and prices.

SOUND CHIPS

Table listing sound chip models and prices.

CLOCK CIRCUITS

Table listing clock circuit models and prices.

74F00

Table listing 74F00 series logic chips and prices.

VISIT OUR RETAIL STORE LOCATED AT 1256 SOUTH BASCOM AVENUE IN SAN JOSE



JDR Microdevices

1224 S. Bascom Avenue, San Jose, CA 95128

800-538-5000 • 800-662-6279 (CA) • (408) 995-5430

FAX (408) 275-8415 • Telex 171-110

HOURS: M-W-F, 9-5 TU-TH, 9-9 SAT, 10-
PLEASE USE YOUR CUSTOMER NUMBER WHEN ORDERING

TERMS: Minimum order \$10.00. For shipping and handling include \$2.50 for UPS Ground and \$3.50 for UPS Air. Orders over 1 lb. and foreign orders may require additional shipping charges - please contact our sales department for the price. Customers must include applicable sales tax. All merchandise is warranted for 90 days unless otherwise stated. Prices are subject to change without notice. We are not responsible for typographical errors. We reserve the right to limit quantities and substitute manufacturers. All merchandise subject to prior sale.

© COPYRIGHT 1985 JDR MICRODEVICES, INC.

THE JDR MICRODEVICES LOGO IS A REGISTERED TRADEMARK OF JDR MICRODEVICES. JDR INSTRUMENTS AND JDR MICRODEVICES ARE TRADEMARKS OF JDR MICRODEVICES. IBM IS A TRADEMARK OF INTERNATIONAL BUSINESS MACHINES. APPLE IS A TRADEMARK OF APPLE COMPUTER.

CIRCLE 281 ON FREE INFORMATION CARD

PARTIAL LISTING ONLY — CALL FOR A FREE CATALOG

CMOS

4001	.19	14419	4.95
4011	.25	14433	14.95
4012	.25	4501	.49
4013	.35	4511	.69
4015	.25	4518	.79
4016	.25	4818	.85
4017	.49	4522	.79
4018	.69	4526	.79
4020	.59	4527	1.95
4021	.49	4528	1.95
4024	.49	4529	2.95
4025	.25	4532	1.95
4027	.39	4538	.95
4028	.55	4641	1.29
4035	.89	4553	5.79
4040	.89	4558	.75
4041	.75	4702	12.95
4042	.59	74C00	.29
4043	.85	74C14	.59
4044	.89	74C74	.69
4045	1.99	74C83	1.49
4046	.89	74C85	1.89
4047	.89	74C95	.99
4049	.29	74C150	8.79
4050	.29	74C151	2.29
4051	.69	74C184	.99
4052	.69	74C183	.99
4053	.69	74C184	1.39
4056	2.19	74C182	1.49
4060	.89	74C193	1.49
4066	.29	74C221	1.79
4069	.19	74C240	1.89
4078	.59	74C244	1.89
4077	.29	74C374	1.99
40A1	.22	74C905	8.95
40B5	.79	74C511	8.95
40B6	.89	74C517	8.95
4093	.49	74C922	4.49
4094	.29	74C923	4.95
14411	5.95	74C240	7.95
18412	5.95	80C97	.96

EDGECARD CONNECTORS

100 PIN ST	B-100	125	3.95
100 PIN WW	B-100	125	4.95
62 PIN ST	IBM PC	100	1.95
50 PIN ST	APPLE	100	2.96
44 PIN ST	STD	156	1.95
44 PIN WW	STD	156	4.95

DIP CONNECTORS

DESCRIPTION	ORDER BY	CONTACTS									
		8	14	16	18	20	22	26	28	40	
HIGH RELIABILITY TOOLED ST IC SOCKETS	AUGAT _{ST}	.82	.79	.89	1.09	1.29	1.39	1.49	1.69	2.49	
HIGH RELIABILITY TOOLED WW IC SOCKETS	AUGAT _{WW}	1.30	1.80	2.10	2.40	2.90	2.90	3.19	3.70	5.60	
COMPONENT CARRIES (DIP HEADERS)	ICC _{xx}	.49	.69	.89	.99	.99	.99	.99	1.09	1.49	
RIBBON CABLE DIP PLUGS (DD)	IDP _{xx}	—	.95	.96	—	—	—	—	1.76	—	2.96

FOR ORDERING INSTRUCTIONS SEE D-SUBMINIATURE BELOW

D-SUBMINIATURE

DESCRIPTION	ORDER BY	CONTACTS						
		5	18	18	26	37	80	
SOLDER CUP	MALE	DB _{xx} P	.82	.90	1.29	1.29	1.80	3.48
	FEMALE	DB _{xx} S	.98	1.15	1.50	1.50	2.39	4.32
RIGHT ANGLE PC SOLDER	MALE	DB _{xx} PR	1.20	1.49	—	1.99	2.96	—
	FEMALE	DB _{xx} SR	1.25	1.59	—	2.00	2.79	—
WIRE WRAP	MALE	DB _{xx} PWW	1.89	2.88	—	3.89	6.40	—
	FEMALE	DB _{xx} SWW	2.76	4.27	—	5.84	8.96	—
IDC RIBBON CABLE	MALE	IDB _{xx} P	2.70	2.95	—	3.96	6.70	—
	FEMALE	IDB _{xx} S	2.92	3.20	—	4.33	6.76	—
HOODS	MtAL	MHOOD _{xx}	1.25	1.25	1.30	1.30	—	—
	GREY	HOOD _{xx}	.65	.66	—	.88	.79	.98

ORDERING INSTRUCTIONS: INSERT THE NUMBER OF CONTACTS IN THE POSITION MARKED "X" OF THE "ORDER BY" PART NUMBER LISTED.
EXAMPLE: A 15 PIN RIGHT ANGLE MALE PC SOLDER WOULD BE DB15PR

MOUNTING HARDWARE \$1.00

IDC CONNECTORS

DESCRIPTION	ORDER BY	CONTACTS					
		10	20	26	34	40	60
SOLDER HEADER	IDH _{xx} S	.82	1.29	1.68	2.20	2.58	3.26
RIGHT ANGLE SOLDER HEADER	IDH _{xx} SR	.85	1.35	1.76	2.31	2.72	3.39
WW HEADER	IDH _{xx} W	1.86	2.89	3.84	4.50	5.25	6.93
RIGHT ANGLE WW HEADER	IDH _{xx} WR	2.00	3.28	4.22	4.45	4.90	7.20
RIBBON HEADS SOCKET	IDB _{xx}	.79	.99	1.39	1.59	1.99	2.25
RIBBON HEADER	IDH _{xx}	—	5.86	5.29	7.09	7.90	9.90
RIBBON EDGE CARD	IDE _{xx}	1.79	2.25	2.68	2.79	3.80	3.95

FOR ORDERING INSTRUCTIONS SEE D-SUBMINIATURE ABOVE

HARD TO FIND "SNAPABLE" HEADERS

CAN BE SNAPPED APART TO MAKE ANY SIZE HEADER. ALL WITH .1" CENTERS

1x40	STRAIGHT LEAD	.89
1x40	RIGHT ANGLE	1.49
2x40	STRAIGHT LEAD	2.49
2x40	RIGHT ANGLE	2.99

SHORTING BLOCKS

GOLD CONTACTS SPACED AT .1" CENTERS

5/\$1.00

Let me tell you how much I appreciate your Sales & Customer Service staffs. My recent order was filled in a most courteous & prompt manner & I will deal with you in the future to the exclusion of other similar firms who obviously don't need customers bothering them. Thank you.

F.K. Chapel Hill, NC.

CALL FOR VOLUME QUOTES

CIRCLE 113 ON FREE INFORMATION CARD

www.americanradiohistory.com

© COPYRIGHT 1985 JDR MICRODEVICES

7400/9000

7400	.19	74147	2.49
7402	.19	74148	2.99
7404	.19	74150	1.35
7408	.29	74151	.55
7407	.29	74153	.55
7408	.24	74154	1.49
7410	.19	74155	.75
7411	.29	74157	.55
7414	.49	74159	1.68
7416	.29	74161	.75
7417	.25	74163	.89
7420	.19	74164	.89
7423	.29	74166	.85
7430	.19	74166	1.00
7432	.29	74175	.89
7436	.29	74177	.79
7442	.49	74178	1.19
7445	.69	74181	2.25
7447	.89	74182	.75
7470	.39	74184	2.00
7473	.34	74191	1.15
7474	.33	74192	.79
7479	.45	74194	.85
7476	.49	74196	.79
7483	.50	74197	.95
7485	.69	74199	1.35
7484	.35	74221	1.35
7489	2.15	74248	1.35
7490	.39	74247	1.25
7492	.60	74248	1.89
7493	.39	74249	1.25
7495	.69	74251	.75
7497	2.75	74255	1.35
74100	2.28	74273	1.95
74121	.28	74278	3.11
74123	.46	74307	.85
74125	.48	74368	.86
74141	.89	9865	3.95
74143	5.95	9862	1.50
74144	2.95	9637	2.95
74145	.90	96502	1.95

74800

74800	.29	748183	1.29
74802	.29	748189	3.60
74803	.29	748174	.79
74804	.29	748176	.79
74805	.29	748148	1.99
74808	.39	748189	1.95
74810	.39	748196	1.49
74815	.35	748196	1.49
74830	.29	748197	1.68
74832	.39	748226	3.95
74837	.89	748240	1.49
74838	.69	748241	1.49
74874	.49	748244	1.49
74885	.95	748257	.79
74886	.95	748253	.79
748112	.90	748258	.95
748124	.79	748290	1.95
748138	.79	748287	1.69
748140	.55	748248	1.69
748151	.79	748299	2.95
748152	.79	748373	1.69
748167	.79	748374	1.69
748184	.95	748471	4.95
748191	1.29	748571	2.95

VOLTAGE REGULATORS

TO-220 CASE			
7808T	49	7905T	59
7808T	49	7908T	59
7812T	49	7912T	59
7818T	49	7918T	59
TO-3 CASE			
7805K	139	7905K	140
7812K	138	7912K	149
TO-92 CASE			
78L05	49	79L05	59
79L12	49	79L12	69

OTHER VOLTAGE REGS

LM323K	SV 3A	TO-3	4.79
LM338K	4A 5A	TO-3	3.95
78x05K	SV 5A	TO-3	7.95
78x12K	12V 5A	TO-3	8.99
78P05K	SV 10A	TO-3	14.99

IC SOCKETS

8 PIN ST	.11	100
14 PIN ST	.11	.09
16 PIN ST	.12	.10
18 PIN ST	.18	.13
20 PIN ST	.18	.16
22 PIN ST	.15	.12
24 PIN ST	.20	.15
28 PIN ST	.32	.18
40 PIN ST	.30	.32
84 PIN ST	1.95	1.49

ST-SOLDER TAIL

8 PIN WW	.99	49
14 PIN WW	.69	.62
16 PIN WW	.59	.58
18 PIN WW	.99	.99
20 PIN WW	1.09	.98
22 PIN WW	1.39	1.28
24 PIN WW	1.49	1.36
28 PIN WW	1.69	1.49
40 PIN WW	1.99	1.89
WW-WIRE WRAP		
18 PIN ZIF	4.95	CALL
24 PIN ZIF	5.95	CALL
28 PIN ZIF	6.95	CALL
40 PIN ZIF	9.96	CALL
ZIF-TEXT TOOL		
IZERO INSERTION FORCE		

LINEAR

TL064	.99	LM733	.99
TL071	.99	LM741	.89
TL072	1.09	LM747	.89
TL074	1.95	LM748	.59
TL081	.99	MC1330	1.69
TL082	.99	MC1350	1.19
TL084	1.49	MC1372	6.95
LM301	.34	LM1414	1.59
LM309K	1.25	LM1458	.49
LM311	.99	LM1488	.49
LM311M	.89	LM1488	.49
LM317K	3.49	LM1499	.85
LM317V	.95	LM1812	8.25
LM318	1.43	LM1889	1.95
LM319	1.25	ULN2003	.79
LM320	***7900	XR2206	3.75
LM322	1.65	XR2211	2.95
LM323K	4.79	XR2240	1.96
LM324	.49	MPQ2907	1.95
LM331	3.95	LM2917	1.95
LM334	1.16	CA3046	.89
LM335	1.40	CA3061	.99
LM338	1.75	CA3082	.96
LM337K	1.95	CA3088	.49
LM338K	3.95	CA3089	1.95
LM335	.69	CA3130E	.99
LM340	***7900	CA3146	1.29
LM350T	4.60	CA3160	1.19
LF353	.55	MC3470	1.95
LF356	.99	MC3480	8.95
LF357	.99	MC3487	2.95
LM358	.99	LM3900	.49
LM380	.89	LM3909	.89
LM383	1.95	LM3911	2.25
LM386	.89	LM3914	2.39
LM393	.45	MC4024	3.49
LM394H	4.60	MC4044	3.99
TL494	4.20	RC4136	1.25
TL497	3.25	RC4558	.69
NE555	.99	LM13600	.99
NE556	.49	78107	1.49
NE554	1.29	75110	1.95
NE564	1.95	75150	1.95
LM565	.95	75184	1.95
LM566	1.49	79188	1.25
LM567	.79	78189	1.25
NE670	2.95	79081	.99
NE590	2.50	75452	.99
NE592	.98	75453	.99
LM710	.79	76477	1.29
LM723	.45	75492	.79

H-T0.5 CAN, R-T0.3 T-T

ORDER TOLL FREE

800-538-5000

800-662-6279 (CA)

BARGAIN HUNTERS CORNER DISK DRIVE SPECIALS

TEAC FD-54B 5 1/4" 5 1/2" DD \$85.00
1/2 HEIGHT, IBM COMPATIBLE DIRECT DRIVE

QUME QT-140 5 1/4" 5 1/2" DD \$69.95
1/2 HEIGHT, IBM COMPATIBLE BELT DRIVE

SHUGART SA-810 8" 5 1/2" DD \$99.95
1/2 HEIGHT DIRECT DRIVE IBM COMPATIBLE

TS-806 CABINET & POWER SUPPLY \$99.95
ONE TEAC FD-54B AND ROOM FOR A FULL OR 1/2 HEIGHT HARD DISK. A CLOSE-OUT SPECIAL FROM A MAJOR MANUFACTURER (WE CAN'T SAY WHO), PERFECT FOR THE HOBBYIST.

**HURRY — QUANTITIES ARE LIMITED!
SPECIALS END 2/28/86**

PAGE WIRE WRAP WIRE PRECUT ASSORTMENT IN ASSORTED COLORS \$27.50

100mm 9.5", 6.0", 6.5", 7.0"
250mm 2.9", 4.5", 5.0"
500mm 3.0", 3.5", 4.0"
SPOOLS
100 feet \$4.30 250 feet \$7.25
500 feet \$13.25 1000 feet \$21.95
Please specify color:
Blue, Black, Yellow or Red

WIRE WRAP PROTOTYPE CARDS FR-4 EPOXY GLASS LAMINATE WITH GOLD-PLATED EDGE-CARD FINGERS

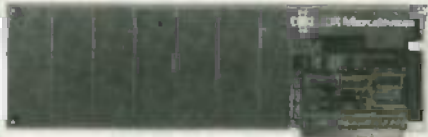

IBM-PR2
IBM
BOTH CARDS HAVE SILK SCREENED LEGENDS AND INCLUDES MOUNTING BRACKET
IBM-PR1 WITH -5V AND GROUND PLANE \$27.95
IBM-PR2 AS ABOVE WITH DECODING LAYOUT \$29.95

S-100
P100-1 BARE - NO FOIL PADS \$16.19
P100-2 HORIZONTAL BUS \$21.80
P100-3 VERTICAL BUS \$21.80
P100-4 SINGLE FOIL PADS PER HOLE \$22.75

APPLE
P500-1 BARE - NO FOIL PADS \$16.15
P500-3 HORIZONTAL BUS \$22.75
P500-4 SINGLE FOIL PADS PER HOLE \$21.80
7060-45 FOR APPLE II IN AUX SLOT \$30.00

SOCKET-WRAP I.O.™

• SLIPS OVER WIRE WRAP PINS
• IDENTIFIES PIN NUMBERS ON WRAP
• SIDE OF BOARD
• CAN WRITE ON PLASTIC, SUCH AS IC #
PINS PART# PCK. OF PRICE
9 IDWRAP 08 10 1.95
18 IDWRAP 14 10 1.95
16 IDWRAP 16 10 1.95
18 IDWRAP 18 5 1.95
20 IDWRAP 20 5 1.95
22 IDWRAP 22 8 1.95
24 IDWRAP 24 5 1.95
26 IDWRAP 28 8 1.95
40 IDWRAP 40 8 1.95
PLEASE ORDER BY NUMBER OF PACKAGES (PCK. OF)
ID WRAP 24



FRAME STYLE TRANSFORMERS

12.6V AC CT 2 AMP 5.95
12.6V AC CT 4 AMP 7.95
12.6V AC CT 8 AMP 10.95
25.2V AC CT 2 AMP 7.95

**25 PIN D-SUB
GENDER
CHANGERS**
\$7.95



SWITCHING POWER SUPPLIES

PS-IBM \$89.95
• FOR IBM PC XT COMPATIBLE
• 130 WATTS
• -5V @ 1.5A, -12V @ 4.2A
• -5V @ .5A, -12V @ .5A
• ONE YEAR WARRANTY



PS-130 \$89.95
• 130 WATTS
• SWITCH ON REAR
• FOR USE IN OTHER IBM TYPE MACHINES
• 90 DAY WARRANTY



PS-A \$49.95
• USE TO POWER APPLE TYPE SYSTEMS
• -5V @ 4A, -12V @ 2.8A
• -5V @ .5A, -12V @ .5A
• APPLE POWER CONNECTOR



PS-SPL200 \$49.95
• -5V @ 2.5A, -12V @ 3.5A
• -5V @ 1A, -12V @ 1A
• UL APPROVED
• ALUMINUM ENCLOSURE



PS-TDK \$29.95
• -5V @ 4A, -12V @ 2A
• -12V @ 2.8A, -12V @ .30A
• 6.2" x 7.4" x 1.7", 1.8 LBS



PS-11951 \$29.95
• MANUFACTURED BY ASTEC
• -5V @ 8A, -12V @ 2A
• -12V @ 1.5A, -12V @ 2A
• 6.0" x 6.0" x 2.0", 1.8 LBS



CAPACITORS TANTALUM

1.0µf	15V	.35	.47µf	35V	.45
6.8	15V	.70	1.0	35V	.45
10	15V	.80	2.2	35V	.65
22	15V	1.35	4.7	35V	.85
22	35V	.40	10	35V	1.00

OISC

10µf	50V	.08	680	50V	.06
22	50V	.05	.0022	50V	.06
33	50V	.06	.005	50V	.06
47	50V	.06	.01	50V	.07
68	50V	.06	.02	50V	.07
100	50V	.06	.05	50V	.07
220	50V	.06	1	12V	.10
560	50V	.06	1	50V	.12

MONOLITHIC

.01µf	50V	.14	.1µf	50V	.18
.047µf	50V	.18	.47µf	50V	.25

ELECTROLYTIC

RADIAL		AXIAL		
1µf	25V	.14	50V	.14
2.2	35V	.10	50V	.10
4.7	50V	.10	15V	.14
10	50V	.18	50V	.20
47	35V	.18	35V	.25
100	16V	18	25V	.30
220	35V	20	470	.50
470	25V	30	1000	.60
2200	16V	70	2200	.70
4700	25V	1.45	4700	1.25
COMPUTER GRADE		44,000µf	30V	3.95

DATAERASE EPROM ERASER \$34.95

• ERASES TWO EPROMS IN 10 MINUTES
• COMPACT-NO DRAWER
• THIN METAL SHUTTER
• PREVENTS UV LIGHT FROM ESCAPING

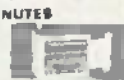

1/4 WATT RESISTORS

5% CARBON FILM ALL STANDARD VALUES FROM 1 OHM TO 10 MEG. OHM
10 PCS same value .05 100 PCS same value .02
50 PCS same value .025 1000 PCS same value .015

RESISTOR NETWORKS

SIP	10 PIN	9 RESISTOR	.69
SIP	8 PIN	7 RESISTOR	.59
DIP	16 PIN	8 RESISTOR	1.09
DIP	16 PIN	15 RESISTOR	1.09
DIP	14 PIN	7 RESISTOR	.99
DIP	14 PIN	13 RESISTOR	.89

SPECIALS ON BYPASS CAPACITORS

.01 µf CERAMIC DISC	100/\$5.00
.01 µf MONOLITHIC	100/\$10.00
.1 µf CERAMIC DISC	100/\$6.50
.1 µf MONOLITHIC	100/\$12.50

NEW BOOKS BY STEVE GIARCIA

BUILD YOUR OWN 286 COMPUTER \$15.95
CIRCUIT CELLAR VOL 1 \$17.95
CIRCUIT CELLAR VOL 2 \$18.95
CIRCUIT CELLAR VOL 3 \$18.95
CIRCUIT CELLAR VOL 4 \$19.95

MICROCOMPUTER HARDWARE HANDBOOK

FROM ELCOMP \$14.95
OVER 600 PAGES OF DATA SHEETS ON THE MOST COMMONLY USED ICs. INCLUDES TTL, CMOS, 74LS80, MEMORY, CPU, MPU SUPPORT, AND MUCH MORE!

WISH SOLDERLESS BREADBOARDS

PART NUMBER	DIMENSIONS	DISTRIBUTION STRIPS	TIE POINTS	TERMINAL STRIPS	TIE POINTS	BINDING POSTS	PRICE
WBU-D	3.5 x 9.5"	1	100	—	—	—	2.99
WBU-T	1.38 x 9.5"	—	—	1	630	—	4.99
WBU-204-3	3.94 x 9.48"	1	100	2	1260	2	17.95
WBU-204	5.13 x 9.48"	—	—	4	1290	3	24.95
WBU-206	6.88 x 9.06"	—	—	5	1690	9	28.95
WBU-208	8.25 x 9.48"	7	700	9	2620	4	38.95



LITHIUM BATTERY AS USED IN CLOCK CIRCUITS

3 VOLT BATTERY \$3.95
BATTERY HOLDER \$1.99

IC MASTER \$79.95



VISIT OUR RETAIL STORE LOCATED AT 1256 SOUTH BASCOM AVENUE IN SAN JOSE



JDR Microdevices

1224 S. Bascom Avenue, San Jose, CA 95128
800-538-5000 • 800-662-6279 (CA) • (408) 995-5430
FAX (408) 275-8415 • Telex 171-110

HOURS: M-W-F, 9-5 TU-TH, 9-9 SAT, 11-5
PLEASE USE YOUR CUSTOMER NUMBER WHEN ORDERING

TERMS: Minimum order \$10.00. Per shipping and handling include \$2.50 for 1st pound and \$3.50 for UPS Air. Orders over 1 lb. and foreign orders may incur additional shipping charges - please contact our sales department for the amount. Resellers must include applicable sales tax. All merchandise is warranted for 90 days unless otherwise stated. Prices are subject to change without notice. We are responsible for typographical errors. We reserve the right to seek quotations from substitute manufacturer. All merchandise subject to prior sale.

© Copyright 1985 JDR Microdevices

PARTIAL LISTING ONLY — CALL FOR A FREE CATALOG

Printer Buffers

FREEES COMPUTER FOR OTHER TASKS WHILE PRINTING LONG DOCUMENTS. STANDALONE DESIGN - WORKS WITH ANY COMPUTER OR PRINTER. ALL MODELS FEATURE PRINT PAUSE, MEMORY CHECK AND GRAPHICS CAPABILITY.

P120P PARALLEL \$139.95
16K UPGRADABLE TO 256K
LED INDICATOR SHOWS VOLUME OF DATA IN BUFFER

P120S RS232 SERIAL \$159.95
16K UPGRADABLE TO 256K
HX SELECTABLE BAUD RATES FROM 300B - 19,200B

P110 PARALLEL \$249.95
16K UPGRADABLE TO 512K
I/OOLS OUTPUT OF UP TO THREE COMPUTERS
LED BAR GRAPH DISPLAYS AMOUNT OF DATA IN BUFFER
RESET FUNCTION CLEARS DATA IN BUFFER
REPEAT FUNCTION CAN PRODUCE MULTIPLE COPIES OF A DOCUMENT



SP120 SP110

3-WAY SWITCH BOXES

- SERIAL OR PARALLEL
- CONNECTS 3 PRINTERS TO 1 COMPUTER OR 3 COMPUTERS TO 1 PRINTER
- ALL LINES SWITCHED
- HIGH QUALITY ROTARY SWITCH MOUNTED ON PCB
- GOLD CONTACTS
- STURDY METAL ENCLOSURE



SWITCH-3P CENTRONICS PARALLEL 99.95
SWITCH-3S RS232 SERIAL 99.95

IBM Printer Cable

- DB25 TO CENTRONICS
- SHIELDED CABLE

\$9.95

JOYSTICKS



\$7.95

\$4.95

FLOPPY DISK DRIVES

TEAC
FD-55B 5 1/4" HEIGHT DS/DD \$89.95
FD-55F 5 1/4" HEIGHT OS/QUAD \$99.95

SHUGART
SA460 5 1/4" (80 TRACK) OS/QUAD \$199.95

TANDON
TM100-2 5 1/4" (FOR IBM) DS/DD \$99.95

MPI
MPI-B52 5 1/4" (FOR IBM) DS/DD \$89.95

SIEMENS 8" DISK DRIVES
FD100-8 SS/DD S&B01R EQUIV. \$119.00
FD200-8 DS/DD S&B51R EQUIV. \$159.00
JFORMAT-2 SOFTWARE \$49.95
SUPPORT FOR QUAD DENSITY DRIVES FROM TALL TREE SYSTEMS

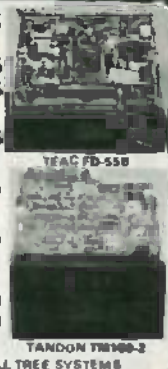

DISK DRIVE CABINETS

5 1/4" DRIVE ENCLOSURES

CAB-APPLE APPLE TYPE DRIVE CABINET WITHOUT POWER SUPPLY \$24.95
CAB-1FH5 FULL HEIGHT 5 1/4" BEIGE DRIVE CABINET WITH POWER SUPPLY \$69.95
CAB-2SV5 DUAL SUMLINE 5 1/4" CABINET WITH POWER SUPPLY - VERTICAL MOUNT \$49.95

8 INCH DRIVE ENCLOSURES BY JMR

CAB-2SV8 DUAL SUMLINE 8" DRIVE CABINET WITH POWER SUPPLY - VERTICAL MOUNT \$209.95
CAB-2FH8 DUAL FULL HEIGHT 8" DRIVE CABINET WITH POWER SUPPLY - HORIZONTAL \$219.95



CAB-1FH5

CAB-2SV5

CAB-2FH8

DISKETTES

NASHUA 5 1/4"
MD2D DS/DD SOFT SECTOR \$9.90
MD2F DS/QUAD SOFT SECTOR \$34.95
MD2H DS/HIGH DENSITY FOR AT \$49.95

NASHUA 8"
FD1 SS/DD SOFT SECTOR \$27.95
FD2D DS/DD SOFT SECTOR \$34.95

NASHUA 3.5"
3.5SS 3.5" SS/DD FOR MACINTOSH \$32.95

VERBATIM 5 1/4"
MD1D SS/DD SOFT SECTOR \$23.95
MD2D DS/DD SOFT SECTOR \$29.95
MD110D SS/DD 10 SECTOR HARD \$23.95

DISKETTE FILE



\$8.95

HOLDS 70 5 1/4" DISKETTES

IBM STYLE COMPUTER CASE

- ATTRACTIVE STEEL CASE, WITH HINGED LID. FITS POPULAR PC/XT COMPATIBLE MOTHER BOARDS.
- SWITCH OUT-OUT ON SIDE FOR PC/XT STYLE POWER SUPPLY
 - CUT-OUT FOR 8 EXPANSION SLOTS
 - ALL HARDWARE INCLUDED



ONLY \$59.95

IBM COMPATIBLE KEYBOARDS

DKM-2000 \$79.95
FULLY IBM COMPATIBLE
83 KEYS WITH CAPACITANCE TYPE SWITCHES
LED STATUS INDICATORS FOR CAPS, NUMBER LOCK
AUDIBLE CLICK



KB-5151 \$99.95
ENHANCED IBM COMPATIBLE
SEPARATE CURSOR AND NUMERIC KEYPADS
CAPS LOCK & NUMBER LOCK INDICATORS
IMPROVED KEYBOARD LAYOUT



NASHUA DISKETTE SPECIALS

5 1/4" SOFT SECTOR DS/DD WITH HUB RINGS
\$9.90 BOX OF 10
89¢ea BULK QTY 50
79¢ea BULK QTY 250

NASHUA DISKETTES WERE JUDGED TO HAVE THE HIGHEST LISH AND RECORDED AMPLITUDE OF ANY DISKETTES TESTED. SEE "COMPARING FLOPPY DISKS", BYTE 9-84

ATTENDER CARDS

IBM	
EPC	\$45.00
LAT	\$68.00
LE II	\$45.00
LE III	\$48.00
LTIBUS	\$56.00

POWER STRIPS

UL APPROVED
15A CIRCUIT BREAKER
\$12.95



KEYBOARD-AP

- REPLACEMENT FOR APPLE II KEYBOARD
- CAPS LOCK KEY
- AUTO-REPEAT
- ONE KEY ENTRY OF BASIC OR CP/M COMMANDS

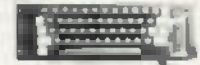

\$49.95

CASE WITH KEYBOARD

FOR APPLE MOTHER-BOARD MODEL KB-1000

- USER DEFINED FUNCTION KEYS
- NUMERIC KEYPAD WITH CURSOR CONTROL
- CAPS LOCK
- AUTO-REPEAT



ONLY \$79.95

HIGH QUALITY TEST EQUIPMENT FROM JDR INSTRUMENTS

20 MHz DUAL TRACE OSCILLOSCOPE

MODEL 2000

\$389



- BAND WIDTH - DC TO 20 MHz (1-3db)
- AC: 10 Hz TO 200MHz (1-3db)
- SWEEP TIME - .2 SEC TO .5 SEC/DIV
- 20 RANGES
- COMPLETE MANUAL AND HIGH QUALITY PROBES INCLUDED
- PUT IMPEDANCE: 1 MEG OHM
- VIDEO SYNC FILTER
- Y AND Z AXIS OPERATION
- 0.220 VOLT OPERATION
- IMPONENT TESTER
- CONSUMPTION - 15 WATTS
- UILT IN CALIBRATOR
- OMATIC OR TRIGGERED TIMEBASE

35 MHz DUAL TRACE OSCILLOSCOPE

MODEL 3500

\$549



- BAND WIDTH - DC TO 35MHz (1-3db)
- AC: 10 Hz TO 350MHz (1-3db)
- SWEEP TIME - .1 SEC TO .5 SEC/DIV
- ON 21 RANGES
- DELAYED TRIGGER - 100 nSEC TO 1 SEC WITH INTENSIFIED AND DELAYED MODES
- COMPLETE MANUAL AND 1X-10X COMPENSATED HOOK-ON PROBES INCLUDED
- VARIABLE HOLD OFF FOR VIEWING COMPLEX WAVES
- TV VIDEO SYNC FILTER
- TRIGGERING OF CH A, CH B, ALTERNATING, LINE DR EXTERNAL
- X, Y AND Z AXIS OPERATION

DIGITAL MULTIMETER PEN MODEL DPM-1000



\$54.95

AUTO RANGING, POLARITY AND DECIMAL!

- LARGE 3.5" DISPLAY
- DATA HOLD SWITCH FREEZES READING
- FAST, AUDIBLE CONTINUITY TEST
- LOW BATTERY INDICATOR
- OVERLOAD PROTECTION
- ONLY 1 1/2 x 6 1/2 x 1 1/2"
- DC VOLTS 1mV-500V
- AC VOLTS 1mV-500V
- 1 OHM - 2 MEG OHM
- WEIGHS ONLY 2.3 OUNCES
- LOW PARTS COUNT, CUSTOM 80 PIN LSI INSURES RELIABILITY
- INCLUDES MANUAL, BATTERIES, HARD CASE, AND ALLIGATOR CLIP

CALL FOR VOLUME QUOTES

© COPYRIGHT 1985 JDR MICRODEVICES

CIRCLE 262 ON FREE INFORMATION CARD

www.americanradiohistory.com

IBM COMPATIBLE INTERFACE CARDS ALL WITH A ONE YEAR WARRANTY

MULTIFUNCTION CARD \$129.95

ALL THE FEATURES OF ASTS 6 PACK PLUS AT HALF THE PRICE



- CLOCK CALENDAR
- 0-384K RAM
- SERIAL PORT
- PARALLEL PORT
- GAME PORT
- SOFTWARE INCLUDED

PRINTER CABLE \$9.95 64K RAM UPGRADE 9/\$6.21

COLOR GRAPHICS ADAPTOR \$99.95

FULLY COMPATIBLE WITH IBM COLOR CARD



- 4 VIDEO INTERFACES: RGB, COMPOSITE COLOR, HI RES, COMPOSITE MONOCHROME, CONNECTOR FOR RF MODULATOR
- COLOR GRAPHICS MODE: 320 x 200
- MONO GRAPHICS MODE: 640 x 200
- LIGHT PEN INTERFACE

MONOCHROME GRAPHICS CARD \$129.95

FULLY COMPATIBLE WITH IBM MONOCHROME ADAPTOR AND HERCULES GRAPHICS CARD



- LOTUS COMPATIBLE
- TEXT MODE 80 x 25
- GRAPHICS MODE 720 x 348
- PARALLEL PRINTER INTERFACE
- OPTIONAL SERIAL PORT \$19.95

FLOPPY DISK DRIVE ADAPTOR \$59.95



- INTERFACES UP TO FOUR STANDARD FDDs TO IBM PC OR COMPATIBLES
- INCLUDES CABLE FOR TWO INTERNAL DRIVES

1200 BAUD INTERNAL MODEM FOR IBM

INCLUDES PC TALK III COMMUNICATIONS SOFTWARE



- Hayes COMPATIBLE
- AUTO DIAL/AUTO ANSWER
- AUTO RE DIAL ON BUSY
- INCLUDES SERIAL PORT
- ONE YEAR WARRANTY

EASYDATA-12B \$195

300 BAUD MODEM FOR APPLE OR IBM

CLOSE-OUT SPECIAL NOW ONLY

\$49.95

INCLUDES ASCII PRO-EZ SOFTWARE (A \$100 VALUE IN ITSELF)

- FCC APPROVED
- BELL SYSTEMS 103 COMPATIBLE
- INCLUDES AC ADAPTOR
- AUTO DIAL/AUTO ANSWER
- DIRECT CONNECT

CABLE FOR APPLE IIC \$14.95

BEST BARGAIN!
Canon
 160 CPS
 PRINTER
 MODEL
 PW-1080A



\$199.95 Printed in Draft mode or Proportional and NLQ

- VERY HIGH SPEED PRINTING (160 CPS)
- 2K PRINT BUFFER
- EPSON/IBM COMPATIBLE CONTROL
- DOWNLOADING FONT BUFFER
- 11 x 9 DOT DRAFT MODE CHARACTERS
- FAN FOLD, CUT SHEET OR ROLL PAPER
- 23 x 18 DOTS IN NEAR LETTER QUALITY
- SOLID "BUSINESS" MACHINE

PS-IBM 100 WATTS \$99.95



TEAC DISK DRIVES FOR IBM PCs



FD-55B DS/00 \$89.95
 FD-55F DS/QUAD \$99.95

UNBELIEVABLE MONITOR DEALS



TAXAN RGB VISION III MODEL 415

- MADE FOR TAXAN BY ACORN
- 640 x 252 PIXEL RESOLUTION
- 16 COLORS
- 18 MHz BANDWIDTH
- 12" BLACK MATRIX
- IBM AND LOTUS COMPATIBLE

CABLE FOR IBM \$15.85

\$289.95



SAKATA COMPOSITE COLOR MODEL SC-100

- TOP RATED FOR APPLE
- 13" COMPOSITE VIDEO
- RESOLUTION 280H x 300V
- INTERNAL AUDIO AMPLIFIER
- ONE YEAR WARRANTY

\$169.95

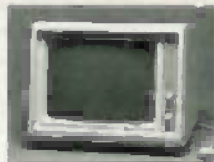

SAMWOO MONOCHROME MODEL DM-216B

- PERFECT COSMETIC MATCH FOR IBM PC
- IBM COMPATIBLE TTL INPUT
- 12" NON GLARE SCREEN
- P19 GREEN PHOSPHOR
- HI RES 22 MHz BAND WIDTH

\$99.95

MONITOR STAND TILTS AND SWIVELS



\$12.95

APPLE COMPATIBLE INTERFACE CARDS

EPROM PROGRAMMER \$59.95



MODEL RP525

- DUPLICATE OR BURN ANY STANDARD 27xx SERIES EPROM
- EASY TO USE MENU DRIVEN SOFTWARE INCLUDED
- MENU SELECTION FOR 2716, 2732, 2732A, 2764 & 27128
- HIGH SPEED WRITE ALGORITHM
- LED INDICATORS FOR ACTIVITY
- NO EXTERNAL POWER SUPPLY REQUIRED
- ONE YEAR WARRANTY



18K RAMCAR \$38.95

- FULL TWO YEAR WARRANTY
- EXPAND YOUR 48K APPLE TO 64K
- USE IN PLACE OF APPLE LANGUAGE CARD

BASE PC CARD W/ INSTRUCTIONS \$9.95



IC TEST CARD \$89.95

- QUICKLY TESTS MANY COMMON ICs
- DISPLAYS PASS OR FAIL
- ONE YEAR WARRANTY
- TESTS: 8000 SERIES CMOS 74HC SERIES CMOS 7400, 74LS, 74L, 74H, 74S, SOME PROMS AND RAMS

DISK DRIVES

FOR APPLE COMPUTERS



BAL-525 \$89.95

- 1/2" HEIGHT ALPS MECHANISM
- 100% APPLE COMPATIBLE
- FULL 1 YEAR WARRANTY

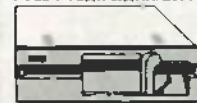

BAL-500 \$129.95

- TEAC MECHANISM DIRECT DRIVE
- 100% APPLE COMPATIBLE
- FULL 1 YEAR WARRANTY



AP-135 \$129.95

- FULL HT. SHUGART MECHANISM
- DIRECT REPLACEMENT FOR APPLE DISK II
- SIX MONTH WARRANTY

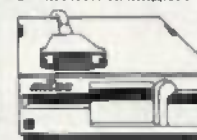

FOR APPLE IIC
 AD-3C \$139.95

- 100% APPLE IIC COMPATIBLE, READY TO PLUG IN W/ SHIELDED CABLE & MOLDED 19 PIN CONNECTOR
- FAST, RELIABLE SLIMLINE DIRECT DRIVE
- SIX MONTH WARRANTY



FOR MACINTOSH
 MAC 535 \$249.95

- 3.5" ADD-ON DISK DRIVE
- 100% MACINTOSH COMPATIBLE
- SINGLE SIDED 400K BYTE STORAGE
- HIGH RELIABILITY DRIVE FEATURES AUTO-EJECT MECHANISM
- FULL ONE YEAR WARRANTY

DISK DRIVE ACCESSORIES

- DISK CONTROLLER CARD \$49.95
- APPLE IIC ADAPTOR CABLE \$19.95
- ADAPTS STANDARD APPLE DRIVES FOR USE WITH APPLE IIC

COMREX CR-1000 DUAL SLIMLINE DISK DRIVE \$199.95

FOR APPLE COMPUTERS

SPACE SAVING DESIGN STACK BETWEEN COMPUTER AND MONITOR

- QUIET, RELIABLE 1/2" HEIGHT DRIVES
- TOTAL STORAGE CAPACITY: 286K BYTES
- AUTO-EJECT MECHANISM
- SHIELDED CABLE INCLUDED

INCLUDES CONTROLLER AND DOS 3.3 WITH DISK UTILITIES

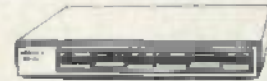

CLOSE-OUT SPECIAL WHILE SUPPLY LASTS

ALL MERCHANDISE 100% GUARANTEED

© COPYRIGHT 1985 JDR MICRODEVICES

CIRCLE 263 ON FREE INFORMATION CARD

www.americanradiohistory.com

What's New at AMERICAN DESIGN COMPONENTS?

"The Source" of the electro-mechanical components for the hobbyist.

We warehouse 60,000 items at American Design Components — expensive, often hard-to-find components for sale at a fraction of their original cost! You'll find every part you need — either brand new, or removed from equipment (RFE) in excellent condition. But quantities are limited. Order from this ad, or visit our retail showroom and find exactly what you need from the thousands of items on display.

Open Mon. — Sat.. 9-5

THERE'S NO RISK.

We'll give you a full 90 day warranty on all items. Items returned for any reason within 90 days will be refunded for your purchase price plus a \$2.00 restocking fee.

19" COLOR X-Y DISPLAY



Originally designed for use in Atari coin-operated games. Contains 3-gun color tube, focus and brightness controls. Requires external X-Y inputs. 250-0-24V transformer for power. May be used for oscilloscopes, reprogrammed for game use, or modified with the use of external vertical and horizontal oscillators to a raster scan display or TV monitor for computer use. (IBM compatible.) Transformer supplied.

Item #5449 \$129.00 New

5 1/4" DISK DRIVE 1/2 HT: 96 T.P.I.



Tandon TM55-4 DS/Quad
Item #1904 \$79.50
2 for \$150.00

COMPUTER TAPE DRIVE (For Adam)



Serial format. Search 80IPS — Read/Write 20IPS. 12V motor. 5V logic. 8 & 9 pin connector cables. Originally designed for the Adam.
Dim: 5" W x 3 1/2" H x 4" deep
Item #6641 \$9.95 New

ASCII 75-KEY KEYBOARD For Adam —



21 user defined keys. 7 pin connection. ASCII 8 bit serial output. Originally designed for the Adam.
Dim: 16" W x 2 1/2" H x 9 1/2" D
Item #6643 \$19.95 New

75-KEY MECHANICAL KEYBOARD — For Adam



For computer upgrade. 21 user defined keys. SPST mechanical switches. 21-pin ribbon cable connection. General instructions for replacement of membrane keyboards incl. Update computers such as the Tandy Sinclair 281/1000.
Dim: 13 1/2" W x 1 1/2" H x 5" D.
Item #6643M \$9.95 New

LINEAR DISK DRIVE POWER SUPPLY

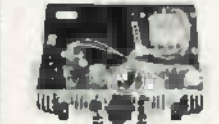

DC Output: — 5V @ 200 ma. +5V @ 3 amps +12V @ 2.9 amps +18V (inductive) @ 1 amp
Input: 115V/60 Hz. Chassis Dim: 11" W x 4" H x 8" D
Item #6642 \$14.95 New

SWITCHING POWER SUPPLY



Input: 115/230VAC. 50/60Hz Output: 12VDC @ .17 amps +24VDC @ 2.2 amps +5VDC @ 3 amps
Dim: 7 1/2" x 6 1/2"
Mfr — Astec #AA11101
Item #6553 \$19.95 New

Logic board of the 'ADAM'



Logic board for the Adam computer. Includes the following components: 8 ea. 4164-4s. 74LS157. 74LS541. LS273N 2 ea. LM339s, plus micro processors with ROMs.
Mfr — Coleco
Item #7231 \$9.95 RFE

COMPUTER & GAME CONTROLLERS (Set of 4) — For Adam

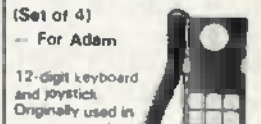

12-digit keyboard and joystick. Originally used in computer and games. Includes coil cord with 9-pin connector. Can also be used with Atari.
Dim: 8 1/2" L x 2 1/2" W x 2 1/2" H
Mfr — Coleco #78002
Item #7013 \$9.95 New

115 CFM MUFFIN FAN



115 VAC/60 Hz., 21W., 28A., 3100 RPM. 5 blade model. aluminum housing. Can be mounted for blowing or exhaust.
Dim.: 4 1/2" sq. x 1 1/2" deep.
Item #5345 \$7.95 RFE
With adjustable speed control \$10.95

30 CFM MINI FANS



26VAC & 6-12VDC
Low noise level. Can be mounted for cooling or exhaust.
Dim.: 3 1/2" sq. x 1 1/2" deep
12VDC — Papst #8312
Item #7017 \$12.95 New
28VAC — IMC Peewee
Item #7018 \$7.95 New

PRINTER MECHANISM

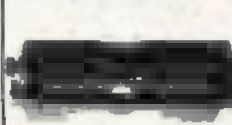

Originally designed for the Gavain computer.
• Centronics interface
• 80 column width
• Friction drive (schematic incl.)
Item #6223 \$19.95 New

PLUG-IN POWER SUPPLY



OUTPUT: +5 VDC. .9A — 5 VDC. .1A +12 VDC. .3A
INPUT: 120 VAC/60 Hz. .25A
Mfr — Coleco #55416
Item #1882 \$6.95 New

KITS ROBOTICS KIT (Springs, Bolts, Pulleys & Gears)

Consists of:
9 Timing Belts (7.5" to 13")
2 Round Belts (12" to 15")
15 Nylon & Plastic Spur & Drive Gears
22 Tension Springs
6 Compression Pulleys
19 Tension Springs
Item #5306 \$14.95 New

TOY MOTOR KIT — For Robotics

Consists of:
18 asst. toy motors, from 1.5V to 12VDC.
Item #7229 \$9.95 New

SWITCH KIT 35 Ass't. Switches

Consisting of 35 assorted: Dip, Toggle, Slide, and Sensitive Miniature and Standard Size Switches
Item #5307 \$9.95 New

RELAY KIT 15 Ass't. Relays

Consisting of 15 ass't'd. AC & DC Relays, 5V, 12V, 24V, & 115V. All types.
Item #5308 \$9.95 New

IC SOCKET KIT 100 Ass't. Sockets

Consisting of 100 assorted IC sockets. From 14 to 40 Pin.
Item #5309 \$9.95 New

COMPONENTS PARTS KIT Hundreds of components

Consisting of Heat Sinks, Capacitor, Trim pots, Resistors, and MORE!
Item #7230 \$15.00 New

PUMPS COMPRESSORS BLOWERS MOTORS POTENTIOMETERS COUNTERS TIMERS RELAYS VOLTAGE REGULATORS POWER SUPPLIES

160 CFM CENTRIFUGAL BLOWER



115VAC/60Hz., 2.2 amps., 3000 RPM. Flange mount. Outlet: 3" x 3 1/2". Inlet: 4" dia.
Dim: 8 1/2" H x 5 1/2" W x 8 1/2" D
Mfr — Fasco 50755 or equiv.
Item #5152 \$10.95 RFE

Rechargeable (Sealed) GEL-CELL BATTERY 12V @ 1.9AH

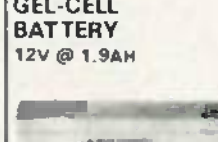

For use with model cars, trains, boats, planes, etc.
Dim.: 7" L x 2 1/2" H x 1 1/2" D
Mfr — Power-sonic #PS1219
Item #7021 \$9.95 New

Rechargeable NICAD BATTERY BACKUPS

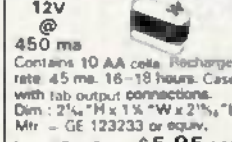

12V @ 450 ma
Contains 10 AA cells. Recharge rate: 45 ma. 16-18 hours. Case with tab output connections.
Dim.: 2 1/2" H x 1 1/2" W x 2 1/2" L
Mfr — GE 123233 or equiv.
Item #5443 \$5.95 RFE
13.2V @ 1.65 AH
Contains 11 C cells. For model boats, toys, etc.
Mfr — GE #4180358800101
Item #8444 \$15.95 New

TELEPHONE



Originally designed to mount on TeleVideo computer, and plug into modem. May be used as a standard phone. Touch-tone, mute button, pulse, redial button, with 12" cord. Ivory. Comes with mounting bracket.
Item #7232 \$9.95 New

AMERICAN DESIGN COMPONENTS, 62 JOSEPH STREET, MOONACHIE, N.J. 07074 YES! Please send me the following items:

Item No.	How Many?	Description	Price	Total

My check or money order is enclosed. ORDER \$15.
 Charge my credit card. RE-26
 Visa Master Card Amex

Card No. _____
Exp. Date _____
Signature _____
Telephone: Area Code _____ Number _____

Name _____
Address _____
City _____
State _____ Zip _____

Shipping & handling: we ship UPS unless otherwise specified. Add \$3 plus 10% total. Canadian: \$3 plus P.O. cost. Charge only. Sales Tax (N.J. residents only). Please add 6% of total. ORDER TOTAL

FREE CATALOG of electro-mechanical devices sent with every order.

For all phone orders, call TOLL-FREE 800-524-0809. In New Jersey, 201-939-2710.

ADVERTISING INDEX

RADIO-ELECTRONICS does not assume any responsibility for errors that may appear in the index below.

Free Information Number	Page		Page
		117	Mouser
			113
268	A.J.S. Satellite	22	NRI
			8
108	AMC Sales	102	NTS
			36
76	AP Products	35	274 OK Industries
			27
—	Ad Mart	32	280 Omnirion
			28
—	Advanced Electronics	17	— Pacific Cable
			117
106	Advanced Computer Products	125	118 Pacific One
			23
107	All Electronics	129	254 Phoenix Institute of Technology
			95
72	Amazing Devices	120	101 Pomona Electronics
			CV3
—	American Design Components	137	275 Print Products International
			26
77	B&K Precision	33	285 Projector Recorder Belt
			104
283, 98	Beckman Industrial	4, 25	126, 255 RAG Electronics
			\$30, 31
265	C & S Sales	14	78 Radio Shack
			119
—	C.O.M.B.	29	70 Ramsey
			124
—	CIE	18	264 Regency
			50
269, 270	Carco Enterprises	23, 40	256 Saratoga Electronics
			34
—	Command Productions	102	276 Saucer City
			22
79	Communications Electronics	3	74 Solid State Sales
			130
277	Copper Electronics	26	75 Spartan Electronics
			138
127	Deco Industries	22, 23	257 Tektronix
			CV2
259	Deltax Dynamic	23	102 Trio-Kenwood
			97
95	Dick Smith Electronics	42, 43	258 U.S. Instrument Rentals
			41
—	Diehl Engineering	64-67	267 Wavetek
			16
—	Diehl Engineering	105-107	103 Wm B. Allen
			120
82	Digi-Key	127	
—	Digital Research Computers	130	
57	Digitron	130	
272	East Coast Transistor Parts	116	
278	Electronic Salvage Parts	109	
120	Elephant Electronics	23	
279	Emco	23	
111, 260	Etronix	95, 109	
100	Firestik II	113	
266	Fluke Manufacturing	7	
—	Fordham Radio	CV4, 13	
271	Grace Industries	22	
—	Grantham College of Engineering	93	
—	Halix Institute	104	
86	Heath	44	
—	ICS Computer Training	40	
65	I & W	126	
261	JDR Instruments	15	
282	JDR Microdevices	131	
281, 113	JDR Microdevices	132-133	
251, 262	JDR Microdevices	134-135	
263	JDR Microdevices	136	
114	Jameco	122, 123	
124	James Walter Satellite Rec.	23	
104	Jan Crystals	102	
—	Joseph Electronics	45	
87	MCM Electronics	121	
105	MIFJ	116	
253	Mark V. Electronics	128	
—	McGraw Hill Book Club	47, 101	
273	Micro-Mart	118	
71	Morning Distributing	23	

Gernsback Publications, Inc.
200 Park Ave. South
New York, NY 10003
(212) 777-6400
President: Larry Steckler
Vice President: Cathy Steckler

ADVERTISING SALES 212-777-6400

Larry Steckler
publisher
Arline Fishman
advertising coordinator
Shelli Weinman
advertising associate
Lisa Strassman
credit manager
Donna Sala
credit associate
Naomi Matten
advertising assistant

SALES OFFICES

EAST/SOUTHEAST

Stanley Levitan
Eastern Sales Manager
Radio-Electronics
200 Park Ave. South
New York, NY 10003
718-428-6037, 212-777-6400

MIDWEST/Texas/Arkansas/Okla.

Ralph Bergen
Midwest Sales Manager
Radio-Electronics
540 Frontage Road—Suite 339
Northfield, IL 60093
312-446-1444

PACIFIC COAST/ Mountain States

Marvin Green
Pacific Sales Manager
Radio-Electronics
15335 Morrison St.—Suite 227
Sherman Oaks, CA 91403
818-986-2001

SPARTAN Electronics Inc.

The Communication and Electronic Source



(516) 499-9500

6094 Jericho Tpke.
Commack, N.Y. 11725

GENERAL INSTRUMENT LCC-58 58 Channel Remote Controller

- On/off line tune
- Wireless
- Installs in minutes

\$79.95



HAYES Smartmodem 1200

- Full or Half Duplex
- 300 BPS or up to 1200 BPS operation
- Auto Answer and Auto Dial
- Connects directly to telephone lines

\$395.95

CARROL TOUCH 232LT Line Tester

- 24 line accessibility
- True in-state monitoring
- Dual color Led's (red, green)
- No battery required
- Complete Accessories

\$159.95



Durable case, reference card, 2 "Y" jumper cables, 6 straight jumper cables, 10' male to female RS232C extension cable, and an operator's manual

NEW 12" DIAGONAL MONITOR

- Monochrome display
- Composite video
- 80 characters & 25 lines
- 700 line resolution all center
- Non-flare CRT

Green \$92.95

Amber \$97.95



PHILIPS REMOTE CABLE CONVERTER

- Micro computer technology
- Dual controlled IC's lock in picture & prevent drift
- 50 channel selection
- Programmable time on & off
- 24 hour LED digital clock
- Favorite channel memory & recall plus scan
- Wireless hand held "infra-red" transmitter system
- Automatic fine tune
- Adaptable to any brand television
- One year warranty service

\$125.00

RS232 TRANSMISSION LINE TESTER

- Features: Male to Female connector for easy insertion into RS232 Line "Test" Lines (TD, RD, RTS, CTS, DSR, CD, DTR) using LED's to indicate status of each
- Directly powered by RS232 Line no AC power needed



\$19.95

WELLER Temperature Controlled Soldering Station

- Control Ranges 600 F, 700 F, 800 F
- Change temperature by simply changing the heat sensing tip
- Safe for IC Soldering
- Storage Tray for extra tips and tip cleaning sponge with receptacle
- Comes with 16" screwdriver tip 700 F,
- 3 wire 4 5' long cord

\$99.95



SGL WABER DATAGARD Spike & Noise Suppressor

- Datagard DG115S provides a single-stage spike filter and a single-stage noise filter to protect against moderate and catastrophic spikes and virtually all unwanted noise interference coming through the wall outlet

\$39.95

PROTECT YOUR COMPUTER WITH DATAGARD

Dealers Welcome

We accept MC, Visa, Amex, COD's \$10 deposit.
Shipping charges as follows

Volume Discounts
Call

	to 75.00	\$2.50
	76.00 to 250.00	\$4.50
	251.00 to 500.00	\$6.00
	501.00 to 750.00	\$8.50
	751.00 to 1000.00	\$12.00

(516) 499-9500

TELEX: 551427 SPARTAN

Store Hours: Mon-Fri 9-6
Sat 9-30-5

CIRCLE 75 ON FREE INFORMATION CARD

What Pomona knows about banana plugs and adapters would fill a book.

For over 30 years the Pomona Electronics line of banana plugs, jacks and adapters has played a major role in our ability to stay on the leading edge of electronics test technology.

Every year we add new banana plug products to make your life as a professional design engineer a little easier. And the complete line is listed in our 1986 General Catalog.

In our new book you'll find over 400 models that utilize or adapt banana plugs in some useful fashion: plugs, jacks, binding posts, adapters, patch cords and cables, in standard or miniature sizes. You name it and you'll probably find exactly what you need in our new catalog.

Here's how to get your copy of our 1986 General Catalog: Just circle the reader service number below; call us at (714) 623-3463; write us at Pomona Electronics, a division of ITT Corporation, 1500 East Ninth Street, P.O. Box 2767, Pomona, California 91769.

Our products are available through your favorite electronics parts distributor.

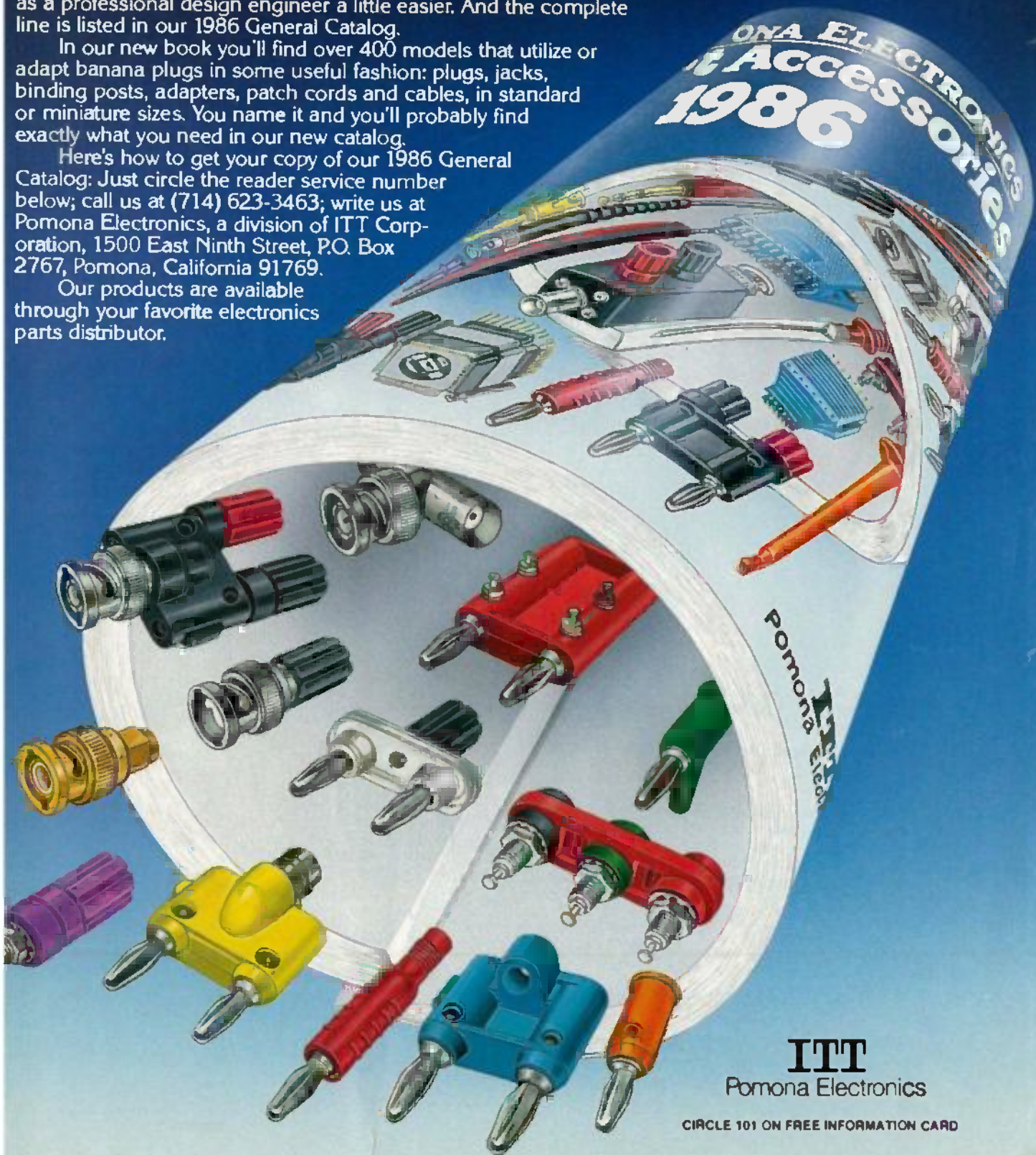

ITT
Pomona Electronics

CIRCLE 101 ON FREE INFORMATION CARD

PERFORMANCE

SCOPE HAND-HELD DIGITAL CAPACITANCE and MULTIMETERS

- 0.5% DC Accuracy
- Highest Quality
- Highest Performance
- Lowest Prices

THE ULTIMATE TEST



Model DCM-602
\$69⁹⁵

3 1/2 Digit Capacitance Meter
8 ranges with full scale values to 2000 uF
FEATURES • Broad test range - 1 pF to 2000 uF • LSI circuit provides high reliability and durability • Lower power consumption • Crystal time base • Protected from charged capacitors • Frequency range • 800 Hz to 8 Hz



Model DVM-634
\$48⁷⁵

7 functions, 32 ranges.
Transistor measurement included

3 1/2 Digit Multimeters

FEATURES • DC Voltage 100 uV - 1000 V • AC Voltage 100 uV - 750 V • AC/DC Current 200 uA - 10 Amps • Resistance 20 Megohms • Capacitance (DVM 636/638) 1 pF - 20 uF • Overload Protection • Auto-decimal LCD readout • Polarity indication • 3000 hour battery life with 9V transistor battery • Low battery indication



Model DVM-638
\$79⁹⁵

11 functions, 38 ranges.
Includes logic level detector,
audible visual continuity,
capacitance and conductance
measurement.



Model DVM-636
\$62⁷⁵

8 functions, 37 ranges.
Capacitance measurement
included.

ASK FOR FREE CATALOG.
Money orders, checks accepted. C.O.D.'s require 25% deposit.



Fordham

260 Motor Parkway, Hauppauge, NY 11788

Toll Free
800-645-9518
In NY State 800-832-1446

Service & Shipping Charge Schedule Continental U.S.A.

FOR ORDERS	ADD
\$25-\$100	\$4.50
\$101-\$250	\$6.00
\$251-\$500	\$8.00
\$501-\$750	\$10.50
\$751-\$1,000	\$12.50
\$1,001-\$1,500	\$16.50
\$1,501-\$2,000	\$20.00
\$2,001 and Up	\$25.00