

48783

**SPECIAL SECTION:
AUTOMOTIVE ELECTRONICS**

**HOW TO DESIGN
DOUBLE-SIDED
PC BOARDS**

**\$1.95 SEPT. 1985
IN CANADA \$2.50**

Radio Electronics

TECHNOLOGY - VIDEO - STEREO - COMPUTERS - SERVICE
Electronics in your car. Electronics under the hood.
Touch-screen CRT's, voice recognition, and navigation systems will be coming to the passenger compartment of your next car. Engine sensors and microprocessors will make the car of the future more efficient and trouble-free.

**Build R-E's digital IC tester.
Test your digital circuits and IC's and learn as you go.**

**How to design with digital IC's.
Learn all about clocked logic and shift registers.**

**Build a printer buffer for your computer.
It's a parallel-to-serial and serial-to-parallel converter too!**

**All about comb filters.
How comb filters deliver better video performance.**

Special 10-page section:

COMPUTER DIGEST

GERNSBACK PUBLICATIONS

PLUS:

- ★ Hobby Corner
- ★ Equipment Reports
- ★ Drawing Board
- ★ Satellite TV
- ★ New Ideas
- ★ Robotics column



You can't judge a scope by its cover.

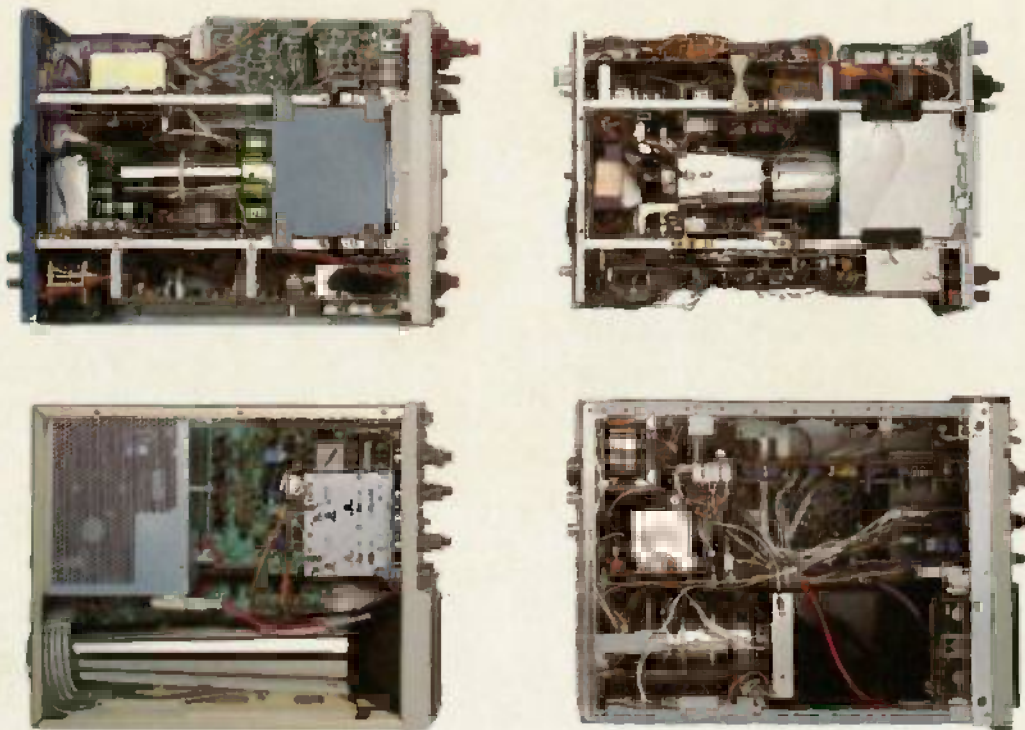

When you look at our simplified, practical internal design, you see why the Tek 2200 Series delivers unparalleled high performance and reliability in the field. You get quality that's unmistakably Tektronix in scopes so advanced, they cost you less to buy and own.

Through an innovative new concept in scope design we reduced the number of mechanical parts by 65%. Reduced cabling by 90%. Virtually eliminated board electrical connectors. And eliminated the need for a cooling fan.

The result: a scope with designed-in simplicity that increases reliability as it cuts downtime and repair costs. All of which means outstanding value in

a compact, lightweight package that your service technicians will appreciate.

Plus, you get a selection of performance to precisely match your needs. There are the 60 MHz single time base delay 2213A at \$1275* and the 60 MHz dual time base 2215A at \$1525*. And at 100 MHz, the dual time base 2235 at \$1750* and the 2236 with an integrated counter/timer/multimeter at \$2650*.

The industry's first three-year warranty† is testimony to 2200 Series dependability. Adding value to value are a variety of optional service plans that can economically extend this coverage to five years.

Consider what you're paying

now in downtime, in service, in back-up scopes. On the bottom line, a Tek 2200 Series scope will save you money, time and trouble now and in the years to come.

Contact your Tek Sales Engineer for a demo today. Or call 1-800-426-2200, Ext. 201. In Oregon, call collect: (503) 627-9000, Ext. 201.

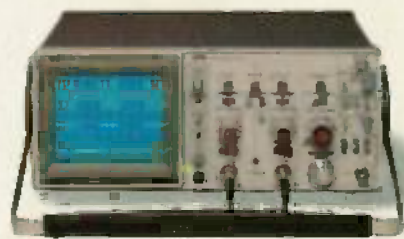

Tektronix
COMMITTED TO EXCELLENCE

*Prices F.O.B. Beaverton, Oregon
†3-year warranty includes CRT and applies to 2200 family oscilloscopes purchased after 1/1/83. Scopes are UL listed, CSA and VDE approved.

Copyright © 1985, Tektronix, Inc. All rights reserved. TTA-517-1
Prices subject to change.

SEPTEMBER '85

**Radio-
Electronics**

Electronics publishers since 1908

Vol. 56 No. 9

SPECIAL SECTION: AUTOMOTIVE ELECTRONICS

- 49 ELECTRONICS IN THE PASSENGER COMPARTMENT**
Navigation systems, multicolored liquid-crystal dashboard displays, and touch-screen CRT's will look right at home in your next car.
Marc Stern
- 53 ELECTRONICS UNDER THE HOOD**
Underhood electronics aren't glamorous and don't make car look better, but they can make it perform better, safer, and more reliably.
Marc Stern

BUILD THIS

- 59 IC TESTER**
This test instrument can be used to test your digital IC's and check your digital circuits. It makes a great learning tool as well.
David H. Dage
- 78 BUFFER/CONVERTER FOR YOUR PRINTER**
Part 2. This month, we expand our 64K printer buffer/converter so that it can be used to program EPROM's. Bill Green
- 81 PC SERVICE**
Now you can use PC foil patterns right from the magazine page!

TECHNOLOGY

- 12 SATELLITE TV**
Digging deeper into the signal scrambling issue. Bob Cooper, Jr.
- 90 ROBOTICS**
Building a programmable moving platform.
Mark J. Robillard

CIRCUITS AND COMPONENTS

- 63 DESIGNING DOUBLE-SIDED PC BOARDS**
Here are a few hints to help make the job easier. Robert Grossblatt
- 71 DESIGNING WITH DIGITAL IC'S**
Part 6. What shift registers are and how they work. Joseph J. Carr
- 94 DRAWING BOARD**
Designing microprocessor circuits.
Robert Grossblatt
- 96 HOBBY CORNER**
How to use relays effectively.
Earl "Doc" Savage, K4SDS

RADIO

- 102 ANTIQUE RADIOS**
All about antennas and grounds. Richard D. Fitch

VIDEO

- 6 VIDEO NEWS**
A review of the fast-changing video scene.
David Lachenbruch
- 67 COMB FILTERS FOR YOUR TV**
Part 2. A look at an experimental comb filter that you can build.
Neil W. Heckt

COMPUTERS

- Following page 92
COMPUTER DIGEST
Touch Screens, Voice Reproduction, and More!

EQUIPMENT REPORTS

- 32 Mastertech Laboratories**
Microlab 1 Digital Laboratory Course
- 35 Video Interface Products**
Hybrid-8 Special-Effects Generator
- 38 MaxiGuard Black Max**
Champion Auto Alarm

DEPARTMENTS

- 124 Advertising and Sales Offices**
- 124 Advertising Index**
- 125 Free Information Card**
- 16 Letters**
- 104 Market Center**
- 46 New Products**
- 4 What's News**

Radio-Electronics, (ISSN 0033-7662) Published monthly by Gernsback Publications, Inc., 200 Park Avenue South, New York, NY 10003. Second-Class Postage paid at New York, NY and additional mailing offices. Second-Class mail authorized at Ottawa, Canada. One-year subscription rate U.S.A. and possessions \$15.97, Canada \$20.97, all other countries \$23.47, subscription orders payable in US funds only, international postal money order or check drawn on U.S.A. bank. Single copies \$1.95 © 1985 by Gernsback Publications, Inc. All rights reserved. Printed in U.S.A. POSTMASTER: Please send address changes to RADIO-ELECTRONICS, Subscription Dept., Box 2520, Boulder, CO 80322. A stamped self-addressed envelope must accompany all submitted manuscripts and/or artwork or photographs if their return is desired should they be rejected. We disclaim any responsibility for the loss or damage of manuscripts and/or artwork or photographs while in our possession or otherwise.

SEPTEMBER 1985

1

COVER 1



If you think that the automobile won't change much as the years pass, think again! Our special section will show you that electronics will change the way you drive. Navigation systems will display your progress on maps as you go, and multicolored liquid-crystal dash displays will become commonplace. Multiplexed wiring schemes will allow more sophisticated functions to be included in your car, but will actually make problems easier to find because your car will be able to diagnose itself!

Although the electronics under the hood aren't as visible, they are at least as important. Cars will run cleaner and more efficiently under microprocessor control. Monitor systems can keep track of performance and keep the driver well informed of any problems. Our special section on Automotive Electronics begins on page 49.

NEXT MONTH

THE OCTOBER ISSUE IS
ON SALE SEPTEMBER 5

MULTIPLE-OUTPUT POWER SUPPLY

Here's a six-output supply that you can build for your workbench. It includes two sets of dual-polarity supplies and two voltage-reference outputs.

BUILD AN IC TESTER/ANALYZER

In Part 2, we'll put the IC tester to work on your digital IC's and circuits.

MULTIPATH RECEPTION

It causes ghosts on your TV and poor stereo reception on your FM receiver. But there are ways to beat it.

ADD A REMOTE CONTROL TO ANYTHING

Two IC's from Motorola make it easy.

A PLYWOOD SATELLITE DISH?

Theory says it's possible, and an experimental dish confirms it.

As a service to readers, Radio-Electronics publishes available plans or information relating to newsworthy products, techniques and scientific and technological developments. Because of possible variances in the quality and condition of materials and workmanship used by readers, Radio-Electronics disclaims any responsibility for the safe and proper functioning of reader-built projects based upon or from plans or information published in this magazine.

Since some of the equipment and circuitry described in RADIO-ELECTRONICS may relate to or be covered by U.S. patents, RADIO-ELECTRONICS disclaims any liability for the infringement of such patents by the making, using, or selling of any such equipment or circuitry, and suggests that anyone interested in such projects consult a patent attorney.

Radio Electronics

Hugo Gernsback (1884-1967) founder
M. Harvey Gernsback, editor-in-chief
Larry Steckler, EHF, CET, publisher

EDITORIAL DEPARTMENT

Art Kleiman, editor
Brian C. Fenton,
technical editor
Carl Laron, WB2SLR,
associate editor
Robert A. Young, assistant editor
Julian S. Martin, editorial associate
Byron G. Wels, editorial associate
Jack Darr, CET, service editor
Robert F. Scott,
semiconductor editor
Herb Friedman,
communications editor
Earl "Doc" Savage, K4SDS,
hobby editor
Bob Cooper, Jr., satellite-TV editor
Robert Grossblatt, circuits editor
David Lachenbruch,
contributing editor
Mark I. Robillard, robotics editor
Bess Isaacson, editorial assistant

PRODUCTION DEPARTMENT

Ruby M. Yee, production manager
Robert A. W. Lowndes,
editorial production
Karen Tucker, advertising production
Geoffrey S. Weil, production traffic

CIRCULATION DEPARTMENT

Jacqueline P. Weaver,
circulation director
Rita Sabalis,
assistant circulation director
Jacqueline Allen, circulation assistant

Radio-Electronics is indexed in
Applied Science & Technology Index
and *Readers Guide to Periodical Literature*.

Microfilm & microfiche editions are
available. Contact circulation depart-
ment for details.

Advertising Sales Offices listed
on page 124.



NEW!

uniden®

Bearcat®



Scanners

Communications Electronics™, the world's largest distributor of radio scanners, introduces new scanners and scanner accessories from J.I.L., Regency and also Uniden/Bearcat. Chances are the police, fire and weather emergencies you'll read about in tomorrow's paper are coming through on a scanner today.

NEW! Regency® MX7000-J

List price \$699.95/CE price \$424.00/SPECIAL 10-Band, 20 Channel • Crystalless • AC/DC Frequency range: 25-550 MHz, continuous coverage and 800 MHz to 1.3 GHz, continuous coverage. In addition to normal scanner listening, the MX7000 offers CB, VHF, and UHF TV audio, FM Broadcast, all aircraft bands (civil and military), 800 MHz communications, cellular telephone, and when connected to a printer or CRT, satellite weather pictures. If you just need continuous frequency coverage of 25-550 MHz, order the Regency MX5000-J for only \$329.00 each.

NEW! Regency® MX4000-J

List price \$629.95/CE price \$299.00/SPECIAL Multi-Band, 20 Channel • No-crystal scanner Search • Lockout • Priority • AC/DC Selectable AM-FM modes • LCD display Bands: 30-50, 118-136, 144-174, 440-512, 800-950 MHz. The Regency MX4000-J gives coverage in the standard VHF and UHF ranges with the important addition of the 800 MHz, and aircraft bands. It features keyboard entry, multifunction liquid crystal display and variable search increments.

NEW! Regency® Z60-J

List price \$379.95/CE price \$218.00/SPECIAL 8-Band, 60 Channel • No-crystal scanner Bands: 30-50, 88-108, 118-136, 144-174, 440-512 MHz. Cover your choice of over 15,000 frequencies on 60 channels at the touch of your finger.

Regency® HX-650P-J

List price \$189.95/CE price \$99.00/SPECIAL 5-Band, 6 Channel • Handheld crystal scanner Bands: 30-50, 146-174, 450-512 MHz. Now, Communications Electronics Inc. offers a special package price on the Regency HX-650 scanner and the following items for only \$94.00. You get the Regency HX-650 scanner, a set of 4 AAA ni-cad batteries, the MA-506 carrying case, six crystal certificates, AC adapter/charger and flexible rubber antenna for only \$99.00 per package plus \$10.00 shipping/handling.

NEW! JIL SX-400-J

List Price \$799.95/CE price \$489.00/SPECIAL Multi-Band, 20 Channel • No-crystal Scanner Search • Lockout • Priority • AC/DC Frequency range: 26-520 MHz, continuous coverage. With optionally equipped RF converters 150KHz-3.7 GHz. The JIL SX-400 synthesized scanner is designed for commercial and professional monitor users that demand features not found in ordinary scanners. The SX-400 will cover from 150 KHz to 3.7 GHz, with RF converters. Order the following RF converters for your SX-400 scanner. RF-1030-J at \$259.00 each for frequency range 150 KHz - 30 MHz, USB, LSB, CW and AM. (CW filter required for CW signal reception); RF-5080-J at \$199.00 each for 500-800 MHz; RF-8014-J at \$199.00 each for 800 MHz - 1.4 GHz. Be sure to also order ACB-300-J at \$89.00 each which is an antenna control box for connection of the RF converters. Add \$3.00 shipping for each RF converter or antenna control box. If you need further information on the JIL scanners, contact JIL directly at 213-926-8727 or write JIL at 17120 Edwards Road, Cerritos, California 90701.

SPECIAL! JIL SX-200-J

List price \$499.95/CE special price \$159.00 Multi-Band - 16 Channel • No-Crystal Scanner Frequency range 26-88, 108-180, 380-514 MHz. The JIL SX-200 scanner tunes military, F.B.I., Space Satellites, Police and Fire, Drug Enforcement Agencies, Defense Department, Aeronautical AM band, Aero Navigation Band, Fish & Game, Immigration, Paramedics, Amateur Radio, Justice Department, State Department, plus other thousands of radio frequencies most other scanners can't pick up. The SX-200 has selectable AM/FM receiver circuits, tri-switch squelch settings - signal, audio and signal & audio, outdoor AC power supply - DC at 12 volts built-in, quartz clock - bright vacuum fluorescent blue readouts and dimmer, dual level search speeds, tri-level scan delay switches, 16 memory channels in two channels banks, receive fine tune (RT) ± 2KHz, dual level RF gain settings - 20 db pad, AGC test points for optional signal strength meter. All in all, the JIL SX-200 gives you more features for the money than any other scanner currently on sale. Order your JIL SX-200 scanner at this special price today.

Regency® HX1000-J

List price \$329.95/CE price \$209.00 6-Band, 30 Channel • No Crystal scanner Search • Lockout • Priority • Scan delay Sidelit liquid crystal display • Digital Clock Frequency range: 30-50, 144-174, 440-512 MHz. The new handheld Regency HX1000 scanner is fully keyboard programmable for the ultimate in versatility. You can scan up to 30 channels at the same time. When you activate the priority control, you automatically override all other calls to listen to your favorite frequency. The LCO display is even sidelit for night use. Order MA-258-J rapid charge drop-in battery charger for \$79.00 plus \$3.00 shipping/handling. Includes wall charger, carrying case, belt clip, flexible antenna and nicad battery. Order now.

NEW! Bearcat® 100XL-J

List Price \$349.95/CE Price \$229.00 9-Band, 16 Channel • Priority • Scan Delay Search • Limit • Hold • Lockout • AC/DC Frequency range: 30-50, 118-174, 408-512 MHz. The world's first no-crystal handheld scanner now has a LCO channel display with backlight for low light use and aircraft band coverage at the same low price. Size is 1 3/4" x 7 1/2" x 2 1/2". The Bearcat 100XL has wide frequency coverage that includes all Public service bands (Low, High, UHF and "T" bands), the AM aircraft band, the 2-meter and 70 cm. amateur bands, plus military and federal government frequencies. Wow... what a scanner! Included in our low CE price is a sturdy carrying case, earphone, battery charger/AC adapter, six AA ni-cad batteries and flexible antenna. Order your scanner now.

NEW! Regency® HX2000-J

The World's First 800 MHz. Handheld Scanner List price \$569.95/CE Price \$299.00/SPECIAL 7-Band, 20 Channel • No-crystal scanner Priority control • Search/Scan • AC/DC Sidelit liquid crystal display • Memory backup Bands: 118-136, 144-174, 440-512, 800-950 MHz. The HX2000 scanner operates on 120V AC or 8 VDC. Scans 18 channels per second. Size 3" x 7" x 1 1/2". Includes wall charger, carrying case, belt clip, flexible antenna and nicad batteries. Selectable AM/FM modes.

NEW! Bearcat® 800XLT-J

List price \$499.95/CE price \$329.00 12-Band, 40 Channel • No-crystal scanner Priority control • Search/Scan • AC/DC Bands: 29-34, 118-174, 406-512, 800-912 MHz. The Uniden 800XLT receives 40 channels in two banks. Scans 15 channels per second. Size 9 1/2" x 4 1/2" x 1 1/2".

OTHER RADIOS AND ACCESSORIES

- Panasonic RF-2600-J Shortwave receiver..... \$179.00
 - Panasonic RF-8300-J Shortwave receiver..... \$195.00
 - RD95-J Uniden Remote mount Radar Detector..... \$139.00
 - BC 300-J Bearcat 50 channel scanner..... \$344.00
 - BC 20/20-J Bearcat 40 channel scanner..... \$274.00
 - BC 210XW-J Bearcat 20 channel scanner..... \$219.00
 - BC 260-J Bearcat 16 channel mobile scanner..... \$274.00
 - BC 201-J Bearcat 16 channel scanner..... \$189.00
 - BC 160-J Bearcat 16 channel scanner..... \$164.00
 - BC-WA-J Bearcat Weather Alert..... \$39.00
 - DX1000-J Bearcat shortwave receiver..... \$459.00
 - PC22-J Uniden remote mount CB transceiver..... \$99.00
 - PC55-J Uniden mobile mount CB transceiver..... \$59.00
 - Z10-J Regency 10 channel scanner..... \$139.00
 - Z30-J Regency 30 channel scanner..... \$154.00
 - Z45-J Regency 45 channel scanner..... \$179.00
 - NX3000-J Regency 30 channel scanner..... \$169.00
 - CA03-J Regency 4 channel scanner..... \$69.00
 - R106-J Regency 10 channel scanner..... \$99.00
 - RH250B-J Regency 10 channel VHF transceiver..... \$329.00
 - RU180B-J Regency 10 channel UHF transceiver..... \$449.00
 - RPH410-J 10 ch. handheld no-crystal transceiver..... \$79.00
 - BC10-J Battery charger for Regency RPH410..... \$79.00
 - MA256-J Drop-in charger for HX1000 scanner..... \$79.95
 - MA257-J Cigarette lighter cord for HX1000..... \$19.95
 - MA258-J Ni-Cad battery pack for HX1000..... \$24.95
 - EC10-J Programming tool for Regency RPH410..... \$20.00
 - SMRH250-J Service man for Regency RH250..... \$20.00
 - SMRU150-J Service man for Regency RU150..... \$20.00
 - SMRPH410-J Service man for Regency RPH410..... \$20.00
 - B-4-J 1.2 V AAA Ni-Cad batteries (set of four)..... \$9.00
 - A-135C-J Crystal certificate..... \$3.00
 - FB-E-J Frequency Directory for Eastern U.S.A..... \$12.00
 - FB-W-J Frequency Directory for Western U.S.A..... \$12.00
 - T80-J "Top Secret" Registry of U.S. Govt. Freq..... \$16.00
 - TIC-J Techniques for Intercepting Comm..... \$15.00
 - RRF-J Railroad frequency directory..... \$10.00
 - CIE-J Covert Intelligence Elect. Eavesdropping..... \$15.00
 - A80-J Magnet mount mobile scanner antenna..... \$35.00
 - A70-J Base station scanner antenna..... \$35.00
 - USAMM-J MAG mount VHF/UHF ant. w/ 18' cable..... \$39.95
 - USAK-J 1/2" hole mount VHF/UHF ant. w/ 17' cable..... \$35.95
 - USATLM-J Trunk lip mount VHF/UHF antenna..... \$35.95
- Add \$3.00 shipping for all accessories ordered at the same time. Add \$12.00 shipping per shortwave receiver. Add \$7.00 shipping per scanner and \$3.00 per antenna.

BUY WITH CONFIDENCE

To get the fastest delivery from CE of any scanner, send or phone your order directly to our Scanner Scanner Distribution Center, Michigan residents please add 4% sales tax or supply your tax I.D. number. Written purchase orders are accepted from approved government agencies and most well rated firms at a 10% surcharge for net 10 billing. All sales are subject to availability, acceptance and verification. All sales on accessories are final. Prices, terms and specifications are subject to change without notice. All prices are in U.S. dollars. Out of stock items will be placed on back-order automatically unless CE is instructed differently. A \$5.00 additional handling fee will be charged for all orders with a merchandise total under \$50.00. Shipments are F.O.B. Ann Arbor, Michigan. No COD's. Most products that we sell have a manufacturer's warranty. Free copies of warranties on these products are available prior to purchase by writing to CE. Non-certified checks require bank clearance.

Mail orders to: Communications Electronics, Box 1045, Ann Arbor, Michigan 48108 U.S.A. Add \$7.00 per scanner for U.P.S. ground shipping and handling in the continental U.S.A. For Canada, Puerto Rico, Hawaii, Alaska, or APO/FPO delivery, shipping charges are three times continental U.S. rates. If you have a Visa or Master Card, you may call and place a credit card order. Order toll-free in the U.S. Dial 800-USA-SCAN. In Canada, order toll-free by calling 800-221-3475. WUI Telex CE anytime, dial 671-0155. If you are outside the U.S. or in Michigan dial 313-973-6888. Order today.

Scanner Distribution Center™ and CE logos are trademarks of Communications Electronics Inc. 1 Bearcat is a registered trademark of Uniden Corporation. 1 Regency is a federally registered trademark of Regency Electronics Inc. AD e081185-J Copyright © 1985 Communications Electronics

For credit card orders call 1-800-USA-SCAN



Consumer Products Division
P.O. Box 1045 □ Ann Arbor, Michigan 48108-1045 U.S.A.
Call 800-USA-SCAN or outside U.S.A. 313-973-6888



CIRCLE 79 ON FREE INFORMATION CARD

WHAT'S NEWS

Equipment protection system removes motive for theft

A US patent has been issued for a new electronic-equipment system that the inventor believes will drastically reduce theft of computers, TV's, electrically tuned radios, or any other equipment that incorporates microprocessors. Called the K-circuit Lockout after its inventor, Norman Kaish, it prevents equipment that has been stolen from operating. Thus it removes the very motive for theft—nobody wants or can sell a piece of electronic equipment that doesn't work.



THIEVES ARE DISCOURAGED from even making an attempt to steal this radio. "Nobody will buy a radio or TV that doesn't work."

The K-circuit Lockout is built into the equipment, and provides an entry code without which, the equipment will not work. (Actually two codes are used, a complex one inserted by the factory and the

owner's personal code, which the owner can change at will.) Any loss of power to the protected unit, whether by pulling the plug, cutting wires, or opening a circuit breaker or fuse in the line, disables the equipment. When power is again applied, the equipment will not work until the owner has keyed in his personal code.

The new system will be licensed to electronics manufacturers by International Electronic Technology Corporation of Far Rockaway, NY, owners of the patent. President Norman Kaish believes that it will add less than \$5 to the price of any item to which it is added.

RCA signs up to service Commodore computer gear

Under a recently signed agreement, RCA Service Co. will provide nationwide warranty service on Commodore computers, disk drives, and color monitors. The company will also provide after-warranty service and will offer long-term service contracts on the above mentioned Commodore equipment.

The Third-Party Maintenance (TPM) agreement is part of a major reorganization and expansion of Commodore's customer service and support system. It is also part of RCA's national expansion of its current computer service expertise. Equipment covered by the agreement includes Commodore models C16, C64, Plus 4 and VIC 20 computers, C1541 disk drive and C1702 color monitor.

A walk-in facility for Commodore customers and non-servicing retailers will be located in each of RCA Service Co's 158 branches; those are located throughout the United States.

Violin bow may be replaced by computer?

In experiments believed to be the first of their kind, Professor Gabriel Weinreich of the University of Michigan and Rene Causse of the Institut de Recherche et Coordination Acoustique/Musique, in Paris, have used a computer to duplicate successfully the vibrations a violin string produces when bowed.

Weinreich points out that to make a metal string vibrate by electrical means is simple. But the action of a string being bowed is different from that of a string vibrating under the influence of an electric force. That is because of the special interaction of the horsehair bow and the string.

By mounting an electronic motion sensor near the string, feeding its output to a computer, and programming the computer to produce immediately the right current to send through the string, Weinreich and Causse were able to make the string vibrate correctly without a bow. They call the experiment the "digital bow."

"I can see a situation where a violinist's left hand might be in its ordinary position on the fingerboard, while his right hand would be operating the computer controls instead of holding the bow," says Weinreich. "Such sounds are especially interesting musically because they maintain a perpetual continuity with what we know as violin music. The more common synthesized sound loses that continuity as soon as any knob is turned."

The National Science Foundation recently awarded Weinreich a special travel grant to enable him to visit the Paris laboratory regularly. R-E

RAG

ELECTRONICS, INC.

New and Used Electronic Test Equipment
Sales • Service • Rental • Leasing

HITACHI
Hitachi Denshi, Ltd.

V1100A DC to 100 MHz Portable Readout Oscilloscope

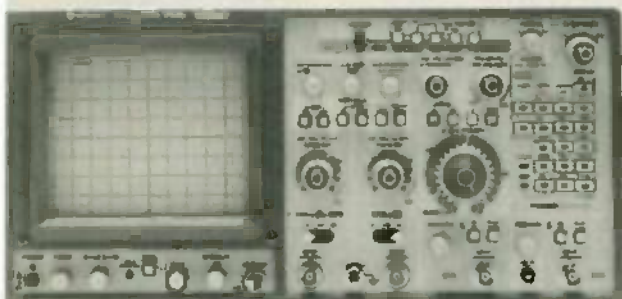

FEATURES

- Character display of set-up information on CRT (VOLTS/DIV, TIME/DIV, CAL or UNCAL, Delay Time, Trigger source, etc.)
- Cursor read-out function eliminates conventional calculation procedures (V, ΔV, ΔV%, ΔT, 1/ΔT, ΔT%, phase).
- Digital measuring function displays DC voltage, AC voltage, and Frequency.
- Comment display function allows user's comments to be displayed on the CRT such as date and measurement data. Excellent for photo documentation.
- 4 channel, 8 trace, DC to 100 MHz, High sensitivity 1 mV/Div. Delayed sweep, Full TV triggering, Alternate triggering.

List Price \$2,490.00 **Sale Price \$2,250.00**

HITACHI
Hitachi Denshi, Ltd.

V-209 DC to 20 MHz Mini-Portable Dual-Trace Oscilloscope

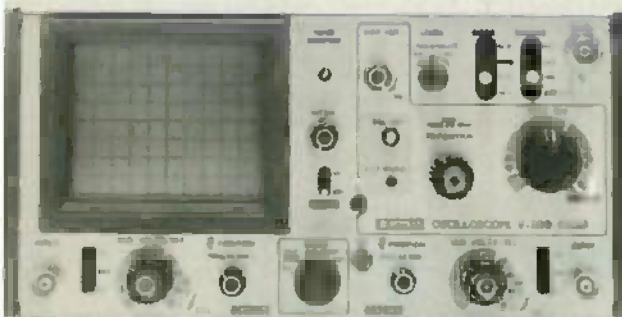

- A three-way power supply takes the V-209 anywhere, anytime for speedy field measurements.
- High sensitivity (1 mV/div at 10MHz) and fast sweep times (50ns/div) make the V-209 a valuable tool in R&D as well as servicing in a wide variety of applications including computers and video equipment.
- A built-in TV sync separation circuit with easily selectable TV-V and TV-H modes ensures stable observation of both vertical and horizontal TV signal waveforms.
- An auto focus feature maintains constant trace without the necessity of troublesome manual focus adjustments.
- The V-209 is just what it claims to be—a powerful field service tool in a compact, lightweight package.

List Price \$945.00 **Sale Price \$708.00**

HITACHI
Hitachi Denshi, Ltd.

Portable Oscilloscopes



Model V-422 shown

MODEL V-212 **\$461.00**
DC to 20 MHz, 1 mV/div, Dual Trace. Features 6" Rectangular CRT (w/two X10 Probes).

MODEL V-422 **\$694.00**
DC to 40 MHz, 1 mV/div, Dual Trace, D.C. offset for DMM Output, Verticle Mode Trigger 6" CRT (w/two X10 probes).

MODEL V-1050F **\$1,276.00**
DC to 100 MHz, .5 mV/div, Quad Trace, Delayed Sweep, Full TV Triggering, Alternate time base (w/two X10 probes).

Full 2 year parts and labor warranties on the above scopes.

HITACHI GSA CONTRACT NUMBER GS00S57322

CIRCLE 126 ON FREE INFORMATION CARD

CALL US TOLL FREE
1-800-732-3457
IN CALIFORNIA TOLL FREE
1-800-272-4225

- Master Charge
- VISA
- COO
- Money Order
- Check



ADD FOR SHIPPING AND INSURANCE	
\$0 to \$250.00	\$4.50
\$251.00 to \$600.00	\$6.50
\$601.00 to \$750.00	\$8.50
\$751.00 to \$1000	\$12.50
over \$1000.00	\$15.00

Prices subject to change without notice.

RAG ELECTRONICS, INC. / 21418 Parthenia Street / Canoga Park, CA 91304 / 1-818-998-6500

VIDEO NEWS



DAVID LACHENBRUCH
CONTRIBUTING EDITOR

• **Stereo TV for Everyone.** On the subject of stereo sound for TV, accessory company Recoton is introducing the first "universal" decoder to adapt any TV set—color or monochrome—to the new multichannel TV sound (MTS) transmissions. Recoton's decoder comes equipped with two sensitive RF probes, one for use with portable and table model TV's with plastic or wood cabinets, and the other for consoles and metal-cabinet sets. With a plastic or wood cabinet, the user moves the probe around the back and sides of the cabinet exterior until the stereo light appears on the adapter (if stereo is being transmitted) or until the sound is clearest through the adapter. The adapter is then affixed to that point with self-stick adhesive. With consoles or metal sets, a service technician installs an insulated probe inside the cabinet near the IF strip.

The adapter has an earphone jack and dual stereo outputs—one for a home stereo system, the other for a stereo VCR. It also creates synthesized stereo from monophonic TV sound, and is expected to retail for around \$150.

• **Video with PCM Audio.** The proponents of the new 8mm video format have now uncorked what might be their biggest weapon in the battle to establish a new home VCR standard—digital sound. At the same time, they have doubled the recording and playing time of the 8mm system to four hours for a newly introduced "two-hour" cassette by installing a two-speed switch on their home decks.

At press time, Sony, Pioneer, and Eastman Kodak had introduced the new audio-video decks that not only can record and play back tapes with pulse code modulation (PCM) digital sound, but also make very creditable audio recorders—with up to 24 hours of digital audio on a single cassette not much bigger than a standard audio cassette. Although standard sound on an 8mm videocassette is the helical FM variety, the official 8mm standards permit PCM sound as an option.

When used for audio only, six tracks are recorded on the 8mm tape—one in the space normally reserved for a digital sound track, and

five more in the space normally occupied by the video signal. At the four-hour speed, the tape passes the recording head six times, providing 24 hours of recording.

• **Pocket Camcorder.** Another 8mm byproduct is the first pocket-sized camera-recorder—well, pocket-book size, anyway. Sony's *Mini 8* is about the size of a large paperback book, weighs 2.2 pounds, contains a CCD pickup, and is designed for the aim-and-shoot Brownie camera trade, as opposed to Sony's more sophisticated



(and larger) *Video 8* camcorder, destined for home-movie hobbyists. Like the Sony PCM-sound video deck, the *Mini 8* is due here this fall, along with a companion record-and-play miniature video deck. A separate deck is required because the *Mini 8* is a record-only machine, unlike the *Video 8*, which will play back as well as record (*Radio-Electronics*, August 1985).

• **Stereo TV Spreads.** Although there is still a shortage of program material, a sharply increasing number of TV stations are now broadcasting in stereophonic sound. As of June 1, there were at least 60 stereo stations on the air, covering an area including more than 50 percent of the nation's population, and it seems almost certain that stereo broadcasting will be within range of just about everyone by the end of this year.

R-E

Superior performance by phone for as low as \$695.



The 8840A Digital Multimeter.

Now, with Fluke telemarketing, you can order the most affordable, most powerful DMM in its class, from any phone in the U.S.A.

Compare features, compare prices and you'll find that no other 5½-digit bench-top or system multimeter can match it.

Add IEEE-488 and true rms options for \$150 each, and a fully-loaded 8840A is still only \$995.

As easy to use as your phone.

The simplified front panel of the 8840A is designed for ease of operation. Functions are clearly labeled. Even the vacuum fluorescent display is easy to read. And closed-case calibration and 50,000 hour MTBF make the 8840A easy to live with.

The 8840A is versatile: it answers your bench or system DMM needs. Standard capabilities include superior dc voltage accuracy (50 ppm at 1 year), 2- and 4-wire ohms, dc current, fast autoranging and user-selected reading rates.

Reach out and test the best.

Call toll-free and our sales engineer will tell you about the 8840A. Ask about our 15-day trial period and our one-year Fluke warranty.

Order now.
1-800-44-FLUKE
(1-800-443-5853) Ask for extension 104.

Fluke 8840A

Autoranging Volts, Ohms, and Amps

50 ppm basic dc accuracy (1 year)

0.16% basic ac accuracy (1 year)

2% .20 and 100 readings/second

FROM THE WORLD LEADER
IN DIGITAL MULTIMETERS.

FLUKE®

CIRCLE 260 ON FREE INFORMATION CARD



With NRI training at home, you can...

Move up to a high paying

And you can start by actually building your own 16-bit IBM-compatible computer!

You can create your own bright, high paying future as an NRI trained computer service technician. The government now reports that computer service and repair is the fastest growing career field. The biggest growth in jobs between now and 1995, according to Department of Labor estimates, will occur in the computer service and repair business, where demand for trained technicians will actually double during the next 10 years! There is still plenty of room for you to get in on the action—if you get the proper training now.

Total computer systems training, only from NRI

If you really want to learn how to work on computers, you have to get *inside* one! And only NRI takes you inside a computer, as powerful and advanced as the Sanyo MBC-550-2. As part of your training, you'll build this Sanyo, which experts have hailed as the "most intriguing" of all the new IBM-compatibles. Computer critics say, "The Sanyo even surpasses the IBM PC in computing speed and graphics quality."

This hands-on experience is backed up with training in programming, circuit design and peripherals. Only NRI gives you such in-depth total systems training.

The kind of understanding built only through experience

Even if you've never had any previous training in electronics, you can **succeed** with NRI training. You'll start with the basics, rapidly building on the fundamentals of electronics until you master such advanced concepts as digital logic, microprocessor design, and computer memory.

You'll build and test advanced electronic

circuits using the exclusive NRI Discovery Lab[®] and professional Digital Multimeter, both of which are

yours to keep.

You'll assemble Sanyo's intelligent keyboard, install the power supply and disk drive, and interface the high resolution monitor—all the while performing hands-on experiments and demonstrations that

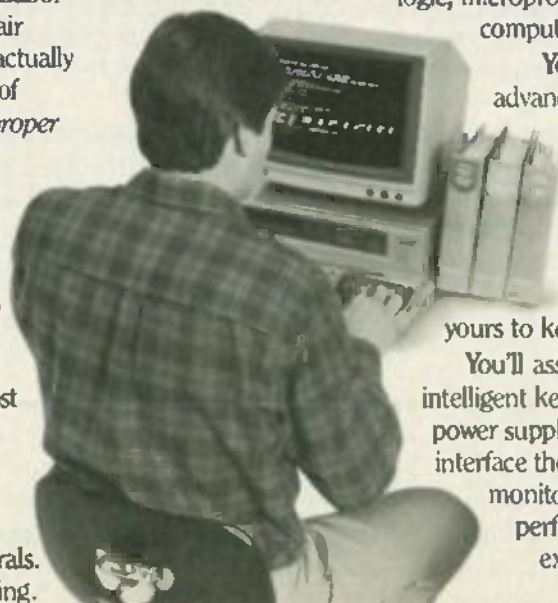



career servicing computers.

fine tune your computer skills. And you also get over \$1,000 worth of software, including WordStar and CalcStar.

Learn to service today's computers

As you train with your Sanyo, you'll gain the knowledge you need to become a computer professional. You'll learn to program in BASIC and machine language. You'll use utility programs to check out the operation of the Sanyo's 8088 microprocessor (the same chip used in the IBM PC). You'll learn how to debug programs and write your own new software.

Most importantly, you'll understand the principles common to all computers. Only a person who fully understands all the fundamentals can hope to be able to tackle all computers. NRI makes sure that you'll get the training you need to maintain, troubleshoot and service computers.

Learn at home in spare time

With NRI training, you'll learn at home on your own time. That means your preparation for a new career or part-time job doesn't have to interfere with your current job. You'll learn at your own pace, in the comfort and convenience of your own home. No classroom pressures, no rigid night school schedules. You're always backed up by the NRI staff and especially your NRI instructor, who will

answer questions, give you guidance and be available for special help if you need it.

Let others worry about computers taking their jobs. With NRI training, you'll soon have computers making good paying jobs for you.

Send for free NRI catalog

Send the post-paid reply card today for NRI's 100-page catalog, that gives all the facts about computer training plus career training in Robotics, Data Communications, TV/Video Servicing and many other fields. If some other ambitious person beat you to the card, write to NRI at the address below.



NRI SCHOOLS

McGraw-Hill Continuing Education Center
3939 Wisconsin Avenue, NW
Washington, DC 20016

We'll Give You Tomorrow. 

IBM is a Registered Trademark of International Business Machines Corporation.

SATELLITE TV



BOB COOPER, JR.*

More on scrambling

WE LEFT YOU LAST TIME WITH SOMETHING of a cliff hanger: HBO had decided to pull back their sales and marketing efforts for home TVRO customers; the TVRO receiver industry had "revolted" against the technical requirements set forth by HBO's scrambling-system supplier, Linkabl. And Showtime, an HBO competitor, was creeping into the scenario with hopes of creating a marketing plan of its own. Before we pick up our story, perhaps it is best if we backtrack a bit and see why HBO felt that scrambling was necessary.

Why scramble?

A satellite programmer scrambles to ensure that only those who are authorized (paying for or otherwise contracted) receive their signals. Home TVRO systems have, until now, been unauthorized. And with over 1,000,000 TVRO's in operation, there's surely a sizable amount of unauthorized viewing going on. Any good businessman would try to figure out some way to collect a fee from those "pirating" his service.

But it goes even deeper than that. HBO already has some 12,000,000-plus homes paying for their service through one of their cable affiliates, and those affiliates have their own theft-of-service problems. According to estimates released by the management of HBO and Showtime, there are probably upward of 8,000,000 U.S. homes now receiving HBO and/or Showtime programming directly from the cable-service systems without paying for it.

Yes, theft of service has reached

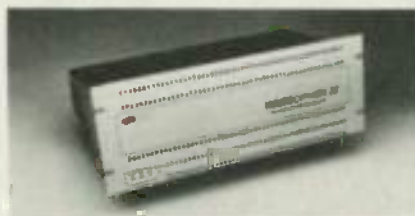

epidemic proportions, but how would scrambling help the situation? Directly, it would not help at all. For if HBO scrambles programming between their uplink and the satellite, upon returning to earth, each cable system "head end" must descramble the signal before it's placed on the cable for transmission to subscribers. So scrambling satellite feeds does not improve cable security. At least not yet, anyway. (There has long been a plan to place scrambled signals on the cable and have cable firms install special addressable descramblers at the customer end. That would, if it ever happened, allow the service to stay scrambled

TVRO dealer "Starter Kit" available

If you own, operate, or are employed by an electronic sales or service center, 1985 may be the year for you to take a hard look at entering the TVRO sales and service business. Having passed the one-millionth terminal-installed mark and expecting to install upwards of 550,000 new home systems in 1985, this may just be "the growth industry" in home electronics for the rest of the 1980's.

Bob Cooper has assembled a collection of important materials for you to study to evaluate your own "chances for success" in the home TVRO business. You may obtain the "TVRO Dealer Starter Kit" free of charge or obligation by writing on company letterhead, or by enclosing a business card to: TVRO Starter Kit, P.O. Box 100858, Ft. Lauderdale, FL 33310.

all the way to the customer's receiver. But that is down the road, perhaps a decade or so away.)

What scrambling offers

HBO knows that it is losing income because some cable operators either fail to report all of their paying customers, or simply sign up for one cable system, but use that feed for the several systems they own. Also, HBO has had significant problems in getting paid promptly by their affiliates. Years ago, HBO would have received payment by the 10th of every month. Not so anymore; significant 30, 60, and 90 day past-due accounts are common.

Since the scrambling system is addressable, each cable head-end descrambler, such as the one shown in Fig. 1, could have its own unique electronic address code. If the cable company is late with its payment, HBO could "pull-the-plug" on that firm's satellite feed. Thus, the scrambling system becomes a useful "collection tool." Firms that have become accustomed to making late payments would be in for a rude awakening.

Some cable operators thought that they could beat the proposed system by ordering a spare descrambler or two. HBO has said that it would willingly sell its cable affiliates a spare descrambler and actually would encourage such purchases. That way, if the main unit quits, the cable affiliate could switch to the spare and maintain uninterrupted service. But local cable operators wanted the spare to be on-line and ready to "go" if the primary unit failed. To that HBO has said: "No way." If that

* publisher of CSD magazine

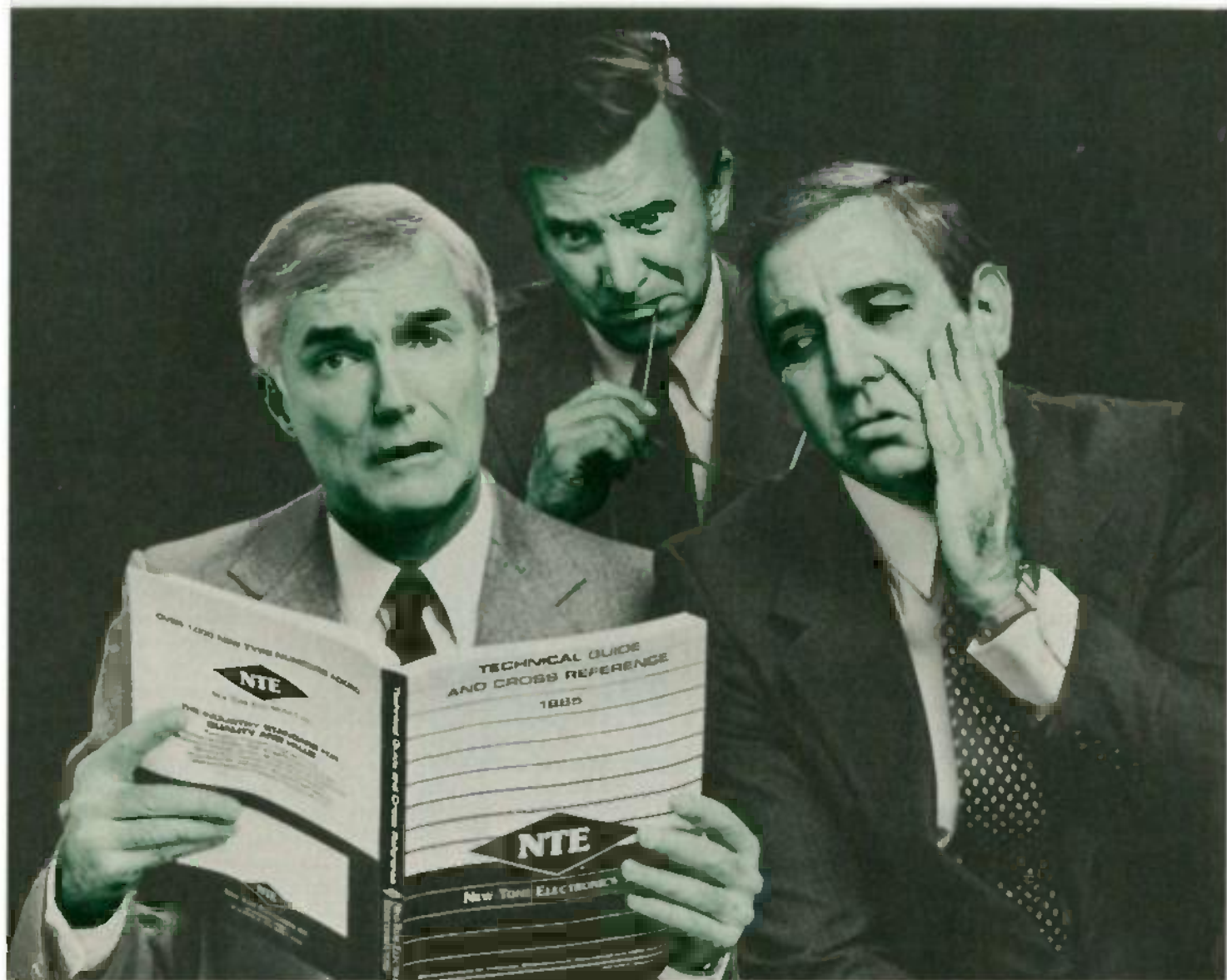

WE'RE TURNING THE COMPETITION GREEN WITH ENVY.

NTE is the red hot success story of the electronics industry and the big boys are green with envy.

They don't like the fact that we've built our reputation on giving you more of what you're looking for in a replacement part. More quality. More reliability. And, more parts to choose from. That's why more and more technicians across the country are picking the package with the green NTE diamond on the front.

NTE parts are extensively tested on state-of-the-art equipment during every phase of production to ensure top performance — performance that's backed by the industry's only two year warranty.

What's more, NTE uses a special computer controlled inventory system, so when you replace or design with NTE, you can be sure that the part you need is on your distributor's shelf. Our new 1985/86 Technical Guide and Cross-Reference manual, which has over 3,100 NTE types cross-referenced to over 220,000 industry part numbers, is now available.

Why settle for our competitor's parts when you get more quality and service with NTE? Look for NTE's replacement parts in the bright green polybags and cartons at your distributor today.

Don't forget to ask about our new Flameproof Resistors and Wire Ties, too!



NTE ELECTRONICS, INC.

44 FARRAND STREET, BLOOMFIELD, NEW JERSEY 07003

CIRCLE 262 ON FREE INFORMATION CARD

were allowed, HBO would have no way of knowing if the spare is actually located where the cable operator claims it to be. The cable operator could use the spare in an entirely different cable system, and thus receive HBO for the second system without paying for the privilege! So for those cable systems that have ordered spare descramblers, there's an elaborate system in effect when the primary fails.

When the primary unit goes down, the cable firm must call an HBO "hot line" to report the failure. HBO then deletes the electronic address code of the primary unit from the uplink data stream (after which it's no longer activated under any circumstances). Then the address code of the standby unit is added to the data stream and the standby turns on. In that way, each cable company has only one HBO (or Cinemax, etc.) de-

scrambler operating at a time. Besides, if the primary unit really goes down, it wouldn't need to be addressed.

So, you can see that HBO and the other cable programmers have a much bigger reason for installing the scrambling system than merely shutting off private home viewers. They have some "accounting problems" in their primary market, their cable (and MDS) affiliates. And the scrambling system, while not the ultimate cure-all for their "security woes," is at least an effective tool for collection of payment and the control of their merchandise.

Continuing our discussion

We closed out last time by suggesting that Showtime came onto the scene as a me-too entrant into the possible packaging of a home TVRO service. We also noted that they were, unfortunately, saddled with the same scrambling technology and Linkabit package as HBO. Thus, any unresolved problems HBO faced with Linkabit were still facing Showtime.

That may not be the case. Up to this point, everything about the home TVRO business has centered almost exclusively on 4 GHz (C-band) technology. It is on C-band (3.7 to 4.2 GHz) that we have 100-plus TV transponders (channels) now operating, and it's C-band TVRO's that have reached the 1,000,000 plateau this year.

At the same time, we have seen the "rise and fall" of the first non-C-band home service entrant, USCI. You may recall that USCI spent upward of \$70,000,000 to ultimately reach approximately 10,000 U.S. homes with a five-channel "quasi-DBS" service through some rented transponders on a Canadian satellite. We've also seen industry giant COMSAT pull back from their \$250,000,000 plan to provide 12-GHz DBS service to America.

Seemingly, with the failure of USCI and the closing down of COMSAT before they even got started at 12 GHz, the prospects for a 12-GHz service would be marginal at best. However, Showtime is not so sure about that as we shall see next time.

R-E

SATELLITE TV/

The First Five Years!



THE MOST COMPLETE report on the mushrooming home TVRO industry ever compiled, written as only the 'father of TVRO' could have prepared. More than 1000 pages (!) tracing the complete story of home TVRO, lavishly illustrated with equipment photos, schematic diagrams, equipment analysis reports. Bob Cooper, the first private individual to own and operate a TVRO (1976) has collected and polished hundreds of individual reports into a unique 'collector's edition' which clearly explains the TVRO phenomenon in North America. From Coop's first 20 foot 'monster' dish to the present day 5 foot 'C-band' TVROs, the fascinating growth of TVRO equipment and its legal status unfolds for you.



THIS TWO VOLUME SET totaling more than 1,000 pages is available for the first time to readers of Radio-Electronics at special discount pricing. Originally sold at \$100 per two-volume set, a limited supply is now available ONLY through this advertisement. PLUS, you will also receive a special extraordinary bonus: the 200 page (+) October 1984 edition of CSD/Coop's Satellite Digest. This very special edition of CSD is a best-seller in the TVRO industry, with the most comprehensive collection of TVRO facts and figures ever compiled. Combined with the 1,000 page 'CSD ANTHOLOGY' report, you have instant reference to everything you will ever need to know about the state of the home TVRO industry. It is MUST reading for every person in, or thinking about 'getting into,' any segment of the home TVRO world.

— SEND CSD ANTHOLOGY/2 Vols. + CSD Bonus.
 — SEND CSD October '84 Special Issue ONLY.

NAME _____ COMPANY _____
 ADDRESS _____
 CITY _____ STATE _____ ZIP _____

Payment: \$60 US funds (Anthology + Bonus). \$15 US funds CSD Oct. ONLY; payable "CSD ANTHOLOGY."
 Shipping charges prepaid. Enter order to: CSD Anthology, Radio-Electronics Magazine, 200 Park Av. S., New York, NY 10003; or call 305-771-0505 for credit card orders ONLY.



TEST INSTRUMENTS

LOWEST PRICES
OFF-THE-SHELF
DIRECTLY TO YOU

CALL TOLL FREE
FOR FAST DELIVERY

800-645-9518

In New York State 800-832-1446

HITACHI 35 MHz DUAL TRACE OSCILLOSCOPE

Model V-355
\$599⁹⁵

(Reg. \$899.95)
Probes included.

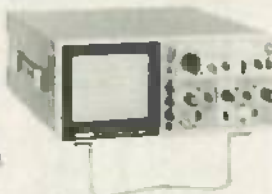

- Thin, lightweight, compact • Large 6" rectangular, internal graticule CRT
- Autofocus

FREE! LOGIC PROBE
BP LP189
(\$40.00 VALUE)
with purchase of
Model V-355

A.W. SPERRY 20 MHz DUAL TRACE OSCILLOSCOPE

Model 620C
\$399⁹⁵

(Reg. \$449.95)
Probes included.

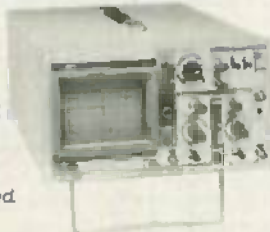

- Built-in component checker • High sensitivity X-Y mode • Internal graticule CRT

HITACHI 100 MHz QUAD TRACE DELAYED SWEEP OSCILLOSCOPE

Model V-1050F
\$1249⁹⁵

(Reg. \$1980)
Probes included.



- Large 6" rectangular CRT w/internal graticule • Delayed alternate and single sweep functions • Autofocus

B&K 60 MHz TRIPLE TRACE OSCILLOSCOPE

Model 1560
\$899⁹⁵

(Reg. \$1150)
Probes included.

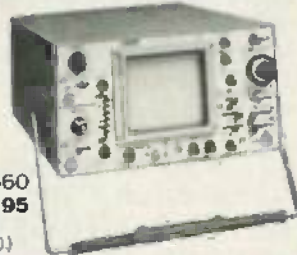

- 1 mV/div sensitivity • 22 calibrated sweeps • Rectangular CRT w/internal graticule & scale illumination
- Autofocus

FORDHAM SWEEP FUNCTION GENERATOR

Model FG-801
\$199⁹⁵

(Reg. \$299.95)
Test Leads included.

- 7 frequency ranges, 0.2Hz to 2MHz
- Accuracy to $\pm 5\%$

SPECIAL PRICE!

FORDHAM 550 MHz FREQUENCY COUNTER

Model FM-8
\$169⁹⁵

(Reg. \$249.95)

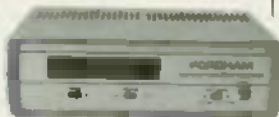

- Completely assembled, pre-tested, pre-calibrated • High intensity 8-digit LED display

FLUKE 3 1/2 DIGIT MULTIMETERS & VOLTMETERS



Model 73 **\$69⁹⁵**

- Resistance, AC/DC current/voltage
- 6 functions including diode test
- 0.7% DC accuracy • Current range to 10A, AC/DC

Model 75 **\$89⁹⁵**

- All features of Model 73, plus • 7 functions including diode and continuity beeper • 3 current ranges - 10A, 320 mA, 32 mA • 0.5% DC accuracy

Model 77-F **\$119⁹⁵**

- All features of Model 75, plus
- "Touch-Hold" function • 0.3% DC accuracy

**ASK FOR OUR
FREE CATALOG!**

PHONE ORDERS ACCEPTED



SERVICE & SHIPPING
CHARGE SCHEDULE
FOR ORDERS ADD

\$25-250	\$4.50
\$251-500	\$6.50
\$501-750	\$8.50
\$751-1,000	\$12.50
\$1,001 and up	\$15.00

Fordham

260 Motor Parkway, Hauppauge, New York 11788

LETTERS

WRITE TO:

LETTERS
Radio-Electronics
200 Park Ave South
New York, NY 10003

PRINTER BUFFER

In the article "Build This Buffer/Converter for your Printer," which appeared in last month's issue of Radio-Electronics, we regrettably left out the ordering information listed below:

The following are available from Alpha Electronics, PO Box 1005, Meritt Island, Florida 32952 (305-453-3534): Buffer board, \$26 postpaid. Program ROM (91341) \$26 postpaid. EPROM Programmer PC board, \$15 postpaid. Complete BufferLink kit (includes all parts

except computer connectors and cables) \$139 plus \$5 shipping and handling. Complete EPROM programmer kit, \$49 postpaid. Florida residents must add 6% sales tax. Canadian orders add \$2, and all other foreign orders must add \$8. MasterCard and Visa orders are accepted.

BALL LIGHTNING

I found R. K. Golka's article on Ball Lightning (Radio-Electronics, March, 1985) quite interesting. An old friend of mine worked with

Tesla back in Colorado Springs, and was involved in rebuilding the power companies' generators when the windings got blown. So I rather wonder how Golka avoided damage to the diesel's electric generator and motor assemblies with the near-simultaneous surges.

Actually, I've seen another form of ball lightning. I was standing near a 2200-volt power line, where I had a half-mile clear view of the system. Lightning struck at the far end, and a fireball-surge traveled

QUALITY COMPONENTS - NOT MAIL ORDER "SECONDS"

Send \$1.00 postage and handling for FREE COMPLETE CATALOG which includes coupon for \$1.00 OFF purchase

ARIES ZERO INSERTION FORCE SOCKETS

Cam actuated, true zero insertion - tin plated solder tail pins - compatible with plugged-in dip sockets, including wire wrap.

Stock No.	Price	1-9	10-99	50
11055	26	4.50	34.30	13.90
11056	28	3.15	4.50	4.95
11067	40	6.81	9.91	6.36
11068	84	12.02	16.88	9.45

IC FOOTERS - Epoxy resin 7 mils of heat beam ICs producing superior heat and better IC lifetimes. Just push IC, resistor up - heat II contracted beam fits and insulates IC and eliminates heat stress.

Stock No.	Price
22225	14
22228	10

WILD ROVER

Touch switch calculator Operating motion in DOS without the use of a levered arm. Extraneous test light and still with four modes. Nicely clean - rated 115 VAC, 1.5 amp 30 minute re-solder - \$15 reduced to 180 pack.

Stock No.	Price
1-9	10.8 UP
12098	81.62

SCREW MACHINED SOCKET

PHB, holes, packaged in bags of 100. Stock No. 11310 in solder tail with gold color tin shell. Stock No. 11311 in wire wrap with 99% gold color tin shell.

Stock No.	Price
11310	1.00
11311	1.00

3 X 4 Elastomeric Keyboards

Each keyboard has 8 p.c. board, elastomeric pad with contacts. ABS bodies and flexible shot molded keys. Ideal for 12 VDC or 5VDC.

Stock No.	Price
11281	30.00
11282	30.00

TI WIRE WRAP SOCKETS

Tin plated phosphor bronze contact - 3 wire.

Stock No.	Price
11301	0.84
11302	0.59
11303	0.64
11304	0.73
11305	0.99
11306	1.12
11307	1.25
11308	1.52
11309	2.05

TI LOW PROFILE SOCKETS

Tin plated copper alloy 688 contact pins with Q&S tight seal.

Stock No.	Price
11201	8.10
11202	0.14
11203	0.16
11204	0.18
11205	0.20
11206	0.22
11207	0.24
11208	0.26
11209	0.40

SUB CUB I and SUB CUB II

High quality, complete LSI Counter Modules with LCD readouts. Modules plug in p.c. board (Stock No. 51071). Complete function evaluation kit (Stock No. 51072) contains p.c. board, 4.5V battery and variable frequency oscillator to supply train of count pulses.

Stock No.	Price
51071	7.80
51072	18.00
51073	24.00
51074	12.00

8 Digit LSI Counter Modules with LCD Readouts

Description Complete Function Evaluation Kit includes batteries but does not include display counter. Mounting P.C. Board only.

Stock No.	Price
51071	7.80
51072	18.00
51073	24.00
51074	12.00

SINGLE ROW SOCKETS

Strip of 25 contact sockets/pins - mount odd-center components usually. Gold plated contacts.

Stock No.	Price
10240	1.28
10241	25.90
10242	91.70
10243	91.90
10244	91.30

OPCOA

Single Digit Displays - Common Cathode. Colors: Red, Green, Yellow, Orange.

Stock No.	Price
12062	81.12
12063	1.84
12067	1.92
12068	2.08

OPTEL LCD's with pins

Stock No. 47005 Description 1 10 47006 3 1/2 47007 4 47008 5 47009 6 47010 7 47011 8

Stock No.	Price
47005	8.95
47006	8.95
47007	8.95
47008	11.80
47009	11.80
47010	11.80
47011	11.80

The Battery Just Wrap Tool

How battery-powered heat wires attached and wrapped. 675 tapered pins without heat for producing and wire-to-dish. Comes with 100 ft 30 AWG wire.

Stock No.	Price
13340	10.30
13341	10.30
13342	7.80
13343	9.94
13344	7.80
13345	7.84

MICRO Charts

Colorful 8 1/2" x 11" charts show the need to assemble through manuals and summarize fully decoded - instant answers - totally comprehensive - gives you data, crystal maps, IFF notes, etc. etc.

Stock No.	Price
23010	9.95
23011	9.95
23012	9.95
23013	9.95
23014	9.95
23015	9.95
23016	9.95
23017	9.95
23018	9.95
23019	9.95
23020	9.95

PIN FORMING TOOL

puts IC's on their true row to row spacing. One side is for 300 centers, flip tool over for devices in 400 centers. Put device in tool and squeeze.

Stock No.	Price
11059	81.98
10200	81.95

ONE TOOL DOES 8 thru 40 PINS!

Hand Tool. NEW! ANTI-STATIC MODEL.

Stock No.	Price
11059	81.98
10200	81.95

SCOTCHMAX Breadboard Systems

Basic Kit comes with 24 versatile Plug Sockets, 40 various Plug Strips, wire and tools. Kit can be used with any of the gas boards.

Stock No.	Price
03500	879.85
03511	18.95
03506	64.95
03507	42.95
03508	36.95
03509	39.95
03510	21.95

Electricity and water don't mix. At least not in our Heavy Duty Digital Multimeters. Because these Oops Proof™ instruments are protected by a system of seals to ensure contamination-free dependability in even the cruddiest conditions.

Other abuse-proof features include the best mechanical protection ever built into a precision Digital Multimeter. In fact, every one of our Oops Proof multimeters will survive a drop from ten feet onto a concrete surface!

All the Heavy Duty series meters measure up to 1000 volts AC and 1500 volts DC, with full overload protection to those maximum voltages even on the lowest range settings. Overload circuitry also provides transient protection to 6KV on all voltage ranges and up to 600 volts on all resistance ranges.

We also invented a unique, long-life rotary switch for our Digital Multimeters. You can actually feel the difference just by

rotating the function selector knob.

You'll find these features in a full line of Heavy Duty DMMs that offer a 4½ digit readout, 0.05% VDC accuracy, a 10-amp current range, a 2000-hour battery life, diode test, true RMS and temperature measurement. All this and a no-questions, one-year warranty.

You'll want to try one out, of course, so drop into your nearest electronics distributor and drop one.

Our lips are sealed.



CIRCLE 98 ON FREE INFORMATION CARD

©1984 Beckman Industrial Corporation, A Subsidiary of Emerson Electric Company,
630 Puente Street, Brea, CA 92621 (714) 773-8111.

Beckman Industrial™

IF YOU WANT TO GET YOU HAVE TO GET INTO

Learn PC Servicing By Building Your Own NTS/HEATH HS-151 Desk-Top Computer, Circuit-By-Circuit

NTS Intronc Home Training Takes You Below The Surface

NTS gets you right down into the heart of computer circuitry. You learn how microprocessors function, how they are designed, how they operate and are used to solve problems. Your program includes a wide variety of tests and projects, as you assemble your PC. You experience the excitement of seeing your own skills grow, the security of knowing you really understand what makes a computer tick.

A Career in PC Servicing

The world of computers is constantly expanding. Applications have spread from business to manufacturing, from industry to medical and scientific fields. Computer-aided design, engineering, and production have revolutionized drafting, graphics, and prototyping. Computer sales figures point to a continuing need for service technicians as well as installation and maintenance specialists. The type of training you receive will largely determine your ability to take advantage of these opportunities and nothing beats the practical, down-to-earth training you get from NTS.

The NTS/HEATH 16-Bit HS-151

This desk-top PC is the most powerful and versatile ever offered in any home training program. Check the advanced features listed below:

1. 128 KB RAM user memory on board, expandable to 640 KB
2. 16-bit 8088 Microprocessor accepts advanced software, speeds word processing; also allows selection from the huge library of IBM software.
3. 5.25-inch floppy disk drive, double density, IBM formatted, stores up to 360 KB. (Expandable to dual disk drive, and optional 10.5 MB hard-disk drive.)
4. MS-DOS operating system, IBM compatibility, make a wide choice of software programs available.
5. Four open IBM-compatible slots provide for future expansion, printer, modem, etc. Will accept most peripheral boards designed for IBM-PC.
6. Two video outputs for color or monochrome display monitor. Your NTS course includes a high resolution monitor displaying 80 characters by 25 lines, or graphics.
7. Editing capabilities help you insert or delete characters and lines, erase, jump or smooth scroll, etc.

Your NTS training course will teach you to program on this outstanding PC, using lessons, texts, and diagrams to make full use of its capabilities. Catalog contains complete details.

**IBM
Compatible**

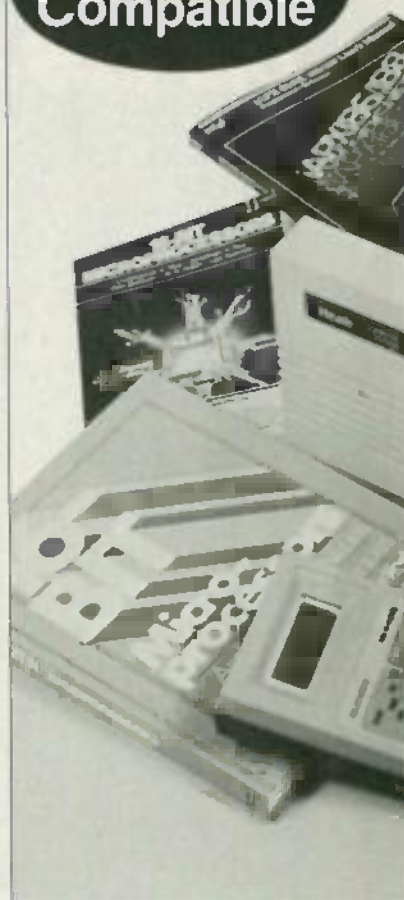

Learning circuitry through the construction of this equipment offers practical training for which there is no substitute. Test equipment is included.

Field servicing is interesting and rewarding. Technicians may work for a service company, manufacturer, or major users.

The NTS/HEATH HS-151 PC completed, includes monitor and full-function keyboard with calculator style keypad, and typewriter format.



INTO PC SERVICING A MICROCOMPUTER

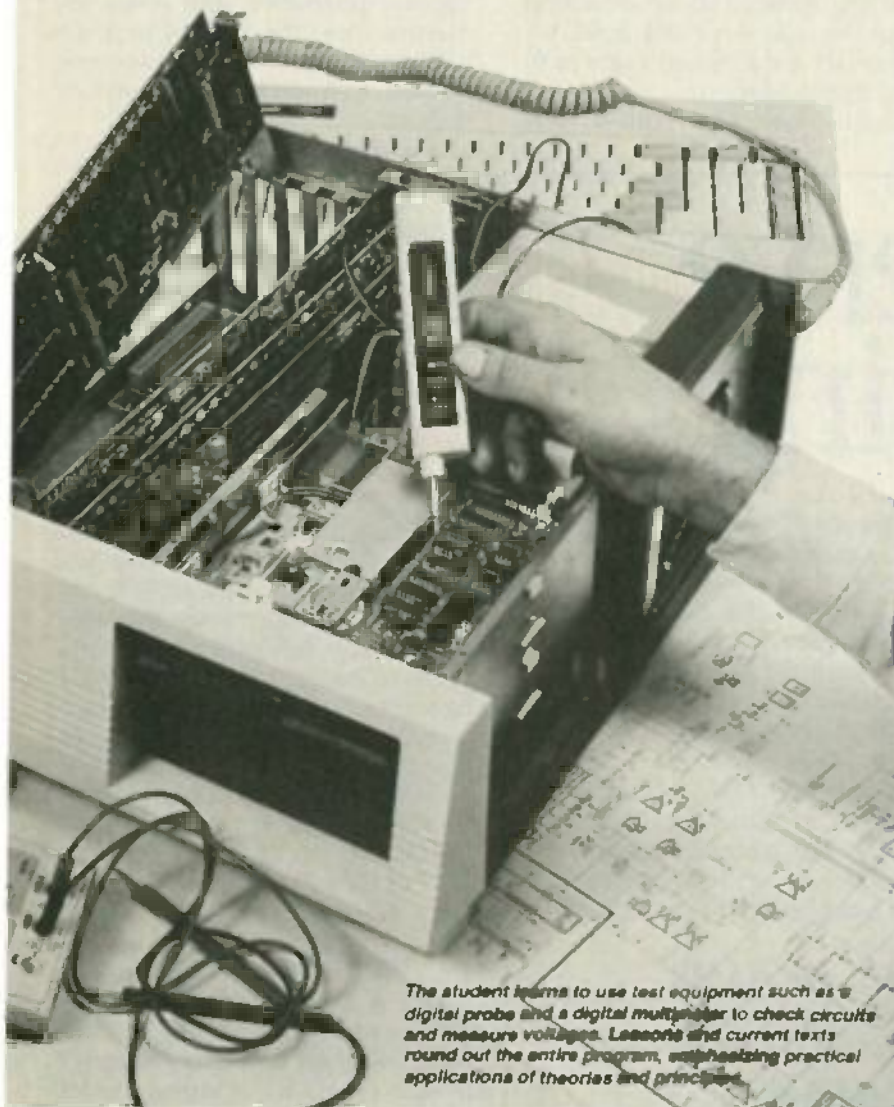

The student learns to use test equipment such as a digital probe and a digital multimeter to check circuits and measure voltages. Lessons and current texts round out the entire program, emphasizing practical applications of theories and principles.

Installing the disk-drive in the PC is one of the final stages in the assembly of the microcomputer. Learning the use of test equipment to check circuits is an integral part of the training which, with field experience, develops invaluable career skills.



NTS COURSES COVER MANY AREAS OF SPECIALIZATION IN ELECTRONICS:

Robotics: Build the NTS/HEATH Hero 1 Robot as you learn robotic programming. Robot is complete with arm and gripper, voice synthesizer. Robotics is becoming increasingly important in industry as almost daily news features attest.

Video Technology: Build one of the most advanced Color TV sets in America as you learn circuit diagnostics, and the use of digital test instruments. Course covers color TV, video tape recorders, computer fundamentals, solid-state devices.

Industrial and Microprocessor Technology covers circuit analysis, microprocessors and automation applications, lasers, and basic industrial robotics.

TV & Radio Servicing is a specialized course offering an excellent foundation in the use and application of both analog and digital test equipment as applied to the TV servicing field. Learn circuits, adjustments, trouble-shooting, and servicing of Color and monochrome monitors.

Digital Electronics offers the student the opportunity to get involved with computer concepts, computer technology fundamentals, and digital equipment by training on the NTS Compu-Trainer.

Basic Electronics is a course designed for those wishing to have an over-view of electronics in many of its aspects including radio receivers, solid state devices, and electronic components.

NTS Intrinsic training programs include a variety of superb equipment, most of which is classified as field-type, making the training practical and career oriented. Texts and lessons have been tested in our Resident School in Los Angeles to assure home study students their courses of training are easy to understand. NTS, now in its 80th year, continues to be at the leading edge in Electronics home training.

* IBM is a trademark of International Business Machines Corp.
* MS is a trademark of Microsoft Corp.

If card is missing, simply write to the address shown below stating the course you are interested in. A FREE color catalog with all details will be sent to you by return mail.

**NTS NATIONAL
TECHNICAL
SCHOOLS**

TECHNICAL TRADE TRAINING SINCE 1905
Resident and Home Study Schools

4000 So. Figueroa St., Los Angeles, CA 90037

up those wires at some 500 miles an hour. Arcs or flashes developed at every crossarm, and the local service transformer went *ker-chunk*, as did the house meter.

There has been quite a bit reported about electromagnetic pulses in case an nuclear bomb is set off at several hundred miles' elevation, with the resultant destruction of electrical systems, transistors, computers and their memory systems, etc. But has one

ever considered what will happen to steel-frame buildings? The columns and steel floor-beams form many low-resistance closed-circuit inductive loops. Under the intense magnetic flux developed, a whale of a high amperage flow would develop—and I'm not so sure that some of those structural inductive loops would hold together. It's not a nice thought as to what might happen.

Finally, I have one request: Sev-

eral AM stations in this area are operating in stereo, I've been told, on one frequency. I have seen nothing on the technique, or the AM circuitry in receivers to handle such signals. Having been involved in radio receivers ever since 1922, when regenerative, super-regenerative, and reflex receivers were the rage, I'm a bit baffled about how it is accomplished. Can you publish the information?

L. S. HANNIBAL,
Fair Oaks, CA 95628

Check the January 1984 issue of *Radio-Electronics* for the description of a circuit to decode Motorola's C-QUAM stereo format. In the future, we hope to bring you decoding circuits for other formats as well.—Editor

Self-serve servicing

The more time you spend having your computer serviced, the less time you have to use it. And that costs you money.

With a basic knowledge of electronics and the help of Sams service data, you can service your computer yourself.

For in-depth computer analysis and repair, choose Sams COMPUTERFACTS™. They're similar to Sams PHOTOFACT® television service data and provide detailed schematics and parts data for even your most intricate computer repairs.

For simple computer maintenance and troubleshooting, use Sams Troubleshooting & Repair Guides. They provide a "problem-solution" approach to servicing with flowcharts explaining each procedure step-by-step.

Together they make computer servicing quick and easy. And that saves you money.

Help yourself to Sams service data, available at Sams dealers everywhere. Or to order direct, call our toll-free number.

Commodore™ 64 Troubleshooting & Repair Guide, No. 22363, \$18.95

IBM® PC Troubleshooting & Repair Guide, No. 22358, \$18.95

Apple® II Plus/IIe Troubleshooting & Repair Guide, No. 22353, \$19.95

Commodore 1541 Disk Drive Troubleshooting & Repair Guide, No. 22470, \$00.00

Over 30 COMPUTERFACTS available for Apple, ATARI®, Commodore, Epson®, Hitachi®, IBM, Osborne®, Panasonic®, Rana Elite, Sanyo®, Texas Instruments and Zenith®. Ask your Sams dealer for details.

800-428-SAMS

Ask for Operator 157.

In Indiana, call 317-298-5566

SAMS

Howard W. Sams & Co., Inc.
A Subsidiary of Macmillan, Inc.

4300 West 62nd Street
Indianapolis, IN 46268



CIRCLE 257 ON FREE INFORMATION CARD

MANUAL NEEDED

I have a problem with a Ford Industries CAP-222 telephone answering machine. Built in 1976, my unit will no longer seize the telephone line (all other functions seem to be operating properly). I have thus far been unable to locate a repair manual for that piece of equipment and was wondering if you or one of your readers might be able to help.

P. ROTH
2987 Cletus Pkwy
Lima, OH 45805

SCHEMATIC NEEDED

This is a request for help from your readers in obtaining a schematic diagram or Sams Photofact (if one exists) for a Sansui model 400 AM-FM stereo. The local Sams dealer here in San Diego informs me a folder was never issued for that model. The amplifier section (stereo) works, but the AM-FM front ends are both inoperative. There must be a stage that is common to both that is at fault (perhaps the power supply), but I don't know where to start.

MICKY McDANIEL
940 Temple Street
San Diego, CA 92106

MISPRINT

I am a freshman, attending Fairmont State College, in hopes of

ADVANCE ELECTRONICS

IS PROUD TO ANNOUNCE

Beckman Industrial™ EASY B.O.B. SERIES

OF PORTABLE

Break Out Boxes

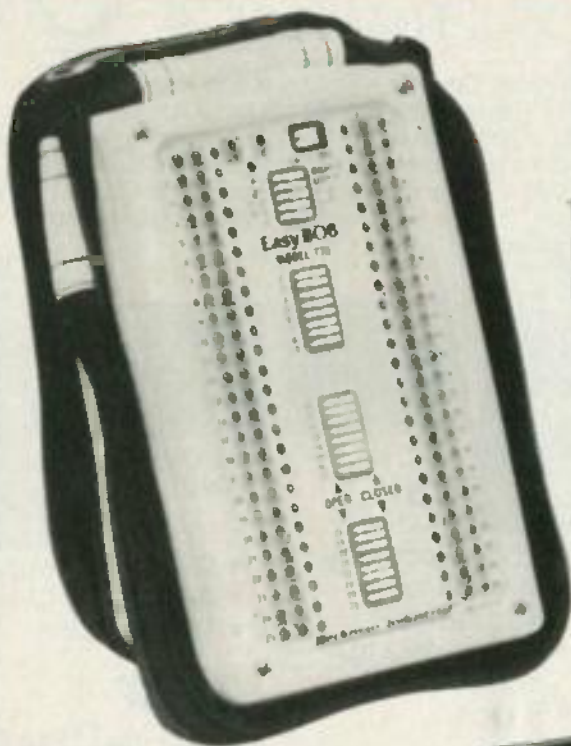

EASY B.O.B.
Model 750, 770
Breakout Box, RS 232C

FEATURES:

- Full RS 232C Breakout
- Line Powered (750) (not shown) or Self-Powered (770) (shown)
- 50 Pairs of Red and Green LED's
- Control Signal Simulation
- 2/3 Swap Switch
- Convenient Dual-Gender Connectors
- Cable Test Feature

*The Ultimate in Interface Testing—
Four State signal status of all lines at
a glance, null modem and loopback
testing at the flip of a switch, dual
gender connectors, switchable
ground line, cable test feature,
choice of powered (Model 770) or
unpowered (Model 750) and more!*

EASY CABLETESTER

Model 715
RS 232C



FEATURES:

- Quickly Identifies Cable Wiring
- Scan and Single Step Test
- Convenient Dual-Gender Connectors
- Fits in the Palm of Your Hand
- Optional Remote Indicator for Analyzing Installed Cables (Model 716)
- No External Power Required
- Open, Continuity and Bridging Light Indicators

EASY B.O.B.

Model 730
Breakout Box, RS 232C

FEATURES:

- Full RS 232C Breakout
- Self-powered
- Sensitive, High Impedance Circuitry
- Dual Pulse Trap
- Control Signal Simulation
- Convenient Dual-Gender Connectors
- 49 Probe Points

**CALL FOR
PRICES!**



TOLL FREE HOT LINE
800-223-0474

212-730-7030

26 WEST 46th STREET, NEW YORK, N.Y. 10036

THE TEST EQUIPMENT SPECIALISTS

**ADVANCE
ELECTRONICS**



- 77
- 0.3% Accuracy
 - Manual or Autorange
 - 10A + mA Range
 - Beeper
 - "Touch-Hold" Function

Sale (with holster)
\$11995

WE CARRY A FULL LINE OF FLUKE MULTI-METERS. IN STOCK NOW

Sale ends Sept. 85

FLUKE 70 SERIES MULTIMETERS

- Analog Display • Rotary Knob • Volts AC & DC • Resistance to 32 MΩ • 10 Amps • Diode Test • 3200 Counts • Fast Autoranging • Function Annunciators in Display • Power-Up Self Test • 2000+ Hour Battery Life w/ Power Down "Sleep Mode" • New Test Leads • VDE & UL Approval



SALE
\$8995

75

- 0.5% Accuracy
- Manual or Autorange
- 10A + 300 mA Range
- Beeper



SALE
\$7995

and free C70 holster 73

- 0.7% Accuracy
- Autorange Only
- 10 Amp Only



4 1/2 DIGIT MULTIMETERS

\$349.00

MODEL 8060A



- Frequency measurements to 200KHz
- dB measurements
- Basic dc accuracy 0.4%; 10μV, 10 nA and 10 mΩ sensitivity
- Relative measurements
- True RMS
- High-speed Beeper

BK PRECISION DYNASCAN CORPORATION

BREAKS THE PRICE BARRIER WITH THESE HIGH PERFORMANCE OSCILLOSCOPES

100 MHz Dual Trace/
Dual Time Base

- 1 mV/div sensitivity
- 23 calibrated sweeps
- Rectangular CRT with internal graticule and scale illumination
- Signal Delay Line

\$995

Does not include probes (\$60.00 pair when purchased with scope)

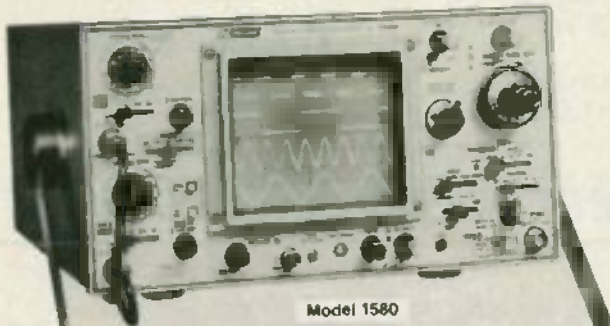

Model 1580

QUANTITIES ARE LIMITED

BK PRECISION



INDUSTRIAL TRANSISTOR TESTER
\$21995

MODEL 520B

- Now with HI/LO Drive
- Works in-circuit when others won't
- Identifies all three transistor leads
- Random lead connection
- Audibly and visually indicates GOOD transistor

BK PRECISION

100 MHz Dual Time Base SCOPE

MODEL 1590

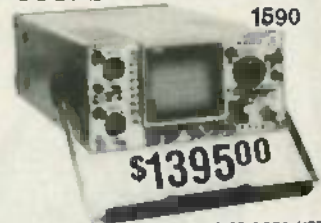

\$1395.00

PRICE DOES NOT INCLUDE PROBES

- 1mV/division sensitivity to 70 MHz
- 500 μV/division cascade sensitivity
- Four-input operation Provides trigger view on 4 separate inputs
- Alternate time base operation
- Switching power supply delivers best efficiency and regulation at lowest weight



CAPACITANCE METERS
\$20995

MODEL 830

- Automatically measures capacitance from 0.1pF to 200mF
- 0.1pF resolution
- 0.2% basic accuracy
- 3 1/2 digit LCD display



\$16995

MODEL 820

- Resolves to 0.1pF
- 4 digit easy-to-read LED display
- Fuse protected against charged capacitors
- Overrange Indication

BECKMAN'S CIRCUITMATE® ALL UNDER \$100

AVAILABLE NOW...



\$64.95

Circuitmate DM 20—
3½-digit, pocket-size
multimeter; 0.8% Vdc
accuracy, diode test,
hFE test, conductance,
10 amps AC and DC
ranges, auto-polarity,
auto-zero, auto-
decimal

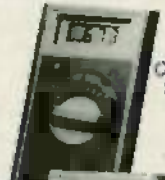

\$69.95

Circuitmate DM 40 —
3½-digit multimeter;
0.8% Vdc accuracy,
diode test, auto-
polarity, auto-zero,
auto-decimal

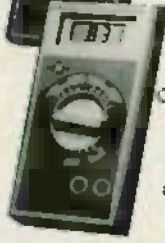

\$89.95

Circuitmate DM 45 —
3½-digit multimeter;
0.5% Vdc accuracy,
diode test, continuity
beeper, 10 amps AC
and DC ranges, auto-
zero, auto-polarity,
auto-decimal



\$79.95

Circuitmate DM 25—
3½ digit, pocket-size
multimeter; 0.5% Vdc
accuracy, diode test,
capacitance, continuity
beeper, conductance,
10 amps AC and DC
ranges, auto-polarity,
auto-zero, auto-
decimal



The DM73 is the smallest digital
multimeter on the market. Its
probe-style design makes it ideal
for taking measurements in hard-
to-reach test areas.

**SALE
\$59.95**

- Small Size
- Complete Autoranging
- "Touch Hold"
- Audible continuity checking



\$76.95

The DM 77 gives you
the convenience of
autoranging plus 10
amps ac/dc
measurement
capability. You simply
select the function
you want, and the
DM 77 automatically
sets the required
range.

... Quality and Performance
Beckman and 4½ Digits...



MODEL 4410

True RMS

\$239.00

AVAILABLE NOW!

BECKMAN does it
again... a true RMS
4½ DMM w/1 year
calibrated cycle at
a 3½ digit price.

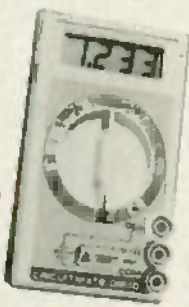

NEW
Beckman
Circuit-mate
DM10

\$39.95

in stock now
Model DM 10B
with Beeper \$49.95

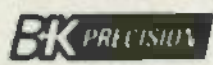

POWER SUPPLIES



\$319.95

MODEL
1601

- Isolated 0-50VDC, continuously variable; 0-2A in four ranges
- Fully automatic shutdown, adjustable current limit
- Perfect for solid state servicing

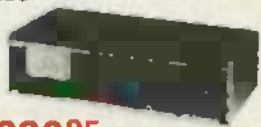

\$339.95

MODEL
1650

- Functions as three separate supplies
- Exclusive tracking circuit
- Fixed output 5VDC, 5A
- Two 0 to 25VDC outputs at 0.5A
- Fully automatic, current-limited overload protection



MODEL
3010

FUNCTION GENERATORS

\$199.95

- Sine, square and triangle output
- Variable and fixed TTL outputs
- 0.1 Hz to 1MHz in six ranges
- Push button range and function selection
- Typical sine wave distortion under 0.5% from 1 Hz to 100kHz

MODEL
3020

\$329.95

SWEEP FUNCTION

- Four instruments in one package — sweep generator, function generator, pulse generator, tone-burst generator
- Covers 0.02Hz-2MHz
- 1000:1 tuning range
- Low-distortion high-accuracy outputs



TOLL FREE HOT LINE
800-223-0474

212-730-7030

26 WEST 46th STREET, NEW YORK, N.Y. 10036

THE TEST EQUIPMENT SPECIALISTS

ADVANCE ELECTRONICS

becoming an electronics engineer. Your magazine, I have found, is very useful and helpful to the beginner. In reality, I've had no prior experience with electronics other than normal in-home uses.

In reading over the article, "3 High-Performance Scanner Antennas," in the April 1985 *Radio-Electronics*, I located a misprint on page 60, third paragraph down from the subhead "Antenna theory."

My teacher in "Circuit Analysis 1" has set great store in knowing how to measure wavelengths both in milles and in meters. I have spent a great deal of time on this subject, and when I saw your expression of wavelengths in meters 3×10^5 I knew immediately that it should have read 3×10^8 meters/second. (I have made the change in my copy of this issue.)

It was recommended that each electronics student start a file,

made up of useful technical literature to assist us now in our studies and later to be applied for use—and also to become aware of the advances taking place in electronics. My teacher recommended that we add your magazine to our file. In so doing, I have received detailed information that I might not have obtained otherwise.

I would like to thank you for the past issues I have read of *Radio-Electronics*, and I look forward to the exciting new electronics advancement features in future issues.

GLORIA J. JANNUZZI,
Morgantown, WV

HELP!

Recently I acquired a General Radio 1570-AL AC regulator, which I intend to use with an emergency generator. Unfortunately, I have not been able to obtain a manual for the unit. None of the usual sources have been able to help, so I was wondering if either you or one of your readers could come to my rescue. As that manual is very much needed, any help would be most appreciated.

WARREN KERNAGHAN
901 E. 108th Street
Kansas City, MO 64131

CORRECTION

In our March 1985 issue, under the list of DMM Manufacturers (page 57) and Scope Manufacturers (page 62) we referred to Soar, 200 13th Ave., Ronkonkoma, NY 11779.

Both the name and the address of that manufacturer has changed. Soar has become North American Soar Corporation, and the address is 1126 Cornell Avenue, Cherry Hill, NJ 08002.

THANKS!

Just a note to thank you for the most useful articles I have ever seen. The "How To" section is always valuable. But the articles by Victor Meeldijk on selection of resistors and capacitors, in your February and March 1985 issues were outstanding. They were the most welcome articles that I have ever come across!

K. HANNING,
Salt Lake City, UT

R-E

Aces high with circuit builders.

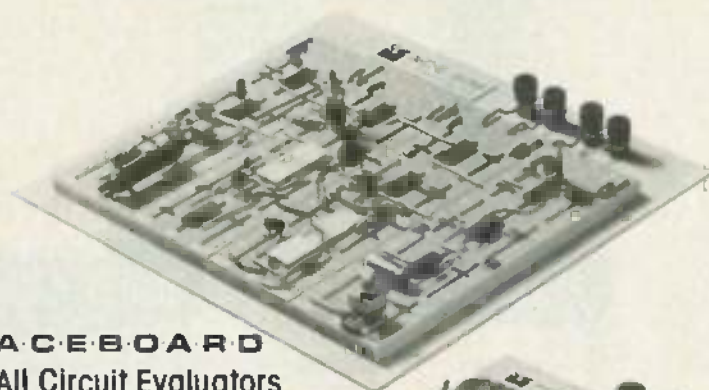

ACEBOARD All Circuit Evaluators for solderless circuit building and testing.

AP PRODUCTS made the first solderless breadboard way back in 1968, and we still make them best. Because our experience taught us to avoid the pitfalls that can mean circuit errors. We do it by paying attention to details. Like using noncorrosive nickel-silver in our frankly superior terminals. And like sealing each contact cell with an adhesive-coated polyethylene foam that prevents short circuiting. That's why you can count on the reliability of our solderless boards when you specify any one of the 10 different ACEBOARD models that offer from 728 to 5424 tie points, and 2 to 36 buses.

AP PRODUCTS made the first modern solderless breadboard, and we still make the best.

Call Toll Free 800-321-9668 for the name of the distributor nearest you. In Ohio, call collect (216) 354-2101.



AP PRODUCTS INCORPORATED
9325 Progress Parkway
P.O. Box 540
Mentor, Ohio 44060
(216) 354-2101
TWX: 810-425-2250

CIRCLE 76 ON FREE INFORMATION CARD

FREE high tech catalog

More than just a catalog, a trustworthy guide to what's new in computers and electronics.

Ever since radio grew into electronics, the illustrated Heathkit catalog has been a guide to new and exciting kit products for people like you to build. To enjoy and learn from, while saving money in the process.

What sets the Heathkit catalog apart is its range of high quality products and accurate information on every product offered. And that's a lot of products — over 450 separate items, including:

- Computer hardware and software
- Robots
- Precision test instruments
- Computerized weather instruments
- Solar hot water systems
- Automotive and home energy products
- Security devices
- Color TVs and video accessories
- Quality stereo components
- Amateur radio gear
- Educational courses that lead from the basics of electronics all the way to high tech.

Computerized Weather Station

Metal Detector

Triple-Trace Oscilloscope/Time-Voltage Display

Ham Radio Transceiver

Discover the pride.

With Heathkit, you'll discover the pride of accomplishment that comes with creating handbuilt quality that is uniquely yours. And you'll develop skills and abilities in many technologies as you follow the step-by-step directions through the building process.

You work confidently, always backed by our simple promise, "We won't let you fail."

If you don't have the latest Heathkit Catalog, you're missing something great, so mail the coupon now, while you're thinking about it.

Microprocessor Trainer & Course

Real Time Spectrum Analyzer

Most Accurate Clock

HERO™ 1 Robot

IBM-PC Compatible Computers

40-Channel Scanner

Send NOW for your **FREE Heathkit Catalog**
It's the beginning of something great for the whole family.

Heathkit
Heath
Company

A subsidiary of Zenith Electronics Corporation

Heath Company
Dept. 020-334
Benton Harbor, Michigan 49022
Please send me the latest
Heathkit Catalog Free.

Name _____

Address _____

City _____ State _____

Zip _____

CL774B

CIRCLE 86 ON FREE INFORMATION CARD

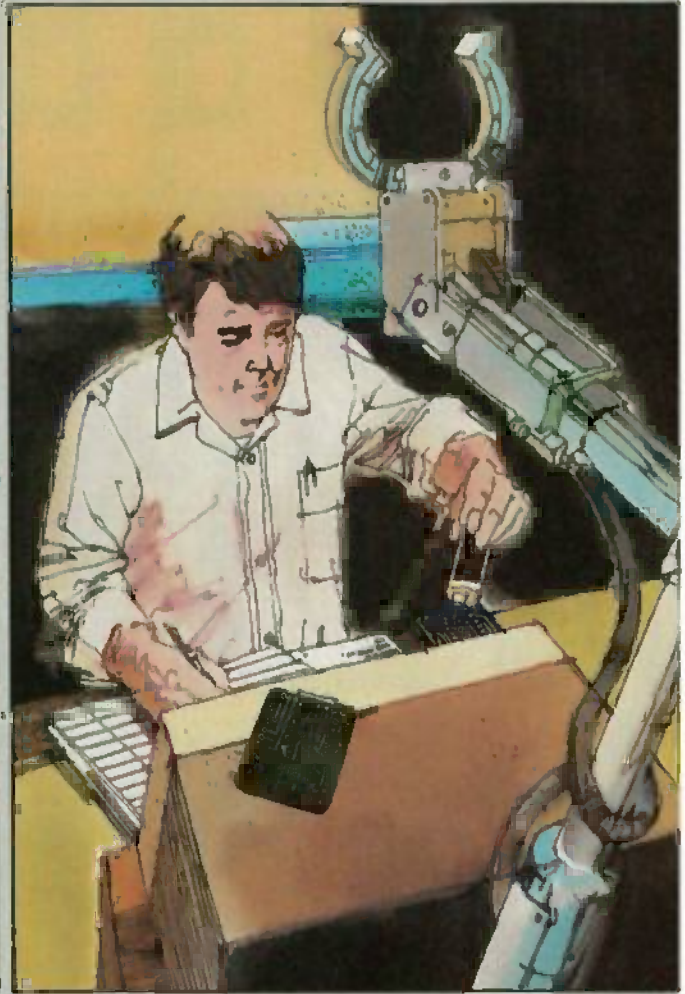

What can you do Just about

CIE can show you how.

Computer technology. Satellite communications. Cable television. Cellular radio. Digital electronics. Robotics. Just a few of the hottest career areas in electronics. The ones everybody is talking about. The ones that are changing the way we live, the way we do business, the way we entertain ourselves. The best way to start a career in any of them? By learning the basic electronics theory and principles of how they work from CIE.

Join a leader.

Leading the world in specialized electronics training, CIE is the largest school of its kind with over 25,000 students at home and abroad. And with over 50 years of experience teaching electronics to thousands of men and women through proven

methods of independent study without classroom sessions.

Learn as much as you want, when you want.

Whether you're interested in learning new skills or upgrading old ones, earning a diploma or an A.A.S. degree, CIE can match your needs with courses and programs that let you start where you want, go as far as you want from a basic beginner course all the way to CIE's Associate in Applied Science Degree in Electronics – a comprehensive program that prepares you for advanced electronics careers.

Custom training
equipment helps you learn.
CIE believes in the importance of learning by

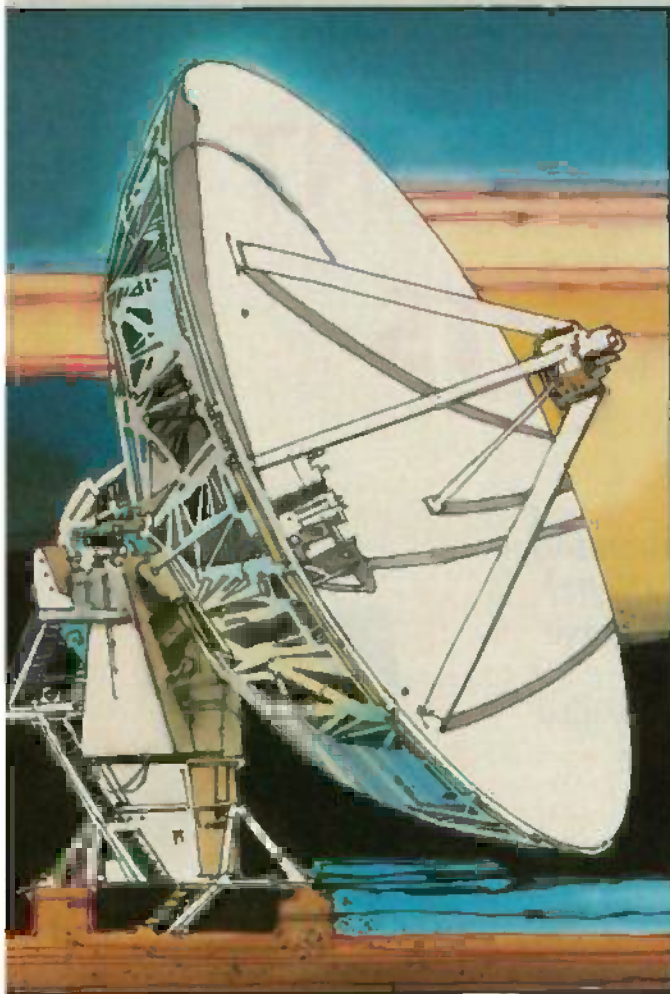

with electronics? anything.

doing. So most of our courses include specialized training laboratories keyed to specific lessons for practical experience through teaching experiments. Our CIE Microprocessor, for example, comes fully assembled and ready to use to teach you how a computer CPU works through a series of experiments you perform on your own.

Are you ready?

If you're ready to do something now about your future, there's no waiting to enroll with CIE. Get all the information you need to enroll simply by calling us toll-free at 1-800-321-2155 (in Ohio, 1-800-362-2105). Or mail in the handy reply coupon or card to Cleveland Institute of Electronics, 1776 East 17th Street, Cleveland, Ohio 44114.

CIE World Headquarters
Cleveland Institute of Electronics, Inc.
 1776 East 17th Street • Cleveland, Ohio 44114

Please send me your CIE Off-Campus Studies Catalog, including details about the Associate Degree program. I understand there is no cost for the catalog and a CIE representative may call, but there is no obligation.

Print Name _____

Address _____ Apt. No. _____

City _____ State _____ Zip _____

Age _____ Area Code/Phone No. _____ / _____

Check box for G.I. Bill bulletin on Educational Benefits

Veteran Active Duty

MAIL TODAY!

RE17

McIntosh®

Get all the newest and latest information on McIntosh stereo equipment from McIntosh Laboratory.

XL 1 Speakers



MC 500 Tuner
MC 502 Amplifier
C 504 Preamp/Filter



C 33 Stereo Preamp/Filter



MC 2255 Stereo Power Amplifier

Send For Your Stereo Information

McIntosh Laboratory Inc.
East Side Station P.O. Box 96
Binghamton, N.Y. 13904-0096

RE

Name _____

Address _____

City _____ State _____

Zip _____

Phone Area Code _____

CIRCLE 67 ON FREE INFORMATION CARD

EQUIPMENT REPORTS

Mastertech Laboratories Microlab 1 Digital Laboratory Course

Learn all about digital
electronics

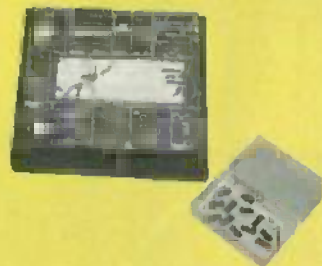

CIRCLE 5 ON FREE INFORMATION CARD

ALTHOUGH WE OFTEN HEAR FROM readers wanting more information on a variety of topics, the one area that seems to attract the most interest is digital electronics. It's little wonder, of course, considering how important that field is, and how explosively it has grown over the past several years.

There is little doubt that it is important to know about digital electronics. But if your background in that area is lacking, where do you turn to to get the knowledge that you need? Perhaps the best way to go for many people is to invest in one of the digital electronics home-study courses currently available. One of the newest of those courses is the *Microlab 1* digital laboratory course from Mastertech Laboratories (6792 Kirkpatrick Crescent, Victoria, B.C., V8X 3X1, Canada).

The *Microlab 1*

The *Microlab 1* digital-electronics course is designed for the student who has little or no knowledge of digital electronics. Indeed, it is possible for someone

with no electronics knowledge whatsoever to use and benefit from the material. The student proceeds at his own pace through a series of lessons and labs so that when he is finished, he has a solid grasp of the fundamentals of each topic.

What makes or breaks a course of this type is the manner in which the material is presented. To be effective, the lessons must be interesting, and taught in such a way that the material will be remembered. One of the best ways to achieve both objectives is to have the student prove to himself each point he is shown.

That is the approach used in the product. Each lesson (there are 40 in all) follows the same basic format: first a theory or concept is presented, and then the student verifies the information for himself via an experiment. A conclusion that summarizes the important points of the lesson, and a short test that helps ensure that the material has been understood, wraps things up.

In order to simplify performing

**United States
Instrument Rentals, Inc.**



A U.S. Leasing Company

2988 Campus Drive
San Mateo, CA 94403

Call for Special Prices and

Free Catalog
800-824-2873



Hitachi Denshi America, Ltd.

Beckman Industrial™



SCOPES

Iwatsu

- All 14 models in stock
- 2-3 year warranties
- 20-250 MHz

Model 5702—\$ 535
5705—\$ 899
5710—\$1245
5711—\$1695
7506—\$ 749

Hitachi

- All 20 models in stock
- 2-3 year warranties
- 20-100 MHz

Model 222—\$ 599
1050—\$1299
509—\$1199
VC 6041—\$5499
422—\$ 699
1100—\$2490
650—\$ 930

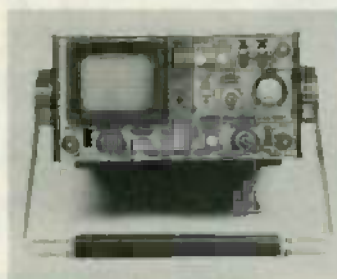

Hitachi V-209

SALE \$695
List \$945

Hitachi V-209

Portable Dual Trace Scope

- DC-20 MHz
- Battery Operated
- 3-Way Power Supply
- Lightweight
- High Sensitivity and Fast Sweep Timer

DIGITAL MULTIMETERS

Beckman

- All 300, HD, and circuitmate series
- All accessories in stock

HD100—\$169 320—\$179
HD110—\$189 330—\$219
HD130—\$239 350—\$229
HD140—\$259 360—\$289
300—\$120 4410—\$239
310—\$145

Fluke

- Autorange • Analog display
- Touchhold function
- 0.3% accuracy • Heavy duty

Model 73—\$ 85 8010A—\$279
75—\$ 99 8012A—\$359
21—\$ 99 8020B—\$199
23—\$145 8022B—\$154
25—\$299 8024B—\$249
27—\$259 8050A—\$389

SALE \$114
List \$129

Fluke 77

Analog/Digital Multimeter



COUNTERS—DIGITAL THERMOMETERS—PLOTTERS

MANY MODELS AVAILABLE — CALL 800-824-2873

Example: **Fluke 1900 Counter** Sale \$389.50

Battery and BCD Data Options Available

**Used Test Equipment, too!—Over 3,000 Models Available at
Huge Discounts with Warranties!**

- Quantity Discounts Available
- Dealers Welcome
- Freight and Tax extra
- Immediate Availability of Equipment

Call

800-824-2873

CIRCLE 254 ON FREE INFORMATION CARD

TOOL DISPOSAL NOTICE

OVER 130 PIECES TOTAL

ATTACHÉ TOOL KITS

Your Choice of Attractive Vinyl Leatherette Case, Heavy Duty ABS Plastic Case or Lightweight Aluminum Case (pictured) plus a Fantastic Assortment of Over 130 Quality Tools Professionals Need and Use Every Day!!!

YOUR COST... \$199.00

Available separately. See below.

FREE DELIVERY



TOOL SET INCLUDES

Free Multi-Tester

- | | | | |
|------------------------------------|---------------------------------------------|-------------------------------------|---------------------------------|
| (2) Alignment Tools | Chisel | Hemostat | Solder in Pull Tube |
| (3) Burnishers | PinNite | #1 x 3" Phillips Screwdriver | Solder Suck Line |
| Decal/Labeling Remover Wheel | 6-1/2" Diagonal Cutting Plier | #2 Phillips Screwdriver - Stubby | Solder Iron Holder |
| 7 Blade Pencil Gauge | 5-1/4" Diagonal Cutting Plier | #2 x 4" Phillips Screwdriver | 110/120V, 30/35W Soldering iron |
| Ball Pen Hammer 4 Oz. | 10" Groove Joint Plier | 3/32" x 7" Slotted Chip Screwdriver | Spring Load Pull |
| Handle, Driver Blades 14-5/8" End | 5-1/4" Long Nose Plier | 1/8" x 4" Slotted Screwdriver | Spring Load Push |
| Handle, Driver Blades 14-5/8" Blue | 5-1/2" Long Nose Plier with Cutter | 1/8" x 6" Slotted Screwdriver | 21PC. U48 Drive Socket Set |
| 10 Hex Driver Blades | Internal Retaining Ring Pliers | 3/16" x 3" Slotted Screwdriver | 1/4" Drive Fingertip Katcher |
| 18 Metric Hex Key Wrenches | Internal Retaining Ring Pliers | 3/8" Slotted Screwdriver - Stubby | 88 Assorted Retaining Pin Tips |
| 10pc. 1/8" Hex Key Wrenches | 3/32" Center Punch | 1/4" x 4" Slotted Screwdriver | Reverse Action Tweezers |
| Case Key | 1/16" Pin Punch | 5/16" x 6" Slotted Screwdriver | Wire Crimper/Stripper |
| Key Chain with 4 Way Screwdriver | 1/8" Pin Punch | (7) Imhoffers Screwdrivers | Wire Squeeze Cutter |
| Electrician Knife | 6" Stainless Rule | Phillips & Slotted Screwdriver | 6" Adjustable Wrench |
| Impression Stamp | Screwdriver Sharp | Solder Aid, Tins and Hook | 8" Adjustable Wrench |
| Multimeter with Probs & Fuse | Offset Electric Screwdriver (Slot/Phillips) | Solder Brush | 88 Ignition Wrenches |
| 198 Nut Driver Blades | 90 x 2-1/2" Phillips Chip Screwdriver | Solder Removal Braid | |

	Mastertech	Microlab 1
OVERALL PRICE		
EASE OF USE		
INSTRUCTION MANUAL		
PRICE / VALUE		
	Poor	Good

Section 1 is a regulated +5-volt supply. Section 2 is an array of 16 discrete LED's. Section 3 is a common-anode 7-segment display. Section 4 contains two squarewave generators. One outputs at a fixed rate of 1 kHz; the other is variable from 1 Hz to a few hundred Hz. Section 5 is a 10-LED bargraph voltmeter. Section 6 is a speaker. Sections 7 through 9 contain switches. And section 10 contains a 5-volt SPDT relay.

In addition to its value in the course, such a board is always handy to have around an electronics workshop. That's because it provides a handy way to design and debug your own circuits.

The course comes complete with everything needed. In addition to the manual and the training board, all components (logic IC's, switches, resistors, and even jumper wires) required for the various experiments are included.

The 40 lessons in the course cover topics such as simple logic gates, flip-flops, shift registers, counters, and more. Once the course is completed, add-on kits that cover such advanced topics as A/D and D/A conversion, speech synthesis, computer-bus interfacing, and microprocessor theory

For Orders of 5 or more sets call Toll Free 800-423-2567 for quantity discount prices!

Qty	Lot No.	Item	Unit Price	Amount
	04953	Vinyl Leatherette Case	\$50.00	
	09053	ABS Plastic Case	\$55.00	
	02263	Aluminum Case	\$89.00	
	09483	130 pc Tool Set	\$158.00	
	20263	Vinyl Leatherette Case & Tools	\$199.00	
	39183	ABS Plastic Case & Tools	\$199.00	
	30063	Aluminum Case & Tools	\$199.00	
Subtotal				
Sales Tax for CA & KY Residents				
Total				

Name _____
 Address _____
 City _____ State _____
 Phone _____ Zip _____
 Signature _____
 Check or money order enclosed
 Charge M/C Visa Exp. Date _____
 Acct. No. _____

HARBOR FREIGHT SALVAGE CO.

3491 Mission Oaks Blvd., P.O. Box 6015,
 Camarillo, CA 93011-0015

PHONE TOLL FREE 800-423-2567

T-963

can be purchased. In fact, through the add-ons to the program, the student can eventually build a CP/M computer.

Unfortunately, the version of the course manual included with the trainer we received was only a preliminary one. That manual was missing several drawings (the manufacturer enclosed a note explaining that those were not ready as yet and would be included in the final version) and covered only the first six lessons. What we saw, however, was of generally good quality, though regular readers of Radio-Electronics might find some of the material a little simplistic. (But remember: One of the course's stated goals was that it could be used by someone who was not familiar with electronics.) If that quality is carried through in the balance of the manual, the *Microlab 1* grades out as an excellent educational product. At its selling price of under \$250, it is also a good value. R-E

Video Interface Products Hybrid-8 Special Effects Generator

Add professional-looking special effects and editing to your videotapes.



CIRCLE 6 ON FREE INFORMATION CARD

IF YOU USE A CAMERA AND VCR TO make your own videotapes, you've probably learned that it's difficult to get professional-looking results. Even if you use a second VCR to edit out the parts you don't want, you still end up with scene-to-scene transitions that look and sound too harsh. We've recently seen a special-effects generator that could end all that: the *Hybrid-8* from Video Interface Products, or VIP (19310 Ecorse Road, Allen Park, MI 48101).

The *Hybrid-8* is a versatile switcher, fader, enhancer, mixer,

NOW THE INDUSTRY'S MOST POPULAR ELECTRONIC DEGREASERS...



Electro-Wash®

A portable CO₂ powered cleaning system! High impact solvents effectively clean and degrease everything from delicate tape heads to PCB's, relays and contacts. Instantly dissolves accumulated grease and oxidation without leaving a residue. Recommended for every phase of electronic and electrical equipment maintenance. Can be used even while equipment is operational!

Tun-O-Wash®

The first step in repairing a TV tuner is to clean it. And nothing does the job as well and easily as the power action of Tun-O-Wash. Formulated to thoroughly degrease oil, dirt and gunk encrusted contacts, Tun-O-Wash restores the tuner to its original condition, leaving parts and contacts like new!

COME EQUIPPED WITH A FREE CHEM-GUN!

CHEM-GUN™ is a unique European designed trigger spray attachment that instantly converts any Chemtronics aerosol product into a precision spray gun. Its comfortable finger grip handle affords easier handling and more precise dispensing of even the smallest quantity of solvent.

Chem-Gun is durable and reusable! Made of rugged polypropylene, Chem-Gun is solvent resistant and virtually unbreakable. Just snap it on to your favorite Chemtronics product and it's ready to use!

Chem-Gun is available FREE (for a limited time only) when you purchase 4 cans of Chemtronics Tun-O-Wash® or Electro-Wash®.

In addition... each 4 pack contains seven dollars of money saving coupons on other popular Chemtronics products!

Look for these specially marked 4 packs. Tun-O-Wash® and Electro-Wash® 4 packs are available from your local Chemtronics distributor.

Order now while supply lasts!



Chemtronics
Keeping pace with high technology

Chemtronics Inc.
681 Old Willets Path
Hauppauge, N.Y. 11788
800-645-5244
In NY 516-582-3322

CIRCLE 54 ON FREE INFORMATION CARD

Radio-Electronics mini-ADS

VIP		Hybrid-8									
OVERALL PRICE											
EASE OF USE											
INSTRUCTION MANUAL											
PRICE/VALUE											
		1	2	3	4	5	6	7	8	9	10
		Poor	Fair	Good	Excellent						

stabilizer, and video-effects generator. It's difficult in a short review to list all of the ways that the unit can be used, so we'll have to settle for bringing out only the more important features.

Switcher/fader

One of the features of the *Hybrid-8* is an A/B switcher that allows you to change quickly from one source to another. The switcher can be used along with the fader so that you can fade out one source and fade in another. The duration of the fade can be adjusted from only a fraction of a second to more than five seconds.

The *Hybrid-8* does not contain any circuitry to prevent picture-roll as you switch from one video source to the other. But we found that by adjusting the fade duration, we could often mask any partial picture roll that occurs.

Special-effects generator

The *Hybrid-8* special-effects generator can be used along with the fader (and switcher, if desired) to produce different wipe patterns. The standard wipe patterns are: rightward, leftward, upward, downward, edge-to-center, and fade to black. All of those wipe patterns can be combined to give you a total of 31 possibilities. You could combine, for example, upward and downward wipes so that the picture would wipe from top and bottom to the center.

Audio switching

As you switch between video sources, you also have options on how you want to handle audio switching. If you are switching between two video signals and using the special-effects wipes, the audio normally fades out and switches along with the video. You do,

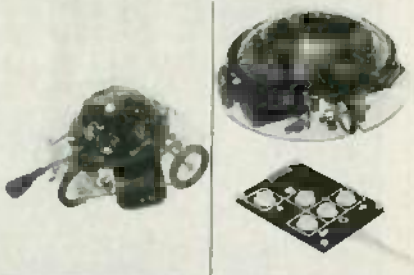

MINI-ROBOTS Priced from \$24.95 (PEPPY, touch/sound controlled, shown at left), to \$74.95 (MEMOCON CRAWLER, 4K programmable memory, shown at right). Each kit includes step-by-step instructions and pre-assembled PC boards. Batteries not included. Add \$2.50 (per unit) for S & H. Other models to choose from. Send \$1.00 for more information and diagrams. **MORNING DISTRIBUTING CO.**, P.O. Box 717, Hialeah, FL 33011 (305) 884-8686.

CIRCLE 276 ON FREE INFORMATION CARD

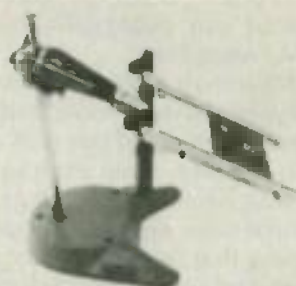

MODEL 333 RAPID ASSEMBLY CIRCUIT BOARD HOLDER. Eight position rotating adjustment and six positive lock positions in the vertical plane. Crossbars available up to 30 inches in length to hold circuit boards up to 28 inches in width. Spring loaded holder features tilt angle adjustment, height adjustment and quick board rotations. Only \$44.49. Contact: **PANAVISE PRODUCTS, INC.**, 2850 East 29th Street, Long Beach, CA 90806, (213) 595-7621.

CIRCLE 252 ON FREE INFORMATION CARD

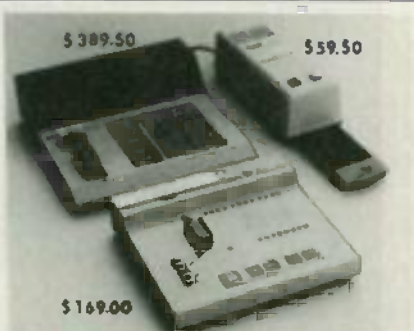

EPROM PROGRAMMERS & ERASERS. Self-contained stand-alone. Programs most 5V EPROMs from 16K to 256K Parallel I/O port or RS-232 (optional). Standard with data entry keypad. Prices from \$169.00. ERASERS - erasers up to 9 chips in 15 min. Build-in electronic timer. Prices from \$44.90. Most products are in stock. **ANGO ELECTRONICS CORP** PO Box 112, Harrison, NJ 07029, (201) 484-1115.

CIRCLE 265 ON FREE INFORMATION CARD

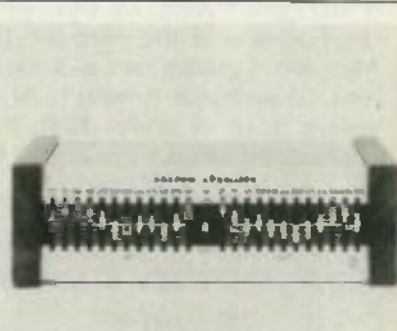

GREAT GRAPHIC EQUALIZER KIT. Twelve (not 10) bands per channel. Ultraquiet (92dB S/N), clean (.02% THD), attractive (solid walnut endpanels). Featured in Radio-Electronics April 1978 cover story. Just \$89. Free shipping w/check. VISA/MC add shipping. Free catalog. **SYMMETRIC SOUND SYSTEMS**, 856 Lynn Rose Ct., Santa Rosa, CA 95404 707/546-3895.



ZENITH SSAVI DESCRAMBLERS only \$169; GATED PULSE & SINEWAVE decoders \$199 each. Reconditioned. Original equipment for UHF chs. 23, 27, 31, 48, 50, 51, 54, 57, 60, 67, 68 etc. Quantity discounts. Surplus Cable TV equipment: Jerrold SB-3, Oak N-12, Zenith Z-Tac, Hamlin 1200, etc. Catalog \$1. 10 days satisfaction guarantee & 90 day warranty. **AT&S SATELLITE**, P.O. Box 1226-E, Dublin, PA 18917. 1-800-643-2001 or 215-249-9411.

CIRCLE 267 ON FREE INFORMATION CARD



THE WIRELESS TELEPHONE TRANSMITTER model WTT-20 is only the size of a dime, yet transmits both sides of a telephone conversation with crystal clarity. Completely automatic. Uses power from the telephone line itself. Never needs a battery! Up to 1/4 mile range. Use with any FM radio. Complete kit only \$29.95. Tax included. **FREE SHIPPING. DECO INDUSTRIES**, Box 607, Bedford Hills, NY 10507. (914) 241-2827.

CIRCLE 127 ON FREE INFORMATION CARD

Radio-Electronics mini-ADS



SATELLITE TELEVISION RECEIVER SEMIKIT with dual conversion downconverter. Features infrared remote control tuning, AFC, SAW filter, RF or video output, stereo output, Polarator controls, LED channel & tuning indicators. Install six factory assembled circuit boards to complete. Semikit \$300.00. Completed downconverter add \$100. Completed receiver and downconverter add \$150. **JAMES WALTER SATELLITE RECEIVER**, 2697 Nickel, San Pablo, CA 94806. Tel 415-724-0587.
CIRCLE 124 ON FREE INFORMATION CARD



HOBBY KITS THE ERECTOR SET of linear electronics. Modules from \$4.95 to \$49.95. Build basic circuits: 2 W audio amplifier (AFA-1, \$4.95), tone decoder (PLL-1, \$6.95), to more complex: VHF Converter (using 4 modules, \$27.80), QRP Transceiver (using 6 modules as shown, \$38.70), HF SSB Transceiver (using 14 modules, \$140.30). Add \$2.50 for S&H. SEND \$1.00 for diagrams, \$5.00 for full manual. **MORNING DISTRIBUTING CO.**, P.O. Box 717, Hialeah, FL 33011 (305) 884-8686.
CIRCLE 275 ON FREE INFORMATION CARD



APPLIANCE REPAIR HANDBOOKS—13 volumes by service experts, easy-to-understand diagrams, illustrations. For major appliances (air conditioners, refrigerators, washers, dryers, microwaves, etc.), elec. housewares, personal-care appliances. Basics of solid state, setting up shop, test instruments, \$2.65 to \$5.90 each. Free brochure. **APPLIANCE SERVICE**, PO Box 789, Lombard, IL 60148. 1-(312) 932-9550.
CIRCLE 84 ON FREE INFORMATION CARD



SUBSCRIPTION TV MANUAL. This information packed book details the methods used by subscription TV companies to scramble and descramble video signals. Covers the Sinewave, Gated Pulse, SSAVI system, and the methods used by most cable companies. Includes circuit schematics, theory, and trouble shooting hints. Only \$12.95 plus \$2.00 first class P&H. **ELEPHANT ELECTRONICS INC.**, (formerly Random Access) Box 41770-R, Phoenix, AZ 85080
CIRCLE 120 ON FREE INFORMATION CARD



FREE CATALOG OF HARD-TO-FIND TOOLS is packed with more than 2000 quality items. Your single source for precision tools used by electronic technicians, engineers, instrument mechanics, schools, laboratories and government agencies. Also contains Jensen's line of more than 40 tool kits. Send for your free copy today! **JENSEN TOOLS INC.**, 7815 46th St., Phoenix, AZ 85044. (602) 968-6231.
CIRCLE 115 ON FREE INFORMATION CARD

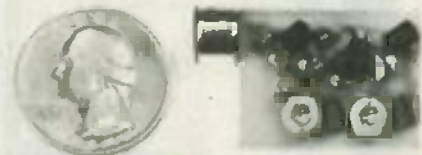

THE MOST EXCITING KIT YOU WILL EVER BUILD The model WAT-50 miniature FM transmitter uses a 4-stage circuit NOT to be confused with a simple wireless microphone. Up to 1 mile range. So sensitive, it will pick-up a whisper 50 feet away! Use with any FM radio. Complete kit only \$29.95 tax incl. **FREE SHIPPING.** **DECO INDUSTRIES**, Box 607, Bedford Hills, NY 10507. (914) 241-2827.
CIRCLE 127 ON FREE INFORMATION CARD



DELTA DUAL TRACE OSCILLOSCOPES WITH PROBES DX5020 20MHz \$379.95. Built in component tester 5MV to 20V/DIV 0.2 microsec. to 0.5s/DIV. Risetline less than 17ns one year limited warranty. Also available DX5035 35MHz \$527.00 DX5045 45MHz \$789.95 DX5015S 15MHz A/C D/C \$479.95. CA. residents add 6.5% tax. Shipping \$8.50. Money orders, checks accepted. **DELTA DYNAMIC INC.**, 20955 E. Lycoming St., Walnut, Calif. 91789. Tel. (714) 594-7131. Telex: 503749 DELTAX.
CIRCLE 251 ON FREE INFORMATION CARD

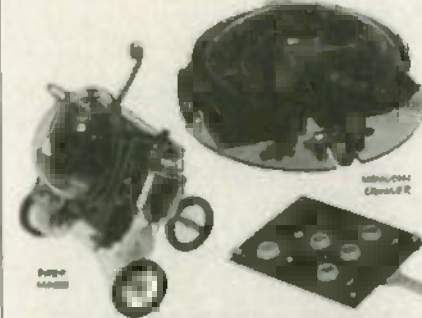

INVASION OF THE ROBOTS. NEW from ELECTROMANIA, the entire "MOVIT" ROBOT line. This month's specials: **PIPER MOUSE**, Command Whistle (included), turns left, stops, right, advances, \$39.95. **MEMOCON CRAWLER** Keyboard programmable Robot for lights, horn, movement, \$69.95. Both require assembly. Educational and fun. Master-Visa 1-800-632-4441 NY STATE, 1-800-645-4441 Nationwide.
CIRCLE 269 ON FREE INFORMATION CARD



TELEPHONE ANSWERING MODULE. ENABLES ANY CASSETTE RECORDER TO ANSWER PHONE AND TAKE MESSAGES! This module automatically answers phone after 1 ring; sends "beep" signal; and activates your recorder for 20 second message. Fully assembled & tested. All patch cords included. Only \$29.95, tax included. **FREE SHIPPING.** 30 day money back guarantee. Dealer Inquiries welcome. **REBEL ELECTRONICS**, P.O. Box 15785, Plantation, Florida 33318.
CIRCLE 256 ON FREE INFORMATION CARD

SEPTEMBER 1988

however, have the option of mixing the audio as you switch video sources. If you do that, the new audio input fades in as the original audio fades out. Another option you can choose, called "video breakaway," lets you keep a single audio input regardless of how you switch the video. That's important if you want to string scenes together without a sense of chop-piness. The unbroken audio has a unifying effect.

Stabilizer/enhancer

The *Hybrid-8* contains an enhancer and stabilizer. To help you properly adjust the stabilizer, you can select a comparison (split screen) mode in which you can view the normal and enhanced picture at the same time. The stabilizer, once selected, doesn't require any adjustment.

Other features included in the *Hybrid-8* are an elapsed-time meter (which is also a 24-hour

clock) and an RF modulator. The manual that is supplied with the unit should serve most consumers well. Although it is lacking technical information, it does give a good description of the proper setup and operation. One thing we especially liked about the manual is that it listed the phone number of "Mr. Hookup." Customers who have trouble can call and receive assistance from him.

An optional accessory, called the *Zip Stick*, lets you take control of the *Hybrid-8's* special-effects generator. Thus, for example, you can manually converge a wipe to "spotlight" a part of the scene, and you can use a joystick to move the spotlight around. By making that spotlight small enough, you can create a video pointer or "bouncing ball." The translucency of the wipe (which makes up the non-spotlighted area) can be continuously adjusted. The *Zip Stick* greatly increases what you can do with the *Hybrid-8*.

The suggested price of the *Hybrid-8* is \$419 while the *Zip Stick* sells for about \$200. If you own only one VCR, those prices might be too high to justify. But if you own two VCR's, the editing power of the *Hybrid-8* is something you don't want to be without, especially if you make a lot of home videotapes. R-E

... Over 3,000,000 Sold and Still The Best General Purpose Multimeter! ...



The Reason Is Clear . . . Simpson 260® VOM Has Features No Digital Can Match!



Latest
260®
Series 7
\$119

- "Instant" null, peak, trend and continuity indications
- High Immunity to transients, RF Interference
- dB measurement capability at no extra cost
- Resistance Indication from zero to infinity
- Self-powered voltage, current and dB ranges—no batteries to fail
- Reliable, accurate performance even under extreme environments
- Easy, low-cost maintenance—no expensive "chips" to fail
- UL Listed per UL-1244 Standard for Safety—Electrical and Electronic Measuring and Testing Instruments
- Complete line of UL recognized accessories
- Options include mirrored scale, extra overload protections, roll top carrying case

See the World Famous 260 Series 7, the 260-6XL, the 270 and the Pocket-Size 160® at Leading Electronics/Electrical Distributors



SIMPSON ELECTRIC COMPANY
A Katy Industries Subsidiary
853 Dundee Avenue, Elgin, IL 60120
(312) 697-2260 • Telex 72-2416 • Cable SIMELCO
Canada: Bach-Simpson Ltd., London, Ontario
England: Bach-Simpson (U.K.) Ltd., Wadebridge, Cornwall

CIRCLE 259 ON FREE INFORMATION CARD

MaxiGuard Black Max Champion Auto Alarm

It stops car thieves cold



CIRCLE 7 ON FREE INFORMATION CARD

THE NUMBER OF CARS STOLEN EACH year keeps going up and up, and that is a trend that is unlikely to be reversed in the near future. If you've ever been through the experience, you know that the

MASTER THE NEW ELECTRONICS WITH MCGRAW-HILL'S

Contemporary Electronics Series

The fast, easy and low cost way to meet the challenges of today's electronic innovations. A unique learning series that's as innovative as the circuitry it explains, as fascinating as the experiments you build and explore.

From digital logic to the latest 32-bit microprocessor, the McGraw-Hill Contemporary Electronics Series puts you into the electronic picture one easy step at a time. Fifteen unique Concept Modules, sent to you one every 4-6 weeks, give you a handle on subjects like optoelectronics, robotics, integrated circuits, lasers, fiber optics and more.

Each Concept Module goes right to the heart of the matter. You waste no time on extraneous material or outdated history. It's a fast, efficient, and lively learning experience... a non-traditional approach to the most modern of subject matter.

Unique Interactive Instruction

With each module, you receive a McGraw-Hill Action Audio Cassette. Each tape is a dynamic discussion that drives home the key facts about the subject. Your learning

With your first module, you get this solderless breadboarding system. You'll use it throughout the series to build electronic circuits and bring concepts to life.



experience is reinforced through interaction with vividly illustrated text, audio cassettes, and actual electronic experiments. Indexed binders preserve backup material, notes, and tapes for convenient referral.

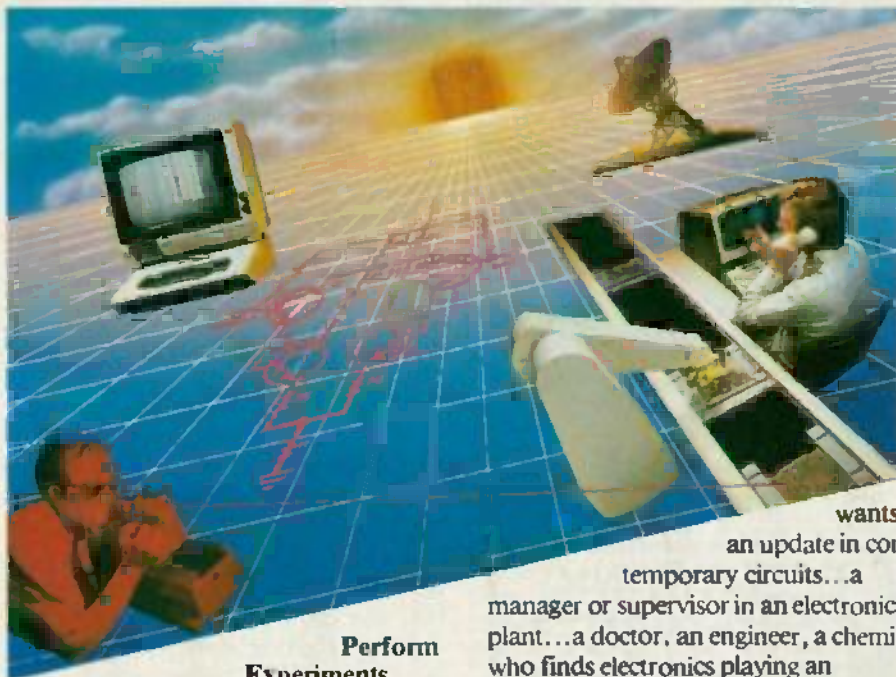

Perform Experiments in Contemporary Electronics

Throughout your series, laboratory experiments reinforce every significant point. This essential experience

...dynamic, hands-on demonstrations of theory in practice... will help you master principles that apply all the way up to tomorrow's latest VLSI (Very Large Scale Integrated) circuitry.

In your very first module, you'll use integrated circuits to build a digital oscillator, verifying its operation with a light emitting diode (LED). You'll learn to identify passive and active components, understand concepts common to all electronic circuits.

For Anyone Interested in Electronics

The Contemporary Electronics Series is designed for anyone from hobbyist to professional. It's for you if you're looking for new fields of interest... if you're a teacher who

wants an update in contemporary circuits... a manager or supervisor in an electronics plant... a doctor, an engineer, a chemist who finds electronics playing an increasingly important role in your work. It's even for electronics engineers or technicians who feel their training needs freshening up. It's the quickest, most convenient, probably least expensive way to do it. And the only one that gives you hands-on experience.



15-Day No-Risk Trial

To order your first module without risk, send the postage-paid card today. Examine it for 15 days under the terms of the order form and see how the Contemporary Electronics Series gets you into today's electronics. If card has been used, write us for ordering information.



McGraw-Hill
Continuing Education Center
3939 Wisconsin Ave.
Washington, D.C. 20016

SUPER LONG PLAY TAPE RECORDERS

10 Hour Model — \$95.00*
14 Hour Model — \$159.00*

Modified Panasonic Slimline. High quality AC-DC Recorders provide 5 or 7 continuous hours of quality recording & playback on each side of cassette for a total of 10 or 14 hours depending on model. Built-in features include • Voice level control • Digital counter, etc. TDK DC 180 Cassette Furnished



PHONE RECORDING ADAPTER

Records calls automatically. All Solid state connects to your telephone jack and tape recorder. Starts recording when phone is lifted. Stops when you hang up. \$24.50*
FCC APPROVED



VOX VOICE ACTIVATED CONTROL SWITCH

Solid state. Self contained Adjustable sensitivity. Voices or other sounds automatically activate and control recorder. Uses either recorder or remote mike. \$24.95*



*Add for ship & Htg Phone Adapter & Vox \$1.50 ea. Recorders \$4.00 ea. Cat. Pgs. add tax. Mail order, VISA/M.C. COD's OK. Money Back Guarantee. Free data avail. Dealer Inquiries invited. Free data. AMC SALES INC. Dept A 9335 Lubec St., Box 928, Downey, CA 90421 (213) 866-8518

CIRCLE 108 ON FREE INFORMATION CARD

ELECTRONIC COMPONENTS



176 PAGE

FREE CATALOG

MANUFACTURERS OF QUALITY ELECTRONIC COMPONENTS

- BATTERY CLIPS & HOLDERS
- CASE SITS • CONNECTORS • CAPACITORS
- DISPLAYS • LED's • SWITCHES • JACKS & PLUGS
- CROSS • LAMP'S • POTENTIOMETERS
- EP COILS • CRYSTALS • RESISTORS
- SWITCHES • SEMICONDUCTORS • SPEAKERS
- TEST EQUIPMENT • TRANSFORMERS • TOOLS
- WIRE & CABLE

OVER 15,000 DIFFERENT ITEMS IN STOCK!

- Info. and Order Desk Open 9am - 6pm (PST)
- TERMS: C.O.D. Via. MasterCard
- 10% - Account Available
- Phone and Mail Order Welcome
- Carriers Mailed Outside USA Send \$2.00

MOUSER ELECTRONICS
11433 WOODSIDE AVE. SANTEE, CA 92071
PHONE (619) 449-2222 TWX 910-331-1175

RADIO-ELECTRONICS

CIRCLE 117 ON FREE INFORMATION CARD

effects of a car theft can be devastating.

Because of that, millions of car owners have turned to one of the multitude of car-alarm systems on the market. Some do little other than give their owners a false sense of security. Others, such as the Black Max *Champion* auto-alarm system from MaxiGuard (2700 Touhy Ave., Grove Village, IL 60007), do an effective job of thwarting potential thieves.

	MaxiGuard	Champion
OVERALL PRICE	1 2 3 4 5 6 7 8 9 10	1 2 3 4 5 6 7 8 9 10
EASE OF USE	1 2 3 4 5 6 7 8 9 10	1 2 3 4 5 6 7 8 9 10
INSTRUCTION MANUAL	1 2 3 4 5 6 7 8 9 10	1 2 3 4 5 6 7 8 9 10
PRICE/VALUE	1 2 3 4 5 6 7 8 9 10	1 2 3 4 5 6 7 8 9 10
	Poor	Fair
	Good	Excellent

The Champion

The *Champion* is a passive protection-system that arms automatically when the ignition key is turned off. It is disarmed from outside the car via a tiny transmitter. That transmitter, dubbed the "radio key" by the manufacturer, is small enough to act as a keychain fob.

The system incorporates four "subsystems" to protect your car in four different ways. First, there is a motion/shock detector. Since a parked car should not move at all, that module monitors for a sharp shock. Such a shock might be caused by a lock being forced, a window being broken, a door or trunk being opening, or the vehicle being moved. If such motion is detected, a piercing siren will sound immediately, and will continue to sound for a full three minutes. Once the three minutes have expired, the system will reset; the cycle is repeated if any further motion is detected.

Second, there is the alarm-control module. When clamped to a battery cable, the module senses current flow. Since opening any door, or the trunk, will cause an accessory light to come on, such an occurrence will cause the siren

to sound. The module also can be activated by switches, so the hood, etc., can be protected in that manner.

Third, there is a passive starter-interrupt module. That module, as its name implies, disables the starter system whenever the alarm system is activated.

Finally, there is the "Maxi-lok" hood dead-bolt system. That securely locks the hood any time the ignition is off. The system can be manually deactivated for servicing, etc.

The system is exceptionally easy to use. All the driver needs do to enter the car is press a button on his keychain transmitter, unlock the car, and turn on the ignition within one minute. If for some reason the ignition is not turned on within that time period, the alarm will sound. The alarm can be reset by simply pressing the button on the keychain transmitter. To verify that the system has received the correct code to disarm, the parking lights turn on for about three seconds to let you know it is safe to enter the car.

Activating the system is even easier. Simply turn off the ignition, remove the key, and exit and lock the car. The alarm is automatically activated one minute after the ignition is turned off.

As this is a consumer product, the documentation provided is skimpy. In fact, aside from a card that provides basic user information, the only documentation provided is related to the installation of the unit. Though that information is intended for a professional installer, installing the alarm system is not particularly difficult, and requires no special tools. You could undertake it yourself if you are handy. However, most of the outlets that carry products of that nature, such as auto-stereo dealers, include installation as part of the purchase price, and that is how the suggested list price for the alarm system (\$650) is quoted by the manufacturer.

On the whole, the unit provides a very high level of protection for your car. It carries a one-year guarantee on the electronics, and all mechanical components are guaranteed for as long as you own your car.

R-E

ECG® IC's for Zenith "Z" Chassis

Philips ECG has replacement integrated circuits for the 221-175, -179 and -190 in the Zenith System 3 "Z" chassis. They are the ECG873, 874 and 875. Just three of the hundreds of integrated circuits available from Philips ECG to replace literally thousands of part numbers. All are manufactured to meet OEM specs so you know they fit and they work.

CIRCLE 281 ON FREE INFORMATION CARD

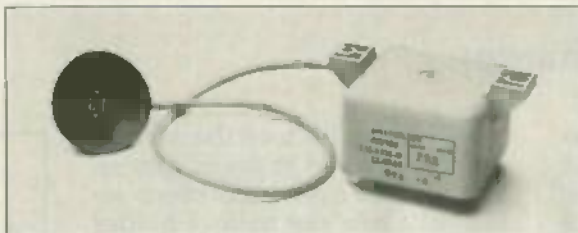
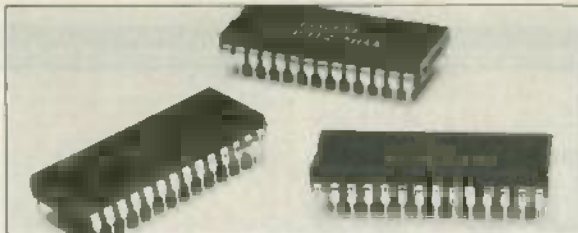

ECG® High Voltage Triplers

You have a choice of 29 types of high voltage triplers from Philips ECG, and these 29 triplers replace hundreds of part numbers. Six step, five step, with damper, with resistor—you name it, Philips has it. For example, the ECG559 replaces the Zenith 212-148 and the ECG560 replaces the Zenith 212-147—and only Philips ECG has replacement parts for these Zenith types.

CIRCLE 265 ON FREE INFORMATION CARD



ECG® Bipolar Transistors

Philips ECG replacement leadership is obvious again. The ECG 29, bipolar transistor, used as a replacement in the fan motor control system of Cadillacs, has been added to the Philips ECG line. (The ECG29 replaces Delco part numbers 139DDF and 7391-BT). There are 322 other bipolar transistors in the Philips ECG line that replace thousands of other domestic and foreign transistor types.

CIRCLE 282 ON FREE INFORMATION CARD



ECG® RF Power Transistors

Philips ECG power transistors are the ideal replacement RF power output devices for fire, police and taxi radios. They are suitable for transmitters and drivers up to 100 Watts RF power. They cover frequencies from the 13 to 30 MHz band to the UHF 806 to 870 MHz band. Most dealers will be happy to learn that Philips ECG replacement RF power transistors are designed to replace units in Asian and European equipment as well as domestic types. So, if it's ECG, it fits and it works... worldwide. Philips offers a selection of over 65 RF transistors that replace literally hundreds of domestic and foreign transistors in a broad range of frequencies.

CIRCLE 283 ON FREE INFORMATION CARD

The one thing we make that you have to replace every year.



The new and expanded ECG® Semiconductors Master Guide.

Your new Master Guide will be looking as dog-eared as the old one before long. Because this year the Master Guide has been expanded to include more than 400 new products and almost 25,000 new cross references. The Master Replacement Guide for 1985. 656 pages. Over 3,500 different ECG devices that provide replacement coverage for more than 227,000 industry types. And everything in the book is cross-referenced so you can find what you're looking for fast, and be sure it fits. Plus, everything we make meets or exceeds the original JEDEC or application specs. So it

works. It's the only book you'll need. But you'll need a new one every year.

To get a copy of the new Master Guide, go to your nearest Philips ECG distributor. For his name and location, just call: 1-800-225-8326 (in Mass., 617-890-6107).

If It's ECG, it fits. And it works.

Philips ECG

A North American Philips Company
Dedicated to Excellence.

NEW IDEAS

A versatile battery charger

IT'S EASY TO FIND BATTERY CHARGERS that are capable of handling one, two, or four cells at once. But when you have some device that requires some odd-ball number of batteries, or perhaps uses more cells than a single charging unit can handle at one time, what do you do? If you own one of the commercially available units, you must charge the maximum number of batteries. And then, after what seems like years, do the same for the remaining cells.

Because of that, I decided to build my own charger; one that would handle any number of AA cells, from one to six and charge at a rate of 50 mA as recommended by the cell's manufacturer. The result is shown in Fig. 1.

A look at the circuit

The operation of the circuit is pretty simple. The supply for the circuit is a conventional full-wave rectifier. An LM317 voltage regulator is configured as a constant-current source. It is used to supply the 50 mA charging current to SO1-SO6, an array of AA-cell bat-

tery holders. Each of the battery holders is wired in series with an LED and its associated shunt resistor. When the battery holder contains a battery, the LED glows during charging.

Note that each of the battery holder/LED combinations is paralleled by a 5.1-volt Zener diode. If the battery holder is empty, the Zener conducts the current around the holder. An exception to that is SO1. A microswitch, S1, is inserted in that battery holder so that the switch is closed when a battery is in place. That switch is the power switch for the circuit.

The balance of the unit is a timing circuit that prevents overcharging. When power is applied to the circuit, timing is initiated by IC2, a CD4541 oscillator/programmable timer. The output of IC2 is fed to Q1, a VN67AF VMOS transistor. When that output is high, the transistor is on, and the charging circuit is completed. When the output is low, the transistor is off, and the path to ground is interrupted.

Note that resistors R1, R2, and R5

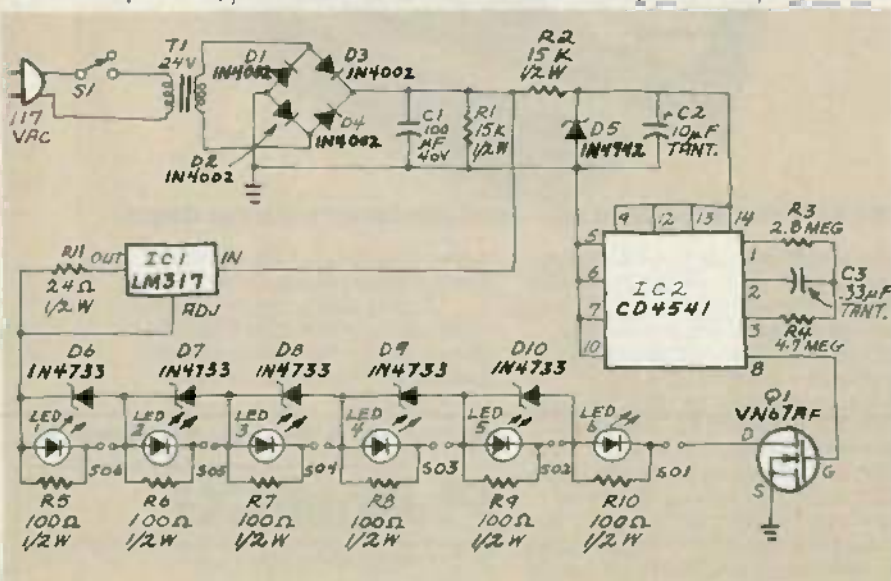

FIG. 1

NEW IDEAS

This column is devoted to new ideas, circuits, device applications, construction techniques, helpful hints, etc.

All published entries, upon publication, will earn \$25. In addition, for U.S. residents only, Panavise will donate their model 333—The Rapid Assembly Circuit Board Holder, having a retail price of \$39.95. It features an eight-position rotating adjustment, indexing at 45-degree increments, and six positive lock positions in the vertical plane, giving you a full ten-inch height adjustment for comfortable working.

I agree to the above terms, and grant Radio-Electronics Magazine the right to publish my idea and to subsequently republish my idea in collections or compilations of reprints of similar articles. I declare that the attached idea is my own original material and that its publication does not violate any other copyright. I also declare that this material has not been previously published.

Title of Idea

Signature

Print Name

Date

Street

City

State

Zip

Mail your idea along with this coupon to: New Ideas Radio-Electronics, 200 Park Ave. South, New York, NY 10003

through R11 are half-watt units. That's because of the power that each may have to dissipate. Also, the VN67AF may be replaced with a VN10KM. The circuit may be built using the construction method of your choice.

There is, however, one precaution to keep in mind; since IC2 is a VMOS device, it is static sensitive and we all know what that means. So be careful when handling the device. The LM317 regulator should be heat sunked to avoid thermal damage to the unit during operation.—Joseph A. Scannell

You may not be able to solve the world's problems. But at least you can listen.



The Panasonic Command Series™. With double superheterodyne tuning, you'll hear the world loud and clear.

Now it's easy to listen in on the world's hot spots. With the Panasonic RF-B600 Command Series FM/LW/MW/SW receiver.

Its advanced microcomputer-controlled tuner lets you preset up to nine different frequencies. And reach them at the touch of a button. Or, press the appropriate buttons and tune in any desired frequency with direct-access digital tuning. It'll lock right in to every signal with a PLL quartz-synthesized tuner. Once tuned in, the Panasonic double superheterodyne system helps deliver a clean, consistent signal.

There's even built-in auto-tuning to let you scan the shortwave band automatically, as well as manually. All this means you can tune in Berlin, pick up Paris, or locate London in an instant. Without dialing all over the band.

Both the RF-B600 and the RF-B300 are packed with features and built to go anywhere.

The Panasonic Command Series offers something for everyone. With equipment sophisticated enough to impress the most avid enthusiast, and automatic features that get you where you want to be. Fast.

There's a whole world out there that's waiting to be heard. Tune in to it with the Panasonic Command Series.



Batteries not included.

CIRCLE 268 ON FREE INFORMATION CARD

Panasonic
just slightly ahead of our time.™

Be an FCC LICENSED ELECTRONIC TECHNICIAN!



Learn at home in spare time. No previous experience needed.

No costly school. No commuting to class. The Original Home-Study course prepares you for the "FCC Commercial Radio-telephone License". This valuable license is your "ticket" to thousands of exciting jobs in Communications, Radio-TV, Microwave, Computers, Radar, Avionics and more! You don't need a college degree to qualify, but you do need an FCC License.

No Need to Quit Your Job or Go To School
 This proven course is easy, fast and low cost! **GUARANTEED PASS** - You get your FCC License or money refunded. Send for **FREE** facts now. **MAIL COUPON TODAY!**

COMMAND PRODUCTIONS

FCC LICENSE TRAINING, Dept 90
 P.O. Box 2223, San Francisco, CA 94126
 Please rush **FREE** details immediately!

NAME _____
 ADDRESS _____
 CITY _____ STATE _____ ZIP _____

LEARN TV/VCR REPAIR



Now you can train at home in spare time for a money-making career as a TV/VCR Repair Specialist. No need to quit your job or school. Everything is explained in easy-to-understand language with plenty of drawings, diagrams and photos. We show you how to troubleshoot and repair video-cassette recorders and TV sets, how to handle house calls and shop repairs for almost any make of television or VCR. You learn about TV receivers, tuners and antennas, x-ray emission, the characteristics of sound, how electrical impulses are converted into a TV picture, and much, much more. Tools are included with your course so you can get "hands-on" practice as you follow the lessons step by step. Send for free facts about opportunities in TV/VCR Repair and find out how you can start making money in this great career.

CALL TOLL FREE
1-800-862-6262/ Dept. DE085
 Ext. 87

CALL ANYTIME—Operators to take your call 24 hours a day, 7 days a week. No cost. No obligation. No salesman will visit you.

OR MAIL COUPON TODAY

SCHOOL OF TV/VCR REPAIR, Dept. DE085
 Scranton, Pennsylvania 18515
 Please send me free facts on how I can learn TV/VCR Repair in spare time.

Name _____ Age _____
 Address _____
 City/State/Zip _____
 Phone () _____

NEW PRODUCTS



CIRCLE 11 ON FREE INFORMATION CARD

UNIVERSAL COUNTER, the Circuitmate model *UC10*, features an 8-digit display and has applications ranging from simple event counting, to audio and computer servicing, to FM-receiver and cordless-telephone repair.

The key functions of the model *UC10* are pushbutton-selectable; they include gate time, attenuator, frequency range, and reset and self-check functions. Four gate times range from 0.1 second to 10.0

seconds. The 14 LED indicators provide visual feedback, and there is also an audible signal indicating that positive contact was made. Because there are two inputs, the counter can also be used to measure frequency ratios and time intervals.

The Circuitmate model *UC10* is priced at \$319.95.—The Instrumentation Products Division, Beckman Industrial Corporation, 630 Puente Street, Brea, CA 91621.

REPLACEMENT STYLI, are available for Shure's *V15 Type IV* and *V15 Type III* phonograph cartridges. The new models are *VN45MR* (for the *V15 Type IV*) and *VN35MR* (for the *V15 Type III*).

Both new models have micro-ridge stylus tips that make use of an extremely small tracing radius to greatly reduce tip-related distortion, while maintaining low indentation for long record life. The model *VN45MR* features a telescoped, aluminum stylus-shank for low effective mass and superior trackability; it also incorporates

Shure's dynamic stabilizer, which removes static electricity and dust

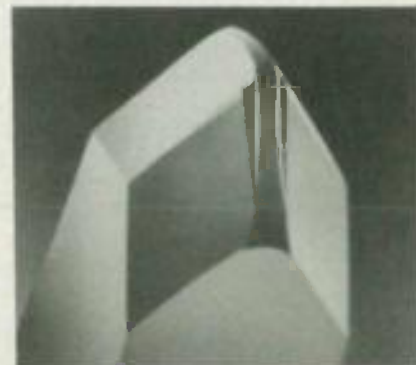

CIRCLE 12 ON FREE INFORMATION CARD

from record surfaces, and allows accurate tracking of warped records.

The model VN45MR is priced at \$80.00; the model VN35MR costs \$58.00.—Shure Brothers Incorporated, 222 Hartrey Avenue, Evanston, IL 60204.

PHONE LINE LOOP TESTER, model 8455, checks line shorts, opens, and multiple ringers. The compact 5½ × 3¾ × 2¾ instrument also measures 0 to 100 volts DC and has two resistance scales: R×1 (100K center scale) and R÷10.



CIRCLE 13 ON FREE INFORMATION CARD

A reverse switch is provided for line checks, and the 0 to 100 points scale calibration conforms with telecom industry standards. A pair of 6' leads with clips is provided, as are an Eveready No. 455 (45 volt) battery and instruction manual.

The model 8455, Catalog No. 12382, is priced at \$110.00. Optional accessories include an extra test lead set and carrying case.—Simpson Electric Company, 853 Dundee Ave., Elgin, IL 60120.

CASSETTE RECEIVERS, model KS-RX450, model KS-RX250, model KS-RX115, and model KS-RX105, are in-dash stereo cassette car receivers offering high power output and high fidelity.

The model KS-RX450 is designed for European, Japanese, and American cars. It features a digital PLL frequency-synthesized tuner



CIRCLE 14 ON FREE INFORMATION CARD

and clock, and offers up to 20 station presets. Compu-tuning, a new feature, automatically tunes to stations broadcasting a good signal, in preset order, when the station being received becomes too weak for clear reception. For improved FM tuning, the unit also features TNCC (Tuner Noise Control Circuit), which reduces unpleasant interstation noise as well as the noise that occurs during signal fading. Other features include Dolby B noise reduction, line-level input and output terminals, preamp fader control, separate BASS and TREBLE tone controls, metal tape compatibility, DX/LOCAL button, key-off release/key-on play mechanism, and power antenna lead. The KS-RX450 is priced at \$399.95.

The model KS-RX250 is an in-dash auto-reverse cassette car receiver featuring digital PLL frequency-synthesized tuning with LCD digital display. Security alarm-ready, there is also a new tape transport mechanism for improved reliability, and TNCC for improved FM tuning. There is also Dolby B noise reduction, independent bass and treble tone controls, and high power output—22 watts per channel. The KS-RX250 is priced at \$399.95.

The model KS-RX115 features auto-reverse control and alarm-readiness, as well as Dolby B noise reduction, preamp fader control, independent bass and treble controls, and a 22-watt-per-channel maximum power output. It is priced at \$259.95.

The model KS-RX105 features a maximum output of 22 watts per channel, Dolby B noise-reduction system, separate bass and treble controls, metal tape compatibility, rewind/auto-play, built-in AFNS, DX/Local button, line-level input and output terminals, and AM/FM stereo tuner. It is priced at \$229.95.—JVC Company of America, 41 Slater Drive, Elmwood Park, NJ 07407.

R-E

SEE YOUR DEALER TODAY

FROM

'Firestik'
ANTENNAS
ACCESSORIES

HERE'S A TIP
THAT'S PERFECT!

AM/FM AUTO RADIO
AND CB

'Firestik' II
GOLDEN SERIES

BARE-HANDS TUNABLE
"NO TOOLS NEEDED"
HIGH PERFORMANCE ANTENNAS

ALSO ANTENNAS FOR
CORDLESS TELEPHONES
MONITOR SCANNERS

Dealer & Distributor Inquiries Invited
SEND FOR FREE CATALOG

Firestik Antenna Company
2614 East Adams/Phoenix, AZ 85034

Name _____
Street _____
City _____
State _____ Zip _____

Serving the CB and
Communications Market Since 1962

5-YEAR REPLACEMENT WARRANTY

CIRCLE 100 ON FREE INFORMATION CARD

KeproClad
by Kepro Circuit Systems, Inc.™

At Home Professional Quality
Fine Line PCB's.

Introducing an easy, inexpensive, step by step method for the home production of professional quality printed circuit boards without a major equipment investment—KeproClad, by Kepro, makers of quality industrial equipment and supplies. KeproClad was designed for the home user who needs professional results with:

A Simple Circuit Board:

Use KeproClad unsensitized copper-clads. These boards come in 2 popular sizes with 1 sided foil, a marking pen, all for a suggested retail price as low as \$3.50.

A Fine Line Detailed Board:

Use KeproClad photosensitized copper-clads. Available in 2 sizes with 1 or 2 sided foil. These copper-clads use the latest technology of negative acting dry-film photoresist. This material is rugged, yet holds extremely fine detail. It comes with a premeasured amount of developer and sells for as little as \$3.90 (suggested retail).

Other KeproClad products such as a photo reversal kit for making negative film, etch, tin plating solution and photo-flood lamps are all available at your local distributor. (For the distributor nearest you, call or write:

KEPRO CIRCUIT SYSTEMS, INC.
630 Administrator Drive, Fenton, MO 63026-2992
In MO 314-343-1630 Toll Free 800-325-3878

CIRCLE 258 ON FREE INFORMATION CARD

SEPTEMBER 1985

47

Do you hear bullets ricocheting across your living room, or turbulent waterfalls crashing down the stairs when you watch TV?

If you hear dump trucks roaring across your living room, cannons exploding all around you, and rain drops splattering the floor when you watch TV, then you probably already have a Teledapter. However, if you don't, read on.

If you have a TV and a stereo system you can enjoy the excitement you've been missing...now! The Teledapter's unique electronics will combine your TV and stereo into a powerful entertainment center that would easily cost thousands of dollars.

Imagine having the best front row seats in town for ball games, musicals, and movies.

Teledapter works with any TV, VCR, or satellite receiver, regardless of age or model, and conveniently plugs into the auxiliary, tape, or tuner input on any stereo amplifier or receiver system.

All TV, satellite, cable, and VCR programs will have the same powerful sound as your stereo system and speakers.

FEATURES

Stereo-Plex™ Circuitry is for all those mono TV's and VCR's. It transforms their mono sound into sparkling two-channel stereo effects. Got a stereo TV or VCR? No problem. Just plug them in. Since most TV and cable programming is mono, the Stereo-Plex circuitry will pick up where your stereo TV or VCR stops short.

Mono sounds, even when played through two speakers, appear to come from one direction (the center).

Stereo sounds come from two directions. The stereo/mono test is really simple; plug the Teledapter up, push the mono-stereo button on



THE MANUFACTURER

For over 12 years we've manufactured TV audio products for home and industry with the best standards we know.

Offering our products direct enables you to make sure that the sales person you speak to is able to answer your questions knowledgeably. And if a Teledapter ever needs service, it will be done quickly, and it will be done correctly.

Teledapter comes complete with all cables, instructions, and a FREE HELpline phone number.

*DNR is a registered trade mark of National Semiconductor Company

your stereo. When you go from mono to stereo, listen to the sounds spread out across the room. Perform the test without a Teledapter and a mono signal will remain in the center.

Ambiance and Spatial Circuits expand a stereo signal to greater separation than it normally has.



At the same time, indirect delayed signals and echoes are accentuated.

DNR® is the latest marvel in noise reduction. It works with all mono or stereo programs, and preserves the Teledapter's excellent 20 to 20,000Hz frequency response.

Tape Monitor Loop allows all the features of Teledapter to be used with all other stereo or mono components, FM, tapes, records, AM, etc.

Other Features include up to four mono or stereo inputs, input level control, isolated and protected low impedance input, and a beautiful walnut and anodized aluminum cabinet. This unit will serve you for years.

NO MAGIC—JUST HIGH TECH

Technology using the latest integrated circuits and manufacturing techniques, are combined in an instrument designed and built in America, from the company that invented Good TV Listening™

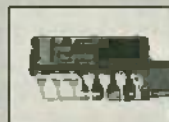

TRY THE TELEDAPTER AT NO RISK

Take the first 30 days with Teledapter™ as a test. If you're not completely satisfied, return it for a complete refund and your mailing costs. You can't lose.

Teledapter™ is also backed with a two-year warranty on parts and labor.

Teledapter™ TE-600, \$145.00 plus \$4.00 postage and handling.

TOLL FREE 1-800-251-8608

In Tennessee Call Collect
1-615-381-9001

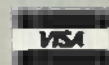

24 HOURS



Send mail orders to address below. Credit card and money orders processed immediately. Checks require 18 days.

RHOADES

NATIONAL CORPORATION
Department 204
Highway 99 East • P.O. Box 1316
Columbia, TN 38402

Turn your TV into a powerful entertainment center with the STEREO TELEDAPTER®

Electronics in the Passenger Compartment

Henry Ford would not have believed how electronics has changed his automobile. In this article, we show you the latest in passenger-compartment electronics.

MARC STERN

IT IS SAFE TO SAY THAT THE AUTOMOBILE IS AMONG the most important innovations of the past hundred years. Although there have been improvements in manufacturing techniques, materials used, etc., the automobile has changed little over time, at least as far as the typical driver is concerned.

That all is changing, thanks to an across-the-board electronics revolution that is occurring in the auto industry. Automakers are currently experimenting with and implementing a variety of micro-processor-controlled systems.

One area where the fruits of the automakers' efforts will become obvious is the passenger com-

partment of your family's car. Already, automobile instrument clusters and displays are beginning to resemble those found in the cockpits of sophisticated jet aircraft. In addition, electronics is making it possible to offer automotive features and options that Henry Ford never even dreamed of.

Here and now

Just what features and options are we talking about? Well, for example, for the last three years Chrysler and Ford have had cars equipped with digital voice synthesizers. Other exciting developments have occurred in the area of display tech-



FIG. 1—A CRT WITH TOUCH-SENSITIVE SCREEN is used to replace traditional mechanical climate controls in this Mark VII Comtech, a limited-production vehicle from Ford.

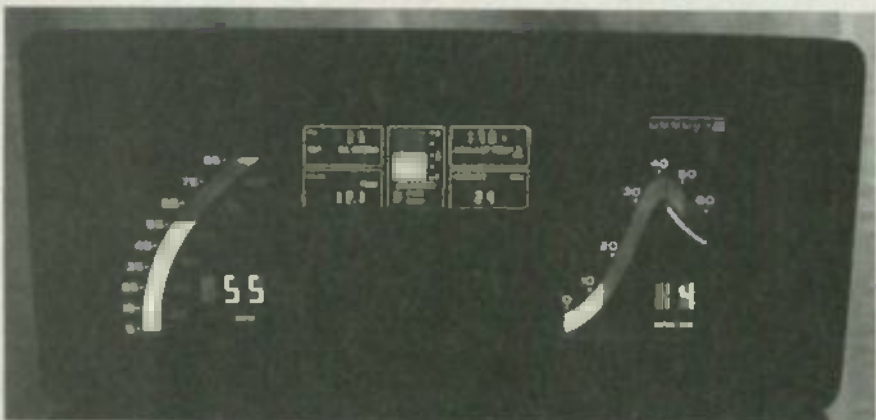

FIG. 2—MULTICOLOR LIQUID-CRYSTAL AND VACUUM-FLUORESCENT displays are being used to present driver information in several current production automobiles.

nology. First developed by Zenith in 1981, vehicular cathode ray terminals with touch-sensitive screens are actively being used in the Buick Riviera and Ford Comtech Mark VII, a limited production model (see Fig. 1). The CRT's are being used to replace traditional mechanical climate and entertainment controls, and

multicolor, liquid-crystal and flat vacuum-fluorescent displays are being used for driver information. (See Fig. 2). Soon, expect to see cars equipped with navigational systems, using maps stored on compact discs, to help make sure that you never get "lost" again.

In fact the first such system is already

available. It is the Etak *Navigator*. Manufactured by Etak, Inc. (1287 Lawrence Station Road, Sunnyvale, CA 94089), the system consists of a 1,024 x 770 pixel, high-resolution vehicular CRT; a cassette tape drive; compass, and the electronics package.

The heart of the system is the map database, designed by Etak, called Etak-Maps. Those maps, stored on cassettes rather than CD's in this first commercially available system, are custom-designed to provide information down to individual addresses, the company says. Once the unit is installed, the owner can customize operation by selection of the appropriate map database.

The system uses a moving-map display to help you navigate. As you drive, your position on the viewing screen, marked by a small triangle, remains constant. Instead, it is the maps that move. The scale of the maps can be changed easily, allowing you to see your position in a neighborhood, a community, a city, or the country. The position of the vehicle relative to the maps is determined by the unit's special compass and sensor system, and is accurate to within 50 feet, on the average. Due to the nature of the system, correct positioning is automatically displayed as soon as the unit is turned on, no matter where the vehicle is located.

According to the company, the system is easily installed in two or three hours. The display and the tape player are mounted at the driver's position, along with the tape player. The sensors are mounted at the wheels, and the electronics package located in the trunk. The cost of the system averages between \$1,350 and \$1,595, depending on the size of the CRT used. (There are two, one seven inches and the other 4.5 inches.) The tape player is designed for trouble-free use because it contains no capstan or pinch roller. The only moving parts are the motor driveshafts.

Microprocessors and the car

The key to all of those hi-tech automotive features is, of course, the microprocessor. For instance, the Buick Riviera uses two eight-bit microprocessors—custom-masked Motorola 6801's—to control that car's CRT display system.

At the moment, each microprocessor in a car is assigned one and only one task (controlling a car's display system, for instance). But automotive experts predict that the day is coming when all of the microprocessors in a car will communicate with each other and with a master control microprocessor designed to oversee the entire vehicle's condition and operation. The advantages of that become quite apparent if you look at the car as a complete system. Let's look at a hypothetical example.

Let's say we are driving a car of the



FIG. 3—THE QUESTOR is a concept car from the Buick division of General Motors. It is being used as a test bed for systems that Buick hopes to incorporate in its products over the next decade.



FIG. 4—THE NAVIGATION SYSTEM in the Questor can display area, region, or state maps on one of the vehicle's center-console CRT's.

future. That car uses a barometric sensor in the manifold air-pressure-sensing system. But that same sensor could also be used to detect changes in air pressure that aren't related to engine variables; such changes would be signaled by a change in air pressure that differs from the normal system parameters. A microprocessor receiving such information could even be programmed to interpret the reading to forecast changing weather conditions!

That information could be relayed to the driver via the car's display system, and passed on to other systems in the car. One microprocessor-controlled system could be in charge of altering the car's handling characteristics to accommodate the impending change in road conditions. Another might tune the car radio to the National Oceanographic and At-

mospheric Administration's frequencies so the driver could have a weather update.

The future

The current move to electronics in the automobile is but a preview of things to come. Already, many of the major automakers, both here and abroad, have developed what are called "concept" cars. Those are automobiles that showcase the features that automakers hope to be incorporating in their products within the next 5 to 10 years. Among those concept cars are Buick's Questor, Ford's Continental Concept 100, Chrysler's Stealth, Nissan's NRV-II, and Mazda's MX-02. Also, Saab recently unveiled its 900 Turbo EV-1.

The Buick Questor (see Fig. 3) is an idea car from GM. It is being used as a test bed for planned future systems. For exam-

ple, the Questor features 14 microcomputers and has such features as a "laser key" entry system (an infrared transmit-receive system for vehicle entry); an automatic level, attitude, and spoiler control system; a "systems sentinel" (which monitors the status of the various systems within the car); a line-of-sight display for the speedometer and gauges (located at the top of the instrument pod); a map and navigation system; automatically aimed headlights; a theft deterrent system; a voice-actuated radiotelephone; a road surface traction monitoring system; a television rear-view mirror system, and a touch command center for entertainment, comfort and convenience functions.

The "heads-up" line-of-sight display is an interesting concept. It works much like the prompters used by public speakers. A specially angled screen, that is always in view of the driver, even while he is looking straight ahead at the road, is used to display information. Even though the screen is directly in the driver's line of sight, it doesn't block his view of the road because, like the displays used in jet fighters, it is transparent and appears as an overlay to the scene ahead. It is the first application of this type of technology to automobiles.

Also, Questor is one of the concept cars that features a navigation system. The Questor's navigation system can display area, region, or state maps on one of two display screens mounted in the center control console. (See Fig. 4.) In the navigation mode, a dot on the screen shows the location of the vehicle and moves when the vehicle moves. An electronic compass display gives the directional heading at all times.

The Chrysler Stealth concept car features the Chrysler Laser Atlas Satellite System (CLASS). This system, shown in Fig. 5, makes use of data from orbiting navigational satellites. Currently, there are five such NAVSTAR satellites in orbit; ultimately there will be a network of 18. Maps are stored on optical discs, touted for their high-density data storage capabilities. It is claimed that the system will be able to display your vehicle's position to within 300 feet.

Mounted in the trunk of the Stealth is a NAVSTAR receiver. As the NAVSTAR satellites circle the globe, they continuously transmit positional information. The CLASS receiver uses positional information from four of those satellites to continuously update the system microprocessor. From that information, and information stored in the system's ROM, the microprocessor is able to determine the car's position at all times. That information is displayed in map form on a nine-inch CRT.

The optical-disc storage system uses eight-inch discs that are capable of storing up to 25,000 images on a single side. That



FIG. 5—CHRYSLER'S CLASS system uses a satellite receiver to obtain navigational information from a system of orbiting satellites.

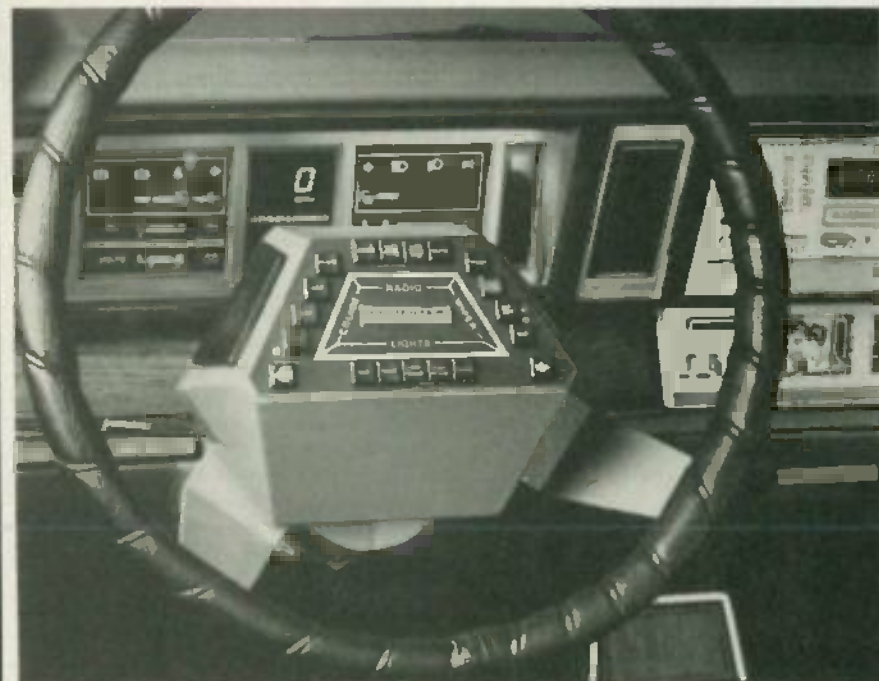

FIG. 6—IN THE CHRYSLER STEALTH concept car, many controls have been relocated to the steering wheel. In that vehicle, the traditional wiring harness has been replaced with a multiplexed wiring scheme.

is more than sufficient for the maps needed to adequately cover the U.S.; a demonstration version of the system contained 13,300 such maps. The leftover capacity could be used for a variety of applications, such as storing hotel, restaurant, and sightseeing information.

Like the system used in Buick's Questor, CLASS uses a moving icon to indicate the car's position on the map. The scale of the maps can be similarly varied, zooming in on a small area, or zooming out to accommodate an area as large as 1,600 square miles. Chrysler will be offering the CLASS system as an option when the NAVSTAR satellite system is fully operational.

Another interesting feature in the Chrysler Stealth concept car is the use of multiplexing for system controls. All controls have been removed from the instrument panel and placed at the hub of the steering wheel. (See Fig. 6.) However, instead of using separate parallel pairs of wires for each control, all the signals are multiplexed on a single bus.

There are many advantages to multiplexing. One is the elimination of heavy and unwieldy wiring harnesses. Also, a multiplexed system offers some unique advantages in the area of diagnostics. Information exchange between the bus-control microprocessor, and the microprocessors controlling the systems that the bus feeds is constant, and two-way. If a system should fail, that data is received by the bus-control microprocessor and either the driver can be informed, or, if possible, a back-up system activated.

Another automobile that makes use of multiplexing is the Nissan NRV-II. In that system, however, fiber optics rather than wires are used for data transmission.

The NRV-II is noteworthy for a few additional reasons. For one, it is equipped with both voice-synthesis and voice-recognition systems. Voice-operated functions include the route-data input for the driver information system, speed warning settings, and control of exterior mirrors, interior lights and hazard flashers.

Another interesting innovation in the Nissan car is a "drowsiness" alert. For that, a microprocessor is used to monitor various functions, such as how the steering wheel is used, to look for signs that the driver might be getting drowsy. If any of those functions vary from the norm, the system sounds an alarm.

As you can see, the electronics revolution has finally reached the passenger compartment of your family's car. But it won't be limited to just that part of the car. Indeed, the role that electronics is, and will be, playing in the engine compartment is at least as important, if not more so. To find out more about the electronics revolution that is occurring "under the hood," turn to the next article in this section.

R-E

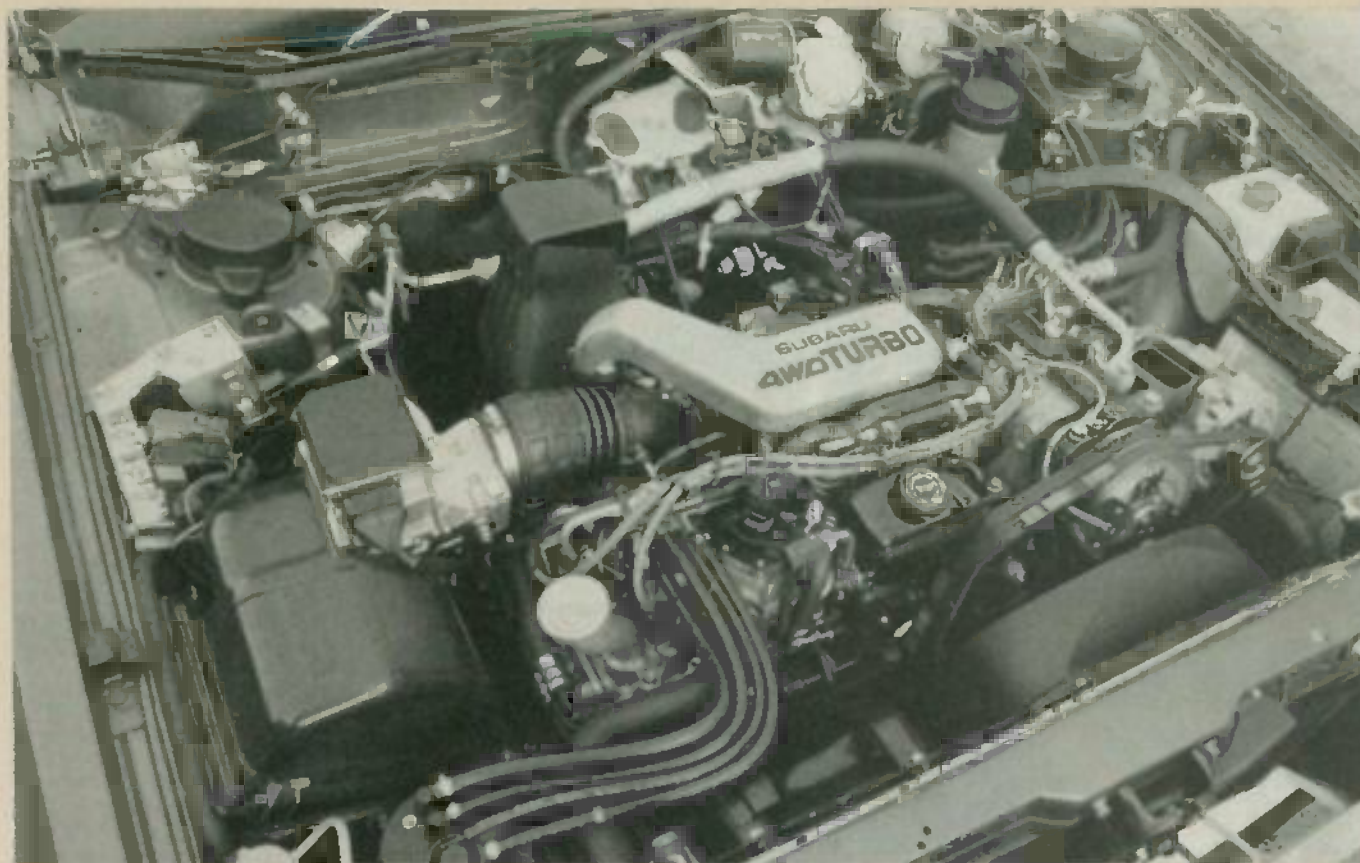

Electronics under the Hood

MARC STERN

Though they may not be as glamorous as those found in the passenger compartment, the new electronics systems found under the hood of your family's car are just as important.

THE NEW ELECTRONICS SYSTEMS FOUND in the passenger compartment may have more "razzle-dazzle," but the new and future systems found under the hood of your family's car have done as much, if not more, to change that vehicle, and the way it operates, forever.

A little history

Up until the 1960's automakers used mechanical, not electronic systems for engine control. Until then, cars tended to run with over-rich air/fuel mixtures because that was what their engines and mechanical control systems were designed for. But, as we now know, that design was not at all beneficial to our environment.

As the various "clean-air" regulations were enacted in the 1960's and 1970's, that situation began to change. At first, the auto industry assumed that it could comply with those regulations without resorting to new designs. It soon realized, however, that that would be impossible.

Continued use of the older mechanical and electro-mechanical engine-control systems resulted in serious tradeoffs in several areas, including reliability and fuel economy. The public began to complain and the industry began to search for alternatives.

The alternative that "worked" was electronic engine control. The first totally electronic engine-control system was introduced by Chrysler in the mid 1970's. Dubbed an engine "computer," it was an analog comparator circuit. The circuit accepted inputs from a limited number of devices and then advanced or retarded the timing, according to those inputs. Unfortunately, the circuit was comparatively slow and could only control two or three variables—air mixture, timing advance, and timing retardation. Further, though the circuit was designed to control air mixture, it proved to be unable to maintain the tight 14.6:1 air-to-fuel ratio required for optimum car performance.

An additional problem with early electronic systems was a lack of reliable sensor devices. There were few air-sampling devices available that could operate reliably over a long period of time in the hostile under-hood environment. (Such sensors have to survive a temperature range as wide as -40°C to $+120^{\circ}\text{C}$.)

Eventually the electronics problems were solved, however, and today almost all automobiles rely on microprocessor controlled electronic engine-control systems.

Microprocessors and the car

Of this country's "Big Three" automakers (GM, Chrysler, and Ford), two are using the Motorola 6800 series of eight-bit microprocessors in their vehicles. According to Charles L. Duesenberry and Arden G. Gillund, two staff engineers at General Motor's Delco Division, the microprocessors that that automotive giant uses are custom-masked 6800's.

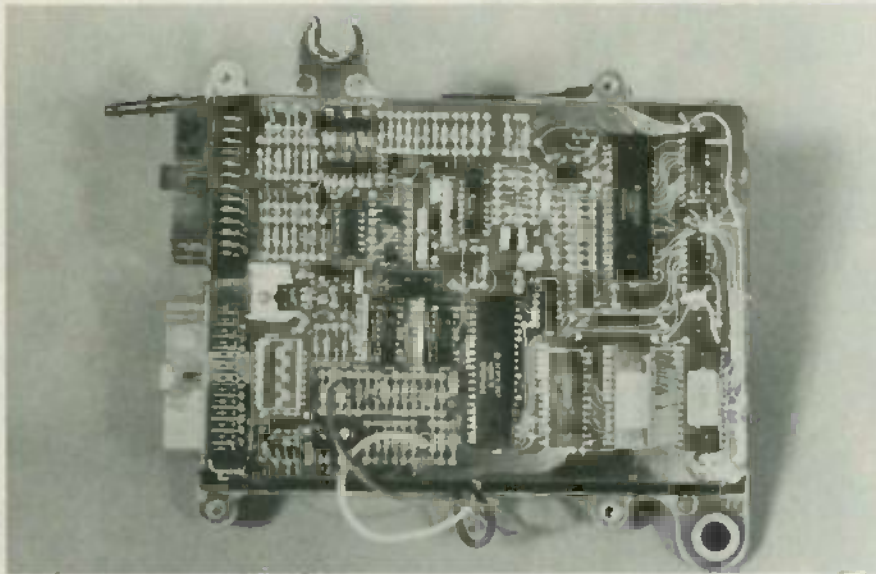

FIG. 1—THE HEART OF CHRYSLER'S engine control system is this 6801-based logic control module.

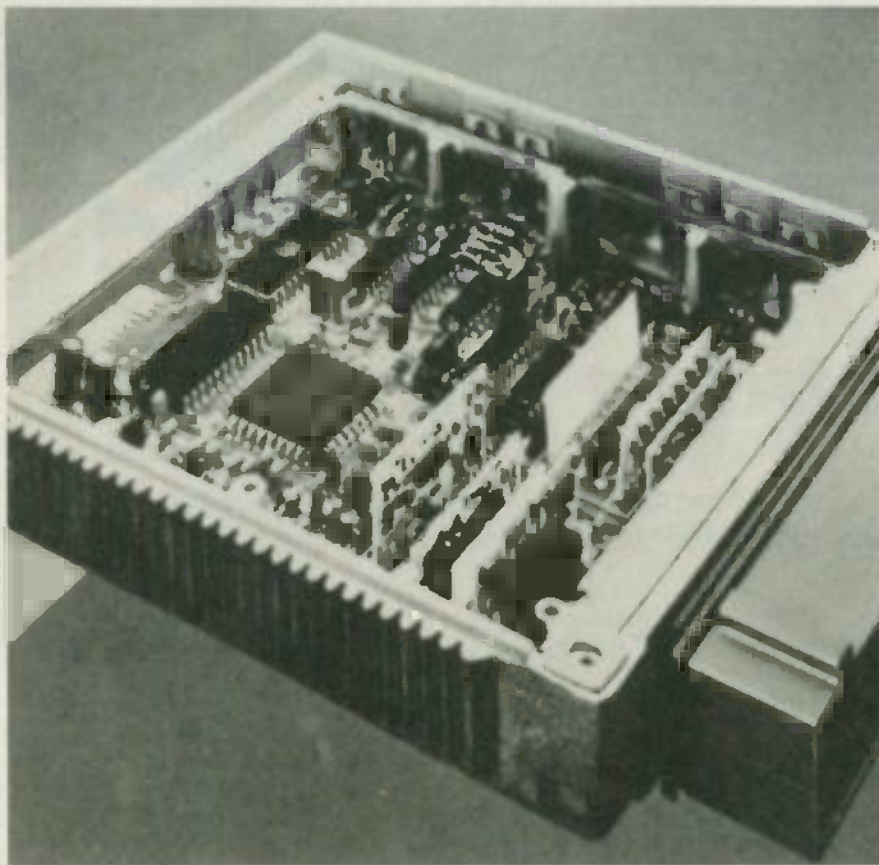

FIG. 2—FORD USES the 16-bit Intel 8061 microprocessor in its EEC-IV engine control system.

Chrysler, too, uses 6800-series microprocessors for its engine control system. The heart of the the Chrysler system is a 6801-controlled logic module. The module is also used in diagnostic operations (see Fig. 1).

In operation, the microprocessor takes inputs from various sensors—manifold air pressure, coolant temperature, exhaust-gas recirculation, etc.—and compares those inputs to parameters stored in ROM. If any of the inputs differs from the

norm, the microprocessor takes steps to correct the cause.

There will be cases, however, where the condition causing the abnormal reading can not be corrected, or where the reading is wildly out of bounds with the norm. Such cases will be recognized by the microprocessor as a system failure, and the unit's self-diagnostics will take over. One function of those self-diagnostics would be to alert the driver to the presence of trouble. Another would be to maintain

operation as well as possible until the fault is repaired.

For example, let's say that the manifold-air pressure sensor fails. That is one of the key sensors in the timing system chain because it constantly monitors air pressure within the manifold, and that information is used by the microprocessor to keep track of acceleration, deceleration, or cruising conditions. If that information is not made available, engine timing will likely be off, which will result in poor performance (stumbling and stalling) and poor fuel economy.

In the event of a manifold-air pressure sensor failure, the microprocessor will be programmed to revert to a set of timing and fuel-flow parameters. Those parameters, which are stored permanently in ROM, allow the car to continue to operate, although not at peak efficiency.

The third of the Big Three, Ford, does not use a 6800-series device. Instead, it has turned to the more powerful 16-bit Intel 8061 for its Electronic Engine Control-IV (EEC-IV) system (see Fig. 2).

Electronic fuel system

For a more detailed look at just how an under-hood electronics system works, let's take a look at the Buick 3.8-liter multiport fuel-injected engine, General Motors' most advanced power plant. Just about every function of that engine is microprocessor-controlled. (See Fig. 3.)

The multiport fuel-injection system used by that engine is controlled by a microprocessor module Buick calls the Electronic Control Module (ECM). It monitors engine operation and environmental conditions, and uses that information to determine the correct air/fuel mixture, ignition timing, and engine idle speed.

Inputs to the ECM come from an oxygen sensor, coolant-temperature sensor, detonation sensor, mass-air-flow sensor, and throttle-position sensor. The ECM also receives inputs on engine speed, vehicle speed, transmission gear selected, and loads placed on the engine by such accessories as power steering and air conditioning.

The multiport fuel-injection system uses six Bosch injectors, one located at each intake port, rather than a single injector found on throttle-body fuel-injection systems. The six injectors are mounted on a fuel rail and are activated simultaneously, once each engine revolution, on signal from the ECM. As a result, for each combustion cycle, two injections of fuel at the cylinder are mixed with incoming air.

According to Buick, the purpose of the fuel injectors is to inject a predetermined amount of fuel, which is mixed with the mass of air at each cylinder. The injector is a solenoid-operated valve; the solenoid winding is energized upon a pulse signal

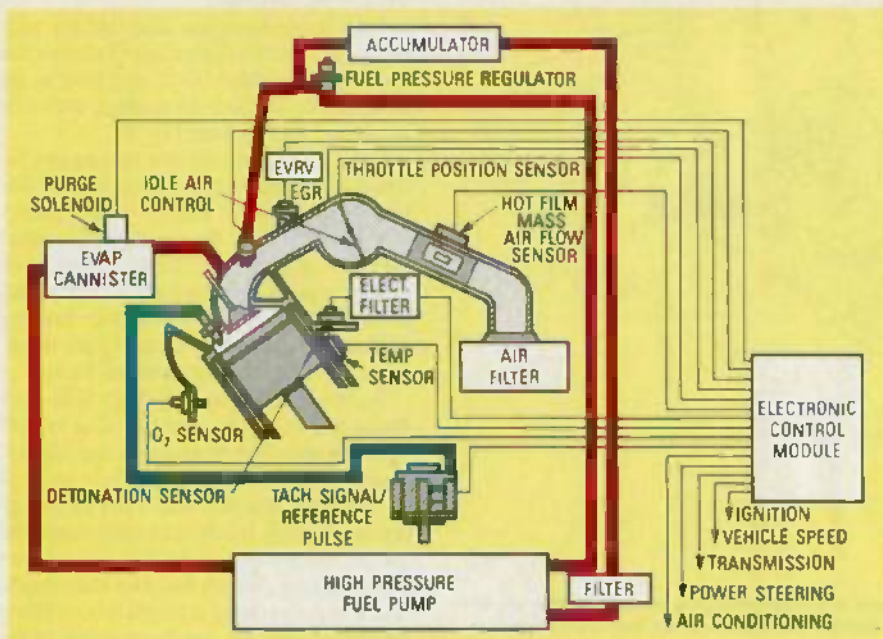

FIG. 3—BUICK'S 3.8-LITER multipoint fuel-injected engine. Just about every function of that engine is microprocessor controlled.

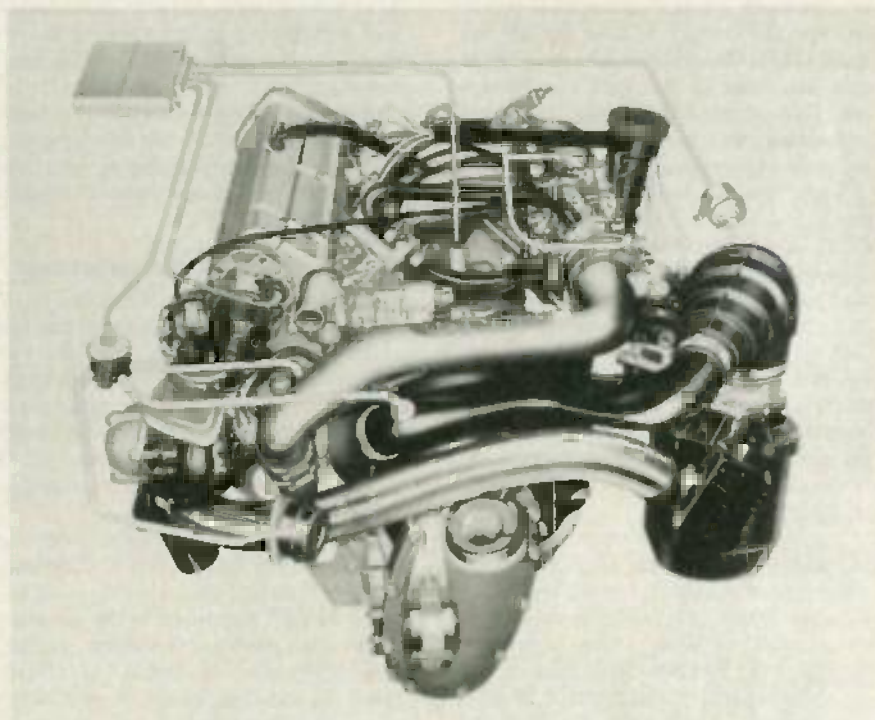

FIG. 4—SAAB'S DIRECT IGNITION SYSTEM. This microprocessor controlled system overcomes many of the problems inherent in standard ignition systems.

from the ECM. As a result, the armature is drawn back, lifting a pin from its seat, which results in a nozzle opening for the pressurized fuel. The length of time the nozzle remains open depends on the width of the pulses from the ECM. The throttle-position sensor provides the ECM with throttle position information and that information helps the microprocessor determine the duration of the pulses.

That system relies on a high-pressure in-tank fuel pump that operates at 4500

rpm. The pump's impeller serves as a vapor separator and precharges the high pressure assembly. System pressure is maintained at 28 to 36 psi by a regulator, and an accumulator is used to dampen hydraulic line hammer (which occurs when all six injectors open simultaneously) in the system. The fuel tank itself is vented through an activated charcoal canister that stores fuel vapors until it receives a purge signal from the ECM. Those vapors are then sent to the

fuel system where they are burned during combustion.

One of the most important parts of that system is the mass-air-flow sensor. Developed by Buick and AC-Delco, it is used to measure the mass of air that is drawn into the cylinders. It is located just ahead of the air throttle in the intake system and consists of a unique heated film that measures the mass of air, rather than just the volume. A thermistor is used to measure the temperature of the incoming air, and that information is sent to an electronics package that is located at the top of the assembly.

That electronics package is designed to maintain the temperature of the film at 75°C over the ambient temperature of the incoming air. If the temperature of the incoming air changes, the package changes the temperature of the film to match. Also, the package informs the engine-control module of the temperature change so that various engine parameters can be adjusted to maintain peak operation.

In the throttle body, there is an idle air-control that provides a bypass channel through which air can flow. It consists of an opening and a valve that is controlled by the ECM through a stepper motor. That bypass provides additional air flow for idling, and during cold-starting conditions until the engine has reached operating temperature. As the temperature rises, the air flow through that bypass is reduced.

The Buick engine uses a new electronic vacuum-regulator valve to control exhaust-gas recirculation and hence automobile emissions. The regulator valve contains a constant-current compensation circuit that ensures a given output vacuum for a given pulse width input, regardless of voltage or resistance variations. It also responds to signals from the ECM. In turn, the exhaust-gas recirculation valve is actuated by a vacuum motor. The exhaust-gas recirculation system operates in response to a signal from the regulator



FIG. 5—THIS PLUG/COIL COMBINATION develops the spark voltage right at each cylinder.

valve. In action, it allows the exhaust to gradually bleed through the system and into the intake manifold, where it heads to the cylinder for combustion.

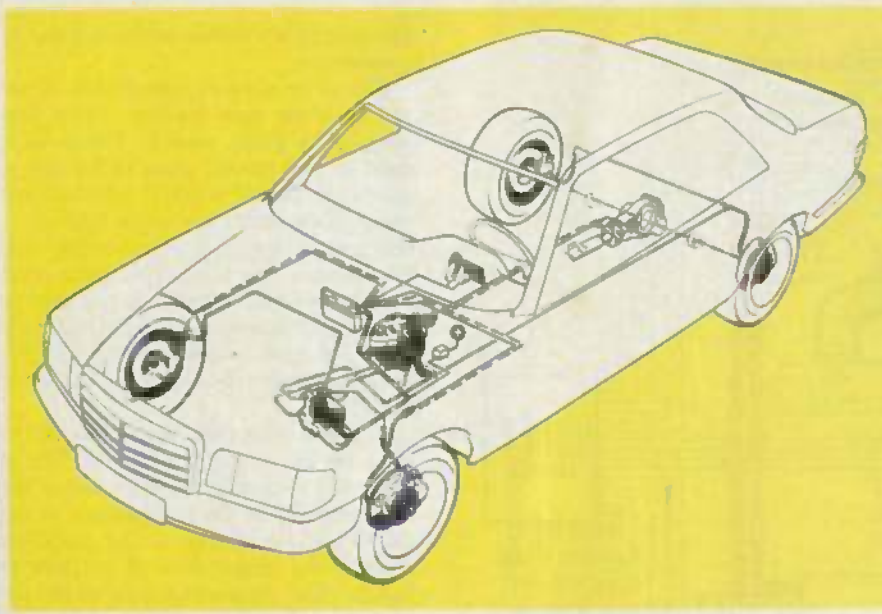

FIG. 6—THE MERCEDES BENZ anti-skid braking system. A microprocessor teams up with four wheel-mounted sensors and one pedal-mounted sensor to combat the brake lock-up that is common in a panic stop. Brake lock-up is what causes skidding to occur.

Solid-state ignition

The 3.8-liter Buick engine uses a solid-state ignition system with a distributor providing a high voltage spark to each plug at the proper time for ignition. The ignition system also sends a timing reference pulse to the ECM.

If detonation—knocking or pinging—occurs, an electronic spark control module is used to adjust the timing. It does that via a piezoelectric sensor that transforms engine detonation vibrations into electrical signals that are fed to the ECM. The ECM then adjusts the spark.

The ECM is also linked to the transmission and monitors the current gear and whether the cruise control is engaged. By monitoring the cruise control, the system avoids frequent disengagement of the clutch during cruising. The ECM also takes inputs from the speedometer drive at the transmission. That information is used for fuel cutoff during coasting above 45 mph.

Finally, the ECM monitors the loads placed upon the engine by accessories, and acts to compensate for them to maintain optimum operation. For instance, the ECM monitors the air conditioner and uses the information it receives to control idle speed when the air conditioner is on. The microprocessor anticipates air conditioner clutch engagement by about a half second. Buick says, and increases the engine idle rate to prevent stalling. It operates in a similar manner when it is adjusting for power steering load changes. That information is sent to the ECM by a pressure sensor in the power-steering system.

More reliable ignition

One of the problems associated with ignitions is related to the design of the

system itself. It relies on a central coil to provide the correct voltage for all the spark plugs. The coil provides the voltage to a distributor so the spark can be sent out. That system has inherent losses and sometimes can't provide the critical timing requirements needed.

Saab, however, has found an answer to that in its direct ignition system (see Fig. 4). It varies from the standard ignition system in that it has no coil in the traditional sense. Spark information is sent to a coil-plug combination at each cylinder (see Fig. 5) and the spark voltage is developed directly at the cylinder. Microprocessor-controlled, the coil-plug combination uses information derived from the engine control microprocessor to fire at the exact moment for top mileage and cleanest emissions.

Another area where microprocessors are finding use is in the area of vehicle-maintenance warnings. For instance, consider the BMW oil-change warning system. Instead of being a simple mileage reminder, the BMW system uses its microprocessor to evaluate the type of driving you do. After evaluating several parameters, such as typical speed, oil and coolant temperatures, and miles driven, the microprocessor sets the oil change warning interval. Nine LED's (five green, one yellow, three red) are used to indicate the service interval. Immediately following an oil change, only the green LED's glow; as you accumulate mileage, they turn off one-by-one. When all of the green LED's are off, it indicates that it's time for an oil change. After a while, the yellow LED lights, issuing a reminder that you're past due for a change. If no service is performed, the red LED's turn on, one at a time, at about 1,000-mile intervals.

Anti-skid braking

Microprocessors are also finding uses in a wide variety of other applications. For instance, Mercedes Benz, and others, are using those devices to control anti-skid braking systems (see Fig. 6).

Such a system consists of sensors located at the pedal, and at each wheel. The microprocessor is alerted to a "panic-stop" situation by the force used to press the pedal down. Once the microprocessor detects a panic-stop, it issues instructions to an electronic module in the braking system. That module then begins to engage the brakes to the point of lockup.

As the brakes near lockup, that condition is detected by a sensor. The system then releases and re-engages the breaks. That process is repeated as many as 12 to 15 times per second. The constant pumping action that results not only stops the car in shorter distances, but also allows you to retain control because the wheels don't stop turning completely. (When wheels do lock up, you lose control of the vehicle.)

As we have seen, there is a great deal of work which has been done and which is still continuing in automotive microprocessor-systems. At the moment, some automakers are experimenting with microprocessor-controlled collision-avoidance systems. Others are experimenting with tire-pressure warning systems that rely on pressure-sensor inputs to head off impending flats.

Servicing and the microprocessor

We discussed multiplexing and its ramifications in the first story in this special section, "Electronics in the Passenger Compartment." With multiplexing, all of the various microprocessors will be linked to each other via a common bus, and all vehicle operations will be monitored by a bus-controller microprocessor.

That will allow several things to occur in the event of a failure. First, diagnostic routines built into such a multiplexed system will alert the driver to the condition earlier than previously possible, perhaps even before the subsystem has actually failed. In addition, it may be possible for other microprocessors in the system to "fill-in" for a failed device, allowing vehicle operation to continue until service can be obtained. Further, the system has the potential to make vehicle servicing simpler and more accurate.

That's because the diagnostic routines that will be built into the multiplexed systems of the future will be able to pinpoint the exact cause of a failure. Those same routines could also be used to give a driver, or service technician, a complete service history of the vehicle. All that information would be taken from the same sensors used for engine control. It's an exciting prospect.

R-E

BUILD THIS

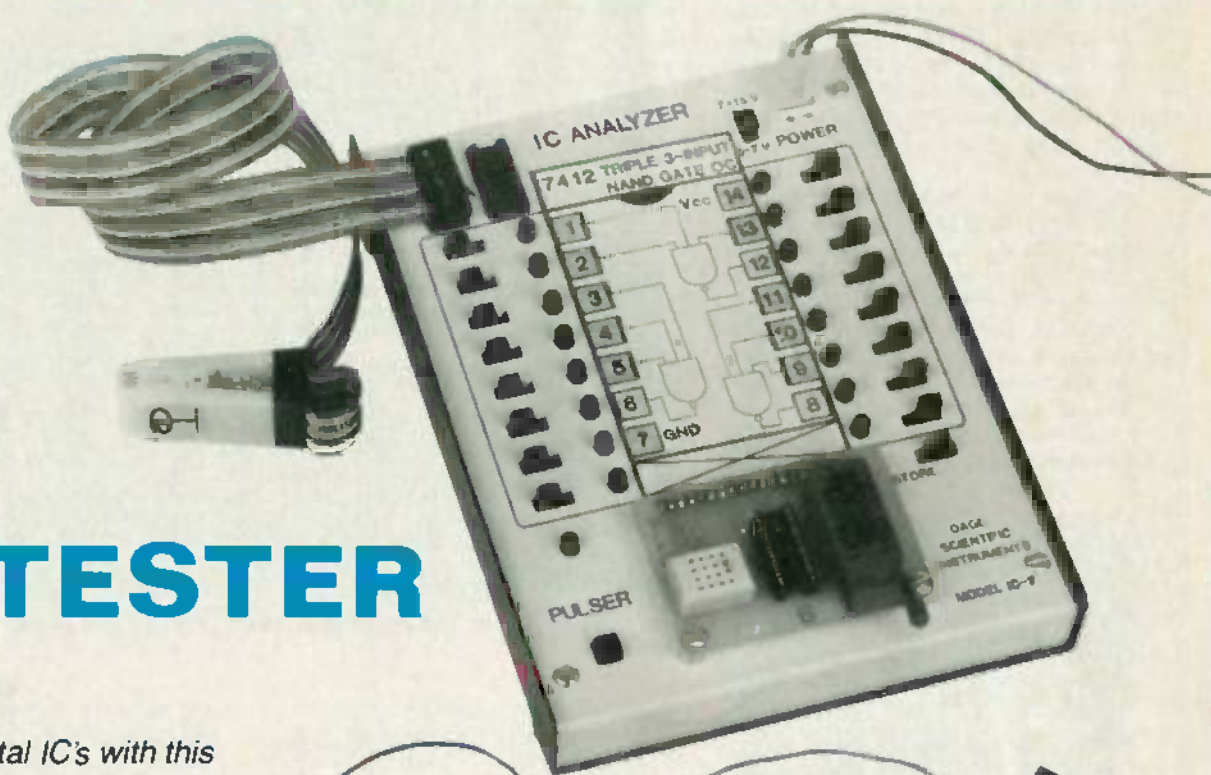

IC TESTER

DAVID H. DAGE

Test your digital IC's with this handy device. It's a breakout box, pulse generator, pulse detector and more!

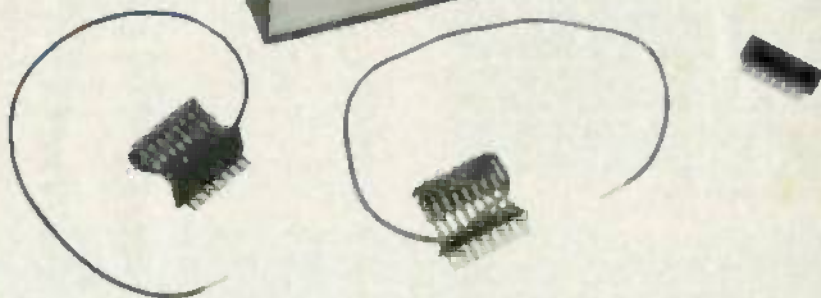

TESTING DIGITAL CIRCUITS SHOULD BE easy. After all, there are only two voltage levels involved. If the signal isn't high, then it's low. So your voltmeter or oscilloscope should be all that you need, right? How wrong that is! Working with digital circuits requires a whole new generation of test instruments ranging from the indispensable logic probe up to the sophisticated logic analyzers and emulators.

We'll show you how to build a device that's several digital test instruments rolled into one. It's a monitor, breakout box, comparator, pulse generator, and pulse detector. It can be used to troubleshoot digital circuits that contain 14- and 16-pin TTL or CMOS IC's. And it makes a great IC tester and trainer.

To use the analyzer for troubleshooting your digital circuits, you connect the analyzer to the in-circuit IC using ribbon cable and an IC test clip. If the analyzer is being used as a monitor, the logic level of each pin is displayed by an LED right next to a pictorial pinout of the IC. Each pin of the IC is accessible at the analyzer for

signal injection or simply for observation. That combination is hard to beat—it's certainly better than tilting your head, holding a databook open with your elbow, and jabbing spasmodically with a logic probe on what may very well be pin 10.

The analyzer gives you a remarkably simple way to troubleshoot an in-circuit IC. You can compare the outputs of the IC operating in-circuit to an IC of the same type that you know to be good. The good IC is inserted in the analyzer, and the power and input pins are connected together using slide switches, while the outputs are compared using EXCLUSIVE OR (XOR) gates. If the LED's remain off, the in-circuit IC is good. It's as simple as that.

The analyzer can also be used to check IC's before installation. Slide switches are used to set logic levels on appropriate pins, while the built-in pulse generator is used to inject single or multiple pulses.

A look at the circuit

The IC analyzer is made up of four main parts: the power feed, a pulse generator, a pulse stretcher, and a set of 16 pin-

monitor circuits. To explain the circuit operation as clearly as possible, we will discuss those sections separately.

The schematic of the power feed is shown in Fig. 1. When testing in-circuit IC's, the analyzer gets its power from the circuit under test, through socket SO6. If that input voltage is higher than seven volts, S18 must be switched to supply 5

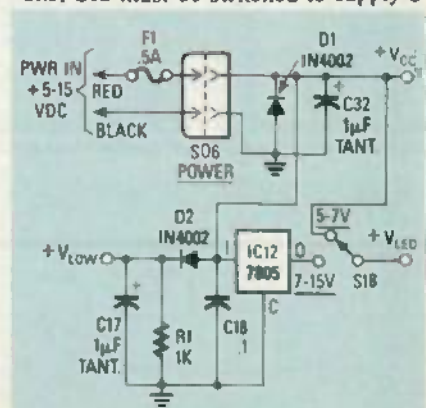

FIG. 1—A POWER-DISTRIBUTION CIRCUIT is used so that the LED's can have their own supply voltage if necessary.

volts to the LED's. Otherwise, the current through them will be too high.

Supply voltage V_{LOW} is 0.8 volt less than V_{CC} and powers the XOR gates and the flip-flops used for the individual pin-monitor circuits. The voltage is derived through D2 and is filtered by C17. This provides a high threshold voltage of 2.1 volts during 5-volt operation (which is necessary for TTL). The rest of the circuits operate between 5 and 15 volts DC.

A block diagram of the pin-monitor logic is shown in Fig. 2, while the schematic is shown in Fig. 3. Since the analyzer can be used to examine 16-pin IC's, it must contain 16 pin-monitor circuits. Instead of showing the circuit 16 times, we have shown it once and have used lettered subscripts. Although that is different from what we normally do in *Radio-Electronics*, it should serve to make

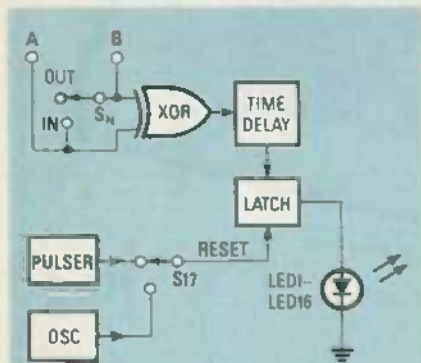

FIG. 2—THE PIN-MONITOR CIRCUIT is shown here in a block diagram.

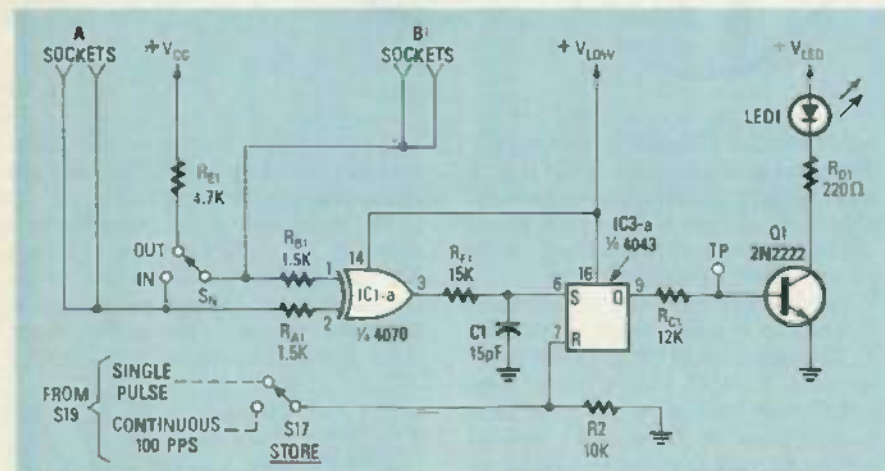

FIG. 3—SCHEMATIC OF THE PIN MONITOR CIRCUIT. Note that because this circuit is repeated 16 times in the analyzer, the part numbers use lettered subscripts.

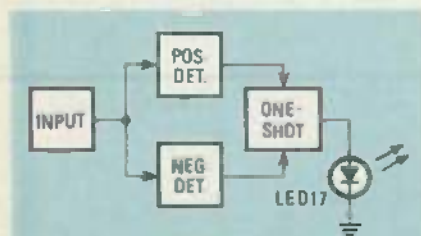

FIG. 4—THE PULSE STRETCHER block diagram.

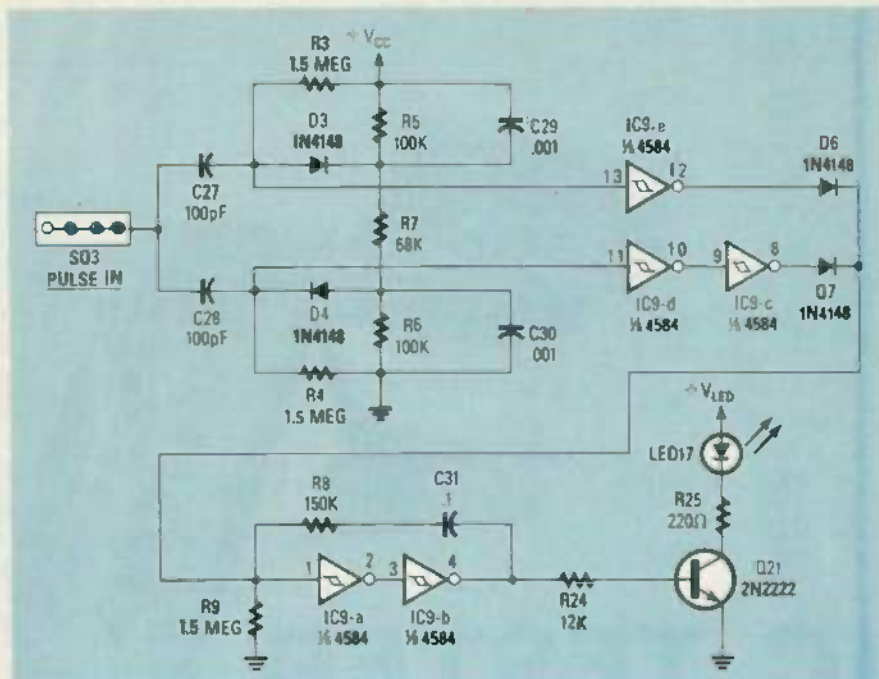

FIG. 5—SCHEMATIC OF THE PULSE STRETCHER. LED17 will light on both positive and negative transitions.

the circuit clearer. When referring to those parts, we'll use an "N" subscript. In Fig. 3, of course, $N=1$. (Since the XOR gate and S-R flip-flop are sections of IC's, we couldn't do that. So we'll mention here that the XOR gates in the pin-monitor circuits are contained in IC1, IC2, IC5, and IC6, while the S-R flip-flops are contained in IC3, IC4, IC7, and IC8.) Just

will turn on transistor Q_N , and thus the LED. Resistors R_{AN} and R_{BN} isolate and protect the analyzer circuits while R_{CN} and R_{DN} limit current flow.

When switch S17 is in the STORE position, the flip-flop can be reset manually using the PULSER switch, S19. When S17 is not in the STORE position, the flip-flop is continually reset by a 100-pps pulse train.

Placing S_N to the IN position, connects pin A_N to pin B_N , so that an in-circuit IC can be compared to an out-of-circuit test IC.

The analyzer has a built in pulse stretcher and pulse generator. Both of those functions can be connected independently to any pin on the IC under test. The pulse stretcher will allow a single pulse or a fast pulse train can be caught and displayed on a separate LED. It is highly sensitive to true logic changes but is immune to low-level noise.

A block diagram of the pulse stretcher is shown in Fig. 4, and its schematic is shown in Fig. 5. As you can see, it uses five of the Schmitt-trigger inverters of IC9. The DC level on the input pins 13 and 11 of that IC is held midway between the switching point by R3 through R7, and diodes D3 and D4.

A negative transition discharges C27 and pulls pin 13 low. The capacitor is then charged through R3 until D3 conducts. The time constant of R3 and C27 coupled to the Schmitt trigger, produces a positive pulse of sufficient duration to then trigger the monostable flip-flop made up of R8, R9, C31 and two inverters, IC9-a and IC9-b. When triggered, output from pin 4 of IC9 will go and remain high for approx-

keep it in mind when you go through the Parts List.

When switch S_N is in the OUT position, the logic level on pin A_N is compared with logic level on pin B_N by the EXCLUSIVE OR gate. If the two levels are different, the high output will set a 4043 flip-flop. Pulses less than 800 ns are considered glitches and are filtered out by R_{FN} and C_N .

A high output from the 4043 flip-flop

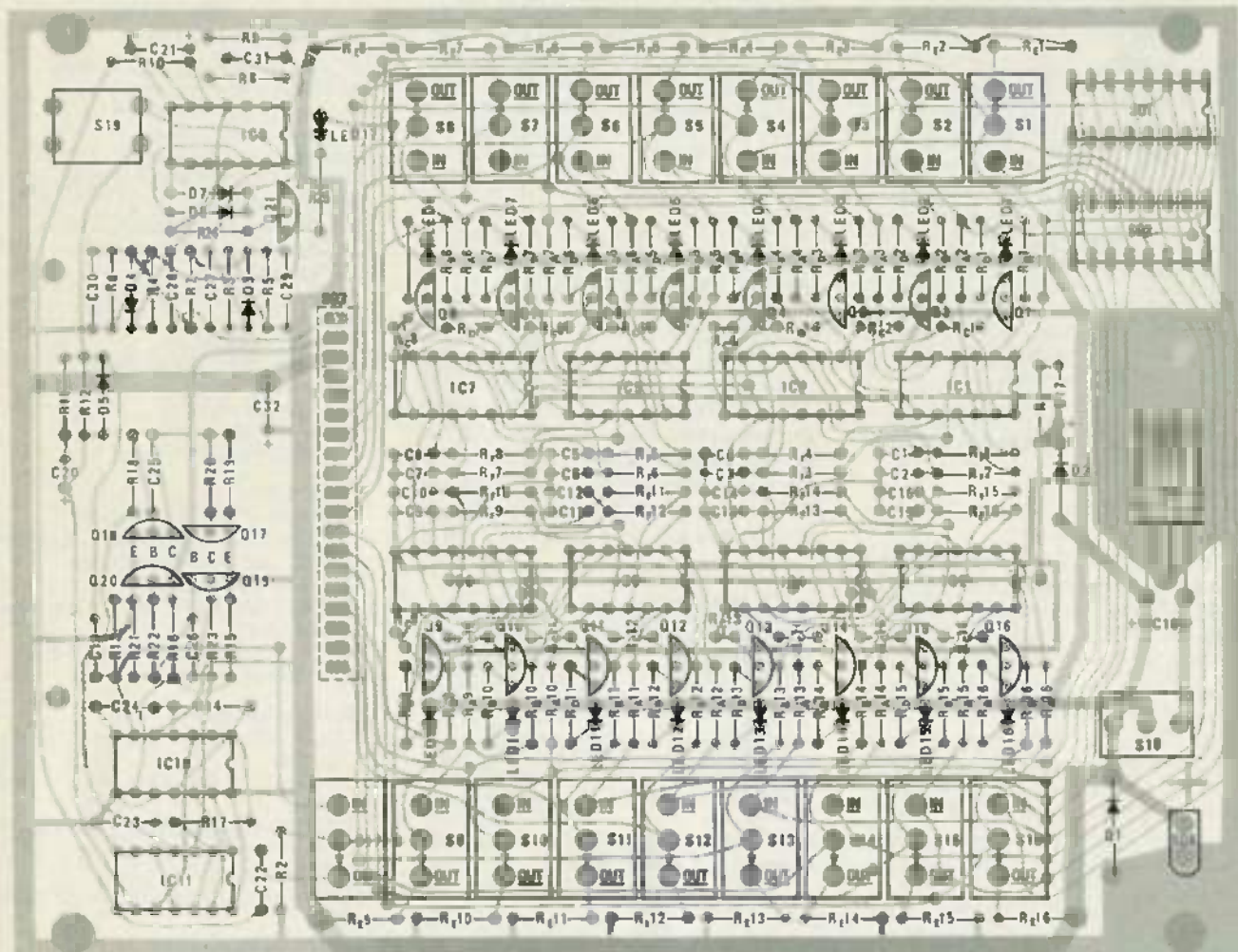

FIG. 9—PARTS PLACEMENT DIAGRAM FOR THE MAIN BOARD. Note SO7, the connection to the B-socket board.

itself by R14 and C24 producing a positive pulse of a few microseconds. That positive pulse latches the external circuit level sensed by IC10-b and, after a slight delay produced by R17 and C23, drives NAND gates IC11-a and IC11-d

If the external circuit is high, the Q output of IC10-b will be high allowing IC11-a to turn on the negative-drive circuit containing Q19 and Q20. Conversely, if the external circuit is low, Q will be high which will turn on gates IC11-d and IC11-b, and then the positive drive circuits containing Q17 and Q18.

The final part of the analyzer's circuit are two plugs, each of which contains 16 identical resistors mounted on a header with all resistors connected to a common lead. The "shorting" plug uses 220 ohm resistors while the "pull-up" plug uses 150K resistors. The schematics of the plugs are shown in Fig. 8.

Building the IC analyzer

The easiest way to build the analyzer is to use printed-circuit boards. See our new "PC Service" section starting on page 81 for foil patterns for a double sided board.

A parts-placement diagram for the 5x6½-inch board is shown in Fig. 9. That main board contains all the analyzer's active circuitry. (We'll also need a second board, called the B-socket board, but we're getting ahead of ourselves.)

In the author's prototype, the 18 IN/OUT slide switches determined the front panel height above this board. Mount a switch and measure this distance. For the unit shown, the distance is 0.35 inch. Make sure that all components that are not supposed to extend above the panel, are installed no higher than the switches. This will require careful assembly and selection of parts. Keep in mind, however, that you can mount switches to the front panel and use point-to-point wiring to connect them to the board. That will make your component sizes less critical. A cover for the analyzer is not absolutely necessary, but you must find some way to protect the circuitry from shorts or mechanical damage.

Install the 17 LED's first. They should extend above the panel by ¼ inch, and their height should be as even as possible. That can be accomplished by making a

mounting jig. A simple strip of aluminum ¾ inches long and ¼ inch high can be placed between the LED leads before soldering. After soldering, the strip is removed, leaving the LED's at a uniform height.

The two "A" sockets, SO1 and SO2, must also be installed about ¼ inch above

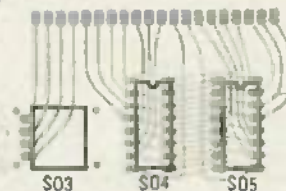
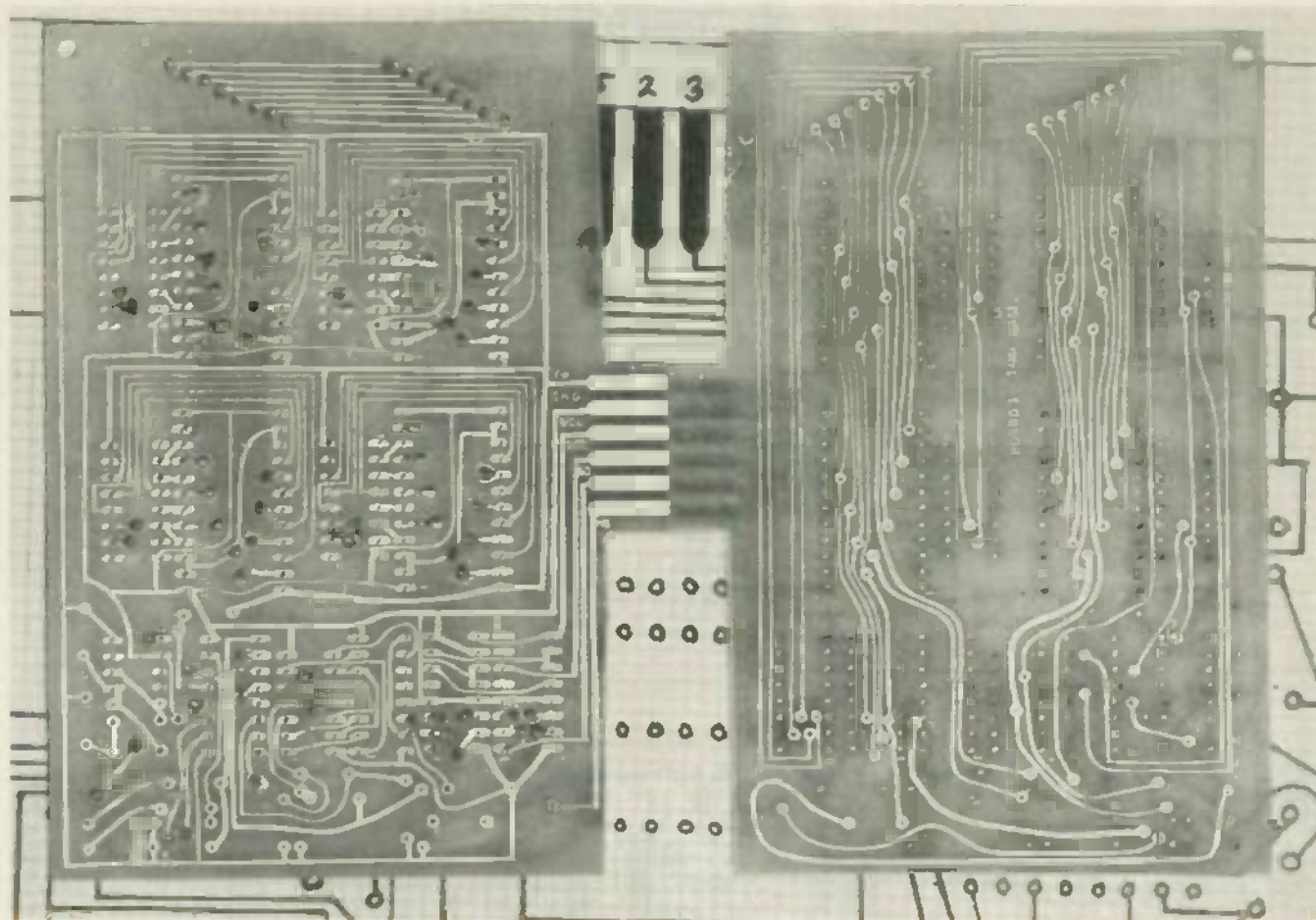

FIG. 10—THE B-SOCKET BOARD parts placement. Note that SO3 is a small solderless breadboard socket.

the PC board so that they protrude about ¼ inch above the panel. Wire wrap IC sockets have the necessary pin length for such above-board mounting. Excess pin length should be trimmed even with the bottom side of the board.

continued on page 101



Designing Double-sided PC Boards

Making a double-sided PC board can be child's play when compared to designing the board's layout. Here are a few hints to make your design easier.

ROBERT GROSSBLATT

ALL ELECTRONIC DESIGNS, FROM THE SIMPLEST light dimmer to the most sophisticated satellite, go through the same three basic stages of development. First, the idea must be thought up, the circuit must be wired up, and then everything must be finished up.

All the electronics technology in the world can't help you much with the first of those. Coming up with an idea is always the most difficult step.

Wiring up the circuit on a breadboard is pretty much standard fare. If your design is sound, any problems that crop up in the breadboard stage can usually be corrected without too much difficulty.

Finishing up a design, however, can be almost as difficult as thinking up the idea. In this article, we're going to concentrate on the most difficult part of finishing up a design: laying out the PC board.

The same advancements in IC technology that simplified the circuit design have made printed-circuit design more difficult. Reducing the component count of a circuit to ten IC's and two resistors is great in electronic terms. But any notion you might have of getting it all on a single-sided board should be thrown out the window. Modern electronic design means double-sided (or even multilayered) PC boards. That unalterable fact has led to a resurgence of point-to-point wiring—an ancient construction technique that PC boards were supposed to replace! You can't whip out a PC layout for a double-sided board with quite the same mad abandon as a single-sided one. There's no getting around the fact that the job is more complex and will take a lot more time, attention, and planning to do properly.

To illustrate the process of making a PC

board, we need a sample circuit. The circuit we'll use is one that generates a time-base and calculates the rate of an input signal. The circuit's function isn't really important to us here; we just need some example to start with.

The schematic of the circuit we'll use as an example is shown in Fig. 1. (*Editor's Note:* You may recognize the circuit as a subsystem of the heart-rate monitor presented in the September 1982 issue of *Radio-Electronics*.) Again, don't bother yourself with the details of how the circuit works. All that's important to us is how to design a PC board.

You can't design a PC board just from the schematic. You have to make a block diagram first—you'll use it as a starting point for your board design. Even if you made a block diagram before you started your schematic (which you *should* do),

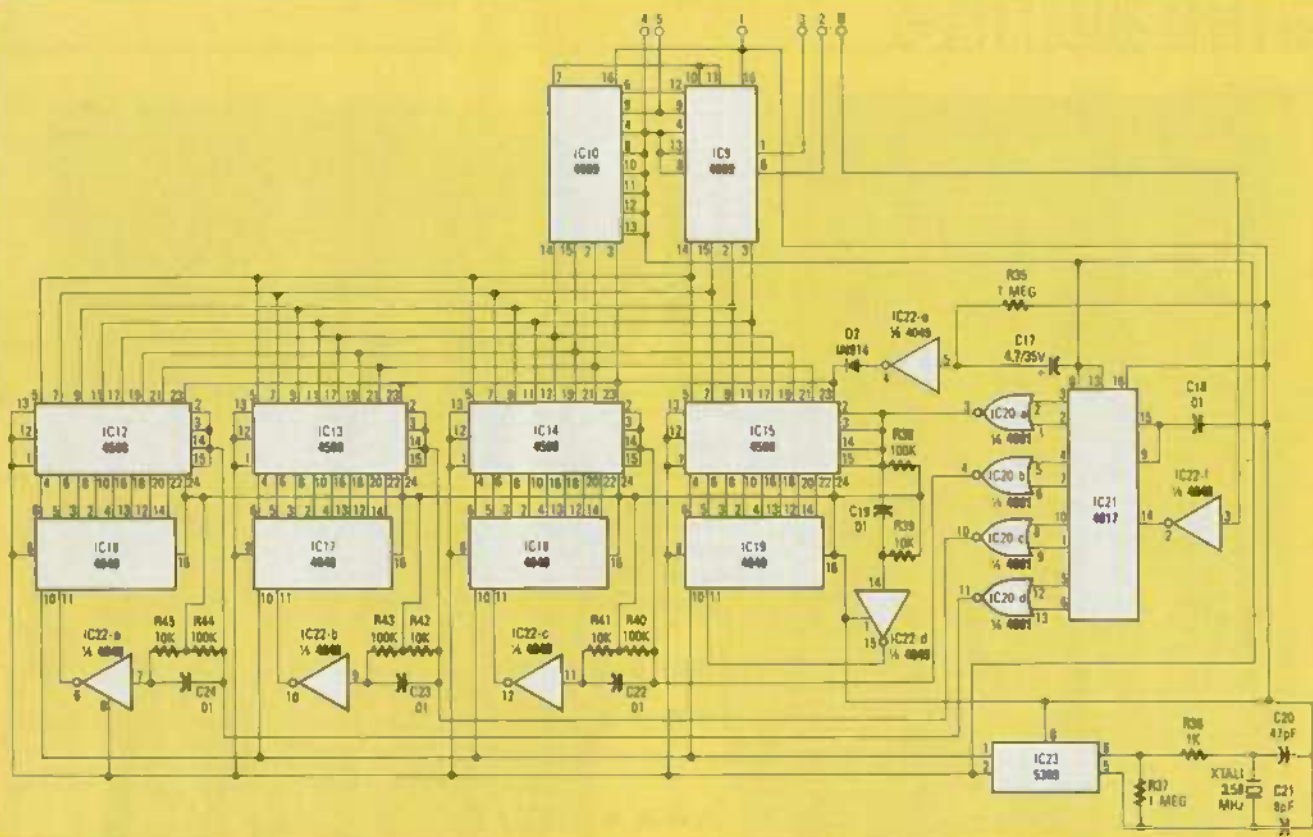

FIG. 1—THE SCHEMATIC OF THE CIRCUIT we'll be using as an example. Don't worry about what the circuit does or how it works.

you'll want to do another one so that you can include IC numbers, etc., as shown in Fig. 2.

Getting started

There are lots of ways to generate double-sided layouts, but all methods have one common goal: to make sure that registration is maintained between the two sides of the boards. The method we're going to describe will give you the high precision that you need while still taking into account the realities of dealing on a home workbench. The supplies you'll need are listed in Table 1. You can find them at any good drafting supply store—except, possibly, the last item.

TABLE 1—SUPPLIES FOR PC BOARD LAYOUT

1. Non-Reprou Blue pencils for drawing in the layout.
2. A pad of ten-to-the-inch graph paper.
3. Several erasers of various sizes and shapes.
4. A good pair of drafting dividers.
5. Large, clear plastic triangles.
6. A ruler with 1/16-inch markings.
7. The actual components you plan to put on the final board.
8. Printed circuit board graphic aids (doughnuts, tape, etc.)
9. Transfer type lettering to label components on the board.
10. A roll of stick-on registration marks.
11. A bottle of correction fluid.
12. A lot of patience.

Your success with a double-sided layout—or a single-sided one, for that matter—depends on how well you understand the particular requirements of your circuit. Current draw, spiking, generation of heat and RF, etc. will determine how you go about routing the traces on the board. Before you start, you should ask yourself:

1. Do some sections require high current?
2. Is RF handled on the board?
3. Will some components get unusually hot?
4. Is there current spiking?
5. Does the final board have to be a particular shape?
6. How is the board I/O going to be handled?
7. Et cetera.

Of all those considerations, the seventh is the most important because each circuit has its own set of operating peculiarities. A workable layout depends on knowing what your circuit wants and doesn't want. The chances are that if your breadboard version is working, most of those questions have already been answered. But be careful. We've seen PC boards that were total clones of the breadboard—but the circuits built on them did nothing but drain the battery. Problems due to such things as inductance, heat transfer, and crosstalk won't show up in continuity checks. There are few things in life more frustrating than a PC layout that connects

the right traces to the right pins of good components...but doesn't work.

What to do first

Once you've decided on the size and shape limitations of the board, you're ready to start planning the actual layout. Draw an actual-size outline of the planned shape on a piece of graph paper. You should use graph paper with 0.1-inch spacing. It's a perfect guide because all the components you'll be using—except for some oddball parts and edge connectors—are based on 0.1-inch spacing.

If your I/O has to appear at a particular place on the board, now is the time to draw it in. The same is true with LED's, and any other indicators that you might be using. At this point, don't worry about which of the connectors go where; you can take care of that later. All you want to do now is decide on the general topography of the layout.

After you decide on the position of all the components that *have* to be at particular places on the board, it's time to decide how all the rest of the components should be laid out. You can not simply place the parts anywhere on the board you like; there are two types of considerations to help you decide how to lay things out. The first is electronic, and the second is aesthetic.

Components that are part of a subsystem should be physically close to each

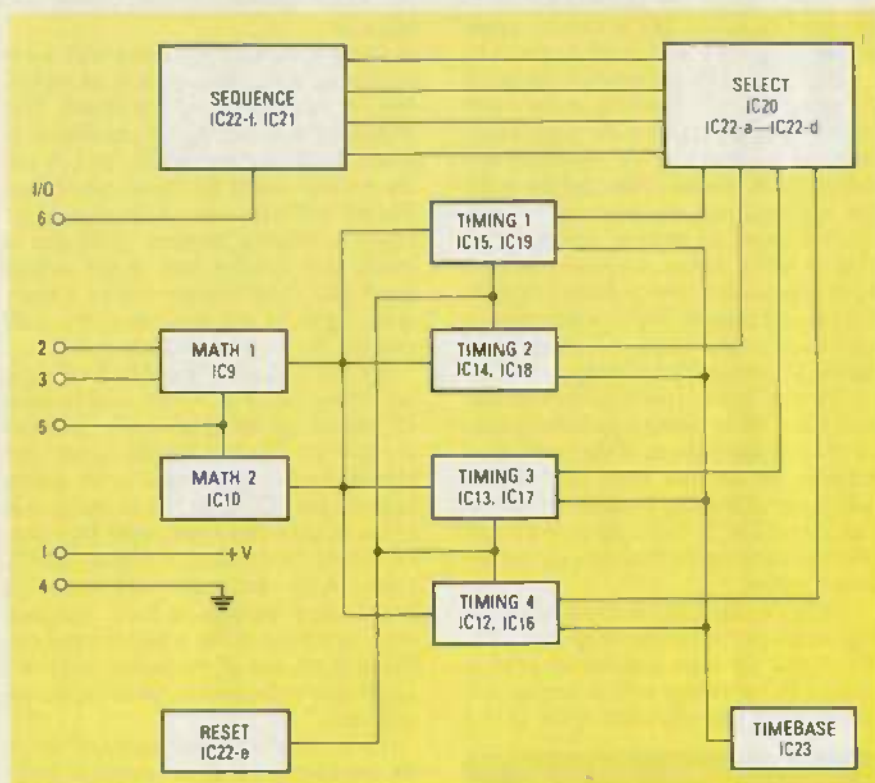

FIG. 2—A BLOCK DIAGRAM OF YOUR CIRCUIT is essential if you want to make an orderly layout. Even if you draw one before drawing your schematic, do it again, including IC numbers, etc.

other. There are probably quite a few of interconnections between the parts of a subsystem, so the PC pattern is going to be much easier to generate if those parts are grouped together. Some sections of your circuit may draw excessive amounts of current, require physical RF shielding, or something else that would dictate their position on the board. We can't give you a full list of considerations but we can give you a general guideline: When in doubt, do! In other words, if you're not sure whether components have to be near each other and it won't hurt anything to do it, go ahead and do it!

The second type of consideration is just good practice: The components should either face in the same direction or be exactly perpendicular to each other. It's much easier to connect common pins along even rows of IC's. You'll also find it easier to keep track of component groups, and, in general, the board will look a lot better.

The best way to group the components is by function, and the best guide for that is the block diagram you've made (or should have made) of your circuit. Using a block diagram makes it a lot easier to delegate board space and to lay out the traces a section at a time. Doing it section by section is going to make it much easier when a part of the design has to be revised.

As you draw each component on the board, keep the IC's at least three tenths of an inch apart. You should really start with a much greater distance; it can al-

ways be reduced later. Remember that nothing you've done at this stage of the game is carved in stone. The drawing you've made does three things: It shows whether all the components fit on the board, it serves as a guide for the final layout, and it tells us how to route the traces for each section.

Knowing how to route the traces is particularly important because of the approach we have to use in doing the final layout. You can't assume that your final layout will look anything like your first layout. The only sensible approach is treat each section as a separate circuit, with connections for power, ground, input, and output. Your first layout, however, gives you a general map of the final board, so you at least know in which direction to route the traces. Designing the power-supply section of the board with all the traces coming off to the left is useless if the rest of the circuitry is to the right!

The actual layout

The first step in doing the actual layout is to get a piece of graph paper at least four times larger than the board. That's because we're going to draw both sides of the board on the same piece of paper and we're going to work double-size. When you're doing a single-sided layout, there's

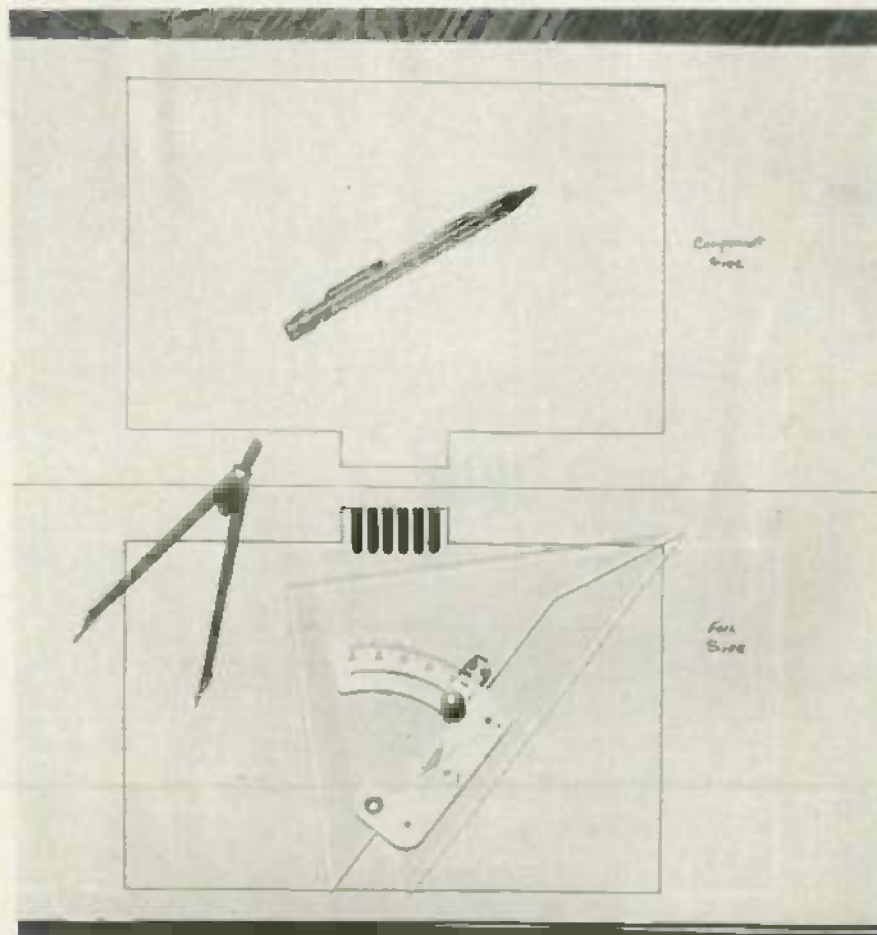

FIG. 3—ONLY THE CIRCUIT I/O is drawn in to start. Any other circuitry that has to be near the edge of the board should be drawn in also.

usually enough room for a bit of slop and actual-sized layouts are possible. But double-sided layouts require a degree of precision that's impossible unless you work at least double size. And even that may not be enough for a really tight layout. Some boards need a pattern so complex that everything will have to be redone three or four times the actual size. It's not necessary to make that decision immediately because it soon becomes evident if you have to go up in magnification.

Take the graph paper and draw a horizontal line across the middle using as fine a black pen as you have. That line will serve as the baseline for the layout. Find the line on the graph paper that's a half an inch (five divisions) below the baseline. That's where you will draw the top edge of your board's bottom (solder) side. Now go up a half an inch from the baseline and draw a line to represent the top edge of your board's top (component) side. Once you have those lines located, you can draw a double-sized outline of both sides of your board with the same black pen you used to draw in the baseline.

You can use the divisions on the graph

paper as a guide for locating the other edges of the board, but be careful! Some graph paper isn't as accurate as it looks!

The secret to a successful double-sided PC layout can be summed up in one word: registration. By dividing the graph paper into two sections, we've effectively unfolded the PC board so we can look at the top and bottom of the board on the same sheet of paper. In order to keep registration on the PC layout, we have to be able to exactly locate corresponding points on the top and bottom. Registration errors at this stage of the game are going to be harder to correct further along.

The only way to guarantee the registration when we're locating the same points on the top and bottom of the board is to transfer the distance from the baseline with a pair of drafting dividers, which you can see in Fig. 3. Let's get to work and start the layout of the board so we can see how it's done.

There's no hard-and-fast rule for deciding which part of the circuit to start with. We found the least amount of grief is caused by beginning with a section that has to directly handle some of the I/O on

the board—display drivers, power supplies, etc.

One good choice is to start with some components that have to look at signals that are fed in from off the board. That includes things like switch circuitry, keyboard decoders, bus signals, and so on. As you start doing the layout, you'll find that the real estate around the edge of the board is valuable property. With that in mind, take another look at the actual-sized placement diagram you've already done. Now is the time to move stuff around. It's a lot harder later on.

By this time you should be looking at something like Fig. 4, the double-sized PC outline on the graph paper. You can see that the I/O and IC placement have already been drawn. Draw in the solder pads for the I/O on the foil (bottom) side of the board using a non-repro blue pencil. Using the dividers, locate the SAME points on the component (top) side of the board, draw the pads in there, and then draw an outline of the actual component. Measure the size of the device and don't forget that we're working at twice the actual size.

We're drawing in the components so we can keep track of the available space on the top side of the board. When we start routing traces there, we're going to be doing some fancy navigating to keep the traces from running into IC's, resistors, and so on. As we keep adding components to the layout, we'll be doing that as a matter of course. Every time we put a pad on one side, we're going to draw it on the other side as well. And we'll be doing all the drawing in non-repro blue until the final design is done. The last step will be to go over everything in black—either with a pen or any of the stick-on graphic aids.

Routing the traces

As you can see in Fig. 4, there are six I/O connections on our board. Those edge-connector fingers are placed in the middle of one side because of size and space requirements on the motherboard to which this board connects. Three of the card-edge fingers go directly to two IC's on the board, so those two IC's are a good place to start.

As you start drawing traces, try to keep them as straight as possible. If you have to change direction, use drafting tools and make the angles definite rather than free-hand curves since this is going to make it much easier when you actually tape up the final layout.

That's all we have room for this month. In the concluding part of this article, we will give you some more guidelines that can help make designing a double-sided board much easier. We'll also show you some of the pitfalls that can crop up in doing the design, and how to best avoid them.

R-E

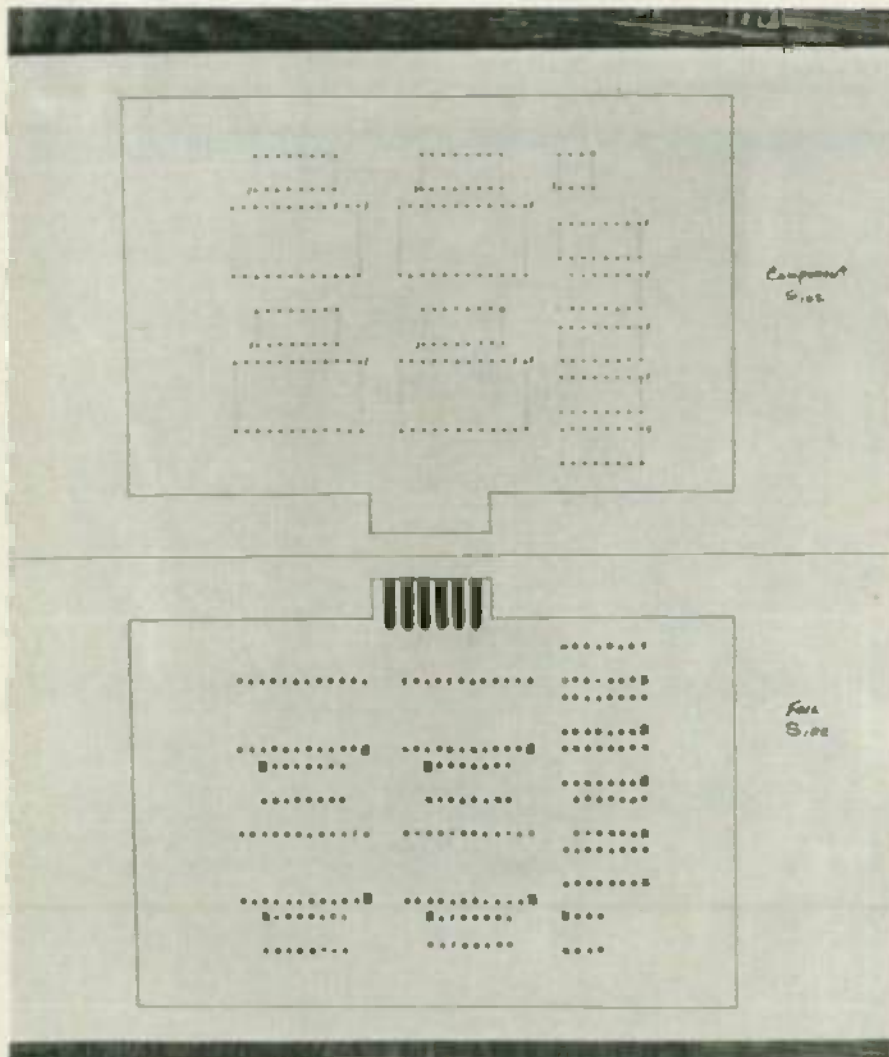
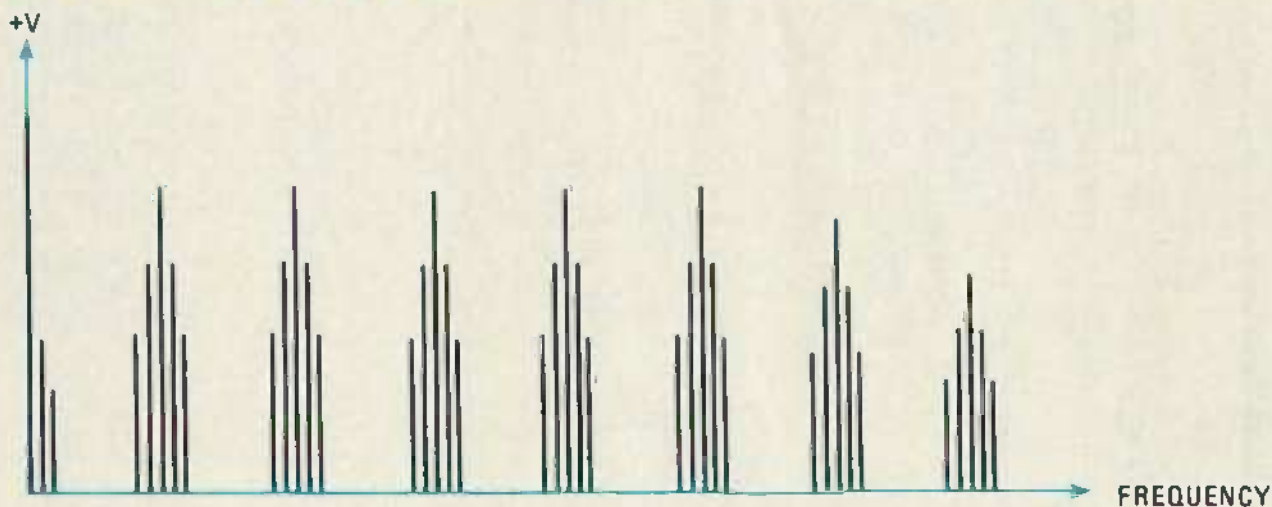

FIG. 4—A DOUBLE-SIZED LAYOUT showing the component placement. You can normally expect to change this layout as you go on.



COMB FILTERS for your TV

Learn all about comb filters, how they work, and how they can be used to improve the performance of your video system.

NEIL W. HECKT

Part 2 LAST TIME, WE COVERED some of the basic principals behind the comb filter. We also looked at two devices, the PW600 and the TDA3301, that could be used to implement such a device. This month we'll take things one step further and show you an experimental NTSC decoder you can build that uses comb filter techniques.

An experimental decoder

The schematic diagram for our experimental decoder is shown in Fig. 11. The NTSC input of 1-volt P-P, negative sync, is AC coupled by a 10 μ F capacitor (C1) to a voltage divider (R1, R2) which supplies a DC bias of 3.4-volts to the PW600 input, pin 3.

A 3.58 MHz color-burst reference, taken from the TDA3301 crystal oscillator, is applied to pin 7 of the PW600. The amplitude of that signal is 0.8-volt P-P, which was found to be just the right amount to run the PW600. It was necessary to place a 27-pF capacitor (C5) directly across pins 7 and 8 of the PW600 to ensure system lock-up. For the color-burst reference, the PW600 and TDA3301 are connected in a loop. The PW600 requires a locked 3.58-MHz burst to correctly separate the chroma signal, and the TDA3301 requires a correctly separated chroma signal to lock on the 3.58-MHz burst reference. The two essentially get together by bootstrapping the burst reference. Adjustment of the 3.58-MHz crystal tuning ca-

pacitor was initially critical, and the inclusion of C5 greatly accelerated the loop capture and made tuning of the crystal capacitor far less critical.

The luminance output, which is taken from pin 15 of the PW600, has a DC bias of 7.5-volts. An emitter follower (Q1) was included as an impedance match to the TDA3301. The 1000-ohm potentiometer (R6) in the emitter circuit serves as a luminance level preset and should be adjusted to produce a 1-volt P-P input at pin 37 of the TDA3301.

The chrominance output, which is taken from pin 1 of the PW600, has a DC bias of 4.7-volts. A PNP emitter follower was used to buffer the chroma output of the TDA3301. It is AC coupled to a 1000-ohm potentiometer, which serves as a chroma level preset and should be adjusted to provide 100-mV P-P at pin 1 of the TDA3301.

That is all there is to connecting the PW600. Just that much of the circuit could be added to any color-TV set to gain the improvements of the comb filter. A tap off the video detector, after the sound trap (which provides 1/2-to 1-volt P-P negative sync video), can be connected to the NTSC input. The luminance and chrominance outputs could then be connected to the normal luminance and chrominance inputs of whatever color-processing circuits are contained within the set. The TV set must also supply the needed voltages (-10 and +24 volts DC).

The PW600 comes factory-adjusted; however, if adjustments are needed, there are three that can be made. Those are shown in Fig. 12. To couple the circuit to an oscilloscope, loop one turn of wire around C23 on the module, and connect the free end to the scope. The three adjustments involve L6, L10, and C_{ADJ} (once again, those are part of the module itself); the positions of those components are shown in Fig. 12. Adjust L6 and L10 for the maximum signal at 10.74 MHz; adjust C_{ADJ} for minimum P-P horizontal sync as shown. For best results, any adjustments should be made in small increments, no more than a quarter turn at a time.

The TDA3301 provides a 3-volt P-P inverted luminance output at pin 35. One half of that is coupled to pin 36, which sets the value of luminance in the RGB outputs. The three-volt signal is also ideal to run a sync separator.

The three-volt output is AC-coupled to the base of a common-emitter transistor switch (Q8) that acts to clamp the positive-sync tips to slightly above ground. The transistor then acts as a switching amplifier, conducting for the sync tips only. The output is a squarewave representing the sync portion of the incoming luminance.

An MM74C221, dual one-shot (IC3), produces the sandcastle pulse. (Sandcastle pulses are used in color sets for black-level clamping of the luminance signals, burst keying, blanking, and chrominance

FIG. 11—THIS CIRCUIT CAN BE USED TO CONVERT AN NTSC INPUT INTO RGB SIGNALS. At the heart of the unit is a PW600 comb-filter module, which is used to derive the chrominance and luminance information from the input signal.

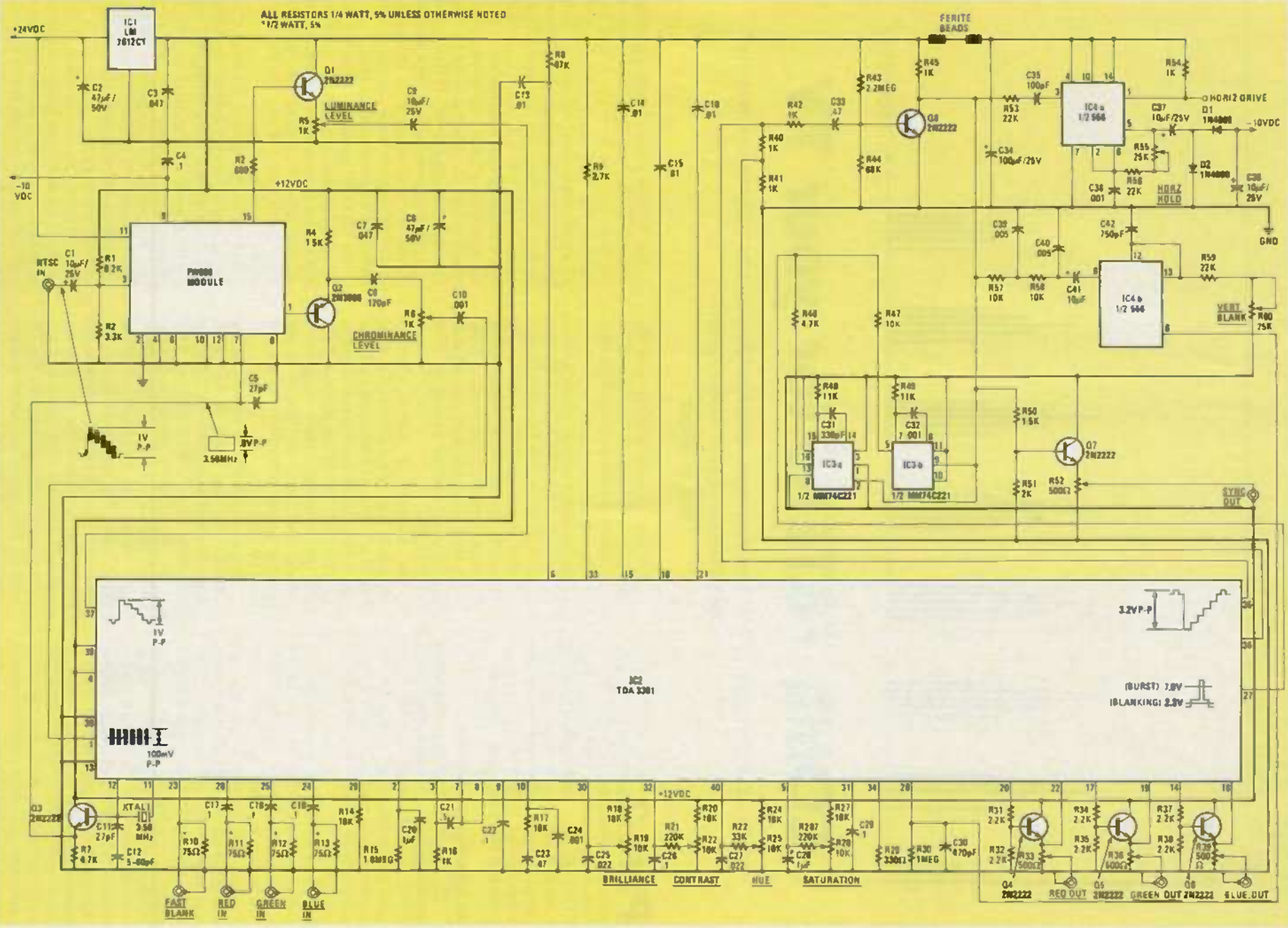

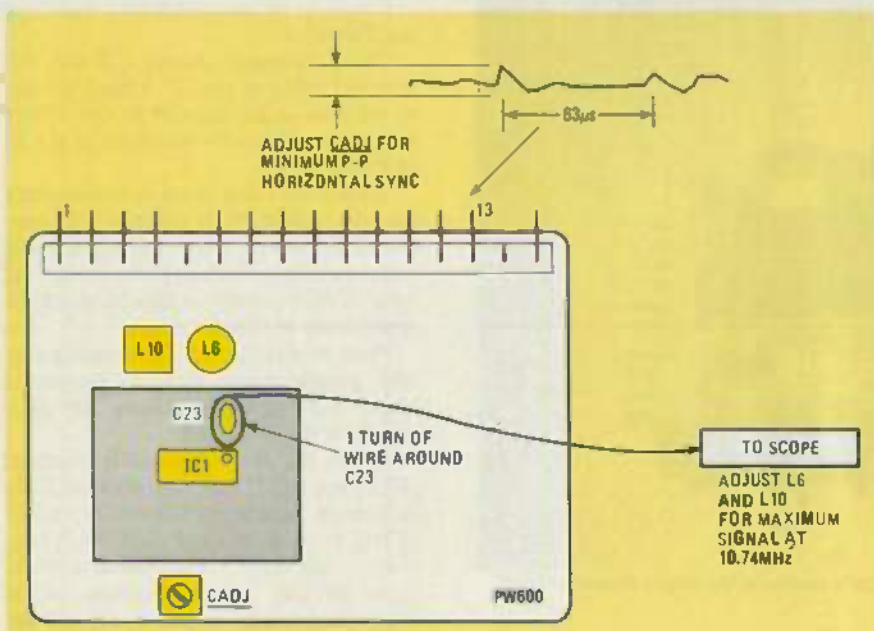

FIG. 12—IF THE PW600 requires adjustments, they can be made as shown here.

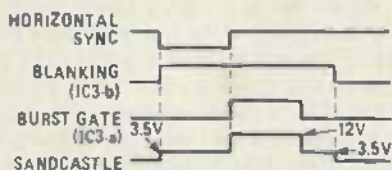

FIG. 13—THE HORIZONTAL SYNC, blanking, and burst gate pulses are used to derive the sandcastle pulse.

channel gating.) On the leading edge of a horizontal-sync pulse, IC3-b triggers, producing a 10- μ s horizontal-blanking pulse. On the trailing edge of the horizontal-sync pulse, IC3-a triggers, producing a 3- to 4- μ s burst-gate flag. The two one-shot outputs are added by R46 and R47 to produce the sandcastle (see Fig. 13). When neither one-shot is running (during active display time), the voltage at pin 27 of TDA 3301 is zero. When the blanking one-shot fires, the 12-volt output is divided by the resistors to produce a 3.5-volt blanking level at pin 27. When the burst one-shot fires, the blanking one-shot is still running. The voltage at pin 27 is then 12 volts. The specified blanking and burst thresholds of the TDA3301 are 2.3 volts and 7.5 volts.

An NE556 dual timer (IC4) is used as a horizontal-oscillator/ -10-volt power supply (IC4-a) and vertical-blanking one-shot (IC4-b).

Looking first at IC4-a, it is a free-running relaxation oscillator with a frequency of about 15,734 Hz. That frequency is set by R55, R56, and C36. The output from pin 5 has substantial current drive capability, and runs a "charge-pump" circuit composed of C37 and C38 and two 1N4000 diodes (D1 and D2). The output of that circuit is approximately -10-volts DC, which is used to satisfy the PW600's -10-volt DC power requirements. The

oscillator is designed to be free-running so that that voltage will be generated with or without an input signal. The oscillator output is synchronized with the horizontal-sync signal via a 100-pF differentiating capacitor (C35) that instantaneously reduces the threshold voltage of the 556 timer at the leading edge of the horizontal-sync pulse. That is done so that any noise generated would tend to appear during horizontal blanking.

The other half of the 556, IC4-b, is connected as a one-shot. It is triggered by a conventional vertical-sync integrator (R57, R58, C39, and C40).

Since vertical sync is not required by the television monitor, why bother to detect it at all? The TDA3301 has a beam-current limiting circuit built in that samples only during vertical blanking. Without a vertical-drive input, the IC's output amplifiers assume an over-current condition and refuse to output anything. The TDA3301 can have the vertical blanking applied either to pin 27 as a super sandcastle pulse or directly to pin 28. For this circuit, we chose to apply it directly to pin 28 as that was the simplest method.

Two ferrite beads were required on the +12-volt DC supply line to the 556 in order to eliminate noise from the video output.

The sync output-amplifier is an emitter follower (Q7). Divider resistors R50 and R51 limit the output to about 5 volts P-P, which is suitable for most computer RGB monitors.

Oscillator and chroma section

Normally, the crystal oscillator consists of a crystal between pins 11 and 12, and a 12-pF capacitor from pin 12 to ground. The TDA3301 will operate without adjustment to the oscillator even when

using low-grade crystals; however, it is necessary to "tap" the 3.58-MHz sine-wave from the oscillator in order to drive the PW600. Emitter-follower Q3 is connected to pin 12. Since the resulting shunt capacitance of the emitter follower is unknown, a 5-60-pF trimmer capacitor (C12) is placed in series with a 27-pF capacitor (C11) to limit its range to a value of about 4- to 18-pF.

Normally the delay-line driver outputs (pins 3 and 4) are used to drive a PAL delay line to generate the U and V (color demodulator) inputs (pins 7 and 8). In this application, the collector of the delay line driver (pin 4) was connected to +12-volts DC, and an emitter load of 1000 ohms was placed in the driver emitter-circuit (pin 3), converting it to an emitter follower. The chroma information at pin 3 was then AC coupled to the U and V inputs by C21. That operates the color demodulators in the R-Y, B-Y mode.

On-screen display inputs

The on-screen display inputs are terminated in 75-ohm resistors. The high-speed blanking input is DC coupled and has a threshold of 0.7 volt. The RED, GREEN, and BLUE inputs are AC coupled and accept inputs of 0.7 to 1.0 volt P-P. Each of these inputs has a 9-MHz bandwidth.

Control section

The brightness, contrast, hue, and saturation inputs are all derived from similar circuits composed of 18K dropping resistors and 10K potentiometers. Those provide approximately zero to five volts-DC to each of the inputs.

The effective range of the brightness input is 1- to 4-volts DC, the contrast input 1- to 4.5-volts DC, the hue input 2- to 4-volts DC, and the saturation input 0.2- to 4.5-volts DC.

Output section

The output stages consist of emitter followers (Q4, Q5, and Q6). The TDA3301 expects to see a feedback voltage of about one half its output. Resistor networks such as R31/R32 divide the outputs by 2. The feedback is taken from the output of the emitter followers. Those provide about two-volts P-P maximum when adjusted to full level. Note that there is about a two-volt DC bias on the outputs. If the monitor to be driven has direct-coupled inputs, it may be necessary to add 10 μ F/10-volt electrolytic capacitors in series with the outputs. The vast majority of monitors are AC-coupled, however.

Normally a delay line would be connected between pins 35 and 36; however, the PW600 unit does not require a delay line. The normal function of the luminance delay line is to compensate for the delay introduced by the chroma bandpass filter. There is no equivalent filter in a comb-filter system.

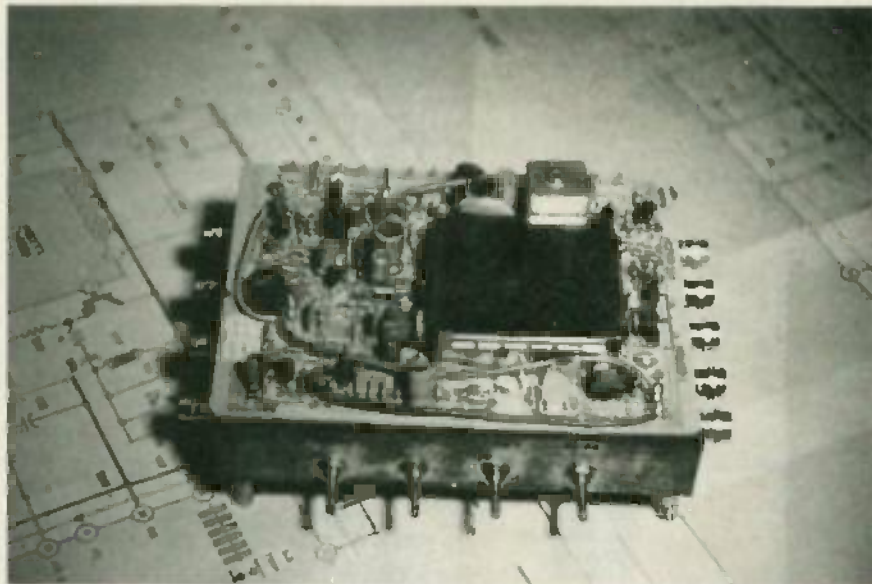

FIG. 14—THE AUTHOR'S PROTOTYPE. Here is the author's version of the circuit shown in Fig. 11.

Building the decoder

Figures 14 and 15 show the completed decoder. The TDA3301 and its associated circuitry were mounted on a piece of perforated construction board. The layout of the board is not critical. As usual, we recommend using IC sockets. The board and the PW600 were mounted on a home-made chassis made from scrap copper-clad solid stock. Once again, that is not critical, so the board and the module can be mounted in any enclosure that is convenient.

Completely wire the TDA3301 and supporting circuits before connecting the PW600. The TDA3301 and supporting circuits can be fully tested without the PW600 installed.

Checkout

Before installing any of the socketed

IC's, run a preliminary power-supply check. With 24-volts DC applied, check the output of IC1 for +12-volts DC. Next, install IC4. Check for -10-volts DC across C38.

Next install IC2 and IC4. Connect a jumper from the junction of R1 and R2 (which will connect to pin 3 of the PW600) to the open end of R3 (which will connect to pin 15 of the PW600). That uses the network of R1/R2 to bias the emitter follower Q1 and couples video to the TDA3301 for luminance and sync tests.

Apply 1 volt P-P video from a color-bar generator or videotape player to the NTSC input. For a videotape player use the frame-freeze mode to provide constant waveforms for the oscilloscope.

Adjust the luminance preset (R5) for 1 volt P-P at pin 37 of the TDA3301. (That

will have to be readjusted after installing the PW600.)

Check for approximately 3.5 volts P-P inverted video at pin 35. Check for detected sync at the collector of Q8. Check for proper sandcastle waveform at pin 27 of the TDA3301.

Assuming everything is satisfactory thus far, adjust the horizontal hold control, R55, until the horizontal-drive signal at pin 1 of IC4 is locked to the horizontal sync. If there are any problems, check the appropriate wiring for errors.

Next, adjust the vertical-blanking control, potentiometer R60, to produce a pulse width of approximately 200 μ s at pin 28 of the TDA3301.

Adjust the brilliance (R19), contrast (R22), hue (R25), and saturation (R28) to half range. Adjust the RED (R33), GREEN (R36), BLUE (R39), and sync (R52) controls to full range. You should now observe positive video waveforms at the RED, GREEN, and BLUE outputs and approximately 5 volts P-P sync at the sync output.

Adjust the RED (R33), GREEN (R36), and BLUE (R39) levels to 1 volt P-P output each. That will set the RED, GREEN, BLUE drive levels equal so that white should result. If a TV monitor is connected to the RED, GREEN, BLUE, and sync outputs, a Black-and-White picture should be visible.

Finally, check for an approximately 0.8-volt P-P, 3.58-MHz signal at the emitter of Q3.

If all is fine, it is now time to connect the PW600. Once that is done, apply power and check for +24-volts DC at pin 11 and -10-volts DC at pin 9. Check for a luminance signal at pin 15 and a chrominance signal at pin 1. If the signal source is a colorbar generator, the waveforms are predictable and should be similar to those shown in the schematic (Fig. 11).

Adjust R5 for 1 volt P-P at pin 37 of the TDA3301, and adjust R6 for 100 mV P-P chrominance at pin 1 of the TDA3301 color demodulator.

Connect a color-TV monitor to the RED, GREEN, BLUE, and sync outputs and adjust C12 for color lock. Adjust the brilliance, contrast, hue, and saturation controls as you would on any color-TV set. You should now have an excellent picture and alignment is complete.

If the TDA3301 is not phase-locked to the color burst, the outputs at pins 1 and 15 of the PW600 will not be distinct on an oscilloscope. Adjust C12 until they appear as clean luminance and chrominance signals.

That completes the construction and adjustment of the unit. For the best possible picture, use the circuit with an RGB color monitor—such as those used in computer applications—that has very wide bandwidth video amplifiers with no sound or chroma notch filters. R-E

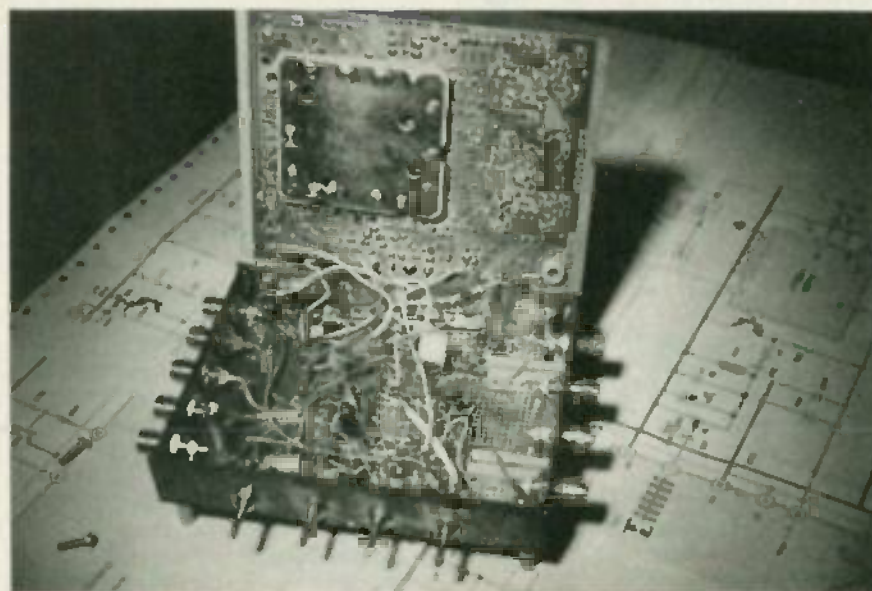

FIG. 15—INTERIOR VIEW of the NTSC decoder. The author mounted the PW600 and the board on a chassis made from scrap stock.

DESIGNING WITH DIGITAL IC'S

This month we learn more about flip-flops, and how they can be combined to form shift registers.

JOSEPH J. CARR

Part 6 LAST TIME WE LEARNED about some basic flip-flops. As we saw then, a flip-flop is a bistable device, meaning it can remain in either of two output states (set or reset). In the set state, the Q output is high, and \bar{Q} is low.

There are four kinds of S-R flip-flops: NAND-logic S-R flip-flop, NOR-logic S-R flip-flop, clocked S-R flip-flop, and master-slave S-R flip-flop (also called a load/transfer flip-flop). The NAND and NOR S-R flip-flops are similar to each other, except for the "polarity" of the inputs (NAND-logic uses active-low inputs, while NOR-logic uses active-high inputs). In both types, a brief active signal to the S input forces the set condition, while a brief active signal to the R input forces the reset condition.

The clocked S-R flip-flop is an S-R flip-flop that uses a third input called clock. (Since the clocked S-R flip-flop is fashioned from NAND gates, its inputs are always active-high.) The clock input must be high before the circuit will respond to signals at the R and S inputs.

The master-slave (or load/transfer) flip-flop is another special case of S-R flip-flop. In that type of flip-flop, the R and S signal commands are stored in the flip-flop when the clock is low, but do not affect the output state until the clock input goes high. The clock input on that type of flip-flop is sometimes called the LOAD/TRANSFER or LT input.

The T flip-flop

The T flip-flop, shown in Fig. 1, is a cross-coupled master-slave flip-flop. In that circuit, the clock input is renamed the T input (for toggle). The T flip-flop is used primarily for binary division (divide-by-2). That is, the frequency of the output is exactly half the frequency of the T-input signal. That action occurs because the output of a T flip-flop changes only on the negative-going transition of the input signal (i.e. when the T-input makes a high-to-low transition).

J-K flip-flop

The equivalent circuit of a J-K flip-flop is shown in Fig. 2; the schematic symbol for that device is shown in Fig. 3. Note that that device is essentially a T flip-flop that uses cross-coupling through NAND gates. The "free" inputs of the two gates become the J and K inputs of the flip-flop, while the T-input is once again designated as a clock input (or CLK).

The J-K flip-flop has two different modes of operation: clocked and unclocked. In the clocked mode output state changes are synchronized with the clock signal. All action occurs on the negative-going (high-to-low) transition of the clock signal. If both J and K are low (i.e. logic 0), then no change occurs on clock line transitions. If J is low, and K is high, then a negative-going transition of the clock line forces the Q output low and \bar{Q} high (that is a "reset" condition). If J is high, and K is low, then a negative-going transition of the clock line forces Q low and \bar{Q} high (this is a "reset" condition). Finally, if both J and K are simultaneously high, then the J-K flip-flop will perform binary division in a manner similar to the T flip-flop (in other words, the output frequency will be one half of the clock frequency).

In most cases, the levels applied to the J and K inputs are quasi-fixed (for instance, in a binary divider J and K are always high). But don't be afraid to use the preceding rules in a dynamic manner. By doing that, you can perform circuit functions that are not immediately apparent from a quick reading of the preceding.

The unclocked mode makes use of the preset and preclear inputs shown in Fig. 3. In the unclocked mode, the J, K, and CLK inputs are ignored. Instead, the preset and preclear inputs are used to set the output of the device. Assuming that the inputs are active low, as is indicated in the diagram, applying an active low to the preset input forces Q high and \bar{Q} low, while applying an active low to the preclear input forces Q low and \bar{Q} high. Note that in most (but not all) cases, the preset and

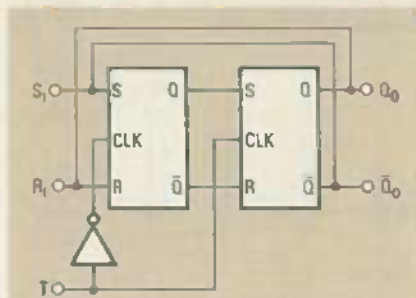

FIG. 1—TWO MASTER-SLAVE S-R flip-flops can be connected to form a T flip-flop.

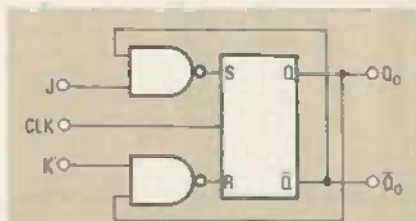

FIG. 2—SCHEMATIC DIAGRAM of a J-K flip-flop. Note that the heart of the circuit is an S-R flip-flop.

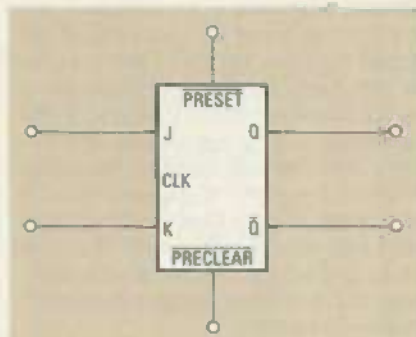

FIG. 3—SCHEMATIC SYMBOL for the J-K flip-flop.

preclear inputs are active-low.

It is good practice to tie unused inputs to the inactive state. For example, active-low preset and preclear inputs should be tied high when not used. That practice is used to prevent noise from triggering the input and thereby producing incorrect responses.

Note that signals applied to preset and preclear are momentary unless the design intent is to preclude response to other signals for awhile. The output changes, however, remain even after the preset/preclear input signals are removed.

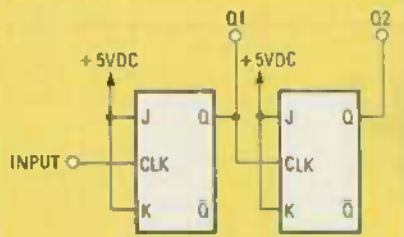

FIG. 4—J-K FLIP-FLOPS can be connected in series to obtain division by a factor greater than two. This two-flip-flop circuit, for example, provides division by four.

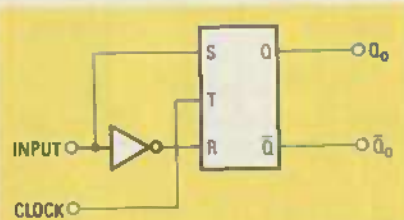

FIG. 5—THE ACTION of a D flip-flop makes it useful as a data latch, or one-bit memory.

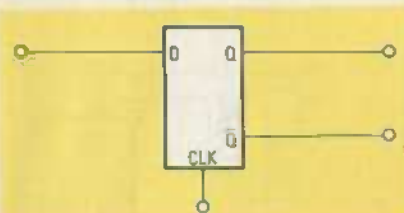

FIG. 6—THE SCHEMATIC SYMBOL for a D flip-flop.

We can cascade J-K flip-flops to obtain division by something other than two. Figure 4 shows two J-K flip-flops connected in series; that is, the Q output of the first flip-flop drives the CLK input of the second flip-flop. Since all J and K inputs are tied high, the flip-flops both act as binary dividers. The frequency of the squarewave at the Q output of the first flip-flop will be one-half the input frequency, while the frequency of the squarewave at the Q output of the second flip-flop will be one-fourth the input frequency. The chain can be extended further, with each additional flip-flop stage producing a further divide-by-two factor.

The D flip-flop

The basic D flip-flop is shown in Fig. 5; the schematic symbol for that device is

shown in Fig. 6. As is shown in Fig. 5, the D flip-flop is basically a clocked S-R flip-flop where r and s inputs are fed from a common line, but, through the use of an inverter, are out of phase with each other. This common input line is designated the Data or D input.

Operation of the D flip-flop is simple: The signal present at the D input is transferred to the Q-output when the clock signal is active. In most D flip-flops, including the one shown in Fig. 5, the clock is active-high. In such a flip-flop the data transfer takes place when the clock signal goes high.

The characteristics of a D flip-flop makes it useful as a data latch (i.e. a one-bit digital memory). That's because signals input to the device during the interval when the clock is active remain at the Q output even after the clock signal has become inactive. Also, input signals during the interval when the clock signal is inactive do not affect the Q output. As a result, the data is said to be "latched".

Shift registers

Figure 7 shows an application of the D flip-flop: a shift register. The particular circuit shown in Fig. 7 is a five-stage serial input shift register. That circuit can output at Q1, Q2, Q3, Q4, or Q5 (parallel), or can provide a serial output.

Note in Fig. 7 that the D inputs and Q outputs of each flip-flop are connected in series, while the clock lines are all connected together. Thus, data presented to each register's input is shifted one stage to the right each time the clock line goes active.

An example of shift register operation is shown in Fig. 8. When the first clock pulse occurs (Fig. 8-b), the input to the first flip-flop in the register is high (Fig. 8-a), so output Q1 goes high (Fig. 8-c). At the second clock pulse, the input is low (and remains low) so a low is entered into the system. Output Q1 goes low, and the high that had been at Q1 is transferred to output Q2 (Fig. 8-c). At the third clock pulse the high on Q2 is transferred to Q3 (Fig. 8-d), the low on Q1 is transferred to Q2, and the low on the input is transferred to Q1. That process continues such that on each subsequent clock pulse, the original high is shifted one stage to the right until it has passed through the entire register.

Shift register types

Shift registers are categorized according to their input/output scheme. Typical types include Serial-In/Serial-Out (SISO), Serial-In/Parallel-Out (SIPO), Parallel-In/Serial-Out (PISO), and Parallel-In/Parallel-Out (PIPO).

In SISO registers, data is applied to the input in a "single-file" manner, and is output in the same manner. Data applied to the input is shifted one stage to the right on each clock pulse. One application of the SISO register is as a digital delay line. That's because the SISO register can be used to create a time delay between input and output of $n + 1$ clock pulses, where n is the number of stages in the register.

The circuit shown in Fig. 7 is an example of an SIPO register. Like the SISO, data is input to the circuit in single file fashion and is shifted one stage to the right on each clock pulse. Unlike the SISO, however, each stage has its own output. There may also be a serial output line, though if there is not, the last output of the device may be used as a de facto serial output.

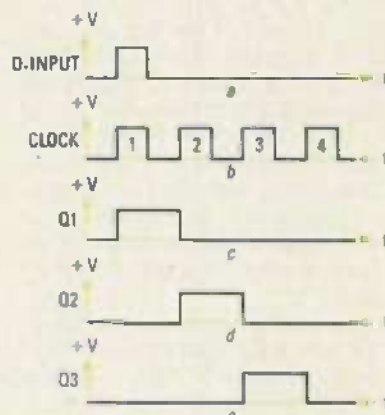

FIG. 8—TIMING DIAGRAMS for the shift register shown in Fig. 7. Note that the outputs of the first three stages only are shown.

In the PIPO register, inputs are fed simultaneously to each stage. Note that the first input of the register can be used as a de facto serial input, while the last output can be used as a de facto serial output.

Finally, the PISO register has parallel inputs, but only a serial output.

Figure 9 shows a SISO/SIPO register that is based on the J-K flip-flop. That circuit has four stages, although it could be shorter or longer if needed for a particular application. Note that all of the clock lines are connected together to form a master clock line, while all of the clear (or reset) lines are connected together to form a master reset line.

Except for the input stage, all J inputs are fed by the Q outputs of the preceding stage; likewise, all K inputs are fed by the Q-bar outputs of the preceding stage. The first stage is connected such that data is fed to the J input; that data is also passed through

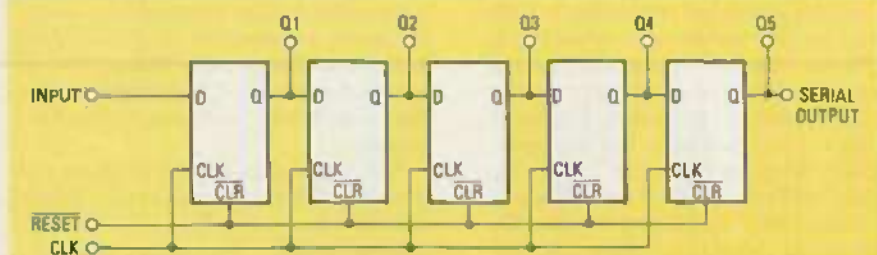

FIG. 7—A SERIAL-IN-PARALLEL-OUT shift register can be fashioned by connecting D flip-flops in series as shown.

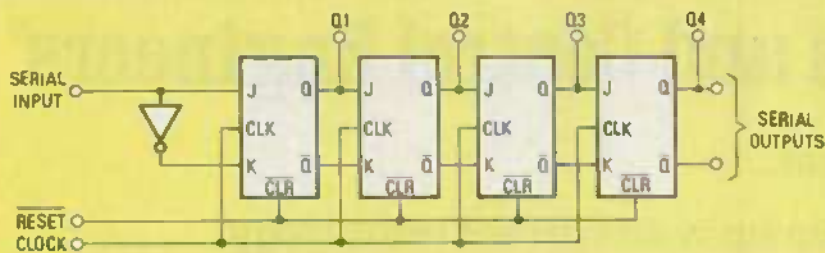

FIG. 9—THIS SISO/SIPO shift register is based upon the J-K flip-flop.

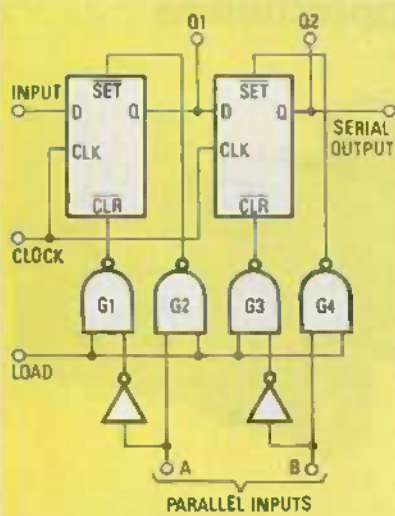

FIG. 10—DATA PRESENTED to the parallel inputs of this PISO shift register is transferred to the outputs when the load line goes high.

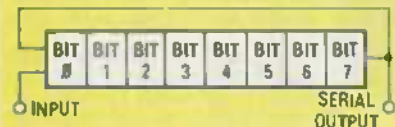

FIG. 11—BLOCK DIAGRAM of a recirculating shift register.

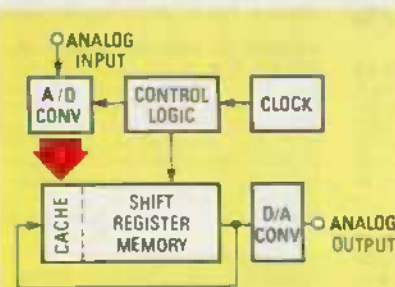

FIG. 12—A RECIRCULATING SHIFT REGISTER can be used as a memory in a digital storage oscilloscope.

an inverter and fed to the first stage's *k* input. Thus, when a high is presented to the *j* input, a low is presented to the *k* input, and vice versa.

Let's see how that register works. First, let's assume that the input to the circuit is a high. That means that a high is presented to the *j* input of the first stage, while a low is presented to the *k* input. Due to the

shown is built from D flip-flops. As in Fig. 7, a SIPO register built around D flip-flops, all of the clock lines have been connected together, and the input of each stage is driven by the Q output of the preceding stage. The D input to the first stage, together with the clock inputs, allow the PISO to be used as either a SISO or SIPO shift register.

Now let's look at how the PISO works. We'll discuss the circuitry attached to the A input; the B circuit works in just the

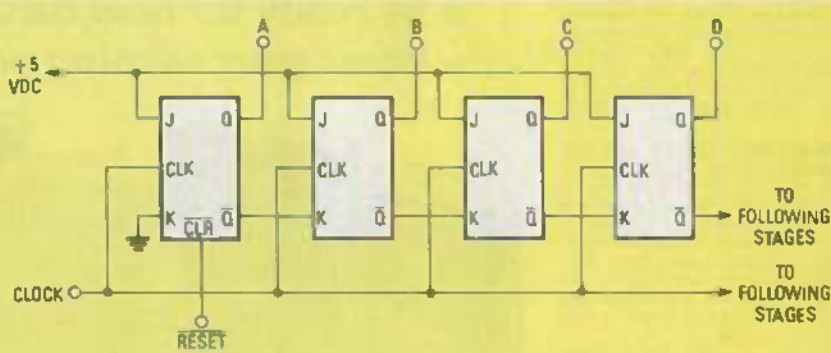

FIG. 13—THIS BUCKET BRIGADE device is analogous to an electromechanical stepper.

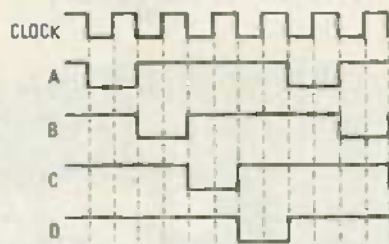

FIG. 14—TIMING DIAGRAM for the bucket brigade device shown in Fig. 13.

same way. The LOAD line synchronizes loading of data at all stages (two, in our case).

Now A may be either high or low. When the load line is low, nothing happens, but when it is high, the input—high or low—will be latched at the Q output. That works as follows.

Assume that the load line is low. When it goes high, the data at A will force the flip-flop to be either set or cleared. If A is high when the load line goes high, the

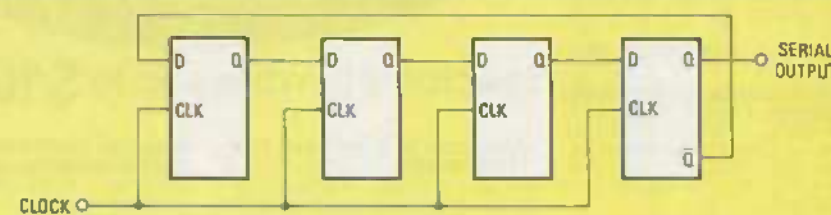

FIG. 15—A PSEUDO-RANDOM NOISE generator. The output of this circuit only appears random; instead it repeats after a long interval.

nature of the J-K flip-flop, the Q1 output will be forced high on the next negative-going transition of the clock signal. Note that the *j* and *k* inputs of the second stage will now be presented with the first stage outputs of the previous cycle (that is, *j* will be high, while *k* will be low). On the next negative-going transition of the clock signal, the Q2 output will be forced high. And so on. The high will be passed one stage to the right on each subsequent negative-going transition of the clock signal until it is clocked out of the register.

Figure 10 shows a PISO shift register; for the sake of simplicity, that particular register has only two stages. The circuit

output of G2 will go low, setting the flip-flop. The input to G1 will be low, so its output will remain high, and the CLR input to the flip-flop will not be affected.

Conversely, if A is low, the input to G1 will be high, and its output low, thus clearing the flip-flop. The input to G2 will be low, so its output will remain high, and the SET input to the flip-flop will not be affected.

So you can see it is the inverter attached to the input that insures that the gates G1 and G2 will always have complementary outputs, thus avoiding the situation wherein both the SET and the CLR inputs to the flip-flop would be low.

continued on page 101

Professional Books That Help You Get Ahead—And Stay Ahead!

Join the **Electronics and Control Engineers' Book Club**® and...

THE MCGRAW-HILL COMPUTER HANDBOOK: Applications, Concepts, Hardware, Software. Edited by H. Helms. 992 pp., 475 illus. Everything you need to know about today's computer science and engineering is here in this massive treasure trove of information. Covers everything from Boolean algebra to hardware selection techniques to artificial intelligence. 279/721 Pub. Pr., \$84.90 Club Pr., \$52.95

TRANSDUCERS: Theory and Applications. By J.A. Allocca and A. Stuart. 497 pp., 328 illus. Thoroughly describes and illustrates the theory and operation of all important transducers used in industrial, communication, medical, and other applications. Photographs, drawings, and diagrams are included throughout this outstanding introduction to a key element in electronic instrumentation. 582997-5 Pub. Pr., \$27.95 Club Pr., \$22.95

ANTENNA ENGINEERING HANDBOOK, 2/e. Edited by R. C. Johnson and H. Jasik, with contributions by 57 recognized authorities. 1,408 pp., 946 illus. This widely acclaimed Handbook gives you the guidance you need to solve problems in antenna design and application. It provides detailed information on physical fundamentals, patterns, structures, and design techniques for practical modern antennas. 322/910 Pub. Pr., \$105.00 Club Pr., \$62.50

INTRODUCTION TO RADAR SYSTEMS. By M. I. Skoink. 2nd Ed., 698 pp., 244 illus. Covering every radar fundamental and all important changes, this EE text exposes you fully to the systems themselves—and to their applications! Topics include radar equation, CW and frequency-modulated radar, MTI, pulse-doppler, tracking radar, receivers, displays, duplexers, noise, and more. 579/091 Pub. Pr., \$47.95 Club Pr., \$35.75

MICROPROCESSOR APPLICATIONS HANDBOOK. Editor-in-Chief, D. F. Stout. 472 pp., 284 illus. At last—a reference guide to microprocessor applications to help you make your systems timely, versatile, and cost-effective. 617/988 Pub. Pr., \$46.00 Club Pr., \$34.75

MICROPROCESSOR AND MICRO-COMPUTER DATA DIGEST. By W. H. Buchsbaum and G. Weissenberg. 336 pp., 93 block diagrams, 106 pin configurations. If you work with electronic devices that use microprocessor or microcomputer integrated circuits, this much-needed book contains all the detailed technical data for every microprocessor IC that is currently listed as a "standard," off-the-shelf item. 582835-9 Pub. Pr., \$29.95 Club Pr., \$22.50

HANDBOOK OF ELECTRIC POWER CALCULATIONS. Edited by A. Seidman, H. Mahrous and T. G. Hicks. 448 pp., 300 illus. Here are 285 tested and proven procedures for handling the electric power problems most frequently encountered in actual practice. You'll find ingenious, time-saving ways to calculate fuel costs, motor efficiency, and power output. 560/617 Pub. Pr., \$48.50 Club Pr., \$35.25

- Keep up with current technology
- Sharpen your professional skills
- Be ready for new career opportunities
- Boost your earning power



New members!
Any one of these great
professional books
for only **\$289**
as a premium with your
1st selection!

Spectacular values up to **\$105.00**

HANDBOOK OF PRACTICAL ELECTRICAL DESIGN. By J. F. McPartland. 416 pp., 300 illus. This volume provides a step-by-step explanation of designing electrical systems for industrial, commercial, and residential applications. Packed with helpful tips for saving time and complying with code requirements from branch circuits to wiring size. 456/95X Pub. Pr., \$40.95 Club Pr., \$27.50

DIGITAL LOGIC DESIGN. By B. Holdsworth. 338 pp., 192 illus. All of the recent advances in digital design techniques are presented here in depth. It's both a text covering basic concepts and a practical guide to design techniques for combinational, clock-driven, and event-driven circuits. 582852-9 Pub. Pr., \$39.95 Club Pr., \$27.50

ELECTRONIC COMMUNICATIONS SYSTEMS. By W. D. Stanley. 566 pp., illus. Emphasizing the signal-processing functions of modulation and demodulation operation, this book presents the essentials of electronic communications in a logical, step-by-step sequence. 582834-B Pub. Pr., \$25.95 Club Pr., \$20.95

MODERN ELECTRONIC CIRCUITS REFERENCE MANUAL. By J. Markus. 1,264 pp., 3,666 circuit diagrams. Complete with values of components and suggestions for revisions—plus the original source of each circuit in case you want additional performance or construction details. 404/461 Pub. Pr., \$79.90 Club Pr., \$57.95

ELECTRONICS ENGINEERS' HANDBOOK, 2/e. Edited by D. G. Fink & D. Christiansen. 2,272 pp., 2,189 illus. This updated and enlarged edition covers all the latest knowledge in the field, including new advances in integrated circuits, pulsed and logic circuits, laser technology, telecommunications, and much more. 209/812 Pub. Pr., \$83.50 Club Pr., \$63.95

DIGITAL CIRCUITS AND MICRO-PROCESSORS. By H. Taub. 608 pp., heavily illus. This fast-paced, carefully written guide gives you thorough explanations of all the basic principles of digital systems and logic design—plus a solid introduction to microprocessors and microprocessor-based designs. 629/455 Pub. Pr., \$41.95 Club Pr., \$32.50

RADIO HANDBOOK. By W. Orr. 22nd Ed., 1,136 pp., more than 1,300 illus. The latest edition of what is universally regarded as the best liked and most useful communications reference in the industry. It's a handy "course" in communications, a fact-packed reference, and a how-to guide—all in a single book! 582442-6 Pub. Pr., \$21.95 Club Pr., \$17.95

INTRODUCTION TO MICROWAVE ELECTRONICS. By T.C. Edwards. 76 pp., illus., softbound. Eliminating unnecessary theory and mathematics, this book provides you with a lucid overview of microwave engineering and the devices and circuits being used today. Helpful even if you have only limited experience with microwave electronics. 583030-2 Pub. Pr., \$14.95 Club Pr., \$10.95

PRACTICAL DIGITAL DESIGN USING ICs, 2/e. By J. D. Greenfield. 717 pp., illus. This revised and expanded Second Edition of a popular guide shows how to get the most out of a wide range of popular integrated circuits. What's more, it contains the specialized know-how today's designer needs to interface ICs with microprocessors. 582853-7 Pub. Pr., \$25.95 Club Pr., \$19.95

ENGINEERING NETWORK ANALYSIS. By G. H. Hostetter. 912 pp., 372 illus. Emphasizing real-world applications, this comprehensive book covers the full range of analytical techniques for everything from source-resistor networks to switched networks. Brings you fully up to date on all the latest developments. 582966-5 Pub. Pr., \$35.50 Club Pr., \$27.95

STANDARD HANDBOOK FOR ELECTRICAL ENGINEERS, 11/e. By D. G. Fink and H. Beaty. 2,448 pp., 1,414 illus. Today's most widely used source of electrical engineering information and data serves you as no other single work when you need detailed, timely, and reliable facts. 209/74X Pub. Pr., \$79.95 Club Pr., \$62.95

MICROWAVE SEMICONDUCTOR CIRCUIT DESIGN. By W. A. Davis. 416 pp., heavily illus. Provides in-depth coverage on microwave circuit analysis, passive microwave components, impedance transformers and circuits, broadband directional couplers, mechanical realization of selected transmission lines, CAD, CAM and CAT, characteristics of amplifiers and oscillators, noise, statistical thermodynamics and PN junction theory.
583044-2 Pub. Pr., \$47.50 Club Pr., \$35.50

INTRODUCTION TO RADIO FREQUENCY DESIGN. By W. M. Hayward. 383 pp., illus. This comprehensive volume prepares you to actually design HF, VHF, and UHF equipment and enables you to follow much of the current literature. Structured equation sets make it easy to write programs for small computers or calculators.
582748-4 Pub. Pr., \$32.95 Club Pr., \$27.25

MCGRAW-HILL ENCYCLOPEDIA OF ELECTRONICS AND COMPUTERS. By S. P. Parker, Editor-in-Chief. 960 pp., 1,266 illus., oversized 8 1/2 x 11 format. It's a single-volume library that covers the entire world of electronics from Edison's pioneering work in electricity right up to optical fiber communications, control systems, lasers, radar, TV receivers, artificial intelligence, and computer storage technology.
454/876 Pub. Pr., \$67.50 Club Pr., \$43.95

ELECTRONICS ENGINEERING FOR PROFESSIONAL ENGINEERS' EXAMINATIONS. By C. R. Hafer. 336 pp., more than 200 illus. Actually two books in one—a quick preparation manual to help you pass your P.E. exams on the first try and a rich source of practical electronics engineering information and know-how.
254/383 Pub. Pr., \$32.50 Club Pr., \$25.50

MCGRAW-HILL CONCISE ENCYCLOPEDIA OF SCIENCE AND TECHNOLOGY. Editor-in-Chief S. P. Parker and the Staff of the McGraw-Hill Encyclopedia of Science and Technology. 2,065 pp., 1,600 illus. This volume serves every need for understanding today's science and technology. Written by over 3,000 of the world's topmost experts, including 19 Nobel Prize winners. It covers 75 disciplines from Acoustics to Zoology. A 30,000-entry index and cross-references throughout make it a snap to find the information you're looking for.
454/825 Pub. Pr., \$55.00 Club Pr., \$36.50

COMPUTER METHODS FOR CIRCUIT ANALYSIS AND DESIGN. By J. Vlach and K. Singhal. 656 pp., 148 illus. Computational methods have become an integral part of circuit analysis and design. And a solid understanding of the basics of computer-aided design is a must for engineers who want to achieve their career objectives. This self-teaching book provides that know-how in a logical, easy-to-follow presentation.
582855-3 Pub. Pr., \$42.50 Club Pr., \$31.95

ELECTRONIC NOISE. By A. Ambrózy. 281 pp., illus. The data you'll find here will help you understand and cope with noise in all types of circuits. Covers noise parameters of linear networks, measurement techniques, effects of nonlinear transfer characteristics, and more.
011/249 Pub. Pr., \$44.50 Club Pr., \$34.25

Be sure to consider these important titles as well!

ENCYCLOPEDIA OF COMPUTER SCIENCE. By A. Raiston and E. D. Reilly, Jr.
582794-8 Pub. Pr., \$47.50 Club Pr., \$48.95

VLSI SYSTEM DESIGN. By S. Muroga.
582123-5 Pub. Pr., \$34.95 Club Pr., \$26.50

MICROPROCESSOR SUPPORT CHIPS: Theory, Design, and Applications. By T. J. Beyer.
095/183 Pub. Pr., \$43.50 Club Pr., \$35.25

ENGINEERING FORMULAS, 4/e. By K. Gnech.
732/191 Pub. Pr., \$18.95 Club Pr., \$14.50

ELECTRONICS CIRCUITS NOTEBOOK. Edited by S. Weber.
182/448 Pub. Pr., \$37.50 Club Pr., \$27.50

ANALYSIS AND DESIGN OF DIGITAL INTEGRATED CIRCUITS. By D. A. Hodges and M. G. Jackson.
291/535 Pub. Pr., \$48.00 Club Pr., \$32.50

HANDBOOK OF OPERATIONAL AMPLIFIER CIRCUIT DESIGN. By D. E. Stout & M. Kautman.
017/871 Pub. Pr., \$48.50 Club Pr., \$34.95

ENGINEERING MATHEMATICS HANDBOOK, 2/e. By J. J. Tuma.
654/791 Pub. Pr., \$41.50 Club Pr., \$28.95

DIGITAL COMMUNICATIONS. By J. Proakis.
585/271 Pub. Pr., \$42.95 Club Pr., \$31.50

SIGNALS AND SYSTEMS. By A. Oppenheim, A. Willsky, and I. Young.
582674-7 Pub. Pr., \$38.95 Club Pr., \$28.95

MAINTAINING AND REPAIRING VIDEOCASSETTE RECORDERS. By R. L. Goodman.
582852-2 Pub. Pr., \$15.45 Club Pr., \$12.50

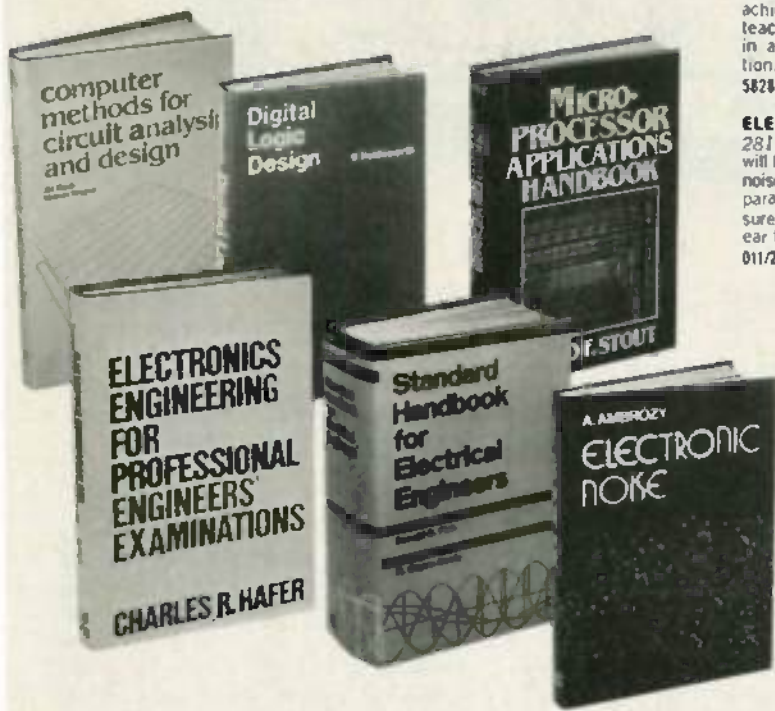

MAIL THIS COUPON TODAY

McGraw-Hill Book Clubs
Electronics and Control Engineers' Book Club®
P.O. Box 582, Hightstown, New Jersey 08520

Please enroll me as a member and send me the two books indicated, billing me for the \$2.89 premium and my first selection at the discounted member's price, plus local tax, shipping, and handling charges. I agree to purchase a minimum of two additional books during my first year of membership as outlined under the Club plan described in this ad. A shipping and handling charge is added to all shipments.

Write Code No. of \$2.89 selection here	Write Code No. of first selection here
<input type="text"/>	<input type="text"/>

Signature _____

Name _____

Address/Apt. # _____

City _____

State _____ Zip _____

This order subject to acceptance by McGraw-Hill. All prices subject to change without notice. Offer good only to new members.

E33734

Why YOU should join now!

- **BEST AND NEWEST BOOKS IN YOUR FIELD** — Books are selected from a wide range of publishers by expert editors and consultants to give you continuing access to the best and latest books in your field.
- **BIG SAVINGS** — Build your library and save money too! Savings ranging up to 30% or more off publishers' list prices—usually 20% to 25%.

BONUS BOOKS—You will immediately begin to participate in our Bonus Book Plan that allows you savings up to 70% off the publishers' prices of many professional and general interest books!

■ **CONVENIENCE** — 12-14 times a year (about once every 3-4 weeks) you receive the Club Bulletin FREE. It fully describes the Main Selection and Alternate Selections. A dated Reply Card is included. If you want the Main Selection, you simply do nothing — it will be shipped automatically. If you want an Alternate Selection — or no book at all — you simply indicate it on the Reply Card and return it by the date specified. You will have at least 10 days to decide. If, because of late delivery of the Bulletin you receive a Main Selection you do not want, you may return it for credit at the Club's expense.

As a Club member you agree only to the purchase of three books (including your first selection) during your first year of membership. Membership may be discontinued by either you or the Club at any time after you have purchased the first selection plus two additional books.

Other McGraw-Hill Book Clubs:
Architects' Book Club • Byte Book Club • Chemical Engineers' Book Club
• Civil Engineers' Book Club • Mechanical Engineers' Book Club
For more information, write to:
McGraw-Hill Book Clubs, P.O. Box 582, Hightstown, New Jersey 08520

BUILD THIS



Buffer/Converter for your Printer

This buffer is more than just a 64K printer buffer—it's also a parallel-to-serial and serial-to-parallel converter. And you can expand it to program EPROM's, too!

BY BILL GREEN

Part 2 THIS MONTH WE SHOW you how to use the buffer. But first, lets finish the construction; have the August issue handy.

Now that the on-board components are mounted, mount the five switches on the front panel. See Fig. 5 and the parts-placement diagram of Fig. 4 (shown last month) to see how that's done. The power switch (S5) is a two-position toggle. The COPY switch (S4) is a pushbutton type, and the three FUNCTION SELECT switches (S1, S2, and S3) are SP3T, three-position toggle switches.

Connect a short piece of bare wire to the top terminal of S1, S2, and S3 and to one terminal of S4. Connect an insulated wire between that terminal of S4 and the pad above IC20 (a source of +5 volts). Connect another piece of bare wire to the bottom terminals of S1, S2 and S3. Connect an insulated wire between the bottom terminal of S1 and the pad indicated. Then connect the remaining insulated wires between the remaining switch terminals and pads shown. You might want to use a length of 6-conductor ribbon cable to make the connections between the switches and the board.

Use 6 inches of 20-gauge "zip cord" to wire the power switch, S5. Assuming that you'll use a SPDT switch for S5, the unused terminal should be the top one.

Connect 4 feet of 20-gauge "zip cord" to the AC input on the board. Run the cord through the hole in the back panel and connect the other end to the wall-mount power transformer (T1). Examine the board for solder shorts and correct installation of the components. If all looks good, plug the transformer in and turn the power on. Measure the voltage at pin 14 of IC18. If it is between 4.8 and 5.2 volts, turn off the power and install IC2, a 7404 hex inverter. Turn on the power and, using a scope, logic probe, etc., check for oscillation at pin 8 of IC26 (8 MHz). If all is well so far, turn off the power and install the remaining IC's. Remember that IC1 through IC10 are MOS devices. Handle them accordingly! Be sure that all IC's are in the correct locations and that pin 1 of each is oriented correctly.

TABLE 1—WIRING FOR THE COMMODORE 64

PLS3 pin	User I/O pin
SIN (7)	M
SINBUSY (8)	K
GND (5,6)	N
*SOUT (1)	C
*SOUTBUSY (2)	O

*Used only for output to C64

Turn on the power and check for a 2-MHz clock signal at pin 6 of IC1. Then check for activity on the data and address buses. If all seems well the unit is probably working properly. If not go back and check for the obvious or even the extremely obvious.

We can't be too specific about how to prepare your cables and connectors. Your printer and computer manuals will be of help. Ten- and fourteen-pin female IDC header connectors may be used with flat cable, or the appropriate chassis mount connectors may be installed on the back panel. The pinout of the header connectors are shown in the schematic.

The PARALLEL INPUT (PL1) and PARALLEL OUTPUT (PL2) ports operate with active-low STROBE and ACKNOWLEDGE and active-high BUSY signals. On the PARALLEL IN connector, an extra ground pin is provided for a PAPER EMPTY signal if needed.

The serial I/O channels operate with high start bits and low stop bits and busy signals. The handshake is hardware—XON/XOFF is not supported.

Using the Commodore 64

Those of you with Commodore 64 computers know that the user I/O port is not RS-232 compatible, and that some of the code from it is not standard ASCII. This

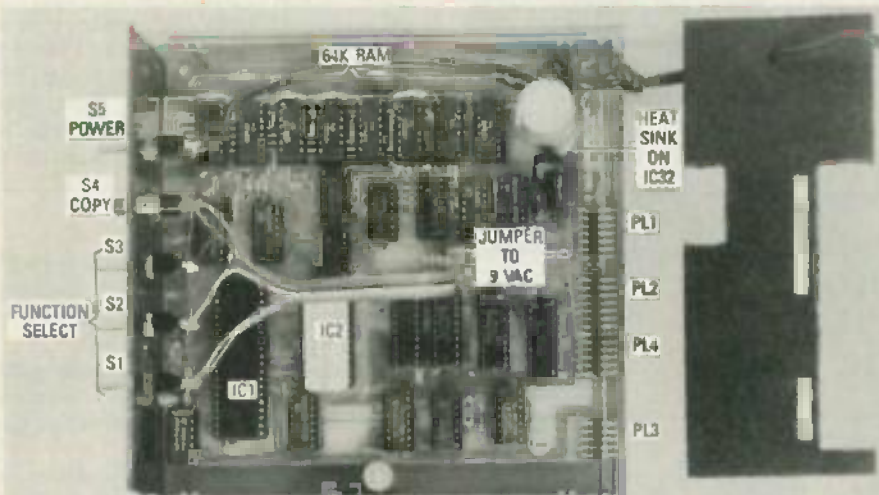

FIG. 5—THIS PHOTOGRAPH SHOWS THE PRINTER BUFFER with its cover removed. Note the heat sink on the regulator and note the jumper that brings 9 volts AC to header plug PL4. See the text for information on how to mount that header.

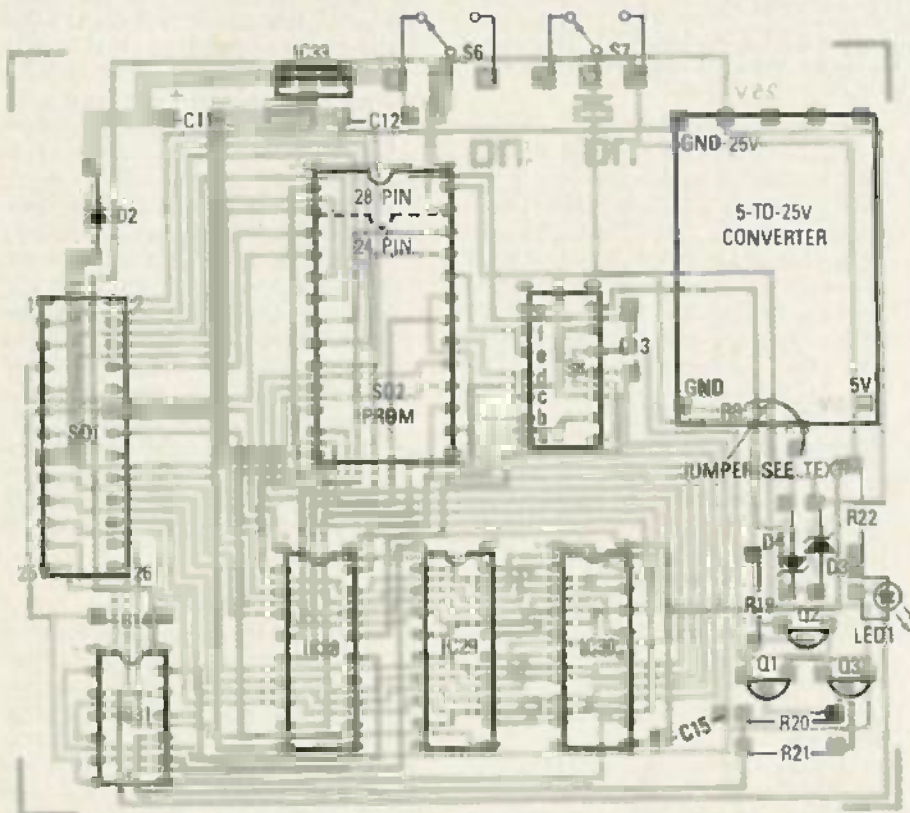

FIG. 6—EPROM PROGRAMMER PARTS PLACEMENT. Note that SO2 is a ZIF type socket. Note the jumper that runs from the board to the 5- to 25-volt converter.

buffer is designed to compensate for those differences but, of course, only when the function-selection switches are set for operation with the Commodore 64. The wiring for the 64's user I/O port is shown in Table 1. Keep in mind that the buffer will let a standard printer be used with a Commodore computer, but not the other way around: You cannot convert the output from a standard computer so that it can

use a printer designed for the Commodore.

With a few changes to the hardware of the buffer, you can use the C-64 like any serial I/O computer with the switches set as you would for other computers. The code from the 64 will not be converted in this case. To make the change for serial input from the 64, connect a jumper from pin 3 of IC27 to pin 9 of PL3. To make the

change for serial output to the Commodore 64, connect a jumper from pin 6 of IC27 to pin 3 of PL3. When you make up the cable for the Commodore 64, wire it for the new connections to PL3.

Install the finished board in a suitable case using three screws. Be sure to use a plastic insulating washer under the screw near IC27. If you're using the case indicated in the Parts List, install the front and rear panels and the top cover. Secure the cover with the screws provided and attach the 4 rubber feet to the bottom of the case.

EPROM programmer assembly

Assembling the EPROM programmer option is not difficult—especially if you use a printed-circuit board. The foil patterns can be obtained from the source indicated in the Parts List, or you can etch your own. The patterns for the double sided board are printed in the special "PC Service" section.

A parts-placement diagram for the EPROM programmer board is shown in Fig. 6 to help you during assembly. Start by installing SO1—a 26-pin female dou-

PARTS LIST—EPROM PROGRAMMER

All resistors 1/4 watt, 5%

- R19—10,000 ohms
- R20, R21—1000 ohms
- R22—470 ohms

Capacitors

- C11—1000 μ F, 25 volts, electrolytic
- C12, C13—0.1 μ F, ceramic disc

Semiconductors

- IC28—IC30—74LS373 octal D-type latch
- IC31—7404 hex inverter
- IC33—LM340 5-volt regulator
- D2—1N4001
- D3—3.9 volt Zener
- D4—22 volt Zener
- LED1—TIL220 standard red LED
- Q1—Q3—MPS5172

Other components

- S6, S7—SPST Toggle
- S8—8-position DIP switch (only 7 positions are used)
- SO1—26-pin female right angle header
- SO2—28-pin ZIF socket
- 5- to 25-volt converter (TDK)

The following are available from: Alpha Electronics, PO Box 1005, Merritt Island, Florida 32952, 305-453-3534; buffer board, \$26.00 postpaid; program ROM (91341) \$26.00 postpaid, EPROM programmer PC board, \$15.00 postpaid. A complete BufferLink kit (Includes all parts except computer connectors and cables) \$139.00 plus \$5.00 shipping and handling; complete EPROM programmer kit \$49.00 postpaid. Florida residents must add 6% sales tax. Canadian orders add \$2.00. All other foreign orders add \$8.00

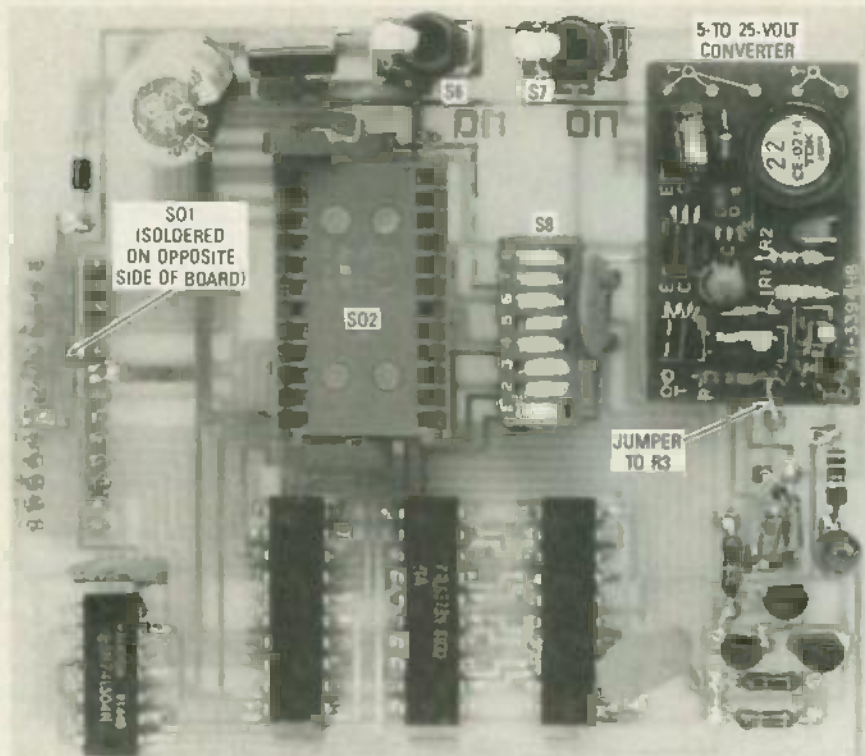

FIG. 7—THE EPROM PROGRAMMER BOARD. Note that the ZIF socket shown is a 24-pin type, although a 28-pin socket should be mounted. Note also that the DIP switch is an 8-position type, even though only 7 positions are shown. (Just try to find a 7-position DIP switch!)

TABLE 2—SETTING THE FUNCTION SELECT SWITCHES

IN	OUT	S3	S2	S1
Parallel	Parallel	0	0	0
Parallel	S300	0	0	1
Parallel	S600	0	0	2
Parallel	S1200	0	1	0
S300	Parallel	0	1	1
S600	Parallel	0	1	2
S1200	Parallel	0	2	0
S300	S300	0	2	1
S300	S600	0	2	2
S300	S1200	1	0	0
S600	S300	1	0	1
S600	S600	1	0	2
S600	S1200	1	1	0
S1200	S300	1	1	1
S1200	S600	1	1	2
S1200	S1200	1	2	0
C64 S1200	Parallel	1	2	1
C64 S1200	S300	1	2	2
C64 S1200	S600	2	0	0
C64 S1200	S1200	2	0	1
Read 2716	EPROM	2	0	2
Read 2732	EPROM	2	1	0
Read 2764	EPROM	2	1	1
Program 2716	EPROM	2	1	2
Program 2732	EPROM	2	2	0
Program 2764	EPROM	2	2	1
Download	—	2	2	2

TABLE 3—SETTING S8

	S8-a	S8-b	S8-c	S8-d	S8-e	S8-f	S8-g
2758	OFF	ON	ON	OFF	ON	OFF	OFF
2716	OFF	ON	ON	OFF	ON	OFF	OFF
2732	ON	OFF	ON	OFF	OFF	ON	OFF
2732A	ON	OFF	ON	OFF	OFF	ON	ON
2764	OFF	ON	OFF	ON	OFF	ON	ON

ble-row header—on the *solder side* of the board. Leave as much clearance as possible between the board and S01. If you don't, you'll have trouble plugging your other connectors into the buffer. Next install sockets for the all IC's except, of course, for the regulator. The EPROM socket, S02, should be a 28-pin ZIF (Zero Insertion Force) type. Then install D2, LED1, the Zener diodes D3 and D4, and the transistors. Make sure that you orient those parts correctly! Then install the resistors and capacitors. Install the voltage regulator IC33 noting that the metal tab should be on the outside of the board.

Next install the 5-volt to 25-volt converter. You'll have to add one jumper from the converter to the board. It runs from the pad on the board above the Zener diodes to the end of R3 (that's R3 on the *converter board*) nearest the 5-volt input pin. Figure 7 shows just what that jumper looks like.

Install all of the switches. Note that they are all board-mounted on the author's prototype. Orient S8 in the same way as it is shown in Fig. 7. The first switch section

should be toward the IC's.

Now it's time to plug the IC's in their sockets and to plug the finished programmer assembly, with the components up, onto PL2 and PL4 of the buffer. Turn S6 off, and power up the buffer. Check for 5 volts at the output of IC33. The EPROM socket, S02, should be empty. Switch S7 to the READ position, and turn S6 on. With S8-g off, there should be about 25 volts at the cathode end of Z1. With S8-g on, there should be about 21 volts.

Using the buffer

Connect the buffer to your computer and printer(s). Before you turn anything on, remember these cautions.

- Apply power to the buffer *last*.
- Before first turning on the buffer each time, set the FUNCTION SELECT switches for the input and output operation that you want.
- Only now should you apply power.

Table 2 shows the 27 settings of the FUNCTION SELECT switches, S1, S2, and S3. Remember, those switches should be set for the function that you want before you turn on the power. Note that in Table 1, the settings for serial operation are indicated by Sxxx, where xxx is the baud rate.

After the power has been applied, or any time after completion of printing (or other function), you may change the switch settings. But you must hold the COPY switch (S4) closed until you have changed the switches to the new function.

A reset switch was not added to the buffer because resetting the Z80 will waste the contents of the dynamic RAM. If you need that capability, you can install a reset switch by connecting a normally open pushbutton switch across capacitor C7. (For safety's sake, mount the new switch on the back panel.) Remember that you can always reset the Z80 simply by turning the power off and back on. The contents of the memory will be lost in either case.

Printing with the buffer

To use the buffer with your printer, set the switches for the desired input and output combinations. After printing is completed, you can print another copy of the buffer contents. Simply press and hold the COPY switch (change the switches if you wish a different output), release the switch, and press it again after a short delay. There is a timing loop involved here that you must get fairly close. It isn't difficult and with a little practice you will master it. If you didn't get it the first time, just try again.

How to download a custom program

You can easily download a custom operating program to the buffer. Set the function switches according to Table 2. (Only parallel and serial at 1200 baud may

(Continued on page 103)

PC SERVICE

One of the most difficult tasks in building any construction project featured in **Radio-Electronics** is making the PC board using just the foil pattern provided with the article. Well, we're doing something about it.

We've moved all the foil patterns to this new section, where they're printed by themselves, full sized, with nothing on the back side of the page. What that means for you is that the printed page can be used directly to produce PC boards!

In order to produce a board directly from the magazine page, remove the page and carefully inspect it under a strong light and/or on a light table. Look for breaks in the traces, bridges between traces, and, in general, all the kinds of things you look for in the final etched board. You can clean up the published artwork the same way

you clean up your own artwork. Drafting tape and graphic aids can fix incomplete traces and doughnuts, and you can use a hobby knife to get rid of bridges and dirt.

An optional step, once you're satisfied that the artwork is clean, is to take a little bit of mineral oil and carefully wipe it across the back of the artwork. That helps make the paper translucent. Don't get any oil on the front side of the paper (the side with the pattern) because you'll contaminate the sensitized surface of the copper blank. After the oil has "dried" a bit—patting with a paper towel will help speed up the process—place the pattern front side down on the sensitized copper blank, and make the exposure. You'll probably have to use a longer exposure time than you are used to.

We can't tell you exactly how long an

exposure time you will need because we don't know what kind of light source you use. As a starting point, figure that there's a 50 percent increase in exposure time over lithographic film. But you'll have to experiment to find the best method to use with the chemicals you're familiar with. And once you find it, stick with it. Don't forget the "three C's" of making PC boards—care, cleanliness, and consistency.

Finally, we would like to hear how you make out using our method. Write and tell us of your successes, and failures, and what techniques work best for you. Address your letters to:

Radio-Electronics
Department PCB
200 Park Avenue South
New York, NY 10003

PC SERVICE

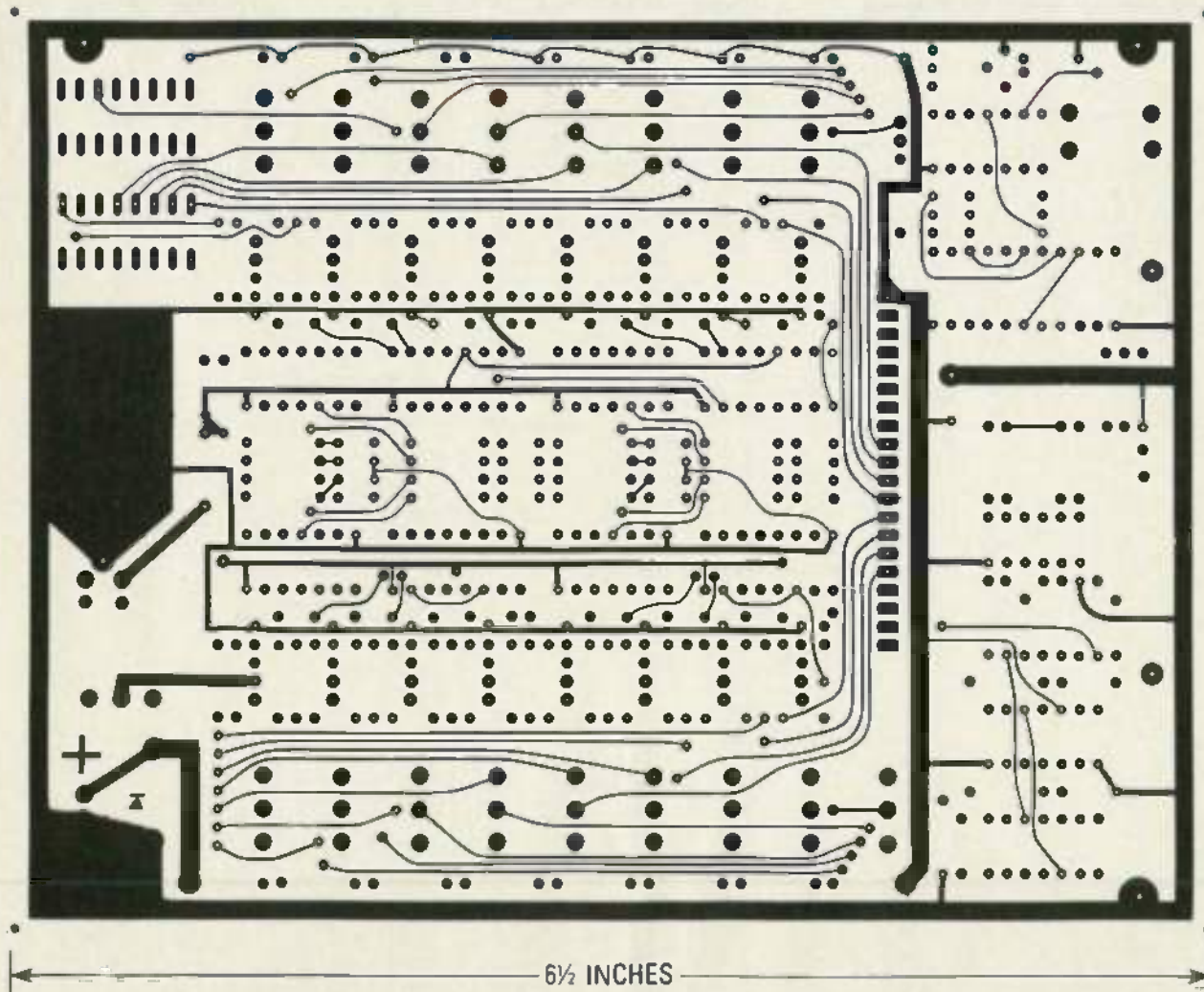

THE COMPONENT SIDE OF THE IC-TESTER BOARD is shown here as a full-sized mirror image. The solder side will appear here next month.

PC SERVICE

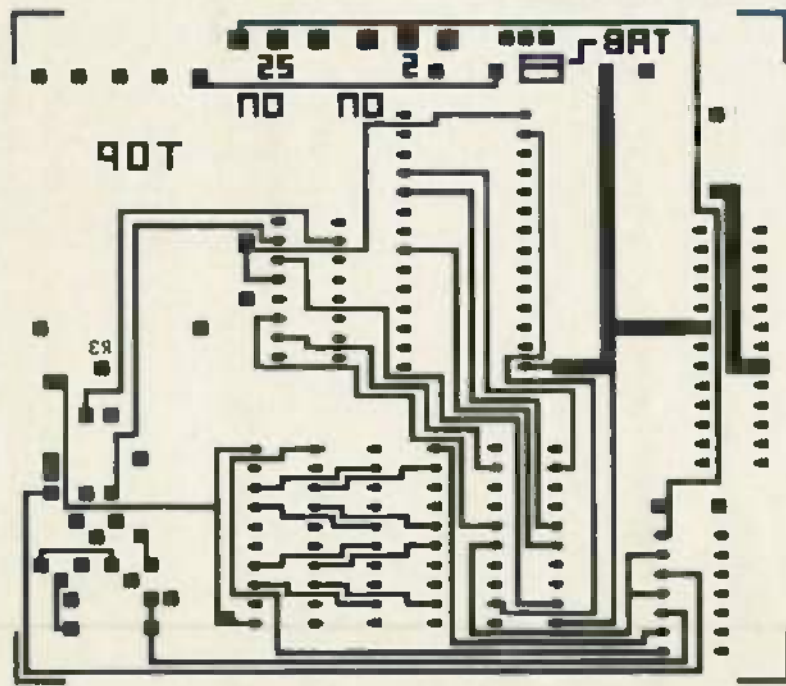

THE COMPONENT SIDE OF THE EPROM PROGRAMMER BOARD is shown here in a full size mirror image.

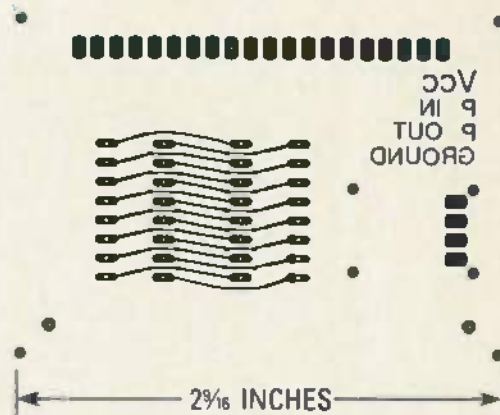

THE COMPONENT SIDE OF THE "B-SOCKET" board for the IC tester is shown here in a full-size mirror image.

PC SERVICE

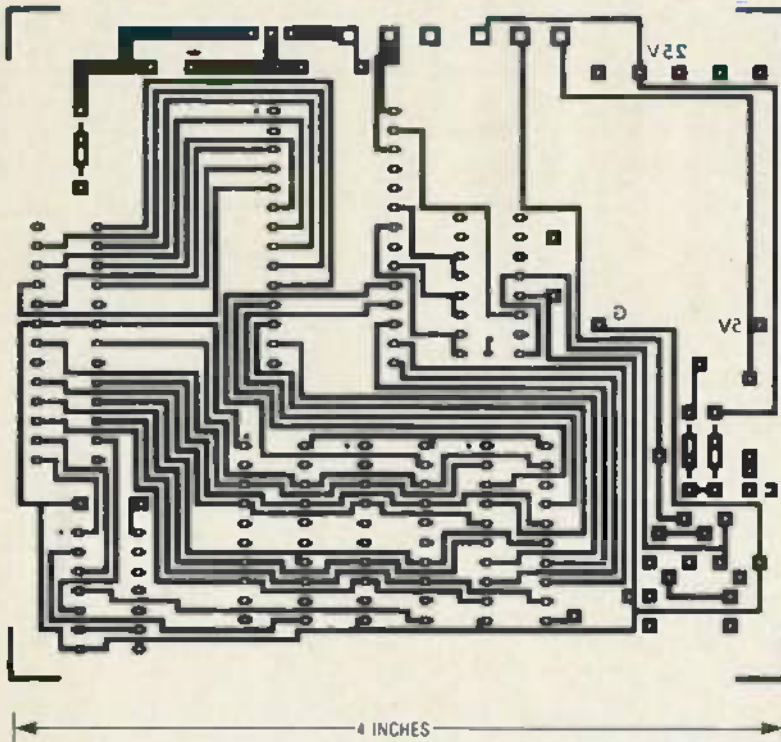

THE SOLDER SIDE OF THE EPROM PROGRAMMER BOARD. See page 78 for more information.

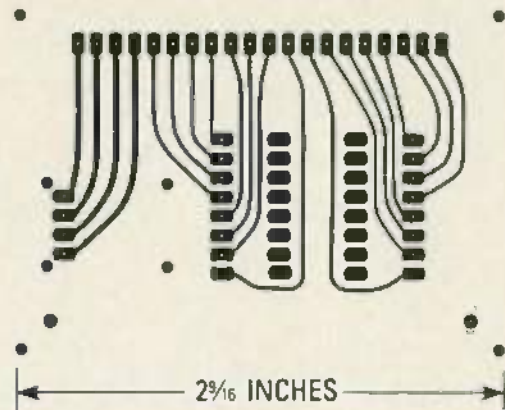

THE SOLDER SIDE OF THE "B-SOCKET" BOARD for the IC tester. See page 59 for more information

MUST LIQUIDATE At Far Below Dealer Cost! TOTAL Personal Computer System

FACTORY REFURBISHED!

GET ALL THIS AT ONE LOW PRICE!
64K Computer • 16 Hue Color, 5" Monitor • Disk Drive • Printer • Two Software Packages: "Easy Script" word processing and "The Manager" data base program!



Carries easily as a suitcase! Plugs into 115V outlet.

FULL FACTORY WARRANTY!

Sorry, we're not permitted to PRINT the famous brand-name. BUT, we CAN "tell all" if you call us TOLL FREE: 1-800-328-0609!

THE COMPUTER.

For business, education and home use! Thousands of programs are available.

Snap-on computer 64K RAM, 20K ROM. Full-size typewriter keyboard. Upper and lower case letters, numerals, symbols, reverse characters, 2 cursor control keys, 4 function keys, programmable to 8. Music synthesizer with 3 independent voices, each with 9 octave range. Input/output ports accommodate user, serial, ROM cartridge, joysticks, external monitor, phone modem.

Built-in disk drive! Intelligent high speed unit with 5 1/4" floppy disk recorder. 170K for formatted data storage; 35 tracks, 16K ROM. Uses single sided, single density disk. Serial interface. Second serial port to chain second drive or printer.

Built-in color monitor! Displays 40 columns x 25 lines of text on 5" screen. High resolution, 320 x 200 pixels. 16 background, character colors.

Built-in ROM cartridge port! Insert ROM program cartridge. Multitude of subjects available in stores across the nation!

THE PRINTER.

Graphics quality 6 x 7 dot matrix printer. An ideal "fit" for this system... and included in the astonishingly low package price below!

Print method: Bi-directional Impact dot matrix.

Character matrix: 6 x 7 dot matrix.

Characters: Upper and lower case letters, numerals and symbols. All PET graphic characters.

Graphics: 7 vertical dots — maximum 480 columns. Dot addressable.

Character codes: CBM ASCII code.

Print speed: 60 characters per second.

Maximum columns: 80 columns.

Character spacing: 10 characters per inch.

Line feed spacing: 6 lines per inch in character mode or 8 lines per inch selectable. 9 lines per inch in graphics mode.

Line feed speed: 5 lines per second in character mode 7.5 lines per second in graphics mode

Paper feed: friction feed. (Tractor feed optional.)

Paper width: 4.5" to 8.5" width. Up to 10" with optional tractor feed.

Multiple copies: Original plus maximum of two copies.

Dimensions: 13"W x 8"D x 3 1/4"H. Wt.: 6 1/2 lbs. Power: 120V AC, 60 Hz.

THE SOFTWARE.

"Easy Script" One of the most powerful word processors at any price! Cut re-typing, create documents from standard paragraphs, do personalized letters, see and change a document before it is printed. Instruction manual has extensive training section that simplifies use... even for someone who has never used a computer or word processor before!

"The Manager" A sophisticated database manager for business or home use. Business uses: accounts payable/receivable, inventory, appointments, task manager. Home uses: mailing lists, home inventory, recipes, collection organizer, investment tracking, checkbook balancing. School uses: research article index, gradebook.

TOTAL Personal Computer System Now Available At FAR BELOW dealer cost!

TOTAL PACKAGE PRICE

\$488

Item H-518-64011.02
Shipping, handling: \$28.00

Other popular brands of computer peripherals available at liquidation prices. For information, call TOLL FREE: 1-800-328-0609.

Compatible with above Computer System (Not included in package price.)

JOYSTICKS (Set of 2)

Give you the fun of playing a wide selection of games.

Mfr. List: \$59.90 pr.

\$18 pr.

Liquidation Price
Item H-518-83822-01 5/H: \$8.00 Pr.

64 MODEM

Access new worlds of information with your computer.

Mfr. List: \$124.95

\$44

Liquidation Price
Item H-518-83848-00 5/H: \$4.00



Credit card members can order by phone. 24 hours a day, 7 days a week.

Toll-Free: 1-800-328-0609

Your check is welcome!
No delays when you pay by check!

C.O.M.B. CO.
Authorized Liquidator
14615 28TH AVENUE NORTH
MINNEAPOLIS, MINNESOTA 55441-3357

SEND ME THE ITEMS I HAVE LISTED BELOW

Price subject to change after 60 days. Sales outside continental U.S. are subject to special conditions. Please call or write to inquire.

Item No.	How Many	Item	Ship/Handl.	Price

C.O.M.B. CO.®

14615 28th Ave. N./Minneapolis, MN 55441-3357

Send the items indicated at left. (Minnesota residents add 6% sales tax. Please allow 3-4 weeks for delivery. Sorry, no C.O.D.)

My check or money order is enclosed. (No delays in processing orders paid by check, thanks to TeleCheck.)

Charge: MasterCard® VISA Am. Ex. Diners Club

Acct. No. _____ Exp. _____

PLEASE PRINT CLEARLY

Name _____

Address _____

City _____

State _____ ZIP _____

Phone _____

Sign here _____

SEPTEMBER 1985



CHECK OUR PRICES FOR IDC CABLE!

IDC COMPUTER CABLE

We buy this cable by the mile direct from the manufacturer, to get the lowest possible price so check our prices before you buy

Type	Cat No.	Price
26 way	W-2750	46¢/ft
34 way	W-2752	60¢/ft
40 way	W-2754	72¢/ft
50 way	W-2756	89¢/ft

MINI ROTARY MUFFIN FAN
Designed for projects where cooling power is needed. Forced air cooling can be mounted to blow or suck 140V motor.

3.2 square in x 1 in deep 2 in radius mounting holes.
Cat Y-8506 \$12.95

SAVE TIME & MONEY.

Pre-built Audio Modules Microphone Preamp

Low impedance mic preamp suitable for most general purpose mics in the 200 ohms to 10k ohms range. Comes complete with a volume control pot and knob, just wire in as required. Instruction sheet included.

SPECIFICATIONS:
Input Sensitivity 0.25mV, Input Impedance: 10k ohms @ 500 Hz, Output Level: 150mV, Frequency Response: 20Hz to 20kHz, S/N Ratio: 55dB, Distortion: 0.2%, Supply: 20-24VDC, Size: 2.8" x 0.8" x 1.4", Cat P-8184

\$9.95

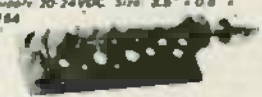

SAME BONZA VALUE ON IDC CONNECTORS

IDC FLAT RIBBON SOCKETS

IDC EDGE CONNECTORS

34 way Cat. P-2760	\$5.25
10 up \$4.80 ea	
40 way Cat. P-2762	\$6.28
10 up \$5.80 ea	
50 way Cat. P-2764	\$6.50
10 up \$6.10 ea	



34 way Cat. P-2750	\$2.75
10 up \$2.55 ea	
40 way Cat. P-2752	\$3.75
10 up \$3.40 ea	
50 way Cat. P-2754	\$3.95
10 up \$3.60 ea	

YOU SAVE!

THE VALUE CONTINUES.

EDGE CONNECTOR 5-100 BUS
Standard 100 pin socket for 5-100. High contact life for maximum efficiency. P-2670
10 up \$7.00 ea **\$7.00**

'D' TYPE CONNECTORS

25 Pin Cat. P-2690	\$1.95
10 up \$1.80 ea	
18 Pin Cat. P-2687	\$1.60
10 up \$1.45 ea	
9 Pin Cat. P-2684	\$1.25
10 up \$1.10 ea	



PLUGS (SOLDER TAIL)

26 Pin Cat. P-2691	\$2.60
10 up \$2.40 ea	
18 Pin Cat. P-2686	\$2.20
10 up \$2.00 ea	
9 Pin Cat. P-2685	\$1.75
10 up \$1.60 ea	

BACKSHIELDS
Snr P-2690, P-2691 \$4.25 10 up
Cat. P-2692 95c ea

Snr P-2687, P-2688 Cat. P-2689 10 up 85c ea **\$1.00**
Snr P-2684, P-2685 Cat. P-2686 10 up 75c ea **90¢**

25 PIN R/ANGLE PCB MOUNT
Cat. P-2695 10 up \$5.30 ea **\$5.75**

25 PIN IDC FLAT RIBBON
Pins Cat. P-2693 10 up \$4.80 ea **\$5.49**

Socket Cat. P-2694 10 up \$5.50 ea **\$5.95**

36 WAY IDC FLAT RIBBON CENTRONICS TYPE PLUG
Cat. P-2678 \$8.50 10 up \$8.00 ea

PRINTER PLUG
S7 30360 type, suits most printers. With cover P-2680 16.95 10 up \$5.95 ea

PRINTER SOCKET
S7 403380 Centronics type socket, P-2681 \$5.95 10 up \$5.50 ea

WE BUY DIRECT - YOU REAP THE BENEFIT!

FOR MORE GREAT AUSSIE VALUE & ADDRESS DETAILS TURN OVER

BUILD YOUR OWN MAG. LIBRARY.
A magnetic binder, cover for any magazine that holds 12 issues in one year, hard spine with metal rods for protection of the magazine. Cat. S-3045 **ONLY \$4.95**

Rainbow Cable
34 AWG, 12 conductor, shielded. Cat. W-2045 304/ft

FROM 25¢ per foot

GREAT VALUE

HUGE SCOOP PURCHASE!
NOW HALF PRICE!
QUALITY NI-CAD Rechargeable Batteries
Type Cat No. 1.99 normally 99¢
AA S-3300 1.99
AAA S-3305 1.95
MONEY BACK GUARANTEE - STOCKS LIMITED!
STOCK UP NOW - STOCKS LIMITED!
OFFER EXPIRES SEPT. 30TH.

Lost your keys again? JUST WHISTLE!
That's right, with one of these little beauties next time you misplace your keys just whistle and it will beep right back at you. A great conversation starter too! Cat. Y-1070 **ONLY \$7.95** **NOW \$12.95**

HERE'S AN END TO 'FUZZY' VIDEO PROCESSOR
Disappointed by the fuzzy picture you get from some video tapes? This deluxe Video Processor lets you make the picture crisper and clearer. Dual 'Detail' and 'Color' controls allow optimum picture enhancement, plus a 'Stabilize' control to let you get stable pictures from CopyGuarded tapes. Mode switch lets you bypass all processing to check the original signal. Suitable for both VHS and Beta. Cat. Y-8510

GREAT VALUE! \$59.95 Cat. Y-8510

TOP VALUE TECH SPRAYS
CLEAR ACRYLIC SPRAY
A fine colorless spray that is ideal for the protection of front panels, etched screen print or Letraset lettering. Will moisture proof components, TV serial terminals, etc. 1.25 gram can. Cat. N-1011. **\$2.90**
SPRAY CLEANER
A cleaning and degreasing moisture removing spray. It is non-toxic, non-explosive, non-inflammable. Can be used on rubber or plastics as well. 1.8 oz. Cat. N-1051. **\$3.95**
SPRAY FREEZER
Instantly freeze components down to minus 50 degrees Celsius. Ideal for servicing electrical & electronic equipment with intermittent problems. 350g spray can. Cat. N-1056. **\$3.65**

NON TOXIC
HEAT SINK COMPOUND
An effective thermal coupler for any heat sink device where efficient cooling is required. Cat. N-1205 **\$1.95**
CUDDLY KOALA
THIS FLUFFY LITTLE FELLA GRIPS YOUR LABEL AND RIDGES WITH YOU AS YOUR MATE WHEREVER YOU GO!
Cat. J9000 FOR \$1.95 ONLY!
10 up \$1.75 ea

NON TOXIC
Unick
HEAT SINK COMPOUND
An effective thermal coupler for any heat sink device where efficient cooling is required. Cat. N-1205 **\$1.95**

WE BUY DIRECT - YOU REAP THE BENEFIT!

15W Audio Amplifier
Fantastic for PA, modulators, intercoms, etc. Multi-tapped output tranny suits 4-16 ohm speakers. Huge 15W peak output (10W continuous) from a 12 V supply. Ideal for car use, too.

SPECIFICATIONS:
Power Output: 15W max. Supply: 12-18VDC, 3.8A at maximum output. Input: 10mV for rated output. Beta has high level input. Input Impedance: Approx 15k ohms. Output Impedance: 4-16 ohms. Frequency Response: 300Hz-10kHz. Size: 2.8" x 1.4" x 1.4". Cat. F-4178

\$24.95



Stereo Preamplifier
Complete, ready-to-connect RIAA phono preamp, ideal for use with amp modules or your own stereo amplifier. Takes supply direct from most amplifiers - 28 - 32 volts. Ideal for converting an old ceramic or crystal turntable to magnetic operation.

SPECIFICATIONS:
Freq Response: 20Hz-20kHz ±1dB. RIAA, Voltage Gain: 35dB. Input Sensitivity: 2.8mV. Input Impedance: 200k ohms. Output Level: 180mV. Imp. 50k Ohm. Distortion: 0.2%. Size: 2.8" x 1.9" x 0.8" Cat. F-4175

\$9.95



5W Audio Amplifier
Don't need all that power? Smaller module has 5W peak rating (3W cont) with extended frequency response and lower supply rail. Think of the uses: intercoms, megaphones, modulators, radio amplifiers, etc., etc.

SPECIFICATIONS:
Power Output: 5W max., 3W cont. supply 9VDC, 0.8A maximum. Input: 10mV for rated output. Input Impedance: Approx. 30k ohms. Output Impedance: 4-16 ohms. Frequency Response: 70Hz-30kHz. Size: 2.8" x 1.2". Cat. F-4105

\$14.95



1-800-332 5373

CATALOG SELLABRATION

MAKE LEARNING FUN!
DICK SMITH
Lesson 1

At last a true learning system that makes learning fun! An ideal educational aid suitable for 4 to 8 year olds. Traditional effective teaching methods have been combined with the latest computer technology so learning becomes fun and easy. Kids can learn logic, skills, spelling and math. All 10 learning activities in one. Features added battery saver which automatically turns off unit after about 6 minutes of non use. Fun lesson book and easy to follow instructions included. Cat V-1020



\$49.00

Jumper Lead Sets

Small
4 x 30" leads fitted with large insulated alligator clips at each end to make testing or passing easy. Four different colors for instant identification. W-4570 10 up \$1.80 ea

Large
A pair of matching red & black leads, 3 feet long, with matching IC test clip at each end. Cat W-4571 10 up \$1.80 ea

Quality Project Boards

Mini-Project Board

3" x 2.4" x .3" one-piece board with 58 groups of 5 connected terminals, and 4 bus lines of 25 connected terminals. Cat P-4814 **\$4.95**

Mini-Project Board

A massive 7" x 2.7" x .3" board which can be split into three parts for convenience. With 128 groups of 5 connected terminals plus 8 bus lines of 25 connected terminals. AND you get the large work sheet pad as well! Cat P-4815 **\$9.95**

DICK SMITH'S FUNWAY INTO ELECTRONICS

Volume 1

Starts off with the very basics, assuming that you know absolutely nothing about electronics. It will show you what all the components look like and how to connect them into the circuit. No soldering required. Cat B-2800 **ONLY \$4.95**

Volume 2

Building the projects in Funway 2 will teach you how to solder onto PCB's and use a multimeter. All useful projects too. Cat B-2805 **\$6.95**

Volume 3

When you've worked your way through Volumes 1 & 2 you're ready for the more complex projects described in full detail in this book. Then you could be ready for a job in electronics. Cat B-2810. **\$6.95**

**PCBS
STOCK UP &
SAVE!**

BLANK PRINTED CIRCUIT BOARDS

Pre-cut high quality PC boards with permanently bonded copper on one side - available in bakelite or heavy duty fiberglass

	1 up	10 up ea
Bakelite 8" x 3"	Cat H-5500	80¢ 40¢
Bakelite 6" x 6"	Cat H-5505	\$1.20 \$1.15
Bakelite 12" x 12"	Cat H-5510	\$4.25 \$4.00
Fiberglass 8" x 3"	Cat H-5540	75¢
Fiberglass 6" x 6"	Cat H-5545	\$1.00
Fiberglass 12" x 12"	Cat H-5550	\$4.00 \$4.50

Plug-In IC Board

Fantastic plug-in printed circuit board. 0.1" pin spacing to accept directly up to 14 x 14 pin or 16 pin IC's or up to 20 "Mini-Dip" IC's. Lands are silver plated and a 24 way 0.1" plug is etched into one end of the board so that it can be used with a 24 pin connector. 0.1" spacing x 2.4" (w) x 4" (l). Cat H-5610 **\$4.50**

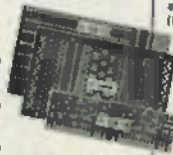

DESIGN BREADBOARD

This is an extremely useful board etched and punched in such a unique pattern it will accommodate almost all types of integrated circuits and transistor packages as well as passive parts. Each board has over 500 holes punched on 0.1" grid and over 200 separate silver plated lands as well as built-in buss bars. It will even take the wide 24, 28, 36 and 40 pin DIL packages as well as the 8, 14 and 16 pin packages. Size: 0.1" spacing x 3" x 6". Cat H-5606 10 up \$1.35 ea **\$4.50**

OP-AMP EXPERIM. PCB

Another very useful design for the experimenter. Suite 741 type op-amps, with provisions made for just about all circuit variations. Input, feedback, compensation and power supply components are all catered for. Ideal for one-offs. Dual circuits. Cat H-5618 10 up \$1.75 ea **\$4.95**

Printed Stripboards

The most versatile board of the lot! Eaches copper strips are predrilled and plated ready for solder. The alpha markings grid facilitates positive pin identification. 0.1" spacing x 3" x 6" **\$1.40** 10 up \$1.35 ea
Cat H-5613
0.1" spacing x 6" x 3" **\$1.40** 10 up 90¢ ea
Cat H-5614

A quality plated copper strip board similar to the English Vero-board. Computer produced striping on a high grade substrate. Packed in plastic sheath to assure you an unblemished, non-oxidized surface. 0.1" spacing x 3.75" x 13" **\$2.95** 10 up \$2.50 ea
Cat H-5112

Versa Strip Board

As H-5612 board, but with pre-cut short tracks making it ideal for multi IC work. Plated strips. Packed in a plastic sheath for protection. 0.1" spacing x 3" x 5" Cat H-5616. 10 up \$1.90 ea **\$4.00**

MATRIX BOARD

Tough phenolic board with punched holes. Ideal for prototypes, bread boards, science or hobby projects. 0.1" spacing x 3" x 3". Cat H-5310 10 up \$1.30 ea **\$1.50**

PC PINS \$1.25/pack

These pins push through 0.1" pitch matrix board or Vero board to form solder terminals on both sides of the board. Cat H-5590 **100 pins 10 up \$1.00/pack**

PC Pin Connectors \$1.75/pack

Fits the H-5590 board pins. Has many uses. Cat H-5592 **10 up \$1.50/pack**

BUG DETECTOR

Find hidden bugs in your home, office or car. The unit is designed to locate unauthorized radio transmitters which can be planted by almost anyone anywhere. This is not a toy. Cat F-1005 **\$99.00**

Etching Kit

Incredible value! a pack consisting of Ferric Chloride. Duro PC resin (Plus), a sample of PC board plus instructions - at less than the price of the etchant and pen on their own! And the Ferric comes in handy 13 fl. oz. bottle. Cat H-5650 **\$6.95**



FERRIC CHLORIDE

Now supplied in a great new non-spill 16 oz. bottle. No more fiddling around with beads and hot water! (Replacement for kit etchants.) Cat H-5652 **\$6.95**

Spot Face Cutter

Remove copper quickly and neatly from all printed circuit board and Vero boards. Cat H-5178 **\$1.75**

Clear Acrylic Sheet

Ideal for using over panels, etc. - makes your project look really professional! Or use for inspection panels, protection devices, etc. 0.12" thick, size is a very useful 8" long x 2" wide. Cat H-5450 **\$1.00** 10 up 90¢ ea

LCD Multi-meter

INCREDIBLE LOW LOW \$29.95

VOLTAGE RANGES:
DC: 0-2-20-200-1000 volts
AC: 0-200-500 volts (RMS)
DC CURRENT: 0-2-20-200-2000 ohms
The specs. Cat Q-1440

We have searched the world for this beautifully made LCD multimeter to sell under \$30. Just look at the specs.

Digital Trainer



For breadboarding, digital circuits, flip-flops, multi-vibrators, counters, encoders, decoders, multiplexers, de-multiplexers, sequencers, registers, LED and 7 segment LED displays, memory devices, etc. Specs: (1) AC power jack DC +12V 800mA; (2) Power switch AC adaptor/battery 1.5V x 4; (3) Pulse Sw: two bounce free push buttons; (4) Logic switches; (5) DCO/P: DC +5V 750mA for users; (6) B-023 breadboard; (7) LED display; (8) clock range selection 10-40KHz. Power supply to suit (not included) M-9530 12V 1 amp \$14.95. Comes complete with training manual. Cat P-4828 **\$129.95** 10 up \$119.95 ea **\$19.50**

LOOK AT OUR PRICE FOR A QUALITY SCOPE

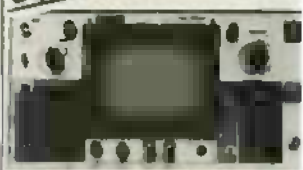

SOAR 20 MHz DUAL TRACE

We looked at heaps of oscilloscopes and decided that our Camp of Japan produced the best 20 MHz Oscilloscope in the world. Built at the foot of the Japanese Alps, his design and its people are known for their ability to produce precision instruments. Model SRS-0222 has a special built-in circuit that allows testing single or multiple components in or out of circuit.

- Large flat-face 6" CRT with integral grille, front panel probe rotator, 2 VU oscillators.
- CRT invert X-Y operation, 1 auto internally modulation, TV-Y (Video) sync separator
- Fully automatic switching regulator power supply for accuracy, high frequency filter in the trigger circuit.
- Smooth voltage exceeding 20 MHz, 100000 beyond 30 MHz.

Comes complete with 100+ test probes and spare leads.

SPIFICATIONS
Vertical Frequency & Deflection: AC 10 Hz/DC to 20 MHz, 5 sec to 200 (ch on 17 ranges), 1.2 V/div, 24 MHz (ch1)

Resolution: 100 mV/div, 100 mV/div, 100 mV/div

Horizontal: CH1 CH2 DUAL, 100 ns/div, 100 ns/div, 100 ns/div

Input Impedance: 1 MΩ/200 pF

Max Input: 200V p-p or 100 VDC + peak AC

Trace Frequency: 200 MHz

Channel Separation: 100% of 1 side

Type Base: Auto or triggered, 10 Auto Modes

Trigger: 100% of 1 side

Sweep Time: 0.1 sec to 0.5 sec/div on 20 ranges in 1.2-5 MHz, 100 MHz

Length: 100 cm

Weight: 10 kg

Power: 100 W

Size: 100 x 100 x 100

**AMAZING VALUE!
ONLY \$599**

**LARGEST SELECTION!
BEST VALUE IN
Electronics
BOOKS!**

The Encyclopedia of Electronic Circuits

This GIANT collection of electronic circuits is a must-have reference for every builder and designer. Totalling over 1,700 of the most needed circuit schematics, it's perhaps the most complete sourcebook of its kind. Cat B-1781 **\$29.95**

World Radio TV Handbook

A brand new edition for 1985. The most thorough and complete listing of international radio and television stations. Used as a reference throughout the world, contains information on frequencies, addresses, call signs, IDs and lots, lots more. Also includes special interest features written by specialists in their own fields. Cat B-2085 **\$19.50**

ORDER TOLL FREE 1-800-332-5373

**DICK SMITH KITS
CHECK THE QUALITY
& VALUE!**

**BUILD YOUR OWN
100 watt Amp
Module**

100 watts RMS; 100 dB signal to noise ratio at 5kHz. That's the 480 amplifier. The ultimate in simplicity: even the power transistors mount on the one PCB. The PCB heatsink bracket is supplied, and the heavy duty fiberglass PCB has a silk-screened overlay to make the construction even easier. Ideal for the home constructor or technician who wants to "roll his own" amplifier system. 1V. Use with K-3438 power supply and M-0144 transformer. Cat K-3442 ★★



\$19.95

**OR BUILD THIS
50 Watt Amp Module**

Ideal for home stereo systems. Same design simplicity as the 100 watt module above, but cheaper because of lower power. And there's added economy as two units can be run from the one K-3438 power supply input sensitivity is 800 mV. Supplied with exclusive instruction booklet. Heatsink bracket is supplied but heatsink itself extra. Cat K-3440 ★★

**VALUE
\$14.95**

**BUILD YOUR OWN
Power Supply**

Full PCB and component kit for one K-3442 or two K-3440 modules. Supplied complete with speaker detump relay and Zener regulated plus & minus 15V preamp rails. Special assembly instructions supplied.

Cat K-3438 ★ **\$14.95**



**HIGH TECH INNOVATION
AM STEREO DECODER KIT**

Now you can pick up some of those 220 AM stereo stations broadcasting using the Motorola system. Designed to fit most wide band AM mono tuners. Why pay a fortune for a new tuner when this little beauty will do the job. Full construction details included. K-6320

LED level meter

Here's the one the beginner can build - and add to a mono or stereo amplifier to give a level meter just like those found on \$\$\$ imported amplifiers! Has 10 green LEDs for display, one yellow for maximum power indication and one red for overload. Requires 10-18V at around 50mA (usually taken direct from preamp supply). Cat K-3370

**Value \$12.95
Musicolor Mk IV**

Four chase patterns plus auto chase and reverse chase AND four channel color organ with built-in microphone (no connection to speakers necessary!) means you're ready to stage a lightshow! Cat K-3143

TOP VALUE! \$99.95

BUILD YOUR OWN!



SEE AUG. REVIEW 73's

**UHF
Watt
Meter Kit**

Have you priced a built up wattmeter lately? Just released. (See review this issue). Featuring stripline circuitry, this kit is easy to build & use.

Specifications
DIRECTIVITY -20db
INSERTION LOSS -0.3db
FREQUENCY RESPONSE (narrow band) 400-520 MHz
usable over freq. range
MAX POWER 100 watts

\$44.95

COMPARE WITH READY BUILT UNITS!

Cat K-6312

BUILD IT YOURSELF!



SEE AUGUST 73's MAG

**The
Dick Smith
2 Meter
T'ceiver Kit**

Over 573 amateurs can't be wrong! That's how many have now built our 2 meter kit in just a few months! The 'Commander' covers the full 144-148 MHz band in 100kHz channels (with 5kHz offset) with full repeater facilities built in. And it delivers around 10-15 watts with a receiver sensitivity of 0.5uV or better! Comprehensive step by step construction manual plus microphone & mounting bracket. Nothing more to buy! Cat K-6308

ONLY \$149
INCLUDES QUALITY HAND MIC.

SUPER VALUE!



ENAMELLED WINDING WIRE

Coil winding, motor rewinding, transformer building are no longer a problem with these handy coils of enamelled wire.



Gauge AWG	Length Feet	Size	Weight	Price
18	05	18	26	3/4oz W-3116
18	04	19	39	3/4oz W-3118
20	03	21	59	3/4oz W-3120
22	02	23	78	3/4oz W-3122
24	02	25	30	8oz W-3124
26	016	27	85	8oz W-3126
30	01	33	164	8oz W-3130
32	008	38	858	8oz W-3132
36	005	40	721	8oz W-3136

\$2.95 roll
10 up \$2.50 roll

STOCK UP NOW!

ELECTRONIC REVERB

Now... Overhe... Over...
... and You can create that echo, reverb and "space" sound of your very own. Ideal for the unsung muso, amateur theatre group or for the sound effects on the stage show or video you've been preparing. Features in/out jacks for microphone or guitar. High level line. Adjustable delay time - 5ms to 95ms. Depth and repeat controls.



Cat P-3000

\$37.50
AMAZING VALUE!

UNIVERSAL TEST LEAD SET

The ultimate test lead set for the professional. Superb quality coated test leads for ease and convenience. 18 different adaptor any test you desire. Scores in connector ends make it simple to carry out their own test. This is the highest quality set around and at the price!

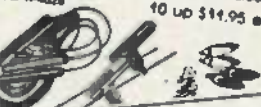

10 up \$14.95 ea **\$12.95**

Are you an existing electronics retailer looking to improve turnover and profit?
Opportunities exist in every city across the U.S. to become a **DICK SMITH RETAILER**.
Enormous buying power enables us to offer generous volume discounts on a unique range of up-to-the-minute products, many of them exclusive to us. We also offer you unrivalled marketing support.
Find out more, contact:
DAVID MILSON ON 415 368 88 94

**General purpose
20 watt Amp**

A general purpose amp as used in television, tape players, musical instruments, sound projectors, etc. A handy device for any hobbyist to add to his workbench. Cat K-3445

ONLY \$9.95

**THE #1 NAME IN
KITS: DICK SMITH
\$29.95**

Stereo Preamp

Amazingly versatile unit can be built as a magnetic cartridge preamp for upgrading your stereo, a tape preamp or an auxiliary preamp with 40, 55 or 80dB gain. Cat K-3427

\$9.95

Mixer Preamp

Designed to suit the 300W amp kit, this mixer preamp has 4 inputs with an impedance of 100k - suitable for most mics, guitars, etc. Ideal also for use with 50W (K-3400) and 100W (K-3442) power amp modules. Cat K-3035

\$24.95

Where the electronic enthusiast is #1

USA Head Office: 390 Convention Way
Redwood City CA 94063
Postal Address: PO Box 2249 Redwood City CA 94063
Telephone: (415) 368 8844
Telex: 160488 DICKS USA Fax: 1 (415) 368 0140
Over 60 Stores In 3 Countries

SHIPPING CHARGES
U.S.A. 5% of merchandise total minimum \$2.50
OUTSIDE U.S.A. 10% of merchandise total minimum \$5.00
We generally ship UPS ground. If you require a faster service please contact us.
Tax 6 1/2%
California residents

DICK SMITH ELECTRONICS
INCORPORATED IN THE STATE OF CALIFORNIA

**ORDERS ONLY CALL
TOLL FREE**

1-800 DEAL DSE
3325 373

and quote your visa or mastercard number

12 hours a day!
(6am-6pm Pacific time)

INQUIRIES: (415) 368-1086

See adjacent column for shipping charges

MAIL ORDER CENTER
390 Convention Way
P.O. BOX 8021
Redwood City CA 94063



Redwood City Berkeley

390 Convention way
Redwood City CA 94063
Phone: (415) 368-8844
Hours: Mon-Fri 10am-6pm



San Jose

2874 Shillock Ave
Berkeley CA 94706
Phone: (415) 866-0756
Hours: Mon, Thu Sun. 10am-6pm



San Francisco Bay Area

4980 Stevens Creek Blvd
(W Lawrence Expressway)
Phone: (408) 241 2266
Hours: Mon, Thu, Sun. 10am-6pm



**MORE STORES
OPENING
SOON**

Watch our ads in leading electronics magazines for further details of new stores

ORDER TOLL FREE 1-800-332 5373

ROBOTICS



MARK J. ROBILLARD
ROBOTICS EDITOR

Building a robot from the bottom up.

IN THE FIRST FEW ISSUES, WE COVERED building a robotics laboratory and talked a little bit about robotic basics. This month, we'll go a little farther and build a simple programmable motion platform. The platform is essentially two wheels mounted on a plywood structure on which your control electronics will be secured.

What can you do with a programmable motion platform? Well, a path-navigation system and various control circuits can be built and studied using such a platform. We've all seen movie and TV robots that roll around on two or more wheels, or those that walk on legs. Although walking robots do exist, they are extremely hard to build; especially for the amateur experimenter. Given that fact, we'll stick with rolling robots, at least for the time being.

Motion platform

Figure 1 shows how the movement of the robot depends on the direction in which each wheel is spinning. When both wheels are turning in the same direction (say forward, as indicated by the arrows in Fig. 1-a), the robot moves forward in a straight line. When the rotation of both wheels is reversed, so is its direction, as Fig. 1-b shows.

But when, as Fig. 1-c shows, the right wheel is turning forward and the left wheel is rotating in the reverse direction, the robot turns or pivots left. The robot will turn right when the directions of those wheels are reversed (see Fig. 1-d). Thus, depending on the rotation of the two wheels, you can make your robot move in any of four different directions. There is, of course, another essential part of

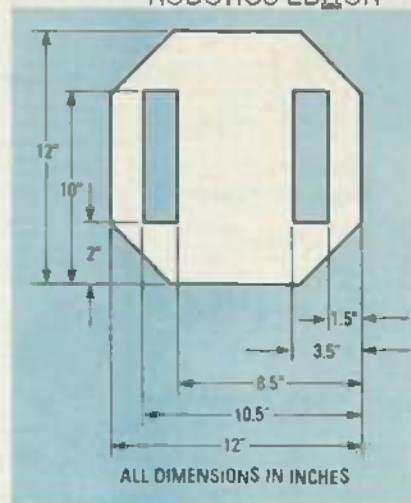

FIG. 2

the platform—casters, which are used to stabilize the back-and-forth rocking of the robot during motion.

The control electronics, including motor drivers, a complete computer-controlled system with various sensors, and even an arm, can be easily mounted on a plywood base. We'll discuss those and other options in the coming months; but for now, let's stick to our two-wheeled device.

The construction of the platform is fairly simple. The first thing you'll need is a base. Plywood was chosen because it's easy to work with, readily available, and relatively inexpensive. And if you make some horrendous mistake, you can easily toss out that piece of wood and start all over again. (That's a sharp contrast to machined aluminum, which tends to be rather expensive and adds a considerable amount of weight.)

Figure 2 shows a simple octagon-shaped base, but you could just as easily use a cylindrical or a square shape for the platform.

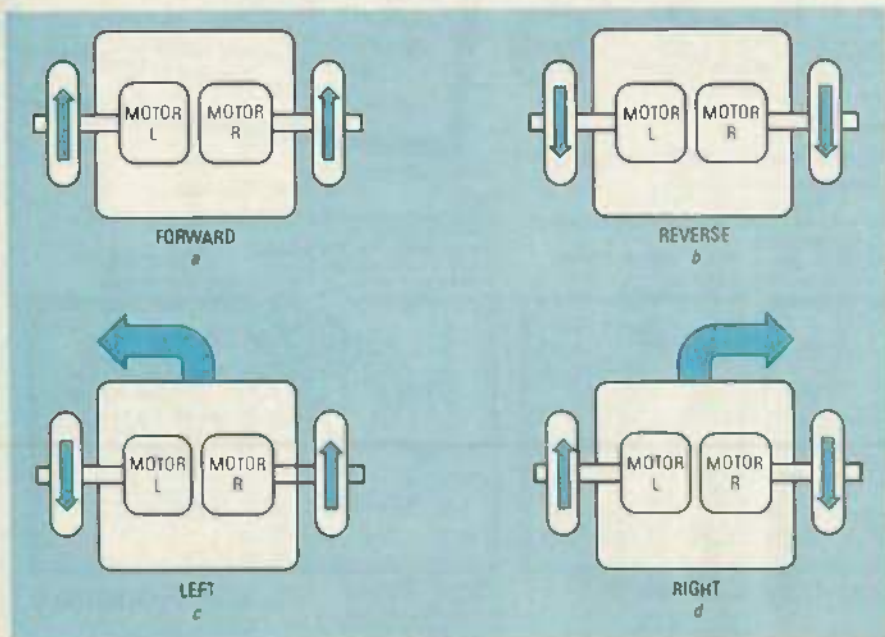
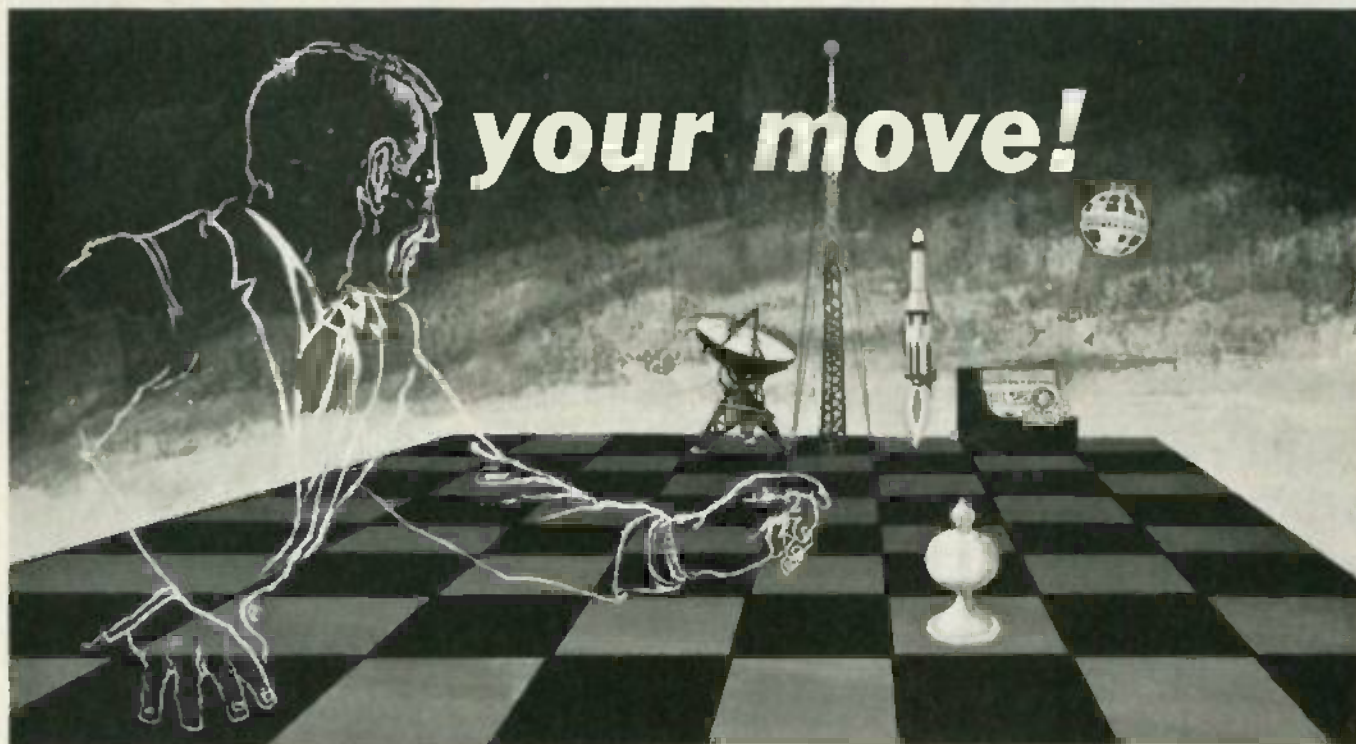

FIG. 1

Where's Your **ELECTRONICS** Career Headed?

your move!



The Move You Make Today Can Shape Your Future

Yes it's your move. Whether on a chess board or in your career, you should plan each move carefully. In electronics, you can *move ahead* faster and further with a

B. S. DEGREE

Put professional knowledge and a **COLLEGE DEGREE** in your electronics career. Earn your degree through independent study at home, with Grantham College of Engineering. No commuting to class. Study at your own pace, while continuing your present job.

The accredited Grantham non-traditional degree program is intended for mature, fully employed workers who want to upgrade their careers . . . and who can successfully study electronics and supporting subjects through

INDEPENDENT STUDY, AT HOME

Free Details Available from:

Grantham College of Engineering
10570 Humbolt Street
Los Alamitos, California 90720

Independent Home Study Can Prepare You

Study materials, carefully written by the Grantham staff for independent study at home, are supplied by the College, and your technical questions related to those materials and the lesson tests are promptly answered by the Grantham teaching staff.

Recognition and Quality Assurance

Grantham College of Engineering is accredited by the Accrediting Commission of the National Home Study Council.

All lessons and other study materials, as well as communications between the college and students, are in the English language. However, we have students in many foreign countries; about 80% of our students live in the United States of America.

Grantham College of Engineering R9-85
10570 Humbolt Street, Los Alamitos, CA 90720

Please mail me your free catalog which explains your B.S. Degree independent-study program.

Name _____ Age _____

Address _____

City _____ State _____ Zip _____

SEPTEMBER 1985

5

CABLE TV CONVERTER REPAIR

- ▷ ALL MAKES
- ▷ ALL MODELS
- ▷ 7 DAY TURNAROUND
- ▷ FLAT RATE PRICING
BY MODEL

CALL FOR INFORMATION

"THE CONVERTER SHOP"

794 Franklin Lakes Ave.
Franklin Lakes, NJ 07417
Tel. (201) 848-8229

ELECTRONIC SALVAGE PARTS

Below Wholesale
Electronic Prices Slashed!

Condensors	Yokes
Capacitors	Antenna Rods
IC's	Fuses
Transistors	CATV
Diodes	Flyback
Triplers	Video Heads
Controls	Needles
Resistors	Wire
Speakers	and Lots of Goodies!

You name it, we've got it,
and cheaper

call or write for
free catalogue

E.S.P.

2706 Middle Country Road
Centereach, N.Y. 11720
(516) 467-9852 (800) 645-5030

Making an octagonal base requires only that you cut the corners off a square piece of wood; that is certainly easier than trying to make a perfect circle. The plywood should be $\frac{1}{4}$ - or $\frac{1}{8}$ -inch thick, whichever is easier for you to find. The wood need not be any thicker than that. Cut the wood according to the dimensions shown in Fig. 2.

When building such a base, a double-axle wheel assembly makes the job a snap. A double-axle assembly is simply two motors connected to independent axles and housed in a plastic case with the proper gearing to provide enough torque to move the robot. (Don't worry about the terminology used, we'll devote some time to it in the future.)

The final assembly of the robot platform includes mounting the wheels, which should fit perfectly on the shafts of the double-axle motor assembly. Mount the motor onto the wooden base using metal or plastic stand-offs. The wheels should protrude through the bottom of the wooden platform. The finished platform with all components in place is shown in Fig. 3. Once done, it's time to think about building the motion-control circuits.

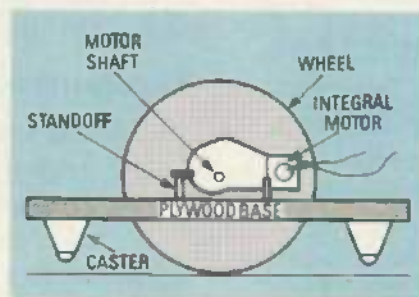

FIG. 3

Controlling the platform

Two simple hookups to control the platform's motion are shown in Fig. 4. Assume that there are two such circuits in each example, one to control the left wheel and the other to control the right.

Figure 4-a shows a manual switch setup that, along with a length of wire from the motors to the switches, can be used to control the robot's movement. When S1 is pressed, the motor rotates in one direction; when S2 is pressed,

the motor rotates in the opposite direction.

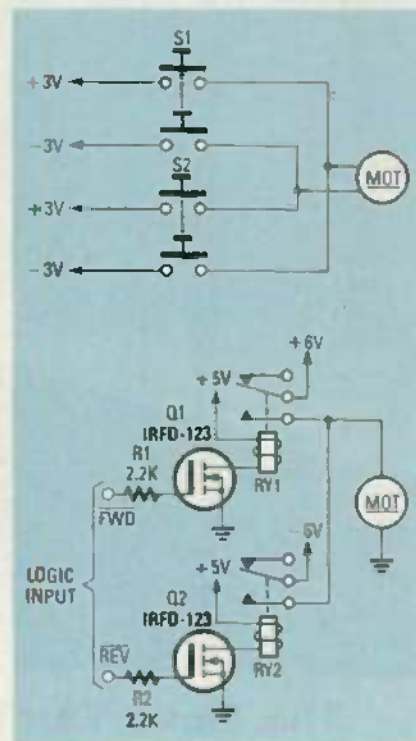

FIG. 4

That simple setup is great for demonstration purposes. But it's more likely that you'll want to interface your robot to a personal computer. To do so, you'll need a circuit like that shown in Fig. 4-b. In that scheme, a logic signal turns on a MOSFET transistor, Q1 or Q2, which then energizes its associated relay. Depending on which transistor is turned on, the motor rotates in either a forward or reverse direction.

The driver circuit, a FET transistor, requires little power. If the specified unit (rated 60 volts at 400 mA) is unavailable, feel free to make substitutions. The relays can be any type that suits the motor's power requirements.

It's a simple matter to write a short program that lets your personal computer control the platform. Figure 5 shows a simple flow chart for designing a control program to activate the motors. Let's assume that this program is looking at a four-button keyboard, one for each direction. When the forward button is pressed, both motors are turned on in the forward motion. Pressing the right-turn button, however, causes the

COMPUTER DIGEST

VOL. 2 NO. 9 September 1985

NEW KIND OF MAGAZINE FOR ELECTRONICS PROFESSIONALS

TOUCHSCREEN TECHNOLOGY

Inputting the
easy way.

EMULATING PRINTERS

How to make your
printer do what
you want.

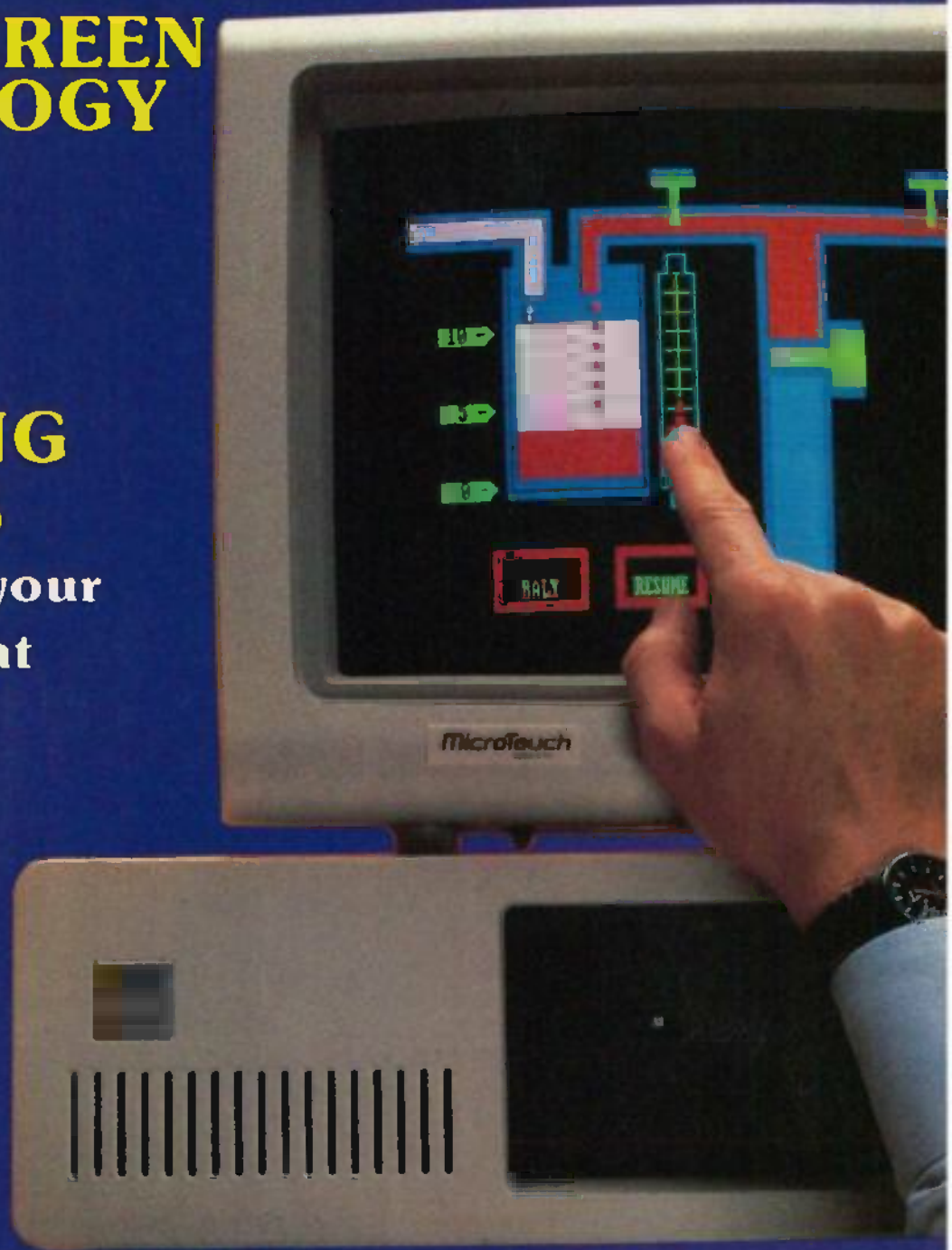

A
GERNSBACK
PUBLICATION

VOICE REPRODUCTION FOR YOUR TIMEX

More than 5 seconds of speech with 16K.

Electronics Paperback Books

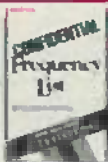

SECRETS OF THE COMMODORE 64 — \$2.95. Master of 64K VLSI and programming tips not found in any user's manual.

INTRO TO PROGRAMMING THE AT80C88 — \$2.50. Perfect companion to the AT80C88 manual. Even shows how to use expanded graphics.

COMPUTER TECHNOLOGY EXPLAINED — \$2.95. Explanations for computer terms often encountered. A dictionary for computer bugs.

INTRO TO 2-88 MACHINE CODE — \$2.75. Speed up your programs. Easy to write but it's worth learning how. Some demo programs are included.

ANTENNA PROJECTS — \$2.00. Practical radio antenna designs that deliver good performance and are actively simple and inexpensive to build.

WHITE'S RADIO LOG — \$2.95. An up-to-date directory of AM, FM and TV stations, including a section on special shortwave stations.

CONFIDENTIAL FREQUENCY LIST — \$2.95. An up-to-date list of AM, FM and TV stations. Also 550-1800 Hz.

SIMPLE TROPICAL & MEDIUM WAVE ANTENNAS — \$2.95. Use them on the 30, 70, 90 and 120 meter bands. Also 550-1800 Hz.

INTRODUCTION TO RADIO DZING — \$2.95. Get into this fascinating hobby. This book tells you just about everything you need to know to get started.

MICRO INTERFACING CIRCUITS—BOOK 1 — \$2.95. Practical and one-to-one transfer your computer into control or measurement equipment.

MICRO INTERFACING CIRCUITS—BOOK 2 — \$2.75. Laboratory sound and speech generators, temperature and optical sensors, motor controllers, and more.

LONG DISTANCE TV DIXIE — \$2.95. A practical and authoritative introduction to this unique aspect of electronics.

HOW TO DESIGN ELECTRONIC PROJECTS — \$2.75. How to use standard circuit elements to make custom electronic projects.

HOW TO GET YOUR ELECTRONIC PROJECTS WORKING — \$2.50. How to find the faults in your projects, repair them and get them working.

DESIGN & MAKE YOUR OWN PC BOARDS — \$2.75. Everything you need to know before you make printed circuit boards for your projects.

INTERNATIONAL DIODE EQUIVALENTS — \$2.75. Helps and replaces parts for rectifier diodes, LEDs, thyristors, photo diodes and display diodes.

INTERNATIONAL TRANSISTOR EQUIVALENTS — \$2.95. Location positive substitutes for a computer user-oriented selection of modern transistors. Japanese, European and American types.

PRACTICAL ELECTRONIC BUILDING BLOCKS — \$2.95. Build the blocks and then combine them to form almost any custom project of your choice.

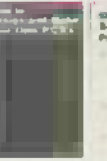

CRYSTAL SET CONSTRUCTION — \$2.95. A variety of crystal radio receivers for the experimenter and hobbyist.

SEMICONDUCTOR THEORY — \$2.75. Elements of Electronics. Leads into transistors and other semiconductor devices.

HOW TO USE OP AMPS — \$2.75. A source book of circuits and 2 reference book for design calculations.

ELECTRONIC SYNTHESIZER PROJECTS — \$2.95. How to assemble the elements of a synthesizer and even put them all together.

ELECTRONIC TIMER PROJECTS — \$2.50. Timing circuits to fit just about every application. Required for every experimenter.

SINGLE IC PROJECTS — \$2.95. All projects in this book are based on one IC and are simple to construct. Great way to get started with ICs.

POPULAR ELECTRONIC PROJECTS — \$2.75. A collection of a wide range of electronic projects and circuits for the experimenter.

IC PROJECTS FOR BEGINNERS — \$2.95. Written especially for the less experienced experimenter. Complete parts layouts and wiring diagrams.

555 PROJECTS — \$2.95. To assure that the IC has an unparalleled reputation. Here's a host of useful applications.

ALTERNATING CURRENT THEORY — \$2.95. Elements of Electronics. Needed for comprehension of speech, music, radio, TV and more.

POPULAR ELECTRONIC BUILDING BLOCKS — \$2.95. Amplifiers of all kinds to add to the circuits from Book 1 of this series.

POPULAR ELECTRONIC BUILDING BLOCKS — \$2.95. More circuits for hobbyists. Audio, radio, test, music, household and more.

POPULAR ELECTRONIC BUILDING BLOCKS — \$2.95. More useful circuits. Some of these projects duplicate those in Book 1 of this series.

POPULAR ELECTRONIC BUILDING BLOCKS — \$2.95. More useful circuits. Some of these projects duplicate those in Book 1 of this series.

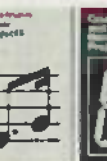
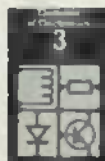

Quality Paperbacks

Affordable Prices

CHECK OFF THE BOOKS YOU WANT

BOOKS LISTED BELOW ARE 25% OFF REGULAR CATALOG PRICE



- STEREO QUADRAPHONY HANDBOOK Now \$2.25
- AUDIO ENTHUSIASTS HANDBOOK Now \$2.00
- SOLID STATE NOVELTY CIRCUITS Now \$2.00
- BUILD HI-FI AUDIO ACCESSORIES Now \$2.00
- 26 TESTED TRANSISTOR PROJECTS Now \$3.15
- 26 PROJECTS USING CA3130 Now \$3.35
- PRACTICAL INTRODUCTION TO DIGITAL ICs Now \$2.10
- FIRST BOOK OF PRACTICAL PROJECTS Now \$2.00
- MAJOR SOLID-STATE HI-FI PROJECTS Now \$2.20
- 50 CIRCUITS USING DIODES Now \$3.00
- IC LM3800 PROJECTS Now \$3.55
- 50 CIRCUITS USING 7400 ICs Now \$3.30
- 50 SIMPLE LED CIRCUITS Now \$2.50
- FIRST BOOK OF TRANSISTOR EQUIVALENTS FOR BEGINNERS Now \$2.00
- 50 PET TRANSISTOR PROJECTS Now \$2.30
- 90 GAMES GUIDE TO BUILDING ELECTRONIC PROJECTS Now \$2.75
- ESSENTIAL THEORY FOR THE ELECTRONIC HOBBYIST Now \$2.75

THE MORE YOU BUY...THE MORE YOU SAVE....THE MORE YOU BUY



SPECIAL CLEARANCE SALE OFFER ENDS SEPTEMBER 15, 1985

ELECTRONIC TECHNOLOGY TODAY INC.
P.O. Box 240, Massapequa Park, NY 11762-0240

Name _____
Address _____
City _____ State _____ Zip _____

Number of books ordered

Total Price of Books \$ _____

Sales Tax (NY State Residents) \$ _____

*Shipping in U.S. only (\$1.00 1st two books, 40c ea additional) \$ _____

TOTAL ENCLOSED \$ _____

*Canadian Shipping \$1.50 first 2 books 50c ea. additional book

CONTENTS

Vol. 2 No. 9

September 1985

8 Touch Screen Technology

It's almost like magic. You point at the screen and things happen. But it isn't magic—it's electronics! **Marc Stern**

12 Voice Reproduction

You can add more than five seconds of speech to your Timex-Sinclair 1000. **Jason M. Kinser**

14 Emulating Printers

Here's the quick-and-easy way to make your printer do the things you want it to. **Herb Friedman**

4 Editorial

"Compatibility" is the big sales word these days, but exactly what does that word mean?

5 Letters

5 Computer Products

7 Software Review

"TYPITALL" is a word processing software system that does it all and is easy to learn.



Page 12



Page 14

ON THE COVER

The new, lower-cost MicroTouch Screen™ employs technology to offer a combination of durability, optical clarity and high resolution not previously attainable to touch screen users. The screen, just announced by MicroTouch Systems, Inc., features a solid glass overlay sensor with a resistive coating bonded to its surface. See page 8.

COMING NEXT MONTH

Build A Firmware Card

It allows you to place a 2K or 4K EPROM anywhere in the USR memory of your Timex/Sinclair 1000.

Protecting Your Electronic Equipment

How to use MOV's (Metal Oxide Varistors) to protect against surges.

Computer Aided Design

Using your computer to help prepare schematics or other diagrams and flow charts.

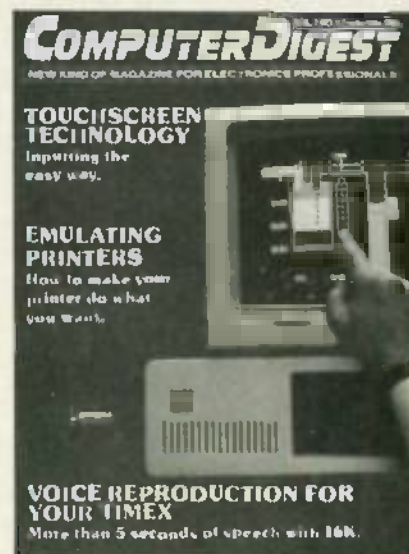

EDITORIAL

Incompatibility.

■ "My wife and I were incompatible," the old joke goes—"I didn't have enough income and she wasn't patable."

Be that as it may, the computer manufacturers know that certain words are necessary if you're going to sell a computer in today's marketplace. "User friendly" is one of the phrases that people look for.

Well, of course. You wouldn't buy an unfriendly computer, would you? And if the manufacturer didn't specifically say it WAS friendly, chances are that there was sufficient reason for that.

"Free" has always been a good sales tool, too. Offer something for nothing, and you may well be on the road to making a sale. "Free" can be anything from a truckload of software that the user may never have any use for, to an accessory or peripheral that he wouldn't know how to use. It doesn't really matter, as long as it's "free."

But what we're really going to jump on here, is the recent plethora of advertisements that boast "IBM Compatible." In fact, just about the only company that does not use this phrase in their advertising, is IBM itself!

What does "IBM Compatible" mean?

If you try to run a piece of IBM software in a foreign computer and the computer doesn't explode in protest, I suppose that's sufficient reason to call it compatible. Maybe so. But compatibility can come in varying degrees. And how compatible the computer you plan to purchase may be is more important than the mere fact that it is at all compatible. Compatibility, by my own measure, is the ability of my computer to run—with no modification—IBM software, and, in turn, allow me to run my own programs on the office IBM machine. Now that's compatibility.

Anything else is advertising.

It's the old story. *Caveat emptor* means "let the buyer beware." So the next time the salesman says "IBM Compatible," ask him exactly what he means. You just might get some very funny answers.

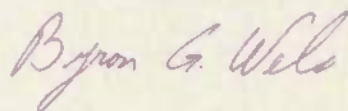

Byron G. Wels
Editor

ComputerDigest is published monthly as an insert in Radio-Electronics magazine by Gernsback Publications, Inc., 200 Park Avenue South, New York, NY 10003. Second-Class Postage Paid at New York, N.Y. and additional mailing offices. Copyright © 1985 Gernsback Publications, Inc. All rights reserved. Printed in U.S.A.

A stamped self-addressed envelope must accompany all submitted manuscripts and/or artwork or photographs if their return is desired should they be rejected. We disclaim any responsibility for the loss or damage of manuscripts and/or artwork or photographs while in our possession or otherwise.

COMPUTER DIGEST

Hugo Gernsback (1884-1967)
founder

M. Harvey Gernsback,
editor-in-chief

Larry Steckler, CET, publisher

Art Kleiman, editorial director

Byron G. Wels, editor

Brian C. Fenton, technical editor

Carl Laron, associate editor

Robert A. Young, assistant editor

Ruby M. Yee, production manager

Robert A. W. Lowndes,
production associate

Karen Tucker,

production assistant

Geoffrey S. Weil,

production assistant

Jacqueline P. Weaver,

circulation director

Arline R. Fishman,

advertising coordinator

Gernsback Publications, Inc.
200 Park Ave. South
New York, NY 10003

Chairman of the Board:

M. Harvey Gernsback

President: Larry Steckler

ADVERTISING SALES 212-777-6400

Larry Steckler

Publisher

EAST/SOUTHEAST

Stanley Levitan

Radio-Electronics

200 Park Ave. South

New York, NY 10003

212-777-6400

MIDWEST/Texas/Arkansas/Okla.

Ralph Bergen

Radio-Electronics

540 Frontage Road—Suite 325

Northfield, Illinois 60093

312-446-1444

PACIFIC COAST

Mountain States

Marvin Green

Radio-Electronics

15335 Morrison St., Suite 227,

Sherman Oaks, CA 91403

818-986-2001

LETTERS

18-Wheel Data Base

I work as a truck driver, and recently pulled into a computerized warehouse. The dispatcher pushed a card into a slot and the next thing I knew, my load was ready, the bill of lading was typed out, and I was almost on my way before I had time for a cup of coffee! On the way I got thinking about it. What would happen if the computer made a mistake? And is it going to be putting warehousemen out of their jobs? Where will it all stop?—Billy Horst, Clifton, NJ.

Don't panic. We're a long way from a computerized truck driver.

Warran-Tease

How can I take advantage of some of the tempting construction projects if my computer is still under warranty? Is there a way the manufacturer can tell if I opened the cabinet?—Jack Wilton, Cambridge, MA.

Yes Jack, there is. Check carefully and you might find a special paper patch cemented over one of the mounting screws, or even a drop of paint. Try to remove that screw and you break the "seal" revealing that you tampered with the unit. The best and safest bet is to wait until the warranty expires.

Wants To Learn

I recently purchased a computer, primarily for use in word processing. I agree with you completely that there is no need to learn to program, as you can buy better software than you could possibly write. But I can see several areas where I would have modified—the commercially-available programs I'm now using. I've tried several books, but they seem too advanced for me.—Fred Sandors, Omaha, Neb.

Fred, try a local Adult Education class in BASIC Programming. There's nothing like having a "live" instructor to answer questions.

COMPUTER PRODUCTS

For more details use the free information card inside the back cover

TAPE BACKUP, the Mountain 6300 combo is completely compatible with the AT&T PC 6300 running under the MSTM-DOS 2.11 operating system. The hard disk is cable-connected to the AT&T PC 6300's hard disk controller. Cabling is provided that allows the combo's disk to be connected either alone, or in addition to, the AT&T PC 6300's internal disk.

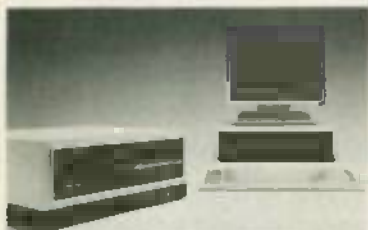

CIRCLE 21 ON FREE INFORMATION CARD

The Mountain 6300 combo backs up 3.4MB per minute, with full error correction, and without using deferred writes, which could mean a loss of data during a power glitch. The tape-backup menu requires that you need only enter a "B" for backup, and walk away with the assurance that all your files will be quickly and accurately backed up. There's no need for the user to get involved in management of the files being transferred, no rewinding, no track addressing, etc.

Restoring tape backup data to disk is also easy. The user can restore the entire disk at the same speed used to back up, or can choose to restore only a single file, or group of files by date of creation, or all files in a subdirectory, or any combination of the above.

The Mountain 6300 combo is priced at \$5,595.00.—Mountain Computer, Inc., 300 El Pueblo Road, Scotts Valley, CA.

EDUCATIONAL GAME, *DragonHawk*, is a disk-based adventure-strategy game.

The player controls *DragonHawk*. The mission is to kill a flying serpent that has put a full mountain range of creatures under its spell. Flying iguanas, phoenix birds, dragon puppies, bats, and mosquitos try to keep *DragonHawk* from gaining access to the flying serpent's airspace. *DragonHawk* destroys them by pouncing on them from above. However, if he stays at one level too long, he will also have to battle a violent lightning storm.

DragonHawk has as many lives as he has feathers, which are indicated by a feather-counter at the top of the screen. When all the creatures have been eliminated, *DragonHawk* faces the flying serpent itself. The fire-breathing serpent chases *DragonHawk*

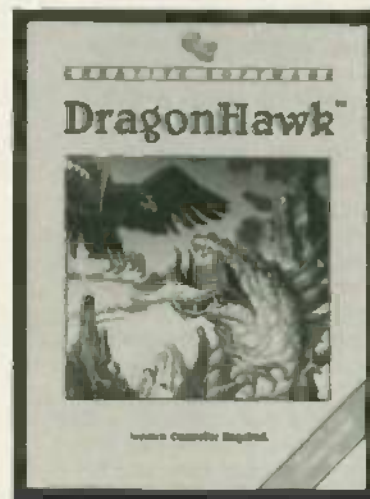

CIRCLE 22 ON FREE INFORMATION CARD

all over mountains and skies until the serpent's weak spot is discovered and it is destroyed. The player must discover that weak spot.

DragonHawk is priced at \$99.95.—Creative Software, 230 East Caribbean Drive, Sunnyvale, CA 94089.

EXPANSION BOARDS, the *Memory Companion/PC*, are designed for use with the Lotus/Intel Expanded Memory Specification; they are add-ons that provide the additional memory necessary for using the specification.

The new expanded memory specification (up to 8M) allows software to address RAM in excess of the standard 640K. The *Memory Companion/PC*



CIRCLE 23 ON FREE INFORMATION CARD

provides IBM PC/XTs™ (and compatibles) with up to 2M of additional memory. The board is compatible with Symphony™ 1.1, and up to four *Memory Companion/PC*'s may be installed in a system, increasing the memory to 8M. The 64K *Memory Companion/PC* is priced at \$349.00; the 256K version sells for \$395.00.—*STB Systems, Inc.*, 601 N. Greenville, Suite 125, Richardson, TX 75081.

STATISTICS PACKAGE, *StatView*, is an interactive statistics program for the Macintosh computer. It is designed for data analysis by people who work with numbers: economists, scientists, students, accountants, actuaries, sociologists, researchers, marketing executives, securities analysts, legislators, political campaign managers, and all other professionals who analyze data. It is a visual data-analysis package that takes advantage of the Macintosh computer's windows, pull-down menus, and mouse.

StatView is designed for use on all Macintosh formats, including 128K and 512K Macintoshes and the 1-Megabyte LISA equipped with Mac Works, the Macintosh emulation disk. *StatView* permits window-scrolling, changes in column width, and choice of font and font-size for data in a window — small for viewing many columns and rows, or for ease of reading. Cut, copy, or

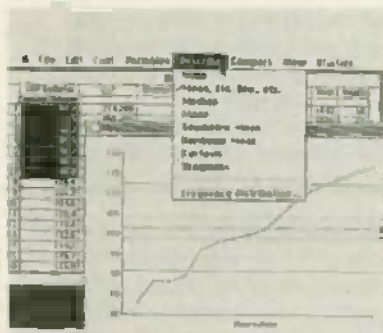

CIRCLE 24 ON FREE INFORMATION CARD

paste operations can be done between applications.

StatView is priced at \$199.95.—*Brainpower, Inc.*, 24009 Ventura Blvd., Calabasas, CA 91302.

MEDIA SAFE, the Sentry Supreme, model 5750 keeps its contents cooler than conventional fire-rated safes that are used for storing paper documents. At 1700°F, the interior of the Sentry Supreme remains below 97°F, and the relative humidity below 80%, levels well below U.L. standards for safe media storage. The safe is also large enough to protect not only diskettes and tapes, but a variety of non-electronics valuables, such as microfiche, photographs, stamp collections, and documents. The safe is tested and classified by Underwriters Laboratories to protect the contents of both storage compartments at temperatures up to 1700°F for one hour.



CIRCLE 25 ON FREE INFORMATION CARD

The Sentry Supreme model 5750 has a retail price of approximately \$600.00. The larger model 5760 is priced at approximately \$750.00.—*John D. Brush & Co., Inc.*, 900 Linden Avenue, Rochester, NY 14625.

FAST POLL MODEM, the model 9600 FP is a fast-training 9600 bps modem designed for use on multipoint networks. The design combines LSI and microprocessor technologies that result in high reliability and low power consumption. Fully automatic adaptive line equalization allows 4-wire full duplex private line operation over 3000 unconditioned leased lines without manual strapping. The digital adaptive equalizer compensates for the effects of delay and amplitude distortion that would otherwise cause intersymbol interference in the received signal. The model 9600 FP features an 8 ms RTS-CTS delay for fast turnaround time.

Also featured is a fallback mode,



CIRCLE 26 ON FREE INFORMATION CARD

which allows the user to change the data rate to 4800 or 7200 bps. Mixed-rate network operation allows independent or tributary modems to transmit to the Host modem at 9600, 7200, or 4800 bps. The model 9600 FP comes equipped with diagnostics for isolating problems in the data-communications path. Built-in test features include local digital loopback, remote activated digital loopback, local analog loopback, remote activated analog loopback, and 511 test pattern generation/checking.

The model 9600FP is priced at \$1995.00.—*Universal Data Systems*, 5000 Bradford Drive, Huntsville, AL 35805-1953.

EXTENDER BOARD, the model 3690-26, is designed for personal computers, and not only allows in-circuit probing of functional boards but also provides convenient marked test-points for all 98 bus lines on both card connectors. The extender includes a heavy-duty bracket to support cards while troubleshooting.

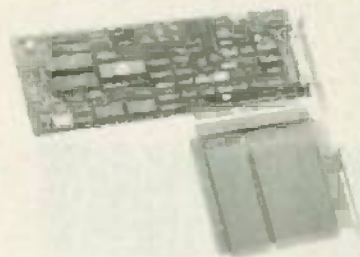

CIRCLE 27 ON FREE INFORMATION CARD

Card-edge-connector contacts are gold-over-nickel plated for low resistance and minimum wear. Receptacle contacts have gold inlays in copper-nickel alloy bifurcated fingers. Bus-line current-ratings are 5 amps with 200-volts RMS or 300-volts DC ratings. The bus lines are protected by a solder mask to prevent inadvertent short circuits while probing, making it ideal for experimenters.

In 1-4 piece quantities, the model 3690-26 extender cards are priced at \$45.13 each.—*Vector Electronic Company*, 12460 Gladstone Avenue, Sylmar, CA 91342 ◀▶

SOFTWARE REVIEW

TYPITALL for word processing

■At last count there were more than 1000 word processor software packages. Unfortunately, some are so difficult to use that just digesting the instruction manual takes several evenings. A really good high-performance word processor should require no longer than an hour or so to learn, be easy to use, and almost never require reference to the documentation. While this kind of word processing software is rare, it does exist, as TYPITALL for the Radio Shack Model 4.

TYPITALL is generally unknown because it is the "Plain Jane" of word processing, having no cute screen displays, menus or individualized function help commands to get in their own way. The program is document oriented, meaning it prepares and saves complete documents, not pages or sections which are later assembled into a document during printing. TYPITALL is specifically designed to simplify boilerplate by saving and tagging as files or blocks bits and pieces of text that will eventually be incorporated into a larger document. In addition to unusual editing functions, TYPITALL has most of the conventional word processing features except for a conventional mail-merge. Instead, it substitutes instantaneous keyboard entry while printing.

Response to all functions except for saving and reading disk "inserts" is instantaneous because no disk overlays are used. Unlike most modern word processors which use disk overlays for routine functions, all of TYPITALL's features including printer commands reside in memory along with the document, and all functions are *command driven*, providing instantaneous response to any command. For example, to completely reformat a document or to skip from the beginning to the end of a 6000 character file takes about a half-second. To reformat or skip to the end of a 25,000 character (4000 word) file takes less than 2 seconds.

Disk overlays are used only for (1) The help screens; (2) Hyphenation—which is done when the entire document is complete and ready for printing; (3) An optional integrated spelling checker; (4) customizing of the program. Somewhat unusual, either temporary or permanent customizing can be done on-the-fly by leaving the program, making the changes, and then returning to exactly where you left off.)

TYPITALL requires a TRS-80 Model 4 computer with one or more disk drives and any commonly-used operating system such as Radio Shack's own TRSDOS 6 or the aftermarket DOSPLUS IV. (A somewhat similar version of Typitall 2 for the Model I and III computers will run under any DOS, including NEWDOS.) The program requires about 15K of RAM, leaving 33K for the document. There is no computer lockup if the full RAM is used since a full or partial dump to disk can be

made because the program does not require additional memory to call in a disk overlay. Similarly, if a disk is full the user can install a disk in any drive and instantly save to the disk. If something causes the computer to hang (which is unlikely), a full reset of the computer and reenter of TYPITALL will come up with the document in the condition it was in just prior to whatever caused the problem. Short of turning the computer off, it is essentially impossible to accidentally lose an active document.

Because the program is document oriented the editing commands process complete sentence elements. In addition to conventional overwrite and insert, with a single command the user can delete or exchange words, sentences, or paragraphs with the previous sentence element, or randomly exchange blocks or pages throughout the document, or delete pages or any marked portion of the document. An on-the-fly line insert mode splits the screen so an insert can be viewed independently of what was written earlier, and the line can be independently edited. Touching a key instantly closes up the line and reformats the entire paragraph if the line insertion is more or less than a full line length. Any change to anything anywhere in the document automatically reformats text until the next end-of-paragraph marker or carriage return. Although TYPITALL is superfast in handling text, its speed requires extra care when deleting anything because the program has neither a paste nor a holding buffer: a deletion is gone forever—there is no recovery.

Boilerplate is under complete control of the user, not the program. Unlimited blocks with conventional filenames or labels A through Z can be marked and saved as either marked blocks or text blocks. Saved text blocks are handled by the program as conventional text or document files, and can be called back and inserted at the cursor position, chained in serial order, or chained to the end of the file. A labeled block is inserted into the text along with its label, leaving it premarked for easy relocation.

Although the screen can show the text as it will be printed on a line-by-line basis, the display isn't "what you see is what you get." If the screen width is the same as the printing width the display will show the proper words per line, but only left justified, like a standard typewritten page.

Except for an *undelete*, TYPITALL can do almost anything, and do it better than most word processors. If it was available for computers other than than the Radio Shack Model 4 there's a good chance that, like WordStar, it would be a legend in its own time.

TYPITALL, Howe Software, 14 Lexington Rd., New City, NY 10956. For Radio Shack Model 4 with one or two disk drives. ◀▶

TOUCHSCREEN TECHNOLOGY

Touchscreen technology can vastly simplify computing.

MARC STERN

■How many times have you heard it said that computers will make your life easier, only to turn around, fire up a microcomputer and have your day go anything but smoothly? If you're like any computer user, you're probably thinking about all the contortions you have to go through to do a simple task.

Just look at telecommunications. You want to dial a number and transfer data or communicate with a second party. You turn on the computer; find your telecommunications program; start the disk operating system; load the program into memory, just to get set. You've just achieved step one. Step two requires you to have the program originate the call; dial the number and connect to the remote system. Somewhere in there—at some time—you also had to set the program up so it would work correctly with the person you are trying to contact.

The same is true of any function in the microcomputer world. Microcomputers are powerful beasts, waiting to do your bidding. Getting that bidding done can take some doing on your part.

Let's say you are using a program which requires you to continually input information from the keyboard. You answer a series of questions which appear on the screen. These may be leading to a relatively simple conclusion, such as setting your microcomputer's printer port; communications port, or clock. Along the way, you must continually hit various keys to answer the questions and then wait until the program updates the microcomputer. As you work with the system, you think there must be a better way of doing things.

Well, many in the microcomputer world agree with you and that's why there's a burgeoning number of input devices on the market, all aimed at making life easier. There's the mouse; the digitizing tablet; the bar code reader, and light pen. All of these give you an alternative input method. The keyboard, considered by many to be THE input device for a microcomputer isn't the only one, nor is it the best.

Many times, one of the alternative devices will work equally well and, more efficiently. In an environment which requires vast amounts of information input, an optical character reader may be the best device, followed by a bar code reader or light pen. Or, let's take a manufacturing environment. In this type of atmosphere, a keyboard would prove more of a hindrance than a help. Or, in a situation where a system merely wants to know your choices, so the work, a simple mousepointing device may be the answer.

In all of this, there is still another device, which,

while it is complex, makes the use of a microcomputer simple, the touchscreen.

There's much more to touchscreen technology than this, but, in its simplest terms, this is all there is to it. To the user, everything appears very simple. All he has to do is press an area on the screen to access a function and the computer does the rest.

Underlying this, of course, is a program and complicated input and output routines which take the simple pointing action and turn it into the action you have chosen with your pointing finger. It's all completely natural, the sort of thing that instinct tells you to do—you point.

Typical applications of touchscreen technology include microcomputer-based directories; automotive electronics—Buick Electra, for example; simple manufacturing inventory; computer-aided



FIG. 1—CRT IN FORD 1985 Mark VII Comtech displays driver information and permits manipulation of such items as climate control simply by touching the screen.

manufacturing environments, and the like, or any environment which doesn't require keyboard input or a keyboard would be inappropriate. (See Fig. 1)

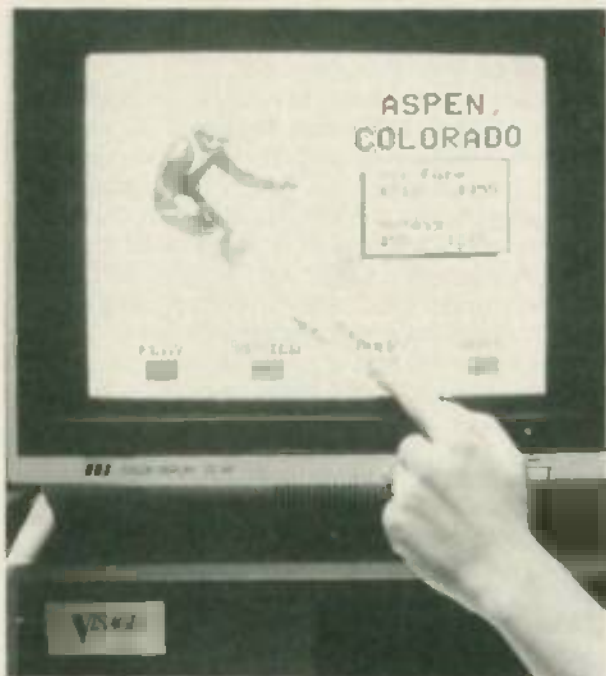

FIG. 2—MICROTOUCH (TM) SCREEN used with interactive videodisc system from Visage, Inc. for point-of-application where users can select vacation travel arrangements.

Three technologies

At the moment, there are three types of touchscreen technology.

The first is the traditional resistive, plastic-type; the second and newest is the resistive-capacitive glass-type, and the third, based on a different technology, is the light emitting diode-type.

The newest expression of touchscreen technology is offered by MicroTouch Systems Inc. of Woburn, MA. (See Fig. 2.) This company has come out with a touchscreen which eliminates many of the problems associated with plastic touch-sensitive screens.

For example, traditional plastic touchscreens are prone to damage from sharp objects, such as pens or pointing styli and they cut down on the optical quality of a computer's video display. Further, the sandwich of plastic overlays and mechanical dots used in traditional touchscreens also degrades a display image.

The MicroTouch screen employs a solid glass sensor and bonded overlay to handle its functions. This type, since it is more impervious to damage, offers greater long-term reliability than traditional technology.

A plastic-based touchscreen system is actually a sandwich system.

Usually employing two or more sheets of plastic and a center electromechanical sheet covered with dots, the plastic-based system uses those dots to represent information to a touchscreen controller. Changes in the resistance of the middle layer indicate positional information. That controller, in turn, takes the information which has been generated by a user's touch and turns it into digital information for use with a driver program in the microcomputer's memory. In turn, the driver program interprets the touch to mean an action and the microcomputer supplies the solution.

If you look at a traditional touchscreen system, you

will see the plastic overlay is linked with the microcomputer either through a parallel or serial port. In those cases where the system is built into a microcomputer, the touchscreen occupies the spot of a logical device in the microcomputer's memory. This means that although the device may not actually be present physically, the microcomputer thinks it is there and accepts its input.

The linkage between the touchscreen and its controller is handled via a bus which is connected to the dot screen that is sandwiched between the two plastic layers. Those layers are coated with an electrically conductive material and make contact with the center dot layer. The changes in electrical resistance that are generated when contact is made determine the input for the controller in the system.

The touchscreen's bus operates on the X-Y axis of the screen and positional inputs are determined in this manner. The contacts at the vertical sides of the screen act as the X-axis, while the contacts along the horizontal act as the Y-axis.

One drawback of this type of touchscreen system is that it is rather coarse in its positional inputs. Since the plastic is very flexible, when a user touches a certain area of the screen many X-Y positional inputs are generated at once. This mass of information is sent along the signal bus to the controller, which determines the action to be taken. Since so many dots are accessed during a touch, you can see it is impossible to have the system act in any more than a broad manner. Unless the driver program changes to a new, more finely tuned function, the touchscreen is incapable of rendering finely tuned input.

Another solution

A more durable solution to the plastic membrane is an LED touchscreen. Again, this system depends on an X-Y axis arrangement, but, instead of using a plastic membrane and electromechanical dots, it uses a rim of LEDs and detectors on the perimeter of the video display tube.

This has the advantage of not detracting from the optical clarity of a display device, but, like the plastic-based touchscreen, it is incapable of high resolution, due to size constraints. No matter how small the LED is, it and its array is still large in comparison to the video display screen and its positional inputs are very broad.

For example, let's say you break three LEDs vertically and four horizontally with your finger. That is a fairly broad area, using even mini-LEDs. So, you can see that resolution is low and, unless the driver program is ready with multiple screens and new choices, then the functionality of this type of technology is limited.

It is an interesting technology itself, though.

To picture an LED-driven touchscreen system, think of the screen of a microcomputer itself. Surrounding the screen, and raised slightly above it, is a bezel containing the ring of LEDs and detectors. Connected to the back of the bezel is the LED system's signal bus, which interacts with the touchscreen controller. That controller can either be in the CRT housing or within the system box. It takes the rough digital positional inputs and sends them on to the microprocessor for

processing. Usually, the controller is an intelligent signal processor, which, like the processor in a plastic-membrane system, may either be recognized as a logical parallel or serial port.

In action, the LEDs emit a crisscross grid of infrared beams over the surface of the display tube and merely breaking the beams causes the positional input to register in the controller.

The problem with the LED touchscreen is not only its basic coarseness, but also the fact that the IR beams are suspended a distance above the highest point on the surface of the curving CRT screen. This can translate to parallax problems for the system. The signal processor must have error correcting capability and this increases its complexity. One advantage to this system is that its digitization is almost instantaneous. Since the IR beam is either continuous or broken (on or off), its inputs are digital and this can eliminate a layer of conversion (analog to digital) since the voltage is on or off.

A new technology

Representing the newest resistive touchscreen technology is that developed by MicroTouch. This technology has certain inherent features that make it more reliable than older forms. For example, since it doesn't rely on plastic membranes, its durability factor is higher, which is important in a heavy use environment. It provides the microcomputer user with greater display clarity. And, since it is part of the touchscreen, no parallax problem.

The key to this system—and systems like it—is a solid glass sensor. It features a solid glass overlay with a resistive coating bonded to its surface. The key to this system is capacitive coupling between the object used for pointing and the surface. This coupling changes the resistive qualities of the glass and information is generated. (See Fig. 2.)

Almost immediately, you can see the advantages of this system. However, it has some advantages which aren't that apparent, such as high-resolution capability. With this type of system, a CRT now has 256 by 256 or 65,536 touch points. With this type of resolution, it should be possible to increase the information content of a program screen and also make the driver program far more efficient for the user. Instead of having to page

through screen after screen of material, most of the choices are presented on one screen.

This system is also capable of nearly instant reaction to multiple touches. With a sampling rate of 50 points per second, a user can make choices far more quickly than with other systems. It can transmit touch data in either a stream mode or in a one point per touch, point mode. This means you can have some detailed screens of information available for the user. Typically, plastic membrane and LED systems have lower sampling rates and are more limited in their functionality. The sampling rate does rely on the type of controller used, but, you will find most touchscreen systems have a 10 to 30 point per second sampling rate.

Driven by a microprocessor, this type of system also is system-independent. It uses an RS-232 serial link to communicate with the microprocessor in a system unit and is capable of operating over a range of 110 to 9,600 baud. It provides a multiplexed, auxiliary RS-232 port for a terminal. (See Fig. 3)

The microprocessor handles several functions. Since the signals generated by a touch on the screen are actually changes in electrical voltage, they are analog in nature and must be converted to digital form before they can be used by the touchscreen's controller. The touchscreen's intelligent controller performs the analog-to-digital conversion and then sends those signals to the controller. The controller, typically an 8-bit microprocessor, has four Read-Only Memory (ROM) based commands, including mode, which permits the user to select the point, stream or inactive mode (no touch data transmitted so a CRT can be used normally); calibration, which aligns the touchscreen with the CRT; data format, which allows the selection of decimal, hexadecimal or binary data representations; reset, which returns the controller to the stream mode and decimal format, clears the output buffer, and runs a diagnostic, and command-point, which is available for the creation and management of special touch zones on the screen.

Since this type of touchscreen is system independent, it also includes programming capability to handle the needs of various microcomputer systems. Different data formats and calibrations can be programmed and stored in an electrically erasable programmable read-only memory.

A breakthrough

Until now, touchscreens have generally lacked the definition and durability to make them effective in many environments. Since their resolution was low, they needed copious software to handle their tasks and this constant need to refer to new screens of information slowed down efficiency. With a system such as the new high-resolution ones now appearing on the market, this has changed and the user can have one screen handle many functions, which speeds efficiency. And, since the coating is bonded to the glass in new systems, it means durability should be very high. It represents a breakthrough which will make touchscreens a very real alternative input technology. ◀▶

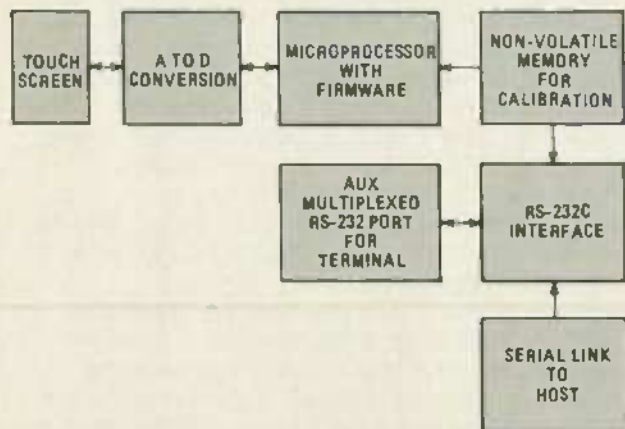

FIG. 3—BLOCK DIAGRAM illustrates simple touchscreen system.

This will be
coming to you
when you
subscribe to
Radio-Electronics

**HELPFUL
CONSTRUCTION
ARTICLES...**

Test Equipment
Hi-Fi Accessories
Telephone Accessories
Music Synthesizers
Computer Equipment
Automotive Equipment
Intruder Alarms-
Home & Car
Video Accessories

**NEWS ON NEW
TECHNOLOGY**

Computers
Microprocessors
Satellite TV
Teletext
Automotive Electronics
Speech Synthesizers
IC Applications

**FASCINATING
"HOW TO DO IT"
ARTICLES...**

Build Your Own
Projects
Make Your Own PC
Boards
Wiring Techniques
Soldering and
Desoldering
Design and Prototyping

SPECIAL
16-PAGE TEAR OUT
COMPUTER DIGEST

Radio- Electronics

COMPUTERS • VIDEO • STEREO • TECHNOLOGY • SERVICE

**BUILD THIS
SATELLITE TV STEREO
DEMODULATOR.**
R-E's add-on for your
satellite TV receiver tunes
you into stereo audio. ▶

**RECHARGEABLE
BATTERIES.**
How to choose
the one that best
suits your needs.

**BUILD A
COMPUTERIZED
IC TESTER.**
With this automated
tester you can quickly
weed out your faulty
digital IC's.

**ELECTRONICS
IN MEDICINE.**
How images of the human
body are produced.



**SATELLITE TV
COMPONENT
BUYERS GUIDE.**
What's available if you want
to piece together your
satellite receiver system.

PLUS:

- ★ Drawing Board
- ★ State-Of-Solid-State
- ★ Hobby Corner
- ★ New Idea
- ★ Service Clinic
- ★ Equipment Reports

• **HOW YOU AND THE COMPUTER
CAN BE FRIENDS...**

Getting Started
Programs, Circuit
Design, Games
AD-D/A Interfacing
Peripheral Equipment

• **NEW AUDIO DIMENSIONS
FOR YOUR PLEASURE...**

Noise-Reduction Devices
How to Connect that
Extra Add-On
Hi-Fi Accessories
New Technology

• **TV WONDERS FOR YOUR
FUTURE...**

Latest Receivers and
Circuits
The Home Entertainment
Center
Projection TV
Satellite TV Receivers
Jack Darr's Monthly
Service Clinic
Service Problems and
Solutions

• **REGULAR MONTHLY FEATURES**

DESIGNERS NOTEBOOK
by Robert Grossblatt
HOBBY CORNER
by "Doc" Savage, K4SDS
STATE-OF-SOLID-STATE
by Bob Scott
WHAT'S NEWS, new
products, stereo news
and **NEW IDEAS**, **STEREO
PRODUCTS**, **NEW
COMPUTER PRODUCTS
FOR HOME/JOB** and
MUCH MORE!

Radio-Electronics covers all
aspects of the fast moving
electronics field...featuring
**COMPUTERS • VIDEO • STEREO
TECHNOLOGY • SERVICE
COMMUNICATIONS • PROJECTS**

Get it all!

Subscribe today to Radio-Electronics! Don't miss a single issue and...see subscription card in back of this issue for big savings.

When you select one of the subscription offers listed on the handy coupon—you'll be assured of having your copy reserved, even if it sells out on the newsstand. Make sure you get all the excitement in every issue of Radio-Electronics, every month, by filling in and mailing your subscription card today.

VOICE REPRODUCTION

More than 5 seconds of speech with 16K.

JASON M. KINSER

■Timex-Sinclair users may have experienced the same feeling. My brother and I were discussing our computers. He owns a Commodore 64 and I have the Sinclair. He laughed because his computer could do "real" things. He had hi-res, and sound, and color.

Interfacing

The Sinclair has no speaker but it does have the two cassette interfaces.

An operational amplifier with a speaker connected to the mic-jack interface of the computer will serve as the speaker. Likewise, a microphone with an amplifier can be connected to the ear-jack interface to act as a microphone. The connecting cables are provided.

The cassette interfaces are tied directly with the TV and somewhat directly to the data bus. Being connected to the TV eliminates the need for one of the amplifiers. (See Fig. 1.)

Since the data bus, cassette interfaces, and the TV are all tied together all of the following programs must be run in the FAST mode. The SLOW mode will keep the display running and this will drown out anything.

Noise from nowhere

The first task of voice synthesis is to have the computer produce simple frequencies. These frequencies are single-amplitude square waves. Voice reproduction will be just differing frequencies.

Access to the mic-jack (output) or the TV speaker is handled by the machine language command `OUT (n)A`. This command takes the contents of the Accumulator and dumps them onto the data bus. The contents are then sent to device number "n."

There are 256 device numbers. The ear-jack is FE and the mic-jack is FF. Therefore, `OUT (FF), A` is used.

This will output one pulse. The signal coming out of the machine will oscillate according to the bit pattern of the Accumulator. These oscillations are too fast to produce an audible tone. They are, however, used to change the flavor of the produced tones.

The frequencies are determined by the amount of time between the output of the Accumulator. This can be set by the programmer. The following program will produce simple frequencies depending on what is in register B. This holds the length of the wait before the

All photos by Bruce Wittenmyer



FIG. 1—AUTHOR POINTS TO SCREEN as computer runs in the "speaking" mode. TV lines flicker according to outputted sound.

Accumulator is sent on to the bus.

The Accumulator will be accessed until BREAK is pressed. `CALL 0F46` is the subroutine which will recognize BREAK. If it is pressed it will return from the subroutine with the Carry low.

The Accumulator can hold any number. Also the screen will display the noise being produced along with the bit pattern of the Accumulator.

```
LD A, FF      3E FF
OUT (FF), A   D3 FF
LD B, 66      06 66
CALL 0F46     CD 46 0F
RET NC        D0
DJNZ FA       10 FA
JR            18 F2
```

The voice reproduction will consist of inputting a voice and having the computer reproduce it.

The input into the machine must be done through the cassette interface (see Fig. 2). If a microphone with an amplifier is not available, then record the voice and play the recording into the computer. It is more work, but better than nothing. (See Fig. 3.)

Inputting is similar to outputting. Instead of `OUT (n), A` the comparable `IN A, (n)` is used. When using the ear-jack `IN A, (FE)` is used.

Unfortunately, the input does not record all of the information. It only sees a threshold. So, the incoming signal is recorded as high if the signal is above the threshold, and low if it is not. The machine will not see



FIG. 2—THE COMPUTER with audio amplifier and mike connected to cassette interfaces. The program seen on the screen is a representation of the machine code program.



FIG. 3—MICROPHONE IS CONNECTED TO AMPLIFIER which enters the ear-jack of the computer. Mic-jack is unconnected but will connect to another amplifier and speaker.

how far above or below the signal is.

The accumulator will have either 39 or B9. The only bit that makes any difference is bit number 7. (Sometimes the lowest bit alters, but this is independent of the incoming signal.) The highest bit is rolled off and saved in succession.

The bad news is that the wave cannot be stored completely. Only the frequency is stored. The amplitude is lost. Voice reproduction is still possible though. Some cleanness will be foregone.

The good news is that now each byte can hold eight different samplings of the signal. This increases the amount of speech time by a factor of eight. This allows for almost six seconds of speech. Generally, a 64 K machine would allow only 2.5 seconds of speech.

The only remaining problem is to find someplace to store the data. The data can be stored in a RAM statement, but you first have to make a REM statement 13,000 characters long. The data could be stored in a string, but these

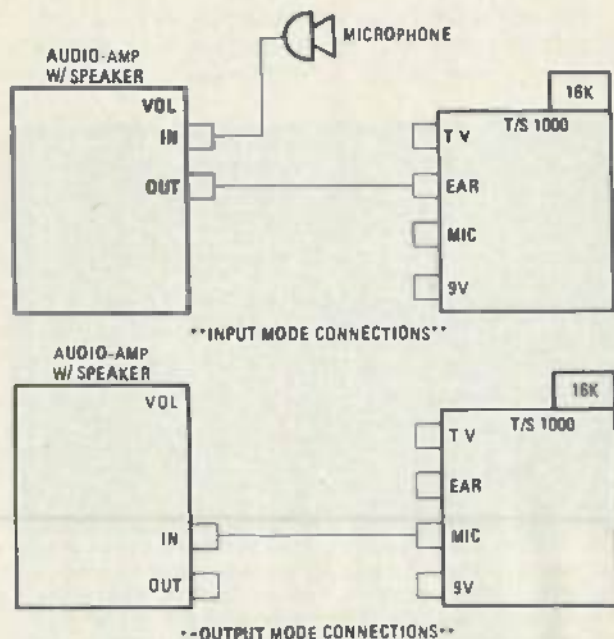

FIG. 4—BLOCK DIAGRAMS reveal input and output mode connections.

are easy to erase and move around in the memory. The data could be put above the RAMTOP, but this cannot be saved on tape. For this demonstration, the data will be put above the RAMTOP.

First move the RAMTOP down.

POKE 16389, 77

POKE 16388, 56

The first location for data storing is 19768. There are 13,000 bytes afterwards set aside for storage.

The following program will load the data. It is best to put the program in a REM statement. Enter the first basic command as a REM statement with at least 71 spaces following. That will make the first available position for the start of this program 16514.

```
LD HL, 4D38      21 38 4D
LD C, 32         OE 32
LD B, FF        O6 FF
LD D, 08        16 08
IN A, (FE)      DB FE
RL A            CB 17
RL E            CB 13
CALL OF46      CD 46 OF
RET NC         DO
DEC D           15
JR NZ, F3      20 F3
LD (HL), E     73
INC HL         23
DEC B          05
JR NZ, EC      20 EC
DEC C          OD
JR NZ, E9      20 E9
RET            C9
```

Reproducing the signal is as simple as putting it into the machine. The data will be accessed one bit at a time. If the bit is high then the contents of the Accumulator are put onto the data bus. If it is low, then that part of the program is bypassed.

The following program is the output. It will take the same data that the computer received and kick it back out. The program should also be put in the REM statement. It will start at 16545.

One section of the program may seem a bit useless.

LD B, 01

DJNZ FE

This is a wait of 1. It can be used to slow down the voice by loading B with another number. Inserting this into the first program can speed up the voice when it is replayed. There are still other uses of this routine that are still being explored. It does slightly slow down the reproduction, but it is not noticeable unless a pure tone is being compared by its reproduction.

Now it is ready. Run the first program and immediately input a voice. Next turn up the TV speaker or turn on the external speaker and run the second program. (See Fig. 4)

What will be heard are the frequencies of the original voice. It will be slightly rough. Remember, the TV will add some fuzziness to the voice. The best response is outputted through the mic-jack.

Now my brother is down to only one laugh. He can no longer laugh about hi-res or his sound any longer. Of course, he still laughs about the the color that his computer produces, but he who laughs last... ◀▶

EMULATING PRINTERS

Resolving some incompatibility problems

HERB FRIEDMAN

■The difficulty with anything as dynamic as personal computing is that perfectly suitable and costly equipment can become obsolete and unusable. This is particularly true of printers, whose functions, features and characteristics are rapidly outstripped by the level of technical competence expected of the user, and by new hardware and software. For example, although the conventional 80-column printer is more than adequate for most of the typical office routines, commercially prepared spreadsheets intended for business use have become so large and complex that an 80 character line barely conveys the desired information. Many of the latest spreadsheets require a 130 column line, or sidewise printing for an endless number of columns per line of printing.

While most matrix printers can be programmed to print "mice type"—meaning 16 to 18 characters per inch, which produces at least 132 characters per line on 8-1/2 inch wide paper—virtually all printer manuals assume the user has some level of competence as a BASIC programmer and can write a short program routine to configure the printer for "mice type." The BASIC program is necessary because few application programs have a direct way to send the printer control codes used to configure the printer. Configuration via the printer's control codes must be done through a BASIC program.

In the early days of personal computing most users had a working knowledge of BASIC, today, more often than not a personal computer is a business tool, and few users have any idea what programming or BASIC is about. Telling a user to write a short BASIC program for a printer is confusing and unproductive.

None of the older printers and almost none of the new non-IBM printers are 100% compatible with the characters produced in IBM computers by ASCII codes higher than 127, yet the IBM PCs and their clones are the standard of reference computer for the small businessman. Although a few of the latest non-IBM printers can reproduce from some to most of the IBM PC's graphic and foreign symbols, at the time this article was prepared none reproduced all characters provided by IBM compatible computers. It gets sort of sticky when you run a commercial applications program that is supposed to print a musical symbol, or

even the omega symbol for resistance, and all your printer turns out is a blank space or characters bearing no relationship to what is seen on the screen.

The printer's computer.

The major reasons for the character incompatibility of specific matrix printers and computers are: (1) Manufacturers attempt to marry the consumer to a particular line of hardware; (2) matrix characters are generated by a computer built into the printer itself, and it is this computer which responds differently to ASCII input signals. The very same ASCII codes that cause one kind of printer to generate graphic lines will cause another printer to generate italic or conventional characters. Actually, reasons 1 and 2 are interlocked because a manufacturer of a complete line of computer equipment can easily modify his software to work properly only with his particular line of printers and vice versa.

Software for hardware

The way to resolve printer incompatibility is to use applications software either as a substitute for a BASIC program or as an emulator for hardware. Depending on



FIG. 1—PRINTER CONFIGURATION SOFTWARE lets the user program a printer's function(s) through menu selection instead of a BASIC program. This menu, from Adapta-Print, allows direct selection of forms control and printer ports. However, while the user can select a serial port for the printer, the port had to be previously configured for serial parameters through the OOS MOOE command.

your particular printer there are three ways this can be accomplished.

First, we have the substitute for a BASIC program. Virtually all printer manuals show a few samples of BASIC programs that might be used to send the control codes which configure a matrix printer for some unusual font, such as double width characters, "mice type," italics, or enhanced characters (correspondence quality). Aside from needing a working knowledge of both printer control codes and BASIC programming, using BASIC for configuration becomes unwieldy if it handles all possible printer functions, and there often isn't enough space on a disk to hold BASIC, the printer configuration program, and the applications software.

The best way to handle control code programming is to avoid the whole thing with printer configuration software, a special program that is generally booted through a batch file so the first thing the user does is configure the printer.

A particular advantage of independent configuration software (compared to a simple BASIC program) is that the software can automatically translate control codes so the correct one is sent to the printer when the user makes a menu selection. For example, the Epson, Okidata and Hewlett Packard printers employ different control codes for emphasized printing. If you were doing your own configuration through a BASIC program you would have to keep track of the correct codes for the various printers. This isn't true if you use a printer package such as Adapta-Print (Computational Systems, Inc., One Energy Center, Peilissippi Parkway, Knoxville, TN 37922), which provides printer configuration from the menu shown in Figure 1.

Adapta-Print is initially configured through an installation program for the printer control codes of a particular kind of printer. The installation provides automatic translation of a menu-selected feature into the proper printer codes for a specific printer. If the user selects *emphasized* printing, the program generates the correct control code for the installed printer. Typical of most printer configuration software, Adapta-Print permits stacking of control codes. As instructed by the menu, a user might enter a 20 for Double Width printing, then a 14 which would provide emphasized double width printing, and finally a 15, which would produce "near letter quality" double-width characters. (Actually, the menu selections can be entered in any order).

Creating characters

The second level of printer configuration software creates characters which are beyond the normal capability of the printer. While virtually all printer manufacturers provide some graphic symbols in response to ASCII codes above 127, there is no standard set of graphic characters: Printer A doesn't produce the same characters as printer B in response to ASCII codes higher than 127. Although many printer manufacturers go their own way because there is no official standard for the graphic codes, IBM has set a defacto standard for graphic characters, and much commercial software utilizes the IBM graphics set.

Unless your printer is 100% compatible with the IBM graphics characters—and few are even partially compatible—what you get from a printer is not what you see on the screen. Many of the most popular printers print the horizontal and vertical lines, and the math and foreign characters of an IBM-compatible screen display as italic characters.

Short of replacing the printer, the way around this problem is printer software such as The DigiCon Print Package (Digital Concepts, Inc., P.O. Box 8345, Pittsburgh, PA 15218), which is intended for Epson and Epson-compatible printers. In addition to other printer control functions, the DigiCon package uses the printer's addressable dot printing feature to generate its own fonts (type styles) such as script, block, and conventional characters, all of which duplicate all 56 characters in IBM's Set 1 and Set 2 character sets.

As shown in Figure 2, a dump of each DigiCon character set is mapped so the user can instantly determine the decimal ASCII value for every IBM character; information that is necessary to easily incorporate the IBM graphics into programs and documents. The ASCII values are determined by locating the vertical (left side) and horizontal (top)



FIG. 2a—THE DIGICON PRINT PACKAGE generates complete IBM graphics printer character sets. This one is for the default character set. The numbers along the left and top edge provide the ASCII code for each character. The omega symbol (used to indicate resistance) is ASCII 23 + 4, or ASCII 234.

values for a character. For example, the upper case A is ASCII 065 (or 65); the omega symbol used to represent "ohms" is 234, while the international symbols for male and female are respectively 011 (11) and 012 (12).

The characters are attained by printing through the DigiCon program, which means that the original file must be saved in ASCII. If you have a WordStar file it



FIG. 2b—SINCE DIGICON GENERATES the characters independently through dot-addressable graphics, it can generate various type faces, such as this "script" font.



FIG. 2c—DIGICON'S CONVENTIONAL printer control functions are determined through menu selection.

must be converted to ASCII (yes, it can be easily done), while a PFS:Write file can be saved directly in ASCII. The same is true for data files or anything else: they must be in ASCII in order to be processed properly by the DigiCon system. Screen dumps are unaffected by the conversion—they do not print what is seen in the screen—because the dump goes directly to the printer, bypassing the conversion software.

Load your own

The most convenient way to accommodate the IBM graphic characters—which is arranged in two Sets—is by programming the printer to recognize and generate the characters directly from conventional software. Low cost programmable printers like the Epson FX+ series are a recent concept for personal computing. The FX+ has its own character set in ROM as well as RAM, which can be user configured with a user-designed font. A program such as the Printer BOSS (Connecticut Software Systems Corp., 30 Wilson Ave., Rowayton, CT 06853), which offers conventional control code configuration for Epson printers, can also program an FX+ printer to recognize and print IBM's graphic character sets. The printer can respond directly to the original applications software without the need for an intermediate ASCII-only print mode. Figure 3 shows the



FIG. 3—THE PRINTER BOSS can actually configure a printer so the printer itself "thinks" it's IBM compatible. It does this by downloading a character set(s) into the printer's memory. The only limitation to this method is that it is presently available only for the Epson FX printer series.

large menu selection screen of the Printer BOSS, which permits the user to program both the printer control codes and the character font at the same time.

A programmed font is the ultimate emulation because the printer itself functions as conventional hardware, meaning that it does not require intermediate translation software. Even screen dumps will produce the accurate hardcopy of the screen display.

Because of the pervasive influence of IBM most printers will reproduce the complete IBM character and graphics set(s). Until then, or until you're ready to purchase a new printer, the best way to generate unconventional type styles and characters is to use software that emulates hardware. ◀▶

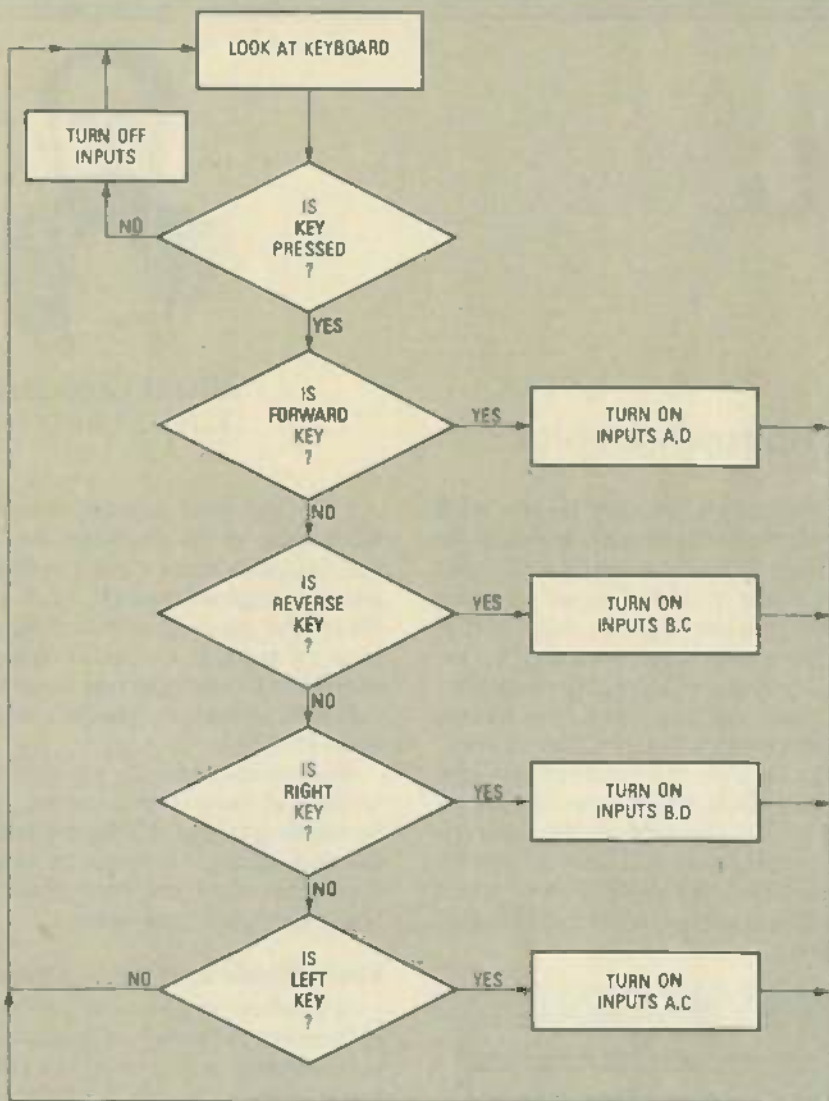

FIG. 5

right motor to rotate backward while the left motor rotates forward, causing the unit to turn right. And so on.

You may be wondering where to get the motors for the two-wheeled device we've described. We've found that for motors, and the many other parts that we'll be needing in the coming months, there's no better place than a surplus store. But some of you may live in areas where suitable surplus outlets simply do not exist. So for you, the following firms can supply suitable motors by mail: Edmund Scientific, 101 E. Gloucester Pike, Barrington, NJ 08007, Phone—609-547-3488 (motor assembly part No. B31-827, \$4.95), and H & R Corporation, 401 E. Erie Avenue, Philadelphia, PA 19134, Phone 215-426-1708 (motor assem-

bly, part No. TM22K638, \$4.95). Those firms list in their catalogs many different motors, motors with wheels, and even complete robot kits.

Next time, we'll take a look at a commercially available robot. In the meantime, why not get started on your mobility base? **R-E**



"About that new natural English syntax translator package, Mossman...!"

Versatile Lab Power Supply



EXCEPTIONAL VALUE!

MODEL 3002A

Only \$125.00

- 0-30 VDC at 0-2A • Excellent Regulation
- Ripple & Noise • 500 uV RMS • Built-In Short-Circuit and Overload Protection

Model 3002A features continuously adjustable current limiting and precision constant voltage/constant current operation with "automatic crossover." This lab-grade unit can also be used as a current regulated power source. Options: 10-Turn Voltage and Current Controls. \$25.00 ea.

DISTRIBUTOR INQUIRIES INVITED
DOMESTIC & FOREIGN



ELECTRO INDUSTRIES

4201 W. Irving Pk., Chicago, IL 60641
312/736-0999

CIRCLE 83 ON FREE INFORMATION CARD

Learn micro-processing with the new MICRO-PROFESSOR 1P

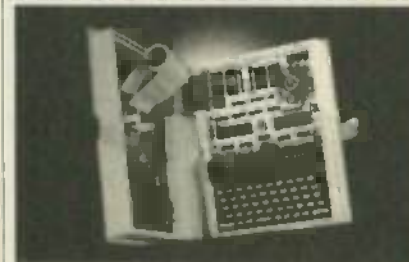

Students, engineers or technicians—upgrade your micro-processing skills with the new Micro-Professor 1P.

The MPF-1P features:

- extensive software support
- more built-in memory
- improved keyboard
- larger display

Three tutorial guides help cover all capabilities. The ideal training tool! MPF-1P will deliver you into the growing world of micro-processing. Invest now!

Plus-FREE GIFT Only \$179.95

Check this box for FREE Z-80 Microprocessor Programming and Interfacing textbook when you order within 7 days. \$12.95 value. (Includes \$5.00 postage & handling)

ETRONIX
Dept. RE0085
14803 N.E. 40th
Redmond, WA 98052

For immediate action call TOLL FREE:

1-800-426-1044

Full money back guarantee.



CIRCLE 111 ON FREE INFORMATION CARD

SEPTEMBER 1985

93

DRAWING BOARD

Designing microprocessor-based circuits

IN THE PAST, WE'VE SPENT PLENTY OF time talking about gates, latches, flip-flops and counters. After all, anyone interested in circuit design needs a clear understanding of what those elements are, how they work, and how they can be used. Although logic families have changed—DTL having given way to RTL, and RTL to TTL and CMOS technologies—the basic design approach has not. Flow charts, block diagrams, and other paper work are all still necessary to obtain a final product.

Some time ago I stated that cir-

cuit design should begin with basic building blocks. But as technology advances, what once was an exotic part becomes so common that we begin to think of it as a basic element. And that's certainly true of the microprocessor.

Many people think that microprocessors are computers. Well, they're not. Computers are one application of microprocessors, but not the only one. Microprocessors are IC's that accept instructions, move data from place to place, and perform logical operations.



ROBERT GROSSBLATT
CIRCUITS EDITOR

Over the next several months, we'll look at microprocessors to see how they can be used to lower power requirements, and cut down the parts count and board size of typical circuits. What's more, you'll see how one basic circuit can be made to handle a multitude of jobs.

Microprocessors can control various elements of a circuit, but something has to tell them what to do and when. That means you'll finally have to come to terms with the great "god," software.

Understanding microprocessors

If you had to pinpoint the basic difference between a gates-only circuit and a microprocessor-based one, it would probably be that the former can do only the specific job it's designed to do, while the latter can do a number of different things, as long as it's properly told what to do. Everything depends on the set of instructions (software) fed to the microprocessor. But for now, let's examine the internal structure of the microprocessor to see what's inside and how it works. Once we have a clear understanding of that, we can start telling it what to do.

Basically, there are two types of microprocessors: top-down and bottom-up. The difference has as much to do with how they handle memory as with their internal organization.

Microprocessors spend a lot of time moving and manipulating data, and they need a place to store the interim and resulting data. The way they handle that task marks another basic difference be-

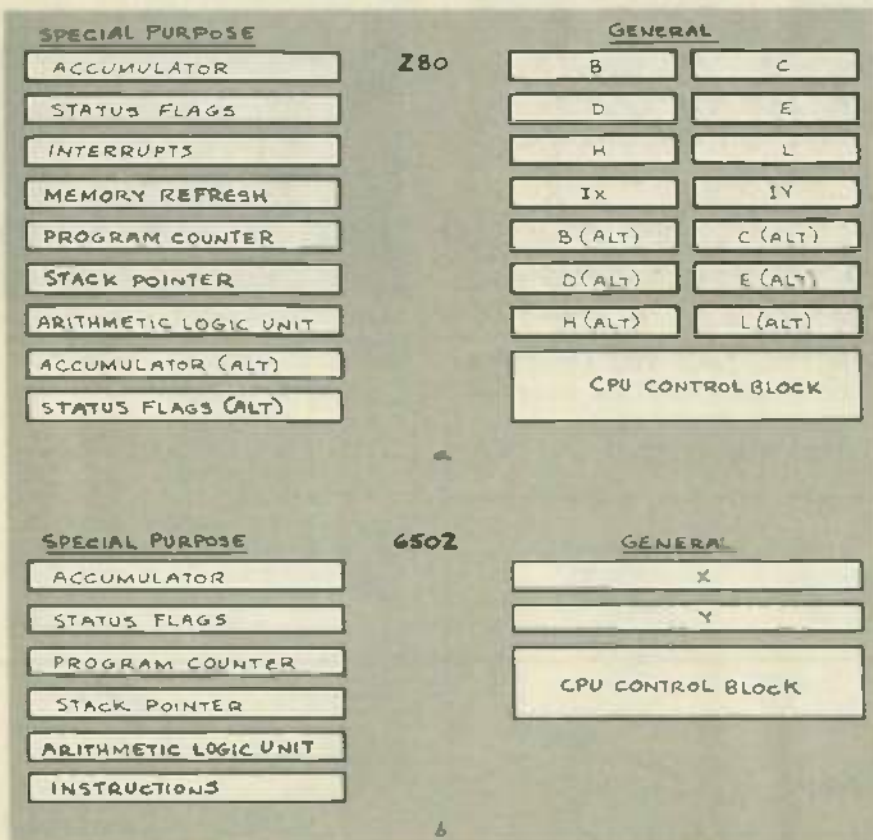

FIG. 1

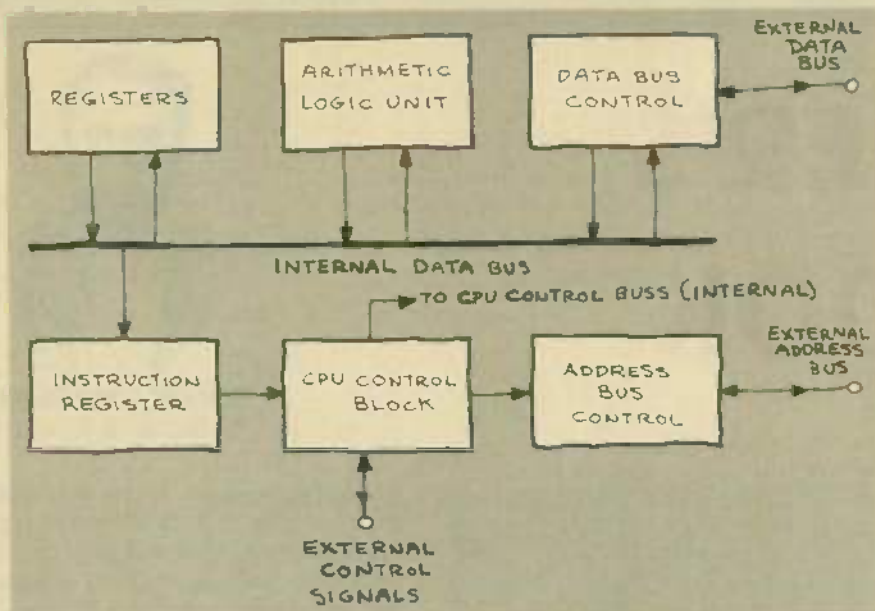

FIG. 2

tween the two types of microprocessor. The bottom-up type has internal registers that can be used for data storage, "house-keeping," counters, and so on. The top-down type uses external memory for the same purpose.

Figure 1 should give you a better idea of what I mean. The Z80 (Fig. 1-a) and 6502 (Fig. 1-b) are perfect examples, respectively, of a bottom-up and a top-down microprocessor or CPU (Central Processing Unit). The Z80 has a total of 14 general-purpose internal registers, while the 6502 has only two. Both have the other registers that all microprocessors need: the accumulator, the stack pointer, the flag register, and so on. We'll cover all of those eventually.

The number of registers doesn't necessarily make one microprocessor better than another, only different. However, that difference can make one better suited for a particular application than another. A CPU with many internal registers (bottom-up) can manipulate data between the registers very quickly. But they slow down when they have to access external memory.

On the other hand, a top-down microprocessor like the 6502 uses external memory for almost everything it does, but it has a speedy way of accessing the bottom range of external memory. By contrast, all external memory appears the

same way to bottom-up microprocessors (another topic for future discussion).

Microprocessors with many internal registers (like the Z80) can move and manipulate data from register to register very quickly, making number-crunching faster—a definite asset in applications doing a lot of arithmetic. But the 6502 is capable of doing BCD (Binary Coded Decimal) math. If BCD is used, the round-off errors that crop up in binary math (the normal way arithmetic computations are handled in that and other microprocessors) are avoided.

Finally, if you're doing a lot of I/O operations, the simpler bus interface requirements of the 6502 are worthy of serious consideration. In any case, when dealing with microprocessors, remember that anything you can do with one, you can also do with another, although maybe not as easily.

Since learning to use a CPU means putting in plenty of time, you should pick your microprocessor carefully. I've chosen to use the Z80 for the balance of our discussions; it's cheap, available, powerful, and there's a wide range of support IC's available for it. To design microprocessor-based circuits you must first understand exactly what the microprocessor can do, and how it does it.

Figure 2 shows a block diagram of the internal structure of the Z80. As you study it, notice that it isn't

really much different from the circuits we've designed in the past. In fact, it would be possible—although not really practical—to build a CPU from discrete logic IC's.

The Z80, like most other microprocessors, is made up of five different parts: the instruction decoder, the CPU control block, the address and data bus controllers, the ALU (Arithmetic Logic Unit), and the storage registers. What separates a CPU from just a collection of discrete elements is the inclusion of the ALU and the instruction decoder.

The ALU is the workhorse of the CPU. That is where addition, subtraction, logical operations (AND, OR, XOR, NOT) and other operations occur. Precisely what goes on in the ALU depends upon another part of the CPU—the instruction decoder.

The instruction decoder is the part of the CPU that contains the instruction set (a preprogrammed series of routines that are performed when the CPU receives the appropriate command). The instruction decoder mediates between the ALU and external memory. It is the job of the instruction decoder to recognize a command, decode it, and issue the appropriate instructions to the ALU. The ALU acts accordingly and then waits for the next set of instructions. The series of commands that the instruction decoder receives, of course, is the program being run.

Translating low-level data manipulation into useful work requires plenty of additional hardware and the right software. As with everything else we've done together, you're going to be doing a lot of work on paper before you ever look at a soldering iron. The first—and probably the most important—thing you have to do before we continue our discussion is to get a good book on the Z80 and start reading. There's just no way to fit all the necessary information into this column.

Our next step will be to put together a bare-bones Z80 system and see what can be done with it. If you're new to microprocessors, I think you'll be amazed by its versatility. R-E

DESIGNER'S NOTEBOOK



ROBERT GROSSBLATT
CIRCUITS EDITOR

Custom-tailored audio

EVERY AREA TO WHICH ELECTRONICS IS applied has its own peculiar requirements; sometimes those requirements get really peculiar. Talk to someone doing amplifier design, and you'll hear about purity of sound, minimum distortion, and bandwidth from DC to daylight. Talk to someone else and you'll hear about wah-wah, fuzz, and flanging.

It seems as if there's all the difference in the world between producing and reproducing sound. In any event, it's a safe bet to say that things aren't as straightforward in making electronic music as they might be. Anyone who gets interested in designing circuitry with an eye toward music, learns rapidly that lots of coloring has to be added to the audio for it to sound "good."

Probably the most basic addition you can add is tremolo. But, before we go any farther, let's make sure we know what tremolo means. Tremolo is produced by modulating (varying) the amplitude of the input signal, making it louder and softer.

A violinist produces tremolo by varying the strength of his bowing. Most other musicians and singers also use tremolo to color the sounds they produce. This month, we'll look at a circuit that lets you easily add tremolo to any audio circuit that you're building.

Audio circuit add-on

Before we get into any of the nitty-gritty of the design, there are a few ground rules that should be laid out. Tremolo sounds best when it's subtle—too little and it won't be heard; too much and

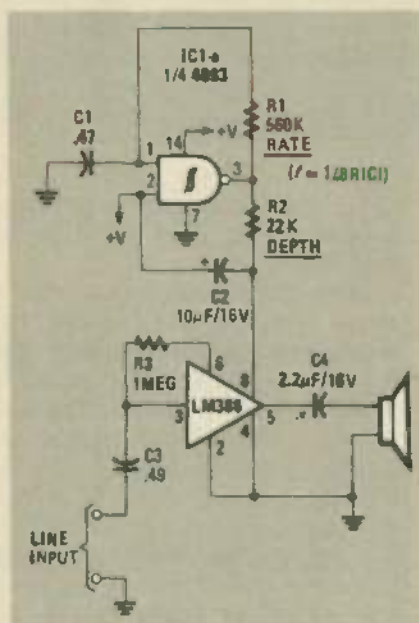

FIG. 1

you'll wish that it couldn't be heard at all.

The simple circuit that's shown in Fig. 1 can be used to color the sound coming from your audio system. Clocking for the circuit is provided by an oscillator built from one quarter of a 4093 quad NAND Schmitt trigger. With the component values shown, it will run at about 5 Hz. The clock frequency is fed to the gain control, pin 8, of an LM386 amplifier. Tremolo is produced by varying the gain of the amplifier.

There are design parameters of that circuit that allow you to tailor it to work any way that you want. However, one thing deserves your particular attention—CMOS oscillators swing almost the full range of the supply voltage (from ground to the supply rail).

If you use a CMOS oscillator to

produce tremolo in an arrangement similar to that shown in Fig. 1, it's going to vary the gain of the amplifier from just about zero to the maximum, and it will sound really weird. Now that we know that much, let's look at the circuit in more detail.

The mathematics used to determine the frequency of the clock is pretty hairy, but you can get a close approximation from:

$$f \approx 1/.8R1C1.$$

If you want to change the tremolo rate, simply plug your own numbers into the formula to get the needed component values. A trimmer potentiometer can be put in series with R1, so that you can easily experiment with different rates. If you decide to do that, however, make R1 about 100,000 ohms and use a 1-megohm trimmer. That should let you dial up frequencies from about 2 to 20 Hz.

Resistor R2 is the depth control. By that we mean that it controls the degree of tremolo that you'll get from the circuit. It's a straight application of an R-C time constant. You can experiment with different values for R2 and C2. And just as we did with the clock rate, you can put a trimmer in series with R2. But if you do, make R2 a 5000-ohm unit and use a 50,000-ohm trimmer. If you're curious, leave it out altogether and see what it sounds like. (After all, music is a subjective art.)

Although I've used a 4093 to build the tremolo clock, you can use just about any oscillator at all. The only requirements are that it will reliably oscillate at below 10 Hz, and that it can produce an out-

(Continued on page 122)

How Many Times Do You Intend To Let "THE SAME DOG" Bite You ?

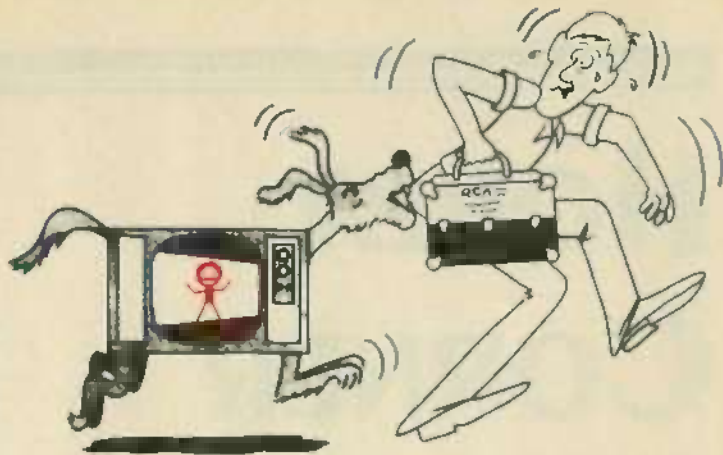

How many times have you worked all day long trying to diagnose the HV regulator circuit of a set that is in shut down only to eventually find that a **shorted video, color, vertical, tuner, AGC, or matrix circuit** was causing the set to shut down and, to find that the HV regulator circuit was working flawlessly all the time?

How many times have you spent the day looking for a **short** that was causing the set to shut down, only to eventually find that an **open vertical, video, matrix circuit** or, an **open HV multiplier** was to blame?

How many times have you worked all day on the same TV set, only to find out that the set's flyback transformer was defective?

How many flyback transformers have you replaced only to find that the original flyback was not defective?

How many horiz output transistors and Sony SG 613 SCRs have you destroyed while simply trying to figure out whether the flyback was good or bad?

How many times have you been deceived by your flyback "ringer"? Can you even count the number of hours that your "ringer" has caused you to waste?

How many times have you condemned a flyback, only to find that a shorted scan derived B+ source was causing the flyback to "appear" as though it were defective?

How many hours have you wasted, working on a TV set, only to find that the CRT had a dynamically shorted 2nd anode (to primary filament)?

How many new sweep transformers have you unknowingly destroyed because a short existed in one of the scan derived B+ sources?

How many times have you said to yourself, "I could fix this --- thing if I could only get it to fire up long enough to lite the screen? --- without blowing an output transistor or a fuse."

How many additional bench jobs could you have gotten, had you been able to give an accurate, "on the spot" estimate on sets that were either in shut down or, not capable of coming on long enough for you to analyze them?

If you had been using our all new Super Tech HV circuit scanner, you would have had an accurate evaluation concerning all of the above in about one minute, at the push of just one single button.

It's true! Push just one test button and our HV circuit scanner will (1) accurately prove or disprove the flyback, (2) Check for any possible shorts in any circuit that utilizes scan derived B+, (3) Check the scan derived power supplies themselves for shorted diodes and/or electrolytic capacitors, (4) Check for primary B+ collector voltage and, (5) Check the horiz output stage for defects.

Our HV circuit scanner works equally well on sets with integrated or outboard HV multipliers. It will diagnose any brand, any age, solid state TV set including Sony. The only exceptions are sets which use an SCR or trace and, another for retrace (i.e., RCA CTC 40 etc.). Our scanner will not work on these sets.

In plain English, our HV circuit scanner is even easier to operate than a "plain vanilla" voltmeter.

First off, when you're using a scanner, you **do not** remove the flyback in order to check it. In fact, you don't even unhook any of the wires that are connected to the flyback! All you do is:

1) Remove the set's horiz output device, plug in the scanner's interface plug, then make one single ground connection. That's all you do to hook it up.

2) If the primary LV supply is functional and, assuming that the emitter circuit of the horiz output stage has continuity, the scanner will tell you that it is ready to "scan" by illuminating the "ready" light, which is the white button on the test / run switch.

(3) Press the spring loaded (test) side of the test / run switch and the scanner will "look" for any type of a short that might exist anywhere on the secondary side of the flyback, including the HV multiplier, any circuit that relies on flyback generated B+ and, including the flyback itself (both primary and all secondary windings). It will simultaneously check for a shorted LV regulator device HV multiplier, or an open or "partially" open safety capacitor.

If a short or, an "excessive load" exists on one secondary winding, all other secondary windings will have "normal" output voltage in spite of the short. Only the shorted winding itself will have zero volts on it. This makes shorted scan derived B+ sources incredibly easy to isolate. During this test, the 2nd anode voltage is being limited to approx 5 kv by the scanner.

If a short is present, the red "flyback" light will either lite, or flash (at various speeds), depending on which type of a short exists. If no shorts exist, the "flyback" light will be green.

Assuming that the "flyback" light is green, no shorts exist and, it is now time (and safe), to begin looking for open circuits which might be causing the set to shut down due to flyback run-a-way. It only stands to reason that if no shorted conditions exist, then one (or more) circuits will have to be open, otherwise, the TV set would be working!

(4) Now that you know that no shorts exists, push the "run" side of the test / run switch (the side that latches). Provided all of the other circuits in the TV set are functional, the scanner will now put a picture on the set's CRT screen that has full vertical and horiz deflection, normal audio, video and color.

Keep in mind that during this test, your scanner is:

- (1) Circumventing all horiz osc/driver related shut down circuits.
- (2) Limiting the set's 2nd anode voltage to approx 20-25 kv.
- (3) Substituting the set's horiz osc/driver circuit and, as a result, eliminating any need that the set might have for an initial start up or B+ resupply circuit for the osc/driver.

Wait about 15 seconds for its filaments to warm up, then look at the CRT. Any circuits that are "open" will now produce an obvious symptom on the screen. Because the scanner has circumvented all of the set's shut down features, you can now use your old reliable "symptom to circuit analysis" technique to troubleshoot the problem, i.e., if the picture has no blue in it --- repair the blue video or blue matrix circuit. If the picture has only partial vertical deflection --- repair the vertical circuit, and so on. The scanner has effectively removed all of the stumbling blocks that would normally prevent you from diagnosing the problem, i.e., start up and shut down features, and allowed you to repair the TV set by using conventional techniques.

When you're using a scanner, all start up, shut down, dead set problems are easy to solve. You don't need anyone to tell you just how difficult these problems can be for those who don't have a scanner!

Our Super Tech HV circuit scanner normally sells for only \$495⁰⁰. Beginning July 4, 1985 thru August 31, they are on sale for only \$395⁰⁰.

VISA, MASTERCHARGE, C.O.D. ORDERS WELCOME

DIEHL ENGINEERING • 6004 Estacado Ln. • Amarillo, TX 79109

PHONE (806) 359-1824 or (806) 359-0329

Phone Orders Welcome

Since the Scanner only has two buttons to press, most technicians never need it but, our "Hot Line" is available to assist new owners in the operation of their scanner. Phone (806) 359-0320.

CIRCLE 273 ON FREE INFORMATION CARD

SEPTEMBER 1985

97

HOBBY CORNER

More control circuits

LAST TIME, WE STARTED LOOKING AT control circuits and talked about various types of manual switches. Such switches are not always best for direct control of a circuit. In addition, the controlling force is not always pressure on a switch. Sound, light, or RF can be made to "reach" out and "flip" a switch!

There are a variety of reasons for using something other than a manual switch for circuit control. One alternative to the manual switch is a relay. A relay is nothing more than an electromagnet that, when energized, pulls on a piece of metal causing the relay contacts to open and/or close. (We'll ignore the source of the voltages being applied to the relay, for now.)

The size and shape of the magnet, and the number and arrangement of the contacts vary greatly, but the operation of all standard relays is the same! Figure 1 shows the schematic representation of several relay types. Figure 1-a is an

example of a SPDT relay. Current passing through the coil, which is wound to activate at a given voltage and/or current, causes the armature (the center contact) to be pulled toward it. The source should match the coil requirement, and the relay's electrical specifications (AC or DC) must be adhered to.

Let's suppose that a controlling voltage is applied to the armature, which is in the upper contact position. When the coil is energized, the armature is pulled downward. Now the armature connects with the relay's lower contact and whatever is connected to that terminal is energized. Because the armature is connected to a spring, it jumps back to its original position as soon as current ceases to flow through the coil—the lower circuit is disconnected and the upper is reconnected.

Another type, a stepping relay, is shown in Fig. 1-b. That type steps

forward (to the next contact) each time the coil is momentarily energized, going from one to four and then repeating. Stepping relays are useful in some applications, but are expensive.

A latching relay is shown in Fig. 1-c. When the upper coil is energized, the armature "latches" (locks) in the upper position. It stays there until current flows through the lower coil, causing the armature to move to the lower position. When you want a short signal to hold a relay "in," you need a latching relay. The latching relay can cost three, or more times as much as one of the common type shown in Fig. 1-a. But when you need one, you need one—or do you?

Fortunately, you can make a latching relay from two of the common variety and save a few bucks, as Fig. 1-d shows. (Assume that there are two electromagnets acting as one.) Note that the contacts are in the double pole configuration; i.e., there are two armatures.

When the momentary switch is pressed, the coil is energized and both armatures are pulled downward. The lower armature contacts make or break the circuit being controlled. When the upper armature makes contact, a voltage is applied to the coil, so that releasing the switch has no effect—the relay is latched in the "on" position.

Of course, the relay will remain latched indefinitely, defeating its purpose in most applications. Therefore, some method of deactivating the relay is needed. A switch (toggle or normally closed momentary) may be inserted between the coil and +V, so that



EARL "DOC" SAVAGE, K4SDS,
HOBBY EDITOR

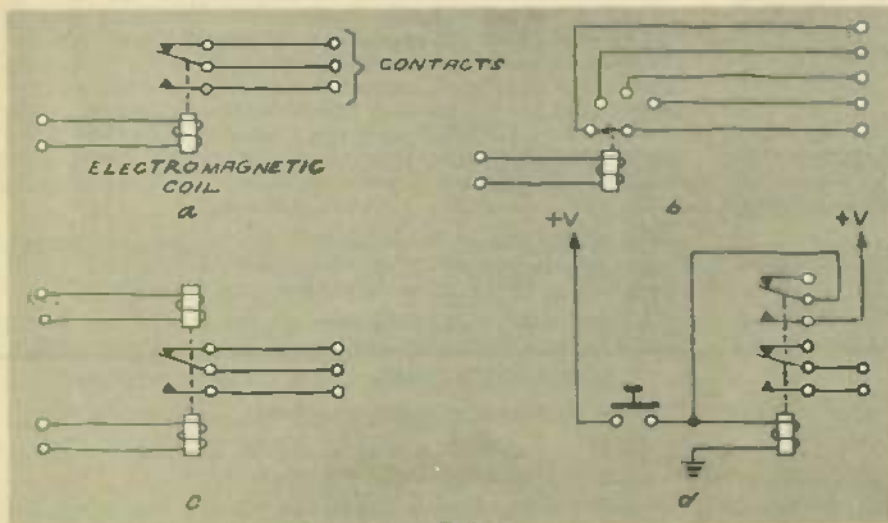
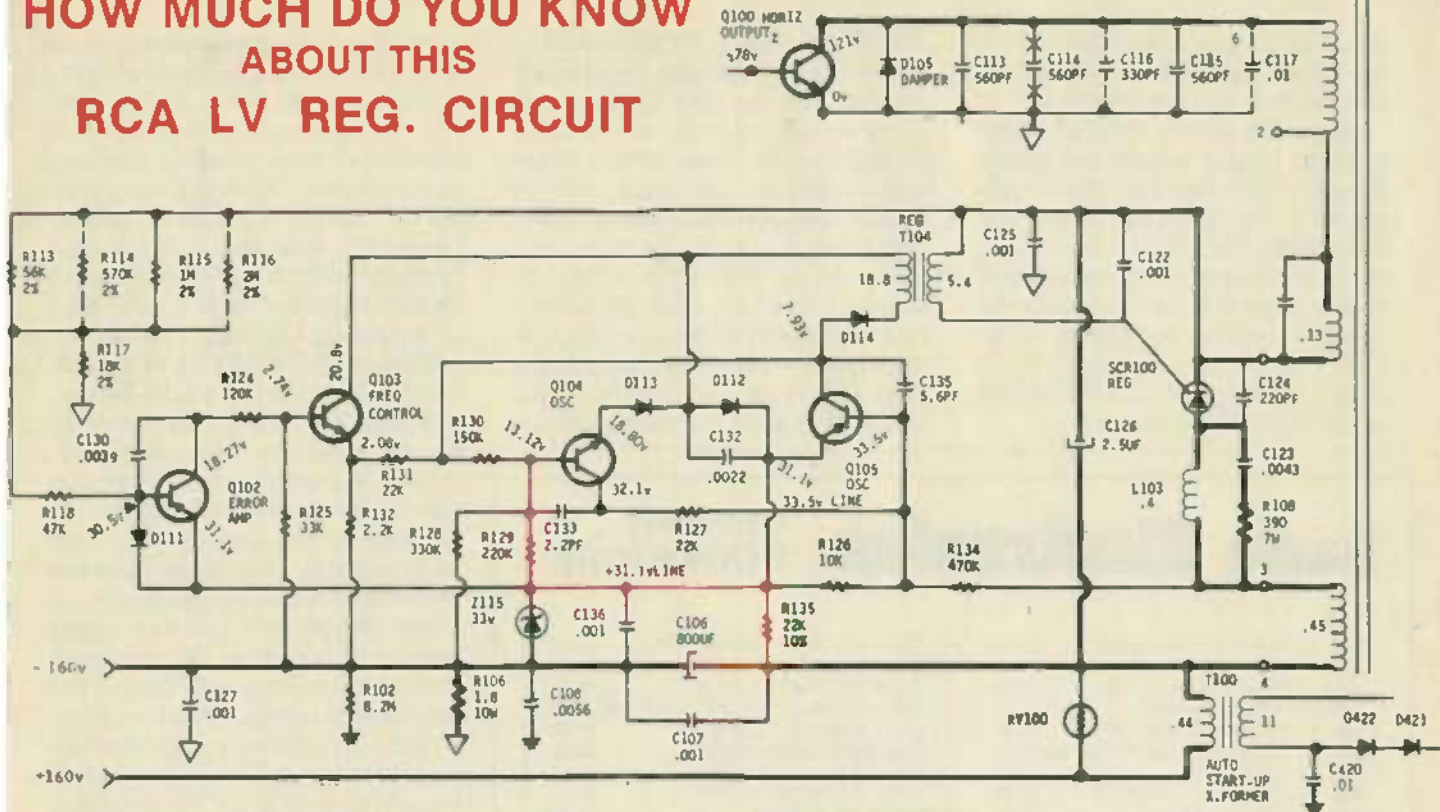

FIG. 1

HOW MUCH DO YOU KNOW ABOUT THIS RCA LV REG. CIRCUIT



Typical of RCA CTC 85 thru 108 LV Regulator Circuits

Schematic by Diehl Engineering

How many of these questions can you answer?

- (1) Every circuit has a beginning and an ending. Where does this circuit begin?
- (2) Specifically, what is the purpose of this circuit?
- (3) What turns it on? What turns it off, or does it ever really turn off?
- (4) Does this circuit have a shut down feature? If so, which components are involved?
- (5) What would happen if Q103 were to become shorted E to C?
- (6) What purpose does Z115 serve?
- (7) What would happen if D114 became shorted?
- (8) What purpose does C126 serve? What will happen if C126 becomes open?
- (9) Is the winding between terminals 3 and 4 of the flyback a primary or a secondary winding?
- (10) What purpose does C117 serve? Exactly what does it do, and exactly how does it do it?
- (11) Exactly what do resistors R113, 114, 115, 116, and 117 do? What happens if they change value?
- (12) What occurs that causes this circuit to produce an initial start up pulse?
- (13) Why does this entire circuit become shorted and begin to destroy horiz output transistors if the regulator SCR becomes shorted?
- (14) There is exactly one safe and practical method of circumventing this LV regulator circuit for test purposes. This technique does not involve a variac. Instead, you must disconnect one wire then connect a jumper wire from terminal #4 directly to terminal #6. Which wire do you disconnect and where do you connect the other end of your jumper wire?
- (15) If SCR100 is shorted, this circuit will still "eat" horiz output transistors even if you are using a variac. Why?
- (16) Why does this circuit use a floating ground?

We publish a monthly magazine called the Technician / Shop Owners Newsletter. Each month we take a popular circuit and absolutely dissect it.

Using color coded pictorial schematics such as the one above, we "map out" every action in the overall sequence of events that must take place during each and every cycle.

Beginning with the very first "action" in the sequence (which just happens to be depicted in the above schematic) we explain exactly what is taking place. We then explain the function of every component in that portion of the circuit. After explaining the function of each component, we show you how to troubleshoot that particular "action" or function.

After reading our newsletter on this circuit, you could answer all of the above questions as fast as anyone could ask them. In fact, you will then know everything there is to know about this circuit. Including how to troubleshoot it!!

Regardless of whether you work on TV sets, stereos, radios or computers, just having the ability to "dissect" an electronic circuit (any circuit) is worth a fortune. In reality, "dissecting" is exactly what our newsletter is designed to teach you.

Because of the manner in which our newsletter is written, the subject matter that is gained from each monthly issue is so extremely broad that it will "spill over" into your everyday troubleshooting routine, and be applied to totally unrelated circuits.

Each monthly issue sells for only \$9⁹⁵, due ten days after delivery. VISA / Mastercharge welcome.

To Order: Send your name, address and phone # to Diehl Publications, 6004 Estacado Ln., Amarillo, TX 79109. Specify Issue # 3.

For Immediate Service Call: (806) 359-0329 or 359-1824.

Do not use the Reader Service Card in this magazine to place your order.

CIRCLE 274 ON FREE INFORMATION CARD

when pushed, current flow is interrupted and both armatures revert to their original positions.

Since the upper armature contacts no longer supply voltage to the coil, the entire unit "sits" waiting for a trigger. In examining the possibilities of the circuit (Fig. 1-d), don't forget that the second switch need not be a manual one. Another relay, a transistor, or an SCR can handle the job. We'll cover transistor and SCR switch substitutes in the future.

Telephone ringer modification

There are many aspects of modern life that we take for granted, but that can present considerable difficulties for those with a physical handicap. Consider, for instance, the difficulty the hearing impaired have using the telephone system. There are, of course, devices that allow the hearing impaired to use that system (such as handset amplifiers and teletype terminals), and others that alert the user to an in-

coming call using something other than a standard telephone ringer.

Such devices are available from the telephone company and others, but their cost may be high. In some cases, however, it is possible to modify a privately owned phone (i.e. one that is not leased from the telephone company) so that it might be more easily used by a hearing impaired person.

Henry Milowski of Ontario, Canada has devised a scheme that requires no change to the telephone circuitry. He simply removed the telephone's cover and taped a magnetic reed switch to the side of the transformer. Then he brought out two wires from the switch and replaced the cover.

The telephone still functions normally; but now, the magnetic field of the transformer causes the reed switch contacts to close. That switch can control any kind of device. In his application, the switch is used to turn on a 555 oscillator that has adjustable tone and volume controls, but, of course, the "ringer" can be any kind of sound or light source.

Repairing old receivers

Obviously there are many "Hobby Corner" readers who are interested in restoring old radios and televisions. My recent mention of Ken McIntosh's newsletter brought forth a flood of inquiries. Some of you need a source of schematics, while others are looking for parts sources.

Well, from Mick McDaniel (CA), W6FGE, I received the information you asked for! Here are a few suggestions from Mick. For schematics, write to: McMahon Vintage Radio, PO Box 1331, North Highlands, CA 95660; Scaramelia, PO Box 1, Woonsocket, RI 02895, or Panaxis Productions, PO Box 130, Paradise, CA 95969.

For parts, write to: JWF Pruett, PO Box 28572, Dallas, TX 75228; The Old Radio Place, 616 St., Rockville, MD 20850, or Antique Electronic Supply, 1725 W. University, Temple, AR 85281. When writing to those (and other) places, remember that you are more likely to get a prompt reply if you send an SASE (Self-Addressed Stamped Envelope)! Our thanks to Mick for sharing that information with us. R-E

Radio-Electronics REPRINT BOOKSTORE

- | | |
|---------------------------------------------------------------------------------------------------------------------------------------------------------------------|-----------------------------------------------------------------------------------------------------------------|
| <input type="checkbox"/> Radio-Electronics back issues (1985) \$3.00
Write in issues desired _____ | <input type="checkbox"/> Special Projects #4 (Summer 1982) \$4.50 |
| <input type="checkbox"/> Radio-Electronics back issues (1984) \$3.50
(February 1984 not available) | <input type="checkbox"/> Special Projects #5 (Winter 1983) \$4.50 |
| <input type="checkbox"/> Radio-Electronics back issues (1983) \$3.50
(January, February 1983, May 1983 not available)
Write in issues desired _____ | <input type="checkbox"/> Special Projects #6 (Spring 1983) \$4.50 |
| <input type="checkbox"/> Radio-Electronics back issues (1982) \$4.00
Write in issues desired _____ | <input type="checkbox"/> Special Projects #7, #8, #9 NOT AVAILABLE |
| <input type="checkbox"/> Radio-Electronics back issues (1981) \$4.00
(Jan., Feb., March, Dec. 1981 not available)
Write in issues desired _____ | <input type="checkbox"/> Special Projects #10 (Spring 84) \$4.50 |
| <input type="checkbox"/> Etch your own PC boards \$3.00 | <input type="checkbox"/> Radio-Electronics Annual 1983 \$3.50 |
| <input type="checkbox"/> Hands On Electronics #1 \$4.00 | <input type="checkbox"/> Radio-Electronics Annual 1984 \$3.50 |
| <input type="checkbox"/> Hands On Electronics #2 \$4.00 | <input type="checkbox"/> Radio-Electronics Annual 1985 \$2.50 |
| <input type="checkbox"/> Hands On Electronics #3 \$3.50 | <input type="checkbox"/> How to Make PC Boards \$2.00 |
| <input type="checkbox"/> Hands On Electronics #4 \$3.50 | <input type="checkbox"/> All About Kits \$2.00 |
| <input type="checkbox"/> VCR Repairs \$3.00 | <input type="checkbox"/> Modern Electronics (Vol. 1, #1 \$2.25
April 1986) |
| <input type="checkbox"/> IBM Typewriter to
Computer Interface \$3.00 | <input type="checkbox"/> Electro Importing Co. Catalog \$4.95
(1918) (176 pp) |
| | <input type="checkbox"/> Low Frequency Receiving Techniques \$6.00
Building and using VLF Antennas |
| | <input type="checkbox"/> New ideas - 42 circuits for experimenters . . \$3.50 |

To order any of the items indicated above, check off the ones you want. Complete the order form below. Include your payment, check or money order (DO NOT SEND CASH), and mail to Radio-Electronics, Reprint Department, 200 Park Ave. South, New York, NY 10003. Please allow 4-6 weeks for delivery.

If you need a copy of an article that is in an issue we indicate is unavailable you can order it directly from us. We charge 50¢ per page. Indicate the issue (month & year), pages and article desired. Include payment in full, plus shipping and handling charge.

ARTICLE _____

PAGES	MONTH	YEAR
_____	_____	_____
TOTAL PAGES	@50¢ each	TOTAL PRICE
_____	_____	_____

MAIL TO: Radio-Electronics
Reprint Department, 200 Park Ave. South, New York, NY 10003 All payments must be in U.S. funds

Total price of order	\$ _____
Sales Tax (New York State Residents only)	\$ _____
Shipping & Handling (U.S. & Canada only) (Includes FIRST CLASS POSTAGE) \$1.00 per item	\$ _____
All other countries (\$2.00 per item, sea mail)	\$ _____
(\$4.00 per item, air mail)	\$ _____
Total Enclosed	\$ _____

Name _____
Address _____
City _____ State _____ Zip _____

RADIO-ELECTRONICS

IC TESTER

continued from page 62

All of the resistors are mounted horizontally on 0.4-inch centers except for R_{C1} to R_{C16} . Mount those resistors vertically with the resistor body down and the bare lead toward the top of the board. (The bare lead will be used as a test point for checking the LED circuitry.) Be sure that the resistors do not extend high enough to touch the top panel when installed. The finished PC board should look something like that shown in Fig. 9.

A second PC board, the B-socket board, contains a small solderless bread-board socket (SO3), a standard 16 pin DIP socket (SO4), and a zero-insertion-force or ZIF socket (SO5). It sits above the main board and the cabinet top and mates to the

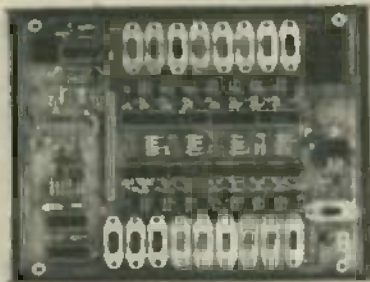

FIG. 11—YOUR FINISHED MAIN BOARD should look like this before you install a top cover.

main board with a 20-pin connector. The foil patterns for that double-sided board are shown in our special "PC Service" section, and the parts-placement diagram is shown in Fig. 10.

The 16-pin resistor plugs can be assembled by using a standard 16 pin header as shown in Fig. 11. The common connection can be made with a tiny PC board or simply by tying the leads together. The shorting plug uses 220-ohm resistors while the pull-up plug uses 150K resistors.

Power is supplied from the circuit under test using a 2-pin connector with leads, mini clips and an in-line fuse. Connection to the IC under test is via an IC test clip, which we'll call a DIP clip. The plugs, DIP clip, and power connector are shown in Fig. 11.

Circuit checkout

Before applying power, check over the entire assembly for solder bridging, poor solder connections or missing solder points. Verify that all 11 DIP IC's are oriented with pin 1 up toward the top of the board. Check all LED's and transistors for polarity, and correct any mistakes now.

Mount the main PC board on the bottom chassis, but don't install the top cover until we're done testing. Plug the small PC board into the main board (through

SO6) and place all of the IN/OUT slide switches to the OUT position (toward the outside). Put the power switch in the 5-7-volt position and apply 5 volts from a regulated external DC source.

To check the pulse detector, connect a 1K resistor between the pulse input (PULSE IN) and V_{CC} on the solderless connector, SO3. Short PULSE IN to ground with a wire lead. The pulser LED must blink each time the short is made or broken. That verifies that either a rising or falling edge will trigger the pulse detector. Remove the resistor and lead.

Immediately to the left of the solderless connector is IC9. Connect pin 6, a square wave output, to PULSE IN using a short piece of wire. The pulser LED should pulse on and off rapidly. Remove the wire. If you have a pulse generator, feed a 25-ns pulse to PULSE IN. The pulser LED should blink for each pulse. Do that with both positive- and negative-going pulses.

To check the output pulser, use a short length of wire to connect PULSE OUT to PULSE IN on the solderless connector. Then connect a 22-ohm resistor from PULSE OUT to V_{CC} . When you momentarily press the pulser button, the pulser LED (LED17) should blink. Next, connect the 22-ohm resistor from PULSE OUT to ground. Once that is done, when you momentarily press the pulser button, the LED17 should blink. Depress and hold the pulser button again. In about 2 seconds the pulser LED should start and keep pulsing on as long as the button is depressed. Remove jumper and resistor.

To check the individual pin logic, insert the 220-ohm shorting plug into one of the A sockets (SO1 or SO2) and connect its common lead to ground. Place the STORE switch to the not-stored position, and cycle each of the individual pin slide switches to verify that the corresponding LED is on when the switch is in the OUT position and off when in the IN position. If an LED does not perform properly, a simple check can determine if the LED and drive transistor are working.

The test is done as follows. To turn off the LED, connect one end of a 1K resistor to ground. With a clip lead or jumper wire, connect the free end of the resistor to the top of R_{CN} . (R_{CN} is the vertically mounted resistor; there's one for each pin). To turn on an LED, connect one end of a 1K resistor to V_{CC} and repeat the above.

To check the STORE function, place the STORE switch to the STORE position. Turn each LED on by placing its switch to the OUT position, then place all IC switches to the IN position. The LED's should remain on until either the store switch is moved "out" or the pulser is pulsed.

Do not continue if the analyzer is not operating as described. Correct any problems before you go on. Next time, we'll see how to use the analyzer. R-E

DIGITAL IC's

continued from page 80

Other shift registers

A recirculating shift register is a special type of shift register whose output is fed back to its input. A block diagram of such a circuit is shown in Fig. 11.

In that circuit, as data is clocked out of the serial output, it is re-entered into the register via the serial input. The result is that after every $n + 1$ clock pulses, where n is the number of stages, or "bits", in the register, the contents of the register is reset to its original state.

One application for that type of shift register is in a digital storage oscilloscope; a block diagram of such a device is shown in Fig. 12. In such a scope, the analog input is converted to digital form by the A/D converter and then stored in the shift register. The section of that register denoted as the "cache" is four to eight bytes of parallel data that are used to update the stored waveform. The serial output of the register is re-converted to analog form by the D/A converter for display on the scope's CRT, and also fed back to the register's input for reinsertion.

Figure 13 shows a bucket brigade device, or stepper; the timing diagram for that circuit is shown in Fig. 14. That circuit is an electronic version of the electromechanical stepper, where a voltage is applied sequentially to a series of contacts.

In that type of shift register, J-K flip-flops are connected so that the J inputs are always high and the K inputs are always low. In that state, the Q outputs of each flip-flop are usually high. However, if a reset pulse is applied, it will force the Q output of the first stage low. As shown in Fig. 14, that low will be passed, in "bucket-brigade" fashion, to each succeeding stage of the register on negative-going transitions of the clock signal.

Figure 15 shows a pseudo-random sequencer. The output of that circuit is a pseudo-random signal (i.e., noise). Such a signal can be used to test a variety of equipment, such as audio amplifiers and radio receivers.

The pseudo-random sequencer can output $2^n - 1$ (where n is the number of stages in the device) different states. The particular state output on a given clock pulse appears to be random. We say "appears" because the outputs do repeat in a sequential manner; however, that sequence is not apparent over a "short" period of time. (Short is a relative term; a 64 stage pseudo-random sequencer will repeat only after $2^{64} - 1$, or 1.84467×10^{19} , clock pulses.)

Next time, we will look at another circuit in which flip-flops are used—the counter. R-E

ANTIQUE RADIOS

Antennas and grounds

SO FAR, WE'VE DISCUSSED LOCATING A suitable radio, restoring the cabinet, and repairing some chassis problems. But what of the antennas used with those sets? These days, you can get good reception by simply using a short length of wire, but that was not always the case. This month, let's step back in time and see what it took to get good reception with those old sets.

Early radio reception

Radio listeners back in the 1920's faced quite a few reception problems. For one thing, RF shielding was not a prime concern in those days. Thus, though there were far fewer sources of man-made interference around, the sources that did exist were troublesome. To make matters worse, transmitters in the mid-twenties used much lower power levels, making it tough sometimes to pull a signal out of the "hash."

One way that early radio listeners fought interference was to locate the antenna as high above ground as possible. Unfortunately, efforts to elevate the antenna were often in vain, as the lead-in still had to pass by and through most of the interference sources.

Often, lead-ins were just dropped down the back of the building and tacked to the window sill or a metal strap, which allowed the window to close. And it was not unusual to see window glass replaced by wood so that a hole could be drilled for the wire. A porcelain tube insulator inserted into a hole drilled through the wall

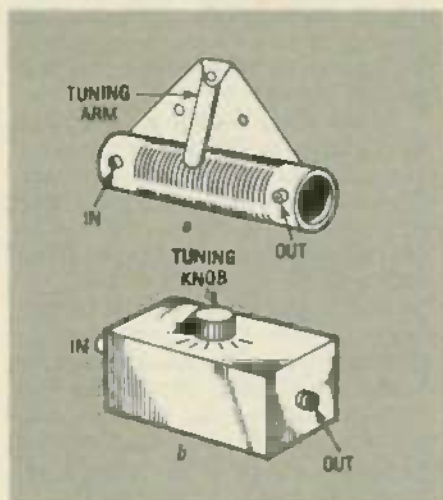

FIG. 1

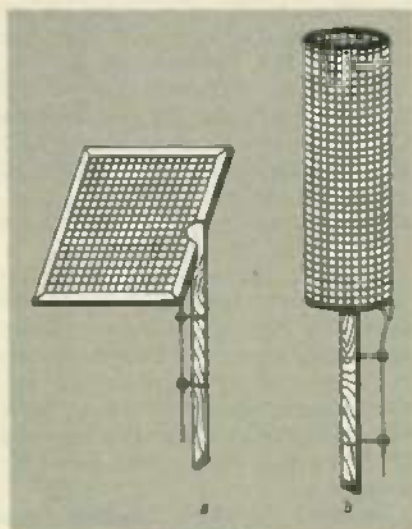

FIG. 2

or window frame (extremely unpopular with landlords) was another method used to bring the lead-in into the house. In any event, by the time the lead-in reached the set, it had usually picked up more signals than the



RICHARD D. FITCH

antenna itself. Putting up with those unwanted signals was considered a part of owning a radio in the early thirties.

Of course, shielded wire would have solved the lead-in problem. But the length of the runs—often down three stories, then through three rooms—made the cost prohibitive. At six to ten cents a foot, three dollars or more could be invested in just the lead-in wire. (That was quite a sum back in those days.) And the high ceilings of old houses added many feet to the distance between the antenna and set.

In any event, the real fun began once the antenna was in place. Even though interference was a fact of life, it was not easily tolerated. That's because it would severely curtail the possibilities of DX. And DX was one of the passions of many an early radio owner.

For those unfamiliar with it, DX is the reception of distant radio signals. A "DX hound" would often spend considerable time and money pursuing any scheme that would bring in that one extra signal.

As a result, many innovations were offered by manufacturers eager to cash in on the DX craze. Some worked wonders, while others only worsened interference problems.

Improving reception

One early device used to improve reception was an *aerial tuner*. The tuner in Fig. 1-a uses a coil with a slide lever (tuning arm) to tune the antenna for best performance. That device sold for

about one dollar and could be home-made. Fig. 1-b shows another antenna tuner common to that period.

One problem with erecting a roof-top antenna was that it were considered unsightly by landlords and neighbors. Further, for a time local fire departments sought to have those antennas banned because they considered them a hazard to fire fighting. One solution to that problem was an antenna called the *Gold Test Aerial*. It was small—only 5 inches wide, and 2½ inches high—and was said to perform as well as 50 feet of wire strung 50 feet high. That antenna was usually screwed inside the radio cabinet; it cost about \$2.50.

In the late 1920's, the *screen aerial*, a round or sometimes flat screen device mounted on a pole (as shown in Fig. 2), came along. Since that antenna eliminated the need to string wire across a roof, it was advertised as having the approval of the Fire Department.

By the 1930's, many of the problems faced by radio listeners began to disappear. Improved transmitters, with increased power, coupled with improved receiver design, all but eliminated the need for long, high-mounted antennas for broadcast reception. R-E

PRINTER BUFFER

continued from page 71

be used to download a program.) The code must be assembled to operate at start address 0900H. The RAM from 0800 to 08FFH is reserved for stack and scratchpad memory if you wish to use it. After your program is downloaded, press and release the copy switch. The processor will jump to 0900H and execute your program. Top of RAM is FFFFH.

There are few subroutines used in the IC2 program EPROM that would be of any value, and because they do wreck nearly all of the registers in the main and alternate bank, we have not supplied their entrance addresses. IC25 decodes 8 port strobes and all may be used as input or output strobes.

Using the EPROM programmer

With the power switches (S5 and S6) off, set the FUNCTION SELECT switches for the proper type of EPROM and for either READ or PROGRAM. Also set S8-a-S8-f according to the EPROM chart of Table 3. Install an EPROM in SO2. If the EPROM is a 2758, 2716, 2732 or 2732A, it must

be installed so that its pin 12 is in pin 14 of the socket. In other words, pins 1, 2, 27, and 28 should be left empty. (Note that the ZIF socket shown in the photos is a 24-pin type. If you haven't already done so, plug the Programmer board onto plugs PL4 and PL2.

Reading an EPROM

Now you're ready to read an EPROM. Switch S7 should be off. Turn on the buffer (S5) and then turn on the programmer. Press and release COPY. You should see LED1 flash when reading 2758's, 2716's and 2764's. When reading 2732 type EPROM's, the LED will not flash. In either case, the READ operation will be completed within one second.

The data from the EPROM will be stored in the buffer's memory. You may read the data from the memory through the serial output port or the parallel output port. (Of course, if you want to use the parallel port, you'll have to remove the programmer board and set the FUNCTION SELECT accordingly.) When your computer is ready to receive the data, press and release COPY. If you wish to copy the data onto another EPROM, remove the copied EPROM and replace it with a blank EPROM. Change the FUNCTION SELECT

switches and S8 for the type of EPROM you wish to program. Follow the instructions for programming an EPROM. (But remember that you already have, in the buffer, the data that you want programmed.

Programming an EPROM

Set up the programmer as described in the section "Using the EPROM programmer" before installing the EPROM to be programmed. With S7 off, turn on the buffer and then the programmer. Dump the data to be programmed through either the parallel or serial (1200 baud only) input port of the buffer. Turn S7 on. (That applies the high programming voltage.) Press and release COPY, pause for a second and repeat. LED1 will light. As data is programmed, it is verified by byte. If the data to be programmed matches the data which is now programmed into the EPROM, the programming will proceed until the last byte sent from the computer has been programmed, at which point the LED will go off. Turn off S7 and S6, and remove the EPROM. If an error is found during the verify operation, the LED will flash. If that occurs, switch off S7, S6 and S5 and repeat the above procedures with another EPROM. R-E

You can help us raise the colorectal cancer cure rate.

When detected early, the cure rate for colorectal cancer is very high. That's why we urge regular checkups for men and women 50 and over.

Warning signs are a change in bowel habits, blood in the stool.

Your doctor can perform the digital and procto exams, and you take care of the stool blood test at home.

Checkup Guidelines for men and women over 50 without symptoms

- digital exam annually
- stool blood test annually
- procto exam every 3 to 5 years after 2 negative stool 1 year apart

No one faces cancer alone.

AMERICAN CANCER SOCIETY

Ad No. 1284-G (2" x 8")
Created as a public service by
Dreyfus, MacKinnon, Johnson, Inc.



DUAL WATTAGE
(100/140) SOLDER
GUN W/ LIGHT
\$12.95
model WG 1400

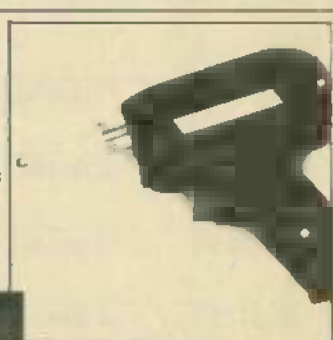

TEMPERATURE CONTROLLED SOLDER STATION
W/ ANALOG METER
CMOS SAFE
\$59.95
model TCS-101



DESOLDER HANDPUMP — ALL METAL
CONSTRUCTION W/ CONDUCTIVE TIP
CMOS SAFE
\$4.95
model DP-1



- TERMS:
- \$10 minimum order. \$1.00 charge for orders under \$10.00.
 - \$20 minimum charge card order.
 - Orders shipped UPS G.O.D.
 - Most orders shipped within 24 hours.
 - Sales office open 8:00 AM-6:00 PM.
 - For prepaid orders add \$2.50 for shipping and handling.
 - Should shipping and handling charges exceed \$2.50, the balance due will be sent G.O.D.

• VISA AND MASTERCARD ACCEPTED •

AMERICAN SOLDERING DEVICES CORP
P.O. BOX 24
SHIRLEY, NY 11967 USA
TEL: (816) 289-4573

CIRCLE 264 ON FREE INFORMATION CARD

MARKET CENTER

SATELLITE TELEVISION

BUILD your own Satellite-TV receiving system and save! Instruction manuals, schematics, circuit boards, parts kits! Send stamped envelope for complete product listing: XANDI, Box 25647, Dept. 21R, Tempe, AZ 85282.

UNSCRAMBLE—Canadian & American satellites. Watch the good stuff. Plans \$19.95—boards & plans \$30.00—units completed \$298.00—kits available—details and order forms \$3.00. SCRAMCO, 8688 Royal Drive, Noblesville, IN 46060.

SATELLITE Descramblers. Lowest prices anywhere! Dealer inquiries welcome. Send \$3.00 for

catalog. We ship C.O.D.s. STARVIEW INC., P.O. Box 103, Rexford, NY 12148.

VIDEOTAPE, instructions for site testing, assembly aiming, tracking troubleshooting any TVRO \$59.95. Info \$3.00. VIDSAT, P.O. Box 7117 Station, Saint John, N.B., Canada E2L 4S5.

UNIQUE Satellite TV Manual for dealers/hobbyists. Includes step-by-step instructions for system installation & tuning, purchasing, marketing, complete list of distributors & equipment plus more. Rush \$19.95 to SATELLITE COM. NETWORK 204 W. 20th St., New York, NY 10011.

FINEST proven names in satellite TVRO systems available at discount prices. Send \$1.00 for our prices. C.V.P., Box 2414, Danbury, CT 06810.

SATELLITE television components, huge savings. Contact FORCE ONE SYSTEMS, 120 16th N.W., Canton, OH 44703. (216) 456-0259.

SATELLITE equipment at discount prices. All major brands available. Send for free price list. GALAXY SATELLITE SYSTEMS, P.O. Box 970499, Miami, FL 33197.

THE LNA specialist! Brand name, lowest noise, lowest prices! We will not be undersold! Send for prices: LNA, 201 E. Southern, Suite 100, Tempe, AZ 85282.

CATALOG: TV descramblers, microwave converters, satellite systems, many types, kits or built. \$1.00 MINUTE KITS, Box 531, Westchester Sq. Sta., Bronx, NY 10461.

SATELLITE-TV systems. Lowest prices! Name brand dishes, receivers, LNA's, etc. Factory guaranteed. Send \$2.00 for latest catalog and information: TITANSAT, Box 101, Lemont, PA 16851.

CLASSIFIED AD ORDER FORM

To run your own classified ad, put one word on each of the lines below and send this form along with your check to:

Radio-Electronics Classified Ads, 200 Park Avenue South, N.Y., N.Y. 10003

PLEASE INDICATE in which category of classified advertising you wish your ad to appear. For special headings, there is a surcharge of \$20.00.

{ } Plans/Kits () Business Opportunities () For Sale
{ } Education/Instruction () Wanted () Satellite Television

Special Category: \$20.00

PLEASE PRINT EACH WORD SEPARATELY, IN BLOCK LETTERS.

(No refunds or credits for typesetting errors can be made unless you clearly print or type your copy.) Rates indicated are for standard style classified ads only. See below for additional charges for special ads. Minimum: 15 words.

1	2	3	4	5
6	7	8	9	10
11	12	13	14	15 (\$37.50)
16 (\$40.00)	17 (\$42.50)	18 (\$45.00)	19 (\$47.50)	20 (\$50.00)
21 (\$52.50)	22 (\$55.00)	23 (\$57.50)	24 (\$60.00)	25 (\$62.50)
26 (\$65.00)	27 (\$67.50)	28 (\$70.00)	29 (\$72.50)	30 (\$75.00)
31 (\$77.50)	32 (\$88.00)	33 (\$82.50)	34 (\$85.00)	35 (\$87.50)

We accept MasterCard and Visa for payment of orders. If you wish to use your credit card to pay for your ad fill in the following additional information (Sorry, no telephone orders can be accepted):

Card Number _____ Expiration Date _____

Please Print Name _____ Signature _____

IF YOU USE A BOX NUMBER YOU MUST INCLUDE YOUR PERMANENT ADDRESS AND PHONE NUMBER FOR OUR FILES. ADS SUBMITTED WITHOUT THIS INFORMATION WILL NOT BE ACCEPTED.

CLASSIFIED COMMERCIAL RATE: (for firms or individuals offering commercial products or services) \$2.50 per word prepaid (no charge for zip code)...**MINIMUM 15 WORDS.** 5% discount for same ad in 6 issues; 10% discount for same ad in 12 issues within one year, if prepaid. **NON-COMMERCIAL RATE:** (for individuals who want to buy or sell a personal item) \$2.00 per word, prepaid...no minimum. **ONLY FIRST WORD AND NAME** set in bold caps at no extra charge. Additional bold face (not available as all caps) \$0.50 per word additional (20% premium). Entire ad in boldface, add 20% premium to total price. **TINT SCREEN BEHIND ENTIRE AD:** add 25% premium to total price. **TINT SCREEN BEHIND ENTIRE AD PLUS ALL BOLD FACE AD:** add 45% premium to total price. **EXPANDED TYPE AD:** \$3.75 per word prepaid. All other items same as for STANDARD COMMERCIAL RATE. **TINT SCREEN BEHIND ENTIRE EXPANDED TYPE AD:** add 25% premium to total price. **TINT SCREEN BEHIND ENTIRE EXPANDED TYPE AD PLUS ALL BOLD FACE AD:** add 45% premium to total price. **DISPLAY ADS:** 1" x 2 1/4" — \$270.00; 2" x 2 1/4" — \$540.00; 3" x 2 1/4" — \$810.00. General information: Frequency rates and prepayment discounts are available. **ALL COPY SUBJECT TO PUBLISHERS APPROVAL ADVERTISEMENTS USING P.O. BOX ADDRESS WILL NOT BE ACCEPTED UNTIL ADVERTISER SUPPLIES PUBLISHER WITH PERMANENT ADDRESS AND PHONE NUMBER.** Copy to be in our hands on the 15th of the third month preceding the date of the issue. (i.e., August issue copy must be received by May 15th). When normal closing date falls on Saturday, Sunday or Holiday, issue closes on preceding working day.

ENJOY SATELLITE TV

DO-IT-YOURSELF AND SAVE

Electronic know-how not required
Easy to build from our plans or kits
Lowest prices on satellite electronics
Send \$1 for catalog or \$8.95 for
"Consumer Guide to Satellite Television"

Mail today to: GFI-D14, Box 9108
Missoula, MT 59807

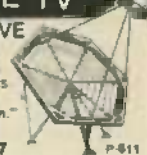

E-Z Satellite kit, computer print-out of your location, 2" liquid compass, inclinometer. MasterCard/Visa. **IN-X-SALES**, Box 45, Tilton, NH 03276. (603) 286-3082.

SATELLITE-TV—Home—RV's. Complete fully operational systems from \$6.95. Send \$2.00 for catalog. **MIDWEST SATELLITE SYSTEMS**, P.O. Box 43008, Mt. Clemens, MI 48043.

BUSINESS OPPORTUNITIES

YOUR own radio station! AM, FM, cable. Home operation possible. **BROADCASTING**, Box 130-F9, Paradise, CA 95969.

US \$8.00 including disk, thousand name brand programs for Apple, IBM-PC, details U.S. \$1.00. **RELIANT**, P.O. Box 33610, Sheungwan, Hong Kong.

HOW to start a small electronics shop at home. Make extra money. Build as large as you want. How to get business, manage the shop, calculate profit. Tax tips \$12.95, plus \$2.00 P&H. **WO-MACK**, Box 1651, Melbourne, FL 32902.

BIG PROFITS ELECTRONIC ASSEMBLY BUSINESS

Start home spare time investment knowledge or experience unnecessary. **BIG DEMAND** assembling electronic devices. Sales handled by professionals. Unusual business opportunity.

FREE: Complete illustrated literature
BARTA, R.E.O. Box 248
Walnut Creek, Calif. 94597

BUY BONDS

FOR SALE

CABLE-TV Secrets—the outlaw publication the cable companies tried to ban. HBO, Movie Channel, Showtime, descramblers, converters, etc. Suppliers list included. \$8.95. **CABLE FACTS**, Box 711-R, Pataskala, OH 43062.

RESISTORS 1/4W, 1/2W, 5% C.F. 3 cents. 1% metal-film, custom wirewounds, capacitors and other components. **JR INDUSTRIES**, 5834-H Swancreek, Toledo, OH 43614.

FREE catalog featuring scanner accessories, carrier-subcarrier detectors, voice scramblers, unusual kits. **CAPRI ELECTRONICS**, Route 1R, Canon, GA 30520.

THE Intelligence Library—Restricted technical information & books on electronic surveillance, surveillance-device schematics, lock-picking, investigation, weapons, identification documents, covert sciences, etc. The best selection available. Free brochures. **MENTOR**, (Dept. Z), 135-53 No. Blvd., Flushing, NY 11354.

WHOLESALE MATV/CATV equipments, antenna, accessories, cartridges, radios, speakers, cables. (718) 897-0509, **D&WR**, 68-12 110 Street, Flushing, NY 11375.

TI-99/4A software/hardware bargains. Hard-to-find items. Huge selection. Fast service. Free catalog. **OYNA**, Box 690, Hicksville, NY 11801.

TUBES, new, unused. Send self-addressed, stamped envelope for list. **FALA ELECTRONICS**, Box 1376-2, Milwaukee, WI 53201.

FREE Automotive Security Catalog. Largest selection available. Do-it-yourself pagers, alarms, hood locks, glass detectors. Allow 4 weeks for delivery, or for rush send \$1.00. **AUTOMOTIVE SECURITY EQUIPMENT COMPANY**, Dept. 1, P.O. Box 382, Plainview, NY 11803.

INDIVIDUAL photofact folders, No. 1 to no. 1400, \$3.00 postpaid. **LBT**, 414 Chesnut Lane, East Meadow, NY 11554.

Power Problems?

AEGIS™ Power Conditioning Equipment. THE SOLUTION! Protects Computers & High-tech Equipment From Damaging Voltage Surges, Lost Data, & Costly Down Time.

SPIKE-SPIKER™
Transient Voltage Surge & Spike Suppressors & Noise Filters • Filter Models—All Models Rated 120V, 15A
Priced From \$29.95

LINE-SAVER™
Stability, Uninterruptible & Emergency Power Systems, Self-Contained Batteries, Compact Design, Completely Automatic.
Priced From \$495.00

Call or write for free literature. Dealer inquiries invited.

KALLO®
8584 Rich Rd., Dept. F
Bethlehem, PA 18017

INSTANT ORDER LINE
800-524-0400
TWX 501-601-2101
IN PENNA 215-637-0700
MADE IN USA

DESCRAMBLERS for downconverters. High gain. Send \$2.00. **RB ELECTRONICS**, P.O. Box 643, Kalamazoo, MI 49005.

ELECTRONICS catalog. Over 4,500 items. Parts & components. Everything needed by the hobbyist or technician. \$2.00 postage & handling (States only), refundable with first \$15.00 order. **T & M ELECTRONICS**, Dept. R, 472 East Main Street, Patchogue, NY 11772. (516) 289-2520.

WANTED: Cash for old tubes, speakers, amplifiers. Western Electric, McIntosh, Marantz, RCA, Cunningham, Altec, JBL, Tannoy, Quad. (713) 726-4343. **MAURY**, 11122 Atwell, Houston, TX 77096.

TUBES, hard-to-find. Send self-addressed stamped envelope for list. **AUDIO VIDEO STOP**, 7477 Village Parkway, Dublin, CA 94568.

FREE catalog. Electronic, electrical, parts, tools, controls, switches, relays, tech books, manuals. **JS CHRISTIANSON, INC.**, 120 Oser Ave., Hauppauge, NY 11788.

THIS IS AN EXPANDED-TYPE AD WITH A TINT SCREEN. See how it jumps out on the page. To order your ad in this format calculate the cost at \$3.75 per word for the expanded-type and add 25% for the tint background.

NEW Convert any portable television into a giant five foot picture screen. Guaranteed. Only \$24.50. **QUEEN ENTERPRISES**, P.O. Box 159, Toronto, Ontario M6M 4Z2.

FREE catalog 99-cent kits—audio, video, TV, computer parts. **ALLKIT**, 434 W. 4th St., West Islip, N.Y. 11795.

CIRCUIT boards: your artwork, quick delivery, reasonable. **ATLAS CIRCUITS**, Dept. A, P.O. Box 892, Lincolnton, NC 28092. (704) 735-3943.

TUNABLE notch filters, brochure, \$1.00. **D.K. VIDEO**, Box 63 6025, Margate, FL 33063. (305) 752-9202.

ASSORTMENT #101—Toko coils (1) 144LY-120K, (1) E520HN-3000023 and (2) BKAN-K5552AXX transformers, (1) BFQ85 Sub., (1) PC, and (1) AC adapter only \$25.00. For fast free shipping, use MasterCard/VISA and call toll free 1-800-821-5226, ext. 426 (orders only) or write **JIM RHODES, INC.**, 1025 Ransome Lane, Kingsport, TN 37660.

CABLE-TV Source Book—a complete listing of suppliers for hard-to-find converters, descramblers, technical information, schematics and much, much more. Full refund if not satisfied. Send \$4.95 to **CABLE**, Box 12505-R, Columbus, OH 43212.

TECHNICA 140 channel cable converter fully remote sound and video unit only \$149.00, Jerrold LCC58 converter only \$79.00, Jerrold DRZ450 converter 90 channel auto tuning only \$89.00. All units carry full manufacturer's warranty, specials while they last. For catalogue send \$3.00. Thanks. **REDCOAT ELECTRONICS**, P.O. Box 28504, Jamaica, NY 11428. (718) 459-5088.

REPLACEMENT FOR

ECC®/GE®/SK®

TRIPLERS Min 5 PC/Type

CE527	
300A/SK3504	9.95
CE528	
525/SK3506	9.95
CE521	
526A/SK3506	9.95
CE528	
528/SK3506	12.75
CE529	
529/SK3507	11.80

OUTPUT TRANSISTORS

SK3155	5 PC Min	100 Min	
163/CE51			2.25 1.95
CE517			
238/SK3710			2.25 1.95
283/SK3467			2.75 2.25
25D1541P/7A	1500V		2.25 1.90

AUDIO POWER

152/SK3893	30	24
153/SK3274	30	24
196/SK3054	49	44
197/SK3083	59	54
291/SK3440	49	44
292/SK3441	49	44

RECTIFIER DIODES

125	1000V/25A	.07	.05
156	1000V/5A	.18	.14
506	Damper-NE Volt Fast Recovery	29	.22

SPECIAL OF THE MONTH

375/SK9118	44¢	10 PC Min	39¢	100 PC Min
712 TV Sound/IF FM/DET/	75¢	10 PC Min	60¢	100 PC Min

SUPER SAVINGS

85	10 MIN	100 MIN	139	10 MIN	100 MIN	189	10 MIN	100 MIN
102A	.21	.18	.16	.11	.11	.50	.45	.45
108	.35	.29	.88	.77	.77	.59	.50	.50
123A	.18	.14	.85	.50	.50	.65	.55	.55
125AP	.18	.14	2.25	1.95	1.95	.65	.53	.53
128	.13	.09	2.35	1.99	1.99	.18	.12	.12
128	.38	.33	.49	.39	.39	.25	.19	.15
128	.38	.33	.38	.30	.30	.287	.29	.22
150	.59	.53	.38	.30	.30	.288	.29	.22
154	.75	.65	.87	.48	.40	.376	.55	.49
157	.49	.39	.50	.43	.43	.398	.59	.49

FOR A COMPLETE LIST CALL OR WRITE—C.O.D. Orders welcome (Min. Order \$25)

DIGITRON ELECTRONICS

110 HILLSIDE AVENUE, SPRINGFIELD, NEW JERSEY 07081
TOLL FREE 1-800-528-4938 IN NJ 201-578-9014 Telex 138441
PRICES SUBJECT TO CHANGE WITHOUT NOTICE. OFFER GOOD WHILE SUPPLY LASTS.
ECC is a Trade Mark of PHILIPS ECC
Digitron Electronics is NOT associated in any way with PHILIPS ECC

POWER SUPPLIES! FOR COMPUTER/HOBBYIST OVERSTOCK INVENTORY AT COST

- Limited quantities • Switchers
- Series Regulated • Wallmount Regulated

WALLMOUNTS (Input plug/output cable w/DIN Conn.)

PART NO.	OUTPUTS				SIZE			PRICE
	1	2	3	4	H	W	L	
WM 063	5v/300mA	-12v/180mA	+12v/180mA		2.20	2.75	3.50	7.90
WM 093	5v/850mA	-5v/300mA	+12v/300mA		2.28	3.10	4.36	10.75

LINEAR (Input/Output Solder Terminals)

FD 272	5v/1.7A	-9v/1.5A	+24v/2A	10v/2A	2.94	4.44	6.56	55.65
FD 284	5v/9A	-5v/9v	+12v/7A		2.75	4.87	11.00	70.35
FD 340	5v/5A	+12v/9A			1.62	4.00	5.50	27.30

SWITCHERS (Input/Output Solder Terminals)

EPS 100-24	24v/4A				2.38	5.28	7.85	128.10
ES 100-12	12v/5A				2.38	5.25	7.65	128.10
EL 30401	5v/2.5A	12v/2A	-12v/1A		1.80	3.80	6.30	34.85
EL 40801	5v/5A	12v/2.5A	-9v/5A	-12v/5A	1.86	4.40	7.20	38.85
EL 40802	5v/5A	12v/2.5A	-9v/5A	-12v/5A	1.85	4.40	7.20	38.85
EL 41008	5v/5A	12v/5A			2.44	4.13	8.08	102.90
EL 41014	5v/10A	12v/4A	-12v/1A	-5v/1A	2.44	4.13	9.08	102.90
EL 41701	5v/15A	12v/4A	-12v/4A		2.44	5.59	10.00	133.35
EL 41702	5v/15A	12v/4A	-12v/4A	24v/4A	2.44	5.59	10.00	133.35
EL 82001*	9v/20A	12v/4A	-12v/4A	24v/2A	2.44	8.06	10.71	148.05

*5in output -9v/2A



OUTSIDE CALIF. TOLL FREE
1-800-438-0600
INSIDE CALIF.
(714) 979-4440

Terms:
• Freight add \$3.50 per unit
• Calif. residents add 6% sales tax.
• Volume discounts (above 100 qty).

CIRCLE 272 ON FREE INFORMATION CARD

TOLL FREE
800-854-8230
 Calif. Residents
714-558-8813

OUR POLICY

- NO surcharge for VISA or Mastercard
- NO sales tax • All shipments insured
- Your card is NOT charged until we ship
- Same day FEDEX shipment is available
- Volume purchasing agreements available
- Government agencies, corporate and institutional PO's accepted
- Orders subject to availability
- All items have manufacturer warranty. Some warranties up to 5 years.
- Pricing subject to change w/o notice
- Returns or cancellations may be subject to restocking fee.
- ACP Retail Store pricing may vary.
- We are not responsible for types.

UPS POWER SUPPLY

Backup Power for your IBM.
 Apply to Computers

UPS-300 300 Watts \$277.00
 UPS-375 375 Watts \$315.00
 UPS-450 450 Watts \$355.00
 UPS-AT 1000 Watts \$675.00

A-B PRINTER WITH

An A-B Backup power up of last printer with power capacitor system. We stand your 11" up to 11" configurations.

AS Backup Converter \$300.00
 AS Backup (2000) \$90.00

COLOR VIDEO CAMERA

Miniature Color Flat \$675.00
 8MM Color Card \$295.00
 8MM Color Card \$295.00
 8MM Color Card \$295.00
 8MM Color Card \$295.00

SPECIAL BUY

Original 3M 4844 14" 2000 Guard Film \$600.00

DRIVE CABINETS

IBM Style Hard Disk with motor \$1100.00
 5 1/4" Hard Disk \$1100.00
 5 1/4" Hard Disk \$1100.00
 5 1/4" Hard Disk \$1100.00

PERSTY CARDS

Peristy Memory Cards - 1MB \$330.00
 Peristy Memory Cards - 2MB \$440.00
 Peristy Memory Cards - 4MB \$660.00
 Peristy Memory Cards - 8MB \$1320.00

MODERN SPECIAL

Modern Special Computer \$210.00

TRANSISTORS

2N2904 2N2904 \$1.00
 2N2905 2N2905 \$1.00
 2N2906 2N2906 \$1.00
 2N2907 2N2907 \$1.00

OPTO ISOLATORS

4N25 4N25 \$1.00
 4N26 4N26 \$1.00
 4N27 4N27 \$1.00
 4N28 4N28 \$1.00

LED LAMPS

LED Lamp \$1.00
 LED Lamp \$1.00
 LED Lamp \$1.00

CAPACITORS

1000µF 25V \$1.00
 1000µF 25V \$1.00
 1000µF 25V \$1.00

CONCOM 6M FILTER

CONCOM 6M Filter \$1.00
 CONCOM 6M Filter \$1.00

MUFFIN PANS

Muffin Pan \$1.00
 Muffin Pan \$1.00

IC SOCKETS

IC Socket \$1.00
 IC Socket \$1.00
 IC Socket \$1.00

EDGE CONNECTORS

Edge Connector \$1.00
 Edge Connector \$1.00

D-SUBMINIATURE

D-Subminiature \$1.00
 D-Subminiature \$1.00

IC CONNECTORS

IDC TYPE	ACP NO	NUMBER OF CONTACTS
Header Header	EDH001	7 10 15 20 25 30 40 50
90 Degree Header	EDH002	7 10 15 20 25 30 40 50
Right Angle Header	EDH003	7 10 15 20 25 30 40 50
Header Header	EDH004	7 10 15 20 25 30 40 50
Header Header	EDH005	7 10 15 20 25 30 40 50
Header Header	EDH006	7 10 15 20 25 30 40 50
Header Header	EDH007	7 10 15 20 25 30 40 50
Header Header	EDH008	7 10 15 20 25 30 40 50

NOTE: To order insert number 29 contacts in place 29 in ACP part number.

OXIDA PRINTERS

Oxida 80 \$150.00
 Oxida 100 \$200.00
 Oxida 120 \$250.00
 Oxida 140 \$300.00

8000

8000 8000 \$1.00
 8000 8000 \$1.00
 8000 8000 \$1.00

8000

8000 8000 \$1.00
 8000 8000 \$1.00
 8000 8000 \$1.00

8000

8000 8000 \$1.00
 8000 8000 \$1.00
 8000 8000 \$1.00

8000

8000 8000 \$1.00
 8000 8000 \$1.00
 8000 8000 \$1.00

8000

8000 8000 \$1.00
 8000 8000 \$1.00
 8000 8000 \$1.00

8000

8000 8000 \$1.00
 8000 8000 \$1.00
 8000 8000 \$1.00

8000

8000 8000 \$1.00
 8000 8000 \$1.00
 8000 8000 \$1.00

8000

8000 8000 \$1.00
 8000 8000 \$1.00
 8000 8000 \$1.00

8000

8000 8000 \$1.00
 8000 8000 \$1.00
 8000 8000 \$1.00

8000

8000 8000 \$1.00
 8000 8000 \$1.00
 8000 8000 \$1.00

8000

8000 8000 \$1.00
 8000 8000 \$1.00
 8000 8000 \$1.00

8000

8000 8000 \$1.00
 8000 8000 \$1.00
 8000 8000 \$1.00

CMOS

CMOS 8000 \$1.00
 CMOS 8000 \$1.00
 CMOS 8000 \$1.00

CMOS

CMOS 8000 \$1.00
 CMOS 8000 \$1.00
 CMOS 8000 \$1.00

CMOS

CMOS 8000 \$1.00
 CMOS 8000 \$1.00
 CMOS 8000 \$1.00

CMOS

CMOS 8000 \$1.00
 CMOS 8000 \$1.00
 CMOS 8000 \$1.00

CMOS

CMOS 8000 \$1.00
 CMOS 8000 \$1.00
 CMOS 8000 \$1.00

CMOS

CMOS 8000 \$1.00
 CMOS 8000 \$1.00
 CMOS 8000 \$1.00

CMOS

CMOS 8000 \$1.00
 CMOS 8000 \$1.00
 CMOS 8000 \$1.00

CMOS

CMOS 8000 \$1.00
 CMOS 8000 \$1.00
 CMOS 8000 \$1.00

CMOS

CMOS 8000 \$1.00
 CMOS 8000 \$1.00
 CMOS 8000 \$1.00

CMOS

CMOS 8000 \$1.00
 CMOS 8000 \$1.00
 CMOS 8000 \$1.00

CMOS

CMOS 8000 \$1.00
 CMOS 8000 \$1.00
 CMOS 8000 \$1.00

CMOS

CMOS 8000 \$1.00
 CMOS 8000 \$1.00
 CMOS 8000 \$1.00

7400

7400 7400 \$1.00
 7400 7400 \$1.00
 7400 7400 \$1.00

7400

7400 7400 \$1.00
 7400 7400 \$1.00
 7400 7400 \$1.00

7400

7400 7400 \$1.00
 7400 7400 \$1.00
 7400 7400 \$1.00

7400

7400 7400 \$1.00
 7400 7400 \$1.00
 7400 7400 \$1.00

7400

7400 7400 \$1.00
 7400 7400 \$1.00
 7400 7400 \$1.00

7400

7400 7400 \$1.00
 7400 7400 \$1.00
 7400 7400 \$1.00

7400

7400 7400 \$1.00
 7400 7400 \$1.00
 7400 7400 \$1.00

7400

7400 7400 \$1.00
 7400 7400 \$1.00
 7400 7400 \$1.00

7400

7400 7400 \$1.00
 7400 7400 \$1.00
 7400 7400 \$1.00

7400

7400 7400 \$1.00
 7400 7400 \$1.00
 7400 7400 \$1.00

7400

7400 7400 \$1.00
 7400 7400 \$1.00
 7400 7400 \$1.00

7400

7400 7400 \$1.00
 7400 7400 \$1.00
 7400 7400 \$1.00

7400

7400 7400 \$1.00
 7400 7400 \$1.00
 7400 7400 \$1.00

7400

7400 7400 \$1.00
 7400 7400 \$1.00
 7400 7400 \$1.00

7400

7400 7400 \$1.00
 7400 7400 \$1.00
 7400 7400 \$1.00

7400

7400 7400 \$1.00
 7400 7400 \$1.00
 7400 7400 \$1.00

7400

7400 7400 \$1.00
 7400 7400 \$1.00
 7400 7400 \$1.00

7400

7400 7400 \$1.00
 7400 7400 \$1.00
 7400 7400 \$1.00

7400

7400 7400 \$1.00
 7400 7400 \$1.00
 7400 7400 \$1.00

7400

7400 7400 \$1.00
 7400 7400 \$1.00
 7400 7400 \$1.00

7400

7400 7400 \$1.00
 7400 7400 \$1.00
 7400 7400 \$1.00

7400

7400 7400 \$1.00
 7400 7400 \$1.00
 7400 7400 \$1.00

7400

7400 7400 \$1.00
 7400 7400 \$1.00
 7400 7400 \$1.00

7400

7400 7400 \$1.00
 7400 7400 \$1.00
 7400 7400 \$1.00

FINEST QUALITY SOLDER

SN 60/40 Rosin Core (RA)

One lb. Reels
 18 swg (084) \$7.95
 18 swg (048) \$8.45
 19 swg (040) \$8.95
 20 swg (036) \$9.45
 21 swg (032) \$9.95



FREE Freight On All Orders
 Over \$25
 Under \$25 add \$2.50 per order.
 Minimum order \$10.

1/2 lb. Reels

22 swg (028) \$5.95

24 swg (022) \$7.95

SN 62 (2% Silver)

Rosin Core

21 swg (031) \$19.95

FREE Soldering Wick with each pound of solder

Check Money Order VISA

MasterCard BY STATE

SolderCraft Call TOLL FREE 800-645-4808

Quality Microwave TV Antennas

Multi-Channel 1.9 to 2.7 GHz
 40dB Gain True Parabolic 26 Inch Dish
 Complete System \$84.95 (Shipping Incl.)
 Dealerships, Qty. Pricing, Replacement Parts
Philips-Tech Electronics
 P.O. Box 34772 • Phoenix, AZ 85067
 (802) 847-7788 (\$3.00 Credit all phone orders)
 MasterCard • Visa • C.O.D.

ROBOTS "Movit" line. Easily assembled. You control. Great fun, educational. Free catalog. **ELECTROMANIA**, 51A Sunrise Highway, Lynbrook, NY 11563

CORDLESS—phone interference? We've got the answer. Have a radar speeding ticket? We can help. Home phone extension in your car? You can have it. 50-page color catalog airmailed \$3.00. **DBE**, P.O. Drawer G, Waikiki, HI 96815. MC VISA orders (808) 395-7458.

CABLE and Subscription-TV secret manual. Build your own descramblers, converters—HBO, Show-

time, Movie Channel, UHF. Latest theory, schematics, instructions, suppliers. Send \$8.95 to **CABLETRONICS**, Box 30502RE, Bethesda, MD 20814

PICTURE Flyer list quality electronics surplus at low prices. Since 1970. Send for the last 3 issues. **STAR-TRONICS**, Box 563, McMinnville, OR 97128

AUTOMOTIVE Security Catalog, new devices not on market yet. Infra-red, ultrasonic, RF, high voltage thief shocker and more. Send \$2.00. **ABSTRACT ELECTRONICS**, 19200 Schoolcraft, Detroit, MI 48223.

CONVERT videotapes, PAL—SECAM—NTSC (overseas). 110-220 Audio video recorders, televisions, discounted. **APPLE AUDIO**, 74-18, 37th Avenue, Jackson Heights, NY 11372. (718) 507-5800.

ZENITH SSAVI Manual. Original manual used by technicians. Theory of scrambling, schematics, parts list, repair for UHF and cable. For speedy delivery send \$15.00, cash or money order. **BAY STATE ELECTRONICS**, P.O. Box 263, Accord, MA 02018.

STUN gun immobilizes your attacker with 40,000 volts. For more information send \$1.00 to **CAMEO ENTERPRISES, INC.**, Box 63, Accord, MA 02018.

CAR stereo, C.B.s, radar detectors, alarms, accessories. Dirt cheap! Free catalog **ELECTROMANIA**, 51B Sunrise Highway, Lynbrook, NY 11563

WRITE FOR

McGEE'S
SPEAKER & ELECTRONICS CATALOG
 1001 BARGAINS IN SPEAKERS
 toll free 1-800-346-2433 for ordering only.
 1901 MCGEE STREET KANSAS CITY, MO. 64108

BEGINNING microprocessors...Especially for beginners. Learn and keep ahead with well written and thoroughly described articles, projects, and experiments. Covers hardware, software, and support electronics from the ground up. 12 issues \$15.00. Box 4757, Englewood, CO 80155.

TRANSIENT voltage suppressors—six outlets plugs in standard duplex outlet—Protects HiFi-TV—stereo—computer from surges—\$13.99. **J.R. ELECTRONICS**, Box 50571 Midland, TX 79710.

IBM XT motherboard same as in July R-E, \$204.00 128K, 30 day money back guarantee, other cards available, CA res. 6%, RGB, 1321 Oro Street, EL Cajon, CA 92021.

TUBES: "Oldies", latest. Supplies, components, schematics. Catalog for S.A.S.E. **STEINMETZ**, 7519 Maplewood Ave., RE, Hammond, IN 46324.

CABLE TV converters—All major brands. Wireless remotes with volume, wired remotes. Cable and Video accessories. Cablemaster distributor. Lowest prices. Ship C.O.D. Catalogs \$3.00. **SONE ASSOCIATES**, 5 Broadway, Suite 201, Troy, NY 12180.

CONVERTERS all types for all systems. Lowest prices anywhere. Quantity discounts. Dealer inquiries accepted. Free catalog. **PG VIDEO CORP.**, 61 Galchell St., Dept. RE, Buffalo, NY 14212.

COLOR monitor RGB 14" distributor closeout originally sold for \$599.00 now \$169.00 delivered. IBM-PC and Apple III compatible with mod. card and cable additional \$29.95. Brochure on request. **UDO CORPORATION**, 282 Main Street, Salem, NH 03079.

MASTERCARD and **VISA** are now accepted for payment of your advertising. Simply complete the form on the first page of the Market Center and we will bill.

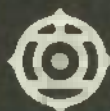

HITACHI

OSCILLOSCOPES

TEST EQUIPMENT

COMPLETE LINE OF INSTRUMENTATION AT THE MOST COMPETITIVE PRICES

DISCOUNT PRICES

<p>V-209 DC-20MHz • Dual Trace Battery Operated</p> <p>Mini-PORTABLE Reg. \$945 \$692 SAVE \$253</p>	<p>V-509 DC-50MHz • Dual Trace Delayed Sweep</p> <p>Mini-PORTABLE Reg. \$1399 \$1099 SAVE \$300</p>	<p>V-1070 100MHz • Quad Trace CRT Readout 6" PDA-CRT</p> <p>Reg. \$1950 \$1532 SAVE \$418</p>	<p>V-650F 60MHz • Dual Trace Delayed Sweep</p> <p>Reg. \$1195 \$936 SAVE \$259</p>	<p>V-1050F 100MHz • Quad Trace Delayed Sweep</p> <p>Reg. \$1595 \$1252 SAVE \$343</p>
<p>V-222 DC-20MHz • Dual Trace</p> <p>Reg. \$715 \$524 SAVE \$191</p>	<p>V-422 DC-40MHz • Dual Trace</p> <p>Reg. \$925 \$679 SAVE \$246</p>	<p>V-1100 100MHz • Quad Trace CRT Readout • 1mV 6" PDA-CRT</p> <p>Reg. \$2490 \$2280 SAVE \$210</p>	<p>V-6015 1MHz/2 Channels • 1000 Words Per Channel</p> <p>DIGITAL STORAGE Reg. \$2095 \$1645 SAVE \$450</p>	<p>V-6041 40MHz/2 Channels • 4000 Words Per Channel</p> <p>DIGITAL STORAGE Reg. \$5855 \$5311 SAVE \$544</p>

TOTAL ELECTRONICS CENTER • OVER 70,000 ITEMS IN STOCK
WM. B. ALLEN SUPPLY CO. INC.
 ALLEN SQUARE
 300 BLOCK NORTH RAMPART STREET, NEW ORLEANS, LOUISIANA 70112

CALL TOLL FREE
800 535-9593
 LOUISIANA TOLL FREE 800 462-9520

DoKay

COMPUTER
PRODUCTS,
Inc.

ORDER TOLL FREE

(800)
538-8800

(CALIFORNIA RESIDENTS)

(800)
848-8008

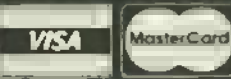

STATIC RAMS

2101	256 x 4	450cs	1.00
2102	1K x 1	150cs	.70
2102L-1	1K x 1	150cs	.20
2102L-2	1K x 1	250cs	1.20
2111	256 x 4	450cs	3.20
2112	256 x 4	450cs	2.20
2114	1K x 4	450cs	.60
2114-20	1K x 4	200cs	1.10
2114L-4	1K x 4	150cs	1.20
2114L-3	1K x 4	300cs	1.30
2114L-2	1K x 4	200cs	1.40
2127	4K x 1	350cs	3.90
3101	256 x 4	450cs	2.00
TM1044-4	4K x 1	180cs	2.90
TM1044-8	4K x 1	200cs	3.40
TM1044-2	4K x 1	200cs	3.90
MS4110	1K x 0	250cs	0.95
TM1010-20	2K x 0	100cs	2.40
TM1010-10	2K x 0	150cs	2.00
TM1010-10	2K x 0	100cs	4.40
MS110-4	2K x 0	200cs	C002 2.10
MS110-3	2K x 0	150cs	C000 3.00
MS110-2	2K x 0	120cs	C003 3.40
MS110P-4	2K x 0	300cs	C003 2.00
MS110P-3	2K x 0	150cs	C003 3.40
MS110P-2	2K x 0	120cs	C003 4.40
2-4132	4K x 0	100cs	26.01
MS121P-16	4K x 0	150cs	C005 7.45
MS121P-10	4K x 0	150cs	C003 0.95
MS121P-12	4K x 0	120cs	C001 10.95

DYNAMIC RAMS

TM34927	4K x 1	250cs	1.45
MP0411	4K x 1	300cs	1.00
MS12101	4K x 1	340cs	1.00
MS12104	8K x 1	200cs	.90
MS12106	8K x 1	200cs	.90
4110-20	1K x 0	200cs	.70
4110-10	1K x 0	120cs	1.00
4110-12	1K x 0	120cs	1.00
2110	1K x 1	150cs	5r 3.50
4104-20	8K x 0	250cs	5r 1.00
4104-20	8K x 1	200cs	5r 1.70
4104-10	8K x 0	150cs	5r 2.00
41250-20	256 x 1	200cs	7.00
41200-10	256 x 1	150cs	4.00

EPROMS

1702	256 x 0	1 m	3.95
2702	1K x 0	450cs	2.40
2750	1K x 0	450cs	3.00
2710	2K x 0	450cs	2.95
2714-4	2K x 0	350cs	3r 3.90
TM12510	7K x 0	450cs	5r 3.90
TM12710	7K x 0	450cs	5r 3.90
TM12532	2K x 0	450cs	5r 0.00
2732	4K x 0	450cs	5r 3.90
2732 A-4	4K x 0	450cs	21r 5.00
2732 A-33	4K x 0	350cs	21r 3.95
2732 A	4K x 0	250cs	21r 0.00
2732 A-2	4K x 0	100cs	21r 4.95
2744	4K x 0	450cs	5r 4.25
2744-20	5K x 0	250cs	5r 4.25
2704-20	3K x 1	200cs	5r 7.00
TM12504	1K x 0	450cs	5r 1.95
MC1001704	4K x 0	450cs	5r 17.90
MC1001744	4K x 0	300cs	5r 10.95
27120-40	1K x 0	230cs	5r 4.45
27124-30	1K x 0	300cs	5r 0.00
27120-25	1K x 0	250cs	5r 10.00
27220-25	52K x 0	250cs	10r 24.91

74LS00

74LS00	23	74LS121	40	74LS260	60
74LS01	24	74LS125	41	74LS266	61
74LS02	24	74LS132	42	74LS273	62
74LS03	24	74LS131	43	74LS270	63
74LS04	23	74LS130	44	74LS276	64
74LS05	24	74LS137	45	74LS260	1.00
74LS00	27	74LS130	44	74LS203	80
74LS00	30	74LS130	44	74LS290	80
74LS10	24	74LS146	115	74LS203	80
74LS11	34	74LS147	246	74LS266	80
74LS12	34	74LS144	130	74LS200	80
74LS13	44	74LS161	54	74LS290	1.70
74LS14	80	74LS153	54	74LS323	3.45
74LS15	44	74LS164	105	74LS324	1.70
74LS20	24	74LS150	54	74LS352	1.25
74LS21	20	74LS194	30	74LS363	1.25
74LS22	24	74LS167	54	74LS363	1.00
74LS26	20	74LS194	30	74LS364	1.00
74LS27	23	74LS190	54	74LS365	64
74LS28	34	74LS181	54	74LS366	44
74LS30	24	74LS202	54	74LS367	44
74LS32	20	74LS180	54	74LS360	64
74LS30	64	74LS184	54	74LS373	1.35
74LS37	34	74LS181	54	74LS374	1.35
74LS38	34	74LS194	130	74LS377	1.30
74LS46	24	74LS194	1.70	74LS370	1.10
74LS42	40	74LS189	1.70	74LS376	1.30
74LS47	74	74LS170	1.45	74LS345	1.05
74LS48	74	74LS173	64	74LS364	44
74LS46	70	74LS174	54	74LS390	1.10
74LS51	24	74LS176	64	74LS363	1.10
74LS04	20	74LS161	210	74LS365	1.10
74LS36	20	74LS190	0.90	74LS399	1.45
74LS33	120	74LS090	30	74LS424	2.00
74LS76	30	74LS161	64	74LS447	3.00
74LS74	34	74LS162	70	74LS400	1.80
74LS76	36	74LS163	70	74LS424	0.65
74LS70	30	74LS160	60	74LS100	2.10
74LS70	40	74LS165	30	74LS444	2.10
74LS43	80	74LS100	70	74LS400	1.00
74LS65	60	74LS197	70	74LS460	1.00
74LS44	30	74LS221	60	74LS470	1.45
74LS60	64	74LS240	94	74LS470	0.90
74LS61	30	74LS241	94	74LS402	0.10
74LS82	64	74LS242	94	74LS203	0.10
74LS83	64	74LS243	98	74LS404	3.10
74LS06	74	74LS244	126	74LS194	3.10
74LS00	60	74LS245	145	74LS340	2.30
74LS107	30	74LS247	74	74LS600	0.10
74LS100	30	74LS248	90	74LS737	23.00
74LS112	30	74LS246	66	01LS05	1.45
74LS113	30	74LS291	60	01LS06	1.45
74LS114	30	74LS263	55	01LS07	1.45
74LS122	44	74LS267	30	01LS08	1.40
74LS123	76	74LS266	30	25LS221	2.75
74LS124	800	74LS260	2.70	25LS260	4.20

We will try to BEAT
All Competitor's Prices
CALL for Quote!

DISC CONTROLLERS

1691	6.00	2705	30.00
1771	14.00	2707	30.00
1701	22.00	0043	20.00
1703	22.00	0272	10.00
0703	22.00	004076	22.00
2142	6.00	004077	22.00
2701	34.00	MC3470	6.00
2703	34.00	UP0701	10.00

CRT CONTROLLERS

0043	11.00	CR75027	10.00
0047	10.00	CR75037	20.00
00047	23.00	DP3550	30.00
00045	10.00	K44505	11.00
7220	30.00	MC1372	6.00
0276	20.00	TM3961AA	30.00

UV ERASERS

QUV-T8/1 \$49.95
ECONOMY Model

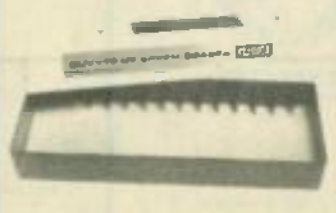

- Erases 15 EPROMS in 20 minutes
- Plastic Enclosure

6500

6500	4.00	6002A	5.00
6504	6.00	6520A	5.00
6505	6.00	6522A	5.00
6507	6.00	6522A	10.00
6510	4.30	6545A	12.00
6512	4.00	6551A	10.00
6515	0.00		
6517	0.00		

6800

6800	2.00	68000-0	34.00
1002	7.00	68000-1	26.00
4002	12.00	68000-2	10.00
4004	12.00	68000-3	10.00
4006	6.00	68000-4	10.00
4008	6.00	68000-5	10.00
4010	2.00	68000-6	10.00
4012	4.00	68000-7	10.00
4014	2.00	68000-8	10.00
4016	13.00	68000-9	10.00
4018	11.00	68000-10	10.00
4020	33.00	68000-11	10.00
4022	24.00	68000-12	10.00
4024	11.00	68000-13	10.00
4026	2.90	68000-14	20.00
4028	5.00	68000-15	10.00
4030	7.00	68000-16	10.00
4032	10.00	68000-17	10.00
4034	0.00	68000-18	0.00
4036	1.00	68000-19	17.00
4038	21.00	68000-20	10.00

8000

0051	14.00	8252	0.00
0055	5.00	8253-5	7.00
0056	6.00	8255	4.45
107-8066	20.00	8256-6	4.00
101-8070	20.00	0111	7.00
0060A	3.00	8257-5	0.00
0065	4.90	8260	0.00
0065A-2	11.00	8261-6	0.00
0066	24.00	8271	0.00
0067-15 Wnd	100.00	8272	10.00
0067-2 Wnd	270.00	8274	20.00
0068	10.00	8276	20.00
0068	60.00	8276-6	0.00
		8276-7	7.00
		8282	0.40
		8283	6.40
		8284	4.00
		8285	0.45
		8287	6.45
		8288	12.00
		8289	44.00
		8292	12.00

8100

4151	2.00	8294	4.00
4156	0.00	8296	0.45
4155-2	7.00	8297	6.45
4156	0.00	8298	12.00
4155	20.00	8299	44.00
4168-2	10.00	8282	12.00

8200

0202	22.00	8300	2.00
0203	30.00	8304	1.00
0205	0.00	8307	2.10
0212	1.70	8308	2.50
0214	3.70	8310	0.00
0218	1.70	8311	3.00
0224	2.20		
0226	1.75		
0228	3.45		
0237	12.00		
0237-5	14.00		
0238	4.45		
0240	4.40		
0250	0.00		
0251	3.00		
0251A	4.45		

8300

0202	22.00	8300	2.00
0203	30.00	8304	1.00
0205	0.00	8307	2.10
0212	1.70	8308	2.50
0214	3.70	8310	0.00
0218	1.70	8311	3.00

8700

0224	2.20		
0226	1.75		
0228	3.45		
0237	12.00		
0237-5	14.00		
0238	4.45		
0240	4.40		
0250	0.00		
0251	3.00		
0251A	4.45		

80000

0060A	3.00	80100-6	99.50
-------	------	---------	-------

Saratoga Electronics



SPECIALS

DYNAMIC RAMS

-41256-150 **\$4.00**

STATIC RAMS

* M58725P-200ns 1.50 *
(6116P-4)

EPROMS

-27128 **\$4.50**
(250ns)

-2764 **\$3.00**

NEW! VLSI TECHNOLOGY

OMTI 5510
HARD DISK CONTROLLER
\$210.00 W/CABLES

DISK DRIVES

Limited Quantities

Shugart: SA800 \$CALL

.5MB (1/2HT)

Shugart: SA850 \$CALL

1.0MB (1/2HT)

Quantum: Q2040 \$CALL

40MB (FB)

Vertex: V70 \$CALL

70MB (FB)

OMI: OMI5619 \$250.00

19MB (FB)

Seagate: ST-412 \$200.00

10MB (FB)

Panasonic: 5 1/2 Floppy \$95.00

(1/2HT) (IBM PC COMP)

SARATOGA ELECTRONICS

12300 SARATOGA-SUNNYVALE ROAD



SARATOGA, CA 95070

(408) 448-4948



Call Us For Inventory Overstock
Specials on 74LS, 74S, CMOS,
8000 Series and Much More!!!

800-621-0854 ext. 245

VISA

order toll free



CIRCLE 253 ON FREE INFORMATION CARD

THIS IS AN EXPANDED TYPE AD. Notice how it stands out on this page. To get your ad set in this type style mark your classified ad order, "Expanded-type ad," and calculate your cost at \$3.75 per word.

EDUCATION & INSTRUCTION

FREE: Math addition program for IBM-PC/PC jr. Send diskette with postage paid return mailer. ROSE, 6799 Carrera, Las Vegas, NV 89103.

FCC Commercial General Radiotelephone License Correspondence Course. 60 individual lessons for \$89.50. Payment plan. Results guaranteed! Details free. AMERICAN TECHNICAL INSTITUTE, Box 201, Cedar Mountain, NC 28718.

ATTENTION ELECTRONIC TECHNICIANS



Highly Effective Home Study BSEE Degree Program for Experienced Electronic Technicians. Our New Advanced Placement Program grants Credit for Previous Schooling & Professional Experience. Advance Rapidly! Our 40th Year! FREE DESCRIPTIVE LITERATURE!
Cook's Institute of Electronics Engineering
P.O. BOX 20345, JACKSON, MS 39209

WANTED

INVENTIONS, ideas, new products wanted! Presentation to industry. National exposition. Call (1-800) 528-6050. Canada (1-800) 528-6060. X831.

REEL-TO-REEL TAPES

AMPEX professional series open reel tape. 1800- or 2400-foot on 7-inch reels, used once. Case of 40, \$45.00. 10 1/2 x 3600 feet and cassettes available. MasterCard/Visa. VALTECH ELECTRONICS, Box 6-RE, Richboro, PA 18954 (215) 322-4866.

INVENTORS!

CAN you profit from your idea? Call us today regarding the marketing of your invention, or write for your free information package. Over a decade of service. AMERICAN INVENTORS CORPORATION, 82 Broad Street, Dept. RE, Westfield, MA 01086, (413) 568-3753 (Not an answering service.) Offices nationwide.

CABLE TV FILTER "CYLINDERS"

SUPER powered notch filters. Equivalent of cable company "cylinders". Eliminate undesirable signals. Any channel 2 through 8; 14(A) through 22(I). (Please specify.) Send \$20.00 each. Money back guarantee. Quantity discounts. CATV, Box 17621, Plantation, FL 33318.

PRINTED-CIRCUIT BOARDS

PRINTED-circuit boards. Quick prototypes, production, design, reflow solder. Send print or description for quote to KIT CIRCUITS, Box 235, Clawson, MI 48017.

Take
stock
in America.



When you put part of your savings into U.S. Savings Bonds you're helping to build a brighter future for your country and for yourself.

COMPUTER PERIPHERALS

APPLE compatible peripherals—Z-80 Card \$34.00, Eprom burner \$39.95, send for product list. MSU PERIPHERALS, P.O. Box 446, Rocklin, CA 95677. (916) 783-9961.

GRAPHIC EQUALIZERS, ETC.

NOISE eliminators, expanders, power meters, others. Twelve-24 bands/channel equalizers from \$89.00. Kit see R-E 5-6/78, 2/80, 3-4/81. Catalog: \$55. 856R Lynnrose, Santa Rosa, CA 95404. (707) 546-3895.

CABLE-TV

DEALERS wanted: Channel 2, 3, and 4 notch filters. Money back guarantee. Send \$15.00 for sample and quantity price list. Specify channel(s). GARY KURTZ, P.O. Box 291394, Oaive, FL 33329.

THE BEST PLACE to BUY, SELL or TRADE NEW and USED EQUIPMENT
NUTS & VOLTS MAGAZINE
BOX 1111-E • PLACENTA, CA 92670
(714) 433-7721

Join Thousands of Readers Nationwide Every Month

ONE YEAR U.S. SUBSCRIPTIONS

\$18.00 - 1st Class • \$15.00 - 2nd Class

\$38.00 - Lifetime - 2nd Class

NUTS & VOLTS

YOUR OWN COMPUTING COPY/TRANSFER
REARERS • OPTICS
TEST EQUIPMENT
REPAIRS
BATTERIES
AUDIO VISUAL
NEW PRODUCTS
COMPONENTS • SPS
ARTIFICIAL SILENT
PUBLICATIONS
PLANS • SERVICES

THIS IS AN ALL BOLDFACE AD. Boldface words cost 50¢ per word additional. If you want your entire ad in boldface, add 20% to the regular cost of your ad.

MASTERCARD AND VISA are now accepted for payment of your advertising. Simply complete the form on the first page of the Market Center and we will bill.

WHAT IS NESDA?

NESDA IS
OVER 2,000 SERVICERS
JOINING TOGETHER

to improve their technical knowledge and business management skills

NESDA IS

A STRONG ALLIANCE
OF STATE ASSOCIATIONS
and confederation of local groups working together to improve conditions in the electronics service industry

NESDA IS
YOUR INDUSTRY
SPOKESMAN AND REPRESENTATIVE AT THE NATIONAL LEVEL

JOIN NESDA
AND YOUR STATE AND LOCAL ASSOCIATION

Write for more information to:
NESDA, 1715 Expo Lane
Indianapolis, Indiana 46224



Radio Shack Parts Place

Everyday Low Prices! Over 1000 Items in Stock!

"Doorbell" Chime and Pulsing Piezo Buzzer



- (1) Electronic chime with familiar "ding-dong" sound. Operates on 1 1/2 VDC at 30 mA. Sound pressure: 75 dB. 4 3/4" leads. #273-067 **6.95**
 (2) Pulsing electronic buzzer has extra-loud 80 dB output with 2 Hz pulse rate. Requires 12 VDC at 20 mA. 4 3/4" leads. #273-058 **2.99**

Light Up Your Project!



- (3) 6-Volt Lamp Assemblies. Two snap-in bases, two red and two yellow lenses. #272-341, Set. **1.49**
 (4) "Jumbo" Red Neon Lamp Assembly. A 120 VAC pilot light that really stands out. #272-710, **1.99**
 (5) COX21 Blinking LED. Red LED has a built-in flasher IC. 5 VDC at 20 mA. #276-036 **1.59**
 (6) XC-5491 Tri-Color LED. Glows red on DC, green on reverse DC, yellow on AC. #276-035 **1.29**

MOV Transient Protectors

Protect computers and sensitive electronics from power-line "spikes".

Application	Cat. No.	Each
Standard	276-570	1.59
Heavy-Duty	276-568	1.89

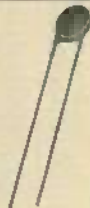

Semiconductor Reference Guide

Half Price! Reg. **1.75**
 3.49

1985 Edition. Cross-reference section lists over 80,000 semiconductor types and their low-cost Radio Shack equivalents. Data on ICs, SCRs, LEDs, diodes and more. 272 pages. #276-4006



Low-Profile DIP Sockets

Low As **49¢**

Quality non-wicking sockets for PCB use. Low-resistance contacts.

Type	Cat. No.	Pkg. of 2
8-Pin	276-1995	.59
14-Pin	276-1999	.89
18-Pin	276-1998	.89

Type	Cat. No.	Each
16-Pin	276-1992	.49
20-Pin	276-1991	.59
24-Pin	276-1989	.79
28-Pin	276-1997	.89
40-Pin	276-1996	.99

Computer / Game Connectors



Fig	Type	Positions	Cat. No.	Each
7	Solder Sub-D Male	9	276-1537	1.99
8	Solder Sub-D Female	9	276-1538	2.49
9	Hood for Above	9	276-1539	1.99
	Solder Sub-D Male	25	276-1547	2.99
	Solder Sub-D Female	25	276-1548	3.99
	Hood for Above	25	276-1549	1.99
10	Printer Connector	36	276-1534	4.99
11	Peripheral Connector	34	276-1564	4.95

1/4-Watt, 5% Resistors

Pkg. of 5 **39¢**

Ohms	Cat. No.	Ohms	Cat. No.
10	271-1301	10k	271-1335
100	271-1311	15k	271-1337
150	271-1312	22k	271-1339
220	271-1313	27k	271-1340
270	271-1314	33k	271-1341
330	271-1315	47k	271-1342
470	271-1317	68k	271-1345
1k	271-1321	100k	271-1347
1.8k	271-1324	220k	271-1350
2.2k	271-1325	470k	271-1354
3.3k	271-1326	1 meg	271-1356
4.7k	271-1330	10 meg	271-1365
6.8k	271-1333		

Special Purchase TV RF Modulator

Only **4.95**

- Prewired ■ High Quality
- Originally for TI 99/4 PC



Lets you use a standard TV set as a monitor. Selectable channel 3/4 output. 5-pin DIN plug accepts video, audio and 12 VDC power inputs. On/off switch has built-in TV antenna/modulator switching. With complete data. #277-1015 **4.95**

Printed Circuit Boards

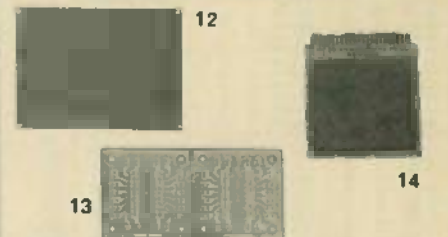

- (12) Grid Board. Accepts DIP devices. 2200 solder-ringed holes. 4 1/2 x 6 3/8". #276-147 **2.99**
 (13) Dual IC Board. Accepts two 8 to 20-pin DIPs. Gives you four connecting points for each IC pin. 1 3/4 x 3 3/8". #276-159 **1.49**
 (14) Plug-in Board. Modern, modular concept allows quick board swaps. Three buses. 4 1/2 x 4" with 1/8" grids. Fits 44-pin socket. #276-154 **2.99**
 Socket for Above. #276-1551 **2.99**

Power Transformers

120 VAC Primaries

Type	Volts	Current	Cat. No.	Each
Miniature	6.3	300 mA	273-1384	2.59
Miniature	12.6	300 mA	273-1385	2.79
Miniature	25.2	300 mA	273-1386	3.49
Miniature	12.6 CT	450 mA	273-1365	3.59
Miniature	25.2 CT	450 mA	273-1366	3.99
Standard	6.3	1.2 A	273-1351	3.99
Standard	12.6 CT	1.2 A	273-1352	4.99
Standard	25.2	1.2 A	273-1353	5.99
Heavy-Duty	12.6 CT	3.0 A	273-1511	6.99
Heavy-Duty	25.2 CT	2.0 A	273-1512	7.49
Heavy-Duty	18.0 CT	2.0 A	273-1515	6.99

CT = Center Tap

Compact, 21-Range LCD Digital Multitester

Save \$20 Reg. **39.95**
 59.95

Handy "Beep" Continuity and Range-Change Indicator

Step up to digital precision and many extra features at one-third off! Has a convenient pushbutton zero-adjust and a diode/semiconductor junction test mode. Measures up to 1000 volts DC, 500 volts AC, AC and DC current to 200 millamps, and resistance to 20 megohms in 6 ranges. With spare fuse, test leads and manual. Batteries extra. #22-191

Case for Above. #22-153 **5.95**



Devices for Experimenters



- (15) SPO256-AL2 Speech Synthesizer. Program stored in its built-in ROM will synthesize any English word. Requires low-cost support components available through Radio Shack and a host computer. 28-pin DIP with data. #276-1784 **12.95**
 (16) TLC555 Timer IC. CMOS version of standard 555 with very low power consumption. Typically one milliwatt with 8 VDC supply voltage. Operates up to 2 MHz. Requires 2 to 18 VDC, single supply. 8-pin DIP. #276-1716 **1.39**
 (17) IRF-511 Power MOSFET. Ideal for switching-type power supplies, motor controls, power inverters, audio amplifiers. Handles up to 80 VDC and 3 amps of current. "On" resistance only 0.8 ohm. TO-220 case. #276-2072 **2.79**

Over 1000 Items in stock: Binding posts, Books, Breadboards, Buzzers, Capacitors, Chokes, Clips, Connectors, Fuses, Hardware, ICs, Jacks, Knobs, Lamps, Multimeters, PC Boards, Plugs, Rectifiers, Relays, Resistors, Switches, Tools, Transformers, Transistors, Wire, Zener Diodes, and more!

Radio Shack

A DIVISION OF TANDY CORPORATION
 Prices apply at participating Radio Shack stores and dealers

Commodore Accessories



RS232 Adapter for VIC-20 and Commodore 64

The JE232CM allows connection of standard serial RS232 printers, modems, etc. to your VIC-20 and C-64. A 4-pole switch allows the inversion of the 4 control lines. Complete installation and operation instructions included.

- Plugs Into User Port - Provides Standard RS232 signal levels - Uses 6 signals (Transmit, Receive, Clear to Send, Request to Send, Data Terminal Ready, Data Set Ready).

JE232CM . . . \$39.95

VOICE SYNTHESIZER FOR COMMODORE VIC-20 AND C-64

Plug-In - Talking in Minutes!
JES20CM . . . \$99.95

TRS-80 Accessories

MP1 5 1/4" DISK DRIVE

- Use as a second drive. Single-sided. Single-double density. Full-height drive. 48 TR. Documentation included. Weight 3.7 lbs.

MP151S . . . \$89.95 or 2 for \$159.95

EXPAND TRS-80 MEMORY TRS-80 MODEL II, III

Each kit comes complete with eight 16Kx256 1984A(1) 11 16K Dynamic RAMs and documentation for expansion. Model II kit equipped with 12 expansion interface can be upgraded to 48K with 7 kits. Model III can be upgraded from 16K to 48K using 3 kits. Each kit is a complete turnkey kit for TRS increments.

TRS-16K3 200ns (Model II) . . . \$6.29
TRS-16K4 250ns (Model II) . . . \$5.49

TRS-80 COLOR AND COLOR II

Easy to install kit comes complete with 8 each 16Kx256 1984A(1) 16K Dynamic RAMs and documentation for expansion. Converts TRS-80 Color Computers with D, E, I, F and HIC boards to color. May convert TRS-80 Color Computer II to 64K. Each kit is a complete turnkey kit for 16K increments.

TRS-64K-2 . . . \$11.95

TRS-80 MODEL IV & 4P

Easy to install kit comes complete with 8 each 16Kx256 1984A(1) 16K Dynamic RAMs and documentation. Converts TRS-80 Model IV computers from 16K to 64K. Plug requires Model 4P from gate to 120K.

TRS-64K-2 . . . \$11.95
TRS-64K2PAL (Model IV only) . . . \$29.95
(It is a 256K with PAL chip to expand from 64K to 128K)

TRS-80 Model 100* NEC Olivetti

*ALSO COMPATIBLE WITH NEC PC-9801 & AND OLIVETTI 4110

Easy to install module plugs right into the second memory bank in 80C increments. Complete with module and documentation for conversion.

M1000K (170-10 Model 100 Expansion) . . . \$39.95
NEC-80K (NEC PC-9801 & Olivetti 4110) . . . \$39.95

PROMETHEUS MODEMS

Intelligent 300/1200 Baud Modem with Real Time Clock/Calendar

The ProModem™ II is a Bell 212A (300/1200 baud) intelligent stand-alone modem. Fully featured & expandable modem. Standard features include Auto Answer and Auto Dial, Help Commands, Programmable Intelligent Dialing, Touch Tone™ & Pulse Dialing and more. Hayes command set compatible plus an additional stand-alone command set. Shows w/alphabetic display option.

PM1200 RS-232 Stand-Alone Unit . . . \$319.95

OPTIONS FOR ProModem 1200

PM-COM ProCom-Distinction Software . . . \$79.95
Please specify Operating System.

PM-OP Options Processor . . . \$79.95

PMO-16K Options Processor Memory - 16K . . . \$ 4.50
PMO-32K Options Processor Memory - 32K . . . \$ 8.00
PMO-64K Options Processor Memory - 64K . . . \$18.00

PM-ALP Alphabetic Display . . . \$79.95

PM-Special Intel Options Processor 64K Memory and Alphabetic Display . . . \$169.95

SALE! • MONITORS • SALE!

12" Monochrome Green Monitor for APPLE II, II+, IIe and IIc*

Also compatible with other computer systems.

FEATURES:

- 75 sq. in. viewing screen
- High resolution display
- 80 character x 24 line display format
- LED power indicator
- Attractive, computer-matched styling
- Brightness control
- Easy access controls
- 48 back of unit
- Complete with all/initial monitor stand

*Input signal compatible video
*Input impedance 75 Ohm
*1000 x 600 resolution
*32° 50' degree deflection green
*Size: 11 1/2" x 16 1/2" x 20 1/2"

MON-12G . . . \$79.95

Muffin-Style and Sprite Style Fans

MUF-60 1/2" 60' 6000rpm . . . \$ 9.95
PWS2107F 1/2" 120' 9000rpm . . . \$18.95

APPLE Accessories



16K RAM Card (Language Card)

The ARC-16K RAM Card allows the Apple II and II+ computers to expand from 48K to 64K. Complete with instructions. Key: (a)

ARC-16K . . . \$39.95

Z-80 CP/M Card

The AZ80-1 is a soft-card compatible. Used with CP/M related programs. Software not included. Key: (a,b)

AZ80-1 . . . \$49.95

EPROM Burner Card

The AEB-2 allows user to program and sort with standard EPROMs (2716, 2732 & 2764). Easy to use, on-board firmware. Menu contains the following options: Write, Read, Copy, Compare, Blank-Check and Monitor. Complete with instructions. Key: (a,b)

AEB-2 . . . \$69.95

80-Column Card w/Soft Switch

The A80-C is an 80-column card designed for the Apple II and II+ computers. The card is equipped with a soft switch which allows easy hookup for 80 columns. The A80-C also features inverse video capabilities. This card is similar to the Video™ 80 column card. Complete with instructions. Key: (b)

A80-C . . . \$74.95

Super Serial Card

The ASSC-P is a serial card with a printer mode. It generates standard RS-232C signals and is similar to the Apple™ Super Serial Card. Complete with instructions. Key: (a,b)

ASSC-P . . . \$99.95

Parallel Graphics Printer Card w/64K Buffer

The APC-64K is a parallel graphics printer card with a 64K buffer and graphic dump capabilities. Complete with instructions. Key: (a,b)

APC-64K . . . \$129.95

80-Column/64K RAM Card

Extended 80-Column/64K RAM Card expands memory by 64K to give 128K when used with programs like VisiCalc™. Complete with instructions. Key: (b)

JE864 . . . \$79.95

*APPLE APPLE II, II+, IIc and IIcxs are registered trademarks of APPLE Computers.
*VisiCalc is a registered trademark of Visi Corp.

APPLE™ Compatible 5 1/4" Half-Height Disk Drive

Reduced pricing!

APPLE™ 5 1/4" Disk Drive & Controller Card

- Ultra Shugart SAS90 mechanics - 102K formatted capacity. Color matched Apple Compatible - Works with Apple Controller or other Apple-compatible controllers (ACC-1) - Complete with formatter - full plug into the disk controller card - 36 inches - Size: 7 1/2" x 5 1/2" x 8-1/2" - Wt. 4.5 lbs. Key: (a,b)

ADD-514 Disk Drive . . . \$149.95
ACC-1 Controller Card . . . \$ 49.95

APPLE™ IIc Compatible 5 1/4" Half-Height Disk Drive

Same specs as ADD-12 but without formatter necessary.

ADD-12 . . . \$129.95
ADD-IIc . . . \$129.95

Additional Apple™ Compatible Products

- Cooling Fan with surge protection - Key: (a,b) . . . \$ 39.95
- Numeric/Aux Keypad - 23 accessible functions - Key: (a,b) . . . \$ 49.95
- EAEC-1 Expanded Apple Enclosure Case only - Key: (a) . . . \$ 49.95
- KMP4007 Switching Power Supply - Key: (a) . . . \$ 59.95
- KB-A68 68-Key Apple Keyboard only - Key: (a) . . . \$ 69.95
- MON-12G 12" Green Monitor with swivel stand - Key: (a, b & c) . . . \$ 79.95
- JES20AP Voice Synthesizer - Plug-in, User Ready - Key: (a,b) . . . \$119.95
- Apple Keyboard and Case - Key: (a) . . . \$119.95
- PM1200A Prometheus Internal Modem - 2 cards - Key: (a,b) . . . \$299.95
- PM1200M Prometheus Macintosh Ext. Modem - Key: (a) . . . \$369.95

General Application Power Supplies

Power/Mate Corp. REGULATED POWER SUPPLY

- Input: 105-125/210-250VAC @ 47-63Hz - Line regulation $\pm 0.05\%$ - Three mounting surfaces - Overvoltage protection - UL recognized - CSA certified

Part No.	Size	Weight	Price
EMAS/68	5V @ 3A / 6V @ 2.5A	6 1/2" x 4 1/4" x 2 1/4"	2 lbs. \$29.95
EMAS/9C	5V @ 6A / 6V @ 5A	5 1/2" x 4 1/4" x 2 1/4"	4 lbs. \$39.95

KEPCO/TKD 4-OUTPUT SWITCHING POWER SUPPLY

- Ideal for disk drive needs of CRT terminals, microcomputers and video games - Input: 115/230VAC 50/60Hz - Output: +5V @ 5A, +12V @ 1.8A, +12V @ 2A, -12V @ 0.5A - 1A, recognized - CSA certified - Size: 7 1/2" x 6-3/16" x 1 1/4" - Weight: 2 lbs.

MRM 174FK . . . \$49.95

4-CHANNEL SWITCHING POWER SUPPLY

- Microprocessor, mini-computer, terminal, medical equipment and process control applications - Input: 115/230VAC 50/60Hz - Output: +5VDC @ 5A - 5VDC @ 1A; +12VDC @ 1A - 12VDC @ 1A - Line regulation: $\pm 0.2\%$ - Ripple: 30mV p-p - Load regulation: $\pm 1\%$ - Overcurrent protection - Adj: 5V main output $\pm 10\%$ - Size: 6 1/2" x 1 1/4" x 4-15/16" - Weight: 1 1/2 lbs.

FCS-804A . . . \$69.95

210 Minimum Order - U.S. Funds Only CA Residents Add 9% Sales Tax. Ship to: 1355 Shoreway Road, Belmont, CA 94002. Phone: (415) 592-8097. Fax: (415) 592-8097. Telex: 178043. *Add shipping and handling charges to all orders. *Ship to: 1355 Shoreway Road, Belmont, CA 94002.

Jameco ELECTRONICS

1355 SHOREWAY ROAD, BELMONT, CA 94002
935 PHONE ORDERS WELCOME - (415) 592-8097 - Telex: 178043

MasterCard **VISA**

IBM Accessories

*** Cables * Cables**

8-Foot Parallel Printer Cable
IBM-8PC (2025) Male to Centronics 26-pin Male . . . \$18.95

6-Foot Serial Printer/Modem Cable
MMS-2206 (2025) Male to Centronics 25-pin . . . \$14.95
MFS-2206 (2025) Male to Centronics 25-pin . . . \$15.25

5-Foot Keyboard Extension Cable for IBM-PC and XT Computers
IBM-KEC . . . \$9.95

MEMORY EXPANSION KITS

IBM PC, PC XT and Compatibles

The IBMPC kit will increase memory in 64K byte increments. The kit is simple to install - just insert the 7 1/2" disk into drive - the installed software sets up the 7 groups of switches. Documentation and computer included.

IBM64K (Nine 200ns 64K RAMs) . . . \$9.95

Each kit comes complete with nine 172C dynamic RAMs and documentation for conversion.

IBM128K (Nine 250ns 128K RAMs) . . . \$79.95

IBM PCXT Equivalent 130 Watt Power Supply

UPGRADE YOUR PC!

- Input: 110V @ 60Hz - Output: +5VDC @ 15A, -5VDC @ 0.5A, +12VDC @ 4.2A, -12VDC @ 0.5A - Plug compatible connectors - Fits into IBM PC - Weight: 6 lbs.

IBM-PS . . . \$119.95

Prometheus Modems

The ProModem 1200B/ES is a 1200/300 baud modem card which plugs into IBM PC and XT provides a third serial port. Two versions available: 1200B (without software) and 1200BS (with software). The PM1200BS is supplied with powerful MITE communications software from Microware Labs.

PM1200B (without software) . . . \$239.95
PM1200BS (with MITE software) . . . \$274.95

Compatible! DISK DRIVES

Documentation included

RFD480 (Remex 5 1/4" DS half-ht.) . . . \$ 89.95
FD558 (Rexac 5 1/4" DS half-ht.) . . . \$119.95
SA455 (Shugart 5 1/4" DS half-ht.) . . . \$109.95
TM100-2 (Random 5 1/4" DS half-ht.) . . . \$129.95

5 1/4" DISK DRIVE ENCLOSURES

Complete with power supply, switch, power cord, fuseholder and connectors.

DDE-1FH (Shugart 5 1/4" DS drive) . . . \$69.95
DDE-2MH (Random 5 1/4" DS drive) . . . \$79.95

General Application Keyboards

Mitsumi 54-Key Unencoded All-Purpose Keyboard

- SPST keyswitches - 20 pin ribbon cable connection
- Low profile keys - Features: cursor controls, case (black), function, enter and shift keys - Color: key-caps: grey - Weight: 1 lb. - Pinout Incl. - Size: 13 1/2" x 4 1/4" x 1 1/4"

KB54 . . . \$14.95

74-Key ASCII Cherry Keyboard

- 7-bit parallel ASCII - Full Upper Case, Full Lower Case except l, m, n, o and p - Cursor keypad - 8PST mechanical keyswitches - 26-pin header connector - Color: white
- Size: 18 1/2" x 6 1/2" x 1 1/4" - Spec. included

KB8201 . . . (1990 available) . . . \$24.95

UV-EPROM ERASER

8 Chips - 21 Minutes

1 Chip - 15 Minutes

Erases all EPROMs. Erases up to 8 chips within 21 minutes (1 chip in 15 minutes). Features: constant exposure distance of one inch. Special conductive foil liner eliminates UVB build-up. Built-in safety lock to prevent UV exposure. Compact - only 9 000" x 3 700" x 2 800". Complete with holding tray for 8 chips.

DE-4 UV-EPROM Eraser . . . \$74.95
UV8-11EL Replacement Bulb . . . \$18.95

RAMSEY

THE FIRST NAME IN ELECTRONIC TEST GEAR

NEW

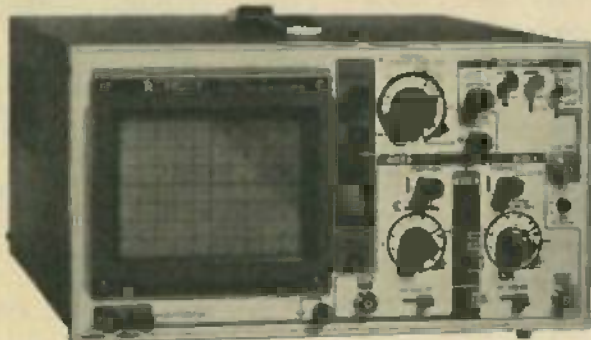

20 MHz DUAL TRACE OSCILLOSCOPE

Unsurpassed quality at an unbeatable price, the Ramsey Oscilloscope compares to others costing hundreds more. Features include a component testing circuit for resistor, capacitor, digital circuit and diode testing • TV video sync filter • wide bandwidth & high sensitivity • internal graticule • front panel trace rotator • Z axis • high sensitivity x-y mode • regulated power supply • built-in calibrator • rock solid triggering

\$399⁹⁵*

High quality built on probe included

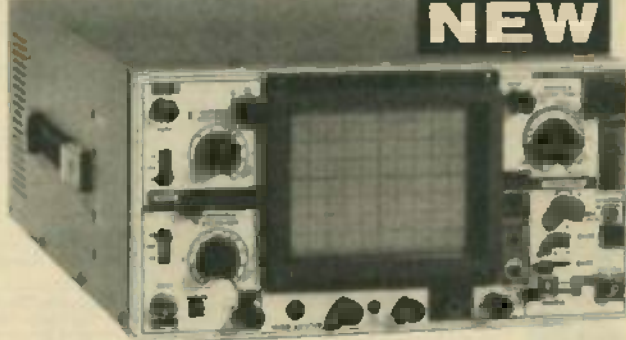

45 MHz DUAL SWEEP OSCILLOSCOPE

The Ramsey 425 is a dual time base, delayed sweep unit that includes a built-in signal delay line to permit clear viewing during very short rise times of high frequency waveforms. Other features include: variable trigger holdoff • 20 colored sweep time ranges from 0.5 ns/div to 0.2 us/div • fully adjustable sweep time • 10 sweep magnification • two trigger sources, CH1, CH2, LINE EXTERNAL and INTERNAL (TV mode) • front panel TV operation 2 amp output • sum channels of CH1, and CH2 waveforms displayed • 1 single trace • beam gate and sweep output • auto focus • single sweep

\$799⁹⁵*

High quality built on probe included



RAMSEY D-1100 VOM MULTIMETER

Compact and reliable designed to service a wide variety of equipment. Features include • mirror black scale • double-reversed precision moving coil • double overload protection • an ideal low coil unit for the beginner or as a spare back-up unit.

\$19⁹⁵

test leads and battery included



NEW RAMSEY 1200 VOM MULTIMETER

Check transistors, diodes and LEDs with this professional quality meter. Other features include: decibel scale • 20K volt metering system • 3 1/2" mirrored scale • polarity switch • 20 measuring ranges • safety probe • high impact plastic case

\$24⁹⁵

test leads and battery included

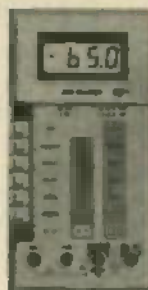

RAMSEY D-3100 DIGITAL MULTIMETER

Reliable, accurate digital measurements at an amazingly low cost • in-line color coded push buttons, speed range selection • ane plastic tilt stand • recessed input jacks • overload protection on all ranges • 3 1/2" digit LCD display with auto zero, auto polarity & low BAT. indicator

\$49⁹⁵

test leads and battery included



CT-70 7 DIGIT 525 MHz COUNTER

Lab quality at a breakthrough price. Features • 3 frequency ranges each with pre amp • dual selectable gate times • 99.9% activity indicator • 50mV @ 150 MHz typical sensitivity • wide frequency range • 1 ppm accuracy

\$119⁹⁵

wired includes AC adapter

CT-70 kit \$99.95
BP-4 head pack 8.95

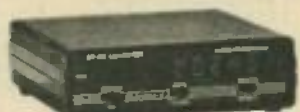

CT-90 9 DIGIT 600 MHz COUNTER

The most versatile for less than \$300. Features 3 selectable gate times • 9 digits & 99.9% indicator • display hold • 25mV @ 150 MHz typical sensitivity • 10 MHz timebase for WWV calibration • 1 ppm accuracy

\$149⁹⁵

wired includes AC adapter

CT-90 kit \$129.95
DV-1 0.1 PPM oven timebase 19.95
BP-4 head pack 8.95

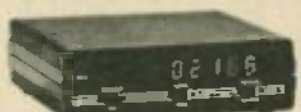

CT-125 9 DIGIT 1.2 GHz COUNTER

A 9 digit counter that will outperform units costing hundreds more • gate indicator • 24mV @ 150 MHz typical sensitivity • 8 digit display • 1 ppm accuracy • display hold • dual inputs with presamps

\$169⁹⁵

wired includes AC adapter

BP-4 head pack 8.95

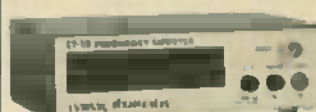

CT-50 8 DIGIT 600 MHz COUNTER

A versatile lab bench counter with optional receiver frequency adapter, which turns the CT-50 into a digital readout for most any receiver • 25 mV @ 150 MHz typical sensitivity • 8 digit display • 1 ppm accuracy

\$169⁹⁵

wired

CT-50 kit \$139.95
RA-1 receiver adapter kit 14.95

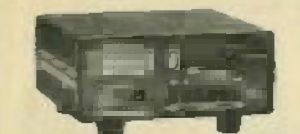

DM-700 DIGITAL MULTIMETER

Professional quality at a hobbyist price. Features include 26 different ranges and 5 functions • 3 1/2 digit, 3/4 inch LED display • automatic diaphragm placement • automatic polarity

\$119⁹⁵

wired includes AC adapter

DM-700 kit \$99.95
MP-1 probe set 4.95

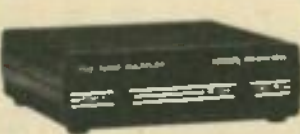

PS-2 AUDIO MULTIPLIER

The PS-2 is handy for high resolution audio resolution measurements, multiplies UP in frequency • great for PL tone measurements • multiplies by 10 or 100 • 0.01 Hz resolution & built-in signal preamp/conditioner

\$49⁹⁵

wired

PS-2 kit \$39.95



PR-2 COUNTER PREAMP

The PR-2 is ideal for measuring weak signals from 10 to 1,000 MHz • nat 25 dB gain • BNC connectors • great for drifting RF • ideal receiver/TV preamp

\$44⁹⁵

wired includes AC adapter

PR-2 kit \$34.95

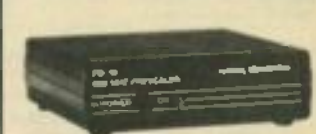

PS-1B 600 MHz PRESCALER

Extends the range of your present counter to 600 MHz • 2 stage preamp • divide by 10 circuitry • sensitivity, 25mV @ 150 MHz • BNC connectors • auto zero

\$59⁹⁵

wired includes AC adapter

PS-1B kit \$49.95

ACCESSORIES FOR RAMSEY COUNTERS

- Telescopic whip antenna—BNC plug \$ 8.95
- High impedance probe, light loading 16.95
- Low pass Probe, audio use 16.95
- Direct probe, general purpose use 13.95
- Tilt ball, for CT-70, 90, 125 3.95

VISA
MasterCard
PHONE ORDERS CALL 716-586-3950
TELEX 466735 RAMSEY CI

TERMS • satisfaction guaranteed • examine for 30 days if not pleased return in original form for refund • add \$3. for shipping and insurance to a maximum of \$10.00 • overseas and 48 hr surface mail • C.O.D. add \$2.50 (C.O.D. in USA only) • orders under \$15.00 add \$1.50 • NY residents add 7% sales tax • 90 day parts warranty on all kits • 1 year parts & labor warranty on all mixed units.

RAMSEY

RAMSEY ELECTRONICS, INC.
2575 Balrd Rd.
Penfield, N.Y. 14626

THE MOST POPULAR KITS IN EUROPE & ASIA ARE COMING NOW! 50 HOT ITEMS FOR YOUR SELECTION. SEND \$1.00 FOR MARK V CATALOG, REFUND UPON ORDER

TA-202 20W AC/DC STEREO AMPLIFIER



- Employs the most advanced SANYO power IC, so it has high power output and low distortion characteristic.
- Both AC and DC power supply can be used so it can be connected to 12V car battery or directly to the mains, suitable for use in car, home or other places.
- Compatible with various magnetic Cartridge, Tuner, Recorder deck, Magnetic microphone and Input from small power car Hi-Fi system.
- A stereo power level indicator is included, of which is attractive and with high precision.

Assembled with Tested \$80.00

TA-2400A ELECTRONIC ECHO/AND REVERBERATION AMPLIFIER

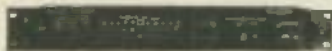

This unit combines the most advanced computer V.L.S.I. technique with high quality Japan made component, so it has the following FEATURES:
It can generate various reflection and reverberation effect such as that in valley and music hall. It has a 3 section effect control which includes reverberation control, delay control and depth control.
All kinds of initial sound effect can be obtained by skilful use of this control. It has LED display to show reflection and reverberation.

Assembled with Tested \$99.85

SM-100 150MC UNIVERSAL DIGITAL FREQUENCY COUNTER

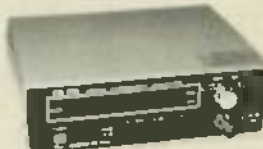

SM-100 is an accurate, easy-operated digital frequency counter. Few pieces of advanced, high technical LSI integrated circuit are used, thus, circuit structure is reliable. SM-100 can give you up to 8 digits of resolution for a wide frequency range of 10Hz to 150MHz. Besides, a memorize system is available, the last input digits can be held on the panel, as compared to the other or even observation.
Input sensitivity: KHz range 10Hz - 100Hz 50mVrms
MHz range 10Hz - 150MHz 40mVrms

Response time: 0.2 sec.
Hold: Hold the last input signal
Power supply: DC6V Battery or DC6V 250MA Adaptor

Assembled with Tested \$99.00

SM-43 MULTIFUNCTIONAL LED D.P.M.



6 different kinds of usages with only one meter, high accuracy (0.1%) (51 digit), high input impedance, high anti-vibrating ability, the display reset to zero automatically when the input is OV, and employs 100PPM/C temperature compensation zener diode which improves the accuracy and stationarity of the meter.
MEASUREMENT RANGE:
D.C. VOLTAGE: 1mV - 1000V
A.C. VOLTAGE: 1mV - 1000V
DIGITAL THERMOMETER: 0°C - 100°C
D.C. CURRENT: 1uA - 2A
CAPACITOR METER: 1pF - 2uF
FREQUENCY COUNTER: 10 KHz - 20KHz
DIMENSION: 98(W) x 48(H) x 103(D) mm

Kit \$29.23 Assembled with tested \$35.00

TA-2500 HIGH QUALITY MULTIPURPOSE PRE AMPLIFIER



This specially designed pre-amplifier includes a professional GRAPH EQUALIZER TONE control system and has a gain of 2 12dB. Frequency response extends from 5Hz to 20KHz, so even in bad listening condition it can improve with. It can accept input from various magnetic cartridge, record deck and tuner. Its output can be connected to all kinds of power amplifier.

Assembled with Tested \$90.00

TA-50A/B MULTIPURPOSE MELODY GENERATOR



This multipurpose melody generator is made with the latest CMOS LSI technology. Operating on a very low current, it can play 8 different songs by using two AA sized batteries (DC3V). Applications include their usages in electronic door bells, musical bells and electronic clock alarm and many more. Better yet, you can choose from 2 models both containing 8 popular, melodious tunes.

Kit \$9.80

TR-355 3.5A REGULATED DC POWER SUPPLY

- It employs high quality IC and HIGH POWER Darlington power transistor so the output is very stable.
- It includes overload protection circuit and LED indicator.
- Suitable for all experimental usage.
- There are two versions:
0-15V/5A (TR-355A)
0-30V/3A (TR-355B)



Kit \$10.00

TA-1500 100W + 100W NEW CLASS 'A' DC STEREO PREMAIN AMPLIFIER

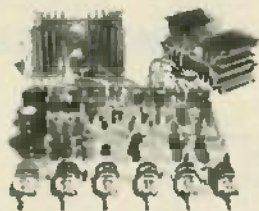

- Features:
1. Preamp employs three LOW NOISE Op. Amp. at RIAA equalizer and 20dB flat amplifier and tone control. It has very good transient response and low noise. It is easy to build up.
 2. Power Amp. employs our powerful audio transistors and an advanced dynamic base class 'A' circuit. The distortion is extremely low and this makes the output stage to minimize the switching distortion. It can reproduce high level bass faithfully.
 3. A specially designed delay system is included and the functions contain: (A) three seconds delay, (B) output short circuit protection, (C) DC output protection. It also equips with LED indicator of double display.
 4. It includes with microphone mixer, so you can sing with those famous singer together. It can also be used as Public Address Amplifier.

Kit \$67.00

TY-41 MKIII INFRARED REMOTE CONTROL UNIT



- This third generation infrared remote control unit employs the most advanced decode IC so it will not be affected by common light and electric spark, therefore it is very reliable.
- It uses modern infrared transmitting and receiving component so no antenna is required. The control range is up to 10 meter (30 feet).
- It has two mode of operation: "Continuous" and "on/off" suitable for controlling various kinds of electrical equipment whose power consumption is within 500W. It can also be used as a burglar alarm.
- The power supply is DC 9-12V. It is simple in construction and easy to guide and align.
- A Deluxe remote control unit box is free of charge.

Kit \$25.00 Assembled with tested \$30.00

WE CAN SUPPLY METAL CABINETS AND POWER TRANSFORMERS FOR OUR KITS! PLEASE REFER TO OUR CATALOG.

TA-302 60W VERSATILE STEREO POWER BOOSTER



- OTL full transistorize and low distortion of SEPP circuit design, high output power and sound fidelity.
- With high and low input impedance for selection, so it can match with all pre-amplifiers, low power of portable sound equipment, and all types of stereo recorder deck to use. It can boast "real-time" type of radio and tape player, too.
- With 10 band colour LED power meter, output power can be easily defined. TA-302 is a versatile amplifier for both visual and listening enjoyment.

Assembled with Tested \$80.00
Kit \$50.00

TERMS

Min order: \$10.00
Charge card order: \$20.00
NO C. O. D. / Cashier's check, phone orders except.
Calif. Res Add 6.5% Sales Tax.
Prices are subject to change without notice.

All merchandises are subject to prior sale.
Shipping & Handling: Inside L.A. 5% of total order, (Min 1.50). Outside L.A. 10% of total order, (Min 2.50). Outside U.S.A. 20% of total order, (Min 5.00).

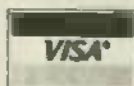
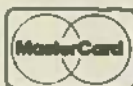

MARK V ELECTRONICS INC.
248 E. Main Street,
Suite 100,
Alhambra, CA91801
For Information (818) 282-1130
For orders, (818) 282-1196

CPU's & SUPPORT CHIPS		INTER FACE & DRIVERS	
280A CPU 1.80	8139-7 7.80	AVS-1013A 3.75	
280B CPU 8.00	8202 12.25	AVS-1018D 8.75	
280A CTC 3.75	8212 1.80	TR1802B 3.85	
280ADAPT 7.80	8214 4.80	TR1841L 3.85	
280A P/O 3.75	8216 1.75	AVS-3802P 9.85	
280A I/O 9.85	8224 4.00		
220A2 4.75	8228 3.80		
AM2801 6.95	8227 3.80		
8607 4.75	8228 3.85		
8800 3.80	8290 16.85		
8802 4.00	8281 4.40		
8803L 6.80	8282 4.40		
8808 8.00	8284.6 8.00		
8810 4.00	8287 6.00		
8821 2.75	8294 6.00		
8845 4.00	8272A 14.00		
8846 3.75	8278 14.85		
8847 4.80	8278-8 8.95		
8848 1.20	8288 8.00		
8849 4.80	8288 12.85		
8850 4.75	8288 20.00		
8851 4.75	8288-7 19.95		
8852 8.00	88000L 75.00		

SHIFT REGISTERS		DISC CONTROLLER	
MM1402 1.75	D785C 10.00	8783 17.00	
MM1403 1.75	1771-1 5.95	1796 17.00	
MM1404 1.75	1771-1 14.00	1797 17.00	
MM1512 2.80			
MM1555 2.80			
MM1556 2.80			
MM1557 2.80			
MM1558 2.80			
MM1559 2.80			
MM1560 2.80			

RAM		CRYSTALS	
MM1561 2.80	2008 2.80	NO. 30	
MM1562 2.80	2110-3 3.00	WIRE WRAP	
MM1563 2.80	2110-4 1.90	WIRE SINGL	
MM1564 2.80	2112-1 1.85	STRAND	
MM1565 2.80	2114-2 1.00	100' \$1.40	
MM1566 2.80	2114-3 2.80		
MM1567 2.80	2114-4 1.90		
MM1568 2.80	2114-5 1.85		
MM1569 2.80	2114-6 1.00		
MM1570 2.80	2114-7 1.85		
MM1571 2.80	2114-8 2.80		
MM1572 2.80	2114-9 2.80		
MM1573 2.80	2114-10 2.80		
MM1574 2.80	2114-11 2.80		
MM1575 2.80	2114-12 2.80		
MM1576 2.80	2114-13 2.80		
MM1577 2.80	2114-14 2.80		
MM1578 2.80	2114-15 2.80		
MM1579 2.80	2114-16 2.80		
MM1580 2.80	2114-17 2.80		
MM1581 2.80	2114-18 2.80		
MM1582 2.80	2114-19 2.80		
MM1583 2.80	2114-20 2.80		
MM1584 2.80	2114-21 2.80		
MM1585 2.80	2114-22 2.80		
MM1586 2.80	2114-23 2.80		
MM1587 2.80	2114-24 2.80		
MM1588 2.80	2114-25 2.80		
MM1589 2.80	2114-26 2.80		
MM1590 2.80	2114-27 2.80		
MM1591 2.80	2114-28 2.80		
MM1592 2.80	2114-29 2.80		
MM1593 2.80	2114-30 2.80		
MM1594 2.80	2114-31 2.80		
MM1595 2.80	2114-32 2.80		
MM1596 2.80	2114-33 2.80		
MM1597 2.80	2114-34 2.80		
MM1598 2.80	2114-35 2.80		
MM1599 2.80	2114-36 2.80		
MM1600 2.80	2114-37 2.80		
MM1601 2.80	2114-38 2.80		
MM1602 2.80	2114-39 2.80		
MM1603 2.80	2114-40 2.80		
MM1604 2.80	2114-41 2.80		
MM1605 2.80	2114-42 2.80		
MM1606 2.80	2114-43 2.80		
MM1607 2.80	2114-44 2.80		
MM1608 2.80	2114-45 2.80		
MM1609 2.80	2114-46 2.80		
MM1610 2.80	2114-47 2.80		
MM1611 2.80	2114-48 2.80		
MM1612 2.80	2114-49 2.80		
MM1613 2.80	2114-50 2.80		
MM1614 2.80	2114-51 2.80		
MM1615 2.80	2114-52 2.80		
MM1616 2.80	2114-53 2.80		
MM1617 2.80	2114-54 2.80		
MM1618 2.80	2114-55 2.80		
MM1619 2.80	2114-56 2.80		
MM1620 2.80	2114-57 2.80		
MM1621 2.80	2114-58 2.80		
MM1622 2.80	2114-59 2.80		
MM1623 2.80	2114-60 2.80		
MM1624 2.80	2114-61 2.80		
MM1625 2.80	2114-62 2.80		
MM1626 2.80	2114-63 2.80		
MM1627 2.80	2114-64 2.80		
MM1628 2.80	2114-65 2.80		
MM1629 2.80	2114-66 2.80		
MM1630 2.80	2114-67 2.80		
MM1631 2.80	2114-68 2.80		
MM1632 2.80	2114-69 2.80		
MM1633 2.80	2114-70 2.80		
MM1634 2.80	2114-71 2.80		
MM1635 2.80	2114-72 2.80		
MM1636 2.80	2114-73 2.80		
MM1637 2.80	2114-74 2.80		
MM1638 2.80	2114-75 2.80		
MM1639 2.80	2114-76 2.80		
MM1640 2.80	2114-77 2.80		
MM1641 2.80	2114-78 2.80		
MM1642 2.80	2114-79 2.80		
MM1643 2.80	2114-80 2.80		
MM1644 2.80	2114-81 2.80		
MM1645 2.80	2114-82 2.80		
MM1646 2.80	2114-83 2.80		
MM1647 2.80	2114-84 2.80		
MM1648 2.80	2114-85 2.80		
MM1649 2.80	2114-86 2.80		
MM1650 2.80	2114-87 2.80		
MM1651 2.80	2114-88 2.80		
MM1652 2.80	2114-89 2.80		
MM1653 2.80	2114-90 2.80		
MM1654 2.80	2114-91 2.80		
MM1655 2.80	2114-92 2.80		
MM1656 2.80	2114-93 2.80		
MM1657 2.80	2114-94 2.80		
MM1658 2.80	2114-95 2.80		
MM1659 2.80	2114-96 2.80		
MM1660 2.80	2114-97 2.80		
MM1661 2.80	2114-98 2.80		
MM1662 2.80	2114-99 2.80		
MM1663 2.80	2114-100 2.80		

TOGGLE SWITCHES		DISC CAPACITORS	
1N4148 (IN914) 15/1.00		1UF 16V 10 65 00	100 48.00
LM1118 DETECTOR 3/21.00		01UF 35V 16 81 00	100 35.00
FP 100 PHOTO TRANS 8.50			
RED LED'S 2" 5/21.00			
RED-YELLOW BIPOLAR LED 8.50			
RED-GREEN BIPOLAR LED 8.50			
RED-YELLOW BIPOLAR LED 8.50			
MLED02 IR LED 8.50			
MFD148 PHOTO DIARR. XTOR 8.50			
MCT2 OPTO ISOLATORS 8.50			
1 WATT ZENERS 3.3, 4.7, 5.1, 5.6, 6.8, 8.2, 9.1, 10, 12, 15, 18, or 22V 4/21.00			

DIP SWITCHES		REGULATORS	
CTS 208-4 4 POSITION .75		78L05 or 18 1.5 30 1M328K 1.85 78	
CTS 208-7 7 POSITION .95		LM3205 5 7.5 3A0T 5.0 8.12 1.20	
CTS 208-8 8 POSITION 1.25		LM317T 91.10 18.10 or 34V 5.78	
CTS 208-10 10 POSITION 1.25		2701 6/12.16 or 24.1 8.95 725 12.00 8.90	
		78M05 12 or 15 3.40 LAS-412	
		272K 1LA1408 91.76 12V3A 63.88	

TANTALUM CAPACITORS		MULTI TURN TRIM POTS	
22UF 35V 5/41.00	15UF 16V 3/41.00	50 OHM 3/\$42.00	
47UF 35V 5/41.00	30UF 6V 5/41.00	100 OHM	
80UF 35V 5/41.00	33UF 16V 6.50	1000 OHM 5K 20K 100K	
1UF 20V 5/41.00	47UF 20V 8.85		
2.2UF 20V 5/41.00	60UF 16V 61.00		
3.3UF 20V 4/41.00	200UF 20V 61.75		
4.7UF 35V 4/41.00	150UF 16V 61.30		
6.8UF 20V 4/41.00	330UF 16V 61.75		
10UF 20V 6.40			
22UF 10V 6.30			

EPOXY GLASS VECTOR BOARD			
1/16" Thick 1/16" Spacing			
4 1/2" x 6 1/2" \$2.40			
SCR's		TRIAC's	
1.5A	3A 35A 110A	PRV 1A	10A 25A
100	35 40 1.40	100	35 60 1.40
200	40 60 1.80	200	60 80 1.80
400	60 70 2.40 12.00	400	70 100 2.80
600	80 100 3.60 15.00	600	100 120 3.80

C/MOS			
74C00	75 74C01	110 74C02	75 4876 80
74C02	35 74C03 3.80	4078 75 4877 75	
74C04	35 4021 3.80	4878 75 4881 75	
74C10	35 4007 3.80	4878 48 4882 2.80	
74C14	35 4008 3.80	4884 1.75 4883 1.50	
74C20	35 4007 3.80	4015 65 4888 1.75	
74C27	35 4008 3.80	4016 75 6891 2.80	
74C42	1.25 4008 4.00	4017 75 4883 8.80	
74C74	30 4018 4.60	4042 65 4504 1.75	
74C78	30 4011 3.00	4043 30 4510 1.20	
74C83	1.20 4012 3.00	4044 30 4811 1.25	
74C88	1.25 4013 3.50	4046 30 4813 1.25	
74C89	40 4014 3.80	4047 30 4516 1.20	
74C93	1.00 4015 3.50	4048 30 4518 1.80	
74C194 3.00	4016 3.50	4049 30 4519 1.80	
74C195 1.70	4017 3.80	4051 75 4518 6.80	
74C191 1.10	4018 3.80	4052 1.80 4520 3.80	
74C174 1.10	4018 4.00	4053 75 4520 1.10	
74C176 1.10	4020 3.80	4054 75 4520 1.40	
74C192 1.40	4021 3.80	4058 40 4528 1.80	
74C183 1.40	4022 3.80	4059 40 4528 1.80	
74C248 1.75	4023 3.80	4060 40 4528 1.75	
74C801 40	4024 3.80	4061 30 4532 1.75	
74C802 30	4025 3.80	4071 75 4532 1.20	
74C807 30	4026 3.25	4072 30 4446 7.50	

74S SERIES			
74S00	30 74S74	74S153	1.75
74S07	35 74S85	74S154	1.25
74S08	35 74S86	74S174	3.00
74S09	35 74S87	74S175	3.00
74S10	35 74S88	74S176	3.00
74S11	35 74S89	74S177	3.00
74S12	35 74S90	74S178	3.00
74S13	35 74S91	74S179	3.00
74S14	35 74S92	74S180	3.00
74S15	35 74S93	74S181	3.00
74S16	35 74S94	74S182	3.00
74S17	35 74S95	74S183	3.00
74S18	35 74S96	74S184	3.00
74S19	35 74S97	74S185	3.00
74S20	35 74S98	74S186	3.00
74S21	35 74S99	74S187	3.00
74S22	35 74S00	74S188	3.00
74S23	35 74S01	74S189	3.00
74S24	35 74S02	74S190	3.00
74S25	35 74S03	74S191	3.00
74S26	35 74S04	74S192	3.00
74S27	35 74S05	74S193	3.00
74S28	35 74S06	74S194	3.00
74S29	35 74S07	74S195	3.00

100% GUARANTEED ICs - MONEY BACK!

1-800-245-2235

SPECIAL
64K DRAM
.45
FULLY FUNCTIONAL
WITH SLIGHTLY
SHORTER LEADS
200ns or FASTER

That's right! . . . 100% money-back guaranteed ICs at prices never before possible! Krueger Technology's unique patented IC removal process is the key to our ability to sell so low. The fact is, it costs less to retrieve and refurbish an IC from an obsolete PC board than manufacture a new one. Since we maintain an inventory in excess of six million ICs and process over 100,000 ICs per day (over thirty million in the past ten years) we can supply you with most, if not all of your IC needs.

Until this year our vast inventory of ICs was available to only manufacturers and distributors. The phenomenal growth of the catalog market has allowed us to open our inventory to you. You can now buy direct and cut out all middlemen.

Call today and discover what seven of the ten largest computer manufacturers already know . . . "The Krueger Alternative." Don't forget, you get an additional 30% discount on orders over \$500!

SPECIALS

2114-300ns	.50
FDC1793	5.00
74LS322	.50
6116-120ns	1.75
8080A	.75
Z80ASIO/O	3.75

MICROPROCESSORS

2901	3.00	8039	2.00
2903	5.00	8080A	.75
68000-8	18.00	8085	2.00
68008-8	18.00	8086	4.00
Z8001	7.50	8086-2	5.00
80186-3	15.00	8048	7.50
8031	5.00	8X300	6.00
8035	2.00	5741A	10.00

ADC/DAC

ADC08XX	3.50
DAC08XX	1.50
DAC80	8.00

CONTROLLERS/UARTS

1691	5.25	2661	4.00
1771	6.50	5027	3.00
1791	10.00	5037	5.00
1793	5.00	7201	4.50
1795	10.00	765	4.00
1797	10.00	COM8116	5.00
2651	4.00	3250	4.00

SOUND CHIPS

76477	2.00
AY3-8910	2.00
AY3-8912	2.00

82XX PERIPHERALS

8202	14.00	8259	2.00
8212	1.00	8272	4.00
8216	1.00	8273	10.00
8224	3.00	8274	9.00
8228	3.00	8275	9.00
8237	3.00	8276	15.00
8238	2.50	8279	3.50
8243	1.50	8281	7.50
8253	2.00	8283	5.50
8253	2.00	8284	2.00
8254	4.00	4268	4.00
8255	2.00	8291	20.00
8257	2.00	8292	21.00

TMS 9900 SERIES

9901	1.50
9918	20.00
9927	5.00
9980	10.00
ALL OTHER 99XX SERIES	3.00

DYNAMIC RAMS

4164-120ns	1.75
4164-150ns	.95
4164-200ns	.85
4164-250ns	.65
4416-150ns	1.50
4116-150ns	.75
4116-200ns	.35
4116-250ns	.25

STATIC RAMS

6264-150ns	6.00
6116-150ns	1.25
6116-200ns	.90
6116-250ns	.65
1420-55ns	2.00
2147, 2148, 2149	2.00
2114-300ns	.50
2114-FASTER	.80

74 SERIES

74XX	.25	74SXX	.35
741XX	.35	74S1XX	.45
742XX	.50	74S2XX	.60
743XX	.50	74S3XX	.60

74LSXX	.25	74ALSXX	.35
74LS1XX	.35	74ALS1XX	.45
74LS2XX	.50	74ALS2XX	.60
74LS3XX	.50	74ALS3XX	.60

74FXX	.35
74F1XX	.45
74F2XX	.60
74F3XX	.60

1-800-245-2235

EPROMS

27128-250ns	5.00
27128-350ns	4.00
27128-450ns	3.00
2764, 2732, 2716	
250ns	3.50
300ns	3.00
350ns	2.75
450ns	2.25
650ns	1.75

1702	1.50
2708	2.00
68766	6.00
68708	4.00

CMOS version at double the above prices

25 Series EPROMS are the same price as 27 Series EPROMS

ECL

ANY 10K LOGIC	1.00
ANY ECL RAM	3.00
ANY 100K LOGIC	5.00

Z80 SERIES

2.5 MHZ	
CPU, CTC, PIO	1.00
DMA, DART, SIO	3.00

4.0 MHZ (A)	
CPU, CTC, PIO	2.00
DMA, DART, SIO	4.50

6.0 MHZ (B)	
CPU, CTC, PIO	3.00
DMA, DART, SIO	9.00

MISCELLANEOUS

0026	1.50
1488	.50
1489	.50
3232	1.00
3242	4.00
3470	1.50
3486	1.00
3487	1.50
CA3XXX	1.00
MC4024	2.00
MC4044	2.00
555	.35
75XXX	.50
8131	2.25
8136	4.00
8303	3.00
8304	1.75
88XX	.50
8YXX	.50
9602	.75
96LS02	1.50

CMOS

ANY 4000 SERIES	.25
ANY 4500 SERIES	.50

6500/6800 SERIES

ANY 65XX	2.00
ANY 65XXA	2.50
ANY 65XXB	3.00
ANY 68XX	2.00
ANY 68AXX	2.50
ANY 68BXX	3.00
6810	.75

OUR POLICY

Delivery: Orders normally shipped within 2 business days. Add \$3 for UPS ground-\$8 & under. Add \$4 for UPS air (\$19.78 & under, for each additional air pound add \$1. Arizona residents add 6% sales tax.

Payment: Visa, MC, cashiers check, certified check, money order, personal check accepted. (Allow 10 days for personal checks to clear.) No surcharge on credit card orders. CODs welcome with cash, certified check, cashiers check or money order. Add \$3 COD handling charge.

Pricing: Prices subject to change without notice. All items limited to stock on hand. We reserve the right to limit quantities.

KRUEGER Technology, Inc.

2219 South 48th Street • Tempe, AZ 85282

800-245-2235

In Arizona 602-438-1570

HOURS: 7a.m.-5:30p.m.
 (MOUNTAIN TIME)
 Monday Thru Friday

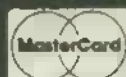
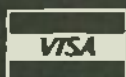

CIRCLE 263 ON FREE INFORMATION CARD

SEPTEMBER 1985

117

PARTIAL LISTING ONLY- PLEASE CALL OR WRITE FOR FREE CATALOG.

STATIC RAMS

2112	256x4	(450ns)	2.99
2114	1024x4	(450ns)	8/9.95
2114-25	1024x4	(250ns)	8/10.95
2114L-4	1024x4	(450ns)(LP)	8/12.95
2114L-3	1024x4	(300ns)(LP)	8/13.45
2114L-2	1024x4	(200ns)(LP)	8/13.95
TMM2016-200	2048x8	(200ns)	3.25
TMM2016-150	2048x8	(150ns)	3.75
TMM2016-100	2048x8	(100ns)	4.75
HM6116-4	2048x8	(200ns)(Hcmos)	3.69
HM6116-3	2048x8	(160ns)(Hcmos)	3.95
HM6116LP-4	2048x8	(200ns)(Hcmos)(LP)	3.95
HM6116LP-3	2048x8	(150ns)(Hcmos)(LP)	4.25
HM6264P-15	8192x8	(150ns)(Hcmos)(LP)	7.75

LP = Low Power

DYNAMIC RAMS

4116-250	16384x1	(250ns)	6/6.95
4116-200	16384x1	(200ns)	8/8.95
4116-150	16384x1	(150ns)	8/10.95
4164-200	65536x1	(200ns)(5v)	9/9.95
4164-150	65536x1	(160ns)(5v)	9/9.95
TMS4164	65536x1	(200ns)(5v)	4.95
41256-200	262144x1	(150ns)(5v)	3.95
41256-150	262144x1	(150ns)(5v)	3.95

5v = Single 5 Volt Supply

EPROMS

2708	1024x8	(450ns)	3.95
2718	2048x8	(450ns)(5v)	3.50
2718-1	2048x8	(350ns)(5v)	4.95
TMS2532	4096x8	(450ns)(5v)	4.95
2732	4096x8	(450ns)(5v)	3.95
2732A-4	4096x8	(400ns)(5v)(K21vPGM)	4.95
2732A-3B	4096x8	(350ns)(5v)(K21vPGM)	4.95
2732A	4096x8	(280ns)(5v)(K21vPGM)	6.95
2732A-2	4096x8	(200ns)(5v)(K21vPGM)	10.95
2784	8192x8	(450ns)(5v)	3.75
2784-250	8192x8	(250ns)(5v)	3.95
2784-200	8192x8	(200ns)(5v)	6.95
27128	16384x8	(250ns)(5v)	5.95
27256	32768x8	(250ns)(5v)	12.95

5v = Single 5 Volt Supply
21vPGM = Program at 21 Volts

**SPECTRONICS CORPORATION
EPROM ERASERS**

	Timer	Chip Capacity	Intensity (uW/Cm ²)	
PE-14	X	9	8,000	83.00
PE-14T	X	9	6,000	119.00
PE-24T	X	9	3,800	175.00

8000

8035	5.95
8039	8.95
8080	3.95
8085	4.95
8085A-2	11.95
8087-3	128.00
8088	19.95
8088-2	12.95
8155	6.95
8155-2	7.95
8156	6.95
8748	24.95
8755	24.95

8200

8203	39.95
8205	3.60
8212	1.80
8216	1.75
8228	3.49
8237-5	15.95
8243	4.45
8250	10.95
8251A	4.49
8263	6.95
8253-5	7.95
8255	4.49
8255-5	5.25
8259	6.90
8259-5	7.50
8272	19.95
8275	29.95
8279	6.95
8282	6.80
8284	5.50
8286	6.50
8288	14.95

Z80

Z80-CPU	2.49
Z80-CTC	2.95
Z80-PIO	2.95
Z80-SIO 0	9.95
4.0 Mhz	
Z80A-CPU	2.49
Z80A-CTC	3.95
Z80A-DART	6.95
Z80A-PIO	3.95
Z80A-SIO 0	10.95
6.0 Mhz	
Z80B-CPU	8.95

6500

6502	4.95
6520	2.95
6522	5.49
6532	9.95
6551	9.95
6502A	5.95
6522A	9.95
6551A	11.95

6800

68000.0	39.95
6800	2.95
6802	7.95
6803	7.95
6809E	8.95
6821	2.95
6845	12.95
6850	3.25
6883	22.95

DISK CONTR

1771	15.95
1781	23.95
1793	23.95
UPD765	19.95

INTERFACE

8T26	1.59
8T28	1.98
DM8131	2.95
OP8304	2.29

CLOCK CHIPS

MM5314	4.95
MM5369	1.95
MM58167	8.95
MSM5832	3.95

DATA ACQ

ADC0804	3.49
ADC0809	4.49
ADC0817	9.95
DAC0806	2.95
MC1408LS	2.95

SOUNDCHIPS

76477	3.95
76488	6.95
AY3-8910	12.95
SS1283	39.95

74LS00

74LS00	24	74LS157	.65
74LS01	25	74LS158	.59
74LS02	25	74LS160	.69
74LS03	25	74LS161	.65
74LS04	24	74LS163	.95
74LS05	25	74LS184	.89
74LS08	28	74LS165	.95
74LS09	29	74LS166	1.95
74LS10	25	74LS169	1.75
74LS11	35	74LS173	.69
74LS12	36	74LS174	.65
74LS13	46	74LS191	.89
74LS14	59	74LS192	.79
74LS20	25	74LS193	.79
74LS21	29	74LS194	.69
74LS28	29	74LS195	.69
74LS27	29	74LS197	.79
74LS32	29	74LS221	.89
74LS33	56	74LS240	.95
74LS37	35	74LS241	.99
74LS38	35	74LS242	.99
74LS40	28	74LS243	.99
74LS42	49	74LS244	1.29
74LS47	76	74LS245	1.49
74LS51	26	74LS251	.59
74LS73	38	74LS253	.59
74LS74	35	74LS257	.59
74LS75	39	74LS258	.59
74LS76	39	74LS259	2.75
74LS85	69	74LS260	.59
74LS86	39	74LS266	.55
74LS90	55	74LS279	.49
74LS92	56	74LS280	1.95
74LS93	55	74LS283	.69
74LS107	39	74LS290	.89
74LS109	39	74LS293	.89
74LS112	39	74LS289	1.75
74LS122	48	74LS323	3.50
74LS123	79	74LS365	.49
74LS124	2.90	74LS367	.45
74LS126	49	74LS368	.45
74LS128	59	74LS373	1.39
74LS132	59	74LS374	1.39
74LS138	39	74LS377	1.39
74LS139	55	74LS390	1.19
74LS145	1.20	74LS640	2.20
74LS148	1.35	74LS645	2.20
74LS151	55	74LS670	1.49
74LS153	95	74LS682	3.20
74LS154	1.90	74LS688	2.40
74LS155	.69	81LS95	1.49
74LS156	69	26LS2521	2.60

7400

7400	.19	7492	.50
7401	.19	7493	.35
7402	.19	74100	1.78
7403	.18	74107	.30
7404	.19	74118	1.55
7405	.25	74121	.29
7406	.29	74122	.48
7407	.28	74123	.48
7408	.24	74125	.48
7409	.19	74126	.45
7410	.18	74132	.45
7411	.26	74148	.60
7413	.35	74148	1.20
7414	.49	74150	1.35
7416	.25	74161	.55
7417	.25	74163	.55
7420	.19	74194	1.28
7421	.35	74185	.75
7425	.29	74157	.55
7427	.29	74189	1.88
7430	.19	74181	.69
7432	.29	74163	.69
7437	.29	74184	.85
7438	.29	74165	.85
7442	.49	74188	1.00
7445	.69	74173	.78
7447	.89	74174	.89
7448	.69	74175	.89
7473	.34	74185	2.00
7474	.33	74192	.79
7475	.45	74193	.79
7476	.35	74194	.85
7483	.50	74289	2.28
7485	.59	74387	.85
7489	2.15	74388	.85
7490	.35	74393	1.35

74S00

74S00	.32
74S02	.35
74S04	.35
74S05	.35
74S08	.35
74S10	.35
74S11	.35
74S20	.38
74S32	.40
74S37	.88
74S74	.90
74S86	.90
74S112	.50
74S124	2.75
74S132	1.24
74S133	.48
74S138	.88
74S139	.88
74S140	.95
74S161	.98
74S163	.98
74S167	.98
74S158	.95
74S161	1.96
74S163	1.95
74S174	.95
74S175	.95
74S240	2.20
74S241	2.20
74S244	2.20
74S280	1.95
74S287	1.90
74S288	1.90
74S373	2.48
74S374	2.48
74S471	4.85

★★★★HIGH-TECH★★★★

27256

* 32K x 8 EPROM
* SINGLE 5 VOLT SUPPLY
* SINGLE LOCATION & HIGH SPEED PROGRAMMING
* 250ns ACCESS TIME

\$12.95

★★★★SPOTLIGHT★★★★

CRYSTALS

32.768Khz	1.95
1.0Mhz	3.95
1.8432	3.95
2.0	2.95
2.4676	2.95
3.579545	2.95
4.0	2.95
5.0	2.95
5.0688	2.95
6.0	2.95
6.144	2.95
8.0	2.95
10.0	2.95
10.738635	2.95
14.31618	2.95
16.0	2.95
16.0	2.95
17.430	2.95
18.432	2.95
20.0	2.95

UARTS

AY5-1013	3.95
AY3-1018	6.95
TR1602	3.95
2851	6.95
IM6402	7.85

BIT-RATE GENERATORS

BR1941	11.95
4702	12.95
COM8116	10.85
14411	11.95

MISC.

3242	7.95
MC3470	4.95
MC3487	2.95
AY5-3600 PRO	11.95
HD46505SP	15.95
CRT5027	19.95

LINEAR

TL084	2.19	NE564	2.95
LM301	.34	LM565	.99
LM307	.45	LM566	1.49
LM308	.69	NE592	.98
LM309K	1.28	LM733	.98
LM310	1.78	LM741	.35
LM311	.84	LM747	.69
LM317T	1.19	LM1310	1.49
LM317K	3.95	MC1330	1.69
LM318	1.49	MC1372	6.95
LM323K	4.95	LM1458	.59
LM324	.59	LM1488	.69
LM331	3.95	LM1489	.69
LM334	1.19	LM1498	.85
LM335	1.40	LM1800	2.37
LM336	1.78	LM1812	8.25
LM337T	1.96	LM1889	1.95
LM338K	3.95	ULN2003	1.29
LM339	.99	XR2206	3.75
LM348	.99	XR2211	8.25
LM350K	4.95	CA3148	1.85
LF351	.6		

PARTIAL LISTING ONLY- PLEASE CALL OR WRITE FOR FREE CATALOG.

**CAPACITORS
ELECTROLYTIC
RADIAL AXIAL**

.47uf	50v .14	10	50v .18
10	50v .16	22	15v .14
47	35v .18	47	50v .20
100	16v .18	100	16v .20
220	35v .20	150	25v .28

50v MONOLITHIC

.01uf	.14	.1	.18
.047	.16	.47	.28

50v DISC

10pf	.05	470	.06
22	.05	560	.05
25	.05	680	.06
27	.05	820	.05
33	.05	.001uf	.05
47	.05	.0018	.06
56	.05	.0022	.06
68	.05	.005	.05
82	.05	.01	.07
100	.05	.02	.07
220	.05	.05	.07
330	.05	.1	.12

BYPASS CAPS

.01uf disc	50v	100/5.00
.1uf disc	12v	100/5.00
.01uf mono	50v	100/12.00
.1uf mono	50v	100/18.00

IC SOCKETS

8 pin ST	.13	.11
14 pin ST	.15	.12
16 pin ST	.17	.13
18 pin ST	.20	.16
20 pin ST	.28	.27
22 pin ST	.30	.27
24 pin ST	.30	.27
28 pin ST	.40	.32
40 pin ST	.49	.39
64 pin ST	4.25	call
ST-SOLDERTAIL		
8 pin WW	.59	.49
14 pin WW	.69	.62
16 pin WW	.49	.58
18 pin WW	.99	.90
20 pin WW	1.09	.98
22 pin WW	1.39	1.28
24 pin WW	1.49	1.38
28 pin WW	1.69	1.49
40 pin WW	1.99	1.80
WW-WIREWRAP		
16 pin ZIF	4.95	call
24 pin ZIF	5.95	call
28 pin ZIF	6.95	call
ZIF-TEXTOL		
(Zero Insertion Force)		

**ACCESSORIES & PERIPHERALS
FOR IBM**

MAXIMIZER Memory Multifunction	259.95
HAYES SMARTMODEM 1200B	419.95
130W POWER SUPPLY	169.95
TEAC FD-55B 1/2 Hc. Disk Drive, DS/DD	89.95
MPI B52 5W FDD, DS-DD	89.95
PROTOTYPE CARD	27.95
PROTOTYPE CARD With Decoding	29.95

FOR APPLE

JDR 16K RAM CARD	39.95
EPROM PROGRAMMER RPS25	79.95
PRINTMAX Parallel printer interface	49.95
BAL-500 1/2 Hc. Disk Drive, Teac Mechanism	139.95
BAL-525 1/2 Hc. Disk Drive, Alps Mechanism	119.95
MITAC AD-1 Full Height, Shugart Mechanism	129.95
DISK CONTROLLER CARD	49.95
VIEWMAX-80 80 Column For Apple IIe	159.95
VIEWMAX-80e 80 Column For Apple IIe	129.95
THUNDERCLOCK Official PRODOS Clock	129.95
KRAFT JOYSTICK	39.95
60W POWER SUPPLY	49.95

MISCELLANEOUS

ZENITH ZVM-123 18 MHz Green Monitor	105.00
NEC JB1201M 20 MHz Green Monitor	169.00
BMC 9M-AU9191U Comp. 13" Color Monitor	279.00
NASHUA DISKETTES 88/80 Box of 10	19.95
VERBATIM DATALIFE DISKETTES DS/DD	34.95
DISKETTE FILE Holds 70 Disquettes	9.95

**BARGAIN HUNTERS CORNER
12VDC CAR CLOCK**

\$4.95



- * EASY TO READ 1/4" FLUORESCENT DISPLAY
 - * DESIGNED FOR USE IN AUTOS
 - * HOURS/MIN. SET SWITCHES MOUNTED ON BOARD
- SPECIAL ENDS 8/31/85**

SWITCHING POWER SUPPLIES

P3-ASTEC	P3-J
MODEL AA 12110	ASTEC AA11190
+12V @ 2A	+5V @ 4A
-12V @ .1A	+12V @ 2.5A
+5V @ 2.5A or	-5V @ .25A
5A if 12V not used	-12V @ .30A
19.95	39.95

5 1/4" DISK DRIVES

TANDON TM100-2	DS/DD	99.95
SHUGART SA400L	SS/DD	199.95
MPI B52	DS/DD	89.95
TEAC FD55B 1/2 Hc.	DS/DD	89.95
TEAC FD55F 1/2 Hc.	DS/Quad	99.95

8" DISK DRIVES

SIEMENS FD200-8	DS/DD	180.00
SIEMENS FD100-8	SS/DD	129.00

BEST SELLING IDC CONN.

RIBBON HEADER SOCKETS		
IDS 20	2.25	IDS 40 1.99
IDS 26	1.39	IDS 50 2.25
IDS 34	1.59	

RIBBON EDGE CARDS

IDE 20	2.25	IDE 40 1.80
IDE 26	2.45	IDE 60 3.95
IDE 34	2.75	

**LIGHT EMITTING DIODES
JUMBO DISPLAYS**

1-99	100-up	MAN-72 CA .3"	.99
RED	.10 .09	MAN-74 CC .3"	.99
GREEN	.18 .15	FND-500 CC .8"	1.49
YELLOW	.18 .15	FND-607 CA .5"	1.48

D-SUBMINIATURE

DESCRIPTION	ORDER BY	CONTACTS			
		9	15	25	37
SOLDER CUPS	MALE D8xxP	1.19	1.59	1.90	2.88
	FEMALE D8xxS	1.50	1.85	2.25	3.90
RT. ANGLE	MALE D8xxP	1.85	2.20	3.00	4.83
	FEMALE D8xxS	2.78	3.03	3.00	5.19
PC SOLDER	MALE D8xxP	2.85	3.90	4.75	6.88
	FEMALE D8xxS	3.28	4.23	5.35	7.38
RIBBON CABLE	MALE D8xxP
	FEMALE D8xxS
HOODS	BLACK HOOD-B
	GRY HOOD-xx	.89	.99	.99	1.09

MOUNTING HARDWARE-.91.00
ORDERING INSTRUCTIONS: INSERT # OF PINS INTO "xx"

9000

8334	2.50
9368	3.95
9602	1.80

INTERSIL

ICL7107	12.95
ICL7660	2.95
ICL8035	3.95

DIP SWITCHES

4 position	.85
6 position	.90
7 position	.95
8 position	.98

TRANSISTORS

2N2222	.25	PN2907	.13
PN2222	.10	2N3065	.79
2N2905	.50	2N3904	.10
2N2907	.25	2N3906	.10

DISCRETE

1N751	5.1v zener	.25
1N759	12.0v zener	.28
1N4148	(1N814) switching	25/1.00
1N4004	400PIV rectifier	10/1.00
K8P02	200PIV 1.5a bridge	.45
4N33	OPTO-ISOLATOR	1.75

RIBBON CABLE

CONTACTS	SINGLE COLOR		COLOR CODED	
	1	10'	1'	10'
25	.48	4.00	1.32	11.80
34	.61	5.40	1.95	16.50
50	.89	7.10	2.99	22.00

36 PIN CENTRONICS

CEN36 MALE SOLDER CUP	7.95
IDCEN36 MALE RIBBON CABLE	8.95
IDCEN36F FEMALE RIBBON CABLE	8.95

VOLTAGE

REGULATORS

7805T	.75	7918T	.85
78M05C	.35	7805K	1.39
7808T	.78	78H08K	9.96
7912T	.75	7912K	1.39
7918T	.75	7912K	1.49
7824T	.85	78L05	.69
7906T	.85	79L05	.79
7912T	.85	79L12	.79

C, T-TO-220, K-TO-3, L-TO-92

CMOS

4001	.25	4027	.48	4066	.39	4538	1.95
4002	.25	4028	.69	4069	.29	4543	1.18
4011	.25	4029	.79	4070	.35	4553	6.79
4012	.25	4040	.75	4071	.29	4584	.78
4013	.38	4042	.69	4081	.29	74C00	.35
4018	.39	4046	.98	4082	.29	74C04	.35
4014	.39	4047	.95	4083	.49	74C14	.59
4017	.69	4049	.35	4503	.65	74C74	.45
4014	.79	4050	.35	4811	.85	74C906	.98
4020	.75	4081	.79	4518	.89	74C922	4.49
4023	.29	4053	.79	4520	.79	74C923	4.95
4024	.65	4060	.89	4828	1.18	74C926	7.95

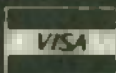

**ORDER TOLL FREE
800-538-5000 800-662-6279 (CA)**

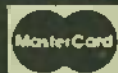

Copyright 1985 JDR Microdata, Inc.

CIRCLE 113 ON FREE INFORMATION CARD

TENMA

the Name You Can Trust in
Electronic Test Equipment

CALL TOLL FREE **1-800-543-4330**

(IN OHIO 1-800-762-4315)

(IN HAWAII OR ALASKA 1-800-858-1849)



TENMA
DROP PROOF
DIGITAL
MULTIMETER

■ DC input impedance 10M ohm
■ Shock-mounted LCD display
■ Overload protection ■ Auto polarity ■ Backed by our 1-year limited warranty ■ For more specifications see MCM catalog #10, page 122

#72-057 **\$29⁹⁵**
each

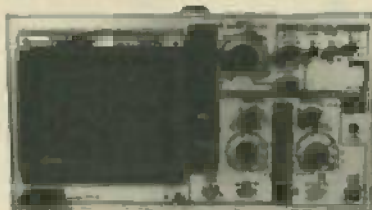

TENMA
20 MHZ DUAL TRACE
OSCILLOSCOPE

■ Two High Quality 10:1 probes included
■ Backed by our 2-year limited warranty
■ For specifications see MCM catalog #10, page 121

#72-320 **\$389⁹⁵**

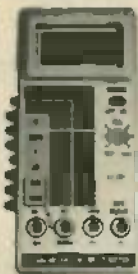

TENMA
3 1/2 DIGIT LCD
MULTIMETER

■ DC input impedance 10M ohm
■ Diode and HFE transistor tests
■ Overload protection ■ Auto polarity ■ Backed by our 1-year limited warranty ■ For more specifications see MCM catalog #10, page 122

#72-050 **\$36⁸⁰**
\$39.80 (1-4) (10-up)

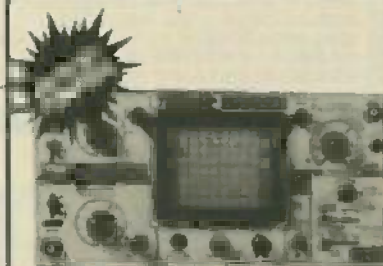

TENMA
15 MHZ DUAL TRACE
BATTERY POWERED
OSCILLOSCOPE

■ Two High Quality 10:1 Probes included ■ Backed by our 2-year limited warranty ■ Internal rechargeable batteries provide 2 hours of continuous operation without the need for any outside power source. ■ For specifications see MCM Catalog #10, page 121

#72-335 **\$489⁹⁵**



TENMA
DIGITAL
CAPACITANCE
METER

■ Measures capacitors from 0.1pF to 1999mFd ■ Accuracy 0.5% typical ■ Fuse protected
■ Checks capacitors in and out of circuit ■ Backed by our 1-year limited warranty ■ For more specifications see MCM catalog #10, page 122

#72-040 **\$54⁹⁵**
\$59.80 each (2-up)



TENMA
35 MHZ DUAL TRACE
OSCILLOSCOPE

■ Two High Quality 10:1 probes included
■ Backed by our 2-year limited warranty
■ For specifications see MCM catalog #10, page 121

#72-330 **\$569⁰⁰**

TENMA
LOGIC PROBE WITH
MEMORY

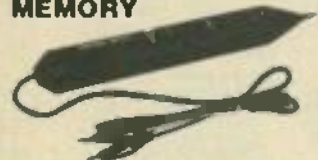

■ Recognizes high, intermediate, or low levels, pulsing modes, open circuit ■ Compatible with DTL/TLU/HIL/CMOS IC ■ Detects pulses as short as 50 nanoseconds

#72-190 **\$19⁹⁵**
each

TENMA
30 Amp Power Supply



■ Cross needle meter: Displays voltage, current, and power simultaneously ■ Over current protection
■ Output voltage: DC 0-15V variable
■ Output current

30A one minute on three minutes off, 22A continuous
■ Backed by our 2-year limited warranty ■ For specifications see MCM Catalog #10, page 123

#72-030 **\$179⁹⁵**

BE SURE TO CALL
FOR YOUR FREE
132
PAGE
CATALOG!
OVER
5,000
ITEMS!



We have the largest selection of computer test equipment in the country!

We Also Have... a full line of test equipment, computer accessories, telephone accessories, speakers, television parts, flybacks, yokes, switches, fuses, lamps, capacitors, resistors, cartridges, styli, wire, CATV equipment, and many more. **Over 5,000 items AT THE LOWEST PRICES AROUND!**

Terms:



- \$10 minimum order \$1.00 charge for orders under \$10
- \$20 minimum charge card order
- Orders shipped UPS C.O.D.
- Most orders shipped within 24 hours
- Sales office open 8:30 am to 7:00 pm, Saturdays 10:00 am to 3 pm EST
- For prepaid orders add \$2.75 for shipping and handling
- Should shipping & handling charges exceed \$2.75, the balance due will be sent C.O.D.



MCM ELECTRONICS
A DIVISION OF PREMIER INDUSTRIAL
858 East Congress Park Drive
Cantersville, Ohio 45459
513-434-0031

SOURCE NO. RE-13

★ QUALITY PARTS ★ DISCOUNT PRICES ★ FAST SHIPPING!

ALL ELECTRONICS CORP.

SEND FOR
FREE
FALL 1985 CATALOG...
48 PAGES!

EDGE CONNECTORS

ALL ARE 1.56 SPACING

- 22/44 EDGE CONNECTOR**
PC style \$2.00 each
10 for \$18.00
- 22/44 EDGE CONNECTOR**
solder lug style \$2.50 each
- 25/44 EDGE CONNECTOR**
PC style \$2.60 each
10 for \$22.00
- 36/72 EDGE CONNECTOR**
PC style \$3.00 each
- 43/68 EDGE CONNECTOR**
PC style \$4.50 each

TRANSISTORS

- 2N708 4 for \$1.00
2N2222A 3 for \$1.00
PN2222A 4 for \$1.00
2N2904 3 for \$1.00
2N2906 3 for \$1.00
2N2905 3 for \$1.00
MJ2155 \$1.50
2N3053 \$1.00
PMD 10x40 \$1.00
TIP 121 75¢
TIP 123 15¢

TRANSFORMERS

- 120 volt primaries
- 5.6 volts @ 750 ma. \$3.00
6 volts @ 150 ma. \$6.25
12 v.c.t. @ 200 ma. \$2.00
18 volts @ 550 ma. \$3.50
18 volts @ 1 amp. \$4.50
24 v.c.t. @ 200 ma. \$2.50
24 v.c.t. @ 400 ma. \$3.00
25 v.c.t. @ 15 amps. \$20.00
30 v.c.t. @ 2 amps. \$5.00

WALL TRANSFORMERS

- All plug directly into 120 vac outlet
- 4 VDC @ 70 ma. \$3.00
6 VDC @ 500 ma. \$3.50
4 VDC @ 750 ma. \$3.50
8 VDC @ 800 ma. \$3.50
12.5 VDC @ 205 ma. \$3.00
24 VDC @ 250 ma. \$3.00
MULTI-VOLTAGE @ 500 ma.
3.6V, 5.7V, 9 or 12 VDC \$7.50

SPRING LEVER TERMINALS

- Two color coded terminals on a sturdy 2 1/4" x 3 1/2" bakelite plate.
Great for speaker enclosures or power supplies.
\$1.00 each 10 for \$5.00

SOUND AND VIDEO MODULATOR FOR T.I. COMPUTER

T.I. # UM1381-1 Designed for use with T.I. computers. Can be used with video sources. Built-in A/B switch. Channel 3 or 4 selection switch. Operates on 12 vdc. Hook-up diagram included.
\$18.00 EACH

SLIM LINE COOLING FAN

Etch 50 99XU182 low noise fan. Measures 3 1/2" square x 1" deep. 21 cfm. 23 db. 1700 rpm.
SPECIAL PRICE \$12.50 each

2K 10 TURN MULTI-TURN POT SPECTROL

MCO 534-7181
\$8.00 EACH

SOLID STATE BUZZER

Star # SMB-06L
8 vdc
TTL compatible
\$1.00 each
10 for \$10.00

REVERBERATION UNIT

Accoustronics coil spring type units. Used in electronic organs to provide acoustic delay sound effects. Input impedance 8 ohms. Output impedance 2200 ohms. Measures 3 1/2" x 1 1/2" x 1 1/2".
\$7.50 EACH

SUB-MINIATURE D TYPE CONNECTORS

DB-15 PLUG \$2.75
DB-15 SOCKET \$4.00
DB-15 MOOD \$1.50
DB 25 PLUG 12.75
DB 25 SOCKET \$3.50
DB 25 MOOD \$1.25

8" P.A. SPEAKER

C.T.S. Model 5B3079
8 ohms coil
3 0 oz. ferrite magnet
Typical response range 100 - 10,000 Hz
Power rating 15 watts max.
Drilled to mount line matching transformers.
\$5.00 each
CASE OF 8 SPEAKERS \$32.00

RELAYS

5 AMP SOLID STATE

Heinemann Electric #101-5A 140-5AMP CONTROL 3-32 vdc. LOAD: 140 vac. 5 amp. SIZE 2 1/2" x 1 1/2".
\$5.00 each 10 for \$45.00

"SPECIAL PRICE" DUAL L.E.D. DISPLAYS

540 high, 7 segment L.E.D. read-out. Mount in 24 pin DIP sockets.
MAN 6640 orange 8.0 75¢ each
FND-5148 red. 6 c 75¢ each
DL-527 red. 6 a 75¢ each

STANDARD JUMBO DIFFUSED T 1 1/2

RED 10 for \$1.50
100 for \$13.00
GREEN 10 for \$2.00
100 for \$17.00
YELLOW 10 for \$2.00
100 for \$13.00

PARALLEL PRINTER CONNECTORS

Solder style 36 pin used on parallel data cables.
MALE CONNECTOR \$5.50 each
FEMALE CONNECTOR \$5.50 each

LINE CORDS

TWO WIRE

6 1/2 SPT-1 flat 3 for \$1.00
6 1/2 SPT-2 flat \$1.25 each
6 1/2 SJT round \$1.25 each

ULTRA-MINIATURE 5 VDC RELAY

For use in PCB applications.
FBR211HE D005M420 High sensitivity COIL 120 ohms CONTACTS 1 amp. Mounts in 1 1/4 pin DIP socket.
\$1.25 each 10 for \$10.00

3 1/2" SPEAKER

8 ohm impedance Full range speaker with 8 mm magnet & diagonal mounting centers.
\$2.50 each 10 for \$20.00

FLASHER LED

5 volt operation red jumbo T 1 1/2 340 \$1.00 each

BI-POLAR JUMBO T 1 1/2

2 for \$1.70

I.O.C. CONNECTORS

Wal press fit on standard ribbon cable.
DB 25 PLUG \$6.25
DB-25 SOCKET \$8.75
35 PIN MALE \$5.50
35 PIN FEMALE \$5.50

THREE WIRE

6 1/2 round \$4.00 each

MINIATURE 6 VDC RELAY

Aromat # RSD-6V Super Small S. PD T relay GOLD color contact 1888d 1 amp @ 30 vdc. Highly sensitive. TTL detect drive possible. 120 ohm coil. Operate from 4.3 - 6 vdc.
\$1.50 each 10 for \$13.00

MINIATURE TOGGLE SWITCHES

ALL ARE RATED 5 AMPS @ 125 VAC

S.P.D.T. (on-on) PC style non-threaded bushing 75¢ each 10 for \$1.00

S.P.D.T. (on-off-on) Solder lug terminals \$1.00 each 10 for \$9.00 100 for \$90.00

S.P.D.T. (on-on) PC style high threaded bushing 75¢ each 10 for \$7.00 100 for \$60.00

D.P.D.T. (on-on) Solder lug terminals \$2.00 each 10 for \$18.00 100 for \$180.00

LED HOLDERS

Two piece holder for jumbo LED 10 for \$5.00

CLEAR CLIP LITE LED HOLDER

Make LED a fancy indicator. Clear 1 for \$1.00

T.I. SWITCHING POWER SUPPLY

Compact, well regulated switching power supply designed to power Texas Instruments computer equipment.
INPUT 14 - 25 vac @ 1 amp
OUTPUT 12 vdc @ 350 ma 5 vdc @ 1.2 amp 6 vdc @ 200 ma
\$5.00 each

13 VDC RELAY

CONTACTS 5 pin C 10 amp @ 120 vac. Energize coil to open contact. COIL 13 vdc 650 ohms.
SPECIAL PRICE \$1.00 each

COMPUTER GRADE CAPACITORS

2,000 mfd. 200 VDC 1 1/2" DIA. x 5" HIGH \$2.00
3,600 mfd. 40 VDC 1 1/2" DIA. x 3 1/2" HIGH \$1.00
6,400 mfd. 60 VDC 1 1/2" DIA. x 4 1/2" HIGH \$2.50
9,700 mfd. 50 VDC 1 1/2" DIA. x 4 1/2" HIGH \$3.00
31,000 mfd. 15 VDC 1 1/2" DIA. x 4 1/2" HIGH \$2.50
72,000 mfd. 15 VDC 2" DIA. x 4 1/2" HIGH \$3.50
185,000 mfd. 6 VDC 2 1/2" DIA. x 4 1/2" HIGH \$1.50

D.P.S.T. LIGHTED ROCKER SWITCH

115 vdc lighted rocker snap mounted in 1/2" x 5/8" hole. Orange lens. 16 amp contact.
\$1.50

MINI-PUSH BUTTON

S.P.S.T. momentary normally open 1/4" bushing. Red button. 35¢ each 10 for \$3.00

13.8 VDC REGULATED POWER SUPPLY

These are solid state, fully regulated 13.8 vdc power supplies. Both feature 100% solid state construction, fuse protection, and L.E.D. power indicator. U.L. listed.
2 amp constant, 4 amp surge \$18.00 each
3 amp constant, 5 amp surge \$25.00 each

4PDT RELAY

14 pin DIN style 3 amp contacts. USED but fully tested. Special coil voltage desired. Either 24 vdc or 120 vac.
\$1.70 each

KEY ASSEMBLY

5 KEY \$1.00 each
8 KEY \$1.25 each
contains 5 single-pole normally open switches. Measures 1 1/2" long.

D.C. CONVERTER

Designed to provide a steady 5 vdc @ 240 ma. from a battery supply of 3.5 to 6.25 volts.
2 1/2" x 3 1/2" x 1 1/2".
\$1.50 each

7 CONDUCTOR RIBBON CABLE

Spectra-strip red marker strip 26 ga. stranded wire \$5.00 per 100 roll

LARGE QUANTITIES AVAILABLE

BOCKETS FOR 14 RELAY 75¢ each

METAL OXIDE VARISTOR

Popular OE # 130LA10A varistor 1/2" diameter \$1.25 each

QUANTITIES LIMITED

MINIMUM ORDER \$10.00
USA: \$3.00 SHIPPING
FOREIGN ORDERS INCLUDING SUFFICIENT SHIPPING CALIF. RES. ADD 6 1/2%

ALL ELECTRONICS CORP.
LOS ANGELES, CA STORE
905 S. Vermont Ave
213 380-8000

VAN NUYS, CA STORE
6228 Sepulveda Blvd
818 997-1806

MAIL ORDERS TO
PO BOX 20406
Los Angeles, CA 90005

1WB - 51010163 ALL ELECTRONIC
EASyLINK MBX - 62867748



TOLL FREE ORDERS ONLY
1-800-826-5432
(ORDER ONLY)
(IN CALIFORNIA 1-800-258-6886)
ALASKA, HAWAII
OR INFORMATION
(213) 380-8000 NO C.O.D.

SEPTEMBER 1985

NEW FALL '85 CATALOG

JUST CLIP AND RETURN THIS COUPON

THIS MONTH'S SPECIALS

D-RAMS

4116 16K .99

4164 64K 150ns 1.50

4164 64K 200ns 1.25

41256 256K 150ns 6.95

EPROMS

2708 1K x 8 450ns 8K 5.95

2716 2K x 8 450ns 16K 3.60

2732A 4K x 8 300ns 32K 4.90

2764 8K x 8 300ns 64K 4.50

27128 16K x 8 300ns 128K 7.50

27256 32K x 8 250ns 256K 14.95

27512 64K x 8 250ns 512K 85.00

FULL LINE OF MICROPROCESSORS AVAILABLE

WE ALSO STOCK...

- Books • Breadboard • Accessories
- Capacitors • Chemicals • Connectors
- Crystals • Plugs & Jacks • Fans
- Enclosures • Filters • Fuses • Heat Shrink Tubing • Heat Sinks • Kits
- Knobs • Paraphernalia • Probes • Q-tips
- PCB Products • Potentiometers

USA

P.O. BOX 9100
WESTBOROUGH, MASS
1-800-343-0874

Active

CANADA
5651 FERRIER ST.
MONTREAL, QUEBEC
1-800-361-5884

MAIL ORDER
PROCUREMENT
24 HOURS

YOUR ELECTRONIC
COMPONENTS
CENTER

CURRENT DATE
CODE PRODUCTS
VOLUME DISCOUNTS

SELF SERVE STORES LOCATED NEAR YOU. JUST CALL...

WESTBOROUGH, MASS
366-9684

BELLEVUE, WASH.
881-8191

MONTREAL, QUEBEC
731-7441

OTTAWA, ONT.
728-7900

TORONTO, ONT.
977-7692

DOWNSVIEW, ONT.
630-0400

EDMONTON, ALTA.
438-5888

CALGARY, ALTA.
235-5300

VANCOUVER, B.C.
438-3321

CIRCLE 51 ON FREE INFORMATION CARD

DESIGNER'S NOTEBOOK

continued from page 96

put with something near a 50% duty cycle. That last restriction is based solely on my own experience and, consequently, it's also subjective.

The LM386 is used because it can directly drive a speaker, but the whole idea can easily be applied to any amplifier. Once again, the idea here is to experiment and adapt the basic principles to suit your own needs.

On a final note: Since the tremolo clock uses the gain-control pin of the amplifier, you'll have to change the value of capacitor C4 in order to change the gain of the amplifier.

You can make C4 larger to increase the gain or smaller to decrease it. The range of values for C4 can go from about .1 to 500 microfarads. But, don't go any lower than .1 μ F because you'll be cutting into the bottom-end frequency response. R-E



One tree can make 3,000,000 matches.

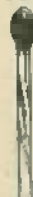

One match can burn 3,000,000 trees.

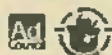

A Public Service of This Magazine
& The Advertising Council

ACTIVE RECEIVING ANTENNA

Gives excellent reception, 50 KHz to 30 MHz.

New MFJ-1024 Active Receiving Antenna mounts outdoors away from electrical noise for maximum signal.

Gives excellent reception of 50 KHz to 30 MHz signals. Equivalent to wire hundreds of feet long. Use any SWL, MW, BCB, VLF or Ham receiver.

High dynamic range RF amplifier. 54 In. whip. 50 foot coax. 20 dB attenuator prevents receiver overload. Switch between two receivers. Select auxiliary or active antenna. Gain control. "ON" LED. Remote unit. 3x2x4 In. Control. 8x2x5 In. 12 VDC or 110 VAC with optional adapter. MFJ-1312. \$9.95.

\$129.95
(+ \$4.00 shipping)

Order from MFJ and try it. If not delighted, return within 30 days for refund (less shipping). One year unconditional guarantee.

Order today. Call TOLL FREE 800-647-1800. Charge VISA, MC. Or mail check, money order. Write for free catalog. Over 100 products.

CALL TOLL FREE 800-647-1800

Call 601-323-5869 in Miss., outside continental USA. Tech/order/repair info. TELEX 53-4590.

MFJ ENTERPRISES, INCORPORATED

Box 494, Mississippi State, MS 39762

CIRCLE 105 ON FREE INFORMATION CARD

AMAZING DEVICES

PERSONAL DEFENSE AND PROPERTY PROTECTION UTILIZE SPACE AGE TECHNOLOGY. CAUTION THESE DEVICES CAN BE HAZARDOUS AND MAY SOON BE ILLEGAL.

- POCKET PAIN FIELD GENERATOR — IPG50
Assembled \$64.50
Plans \$8.00 IPG5K 10V/Plans \$44.50
- PHASOR PAIN FIELD CROWD CONTROLLER — PPF10
Assembled \$250.00
Plans \$15.00 PPF1K Kit/Plans \$175.00
- BLASTER — Provides a plasma discharge capable of puncturing a can. Produces a 100,000 WATT PULSE
ASSEMBLED \$89.50
BLS1 PLANS \$10.00 BLS1K KIT/PLANS \$69.50
- PLASMA STUN GUN — Very intimidating and effective 5 to 10 feet. 100,000 VOLTS
ASSEMBLED \$99.50
ITM1 PLANS \$10.00 ITM1K KIT/PLANS \$69.50

RUBY LASER RAY GUN — Intense visible red beam burns and welds hardest of metals. **MAY BE HAZARDOUS.**

RUB3AH Parts Available for Completing Device \$15.00

CARBON DIOXIDE BURNING, CUTTING LASER — Produces a continuous beam of high energy. **MAY BE HAZARDOUS.**

LC5 All Parts Available for Completing Device \$15.00

VISIBLE LASER LIGHT GUN — produces intense red beam for sighting, spotting, etc. Hand held complete

LGUS Plans \$10.00 (Kit & Assembled Units Available)

PULSED LASER RIFLE — Produces 15-30 watt infra-red pulses at 200-2000 per sec

LRG3 All Parts & Diodes Available \$10.00

BEGINNERS LOW POWER VISIBLE LASER — Choice of red, yellow, green — provides an excellent source of monochromatic light.

LHC2 Plans \$5.00 LHC2K 101 \$34.50

SNOOPER PHONE — Allows user to call his premises and listen in without phone ever ringing

SNP20 Assembled \$89.50

SNP2 Plans \$9.00 SNP2K Plans/Kit \$59.50

LONG RANGE WIRELESS MIKE — Miniature device clearly transmits well over one mile. Super sensitive, powerful

MFT1 Plans \$7.00 MFT1K Plans/Kit \$49.50

WIRELESS TELEPHONE TRANSMITTER — Transmits both sides of phone conversation over one mile. shuts off automatically

VWPM5 Plans \$6.00 VWPM5K Plans/Kit \$39.50

TALK & TELL AUTOMATIC TELEPHONE RECORDING DEVICE — Great for monitoring telephone use.

TAT20 Assembled \$24.50

TAT2 Plans \$5.00 TAT2K Plans/Kit \$14.50

Our phone is open for orders anytime. Technicians are available 9-11 a.m., Mon. Thurs for those needing assistance or information. Send \$1.00 for catalog of hundreds more similar devices. Send check, cash, MO, Visa, MC. COD to INFORMATION UNLIMITED

DEPT. RB, P.O. Box 716, Amherst, N. H. 03031 Tel. 603-673-4730

CIRCLE 72 ON FREE INFORMATION CARD

How to live with someone who's living with cancer.

When one person gets cancer, everyone in the family suffers.

Nobody knows better than we do how much help and understanding is needed. That's why our service and rehabilitation programs emphasize the whole family, not just the cancer patient.

Among our regular services we provide information and guidance to patients and families, transport patients to and from treatment, supply home care items and assist patients in their return to everyday life.

Life is what concerns us. The life of cancer patients. The lives of their families. So you can see we are even more than the research organization we are so well known to be.

No one faces cancer alone.

AMERICAN CANCER SOCIETY

SPARTAN Electronics Inc



CALL (516) 499-9500 MAIL

6094 Jericho Tpke. Commack, N.Y. 11725

T V ACCESSORIES

JERROLD LCC-58 CONVERTER	84.95
JERROLD LCC-01 remote	104.95
PHILIPS CV-1000 CONVERTER W/VOLUME CONTROL	169.95
PHILIPS CT09A CONVERTER	129.95
WINEGUARD ANTENNA ROTOR WR-5000	89.95
HOME TV ANTENNA	49.95
MARINE TV ANTENNA	59.95
TUSA CVU-40 BLOCK CONVERTER	28.95
CVU-1000 BLOCK CONV	38.95
COAX CABLE 59U 500'	35.00
ROTOR CABLE 20'4 500'	35.00

T R I P T E R E Q U I P M E N T

BECKMAN			
DM-10	\$35	DM-45	\$89
DM-20	65	DM-73	63
DM-25	79	DM-77	75
DM-40	69	CM-20	129
TRIPLETT			
P/N 3400	\$122	P/N 50	\$59
3500	108	630NA	169
3550A	79		
BAX			
P/N 820	\$174	P/N 3300	\$339
2802	47	111	39
2815	140	116	64
2818	128	1042	19
		1045	336

POCKET TECHNOLOGY, INC
 LogicScope 138
 w/ Probes \$695
 w/o Probes \$595

RS232 TRANSMISSION LINE TESTER
 All 25 signal lines accessible. Dual color LEDs (red/green) Jumpers and case incl. \$169.95

C O M P O N E N T S

PHILIPS ECG SEMICONDUCTORS
 We have a complete line of ECG replacement semiconductors for all your electronic needs
—DISCOUNT PRICES—

ECG (EQUIV) 1155	\$4.95
ECG (EQUIV) 128	5.9
ECG (EQUIV) 4016	80
ECG (EQUIV) 5070	1.28

CONNECTORS
 RS-232C (SOLDER TYPE)

Male \$150 Female \$1.95
5HC Male 8.95 per 10
UPH Male 9.90 per 10
1" Male 2.50 per 10
PCA Male 2.95 per 10
CHANGER RS232 M/M 19.95
CHANGER RS232 F-F 19.95

C H E M I C A L S

TECH-SPRAY

Fluor-Stripper 18oz	\$4.65
Blue Shower 24oz	3.45
FD 24oz	5.65
Instant Chiller 16oz	3.10
Kleen-It 6oz	1.40
SLIC 8oz	3.35
Zero-Charge 15oz	8.55
Blue Stuff 8oz	3.65

R I S

IC

Pocket Dice \$15	Metal Digi. 36
Logic Probe 8	Dig. Clock 39
Body Blinder 8	Binary CR 36
Digital Dice 14	Dig. Router 29

P C A C C E S S

IBM PRINTER CABLE	822
SAKATA 12" AMBER MONITOR	129
12" GREEN MONITOR	119
ZENITH 138 13" COLOR COMPOSITE RGB AUDIO H.RES	524
NOTES SMARTMODEMS	
300 BAUD	\$234
1200 300 BAUD	469
1200H INTERNAL (IBM)	389
2400/1200 BAUD	789

S A M S

SAM'S PHOTOFACTS

PHOTOFACTS	\$9.45
P.O.M.'S	33.75
COMPUTERFACTS	19.95
COMPUTERFACTS (SYS)	39.95

Volume Discounts

Min. Order \$25.00
 International shipping Add 1
 Prices subject to change without notice
 COD 2.00 Extra
 Add 1 shipping for monstors

to 75.00	\$2.50
76.00 to 250.00	\$4.50
251.00 to 500.00	\$6.00
501.00 to 750.00	\$8.50
751.00 to 1000.00	\$12.00
Over 1000.00	\$12.50

(516) Mon Th Tu W F Sa
 499-9500 9-8 9-6 9:30-5

ADVERTISING INDEX

RADIO-ELECTRONICS does not assume any responsibility for errors that may appear in the Index below.

Free Information Number	Page		Page		
267	AIS Satellite	36	— NTS	18	
108	AMC Sales	42	262	New-Tone Electronics	13
76	AP Products	26	—	Pacific Cable	105
51	Active Electronics	122	252	PanaVise	36
—	Advance Electronics	23,24,25	268	Panasonic	45
106	Advanced Computer Products	107	68,265	Philips ECG	43
107	All Electronics	121	—	Phoenix Electronics	92
72	Amazing Devices	122	126	RAG Electronics	5
266	Ange Electronics	36	78	Radio Shack	111
84	Appliance Service	37	70	Ramsey	114
264	Automated Products Equipment	103	—	Rhodes	48
77	B&K Precision	CV3	253	Saratoga Electronics	110
98	Beckman Industrial	17	259	Simpson	38
—	C.O.M.B.	85	73	Sintec	16
—	CIE	28	74	Solid State Sales	116
54	Cbemtronics	35	75	Spartan Electronics	124
—	Command Productions	46	—	Symmetric Sound	36
79	Communications Electronics	3	—	Tektronix	CV2
—	Coop's Satellite Digest	14	254	U.S. Instrument Rentals	33
127	Deco Industries	36,37	103	Wm B Allen	108
251	Deltax Dynamic	37			
—	Dick Smith Electronics	86,87,88,89			
273,274	Diehl Engineering	97,99			
82	Digi-Key	123			
57	Digitron	106			
110	Dokay	109			
272	ELPAC	106			
83	Electro Industries	93			
269	Electro Mania	37			
270	Electronic Salvage Parts	92			
60	Electronic Specialists	116			
—	Electronic Technology Today	CD2			
—	Electronics Book Club	57			
120	Elephant Electronics	37			
111	Etronix	93			
100	Firestik III	47			
260	Fluke Manufacturing	7			
—	Fordham Radio	15, CV4			
—	Grantham College of Engineering	91			
257	HW Sams	22			
—	Harbor Freight Salvage	34			
86	Heath	27			
—	ICS Computer Training	46			
—	ISET	110			
65	J & W	116			
113	JDR Microdevices	118,119			
114	Jameco	112,113			
124	James Walter Satellite Rec.	37			
115	Jensen Tools	37			
258	Kepro Circuit Systems	47			
263	Krueger Technology	117			
87	MCM Electronics	120			
105	MEJ	122			
255	Mark V. Electronics	115			
—	McGraw Hill Book Club	39,74			
67	McIntosh Labs	32			
275,276	Morning Distributing	36,37			
117	Mouser	42			
—	NRI	8			

Gernsback Publications, Inc.
 200 Park Ave. South
 New York, NY 10003
 (212) 777-6400
 Chairman of the Board:
 M. Harvey Gernsback
 President: Larry Steckler

ADVERTISING SALES 212-777-6400

Larry Steckler
 publisher
 Arline Fishman
 advertising coordinator
 Shelli Weinman
 advertising associate
 Lisa Strassman
 credit manager
 Donna Sala
 credit associate
 Naomi Matten
 advertising assistant

Sales Offices

EAST/SOUTHEAST

Stanley Levitan
 Radio-Electronics
 200 Park Ave. South
 New York, NY 10003
 718-428-6037, 212-777-6400

MIDWEST/Texas/Arkansas/Okla.

Ralph Bergen
 Radio-Electronics
 540 Frontage Road—Suite 325
 Northfield, IL 60093
 312-446-1444

PACIFIC COAST/ Mountain States

Marvin Green
 Radio-Electronics
 15335 Morrison St.—Suite 227
 Sherman Oaks, CA 91403
 818-986-2001

Quick... who makes the scopes that out-tech the competition?

NEW
50MHz
1596
\$2095

NEW
100MHz
1590A
\$1795

80MHz
1570A
\$1395

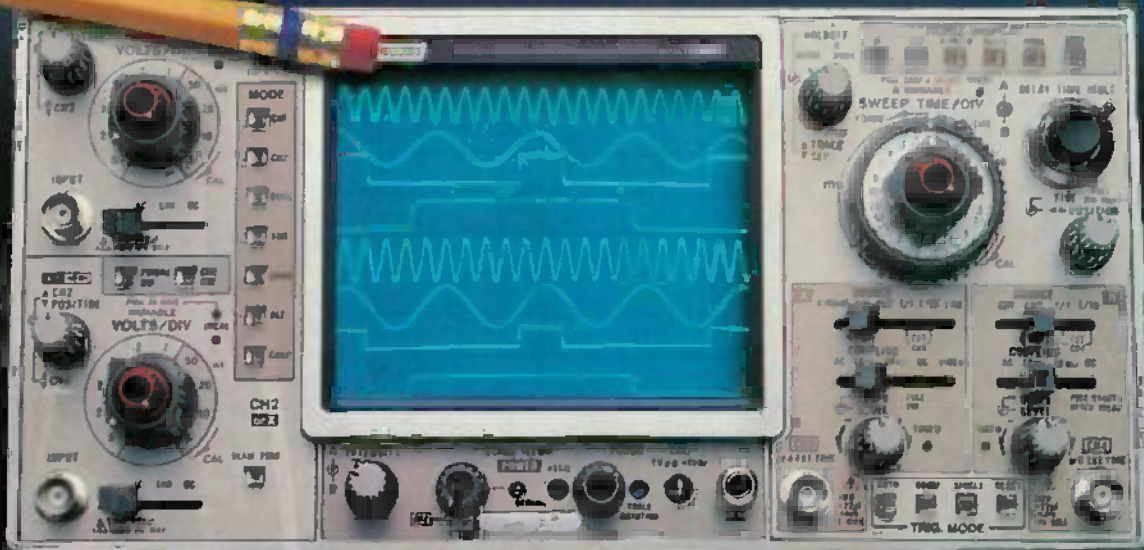

Now... up to 150 MHz
Compare these features and performance specifications.

Bright 20KV display
(12KV on 1570A)
with illuminated
graticule.

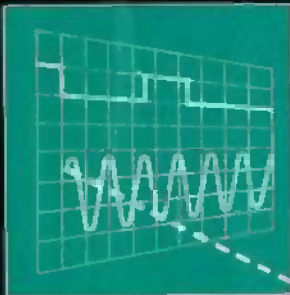

1mV
TRUE
SENSITIVITY



Dual
independent
timebase*

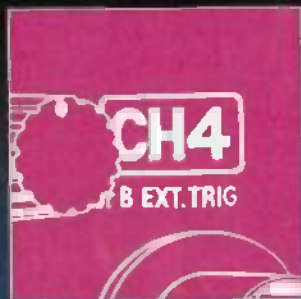

Four vertical inputs
with 8-trace display

- ±2% VERTICAL AND HORIZONTAL ACCURACY
- V-MODE DISPLAYS FOUR UNRELATED SIGNALS
- SOFT-TOUCH, LIT CONTROLS
- 500 μV CASCADE SENSITIVITY
- CHANNEL 1 BUFFERED OUTPUT

Five times more
sensitive than
most competitors.

Compare all of the features and performance benefits
with any scopes in their price range. See your local
stocking distributor or contact B&K-PRECISION.

B&K PRECISION DYNASCAN CORPORATION

6460 West Cortland Street • Chicago, Illinois 60635 • 312 889-9087

International Sales, 6460 W. Cortland St., Chicago, IL 60635

Canadian Sales, Atlas Electronics, Ontario

South and Central American Sales, Empire Exporters, Plainville, NY 11962

*Not on 1570A

CIRCLE 77 ON FREE INFORMATION CARD

PERFORMANCE

SCOPE HAND-HELD DIGITAL CAPACITANCE and MULTIMETERS

- 0.5% DC Accuracy
- Highest Quality
- Highest Performance
- Lowest Prices

THE ULTIMATE TEST



Model DCM-602
\$79.95

3 1/2 Digit Capacitance Meter
8 ranges with full scale values to 2000 uF

- FEATURES** • Broad test range - 1 pF to 2000 uF • LSI circuit provides high reliability and durability • Lower power consumption • Crystal time base • Protected from charged capacitors • Frequency range - 800 Hz to 8 Hz



Model DVM-634
\$48.75

7 functions, 32 ranges.
Transistor measurement included.

3 1/2 Digit Multimeters

- FEATURES** • DC Voltage 100 uV - 1000 V • AC Voltage 100 uV - 750 V • AC/DC Current 200 uA - 10 Amps • Resistance 20 Megohms • Capacitance (DVM 636/638) 1 pF - 20 uF • Overload Protection • Auto-decimal LCD readout • Polarity indication • 3000 hour battery life with 9V transistor battery • Low battery indication



Model DVM-638
\$79.95

11 functions, 38 ranges.
Includes logic level detector, audible visual continuity, capacitance and conductance measurement



Model DVM-636
\$62.75

8 functions, 37 ranges.
Capacitance measurement included.

ASK FOR FREE CATALOG.

Money orders, checks accepted. C.O.D.'s require 25% deposit.



Fordham

260 Motor Parkway, Hauppauge, NY 11788

Toll Free
800-645-9518
In NY State 800-832-1446

Service and Shipping Charge Schedule	
FOR ORDERS	ADD
\$25-250	\$4.50
\$251-500	\$6.50
\$501-750	\$8.50
\$751-1,000	\$12.50
\$1,001 and up	\$15.00