

# Radio **Electronics**

SAVE MONEY BY  
SALVAGING SURPLUS  
ELECTRONIC EQUIPMENT

SPECIAL SECTION  
SATELLITE TV  
\$1.95 JUNE 1985  
IN CANADA \$2.25

TECHNOLOGY - VIDEO - STEREO - COMPUTERS - SERVICE

**A look at the nuts and bolts  
of installing your own  
satellite TV system**

**What you  
need to  
know before  
you buy a  
satellite TV  
system**

**Build R-E's  
paragrap  
voltmeter  
for  
your  
car  
and  
keep tabs on  
your battery's condition**

**Build R-E's add-on  
accessory and turn your  
DVM into a thermometer**

**Electronics in medicine -  
New devices help the blind**

**R-E's step-by-step  
guide to  
troubleshooting  
cordless  
telephones**

A  
**GERNSBACK**  
PUBLICATION.

**Special 16-page section:  
COMPUTERDIGEST**

**PLUS:**

- ★ Hobby Corner
- ★ Equipment Reports
- ★ Drawing Board
- ★ Service Clinic
- ★ New Idea
- ★ State-Of-Solid-State



# Now! Tek quality and expert advice are just a free phone call away!

**100 MHz dual time base scope.** Easy-to-read CRT; bright, full-sized 8x10 cm; 14 kv accelerating potential complete with BEAM FIND, separate A/B dual intensity controls, FOCUS and TRACE ROTATION.

**Wide range vertical sensitivity.** Choose from 2 mV/div (1x probe) to 50 V/div (10x probe); color-keyed for 1x and 10x probes; variable control increases scale factor by 2.5 to 1.

**Two 100 MHz, high sensitivity channels.** 3.5 ns risetime; dc to  $\geq$  100 MHz bandwidth from 5 V/div to 5 mV/div; extended sensitivity of 2 mV/div at  $\geq$  90 MHz.

**A/B sweep selection.** Calibrated A sweeps from 50 ns/div to 0.5 s/div; B sweeps from 50 ns/div to 50 ms/div; variable control for up to 2.5 to 1 reduction and 10x magnification for sweeps to 5 ns/div.

**Dual time base measurements.** Select either A or B sweeps, or both alternately with A intensified by B.

**B trigger slope and level.** Use B trigger level to select B-triggered or run-after-delay modes; use B TRIGGER SLOPE to select transitions.



**Our direct order line gets you the industry's leading price/performance portables... and fast answers from experts!** The 60 MHz single time base delay 2213A, the 60 MHz dual time base 2215A and the 100 MHz dual time base 2235 offer unprecedented reliability and affordability, plus the industry's first 3-year warranty\* on labor and parts, CRT included.

**The cost: just \$1275 for the 2213A, \$1525 for the 2215A, \$1750 for the 2235.**† Even at these low prices, there's no scrimping on performance. You

have the bandwidth for digital and analog circuits. The sensitivity for low signal measurements. The sweep speeds for fast logic families. And delayed sweep for fast, accurate timing measurements. All scopes are UL Listed and CSA approved.

**You can order, or obtain literature, through the Tek National Marketing Center.** Technical personnel, expert in scope applications, will answer your questions and expedite delivery. Direct orders include comprehensive 3-year warranty\*, operator's

manual, two 10X probes, 15-day return policy and worldwide service backup.

**Order toll free:  
1-800-426-2200,  
Ask for Rick.**

In Oregon, call collect (503) 627-9000. Or write Tektronix, Inc. P.O. Box 500, Delivery Station Y6-088 Beaverton, OR 97077

**Tektronix®**  
COMMITTED TO EXCELLENCE

# PERFORMANCE

## SCOPE HAND-HELD DIGITAL CAPACITANCE and MULTIMETERS

- 0.5% DC Accuracy
- Highest Quality
- Highest Performance
- Lowest Prices

# THE ULTIMATE TEST



**Model DCM-602**  
**\$7995**

### Digital Capacitance Meter

8 ranges with full scale values to 2000 uF

**FEATURES** • Broad test range - 1 pF to 2000 uF • LSI circuit provides high reliability and durability • Lower power consumption • Clear readout even in bright light • Crystal time base • Easy to operate, compact, lightweight • Protected from charged capacitors • Frequency range - 800 Hz to 8 Hz



**Model DVM-634**  
**\$4875**

7 functions, 32 ranges.  
Transistor measurement included.

### Digital Multimeters

- DC Voltage 100 uV - 1000 V
- AC Voltage 100 uV - 750 V
- AC/DC Current 200 uA - 10 Amps
- Resistance 20 Megohms
- Capacitance (DVM 636/638) 1 pF - 20 uF



**Model DVM-638**  
**\$7995**

11 functions, 38 ranges.  
Includes logic level detector, audible visual continuity, capacitance and conductance measurement.



**Model DVM-636**  
**\$6275**

8 functions, 37 ranges.  
Capacitance measurement included.

**FEATURES** • Overload Protection • Auto-decimal LCD readout • Polarity Indication • 3000 hour battery life with 9V transistor battery • Low battery indication

Charge it with VISA/MasterCard. Money orders, checks accepted. C.O.D.'s. Call for quantity pricing. Ask for Free Catalog.

# Fordham

260 Motor Parkway, Hauppauge, NY 11788

Toll Free  
**800-645-9518**  
In NY State 800-832-1446

Service and Shipping Charge Schedule	
FOR ORDERS	ADD
\$25-250 .....	\$4.50
\$251-500 .....	\$6.50
\$501-750 .....	\$8.50
\$751-1,000 .....	\$12.50
\$1,001 and up .....	\$15.00

# NEW!

# Uniden® Bearcat®

# Regency®

## Scanners

Communications Electronics™, the world's largest distributor of radio scanners, introduces new scanners and scanner accessories from J.I.L., Regency and Uniden/Bearcat. Chances are the police, fire and weather emergencies you'll read about in tomorrow's paper are coming through on a scanner today.

### NEW! Regency® MX7000-H

List price \$699.95/CE price \$449.00  
**10-Band, 20 Channel • Crystalless • AC/DC**  
Frequency range: 25-550 MHz. continuous coverage and 800 MHz. to 1.2 GHz. continuous coverage  
In addition to normal scanner listening, the MX7000 offers CB, VHF, and UHF TV audio, FM Broadcast, all aircraft bands (civil and military), 800 MHz communications, cellular telephone, and when connected to a printer or CRT, satellite weather pictures.

### NEW! Regency® MX5000-H

List price \$599.95/CE price \$354.00  
**Multi-Band, 20 Channel • No-crystal scanner**  
**Search • Lockout • Priority • AC/DC**  
**Selectable AM-FM modes • LCD display**  
World's first continuous coverage scanner  
Frequency range: 25-550 MHz. continuous coverage.  
Never before have so many features come in such a small package. The Regency MX5000 mobile or home scanner has continuous coverage from 25 to 550 MHz. That means you can hear CB, Television audio, FM broadcast stations, all aircraft bands including military and the normal scanner bands, all on your choice of 20 programmable channels.

### NEW! Regency® MX4000-H

List price \$629.95/CE price \$394.00  
**Multi-Band, 20 Channel • No-crystal scanner**  
**Search • Lockout • Priority • AC/DC**  
**Selectable AM-FM modes • LCD display**  
Bands: 30-50, 118-136, 144-174, 440-512, 800-950 MHz.  
The Regency MX4000 is gives coverage in the standard VHF and UHF ranges with the important addition of the 800 MHz. and aircraft bands. It features keyboard entry, multifunction liquid crystal display and variable search increments.

### NEW! Regency® Z60-H

List price \$379.95/CE price \$249.00  
**8-Band, 60 Channel • No-crystal scanner**  
Bands: 30-50, 88-108, 118-136, 144-174, 440-512 MHz.  
Cover your choice of over 15,000 frequencies on 60 channels at the touch of your finger.

### NEW! JIL SX-400-H

List price \$799.95/CE price \$499.00  
**Multi-Band, 20 Channel • No-crystal Scanner**  
**Search • Lockout • Priority • AC/DC**  
Frequency range: 26-520 MHz. continuous coverage.  
With optionally equipped RF converters 150KHz-3.7 GHz.  
The JIL SX-400 synthesized scanner is designed for commercial and professional monitor users that demand features not found in ordinary scanners. The SX-400 will cover from 150 KHz to 3.7 GHz. with RF converters. Order the following RF converters for your SX-400 scanner. RF-1030-H at \$259.00 each for frequency range 150 KHz - 30 MHz. USB, LSB, CW and AM. (CW filter required for CW signal reception); RF-5080-H at \$199.00 each for 500-800 MHz.; RF-8014-H at \$199.00 each for 800 MHz.-1.4 GHz. Be sure to also order ACB-300-H at \$99.00 each which is an antenna control box for connection of the RF converters. Add \$3.00 shipping for each RF converter or antenna control box. If you need further information on the JIL scanners, contact JIL directly at 213-926-6727 or write JIL at 17120 Edwards Road, Cerritos, California 90701.

### SPECIAL! JIL SX-200-H

List price \$499.95/CE special price \$189.00  
**Multi-Band - 16 Channel • No-Crystal Scanner**  
Frequency range 26-88, 108-180, 380-514 MHz.  
The JIL SX-200 scanner tunes military, F.B.I., Space Satellites, Police and Fire, Drug Enforcement Agencies, Defense Department, Aeronautical AM band, Aero Navigation Band, Fish & Game, Immigration, Paramedics, Amateur Radio, Justice Department, State Department, plus other thousands of radio frequencies most other scanners can't pick up. The SX-200 has selectable AM/FM receiver circuits, tri-switch squelch settings - signal, audio and signal & audio, outboard AC power supply - DC at 12 volts built-in, quartz clock - bright vacuum fluorescent blue readouts and dimmer, dual level search speeds, tri-level scan delay switches, 16 memory channels in two channels banks, receive fine tune (RIT) ± 2KHz., dual level RF gain settings - 20 db pad, AGC test points for optional signal strength meters. All in all, the JIL SX-200 gives you more features for the money than any other scanner currently on sale. Order your JIL SX-200 scanner at this special price today.

### Regency® HX1000-H

List price \$329.95/CE price \$209.00  
**6-Band, 30 Channel • No Crystal scanner**  
**Search • Lockout • Priority • Scan delay**  
**Sidelit liquid crystal display • Digital Clock**  
Frequency range: 30-50, 144-174, 440-512 MHz.  
The new handheld Regency HX1000 scanner is fully keyboard programmable for the ultimate in versatility. You can scan up to 30 channels at the same time. When you activate the priority control, you automatically override all other calls to listen to your favorite frequency. The LCD display is even sidelit for night use. A die-cast aluminum chassis makes this the most rugged and durable hand-held scanner available. There is even a backup lithium battery to maintain memory for two years. Includes wall charger, carrying case, belt clip, flexible antenna and nicad battery. Order your Regency HX1000 now.

### Bearcat® 100-H

The first no-crystal programmable handheld scanner.  
List price \$449.95/CE price \$229.00  
**8-Band, 16 Channel • Liquid Crystal Display**  
**Search • Limit • Hold • Lockout • AC/DC**  
Frequency range: 30-50, 138-174, 406-512 MHz.  
The world's first no-crystal handheld scanner has compressed into a 3" x 7" x 1 1/4" case more scanning power than is found in many base or mobile scanners. The Bearcat 100 has a full 16 channels with frequency coverage that includes all public service bands (Low, High, UHF and "T" bands), the 2-Meter and 70 cm. Amateur bands, plus Military and Federal Government frequencies. Wow...what a scanner!

Included in our low CE price is a sturdy carrying case, earphone, battery charger/AC adapter, six AA ni-cad batteries and flexible antenna. Order your scanner now.

### QUANTITY DISCOUNTS AVAILABLE

Order two scanners at the same time and deduct 1%, for three scanners deduct 2%, four scanners deduct 3%, five scanners deduct 4% and six or more scanners purchased at the same time earns you a 5% discount off our super low single unit price.

### NEW! Regency® HX2000-H

The World's First 800 MHz. Handheld Scanner  
List price \$569.95/CE price \$359.00  
**7-Band, 20 Channel • No-crystal scanner**  
**Priority control • Search/Scan • AC/DC**  
**Sidelit liquid crystal display • Memory backup**  
Bands: 118-136, 144-174, 440-512, 800-950 MHz.  
The HX2000 scanner operates on 120V AC or 6 VDC. Scans 15 channels per second. Size 3" x 7" x 1 1/2". Includes wall charger, carrying case, belt clip, flexible antenna and nicad batteries. Selectable AM/FM modes.

### OTHER RADIOS AND ACCESSORIES

- RO55-H Uniden Visor mount Radar Detector..... \$119.00
  - RD95-H Uniden Remote mount Radar Detector..... \$139.00
  - BC 300-H Bearcat 50 channel scanner..... \$344.00
  - BC 20/20-H Bearcat 40 channel scanner..... \$274.00
  - BC 210XL-H Bearcat 18 channel scanner..... \$209.00
  - BC 260-H Bearcat 16 channel mobile scanner..... \$274.00
  - BC 201-H Bearcat 16 channel scanner..... \$189.00
  - BC 180-H Bearcat 16 channel scanner..... \$164.00
  - BC-WA-H Bearcat Weather Alert™..... \$39.00
  - DX1000-H Bearcat shortwave receiver..... \$499.00
  - PC22-H Uniden remote mount CB transceiver..... \$99.00
  - PC55-H Uniden mobile mount CB transceiver..... \$59.00
  - Z10-H Regency 10 channel scanner..... \$149.00
  - Z30-H Regency 30 channel scanner..... \$189.00
  - Z45-H Regency 45 channel scanner..... \$199.00
  - MX3000-H Regency 30 channel scanner..... \$219.00
  - C403-H Regency 4 channel scanner..... \$69.00
  - R106-H Regency 10 channel scanner..... \$99.00
  - HX650-H Regency 6 channel handheld scanner..... \$99.00
  - HX-650P-H HX650 with batt., case, crystal certs..... \$124.00
  - RH250B-H Regency 10 channel VHF transceiver..... \$379.00
  - RPH410-H 10 ch. handheld no-crystal transceiver..... \$399.00
  - BC10-H Battery charger for Regency RPH410..... \$79.00
  - EC10-H Programming tool for Regency RPH410..... \$20.00
  - SMRH250-H Service man. for Regency RH250..... \$20.00
  - SMRU150-H Service man. for Regency RU150..... \$20.00
  - SMRPH410-H Service man. for Regency RPH410..... \$20.00
  - B-4-H 1.2 V AAA Ni-Cad batteries (set of four)..... \$9.00
  - A-135C-H Crystal certificate..... \$3.00
  - FB-E-H Frequency Directory for Eastern U.S.A..... \$12.00
  - FB-W-H Frequency Directory for Western U.S.A..... \$12.00
  - A60-H Magnet mount mobile antenna..... \$35.00
  - A70-H Base station antenna..... \$35.00
- Add \$3.00 shipping for all accessories ordered at the same time.  
Add \$12.00 shipping per shortwave receiver.  
Add \$7.00 shipping per scanner and \$3.00 per antenna.

### BUY WITH CONFIDENCE

To get the fastest delivery from CE of any scanner, send or phone your order directly to our Scanner Distribution Center. Be sure to calculate your price using the CE prices in this ad. Michigan residents please add 4% sales tax or supply your tax I.D. number. Written purchase orders are accepted from approved government agencies and most well rated firms at a 10% surcharge for net 10 billing. All sales are subject to availability, acceptance and verification. All sales on accessories are final. Prices, terms and specifications are subject to change without notice. All prices are in U.S. dollars. Out of stock items will be placed on back-order automatically unless CE is instructed differently. A \$5.00 additional handling fee will be charged for all orders with a merchandise total under \$50.00. Shipments are F.O.B. Ann Arbor, Michigan. No COD's. Most products that we sell have a manufacturer's warranty. Free copies of warranties on these products are available prior to purchase by writing to CE. Non-certified checks require bank clearance.

Mail orders to: Communications Electronics, Box 1045, Ann Arbor, Michigan 48106 U.S.A. Add \$7.00 per scanner for U.P.S. ground shipping and handling in the continental U.S.A. For Canada, Puerto Rico, Hawaii, Alaska, or APO/FPO delivery, shipping charges are three times continental U.S. rates. If you have a Visa or Master Card, you may call and place a credit card order. Order toll-free in the U.S. Dial 800-USA-SCAN. In Canada, order toll-free by calling 800-221-3475. WUI Telex CE anytime, dial 671-0155. If you are outside the U.S. or in Michigan dial 313-973-8888. Order today.

Scanner Distribution Center™ and CE logos are trademarks of Communications Electronics Inc.

† Regency is a registered trademark of Uniden Corporation. ‡ Bearcat is a federally registered trademark of Regency Electronics Inc. AD #041585-H

Copyright © 1985 Communications Electronics

## For credit card orders call 1-800-USA-SCAN

# COMMUNICATIONS ELECTRONICS INC.

Consumer Products Division  
P.O. Box 1045 □ Ann Arbor, Michigan 48106-1045 U.S.A.  
Call 800-USA-SCAN or outside U.S.A. 313-973-8888

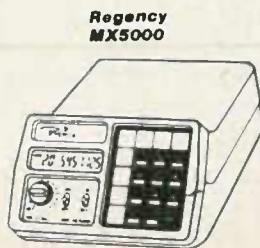

CIRCLE 79 ON FREE INFORMATION CARD

## SPECIAL SECTION

- 43 RECEIVING SATELLITE TELEVISION**  
If you're thinking about buying a satellite-TV receiving station, make sure to read this special section. It not only covers what you need to know before you go out and make your purchase; it also looks at what you can expect once you get everything home.  
**Bob Cooper, Jr.**
- 45 KNOW BEFORE YOU BUY**
- 49 INSTALLING YOUR TVRO**

## BUILD THIS

- 39 TEMPERATURE MEASURING ADD-ON FOR YOUR DVM**  
Why just use your digital voltmeter to measure voltage? Turn it into a precision electronic thermometer. **Harry L. Trietly**
- 60 BAR-GRAPH VOLTMETER FOR YOUR CAR**  
The best way to keep tabs on your car's charging system is by using a voltmeter. This bargraph meter is perfect for your dashboard.  
**Steve Pence**

## TECHNOLOGY

- 12 SATELLITE TV**  
The evolution of TVRO antennas.  
**Bob Cooper, Jr.**
- 57 ELECTRONIC AIDS FOR THE BLIND**  
Electronic technology can't restore sight, but it can help the blind in other ways.  
**Ray Fish, Ph.D., M.D.**
- 67 SERVICING CORDLESS TELEPHONES**  
As cordless phones grow in popularity, broken cordless phones will grow in number. But you can help put an end to that! **Christopher Kite**

## CIRCUITS AND COMPONENTS

- 63 HOW TO SALVAGE SURPLUS COMPONENTS**  
There are many bargains to be had in surplus components and equipment—if you know what to look for. **Harold Wright**
- 72 HOBBY CORNER**  
Generating 60-Hz clock pulses.  
**Earl "Doc" Savage, K4SDS**
- 80 DESIGNER'S NOTEBOOK**  
Speed controls for DC motors.  
**Robert Grossblatt**
- 86 STATE OF SOLID STATE**  
A high-energy ignition system. **Robert F. Scott**

## RADIO

- 78 COMMUNICATIONS CORNER**  
Computer security.  
**Herb Friedman**
- 82 ANTIQUE RADIOS**  
Restoring the cabinet.  
**Richard D. Fitch**

## VIDEO

- 8 VIDEO NEWS**  
The present and future in the fast-changing video scene. **David Lachenbruch**
- 88 SERVICE CLINIC**  
Multichannel television sound. **Jack Darr**

## COMPUTERS

- Following page 70
- COMPUTER DIGEST**  
A light pen for your Commodore—and lots more.
- 74 COMPUTER CORNER**  
The MSX standard.  
**Lou Frenzel**

## EQUIPMENT REPORTS

- 28 Global Specialties Model 1301 Power Supply**
- 31 Datak Circuit Fix PC-Board Repair Kit**

## DEPARTMENTS

- 110 Advertising and Sales Offices**
- 110 Advertising Index**
- 111 Free Information Card**
- 20 Letters**
- 91 Market Center**
- 23 New Products**
- 6 What's News**

# COVER 1



A lot of people are confused about what they have to do to receive satellite TV. After all, the equipment needed to receive signals from satellites like the one pictured on our cover is rather different from that used for terrestrial TV, and requires special considerations.

Our special section on satellite TV should clear up some of the confusion. One article outlines points you should consider before you spend even a dime. The second article tells you what to do after you buy your equipment—the actual nuts and bolts of installation. Even if you are receiving satellite TV right now, don't pass these two special articles by.

# NEXT MONTH

THE JULY ISSUE IS  
ON SALE JUNE 6

## ROBOTICS

Our new monthly column on one of the most exciting areas of electronics.

## PC BOARDS

We'll make etching boards from **Radio-Electronics** easier than ever before.

## BUILD YOUR OWN IBM-COMPATIBLE COMPUTER

You can get the power of an IBM PC without paying IBM's price.

## BUILD A DWELL/TACHOMETER FOR YOUR CAR

Tune up your car the right way with our digital dwell/tachometer.

## ELECTRONIC PEST REPELLERS

We'll show you how they work & how you can make your own.

## AND LOTS MORE!

As a service to readers, Radio-Electronics publishes available plans or information relating to newsworthy products, techniques and scientific and technological developments. Because of possible variances in the quality and condition of materials and workmanship used by readers, Radio-Electronics disclaims any responsibility for the safe and proper functioning of reader-built projects based upon or from plans or information published in this magazine.

Since some of the equipment and circuitry described in RADIO-ELECTRONICS may relate to or be covered by U.S. patents, RADIO-ELECTRONICS disclaims any liability for the infringement of such patents by the making, using, or selling of any such equipment or circuitry, and suggests that anyone interested in such projects consult a patent attorney.

# Radio-Electronics

Hugo Gernsback (1884-1967) founder  
M. Harvey Gernsback, editor-in-chief  
Larry Steckler, CET, publisher

## EDITORIAL DEPARTMENT

Art Kleiman, editor

Brian C. Fenton,  
technical editor

Carl Laron, WB2SLR,  
associate editor

Robert A. Young, assistant editor

Julian S. Martin, editorial associate

Byron G. Wels, editorial associate

Jack Darr, CET, service editor

Robert F. Scott,  
semiconductor editor

Herb Friedman,  
communications editor

Earl "Doc" Savage, K4SDS,  
hobby editor

Bob Cooper, Jr. satellite-TV editor

Robert Grossblatt, circuits editor

David Lachenbruch,  
contributing editor

Lou Frenzel, contributing editor

Bess Isaacson, editorial assistant

## PRODUCTION DEPARTMENT

Ruby M. Yee, production manager

Robert A. W. Lowndes,  
editorial production

Dianne Osias, advertising production

Karen Tucker, production traffic

## CIRCULATION DEPARTMENT

Jacqueline P. Weaver, circulation  
director

Rita Sabalis, assistant circulation  
director

Jacqueline Allen, circulation assistant

Cover photo courtesy of  
GTE Spacenet

Radio-Electronics is indexed in  
*Applied Science & Technology Index*  
and *Readers Guide to Periodical Literature*.

Microfilm & Microfiche editions are  
available. Contact circulation depart-  
ment for details.

Advertising Sales Offices listed on page  
110.

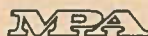

# Confidence is knowing your system has an ace in the hole.

We bet the Fluke 8840A is the right 5½-digit multimeter for you.

It's easy to program and operate, and it's easy to integrate into your system. The 8840A is versatile; if your system changes, your DMM doesn't have to.

You get the functions you need. With

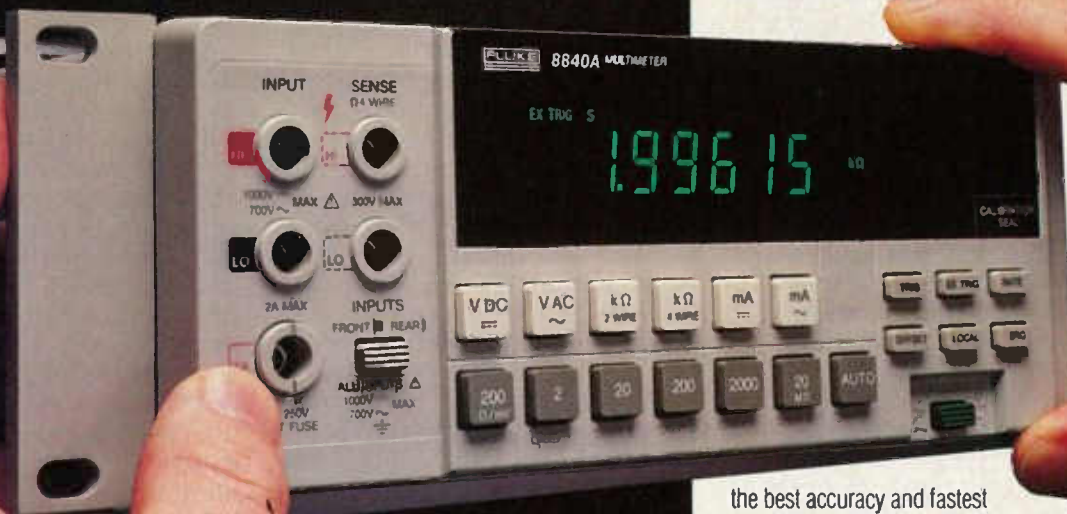

the best accuracy and fastest reading rates in its class.

You also get the security of Fluke's support to help bring your system on line quickly. Plus reliability and long-interval, in-place calibration for reduced down time.

All starting at **\$695**. IEEE-488 interface and true rms ac options are available for just **\$150** each.

Add it up, and you've got a great deal on a 5½-digit rack-mountable DMM. Why gamble on anything less?

For more information, contact your local Fluke representative or call toll-free

**1-800-426-0361.**

**FROM THE WORLD LEADER  
IN DIGITAL MULTIMETERS.**

#### Fluke 8840A

Autoranging Volts, Ohms, and Amps	
50 ppm basic dc accuracy (1 year)	
0.16% basic ac accuracy (1 year)	
2½, 20, and 100 readings/second	
-05 IEEE-488 interface option	\$150
-09 true rms ac option	\$150
Y8834 single rack kit	\$ 35
Y8835 dual rack kit	\$ 75

**FLUKE**®

# WHAT'S NEWS

## Electronic translator enables deaf to use the telephone

A new compact, portable device, invented simultaneously by a South Carolina electrical engineer and a computer specialist at the General Electric R&D Center in Schenectady, NY, makes it possible for deaf persons to receive messages "tapped out" for them on a push-button phone. The messages are received by a small device 7 × 1 × 4 inches in dimension, in letters that flow across its liquid-crystal display window in ticker-tape fashion. The instrument can be connected to any telephone via a suction cup attached to the handpiece.

The new device works by translating the tone signals from the push-button phone keyboard into numbers and letters of the alphabet. To transmit the letter A, for example, the caller taps the middle key in the top row (A,B,C) then the "1" key (to show the letter's position on the key). For the letter B, he taps the same key, followed by a "2" (two taps of the upper middle button). To transmit a number, the key for the desired

number, then the "#" key is depressed.

The Carolina engineer, Stephen Fowler, developed the device to talk to his deaf mother. Applying for a patent, he found that it had just been patented by Edwin Underkoffler of General Electric. Fowler called GE and learned that the company hoped to license the technology. For a nominal fee, he then purchased the rights to manufacture and market the instrument, starting his own company, Palmetto Technologies.

Additional information about the device, called Echo 2000, which sells for \$250, can be obtained from Palmetto Technologies, Inc., P.O. Box 498, Duncan, SC 29334.

## Fastest PAL devices by National Semiconductor

A new family of PAL (Programmable Array Logic) devices, with a 15-nanosecond access time, has been put into production by National Semiconductor of Santa Clara, CA. The devices are claimed to be the world's fastest.

The 15-nanosecond performance, says the company, is achieved by advances in circuit design and use of National Semiconductor's proprietary OXISS fully implanted, oxide-insulated bipolar process, with high reliability titanium-tungsten fuse links.

## 1,000 times more storage on new compact-disc ROM

A breakthrough by Nippon Columbia of Kawasaki, Japan (credited with having developed digital audio (PCM) recording in 1972) makes it possible to store 550 megabytes on one side of a compact disc. This is the equivalent memory potential of 500 to 1,000 ordinary 5¼-inch floppy discs. All the application software a comput-

er could ever use (including the necessary documentation) could easily fit on one Compact Disc Read-Only Memory (CD-ROM). The new disc has the same dimensions (4¾ inch or 120 mm) and uses the same type of pickup mechanism as an audio CD.

The new CD-ROM computer drive is produced in the United States by Denon America Inc., subsidiary of Nippon Columbia. The Denon interface circuitry permits connection to practically any personal computer. The enormous storage capacity (the equivalent of more than 275,000 pages of text) provides exceptional opportunities to include high-resolution graphics to accompany and clarify the text.

Likely applications for the new CD-ROM disc are storage of reference works, directories, volumes of professional journals and catalogs.

## Silicon semiconductors on the way out?

"The end may be in sight for silicon, the material that made the computer boom possible and gave its name to California's Silicon Valley," says Frost & Sullivan, a market research firm of New York and London. "Use of gallium arsenide (GaAs) in semiconductors, a faster, harder substance, will multiply tenfold by 1992, to nearly \$3.2 billion."

"In lower field intensities," says the report, "the greater electron mobility of GaAs could translate into processing speeds ranging from three to ten times as fast as silicon at similar power."

GaAs is also operable at much higher temperatures than silicon. Its radiation resistance is also superior—an important feature in space applications and in other harsh environments. **R-E**



**PHONE READER FOR THE DEAF.** The compact, battery-powered device attaches to any phone.



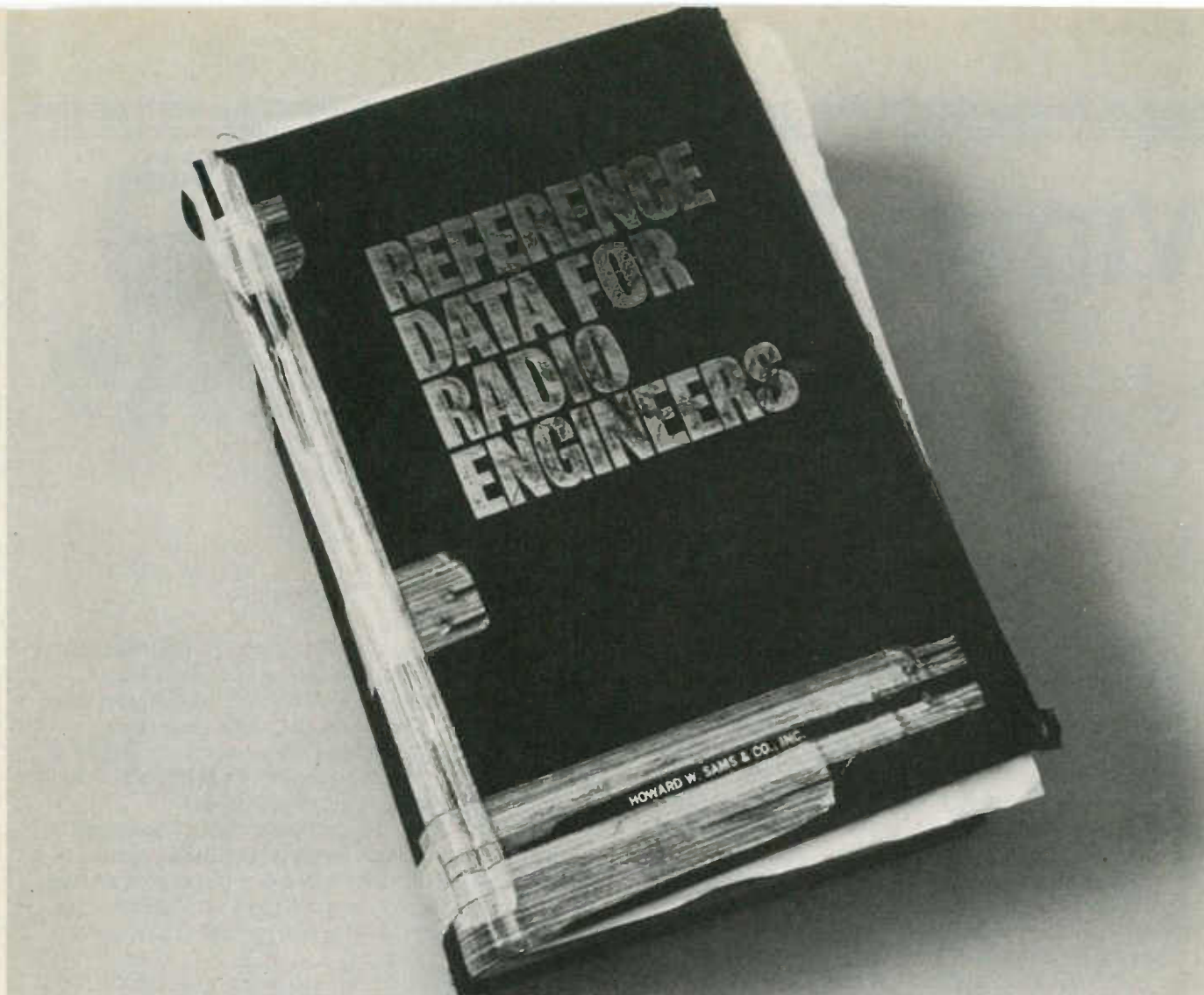

# Reference preference

**T**he more you use Sams reference books, the more you'll like them. They're accurate, easy-to-read and cover more information than any other references. And because they're written by well-known professionals working in the field, you know you're using data that's reliable and up-to-date.

You're going to like Sams reference books even more. Because now there's more of them. Books you'll rely on again and again for the latest in communications, digital and audio electronics, with more to come.

No wonder more people buy Sams reference books than any other brand. Make Sams your reference preference. Visit

your local Sams dealer. Or call our toll-free number and ask for Operator 130.

Image Tubes, No. 22023, \$44.95

Electronics: Circuits and Systems, No. 21984, \$39.95

Data Communications, Networks, and Systems, No. 22235, \$39.95

Reference Data for Radio Engineers (7th Edition), No. 21563, \$49.95

Semiconductor Device Technology, No. 22074, \$34.95

Practical Microwaves, No. 21945, \$39.95

Handbook for Sound Engineers, No. 21983, \$44.95

Gallium Arsenide Technology, No. 22375, \$44.95

Principles of Solid State Power Conversion, No. 22018, \$44.95



**800-428-SAMS**

In Indiana, call 317-298-5566

**SAMS**™

Howard W. Sams & Co., Inc.

4300 West 62nd St., Indianapolis, IN 46268

CIRCLE 273 ON FREE INFORMATION CARD

# VIDEO NEWS



**DAVID LACHENBRUCH**  
CONTRIBUTING EDITOR

● **Flat color displays.** Two new flat color panels have been demonstrated in Japan. Matsushita, the parent of Panasonic and Quasar, showed 10- and 15-inch displays that were less than three inches deep. The display, encased in a rectangular glass panel, is a vacuum-tube device. Its surface, completely flat, is screened into 3,000 rectangular "picture cells," each containing phosphor stripes. There are 3,000 separate phosphor beams, each scanning an individual picture cell. The beams are formed by 15 horizontal filament cathodes, intersected at right angles by 200 electron-beam deflection electrodes. Horizontal and vertical deflection electrodes perform deflection functions. There is no shadow mask, and the red, green, and blue electron beams operate sequentially. The positioning and size of the beams are determined by a microprocessor.

picture tube developed by Sanyo. In appearance, it is very similar to the 2- and 4-inch black-and-white picture tubes used by Sony in the portable Watchman TV sets, with the neck in an axis parallel to the face of the tube—a sort of lollipop configuration. The tube makes possible a portable color set less than two inches thick.

The Sanyo tube uses a variation of the beam-indexing principle developed by Philco in the 1950's. Applied to its screen are phosphor stripes of the three primary colors plus an index stripe. A special IC provides signal processing required for the beam indexing.

Sanyo plans to introduce a color set this fall in Japan using the new tube. The set's dimensions will be 5.1 inches wide by 8.3 inches high and 1.7 inches deep. It will operate for about 1½ hours on eight alkaline AA batteries. Price in Japan is expected to be about \$385.



Matsushita said the panel has virtually no size limitations, and that it is currently working on methods to mass-produce the precision display. There was no information on either the cost or production timetable.

Apparently much closer to production—it's scheduled for this fall—is a 3-inch flat color

● **HDTV on UHF band?** High-definition TV may be coming down to earth. Many of the proposals for the new super service (more than 1,000 lines, widescreen aspect ratio) have centered on inaugurating it via direct satellite transmission, or possibly over special cable channels. An industrywide working group, Advanced Television Systems Committee (ATSC), has been looking into the entire subject. Now, for the first time, there are strong hints that HDTV could actually start on the standard broadcast frequencies—in the UHF band—as a compatible service. Here's how it would work: A UHF channel would transmit a standard 525-line picture, receivable by any conventional TV set. An adjacent channel would simultaneously transmit the additional information needed to provide a 1,050-line widescreen picture to special advanced HDTV receivers. (UHF would have to be used: There's no room in the VHF band for such adjacent-channel broadcasts.) Thus, HDTV could come in as color did—on a completely compatible basis.

# ADVANCE ELECTRONICS

IS PROUD TO INTRODUCE

## **Beckman Industrial™** 9000 SERIES

### HIGH PERFORMANCE PROFESSIONAL

# OSCILLOSCOPES

**9060 60 MHz** • Dual Trace with Delayed Sweep • 1mV Vertical Sensitivity • 8 Traces • 12KV Acceleration Voltage • XY Mode • Channel 1 Output • 3 Vertical Inputs • Service Manual included

**9100 100MHz** • Dual Trace With Delayed Sweep • 1mV Vertical Sensitivity • 8 Traces •  $\leq 3.5\text{nS}$  Rise Time • 18KV Acceleration Voltage • XY Mode • Channel 1 Output • 3 Vertical Inputs

ENGINEERED SO THAT SPECIFICATIONS ARE MET IN THE FIELD NOT JUST ON THE DRAWING BOARD



**SPECIAL 3 YEAR EXTENDED WARRANTY\***



### Circuitmate™ model UC10 universal counter.

- 5Hz to 100MHz.
- Two Input Channels.
- Measures Frequency, Period, Frequency Ratio, Time Interval, and Unit Count.
- 20mV Input Sensitivity to 100 MHz.
- 4 Selectable Gate Times.
- 14 LED Indicators.
- 8-Digit LED Display.

### Circuitmate™ model FG2 function generator.

- 7 Ranges: 0.2 Hz to 2 MHz.
- Outputs: Square, Triangle, Sine, Waves and TTL Pulses.
- Duty Cycle Control.
- VCF Input.
- Variable/Fixed Attenuators.
- Variable DC Offset Control.
- Inversion Feature.

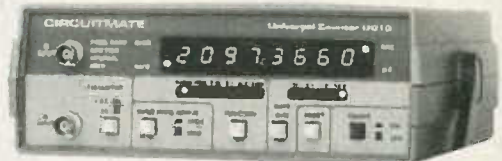

\*These new Oscilloscopes are so reliable that we are offering a SPECIAL 3 YEAR WARRANTY when you purchase these scopes from ADVANCE ELECTRONICS

**AVAILABLE NOW**  
**CALL FOR PRICES**



TOLL FREE HOT LINE  
**800-223-0474**

212-730-7030  
26 WEST 46th STREET, NEW YORK, N.Y. 10036

THE TEST EQUIPMENT SPECIALISTS

**ADVANCE**  
**ELECTRONICS**



- 77**
- 0.3% Accuracy
  - Manual or Autorange
  - 10A + mA Range
  - Beeper
  - "Touch-Hold" Function

Sale (with holster)  
**\$11995**

**WE CARRY A FULL LINE OF FLUKE MULTI-METERS. IN STOCK NOW**

Sale ends June 85

# FLUKE 70 SERIES MULTIMETERS

- Analog Display • Rotary Knob • Volts AC & DC • Resistance to • 32 MΩ • 10 Amps • Diode Test • 3200 Counts • Fast Autoranging • Function Annunciators in Display • Power-Up Self Test • 2000+ Hour Battery Life w/ Power Down "Sleep Mode" • New Test Leads • VDE & UL Approval



**\$9900**

**75**

- 0.5% Accuracy
- Manual or Autorange
- 10A + 300 mA

**\$7995**

and free C70 holster **73**

- 0.7% Accuracy
- Autorange Only
- 10 Amp Only



## MODULAR PROBES FOR SALE

For All Oscilloscopes  
 To 300MHz  
 X1 to X100  
 Attenuation



*Pictured Accessories Included*

### INSTANT REPAIR

Probe tip, Head, BNC and Cable all screw into place easily and quickly.

**TEST PROBES, INC. TPI**

Your Probe Specialists

### COMPARE PRICE — COMPARE PERFORMANCE

Model	Attenuation	Bandwidth	Price
M12SW	X1-X10 Switchable	X1-10MHz X10-250MHz	\$69.00
M12X10	X10	250MHz	59.00
M12X10AP	X10 with Readout	250MHz	65.00
M15X100	X100	250MHz	89.00
M15X10HF	X10	300MHz	75.00
SP100	X1-X10 Switchable	100MHz	39.95

CIRCLE 296 ON FREE INFORMATION CARD

**BK PRECISION**

**INDUSTRIAL TRANSISTOR TESTER**

**\$19995**



**MODEL 520B**

- Now with HI/LO Drive
- Works in-circuit when others won't
- Identifies all three transistor leads
- Random lead connection
- Audibly and visually indicates GOOD transistor



**\$32995 MODEL 1650**

- Functions as three separate supplies
- Exclusive tracking circuit
- Fixed output 5VDC, 5A
- Two 0 to 25VDC outputs at 0.5A
- Fully automatic, current-limited overload protection

**BK PRECISION DYNASCAN CORPORATION BREAKS THE PRICE BARRIER  
WITH THESE HIGH PERFORMANCE  
OSCILLOSCOPES**

**100 MHz Dual Trace/  
Dual Time Base**

- 1 mV/div sensitivity
- 23 calibrated sweeps
- Rectangular CRT with internal graticule and scale illumination
- Signal Delay Line

**\$995**

Does not include probes  
(\$60.00 a pair when purchased with scope)

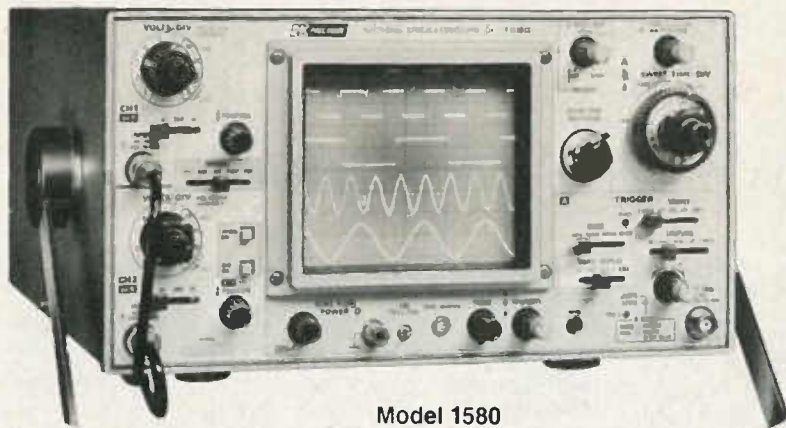

Model 1580

**QUANTITIES ARE LIMITED**

**BECKMAN'S CIRCUITMATE<sup>®</sup>  
ALL UNDER \$100**

AVAILABLE NOW....



**\$64.95**

Circuitmate DM 20—  
3½-digit, pocket-size  
multimeter; 0.8% Vdc  
accuracy, diode test,  
hFE test, conductance,  
10 amps AC and DC  
ranges, auto-polarity,  
auto-zero, auto-  
decimal



**\$79.95**

Circuitmate DM-25—  
3½ digit, pocket-size  
multimeter; 0.5% Vac  
accuracy, diode test,  
capacitance, continuity  
beeper, conductance,  
10 amps AC and DC  
ranges, auto-polarity,  
auto-zero, auto-  
decimal



**\$69.95**

Circuitmate DM-40 —  
3½-digit multimeter;  
0.8% Vdc accuracy,  
diode test, auto-  
polarity, auto-zero,  
auto-decimal

**\$89.95**

Circuitmate DM 45 —  
3½-digit multimeter;  
0.5% Vdc accuracy,  
diode test, continuity  
beeper, 10 amps AC  
and DC ranges, auto-  
zero, auto-polarity,  
auto-decimal



The DM73 is the smallest digital  
multimeter on the market. Its  
probe-style design makes it ideal  
for taking measurements in hard-  
to-reach test areas.

**SALE  
\$59.95**

- Small Size
- Complete Autoranging
- "Touch Hold"
- Audible continuity checking

**\$76.95**

The DM 77 gives you  
the convenience of  
autoranging plus 10  
amps ac/dc  
measurement  
capability. You simply  
select the function  
you want, and the  
DM 77 automatically  
sets the required  
range.



**TOLL FREE HOT LINE  
800-223-0474**

212-730-7030

26 WEST 46th STREET, NEW YORK, N.Y. 10036

**THE TEST EQUIPMENT SPECIALISTS**

**ADVANCE  
ELECTRONICS**

# SATELLITE TV



BOB COOPER, JR.

## The evolution of TVRO antennas

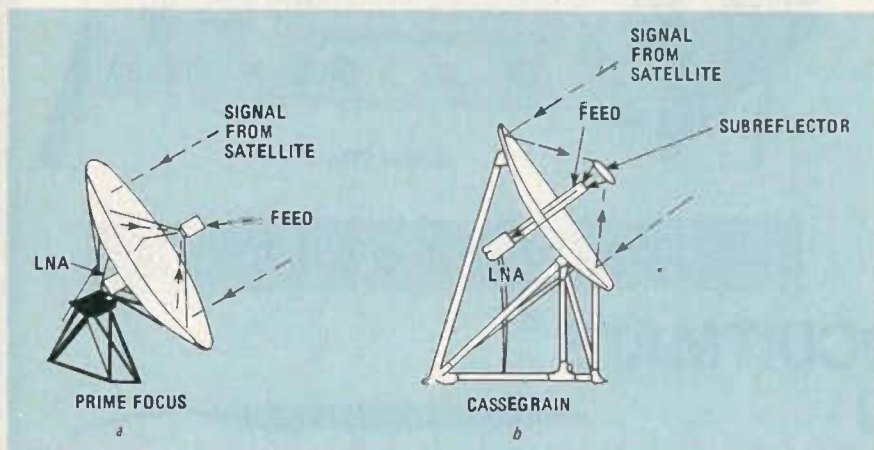

FIG. 1

THE TVRO INDUSTRY PROJECTS THAT the one-millionth home (C-band) TVRO will be installed during the last week in May of this spring. As TVRO moves across the million-terminal mark, roughly 25% of underserved or unserved areas now have high-quality television. That means that there is still a significant market remaining for TVRO's in rural areas. Even so, the move is now on to march into the suburbs with TVRO systems.

Over three decades ago, cable TV went through the same process. And just as cable ran into opposition from the broadcasters as it tackled urban markets, satellite TV has run into opposition from the cable folks. Each new technology is a threat to someone, and must prove itself in the marketplace, in the courts, and before the legislatures.

Satellite TV faces serious problems in urban markets, two of which are rooted in technology. First, there's the antenna—it's big

and not too pretty. Hundreds of communities have already enacted special zoning ordinances placing limitations on the maximum antenna size. Others have limited the placement of such antennas to the rear yard, or have banned them altogether.

Another problem is Terrestrial Interference (TI). The 3.7 to 4.2 GHz satellite band is shared on earth with point-to-point microwave systems operated primarily by telephone companies. If those terrestrial transmitters are near to

the proposed TVRO location, they can (and will) cause interference.

In severe cases, terrestrial interference can eliminate all satellite-TV reception for a home or entire neighborhood. In milder cases, one or a handful of transponders (channels) on a single satellite may be wiped out by the interference.

Although the two problems we just mentioned are quite different, they have a common denominator—the antenna system. But with the latest in high-tech antenna engineering, it's possible to make the antenna far less obtrusive and/or less susceptible to TI.

### Feed systems

Virtually every home TVRO antenna sold to date uses the *prime-focus* feed system. That system, as Fig. 1-a shows, places the antenna's feed—30 to 60% of the dish diameter—in front of the dish at the focal point. That means that a 10-foot dish has the feed positioned from 3–6 feet forward of the dish surface to collect reflected microwave energy.

In the *cassegrain* feed system, the dish is made deep; and, as Fig. 1-b shows, the feed is mounted in the center of the dish pointing not at the reflector, but at the satellite itself. Microwave energy is bounced off the main reflector, which focuses the energy to a smaller, *sub-reflector*. From the sub-reflector, the signal is directed to the feed itself.

Each technique has its advantages and disadvantages. The prime-focus feed is cheaper to build, and easier to install. And it has only one moving part—the

### Want to know more about satellite TV?

BOB COOPER'S *CSD* publication has created a TVRO dealer Starter Kit for electronic sales and service centers interested in becoming better acquainted with the 1985 world of TVRO. There is no charge for this informative packet, which reports on the status of the industry and gives tips on becoming a TVRO dealer. For your free copy, write (on your company letterhead or enclose a business card) to: *Starter Kit, CSD Magazine*, P.O. BOX 100858, Ft. Lauderdale, FL 33310.

\* Publisher, *CSD/Coop's Satellite Digest*

# B&K OSCILLOSCOPES

LOWEST PRICES  
OFF-THE-SHELF  
DIRECTLY TO YOU

CALL TOLL FREE  
FOR FAST DELIVERY

## 800-645-9518

In New York State 800-832-1446

### B&K 100 MHz DUAL TRACE, DUAL TIME BASE OSCILLOSCOPE



Model 1580  
**\$1249<sup>95</sup>**  
(Reg. \$1,595.00)

**FEATURES** • 1 mV/div sensitivity • 23 calibrated sweeps • Rectangular CRT with internal graticule and scale illumination • Signal Delay Line • Video Sync Separators • 20 MHz Limiter • X-Y Operation • Z axis input • 16 kV Accelerating Voltage • X10 Sweep Mag-

nification • Delayed Sweep/Dual Time Base • Single Sweep • V Mode - display two signals unrelated in frequency • Sum and Difference Capability • Channel 1 Output • Includes Probes

### B&K 40 MHz DUAL TRACE OSCILLOSCOPE



Model 1540  
**\$799<sup>95</sup>**  
(Reg. \$950.00)

**FEATURES** • 1 mV/div sensitivity • 21 calibrated sweeps • Rectangular CRT with internal graticule and scale illumination • Signal delay line • Video sync separators • X-Y operation • Z axis input • 12 kV accelerating voltage • X10 sweep

magnification • Delayed sweep/dual time base • Single sweep • Auto focus • V mode-displays two signals unrelated in frequency • Sum & difference capability • Channel 1 output • Includes probes

### B&K 80 MHz QUAD INPUT DUAL TIME BASE OSCILLOSCOPE



Model 1570  
**\$1095<sup>00</sup>**  
(Reg. \$1395.00)

**FEATURES** • 1 mV/div sensitivity to full bandwidth • 500 uV/div cascade sensitivity to 40 MHz • 22 calibrated sweeps • Rectangular CRT with internal graticule and scale illumination • 12 kV accelerating voltage • Mode - display four signals unrelated in frequency •

• Alternate timebase operation • Signal delay line • 20 MHz bandwidth limiter • Lighted pushbutton function switching • Video sync separators • Includes probes

### B&K 20 MHz DUAL TRACE TRIGGERED SWEEP OSCILLOSCOPE



Model 1522  
**\$569<sup>95</sup>**  
(Reg. \$695.00)

**FEATURES** • 1 mV/div sensitivity • 20 calibrated sweeps • Rectangular CRT with internal graticule and scale illumination • Video sync separators • X-Y operation • Z axis input • 6kV accelerating voltage • X10 sweep magnification • Auto sweep • V mode-displays two signals unrelated in frequency • Sum & differ-

ence capability • Channel 1 output • Includes probes

### B&K 60 MHz TRIPLE TRACE OSCILLOSCOPE



Model 1560  
**\$899<sup>95</sup>**  
(Reg. \$1150.00)

**FEATURES** • 1 mV/div sensitivity • 22 calibrated sweeps • Rectangular CRT with internal graticule and scale illumination • Signal delay line • Video sync separators • X-Y operation • Z axis input • 16 kV accelerating voltage • X10 sweep

magnification • Delayed sweep dual time base • Single sweep • Auto focus • V mode-displays two signals unrelated in frequency • Sum & difference capability • Channel 1 output • Includes probes

MASTERCARD/VISA  
ACCEPTED

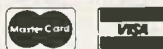

PHONE ORDERS  
ACCEPTED

Service and Shipping  
Charge Schedule

FOR ORDERS	ADD
\$501-750 .....	\$8.50
\$751-1,000 .....	\$12.50
\$1,001 and up .....	\$15.00

# Fordham

260 Motor Parkway, Hauppauge, New York 11788

feed—to optimize. The cassegrain feed, on the other hand, requires considerably greater precision since the signals are caught, reflected, and focused twice. Interplay between the two reflectors and the feed can be a nightmare.

The cassegrain feed is capable of narrower beamwidths—a definite plus when it comes to cutting down on terrestrial interference. Also, it is capable of slightly more gain than a prime-focus type of the same size.

There are those who argue that while the cassegrain feed system is effective, it does not do well on smaller dishes because the sub-reflector acts as a shield, blocking part of the main reflector surface. But, extensive field testing shows that if properly engineered, cassegrain antennas may be a partial salvation for TVRO dealers because they operate in urban areas where TI is especially difficult.

Southern Star Satellite Antennas (269 19th St. North, St. Petersburg,

FL 33705—813-821-6681) is one supplier that has tackled the problem head-on. SSSA produces a single, one-piece (7-foot, 8-inches in diameter) fiberglass antenna (see Fig. 2). The dish is extremely lightweight (under 100 pounds) and very strong. It also uses the cassegrain-type reflector and feed system for better control of unwanted signals and noise.

Finally, the system offers an optional *microwave fence* (dealer installable) to provide further shielding to the feed system to further reduce TI. A study of several hundred TI cases showed that about 20% them were resolved by simply replacing a prime-focus feed antenna with the SSSA-7.8.

The SSSA-7.8 has an extremely high efficiency (or gain) rating (76% measured on an antenna test range). That's close to a less-well-made 9.5- or 10-foot dish. By using a higher-grade LNA, like one of the newer 55° units, the dealer may be able to make up for signal losses and clear up TI when down-sizing from, say, an 11 or 12 foot antenna to the SSSA-7.8.

### Looks vs. neighbors

Even if TI can be resolved or held in check, how do you deal with neighbors who vow that you will *not* place a monster antenna in your yard, creating what they see as an eyesore? No matter what color you paint or finish a solid antenna, it still looks like the solid surface it is.

See-through mesh antennas (which have been used for several years now) can be black or dark green and still blend with the environment. Are mesh antennas possible "tools" for the dealer who is fighting protests against "visual pollution?" They could be—but they, too, have disadvantages.

Mesh antennas, like that shown in Fig. 3, have the reputation for being: 1. Difficult to assemble properly; 2. sub-standard for long-term performance (i.e. they fall apart); 3. large and bulky to install, requiring extra help, and 4. below standard in performance. Given those deficiencies, mesh antennas still outsell all other types.

There is one aspect to the mesh  
*continued on page 81*

## SATELLITE TV/

### The First Five Years!



**THE MOST COMPLETE** report on the mushrooming home 'TVRO' industry ever compiled, written as only the 'father of TVRO' could have prepared. More than 1000 pages (!) tracing the complete story of home TVRO, lavishly illustrated with equipment photos, schematic diagrams, equipment analysis reports. **Bob Cooper**, the first private individual to own and operate a TVRO (1976) has collected and polished hundreds of individual reports into a unique 'collector's edition' which clearly explains the TVRO phenomenon in North America. From Coop's first 20 foot 'monster' dish to the present day 5 foot 'C-band' TVROs, the fascinating growth of TVRO equipment and its legal status unfolds for you.

**THIS TWO VOLUME SET** totaling more than 1,000 pages is available for the first time to readers of *Radio-Electronics* at special discount pricing. **Originally** sold at \$100 per two-volume set, a limited supply is now available **ONLY** through this advertisement. **PLUS**, you will also receive a special extraordinary bonus; the 200 page (+) **October 1984** edition of *CSD/Coop's Satellite Digest*. This very special edition of *CSD* is a best-seller in the TVRO industry, with the most comprehensive collection of TVRO facts and figures ever compiled. Combined with the 1,000 page 'CSD ANTHOLOGY' report, you have instant reference to **everything** you will ever need to know about the state of the home TVRO industry. It is **MUST** reading for every person in, or thinking about 'getting into,' any segment of the home TVRO world.



\_\_\_ SEND CSD ANTHOLOGY/2 Vols. + CSD Bonus.  
\_\_\_ SEND CSD October '84 Special Issue ONLY.

NAME \_\_\_\_\_ COMPANY \_\_\_\_\_  
ADDRESS \_\_\_\_\_  
CITY \_\_\_\_\_ STATE \_\_\_\_\_ ZIP \_\_\_\_\_

Payment: \$60 US funds (Anthology + Bonus), \$15 US funds CSD Oct. ONLY; payable "CSD ANTHOLOGY."  
Shipping charges prepaid. Enter order to: **CSD Anthology**, Radio-Electronics Magazine, 200 Park Av. S., New York, NY 10003; or call 305-771-0505 for credit card orders ONLY.



# SS-5705, THE ALL-NEW 3-INPUT 6-TRACE 40 MHz OSCILLOSCOPE FROM IWATSU

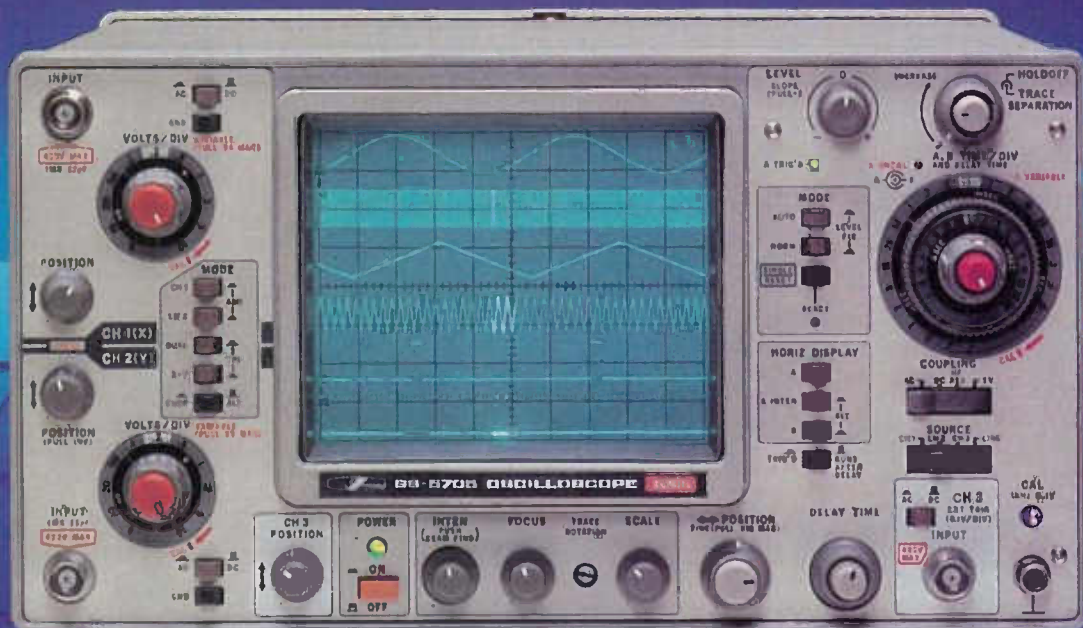

DC to 40 MHz

SS-5705 40 MHz \$899.00  
SS-5706 30 MHz \$749.00

- H and V axes accurate to within  $\pm 2\%$
- CRT with 12 kV accelerating voltage for bright traces
- Three input channels, six traces: an enlarged delayed sweep waveform can be displayed for each channel for a total of 6 simultaneous traces. Each channel has its own position control.
- Maximum delay jitter of 1/20,000
- Fastest sweep rate of 10 ns/div
- Jitterless circuitry for stable high frequency signals observation.
- High sensitivity: 1 mV/div
- CH 1 signal output: 50 mV/div (into 50  $\Omega$ )
- High-stability calibrator with frequency and voltage accurate to within  $\pm 1\%$ .
- Stable observation of video signals possible
- Traces do not shift when the attenuator is switched
- Pushbutton controls for easier operability and improved reliability.
- Accuracy guaranteed in temperatures ranging from 10 to 35°C (50 to 95°F).
- Variable holdoff for triggering when observing complicated waveforms.
- FIX triggering
- Beam finder

- Frequency response extends beyond 40 MHz rating
- Superb trigger sensitivity freezes even low level signals.

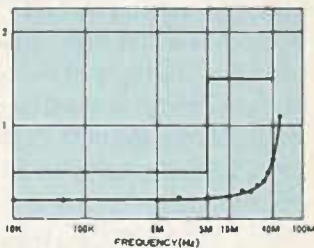
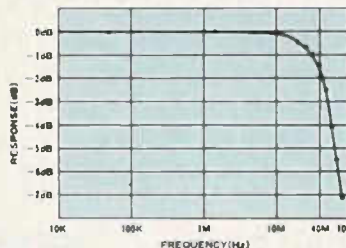

- Single sweep: essential if waveforms are to be photographed.
- Trace rotation control allows compensation for inclination of traces due to terrestrial magnetism.
- Two probes provided as standard accessories: both switchable between 10:1 and 1:1.
- Wide range of optional extras for more diverse applications.
- Compact and lightweight: 282W x 152H x 403D mm (11-1/8" x 6" x 15-7/8"), 7.2 kg (15.9 lbs).



**IWATSU INSTRUMENTS INC.**

430 Commerce Boulevard, Carlstadt, NJ 07072 Phone: (201) 935-5220 TLX: 7109890255

CIRCLE 64 ON FREE INFORMATION CARD



**With NRI training at home, you can . . .**

# Move up to a high paying

## And you can start by actually building your own 16-bit IBM-compatible computer!

You can create your own bright, high paying future as an NRI trained computer service technician. The government now reports that computer service and repair is the fastest growing career field. The biggest growth in jobs between now and 1995, according to Department of Labor estimates, will occur in the computer service and repair business, where demand for trained technicians will actually double during the next 10 years! There is still plenty of room for you to get in on the action—if you get the proper training now.

### Total computer systems training, only from NRI

If you really want to learn how to work on computers, you have to get *inside* one! And only NRI takes you inside a computer, as powerful and advanced as the Sanyo MBC-550-2. As part of your training, you'll build this Sanyo, which experts have hailed as the "most intriguing" of all the new IBM-compatibles. Computer critics say, "The Sanyo even surpasses the IBM PC in computing speed and graphics quality."

This hands-on experience is backed up with training in programming, circuit design and peripherals. Only NRI gives you such in-depth total systems training.

## The kind of understanding built only through experience

Even if you've never had any previous training in electronics, you can succeed with NRI training. You'll start with the basics, rapidly building on the fundamentals of electronics until you master such advanced concepts as digital logic, microprocessor design, and computer memory.

You'll build and test advanced electronic

circuits using the exclusive NRI Discovery Lab® and professional Digital Multimeter, both of which are yours to keep.

You'll assemble Sanyo's intelligent keyboard, install the power supply and disk drive, and interface the high resolution monitor—all the while performing hands-on experiments and demonstrations that

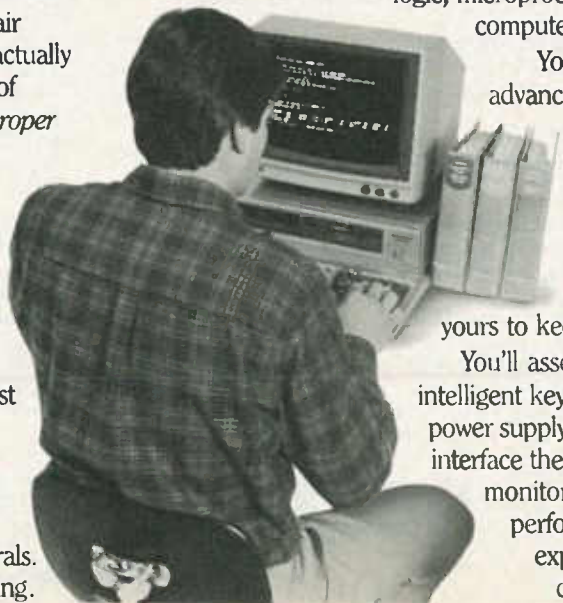



# career servicing computers.

fine tune your computer skills. And you also get over \$1,000 worth of software, including WordStar and CalcStar.

## Learn to service today's computers

As you train with your Sanyo, you'll gain the knowledge you need to become a computer professional. You'll learn to program in BASIC and machine language. You'll use utility programs to check out the operation of the Sanyo's 8088 microprocessor (the same chip used in the IBM PC). You'll learn how to debug programs and write your own new software.

Most importantly, you'll understand the principles common to all computers. Only a person who fully understands all the fundamentals can hope to be able to tackle all computers. NRI makes sure that you'll get the training you need to maintain, troubleshoot and service computers.

## Learn at home in spare time

With NRI training, you'll learn at home on your own time. That means your preparation for a new career or part-time job doesn't have to interfere with your current job. You'll learn at your own pace, in the comfort and convenience of your own home. No classroom pressures, no rigid night school schedules. You're always backed up by the NRI staff and especially your NRI instructor, who will

answer questions, give you guidance and be available for special help if you need it.

Let others worry about computers taking their jobs. With NRI training, you'll soon have computers making good paying jobs for you.

## Send for free NRI catalog

Send the post-paid reply card today for NRI's 100-page catalog, that gives all the facts about computer training plus career training in Robotics, Data Communications, TV/Video Servicing and many other fields. If some other ambitious person beat you to the card, write to NRI at the address below.



# NRI SCHOOLS

McGraw-Hill Continuing Education Center  
3939 Wisconsin Avenue, NW  
Washington, DC 20016

We'll Give You Tomorrow. 

IBM is a Registered Trademark of International Business Machines Corporation.

# LETTERS

## ANTIQUÉ RADIO CONFERENCE

The first International Antique Radio Conference of the Antique Radio Club of America, to be hosted by the Niagara Frontier Wireless Association, will be held this June 6 through June 9 at the Holiday Inn, Whitehaven Road, Grand Island, NY. Among the events will be talks, a flea market and swap meet, an antique radio and equipment auction, antique radio displays, tours of local attractions, and a banquet. If any of your readers would like more information, it can be obtained from: The Niagara

Frontier Wireless Association, PO Box 68, Central Park Station, Buffalo, NY 14215.

*Felicia Kreuzer, Secretary  
Niagara Frontier Wireless Association*

## UNINTERRUPTABLE POWER SUPPLY

Some errors have crept into the schematic for the uninterruptible power supply published in your March 1985 issue. First, 12 volts must be applied to pin 4 of IC1. (A jumper from pin 8 will do fine.) Also, two connection dots were omitted: one at the junction of R1,

R7, and the drain of Q3, and the other at the junction of R4, R8, and the drain of Q4.

DAVID J. SWEENEY  
*Somers Point, NJ*

## OOOPS!

A few errors appeared in Steve Pence's article on building a video sync separator (R-E, April 1985). In the Parts List, C2 was listed as a ceramic disc capacitor. It should be a 10%, polyester-film type. Also, R18 was not listed. As shown in the schematic, it has a value of 68K. In the parts-placement diagram, Q3 was shown upside-

WRITE TO:

LETTERS

Radio-Electronics  
200 Park Ave South  
New York, NY 10003

# Your customer just paid good money for a service call. Don't let him blow it!

All your hard work and your customer's hard-earned money are wasted when a voltage surge hits. All it takes is a nearby lightning strike or the switching of a load within a building. RCA's Voltage Surge Suppressor can prevent this damage to sensitive electronic equipment, and assure you of extra profit on every service job you do.

Available in a 3-way version, SK403, and a single-socket version, SK401, the suppressor plugs into any 15-amp, 125-volt grounding receptacle or cord connector. If constantly overloaded, the suppressor will cut off power to equipment connected to it, guarding against unprotected operation and signalling the



need for a replacement suppressor. Once they realize how much damage it can prevent, your customers will want to buy RCA's Voltage Surge Suppressor to protect their TVs, computers, sound systems, microwave ovens and other electronic equipment. Every SK403 and SK401 has been tested before leaving the factory. So why blow a perfect opportunity to protect a satisfied customer? Stock up on RCA's profitable Voltage Surge Suppressors today.

Call your RCA SK Distributor or write: RCA Distributor and Special Products Division, 2000 Clements Bridge Road, Deptford, NJ 08096, Attn: Sales Promotion Services.

**RCA**  
SK Replacement  
Solid State

### ECG® LED Lamps

Philips ECG has LED lamps in shapes and sizes for virtually any application. They're available in round, rectangular, triangular and square shapes. They come in red, yellow, green, or even in two colors. And there's a choice of clear and diffused reds. Some have jewelled lenses. And some are even available as flashing LEDs with the flasher circuit built in.

In addition, long-life, shock-resistant, vibration-resistant, LED replacements for incandescent cartridge indicator lamps are also available in red, yellow or green. Common applications: All LED indicator applications. LED cartridges are ideal replacements for cartridge-type incandescent lamps. CIRCLE 297 ON FREE INFORMATION CARD

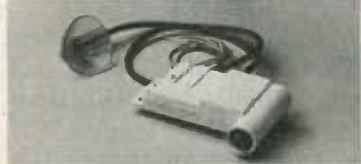

### ECG® High-Voltage Rectifier and Voltage Divider Network

Philips ECG's ECG568 is a high-voltage rectifier used in Sanyo and Sears TV sets to supply high voltage to the picture tube. It also contains a voltage divider network which supplies focus voltage to the picture tube.

Common applications: For use in television service and repair. CIRCLE 298 ON FREE INFORMATION CARD



### EMF® Transient Voltage and RF Interference Suppressors

EMF transient voltage surge suppressors by Philips ECG clamp voltage spikes on 120 VAC line to levels safe for all electronic equipment. They can handle up to 40% greater surge current than other suppressors. Single outlet suppressors are available in both two- and three-prong versions.

The multiple outlet EMF315 incorporates both a spike suppressor and a PI filter to suppress RF interference on the AC line. RF interference causes audio and video degradation and causes digital equipment to function imperfectly.

Common applications: Electronic equipment such as hi-fi and television, stereo, computers or other line-operated electronic equipment subject to voltage surges and radio frequency interference from the AC line. CIRCLE 299 ON FREE INFORMATION CARD

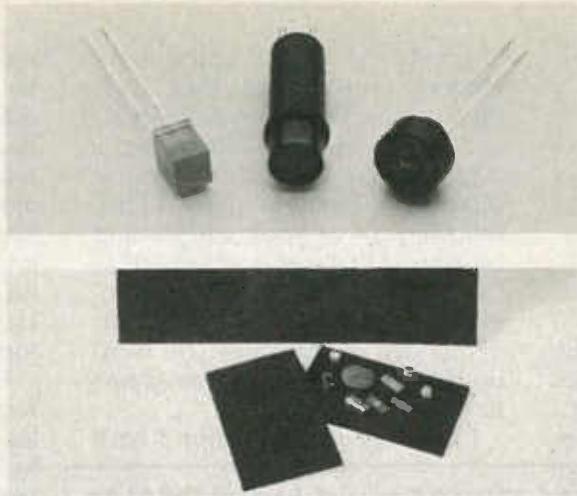

### ECG® A-STAT Material

Philips ECG has two sizes of anti-static foam that will prevent damage to semiconductors from static electricity. The A-STAT 12 measures 12" x 12" and is perfect for bench use. The A-STAT 2 measures 3" x 5" and can be carried in the tool box. When semiconductors are kept in A-STAT foam, static electricity is shunted through the foam instead of into the semiconductor, where it could have caused damage.

Common applications: Essential for semiconductor protection on the workbench or in the field.

CIRCLE 264 ON FREE INFORMATION CARD

# The one thing we make that you have to replace every year.



### The new and expanded ECG® Semiconductors Master Guide.

Your new Master Guide will be looking as dog-eared as the old one before long. Because this year the Master Guide has been expanded to include more than 400 new products and almost 25,000 new cross references. The Master Replacement Guide for 1985. 656 pages. Over 3,500 different ECG devices that provide replacement coverage for more than 227,000 industry types. And everything in the book is cross-referenced so you can find what you're looking for fast, and be sure it fits. Plus, everything we make meets or exceeds the original JEDEC or application specs. So it

works. It's the only book you'll need. But you'll need a new one every year.

To get a copy of the new Master Guide, go to your nearest Philips ECG distributor. For his name and location, just call: 1-800-225-8326 (in Mass., 617-890-6107).

**If it's ECG, it fits. And it works.**

## Philips ECG

A North American Philips Company

*Dedicated to Excellence.*

CIRCLE 68 ON FREE INFORMATION CARD

down. We're sorry for any inconvenience those errors caused.—  
Editor

### LEARNING FROM TIMEX/ SINCLAIR

I just wanted to add my two cents worth to your Timex/Sinclair discussion.

One topic that no one has really addressed is the educational value versus the monetary investment. Five years ago I purchased a Radio

Shack *Model 1* and enjoyed it immensely until the kids took over; then it sat until it was sold for non-use. One year ago I purchased a *ZX81* kit for the experience of building it. Since that time I have followed all of your articles and built most that were published for the *ZX81* and *Timex 1000*. The hardest part about owning the Sinclair is the lack of software; you wind up having to write most programs to fit your system.

I consider the education I have

received from the Sinclair worth far more than I have put into the machine in cash. I have equipped my computer with 64K, standard-type keyboard, direct-connect modem, and a video output for about \$350.00. And, best of all, I know how it all works. I have direct access to all outside sources, including CompuServe and Dow Jones.

That's my side of it—I hope to hear from other readers who have learned from their Sinclair.

MICHAEL KNUTSON  
Henderson, NV

### NEW CARTOONS, PLEASE!

I have been a reader of your magazine for about five years and must say I have no complaints about its contents. It is the best, if not only true electronics magazine on the market. As trivial as it may seem I have, however, noticed that the cartoons in the December 1984 and January 1985 issues were repeats from previous issues. I understand how hard it must be finding original cartoons for an electronics magazine, but have you considered asking your readers? I'm sure there are many people who would be interested in creating electronics-related comic for publication in *Radio-Electronics*. What do you think? You could probably make it a contest of sorts.

WILLIAM F. MORRIS  
Ramstein AB, Germany

### TWO REQUESTS

I would like to suggest the following for future consideration: Let's see more use of LCD's in your projects. (LED's are nearly useless outdoors.)

Secondly, I would like to see a schematic and block diagram of a typical computer color monitor. I have a Commodore 1702 color monitor. Written requests to Commodore, for a schematic, have been ignored. Those self-proclaimed "friendly computer people" seem to be friendly only when they take your money.

Finally, you have my vote for continuing and expanding *ComputerDigest*.  
CHARLES MATLIN  
Bell Gardens, CA

R-E

## For Quality 3½ or 4½ Digit Hand-Held DMMS

Ask for  
**Simpson®**

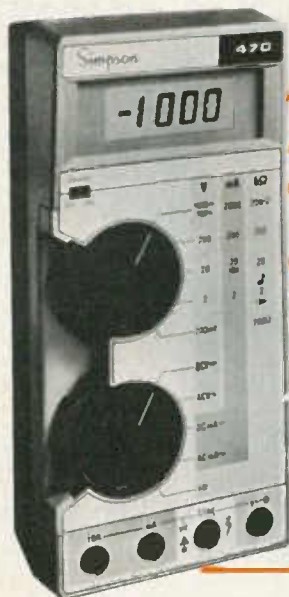

3½ Digit 470™  
.15% Basic DC Accuracy  
**\$139**

4½ Digit 474™  
.03% Basic DC Accuracy  
**\$219**

### FULL FUNCTION DMMS WITH THESE MOST WANTED FEATURES . . .

- ✓ Full Measurement Capability
- ✓ 6 kV Transient Protection
- ✓ Double Fusing System
- ✓ Audible Continuity Indication
- ✓ Diode Test Function
- ✓ User Engineered Range/Function Selector Knobs
- ✓ Large, Easy-to-Read LCD Display
- ✓ High Impact ABS Case
- ✓ 2-Way Tilt Stand
- ✓ Extended Battery Life
- ✓ UL Recognized Test Leads
- ✓ Full Line of Optional Accessories
- ✓ Full Simpson Warranty

### AT LEADING ELECTRICAL/ELECTRONICS DISTRIBUTORS



### SIMPSON ELECTRIC COMPANY

A Katy Industries, Inc. Subsidiary  
853 Dundee Avenue, Elgin, Illinois 60120-3090  
(312) 697-2260 • Telex 72-2416  
Cable SIMELCO

CIRCLE 272 ON FREE INFORMATION CARD

# NEW PRODUCTS

**PERSONAL SECURITY SYSTEM, Body Guard**, designed for customer installation, summons help in medical, police, fire, or other life-threatening emergencies. It consists of a portable pocket transmitter and compact command center. It is programmed by the owner to reach as many as 16 emergency telephone numbers with four separate messages. By depressing a button on the pocket transmitter, a pre-recorded call for police, fire department, medical, or other form of assistance is immediately received by four different friends, relatives, or emergency services.



CIRCLE 11 ON FREE INFORMATION CARD

The *Body Guard* transmitter can be operated up to 300 feet from the command center, which is easily installed and programmed. It is priced at \$299.00.—**Bodyguard Industries**, 25 Lumber Road, Roslyn, NY 11576.

**BINARY SELECTABLE RESISTORS, the B710 Series**, are available in ten types, which allow the end-user the capability to formulate values from zero to 1 megohm. The de-



CIRCLE 12 ON FREE INFORMATION CARD

sired value of the BSR is obtained by a simple removal of external shorting links dictated by the corresponding 12-bit binary code.

Features for the *B710 Series* include the ability to create more than 40,000 resistance values from the ten BSR types; the flexibility of producing resistor values as required without dedicating the remaining available stock, and a totally usable inventory.

The *B710 Series*, is priced as low as \$3.59 each in quantities of 1,000 — **Solitron Devices, Inc.**, Precision Resistive/Hybrid Group, Cove Road, Port Salerno, FL 33492.

**MOVING-COIL CARTRIDGE, the model 23RS-MR**, features a solid, tapered ruby cantilever reduced in size to 2.3mm in length—one-third the size used in the average cartridge. That allows for reduced mass and increased trackability.



CIRCLE 13 ON FREE INFORMATION CARD

The new ruby also features the *Micro-Rach* stylus, with its special shape that prevents change in  
*continued on page 26*

SEE YOUR DEALER TODAY

FROM

**'Firestik'**  
ANTENNAS  
ACCESSORIES

HERE'S A TIP  
THAT'S PERFECT!

AM/FM AUTO RADIO  
AND CB

**'Firestik' II**  
GOLDEN SERIES

BARE-HANDS TUNABLE  
"NO TOOLS NEEDED"  
HIGH PERFORMANCE ANTENNAS

ALSO ANTENNAS FOR  
CORDLESS TELEPHONES  
MONITOR SCANNERS

Dealer & Distributor Inquiries Invited  
SEND FOR FREE CATALOG

'Firestik' Antenna Company  
2614 East Adams/Phoenix, AZ 85034

Name \_\_\_\_\_  
Street \_\_\_\_\_  
City \_\_\_\_\_  
State \_\_\_\_\_ Zip \_\_\_\_\_  
Serving the CB and  
Communications Market Since 1962.

**5-YEAR REPLACEMENT WARRANTY**

CIRCLE 100 ON FREE INFORMATION CARD

Learn micro-processing with the new  
**MICRO-PROFESSOR 1P**



Students, engineers or technicians—  
upgrade your micro-processing skills  
with the new **Micro-Professor 1P**.

The **MPF-1P** features:

- extensive software support
- more built-in memory
- improved keyboard
- larger display

Three tutorial guides help cover all capabilities. The ideal training tool! **MPF-1P** will deliver you into the growing world of micro-processing. Invest now!

**Plus-FREE GIFT** Only **\$179.95**

Check this box for **FREE**  
Z-80 Microprocessor  
Programming and  
Interfacing textbook when  
you order within 7 days.  
\$12.95 value. (Include  
\$5.00 postage &  
handling)

**ETRONIX**

Dept. RE0685  
14803 N.E. 40th  
Redmond, WA 98052

For immediate action call **TOLL FREE:**

**1-800-426-1044**

Full money back guarantee.



CIRCLE 111 ON FREE INFORMATION CARD

# WHAT'S FAIR DINKUM VALUE?

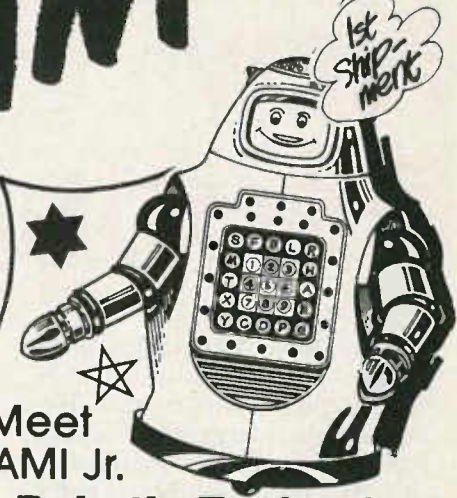

Meet ELAMI Jr.

**Latest Robotic Technology  
Amazing Low Price**

Elami Jr. can be happy, sleepy, angry or sad. He has a 190 word english vocabulary - you can program words and sentences. He'll move left, right, forward and backward in a series of programmed moves. 12" tall with blue eyes, an individual security code makes him just yours to command.  
Cat Y-2000

**ONLY \$149<sup>00</sup>**

For the technically minded 8 bit microcomputer, custom designed, built-in 2K ROM and 1/2K of RAM for storing and operating of programs, plus 16K of ROM and 1/2K of ROM, for speech processor.

**Now's the time to get into satellite TV!**

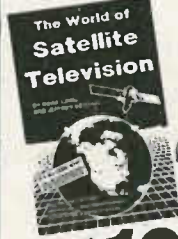

**\$10<sup>95</sup>**

### THE WORLD OF SATELLITE TV

Tells you all you need to know about selecting, installing and trouble shooting a system. Complete with maps, charts and satellite 'foot prints' so you'll know what's up there and how to find it. Mark Long and Jeffrey Keating. 224 pages. Cat B-1842

### HOME SATELLITE TELEVISION

Is home satellite TV worthwhile? What about equipment, cost and legal restrictions? This book will answer all your questions and be a valuable source system. Cook & Vaughan. 326 pages. Cat B-1840

**\$13<sup>50</sup>**

**FAIR DINKUM VALUE STARTS HERE**



When Australians say 'Fair Dinkum' about something, they mean; that's it, the genuine article, true blue, ridgy didge, absolutely true. It could refer to a story, or a person; like a 'fair dinkum mate' is a true friend or, as in our case, the value you get when you buy from Dick Smith Electronics. Fair dinkum value because:

- You will be served by dedicated electronics enthusiasts
- We buy directly from the manufacturer so save agents' and middle-man commissions.
- We have thousands of exciting new and unique products
- We keep our overhead costs down and pass it on in lower prices to you

**IT'S FAIR DINKUM VALUE!**



### MOTORCYCLE INTERCOM

**BIKERS** - No more shouting against the wind. This intercom fits snugly under your helmet and detaches instantly in case you are separated from your partner. Communicate in comfort while you ride. Cat F-1000

**ONLY \$39<sup>95</sup>**

**AMAZING LOW PRICE**

### DICK SMITH'S FUNWAY INTO ELECTRONICS GIFT PACK

**NO SOLDERING REQUIRED**

Contains the famous Introductory Funway into Electronics Vol. 1 which starts off from the very basics of electronics and shows you how to make 20 different projects, including: Transistor Tester, Beer Powered Radio, Light/Dark Indicator, Electronic Stren, Radio Receivers, Music Maker and many more. Book and all components included. Cat K-2605



**ONLY \$24<sup>95</sup>**

Like what you see? Our new catalog (out in June) will have 4000's more fascinating products.

Mail this coupon today along with \$2.00 for the catalog and \$4.00 for shipping and handling and be among the first to receive our massive, goody packed, 432 page **ELECTRONICS ENTHUSIASTS' CATALOG** and ask about the draw for a TRIP TO THE LAND DOWNUNDA FOR 2 PEOPLE FLYING QANTAS

Name.....

City..... State..... Zip.....

Mail to: Dick Smith Electronics, Inc.  
PO Box 2249 Redwood City CA 94063



A quality LCD Multimeter that measures capacitance as well as 3 1/2 digit display

ONLY \$99<sup>95</sup>



Very high accuracy full range digital multimeter. Complete with test leads, carry case and full instruction manual. Cat Q-1460

LOOK AT OUR PRICES FOR A PRO QUALITY SHOTGUN MIC

Use with your video or movie camera for high quality sound. Super directional response pattern allows you to pick out specific sound sources. Switch from super cardioid to unidirectional for long or short range. Cat C-1069

\$59<sup>95</sup>



WHY PAY MORE?

20 more fun projects to build in **FUNWAY 2**

VOLUME 2

Building the projects in Funway 2 will teach you how to solder onto PCB's and use a multimeter. All useful projects too. Cat B-2605

\$6<sup>95</sup>

Now your into IC's **FUNWAY 3**

VOLUME 3

When you've worked your way through Volumes 1 & 2 you're ready for the more complex projects described in full detail in this book. Then you could be ready for a job in electronics. Cat B-2610

ONLY \$6<sup>95</sup>

\$6<sup>95</sup>

ONLY \$6<sup>95</sup>

ONLY \$6<sup>95</sup>

ONLY \$6<sup>95</sup>

ONLY \$6<sup>95</sup>

ONLY \$6<sup>95</sup>

ONLY \$6<sup>95</sup>

ONLY \$6<sup>95</sup>

ONLY \$6<sup>95</sup>

ONLY \$6<sup>95</sup>

ONLY \$6<sup>95</sup>

ONLY \$6<sup>95</sup>

ONLY \$6<sup>95</sup>

ONLY \$6<sup>95</sup>

ONLY \$6<sup>95</sup>

ONLY \$6<sup>95</sup>

ONLY \$6<sup>95</sup>

ONLY \$6<sup>95</sup>

ONLY \$6<sup>95</sup>

ONLY \$6<sup>95</sup>

ONLY \$6<sup>95</sup>

ONLY \$6<sup>95</sup>

ONLY \$6<sup>95</sup>

ONLY \$6<sup>95</sup>

ONLY \$6<sup>95</sup>

ONLY \$6<sup>95</sup>

ONLY \$6<sup>95</sup>

ONLY \$6<sup>95</sup>

ONLY \$6<sup>95</sup>

ONLY \$6<sup>95</sup>

ONLY \$6<sup>95</sup>

ONLY \$6<sup>95</sup>

ONLY \$6<sup>95</sup>

ONLY \$6<sup>95</sup>

ONLY \$6<sup>95</sup>

ONLY \$6<sup>95</sup>

ONLY \$6<sup>95</sup>

ONLY \$6<sup>95</sup>

ONLY \$6<sup>95</sup>

ONLY \$6<sup>95</sup>

ONLY \$6<sup>95</sup>

ONLY \$6<sup>95</sup>

ONLY \$6<sup>95</sup>

ONLY \$6<sup>95</sup>

ONLY \$6<sup>95</sup>

ONLY \$6<sup>95</sup>

ONLY \$6<sup>95</sup>

ONLY \$6<sup>95</sup>

ONLY \$6<sup>95</sup>

ONLY \$6<sup>95</sup>

ONLY \$6<sup>95</sup>

ONLY \$6<sup>95</sup>

ONLY \$6<sup>95</sup>

ONLY \$6<sup>95</sup>

ONLY \$6<sup>95</sup>

ONLY \$6<sup>95</sup>

ONLY \$6<sup>95</sup>

ONLY \$6<sup>95</sup>

ONLY \$6<sup>95</sup>

ONLY \$6<sup>95</sup>

ONLY \$6<sup>95</sup>

ONLY \$6<sup>95</sup>

ONLY \$6<sup>95</sup>

ONLY \$6<sup>95</sup>

ONLY \$6<sup>95</sup>

ONLY \$6<sup>95</sup>

ONLY \$6<sup>95</sup>

ONLY \$6<sup>95</sup>

ONLY \$6<sup>95</sup>

ONLY \$6<sup>95</sup>

ONLY \$6<sup>95</sup>

ONLY \$6<sup>95</sup>

ONLY \$6<sup>95</sup>

ONLY \$6<sup>95</sup>

ONLY \$6<sup>95</sup>

ONLY \$6<sup>95</sup>

ONLY \$6<sup>95</sup>

ONLY \$6<sup>95</sup>

ONLY \$6<sup>95</sup>

ONLY \$6<sup>95</sup>

ONLY \$6<sup>95</sup>

ONLY \$6<sup>95</sup>

ONLY \$6<sup>95</sup>

ONLY \$6<sup>95</sup>

ONLY \$6<sup>95</sup>

ONLY \$6<sup>95</sup>

ONLY \$6<sup>95</sup>

ONLY \$6<sup>95</sup>

ONLY \$6<sup>95</sup>

ONLY \$6<sup>95</sup>

ONLY \$6<sup>95</sup>

ONLY \$6<sup>95</sup>

ONLY \$6<sup>95</sup>

ONLY \$6<sup>95</sup>

ONLY \$6<sup>95</sup>

ONLY \$6<sup>95</sup>

ONLY \$6<sup>95</sup>

ONLY \$6<sup>95</sup>

ONLY \$6<sup>95</sup>

ONLY \$6<sup>95</sup>

ONLY \$6<sup>95</sup>

ONLY \$6<sup>95</sup>

ONLY \$6<sup>95</sup>

ONLY \$6<sup>95</sup>

ONLY \$6<sup>95</sup>

ONLY \$6<sup>95</sup>

ONLY \$6<sup>95</sup>

ONLY \$6<sup>95</sup>

ONLY \$6<sup>95</sup>

ONLY \$6<sup>95</sup>

ONLY \$6<sup>95</sup>

ONLY \$6<sup>95</sup>

ONLY \$6<sup>95</sup>

ONLY \$6<sup>95</sup>

ONLY \$6<sup>95</sup>

ONLY \$6<sup>95</sup>

ONLY \$6<sup>95</sup>

ONLY \$6<sup>95</sup>

ONLY \$6<sup>95</sup>

ONLY \$6<sup>95</sup>

ONLY \$6<sup>95</sup>

ONLY \$6<sup>95</sup>

ONLY \$6<sup>95</sup>

ONLY \$6<sup>95</sup>

ONLY \$6<sup>95</sup>

ONLY \$6<sup>95</sup>

ONLY \$6<sup>95</sup>

ONLY \$6<sup>95</sup>

ONLY \$6<sup>95</sup>

ONLY \$6<sup>95</sup>

ONLY \$6<sup>95</sup>

ONLY \$6<sup>95</sup>

ONLY \$6<sup>95</sup>

ONLY \$6<sup>95</sup>

ONLY \$6<sup>95</sup>

ONLY \$6<sup>95</sup>

ONLY \$6<sup>95</sup>

ONLY \$6<sup>95</sup>

ONLY \$6<sup>95</sup>

ONLY \$6<sup>95</sup>

ONLY \$6<sup>95</sup>

ONLY \$6<sup>95</sup>

ONLY \$6<sup>95</sup>

ONLY \$6<sup>95</sup>

ONLY \$6<sup>95</sup>

ONLY \$6<sup>95</sup>

ONLY \$6<sup>95</sup>

ONLY \$6<sup>95</sup>

ONLY \$6<sup>95</sup>

ONLY \$6<sup>95</sup>

ONLY \$6<sup>95</sup>

ONLY \$6<sup>95</sup>

ONLY \$6<sup>95</sup>

ONLY \$6<sup>95</sup>

ONLY \$6<sup>95</sup>

ONLY \$6<sup>95</sup>

ONLY \$6<sup>95</sup>

ONLY \$6<sup>95</sup>

ONLY \$6<sup>95</sup>

ONLY \$6<sup>95</sup>

ONLY \$6<sup>95</sup>

ONLY \$6<sup>95</sup>

ONLY \$6<sup>95</sup>

ONLY \$6<sup>95</sup>

ONLY \$6<sup>95</sup>

ONLY \$6<sup>95</sup>

ONLY \$6<sup>95</sup>

ONLY \$6<sup>95</sup>

ONLY \$6<sup>95</sup>

ONLY \$6<sup>95</sup>

ONLY \$6<sup>95</sup>

ONLY \$6<sup>95</sup>

ONLY \$6<sup>95</sup>

ONLY \$6<sup>95</sup>

ONLY \$6<sup>95</sup>

ONLY \$6<sup>95</sup>

ONLY \$6<sup>95</sup>

ONLY \$6<sup>95</sup>

ONLY \$6<sup>95</sup>

ONLY \$6<sup>95</sup>

ONLY \$6<sup>95</sup>

ONLY \$6<sup>95</sup>

ONLY \$6<sup>95</sup>

ONLY \$6<sup>95</sup>

ONLY \$6<sup>95</sup>

ONLY \$6<sup>95</sup>

ONLY \$6<sup>95</sup>

ONLY \$6<sup>95</sup>

ONLY \$6<sup>95</sup>

ONLY \$6<sup>95</sup>

ONLY \$6<sup>95</sup>

ONLY \$6<sup>95</sup>

ONLY \$6<sup>95</sup>

ONLY \$6<sup>95</sup>

ONLY \$6<sup>95</sup>

ONLY \$6<sup>95</sup>

ONLY \$6<sup>95</sup>

ONLY \$6<sup>95</sup>

ONLY \$6<sup>95</sup>

ONLY \$6<sup>95</sup>

ONLY \$6<sup>95</sup>

ONLY \$6<sup>95</sup>

ONLY \$6<sup>95</sup>

ONLY \$6<sup>95</sup>

ONLY \$6<sup>95</sup>

ONLY \$6<sup>95</sup>

ONLY \$6<sup>95</sup>

ONLY \$6<sup>95</sup>

ONLY \$6<sup>95</sup>

ONLY \$6<sup>95</sup>

ONLY \$6<sup>95</sup>

ONLY \$6<sup>95</sup>

ONLY \$6<sup>95</sup>

ONLY \$6<sup>95</sup>

ONLY \$6<sup>95</sup>

ONLY \$6<sup>95</sup>

ONLY \$6<sup>95</sup>

ONLY \$6<sup>95</sup>

ONLY \$6<sup>95</sup>

ONLY \$6<sup>95</sup>

ONLY \$6<sup>95</sup>

ONLY \$6<sup>95</sup>

ONLY \$6<sup>95</sup>

ONLY \$6<sup>95</sup>

ONLY \$6<sup>95</sup>

ONLY \$6<sup>95</sup>

ONLY \$6<sup>95</sup>

ONLY \$6<sup>95</sup>

ONLY \$6<sup>95</sup>

ONLY \$6<sup>95</sup>

ONLY \$6<sup>95</sup>

ONLY \$6<sup>95</sup>

ONLY \$6<sup>95</sup>

ONLY \$6<sup>95</sup>

ONLY \$6<sup>95</sup>

## NEW PRODUCTS

continued from page 23

music quality due to stylus wear. The model 23RS-MR has a 20 Hz to 90,000 Hz frequency response, with low distortion and wide dynamic range. It has a suggested list price of \$330.00 to \$350.00.—**Dynavector Systems USA**, 1721 Newport Circle, Santa Ana, CA 91705.

**SCANNER**, model *HX650*, is a hand-held portable unit that measures  $3\frac{3}{4} \times 5\frac{1}{2} \times 1$ -inch and weighs nine ounces (without batteries). It offers five-band, six-channel coverage, pulling in signals like its larger counterparts, including the action on police, fire, public safety, business, and amateur bands.

The five popular bands covered are: low and high VHF (30–50 and 146–174 MHz), UHF (450–470 MHz), UHF "T" (470–512 MHz), and 2-

meter amateur (144–148 MHz). It can scan automatically at a rate of about 15 channels per second, or it



CIRCLE 14 ON FREE INFORMATION CARD

can be stepped manually from channel to channel.

The model *HX650* is priced at \$119.95.—**Regency Electronics, Inc.**, 7707 Records Street, Indianapolis, IN 46226-9989.

**DMM**, model *DM-2000*, is a rotary-switch  $3\frac{1}{2}$ -digit multimeter. Although only  $4.8" \times 2.8" \times 0.9"$  in size, it has 8 functions and 22 ranges.

The functions are: DC volts, AC volts, DC current, resistance, conductance, diode test, HFE test, and battery test. All ranges are overload-protected. Solid-state protection on all resistance ranges protects the instrument and user up to 250 volts AC/DC without



CIRCLE 15 ON FREE INFORMATION CARD

fuse-blowing. Its basic DC accuracy is 0.5%. The model *DM-2000* is priced at \$54.95.—**A. W. Sperry Instruments, Inc.**, 245 Marcus Boulevard, Hauppauge, NY 11788.

R-E

## Texas Instruments Understanding Series.™

# Books about today's science and technology...for everyone.

Only \$14.95 each.



Novice, professional, technician or hobbyist, there's an Understanding Series title just for you. Each book is a self-contained volume that takes you through the material step-by-step. For the newcomer, it's a quick and easy way to learn. Practitioners will find it an ideal way to catch up, keep pace and review. You'll like the look, too. These editions will make attractive additions to any reference library. Information-intensive, with color illustrations, they're easy to read. And marginal notes speed and simplify summary or review. The Understanding Series. Exciting, timely subjects in an inviting new format. Check your choices on the coupon and mail it, today.



## TEXAS INSTRUMENTS

Creating useful products and services for you.

Please send me the following titles @ \$14.95 each:

# of copies

- \_\_\_\_\_ Understanding Automation Systems LCB8472
- \_\_\_\_\_ Understanding Automotive Electronics LCB8475
- \_\_\_\_\_ Understanding Communications Systems LCB8474
- \_\_\_\_\_ Understanding Computer Science LCB8452
- \_\_\_\_\_ Understanding Data Communications LCB8483
- \_\_\_\_\_ Understanding Digital Electronics LCB8471
- \_\_\_\_\_ Understanding Digital Troubleshooting LCB8473
- \_\_\_\_\_ Understanding Microprocessors LCB8451
- \_\_\_\_\_ Understanding Solid State Electronics LCB8453
- \_\_\_\_\_ Understanding Telephone Electronics LCB8482

Add \$1.25 per book, postage and handling. Prices subject to change without notice.

Enclose check or money order with sales tax (except AK, DE, NH, OR). Foreign orders must be in U.S. dollars and include shipping charges. Sorry, no phone orders.

© 1985 Texas Instruments Incorporated

Mail to:

Texas Instruments Incorporated  
Information Publishing Center  
P.O. Box 225474, M/S 8218  
Dallas, Texas 75265

Name \_\_\_\_\_

Address \_\_\_\_\_

City \_\_\_\_\_

State \_\_\_\_\_ Zip \_\_\_\_\_

2122  
RE485

# Where's Your **ELECTRONICS** Career Headed?



## your move!

### The Move You Make Today Can Shape Your Future

Yes it's your move. Whether on a chess board or in your career, you should plan each move carefully. In **electronics**, you can *move ahead* faster and further with a

## B. S. DEGREE

Put professional knowledge and a COLLEGE DEGREE in your electronics career. Earn your degree through independent study at home, with Grantham College of Engineering. No commuting to class. Study at your own pace, while continuing your present job.

The accredited Grantham non-traditional degree program is intended for mature, fully employed workers who want to upgrade their careers . . . and who can successfully study electronics and supporting subjects through

### INDEPENDENT STUDY, AT HOME

Free Details Available from:

**Grantham College of Engineering**  
10570 Humbolt Street  
Los Alamitos, California 90720

### Independent Home Study Can Prepare You

Study materials, carefully written by the Grantham staff for independent study at home, are supplied by the College, and your technical questions related to those materials and the lesson tests are promptly answered by the Grantham teaching staff.

### Recognition and Quality Assurance

Grantham College of Engineering is accredited by the Accrediting Commission of the National Home Study Council.

All lessons and other study materials, as well as communications between the college and students, are in the English language. However, we have students in many foreign countries; about 80% of our students live in the United States of America.

**Grantham College of Engineering** R6-85  
10570 Humbolt Street, Los Alamitos, CA 90720

Please mail me your free catalog which explains your B.S. Degree independent-study program.

Name \_\_\_\_\_ Age \_\_\_\_\_

Address \_\_\_\_\_

City \_\_\_\_\_ State \_\_\_\_\_ Zip \_\_\_\_\_

# EQUIPMENT REPORTS

## Global Specialties Model 1301 Power Supply

*A DC power supply for both analog and digital applications.*



CIRCLE 5 ON FREE INFORMATION CARD

AS ANY ELECTRONICS TECHNICIAN OR hobbyist knows, one of the most important instruments on any workbench is a stable, dependable DC power supply. And that's

true whether you work with analog or digital circuitry. But if you work with both, often you will need two such supplies. That's because a supply intended for use

with analog circuitry, often is unsuitable for digital circuitry, and vice versa.

One supply that nicely bridges both worlds is the Global Specialties (70 Fulton Terrace, PO Box 1942, New Haven, CT 06509) model 1301 DC power supply. That's because that supply is made up of three independent supplies—a fixed 5-volt supply rated at 1-amp maximum, and two variable 5- to 18-volt supplies rated at 0.5-amp maximum.

### The 1301

The model 1301 power supply

This unique line of 12 lightweight and comfortable precision cutters, pliers and crimpers are specially adapted to meet the demanding requirements of the electronic industries. All the tools feature custom contoured ribbed handles which provide a non-slip gripping surface, and specially designed lifetime return springs which eliminate operator fatigue.

## Precision Pliers, Cutters and Crimpers

- Flush cutters
- Semi-flush cutters
- Reverse cutters
- Cutter/crimper
- Cutter/bender
- Pliers

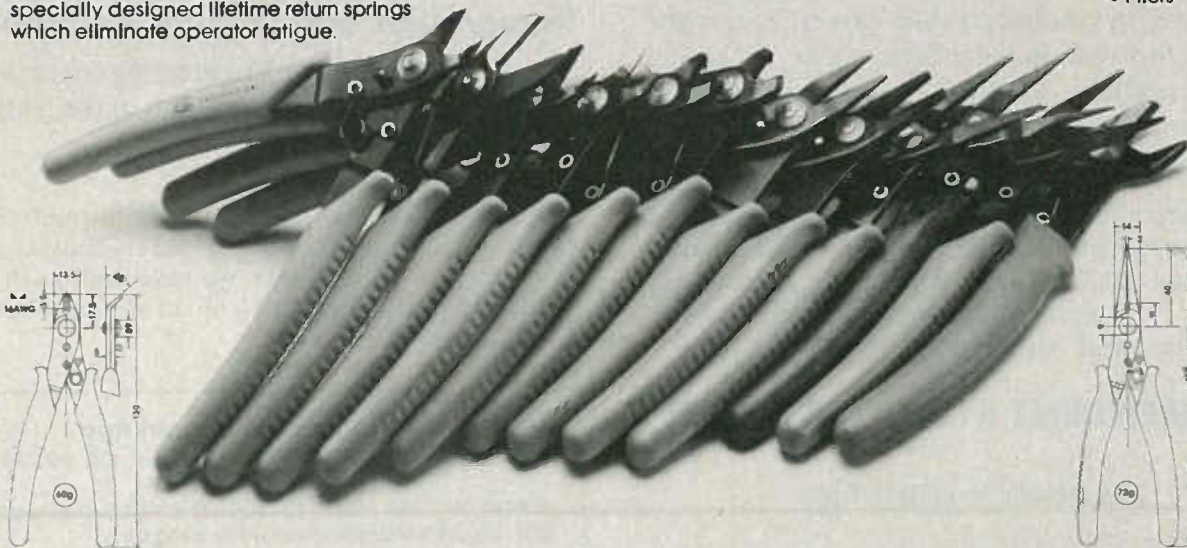

3455 Conner Street, Bronx, New York, 10475, U.S.A.  
Telex 125091 OK NYK Telex 232395 OK NY UR  
Phone (212) 994-6600

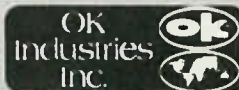



can be used in a wide variety of applications. Priced at 219.95, it is equally at home in industry, service shops, schools, or on a hobbyist's workbench.

Housed in a functional, yet attractive, black aluminum case, the unit measures 4 x 14 x 7 inches. It weighs 5 pounds. Power (117-volts AC) is supplied to the unit via a three-wire cord; a 240-volt AC version of the power supply is also available for use abroad.

The three supply outputs are available from the front of the unit via three sets of color-coded binding posts. Those three supplies are isolated, and can be floated to a DC level from any other supply, or from the equipment to which it is connected. In addition, all three supplies can be floated to different levels if desired.

If an earth-ground reference is required for an application any of the six binding-post terminals can be connected to the front-panel "earth-ground reference" binding post. Also, if required, one terminal from one, two, or all three sup-

Global	1301									
OVERALL PRICE	1	2	3	4	5	6	7	8	9	10
EASE OF USE	1	2	3	4	5	6	7	8	9	10
INSTRUCTION MANUAL	1	2	3	4	5	6	7	8	9	10
PRICE/VALUE	1	2	3	4	5	6	7	8	9	10
	Poor	Fair	Good	Excellent						

plies can be simultaneously connected to the earth-ground terminal.

### Using the unit

The supplies can be used independently, or can be interconnected to accommodate different voltage and current requirements. For instance, the two variable supplies may be connected in series to provide a variable 10- to 36-volt, 0.5-amp power supply. For a higher voltage, the 5-volt supply can be also combined in series with the two variable supplies, yielding a 15- to 41-volt, 0.5-amp supply. The two variable supplies can also be

paralleled, using equalizing resistors, to yield a 5- to 18-volt, 1-amp supply.

Other interconnection schemes are also possible; those are outlined in the unit's instruction manual (more on that later).

Aside from the binding posts, and the potentiometers used to set the output levels of the variable supplies, the dominant feature of the front panel is the two meters used to monitor the voltage and current outputs of the three supplies. Since only one of the supplies can be monitored at one time, a front-panel MONITOR switch is used to select which of the supplies is monitored.

The 1301 uses current limiting to guard against damage due to short circuits. If the output should be shorted, the voltage drops to zero and the current is limited to about 2.5 amps for the 5-volt supply, and 1 amp for the variable supplies.

The supply is also protected against thermal overloads. Should heat dissipation in the regulator become excessive, the regulator

## ChannelPlus™

INTERCONNECT VIDEO WITHOUT SWITCHES

ChannelPlus actually adds new channels right to your existing antenna or cable wires. Take each of your video sources; VCRs, satellite dish, video disk, computer, color or black and white camera, video game, etc. and connect them to ChannelPlus.

As seen in POPULAR SCIENCE and VIDEO MAGAZINE.



If you are adding:  
 one video source—  
 use model H1V—\$129.95  
 two video sources—  
 use model H2V—\$199.95

one video & one pay TV—  
 use model HRV—\$239.95  
 three video sources—  
 use model H3V—\$269.95

Video source picture quality is often improved because ChannelPlus uses the direct video and audio outputs. Use the channel 3 or 4 output from pay TV sources.

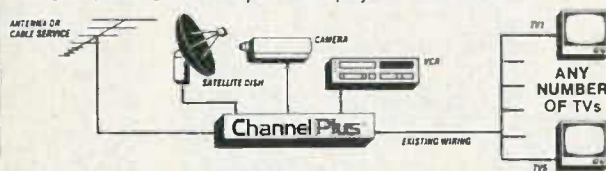

*Yours Truly*

Please charge my  Visa  Mastercard

Expiration Date \_\_\_\_\_

Signature \_\_\_\_\_

Card Number \_\_\_\_\_

1484 North Kraemer Blvd., Suite 382  
 Placentia, CA 92670 • 714-680-0645

CIRCLE 277 ON FREE INFORMATION CARD

## SAVE BY BUILDING OUR RACK MOUNT STUDIO EQUIPMENT

**QUADRAFUZZ** — for separate frequency bands of distortion are mixed for the smoothest fuzz you've ever heard. no. 6720..... \$39.88

**HYPERFLANGE/CHORUS** — the cleanest, widest range, most-versatile flanger anywhere at any price. no. 6750..... \$149.95

**VOCODER** — unmatched performance in a versatile, low cost rack package. no. 6710..... \$99.95

**HOT SPRINGS** — user's agree, short of studio plate systems, you won't find a better reverb at any price. no. 6740..... \$59.95

ADD \$3 SHIPPING FOR EACH KIT ORDERED

Innovative, cost effective designs by Craig Anderton in easy to assemble kits from:

**PAIA Electronics, Inc.**  
 Direct mail orders and inquiries to: Dept. 11R  
 1020 W. Wilshire, Oklahoma City, OK 73116 (405)843 9626

Ask for your free catalog.

CHARGE TO VISA OR MC TOLL-FREE  
 1-800-654-8657 9AM to 5PM CST MON-FRI

CIRCLE 90 ON FREE INFORMATION CARD

## DON'T FORGET



USE YOUR READER SERVICE CARD

output is turned off, shutting down the supply. Of course, the unit is also fused.

As mentioned previously, the supply is well-regulated. Under a 25%-100% load, the output of the variable supplies is stable to within  $\pm 150$  mV; the output of the 5-volt supply is stable to  $\pm 50$  mV. Ripple for the variable supplies is specified as less than 10-mV P-P; for the 5-volt supply it is less than 5-mV P-P.

### The manual

The documentation that accompanies the unit is brief, but it is well illustrated and does a more than adequate job of describing the unit and how it is used. In addition to specifications and operating instructions, it includes maintenance and calibration information, a circuit description, and a schematic diagram.

Our impressions of the Model 1301 power supply are that it is solidly built and that it performs reliably. The unit is backed by a one-year warranty. **R-E**

## Datak Circuit Fix PC-Board Repair Kit

Repair those damaged PC boards quickly and easily.

CIRCLE 6 ON FREE INFORMATION CARD



JUST ABOUT ALL OF US HAVE RUN INTO a problem with a damaged circuit board somewhere along the line. For instance, it is very easy to lift traces when removing defective components from a PC board. And, sometimes, boards are damaged even before they've been "stuffed." That happens when a board comes out of the etchant missing a trace or two (that is especially likely to occur when working with very thin traces). For circuit designers, rarely is a prototype board finished without at least one last-minute change.

Datak (65 71st Street, Gutten-

berg, NJ 07093) has produced a product that can greatly simplify repairing damaged boards or modifying prototype boards. That product is called *Circuit Fix*. It is a board-repair system that consists of a spring-loaded clamp and cutting guide, cutting knife, 154 copper donuts (of varying sizes), 32 square inches of copper foil, and an instruction booklet. The copper foil and donuts are supplied on an adhesive backing.

### The Circuit Fix system

The heart of the system is the spring-loaded steel clamp and cut-

## DUAL TRACE OSCILLOSCOPES

(TWO QUALITY 10-1 HOOK ON PROBES INCLUDED)



**DX5020 20MHz \$379.95**

**SALIENT FEATURES:**  
BUILT-IN COMPONENT TESTER.  
AUTOMATIC TRIGGERING.  
TV VIDEO SYNC. FILTER.

**BRIEF SPECIFICATIONS:**  
DEFLECTION FACTOR:  
5MV to 20V/DIV.  
RISE TIME: Less than 17ns.  
TIME BASE: 0.2 $\mu$ s to 0.5 s/DIV.



**DX5015S 15MHz \$510.00**

**SALIENT FEATURES:**  
PORTABLE. WORK ON AC/DC.  
BUILT-IN BATTERY.  
AUTOMATIC RECHARGE

**BRIEF SPECIFICATIONS:**  
DEFLECTION FACTOR:  
2MV to 10V/DIV.  
RISE TIME: Less than 23ns.  
TIME BASE: 0.5 $\mu$ s to 0.5 s/DIV.

**ALSO AVAILABLE:** DUAL TRACE OSCILLOSCOPES WITH DELAYED TRIGGERING SWEEP FEATURE AND PROBES INCLUDED. DX5035 35 MHz at \$527.00. DX5045 45 MHz at \$789.95.

### TERMS:

One year limited warranty on parts and labor. Satisfaction guaranteed, or return unit in original form for refund within 10 days from date merchandise received. California residents add 6 1/2% sales tax. Orders shipped UPS, add \$8.50 for shipping handling and insurance.

**TO ORDER: CALL COLLECT (714) 594-7131 VISA, MONEY ORDER, MASTERCARD, C.O.D. (REQUIRED 25% DOWN)**

**DELTA** DELTA DYNAMIC INC.  
20955 E LYCOMING ST., WALNUT, CALIF. 91789. TELEX: 503749 DELTAX

CIRCLE 258 ON FREE INFORMATION CARD

**DESOLDER-IT,  
CLEAN-IT, COAT-IT,  
FREEZ-IT...SEND FOR IT!**  
Our new electronic problem solving catalog!



**Chemtronics**  
681 Old Willlets Path  
Hauppauge, NY 11788  
800-645-5244  
In NY 516-582-3322  
Telex 968567

CIRCLE 54 ON FREE INFORMATION CARD

**Small size.  
Small price.**

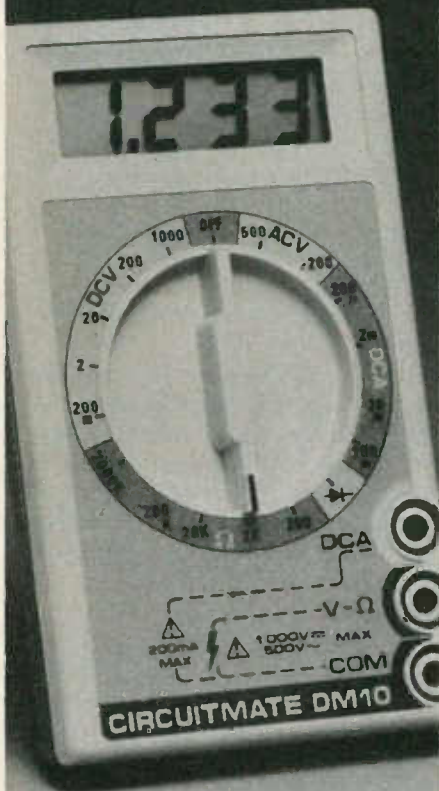

**DM10 . . . \$39.95\***

Don't settle for an analog multimeter. Now, for the same low price you can have a reliable digital multimeter that's easier to use, easier to read, and is three times more accurate.

- DCV accuracy 0.8% of reading
- 1/2" LCD digits
- 5 Functions (ohms, DCA, ACV, DCV, Diode check)
- Overload protection (250V in ohms)
- 250 Hour battery life.

This is the ideal carry-one-anywhere meter. Tool box, glove box, shirt pocket. Whenever you need to make a measurement, you're ready.

Also available, featuring a continuity beeper, is the DM10B for only \$49.95.\*

Both models include a 9V battery, safety test leads, and operator's manual.

Get one now at your local Beckman Industrial distributor. \*Suggested list price.

Beckman Industrial  
A subsidiary of Emerson Electric Co.  
630 Puente Blvd.  
Brea, Calif. 92621

**Beckman Industrial**

ting guide. To cut a strip of copper to a precise width, two conditions must be satisfied—the sheet from which it is cut must be gripped firmly along its entire width, and the knife used to make the cut must be perfectly vertical. The clamp and cutting guide allow both conditions to be fulfilled.

Using the clamp and cutting guide is simple. The copper sheet is slid between the unit's base plate and the guide so that a strip of the required width extends out the cutting side, and the strip is cut using the supplied knife. To ensure a straight cut, the side of the guide is offset from the cutting edge precisely 1/2 the diameter of the knife's handle. That ensures that the knife blade will be precisely vertical when the knife handle is held against the side of the guide. The cut is made by running the knife along the guide edge, using light to medium pressure; the backing is removed from the adhesive copper strip, and the strip is used to repair or modify your board.

	Circuit fix									
OVERALL PRICE										
EASE OF USE										
INSTRUCTION MANUAL										
PRICE/VALUE										
	1	2	3	4	5	6	7	8	9	10
	Poor			Fair			Good			Excellent

The guide is not needed or used to replace pads. Simply select a donut of appropriate size from the sheet supplied, using tweezers or a knife blade, position it on the board, and burnish hard into place.

The donuts supplied are actually misnamed, since they have no center holes—only pilot points. When doing a repair, the center hole is created in the donut after it is in place by pushing a pin or wire through the pilot point and the existing hole in the board. If, however, the donut is to be part of a new trace, drill through the donut (once it is in place) and the board in the usual way.

**The instruction booklet**

The instruction booklet that is supplied with the *Circuit Fix* kit is certainly nothing fancy—it consists of just three pages. But within those three pages is more than enough information to allow you to use the product. In addition to the instructions on how to assemble and use the clamp and cutting guide, there is a wealth of useful hints on getting the best results from your repairs and modifications. There is even a description of some common problems encountered when cutting traces from the copper-foil sheets, such as spiral cuts and ragged edges, what causes them, and how they can be prevented.

The *Circuit Fix* kit is not intended for use in making circuit boards "from scratch." (Datak does supply other products for that purpose; for more information on those, contact the manufacturer.) As such, patterns for such things as IC's are not supplied. But the kit does include just about everything needed for practical and effective circuit-board repair. The *Circuit Fix* kit sells for \$21.95. R-E

**CAN/AM SATELLITE TV DESCRAMBLER**

Works on Everything

Fully Assembled & Tested

No Internal Connections to Receiver

Works on both American & Canadian Birds

For Use with TVRO's Only

Modulator Installed, Baseband Output Optional

**\$395.00**

**Tampa Electronic Supply**  
9207 N. 14th St.  
Tampa, FL 33612  
(813)933-5795

CIRCLE 267 ON FREE INFORMATION CARD



# LITTLE THINGS MEAN A LOT

Being the first company to make solderless breadboards isn't necessarily what makes us the best. It's all the little things you don't see, like our spring clip terminals, that make AP PRODUCTS ACEBOARDS so big on reliability.

From our largest ACEBOARD with over 5000 tie points, to a single tie point block, our spring clip terminals give you nothing but good, solid contact on every connection. They accommodate a wide variety of leads and have the best electrical properties, because our spring clips are solid alloy, not plated nickel. We've even developed enough normal force to break through any oxides which could occur on solder plated leads. You've come to trust our test clips for the same reason.

Since one bad connection can ruin a whole circuit, we pay close attention to how well our spring clip terminals sit within the insulator cell areas. Spring clip edges are never exposed at the insertion window.

Leads won't buckle, clips won't oxidize, it all adds up to longer life.

Even from the outside there's more to an ACEBOARD than meets the eye. Our durable Acetal Copolymer plastic body is a

good insulator with excellent dielectric properties. And special manufacturing techniques in the insertion of the contacts into the plastic body insure that your Breadboard will always remain flat. No skimping or planned obsolescence here. Again, just good solid contact on every connection.

Turn our breadboard body over...and you'll discover another key to its reliability. The double-sided adhesive foam you'll

see there is more than a pressure sensitive mount. It also insulates to prevent shorts and seals the bottom of the individual spring clip cells.

If solder shavings from resistors or component leads drop into the cell, they can't spread into other cells to short them out.

Take a close look at our ACEBOARDS. AP PRODUCTS has the biggest and most complete line of ACEBOARD sizes. It's also our commitment to you that if your ACEBOARD doesn't

work perfectly, bring it back to your AP PRODUCTS distributor. He'll replace it, no hassles.

To help you see for yourself what a big difference the little things make, we're offering you a 10% discount on the entire AP PRODUCTS ACEBOARD/Breadboard line.

Just fill out the coupon and present it to your AP PRODUCTS distributor.

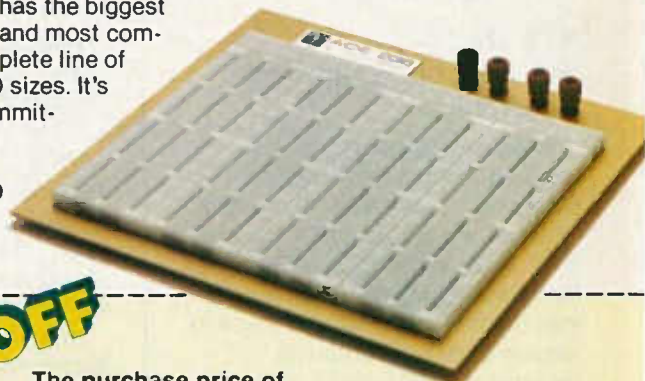
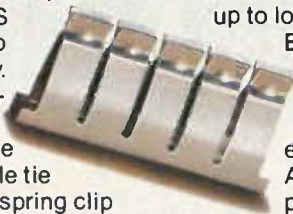

For the name of the distributor nearest you, call TOLL FREE (800) 321-9668. (In Ohio, call collect: (216) 354-2101).



AP PRODUCTS INCORPORATED

9325 Progress Parkway, Box 540  
Mentor, Ohio 44060, (216) 354-2101  
TWX: 810-425-2250

In Canada, call Lenbrook Electronics • (416) 477-7722

CIRCLE 76 ON FREE INFORMATION CARD

# 10% OFF

The purchase price of any size ACEBOARD or Breadboard product.

Your Name \_\_\_\_\_

Address \_\_\_\_\_

City \_\_\_\_\_ State \_\_\_\_\_ Zip \_\_\_\_\_

Dealer Name \_\_\_\_\_

ACEBOARD # \_\_\_\_\_

Limit 5 ACEBOARDS or Breadboards per coupon. Offer valid only at participating AP PRODUCTS distributors. **RE 685**

# FOR POWERFUL SERVICING

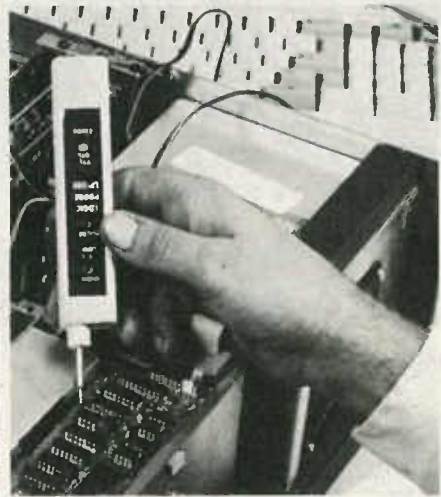

- G. Editing capabilities help you insert or delete characters and lines, erase, jump or smooth scroll, plus several other convenience features.
- H. The NTS/HEATH HS-151 is complete with full-function keyboard, calculator-style keypad, and typewriter format.

## NTS Training Takes You Beyond Equipment Assembly.

Field service personnel are required to analyze and solve problems, many times on the spot. Whether the problem is in the disk-drive or the monitor, the memory or the power input, you learn how to spot the difficulty and take steps to resolve it. Your NTS course includes test equipment, and teaches you how to use it.

Three courses, one starting with basics, and two different advanced courses for those with previous experience, give you a choice of programs suited to your particular needs. You learn how to program this advanced computer with excel-

lent support material. And, equally important, the NTS/HEATH HS-151 enjoys a reputation backed by a major American manufacturer. There is no substitute for first-class equipment, and you keep it to use for years in your home or business.

## NTS TRAINING PROGRAMS COVER MANY AREAS OF ELECTRONICS:

**Robotics:** Build the NTS/HEATH Hero 1 Robot as you learn Robotic programming technology. This field is at the leading edge of electronics.

**Video Technology:** Learn circuit diagnostics and digital principles as you build one of the most advanced color TV sets available. Your course also covers VTR's, computer fundamentals, solid-state devices.

**Industrial and Microprocessor Technology:** Train in microprocessor and automation applications, lasers, and basic industrial robotics.

**TV & Radio Servicing:** Acquire a foundation in the use and application of both analog and digital test equipment in the TV servicing field. Learn to service Color and monochrome monitors, troubleshoot receivers, and maintain entire systems.

**Basic Electronics** is a course designed to give you an over-view of electronics. It is particularly helpful to electronic sales personnel, and those wishing to get into technical writing.

**NTS Intrinsic training** programs are practical, and job-oriented. You train on field-type equipment, and lessons and texts are tested and proved in our Resident School in Los Angeles. This assures you of understandable lessons and texts, as well as projects which get right to the heart of your subject. NTS, now in its 80th year, continues to offer economical training at the leading edge of Electronics.

\*IBM is a trademark of International Business Machines Corp. \*MS is a trademark of Microsoft Corp.

If card is missing, write directly to the School at the address below stating the course in which you are interested. A FREE color catalog and all details will be sent to you by return mail.

**NTS NATIONAL TECHNICAL SCHOOLS**

TECHNICAL TRADE TRAINING SINCE 1905  
Resident and Home-Study Schools

4000 South Figueroa Street  
Los Angeles, CA 90037-9988

# POWERFUL TRAINING CAREERS IN PC



## Learn PC Servicing By Assembling Your Own NTS/HEATH HS-151 16-Bit Desk-Top Computer

This is the most powerful and versatile Personal Computer ever offered in any home study course, and NTS Intrinsic Training gets you right down into the heart of it. You learn how microcomputers function, and how they operate to solve problems. Your program includes a wide variety of tests and projects you perform as you build this remarkable PC, circuit board by circuit board. There is no better way to learn PC servicing. Lessons, texts and equipment are completely integrated to make your training easier to understand, more practical, and applicable to many other types of computers.

### Rewarding Career in PC Servicing Lies Ahead.

The world of computers is constantly expanding. Industrial and business applications of computers show every sign of consistent growth. In fact, the market for PC's will expand to an expected 3.7 million units this year, and by the end of the decade the entire computer market worldwide will pass the billion dollar mark.

These sales figures point to continued growth in the peripherals market, networking, modems, printers, and a host of other "add-ons" needing installation technicians and skilled service-maintenance personnel. It's a career field with dynamic potential, and NTS PC Training is aimed right at it.

### Your Training Includes Test and Other Equipment

Most NTS courses include test equipment to teach you the uses and applications of such units as Digital Logic Probes, Digital Multimeters, Trans/Diode Testers, and the like. The NTS Compu-Trainer is included in several courses to familiarize you with principles involved in circuitry used in a wide variety of computer types and brands. You perform hundreds of experiments with it, learning the how and why of computer operation. NTS courses are designed to prepare you for jobs in electronics where you can grow with the experience you receive in the field. It's the kind of training that keeps pace with developments, assuring you of a solid foundation on which to build a career.

### The Exciting NTS/HEATH 16-Bit HS-151 is Loaded with Features:

- A. 128KB RAM user memory on board, expandable to 640KB.
- B. 16-Bit 8088 microprocessor accepts advanced software and speeds word processing; also allows selection from the huge library of IBM\* software.
- C. IBM-compatibility with \*MS-DOS operating system.
- D. 5.25-inch floppy disk drive, double density, IBM formatted, stores up to 360KB. (Expandable to dual-disk drive, and optional 10.5MB hard-disk drive.)
- E. Four open IBM-compatible slots provide for future expansion, printer, modem, etc. Will accept most peripheral boards designed for the IBM PC.
- F. Two video outputs for color or monochrome display monitor. Your NTS course includes a high-resolution monitor displaying 80 characters by 25 lines, or graphics.

# FREE

# high tech catalog



Metal  
Detector



Triple-Trace  
Oscilloscope/Time-  
Voltage Display



Ham Radio  
Transceiver



Computerized  
Weather Station



## Discover the pride.

With Heathkit,  
you'll discover the  
pride of accomplish-  
ment that comes with  
creating handbuilt quality  
that is uniquely yours.

And you'll develop skills and  
abilities in many technologies as  
you follow the step-by-step direc-  
tions through the building process.

You work confidently, always backed  
by our simple promise, "We won't  
let you fail."

If you don't have the latest Heathkit  
Catalog, you're missing some-  
thing great, so mail the coupon now,  
while you're thinking about it.

Microprocessor  
Trainer & Course



Most  
Accurate  
Clock

Real Time  
Spectrum Analyzer



HERO® 1  
Robot



IBM-PC Compatible  
Computers



40-Channel  
Scanner



**Send NOW for your  
FREE Heathkit Catalog**  
It's the beginning of something great  
for the whole family.

Heath Company  
Dept. 020-304  
Benton Harbor, Michigan 49022  
Please send me the latest  
Heathkit Catalog Free.

Name \_\_\_\_\_

Address \_\_\_\_\_

City \_\_\_\_\_ State \_\_\_\_\_

Zip \_\_\_\_\_

CL-774A

**Heathkit**<sup>®</sup>  
Heath  
Company

A subsidiary of Zenith Electronics Corporation

CIRCLE 86 ON FREE INFORMATION CARD

## Temperature Measuring add-on for your DMM

*If you own a digital voltmeter, you already have one half of a precision digital thermometer. Here's how to build the other half.*

HARRY L. TRIETLY



A PRECISE DIGITAL THERMOMETER CAN have a wide variety of uses around the home and shop. Whether you need to check the operation of your heating system or your refrigerator, to test a circuit for hot spots, or to measure the outdoor temperature, a digital thermometer can help make it easy.

The only problem is that a thermometer that can read to one tenth of one degree can cost well in excess of one hundred dollars. But if you own a DVM, you already have half of such a thermometer. All you have to do is to add a precision thermistor and the single-IC interface circuit that we'll describe here.

The DVM-to-temperature adapter can be built for one of two temperature ranges. The first range is from 0 to 100 degrees Celsius (or 32 to 212 degrees Fahrenheit). Alternately, the adapter may be designed for a range of  $-30$  to  $50^{\circ}\text{C}$  ( $-22$  to  $122^{\circ}\text{F}$ ). In either case, the output provided is ten millivolts per degree. A DVM with a sensitivity of one millivolt will yield a resolution of 0.1 degree. Accuracy will be  $0.4^{\circ}\text{C}$  or better, exclusive of the DVM.

### The thermistor

In our thermometer, the temperature sensor is a network made up of two precision thermistors and two resistors. Using a single thermistor would not be desirable because its resistance-versus-temperature characteristic is highly nonlinear, as we can see from Fig. 1. If a thermistor is used in a Wheatstone bridge, however, its output characteristic is reasonably linear over a limited temperature range. (See Fig. 2) For example, linearity within  $\pm 1^{\circ}\text{C}$  is possible over a 0 to  $50^{\circ}\text{C}$  range. The linear range will be approximately centered at the temperature where the thermistor's resistance equals the series fixed resistor.

Figure 3 shows a way to improve the linearity even more by adding a second thermistor and resistor. Not only does that improve the linearity, but it also extends the linear range. From 0 to  $100^{\circ}\text{C}$ , for instance, linearity will be within  $\pm 0.22^{\circ}\text{C}$ . Thermistor pairs are specifi-

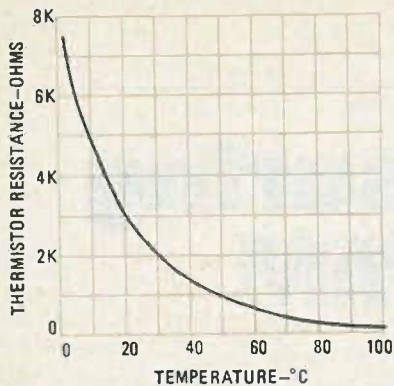

FIG. 1—A SINGLE THERMISTOR has a highly nonlinear resistance-vs.-temperature characteristic.

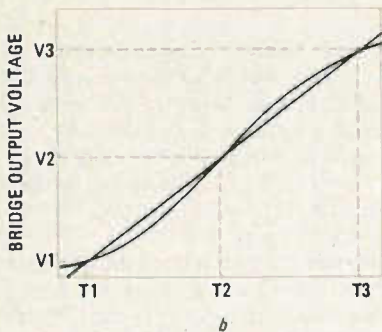

FIG. 2—WHEN USED IN A WHEATSTONE BRIDGE, a thermistor can provide a nearly linear output over a limited temperature range.

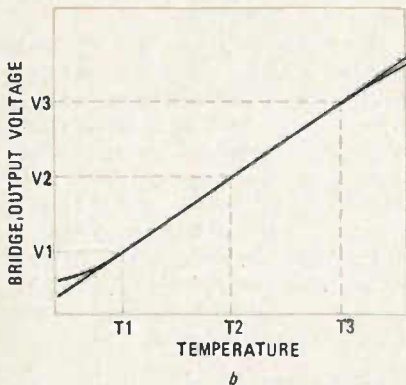

FIG. 3—ADDING A SECOND THERMISTOR greatly improves the linearity and extends the linear range.

cally chosen for that use and packaged as a single, three-lead component. The prototype was built using a composite manufactured for the Yellow Springs Instrument Company (Box 465, Yellow Springs, Ohio 45387) and sold under the trade name *Thermilinear*. A distributor for the composite is mentioned in the Parts List, but you can contact YSI for a distributor near you. Other manufacturers also offer similar devices.

Calculating the values for the fixed resistors is not easy, but the manufacturers have precalculated optimum network values for several temperature ranges and can calculate others using specially-developed computer programs. (For more information on thermistors and thermistor

networks, see the January through March 1985 issues of *Radio-Electronics*.)

### The adapter circuit

As shown in Fig. 4, the DVM-to-temperature adapter is built around a single IC. National's LM10. That micropower IC contains a stable 0.2-volt reference, a reference amplifier and a general-purpose operational amplifier. The remainder of the adapter's circuit requires only eight fixed resistors, two switches, and four trimmer potentiometers. It can be simplified farther if Fahrenheit/Celsius switching is not needed.

The circuit of Fig. 4 is designed for a linear temperature range of 0 to 100°C (32 to 212°F). Minor changes to the circuit and resistor values will let you measure from -30 to 50°C (-22 to 122°F) instead. That circuit is shown in Fig. 5. Note that many of the part numbers are the same as in Fig. 4. Keep that in mind when selecting parts for the thermometer and when studying the Parts List.

The 0.2-volt reference and reference amplifier provide a stable, fixed excitation voltage to the Wheatstone bridge. The voltage is determined by a feedback network consisting of R1 through R6. Switch S2-a configures the feedback to increase the voltage from 0.6 volt on the Celsius range to 1.08 volts on the Fahrenheit range, compensating for the fact that one degree Fahrenheit produces a smaller resistance change than does one degree Celsius.

Resistors R1 through R6 also form the fixed leg of the Wheatstone bridge, nulling the bridge output at zero degrees. Since 0°C is different from 0°F, S2-b is used to select the appropriate offset. The measurement leg of the bridge is formed

by the R<sub>T1</sub> and R<sub>T2</sub> (the *Thermilinear* composite) along with fixed resistors R7 and R8. Those two fixed resistors must have a tolerance of 0.1% or better to achieve the full rated accuracy and linearity of the network. A source for the resistors is given in the Parts List, but you can create your own from series-parallel resistor combinations using a 0.1% or better ohmmeter.

The LM10's operational amplifier, along with R9 through R12, forms a differential amplifier that boosts the bridge output to 10 millivolts per degree. Since a single supply is used, and since the output must be able to swing both positive and negative, the output is referenced to the bridge supply voltage rather than to supply common.

### Building the converter

Due to the simplicity of the circuit and the fact that the layout is not at all critical, it is not necessary to use a custom-designed circuit board. As you can see in Fig. 6, the converter was built using a prototyping board, which is housed in a small plastic experimenter's box. Connections to the *Thermilinear* composite are made via J1, a 1/4-inch, 3-connector phone jack. Other jacks may be used, of course. The phone jack was chosen because it mated with the probe used (YSI 700 series probe). An enclosed-type jack is used, and is glued to the circuit board. That allows the jack to be used to mount the board to the case via the jack's mounting hole. Before gluing the jack to the board, resistor R7 is connected between the tip and ring terminals and two connecting wires are soldered to the ring and barrel. The board is sized so that when installed, just enough space is left be-

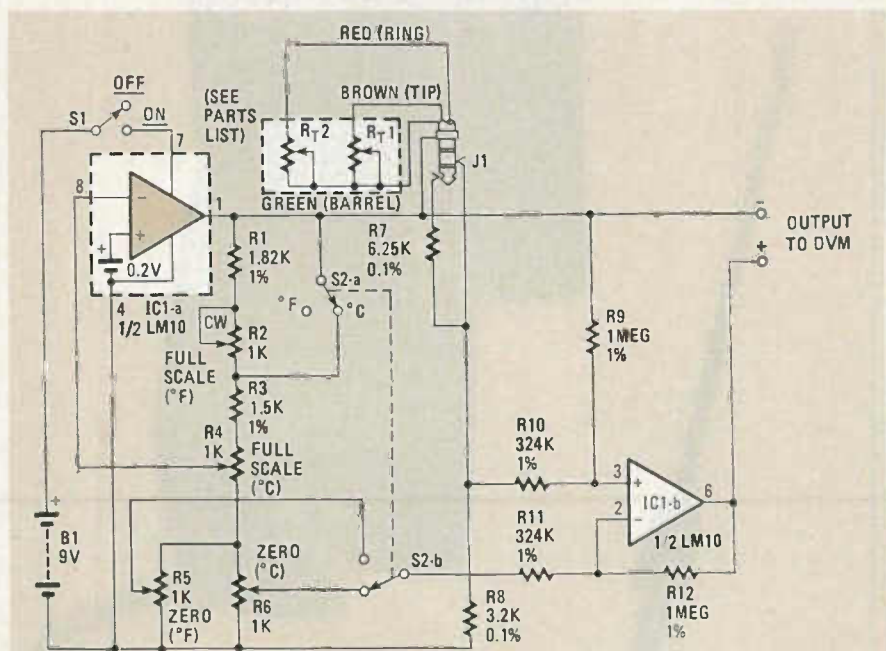

FIG. 4—THE ADAPTER CIRCUIT for a range from 0°-100°C. It uses only one IC, which supplies both the reference voltage and the bridge amplifier.

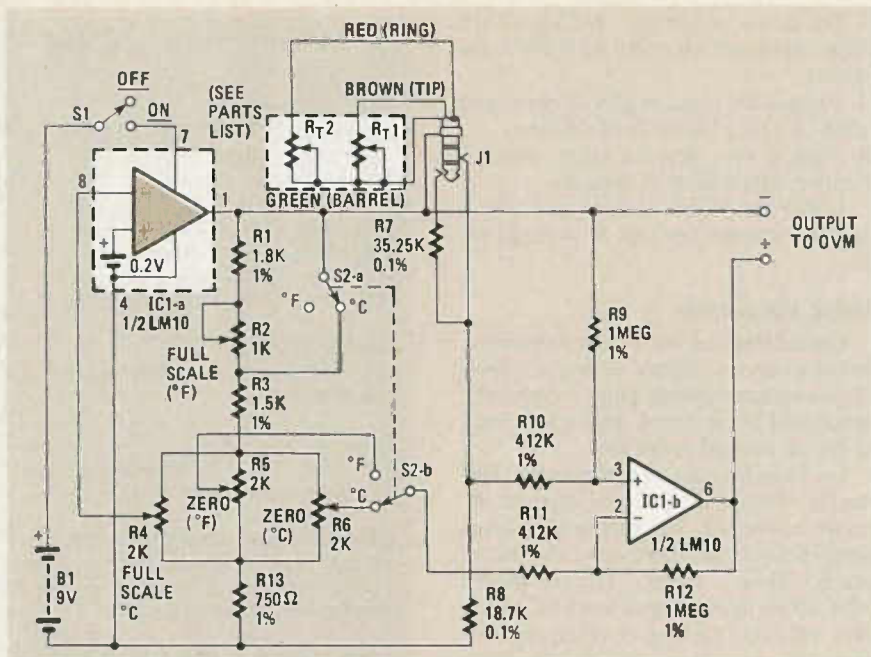

FIG. 5—THIS SLIGHTLY MODIFIED CIRCUIT measures from  $-30$  to  $+50^{\circ}\text{C}$ .

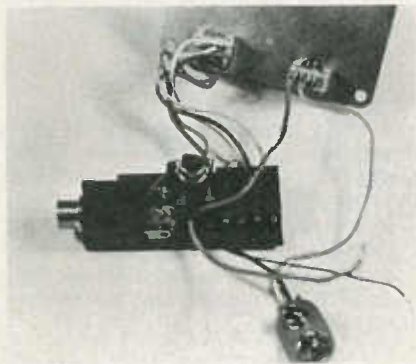

FIG. 6—THE COMPLETED BOARD before installation. Note that the ICs are in a TO-5 package, not a DIP.

tween its edge and the side of the case to contain a 9-volt transistor radio battery.

Figure 7 shows the component layout for the 0 to  $100^{\circ}\text{C}$  circuit. Construction details are not shown for the  $-30$  to  $50^{\circ}\text{C}$  range, but only minor changes from the 0 to  $100^{\circ}\text{C}$  layout are required. Be sure to cut out a portion of the breadboard corresponding to the layout shown.

Begin assembly by cutting lead 5 from the LM10 IC. That lead is not used, and the corresponding pad on the circuit board is used as a tie point. Insert and solder the IC, resistors, trimmer potentiometers, and the seven wires for connection to the switches, battery and output. Turn the board over and install the eleven jumpers (shown as dashed lines in Fig. 7) and the two additional switch wires. Jumpers between adjacent pads may simply be solder bridges. Complete the board assembly by installing the prewired phone jack.

Drill a hole at one end of the case for the phone jack, located so as to hold the board in the correct position. At the other end

drill two holes  $3/4$  inch apart and install the banana plugs. Standard banana plugs may be held in place using  $1/4$ -28 nuts in place of the screw-on plastic insulators. Drill holes and install the two switches in the box's cover. Wire the board, switches,

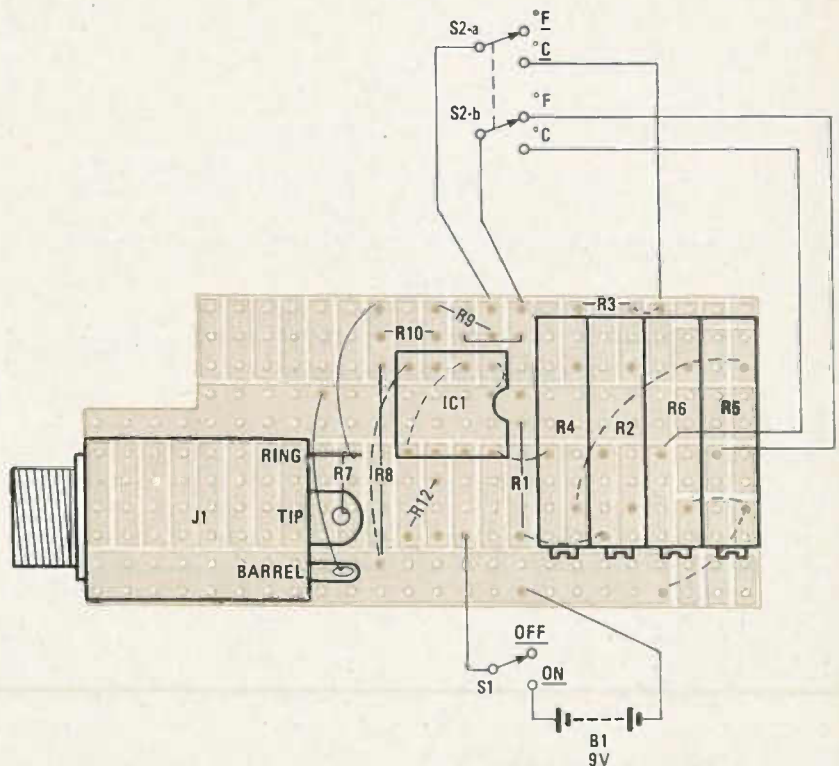

FIG. 7—CIRCUIT-BOARD ASSEMBLY using a "universal circuit board." Most of the fixed resistors must be "hairpinned" and stood on end to fit in the space allowed. Cut pin 5 from IC1—it's not needed, and a jumper is installed in its position. Note that top-side and bottom-side jumpers are shown. Those on the bottom are shown dashed. Solder R7 directly between the ring and tip of J1 before gluing the jack to the board.

battery, and banana plugs. For most DVM's the left banana plug should be positive: Check your meter and wire accordingly. Remember also to connect the positive battery terminal to S1. At this point, your board should look something like that shown in Fig. 6. Do not install the board in the case until after calibration.

### Calibration

The Thermilinear composite is a precision device, specified at  $\pm 0.15^{\circ}\text{C}$  accuracy or better from  $-30$  to  $100^{\circ}\text{C}$ . Thus, calibration requires no temperature baths; only a precision resistor to simulate the thermistors. Use a precision (0.1% or better) decade box or create 0.1% calibration resistances using series-parallel resistors and a 0.1% or better ohmmeter.

Connect the calibration resistor in place of thermistor T2: No connection is necessary in place of T1. If you have built the 0 to  $100^{\circ}\text{C}$  version proceed as follows:

1. Set the C/F switch to C. Provide 20,519 ohms input and adjust R6 for 0 millivolts output.
2. Change the input to 1578.7 ohms and adjust R4 for a 1000 millivolt output.
3. Set the C/F switch to F. Provide a 77,387 ohm input and adjust R5 for a 0 millivolts output.
4. Change the input to 2094.9 ohms and adjust R2 for 1900 millivolts output.



FIG. 8—THE ASSEMBLED CONVERTER ready to be plugged into a DVM.

5. Repeat the previous steps, making minor readjustments if necessary.

For the  $-30$  to  $50^{\circ}\text{C}$  version:

1. Set the C/F switch to C. Provide a 34,651 ohms input in place of T2 and adjust R6 for 0 millivolts output.

2. Change the input to 8536.2 ohms and adjust R4 for 500 millivolts output.

3. Set the C/F switch to F. Provide 63,115 ohms input and adjust R5 for 0 millivolts output.

4. Change the input to 8536.2 ohms and adjust R2 for 1220 millivolts output.

5. Repeat the previous steps, making minor readjustments if necessary.

Install the board, battery, and cover, and the adapter, see Fig. 8, is ready for use.

#### Using the adapter

Connecting the thermistor composite to the adaptor is simple. Using a  $\frac{1}{4}$ -inch three-conductor phone plug, connect the green lead to the barrel, brown (or clear) to the tip and red to the ring.

For measuring air temperature the thermistor composite should be exposed directly to the air. For measuring liquid temperatures the thermistor should be placed inside a metal, glass, or plastic tube whose tip has been closed by soldering, welding, melting or epoxying. For fastest response time, the space between

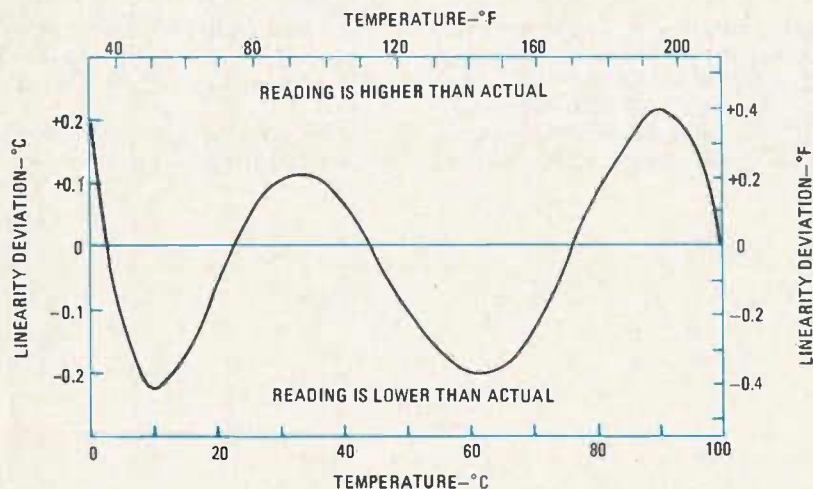

FIG. 9—TO CORRECT FOR NONLINEARITY ERRORS on the  $0-100^{\circ}\text{C}$  range, use this curve.

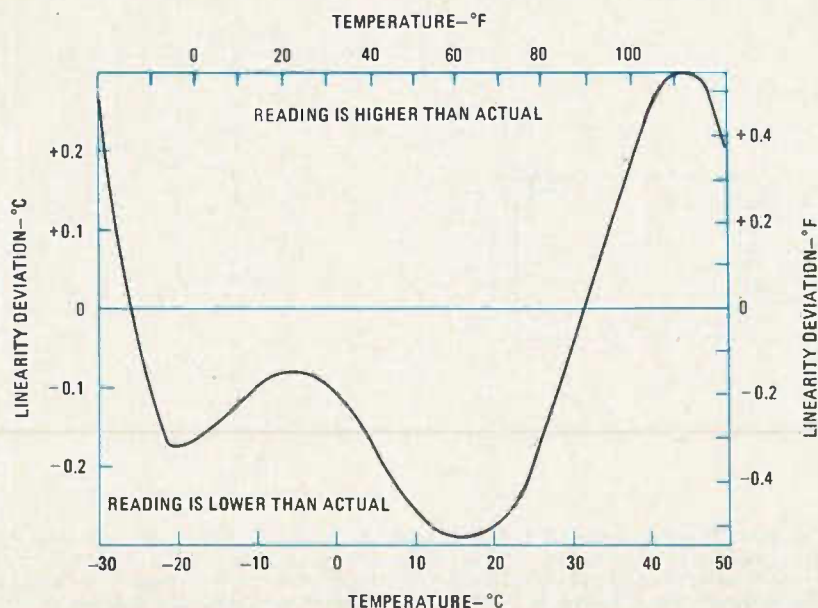

FIG. 10—TO CORRECT FOR NONLINEARITY ERRORS on the  $-30$  to  $+50^{\circ}\text{C}$  range, use this curve.

#### PARTS LIST— $0-100^{\circ}\text{C}$ VERSION

##### Resistors

- R1—1820 ohms, 1%
- R2, R4, R5, R6—1000-ohm multiturn trimmer potentiometer
- R3—1500 ohms, 1%
- R7—6250 ohms, 0.1%
- R8—3200 ohms, 0.1%
- R9, R12—1 megohm, 1%
- R10, R11—324,000 ohms, 1%
- R<sub>T1</sub>, R<sub>T2</sub>—Thermilinear composite

##### Semiconductors

- IC1—LM10 op amp/voltage regulator IC (National)

##### Other components

- S1—SPST miniature toggle switch
- S2—DPDT miniature toggle switch

Miscellaneous: Prototyping board, plastic case,  $\frac{1}{4}$ -inch three-conductor phone jack (enclosed type), banana plugs, 9-volt battery and connector, etc.

#### PARTS LIST— $-30$ to $+50^{\circ}$ VERSION

As above, except:

- R4, R5, R6—2000 ohms multiturn trimmer potentiometer
- R10, R11—412,000 ohms, 1%
- R13—750 ohms, 1%

R<sub>T1</sub>, R<sub>T2</sub>, R7, and R8 are available as a complete set of components as YSI part no. 44201 ( $0-100^{\circ}\text{C}$ ) or 44203 ( $-30$  to  $+50^{\circ}\text{C}$ ). The price is \$24 from Newark Electronics, Route 22 East, Springfield, NJ 07081. Contact YSI Industrial Sales, Yellow Springs, OH 45387 for the name of the distributor nearest you.

the thermistor and the tube should be filled with epoxy. For measuring surface temperatures the thermistor should be thermally bonded to the surface with heat-sink compound. If you prefer, ready made probe assemblies are available. Contact YSI for more information.

To use the adapter, set your DVM to a DC voltage range having a sensitivity of one millivolt or better. Plug the thermistor composite or probe into the adapter and the adapter into the meter, turn the adapter on and read temperature. The meter will read ten millivolts per degree so that, for example, 1,000 volts (1000 millivolts) indicates 100.0 degrees. Readings may be converted from Celsius to Fahrenheit simply by throwing the C/F switch.

Within its range, the units accuracy will be excellent. The worst-case error will be the sum of the thermistor's specified accuracy ( $\pm 0.15^{\circ}\text{C}$ , or  $0.27^{\circ}\text{F}$ ), your DVM's accuracy and the Thermilinear network's nonlinearity. That error may be corrected for using the graphs in Figs. 9 and 10. For example, on the  $0$  to  $100^{\circ}\text{C}$  range, the reading will be  $0.12^{\circ}\text{C}$  too high at  $33^{\circ}\text{C}$  and  $0.20^{\circ}\text{C}$  too low at  $60^{\circ}\text{C}$ . R-E



**Radio  
Electronics**

**RECEIVING** ■

JUNE 1985

# **Satellite**®

**TELEVISION**



**Installing  
your  
TVRO**

**Know Before you Buy**

We Bring You the World™

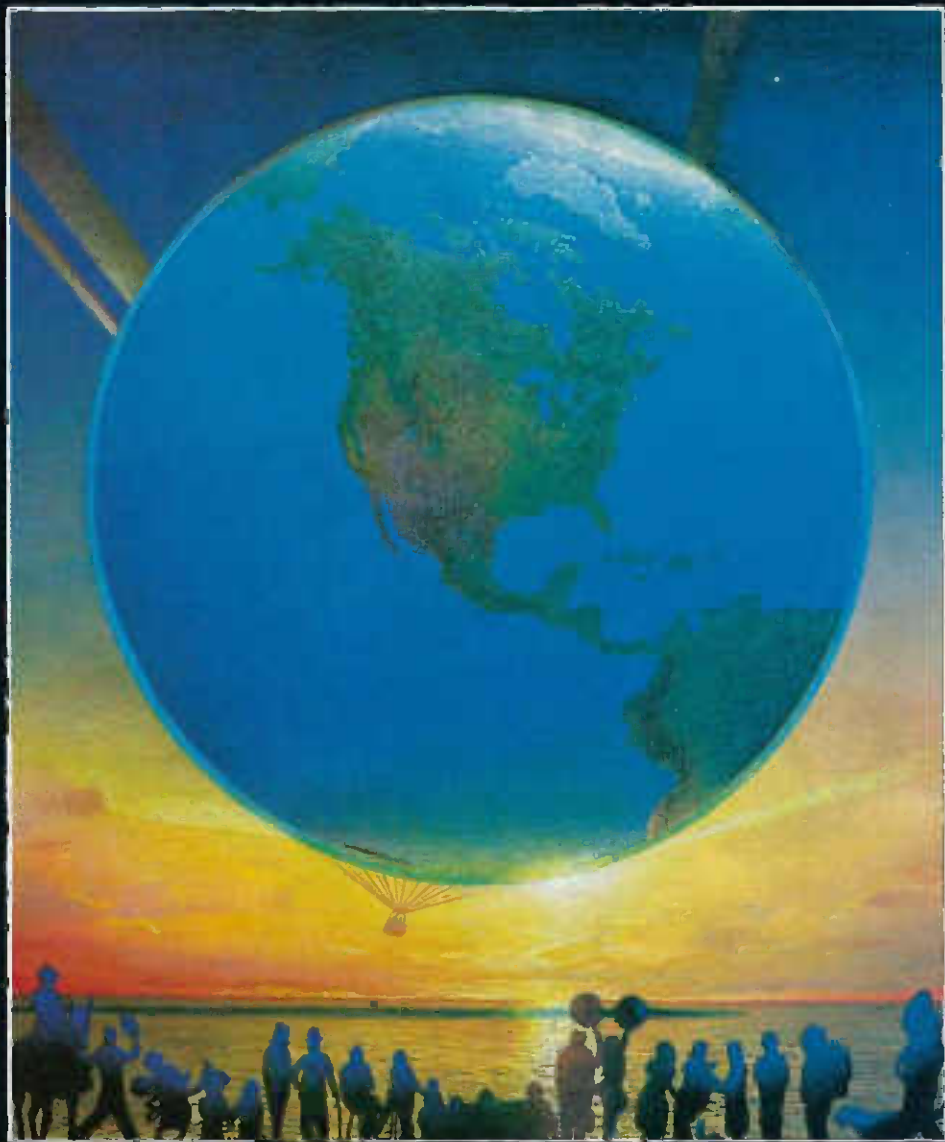

The fastest growing, most complete  
video programming log for satellite television.  
Satellite TV Week gets it straight —  
bringing information to  
industry, dealers and viewers.

## **Satellite TV Week**

P.O. Box 308, Fortuna, California 95540  
800-358-9997 or in CA 800-556-8787  
707-725-2476

CIRCLE 255 ON FREE INFORMATION CARD

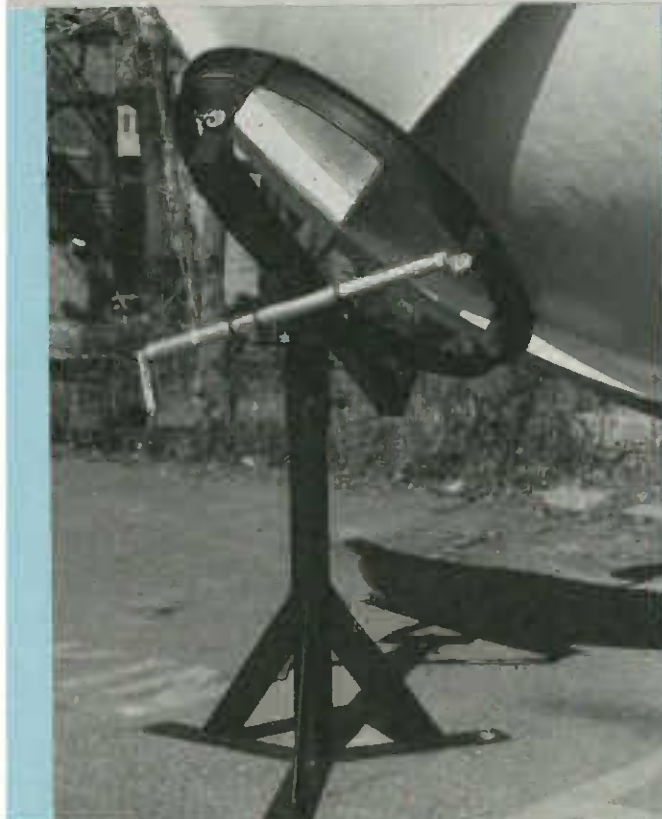

# Know Before you Buy

*Here are some things to think about before you buy that TVRO system.*

**BOB COOPER, JR.\***  
SATELLITE TV EDITOR

INSTALLING A HOME TVRO SYSTEM CAN BE A CONFUSING AND bewildering experience. That is especially true for a newcomer to the field of satellite TV. (Though such a newcomer brings with him none of the long held "old wives' tales" concerning the field; a person can know "too much" and consequently be leary of the often simplistic technical explanations and instructions that are so common in the TVRO field.)

Even so, installing the system is less of a challenge than the task of selecting the equipment. There is an entire family of "buzz words" in TVRO (even TVRO itself is something of a buzzword, standing for *Television Receive Only*), and they defy understanding to those who are "outside looking in." If you do not understand the buzz words, then the industry's literature is \*PUBLISHER, CSD MAGAZINE



virtually useless because most of it has been written with the belief that the reader is at least "versed" in the terminology. So where do you start? We hope here!

### One or more?

We have developed a "chain of decisions" for you to follow in both understanding how a TVRO system works, and in formulating your own concept of how you might wish to select and perhaps install such a system for your home. We'll ask you some questions and from your answers we'll follow different routes to arrive at the equipment selection that most suits your needs. That will make it simpler for you to create your own system "on paper" since you will only concentrate on those system elements that pertain to the particular system design you have chosen.

Our first question is: Do you need to have control of your satellite program selection located at more than one spot in your home? That seems like an innocent enough question, but the answer has many ramifications, as we are about to learn.

The important thing to remember about program selection is that it can be done only at the satellite receiver. Satellite signals are in the microwave range, from 3700 to 4200 MHz. At those frequencies, cable losses are tremendous. To prevent that, the downconverter—essentially the first IF stage of a satellite receiver—is located outdoors at the dish. Since the IF is much lower than the frequency of the satellite signals, doing that allows ordinary coax to be used between the dish and the rest of the satellite receiver.

The drawback to that is that the selection of the frequency to be received is performed in that first IF, under control of the receiver. Therefore only a single frequency is carried over the coax line. That signal is fed to the receiver for further processing, and then fed to your TV, usually via either Channel 3 or 4. While it is possible (and economical) to share the satellite receiver output between two or more television sets located in the same home, it follows that the individual selecting the program from the TVRO receiver will in turn select the satellite-fed program for all the TV's fed from that receiver. A setup of that type is shown in Fig. 1-a. In that diagram, all satellite program selections are done at one site, called the master location; all other locations are called slave locations. It follows that having all the slave locations dependent upon the program selected at the master location may not be the most desirable system for your home, but how do we get around it? The answer is with *block downconversion*.

In block downconversion, the first IF stage passes the entire band of satellite signals. Selection of the satellite frequency you wish to view is done in a subse-

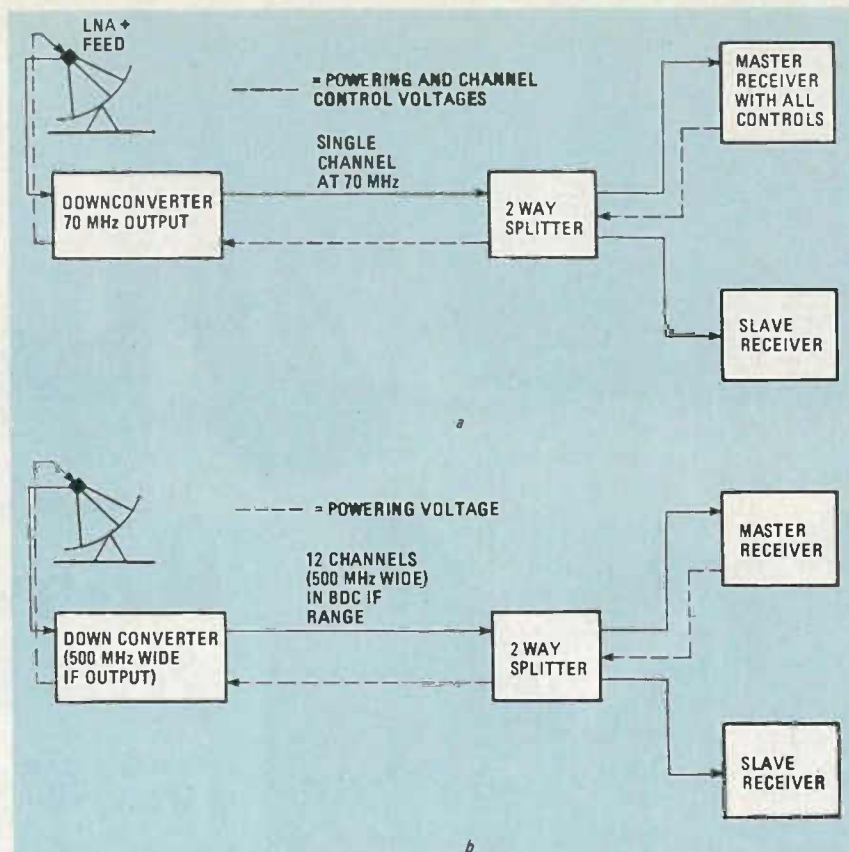

FIG. 1—IN THE SYSTEM shown in a, only the transponder selected at the downconverter is passed to the receivers in the system; all receivers can be used only to view the same signal. In a block-downconversion system (shown in b), each receiver is free to select the channel that is to be viewed.

quent stage in the receiver itself. Since each receiver connected to the output of the first IF stage now has access to all of the satellite frequencies, each receiver can be used to independently select the signal that will be viewed.

In a block downconversion system, we still have a master receiver and one or more slave receivers, although each receiver has the ability to independently tune in any transponder channel they wish (see Fig. 1-b). We'll see why, shortly. For now, just remember that you do have a choice; the same program in all rooms on all TV sets as selected by the master, or individualized reception selected at any receiver location by either the master or attendant slave units.

### Selecting the control location

Having selected a desirable approach to planning a home system, we now move into some of the subordinate questions you must face. For instance, let's consider dish control.

Whatever downconversion scheme you select, you must still decide how and from where you will move the dish. Here are some basic facts to consider:

- A modern satellite can carry as many as 24 separate TV channels or programs, simultaneously.
- There are more than a dozen satellites within view of a typical backyard dish located in most parts of North America.

Virtually none of the programs or services repeat their transmissions on two different satellites, so you in effect have a potential of  $24 \times 12$ , or more than 280 TV channels in space right now. (As a practical matter, seldom do we find more than 90 of those potential video channels in use at any single moment.)

● To change channels, you first select the satellite you wish to view, and then select the channel you wish on that satellite. Changing channels is all electronic; changing satellites involves repointing the dish from one area of the sky to another.

Which brings us to the *dish positioner*, a device that uses either a motor-driven or manually operated mechanical arm to point the dish.

### Moving the dish

It is now time to turn to our second question: Do you wish to be able to move your dish from one satellite to another by remote control?

That question presupposes that you will wish to move your dish somehow. If not by remote control, you can always trot out into the side or backyard and move it by hand when you wish to change satellites. Without a motorized dish, positioner system, your dish will most likely still have a mechanical arm that will allow you to do the same thing manually (overlooking the futility of trying to move the dish precisely, at 2 AM in the morning, during a

thunderstorm or blinding snowstorm, dressed in your bathrobe!).

Turning to the motorized units, the basic dish positioner is a pretty simple device. It consists of a jackscrew connected to a motor with reversible windings, so the jackscrew can turn clockwise or counterclockwise upon command from a control unit located inside the house.

Perhaps we should note here that even if you've opted for a block-downconversion system, you will still be able to control the dish positioner from only one location in the house. That's the reason one of the receivers in Fig. 1-b is still denoted as a master receiver. All other locations will still be able to select which transponder they wish to view, but not which satellite.

Getting back to the dish positioner, if the dish is properly installed, as the jackscrew rotates the dish will move in such a way as to track or follow something known as the Clarke Orbit belt. That's the arc in the sky, directly above the equator at a height of some 22,300 miles, where the geostationary satellites used for satellite TV are located.

The most basic dish positioners are much like the early home TV-antenna rotors that required that the user hold down on the button until the new TV station was peaked-in. They, too, require that the user hold down a button while the dish tracks across the sky.

But that task can get to be tedious. Consider, for instance, the following. Let's say you have been watching WTBS on transponder 18 on Galaxy 1 (G1). That's down low to the ground at the far western end of the satellite belt. It is a Thursday evening, and you decide you want to watch BoreSight, a special program, intended for TVRO owners, that reports on new products and developments in the TVRO industry. That program is transmitted via transponder 20 on RCA F4, a satellite that is much higher in the belt. To repoint the dish from G1 to F4, requires that the dish track quite a distance through the arc, passing 8 to 10 other operating satellites along the way.

To repoint the dish, the first thing you do is set your receiver to receive transponder 20 (remember that transponder frequencies are the same on each satellite, making the job of tuning a lot easier). Then push, and hold down, the button that causes the dish to track to the east. Continue to hold down the button while the dish tracks across the sky. As you are tracking and passing satellites in the belt, the programming on transponder 20 on those satellites will appear on your TV. When you finally have the dish pointed at RCA F4, the BoreSight program that you were looking for will appear. That tells you that the dish is correctly aimed and that you can release the button.

One problem with all of that is that the operation will typically take about 60 sec-



**A DISH POSITIONER** is nothing more than a motorized jackscrew that extends and retracts upon command. Simplistic drive/controller packages provide east and west movement under pushbutton control, while more elaborate systems include location sensors and location memory.



**THIS DISH CONTROLLER** is just about the ultimate in luxury; its handheld infrared control can be extended to distant points in house for total control over the dish and system.

onds. That's a long time to be standing there with your finger on a button.

If holding a button down and waiting for the dish to move to the right satellite is not your idea of modern technology, prepare to spend extra money for extra convenience. For instance, dish positioners can be programmed, as we noted earlier, so that you simply push one (or two) buttons to tell the dish to move from wherever it is now to where (ie. which satellite) you want it to be.

A preprogrammed dish positioner naturally costs more than a non-programmed one, and one with a remote control costs even more. But a remote-controlled unit offers a significant advantage. With it, there are techniques available to allow you to extend the range of the remote control out of the room where the master receiver is located. And that is true whether your remote is of the infrared or RF variety. Let's take a look at an example.

In our example, the master unit is located in the family room where much of the TV viewing is done. But, there is also a slave unit in the bedroom. The question here is whether you should locate the master in the bedroom and the slave in the living room (weighing whether it is more inconvenient to get out of bed to change satellites than it is to get out of a chair.)

Remote control to the rescue.

The range of infrared remote-control

units can be extended with remote pickups all over the house; anyplace you can run a wire back to the master receiver can be a secondary pickup point for an infrared unit. And, if your remote is of the RF variety, its signals will not be impeded by such things as walls and floors, so you can simply wander with the remote and change both channels and satellites from anyplace in the house.

### Picture quality

Our next question is: "What level of picture quality is acceptable?" Before you answer that, however, perhaps we should rephrase that to read: "What level of picture quality are you willing to pay for?" The following may help make that decision a little easier.

You have doubtless heard that having a satellite system in your home is the next best thing to being inside a network control room. And it in fact can be. But it can also be a test of your eyesight since there are many low-cost, marginally performing, home systems. Perhaps a good analogy would be to compare those low-cost systems to a shirt pocket AM radio, that for \$3.95 does indeed "receive" AM signals. But, as you might imagine, how well it receives them for that price is an entirely different matter.

You will have to decide what level of picture quality you want for your system and, as you might suspect, the better the quality, the higher the cost. According to recently conducted national surveys, the average home TVRO system, installed by a dealer (often referred to as a turnkey system), costs just under \$3000 (\$2993, if you like exact figures). Yet you have most likely seen advertisements for complete systems that you can install yourself for under \$500. On the other hand, there are systems on the market that even today can run \$8000. Logic should suggest that the \$8000 system must do something the \$500 system does not do, or the guy selling the \$8000 system would shortly be in another line of work.

What are those differences? There's convenience, for instance. You will certainly not find such things as motorized dish positioners or remote control on a \$500 system you install yourself; those are items found only on upper-price bracket systems. But what about reception quality?

There are three factors that directly effect the quality of the reception you can expect. We'll try to deal with each in such a way that you will understand the trade-offs involved.

One of those factors is dish size. With present technology, it is not yet possible to produce as clear pictures from as many channels with a 6-foot dish as it is with a 12-foot dish. Dish size relates directly to dish gain, or the sensitivity of the system.

It would be nice to be able to tell you



**NOISE IN THE VIDEO** results from an insufficient carrier-to-noise ratio, which is a function of antenna gain (size), LNA noise-temperature, and receiver design. This is the reception quality afforded by an 8-foot dish in a weak signal area.

that with a 6-foot dish you will receive 47 channels, with an 8-foot dish 52 channels, with a 10-foot dish 68 channels and with a 12-foot dish 92 channels. Unfortunately, we cannot do that because how many channels you can receive, and at what quality level, also depends on where you install the dish.

Between the Hughes (Galaxy), RCA (Satcom), Western Union (Westar), AT&T (Comstar and Telstar), Canadian (Anik) and other satellite families now littering the Clarke Orbit belt, we have many different philosophies of how a satellite should beam its signal toward earth. RCA, for example, believes that all satellites should favor the mid-western part of the U.S. with gradually weaker signals in all directions (towards both coasts). Hughes believes that all satellites should cover significant parts of a hemisphere (which is substantially larger than the U.S. alone). AT&T sees no reason to cover anything but the 48 continental states, so reception from their satellites is peaked directly into the U.S. and falls off rapidly outside of our continental borders. And on and on.

That means that the signal strength received on the ground (the pattern of signal strength is often referred to as the satellite's footprint) varies from location to location, and from satellite to satellite. A 6-foot dish in Florida works poorly on Satcom, but better on Galaxy. A 10-foot dish produces perfect AT&T (CBS and ABC) network signals in Kansas, but produces virtually no pictures at all in the Bahamas. We could fill pages with that kind of information, but all it would do is confuse you. Instead, we offer the following:

- People who live in the central part of the U.S. (such as Kansas and the surrounding states) are best off because most satellites at least maintain maximized signal strengths into the center of the U.S.
- People who live in New England and Florida are worst off with the exception of those who live in Hawaii, because both of these portions of the continental land mass are least favored by most of the satellites that carry video programming.

(Hawaii, because of its distance from the continental U.S., is covered only by low-power spot beams. Only about 50% of the available channels are carried by those beams, and because of their low power, dishes less than 12-feet in diameter are generally not useable.)

Which brings us to a completely unreliable rule of thumb: Use bigger antennas around the edges of the 48 continental states and use smaller antennas as you get closer to the central states.

Now, here's why that rule of thumb is completely unreliable. A 6-foot dish in New Jersey will work quite well; but only on certain of the Galaxy and Satcom transponders. If a person will be happy (as in satisfied) with say 15-18 clean channels and a multitude of others that are not clean (as in snow and interference), he's a candidate for a small dish at a cheap price, even in New Jersey, Connecticut, or Florida. If he took the same small dish to Kansas, Oklahoma, etc., he'd find 50 or 60 clean channels to watch.

Now, how do you find out what kind of dish you are going to need or want to be satisfied? Check around your own area. Inspect dishes that have been installed and see what the reception looks like. Here are some things to look for to help you quickly separate the good systems from the not so good ones:

- Ask to see transponders 2, 4, 10, 14, and 22 on RCA Satcom F3R. Those are universally weak. If they look clean, you are probably watching a good performing system for its size, anywhere in the 48 states.

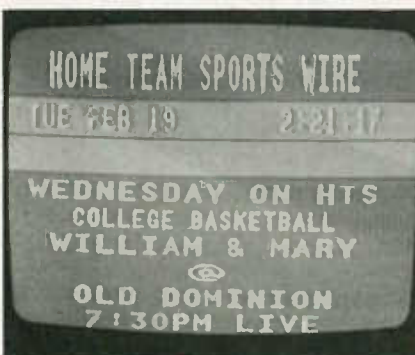

**INCREASING THE DISH SIZE** to 12-feet provides a rock-steady, noise-free signal.

- If you are west of the Rockies, ask to see transponder 21 on F3R (The Weather Channel). If it is not perfect, the dish is probably not large enough.
- If you are along the east coast, ask to see transponder 8 on F3R (CBN) and transponder 5 on Galaxy 1 (Showtime). Again, they are weaker than the others and as such will help you judge a system's performance.
- If you are outside the U.S., in the Caribbean, ask to see all of the above plus Telstar 301 (96 degrees west), transponders 2 and 10 for the CBS and ABC net-

work feeds respectively.

Another factor influencing the quality of the reception is the sensitivity of the Low-Noise Amplifier, or LNA. This is the signal booster/amplifier that is installed at the dish proper. They are rated in two-ways: by something called noise temperature, and by their gain.

Noise temperature is a measurement performed on LNA's to determine how much noise they add to the satellite signals while they amplify them. Noise is bad, clean signal is good, therefore an LNA that adds less noise is better than one that adds more noise.

Noise shows up on the screen as snow (called sparklies in the TVRO trade). Noise degrades the picture and sound. LNA noise temperatures fall between 55 degrees and 120 degrees Kelvin at the present time. A 55-degree unit is more expensive than a 120-degree unit. Most systems sold today routinely use 85- or 100-degree units because they are cost effective. There is not a great deal of price difference between a 85-degree unit and a 120-degree unit anymore (not at the dealer level, anyhow). But the 55-degree units can still cost from two to four times as much as a 100-degree unit.

Gain is important too, but here you almost have to take the word of somebody who has selected the component units for you. Some receivers work no better with a 50-dB gain LNA than they do with a 40-dB gain LNA. In some systems, the trend is to take some of the gain away from the LNA (such as dropping it from 50 dB to 40 dB) and then to make up for it by adding additional gain stages in the receiver proper.

Then again, some receivers don't use LNA's; they use LNB's or LNC's. An LNA is a stand-alone amplifier that does nothing but amplify. It is followed by a stand-alone downconverter that does nothing but convert frequencies. An LNB is a Low-Noise Block downconverter, which means that the amplifier and a block downconverter are packaged in a single housing or container. The LNB now has a noise temperature rating but it will no longer have a gain rating since the gain is part of the converter package and the meaning of that rating is lost in the marriage of the two units.

An LNC, or a Low-Noise Converter, is the combination of the LNA and a standard-type downconverter. Again, they are rated with a noise temperature but not a gain specification.

Which is best is not an easy question to answer since no *one* is really best. That's because those units are part of a system and are worthless unless connected to a receiver. A really great LNB, for example, will not produce good quality reception when connected to a system with a not-so-good receiver.

*continued on page 81*

# Installing your TVRO

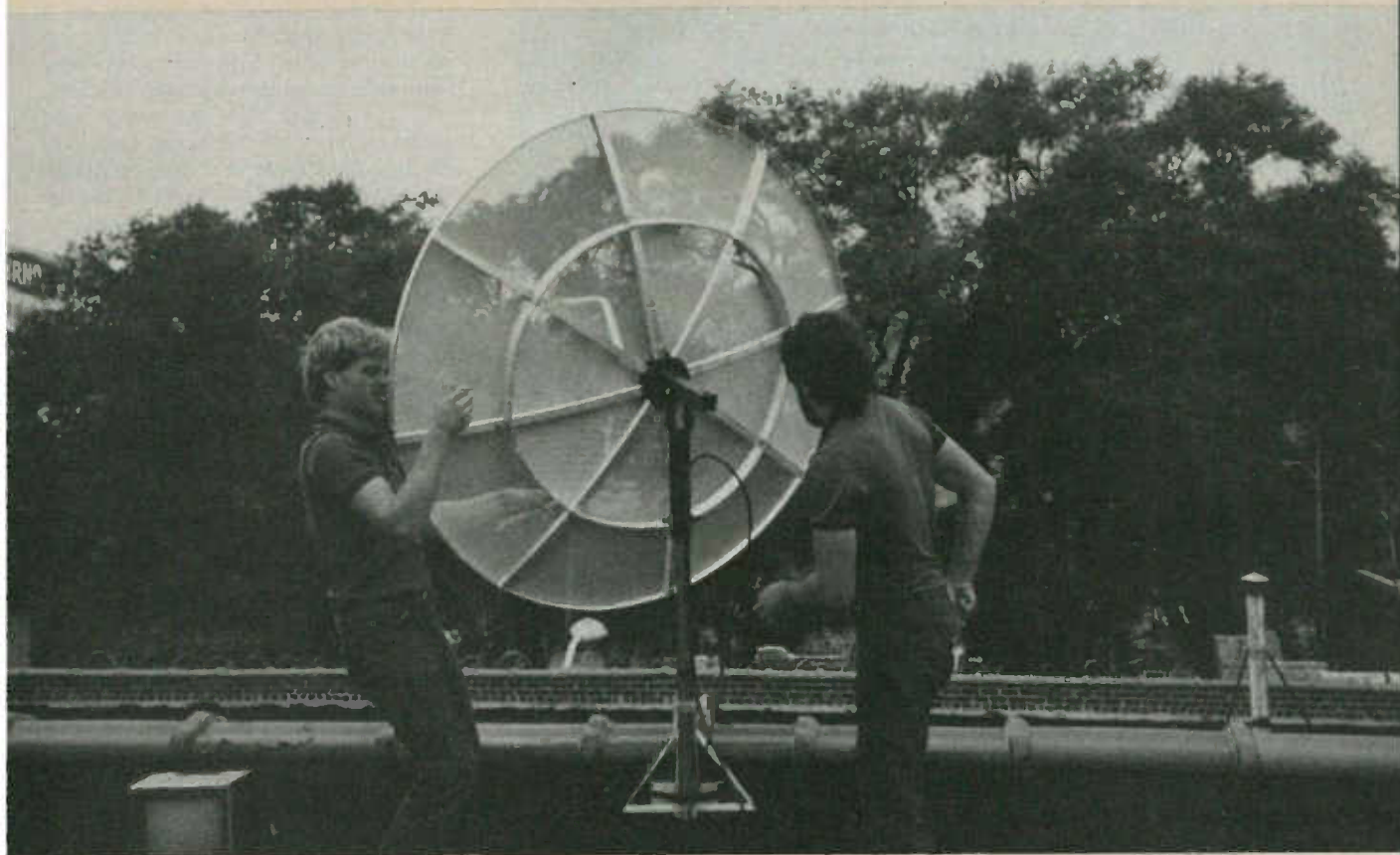

BOB COOPER, JR.\* SATELLITE TV EDITOR

*Take the guesswork out of TVRO installation with this step-by-step guide.*

THE FIRST STEP IN SETTING UP A HOME TVRO system, before spending even one dollar on equipment, is to sit down and do some thinking. For instance, have you given any thought to where the dish is going to be located? Unfortunately, for reasons we will get into in a moment, not every yard can accommodate a dish. If yours turns out to be one of those, you could try to place the dish on your roof; but that requires some special mounting considerations, as a dish elevated in that manner is subjected to quite a bit of wind and ice loading. An improper installation can lead to a damaged dish, or worse, a damaged house.

When you are planning out where you are going to locate your dish, there are certain rules that should be observed:

- The satellites are located in a belt over the equator, at a height of 22,300 miles (see Fig. 1). If you are in North America, that generally means that the satellites will be south to southwest of you.
- The majority of satellites transmit back to earth using frequencies in the 4-GHz

band (also called the C-band). That is a microwave-frequency band and like all other microwave signals, there can be no physical obstructions between the signal source (the satellite) and the dish. Thus your dish should be located so that no buildings, trees, hills, or other "obstructions" block its view to the south or southwest.

- The satellites that are located due south of your location will be the ones that are the highest in the sky. Those located to the southeast or southwest of your location will be located close to the horizon (i.e. close to the ground). We specify a satellite's position in the sky, from your location, using something called look angles. There are two look angles that count: how far up or above your horizon the satellite is located, and the angular bearing from your location to the satellite's location.

The "up" direction or angle is called the elevation. It is the angle formed by a line drawn from your dish to the horizon and a line drawn from your dish to the satellite of interest. The angular bearing is called azimuth and it is referenced to true

north (with true north being 0 degrees). Thus, a satellite due south of you would have an azimuth of 180 degrees, while due southwest would have an azimuth of 270 degrees.

Note that our reference point is true north. Because the north pole and the magnetic pole are not in the same location, the compass that points north may actually be pointing ten degrees or more away from true north. When we lay out or plan a system, and we try to determine if we have any blockage from our intended dish location toward the satellite, it is important that we correct our magnetic north to true north if there appear to be any close blockages in the area.

The local airport control tower, the local survey office, a stationary or engineering supply store that sells USGS Geodetic Survey Maps will have available to you the proper magnetic correction to be applied to a compass reading for your locale. If your location is Colorado, for example, the compass will point 14 degrees west of true north. Once you have the proper correction factor, it is a simple matter to de-

\*PUBLISHER, CSD MAGAZINE

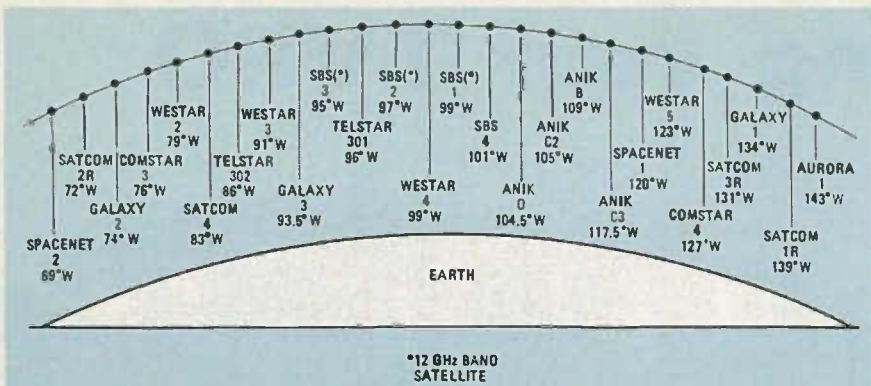

FIG. 1—CHARTING THE SATELLITES. The positions of all North American satellites in the Clarke Belt are shown here.

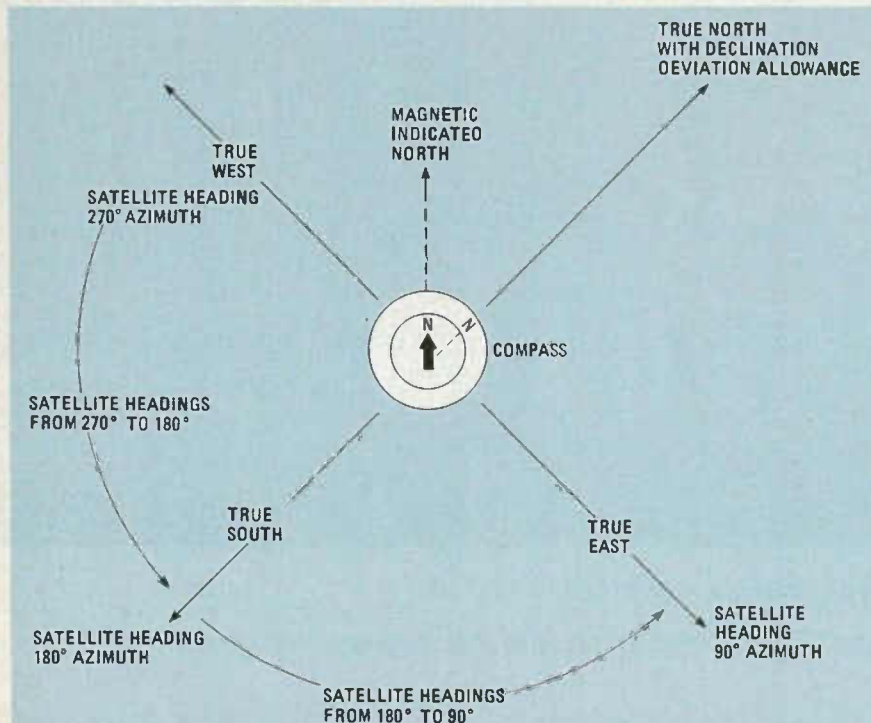

FIG. 2—WHEN DETERMINING WHERE a satellite is, relative to your location, be sure to allow for the difference between magnetic north and true north.

termine the direction of true north and to use that information to locate the azimuth headings of the various satellites (see Fig. 2).

We now know that the satellites are located more or less to our south, and at some elevation above the horizon. But we still don't know exactly where they are. Unfortunately, we can't provide a simple answer to that, as the answer varies from location to location.

So it is still somewhat difficult to calculate which location on our property might have a clear access or view to the satellite belt. To do that properly we need a reference source, some type of "pointing guide" that will allow us to take our own location (by geographic latitude and longitude coordinates) and then determine that our view of the desired satellites is clear. A full description of that subject is beyond the scope of this article so we will give you some other choices:

- Find somebody locally who already

has that information for your area (as we said, the settings do change with each locale or region, since your latitude and longitude to the nearest degree determines how you need to point your dish).

- Invest \$15.00 or so in a satellite aiming guide. For instance, *World Satellite Aiming Guide* (PO Box 2347, Shelby, NC 28150) provides an aiming guide for \$15 that allows the user to find the elevation



AN "INCLINOMETER" is a valuable tool in TVRO installation. Here we see how one commonly available unit is used.

and azimuth settings for virtually any satellite from any location. It can be a bit difficult to use, but it does get the job done.

If someone in your area already has a TVRO, you could also use a compass and an "inclinometer" (a device used to measure elevation angles) to measure the various look angles. (One commonly used inclinometer is the Craftsman *Universal Protractor, Plumb & Level*, available from your local Sears.) To do so, use the compass to measure the azimuth heading (that is easy to do with wire mesh dishes, as you can simply stand behind the dish and use the feedhorn support as a pointing guide). Next, use the inclinometer to measure the elevation heading at the dish's back plate. Repeat the procedure for every satellite that the TVRO owner can view. When you are done, you should have a set of readings that looks somewhat like the one shown in Table 1.

Once we have the headings to the satellites from our location, we can use that information to determine if our selected dish site is appropriate. To do that:

- Stand in the selected spot.
- Use a compass to determine true north, as previously described. True south will be 180 degrees from true north. To make things easier, use stakes to mark out a line from true north to true south.
- Using the information for our hypothetical location, our chart tells us that Westar 4 is located on a true bearing of 214.4 degrees. Use a simple plastic protractor (the type found at a drugstore school-supplies counter), laid on the ground, or a compass, to determine where 214.4 degrees is from our spot (remember, true north is 0 degrees, true south, 180 degrees). Face in that direction, and with the inclinometer temporarily mounted on a short piece of lumber such as a 1 x 2 (make sure that the piece is straight) tip the 1 x 2 plus inclinometer upward until it reads approximately 34 degrees.
- If you can sight along the line indicated by the inclinometer and not see anything but sky (assuming, of course, that you are facing in the proper direction), then your site will be fine for your dish (see Fig. 3).

Now, what kind of changes can you expect if you don't live in or near our selected location (Albany, New York)? Obviously the satellite belt stays in the same position; so as you move north, south, east, or west from our example location, the apparent position of that belt in the sky is going to change.

There are several rules of thumb that apply and a look at Table 2 will help show how those rules of thumb are applied.

- The farther south you live, the higher and higher the satellites appear in the sky (the converse of that being that the farther north you go, the lower they appear in the sky).
- Satellites due south of you will always



**TABLE 1—ELEVATION AND AZIMUTH HEADINGS**

Satellite	Orbit Location	Elevation	Azimuth
RCA F1R	139° W	9.4°	252.4°
Galaxy G1	134° W	12.3°	249.0°
RCA F3R	131° W	15.1°	246.0°
Comstar D3	128° W	17.1°	243.6°
ANIK D1	105° W	31.4°	221.4°
Westar 4	99° W	34.3°	214.4°
Westar 3	91° W	37.5°	204.1°
RCA F4	83° W	39.5°	193.1°
Galaxy G2	74° W	40.4°	178.5°

**TABLE 2—LOOK ANGLES**

Satellite	Concord, NH (43.2N, 71.5W)		Port Au Prince, Haiti (19N, 72W)		Pratt, KS (37.7N, 98.7W)		Mexico City, DF (19.4N, 99.1W)	
	Elev.	Azimuth	Elev.	Azimuth	Elev.	Azimuth	Elev.	Azimuth
F1R/139 W	8°	254°	13.2°	262°	29.6°	234°	39.7°	249°
G1/134 W	11.6°	250°	18.1°	260°	33°	229°	44.6°	245°
F3R/131 W	13.7°	248°	21°	259°	35°	225°	47.4°	243°
D3/128 W	15.8°	245°	24°	258°	37°	222°	50°	240°
AD1/104 W	30.9°	223°	47.4°	243°	45.6°	188°	67°	195°
W4/99 W	33.4°	217°	53°	236°	46°	180°	67.7°	180°
W3/91 W	37°	207°	59°	227°	45°	167°	66°	157°
F4/83 W	39°	196°	64.4°	211°	43°	155°	61.2°	139°
G2/72 W	40°	181°	67.6°	180°	38°	140°	52.1°	123°

be highest in the sky (ie. be of the maximum elevation). Satellites significantly southeast or southwest of you will have the lowest elevation

• The most difficult satellites to receive are those that are located very close to your own horizon (ie. at elevations of less than 15 degrees). We'll see why, shortly.

Table 2 shows the subtle changes that take place when two locations at the same longitude but at differing latitudes wish to receive the same satellites. For example, both Port Au Prince (Haiti) and Concord (New Hampshire) happen to be near 72 degrees west longitude. But the look angles, particularly the elevation, vary significantly between the two—to RCA F1R, for example. From Concord, the elevation is 8 degrees (barely above the horizon), and the azimuth is 254 degrees. From Port Au Prince, the same satellite has an elevation of 13.2 degrees, and an azimuth of 262 degrees.

What about locations that are farther west? Let's consider the look angles from

Mexico City (19.4 north and 99.1 west) and Pratt, Kansas (37.7 north and 98.7 west). Again from Table 2, from Mexico City, the look angles for F1R are 39.7 degrees elevation, and 249 degrees azimuth. From Pratt, those angles are 29.6 degrees and 234 degrees, respectively. As you can see from the preceding, satellites appear higher in the sky at longitudes that are closer to their own. On the other hand, at greatly different longitudes, the satellite appears closer to the horizon. When you reach a point around 5 degrees elevation (ie. your antenna would only be pointed up by 5 degrees), you begin to have special problems with satellite microwave reception. In particular, noise problems created by the earth itself can become severe, since the antenna is now pointing so low to the earth that it is barely skimming over the distant horizon.

So special and unpleasant circumstances prevail for low look angles. Even if you live on a mountain top and have no obstructions, you may find ultra-low look-angle reception a special challenge.

To review, select a location for your dish where the dish center (not merely the top edge) has a clear, unobstructed view of the satellite belt. If you do not have such a location available (and many do not), you will have to settle for reception of just those satellites that you can "see" from your location.

**Up or down**

You have two choices for where you will install the dish—on the ground (which is the best choice, if possible) or on a roof. You gain nothing (but potential grief) if you mount your dish anywhere but on the ground when you do not have

to. Additional height accomplishes nothing here, since the satellite signal arrives just as strong to a clear-vision site located on the ground as it does to a similar site on a roof.

Sometimes, however, you simply can not "see" the satellite belt (or the part you want) from a ground-located site. Up, on the roof, is the only choice left.

Satellite antennas are available in a number of design configurations. Here are the choices open to you:

• Solid metal, made of either aluminum or steel; there are also solid dishes made of fiberglass. All those tend to be strong, but heavy. They also present a solid surface to the wind, and wind is an important consideration when you are mounting the dish on a roof or tall pole.

• Screen-mesh dishes are lightweight and present less wind loading since some of the wind will blow through the mesh surface. As such, mesh dishes are preferred for roof mounting.

If it is not possible to mount your dish on the ground, there are two options that are available to you. The antenna can be mounted on a metal pole (typically 3 to 5 inch OD, schedule 40, steel), which is in turn supported along the side of a house or building, so that just a short stub protrudes above the roof line. Otherwise, special roof-mounts, which use three or four metal legs to attach to the roof, provide a platform for the antenna itself. The top of such mounts usually ends up being a 3 to 5 inch OD pipe, since most antennas have a collar that requires a pipe of that size to slide down over as the point of attachment.

An unsupported steel pipe, no matter how strong, or a tower *can't* be counted on to hold the dish steady and stable in the air. That is important since the dish must stay pointed at the satellite with a stability-accuracy in the region of 1/8 inch in all kinds of weather. The dish cannot sit up there and move about in the breeze (because the pipe is moving slightly under the force of the wind). If it does that, the pictures will fade in and out (mostly out) as the wind moves the dish about ever so slightly (1/8 inch play might seem slight, but in this case it is far too much).

And, a three or four legged rooftop mount has to be installed so that the antenna does not rip loose (taking part of the roof with it!) in a strong wind. Remember that even a mesh antenna is not too different, for windloading purposes, from a sail; and the same wind forces that drive a sailboat will rip and tug at the dish and its mount. People who have attempted to attach rooftop mounts with long lag screws through the roofing material usually come back in a short time to pick up a tangled mess from the yard below (or worse yet, a neighboring yard). About the only acceptable method of installing a three or four legged mount on a roof is to place a steel

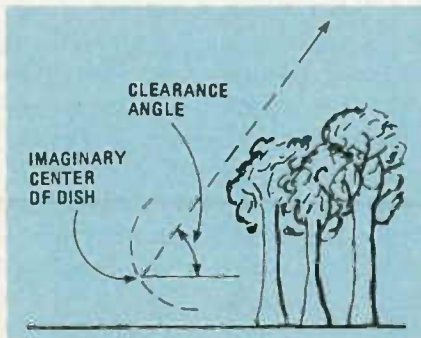

**FIG. 3—WHEN SELECTING A SITE** for your dish, be sure that there are no obstacles between the dish and any satellites that you wish to view.

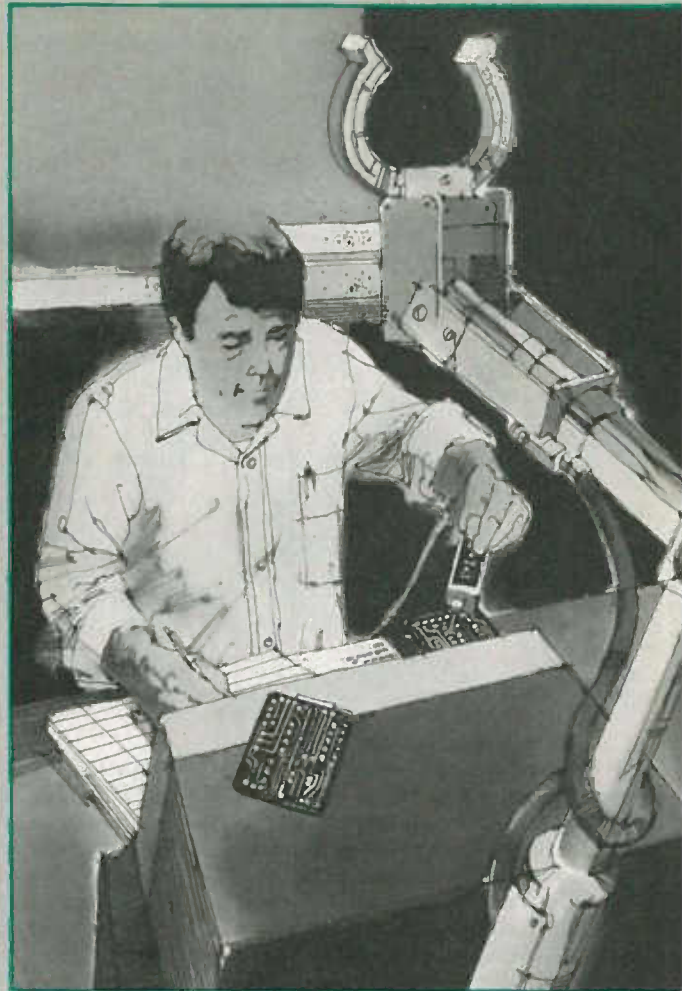
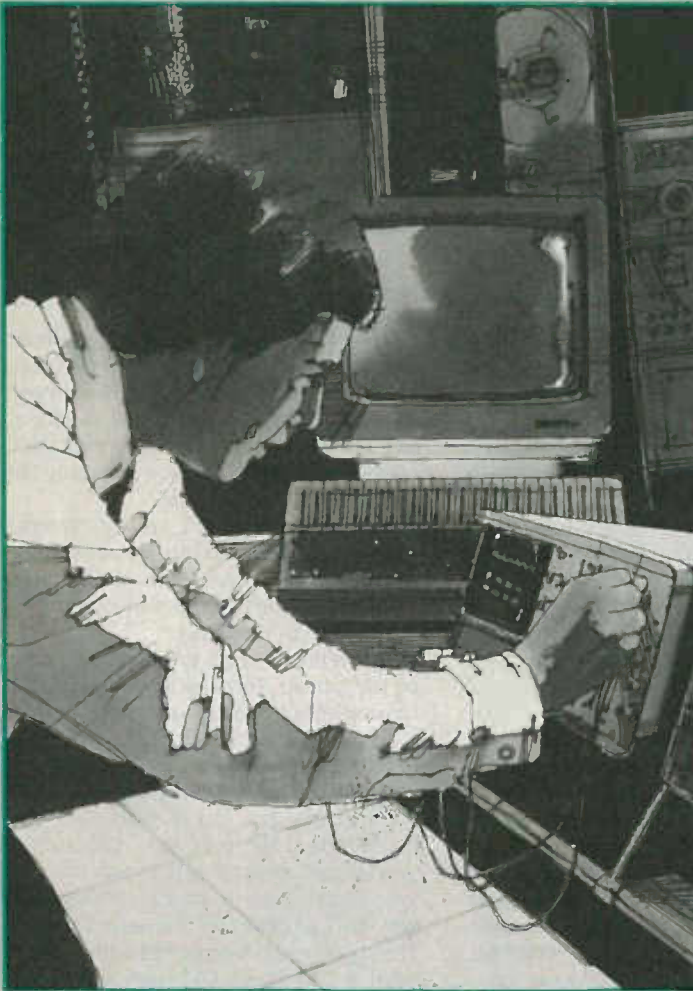

# What can you do Just about

## CIE can show you how.

Computer technology. Satellite communications. Cable television. Cellular radio. Digital electronics. Robotics. Just a few of the hottest career areas in electronics. The ones everybody is talking about. The ones that are changing the way we live, the way we do business, the way we entertain ourselves. The best way to start a career in any of them? By learning the basic electronics theory and principles of how they work from CIE.

## Join a leader.

Leading the world in specialized electronics training, CIE is the largest school of its kind with over 25,000 students at home and abroad. And with over 50 years of experience teaching electronics to thousands of men and women through proven

methods of independent study **without** classroom sessions.

## Learn as much as you want, when you want.

Whether you're interested in learning new skills or upgrading old ones, earning a diploma or an A.A.S. degree, CIE can match your needs with courses and programs that let you start where you want, go as far as you want from a basic beginner course all the way to CIE's Associate in Applied Science Degree in Electronics -- a comprehensive program that prepares you for advanced electronics careers.

## Custom training equipment helps you learn.

CIE believes in the importance of learning by

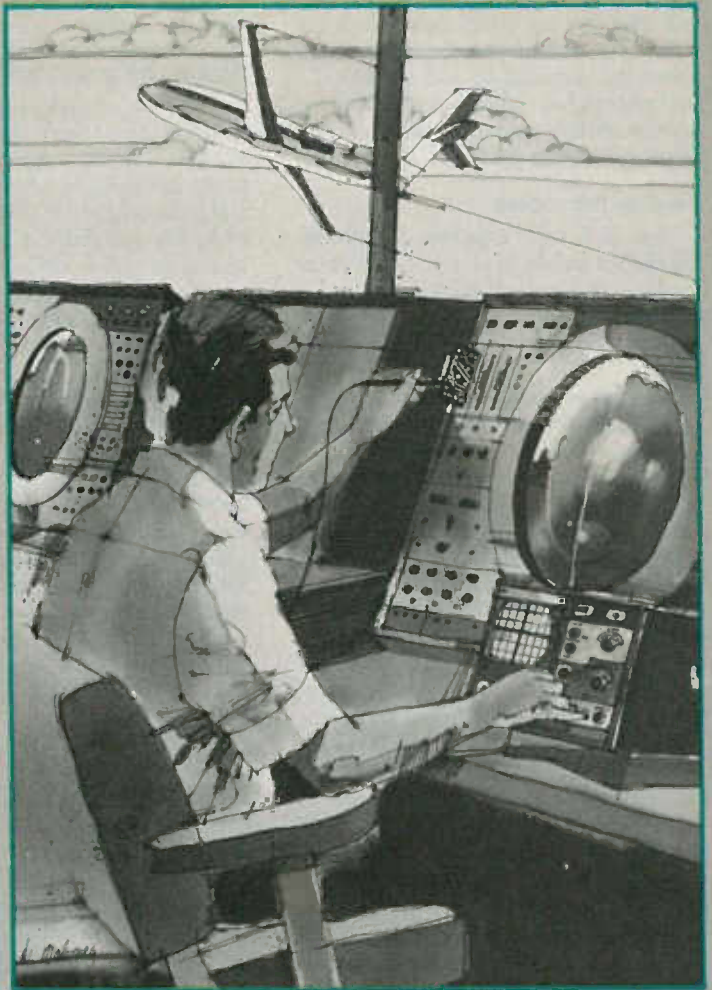
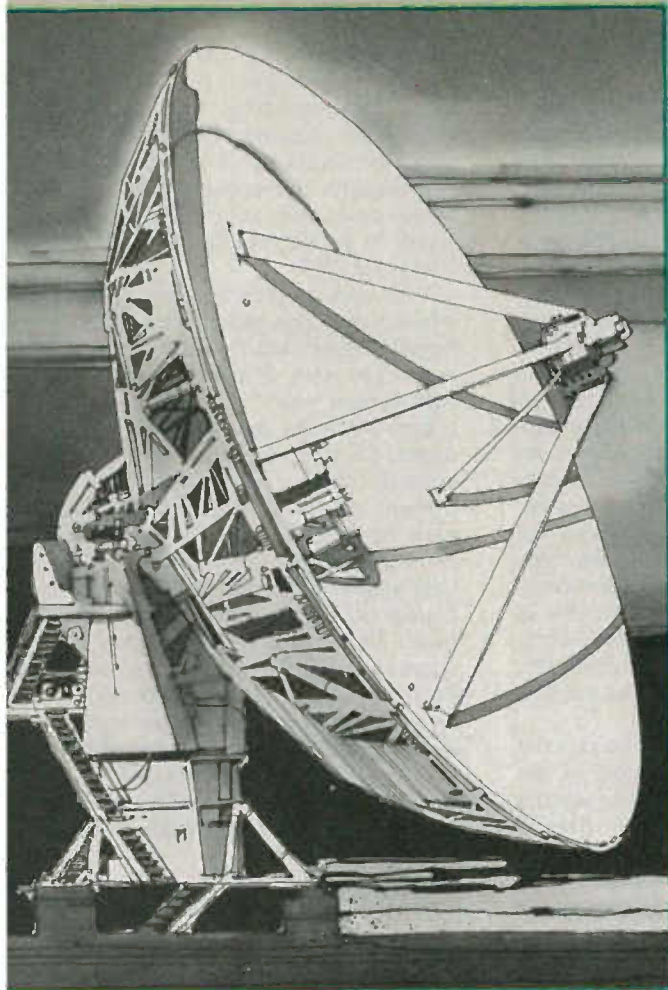

# with electronics? anything.

doing. So most of our courses include specialized training laboratories keyed to specific lessons for practical experience through teaching experiments. Our CIE Microprocessor, for example, comes fully assembled and ready to use to teach you how a computer CPU works through a series of experiments you perform on your own.

## Are you ready?

If you're ready to do something now about your future, there's no waiting to enroll with CIE. Get all the information you need to enroll simply by calling us toll-free at **1-800-321-2155** (in Ohio, 1-800-362-2105). Or mail in the handy reply coupon or card to Cleveland Institute of Electronics, 1776 East 17th Street, Cleveland, Ohio 44114.

**CIE** World Headquarters  
**Cleveland Institute of Electronics, Inc.**  
 1776 East 17th Street • Cleveland, Ohio 44114

- Please send me your CIE Off-Campus Studies Catalog, including details about the Associate Degree program. I understand there is no cost for the catalog and a CIE representative may call, but there is no obligation.

Print Name \_\_\_\_\_

Address \_\_\_\_\_ Apt. No. \_\_\_\_\_

City \_\_\_\_\_ State \_\_\_\_\_ Zip \_\_\_\_\_

Age \_\_\_\_\_ Area Code/Phone No. \_\_\_\_\_ / \_\_\_\_\_

Check box for G.I. Bill bulletin on Educational Benefits

Veteran  Active Duty

**MAIL TODAY!**

RE-11

plate (1/4th inch thick or more) under the roof and use lag bolts, rather than lag screws, to ensure that the legs of the mount are attached to and through the steel plate below, rather than merely to the wooden roofing structure—which is certain to give under pressure.

### Routing the cables

Your dish will interconnect with the electronics inside your home via some quantity and type of cables. Here is a rundown on some of the cabling that you're liable to find in a TVRO installation.

- A length of coaxial cable (RG-59/U or RG-6/U) that's used to carry the signal indoors from the outdoor mounting LNB/LNC or downconverter.
- A three to five (or more) conductor cable that's used to carry the motor drive voltage to the dish positioner jackscrew, and carry sensor "feedback" signals back inside to the dish positioner control box.
- A piece of RG-59/U or RG-6/U (or in some systems simply a pair of wires) that's used to carry a tuning voltage from the indoor receiver out to the downconverter/LNC (in systems in which only a single frequency is passed from the downconverter to the receiver).
- A two or three conductor cable used to select the polarization of the LNA.

Those are the basics, but some systems use even more cable between the dish site and the inside electronics. Now, how does one route all of that cable safely and attractively—or at least reasonable so?. The logical way is to bury the cable underground. There are two ways to accomplish that: use so-called direct burial cable, or route the cable through a length of PVC pipe. Direct burial cables are now available in a single weatherproof sheath or wrapping that contains all of the individual wires or cables needed. With it, you bring indoors only one large cable, rather than several individual cables. But even if you do chose to use that type of cabling, the use of a PVC pipe is recommended. Direct burial cable is, for instance, not immune to damage from a burrowing animal, such as a rodent (those nasty little creatures can really do quite a bit of damage to cables), and such cable is fair game for anyone armed with a shovel or a spade.

Make sure when you select your cable that you take the following points into consideration:

- The length of your cable is important; some of the control wires and the signal (coaxial) cable have specified maximum lengths. If your runs of cable exceed those lengths, line losses may cause your system to fail to work altogether.
- Some areas have special electrical installation codes affecting TVRO's (Los Angeles, for example). You may need an outdoor wiring permit before you install your cables, or the entire TVRO system

for that matter; it is best to check before you start to make sure you comply.

### Equipment protection

Our look at protecting TVRO equipment will cover two major topics: protecting the equipment that is outside from being damaged by weather or moisture, and protecting any of the electronic equipment from electrical spikes and transients. Let's first see how we can protect outside equipment from the elements.

In any type of system we have at least an LNA/LNB/LNC unit out of doors. It has a signal input end, which is connected to the feedhorn, and a signal output end that is connected directly to the indoor equipment. (If we are dealing with an LNA, we will also have a separate downconverter between the LNA and the indoor equipment.) The connections between the LNB/LNC, or the LNA/downconverter, are made with coaxial cable, as previously discussed. Those cables must be able to withstand weather/environmental conditions such as moisture, heat, cold, dirt, and dust. Moisture, in particular, can be a serious problem.

Moisture of any type *must* be kept out of the system. That means out of the LNA/LNB/LNC, separate downconverter (if used), and any connectors. Special moisture-barrier compounds have been developed; one such is *Coax-Seal* (available at Radio Shack). Those compounds seal any equipment housing or connector/fitting so that it resists moisture penetration.

Moisture and ice present special problems to TVRO dish positioners. The jackscrew drives are apt to freeze when they get coated with ice and snow. (Another, related problem is that snow may fill the dish, and the combined weight of the snow and dish may be more than the drive can move. The solution to that problem, of course, is to make sure that any snow has been cleared from the dish before attempting to move it.)

If you live in an area where ice and snow are common, anticipate winter problems with motor drives. A cage or shield, probably best custom-made by you for your installation, to keep the ice from coating the motor drive and freezing up the system would be a good Saturday afternoon project after the system is installed. And it sure beats missing the Super Bowl in late January because of a heavy ice storm!

As to transient or surge suppression, for safety's sake: All TVRO hardware should be protected with an external surge/transient suppressor. Those plug-in devices (available from many sources and often for under \$10) will save you countless moments of frustration. Remember, anything in the TVRO system should be so protected, even if the equipment supplier makes his own claim for internal surge and transient protection.

### A model system

Of course, no two systems are exactly alike, although each will have the same basic parts and approach to system design. To wrap things up, we'll walk through the elements of a "model" system, including how it is selected and how it is installed. Our model will use a block downconversion scheme, since that seems to be the most popular receiver format for 1985.

Let's start out with the dish, as that is where most people perceive the system to begin. We have already looked at why and where you want to locate the dish, and why certain types of installation procedures may be more attractive than others. So, what else do we need to know about the dish?

Well, for one thing, the dish surface must be highly accurate. As you may know, the surface of most dishes are parabolic shaped so that the weak signals that bounce off them are focused at a single point. That concentrating of signal produces a signal that is strong enough for the following electronics to process. As would follow, then, the more accurate the surface the stronger the signal produced; in other words, the higher the gain. But, how do you select a dish that has an accurate surface? Here are some rules of thumb.

Dishes that are "parabolic both ways" are generally better than dishes that use "flat panels". Parabolic both-ways simply means that the panel sections follow the parabolic curve lengthwise (from center to outer edge) and crosswise (across the panel). Some dishes use flat panel sections that follow the parabolic curve only from center outward to the rim edge. Dishes that use flat panel construction have less gain than those that are parabolic both ways, assuming that all other factors (size, shape-accuracy, etc.) are the same. The difference in gain is on the order of 1 dB, and possibly greater.

Dishes that use ribs with structural support should have greater surface accuracy than those that have ribs that are simply pressed into a parabolic shape. Metal has "memory"—when you stamp, stretch, or force a piece of metal to follow the parabolic curve, the metal wants to regain its original shape (i.e., a straight piece of aluminum or steel). It is possible that with time, plus heat and cold, the metal may lose some of its surface accuracy.

The rear support structure of the dish is very important. It provides rigidity for the entire dish and ensures that it does not warp or bend out of the desired shape.

Unfortunately, most of us are probably incapable of evaluating a back-plate system for its ability to maintain dish shape. Still, a dish minus any form of back-plate system should at best be suspect.

That's all we have room for now. Next time, we'll start off with a look at how to assemble your dish.

## Electronic Aids for the Blind

*While electronic aids can't restore sight to the sightless, they can help reduce some of the hardships of being blind.*



RAYMOND M. FISH, Ph.D., M.D.

IN 1751, BENJAMIN FRANKLIN SUGGESTED that sight could be restored through the use of some form of electrical stimulation. That has, at least thus far, not proven to be possible. We have, however, devised many useful electronic aids for the blind in the 200-plus years that have passed. In this article, we will examine some of those aids, and see how electronics can be used to minimize some of the disability that accompanies blindness.

Aides for the blind can generally be divided into two general categories, reading aides and mobility aides. Reading aides allow persons with limited or no vision to gain access to printed information. Mobility aides permit the visually handicapped to move about in an unfamiliar environment.

### Reading aides

Persons with very poor vision (but who are not completely blind) can be helped by devices that magnify print. Some such devices are purely optical, while others use television cameras or computers to achieve their objective.

There are also many devices that allow a totally blind individual access to the printed word. Those are often scanning devices that produce an audio or other signal in response to the printed material that is input to them.

Not all scanning devices are recent innovations. The Optophone, for instance, was invented in 1913. The device, and later models of it, have up to 9 light sensitive detectors arranged in a vertical column. The array of detectors is manually scanned across a printed line. Each detector activates (or deactivates) a tone of a certain frequency. The higher up in the column the detector is located, the higher the frequency of the tone that it controls. As the array of detectors is moved across printed material, time varying chords or tones are produced. With practice, the user can use those tones to "read" the material. "Reading speeds" of up to 60 words per minute have been achieved with the Optophone.

There are, of course, many similar devices. The Lexiphone is a reading aide that recognizes letters and emits a different sound for each. Other devices pronounce the actual letters. No doubt future devices will automatically scan a page, recognize and pronounce many words, and spell the others.

Some devices replace the audio signal with tactile simulation (stimulation of different regions of the skin). In the Visotactor, eight photocell signals activate eight

tactile stimulators. There are two stimulators on each of four fingertips. Other tactile devices have two dimensional arrays of over 100 photodetectors. Each detector causes vibration of a pin in a corresponding array of tactile stimulators on a finger. One such aide, the Optacon, allows users to "read" printed and typewritten material as well as characters on a computer monitor.

A variety of different devices have been developed that permit the visually handicapped to "read" the output of a computer. It is relatively easy to make an LED or television monitor with large print for persons who have limited vision. For the totally blind, commercially available computer terminals with speech synthesizers can speak at rate of several hundred words per minute.

### Mobility aides

The purpose of a mobility aide is to allow a blind individual to move reasonably rapidly in an unfamiliar environment.

Development of the laser cane began in the 1950's. Those devices, which are now commercially available, emit pulses of infrared light that are reflected from obstacles. With the laser cane, distance is inferred by optical triangulation. In one version of the cane, lasers emit 0.1-microsecond pulses of light 40 times a second. Light reflected from objects is detected by a photodiode, which is mounted behind a lens. The angle made by the reflected ray passing through the receiving lens is a function of the distance to the object. Three beams are emitted. One downward, one straight ahead, and one upward. The downward beam warns of stairs and curbs by means of a low-pitched tone. The beam that is emitted straight ahead warns of obstacles by stimulating the index finger of the hand holding the cane. The upward beam detects obstacles at head height and warns of them by means of a high pitched tone. Information about objects to either side is obtained by twisting the wrist in a rhythmic fashion while walking.

The Kay Ultrasonic Spectacles radiate ultrasonic signals that are reflected by obstacles. One receiver for each ear transforms the reflected energy into audible sounds. Left-right direction is coded primarily by the relative intensity of the signals in the two ears. For instance, the sound will seem to come from the left if the sound is louder in the left ear, and from the far left if a lot louder in the left ear; the same holds true, of course, for sounds heard in the right ear. A sound will seem to come from straight ahead if it is heard equally in both ears.

The Kay Spectacles code distance by changing the frequency of the sound. The reflective properties of the obstacle effect the amplitude and pattern of the sound heard. Loudness increases as the distance

to an obstacle is reduced. The elevation of an object can be determined by moving the head up and down (the maximum sound indicates the height).

The output of the Kay Spectacles is coupled to the ears through small plastic tubes that do not touch the ears; it is important to not interfere with normal hearing, which is in itself important for safe travel.

Tactile mobility aides present pictures of a person's surroundings by stimulating the skin mechanically or electrically. One such unit is the Mowat sensor. That device emits a tight beam of ultrasonic signals. When the signals strike an object, they are reflected back to the unit, which vibrates in response. Proximity to an object is indicated by the rate of vibration. Using that device, it is possible to detect large objects in the user's path, or conversely, openings, such as doorways and windows, in a wall, etc.

It is also possible to use the output of a TV camera to convey information to a blind individual. Information from the camera can be presented in either tactile or audible form. In a tactile system, an array of several hundred mechanical vibrators or electrical stimulators, applied to the forehead, back, or other part of the body, is used. The vibrations or electrical stimulation given at each point in the array corresponds to the image detected by a television camera. With a few hours of training, such a system can allow a person to recognize several dozen different objects and move about in simple environments.

Similar results can be obtained by coding the image detected by a television camera by sound. A television image is scanned in raster fashion over a period of about 10 seconds. The intensity of light at every point in the picture determines the loudness of the sound the person hears.

The left-right and vertical positions of the sound are presented to the person by means of stereo headphones. A block diagram of one such system is shown in Fig. 1. As the scan moves from left to right, the loudness in the right ear becomes greater than that in the left. The vertical position of the scan is coded by sound frequency—high locations are coded by high frequencies, lower positions by lower frequencies. That coding scheme permits persons with a few hours of training to recognize a limited number of real objects and to walk about in a simple environment.

Figure 2 shows the audio signal presented to each ear as the scan moves from left to right. The top waveform is that present at point c in the block diagram of Fig. 1; the bottom waveform is at point d in Fig. 1. When the scan is at the left, the sound is mostly presented to the left ear. In the center, the sound intensity is equal in the two ears. At the right the sound is loudest in the right ear. Sound intensity varies exponentially with left-right position. Varying the sound intensities linearly with position can be done, but the sound will not seem to the listener to move with a constant speed from left to right during the scan.

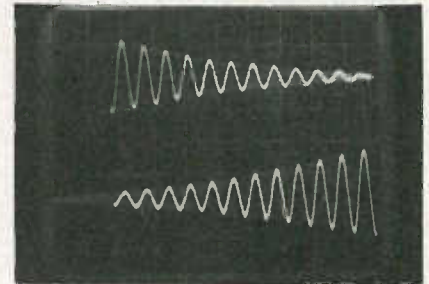

FIG. 2—AUDIO OUTPUT versus horizontal position. The top waveform in this photograph is the audio signal fed to the left ear as the scan moves from left to right. The bottom waveform is fed to the right ear.

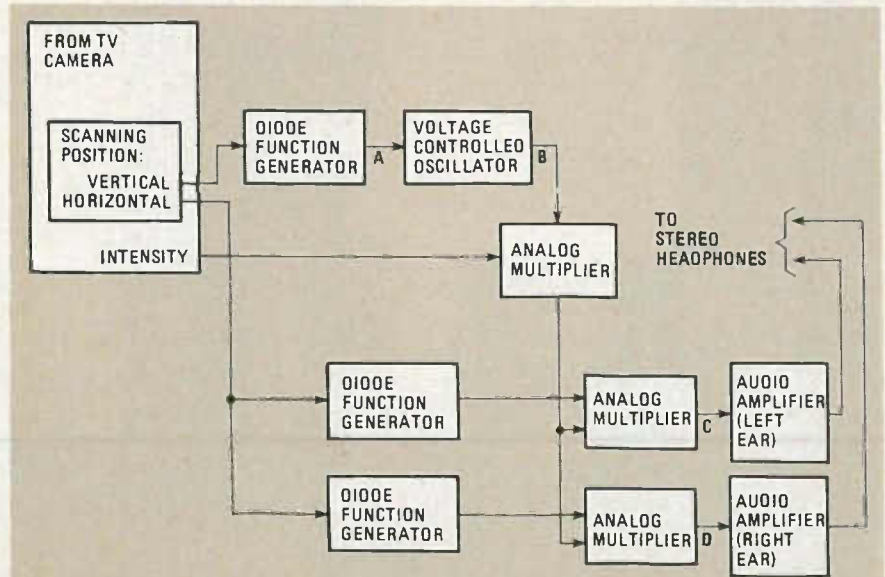

FIG. 1—BLOCK DIAGRAM of a system that converts the output of a camera system into an audio signal. That audio signal can be used by a blind person to locate various objects and obstacles.

The top waveform in Fig. 3 shows the audio signal generated with vertical position. Higher frequencies are associated with higher positions in the image. That signal is output by the VCO in response to an exponential input signal (the bottom waveform in Fig. 3) that is generated by the diode function generator. In the block diagram, the top waveform in Fig. 3 is found at point B, while the bottom waveform is found at point A.

Figure 4 shows the Diode Function Generator. The DFG produces an output voltage that varies approximately exponentially. While the input signal to the DFG (the raster scan voltage) increases linearly, the output will increase with several changes in slope, as shown in the bottom waveform of Fig. 3. (There is also a polarity change because of the inverting operation of the amplifier, but here we are discussing only increases in magnitude). Signals under about 2 volts are passed linearly to the operational amplifier. When the input voltage gets above 2 volts, the diode controlling SLOPE 2 turns on, passing even more current to the summing junction (inverting input) of the operational amplifier. The current through the diode divides, part going to ground through R7, and the rest going to virtual ground through R5. The voltage that must occur on the input to cause the diode to conduct is determined by the values R21 and R22. The increase in slope obtained in the output voltage depends on the values of the R5 and R7. As the input voltage increases, additional changes in slope are made by the other diode/resistor networks.

Unfortunately, such systems can not present a detailed picture of an area to a blind individual. The tactile and auditory systems can only present information about several hundred points in a few seconds. Most real environments contain images that need to be coded with hundreds of thousands of points if complete information is to be conveyed. A reconstruction of an image with even 10,000 points (100 on a side) will look blurred. An image made up of 400 points (about the capacity of most systems) is hopelessly blurred. Examine some newspaper images closely, seeing how many dots are needed to reproduce various types of images. It will become clear that the above systems cannot code clear images of a real environment.

Thus, to determine such things as the presence of small obstacles or irregularities in the ground, it is still best to rely on a cane. The tactile and auditory systems can be useful, however, for such things as sensing distance to any obstacles, and to the ground. That information would be presented to the blind person in the form of auditory or tactile stimulation; the stronger the stimulation, the nearer the object. In addition, such systems give

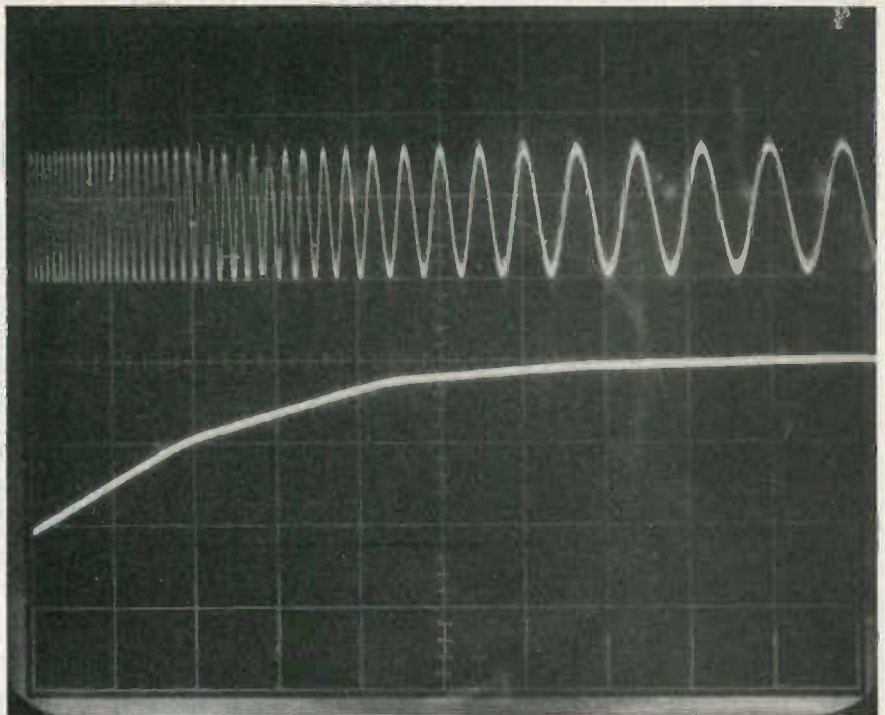

FIG. 3—HEIGHT INFORMATION is coded by changes in frequency. The top waveform shows the frequency change as the scan moves from top to bottom. That waveform is generated in response to the signal shown in the bottom of the photograph.

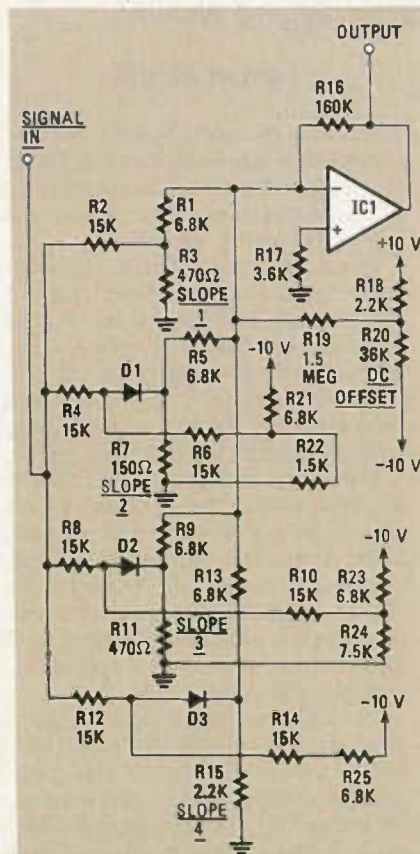

FIG. 4—SCHEMATIC DIAGRAM of the diode function generators used in the scanning system of Fig. 1.

a more three-dimensional picture of the environment by giving the up-down, left-right positioning of objects. In audio systems, that position is coded as discussed

above. In tactile systems, the location of the object is coded by the position of the tactile stimulator.

#### Direct stimulation of the brain

As we stated at the start, Benjamin Franklin suggested that sight could be restored to the blind through electrical stimulation. Experiments to do just that have, in fact, been performed, but with very, very limited success. At best, a blind person has been able to discern several dozen spots of light when electrodes implanted in the brain were stimulated.

When one examines the nature of sight, and the structure and function of the brain, the reasons for the poor results become apparent. For one thing, for adequate sight, it is necessary to transmit an image to the brain that consists of over 10,000 individual points. In addition, the image must be updated at least once a second.

The major limitation is on the number of points of light that can be communicated to the brain. Thus far, the effective minimum spacing for electrodes is about 2 millimeters. By comparison, the optic nerve is only about 2 millimeters in diameter, and the entire visual cortex of the brain (the region of the brain that "processes" the signals that come from the eyes) is only several centimeters in size. Because of that, the maximum number of electrodes that can be used is limited to a very few.

Therefore, providing real vision for the blind seems to be an impossible dream, or a challenge for doctors and engineers looking for a new frontier.

R-E

## Bar-Graph Voltmeter



## for your CAR

*Your car's ammeter can't warn you about impending battery failure. But this bargraph voltmeter will help you keep tabs on your car's charging system!*

STEVE PENCE

HAVE YOU EVER BEEN STRANDED IN A parking lot because of a dead battery? Nearly all of us have at one time or another—usually at the most inconvenient time. But that situation could be easily avoided if you knew your battery's condition.

Adding a voltmeter to your dashboard instruments is the best way to track your battery's performance. We'll show you how to build a voltmeter that's a bit different from the ones you are accustomed to seeing. Instead of a traditional mechanical meter movement, this one uses a sleek-looking, easy-to-read bargraph display. The display uses ten LED's (Light Emitting Diodes) to display a voltage range from 10.5 to 15 volts. Each LED represents a 0.5-volt step in voltage.

The voltmeter is designed around National Semiconductor's LM3914 dot/bar display driver. Using that IC keeps the rest of the circuit simple: only 15 passive components plus the 10 display LED's are required.

### The voltmeter circuit

The schematic of the voltmeter is shown in Fig. 1. The heart of the circuit is IC1, the LM-3914 dot/bar display driver. That IC contains nearly everything needed to construct a surprisingly accurate voltmeter.

As you can see from the simplified representation of the driver's internal circuitry shown in the schematic, the device

contains a precision voltage reference source that is very stable over a wide range of supply voltages and temperatures. It also has a precision voltage-divider chain made up of ten 1K resistors.

When the voltage reference is properly connected across the divider chain, 10 very accurate voltages are set up at the junctions of each of the 1K resistors. Each of these reference voltages are fed to the input of a separate comparator, which compares the reference voltage with the voltage presented to the input at pin 5.

If the input voltage is greater than the reference voltage, the comparator's output will go low, turning on its respective LED. As the input voltage goes higher, successively higher LED's turn on. The voltage that each LED represents is determined by the total voltage applied to the divider chain. If one volt is applied then each step will equal .1 volt.

You will note that the input voltage applied to pin 5 is first divided in half by R1 and R2. That's because the 3914 cannot measure a voltage that is equal to its supply voltage. We use the voltage divider to cut it in half to provide plenty of headroom. This means that when the battery voltage changes by .5 volt the input to the driver sees only a .25-volt change.

In order for the driver to measure in .25-volt steps we must apply 2.5 volts to the internal divider chain. That is accomplished by setting trimmer potentiometer R5 to the correct value. The internal volt-

age reference is set up to provide a constant current down through R5 (which is in parallel with the precision divider) and through R6. The voltage dropped across R5 is therefore also seen across the precision divider.

Resistor R6 is needed because we must begin our measurement at 10.5 volts instead of ground. That resistor essentially extends the bottom of the internal divider. The first comparator therefore turns on when the input signal is .25 volt above the voltage seen at the top of R6. If the constant current from the reference source is set to provide a 5.0-volt drop across R6, then the first comparator will turn on when the input voltage is equal to 5.25 volts (which corresponds to a battery voltage of 10.5 volts that is divided in half).

Trimmer potentiometer R5 is next adjusted to so that 7.5 volts is applied to the top side of the divider. You now have 2.5 volts across the divider for the required .25 volt per step. Since the current through R5 and R6 is constant, the voltage dropped across R6 will be constant, even if the value of R5 is changed.

Resistor R7 and diodes D2 through D5 clamp the voltage applied to the LED's to about 3 volts. This limits the power that the driver IC must handle and improves measurement linearity.

The electrical systems of most automobiles are extremely noisy, often producing narrow spikes as much as 200 volts in amplitude. Spikes of that magnitude



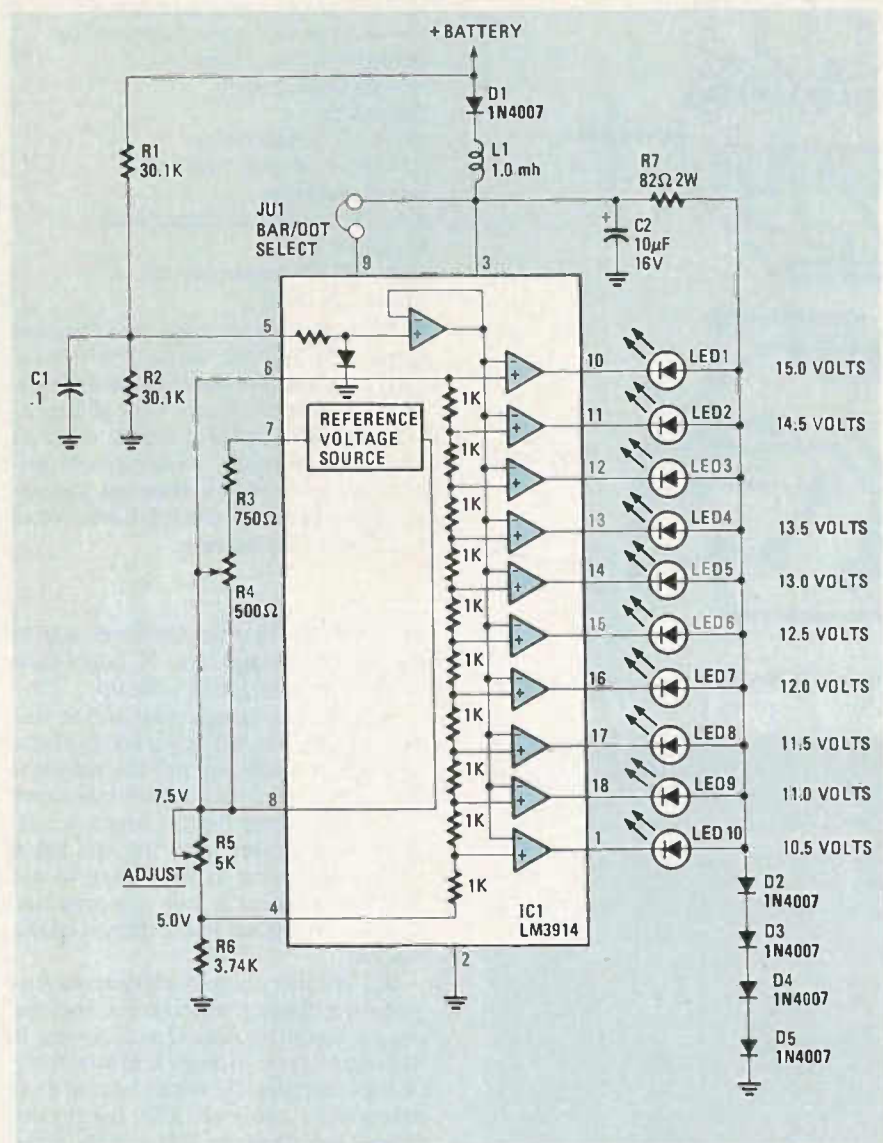

FIG. 1—THE BARGRAPH VOLTMETER SCHEMATIC shows that the circuit is not complex. To make the meter easy to read at a glance, you might consider installing yellow, green and red LED's to represent different voltage ranges.

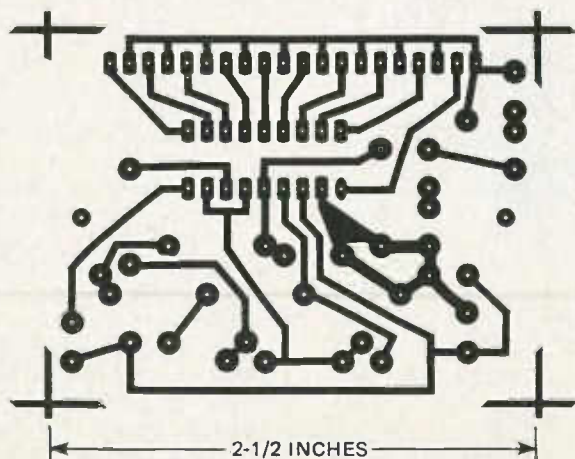

FIG. 2—THE FOIL PATTERN for the bargraph voltmeter is shown full size. The circuit layout is not critical, so you may prefer to use point-to-point wiring. But a PC board will certainly keep things neater.

can easily ruin a project of this nature if precautions are not taken. A lowpass filter made up of L1 and C2 guards against voltage spikes. Diode D1 is used to protect against reverse voltage in case the voltmeter is hooked up backward. Although those three components are not required for the voltmeter to operate, you should install them: They do increase long term reliability.

### Building the voltmeter

The bargraph voltmeter is easy to build. It's made up of a printed-circuit board, one integrated circuit, and a few discrete components. A PC board is not essential, but it certainly is a convenience. A foil pattern for a board is shown in Fig. 2. You can, however, build the meter using pre-punched circuit board and point-to-point wiring techniques. The layout of the circuit is not critical. The parts are available from a large number of electronics distributors or from the source listed in the parts list.

Once you have all the parts together, you can begin assembly by installing the components by following the parts-placement guide of Fig. 3. Remember that the diodes, the LED's, and capacitor C2 are polarized and must be installed in the correct direction.

When installing the LED's be sure they are all placed the same height from the PC board (approximately .150 inches). That's most easily done by having someone hold the board for you while you solder them into place. Have him hold the board foil side up, with the LED's installed over a flat surface. That will force the faces of all the LED's to be at the same height from the board. After they are all soldered in, bend them over so they are parallel to the surface of the board (see Fig. 4).

If you have access to different-colored LED's, you might consider installing them to signal different voltages. For example, yellow could represent anything under 12 volts, green could indicate inputs between 12 and 14 volts, and red could be used to indicate that your battery is overcharging.

Don't forget to install the jumper wire, J1, on the printed circuit board. That programs the LM3914 to display in the bar-mode. If, on the other hand, you prefer the dot mode (in which only one LED at a time comes on) simply leave the jumper out.

### Calibrating the meter

Calibration is easy to do—but it does require the use of an accurate voltmeter as a reference. The calibrating meter should be able to read to within at least .1 volt on a 10-volt range.

## PARTS LIST

### Resistors

- R1, R2—30,100 ohms, 1/4 watt, 1%
- R3—750 ohms 1/4 watt, 5%
- R4—500 ohms trimmer potentiometer
- R5—5000 ohms, trimmer potentiometer
- R6—3740 ohms, 1/4 watt, 1%
- R7—82 ohms, 2 watts

### Capacitors

- C1—0.1  $\mu$ F, ceramic disc
- C2—10  $\mu$ F, 16 volts, tantalum

### Semiconductors

- IC1—LM3914 bar/dot display driver
- D1—D5—1N4001
- LED1—LED10—rectangular red LED
- L1—1.0  $\mu$ H choke

The following are available from **Elephant Electronics Inc.**, P.O. Box 41770-P, Phoenix, AZ., 85000: Printed circuit board only, (BVM-1) \$5.95; PC board with all board-mounted parts, (BVM-2) \$19.95; Kit of all parts including case, (BVM-4) \$24.95. Arizona residents add 6% sales tax. Canadian orders please remit in U.S. funds. Allow 4 to 6 weeks for delivery.

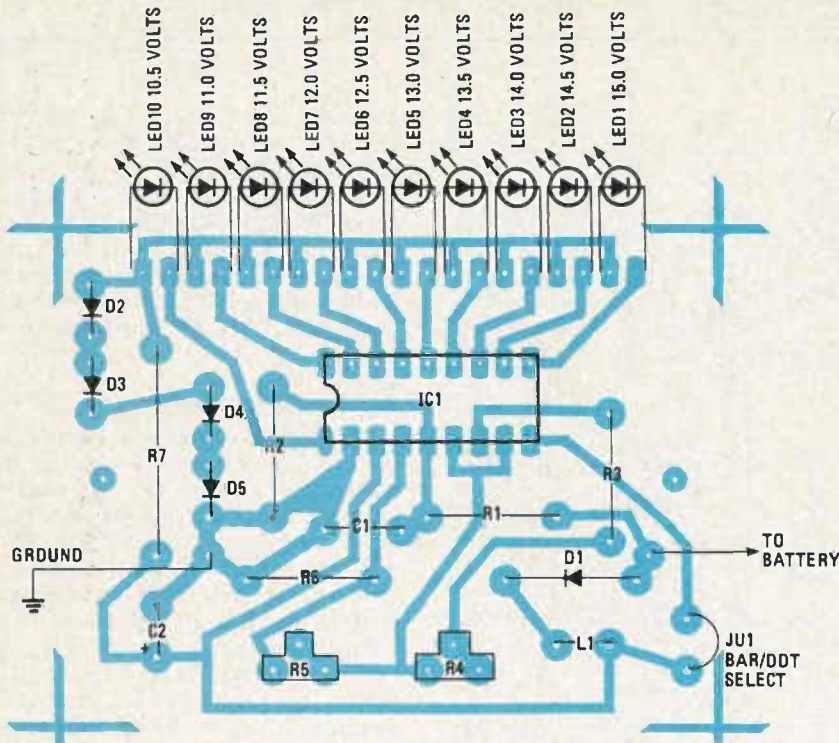

FIG. 3—PARTS PLACEMENT DIAGRAM. Note that for the unit to read from left to right, it must be installed foil-side up.

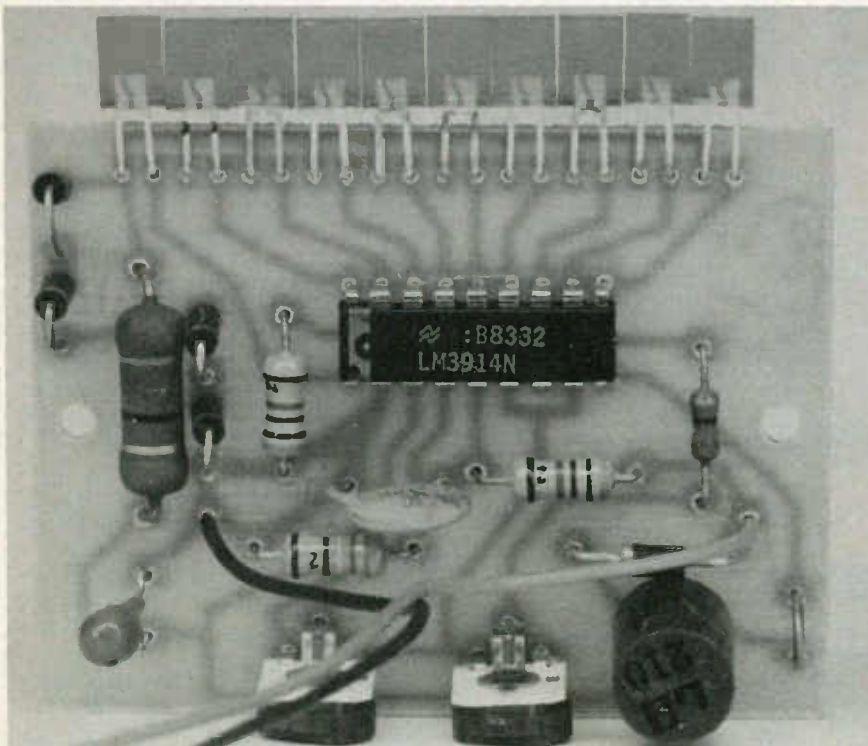

FIG. 4—THE ASSEMBLED VOLTMETER BOARD. When you install the LED's, make sure that you keep them all the same height, and bend them evenly.

Preset variable resistors R4 and R5 to the center of their range. Connect the meter to a source between 12 volts and 15 volts. With your calibrating voltmeter, measure the voltage from pin 4 of the IC to ground (across resistor R6). Adjust R4 for exactly 5.0 volts at this point.

Next measure the voltage from pin 8 of

the IC to ground (across R5 and R6). Adjust R5 for exactly 7.5 volts. The two adjustments should not interact, but recheck the voltage at pin 4 just to be sure.

### Installing the voltmeter

Mechanically, there is only one thing you have to keep in mind when installing

the voltmeter: In order for the display to read from left to right, the PC board must be mounted with the foil side up.

Many cars come equipped with an ammeter to indicate charging is taking place. Although this tells you that the alternator is charging, it does not tell whether or not the battery is accepting the charge. A voltmeter on the other hand lets you know immediately what is happening in the charging system. It can give you advanced warning that your battery is on the way out.

If your battery is fully charged, the engine is not running, and no accessories are on, you should measure 12 to 12.5 volts. If the battery is placed under load by turning on the headlights the voltage should drop only a half a volt or so. After starting the engine, the alternator will quickly bring the battery voltage up to 13 or 14 volts if the system is charging properly.

If the alternator voltage were to rise more than 2 volts above the battery voltage, it would indicate overcharging. One possible reason could be a bad voltage regulator ground. Overcharging will cause excessive boiling of the electrolyte and warping of the plates. That can lead to internal shorts.

If the battery isn't holding a charge properly, it is easily detected by checking the voltage just before starting the engine. If the voltage has dropped to 11 volts or less over night, you may soon be stuck in a parking lot somewhere.

One of the real advantages to the voltmeter is that you become accustomed to the normal pattern of voltage fluctuations. When a problem rears its head, the pattern will change and you then have an early warning of impending doom. R-E

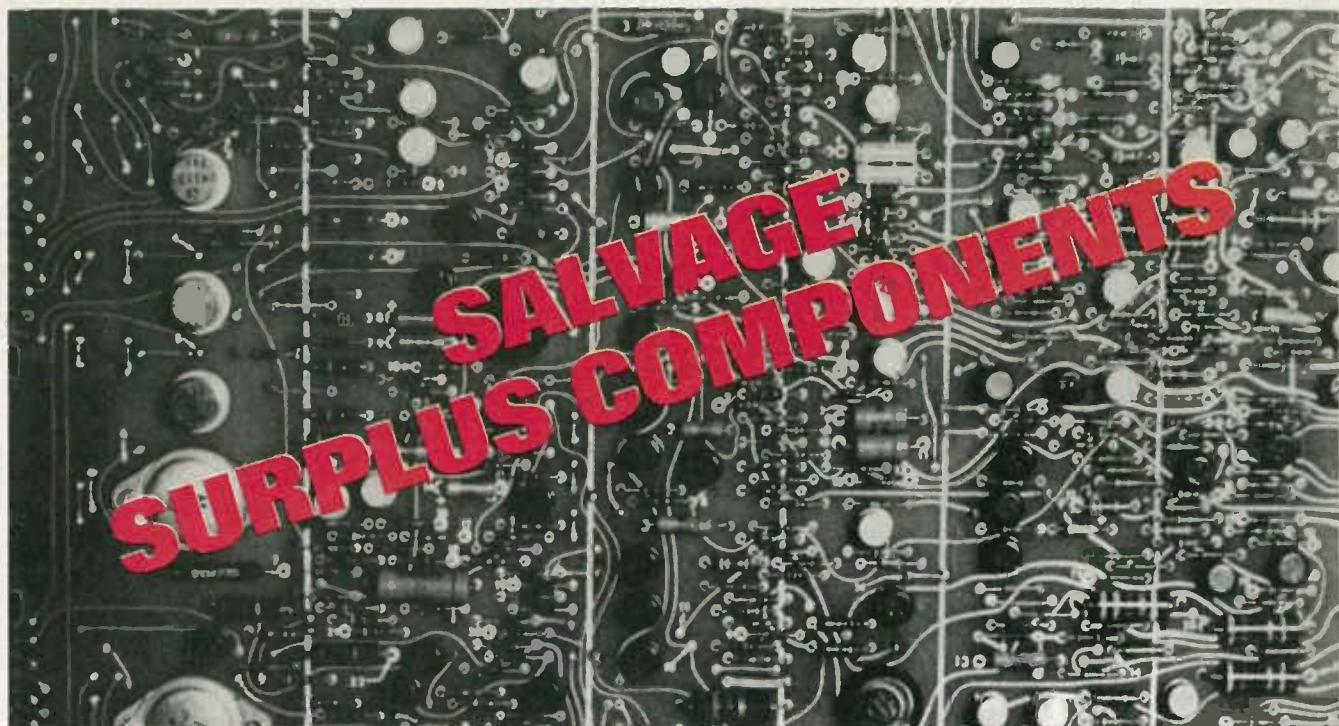

*Don't throw away those old or inoperable circuit boards; the board and many of its components can be salvaged!*

## HAROLD WRIGHT

IN THESE TIMES OF RECESSION AND INFLATED electronics prices, re-stocking your parts cabinets from surplus equipment begins to look very attractive. What's more, for the cost of about \$3.00 or \$4.00, you can get an obsolete circuit board chuck full of diodes, transistors, capacitors of various types, and resistors (both fixed and trimmer).

The obvious advantage of buying surplus boards, like the one shown in Fig. 1, is low cost, but there is another reason for such a purchase: most of the material comes from professional equipment, where high-quality, high-tolerance components are the rule rather than the exception.

If you are willing to spend a bit of time browsing around in surplus stores, or going through surplus fliers and advertisements, you'll find plenty of equipment and circuit boards that can be bought "dirt-cheap." Those bargains can run from bags of surplus components to sub-assemblies to even complete pieces of equipment. And if you like to experiment with digital circuitry, you'll find that there's an equally rich harvest of logic components available.

### Where to look

A good place to begin your search for surplus bargains without leaving your

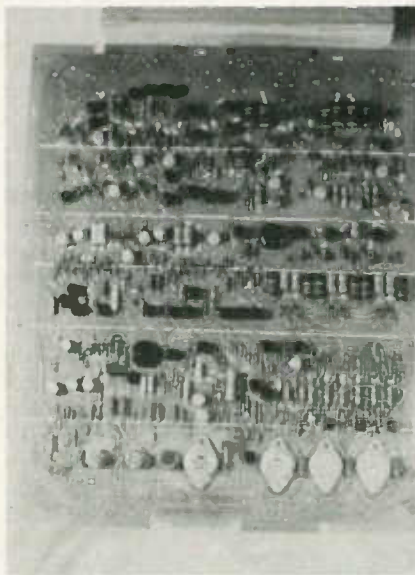

FIG. 1—SURPLUS CIRCUIT boards often contain high-quality components worth far more than the price paid for the board.

easy-chair is in the back pages of **Radio-Electronics**. But an even better source is an electronics surplus retailer. That's because you can examine and handle the material before you buy it. You can find surplus retailers in most of the larger cities throughout the country.

Flea markets are another possible

source. With surprising frequency, you'll find electronic surplus scattered through the tables. There are even flea markets dedicated to nothing but electronics and computer equipment. Ham associations, for instance, often hold flea markets of that type.

### Choosing surplus components

The "grab-bag" type of surplus can be a risky investment. Sealed in plastic bags, it is extremely difficult to evaluate the components, and the bag may contain many unmarked components, or ones with non-standard values.

If you browse through the stores, carry a small lighted magnifier. Many surplus outlets are poorly lighted and there's no fun in trying to read the tiny labels on IC's and transistors under those conditions.

If you are working on a board covered with IC's and discover that the only markings on them are manufacturer's numbers, study the layout before starting component removal. There are clues that can help to identify ground pins and positive supply pins. You might also want to go over Kenneth H. Recorrs' article (**Radio-Electronics** March, 1981) "Identifying Unmarked IC's" and "How to Identify Unmarked IC's" by Olson and Ann L. Zevnik in the January 1980 issue.

Avoid, like the plague, boards that have

been sprayed with a clear epoxy or a similar coating after assembly. They may look clean and pretty, but removing the parts from the boards almost always destroys them. Look for double-sided printed-circuit boards with plated-through holes. Except for the IC's, the components are easier to remove than those on single-sided boards (more on that later).

Be wary of CMOS IC's, particularly the 4000 series. You may sometimes find them packaged in anti-static tubes or plugged into conductive foam, but if they're loose in a bin or packaged in non-conductive plastic bags, don't even bother with them. They've probably already been zapped into uselessness by static charges during handling.

Surplus boards covered with TTL IC's, and little else, are not usually worth the time and trouble it takes to remove the components without damage. Besides, most TTL IC's can be had new for a few cents each.

Look for boards where the resistors, capacitors, and transistors have been mounted so that they stand off the board, making it easier (especially with transistors) to remove the component without heat or mechanical damage. At times, you may find a board on which the transistors are mounted with a spacer collar between the board and the component body. Those collars are easily crushed, without damaging the transistor, leaving the leads exposed and accessible.

Vertically mounted resistors and capacitors are easily removed, but remember that the leads have been trimmed so that one is much shorter than the other.

It's also a good idea to try to get circuit boards from the pre-IC era. Often the monetary value of the components found on such boards far out-weigh the price you pay. For example, the circuit board shown in Fig. 1 had two tantalum capacitors on it that were worth more than the total price of the board.

Tantalum capacitors come in several case styles (tubular, disc, teardrop shaped) as Fig. 2 shows. Such units were used quite freely in older equipment, and are among the more expensive capacitors

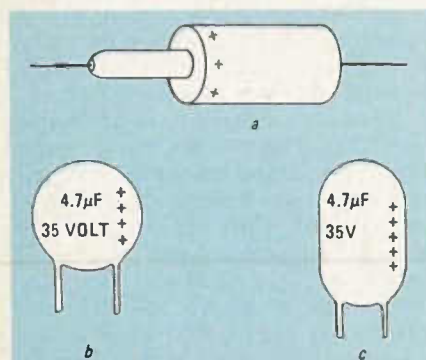

FIG. 2—TANTALUM CAPACITORS come in variety of shapes and sizes: a shows a tubular type; a disc type is in b, and c is a teardrop shaped unit.

when bought new. The tubular type (see Fig. 2-a) is easily recognized by the rod-like protrusion at the positive terminal. The negative lead connects directly to the case.

Other tantalum capacitors may resemble ceramic types, like those shown in Fig. 2-b and Fig. 2-c. Those small tantalum units can be distinguished from the ceramic types by the capacitance and voltage ratings, and *polarity* markings that are printed on them. In most cases, you'll find their capacitance value to be far higher for their size than that of ceramic types.

You should also try to get older, complete sections of equipment. They're often pretty cheap, and may contain reusable multiconductor color-coded cables and a wealth of high quality hardware (bolts, nuts, washers, cable clamps, angle brackets, etc).

Keep an eye out for complete power supplies. Some of those units can supply  $\pm 5$ -volts at 10 amps or more,  $\pm 10$  or 12 volts, and so on. Occasionally the power supply may have uncommitted (rectified and filtered, but unregulated) outputs of up to 30 volts, which is perfect for building your own variable supply around a three terminal regulator like the LM317. Such power supplies can often be had for about the price you would pay for just one of the 10,000 to 30,000  $\mu$ F filter capacitors that they contain.

### Stripping tools

When stripping or salvaging old boards, there are a few tools that are essential. Most of those, fortunately, should already be in your electronics tool kit. Perhaps the only tool you might consider purchasing, if you don't already have one, is some sort of desoldering bulb or a solder sucker. Those can be had for just a couple of dollars. (You might be tempted to spring for one of those motorized vacuum pump desoldering tools, but it makes little sense to spend large sums of money just to save a few dollars on surplus parts. A desoldering bulb works well and will last for several years.) Not only are such devices useful in salvage operations, but they're also handy to have around when you accidentally bridge solder across the traces or pads on PC boards while building some electronics project. Other essentials in the salvage operation include a set

of jeweler's screwdrivers, needle nose pliers, small flush cutters, miniature pointed-nose and spring-loaded aluminum heat sinks, and a low-wattage soldering iron.

### Stripping boards and equipment

When removing parts from PC boards, the small jeweler's screwdrivers (mentioned above) are used as wedges and prying tools to remove resistors, capacitors, and diodes, as Fig 3 shows. If there's room, wedge the screwdriver between the lead and the body of the component (see Fig. 3-a) so that the screwdriver doubles as a heat sink.

On the other hand, if that's not possible, you'll have to place the screwdriver under the component body itself, as shown in Fig. 3-b. (It may be necessary to also use a heat sink if your working with heat-sensitive parts, like diodes.) When that method is used to remove glass-encased signal diodes and  $\frac{1}{8}$ -watt resistors, take your time and be careful. Too much pry power can break the component.

Before applying heat to the joint, clean the soldering iron tip on a piece of damp terry cloth and tin it (apply a small amount of solder) to ensure the best heat transfer. The small molten-solder bead that forms on the tip of the iron causes the old solder joint to melt almost instantly. Aim carefully or you may lose the bead to an adjacent trace.

With the screwdriver in place, flip the board over and apply heat to the solder joint, prying the component away from board until the end pops free. Now the component can be bent straight up. Free the second end by gripping the bottom lead (see Fig. 4) with a needle nose pliers, which doubles as a heat sink, to avoid strain on the component body. Then apply heat and pull straight up.

Resistors, capacitors, and diodes with leads bent at right angles and then soldered in place can be troublesome. But, by using the procedure outlined in Fig. 5, a lot of the hassle can be eliminated. (Notice that the figure shows the soldering iron applied to the component side of the board; that will be explained shortly.)

The first thing to do in the case of bent leads is to melt the joint and remove as much of the solder as possible, as Fig. 5-a shows. If there is any space between the

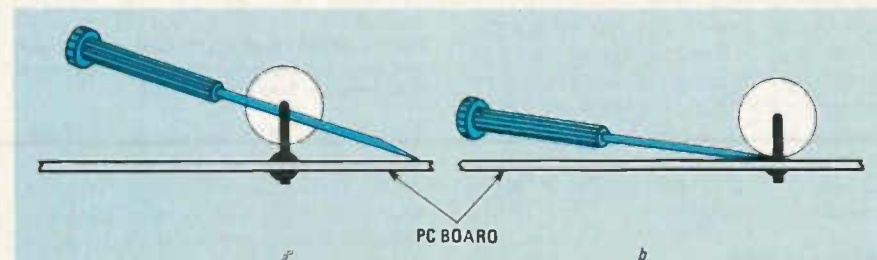

FIG. 3—SMALL JEWELERS' SCREWDRIVERS are ideal for component salvaging operations where prying is necessary: in a the screwdriver is placed between the body and lead of the unit; in b it is placed under the body itself.

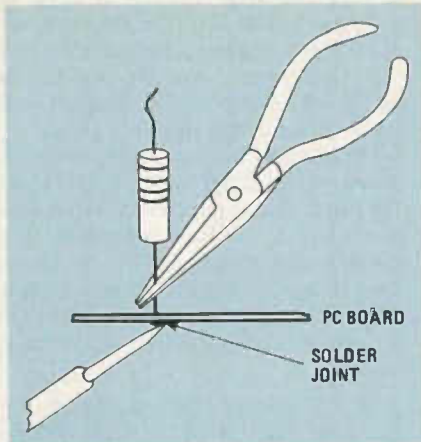

FIG. 4—NEEDLE NOSE pliers holding the component lead double as a heat sink to prevent possible thermal damage.

component body and the board, it is better to heat the joint and push the lead further into the hole (see Fig. 5-b). That leaves the bent portion of the lead far enough away from the board and the solder so that it can be straightened out (Fig. 5-c).

Now when the solder joint is reheated (see Fig. 5-d), the component lead can be easily pulled free. Then free the other end of the component (see Fig. 5-e). If, on the other hand, there is no slack between the component and the board, and the leads are bent, they'll have to be straightened using the edge of a small knife before attempting to remove the component.

Removing components from double-sided boards with plated-through holes is easier because the joints can be heated from the component side of the board (as shown in Fig. 5). That makes identification of the correct solder joint simple. (Have you ever applied heat to a solder joint on a single-sided board and dis-

covered that you'd been heating the wrong connection?)

The molten-solder method can be used to extract parts from a single-sided board while working from the component side. To do so, simply heat the lead of the component with a freshly tinned soldering iron tip and allow the heat to be transferred to the solder joint. In just a few seconds, the joint will be melted and the lead can be freed from the board.

Regardless of which side of the board you work from, use caution when removing tantalum capacitors and signal diodes. They're easily damaged by excessive heat.

Removing transistors from the board without damaging them can be either extremely easy or almost impossible. Transistors mounted with the case flush to the board are extremely difficult to remove without heat damage to the unit, or mechanical damage to the leads. Prying with a jeweler's screwdriver or a knife can break off one or more leads flush with the case. With flush-mounted transistors, braking the board (which we'll cover shortly) may do the trick, but the leads will be so short that they'll be difficult work with.

When transistors are mounted with stand-offs or space between the body and the board, the leads can be quickly and safely clipped at the board surface using flush cutters and still leave enough lead to allow easy installation on your project. However, if you prefer to desolder the unit, heat sinks should be clipped onto each lead as it's heated and removed.

The removal of multi-turn trimmer potentiometers is easy if the right technique is used. The only real problem here is similar to that of flush-mounted tran-

sistors—the danger of lead breakage. Most small soldering irons have a tip long enough to bridge the two closest pins at the turn-screw end of the unit, as Fig. 6 shows.

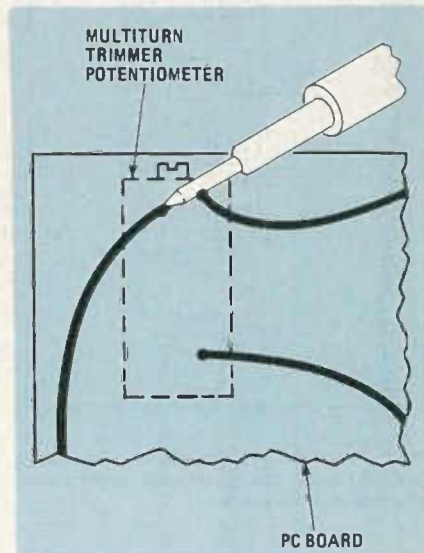

FIG. 6—TWO TERMINALS of a multiturn trimmer potentiometer can be freed using this technique.

Before you begin, make sure that the tip of the iron has been cleaned and tinned. With heat applied, lift or gently pry the front end of the body until it just begins to separate from the board. Trying to completely free the turn-screw end at this stage can snap the back pin. Move to the back terminal and repeat the procedure, very carefully going back and fourth until the component pops free.

Going back and forth between the two ends in that manner releases the unit without damage. If the leads have been bent, you will have to clean and straighten them before attempting to free component from the board. The above method also works well with small transformers, ferrite pulse transformers, and small encased chokes.

A more brutal approach to component removal is board breaking—a simple task with plastic boards, but a bit more difficult with glass-epoxy types. If the leads are aligned (as in Fig. 7), a whole row of components can be freed in one operation. For this method, the first thing to do is to etch a straight line along the row of components with a straight edge razor (as indicated by the dotted line).

Then all you have to do is break off the strip with a pair of heavy-duty pliers, starting at one end and working along the row. Just try to crack the board slightly on the first pass. Once the full length of the row has been cracked, go over it again, completing the break. Watch for leads that remain attached to the break-off strip. (The component may break on the final bend.) By nibbling at the board with a pair of heavy diagonal cutters, the component can be completely freed.

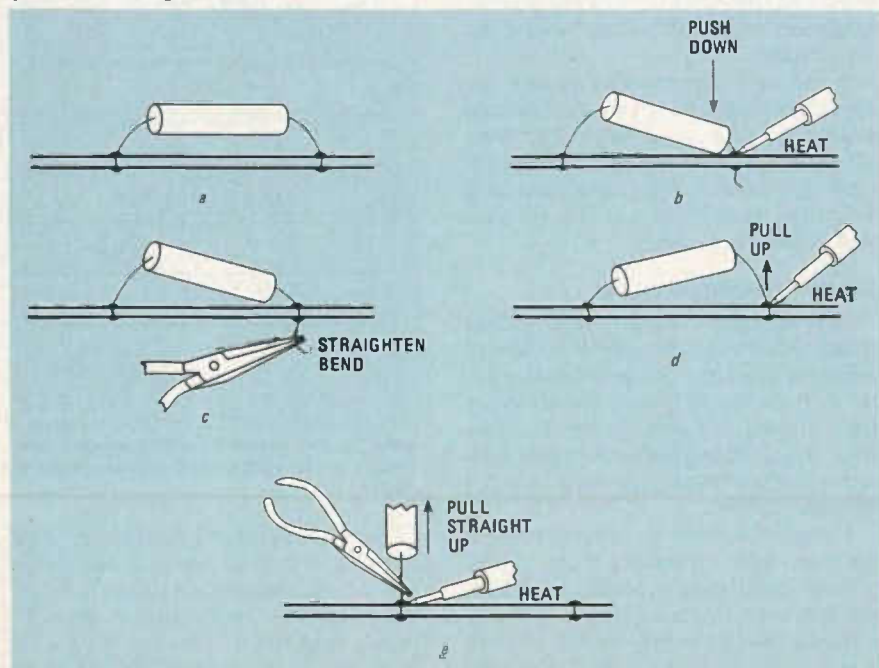

FIG. 5—THE FIVE STEP PROCEDURE for removing components whose leads have been bent and soldered down is shown here.

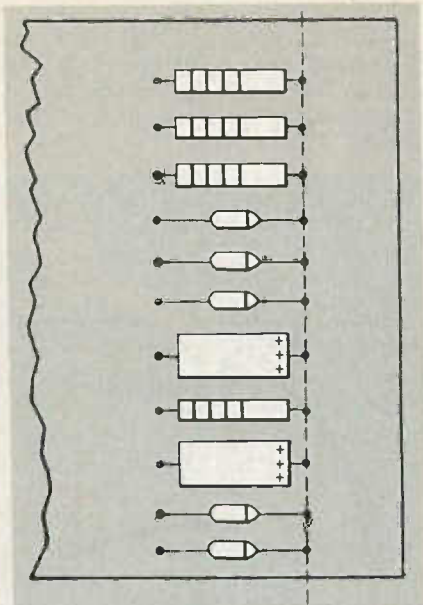

FIG. 7—CIRCUIT BOARDS can be easily stripped using this brute-force method when components are aligned.

Where components form staggered lines or patterns, two pair of heavy pliers can be used to break off squares or strips. And then using your cutters, the individual components can be nibbled free. At this point, there may be scraps of printed-circuit material still clinging to the lead. Simply melt the solder surrounding the lead and slide off the circuit material. If the leads are bent, follow the technique outlined (above) for bent leads.

### Salvaging PC boards

Some boards may be re-usable after stripping, however, that's usually only worth while where card-edge connectors with gold-plated contacts are involved and if matching surplus sockets are available. Once the components have been removed and the board is completely clean (no bits of lead anywhere), the old circuit-board traces can be stripped with a small air-powered or electric high-speed chisel.

The blade must be razor sharp and have an absolutely straight edge. To strip the board, lay it flat on a solid surface and let the rapid strokes of the chisel peel off printed-circuit material, but be sure the contacts of the card edge are left intact. Now stick-on copper traces and pads can be used to layout the new circuit pattern. You might also want to drill holes as needed to accommodate the new circuit, and use point-to-point wiring as done with perforated construction board.

It is also possible to cut the contact portion of the board away from the component section and attach another piece of circuit board. If you have surplus cards with good gold-plated contacts and a card cage to match, cut the card, as shown in Fig. 8, separating the component section and contact portions completely. In this

operation, use a straight edge to score as deeply as possible on both sides of the board before breaking. Be sure to leave enough of the trace leading to the contacts to allow for later connection to the new circuit without invading the contact area.

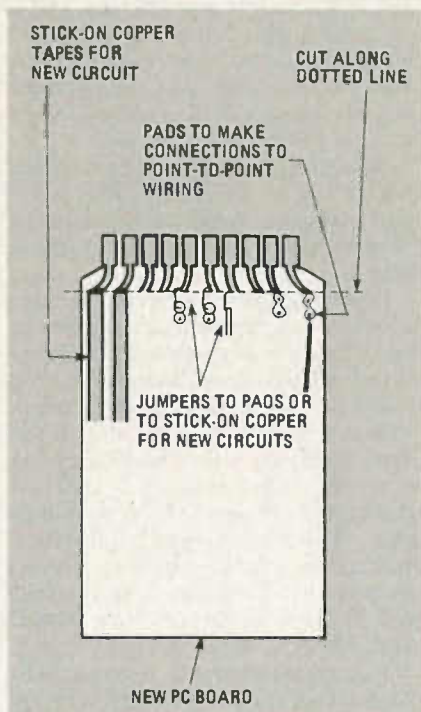

FIG. 8—PC BOARDS can be salvaged by removing the tracings and using stick-on copper tapes and pads for the new layout.

A new piece of perforated construction board can be attached to the contact portion of the board using a thin plastic (splicer) strip and epoxy glue. Once the contact area is separated from the component section of the board, the two pieces of circuit board that are to be joined should be sanded with a medium grade of sandpaper to provide some "tooth" for the cement.

If the card cage has card guides, the splicer strip must be left clear of the card edges so that the board does not get hung up on the guides when inserted into the card cage. Use 5-minute epoxy and keep everything perfectly flat so that the card will follow the guides.

### Stocking salvaged parts

Nothing can be more frustrating than trying to find a specific value of resistor or capacitor in a large can of mixed components. If the boards are stripped as you get them and the components are sorted by their values, paying attention to their voltage or wattage ratings, life in the shop can be much simpler.

Using a cabinet with small drawers is the usual approach to parts storage. But if you are developing a project on a protoboard, or wiring up a chassis, you can wind-up making twenty to fifty trips to that cabinet. A better way of storing your surplus is to build a few shoe-box sized

wooden boxes from scraps of plywood and panel board. You'll be surprised how much easier it makes construction or circuit development. And the box can sit next to what ever you're working on, with every value in plain sight at a glance.

Details of box construction, and its dimensions, are given in Fig. 9 and Fig 10. The partitions are spaced to hold five rows of ten  $1\frac{5}{8} \times 3\frac{1}{4}$  inch pill bottles. Unmarked, inexpensive bottles can be obtained from your local pharmacy in lots of 100 or 200. Circular self-stick labels can be used to mark the bottles according to value.

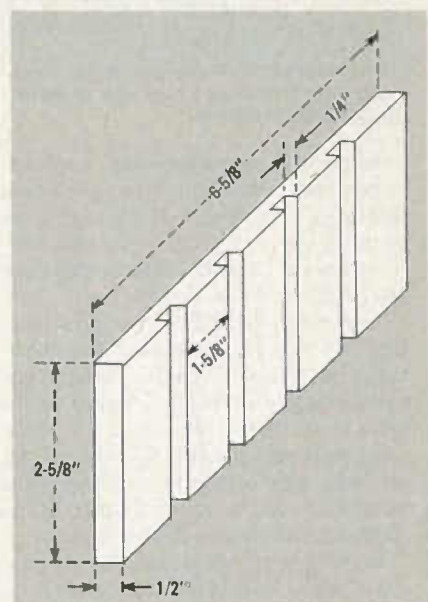

FIG. 9—DIMENSIONS FOR the side panels of the parts box is shown here.

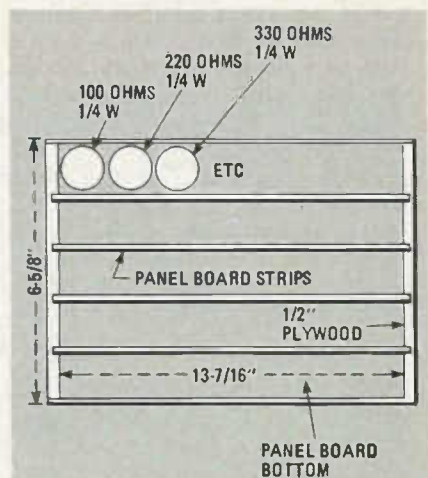

FIG. 10—DIVIDERS FOR THE box are made of paneling and should be evenly spaced. Small bottles can be used to hold various component values.

The two slotted end portions are made from half-inch thick plywood and should be cut to the dimensions shown in Fig. 9. Then cut four evenly spaced slots,  $1\frac{5}{8}$  inches apart and  $\frac{1}{4}$  inch deep, into each to hold the panel-board dividers. Cut the

*continued on page 90*

## Servicing Cordless Telephones

*A cordless telephone, like any other piece of electronic equipment, is bound to break down sooner or later. This article will show you how to troubleshoot and repair the problem.*

CHRISTOPHER KITE

**Part 2** THIS MONTH, WE'LL continue our look at troubleshooting cordless telephones by looking at our second operational test, the dial-tone test.

### Dial-tone-test analysis

At the conclusion of the ring test, disconnect the ring generator and apply a 0.05-volt RMS dial tone. That is a dual audio-tone of 352 Hz and 440 Hz, however a single tone in the 300–3000 Hz

range may be used to simulate the dial tone. Pick up the portable unit, set it to TALK, and listen for the dial tone. Also note whether the IN USE indicator on the base unit is lighted; most cordless phones have an IN USE indicator to show when they are off-hook.

Let us again examine the block diagram of Fig. 2 (although it originally appeared last month, it is shown here once again for your convenience) and analyze what that test can show us. When the

portable unit is placed in the TALK mode, its RF transmitter and pilot signal (guard-tone) generator are turned on. The base unit's receiver detects the RF signal and recognizes the guardtone. Guardtone detection causes the hybrid relay to go into an off-hook state, which completes the connection to the telephone line and turns on the IN USE indicator.

Let's see what needs to happen for the dial tone to be heard in the portable unit. First, the phone must go off-hook, which



is checked by operation of the IN USE indicator, as just described. When the hybrid relay goes off-hook, it turns on the base unit's RF transmitter (this time without ring-signal modulation). Dial-tone audio from the telephone line modulates the RF carrier, which is detected by the portable unit's receiver and fed through the audio circuits to the earpiece.

If you can hear dial tone, both paths are operating. If the IN USE indicator lights, the portable-to-base path is operating. If the IN USE indicator does not light, the problem lies elsewhere. The dial test procedure is summarized in Fig. 5.

The dial-tone test should be performed even if the ring test should prove unsuccessful. That's because performing the two tests can help further narrow down the source of the problem.

For instance, if neither the CALL button nor 20-Hz ring generator will ring the portable unit, and neither the IN USE indicator lights nor the dial tone is heard, the problem may be in the base unit's power supply. A defective power supply may cause both the RF transmitter and receiver of the base unit to be inoperative. Dead batteries in the portable unit could also cause that symptom, as both the RF transmitter and receiver of the portable unit would then not work.

If the CALL button rings the portable unit and the IN USE indicator works, but the ring generator will not ring the portable unit and a dial tone is not heard, the telephone cord is probably defective.

If neither the CALL button nor the 20-Hz ring generator will cause the portable unit to ring, but the IN USE indicator lights, listen to the portable unit for receiver hiss. If hissing is heard, it is likely that the base-unit transmitter is not providing an RF carrier signal. If nothing is heard, the portable unit-receiver is likely defective.

### Dial-test analysis

If the ring test and dial-tone test are successful, the dial test should be performed. If either of the first two tests is unsuccessful, troubleshooting and repair of the problems unearthed must be attended to first.

The dial test consists of dialing all digits 0 through 9 and observing that those same digits are displayed on the dial decoder. If so, we will proceed to the voice test. If not, we have a dialing problem to troubleshoot. We'll cover that in more detail later in this article. The dial test procedure is summarized in Fig. 6.

### Voice-test analysis

If you have successfully completed the first three tests, you should now perform a voice test. That test consists merely of speaking into the portable unit mouthpiece and listening to the sidetone for adequate level and voice quality.

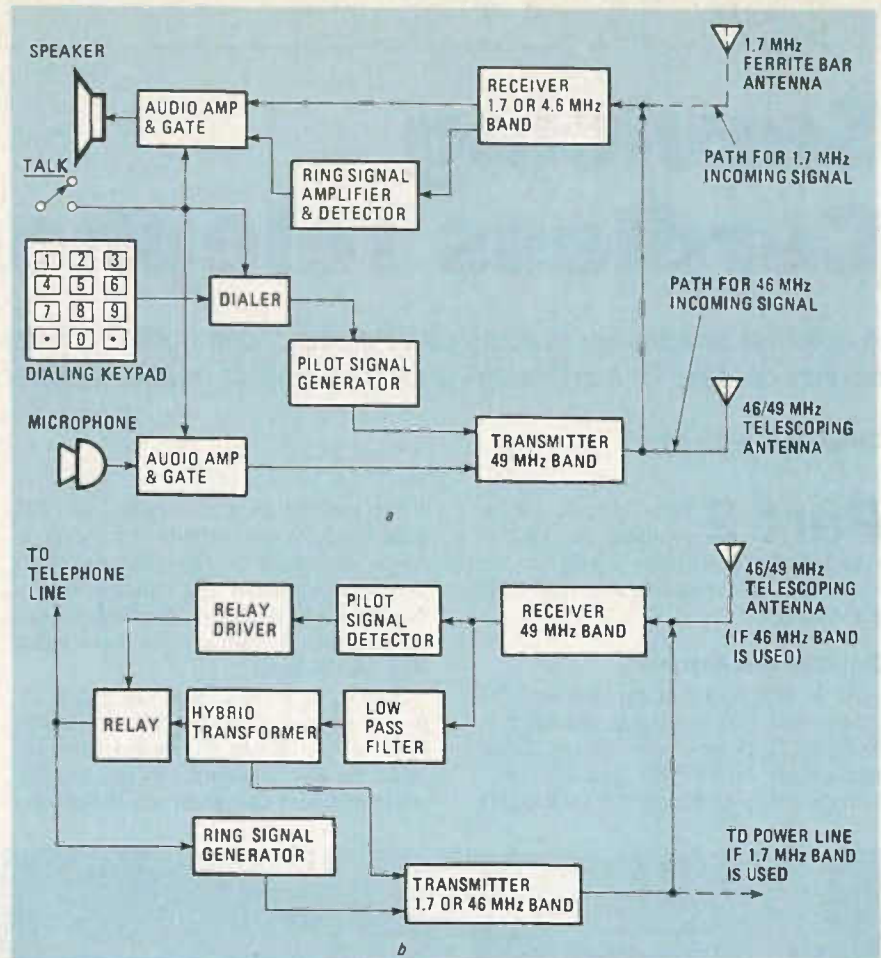

FIG. 2—HOW A CORDLESS TELEPHONE WORKS. A block diagram of a portable unit is shown in a, while the block diagram of the base unit is shown in b.

The earlier tests have already checked out the RF path in both directions and confirmed that the telephone cord is good. The dial-tone test has even confirmed the audio path from telephone line to the portable unit. This last test will additionally confirm the audio path from portable unit to the telephone line, recheck the return audio path, check for voice level, and check for distortion. The voice test procedure is summarized in Fig. 7.

If the voice test reveals an inadequate sidetone level, the following tests should be conducted. Connect an AC voltmeter to the telephone line simulator and observe the reading while talking into the portable unit of the telephone.

Low voice-sidetone-level may be caused in either direction; microphone audio is fed through the portable-to-base RF link, is coupled by a hybrid transformer to the telephone line, and into the base-to-portable RF link at the base unit and fed back to the earpiece. Measuring the voice level at the telephone line splits that path to help isolate the cause of attenuation. If speaking into the portable unit does not cause the meter to read 0.1-volt RMS, or more, the portable-to-base link is suspect. Otherwise, the problem is likely to lie in the base-to-portable link.

### Troubleshooting

Once the operational checks have shown a problem and narrowed it down to a broad group of circuits, further troubleshooting will be required to pinpoint the specific circuit that is faulty. The following methods should be helpful in performing such troubleshooting. Due to the fact that repair might uncover or create new problems, it is always a good idea to go back and repeat the operational tests after the cordless telephone has been repaired.

If the portable unit will not ring from the CALL button on the base unit, we need to determine whether the problem is in the base-unit transmitter or the portable unit-receiver. First, let's check out the base-unit transmitter.

The first measurement that should be taken is of the RF output-level. For 1.7-MHz band units, checking the RF level is rather difficult. The RF signal must be removed from the AC power line, demodulated, and then fed to a meter. We do not recommend trying to build your own circuit for that test. Failure to completely remove the 60-Hz AC component from the RF signal could result in electrical shock or severe damage to the equipment used in demodulating and measuring the



RF signal. Thus, it is better to rely on equipment that is specially designed for that task; the B + K 1050 previously mentioned is one unit that is appropriate for such testing.

For 46-MHz band units, connect an RF probe to a multimeter. Touch the probe to the antenna of the base unit and read the level on the meter while holding the CALL button on the base unit.

For either 1.7-MHz band or 46-MHz band units, most good cordless telephones should measure about 4 volts, but a reading of even 1/2 volt should permit ringing at close range. If there is no reading, the base unit transmitter is completely dead. Make DC voltage and resistance measurements in the RF oscillator and output stages to determine the cause of the problem.

If an RF output is indicated, we should measure frequency error and ring-signal modulation. Turn on the base-unit transmitter without ring-voltage modulation and measure the RF frequency error (using a frequency counter). If the frequency error is more than 2 kHz, the base-unit transmitter frequency should be adjusted.

If the base-unit transmitter is working, we should check that the transmitter is being modulated by the proper ring signal (in the 700- to 1500-Hz range). The ring signal is generated either when the CALL button has been pressed or when a 20-Hz ring signal is detected from the telephone line. It is important that that signal be of correct frequency and amplitude, otherwise it will not be passed by the filter in the portable unit. The ring signal should produce about 3 to 4 kHz of deviation. We can measure the ring signal frequency by using a frequency counter connected to a demodulator circuit (an appropriate demodulator is provided in the 1050). To measure the modulation caused by the ring signal, a deviation meter must be used (see Fig. 8).

If all of the previous tests work, we know that the fault is in the portable unit. The first step in troubleshooting the portable unit is making sure that it is receiving the signal. Transmit an RF signal to the portable unit, modulating it with the proper ring-signal frequency (adjust the level for 4 kHz of deviation). Connect a probe to the output of the discriminator (the demodulator in an FM receiver is often called a discriminator) and measure the AC-signal level using an AC voltmeter. It may be wise to actually view the signal on an oscilloscope to make sure that it has not been distorted in the demodulation process.

If no signal is present, the problem is in the RF or IF section of the portable unit's receiver. Check that each of the oscillators is operating, and check each IF signal to make sure that the mixers are operating properly. Most receivers are dual con-

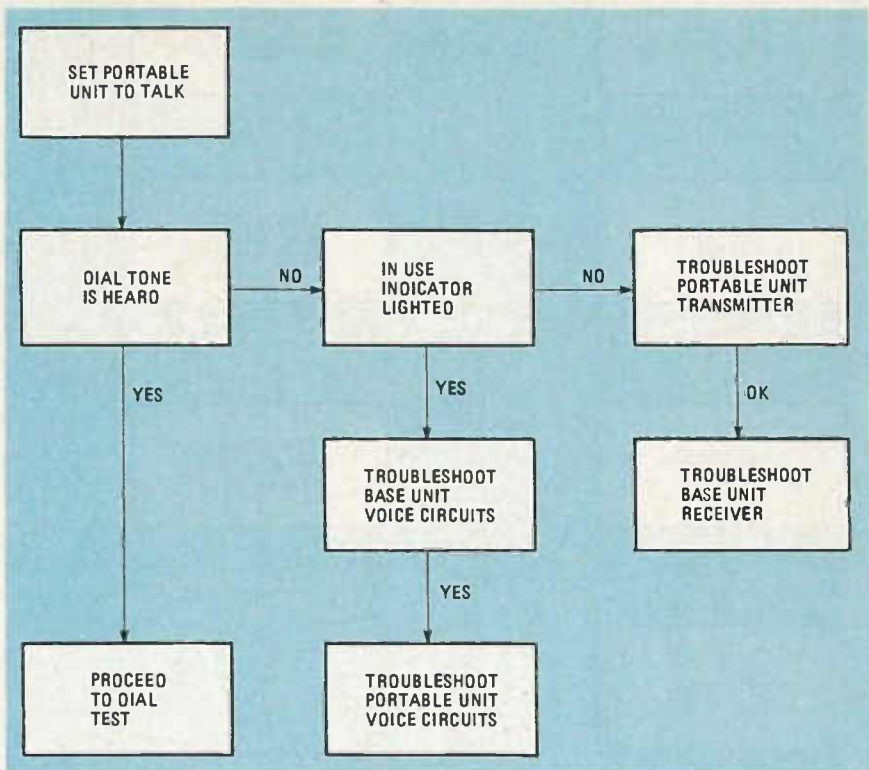

FIG. 5—EVEN IF THE RING TEST should uncover a fault, the dial-tone test should be performed.

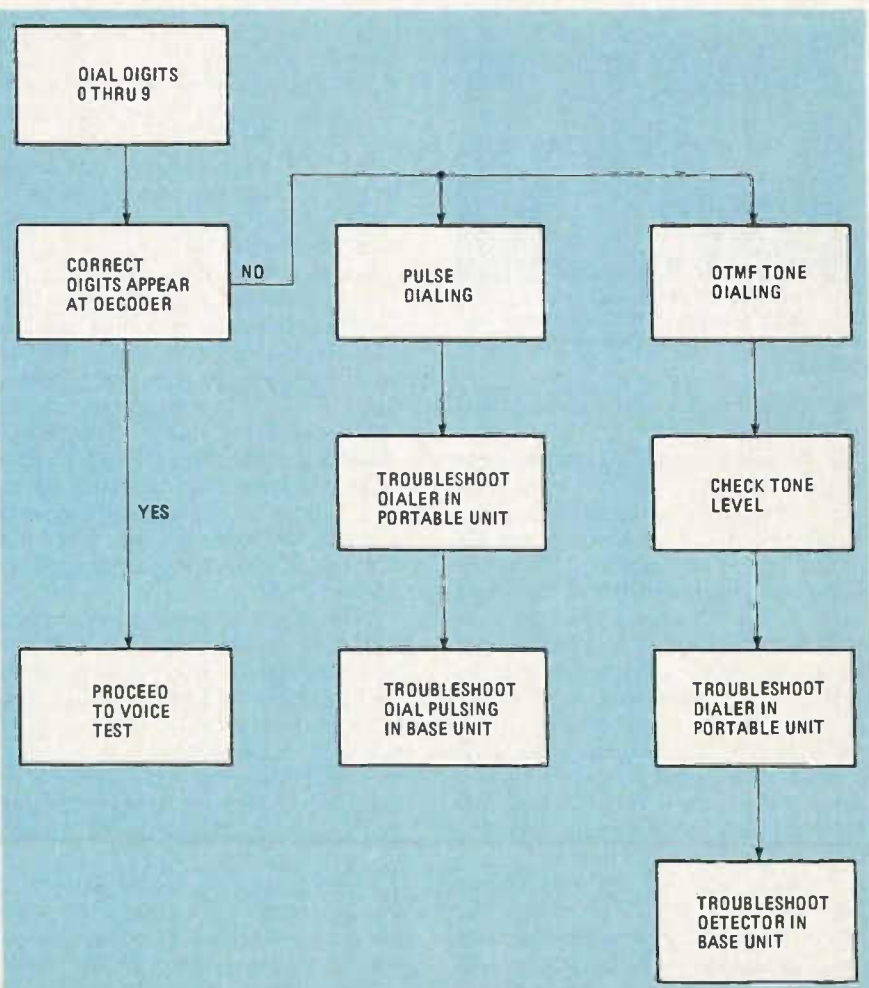

FIG. 6—TO DETERMINE if there is a problem with the telephone's dialing system, this test should be performed.

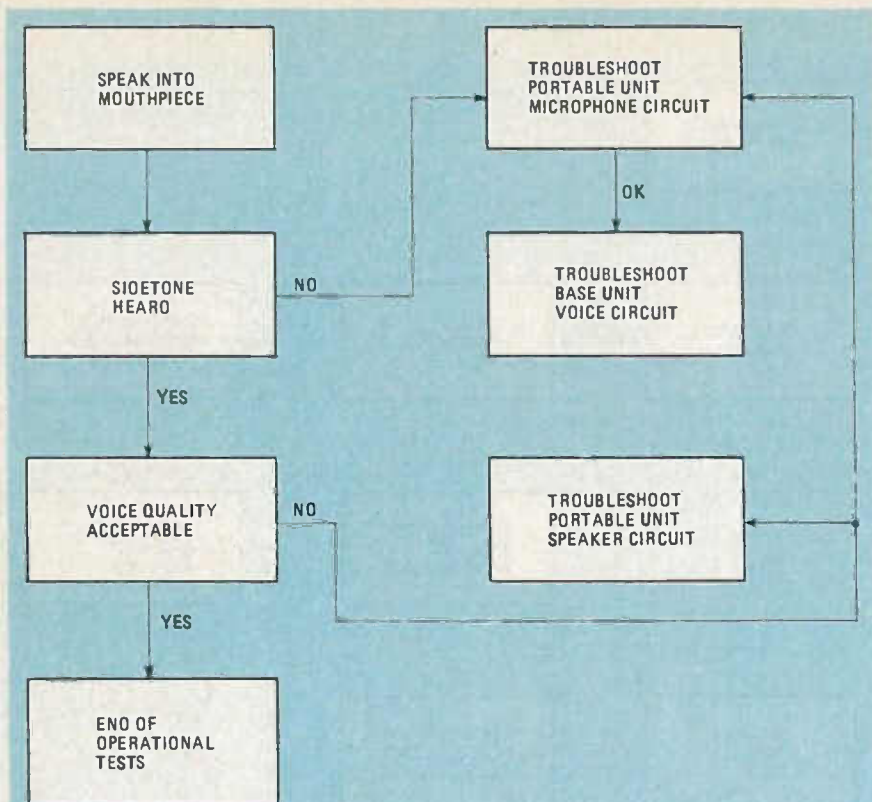

FIG. 7—THE VOICE TEST is the final check to be performed. Once all of the tests are performed, it's possible to troubleshoot and repair the telephone.

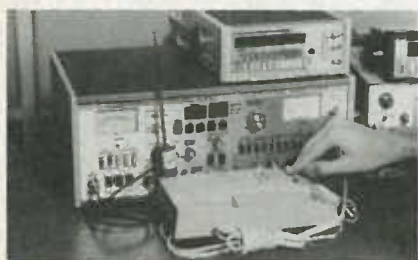

FIG. 8—USING AN FM DEVIATION METER to measure FM modulation. For a cordless phone, 3 to 4 kHz of deviation should be seen during the ring signal.

version, using two local oscillators and two IF stages.

If the undistorted signal is present at the discriminator, the problem is in the ring-signal detector, audio generator, or the speaker (some units may use a separate buzzer for the ring signal). Moving the probe over to the output of the ring-signal detector, you should once again get a deflection on the meter. If no signal is present, try varying the frequency of the audio generator. If that causes a signal at the output of the ring-signal detector, check the frequency where ringing occurs and re-adjust the base unit's ring-signal generator to that frequency. If varying the audio frequency does not produce an output the ring-signal detector is defective.

If a signal is present at the output of the ring-signal detector, move the probe to the output of the audio generator to make sure that an audio tone is being generated. If no audio signal is being generated, the audio generator is defective. If an audio

signal is being generated, the speaker is probably defective.

If the portable rings normally from the CALL button on the base, but does not ring from the 20-Hz signal applied to the telephone cord, we should make sure that the telephone is actually on-hook. When the cordless telephone is supposed to be on-hook, measure the impedance at the telephone cord (with the cord disconnected from the line simulator or telephone line). If the impedance is very high, the telephone is on-hook. If the impedance is low (approximately 250 ohms) the telephone is off-hook. (If the impedance is 0, the cord is probably shorted.) A possible cause for the base being off-hook might be another portable unit operating on the same carrier and guardtone frequencies capturing the base, or a fault in the base that is placing a low impedance across the telephone line.

If the telephone proves to be on-hook, the 20-Hz ring-detector circuit in the base unit should be checked. Apply a continuous ring signal and trace the ring signal through the suspected circuit with an AC voltmeter. If the telephone cord is open, there will be no ring signal present at the input to the 20-Hz ring-detector. The ring-detector circuit often uses an optoisolator to switch on the RF transmitter and 700–1500-Hz ring-signal generator. Check whether the output of the optoisolator is switching. A non-continuous ring signal should be used for that check.

If the dial tone cannot be heard at the speaker of the portable unit when the IN

USE indicator is on, the problem must lie in the base-to-portable link. Because we have already checked most of the circuits involved in the base-to-portable link during the ring test, we can narrow down the defective circuits to either the audio-amplifier-and-gate (in the portable unit) or the voice-audio circuits in the base unit. If a separate buzzer is used for ringing, also check the speaker in the portable unit.

If no dial-tone signal is heard and the IN USE indicator fails to light, troubleshoot the circuits in the portable-to-base link. Let's start with the portable unit.

First check the RF level using an RF probe and a multimeter. As stated previously, most good cordless telephones should measure about 4 volts, but a reading of even ½ volt should permit close range operation. The portable unit is completely dead if there is no reading. Make DC voltage and resistance measurements in the RF oscillator and output stages to pinpoint the problem.

If an RF output is indicated, we should measure the frequency error and guardtone modulation. If the error is more than 2 kHz, the portable unit's transmitter frequency should be adjusted.

If the portable-unit transmitter is working, we should check that the transmitter is being modulated by the proper pilot signal (guardtone). It is important that that signal be of correct frequency and amplitude because the pilot-signal detector will not recognize a signal that is of the wrong frequency or too weak. The pilot signal should produce about 3 to 4 kHz of deviation. Using a frequency counter, the pilot-signal frequency can be measured at the output of a demodulator circuit, such as the one provided on the 1050. If the pilot-signal (guardtone) frequency is not within specifications, adjust it accordingly and proceed to testing the base unit. Typical guardtone tolerance is  $\pm 50$  Hz.

If the portable unit proves to be in proper operating condition, we must check the base unit. The first step is to check that the base unit is actually receiving and demodulating the RF signal. Transmit an RF signal (of the proper frequency) to the base unit. Modulate the RF signal with the proper pilot-signal (guardtone) frequency at a level high enough to produce 3 kHz of deviation. Also apply an audio tone in the 300 to 3000 Hz range with an amplitude high enough to cause an additional 3 kHz of deviation (6 kHz of total deviation). Connect an oscilloscope to the discriminator output of the 49-MHz band receiver and check that the guardtone is present. If it is, make sure that the signal is of the proper frequency. If the signal isn't present or has been distorted or altered, the receiver is defective.

That's all we have room for now. Next time, we'll finish up by showing you more on how to pinpoint the cause of your cordless telephone failure. **R-E**

# COMPUTER DIGEST

VOL. 2 No. 6

June 1985

NEW KIND OF MAGAZINE FOR ELECTRONICS PROFESSIONALS

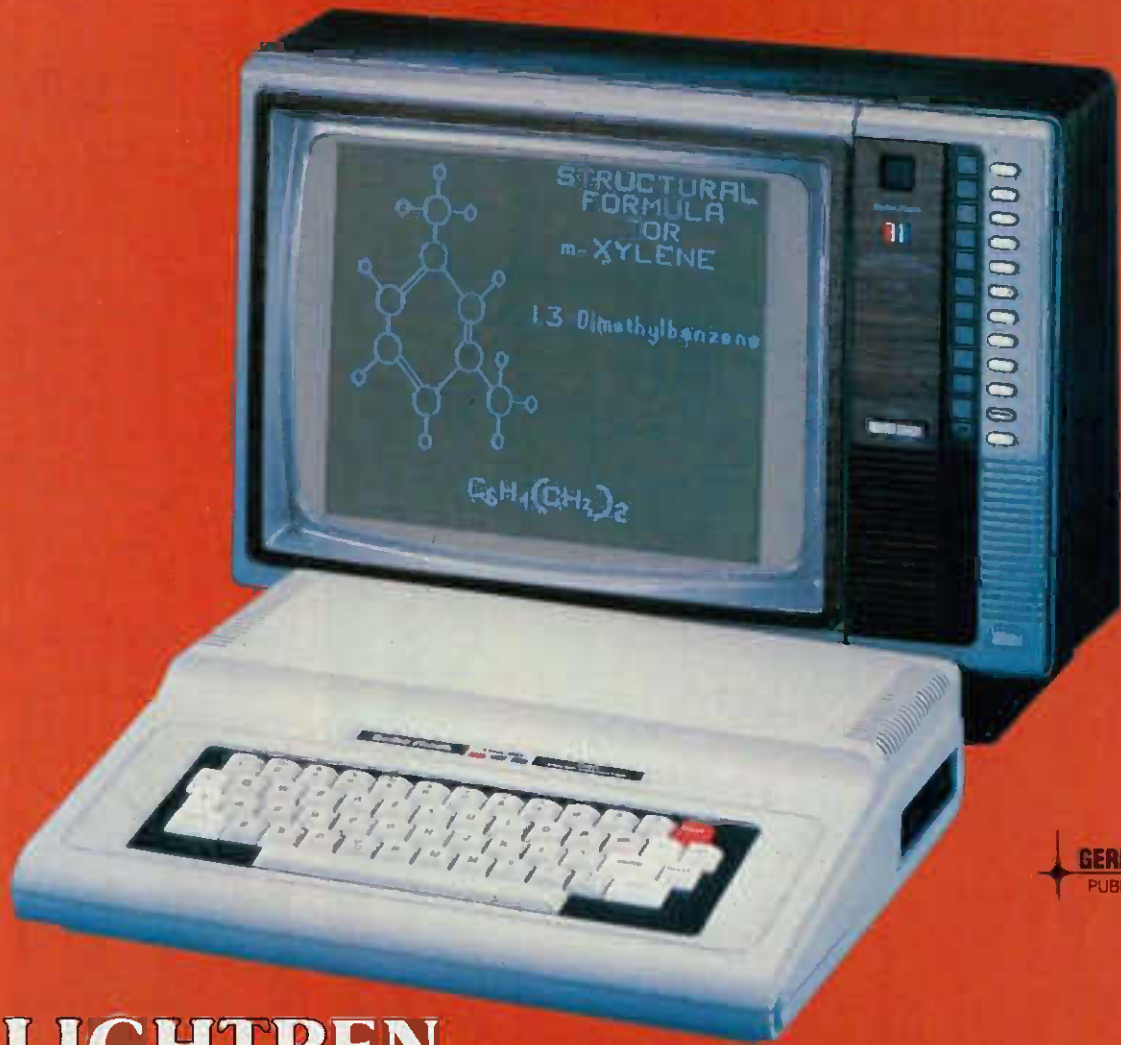

A  
**GERNSBACK**  
PUBLICATION

## LIGHTPEN FOR YOUR COMMODORE

Make your 64 more versatile.

## UPGRADE THE COCO

That color computer you bought for playing games can be retrofitted to use for serious business applications.



# Take home a world champion.

**\$85\*** gets you a technical knockout.  
**The Fluke 70 Series.**

**Winners of the digital vs. analog battle.**

Since their debut, they've become the worldwide champions of the industry.

Never before have such tough, American-made meters offered so many professional features at such unbeatable prices.

Each comes with a 3-year warranty, 2,000+ hour battery life, and instant autoranging.

You also get the extra resolution of a 3200-count LCD display, plus a responsive analog bar graph for quick visual checks of continuity, peaking, nulling and trends.

Choose from the Fluke 73, the ultimate in simplicity. The feature-packed Fluke 75. Or the deluxe Fluke 77, with its own protective holster and unique "Touch Hold" function\*\* that captures and holds readings, then beeps to alert you.

So don't settle for just a contender. Take home a world champion.

For your nearest distributor or a free brochure, call toll-free anytime  
**1-800-227-3800, Ext. 229.** From outside the U.S., call 1-402-496-1350, Ext. 229.

**FROM THE WORLD LEADER  
IN DIGITAL MULTIMETERS.**



#### FLUKE 73

\$85\*  
Analog/digital display  
Volts, ohms, 10A, diode test  
Autorange  
0.7% basic dc accuracy  
2000+ hour battery life  
3-year warranty

#### FLUKE 75

\$99\*  
Analog/digital display  
Volts, ohms, 10A, mA, diode test  
Audible continuity  
Autorange/range hold  
0.5% basic dc accuracy  
2000+ hour battery life  
3-year warranty

#### FLUKE 77

\$129\*  
Analog/digital display  
Volts, ohms, 10A, mA, diode test  
Audible continuity  
"Touch Hold" function  
Autorange/range hold  
0.3% basic dc accuracy  
2000+ hour battery life  
3-year warranty  
Multipurpose holster

\* Suggested U.S. list price, effective July 1, 1984.  
\*\* Patent pending.

**FLUKE**®

# CONTENTS

Vol. 2 No. 6

June 1985



See Page 8



See Page 12

- 8 Upgrading the CoCo and 64**  
Here's how to retrofit that computer you bought for game-playing so it can get down to some serious work in business. **Herb Friedman**
- 12 Build A Light Pen for the Commodore 64**  
This simple one-evening project will provide added versatility for your computer. **Jim Stephens**
- 4 Editorial**
- 5 Letters**
- 5 Computer Products**
- 16 Software Review**

## ON THE COVER

The Radio Shack Color Computer, familiarly known as the "CoCo" gets the full treatment and rolls up its sleeves for some real business and scientific applications. Cover photo Courtesy of Radio Shack, A Division of Tandy Corporation. **See page 7.**



# EDITORIAL

## Here's how to get started as an author!

■ Surely, you've got a pet project that you looked at and said "Hey! that would make a great article for **ComputerDigest!** You might be right.

You write a letter to the Editor, telling what the project is, how well it works, why our readers will want to see it, and what it's all about. If we think it's interesting, you'll get a letter asking you to go ahead with the project.

Now you're going to write about your project. Start at the beginning, telling our readers why you needed it, how you constructed it, and how it works. Since the **ComputerDigest** reader is knowledgeable, you can go into detail. Explain how to connect it into the system, test it, and use it.

When you're writing about it, write to *express*, not to *impress*. Don't worry about using "big words" or flowery language. Say what has to be said concisely, as though you were explaining it to a friend. We do not pay "by the word" so adding material won't enhance your income. Include a detailed parts list with sources for all parts used. Reference all art and photos in the text ("See Fig. 1, etc.")

### Illustrations

Draw all schematics carefully. We don't expect finished artwork, but we want to be able to make out what you're trying to show. Use a ruler and add your lettering carefully.

We're going to need photographs. Good, clear, contrasty, sharp, black-and-white pictures. We cannot use color photos in any form whatever. If you lack photographic skills, we may ask you to send the project in so we can photograph it here.

Things don't happen overnight. Nobody is going to drop everything to rip your envelope open. More than one person will review the material, and a decision made.

If (what joy!) you sent what we wanted, a contract will be sent for your signature. When that comes back, a check will be issued by our accounting department, and your article goes into the works.

### Now what happens?

You open the new issue of **ComputerDigest** and see a familiar project. It's yours, and under the title, is *YOUR NAME!*

Let me tell you something, that makes it all worthwhile.

You won't get rich on the payment you receive. We do pay competitively. It usually works out to about \$100 a page. Certainly it's enough to make your effort worthwhile, and while it is your money, we recommend that you take some of it and treat the wife to a good dinner, just to celebrate.

Okay. Now you know how and you know why, so put on your thinking caps, and let us hear from you. ◀▶



Byron G. Wels  
Editor

ComputerDigest is published monthly as an insert in Radio-Electronics magazine by Gernsback Publications, Inc., 200 Park Avenue South, New York, NY 10003. Second-Class Postage Paid at New York, N.Y. and additional mailing offices. All rights reserved. Printed in U.S.A.

A stamped self-addressed envelope must accompany all submitted manuscripts and/or artwork or photographs if their return is desired should they be rejected. We disclaim any responsibility for the loss or damage of manuscripts and/or artwork or photographs while in our possession or otherwise.

# COMPUTER DIGEST

**Hugo Gernsback** (1884-1967)  
founder

**M. Harvey Gernsback**, editor-in-chief

**Larry Steckler**, CET, publisher  
**Art Kleiman**, editorial director

**Byron G. Wels**, editor

**Brian C. Fenton**, technical editor

**Carl Laron**, associate editor

**Robert A. Young**, assistant editor

**Ruby M. Yee**, production manager

**Robert A. W. Lowndes**, production  
associate

**Dianne Osias**, production  
assistant

**Karen Tucker**, production assistant

**Jacqueline P. Weaver**, circulation  
director

**Arline R. Fishman**,  
advertising coordinator

---

Gernsback Publications, Inc.

200 Park Ave. South

New York, NY 10003

Chairman of the Board:

M. Harvey Gernsback

President: Larry Steckler

### ADVERTISING SALES 212-777-6400

Larry Steckler

Publisher

### EAST/SOUTHEAST

Stanley Levitan

Radio-Electronics

200 Park Ave. South

New York, NY 10003

212-777-6400

### MIDWEST/Texas/Arkansas/Okla.

Ralph Bergen

Radio-Electronics

540 Frontage Road—Suite 325

Northfield, Illinois 60093

312-446-1444

### PACIFIC COAST Mountain States

Marvin Green

Radio-Electronics

15335 Morrison St., Suite 227,

Sherman Oaks, CA 91403

818-986-2001

# LETTERS

## Air Conditioning?

There's a "computer room" where I work, that's air-conditioned and scrupulously clean, with a raised floor and recessed lighting. I just got a new computer for home, and have none of these refinements. Just how important are they?—J. Sweeney, Stamford, CT.

*Not at all. Certainly, they're nice to have, but for the average home computer they aren't at all essential. Where critical material is stored and run, a controlled environment is more important. I wouldn't worry about that, however.*

## Can Anybody Help?

I own a Timex 1000 and a TVRO Earth Station. I've been looking for a program to plot stationary satellite positions, looking from different parts of the U.S. Is there such a program? Where can it be obtained?—William Scott, Manteca, CA.

*Bill, if there is such a program, I'm sure we'll hear from somebody!*

## The Katt's Meow

I've been following Marc Stern with great interest. He's one of my favorite authors. —Tager Katt, Framingham, MA.

*Thank's, Tager. We like Marc too. In fact, we think he's purrfect!*

## What's New?

It seems that each time there's a computer show, something radically new is added that you just can't do without. I'm sure that from where you sit, you must get advance notice of what's coming 'round the bend. Can you give us a hint about what to expect in the new computers?—R. D. Carlton, Manassas, VA.

*Not really. The manufacturers don't usually like to spill the beans until showtime, and we're kept as much in the dark as you are.*

## Southern Comfort

Purely as an exercise, I programmed all of the facts regarding the Civil War into my computer, and ran the program, to discover that the South won the war. I proceeded to debug the

program for history teaches that the North was victorious. Yet try as I will, I can't find a single glitch, and the South keeps coming up winner. After all these years, can history be in error?—Sam Goodsell, Atlanta, GA.

*Sam, I hate to be the one to dash your hopes, but try having a Yankee debug that program for you! (Insert one Rebel Yell.)*

## Orphans

In shopping around the several computer stores, I frequently see what appears to be a real bargain, and then notice that it's the product of a company that is no longer in business. Is it a safe bet to buy one of these computers? Or am I asking for trouble?—J. P. Sandro, Helena, Mont.

*It all depends, J.P. If the store will offer a warranty and will stand behind the equipment, you might make a good deal. Just be sure that they will honor a service contract on the unit and that they have the service facility to back it up. ◀▶*

# COMPUTER PRODUCTS

For more details use the free information card inside the back cover

**X-Y RECORDERS**, model *RW-21T* and model *RW-201T*, are precision X-Y recorders that allow recording on two chart sizes.

Features include: electrostatic chart hold with LED chart positioning lights; high pen speed, faster than 1200 mm/second; built-in time sweep (quartz controlled); remote/local penlift; accuracy better than  $\pm 0.25\%$  FS., and 18 switch-selected input ranges from  $50\mu\text{V}/\text{cm}$ .



CIRCLE 17 ON FREE INFORMATION CARD

The model *RW-21T* uses DIN A4 format (8½ × 11") and is priced at \$1695.00. The model *RW-201T* uses DIN A3 (11 × 17") and is priced at \$2395.00.—**PrimeLine**, PO Box 818, Sun Valley, CA 91353-0818.

**LIGHT PEN GRAPHICS PACKAGE**, designed for the IBM Personal Computer and the PCjr, features the Tech Sketch light pen with fingertip control and a coil-free cord to allow precise

and unrestricted movement. The Micro Illustrator color software included has the ability to store light-pen pictures on diskette and print pictures in color or black-and-white. The artist can select from 10 different brush strokes and 10 different drawing modes, including lines, rays, boxes, circle, color filling, and freehand drawing. Sixteen colors and 16 shades are available. The program will erase mistakes, magnify to provide pixel-by-pixel resolution, store up to 48 screens on diskette, and allow binary storage for hard-copy printing or telephone transmission.



CIRCLE 18 ON FREE INFORMATION CARD

The light pen plugs directly into either computer. A color graphics board is required on the IBM-PC when using Micro Illustrator. No extra equipment is needed for the PCjr. The package is priced at under \$70, including software.—**Tech Sketch, Inc.**, 26 Just Road, Fairfield, NJ 07006.

**UNINTERRUPTIBLE POWER SYSTEM**, the Mini-UPS, model 26-00-50750-3800, is designed to provide up to six times the rated current for very short durations, and is particularly suited for use with small micro and minicomputer systems that require high start-up power for disk drives.



CIRCLE 19 ON FREE INFORMATION CARD

The Mini-UPS always operates between the AC line and the critical load to provide complete protection from all AC power problems that affect small, sensitive electronic equipment—problems including brownouts, blackouts, voltage transients, and electrical line noise.

In the event of a blackout, the unit continues to provide up to 10 minutes of regulated power to the load from its self-contained backup battery. Be-

cause the backup battery is always on-line, output continues without interruption. Auxiliary battery packs are available to provide an additional 250 minutes of emergency power. The Mini-UPS is priced at \$2178.00.—**Sola Electric**, 1717 Busse Rd., Elk Grove Village, IL 60007.

**PRINTER**, the model SP-1200, features 80-column capacity and has a printing speed of 120 characters per second. This serial dot-matrix printer can provide emphasized and double-print modes, plus superscript/subscript modes. Both single and double-resolution graphic modes are available, as well as logic-seeking printing or incremental printing with high-response stepping motor. Fixed-pitch and proportional-pitch modes are available.

The model SP-1200 can be used with fanfold, roll, or cut sheet paper, and the head can be replaced without needing any special tool. Included is an 8-language international character



CIRCLE 20 ON FREE INFORMATION CARD

font, including French, Spanish, Italian, Swedish, German, Danish, and English. The characters available include pica and double-width pica, elite and double-width elite, condensed, double-width condensed, and graphic.

The model SP-1200 is priced at \$399.00.—**Sakata U.S.A. Coporation**, 651 Bonnie Lane, Elk Grove, IL 60007.

**JOYSTICK CONTROL**, model 862, with serial RS422 output, is designed to yield high performance and easy, compatible interfacing through most serial ports. High performance is achieved by providing a built-in dead band at null and a human-engineered exponential transfer curve that allows the operator to perform single-element positioning and high slew rates with just a small change in the applied force. Compatible interfacing is made easy by the microprocessor-controlled conversion that can be programmed to meet specific user requirements for either an RS232C or an RS422 port.

The model 862 with serial RS422

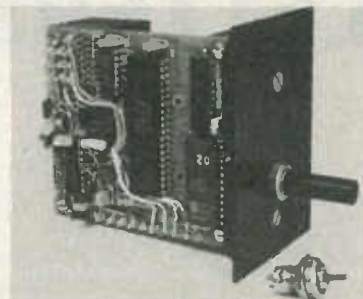

CIRCLE 21 ON FREE INFORMATION CARD

output is priced at \$2000.00.—**Measurement Systems, Incorporated**, 121 Water Street, Norwalk, CT 06854.

**MODEM SERIES**, the Intellimodem model XL, model ST, and model XT are plug-in modem products for the IBM PC/XT/AT. All three modems are 300/1200 baud, auto-answer/auto-dial; include Intellisoft communications software; have unlimited on-line telephone directories and XMODEM protocol file transfer; operate in full or half-duplex, and are 100% Hayes compatible.

The Intellimodem model XL operates in dual command role. The user can choose between data transmitted only, using virtually any communication software package written, or use the shared voice and

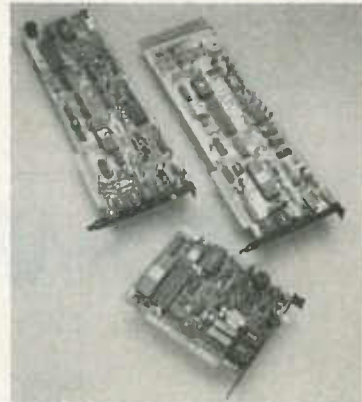

CIRCLE 22 ON FREE INFORMATION CARD

data feature. Voice and data on the same line allows the user to switch between the two with a single keystroke, without having to hang up or redial. It is priced at \$549.00.

The Intellimodem model ST and model XT is for users who don't need the application of shared voice and data. The model ST implements the Hayes *Smartmodem 1200* command set precisely. It is priced at \$499.00. The model XT is a minicard that will fit into all the short slots of the IBM PC/XT. It is priced at \$549.00.—**Bizcomp**, 532 Mercury Drive, Sunnyvale, CA 94086. ◀▶



# ZORBA

## PORTABLE COMPUTER

### THE EXPERTS' CHOICE

#### FEATURES:

- 9" GREEN OR AMBER CRT
- 19 INDEPENDENT 55 PROGRAMMABLE FUNCTION KEYS
- TWO 400K DSDD DRIVES
- 64K BYTES 200 NS RAM
- C BASIC COMPILER
- IEEE 488 BUS MASTER PORT
- 24.6 LBS
- CPM 2.2 OPERATING SYSTEM
- M80 (L80, LIB80, CREF80)
- SOURCE CODE OF THE BIOS PLUS UTILITIES
- DATA COMMUNICATIONS SETUP PACKAGE
- SERIAL & PARALLEL PRINTER PORT
- DATA COMMUNICATION PORT

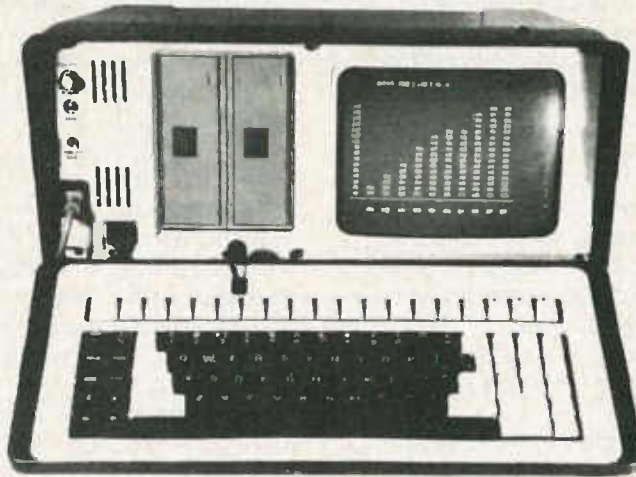

#### OPTIONS:

- 16 BIT 256K RAM UPGRADE (8088 CPU) \$600.00
- 800K DSQD 96TPI DRIVES \$200.00
- COMPOSITE VIDEO OUTPUT \$100.00
- SOFT VINYL CASE \$25.00
- TUTOR KIT: \$15.00 (CPM, WORDSTAR, CALCSTAR)
- SCHEMATIC SET \$10.00
- 10MB HARD DISK DRIVE

VISA/MC

BUNDLED WITH  
WORDSTAR, MAIL MERG, SPELLSTAR,  
DATA STAR, REPORTSTAR, CALCSTAR

# \$849.00

W/O Bundle

## DEALER INQUIRIES INVITED

# \$1049.00

With Bundle

#### General Specifications

ZORBA is the lowest cost full featured portable computer. This light weight computer is ruggedly packaged in a convenient carrying case. The case surrounds a strong inner chassis which further protects the Z80A based computer with its two double sided double density disk 400K drives, large easy to read 9" display screen and well designed detachable keyboard.

ZORBA uses CP/M, the industry standard operating system, which means that a wide range of existing software is readily available to the user.

The ZORBA users manual covers operation of the unit, all supplied software and all interface and internal information. A system diskette is supplied with all system files and utilities. A second diskette contains the sources for all ZORBA software including BIOS, SETUP, FORMAT, and PATCH.

#### Keyboard

Keyboard communicates serially with CPU  
Detachable with 2 foot coiled cord  
95 keys in standard QWERTY format  
13 Key Numeric pad  
Independent Caps Lock and Shift Lock  
55 Software programmable function keys  
All keys auto-repeat after 1 second delay  
All Standard cursor and terminal control keys

#### Disk System

Controller: WD1793  
Drives: 5.25 Double Sided,  
Double Density, 400K  
48 TPI

Built-in disk interchange formats: Xerox 820 (SD, DD), Kaycomp (DD), DEC VT-180 (SD), Osborne (SD) and IBM-PC (eg. CPM/86) and Televideo 802 (Read/Write and Format compatibility) (Expandable to 61 Formats)



**GEMINI  
ELECTRONICS, INC.**

130 Baywood Avenue, Longwood, Florida 32750  
305-830-8886 800-327-7182

#### Specifications

##### General Mechanical and Electrical

Width -17.5 inches (44.45 cm)  
Height - 9.0 inches (22.86 cm)  
Depth -16.0 inches (40.64 cm)  
Weight -24.6 pounds (11.1 Kg)  
Power -80-130 VAC or 190-245 VAC  
50/60 Hz  
170 watts max

##### Display

Display Tube:  
9" diagonal, Green or Amber  
High resolution display circuitry  
60 Hz refresh rate

##### Display Format:

25 lines x 80 columns  
5x7 Character Font with full descenders  
128 ASCII Characters  
8x9 32 Characters Graphic Font  
2K Memory Mapped Display Buffer

#### CPU Board

Z80A CPU running at 4 Mhz with no wait states  
64K bytes of 200 ns RAM (58K after CP/M loaded)  
16K bytes of EPROM (2732) can be switched in and out by software  
12K available for user EPROMS  
8275 CRT controller, DMA driven  
1793 Floppy disk controller, SMC data separator  
Bipolar proms configure 10 addresses  
Fully structured interrupts prioritized by bipolar proms

#### Interfaces

- Full asynchronous RS232 port with modem control. Baud rates and data translation and protocol programmable
- Full asynchronous full duplex RS232 port with hardware handshake (for printers). Baud rates and protocol programmable. (Serial Printer Port)
- One 8 Bit parallel port with independent strobe and ready lines. Supports Centronics interface with an available adaptor cable.
- IEEE 488 Bus Master Port (ie: General Purpose Instrumentation Bus) not Software Supported.
- 21 Standard Software Programmable Baud Rates: 45.5 to 19,200 BPS

# UPGRADING The CoCo and 64

*Getting more from the CoCo and the 64.*

## HERB FRIEDMAN

■As the software for even the least expensive computers gets more sophisticated, the limitations of the low-cost home-and-family computers becomes even more inconvenient. While it was fun to record your check file on a tape that took a few minutes to load, the spreadsheet analysis of the parts you need to stock for TV and VCR repairs now becomes unweildy and inconvenient, taking five minutes just to load.

And one must not overlook the fact that most of the really good software—let's call it "professional quality"—is now supplied primarily on disk or in cartridge form (depending on the particular computer for which it's intended). Most of the newest and hottest software for the Radio Shack *Color Computer* (known as the CoCo) is supplied on disk, while the interminably slow disk drive of the Commodore *64* has resulted in more good software being released in cartridge form.

But there are problems in upgrading to the newest and the best. The cost of a single disk drive system for the CoCo is relatively expensive both for the family and for the service shop, while popping cartridges in and out of a Commodore *64*'s user port doesn't necessarily do the port's connector any good.

Two recently-introduced products however, take care of both problems at reasonable cost, and throw in an extra feature or two that's particularly useful to the programmer and technician.

The devices we're going to cover are the J & M "*CoCo Disk Controller*"—same model for both the Model I and Model 2 CoCos—and the Handic "*Super Box 64*", a cartridge switcher and IEEE I/O for the Commodore *64*.

## Getting it on disk.

Normally, it does not pay to purchase a third-party disk controller and the disk drive separately because the total price is about the same as the latest reduced Radio Shack price; actually lower if you order the Radio Shack disk system from a mail order discounter. But the marketplace is now awash in a sea of obsolete disk drives that can be purchased at rock bottom prices. Fortunately for CoCo users, while the drives might be obsolete for the newest computers, virtually every one is suitable for use with the CoCo.

Okay, this takes some explaining. Early disk drives had a track access time of 25 to 30 milliseconds, which is relatively slow compared to modern drives which have a track access time of nominally 6 milliseconds. Modern software (operating systems) is written to utilize a 6 millisecond drive. If you use 6 millisecond drive, the computer has no idea what's going on. At best, it will come up with an error message such as "DIRECTORY READ ERROR," or the computer will just hang up and require a full reset.

As always happens when there's a technological advance, warehouses are left bulging with the old stuff, and in this instance, the old stuff is disk drives with track access times of 25 to 30 milliseconds.

These can't be used in IBM PCs and PC compatible, nor in the Radio Shack *Model 4*. And certainly not in the Commodore, Atari and Apple computers because their disk drives are off in a world of their own. Also, many of the older drives are 35 tracks, and all new computers except the CoCo require 40-track drives.

And so, with the surplus marketplace flooded with obsolete drives, it's possible to purchase a disk drive for the CoCo for as little as \$125 (new), under \$100 used. Maybe \$160 with a power supply and case., or you can build your own power supply from junk-box parts. At these prices it pays to assemble your own disk system using a third-party device such as the J & M *CoCo Disk Controller*.

What's that? You want to know why a 35-track drive with a 30 millisecond track access will work? Because a 35-track drive is much less read-error prone than the 40-track models. So Radio Shack has always provided for a 35-track drive on their budget computers. (It's



THE J & M SYSTEMS COCO DISK CONTROLLER plugs into the cartridge slot of the Radio Shack Color Computer. It works with either the old or the new models.

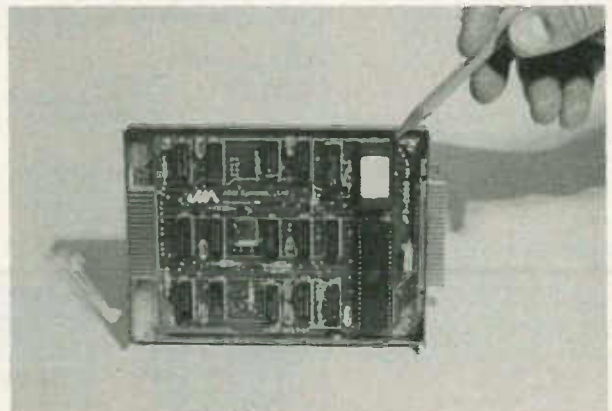

PENCIL POINTS TO THE ROM within the controller that contains JDOS Extended Disk Basic.

why their early Model I had less disk drive problems than the later, more sophisticated competition that used 40 track drives.)

While Radio Shack's own disk system is 35 tracks, aftermarket disk controllers such as the J & M provide for 35 or 40 track operation; you specify the number of tracks when you format the disks. If you happen to have a 40-track drive you can use 35 or 40 tracks. The

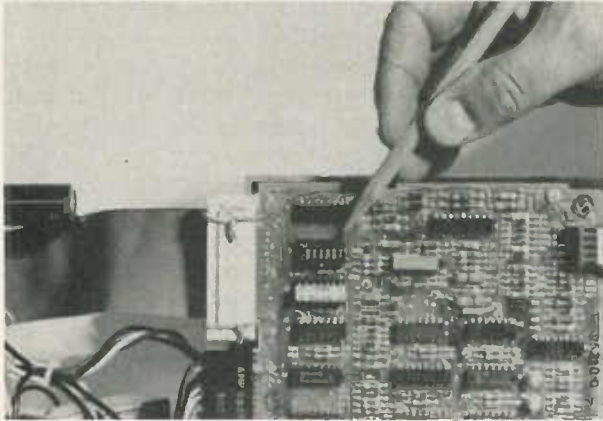

**THE DISK DRIVE'S SHUNT BLOCK** looks like a DIP IC except for metal straps which shunt the terminals.

computer works just fine with a 35-track drive.

If you want to know what kind of surplus disk drive you're looking for, it must be advertised as TRS-80 compatible, (35 track) or Shuggart 400L (40 track) compatible.

If the drive is advertised as being IBM-PC compatible, it is probably a 6 millisecond model and

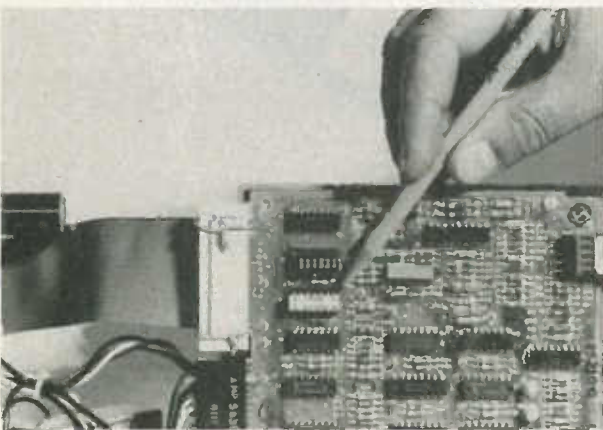

**THE RESISTOR BLOCK** looks just like a DIP IC. It is usually located right next to the shunt block and is often marked with its resistor value.

is perfectly suitable for use with the CoCo. In combination with the J & M Disk Controller the CoCo works with 30 or 6 millisecond drives; in fact, the J & M Disk Controller "comes up" ready for a 6 millisecond drive. The user must specifically initialize the controller for a slower drive by entering the command RATE 3 prior to using the disk system. RATE 3 means a 30 millisecond step rate.

The J & M Controller plugs into the program cartridge port on the right side of the CoCo. In fact, the controller looks like an oversize program cartridge, the only differences being that the cabinet is metal and there are connectors at both ends: One for connection to the CoCo and the other for the cable that connects to the disk drive.

Inside the cabinet are the disk controller and a ROM containing the disk operating system and *Disk BASIC*, *Disk BASIC* being an overlay to the CoCo's ROM BASIC which provides the extra functions available through a disk (such as random data files, etc.)

The disk controller has no adjustments of any kind; all you have to do is plug it in and connect the disk drive. If you have any problems it will be in connecting the disk drive. Unlike Radio Shack's own disk controllers which are for the old or new models of the CoCo, the J & M controller works with any version of the CoCo without the need for wiring retrofits or adjustments.

#### All alike.

Regardless of the kind of disk drive you purchase, if it is TRS-80 compatible it has certain standard features:

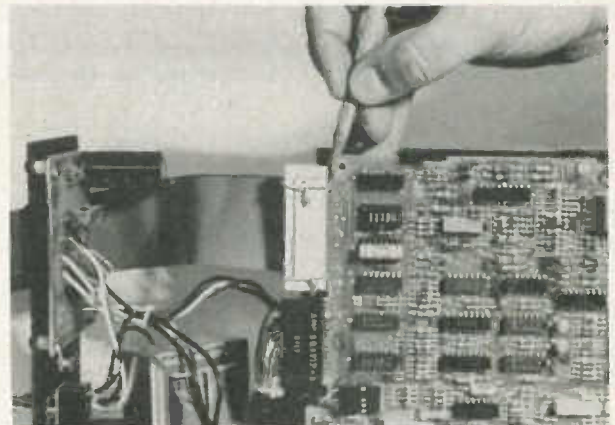

**IF THE DISK DRIVE'S PRINTED CIRCUIT BOARD** has holes drilled opposite the #1 and #33 terminals, pass a length of insulated #20 or #22 solid wire through the holes and around the ribbon connector. A couple of twists secures the wire and the connector.

Among them a 34-terminal edge card connector, a DIP socket with shunt straps used to select the drive, and a DIP resistor network that resembles a 14-terminal DIP IC. Everything else about the disk drive's electronics might be different, but these three things are always the same.

The first thing is to set the drive-select connections. Radio Shack normally does this by pulling terminals out of the disk drive connector, which is a good idea if you want to sell a product that can be taken home and put together by an 8-year old. (This was one of the truly great ideas for non-technical users.)

You, as a technician, will program the drive because: a) it is hard to pull a terminal without the proper tool and b) Radio Shack's own cable is unnecessarily expensive (assuming you can get one).

The :O drive uses the disk drive's No. 2 Drive Select connection. Locate the DIP socket containing the shunt. The shunt will probably be short one jumper; this is

normal. Though the DIP socket has 14 terminals providing 7 circuits, the jumper is 12 terminals providing 6 circuits. You will use only the top six circuits, those labelled HS, DS1, DS2, DS3, MX, and blank. "Blank" is an unused circuit located between MX and HM. On disk drives intended for the IBM-PC the "blank" terminal is labelled "4" for DS4. HM isn't used, you always leave it open. Do not make a mistake and move the shunt device down one step so the top HS terminals are open and the HM terminals are closed.

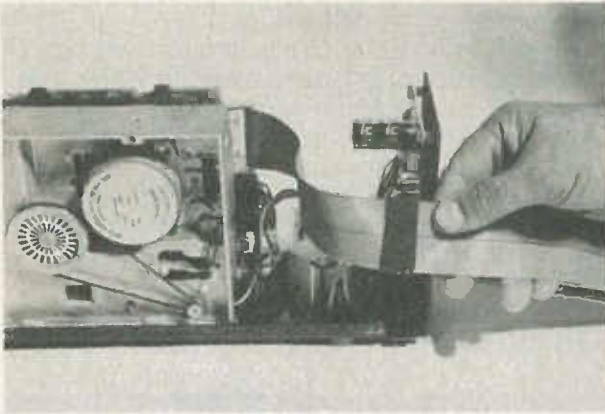

**WRAP TWO TURNS** of friction tape around the ribbon wire to protect it where the disk drive's cabinet and the rear panel meet.

To avoid damage, don't attempt to cut through a shunt even though every book tells you to do it with a special tool. (I have never seen this tool sold anywhere!) Instead, remove the shunt block using an IC puller tool and then bend up one pin from the circuits you won't be using.

In the case of the CoCo, DS2—meaning the disk



**THE COCO WITH THE DISK DRIVE WHEN COMPLETED.** If you want two drives, simply install a second connector on the ribbon.

drive's internal No.2 drive select—path is the one used when the drive is to function as DRIVE :O (Drive select connections in the drive itself have nothing to do with the drive number.) So bend outward one pin for DS1 and DS3. Then replace the shunt block in the socket, taking care that all pins except one pin for the DS1 and

DS3 circuits are inserted; that one or more pins have not folded under the shunt block.

If you later decide to add a second drive you must complete the drive select only for drive :1 (which is DS1) on the new drive, and open the MX shunt on all drives. MX means multiplex; if you are using only one drive, it is closed; if you use two or more drives, it is open on drives. Remember, only one drive select is closed on each disk drive.

Doublecheck that the resistor block is installed. All drives should be supplied with one. It is generally located in a DIP socket immediately adjacent to the shunt socket. If you see an empty socket and can't find the resistor block—which looks like an IC, though it might be marked 150 or 22 ohms—look in the shipping carton as it might have been packaged separately (very uncommon, but it happens). If you can't find the resistor block, call the outfit that sold you the drive.

The block is always installed in the first drive, in this instance, drive :O. If you have more than one drive, you must remove the block from all drives except drive :O.

With the disk drive's shunt set and the resistor block installed, all you need is a connecting cable, which consists of two 34-terminal insulation-displacement (press-on) edge card connectors and about five feet of 36-conductor cable ribbon. Why 36 conductor?

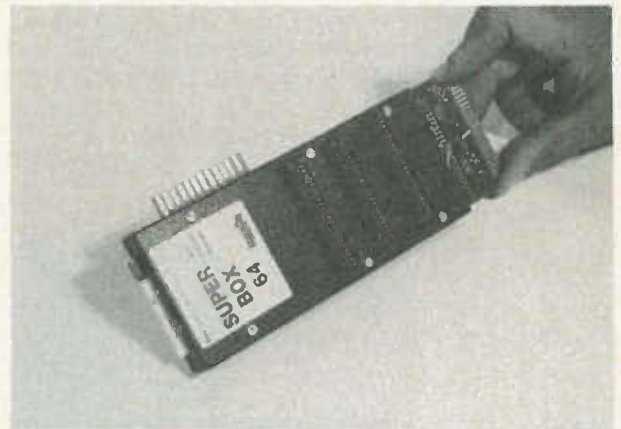

**THE SUPER BOX 64** is a complete three-cartridge switching system an IEEE I/O for the Commodore 64.

Because that's the way it's usually sold. Nick the insulation two wires from the edge without the color code and strip off two conductors. Be careful that you don't strip the insulation from a third wire because then you will be short one.

Now you must take extra care to doublecheck everything. Note that only one end of the ribbon cable has a color code—usually red, or one edge and every fifth or tenth wire is color coded. If every conductor is a different color, the cable is probably the wrong stuff. Multi-color wire is a heavier gauge and tends to jam in the connectors—it can cause a lot of grief.

Taking extra care that the color-coded edge connector is opposite the #1 connector terminal, use a vise to squash a connector on each end of the ribbon. Before you squash, triple check that the color-coded conductor is on the side of the connector with the #1

and #2 terminals. The connector end with the #33 and #34 terminals does not get a color-coded conductor. Don't worry about what terminal is which; if you simply get the color-coded wire on the side of the connector marked #1 and #2 the #1 wire is automatically positioned correctly.

Install one connector on the matching disk drive edge connector with the color-coded conductor opposite the #1 terminal on the drive. Some drives have the #1 terminal marked, some don't. It is always the terminal farthest from the power supply plug. If you have the drive vertically mounted in a standard cabinet, the plug is on the bottom and the #1 terminal is towards the top of the drive.

Some disk drives have small holes adjacent to the ribbon connector near terminals #1 and #33. If your drive has the holes (even one), pass an insulated #20 or #22 solid wire through the hole and twist it around

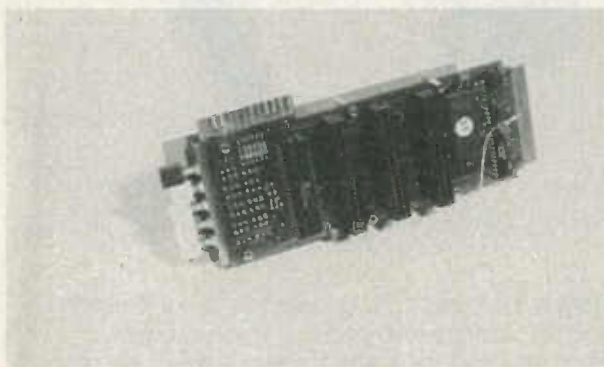

**OPEN, THERE'S NOT MUCH TO SEE.** A few IC's that do the electronic switching and an AV-6250 for the IEEE I/O.

the connector to make certain it can't pull out. It's not convenient to have to open the cabinet to re-install a connector that's been pulled loose.

Next, protect the ribbon cable against damage where it passes through the cabinet. Allowing for a slight slack, mark where the ribbon will pass through the cabinet and wrap a couple of turns of friction or plastic tape around the cable. Don't overdo the tape.

Finally, make certain the computer's power switch is OFF and plug the controller into the cartridge slot, then plug the disk drive into the back with the color-coded wire towards the back of the computer.

Turn on the power to the disk drive and the computer. You will see the J & M Systems sign-on message indicating it has control of the computer. Play it safe by entering the command RATE 3 on the keyboard. Until you experiment and find out the fastest track access rate for your drive, use 30 milliseconds.

The first thing you will have to do is format a disk so you can save your program and data. The disk initializing command lets you decide whether you want a 35 or 40 track format. To steer you in the right direction, keep these figures in mind:

TRACKSDISK *per disk capacity*  
 35 (SS) 161K 40 (SS) 184K 40 (DS) 368K (SS = Single-Sided, DS = Double-Sided)

## The Super Box 64.

The Super Box 64 is one of those devices that you'll wonder how you ever got along without. With more and more Commodore programs going the cartridge route, because the disk system is s-l-o-w, the Super Box 64 takes the effort out of changing programs. Basically, it is a 3-way electronic switch that plugs into the Commodore 64's user port, providing three user sockets at the back of the computer. While this is nothing spectacular, the IEEE I/O is.

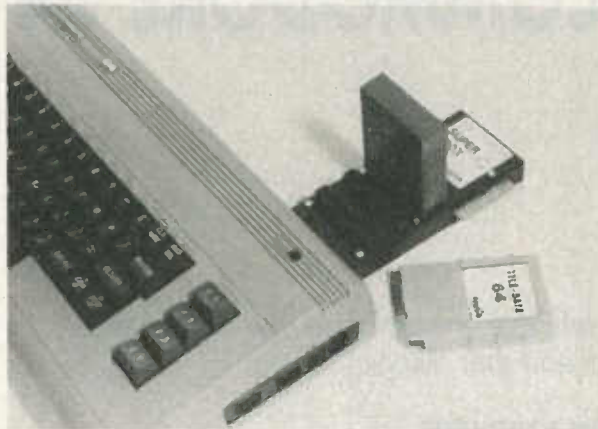

**THE SUPER BOX 64 PLUGS INTO THE USER PORT** on the back of the Commodore 64. The program cartridges are then plugged into any of the three ports on the Super Box. The edge connector sticking out is the IEEE I/O. Mounting feet on the bottom of the unit raises it to the same height as the computer so everything sits flat on the table.

The Super Box 64 is built by Handic, in Sweden, where the best selling computer, as in most of Europe, is the Commodore 64. So the computer is put to some rather heavy use in schools and even industry, and many scientific devices use the IEEE bus.

So Handic built an IEEE I/O into the Super Box 64. It appears as a standard IEEE edge connection sticking out the side of the Super Box. For switches on the back of the device select any of the three cartridge ports, the IEEE I/O, or OFF, meaning the Super Box's ports are switched completely at the output.

Unfortunately, the Commodore 64 must be opened to enable the IEEE bus because one required connection isn't available on the user port. (If you have no need for the IEEE I/O simply plug the device into the 64's user port.)

At the front of Super Box is a small cutout in the metal cabinet with a small pin terminal sticking through. Supplied with the device is a wire having a clip lead on one end and a slip-on terminal on the other. Slide the clip lead on the pin terminal. Open the 64's cabinet and locate a resistor marked R44. It is almost out in the clear in front of the PROM. Simply apply the clip to the right hand side of the resistor, route the wire out the back of the computer adjacent to the Datssette connector and reassemble the cabinet.

That's all there is to installing the Super Box 64. Plug in up to three program cartridges and your program is ready at the touch of a button. ◀▶

# BUILD A LIGHT PEN FOR YOUR COMMODORE 64

*Here's an inexpensive and easy way to add that "Magic Pencil."*

**JIM STEPHENS**

■What follows is a simple light pen that can be used to demonstrate light pen/computer operations, menu selection and can even be used for simple design drawings with the proper programming.

## How light pens operate

In order to fully understand how a light pen works, a few details on how the TV creates the picture are necessary. Once these are understood, the operation of the light pen will seem simple.

The picture on the screen is "painted" by a rapidly moving light beam that starts at the top of the screen and scans line-by-line down to the bottom. The movement is so fast that our eyes cannot see the change. There are 512 lines in the picture and a complete screen picture is painted on the screen many times each second. If the painted area of the screen is to be white, the beam is turned on. If the area is to be black, the beam is turned off. The screen glows when the beam strikes the front of the picture tube. If a fast-acting light sensor such as a simple photo-transistor was placed near the screen, the emitted light would trigger the sensor each time the beam went under it. This is exactly what our light pen will do.

The Commodore 64 creates its own picture information by producing pulses that cause the picture tube beam to scan and turn on and off at the right time. This work is done by a specialized chip in the computer called the "Video Interface Controller" or VIC. The controller constantly reads a selected portion of memory in the computer and converts the data from these locations into readable characters on the screen. More importantly, the controller keeps up with where the beam is located by measuring the time from

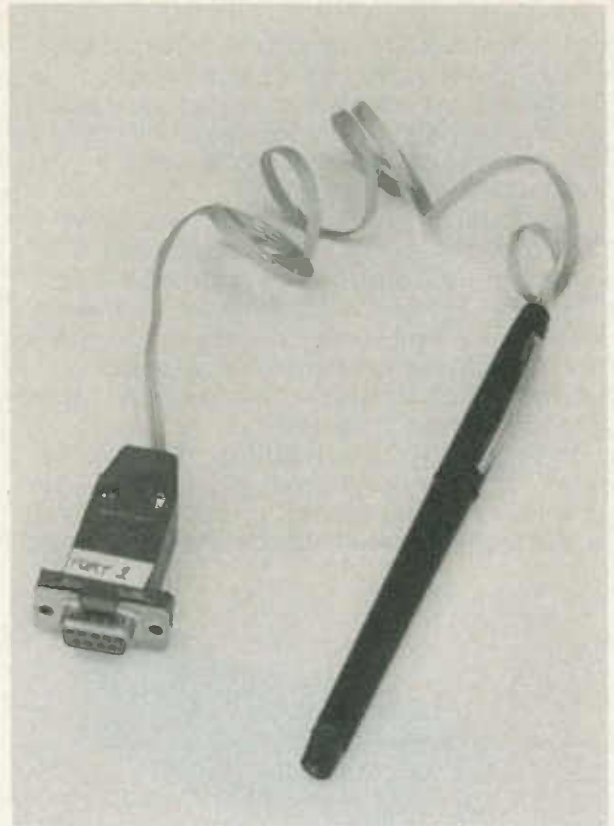

starting the current line. It does this by incrementing special counters in its circuitry. These counters effectively give the X and Y coordinates of the beam. If these two counters could be read, we could tell where the beam was located at any one instant.

What is needed is a device that would cause the controller to place this information into memory so it could be read out by a special program. This can be accomplished easily using only four components.

Game Port 1 has a pin called A/LP. The LP stands for "Light Pen." If this pin is rapidly switched to ground (negative), the controller will place the contents of its X and Y counters into memory. The X counter data is placed into memory location 53267 and the Y counter data is placed into 53268. If we were to peek these locations as pin 6 of the game port was pulsed, we could see the contents of these locations as they changed from each update. This can be easily done using the following two line program and a joystick plugged into port 1.

```
10 PRINT PEEK (53267), PEEK (53268)
20 GOTO 10
```

Since the fire button is connected to the Light Pen connection of the port, all we need to do is to pulse the fire button to update the memory locations. The contents are printed out each time the program goes through line 10. The fire button does not switch the LP pin clean enough to produce a clear change but you can see the contents change intermittently each time a good pulse is obtained. If a photo-transistor was placed on the screen, and a small switching circuit was

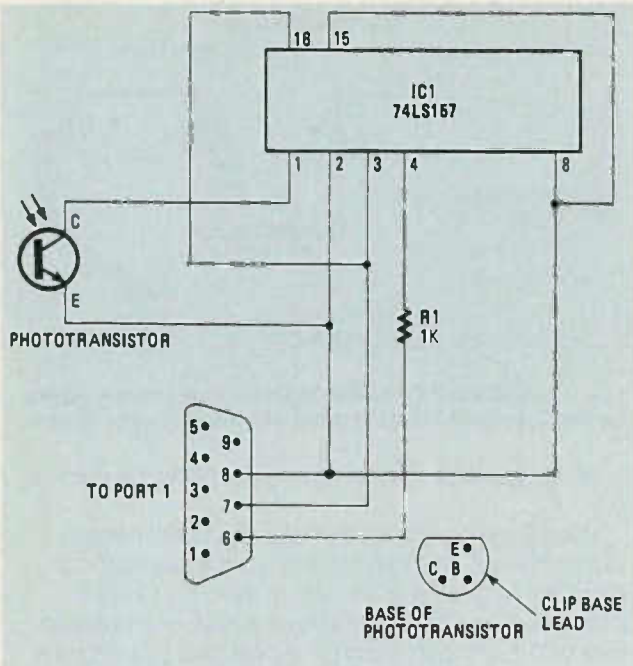

**FIG. 1—COMPLETE WIRING DIAGRAM.** Only one gate is needed for proper operation.

substituted for the fire button, the numbers would numerically tell us where on the screen the phototransistor was located.

My major purpose is to demonstrate the operation and construction of a light pen, but the final product can be an extremely useful tool in your programming. Those that are more expert in the field of programming can make this little gadget do all that a far-more expensive pen could do.

The parts count for the project is very low. Only four components are required to make it work. None of the parts cost more than a dollar each.

First, you need a good photo-transistor. Radio Shack sells the FPT 100 type. This is a silicon unit with a built-in lens for light gathering. The switching will be done using a 74LS157 IC. This is an electronic toggle switch that switches the LP pin from high to low and back again each time the photo-transistor detects the light beam on the screen. The 74LS157 can be bought at most any electronic supply house. You'll need a female connector that will connect the three wires to the pins of Port 1. There is also a little 1K ohm resistor which is needed, but it is only used so that the keyboard will work correctly when the joystick is plugged in.

If you have a solderless breadboard, this would be a good time to use it to test the circuit before making the complete pen. However, there are so few connections, most pens work on the first try.

### Construction.

You will need a plastic felt-tip pen with a cap that snaps over the pointed end. These usually have plastic plugs in the end opposite the felt tip. Proceed as follows to construct the light pen body.

The cap of the felt pen snaps on to cover the tip. This is usually the result of either small nibs on the

barrel or an indentation. Remove the cap and saw off the end of the pen right above the nibs. Leaving the nibs will allow the cap to be snapped back on. Remove the plastic plug on the other end of the pen and push out the wick that holds the ink. Throw the felt tip piece away and wash the remaining parts.

Next, take the 74LS157 IC and clip all of the leads down close to the IC chip. Leave about an eighth of an inch of lead on the IC. See Fig. 1. With the leads shortened, the IC should readily slide into the pen's cap. If so, you are ready to work on the pen barrel. If the IC seems too large for the pen's cap, you'll need a larger felt tip pen. Again, Fig. 2 shows how the circuit will be inserted.

The photo-transistor comes with three leads. The base or B lead will need to be clipped off. Figure 1 has a bottom view of the transistor that will help in identifying which lead to clip.

Make the hole in the end of the barrel of the pen big enough to insert the photo-transistor. If, after removing the plastic plug, the hole is too large, you can wrap the transistor with tape later when you insert it permanently into the pen housing.

Solder two different color light-gauge wires to the two leads coming from the photo-transistor. Make a note on which of the colors goes to the collector or C lead and which goes to the E or emitter. These wires should be flexible and slightly longer than the barrel of the pen. The solder joints at the transistor should be wrapped with one turn of masking tape to keep them from shorting together. Thread these two wires through the end of the barrel as shown in figure 2.

### PARTS LIST

- R1—1000 ohm, 1/8-watt resistor
- IC1—74LS157 two-to-one line multiplexer
- Phototransistor—FPT 100
- 9-Pin subminiature female connector, 24-inch ribbon cable, Felt-tip pen body (see text).

Drill a small hole into the end of the pen's cap and insert three wires that are about 24-inches long. These should be flexible, insulated and multi-strand types. I used three color coded wires which were from a piece of ribbon cable. Pull about three inches of the wires through the cap and tie a knot in these to create a strain relief. Don't pull the knot back into the cap until ready to assemble the complete pen.

Make sure you have a good pencil-type soldering iron rated at 25 watts. Large soldering irons could over-heat the pins of the IC since we are going to be soldering directly to them.

Using the connection diagram in figure 1 and small lengths of insulated wire, solder the inter-connections on the 74LS157. Use as little solder as possible and do not over-heat the pin. Notice that pins 2, 8 and 15 are all connected together. Pins 3 and 16 also connect together. The 1K ohm resistor can be placed flat on top of the IC and one of its leads can be soldered directly to pin number 4. The diagram in figure 1 shows the

74LS157 as it would appear from the top with its leads pointing down. Notice that a notch in the IC marks the end on which pin one is found. Some IC's may not have the notch but a small dot placed over pin 1.

The C or collector lead wire from the photo-transistor connects to pin 1 of the IC and the E or emitter lead connects to pin 2. Be careful not to unsolder the connection made to this pin earlier. One of the colored wires coming through the cap is soldered to pin 2, 8 or 15 also. One of the other colored leads solders to pin 3 and the remaining wire solders to the unused end of the 1K resistor.

Now solder the 24 inch-long wires to the female joystick socket. This socket is sold by Radio Shack and other outlets. The parts list gives the Radio Shack part number. Figure 1 shows the rear of the connector that receives the wires. This view is as though it were plugged into the joystick port and you were looking at it. The pins are numbered along the bottom as 6,7,8, and 9. We will be using pins 6 through 8 only.

The wire from the 1K resistor solders to pin 6 of the socket. This is the Light Pen connection. It is a good idea to get some small lengths of 1/8th-inch heat-shrink tubing to fit on these connections since they are very closely spaced. The wire coming from pin 3 of the IC is the positive power connection and it goes to pin 7 of the socket since this is the plus or positive connection of the computer power supply. The remaining wire comes from the ground connection of the IC at pin 8 and goes to pin 8 of the socket.

After you are sure all connections are correct and with the computer off, you can plug the connector into port 1. Now turn on the computer. The 64 Ram System message should come up within two seconds. If not, turn the 64 off and unplug the socket. Recheck all of the wiring, especially the power connections.

If the System notice comes up as it should, but the cursor is moving across the screen on its own, then turn the computer off since the LP pin is getting a negative voltage when it should be positive. Again, recheck the wiring using figure 1. Double check that the correct leads from the photo-transistor are going to the correct pins on the IC. Unless you used a blow-torch on the IC and it doesn't look like it's half-melted, the IC is probably OK. However, if you connected the leads going to pins 7 and 8 on the socket backward, this can ruin the IC if left on for more than 2 or 3 seconds. If the cursor remains at the first location on the screen, you are ready to test the circuit using software.

### Testing the Light Pen.

Listing 1 is a test of the light pen's response to the screen. This short routine lets you set the intensity of the monitor or TV in order to obtain the best response from the light pen. Line 30 is entered simply as a print command and the control key is held down as the numeral 2 key is pressed. This changes the character color to bright white. Line 50 is entered also by a print command that prints while lines (reverse spaces) on the screen 24 times. This is done by first holding down the Control key and pressing numeral 9 key. Then space over 39 spaces and turn off the reverse print by

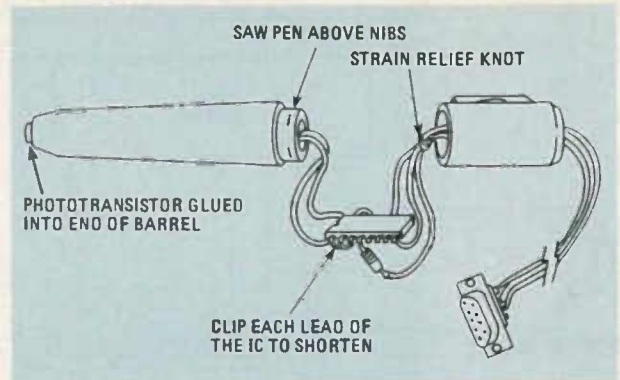

FIG. 2—ASSEMBLY OF COMPONENTS. Note that the points on the IC are wired point-to-point with short lengths of wire.

holding down the control key and pressing the numeral 0.

Line 90 is a command that uses the print character string (19) as a command to instruct the computer to go to the beginning of the screen. Line 100 prints a clear line at the top of the screen to give an indication area of the light pen readings. It does this by printing a blank area of 20 regular spaces. Type in the program listing and save it. With the pen plugged in, run the program. The screen will turn bright white with a dark border. Look at the column and line numbers at the top of the screen. These are the numbers placed in the memory registers when the system was turned on. Place the photo-transistor near the screen and these numbers will start to change as the pen is moved around. If they do not change, turn up the brightness or intensity of the screen. If the numbers still don't respond, check your typing of the program. If it looks OK, turn the computer off and recheck your wiring. Some black and white sets have a shaded plastic cover over the picture tube. This may have to be removed before enough brightness can be obtained.

Most likely the pen will work correctly. But, if the numbers are changing before the pen is placed near the screen, then the pen may be picking up light from the room and the photo-transistor will need to be

### LISTING 1 - Short routine by which to test the operation of the light pen. The intensity of the screen can be properly set using this program.

```

10 REM SCREEN INTENSITY TEST
15 REM LIGHT PEN TEST
20 REM JIM STEPHENS-NASHVILLE, TN.
25 REM C = COLUMN L = LINE
30 PRINT "[CONTROL 2]"
40 FOR N = 1 TO 24
50 PRINT " [RVS ON] [39 SPACES] [RVS OFF]"
60 NEXT N
65 PRINT "TAB(12)"INTENSITY TEST"
70 C = PEEK (53267)
80 L = PEEK (53268)
90 PRINT CHR$(19); "C = "; C; TAB(10) "L = "; L
100 PRINT CHR$(19); "[20 SPACES]"
110 GOTO 70

```

placed deeper into the pen's tip for shielding.



Place the tip of the photo-transistor near the middle of the screen. Notice that the numbers remain within a small range even though they are still changing. Notice too, that the column number changes much more than the line number. This is normal and the program will take this into account by looking for ranges rather than a specific column or line numbers. If the numbers start changing before the pen touches the screen, turn the brightness down.

Place the pen in the top left corner of the white area and the column number should be in a range of around 30 to 40. The line number will be around 55-60. Moving the light pen down increases the line numbers and moving the pen to the right increases the column numbers. When the pen is in the bottom right-hand corner of the white area, the column and line numbers should be around 230. If this test is successful then slip the IC and wires into the pen cap and snap the cap and barrel together. The light pen is now complete. You may also improve the socket by adding the socket shroud on the plug.

### Make the Light Pen Useful.

If the Light Pen responded correctly to the intensity test shown in Listing 1, then type in the small demo program in Listing 2 and save it. Enter RUN and the screen will clear and present you with four options. These options could have been most any menu but I chose fruit since my mind has turned to mud and I couldn't think of anything clever. This short program shows the ability of the light pen to sense where it is on the screen. By placing a white square in various areas on the screen with an explanation by each, the computer will respond according to the area at which the screen command is located. For example, you might place the square in the lower left and write "sound" by it. If the computer sensed the pen in that area, it would go to a sound producing routine. In Listing 2, four choices are provided. Apple, Pear, Orange, and a command to clear the whole screen. When the pen is placed over the appropriate square, the computer responds as though it saw where the pen was placed. It does this as follows:

Line 25 is a print command. By holding down the CONTROL key and pressing the numeral 2, the screen color is changed to bright white again. This makes the light brighter for the sensor. Line 30 is a FOR NEXT loop that prints the character string 17 twenty-two times. CHR\$(17) means to move the cursor down one line. This has the same effect as clearing the whole screen. Line 70 tells the computer to go to the beginning of the screen by using the print command and a CHR\$(19). Then, by printing one "CURSOR DOWN" the cursor will drop down one line on the screen. Lines 90 through 120 print the white squares and the words by each. This is done in line 90 by first printing one Cursor Down (CURS DWN) which means typing your first quote sign and then pressing the cursor down arrow. The result as in line 70, is a reversed Q. You then tab over to column 20 and place a white square. The white square is done by again printing a "reverse on (RVS ON) which is written by holding the CONTROL key and pressing the

**LISTING 2 - This program shows what can be done with the light pen. This same procedure could be used for many other purposes.**

```

5 REM LIGHT PEN DEMO
10 REM BY JIM STEPHENS - NASHVILLE, TN.
15 B=0
20 C=0
25 PRINT "[CONTROL 2]"
30 FORN=1 TO 22:PRINTCHR$(17):NEXTN
40 LETA$ = "APPLE"
50 LETB$ = "PEAR"
60 LETC$ = "ORANGE"
70 PRINT CHR$(19); "[CURS DWN]"
80 PRINT " CHOOSE YOUR FAVORITE FRUIT"
90 PRINT "[CURS DWN] TAB(20)"OM"[5 SPACES]
  [RVSOFF]"A$; "[3 CURS DWN]"
100 PRINT "[CURS DWN] TAB(20)"[RVSON]
  [5 SPACES][RVSOFF]"B$; "[3 CURS DWN]"
110 PRINT "[CURS DWN]" TAB(20)"[RVSON]
  [5 SPACES][RVSOFF]"C$; "[3 CURS DWN]"
120 PRINT "[CURS DWN]" TAB(20)
  "[RVSON][5 SPACES][RVSOFF] CLEAR
  SCREEN"
130 Y=PEEK (53268):C=C+1;IF C=1 THEN B=Y
140 IF B=Y THEN GOTO 130
150 IF Y> 190 AND Y< 210 THEN GOTO 10
160 IF Y> 70 AND Y< 90 THEN GOTO 220
170 IF Y> 110 AND Y< 130 THEN GOTO 230
180 IF Y> 190 AND Y< 210 THEN GOTO 10
190 B=Y
200 PRINTCHR$(19); "YOU CHOSE THE";C$
210 GOTO 130
220 PRINTCHR$(19); "YOU WANT THE"
  A$:B=Y:GOTO 130
230 PRINTCHR$(19); "SO YOU WANT A";B$: B=Y:
  GOTO 130
240 B=Y
250 GOTO 130

```

Numeral 9. You enter spaces (which are now white) then again hold the CONTROL Key and press the numeral 0 key for a reverse off (RVS OFF). The word "APPLE" is printed in response to the A\$ and then three cursor downs are printed inside the quotes to make the cursor drop on the screen 3 lines. This is repeated in lines 100 through 120 to place the white squares and words in the appropriate places.

Lines 200 through 230 are the routines to which the program jumps when it has read the value of the light pen registers. The printing of the CHR\$(19) simply tells the computer to print on the first line of the screen.

Place the pen on your choice and watch the response of the computer at the top of the screen. Lines 150 to 180 of the program checks the range of the line coordinate and lines 200 to 230 prints the appropriate responses. The "clear screen" option was included to demonstrate that most any operation can be executed by just a touch of the screen.

### Summary

The light pen shown here is not as exact as those \$200 units. Neither are much good without the proper programming however. I think that this small inexpensive unit can be made to be more exact and more useful by good software routines. ◀▶

# SOFTWARE REVIEW

## *SmartKey II Plus (IBM version tested)*

■ SmartKey II Plus is a key definition program for CP/M and PC/MS-DOS compatible computers that positions itself between the keyboard and the computer's input buffer. It intercepts keystrokes so the user can redefine one or more before sending them on to the computer or the applications program. A user-defined keystroke can represent just one or up to 30,000 characters, the precise limitation depending on available user RAM or how much RAM the user decides to reserve for key definitions. (Key definition is a synonym for what is commonly called a macro.) For example, BASIC programmers can swap the ";" and ":" symbols so that the more commonly used ":" is unshifted while ";" becomes the shifted symbol. By the same definition procedure, the Alternate-H keys might be redefined to provide a complete letter heading, or even a form letter to be called up by simply touching two keys.

Almost every key, and all their Alternate, Control and Shifted values can be redefined. Also, SmartKey II Plus has its own SuperShift key—usually the tilde (~), but which can be user-selected—so that no desired redefinition will conflict with an application program's use of the same key or combination of keys. One popular key redefining program uses virtually every combination of the A, B and C characters for internal use, preventing a definition of the keys so that Alternate-A means DIR A., Alternate-B means DIR B.

### **The power**

The real power of SmartKey II Plus is an on-screen window that breaks into the normal screen display of the application program and shows everything going on with SmartKey II Plus independent of the applications program. The window permits the user to: define a key at any time without disturbing the program; record keystrokes for use at a later time; check a key's definition at any time without disturbing the program; correct a definition; and nest definitions.

When the definition is called, the word DATE would be automatically entered on the screen, and then the computer would wait for the date to be entered from the keyboard. The <RETURN> following the keyboard entry would resume insertion of the definition: CUSTOMER No. would be inserted and the definition would again pause for keyboard entry of the customer's reference number. The <RETURN> following the keyboard entry would resume the inventory program.

Actual programming of the definition can be done

on-the-fly by simply touching what is called the SmartKey—the ":". If it is touched once SmartKey II Plus breaks away from the applications program and displays its window. After the definition(s) is entered, touching the SmartKey a second time programs the definition into a key and returns control to the application program or the disk operating system. If the actual ":" key is required for the program the user simply touches it twice in rapid succession, which causes conventional entry of the symbol. If the ":" is commonly required for your own programs or word processor, you can reconfigure SmartKey II Plus to use a different symbol for the SmartKey.

One unusual strength of SmartKey II Plus is that definitions can be programmed in ASCII—decimal or HEX—which permits the IBM PC's international, math and Greek characters to be available as a single keystroke that feeds both the screen and the printer. For example, the infinity symbol (ASCII 236) is not available directly as a key, nor is the Omega symbol (ASCII 234) which represents resistance to electronic technicians, but by using SmartKey II Plus you could put infinity on, perhaps, the Alternate-I key, and Omega on the Alternate-O key. However, ASCII definitions were possible only through definition files created with a word processor, although the manual sort of implies it's possible to do on-the-fly. (It is not really made clear.)

SmartKey II Plus is supplied with a program called SmartPrint II Plus which also is transparent to the application program, only this time the program is positioned between the application program and the printer. SmartPrint II Plus automatically allows use of most conventional matrix printer functions such as wide, emphasized and condensed printing, as well as super and sub scripts. Unlike SmartKey II Plus, SmartPrint II Plus cannot be programmed on-the-fly because it is really a translation program, and a translation/definition file for your particular printer must be created, or you can use one of the supplied printer definition files. However, again the definitions can be created directly on the screen in a window and then saved as a file. Alternately, you can create the definition file with a word processor, but once again it's easier using SmartPrint II Plus' window.

SmartPrint II Plus commands can be imbedded in almost any kind of applications program—word processing, data base, spreadsheet, whatever. The printer command is anything following the reverse slash ("\"), as the control key. For example, \w turns wide print off. In the line "This is \Wwidew type," the word wide would be printed in large type.

While SmartKey II Plus and SmartPrint II Plus can be loaded before or after an applications program, some RAMdisk software hangs the computer if SmartKey II Plus is loaded before the RAMdisk driver. If this happens to you, simply rewrite your AUTOEXEC.BAT file so the RAMdisk is loaded before SmartKey II Plus.

Otherwise, both programs proved reliable and superb performers, both being notably easy to use. SmartKey II Plus (Includes SmartPrint II Plus), Software Research Technologies, Inc. Suite 211, 3757 Wilshire Blvd., Los Angeles, CA 90010. ◀▶

**SUPER TECH'S**  
**\$10,000<sup>00</sup>**  
**RCA CHALLENGE**

**JUST ONE SUPER TECH MARK IV  
 — AGAINST —  
 ANY FIFTEEN RCA FACTORY ENGINEERS**

Who understands **RCA** TV sets better than the engineering team that designed them? The answer is no one. Who has the finest, most qualified engineering staff in the TV industry? We think **RCA** does. If we thought otherwise, we would have selected someone else to challenge!

Yet the fact is, we are thoroughly convinced that just one "average" technician using a Super Tech computer can diagnose **nine** RCA color TV sets (CTC 85 thru CTC 118) down to circuit level, before any **fifteen** RCA factory design engineers can do likewise to just **three**.

**SUPER TECH WILL GIVE THE RCA ENGINEERS  
 THREE TO ONE ODDS  
 AND STILL WIN**

We're willing to start out with twelve **RCA** color sets. Let **RCA** "install" two major flyback, start up, shut down related problems of any type in each, so as to make each set as difficult to diagnose as possible, without mis-wiring the set. Let **Diehl Engineering** do likewise, so that each set will now have **four** major problems.

By drawing straws, **Diehl Engineering** will "select" nine sets and, **RCA** will inherit the other three to diagnose.

All four problems in a given set must be **accurately** diagnosed before the next set can be looked at. All sets may be "modified" to employ a "bolted in" horiz output transistor prior to the contest, which will be held at **Diehl's** facilities in Amarillo, Texas. **RCA** may use **any amount** of "other" test equipment that is presently available to any independent TV shop. **Diehl Engineering** agrees to use nothing more than a Mark IV Super Tech, an / HV probe and an **RCA** senior volt ohmist (what else)!

**If we fail to accurately diagnose all NINE of our sets  
 before RCA can diagnose their THREE  
 We will hand the RCA team \$10,000 in cash.**

Diehl Engineering reserves the right to publicize the results.

With **Super Tech**, all we have to do is remove the horiz output transistor, plug in Super Tech's interface plug, make one ground connection then, push four buttons. Within sixty seconds (per set), including hook up time, we will accurately diagnose all four problems down to circuit level. Sixty seconds x nine sets = nine minutes! Lord only knows what fifteen **RCA** engineers can do!

**Shouldn't you be using a Super Tech Computer?  
 At only \$995<sup>00</sup> can you afford NOT to be using one!**

(Also notice our ad on service literature. See our ad on page 75.)

**Nothing Can Compete With A Super Tech  
 No Matter How Good It Is - - - No Matter Who Is Using It!**

Visa, Master Charge and C.O.D. orders welcome.

Phone (806) 359-1824 or (806) 359-0329

**DIEHL ENGINEERING • 6004 Estacado Lane • Amarillo, TX 79109**

CIRCLE 282 ON FREE INFORMATION CARD

# HOBBY CORNER



EARL "DOC" SAVAGE, K4SDS,  
HOBBY EDITOR

## Generating 60-Hz clock pulses

WHEN YOU'RE VERY YOUNG, YOU FORGET things simply because there's so much to learn. Later, your memory fails because there are so many things to do. And still later, you forget because there are too many things to remember! I probably fit into all three categories, but I get by, with a little help!

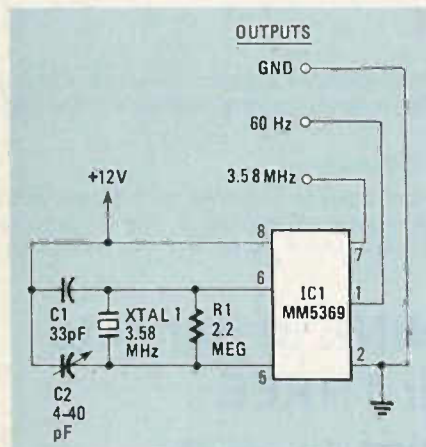

FIG. 1

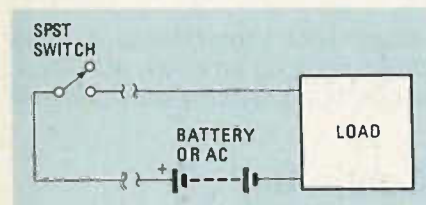

FIG. 2

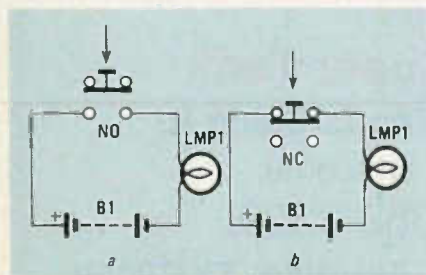

FIG. 3

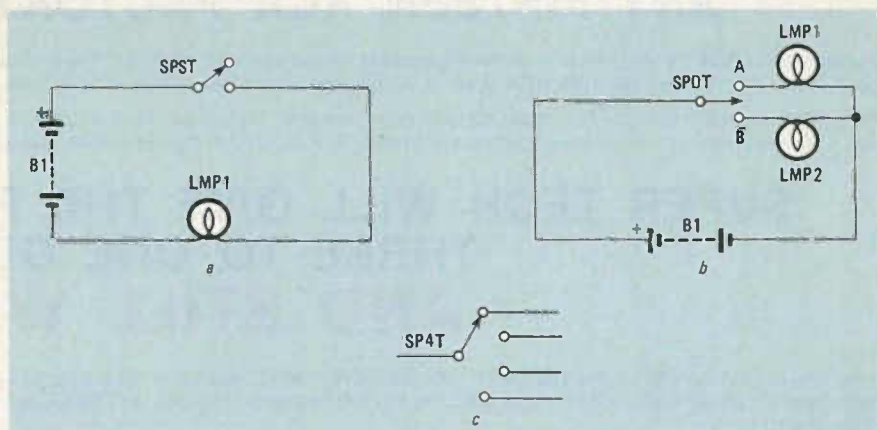

FIG. 4

Dan Sutch (FL) sent me a gentle reminder that I'd promised to pass along a circuit that generates a 60-Hz signal for use in battery-operated clocks. So here it is—a little late, perhaps, but still useful.

The circuit shown in Fig. 1 is commonly used to provide a 60-Hz clock pulse for timing purposes. Its clean and stable squarewave output is often used in battery-operated clocks like those found in automobiles. And although a 12-volt supply is shown, the circuit can operate from supplies of 6 to 15 volts.

The values of the capacitors and resistor can be varied over a reasonable range. The 5369 CMOS oscillator/divider and the colorburst crystal are the type commonly used in television sets. Both parts are inexpensive and readily available. The placement of the parts and wiring method is up to you.

Note that in addition to the 60-Hz output, there is another output of 3.58 MHz. You may find that useful as a marker signal on ham

and other shortwave bands. For example, it can be a big help in locating the bulletin and code practice transmissions of W1AW (at 3.58, 7.08, and 14.07 MHz).

Now back to our clock. Let's say that you have an AC-powered clock—the type that gets its timing from the AC line—and you want to install a backup battery supply in the clock (as discussed in the March, 1985 issue). Although the backup supply can provide the voltage to power the clock, it can't supply the 60-Hz signal needed to maintain proper timing.

By using the circuit in Fig. 1 in conjunction with the backup supply, your clock will be able to keep the correct time even when the AC power fails. That's all there is to it, Dan; Good luck and thanks for reminding me.

### Control circuits

Many have asked questions about control circuits of one kind or another that can be used to operate a variety of devices without having to walk over to them and

give them a push, pull, or kick! Since all of the inquiries have a common thread—the desire to remotely control some device—it appears that a roundup of control circuits is in order. So, during the coming months, we'll set aside some space in "Hobby Corner" to explore a variety of control circuits.

We'll start with the basics, to make sure that we're all together. Later, we'll get into more complex circuits that are easy to build, and yet have a variety of uses. You are invited during this time to send in any control circuits that you've developed or have used, so that can be shared with others.

Well, let's get the basics out of the way, so we can move on to better things. The simplest control circuit (see Fig. 2) is a simple switch connected by wire to the device to be controlled. Of course, the most important part is the switch, which can be one of several types: momentary or latching, rotary, push-button, or toggle.

A momentary switch is one that remains open or closed only as long as it's held down—release it and it "springs" back to its original position. Fig. 3-a shows a normally open (NO) momentary switch and Fig. 3-b shows a normally closed (NC) type.

When the switch in Fig. 3-a is pressed in the direction of the arrow, it completes the circuit, supplying power to the device to which it is connected. The switch in Fig. 3-b works the opposite way. Either switch remains in the position to which it is set only as long as it is held in that position; release it and it reverts to its original position.

Most switches "latch" (stay) in the position into which they are placed (a wall switch, for example). Figure 4 shows several versions of the latching switch. Figure 4-a represents a single-pole, single-throw (SPST) switch. It can control only one leg (positive or negative) of a single circuit.

Figure 4-b shows a single-pole, double-throw (SPDT) switch, which can be used to turn on LMP1 or LMP2 depending on which way the switch is flipped. A single-pole, 4-throw (SP4T) switch is

shown in Fig. 4-c. However, switches with up to 12 contacts (SP12T) are not uncommon. That type can be used to turn on several different devices one at a time.

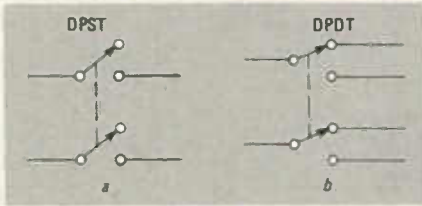

FIG. 5

Of course, a switch can have more than one pole. Double-pole switches, like those in Fig. 5, are like having two single-pole switches tied together and operated with one handle or button.

Figure 5-a represents a DPST switch. The dashed line indicates that the two parts operate together. Such switches can be used to either control both the positive and ground input to the device or two separate devices simultaneously. In Fig. 5-b, a double-pole double-throw switch is shown.

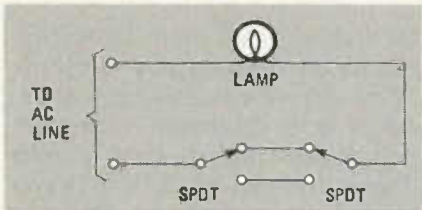

FIG. 6

Incidentally, you may have wondered how two switches are wired so that each has complete control over a single light. The answer is to use two SPDT switches connected as shown in Fig. 6. You should be aware, however, that electricians don't call them SPDT switches, they call them "three way" switches. (So, if you need a replacement for that type, you know what to ask for!)

Next time, we'll look at other components (relays, transistors, and SCR's) that are used as switches. And we'll eventually replace the connecting wires with such things as sound, light, radio waves (RF), and magnetism. And we'll also get into some practical applications that you can use.

So stick around for the fun. And don't forget to send in your favorite control circuits. R-E

## New from B&K-PRECISION

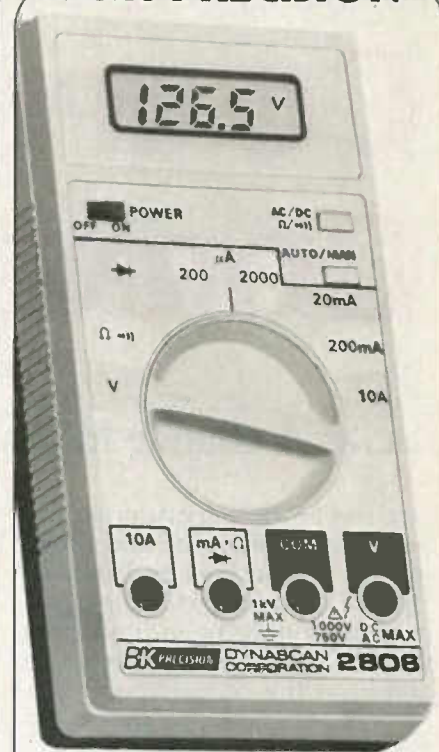

## Auto/manual ranging DMMs from \$75

### Model 2806

- Autoranging on volts and ohms
- Manual ranging on amps
- 0.7% DC accuracy
- 500 hour battery life
- Continuity test beeper
- Diode check
- Transient and overload protected
- High energy fuse

### Model 2807 \$115

Manual or autoranging on volts and ohms with 0.5% DC accuracy.

### Model 2816 \$150

Same features as 2807 with 0.25% DC accuracy.

For more information contact your B&K-PRECISION distributor or write for specifications.

**BK PRECISION**  
**DYNASCAN CORPORATION**

6460 West Cortland Street  
Chicago, Illinois 60635 • 312/889-9087  
International Sales: 6460 W. Cortland St., Chicago, IL 60635  
Canadian Sales: Atlas Electronics, Ontario  
South and Central American Sales:  
Empire Exporters, Plainville, NY 11803

# COMPUTER CORNER



LOU FRENZEL  
CONTRIBUTING EDITOR

## MSX: A chance for Japanese computers?

EVER SINCE THE PERSONAL-COMPUTER business began in the mid 1970's, market researchers and consultants, the press, and the industry in general have been predicting that the Japanese would come in and blow the competition away. After all, the Japanese are leaders in the consumer-electronics field, and home computers clearly fall into that category.

No one disputes Japanese dominance in such areas as TV's, VCR's, stereos, and the like. They are strong technically and certainly have the capabilities to produce high-quality, low-cost home computers. So, why haven't they?

Actually, they have! Over a dozen Japanese manufacturers make a variety of outstanding computer products, but most of them are sold in Japan. (Personal computers are just as much the rage in Japan as they are in United States.) In fact, the Japanese computer market is comparable in size to the American market—and that's enormous!

With their semiconductor capability, low-cost labor, and high productivity, the Japanese could easily build a computer that would be a tough competitor to American built machines. Yet, to date, they have sold few computers, business or otherwise, in the United States. According to the statistics, Japanese computers represent only about 2% of the total U.S. market. But why aren't the Japanese doing what everyone expects them to?

### A look at the problem

The difficulty lies not so much in



FIG. 1

technology and manufacturing, but in distribution and software. Although new technological developments do affect the computer business, they do so to a lesser degree than do marketing power (distribution) and the available software.

The computer market has reached a point where it takes tremendous amounts of money to promote and sell personal computers, and to gain visibility amongst the clutter in today's marketplace. Therefore, the companies with largest advertising budgets and the best retail distribution system win hands down.

Take, for instance, the success that IBM has with its personal computers, like the *PC* and *XT*. While they are excellent machines, they are not what you'd call exciting or leading-edge; nevertheless, IBM sells many of them. The reason they sell so many of their machines is because of their superior marketing, and distribution capabilities—not to mention their excellent reputation and image. Few competitors, including the Japanese, can match that.

The other major area where the

Japanese are having difficulty is in software. They have been ineffective in that area, and the language barrier is certainly a problem. As a result, the Japanese have relied heavily on American software efforts in modifying existing programs to make them compatible (where possible) with Japanese-made machines. While using existing software seems to be a reasonable strategy, it has not worked well for them.

Personal computers generally do not sell well unless there's a significant amount of software available to support them. On the other hand, few software writers are willing to create programs for machines with a questionable sales volume.

### Possible solutions

Although the Japanese are having their problems, you can expect to them continue to explore new ways to become more visible in the U.S. market—and that's no easy job. Fortunately (for them), they don't give up easily.

There are many different operating systems, etc. used in American-made computers, and each is different in some way. The problem here has been which machine to emulate, and what software should it use?

A standard would greatly simplify the things and permit many Japanese companies to build computers that would give American manufacturers a run for their money. Such a standard—at least for the low-end, home-computer market—has been proposed by

*continued on page 90*

# ATTENTION TV TECHNICIANS

Diehl Engineering, the same people who conceived, designed and now manufacture **Super Tech** diagnostic computers for analyzing start up, shut down, flyback and flyback related circuits, now has something else that will make your job faster, easier and much more profitable.

## A NEW PUBLICATION

You might say that our monthly **Technician / Shopowner** newsletter is an all out training program for those who are already working in the TV service industry, as well as for those who soon plan to be doing so.

Each month we take at least one concept, circuit or function and totally dissect it. We then explain every conceivable aspect in plain and simple English. When we are finished, you not only understand the operation, you also understand how the operation, "inter-reacts" with all of the other circuits that it is related to.

Once every aspect of operation has been explained, we show you how to break the subject down into sections. Then, show you how to troubleshoot each section on an individual basis.

Because of the manner in which our publication is written, the subject knowledge that is gained in each monthly issue is so broad, that it "spills over" into your every day troubleshooting routine.

Our **Technician/Shop owner** monthly newsletter is 100% devoted to the TV technician. It contains nothing but pertinent information on TV repair. We do not sell advertising space. Those who subscribe, do so because of its technical content, which we pledge to be far superior to anything else that you can obtain.

Each monthly issue (manual) contains up to 68 pages filled with schematics, diagrams and illustrations that relate to the very circuits that you are seeing today. We do not teach this year's chassis, we realize that you are seeing sets that are five, ten or even fifteen years old.

Our newsletter is not a collection of part numbers that cause specific problems in specific chassis when they fail. Instead, we explain what each individual component in a given circuit does, what purpose it serves, and what effect it will have if and when it fails.

Our subscribers can look at any resistor, any capacitor, any diode, any transformer, etc., in any circuit, and know exactly what purpose it serves. They will know what turns the circuit on, what turns it off, why and when such action occurs, and what happens if a specific action does not occur.

Our subscribers will no longer have to be content to know that R421 causes a particular chassis to shut down if it becomes open, they will know **why** it does.

Our subscribers will no longer run around in circles hoping to stumble over a "bad" component, they will know **exactly** what they are looking for, and --- how to find it!

When it comes to troubleshooting color TV sets, we have introduced more, innovative techniques than any other firm in the world (including manufacturers).

### In case that amuses you, consider this:

Everyone else in the industry is telling you to probe here and there in this chassis, there and somewhere else in another chassis, in hopes of isolating the actual circuit that has failed. Conventionally, one specific technique that works for one chassis may do nothing but smoke components in the next.

Yet, while others have been teaching "conventional" techniques (usually a different one for each chassis), we at **Diehl Engineering**



designed a computer that will isolate the defective stage in any hi-voltage circuit that employs a horiz output transistor (including Sony). With our **Super Tech** computer, you push the same four buttons no matter which set you are working on. Any brand, any age any chassis, Super Tech will give you an **accurate** answer. (see our ad on pg. 71)

We are not implying that those who teach "conventional" techniques are technically incompetent. Far from it, some of them are brilliant! We simply have a new and much easier way of looking at things. Ours is easier to understand and far more versatile. Because of the manner in which we present it, the retention level is also higher (according to those who are now using our literature).

Any staff that can design a computer that can analyze **any** hi-voltage circuit (except for those which use a trace and retrace SCR i.e. RCA CTC 40-81) must surely have a thorough knowledge of **all** circuits. Soon we will release similar computers for vertical and audio circuits, another for tuner, IF, AGC, video, blanking, ABL, Chroma, matrix and CRT, and still another for troubleshooting VCR!

The point is, we at **Diehl engineering** understand circuitry. We also know how to **explain** circuitry in such a way that it is easily understood.

Each month's issue is printed in the form of a manual. Each manual is pre-drilled so that it can be filed in a 3 ring binder for instant reference (the 3 ring binder is not provided).

**The First Issue** covers resistors, capacitors, diodes, inductors, transistors, IC chips and time constant circuitry. It explains how each component works, why it works, why it fails, and how each component relates to the overall circuit, all in plain and simple, down to earth, everyday English, without the use of mathematical formulas. After reading this issue, you can look at any component in any circuit and **truly** understand **what** it does, **why** it does it and what will happen if it doesn't do it; right down to each individual resistor, capacitor, and diode.

**The Second Issue** covers SCR driven hi-voltage circuits such as those used in RCA CTC 40-81, Philco, Coronado, Bradford, etc. After reading this issue, this circuit will become no more complex than simple amplifier. Over 30 illustrated schematics are used to teach this circuit in absolute detail. Such things as HV regulator functions, shut down features, etc. are thoroughly explained.

**The Third Issue** covers RCA LV regulator circuits (CTC 85 and up). It explains how each individual component operates, what it does, when it does it and, how to effectively troubleshoot the overall circuit.

Our no paid advertising policy makes our newsletter a little more expensive, but it also gives us "cover to cover" space for nothing but pertinent technical information on TV service. At \$9.95 per issue, a twelve month subscription costs only \$119.40. Very economical, considering that its technical content is equal to a "full blown" study course on TV repair. If you wish, you may try the first three issues for only \$21.00 (just seven dollars per issue, a savings of \$8.85 off the regular price).

For immediate service on C.O.D., Visa, or Master Charge orders:

**Phone (806) 359-1824 or (806) 359-0329.**

**If you are looking for help . . . we have it!**  
Diehl Engineering, 6004 Estacado Lane, Amarillo, Texas 79109.

**CIRCLE 281 ON FREE INFORMATION CARD**

# RAG

## ELECTRONICS, INC.

New and Used Electronic Test Equipment  
Sales • Service • Rental • Leasing

### ☰ Polaroid DS-34

Now you can get an instant picture in black & white or color from any oscilloscope screen. Includes CRT hood.  
\*Large hoods also available to fit computer terminals and CAD/CAM screens.

**\$369.00**



### LEADER Instruments Corporation

#### Audio Sine/Square Wave Generator

- Distortion from <0.03%
- 10 Hz to 1 MHz

**\$259.00**



LAG-120B

### BK PRECISION

#### FUNCTION GENERATOR

**\$189.00**



#### MODEL 3010

- Sine, square and triangle output
- Variable and fixed TTL outputs
- 0.1 Hz to 1 MHz in six ranges
- Typical distortion under 0.5% from 1 Hz to 100 KHz
- Variable DC offset
- VCO input for sweep tests

## POWER SUPPLIES

### GLOBAL SPECIALTIES TRIPLE OUTPUT POWER SUPPLY



#### MODEL 1301

**\$198.00**

- Fully regulated triple output
- Fixed 5VDC, 1A
- V1 + 5 VDC to 18 VDC .5A
- V2 - 5 VDC to 18 VDC .5A
- Fully automatic current limiting

### BK PRECISION

#### TRIPLE OUTPUT POWER SUPPLY



#### MODEL 1650

**\$319.00**

- Functions as three separate supplies
- Exclusive tracking circuit
- Fixed output 5 VDC, 5A
- Two 0 to 25 VDC outputs at 0.5A
- Fully automatic, current-limited overload protection
- + and - terminals of each output are fully isolated, in all modes
- All three outputs may be connected in series or parallel for higher voltage or current

### ELECTRO INDUSTRIES, INC. Precision Test Instruments



#### DC POWER SUPPLY

**\$125.00**

MODEL 3002A/0-30 VDC/0-2A

### VIZ

#### MULTI-FUNCTION COUNTER



#### MODEL W0-755

**\$259.00**

- 5 Hz to 125 MHz
- 8 Digit LED Display
- Period Measurement 5 Hz to 2 MHz
- Totalizes to 99,999,999 Plus Overflow
- Frequency Ratio Mode
- Time Interval Mode
- Switchable Attenuator & Low Pass Filter

### STACO ENERGY PRODUCTS CO.

#### VARIABLE TRANSFORMER

**\$145.00**



MODEL 3PN1010V

RAG CARRIES THE COMPLETE STACO VARIABLE TRANSFORMER LINE  
CALL US WITH YOUR REQUIREMENTS.

## PROBE MASTER Oscilloscope Probes

MODEL	ATTENUATION	BAND WIDTH (MHZ)	PRICE
2904	10X	100	\$35.00
2901	10X/1X	100/5	\$39.00
2205	10X	250	\$59.00
2960	10X	60	\$30.00

### DIGITAL CAPACITANCE METER

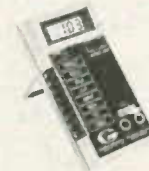

- Battery operated
- 3 1/2 digit LCD display
- Range 1 PF to 2,000 UF
- 0.2% basic accuracy

GLOBAL  
MODEL 3000  
**\$139.00**

CALL US TOLL FREE

**1-800-732-3457**

IN CALIFORNIA TOLL FREE

**1-800-272-4225**

- Master Charge
- VISA ■ COD
- Money Order
- Check



ADD FOR SHIPPING AND INSURANCE

\$0 to \$250.00	\$4.50
\$251.00 to \$600.00	\$6.50
\$501.00 to \$750.00	\$8.50
\$751.00 to \$1000.00	\$12.50
over \$1000.00	\$15.00

COD's extra (required 25% deposit)

RAG ELECTRONICS, INC. / 21418 Parthenia Street / Canoga Park, CA 91304 / 1-818-998-6500



# SCOPE SPECTACULAR



## PORTABLE OSCILLOSCOPES



Model V-212 shown



Model V-1050F shown

**MODEL V-212** **\$461.00**  
DC to 20 MHz, 1 mV/div, Dual Trace  
Features 6" Rectangular CRT  
Full 2 year parts and labor warranty (w/two X10 probes).

**MODEL V-222** **\$536.00**  
DC to 20 MHz, 1 mV/div, Dual Trace, D.C. offset for DMM Output, Vertical Mode Trigger  
6" CRT (w/two X1/X10 probes).

**MODEL V-422** **\$694.00**  
DC to 40 MHz,  
other features same as V-222 (w/two X1/X10 probes)

**MODEL V-1050F** **\$1276.00**  
DC to 100 MHz, .5 mV/div, Quad Trace, Delayed Sweep, Full T.V. Triggering, alternate time base (w/two X10 probes)

**MODEL V-650** **\$956.00**  
DC to 60 MHz, 1 mV/div, tripple trace, delayed sweep, Full T.V. Triggering, variable trigger hold-off (w/two X10 probes)



## PORTABLE OSCILLOSCOPES

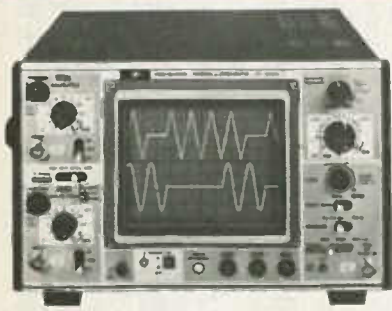

**MODEL SS-5702** **\$535.00**  
DC - 20MHz, 5 mV/div  
Dual trace  
6 inch rectangular internal graticule CRT.  
Includes 2 each X1/X10 probes and full factory warranty; 2 years on parts, labor and CRT.



**MODEL SS-5705** **\$899.00**  
DC to 40MHz  
Vertical and horizontal deflection accurate within  $\pm 2\%$ . CRT acceleration voltage 12KV. 3 channels, 6 traces. High precision calibrator ( $\pm 1\%$ ). Fastest sweep rate: 10 ns.  

- High sensitivity 1 mv/div
- CH1 signal output
- Beam finder
- Delayed sweep
- Alternate time base
- 2 ea. X1/X10 Probes

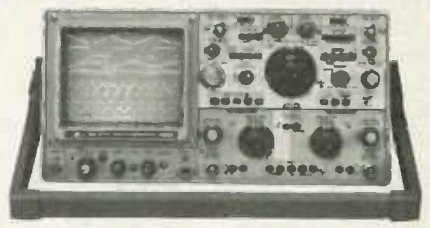

**MODEL 5711** **\$1695.00**  
DC to 100MHz (typically over 120 MHz), 5 mV/div, True 4 channel input, eight trace, Delayed sweep, alternate time base, CRT acceleration voltage 20 KV, (w/saddle bag, front cover, 2 ea. X10 probes).

**MODEL 57110** **\$2495.00**  
(5711 with counter and DMM).

CIRCLE 253 ON FREE INFORMATION CARD

# COMMUNICATIONS CORNER



HERB FRIEDMAN,  
COMMUNICATIONS EDITOR

## Computer security

SECURITY HAS ALWAYS BEEN A PROBLEM in communications. That's because if security measures are so elaborate that no unauthorized persons can breach them, they become so difficult and time consuming to use that it's not worth the effort. In fact, except for official "top secret" information, communications security has meant the minimum amount of special hardware or encoding needed to make it difficult for someone to more or less stumble across valuable data.

For secure voice communications we generally use a speech scrambler that garbles the transmission. In operation and function, it's based on the same techniques used for SSB (single sideband) transmission. Hence, it is easily broken by anyone who really gives it a shot, unless the scrambling uses a locked *sliding carrier* oscillator—an expensive and complicated device.

International cable communications usually use low-level commercial code (the lowest form of communications security), whose five-character groups can often be deciphered as they're being read. That's just one notch above a *Space Cadet Interplanetary Decoder Ring* (five box tops and \$2).

Because computer-to-computer data exchange is rapidly replacing many of the voice, cable, and facsimile communications systems, the question of communications security takes on a whole new meaning: the old, simple systems are no longer adequate.

### Security devices

Formerly, communications se-



FIG. 1

curity protected primarily against the listener who just stumbled across the radio signal. Today, things are different. Security must protect against the person getting even with the local utility or bank, a politician, judge, etc. Almost weekly, we've been treated to amusing newspaper or magazine articles about teen-aged hackers breaking into a computer belonging to some organization.

Imagine, for a moment, someone familiar with the ins-and-outs of a computer whose life was made miserable by an unfair teacher; or someone who had to wait years for a tax refund because "the computer lost the records." Whether the grudge is legitimate or not, that person has the power to wreak havoc if he can break into the computer—electronically speaking.

Protecting against someone getting even is one thing that keeps communications specialists up at night, and it's spawning a whole new branch of technology called telecommunications security. Just about everything is being tried to make computers more secure: everything from software, to "Star Wars" hardware, to voodoo if necessary.

The problem with software is that it works within the computer,

either to keep the unauthorized user out or to limit access to specific programs. And the security programs that are available can be expensive. In fact, one outfit that specializes security software for banks charges an annual rental fee of \$100,000, plus extra for unusual upgrades.

One reason for the tremendous expense is that once someone has accessed a computer through the dial-up telephone system, it's extremely difficult to restrict that person to selected files and functions. The computer becomes one big cookie jar full of goodies. It takes plenty of sophisticated software to restrict the goodies to only those who should have them.

A different approach, particularly for users of personal computers, has been through a hardware interface located between the telephone modem and the computer. The objective of such devices is to keep the troublemaker out of the computer itself.

One device designed to handle that task is the *Gateway* from Adalogic (1522 Wistaria Lane, Los Altos, CA 94022). *Gateway*, shown in Fig. 1, protects against unauthorized access by requiring that a correct user name and password be entered; otherwise access is denied, the user disconnected from the modem, and the event is recorded.

At no time does the unit permit access to the computer itself, unless the correct identification is received. Up to 20 user names and passwords can be assigned, changed, or canceled either re-

motelly or locally, and as often as necessary. And if you suspect that someone has discovered a user-access code, it can be instantly changed by the operator.

Passwords are mathematically hashed and can be combined with minimum password length to insure almost unbreakable access codes. In addition, each individual user can change his or her own passwords for additional security. It would be almost impossible (nothing is absolutely impossible) for an unauthorized user to get past the *Gateway* system into the computer.

Another such interface is a combination modem and memory bank, called *Visionary 100* (VEI, 141 Parker Ave., San Francisco, CA 94118). In addition to many Telex and TWX functions (such as answer back), the *Visionary 100* includes 48K of RAM, an internal clock/calendar, and on-board software for sending and receiving.

The important feature of the *Visionary 100* is that it can do almost anything independent of the computer. For example, assume that your business associate wants to swap a program or data, or enter information into your computer via an unattended modem. The *Visionary 100* will turn on at the proper time and take the modem transmission into its own memory.

Later, you turn on your computer and transfer the data or program from the modem's memory to your computer. Or it might work the other way: You want to automatically transmit data at specific time but you don't want anyone on the receiving end to access your computer through the connection. No problem! You store the transmission in the unit's memory and turn off your computer. At the programmed time the *Visionary 100* performs the data transfer. Either way, your computer is off and cannot be accessed by unauthorized persons.

Typical of the latest communications devices, neither the *Visionary 100*, nor the *Gateway* are festooned with switches or any other types of controls. Virtually all those units' functions are under software control of the computer, which can't be accessed by unauthorized users.

R-E

## SUPER LONG PLAY TAPE RECORDERS

10 Hour Model — \$95.00\*  
14 Hour Model — \$159.00\*

Modified Panasonic Slimline. high quality. AC-DC Recorders provide 5 or 7 continuous hours of quality recording & playback on each side of cassette for a total of 10 or 14 hours depending on model. Built-in features include • Voice level control. • Digital counter. etc. TDK DC 180 Cassette Furnished.



### PHONE RECORDING ADAPTER

Records calls automatically. All Solid state connects to your telephone jack and tape recorder. Starts recording when phone is lifted. Stops when you hang up. \$24.50\*  
FCC APPROVED



### VOX VOICE ACTIVATED CONTROL SWITCH

Solid state. Self contained. Adjustable sensitivity. Voices or other sounds automatically activate and control recorder. Uses either recorder or remote mike. \$24.95\*  
Add for ship & hdg. Phone Adapter & Vox \$1.50 ea. Recorders \$4.00 ea. Cal. Res. add tax. Mail order. VISA/MC. COD's OK. Money Back Guarantee. Qty disc. avail. Dealer Inquiries invited. Free data.  
AMC SALES INC. Dept A 9335 Lubec St., Box 928. Downey, CA 90421 (213) 869-9519



CIRCLE 108 ON FREE INFORMATION CARD

## SATISFACTION GUARANTEED

ON



Since 1965

Call or Write Us for Your Crystals

All Quantities

General Communication Industry  
Marine VHF  
Scanners  
Amateur Band  
CB Standard  
CB Special  
Microprocessor

You'll Get  
**COST SAVINGS**  
**PROMPT SERVICE**  
**HIGH STABILITY**

**JAN CRYSTALS**  
P.O. Box 06017  
Fort Myers  
FL 33906-6017  
(813) 936-2397

JAN CRYSTALS

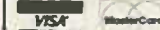

CIRCLE 104 ON FREE INFORMATION CARD

FREE

## McIntosh STEREO CATALOG and FM DIRECTORY

Get all the newest and latest information on the new McIntosh stereo equipment in the McIntosh catalog. In addition you will receive an FM station directory that covers all of North America.

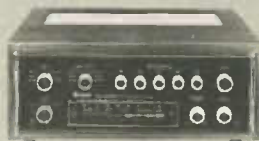
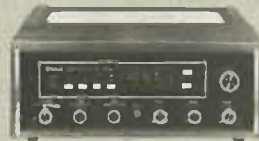
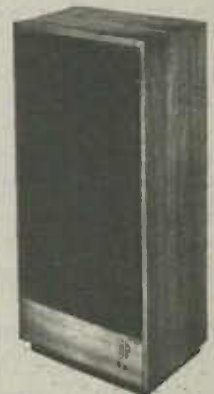

SEND TODAY!

McIntosh Laboratory Inc. RE  
East Side Station P.O. Box 96  
Binghamton, N.Y. 13904-0096

NAME \_\_\_\_\_

ADDRESS \_\_\_\_\_

CITY \_\_\_\_\_ STATE \_\_\_\_\_ ZIP \_\_\_\_\_

If you are in a hurry for your catalog please send the coupon to McIntosh. For non rush service send the Reader Service Card to the magazine.

CIRCLE 67 ON FREE INFORMATION CARD

JUNE 1985

79

# DESIGNER'S NOTEBOOK



ROBERT GROSSBLATT

## More on DC-motor speed controls

A HARD-AND-FAST RULE IN ELECTRONICS is there's always another way to do something, and no matter how slick the design, it can always be improved. So, when I get an idea for some circuit, I usually try out the basic principle on a breadboard using whatever components I happen to have lying around. Once I'm sure the basic idea is sound, the task of improving on the design begins. And it's at that point that I usually find myself ordering components.

A few months ago, in the November, 1984 installment of this column, I presented a little circuit that could be used to control the speed of a DC motor. Since then, I've received several inquiries about it. The questions asked mostly dealt with the my choice of components and a few details, which I guess weren't entirely clear in the article. Let me see if I can clear things up.

### Controlling DC motors

First of all, there was a typographical error in the schematic; the V+ pin for the 4049 was incorrectly shown as pin 16 instead of pin 1. The 4049 is unique in the CMOS world because it has almost become a standard for the power pin to be directly across the IC from pin 1. The only saving grace is that pin 16 isn't used by the 4049, so the worst thing that can happen if you didn't catch the error is that the circuit won't work. (Usually, an error like that one would make things go up in smoke!)

Some of you out there have been wondering if the 4049 can be replaced by something else. Well,

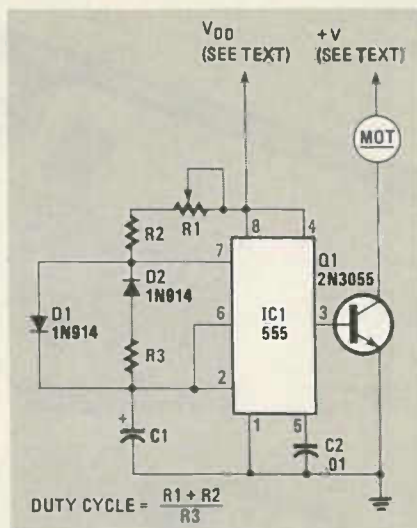

FIG. 1

if you find yourself asking that question, you should look at the article again because I don't think you have a clear idea of how it works. Any sort of oscillator can be used.

The important part is making sure that you can design some way to control the duty cycle of the output. As with so many other things, it's not the particular circuit that's important, it's the idea behind the circuit. In other words, if you can understand the theory behind the circuit, you can redesign it any way you want.

To give you an idea of what I mean, let's look at Fig. 1. There we see a motor-speed controller that uses the most common oscillator I can think of—a 555. The basic idea behind its operation is exactly the same as the circuit shown in the November column.

If it looks at all confusing, cross out the diodes and you'll be look-

ing at a simple 555 oscillator. The purpose of the diodes is to let us separate—and consequently control—the duration of the positive and negative halves of the output individually.

Although there are some minor practical differences between the operation of a plain 555 oscillator and the circuit shown in Fig. 1, you can use the standard design formulas to calculate the component values needed for your particular application. The frequency to aim for will depend on the motor you're trying to control. Generally speaking, the chunkier the motor, the lower the frequency you'll need. (Use that as a rule of thumb.)

There are some advantages to using the 555 instead of the 4049 used originally. The most evident is that the 555 can provide 200 milliamps of drive current. Most small motors will whirl away happily with a somewhat smaller amount of current. But, if you're operating a heavier motor, you'll need to use the transistor output stage shown in the figure. If you have any doubts, put the transistor in the circuit.

If you're trying to control a motor that takes two men to lift, you can use the control circuit, but the design of the output stage is a whole separate matter. You'll need much more than a simple one-transistor switch. When you work out the values you'll need, remember that the duty cycle is controlled by the formula:

$$\text{Duty cycle} = R1 + R2/R3.$$

Also, several other readers have asked about the relationship be-

tween  $V_{DD}$  on the IC and  $V+$  on the motor. Actually, they don't have any relationship. However, if the supply voltage for the motor falls within the allowable CMOS voltage range (3 to 15 volts), there's nothing stopping you from operating both the motor and the control circuit from the same supply.

The circumstances that first led to the development of the circuit that appeared in November involved a motor that ran on 48 volts...a bit outside the range of CMOS. In that case, I used a voltage divider to get the 12 volts needed to power the control circuit. But it would have worked just as well had I used a separate supply.

What you do is up to you. The motor-speed controller draws next to nothing in terms of power. However, if you do decide to supply  $V+$  and  $V_{DD}$  separately, then what you'll have to do is make sure that they share a common ground. CMOS is marvelously noise immune, so things like motor noise has no effect on the circuit.

If you look the circuit over carefully, you should be able to figure out a way to not only control the speed of the motor, but the direction of rotation as well. If you understand what the circuit's doing, you can easily get the additional control for free. As a final note on this subject, remember that the circuit will power only DC motors. Controlling the speed of AC motors is something else altogether and if there's enough interest we'll get into it in a future column. R-E

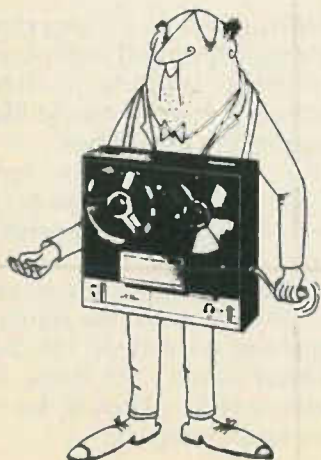

## SATELLITE TV

continued from page 14

antennas that begs for further dealer attention; you can see right through most of them. Antennas that blend with the surrounding area, especially from a distance, are an important tool in the battle to gain access to neighborhoods or communities where visual-pollution is a concern. (A dealer may find himself handling mesh antennas simply to satisfy the visual-pollution argument.)

Is there a "marriage" here?—a see-through mesh antenna that provides the TI rejection ability of the SSSA-7.8. Not yet, but several manufacturers are working on it! In the meantime, the march into the suburbs continues unabated. The "rural roots" of TVRO are being challenged daily by new technology in an attempt to mold TVRO into a suburban/urban service. It appears that 1985 will be to satellite TV what 1953 was to terrestrial TV! R-E

## TVRO INSTALLATION

continued from page 48

Fortunately, most of the people who make receivers also make or offer an LNB, LNC, or stand-alone downconverter to which the installer adds an LNA as part of a complete receiver package. So you are not likely to run into the option of selecting which amplifier will go with which receiver.

Some people—including many satellite-TV dealers—believe that you can trade off low noise temperatures for smaller dish size. For example, you may be told that you have the choice between an 8-foot dish with a 75-degree LNA or a 10-foot dish with a 100-degree LNA. They may even tell you that the performance will be the same with either choice.

That's simply not true. A lower noise LNA can help make up for the shortcomings of a smaller dish, but you can't entirely get back the gain lost by cutting back the dish's diameter two feet by using a better LNA. In other words, you can't recover a signal that you never had in the first place.

That's all we have room for this time. When we continue, we'll look at receiver IF bandwidth, the third factor that determines picture quality. We'll also look at a large sampling of some of the other things that you should think about *before* you buy that TVRO. R-E

# Be an FCC LICENSED ELECTRONIC TECHNICIAN!



No costly School. No commuting to class. The Original Home-Study course that prepares you for the FCC Radiotelephone license exam in your spare time! An FCC Government license is your "ticket" to thousands of exciting jobs in Communications, Radio & TV. Mobile two-way, Microwave, Computers, Radar, Aerospace and more. You don't need a college degree to qualify, but you do need an FCC License. No need to quit your job or go to school! You learn how to pass the FCC License exam at home at your own pace with this easy-to-understand, proven course. It's easy, fast and low cost! **GUARANTEED PASS**—You get your FCC License or money refunded. Write for free details. Soon you could be on your way to being one of the highest workers in the electronics field. Send for **FREE facts now. MAIL COUPON TODAY!**

## COMMAND PRODUCTIONS

FCC LICENSE TRAINING, Dept. 90  
P.O. Box 2223, San Francisco, CA 94126  
Rush **FREE** facts on how I can get my FCC License in spare time. No obligation. No salesman will call.

NAME \_\_\_\_\_  
ADDRESS \_\_\_\_\_  
CITY \_\_\_\_\_ STATE \_\_\_\_\_ ZIP \_\_\_\_\_

## ELECTRONIC COMPONENTS



### MANUFACTURERS OF QUALITY ELECTRONIC COMPONENTS

- BATTERY CLIPS & HOLDERS
- CABLE SETS • CONNECTORS • CAPACITORS
- DISPLAYS • LEDS • FUSES • JACKS & PLUGS
- KNOBS • LAMPS • POTENTIOMETERS
- RF COILS • RELAYS • RESISTORS
- SWITCHES • SEMICONDUCTORS • SPEAKERS
- TEST EQUIPMENT • TRANSFORMERS • TOOLS
- WIRE & CABLE

OVER 15,000 DIFFERENT ITEMS IN STOCK!

- Sales and Order Desk Open from 8:00a.m.(PST)
- Phone and Mail Orders Welcome
- TEBMS, C.O.D., Visa, MasterCard
- Catalogs Mailed Outside USA
- Send \$2.00 (Open Accounts Available)

### MOUSER ELECTRONICS

11433 WOODSIDE AVE SANTEE CA 92071  
PHONE (619) 449-2222 TWX 910 331-1175

CIRCLE 117 ON FREE INFORMATION CARD

# ANTIQUEN RADIOEN

Restoring antique radio cabinets



RICHARD D. FITCH



FIG. 1

LAST TIME, WE FOCUSED OUR ATTENTION on seeing whether our antique radio would play, or if it could at least be made to play. We looked at that first because if you can't restore the chassis, there would be little reason to bother refinishing the cabinet.

Cabinet restoration can be anything from cleaning and polishing to a complete stripping and refinishing. And there will be times when minor to major veneer repairs may be needed. However, we should emphasize that if the old finish can be saved, by all means save it! After all, we want an au-

thentic antique radio—that means inside *and* out.

## Cabinet restoration

Most old radio cabinets that you're likely to come across will have a veneer surface (a thin layer of fine wood glued on a cabinet of less-attractive wood). But some may be made of expensive solid wood or even metal. The important thing is to try to retain as much of the original design as possible.

Some of you may have found an old radio with a dull or faded finish. If so, the cabinet may need nothing more than some furniture polish to restore its original luster. Even if the cabinet has a few scratches, the polish will probably hide them as well. But if a few minor scars are still visible, you can always use a touch-up kit to conceal them.

Except for the small damage on the speaker grill, the finish of the unit shown in Fig. 1 was restored with polish alone. Most furniture polishes will clean as well as polish; but if the cabinet is really filthy, you may have to use a mild soap and warm water to clean it

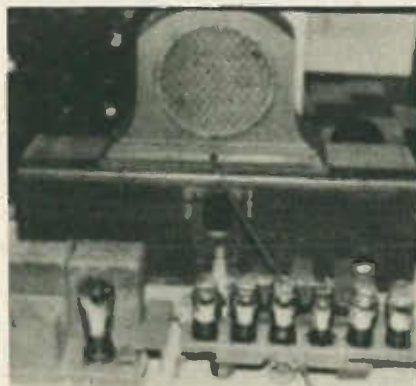

FIG. 2

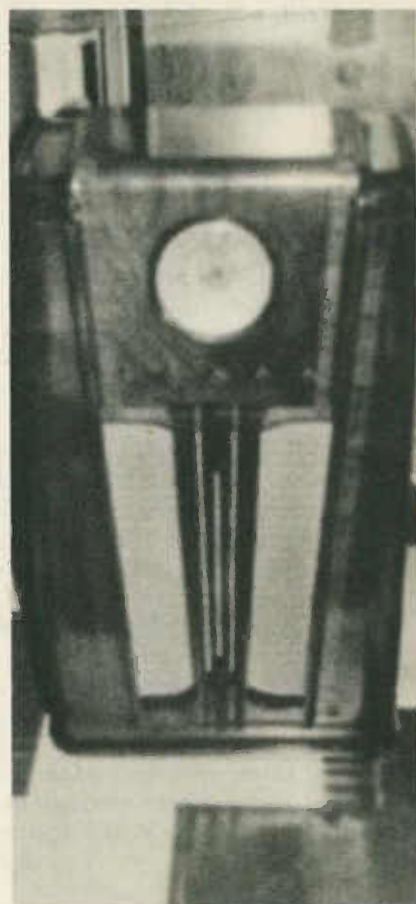

FIG. 3

up. All you need is a damp cloth. *Do not* use a hose and scrub-brush on the veneer. If you do, you'll end up with something that looks like a corrugated cardboard box.

If the finish cannot be saved with polish, it will have to be removed. Harsh paint removers, scrapers, burning, and sanding should be avoided whenever possible. They'll probably damage and discolor the veneer. The chassis, knobs, scroll, grill cloth, and any decorations should be removed before starting.

Hand stripping with steel wool and a solvent is one of the better ways to bare the cabinet. Solutions like Fornby and Minwax may be used to remove the old finish without damaging the veneer. When using such products, follow the package directions, wear protective gloves, and work in a well ventilated area.

Solid-wood cabinets, like that of the *Radiola 18* shown in Fig. 2, also respond well to the hand-strip method. Of course, any portion of the cabinet that is stripped and re-finished will be lighter than the remaining original finish, unless you use some type of stain to match the original.

In cases where the finish has been damaged severely or covered with several coats of paint, it will be necessary to completely strip the cabinet—a truly unpleasant job. Harsh solvents are not recommended. Use one of the many products made specifically for furniture stripping. For obvious reasons, burning the paint off is not recommended. Burning damages the thin veneer, and also leaves dark spots that even wood stain won't hide.

Scraping and sanding should be used *only* as a last resort. Assorted scrapers, knives, or even pieces of glass can be used (but wear heavy gloves in case the glass breaks). Also, if you scrap off the paint, it may be necessary to do a little sanding to smooth out the rough spots. If you go with sanding, use a fine grade of paper.

Once the stripping is completed, use a heavy hand-rub stain to cover up scratches and sanding marks. If the newly-stained cabinet appears darker than desired, light sanding will bring up the tone a bit. Once the stain is dry and you are satisfied with the tone, make sure that the surface of the unit is dust-free. Then use varnish to preserve the finish.

#### Veneer repair

Replacing a piece of veneer that has peeled from an intricate pattern can be a delicate operation. The old *Silvertone* unit shown in Fig. 3 had several small pieces of veneer missing, but the rest of the cabinet was passable. The damaged portions of the veneer



FIG. 4

were patched using veneer removed from the old Zenith shown in Fig. 4.

So much of the veneer was missing from that old set that taking off another piece didn't matter. After peeling off enough of the veneer, scissors were used to cut pieces to match the missing portions of the *Silvertone*.

Keep in mind that a local craft shop may have just what you need to replace a section of veneer.

Sometimes the veneer may be warped. By forcing some free-flowing white glue or wood glue between the veneer and the base wood, and clamping it down until it dries, you may be able to save the original finish. If wood blocks are used between the clamps, be sure not to glue the blocks to the cabinet. Once dry, any excess glue can be wiped off with a damp cloth.

#### Replacing cabinet accessories

After the cabinet has been made museum-ready, the accessories—grill cloth, fancy scroll work, knobs, etc.—will have to be restored to their original condition

**KeproClad**  
by Kepro Circuit Systems, Inc. ■

#### At Home Professional Quality Fine Line PCB's.

Introducing an easy, inexpensive, step by step method for the home production of professional quality printed circuit boards without a major equipment investment—KeproClad, by Kepro, makers of quality industrial equipment and supplies. KeproClad was designed for the home user who needs professional results with:

##### A Simple Circuit Board;

Use KeproClad unsensitized copper-clads. These boards come in 2 popular sizes with 1 sided foil, a marking pen, all for a suggested retail price as low as \$3.50.

##### A Fine Line Detailed Board;

Use KeproClad photosensitized copperclads. Available in 2 sizes with 1 or 2 sided foil. These copperclads use the latest technology of negative acting dry-film photoresist. This material is rugged, yet holds extremely fine detail. It comes with a premeasured amount of developer and sells for as little as \$3.90 (suggested retail).

Other KeproClad products such as a photo reversal kit for making negative film, etch, tin plating solution and photofood lamps are all available at your local distributor. (For the distributor nearest you, call or write:

**KEPRO CIRCUIT SYSTEMS, INC.**  
630 Axminister Drive., Fenton, MO 63026-2992  
In MO 314-343-1630 Toll Free 800-325-3878

CIRCLE 271 ON FREE INFORMATION CARD

## EARN BIG MONEY REPAIR GAMES & COMPUTERS

### COMMODORE™

EXCLUSIVE... Service Data. All popular parts. I.C.'s. Connecting Cables, etc. NOW AVAILABLE from EWC...

It's now easier than ever to get into the computer repair market with an inexpensive starter parts kit that includes the most popular 7-I.C.'s and servicing information for the Commodore-64 & Vic-20 units. Total cost of the chips is regularly \$95.90 and the technical information is \$39.90, but our combination package totals only \$125, a savings of \$10.00!

Don't forget, EWC is still the largest parts distributor of ATARI 2600/A, 400/800, 5200 and COLECOVISION, and INTELLIVISION parts and technical information.

Over 30 years of proven quality, affordable prices, fast service, and guaranteed satisfaction at EWC. YOUR one-stop parts supplier.

**COMPARE OUR LOW PRICES  
AND TRY US FOR YOUR  
EVERY-DAY REQUIREMENTS.**

**GENERAL  
ELECTRIC  
TUBES**  
10 piece minimum  
**75% OFF LIST**

**ZENITH  
9-92C  
MODULES**  
No exchange required  
**\$9.95 each**

Call toll-free on our 24 hour order hotline and ask for your copy of our new 104 page catalog.

**ELECTRONIC WAREHOUSE CORP.**  
1910 Coney Island Avenue  
Brooklyn, N.Y. 11230 • (718) 375-2700  
CALL TOLL FREE: (800) 221-0424

CIRCLE 266 ON FREE INFORMATION CARD

to complement your newly-finished cabinet. Grill cloths almost always have to be replaced.

Dirty, dry-rotted, or torn grill cloths can rarely be saved. Take the old grill cloth to a large craftshop and try to match it to a piece from their stock. (Don't expect the replacement to be an exact match; it may not even come close.) Install the grill cloth tightly and if there is a pattern, center it properly.

The fancy scroll work on some old radios may not be made of wood. The molded material may be brittle and hard to remove. Spray-painting the molding to match the cabinet seems to be the best solution. Old radios are often missing knobs. Many craft stores stock large selections of obsolete knobs. However, if the cabinet is decorated with unusual knobs, and you want to duplicate them, you'll have to make your own.

Wooden dowels of assorted diameters can be used to make most knobs. After cutting the dowel to the proper thickness, the knob can be further shaped in a drill press with a file. The home-made knobs should be force-fitted on a shaft. (Installing set-screws adds problems.) The home-made knob will cover up the shaft and it can also be stained to match the cabinet.

Brass accessories can be cleaned and coated with a clear lacquer to prevent tarnishing. For the best results, always follow the manufacturers instructions for the product that you use. Once the cabinet is done, it's time to install the chassis. Use a vacuum cleaner with attachments to clean the inside of the cabinet before replacing the chassis.

As a reminder, be sure to: Wear a dust-mask when sanding; wear protective gloves when using solvents, and work in a well-ventilated area. And be sure to follow manufacturers' instructions when using solvents.

For those who are unable to locate the appropriate veneer in their area, it may be purchased from: Craftwoods, 10921 York Rd., Cockeysville, MD 21030; their telephone number is (301) 667-9663. They will supply a mail-order price list on request.

R-E



**THE WIRELESS TELEPHONE TRANSMITTER** model WTT-20 is only the size of a dime, yet transmits both sides of a telephone conversation with crystal clarity. Completely automatic Uses power from the telephone line itself. Never needs a battery! Up to ¼ mile range. Use with any FM radio. Complete kit only \$29.95. Tax included.

FREE SHIPPING. DECO INDUSTRIES, Box 607, Bedford Hills, NY 10507. (914) 241-2827.

CIRCLE 261 ON FREE INFORMATION CARD



### NEW LOW-COST EPROM PROGRAMMER

Programs almost every MOS and CMOS EPROM and EEPROM on the market, from 16k to 256k for only \$1,450 (U.S. list price). Full-stroke keyboard • Large alpha display • Full editing • Intelligent algorithms • 32k x 8 RAM • RS 232C • Remote control. Call (800) 547-4000, Dept. 124\*\* DATA I/O, 10525 Willows Road N.E., P.O. Box 97046, Redmond, WA 98073-9746.

\*\*In Oregon 1-503-684-3000. Not upgradeable.



**ZENITH SSAVI DESCRAMBLERS** only \$169; GATED PULSE & SINEWAVE decoders \$199 each. Original equipment for UHF chs. 23,27,31,51,54,57,68, etc. Quantity discounts. Surplus Cable TV equipment: Jerrold SB-3, Oak N-12, Zenith Z-Tac, Hamlin 1400, etc. Complete **Satellite Systems** at \$845 and up; Installation and program guide, \$3. Dealers welcomed. Catalog \$1. Visa/MasterCard. Satisfaction guaranteed. AIS SATELLITE, P.O. Box 1226-E, Dublin, PA 18917. 1-800-643-2001 or 215-249-9411.

CIRCLE 265 ON FREE INFORMATION CARD

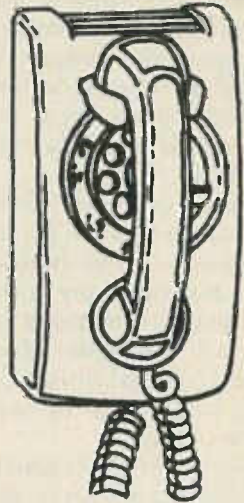

## CALL NOW AND RESERVE YOUR SPACE

- 6 x rate \$650 per each insertion.
- Reaches 225,016 readers.
- Fast reader service cycle.
- Short lead time for the placement of ads.
- We typeset and layout the ad at not additional charge.

Call 212-777-6400 to reserve space. Ask for Arline Fishman. Limited number of pages available. Mail materials to: mini-ADS, RADIO-ELECTRONICS, 200 Park Ave. South, New York, NY 10003.



### ELECTRO IMPORTING CO. CATALOG.

This reprint of the historic 176-page catalog No. 20 gives you an accurate look at the state of electronics in 1918. Contains everything from a Zinc Spark Gap to a 1000-Mile Receiving Outfit. You can get your own copy of this modern antique, profusely illustrated, for only \$4.95 plus \$1.00 P&H. Order yours from R-E BOOKSTORE, Radio-Electronics, 200 Park Avenue South, New York, NY 10003.



# Radio-Electronics mini-ADS

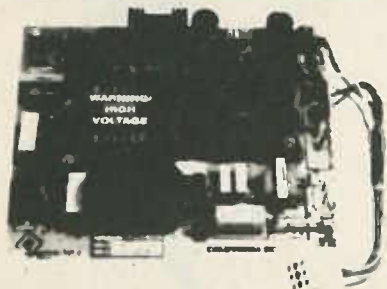

**CALIFORNIA-DC REGULATED SWITCHING POWER SUPPLY** +5v dc @ 5 amp + 12v dc @ 2.8 amp + 12v dc @ 2 amp - 12v dc @ .5 amp 115-230v ac input, fused. EMI filtered. Removable DC Power Harness and Schematics included. 7.4" x 6.2" x 1.7" ht. Visa/MC/M.O./check; when clears. **\$37.50 ea.** (Free shipping in U.S.) 1-800-327-7182/305-830-8886. **POWER PLUS**, 130 Baywood Ave., Longwood, FL 32750. (Call for quantity price).  
**CIRCLE 125 ON FREE INFORMATION CARD**

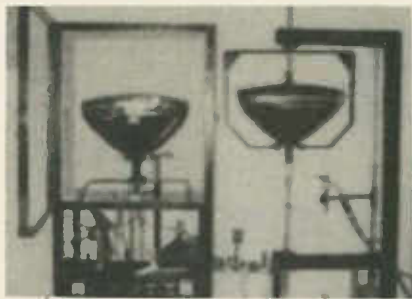

**ONE MAN CRT FACTORY**, easy operation. Rebuild CRT's for tv's, bus. machines, monitors, scopes, etc. Color, b&w, 20mm, foreign or domestic. 3x6 ft. space required. Profits??? Average CRT rebuilding costs—\$5. Sell for \$100 = \$95 profit; x 5 CRT's = \$475 daily; x 5 days = \$2375 weekly profit. Higher profits overseas. Investigate this opportunity today. We service the entire world. Contact: **CRT FACTORY**, 1909 Louise St., Crystal Lake, IL 60014, (815) 459-0666.

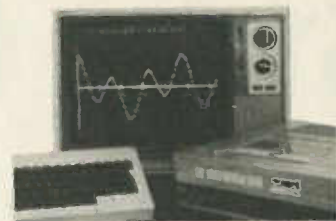

**CONVERT YOUR TV to a High Quality Monitor/Receiver...TRVM kit** Features: Dual Mode operation on transformer isolated B&W or Color Sets • High Resolution Direct Video • Up to 80 characters per line • Wide Bandwidth • Easy installation • Low cost...\$34.95...DVM-1 kit with Audio available for "Hot Chassis" sets...\$64.95. Kits usable with Computers, VCR's and Video Cameras. **VAMP INC.**, Box 411 Los Angeles, California 90028. (213) 466-5533  
**CIRCLE 257 ON FREE INFORMATION CARD**

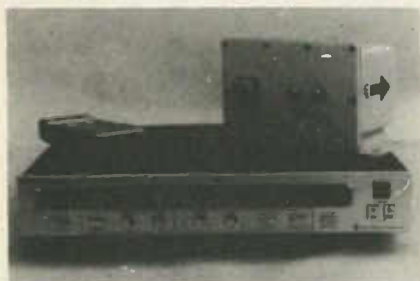

**SATELLITE TELEVISION RECEIVER SEMIKIT** with dual conversion downconverter. Features infrared remote control tuning, AFC, SAW filter, RF or video output, stereo output, Polarator controls, LED channel & tuning indicators. Install six factory assembled circuit boards to complete. **Semikit \$300.00**. Completed downconverter add \$100. Completed receiver and downconverter add \$150. **JAMES WALTER SATELLITE RECEIVER**, 2697 Nickel, San Pablo, CA 94806. Tel 415-724-0587.  
**CIRCLE 124 ON FREE INFORMATION CARD**



**IntelliBurner EPROM-EEPROM & MICRO-CONTROLLER programmer** \$299 Communicates through the serial port of any personal computer. Use your PC's modem software to read, verify, or program all popular EPROMs, EEPROMs and 87xx series micro controllers. Custom software included for IBM, CP/M or Radio Shack PCs. Other programmers from \$149. Bare PC boards with software from \$39. **ROSS CUSTOM ELECTRONICS**, 1307 Darlene Way #A12, Boulder City, NV 89005. 702-293-7426.  
**CIRCLE 254 ON FREE INFORMATION CARD**



**GALAXY ELECTRONICS, INC.** the leader in microwave announces the new dual-polarity, multi-channel, wide-band microwave TV tuner. Tunes entire 800 MHz from 1.9 to 2.7 GHz. Receive sports, education, religious, news, movie programming, & more is being added to this frequency spectrum almost on a daily basis in most major cities. Complete systems from \$69.95. **GALAXY ELECTRONICS, INC.**, 5644 North 53rd Avenue, Glendale, AZ 85301. 602-247-1151.  
**CIRCLE 252 ON FREE INFORMATION CARD**



**R & D SHEET METAL WORKER** new multi-purpose machine now with 6" male dies and removable female dies. A complete R&D in-house shop at 1/3rd the cost. Over (1500) worldwide industrial/government/educational. Call today—TELEX 4996168 POC NPT, **PACIFIC ONE CORP.**, STEK548513 Superior Ave., Newport Bch., CA 92663. (714) 645-5962.  
**CIRCLE 118 ON FREE INFORMATION CARD**

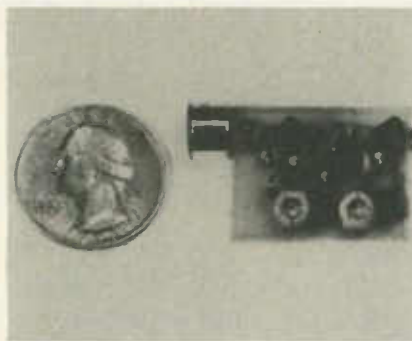

**THE MOST EXCITING KIT YOU WILL EVER BUILD** The model WAT-50 miniature FM transmitter uses a 4-stage circuit NOT to be confused with a simple wireless microphone. Up to 1 mile range. So sensitive, it will pick-up a whisper 50 feet away! Use with any FM radio. Complete kit only \$29.95 tax incl. **FREE SHIPPING**. **DECO INDUSTRIES**, Box 607, Bedford Hills, NY 10507. (914) 241-2827.  
**CIRCLE 266 ON FREE INFORMATION CARD**



**SUBSCRIPTION TV MANUAL.** This information packed book details the methods used by subscription TV companies to scramble and descramble video signals. Covers the Sinewave, Gated Pulse, SSAVI system, and the methods used by most cable companies. Includes circuit schematics, theory, and trouble shooting hints. Only \$12.95 plus \$2.00 first class P&H. **ELEPHANT ELECTRONICS INC.**, (formally Random Access) Box 41770-R, Phoenix, AZ 85080  
**CIRCLE 120 ON FREE INFORMATION CARD**

# STATE OF SOLID STATE



ROBERT F. SCOTT,  
SEMICONDUCTOR EDITOR

What's new in automotive electronics

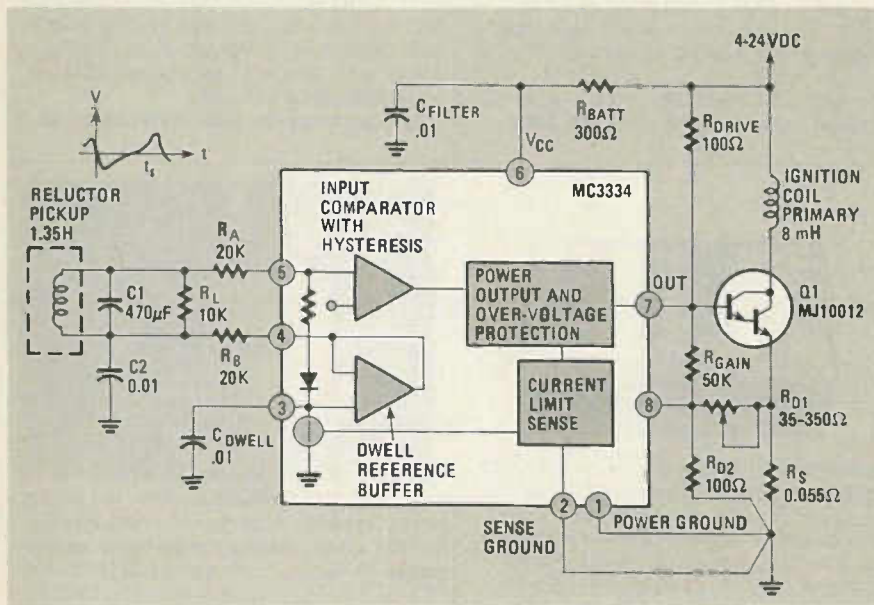

FIG. 1

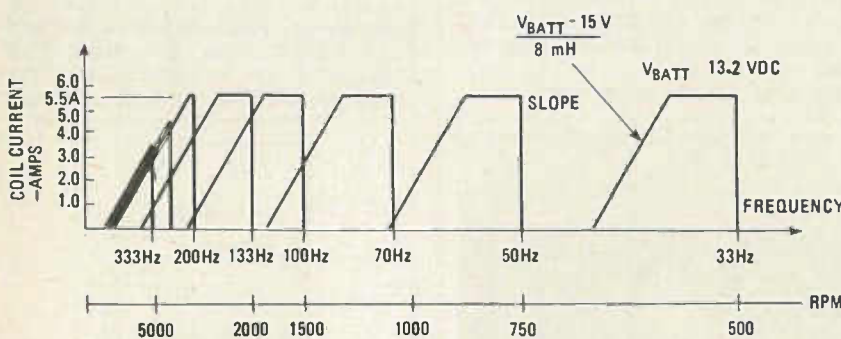

FIG. 2

ELECTRONIC IGNITIONS FOR AUTOMOBILES have been around for nearly twenty years and are now making their debut in small gasoline engines like those used in lawn mowers, garden tractors, snow blowers, and the like.

In the modern breakerless electronic ignition system, a voltage pulse is induced in a magnetic

pickup (retractor). That pulse is used to gate a power transistor or SCR and thus control current flow through the ignition coil.

Motorola's MC3334 monolithic high-energy ignition system is the latest addition to a line of IC's for automotive applications. It's intended for use in after-market 5-terminal ignition systems.

Figure 1 shows a typical application using the MC3334. That circuit takes the magnetic signal developed by the magnetic pickup and processes it to supply a precisely controlled drive to an external Darlington power transistor. When the transistor is turned on, it permits current to build up in the primary of the ignition coil.

Then, at the proper time, the transistor is turned off and current flow is interrupted. The collapse of the magnetic field surrounding the ignition-coil primary produces a flyback action that generates the high secondary voltage needed for the spark.

The MC3334 features an automatically adjusted dwell to produce energy at all engine speeds. It also features a wide supply-voltage operating range ( $V_{BATT} = 4.0$  to 24 volts), over-voltage shut-down at 30 volts (to prevent component damage by transients and excessive battery voltage due to load-dump) and low external component count with no critical resistors.

The MC3334 provides a variable DC reference voltage that is used to vary the dwell angle in response to variations in engine speed. (If the dwell angle is fixed, it produces a fixed duty cycle. That results in too little stored energy at high RPM's and wasted power at low engine speeds.) The variable reference voltage is developed and stored across capacitor  $C_{DWELL}$ . It's then buffered and fed to the bottom end of the retractor (pickup) coil.

At high RPM's, the MC3334 holds the output off for around 1

**TABLE 1  
COMPONENT VALUES**

PICKUP	—Series resistance = $800\Omega \pm 10\%$ @ $25^\circ\text{C}$ inductance = $1.35\text{H} @ 1.0\text{KHz} @ 15 V_{\text{rms}}$
IGNITION COIL	—Leakage $L = 0.6\text{ mH}$ . Primary $R = 0.43\Omega \pm 5\%$ @ $25^\circ\text{C}$ Primary $L = 7.5\text{ to } 8.5\text{ mH} @ 5.0\text{A}$
$R_L$	—Pick-up load resistor = $10\text{K} \pm 20\%$
$R_A, R_B$	—Input buffer resistors, provide additional transient protection to the already clamped inputs = $20\text{K} \pm 20\%$
$C1, C2$	—For reduction of high frequency noise and spark transients induced in pick-up and leads, optional and non-critical
$R_{\text{BATT}}$	—Provides load dump protection (but small enough to allow operation at $V_{\text{BATT}} = 4.0\text{ V}$ ) = $300\Omega \pm 20\%$
$C_{\text{FILTER}}$	—Transient filter on $V_{\text{CC}}$ non-critical
$C_{\text{DOWELL}}$	—Stores reference, circuit designed for $0.1\mu\text{F} \pm 20\%$
$R_{\text{GAIN}}$	— $R_{\text{GAIN}}/R_{\text{D1}}$ sets the DC gain of the current regulator = $5.0\text{K} \pm 20\%$
$R_{\text{D2}}$	— $R_{\text{D2}}/R_{\text{D1}}$ set up voltage feedback from $R_s$
$R_s$	—Sense resistor (PdAg in thick film techniques) = $0.055\Omega \pm 50\%$
$R_{\text{DRIVE}}$	—Low enough to supply drive to the output Darlington, high enough to keep $V_{\text{CE(alt)}}$ of the IC below Darlington turn-on during load dump = $100\Omega \pm 20\%$ , $5.0\text{ W}$
$R_{\text{D1}}$	—Starting with $35\Omega$ assures less than $5.5\text{ A}$ , increasing as required to set $5.5\text{ A}$
	$R_{\text{D1}} = \frac{I_{\text{O(pk)}} R_s - V_{\text{ret}}}{\frac{V_{\text{ret}}}{R_{\text{D2}}} - \frac{1.4}{R_{\text{GAIN}}}} - 100\Omega (\text{nom})$

millisecond to permit the energy stored in the spark coil to fully discharge across the spark plug before it turns on the transistor. At that point, ignition coil current begins to increase linearly at a rate determined by the combination of  $V_{\text{BATT}}$  and the ignition coil's resistance.

As the engine slows, ignition coil-current increases and is limited only by the coil resistance. When the MC3334 is used, peak coil current can be set by an external adjustment, potentiometer

$R_{\text{D1}}$ . Resistor  $R_s$  senses the coil current.

Figure 2 shows that when the coil primary resistance is  $0.42\text{ ohm}$ ,  $R_{\text{D1}}$  is adjusted to limit coil current to about  $5.5$  amperes when engine speed drops below about  $4000\text{ RPM}$ . For instance, a frequency of  $333\text{ Hz}$  corresponds to  $5000\text{ RPM}$  for an 8-cylinder, 4-cycle engine.

As engine speed continues to drop, the coil current is held at  $5.5$  amperes for a short period to ensure that there is enough electromagnetic energy in reserve for sudden acceleration.

When battery voltage is low and the engine turns over slowly—during cold weather, for example—the transistor switches on for longer periods to compensate for the slower current build-up. Under those conditions, the ON period may be stretched for nearly a full cycle. Table 1 describes the functions of the external components and gives some typical values.—**Motorola Semiconductor Products**, PO Box 20912, Phoenix, AZ 85036.

#### Data and application guide

The *MOSPPOWER Applications Handbook* is 512-pages, dedicated solely to power MOSFET's and their applications. The handbook covers a broad range of subjects, including topics such as design data on power supplies, converters, motor controls, and state-of-the-art MOSFET power circuits.

In all, there are more than  $70$  articles and application notes. Price per copy is  $\$20.00$ —**Siliconix Inc.**, MS-05, 2201 Laurelwood Road, Santa Clara, CA 95054.

#### RMS to DC conversion guide

The *RMS to DC Conversion Application Guide* is a 56-page soft-cover booklet that covers RMS-to-DC conversion theory, RMS design considerations, and applications circuits for Analog Devices' AD536, AD636, and AD737 converters. The booklet also covers conversion methods like absolute deviation, and explicit and implicit computation. Also included are discussions on audio processing, modem line monitors, and RMS panel meters.—**Analog Devices, Inc.**, 2 Technology Way, Norwood, MA 02062.

## Radio-Electronics

is happy to announce a new column to serve our readers. If you have a question regarding any area of electronics, ask us! We'll do our best to find an answer to your question or, at least, suggest where you might find one. Send your questions to:

**Ask Radio-Electronics  
200 Park Avenue South  
New York, NY 10003**

## IF YOU OWN A CABLE TV DESCRAMBLER

THE NEW FEDERAL LAW  
EFFECTIVE DEC 29, 1984  
APPLIES TO YOU.  
BEFORE YOU FALL FOR  
"MISLEADING" ADVERTISING  
GET THE FACTS!!!

SEND  $\$9.95$  IN CHECK OR  
MONEY ORDER TO:

CONSUMER CABLE PRODUCTS  
794 FRANKLIN AVE.  
FRANKLIN LAKES, NJ 07417

### PROTECT YOURSELF

THIS IS INFORMATION  
YOU CANNOT AFFORD  
TO BE WITHOUT.

mail service only

# SERVICE CLINIC



JACK DARR

## Stereo sound for television

UNTIL RECENTLY, TV AUDIO HAD ALWAYS been monaural. But the FCC's approval of a system for transmitting stereo TV sound has changed that. The system, called Multichannel Television Sound (MTS) by the BTSC (Broadcast Television Systems Committee of the Electronic Industries Association), is somewhat similar to the one used for FM stereo. One major difference is the noise-reduction scheme that's used for MTS.

### Stereo TV

Figure 1 is a diagram showing a fully-loaded MTS audio baseband. The main-channel audio is limited to between 0.05 and 15 kHz as done with conventional television broadcasts. But unlike conventional TV, the stereo baseband also contains the amplitude-modulated, stereo-difference subcarrier, a pilot signal, Second Audio Program (SAP), and a professional channel.

The SAP channel can be used for

several program-related uses, for instance, voice in a second language (Spanish, for example, in heavily Spanish-speaking areas). It can also be used to transmit non-program-related information. The professional channel can be used for many purposes, such as transmitting data or even communicating with remote crews, say, for "on-the-spot" news broadcasts.

The MTS system is made up of a transmission system (developed by Zenith) and a noise-reduction system developed by dbx. An important thing about the transmission system is that it is compatible with existing TV's. To make MTS signals compatible, the main channel of the Zenith system must be compatible. Thus the main channel contains the monaural signal (the sum of the left and right channels,  $R+L$ ), which frequency-modulates the TV carrier, as is done with conventional mono signals. The stereo-difference signal ( $L-R$ ) amplitude modulates a sub-

carrier centered at 31,468 MHz (double the 15,734 MHz horizontal scan rate,  $2f_H$ ).

The pilot signal that's used by the receiver to decode stereo information is located in the baseband at  $1f_H$ . A standard TV receiver will ignore everything except the main channel, and recover the  $L+R$  audio signal just as it would a monaural TV signal. But a stereo-compatible receiver would use the pilot signal to recognize the presence of the stereo signal, and generate a carrier for decoding the  $L-R$  component.

By combining the sum and the difference signals, both in phase and out of phase, the stereo decoder can reconstruct the individual left and right channel signals:

$$(L+R) + (L-R) = 2L$$

$$(L+R) - (L-R) = 2R$$

The  $L-R$  subcarrier suffers more from noise than the main channel (due to the characteristics of the TV signal). Hence a noise-reduction system is needed. Increasing the modulation (deviation) of the  $L-R$  signals helps, but it's limited to 6dB because over-modulation would add interference to the main channel. Even with the increased modulation of the  $L-R$  channel, the stereo noise level is about 15dB greater (even under ideal conditions) than monaural reception.

Under less-than-ideal conditions, the problem is increased. For instance, if the set is located in a grade-B reception area—where the received picture is kind of snowy, but acceptable to most viewers—the signal-to-noise ratio is about 65 dB, which most lis-

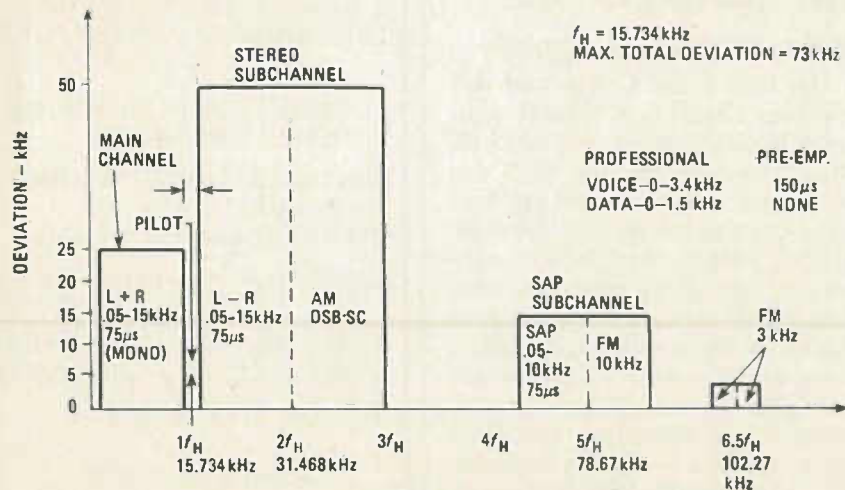

FIG. 1

teners wouldn't notice. But without noise reduction, the signal-to-noise ratio becomes about 50 db.

The dbx system for stereo TV is a companding system. In that system, the signal is encoded or COMPRESSED before it is transmitted and then decoded or EXPANDED by the receiver. The compander brings the level of the audio up to the "masking level." The masking level is simply a point where the desired signal covers up the noise so that the audio comes through clearly.

The compander differentiates between frequencies, and applies more gain to the highs, since the highs are more affected by hiss than are the lows. In low-signal areas, the signal has greater amounts of high-frequency hiss than in strong areas. But, de-emphasis in the audio system reduces the amount of hiss.

Not only is hiss annoying to the ear, but it can sometimes cause the stereo indicator to light when there is no stereo signal being received. That effect is called *falsing*. Falsing can also occur when some nearby cable system is using amplifiers in their equipment that are not suitable for the rejection of spurious signals. Cable companies are not required to conform to the standards established for broadcast stations, so their transmissions may emit harmonics that are at (or very near) the pilot frequency.

TV games, VCR's, and home computers can also generate frequencies or harmonics that trigger the stereo LED. And it's also possible that the carrier frequencies allocated for stereo and SAP transmissions may already be in use for some other purpose.

Stereo audio in general cannot be recorded on a VCR, because the stereo portion of the signal just isn't in the bandpass of the recorder. But the picture and the left and right (main) audio channels can be recorded in the same way as any other TV signal. (For a more detailed look at stereo TV, see the article, "Stereo Audio For TV," appearing in the February and March, 1985 issues of **Radio-Electronics**.)

While we're on the subject of stereo TV; I received a letter some

time ago from a reader concerning stereo satellite-TV broadcasts. I told the reader that his stereo adapter for conventional TV would work with stereo satellite transmissions just as it would with any conventional TV signal.

Since then, I've discovered that I told the poor fellow a whopper! Although most of the birds currently circling the earth do in fact transmit stereo signals, conventional TV stereo-adapters are not capable of decoding those sig-

nals. Also, current satellite receivers have provisions for decoding the MTVS signal provided it's being transmitted from the satellite!

### Servicing stereo TV

Repairing the stereo-sound stages of a TV set should be about the same as servicing FM stereo—check for the presence or absence of the FM pilot frequency, either 15,750 Hz or 31,408 Hz, that can be verified with a scope. **R-E**

## Radio-Electronics REPRINT BOOKSTORE

- |  |  |
|--|--|
| <input type="checkbox"/> Build Your Own Satellite TV Receiver ..... \$7.00 | <input type="checkbox"/> Special Projects (Spring 1981) ..... \$4.50         |
| <input type="checkbox"/> 8-Ball Satellite TV Antenna ..... \$5.00          | <input type="checkbox"/> Special Projects #4 (Summer 1982) ..... \$4.50      |
| <input type="checkbox"/> Build Your Own Robot ..... \$12.00                | <input type="checkbox"/> Special Projects #5 (Winter 1983) ..... \$4.00      |
| <input type="checkbox"/> TV Descrambler (January, February 1981) \$3.00    | <input type="checkbox"/> Special Projects #6 (Spring 1983) ..... \$4.00      |
| <input type="checkbox"/> Radio-Electronics back issues (1984) ..... \$3.00 | <input type="checkbox"/> Special Projects #7 (Summer 83) NOT AVAILABLE       |
| <input type="checkbox"/> Radio-Electronics back issues (1983) ..... \$3.50 | <input type="checkbox"/> Special Projects #8 (Fall 83) ... NOT AVAILABLE     |
| (January, February, May 1983 not available)                                | <input type="checkbox"/> Special Projects #10 (Spring 84) ..... \$4.00       |
| Write in issues desired  | <input type="checkbox"/> Radio-Electronics Annual 1983 ..... \$3.50          |
| <input type="checkbox"/> Radio-Electronics back issues (1982) ..... \$3.50 | <input type="checkbox"/> Radio-Electronics Annual 1984 ..... \$2.50          |
| Write in issues desired  | <input type="checkbox"/> How to Make PC Boards ..... \$2.00                  |
| <input type="checkbox"/> Radio-Electronics back issues (1981) ..... \$4.00 | <input type="checkbox"/> All About Kits ..... \$2.00                         |
| (Jan., Feb., March, Dec. 1981 not available)                               | <input type="checkbox"/> Modern Electronics (Vol. 1, #1 ..... \$2.25         |
| Write in issues desired  | April 1908)  |
| <input type="checkbox"/> Etch your own PC boards ..... \$3.00              | <input type="checkbox"/> Electro Importing Co. Catalog ..... \$4.95          |
| <input type="checkbox"/> Hands On Electronics #1 ..... \$3.00              | (1918) (176 pp)  |
| <input type="checkbox"/> RE Annual '85 ..... \$2.50                        | <input type="checkbox"/> Low Frequency Receiving Techniques ..... \$6.00     |
| <input type="checkbox"/> VCR Repairs ..... \$3.00                          | Building and using VLF Antennas  |
| <input type="checkbox"/> IBM Typewriter to                                 | <input type="checkbox"/> New ideas - 42 circuits for experimenters .. \$3.75 |
| Computer Interface ..... \$3.00  |  |

To order any of the items indicated above, check off the ones you want. Complete the order form below, include your payment, check or money order (DO NOT SEND CASH), and mail to Radio-Electronics, Reprint Department, 200 Park Ave. South, New York, NY 10003. Please allow 4-6 weeks for delivery.

If you need a copy of an article that is in an issue we indicate is unavailable you can order it directly from us. We charge 50¢ per page. Indicate the issue (month & year), pages and article desired. Include payment in full, plus shipping and handling charge.

ARTICLE \_\_\_\_\_

PAGES \_\_\_\_\_

MONTH \_\_\_\_\_

YEAR \_\_\_\_\_

TOTAL PAGES \_\_\_\_\_

@50¢ each

TOTAL PRICE \_\_\_\_\_

#### MAIL TO: Radio-Electronics

Reprint Department, 200 Park Ave. South, New York, NY 10003

All payments must be in U.S. funds

Total price of order ..... \$ \_\_\_\_\_

Sales Tax (New York State Residents only) ..... \$ \_\_\_\_\_

Shipping & Handling (U.S. & Canada only) (Includes FIRST CLASS POSTAGE) \$1.00 per item \$ \_\_\_\_\_

All other countries (\$2.00 per item, sea mail) ..... \$ \_\_\_\_\_

(\$4.00 per item, air mail) ..... \$ \_\_\_\_\_

Total Enclosed ..... \$ \_\_\_\_\_

Name \_\_\_\_\_

Address \_\_\_\_\_

City \_\_\_\_\_ State \_\_\_\_\_ Zip \_\_\_\_\_

## COMPUTER CORNER

continued from page 74

Microsoft (the largest U.S. software publisher).

That standard, known as MSX, has the potential for giving the Japanese a start in the U.S. market and the consumer an outstanding computer value. Even U.S. manufacturers adopting the standard could benefit.

At present, one U.S. manufacturer—Spectravideo—is offering two MSX-compatible machines; the SVI-728, and the SVI-328 (shown in Fig. 1). Both computers run Digital Research's popular CP/M operating system. However, so far, there is little software available for those MSX-based machines.

### Defining MSX

MSX is a hardware and software standard that defines specific components and software for use in computers. Table 1 is a summary of that standard. At the heart of an MSX system is a Z80A microprocessor, probably the single most popular 8-bit CPU in use today. When combined with Texas Instruments' TMS9918 graphics IC, General Instrument's AY-3-8910 sound IC, and Microsoft BASIC, a powerful computer is created. The 8-bit design keeps the cost low.

While the lack of a 16-bit design may seem to be a handicap, remember that low cost and software compatibility are their primary goals. With that design, most programs are expected to be written in Microsoft BASIC and then stored on either audio-cassette tapes or plug-in ROM modules.

Currently, the major missing elements of the MSX standard is a floppy-disk drive and operating system. While those omissions keep the cost low, the inability to expand to floppy-disk mass storage is certainly a handicap. However, Microsoft is said to be working on a disk drive and operating-system to be used with the MSX standard.

### MSX status

Approximately fifteen Japanese manufacturers have already

TABLE 1

<b>CPU:</b> Z80A (3.579545 MHz clock)
<b>Memory:</b> ROM—32K bytes (Microsoft BASIC)
RAM—32K bytes or more (Both RAM and ROM expandable)
<b>Video display processor:</b> Texas Instruments' TMS9918A
<b>Display:</b> Text—40 × 24 or 32 × 24
Graphics—256 × 192 pixels with 16 colors, and sprite capabilities
<b>Programmable Sound Generator:</b> General Instrument's AY-3-8910
<b>Sound:</b> 8 octaves, triple chord output
<b>Cassette Interface:</b> FSK (Frequency-Shift Keying), 1200/2400 baud
<b>Bus:</b> 50 pin—for ROM cartridges and I/O extensions
<b>Programmable Peripheral Interface:</b> 8255 PPI Integrated circuit
<b>Printer Interface:</b> 8 bit parallel, Centronics compatible
<b>Joysticks:</b> One or two
<b>Software:</b> Advanced version of Microsoft BASIC interpreter with graphics and sound, and cassette/ROM operating system.

bought licenses from Microsoft for the MSX standard. And several have already introduced MSX machines into the Japanese market with unusual success. MSX-based machines are also becoming popular in Korea, Taiwan, Hong Kong, and parts of Europe. However, none of those companies have released their products for sale in the United States.

Even with the MSX standard, the Japanese will have a tough time wedging their way into the U.S. computer market. That's because American firms—like Commodore, Apple, and so on—have already established themselves and will not give up any part of their market percentage without a hard fight.

Commodore, for example (a leader with its low-cost model 64), is expected to intensify its aggressive approach. Atari will continue its efforts to mount a recovery in the computer market. Apple is expected to become even more effective in the industry as they further reduce prices on their popular Apple IIe computer, and introduce new ones like the IIc.

With such fierce competition, is it any wonder that the Japanese are reluctant to take the plunge without some significant advantage. Whether that standard will be effective in the competitive U.S. market is something else. R-E

## SURPLUS COMPONENTS

continued from page 66

dividers and outer panels of the box to length and join to side panels as shown in Fig. 10. The bottom of the box is also made of paneling.

### The ultimate in surplus

If you dabble a great deal in surplus and browse around the stores a lot, once in a while that perfect deal comes along, perhaps a complete heavy-duty power supply to power all of your experiments for the next ten years. The author's perfect deal came in the form of the equipment rack shown in Fig. 11. Only the upper unit was not part of the original package, although it was built almost entirely from surplus.

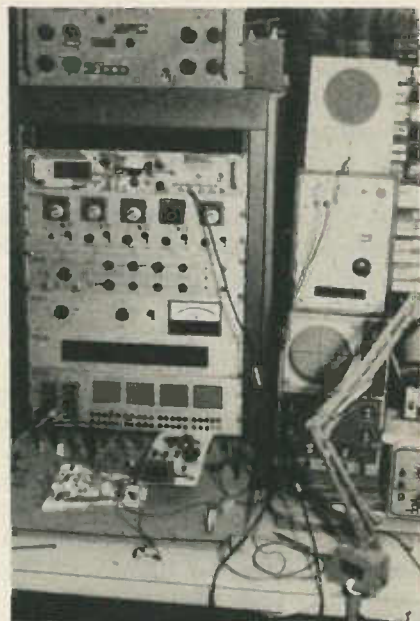

FIG. 11—AN EXAMPLE OF what can be had for little cost by shopping around for surplus.

That solid-state surplus bargain was built, at a cost of probably many thousands of dollars, for factory testing of IC's, and contained the ideal lineup of equipment for prototyping. Among its features were four variable voltage supplies, a variable current supply, and a pulse generator. The package also included a high-quality precision voltmeter, two resistance decade boxes, two capacitor decade boxes, and a switching system. (The switching system originally was used to route the outputs from the various supplies and the pulse generator to the appropriate pins on various IC's, and the outputs of those IC's to the onboard test instruments. Now it is used to feed the author's prototyping board via a series of universal binding posts.) All that, including the rack and main power supply came to \$70. So if you are into surplus, don't forget to look at the big things as well as the little ones! R-E

# MARKET CENTER

## SATELLITE TELEVISION

SATELLITE-TV receiver breakthrough! Build your own system and save! Instruction manuals, schematics, circuit boards! Send stamped envelope: XANDI, Box 25647, Dept. 21M, Tempe, AZ 85282.

SATELLITE systems \$595.00 up. Information \$1.00. Also Satellite descramblers. STARLINK, INC., 1122 Park Plaza, Huntsville, AL 35801.

## CABLE CONVERTERS & DESCRAMBLERS

### HAMLIN OAK JERROLD SCIENTIFIC SYLVANIA ZENITH

ALL TYPES OF CABLE TV EQUIPMENT  
MICROWAVE ANTENNAS & ACCESSORIES  
— FREE ILLUSTRATED BROCHURE —



— CALL OR WRITE —  
H.M.R. SALES  
221 E. CAMELBACK #1  
PHOENIX, AZ 85012  
(602) 993-0398



HOME Satellite Handbook has everything you need to know about Satellite Television. \$10.00, H&G, Box 422, Seaford, NY 11783.

UNSCRAMBLE—Canadian & American satellites. Watch the good stuff. Plans \$19.95—boards & plans \$30.00—units completed \$298.00—kits available—details and order forms \$3.00. SCRAMCO, 8688 Royal Drive, Noblesville, IN 46060.

E-Z satellite kit, computer print-out of your location, 2" liquid compass, inclinometer. IN-X-SALES, Box 45, Tilton, NH 03276, (603)286-3082.

SATELLITE system. Big savings! Easy installation plans featuring quality equipment, \$9.95. ANUSKIEWICZ, 625 Pennsylvania Avenue, Oakmont, PA 15139.

SATELLITE systems and accessories. Dishes, receivers, LNAs, actuators. Top brands, low prices. \$5.00 catalog, B&T ELECTRONICS, P.O. Box 3156, Grand Rapids, MI 49501.

GOT problems with satellite descrambler sold by T&D Engineering? We can help. State what receiver you use and problems. Write to: CUSTOM ELECTRONICS, P.O. Box 441, Akron, OH 44311.

T199/4A owners, cassette program for TVRO. Look angles, dish data, windload and more. \$20.00, S.A.S.E. for information. JTL ELECTRONICS, P.O. Box 76, Alcoa, TN 37701.

SATELLITE television systems \$895.00. Send to CSS, Route 8, Box 6, Corbin, KY 40701. Shipping charges C.O.D.. Other systems available upon request.

SATELLITE-TV system \$600.00! I'll tell you how I did it. Send \$5.00 to RALTEC, 2805 Carriage Ct., Carrollton, TX 75006.

COMPLETE satellite-TV system under \$600.00! \$2.00 (refundable) complete catalog, SHAD-OWFAX, P.O. Box 152R, Foristell, MO 63348.

## CLASSIFIED AD ORDER FORM

To run your own classified ad, put one word on each of the lines below and send this form along with your check to:

Radio-Electronics Classified Ads, 200 Park Avenue South, N.Y., N.Y. 10003

PLEASE INDICATE in which category of classified advertising you wish your ad to appear. For special headings, there is a surcharge of \$20.00.

( ) Plans/Kits ( ) Business Opportunities ( ) For Sale  
( ) Education/Instruction ( ) Wanted ( ) Satellite Television

Special Category: \$20.00

PLEASE PRINT EACH WORD SEPARATELY, IN BLOCK LETTERS.

(No refunds or credits for typesetting errors can be made unless you clearly print or type your copy.) Rates indicated are for standard style classified ads only. See below for additional charges for special ads. Minimum: 15 words.

1	2	3	4	5
6	7	8	9	10
11	12	13	14	15 (\$37.50)
16 (\$40.00)	17 (\$42.50)	18 (\$45.00)	19 (\$47.50)	20 (\$50.00)
21 (\$52.50)	22 (\$55.00)	23 (\$57.50)	24 (\$60.00)	25 (\$62.50)
26 (\$65.00)	27 (\$67.50)	28 (\$70.00)	29 (\$72.50)	30 (\$75.00)
31 (\$77.50)	32 (\$88.00)	33 (\$82.50)	34 (\$85.00)	35 (\$87.50)

We accept MasterCard and Visa for payment of orders. If you wish to use your credit card to pay for your ad fill in the following additional information (Sorry, no telephone orders can be accepted.):

Card Number

Expiration Date

Signature

IF YOU USE A BOX NUMBER YOU MUST INCLUDE YOUR PERMANENT ADDRESS AND PHONE NUMBER FOR OUR FILES. ADS SUBMITTED WITHOUT THIS INFORMATION WILL NOT BE ACCEPTED.

CLASSIFIED COMMERCIAL RATE: (for firms or individuals offering commercial products or services) \$2.50 per word prepaid (no charge for zip code)...MINIMUM 15 WORDS. 5% discount for same ad in 6 issues; 10% discount for same ad in 12 issues within one year; if prepaid. NON-COMMERCIAL RATE: (for individuals who want to buy or sell a personal item) \$2.00 per word, prepaid...no minimum. ONLY FIRST WORD AND NAME set in bold caps at no extra charge. Additional bold face (not available as all caps) 50¢ per word additional (20% premium). Entire ad in boldface, add 20% premium to total price. TINT SCREEN BEHIND ENTIRE AD: add 25% premium to total price. TINT SCREEN BEHIND ENTIRE AD PLUS ALL BOLD FACE AD: add 45% premium to total price. EXPANDED TYPE AD: \$3.75 per word prepaid. All other items same as for STANDARD COMMERCIAL RATE. TINT SCREEN BEHIND ENTIRE EXPANDED TYPE AD: add 25% premium to total price. TINT SCREEN BEHIND ENTIRE EXPANDED TYPE AD PLUS ALL BOLD FACE AD: add 45% premium to total price. DISPLAY ADS: 1" x 2 1/4"—\$270.00; 2" x 2 1/4"—\$540.00; 3" x 2 1/4"—\$810.00. General Information: Frequency rates and prepayment discounts are available. ALL COPY SUBJECT TO PUBLISHERS APPROVAL. ADVERTISEMENTS USING P.O. BOX ADDRESS WILL NOT BE ACCEPTED UNTIL ADVERTISER SUPPLIES PUBLISHER WITH PERMANENT ADDRESS AND PHONE NUMBER. Copy to be in our hands on the 15th of the third month preceding the date of the issue. (i.e., August issue copy must be received by May 15th). When normal closing date falls on Saturday, Sunday or Holiday, issue closes on preceding working day.

## BUSINESS OPPORTUNITIES

MECHANICALLY inclined individuals desiring ownership of small electronics manufacturing business—without investment. Write: BUSINESSSES, 92-R, Brighton 11th, Brooklyn, NY 11235.

MAKE money selling stereo's, boosters, speakers, serious individuals only! S.A.S.E. to: CONNELLY, 329-76th, N. Bergen, NJ 07047.

## BIG PROFITS ELECTRONIC ASSEMBLY BUSINESS

Start home, spare time. Investment knowledge or experience unnecessary. BIG DEMAND assembling electronic devices. Sales handled by professionals. Unusual business opportunity.

FREE: Complete illustrated literature  
BARTA, RE-O Box 248  
Walnut Creek, Calif. 94597

## CABLE TV

DEALERS wanted: Channel 2, 3, and 4 notch filters. Money back guarantee. Send \$15.00 for sample and quantity price list. Specify channel(s). GARY KURTZ, P.O. Box 291394, Davie, FL 33329.

## INVENTORS!

CAN you profit from your idea? Call us today regarding the marketing of your invention, or write for your free information package. Over a decade of service. AMERICAN INVENTORS CORPORATION, 82 Broad Street, Dept. RE, Westfield, MA 01086, (413) 568-3753. (Not an answering service.) A fee based marketing company, offices nationwide.

MASTERCARD AND VISA are now accepted for payment of your advertising. Simply complete the form on the first page of the Market Center and we will bill.

## FOR SALE

**CABLE-TV Secrets**—the outlaw publication the cable companies tried to ban. HBO, Movie Channel, Showtime, descramblers, converters, etc. Suppliers list included. \$8.95. **CABLE FACTS**, Box 711-R, Pataskala, OH 43062.

**RESISTORS** 1/4W, 1/2W 5% C.F. 3 cents. 1% metal-films, custom wirewounds, capacitors and other components. **JR INDUSTRIES**, 5834-B Swancreek, Toledo, OH 43614.

FREE catalog featuring scanner accessories, carrier/subcarrier detectors, voice scramblers, unusual kits. **CAPRI ELECTRONICS**, Route 1R, Canon, GA 30520.

**THE Intelligence Library**—Restricted technical information & books on electronic surveillance, surveillance-device schematics, lock-picking, investigation, weapons, identification documents, covert sciences, etc. The best selection available. Free brochures. **MENTOR**, (Dept. Z), 135-53 No. Blvd., Flushing, NY 11354.

**WHOLESALE MATV/CATV** equipments, antenna, accessories, cartridges, radios, speakers, cables. (718) 897-0509, **D&WR**, 68-12 110 Street, Flushing, NY 11375.

**TI-99/4A** software-hardware bargains. Hard-to-find items. Huge selection. Fast service. Free catalog. **DYNA**, Box 690, Hicksville, NY 11801.

**TUBES**, new, unused. Send self-addressed, stamped envelope for list. **FALA ELECTRONICS**, Box 1376-2, Milwaukee, WI 53201.

FREE Automotive Security Catalog. Largest selection available. Do-it-yourself pagers, alarms, hood/locks, glass detectors. Allow 4 weeks for delivery, or for rush send \$1.00. **AUTOMOTIVE SECURITY EQUIPMENT COMPANY**, Dept. 1, P.O. Box 382, Plainview, NY 11803.

**INDIVIDUAL** photofact folders. No. 1 to no. 1400, \$3.00 postpaid. **LBT**, 414 Chestnut Lane, East Meadow, NY 11554.

## FINEST QUALITY SOLDER

SN 60/40 Rosin Core (RA)

One lb. Reels

16 swg (.064) \$7.95  
18 swg (.048) \$8.45  
19 swg (.040) \$8.95  
20 swg (.036) \$9.45  
21 swg (.032) \$9.95

1/2 lb. Reels

22 swg (.028) \$5.95  
24 swg (.022) \$7.95

SN 62 (2% Silver)

Rosin Core

21 swg (.031) \$19.95



**FREE Freight On All Orders**  
Over \$25 Under \$25 add \$2.50 per order.  
Minimum order \$10.

**FREE Desoldering Wick** with each pound of solder

Check Money Order VISA  
MasterCard N.Y. State residents add appropriate sales tax.

**SolderCraft** Call TOLL FREE 800-645-4808  
P.O. Box 666 R, Jamaica, N.Y. 11753  
in NYS (516) 334-2860

**DESCRAMBLERS** for downconverters. High gain. Send \$2.00. **RB ELECTRONICS**, P.O. Box 643, Kalamazoo, MI 49005.

**TOKO** coil set (four) \$8.00. **BFQ85** substitute transistor \$2.00. **JIM RHODES, INC.**, 1025 Ransome Lane, Kingsport, TN 37660.

**TOKO** coils and printed circuits. Quantity discounts. **JIM RHODES, INC.**, 1025 Ransome Lane, Kingsport, TN 37660.

**ELECTRONICS** catalog. Over 4,500 items. Parts & components. Everything needed by the hobbyist or technician. \$2.00 postage & handling (States only), refundable with first \$15.00 order. **T & M ELECTRONIC**, Dept. R, 472 East Main Street, Patchogue, NY 11772, (516) 289-2520.

**CORDLESS**—phone interference? We've got the answer. Have a radar speeding ticket? We can help. Home phone extension in your car? You can have it. 50 page color catalog airmailed \$3.00. **DBE**, P.O. Drawer G, Waikiki, HI 96815, MC/VISA orders (808) 395-7458.

**CABLE-TV** converters, police radar detectors, and scanners. Send \$1.00 for catalog. **GREAT LAKES COMMUNICATIONS, INC.**, 1717 4 Mile Rd. N.E., Grand Rapids, MI 49505.

**WANTED:** Cash for old tubes, speakers, amplifiers. Western Electric, RCA, Cunningham, McIntosh, Marantz, Quad, Tannoy, JBL, Altec, Dynaco, Leak, (713) 728-4343. **MAURY**, 11122 Atwell, Houston, TX 77096.

**VIDEO** Hook-Up Diagram Manual—shows how to hook-up TV, VCR, satellite, stereos, multi-sets: \$6.00. **NORTHSTAR VIDEO SERVICES**, Dept. R, PO Box 1992, Hollywood, FL 33020.

**CABLE-TV**, converters, & VCR's. Unlock the mystery of recording one channel while watching another. \$4.95/diagrams, instructions: **ADDITIONAL OUTLET CORP.**, 1041 W. Commercial Blvd., Ft. Lauderdale, FL 33309.

**EPROM** programming, low rates. **RICHARD ASHLAW**, Rt. 1, Box 163, St. Regis Fls, NY 12980.

**PC-2** & Sharp PC-1500 owners: floppy disk emulator for your cassette files. **A/MP**, Box 78533, L.A., CA 90016.

**SCIENTIFIC** Atlanta cable systems. Introducing the new CM-04 descrambler. Works with 8500 series systems. Send \$2.00. **ADVANCED TECHNOLOGY SYSTEMS**, Box 316, Auburn, MA 01501. (617) 832-2339.

**TUBES**, hard-to-find. Send self-addressed stamped envelope for list. **AUDIO VIDEO STOP**, 7477 Village Parkway, Dublin, CA 94568.

**CABLE-** and Subscription-TV secret manual. Build your own descramblers, converters—HBO, Showtime, Movie Channel, UHF. Latest theory, schematics, instructions, suppliers list. Send \$8.95 to: **CABLETRONICS**, Box 30502, Bethesda, MD 20814.

**CABLE-TV** products. Jerrold, Hamlin, and Oak converters. Send \$3.00 for information. **ADDITIONAL OUTLET CORP.**, 1041 W. Commercial Blvd., Ft. Lauderdale, FL 33309.



# HITACHI

## OSCILLOSCOPES

# TEST EQUIPMENT

COMPLETE LINE OF INSTRUMENTATION AT THE MOST COMPETITIVE PRICES

# DISCOUNT PRICES

<p><b>V-209</b> DC-20MHz • Dual Trace Battery Operated</p>  <p>Reg. \$945 <b>\$692</b></p> <p>MINI-PORTABLE SAVE \$253</p>	<p><b>V-509</b> DC-50MHz • Dual Trace Delayed Sweep</p>  <p>Reg. \$1399 <b>\$1099</b></p> <p>MINI-PORTABLE SAVE \$300</p>	<p><b>V-1070</b> 100MHz • Quad Trace CRT Readout 6" PDA-CRT</p>  <p>Reg. \$1950 <b>\$1532</b></p> <p>SAVE \$418</p>	<p><b>V-650F</b> 60MHz • Dual Trace Delayed Sweep</p>  <p>Reg. \$1195 <b>\$938</b></p> <p>SAVE \$257</p>	<p><b>V-1050F</b> 100MHz • Quad Trace Delayed Sweep</p>  <p>Reg. \$1595 <b>\$1252</b></p> <p>SAVE \$343</p>
<p><b>V-222</b> DC-20MHz • Dual Trace</p>  <p>Reg. \$715 <b>\$524</b></p> <p>SAVE \$191</p>	<p><b>V-422</b> DC-40MHz • Dual Trace</p>  <p>Reg. \$925 <b>\$679</b></p> <p>SAVE \$246</p>	<p><b>V-1100</b> 100MHz • Quad Trace CRT Readout • 1mV 6" PDA-CRT</p>  <p>Reg. \$2490 <b>\$2260</b></p> <p>SAVE \$230</p>	<p><b>V-6015</b> 1MHz/2 Channels • 1000 Words Per Channel</p>  <p>Reg. \$2095 <b>\$1645</b></p> <p>DIGITAL STORAGE SAVE \$450</p>	<p><b>V-6041</b> 40MHz/2 Channels • 4000 Words Per Channel</p>  <p>Reg. \$5855 <b>\$5311</b></p> <p>DIGITAL STORAGE SAVE \$544</p>

TOTAL ELECTRONICS CENTER • OVER 70,000 ITEMS IN STOCK

**WM. B. ALLEN SUPPLY CO. INC.**  
**ALLEN SQUARE**

300 BLOCK NORTH RAMPART STREET, NEW ORLEANS, LOUISIANA 70112

CALL TOLL FREE

**800 535-9593**

LOUISIANA TOLL FREE 800 462-9520





# ENJOY SATELLITE TV

## DO-IT-YOURSELF AND SAVE

Electronic Know-how not required  
Easy to build from our plans or kits.  
Lowest prices on satellite electronics.  
Send \$1 for catalog or \$8.95 for  
"Consumer Guide to Satellite Television"  
GFI-D14, Box 9108  
Missoula, MT 59807



IBM PC compatible support: Multifunction card \$149.95, disk controller \$79.95, color graphics adapter \$149.95, keyboard \$109.95, 100W power supply \$99.95, motherboard assembled \$299.95. Great APPLE card prices too! Free listing! 3 month warranty. KOMPUTECH, Box 597, Alexandria Bay, NY 13607.

CABLE-TV converters—all major brands. Wireless remotes with volume, wired remotes. Cable and video accessories. Cablemaster distributor. Lowest prices. Ship C.O.D.. Catalogs \$3.00, SONE ASSOCIATES, 5 Broadway, Suite 201, Troy NY 12180. (518) 274-0608.

TUBES: "Oldies", latest. Supplies, components, schematics. Catalog free (stamp appreciated). STEINMETZ, 7519 Maplewood, RE, Hammond, IN 46324.

PAY TV in Canada. 54 pages. Theory, schematics, and sources for all systems used. Satellite information included. \$11.95. Catalogue of all books, kits, and software \$1. SHOJIKI ELECTRONICS CORP., 1327 Niagara St., Niagara Falls, N.Y., 14303. C.O.D.'s call (716) 282-1001.

## PLANS AND KITS

HI-FI speaker kits, auto speaker systems and speaker components from the world's finest manufacturers. For beginners and experts. Free literature. A & S SPEAKERS, Box 7462R, Denver, CO 80207 (303) 399-8609.

CATALOG: Hobby, radio broadcasting, CB, lowfers. Transmitters, linears, active antennas, converters, scramblers, bugging devices, more! PANAXIS, Box 130-F6, Paradise, CA 95969.

DIGITAL Klock Kit plays 1-of-12 melodies each quarter hour. Displays time, date, and other features. Send \$2.50 for assembly plans and pricing to KERBER KLOCK CO., 36117 Hillcrest, Eastlake, OH 44094.

DESCRAMBLER plans. New design decodes gated sync suppressed signals—newest pilotless method. Circuit boards, most parts from Radio Shack. Detailed theory, drawings, schematics, instructions \$14.95 plus \$2.00 shipping. DIRIJO CORP., Box 212, Lowell, NC 28098.

CABLE-TV converters: Jerrold, Hamlin, SB-3, Mini-Code, & more. UHF converters: Deluxe II sine-wave kits \$95.00, gated pulse add/on \$70.00. Complete units \$195.00, with gated pulse \$255.00. (Quantity discounts.) Repairs of all converters & cable boxes. Send S.A.S.E. (54 cents postage) or call for info. 1 (312) 637-4408. HIGGINS ELECTRONICS, 5143 W. Diversy, Chicago, IL 60639. Mail order only. C.O.D. orders accepted. No. Illinois orders accepted.

KITS! Sound effects generator, capacitance meter, C64 drum machine, stereo scratch filter, and more. Semi-assembled and tested. Free literature. GRAYCO, 1024 Lancer, San Jose, CA 95129.

TV Stereo Decoder plans—This is not stereo simulation. Circuit actually decodes stereo signals transmitted by station. For additional information, send S.A.S.E. to SOKOLOWSKI, P.O. Box 150, Elmont, NY 11003.

## CB MODIFICATIONS

Increase channels, range, privacy! We specialize in frequency expanders, speech processors, FM converters, PLL & slider tricks, how-to books, plans, kits. Expert mail-in repairs & conversions. 16-page catalog \$2.

CBC INTERNATIONAL, P.O. BOX 31500RE, PHOENIX, AZ 85046 (602) 996-8700

VCR amplifier transmits VCR output to any TV in your house. Send \$24.95 for complete kit (less chassis and power supply) to CAS ELECTRONICS, 1559-J Amar Road, Suite 457, West Covina, CA 91792.

LEARN by building functional Reed relays and proximity switches. Design your own burglar alarm system, etc. Send for our free price list. ALLREED, 138 5th Ave., Suite 160, Pelham, NY 10803.

UHF descramblers; complete plans and parts list \$5.00. AUTEN ENTERPRISES, P.O. Box 758, Brooklyn, NY 11202.

PRINTED circuit board design—custom artwork (masters, negatives) designed to your specifications. Other engineering services available (hardware software design, prototype development, etc.). Send print for quote or call ELECTRONIC SYSTEMS CONSULTANTS, INC., P.O. Box 1105, Smithtown, NY 11787, (516) 361-8142.

PULSE King—five function pulse generator—adjustable power supply—plans \$5.00, ESC, Box 98, Clearlake, WI 54005.

NEW antenna invention delivers 30dB gain when compared to a dipole, on all amateur and CB bands. Total parts cost under \$25.00, and are readily obtainable. For complete plans send \$20.00, postpaid to: R. CHRISTIE, 215-28 Spencer Ave., Queens Village, NY 11427.

EPROM programmer: read, write, copy, your Eproms with TRS 80 III, TS 1000, kit-\$49.95, plans-\$5.00. Information: ROBOTRON INDUSTRIES, 1417 Wauwatosa Avenue, Wauwatosa, WI 53213.

AUTOMATIC telephone redialer. Complete plans convert telephone into automatic redialer: \$5.00. PHONE, 1862 Camino Alicante, Tucson, AZ 85715.

## WANTED

INVENTIONS, ideas, new products wanted! Industry presentation/national exposition. Call free (1-800) 528-6050. Arizona, (1-800) 352-0458. X831.

<b>74LS00</b> 74LS00 .18 74LS09 .18 74LS32 .25 74LS74 .32 74LS107 .25 74LS125 .45 74LS158 .35 74LS164 .55 74LS240 .85 74LS243 .45 74LS244 .85 74LS373 .85 74LS374 .85	<b>EPROMS</b> 2716-450 2.75 2732-450 3.95 2732A-250 5.95 2732A-200 7.95 2764-450 3.75 2764-200 5.75 27128-250 6.75  <b>DYNAMIC RAMS</b> 4116-200 .72 4116-150 1.00 4164-200 1.75 4164-150 1.75 41256-150 6.95*	<b>STATIC RAMS</b> 2114-450 1.00 2114LP-450 1.15 2114LP-200 1.25 6116P-4 2.85* 6116P-3 3.75 6116P-2 4.95 6116LP-4 3.50 6116LP-3 4.25 6116LP-2 5.25 6264LP-15 12.95	<b>8200</b> 8237A-5 12.95 8243 5.75 8250 9.75 8251 4.25 8253 5.95 8253-5 6.50 8255 3.95 8255-5 4.95 8259 6.25 8259-5 7.50 8272 14.95* 8284 6.25 8288 12.95	<b>8000</b> 8085 4.50 8085-2 9.95 8088 10.00* 8748 17.95 8755 18.95  <b>DTC-5150 10MB DISK (IBM CONTROLLER w/cables)</b> \$215.00	<b>CRYSTALS</b> 1.0 MHZ 3.25 1.8432 3.50 2.0 2.50 4.0 2.50 5.0 2.50 6.0 2.50 10.0 1.50* 14.31818 2.50 15.0 2.50 16.0 2.50 17.430 2.50 18.0 2.50 18.432 2.50 20.0 2.50 32.0 2.55	
<b>74S00</b> 74S00 .29 74S04 .32 74S08 .32 74S74 .45 74S139 .75 74S163 1.85 74S240 2.00 74S244 2.00 74S273 1.50 74S280 1.75 74S373 2.00 74S374 2.00	<b>LINEAR</b> LM1488 .65 LM1489 .65 LM311 .59 LM317T .99 LM317K 3.25 LM324 .50 LM339 .79 NE555 .30 LM741 .25 LM747 .59 MC4044 3.95 75150 1.75 LH350K 3.95 LM338K 4.95	<b>LOW PRICES! &amp; TOLL FREE!</b>		<b>64K RAM SET</b> \$15.75	<b>DIP SWITCHES</b> 4 POSITION .75 5 POSITION .75 6 POSITION .75 7 POSITION .75 8 POSITION .75	
<b>CMOS</b> 4011 .22 4013 .35 4049 .32 4053 .75 4503 .50 4520 .75 74C163 .75	<b>misc.</b> 1793 16.00 6845 9.00 2651 7.00 3242 6.50	<b>EPROMS</b> •27128 \$6.75 (250ns) •2764 \$3.75		<b>DYNAMIC RAMS</b> •41256-150 \$6.95		<b>EDGE CARD CONN.</b> 62 PIN ST 3.50 50 PIN ST 3.50
<b>74150</b> .75¢ <b>ECL</b> 10132L .60¢	<b>SARATOGA ELECTRONICS, INC.</b> 12380 SARATOGA-SUNNYVALE ROAD SARATOGA, CA 95070 (408) 446-4949					<b>IC SOCKETS</b> 8 PIN ST .10 14 PIN ST .12 16 PIN ST .15 18 PIN ST .18 20 PIN ST .25 22 PIN ST .28 24 PIN ST .30 28 PIN ST .38 40 PIN ST .45 64 PIN ST 4.00
\$10 MIN. ORDER. SEND CHECK, M.O., VISA OR MASTERCARD ALL PRODUCTS GUARANTEED FOR 90 DAYS. PRICES AND SPECIALS SUBJECT TO PRIOR SALE. PLEASE INCLUDE \$2.50 FOR UPS GROUND.						
<b>800-621-0854 ext. 245</b>		CALL AND GET ON OUR MAILING LIST! WE HAVE MANY OTHER ITEMS IN STOCK!		<b>800-242-4949 (CA)</b>		

# WE HAVE QUALITY PARTS, DISCOUNT PRICES AND FAST SHIPPING!

## TRANSFORMERS

120 volt primaries



5.6 VOLTS @ 750 MA \$3.00  
6 VOLTS @ 150 MA \$1.25  
12 VCT @ 200 MA \$2.00  
18 V. @ 650 MA \$3.50  
18 VOLTS @ 1 AMP \$4.50  
24 VOLTS @ 250 MA \$2.50  
24 VCT @ 1 AMP \$4.50

## WALL TRANSFORMER

ALL ARE 115 VAC PLUG IN



4 VDC @ 70 MA \$2.00  
9 VAC @ 1 AMP \$3.00  
12.5 VAC @ 285 MA \$2.50  
17 VAC @ 500 MA \$4.00  
24 VAC @ 250 MA \$3.00

## SPRING LEVER TERMINALS

TWO COLOR CODED TERMINALS ON A STURDY 2 3/4" x 3 3/4" BAKELITE PLATE GREAT FOR SPEAKER ENCLOSURES OR POWER SUPPLIES.



\$1.00 EACH 10 FOR \$9.00

## TI SWITCHING POWER SUPPLY

TI # 1053214-2 COMPACT, WELL REGULATED SWITCHING POWER SUPPLY DESIGNED TO POWER TEXAS INSTRUMENTS COMPUTER EQUIPMENT.

INPUT: 14VAC-25 VAC AT 1A  
OUTPUT: +12VDC AT 350MA  
+ 5VDC AT 1.2A  
- 5VDC AT 200MA

SIZE: 4 3/4" x 4 3/4" x 1 1/4" \$5.00 EACH



\$5.00 EACH

\$5.00 EACH

\$5.00 EACH

\$5.00 EACH

\$5.00 EACH

\$5.00 EACH

\$5.00 EACH

\$5.00 EACH

\$5.00 EACH

\$5.00 EACH

\$5.00 EACH

\$5.00 EACH

\$5.00 EACH

\$5.00 EACH

\$5.00 EACH

\$5.00 EACH

\$5.00 EACH

\$5.00 EACH

\$5.00 EACH

\$5.00 EACH

\$5.00 EACH

\$5.00 EACH

\$5.00 EACH

\$5.00 EACH

\$5.00 EACH

\$5.00 EACH

\$5.00 EACH

\$5.00 EACH

\$5.00 EACH

\$5.00 EACH

\$5.00 EACH

\$5.00 EACH

\$5.00 EACH

\$5.00 EACH

\$5.00 EACH

\$5.00 EACH

\$5.00 EACH

\$5.00 EACH

\$5.00 EACH

\$5.00 EACH

\$5.00 EACH

\$5.00 EACH

\$5.00 EACH

\$5.00 EACH

\$5.00 EACH

\$5.00 EACH

\$5.00 EACH

\$5.00 EACH

\$5.00 EACH

\$5.00 EACH

\$5.00 EACH

\$5.00 EACH

\$5.00 EACH

\$5.00 EACH

\$5.00 EACH

\$5.00 EACH

\$5.00 EACH

\$5.00 EACH

\$5.00 EACH

\$5.00 EACH

\$5.00 EACH

\$5.00 EACH

\$5.00 EACH

\$5.00 EACH

\$5.00 EACH

\$5.00 EACH

\$5.00 EACH

\$5.00 EACH

\$5.00 EACH

\$5.00 EACH

\$5.00 EACH

\$5.00 EACH

\$5.00 EACH

\$5.00 EACH

\$5.00 EACH

\$5.00 EACH

\$5.00 EACH

\$5.00 EACH

\$5.00 EACH

\$5.00 EACH

\$5.00 EACH

\$5.00 EACH

\$5.00 EACH

\$5.00 EACH

\$5.00 EACH

\$5.00 EACH

\$5.00 EACH

\$5.00 EACH

\$5.00 EACH

\$5.00 EACH

\$5.00 EACH

\$5.00 EACH

\$5.00 EACH

\$5.00 EACH

\$5.00 EACH

\$5.00 EACH

\$5.00 EACH

\$5.00 EACH

\$5.00 EACH

\$5.00 EACH

\$5.00 EACH

\$5.00 EACH

\$5.00 EACH

\$5.00 EACH

\$5.00 EACH

\$5.00 EACH

\$5.00 EACH

\$5.00 EACH

\$5.00 EACH

\$5.00 EACH

\$5.00 EACH

\$5.00 EACH

\$5.00 EACH

\$5.00 EACH

\$5.00 EACH

\$5.00 EACH

\$5.00 EACH

\$5.00 EACH

\$5.00 EACH

\$5.00 EACH

\$5.00 EACH

\$5.00 EACH

\$5.00 EACH

\$5.00 EACH

\$5.00 EACH

\$5.00 EACH

\$5.00 EACH

\$5.00 EACH

\$5.00 EACH

\$5.00 EACH

\$5.00 EACH

\$5.00 EACH

\$5.00 EACH

\$5.00 EACH

\$5.00 EACH

\$5.00 EACH

\$5.00 EACH

\$5.00 EACH

\$5.00 EACH

\$5.00 EACH

\$5.00 EACH

\$5.00 EACH

\$5.00 EACH

\$5.00 EACH

\$5.00 EACH

\$5.00 EACH

\$5.00 EACH

\$5.00 EACH

\$5.00 EACH

\$5.00 EACH

\$5.00 EACH

\$5.00 EACH

\$5.00 EACH

\$5.00 EACH

\$5.00 EACH

\$5.00 EACH

\$5.00 EACH

\$5.00 EACH

\$5.00 EACH

\$5.00 EACH

\$5.00 EACH

\$5.00 EACH

\$5.00 EACH

\$5.00 EACH

\$5.00 EACH

\$5.00 EACH

\$5.00 EACH

\$5.00 EACH

\$5.00 EACH

\$5.00 EACH

\$5.00 EACH

\$5.00 EACH

\$5.00 EACH

\$5.00 EACH

\$5.00 EACH

\$5.00 EACH

\$5.00 EACH

\$5.00 EACH

\$5.00 EACH

\$5.00 EACH

\$5.00 EACH

\$5.00 EACH

\$5.00 EACH

\$5.00 EACH

\$5.00 EACH

\$5.00 EACH

\$5.00 EACH

\$5.00 EACH

\$5.00 EACH

\$5.00 EACH

\$5.00 EACH

\$5.00 EACH

\$5.00 EACH

\$5.00 EACH

\$5.00 EACH

\$5.00 EACH

\$5.00 EACH

\$5.00 EACH

\$5.00 EACH

\$5.00 EACH

\$5.00 EACH

\$5.00 EACH

\$5.00 EACH

\$5.00 EACH

\$5.00 EACH

\$5.00 EACH

\$5.00 EACH

\$5.00 EACH

\$5.00 EACH

\$5.00 EACH

\$5.00 EACH

\$5.00 EACH

\$5.00 EACH

\$5.00 EACH

\$5.00 EACH

\$5.00 EACH

\$5.00 EACH

\$5.00 EACH

\$5.00 EACH

\$5.00 EACH

\$5.00 EACH

\$5.00 EACH

\$5.00 EACH

\$5.00 EACH

\$5.00 EACH

\$5.00 EACH

\$5.00 EACH

\$5.00 EACH

\$5.00 EACH

\$5.00 EACH

\$5.00 EACH

\$5.00 EACH

\$5.00 EACH

\$5.00 EACH

\$5.00 EACH

\$5.00 EACH

\$5.00 EACH

\$5.00 EACH

\$5.00 EACH

\$5.00 EACH

\$5.00 EACH

\$5.00 EACH

\$5.00 EACH

\$5.00 EACH

\$5.00 EACH

\$5.00 EACH

\$5.00 EACH

\$5.00 EACH

\$5.00 EACH

\$5.00 EACH

\$5.00 EACH

\$5.00 EACH

\$5.00 EACH

\$5.00 EACH

\$5.00 EACH

\$5.00 EACH

\$5.00 EACH

\$5.00 EACH

\$5.00 EACH

\$5.00 EACH

\$5.00 EACH

\$5.00 EACH

\$5.00 EACH

\$5

**UNLOCK THE POWER OF YOUR  
TIMEX OR SINCLAIR COMPUTER**

Centronics Printer I/F..... \$50.00  
with 5' printer cable..... \$69.95  
as above + computer cable.. \$89.95

Floppy Drive I/F..... \$190.00  
+ 5' 5-1/4" drive cable... \$199.95

When ordering, specify type of computer  
Allow 4-6 weeks for delivery

CALL or Write for free catalog to:

Research Service Labs  
P O Box 19124 OKC, OK 73144  
(405) 745-9322

Phone hrs: 2-10PM Monday thru Friday

**SCANNERS**

JOIN 30,000 other scanner owners in the nation's largest not-for-profit association of scanner owners. Bi-monthly publication with tech tips, fascinating true stories, news of new listening adventures. Plus member benefit package including car rental discounts, no-extra-cost insurance coverage, free classified ad service, and more. Send just \$9.75 for 10-month trial membership to: **SCANNER ASSOCIATION OF NORTH AMERICA**, 240-A Fencil Lane, Hillside, IL 60162.

**PRINTED-CIRCUIT BOARDS**

PRINTED- circuit boards, 8" x 10" max. Send us your positive, any size (please specify), thru component side artwork, along with a certified check or money order for \$20.00 & \$3.00 shipping, and we will send you an FR-4 fiberglass board, with your artwork, the same day. Send us your hole specs, we'll drill it for free. **EJS LABORATORY**, 11908 Detroit Ave., Cleveland, OH 44107, (216) 529-1611.

PRINTED-circuit boards. Quick prototypes, production, design, reflow solder. Send print or description to **KIT CIRCUITS**, Box 235, Clawson, MI 48017.

PRINTED- circuit boards double-sided with plated through holes or single sided. No set up charge. **CAUDILL INC.**, 205 East Westwood Ave., Highpoint, NC 27262. (919) 884-0229.

CIRCUIT- boards, single sided boards 48 hour turnaround. No set up charge. call for quote. **EMCON PCB'S**, (602) 483-2464

**EPROM PROGRAMMING**

**HOBBYISTS:** EPROM's sold with your programming installed. Listing provided. Fast service. Write or call: **ROMULUS MICROCONTROL**, Box 8669, Rockville, MD 20856, (301) 540-8863.

**FCC LICENSE TRAINING**

EARN \$600.00 + week! Get your "F.C.C. General Radiotelephone License." Electronics home study. Fast, inexpensive! "Free" details. **COMMAND**, D-168, Box 2223, San Francisco, CA 94126.

**GRAPHIC EQUALIZERS, ETC.**

**NOISE** eliminators, expanders, power meters, others. Twelve-24bands/channel equalizers from \$89.00. Kit see R-E 5-6/78, 2/80, 3-4/81. Catalog: **SSS**, 856R Lynnrose, Santa Rosa, CA 95404. (707) 546-3895.

**CABLE TV FILTERS**

**SUPER** powered notch filters. Equivalent of cable company "cylinders". Eliminate undesirable signals. Any channel 2 through 8; 14(A) through 22(!). Send \$20.00 each. Money back guarantee. Quantity discounts, **CATV**, Box 17621, Plantation, FL 33318.

**EDUCATION & INSTRUCTION**

**F.C.C. Commercial General Radiotelephone License.** Electronics home study. Fast, inexpensive! "Free" details. **COMMAND**, D-167, Box 2223, San Francisco, CA 94126.

**LEARN** how to use a computer. Train at home in spare time! No previous experience needed! Learn computer programming, computer applications and operations...even computer games. Use hundreds of programs already available or learn to write your own. Experts explain everything in easy-to-understand language with step-by-step directions. Call for free facts! 1-800-862-6262, extension 56 or write **ICS COMPUTER SCHOOL**, Dept. DEC55, Scranton, PA 18515.

**FCC Commercial General Radiotelephone License Correspondence Course.** 60 individual lessons for \$89.50. Payment plan. Results guaranteed! Details free. **AMERICAN TECHNICAL INSTITUTE**, Box 201, Cedar Mountain, NC 28718.

**COMMODORE 64** Pub Domain Software. Specify business, educational, utilities, games. Over 100 programs on four diskettes. \$7.95/disk. **SOFTRAM**, Box 60, Mason, OH 45040.

**REEL-TO-REEL TAPES**

**AMPEX** professional series open reel tape, 1800-or 2400-feet on 7-inch reels, used once. Case of 40, \$45.00. 10 1/2" x 3600 feet and cassettes available. MasterCard/Visa. **VALTECH ELECTRONICS**, Box 6-RE, Richboro, PA 18954 (215) 322-4866.

**DO-IT-YOURSELF TV REPAIR**

**NEW!**...Repair any TV...Easy. Anyone can do it. Write, **RESEARCH**, Rt. 3, Box 601 BR, Colville, WA 99114.

**LOOK NO FURTHER WE'LL BEAT ANY PRICE  
IN THIS MAGAZINE OR ANY OTHER**

**64K RAM**  
Set of 9 \$17.00

**27128**  
\$7.80

**41256-150**  
\$9.00

**27256**  
\$49.95

**27C64**  
\$9.25

**2764-200**  
\$4.00

**2732-200**  
\$3.50

**8087-3**  
\$175.00

**6264LP-15**  
\$11.50

**6116P-3**  
\$2.75

**8000**

8031AH \$7.50  
8035 2.75  
8039 3.00  
8085AP 3.40  
8086P 10.15  
8088 10.00  
8155 2.70  
8216 1.19  
8237A5 8.10  
251A 2.70  
8253C 2.70  
8255A 2.70  
8257P-5 2.70  
8259AC-2 2.70  
8274 7.50  
8284A 2.95  
8288 8.10

8755 12.00  
8748 11.00  
8749 13.50

**Z-80**  
Z80BCPU \$4.05  
Z80BCTC 4.75  
Z80B-P10 4.75

**LINEAR**  
LM312H 1.60  
LM318CN 1.45  
LM319N 1.10  
MCC1330 1.50  
MCC1349 1.70  
MCC1350 1.05  
MCC1358 1.50

MCC1372 6.15  
CA3023 2.45  
CA3059 2.60  
CA3060 2.60  
CA3081 1.50  
CA3082 1.50

**7400**  
7443 .58  
7444 .62  
7489 1.95  
7497 2.47  
74100 1.58  
74142 2.65  
74143 4.45  
74144 2.65  
74390 1.58  
74393 1.22  
74490 2.30

**74S00**

74S124 2.50  
74S132 1.15  
74S133 .40  
74S194 1.35  
74S195 1.35  
74S251 .85  
74S253 .85  
74S280 1.75  
74S287 1.70  
74S288 1.70  
74S570 2.70  
74S571 2.70

**CMOS**

4034 1.75  
4035 .76  
4094 2.70  
4098 2.25

4099 1.75  
4507 1.15  
4508 1.75  
4514 1.15  
4515 1.60  
4516 1.40

**74LS00**

74LS145 \$1.05  
74LS147 2.20  
74LS148 1.17  
74LS154 1.65  
74LS166 1.70  
74LS181 1.90  
74LS189 8.00  
74LS348 2.25  
74LS364 1.70  
74LS674 8.60

**74HC00**

74HC85 1.25  
74HC154 2.25  
74HC166 2.65  
74HC299 4.50

**74HCT00**

74HCT85 1.35  
74HCT154 2.70  
74HCT166 2.70  
74HCT299 4.75

**INTERACTIVE  
COMPONENTS**

4401 Atlantic Ave #219 Long Beach, Calif. 90807  
213-423-6644 Telex 592022

**IF YOU DON'T SEE IT  
HERE CALL COLLECT!!!**

\$100.00 min. order — U.S. Funds Calif. Res. add 6 1/2%. Shipping — 5% plus \$1.50 Ins. VISA, MC, M.O., cashier checks, preapproved co. checks. We reserve right to substitute manufacturers. We are not responsible for typographical errors.

# RAMSEY

# THE FIRST NAME IN ELECTRONIC TEST GEAR

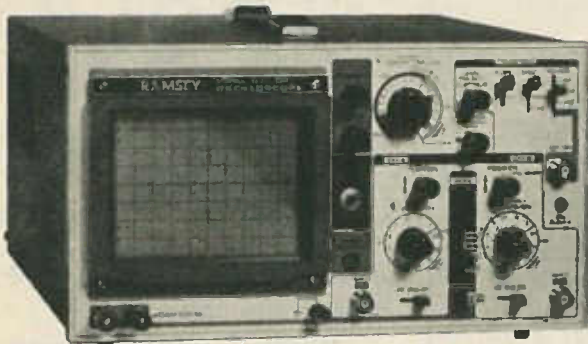

## 20 MHz DUAL TRACE OSCILLOSCOPE

Unsurpassed quality at an unbeatable price, the Ramsey oscilloscope compares to others costing hundreds more. Features include a component testing circuit for resistor, capacitor, digital circuit and diode testing • TV video sync filter • wide bandwidth & high sensitivity • internal graticule • front panel trace rotator • 2 axis • high sensitivity x-y mode • regulated power supply • built-in calibrator • rock solid triggering

\*USA—Add \$10.00 per unit for postage, overseas orders add 15% of total order for insured surface mail.

**\$399<sup>95</sup>\***

high quality hook on probes included

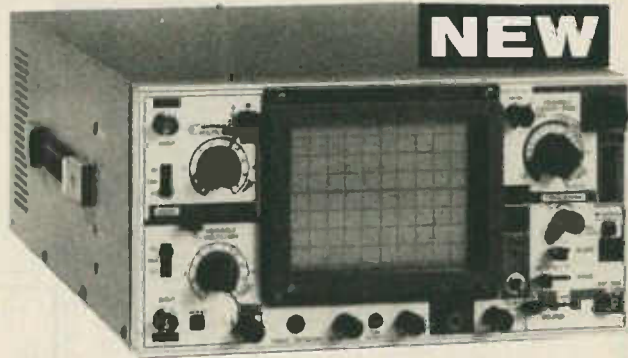

**NEW**

## 45 MHz DUAL SWEEP OSCILLOSCOPE

The Ramsey 625 is a dual time base, delayed sweep unit that includes a built-in signal delay line to permit clear viewing during very short rise times of high frequency waveforms. Other features include: variable trigger holdoff • 20 calibrated sweep time ranges from 0.5  $\mu$ s/div to 0.2  $\mu$ s/div • fully adjustable sweep time • X5 sweep magnification • five trigger sources: CH1, CH2, LINE EXTERNAL and INTERNAL (V mode) • front panel x-y operation • Z axis input • sum difference of CH1, and CH2 waveforms displayed as single trace • sweep gate and sweep output • auto focus • single sweep

\*Same as unit to left.

**\$799<sup>95</sup>\***

high quality hook on probes included



## RAMSEY D-1100 VOM MULTITESTER

Compact and reliable, designed to service a wide variety of equipment. Features include • mirror back scale • double-jeweled precision moving coil • double overload protection • an ideal low cost unit for the beginner or as a spare back-up unit.

**\$19<sup>95</sup>** test leads and battery included



## NEW RAMSEY 1200 VOM MULTITESTER

Check transistors, diodes and LEOs with this professional quality meter. Other features include: decibel scale • 20K volt metering system • 3 $\frac{1}{2}$ " mirrored scale • polarity switch • 20 measuring ranges • safety probes • high impact plastic case

**\$24<sup>95</sup>** test leads and battery included



## RAMSEY D-3100 DIGITAL MULTIMETER

Reliable, accurate digital measurements at an amazingly low cost • in-line color coded push buttons, speeds range selection • abs plastic tilt stand • recessed input jacks • overload protection on all ranges • 3 $\frac{1}{2}$  digit LCD display with auto zero, auto polarity & low BAT. indicator

**\$49<sup>95</sup>** test leads and battery included



## CT-70 7 DIGIT 525 MHz COUNTER

Lab quality at a breakthrough price. Features • 3 frequency ranges each with p-p amp • dual selectable gate times • gate activity indicator • 50mV @ 150 MHz typical sensitivity • wide frequency range • 1 ppm accuracy

**\$119<sup>95</sup>** wired includes AC adapter

CT-70 kit ..... \$99.95  
BP-4 nicad pack ..... 8.95



## CT-90 9 DIGIT 600 MHz COUNTER

The most versatile for less than \$300. Features 3 selectable gate times • 9 digits • gate indicator • display hold • 25mV @ 150 MHz typical sensitivity • 10 MHz timebase for WWW calibration • 1 ppm accuracy

**\$149<sup>95</sup>** wired includes AC adapter

CT-90 kit ..... \$129.95  
OV-1 0.1 PPM oven timebase ..... 59.95  
BP-4 nicad pack ..... 8.95



## CT-125 9 DIGIT 1.2 GHz COUNTER

A 9 digit counter that will outperform units costing hundreds more. • gate indicator • 24mV @ 150 MHz typical sensitivity • 9 digit display • 1 ppm accuracy • display hold • dual inputs with preamps

**\$169<sup>95</sup>** wired includes AC adapter

BP-4 nicad pack ..... 8.95



## CT-50 8 DIGIT 600 MHz COUNTER

A versatile lab bench counter with optional receive frequency adapter, which turns the CT-50 into a digital readout for most any receiver • 25 mV @ 150 MHz typical sensitivity • 8 digit display • 1 ppm accuracy

**\$169<sup>95</sup>** wired

CT-50 kit ..... \$139.95  
RA-1 receiver adapter kit ..... 14.95



## DM-700 DIGITAL MULTIMETER

Professional quality at a hobbyist price. Features include 26 different ranges and 5 functions • 3 $\frac{1}{2}$  digit,  $\frac{1}{2}$  inch LED display • automatic decimal placement • automatic polarity

**\$119<sup>95</sup>** wired includes AC adapter

DM-700 kit ..... \$99.95  
MP-1 probe set ..... 4.95



## PS-2 AUDIO MULTIPLIER

The PS-2 is handy for high resolution audio resolution measurements, multiplies UP in frequency • great for PL tone measurements • multiplies by 10 or 100 • 0.01 Hz resolution & built-in signal preamp/conditioner

**\$49<sup>95</sup>** wired

PS-2 kit ..... \$39.95



## PR-2 COUNTER PREAMP

The PR-2 is ideal for measuring weak signals from 10 to 1,000 MHz • flat 25 db gain • BNC connectors • great for shifting RF • ideal receiver/TV preamp

**\$44<sup>95</sup>** wired includes AC adapter

PR-2 kit ..... \$34.95

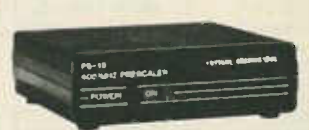

## PS-1B 600 MHz PRESCALER

Extends the range of your present counter to 600 MHz • 2 stage preamp • divide by 10 circuitry • sensitivity: 25mV @ 150 MHz • BNC connectors • drives any counter

**\$59<sup>95</sup>** wired includes AC adapter

PS-1B kit ..... \$49.95

## ACCESSORIES FOR RAMSEY COUNTERS

Telescopic whip antenna—BNC plug ..... 8.95  
High impedance probe, light loading ..... 16.95  
Low pass probe, audio use ..... 16.95  
Direct probe, general purpose use ..... 13.95  
Tilt ball, for CT-70, 90, 125 ..... 3.95



PHONE ORDERS CALL  
**716-586-3950**  
TELEX 466735 RAMSEY CI

TERMS • satisfaction guaranteed • examine for 10 days, if not pleased return in original form for refund • add 6% for shipping and insurance to a maximum of \$10.00 • overseas add 15% for surface mail • COD add \$2.50 (COD in USA only) • orders under \$15.00 add \$1.50 • NY residents add 7% sales tax • 90 day parts warranty on all kits • 1 year parts & labor warranty on all wired units



RAMSEY ELECTRONICS, INC.  
2575 Baird Rd.  
Penfield, N.Y. 14626

CIRCLE 70 ON FREE INFORMATION CARD

JUNE 1985

97

CPU's & SUPPORT CHIPS			
280A CPU 4.75	8155-2	8.00	
280B CPU 5.00	8202	10.95	
280A CTC 4.50	8212	3.50	
280A DART 3.00	8214	4.00	
280A P10 4.50	8218	3.50	
280A 510 10.95	8226	3.50	
82CA1	10.00	8317	15.00
AMD2901	8.95	8338	3.95
6502	4.75	8260	10.95
6800	2.50	8251	8.00
6801	12.95	8253	8.00
6809	3.95	8254-A-5	8.00
6810	4.00	8257	8.00
6821	4.50	8259	8.00
6845	13.95	8272A	26.00
6850	3.80	8275	24.80
6875	4.50	8278	6.95
D7220 1	24.00	8268	17.00
8085	8.95	8355	12.95
8080A	4.75	8742	20.00
8085A	3.00	TM89927ML	9.95
8085	16.00	6800C1L8	30.50

EPOXY GLASS VECTOR BOARD						
1/16" thick with 1/10" spacing						
4 1/2" x 6 1/2" \$2.40						
SCR's		TRIAC's				
1.5A	6A	35A	110A	PRV 1A	10A	25A
100	.35	.40	1.40	100	.35	6.00
200	.40	.50	1.80	200	.50	8.00
400	.60	.70	2.40	400	.70	1.00
600	.80	1.00	3.60	600	1.00	1.20

C/MOS			
74C00	50	74C007	90
74C02	40	74C010	110
74C04	40	74C021	350
74C10	40	4001	30
74C14	50	4002	30
74C20	40	4007	30
74C22	75	4008	85
74C74	80	4009	40
74C78	75	4011	45
74C83	120	4012	30
74C85	125	4013	35
74C86	40	4014	75
74C93	100	4015	40
74C154	200	4016	40
74C187	170	4017	35
74C188	170	4018	35
74C174	110	4019	40
74C176	110	4020	75
74C192	140	4021	75
74C193	140	4022	75
74C245	175	4023	35
74C293	80	4024	35
		4025	30

SHIFT REGISTERS			
MM1402	1.75		
MM1403	1.75	D765C	10.00
MM1404	1.75	1771	5.95
MM5013	2.50	1791	14.00
MM5055	2.50	1793	17.00
MM5056	2.50		
MM5057	2.50		
MM5058	2.50		
MM5060	2.50		

RAM's			
211023	90		
2101A	4	1.50	
2111A	1.75		
2112	1.95		
2114-2	1.40		
2118-4	2.50		
21473	2.50		
3242	6.00		
3M5409	1.75		
3M5407-3	1.75		
3M5408-2	2.95		
3M5409-1	2.50		
4108-3	1.50		
4116-2	1.00		
4118-4	4.00		
4120-3	5.85		
4121-4	4.50		
4122-3	4.50		
4123-6	6.00		
4124-3	4.95		
4125-3	4.95		
6167P-3	9.00		

TRANSISTOR SPECIALS			
TIP 318 NPN Si TO-220		\$ 40	
TIP 328 PNP Si TO-220		\$ 40	
TIP 34 PNP Si		\$ 25	
TIP 111		\$ 50	
TIP 121 NPN Si U84		\$ 50	
TIP 141 NPN Si U87		\$100	
TIP 295 PNP Si TO-18		\$1.75	
BU205		\$1.75	
2N404A PNP GE TO-3		\$381.00	
2N404B PNP GE TO-3		\$381.00	
2N406A PNP GE TO-3		\$381.00	
2N406B PNP GE TO-3		\$381.00	
2N407A PNP GE TO-3		\$381.00	
2N407B PNP GE TO-3		\$381.00	
2N408A PNP GE TO-3		\$381.00	
2N408B PNP GE TO-3		\$381.00	
2N409A PNP GE TO-3		\$381.00	
2N409B PNP GE TO-3		\$381.00	
2N410A PNP GE TO-3		\$381.00	
2N410B PNP GE TO-3		\$381.00	
2N411A PNP GE TO-3		\$381.00	
2N411B PNP GE TO-3		\$381.00	
2N412A PNP GE TO-3		\$381.00	
2N412B PNP GE TO-3		\$381.00	
2N413A PNP GE TO-3		\$381.00	
2N413B PNP GE TO-3		\$381.00	
2N414A PNP GE TO-3		\$381.00	
2N414B PNP GE TO-3		\$381.00	
2N415A PNP GE TO-3		\$381.00	
2N415B PNP GE TO-3		\$381.00	
2N416A PNP GE TO-3		\$381.00	
2N416B PNP GE TO-3		\$381.00	
2N417A PNP GE TO-3		\$381.00	
2N417B PNP GE TO-3		\$381.00	
2N418A PNP GE TO-3		\$381.00	
2N418B PNP GE TO-3		\$381.00	
2N419A PNP GE TO-3		\$381.00	
2N419B PNP GE TO-3		\$381.00	
2N420A PNP GE TO-3		\$381.00	
2N420B PNP GE TO-3		\$381.00	
2N421A PNP GE TO-3		\$381.00	
2N421B PNP GE TO-3		\$381.00	
2N422A PNP GE TO-3		\$381.00	
2N422B PNP GE TO-3		\$381.00	
2N423A PNP GE TO-3		\$381.00	
2N423B PNP GE TO-3		\$381.00	
2N424A PNP GE TO-3		\$381.00	
2N424B PNP GE TO-3		\$381.00	
2N425A PNP GE TO-3		\$381.00	
2N425B PNP GE TO-3		\$381.00	
2N426A PNP GE TO-3		\$381.00	
2N426B PNP GE TO-3		\$381.00	
2N427A PNP GE TO-3		\$381.00	
2N427B PNP GE TO-3		\$381.00	
2N428A PNP GE TO-3		\$381.00	
2N428B PNP GE TO-3		\$381.00	
2N429A PNP GE TO-3		\$381.00	
2N429B PNP GE TO-3		\$381.00	
2N430A PNP GE TO-3		\$381.00	
2N430B PNP GE TO-3		\$381.00	
2N431A PNP GE TO-3		\$381.00	
2N431B PNP GE TO-3		\$381.00	
2N432A PNP GE TO-3		\$381.00	
2N432B PNP GE TO-3		\$381.00	
2N433A PNP GE TO-3		\$381.00	
2N433B PNP GE TO-3		\$381.00	
2N434A PNP GE TO-3		\$381.00	
2N434B PNP GE TO-3		\$381.00	
2N435A PNP GE TO-3		\$381.00	
2N435B PNP GE TO-3		\$381.00	
2N436A PNP GE TO-3		\$381.00	
2N436B PNP GE TO-3		\$381.00	
2N437A PNP GE TO-3		\$381.00	
2N437B PNP GE TO-3		\$381.00	
2N438A PNP GE TO-3		\$381.00	
2N438B PNP GE TO-3		\$381.00	
2N439A PNP GE TO-3		\$381.00	
2N439B PNP GE TO-3		\$381.00	
2N440A PNP GE TO-3		\$381.00	
2N440B PNP GE TO-3		\$381.00	
2N441A PNP GE TO-3		\$381.00	
2N441B PNP GE TO-3		\$381.00	
2N442A PNP GE TO-3		\$381.00	
2N442B PNP GE TO-3		\$381.00	
2N443A PNP GE TO-3		\$381.00	
2N443B PNP GE TO-3		\$381.00	
2N444A PNP GE TO-3		\$381.00	
2N444B PNP GE TO-3		\$381.00	
2N445A PNP GE TO-3		\$381.00	
2N445B PNP GE TO-3		\$381.00	
2N446A PNP GE TO-3		\$381.00	
2N446B PNP GE TO-3		\$381.00	
2N447A PNP GE TO-3		\$381.00	
2N447B PNP GE TO-3		\$381.00	
2N448A PNP GE TO-3		\$381.00	
2N448B PNP GE TO-3		\$381.00	
2N449A PNP GE TO-3		\$381.00	
2N449B PNP GE TO-3		\$381.00	
2N450A PNP GE TO-3		\$381.00	
2N450B PNP GE TO-3		\$381.00	
2N451A PNP GE TO-3		\$381.00	
2N451B PNP GE TO-3		\$381.00	
2N452A PNP GE TO-3		\$381.00	
2N452B PNP GE TO-3		\$381.00	
2N453A PNP GE TO-3		\$381.00	
2N453B PNP GE TO-3		\$381.00	
2N454A PNP GE TO-3		\$381.00	
2N454B PNP GE TO-3		\$381.00	
2N455A PNP GE TO-3		\$381.00	
2N455B PNP GE TO-3		\$381.00	
2N456A PNP GE TO-3		\$381.00	
2N456B PNP GE TO-3		\$381.00	
2N457A PNP GE TO-3		\$381.00	
2N457B PNP GE TO-3		\$381.00	
2N458A PNP GE TO-3		\$381.00	
2N458B PNP GE TO-3		\$381.00	
2N459A PNP GE TO-3		\$381.00	
2N459B PNP GE TO-3		\$381.00	
2N460A PNP GE TO-3		\$381.00	
2N460B PNP GE TO-3		\$381.00	
2N461A PNP GE TO-3		\$381.00	
2N461B PNP GE TO-3		\$381.00	
2N462A PNP GE TO-3		\$381.00	
2N462B PNP GE TO-3		\$381.00	
2N463A PNP GE TO-3		\$381.00	
2N463B PNP GE TO-3		\$381.00	
2N464A PNP GE TO-3		\$381.00	
2N464B PNP GE TO-3		\$381.00	
2N465A PNP GE TO-3		\$381.00	
2N465B PNP GE TO-3		\$381.00	
2N466A PNP GE TO-3		\$381.00	
2N466B PNP GE TO-3		\$381.00	
2N467A PNP GE TO-3		\$381.00	
2N467B PNP GE TO-3		\$381.00	
2N468A PNP GE TO-3		\$381.00	
2N468B PNP GE TO-3		\$381.00	
2N469A PNP GE TO-3		\$381.00	
2N469B PNP GE TO-3		\$381.00	
2N470A PNP GE TO-3		\$381.00	
2N470B PNP GE TO-3		\$381.00	
2N471A PNP GE TO-3		\$381.00	
2N471B PNP GE TO-3		\$381.00	
2N472A PNP GE TO-3		\$381.00	
2N472B PNP GE TO-3		\$381.00	
2N473A PNP GE TO-3		\$381.00	
2N473B PNP GE TO-3		\$381.00	
2N474A PNP GE TO-3		\$381.00	
2N474B PNP GE TO-3		\$381.00	
2N475A PNP GE TO-3		\$381.00	
2N475B PNP GE TO-3		\$381.00	
2N476A PNP GE TO-3		\$381.00	
2N476B PNP GE TO-3		\$381.00	
2N477A PNP GE TO-3		\$381.00	
2N477B PNP GE TO-3		\$381.00	
2N478A PNP GE TO-3		\$381.00	
2N478B PNP GE TO-3		\$381.00	
2N479A PNP GE TO-3		\$381.00	
2N479B PNP GE TO-3		\$381.00	
2N480A PNP GE TO-3		\$381.00	
2N480B PNP GE TO-3		\$381.00	
2N481A PNP GE TO-3		\$381.00	
2N481B PNP GE TO-3		\$381.00	
2N482A PNP GE TO-3		\$381.00	
2N482B PNP GE TO-3		\$381.00	
2N483A PNP GE TO-3		\$381.00	
2N483B PNP GE TO-3		\$381.00	
2N484A PNP GE TO-3		\$381.00	
2N484B PNP GE TO-3		\$381.00	
2N485A PNP GE TO-3		\$381.00	
2N485B PNP GE TO-3		\$381.00	
2N486A PNP GE TO-3		\$381.00	
2N486B PNP GE TO-3		\$381.00	
2N487A PNP GE TO-3		\$381.00	
2N487B PNP GE TO-3		\$381.00	
2N488A PNP GE TO-3		\$381.00	
2N488B PNP GE TO-3		\$381.00	
2N489A PNP GE TO-3		\$381.00	
2N489B PNP GE TO-3		\$381.00	
2N490A PNP GE TO-3		\$381.00	
2N490B PNP GE TO-3		\$381.00	
2N491A PNP GE TO-3		\$381.00	
2N491B PNP GE TO-3		\$381.00	
2N492A PNP GE TO-3		\$381.00	
2N492B PNP GE TO-3		\$381.00	
2N493A PNP GE TO-3		\$381.00	
2N493B PNP GE TO-3		\$381.00	
2N494A PNP GE TO-3		\$381.00	
2N494B PNP GE TO-3		\$381.00	
2N495A PNP GE TO-3		\$381.00	
2N495B PNP GE TO-3		\$381.00	
2N496A PNP GE TO-3		\$381.00	
2N496B PNP GE TO-3		\$381.00	
2N497A PNP GE TO-3		\$381.00	
2N497B PNP GE TO-3		\$381.00	
2N498A PNP GE TO-3		\$381.00	
2N498B PNP GE TO-3		\$381.00	
2N499A PNP GE TO-3		\$381.00	
2N499B PNP GE TO-3		\$381.00	
2N500A PNP GE TO-3		\$381.00	
2N500B PNP GE TO-3		\$381.00	

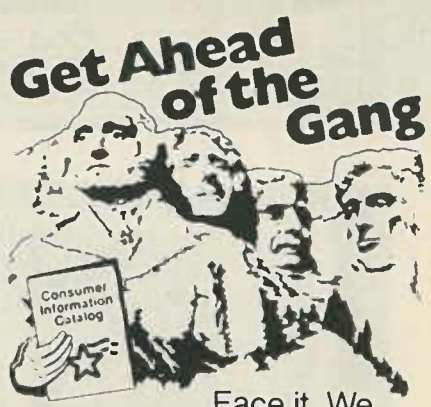

Face it. We could all use a little concrete advice now and then.

Whether you're making a monumental decision like a career change, or a more routine one like an oil change, the free Consumer Information Catalog can make it easier.

The Catalog is published quarterly by the Consumer Information Center of the U.S. General Services Administration to bring you the latest on government programs and a mountain of other information that you can use.

The Catalog lists more than 200 government booklets to help you... start a business, find a job, plan your retirement, repair your home, or carve out a nutrition and exercise program to improve your profile. And many of these booklets are free.

So order your Catalog today. Any way you look at it, you'll be head and shoulders above the crowd.

Just send your name and address on a postcard:

# MCM ELECTRONICS

WE HAVE WHAT YOU NEED AT  
THE PRICES YOU WANT!

CALL TOLL FREE  
**1-800-543-4330**

(IN OHIO 1-800-762-4315)

(IN HAWAII OR ALASKA 1-800-858-1849)



**TENMAT®**  
**DROP PROOF  
DIGITAL  
MULTIMETER**

- DC Input Impedance 10M ohm
- Shock-mounted LCD display
- Overload protection ■ Auto polarity ■ Backed by our 2-year limited warranty ■ For more specifications see MCM catalog #9, page 124

#72-057 **\$29<sup>95</sup>** each

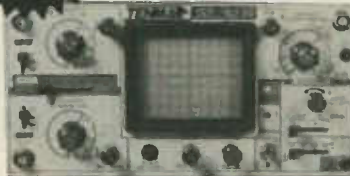

**TENMAT®**  
**15 MHz DUAL TRACE  
BATTERY OPERATED  
OSCILLOSCOPE**

- Two High Quality 10:1 Probes Included ■ Backed by our 2-year Limited Warranty ■ Internal rechargeable batteries provide 2 hours of continuous operation without the need for any outside power source. ■ For specifications see Supplement #4 of Catalog #9.

#72-335 **\$489<sup>95</sup>**



**TENMAT®**  
**3 1/2 DIGIT LDC  
MULTIMETER**

- DC Input Impedance 10M ohm
- Diode and HFE transistor tests
- Overload protection ■ Auto polarity ■ Backed by our 2-year limited warranty ■ For more specifications see MCM catalog #9, page 118

#72-050 **\$36<sup>80</sup>** (1-9) (10-up)



**TENMAT®**  
**35 MHz DUAL TRACE  
OSCILLOSCOPE**

- Two High Quality 10:1 probes included
- Backed by our 2-year limited warranty
- For specifications see MCM catalog #9, page 118

#72-330 **\$569<sup>00</sup>**



**TENMAT®**  
**DIGITAL  
CAPACITANCE  
METER**

- Measures capacitors from 0.1pF to 1999mFd ■ Accuracy 0.5% typical ■ Fuse protected
- Checks capacitors in and out of circuit ■ Backed by our 2-year limited warranty ■ For more specifications see MCM catalog #9, page 118

#72-040 **\$54<sup>95</sup>** each (2-up)

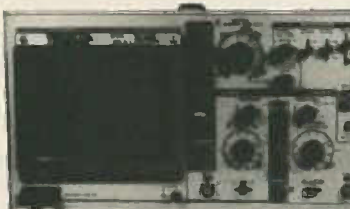

**TENMAT®**  
**20 MHz DUAL TRACE  
OSCILLOSCOPE**

- Two High Quality 10:1 probes included
- Backed by our 2-year limited warranty
- For specifications see MCM catalog #9, page 118

#72-320 **\$389<sup>95</sup>**

**PORT SWITCHES**

Eliminates the need to plug and unplug cables when you need to use a different printer or CRT. Enables you to easily access one printer from different computers; or access multiple printers from one computer with the turn of a switch. Two different models:

25 pin RS232 female type: Connect up to 4 peripherals to a single I/O port. Pin one common ground.

36 pin Centronics type: Connect up to 2 printers or modems to a single port. All 36 conductors are switched pin for pin.

(no mixed quantities)



#83-600  
RS232 type



#83-610  
36-pin  
Centronics type

\$64.80 (1-3)

**\$59<sup>95</sup>** (4-up)

**BE SURE TO CALL  
FOR YOUR FREE**

**132  
PAGE  
CATALOG!  
OVER  
5,000  
ITEMS!**



We have the Largest Selection of Original Japanese Semiconductors in the Country!

**We Also Have...** a full line of test equipment, computer accessories, telephone accessories, speakers, television parts, flybacks, yokes, switches, fuses, lamps, capacitors, resistors, cartridges, styl, wire, CATV equipment, and many more. Over 5,000 items AT THE LOWEST PRICES AROUND!

**Terms:**



- \$10 minimum order, \$1.00 charge for orders under \$10.
- \$20 minimum charge card order.
- Orders shipped UPS C.O.D.
- Most orders shipped within 24 hours.
- Sales office open 8:30 am to 6:00 pm. Saturdays 10:00 am to 3 pm EST.
- For prepaid orders add \$2.50 for shipping and handling.
- Should shipping & handling charges exceed \$2.75 the balance due will be sent C.O.D.



**MCM  
ELECTRONICS**  
858 East Congress Park Drive  
Centerville, Ohio 45459  
513-434-0031

SOURCE NO. RE-10

# For cable accessories, there's no place like Sone.



1. **JERROLD RSX WIRED REMOTE\*** This 36 Channel Remote features: fine tuning control-20 foot cord-90 day warranty.
2. **JERROLD JRX WIRED REMOTE\*** This 36 Channel Remote features: 20 foot cord-fine tuning control-90 day warranty.
3. **JERROLD RSC WIRED REMOTE\*** This 30 Channel Remote's features include: 20 foot cord-fine tuning control-90 day warranty.
4. **EAGLE EVSC-2000 REMOTE CABLE TV CONVERTER** You can choose from up to 60 cable TV Channels with this powerful unit. Other features include: last channel recall-favorite channel scan-remote control.
5. **DW-63K ELECTRONIC VIDEO SELECTOR** This sophisticated video selector allows you to connect up to 6 different inputs and 3 outputs. Features include: LED monitor display-soft touch keyboard.
6. **VIEWSTAR VSS-1000 REMOTE TV CONVERTER WITH VOLUME CONTROL** Expand the excitement of cable TV viewing with this 67 Channel unit. Features include: fine tuning control-last channel recall-remote control.
7. **CABLE TV BLOCK CONVERTER** Program your VCR to record one channel while you watch another. This unit also restores control functions and fine tunes for offset channels.
8. **CHANNEL SCAN WIRELESS REMOTE CONTROL** A fully assembled, easy to install remote control for your TV. Features include: channel changer and illuminated channel indicator.
9. **DW-42K ELECTRONIC VIDEO SELECTOR** This unit can handle up to 4 different inputs and 2 outputs. Features include: LED display monitor-soft touch keyboard.

\* Factory Refurbished

**Now You Can Record Boxing on ESPN at 8P.M.,  
Your Favorite Sitcom on Network at 10 and the Late Movie on HBO —  
All Without Ever Going Home to Change Channels.  
Introducing CableMaster**

CableMaster features a special time-control capability that allows you to record any combination of channels unattended — up to 8 events, two weeks in advance.

There's no special installation needed, and no new connection necessary to your cable equipment or VCR. All you do is plug the CableMaster into an electrical outlet, plug in the special



"Personality Module" that's coded for the descrambler used by your cable company, and the CableMaster is ready to record your favorite programs.

**Special Features**  
Include: • 14 day, 8 event timer • Quartz Clock • Automatic Sequencing of Programmed Events  
**Only \$149.**

Check method of payment	Quantity	Prices	1 piece	3 pieces	10 pieces Total
<input type="checkbox"/> VISA <input type="checkbox"/> MASTERCARD <input type="checkbox"/> C.O.D. (Cash)	1. Jerrold RSX	\$44	\$44	\$40	\$35
Credit card number _____ Expiration date _____	2. Jerrold JRX	\$49	\$44	\$39	\$35
Signature _____ Name _____	3. Jerrold RSC	\$39	\$35	\$30	\$25
Address _____	4. Eagle EVSC	\$99	\$89	\$79	\$69
City _____ State _____ Zip _____	5. DW-63K	\$69	—	\$52	\$45
For CableMaster, please list the descrambler used by your Cable Company	6. Viewstar	\$119	\$109	\$99	\$89
	7. Block	\$19	\$15	\$11	\$8
	8. Channel Scan	\$49	\$44	\$39	\$35
	9. DW-42K	\$45	—	\$39	\$35
	10. CableMaster	\$149	—	\$145	\$140

For larger quantities or catalog, please call or write.

**Sone Associates • 5 Broadway - Suite 201 • Troy, N.Y. 12180 • (518) 274-0608**

# Do Kay

COMPUTER PRODUCTS, Inc.

## APPLE ACCESSORIES

80 Column Apple II+	... 149.95
80 Column Apple IIE	... 129.95
Z80 Apple II+	... 89.00
Z80 Apple IIE	... 89.00
16K Card	... 39.95
Cooling Fan	... 38.95
Power Supply	... 74.95
Joystick	... 29.95
RF Modulator	... 13.95
Disk Drive	... 199.00
Controller Card	... 59.95
Paddles	... 7.95

## Reg. Power Supply Model 4A/PS (99/4)

**3 DC Outputs:**

12V @ .4A, +5V @ 1.1A  
-5V @ .2A Highly Filtered

**6.95**



## MEMORY EXPANSION KIT



**4164 150ns**

**9 for \$29.97**

ORDER TOLL FREE

**(800)**

**538-8800**

(CALIFORNIA RESIDENTS)

**(800)**

**848-8008**



**Telex: 756440**

VISIT OUR RETAIL STORE

2100 De La Cruz Blvd  
Santa Clara, CA 95050  
(408) 988-0697

CIRCLE 110 ON FREE INFORMATION CARD



# Radio Shack Parts Place®

Over 1000 Items in Stock! At Everyday Low Prices!

## 4000-Series CMOS ICs

With Pin-Out and Specs



Type	Cat. No.	Each
4001	276-2401	.99
4011	276-2411	.99
4013	276-2413	1.19
4017	276-2417	1.49
4049	276-2449	1.19
4066	276-2466	1.19

## TTL Digital ICs

With Pin-Out and Specs

Type	Cat. No.	Each
7400	276-1801	.89
7404	276-1802	.99
7408	276-1822	1.29
7447	276-1805	1.59
7490	276-1808	1.09

## Axial-Lead Electrolytic Capacitors

- Factory-Fresh
- Highest Quality



µF	WVDC	Cat. No.	Each
4.7	35	272-1012	.49
10	35	272-1013	.59
22	35	272-1014	.69
47	35	272-1015	.69
100	35	272-1016	.79
220	35	272-1017	.89
470	35	272-1018	.99
1000	35	272-1019	1.59
2200	35	272-1020	2.49
4700	35	272-1022	3.59

## 1/4-Watt, 5% Resistors

39¢ Pkg. of 5



Ohms	Cat. No.	Ohms	Cat. No.
10	271-1301	10k	271-1335
100	271-1311	15k	271-1337
150	271-1312	22k	271-1339
220	271-1313	27k	271-1340
270	271-1314	33k	271-1341
330	271-1315	47k	271-1342
470	271-1317	68k	271-1345
1k	271-1321	100k	271-1347
1.8k	271-1324	220k	271-1350
2.2k	271-1325	470k	271-1354
3.3k	271-1328	1 meg	271-1356
4.7k	271-1330	10 meg	271-1365
6.8k	271-1333		

## Power Transformers

120 VAC Primaries

Type	Volts	Current	Cat. No.	Each
Miniature	6.3	300 mA	273-1384	2.59
Miniature	12.6	300 mA	273-1385	2.79
Miniature	25.2	300 mA	273-1386	3.49
Miniature	12.6 CT	450 mA	273-1365	3.59
Miniature	25.2 CT	450 mA	273-1366	3.99
Standard	6.3	1.2 A	273-1351	3.99
Standard	12.6 CT	1.2 A	273-1352	4.99
Standard	25.2	1.2 A	273-1353	5.99
Heavy-Duty	12.6 CT	3.0 A	273-1511	5.99
Heavy-Duty	25.2 CT	2.0 A	273-1512	6.29
Heavy-Duty	18.0 CT	2.0 A	273-1515	6.99

CT = Center Tap

## 120 VAC Circuit Breaker

Rated 2 amps at 120 VAC. Mounts in single 3/8" hole. Trips within 120 seconds at 3 1/2 amps. U.L. recognized. 270-1310 ..... 1.49

## Heavy-Duty AC Line Filter

795



Rated 250 VAC at 5 Amps, 50/60 Hz

Ideal for computers and transceivers. Keeps RFI from being conducted into equipment (or from equipment) through the AC power line. U.L. recognized. 273-103 ..... 7.95

## MOV Transient Protectors

Protect computers and sensitive electronics from damaging power-line "spikes".

Power Diss.	Cat. No.	Each
600 mW	276-570	1.59
1 watt	276-568	1.69

## Melody-Maker IC SALE!

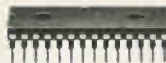

AY-3-1350. Pre-programmed with 28 popular tunes including Star Wars, Beethoven's 5th, Wedding March, and others. 28-pin DIP with data. Build a musical phone ringer or doorbell! Requires some extra parts. Reg. \$5.99. 276-1782 ..... Sale 2.99

## Submini Lever Switch



3/4"-long lever requires 45 grams to operate. Rated 5 amps at 250 VAC. Size: 3/4 x 1/4 x 3/8". 275-016 ..... 1.19

## Submini DPDT DIP Relay



For PC board or 16-pin socket mounting. 12 VDC coil. Contacts rated 1 amp at 125 VAC. 275-213 ..... 3.99

## SPECIAL PURCHASE! Continuity Tester Chassis



Circuit continuity produces a warbling tone. Possible uses: doorbell, security alarm, moisture sensor, capacitor/diode checker and more. Great experimenter's item at a bargain price! 9V battery extra. 277-1014 .. 1.95

## SALE! TV RF Modulator

30% Off

695 Reg. 9.95



This compact, wired chassis produces a high-quality video/sound signal on channel 3 or 4. Requires 6 VDC and a few external components (not incl.). With data. 277-221 ..... 6.95

## Speech Synthesizer IC

SPO256-AL2. This MOS LSI device uses a program stored in its built-in 16K ROM to synthesize natural sounding speech. Easy to interface with most computers. 28-pin DIP with detailed data. Requires external components, not incl. 276-1784 ..... 12.95

## Computer Connectors



Type	Positions	Cat. No.	Each
Solder Sub-D Male	25	276-1547	2.99
Solder Sub-D Female	25	276-1548	3.99
Hood for Above	25	276-1549	1.99
Printer Connector	36	276-1534	6.99
Sub-D Dustcaps (2)	25	276-1546	.39
Card Edge Connector	34	276-1564	4.95

## Timer IC Project Kit

Only 12<sup>95</sup> NEW!

Learn as you build! This package includes a special edition of our Engineer's Mini Notebook and parts to build 14 circuits with the versatile 555 timer IC. Features easy-to-understand text and large diagrams. Prepared by Forrest Mims III. Requires breadboard socket, such as our #276-175, and 9V battery. 277-051 .... 12.95

## Dictionary of Microcomputer Terms

Only 279



This valuable reference defines over 1000 terms which apply to personal computers and computing. 96 pages, paperback, with many illustrations. Easy-to-read. 62-1392 .... 2.79

## Fold-Up Autoranging LCD Multimeter



79<sup>95</sup>

Our Best!  
The DVM  
That "Thinks"

You choose the function and our professional quality DVM selects the correct range and polarity for you. Features a jumbo 1 1/8" display. "Beep" continuity function and diode/semiconductor junction test. Handy pushbutton ohms zero adjust. Automatic power-off conserves batteries. With leads, manual. Batteries extra. 22-193 .... 79.95

Over 1000 items in stock: Binding posts, Books, Breadboards, Buzzers, Capacitors, Chokes, Clips, Connectors, Fuses, Hardware, ICs, Jacks, Knobs, Lamps, Multitesters, PC Boards, Plugs, Rectifiers, Relays, Resistors, Switches, Tools, Transformers, Transistors, Wire, Zener Diodes, and more!

**Radio Shack**  
A DIVISION OF TANDY CORPORATION

Prices apply at participating Radio Shack stores and dealers

12 MILLION PC IC CLEARANCE CALL FOR QUANTITY DISCOUNTS

Table with columns: Part No., Price, Description. Includes various ICs like 7400, 7410, 7411, etc.

Table with columns: Part No., Price, Description. Includes various ICs like 7412, 7413, 7414, etc.

Table with columns: Part No., Price, Description. Includes various ICs like 7415, 7416, 7417, etc.

Table with columns: Part No., Price, Description. Includes various ICs like 7418, 7419, 7420, etc.

Table with columns: Part No., Price, Description. Includes various ICs like 7421, 7422, 7423, etc.

NEW EPROM

Table with columns: Part No., Price, Description. Includes 2816, 24 2048x8 16K EPROM 300ns...

Features: On-board Address/Data Latches, Auto-Timed Byte Write (on chip memory), 5V Erase/Write/Read, Optional High Voltage Erase/Program (12.5V), Power Up/Down Write Protection, Auto Check Before Write...

Digitaltalker™

DT1050 - Application: Loading test, software check, automatic, intelligent, language translation... DT1050 is a standard DIGITAL TALKER kit...

DT1050 Digitaltalker™ ..... \$34.95 ea. MM54104 Processor Chip..... \$14.95 ea.

DT1057 - Expands the DT1050 capacity from 132 to over 200 words. Read 2 800ms and opens. Part No. DT1057..... \$24.95 ea.

INTERISIL

Table with columns: Part No., Price, Description. Includes various ICs like 30009, 1983 INTERISIL Data Book (135pp)...

74HC High Speed CMOS

Table with columns: Part No., Price, Description. Includes various 74HC series ICs like 74HC00, 74HC01, etc.

74C G/MOS

Table with columns: Part No., Price, Description. Includes various 74C series ICs like 74C00, 74C01, etc.

LINEAR

Table with columns: Part No., Price, Description. Includes various linear ICs like LM7401, LM7402, etc.

MICROPROCESSOR COMPONENTS

Table with columns: Part No., Price, Description. Includes Microprocessor Chips like 6800, 6801, etc.

Table with columns: Part No., Price, Description. Includes Dynamic RAMs like 1102, 1103, etc.

Table with columns: Part No., Price, Description. Includes Static RAMs like 2102, 2103, etc.

Table with columns: Part No., Price, Description. Includes PROMs/EPROMs like 1702A, 1702B, etc.

Table with columns: Part No., Price, Description. Includes ROM/ROM Series like 8003, 8004, etc.

Table with columns: Part No., Price, Description. Includes ROM/ROM Series like 8005, 8006, etc.

Table with columns: Part No., Price, Description. Includes ROM/ROM Series like 8007, 8008, etc.

Table with columns: Part No., Price, Description. Includes ROM/ROM Series like 8009, 8010, etc.

Table with columns: Part No., Price, Description. Includes ROM/ROM Series like 8011, 8012, etc.

Table with columns: Part No., Price, Description. Includes ROM/ROM Series like 8013, 8014, etc.

Table with columns: Part No., Price, Description. Includes ROM/ROM Series like 8015, 8016, etc.

Table with columns: Part No., Price, Description. Includes ROM/ROM Series like 8017, 8018, etc.

Table with columns: Part No., Price, Description. Includes ROM/ROM Series like 8019, 8020, etc.

Table with columns: Part No., Price, Description. Includes ROM/ROM Series like 8021, 8022, etc.

Table with columns: Part No., Price, Description. Includes ROM/ROM Series like 8023, 8024, etc.

Table with columns: Part No., Price, Description. Includes ROM/ROM Series like 8025, 8026, etc.

Table with columns: Part No., Price, Description. Includes ROM/ROM Series like 8027, 8028, etc.

Table with columns: Part No., Price, Description. Includes ROM/ROM Series like 8029, 8030, etc.

Table with columns: Part No., Price, Description. Includes ROM/ROM Series like 8031, 8032, etc.

**Commodore Accessories**



**RS232 Adapter for VIC-20 and Commodore 64**

The JE232CM allows connection of standard serial RS232 printers, modems, etc. to your VIC-20 and C-64. A 4-pole switch allows the inversion of the 4 control lines. Complete installation and operation instructions included. Plugs into User Port • Provides Standard RS232 signal levels • Uses 6 signals (Transmit, Receive, Clear to Send, Request to Send, Data Terminal Ready, Data Set Ready).  
**JE232CM ..... \$39.95**

**VOICE SYNTHESIZER FOR APPLE AND COMMODORE**

**Plug-In - Talking in Minutes!**

**JE520CM** ..... \$114.95  
**JE520AP** ..... \$149.95

• Over 250 word vocabulary - allows all the formation of more than 500 words • Built-in amplifier, speaker, volume control, and audio jack • Recreates a clear, natural male voice • Plug-in user ready with documentation and sample software • Case size: 7 1/4" L x 3 1/4" W x 1-3/8" H

**APPLICATIONS:** • Security Warning • Telecommunication • Teaching • Handicap Aid • Instrumentation • Games

Part No.	Description	Price
JE520CM	For Commodore 64 & VIC-20	\$114.95
JE520AP	For Apple II, II+, and IIe	\$149.95

**Computer Memory Expansion Kits**

**IBM PC, PC XT and Compatibles**  
Most of the popular Memory Boards (e.g. Quadram® Expansion Board) allow you to add an additional 64K, 128K, 192K or 256K. The IBM64K Kit will simulate these boards in 64K byte increments. The Kit is simple to install - just insert the 8 - 64K RAM chips in the provided sockets and set the 2 groups of switches. Complete conversion documentation included.  
**IBM64K (Nine 200ns 64K RAMs)..... \$19.95**

**IBM PC AT**  
Each kit comes complete with nine 128K dynamic RAMs and documentation for conversion.  
**IBM128K (Nine 250ns 128K RAMs).... \$174.95**

**APPLE IIe**  
Extended 80-Column/64K RAM Card. Expands memory by 64K to give 128K when used with programs like VisiCalc™. Fully assembled and tested.  
**JE864..... \$99.95**

**TRS-80 MODEL I, III**  
Each Kit comes complete with eight MM5290 (UPD41116) 16K Dynamic RAMs and documentation for conversion. Model I: 16K equipped with Expansion Interface can be expanded to 48K with 2 Kits. Model III: Can be expanded from 16K to 48K using 2 Kits. Each Kit will expand computer by 16K increments.  
**TRS-16K3 200ns (Model III)..... \$6.29**  
**TRS-16K4 250ns (Model I)..... \$5.49**

**TRS-80 MODEL IV & 4P**  
Easy to install Kit comes complete with 8 ea. 4164N-20 (200ns) 64K Dynamic RAMs and conversion documentation. Converts TRS-80 Model IV computers from 16K to 64K. Also expands Model 4P from 64K to 128K.  
**TRS-64K-2..... \$17.95**  
(Converts the Model IV from 16K to 64K or will expand the Model 4P from 64K to 128K)  
**TRS-64K2PAL (Model IV only)..... \$38.95**  
(8 - 4164's with PAL Chip to expand from 64K to 128K)

**TRS-80 COLOR AND COLOR II**  
Easy to install Kit comes complete with 8 ea. 4164N-20 (200ns) 64K Dynamic RAMs and documentation for conversion. Converts TRS-80 Color Computers with D, E, EE, F and HC circuit boards to 32K. Also converts TRS-80 Color Computer II to 64K. Flex D0S or D0S-9 requires to utilize full 64K RAM on all computers.  
**TRS-64K-2..... \$17.95**

**INDUSTRIES**

**PROTECT YOURSELF... DATASHIELD® Surge Protector**

Eliminates voltage spikes and EM-RF noise before it can damage your equipment or cause data loss. 6-mo warranty. Power dissipation (100 microsecond): 2,000,000 watts

MODEL	DESCRIPTION	PRICE
MODEL 75	4 Sockets, On/Off Switch.....	\$48.95
MODEL 85	6 Sock., Super Filters, On/Off Switch.....	\$59.95
MODEL 100	6 Sock., Super Filters, Low Volt Alarm.....	\$69.95
MODEL 110AMS	6 Sockets, Super Filters, Auto Master Switch.....	\$99.95

**DATASHIELD Back-Up Power Source**

Protect your computer from black-out, brown-out, power surges and line noise. PT1 & PC200 is designed for PCs with floppy disk memory, the XT200 for hard disk memory and the AT200 for multi-user systems. A typical compatible PC for each of these standbys will be supported for 16 to 22 minutes after power is lost. Weight (PC200: 24 lbs.) (PC100: 37.5 lbs.) (XT200: 83 lbs.) (AT200: 83 lbs.)

PC200 (200 Watt Rating).....	\$299.95
XT200 (300 Watt Rating).....	\$399.95
AT200 (500 Watt Rating).....	\$499.95
AT800 (800 Watt Rating).....	\$799.95

**\*\*\* SUMMER SPECIALS \*\*\***



**Intelligent 300/1200 Baud Telephone Modem with Real Time Clock/Calendar**

The ProModem™ is a Bell 212A (300/1200 baud) Intelligent stand-alone modem. Full featured expandable modem. Standard features include Auto Answer and Auto Dial, Help Commands, Programmable Intelligent Dialing, Touch Tone™ and Pulse Dialing & More. Hayes command set compatible plus an additional extended command set. Shown w/Alphanumeric display option.

Part No.	Description	Price
PM1200	RS-232 Stand Alone Unit.....	\$319.95
PM1200A	Apple II, II+ and IIe Internal Unit.....	\$299.95
PM1200B	IBM PC and Compatible Internal Unit.....	\$239.95
PM1200BS	IBM PC & Compatible Internal Unit w/Mite Software.....	\$274.95
MAC PAC	Macintosh Package.....	\$369.95

(Includes PM1200, Cable, and ProCom-M Software)

**OPTIONS FOR ProModem 1200**

PM-COM	(ProCom Communication Software).....	\$79.95
PM-OP	(Options Processor).....	\$79.95
PMO-16K	(Options Processor Memory - 16K).....	\$ 4.50
PMO-32K	(Options Processor Memory - 32K).....	\$ 9.00
PMO-64K	(Options Processor Memory - 64K).....	\$18.00
PM-ALP	(Alphanumeric Display).....	\$79.95

**PM-Special** (Includes Options Processor, 64K Memory and Alphanumeric Display)..... **\$169.95**

**KEYBOARDS**

**Mitsumi 54-Key Unencoded All-Purpose Keyboard**

- SPST keyswitches • 20 pin ribbon cable connection • Low profile keys • Features: cursor controls, Control Caps Lock, function enter and shift keys • Color (keycaps): grey • WL: 1 lb. • Pinout included

**KB54..... \$14.95**

**82-Key ASCII Cherry Keyboard**

- 7-bit parallel ASCII • 11-key numeric keypad • Cursor keypad • SPST mechanical keyswitches • 4 illuminated keys • 26-pin header connector

Color: white • Size: 18" L x 8 1/2" W x 1 1/4" H • Spec included  
**KB8201..... (1700 avail)..... \$29.95**

**Apple Keyboard and Case for Apple II and II+**

Keyboard: 68 keys • 15-key keypad • Direct connection with 16-pin ribbon connector • 26 special functions • Size: 14 1/2" L x 5 1/2" W x 1 1/4" H

Case: Accommodates KB-A68 • Pop-up lid for easy access • Fits power supply and motherboard too • Size: 15 1/2" L x 18" D x 4 1/4" H

Part No.	Description	Price
KB-EA1	Apple Keyboard and Case (pictured above).....	\$134.95
KB-A68	68-Key Apple Keyboard only.....	\$ 79.95
EAEC-1	Expanded Apple Enclosure Case only.....	\$ 59.95

**POWER SUPPLIES**

**Power/Mate Corp. REGULATED POWER SUPPLY**

- Input: 105-125/210-250VAC at 47-63Hz • Line regulation: ±0.05% • Three mounting surfaces • Overvoltage protection • UL recognized • CSA certified

Part No.	Output	Size	Weight	Price
EMAS/6B	5V0.3A/6V0.25A	4 1/2" L x 4" W x 2 1/2" H	2 lbs	\$29.95
EMAS/6C	5V0.6A/6V0.5A	5 1/2" L x 4 1/2" W x 2 1/2" H	4 lbs	\$39.95

**KEPCO/TDK 4-OUTPUT SWITCHING POWER SUPPLY**

- Ideal for disk drive needs of CRT terminals, microcomputers and video games • Input: 115/230VAC/50/60Hz • Output: +5V @ 5 Amp, +12V @ 1.8 Amp, +12V @ 2 Amp, -12V @ 0.5 Amp • UL recognized • CSA certified • Size: 7 1/4" L x 5-3/16" W x 1 1/4" H • Weight: 2 lbs.

**\$59.95 each or MRM 174FK..... \$2 for \$99.95**

**Switching Power Supply for APPLE II, II+ & IIe™**

- Can drive four floppy disk drives and up to eight expansion cards • Short circuit and overload protection • Fits inside Apple computer • Fully regulated +5V @ 5A, +12V @ 1.5A, -5V @ 5A, -12V @ 5A • Direct plug-in power cord included • Size: 9 1/4" L x 3 3/4" W x 2 1/4" H • Weight: 2 lbs.

**KHP4007 (SPS-109)..... \$59.95**

**4-CHANNEL SWITCHING POWER SUPPLY**

- Microprocessor, mini-computer, terminal, medical equipment and process control applications • Input: 90-130VAC, 47-440Hz • Output: +5VDC @ 5A, -5VDC @ 1A, +12VDC @ 1A, -12VDC @ 1A • Line regulation: ±0.2% • Ripple: 30mV p-p • Load regulation: ±1% • Overcurrent protection • AGV-5V main output • 10% • Size: 5 1/4" L x 1 3/4" W x 4-15/16" H • Weight: 1 1/2 lbs.

**FCS-604A..... \$69.95**

**IBM PCXT EQUIVALENT 130 WATT POWER SUPPLY UPGRADE YOUR PC!**

- Input: 100V-130V/200V-260V selectable @ 47 to 63Hz • Output: -5VDC @ 1A, -5VDC @ 0.5A, +12VDC @ 4.2A, -12VDC @ 0.5A • Plug compatible connectors • Fits into IBM PC • Weight: 6 lbs.

**IBM-PS..... \$159.95**

\$10 Minimum Order - U.S. Funds Only CA Residents: Add 6 1/2% Sales Tax Spec Sheets - 30¢ each Shipping: Add \$4 plus \$1.50 Insurance Send \$1 Postage for FREE 1985 Jameco Catalog Prices Subject to Change Send stamped, self-addressed envelope to receive a Monthly Sales Flyer - FREE



1355 SHOREWAY ROAD, BELMONT, CA 94002

6/85 PHONE ORDERS WELCOME - (415) 592-8097 - Telex: 176043

CIRCLE 114 ON FREE INFORMATION CARD

**Apple Accessories**

**5 1/4" APPLE™ Direct Plug-In Compatible Disk Drive and Controller Card**

The ADD-514 Disk Drive uses Shugart SA-390 mechanics - 143K formatted storage • 35 tracks • Compatible with Apple Controller & ACC-1 Controller • The drive comes complete with connector and cable - just plug into your disk controller card • Size: 6 1/2" L x 3 1/2" W x 8-9/16" D • Weight: 4 1/2 lbs.

**ADD-514 (Disk Drive)..... \$189.95**  
**ACC-1 (Controller Card)..... \$ 49.95**

**More Apple Compatible Add-Ons...**

APF-1	(Cooling Fan with surge protection).....	\$39.95
KHP4007	(Switching Power Supply).....	\$59.95
JE614	(Numeric/Aux. Keypad for IIe).....	\$59.95
KB-A68	(Keyboard w/Keypad for II & IIe).....	\$79.95
MON-12G	(12" Green Monitor w/swivel stand).....	\$99.95
JE864	(80 Col. • 64K RAM for IIe).....	\$99.95
ADD-12	(5 1/4" Half-Height Disk Drive).....	\$169.95

**ADDITIONAL APPLE™ ADD-ONS AVAILABLE**

**ARC-16K** (16K RAM Card for Apple II & II+)..... \$39.95  
**AEB-2** (EPROM Burner for Apple II, II+ & IIe) Allows copy of standard EPROMS 2716, 2732, 2764..... \$69.95

**A80-C** (80-Column Card w/Soft Switch)..... \$74.95  
**ADD-IIc** (5 1/4" Half-Height Disk Drive for Apple IIc)..... \$169.95

**DISK DRIVES**

**Documentation Included Best Buy!**

MPI51S	(MPI 5 1/4" SS full-ht.).....	\$ 89.95
RFD480	(Random 5 1/4" DS full-ht.).....	\$109.95
TM100-2	(Tandem 5 1/4" DS full-ht.).....	\$159.95
FD55B	(Teac 5 1/4" DS half-ht.).....	\$149.95
SA455	(Shugart 5 1/4" DS half-ht.).....	\$159.95
FDD100-8	(Siemens 8" SS full-ht.).....	\$119.95
PKC-5	(5 1/4" Power Cable Kit).....	\$2.95
PKC-8	(8" Power Cable Kit).....	\$3.95

**UV-EPROM Eraser**

**8 Chips - 21 Minutes**

Erases all EPROMs. Erases up to 8 chips within 21 minutes (1 chip in 15 minutes). Maintains constant exposure distance of one inch. Special conducting foam line eliminates static build-up. Built-in safety lock to prevent UV exposure. Compact - only 9.00" L x 3.70" W x 2.60" H. Complete with holding tray for 8 chips.  
**DE-4 UV-EPROM Eraser..... \$74.95**

**1 Chip - 15 Minutes**

Erases all EPROMs. Erases up to 8 chips within 21 minutes (1 chip in 15 minutes). Maintains constant exposure distance of one inch. Special conducting foam line eliminates static build-up. Built-in safety lock to prevent UV exposure. Compact - only 9.00" L x 3.70" W x 2.60" H. Complete with holding tray for 8 chips.  
**UVS-11EL Replacement Bulb..... \$16.95**

**JE664 EPROM PROGRAMMER**

See Our New IBM Communications Program!

**24 & 28 PIN PACKAGES**

**8K to 64K EPROMs**

**REQUIRES NO ADDITIONAL SYSTEMS FOR OPERATION**

Programs and validates EPROMs • Checks for properly erased EPROMs • Emulates PROMs or EPROMs • Loads data in RAM by keyboard • Changes data in RAM by keyboard • Loads RAM from an EPROM • 64K RAMs can be used for external microprocessor development • Compares EPROMs for content differences • Copies EPROMs • Inputs: 115VAC @ 60Hz • Assembled and tested • Size: 15 1/4" L x 8 1/4" D x 3 3/4" H • Wt: 5 1/2 lbs • 2716 Module included  
**JE664-A EPROM Programmer..... \$995.00**

**JE65-RS232C INTERFACE OPTION** - This option implements computer access to the JE664-A RAM, allowing computer to manipulate, store, and transfer EPROM data to and from the JE664. Sample program listing is supplied in BASIC for CP/M computers • Documentation provided to assist the software to other computers with an RS232C port • Specs: 9600 Baud; 8-bit word, odd parity with 2 stop bits • Assembled and tested • 2716 Module included  
**JE664-ARS w/JE65 Option..... \$1195.00**

**JE884-ARS COMMUNICATION PROGRAM FOR IBM-PC or XT and Compatibles**

• Fast compatible BASIC program • Easy to use, menu-driven • Print hard-copy of EPROM data • View data in HEX and ASCII

**NEW!** The JE664-ARS Communication Program was written for quick interfacing between the JE664-ARS EPROM Programmer and the IBM-PC computer and compatible. Menu-driven program allows user to Load and Save EPROM data to and from the computer or floppy disk. Data entered by the computer can be viewed in Hex & ASCII form. Printed hard-copies are also displayed in both formats. Program is ideal for keeping archives of master EPROMs on disk. The program is compatible with all IBM-PC and XT computers. Computer requirements: IBM-PC, XT (or eq) with at least 128K RAM and one serial port. Optional: One parallel port for printer.  
**JE664-ARS-CP..... \$49.95**  
**JE664-ARS Communication's Program (5 1/4" Disk and User's Instructions)..... \$29.95**

**JE664-CP CABLE..... \$29.95**  
Cable for IBM-PC to JE664-ARS Program (5 Shielded Cable Assembly).  
**JUMPER (Personality) MODULES** - Jumper (Personality) Modules for SA 16K, 32K, and 64K EPROMs. Please specify EPROM and manufacturer.  
**JUMPER (Personality) MODULE..... \$14.95 each**

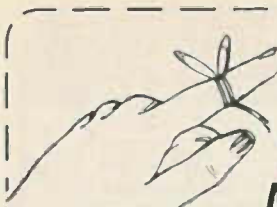

## "INCREASE YOUR MEMORY WITH 64K DRAM MEMORY CHIPS"

Return this ad for your complimentary catalog



Books • Breadboard & Accessories • Capacitors • Chemicals • Connectors • Crystals • Plugs & Jacks • Enclosures • Fans • Filters • Fuses • Heat Sinks • Kits • Knobs • Peripherals • Probes • Opto • PCB Products • Potentiometers • Power Supplies • Relays • Resistors • Cable Assemblies Sockets

**SPECIAL OF THE MONTH**

### Computer chips

4118	18K	150 NS	\$ .95
4164	64K	150 NS	\$ 2.15
41256	256K	150 NS	\$ 14.60

CALL FOR QUANTITY PRICING

## Active

YOUR ELECTRONIC COMPONENT CENTER

**MAIL ORDERS PROCESSED WITHIN 24 HRS**

SELF SERVE STORES

US	WESTBOROUGH MASS (617) 366-9684	BELLEVUE WASH (206) 881-8191
CANADA	MONTREAL (514) 731-7441 OTTAWA (613) 728-7900 TORONTO (416) 977-7692	DOWNSVIEW (416) 630-0400 EDMONTON (403) 438-5888 VANCOUVER (604) 438-3321 CALGARY (403) 235-5300

Correspondence P.O. Box 9100 Westborough, Mass 01581 USA 5851 Ferner St Montreal, Quebec H4P 1N1 CAN

CAN. 1-800-361-5884  
U.S. 1-800-343-0874

**DISK DRIVE SPECIAL:** Canon #MDD 210 5 1/4 In. 2/3 Height. New In Box. 40 Track, SS-DD. Compare At Up To \$159 Ea. Our Price \$49.95 or Two For \$85. Limited Qty.

## THE NEW ZRT-80 CRT TERMINAL BOARD!

A LOW COST Z-80 BASED SINGLE BOARD THAT ONLY NEEDS AN ASCII KEYBOARD, POWER SUPPLY, AND VIDEO MONITOR TO MAKE A COMPLETE CRT TERMINAL. USE AS A COMPUTER CONSOLE, OR WITH A MODEM FOR USE WITH ANY OF THE PHONE-LINE COMPUTER SERVICES.

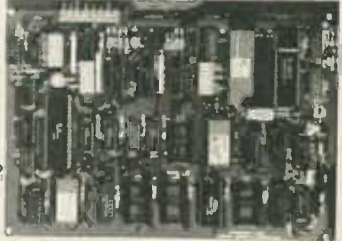

- FEATURES:**
- Uses a Z80A and 6845 CRT Controller for powerful video capabilities.
  - RS232 at 16 BAUD Rates from 75 to 19,200.
  - 24 x 80 standard format (60 Hz).
  - Optional formats from 24 x 80 (50 Hz) to 64 lines x 96 characters (60 Hz).
  - Higher density formats require up to 3 additional 2K x 8 6116 RAMS.
  - Uses N.S. INS 8250 BAUD RATE GEN. and USART COMBO IC.
  - 3 Terminal Emulation Modes which are Dip Switch selectable. These include the LSI-ADM3A, the Heath H-19, and the Beehive.
  - Composite or Split Video.
  - Any polarity of video or sync.
  - Inverse Video Capability.
  - Small Size: 6.5 x 9 inches.
  - Upper & lower case with descenders.
  - 7 x 9 Character Matrix.
  - Requires Par. ASCII keyboard.

BLANK PCB WITH 2716 CHAR. ROM, 2732 MON. ROM

**\$49.95**

SOURCE DISKETTE - ADD \$10  
SET OF 2 CRYSTALS - ADD \$7.50

WITH 8 IN. SOURCE DISK! (CP/M COMPATIBLE)

**\$99.95** (COMPLETE KIT, # ZRT-80, 2K VIDEO RAM)

## Digital Research Computers

P.O. BOX 461565R • GARLAND, TEXAS 75046 • (214) 225-2309

Call or write for a free catalog on Z-80 or 6809 Single Board Computers, SS-50 Boards, and other S-100 products.

TERMS: Add \$3.00 postage. We pay balance. Orders under \$15 add 75c handling. No C.O.D. We accept Visa and MasterCard. Texas Res. add 5-1/8% Tax. Foreign orders (except Canada) add 20% P & H. Orders over \$50 add 85c for insurance.

ALL SALES SUBJECT TO THE TERMS OF OUR 90 DAY LIMITED WARRANTY. FREE COPY UPON REQUEST.

## MICRO MART

508 Central Ave.  
Westfield, N.J. 07090  
(201) 654-6008

**UHF-TV PREAMP**  
(As featured in Radio Electronics March/May articles, 1982)

This inexpensive antenna mounted pre-amp can add more than 25 db of gain to your system. Lots of satisfied customers and repeat orders for this high quality kit, which includes all component parts. PC BD, Case, Power Supply and Balun \$34.50 Assembled Version \$57.50

COILS FOR RADIO ELECT'S FEB 84 TV PROJECT, TOKO #B T-1,T-2, L-1(12UH) L-2(1.07UH) COMPLETE SET OF ALL 4 COILS.....	8.50
ROTARY SWITCH POSITION, SA 129V 3/1.00	
KC1330 PRIME (MOTO).....	1.19
8P4-9S TRANSISTOR.....	1.50
DISC CAPS. 0.01UF.....	20/1.00
PRECISION TRIM POT'S-100 OHM, 500 OHM, 1K, 2K, 5K, 10K, 20K, 50K, 100K, 200K, 500K, 1M.....	31/1.95
74123 1711.....	.49
GIGI'S ALPHA BUREAU DISKETS 1 1/2" 5 1/4" 3 1/2" 5 1/4" RED LED MATRIX, W/DATA.....	4.95
ALL LED BEE GRAB BARE-2 3/4" LONG, RECT LED 5/8" SPEC'Y RED, ORN, AMB/W/DATA.....	2.69
MULTIPLE LED 15-3801-19 RANGES W/BUZZER CONTINUITY & TRANS. TEST LEADS, W/LED FUSE DIODE PROTECTED, W/TEST LEADS, 19.95	
OHM BUCKLE-ALARM 15-8901-1MC SIREN, TINY NE CHAIN TRANSMITTER W/DIO RADIO CONTROL PROTECTS COORDS, HOOD, TRIM, CB, ETC.....	119.95
2-2222A PLASTIC, PC LEADS (44").....	20/1.00
1M94 IPRIME, T & B.....	40/1.00
10K W/DRELESS BREADBRD-640 TIE PTS. 9.95	
AND 1390 TIE PTS ON ALUMINUM 84 PLATE MOUNTING HOLES.....	14.95
7812 VOLTAGE REGULATOR IPRIME-TD-220.....	.39
7812 VOLTAGE REGULATOR IPRIME.....	.39
7805 VOLTAGE REGULATOR IPRIME.....	.39
7805 VOLTAGE REGULATOR IPRIME.....	.39
7824 VOLTAGE REGULATOR IPRIME.....	.39
TAPPED TRANSFORMER 17A1, 7.5, 9, 15, 18V-0.95	
WALL PLUG TRANSFORMER 24V 232MA.....	83.95
464 PINNAC RAINBOW 84 DATE CODE, PRIME IDEAL FOR IBM PC'S & CLOSERS (150A).....	3.95
1 OHM CHRYSTALS.....	3.95
JUMBO RED LED'S-DIFFUSED LENS, PRIME (11) NO COSMETIC DEFECTS. ALL 100%.....	15/1.00
1000, 100, 1, 0.001, .01, .05.....	3/1.00
8 PIN IC SOCKETS.....	15/1.00
47K 5W RADIAL (1MCH10M).....	10/1.00
TE-AS INST/404A CAL BOARD-1MC/DATA 40P PINS MADE WHEN EACH KEY DEPRESSED.....	4.95
CLOCK-MODULE-CRYSTAL CONTROLLED, GREEN	

DISPLAY/200C/TIME SET SWITCHES/DATA-8.95	
MINI-DISPLAY/100C/TIME/LEVEL/DETECTION	
BIT-ENB AUTO/MANUAL OR ANI EXTER LEVEL APPLICATIONS. INCLUDES 25 DR. 6M CARLS. & ILLUSTRATIONS. 92.22. PROTECT CASE 82	
POTS-7 REG. LINEAR TAPER.....	3/1.00
01P SWITCH-3 POSITION.....	10/1.00
MOTION DETECTOR BOARDS-82 EACH.....	7/10.00
MOTION DETECTOR IC-SILICON 2232313/82, 20/610	
BLACK PLASTIC PROJECT BOX FOR ABOVE-1.95	
EXTENSIVE CONSTRUCTION ARTICLE FOR DET. \$1 1,000 PC RESISTOR ASS'T 130 VALUES/2M-83	
7805 VOLTAGE REGULATORS.....	10/1.00
.22UF 50V MONOLITHICS.....	20/1.00
4.7UF 40V RADIAL.....	19/1.00
TRIM POT'S-PIPER P10M, HOR, 31B-REX/PATEL, 100 OHM, 1W, 10K, 25K, 50K, 100K, 200K.....	4/1.00
LM1310'S.....	2/1.00
CD4047.....	.75
LM380 (LM2280).....	.95
MOLBY PINS-7 PIPER PIP-900/4.00, 1,000/96	
2N5308.....	10/1.00
LED MOUNTING CLIPS/RINGS.....	19/1.00
ZENER DIODES-20V 1W.....	30/1.00
1M4007'S.....	20/1.00
25W/1W REPLACEMENT IC BECKMAN 8A EACH	
221-42, 221-43, 221-45, 221-48, 221-49, 221-79, 221-87, 221-96, 221-104, 221-105, 221-106	
221-140 INDUSTRY REPLAC.....	1.00, 4.90
REPLACEMENT 8441CA32171, 20 PIN IC.....	8.90
26C1122B1T0818A HORIZ. OUTPUT.....	1.95
3.3795458 COLOR BURST CRYSTAL.....	.85
2932 EPROMS.....	2/1.95
TRANSFORMERS-8.2W 1.2AMP.....	1.95
ADJUSTABLE COIL-0.8UH.....	7.90
ADJUSTABLE COIL-1.2UH.....	2.90
2240 & 2740 W/5V.....	50/1.00
CHIP CAPS-SET OF 4, 2 EACH 2.7K, 30P 1.00	
ZENER DIODES-15V 1W, 0.45W.....	20/1.00
SHC-T CONNECTOR (AMPHENOL) 274.....	.95
MINIATURE GEAR MOTOR (ALUPOW).....	2/1.00
9.000UF 25V LYTC (COMPUTER GRADE) 31.00	
1UF 50V MONOLITHIC.....	10/1.00
22144 PIN CONNECTOR (PUSH) 221-44RT1 21.00	
22144 (INSUREAF-GOLD) 221-44RT2 21.00	
LM565, PRIME, HOUSE#BL4505.....	21.00
ANTENNE-15 A.C. AMPERS.....	4.95
CD4559 IPRIME.....	4.95
LM329 IPRIME.....	.95
1/2 W ANTS-INDOOR POLE MT, OUTDOOR MT	
78 INDOOR WALL SPEC. 11MC HPDWR, 809 9.95	
VOLTAGE REGULATORS (10-220) 1W 25 POS/NEG	
W AD3, UNMARKED, YOU TEST/HOBBY 10/1.00	

**MICRO-CONTROLLER BOARD (Kit/\$119.50)**

Terms: MICRO-MART accepts Visa, MC and telephone C.O.D.'s. Minimum order \$10.00. Shipping—US orders \$2.00. Canada and other countries \$3.50 (includes ins.) Shipping rate adjusted where applicable. NJ residents add 6% sales tax.

**MICRO-MART • 508 CENTRAL AVE., WESTFIELD, NJ 07090 • (201) 654-6008**

## MICROWAVE TV ANTENNA SYSTEMS

Freq. 2.1 to 2.7 GHz . 34 db Gain +

**COMPLETE SYSTEMS:**  
(as Pictured)

**Commercial 40"**  
Rod Style \$99.95  
Parabolic 20"  
Dish Style \$79.95

**COMPONENTS**  
Down Converters  
(either style) \$34.95  
Power Supplies \$24.95  
(12V to 16V. DC+)

Data Info (Plans) \$ 9.95

**LIFETIME LIMITED WARRANTY PARTS & LABOR**

Shipping & Handling Add \$5.00  
We Repair Most Types Down Converters & Power Supplies

**Phillips-Tech Electronics**  
P.O. Box 34772  
Phoenix, AZ 85087  
(602) 947-7700  
Special Quantity Pricing Dealers Wanted

MasterCard VISA COD'S

RADIO-ELECTRONICS

NATIONAL SEMICONDUCTOR • PANALOC MACHINE • EWC, INC. • INTERSIL, EAC, INC. • J. W. MILLER • AAVID ENG E. F. JOHNSON • ATLANTIC SEMICON

QUALITY - Name brand products from nationally recognized manufacturers. SERVICE - Computerized order processing and inventory control. SAVINGS - Volume Discounts • OEM Quantity Pricing • Toll Free 800 Number

TIC DIODES • DIAMOND TOOL • UNGAR • STRIES • CW INDUSTRIES • AMDEK • G.E. • UNGAR • YAGEO • J. W. MILLER • LUXO • GC CHEMICAL • ARIES • PLESBEY

INTEGRATED CIRCUITS

Table listing various integrated circuits such as 74LS00, 74LS01, 74LS02, etc., with their respective prices.

METAL FILM RESISTORS

Table listing metal film resistors with values like 100 Ohm, 1K, 10K, etc., and their prices.

TIC SOCKETS

Table listing TIC sockets with various pin counts and prices.

PANASONIC ELECTROLYTIC KIT

Table listing Panasonic electrolytic capacitors with values like 100uF, 220uF, etc., and prices.

DISC CAPACITORS

Table listing disc capacitors with various values and prices.

TANTALUM CAPACITORS

Table listing tantalum capacitors with various values and prices.

STANDARD RESISTOR VALUE TABLE

Table showing standard resistor values for E24, E96, and E192 series.

Carbon Film Resistors

Table listing carbon film resistors with values and prices.

WIRE WRAP DIP SOCKETS

Table listing wire wrap DIP sockets with various pin counts and prices.

TI EDGEBOARD CONNECTORS

Table listing TI edgeboard connectors with various pin counts and prices.

250 DISC CAPACITORS

Table listing 250 disc capacitors with various values and prices.

PANASONIC TANTALUM KIT

Table listing Panasonic tantalum capacitors with various values and prices.

416 200 nrad. 16.384 I/O Ham

Table listing 416 200 nrad. 16.384 I/O Ham components with prices.

Si Silicon Transistors

Table listing silicon transistors with various types and prices.

4H SERIES "16" 200' EDGEBOARD CONNECTORS

Table listing 4H series edgeboard connectors with various pin counts and prices.

PANASONIC 5V SERIES

Table listing Panasonic 5V series capacitors with various values and prices.

150 TANTALUM CAPACITORS

Table listing 150 tantalum capacitors with various values and prices.

PANASONIC TSW SERIES

Table listing Panasonic TSW series capacitors with various values and prices.

1 AMP SILICON RECTIFIERS

Table listing 1 amp silicon rectifiers with various types and prices.

3 AMP SILICON RECTIFIERS

Table listing 3 amp silicon rectifiers with various types and prices.

ELECTRONIC HARDWARE KIT

Table listing electronic hardware kit components with prices.

4H SERIES "16" 200' EDGEBOARD CONNECTORS

Table listing 4H series edgeboard connectors with various pin counts and prices.

170 METALLIZED POLYESTER KIT

Table listing 170 metallized polyester kit components with prices.

AMP Champ Converters

Table listing AMP Champ converters with various types and prices.

416 200 nrad. 16.384 I/O Ham

Table listing 416 200 nrad. 16.384 I/O Ham components with prices.

Si Silicon Transistors

Table listing silicon transistors with various types and prices.

4H SERIES "16" 200' EDGEBOARD CONNECTORS

Table listing 4H series edgeboard connectors with various pin counts and prices.

PANASONIC 5V SERIES

Table listing Panasonic 5V series capacitors with various values and prices.

150 TANTALUM CAPACITORS

Table listing 150 tantalum capacitors with various values and prices.

PANASONIC TSW SERIES

Table listing Panasonic TSW series capacitors with various values and prices.

1 AMP SILICON RECTIFIERS

Table listing 1 amp silicon rectifiers with various types and prices.

3 AMP SILICON RECTIFIERS

Table listing 3 amp silicon rectifiers with various types and prices.

ELECTRONIC HARDWARE KIT

Table listing electronic hardware kit components with prices.

4H SERIES "16" 200' EDGEBOARD CONNECTORS

Table listing 4H series edgeboard connectors with various pin counts and prices.

170 METALLIZED POLYESTER KIT

Table listing 170 metallized polyester kit components with prices.

AMP Champ Converters

Table listing AMP Champ converters with various types and prices.

WHEN ORDERING BY PHONE CALL 1 800 344-4539 OR 218 681-6674 BY MAIL SEND YOUR ORDER TO DIGI KEY 701 Brooks Ave South, Thief River Falls, MN 56581

WHILE ORDERING BY PHONE CALL 1 800 344-4539 OR 218 681-6674 BY MAIL SEND YOUR ORDER TO DIGI KEY 701 Brooks Ave South, Thief River Falls, MN 56581

WHILE ORDERING BY PHONE CALL 1 800 344-4539 OR 218 681-6674 BY MAIL SEND YOUR ORDER TO DIGI KEY 701 Brooks Ave South, Thief River Falls, MN 56581

WHILE ORDERING BY PHONE CALL 1 800 344-4539 OR 218 681-6674 BY MAIL SEND YOUR ORDER TO DIGI KEY 701 Brooks Ave South, Thief River Falls, MN 56581

WHILE ORDERING BY PHONE CALL 1 800 344-4539 OR 218 681-6674 BY MAIL SEND YOUR ORDER TO DIGI KEY 701 Brooks Ave South, Thief River Falls, MN 56581

**PARTIAL LISTING ONLY- PLEASE CALL OR WRITE FOR FREE CATALOG.**

**STATIC RAMS**

2112	256x4 (450ns)	2.99
2114	1024x4 (450ns)	8/9.95
2114-25	1024x4 (250ns)	8/10.95
2114L-4	1024x4 (450ns)(LP)	8/12.95
2114L-3	1024x4 (300ns)(LP)	8/13.45
2114L-2	1024x4 (200ns)(LP)	8/13.95
TMM2016-200	2048x8 (200ns)	3.25
TMM2016-150	2048x8 (150ns)	3.75
TMM2016-100	2048x8 (100ns)	4.75
HM6116-4	2048x8 (200ns)(cmos)	3.69
HM6116-3	2048x8 (150ns)(cmos)	3.95
HM6116LP-4	2048x8 (200ns)(cmos)(LP)	3.95
HM6116LP-3	2048x8 (150ns)(cmos)(LP)	4.25
HM6264P-15	8192x8 (150ns)(cmos)(LP)	10.25

LP = Low Power

**DYNAMIC RAMS**

4116-250	16384x1 (250ns)	8/6.95
4116-200	16384x1 (200ns)	8/8.95
4116-150	16384x1 (150ns)	8/10.95
4164-200	65536x1 (200ns)(5v)	9/19.95
4164-150	65536x1 (150ns)(5v)	9/21.95
TMS4164	65536x1 (150ns)(5v)	7.95

5v = Single 5 Volt Supply

**EPROMS**

2708	1024x8 (450ns)	3.95
2716	2048x8 (450ns)(5v)	3.95
2716-1	2048x8 (350ns)(5v)	4.95
TMS2532	4096x8 (450ns)(5v)	4.95
2732	4096x8 (450ns)(5v)	4.25
2732A-4	4096x8 (400ns)(5v)(21vPGM)	4.95
2732A-35	4096x8 (350ns)(5v)(21vPGM)	4.95
2732A	4096x8 (250ns)(5v)(21vPGM)	6.95
2732A-2	4096x8 (200ns)(5v)(21vPGM)	10.95
2764	8192x8 (450ns)(5v)	4.95
2764-250	8192x8 (250ns)(5v)	5.25
2764-200	8192x8 (200ns)(5v)	8.95
27128	16384x8 (250ns)(5v)	11.95
27256	32768x8 (250ns)(5v)	29.95

5v = Single 5 Volt Supply  
21vPGM = Program at 21 Volts

**SPECTRONICS CORPORATION  
EPROM ERASERS**

	Timer	Chip Capacity	Intensity (uW/Cm <sup>2</sup> )	
PE-14		9	8,000	83.00
PE-14T	X	9	8,000	119.00
PE-24T	X	9	9,600	175.00

**8000**

8035	5.95
8039	5.95
8080	3.95
8085	4.95
8085A-2	11.95
8087-3	129.00
8087-6	119.00
8088	19.95
8155	6.95
8155-2	7.95
8156	6.95
8748	24.95
8755	24.95

**8200**

8203	39.95
8205	3.50
8212	1.80
8216	1.75
8228	3.49
8237-5	15.95
8243	4.45
8250	10.95
8251A	4.49
8253	6.95
8253-5	7.95
8255	4.49
8255-5	5.25
8259	6.90
8259-5	7.50
8272	19.95
8275	29.95
8279	6.95
8282	6.50
8284	5.50
8286	6.50
8288	14.95

**Z80  
2.5 Mhz**

Z80-CPU	2.49
Z80-CTC	2.95
Z80-PIO	2.95
Z80-SIO/0	9.95

**4.0 Mhz**

Z80A-CPU	2.49
Z80A-CTC	3.95
Z80A-DART	8.95
Z80A-PIO	3.95
Z80A-SIO/0	10.95

**6.0 Mhz**

Z80B-CPU	8.95
----------	------

**6500**

6502	4.95
6520	2.95
6522	5.49
6532	9.95
6551	9.95
6502A	5.95
6522A	9.95
6551A	11.95

**6800**

68000-8	39.95
6800	2.95
6802	7.95
6809	8.95
6809E	8.95
6821	2.95
6845	12.95
6850	3.25
6883	22.95

**DISK CONTR**

1771	15.95
1791	23.95
1793	23.95
UPD765	19.95

**INTERFACE**

8T26	1.59
8T28	1.98
DM8131	2.95
DP8304	2.29

**CLOCK CHIPS**

MM5314	4.95
MM5369	1.95
MM58167	8.95
MSM5832	3.95

**DATA ACQ**

ADC0804	3.49
ADC0809	4.49
ADC0817	9.95
DAC0808	2.95
MC1408L8	2.95

**SOUND CHIPS**

76477	3.95
76488	5.95
AY3-8910	12.95
SSI263	39.95

**74LS00**

74LS00	.24	74LS157	.65
74LS01	.25	74LS158	.59
74LS02	.25	74LS160	.69
74LS03	.25	74LS161	.65
74LS04	.24	74LS163	.65
74LS05	.25	74LS164	.69
74LS08	.28	74LS165	.95
74LS09	.29	74LS166	1.95
74LS10	.25	74LS169	1.75
74LS11	.35	74LS173	.69
74LS12	.36	74LS174	.55
74LS13	.46	74LS191	.89
74LS14	.59	74LS192	.79
74LS20	.25	74LS193	.79
74LS21	.29	74LS194	.69
74LS22	.29	74LS195	.69
74LS26	.29	74LS197	.79
74LS27	.29	74LS221	.89
74LS32	.29	74LS240	.95
74LS33	.56	74LS241	.99
74LS37	.35	74LS242	.99
74LS38	.36	74LS243	.99
74LS40	.25	74LS244	1.29
74LS42	.49	74LS245	1.49
74LS47	.75	74LS251	.59
74LS51	.25	74LS253	.59
74LS73	.39	74LS257	.59
74LS74	.36	74LS258	.59
74LS75	.39	74LS259	2.75
74LS76	.39	74LS260	.59
74LS85	.69	74LS266	.55
74LS86	.39	74LS279	.49
74LS90	.55	74LS280	1.98
74LS92	.55	74LS283	.69
74LS93	.55	74LS290	.89
74LS107	.39	74LS293	.89
74LS109	.39	74LS299	1.75
74LS112	.39	74LS323	3.50
74LS122	.45	74LS365	.49
74LS123	.79	74LS367	.45
74LS124	2.90	74LS368	.45
74LS125	4.49	74LS373	1.39
74LS126	4.49	74LS374	1.39
74LS132	5.9	74LS377	1.39
74LS136	39	74LS390	1.19
74LS138	55	74LS393	1.19
74LS139	55	74LS640	2.20
74LS145	1.20	74LS645	2.20
74LS148	1.35	74LS670	1.49
74LS151	.55	74LS682	3.20
74LS153	.55	74LS688	2.40
74LS154	1.90	81LS95	1.49
74LS155	.69	25LS2521	2.80
74LS156	.69		

**7400**

7400	.19	7492	.50
7401	.19	7493	.35
7402	.19	74100	1.75
7403	.19	74107	.30
7404	.19	74116	1.55
7405	.25	74121	.29
7406	.29	74122	.45
7407	.29	74123	.49
7408	.24	74125	.45
7409	.19	74126	.45
7410	.19	74132	.45
7411	.25	74145	.60
7413	.35	74148	1.20
7414	.49	74150	1.35
7416	.25	74151	.55
7417	.25	74153	.55
7420	.19	74154	1.25
7421	.35	74155	.75
7425	.29	74157	.55
7427	.29	74159	1.65
7430	.19	74161	.69
7432	.29	74163	.69
7437	.29	74164	.85
7438	.29	74165	.85
7442	.49	74166	1.00
7445	.69	74173	.75
7447	.69	74174	.89
7448	.69	74175	.89
7473	.34	74185	2.00
7474	.33	74192	.79
7475	.45	74193	.79
7476	.35	74194	.85
7483	.50	74259	2.25
7485	.59	74367	.65
7489	2.15	74368	.65
7490	.35	74393	1.35

**74S00**

74S00	.32
74S02	.35
74S04	.35
74S05	.35
74S08	.35
74S10	.35
74S11	.35
74S20	.35
74S32	.40
74S37	.88
74S74	.50
74S86	.50
74S112	.50
74S124	2.75
74S132	1.24
74S133	.45
74S138	.85
74S139	.85
74S140	.55
74S151	.95
74S153	.95
74S157	.95
74S158	.95
74S161	1.95
74S163	1.95
74S174	.95
74S175	.95
74S240	2.20
74S241	2.20
74S244	2.20
74S280	1.95
74S287	1.90
74S288	1.90
74S373	2.45
74S374	2.45
74S471	4.95

**★★★★HIGH-TECH★★★★**

**8087-6 \$119.00**

- \* 4.87 MHz VERSION
- OF 8087 MATH COPROCESSOR
- \* IBM-PC COMPATIBLE
- \* RUNS TURBO PROGRAMS AS MUCH AS 100 TIMES FASTER THAN 8088 ALONE

**★★★★SPOTLIGHT★★★★**

**CRYSTALS**

32.768Khz	1.95
1.0Mhz	3.95
1.8432	3.95
2.0	2.95
2.4576	2.95
3.579545	2.95
4.0	2.95
5.0	2.95
5.0688	2.95
6.0	2.95
6.144	2.95
8.0	2.95
10.0	2.95
10.738635	2.95
14.31818	2.95
15.0	2.95
16.0	2.95
MC3470	2.95
MC3487	2.95
17.430	2.95
18.432	2.95
20.0	2.95

**UARTS**

AY5-1013	3.95
AY3-1015	6.95
TR1602	3.95
2651	8.95
IM6402	7.95

**BIT-RATE GENERATORS**

BR1941	11.95
4702	12.95
COM8116	10.95
14411	11.95

**MISC.**

3242	7.95
MC3470	2.95
MC3487	4.95
16.0	2.95
AY5-3600 PRO	11.95
HD46505P	15.95
CRT5027	19.95

**LINEAR**

TL084	2.19	NE564	2.95
LM301	.34	LM565	.99
LM307	.45	LM566	1.49
LM308	.69	NE592	.98
LM309K	1.25	LM733	.98
LM310	1.75	LM741	.35
LM311	.64	LM747	.69
LM317T	1.19	LM1310	1.49
LM317K	3.95	MC1330	1.69
LM318	1.49	MC1372	6.95
LM323K	4.95	LM1458	.59
LM324	.59	LM1488	.69
LM331	3.95	LM1489	.69
LM334	1.19	LM1496	.85
LM335	1.40	LM1800	2.37
LM336	1.75	LM1812	8.25
LM337T	1.95	LM1889	1.29
LM338K	3.95	ULN2	

# PARTIAL LISTING ONLY- PLEASE CALL OR WRITE FOR FREE CATALOG.

## CAPACITORS

### ELECTROLYTIC

RADIAL		AXIAL	
47uf	50v .14	10	50v .16
10	50v .15	22	16v .14
47	35v .18	47	50v .20
100	16v .18	100	15v .20
220	35v .20	150	25v .25

### 50v MONOLITHIC

.01uf	.14	.1	.18
.047	.15	.47	.25

### 50v DISC

10pf	.05	470	.05
22	.05	560	.05
25	.05	680	.05
27	.05	820	.05
33	.05	.001uf	.05
47	.05	.0015	.05
56	.05	.0022	.05
68	.05	.005	.05
82	.05	.01	.07
100	.05	.02	.07
220	.05	.05	.07
330	.05	.1	.12

### BYPASS CAPS

.01uf disc	50v	100/6.00
.1uf disc	12v	100/8.00
.01uf mono	50v	100/12.00
.1uf mono	50v	100/15.00

## ACCESORIES & PERIPHERALS

### FOR IBM

MAXIMIZER Memory Multifunction	259.95
HAYES SMARTMODEM 1200B	419.95
130W POWER SUPPLY	159.95
TEAC FD-55B 1/2 Ht. Disk Drive, DS/DD	119.95
MPI-B52 5 1/4" FDD, DS/DD	109.95
PROTOTYPE CARD	27.95
PROTOTYPE CARD With Decoding	29.95

### FOR APPLE

JDR 16K RAM CARD	39.95
EPROM PROGRAMMER RP525	79.95
PRINTMAX Parallel printer interface	49.95
BAL-500 1/2 Ht. Disk Drive, Teac Mechanism	169.95
BAL-525 1/2 Ht. Disk Drive, Alps Mechanism	139.95
MITAC AD-1 Full Height, Shugart Mechanism	179.95
DISK CONTROLLER CARD	49.95
VIEWMAX-80 80 Column For Apple II-	159.95
VIEWMAX-80e 80 Column For Apple IIe	129.95
THUNDERCLOCK Official PRODOS Clock	129.95
KRAFT JOYSTICK	39.95
60W POWER SUPPLY	49.95

### MISCELLANEOUS

ZENITH ZVM-123 15 MHz Green Monitor	105.00
NEC JB1201M 20 MHz Green Monitor	169.00
BMC BM-AU9191U Comp. 13" Color Monitor	279.00
BMC BX-80 PRINTER	199.95
NASHUA DISKETTES SS/SD Box of 10	19.95
VERBATIM DATALIFE DISKETTES DS/DD	34.95
DISKETTE FILE Holds 70 Diskettes	9.95

## BARGAIN HUNTERS CORNER

### SPECIAL PURCHASE!

### TAXAN RGB VISION III \$299.95

#### SUPER HI-RES RGB MONITOR ORIGINALLY MADE FOR ACORN COMPUTER

- 12" SCREEN
- 18 MHz BANDWIDTH
- 640 x 262 PIXELS
- 25 LINES X 80 COL.
- .38mm DOT PITCH WITH BLACK MATRIX FOR A SHARP IMAGE AND HIGH CONTRAST.

NO C.O.D. ORDERS PLEASE!

### ACCESSORIES

COLOR DISPLAY ADAPTOR FOR IBM PC/XT	\$129.00
RGB CABLE FOR IBM	\$16.95

### SPECIALS ENDS 6/30/85

## SWITCHING POWER SUPPLIES

### PS-ASTEC

MODEL AA 12110

+12V @ 2A

-12V @ .1A

+5V @ 2.5A or

5A if 12V not used

19.95

### PS-3

ASTEC AA11190

+5V @ 4A

+12V @ 2.5A

-5V @ .25A

-12V @ .30A

39.95

## IC SOCKETS

1-99 100

8 pin ST	.13	.11
14 pin ST	.15	.12
16 pin ST	.17	.13
18 pin ST	.20	.18
20 pin ST	.29	.27
22 pin ST	.30	.27
24 pin ST	.30	.27
28 pin ST	.40	.32
40 pin ST	.49	.39
64 pin ST	4.25	call

### ST-SOLDERTAIL

8 pin WW	.59	.49
14 pin WW	.69	.52
16 pin WW	.69	.58
18 pin WW	.99	.90
20 pin WW	1.09	.98
22 pin WW	1.39	1.28
24 pin WW	1.49	1.35
28 pin WW	1.69	1.49
40 pin WW	1.99	1.80

### WW-WIREWRAP

16 pin ZIF	4.95	call
24 pin ZIF	5.95	call
28 pin ZIF	6.95	call

### ZIF-TEXTTOOL (Zero Insertion Force)

## DISKETTE FILE

**\$8.95** IF PURCHASED WITH 50 DISKETTES OR MORE \$9.95 if purchased alone

- SMOKED ACRYLIC CASE WITH SIX INDEXED DIVIDERS
- RUGGED, HIGH QUALITY CONSTRUCTION
- HOLDS 70 5 1/4" DISKETTES, WITH ROOM TO SPARE



## NASHUA DISKETTES 5 1/4" SOFT SECTOR

DOUBLE SIDED, DOUBLE DENSITY WITH HUB RINGS

BULK PACKAGED IN FACTORY SEALED BAGS OF 50 INCLUDES DISKETTE SLEEVES AND WRITE PROTECT TABS. IDEAL FOR SCHOOLS, CLUBS, AND USERS GROUPS. THIS IS A SPECIAL PURCHASE. SO QUANTITIES ARE LIMITED. 5 YEAR WARRANTY.

**\$1.39 ea.** QTY 250    **\$1.49 ea.** QTY 100    **\$1.59 ea.** QTY 50

## D-SUBMINIATURE

DESCRIPTION	ORDER BY	CONTACTS				
		9	15	25	37	
SOLDER CUPS	MALE	DBxxP	1.19	1.59	1.99	2.85
	FEMALE	DBxxS	1.50	1.85	2.25	3.90
RT ANGLE	MALE	DBxxPR	1.65	2.20	3.00	4.83
PC SOLDERS	FEMALE	DBxxSR	2.18	3.03	3.00	6.19
RIBBON CABLE	MALE	IDBxxP	2.95	3.90	4.75	6.95
	FEMALE	IDBxxS	3.25	4.29	5.25	7.95
HOODS	BLACK	HOOD-B	---	---	.99	---
	GREY	HOOD	.89	.99	.99	1.09

### MOUNTING HARDWARE-S1.00

FOR ORDERING INSTRUCTIONS, SEE IDC CONN. ABOVE.

9000

9334	2.50
9368	3.95
9602	1.50

### INTERSIL

ICL7107	12.95
ICL7660	2.95
ICL8038	3.95

### DIP SWITCHES

4 position	.85
6 position	.90
7 position	.95
8 position	.95

## TRANSISTORS

2N2222	.25	PN2907	.13
PN2222	.10	2N3055	.79
2N2905	.50	2N3904	.10
2N2907	.25	2N3906	.10

## DISCRETE

1N751	5.1v zener	.25
1N759	12.0v zener	.25
1N4148	(1N914) switching	25/1.00
1N4004	400PIV rectifier	10/1.00
KBP02	200PIV 1.5a bridge	.45
4N33	OPTO-ISOLATOR	1.75

## RIBBON CABLE

CONTACTS	SINGLE COLOR		COLOR CODED	
	1'	10'	1'	10'
25	.45	4.00	1.32	11.80
34	.61	5.40	1.65	14.50
50	.89	7.50	2.50	22.00

## 36 PIN CENTRONICS

CEN36 MALE SOLDER CUP	7.95
IDCEN36 MALE RIBBON CABLE	8.95
IDCEN36F FEMALE RIBBON CABLE	8.95

## VOLTAGE REGULATORS

7805T	.75	7915T	.85
78M05C	.35	7805K	1.39
7808T	.75	78H05K	9.95
7812T	.75	7812K	1.39
7815T	.75	7912K	1.49
7824T	.85	78L05	.69
7905T	.85	79L05	.79
7912T	.85	79L12	.79

C, T=TO-220, K=TO-3, L=TO-92

## CMOS

4001	.25	4027	.45	4066	.39	4538	1.95
4002	.25	4028	.69	4069	.29	4543	1.19
4011	.25	4029	.79	4070	.35	4553	5.79
4012	.25	4040	.75	4071	.29	4584	.75
4013	.38	4042	.69	4081	.29	74C00	.35
4015	.39	4046	.85	4082	.29	74C04	.35
4016	.39	4047	.95	4093	.49	74C14	.59
4017	.69	4049	.35	4503	.65	74C74	.65
4018	.79	4050	.35	4511	.85	74C906	.95
4020	.75	4051	.79	4518	.89	74C922	4.49
4023	.29	4053	.79	4520	.79	74C923	4.95
4024	.65	4060	.89	4528	1.19	74C926	7.95

VISA

ORDER TOLL FREE

800-538-5000

800-662-6279 (CA)

MasterCard

Copyright 1985 JDR Microdevices

CIRCLE 113 ON FREE INFORMATION CARD

# ACTIVE RECEIVING ANTENNA

Gives excellent reception, 50 KHz to 30 MHz.

New MFJ-1024 Active Receiving Antenna mounts outdoors away from electrical noise for maximum signal. Gives excellent reception of 50 KHz to 30 MHz signals. Equivalent to wire hundreds of feet long. Use any SWL, MW, BCB, VLF or Ham receiver. High dynamic range RF amplifier. 54 in. whip. 50 foot coax. 20 dB attenuator prevents receiver overload. Switch between two receivers. Select auxiliary or active antenna. Gain control. "ON" LED. Remote unit, 3x2x4 in. Control, 6x2x5 in. 12 VDC or 110 VAC with optional adapter, MFJ-1312, \$9.95.

**\$129.95** (+\$4.00 shipping)

Order from MFJ and try it. If not delighted, return within 30 days for refund (less shipping). One year unconditional guarantee. Order today. Call TOLL FREE 800-647-1800. Charge VISA, MC. Or mail check, money order. Write for free catalog. Over 100 products.

CALL TOLL FREE 800-647-1800

Call 601-323-5869 in Miss., outside continental USA, tech/order/repair info. TELEX 53-4590.

**MFJ ENTERPRISES, INCORPORATED**  
Box 494, Mississippi State, MS 39762

CIRCLE 105 ON FREE INFORMATION CARD

# THE BEST PRICES

5 1/4 DISKS FROM 82¢ Excellent quality, 1 year replacement warranty. With sleeve and label! RUD1D 55/00 10/48/80 RUD2D 55/00 10/412/90 RUD1M 55/00 bulk 100/482 RUD2M 55/00 bulk 100/4119	SOLAR CELLS FROM 99¢ Converts light to a.c. or d.c. 1500mA \$2.95 3/810 24/669 800mA \$1.95 3/85 24/825 900mA 99¢ 6/85 24/818
MONSTER CAPS 4/94 15,000V, 25V, w/screw terminals Tiny but high pur! #CGCAP15K	COPPER CLAD 88¢ 10/97 2-sided FR4, 8x10", 1 oz. Unetched or drilled. #8100C
RECHARGEABLES \$3 6 Volt 450mAh batteries, sealed lead-acid #4549P	SAG (PCB) FUSES 1/2, 1, 2, 3, 6 Amp 25/81 510-B10 /3, 1, 3 Amp 10/81
12 VOLT GENER 8/91 1 watt, prime quality! #1M472A	SPOT MOUNT TOGGLE 3/91 Alc., threaded bushing, 50, W/mware. #SPD7ALCO

RFS IC'S: Removed from sockets of unused boards, tested, guaranteed, full spec. Partial list, send for full list

74LS00	15	74LS197	75	7804-PIU 2	45	6162	8.50
74LS02	15	74LS21	75	7804-S101 2.00	6502	4.50	
74LS03	19	74LS241	75	LK901	28	6505	8.50
74LS04	19	74LS244	75	LK908	69	6528	12.50
74LS05	19	74LS247	75	LM317T	1.50	6532	8.00
74LS08	19	74LS248	1.10	LM318	7.95	6800	2.50
74LS10	19	74LS251	43	LM319	1.10	6802	7.95
74LS14	25	74LS253	48	LM324	50	6809	6.95
74LS20	19	74LS257	1.70	LM331	85	6810	2.50
74LS27	29	74LS264	35	LM350	99	68445	11.75
74LS28	29	74LS273	50	LM393	60	6850	2.95
74LS32	20	74LS283	40	ME321	68	8008	1.00
74LS37	25	74LS298	65	ME355	43	8048	12.50
74LS51	20	74LS302	28	LM389	40	8054	1.50
74LS51	20	74LS363	1.35	ME364	1.50	80P8A	4.00
74LS74	30	74LS368	35	LM375	70	8096	17.00
74LS75	30	74LS373	90	LM723	28	8098	17.00
74LS76	30	74LS374	90	LM741/NI	20	837A	19.95
74LS83	30	74LS374	90	LM743	60	8431	3.50
74LS86	30	74LS375	40	LM765	12.88	8233	6.20
74LS90	40	74LS377	75	8300C	20	8253	3.50
74LS93	50	74LS393	90	811-013A	2.50	8257	4.50
74LS107	30	74LS393	1.20	MC1458	40	8259	3.50
74LS123	45	EP08S	1480	40	8272	12.50	
74LS132	45	74LS132	1489	40	8278	25.00	
74LS138	40	1702A	60	FD1795	17.00	8283	7.50
74LS145	99	2708	99	CD3001B	2.00	82DA	17.75
74LS153	40	2716(SV)	99	27101	45	8211	17.75
74LS154	30	272516	99	27102	45	8289	19.95
74LS155	40	272516	99	27103	45	8291	17.75
74LS159	28	2722(SV)	3.00	2112	1.00	8741	18.50
74LS160	60	276232	3.00	2114	1.00	8748	18.50
74LS161	45	2764(SV)	3.00	2118	2.25	8749	19.50
74LS163	40	276274	3.00	2147	1.85	8751	18.50
74LS164	35	27128	19.95	2140	4.50	8755A	18.50
74LS173	40	OTHER IC'S	75	LM3900	68	75431	18.50
74LS174	40	OTHER IC'S	75	LM3900	7.50	75454	18.50
74LS191	70	8750	75	4118	3.50	75492	7.75
74LS192	70	780-CPU	2.00	4118	1.50		
74LS193	70	780-CPU	3.00	4164-150	1.88		
74LS195	35	180-DMA	7.50	AM5012	.22		

SEND TO ORDER: Order by phone or mail, pay by MC, Visa, Amex, CO.D. check, min order \$10. Include at least 10¢ for shipping, but refunded. GUARANTEED SATISFACTION OR 7-DAY MONEY BACK GUARANTEE. No restocking fee. SEND FOR FREE FLYER! (retreived from equipment)

**UNITECH (800)343-0472**  
IN MASS: (617)UNI-TECH"  
20R HURLEY ST. CAMBRIDGE, MA 02141

CIRCLE 263 ON FREE INFORMATION CARD

# JAM IT!

Even the Very Best Radar Detector Can't Protect You from the Newest Radar



THE ULTIMATE IN RADAR PROTECTION

Radar Jammer: Compact under-dash unit sends spoof radar guns to read out a percentage of your true speed, whatever speed you'd like. Or, new "SCRAMBLE" mode will prevent radar from obtaining any reading. Activated by Whistler, Escort, or other detector. Best defense against instant radar. Operates on both X and K bands. WARNING: This device is not legal for use against police radar, and is not FCC approved.

Transmitters: The heart of the Jammer is the microwave oscillator (transmitter). In the past, these oscillators expensive and limited to only about 100 milliwatts of power. We now have our own Low Cost, High Power Transmitters up to 500 milliwatts or more. Please call for prices.

Radar Detectors: We highly recommend using a remote detector that is permitted to shut nothing is readily able to detect the police, or thieves. (A dash mount detector is an invitation to thieves and an invitation to police!) We agree with Motor Trend and Autoweek that WHISTLER SPECTRUM is the best detector available, and we know of no other remote detector that is even in the same LEAGUE as the SPECTRUM REMOTE. Order the best for yourself now. (Our detectors are already modified for direct connection to the jammer.)

ORDER TODAY - MONEY BACK GUARANTEE

- Complete Literature & Plans Pkg. \$ 34.95
- Set of Circuit Boards 40.00
- X and K-Band Microwave Oscillator (Transmitter) 60.00
- Whistler Spectrum (modified for use with Jammer) 259.00
- Whistler Spectrum Remote (modified) 299.00
- Modify your Spectrum for use with Jammer 35.00

CALL or send the following information:  
• Items Ordered • Name • Shipping Address  
• Payment: Check, Money Order, VISA or MC (include card number, expiration date, and signature)  
SEND TO: Radar Microwave Inc., 601 S.W. 7th Street, Ft. Lauderdale, Florida 33304  
Telephone: (305) 551-1111 FAX: (305) 551-1111  
©1988 Radar Microwave Inc.

CIRCLE 274 ON FREE INFORMATION CARD

# AMAZING DEVICES

PERSONAL DEFENSE AND PROPERTY PROTECTION UTILIZE SPACE AGE TECHNOLOGY. CAUTION THESE DEVICES CAN BE HAZARDOUS AND MAY SOON BE ILLEGAL.

- POCKET PAIN FIELD GENERATOR — IPG50 Assembled..... \$64.50
- IPG5 Plans..... \$8.00 IPG5KIT..... \$44.50
- PHASOR PAIN FIELD CROG CONTROLLER — PPF10 Assembled..... \$250.00
- PPF1 Plans..... \$15.00 PPF1KIT..... \$175.00
- BLASTER — Provides a plasma discharge capable of puncturing a can. Produces a 100,000 WATT PULSE.
- BLS10 ASSEMBLED..... \$89.50
- BLS1 PLANS..... \$10.00 BLS1KIT..... \$69.50
- PLASMA STUN GUN — Very intimidating and effective 5 to 10 feet 100,000 VOLTS
- ITM10 ASSEMBLED..... \$99.50
- ITM1 PLANS..... \$10.00 ITM1KIT..... \$69.50

- RUBY LASER RAY GUN — Intense visible red beam burns and welds hardest of metals. MAY BE HAZARDOUS.
- RUB3 All Parts Available for Completing Device \$15.00
- CARBON DIOXIDE BURNING, CUTTING LASER — Produces a continuous beam of high energy. MAY BE HAZARDOUS.
- LC5 All Parts Available for Completing Device. \$15.00
- VISIBLE LASER LIGHT GUN — produces intense red beam for sighting, spotting, etc. Hand held complete
- LGU3. Plans. \$10.00 (Kit & Assembled Units Available)
- IR PULSED LASER RIFLE — Produces 15-30 watt infra-red pulses at 200-2000 per sec.
- LRG3..... All Parts & Diodes Available..... \$10.00
- BEGINNERS LOW POWER VISIBLE LASER — Choice of red, yellow, green — provides an excellent source of monochromatic light.
- LHC2 Plans..... \$5.00 LHC2KIT..... Kit..... \$34.50

- SNOOPER PHONE — Allows user to call his premises and listen in without phone ever ringing.
- SNP20..... Assembled..... \$89.50
- SNP2 Plans..... \$9.00 SNP2KIT..... Plans/Kit..... \$59.50
- LONG RANGE WIRELESS MIKE — Miniature device clearly transmits well over one mile. Super sensitive, powerful
- MFT1 Plans..... \$7.00 MFT1KIT..... Plans/Kit..... \$49.50
- WIRELESS TELEPHONE TRANSMITTER — Transmits both sides of phone conversation over one mile, shuts off automatically.
- VWPM5 Plans..... \$8.00 VWPM5KIT..... Plans/Kit..... \$39.50
- TALK & TELL AUTOMATIC TELEPHONE RECORDING DEVICE — Great for monitoring telephone use.
- TAT20..... Assembled..... \$24.50
- TAT2 Plans..... \$5.00 TAT2KIT..... Plans/Kit..... \$14.50

Our phone is open for orders anytime. Technicians are available 9-11 a.m., Mon-Thurs for those needing assistance or information. Send \$1.00 for catalog of hundreds more similar devices. Send check, MO, Visa, MC, CO.D. to: INFORMATION UNLIMITED, DEPT RR, P.O. Box 716, Amherst, N.H. 03031 Tel: 603-673-4730

CIRCLE 72 ON FREE INFORMATION CARD

# QUALITY SPECIALS

INSTANT COLOR HARD COPY

Everything you need to begin lab print pictures immediately...  
About use of either the color instamatic camera (included) or your own 35mm camera (adapter included).  
Please specify the size of your CRT screen: 8 1/2 or 13 inch when ordering.

COMPLETE SYSTEM \$339.00

# DELUXE 46 CHANNEL CABLE TV CONVERTER

With Fine Tuning Dial  
• Shifts all cable channels to UHF  
• Extend pay TV to all your TV sets without extra monthly fee  
• Allows facing pay TV (decoder required) while viewing another channel  
• Restore TV remote control and VCR programming ability

4 FOR \$189.95 \$24.95

# NEW DIGITAL SCALE

Lab accuracy at an everyday price...reads 1 gram or .1 oz.  
Gives fast, exact weight in ounces or grams for the lab, dining, postage, photography. Capacity 192 grams/10 oz. with automatic tare. Free postage & dist. cart.

Best Value \$74.95

# EXTRA STATIONS FROM YOUR STEREO

The revolutionary PARSEC T401 is equipped with a very powerful signal amplifier (0-24dB adjustable gain). Normally hidden weak signals are captured, amplified and carried to the tuner by the extremely sensitive unit, resulting in not only an increase in the number of available FM stations but also audible reception improvement in those and all other existing stations.

**GOLDSMITH SCIENTIFIC CORPORATION**  
720 E. Industrial Park Dr., Manchester, NH 03103  
PHONE ORDERS WELCOME (603) 624-8030  
FREE CATALOG OF NEW DEVICES  
POSTAGE—ADD 1% PLUS \$1.50 INSURANCE, C.O.D. \$2.00 EXTRA  
SATISFACTION FULLY GUARANTEED

CIRCLE 268 ON FREE INFORMATION CARD

# DON'T BLAME THE SOFTWARE!

Our Isolators eliminate equipment interaction, clean up interference, curb damaging power line spikes and lightning bursts.



ISO-1 ISOLATOR  
3 isolated sockets; quality spike suppression; basic protection. . . \$81.95

ISO-3 SUPER-ISOLATOR  
3 dual isolated sockets; suppressor; commercial protection. . . . \$122.95

ISO-17 MAGNUM ISOLATOR  
4 quad isolated sockets; suppressor; laboratory grade protection. . \$213.95

**ESB Electronic Specialists, Inc.**  
171 S. Main, Natick, MA 01780 (617) 855-1532  
Toll Free Order Desk 1-800-225-4878  
MasterCard, VISA, American Express

CIRCLE 60 ON FREE INFORMATION CARD





**SPARTAN** Electronics Inc  
 CALL (516) 499-9500 MAIL  
 6094 Jericho Tpke.  
 Commack, N.Y. 11725

**CTC9R Philips Remote Cable Converter**

Micro computer technology • Quartz controlled IC's lock in picture & prevent drift • 50 channel selections • Programmable time on & off • 24-hour LED digital clocks • Favorite channel memory & recall plus scan • Wireless hand held infra red transmitter system • Automatic line tune • Adaptable to any brand television • One year warranty service

**\$129.95**

**Jerrold 58 Channel Wireless Remote Converter \$84.95**  
**Replacement Transmitter \$29.95**  
**Wireless/Hand-held w/on/off/Fine Tuning \$29.95**

**CABLES**

**RS232 male-male 6' 14.95**  
 pins 1-8 & 20  
**DP25P male to Centronics 6' 21.95**  
 parallel printer cable

**ZENITH data systems \$2249.00**

Go Beyond IBM Compatibility... Reach for total Performance  
 Zenith's Z-150PC!

Memory—320K RAM expandable to 640KB  
 Disks—Dual 5 1/4" Floppies (720KB total)  
 Video—RGB Composite monochrome (80Char x 25lines)  
 I/O—1-Series port/1-Parallel Printer Port  
 Keyboard—Detached/Shift lock & Numeric lock indicators

**RS232 TRANSMISSION LINE TESTER**

Features: \*All 25 Signal lines accessible \*Dual Color: Red Green

Accessories: 1 Cable 10' male to Female Extension Jumper Set 6 Straight 1 T-Jumper

Vinyl Case  
**Call for quantity prices \$169.95**

**POCKET TECHNOLOGY, INC. 10 MHz LogicScope 136**

10 MHz Real Time Handheld  
 50-100 MHz Clock & Counter  
 True Hand Trigger  
 Five 200 Element F.D. Displays  
 50-100 Bit Waveform Memory  
 1 Input Channels (A, B, T)  
 9 Volt Battery AC Operation  
 8 inch Weight, Hand Held  
 Under 1 inch thick

**SCALL IN STOCK**

The Next Logical Step in Test Instrumentation  
 The LogicScope 136 contains the features of Logic Analyzer and Counter/Scope Technology and weighs only 1.35 pounds!

**BEFORE YOU PAY \$\$ FOR A TELEPHONE SERVICE CALL, TEST IT YOURSELF**

Telephone Line Analyze Model #1042 **BK PRECISION**

Tests telephone line functions that affect telephone operation  
 Warns line and ring voltage levels  
 Checks condition of telephone line from central office to user's telephone jack  
 Warns telephone line polarity that can affect polarity sensitive telephones

**\$19.95**

**BK PRECISION PROFESSIONAL TELEPHONE PRODUCT TESTER**

Features: **MODEL 1045**

Provides basic operation tests for corded and cordless telephones, answering machines, and automatic dialers  
 Checks telephone line cords and handset cords for continuity shorts and interferences  
 Warns number dial and needed for pulse or touch-tone telephones  
 Provides low and normal speed ring test sequence  
 Warns that speed and DTMF (Dual Tone Multiple Frequency) tones are above minimum required level

Can be used by the consumer without the aid of a subscription—see photo below instructions card is provided with the tester  
 Can be used by the subscription to demonstrate operation and features of telephone products and to screen returns before making an exchange

**\$335.95**

**Volume Discounts**

Min. Order \$25.00 \$75.00 to 75.00 \$2.50  
 International Shipping Add 75.00 to 250.00 \$4.50  
 Prices subject to change 251.00 to 500.00 \$6.00  
 without notice 501.00 to 750.00 \$8.50  
 COD 2.00 Extra 751.00 to 1000.00 \$12.00  
 Add shipping for monitors over 1000.00 \$12.50

**(516) 499-9500 Mon Th Tu W F Sa**  
 TEL TX 551427 SPARTAN 9-8 9-6 9:30-5

**ADVERTISING INDEX**

RADIO-ELECTRONICS does not assume any responsibility for errors that may appear in the index below.

Free Information Number	Page	Page	
265	A.I.S. Satellite	84	Power Plus
108	AMC Sales	79	RAG Electronics
76	AP Products	33	RCA D&SP
—	Active Electronics	104	Radio Shack
296	Advance Electronics	9,10,11	Ramsey
106	Advanced Computer Products	109	Ross Custom
107	All Electronics	95	Saratoga Electronics
72	Amazing Devices	108	Satellite TV Week Magazine
77	B&K Precision	73	Simpson
98	Beckman Instruments	32	Solid State Sales
—	CIE	52	Sone
—	CRT	85	Spartan Electronics
54	Chemtronics	31	Tampa Electronic Supply
—	Command Productions	81	Tektronix
79	Communications Electronics	2	Texas Instruments
—	Coop's Satellite Digest	14	Unitech
251	Dick Smith Electronics	24, 25	VAMP
276	Dalbani	29	Wm B Allen
—	Data I/O	84	Yours Truly
261	Deco Industries	84, 85	
258	Deltax Dynamic	31	
281,282	Diehl Engineering	71,75	
82	Digi-Key	105	
—	Digital Research Computers	104	
110	Dokay	100	
60	Electronic Specialists	108	
266	Electronics Warehouse Corp.	83	
120	Elephant Electronics	85	
111	Etronix	23	
100	Firestik II	23	
259,283	Fluke Manufacturing	5,CD2	
—	Fordham Radio	1,13,CV4	
252	Galaxy	85	
262	Gemini Electronics	CD7	
268	Goldsmith Scientific	108	
—	Grantham College of Engineering	27	
273	HW Sams	7	
86	Heath	38	
64	Iwatsu	15	
260	Interactive Components	96	
113	JDR Microdevices	106,107	
114	Jameco	102,103	
124	James Walter Satellite Rec.	85	
104	Jan Crystals	79	
271	Kepro Circuit Systems	83	
87	MCM Audio	99	
105	MFJ	108	
67	McIntosh Labs	79	
270	Micro-Mart	104	
117	Mouser	81	
—	NRI	16	
—	NTS	34	
269	OK Industries	28	
274	Oregon Microwave	108	
—	Pacific Cable	93	
118	Pacific One	85	
90	Paia	30	
68,264,297	Philips ECG	21	
298,299			
116	Philips Tech	104	
—	Phoenix Electronics	87	
101	Pomona Electronics	CV3	

THE BEST PLACE TO BUY, SELL or TRADE NEW and USED EQUIPMENT

**NUTS & VOLTS MAGAZINE**  
 BOX 1111-E • PLACENTIA, CA 92670  
 (714) 632-7721

Join Thousands of Readers Nationwide Every Month

**ONE YEAR U.S. SUBSCRIPTIONS**  
 \$10.00 - 3rd Class • \$15.00 - 1st Class

**\$35.00 - Lifetime - 3rd Class**

**NUTS & VOLTS**  
 HAM GEAR  
 COMPUTERS  
 SOFTWARE  
 SCANNERS • OPTICS  
 TEST EQUIPMENT  
 MICROWAVE  
 SATELLITE  
 AUDIO VISUAL  
 NEW PRODUCTS  
 COMPONENTS • KITS  
 ANTIQUE ELECT.  
 PUBLICATIONS  
 PLANS • SERVICES

Gernsback Publications, Inc.  
 200 Park Ave. South  
 New York, NY 10003  
 (212) 777-6400  
 Chairman of the Board:  
 M. Harvey Gernsback  
 President: Larry Steckler

**ADVERTISING SALES 212-777-6400**

Larry Steckler  
 publisher  
 Shelli Weinman  
 advertising associate  
 Arline Fishman  
 advertising coordinator  
 Lisa Strassman  
 credit manager  
 Donna Sala  
 credit associate  
 Naomi Malten  
 advertising assistant

Sales Offices

**EAST/SOUTHEAST**  
 Stanley Levitan  
 Radio-Electronics  
 200 Park Ave. South  
 New York, NY 10003  
 718-428-6037, 212-777-6400

**MIDWEST/Texas/Arkansas/Okla.**  
 Ralph Bergen  
 Radio-Electronics  
 540 Frontage Road—Suite 325  
 Northfield, IL 60093  
 312-446-1444

**PACIFIC COAST/ Mountain States**  
 Marvin Green  
 Radio-Electronics  
 15335 Morrison St.—Suite 227  
 Sherman Oaks, CA 91403  
 818-986-2001

RADIO-ELECTRONICS

# PRODUCT SAFETY ALERT

## Testing High Voltages Can Be FATAL

There are reported instances of injury or death occurring from the *MISUSE* of ITT Pomona Electronics high voltage test probes, (Illustrated at right). The reported *MISUSE* is the attachment of the Alligator Clip to high voltage instead of earth/ground/chassis.

### Be Certain That:

- If you own or use an ITT Pomona H.V. probe, be sure it is in good working order, clean and free of all contaminants.
- The ground lead/alligator clip is **FIRST** connected to earth/ground/chassis **ONLY**.  
**NEVER CONNECT THE GROUND LEAD TO THE POWER SOURCE**
- If the meter reads in reverse **STOP**. Do not attempt to measure the voltage. You are using the wrong model probe. (See list below for the designed usage.)
- No parts of your body or tools connected to your body should come close to the high voltage power source or any grounded structure. Allow yourself sufficient working space.

### POMONA ELECTRONICS HIGH VOLTAGE TEST PROBES

MODEL	VOLTAGE	DESIGNED TO MEASURE
4250	42 KVDC	Positive & Negative Voltages
4475	15 KVDC	Positive & Negative Voltages
2900	30 KVDC	Positive Voltages Only
4242	42 KVDC	Positive Voltages Only
4242A	42 KVDC	Positive Voltages Only
3157	15 KVDC	Positive Voltages Only
4000	36 KVDC	Positive Voltages Only
3163	6 KVDC	Positive Voltages Only
4312	15 KVDC	Negative Voltages Only
3200	10 KVAC	AC Voltages Only

### ELIMINATE THE POSSIBILITY OF INJURY OR DEATH OCCURRING FROM MISUSE OF ANY ITT POMONA PROBE:

- ITT Pomona recommends that you immediately do either of the following:
1. Return any ITT Pomona probe in your possession (to the address below) in exchange for your purchase price plus \$5.00 handling fee;
  2. Call for, and immediately attach, a free set of warning labels to your ITT Pomona H.V. probe in the space designated on the probe handle.

**BE SAFE—CALL COLLECT  
(714) 623-3463**

**ITT Pomona Electronics**  
1500 East Ninth Street, Pomona, California 91766



# VIDEO ACCESSORIES

■ Highest quality ■ Highest performance ■ Lowest prices

## bp VIDEO-CINE CONVERTER

The BP Video-Cine Converter is an optical device that allows the easy transfer of slides, 8mm or 16mm movie film to VCR tape. The Video-Cine Converter's precision optics put the image from your movie or slide projector on a high-contrast, rear projection screen. Your video camera shoots that image, can color-correct faded pictures, add narration to other sound. Can be used with any video camera or slide projector. If your video camera lacks close-up capability, you will need a macro lens attachment.

MODEL V-1701 **\$34<sup>95</sup>**



# FOR ULTIMATE VIEWING

### TEKNIKA

WIRELESS REMOTE CONTROL TV TUNER & CABLE CONVERTER WITH VOLUME CONTROL

Model 6510 **\$169<sup>95</sup>**



Wireless remote control with volume for cable TV, VHF-UHF antenna systems upgrades any TV to 140 channel capability.

- Works with any TV set
- Quick, easy installation
- Off-air and cable compatible
- Quartz frequency synthesizer tuning
- Direct access/memory scan selector
- Ultra-compact, hand-held wireless remote control



61 CHANNEL WIRELESS REMOTE CONTROL

Model V7661 **\$79<sup>95</sup>**



Wireless remote control on/off, channel selection and fine tuning.

- Works with any TV
- 61 channel capability
- Microcomputer controlled PLL operation
- Converter panel controllable for channel up, down, on/off, fine tuning.
- LED display
- Compatible with CATV systems.



STABILIZER/IMAGE ENHANCER/RF CONVERTER/VIDEO FADER/2-WAY DISTRIBUTION AMPLIFIER

Model V1880 **\$99<sup>95</sup>**



Hook-up cable kit **\$11.75**

The most versatile, all-in-one video processor. Can be used as a video guard remover for video tapes, enhancer, video to RF converter, professional video fade in and out and a dual output distribution amplifier.



VIDEO SWITCH



Model V4804 **\$49<sup>95</sup>**

Record a pay channel while viewing a standard channel. You can also connect an antenna/cable, VCR, video disc player, home computer and video game.



VIDEO TAPE REWINDER



Model V7777 VHS **\$49<sup>95</sup>**

Model V7778 BETA **\$49<sup>95</sup>**

Reduce wear and tear of your VCR heads with the AC powered circuit protected rewinders, LED power-on indicators.

Charge it with VISA/MASTERCARD. Phone orders accepted. C.O.D.S.

Call for quantity pricing. Ask for free catalog.

# Fordham

260 Motor Parkway, Hauppauge, NY 11788

Toll Free  
**800-645-9518**  
In NY State 800-832-1446

#### Service and Shipping Charge Schedule

FOR ORDERS	ADD
\$25-250 .....	\$4.50
\$251-500 .....	\$6.50
\$501-750 .....	\$8.50
\$751-1,000 .....	\$12.50
\$1,001 and up .....	\$15.00