

Radio - **Electronics**

**STOP WRONG NUMBERS!
BUILD A TELEPHONE ADD-ON**

\$1.75 MAR. 1984
U.K. 85p

COMPUTERS - VIDEO - STEREO - TECHNOLOGY - SERVICE

Build this deluxe
VIDEO TEST GEN
with gen-lock, multiburst, and more

GERNSBACK
PUBLICATION



Who's in control?
JET LANDING SYSTEMS
How they work

Will this work with that?
COMPUTER COMPATIBILITY
Know before you buy

Build an
AUDIO GENERATOR
with digital frequency display

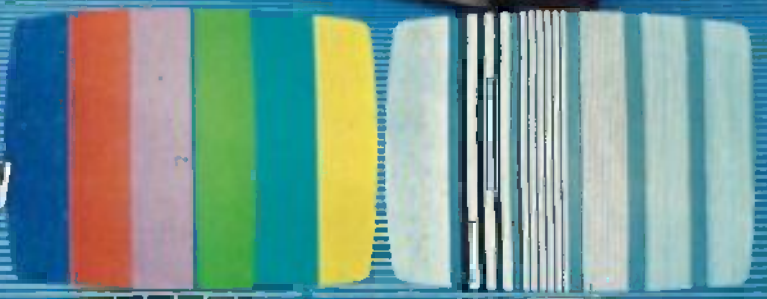

How to design
POWER SUPPLIES
to fit your needs

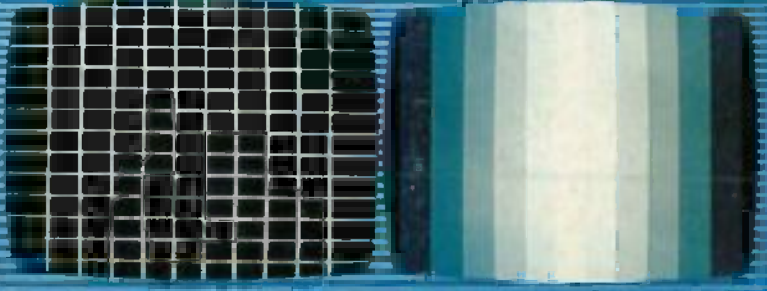

PLUS:

- ★ Hobby Corner
- ★ Equipment Reports
- ★ Drawing Board
- ★ Service Clinic
- ★ New Idea
- ★ State-Of-Solid-State



THE ULTIMATE SCANNER RADIO HAS ARRIVED.

Starting today, we're standing the scanner radio on its ear. Because we've forged ahead—way ahead—in radio frequency and digital technology.

Introducing the Bearcat® CompuScan™ 2100.

It's the first scanner radio designed to put the power of a personal computer to work for you. Now you can scan up to two hundred channels. Stack levels of priority so you'll hear vital calls in order of importance. Automatically search, store and count transmissions for accurate "pictures" of activity within frequency limits you select.

And with automatic video memos you'll know more than you've ever known before. The channel user, special codes, jurisdictions, phone numbers, alternate frequencies—any information you've programmed is automatically displayed when the channel is active.

With ten bands including 70-centimeter, 2, 6 and 10 meter FM Amateur, Military Land Mobile, AM Aircraft, plus Low, High, UHF and UHF-T bands.

For a real earful—and eyeful—see your Bearcat scanner dealer. For the name of the dealer nearest you, just call 1-800-S-C-A-N-N-E-R.

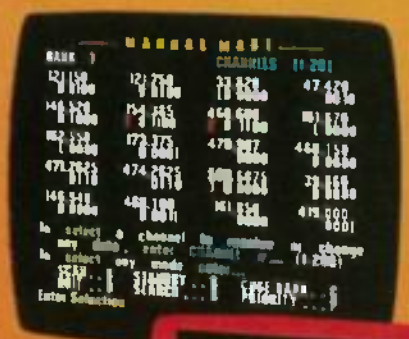

BEARCAT® SCANNERS

Electra Company
Division of Masco Corp. of Indiana
300 East County 18th Road
Columbus, Indiana 47229

© 1983 Masco Corp of Indiana

CIRCLE 81 ON FREE INFORMATION CARD

www.americanradiohistory.com

Proficient, profitable servicing demands accurate, complete, and timely service information! That's why you should subscribe to . . .

RCA

SERVICE LITERATURE



- Accurate**, because it's prepared by service-experienced editors who work closely with RCA Consumer Electronics engineers
- Complete**, because it gives you all of the essential information you need to proficiently service RCA Consumer Electronic products . . . including schematics, circuit board views, disassembly/reassembly instructions, service adjustments procedures, parts lists . . . plus service bulletins that keep you abreast of the latest factory-recommended servicing procedures and repairs.
- Timely**, because it's promptly shipped directly to you when each new model is introduced, so that you have it when you need it.

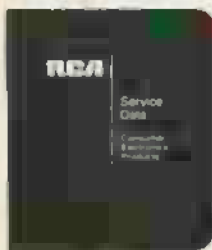

BINDERS INCLUDED
TV, VCR, and VideoDisc service literature subscription includes durable, three-ring, 2½-inch vinyl-covered binders. (See order form below for binder quantity included with each subscription.)



10-YEAR INDEX ALSO INCLUDED!
References RCA service literature by model, and includes Warranty Obligation Codes and a separate listing of service bulletins.

FREE CATALOG . . .

Check the "RCA Service Literature Catalog" box in the order form below to receive a free copy of the 1984 edition of RCA's Service Literature Catalog.

1984 RCA SERVICE LITERATURE SUBSCRIPTION ORDER FORM

CHECK APPROPRIATE BOX, INDICATE QUANTITIES AND PRICE TOTALS, AND ENCLOSE CHECK

MAIL TO: RCA CONSUMER ELECTRONICS 1-450
P.O. BOX 1976
INDIANAPOLIS, IN 46206

RCA

1984 SERVICE LITERATURE SUBSCRIPTIONS:

- TELEVISION (with 2 binders)
- VCR (with 2 binders)
- VideoDisc Player (with 1 binder)
- Video Camera
- FREE 1984 Service Literature Catalog

PRICE	QUANTITY	PRICE TOTAL
\$71.85 ea	_____	\$ _____
74.85 ea	_____	_____
44.85 ea	_____	_____
34.85 ea	_____	_____

TOTAL (AMOUNT OF YOUR CHECK*) \$ _____

NAME _____

STREET ADDRESS _____

CITY _____ STATE _____ ZIP _____

*Make check payable to "RCA Consumer Electronics"

RE84

NEW!

Regency[®] Scanners

Communications Electronics, the world's largest distributor of radio scanners, introduces new models with special savings on all radio scanners. Chances are the police, fire and weather emergencies you'll read about in tomorrow's paper are coming through on a scanner today.

We give you excellent service because CE distributes more scanners worldwide than anyone else. Our warehouse facilities are equipped to process thousands of scanner orders every week. We also export scanners to over 300 countries and military installations. Almost all items are in stock for quick shipment, so if you're a person who prefers fact to fantasy and who needs to know what's really happening around you, order your radio today from CE.

NEW! Regency[®] MX3000

List price \$299.95/CE price \$199.00
6-Band, 30 Channel • No-crystal scanner
Search • Lockout • Priority • AC/DC
Bands: 30-50, 144-174, 440-512 MHz
The Regency Touch MX3000 provides the ease of computer controlled, touch-entry programming in a compact-sized scanner for use at home or on the road. Enter your favorite public service frequencies by simply touching the numbered pressure pads. You'll even hear a "beep" tone that lets you know you've made contact.

In addition to scanning the programmed channels, the MX3000 has the ability to search through as much as an entire band for an active frequency. The MX3000 includes channel 1 priority, dual scan speeds, scan or search delay and a brightness switch for day or night operation.

NEW! Regency[®] HX650

List price \$119.95/CE price \$84.00
5-Band, 6 Channel • Handheld crystal scanner
Bands: 30-50, 144-174, 450-512 MHz
Now you can tune in any emergency around town, from wherever you are, the second it happens. Advanced circuitry gives you the world's smallest scanner. Our low CE price includes battery charger/A.C. adapter.

NEW! Regency[®] MX7000

Allow 120-240 days for delivery after receipt of order due to the high demand for this product.
List price \$699.95/CE price \$449.00
10-Band, 20 Channel • Crystalline • AC/DC
Frequency range: 26-27, 30-108, 108-136 AM, 144-174, 440-512, 806-881 MHz, 1.0 GHz, 1.1 GHz
In addition to normal scanner listening, the MX7000 offers CB, VHF, and UHF TV audio, FM Broadcast, all aircraft bands (civil and military), 800 MHz communications, cellular telephone, and when connected to a printer or CRT, satellite weather pictures.

NEW! JIL SX-200

CE price \$269.00/NEW LOW PRICE
8-Band, 16 Channel • No-crystal scanner
Quartz Clock • AM/FM • AC/DC
Bands: 26-88, 108-180, 380-514 MHz
Tune Military, F.B.I., Space Satellites, Police & Fire, D.E.A., Defense Department, Aeronautical AM band, Aero Navigation Band, Fish & Game, Immigration, Paramedics, Amateur Radio, Justice Department, State Department, plus thousands of other restricted radio frequencies no other scanner is programmed to pick up.

NEW! JIL SX-100

CE price \$134.00/NEW LOW PRICE
6-Band, 16 Channel • Crystalline • AC/DC
Frequency range: 30-54, 140-174, 410-514 MHz
The JIL SX-100 scanner is a mobile keyboard programmable scanner that puts you in the seat of the action at home or in your car. Compact and good looking, the SX-100 even gives you the time and date. It's small size will easily fit in most domestic or foreign cars and it's AC/DC adaptable for home use.

Regency[®] HX1000

Allow 90-180 days for delivery after receipt of order due to the high demand for this product.
List price \$329.95/CE price \$209.00
6-Band, 20 Channel • No Crystal scanner
Search • Lockout • Priority • Scan delay
Slideit liquid crystal display
Frequency range: 30-50, 144-174, 440-512 MHz
The new handheld Regency HX1000 scanner is fully keyboard programmable for the ultimate in versatility. You can scan up to 20 channels at the same time. When you activate the priority control, you automatically override all other calls to listen to your favorite frequency. The LCD display is even slideit for night use. A die-cast aluminum chassis makes this the most rugged and durable hand-held scanner available. There is even a backup lithium battery to maintain memory for two years. Includes wall charger, carrying case, belt clip, flexible antenna and nicad battery. Reserve your Regency HX1000 now.

Regency[®] R106

List price \$149.95/CE price \$99.00
5-Band, 10 Channel • Crystalline • AC/DC
Frequency range: 30-50, 144-174, 450-512 MHz
A versatile scanner, the Regency R-106 is built to provide maximum reception at home or on the road. Rugged cabinet protects the advanced design circuitry allowing you years of dependable listening.

NEW! Regency[®] D810

List price \$399.95/CE price \$259.00
8-Band, 50 Channel • Crystalline • AC only
Bands: 30-50, 88-108, 118-136, 144-174, 440-512 MHz
This scanner offers Public service bands, Plus Aircraft and FM broadcast stations. You can listen to Bach or a Boeing 747, the Rolling Stones or the riot squad, or any of 50 channels. Plus special direct access keys let you listen to police, fire, emergency, or any of your favorite channels just by pushing a button.

Regency[®] R1040

List price \$199.95/CE price \$129.00
6-Band, 10 Channel • Crystalline • AC only
Frequency range: 30-50, 144-174, 440-512 MHz
Now you can enjoy computerized scanner versatility at a price that's less than some crystal units. The Regency R1040 lets you in on all the action of police, fire, weather, and emergency calls. You'll even hear mobile telephones.
Programming the R1040 is easy. Merely touch the keyboard and enter any of over 15,000 frequencies on your choice of 10 channels.

TEST ANY SCANNER

Test any scanner purchased from Communications Electronics[®] for 31 days before you decide to keep it. If for any reason you are not completely satisfied, return it in original condition with all parts in 31 days, for a prompt refund (less shipping/handling charges and rebate credits).

OTHER RADIOS & ACCESSORIES

Regency [®] CA03 Scanner.....	\$59.00
NEW! Panasonic RF-850 Shortwave receiver.....	\$129.00
Panasonic RF-9 Shortwave receiver.....	\$64.00
Panasonic RF-799 Shortwave receiver.....	\$219.00
Panasonic RF-2600 Shortwave receiver.....	\$199.00
Panasonic RF-2900 Shortwave receiver.....	\$249.00
Panasonic RF-3100 Shortwave receiver.....	\$269.00
Panasonic RF-8300 Shortwave receiver.....	\$539.00
NEW! Bearcat [®] 151 Scanner.....	\$189.00
NEW! Bearcat [®] Five-Six Scanner.....	\$129.00
Bearcat [®] 300 Scanner.....	\$349.00
Bearcat [®] 250 Scanner.....	\$279.00
Bearcat [®] 200 Scanner.....	\$189.00
Bearcat [®] 210XL Scanner.....	\$229.00
Bearcat [®] 20/20 Scanner.....	\$289.00
Bearcat [®] 100 Scanner.....	\$289.00
Bearcat [®] Weather Alert.....	\$49.00
Freedom Phone [®] 4000 Cordless telephone.....	\$239.00
Fanon FCT-200 Cordless telephone.....	\$139.00
Fanon 6-MLU Scanner.....	\$99.00
Chie-6 Fanon AC Adapter/Battery Charger.....	\$18.00
CAT-6 Fanon carrying case with belt clip.....	\$15.00
SP65 Carrying case for Bearcat Five-Six.....	\$15.00
MA-506 Carrying case for Regency HX650.....	\$15.00
SCMA-6 Fanon Mobile Charger/Audio Amplifier.....	\$49.00
AUC-3 Fanon auto lighter adapter/Battery Charger.....	\$15.00
FB-E Frequency Directory for Eastern U.S.A.....	\$12.00
FB-W Frequency Directory for Western U.S.A.....	\$12.00
TSG "Top Secret" Registry of U.S. Government Freq.....	\$15.00
RRF Railroad Frequency Directory.....	\$10.00
ESD Energy Services Directory.....	\$10.00
ASD Frequency Directory for Aircraft Band.....	\$10.00
SFR Survival Radio Frequency Directory.....	\$10.00
TIC Techniques for Intercepting Comm. Manual.....	\$12.00
CIE Cover/Intelligence, Elect. Eavesdropping Man.....	\$12.00
B-4 1.2 V AAA Ni-Cad batteries (set of four).....	\$9.00
B-6 1.2 V AA Ni-Cad batteries (set of four).....	\$12.00
A-135c Crystal certificate.....	\$3.00
Add \$3.00 shipping for all accessories ordered at the same time. Add \$12.00 per shortwave receiver for U.P.S. shipping.	

INCREASED PERFORMANCE ANTENNAS

If you want the utmost in performance from your scanner, it is essential that you use an external antenna. We have a base and a mobile antenna specifically designed for receiving all bands. Order #A60 is a magnet mount mobile antenna and order #A70 is an all band base station antenna. Price is \$35.00 each plus \$3.00 for UPS shipping in the continental United States.

BUY WITH CONFIDENCE

To get the fastest delivery from CE of any scanner, send or phone your order directly to our Scanner Distribution Center. Be sure to calculate your price using the CE prices in this ad. Michigan residents please add 4% sales tax or supply your tax I.D. number. Written purchase orders are accepted from approved government agencies and most well rated firms at a 30% surcharge for net 30 billing. All sales are subject to availability, acceptance and verification. All sales on accessories are final. Prices, terms and specifications are subject to change without notice. All prices are in U.S. dollars. Out of stock items will be placed on back-order automatically unless CE is instructed differently. Minimum prepaid order \$35.00. Minimum purchase order \$200.00. Most products that we sell have a manufacturer's warranty. Free copies of warranties on these products are available prior to purchase by writing to CE. International orders are invited with a \$20.00 surcharge for special handling in addition to shipping charges. All shipments are F.O.B. Ann Arbor, Michigan. No COD's please. Non-certified and foreign checks require bank clearance.

Mail orders to: Communications Electronics, Box 1002, Ann Arbor, Michigan 48106 U.S.A. Add \$7.00 per scanner for U.P.S. ground shipping and handling in the continental U.S.A. If you have a Visa or Master Card, you may call and place a credit card order. Order toll-free in the U.S. Dial 800-521-4414. In Canada, order toll-free by calling 800-265-4828. Telex anytime 810-223-2422. If you are outside the U.S. or in Michigan dial 313-973-8888. Order today.

Scanner Distribution Center[®] and CE logos are trademarks of Communications Electronics.
† Bearcat is a federally registered trademark of Electra Company, a Division of Masco Corporation of Indiana.
‡ Regency is a federally registered trademark of Regency Electronics Inc.

AD #092683

Copyright ©1983 Communications Electronics

Order Toll Free ... call 1-800-521-4414

COMMUNICATIONS ELECTRONICS[™]

Consumer Products Division

818 Phoenix □ Box 1002 □ Ann Arbor, Michigan 48106 U.S.A.
Call toll-free 800-521-4414 or outside U.S.A. 313-973-8888



CIRCLE 35 ON FREE INFORMATION CARD

Radio-Electronics

THE MAGAZINE FOR NEW IDEAS IN ELECTRONICS

Electronics publishers since 1908

MARCH 1984 Vol. 55 No. 3

SPECIAL FEATURE

- 49 **INSTRUMENT LANDING SYSTEMS**
Though many people are afraid to fly, airplanes are the safest way to go—thanks to instrument landing systems. **Bill Sewell**

BUILD THIS

- 43 **VIDEO TEST GENERATOR**
This test generator can be used not only for TV servicing. You can use it to service just about any video equipment. **Gene Roseth**
- 54 **AUDIO-FREQUENCY GENERATOR**
Use this AF generator with digital frequency readout to test your audio system. **Richard Schroeder**
- 59 **NO MORE WRONG NUMBERS**
Build this telephone add-on and never be bothered by wrong numbers or unwanted telephone sales calls again! **Gary McClellan**

TECHNOLOGY

- 4 **VIDEO ELECTRONICS**
Tomorrow's news and technology in this quickly changing industry. **David Lachenbruch**
- 8 **SATELLITE/TELETEXT NEWS**
The latest happenings in communications technology. **Gary H. Arlen**

CIRCUITS AND COMPONENTS

- 31 **NEW IDEAS**
An award-winning project from one of our readers.
- 63 **HOW TO USE DIGITAL PANEL METERS**
Part 2. We'll show you how to use digital panel meters to measure frequency and temperature. **Ray Marston**
- 67 **HOW TO DESIGN POWER SUPPLIES**
This month, our back-to-school series shows you how to design regulated and unregulated DC power supplies. **Mannie Horowitz**
- 76 **HOBBY CORNER**
A look at a metal-sensing circuit. **Earl "Doc" Savage, K4SDS**
- 78 **DESIGNER'S NOTEBOOK**
A new column full of useful ideas. **Robert Grossblatt**
- 88 **STATE OF SOLID STATE**
A telephone-ringer IC. **Robert F. Scott**
- 90 **DRAWING BOARD**
Putting the 4018 to use. **Robert Grossblatt**

VIDEO

- 92 **SERVICE CLINIC**
Testing integrated flyback transformers. **Jack Darr**
- 95 **SERVICE QUESTIONS**
Radio-Electronics' service editor solves technicians' problems.

RADIO

- 80 **COMMUNICATIONS CORNER**
What's to come in the future? **Herb Friedman**

COMPUTERS

- 71 **COMPATIBILITY**
When you buy hardware or software, make sure that it will work on your system. **Abe Isaacs**
- 82 **COMPUTER CORNER**
A look at IBM's PCjr. **Lou Frenzel**

EQUIPMENT REPORTS

- 22 **Heath EE-103 IC Timer Course**
- 26 **Tektronix Model 214 Storage Oscilloscope**

DEPARTMENTS

- | | | | |
|-----|-------------------------------|-----|---------------|
| 6 | Advertising and Sales Offices | 102 | Market Center |
| 128 | Advertising Index | 99 | New Books |
| 129 | Free Information Card | 32 | New Products |
| 10 | Letters | 6 | What's News |

ON THE COVER

There are many manufacturers who sell TV-test equipment such as dot-pattern generators. But if you want to service video equipment other than TV's, then you need something more. This month we'll describe how to build and how to use a full-feature video test generator. You can use it to test VCR's, monitors, video amplifiers—just about any video equipment. It not only generates standard test patterns. It even has provision for external inputs (from a computer, for example) so that you can create your own test patterns for your own specific purpose. The story begins on page 43.

ANNUAL INDEX JANUARY—DECEMBER 1983

To present the maximum number of articles to our readers, we have not published the Annual Index as part of this issue. A 4-page brochure containing this index is available for those who need one. To get your free copy, send a stamped self-addressed envelope (legal size) to:

Radio-Electronics
Annual Index
45 East 17th Street
New York, NY 10003

Any requests postmarked on or before April 30 are free. After that date there is a 50¢ fee. Questions and comments about anything other than the index that are included with your request cannot be handled. Send them separately to our Editorial Offices.

Radio-Electronics, (ISSN 0033-7862) Published monthly by Gernsback Publications, Inc., 200 Park Avenue South, New York, NY 10003. Second-Class Postage Paid at New York, N.Y. and additional mailing offices. One-year subscription rate: U.S.A. and U.S. possessions, \$14.97; Canada, \$17.97; Other countries, \$22.47 (cash orders only, payable in U.S.A. currency). Single copies \$1.75. © 1984 by Gernsback Publications, Inc. All rights reserved. Printed in U.S.A.

POSTMASTER Please send address changes to RADIO-ELECTRONICS, Subscription Dept., Box 2520, Boulder, CO 80322.

A stamped self-addressed envelope must accompany all submitted manuscripts and/or artwork or photographs if their return is desired should they be rejected. We disclaim any responsibility for the loss or damage of manuscripts and/or artwork or photographs while in our possession or otherwise.

As a service to readers, Radio-Electronics publishes available plans or information relating to newsworthy products, techniques and scientific and technological developments. Because of possible variances in the quality and condition of materials and workmanship used by readers, Radio-Electronics disclaims any responsibility for the safe and proper functioning of reader-built projects based upon or from plans or information published in this magazine.

VIDEO ELECTRONICS

DAVID LACHENBRUCH
CONTRIBUTING EDITOR

NEW PICTURE TUBES

TV picture tubes will get bigger later this year, when American manufacturers adopt the next generation of square-cornered designs. Unlike some Japanese manufacturers, who already are substituting the so-called **FST** (Flat Square Tubes) in the smaller sizes (*Radio-Electronics*, October 1983), American TV makers have decided to retain the same faceplate curvature as at present in their new squarish models—at least for the time being. All four American picture-tube manufacturers have finalized their plans. Three of those manufacturers—General Electric, Philips and RCA—will offer new 26-inch tubes while the fourth manufacturer, Zenith, has decided to adopt the 27-inch size as offering a noticeably larger picture than the current 25-inch tube.

Zenith's 27-inch tube will have a 340-square-inch viewable picture, 7.9% larger than a 25-inch (which measures 315 square inches) and 4.5% larger than the the 324 square inches of the 26-inch version. All of the manufacturers will continue to offer 25-inch tubes, at least for a time, for use in lower-priced big-screen models. In 1985 or 1986, RCA plans to add a premium flat-faced tube of completely new design, which it calls the **SP** (for Square Planar). That new tube is expected to measure 27-inches.

American manufacturers are expected to follow the Japanese later into new 20-inch and 14-inch square-cornered versions of the current 19- and 13-inch tubes, but it's doubtful that they'll adopt the flat face, with which Japanese manufacturers are said to be having difficulty in production.

LASERVISION GOES SOLID-STATE

The first laser disc-player using a solid-state laser pickup has been introduced in Japan by Pioneer. By eliminating the complex power-supply system formerly required by the tube laser, size and cost have been reduced. The random-access programmable player with wireless remote control is priced in Japan at about \$825, or \$125 below the original model. Its size also has been sharply reduced—it's smaller than RCA's random-access CED player. In another innovation, the player is simpler to use because it is slot-loaded from the front, eliminating the requirement of lifting the lid and placing the disc on a turntable. A similar model is expected in the U.S. this winter.

JAPAN ELECTRONICS SHOW

The Japan Electronics Show is usually a preview of what Americans will see in the following year, but the Fall 1983 show was lacking in any major excitement. The expected hit of the show—the new 8-mm video format—was completely missing, in line with our report that it has been shelved in Japan (*Radio-Electronics*, December 1983). In its place was the JVC-developed VHS Video Movie, the compact camera-recorder using the small VHS-C cassette. The show demonstrated that solid-state cameras are well on the way—with **CCD** (Charge-Coupled Device) models from Sony (already introduced in the U.S.), Mitsubishi, and Sanyo, along with a new version of Hitachi's MOS camera. Sanyo demonstrated a pocket LCD color set with three-inch screen, scheduled for the second half of 1984 at about \$425 in Japan. Prototype digital-TV sets were shown by Panasonic, NEC, Sharp, Sony, and Toshiba, but it now seems unlikely that any of those will reach the American market in 1984.

VIDEO DISC GAMES

The coin-operated videodisc games, which have been nabbing quarters at a smart pace in amusement arcades, may be coming into the home. And they may come in two different versions—Laservision and CED. Although the first arcade videodisc games have involved the use of laser optical discs, Bally Manufacturing Co. chose the new RCA interactive CED disc system for its NFL football game. The game involves two players, representing offensive and defensive teams, who choose plays that are enacted in actual film footage. RCA has been talking with home-computer and videogame manufacturers about introducing home versions combining the CED disc system with game hardware and software. The company is expected to introduce a new version of its interactive videodisc system later this year with specific ports for home computers and videogames. Also, RCA recently reduced the prices of its videodisc players and discs to enhance the sales rate.

R-E

100 MHz scope, counter, timer, multimeter: All one integrated system.

100 MHz dual time base scope. 3.5 ns risetime; sweeps from 0.5 s to 5 ns/div; alternate sweep; $\pm 2\%$ vertical/horizontal accuracy; vertical sensitivity to 2 mV/div @ 90 MHz.

9-digit fluorescent display. Digitally accurate readouts accompany the CRT waveform. Error messages and prompts also appear on the display.

Dc volts and ac coupled true RMS volts. Measured through the Ch 1 scope input.

Gated measurements. Use the scope's intensified marker to measure frequency, period, width and to count events within specified portions of the signal.

Auto-ranged, auto-averaged counter/timer. Frequency, period, width, delay time, Δ -time, plus totalize to more than 8 million events — with 7 digits plus exponent displayed.

Auto-ranged DMM. Use floating DMM side inputs with up to 5000-count resolution. Get precise readouts of average dc and true RMS voltage. Measure resistance from milliohms to gigohms.

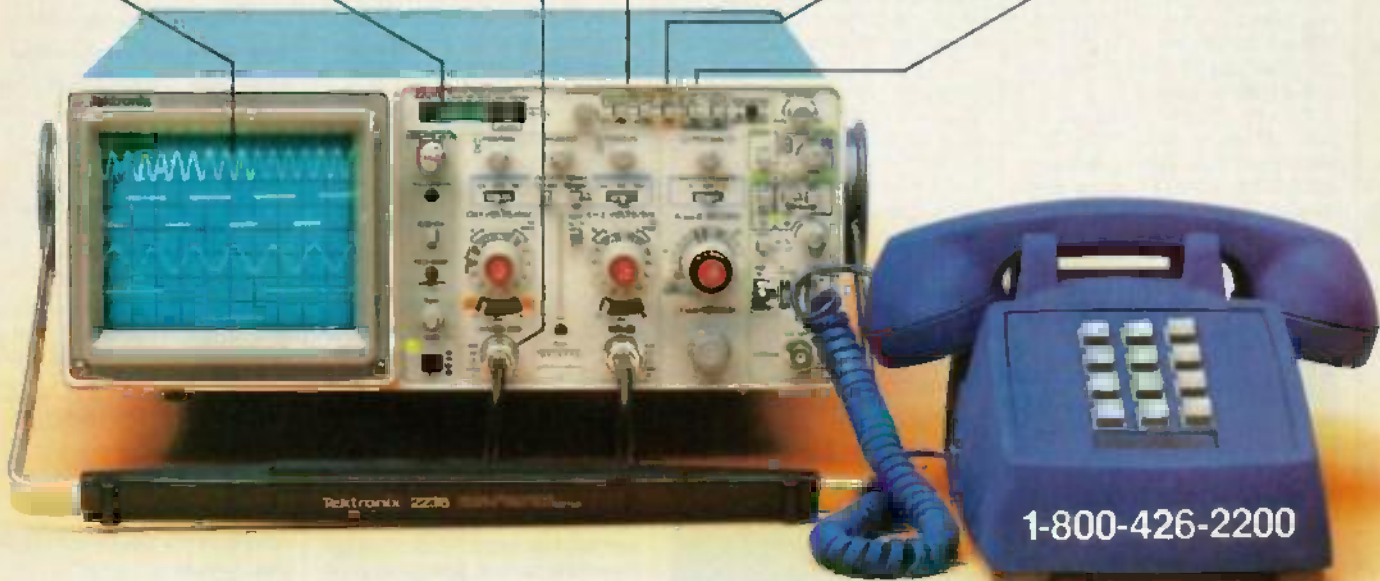

Now make measurements faster, easier, with greater accuracy and user confidence.

The Tek 2236 makes gated counter measurements, temperature, time, frequency, resistance and voltage measurements push-button easy. You see results concurrently on the 9-digit numeric readout and CRT display.

Its complete trigger system includes pushbutton trigger view, plus peak-to-peak auto, TV line, TV field, single sweep and normal modes.

At just \$2650,* the 2236 includes the industry's first 3-year warranty on all parts and labor, including the CRT.

Integrated measurement system. 3-year warranty. 15-day return policy. And expert advice. One free call gets it all! You can order, or obtain literature, through the Tek National Marketing Center. Technical personnel, expert in scope applications, can answer your questions and expedite delivery. Direct orders include operating and

service manuals and worldwide service back-up.

**Call toll-free:
1-800-426-2200,
Extension 144.**

In Oregon, call collect:
(503) 627-9000, Ext. 144.
Or write Tektronix, Inc.
P.O. Box 1700
Beaverton, OR 97075

Tektronix®
COMMITTED TO EXCELLENCE

WHAT'S NEWS

New solid-state switch handles 12,000 watts

A new semiconductor switch was described by scientists of General Electric to the recent International Electron Devices Meeting in Washington, DC. It has the highest power-handling capacity so far attained in power metal-oxide-semiconductor (MOS) devices.

A second-generation insulated gate transistor (IGT) switch, the new device is rated at 25 amperes, 500 volts continuous, and can handle peak gate turn-off currents as high as 150 amperes.

IGTs combine in a single IC the best features of power MOSFETs and bipolar transistors. Like power MOSFETs, the IGT has low turn-on power requirements; and like bipolar transistors, the new device can handle high currents.

The first-generation IGT was rated at 10 amperes and 500 volts. To increase the power rating, the GE researchers made it larger and more densely packed. The 25-ampere device measures 200 by 200 mils and contains 16,000 interconnected cells, as against the 140 by 140 mils and 6,500 cells of the older unit. The research and development team also improved the device by reducing the gate turn-off time from four microseconds to approximately one microsecond.

Those improvements are expected to extend the device's applications considerably, making it highly suitable, for instance, for the drives of motors up to five horsepower, whereas the older IGT was limited to only half-horsepower devices.

Foreign "pirates" steal US satellite programs

The American film industry is becoming greatly concerned about the interception by foreign concerns of American satellite programs intended for U.S. cable TV. Those programs are then being re-broadcast for their own clients—or for the viewing public—in their own countries.

Losses, the motion-picture industry asserts, are often serious to American motion-picture companies who depend on foreign film sales for a critical portion of their profits. In Jamaica, for example, the government-owned broadcast administration showed four important films not yet released to Jamaican theaters. Coincidentally, there was a 50 percent drop in the revenues of Jamaican movie theaters.

(The Jamaican government, which says it is making arrangements with American interests to purchase the rights to use American films, has since stopped the broadcasts.)

According to the Motion Picture Association of America, the pirating takes place in most of the Central American countries, in the Bahamas, Haiti, and Dominica, as well as in Jamaica. "Pirates" range from hotel owners, who pick up the signals to show for their room guests, to major television companies that cover a whole country. Most of them insist that their actions are legal—that copyright laws covering such transmissions are either ambiguous or nonexistent in their countries.

More than a quarter million Americans are also watching satellite television programs picked up from their own backyard antennas. The legality of that action is in dispute, though persons who use such reception for profit can be prosecuted immediately; and usually, that is what happens.

The problem is expected to increase greatly as France, Germany, Brazil, Japan, and Saudi Arabia launch satellites for television programming. Those satellites will broadcast a tremendous amount of copyrighted material over practically the whole populated earth.

Radio-Electronics

Hugo Gernsback (1884-1967) founder

M. Harvey Gernsback, editor-in-chief

Larry Steckler, CET, publisher

Arthur Kleiman, editor

Carl Laron, WB2SLR, associate editor

Brian C. Fenton, assistant technical editor

Robert A. Young, assistant editor

Jack Darr, CET, service editor

Robert F. Scott, semiconductor editor

Herb Friedman, communications editor

Gary H. Arlen, contributing editor

David Lachenbruch, contributing editor

Earl "Doc" Savage, K4SDS, hobby editor

Lou Frenzel, contributing editor

Ruby M. Yee, production manager

Robert A. W. Lowndes, production associate

Dianne Osias, production assistant

Joan Roman, circulation director

Arline R. Flahman, advertising coordinator

Cover photo by Robert Lewis

Radio-Electronics is indexed in Applied Science & Technology Index and Readers Guide to Periodical Literature.

Gernsback Publications, Inc.
200 Park Ave. South
New York, NY 10003
President: M. Harvey Gernsback
Vice President: Larry Steckler

ADVERTISING SALES 212-777-6400

Larry Steckler
Publisher

EAST/SOUTHEAST

Stanley Levitan
Radio-Electronics
200 Park Ave. South
New York, NY 10003
212-777-6400

MIDWEST/Texas/Arkansas/Okla.

Ralph Bergen
Radio-Electronics
540 Frontage Road—Suite 325
Northfield, Illinois 60093
312-446-1444

PACIFIC COAST

Mountain States
Marvin Green
Radio-Electronics
15335 Morrison St., Suite 227,
Sherman Oaks, CA 91403
818-986-2001



THE NEW IGT SWITCH HANDLES 12,000 WATTS. Though it measures less than a quarter inch square, it contains 16,000 interconnected cells, and is rated at 25 amperes, 500 volts.



R-E

The Digital vs. Analog battle is over.

\$85* buys you the new champion. **The new Fluke 70 Series.**

They combine digital and analog displays for an unbeatable two-punch combination.

Now, digital users get the extra resolution of a 3200-count LCD display.

While analog users get an analog bar graph for quick visual checks of continuity, peaking, nulling and trends.

Plus unparalleled operating ease, instant autoranging, 2,000+ hour battery life and a 3-year warranty.

All in one meter.

Choose from three new models. The Fluke 73, the ultimate in simplicity. The feature-packed Fluke 75. Or the deluxe Fluke 77, with its own multipurpose protective holster and unique "Touch Hold" function (patent pending) that captures and holds readings, then beeps to alert you.

Each is Fluke-tough to take a beating. American-made, to boot. And priced to be, quite simply, a knockout.

For your nearest distributor or a free brochure, call toll-free anytime **1-800-227-3800**,

Ext. 229. From outside U.S., call 1-402-496-1350. Ext. 229.

FROM THE WORLD LEADER IN DIGITAL MULTIMETERS.



Fluke 73

\$85*
Analog/digital display
Volts, ohms, 10A, diode test
Audible continuity
Autorange
0.7% basic dc accuracy
2000+ hour battery life
3-year warranty



Fluke 75

\$99*
Analog/digital display
Volts, ohms, 10A, mA, diode test
Audible continuity
Autorange/range hold
0.5% basic dc accuracy
2000+ hour battery life
3-year warranty



Fluke 77

\$129*
Analog/digital display
Volts, ohms, 10A, mA, diode test
Audible continuity
"Touch Hold" function
Autorange/range hold
0.3% basic dc accuracy
2000+ hour battery life
3-year warranty
Multipurpose holster

* Suggested U.S. list price, effective October 1, 1983



MARCH 1984

7

SATELLITE/TELETEXT NEWS

GARY ARLEN
CONTRIBUTING EDITOR

CBS, COMSAT TEAM UP

Two of the largest companies readying direct-broadcast satellite services are consolidating their plans—and it's possible that other major organizations will affiliate with this "joint effort." Comsat (through its Satellite TV Corp. DBS subsidiary) and CBS Inc., which are among the eight DBS applicants, will work together on video-program development and acquisition, equipment and technical design, financing, and other factors. It's unclear what the new teaming will do to the plans of each company: Comsat had intended to launch its East Coast direct-to-home service this fall (1984). CBS's proposal includes high-definition TV features, such as 1125-line video, wide-screen display, and stereo sound.

EQUIPMENT HIGHLIGHTS

The *Nova SS* satellite-receiving dish—made of stainless steel—comes in 7.5- and 9-foot sizes with prime focus feed or subreflector feed. Steel construction is said to have greater tensile strength than aluminum. (Kaul-Tronics, PO Box 292, Lone Rock, WI 63556.)

Norsat 3000 satellite receiver is a fifth-generation unit with dual downconversion, continuous tuning, active limiting and clamping, ultra-linear low-noise oscillators, and digital metering. (Norsat International Inc., 205-19425 Langley Bypass, Surrey, British Columbia V3S 4N9 Canada.)

HBO STARTS SCRAMBLING

Home Box Office has begun its large-scale testing of "VideoCipher," the signal-scrambling system it has developed with M/A-Com. Both the regular HBO and the Cinemax feeds are being scrambled on HBO East transponders aboard Hughes' Galaxy Satellite. HBO says that new refinements in the scrambling technology have greatly reduced the price for cable-TV headend equipment—suggesting that the timetable for scrambling of all HBO service may be speeded up.

DBS AROUND THE WORLD

Another all-European direct-broadcasting-satellite plan has emerged from Luxembourg—this one coordinated by the government of that small country. The new proposal envisions a 16-channel system, using a modified 50-watt satellite now under construction; service would start by 1986. An earlier "Luxsat" plan using a high-powered 200-watt bird, proposed by Radio Tele-Luxembourg, has run into political problems because other countries fret about implications of programs being transmitted across national borders. Under the new plan, electronics companies in each European country would build and install small-diameter DBS dishes—costing the equivalent of about \$500—to pick up the signals.

The British Broadcasting Corp. has begun negotiations with U.S. programmers for shows to be used on their proposed two-channel DBS system that is expected to use the new C-Mac technical format. However, delays may push British DBS back from the targeted 1986 launch; by target date, there may not be enough homes equipped with appropriate reception equipment to pick up C-Mac signals.

China may develop a Ku-band DBS service for education and community information. Since only 30% of the Chinese population has access to conventional TV signals, DBS is seen as a way to expand service nationwide; China has three orbital slots for domestic service. No timetable has been established for the low-powered DBS service.

HYBRID INTERACTIVE SYSTEM

Cox Cable Communications, a leading cable-TV operator, will team up with Chase Manhattan Bank, Jerrold Electronics (a major cable equipment firm), and other partners to develop an innovative hybrid teletext/videotex service by 1985. The system will use cable TV as well as telephone lines to deliver information, education, data processing, banking, and other interactive services through Jerrold's Communicom terminals. The Communicom cable-TV converters use a NAPLPS teletext-standard system for high-resolution graphics and will be installed on new Cox cable systems. In non-cable homes the same device—stripped of its cable channel-selector components and fitted with a phone modem—will be installed, making it possible to offer the information/banking/shopping service to homes that will connect to the system through a conventional phone-TV setup.

R-E

OK's Hot Tip for Desoldering Problems

SA-6 DESOLDER IRON

Revolutionary new electric desoldering iron combines the ease and portability of a hand-held, manual, desolder pump, with performance of an industrial desolder station. This unique AC powered compact tool features portable, one-hand desoldering eliminating the need for separate soldering iron and desolder pump. No shop air required. Essential for all tool kits, field service technicians, and repairmen, as well as production applications. Vacuum chamber is easily removed for cleaning or replacement. Replacement tips available. Tool is supplied with SAT-6-059 tip; diameter .059 inch (1.5mm).

FEATURES:

- Self contained suction power and heating element.
- Economical.
- Lightweight 4oz. (113gms).
- Compact size 10¼ inches (26cm).
- Replacement nozzles available.

MODEL NO.	INPUT VOLTAGE	
SA-6-115	115V AC 50/60Hz	
SA-6-230	230V AC 50/60Hz	
NOZZLE	NOZZLE HOLE DIAMETER	
	INCH	MM
SAT-6-059	.059	1.5
SAT-6-070	.070	1.77

3455 Conner Street, Bronx, New York, 10475, U.S.A.
Telex 125091 OK NYK, Telex 232395 OK NY UR
Phone (212) 994-6600.



CIRCLE 98 ON FREE INFORMATION CARD

LETTERS

Address your comments to: Letters, Radio-Electronics,
200 Park Avenue South, New York, NY 10003

OOOOPS!

We've noticed an error in the parts-placement diagrams that appeared in January's cover story "Build This C-QUAM AM Stereo Converter." The part labeled Q1 in Figs 7, 9, and 11 should be labeled IC2 (the LM317LZ voltage regulator). We're sorry for any confusion that oversight might have caused.

We also neglected to mention that C-QUAM is a registered trademark of Motorola, Inc. Our apologies.—*Editor*

CORRECTION

This is in response to the brief item in the "What's News" department of **Radio-Electronics** for September 1983. The writeup was accurate except for one very important point: Neither AT&T nor Motorola Corporation have posed any objections to Geostar's FCC filing. In fact, Geostar's filing has received overwhelming support. The one objection registered was by a small Gulf Coast microwave-communications firm, whose markets would be placed in severe jeopardy by Geostar's technology.

I believe that the Motorola and AT&T objections that you were referring to were directed at Mobilsat, which is a voice-communications system also under review by the FCC. The *New York Times* published an article in which the author erroneously mixed public reaction to Geostar with that of Mobilsat. Perhaps the error in your writeup was due to the misinformation in that article.

I would appreciate it very much if you would publish this correction, because such misinformation could be injurious to Geostar.

T. STEPHEN CHESTON,
Vice President for Administration,
Geostar Corp.

TRANSIENT SUPPRESSOR

I would like to comment on Herb Friedman's fine article, "Build This Powerline Transient Suppressor," in the September 1983 **Radio-Electronics**. Last spring, I realized my need for such a device and set about designing and building one. The design I came up with was very similar to Mr. Friedman's. There are, however, a few differences worth noting.

Fuse F1 in Mr. Friedman's circuit is a failsafe device for the varistor, and is a good idea; but it will not act as a protective fuse for the unit itself, or for any device plugged into it.

A protective fuse must be added to the hot powerline entering the unit. Because the filter used (Radio Shack 273-100) has a 5-amp current rating, that fuse must be rated for 5 amps or less. If your computer system requires more power, filters with a higher rating may be purchased from electronics supply houses.

I built my unit completely inside a power strip. A heavy-duty, six-outlet, metal cabinet power strip was purchased. By removing two of the outlets (there are three standard AC household receptacles inside) there was enough room for all the components. It was a tight fit that required careful construction, but I was able to build it without any problems. Another difference in my design was that I placed the filter between the relay and the power outlets to filter any possible noise generated by the relay coil. The net result was a compact, easy-to-mount power source that protected up to four computer components against all three powerline problems outlined in the article.

The total cost for the unit was about \$35—quite a saving over the \$100 to \$200 charged for equivalent commercial suppressors.

GARY E. WHITNEY
Portland, OR

WHICH IS RIGHT?

In reference to page 45 of the November 1983 **Radio-Electronics**, in the article, "Hi-Fi Sound Converter for Your TV", refer to page 47, Fig 2. Resistor R18 is connected directly to the emitters of Q1 and Q2 and R19 via C23.

However, the printed-circuit board shows R18 and R19 (on page 48, Fig 4) both directly connected to Q1 and Q2's emitters.

Please tell me which is correct—the schematic or the board.

JAMES C. MORALL
Baldwin, NY

The parts-placement diagram is correct—but so is the schematic. To make both match, simply reverse the positions of R19 and C23 on the schematic. (For those of you who can't find R18, it's the resistor labeled R13, right on top of R19.)—Editor.

STAY AS YOU ARE

Please add my name to the growing list of those who have either canceled or refused to renew their subscriptions to that electronics magazine which converted itself into just another trendy all-computer publication in 1982. **Radio-Electronics** is now the last remaining magazine that authoritatively covers all aspects of electronics. I have benefited immeasurably for the past three decades from your fine instructional and construction articles,

especially those on test instruments. Please, please stay as you are now and have been in the past. Viva **Radio-Electronics!**

BERNARD J. FINNEGAN
Los Angeles, CA

NOT PROPRIETARY

I would like to point out an error involving our listing in your recent computer buying-guide issue (October 1983, **Radio-Electronics**).

The 16-bit operating system listed (Z-DOS) is not proprietary, as indicated. Rather, it is our version of Microsoft's MS-DOS, and thus is compatible with much of the software written for IBM, TI, and other system using MS-DOS or a variation.

ROBERT L. WINTER
Zenith Data Systems

THE SANDCASTLE PULSE

I just received your September 1983 issue of **Radio-Electronics**, and read in the "Service Questions" section on page 99 a "good question." (What is a sandcastle generator and where did it get that name?) I think I have sort of an answer to it.

The sandcastle pulse is a complex waveform with a repetition rate of the horizontal frequency. It looks like the waveform shown in Fig. 1-a.

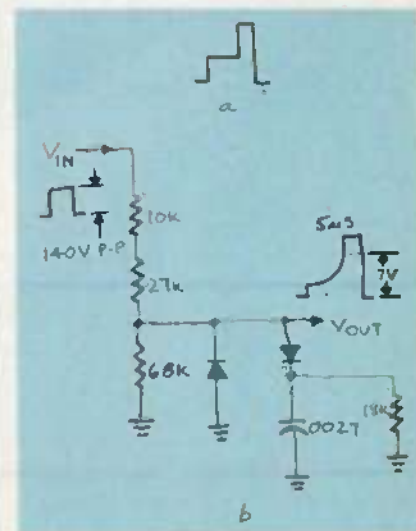

FIG. 1

The displacement of the upper part allows the separation of the burst signal. Sandcastle pulses are used in color-TV sets for the following purposes: (1) black-level clamping of luminance.

continued on page 20

THE POMONA PROMISE

We provide the design engineer with the best
"black boxes" made in this country.
Or anywhere.

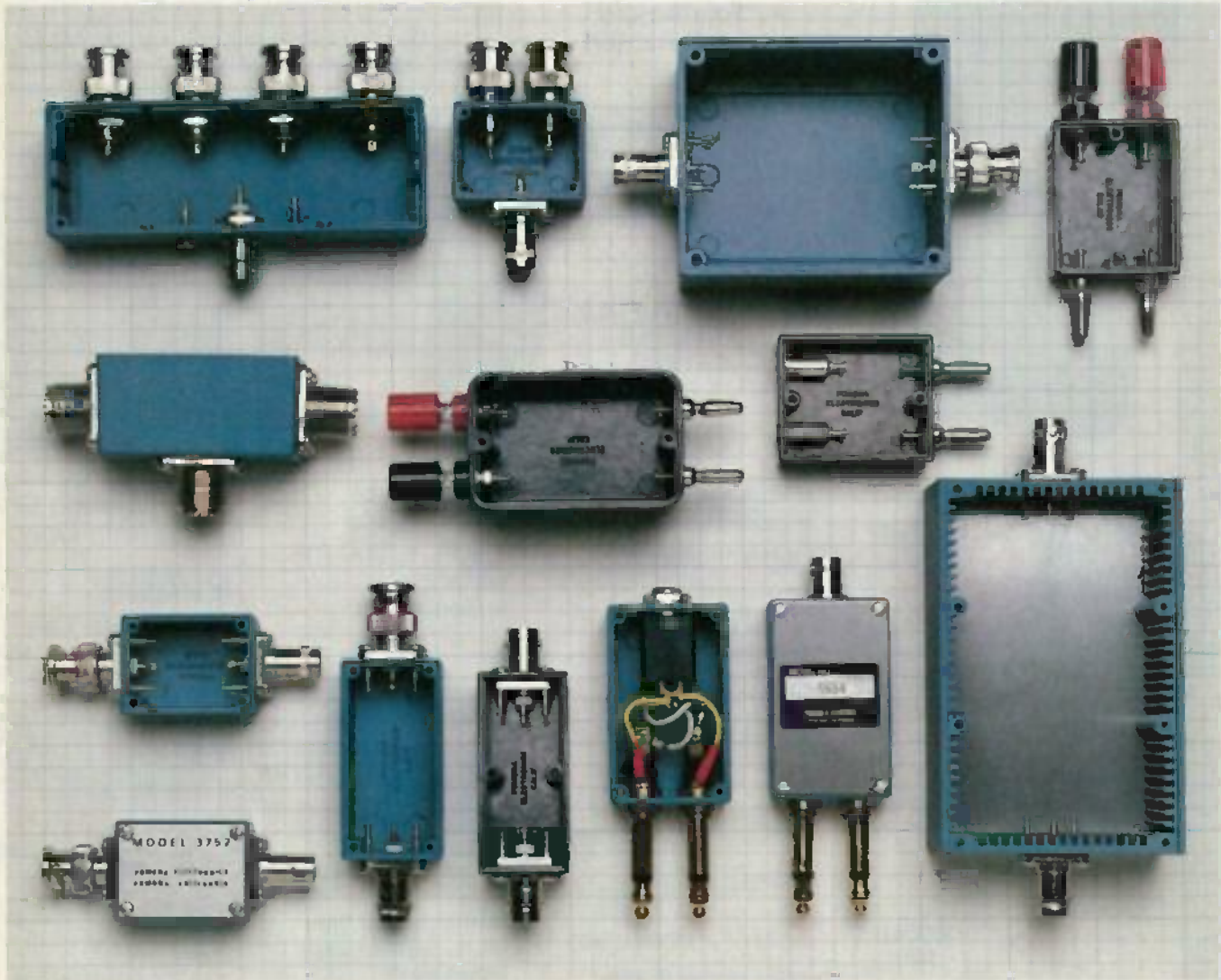

That may seem like a tough promise to deliver on. But if you talk to the professionals of the electronics industry, you'll learn quickly and with great assurance that the "black boxes" designed and produced by ITT Pomona Electronics are looked upon as the best in the business. Bar none.

The reason goes back to when we first introduced the idea of providing convenient containers for special test circuits. We promised then that ours would be the best. And that's the way it's been.

Since then our line has ex-

panded to eleven different series to accommodate just about any component packaging requirement you'll ever need.

At ITT Pomona Electronics, we know there is no such thing as standing pat. We also know that your needs change and your expectations become greater as the demands become more severe. To this end we will continue to create a better way. A better product.

That's a promise.

All of our products are described and illustrated in our General Catalog, and it's free. Just call (714) 623-3463 or 623-6751.

TWX 910-581-3822. Write to us at ITT Pomona Electronics, a Division of ITT Corporation, 1500 E. Ninth St., Pomona, CA 91766.

In Europe: ITT CANNON BELGIUM S.A./N.V. Rue Colonel Bourg Str. 105 Space A (B.3) 1140 Brussels, Belgium. Phone: 02-735-6094.

Our products are available through your favorite electronics parts distributor.

ITT Pomona Electronics

CIRCLE 73 ON FREE INFORMATION CARD

MARCH 1984

2



- 77**
- 0.3% Accuracy
 - Manual or Autorange
 - 10A + mA Range
 - Beeper
 - "Touch-Hold" Function

\$129⁰⁰

WE CARRY A FULL LINE OF FLUKE MULTI-METERS. IN STOCK NOW

FLUKE 70 SERIES MULTIMETERS

- Analog Display • Rotary Knob • Volts AC & DC • Resistance to • 32 MΩ • 10 Amps • Diode Test • 3200 Counts • Fast Autoranging • Function Annunciators in Display • Power-Up Self Test • 2000+ Hour Battery Life w/ Power Down "Sleep Mode" • New Test Leads • VDE & UL Approval



\$99⁰⁰

75

- 0.5% Accuracy
- Manual or Autorange
- 10A + 300 mA Range
- Beeper



\$85⁰⁰

73

- 0.7% Accuracy
- Autorange Only
- 10 Amp Only



4 1/2 DIGIT MULTIMETERS

\$349⁰⁰

MODEL 8060A



- Frequency measurements to 200KHz
- dB measurements
- Basic dc accuracy 0.4%: 10μV, 10 nA and 10 mΩ sensitivity
- Relative measurements
- True RMS
- High-speed Beeper



POWER SUPPLIES



\$299⁹⁵

MODEL 1601

- Isolated 0-50VDC, continuously variable; 0-2A in four ranges
- Fully automatic shutdown, adjustable current limit
- Perfect for solid state servicing



\$329⁹⁵

MODEL 1650

- Functions as three separate supplies
- Exclusive tracking circuit
- Fixed output 5VDC, 5A
- Two 0 to 25VDC outputs at 0.5A
- Fully automatic, current-limited overload protection



INDUSTRIAL TRANSISTOR TESTER

\$199⁹⁵

MODEL 520B

- Now with H/L/O Drive
- Works in-circuit when others won't
- Identifies all three transistor leads
- Random lead connection
- Audibly and visually indicates GOOD transistor



PRICE DOES NOT INCLUDE PROBES

- 1mV/division sensitivity to 70 MHz
- 500 μV/division cascade sensitivity
- Four-input operation provides trigger view on 4 separate inputs
- Alternate time base operation
- Switching power supply delivers best efficiency and regulation at lowest weight



FUNCTION GENERATORS

\$189⁹⁵

MODEL 3010

- Sine, square and triangle output
- Variable and fixed TTL outputs
- 0.1 Hz to 1MHz in six ranges
- Push button range and function selection
- Typical sine wave distortion under 0.5% from 1 Hz to 100kHz

MODEL 3020 \$319⁹⁵

SWEEP FUNCTION

- Four Instruments in one Package — sweep generator, function generator, pulse generator, tone-burst generator
- Covers 0.02Hz-2MHz
- 1000:1 tuning range
- Low-distortion high-accuracy outputs



CAPACITANCE METERS

\$199⁹⁵

MODEL 830

- Automatically measures capacitance from 0.1pF to 200mF
- 0.1pF resolution
- 0.2% basic accuracy
- 3 1/2 digit LCD display



\$159⁹⁵

MODEL 820

- Resolves to 0.1pF
- 4 digit easy-to-read LED display
- Fuse protected against charged capacitors
- Overrange indication

BECKMAN'S CIRCUITMATE[®] ALL UNDER \$100

AVAILABLE NOW . . .

\$64⁹⁵



Circuitmate DM 20—
3½-digit, pocket-size
multimeter; 0.8% Vdc
accuracy, diode test,
hFE test, conductance,
10 amps AC and DC
ranges, auto-polarity,
auto-zero, auto-
decimal

\$79⁹⁵



Circuitmate DM-25—
3½ digit, pocket-size
multimeter; 0.5% Vac
accuracy, diode test,
capacitance, continuity
beeper, conductance,
10 amps AC and DC
ranges, auto-polarity,
auto-zero, auto-
decimal



\$69⁹⁵

Circuitmate DM-40 —
3½-digit multimeter;
0.8% Vdc accuracy,
diode test, auto-
polarity, auto-zero,
auto-decimal



\$89⁹⁵

Circuitmate DM 45 —
3½-digit multimeter;
0.5% Vdc accuracy,
diode test, continuity
beeper, 10 amps AC
and DC ranges, auto-
zero, auto-polarity,
auto-decimal



\$76⁹⁵

The DM 77 gives you
the convenience of
autoranging plus 10
amps ac/dc
measurement
capability. You simply
select the function
you want, and the
DM 77 automatically
sets the required
range.



The DM73 is the smallest digital
multimeter on the market. Its
probe-style design makes it ideal
for taking measurements in hard-
to-reach test areas.

\$63⁹⁵

- Small Size
- Complete
Autoranging
- "Touch Hold"
- Audible
continuity
checking

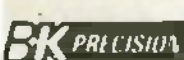

70 MHz Dual Time BASE SCOPE

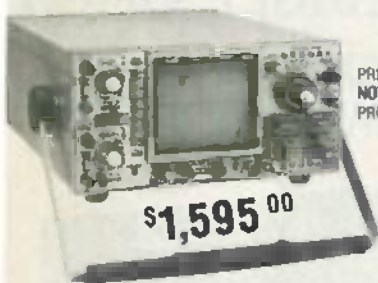

PRICE DOES
NOT INCLUDE
PROBES

\$1,595⁰⁰

MODEL 1590

- 1mV/division sensitivity to 100MHz
- 500 V/division cascade sensitivity
- 2ns/division sweep rate with 10x magnifier
- Four-input operation provides trigger views or four separate inputs
- Selectable 1M Ω or 50 Ω inputs
- Alternate timebase operation
- 20MHz bandwidth limiter for best view of low frequency signals
- Lighted function pushbuttons employing electronic switching with non-volatile RAM memory
- Switching power supply delivers best efficiency and regulation at lowest weight
- Selectable frequencies for chop operation

PROBES FOR SALE

FROM THE BEST SOURCE FOR OSCILLOSCOPE
PROBES AND DMM/VOM TEST LEAD SETS

- Low Cost
- High Quality
- Excellent Performance
- Slender, Flexible Cable
- Wide Range of Choice
- Switchable X1 and X10 Attenuation Factor
- 100 MHz Bandwidth

MODEL SP100

\$39⁹⁵
EACH



TEST PROBES, INC. TPI Your Probe Specialists

Circle Reader Service 7 for more information

TOLL FREE HOT LINE
800-223-0474

26 WEST 46th STREET, NEW YORK, N.Y. 10036
212-730-7030

THE TEST EQUIPMENT SPECIALISTS

**ADVANCE
ELECTRONICS**

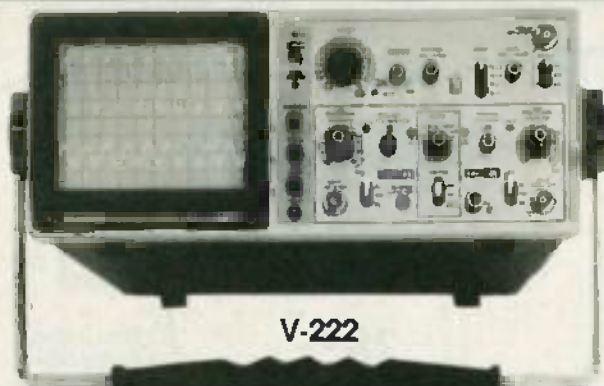

V-222

HI-PERFORMANCE PORTABLE OSCILLOSCOPES

ALL FEATURE 6" RECTANGULAR CRT
Full 2 year parts & labor warranty.

HITACHI

\$599⁹⁵

V-422
DC to 40 MHz,
1mV/div, dual-trace,
DC offset function



V-1050

\$1,249⁹⁵

V-1050F
100 MHz Quad Trace
w/delay sweep

\$499⁹⁵

V-222
DC to 20 MHz,
1mV/div, dual-trace,
DC off. func., Alt.
magnify function

\$439⁹⁵

V-212
DC to 20 MHz,
1mV/div, dual-trace

\$939⁹⁵

V-650F
60 MHz Dual Trace
w/delay sweep

PRICE DOES NOT INCLUDE PROBES. PROBES \$50. A PAIR WHEN PURCHASED WITH SCOPE. \$15 SHIPPING WITHIN CONTINENTAL U.S.

A.W. SPERRY AUTO RANGING



DM-6500

\$74⁹⁵

DC Volts

RANGE	ACCURACY
200mV	±(0.5% rdg + 4d)
2V	
20V	±(0.7% rdg + 4d)
200V	
1000V	±(1% rdg + 4d)

AC Volts

RANGE	ACCURACY 40-500 Hz
2V	
20V	±(1% rdg + 8d)
200V	
600V	±(1.2% rdg + 8d)

DC Current

RANGE	ACCURACY
200mA	±(1.5% rdg + 4d)
10A	±(1.7% rdg + 4d)

AC Current

RANGE	ACCURACY 40-500 Hz
200mA	±(2% rdg + 8d)
10A	±(2.2% rdg + 8d)

Resistance

RANGE	ACCURACY	SHORT CIRCUIT CURRENT (approx.)
200		Hi 1.5mA Lo —
2K	±(0.8% rdg + 5d) Hi	300µA 150µA
20K	±(1% rdg + 10d) Lo	30µA 15µA
200K		3µA 1.5µA
2000K	±(2% rdg + 10d)	0.3µA 0.15µA

MULTI-METERS.

THE RELIABLE ONES.

2 YEAR NO NONSENSE GUARANTEE



DM-6590

\$63⁷⁵

RANGES

DC VOLTS

RANGE	ACCURACY
2V	±0.5% rdg ±4 dgt
20V	
200V	±0.7% rdg ±4 dgt
500V	±1.0% rdg ±4 dgt

AC VOLTS

RANGE	ACCURACY
2V	
20V	
200V	±1.0% rdg ±8 dgt
500V	

RESISTANCE

RANGE	ACCURACY
2KΩ	
20KΩ	±0.7% rdg ±4 dgt
200KΩ	
2000KΩ	±1.2% rdg ±4 dgt

ORDERING INFORMATION

We don't just take orders, we ship them
Advance Electronics endeavors to keep everything we advertise in stock for immediate delivery.



- Mastercharge & Visa shipped within 24 hours.
 - Bank checks or Money Orders shipped within 24 hours.
 - Personal checks — please allow 3 weeks for check to clear.
 - All prices plus shipping charges. Please call for appropriate charges. Use our toll free number.
 - New York State residents add appropriate sales tax.
 - PRICES SUBJECT TO CHANGE WITHOUT NOTICE.
- Quantities are limited



V-151F

FEATURES

1mV/div high sensitivity design. Effective for measurement of weak signals.
Employs TV sync separator circuitry with one touch synchronization of both TV horizontal and vertical signals.

Delayed sweep function with one touch control 10 x magnification.

Trace rotation system for easily adjusting trace inclination caused by terrestrial magnetism.

Fine adjusting click positioning function enhances measuring efficiency.

Signal output: Vertical output terminal to Frequency Counter, etc.

Z axis Input provided — possible to use as CRT display.

One touch shifting of waveform slopes for easy observation of rise and fall of waves.

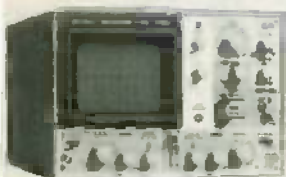

MODEL 302F

DUAL TRACE
W/DELAY

All HITACHI Oscilloscopes feature 2 year parts & labor warranty.

HITACHI 30 MHz SCOPE

\$549⁹⁵

Price does not include probes. Probes \$50, a pair when purchased with scope. \$15. shipping within continental U.S.

15 MHz TRIGGERED SCOPE

QUANTITIES ARE LIMITED

\$329⁹⁵

SPECIFICATIONS

Vertical Deflection	5mV/div to 5V/div ±5%, 10 calibrated steps									
Sensitivity	1mV/div to 1V/div ±0% (When using x5 amplifier) Uncalibrated continuous control between steps 1: < 2.5 (provided with click-positioning function)									
Bandwidth	DC to 15MHz, -3dB (at 4 div) DC to 7MHz, -30dB (at 4 div) (When using x5 amplifier) 24ns. (for x5) 70ns typ									
Rise Time	—									
Signal Delay Line	—									
Max. Input Voltage	600Vp-p or 300V DC + AC peak, at 1kHz									
Input Coupling	AC, GND, DC									
Input Impedance	Direct 1M ohm, approx. 30pF									
Operating Modes	Single trace									
X,Y Operation	External trigger input: X axis, Vertical Input: Y axis									
Sensitivity	X axis: approx. 200mV/div, Y axis: same as Vertical input									
Phase Difference	DC to 10kHz within 3°									
X Bandwidth	DC to 500kHz, -3dB									
Dynamic Range	4 div or more									
Vertical Output	—									
Output Voltage	20mV/div or more (terminated into 50Ω)									
Bandwidth	50Hz to 5MHz, -3dB									
Output Impedance	Approx. 50Ω									
Horizontal Deflection	AUTO, NORM, TV (+), TV (-)									
Trigger Modes	LINE, EXT									
Trigger Source	AC									
Trigger Coupling	TV sync separation circuit									
TV Sync	1 div or more (TV sync-signal)									
Internal	1Vp-p or more (TV sync-signal)									
External	—									
Trigger Sensitivity	<table border="1"> <thead> <tr> <th>Frequency</th> <th>Internal</th> <th>External</th> </tr> </thead> <tbody> <tr> <td>20Hz to 2MHz</td> <td>0.5div</td> <td>200mV</td> </tr> <tr> <td>2 to 15MHz</td> <td>1.5div</td> <td>800mV</td> </tr> </tbody> </table>	Frequency	Internal	External	20Hz to 2MHz	0.5div	200mV	2 to 15MHz	1.5div	800mV
Frequency	Internal	External								
20Hz to 2MHz	0.5div	200mV								
2 to 15MHz	1.5div	800mV								
AUTO Low Bandwidth	30Hz									
Trigger Slope	±									
External Trigger Input	Input impedance: approx. 1M ohm, 30pF or less Max. input voltage: 100V (DC + AC peak at 1kHz)									
Sweep Time	0.2μs/div to 0.2s/div, ±5% 19 calibrated steps Uncalibrated continuous control between steps 1: < 2.5 (provided with click-positioning function)									
Sweep Time Magnifier	10 times (±7%)									
Max. Sweep Time	100ns/div 120ns/div and 50ns/div, not calibrated									
Amplitude Calibrator	—									
Waveform	Approx. 1kHz ±10% (typ), square wave									
Voltage	0.5V ±5%									
Power Requirements	100/120/220/240V ±10% 50 to 60Hz, approx. 40W									
Dimensions	Approx. 275(W) x 190(H) x 400(D) mm									
Weight	Approx. 8.5kg									

Price does not include probe. Probe \$20, when purchased with oscilloscope.

Full 2 year parts & labor warranty.

WE CARRY A FULL LINE OF HITACHI
OSCILLOSCOPES



TOLL FREE HOT LINE
800-223-0474

212-730-7030

26 WEST 46th STREET, NEW YORK, N.Y. 10036

THE TEST EQUIPMENT SPECIALISTS

ADVANCE ELECTRONICS

Only NRI Gives You This Kind of Training and Equipment.

Only NRI Gives You So Much Professional Preparation For a TV/Audio/Video Servicing Career.

Build this 25" Heath/Zenith Color TV with 112 channel tuning system, infrared remote control, advanced sound system, and in-set space phone.

Get complete, thorough instruction in the theory, servicing, and repair of TV, VCR, video disc players, audio equipment, AM/FM receivers, antenna systems, home video cameras, projection TV, and more with 65 easy-to-digest, bite-size lessons.

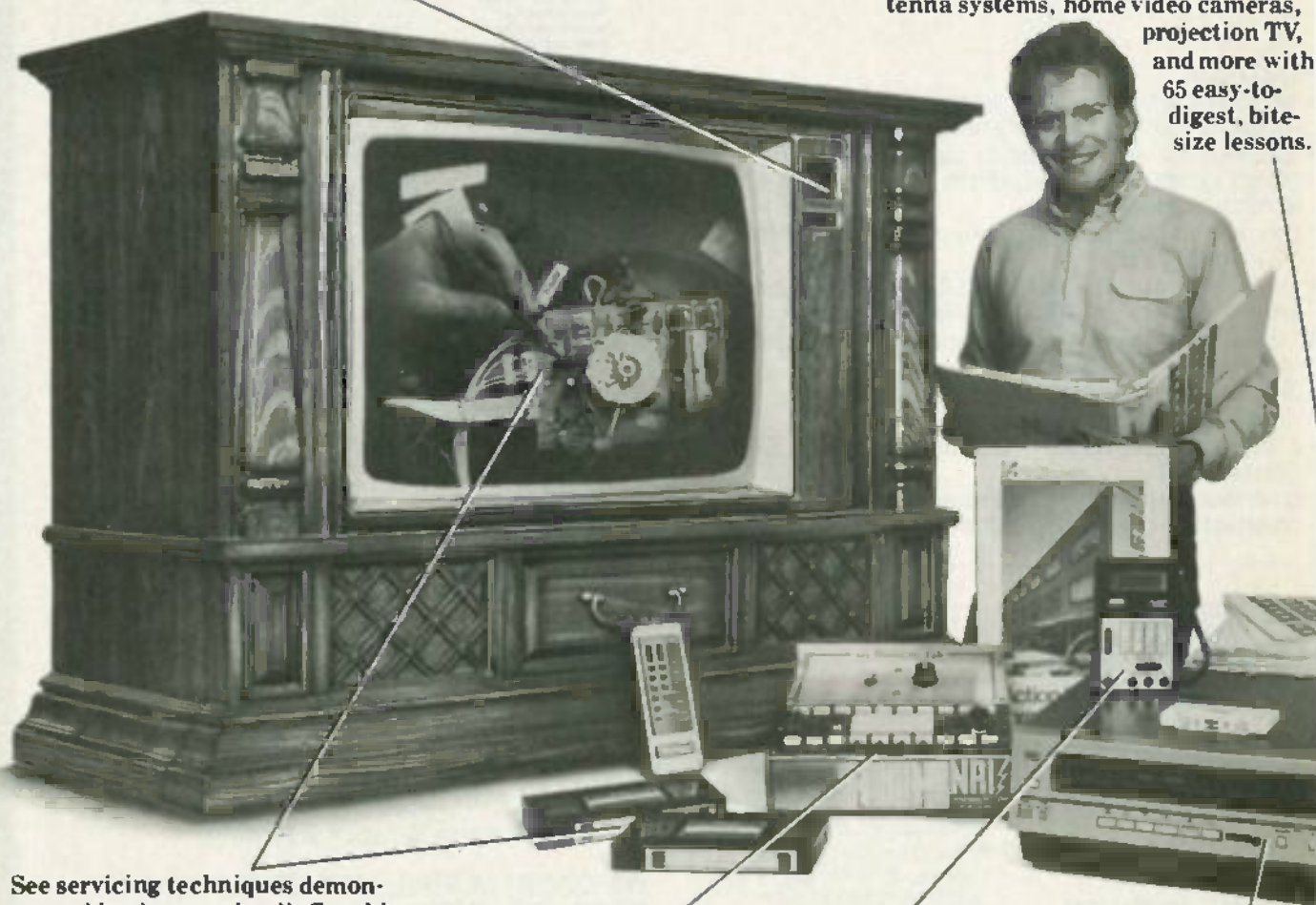

See servicing techniques demonstrated in close-up detail. Graphic presentations make theory and systems come alive on NRI Action Videotapes covering VCRs, disc players, and TVs.

Perform challenging state-of-the-art electronic experiments and demonstrations using your NRI Discovery Lab®.

Learn how to diagnose problems using a professional 3½-digit digital multimeter. Exclusive NRI Action Audio instructions talk you through its complete operation and use.

Learn servicing and adjustment techniques with this 6-hour, remote control videocassette recorder you get as part of your training.

Only NRI gives you so much practical training with equipment you earn on and keep. You learn by doing. That's the way to make it interesting, that's the way to make it enjoyable, that's the way to get the hands-on experience and know-how you need.

Hands-On Training For Real Bench Experience and Priceless Confidence

You start with experiments and demonstrations on the unique NRI Discovery Lab. You learn basic circuit wiring and soldering techniques, and then quickly move on to more advanced concepts as you come to understand electronic theory, solid-state devices, digital systems, and microprocessors. You learn by actually building and observing the operation of circuitry you'll be working with in real-life situations.

Exclusive NRI Training On Videotape

In addition to profusely illustrated lessons, you get NRI's Action Audio cassette to "talk" you through the use and operation of the professional digital multimeter you receive as part of your equipment. Even more exciting are your NRI Action Video cassettes... videotaped lessons that show you graphic presentations of electronic systems, vivid closeups of servicing techniques and professional "shortcuts" to study and replay as often as you want.

You Get TV, VCR, DMM and More Equipment To Keep

You also build your own 25" Heath/Zenith color TV, a state-of-the-art unit that includes infrared remote control, a Time Control Programmer, and the incredible Advanced Space Phone that lets you telephone from your chair. Using the videocassette recorder that's included as part of your training, you learn how to adjust, service and re-

pair these fast-selling units. Your front-loading VCR features up to 6-hour recording capacity, remote control, and programmable touch-button tuning.

The digital multimeter you receive is a truly professional instrument. You use it in the experiments throughout your course and as a key servicing tool on the job. Using the meter along with the NRI Discovery Lab, you'll learn how to measure voltage, current and resistance and how to diagnose all types of servicing problems.

Advanced Systems Demand Advanced Technicians for Service and Maintenance

The art of TV/Audio/Video servicing has taken quantum leaps into the future. Now, successful technicians must understand advanced concepts like digital control, electronic tuning, laser video discs, microprocessors, and more. NRI gives you the training you need for success... state-of-the-art concepts and practical, hands-on experience working with the kind of equipment you'll encounter on the job.

7 Decades of Teaching Electronics Skills At Home

NRI is the oldest, largest, and most successful school of its kind in the world. It has pioneered and refined the teaching techniques that make learning at home the NRI way

one of the most economical and effective methods ever conceived. You learn at your convenience as a class of one, backed by skilled NRI instructors and carefully designed lessons that take you a step at a time toward your goal. No time away from your job, no night school grind, no classroom pressures. Yet your training is thorough and complete, with a foundation of hands-on experience unequalled by any other training organization.



Send For Free Catalog Covering 12 Electronics Courses

Our 104-page catalog gives you all the details. In it, you'll find a summary description of every lesson, and photos and specifications for every item of equipment included in your course. You'll also learn about other fascinating career opportunities in the world of electronics... Microcomputers, Industrial Electronics including robotics, Communications, and more.

Mail the postage-paid card today for your free copy. See how completely and how thoroughly NRI gets you started on your tomorrow today.



NRI SCHOOL OF ELECTRONICS
McGraw-Hill Continuing Education Center
3939 Wisconsin Avenue
Washington, DC 20016

MARCH 1984

LETTERS

continued from page 10

nance signals (2) burst keying (3) blanking (horizontal and vertical) (4) chrominance channel gating.

The sandcastle pulse can be generated by any of the following integrated circuits and many others generally used in the horizontal oscillator and/or sync section, such as: TDA 2573A and TDA 2575A for 525-line systems; TDA 2576A for 625-line systems; TDA 2571, TDA 2590, TDA 2591, TDA 2593, et al. The sandcastle pulse is required in several luminance and chrominance processors, mostly

one-chip systems, such as TA 10313 (by RCA), TDA 3300 (by Motorola), TDA 3560 (PAL-decoder by Philips), TDA 3570 (NTSC decoder, by Philips) to name just a few of the better-known types. There are many other IC's that use a sandcastle pulse or generate one.

If you don't have a sandcastle pulse, but need one, you can generate it from a horizontal flyback pulse by means of the circuit shown in Fig. 1-b.

EGON STRAUSS
Buenos Aires, Argentina

ON TESLA'S PATENTS

It is quite refreshing to see the amount of interest generated from your articles on

Nikola Tesla. All too often, we tend to take for granted the goods and services that make our lives comfortable, with little or no regard for the price paid by the originators of those goods or services.

In your recent article, the departure of Tesla might induce a sense of pity in the reader, because for one to be penniless and at the mercies of others after having contributed so much to the entire world is a sad epilogue. On the other hand, it seems that a great majority of geniuses get a tremendous sense of satisfaction from the work itself, and not necessarily the financial rewards. We might ask who determines what yardstick is used to measure rewards.

That brings us to the important matter—the subject of patents. The general assumption is that as long as one owns a patent, one is guaranteed financial success; but Tesla owned hundreds of them. That did not make him rich, which says that the invention itself and the marketing of the invention are two different and often unrelated subjects. Most inventors are not able to handle or are even concerned with the latter. Then the question is: Why go through all the trouble and expense to obtain letters of patent in the first place? It must be for the same reason that people climb Pike's Peak, hang glide, watch birds, etc: to obtain the rewards therefrom, using their own personal yardsticks.

As a patent researcher, I have assembled a list of Nikola Tesla's patents. It is available to your readers from the address below at \$3.50 for mailing and handling.

A complete set of copies of all 113 patents (full disclosure), enclosed in a binder and fully indexed, is also available from the same address: \$79.95. (Patents may also be ordered directly from the US Patent and Trademark Office by sending each individual patent number, along with \$1 for each patent. The total, then, comes to \$113.00 for the set, unbound and not indexed.)

DR. ETHAN KING
EDG Enterprises
Box 5155
Washington, DC 20019

LOTTO DEVICE

I am writing in regard to "Hobby Corner," in the November 1983 issue of *Radio-Electronics*. That is the column in which a lotto device was featured.

In the schematic representation of Fig. 3, I've noticed a few errors concerning the pin-outs of the IC's—7404 (hex inverter) and the 74145 (BCD to decimal decoder). First, the V_{CC} for a 7404 is pin 14, not pin 5 as denoted (pin 14 is being used as a clock input here), and pin 16, not pin 6, for the 74145. Pin 6 is denoted twice here, so it's probably just a typographical error.

Also, numerous input pins of the 7404 (11, 9, 3, and 1) are tied to the A, B, C, and D inputs of the 74145. That's surely a no-no, considering how some of those pins are being used here.

TOM STACEY
Princeton, NJ

You're right, there are errors. The 7404 in Fig. 3 is mislabeled—it should be a 7490. A 7404 should be used to invert the A, B, C, and D outputs of the 74145. Sorry for any inconvenience that error caused—Editor. R-E

Scan the World.



R-2000

SSB, CW, AM, FM, digital VFO's, 10 memories, memory/ band scan, optional 118-174 MHz coverage...

The R-2000 is an innovative all-mode SSB, CW, AM, FM receiver that covers 150 kHz-30 MHz, with an optional VC-10 VHF converter unit to provide coverage of the 118-174 MHz frequency range.

R-2000 FEATURES:

- Covers 150 kHz-30 MHz in 30 bands. UP/DOWN band switches. VFO's tune across 150 kHz-30 MHz.
- All mode: USB, LSB, CW, AM, FM.
- Digital VFO's. 50-Hz, 500-Hz or 5-kHz steps. F, LOCK switch.
- Ten memories store frequency, band, and mode data. Each memory may be tuned as a VFO. Original memory frequency may be recalled.
- Lithium batt. memory back-up. (Est. 5 yr. life).
- Memory scan. Scans all or selected memories.
- Programmable band scan. Scans within programmed bandwidth.
- Fluorescent tube digital display of frequency (100 Hz resolution) or time. DIM switch.
- Dual 24-hour quartz clocks, with timer.
- Three built-in IF filters with NARROW/WIDE selector switch. (CW filter optional.)
- Squelch circuit, all mode, built-in.
- Noise blanker built-in.
- Tone control.
- Large front mounted speaker.
- RF step attenuator. 10-10-20-30 dB.
- AGC switch. (Slow-Fast.)
- "S" meter, with SINPO "S" scale.
- High and low impedance antenna terminals.
- 100/120/220/240 VAC, or 13.8 VDC (Optional operation).
- RECORD output jack.
- Timer REMOTE output. (not for AC power)
- "Beeper"
- Carrying handle.



R-1000 High performance receiver • 200 kHz-30 MHz • digital display/clock/timer • 3 IF filters • PLL UP conversion • noise blanker • RF step attenuator • 120, 240 VAC (Optional 13.8 VDC).

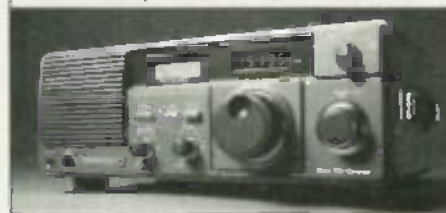

R-600 General coverage receiver • 150 kHz-30 MHz • digital display • 2 IF filters • PLL UP conversion • noise blanker • RF attenuator • front speaker • 100-240 VAC (Optional 13.8 VDC).

Optional accessories:

- VC-10 118-174 MHz converter.
- H1S-4, H1S-5, H1S-6, H1S-7 headphones.
- DCK-1 DC cable kit.
- YG-455C 500-Hz CW filter.
- HC-10 World digital quartz clock.
- AL-2 Surge Shunt

KENWOOD

TRIO-KENWOOD COMMUNICATIONS
1111 West Walnut/Compton, CA 90220
Telephone (213) 639-9000

CIRCLE 45 ON FREE INFORMATION CARD

Regency Hand Held Scanners

Bring you the excitement of Police, Fire, Emergency Radio, and more.

When you need to hear the action from wherever you are, Regency delivers. Our portable scanners keep you in touch with the local news. Whether it's bank hold ups, three alarm fires, weather, business, marine radio, or aircraft calls, Regency portables bring you the on the scene action. While it's happening from where it's happening . . . in your neighborhood.

MAXIMUM VERSATILITY

The all new HX1000 keyboard programmable hand held scanner lets you cover your choice of

over 15,000 frequencies on 20 channels at the touch of your finger. No crystals are necessary. Six band coverage, search and scan, priority control, and a liquid crystal display with special programming messages and clock are all part of the package. And with the sealed rubber keyboard and die-cast aluminum chasis, the HX1000 is the most rugged and durable hand held on the market.

WITH OR WITHOUT AIRCRAFT

If you don't need all the features of the HX1000, but you want the convenience of portability, we've got you

covered. Our two new crystal controlled hand held scanners, the HX650 and HX750, offer six channels, individual channel lock outs, LED channel indicators, step control, two antennas and an adaptor/charger. Both cover VHF high and low, UHF and "T" public service bands, with the HX750 offering the additional coverage of VHF aircraft band.

DECIDE FOR YOURSELF

Your Regency Scanner dealer would be happy to give you a free demonstration of these and other new Regency Scanners. Stop in today. Or, write Regency Electronics, 7707 Records St., Indpls., IN 46226.



ELECTRONICS, INC.

7707 Records Street, Indianapolis, Indiana 46226

CIRCLE 19 ON FREE INFORMATION CARD

EQUIPMENT REPORTS

Heath EE-103 IC Timer Course



CIRCLE 101 ON FREE INFORMATION CARD

Heath		EE103									
OVERALL PRICE											
EASE OF USE											
INSTRUCTION MANUAL											
PRICE/VALUE											
		1	2	3	4	5	6	7	8	9	10
		Poor	Fair	Good	Excellent						

ONE OF THE MOST COMMONLY USED DEVICES IN modern electronics is the timer

IC. Its use is so common that most of us have come to take it for granted. But, that

hasn't always been the case; after all, the IC timer has only been around for a little more than 10 years. Previously, timer circuits had to be designed using discrete components.

Since its application is so widespread, a working knowledge of the inner workings of the timer IC is valuable. That's true not only for the newcomer, but even to the veteran service technician or advanced hobbyist. After all, we can all use a refresher now and then to keep our skills up to date.

That's why we recommend Heath's EE-103 IC timer course so highly. At \$44.95, that follow-up to Heath's EE-3210A digital-techniques course provides an economical yet effective way

QUALITY COMPONENTS - NOT MAIL ORDER "SECONDS" ★

Send SASE for FREE Flyer or send \$1.00 postpaid and handling for FREE COMPLETE CATALOG which includes coupon for \$1.00 OFF purchase

ARIERS ZERO INSERTION FORCE SOCKETS

can actuated, true zero insertion - tin plated solder tail pins - capable of being plugged into dip sockets, including wire wrap.

Stock No.	No. Pins	1-8	10-20	30
11055	24	4.95	8.35	\$3.90
11056	28	6.15	4.50	4.85
11057	40	8.21	5.85	5.30
11058	64	13.00	10.50	9.40

IC-COOLERS

ULTRACON

Stock No.	Top Heat in IC	Price
22225	14	\$ 2.29
22226	18	2.89
22228	18-20	18.20

MIC 6000Z DIGITAL MULTIMETER

Single battery switch operates both LCD's - 10000 counts - 3 1/2 digit display - 6000 hours operating life with single 9V battery. Seven functions - DC Volt, DC Amps, Ohms, AC Volt, AC Amps, Diode and Resistor Junction, Auto On/Off Continuity Check.

Stock No. 9991 \$75.00

1 yr. warranty

TI WIRE WRAP SOCKETS

Tin plated phosphor bronze contact - 3 wrap

Stock No.	No. Pins	1-99	499	500
11301	8	\$ 3.40	\$ 3.30	\$ 3.30
11302	14	.59	.54	.45
11303	16	.64	.58	.48
11304	18	.73	.66	.55
11305	20	.99	.90	.75
11306	22	1.12	1.02	.83
11307	24	1.25	1.14	.95
11308	28	1.52	1.38	1.15
11309	40	2.05	1.86	1.55

TI LOW PROFILE SOCKETS

Tin plated copper alloy 688 contact pins with gas tight seal

Stock No.	No. Pins	1-24	25-99	999
11201	8	\$ 1.0	\$ 0.9	\$ 0.8
11202	14	.14	.13	.12
11203	16	.16	.15	.14
11204	18	.18	.17	.16
11205	20	.20	.18	.16
11206	22	.22	.20	.18
11207	24	.24	.22	.20
11208	28	.28	.26	.25
11209	40	.40	.37	.33

WILD ROVER

Touch switch capsule - Operating voltage is 200V without the use of a special gun. Extremely fast set and all with low noise. Normally operated 115 VAC, 1.5 amp 30 minimum resistance - 819 rated by 150 (check)

Stock No.	1-8	10 & up
12098	\$1.43	\$1.28

80/40 ROSIN CORE SOLDER

Stock No.	Size	Length	Weight	Price
50015	80/20	6	5	\$1.15
50016	80/20	25	4	2.30
50017	80/20	50	8	4.25
50018	80/20	33	15	1.31
50019	60/40	6	5	2.37
50020	60/40	17.5	8	4.87

EKI KITS come with all parts necessary to assemble

- Stock No. 88844 TV Jammer Kit - wipes out your TV screen - \$ 7.71
- Stock No. 88850 Whooper Alarm Kit - makes a Great Alarm or siren - \$11.33

MANY, MANY MORE KITS AVAILABLE IN FULL LINE CATALOG

ELPAC POWER SUPPLIES - DC/DC CONVERTERS

Stock No.	Input Voltage (VDC)	Output Voltage (VDC)	Output Current (mA)	Dimensions (inches)	Price
13815	3.0-7.0	1.5±0.3	0.25	48-31-13.05	7.95
13816	3.0-7.0	1.2±0.3	0.25	48-31-13.05	7.95
13817	3.0-7.0	1.0±0.7	0.20	48-31-13.05	7.95
13818	3.0-7.0	1.0±0.7	0.00	44-31-13.05	7.95
13819	3.0-7.0	1.0±0.7	0.10	48-31-13.05	7.95
13820	3.0-7.0	0.8±0.7	0.10	48-31-13.05	7.95

Special of the Month! MODUTEC BATTERY TESTER

Tests all batteries ranging from 1.35V to 4.5V. Controls: 3-position switch provides ranges: 1.35-1.5V, 2.7-3.0V, 4.05-4.5V. Durable, pocket size, self-contained. Test leads are permanently attached. Stock No. 13733 \$6.95!

OPCOA Single Digit Displays - Common Cathode

Stock No.	Color	1	100
12082	Red	\$1.12	\$.98
12085	Green	1.84	1.63
12087	Yellow	1.92	1.70
12089	Orange	2.06	1.84

Right Angle Socket for Above Displays

Stock No.	1	100
11010	\$1.24	\$.99

The Battery Just Wrap Tool

Rope battery terminal lead wrap revolutionizes around 2075 meters (6800 feet) for any cutting and grip stripping. Comes with 14 and 100 ft. 30 (200) wire.

Stock No.	Description	Price
13340	Battery self-wrap tool with 14 and 100 ft. 30 AWG wire	649.99
13341	Replacement kit	9.95
13342	100 ft. black replacement wire	9.95
13343	100 ft. white replacement wire	9.95
13344	100 ft. yellow replacement wire	9.95
13345	100 ft. red replacement wire	9.95

MINI-DRILL

This portable hand drill is designed for circuit board drilling. Runs at 2300 RPM on a 4" x 1/2" battery (not included). Supplied with one 230 size drill bit and a 1/2" diameter bit and press for circuit hole drilling.

Stock No.	Description	Price
13346	Hand drill with 230 size bit and batteries	674.95
13347	Replacement kit - 3 each of D40 and 080 size	8.95
13348	Drill stand	13.95

PIN FORMING TOOL

puts IC's on their true low to low spacing. One side for 300 centers. Flip tool over for devices on 800 centers. Put device in tool and squeeze!

NEW! ANTI-STATIC MODEL Stock No. 10200 \$14.95

ONE TOOL DOES 8 thru 40 PINS! Stock No. 11059 \$12.95

OPTEL LCD's with pins

18:88 Stock No. 47005

88:88 Stock No. 47006

88:88 Stock No. 47007

Stock No.	Description	1	10
47005	3 1/2 dig. 5" x 5" 5.95	\$ 5.95	\$ 5.50
47006	4 dig. 5" x 5" 5.95	\$ 5.95	\$ 5.50
47007	4 dig. 7" x 11.90	\$ 11.90	\$ 11.00

IC INSERTION/EXTRACTION KIT

Includes Chip IC Extractor and Injector to accommodate all IC's from 14 to 60 pins. Tool with rugged cylindrical pins in an IC-LOCK safe and includes 100 light Blue IC's. Stock No. 13309 \$37.74

SOCKET WRAP KIT

Stock No.	Description	Price
13391	14 pin	1.29
13392	18 pin	1.49
13393	24 pin	1.99
13394	28 pin	2.49
13395	32 pin	2.99
13396	36 pin	3.49
13397	40 pin	3.99
13398	44 pin	4.49
13399	48 pin	4.99
13400	52 pin	5.49
13401	56 pin	5.99
13402	60 pin	6.49

81 82 per deck

IC EXTRACTOR

One-piece, spring steel construction. Will extract all LSI, MSI and SSI devices with 8 to 24 pins. Stock No. 13313 \$2.10

Great ideas in design: ours/yours

How many times have you looked at a clever piece of circuitry and thought "I could have designed that." Or... "I thought of that years ago, if only I had..."

Well now you can. Learn. Design. Create...your own electronic circuits. The new Heathkit/Zenith Engineering Design Series Experiment/Trainer and Courses make it easy.



If you enjoy the challenge of creating your own circuits or have the desire to learn...then, the new **ET-1000 Analog/Digital Circuit Design Experiment/Trainer** is for you. Designed to be a multi-purpose lab for experimental circuit design, the **ET-1000** makes it easy to design, develop and experiment with circuits of your own design.

Unit features large solderless plug-in breadboard, built-in power supplies, 1 Hz to 100 kHz signal generator, "no bounce" logic switches, LED indicators, logic probe and much, much more.

And if you need to learn circuit design before starting to create on your own, there are two self-study courses in passive and transistor circuits that will teach this exciting area to you right on the **ET-1000**.

Find out more about the new **ET-1000** trainer and courses today. Complete specifications and details are in the new free Heathkit Catalog. The catalog also features more than 450 kit and educational products for your home, hobby and business. **Circle reader service number below.**

New Engineering Design Series

Heathkit®

Heathkit/Zenith
Educational Systems

to acquire or update knowledge about those important devices.

What's covered

Although it isn't the longest course that Heath (Benton Harbor, MI 49022) offers, its six units are packed with information whose aim is to give you a working knowledge of IC timers, their uses, and the various types of those devices available. For example, Unit One explores timer basics and goes into an explanation of the monostable multivibrator and the astable timer.

Unit Two introduces the types of timers

you will find. It first explores the 555 timer and presents you with a functional diagram and schematic of that device; it also discusses such things as pin functions and the operating modes. Next, it moves to the 556 dual-unit general-purpose timer and then on to the 322 and 3905 timers.

Unit two also takes you through some timer-counters, such as the 2240 binary programmable timer/counter, the 2250 BCD programmable timer/counter, and the 8260 seconds-minutes-hours BCD programmable timer/counter. The unit also moves through a series of experi-

ments with those devices in order to give you hands-on experience with them.

Unit Three covers operating procedures and some precautions to take with timer devices. Included in the discussion are such topics as the selection of external components that can be used with the various devices.

Moving on to Unit Four, the knowledge you have gained through the three previous units is expanded with a detailed discussion of monostable multivibrator (one-shot) circuits and some of their applications. For instance, it discusses the 555-based one-shot with an auxiliary output, the inverted one-shot, and manually triggered one-shot circuits. Other applications covered include pulse generators, programmable one-shots, extended-range one-shots, voltage-controlled one-shots, and a ratio-metric voltage-to-pulse width converter. A series of experiments rounds out the unit; each one is designed to give you experience handling one-shot circuits.

Unit Five is an in-depth discussion of astable timer circuits. Included in that chapter are circuits based on a variety of IC timers. A series of experiments help insure that the information presented will be retained.

Unit Six turns its attention to practical applications. Among the circuits covered are the Schmitt trigger, inverting bi-stable buffer, RS flip-flop, voltage comparator, zero-crossing detector, window detector, differential line-driver, and opto-isolated data link.

The unit also discusses output-drive circuits and shows how LED's, as well as incandescent lamps, relays, and booster amplifiers can be driven. After that, the unit moves on to time-delay relay circuits and then on to function generators such as a CMOS function-generator, a wide-range tunable function-generator, a function generator with logarithmic-control characteristics, voltage-controlled oscillators, and triangular-wave-to-sinewave converters. Other applications include DC-DC converters, a precise clock source, a universal appliance-timer, a time-mark generator, phased-lock loops, a bipolar staircase generator, an A/D converter, a speed alarm, a power-monitor error detector and a burglar alarm. Finally, Unit six closes with a presentation of a series of experiments.

As you can see, the IC timer course is a thorough examination of timer circuits and it should easily give you the basic knowledge you need about them or refresh and update the knowledge you have. It will also serve as a good reference resource when you have finished the course, because it contains an appendix with manufacturer's data sheets, a second-source guide, and a list of timing-component manufacturers.

Overall, it's a good investment in your

Where's Your **ELECTRONICS CAREER** Headed?

Put Professional Knowledge and a
COLLEGE DEGREE
in your Electronics Career through

**HOME
STUDY**

Earn Your
DEGREE

No commuting to class. Study at your own pace, while you continue on your present job. Learn from easy-to-understand lessons, with help from your instructors when you need it.

Grantham has been training students for electronics degrees longer than any other home-study, independent-study, or correspondence institution. *Grantham is the only school in the United States offering an accredited B. S. Degree in electronics by home study, independent study, or correspondence.*

Our free bulletin gives full details of the home-study program, the degrees awarded, and the requirements for each degree. Write for our free *Bulletin 2-84.*

Grantham College of Engineering is a specialized institution catering to mature individuals who are employed in electronics and allied fields such as computers. The field of electronics is so enormous that opportunity for advancement is always present. Promotions and natural turnover make desirable positions available to those who are *prepared to move up!*

Advancement in electronics is made easier and more certain by (1) superior knowledge, and (2) documentation of that knowledge. Grantham specializes in making both 1 and 2 as listed above available to you.

Grantham's home-study program leading to the

B. S. DEGREE

may fill an important need for you. This is a comprehensive correspondence program in which you first review some things you already know, in preparation for the studies that come later. Some previous knowledge in the field is presumed, but is thoroughly reviewed in depth, so as to give you a thorough foundation for the level of studies you have not previously undertaken. Even though some students hold associate degrees before enrolling, an A. S. Degree is awarded along the way toward the B. S. Degree.

For full information, write for Bulletin 2-84.

Grantham College of Engineering
2500 So. La Cienega Blvd.
P. O. Box 35499
Los Angeles, CA 90035

The best 60MHz scope costs only \$1150. It's from Kikusui.



That's right. Only \$1150 for Kikusui's top-of-the-line 5060 model oscilloscope. And we also have four other scopes for as low as \$600 in our new 5000 Series.

Not only that, we're offering a two year warranty on each of them, compared to other big name companies' limited one year warranties.

When it comes to performance, our 5000 Series has the edge over the Tektronix 2200 Series in lab quality, chop frequency, and trigger view. Ours also have more display modes, higher acceleration for better brightness, and sharper focus for better resolution.

Each scope in our 5000 Series is crafted so that it can be used for production, field service, consumer electronics servicing, or even personal use. The 5060 is a 60MHz scope with 3 channels, eight traces, delayed sweep, delay line and alternate sweep, and priced at \$1150. Models 5040 and 5041 are 40MHz, dual channel scopes, featuring peak-to-peak automatic triggering, automatic focus control and a delay line. If you're interested in a 20MHz scope, we have our 5020 and 5021 models with features similar to our 40MHz scopes. Both the 5041 and 5021 also have delayed sweep. Prices at \$920 for the 5041, \$795 for the 5040, \$690 for the 5021 and \$595 for the 5020. So, whatever model suits you best, you can't get a better scope for the money.

Of course, there's a reason we're able to offer these bargains and quality. We're one of the biggest manufacturers of scopes in the world, with over 30 years in the business. Another reason is KIK's nationwide network of lab quality maintenance facilities.

Write us and we'll send complete specifications back to you. Or just take a little time to call us. It's a small price to pay to get big time quality and service.

For sales and technical information
call toll free **800-421-5334**
(in Calif., Alaska, Hawaii 213-515-6432).

Order Toll Free
800-421-5334



17819 Figueroa Street
Gardena, Calif. 90248
TWX 910-346-7648

✚ In Canada call: Interfax Systems, Inc. 514-366-0392

Subsidiary of Kikusui Electronics Corp., 3-1175 Shinmausu Higashi, Nakaharu-Ku, Kawasaki City, Japan 1044 411 0111

CIRCLE 48 ON FREE INFORMATION CARD



MARCH 1984

25

future. Like other Heath courses, it contains all the parts needed to complete the series of experiments and is a complete unit. As with other Heath courses, you will need the *ET-3300B* breadboard or an equivalent to lay out the experiments, and you will also need access to a good oscilloscope and a digital multimeter. If you don't have access to those items, buying them can significantly increase the cost of the course. Heath offers a package of the *ET-3300B* breadboard and the *EE-103* course for \$129.95. On the other hand, those additional items should be part of any reasonably equipped workbench. R-E

Tektronix Model 214 Storage Oscilloscope



CIRCLE 102 ON FREE INFORMATION CARD

Tektronix	214									
OVERALL PRICE	1	2	3	4	5	6	7	8	9	10
EASE OF USE	1	2	3	4	5	6	7	8	9	10
INSTRUCTION MANUAL	1	2	3	4	5	6	7	8	9	10
PRICE/VALUE	1	2	3	4	5	6	7	8	9	10
	1	2	3	4	5	6	7	8	9	10
	Poor	Fair	Good	Excellent						

Introducing the analog/digital handheld multimeter.

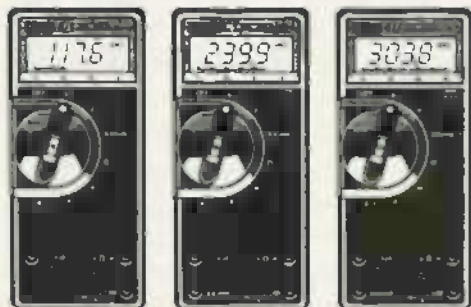

Fluke 73

\$85

Analog/digital display
Volts, ohms, 10A mA, diode test
Autorange
0.7% basic dc accuracy
2000-hour battery life
3-year warranty

Fluke 75

\$99

Analog/digital display
Volts, ohms, 10A mA, diode test
Audible continuity
Autorange/range hold
0.5% basic dc accuracy
2000-hour battery life
3-year warranty

Fluke 77

\$129

Analog/digital display
Volts, ohms, 10A mA, diode test
Audible continuity
Touch Hold function
Autorange/range hold
0.3% basic dc accuracy
2000-hour battery life
3-year warranty
Multipurpose holster

FROM THE WORLD LEADER
IN DIGITAL MULTIMETERS

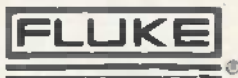

The Professional Test Equipment Source



The Instrument Mart
295 Community Drive, Great Neck, New York 11021
(516) 487-7430 Outside N.Y. (800) 645-6535

Sales, Service, Rental/Leasing Programs
... and Pre-Owned Test Equipment also Available



IF YOU DO MUCH WORK IN THE FIELD, YOU know the importance of having compact equipment that can stand up to the rigors of portable operation. We recently had a chance to review an oscilloscope that fills those requirements and adds some bonuses, including dual-trace capability, the ability to display one sweep at a time, and the ability to store a display. The unit is the model 214 storage oscilloscope from Tektronix (PO Box 500, Beaverton, OR, 97077).

To say that the unit is compact is an understatement. It would indeed be difficult to find an oscilloscope that was significantly smaller than this 3 x 5 1/4 x 9 1/2-inch unit. The weight is a scant 3 1/2 pounds. The graticule area is 6 divisions (vertical) by 10 divisions (horizontal), with each division being about 3/10 inch.

The sturdy looking case is made from a high-impact plastic. At the rear of the case is a set of permanently attached high-impedance test probes. As you would expect of a portable scope, the unit can be operated either from the AC power line or from its built-in rechargeable batteries.

Specifications

Turning to what the scope can do, it has a bandwidth of DC to 500-kHz. The vertical deflection can be set for anywhere between one-millivolt to 50-volts-per-division. The vertical deflection controls are set up in the familiar 1-2-5 sequence and the entire range is covered in 15 steps.

When the scope is in the dual-trace mode, the display will either be chopped or alternated, depending on the sweep rate (time base) selected. The display is chopped for sweep rates of 500-milliseconds-per-division to 2-milliseconds-per-division; the chopping rate is approximately 40 kHz. The display is alternated for sweep rates of 1-millisecond-per-division to 5-microseconds-per-division. A variable uncalibrated magnifier can increase the sweep rate by at least five times the setting, giving a maximum sweep-rate of 1-microsecond-per-division (uncalibrated). Either trace can be turned off by using its POSITION control.

The scope may be internally triggered (two modes) or externally triggered. In



performance by design

Folding Meters are Better

Not all multimeters fold. There's a reason. While other manufacturers were busy copying each others designs, BBC looked at where portable meters were used and how they could be improved.

The result is a unique approach. Folding meters with large displays (18 mm LCDs) and adjustable viewing angles. Now you can have high performance in a meter that excels in the field and on the bench.

Hands Free vs Handheld

In multimeters "hands free" is significantly better than "handheld." You need three hands to operate the typical "handheld" meter in the field. One for the meter and two for the probes. BBC's folding design lets you use a neck strap for the meter. This frees your hands for the probes.

On the bench, the large, adjustable displays pay off. It's a sensible design that lets you make measurements faster and more easily.



A Heritage of Precision

BBC's track record of expertise in precision engineering spans eight decades. All our meters are built to tough VDE and DIN safety standards. The 3½-digit DMM's feature 0.1% basic dc accuracy and externally accessible fuses for overload protection.

CIRCLE 72 ON FREE INFORMATION CARD

Compact, Rugged and Affordable

To design the impact resistant case that protects these DMM's, BBC relied on the industrial design skills of the Porsche Design Studios.

When open, the display angle is easily adjustable. When closed, the display and the controls are protected, and the meters turn off automatically. Competitive pricing is another feature of BBC meters. Prices start at \$193.00.

Available Locally

BBC meters are available throughout the U.S. If your instrumentation supplier doesn't carry BBC yet, we'll gladly tell you who does. Call toll free:

1-800-821-6327
(In CO, 303-469-5231)

BBC - METRAWATT/GOERZ
6901 W. 117th Avenue
Broomfield, CO 80020, Telex 45-4540

Engineering Excellence In Test and Measurement



the COMP mode, the trigger signal is derived from the unit's vertical-deflection system after vertical switching has occurred. Note that when the COMP mode and dual-trace operation have both been selected, triggering will take place on the vertical chopping signal, and not at the selected triggering level. In the CHANNEL-TWO mode the trigger signal is again derived from the vertical-deflection system, but before vertical switching has occurred and only from the channel-two signal (hence the name). Triggering sensitivity is 0.2 divisions from DC to 500 kHz in the COMP mode and 0.2 divisions from 2 Hz

to 500 kHz in the CHANNEL TWO mode.

An external signal can also be used to trigger the scope. The external trigger signal must be time-related to the inputs for the display to be stable. The minimum usable level for the external trigger signal is 1 volt; the maximum level is 16 volts.

In some applications it is more useful to display one signal against another instead of against time. The scope has an X-Y function that allows you to do that. In it, the vertical (Y) signal is applied to channel 1, while the horizontal (X) signal is applied to channel 2. Note that in this mode the bandwidth is limited to 50 kHz.

Special features

There are two features that are surprising for a scope this size: storage and single sweep. The storage feature freezes the display. That's particularly handy in cases where you want to carefully analyze a waveform. It's also handy in cases where you need to take notes—the display stays on the screen even after the probes have been removed from the test points, allowing you to take those notes at your leisure.

Sometimes, the signal that you are interested in does not repeat regularly, or varies in amplitude, time, or shape. In those cases, using a conventional sweep can cause an unstable display. That's where the single-sweep function comes in. When that function is activated, the next trigger pulse initiates the sweep and a single trace will be displayed. At the end of that trace the sweep generator is locked out until the scope is reset. The single trace feature, when used with storage function, is especially handy for such things as looking for random or intermittent signals. When storing single sweeps, an automatic enhance feature allows the scope to display traces that exceed the device's normal writing speed. It is activated at sweep rates of 0.1-millisecond-per-division and faster.

Manuals

The unit we reviewed was supplied with two manuals. The smaller "operators manual" includes a rundown on the scope's inputs and controls, gives operating information, outlines some simple adjustments that can be made by the operator, and lists sample applications.

Far more impressive was the "service manual." It covers much of the information presented in the operator's manual but adds specifications and complete maintenance, calibration, and troubleshooting information. Also included are circuit descriptions, schematic and parts-placement diagrams, and a parts list.

We have one major safety-related complaint about the device. As with the other units in this series from Tektronix, due to its design, a possible shock hazard is present at the AC-power plug when the scope is battery-operated. Warning is given in the manual, with instructions to store the plug in an insulated compartment at the rear of the scope during battery operation. Still, accidents do happen and we feel that that measure is inadequate.

When you come right down to it, what sets this unit apart is its small size. If you've ever had to lug a full-sized scope around from place to place you know what we mean. Also the storage and single-sweep functions are sure to come in handy: once you've had a scope with those features, you'll wonder how you ever got along without them. The model 214 lists for \$2410. **R•E**

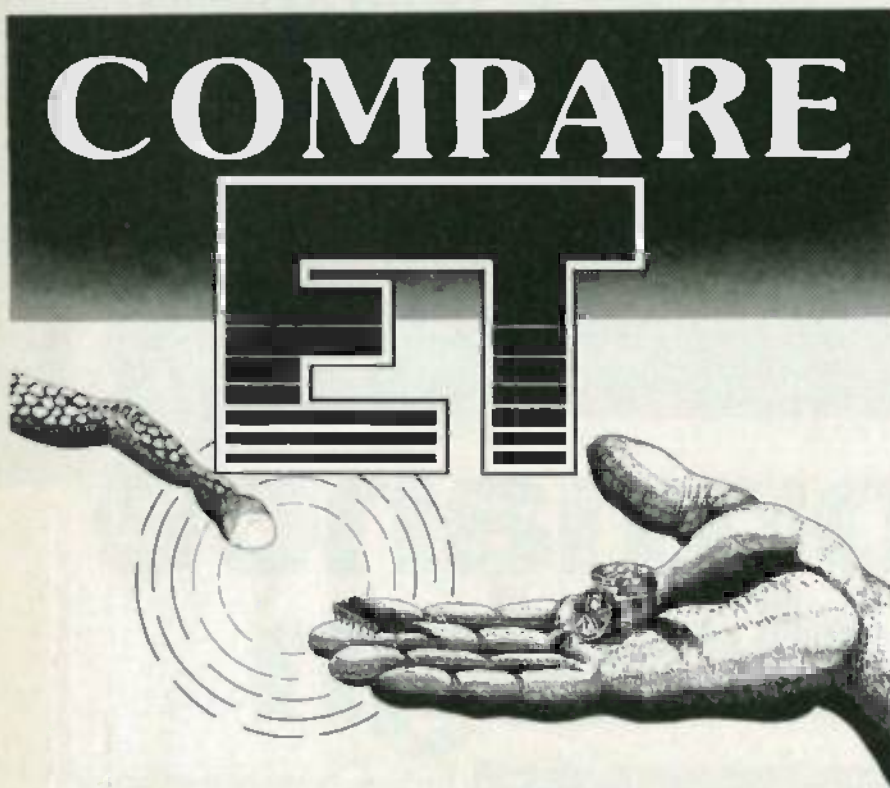

SEMICONDUCTORS

Consolidated Electronics is offering you a new semiconductor line. ET (Electronic Technician Replacement line) has quality semis that you need at the lowest prices imaginable! The ET semiconductor line also has an exclusive **THREE YEAR WARRANTY! FOR DETAILS CALL TOLL FREE TODAY!**

1-800-762-3412
OHIO WATS



1-800-543-3568
NATIONAL WATS

705 Watervliet Ave., Dayton, Ohio 45420
In Dayton call 252-5662

CIRCLE 18 ON FREE INFORMATION CARD.

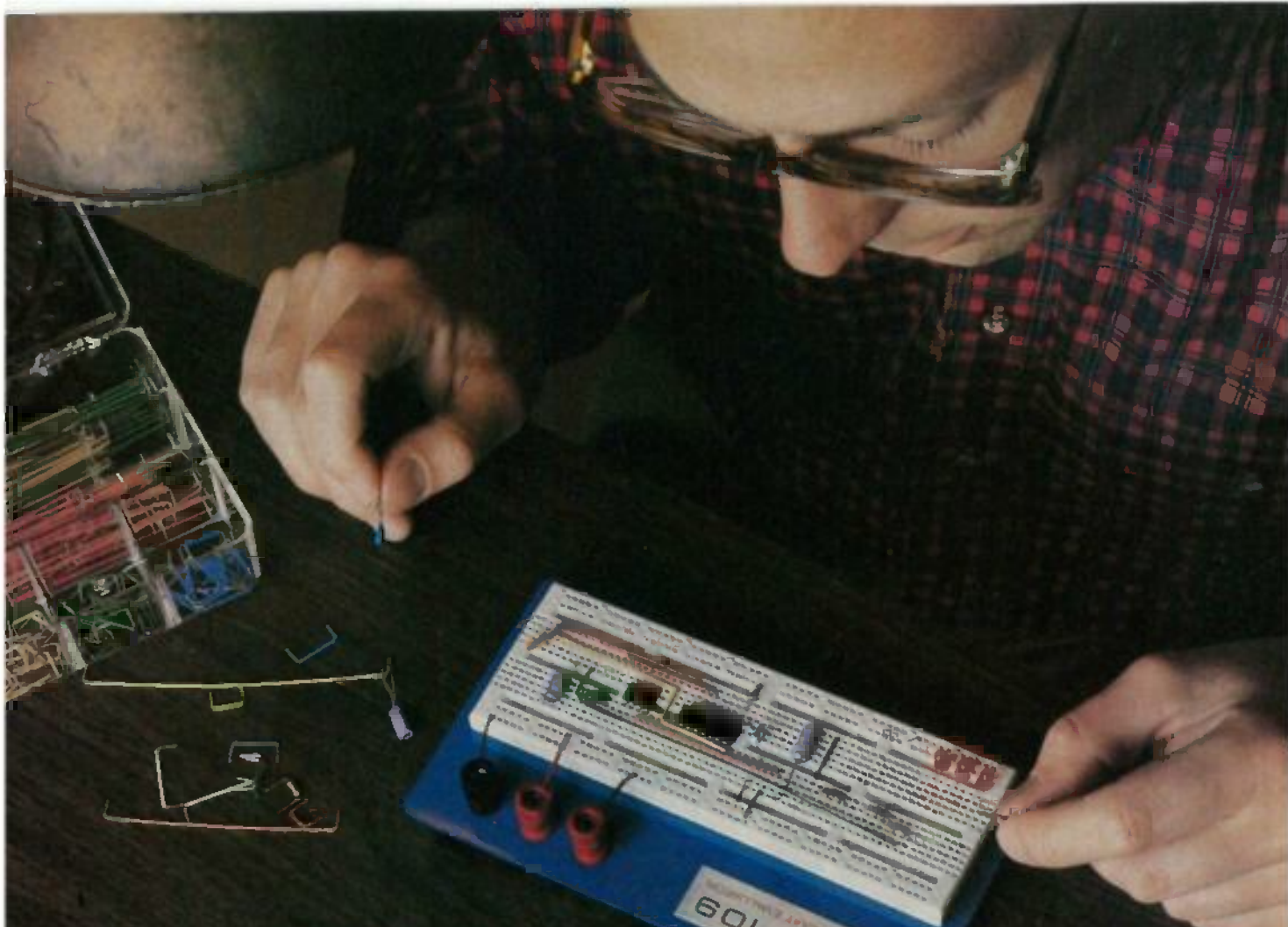

Last night Mark Davis started over from scratch. Without wasting so much as a lead wire.

Some day Mark will be working on bigger projects. But right now, he's learning. Fortunately, the new ACE 109 solderless breadboard from A P PRODUCTS, just made learning a lot more affordable.

The ACE 109 is the newest, lowest priced All Circuit Evaluator in the A P PRODUCTS line. It has a universal matrix of 840 solderless plug-in tie-points. And is ideal for designing, testing and modifying small circuits. ACE 109 has three, standard 5-way binding posts for easy access to power sources.

With an ACE 109, there's no wiring, soldering or desoldering. Just plug in your components and interconnect them with ordinary solid hook-up wire. If you want to make a circuit change, just unplug the components involved and start over. It's just that easy.

Every ACE breadboard makes circuitry easy, fast, flexible. Now A P PRODUCTS has made it even more affordable. The ACE 109 is priced under \$20.*

Look for the complete line of ACE breadboards and other A P PRODUCTS at your favorite electronics distributor. For the name of the A P PRODUCTS distributor nearest you, call Toll-Free: (800) 321-9668. (In Ohio, call collect (216) 354-2101.) Make the A P connection.



**ACE 109 SOLDERLESS BREADBOARD
PRICED UNDER \$20.***
* SUGGESTED U.S. RESALE PRICE



A P PRODUCTS INCORPORATED • 9450 Pineneedle Drive • P.O. Box 540 • Mentor, Ohio 44060 • (216) 354-2101 • TWX: 810-425-2250
In Europe, contact A P PRODUCTS GmbH • Baumlesweg 21 • D-7031 Weil 1 • West Germany
CIRCLE 87 ON FREE INFORMATION CARD



Drop-proof



Overload-proof

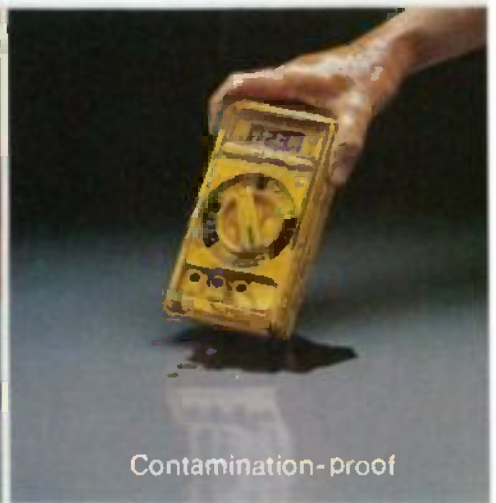

Contamination-proof

Oops proof.

Now there's a new breed of Beckman hand-held DMMs tough enough to withstand accidental drops, input overloads and destructive environments.

The new HD100 and HD110 DMMs are drop-proof, packed with overload protection and sealed against contamination. You won't find more rugged meters than the Beckman HDs. Inside or out.

Drop Proof

Constructed of double-thick thermoplastics, the HD100 series DMMs resist damage even after repeated falls. All components are heavy-duty and shock mounted.

Contamination Proof

The HD series meters are designed to keep working even around dirt, heavy grime, water and oil. The special o-ring seals, ultrasonically-welded display window and sealed input jacks protect the internal electronics of the HD meters. The oops-proof meters are sealed so tightly, they even float in water.

Accidental Overload Protection

All DC voltage inputs are protected up to 1500 Vdc or 1000 Vrms. Current ranges are protected to 2A/600V with resistance ranges protected to 600 Vdc. Transient protection extends up to 6KV for 10 microseconds.

More Meter for Your Money

For starters you can get 2000 hours of continuous use from a

common 9V transistor battery. You can run in-circuit diode tests and check continuity. You even get

a one year warranty.

The 0.25% basic dc volt accuracy HD meters serve you with 7 functions and 27 ranges. The HD 110 also gives you 10 AMPS ac and dc. With one simple turn of the single selector switch, you can go directly to the function and range you need. There's less chance of error.

Also available is the electrical service kit. It includes the meter of your choice, a current clamp, deluxe test leads and a heavy-duty case designed to carry both meter and accessories, conveniently.

Feature for feature you can't find a more dependable meter with prices starting at just \$169 (U.S. only).

To locate your nearest distributor, write Beckman Instruments, Inc., Instrumentation Products, 2500 Harbor Blvd., Fullerton, CA 92634 or call (714) 993-8803.



CIRCLE 100 ON FREE INFORMATION CARD

BECKMAN

NEW IDEAS

Use your scope as a capacitance meter

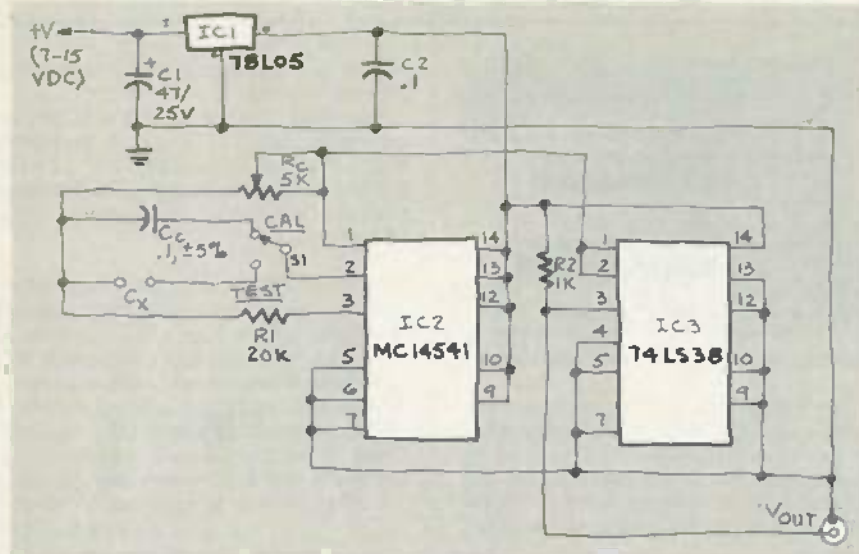

FIG. 1

THIS MONTH WE'LL TAKE A LOOK AT A handy little circuit that allows your oscilloscope to be used as a precision capacitance meter. Basically, the device is an R-C oscillator and a wave shaper. Figure 1 shows the schematic for that circuit. As you can see, it consists of three IC's along with some resistors and capacitors.

The circuit shown is powered by a 7- to 15-volt DC supply. (A 9-volt transistor battery works just fine.) The supply consists of IC1 (a 78L05 voltage regulator) and two filter capacitors. Next, look at the oscillator/shaper circuit; that circuit consists of IC2 (a MC14541 oscillator/timer) and IC3 (a 74LS38 quad NAND buffer) along with some resistors and capacitors. There are several IC's that might have been used but those were chosen because of their availability.

To calibrate the device, first connect your scope to V_{OUT} . Then put the CAL/TEST switch to the calibrate position and adjust the 5-kilohm potentiometer R_c until a 1-millisecond cycle is generated. That's it; easy, isn't it? The next step is to try it out using a known-valued capacitor.

To find the value of the capacitor, simply connect the component leads to the points labeled C_x in the schematic. With the scope still connected to V_{OUT} , set the scope's attenuation to (typically) 2 volts. Now, adjust the sweep of the scope until you see 3 cycles or so on the screen. At

that point, measure the time between two identical points on the trace (one complete cycle) and multiply that value by 100. That calculated value is the capacitance value in microfarads. It should be pretty close to the specified value of the capacitor. If so, you can now find the value of an unknown capacitor.

The precision of the device, as well as the value of the smallest capacitor it can measure, is limited by the scope and the calibration capacitor C_c . Typically, the device can be calibrated to 2% or better without difficulty by using a capacitor good to 1% or better. Those capacitors are generally more expensive, but we're sure you'll find that they're worth it.—Jeff C. Verive



"First Ogg invented the wheel, then he discovered fire. Now he's trying to build a receiving dish for satellite TV."

NEW IDEAS

This column is devoted to new ideas, circuits, device applications, construction techniques, helpful hints, etc.

All published entries, upon publication, will earn \$25. In addition, for U.S. residents only, Panavise will donate their model 333—The Rapid Assembly Circuit Board Holder, having a retail price of \$39.95. It features an eight-position rotating adjustment, indexing at 45-degree increments, and six positive lock positions in the vertical plane, giving you a full ten-inch height adjustment for comfortable working.

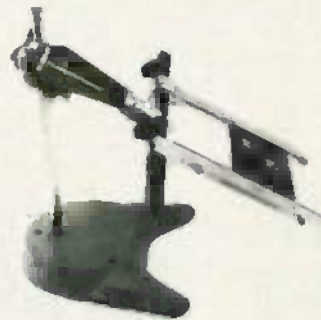

I agree to the above terms, and grant Radio-Electronics Magazine the right to publish my idea and to subsequently republish my idea in collections or compilations of reprints of similar articles. I declare that the attached idea is my own original material and that its publication does not violate any other copyright. I also declare that this material has not been previously published.

Title of idea

Signature

Print Name

Date

Street

City

State

Zip

Mail your idea along with this coupon to: New Ideas Radio-Electronics, 200 Park Ave. South, New York, NY 10003

MARCH 1984

NEW PRODUCTS

For more details use the free information card inside the back cover

SIGNAL GENERATORS, model LSG-215, model LSG-216, and model LSG-217 are programmable, and all feature convenient keyboard control of frequency and output level. Semi-automatic operation is available by preprogramming up to 100 different test conditions. A 2K memory stores frequency, output level, and modulation (0 to 100% AM, 0 to 100 kHz FM) data for each test condition.

The LSG-217 offers an output frequency range of 0 to 70 MHz in two bands: 0.1 to 19.9999 MHz in 100-Hz steps and 20 to 70 MHz in 1-kHz steps. Output-level range is 0 to 120 dB μ V in 1-dB steps.

The model LSG-215 and model LSG-216 offer frequency ranges of 0.1 to 30 MHz in 100-Hz steps and 75 to 115 MHz in 1-KHz steps. The model LSG-216 also offers FM stereo multiplex with L, R, MAIN and SUB functions.

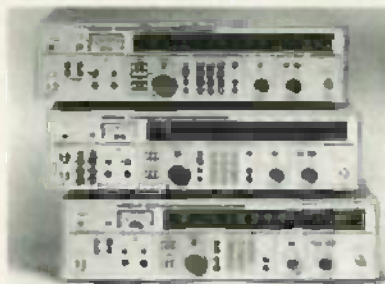

CIRCLE 103 ON FREE INFORMATION CARD

The model LSG-217 is designed particularly for use in the communications industry but is an ideal general-purpose signal generator as well. The model LSG-215 and the model LSG-216 are designed for AM/FM receiver design and production environ-

ments, and are also suitable for AM/FM broadcast testing.

The model LSG-215 is priced at \$1,685.00; the model LSG-216 is priced at \$1,900.00, and the model LSG-217 costs \$1,980.00.—**Leader Instruments Corporation**, 380 Oser Avenue, Hauppauge, LI, New York 11788.

INDUCTANCE ANALYZER, model 3245, combines in a single, highly intelligent and interactive benchtop unit, the capability to drive, bias, and measure inductances at a wide range of frequencies. Associated series and parallel resistance and capacitances may be measured simultaneously, and associated "minor terms"—Q, D, (dissipation factor), and R—are automatically computed from the measurement. Inductances of transform-

continued on page 39

Diskette Users...

When you've heard from all the animals in the diskette zoo, but you need fast delivery and high quality diskettes...



Call Communications Electronics

Diskette order desk
800-521-4414
In Canada 800-265-4828

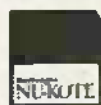

Choose your brand
Choose your price

Product Description	Wabash Part #	CE amount per diskette
5 1/4" 525K 5 Diskettes 1280K, 74 Sector	W111	1.00
5 1/4" 525K 5 Diskettes 1280K, 32 Hard Sector	W112	1.00
5 1/4" 525K 5 Diskettes 720K, 32 Hard Sector	W113	2.00
5 1/4" 525K 5 Diskettes 360K, 32 Hard Sector	W114	2.00
5 1/4" 525K 5 Diskettes 180K, 32 Hard Sector	W115	2.00
5 1/4" 525K 5 Diskettes 90K, 32 Hard Sector	W116	2.00
5 1/4" 525K 5 Diskettes 45K, 32 Hard Sector	W117	2.00
5 1/4" 525K 5 Diskettes 22.5K, 32 Hard Sector	W118	2.00
5 1/4" 525K 5 Diskettes 11.25K, 32 Hard Sector	W119	2.00
5 1/4" 525K 5 Diskettes 5.625K, 32 Hard Sector	W120	2.00
5 1/4" 525K 5 Diskettes 2.8125K, 32 Hard Sector	W121	2.00
5 1/4" 525K 5 Diskettes 1.40625K, 32 Hard Sector	W122	2.00
5 1/4" 525K 5 Diskettes 703.125K, 32 Hard Sector	W123	2.00
5 1/4" 525K 5 Diskettes 351.5625K, 32 Hard Sector	W124	2.00
5 1/4" 525K 5 Diskettes 175.78125K, 32 Hard Sector	W125	2.00
5 1/4" 525K 5 Diskettes 87.890625K, 32 Hard Sector	W126	2.00
5 1/4" 525K 5 Diskettes 43.9453125K, 32 Hard Sector	W127	2.00
5 1/4" 525K 5 Diskettes 21.97265625K, 32 Hard Sector	W128	2.00
5 1/4" 525K 5 Diskettes 10.986328125K, 32 Hard Sector	W129	2.00
5 1/4" 525K 5 Diskettes 5.4931640625K, 32 Hard Sector	W130	2.00
5 1/4" 525K 5 Diskettes 2.74658203125K, 32 Hard Sector	W131	2.00
5 1/4" 525K 5 Diskettes 1.373291015625K, 32 Hard Sector	W132	2.00
5 1/4" 525K 5 Diskettes 686.6455078125K, 32 Hard Sector	W133	2.00
5 1/4" 525K 5 Diskettes 343.32275390625K, 32 Hard Sector	W134	2.00
5 1/4" 525K 5 Diskettes 171.661376953125K, 32 Hard Sector	W135	2.00
5 1/4" 525K 5 Diskettes 85.8306884765625K, 32 Hard Sector	W136	2.00
5 1/4" 525K 5 Diskettes 42.91534423828125K, 32 Hard Sector	W137	2.00
5 1/4" 525K 5 Diskettes 21.457672119140625K, 32 Hard Sector	W138	2.00
5 1/4" 525K 5 Diskettes 10.7288360595703125K, 32 Hard Sector	W139	2.00
5 1/4" 525K 5 Diskettes 5.36441802978515625K, 32 Hard Sector	W140	2.00
5 1/4" 525K 5 Diskettes 2.682209014892578125K, 32 Hard Sector	W141	2.00
5 1/4" 525K 5 Diskettes 1.3411045074462890625K, 32 Hard Sector	W142	2.00
5 1/4" 525K 5 Diskettes 670.5522522723234375K, 32 Hard Sector	W143	2.00
5 1/4" 525K 5 Diskettes 335.27612613616191875K, 32 Hard Sector	W144	2.00
5 1/4" 525K 5 Diskettes 167.6380730680809375K, 32 Hard Sector	W145	2.00
5 1/4" 525K 5 Diskettes 83.81903653404046875K, 32 Hard Sector	W146	2.00
5 1/4" 525K 5 Diskettes 41.909518267020234375K, 32 Hard Sector	W147	2.00
5 1/4" 525K 5 Diskettes 20.9547591335101171875K, 32 Hard Sector	W148	2.00
5 1/4" 525K 5 Diskettes 10.47737956675505859375K, 32 Hard Sector	W149	2.00
5 1/4" 525K 5 Diskettes 5.2386897833775292796875K, 32 Hard Sector	W150	2.00

Wabash diskettes
\$1.29 each

Ultra diskettes
\$1.39 each

3M diskettes
\$1.94 each

Memorex diskettes
\$1.94 each

Burroughs diskettes
\$2.09 each

Dysan diskettes
\$2.99 each

For more information about this brand call:

8 year warranty
800-323-8888
In Canada 513-683-6667

Lifetime warranty
408-728-7777
In Canada 513-683-6667

Lifetime warranty
800-328-9438
In Canada 513-683-6667

8 year warranty
800-538-8080
In Canada 513-683-6667

8 year warranty
800-552-1422
In Canada 513-683-6667

8 year warranty
800-552-2211
In Canada 513-683-6667

CIRCLE 86 ON FREE INFORMATION CARD



IBM-PC[®] SOFTWARE COMPATIBLE

INTRODUCING THE
IBM-PC[®] ALTERNATIVE...

THE  **SANYO** MBC550

16 BIT MS-DOS REG. \$995⁰⁰ **AT ONLY \$895⁰⁰*** **PLUS**

FREE BUSINESS SOFTWARE

INCLUDING:
MICROPRO WORDSTAR • CALCSTAR
IUS EASYWRITER
AND THE SYSTEM DISK

- IBM PC Compatible
- Single-Dual Disc Drive
- 128K Memory
- Centronics Printer Port Included
- Color Graphics Capability
- 8088 CPU
- Self-Diagnostics

*IBM PC registered trademark of IBM Corporation

LETTER-QUALITY PRINTERS



PR 5500

- 16 characters per second
- Bi-Directional printing
- Quiet operation
- Choice of 10, 12 or 15 characters per inch

\$795⁰⁰
Reg. \$995⁰⁰

not shown

PR 5000 10 characters per second
\$495⁰⁰* REG. \$595⁰⁰

*When purchased with Computer

SANYO MBC555

REG. \$1395⁰⁰ **\$1295⁰⁰*** **PLUS**
DUAL-DISK DRIVE **FREE SOFTWARE**

MICROPRO SOFTWARE (\$2000⁰⁰ VALUE)
• WORDSTAR • SPELLSTAR • CALCSTAR
• MAILMERGE • INFOSTAR

SANYO MONITOR CRT-36

MATCHING 12" SCREEN
HIGH-RESOLUTION GREEN MONITOR
\$169⁹⁵*
REG. \$199⁹⁵

*When Purchased with Computer



ADVANCE
THE PEOPLE WHO KNOW
COMPUTERS

TOOL FREE HOT LINE
800-223-0474

26 WEST 16th STREET, NEW YORK, N.Y. 10036 212-730-7030

* When purchased with monitor and printer. (Model MBC550 \$895 if purchased separately. Model MBC555 \$1395 if purchased separately.)

MARCH 1984

In Computer Electronics...

NTS INTRONIC™ HOME TRAINING GIVES YOU THE EDGE

The competition for High-Technology careers is strong, and the rewards are great. Give yourself the edge you need by training with NTS.



NTS INTRONIC™ home training provides you with a special kind of "Hands-On" experience that prepares you better, develops your skills faster. You advance as quickly as you wish, working with actual circuits, diagrams, schematics, and state-of-the-art hardware. There are a dozen different NTS programs in electronics to help you develop and reach your potential. They range from basics to advanced areas in several fields. And the ALL-NEW NTS course catalog spells it all out. It's free, and does not obligate you in any way. Send for it today.

A GROWTH INDUSTRY

High-Technology is a growth industry. The evidence is clear, and most observers predict a steady expansion due to a relatively strong flow of investment capital into computers, electronics and precision instruments. Sales of computers alone will reach an estimated ten million units this year. This means challenges and new

employment opportunities, especially in servicing and maintenance. Computer servicing skills can best be learned by working directly on field-type equipment. NTS electronic hardware is selected and developed especially for the training program with which it is associated. You learn by doing, by assembling, by performing tests and experiments, covering principles of computer electronics, microprocessor troubleshooting, and circuitry.

MICROCOMPUTERS

NTS offers three programs in computer electronics. You will receive training covering solid-state devices, digital logic circuitry, and the fundamentals of the computer itself. Instruction includes micro-control technology and detailed operation of microcomputers. These courses will prepare you for entry-level in many facets of the computer industry such as field service and customer engineering as well as programming. In addition to written texts your course includes the NTS/HEATH disc-drive computer which you assemble as part of the training process. The assembly and use of the computer will serve to reinforce practical application of principles.

MICROPROCESSOR TECHNOLOGY

The field of industrial and microprocessor technology encompasses the application of electronic microprocessor control principles. Your course takes you from fundamentals of digital electronics and associated circuitry through the application of the microprocessor as a control device. You will learn how to move and manipulate instructions and information. The microprocessor trainer included in your course is a microcomputer system designed as a practical tool for learning the use of software and hardware techniques utilized in the linking of microprocessors to various systems.

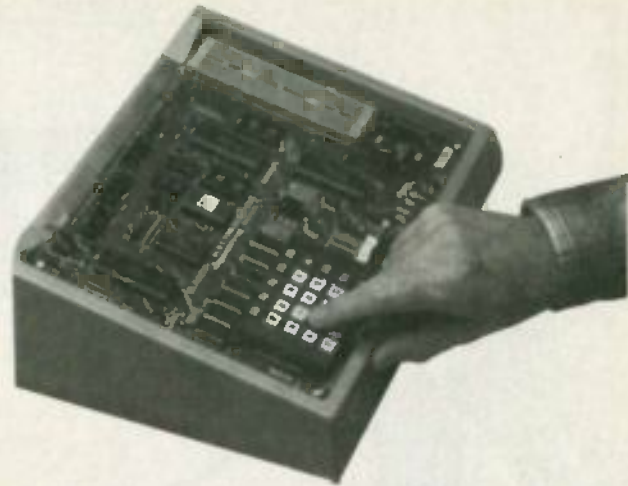

DIGITAL ELECTRONICS

The NTS Compu-Trainer is a fascinating solid-state device which you will build in order to perform over ninety logic circuit experiments. These experiments serve to emphasize an area of electronics which is essential to the understanding of state-of-the-art control equipment; they are also extremely important to those wanting to pursue a career in computer servicing. Separate courses involving the Compu-Trainer are also available in Microcomputer Servicing and Digital/Analog Electronics.

ROBOTICS & VIDEO TECHNOLOGY

Other NTS courses cover a wide range of specialization. In Robotics, the NTS/Heath Hero I is included to train you in robotic applications in

manufacturing processes. In Video technology, a new course features the advanced NTS/Heath Z Chassis "Smart Set" color TV with computer space command remote control and space phone. This is an excellent program for those interested in a career in video servicing with microcomputer basics.

EARN CEU CREDITS

America's industrial giants are turning more and more frequently to home study as an effective way to upgrade employee skills. You benefit from the experience NTS has gained in its 79 years as a leader in technical training. The skills and experience gained in the building of kits and test equipment provide you with training that cannot be duplicated. And, depending on the program you select, you can earn up to 30 CEU credits for successful completion. Complete details included in the catalog.



Use the mail-in card or fill out and mail the coupon. Indicate the field of your choice. (One, only please.) FREE full color catalog will be sent to you by return mail.

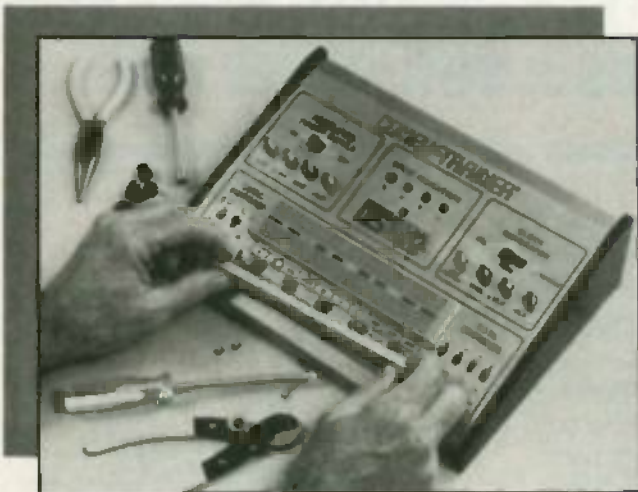

NO OBLIGATION NO SALESMAN WILL CALL

NTS NATIONAL TECHNICAL SCHOOLS

TECHNICAL TRADE TRAINING SINCE 1905
Resident and Home-Study Schools
4000 So. Figueroa St., Los Angeles, CA 90037

NATIONAL TECHNICAL SCHOOLS Dept. 206-034
4000 South Figueroa Street, Los Angeles, CA 90037

Please send FREE color catalog on course checked below.

- | | |
|---|---|
| <input type="checkbox"/> Robotics | <input type="checkbox"/> Computer Electronics |
| <input type="checkbox"/> Digital Electronics | <input type="checkbox"/> Video Technology |
| <input type="checkbox"/> Auto Mechanics | <input type="checkbox"/> Home Appliances |
| <input type="checkbox"/> Air Conditioning/Solar Heating | |

Name _____ Age _____
Address _____ Apt _____
City _____ State _____
Zip _____ Phone () _____

- Check if interested ONLY in classroom training in Los Angeles
 Check if interested in G.I. Bill information.

MARCH 1984

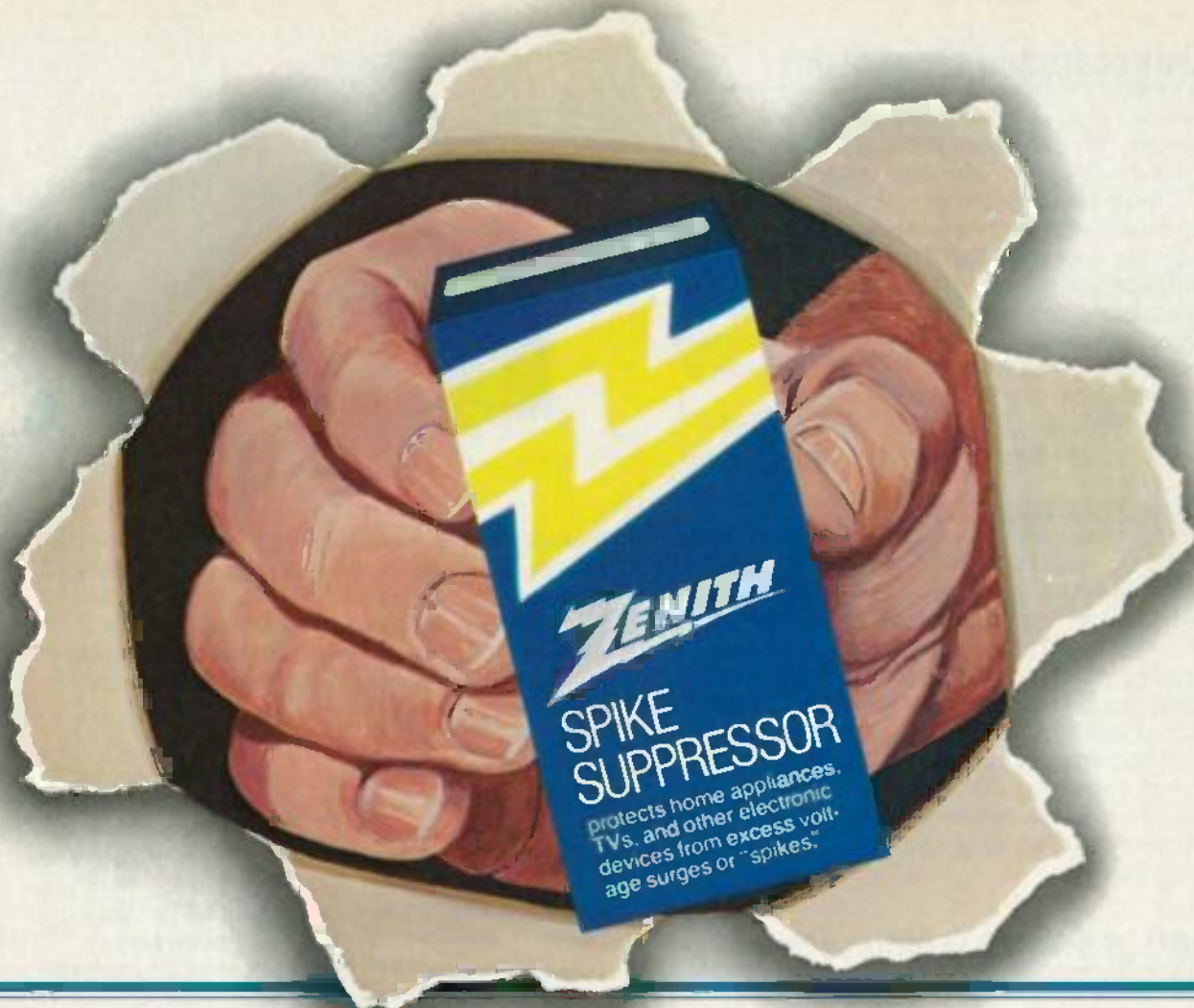

New protection – especially in stormy weather – for the electronics you use, sell or service!

A brief, high voltage surge – or spike – can occur in any AC line system and, at amplitudes lower than 600V, cause little or no damage.

But at greater amplitudes, a spike can do real damage. And the greater the high voltage surge – resulting from nearby lightning, for example – the greater the risk of harm, especially to solid-state devices.

That's why Zenith now announces the availability of two Spike Suppressors – one with a grounding plug and the other without.

Both are designed to provide susceptible TV receivers, household appliances and other electronics with two-way protection from high-voltage surges.

First, a Zenith Spike Suppressor absorbs a wide range of voltage spikes so only a safe voltage level reaches the protected equipment.

Second, heavy or prolonged voltage surges cause a Zenith Spike Suppressor to cut off power completely to protected equipment thereby signaling the need for a replacement Spike Suppressor.

That's double-duty protection against spikes for the electronics you use, sell or service. And ample reason for you to lay in a supply of Zenith Spike Suppressors soon.

Chances are they're available at your Zenith dealer's now. Call and pick up several before the next storm hits!

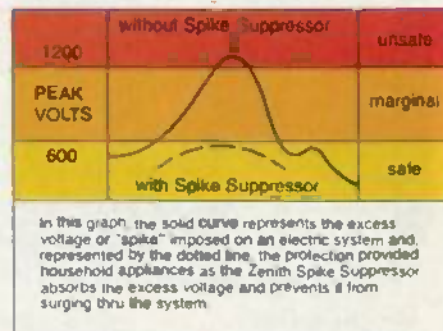

ZENITH

The quality goes in before the name goes on.®

NEW PRODUCTS

continued from page 32

mers, wire-round resistors, and even printed-circuit board traces, can be measured and evaluated, without designing a test setup or performing off-line computations.

Extensive output and remote-control fea-

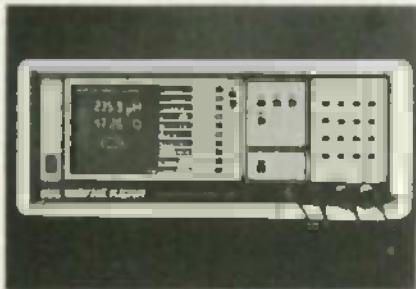

CIRCLE 104 ON FREE INFORMATION CARD

tures (optional) allow the model 3245 to be networked as part of an automatic parts-handling station, remote-testing instrument, or part of an ATE installation. Optional RS-232 or IEEE-488 ports are available. In addition to those digital-output options, analog outputs may be generated (0-1-volt DC) proportional to measured values.

The model 3245 is priced at \$7995.00.—Wayne Kerr, Inc., 400 West Cummings Park, Woburn, MA 01801.

TRANSFER DEVICE, the **PORTAPAC**, is a portable data-retention and transfer device with storage capacity of up to 64K bytes of data. The **PORTAPAC** is line-transparent, using standard RS232C interface with RTS/CTS handshake and is selectable from

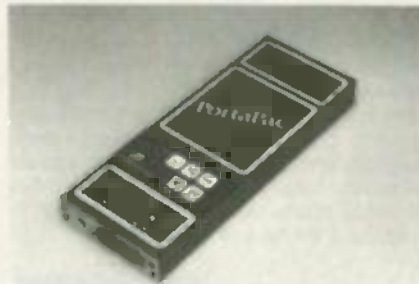

CIRCLE 105 ON FREE INFORMATION CARD

50-19,200 baud. Information can be transferred regardless of software protocols or disk format. Typical battery power retains memory for 15 months to 5 years, depending upon storage size. Power automatically switches to an internal battery source when the external source is disconnected. That switching causes neither loss nor alteration of data.

The **PORTAPAC** is particularly apt for transferring data between incompatible computer systems. It can also be used as a printer buffer, external storage for portable computers, or for backup storage. The **PORTAPAC** comes in three capacity versions: 16K, priced at \$345.00; 32K, priced at \$545.00 and the 64K version at \$695.00 — **Cryptonics, Inc.**,

11711 Coley River Circle, Suite 7, Fountain Valley, CA 92708.

OSCILLOSCOPE, model **LBO-525L**, is a 50-MHz, two-channel oscilloscope that offers the flexibility and advanced features required for critical applications while being easy to operate.

It has a true calibrated delayed timebase with both run-after-A and trigger-after-A modes. There is 500 μ V maximum sensitivity and 20 ns maximum sweep speed that permits analysis of low-level and high-frequency signals, while still offering a maximum input rating of 500 V (DC plus AC peak). There is

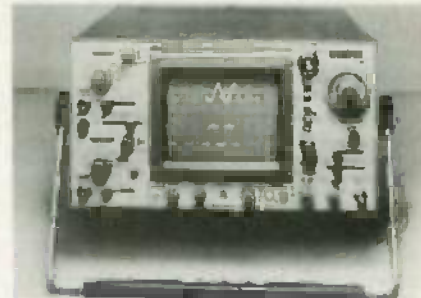

CIRCLE 106 ON FREE INFORMATION CARD

also an illuminated internal graticule for precise measurements and photography and 12 kV CRT accelerating potential for maximum trace intensity, even when observing transients at high sweep speeds. In addition,



Service more than 95 RCA and other brand models with these VCR Parts Kits:

199094 and 199095 Belt Kits, 199096 Lamp Kit, 199097 Fuse Kit, 199300 IC Kit

One source for thousands of VCR parts.

RCA VCR parts are available from more than 600 authorized RCA parts distributors. See your local RCA distributor for RCA's new VCR parts kits — they're easy to use and reuse. Each package has a handy slide top — and features detailed cross-references to other manufacturers' model numbers and stock numbers.

One more thing. Kit prices are lower than the total cost of the individual parts. So see your RCA distributor today. Also ask for a copy of the VCR Parts Cross Reference of more than 8000 VCR parts (Form 1F6627) and VCR Tool Catalog (Form 1F6857). Or write: RCA Distributor and Special Products Division, 2000 Clements Bridge Road, Deptford, NJ 08096.

RCA VCR Parts

MARCH 1984

39

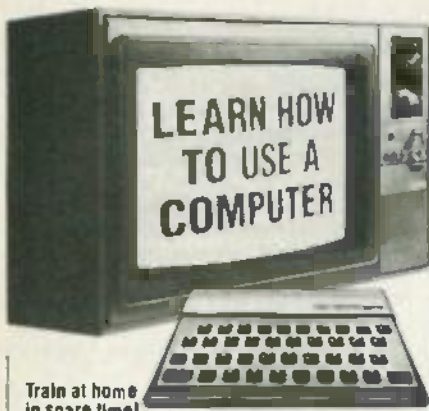

Train at home
in spare time!

Learn it all...at the office, or at home...computer operations, applications and programming!

Learn how and why a computer can help you. Learn to write your own computer programs. How to program in BASIC. How to understand and use more than 80 BASIC commands and functions. How to use pre-packaged software and change it to meet your special needs. How to make sense of the overwhelming maze of books, information and advice available at your local computer store. See how easy it is to use different programs already available. See how they fit into your home or business operations...budgeting, real estate, book-keeping, inventories, expenses, pricing, profit margins, investments, interest, taxes...hundreds more including foreign languages, and graphics. Never again be at the mercy of a so-called "computer expert."

**EXPERTS SHOW YOU
WHAT TO DO, HOW TO
DO IT...TO MAKE YOUR
LIFE EASIER**

Everything is explained in easy-to-understand language with plenty of examples. Step-by-step you learn how to program in BASIC. How to understand and use more than 80 BASIC commands and functions. How to use pre-packaged software and change it to meet your special needs. How to make sense of the overwhelming maze of books, information and advice available at your local computer store. You learn everything you need to know to use the computer. You'll be able to understand computer experts and talk their language... storage, systems, terminals and much, much more. NOW... ALL THIS IN ONE COURSE!

- Computer Training • Computer Programming • Computer Applications
- Find out what you need to know about computer operations

**TIMEX SINCLAIR 1500
WITH BUILT IN 16K MEMORY
INCLUDED WITH
YOUR TRAINING
Plugs into any TV!**

**SEND FOR
FREE FACTS!**



COMPUTER TRAINING, Dept DE024
Scranton, Pennsylvania 18515

Please rush me free facts and color brochure that tells how I can learn computer applications, programming and operation at home in spare time

Name _____ Age _____
Address _____
City/State/Zip _____

there is alternate triggering capability that allows the simultaneous display of two asynchronous signals.

The model LBO-525L is priced at \$1195.00 —Leader Instruments Corporation, 380 Oser Avenue, Hauppauge, NY 11788.

PROTECTIVE COATING. *Konform.* Is an aerosol-packaged, silicone/elastoplastic-based conformal coating for protecting rigid and flexible printed-circuit boards, thick film circuits, and electrical and electronics components and assemblies. It guards against moisture, fungus, thermal stress and mechanical abuse. *Konform* is formulated to withstand the heat of densely-packed com-



CIRCLE 107 ON FREE INFORMATION CARD

puter circuitry, as well as the cold of aerospace communications systems in subzero temperatures. It meets the MIL-I-46058C Type SR and has been approved by Underwriters Laboratories. *Konform* is priced at \$10.75 per 16-ounce container.—Chemtronics, 681 Old Willets Path, Hauppauge, NY 11788.

WIRE STRIPPER. the Rush model 2, is designed for removing PVC-type insulation from the ends of stranded or solid wires from size 17 to 24 AWG.



CIRCLE 108 ON FREE INFORMATION CARD

The automatic hand stripper is self-adjusting for different wire sizes, and cleanly cuts the insulation on both stranded and solid wires.

Stripping a wire is accomplished by placing the wire between two holding pads and closing the two handles. The insulation is cut automatically, and the unwanted insulation slug is removed from the end of the wire. The

Radio-Electronics REPRINT BOOKSTORE

- Build Your Own Satellite TV Receiver \$7.00
- 8-Ball Satellite TV Antenna \$5.00
- Build Your Own Robot \$12.00
- TV Descrambler (January, February 1981) \$3.00
- Radio-Electronics back issues (1983) \$3.00 (January, February 1983 not available)
Write in issues desired
- Radio-Electronics back issues (1982) \$3.50 (January 1982 not available)
Write in issues desired
- Radio-Electronics back issues (1981) \$4.00 (February, March, December 1981 not available)
Write in issues desired
- Etch your own PC boards \$3.00
- Special Projects (Spring 1981) \$4.50
- Special Projects #4 (Summer 1982) \$4.50
- Special Projects #5 (Winter 1983) \$4.00
- Special Projects #6 (Spring 1983) \$3.50
- Special Projects #7 (Summer 83) NOT AVAILABLE
- Special Projects #8 (Winter 83) \$3.50
- Special Projects #9 (Winter 84) \$3.00
- Radio-Electronics Annual 1983 \$3.50
- Radio-Electronics Annual 1984 \$2.50
- How to Make PC Boards \$2.00
- All About Kits \$2.00
- Modern Electronics (Vol. 1, #1 April 1988) \$2.25
- Electro Importing Co. Catalog (1918) (176 pp) \$4.95

To order any of the items indicated above, check off the ones you want. Complete the order form below, include your payment, check or money order (DO NOT SEND CASH), and mail to Radio-Electronics, Reprint Department, 200 Park Ave. South, New York, NY 10003. Please allow 4-6 weeks for delivery.

If you need a copy of an article that is in an issue we indicate is unavailable you can order it directly from us. We charge 50¢ per page. Indicate the issue (month & year), pages and article desired. Include payment in full, plus shipping and handling charge.

ARTICLE _____
MONTH _____ YEAR _____
PAGES _____
TOTAL PAGES _____ @ 50¢ each TOTAL PRICE _____

MAIL TO: **Radio-Electronics** 1-84
Reprint Department, 200 Park Ave. South, New York, NY 10003 All payments must be in U.S. funds

Total price of order \$ _____
Sales Tax (New York State Residents only) \$ _____
Shipping & Handling (U.S. & Canada only) (Includes FIRST CLASS POSTAGE) \$1.00 per item \$ _____
All other countries (\$2.00 per item, sea mail) \$ _____
(\$4.00 per item, air mail) \$ _____

Total Enclosed \$ _____
Name _____
Address _____
City _____ State _____ Zip _____

model 2 strippers are suitable both for production and occasional use and incorporate an Integral wire cutter for cutting wires to length. The tool weighs 6 ounces and is 7 1/4 inches long.

The Rush model 2 is priced at \$22.70—The Eraser Company, Inc., PO Box 4961/Oliva Drive, Syracuse, NY 13221.

TVRO FILTER. model 3217U1 and model 3217U2 (shown) remove 4-GHz interference by trapping its downconversion at the receiver IF.

The model 3217U1 has a notch depth of 25 dB with a 3-dB bandwidth of ± 1.5 MHz. Filters come with 50-ohm SMA connectors. It is priced at \$165.00.



CIRCLE 109 ON FREE INFORMATION CARD

The model 3217U2 has a notch depth of 50 dB and a 3-dB bandwidth of ± 1.5 MHz. It is priced at \$340.00.—Microwave Filter Co., Inc., 6743 Kinne Street, East Syracuse, NY 13057.

MULTIFUNCTION TESTER. model 105, consists of two different type function generators, a pulse generator, a frequency counter, and an AC voltmeter. Each of those pieces is basically familiar test equipment and can be used in the normal manner. In addition, when



CIRCLE 110 ON FREE INFORMATION CARD

the various sections are properly connected to each other and to an X-Y plotter or scope, the system will generate a frequency-response plot. When connected to a scope, it will provide a response plot for breadboard

work on amps and filters. When connected to a plotter, it provides hard-copy certification of equipment response.

The first function generator is called the timebase. Its primary task is to provide sweep voltage for the sweep generator and trigger voltage for the pulse generator. It generates a ramp with independently controlled leading and trailing sides. The timebase also produces sinewaves and squarewaves, has amplitude and DC-offset controls, and has an externally triggered FSK mode. There is a decade frequency-range switch which selects one of seven ranges from .001 Hz to 1kHz, and variable controls which multiply those ranges by a factor of 1 to 100. Output impedance is 600 ohms.

The second function generator is called the sweep generator. It can be swept internally with the timebase section, with an external signal, or manually with COARSE and FINE front-panel controls. There are log- and linear-sweep modes. Maximum linear-sweep range is 20 Hz to 20 kHz. Maximum log-sweep range is 10 Hz to 1 MHz. The unit can be set to sweep any portion of those ranges.

The pulse generator has a decade range switch and a variable control to produce pulse widths from 30 nanoseconds to 3 seconds. It can be triggered by the timebase or the sweep generator.

The frequency counter is seven-digits and updates every half second. It can be triggered by either the sweep generator or the voltmeter.

The AC voltmeter measures true RMS, has linear and log modes, and has fast and slow damping select. The meter will measure the signal at the timebase, sweep generator outputs, or an external output.

The model 105 is priced at \$750.00—FSI, PO Box 1423, Victorville, CA 92392.

PROTECTION UNIT, the Protector 6000, eliminates the damaging effects of transient voltage surges to expensive, sensitive electronics equipment. It uses silicon PN junction devices to provide fast response to surges.



CIRCLE 111 ON FREE INFORMATION CARD

before they can reach the equipment. It also provides full protection from electromagnetic and radio-frequency interference. The unit operates in both common and differential modes, and is outfitted with a circuit breaker to guard against current overloads higher than 15 amperes.

The Protector 6000 is priced at \$159.95.—New-Tone Electronics, Inc., 44 Farrand Street, Bloomfield, NJ 07003. R-E

FREQ COUNTERS TO 1.3 GHZ



EXCLUSIVE NEW FEATURE: SIGNAL STRENGTH LED BAR GRAPH

6 MODELS: \$150.-\$499.
ALL ALUMINUM CASES
FULL YEAR GUARANTEE
OPTIONAL PRECISION TIMEBASES
AC, DC OR BATTERY PORTABLE
CERTIFIED NBS CALIBRATION
MADE IN U.S.A.—10TH YEAR
LARGE SELECTION ACCESSORIES



OPTOelectronics inc

5821 N.E. 14th Avenue
Ft. Lauderdale, Florida 33334

1-800-327-5912

FLA (305) 771-2050 TELEX 514849

CIRCLE 62 ON FREE INFORMATION CARD

MARCH 1984

SUPERSALE

BECKMAN Circuitmate® DMM

MODEL DM73
\$72⁹⁵

• Smallest digital multimeter on the market • Probe-style design makes it ideal for taking measurements in hard-to-reach test areas



\$64⁹⁵ MODEL DM20

• 3 1/2-digit, pocket-size multimeter • 0.8% Vdc accuracy • diode test • hFE test • conductance • 10 amps AC and DC ranges • Autopolarity • Auto-Zero • Auto-decimal



\$79⁹⁵ MODEL DM25

• 3 1/2-digit, pocket-size multimeter • 0.5% Vdc accuracy • diode test • capacitance • continuity beeper • conductance • 10 amps AC and DC ranges • auto-polarity • auto-zero • auto-decimal



B&K PRECISION

100 MHz FREQUENCY COUNTER

MODEL 1803
REG. \$169.95
OUR PRICE \$144⁵⁰

• 5 Hz to 100 MHz range • 8 digit LED display • Leading zero blanking • Low pass filter • BNC Connector input • Overflow Indicator • Battery or AC powered • Charger/AC Adaptor included with Model 1803



NTSC COLOR BAR GENERATOR

MODEL 1251
REG. \$995.00

OUR PRICE
\$849⁹⁵

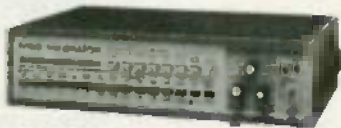

• Generates a wide variety of test signals and patterns for comprehensive testing servicing and adjustment of virtually all types of television and video equipment • Video patterns include standard NTSC color bars, IWQ, and staircase at two levels of burst phase chrominance • A full assortment of convergence patterns, raster colors, gated or full field multiburst

HITACHI PORTABLE OSCILLOSCOPES

MODEL V-222 (20 MHz)
REG. \$895.00

MODEL V-422 (40 MHz)
REG. \$895.00



CALL FOR SPECIAL PRICING

• New series of scopes provides high performance and light weight • Large 6-inch rectangular, internal graticule CRT • Autolocus circuit and scale illumination • DC offset function • Voltage and frequency reading outputs • High accuracy - ±3% • High sensitivity - 1 mV/div

BP DIGITAL CAPACITANCE METER

MODEL DCM-601
REG. \$149.95

OUR PRICE
\$79⁹⁵

• Digital display easy and correct readout • High accuracy, 100 PPM 0.5% • LSI circuit provides high reliability and durability • LCD display provides low power consumption



FORDHAM 550 MHZ FREQUENCY COUNTER

MODEL FM-8
REG. \$199.95
OUR PRICE \$149⁹⁵

• 8-digit high frequency counter with a switch selectable input using single BNC • Completely assembled • Pre-Calibrated, Pre-tested



LEADER NTSC WAVEFORM MONITOR

MODEL LBO-5880
REG. \$2050.00
OUR PRICE \$1850

Permits displaying vertical interval test and reference signals by front panel line selector.



NTSC VECTORSCOPE
MODEL LVS-5850
REG. \$2050.00
OUR PRICE \$1850

Convenient method for observing and measuring the relative phase and amplitude of chrominance signal components



FLUKE 70 73

• Analog Display • Rotary Knob • volts AC & DC • Resistance to 32 MΩ • 10 Amps • Diode Test • 3200 Counts • Fast Autoranging • Function Annunciators in Display • Power-Up Self Test • 2000+ Hour Battery Life w/Power Down "Sleep Mode" • New Test Leads • VDE & UL Approval

\$85⁰⁰

• 0.7% Accuracy • Autorange Only • 10 Amp Only



75
\$99⁰⁰

• 0.5% Accuracy • Manual or Autorange • 10A + 300 mA Range • Beeper



77
\$129⁰⁰

• 0.3% Accuracy • Manual or Autorange • 10 A + 300mA Range • Beeper • "Touch-Hold" Function



VIZ DC TRIPLE POWER SUPPLY

MODEL WP-708
REG. \$479.95
OUR PRICE
\$399⁹⁵

• Dual DC Voltmeter • Triple DC Power Supply • Three separate completely isolated DC power supplies, two 0-20V at 0-2A, one fixed 5V at 4A



WELLER SOLDERING STATION

MODEL EC1000
OUR PRICE
\$109⁹⁵

• Identical to the EC2000 except LED Digital temperature readout • The EC1000 is dial controlled



MODEL EC2000
OUR PRICE
\$139⁹⁵

• Continuously variable tip temperature from 350 to 850 F • Positive temperature coefficient sensor inside the tip provides temperature feedback to maintain tip temperature at a set point



FORDHAM

260 Motor Parkway, Hauppauge, N.Y. 11788

Master Charge
VISA
COO
Money Order
Check

N.Y. State residents add appropriate sales tax.

COO's extra (required 25% deposit)

ADD FOR SHIPPING AND INSURANCE

60-\$250.00	\$ 4.50
\$251.00 to \$ 500.00	\$ 6.50
\$501.00 to \$ 750.00	\$ 8.50
\$751.00 to \$1000.00	\$12.50
over \$1000.00	\$15.00

TOLL FREE
(800) 645-9518
in N.Y. State call 800-832-1446

Free Catalog on Request

BUILD THIS

LOW-COST TEST EQUIPMENT FOR TELEVISION servicing has been available for many years. Today, it is possible to buy TV test generators—with dot-pattern, cross-hatch-pattern, and even color-bar outputs—for less than \$100. If you add in more features—such as a staircase-pattern output, RF and baseband-video outputs, and horizontal- and vertical-sync signals for oscilloscope triggering—the price can easily triple. And if you need an even more versatile instrument—and add in a multiburst-signal output and the means to interface the unit for gen-locking (we'll discuss that later)—then you can end up spending hundreds more.

The video test generator that we'll describe here will do all the things we've mentioned—and even more! Therefore, it

can be used not only to service TV's and monitors, but also to test and align VCR's, video amplifiers, CATV systems—virtually all TV/video equipment. We will not only discuss how to build the generator, but also how to use it for testing video equipment.

A look at the output signals

The test signals that the generator provides include: multiburst, up/down step, gray level, dots, hatch, and color bars. Figure 1 shows those various test signals, as well as what they look like on a monitor or TV screen. Some typical uses for each pattern are also listed, but we'll discuss how to use the test signals in more detail later.

Along with the test signals, sync-gen-

erator reference signals (LS-TTL compatible) are also available at a rear-panel card edge. They include: composite sync, blanking, colorburst gate, horizontal drive, and vertical drive. Front-panel vertical-rate and horizontal-rate outputs are provided for convenient oscilloscope synchronization.

Also at the card edge are provisions for external digital inputs (three for each primary color, three for synchronizing the generator from an external source, and one external-audio input). Although it is not easy, it is possible, by interfacing the generator with a computer, to generate any real-time pattern or display desired.

The basic generator

A block diagram of the video test gen-

Build this low-cost, general-purpose video test generator and service TV receivers, video amplifiers, monitors, VCR's, and other video equipment.

GENE ROSETH

VIDEO TEST GENERATOR



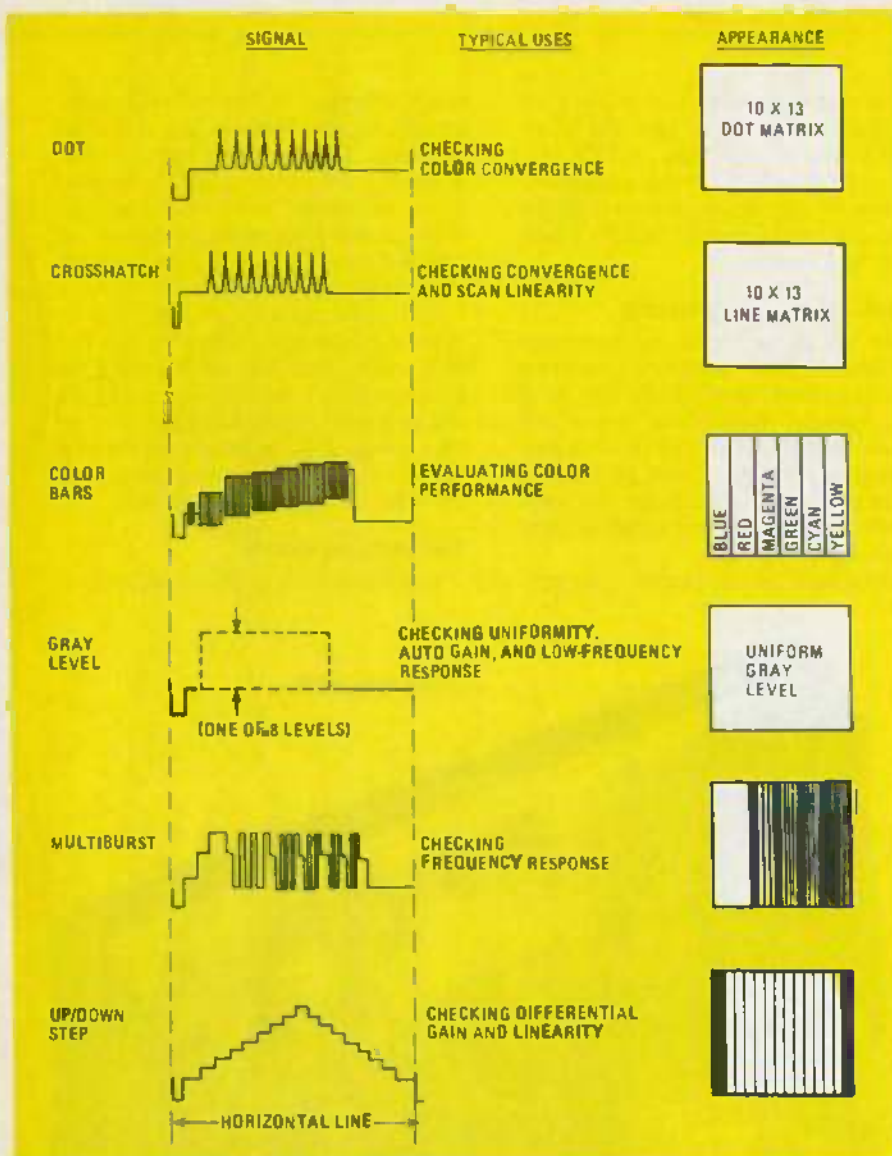

FIG. 1—THE TEST SIGNALS THAT THE generator produces are shown here along with their appearances on a TV screen, and some common test applications.

erator is shown in Fig. 2. We'll start with the 14.31818-MHz (we'll call it 14 MHz) oscillator, whose output is divided by 7 to provide the proper clock for the sync generator. The oscillator's output is also divided by 4 to generate the 3.579545-MHz color subcarrier. The divider, and thus the color subcarrier (at what we'll hereafter call 3.58 MHz) is synchronized with the sync generator by the field detector to maintain NTSC compatibility. It is then waveshaped and shifted in phase by 90° to act as a quadrature reference for the RF modulator section.

The four signal-generator blocks (multiburst, step/gray, color bar, and dot/hatch) receive timing information from the horizontal clock and the line counter. The signals that they produce are fed to a multiplexer that is controlled by switch S1. The multiplexer routes the selected test signal (or the external digital video signal) to a D/A converter and sync mixer.

The standard composite-video signal output from the sync mixer is buffered and is then sent to the video-output jack. It is also sent to an RF modulator (TV channel 3) and then to the RF-output jack. An audio signal is also modulated on the RF. That signal can be either a 1500 Hz internally generated sinewave, or any externally provided audio signal. Switch S3 selects between the internal and external signal.

The power supply for the generator provides +12 volts, -12 volts, and separate +5-volt rails for the digital and the analog portions of the circuit. Having separate +5-volt supplies minimizes crosstalk and prevents the various analog signals from being distorted by digital switching spikes.

A look at the circuit

A schematic of the video test generator is shown in Fig. 3. Since we started our

look at the block diagram with the oscillator, we'll do the same here. Transistor Q4 and its associated components make up the crystal-controlled 14.31818-MHz oscillator that is the master clock for the test-generator system. The frequency of the oscillator can be fine-tuned by trimmer capacitor C22. The oscillator output is buffered by one of the AND gates in IC41 and is then fed to a countdown circuit made up of IC34 (an up/down synchronous counter) and IC35 (a dual J-K flip-flop).

Those IC's divide the oscillator's output by 7 to provide the 2.04545 MHz that the sync generator (IC36) needs. They are also used to divide the oscillator's frequency by 4 to provide 3.58 MHz for the color subcarrier. That 3.58-MHz signal is fed to op-amp IC40, which (along with its associated components) triangulates the signal. The output of the op-amp is fed to IC19. The nonlinearity of that IC is used to form a sinewave whose shape can be adjusted by R52.

The sinewave is then sent to the RF modulator, IC3. The network made up of C6, C7, R12, and R14 provide a quadrature phase relationship between pins 1 and 18 (the CHROMA-LEAD and -LAG pins) of the RF modulator.

Another countdown circuit is made up of IC23 and IC24. Its purpose is to "segment" each horizontal line to provide timing signals for the signal generators. The four-bit binary counter, IC38, serves a similar function. It provides timing signals by counting the individual horizontal scan lines produced by IC36.

A shift register, IC25, controls the timing of each of the five frequencies of the multiburst generator and its white flag (the beginning, white portion of the multiburst pattern). The multiburst frequencies originate in separate oscillators made up of IC28, IC29, and IC30 and their associated R-C networks. One half of both IC22 and IC26, and parts of IC21 and IC27, control the phasing and switching of the multiburst generator. The multiburst output is buffered by IC37 and is then sent to the multiplexer.

The up/down-step and gray-level generator consists of IC20 (an up/down counter) and parts of IC21, IC22, and IC19. A one-Hz oscillator is formed by R28, R29, C13, and IC19; which, along with S2, allows the user to select one of eight gray levels by momentarily pushing S2. You can also step through each of the eight gray levels at a one-Hz rate by holding S2 closed. A provision (jumper JU1) is made for changing the source of the up/down control signal to IC20 (pin 5) from pin 9 to pin 8 of IC22. That has the following effect: Instead of the TV screen displaying the maximum white level at center screen and black at the extreme edges, the opposite occurs. (That is, black is displayed in the middle of the screen, stepping to

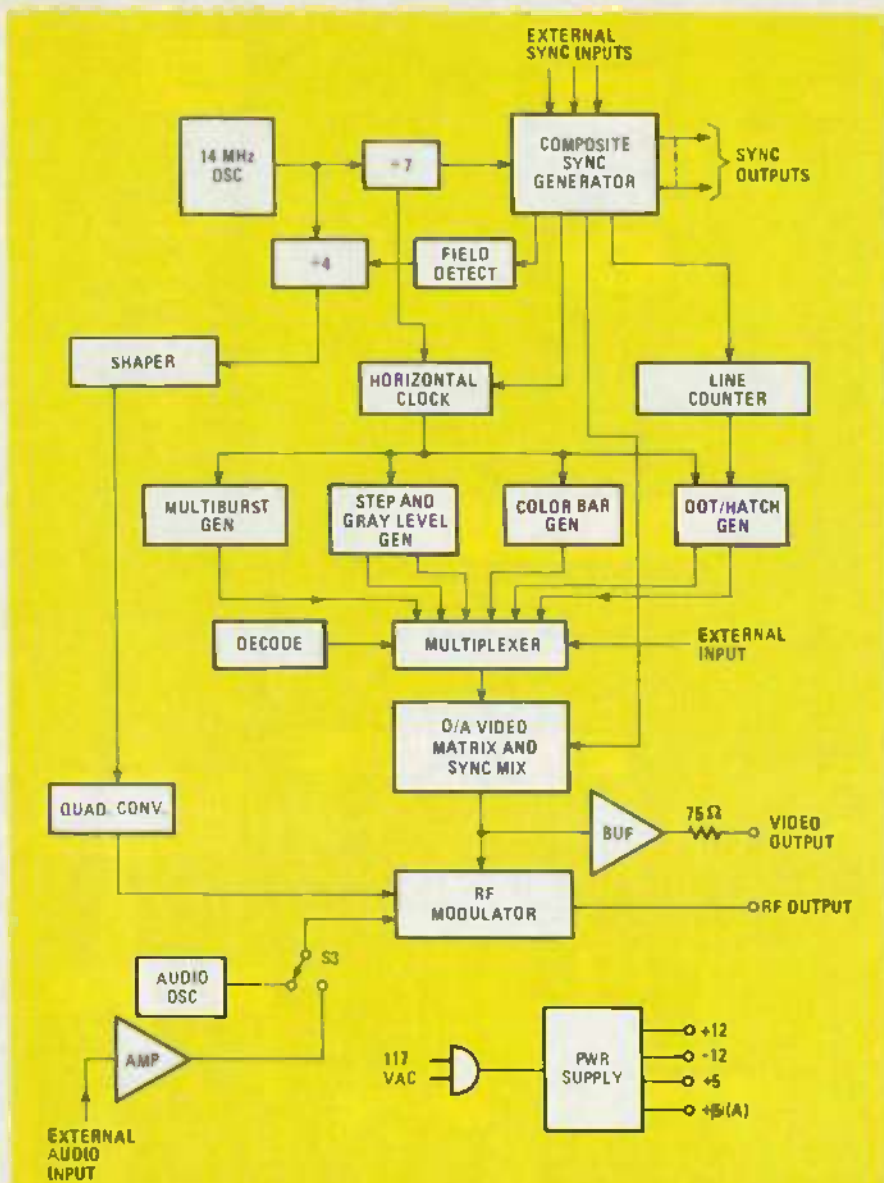

FIG. 2—A BLOCK DIAGRAM of the video test generator is shown here. Note that the power supply has two +5-volt outputs. That helps to keep digital switching spikes from distorting analog waveforms.

white at both edges.)

The dot- and hatch- pattern generator is made up of IC17 and part of IC5. Those IC's combine the outputs of the line counter and the horizontal clock at the proper times so that the hatch and dot patterns are produced. Those outputs are then sent to the multiplexer.

The color-bar generation is performed by a counter, IC16. It simply provides different binary states (which correspond to three primary and the three complementary colors) to a multiplexer, which routes them to the color inputs of IC4, a TV video matrix D/A converter.

The multiplexer that we've mentioned is made up of IC7-IC15. It selects one of the signals from the signal generators (or the externally generated digital video signal at the edge connector) and then routes that signal to IC4.

The multiplexer is controlled by the function-select switch (S1) through the

decoding network (D5-D14 and R20-R25). The operation is straightforward, except in the multiburst mode. In that mode, the decoding matrix changes its output state (and therefore the multiplexer input address) during the short time between each separate multiburst frequency. That causes the multiplexer to momentarily route a gray level "4" to the D/A video matrix which gives a more pleasing appearance to the multiburst display. That is, the displayed pattern will be black and gray instead of black and white. That function is performed by IC22, IC26, D4, and part of IC5.

Taking a closer look at IC4, we see that it encodes luminance and color-difference signals from 3-bit RGB inputs. It also mixes the various sync signals to form a standard, sync-negative, composite-video signal. The composite-video output signal goes to Q3 for output buffering and also to IC3 where it is RF modulated.

Transistor Q2 also receives composite video from pin 13 of IC3, but with the chrominance information included. The two signals are selected by part of IC2, depending on the function selected by S1. The reason that there are two separate paths for the video is because of bandwidth limitations of IC3. Either way, the video signal passes through emitter-follower Q1 and then is buffered for output by IC1, an LH0002 current amplifier. That IC can drive long lengths of coax without difficulty.

An audio oscillator (IC42 and associated components) produces about a 1500-Hz sinewave. That signal goes to S3, which is used to select between the internal audio source or an external signal from the edge connector. The selected signal is applied to Q5 whose collector-base capacitance acts as a varactor diode to modulate the audio subcarrier at IC3. Coil L2 can be used to adjust the frequency of the subcarrier, which is nominally 4.5 MHz. The RF carrier's frequency is adjusted at L1.

Building the generator

You must use printed-circuit boards for this project because the placement of many of the components is critical and will affect the generator's operation. Foil patterns are shown (half-size) for the two required double-sided boards in Figs. 4, 5, 6, and 7. Due to space restrictions, Figs. 6 and 7 are not shown in this issue. They will appear when the story continues in a future issue. If you are not equipped to etch boards, pre-etched, drilled, and silk-screened boards are available from the supplier indicated in the Parts List.

Installing the parts on the board is pretty much straightforward, but there are a few points that we'll mention in the following paragraphs. First, make sure that you follow proper soldering practices. In other words, avoid cold solder joints—make sure that the connection is properly heated *before* you apply solder. (Of course, when soldering transistors and other heat-sensitive components, try not to use too much heat. If possible, use a soldering heat sink.) Don't use so much solder that you form solder bridges between PC-board traces. Finally, it is a good practice to use sockets for all IC's.

Now we can discuss the parts-placement diagrams. There are three, even though you might have expected two. Figure 8 shows the on-board component placement for what we'll call board A and the inter-board jumpers to board B. Figure 9 shows the off-board components for Board A and also 37 on-board jumpers. That brings us to board B, whose parts-placement diagram (both on- and off-board components) is shown in Fig. 10. (Note that Figs. 8, 9, and 10 will appear in a future issue.)

Assembly consists mainly of inserting

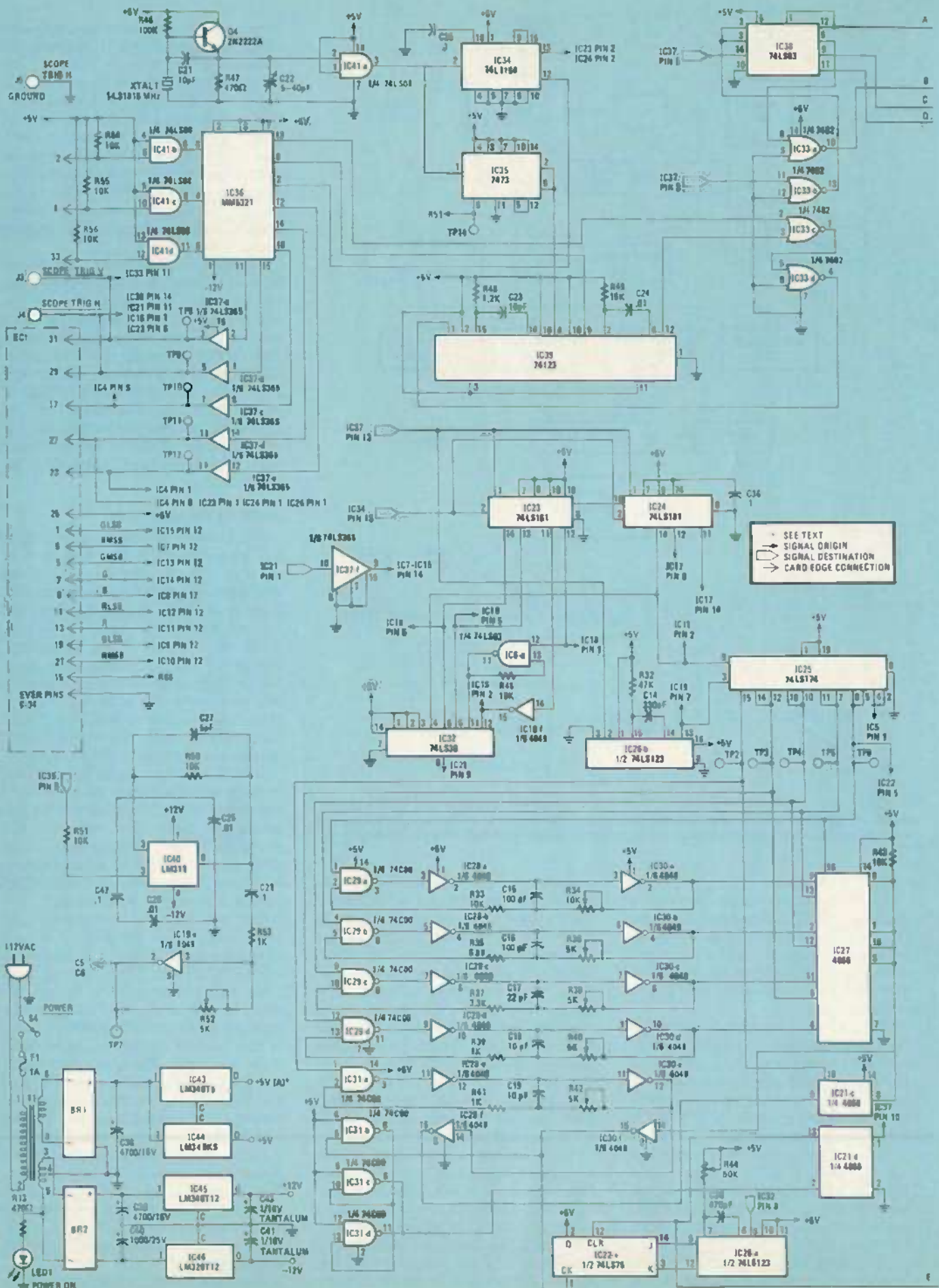
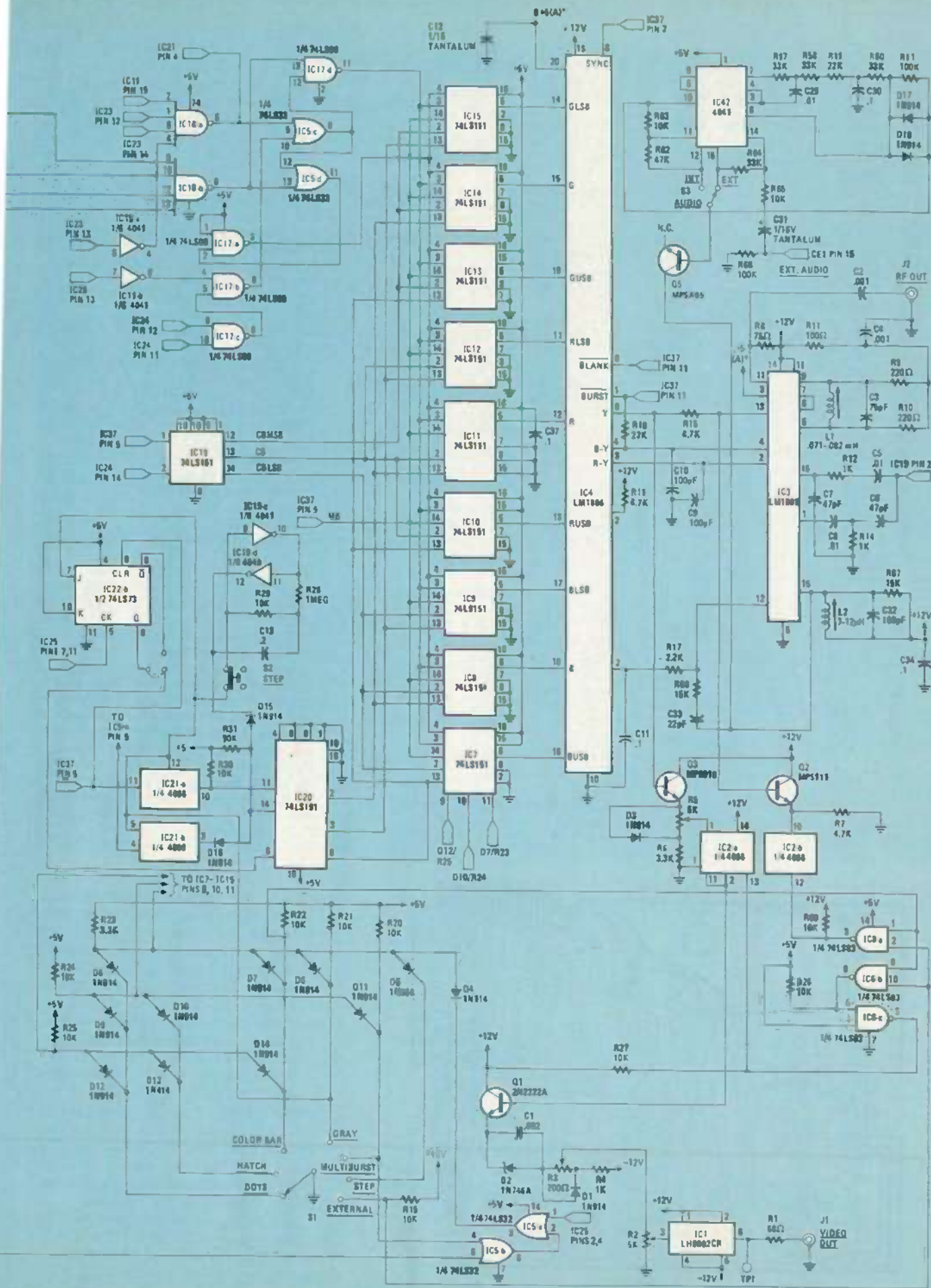

FIG. 3—VIDEO TEST GENERATOR SCHEMATIC. Note that some voltage sources are labeled +5V, while others are labeled 5(A). That is because



As mentioned previously, there are two separate +5-volt supplies.

PARTS LIST

All resistors 1/4-watt, 5%, unless noted

R1—68 ohms
 R2, R5, R36, R38, R40, R42, R52—5000 ohms, trimmer potentiometer
 R3—200 ohms, trimmer potentiometer
 R4, R12, R14, R39, R41, R53—1000 ohms
 R6, R23, R37—3300 ohms
 R7, R15, R18, R48—4700 ohms
 R8—75 ohms
 R9, R10—220 ohms
 R11—100 ohms
 R13, R47—470 ohms
 R16—27,000 ohms
 R17—2200 ohms
 R19, R20—R22, R24—R27, R29—R31, R33, R43, R45, R50, R51, R54—R56, R63, R65, R69—10,000 ohms
 R28—1 megohm
 R32, R62—47,000 ohms
 R34—10,000 ohms, trimmer potentiometer
 R35—68,000 ohms
 R44—50,000 ohms, trimmer potentiometer
 R46, R61, R66—100,000 ohms
 R49, R67, R68—15,000 ohms
 R57, R58, R60, R64—33,000 ohms
 R59—22,000 ohms

Capacitors

C1—0.002 μ F, ceramic disc
 C2, C4—0.001 μ F, ceramic disc
 C3—75 pF, mica
 C5, C8, C24—C26, C29—0.1 μ F, ceramic disc
 C6, C7—47 pF, ceramic disc
 C9, C10, C15, C16, C32—100 pF, ceramic disc
 C11, C28, C30, C34—C37, C42—0.1 μ F, ceramic disc
 C12, C31, C41, C43—1 μ F, 16 volts, tantalum
 C13—0.2 μ F, ceramic disc
 C14—330 pF, ceramic disc
 C17, C33—22 pF, ceramic disc
 C18, C19, C21—10 pF, ceramic disc
 C20—470 pF, ceramic disc

C22—5–40 pF, trimmer capacitor
 C23—10 pF, ceramic disc
 C27—5 pF, ceramic disc
 C38, C39—4700 μ F, 16 volts, electrolytic
 C40—1000 μ F, 16 volts, electrolytic

Semiconductors

IC1—LH0002CN current amplifier (National)
 IC2, IC21, IC27—4066 quad bilateral switch
 IC3—LM1889 TV video modulator
 IC4—LM1886 TV video matrix D/A converter
 IC5—74LS32 quad OR gates
 IC6—74LS03 quad NAND gates
 IC7—IC15—74LS151 one-of-eight selector/multiplexer
 IC16, IC23, IC24—74LS161 synchronous 4-bit counter
 IC17—74LS00 quad NAND gates
 IC18—74LS20 dual 4-input NAND gate
 IC19, IC28, IC30, IC42—4049 hex inverting buffer
 IC20—74LS191 synchronous up/down counter
 IC22—74LS73 dual J-K flip-flop
 IC25—74LS174 hex D-type flip-flop
 IC26, IC39—74LS123 dual retriggerable monostable multivibrator
 IC29, IC31—74C00 quad NAND gates
 IC32—74LS30 8-input NAND gates
 IC33—7402 quad NOR gate
 IC34—74LS169 4-bit synchronous up/down counter
 IC35—7473 dual J-K flip-flop
 IC36—MM5321 TV camera sync generator (National)
 IC37—74LS365 hex bus driver
 IC38—74LS93 4-bit binary counter
 IC40—LM318 op-amp
 IC41—74LS08 quad AND gate
 IC43—LM340T5 5-volt regulator, TO-220 case
 IC44—LM340K5 5-volt regulator, TO-3 case

IC45—LM340T12 12-volt regulator, TO-220 case
 IC46—LM320T12 12-volt negative regulator, TO-220 case
 Q1, Q4—2N2222A
 Q2, Q3—MPS918
 Q5—MPSA05
 D1, D3—D18—1N914 or 4148
 D2—1N746A
 S1—7-position rotary switch (Allied 7471001 or similar)
 S2—pushbutton switch, normally closed
 S3—SPDT toggle switch
 S4—SPST toggle switch
 LED1—standard red
 T1—Transformer (Triad F-166XP or similar), primary: 117 volts; secondary: 24 volts, center-tapped, .125 amps; 9 volts, center-tapped, .5A
 BR1, BR2—bridge rectifier, 1.5 amps
 L1—0.071–0.082 mH adjustable coil (J.W. Miller 48A778MPC or similar)
 L2—7–12 μ H adjustable coil (J.W. Miller 23A105RPC or similar)
 XTAL1—14.31818 MHz crystal
 F1—fuse, 1 amp, pigtail leads
 J1—BNC jack
 J2—type N jack
 J3–J5—standard tip jacks

Miscellaneous—Heat sinks, cabinet (Pactec CM86-225), power cord, strain relief, TO-3 mounting kit, IC sockets, etc.

The following are available from Jengco, 3232 San Mateo, Suite 75, Albuquerque, NM, 87110: Complete kit including PC boards, all components, cabinet (no IC sockets), \$295; Etched, drilled, and silkscreened PC boards (boards A and B), \$49.50; Complete test generator, assembled and tested, \$395. Please add 5% for postage and handling, New Mexico residents add 4.25% sales tax, allow 6–8 weeks for delivery.

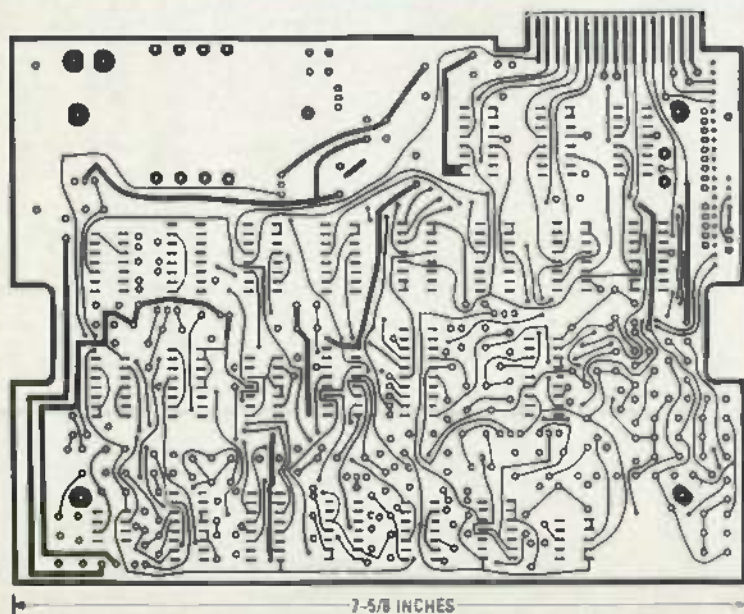

FIG. 4—THE COMPONENT SIDE of board A is shown here at half its actual size.

parts in the board and soldering them. Follow the three diagrams and the parts list, and solder the parts where shown. Make sure that you are careful about the polarity of the diodes, transformer T1, polarized capacitors, and the two bridge rectifiers (BR1 and BR2). It is probably best to start with the resistors. Definitely do *not* start with the jumpers—we'll get to those shortly.

A few notes are in order: All resistors, except R15, should be installed so that they stand on one end. The power indicator, LED1, should have its leads left long enough to be inserted through the front panel hole. For safety's sake, insert the pigtail fuse into a short length of shrink tubing before soldering it in place.

It is best to use sockets for all the IC's. And don't forget that some of the IC's are static-sensitive and should be handled accordingly. Those include IC2, IC19,

continued on page 98

ALL ABOUT

"UNITED TWO-FORTY-TWO HEAVY, HEADING one four zero, number two for the ILS runway fourteen left," the controller's voice crackled in the headset. The 747 made a slow right turn and continued its descent toward what looked like a sea of white—the top of the overcast. As the aircraft entered the clouds, the flight attendant went through her standard "Seat back, tray tables in the upright and locked position" speech. Minutes later, the ground loomed dim and gray through the rain-streaked windows and, with a gentle

bump, another 300 passengers arrived safely at Chicago's O'Hare International Airport. It was just one of an average two-million-plus instrument landings routinely made every year in the United States.

But how can a pilot put a giant airliner exactly on the center of the runway when he cannot even see the airport except during the last seconds of the flight? The answer is his ILS or Instrument-Landing System—part of a complex world-wide electronic navigation-and-landing system

that makes airplanes the safest and most dependable way to travel.

The early years

Toward the end of World War I, while aviation was still in its infancy, there was no governmental control over civilian pilots or the aviation industry. Automobiles were the up-and-coming thing, and aviators were pretty much left to their own resources. The Army Air Corps had a few airfields, but civilian aircraft landed anywhere there was an open and flat area

Instrument Landing Systems

Have you ever wondered how a pilot can safely land an airplane when weather conditions are so bad that he can't even see the runway? If so, read on as we describe instrument landing systems.

BILL SEWELL



MARCH 1984

45

large enough to get down safely (and sometimes even where there wasn't).

If a pilot needed to make a night landing, he might arrange for a friend to build a fire in a field where he planned to land. He would then circle the field when he arrived and the friend on the ground would frantically pile straw and wood on the fire so that it would blaze up and light the field. Because of the use of that technique, many a pilot came down with parts of his airplane on fire!

Civil aviation got its start in May, 1918, when the first bag of air mail left the infield of Belmont Race Track on Long Island (the airplane was a Curtiss Jenny) and landed three hours and forty minutes later on the polo grounds of Washington, D.C. The pilot who was to carry the North-bound mail to New York shook hands with President Wilson and then took off from the polo grounds and turned Northeast. He landed in Delaware to ask directions and broke his propeller in the process. His bag of air mail went to New York on the train!

After that shaky start, however, air mail did settle down to regular service. In order to keep the mail flying, even in bad weather, large beacon lights were installed at airports and along the routes. Their purpose, of course, was to help pilots find their way in reduced visibility. But the pilots often described the beacons, saying, "When you need 'em, you can't see 'em, and when you can see 'em, you don't need 'em." That fact, coupled with pressure from Congressman Fiorello LaGuardia, led to the adoption of the Air Commerce Act in May, 1926, and the development of civil aviation came into full bloom.

One of the first goals of the Commerce Department's new Civil Aviation Authority was to develop a system that would allow planes to take off, fly, and land without any reference to the ground. General Jimmy Doolittle was chosen to head that task. On September 24, 1929, during a secret demonstration flight, Doolittle took off, flew a prescribed course, and landed while sitting under a canvas hood that completely covered his cockpit. He had with him a compass, an altimeter, a stop watch, and a spotter pilot (who never touched the controls) in the front cockpit.

That same year, two-way radio came into its own and enabled the pilot to talk to spotters on the ground who could assist in landing. Also during that time, Elmer Sperry and the Sperry Gyroscope Company were busily developing flight instruments. In May, 1932, Albert F. Hegenberger made the first solo flight from takeoff to landing while completely in the blind. Shortly after that, the Sperry Company developed the auto-pilot and radio direction-finder. But there was still clearly a need to be able to bring an airplane to a safe and precise landing after a

long flight.

From 1928 to 1938, several system approaches were tried, but none really gave satisfactory performance. In 1938, the Bendix Corporation and the United Airlines Company demonstrated a localizer system which would bring the aircraft in on the runway heading using two highly directional antenna arrays radiating different signals down either side of the runway. Shortly thereafter, the Federal Telecommunications Laboratories installed four identical instrument-landing systems at Indianapolis, Indiana. The development of those systems under contract from the Civil Aviation Agency led to a precision instrument-landing system before the end of World War II. That system was adopted as a world standard by the International Civil Aviation Organization (ICAO) in 1949. The basic technology developed at Indianapolis has remained virtually unchanged to this day.

The basic system

The basic instrument-landing system consists of four (or five) transmitting stations, as Fig. 1 shows. The *localizer* transmits a signal down the runway to provide lateral guidance and line the aircraft up on the runway. The *glide slope* transmits a signal which is inclined with respect to the ground at an angle around 3°. It ensures that the aircraft will make a smooth descent to the end of the runway while safely clearing all obstacles on the ground under the approach path. The other transmitters are the *fan markers*. The *outer marker* transmits a narrow beam straight up through the approach path to mark the point where the pilot must begin his final descent. That point is about three to five miles from touchdown. The *middle marker* also transmits a narrow vertical beam which marks the point where the aircraft should be below the clouds. That point is

typically one-half to three-quarter mile from touchdown. If the clouds are so low that the pilot cannot see the runway within a few seconds after passing the middle marker, he is required to immediately execute a "missed approach." That means he must climb to a prescribed altitude and fly to a prearranged point so that the air-traffic controller can get him set up to try again. A few airports around the country use a high-precision ILS. Specially trained flight crews are allowed to continue their approach and land even though the cloud cover is down to within a few feet of the runway and the forward visibility is virtually zero. At those airports, there is a third fan marker, the *inner marker*.

The localizer

The localizer transmitting-antenna array is located just off the stop end of the runway. A typical array consists of eight folded-dipole elements or horizontally polarized loops that radiate a highly directional signal down the runway and into the space beyond. The two center antennas radiate an RF carrier (f_c) on one of 40 assigned channels between 108.1 and 111.9 MHz. That carrier is modulated 20% with 90-Hz and 150-Hz audio tones; the sidebands ($f_c \pm 90$ and $f_c \pm 150$) are also radiated. (A three-letter Morse-code identifier is also put on the carrier using a 1020-Hz tone as a cross check to tell the pilot which station he has selected. The absence of the identifier upon proper selection of the station tells the pilot that the station is off the air.)

The other 6 antennas radiate only the 90-Hz and 150-Hz sidebands—the carrier is suppressed. The signals transmitted from one side of the center are 180° out of phase with those transmitted from the other side, and both sides are 90° out-of-phase with the center antenna. Let's see why that is important.

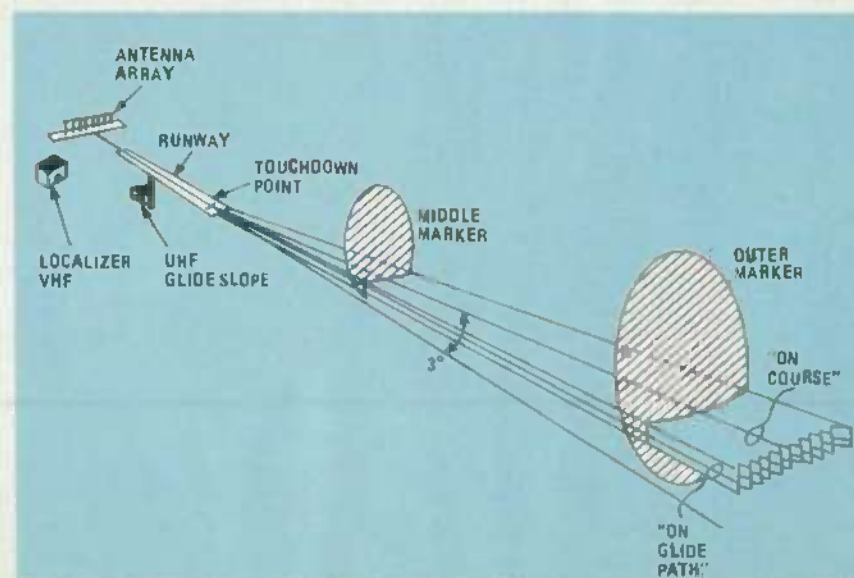

FIG. 1—A BASIC INSTRUMENT-LANDING SYSTEM at an airport consists of localizer and glide-slope transmitters, and two or three fan markers.

If a single omnidirectional antenna radiates a signal, the strength of the signal at a given distance is (ideally) constant—regardless of the direction you choose with respect to the antenna. However, if two antennas that radiate the same signal are spaced some distance apart (say $\frac{1}{2}$ wavelength), then the signals arrive at a receiver exactly in-phase, exactly out of phase, or somewhere in between—depending on the position of the receiver. That principle is used in ILS so that the relative strengths of the radiated 150-Hz and 90-Hz sideband signals depend on the position of the aircraft with respect to the transmitting antennas. Let's see how it's done.

We mentioned that the signal in the left side is 180° out of phase relative to the signal in the right side. Those signals combine with the carrier-plus-sideband signal in such a way that, on one side of the array, the 90-Hz sideband-only signal adds to the 90-Hz sideband of the carrier, while the 150-Hz sideband-only signal subtracts from the 150-Hz sideband of the carrier. On the other side of the array, the opposite is true. Figure 2 shows the resulting simplified radiation pattern—two narrow lobes, one effectively

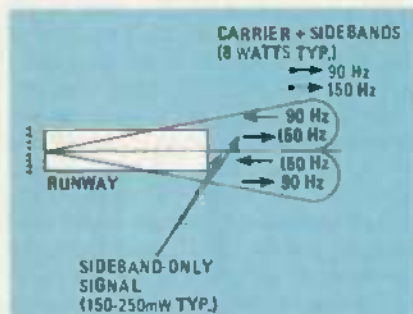

FIG. 2—THE SIGNAL ALONG the center or "on-course" line: the 90- and 150-Hz signals are equal.

modulated with 90 Hz and the other with 150 Hz.

At this point, we can make some simplifications that will make the rest of the explanation easier to understand. The array of eight antennas can be thought of as three antennas. First, the center two antennas can be thought of as a single antenna, A_{11} , radiating carrier-plus-sideband signals. The other antennas can be thought of single antennas to the left and right of the center antenna. They radiate sideband-only signals.

The 90-Hz sideband energy in what we'll call antenna A_1 will lag the 90-Hz energy from A_0 by 90° , while the 90-Hz sideband energy from what we'll call A_2 will lead that from A_0 by 90° (thus there is a 180° phase difference between A_1 and A_2). The 150-Hz sideband signals from A_1 will lag those from A_0 by 90° , while the 150-Hz signals from A_2 will lead those from A_0 by 90° .

Because the sideband-only signals radiating from our two antennas are 180° out of phase, the signal along the center line separating the antennas consists of equal 90-Hz and 150-Hz components. That's because the sideband-only signals cancel completely at that point—leaving behind the 90-Hz and 150-Hz signals that were radiated with the carrier; the amplitudes of those signals are set equal to each other in the transmitter.

Now that we have gone to all this trouble of putting an electronic line down the runway, how does the aircraft follow the line?

On board the aircraft, the signal is received and detected. The recovered audio is sent to a 90-Hz filter and a 150-Hz filter as is shown in Fig. 3. The filtered audio is then rectified, and a DC current that is proportional to the amplitude of the audio signal energizes a galvanometer-type meter movement. As the aircraft flies along the center line of equal audio, the needle will be centered, indicating that the aircraft is "on course."

Current will flow through resistor R_M whenever either a 90- or 150-Hz signal is

present. The current flow is used to tell the pilot that the system is operational by energizing a solenoid. When no current flows, the solenoid is de-energized, and a warning flag appears in the instrument.

Now let's say the aircraft drifts to the right of the center-line course as in Fig. 4. Remember that the 90-Hz sidebands from A_1 lag those from A_{11} , while the 90-Hz signals from A_2 will lead those from A_0 . As the wave travels to the airplane, the phase of the signal from A_1 along d_1 is advanced with respect to the signals from A_{11} . The opposite is true of the signals from A_2 . The resultant of the 90-Hz sidebands is 180° out of phase with the signals from A_{11} , and therefore produce a weakened 90-Hz signal.

On the other hand, the sidebands of the 150-Hz signal from antenna A_2 lag those from antenna A_{11} , while the 150-Hz sidebands from A_1 lead those in A_{11} . The phase of the 150-Hz sideband signal from A_1 (travelling along d_1) is advanced with respect to that from A_0 , while the opposite is true of the signals from A_2 . The resultant is in phase with the signal from A_{11} , and therefore adds to it to produce a

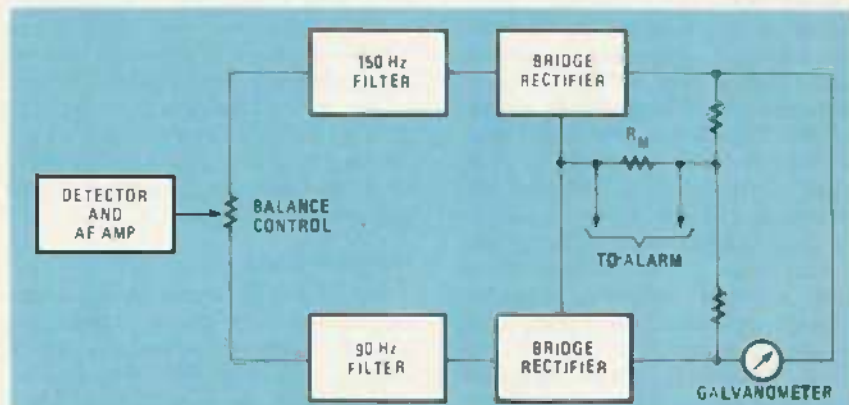

FIG. 3—THE LOCALIZER INDICATOR is usually combined with the glide-slope indicator to form a cross pointer.

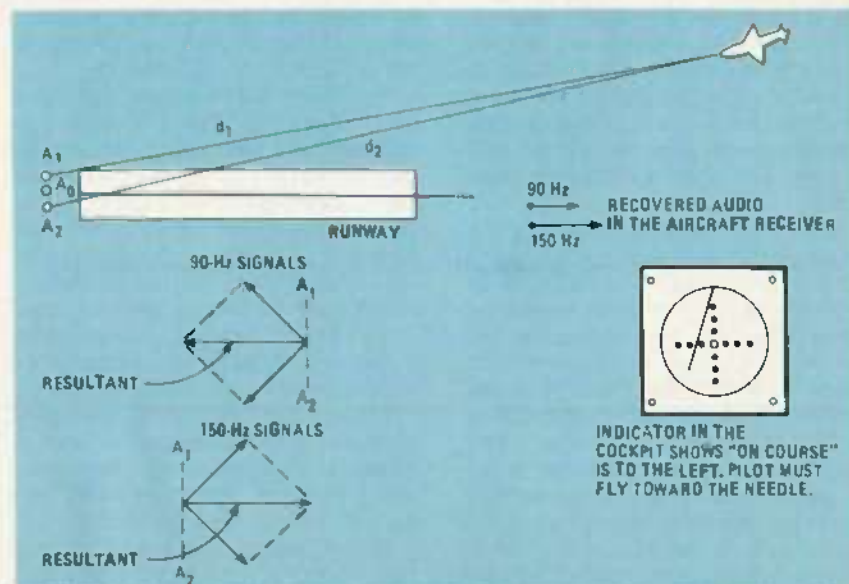

FIG. 4—WHEN A PLANE is flying off-center, the sideband-only signals add to or subtract from the 90- and 150-Hz sidebands in the carrier-plus-sideband signals to tell the pilot which direction to move.

150-Hz signal that is much stronger than the 90-Hz signal.

The resulting unbalance causes the meter-movement needle to swing to the left side of the indicator, telling the pilot that he must fly to the left to get back on course. The same principle applies on the opposite side of the centerline with the 90-Hz sidebands becoming larger than the 150-Hz sidebands and deflecting the needle in the opposite direction.

Generating the localizer signal

Figure 5 shows that the localizer transmitting station consists of a transmitter, power supply, oscillator/keyer, modulator, control unit, monitor, and antenna distribution unit. The transmitter section generates the RF carrier using a crystal-controlled exciter operating at one-half the assigned frequency. That signal then passes through a frequency doubler and five stages of amplification. The high voltage in the final stage of the power amplifier is modulated with a 1020-Hz Morse-code identifier tone from the oscillator/keyer to put the station identifier on the carrier.

The RF carrier is then sent to the modulator. Inside the modulator, the RF is divided into two components by an RF coupler. One of those components is divided again and sent to the 90-Hz and 150-Hz sideband generators where pure double-sideband signals are produced. The outputs of the sideband generators are sent to the sideband hybrid unit where they are combined to form the composite sideband signal. There are two outputs from the sideband hybrid unit. One output is sent straight to the antenna distribution unit and the other output is sent to the carrier hybrid unit. In that unit, the carrier signal from the first RF coupler is combined with the sidebands to give the carrier + sideband signal. That signal is then sent to the antenna distribution unit.

The antenna distribution unit provides the 180° phase difference in the sideband signals at opposite sides of the array. Power dividers are used to distribute the antenna currents to ensure that the radiated signal is balanced and highly directional.

To be certain that the signal is within proper safety specifications, the signal is constantly monitored. That's done either by pick-up probes in the transmitting antennas or by receiving antennas mounted in front of the transmitting array. The course centerline is maintained within one-tenth of one degree to either side of the runway's center stripe. The course width (the area in approach zone where the aircraft needle is not pegged to either side of the indicator) may not exceed 700 feet in width at the outer marker or 3° either side of the center stripe with respect to the center of the antenna array, whichever is smaller. If either of these limits are

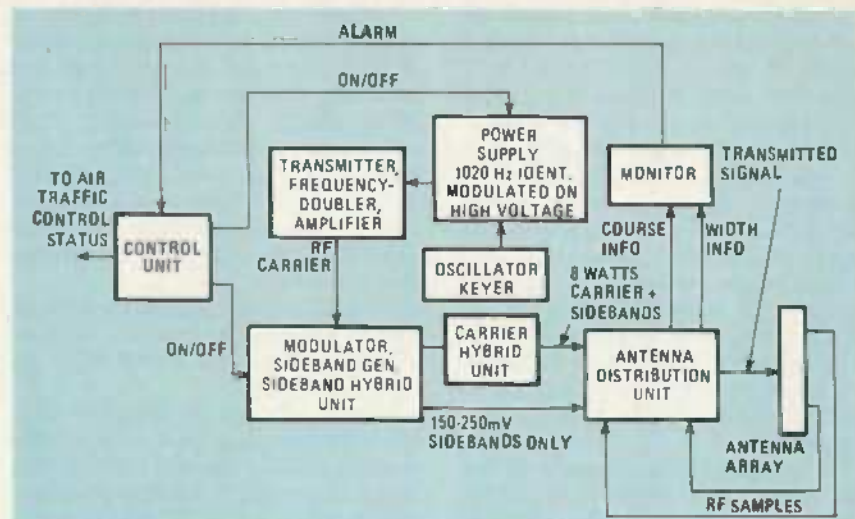

FIG. 5—LOCALIZER BLOCK DIAGRAM. The localizer is constantly monitored to make sure that it is within safety specifications.

exceeded, an alarm is generated in the monitor circuitry. Also, if the radiated power (typically 8 watts) is reduced more than 50%, or if the Morse-code identifier is missing, or the modulation level changes more than 17%, an alarm is generated. Those alarm signals are sent to the control unit which shuts the station down and immediately alerts the air-traffic controller and maintenance personnel that there is a problem with the station. As you can imagine, there is then a mad scramble to get the station back on the air in the least amount of time possible.

The glide slope

The glide-slope station provides vertical guidance to the aircraft to make sure that the descent to the runway is smooth and that the aircraft will safely clear all obstacles under the approach path. Many airports that were once some distance out of town now find themselves surrounded by houses, factories or office buildings. The glide slope protects the building and the airplanes from each other.

The glide-slope transmitter operates in the UHF range of 329.3–335.0 MHz. All localizers and glide slopes are assigned their frequencies using a frequency-pairing arrangement. For example, all localizers that operate on 108.5 MHz will have their associated glide slopes operating on 329.9 MHz. That relieves the pilot from having to tune in both stations—aircraft receivers are built so that when the localizer is dialed in, the proper glide-slope frequency is automatically selected.

The signal generation of the glide slope is almost identical to that of the localizer (except for a frequency-triplet stage that is added in the transmitter to get the RF from the VHF band to the UHF band.)

The glide-slope antenna is an array consisting of two dipole antennas mounted on a 40-foot mast. The lower antenna radiates the carrier (f_c) with its

sidebands ($f_c \pm 90$ and $f_c \pm 150$). The upper antenna radiates only the sidebands. Those two dipoles use reflectors to make the signal forward directional.

Unlike the localizer, the 150-Hz sidebands in both signals are radiated in phase. But the 90-Hz sidebands in the carrier (lower) antenna are radiated 180° out of phase with the 90-Hz signal in the sideband-only (upper) antenna. Part of that signal propagates along the ground and has a strong 150-Hz component (because both 150-Hz signals are in phase). In addition, part of the signal is reflected off the ground. That reflection is very complex, but in essence, it causes the 90-Hz sidebands in the reflected signal to be in phase, and the 150-Hz sidebands to be out of phase. The angle at which the signal bounces off the ground is at a slightly higher angle than the direct signal. As shown in Fig. 6, that effectively puts 90-Hz modulation above the "on-path" line and 150-Hz below. Each of those signals

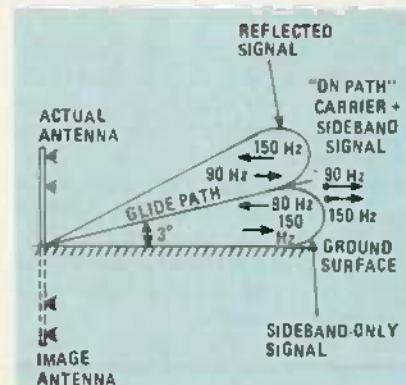

FIG. 6—THE GLIDE PATH's "on-path" line makes an angle of 3° with the ground surface.

retains the same "small amount" of the other just as in the localizer. In other words, a strong 90-Hz signal and weak 150-Hz signal above the on-path line, and the opposite below.

The reflected signal makes the entire radiation pattern seem to originate from a point at the base of the mast, midway between the actual antenna and its mirror image. If that "image" antenna is taken into account, then the array really looks like a localizer turned on edge.

But in the localizer array, the on-course signal was perpendicular to the axis of the antenna—that would put the glide path along the ground. But the glide-slope antenna heights are adjusted so that the distance between the actual and image antenna is not $\frac{1}{2}$ wavelength. Because of that, the on-path signal is skewed about 3° above the horizon. The antenna mast is precisely located so that an aircraft flying down the path will cross the end of the runway between forty-five and fifty-five feet about the ground.

As you might expect, the ground contour in front of the antenna is assumed to be flat and level when the design calculations are made. But in reality, the actual ground is seldom perfect. At most metropolitan airports the ground is reasonably flat and smooth enough to form a straight and smooth path well within the FAA's strict safety limits. Smaller airports and those in mountainous or unusual terrain, however, often have rough ground next to the runway or they have little or no room in front of the touchdown zone to form the signal. These airports have always been denied the luxury of an all-weather landing system and are forced to close when the weather turns sour.

An antenna system called the *end-fire array* has just passed its final tests. It was expected to begin to appear at those smaller airports by early 1984. That array does not use the ground to form the path signal in space. It radiates its signal, instead, from a slotted coaxial cable into space. It gets its name from the fact that all the path information is radiated from the end of the axis of the array (hence, "end-fire") instead of broadside to the array as in the other two types discussed so far. That array promises to bring all-weather operation to many more airports around the world.

As stated earlier, the generation of the glide-slope signal is the same as the localizer except for a frequency-tripler stage in the transmitter exciter. Another difference is that no identification tone is transmitted from the glide slope.

A monitoring system is also used for glide-slope systems. The signal is monitored by a pick-up antenna in front of the mast; the station will automatically shut itself down if the glide-slope angle changes more than 0.2° or the modulation decreases by more than 26% or the radiated power changes more than 45%. Again, when a station shuts itself down there is a mad scramble to find out why and get it back on the air. Incidentally, such shutdowns occur only two or three

times a year at the average station. But since the stations are generally on 24 hours a day, the shutdowns often occur during clear weather. There has never been an aircraft accident in the United States which was attributable to an ILS shutdown.

The fan markers

Two marker-beacon transmitting stations are part of the standard ILS. And as we mentioned previously, a third, inner fan marker is added in the high-precision systems.

The outer marker is installed about three to five miles from touchdown. Its exact location and the height of the on-path signal above the ground at that point are depicted on a chart which the pilot has in the cockpit for that particular runway. That gives the pilot an opportunity to crosscheck his instruments against known conditions as he starts his final approach.

The middle marker is located about 3500 feet from the end of the runway and, as stated earlier, is the point at which the pilot must either begin a visual approach—that is, he must be able to see the runway—or execute a missed approach.

With a high-precision system, an inner marker is installed 1000 feet from the end of the runway; that lets the pilot know he is about to cross the end of the runway and he should be completely set up for touchdown.

Each marker station is nearly identical in the way it generates its signal. Each has an exciter that generates the 75-MHz RF carrier that all marker stations operate on. An audio tone is modulated onto the carrier to identify the marker as outer, middle, or inner. The outer marker is identified by a continuous series of Morse-code dashes using a 400-Hz audio tone at a rate of two dashes per second. The middle marker transmits alternate dots and dashes using a 1300-Hz tone. The inner marker is identified by a continuous series of Morse-code dots (six-per-second) using a 3000-Hz tone.

After leaving the exciter, the modulated 75-MHz signal goes through three stages of amplification and is sent out to the antenna. The antenna is highly directional and the beam width along the runway centerline is about 1000 feet when the aircraft is 1500 feet above the antenna.

A small pick-up antenna is mounted with the main antenna and monitors the radiated signal. If the identification stops or if the power is reduced by 50%, the station shuts itself down.

The future

The future of instrument navigation and landing systems may take one of two radically different approaches. One approach is to continue with a vast network of land-based systems. That is the course that the

current FAA administration is pursuing in its recently released National Airspace System Plan which outlines the direction that the air-traffic control and airway-facilities systems will take through the year 2000. The other approach is a satellite-based system which is now well under development by a private firm.

The replacement of some ILS's will begin in early 1985. The new system is called MLS or *Microwave Landing System*. That system works in the 5-GHz band and transmits course and glide-path data to the aircraft by sweeping a narrow fan-shaped beam back-and-forth and another beam up-and-down. The airborne receiver measures the time between the left-to-right scan (or the "up" scan) and the right-to-left (or the "down" scan). That time difference will give the aircraft's position relative to the start of the scan. An on-board computer then translates the information to position relative to the runway centerline or the glide path. Synchronization of the receiver to the scan start is done by data words transmitted to the aircraft on the same scanning beam using differential phase shift keying (DPSK). Station identification and other data is transmitted in the same way. The data and position data may be displayed on a single CRT in the cockpit.

MLS has started to pick up some opposition among some aircraft-user groups who are lobbying in Congress in favor of a satellite-based system which may turn out to be cheaper for the taxpayer, since the system would not be government-owned as most ILS's are, and would be paid for exclusively by its users.

That system would use four satellites parked in a stationary orbit over the continental United States. A user would transmit a signal which would be picked up by at least three of the four satellites. The satellites then communicate with each other and compare signal-arrival times to calculate the transmitter's position in three axes. The features that make the system more desirable are the fact that it operates using four satellites as opposed to thousands of ground-based systems; and also, the ground-based systems are dedicated to aircraft only and to the small areas the individual systems serve, whereas the satellite system could be used by anyone with the proper transceiver, whether an airplane, ship, commercial truck, private auto, or even a backpacker. According to estimates by the company developing the system, it could be in place by 1987; however, it would probably be a few years after that before the final system would be fully operational.

No matter what systems are ultimately put in place, the air traveler can take comfort in knowing that when he boards the aircraft, he is about to participate in the most extensive and safest transportation system available to man. R-E

BUILD THIS

Audio-Frequency



Generator

Here's an audio-frequency generator with a digital frequency-readout that is easy to build, align, and use, yet is precise enough for servicing today's sophisticated audio equipment.

RICHARD SCHROEDER

TO SAY THAT BOTH HOME AND PROFESSIONAL sound installations have become extremely sophisticated would be an understatement. For example, a $\frac{1}{3}$ -octave band equalizer as well as lowpass and highpass filters are integral parts of virtually all professional sound systems. In fact, these days equalizers, tone controls, and lowpass and highpass filters are considered to be necessary even in home or auto systems.

Today's consumer demands more in the way of performance, which means more precision is required when servicing audio devices and circuits. Because of that, old-fashioned frequency generators often prove to be inadequate. Among other things, they suffer from inaccurate frequency dials, require range switching, and often their output level changes as the frequency is varied. What we need, then, is an audio-frequency generator that has an accurate output-frequency indicator, a "flat" output level as the frequency is varied, and one that is free of any range switching, thereby allowing the operator to "sweep" the entire audio range with

just a "twist of the wrist."

Well, look no further, because the audio-frequency generator described in this article has all the above-mentioned desirable qualities and a few more. Let's look at some of its features and specifications.

It has a frequency range of 10 Hz to 50 kHz. That range is continuous, which eliminates the need for range switching. For increased precision, two controls are used to set the frequency. The COARSE FREQUENCY control is used to set the approximate frequency while the FINE FREQUENCY control is used to zero it in precisely.

The amplitude of the generator's sine-wave output is adjustable from 0- to 6-volts RMS into a high-impedance load or 0- to 3-volts RMS into a 600-ohm load. The device's output impedance is 600 ohms. The sinewave has a distortion figure of less than 1% (THD), and its output level doesn't vary more than a few tenths of a dB as the frequency is changed over the entire range. The unit also boasts a simultaneous squarewave output with a low source impedance and a fixed 5-volt level

for TTL or CMOS logic work.

One unique feature is a built-in frequency counter that continually monitors the output frequency. The device can also be wired so that the counter can be used to measure external signals. That frequency counter not only allows you to make precise frequency settings, but also eliminates the need for usual large, cumbersome dial with its myriad of marks and numbers. Generators using that type of frequency "readout" have always been difficult for the hobbyist to build and calibrate.

The frequency counter itself features autoranging and a large, four-digit LED display. For frequencies up to 9,999 Hz, the display reads out in Hz with 1-Hz resolution. For higher frequencies, the counter automatically switches to the kHz mode, which features 10-Hz resolution. You can tell which mode the generator is in by the absence or presence of the decimal point. In the kHz mode, a decimal point appears after the first two significant digits.

All of the components except the power

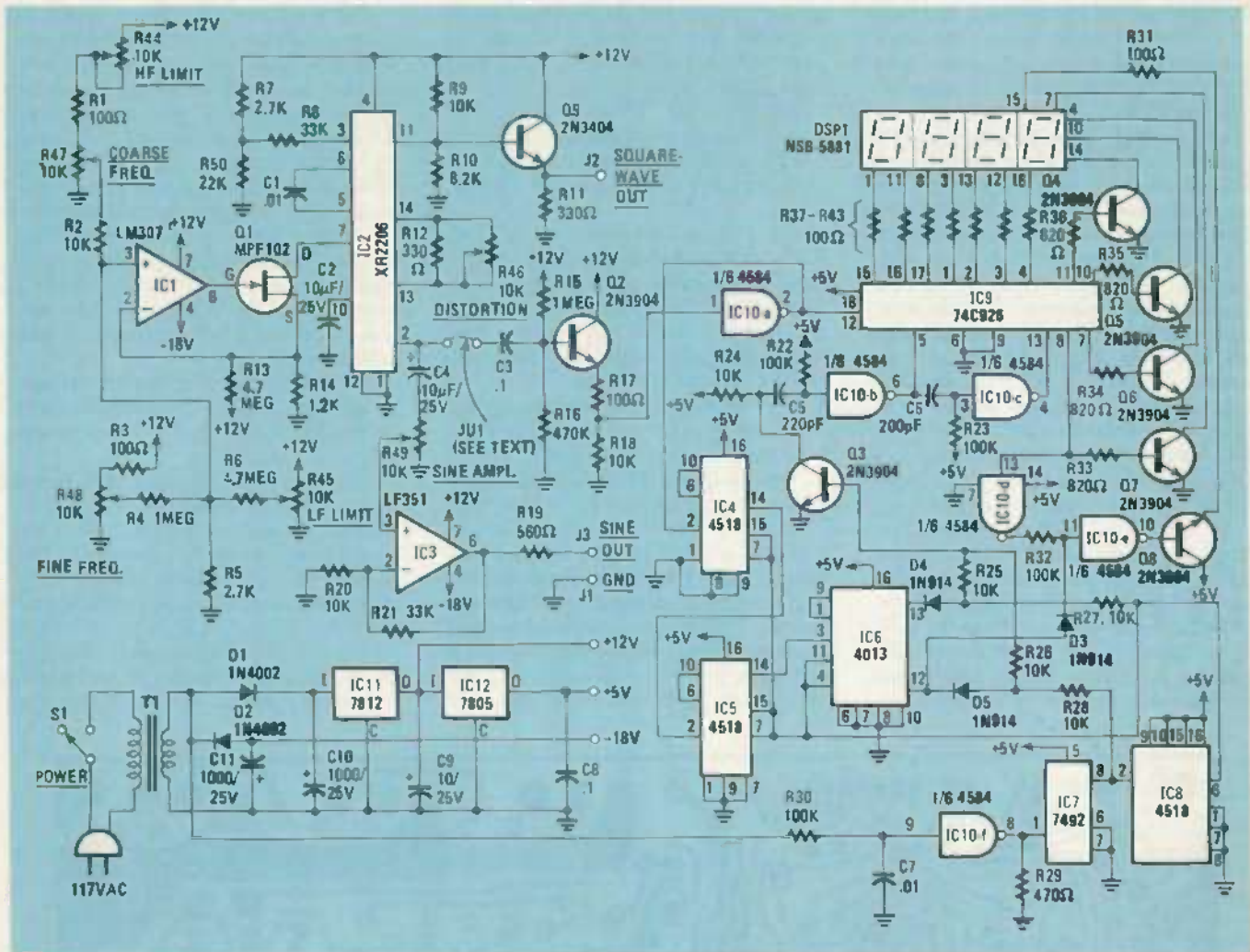

FIG. 1—SCHEMATIC DIAGRAM of the audio-frequency generator. If you want to use the built-in frequency counter to measure external signals, jumper JU1 should be replaced with a SPDT switch (see text).

transformer, potentiometers, display, and output connectors mount on a single PC board. The completed project can be housed in a small, metal cabinet.

In short, this is an audio-frequency generator that provides high-quality performance at a low cost, along with some unique features.

How the circuit works

A schematic diagram of the unit is shown in Fig. 1. Let's start with the audio-frequency-generator section. Positive voltage is applied to the COARSE FREQUENCY potentiometer, R47, through trimmer potentiometer R44 (labeled H.F. LIMIT) and resistor R1. In a similar manner, positive voltage is applied to the FINE FREQUENCY potentiometer R48, through

resistor R3. Depending on the settings of those potentiometers, some voltage will be fed to the non-inverting input of op-amp IC1 through resistors R2 and R4. Note that a very small voltage will reach that same input through R6 in conjunction with trimmer potentiometer R45 (labeled L.F. LIMIT). That arrangement sets the low-frequency limit of the generator when the COARSE and FINE FREQUENCY potentiometers are set to their low-frequency positions, which, of course, is when both wipers are all the way toward ground. Trimmer potentiometer R44, in setting the maximum voltage that is applied to R47, in turn sets the generator's high-frequency limit when R47 is set to maximum.

Op-amp IC1, along with transistor Q1

and its associated components make up a voltage-to-constant-current converter, the current of which controls the output frequency of function-generator IC2. The sinewave output signal from IC2 (pin 2) feeds the SINE AMPLITUDE potentiometer, R49, through capacitor C4. Depending on the setting of the potentiometer, some voltage will be fed to the non-inverting input of op-amp IC3. That op-amp amplifies the signal, which is then fed to the SINE output binding post through resistor R19.

Note that the sinewave signal from IC2 also feeds the base of transistor Q2 through a jumper wire and capacitor C3. That transistor is configured as an emitter follower and acts as a buffer between the audio-frequency generator section and the frequency-counter section.

The squarewave output signal from

function generator IC2 (pin 11) feeds the base of transistor Q9. That transistor is configured as an emitter follower and serves as a level shifter, buffer, and impedance matcher to provide a squarewave level of 5 volts from a low-impedance source at the SQUARE output binding post.

Trimmer-potentiometer R46 (labeled DISTORTION) sets the sinewave distortion to its lowest possible point. The other capacitors and resistors associated with IC2 set its frequency range and sinewave-amplitude levels.

Let's now turn to the frequency-counter section. Sinewave signals from the output of emitter-follower Q2 (actually the junction of resistors R17 and R18) are fed to the input (pin 1) of one of the six Schmitt triggers contained in IC10. That stage "squares up" the sinewave signal and feeds it to the input (pin 12) of the four-digit counter IC9. That IC counts or totals the squarewave "events," and because the counter is reset at 1- or $\frac{1}{10}$ -second intervals, it causes the readout to display in either Hz or kHz. Resistors R37 through R43, along with transistors Q4 through Q7 and their associated resistors, make up the segment and digit-drive system.

Note that the "squared up" signal that feeds the four-digit counter also feeds the input (pin 2) of dual decade-counter IC4, and that IC4's output feeds the input (pin 2) of another dual decade-counter, IC5. Those four counters connected in cascade make up a divide-by-10,000 counter that produces an output only when the fre-

quency to be counted is equal to or greater than 10 kHz. That serves as the detector that determines which mode the auto-range system will settle on. The output of that counter (pin 14, IC5) feeds the input (pin 3) of flip-flop IC6. That device, and its associated components, serves to determine whether 1-second- or .1-second-period signals from the timebase (to be discussed shortly) ultimately reach the latch and reset points on the main four-digit counter, IC9.

Transistor Q3, IC10-b, IC10-c, and their associated components make up pulse generators that supply the latch and reset signals for the four-digit counter, IC9.

The circuit composed of IC10-d, IC10-e, Q8, and their associated components make up the gated decimal-point-drive system. That system works with signals from flip-flop IC6 to display a decimal point only when the frequency counter is in the kHz mode.

Next we turn to the timebase for the frequency counter. AC voltage from the secondary of power transformer T1 is fed to the input (pin 9) of Schmitt trigger IC10-f through resistor R30. That stage "squares up" the 60-Hz signal and feeds it to the input (pin 1) of the divide-by-six counter, IC7. The output of that counter (pin 8), with its frequency of 10 Hz and period of .1 second, is fed to a resistor/diode system that works with flip-flop IC6 and transistor Q3 to ultimately become the timebase for the kHz mode. That same

10-Hz signal is also fed to the input (pin 2) of divide-by-ten counter IC8. The output of that counter (pin 6), with its frequency of 1 Hz and period of 1 second, is also fed to the resistor/diode system to ultimately become the timebase for the Hz mode. That latter signal is also fed to the reset points on IC4, IC5, and IC6.

The regulated DC power supply is made up of two half-wave rectifiers configured in such a way as to produce both positive and negative voltages from the 12-volt secondary of power transformer T1. The positive voltage is fed to the input of voltage-regulator IC11, which produces at its output a stable 12-volts DC that powers the audio-frequency-generator section. That same 12-volts DC is fed to the input of voltage-regulator IC12, which produces at its output 5-volts DC, which powers the frequency-counter section. AC power is switched on or off with power switch S1.

We mentioned earlier that the frequency counter could also be used to monitor an external signal. That is where jumper J1 comes in.

That jumper should be wired as shown on the schematic diagram if you want the frequency counter to always measure the output frequency of the generator. If you would prefer that the frequency counter be able to also measure external signals, then omit the jumper, and wire an SPDT switch with its pole connected to the input of the frequency counter (the jumper terminal that connects to C3). Of the other

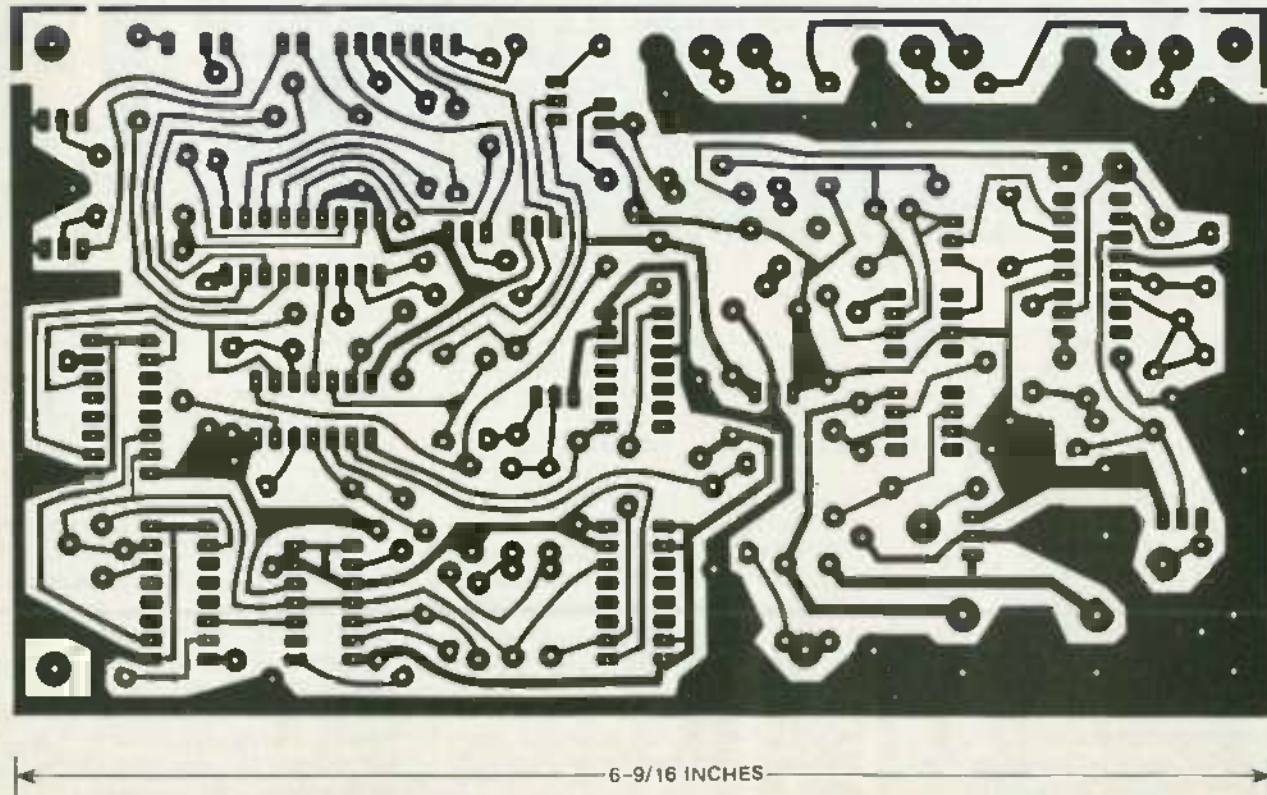

FIG. 2—ALTHOUGH POINT-TO-POINT wiring could be used, it is recommended that the project be built using the PC board above. That board is shown full-sized.

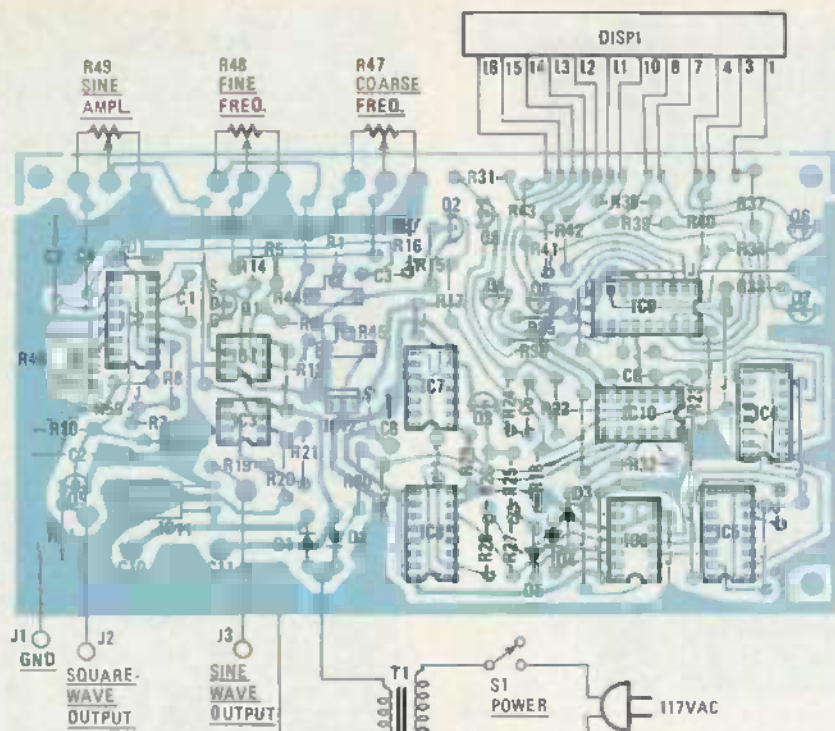

FIG. 3—THE PARTS-PLACEMENT diagram for the PC board shown in Fig. 2 is shown here. Note that even if you are using perforated construction board and point-to-point wiring it is recommended that you follow the layout shown.

two switch contacts, connect one to the jumper terminal that connects to pin 2 of IC2; the other switch contact becomes the "external" input terminal.

Construction

Several methods of construction are possible. You may choose to mount the components on perforated construction-board (with .1 inch hole spacing) and use point-to-point wiring. A much better idea is to use a PC board. A foil pattern for an appropriate board is shown in Fig. 2; a parts-placement diagram for the board is shown in Fig. 3. If you decide to use perforated construction-board and point-to-point wiring, it is recommended that you lay out the components much as they are in the PC board layout to avoid ground loops, noise, and other undesirable characteristics.

If you plan to use a PC board, and will be drilling it yourself, you will find that a No. 60 drill bit works well for all holes except those for the trimmer potentiometers and external wires. For those, a No. 55 bit is needed; and, of course, the holes for mounting the three terminal voltage regulators and the PC-board mounting holes will require a larger bit, say $\frac{3}{16}$ inch.

After the PC board has been drilled, it should be thoroughly burnished with steel wool or very fine sandpaper to remove the photochemicals and tarnish. That will definitely contribute to better solder connections. All soldering should be done with a high-quality rosin-core solder and a pencil-type iron. The newer type metal-

clad tips are highly recommended.

Use special care to properly install polarized components such as diodes, transistors, IC's, and electrolytic capacitors, because those are very unforgiving when put in backwards. If you follow the parts-placement layout shown in Fig. 3 you should have no problems.

Although IC sockets are not required, their use is recommended. If nothing else, it will make servicing and troubleshooting the instrument easier later on.

Note several things in regard to mounting the three-terminal voltage regulators. The 12-volt regulator, IC11, is mounted with a $\frac{3}{8}$ x $1\frac{1}{2}$ -inch brass bolt and a $\frac{1}{4}$ -inch hex nut, with the excess bolt length extending upward. The bolt provides a small but adequate heat sink for the voltage regulator. The 5-volt regulator, IC12, mounts in a vertical position and it, too, has a brass bolt mounted to it for heat-sinking purposes. The excess bolt length should extend toward the rear of the PC board. Be sure to install the regulator with its bare-metal side facing the panel-mounted potentiometers (see Fig. 4).

The three panel-mounted potentiometers connect to the PC board by means of short wires that hold their solder lugs about $\frac{1}{8}$ to $\frac{1}{4}$ inch above the surface of the PC board. That is done to allow the potentiometers some flexibility, so that when they are finally tightened against the front panel they will align properly without breaking. It would be best to attach those wires first to the solder lugs and then solder them to the board. Make sure that

each wire passes through the lug hole with the wire being wrapped several times around the lug and soldered. Be sure that when finally soldering the wires to the PC board that you not only make allowance for the required clearance, but that you keep that clearance uniform for all three potentiometers so as to have them reasonably in line horizontally.

In a similar manner, the four-digit display is supported mechanically by its twelve signal wires. The attaching of the wires is best done by soldering a two- to three-inch length of bare No. 22 solid wire to each of the twelve appropriate connectors on the display board. Note that there are 16 total connectors on the display, but that four of them are not used. As an aid to getting the wires soldered to the proper points, tape or clamp the display to your work table with the viewing surface facing downward and the solder connectors closest to you. The connector on the left front corner can be considered as connector 16 and the one on the right as connector 1.

Solder wires then to the following connectors: 16, 15, 14, 13, 12, 11, 10, 8, 7, 4, 3, and 1. Be very gentle in soldering and handling the display because the foils are very thin and breakable. When all the wires have been attached, bend them downward (toward you) with the right-angle bends made close to the connectors. The display with its attached wires can now be installed on the PC board. Insert the display wires into the appropriate PC-board holes and be sure to hold the display level with its horizontal center line about an inch above the PC-board surface before soldering the signal wires into place. After soldering, cut off any excess wire.

When choosing your cabinet be sure that it is large enough to accommodate the board and the off-board components comfortably. Also, using a vented cabinet is a good idea.

At some point, you will need to drill the various holes and a rectangular opening in the cabinet for the potentiometers, display bezel, PC-board mounting bolts, transformer, etc. Plan ahead and carefully measure everything so that it will all fit well. Although most cabinets have a thin coat of paint when purchased, the drilling process usually puts some nicks and scratches in it. Most find that re-painting at least the front panel and then applying press-on lettering gives the instrument a professional appearance.

The PC board is supported about $1\frac{1}{4}$ inches above the bottom of the cabinet with four $\frac{3}{8}$ x $1\frac{1}{2}$ -inch bolts. Each bolt has three $\frac{3}{8}$ x $\frac{1}{4}$ -inch hex nuts attached; one holds the bolt to the cabinet and the other two sandwich the PC board at the proper height.

When all the PC-board components have been soldered in place, it's a good idea to thoroughly check the parts place-

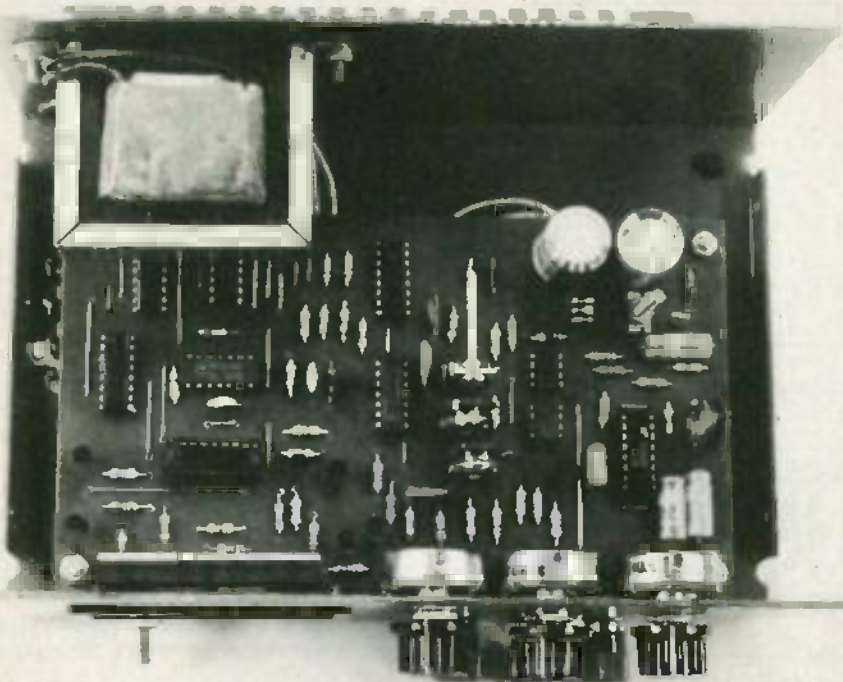

FIG. 4—THE COMPLETED BOARD is shown here mounted inside the case. Note the orientation of IC12.

ment, and the solder connections to be sure all is correct. When that has been done, it's time to "fire up" the device to test and calibrate it. Although that can be done with the PC board and transformer mounted in the cabinet, it is usually best to at least do the initial testing and calibration with the "electronics" out on the bench.

Testing and calibration

All you will need in the way of calibration equipment is an oscilloscope to check the squarewave and sinewave outputs. The frequency-limit adjustments, of course, can be made using the built-in frequency counter.

Before applying power, set all the trimmer and front-panel potentiometers to their approximate mechanical midrange. Connect the oscilloscope to the sinewave output and apply power. The oscilloscope should display a sinewave, although it may be distorted, and the frequency counter should display the frequency of the waveform. Confirm that the frequency changes as the COARSE FREQUENCY and FINE FREQUENCY controls are rotated. Set the frequency at approximately 1 kHz and adjust the DISTORTION trimmer potentiometer (R46) for a sinewave that looks normal on the oscilloscope. If you're a purist you'll need a distortion meter or spectrum analyzer for that adjustment, but for most of us, the eyeball method works well enough. Next, check the squarewave using the oscilloscope. It should look the way the name implies and have a peak-to-peak value of around five volts.

The next step is to adjust the L.F. LIMIT

and H.F. LIMIT potentiometers. Rotate the COARSE FREQUENCY and FINE FREQUENCY controls to their lowest-frequency positions (fully counter-clockwise) and adjust the L.F. LIMIT potentiometer (R45) for a frequency of 10 Hz. Then, rotate the COARSE FREQUENCY control to its highest-frequency position (fully clockwise) and adjust the H.F. LIMIT potentiometer for a frequency of 50 kHz. Check the FINE FREQUENCY control by rotating it to its extremes while observing the frequency change. It should have a total range of around 500–700 Hz, regardless of where the COARSE FREQUENCY control is set. That completes the testing and calibration procedure.

If you experience some problems, here are some troubleshooting hints that may be helpful:

As experience has shown, most problems in home-built instruments are caused by poor solder connections, solder bridges between two adjacent foils, or components installed backwards. It would be wise then to first check for those troublemakers.

If you still can't track down the problem, the use of a multimeter is required. With it, check the three major DC power-supply points at various points on the PC board with respect to the ground foil. The output side of the 12-volt regulator (IC11) should of course measure +12 volts \pm .5 volt, and the output of the 5-volt regulator (IC12) should of course measure 5 volts \pm .25 volts. The negative voltage bus (the negative side of C11) should measure around -17volts.

It should be noted that the voltage regulators normally operate quite hot to the

PARTS LIST

All resistors ¼ watt, 5% unless otherwise specified

R1, R3, R17, R31, R37–R43—100 ohms
R2, R9, R18, R20, R24–R28—10,000 ohms

R4, R15—1 megohm
R5, R7—2700 ohms
R6, R13—4.7 megohms
R8, R21—33,000 ohms

R10—8200 ohms
R11, R12—330 ohms
R14—1200 ohms
R16—470,000 ohms
R19—560 ohms
R22, R23, R30, R32—100,000 ohms
R29—470 ohms

R33–R36—820 ohms
R44–R46—10,000 ohms, trimmer potentiometer, upright mount, thumbwheel
R47—10,000 ohms, potentiometer, panel mount, audio taper
R48, R49—10,000 ohms, potentiometer, panel mount, linear taper
R50—2200 ohms

Capacitors

C1—.01 μ F, 100 volts, mylar or polyester
C2, C4, C9—10 μ F, 25 volts, electrolytic
C3, C8—.1 μ F, 50 volts, ceramic disc
C5, C6—220 pF, 50 volts, ceramic disc
C7—.01 μ F, 50 volts, ceramic disc
C10, C11—1000 μ F, 25 volts, electrolytic

Semiconductors

IC1—LM307 op-amp
IC2—XR2206 function generator (Exar)
IC3—LF351 op-amp
IC4, IC5, IC8—4518 dual decade counter
IC6—4013 D flip-flop
IC7—7492 divide-by-six counter
IC9—74C926 4-digit counter/driver
IC10—4584 hex Schmitt trigger
IC11—7812 voltage regulator
IC12—7805 voltage regulator
DSP1—NSB-5881 4-digit LED display
Q1—MPF-102 FET
Q2–Q9—2N3904 NPN or equivalent
D1, D2—1N4002
D3–D5—1N914

T1—117-volt primary, 12- or 12.6-volt secondary, 5 to 1 amp
S1—SPST, miniature toggle.

J1–J3—binding posts

Miscellaneous: PC board, cabinet, display bezel with red filter, knobs, line cord, ½ nuts and bolts, etc.

An etched and drilled printed-circuit board is available from: E7VSI, PO Box 72100, Roselle, IL 60172 for \$21.00 (check or money order) postpaid. Shipping by UPS or best way 3-5 days after receipt of order.

touch and the same holds true for the main four-digit counter IC. So, if the voltages are normal, don't let that be a source of concern.

If a problem exists in the frequency-counter section, some key points to check would be the 60-Hz, 10-Hz, and 1-Hz points on the time-base system and also the squarewave signal that constitutes the frequency to be counted. That latter point can be found at the input of the main four-digit counter IC9, at pin 12. R-E

BUILD THIS

Telephone Add-On

NO MORE WRONG

NUMBERS!

Receive only the calls you want to receive with this inexpensive and easy-to-build telephone accessory.

GARY McCLELLAN

IT'S 3 O'CLOCK IN THE MORNING AND YOU are jarred out of a sound sleep by the telephone ringing. You get up to answer it, but by the time you pick up the phone the caller has hung up. Naturally, you can't go back to sleep and so you start the day in a bad mood.

Or perhaps you are enjoying a nice dinner with friends. The phone rings and you answer it. A salesperson who can't pronounce your name wants to sell you aluminum siding for your new house.

Do those annoying little scenarios sound familiar? All of us at one time or another have received unwanted telephone calls, often at inconvenient times. But there is an electronic solution to that problem and once you build it you won't have to tolerate unwanted calls.

The project we'll be describing has a variety of special features. First, it works with either pushbutton or rotary-dial-type phones. Installation is easy, too—it simply plugs into an AC outlet and a modular phone jack. All phones connected to that line are protected from unwanted calls. And finally, the project operates unattended. The only controls are the POWER and RESET switches. The POWER switch is included for those times when you want to receive all calls. The RESET switch is in-

cluded to silence an internal ringer, which would otherwise sound for 10 seconds.

The project is easy to build and inexpensive, too. The parts cost about \$60, although careful shopping can reduce that figure greatly. The construction is simplified in that all parts are contained on two small PC boards. A third PC board serves as a front panel, providing a professional appearance for the project. In all, 12 IC's are used, plus a small handful of discrete parts.

Aligning the project is simple, and requires just three easy-to-make adjustments. The only thing you need to make those adjustments is a friend with a push-button phone. A frequency counter would also be useful, but is not necessary.

And finally, a few words about the FCC. Special attention was paid to Part 15 requirements during the design of the project. Optoisolators were used to prevent noise or interference from being coupled to the phone line, and the use analog circuitry minimizes the chances of interference being generated. In the places where digital circuitry is used, the maximum frequency is limited to under 1500 Hz. All that helps assure the user of interference-free operation.

One last point. Due to the fact that the

project must be connected directly to the phone line, we recommend that construction should be undertaken only by experienced individuals. In other words, do not make this your first construction project. Also, do not make parts substitutions unless you are certain of what you are doing.

Theory of operation

Basically, the circuit works on the principal that if the phone doesn't ring you don't answer it. In other words, when an undesirable caller dials your number, the phone doesn't ring. But if a friend, relative, or someone else who you don't mind hearing from calls, the device sounds a beeping tone, telling you to answer the phone.

So how does the circuit know the difference between friend or other? It is really quite simple. As soon as a telephone connection is made, the circuit captures the line preventing your phone from ringing. It then waits 10 seconds for the party at the other end to dial (or press) an extra "code" number. If the device receives the code number it beeps for 10 seconds alerting you to pick up your phone. Otherwise, if no code number, or if the wrong code number is received, the

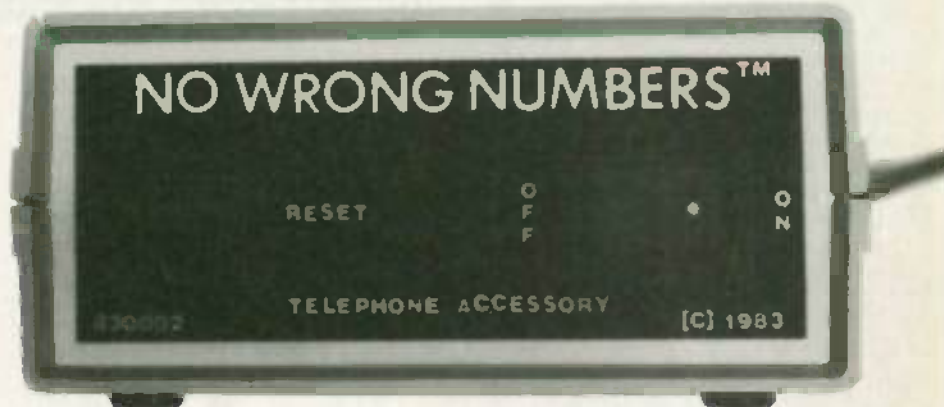

device disconnects the phone line, terminating the call. If you give the code number only to those who you want to be able to reach you at any time, then they will be the only one's you will hear from when the device is active.

Figure 1 shows a block diagram of the project. Note that two PC boards are used in the device: a main board and a decoder board. We will discuss both boards briefly and then go into detail on the main board. The decoder board will be discussed in the next part of this article.

The main board is the workhorse of the project. It contains the circuitry that detects the ring signal and listens to the line. Plus, there is the beeper circuitry, power-on-reset circuitry, and a power supply.

In operation, the ringing signal is detected by IC1. The output from the optoisolator drives a ring-detector circuit, IC2. When three things happen, the ring detector produces an output. First, the ring-signal amplitude must exceed 0.5 volt. Second, the ring frequency must be within 15 and 50 Hz. And third, the signal must last for at least 0.5 second. The purpose of those conditions is to prevent the project from being falsely triggered by telephone line checking equipment, line noise, or outgoing calls being made. If

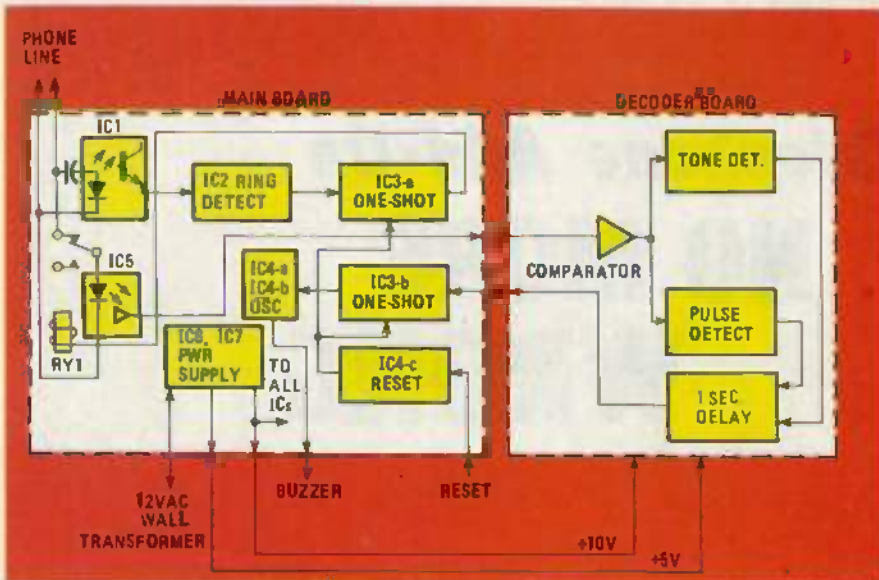

FIG. 1—BLDCK DIAGRAM of the project. Note that the circuitry is contained on two boards. The main board is the topic of this article; the decoder board will be discussed in full in the next installment.

those conditions aren't met, the ring detector IC resets itself and no output is generated.

The ring detector's output triggers a 10-second one-shot, IC3-a. That device closes relay RY1 for 10 seconds. When the

relay closes, optoisolator IC5 is connected across the phone line, which in effect "answers the phone." The output from IC5 contains any audio or dial pulse information and is sent to the decoder board.

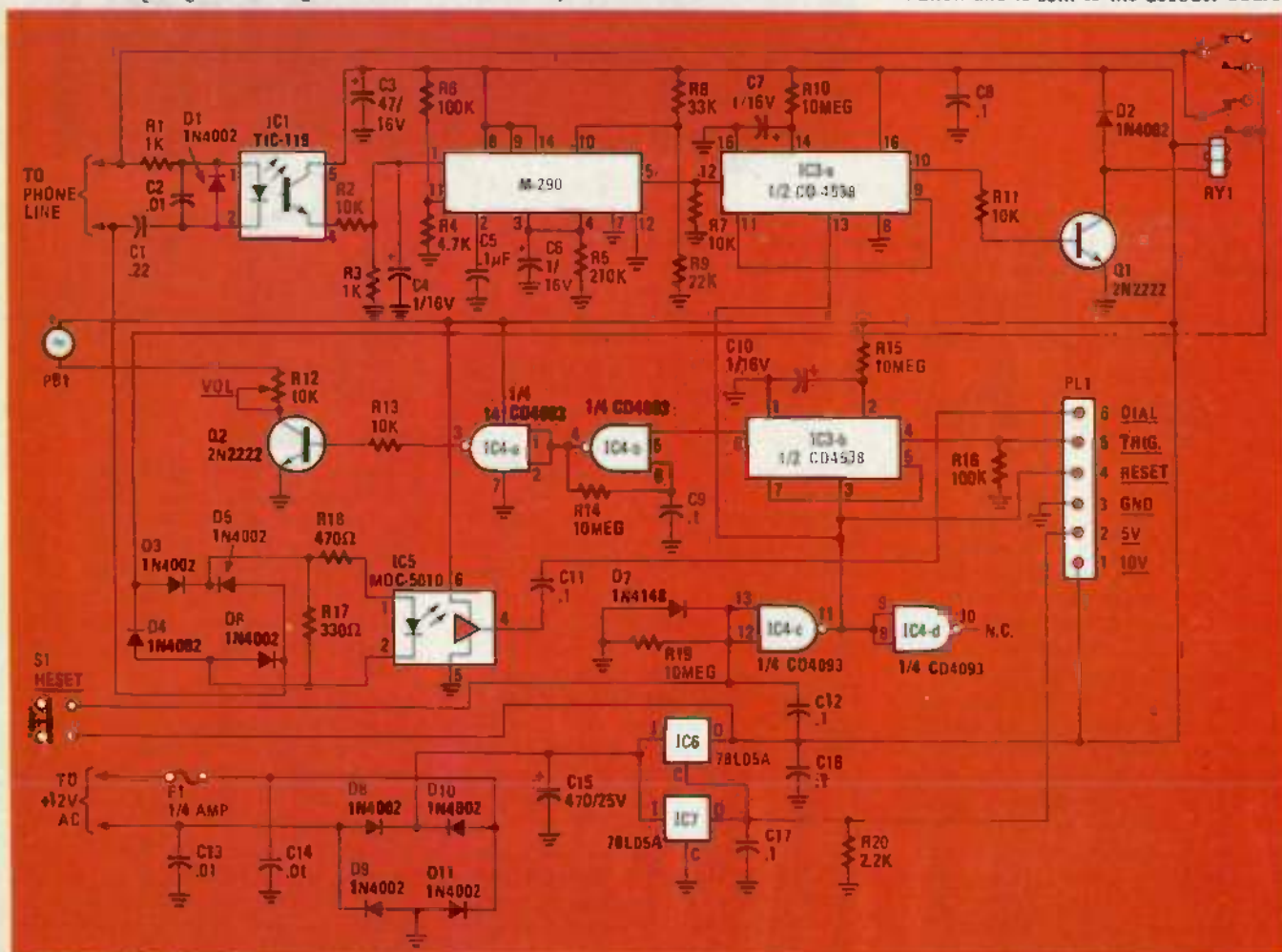

FIG. 2—SCHEMATIC DIAGRAM of the main board. The use of optoisolators prevent any chance of noise or interference being coupled to the phone line.

After IC3-a times out, the relay opens and the project is ready for another caller.

If the decoder board detects a valid code, one-shot IC3-b is triggered. That simply enables a 2-Hz oscillator, IC4-a and IC4-b, which causes a piezoelectric beeper, PB1, to sound. The result is a steady beeping tone that lasts for 10 seconds.

The remainder of the circuitry consists of a power-on reset circuit and a power supply. The purpose of the power-on reset circuit is to reset both one-shots (IC3-a and IC3-b). Otherwise, upon power-on, the project would answer the phone and beep for 10 seconds. Schmitt trigger IC4-c handles that function. A pushbutton RESET switch, S1, is included to silence the beeper if it is still sounding when you pick up the phone. The power supply provides 10 volts from IC6 for all circuitry. A 5-volt output (IC7) is also provided exclusively for the tone decoders on the decoder board. Both of those IC's are standard three-terminal voltage regulators.

The decoder board simply detects the incoming code signal. Two decoder circuits are used to detect the tones from pushbutton phones or dial pulses from rotary dial phones. A one-second delay circuit is connected to the decoder outputs to prevent speech or people playing with the phone from false triggering the project.

Let's turn next to Figure 2, the schematic diagram, for a more detailed discussion of the main board circuitry.

The incoming phone line is AC coupled to optoisolator IC1. As a result, IC1 is triggered only on the high-voltage ringing pulses, which are typically 90 volts AC at 20 Hz. The output from IC1 is attenuated, filtered by C4, and drives IC2, the ring-detector circuit.

The ring detector replaces a handful of IC's and contains three basic sections. The first section is a signal processor that amplifies and shapes the incoming signals. Also provided is a Schmitt trigger circuit that prevents dial-phone contact bounce from false triggering the circuit. Resistors R4 and R6 set the input hysteresis to 0.45 volt. The second section determines the period of the incoming signals and detects signals in the 15- to 50-Hz range. Resistors R8 and R9 center the frequency range. And finally, the third section is a one-second timer. Capacitor C6 and R5 set the time period. The output of the ring detector is at pin 5 and it is fed to one-shot IC3-a.

One-shot IC3-a determines how long a caller has to dial in the code number. Capacitor C7 and resistor R10 set the time period. With the values shown, that time interval will be 10-seconds. The output from IC3-a drives transistor Q1, which controls relay RY1.

When RY1 closes, it connects a bridge

rectifier made up of D3-D6 across the phone line. That circuitry completes a DC path that "answers the phone." Resistors R17 and R18 reduce the line current to values acceptable to optoisolator IC5. Thus, that circuitry draws 20 mA from the line, simulating a phone that has been answered.

Optoisolator IC5 has been designed by Motorola especially for this type of application and it contains a built-in amplifier. The output from IC5 is AC coupled to SO1, which is the interconnection to the decoder board.

Moving on, the beeper is activated by a positive-going pulse from pin 5 of PL1. That pulse triggers another 10-second one-shot, IC3-b. Capacitor C10 and resistor R15 set the one-shot's time period. The output from IC3-b controls a 2-Hz oscillator, IC4-b. The output from IC4-b is inverted by IC4-a and drives transistor Q2. That transistor simply switches power to a piezoelectric buzzer, PB1. Potentiometer R12 serves as a volume control.

The power-on reset circuitry consists of IC4-c. When the power is turned on, capacitor C12 charges through resistor R19. That action resets the one-shots. After about a second, C12 is charged and reset is removed. Note that a reset may be manually performed using switch S1. Diode D7 is included to prevent C12 from discharging through the IC when the power is removed. Also note that a reset is supplied to SO1. However, with the decoder

board used in this project that reset signal is unused.

The remaining circuitry on the main board is the power supply. AC voltage from a plug-in transformer passes through a fuse, F1, and is rectified by D8-D11. The DC output from that circuit is filtered by C15 and regulated by two three-terminal regulators, IC6 and IC7. The 10-volt output of IC6 powers all analog and digital circuitry except for the tone decoders; the 5-volt output of IC7 takes care of them.

That completes our discussion of the theory. Now, let's move on and assemble the main board.

Assembly

The first step is, of course, to obtain the parts; here are a few suggestions regarding that. The parts used are common and may be obtained from many of the advertisers in this magazine. Regarding the capacitors—we specify both the value and the type of each unit. One problem area might be the tantalum types. If desired, low leakage electrolytics may be substituted to save money. However, do not use standard electrolytics—the high leakage and wide capacitance tolerance of those will cause problems.

About the fuse clips for F1: Industry standard PC type fuse clips are specified. Most larger electronic stores carry them or substitutes. If you can't get them, simply use a pigtail fuse for F1.

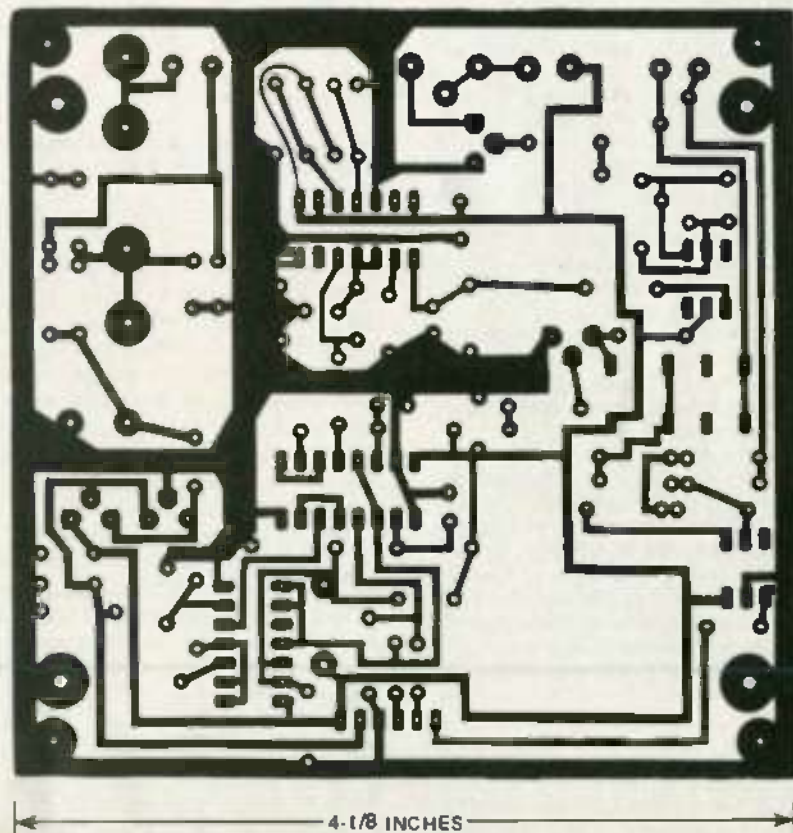

FIG. 3—PRINTED-CIRCUIT BOARDS should be used for this project. The foil pattern for the main PC-board is shown here full size.

PARTS LIST—MAIN BOARD

All resistors 1/2-watt, 5% unless otherwise noted

R1, R3—1000 ohms
 R2, R7, R11, R13—10,000 ohms
 R4—4700 ohms
 R5—270,000 ohms
 R6, R16—100,000 ohms
 R8—33,000 ohms
 R9—22,000 ohms
 R10, R14, R15, R19—10 megohms
 R12—10,000 ohms, potentiometer, linear taper, PC-board mount (Radio Shack 271-218)

R17—330 ohms
 R18—470 ohms
 R20—2200 ohms

Capacitors

C1—0.22 μ F, 250 volts, metal film
 C2, C13, C14—0.01 μ F, 50 volts, ceramic disc
 C3—47 μ F, 16 volts, radial leads, electrolytic
 C4, C6, C7, C10—1 μ F, 16 volts, radial leads, tantalum
 C5, C9, C11, C12—0.1 μ F, 50 volts, polyester
 C8, C16, C17—0.1 μ F, 16 volts, ceramic disc
 C15—470 μ F, 25 volts, radial leads, electrolytic

Semiconductors

IC1—TIL-119 optoisolator (Texas Instruments)
 IC2—M290 ring-detector subsystem (Mendakota—see below)
 IC3—CD4538 CMOS one-shot (RCA)
 IC4—CD4093BE CMOS Schmitt trigger NAND gates
 IC5—MOC-5010 optoisolator (Motorola)
 IC6, IC7—78L05ACP 5-volt, 100-mA regulator (Motorola)
 Q1, Q2—2N2222 NPN transistor
 D1—D6, D8—D11—1N4002 diodes
 D7—1N4148 diode
 F1—0.25 amp, 3AG fuse
 PL1—6 pin male PC-header (GC Electronics 41-046 or similar)
 RY1—DPDT relay, 12-volt DC coil (Radio Shack 273-213 or equivalent)
 PB1—Piezoelectric buzzer (Radio Shack 273-060 or equivalent)
 S1—SPST momentary pushbutton switch (Radio Shack 275-618 or equivalent)
 Miscellaneous: PC board, solder, wire, 2 PC-mount fuse clips (Littlefuse 122087), IC sockets, etc.

The following is available from Mendakota Products, Ltd., PO Box 20HC, 1920 W. Commonwealth Ave., Fullerton, CA 92633: A set of three PC boards and the M290 ring detector IC (order part No. NWR). The cost is \$26.00 postpaid in the U.S. and Canada. The M290 is available for \$12. California residents please add 6% sales tax. Sorry, no C.O.D.'s or credit-card orders.

About the header, PL1: Many better stocked electronics stores sell GC Electronics products, so try your local stores. Otherwise contact GC Electronics (400 South Wyman St., Rockford, IL 61101) directly for your local dealer. If all else

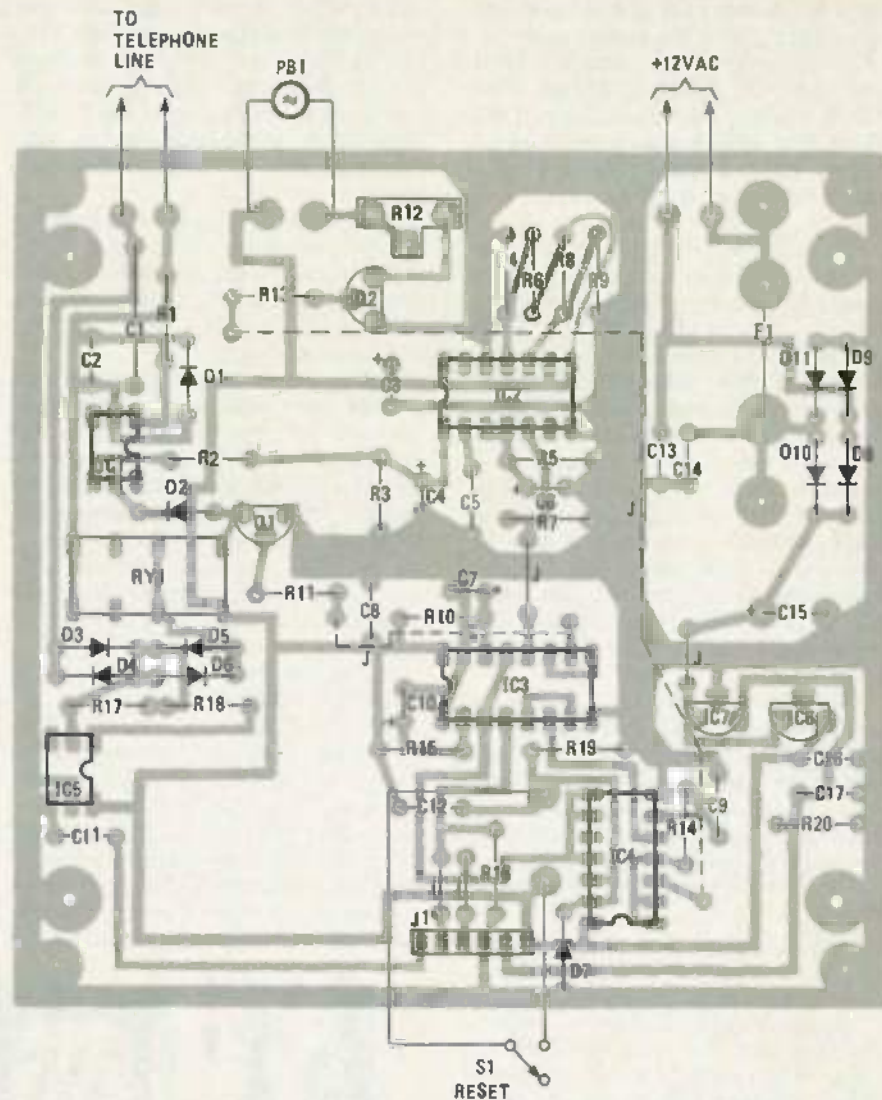

FIG. 4—PARTS-PLACEMENT DIAGRAM for the main board. Note that two Insulated jumpers are installed on the foil side of the board.

fails, any miniature 6-pin connector may be substituted.

About the IC's: Note that the M290 ring-detector circuit is custom made for this project and is available only from the supplier given in the Parts List. The other IC's are standard types, and are available from many sources. Note that while we used 78L05A voltage regulators, standard 78L05 units may be used without problem. We used the 78L05A's simply because they were available.

And finally, you must make or buy the circuit boards. Due to the high gain of some parts in this project, plus the possibility of noise problems, PC-board construction is a must. That way you don't have to worry about ground loops and wiring errors.

The foil pattern for the main board is shown in Fig. 3. The parts placement diagram for that board is shown in Fig. 4. Begin assembly by installing the IC sockets and PL1. Be sure to position them with the pin 1 notch as shown before soldering. Install a 14-pin socket at IC2, a 16-pin

socket at IC3, and another 14-pin socket at IC4. Next, install the header at PL1. Note that it is installed so that the plastic tab is adjacent to resistor R16.

Install the fuse clips and fuse next. Place a fuse clip into the holes at F1. Push down firmly and solder. Likewise, install the other fuse clip in the same way. Snap a 0.25 amp, 3AG fuse in place when the clips are cool. Then install IC1 and IC5. Note that sockets are not used on the optoisolators. Install a TIL-119 at IC1, positioning it as shown. Likewise, install a MOC-5010 at IC5, positioning it as shown.

After that, install relay RY1. Note that the relay can be inserted into the board only one way. Install the relay and push against the board firmly and then solder.

We're almost done with the main board now, but unfortunately, we've run out of room for this month. When we continue this article, the first thing we'll attend to is finishing up that main board. Then we'll turn our attention to the smaller decoder board. R-E

How To Use



DIGITAL PANEL METERS

This month we look at how digital panel-meters can be used to measure temperature and frequency.

RAY MARSTON

Part 2 IN LAST MONTH'S article we explained the basic characteristics and use of 3½-digit LCD digital panel meter modules, with particular emphasis on the Datel-Intersil (11 Cabot Boulevard, Mansfield MA 02048) DM-3100U1. We showed how these units can be used to measure voltage, current, and resistance. In this month's conclusion we'll see how those units can be used to measure other parameters such as temperature and frequency. Let's start off by looking at temperature-measuring techniques.

Digital thermometers

A digital panel-meter module can be made to act as a wide-range (-50°C to $+150^{\circ}\text{C}$) digital thermometer by feeding the output of a linear-voltage-generating temperature sensor to its inputs. One suitable type of sensor is the ordinary bipolar silicon transistor; dedicated temperature sensor IC's are also available. In either case, the resulting digital thermometer is sensitive to changes of as little as 0.1°C . Its linear accuracy varies from 0.5°C to 1.5°C , depending on the sensor and circuitry used.

Because of the low mass of a transistor sensor, the device has a thermal response time some 10 to 100 times faster than that

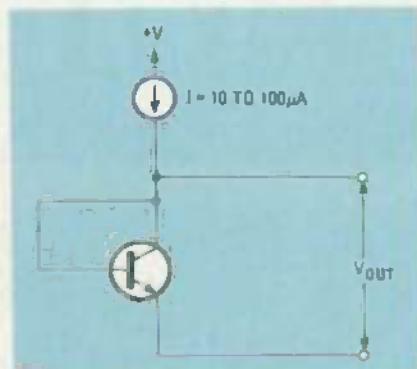

FIG. 12—WHEN AN ORDINARY TRANSISTOR is connected as shown and driven from a constant current source, the value of V_{OUT} will vary in direct proportion with the temperature.

of a normal mercury thermometer. When used to measure a sharp change in the temperature of free air, a transistor-sensor circuit typically settles to within 0.1°C of the new temperature within one minute; a mercury thermometer takes some 20 minutes to attain the same accuracy.

When an ordinary NPN silicon transistor is connected as shown in Fig. 12 and is driven from a constant-current source, it generates an output voltage that varies in direct proportion to the temperature of the transistor. That voltage has a negative temperature coefficient of about -2 mV

per- $^{\circ}\text{C}$, and typically varies from about 600 mV at 0°C to 400 mV at 100°C , as shown in the idealized graph of Fig. 13-a.

In practice, the "straight line" graph shown in Fig. 13-a is linear within 1 mV or so over the 0°C -to- 100°C range, but the

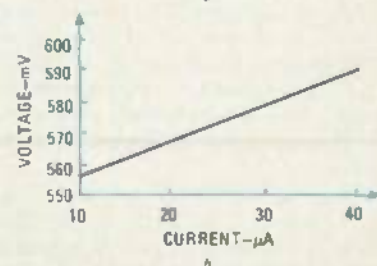
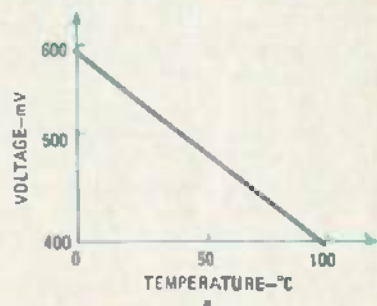

FIG. 13—HOW VOLTAGE VARIES with temperature is shown in a. The relationship between the output voltage and the drive current at 25°C is shown in b.

precise voltage generated at any given temperature depends on the individual transistor and its operating current. If operating currents are kept below 100 μ A, errors due to self-heating are negligible. Figure 13-b shows how output voltage varies with drive current at 25°C. That graph was obtained by measuring that relationship in a small sample of transistors.

Figure 14 shows how to connect the sensor circuit of Fig. 12 to a digital panel-meter so that the meter gives a direct read-out of temperature in °C. The output of the sensor is fed directly to the units ANALOG LOW input, pin A2, and a 600-mV offset voltage (equal to the sensor voltage at 0°C) is fed to the ANALOG HIGH input, pin B5. The module actually responds to the differential value of the inputs (that is, the voltage at pin B5 minus the voltage at pin A2), so that it sees an input of 600 mV - 600 mV = 0 mV, and gives a reading of 00.0. At 100°C the module sees an input of 600 mV - 400 mV = 200 mV, and since a reference voltage of 200 mV (equal to the difference voltage between 0°C and 100°C) is fed to the REFERENCE input, pin B1, the meter gives a reading of 100.0.

Figures 15 and 16 show two practical digital thermometers. The circuit shown in Fig. 15 is virtually the "standard" one found in many magazine articles and application sheets, and has a typical linear accuracy of 1.5°C over the 0°C to 100°C temperature range.

The circuit as shown requires a stable supply of approximately 2.8 volts to operate properly. A regulated 6.9 volts is available from the panel meter's internal LM329 via pin B2. That voltage can be divided by resistors R6 and R7 to provide an appropriate supply. When that is done, R1 drives the sensor with a current of about 22 μ A at 0°C, rising to about 24 μ A at 100°C. That current variation, combined with the basic linear error of the transistor, causes the 1.5°C linear error of the circuit. The CAL-0° voltage feeding A2 can be varied from zero to 875 mV using R4, and the CAL-100°C voltage feeding B1 can be varied from zero to 255 mV via R5. Those two controls are used to calibrate the meter; we will describe how shortly.

Figure 16 shows a precision version of the digital thermometer: it has a linear accuracy of about 0.5°C. In that circuit the transistor sensor is energized at about 20 μ A via constant-current generator Q1, which is temperature compensated by Q2. That section of the circuit works as follows.

Voltage divider R3-R4 generates a voltage V_T (about 1 volt) across R3. That voltage is "followed" by NPN transistor Q2, causing $V_T + V_{BE2}$ (the base-emitter voltage of Q2) to appear on the base of Q1; let's call that voltage V_B . The voltage V_E appearing on the emitter of PNP transistor

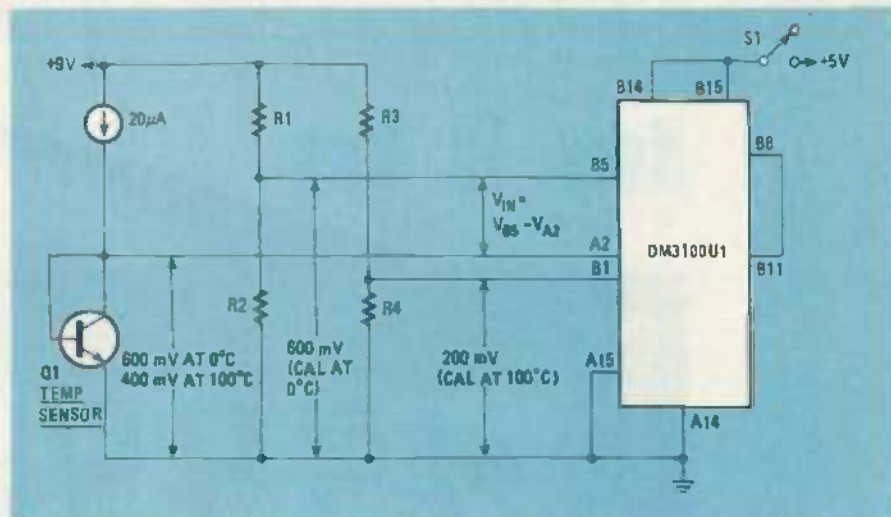

FIG. 14—A BASIC DIGITAL THERMOMETER circuit using the idealized sensor shown in Fig. 12.

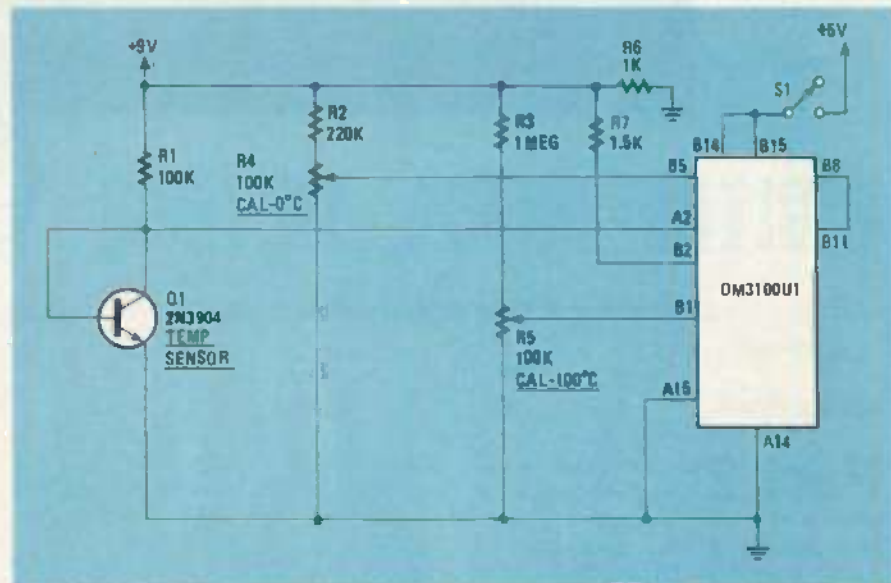

FIG. 15—A PRACTICAL thermometer circuit. The linear accuracy of this design is about 1.5°C.

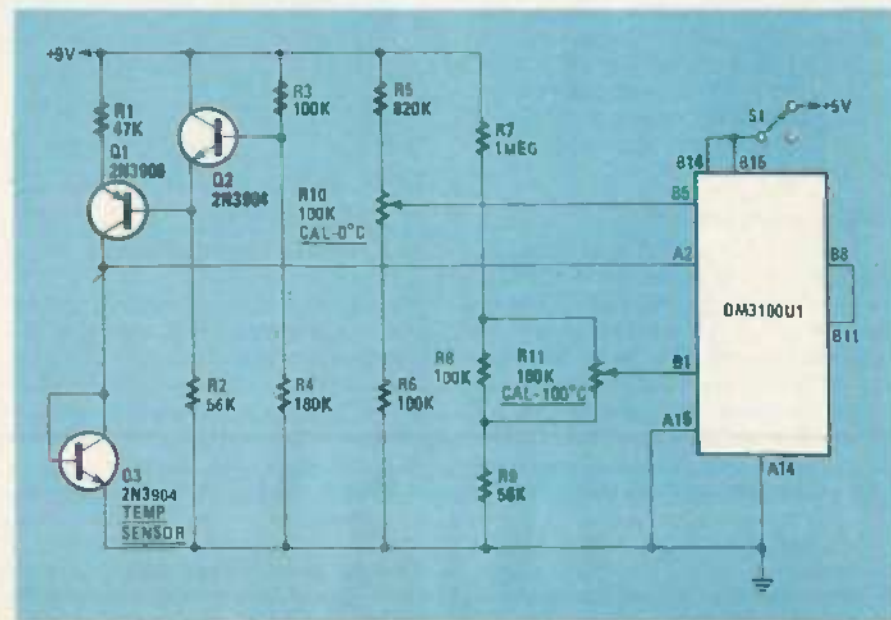

FIG. 16—A PRECISION digital thermometer using a transistor sensor. The linear accuracy of this circuit is 0.5°C.

Q_1 is equal to $V_B - V_{BE1}$ (the base-emitter voltage of Q_1), and it is that voltage and the value of R_1 that determine the magnitude of the constant-current output of Q_1 . Note, however, that V_E is in fact equal to $V_T + V_{BE2} - V_{BE1}$, and that, since Q_1 and Q_2 operate at virtually identical temperatures and at similar current levels, the V_{BE1} and V_{BE2} values cancel out at all temperatures and V_E thus equals V_T . Thus, the output current of Q_1 is independent of the ambient temperature.

Another point to note about the precision circuit shown in Fig. 16 is that the output of the CAL-0°C control, R10, is adjustable over the range of 460 to 710 mV, and that the CAL-100°C control, R11, is adjustable over the range of 140 to 260 mV. Those controls allow very precise adjustment of each calibration point.

Calibration procedure

The procedure for calibrating the circuits shown in Figs. 15 and 16 is as follows. First, solder the base and collector leads of the sensor transistor together, solder the sensor to a pair of flexible leads, and connect the leads to the meter circuit. Coat all visible transistor leads and solder joints with insulating varnish; GC Electronics' (200 Wyman St., Rockford, IL 61101) Red GLPT is excellent for that. Next, set R10 and R11 at mid value, mix a quantity of crushed ice and cold water in a tumbler (to act as a "0°C" standard), and immerse the sensor in the tumbler. Now adjust R10 to give a reading of 00.0 on the meter. Next, remove the sensor from the tumbler and immerse it in gently boiling water (to act as a "100°C" standard) and adjust R11 to give a meter reading of 100.0. When that's done the basic calibration is complete.

Frequency Measurement

A digital panel-meter module can be made to read frequency by connecting the unknown frequency to the module's input via a frequency-to-voltage converter. A suitable converter can easily be made by using a 7555 monostable multivibrator; Fig. 17 shows the principles behind such a converter. The input signal is first fed to an input conditioner and trigger-pulse generator, which triggers a fixed-period 7555 monostable multivibrator on the arrival of each new input cycle. The output pulses of the 7555 are converted to mean DC values by integrator R2-C2, scaled by R3-R4, and then fed to the input of the digital panel-meter.

The mean DC value of the 7555 output pulses equals V_p (the peak amplitude of the pulses) multiplied by W/P , where W and P are the widths and periods of the pulses respectively. The values of V_p and W are, however, fixed. Only the pulse period is variable, and that period is inversely proportional to the input frequency, f , so the mean output voltage is equal to V_p

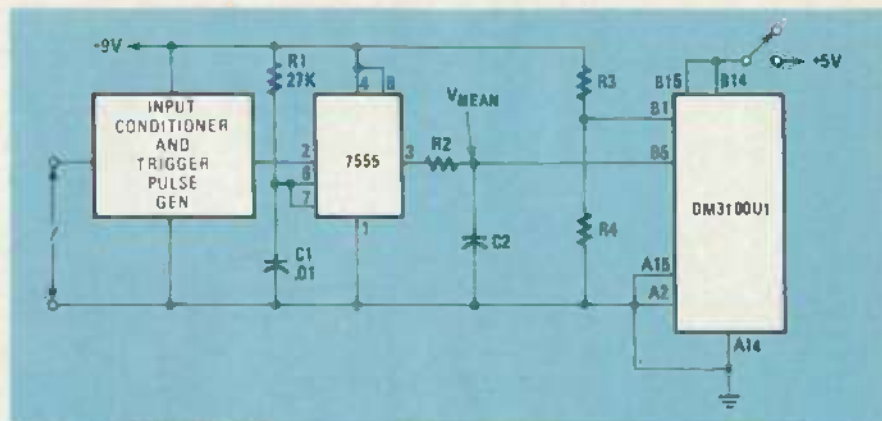

FIG. 17—THE BASIC METHOD of using a digital panel meter to measure frequency is shown here.

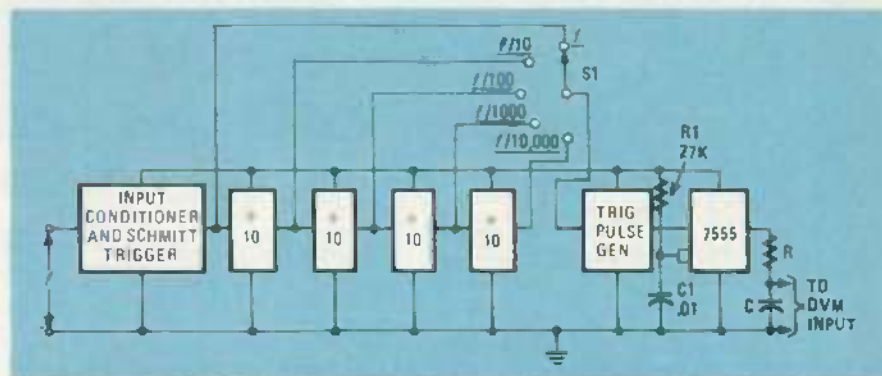

FIG. 18—EXPANDING THE basic frequency meter shown in Fig. 17 into a multirange circuit.

$\times W \times f$ and is thus directly proportional to f . Therefore, when a digital panel-meter module is suitably scaled via resistors R3-R4 it gives a direct reading of the input frequency.

In practice, the lowest convenient full-scale frequency range of a digital-panel-meter-based $3\frac{1}{2}$ -digit frequency meter is 1.999 kHz. The 7555 pulse has a period of 500 μ s at full scale. For maximum accuracy, the pulse width must be as large as possible but must not be greater than $\frac{1}{3} P$. A pulse width value of about 300 μ s is thus called for, and that can be obtained from the 7555 by making R1 equal to 27 kilohms and C1 equal to .01 μ F.

Figure 18 shows how the basic circuit shown in Fig. 17 can be modified to act as a multi-range frequency meter. In that case the input signal is fed to an input conditioner and Schmitt trigger, and the Schmitt output is used to ripple-clock four decade dividers. The 7555 300- μ s monostable multivibrator is provided with a trigger generator that can be fed from the output of the Schmitt or from any of the dividers. Thus, when the 7555 is triggered directly from the Schmitt, the meter reads 1.999 kHz full scale, and when fed from the output of the last divider stage, the meter reads 19.99 MHz full scale.

Practical frequency meters

Figure 19 shows a practical digital-panel-meter-based digital frequency meter circuit that reads up to 19.99 MHz full-

scale in five decade ranges. When calibrated, the meter has a reading accuracy of ± 1 digit. The circuit accepts input signals in the range 200 mV to 5-volts RMS, and operates as follows.

Input signals are fed, via C1-R1, directly to the input of IC1-a, $\frac{1}{4}$ of a very fast 74HC132 CMOS Schmitt trigger, which is biased at half the 4.5-volt supply via R2-R3. The Schmitt output is used to ripple-clock four decade-divider stages. Ordinary CMOS dividers typically operate at maximum speeds of only 800 kHz or so when powered from 4.5-volt supplies, so, to give the required fast operating speeds, the very latest "HC" types of silicon-gate CMOS counters are used for the first two counters (IC2 and IC3).

The output of IC1-a and the four divider stages are fed to range-selector switch, S1-a, and from there to a 4- μ s trigger-pulse generator, made up of C4, R4, IC1-b, and IC1-c, which triggers the 7555 monostable multivibrator via Q1. The output of the 7555 is fed to the ANALOG HIGH input of the unit, pin B5, via R8-R9, and a calibration "reference" voltage is fed to REFERENCE HIGH input, pin B1, via R12. The circuit is calibrated by feeding in a signal of known frequency, switching to the appropriate range, and trimming R12 for the appropriate reading.

Once R12 has been initially calibrated, that calibration is influenced only by variations in the width of the pulses output by the 7555. Since such variations can be

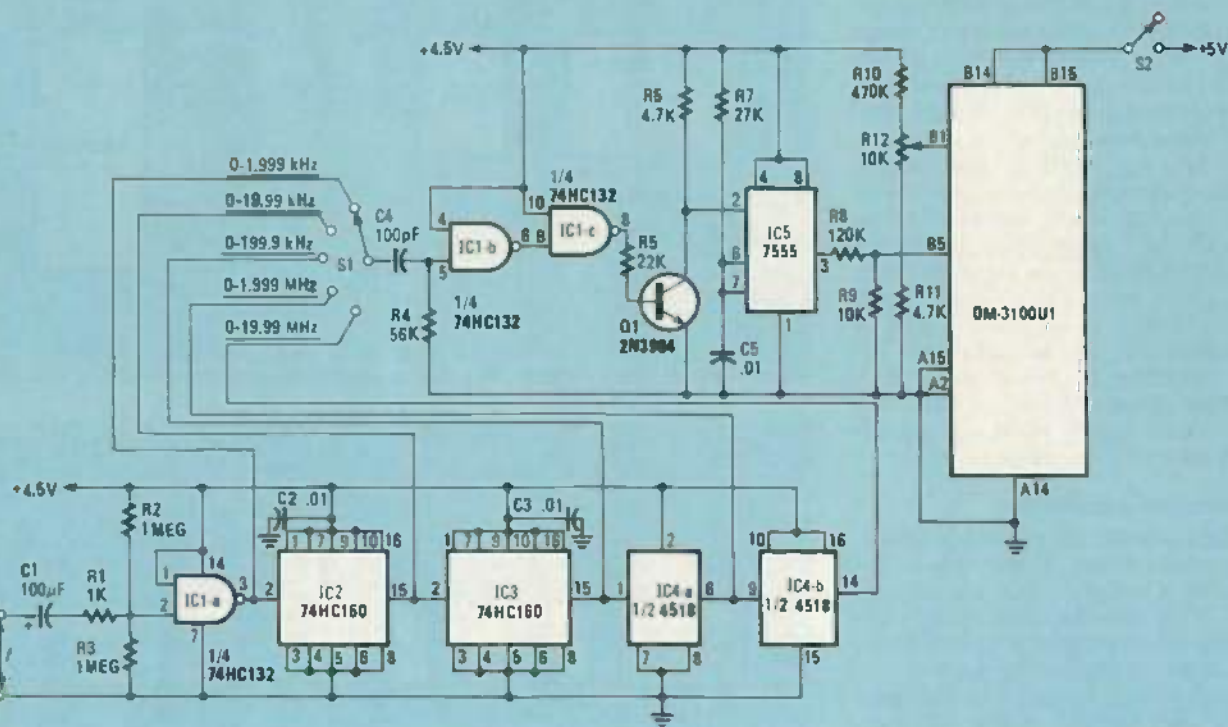

FIG. 19—A PRACTICAL five-range digital frequency-meter. It can handle input frequencies of from 0 to 19.99 MHz.

TABLE 1—SUPPLIERS

In addition to the manufacturer mentioned in the article, digital panel meters are available from a wide variety of sources. Some of those sources are listed below.

- Ametek**
2 Station Square
Paoli, PA 19301
- Analog Devices**
PO Box 280
Norwood, MA 02062
- Analogic Corporation**
Audubon Rd.
Wakefield, MA 01880
- API Instruments**
1601 Trapelo Rd.
Waltham, MA 02254
- Ballantine Labs**
90 Fanny Rd.
Boonton, NJ 07005
- Data Precision Corporation**
Electronics Ave.
Danvers, MA 01923
- Fluke Manufacturing Company**
Box C9090
Everett, WA 98206
- Non-Linear Systems**
533 Stevens Ave.
Solana Beach, CA 92075
- Sigma Instruments**
170 Pearl St.
Braintree, MA 02184
- Simpson Electric Company**
853 Dundee Ave.
Elgin, IL 60120
- Weston Instruments**
614 Frelinghuysen Ave.
Newark, NJ 07114

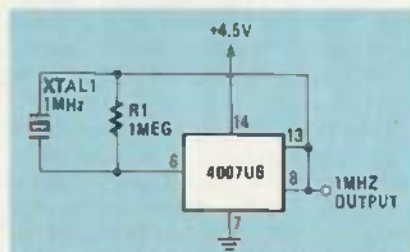

FIG. 20—THIS 1-MHz crystal calibrator can be easily added to the circuit shown in Fig. 17.

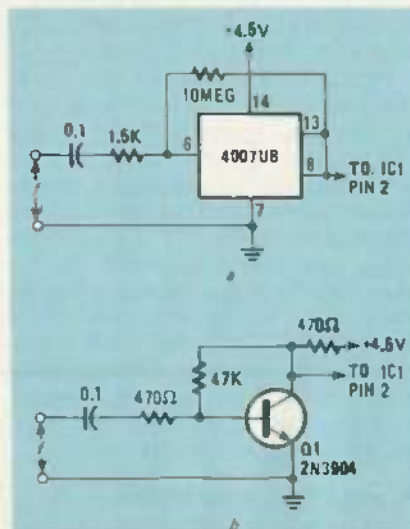

FIG. 21—TWO SIMPLE PREAMPLIFIERS that can be used with the digital frequency-meter are shown here.

caused if the values of R7 and C5 change due to changes in temperature, care should be taken so that the units chosen are thermally stable.

The circuit shown in Fig. 19 can be modified in a variety of ways to satisfy individual requirements. Figure 20 shows a 1-MHz crystal calibrator designed around one section of a 4007UB CMOS IC. That circuit can easily be added to the frequency meter and consumes a mere 300 µA when active. Figure 21 shows two simple pre-amplifiers that can be used to improve the basic sensitivity of the meter. The circuit shown in Fig. 21-a, which uses one section of a 4007UB, has an input impedance of about 1 megohm and improves the sensitivity of the frequency meter by about 20 dB (to 20-mV RMS) at audio frequencies, but is useful to only a few hundred kHz. The simple design shown in Fig. 21-b also gives a gain of about 20 dB at low frequencies, but has a low input impedance (about 2.2 kilohms) and is useful to several MHz.

We've only touched upon a few possible applications for a digital panel-meter. There are, of course, many more as those devices can be used to indicate the value of any parameter that can be converted into a predictable (linear or log) voltage, current, or resistance. Linear transducers are available for measuring values of pH, light intensity, radiation, and many other factors. Cyclic parameters such as RPM and heart rate can be measured by adapting the frequency-meter circuit. R-E

How to Design Power Supplies

MANNIE HOROWITZ

All about unregulated and regulated power supplies, IC regulators, and overvoltage-protection circuits.

IN THIS, THE FINAL INSTALLMENT IN OUR series, we will turn our attention to power supplies for analog circuits. All circuits require some source of power to operate and the most convenient source of such power is an AC wall outlet. Unfortunately, many electronic circuits cannot make use of AC directly. Instead, some way to convert the AC to DC is required.

Let's look once again at the junction diode. You will recall that in our previous discussions of that device we saw that it only conducts when its anode is positive with respect to its cathode. That property is important when we are dealing with AC. If the diode were connected in a series circuit along with an AC supply and a load, its presence would mean that current could only flow through the load during the half of the AC cycle when the anode was positive with respect to the cathode. During the other half cycle the diode would not conduct and no current could flow.

Such an arrangement is referred to as a half-wave rectifier because only half the waveform (i.e. alternate half-cycles) is allowed to pass freely. The other half of the waveform is cut off.

The presence of those half-cycles of current causes pulsating DC to be generated across the load. The amount of voltage variation in that pulsating DC can be reduced by wiring a "filter" capacitor across the load. The amount of ripple in the output is then determined by the values of the capacitor and the load.

Full-wave rectifiers

When dealing with electronic circuits such as amplifiers, the power source should be as stable (i.e. free of ripple) as possible. The ideal power source then is a battery, as all DC voltages that are derived

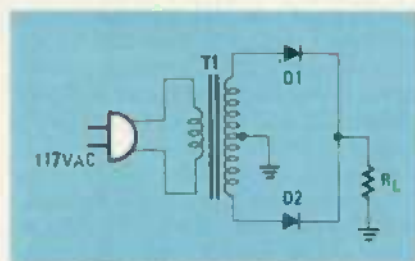

FIG. 1—A SIMPLE full-wave rectifier using a center-tapped transformer.

from an AC supply have some ripple. Using a battery is not always possible or practical, but fortunately most circuits can tolerate the presence of ripple if it is sufficiently attenuated.

One way to minimize ripple is to use a full-wave rectifier. Such a circuit is shown in Fig. 1-a. Note that the circuit consists of a center tapped transformer, with the tap grounded, and two diodes. Let's see how this circuit works. We'll start by looking at what happens during the positive half-cycle. During that half-cycle the polarity of the applied voltage is such that the upper terminal of the transformer's secondary is positive with respect to the center tap and the lower terminal. Also, during that half-cycle the polarity across D1 is such that the anode of the diode is positive with respect to its cathode and the device conducts. Thus, current flows from the upper transformer terminal, through D1 and R_L , and back to the center tap through the ground. Note that the voltage during this half-cycle varies in phase from 0° to 180° and that the current varies from zero, to some peak value, and then back to zero. Because of that varying current, the voltage developed across R_L varies identically with the input waveform. Finally, during the positive half-cycle the cathode of D2 is more positive than its anode, so the diode does not conduct and no current

flows through it.

The polarity of the voltage across the transformer is reversed during the negative half-cycle. Now, the bottom terminal of the transformer is positive with respect to ground and with respect to the top terminal. Diode D1 ceases to conduct, because its cathode is more positive than its anode. But as for D2, its anode is now positive with respect to its cathode and the device conducts. Thus, current flows from the lower terminal of the transformer, through D2 and R_L , and back to ground and the center tap, and a positive half-cycle of voltage is developed across R_L . Note that here, once again, the voltage across R_L varies identically with the input waveform, but the polarity of the voltage across the resistor is reversed—it is positive.

That sequence repeats during the succeeding positive and negative half-cycles. Note that current always flows through R_L in the same direction so that only a positive voltage with respect to ground is across the load. That is true regardless of the instantaneous polarities of the AC voltage applied to the circuit.

The advantage of the full-wave rectifier over the half-wave rectifier lies in the fact that in the half-wave circuit no voltage is developed across the load during negative half-cycles. Because of that, the ripple in the output of the half-wave rectifier is higher.

For ripple to be minimized in either type of circuit, some type of filtering must be used. To do so, a large capacitor is usually placed across R_L . That capacitor is charged to the peak voltage, V_P , during the first half-cycle. Between peaks, it discharges slowly through R_L . But it does not have enough time to discharge substantially before the next half-cycle appears and recharges it.

Without the capacitor, the ripple voltage across R_L varies from $+V_P$ to 0 volts. But with the capacitor present, it varies from $+V_P$ to whatever its voltage

dropped to before the next half-cycle appeared to recharge it. From that, you should be able to see why the ripple is easier to filter in a full-wave rectifier. The reason is that the filter capacitor is recharged once during each half-cycle in a full-wave circuit, while in the half-wave arrangement it is recharged only once during each full cycle. Because of this longer recharge cycle, the voltage across the capacitor drops to a lower level. The ripple voltage, the voltage variation from $+V_p$ to that discharge voltage level, is therefore larger for the half-wave than the full-wave circuit.

In both circuits, the amount of ripple at the output is related to the values of the filter capacitor and the load resistor. For a full-wave circuit, ripple will be kept within reasonable limits if the product of the values of the load resistor and the filter capacitor is about 0.1. To keep the ripple to the same levels in a half-wave circuit, that product must be about 0.15. In other words, since we must assume the load to be fixed, the value of the capacitor must be more than 50% higher than for the full-wave circuit.

We want to mention one more thing about ripple before we move on. If the voltage across the filter capacitor varies during the cycle, the mean DC voltage output will be somewhat less than its possible maximum. Thus, for maximum DC output, the ripple must be very low.

Full-wave bridge

The circuit shown in Fig. 2 shows another type of full-wave rectifier, the full-wave bridge. Notice that it does not normally require the use of transformer, although one can be used if the input voltage needs to be stepped up or down.

Let's see how that circuit works. During positive half-cycles, current flows through D1, R_L , and D4. During the negative half-cycle current flows through D2, R_L , and D3. Note that the current always flows in the same direction regardless of the polarity of the input voltage and that the end of R_L marked + is always positive with respect to the end marked -. As before, a capacitor is usually wired across the load resistor to filter out the ripple.

Voltage doubler

When a transformer is used in a rectifier

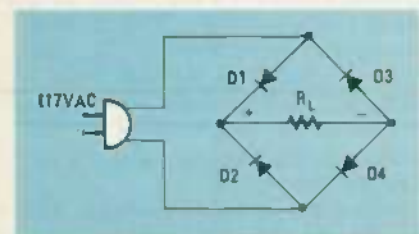

FIG. 2—A FULL-WAVE BRIDGE RECTIFIER uses four diodes but eliminates the need for a transformer.

circuit, the output, or DC voltage across the load, is determined by the peak voltage across the secondary of the transformer (or across one-half the secondary of a center-tapped transformer if a full-wave rectifier is being used). Should one of the previously described rectifiers be used without a transformer between it and the voltage source, the DC voltage at its output seems to be limited to the peak voltage of the AC source. But a voltage-doubler circuit can be used to increase the level of the rectified DC. Two circuits involving doublers are shown in Fig. 3.

In the circuit shown in Fig. 3-a, C1 is charged to the peak level of the supply voltage through D1 during the positive half-cycle. On the negative half-cycle, C2 is charged through D2 to the same peak level. Since the series combination of the two capacitors is across the load, the voltages across them add; and that sum is applied to the load, R_L .

In the circuit shown in Fig. 3-b, during positive half-cycles, C1 is charged to the peak supply voltage through D1. During negative half-cycles D2 conducts, allowing C2 to be charged to the peak supply voltage. In addition, the previously charged C1 discharges through D2 to C2. The supply voltage and the voltage across C1 are then summed in C2; and that sum, which is nearly twice the supply voltage, is applied to the load, R_L , when the waveform goes positive and D2 is once again cut off.

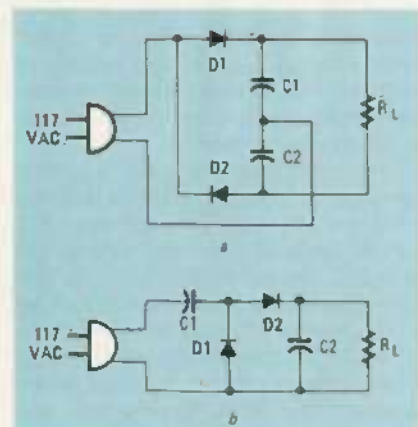

FIG. 3—TWO VOLTAGE DOUBLERS. These circuits are used between the AC source and the rectifier circuit to nearly double the level of the DC output.

Combinations of these circuits can be used to form triplers, quadruplers, and so on. A tripler is shown in Fig. 4-a. In it, the portion of the circuit involving D1, D2, C1, and C2 is identical to the circuit shown in Fig. 3-b, while the D3-C3 portion behaves just as the D2-C2 circuit of Fig. 3-a. The sum of the voltages across C2 and C3 are applied across R_L .

As for the quadrupler circuit, shown in Fig. 4-b, two circuits similar to the one shown in Fig. 3-b, are used. After the two double voltages are developed across C2

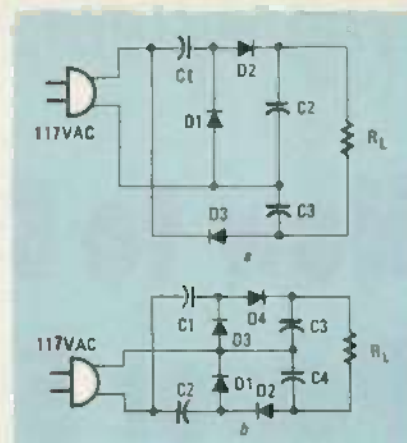

FIG. 4—TWO OR MORE voltage doublers can be combined to form voltage triplers, such as the one shown in a, or a voltage quadrupler, such as the one shown in b.

and C4 they are applied across R_L .

Specifying the diode and transformer

When the rectifying diode is not conducting, twice the peak supply or transformer secondary voltage may be across the device. This is true for all full-wave, half-wave and, voltage-multiplier circuits with the exception of the full-wave bridge. So when designing a power supply circuit, be certain that the diodes have a sufficient voltage rating.

The average current flowing through the diode is equal to the voltage across the load resistor divided by its resistance. The diode once again must be capable of accommodating that amount of current.

Power dissipation capabilities of the diode are limited. Information as to just what these limits are is supplied by the manufacturer and can be found on data sheets. The power the diode must be able to dissipate is equal to the average current it passes in the forward direction multiplied by 1 volt. At times, it may be necessary to mount the diode on a heat sink so that its operating temperature will not exceed its specified limit.

When a circuit involving a diode is first turned on, the filter capacitor being charged by the DC behaves as a short circuit. Because of that, a large initial current surges through the diode. That surge current is equal to the supply-voltage peaks divided by all resistance in the circuit other than the resistances wired across the shorting capacitor. If the surge current is more than the diodes being used can accommodate, the device will be damaged. The best way to avoid damage is to use diodes that can safely handle that initial current surge. Alternately, you can connect a small resistor in series with each diode to limit current surges to safe levels.

As for the transformer, it, too, can overheat if it conducts excessive quantities of current. To check if a transformer is operating within reasonable temperature lim-

its, first measure the cold resistance of one winding while noting the ambient temperature in °C. Refer to that as R_C , the cold resistance. Then apply power to the transformer while its output is loaded as it would be normally. Be sure that all environmental factors (ambient temperature, etc.) are what they would be under normal operating conditions and run the transformer for eight hours. After that time, remove the power from the circuit. Immediately after removing the power, check the hot resistance, R_H , of the winding. Be sure that nothing is connected across this winding. The temperature rise of the transformer, in °C is:

$$\Delta T = 254 \left(\frac{R_H - R_C}{R_C} \right)$$

Add the value you get for ΔT to R_C . If the total exceeds 90°C you should start to be concerned. If it exceeds 105°C, then the transformer is overheating and a different transformer should be used in the circuit.

Regulated power supplies

Throughout the discussion, it was assumed that the line voltage is fixed at 117-volts AC and that the load does not change in resistance but remains a constant R_L . If anyone assumes that to be a realistic condition, then he is living in a dream world. Line voltage fluctuates from minute to minute. Over time it can vary $\pm 10\%$ or more. During periods of extremely heavy usage, power companies have been known to greatly reduce voltage levels.

As for the load, it is seldom a fixed resistor. If the supply is feeding an audio, RF, or electronic-switching circuit, the load impedance varies, sometimes from instant-to-instant, with the signal or switch current fed to it.

A fixed, stable voltage is frequently required when powering an electronic circuit. That constant voltage is not present when there are either supply-voltage or load variations. As we discussed earlier in this series, a fixed voltage developed across a Zener diode can be used to stabilize the voltage across a load if the Zener is placed across that component or circuit. That is fine where low currents are involved. But when large quantities of current must flow through the load, the Zener diode can seldom be used economically as the sole regulating device for the circuit. Series, parallel, and feedback circuits using Zener diodes along with one or more transistors have been developed as practical regulators.

Series regulators

In the series-regulator circuit, DC current flows from the unregulated portion of the DC power supply through a transistor to the load. If the circuits are like the ones shown in Fig. 5, the voltage across the load is regulated. In both of those circuits, current flows through R_1 and Zener diode

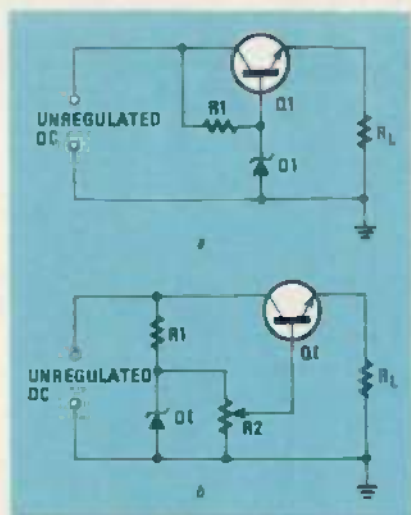

FIG. 5—SERIES REGULATOR CIRCUITS. The one in a provides a fixed voltage while the output from the one in b can be varied using R_2 .

D_1 which causes a fixed voltage to be developed across D_1 . In Fig. 5-a, current flowing through R_1 also flows through the base-emitter junction of Q_1 . A fixed voltage, about 0.6 or 0.7 volt, is developed across this junction, turning on Q_1 . The voltage between the emitter of Q_1 and ground, or across R_L , is about 0.7 volt plus the voltage across D_1 . That fixed voltage is across R_L regardless of supply-voltage or load variations.

In that circuit, little current flows through the Zener diode. What does flow is limited to safe values by R_1 . The current that is supplied to R_L flows through Q_1 . If the required load current is high, Q_1 should be rated adequately and mounted on a heat sink. Circuit components must be chosen so that the transistor is not in saturation at any time.

The regulated output-voltage can be varied by simply placing a potentiometer across the Zener diode and connecting its wiper, rather than the cathode of D_1 , to the base of Q_1 . That is shown in Fig. 5-b. Now, the voltage across R_L is the sum of the voltages between the wiper of the potentiometer and ground, which is the voltage between the base and emitter of the transistor. Resistor R_1 must be selected so

that the proper current is available at the base of Q_1 to keep it turned on and out of saturation at all times.

Several improvements can be made in the circuit shown in Fig. 5-a. Those are shown in Fig. 6.

In order to achieve good regulation, the Zener diode should see a high impedance. In Fig. 5-a it sees an impedance equal to R_L multiplied by the beta of Q_1 . To increase the impedance, a Darlington circuit can be used rather than an individual pass transistor. Such a Darlington pair is shown in Fig. 6 as Q_1 and Q_2 . The impedance seen by D_1 in that circuit is essentially the product of the betas of the two transistors multiplied by R_L .

To further improve regulation, a constant current should be applied to D_1 and to the base-emitter circuits of the series transistors. The circuit around Q_3 establishes that constant current. Current flows through D_3 , D_4 , and R_1 due to the voltage from the unregulated DC supply. The voltage across the two forward-biased diodes, D_3 and D_4 , is relatively fixed at 1.4 volts (0.7 volt across each diode). That voltage is between the upper end of R_2 and the base of Q_3 . Because the base-emitter junction of Q_3 is turned on at 0.7 volt, the balance of the 1.4 volt, or 0.7 volt, is across R_2 . The fixed emitter current, in milliamps, is $0.7/R_2$. The collector current is just about equal to the emitter current of Q_3 and the collector and emitter currents do not fluctuate to any degree. The collector current is applied to the Zener diode and base of Q_2 . Resistor R_2 is selected to set the current at the desired level.

In the event that a short is placed accidentally across R_L , excess current will flow through Q_1 , which is likely to destroy the device. The circuit around Q_4 performs the function of protecting Q_1 in the event of a short.

Transistor Q_4 is turned off when the current flow through the circuit is at its normal level. It remains off until the current flowing through R_4 , which is also the current through the load, is sufficient to develop about 1.4 volts across the resistor. Notice in Fig. 6 that Q_4 's collector is

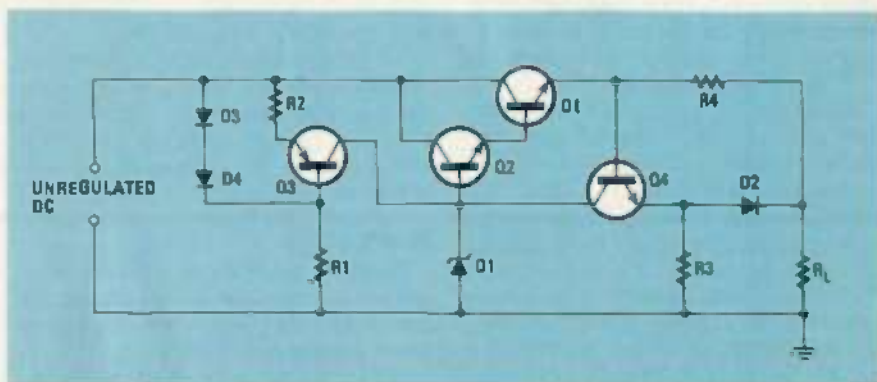

FIG. 6—THE BASIC SERIES regulator circuit can be improved by using a Darlington pair in place of Q_1 and adding a constant-current source.

connected to the junction of Q2, Q3, and D1. When Q4 is on, it draws the bulk of the current from Q3 so that insufficient current remains to fully turn on the base-emitter junctions of Q1 and Q2. That also reduces Q1's collector current. Thus, less power is dissipated by Q1, preventing it from being destroyed due to the presence of an excessively heavy load.

Parallel regulators

There are two types of parallel regulator circuits—one supplying a voltage that is only slightly lower than the breakdown voltage of the Zener diode used in the circuit, and one supplying a voltage that is considerably higher than that of the diode. Both are shown in Fig. 7.

In Fig. 7-a, current flows through R1, D1, and the base-emitter junction of Q1. Fixed voltages are developed across D1 and the base-emitter junction of Q1. The sum of those two voltages is the regulated voltage applied across R_L.

In Fig. 7-b, current flows through R1, R2, the base-emitter junction of transistor Q1, and Zener diode D1. A fixed voltage is developed between the emitter and collector of Q1. The circuit's regulated output, V_R, which is across R_L, is equal to the sum of the Zener voltage, V_Z, and the voltage developed across Q1. It can be shown that that voltage is equal to:

$$V_Z \left(\frac{R_2 + R_3}{R_3} \right)$$

Resistor R4 is critical in and must be selected by trial and error. That resistor should be selected for the minimum variation of voltage across R_L as the unregulated input voltage is varied from its minimum to its maximum.

Performance can be improved by using Darlington pairs rather than individual transistors and by replacing R1 with a constant-current source.

Feedback regulators

A commonly used series regulator-circuit using feedback is shown in Fig. 8.

Current from R2 flows into both the collector of Q3 and the base of Q2. Because of D1, the emitter of Q3 is at a fixed voltage with respect to ground. Note that the regulated voltage is across R_L as well as across R3 so that R3 can be used to adjust the voltage across R_L.

Should voltage V_R across R_L increase above the desired level, the voltage at the base of Q3 rises. That transistor conducts more heavily than when V_R was at its proper level. The base of Q3 is then more positive with respect to its emitter than it was when the level of V_R was correct. That causes the transistor to draw more current than it did before from R2, reducing the amount of current previously available for the base of Q2. Because current through Q2, and consequently the current through Q1, are reduced, less cur-

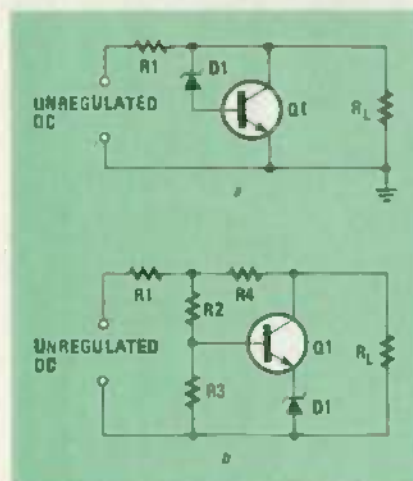

FIG. 7—PARALLEL REGULATOR CIRCUITS. The output from a is 0.7 volt above the Zener breakdown voltage; the output from b is considerably higher.

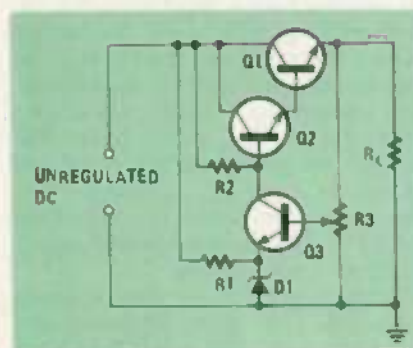

FIG. 8—THIS REGULATOR circuit uses feedback.

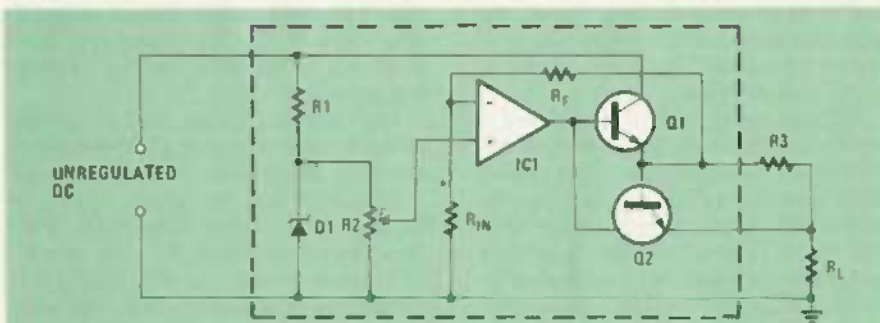

FIG. 9—REGULATOR CIRCUITS are commonly found in IC form. The circuitry within the dashed box is usually contained in the IC.

rent than before remains for R_L.

In the opposite condition, when the voltage across R3 and R_L is below the desired fixed level, less current flows through Q3. More current is now available to flow through Q2 and Q1, rebuilding the output voltage to its desired level.

IC regulators

Figure 9 shows a typical IC regulator and some of its surrounding circuitry; the part of the circuit enclosed by the dashed box is usually part of the IC.

A fixed voltage is developed across D1. A portion of that voltage, as set by R2, is applied as a reference voltage to the non-

inverting input of the op-amp. The output from the op-amp is passed on to Q1. The voltage at the emitter of Q1, which is close to the voltage at the output of the op-amp, is fed back through R_F to the inverting input terminal of the op-amp. That inverting input is connected to ground through R_{IN}. The voltage at the inverting input, and at the emitter of Q1, is equal to the voltage at the non-inverting input multiplied by 1 + (R_F/R_{IN}). The output voltage is therefore fixed by the voltage across D1, the setting of R2, and the ratio of resistors R_F and R_{IN} at the inverting input.

In Fig. 8 we've added a circuit to protect against damage in the event there is a demand for excessive current from the regulator. Excess current flow can not only damage a transistor, but can destroy an op-amp, and consequently an IC. Transistor Q2 is in the IC to protect it from being damaged. When excess current flows, sufficient voltage is developed across R3 to turn on Q2. When turned on, the base-collector circuit of Q2 is across the base-emitter circuit of Q1, preventing it from conducting excess current.

Crowbar circuits

A crowbar circuit is used to prevent damage to a regulated power supply in the event a high voltage is applied across the load. In the arrangement shown in Fig. 10, the inverting input of the op-amp is fixed at the breakdown voltage of D1. Resistors R2 and R3 are selected so that with normal voltage across R_L, the voltage at the non-inverting input of the op-amp is

less than the voltage at the inverting input and the output from the op-amp is negative. The gate of SCR1 is then also negative with respect to its cathode so the SCR remains off.

When a high voltage is applied across R_L, the voltage across D1 and at the inverting input of the op-amp, remain fixed. But the voltage at the non-inverting input increases. Divider resistors R2 and R3 should be selected so that the voltage at the non-inverting input exceeds that at the inverting input when a high voltage from an external source is applied across R_L. When such a high voltage is across R_L the

continued on page 101

Compatibility

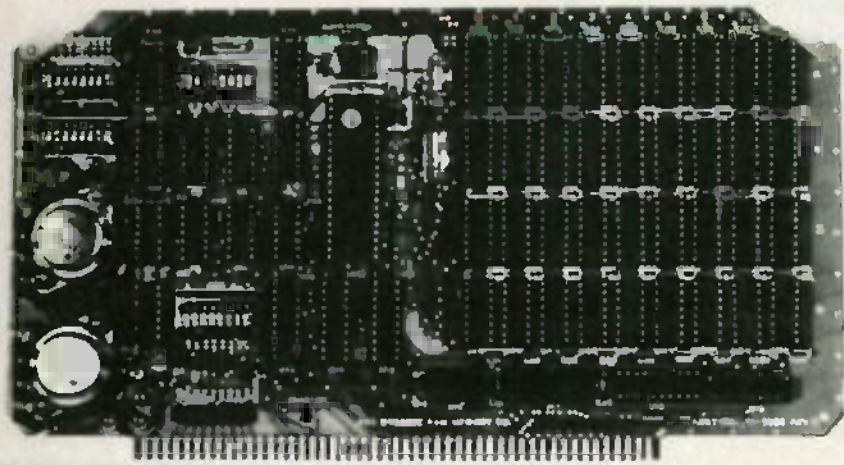

FIG. 1—BEFORE YOU BUY an accessory board for your computer, try to see it in action and make sure that it won't conflict with other boards you have installed in your computer.

THE BIG QUESTION THESE DAYS, AFTER YOU UNPACK YOUR computer, is not "Will it work?" or "What can I do with it?" but "Will it work with all the other stuff I bought to go along with it?"

If all your equipment—let's say your computer, printer, and disk drives—as well as your software came from the same manufacturer, everything *should* have been designed so there would be no conflicts, and you should be merrily on your way in no time at all to whatever it is you are going to do with your computer.

If, on the other hand, you decided that you liked the features of the "Brand Y" printer over those of the printer available from the manufacturer of your "Brand X" computer, you may find that the two refuse to communicate with each other, despite claims from both sides about their supposed compatibility.

Similarly, you may find that the word-processing software you bought by mail order: a) generates a display too wide for your video screen, b) won't output to your printer, or c) won't even run on your computer!

After you've asked the *big* question—Why?—the next question should be "What did I do wrong—and how can I avoid doing it again." What follows will, we hope, guide you in selecting a computer system all of whose parts will work together smoothly and without giving you cause to regret your investment.

Compatibility

If one piece of equipment is described as being compatible with another, that is usually taken to mean that the two will work together without problems. In the world of computers, however, that is not always the case.

Consider, for instance, the case of a computer with a "Centronics-type" printer port and a printer from another manufacturer that is "Centronics compatible." Centronics, a pioneer in microcomputer printers, uses a parallel interface where each specific line brought out for connection to the computer serves a specific function and, if there are timing requirements, as is the case with the strobe lines, the characteristics of the timing pulses are strictly defined. Centronics also uses a special connector on its printer cables. All Centronics printers use the same scheme.

Radio Electronics
YOUR OWN
Software



Compatibility and Standards

With so many different computers, peripherals, and types of software to choose from, how can you be sure of putting together a system in which everything will work together?

ABE ISAACS

Centronics, however, does not manufacture computers—or other printer brands. If a computer manufacturer claims that the parallel printer port on his computer is Centronics-compatible, you would assume that he has carefully studied Centronics own specifications and matched his device to them. That is frequently not the case. There are a number of possibilities.

His timing could be different from that specified by Centronics, which would cause the printer to print "garbage," if, indeed, it printed anything at all. His pinout—the way the functions of the various lines are assigned to the pins of a connector—may be different from Centronics'. Again, more garbage, or nothing at all. He may not use a Centronics-type connector. In fact, the closest that some Centronics-compatible interfaces may come to being Centronics compatible is the fact that they are parallel rather than serial!

In the world of microcomputers—a world that is splintered into a large number of so-called standards, each of which is considered by its proponents to be the best—true compatibility is something more often dreamed of than accomplished.

A few standards really do exist in the industry: the RS-232 serial communications protocol (along with a frequently adhered to definition of which line is used for which purpose), the S-100/IEEE-696 bus used in a number of "serious" computers, the IBM 3740 format for single-sided, single-density eight-inch floppy disks, the CP/M operating system, and a few others.

Unfortunately, while those standards have been defined, they are not always adhered to. Add to that fact all the other "standards"—many of which are used by only one manufacturer—and you have a situation best described as...chaotic.

Our advice to the innocent is: **Never believe anything you're told or that you read! No matter how "standard" something is claimed to be, or how compatible it is supposed to be with something else, don't believe that's the case unless you actually see proof of it for yourself.**

Hardware

Fortunately, hardware compatibility is not a big problem these days. If you buy an I/O (input/output) or memory board (see Fig. 1) that's claimed to work in an Apple or IBM computer, it probably will.

Of course, there may be a requirement that the board reside in a particular slot (receptacle) in the computer. Be sure that that you don't require that slot for something else. Also, make sure that the memory space that the board occupies, if it requires a memory location, doesn't conflict with the memory requirements of other hardware—or software—you may be using.

How can you be sure that one piece of equipment will work with another? You can't, at least not from the manufacturer's or vendor's descriptions. The only guaranteed way to know whether board "Y" will work in computer "X" is to see that board in action for yourself in the computer in question. Then, and only then, can you begin to feel safe about buying it for yourself. Don't forget though, that you may own a board "Z" that can upset the applicart. If at all possible, find a vendor who can show you the piece of equipment you're interested in actually working in an exact duplicate of your own system.

One of the big hardware "gotcha's" (as in "Aha! Got ya!") is connectors and cables. In the first place, be aware that many items that require cables, such as disk drives and printers, are frequently sold without them. Make sure when you place your order that all the cables required to use a device are either included in the purchase price, or are available optionally. If they are options, find out exactly what you need, and order it with the equipment.

Do not assume that a salesperson knows what type of cables you require. Spell it out. Indicate that you have a Brand-X computer (and add, if necessary, that the cable will be connected to a Brand-Y board within the computer). Tell him how long the cable has to be. And, if there are any "funny" connectors involved, give him that information, too.

Disks

Floppy disks come in two diameters: 8-inches and 5¼-inches. (There's a batch of under-4-inch disks coming over the horizon, but until they start to show up in force, and a "standard" is established—there are at least three different sizes being offered for sale—don't worry about them.) That really doesn't present much of a problem when you have to go out and buy disks—if there's any doubt in your mind as to what size your system needs, use a ruler.

The fun begins when we start looking at how the disks are set up for sectoring. (Sectoring is the process that divides the surface of the disk into small—usually 128-byte—sections that the computer can easily keep track of). Disks can be hard sectored or soft sectored. Examples of both types can be seen in Fig. 2.

All floppy disks have an index hole. That hole tells the computer when the rotating disk has come full circle and indicates the beginning of the first sector on it. That is the only hole found in soft-sectored disks (a soft-sectored disk is shown in Fig. 2-a). The actual sectoring is performed by the computer when the disk is formatted (a process we'll mention briefly below). Perhaps because the operation is performed by software, those single-hole disks are referred to as soft sectored.

Hard-sectored disks, however, in addition to having an index hole, have sector holes that serve to indicate where the sectors begin. The term "hard sectored" may have originated because the sector determination is done by hardware. As can be seen from Fig. 2-b, there are several types of hard-sectored disks. Eight-inch ones have 32 sector holes, but 5¼-inch hard-sectored floppies can have either 10 or 16 holes. It is important for you to know which type of disk your system requires, because if you try to use the wrong one, it just won't work.

Fortunately, with a few exceptions, most systems these days use soft-sectored disks. Sometimes you have the choice of buying blank floppies formatted or unformatted. Formatting determines the number of tracks on the surface of the disk—sort of like the grooves on phonograph records—that will be used for writing and reading data. (In the case of soft-sectored disks, it also performs the sectoring operation). Since your computer will undoubtedly come with a program that formats blank disks, your best bet is to buy unformatted ones. Not only can you save a little



FIG. 2—A SOFT-SECTORED disk, shown in a, has a single index hole. However, the number of sector holes in a hard-sectored disk varies. Shown in b is a hard-sectored 8-inch disk with 32 sector holes, a 5¼ disk with 10 sector holes and another with 16 sector holes.

money, but, by having your computer do the formatting job to its own specifications, you will always get what you need.

You should also know whether your computer uses single-sided or double-sided disks, and whether it can record (and read) both single- and double-density disks, or single-density ones only. Double-sided, and double-density, disks both have twice the capacity of their single-sided or single-density counterparts. A disk that is both double-sided and double-density will have four times the capacity of a single-sided, single-density one.

A computer that can make use of the higher-capacity media can almost always use the simpler ones, but the reverse is not true. A double-sided disk will be of no use in a single-sided drive. In fact, it may not work at all! And, while a blank disk that's certified for double density recording will work in a single-density drive, it's a waste of money. It's alright to spend money for high-quality disks, but it's ridiculous to waste it on features you can't use.

Software compatibility

Assuming that you have not encountered any hardware problems, or that you have overcome the ones you have run into, you are now ready to face the question of software compatibility. That is—will a particular program work with your system? There are both hardware and software aspects to the problem, and they sometimes tend to overlap. Bear with us, though, and we'll try to make things clear.

The first obstacle we'll deal with concerns *machine dependency*, and it, too, can be broken down into two parts. The first has to do with the type of microprocessor used by the computer. There are several different microprocessors used in personal computers—among them the Z80, 6502, and 8088—and not one of them is directly compatible with any of the others! A program written for a computer like the IBM PC, which uses an 8088, will not work at all on a computer like the TRS-80 Model IV, which uses a Z80, or on the Apple IIe, which uses a 6502. While there are a few exceptions (programs written for the 8080 microprocessor will run on a Z80, for instance; the reverse, however, is not necessarily the case), it is safe to assume that if a program does not specifically indicate that it is intended for use on the type of computer you own, it will not run.

CP/M software (see the article on the CP/M operating system in last month's *Radio-Electronics* and the discussion of CP/M below) will run both on computers using 8080's and Z80's. That is, most of it will. Some of it is written using Z80 instructions

that the 8080 can't understand...and the ads don't always advise you of the fact. If you're not sure whether a program will work with your computer, ask! Better yet, get someone to show it to you running on a system like yours.

The second part of the machine-dependency problem has to do with the computer's physical configuration—particularly the way its display is set up. As an example, let's consider a TRS-80 Model III and another Z80-based computer. But, while the keyboard and video screen of the TRS-80 are an integral part of the computer, the other computer uses a separate terminal connected to it through an RS-232 serial communications port.

What's the difference between the two? First, the TRS-80 uses what's called a memory-mapped display—every one of the 1024 individual locations on its 64 × 16 display has a corresponding byte of memory allocated to it. That means that you can make characters or graphics symbols show up in any one of those locations by putting data directly into the corresponding memory address.

You can't do that with an ordinary terminal. It has its own, more complex, system for displaying information, one that has nothing to do directly with the contents of the computer's memory.

The other big difference is that while the Model III's display is an array of 64 columns by 16 lines, most terminals are set up to display at least 80 columns by 24 or 25 lines.

Now imagine that you buy a program with graphics that you want to use on both computers. How do you do it? You can't! If the program was written for the TRS-80, the method used to generate the graphics won't work on the terminal. If, on the other hand, it was written for use on an 80-column terminal, the lines won't fit on the TRS-80's 64-column screen; they'll break at the wrong places, and columns of figures won't line up.

There's not much you can do about incompatibilities caused by machine-dependency except to try to avoid them from the start by choosing your hardware and software with great care.

Machine dependency: software

The other big computer-compatibility problem stems from computers that are supposed to be compatible with other computers, and it, too, involves both hardware and software. For example, even if a program is stated to be "IBM-compatible," and you own an "IBM clone"—a computer that claims it works just like the IBM—there is no guarantee that it will run on your system. Why should that be? After all, the displays are the same, the disk sizes are the same, even the expansion buses are the same. Why shouldn't it work?

The answer lies in the fact that, while IBM made public many specifications of its computer, it did not divulge the full details of the operating system contained in its ROM (Read-Only Memory). And, while IBM made no fuss over other companies' bringing out IBM-compatible memories, I/O boards, and the like, it would certainly have a fit if someone were to duplicate its copyrighted operating system. (That, by the way, is why Apple is so upset about the Apple II look-alikes that are finding their way into this country from overseas—the ROM's contained by many of those computers are exact duplicates of Apple's own.)

Much software for the IBM PC depends heavily on what's in IBM's ROM's. This is particularly true for graphics, but applies to a number of other areas as well. And, since the IBM clones can't duplicate IBM's ROM's, a lot of that software doesn't work. If you want to buy a program for your IBM clone, make sure that you see it running on a machine like yours before you commit yourself.

Another thing to watch out for is programs that imply that they will run on a computer like the IBM PC as well as on other totally unrelated computers like the TRS-80 family or the Apple II family. Each one of those families, as we mentioned earlier, uses a different microprocessor, and none can understand the language of the others.

It's possible that, if a program exists that will allow a computer using one disk format to read disks made using another format (and such programs do exist), a computer from one

family will be able to load a program written for another into its memory. But that's as far as it will go. A program written for one microprocessor will be unintelligible to another.

The last area of software compatibility—if you still believe in such a thing—brings us back to hardware. We briefly discussed disk formats earlier, regarding the various types of disks that are available. What we didn't mention was the fact that almost every computer manufacturer has his own system for recording on the disks. A recent look at an ad from a major software distributor showed at least 20 different formats available, and there were many computers that weren't included in the list.

Fortunately, you'll probably find your computer on the list of some software distributor. In addition, some computers, like the Kaypro II, (see Fig. 3) can read disks written in several different formats. Once again, don't buy anything unless you know that it will work with your system.

BASIC

BASIC (Beginner's All-purpose Symbolic Instruction Code) has become the *de facto* high-level microcomputer programming language. There are plenty of others available—Pascal, C, and Pilot, to name a few—but the majority of the high-level-language programs around are written in BASIC.

As you may have guessed, there are almost as many dialects



FIG. 3—THE KAYPRO II shown here, can read several different disk formats.

of BASIC as there are computer manufacturers. That is especially true of computers that have BASIC built into their ROM's. Those BASIC's are heavily machine-dependent, and a program written for one system will not run on another. Interestingly enough, most of those BASIC's have the same origin, a company called Microsoft. However, each computer manufacturer who contracts with Microsoft to create his BASIC also specifies the "peculiarities" of his system (what math functions he'll need, what graphics functions he'll want, what addresses his display memory occupies, etc.). It makes for a real can of worms, and there's no easy solution, at least for "budget" computer systems.

If you can get a listing of a program you want to run, but it doesn't quite fit your BASIC, you may be able to make it work by referring to a book called *The BASIC Handbook*, by David A. Lien (Composoft Publishing, 535 Broadway, El Cajon, CA 92021). It's an encyclopedia of BASIC statements and, if you come across one that is unfamiliar to you (and your computer), the book frequently suggests a substitute that may work.

For CP/M-based systems there are several BASIC's that are "standard," and software originators almost always specify which BASIC is needed to run their programs.

Disk operating systems

Every computer that uses disk drives also uses a disk operating system, or DOS. It allows the computer to store data on, and retrieve it from, the disk. It also provides a number of useful facilities, such as the abilities to list a directory of all the files (programs and collections of data) on the disk, to copy files from one disk to another, and to erase files that are no longer needed.

Almost without exception, DOS's are machine-dependent. An Apple DOS will not work with an IBM computer, and neither IBM's nor Apple's DOS's will work with, say, one of Commodore's computers.

Most of the time that will not be a problem for you—you'll purchase programs that were written to run with your DOS on your computer. Lately, though, a number of programs have been advertised that would appear to run under the various DOS's used by IBM and the companies that make IBM work-alikes.

IBM's DOS is known as PC-DOS or MS-DOS (the "MS" stands for "Microsoft"—who else?). A similar DOS used by the Heath/Zenith HIZ-100-series computers is called Z-DOS. You can be led to believe that the two are compatible, but in a number of ways they are not. Again, the problem appears to lie in the computers' ROM's. Still, software is advertised that would lead you to believe that it can be run on either computer. Beware! See the program running before you buy it. In some cases you'll find that there are several versions of a program, each tailored to a particular computer. Make sure you buy the one intended for yours and, if there's any question, don't make your purchase until you know it will work for you.

There are a number of IBM-type systems around, but they don't all work like PC's.

CP/M

Believe it or not, there is a DOS that is compatible with a large number of computers, that has a vast library of programs available to run under it, and that is recognized as a standard. It's the CP/M operating system that we've mentioned here from time to time.

CP/M stands for Control Program for Microcomputers. (Actually, it originally stood for Control Program Monitor, but as its popularity grew, it changed its name.) It will run on any computer that uses an 8080, 8085, or Z80 microprocessor. Its universality lies in that fact that it does not rely directly on ROM-based routines to communicate with the computer or with its peripheral devices like printers and terminals.

Instead, it treats such peripherals as what are known as "logical devices." A logical device can be considered to be a generalization. In other words, a program running under CP/M does not have to be told that you are using a Brand-A terminal and a Brand-B printer connected to a Brand-C computer. When the time comes for the program to direct its output to your printer, it tells CP/M to take care of it. A CP/M-based program doesn't care whether you're using a terminal or a memory-mapped video display. If the output is to go to a modem connected to a telephone, CP/M knows how to get the data there—such tasks no longer become the responsibility of the program or of the computer, and, for that reason, CP/M software is *transportable*—it can be used on any CP/M-based system.

The CP/M operating system itself must, of course, be tailored to your system so that it knows how to communicate with the computer and whatever peripherals you may have. That job is usually done by the company that supplies the CP/M for your system; it may be the manufacturer, or it may be the company that sold you the computer. In any case, you hardly ever have to worry about setting it up yourself and, once you learn to use it, a world of programs of every sort opens itself up to you.

CP/M is available for just about any computer you can name. If the computer doesn't use an 8080, 8085, or Z80, there is usually a Z80 adaptor available for it. Microsoft makes one for the Apple II series, and a company called Microlog makes a board containing a Z80 for the IBM PC. Several manufacturers

supply modification kits that allow Radio Shack's Z80-based TRS-80 computers to run CP/M. And, as we'll see, there are versions of CP/M for other types of computers, too.

Different CP/M's

The original CP/M, which runs on computers using the 8080, 8085, or Z80, is known as CP/M version 2.2. (That is the most recent version—there was originally a version 1.0, and later versions 1.4 and 2.0.) It is frequently offered as part of a package included in the price of a number of computers. If your version bears a number like 2.21, the last digit refers to the latest revision made by the company that supplied you with the CP/M. You may also see CP/M 2.2 advertised as CP/M-80.

Digital Research, the originator and supplier of CP/M, recently introduced a CP/M version 3.0, more commonly known as CP/M Plus. It is intended for use on large systems, or for the serious programmer. In addition to having an on-screen HELP function, CP/M Plus also allows you to "stamp" your files with the time and date you work on them. It can also address larger amounts of memory than CP/M 2.2 and, in the case of floppy disks, is faster.

If you should see CP/M Plus advertised by itself, and not already configured for a specific system, *don't buy it!* Configuring CP/M Plus is a job only for someone who has a thorough knowledge of assembly-language programming, and is on intimate terms with his system.

There is also a CP/M-85. This is, as far as we can tell, identical to CP/M-80. The reason for adding the numbers to the different CP/M's is to indicate which microprocessor family they work with. CP/M-80, as we've said, works with the 8080 and Z80 microprocessors (and the 8085). Manufacturers marketing 8085-based systems sometimes call the CP/M they offer CP/M-85, presumably in honor of their equipment.

CP/M-86, on the other hand, is quite different from the versions we have mentioned so far. It is a higher-performance version of CP/M than version 2.2 (CP/M-80) but is specifically designed for 16-bit 8086- and 8088-based computers like the IBM PC, which uses an 8088. It is faster than CP/M-80, and takes advantage of the 16-bit microprocessor's ability to address large amounts of memory.

It is compatible with CP/M-80 only to the extent that both use the same system for keeping files on disk. That means that a file—like a document created using a word processor—can be created on a Z80 computer, for example, and read by an 8088-based one. It does not mean, as some advertisers may lead you to believe, that a program written for a computer using an 8080 or Z80 and running CP/M will work on an 8088-based system. That won't work! If you're using an 8088-based computer, stick to 8088 software!

Concurrent CP/M-86 is a version of CP/M-86 for use on single-user systems that allows the computer to perform more than one task at a time.

MP/M II, for 8080/Z80 computers (MP/M-86 for 8086/8088 computers), not only allows a computer to perform several tasks at once, it also permits several people to use the same computer at the same time. It is called a multi-user, multi-tasking operating system and can support up to 16 users, 16 printers, and 16 disk drives with 512 megabytes of storage each.

Two other types of CP/M are CP/M-68K and CP/NET. Due to space restrictions we won't discuss them. But suffice it to say that there's a CP/M for almost everyone, and thousands of programs of every sort to go with it. This article was written on one CP/M-based computer, and the material stored on disk was edited on another one from a different manufacturer. The edited material was transmitted by modem to still another CP/M system (from a third manufacturer), where it was prepared for typesetting.

Don't be frightened by all the examples of incompatibility you've read here. Instead, just be aware such pitfalls exist, and that—knowing in advance what to watch out for—you're likely to wind up with a smooth-running system that does everything you intended it to, and *nothing* that you hadn't expected. R.E

UNGAR DESOLDERING & SOLDERING

Special Pricing... Special Free Offer

Hot VAC Desoldering System



Reg \$599.95
OUR SPECIAL PRICE
\$379.95

Model 4000

Built-in vacuum pump eliminates the need for shop air. Compact design and portability make it ideal for use at any location where there is an AC electrical plug-in outlet.
Self-Contained, Super-Quiet Air Pump: The vacuum pump is not only virtually maintenance free, it is remarkably quiet. The pump operates only when the handle switch is actuated.
Temperature Control: Variable solid-state control that adjusts the tip temperature from 500° - 1000°F. An electric circuit assures that transient spikes are fully suppressed thereby making the system safe for desoldering voltage-sensitive components.

Electronic Temperature Controlled Soldering System with Built-in Controller

OUR SPECIAL PRICE
\$89.95



Model 9100

Includes: base unit with built-in controller, micro-size handle with THERMO-DURIC heater, 1/16" #9012 screwdriver tip, sponge and tip tray, sponge and Iron Holder. A low cost alternative in an operator-adjustable, temperature controlled soldering system.
 • Electronic, closed-loop temperature control for maximum precision • Temperature is operator-adjustable from 400 F to 800 F • Continuous, variable control so you can select the exact temperature you need • Neon "on-off" light • Iron Holder can be right or left hand mounted to accommodate all operators.

FREE UNGAR 9100
 with purchase of
 Ungar 4000

TOLL FREE (800) 645-9518

FORDHAM

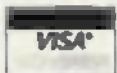
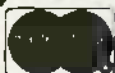

260 Motor Parkway, Hauppauge, N.Y. 11788

In N.Y. State 800-832-1446

- VISA ■ COD ■ Master Charge
 - Money Order N.Y. State residents add appropriate sales tax.
 - Check
- COD's extra (required 25% deposit)

ADD FOR SHIPPING AND INSURANCE

\$250.00	\$4.50
\$251.00 to 500.00	6.50
501.00 to 750.00	8.50
751.00 to 1000.00	12.50
over 1000.00	15.00

FORDHAM DISCOUNTS DISCOUNT PRICES ON HITACHI SCOPES

SPECIAL OFFER!
 For a limited time only

35 MHz DUAL TRACE SIGNAL DELAY LINE

Vertical sensitivity 5m V/div to 5V/div and 1m V/div to 1 V/div with 5X amplifier • Trigger modes Automatic, Normal, TV (+), TM(-)

REG \$895
OUR PRICE
\$599.95
 WITH PROBES

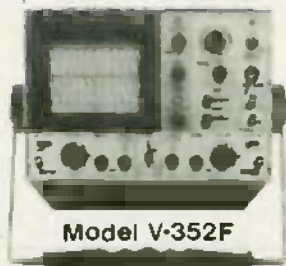

Model V-352F

60 MHz DUAL TRACE DELAYED SWEEP

High sensitivity • 1 mV/div (10 MHz) • 5 ns/div sweep rate
 • 3rd channel display (trigger view) • Variable trigger hold-off
 • Full TV triggering • Single sweep • Automatic focus correction

OUR PRICE
\$995
 WITH PROBES



Model 650F

100 MHz QUAD TRACE DELAYED SWEEP

Large, bright 8x10 cm screen
 • Quad trace operation/Ch1, Ch2, A trigger and B trigger • High sensitivity 500 μ V/div (5 MHz)
 • Full TV triggering

OUR PRICE
\$1299.95
 WITH PROBES

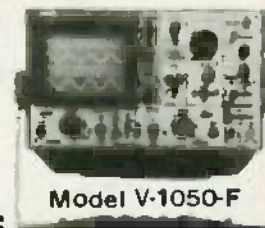

Model V-1050-F

TOLL FREE (800) 645-9518

FORDHAM

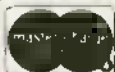

260 Motor Parkway, Hauppauge, N.Y. 11788

In N.Y. State 800-832-1446

- VISA ■ COD ■ Master Charge
 - Money Order N.Y. State residents add appropriate sales tax.
 - Check
- COD's extra (required 25% deposit)

ADD FOR SHIPPING AND INSURANCE

\$250.00	\$4.50
\$251.00 to 500.00	6.50
501.00 to 750.00	8.50
751.00 to 1000.00	12.50
over 1000.00	15.00

MARCH 1984

HOBBY CORNER

Sensing circuits

EARL "DOC" SAVAGE, K4SDS, HOBBY EDITOR

THIS MONTH, WE'LL BEGIN OUR DISCUSSION with three related questions. The first one is from George Rodriguez (FL) who is looking for a device that will give an indication when a certain circuit in his car is activated. We assume that he has considered all the obvious ways to do so, which would include using a mechanical relay, an SCR or a Triac.

The related questions are from S. Kinsey (NY) and Kelly Walder (FPO, NY), who asked about using a coil to detect the presence of current in a circuit. A part of the answer to George's inquiry applies to the needs of those fellows, which brings into play three more ways to detect an activated circuit. Those methods are: (1) a phototransistor switch, (2) a sensing coil, and (3) a series dropping resistor. We'll give you the basic ideas behind each of the three so that you can choose the one that best suits your needs.

Phototransistor switch

If the circuit contains a light-producing device (panel lamp, trunk light, or overhead light) you can couple a phototransistor switch to it. Here, the phototransistor is activated when the light goes on and that, in turn, switches on an alarm circuit or other such device. That is a straightforward application and you should need no further details.

Sensing coil

The second sensing method uses a coil to take advantage of the relationship between current and magnetism. (Kelly and Kinsey, are you reading?) What we're going to do is to make a simple transformer. Take a look at Fig. 1-a: As you can see, coil L1 is carrying a current and that current generates a magnetic field about the coil. Now, let's put another coil, L2, right next to L1, as shown in Fig. 1-b. The

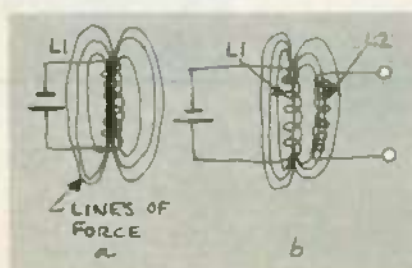

FIG. 1

second coil, L2, is affected by the magnetic field (lines of force) that surround L1.

Every time the lines of force from L1 cut across the wires in L2, a voltage is generated or induced in L2. (Note that the key word here is "cut".) If neither the coil nor the lines of force are moved, there'd be no voltage generated in the second coil. In other words, when more or fewer lines cut across the wire (or the field intensity is varied) a voltage is induced in the second coil. (A mechanical generator moves the coils, but a transformer moves the lines of force.)

Let's try a little experiment. It's not much trouble and it will help you to understand the principles involved here. Besides, nothing beats "hands-on" experience. In addition, you'll have a head start in designing a circuit to suit your specific needs. All that's needed is a flashlight battery; a flashlight bulb; a couple of coils, and a low-range voltmeter. The coils can be made, bought, or salvaged from almost anything—we've used coils from relays, RF chokes, hand-wound coils of few or many turns, and even two spools of hook-up wire. (Incidentally, you can wind a coil easily by putting a nail or wooden dowel in a drill and feeding the wire on as it turns.)

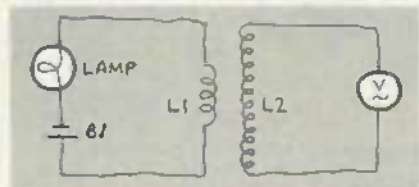

FIG. 2

Place the coils side-by-side and wire-up the circuit as shown in Fig. 2. Let the larger coil (the one with the greater number of turns of wire) be the output coil. Have it all done? What's happening? Nothing! Remember that L2 must be cut by the lines of force that surround L1. As you can see, at this point L2 is just lying there in the magnetic field and the result is nil (as far as this experiment is concerned).

One way to cause the cutting action is to move one of the coils. Let's very quickly move coil L2 away from L1, you should see an indication on the meter. Now, put it

back and you will see another indication. Say, that's fun, but it's a heck of a way to get an output and very tiring, to say the least! Let's get the cutting action another way. With the coils side-by-side again, make and break the current path by turning the bulb on and off (the bulb acts as the switch in the circuit). Each time the bulb is turned on or off you will get an indication on the meter. Obviously, the wires of the coil are being cut by the magnetic lines of force. How?...When the current in L1 is turned off, the lines collapse into (or tighten-up around) L1, cutting across the wires of L2 in the process. When the current in the circuit is turned on, the magnetic field around L1 expands and L2 is again cut by the lines of force. Another way of saying that is: When the field around L1 is varied in intensity the magnetic lines of force cut across the wires of L2 and thus induce a voltage in L2.

Now, take the bulb out of the circuit (temporarily) and make and break the circuit. The meter will jump higher because there is a greater current flow in the circuit without the bulb to limit it. Actually, you've made a crude transformer and that experiment has also shown why a transformer will not work on DC current (no cutting of wires by lines of force). As you know, AC current reverses itself with each half-cycle, in effect, turning the current on and off with each alternation.

There are several variations of that experiment that you should try while you have the circuit set up. First, add an automatic "maker/breaker" to the circuit. That can be done in either of two ways. One way is to put L1 in series with an LED and connect it to the output of a 555 astable oscillator (see past issues of the "Hobby Corner" for 555 circuits). The 555 will turn the current on and off faster and more regularly than you can, without getting tired. An easier way is to apply an AC voltage to the input as shown in Fig. 3. Either method will give a constant input and enable you to get a meaningful output measurement.

Here are the variations you should try. Don't forget to make a record of the output measurements. If either or both of your coils do not have iron cores, stick a nail through the center and watch the effect that that has on the output. Try the

coils in various positions—side-by-side, end-to-end, parallel, perpendicular, close, and not-so-close. Exchange those coils for others that you have on hand and try them in various combinations.

One final experiment: Wrap a dozen or so turns of wire around your output coil and use those turns for the input coil. Measure the output of the base coil. Now take off all but three or four turns of the input coil. Measure the output and compare it with the previous measurement. By this time you have learned a lot by observing the results of your experimentation.

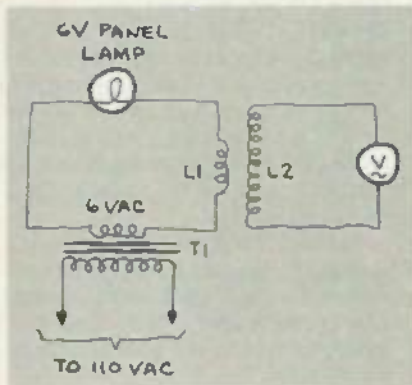

FIG. 3

Let's summarize:

1. Iron cores give greater output than air cores.
2. The closer the coupling of the coils—that is, the closer the input and output coils are positioned—the greater the output.
3. The closest coupling (and greatest output) is obtained when one coil is wound on top of the other.
4. The greater the ratio of the number of turns on the coils (output to input), the greater the output.
5. The greater the current through the input coil, the greater the output.
6. DC current produces output only when it is turned on or off.

Now, fellows, you're ready to make your sensing device. All you have to do is to make a coil out of some of the wire in the automobile (or other) circuit that you want to cause the action. The number of turns needed in the coil will be determined by the amount of current going through it and the amount of output you need to operate your signalling device. If the input circuit is straight DC, you will get only a pulse in the output. If it is AC or pulsating DC (as in the small 12-volt line to the distributor of a car), you will get a constant voltage output that can be rectified to operate the signaling device.

One further word on this sensing method: if the input current is very heavy, as in the case of a car-battery cable when using the starter, one turn may produce enough output for your needs.

Series dropping resistor

The third sensing method mentioned

earlier, uses a series dropping resistor. As shown in Fig. 4, you can place a resistor in any circuit and a "voltage drop" will develop across it. That voltage can be picked off and used to operate another device. Of course, that voltage is subtracted from the

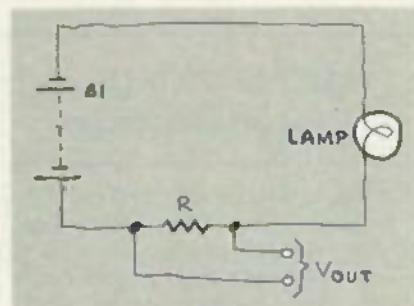

FIG. 4

voltage that would otherwise be available to the normal load (the lamp in the illustration). The amount of voltage dropped across the resistor can be determined experimentally or by using Ohm's Law ($E = I \times R$). Depending upon the nature of the circuit, you may have to exercise special care to determine the power rating (wattage) necessary for the resistor. That's best found by using the formula $P = I^2 \times R$. Also it's a good idea to allow a safety margin by using a resistor with a power rating that's about 50% greater than the formula indicates.

R-E

NEW



Universal Keyboard Controllers

The new Series V Digital/Analog Keyboard Controllers from PAIA offer enough standard features and options to fill every need from stage to studio. Standard features include Pitch & Modulation Wheels, Gate and Re-trigger outputs, Low Note Rule Priority, Smooth Pratt-Read Action, Light weight and only 2" high.

You have your choice of:

- 37 or 61 Note Actions
- Exponential Or Linear C.V.
- MIDI or Parallel Digital
- Mono or Poly
- Factory Assm. or Low Cost Kits

Best of all, prices start at less than \$180

call our toll-free line

1-800-654-8657

9AM to 5PM CST MON-FRI

for price & ordering details
& get your free PAIA catalog!

Direct mail orders and inquiries to: Dept. 11R

PAIA Electronics, Inc.

1070 W. Wolshire, Oklahoma City, OK 73116 1-405-843-9626

CIRCLE 52 ON FREE INFORMATION CARD

THE INDUSTRY'S NEWEST CHASSIS MOUNT

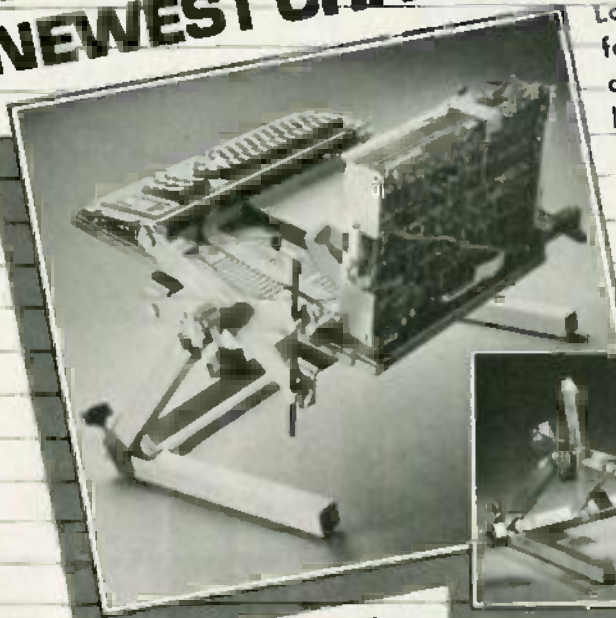

Loaded with
features and
advantages never
before available
for
only \$199.95

Price subject to change
without notification.

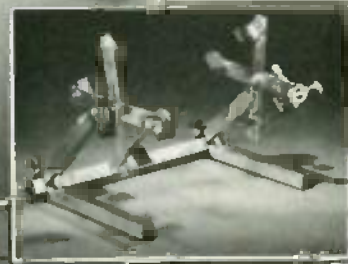

For complete information
contact:

PANAVISE

2850 East 29th Street Long Beach, California 90806 (213) 595-7621

CIRCLE 22 ON FREE INFORMATION CARD

MARCH 1984

77

DESIGNER'S NOTEBOOK

A negative-voltage supply

ROBERT GROSSBLATT

THE MOST VALUABLE TOOL ANY DESIGNER can have is his personal notebook. It's filled with all the results of his past experience—everything from shortcuts in design, to handy circuits, to easy ways to avoid production problems. The contents of the book all have one thing in common: they're the results of bitter experience and often expensive mistakes. The more experienced the designer, the fatter his notebook. You probably have one of your own even though it may not be as neatly organized as you'd like it to be.

Every month we're going to give you another page that you can add to your own personal notebook. None of the things will be a finished circuit or complete idea. Each of them will, however, be useful in designing larger systems and will save gallons of midnight oil. They'll range from perfectly obvious to wonderfully elegant and they only have to come in handy once to make them worth remembering.

I'll cover everything from breadboarding, to actual circuitry, to production of the finished product. If you know a way to do the same thing that's easier, faster, cheaper, safer, or slicker, drop me a line and let me know about it. Designing something is tricky enough, and one of the first things to learn is to take all the help you can get. And since the point of this page is to share more than instruct, if you have something to say that's worth listening to, I'll turn the page over to you and we'll all learn something.

ONE OF THE MOST ANNOYING SITUATIONS you can run across when you're designing electronic circuits is the need for oddball numbers in the power supply. In the "Drawing Board" columns that appeared in the May through August 1983 issues of **Radio-Electronics**, we spent a lot of time learning how to handle power-supply designs that would take care of just about any contingency you might run across in a circuit design. We found out how to make cheap regulators do expensive things and how to safely get relatively monster amounts of current from tiny, three-terminal regulators. If you check back through the series, you'll see that we even went into what is ordinarily a real bear of a problem—namely, designing a variable supply that could go all the way down to zero-volts output.

There was a hitch, however. You can

only get zero volts out if you can provide the circuit with a real negative reference-voltage—and therein lay the rub. It's always frustrating to need a few measy milliamps from a negative supply when all you have to work with is a supply that's giving you a positive voltage. Now, there are all sorts of schemes for generating something that can be used as a negative voltage or arranging for the rest of the circuit to bias itself halfway up the supply rail. All those things will produce a negative-like voltage, but they're a far cry from having a voltage that really lies below ground level.

A better way

Well, for all of you who have run up against that problem, and for anyone who might, here's a handy way to take care of it. The parts count is really low and the components are ones you probably have lying around.

The heart of the circuit shown in Fig. 1 is the 555 timer. For this application, that timer is set up in its astable mode—in other words, it's an oscillator. With the values shown, the frequency will be about 45 kHz and the duty cycle is pretty close to 50%. (We'll have more to say about that later.) Basically, the components that are connected to the output of the 555 are set up as a voltage-doubling rectifier. Diodes D1 and D2 work as steering diodes much the same as they would on any AC/DC converter.

On the positive half of the 555's output swing, D1 is forward biased, D2 is reverse biased, and C1 charges up. When the 555 goes into the negative half of its output cycle, capacitor C1 dumps its stored

charge through D1 and charges up C2. Diode D2 prevents C2 from discharging through C1. What we wind up with is a negative voltage at the anode of diode D2 with respect to system ground and that voltage is renewed with every full cycle of the 555's output swing. With no load on the output you will get a negative voltage from the circuit that is just about equal to the supply voltage.

But that's with no load. In practice, the negative voltage available will be several volts below the supply voltage—exactly how much below will depend on the amount of current you want to draw from the circuit.

The 555 can easily supply 200 milliamps but the most you can safely expect from the negative supply is about 60 milliamps since we're only renewing the charge on C2 during half the output swing of the 555. If you study the schematic closely, you'll see that capacitor C2 is only being used to store the charge originally on C1.

Now you can see why the frequency of the 555 is set fairly high—we have to renew the charge on capacitor C2 fairly often if we want to power anything remotely useful with the circuit. The duty cycle of the 555 has been set close to 50% because we have to allow time for capacitor C1 to discharge.

If you only need a small amount of current from a negative supply for your application—to power something like an op-amp, for instance—you'll find that circuit to be just what the doctor ordered. On the other hand, be aware that if you're looking for really serious amounts of power, that approach won't help and you'll actually need a split supply.

There's no reason why you can't regulate the negative supply by using a series regulator (any of the 79xx series). Since they only use a few milliamps to operate, there won't be any undue load on the circuit—there will be about a 2-volt loss, however.

The next time you design something that has to have a split supply, add up the current you'll need from the negative side and see whether this circuit can supply it. If so, why not give it a try; it's easy to put together and a lot cheaper than a center-tapped transformer.

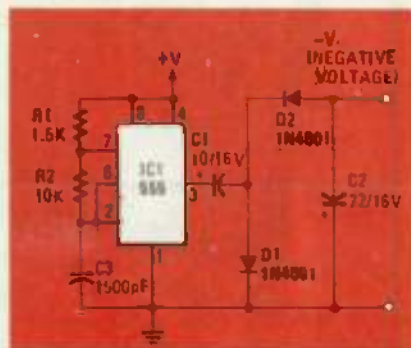
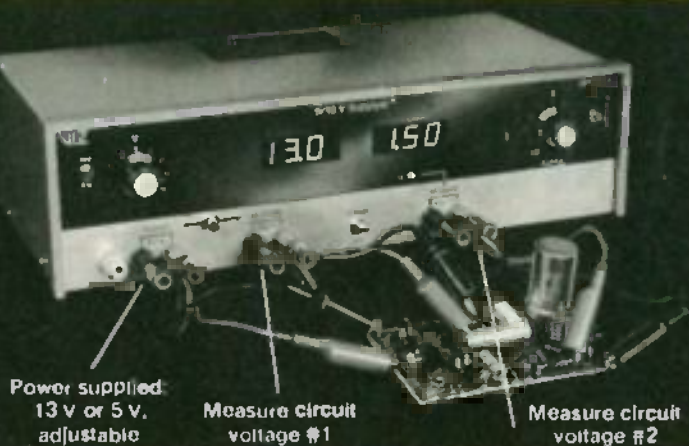

FIG. 1

R-E

WP-709.
Double-slot
Supplyst™
power supply.



Power supplied:
13 V or 5 V,
adjustable

Measure circuit
voltage #1

Measure circuit
voltage #2

Outputs: 5V or 13V DC,
adjustable $\pm 1\frac{1}{2}V$
 Zero to 7.5 amp, each voltage.
 Two LED displays,
monitor V or A—
or two DC voltmeters
 Adjustable current limiting

Only
\$339.00

DC power to test logic or mobile equipment. Another VIZ Value

HERE'S REAL PRECISION
 Select the precise voltage you want:
 5V or 13V, adjustable $\pm 1\frac{1}{2}V$ at each
 range. Output is laboratory quality.
 Ripple less than 10mV, peak to peak.
 Regulation better than 0.1%.

HERE'S REAL POWER
 Up to 7.5 amp. at each voltage—

plenty for computer circuits, PA
 systems, mobile transmitters, autos,
 boats, planes.

HERE'S REAL CONVENIENCE
 Front panel controls for instant
 voltage adjustment and precise fine
 adjustment to within 0.1V. Two 3-digit
 LED displays permit continuous

monitoring of both voltage and
 current during use. Current limiting
 control with instant pushbutton reset.

The WP-709 is like two precision
 power supplies for a price less than
 you might pay for one— PLUS two
 digital DC voltmeters

VIZ Supplyst™

power supplies with digital displays of voltage and current

Fully regulated, adjustable current limiting power supplies. PLUS two built-in digital DC voltmeters in a single quality unit. Digitally monitor output voltage or current, or two external voltages.



WP-705 \$325.00
 Single output
 0-50VDC, 0-2A.

WP-706 \$341.00
 Single output
 0-25VDC, 0-4A.



WP-707 \$423.00
 Dual output
 Two 0-25VDC, 0-2A.

WP-708 \$489.00
 Triple output Two 0-20VDC, 0-2A.
 One 5VDC, 0-4A.

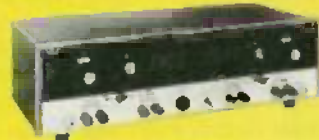

VIZ DC power supplies

Fully regulated, continuously adjustable voltage
 outputs with short circuit protection.
 Analog meters and overload indicators.



Single WP-703A
 0-20VDC, 0-500mA **\$119.00**



Single WP-704A
 0-40VDC, 0-250mA **\$125.95**



Dual WP-702A Two 0-20VDC, 0-200mA **\$167.00**

VIZ RELIABILITY

VIZ is a 50 year-old company. Our instruments are
 fully warranted, parts and labor, for a year.
 All items tested to NBS standards. We offer service and parts
 availability for a minimum of ten years. Over 15 repair depots in U.S.A.

Want full technical details and a demonstration? Call toll-free, 1-800-523-3696, for the VIZ distributor nearest you



Look to VIZ for value, quality, availability.
Over 70 instruments in the line— PLUS full accessories.

VIZ Mfg. Co., 335 E. Price St., Philadelphia, PA 19144

CIRCLE 91 ON FREE INFORMATION CARD

COMMUNICATIONS CORNER

Changes in communication technology

HERB FRIEDMAN, COMMUNICATIONS EDITOR

CALL IT HIGH-TECHNOLOGY SHOCK, OR whatever you choose, the rapidly changing ways in which we communicate has finally shaken those who own and operate our present communications systems, as well as the politicians who regulate them.

Since we all use some type of communications system, we thought you might be interested in knowing what's going on in the communications industry.

First, in case you haven't heard, on July 22, 1983 virtually all restrictions came off the FM broadcast-station SCA (Subsidiary Communications Authorization) subcarriers. Simply stated, what that means is that the operators of common-carrier, paging systems and the like, are no longer required by regulations to carry program material on the main channel to carry programming on the SCA subcarrier. As long as the station-identification is given on the hour, the main channel can be dead, with only the SCA subcarriers in operation. (How long will the FCC permit that to continue?)

Reminiscent of the forty-niners rushing to get to the goldmines of California, the modern-day prospector rushed to put almost everything imaginable on the FM subcarriers. Everything from travel tips, to computer data, to common-carrier services, and even radio paging for Mom, Dad, and the tots may be carried via your local FM station. Say, for example, you want to call Junior and Sis in from the sandbox, or have them meet at one of those empty-ump-acre theme parks: Just dial a phone number and your local FM station will make their pocket pagers go

beep beep. Of course, the next step is sure to be some sort of code (One beep means come home, two beeps: pick up a dozen eggs, and three beeps: bring home a hot-fudge sundae, etc.).

All joking aside, we haven't begun to comprehend the effect that FM-broadcast paging will have on our lives. With the stacking of calls permitted by digital signaling, the gradual movement away from VHF services, and high-tech designs pushing the cost of a pocket pager to below \$50; we may soon be buying our personal pager at the local supermarket. It will probably be sold like *The Source* and Dow Jones information services for computers.

Don't think that SCA digital signals are limited to just paging. Straight data such as stock-market quotes, and even computer programs for the home can be provided—though no one has figured out a cheat-proof billing system yet. However, the potential is so great that VHF operators must restudy where their service stands as the new age of personal communications unfolds.

The second group to suffer the aftershock was the politicians. In some areas, cable-TV was the politician's pot of gold; they've taxed the cable services for just about everything possible. They've even gone so far as to push them into providing so-called free public-access channels along with studio facilities. Very often the politicians were so busy trying to find new ways to tax the cable industry that years dragged by before the cable was ever installed. For example: in New York City,

the leading center for communications, cable TV outside of Manhattan (what visitors usually consider to be the entire city) was ten years behind the times because the politicians tried to squeeze blood from a stone. In fact, until they saw the specter of high technology on the wall, nearly four million people had no hope of receiving cable TV in their homes. Unfortunately, the system they'll get will probably be outdated before it's ever installed.

What is the specter on the wall? It's DBS (Direct Broadcast Satellite). Only three years ago there was no such thing as DBS, not even the concept. For those not familiar with DBS, it works in the following way. Imagine a small microwave-dish antenna (under two feet in diameter) on everyone's rooftop. That antenna could possibly receive 100 channels directly from a satellite. For encoded pay-TV, viewers could order a decoding signal transmitted through the telephone system and have the costs for the service charged to their credit cards.

The idea of DBS broadcasts completely free of local and state control really shook-up the politicians. In fact, it resulted in a hard-hitting letter to the *New York Times* by a state legislator who feared that DBS would eventually eliminate the need for interactive cable service. That was the first time the general public learned that there was a state committee looking into cable service and not from the viewpoint of TV reception. (What's happening in your state?)

The reason for interest on the state level is that cable TV is presently the most advanced form of interactive communications. Since almost anything you want or do will wind up on some form of TV display, the easiest thing to do is to integrate it into a home system. The general idea is that two-way digital communications could be multiplexed on the cable in addition to regular TV programs. That would allow viewers to transmit requests for specific TV shows, computer programs, videotex or teletext data, and even pay their bills through the bank using a home computer system. An example of what a DBS setup might look like in your home is shown in Fig. 1. For simplicity we won't go into the transmission of digital TV pictures.

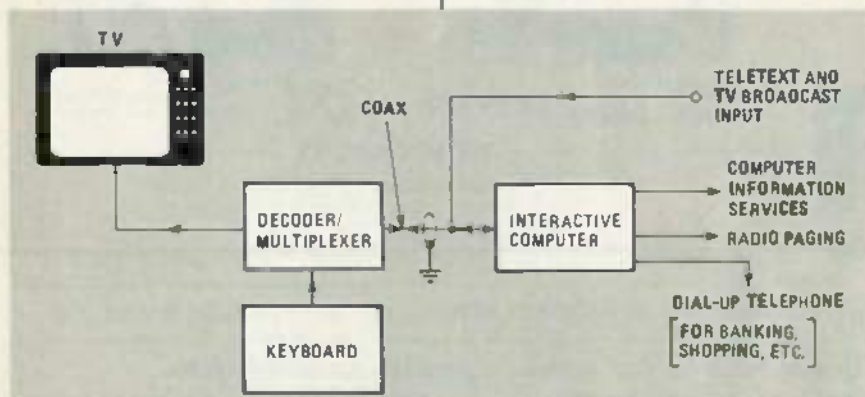

FIG. 1

SUPER LONG PLAY TAPE RECORDERS

10 Hour Model — \$95.00*
14 Hour Model — \$159.00*

Modified Panasonic Slimline, high quality AC-DC Recorders provide 5 or 7 continuous hours of quality recording & playback on each side of cassette for a total of 10 or 14 hours depending on model. Built-in features include • Voice level control • Digital counter, etc. TDK DC 180 Cassette Furnished



PHONE RECORDING ADAPTER

Records calls automatically. All Solid state connects to your telephone jack and tape recorder. Starts recording when phone is lifted. Stops when you hang up. \$24.50*
FCC APPROVED



VOX VOICE ACTIVATED CONTROL SWITCH

Solid state. Sell contained. Adjustable sensitivity. Voices or other sounds automatically activate and control recorder. Uses either recorder or remote mike. \$24.95*



*Add for ship & H&G Phone Adapter & Vox \$1.50 ea. Recorders \$4.00 ea. Cal. Res. add tax. Mail order, VISA, M/C, C.O.D.'s OK. Money Back Guarantee. Qty. disc. avail. Dealer inquiries invited. Free data.
AMC SALES INC. Dept. 9335 Lubec St., Box 928, Downey, CA (213) 90421 Phone 869-8519

CIRCLE 87 ON FREE INFORMATION CARD

ELECTRONIC COMPONENTS

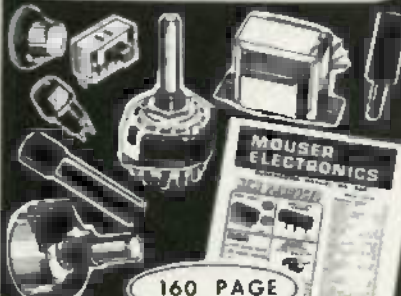

160 PAGE

FREE CATALOG

MANUFACTURERS OF QUALITY ELECTRONIC COMPONENTS

Battery Clips & Holders
Cable Sets, Connectors, Capacitors
Displays, LED Fuses, Jacks & Plugs
Knobs, Leaps, Potentiometers
RF Coils, Relays, Resistors
Switches, Semiconductors, Speakers
Test Equipment, Transformers, Tools
Wires & Cables

WE STOCK What We Catalog!

- Bulk and Order Data Open 11:00-8:00 (1217)
- Phone and Mail Order Welcome
- 100% C.O.D. Free Master-Charge (Open accounts available)
- Over 10,000 Different Items in Stock

MOUSER ELECTRONICS

11433 WOODSIDE AVE., SANTEE, CA 92071
PHONE: (619) 449-2222 TWX: 910-331-1173

CIRCLE 95 ON FREE INFORMATION CARD

How it works

That setup could consist of a TV receiver, a digital keyboard, and a multiplexer (as shown). The multiplexer would encode and decode digital information. The digitized instruction (or data) is generated at the keyboard and encoded by the multiplexer. That signal would then be transmitted to the head-end (cable service) using standard coaxial cable that handles signals in both directions. At the head-end, the digitized instructions (received from your home) are sent to a central computer that can handle any number of specialized services. That computer would do the routing to the bank, control the electronic lock on your TV (so you can view a pay-TV program), or even make your doctor's pager go beep because your blood pressure is too high. The customer could also order computer programming that would keep personal records, tutor the tots, or whatever is desired.

Aside from the loss of tax revenue, what worries politicians is that DBS might mean the death of interactive cable. After all, DBS can provide all the non-interactive services such as TV; while the interactive functions could easily be accomplished through the telephone system, using personal computers, as is presently being done by some local banks. Then, why have interactive cable? The why is what bothers the politician, because it means the *loss of information*.

Politicians foresaw the ability to learn everything there was to know about their constituents through the interactive cable-network. How you ask? Say, for instance that you pay your doctor, lawyer, bank, charge account, etc. by interactive cable (which is what the bankers envisioned). Now, add to that information on what kind of movies you order (adventure, triple-X, or PG); Couple that to the kind of programs you're willing to pay for, and whether you've made a contribution to a political party through an interactive fund-raiser. And you'll find that a single billing computer has an almost perfect profile on you and your family. That's one heck of a lot of personal data, worth more than the cost of the cable service (to the politician).

As you can see, if DBS systems were used for TV reception, the whole cable system would not be necessary. With a small personal computer connected to the telephone system you could handle your own communications directly with the bank, the doctor, the computer service, or anyone. Also, there'd be no centralized records on you or your family.

Right now, FM subcarriers and the interactive cable system represent the leading edge of high technology for personal and family communications. But keep an eye on DBS. It can do a lot more than just transmit TV pictures. R-E

Here's why we're Number One.

When it comes to logic probes, more people buy Global Specialties. Because no one can match us for value. Our four logically-priced probes—including our remarkable new 150 MHz ECL—deliver more speed, accuracy, flexibility and reliability than others costing considerably more! So why compromise? Discover for yourself why we're the number-one logical choice!



- Standard LP-1, \$50.00; with memory — captures pulses to 50 nsec, 10 MHz, guaranteed.
- Economy LP-2, \$32.00; to 50 nsec, 1.5 MHz.
- High-speed LP-3, \$77.00; with memory, guaranteed to 10 nsec (6 nsec, typical), 50 MHz!
- New ECL LP-4, \$150.00; the new industry standard—with memory, guaranteed to 4 nsec (2 nsec, typical), 150 MHz!

GLOBAL SPECIALTIES CORPORATION

70 Fuller Ter. New Haven, CT 06509 (203) 624-3103, TWX 710 465 1227
OTHER OFFICES: San Francisco (415) 648-0611, TWX 910 372 1992
Europe: Phone Salford, Warden 0799 21682, TLX 117477
Canada: Linn Finkler 430, Downsview, Ontario

Call toll-free for details
1-800-243-6077

During business hours

*Suggested U.S. retail prices. Specifications subject to change without notice.
© Copyright 1984 Global Specialties Corporation

CIRCLE 96 ON FREE INFORMATION CARD

MARCH 1984

81

COMPUTER CORNER

IBM's new computer

LOU FRENZEL

IBM HAS BEEN IN THE PERSONAL-COMPUTER business for only a little over two years. However, in that short period of time it has managed to capture approximately 25% of the total market. That's an incredible amount and the greatest percentage held by any one manufacturer. Apple is second with over 20%, while the rest of the market is divided up among well over a hundred others including Texas Instruments, Commodore, Radio Shack, and Atari.

IBM's success is attributed to two major factors. The first is that the IBM PC is a fine machine. It is powerful, flexible, and can be configured and expanded to almost any application.

Of course, the other reason is IBM's well-known name and reputation. It's a big company that one can trust. Consumers like that.

The IBM PC, however, is really no home computer. By that we mean that it is an expensive machine that few individuals can afford for home applications. While the PC can play games with the best of them, it is not the kind of machine one buys for entertainment alone; it is a serious computer for business applications.

The new machine

On November 1, 1983, IBM announced a new home computer called the *PCjr* (see Fig. 1). Rumors about that new home computer, which had been code-named Peanut, have been around for almost a year. Unlike the PC, IBM's new machine is a product that's aimed directly at the home-computer marketplace.

The rumors about the *PCjr*, which IBM would neither confirm nor deny, greatly affected the home-computer industry. The most significant effect that it has had was to hold prospective buyers in place to wait for the new product. Competitors claim that that took away a lot of sales. Now that the new computer is available, perhaps the home-computer marketplace will settle down for a while. Then again, maybe it won't.

So what is the new *PCjr* like? First of all, it uses the popular 8088 microprocessor. The original rumors indicated that the machine would use Intel's latest variation of the 8088 known as the 80188. However, large-scale production problems and/or high price levels could have

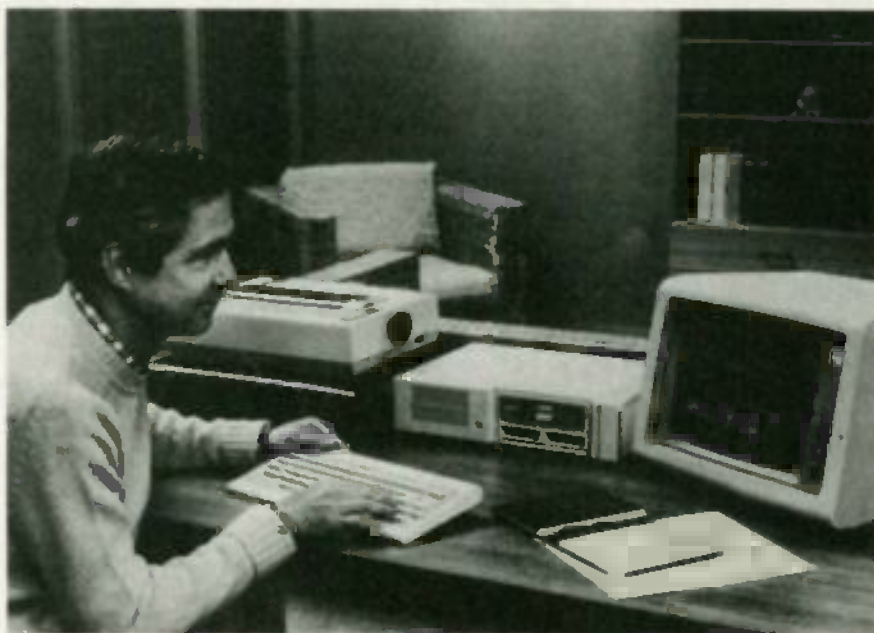

FIG. 1

been what made IBM change its mind.

The *PCjr* comes in two basic forms. In its lower price form it contains 64K of RAM and no disk drive. It does have provision, however, for two plug-in ROM cartridges.

In its expanded form, the *PCjr* comes with 128K of RAM and a single 360K disk drive. (The basic model can be upgraded to the enhanced version.) To use the disk drive, you must have IBM's latest version of the PC-DOS operating system, version 2.1. That updated and revised version of PC-DOS 2.0, which was introduced in March 1983, is used by the IBM *PC/XT*. The *PCjr* cannot run PC-DOS 1.1, which is the primary operating system for most IBM personal computers.

One of the most interesting features of the new machine is its keyboard. The unit uses its own specially designed 62-key keyboard. It is unique because it's cordless. The keyboard communicates with the base unit via infrared, using an arrangement similar to that used with most remote control units on TV sets. The keyboard has a range of about 20 feet and, of course, contains its own built-in battery supply. That cordless feature gives great flexibility in using the machine and

should make it popular in a home environment. A cord is available at extra cost for those who want one, or for those instances where more than one unit is in use.

That's not to say that all is well regarding the keyboard. Rather than using a standard typewriter-type keyboard, IBM has chosen to go with calculator-type keys. That type of keyboard is just not suitable for applications such as word processing or any other task where productivity is important. The reasons for IBM's choice of keys is not clear. Cost may have been a factor, or perhaps the company was worried that the *PCjr* would cut into the sales of PC's to business.

Like most other personal computers, the *PCjr* comes with BASIC. Here, a version of Microsoft's BASIC interpreter is stored in ROM. Also stored in ROM is a cassette-tape operating system that lets you use a cassette recorder for mass storage. The ROM also contains a short tutorial on how to use the keyboard.

Many of the applications programs for the *PCjr* are supplied in plug-in ROM cartridges. Most of those are games and simple educational programs. Included among those cartridges is a 32K BASIC enhancement that allows you to use a

joystick or lightpen. It also upgrades the BASIC's graphics and music capability.

For more advanced applications, the software is, of course, available on disk. Among the disk software currently available for the machine is *PFS:File*, *PFS:Report*, and *Time Manager*.

Note that most of the disk software available for the *PCjr* is not compatible with the original *PC* and vice versa. It would have been foolish of IBM to make the two machines compatible. IBM would lose millions in sales of their big machine to the *PCjr* if that were the case. While many of the available programs can be run on both, they come in versions that are specially adapted to the particular machine.

Finally, the *PCjr* displays 40 columns (80 columns in its enhanced version) on a standard TV set, color video monitor, or RGB monitor.

With regard to accessories and peripherals, IBM offers an internal modem module for communications applications, joysticks, and a parallel interface for a printer. IBM is also offering a compact thermal printer that will accommodate 80-character lines and graphics. At a suggested price of \$169, it is one of the lowest priced printers on the market.

It's anybody's guess how popular the IBM *PCjr* will be. But if the popularity of IBM's original *PC* is any indication, you can expect it to be an overwhelming success. It'll probably be tough to beat. With a huge number of sales expected, third-party software and accessories companies will spring up everywhere to provide software and hardware of all types. If you are shopping for a home computer to play games, or to use for educational purposes, the *PCjr* is a good one to look at. In its basic form it sells for \$695. The enhanced disk-drive model sells for \$1295.

Long Live the Competition.

The *PCjr* will obviously make a dent in the home-computer market. However, it is high priced for a home computer, leaving ample marketing opportunities for other manufacturers. Popular home computers like the Commodore 64 and Radio Shack's *Color Computer* models may not be severely affected by the *PCjr*. Most of those machines sell in the \$200 to \$300 category and, as a result, are a lot more affordable than the up-scale *PCjr*. There are still millions of people who want a low priced entry-level machine. For instance, for those just coming to personal computers, an inexpensive introductory product is desirable since it limits their outlay should they find that they don't like computing. Better to have a \$200 machine on a closet shelf than a \$600 or \$1200 one.

IBM's new entry seems to be targeted at more affluent entry-level customers. It is also aimed at home users looking for their second machine. The *PCjr* is certainly a

step up from the low-end machines, but it does not require the cash commitment that a machine like the *PC* does.

Another area that the machine should do well in is education. In fact, the *Wall Street Journal* recently reported that Virginia Polytechnic Institute has ordered 1600 units for use by their engineering students.

IBM, then, has chosen an interesting niche for its new machine, one that will guarantee them incredible volume but also one that will not destroy the competition or their booming *PC* business. R-E

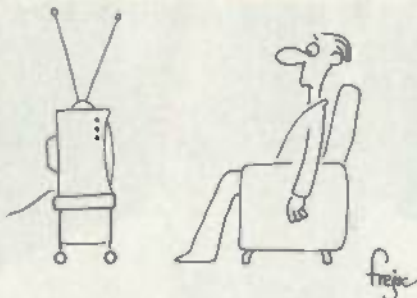

"Acme University is recalling all engineering graduates between the years 1975 and 1979, due to a defect in their engineering studies program."

Be an FCC LICENSED ELECTRONIC TECHNICIAN!

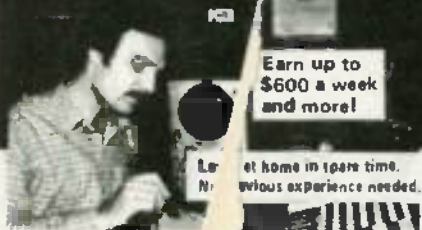

Let it home in spare time. No previous experience needed.

No costly School. No commuting to class. The Original Home-Study course that prepares you for the FCC Radiotelephone license in your spare time! An FCC Government license your "ticket" to thousands of exciting jobs in Communications, Radio & TV, Mobile two-way, Microwave, Computers, Radar, Aerospace and more. You don't need a college degree to qualify, but you do need an FCC License. No need to quit your job or go to school! You learn how to pass the FCC License course at home at your own pace with this easy-to-understand proven course. It's easy, fast and low cost! GET YOUR "NEED PASS" - You get your FCC License or your money back. Write for free details. Soon you could be on your way to being one of the highest workers in the electronics field. Send for FREE facts now. MAIL COUPON TODAY!

COMMAND PRODUCTIONS

FCC LICENSE TRAINING, Dept. 90
P.O. Box 2223, San Francisco, CA 94126
Rush FREE facts on how I can get my FCC License
in spare time. No obligation. No salesman will call.

NAME _____
ADDRESS _____
CITY _____ STATE _____ ZIP _____

FAST RELIEF

from

SOLID STATE HEADACHES

Model 216



SEMICONDUCTOR ANALYZER

Easy, automatic, "hands off" operation (Frees both hands for troubleshooting)

Simple to use — no set up — no data books

In, or out of circuit, GOOD-BAD analysis of NPN's, PNP's, FET's, diodes and SCR's

Instant, In or out-of-circuit leakage detection

Digital scanning circuit automatically determines lead configuration

Low-power CMOS design for extended battery life

Uses two standard 9V batteries (not included)

Weights only 12 ounces — fits in your pocket

High Impact thermoplastic case with snap-shut protective cover

PRICED UNDER \$150
THE MODEL 216 IS FAST,
RUGGED AND AFFORDABLE



THE HICKOK ELECTRICAL INSTRUMENT CO
10514 Dupont Avenue • Cleveland, Ohio 44108
(216) 541-8060 • TWX: 810-421-8286

CIRCLE 85 ON FREE INFORMATION CARD

MARCH 1984

**Learning electronics
is no picnic.**

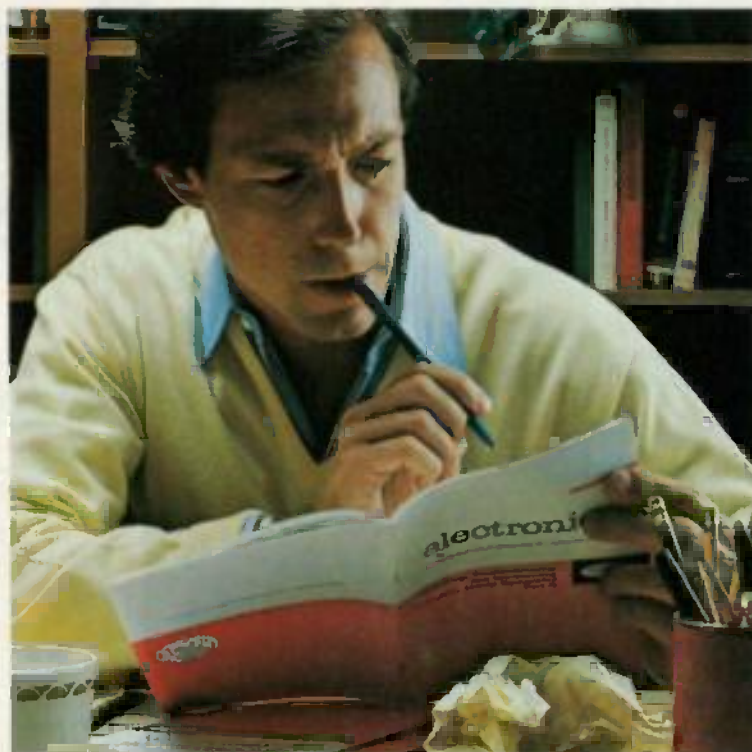

**At any level it takes
work and a few
sacrifices. But with
CIE, it's worth it.**

Whoever said, "The best things in life are free," was writing a song, not living a life. Life is not just a bowl of cherries, and we all know it.

You fight for what you get. You get what you fight for. If you want a thorough, practical, working knowledge of electronics, come to CIE.

You can learn electronics by spending some hard-working time at home. Or, would you rather go bowling? Your success is up to you.

At CIE, you *earn* your diploma. It is not handed to you simply for putting in hours. But the hours you do put in will be on your schedule, not ours. You don't have to go to a classroom. The classroom comes to you.

Why electronics training?

Today the world depends on technology. And the "brain" of technology is electronics. Every year, companies the world over are finding new ways to apply the wonders of electronics to control and program manufacturing, processing...even to create new leisure-time products and services. And the more electronics applications there are, the greater the need will be for trained technicians to keep sophisticated equipment finely tuned and operating efficiently. That means career opportunities in the eighties and beyond.

Which CIE training fits you?

Beginner? Intermediate? Advanced? CIE home study courses are designed for ambitious people at all entry levels. People who may have:

1. No previous electronics knowledge, but do have an interest in it;
2. Some basic knowledge or experience in electronics;
3. In-depth working experience or prior training in electronics.

You can start where you fit and fit where you start, then go on from there to your Diploma, an Associate Degree if you want it, and career.

Many people can be taught electronics.

There is no mystery to learning electronics. At CIE you simply start with what you know and build on it to develop the knowledge and techniques that make you a specialist. Thousands of CIE graduates have learned to master the simple principles of electronics and operate or maintain even the most sophisticated electronics equipment.

CIE specializes in electronics.

Why CIE? CIE is one of the largest independent home study schools that specializes in electronics. Nothing else. CIE has the elec-

tronics course that's right for you.

Learning electronics is a lot more than memorizing a laundry list of facts about circuits and transistors. Electronics is interesting! It is based on recent developments in the industry. It's built on ideas. So, look for a program that starts with ideas and builds on them. Look to CIE.

Programmed learning.

That's exactly what happens with CIE's Auto-Programmed® Lessons. Each lesson uses famous "programmed learning" methods to teach you important principles. You explore them, master them completely, before you start to apply them. You thoroughly understand each step before you go on to the next. You learn at your own pace.

And, beyond theory, some courses come fully equipped with electronics gear (the things you see in technical magazines) to actually let you perform hundreds of checking, testing, and analyzing projects.

Experienced specialists work closely with you.

Even though you study at home, you are not alone! Each time you return a completed lesson, you can be sure it will be reviewed, graded, and returned with appropriate instructional help. When you need additional individual help, you get it fast and in writing from the faculty technical specialist best qualified to answer your question in terms you can understand.

CIE offers you an Associate Degree.

One of the best credentials you can have in electronics—or any other career field—is a college degree. That's why CIE gives you the opportunity to earn an Associate in Applied Science in Electronics Engineering Technology. Any CIE career course can offer you credit toward the degree...more than half of the number needed in some cases.

You can also prepare for the government-administered FCC (Federal Communications Commission) Radiotelephone License, General Class. It can be a real mark in your favor...government-certified proof of your specific knowledge and skills.

Today is the day. Send now.

Fill in and return the postage-free card attached. If some ambitious person has removed it, cut out and mail the coupon. You'll get a FREE school catalog plus complete information on independent home study. For your convenience, we'll try to have a CIE representative contact you to answer any questions you may have.

Mail the card or the coupon or write CIE (mentioning the name and date of this magazine) at:
1776 East 17th
Street, Cleveland,
Ohio 44114.

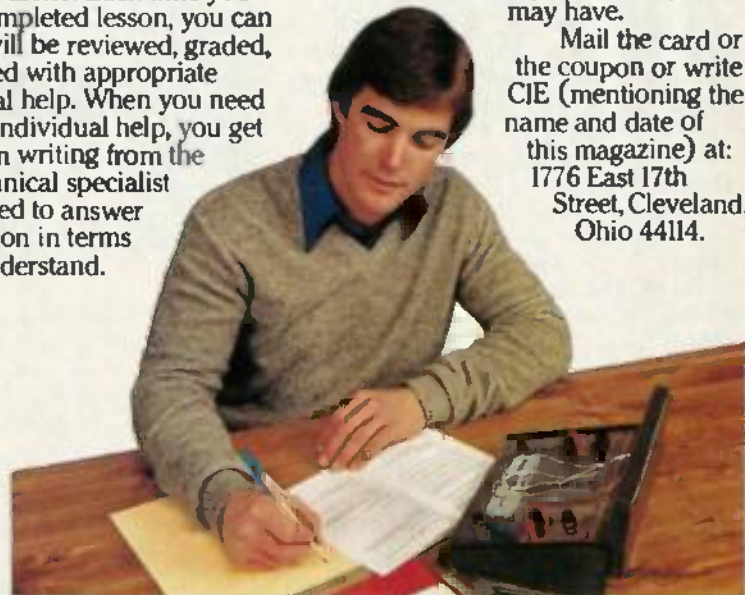

CIE Cleveland Institute of Electronics, Inc. RE 80
1776 East 17th Street, Cleveland, Ohio 44114
Accredited Member National Home Study Council

YES...I want to learn from the specialists in electronics—CIE. Send me my FREE CIE school catalog...including details about the Associate Degree program... plus my FREE package of home study information.

Print Name _____

Address _____ Apt. _____

City _____ State _____ Zip _____

Age _____ Area Code/Phone No. _____ / _____

Check box for G.I. Bill bulletin on Educational Benefits: Veteran Active Duty

MAIL TODAY!

STATE OF SOLID STATE

Telephone ringer IC's

ROBERT F. SCOTT, SEMICONDUCTOR EDITOR

FOR YEARS, MANY OF US HAVE FOUND THE strident tones of a telephone bell annoying and have wished for something with a more pleasant tone. Others have wanted an extension telephone ringer in the garage, workshop, or similar location, but never got around to having one installed by the telephone company. Now, Motorola has introduced the MC34012 telephone bell ringer IC, a simple solid-state device that can be used as a solution to both problems. A pinout of that device is shown in Fig. 1.

Let's see what the pin functions are: Pin 1 (RG) is the negative output of the internal diode bridge. Pins 2 and 3 (AC₁ and AC₂) are the input terminals for the AC telephone-line ringing signal. Pin 4 (RO) is the ringer output terminal. Pin 5 (RI) is the positive supply terminal for the oscillator, frequency divider, and buffer/amplifier circuits. Pin 6 (RS) connects to an external sense resistor, pin 7 (RF) connects to a filter capacitor, and pin 8 (RC) connects to an external R-C circuit that controls the frequency of the internal oscillator.

The MC34012, a monolithic L²L linear device, is housed in an 8-pin plastic DIP. That IC is used to drive a piezoelectric ceramic sound transducer to produce a pleasant warbling tone at a suitably high audio level. It is available in three output-frequency ranges, and those ranges are indicated by the suffixes -1, -2 and -3 that identify the 1-kHz, 2-kHz and 500-Hz devices, respectively.

The MC34012-1 has a base frequency of 4 kHz and produces 800-Hz and 1000-Hz tones. Similarly, the MC34012-2 oscillator operates at 8 kHz and generates 1600 and 2000-Hz tones. The MC34012-3

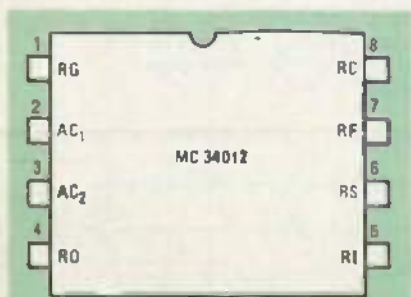

FIG. 1

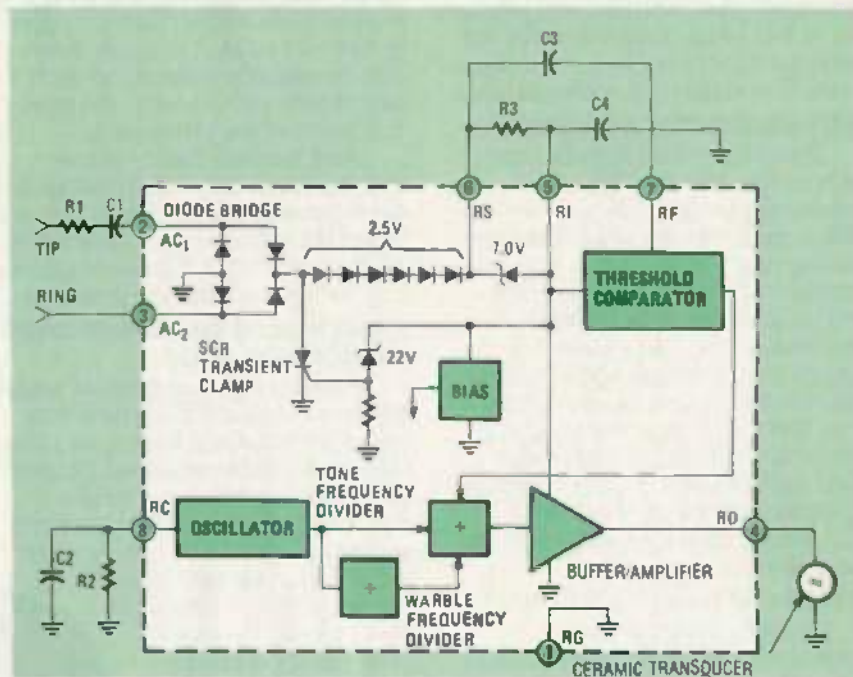

FIG. 2

has a 2-kHz oscillator and produces a 400- and 500-Hz tone. The warble frequency of the devices is 13 Hz. The tone ringer output can source or sink 20 mA with an output-voltage swing of 20 volts peak-to-peak.

The input impedance presented to the telephone line by the devices meets Bell and EIA requirements. Typical performance characteristics of the three devices are given in a table available from the manufacturer. Now, let's look at how those devices work.

How the ringer works

Figure 2 shows the functional block diagram of the MC34012. It consists of a relaxation oscillator and two frequency dividers that provide the high- and low-frequency segments of the warble tone, as well as the 12.5-Hz warble rate. The IC is connected across the telephone line through the series network consisting of R1 and C1. The line-input resistor, R1, controls the ringer's input impedance as seen by the telephone line. That resistor also limits potentially harmful current surges caused by line transients, and in-

fluences the ringing-threshold voltage. The value of R1 can range from 2000 to 10,000 ohms. Capacitor C1 provides AC coupling between the line and the IC, and also controls the ringer's input impedance at low frequencies. The value of that capacitor can range from 0.4 to 2.0 μ F.

The base frequency of the relaxation oscillator, which can range between 1 kHz and 10 kHz, is determined by the values of R2 and C2. The capacitance value of C2 may range between 400 pF and 2000 pF. Frequency-determining resistor R2 may be a selected value between 150 and 300 kilohms. The frequency of the warble tone at the ringer output terminal (pin 4) switches between $f_0/4$ and $f_0/5$ at a 12.5-Hz rate.

The DC voltage needed to power the IC is obtained by rectifying and filtering the 20-Hz AC ring-signal voltage (60 to 90 volts RMS). That DC voltage supplies power to the tone generator and the circuits needed to drive the ceramic transducer. The ringing-signal voltage is rectified by the full-wave bridge and develops currents along two paths. In one path, an

continued on page 96

ELECTRONICS BOOK CLUB

The Best Source for Hobbyists and Professionals
for Over 18 Years!

Time- and Money-Saving Advice . . .
Practical Troubleshooting & Repair Tips . . .
State-of-the-art Technology . . . Hundreds
of Projects . . . Plus, Exceptional Savings

Select 6 Books
for Only \$2⁹⁵

values to
\$123.70



1498
List \$18.95



1474
List \$15.95



1483
List \$16.95

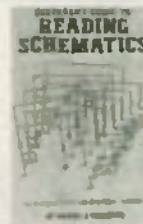

1536
List \$14.95



805
List \$18.95 (Paper)



1446
List \$17.95



1199
List \$19.95



1108
List \$15.95



1380
List \$16.95



1277
List \$19.95



1451
List \$18.95



1409
List \$15.95



1296
List \$18.95



1225
List \$9.95 (paper)



918
List \$15.95



1487
List \$15.95



1497
List \$15.95



1429
List \$14.95



1604
List \$21.95



1000
List \$13.95



1532
List \$17.95



1537
List \$16.95



1539
List \$19.95

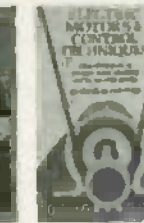

1465
List \$15.95



1505
List \$18.95



1337
List \$10.95



1473
List \$19.95



1503
List \$21.95

FREE guide to
mail order sources
for electronic parts
and components

A \$6.95
Value!



FREE When You Join Now

7 very good reasons to join The Electronics Book Club

- **Big Savings.** Save 20% to 75% on books sure to increase your electronics know-how
- **No-Risk Guarantee.** All books returnable within 10 days without obligation at Club expense
- **Club News Bulletins.** All about current selections—mains, alternates, extras—plus bonus offers. Comes 13 times a year with hundreds of up-to-the-minute titles you can pick from
- **"Automatic Order."** Do nothing, and the Main selection will be shipped automatically! But . . . if you want an Alternate selection—or no books at all—we'll follow the instructions you give on the reply form provided with every News Bulletin
- **Bonus Books.** Immediately get a Dividend Certificate with every book purchased and qualify for big discounts of 60% to 80%
- **Extra Bonuses.** Take advantage of added-value promotions, plus special discounts
- **Exceptional Quality.** All books are first-rate publisher's editions selected by our Editorial Board and filled with useful, up-to-the-minute information

ELECTRONICS BOOK CLUB

P.O. Box 10
Blue Ridge Summit, PA 17214

Please accept my membership in the Electronics Book Club and send the 6 volumes circled below, and my FREE copy of *The Electronics Buyer's Guide*, billing me \$2.95 plus shipping and handling charges. If not satisfied, I may return the books within ten days without obligation and have my membership canceled. I agree to purchase 3 or more books at reduced Club prices (plus shipping/handling) during the next 12 months, and may resign any time thereafter.

800 1000 1108 1183 1199 1225 1277 1296 1337
1380 1409 1429 1451 1465 1473 1474 1486 1487 1497
1498 1503 1505 1532 1536 1537 1539 1604 1632

Name _____ Phone _____
Address _____
City _____
State _____ Zip _____

Valid for new members only. (Foreign customers must pay in advance in U.S. currency.) This order subject to acceptance by the Electronics Book Club RE-384

CIRCLE 8 ON FREE INFORMATION CARD

MARCH 1984

THE DRAWING BOARD

Using the 4018

ROBERT GROSSBLATT

LET'S CONTINUE THE DISCUSSION OF THE 4018 that we began last time.

Before we see what's necessary to make the 4018 start to do things in the real world, it's a good idea to spend a little time going over the circuitry we need to make the device programmable. The first thing you should realize if you start playing with the IC is that the JAM inputs and Q outputs are complimentary—when an input is low, the corresponding output is high. The reason for that apparent bit of insanity has to do with the internal design of the device and is just one of those things we'll have to live with. In passing, it should be mentioned that there are ways to take care of that if you regard it as a problem.

Remember that that IC is really a series of daisy-chained flip-flops; i.e. a shift register with parallel and serial inputs. When we make it programmable, all we're doing is preloading the flip-flops. That fact, coupled with the fact that the zero count has all highs on the outputs, makes the coding of the 4018 unique. Table 1 is a listing of the code to keep in mind when you use the JAM inputs.

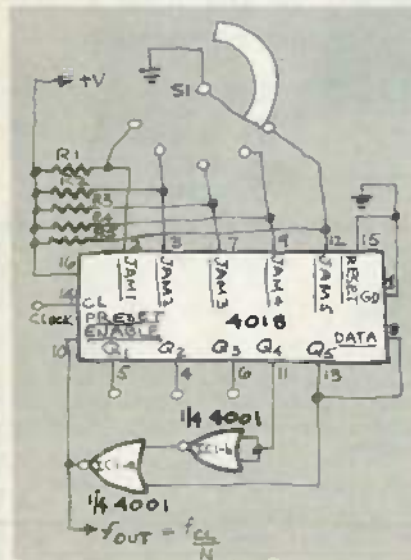

FIG. 1

In Fig. 1 we have the circuitry we talked about last month. Resistors R1 and R5 hold all the JAM inputs high. They're selectively brought low with SI, a rotary

TABLE 1

JAM1	JAM2	JAM3	JAM4	JAM5	COUNT	Q1	Q2	Q3	Q4	Q5
0	0	0	0	0	0	1	1	1	1	1
1	0	0	0	0	1	0	1	1	1	1
1	1	0	0	0	2	0	0	1	1	1
1	1	1	0	0	3	0	0	0	1	1
1	1	1	1	0	4	0	0	0	0	1
1	1	1	1	1	5	0	0	0	0	0
0	0	1	1	1	6	1	0	0	0	0
0	0	1	1	1	7	1	1	0	0	0
0	0	0	1	1	8	1	1	1	0	0
0	0	0	0	1	9	1	1	1	1	0

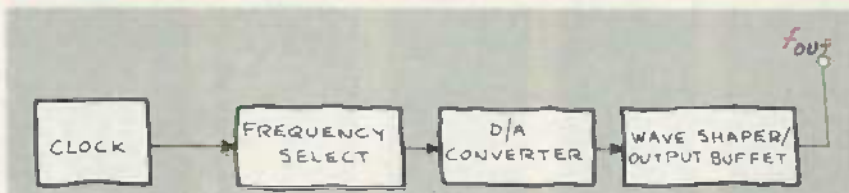

FIG. 2

switch that encodes all the inputs properly. The 4018 won't pay any attention to the JAM inputs unless the PRESET ENABLE pin, pin 10, is brought high. That is taken care of by IC1-a and IC1-b, half of a 4001 quad NOR gate. If you look at the data in Table 1 you'll see that Q4 and Q5 can be decoded when the count reaches nine and we can use that to flash a high at the PRESET ENABLE. If that looks strange compared to the 4017, remember that preloading the 4018 at the JAM inputs means that we're telling the IC what number to start the count with; on the 4017 we were telling the IC what number to end the count with. That may seem a bit strange but such are the peculiarities of things in the digital world. Seriously though, it's really a very important point and you should make sure you understand it.

There is a fundamental difference in the 4018's fixed and programmed modes. Obviously the hardware is different, but there's also a difference in just how the IC goes about actually dividing a frequency. In the fixed mode, the data on the selected output pins is constantly being recirculated through the internal flip-flops.

When the count reaches the number you've chosen for division, a logic one (high) is force-fed to the DATA input and appears at the Q1 output with the arrival of

the next incoming clock pulse. What is really happening here is that a particular stream of ones and zeros are trapped in the IC. Division, then, is being done by starting with a count of zero and working our way up the ladder.

Fixed mode division, as we've already seen, is quite a different thing. We preload the beginning number and let the device count from there to ten. The output frequency in that case can be picked off the DATA input just as it was in the fixed mode, but the waveforms are very different in the two cases. With fixed-mode division we wind up with a 50/50, or nearly 50/50, duty cycle. In the programmed mode, symmetry is out the window.

What, you may very well ask, is the advantage in using that IC? Well, the parts count is lower in circuits using the 4018 than in circuits using the 4017—only two external gates are needed as opposed to four—and we have a means of programming the IC that is completely independent of the outputs. If you think about that for a moment and take another look at Fig. 1, you'll realize that the rotary switch there could easily be replaced by something much more exciting and versatile, namely a microprocessor. We'll get back to that in a few months or so.

continued on page 97

"I built this 16-bit computer and saved money. Learned a lot, too."

Save now by building the Heathkit H-100 yourself. Save later because your computer investment won't become obsolete for many years to come.

Save by building it yourself. You can save hundreds of dollars over assembled prices when you choose the new H-100 16-Bit/8-Bit Computer Kit - money you can use to buy the peripherals and software of your choice.

H-100 SERIES COMPUTER SPECIFICATIONS:

USER MEMORY:
192K-768K bytes*

MICROPROCESSORS:
16-bit: 8088
8-bit: 8085

DISK STORAGE:
5.25" disk drive.
8" disk drive
Winchester drive

KEYBOARD:
Typewriter style, 95 keys.
13 function keys.
18-key numeric pad

GRAPHICS:
Always in graphics mode.
640h 225v resolution; up to
eight colors are available**

COMMUNICATIONS:
Two RS-232C Serial
Interface Ports and
one parallel port

DIAGNOSTICS:
Memory self-test
on power-up

AVAILABLE SOFTWARE:
Z-DOS (MS-DOS)
CP/M[®]
Z-BASIC Language
Microsoft BASIC
Multiplan
SuperCalc
WordStar

MailMerge
Data Base Manager
File Manager
General Ledger
Accounts Receivable
Accounts Payable
Inventory Control
Sales Invoicing
Lotus 1,2,3
PeachText 5000
Fortran-86
Cobol-86
Pascal
Basic Compiler
Most standard
8-bit CP/M
Software

The H-100 is easy to build - the step-by-step Heathkit manual shows you how. And every step of the way, you have our pledge - "We won't let you fail." Help is as close as your phone, or the nearest Heathkit Electronic Center.†

And what better way to learn state-of-the-art computing techniques than to build the world's only 16-bit/8-bit computer kit? To run today's higher-speed, higher-performance 16-bit software, you need an H-100. It makes a big difference by processing more data faster.

Dual microprocessors for power and compatibility. The H-100 handles both high-performance 16-bit software and most current Heath/Zenith 8-bit software.

Want room to grow? The H-100's standard 192K byte Random Access Memory complement can be expanded to 768K bytes - compared to a 64K standard for many desktop computers.

And the industry-standard S-100 card slots support memory expansion and additional peripheral devices, allowing your investment to grow.

High-capacity disk storage, too. The H-100's 5.25" floppy disk drive can store 320K bytes on a single disk. The computer also supports an optional second 5.25" and external 8" floppy disk drives. For maximum storage, an optional internal Winchester disk drive is also available.

For more information, circle the reader service number below. Better yet, visit your Heathkit Electronic Center for a demonstration!

*The H-100 gives me
the most for my
computer dollar!*

*192K bytes standard.
**Optional.
CP/M is a registered
trademark of Digital
Research.



Heathkit
Heath
Company

A subsidiary of Zenith Radio Corporation

†Heathkit Electronic Centers are units of Veritechnology Electronics Corporation.

CIRCLE 97 ON FREE INFORMATION CARD

SERVICE CLINIC

An easy and accurate IFT test

JACK DARR, SERVICE EDITOR

SEVERAL YEARS AGO, THE FIRST integrated flyback transformers (IFT) began to appear. Those first IFT's gave many technicians quite a bit of trouble, so it was very natural that they weren't too fond of them! However, over the years they've been dramatically improved and today are used in many modern TV sets. Because of that, we thought you might be interested in an easy and very accurate test method that we've recently run across.

The method that we'll describe here doesn't use any test equipment that you don't already have (or should have!). All that's needed is a variable transformer, a scope (either single or dual trace), an AC ammeter, and a couple of short clip-leads. Basically, all you have to do is to arrange

things so that the horizontal oscillator runs. Then monitor the prescribed test points (with a scope) while gradually increasing the line voltage to approximately 1/3 of its normal value.

Procedure

The first thing to do is to connect the variable transformer and ammeter as shown in Fig. 1. The ammeter should have a range of at least 5 amps.

Figure 2 shows a partial schematic of Sylvania's C3 color-TV chassis that we talked about last month. While we'll talk specifically about that chassis, the method we'll use can be adapted to others. Assuming that you're using a dual-trace scope, first connect Channel A of the



FIG. 1

scope to the output of IC500, the horizontal oscillator. (That IC isn't shown in the figure, but its output is—at the input of Q400.) Set the Channel A attenuation to 5 volts and the timebase to 10 μ s-per-divi-

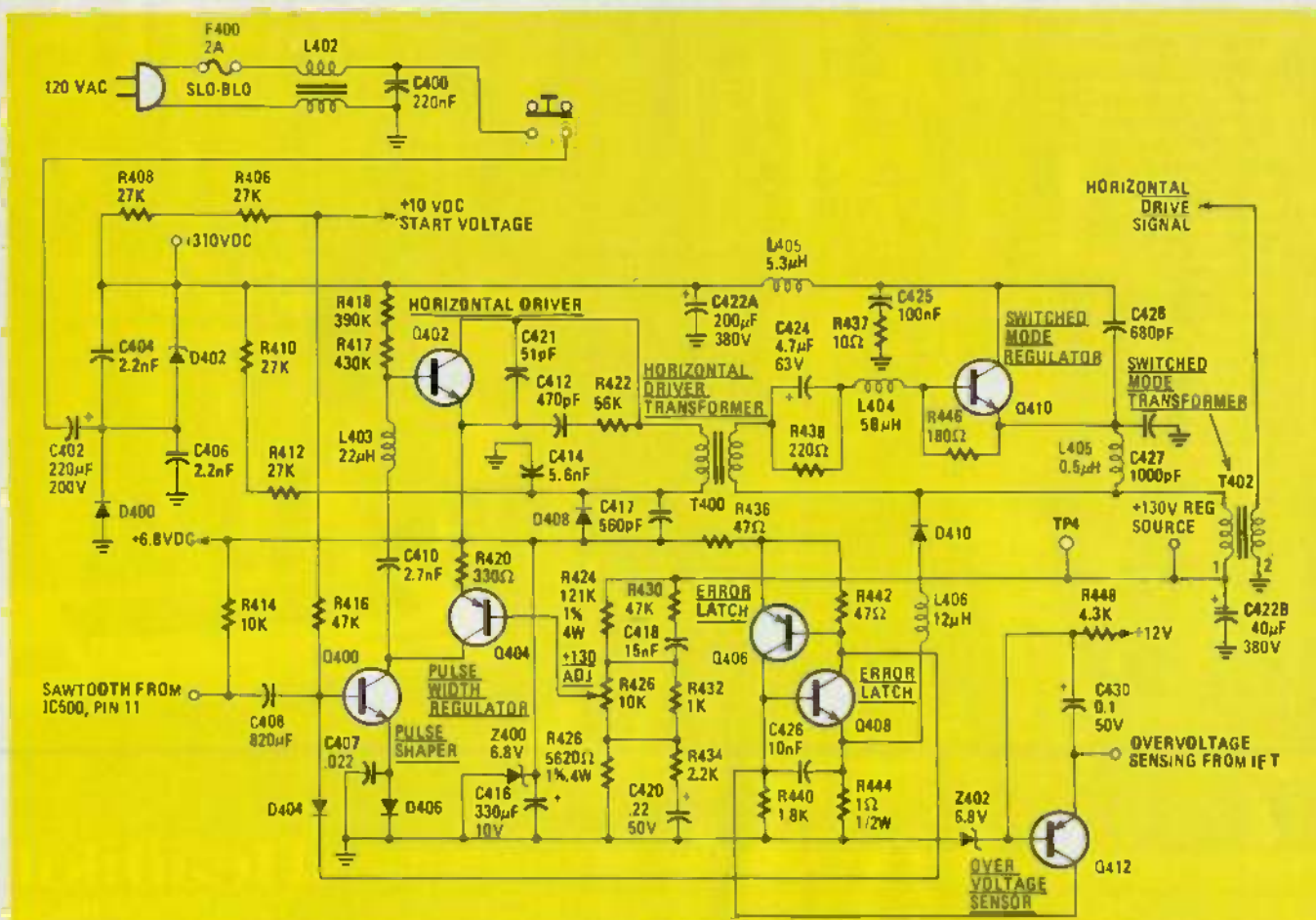

FIG. 2

sion. Now, connect Channel B to the collector of Q452, the horizontal-output transistor. (That transistor also isn't shown. The horizontal drive signal—from T402—is fed to its base.) Set the scope to 10 μ s-per-division and the attenuation to 100 volts.

Next, connect a clip lead across R406 in the starter circuit. Doing so raises the start voltage to a level that will maintain the operation of the horizontal oscillator. That voltage is normally 10-volts DC, but at the reduced line voltage you should read about +5.6 volts. Note: Our tests were made with the line voltage as low as 40-volts AC; you shouldn't have to raise the voltage above 70-volts AC. Before going any further it's a good idea to disable the error latch circuit by removing R436. That's because if there's some other trouble with the set, the error latch may fire and kill the horizontal drive signal. **Caution:** be sure that the set is never plugged into full line voltage with R436 removed or you'll be inviting a mess of trouble for yourself.

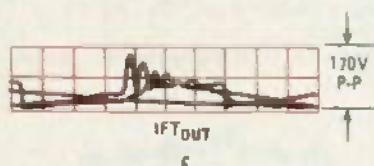
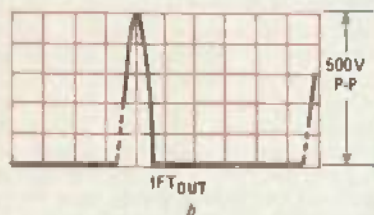

FIG. 3

Now using the variable transformer, gradually increase the line voltage until you see a 7-volt peak-to-peak sawtooth signal on Channel A of your scope. That sawtooth signal goes to the pulse-shaper and the switched-mode transformer that drives the horizontal-output circuitry. If the Channel A scope pattern is like the one shown in Fig. 3-a, you have a good drive signal. Now, look at Channel B, you should see a clean 500-volt peak-to-peak pulse as shown in Fig 3-b, if so the IFT is good. If the drive signal is good but you have a distorted or scrambled signal on Channel B, as shown in Fig. 3-c, you've got a problem.

If the signal is distorted be sure to

check all rectifiers used in the numerous low-voltage supplies (there are 4 or 5 of them). Watch out for shorts. Should your measurements indicate a short, stop and check out all of the low-voltage supply circuits. A shorted diode in any one of those supplies will cause trouble. Also, check for blown fuses and burnt components. If you discover any evidence of a short, measure the resistance of the associated components and make any necessary repairs. Study the schematic carefully to see if there is a low-voltage shutdown circuit in the set. If so, disable it and follow the same procedure as be-

fore. (The same precautions apply.) If after making all the necessary checks, you still get an indication of a short circuit, you can be fairly sure that the IFT is bad and should be replaced. If you don't get the correct waveform, check the time-per-division setting of your scope. After servicing, check to see that all jumpers have been removed and all disconnected parts have been replaced.

Though the above method was developed for the Sylvania/Phileo C3 chassis, we don't see why the basic procedure couldn't be adapted to other manufac-

continued on page 95

The Professionals' Choice

PTS

All makes/all models Eight hour tuneround

4:30 After a final visual inspection tuners are packaged to protect against damage during shipping. Identification codes are checked and fully rebuilt tuners are ready for shipping.

8:00 Tuners arrive and are unpacked at one of PTS' nationwide Servicenters.

8:30 Tuners are ultrasonically cleaned, degreased, then assigned to a tuner specialist.

10:00 Visual inspections determine missing or broken parts, burned or damaged components, and overall integrity.

10:50 preliminary electrical checks prevent any damage to sensitive testing equipment.

4:00 Quality control technician inspects tuners' circuitry and air test performance.

2:30 Tuners are subjected to temperature cycling, retested and air tested in a live television chassis.

1:00 Tuners are fully overhauled and aligned to meet or exceed original manufacturers' specifications. Repairs are recorded in service log to identify repeated component failure for future automatic updates.

11:25 Automatic updates are made for "better than brand new" performance.



PTS Corporation

The world's largest independent electronics rebuilder.

P.O. Box 272
Bloomington, IN 47402
(812) 824-9331

Thousands of professional television servicemen have turned to PTS for fast, eight hour tuneround service. No matter what time of day a tuner or module comes in, it immediately enters the rebuilding cycle. And PTS doesn't sacrifice quality for speed. Depend on PTS quality backed by a full year limited warranty.

CALL NOW AND RESERVE YOUR SPACE

- 6 x rate \$605 per each insertion.
- Reaches 235,323 readers.
- Fast reader service cycle.
- Short lead time for the placement of ads.
- We typeset and layout the ad at no additional charge.

Call 212-777-6400 to reserve space. Ask for Arline Fishman. Limited number of pages available. Mail materials to: mini-ADS, RADIO-ELECTRONICS, 200 Park Ave. South, New York, NY 10003.



MAE 3 MICROWAVE ANTENNA—32 DB Gain 1.9-2.5 GHz Tuneable. Complete with hardware for horizontal or vert. polarity, power supply, down converter, 2 stage RF AMP. Commercial grade. \$89.95. By phone or mail order only. Visa or MC. *Check or M.O. *Check orders held 30 days before shipping. 5% shipping & handling. **KASHIWAGI ELECTRONICS CORP.** 3555 S. Highland Dr. Suite 14, Las Vegas, NV. 89103, 702-367-1241.

CIRCLE 63 ON FREE INFORMATION CARD



VIDEO CASSETTE REWINDER VHS and BETAMAX—Prolongs the life of tapes and tape heads. Saves time and is fully automatic. \$49.95 plus 5% shipping and handling. Check or money order. No COD'S please. Send \$2.00 for catalog on Video, Computers, and telephones. **Bay State Electronics, P.O. Box 263, Accord, Mass. 02018.**

RE MAY 1978

CIRCLE 32 ON FREE INFORMATION CARD



THE MEAN LITTLE KIT New compact kit of electronic tools. Includes 7 screwdrivers, adjustable wrench, 2 pair pliers, wire stripper, knife, alignment tool, stainless rule, hex-key set, scissors, 2-flexible files, burnisher, soldering iron, solder aid, solder and desoldering braid. Highest quality padded zipper case. Send check or charge BankAmericard, Mastercard, or American Express. The JTK-6 sells for \$95.00—**JENSEN TOOLS INC.**, 7815 S. 46th Street, Phoenix, Arizona 85040, (602) 968-6231.

CIRCLE 69 ON FREE INFORMATION CARD



CELSISTRIP® TEMPERATURE RECORDING LABELS cover a range from 105°F to 500°F, available in individual dots or multi-recording strips. Celsistrip® gives a permanent reading of any surface. Use them as a guarantee misuse claim waiver label. Priced as low as 17¢ each (in quantity). Free sample. **SOLDER ABSORBING TECHNOLOGY, INC.**, South End Bridge Circle, Agawam, MA 01001. Toll free #1-800-628-8862.

CIRCLE 14 ON FREE INFORMATION CARD



MINIATURE 1/4W 5% CARBON FILM RESISTORS offer superior overall performance characteristics compared to carbon composition resistors - at significant cost savings! EIA color coding. 1 ohm thru 10 megohm. \$3.75 per hundred per value. Mastercard, Visa, American Express, accepted. Please add \$2.00 for shipping. California residents add 6% Sales Tax. No C.O.D. **ACORN INDUSTRIAL ELECTRONICS P.O. Box 10846, SANTA ANA Ca. 92711. 1300-D E. Edinger Ave., Santa Ana, Ca. 92705. (714) 547-8424.**

CIRCLE 46 ON FREE INFORMATION CARD



WIRELESS & ELECTRICAL CYCLO-PEDIA. Originally printed in 1918, this 176-page reprint of the complete catalog gives you an accurate look at the state of electronics in 1918. Contains everything from a Zinc Spark Gap to a 1000-Mile Receiving Outfit. You can get your own copy of this modern antique, profusely illustrated, for only \$4.95 plus \$1.00 P&H. Order yours from **R-E BOOKSTORE, Radio-Electronics, 200 Park Avenue, South, New York, NY 10003.**



SUBSCRIPTION TV MANUAL. This information packed book details the methods used by subscription TV companies to scramble and descramble video signals. Covers the sinewave, gated pulse, SSAVI system, and the methods used by most cable companies. Includes circuit schematics, theory, waveforms and trouble shooting hints. Only \$12.95 plus \$1.50 first class shipping and handling. **RANDOM ACCESS, Box 41770R, Phoenix, AZ 85080.**

CIRCLE 17 ON FREE INFORMATION CARD



APPLIANCE REPAIR HANDBOOKS—13 volumes by service experts; easy-to-understand diagrams, illustrations. For major appliances (air conditioners, refrigerators, washers, dryers, microwaves, etc.), elec. housewares, personal-care appliances. Basics of solid state, setting up shop, test instruments. \$2.65 to \$5.90 each. Free brochure. **APPLIANCE SERVICE, PO Box 789, Lombard, IL 60148. 1-(312) 932-9550.**

CIRCLE 77 ON FREE INFORMATION CARD

SERVICE CLINIC

continued from page 93

turer's sets using the same type circuitry with a little ingenuity. That is, provide a start-up and run voltage to the horizontal oscillator with an external low-voltage DC supply. You don't have one? How about the bias box in your alignment setup? They have the right voltage and most of them will supply the full current needed! If you don't have one, but your sweep generator or marker/adder has one or two built-in, that's fine (my Heathkit IG-57 does).

Why not try looking for other ways to use that test setup; it just might turn out to be a handy-dandy idea! R-E

SERVICE QUESTIONS

SYNC PROBLEMS

I am having trouble tracking down the cause of a problem with an RCA EQ-335W. The set works fine until there is a dark
continued on page 110

Get this catalog to SAVE MONEY! It's free!



Quality Crystals Available for
Communications Industry
Marine VHF Scanners
Amateur Bands CB Standard
Microprocessor CB Specials
"Just One or Hundreds"

Our low prices result from modern equipment and technology, efficient trained employees, and low sales costs. Call us.

JAN CRYSTALS



P.O. Box 06017
Ft. Myers, FL 33906
Call (813) 936-2397

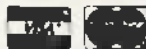

CIRCLE 38 ON FREE INFORMATION CARD

SEE YOUR DEALER TODAY

FROM

Firestik
ANTENNAS
ACCESSORIES

HERE'S A TIP THAT'S PERFECT!

AM/FM AUTO RADIO AND CB

'Firestik' II
GOLDEN SERIES

BARE-HANDS TUNABLE
"NO TOOLS NEEDED"
HIGH PERFORMANCE ANTENNAS

ALSO ANTENNAS FOR
CORDLESS TELEPHONES
MONITOR SCANNERS

Dealer & Distributor Inquiries Invited
SEND FOR FREE CATALOG

Firestik Antenna Company
2614 East Adams/Phoenix, AZ 85004

Name _____
Street _____
City _____
State _____ Zip _____

Serving the CB and
Communications Market Since 1962.

5-YEAR REPLACEMENT WARRANTY

CIRCLE 40 ON FREE INFORMATION CARD

The world of electronics gee-wizardry



-YOURS FREE.

32-pages of test instruments - from the latest digital multimeters to the famous EICO scopes. Security systems. Automotive and hobbyist products. Kits and assembled. EICO quality. EICO value. For FREE catalog, check reader service card or send 50¢ for first class mail.

EICO 108 New South Road
Hicksville, N.Y. 11801

CIRCLE 59 ON FREE INFORMATION CARD

FREE

McIntosh STEREO CATALOG and FM DIRECTORY

Get all the newest and latest information on the new McIntosh stereo equipment in the McIntosh catalog. In addition you will receive an FM station directory that covers all of North America.



SEND TODAY!

McIntosh Laboratory Inc. RE
East Side Station P.O. Box 96
Binghamton, N.Y. 13904-0096

NAME _____

ADDRESS _____

CITY _____ STATE _____ ZIP _____

If you are in a hurry for your catalog please send the coupon to McIntosh. For non rush service send the Reader Service Card to the magazine.

CIRCLE 93 ON FREE INFORMATION CARD

New from B&K-PRECISION Autoranging and manual control in one DMM



Model 2816 \$150

- Full manual or full autoranging on volts and ohms
- Single rotary selector switch control
- 0.25% DC accuracy
- 500 hour battery life
- Continuity test beeper
- Diode check
- Transient and overload protected
- High energy fuse

Model 2807 \$115

Same features as Model 2816 with 0.5% DC accuracy

Model 2806 \$75

Autoranging only on volts and ohms, manual amps. 0.7% DC accuracy

For more information contact your B&K-PRECISION distributor or write for specifications.

BK PRECISION
DYNASCAN
CORPORATION

6460 West Cortland Street
Chicago, Illinois 60635 • 312/889-9087

International Sales: 6460 W. Cortland St., Chicago, IL 60635
Canadian Sales: Atlas Electronics, Ontario
South and Central American Sales:
8 Merritt Road, Plainville, NY 11803

CIRCLE 16 ON FREE INFORMATION CARD

STATE OF SOLID STATE

continued from page 88

internal Zener diode between pin 5 and ground provides 22 volts to operate the oscillator, frequency dividers, and buffer/amplifier output stage. Capacitor C4 (1.0 to 10.0 μ F) filters the supply voltage for the tone-generator circuits and provides an AC-current path to ground for the 10-volt RMS ringer signal when the phone ringer is not driving a load. Potentially harmful line transients trigger the SCR when the Zener regulator current exceeds about 50 mA. When the SCR fires, it diverts current from the shunt regulator and reduces the power dissipated within the IC.

In the second current path the rectified ring-signal voltage produces a current flow through R3, the input-current sense-resistor, to control the ringing-threshold voltage. The design range for R3 is 800 to 2000 ohms; increasing that resistor decreases the ring-start voltage. Capacitor C3 filters the voltage across R3 at the input to the threshold comparator and also filters out the transients developed by the telephone dialer. When the voltage across C3 exceeds 1.7 volts, the threshold comparator enables the output buffer/ampli-

fier so that the warbling tone-ringer output signal reaches the ceramic transducer. Suitable values for C3 range between 0.5 and 5 μ F.

The MC34012 telephone tone ringer is available from Motorola distributors, and wholesale and retail parts suppliers and is priced at \$1.24 each in lots of 100 to 999. Suitable piezoelectric transducers include the PT-7 and PT-8 models from Mallory Distributor Products Co. (Box 1284, Indianapolis, IN 46206) and some of the transducers from L&M Components. (PO Box 25110, Portland, OR 97225).

New microelectronics data book

Microelectronics Data Catalog is a new (1983) 559-page edition that provides detailed technical and design data on General Instrument's line of integrated circuits. The nine families of digital microcircuits presented are dedicated to the computer and communications industries. Product categories listed by chapter, include ROM'S, EAROM'S (Electrically Alterable Read-Only Memories), Microcomputer, Audio, Telephony, Data Communications, ULA'S (Uncommitted Logic Arrays), Video, and Tuning. It is offered free and may be obtained through world-wide sales offices **General Instrument, Microelectronics Div.**, 600 W. John St., Hicksville, NY 11802. R-E

THE SA-4 DESOLDER STATION



- NO CLOGGING
- SELF CONTAINED PUMP
- CERAMIC HEATING ELEMENT
- HEAT RESISTANT SUCTION HOSE
- POWERFUL SUCTION CAPABILITY
- HIGHLY FUNCTIONAL HANDPIECE
- LONG LIFE REPLACEABLE NOZZLE
- EASY CLEANING AND FILTER REPLACEMENT

The new model SA-4 Desoldering Station features a self-contained high-volume vacuum pump. Compact and lightweight for complete portability, yet with power to spare for the most difficult thru-hole and multilayer applications. Equally suited for production as well as prototype and laboratory use, the SA-4 features a convenient pistol grip handpiece, trigger-actuated operation, no-choke straight flow design, easy collector cleaning, and a handy tool holder built into the control unit. Designed for long life and low maintenance, the SA-4 is also easily disassembled when service is required. Supplied with 0.039 inch (1.0mm) tip, tip cleaning pin, and spare filters.

*Does not include shipping charges and local taxes.

dti **DTI CORPORATION**
ELECTRONIC TOOLS & ACCESSORIES

2-05 Banta Place, Fair Lawn, NJ 07410 USA Tel 201-796-1720

CIRCLE 54 ON FREE INFORMATION CARD

DRAWING BOARD

continued from page 90

A sinewave generator

For the moment, however, let's get back to the reason we started playing around with the 4018. Look back at the timing diagram that appeared in February's column, the first thing that comes to mind is that the symmetry of the outputs is perfect for generating sinewaves. As a matter of fact, that is one of the most common uses for the 4018. Before we actually start doing the design, let's lay down the design criteria.

1. The parts count will be as low as possible.
2. Battery operation will be possible.
3. The bandwidth will be at least 100 Hz to 100 kHz.
4. The output frequency will be controlled by a potentiometer.

There are all sorts of additional bells and whistles that we could add to that list—readouts, keyboard frequency-selection, and so on. All those sorts of things are design problems on their own and are really beside the point. Once we've described the basics we can spend a bit of time exploring the extras.

If you stop and think about it for a moment, the basic method behind generating a sinewave with a 4018 is simple. Of course, that's just the basic method. Just as with anything in electronics, once you get past the beginning, things have a nasty habit of getting incredibly hairy. How sharp your razor has to be in order to cut through it all depends on a lot of things ranging from the depth of your interest to the extent of your need.

As you should all know by now, the first step in any design is to make sure you know what you want to do and then work out the bare bones of the problem on paper. You can't talk about components and circuitry unless and until you've got a clear idea of your objectives and a block diagram of a possible solution in front of you. Since we know what we want to do, our next step is to draw a block diagram.

Figure 2 is a representation of what we want to design. It looks simple because the problem is simple—don't forget that we've already decided, at least for the moment, to drop a lot of the bells and whistles.

All of our discussions the last few months have been aimed at laying the groundwork for an understanding of the design of the D/A converter shown in the block diagram. All we're talking about there is using the 4018 to convert a stream of clock pulses into something that can be made into a sinewave. How we would go about doing that should be evident after a quick look at the 4018 timing chart in February's column. All that wonderful regularity at the outputs is just perfect for

what we have in mind. It's a matter of adding the outputs together in some way to create an up and down staircase that we can iron smooth with the wave shaper.

As with any D/A conversion, the more digital steps you start with, the better the analog signal you wind up with. Since the 4018 has five internal flip-flops, we'll use them all. Not only will that give us the maximum number of digital steps, but it helps us satisfy the first of our design criteria—keeping the parts count down. Using all the flip-flops in the device means that we're setting it up to divide by ten. Again, take a look at February's col-

umn if you're not clear about that. When you use the 4018 for fixed division by ten, the external parts count is exactly zero! You can't do much better than that.

If the IC is going to be dividing by ten, it follows logically that the input clock has to run ten times faster than the maximum frequency we want for our sinewave. Criterion 3 means that we're going to need an input clock that can put out everything from a minimum of 1 kHz to a top of at least 1 MHz.

When we continue next time, we'll work out the details of the circuit and see what we have to do to make it work. R-E

Electronics Paperback Books NEW Paperbacks You'll Want To Read CHECK OFF THE ONES YOU WANT



20 PROGRAMS FOR THE SPECTRUM ANALYZER—\$8.95. Includes with each program a detailed flow chart for both general use and practical applications in freq. analysis, and engineering.

20 BOLDERLESS SPREADSHEET PROGRAMS—\$8.95. 20 more new spreadsheets based on CMOS ICs that will cut 50% in minutes on an electronic spreadsheet.

HOW TO GET YOUR ELECTRONIC PROJECTS—\$8.95. When you can't get the time-built equipment to work, the book may have the answers you need.

ART OF PROGRAMMING THE 18K EX81—\$8.95. What this book when you add the PLAM pak. Scrolling, PEEK, POKE, Page graphics and more.

25 SIMPLE AMATEUR BAND ANTENNAS—\$8.95. Includes designs for classic designs, things you can do, and even a non-technical manual. Includes a complete set of dimension tables.

EASY ADD-ON PROJECTS FOR SPECTRUM ANALYZER—\$7.95. Pulse generator, picture digitizer, binary DAC, model controller, light pen, and more.

INTERNATIONAL TRANSMITTER EQUIPMENT GUIDE—\$7.95. Lists possible substitutes for a complete list of modern transmitters. The products of more than 100 manufacturers are included.

ELECTRONICS SMOULDERING—CRYSTAL SET COMBINATION—\$8.95. All of these readers are designed around modern inexpensive components and transistors coils.

INTERNATIONAL IC EQUIVALENTS GUIDE—\$8.95. First book of its kind. Find out what you can substitute for the ICs of the world. Includes MOS, bipolar, CMOS, microprocessors and other ICs.

AN INTRODUCTION TO PROGRAMMING THE 6801—\$8.95. A new authoritative manual for owners of the new personal computer.

BASIC PASCAL IN PARALLEL—\$8.95. Outlines programs in both languages. Simple programs illustrate step-by-step.

AN INTRODUCTION TO PROGRAMMING THE 6801—\$8.95. A new authoritative manual for owners of the new personal computer.

INTERNATIONAL IC EQUIVALENTS GUIDE—\$8.95. First book of its kind. Find out what you can substitute for the ICs of the world. Includes MOS, bipolar, CMOS, microprocessors and other ICs.

MULTI-CIRCUIT BOARD PROJECTS—\$8.95. 21 simple projects that can all be built on one circuit board. Use the same components in several projects.

INTERNATIONAL TRANSMITTER EQUIPMENT GUIDE—\$7.95. Lists possible substitutes for a complete list of modern transmitters. The products of more than 100 manufacturers are included.

ELECTRONICS SMOULDERING—CRYSTAL SET COMBINATION—\$8.95. All of these readers are designed around modern inexpensive components and transistors coils.

THE PCB HANDBOOK—\$8.95. Aimed at the beginner with no knowledge of computing. An easy non-technical discussion.

DESIGN & MAKE YOUR OWN PRINTED CIRCUIT BOARD—\$8.95. Everything you ever needed to know about how to make printed circuit boards at home.

PROGRAMMING THE ZX SPECTRUM—\$7.95. Make the color computer go to work. With this book it's easy.

PRACTICAL ELECTRONIC BUILDING BLOCKS—\$8.95. Electronic building blocks are all made up of individual building blocks. Make the blocks, then combine them to build the circuits you need.

PRACTICAL ELECTRONIC BUILDING BLOCKS—\$8.95. Follow up to Volume 1 presents more building blocks for the experimenter.

AN INTRODUCTION TO VIDEO—\$8.95. Covers most of the practical aspects of video recording that a newcomer to the subject might require.

20 PROGRAMS FOR THE SPECTRUM ANALYZER—\$8.95.

20 BOLDERLESS SPREADSHEET PROGRAMS—\$8.95.

HOW TO GET YOUR ELECTRONIC PROJECTS—\$8.95.

ART OF PROGRAMMING THE 18K EX81—\$8.95.

25 SIMPLE AMATEUR BAND ANTENNAS—\$8.95.

EASY ADD-ON PROJECTS FOR SPECTRUM ANALYZER—\$7.95.

INTERNATIONAL TRANSMITTER EQUIPMENT GUIDE—\$7.95.

ELECTRONICS SMOULDERING—CRYSTAL SET COMBINATION—\$8.95.

THE PCB HANDBOOK—\$8.95.

DESIGN & MAKE YOUR OWN PRINTED CIRCUIT BOARD—\$8.95.

PROGRAMMING THE ZX SPECTRUM—\$7.95.

PRACTICAL ELECTRONIC BUILDING BLOCKS—\$8.95.

PRACTICAL ELECTRONIC BUILDING BLOCKS—\$8.95.

AN INTRODUCTION TO VIDEO—\$8.95.

20 PROGRAMS FOR THE SPECTRUM ANALYZER—\$8.95.

20 BOLDERLESS SPREADSHEET PROGRAMS—\$8.95.

HOW TO GET YOUR ELECTRONIC PROJECTS—\$8.95.

ART OF PROGRAMMING THE 18K EX81—\$8.95.

25 SIMPLE AMATEUR BAND ANTENNAS—\$8.95.

EASY ADD-ON PROJECTS FOR SPECTRUM ANALYZER—\$7.95.

INTERNATIONAL TRANSMITTER EQUIPMENT GUIDE—\$7.95.

ELECTRONICS SMOULDERING—CRYSTAL SET COMBINATION—\$8.95.

THE PCB HANDBOOK—\$8.95.

DESIGN & MAKE YOUR OWN PRINTED CIRCUIT BOARD—\$8.95.

PROGRAMMING THE ZX SPECTRUM—\$7.95.

PRACTICAL ELECTRONIC BUILDING BLOCKS—\$8.95.

PRACTICAL ELECTRONIC BUILDING BLOCKS—\$8.95.

AN INTRODUCTION TO VIDEO—\$8.95.

20 PROGRAMS FOR THE SPECTRUM ANALYZER—\$8.95.

20 BOLDERLESS SPREADSHEET PROGRAMS—\$8.95.

HOW TO GET YOUR ELECTRONIC PROJECTS—\$8.95.

ART OF PROGRAMMING THE 18K EX81—\$8.95.

25 SIMPLE AMATEUR BAND ANTENNAS—\$8.95.

EASY ADD-ON PROJECTS FOR SPECTRUM ANALYZER—\$7.95.

INTERNATIONAL TRANSMITTER EQUIPMENT GUIDE—\$7.95.

ELECTRONICS SMOULDERING—CRYSTAL SET COMBINATION—\$8.95.

THE PCB HANDBOOK—\$8.95.

DESIGN & MAKE YOUR OWN PRINTED CIRCUIT BOARD—\$8.95.

PROGRAMMING THE ZX SPECTRUM—\$7.95.

PRACTICAL ELECTRONIC BUILDING BLOCKS—\$8.95.

PRACTICAL ELECTRONIC BUILDING BLOCKS—\$8.95.

AN INTRODUCTION TO VIDEO—\$8.95.

20 PROGRAMS FOR THE SPECTRUM ANALYZER—\$8.95.

20 BOLDERLESS SPREADSHEET PROGRAMS—\$8.95.

HOW TO GET YOUR ELECTRONIC PROJECTS—\$8.95.

ART OF PROGRAMMING THE 18K EX81—\$8.95.

25 SIMPLE AMATEUR BAND ANTENNAS—\$8.95.

EASY ADD-ON PROJECTS FOR SPECTRUM ANALYZER—\$7.95.

INTERNATIONAL TRANSMITTER EQUIPMENT GUIDE—\$7.95.

ELECTRONICS SMOULDERING—CRYSTAL SET COMBINATION—\$8.95.

THE PCB HANDBOOK—\$8.95.

DESIGN & MAKE YOUR OWN PRINTED CIRCUIT BOARD—\$8.95.

PROGRAMMING THE ZX SPECTRUM—\$7.95.

PRACTICAL ELECTRONIC BUILDING BLOCKS—\$8.95.

PRACTICAL ELECTRONIC BUILDING BLOCKS—\$8.95.

AN INTRODUCTION TO VIDEO—\$8.95.

20 PROGRAMS FOR THE SPECTRUM ANALYZER—\$8.95.

20 BOLDERLESS SPREADSHEET PROGRAMS—\$8.95.

HOW TO GET YOUR ELECTRONIC PROJECTS—\$8.95.

ART OF PROGRAMMING THE 18K EX81—\$8.95.

25 SIMPLE AMATEUR BAND ANTENNAS—\$8.95.

EASY ADD-ON PROJECTS FOR SPECTRUM ANALYZER—\$7.95.

INTERNATIONAL TRANSMITTER EQUIPMENT GUIDE—\$7.95.

ELECTRONICS SMOULDERING—CRYSTAL SET COMBINATION—\$8.95.

THE PCB HANDBOOK—\$8.95.

DESIGN & MAKE YOUR OWN PRINTED CIRCUIT BOARD—\$8.95.

PROGRAMMING THE ZX SPECTRUM—\$7.95.

PRACTICAL ELECTRONIC BUILDING BLOCKS—\$8.95.

PRACTICAL ELECTRONIC BUILDING BLOCKS—\$8.95.

AN INTRODUCTION TO VIDEO—\$8.95.

20 PROGRAMS FOR THE SPECTRUM ANALYZER—\$8.95.

20 BOLDERLESS SPREADSHEET PROGRAMS—\$8.95.

HOW TO GET YOUR ELECTRONIC PROJECTS—\$8.95.

ART OF PROGRAMMING THE 18K EX81—\$8.95.

25 SIMPLE AMATEUR BAND ANTENNAS—\$8.95.

EASY ADD-ON PROJECTS FOR SPECTRUM ANALYZER—\$7.95.

INTERNATIONAL TRANSMITTER EQUIPMENT GUIDE—\$7.95.

ELECTRONICS SMOULDERING—CRYSTAL SET COMBINATION—\$8.95.

THE PCB HANDBOOK—\$8.95.

DESIGN & MAKE YOUR OWN PRINTED CIRCUIT BOARD—\$8.95.

PROGRAMMING THE ZX SPECTRUM—\$7.95.

PRACTICAL ELECTRONIC BUILDING BLOCKS—\$8.95.

PRACTICAL ELECTRONIC BUILDING BLOCKS—\$8.95.

AN INTRODUCTION TO VIDEO—\$8.95.

20 PROGRAMS FOR THE SPECTRUM ANALYZER—\$8.95.

20 BOLDERLESS SPREADSHEET PROGRAMS—\$8.95.

HOW TO GET YOUR ELECTRONIC PROJECTS—\$8.95.

ART OF PROGRAMMING THE 18K EX81—\$8.95.

25 SIMPLE AMATEUR BAND ANTENNAS—\$8.95.

EASY ADD-ON PROJECTS FOR SPECTRUM ANALYZER—\$7.95.

INTERNATIONAL TRANSMITTER EQUIPMENT GUIDE—\$7.95.

ELECTRONICS SMOULDERING—CRYSTAL SET COMBINATION—\$8.95.

THE PCB HANDBOOK—\$8.95.

DESIGN & MAKE YOUR OWN PRINTED CIRCUIT BOARD—\$8.95.

PROGRAMMING THE ZX SPECTRUM—\$7.95.

PRACTICAL ELECTRONIC BUILDING BLOCKS—\$8.95.

PRACTICAL ELECTRONIC BUILDING BLOCKS—\$8.95.

AN INTRODUCTION TO VIDEO—\$8.95.

20 PROGRAMS FOR THE SPECTRUM ANALYZER—\$8.95.

20 BOLDERLESS SPREADSHEET PROGRAMS—\$8.95.

HOW TO GET YOUR ELECTRONIC PROJECTS—\$8.95.

ART OF PROGRAMMING THE 18K EX81—\$8.95.

25 SIMPLE AMATEUR BAND ANTENNAS—\$8.95.

EASY ADD-ON PROJECTS FOR SPECTRUM ANALYZER—\$7.95.

INTERNATIONAL TRANSMITTER EQUIPMENT GUIDE—\$7.95.

ELECTRONICS SMOULDERING—CRYSTAL SET COMBINATION—\$8.95.

THE PCB HANDBOOK—\$8.95.

DESIGN & MAKE YOUR OWN PRINTED CIRCUIT BOARD—\$8.95.

PROGRAMMING THE ZX SPECTRUM—\$7.95.

PRACTICAL ELECTRONIC BUILDING BLOCKS—\$8.95.

PRACTICAL ELECTRONIC BUILDING BLOCKS—\$8.95.

AN INTRODUCTION TO VIDEO—\$8.95.

20 PROGRAMS FOR THE SPECTRUM ANALYZER—\$8.95.

20 BOLDERLESS SPREADSHEET PROGRAMS—\$8.95.

HOW TO GET YOUR ELECTRONIC PROJECTS—\$8.95.

ART OF PROGRAMMING THE 18K EX81—\$8.95.

25 SIMPLE AMATEUR BAND ANTENNAS—\$8.95.

EASY ADD-ON PROJECTS FOR SPECTRUM ANALYZER—\$7.95.

INTERNATIONAL TRANSMITTER EQUIPMENT GUIDE—\$7.95.

ELECTRONICS SMOULDERING—CRYSTAL SET COMBINATION—\$8.95.

THE PCB HANDBOOK—\$8.95.

DESIGN & MAKE YOUR OWN PRINTED CIRCUIT BOARD—\$8.95.

PROGRAMMING THE ZX SPECTRUM—\$7.95.

PRACTICAL ELECTRONIC BUILDING BLOCKS—\$8.95.

PRACTICAL ELECTRONIC BUILDING BLOCKS—\$8.95.

AN INTRODUCTION TO VIDEO—\$8.95.

20 PROGRAMS FOR THE SPECTRUM ANALYZER—\$8.95.

20 BOLDERLESS SPREADSHEET PROGRAMS—\$8.95.

HOW TO GET YOUR ELECTRONIC PROJECTS—\$8.95.

ART OF PROGRAMMING THE 18K EX81—\$8.95.

25 SIMPLE AMATEUR BAND ANTENNAS—\$8.95.

EASY ADD-ON PROJECTS FOR SPECTRUM ANALYZER—\$7.95.

INTERNATIONAL TRANSMITTER EQUIPMENT GUIDE—\$7.95.

ELECTRONICS SMOULDERING—CRYSTAL SET COMBINATION—\$8.95.

THE PCB HANDBOOK—\$8.95.

DESIGN & MAKE YOUR OWN PRINTED CIRCUIT BOARD—\$8.95.

PROGRAMMING THE ZX SPECTRUM—\$7.95.

PRACTICAL ELECTRONIC BUILDING BLOCKS—\$8.95.

PRACTICAL ELECTRONIC BUILDING BLOCKS—\$8.95.

AN INTRODUCTION TO VIDEO—\$8.95.

20 PROGRAMS FOR THE SPECTRUM ANALYZER—\$8.95.

20 BOLDERLESS SPREADSHEET PROGRAMS—\$8.95.

HOW TO GET YOUR ELECTRONIC PROJECTS—\$8.95.

ART OF PROGRAMMING THE 18K EX81—\$8.95.

25 SIMPLE AMATEUR BAND ANTENNAS—\$8.95.

EASY ADD-ON PROJECTS FOR SPECTRUM ANALYZER—\$7.95.

INTERNATIONAL TRANSMITTER EQUIPMENT GUIDE—\$7.95.

ELECTRONICS SMOULDERING—CRYSTAL SET COMBINATION—\$8.95.

THE PCB HANDBOOK—\$8.95.

DESIGN & MAKE YOUR OWN PRINTED CIRCUIT BOARD—\$8.95.

PROGRAMMING THE ZX SPECTRUM—\$7.95.

PRACTICAL ELECTRONIC BUILDING BLOCKS—\$8.95.

PRACTICAL ELECTRONIC BUILDING BLOCKS—\$8.95.

AN INTRODUCTION TO VIDEO—\$8.95.

20 PROGRAMS FOR THE SPECTRUM ANALYZER—\$8.95.

20 BOLDERLESS SPREADSHEET PROGRAMS—\$8.95.

HOW TO GET YOUR ELECTRONIC PROJECTS—\$8.95.

ART OF PROGRAMMING THE 18K EX81—\$8.95.

25 SIMPLE AMATEUR BAND ANTENNAS—\$8.95.

EASY ADD-ON PROJECTS FOR SPECTRUM ANALYZER—\$7.95.

INTERNATIONAL TRANSMITTER EQUIPMENT GUIDE—\$7.95.

ELECTRONICS SMOULDERING—CRYSTAL SET COMBINATION—\$8.95.

THE PCB HANDBOOK—\$8.95.

DESIGN & MAKE YOUR OWN PRINTED CIRCUIT BOARD—\$8.95.

PROGRAMMING THE ZX SPECTRUM—\$7.95.

PRACTICAL ELECTRONIC BUILDING BLOCKS—\$8.95.

PRACTICAL ELECTRONIC BUILDING BLOCKS—\$8.95.

AN INTRODUCTION TO VIDEO—\$8.95.

20 PROGRAMS FOR THE SPECTRUM ANALYZER—\$8.95.

20 BOLDERLESS SPREADSHEET PROGRAMS—\$8.95.

HOW TO GET YOUR ELECTRONIC PROJECTS—\$8.95.

ART OF PROGRAMMING THE 18K EX81—\$8.95.

25 SIMPLE AMATEUR BAND ANTENNAS—\$8.95.

EASY ADD-ON PROJECTS FOR SPECTRUM ANALYZER—\$7.95.

INTERNATIONAL TRANSMITTER EQUIPMENT GUIDE—\$7.95.

ELECTRONICS SMOULDERING—CRYSTAL SET COMBINATION—\$8.95.

THE PCB HANDBOOK—\$8.95.

DESIGN & MAKE YOUR OWN PRINTED CIRCUIT BOARD—\$8.95.

PROGRAMMING THE ZX SPECTRUM—\$7.95.

PRACTICAL ELECTRONIC BUILDING BLOCKS—\$8.95.

PRACTICAL ELECTRONIC BUILDING BLOCKS—\$8.95.

AN INTRODUCTION TO VIDEO—\$8.95.

20 PROGRAMS FOR THE SPECTRUM ANALYZER—\$8.95.

20 BOLDERLESS SPREADSHEET PROGRAMS—\$8.95.

HOW TO GET YOUR ELECTRONIC PROJECTS—\$8.95.

ART OF PROGRAMMING THE 18K EX81—\$8.95.

25 SIMPLE AMATEUR BAND ANTENNAS—\$8.95.

EASY ADD-ON PROJECTS FOR SPECTRUM ANALYZER—\$7.95.

INTERNATIONAL TRANSMITTER EQUIPMENT GUIDE—\$7.95.

ELECTRONICS SMOULDERING—CRYSTAL SET COMBINATION—\$8.95.

THE PCB HANDBOOK—\$8.95.

DESIGN & MAKE YOUR OWN PRINTED CIRCUIT BOARD—\$8.95.

PROGRAMMING THE ZX SPECTRUM—\$7.95.

PRACTICAL ELECTRONIC BUILDING BLOCKS—\$8.95.

PRACTICAL ELECTRONIC BUILDING BLOCKS—\$8.95.

AN INTRODUCTION TO VIDEO—\$8.95.

20 PROGRAMS FOR THE SPECTRUM ANALYZER—\$8.95.

20 BOLDERLESS SPREADSHEET PROGRAMS—\$8.95.

HOW TO GET YOUR ELECTRONIC PROJECTS—\$8.95.

ART OF PROGRAMMING THE 18K EX81—\$8.95.

25 SIMPLE AMATEUR BAND ANTENNAS—\$8.95.

EASY ADD-ON PROJECTS FOR SPECTRUM ANALYZER—\$7.95.

INTERNATIONAL TRANSMITTER EQUIPMENT GUIDE—\$7.95.

ELECTRONICS SMOULDERING—CRYSTAL SET COMBINATION—\$8.95.

THE PCB HANDBOOK—\$8.95.

DESIGN & MAKE YOUR OWN PRINTED CIRCUIT BOARD—\$8.95.

PROGRAMMING THE ZX SPECTRUM—\$7.95.

PRACTICAL ELECTRONIC BUILDING BLOCKS—\$8.95.

PRACTICAL ELECTRONIC BUILDING BLOCKS—\$8.95.

AN INTRODUCTION TO VIDEO—\$8.95.

20 PROGRAMS FOR THE SPECTRUM ANALYZER—\$8.95.

20 BOLDERLESS SPREADSHEET PROGRAMS—\$8.95.

HOW TO GET YOUR ELECTRONIC PROJECTS—\$8.95.

ART OF PROGRAMMING THE 18K EX81—\$8.95.

25 SIMPLE AMATEUR BAND ANTENNAS—\$8.95.

EASY ADD-ON PROJECTS FOR SPECTRUM ANALYZER—\$7.95.

INTERNATIONAL TRANSMITTER EQUIPMENT GUIDE—\$7.95.

ELECTRONICS SMOULDERING—CRYSTAL SET COMBINATION—\$8.95.

THE PCB HANDBOOK—\$8.95.

DESIGN & MAKE YOUR OWN PRINTED CIRCUIT BOARD—\$8.95.

PROGRAMMING THE ZX SPECTRUM—\$7.95.

PRACTICAL ELECTRONIC BUILDING BLOCKS—\$8.95.

PRACTICAL ELECTRONIC BUILDING BLOCKS—\$8.95.

AN INTRODUCTION TO VIDEO—\$8.95.

20 PROGRAMS FOR THE SPECTRUM ANALYZER—\$8.95.

20 BOLDERLESS SPREADSHEET PROGRAMS—\$8.95.

HOW TO GET YOUR ELECTRONIC PROJECTS—\$8.95.

ART OF PROGRAMMING THE 18K EX81—\$8.95.

25 SIMPLE AMATEUR BAND ANTENNAS—\$8.95.

EASY ADD-ON PROJECTS FOR SPECTRUM ANALYZER—\$7.95.

INTERNATIONAL TRANSMITTER EQUIPMENT GUIDE—\$7.95.

ELECTRONICS SMOULDERING—CRYSTAL SET COMBINATION—\$8.95.

THE PCB HANDBOOK—\$8.95.

DESIGN & MAKE YOUR OWN PRINTED CIRCUIT BOARD—\$8.95.

PROGRAMMING THE ZX SPECTRUM—\$7.95.

PRACTICAL ELECTRONIC BUILDING BLOCKS—\$8.95.

PRACTICAL ELECTRONIC BUILDING BLOCKS—\$8.95.

AN INTRODUCTION TO VIDEO—\$8.95.

20 PROGRAMS FOR THE SPECTRUM ANALYZER—\$8.95.

20 BOLDERLESS SPREADSHEET PROGRAMS—\$8.95.

HOW TO GET YOUR ELECTRONIC PROJECTS—\$8.95.

ART OF PROGRAMMING THE 18K EX81—\$8.95.

25 SIMPLE AMATEUR BAND ANTENNAS—\$8.95.

EASY ADD-ON PROJECTS FOR SPECTRUM ANALYZER—\$7.95.

INTERNATIONAL TRANSMITTER EQUIPMENT GUIDE—\$7.95.

ELECTRONICS SMOULDERING—CRYSTAL SET COMBINATION—\$8.95.

THE PCB HANDBOOK—\$8.95.

DESIGN & MAKE YOUR OWN PRINTED CIRCUIT BOARD—\$8.95.

PROGRAMMING THE ZX SPECTRUM—\$7.95.

PRACTICAL ELECTRONIC BUILDING BLOCKS—\$8.95.

PRACTICAL ELECTRONIC BUILDING BLOCKS—\$8.95.

AN INTRODUCTION TO VIDEO—\$8.95.

20 PROGRAMS FOR THE SPECTRUM ANALYZER—\$8.95.

20 BOLDERLESS SPREADSHEET PROGRAMS—\$8.95.

HOW TO GET YOUR ELECTRONIC PROJECTS—\$8.95.

ART OF PROGRAMMING THE 18K EX81—\$8.95.

25 SIMPLE AMATEUR BAND ANTENNAS—\$8.95.

EASY ADD-ON PROJECTS FOR SPECTRUM ANALYZER—\$7.95.

INTERNATIONAL TRANSMITTER EQUIPMENT GUIDE—\$7.95.

ELECTRONICS SMOULDERING—CRYSTAL SET COMBINATION—\$8.95.

THE PCB HANDBOOK—\$8.95.

DESIGN & MAKE YOUR OWN PRINTED CIRCUIT BOARD—\$8.95.

PROGRAMMING THE ZX SPECTRUM—\$7.95.

PRACTICAL ELECTRONIC BUILDING BLOCKS—\$8.95.

PRACTICAL ELECTRONIC BUILDING BLOCKS—\$8.95.

AN INTRODUCTION TO VIDEO—\$8.95.

20 PROGRAMS FOR THE SPECTRUM ANALYZER—\$8.95.

20 BOLDERLESS SPREADSHEET PROGRAMS—\$8.95.

HOW TO GET YOUR ELECTRONIC PROJECTS—\$8.95.

ART OF PROGRAMMING THE 18K EX81—\$8.95.

25 SIMPLE AMATEUR BAND ANTENNAS—\$8.95.

EASY ADD-ON PROJECTS FOR SPECTRUM ANALYZER—\$7.95.

INTERNATIONAL TRANSMITTER EQUIPMENT GUIDE—\$7.95.

ELECTRONICS SMOULDERING—CRYSTAL SET COMBINATION—\$8.95.

THE PCB HANDBOOK—\$8.95.

DESIGN & MAKE YOUR OWN PRINTED CIRCUIT BOARD—\$8.95.

PROGRAMMING THE ZX SPECTRUM—\$7.95.

PRACTICAL ELECTRONIC BUILDING BLOCKS—\$8.95.

PRACTICAL ELECTRONIC BUILDING BLOCKS—\$8.95.

AN INTRODUCTION TO VIDEO—\$8.95.

20 PROGRAMS FOR THE SPECTRUM ANALYZER—\$8.95.

20 BOLDERLESS SPREADSHEET PROGRAMS—\$8.95.

HOW TO GET YOUR ELECTRONIC PROJECTS—\$8.95.

ART OF PROGRAMMING THE 18K EX81—\$8.95.

25 SIMPLE AMATEUR BAND ANTENNAS—\$8.95.

EASY ADD-ON PROJECTS FOR SPECTRUM ANALYZER—\$7.95.

INTERNATIONAL TRANSMITTER EQUIPMENT GUIDE—\$7.95.

ELECTRONICS SMOULDERING—CRYSTAL SET COMBINATION—\$8.95.

THE PCB HANDBOOK—\$8.95.

DESIGN & MAKE YOUR OWN PRINTED CIRCUIT BOARD—\$8.95.

PROGRAMMING THE ZX SPECTRUM—\$7.95.

PRACTICAL ELECTRONIC BUILDING BLOCKS—\$8.95.

PRACTICAL ELECTRONIC BUILDING BLOCKS—\$8.95.

AN INTRODUCTION TO VIDEO—\$8.95.

20 PROGRAMS FOR THE SPECTRUM ANALYZER—\$8.95.

20 BOLDERLESS SPREADSHEET PROGRAMS—\$8.95.

HOW TO GET YOUR ELECTRONIC PROJECTS—\$8.95.

ART OF PROGRAMMING THE 18K EX81—\$8.95.

25 SIMPLE AMATEUR BAND ANTENNAS—\$8.95.

EASY ADD-ON PROJECTS FOR SPECTRUM ANALYZER—\$7.95.

INTERNATIONAL TRANSMITTER EQUIPMENT GUIDE—\$7.95.

ELECTRONICS SMOULDERING—CRYSTAL SET COMBINATION—\$8.95.

THE PCB HANDBOOK—\$8.95.

DESIGN & MAKE YOUR OWN PRINTED CIRCUIT BOARD—\$8.95.

PROGRAMMING THE ZX SPECTRUM—\$7.95.

PRACTICAL ELECTRONIC BUILDING BLOCKS—\$8.95.

PRACTICAL ELECTRONIC BUILDING BLOCKS—\$8.95.

AN INTRODUCTION TO VIDEO—\$8.95.

20 PROGRAMS FOR THE SPECTRUM ANALYZER—\$8.95.

20 BOLDERLESS SPREADSHEET PROGRAMS—\$8.95.

HOW TO GET YOUR ELECTRONIC PROJECTS—\$8.95.

ART OF PROGRAMMING THE 18K EX81—\$8.95.

25 SIMPLE AMATEUR BAND ANTENNAS—\$8.95.

EASY ADD-ON PROJECTS FOR SPECTRUM ANALYZER—\$7.95.

INTERNATIONAL TRANSMITTER EQUIPMENT GUIDE—\$7.95.

ELECTRONICS SMOULDERING—CRYSTAL SET COMBINATION—\$8.95.

THE PCB HANDBOOK—\$8.95.

DESIGN & MAKE YOUR OWN PRINTED CIRCUIT BOARD—\$8.95.

PROGRAMMING THE ZX SPECTRUM—\$7.95.

PRACTICAL ELECTRONIC BUILDING BLOCKS—\$8.95.

PRACTICAL ELECTRONIC BUILDING BLOCKS—\$8.95.

AN INTRODUCTION TO VIDEO—\$8.95.

20 PROGRAMS FOR THE SPECTRUM ANALYZER—\$8.95.

20 BOLDERLESS SPREADSHEET PROGRAMS—\$8.95.

HOW TO GET YOUR ELECTRONIC PROJECTS—\$8.95.

ART OF PROGRAMMING THE 18K EX81—\$8.95.

25 SIMPLE AMATEUR BAND ANTENNAS—\$8.95.

EASY ADD-ON PROJECTS FOR SPECTRUM ANALYZER—\$7.95.

INTERNATIONAL TRANSMITTER EQUIPMENT GUIDE—\$7.95.

ELECTRONICS SMOULDERING—CRYSTAL SET COMBINATION—\$8.95.

THE PCB HANDBOOK—\$8.95.

DESIGN & MAKE YOUR OWN PRINTED CIRCUIT BOARD—\$8.95.

PROGRAMMING THE ZX SPECTRUM—\$7.95.

PRACTICAL ELECTRONIC BUILDING BLOCKS—\$8.95.

PRACTICAL ELECTRONIC BUILDING BLOCKS—\$8.95.

AN INTRODUCTION TO VIDEO—\$8.95.

20 PROGRAMS FOR THE SPECTRUM ANALYZER—\$8.95.

20 BOLDERLESS SPREADSHEET PROGRAMS—\$8.95.

HOW TO GET YOUR ELECTRONIC PROJECTS—\$8.95.

ART OF PROGRAMMING THE 18K EX81—\$8.95.

25 SIMPLE AMATEUR BAND ANTENNAS—\$8.95.

EASY ADD-ON PROJECTS FOR SPECTRUM ANALYZER—\$7.95.

INTERNATIONAL TRANSMITTER EQUIPMENT GUIDE—\$7.95.

ELECTRONICS SMOULDERING—CRYSTAL SET COMBINATION—\$8.95.

THE PCB HANDBOOK—\$8.95.

DESIGN & MAKE YOUR OWN PRINTED CIRCUIT BOARD—\$8.95.

PROGRAMMING THE ZX SPECTRUM—\$7.95.

PRACTICAL ELECTRONIC BUILDING BLOCKS—\$8.95.

PRACTICAL ELECTRONIC BUILDING BLOCKS—\$8.95.

AN INTRODUCTION TO VIDEO—\$8.95.

20 PROGRAMS FOR THE SPECTRUM ANALYZER—\$8.95.

20 BOLDERLESS SPREADSHEET PROGRAMS—\$8.95.

HOW TO GET YOUR ELECTRONIC PROJECTS—\$8.95.

ART OF PROGRAMMING THE 18K EX81—\$8.95.

25 SIMPLE AMATEUR BAND ANTENNAS—\$8.95.

EASY ADD-ON PROJECTS FOR SPECTRUM ANALYZER—\$7.95.

INTERNATIONAL TRANSMITTER EQUIPMENT GUIDE—\$7.95.

ELECTRONICS SMOULDERING—CRYSTAL SET COMBINATION—\$8.95.

THE PCB HANDBOOK—\$8.95.

DESIGN & MAKE YOUR OWN PRINTED CIRCUIT BOARD—\$8.95.

PROGRAMMING THE ZX SPECTRUM—\$7.95.

PRACTICAL ELECTRONIC BUILDING BLOCKS—\$8.95.

PRACTICAL ELECTRONIC BUILDING BLOCKS—\$8.95.

AN INTRODUCTION TO VIDEO—\$8.95.

20 PROGRAMS FOR THE SPECTRUM ANALYZER—\$8.95.

20 BOLDERLESS SPREADSHEET PROGRAMS—\$8.95.

HOW TO GET YOUR ELECTRONIC PROJECTS—\$8.95.

ART OF PROGRAMMING THE 18K EX81—\$8.95.

25 SIMPLE AMATEUR BAND ANTENNAS—\$8.95.

EASY ADD-ON PROJECTS FOR SPECTRUM ANALYZER—\$7.95.

INTERNATIONAL TRANSMITTER EQUIPMENT GUIDE—\$7.95.

ELECTRONICS SMOULDERING—CRYSTAL SET COMBINATION—\$8.95.

THE PCB HANDBOOK—\$8.95.

DESIGN & MAKE YOUR OWN PRINTED CIRCUIT BOARD—\$8.95.

cable tv

DESCRAMBLER PARTS

We stock the exact parts and PC Board for Radio Electronic's February Article on building your own Cable TV Descrambler.

#701 PARTS PACKAGE \$29.95
Includes all resistors, capacitors, diodes, transistors, integrated circuits, coils and IF transformers (BKAN-K5552AXX)

#702 PC BOARD \$16.95
Etched and drilled silk-screened PC Board as shown in article

BOTH #701 & #702 \$39.00

Add \$2.50 Postage & Handling



Orders only 1-617-339-5372

J & W ELECTRONICS, INC.

P. O. Box 52
Cumberland, RI 02864

CIRCLE 4 ON FREE INFORMATION CARD

CABLE TV

Buy Direct & Save

SUPER SPECIALS



**40 CHANNEL
CONVERTER
\$29⁹⁵**

Advanced and State design and circuitry allow you to receive mid & super band channels. Restores pro-gramming. Video Recorders.



**38 CHANNEL
REMOTE CONTROL
CABLE CONVERTER
\$69⁹⁵**

JERR
THE I
CON'

TE CABLE TV

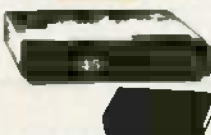

**60 CHANNEL
INFRARED
REMOTE
CONTROL
\$129⁹⁵**

Send \$5 for Complete Catalog

DIRECT VIDEO SALES

P.O. BOX 1329
JEFFERSONVILLE, INDIANA 47130

CALL
1-812-282-4766

CIRCLE 53 ON FREE INFORMATION CARD

VIDEO GENERATOR

continued from page 48

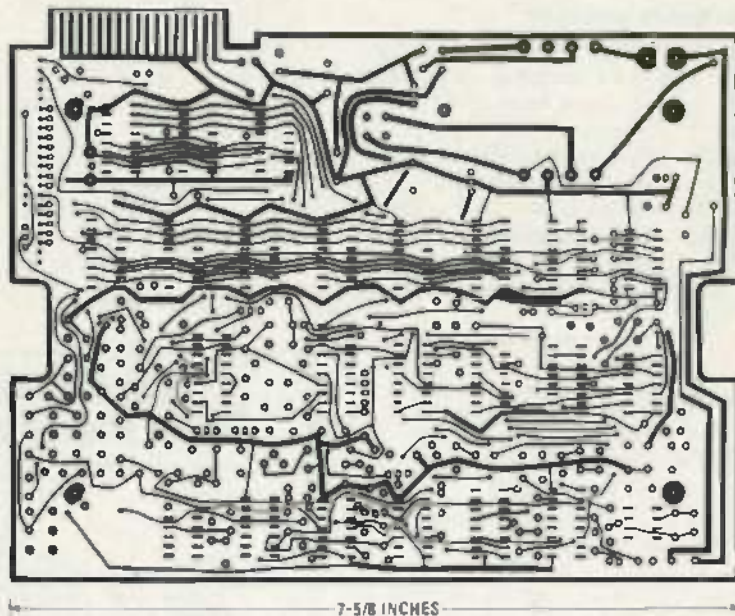

FIG. 5—THE SOLDER SIDE of board A is shown here, also at half its actual size.

IC21, IC27-IC31, IC36, and IC42. The IC's in the TO-220 cases (IC43, IC45, and IC46) mount with the metal tab either to the top of the board (IC46) or to the right of the board (IC43 and IC45) as shown in the parts-placement diagrams.

We'll assume that you have all of the on-board components mounted on both boards. The next step is to install the 37 jumpers on board A, using No. 26 wire. Their connections are marked on the parts-placement diagram in Fig. 10. Some of the jumper ends, as indicated, also serve as test points. Leave some extra bare wire protruding through the component side of the board for that purpose.

When all the board-A jumpers are mounted, the inter-board jumpers should be installed. Of course, before you install the jumpers, you must decide how you will mount the boards in a cabinet. Figure 11, not shown in this issue, shows how the boards are mounted in the author's prototype. Board A is mounted on the bottom half of the cabinet on 1/4-inch spacers, and board B mounts without spacers in a complimentary fashion on the top half. The 26 inter-board signal wire connections (No. 26 wire) are 3 1/4 inches long; and the two inter-board power wire connections (No. 20 wire) are 4 inches long. If you keep the connections to that length, they will fold neatly when the two halves of the cabinet are joined. Yet you will still have easy access to both boards (for alignment and service) when the cabinet is open. Note that IC44 is mounted on the rear panel of the cabinet. Be sure to use a heat sink and a TO-3 mounting kit. Apply silicone

grease between case and heat sink for good thermal transfer, and use at least No. 22 wire for connection to the board.

The other off-board connections include the front-panel components: switches S1-S4, and jacks J1-J5. Use No. 26 wire for those, except J2; use a short piece of minicoax (RG-174) for that connection. Use a strain relief for the power cord on the back panel and your construction should be complete.

When we continue, we'll discuss how to check out and align the generator, and we'll show you Figs. 6-11. R-E



"It looks as if his horizontal hold needs some adjusting."

NEW BOOKS

For more details use the free information card inside the back cover

ELECTROSTATIC DISCHARGE CONTROL: Successful Methods for Microelectronics Design and Manufacturing, by Tarak N. Bhar & Edward J. McMahon; Hayden Book Company, Inc., 50 Essex Street, Rochelle Park, NJ 07662; 194 pages including references and index; 6 1/4 x 9 inches; hardcover; \$14.95.

Static electricity is familiar to us all as lightning, static cling of clothing, and sparking when we touch a doorknob or other metallic objects in cool, dry weather. Static voltages up to and sometimes exceeding 15,000 volts can be generated by simple motions such as getting up from a chair, walking across a room, rubbing of clothing, and hundreds of other normal, everyday movements.

This book presents the phenomena of electrostatic discharge (ESD), its impact on electronics components, and the precautionary design measures that need to be used in

controlling static electricity.

Case histories of ESD damage to microelectronics components are surveyed to alert readers to the severity of damage from the ESD phenomena. The manufacturing processes that generate static electricity are detailed, and failure modes and mechanisms are discussed in depth and are illustrated with examples.

A guide for establishing, implementing, and monitoring an ESD control program is provided.

CIRCLE 121 ON FREE INFORMATION CARD

PASCAL PROGRAMS IN SCIENCE AND ENGINEERING, by Jules H. Glider & J. Scott Barrus; Hayden Book Company, Inc., 50 Essex Street, Rochelle Park, NJ 07662; 339 pages — no index; 6 1/4 x 9 1/4 inches; softcover; \$18.95.

This book contains 112 programs that solve

problems that are encountered by students, scientists, and engineers. Each application includes a brief introduction to the program's theory and algorithm, a complete program listing, a sample run, and an explanation of the results.

The first five chapters concentrate on programs in general mathematics: coordinate transformations, derivatives, integrals, systems of differential equations, matrix operations, statistics for data analysis, curve fitting, and much more.

The next two chapters provide calculations in basic electricity and electronics, from resistor coding to calculations of resonant circuits. The last five chapters offer programs for computer-aided design of amplifiers, power supplies, active filters, passive filters, communications lines, and much more.

All the programs have been tested on Apple II+ and Apple IIe microcomputers with

PICK YOUR WICK

Chemtronics manufactures desoldering wicks in two wire constructions: Chem-Wik for general purpose desoldering with maximum solder holding capacity and Chem-Wik Lite, faster acting for critical heat sensitive components. As electronic equipment becomes smaller, more complex, more demanding, Chemtronics family of pure copper desoldering wicks will meet your needs with a choice of performance characteristics for virtually every desoldering application.

Send for free literature today.



Chemtronics
681 Old Willets Path
Hauppauge, NY 11788
800-645-5244
In NY 516-582-3322
Telex 968567



CIRCLE 37 ON FREE INFORMATION CARD

WHY SPEND A FORTUNE ON A DIGITAL CAPACITANCE METER?

The MC100A comes completely assembled and calibrated and at \$79.95 is an outstanding value. The extensive range of 1 pF to 9,999 uF (no external meters required) and true hand held portable size (only 4 1/2" x 2 1/2" x 1 1/4") make the MC100A an extremely practical and easy to use instrument for the hobbyist technician or engineer.

CHECK THESE OTHER FEATURES

- * Basic accuracy 1% (\pm one count) on pF, nF ranges, 3% (\pm one count) on uF range.
- * Uses single 9V battery (not included).
- * Decimal points light up when battery is low or when capacitor is overrange.
- * Full 4 digit high efficiency LED display uses special circuitry to save on batteries.
- * Constructed with a tough impact resistant plastic case.

ONE YEAR PARTS & LABOUR WARRANTY



DAETRON
SUITE 105
1748 MAIN STREET
BUFFALO, N.Y. 14211
(416) 258-9701
DEALER INQUIRIES WELCOME



1 pF to 9,999 uF

\$79.95

PLEASE SEND ME

_____ (Quantity) MC100A(s) @ \$79.95 U.S.

SHIPPING AND HANDLING \$2.75 (per instrument)

ENCLOSE CHECK MONEY ORDER BILL MY VISA VISA CARD NO. _____

TOTAL \$ _____

EXPIRY DATE _____ SIGNATURE _____

Immediate shipping on orders with money orders or VISA
Personal checks please allow 2 to 3 weeks for clearance

NAME _____

ADDRESS _____

CITY _____

STATE _____

ZIP CODE _____

MARCH 1984

CABLE TV

CONVERTERS DESCRAMBLERS

Largest Selection
of Equipment Available
\$ Buy Warehouse Direct & Save \$



36 channel
converter
\$45.95

36 channel
wired remote
converter
only
\$88.95



Send \$2 for complete catalog
of converters and unscramblers

Quantity Discounts • Visa • Master Charge
Add 5% shipping — Mich. residents add 6% sales tax

C&D Electronics, Inc.
P.O. Box 21, Jenison, MI 49428
(616) 669-2440

Versatile Lab Power Supply

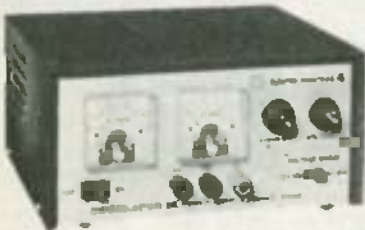

EXCEPTIONAL
VALUE!

Only \$125.00

• 0-30 VDC at 0-2A • Excellent Regulation
• Ripple & Noise - 500 uV • Built-in Short-
Circuit and Overload Protection

Model 3002A features continuously
adjustable current limiting and precision
constant voltage/constant current operation
with "automatic crossover." This lab-grade
unit can also be used as a current regulated
power source.

Optional 10-turn voltage & current controls:
\$25 each. Add \$3.00 for UPS shipping in
Continental U.S. Check, Money Order or
C.O.D. accepted. Illinois residents add 6%
sales tax.



ELECTRO INDUSTRIES, INC.
4201 W. IRVING PK., CHICAGO, IL 60641
312/738-0999

64K memory and the Apple Pascal system.
All are easy to read and modify.

CIRCLE 122 ON FREE INFORMATION CARD

ELECTRICAL FUNDAMENTALS (Second Edition) by J. J. DeFrance; Prentice-Hall, Inc., Englewood Cliffs, New Jersey 07632; 692 pages including appendices and index; 6 1/2 x 9 1/4 inches; hardcover; \$26.95.

This book is essentially an updated version of the author's earlier *Direct Current Fundamentals* and *Alternating Current Fundamentals*; it is intended for use as a first course in electrical/electronics technology, and is aimed primarily at the technical institute, community, and junior college level. It is written in the conversational style that proved to be successful in those earlier volumes.

The emphasis is on concepts and not on mathematical derivations, although mathematics is used whenever the material presented has quantitative aspects that the student needs to be able to evaluate. At the end of each chapter are review questions that will enable the student to evaluate his or her comprehension of the material just covered.

The student must have a foundation in the principles of algebra, and some knowledge of basic trigonometry and logarithmic functions. Calculus is used in some of the derivations, so some background there would be helpful; but it is not needed for the comprehension of electrical theory or for solving problems.

A major change in this edition is the switch from the phrase "electron flow" to "current flow."

CIRCLE 123 ON FREE INFORMATION CARD

DOING BUSINESS WITH SUPERCALC, by Stanley R. Trost; Sybex, Inc., 2344 Sixth Street, Berkeley, CA 94710; 248 pages including appendix, bibliography, and index; 7 x 9 inches; softcover; \$12.95.

This book is a collection of over 40 useful applications for the SuperCalc program. SuperCalc can be used to forecast sales, prepare income-tax reports, analyze real-estate investments, create expense registers, and prepare invoices, among many other uses.

Many of the programs presented here can be used directly to meet individual business needs, or they can be modified easily to meet specific requirements.

The goal of this book is (1) to present a collection of SuperCalc programs that can be applied to business, and (2) to guide the SuperCalc user toward an advanced level of familiarity with that powerful tool.

CIRCLE 124 ON FREE INFORMATION CARD

OSBORNE 4 & 8-BIT Microprocessor Handbook by Adam Osborne & Gerry Kane; Osborne, A McGraw-Hill Company, 630 Bancroft Way, Berkeley, CA 94710; 7 x 9 1/4 inches; softcover; \$21.95.

This is a thick book, and not because of thick paper; its third dimension comes to 1 1/2 inches. We mention that because it is not paginated in such a way that one can tell, without counting, exactly how many pages there are. (There is a separate pagination for each of the 15 chapters, as well as for the data-sheets pages that follow the chapters.)

What this book does is to give you, from an independent source, a description of virtually every 4 and 8-bit microprocessor on the market. It can be used to supplement the *Osborne 16-Bit Microprocessor Handbook*

(formerly *An Introduction to Microcomputers: Volume 2 — Some Real Microprocessors*).

Subjects covered in this volume include electrical characteristics, applications, supply current, reset operation, external interrupts, data-input timing, signal sequences, clock periods, direct-memory access, logic, test circuits, manufacturers data sheets, instruction sets, slow memory, bus-expander signals, and a host of others.

CIRCLE 125 ON FREE INFORMATION CARD

ELECTRONIC INSTRUMENTATION (Third Edition) by Sol D. Prenskey & Richard L. Castellucci; Prentice-Hall, Inc., Englewood Cliffs, NJ 07632; 7 x 9 1/4 inches; 465 pages; hardcover; \$26.95.

This new edition retains the style and approach of the first two editions, presenting the latest refinements in technique, accuracy, and operation to be found in the field of electronic instrumentation.

Although the latest instruments are discussed, the authors concentrate upon the most representative, describing each category of instrument in terms of its fundamental technique and approach, and the particular way in which it offers improved capability of measurement.

CIRCLE 126 ON FREE INFORMATION CARD

SCIENCE AND ENGINEERING PROGRAMS FOR THE IBM PC, by Cass Lewart; Micro Text Publications, Inc., Prentice-Hall, Inc., Englewood Cliffs, NJ 07632; 132 pages, including appendices, references and further reading, and index; 6 x 9 inches; softcover \$12.95 (also available in hardcover, \$18.95).

This book presents 19 programs designed to make optimum use of the personal computer for scientific and engineering applications. There is thorough documentation, sample runs, and formulae. The programs include: graph for plotting and interpretation; function generator for numerical function evaluation; azimuth and elevation for geosynchronous satellites; bit-error rates for various modulation schemes; system-reliability evaluator; any base to any base conversion, and finding resonant L-C circuit parameters.

All programs are written in IBM PC BASIC and are compatible with BASIC versions 1.10 and 2.0.

CIRCLE 127 ON FREE INFORMATION CARD

SIMPLE INTERFACING PROJECTS, by Owen Bishop; Prentice-Hall, Inc., Englewood Cliffs, NJ 07632; 168 pages, no index; 6 x 9 inches; softcover \$10.95 (also available in hardcover, \$17.95).

This book is directed to the microcomputer owner and presents projects through which he or she can make that microcomputer more powerful.

In addition to complete, step-by-step instructions for constructing the 12 interfacing projects presented, there are guidelines for testing, troubleshooting, and programming, as well as flow charts. All of the projects can be adapted for use on any microcomputer.

The 12 projects are: electric-kettle controller, real-time clock, beeper, graphic tablet, music generator, ROM board, mains remote control, voice-operated controller, sound processor, digitiser pad, telephone modem, and alarm-clock timer.

R-E
CIRCLE 128 ON FREE INFORMATION CARD

DON'T FORGET



USE
YOUR
READER
SERVICE
CARD

"Maybe it will go away."

The five most dangerous words in the English language.

American Cancer Society

POWER SUPPLIES

continued from page 70

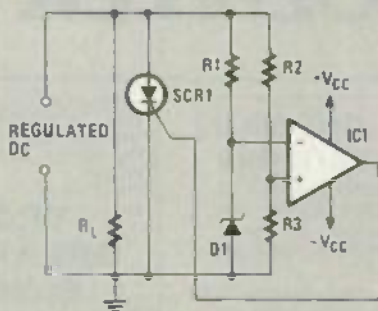

FIG. 10—AN OVERVOLTAGE crowbar circuit can be used to protect the power supply and the load in the event that an excessively high voltage is applied to the load.

output from the op-amp is positive. That positive voltage is applied to the gate of the SCR, turning it on. When on, the SCR acts like a short circuit across R_L , protecting both the load and the supply.

If the connections to the inverting and non-inverting inputs to the op-amp in Fig. 10 were interchanged, we would have an undervoltage protection circuit. The load and regulated supply would be shorted by the SCR when the voltage across R_L drops below a specific level. R-E



Be a MICROCOMPUTER SERVICE TECHNICIAN

Train at home in spare time... No previous experience needed

Sales of small computers are running over a billion dollars a year. That's why a whole new business is starting up—devoted entirely to small computer repair. And right now is the time to get in on the ground floor—either working for someone else or in your own computer repair business.

Start making money in electronics

No need to quit your job, change your daily routine or take time from family responsibilities. And you don't waste time going to and from class because you train at home in spare time.

The ICS Microcomputer Repair Course is designed for beginners—people with no previous experience who want to get started fast. And you should be ready for an entry-level job repairing small computers even before you finish this course.

Experts show you what to do... how to do it! We start you fast with the basics, and everything is explained in easy-to-understand language complete with plenty of diagrams and drawings.

SEND FOR FREE FACTS!

ICS School of Computer Repair, Dept. DE024 (since 1971) Scranton, Pennsylvania 18515

Send free facts and color brochure telling how I can get into computer repair at home in my spare time. No obligation. No salesman will call.

Name _____ Age _____
Address _____
City/State/Zip _____

GET INTO SMALL COMPUTER REPAIR



THE RIGHT STUFF.

The growth of NTE quality replacement parts has been nothing short of astronomical. And the proof is in our new 1984 Replacement Master Guide, destined to be the standard directory for technicians across the country. In excess of 3,000 quality NTE types are cross-referenced to more than 220,000 industry part numbers.

- YOU'LL FIND ALL THE RIGHT STUFF FOR REPLACEMENT, MAINTENANCE AND REPAIR:
- Transistors
 - Thyristors
 - Integrated Circuits
 - Rectifiers and Diodes
 - High Voltage Multipliers and Dividers
 - Optoelectronic Devices
 - Zeners
 - Microprocessors and Support Chips
 - Memory IC's
 - Thermal Cut-Offs
 - Bridge Rectifiers
 - Unijunctions
 - RF Transistors
 - Microwave Oven Rectifiers
 - Selenium Rectifiers
 - NEW! The Protector 6000™ Transient Voltage Protection Strip

Look for our Replacement semiconductors in the bright green polybags and cartons that list rating limits, device type, diagrams and competitive replacement right on the package. NTE quality parts are available from your local NTE distributor and come backed by our exclusive two-year warranty. Ask for your FREE NTE Replacement Master Guide and take off with NTE!



NEW-TONE ELECTRONICS, INC.
44 FARRAND STREET • BLOOMFIELD, NEW JERSEY 07003
(FORMERLY TCO)

MARCH 1984

MARKET CENTER

BUSINESS OPPORTUNITIES

WHOLESALE MATV/CATV/VCR equipment, antennas, audio cables, adapters, original/replacement cartridges & styl, telephone accessories, radios, cassette recorders, speakers, etc... send letterhead for free catalog (212) 897-0509 **D&WR**, 68-12 110th St., Flushing, NY 11375.

MECHANICALLY inclined Individuals desiring ownership of small electronics manufacturing business—without investment. Write: **BUSINESSES**, 92-R. Brighton 11th, Brooklyn, NY 11235.

VIDEO game repair business. Start your own. Information/parts list \$5.00. **BEST ELECTRONICS**, 4440 Sheena, Phoenix, AZ 85032.

PROJECTION TV... Make \$\$\$ assembling projectors... Easy... Results comparable to \$2,500.00 projectors... Your total cost less than \$200.00... Plans, B' lens, & dealers information \$17.50... Illustrated information free... **MACROCOMA-GGX**, Washington Crossing, PA 18977. Creditcard orders 24 hours. (215) 736-2880.

TECHNICAL writers make big money... writing short sentences! Free details: **TEK PUBS**, Box 2458-E, Oroville, CA 95965.

LCD watches \$2.50. Penwatch \$2.00. Catalog \$1.00. **RELIANT ENGINEERING COMPANY**, Box 33610, Sheungwan, Hong Kong.

YOUR own radio station! AM, FM, Cable, licensed, unlicensed, transmitter kits! Write: **BROADCASTING**, Box 130-F3, Paradise, CA 95969.

HIGHLY PROFITABLE ONE-MAN ELECTRONIC FACTORY

Investment unnecessary, knowledge not required, sales handled by professionals. Ideal home business. Write today for facts! **Postcard will do, Barta-RE-X, Box 248, Walnut Creek, CA 94597.**

BECOME alarmingly successful. Tremendous employment-business opportunities. Residential-business burglar alarms. Easily learned. Information \$2.00. **DYNAMIC SECURITY MARKETING**, PO Box 1456-X, Grand Rapids, MI 49501.

48K computer US\$380.00 and hundreds Apple compatible softwares. Details US \$1.00. **RELIANT**, PO Box 33610, Sheungwan, Hongkong.

EDUCATION & INSTRUCTION

EARN your university degree through evaluation assessment of existing education, experience, achievements. Call, (614) 863-1791, or write, **ASSESSMENT**, Box 13130R, Columbus, OH 43213.

UNIVERSITY degrees by mail Bachelors, Masters, Ph.D's... Free revealing details. **COUNSELING**, Box 317-RE3, Tustin, CA 92680.

FEAR of failing? Substandard school performance? Educator offers psychological and practical coping methods for persons taking difficult technical

courses—college, vocational, or correspondence school. Send \$10.00 for treatise "Learning Problems," additionally entitling you to personal replies for six months. **SCHWARTZ**, Box 325, Nesconset, NY 11767.

TRAIN FOR A GREAT CAREER IN ELECTRONICS

LEARN AT HOME IN SPARE TIME... The fast-growing Electronics field offers excellent career opportunities... even at the entry level! A knowledge of **BASIC ELECTRONICS** can help you get your foot in the door, qualify for good jobs like Inspector, Electronic Sales, Junior Technician/Tester and more. Easy-to-follow home-study course starts you at the very beginning... explains everything step by step with plenty of photos, charts, diagrams. Multimeter, parts kits, calculator, digital VOM included. Hands-on training lets you learn by doing. Get **FREE FACTS**. No salesman will call. **MAIL COUPON TODAY!**



BASIC ELECTRONICS COURSE DE024
Dept. 00000 Scranton, PA 18515

Name _____ Age _____

Address _____

City/State/Zip _____

ATTENTION ELECTRONIC TECHNICIANS

Highly Effective Home Study BSEE Degree Program for Experienced Electronic Technicians. Our New Advanced Placement Program grants Credit for previous Schooling & Professional Experience. Advance Rapidly! Our 36th Year! **FREE DESCRIPTIVE LITERATURE!** Cook's Institute of Electronics Engineering, DESK 15, P.O. BOX 20345, JACKSON, MS 39209.

CB EQUIPMENT

CB radio books, kits, modifications, catalog \$1.00 refundable. **APS**, POB 263RE, Newport, RI 02840. **PALOMAR** Pride electronics—exclusive repair facility. Service—update—improvements on these and similar equipment. **PALOMAR PRIDE REPAIR**, 1320 Grand, San Marcos, CA 92069 (619) 744-0720.

CB MODIFICATIONS

Increase channels, range, privacy! We specialize in frequency expanders, speech processors, FM converters, PLL & slider tricks, how-to books, plans, kits. Expert mail-in repairs & conversions. 16-page catalog \$2. **CBC INTERNATIONAL**, P.O. Box 31500NE, PHOENIX, AZ 85046 (602) 996-8700.

WANTED

WANTED: old Western Electric & RCA tubes, speakers, amplifiers, McIntosh, Marantz, tube amps (713) 728-4343 **MAURY CORB**, 11122 Atwell, Houston, TX 77096.

INVENTIONS, ideas, new products wanted for presentation to industry and exhibition at national technology exposition. Call 1-800-528-6050. Arizona 1-800-352-0458 X831.

HALLICRAFTERS S-40, S-52, S-77. Any condition. Paying \$20.00-\$40.00 each. **FALA ELECTRONICS**, Box 04134-2, Milwaukee, WI 53204.

TI-99/4A SOFTWARE

TI-99/4A owners. Get your free catalog of new, exciting, low cost software. **DYNA**, Box 690, Hicksville, NY 11801.

Sanyo's Low Distortion Thick Film IC Audio Power Modules AUDIO AMPLIFIERS

Stereo Volt Amp \$8 with spec's Typically 0.05% THD

100 WATT 02% 59 Power Amp Typically 0.004% THD 1/2 rated output

Both modules require Bipolar Power Supplies & External Components.

Set of one STK3082 Stereo Volt Amp & two STK0080R Power Amplifiers with 16 Pages of Infor. \$18

EDWARDS SECURITY ALARM HORN Loud 120 VAC 125A 1 1/2 lb \$6

5" x 5" x 2 1/4"

40 AMP 800V Q6040C \$4.75
40 AMP 800V SC284M \$5.75
25 AMP 800V Q6025P \$3.75
15 AMP 600V MAC15-6 \$1.75
8 AMP 800V MAC228-8 75c

TOUCH TONE DECODER Decode standard telephone touch tones & control up to 16 separate functions or devices over 2 wires. Control your home remotely! Low power consumption of 12 VDC @ 30 MA is perfect for robotics. **MITEL CM8833 \$45.00**

SEMI'S 49c each per tube of 17

90L80DC/AK x 1 Dynamic RM
P2107B/TMS4060-2 \$8.33 or RMS280N 95c each
Tri-state Output
MDA3504
Full Wave Bridge Rectifier 400 Volt 35 AMP \$2.49
V130LA10A
130V RMS 10 Joule Metal Oxide Varistor 99c
T11305/5x7 \$2.25
Alphanumeric LED Display IEE 1704R 0.3" char. hgt.

CABLE SALE

28 22 awg. Shielded Belden 8781 2a 100' \$5.00

2a 22 plus 2a 22 Shielded Belden 8732 3a 100' \$15.00

LM378 Stereo 4 Watt Channel Audio Amplifier \$1.95 with spec's

for robotics, precision movement application, etc.

STEPPER MOTOR

(Unifiler Wound)
5 VDC 3 1/2 Watts 7.5°X
48 Step/Rev. 28 RPM
0-280PPS with 5 Pages of Information
Airpax x62400/A82478 \$3.00
2-1/8 Dlex 1.5"x5/8" shaft .093 Dia

ROBOTICS, ANDROID GEARED PM MOTOR

Reversible • Heavily geared • Permanent Magnet
3.5 RPM on 6 VDC
10 RPM @ 12 VDC \$3.00
Roxe 500 Series 3" overall, 3/4" shaft, 7/16" dia
12 teeth, solid brass gear

Bassick 4814 self-lube ball bearing

SWIVEL CASTERS

Soft Rubber Wheel
Top Plate 1-7/8" x 2-5/8" 3/4" aa 4/\$6.00
2" Dia x 1 1/2" WHEEL Dia

NI-CAD STICK SALE

D Heaviest Duty
4 AMP Hr 1/2 lb. 2-3/4x1-1/4 1183.00
4 1/2x2 1/2 1-1/4 lb. 439.95
11-5/8x1-1/4 2lb. 5811.95
1.2 Volt @ 2 AMP Hr
Sub C/D = \$1.75
7/8 Dia x 2-3/16 1/2 lb.

500 MAHr 2/52 2oz. 1.2 Amp Hr
AA 3-13/16x9/16 Dia 7 x Sub C
Uninsulated for \$8.75
61or \$4.90
NEW, UNUSED MILITARY SURPLUS TESTED BY THEM & GUARANTEED BY US

46 SWITCH KEYBOARD \$15.00

All N. open switches with standard 10-key numeric pad on right, encoded with MM5740AAE/N encoder, Color Coded Keys, with 3 pages of information. Removeable/replaceable legends
11-3/4x4-3/4x1 1/2 1 1/2 lb.

MAIL ORDER ONLY ADD POSTAGE:

Continental U.S. add \$1.60 for 1st pound & 50c for each additional pound
West Coast add \$1.80 for the 1st pound & 50c for each additional pound
MC & VISA with all information from card & phone no.
Send SASE for complete lists (FL residents add 5% Sales Tax)
Ask about our discounts all orders processed same day quantities fill

CIRCLE 74 ON FREE INFORMATION CARD

R & D Electronics
1202H Pine Island Road
Cape Coral, FL 33909

SUBSCRIBE TO High Technology Magazine AND PROFIT FROM OTHER PEOPLE'S SUCCESS.



Morita
High Technology
November 1983

"The concept that television is something to just sit and look at is being swept away by this new wave of interactive video technology. With Sony's microprocessor-based laser videodisc player, the viewer is no longer an observer, but rather an active participant who can shape the program being viewed."

**Akio Morita, Chairman and CEO
Sony Corp.**



Jackson
High Technology
December 1983

"The future for microcomputers lies in powerful operating systems, multiuser capabilities, communication with larger systems, and local-area networking."

**David Jackson, President
Altos Computer Systems**



Sykes
High Technology
December 1983

"Terrific progress has been made in developing new antibiotics, and with it has come intense competition in marketing these drugs."

**Richard B. Sykes
VP, Biol. Research Dir.
Squibb Institute**



Hendrix
High Technology
February 1984

"Systems that understand natural English truly personalize computing by allowing the individual to function according to his normal workstyle and concept base."

**Gary Hendrix
Chairman, Symantec**

Whether you're an engineer, technician, manager, or investor—or a combination of all three—you can reap the rewards of the technological revolution. Let High Technology magazine show you how. With articles that acquaint you with advances in fields outside your own. Inform you of important trends emerging in companies like yours. And introduce you to the people and corporations that are making things happen today in the industries of the future. As high technology transforms the world we live in, rare opportunities for success are becoming unlimited opportunities overnight. See for yourself. Take this opportunity to try a free issue. There's no obligation to subscribe.

Please use the adjacent subscription card to order your free copy plus 11 additional issues, for just \$18.00 (\$1.50/copy), or write to:

highTechnology

P.O. Box 2808, Boulder, Colorado 80321

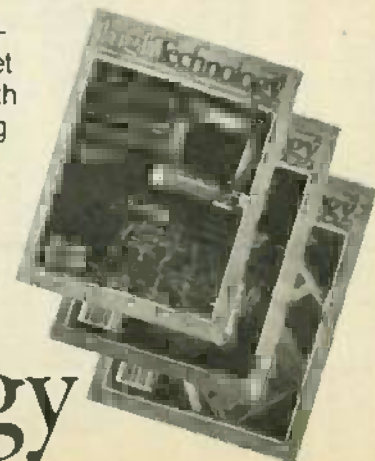

QUALITY SPECIALS

SOPHISTICATED I.C.'S

DATA SHEETS ARE PROVIDED FREE WITH ALL THE CITED CIRCUITS LISTED BELOW

PART #	DESCRIPTION	PRICE (each)
LS724	TOUCH SENSITIVE LIGHT DARKNESS SWITCH	\$4.99
LS725	NON-FLYING TOUCH TO SWITCH PLATE TUBING LIGHTS ON OR OFF - PHOTO-SENSITIVE TOUCH SENSITIVE SWITCH OR BRIGHTNESS A BLEND COLOR LIGHT ALLIANCE AUTOMATIC BLUE SHOOTING TO OFF - USE FOR VCR'S FOR CHILDREN'S FEAR OF DARK BEDROOMS	\$2.99
LS726	CHORD-DRIVE I.C. - HAS TOUCH SENSITIVE SELECTABLE INPUT TO FIELD DRIVES BY 100 MS. USE ON 1000'S CIRCUITS	\$2.99
LS727	D.C. TO A.C. DECADE 1000 PULSE COUNTER WITH A DECADE LATCH AND MULTIPLE A.C. OUTPUTS AND SOFT-TRIGGER ACCESS TO LED LATCHES ALLOWS ATTACHMENT OF PRECISIONS OR COUNTERS TO 100 MHz	\$10.95
LS728	55 PHOP AUTOMATICALLY HELPS ANTI-FRETT CONTACT LOCK CIRCUIT HAS 550 I/O INPUT COMBINATIONS WITH 25 MICROAMP STANDBY "SAVE MODE" FOR TEST SIGNALS	\$2.99
LS729	MULTIPLIER DETECTOR I.C. FOR ANALOG SIGNAL PHO COUNTERS. CONTAINS 8 CHANNEL ANALOG 8-BIT MODULATORS AND INDICATORS WITH 400 OHM OR 500 OHM INPUTS. I.P. SWITCHES APPLICATIONS FOR PHASE DETECTOR UP TO 100 MHz. ALL DESIGNERS FROM AN DETECTOR OR GENERATOR TRIGGERS TO 100 MHz. CONTAINS 8-BIT REGISTER TRANSISTOR	\$3.99
LS730	PHOTO-DRIVE FROM GENERATOR I.C. PRODUCES BASE-DRIVE TRIGGER SIGNALS FROM 100 MHz TO 100 MHz. WITH PHOTODIODES AND COMPONENTS FROM 100 MHz TO 100 MHz. FOR PRECISION ALL TEST INSTRUMENTS	\$1.75
LS731	HIGH FREQUENCY PHASE-LOCKED LOOP (PLL) I.C. FOR BOTH ANALOG AND DIGITAL COMMUNICATIONS. 500 TO 1000 MHz. USES INCLUDES IN MODULATORS, FREQUENCY SYNTHESIS FOR CODING DECODING MODULATORS, PLL, PLL, I/O LOCK COMPATIBLE	\$4.99
LS732	INTRUSION ALARM OPTICAL TRANSDUCER I.C. HELPS IN LED PHOTO DIODE A PASSIVE PART TO BE COMPLETE OPTICAL TRANSDUCER SYSTEM CAN BE MADE OPEN TO AMBIENT LIGHT WITHOUT FALSE ALARMS	\$9.99
LS733	HALL EFFECT SENSOR FOR MAGNETIC FIELD CHANGES TOO SMALL TO CREATE THE HALL SWITCHES OUTPUT IS A LINEAR FUNCTION OF MAGNETIC FIELD INTENSITY. MONITORING I.C. INCLUDES HALL DEL AMPHIFIER AND VOLTAGE REGULATOR FOR A 4.5 TO 20 VDC SOURCE. HIGH SENSITIVITY AND FAST RESPONSE. 3 mA I/O	\$2.99
LS734	BASE AS LOG 3001 BUT WITH PROVISION FOR TUNING THE OUTPUT OFFSET VOLTAGE 8 PIN DIP	\$2.99
LS735	HALL EFFECT SENSOR WITH DIFFERENTIAL OUTPUT A LINEAR FUNCTION OF MAGNETIC FIELD SUPPLIED WITH AN ORIGINAL DATA SHEET CHART 175. STORES 1000'S OF VOLTS FOR CALIBRATING TESTERS AND ALONG WITH MAGNETIC SENSING DEVICES 8 PIN DIP	\$9.99

FREE CATALOG OF NEW DEVICES

GOLDSMITH SCIENTIFIC CORPORATION

P.O. BOX 3109, COMMACK, NY 11725
PHONE ORDERS WEL COME - (815) 679-7944
MASTERCARD AND VISA ACCEPTED
NEW YORK STATE RESIDENTS ADD SALES TAX
POSTAGE - ADD 1% PLUS \$1.50 INSURANCE. C.O.D. \$1.00 EXTRA
APPLICABILITY OF CERTAIN ITEMS MAY BE LIMITED

SATELLITE TELEVISION

SATELLITE TV receiver breakthrough! Build your own commercial quality receiver now! Instruction manual, schematics, circuit boards! Send stamped envelope: XANOI, Box 25647, Dept. 21W, Tempe, AZ 85282.

FREE! Information on 100 satellite-television channels plus free catalog of proven do-it-yourself plans/kits for easy, low-cost, attractive satellite antennas. Also, wholesale electronics components. GFI-S, Box 9106, Missoula, MT 59807. (406) 642-3405 "Consumer Guide to Satellite Television" - \$6.95.

SATELLITE television: receivers \$300.00, dishes \$100.00. LNAs, downconverters. Complete information. Catalog \$4.00. **SATELLITE SYSTEMS**, Dept. R, Box 164, Milpitas, CA 95035.

SATELLITE antenna: Build for less than \$200.00. Get complete plans, material list, settings for geostationary orbit of satellites and TV programming. Send \$9.95. **HERITAGE ANTENNA SYSTEMS**, PO Box 14672, Fort Worth, TX 76117.

SATELLITE TV VIEWERS

Get the most complete weekly listings. Send \$1 for sample copy.

Satellite TV Week

P.O. Box 308, Fortuna, California 95540
800-256-9997 (U.S.) • 800-356-9787 (Can.)
707-725-9476 (all others)

SATELLITE T.V. VIEWERS

Now build your own Satellite T.V. Earth Station at a fraction of the cost. Exciting NEW book used by major manufacturers gives step-by-step directions. Secret facts now available!

ONLY \$10.00 p.p.
SATELLITE INC., P.O. BOX 3561-C
Conroe, Texas 77305

PLANS & KITS

PRINTED-circuit boards. Quick prototypes. production, design, reflow solder send print or description for quote to **KIT CIRCUITS**, Box 235, Clawson, MI 48017.

CABLE TV converters and equipment. Plans and parts. Build or buy. For information send \$2.00. **C & D ELECTRONICS**, PO Box 21, Jenison, MI 49428.

HI-FI speaker kits, auto speaker systems, and raw drivers from the world's finest manufacturers. For beginners or experts. Free literature. **A&S SPEAKERS**, Box 7462R, Denver, CO 80207 (303) 399-8609.

LIGHT chase/color organ kits, rack mount units. 20% off sale. **DESIGN SPECIALTY**, PO Box 1995, Huntington Beach, CA 92647.

PROJECTION TV. Convert your TV to project 7-foot picture... Results comparable to \$2,500.00 projectors... Total cost less than \$30.00... Plans & 8" lens \$19.95... Illustrated information free... **MACROCAMA-GG**, Washington Crossing, PA 18977. Credit card orders 24 hours. (215) 736-3979.

HOBBYISTS... simplify digital circuit design using EPROM. How to guidebook also includes nine projects you can build... \$15.00 to **TECHNOLOGIK**, PO Box 45, Essex, VT 05451.

MOST advanced sine converter describable available. PCB and plans \$15.00. **JIM RHODES**, 1025 Ransome Ln., Kingsport, TN 37660.

FREE KIT Catalog

FUNCTION GENERATOR KIT \$59.95
Auto-Ranging Cap-meter kit \$79.95

Phone 209-772-2076

Write or Phone for FREE CATALOG

DAGE SCIENTIFIC INSTRUMENTS
BOX 144 VALLEY SPRINGS, CA 95282

contains TEST & EXPERIMENTER'S EQUIP.

CIRCUIT SPECIALISTS

YOUR SEMICONDUCTOR SUPERMARKET

74LS00 SALE

74LS00	20	74LS123	50	74LS249	1.25	7400	20	7475	.50
74LS01	24	74LS125A	50	74LS251	.80	7401	29	7476	.38
74LS02	24	74LS126A	50	74LS253	.60	7402	29	7485	1.10
74LS03	24	74LS132	.80	74LS255	1.50	7403	29	7486	.35
74LS05	24	74LS133	.80	74LS257A	.80	7404	31	7489	2.40
74LS08	24	74LS136	.40	74LS258A	.80	7405	32	7490	.52
74LS09	24	74LS137	1.00	74LS259	1.25	7406	38	7492	.52
74LS10	24	74LS138	.80	74LS260	.56	7408	31	7493	.52
74LS11	24	74LS139	.80	74LS266	.55	7410	30	7495	.67
74LS12	24	74LS141	1.30	74LS273	1.25	7411	31	7496	.73
74LS13	45	74LS147	1.65	74LS279	.55	7413	46	74107	.35
74LS14	80	74LS148	1.65	74LS280	2.25	7414	59	74121	.40
74LS15	80	74LS151	.55	74LS283	.90	7417	32	74123	.58
74LS16	32	74LS153	.55	74LS290	.80	7420	29	74125	.52
74LS20	29	74LS155	.85	74LS293	.90	7425	31	74145	.75
74LS21	32	74LS158	.80	74LS295A	.85	7427	32	74147	1.87
74LS22	32	74LS157	.80	74LS298	.90	7430	30	74151	.75
74LS26	32	74LS158	.80	74LS299	2.60	7432	31	74153	.75
74LS27	32	74LS160A	.85	74LS322A	4.60	7437	31	74154	1.17
74LS28	32	74LS161	.85	74LS323	4.80	7438	31	74157	.75
74LS30	32	74LS162	.80	74LS348	1.75	7440	29	74164	1.05
74LS32	32	74LS163A	.80	74LS352	1.25	7441	1.00	74165	1.05
74LS33	32	74LS164	.80	74LS353	1.25	7442	.80	74174	1.00
74LS37	40	74LS165	1.25	74LS365A	.55	7446	.83	74175	.83
74LS40	35	74LS166	1.25	74LS366A	.55	7447	.83	74176	.80
74LS42	80	74LS168	1.25	74LS367A	.55	7448	.83	74177	.80
74LS47	89	74LS169	1.25	74LS368A	.55	7450	29	74190	1.08
74LS48	1.00	74LS170	1.75	74LS373	1.35	7472	35	74192	.99
74LS49	1.00	74LS173	.80	74LS374	1.25	7473	35	74193	.99
74LS51	29	74LS174	.55	74LS375	.55	7474	.35	74196	.80
74LS54	29	74LS175	.60	74LS377	1.25				
74LS55	29	74LS181	2.25	74LS378	1.25				
74LS73A	42	74LS182	1.25	74LS379	1.25				
74LS74A	42	74LS183	2.75	74LS385	3.50				
74LS75	45	74LS190	.85	74LS385	.55				
74LS76A	45	74LS191	.85	74LS390	1.25				
74LS77	70	74LS192	.85	74LS393	1.25				
74LS78A	49	74LS193	.85	74LS395	1.85				
74LS83A	75	74LS194A	.80	74LS398	2.25				
74LS85	90	74LS195A	.80	74LS399	1.25				
74LS86	45	74LS196	1.00	74LS490	2.10				
74LS90	45	74LS197	1.00	74LS540	2.10				
74LS91	1.10	74LS221	1.25	74LS541	2.10				
74LS92	55	74LS240	1.25	74LS568	3.99				
74LS93	55	74LS241	1.25	74LS569	3.99				
74LS95B	65	74LS242	1.25	74LS620	2.00				
74LS107A	45	74LS243	1.25	74LS621	2.00				
74LS109A	45	74LS244	1.25	74LS622	2.00				
74LS112A	45	74LS245	1.75	74LS623	2.00				
74LS113A	45	74LS247	1.25	74LS640	2.00				
74LS114A	80	74LS248	1.25						
74LS122	.80								

7400

7400	20	7475	.50
7401	29	7476	.38
7402	29	7485	1.10
7403	29	7486	.35
7404	31	7489	2.40
7405	32	7490	.52
7406	38	7492	.52
7408	31	7493	.52
7410	30	7495	.67
7411	31	7496	.73
7413	46	74107	.35
7414	59	74121	.40
7417	32	74123	.58
7420	29	74125	.52
7425	31	74145	.75
7427	32	74147	1.87
7430	30	74151	.75
7432	31	74153	.75
7437	31	74154	1.17
7438	31	74157	.75
7440	29	74164	1.05
7441	1.00	74165	1.05
7442	.80	74174	1.00
7446	.83	74175	.83
7447	.83	74176	.80
7448	.83	74177	.80
7450	29	74190	1.08
7472	35	74192	.99
7473	35	74193	.99
7474	.35	74196	.80

VOLT-REGS

7805	.80	LM317T	1.00
7806	.60	LM317K	3.75
7808	.60	LM323K	6.95
7812	.60	LM350T	3.25
7815	.80	LM350K	5.50
7818	.80	LM338K	7.80
7824	.80	LM337T	1.90
7905	1.30	78L05	.40
7906	1.30	78L12	.40
7908	1.30	78L18	.40
7912	1.30	79L05	.80
7915	1.30	79L12	.80
7918	1.30	79L15	.80
7924	1.30	78H05KC	9.25
		78H12KC	9.25

LINEAR IC'S

LM301AN	48	LM3900	.75	MC1489P	1.10
LM307N	.58	LM3909	1.00	MC1496P	1.48
LM308N	.71	LM3911	1.50	MC1723P	.62
LM310N	2.40	LF347	2.35	MC1741CP1	.58
LM311N	.69	LF351	.60	MC3301	.90
LM318N	2.60	LF353	.99	MC3302	.80
LM319N	2.40	LF357	1.10	MC3401	.90
LM324N	.71	NE555	.42	MC3403P	1.30
LM325N	3.30	MC1306P	1.10	MC1648P	3.80
LM328N	3.30	MC1310	4.29	MC1658P	1.50
LM556N	93	MC1330A1P	1.50	MC4024P	4.49
LM339N	69	MC1349P	1.17	MC4044P	4.49
LM383T	2.30	MC1350P	.98	ICM7208	15.95
LM377N	2.40	MC1351P	1.70	ICM7207A	6.00
LM378N	3.15	MC1357P	1.49	ICM7217A	9.95
LM379N	4.60	MC1358P	1.30	ICM7205	12.95
LM380N	.90	MC1372P	4.42	ICM7045	15.50
LM381N	2.25	MC1373P	3.54	ICL8038	3.40
LM381AN	3.60	MC1403U	2.71	ICM7555	1.20
LM384N	2.00	MC1405L	9.70	MWA110	7.45
LM386N	.99	MC1413P	1.20	MWA120	7.80
LM585N	1.35	MC1374P	2.81	MWA130	6.25
LM566N	2.30	MC1376P	2.08	MWA310	6.25
LM567N	1.35	MC1458CP1	7.77	MWA320	6.65
LM1889	3.20	MC1488P	1.10	ZN414	2.00

CMOS

CD4001	.30	CD4046	1.50	MC14000	40	MC14023	1.22
CD4007	.32	CD4047	1.40	MC14001	40	MC14024	1.06
CD4010	.55	CD4049	.45	MC14002	40	MC14024	40
CD4011	.32	CD4050	.45	MC14006	1.42	MC14027	72
CD4013	.45	CD4051	1.00	MC14007	.80	MC14028	1.02
CD4016	.50	CD4066	.65	MC14008	1.25	MC14032	1.93
CD4017	1.00						

GET THE PARTS YOU NEED AT THE SHACK®

Factory Fresh!

No Postage to Pay!

See Before You Buy!

Power Transformers

120VAC Primaries

Type	Volts	Current	Cat No	Each
Mini	6.3	300 mA	273-1384	2.59
Mini	12.6	300 mA	273-1385	2.79
Mini	25.2	300 mA	273-1386	2.99
Mini	12.6 CT	450 mA	273-1385	3.59
Mini	25.2 CT	450 mA	273-1386	3.99
Std.	6.3	1.2A	273-050	3.79
Std.	12.6 CT	1.2A	273-1505	3.99
Std.	25.2	1.2A	273-1480	4.39
H-D	12.6 CT	3.0A	273-1511	5.99
H-D	25.2 CT	2.0A	273-1512	6.29
H-D	18.0 CT	2.0A	273-1515	6.99

Tantalum Capacitors

- 20% Tolerance
- IC Pin Spacing



µF	VWDC	Cat No	Each
0.1	35	272-1432	.49
0.47	35	272-1433	.49
1.0	35	272-1434	.49
2.2	35	272-1435	.59
10	16	272-1436	.69
22	16	272-1437	.79

Ceramic Disc Capacitors

For RF, Bypass and Coupling Applications



Low As **39c** Pkg. of 2

Moistureproof coating. Hi-Q design for low loss in RF circuits. 50 WVDC minimum.

pF	Cat No	Pkg of 2	µF	Cat No	Pkg of 2
4.7	272-120	39	.001	272-126	39
47	272-121	39	.005	272-130	39
100	272-123	39	.01	272-131	39
220	272-124	39	.05	272-134	49
470	272-125	39	.1	272-135	49

Submini Switches

Low As **189**



Toggle types, rated 10 amps at 125 VAC. Each includes four colored handle covers. 1/2 x 7/16 x 1/2". Mount in 1/4" holes.

Type	Cat No	Each
SPST	275-324	1.89
SPDT	275-326	1.99
SPDT Center-Off	275-325	2.19
DPDT	275-1546	2.39
DPDT Center-Off	275-1545	2.59

Home Computer Programs

Save **\$5**

Reg. **2.95**
7.95

For TRS-80® 16K Models I, III, 4

Listings for over 75 useful programs—financial, automotive, kitchen helpmates, scheduling, filing, math, metric conversion, games and more. 330 pages 62-2069 Sale **2.95**

Low-Profile DIP Sockets

Quality non-wicking sockets for PC use. Low-resistance contacts.

Type	Cat No	Pkg of 2
8-Pin	276-1995	.59
14-Pin	276-1999	.89
16-Pin	276-1998	.89

Type	Cat No	Each
18-Pin	276-1992	.49
20-Pin	276-1991	.59
24-Pin	276-1989	.79
26-Pin	276-1997	.89
40-Pin	276-1996	.99

Computer Connectors

Type	Position	Cat. No	Each
ID Card Edge	34	276-1564	4.95
ID Card Edge	50	276-1566	4.95
Card-Edge Socket	44	276-1551	2.99
ID D-Sub Male	25	276-1559	4.99
ID D-Sub Female	25	276-1565	4.99
Solder D-Sub Male	25	276-1547	2.99
Solder D-Sub Female	25	276-1548	3.99
Hood	—	276-1549	1.99
D-Sub Male	15	276-1527	2.49
D-Sub Female	15	276-1528	3.49
Hood	—	276-1529	1.99
D-Sub Solder Male	9	276-1537	1.99
D-Sub Solder Female	9	276-1538	2.49
Hood	—	276-1539	1.99

Communications ICs

Type	Cat No	Each
AY-3-1015 UART	276-1794	5.95
AY-5-8116 Baud Rate Gen	276-1795	8.95
TCM1512A Phone Ring Det	276-1302	3.99
TCM5089 Phone Tone Encoder	276-1301	3.99

RF/IF Devices

Type	Cat No	Only
MC1330 Video Detector	276-1757	2.29
MC1350 IF Amplifier	276-1758	1.99
MC1358/CA3065 FM Det	276-1759	1.79
SFE4 5MB 4.5 MHz Ceramic Filter	276-1304	.69
CDA4 5MD3 4.5 MHz Ceramic Discriminator	276-1305	.79
MRF 901 Microwave RF Transistor	276-2044	2.99
H-P 5082-2835 Microwave Diodes	276-1124	2/1.99

Linear ICs

Type	Cat No	Each
ICL8038 Waveform Gen	276-2334	5.95
LM387 Stereo Preamp	276-1737	.99
LM380 Audio Amplifier	276-706	1.59
MOC3010 Optocoupler	276-134	1.99

Semiconductor Reference Guide **349**

1984 Edition. Exclusive cross-reference and substitution section lists over 80,000 types and their low-cost Radio Shack replacements. Data on ICs, SCRs, LEDs, diodes, opto devices. Helpful replacement tips, too. Illustrated 272 pages **2.75-4.00**



Replacement Transistors



Type		Cat No.	Each
2N1305	PNP	276-2007	1.19
MPS222A	NPN	276-2009	.79
PN2484	PNP	276-2010	.89
MPS3904	NPN	276-2016	.69
TIP31	NPN	276-2017	.99
TIP3055	NPN	276-2020	1.59
MPS2907	PNP	276-2023	.79
MJE34	PNP	276-2027	1.49
2N3053	NPN	276-2030	.89
MPS3638	PNP	276-2032	.79
TIP120	NPN	276-2068	1.29
2N3055	NPN	276-2041	1.99
MJ2955	PNP	276-2043	2.19
2N4124	NPN	276-2057	.59
2N4401	NPN	276-2058	.59
MPSA06	NPN	276-2059	.59
MPSA13	NPN	276-2060	.59
MPSA42	NPN	276-2061	.69
MU4891	UJT	276-2029	.99
2SD313	NPN	276-2048	1.79
2SC945	NPN	276-2051	.79
2SC1308	NPN	276-2055	7.95
2N3819	N-FET	276-2035	.99
MPF102	N-FET	276-2062	.99

4000-Series CMOS ICs

Low As **79c**



With Pin-Out and Specs

Type	Cat No	Each
4001	276-2401	.79
4011	276-2411	.79
4013	276-2413	.99
4017	276-2417	1.49
4023	276-2423	.99
4049	276-2449	.99
4066	276-2466	.99

TTL Digital ICs

With Pin-Out and Specs

Type	Cat. No.	Each
7400	276-1801	.59
7404	276-1802	.79
7408	276-1822	.79
7447	276-1805	1.19
7490	276-1808	.89

Operational Amplifiers



Type	Cat No.	Each
741 (Single)	276-007	.79
MC1458 (Dual)	276-038	.99
LM324 (Quad)	276-1711	1.29
TL082 (Dual)	276-1715	1.89
TL084C (Quad)	276-1714	2.99
LM3900 (Quad)	276-1713	1.39
LM339 (Quad)	276-1712	1.49

Voltage Regulator ICs

Type	Adjustable	Cat No	Each
LM723	0 to 40 VDC	276-1740	.89
LM317T	1.2 to 37 VDC	276-1778	2.79

Type	Fixed Output	Cat No	Each
7805	+5 VDC	276-1770	1.59
7812	+12 VDC	276-1771	1.59
7815	+15 VDC	276-1772	1.59
7905	-5 VDC	276-1773	1.59
7912	-12 VDC	276-1774	1.59

A DIVISION OF TANDY CORPORATION

Radio Shack

OVER 8800 LOCATIONS WORLDWIDE

Prices apply at participating Radio Shack stores and dealers.

CIRCLE 61 ON FREE INFORMATION CARD

PREVENT HI-TECH HEADACHES

Our Isolators eliminate equipment interaction, clean up interference, curb damaging power line spikes and lightning surts.



ISO-1 Isolator

3 isolated sockets; quality spike suppression; basic protection. . . \$76.95

ISO-3 Super Isolator

3 dual isolated sockets; suppressor; commercial protection. 115.95

ISO-17 Magnum Isolator

4 quad isolated sockets; suppressor; laboratory grade protection. . . 200.95

Electronic Specialists, Inc.
171 S. Main St., Box 389, Natick, MA 01780
Toll Free Order Desk 1-800-225-4876
MasterCard, VISA, American Express

CIRCLE 6 ON FREE INFORMATION CARD

TIMEX/SINCLAIR VIC-20 bible pack. Design build any peripheral imaginable. Includes cassettes. \$39.95, info \$6.00 refundable. **JORGE SAMPSON**, Box 38663, Houston, TX 77288.

AUTOMATIC fine tuning (AFT) for UHF/VHF converter board Deluxe I, II—never again readjust line tuning, **state of the art design**, plans, circuit, parts list \$15.00. Deluxe I, II get clear picture as normal commercial TV channel, improve sound adjustment, stop vertical jitter \$11.00. **ADVANCE ELECTRONICS**, PO Box 3298, Culver City, CA 90230.

SAVE 90% free catalog 8 and 16 bit computer systems. Plans, boards, ROM's, software, parts, more. **DIGATEK CORPORATION**, Suite E, 2723 West Butler Drive, Phoenix, AZ 85021.

WERSI electronics

ORGAN & PIANO KITS

ALPHA DX 300

fully DIGITAL RS232 Interface

THE WORLD LEADER

For Free Sound Info
Call 1-800-233-3865
or write WERSI USA
Dept. M B.P.O. Box 5318
Lancaster, PA 17601

DESCRAMBLERS

AMERICAN—CANADIAN

C-1000 / ZENITH TYPE

Descrambles "over the air" and "cable" sync suppressed active video inversion signals

Ready to go C-1000 **379.95**
Complete Kit C-1000K **274.95**
Printed Circuit & Manual **74.95**

C-100 / JERROLD TYPE

Cable Descrambler for in-band gated suppressed systems

Ready to go C-100 **119.95**
Complete Kit C-100K **54.95**

SEND \$2 FOR COMPLETE INFORMATIVE CATALOG TO DETERMINE WHAT TYPE YOU NEED

FALL SPECIAL

Buy 1 kit
Get 2nd kit
at 1/2 price

Offer ends 7/1/84

J & D ENGINEERING

P.O. Box 6099
Falmouth, Maine 04105

Dealers Wanted
Special Quantity Pricing
COD's—OK

All J & D products are engineered, not copied. All are guaranteed 90 days & we stand behind our products where others fail!

CATALOG: Hobby, CB, broadcasting! Linears, transmitters, bugs, scramblers, downconverters, antennas, modifications, more! **PANAXIS** Box 130-F3, Paradise, CA 95969.

HIGH performance audio kits. MM & MC phono preamps, parametric eq., delay, NR, and more. Send for catalog. **PHOENIX SYSTEMS-RE**, 91 Elm Street, Manchester, CT 06040.

ROBOTS—world directory. MFG's, plans, patents. \$3.00. **WM. OLIVADOTTI**, 2515 Santa Clara Ave., Alameda, CA 94501.

DIGITAL oscilloscope... Build for less than \$150.00! Complete schematics \$5.00. **MIKE MCLINCHY**, 1878 Newell Ave., Walnut Creek, CA 94595.

LASERS— build your own—complete list of parts and suppliers \$2.00. **EASTERN KANSAS ENERGY SAVERS**, Box 2125, Emporia, KS 66801.

UP-TO-DATE electronics kits. Unbelievable low price. Amazing high quality **Free** colorful catalog. **INTERNATIONAL POLYTECHNIQUES**, PO Box 862A, New York, NY 10002.

BUY many best electronics kits with our unbelievable low price and high quality **Free** catalog. **INTERNATIONAL POLYTECHNIQUES**, Box 862K, New York, NY 10002.

FLEAS? Rid your house of bugs/rodents ultrasonically. Plans \$2.95. **KJOD**, 4925 Seawolf, Santa Rosa, CA 95405.

UHF Zenith units, cable-TV units, and much more. **Free** welcome: call (301) 882-9362. Send \$2.00 for catalog to **SATELLITE ELECTRONICS**, Box 9534, Baltimore, MD 21237.

GOT sinewave audio problems? Auto switching circuit. Plus much, much more. Video units. Send \$1.00 for info. **CAPTAIN VIDEO**, PO 9388, Baltimore, MD 21228.

FREE LCD WATCH WITH KIT

LSR UHF converter kits with AGC: gated pulse wave BT-1 (includes speaker box), \$115.00. Sound out from the TV type: Deluxe IIB sine wave, \$79.95 (wooden cabinet, \$15.00 extra); New! I, F (inside the TV) sinewave, \$39.95; Digital Z/FV-5 (includes aluminum cabinet), \$175.00. Store at 3806 W. Lawrence, Chicago. Quantity discounts (312) 588-8828 & (312) 267-3455. Free shipping & handling for prepaid orders. Plans: large SASE (\$4 cents postage). **LSR ENGINEERING**, Dept. RE, Box 6075, Chicago, IL 60680-6075.

COMMUNICATIONS EQUIPMENT

VIDEOSCAN 1000 slow scan TV—high resolution (amateur, phone line, surveillance, teleconferencing). **CODESTAR**—decode Morse, RTTY, ASCII. Large LED display. Connect VIC-20 computer/priener. Tri-voltage power supply. Kits assembled. **Free** brochures. **MICROCRAFT CORPORATION**, Box 513-RE, Thiensville, WI 53092. (414) 241-8144.

FREE GIANT CATALOG

Send for our **FREE 1984** catalog of electronic components, kits, IC's, computer software, computer peripherals and unique items.

PARTS SUPER SPECIALS!

MICRO MINIATURE SPEAKER
Only 1/8" dia. fits standard 1/2" hole. 100 Hz. 100 mW. \$1.95

KESTER PC TYPE SOLDER
A flow and no flux solder for use on 90/10 rosin core solder. 100% lead. 100% tin. 100% flux. 100% lead. 100% tin. 100% flux. \$1.95

SOUND EFFECTS GENERATOR KIT
Working sound effects kit with 1000 Hz oscillator. 1000 Hz oscillator. 1000 Hz oscillator. 1000 Hz oscillator. \$14.95

BOX OF RESISTORS
1000 resistors. 1/4 W. 1% tolerance. 1000 resistors. 1/4 W. 1% tolerance. \$9.99

VALUABLE SURPRISE PACKAGE
1000 resistors. 1/4 W. 1% tolerance. 1000 resistors. 1/4 W. 1% tolerance. \$9.99

TYPIC VARIABLE STABLE LIGHT LED
Common cathode. 5 mm. 1000 resistors. 1/4 W. 1% tolerance. \$9.99

PACTIC ELECTRONIC ENCLOSURE
Professional looking case in wood or plastic. 1000 resistors. 1/4 W. 1% tolerance. \$9.99

FASCINATION STAR KIT
Professional looking case in wood or plastic. 1000 resistors. 1/4 W. 1% tolerance. \$9.99

3 CHANNEL COLOR ORGAN KIT
Works up to 1000 Hz. 1000 resistors. 1/4 W. 1% tolerance. \$9.99

NEGATIVE ION GENERATOR BOARD
Works up to 1000 Hz. 1000 resistors. 1/4 W. 1% tolerance. \$9.99

CHANEY P.O. BOX 27038
DEPT. E, C/O, 400 8077
303 731 8768

Phone Orders: 303 731 8768
• Minnesota AD Order 99.00
• Plans include \$2.00 for postage, S/P
• VISA, MC, AMEX
• Priority orders are available
Send for our free catalog of unique items

CIRCLE 34 ON FREE INFORMATION CARD

MICRO-PROFESSOR

REV. 1 1983 1.5 AMP

L2939A

Z-80 BASED

MICROCOMPUTER

A superb learning tool for students, instructors, hobbyists.

Nothing else needed. Just plug in and start learning! Complete experimenters manual, easy instructions, 18 experiments. Fully expandable for Z80-CTC, Z80-PIO, EPROM. Breadboarding and prototyping. Invest with confidence. Now only \$129.95, two for only \$239.95. 2KB BASIC interpreter now available, only \$19.00. Full money back guarantee!

plus-FREE GIFT

Check this box for **FREE Z-80 Microprocessor Programming and Interfacing textbook** when you order within 7 days. \$12.95 value.

ETRONIX

Dept. RE-034
14803 N.E. 40th
Redmond, WA 98052

1-800-426-1044

For immediate action call TOLL FREE

NAME _____

ADDRESS _____

CITY _____ ST. _____ ZIP _____

VISA MSTRCD EXP

ACCT. NO. _____

CIRCLE 39 ON FREE INFORMATION CARD

SCANNERS

SCANNERS— discount prices Bearcat BC-100 \$279.99; Bearcat 210XL \$214.99; Bearcat 300 \$335.99; Regency MX3000 \$186.99; JIL SX100 \$138.99; JIL SX200 \$269.99; Bearcat 20/20 \$275.99; Spectrum radar detector \$214.99; plus \$3.00 shipping. Free discount catalog. Lowest prices anywhere on scanners, radar detectors, marine radios, two-way accessories. **SCANNER WORLD**, 10-RE New Scotland, Albany, NY 12208 (518) 436-9606.

SUPERIOR UHF PREAMP KIT

MOST advanced UHF preamp kit ever to be offered! Unit will drastically improve picture quality of all UHF-TV stations and even find stations you never thought existed. Great for generating that extra gain decoders need for maximum stability. Kit includes all parts, power supply, enclosure and instructions for only \$29.95. Free postage/handling for prepaid orders. COD's \$1.75, catalog \$2.00. **HOWARD RESEARCH AND DESIGN**, PO Box 204, Ellicott City, MD 21043 (301) 465-8116.

CABLE TV

DEALERS wanted: Channel 2, 3, and 4 notch filters. Money back guarantee. Send \$15.00 for sample and quantity price list. Specify channel(s). **LEE KURTZ**, PO Box 291394, Davie, FL 33329.

DESCRAMBLER TROUBLES

SINE wave descrambler problems? Manual includes trouble shooting, alignment, antenna hookup, improvements, theory. \$10.00 **SIGNAL**, Box 2512-R, Culver City, CA 90230.

FOR SALE

CABLE TV SECRETS—the outlaw publication the cable companies tried to ban. HBO, Movie Channel, Showtime, descramblers, converters, etc. Suppliers list included. Send \$8.95 to **CABLE FACTS**, Box 711-R, Pataskala, OH 43062.

RESISTORS 1/2% & 5% C.F. 3 cents. 1% M.F. All values. No minimums. Volume discounts. Write **JR INDUSTRIES**, 5834-B Swancreek, Toledo, OH 43614.

SCANNER monitor accessories—kits and factory assembled. Free catalog. **CAPRI ELECTRONICS**, Route 1R, Canon, GA 30520.

ALARM VIC 20 64 CoCo Sinclair become \$1000.00 burglar fire system. Cassette, documentation (specify microprocessor) \$29.00. Catalog \$2.00 refundable. **SKIDMORE'S H'N'S**, PO Box 5097, Greensboro, NC 27403. Auto dialer with telephone book program \$49.00 Commodore, Sinclair.

DESCRAMBLERS for downconverters, high gain. Send \$1.00. **RB ELECTRONICS**, PO Box 643, Kalamazoo, MI 49005.

PICTURE flyer lists quality electronics surplus at low prices. Since 1970. Send for the last 3 issues. **STAR-TRONICS**, Box 683, McMinnville, OR 97128.

LATEST bug-detection equipment for home or office. Literature, \$1.00. **CLIFTON**, Box 220-X, Miami, FL 33168.

World's Most Remarkable Radar Jammer!



Countless radar guns and devices to read the **WIND** choice of either a percentage of your true speed when in automatic mode (example: Your speed 78 mph, auto mode set for 75%, speed displayed — 57 mph), or the speed that you dial in when in manual mode. Transmits only in the presence of speed radar, or by manual override. Operates on both X and K bands. **WIND** The device described in this literature is not legal for use against police radar, and is not FCC approved.

For complete literature and price package send \$14.95 to:
Phillips Instrument Design Co. Inc.
 9660 N.W. Harbor Blvd., Suite #100 S
 Portland, Oregon 97219

POPULAR TELEVISION CIRCUITS



WHY PAY MORE? SINE WAVE SUPER BOARD

- KSW 1483 Sinewave Kit \$119.95 - \$5.95 S/H
- KSC 1484 Sinewave Minus PCB \$99.95 - \$5.95 S/H
- PCS 8232 Sinewave PCB only \$20.00 - \$3.00 S/H



State of the art technology brings you this superior Sinewave Superboard. It has no internal connection to TV. RF modulator built on the board, AGC for stability and tunes the entire band with a varactor tuner and multi-tune pot. A high quality plated-thru circuit board with silk-screened parts layout, easy to follow, fully illustrated instructions and quality parts make this kit easy to assemble. The beautifully finished cabinet will add a touch of class to the many hours of enjoyment you will receive building and using this kit.

ZENITH M1 FV-5

09-151-03

Phase Video

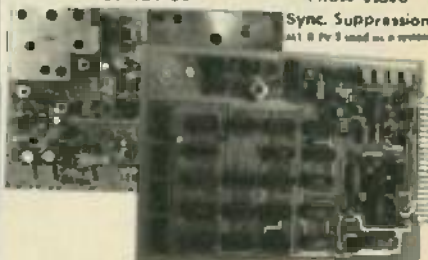

- KCM 2083 M1 FV-5 Kit \$199.95 - \$6.95 S/H
- KCG 2084 FV-5 Kit (minus M1) \$149.95 - \$6.95 S/H
- PCZ 2085 FV-5 PCB only \$30.00 - \$3.00 S/H
- ZMO #151 M1 Board only \$69.95 - \$5.95 S/H

This advanced baseband video interlaced/line suppression system which is most often used nationwide is one of our most popular kits. It features AGC for stability, RF modulator built on the board, no internal connection to TV, and full band variable tuning. High quality parts, fully illustrated instructions, punched cabinet and plated-thru/solder-masked PCB board make this kit a breeze to assemble. The M1 varactor tuner board is assembled and tested and need only be interconnected to the FV-5 board. The completed circuitry is then placed in the beautifully finished cabinet. Place your order today.

MICROWAVE PROBE

- KMP 2030 Micro Probe Kit \$24.95 - \$3.00 S/H
- PCM 2000 Micro PCB only \$4.95 - \$3.00 S/H

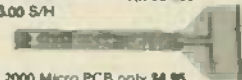

BRAND NEW!

- MPD 2000 Micro 20" Dish \$14.95 - \$5.95 S/H
- MPO 2000 Micro Power Supply Kit \$19.95 - \$3.00 S/H

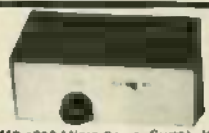

UNSURE? Order any manual for only \$9.95 post paid. Refundable with order.

- HOBBY USE ONLY, NOT FOR UNAUTHORIZED RECEPTION OF TV SIGNALS
- AVAILABLE BY MAIL ONLY • SEND FOR INFORMATION ON OTHER ITEMS
- COMPLETE REPAIR SERVICE • CHECKS HELD 3 WEEKS FOR CLEARANCE

4218 S. 36TH PL. PHOENIX, ARIZONA 85040

ORDERS ONLY: **(800) 243-6700**



WESTECH ELECTRONICS
(602) 276-1600

CIRCLE 13 ON FREE INFORMATION CARD

TUSA

A WHOLE NEW WORLD OF TV VIEWING WITH TUSA'S NEW MODEL CVM-40, 40 CHANNEL, CABLE TV CONVERTER. Replaces the EXTRA CABLE TV "MIDBAND" & SUPERBAND CHANNELS on your VHF SET.

Eliminates the need for wiring or tapping. This system takes the "Midband" and "Superband" channels your TV VCR or projector sport receiver and converts them to standard TV channels that any set can tune.

A MUST FOR VIDEO TAPING FROM CABLE TV
 This system allows you to program both any VCR or video deck and add a channel for VCR or video deck use.

Now **\$28.95** each. (Includes shipping and handling charges on all orders.)

NEW AVAILABLE
NEW TUNABLE DELUXE MODEL CVM-1000 \$34.95

UHF TUNERS

40 MHz Output

Cine-Sound Direct Tune Model. Excellent for replacement use or experimental work. Includes LEAF receptors for home or TV.

WHILE THEY LAST \$3.95 ea. 10 or more **\$2.99** ea.

POPULAR IC'S

TYPE	DESCRIPTION	1-10	10-50	50-100
LM3886	3-Watt Audio Preamplifier	1.25	1.00	0.75
LM3886B	Low Voltage Audio Amp	1.00	0.75	0.50
LM567	Phase-Locked Loop	1.00	0.75	0.50
LM567C	Phase-Locked Loop	0.75	0.50	0.35
MC-1496	Phase-Locked Loop	2.00	1.50	1.00
MC-1388	Video Sync Amp	0.75	0.50	0.35
MC-1382	Phase-Locked Loop	0.75	0.50	0.35
MC-1388	Audio Sync Amp	1.75	1.25	0.85
MC-1374P	RF Modulator	3.00	2.25	1.50
MC-1456	Color Sync. Cr. Amp	0.75	0.50	0.35
MC-1456B	Color Sync. Modulator	1.75	1.25	0.85
LM3886	3-Watt Audio Preamplifier	1.25	1.00	0.75
LM3886B	Low Voltage Audio Amp	1.00	0.75	0.50
LM7812	12 Volt Positive Volt. Reg.	1.10	0.80	0.55
LM7818	18 Volt Positive Volt. Reg.	1.10	0.80	0.55
LM7809	9 Volt Positive Volt. Reg.	1.10	0.80	0.55
LM7824	24 Volt Positive Volt. Reg.	1.10	0.80	0.55

THE ORIGINAL WE-808 IS NOW BACK IN STOCK!
 \$3.99 Each

WIRELESS 7-ELEMENT 75 OHM UHF YAGI ANTENNAS

Options:
 12 dB GAIN \$10.95 ea.
 Speedy Channel \$8.95 ea.
 4-8 dB GAIN \$6.95 ea.
 10 or more \$7.95 ea.

NEW 1984 B&K AUTO/MANUAL RANGING MULTIMETER

MODEL 8007

SPECIAL PRICE! \$94.00 ea.

BK PRECISION

JEROLD 400 ORIGINAL SATV CONVERTER

The first satellite TV kit allowing you to watch satellite TV in your home. This unit converts all 12 TV channels and carries them to Channel 3. With the satellite system you can watch satellite TV on TV or VCR, or use for live feed & rebroadcast.

Now **\$119.95** ea. (Includes shipping and handling charges on all orders.)

REMY DISK
 15 for \$1.00
 100 for \$5.00

COLORMAX 36 CHANNEL REMOTE SATV CONVERTER

Now you can change channels of line thru your TV set by remote control up to 20 ft. away. This unit receives channels 3-13 plus mag & generates color subcarrier from outputs. Plug on Channel 3.

MODEL C286 2P
 8 pc. REMOTE CONTROL \$69.95 ea.
 5 or more \$64.95 ea.

QUALITY POWER TRANSFORMERS

34V CT 500 mA
\$3.18 ea. 10 or more **\$2.75** ea.
\$6 or more **\$2.25** ea.
 For Larger Quantities Call

SONY SURPLUS UHF-VHF VARIATOR TUNERS

These tuners receive all channels 2-63, plus additional channels available and are perfect for home-brew TV circuits. Output Freq 45 kHz. Mount on 1/2" standard size board.

Now **\$15.95** ea.

DELUXE A-8 SWITCHES

Special Pushbutton for VCR type

For SATV SATV VCR 75 ohm 50 ohm termination
\$8.50 ea.
 2 or more **\$5.95** ea.

PROJECT BOXES

Standard
 Two sizes 4 1/2" x 7 1/2" x 7 1/2" & 6 1/2" x 6 1/2" x 6 1/2".
 Now **\$10.95** ea. (Includes shipping and handling charges on all orders.)
 For Larger Quantities Call

Phoned One A Fenna

LETTERS COME TELEPHONIC RANGE UP TO 5 MILES!

Now **\$37.95**

ORDER NOW
 TOLL FREE
800-854-4855
 CALIFORNIA CALL ONLY
714-635-5090
 REDDING, CALIFORNIA

R.F. ELECTRONICS
 1056 H STATE COLLEGE BLVD. DEPT R
 ANAHEIM, CALIFORNIA 92805

PERSONAL CHECKS HELD FOR CLEARANCE — NO MINIMUM ORDER
 ALL PREPAID ORDERS 2 LBS OR LESS MUST INCLUDE \$2.50 SHIPPING & HANDLING — SHIPPED SAME DAY RECEIVED

MARCH 1994

CIRCLE 27 ON FREE INFORMATION CARD

109

www.americanradiohistory.com

ELECTRONIC KITS FROM HAL-TRONIX

2304 MHz DOWN CONVERTERS TUNES IN ON CHANNELS 2 TO 7 ON YOUR OWN HOME TV. HAS FREQUENCY RANGE FROM 2000 MHZ TO 2500 MHZ. EASY TO CONSTRUCT AND COMES COMPLETE WITH ALL PARTS INCLUDING A DIE-CAST ALUM CASE AND COAX FITTINGS. REQUIRE A VARIABLE POWER SUPPLY AND ANTENNA (Antenna can be a dish type or coffee can type depending on the signal strength in your area.)

- 2304 MOD 1 (Basic Kit) \$19.95
(Case case & fittings)
- 2304 MOD 2 (Basic Pre-amp) \$29.95
(Case case & fittings)
- 2304 MOD 3 (Hi-Gain Pre-amp) \$39.95
(Includes case & fittings)
- POWER SUPPLY FOR EITHER MODEL ABOVE IS AVAILABLE. COMES COMPLETE WITH ALL PARTS, CASE, TRANSFORMER, ANTENNA SWITCH AND CONNECTORS (KIT) \$24.95
Assembled..... \$34.95
Slotted Microwave Antenna For Above Downverters \$39.95

PREAMPLIFIERS

HAL PA-1B—1.5 mhz to 150 mhz, 19db gain operates on 8 to 18 volts at 10ma. Complete unit \$8.95
HAL PA-1A—3 mhz to 1.4 ghz, 10 to 12 db gain operates on 8 to 18 volts at 10 ma. Complete unit \$12.95
(The above units are ideal for receivers, counters, etc.)

- 16 LINE TOUCH TONE DECODE KIT WITH P.C. BOARD AND PARTS \$69.95
- 12 LINE TOUCH TONE DECODE KIT WITH P.C. BOARD AND PARTS \$39.95
- 16 LINE ENCODER KIT, COMPLETE WITH CASE, PAD AND COMPONENTS \$39.95
- 12 LINE ENCODER KIT, COMPLETE WITH CASE, PAD AND COMPONENTS \$29.95

Complete Sets of P.C. Boards Available For: Unicorn Robot Project and Heart-A-Matic Project.

MANY, MANY OTHER KITS AVAILABLE

Send 20 cents stamp to HAL-TRONIX for literature and list of other kits. 100000 products. To order by phone 1-800-323-1327

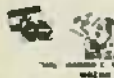

HAL-TRONIX
P.O. Box 1101
Southgate, MI 48193

SHIPPING INFORMATION: ORDERS OVER \$100 WILL BE SHIPPED POSTPAID EXCEPT IN THOSE STATES ADDITIONAL CHARGES ARE REQUESTED. DELIVERY IS 1-2 WEEKS FROM DATE OF RECEIPT INCLUDING ADDITIONAL \$4.50 FOR HANDLING AND INSURANCE CHARGES.

CIRCLE 75 ON FREE INFORMATION CARD

NEW! MULTI-CHANNEL MICROWAVE

Complete Antenna Systems from \$69.95

Full 800 Mhz Range
Tune 1.9-2.7 Ghz
Includes all
ITFS Channels

DEALERS WANTED

COO's and Credit Card
Orders call TOLL FREE
1-800-247-1151

GALAXY
ELECTRONICS
6009 N. 61 Avenue
Glendale, AZ 85301
1-602-247-1151



MILITARY communications radios: R-174 receiver, tunes 1.5-18 MHz, AM-CW-SSB, amateur, short-wave frequencies \$47.50 mint, \$27.50 good. Canadian backpack radio PRC-510, 38-54 MHz FM transceiver with headset, battery box, antenna \$39.50, 2/\$77.50 good condition. R-108 receiver, 20-28 MHz FM: \$27.50 mint. ARC-27 aircraft guard receiver, 220-250 MHz AM single channel: \$12.50 mint. 45 day replacement guarantee, add \$5 unit shipping. BAYTRONICS, Dept. RE, Box 591, Sandusky, OH 44870.

CABLE TV equipment for "beeping" or "buzzing" channels. Information \$1.00. GOLD COAST, PO Box 63 6025F, Margate, FL 33063 (305) 752-9202

SERVICE QUESTIONS

continued from page 95

scene. When that occurs, the set loses its vertical and horizontal sync. The problem can also be induced by reducing the brightness and contrast using the appropriate controls; the symptoms can also be induced by adjusting the screen controls.

I have tried to trace the problem with a scope, but that did not help and only led me in circles. Any ideas?—M.S., East Meadow, NY

From the symptoms that you've described it would appear that either one or both of the resistors that feed boosted B+ to the horizontal oscillator circuit have changed value. Those are R40 and R41, and are 220K and 120K units respectively. If memory serves, those resistors have a history of doing that, with the results you have described.

One word of warning is in order here. The location, and even the values, of those resistors have been known to vary from those shown in the Sams service literature. They should be easy enough to track down however. Also, even if only one is bad, replace both of them. Otherwise, you'll have to go back into the set before too long to do it anyway. R-E

SEI, Inc.

641 Academy Drive • Northbrook, Illinois 60062

For information (312) 564-0104 • To order outside Illinois 1-800-323-1327

SOLID STATE STEREO REVERBERATION AMPLIFIER

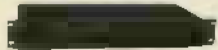

Specifications • Total harmonic distortion less than .05% • Frequency response 10 Hz to 80K Hz -10dB • S/N Ratio 90dB • Reverberation time 0 to 3 sec. • Input 150mV/50K Ohm Max. Input 2V • Accepts input from tape, phono, or aux.
Includes an LED Reverb Level display. Kit comes with all electronic components, transformer and instructions, and 18" rack mount cabinet.

Model TA-2400 \$89.95

AMATEUR MICROWAVE Receiver System 1.9-2.5 GHz



MICROWAVE RECEIVER SYSTEM
• Commercial grade construction • Sturdy Parabolic aluminum reflector antenna • High gain 50 dBi • Line of sight distance is essential
• Complete system: power supply, cable, assembled reflector antenna, and downconverter.
• Downconverter mounted in attractive cabinet.

90 day warranty on PS-5!
PS5 Assembled \$109.95
Kit Form \$ 79.95

Microwave Preamp! NEW KIT

Use with PS-3 Kit. Adds 20-25 db gain to boost reception distance.
• Low Noise
• High Gain
• Can be used with all existing stop sign board receivers.
• 1.9-2.5 GHz Freq Range

PS-4 (Kit) \$34.95

SOLID STATE STEREO GRAPHIC EQUALIZER PRE AMP KIT



Specifications • Total Harmonic Distortion Less than 0.05% • Inter-modulation Distortion (70Hz-7KHz) < 41 SMPTE Method) Less than 0.03% • Frequency Response Overall 10Hz to 10000Hz +0.2dB -10dB • RIAA Curve Deviations: (Phono) +0.2dB -0.2dB (30Hz to 15KHz) • Channel separation (at rated output 1KHz) • Phono, Tuner, Aux and Tape Monitor better than 70dB. • Input sensitivity and impedance (1KHz for rated output).
Phono: 2MV 47K Ohms Aux: 130mV 50K Ohms Tuner: 1.20mV 50K Ohms Tape: 1.00mV 50K Ohms
Graphic Equalizer Control: 10 Band Slide Control Frequency Bands 31.5Hz: 63Hz 125Hz: 250Hz 500Hz, 1KHz, 2KHz, 4KHz 8KHz 16KHz also with on panel selector for Phono, Tuner, Aux 1 and Aux 2 Power Supply: 117 VAC. Kit comes with all electronic components, transformer, instructions and a 18" rack mount type metal cabinet.

TA-2500 (Kit) \$119.00

20 STEP LED POWER LEVEL INDICATOR KIT

This new stereo level indicator kit consists of 40 3-color LED's to indicate sound level output of your amplifier from -57 dB to 0 dB. Comes with an attractive silk screen printed panel. Has selector switch to allow floating or gradual output indicating. Kit includes all parts. Front panel and power supply.

TY-45 (Kit) \$34.95

SPY EAR

A very popular device designed to listen to sounds & voices through rooms or 3 R. thick concrete walls. Piezo listening sensor against wall and earphone in ear. Adjust volume control. Clearly hear things you may not want to!

CM-8 \$89.95

INFRA-RED REMOTE CONTROL SWITCH KIT



The TK-41 has effective control up to 10 miles! No antenna needed. Features latest IC controller which excludes interferences from light or AC pulse signal.

TK-41 Kit \$24.95

STEREO AMP KIT 150 Watt Total 80W + 80W

This is a solid state all transistor circuitry on board stereo amplifier. Power output employs 2 pairs of matching Darlingtons transistors. THD less than .01% between DC to 200 KHz. Power supply requires 30 VCT 2 amp • FMR

TA-802 \$39.95

Transformer (optional) \$9.95

LOW TIM DC STEREO PRE-AM KIT TA-2800

Incorporates state of the art design that gives a frequency response from 0Hz-100KHz • 90dB. • Features tone defeat switch, low onness treble, midrange bass balance. • Contains quad DiFet op-amp to develop T.H.D. of 0.05% at rated output • Input sensitivity phone 2.5 MV tuner, 8mV tape play 100mV/100K • Power supply • 18 volt DC at 2A. Kit comes with regulated power supply, all you need is a 15-20 VCT 2 amp XFMR.

TA-2800 ONLY \$44.50

KFMR \$4.50 ee

UHF TV PREAMP



FEATURES:
• 25 dB gain!
• Kit

Your reception will dramatically improve! This unit will enable you to pull in signals you never knew were there! For both indoor and outdoor use. Input and output impedance 75 Ohm. No adjustment. Easy assembly.

JH-0 Kit \$23.95

R.F. MODULATOR

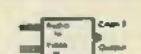

Combine both audio and video output onto channel 3 or 4 of your T.V. set. Single J.C. One (MIC 127A) makes for quick and easy assembly. Single adjustment control. A must for every video recording or computer enthusiast.

VH-0 Kit \$19.95

PHILIPS VARACTOR TUNER



Comes with adaptor board to directly replace Mitum tuner! Can use this with any board drilled for Mitum! High gain and phenomenal picture quality.

Specifications • Freq Range UHF 470-800 MHz • Output Channel 3 • Input 75 Ohm • Gain 18 dB

ELC 1045 \$23.95

DIGITAL MULTIMETER

• 3 1/2 digit LCD meter
• Input impedance 20 Ohm
• hFE measurement
• DC 5% accuracy
• Leads up to 10 amps
• Leads and battery included

MIC-3300A \$59.95
Carrying Case \$ 9.95

Add 10% shipping on orders under \$35.00. Orders over \$35.00, add 5%.

Catalog-\$1.00. Visa & Mastercharge accepted.

CIRCLE 60 ON FREE INFORMATION CARD

THE Intelligence Library—Restricted technical information & books on electronic surveillance, surveillance device schematics, lock-picking, investigation, weapons, identification documents, covert sciences, etc. The best selection available. Free brochures. MENTOR, (Dept. Z), 135-53 No. Blvd., Flushing, NY 11354.

FORTY-nine educational electronics kits with self-learning project manual. Details \$2.00 refundable with order. **TRIANGLE ELECTRONICS** 89 Arkay Drive, Hauppauge, NY 11788.

RF parts—Motorola transistors. MRF454 \$16.50. MRF455 \$13.50. Catalog available. **RF PARTS CO.**, 1320 Grand, San Marcos, CA 92069. (619) 744-0728.

UP to \$500.00 per month. Sell computer software in your home. Write to: **COMPUTER SERVICES**, PO Box 7748, Tucson, AZ 85725.

FREE pay-TV reception. "How-To" book. HBO, Showtime, Cinemax. \$4.95. **OIPTRONICS**, PO Box 80H, Lake Hiawatha, NJ 07034.

CORDLESS telephone owners. Increase range. Reduce static. Simple add on. **OSTALLS** \$1.00. **PHONES**, PO Box 273, Mesa, AZ 85201.

COMPUTER owners personal or business you need an uninterruptible power supply. We have Trpp Lite's 400 watt model for only \$240.00 **ANDERSON ENGINEERING**, RT 9, Box 19, Tampa, FL 33610.

CORDLESS telephone owners: Prevent unauthorized calls with Call-Garde. Write **BROADCAST COMPANY, LTD.**, PO Box 59, Westmont, IL 60559.

CABLE-TV products Jerrold, Hamlin, and Oak converters. Send \$3.00 for information. **ADDITIONAL OUTLET CORP.**, 111 E. Commercial Blvd., Ft. Lauderdale, FL 33334.

TEMPERATURE probe, 0.2°C accurate. Plugs into your digital multimeter. \$14.95. Details free. **SPACE-TRON**, 948 Prospect, Elmhurst, IL 60126.

LOW surplus component prices—guaranteed quality. Free flyer. **ELECTRONIX LTD.**, 3214 South Norton, Sioux Falls, SD 57105.

ELECTRONIC touch light control pad. Write for free brochure. **EXOTIC IDEAS**, PO Box 446, Lake Bluff, IL 60044.

TUBES: "oldies," latest. Supplies, components, schematics. Catalog free (stamp appreciated). **STEINMETZ**, 7519-RE Maplewood, Hammond IN 46324.

RECONDITIONED test equipment. \$1.00 for catalog. **JAMES WALTER TEST EQUIPMENT**, 2697 Nickel, San Pablo, CA 94806.

GADGETS for a catalog of electronic toys and gadgets send \$1.00 (refundable with order) to: **GADGET ELECTRONICS**, Box 37218, Dept. RE3, Omaha, NE 68137.

INTEL 8051 family cross assembler for IBM-PC or CP/M-80. Free shipping immediate delivery \$50.00. Send check to **GLO LABS**, PO Box 8625, Rockville, MD 20856.

PRINTED-circuit boards: quotes free. SASE to **JAHMAAL ELECTRONIC SUPPORT**, PO Box 397, Troy, NY 12181.

JERROLD ORX 3DIC 105 \$159.00. Oak wireless converters only \$189.00, Jerrold 60-channel converter \$89.00, line traps, filters, only \$49.00. **RED-COAT ELECTRONICS**, 104-20 68th Cr., Forest Hills, NY 11375 (212) 459-5088.

INFRARED detector. Valuable tool for detecting infrared light. Use for troubleshooting and testing IR LEDs used in sensors, remote controls, and various other IR devices. Send \$8.00 each. **TRU-TECH CO.**, 226 Pointview, Dayton, OH 45405.

WRITE FOR
McGEE'S
SPEAKER & ELECTRONICS CATALOG
1001 BARGAINS IN SPEAKERS
Tel: 1 (816) 842 5092
1901 MCGEE STREET KANSAS CITY, MO. 64108

BEC Electronics

P.O. BOX 461244R
GARLAND, TX. 75046
(214) 487-9031

TERMS
• COD MINIMUM \$20.00 • ADD \$2.50 FOR COD'S
• UPS DELIVERY ADDRESS MUST ACCOMPANY
• ALL COD ORDERS
• \$1.00 HANDLING ON ORDERS UNDER \$10.00
• ADD 6% FOR SHIPPING
• TEXAS RESIDENTS ADD 5% STATE SALES TAX
• ALL FOREIGN ORDERS ADD 25% FOR SHIPPING
(CANADA 15% NO FOREIGN CDS)
• CALL (214) 487-9031 TO PLACE CREDIT CARD OR COD ORDER

OVER 45,000 SOLD SINCE 1977! SOUND EFFECTS KIT



This unit uses the TI 76477 IC and after the easy assembly is completed you will be able to reproduce almost any sound you want! Quality PC board and all necessary components are provided. All you need to add is a speaker. The circuitry of the kit provides you with a Pulse Generator, MUX Oscillator & Comparator to make more complex sounds a snap. Programming examples provided to help you get used to using the unit.

18.50 ea.
2/34.50

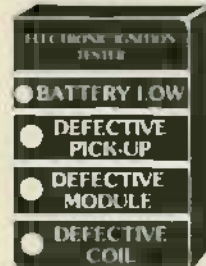

THE BEST DEAL!

This hand held Automatic Tester checks and tests the functions listed below easily and quickly. The original manufacturer sold over a million units in 1983 at 19.95 each. Instructions and charts are printed on the back of each unit. This tester will save hours of frustration and pay for itself the first time used. Units are all new, 100% guaranteed for 90 days from date of purchase.

TESTS: Battery Condition, Pick-up Coil, Ignition Module, and HV Coil

11.88 each → order 2

ORDER: AS-25
BEFORE MARCH 30
PAY 18.50 FOR BOTH!

SUPER MUSIC MAKER KIT 27.95



This popular kit is great for car horns or doorbell applications. We include all components and quality PC board. You'll love our easy to follow assembly instructions. The package price includes the kit, case w/ brown panel tune selection switches, and a preprogrammed 2706 memory chip (ROM) with 35 additional tunes. 160 total! Additional ROM's are available for 9.95 to 14.95 ea. (Listing sent with order). Order Now! Offer expires March 30, 1984! 12VAC transformer is available. Order: TN-28 2.60 ea.

12 VOLTS AC/DC SPEAKER NOT INCLUDED

INCLUDES CASE & ROM CHIP ORDER KSM-01

OR WRITE FOR CATALOG IS CRAMMED WITH NICE GOODIES SEND NO REFUNDABLE ON 1ST ORDER. FREE W/ ORDER

WINDSHIELD WIPER DELAY

Complete assembled PC card with IC, relay, and control with schematic. Complete with custom molded plastic case with bracket and hardware. Special introductory price! Order: AS-01

LM1088 Audio IF & Suppressor 2W Audio output

ICL1088 TDA1082 2W audio output. Order: ICL-1082 1.35. LM301 Linear 8 pin Op Amp. Order: ICL-01A .39. CD 4433 Coupler & 7 seg decoder driver IC House 7. Order: ICL-4433 .69.

TELEPHONE RINGER SEMI KIT

Contains special ML8204 tone ringer IC and components to build a pleasant tone ringer for your phone. 5 pgs. of specs and circuit. Order: NTR-015 2.39. PC Board for above. Order: PCB-01 2.00.

TRANSFORMER

24 VAC @ 3A 12 VAC @ 1A 6 VAC @ 2A. Completely shielded 115 VAC Primaries. 7.35 ea. 10-68-30. ORDER: TN-30

TV ANTENNA WIRE 300 OHM TWIN LEAD
UNF-IMP-FM RECEPTION DIELECTRIC
W-0365 50 FT WT 0.840 1.50

NPN POWER TRANSISTOR
80 VOLT 7 AMP 112 PATT
NFE-15-50 TO-18
ONE-STEP REPAIR KIT FOR AUDIO AMP
POWER SUPPLIES, ETC.
40¢

8/16 TRACK TAPE HEADS
REPAIR/REPLACEMENT HEADS OVER 1,000 PER RD WITH A RESPONSE >50,000 Hz. AT 1/2 IN. THE HEADS REVISION 1 & TRACK 00 1" TAPE. TWO HEADS CAN BE STAPLED TO ANY 1/2 IN. TRACKS.
UNUSED \$35 EACH
THIS BATCH IS NEW, UNMOVED ON 3" UNF. DUAL VIDEX-1 FROM EQUIPMENT IS LITTLE USED. CRASE ALL ON 8" BASS. REPAIR KIT THROUGHOUT. P-1 1" HEADS. YOUR CHOICE \$15 EACH. P-1 1" HEAD SURPRISE ANY!

TWIN FOAM 300Ω TV LEAD-IN WIRE
NO TRANSFORMER REQUIRED
UNF-IMP-FM RECEPTION
IDEAL FOR COLOR FM MULTIPLE & ALL TV-FM FUNCTIONS. MET BY UNION CARBIDE. MOISTURE PROOF. WEATHER SEALED POLY JACKET.
W-0350 50 FT WT 1.150 3.49
W-0355 50 FT WT 1.148 3.29
W-0360 100 FT WT 0.840 6.79

MODULAR PHONE JACK
A 6357 WLO 1 LB
STANDARD TELEPHONE AREA
HAS 5" FT. COILS. COILS LEADS. FERRITE CORE. NO SPONGE LUM. AT THIS PRICE YOU CAN PUT A PHONE IN EVERY ROOM.
2/91

5 VOLT 18 AMP POWER SUPPLY
A-1006 WT 2 LB
PORTABLE MODEL. 0005-048
FEATURES: ADJUSTABLE VOLTAGE, CURRENT LIMIT, OVERVOLTAGE PROTECTION. BRAND NEW.
49

C 126 D 400 VOLT 12 AMP SCR
#0-220 CABLE
99¢
10/19

C SIZE NI-CAD BATTERIES
RECHARGEABLE
#104 WT 0.1 LB
1.95 10/17

N SIZE NI CADS 12-PAK
#104 WT 0.1 LB
100% RECHARGEABLE. 0.0025 C. CASE. FULL POWER. YOUR PORTABLE PROJECTS WITH CHEAP RECHARGEABLE POWER. EACH CELL RATED 1.2 V. 100 MAH. RECHARGEABLE. 100% OF TIME. PLUS, YOU GET A PLASTIC PROTECTOR CASE (PRICE) APPROX 2.4. 4.8 7.2. WITH SWITCH, LED (PRICE) 1.0M, FUSE, ETC.
6.95

WIRESWAP IC SOCKETS
#10 100
S-1405 14 PIN 55 49 41
S-1805 18 PIN 60 54 45
S-1805 18 PIN 75 66 57

24 VDC 2.3 AMP POWER SUPPLY
LAMBDA TYPE LOS V 24
FEATURE: 120/240 VAC OPERATION, VOLTAGE & CURRENT LIMIT. ALL REMOVED FROM EQUIPMENT. GREAT CONDITION - GREAT FOR DISC DRIVES. ORDER TODAY!
P-1220 WT 5 LB 29

24 VAC 46 AMP AC Adapter
1-1090 WT 0 LB 3
GREAT DEAL ON A UL APPROVED AC ADAPTER FOR YOUR DECODERS AND PROJECTS. COMPACT ADAPTER HAS SCREW TERMINAL OUTPUTS.

8 OHM 5 Watt WEATHERPROOF 5" PAGING HORN
SUPER QUALITY. BROWN & ALUMINUM. MORE AT A BARGAIN PRICE. 6 OHM, 8 WATT. 1875. DUBBLE PACKAGES.
6.95 WT 2 LB

DIP RELAY 15VDC SPST
NORMALLY OPEN
#1210 WT 0 LB 1.95

ELECTRONIC BARGAINS
IF YOU'RE NOT ON OUR MAILING LIST, YOU'RE MISSING OUT - STANDING OUTS ON THE FINEST IN ELECTRONIC PARTS FOR THE BUILDER. IN 8 YEARS OVER 250,000 HOBBYISTS HAVE DISCOVERED WHERE TO FIND USEFUL, UNIQUE OR BARGAIN STRANGE ELECTRONICS AT GREAT PRICES. WHY NOT SEND FOR OUR CATALOG TODAY - IT'S FREE!

LA1384 5 W 24VDC AMP
P-1055
T-0 25% 14 PIN DIP
800-450245
A-34 46
V-1 - 2000 mA
STOCK UP NOW!
DATA SHEET 237

Ammonium Persulfate ETCHANT
FAST & EASY TO USE
JUST ADD BATH & ETCH
TURNS BLUE WHEN FULL OF COPPER. 1 LB. BARS.
1 GALONS #1-2240 10/17

DIAMONDBACK ELECTRONICS COMPANY
PO BOX 12095 Dept 102
SARASOTA, FLA. 33578
Phone Orders (813) 953-2829

POWER SUPPLY 12 VOLT 1.6 AMP
COMMERCIAL POWER SUPPLY
STANDARD POWER TYPE UPS
10-5 GRAB NEW, INDIVIDUAL
LY BOTTLED. 12V/1.6A INPUT
VOLTAGE REGULATED. CURRENT LIMIT
SUPER SPECIAL \$15

LARGE RED LEOS
#1005 WT 0.1 LB
10/19
PRIME, BRIGHT UNIFORM
LEDS ARE GREAT FOR
LIGHTING UP YOUR PROJECTS.
3-170 2.0, 6-800 1.000 FULL
LEADS. UNLEADED SOLDER.

DIAMONDBACK ELECTRONICS COMPANY
PO BOX 12095 Dept 102
SARASOTA, FLA. 33578
Phone Orders (813) 953-2829
CONTINENTAL US ADD \$4.00 FOR THE FIRST LB. 50¢ FOR EACH ADDITIONAL LB. FLA. ADD 5% TAX. WEST COAST ADD \$1.00 FOR THE FIRST POUND. 50¢ FOR EACH ADDITIONAL POUND.
MAIL ORDER \$7 MINIMUM
COD & CREDIT CARD \$15 MINIMUM

4164

64K DYNAMIC
200 NS

\$595

TMM2016

2KX8 STATIC
200 NS \$415

STATIC RAMS

Table with 3 columns: Part Number, Description, Price. Includes items like 2101, 5101, 2102-1, etc.

LP = Low Power Qstat = Quiet-Static

EPROMS

Table with 3 columns: Part Number, Description, Price. Includes items like 1702, 2708, 2764, etc.

5v = Single 5 Volt Supply 21vPGM = Program at 21 Volts

CRYSTALS

Table with 3 columns: Frequency, Description, Price. Includes items like 32.768 kHz, 1.0 mhz, etc.

CMOS

Table with 3 columns: Part Number, Description, Price. Includes items like 4000, 4001, 4002, etc.

DYNAMIC RAMS

Table with 3 columns: Part Number, Description, Price. Includes items like TMS4027, UPD411, MMS280, etc.

5V = single 5 volt supply

EPROM ERASERS
SPECTRONICS CORPORATION

Table with 4 columns: Part Number, Timer, Capacity, Intensity. Includes items like PE-14, PE-14T, etc.

- Computer managed inventory - virtually no back orders!
Very competitive prices!
Friendly staff!
Fast service - most orders shipped within 24 hours!

UARTS

Table with 3 columns: Part Number, Description, Price. Includes items like AY3-1013, AY3-1014, etc.

GENERATORS
BIT-RATE

Table with 3 columns: Part Number, Description, Price. Includes items like MC14411, SR1941, etc.

FUNCTION

Table with 3 columns: Part Number, Description, Price. Includes items like MC4024, LM566, etc.

MISC.

Table with 3 columns: Part Number, Description, Price. Includes items like UPD7201, TMS98532, etc.

CLOCK CIRCUITS

Table with 3 columns: Part Number, Description, Price. Includes items like MMS314, MMS369, etc.

KEYBOARD CHIPS

Table with 3 columns: Part Number, Description, Price. Includes items like AY3-2376, AY3-3600, etc.

6800

Table with 3 columns: Part Number, Description, Price. Includes items like 68000, 6800, 6802, etc.

6500

Table with 3 columns: Part Number, Description, Price. Includes items like 6502, 6504, 6505, etc.

8000

Table with 3 columns: Part Number, Description, Price. Includes items like 8035, 8039, IN8-8060, etc.

8200

Table with 3 columns: Part Number, Description, Price. Includes items like 8202, 8203, 8205, etc.

Z-80

Table with 3 columns: Part Number, Description, Price. Includes items like Z80-CPU, Z80-CTC, etc.

DISC CONTROLLERS

Table with 3 columns: Part Number, Description, Price. Includes items like 1771, 1791, 1793, etc.

CRT CONTROLLERS

Table with 3 columns: Part Number, Description, Price. Includes items like 6845, 6845, HD46505SP, etc.



JDR Microdevices

1224 S. Bascom Avenue, San Jose, CA 95128
800-538-5000 • 800-662-6279 (CA)
(408) 995-5430 • Telex 171-110

Copyright 1984 JDR Microdevices

VISIT OUR RETAIL STORE

HOURS: M-W-F, 9-5 T-Th, 9-9 Sat. 10-3

PLEASE USE YOUR CUSTOMER NUMBER WHEN ORDERING

TERMS: Minimum order \$10. For shipping and handling include \$2.50 for UPS Ground and \$3.50 for UPS Air. Orders over 1 lb. and foreign orders may require additional shipping charges...

2114

450 NS

8/\$9.95

2114

250 NS

8/\$10.95

74LS00

74LS00	.24	74LS173	.89
74LS01	.25	74LS174	.55
74LS02	.25	74LS175	.55
74LS03	.25	74LS181	2.15
74LS04	.24	74LS189	9.95
74LS05	.25	74LS190	.89
74LS08	.28	74LS191	.89
74LS09	.29	74LS192	.79
74LS10	.25	74LS193	.79
74LS11	.35	74LS194	.89
74LS12	.35	74LS195	.89
74LS13	.45	74LS196	.79
74LS14	.89	74LS197	.79
74LS15	.35	74LS221	.89
74LS20	.25	74LS240	.85
74LS21	.29	74LS241	.89
74LS22	.25	74LS242	.89
74LS26	.29	74LS243	.89
74LS27	.25	74LS244	1.29
74LS28	.35	74LS245	1.49
74LS30	.25	74LS247	.75
74LS32	.29	74LS248	.89
74LS33	.55	74LS249	.89
74LS37	.35	74LS251	.59
74LS38	.35	74LS253	.59
74LS40	.49	74LS258	.59
74LS47	.79	74LS259	2.75
74LS48	.75	74LS260	.59
74LS49	.75	74LS266	.55
74LS51	.25	74LS273	1.49
74LS54	.29	74LS275	3.35
74LS55	.29	74LS279	.49
74LS63	1.25	74LS280	1.99
74LS73	.39	74LS283	.89
74LS74	.35	74LS290	.89
74LS75	.39	74LS293	.89
74LS78	.39	74LS295	.99
74LS78	.49	74LS298	.89
74LS83	.89	74LS299	1.75
74LS85	.89	74LS323	3.50
74LS88	.39	74LS324	1.75
74LS90	.55	74LS352	1.29
74LS91	.89	74LS353	1.29
74LS92	.55	74LS363	1.35
74LS93	.55	74LS364	1.95
74LS95	.79	74LS365	.49
74LS96	.89	74LS366	.49
74LS107	.39	74LS367	.45
74LS109	.39	74LS368	.48
74LS112	.39	74LS373	1.29
74LS113	.39	74LS374	1.39
74LS114	.39	74LS375	.95
74LS122	.45	74LS377	1.39
74LS123	.79	74LS378	1.18
74LS124	2.89	74LS379	1.35
74LS125	.89	74LS385	3.90
74LS128	.49	74LS388	.45
74LS132	.89	74LS390	1.19
74LS133	.59	74LS393	1.19
74LS136	.39	74LS395	1.19
74LS137	.99	74LS399	1.49
74LS138	.55	74LS424	2.95
74LS139	.55	74LS447	.85
74LS145	1.29	74LS490	1.85
74LS147	2.49	74LS494	3.89
74LS148	1.35	74LS496	2.20
74LS151	.55	74LS495	2.20
74LS153	.55	74LS498	1.89
74LS154	1.99	74LS499	1.89
74LS155	.89	74LS497	1.49
74LS158	.89	74LS497A	14.95
74LS157	.85	74LS498	3.20
74LS158	.59	74LS498A	3.20
74LS160	.89	74LS498A	3.20
74LS161	.65	74LS498B	3.20
74LS162	.69	74LS498C	2.40
74LS163	.85	74LS499	3.20
74LS164	.89	81L995	1.49
74LS165	.95	81L996	1.49
74LS166	1.95	81L997	1.49
74LS168	1.75	81L998	1.49
74LS169	1.75	25LS32521	2.89
74LS170	1.49	25LS2569	4.25

74S00

74S00	.32	74S132	1.24	74S225	7.95
74S02	.35	74S133	.45	74S240	2.20
74S03	.35	74S134	.50	74S241	2.20
74S04	.35	74S135	.89	74S244	2.20
74S05	.35	74S138	.85	74S251	.85
74S08	.35	74S139	.85	74S253	.95
74S09	.40	74S140	.55	74S257	.95
74S10	.35	74S151	.95	74S258	.95
74S11	.35	74S153	.95	74S260	.79
74S15	.35	74S157	.95	74S273	2.45
74S20	.35	74S156	.95	74S274	18.95
74S22	.35	74S181	1.95	74S275	19.95
74S30	.35	74S162	1.95	74S280	1.95
74S32	.40	74S163	1.95	74S287	1.90
74S37	.89	74S158	3.95	74S288	1.90
74S38	.85	74S188	3.95	74S289	6.89
74S40	.35	74S174	.95	74S301	6.95
74S41	.35	74S175	.95	74S373	2.45
74S44	.40	74S181	3.95	74S374	2.45
74S45	.40	74S182	2.95	74S381	7.89
74S74	.59	74S188	1.95	74S387	1.99
74S85	1.99	74S189	6.95	74S412	2.85
74S86	.50	74S194	1.49	74S471	4.95
74S112	.50	74S195	1.49	74S472	4.85
74S113	.50	74S196	1.49	74S474	4.95
74S114	.55	74S197	1.49	74S482	18.25
74S124	2.75	74S201	6.95	74S570	2.95
				74S571	2.95

VOLTAGE REGULATORS

7805T	.75	7905T	.85
7805C	.35	7906T	.85
7808T	.75	7912T	.83
7812T	.75	7915T	.85
7815T	.75	7924T	.85
7924T	.75		
7805K	1.39	7912K	1.49
7812K	1.39	7915K	1.49
7815K	1.39	7924K	1.49
7824K	1.39		
79L05	.89	79L12	.79
79L12	.69	79L15	.79
79L15	.89		
79H05K	9.95	LM323K	4.95
79H12K	9.95	UA78840	1.95

C, 7 - 70-220 K - 70-3
L - 70-92

SOUND CHIPS

78477	3.95	AY3-8910	12.95
78488	5.95	AY3-8912	12.95
78489	8.95	MC3340	1.49

7400

7400	.19	74129	.49
7401	.19	74125	.45
7402	.19	74126	.45
7403	.19	74132	.49
7404	.19	74136	.89
7405	.25	74143	4.95
7406	.29	74145	.69
7407	.29	74147	1.79
7408	.24	74148	1.29
7409	.19	74150	1.99
7410	.19	74151	.89
7411	.25	74153	.55
7413	.35	74184	1.25
7414	.49	74155	.75
7415	.25	74157	.55
7417	.25	74159	1.65
7420	.19	74160	.85
7421	.35	74181	.89
7425	.29	74183	.89
7427	.29	74184	.85
7430	.19	74195	.85
7432	.29	74184	1.00
7437	.29	74157	2.95
7438	.29	74170	1.65
7442	.49	74173	.75
7445	.69	74174	.99
7446	.89	74175	.89
7447	.89	74177	.75
7448	.89	74191	2.25
7451	.23	74184	2.00
7473	.34	74195	2.00
7474	.33	74191	1.15
7475	.45	74192	.79
7478	.35	74193	.79
7482	.95	74194	.85
7483	.69	74195	.85
7485	.59	74187	.79
7486	.35	74198	1.35
7489	2.19	74221	1.35
7490	.35	74246	1.39
7492	.50	74247	1.25
7493	.35	74259	2.25
7495	.55	74273	1.85
7497	2.75	74278	1.25
74100	1.79	74279	.75
74107	.30	74386	.85
74108	.45	74387	.85
74118	1.55	74388	.85
74121	.29	74393	1.35
74122	.45		

DATA ACQUISITION

ADC0800	15.55	DAC0908	2.95
ADC0804	3.49	DAC1020	8.25
ADC0809	4.49	DAC1022	5.95
ADC0817	8.95	MC1408L8	1.95
DAC0800	4.95	MC1408L8	2.95

INTERFACE

8T26	1.59
8T28	1.89
8T95	.89
8T96	.89
8T97	.89
8T98	.89
DM8131	2.95
OP8304	2.29
OS8833	2.25
OS8835	1.99
OS8836	.99
OS8837	1.85
OS8838	1.30

CENTRONICS

IDCEN36	
Ribbon Cable 36 Pin Male	8.95
IDCEN36-F	
Ribbon Cable 36 Pin Female	8.95
CEN36	
Solder Cup 36 Pin Male	7.95

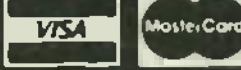

MICROCOMPUTER HARDWARE HANDBOOK FROM ELCOMP - \$14.95

Over 800 pages of manufacturers data sheets on most commonly used IC's.

- Includes:
- TTL - 74/74LS and 74F
 - CMOS
 - Voltage Regulators
 - Memory - RAM, ROM, EPROM
 - CPU's - 6800, 6500, Z80, 8080, 8085, 8086/8
 - MPU support & interface - 6800, 6500, Z80, 8200, etc.

FEDERAL EXPRESS SERVICES AVAILABLE!

CONNECTORS

RS232 Male	2.50
RS232 Female	3.25
RS232 Hood	1.25
8-100 ST	3.95

EXAR

XR 2206	3.75
XR 2207	3.75
XR 2208	3.75
XR 2211	5.25
XR 2240	3.25

INTERSIL

ICL7108	9.95
ICL7107	12.95
ICL7880	2.95
ICL8038	3.95
ICM7207A	5.59
ICM7208	15.95

9000

9316	1.00
9334	2.50
9368	3.95
9401	9.95
9603	.75
9602	1.50
96502	1.85

LINEAR

LM301	.34	LM340 (see 7900)		LM555	.99	LM1558H	3.10
LM301H	.79	LM346	.99	LM556	1.49	LM1800	2.27
LM307	.45	LM350K	4.95	LM567	.89	LM1812	8.25
LM308	.89	LM350T	4.89	NE570	3.95	LM1830	3.50
LM308H	1.15	LM358	6.60	NE571	2.95	LM1871	5.49
LM309H	1.95	LM359	1.79	NE590	2.60	LM1872	5.49
LM309K	1.25	LM376	3.75	NE592	2.75	LM1877	3.25
LM310	1.75	LM377	1.95	LM709	.59	LM1889	1.95
LM311	.84	LM378	2.50	LM710	.75	LM1896	1.79
LM311H	.89	LM379	4.50	LM711	.79	ULN2003	2.49
LM312H	1.79	LM380	.89	LM723	.49	LM2677	2.05
LM317K	3.95	LM380M-8	1.10	LM723H	.55	LM2678	2.25
LM317T	1.19	LM381	1.60	LM733	.99	LM2900	.95
LM318	1.49	LM382	1.60	LM741	.35	LM2901	1.00
LM318H	1.59	LM383	1.95	LM741N-14	.35	LM3900	.59
LM319H	1.90	LM384	1.95	LM741H	.40	LM3905	1.29
LM319	1.25	LM386	.89	LM747	.89	LM3908	.99
LM320 (see 7900)		LM387	1.40	LM748	.59	LM3911	2.25
LM322	1.65	LM389	1.35	LM1014	1.19	LM3914	3.95
LM323K	4.95	LM390	.85	LM1303	1.95	LM3915	3.95
LM3							

CABINETS FOR 5 1/4" DISK DRIVES

CABINET #1 \$29.95

- * DIMENSIONS 8 1/2" x 5 1/2" x 3 1/2"
- * COLOR MATCHES APPLE
- * FITS STANDARD 5 1/4" DRIVES.
- INCL SHUGART
- * INCLUDES MOUNTING HARDWARE AND FEET

CABINET #2 \$79.00

- * COMPLETE WITH POWER SUPPLY, SWITCH, LINE CORD, FUSE & STANDARD POWER CONNECTOR
- * DIMENSIONS: 11 1/2" x 5 1/2" x 3 1/2"
- * +5V @ 1 AMP, +12V @ 1.5 AMP
- * FITS STANDARD 5 1/4" DRIVES
- * PLEASE SPECIFY GRAY OR TAN

NOTE: Please include sufficient amount for shipping on above items.

TRANSISTORS

2N918	.50	MP83706	.15
MP8918	.25	2N3772	1.85
2N2102	.75	2N3903	.25
2N2218	.50	2N3904	.10
2N2218A	.50	2N3906	.10
2N2219	.30	2N4122	.25
2N2219A	.50	2N4123	.25
2N2222	.25	2N4248	.25
PN2222	.10	2N4304	.75
MP82349	.25	2N4401	.25
2N2484	.25	2N4402	.25
2N2905	.50	2N4403	.25
2N2907	.25	2N4457	1.00
PN2907	.125	PN4916	.25
2N3086	.75	2N5086	.25
3055T	.89	PN5129	.25
2N3393	.30	PN5139	.25
2N3414	.25	2N5209	.25
2N3563	.40	2N6026	.35
2N3565	.40	2N6043	1.78
PN3565	.25	2N6045	1.78
MP83636	.25	MP8-A05	.25
MP83640	.25	MP8-A06	.25
PN3643	.25	MP8-A55	.25
PN3644	.25	TIP29	.85
MP83704	.15	TIP31	.75
		TIP32	.75

DISK DRIVES TANDON

TM100-1 5 1/4" (FOR IBM) SS/DD 229.00
 TM100-2 5 1/4" (FOR IBM) DS/DD 259.00

SHUGART

SA 400L 5 1/4" (40 TRACK) SS/DD 199.95
 SA 400 5 1/4" (35 TRACK) SS/DD 189.95

PERTEC

FD-200 5 1/4" DS/DD 179.95
 FD-250 5 1/4" DS/DD 199.95

MPI

MP-52 5 1/4" (FOR IBM) DS/DD 249.00

NOTE: Please include sufficient amount for shipping on above items.

DIODES

1N781	5.1 volt zener	.25
1N759	12.0 volt zener	.25
1N4148	(1N914) switching	25/1.00
1N4004	400PIV rectifier	10/1.00
KBP02	200PIV 1.5amp bridge	.45
KBP04	400PIV 1.5amp bridge	.55
YM48	Dip-Bridge	.35

IC SOCKETS

8 pin ST	1.00	100
14 pin ST	.13	.11
16 pin ST	.16	.12
18 pin ST	.17	.13
18 pin ST	.20	.18
20 pin ST	.29	.27
22 pin ST	.30	.27
24 pin ST	.30	.27
26 pin ST	.40	.32
40 pin ST	.49	.39
64 pin ST	4.25	call
ST = BOLDERTAIL		
8 pin WW	.59	.49
14 pin WW	.59	.52
16 pin WW	.68	.56
18 pin WW	.99	.90
20 pin WW	1.09	.96
22 pin WW	1.39	1.28
24 pin WW	1.49	1.35
26 pin WW	1.99	1.49
40 pin WW	1.99	1.80
WW = WIREWRAP		
16 pin ZIF	5.95	call
24 pin ZIF	7.95	call
28 pin ZIF	8.95	call
ZIF = TEXTTOOL		
(Zero Insertion Force)		

NEW UN-USED MUFFIN FANS

4.86" Square 14.95
 3.125" Square 14.95

HEAT SINKS

TO-3 style .95
 TO-220 style .38

SWITCHES

SPDT mini-toggle 1.25
 DPDT mini-toggle 1.50
 SPST mini-pushbutton .39

OPTO-ISOLATORS

4N26	1.00	MCA-7	4.25
4N27	1.10	MCA-255	1.75
4N28	.69	IL-1	1.25
4N33	1.75	ILA-30	1.25
4N35	1.25	ILQ-74	2.75
4N37	1.25	H11C5	1.25
MCT-2	1.00	TIL-111	1.00
MCT-6	1.50	TIL-113	1.75

EDGE-CARD CONNECTORS

S-100 ST	3.95
S-100 WW	4.95
72 pin ST	6.95
72 pin WW	7.95
50 pin ST	4.95
44 pin ST	2.95
44 pin WW	4.95

RESISTORS

1/4 WATT 5% CARBON FILM ALL STANDARD VALUES FROM 1 OHM TO 10 MEG OHM
 50 PCS. SAME VALUE .025
 100 PCS. SAME VALUE .02
 1000 PCS. SAME VALUE .015

OUR BUYER BLEW IT... & BOUGHT TOO MANY OF THESE!

4116 250NS 8/7.95

RIBBON CABLE

CONTACTS	SINGLE COLOR		COLOR CODED	
	1'	10'	1'	10'
10	.50	4.40	.83	7.30
16	.55	4.80	1.00	8.80
20	.65	5.70	1.25	11.00
25	.75	6.60	1.32	11.60
26	.75	6.60	1.32	11.60
34	.98	8.60	1.66	14.50
40	1.32	11.60	1.92	16.80
50	1.38	12.10	2.50	22.00

D-SUBMINIATURE

DESCRIPTION	SOLDER CUP		RIGHT ANGLE PC SOLDER		IDC RIBBON CABLE		HOODS		
	MALE	FEMALE	MALE	FEMALE	MALE	FEMALE	BLACK	GREY	
ORDER BY	DBxxP	DBxxS	DBxxPR	DBxxSR	IDBxxP	IDBxxS	HOOD-B	HOOD	
CONTACTS	9	2.08	2.66	1.85	2.18	3.37	3.69	---	1.60
	15	2.69	3.63	2.20	3.03	4.70	5.13	---	1.60
	25	2.50	3.25	3.00	4.42	6.23	8.84	1.25	1.25
	37	4.80	7.11	4.83	6.19	9.22	10.08	---	2.95
	50	8.05	9.24	---	---	---	---	---	3.50

For order instructions see "IDC Connectors" below.

MOUNTING HARDWARE 1.00

IDC CONNECTORS

DESCRIPTION	SOLDER HEADER	RIGHT ANGLE SOLDER HEADER	WW HEADER	RIGHT ANGLE WW HEADER	RIBBON HEADER SOCKET	RIBBON HEADER	RIBBON EDGE CARD
ORDER BY	IDHxxS	IDHxxSR	IDHxxW	IDHxxWR	IDSxx	IDMxx	IDExx
CONTACTS	10	.85	1.86	2.06	1.15	---	2.25
	20	1.29	2.98	3.28	1.86	5.50	2.36
	26	1.68	3.84	4.22	2.43	6.25	2.65
	34	2.20	4.50	4.45	3.15	7.00	3.25
	40	2.58	5.28	4.80	3.73	7.50	3.80
	50	3.24	6.63	7.30	4.65	8.50	4.74

ORDERING INSTRUCTIONS: Insert the number of contacts in the position marked "xx" of the "order by" part number listed. Example: A 10 pin right angle solder style header would be IDH10SR.

VISIT OUR RETAIL STORE

HOURS: M-W-F, 9-5 T-Th., 9-9 Sat. 10-3

PLEASE USE YOUR CUSTOMER NUMBER WHEN ORDERING

TERMS: Minimum order: \$10. For shipping and handling include \$2.50 for UPS Ground and \$3.50 for UPS Air. Orders over 1 lb. and foreign orders may require additional shipping charges. Please contact our sales department for the amount. CA residents must include 6% sales tax. Bay Area and LA residents include 6 1/2%. Prices subject to change without notice. We are not responsible for typographical errors. We reserve the right to limit quantities and to substitute manufacturer. All merchandise subject to price sale.

Copyright 1984 JDR Microdevices

 **JDR Microdevices**
 1224 S. Bascom Avenue, San Jose, CA 95128
 800-538-5000 • 800-662-6279 (CA)
 (408) 995-5430 • Telex 171-110

CIRCLE 49 ON FREE INFORMATION CARD

FOR APPLE COMPUTER USERS



JDR Microdevices

THOUSANDS SOLD!

JDR-16K RAM CARD FOR APPLE II+

- * Expand your 48K Apple to 64K
 - * Fully compatible with Apple Language System — Use in place of Apple Language card
 - * Highest quality card features: gold edge connector, sockets for all IC's
 - * 2 YEAR WARRANTY
- Kit with Instructions \$40.95
Bare PC Card \$14.95

\$44.95

GET SLIM IN 1984! JDR HALF-HEIGHT DISK DRIVE

- * 35 Track If used with Apple Controller
- * 40 Track Controller and DOS Available (Call for Price)



\$209.95

MA SYSTEMS FD-35 DISK DRIVE



\$199.95

- * Shugart Mechanism — Made in U.S.A.
- * Direct Replacement for Apple Disk II
- * Compatible with Apple Controller or other Apple compatible controllers
- * Specially designed electronics with low power consumption
- * DOS 3.3 and 3.2 compatible
- * One Year Warranty

CONTROLLER CARD \$69.95

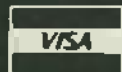

APPLE COMPATIBLE POWER SUPPLY

- * Use To Power Apple-Type Systems
- * +5V @ .5A +12V @ 3A
- * -5V @ .5A -12V @ .5A
- * Instructions Included

\$79.95

BMC BMX-80 PRINTER

- * 80 CPS Dot Matrix Printer
- * Prints Bi-Directional in 40, 80, 71 or 142 Columns in Normal, Double Width or Compressed Text.
- * Print Superscript As Well As Superb Graphics in Character or Bit Image



\$279

micromax

VIEWMAX-80

NOW ONLY \$159.95

- * 80 Column Card for Apple II+
- * Video Soft Switch
- * Inverse Video
- * 2 Year Warranty

VIEWMAX-80e

NEW \$129.95

- * 80 Column Card for Apple IIe
- * 64K RAM Expandable to 128K
- * 64K RAM Upgrade \$47.60

GRAPHMAX \$129.95

- * Hi Resolution Graphics
- * Printer Card
- * Centronics Parallel Interface

Graphmax with Color & Zoom Options... \$149.95

NASHUA DISKETTES 5 1/4" WITH HUB RING

MD1 SOFT SECTOR, SS/DD	19.95
MD1D SOFT SECTOR, SS/DD	28.25
MD2D SOFT SECTOR, DS/DD	30.75
MD2F SOFT SECTOR, DS/QUAD DENSITY	45.00
MD110 10 SECTOR HARD, SS/SD	19.95
MD210D 10 SECTOR HARD, DS/DD	30.75

5" WITHOUT HUB RING

FD1 SOFT SECTOR, SS/SD	24.75
FD1D SOFT SECTOR, SS/DD	30.00
FD2D SOFT SECTOR, DS/DD	36.75

VERBATIM DATALIFE DISKETTES

SS/DD SOFT SECTOR	\$29.95
SS/DD 10 HARD SECTOR	\$29.95

5 1/4" DISKETTE FILE

- * ATTRACTIVE FUNCTIONAL DISK STORAGE SYSTEM
 - * 75 DISK STORAGE CAPACITY
 - * MOLDED FROM DURABLE SMOKED PLASTIC WITH FRONT-CARRYING HANDLE
- \$16.99**

OTHER ACCESSORIES FOR APPLE II

THUNDERCLOCK \$129.95

- * Real-Time Clock Calendar
- * Software Included
- * Mountain Software Compatible
- * BSR Control Options Available

KRAFT JOYSTICK \$39.95

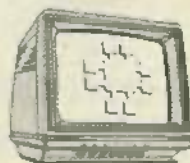

MONITORS

BMC MONITOR STAND MODEL PA-900

Your Display Will Tilt & Swivel **\$29.95**

MONOCHROME

BMC BM 12AUW GREEN 12"	\$89.95
BMC BM 12EUY 10 MHZ AMBER	\$139.95
BMC BM 12EUN 10 MHZ HIGH RES GREEN	\$115.00
NEC JB1201M - 20 MHZ GREEN	\$169.00
ZENITH ZVM-121 - 18 MHZ GREEN	\$99.00

COLOR

BMC BM-AUB191U COMPOSITE 13"	\$279.00
------------------------------------	----------

NO C.O.D. ORDERS PLEASE



JDR Microdevices

1224 S. Bascom Avenue, San Jose, CA 95128
800-538-5000 • 800-662-6279 (CA)
(408) 995-5430 • Telex 171-110

Apple is a trademark of Apple Computer Corporation

VISIT OUR RETAIL STORE

HOURS: M-W-F, 9-5 T-Th., 9-9 Sat 10-3

PLEASE USE YOUR CUSTOMER NUMBER WHEN ORDERING

TERMS: Minimum order \$10. For shipping and handling include \$2.50 for UPS Ground and \$3.50 for UPS Air. Orders over 1 lb. and foreign orders may require additional shipping charges — please contact our sales department for the amount. CA residents must include 6% sales tax. Bay Area and LA residents include 8%. Prices subject to change without notice. We are not responsible for typographical errors. We reserve the right to limit quantities and to substitute manufacturer. All merchandise subject to prior sale.

© Copyright 1984 JDR Microdevices

MARCH 1984

ACTIVE RECEIVING ANTENNA

Gives excellent reception, 50 KHz to 30 MHz.

New MFJ-1024 Active Receiving Antenna mounts outdoors away from electrical noise for maximum signal.

Gives excellent reception of 50 KHz to 30 MHz signals. Equivalent to wire hundreds of feet long. Use any SWL, MW, BCB, VLF or Ham receiver.

High dynamic range RF amplifier. 54 in. whip. 50 foot coax. 20 dB attenuator prevents receiver overload. Switch between two receivers. Select auxiliary or active antenna. Gain control. "ON" LED. Remote unit, 3x2x4 in. Control, 6x2x5 in. 12 VDC or 110 VAC with optional adapter, MFJ-1312, \$9.95.

\$129.95 ~~134.00~~

Order from MFJ and try it. If not delighted, return within 30 days for refund (less shipping).

One year unconditional guarantee.

Order today. Call TOLL FREE 800-647-1800.

Charge VISA, MC. Or mail check, money order.

Write for free catalog. Over 100 products.

CALL TOLL FREE 800-647-1800

Call 601-323-5869 in Miss., outside continental USA, tech/order/repair info. TELEX 53-4590.

MFJ ENTERPRISES, INCORPORATED

Box 494, Mississippi State, MS 39762

CIRCLE 66 ON FREE INFORMATION CARD



Active Electronics

NUMBER ONE IN

QUALITY SERVICE AVAILABILITY

THE WORLD'S MOST COMPLETE PROFESSIONAL AND HOME ELECTRONICS ENTHUSIAST INVENTORY

- Semiconductors + Memories
- Microprocessors + Support Circuits
- Microcomputer Systems + Peripherals
- Passive Electronic Components
- Hand Tools, Wire Wrapping, Soldering Equipment + Hardware

NOW AVAILABLE — FREE 1983 80-page catalog

A complete listing of products and specifications

Call, write or circle the inquiry card for your free copy today.

P.O. Box 8000, Westboro, Mass. 01581
 CALL TOLL FREE: 1-800-343-0874

Mass customers call (617) 366-0500

CIRCLE 3 ON FREE INFORMATION CARD

SURPLUS BARGAINS

ATTN: Hams, Experimenters



120 CPS I RS-232

A superior TTY Replacement The G.E. "TERMINET 1200" featuring:

- 110, 300, & 1200 Baud (11.30 & 120 cps)
- Full KSR & RS-232-C I/O
- Compact, table-top configuration
- Upper & lower case continuous band
- Made in USA by General Electric

TERMINET 1200, tested, operational \$349.00



12" MOTOROLA Video Monitors

Model #XM-351 Series. These popular monitors feature: 12" diag. CRT, adj. horiz. bandwidth and scan rate up to 80 x 24. Isolated power supply, 115/230 VAC operation, 50/60 Hz. "less" brightness and contrast controls. Requires composite video input (2-wire). Ready for case of your choice. Used, tested and operational. Data and schematics included.

12" "composite" input CRT: tested, oper'l \$44.00

15" Motorola CRT Monitor, used, good cond'n, TTL input \$49.00

9" "composite" input CRT monitor tested & oper'l \$39.00

Computer Products & Peripherals Unlimited

WAREHOUSE 18 Granite St. Haverhill, Mass. 01830
 MAIL ORDERS Box 204 Newton New Hampshire 03858

617/372-8637

Sorry No Collect Calls

MasterCard & VISA Accepted



CIRCLE 68 ON FREE INFORMATION CARD

TECHNICIANS & SERVICEMEN COMPONENTS FOR YOUR MAINTENANCE & REPAIR WORK SPECIAL: OUR LOW LOW PRICES

REPLACEMENT FOR ECG® TYPES

TYPE NO.	YOUR COST	TYPE NO.	YOUR COST
85	FOUR for .99	125	SEVEN for .99
102A	THREE for .99	159AP	FOUR for .99
123A	FIVE for .99	177	EIGHT for .99
123AP	SIX for .99	199	FIVE for .99

SUPER SPECIAL (MIN. 5 PC. EACH)

TYPE NO.	YOUR COST	TYPE NO.	YOUR COST	TYPE NO.	YOUR COST
124	.85	165	2.25	375	.90
128	.45	171	.85	506	.55
129	.45	184	.45	500A	8.95
130	.80	185	.45	523	9.95
152	.40	238	2.25	526A	10.20
153	.40	276	6.95	529	13.75
154	.60	291	.95	712	1.25

JAPANESE TYPES (MIN. 5 PC. EACH)

2SC867A	2.75	HA1366W	1.85	STK0029	3.80
2SC1114	3.25	HA1377A	2.90	STK0080	9.99
2SC1308K	1.95	LA4102	1.25	TA7205AP	1.50
AN214Q	1.45	M51515BL	2.95	TA7208P	1.85
AN239A	4.60	STK433	3.95	TA7222AP	1.95
BA532	1.80	STK435	3.95	UPC1181H	1.25
GH3F	.89	STK437	6.25	UPC1182H	1.25
HA1342A	2.30	STK439	6.50	UPC1185H	2.99

COD ORDERS WELCOME (\$25 MIN. ORDER)

For Complete Component Catalog Call or Write

DIGITRON ELECTRONIC

110 HILLSIDE AVENUE, SPRINGFIELD, N.J. 07081

Toll Free: 800-526-4928 In NJ: 201-379-9016

*EGG IS A TRADE MARK OF PHILIPS ECG

DIGITRON ELECTRONIC IS NOT ASSOCIATED IN ANY WAY WITH PHILIPS ECG

CIRCLE 11 ON FREE INFORMATION CARD

ADVANCED COMPUTER PRODUCTS

SEND \$2.00 for 1983 CATALOG

16K Apple™ Ramcard

LIST 195
ACP
\$49.95



- With 80 Columns
- Expand Apple II 48K to 64K
- Compatible with 2-80 Softcard
- Top quality — gold fingers
- Full 1 year warranty

64K Apple IIe Ramcard

• Also with 80 Columns... only \$99.95

RAM UP-GRADES

64K D RAM (4164-200nS)

9 pcs for \$50.00

16K D RAM (4116-200nS)

8 pcs for \$12.95

REPEAT OF SELL-OUT

58 Key Unencoded Keyboard

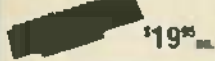

\$19.95

This is a new 58 key terminal keyboard manufactured by a major manufacturer. It is unencoded with 58 keys unattached to any PC board. Solid molded plastic shell measures 11" x 4"

Unencoded Key Pad

15 key keypad with 1.80 keys and full return (L, C and R)

Only \$9.95

UV "EPROM" ERASER

Model DE-4 \$89.95

Model S-52T \$325.00

STEPPER MOTOR

Operates by applying 5VDC to one direction and then reversing polarity for reverse travel. Used for disk drives, tape drives, etc.

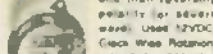

Order 3 RPM at 4 p.p.s. with a 5 degree stepping angle

ACP Price \$3.95

RS232 SIGNAL TESTER

COEX RS232 LINE TESTER (7) LED indicators

Only \$24.95

Other Styles Also Available

64K CMOS RAMCARD

Compatible Uses Low Power 5V Single Supply

Assem and Tested \$299.95

SURGE SUPPRESSOR

"Surgeonics" Power Sentry 15 Amps 250 Volts transient suppression

ACP Low Price \$39.95

CONNECTORS

DB25P (RS232) \$3.25

DB25S Female 5.75

Head 1.25

50-100 5-100 Connector w/ser 4.80

50-100 3-100 Connector S/T 3.85

MICROPROCESSORS

8080	644.00	8081	814.00	8088P	57.85
8088P	51.95	8081A	815.00	8088	8.80
8088	4.95	8088A	816.00	8087	34.80
8088P	18.95	8089	4.95	8736	20.20
8089	19.20	8089A	4.95	8748	39.80
8089P	8.75	8089B	35.95	8080	14.80
8089A	3.95	8089C	18.00	8089	19.80
8089B	5.00	8089D	18.95	8089	49.80

RAMS

6116-2018	\$7.85	7147	64.00	5280	\$1.80
6264-64K	6.95	411	8.00	6502	6.50
4116-2	1.80	414	4.00	6508	6.50
4116-2	812.95	1101	80.00	8118	6.70
2101	1.80	1103	80.00	8561	3.70
2102	7.9	4027	4.00	8604	3.80
2102-9	1.40	4044	3.80	8605	3.80
2102-4	2.40	4080	4.00	8130	8.90
8111	2.90	4080	4.00	8140	8.90
8112	2.70	4080	3.80	8048	8.90
2114	1.44	4115	1.44	8042S	8.80
2114-L-2	2.20	4200	7.95	8101	3.75
2148-L-6	1.80	4402	1.80	28132	24.95
2125	8.99	5280	4.80		

SUPPORT

5150	17.95	6262	88.80	6576	55.70
5156	9.95	6880	88.80	6880	2.10
6202	71.20	6884	5.95	6887	22.70
6205	2.80	6780	8.80	6848	18.85
6212	2.40	6887	8.80	6505	18.95
6214	4.95	6788	20.00	8520	4.50
6216	1.75	6889	40.00	8522	7.95
6224	2.20	80	3.00	8520 X	20.80
6226	2.70	6890	6.00	8526	5.95
6880	3.85	6891	4.90	6531	11.75
6243	6.95	6828	10.00	280 P/D	4.95
6250	14.95	6834	10.00	280A P/O	8.80
6251	4.20	6841	10.00	280-C/CTC	4.40
6253	4.20	6847	14.95	280A-C/TC	8.50
6256	4.20	8650	4.50	280A-DMA	11.85
6257	2.80	6650	4.00	280A-DMA	15.95
6258	6.95	6880	10.95	280-B/D	14.95
6275	25.95	6882	10.95	280A-B/D	14.95
6278	8.50				

MOS PROMS

7784 (8Kx8) TS	54.95	2708 (430x8)	53.95
7792 (4Kx8) TS	6.95	80784 (8Kx8)	30.95
2702 (4Kx8) TS	6.95	27188 (16Kx8)	18.95
27182516.5V (2Kx8) TS	4.95	1702A	4.50
7792718.5V (2Kx8) TS	4.95		
7792718.5V (2Kx8) TS	17.80	AM2503A/Q	14.50
7792718.5V (2Kx8) TS	31.50	AM2504A	8.95

HI TECH

2813-801 (8K) Laster	15.80	DA08	80.35
2813-802 (8K) Laster	18.95	DA09	9.95
2813-803 (8K) Laster	14.80	DA10	4.80
MC28078 A/B/C Dated	12.80	MC2808 Y/D	2.90
MC28078 A/B/C Dated	13.80	MC2809 Y/D	1.95
1774-814 (8K) Laster	14.80	28228 Laster Encoder	7.75
1774-814 (8K) Laster	14.80	71-10000 100 120	6.50
1774-814 (8K) Laster	89.95	415-101 MC2809	4.95
1774-814 (8K) Laster	99.80	415-101A MC2809	4.95
1774-814 (8K) Laster	44.95	415-101A MC2809	4.95
1774-814 (8K) Laster	46.95	415-102	2.85
1774-814 (8K) Laster	54.95	415-103	2.85
1774-814 (8K) Laster	71.75	2280 U/B/T	4.95
2145 (8K) Laster	88.80	MC2810	24.95
4780 8 K Ram	13.80	MC2811	11.85
4780 16 K Ram	22.80	4782	14.85
4780 32 K Ram	38.80	8894-1	9.85
4780 64 K Ram	71.75	8894-2	18.85
4780 128 K Ram	138.80	8894-3	15.85
4880 4 K Ram	8.85	479-2178	10.75
4880 8 K Ram	13.85	479-2880	13.75
4880 16 K Ram	19.85	8895/8896	8.85

SOCKETS

LOW PROFILE SOCKETS (TIN)

8 pin LP	16	19	14
14 pin LP	20	19	18
18 pin LP	22	25	20
18 pin LP	29	28	37
20 pin LP	24	22	29
22 pin LP	38	37	24
24 pin LP	38	37	30
28 pin LP	46	44	43
40 pin LP	80	85	28

3L WIREWRAP SOCKETS (GOLD)

8 pin WW	38	34	49
14 pin WW (Tin)	50	48	80
18 pin WW	78	77	87
18 pin WW	88	87	79
18 pin WW	95	88	81
20 pin WW	115	108	90
22 pin WW	145	135	123
24 pin WW	138	125	114
28 pin WW	168	155	138
40 pin WW	230	210	188

LINEAR

7805K	53.95	LM1418N	81.80
7805B	9.49	LM1486CM	41
7805G	1.40	MC1488N	99
LM1084H	2.95	MC1488N	80
LM1084H	88	LM1484H	80
LM1084H	35	LM1484H	1.80
LM1084H	1.80	LM1500N	85
LM1084H	3.25	LM1889N	310
LM1084H	1.75	LM2111B	1.75
LM1084H	88	LM2902N	99
LM1084H	1.80	LM2901H	2.50
LM1084H	1.25	LM2917N	2.95
LM1084H	8.80	CA3013T	2.10
LM1084H	1.70	CA3015T	1.80
LM1084H	1.80	CA3021T	3.44
LM1084H	1.25	CA3022T	2.99
LM1084H	1.25	CA3025T	2.78
LM1084H	1.28	CA3028T	1.28
LM1084H	1.28	CA3048N	3.15
LM1084H	1.28	LM3053N	1.48
LM1084H	4.95	CA3056N	3.15
LM1084H	3.18	CA3060N	3.18
LM1084H	4.95	CA3062N	4.95
LM1084H	1.48	LM3068N	1.48
LM1084H	1.88	CA3080T	1.88
LM1084H	1.88	CA3081N	1.88
LM1084H	1.88	CA3082N	1.88
LM1084H	1.55	CA3083N	1.55
LM1084H	1.95	CA3084N	1.95
LM1084H	1.20	CA3088N	2.88
LM1084H	5.80	CA3094N	3.88
LM1084H	1.88	CA3097N	1.88
LM1084H	1.88	CA3130T	1.88
LM1084H	1.95	CA3140T	1.10
LM1084H	3.75	CA3148N	2.48
LM1084H	3.75	CA3180T	1.10
LM1084H	1.25	CA3190N	1.95
LM1084H	2.78	CA3414N	88
LM1084H	1.95	MC3423N	1.49
LM1084H	1.28	MC3480N	3.95
LM1084H	1.40	SO3524N	3.95
LM1084H	1.98	CA3058N	3.98
LM1084H	3.75	NE531V	1.95
LM1084H	30	LM3056N	1.19
LM1084H	88	LM3056V	88
LM1084H	18.95	NE581E	18.95
LM1084H	1.25	LM3015N	3.75
LM1084H	1.95	LM3018N	3.75
LM1084H	2.78	PC4151N	2.95
LM1084H	2.78	PC4158N	5.10
LM1084H	3.70	PC4181N	3.70
LM1084H	4.95	PC4184T	4.95
LM1084H	6.40	CA4195T	6.40
LM1084H	1.25	LA28001	1.25
LM1084H	1.80	LA28002	1.80
LM1084H	30	SH75450N	30
LM1084H	30	SH75451N	30
LM1084H	1.15	SH75452N	1.15
LM1084H	33	SH75453N	33
LM1084H	18	SH75454N	18
LM1084H	1.80	SH75455N	1.80
LM1084H	30	SH75452N	30
LM1084H	30	SH75453N	30
LM1084H	30	SH75454N	30
LM1084H	30	SH75455N	30
LM1084H	30	SH75456N	30
LM1084H	30	SH75457N	30
LM1084H	30	SH75458N	30
LM1084H	30	SH75459N	30
LM1084H	30	SH75460N	30
LM1084H	30	SH75461N	30
LM1084H	30	SH75462N	30
LM1084H	30	SH75463N	30
LM1084H	30	SH75464N	30
LM1084H	30	SH75465N	30
LM1084H	30	SH75466N	30
LM1084H	30	SH75467N	30
LM1084H	30	SH75468N	30
LM1084H	30	SH75469N	30
LM1084H	30	SH75470N	30
LM1084H	30	SH75471N	30
LM1084H	30	SH75472N	30
LM1084H	30	SH75473N	30
LM1084H	30	SH75474N	30
LM1084H	30	SH75475N	30
LM1084H	30	SH75476N	30
LM1084H	30	SH75477N	30
LM1084H	30	SH75478N	30
LM1084H	30	SH75479N	30
LM1084H	30	SH75480N	30
LM1084H	30	SH75481N	30
LM1084H	30	SH75482N	30
LM1084H	30	SH75483N	30
LM1084H	30	SH75484N	30
LM1084H	30	SH75485N	30
LM1084H	30	SH75486N	30
LM1084H	30	SH75487N	30
LM1084H	30	SH75488N	30
LM1084H	30	SH75489N	30
LM1084H	30	SH75490N	30
LM1084H	30	SH75491N	30
LM1084H	30	SH75492N	30
LM1084H	30	SH75493N	30
LM1084H	30	SH75494N	30
LM1084H	30	SH75495N	30
LM1084H	30	SH75496N	30
LM1084H	30	SH75497N	30
LM1084H	30	SH75498N	30

Do Kay

COMPUTER
PRODUCTS,
Inc.

ORDER TOLL FREE

(800)

538-8800

(CALIFORNIA RESIDENTS)

(800)

848-8008

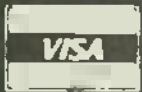

TERMS: For shipping include \$2.00 for UPS Ground or \$3.00 for UPS Blue Air. \$10.00 minimum order. Bay Area and Los Angeles Counties add 6 1/2% Sales Tax, other California residents add 6% Sales Tax. We reserve the right to limit quantities and substitute manufacturer. Prices subject to change without notice.

VISIT OUR RETAIL STORE

2100 De La Cruz Blvd.
Santa Clara, CA 95050
(408) 988-0697

Do Kay

STATIC RAMS

2181	256 x 4 (450ns)	1.90
5101	256 x 4 (450ns) (cmos)	3.90
2102-1	1024 x 1 (450ns)	.88
2102L-4	1024 x 1 (450ns) (LP)	.80
2102L-2	1024 x 1 (250ns) (LP)	1.45
2111	256 x 4 (450ns)	2.40
2112	256 x 4 (450ns)	2.95
2114	1024 x 4 (450ns)	670.90
2114-25	1024 x 4 (250ns)	679.95
2114L-4	1024 x 4 (450ns) (LP)	6711.95
2114L-3	1024 x 4 (300ns) (LP)	6712.45
2114L-2	1024 x 4 (200ns) (LP)	6712.95
2147	4096 x 1 (55ns)	4.90
TMS4044-4	4096 x 1 (450ns)	3.45
TMS4044-3	4096 x 1 (300ns)	3.95
TMS4044-2	4096 x 1 (200ns)	4.45
MK4118	1024 x 8 (250ns)	9.90
TMM2016-200	2048 x 8 (200ns)	4.10
TMM2016-150	2048 x 8 (150ns)	4.90
TMM2016-100	2048 x 8 (100ns)	8.10
HM6116-4	2048 x 8 (200ns) (cmos)	4.70
HM6116-3	2048 x 8 (150ns) (cmos)	4.90
HM6116-2	2048 x 8 (120ns) (cmos)	6.90
HM6116LP-4	2048 x 8 (200ns) (cmos)(LP)	5.90
HM6116LP-3	2048 x 8 (150ns) (cmos)(LP)	6.90
HM6116LP-2	2048 x 8 (120ns) (cmos)(LP)	8.95
Z-6132	4096 x 8 (300ns) (Dstat)	33.95

LP = Low Power Dstat = Quasi-Static

DYNAMIC RAMS

TMS4027	4096 x 1 (250ns)	1.95
UPD411	4096 x 1 (300ns)	2.95
MM5290	4096 x 1 (300ns)	2.95
MK4108	8192 x 1 (200ns)	1.90
MM5298	8192 x 1 (250ns)	1.80
4110-300	16384 x 1 (300ns)	6710.75
4116-250	16384 x 1 (250ns)	6710.95
4116-200	16384 x 1 (200ns)	6711.95
4116-150	16384 x 1 (150ns)	6719.95
4116-120	16384 x 1 (120ns)	6728.95
2118	16384 x 1 (150ns) (5v)	4.90
4164-200	65536 x 1 (200ns) (5v)	CALL
4164-150	65536 x 1 (150ns) (5v)	CALL

5V = single 5 volt supply

EPROMS

1782	256 x 8 (1µs)	4.45
2788	1024 x 8 (450ns)	3.90
2758	1024 x 8 (450ns) (5v)	6.90
2788	2048 x 8 (450ns) (5v)	3.90
2716-1	2048 x 8 (350ns) (5v)	5.90
TMS2516	2048 x 8 (450ns) (5v)	5.45
TMS2532	2048 x 8 (450ns)	7.90
Z732	4096 x 8 (450ns) (5v)	5.90
4096 x 8 (450ns) (5v)		4.90
4096 x 8 (250ns) (5v)		8.90
4096 x 8 (200ns) (5v)		10.95
8182 x 8 (450ns) (5v)		9.90
8182 x 8 (250ns) (5v)		13.95
8182 x 8 (200ns) (5v)		23.95
TMS2564	8192 x 8 (450ns) (5v)	18.95
MCS2704	8192 x 8 (450ns) (5v)(24 pin)	38.95
27128	16384 x 8 Call	Call

5v = Single 5 Volt Supply

74LS00

74LS00	.23	74LS92	.54
74LS01	.34	74LS93	.54
74LS02	.24	74LS95	.74
74LS03	.24	74LS96	.68
74LS04	.23	74LS107	.38
74LS05	.24	74LS109	.38
74LS08	.27	74LS112	.38
74LS09	.28	74LS113	.38
74LS10	.34	74LS114	.38
74LS11	.54	74LS122	.44
74LS12	.34	74LS123	.78
74LS13	.44	74LS124	2.85
74LS14	.58	74LS125	.48
74LS15	.34	74LS128	.48
74LS20	.28	74LS132	.58
74LS21	.28	74LS133	.58
74LS22	.24	74LS136	.38
74LS28	.38	74LS137	.98
74LS27	.28	74LS138	.54
74LS28	.34	74LS139	.54
74LS30	.34	74LS145	1.15
74LS32	.28	74LS147	2.45
74LS33	.54	74LS148	1.30
74LS37	.34	74LS151	.54
74LS38	.34	74LS153	.54
74LS40	.24	74LS154	1.85
74LS42	.48	74LS155	.68
74LS47	.74	74LS156	.68
74LS48	.78	74LS157	.64
74LS49	.74	74LS158	.58
74LS51	.24	74LS160	.68
74LS54	.28	74LS161	.64
74LS55	.28	74LS162	.68
74LS63	1.20	74LS163	.64
74LS73	.38	74LS164	.68
74LS74	.34	74LS165	.94
74LS75	.38	74LS166	1.90
74LS76	.38	74LS168	1.70
74LS78	.48	74LS169	1.70
74LS83	.58	74LS170	1.45
74LS85	.68	74LS173	.68
74LS86	.38	74LS174	.54
74LS90	.54	74LS175	.54
74LS91	.88	74LS181	2.10

74LS189	8.90	74LS383	1.30
74LS190	.88	74LS384	1.90
74LS191	.88	74LS385	.48
74LS192	.78	74LS386	.48
74LS193	.78	74LS387	.44
74LS194	.88	74LS388	.44
74LS195	.68	74LS373	1.35
74LS196	.78	74LS374	1.35
74LS187	.78	74LS377	1.35
74LS221	.88	74LS378	1.13
74LS240	.94	74LS379	1.30
74LS241	.98	74LS385	1.85
74LS242	.98	74LS385	.44
74LS243	.98	74LS390	1.15
74LS244	1.25	74LS393	1.15
74LS245	1.45	74LS395	1.15
74LS247	.74	74LS399	1.45
74LS248	.98	74LS424	2.90
74LS249	.98	74LS447	.36
74LS251	.58	74LS490	1.90
74LS253	.58	74LS424	3.95
74LS257	.58	74LS640	2.15
74LS258	.58	74LS645	2.15
74LS259	2.70	74LS668	1.85
74LS260	.58	74LS669	1.85
74LS266	.84	74LS670	1.45
74LS273	1.45	74LS674	9.60
74LS275	3.30	74LS682	3.15
74LS279	.48	74LS683	3.15
74LS280	1.95	74LS684	3.15
74LS283	.68	74LS685	3.15
74LS290	.88	74LS688	2.35
74LS293	.88	74LS689	3.15
74LS295	.98	74LS783	23.95
74LS296	.88	81LS95	1.45
74LS299	1.70	81LS96	1.45
74LS323	3.45	81LS97	1.45
74LS324	1.70	81LS98	1.45
74LS352	1.25	25LS2521	2.75
74LS353	1.25	25LS2689	4.20

6500

1MHZ

6502	4.90
6504	8.90
6505	8.90
6507	9.90
6520	4.30
6522	7.90
6532	9.90
6545	21.90
6551	10.85

2 MHZ

6502A	8.90
6522A	9.90
6532A	10.95
6545A	28.95
6551A	10.95

3 MHZ

6502B	13.95
-------	-------

6800

68000	58.95
6800	3.90
6802	7.90
6808	12.90
6809E	18.95
6809	10.95
6810	2.90
6820	4.30
6821	3.20
6828	13.95
6840	11.85
6843	33.95
6844	24.95
6845	13.95
6847	10.95
6850	3.20
6852	15.70
6855	9.90
6862	10.95
6875	8.90
6880	2.20
6883	21.95
68047	23.95
68488	18.95

6800

1MHZ

68B00	8.95
68B02	21.25
68B09E	28.95
68B09	28.95
68B10	8.90
68B21	6.90
68B45	18.95
68B50	5.90

8000

8035	5.90
8039	8.90
INS-8060	18.95
INS-8073	49.25
8080	3.90
8085	5.90
8085A-2	10.95
8086	28.95
8087	CALL
8088	38.95
8089	68.95
8155	6.90
8155-2	7.90
8156	6.90
8185	28.95
8185-2	38.95
8741	38.95
8748	43.95
8755	23.95

8200

8202	23.95
8203	38.95
8205	3.45
8212	1.75
8214	3.80
8216	1.70
8224	2.20
8226	1.75
8228	3.45
8237	18.95
8237.5	20.95
8238	4.45
8243	4.40
8250	9.95
8251	4.45
8253	6.90
8253-5	7.90
8255	14.95
8255-5	18.95
8257	7.90
8257-5	9.90
8259	6.85
8259-5	7.45
8271	38.95
8272	38.95
8275	28.95
8279	8.90
8279-8	9.00
8283	6.45
8284	14.95
8286	8.45
8287	6.45
8288	24.00
8289	48.95

Z-80

2.5 Mhz

Z80-CPU	3.90
Z80-CTC	4.45
Z80-DART	9.95
Z80-DMA	13.95
Z80-PIO	4.45
Z80-SIO/0	15.95
Z80-SIO/1	15.95
Z80-SIO/2	15.95
Z80-SIO/9	15.95

4.0 Mhz

Z80A-CPU	4.80
Z80A-CTC	4.90
Z80A-DART	10.95
Z80A-DMA	15.95
Z80A-PIO	4.90
Z80A-SIO/0	15.95
Z80A-SIO/1	15.95
Z80A-SIO/2	15.95
Z80A-SIO/9	15.95

6.0 Mhz

Z80B-CPU	12.95
Z80B-CTC	12.95
Z80B-PIO	12.95
Z80B-DART	18.95

ZILOG

Z8132	33.95
Z8671	38.95

DISC CONTROLLERS

1771	15.95
1791	23.95
1793	25.95
1795	48.95
1797	48.95
2791	53.95
2793	53.95
2795	58.95
2797	58.95
6843	33.95
8272	38.95
UPD765	38.95
MB8876	28.95
MB8877	33.95
1891	18.95
2143	17.95

UARTS

AY3-1014	6.90
AY5-1013	3.90
AY3-1015	6.90
PT-1472	8.90
TR1602	3.90
2350	9.90
2651	6.90
TMS8011	5.90
IM8402	7.90
IM8403	8.90
INS8250	9.95

INTERFACE

8T26	1.54
8T28	1.64
8T95	.58
8T96	.88
8T97	.68
8T98	.68
DM8131	2.90
DP8304	2.24
DS8835	1.94
DS8836	.98

VOLTAGE REGULATORS

7905T	.74	7905T	.84
78MOSC	.34	7908T	.84
7908T	.74	7912T	.84
7812T	.74	7915T	.84
7815T	.74	7924T	.84
7824T	.74	7905K	1.44
7905K	1.34	7912K	1.44
7912K	1.34	7915K	1.44
7915K	1.34	7924K	1.44
7924K	1.34	79L05	.78
79L05	.68	79L12	.78
79L12	.68	79L15	.78
79L15	.68	LM323K	4.90
78H05K	9.90	UA78S40	1.90
78H12K	9.90		

C.T = TO-220 K = TO-3 L = TO-92

DIP SWITCHES

4 POSITION	.84
5 POSITION	.89
6 POSITION	.89
7 POSITION	.94
8 POSITION	.94

IC SOCKETS

	1-99	100
8 pin ST	.12	.10
14 pin ST	.14	.11
18 pin ST	.18	.12
18 pin ST	.19	.17
20 pin ST	.28	.26
22 pin ST	.29	.26
24 pin ST	.29	.26
28 pin ST	.39	.31
40 pin ST	.48	.38
64 pin ST	4.20	call

ST = SOLDERTAIL

8 pin WW	.56	.48
14 pin WW	.68	.51
18 pin WW	.68	.57
18 pin WW	.98	.89
20 pin WW	1.04	.97
22 pin WW	1.34	1.23
24 pin WW	1.44	1.30
28 pin WW	1.64	1.44
40 pin WW	1.94	1.75

WW = WIREWRAP

18 pin ZIF	8.70	call
24 pin ZIF	9.90	call
28 pin ZIF	9.95	call

ZIF = TEXTTOOL (Zero Insertion Force)

CRYSTALS

32.768khz	1.90
1.0 mhz	4.90
1.8432	4.90
2.0	3.90
2.097152	3.90
2.4576	3.90
3.2768	3.90
3.579535	3.90
4.0	3.90
5.0	3.90
5.0688	3.90
5.185	3.90
5.7143	3.90
6.0	3.90
6.144	3.90
6.5536	3.90
8.0	3.90
10.0	3.90
10.736635	3.90
14.31818	3.90
15.0	3.90
18.0	3.90
17.430	3.90
18.0	3.90
18.432	3.90
20.0	3.90
22.1184	3.90
32.0	3.90

RESISTORS

1/4 WATT 5% CARBON FILM ALL STANDARD VALUES FROM 1 OHM TO 10 MEG OHM

50 PCS.	1.25
100 PCS.	2.00
1000 PCS.	15.00

BULK DISKETTES

5 1/4" DISKETTES
ATHANA OR NASHUA

SSDD	18.95
SSDD	22.95
DSDD	27.95

5 1/4" DISKETTES
NO LABEL

SINGLE SIDED DOUBLE DENSITY
(WITH JACKETS AND HUB RING)

Pack of Ten	8 18.95
Pack of 100	\$149.00

APPLE ACCESSORIES

80 Column Card	129.95
16 K Card	42.50
Fan	38.95
Power Supply	84.95
RF Mod	24.95
Joy Stick (Apple II)	29.95
Paddle Apple	9.95
Z80 Card	129.95
SCRG Switch-A-Slot	19.95
Paddle Apple	24.95
Extend-A Slot	195.95
Disk Drive	224.95
Controller Card	69.95

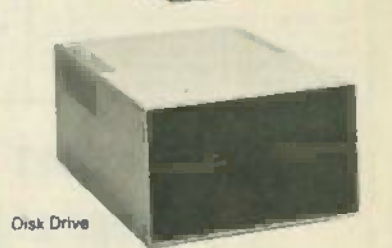

The Flip Sort Plus™

The Flip Sort Plus™ adds new dimensions to storage. Designed with similar elegant lines as the original Flip Sort™, in a transparent smoked acrylic. The Flip Sort Plus™ has a storage capacity of over 100 diskettes and has all the outstanding features you have come to expect from the flip sort Family. 24.95 each

Do Kay

2100 De La Cruz Blvd.
Santa Clara, CA 95050



FORMULA INTERNATIONAL INC.

12603 Crenshaw Blvd., Dept. B, Hawthorne, CA 90250

For Information (213) 973-1921 • Orders Only (outside Calif.) (800) 672-8758



MARK IV — 15 STEP LEO POWER LEVEL INDICATOR KIT

This new stereo indicator kit consists of 36 4-color LED's (15 per channel) to indicate the sound level output of your amplifier from -36dB to +3dB. Comes with a well designed silk screen printed plastic panel and has a selector switch to allow floating or gradual output indicating. Power supply @ 6-12VDC with THG on board input sensitivity controls. This unit can work with any amplifier from 1W to 200W. Kit includes 70 pcs driver transistors, 38 pcs matched 4-color LED's, all electronic components, PC Board and front panel. **MARK IV KIT \$31.50**



By FCC License Required
OUR PRICE \$48.50
Additional Microphone (transmitter available at \$28.00 ea.)
MURA WMS-49



CRYSTAL CONTROLLED WIRELESS MICROPHONE SYSTEM

Transmitter: FET mic for flat 30Hz-18KHz response. Xtal controlled 49MHz AM Band for drift-free performance. 100mW output (range approx. 1/4 mile) for reliable long range transmission. Powered by a 9V radio battery. Receiver: Xtal controlled locks on 49MHz transmitter signal. On panel VU meter, monitors the signal strength from the microphone. Standard phone jack outlet connection to a P.A., or other phone input. 9V battery included. This professional set is ideal for on stage, in field, church, in house or outdoor use.



pinecom™ DP-64



- Dual Processor (6502 and Z80A)
- Detached Keyboard
- 64K RAM Expandable to 192K
- 25 Function Key Keyboard
- Auto Repeat Keys w/Upper/lower Case
- 2 Slim Disk Drives (optional)
- 100% Apple II Compatible
- 40/80 Column Display (optional)
- Runs Both Apple Soft and CP/M Software

Model DP-64

Fully Assembled ...

\$650⁰⁰

TA-1000 KIT \$51.95

Power
Transformer
\$24.00 ea.

100W CLASS A POWER AMP KIT

Dynamic Bias Class "A" circuit design makes this unit unique in its class. Crystal clear, 100 watts power output will satisfy the most picky fans. A perfect combination with the TA-1020 low TIM stereo pre-amp.

Specifications: • Output power 100W RMS into 8Ω, 125W RMS into 4Ω • Frequency response 10Hz-100KHz • THD less than 0.01% • S/N ratio better than 80dB • Input sensitivity 1V max. • Power supply = 40V @ 8A.

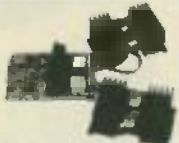

LOW TIM DC STEREO PRE-AMP KIT TA-1020

Incorporates brand-new DC design that gives a frequency response from 0-100KHz ±0.5dB. Added features like tone delect and loudness control let you tailor your own frequency supplies to eliminate power fluctuations.

Specifications: • THD-TIM less than .005% • Frequency response DC to 100KHz ±0.5dB • RIAA deviation ±0.2dB • S/N ratio better than 70dB • Sensitivity: Phone 3mV 47KΩ, Aux 100mV 100KΩ • Output level 1.2V • Max output 15V • Tone controls: Bass ±10dB @ 50Hz, Treble ±10dB @ 15KHz • Power supply ±24VDC @ 0.5A. Kit comes with regulated power supply. As you need @ a 48VCT transformer @ 0.5A.

Only \$44.50
Transformer
\$4.50 ea.



pinecom™

Pioneer of Low Cost Apple* Compatible Computer



Now
with New
Improved
Keyboard
and 64K RAM

No Copyright Problems!

Compare These Features with Our Competitors:

- Powerful Utility Program (100% Apple Compatible)
- 68-Key Upper & Lower Case Keyboard with Numeric Keypad
- 25 Pre-programmed Function Keys
- 2 Speed Auto Repeat Function
- 64K User Memory—expandable to 192K
- 5A Switching Power Supply (110/220VAC)
- All ICs Are Socketed for Easy Service
- Nation-wide Dealer Network for Convenient Technical Support

And best of all, the price
Assembled and Tested is just.

\$499⁰⁰

SEND ONE DOLLAR
FOR OUR DETAIL CATALOG

Inside California
Outside Calif. (Incl. Mexico & Canada)
Overseas

Shipping & Handling Charges	
Under \$50.00	Over \$50.00
Purchase 10%	Purchase 8%
15%	10%
25%	20%

Minimum Order \$10.00/Calif. Residents add 6.5% Sales Tax. Phone Orders Accepted on VISA or MC ONLY. NO C.O.D.'s. Prices subject to change without notice.



STORE HOURS
MON-FRI—10-7
SAT—10-6



★ SPECIAL ★
Excellent Price!
Model 001-0034
\$29.50 per Kit
Transformer
\$10.50 ea.

TA-322 30 WATTS TOTAL 15W + 15W STEREO AMP KIT

This is a solid state all transistor circuitry with on board stereo pre-amp for most microphones or phone input. Power output employs a heavy duty Power Hybrid IC. Four built on board controls for, volume, balance, treble and bass. Power supply requires 48VCT 2.5A transformer. THD of less than 0.1% between 100Hz-10KHz at full power (15 Watts + 15 Watts loaded into 8Ω)

MAGNETIC HEAD EQUALIZER

• Standard RIAA curve for all kinds of magnetic heads • 3 stages crossover circuit for best results. Output voltage guaranteed to be stable without any oscillation • Power Supply: 24 V.D.C.



MODEL: MA-142
Part #370-370 \$6.95 ea.

PROFESSIONAL REGULATED VARIABLE DC POWER SUPPLY KIT

All solid state circuitry with high efficiency power transistor 2SD388 and IC voltage regulator MC1733. Output voltage can be adjusted from 0-30V at 1A current limited at 0-15V @ 2A current limited. Internal reset, since is less than 0.0081, ripple and noise less than 1mV, dual on panel meters for voltage and current reading, also with on board LED and audible over load indicator. Kit comes with pre-drilled PC Board, instructions, all necessary electronic components, transformer and a professional looking metal cabinet. The best project for school and the most useful instrument for repairmen. Build one today!



Model TR86A
0-18VDC @ 2A
Model TR86B
0-30VDC @ 1A
\$59.50 per Kit

60W + 60W O.T.L. AMP

Stereo pre-amp + tone control + power amp. All in on unit, fully assembled! Compact in size: 7"x4"x2 1/2". Can be fitted into most cabinets. Power transistors using 2SC1667 X 4 to give a mass output of 60W + 60W (8Ω)

• Frequency response: 20Hz-85KHz ±1dB • Total harmonic distortion: 0.02% (10KHz) • Signal/Noise Ratio: 65 dB (open loop) • Tone control: 100 Hz ±16 dB 10 KHz ±14dB • Dynamic range: 80 dB • Power Supply: 48V - 70V 5 Amp. • Filter Capacitor: 4700µF 75V or better.

MODEL:
SA-4520



Part #370-0350 \$39.95 ea.
1 Transformer Part #670-0230... \$22.50 ea.
2 Filter Capacitor 4700µF 70V \$6.50 ea.

STEREO MIC. AND ECHO MIXER FOR STEREO AMPLIFIER SYSTEM

The circuitry employs all integrated circuits. 800 type echo circuit, echo time can be adjusted (max. 30 Msec.) Also with a microphone preamp on the board. Fully assembled.



MODEL: MX205
Part #370-0360 \$29.95 ea.

LOW T.I.M. TRANSISTORS 100W + 100W

• Employs Hitachi low noise LC for pre-amp • Max. output 16 V P-P (non distortion) • With 14-ohm filter, and tone delect circuit • Rear power amp with short circuit protection • Giant heat sink for maximum results • Tone controls ±14dB • All components (except pots for volume, and tone controls) are pre-assembled, the quality is guaranteed • Power supply DC ±35V-50V



MODEL: SA802C
Part #370-0340 \$35.00
POWER TRANSFORMER
(88V-80V CT 6 AMP)
Part #670-0220 \$24.50

NETWORK SALES, INC.

7400		74LS00		CMOS		MISC.							
7400	.19	7473	.29	74LS00	.23	74LS153	.55	4000	.29	4073	.29	9601	.75
7401	.19	7474	.33	74LS03	.24	74LS154	1.85	4001	.25	4075	.29	9602	1.50
7402	.19	7485	.95	74LS04	.24	74LS157	.85	4002	.29	4076	.79	DS8640	.88
7403	.19	7486	.35	74LS05	.25	74LS162	.69	4007	.29	4078	.29	8811	.89
7404	.18	7490	.35	74LS08	.28	74LS163	.65	4009	.39	4081	.29	DS8820	1.45
7405	.23	7491	.79	74LS10	.25	74LS164	.69	4010	.45	4082	.29	INS8060	15.95
7407	.29	7492	.95	74LS11	.34	74LS170	1.45	4011	.25	14412	8.95	DM8130	3.00
7408	.29	7494	.60	74LS15	.35	74LS174	.55	4012	.25	4802	.95	9300	.88
7409	.19	7496	.89	74LS20	.25	74LS178	.65	4013	.39	4503	.65	82S25	2.95
7410	.19	74121	.29	74LS27	.29	74LS181	2.18	4014	.79	4510	.85	8233	1.95
7411	.24	74123	.79	74LS30	.25	74LS190	.89	4015	.39	4512	.85	8234	1.95
7414	.49	74148	.59	74LS32	.29	74LS194	.89	4017	.89	4816	1.45	3266	2.25
7417	.25	74148	1.19	74LS38	.35	74LS197	.79	4018	.79	4518	.89	8273	3.25
7420	.19	74150	1.19	74LS42	.49	74LS240	.95	4019	.39	4520	.79	8281	.88
7423	.59	74151	.55	74LS47	.75	74LS241	.99	4020	.75	4526	1.25	82S123	2.95
7430	.25	74153	.95	74LS74	.35	74LS244	1.29	4021	.79	4527	1.95	82S141	4.85
7432	.29	74155	.89	74LS76	.39	74LS245	1.49	4023	.29	4536	4.25	4833	2.25
7438	.29	74187	.95	74LS96	.38	74LS253	.53	4025	.29	4555	1.49	8T09	1.25
7439	.59	74188	1.85	74LS90	.95	74LS257	.59	4027	.45	4556	1.18	8T37	1.75
7442	.45	74160	.69	74LS92	.55	74LS273	1.49	4030	.39	4581	3.50	8T97	1.50
7446	.69	74165	.89	74LS113	.39	74LS279	.49	4034	1.95	4583	2.50	8854	2.25
7447	.69	74170	1.29	74LS123	.79	74LS366	.49	4035	.85	4584	.75	NE510	3.95
7451	.19	74174	.89	74LS125	.49	74LS387	.45	4041	.75	74C00	.35	3341	8.95
7453	.19	74181	1.85	74LS136	.39	74LS373	1.49	4042	.69	74C02	.35	75107	.75
7454	.19	74190	.89	74LS138	.55	74LS374	1.49	4043	.79	74C14	.59	75108	.75
7472	.19	74191	.69	74LS139	.95	74LS870	1.49	4047	.95	74C15	.35	75110	2.25
				74LS181	.55			4049	.35	74C154	3.20	75150	.95
								4051	.79	74C181	1.19	75325	1.75
								4066	.39	74C184	1.39	7845Z	.75
								4069	.29	74C223	1.75	Z-80A-CPU	4.95
								4070	.35	74C901	.39	Z-80A-510/0	18.95
												8279	8.95
												8279-5	10.00
												2718	3.95
												2732	4.95

RIBBON CABLE CONNECTOR
These very popular 40 PIN ribbon cable connectors are used by a number of mfgs. of micros for internal board to board terminations and I/O port connections



40 CONDUCTOR RIBBON CABLE
gray color 70¢/ft.

DIP SWITCHES
High quality DIP switches mfg. by CTS Available in the following configurations

- 4 POS—80¢
- 5 POS—80¢
- 8 POS—80¢
- 7 POS—80¢



DB-25 S (FEMALE)
The most popular computer connector Mfg. by AMP .025" gold PC pins with mlg holes \$1.50



TERMS: Visa, M.C., Check, Money Order or COD (addit. \$3.00), Min. Order \$10.00. Add \$2.50 S&H for USA. Ill. add 8% Tax. **MAIL ORDER ONLY.** Prices subject to change without notice.

NETWORK SALES, INC.
2343 W. BELMONT AVE.
CHICAGO, IL. 60618
312-248-3202

Phone Orders Welcome.
WRITE FOR OUR MONTHLY UN-ADVERTISED SPECIALS QUANTITIES MAY BE LIMITED
©COPYRIGHT 1984 NETWORK SALES, INC.

LINEARS

LM301	.48	MC1350	1.15
LM311	.85	LM1488	.49
LM317T	1.19	MC1496	1.25
LM319	1.95	LM1889	2.25
LM317K	3.95	LM3900	.59
LM323K	4.95	LM3914	3.95
LM324	.59	7805T	.80
LM339	.39	7805K	1.45
LM350K	4.95	7808T	.80
LF353	.95	7812T	.80
LM380	1.29	7812K	1.45
LM389	1.35	7815T	.80
LM386	.69	7818T	.80
LM555	.50	7905T	.80
NE564	2.95	7906T	.90
LM565	1.00	7912T	.90
LM723	.49	7915T	.90
LM741	.35	7918T	.90
MC1330	1.25		

74S00

74S00	.32	74S157	.95
74S04	.35	74S240	2.20
74S11	.35	74S244	2.20
74S15	.35	74S257	.95
74S32	.40	74S571	2.95
74S74	.50		

74H01

74H01	.25	74H50	.35
74H04	.28	74H51	.35
74H08	.35	74H53	.35
74H20	.35	74H55	.35
74H21	.29	74H82	.35
74H30	.35	74H72	.55
74H40	.32		

CIRCLE 90 ON FREE INFORMATION CARD

MICROWAVE TV ANTENNA SYSTEMS
Freq. 2.1 to 2.6 GHz • 34 db Gain +

COMPLETE SYSTEMS
(as Pictured)
Commercial 40"
Rod Style \$ 89.95
Parabolic 20"
Dish Style \$ 79.95

COMPONENTS
Down Converters
(both types) \$ 34.95
Power Supplies
(12V to 16V) \$ 24.95
Data Info (Plans) \$ 9.95

CALL OR WRITE FOR KITS, PARTS, INDIVIDUAL COMPONENTS
We Repair All Types Down Converters & Power Supplies

Phillips-Tech Electronics
P.O. Box 34772
Phoenix, AZ 85067
(602) 285-8255
Special Quantity Pricing
Dealers Wanted

CIRCLE 29 ON FREE INFORMATION CARD

COMPUTERIZED THERMOSTAT
FULLY PROGRAMMABLE • GUARANTEED TO REDUCE YOUR HEATING-COOLING BILLS 30-50%!!

- For Home or Office
- Patented Microprocessor
- Up to 6 settings a day, 7 days per week
- Simple one-button operation
- Simple 10 minute installation for do-it-yourselfer
- Qualifies for 15% Energy Tax Credit
- Warranty

COMPLETE UNIT \$79.95
KIT FORM \$64.95
INCL. \$2.50 FOR SHIPPING

Dealers Wanted

Dimensions 5 3/8" H x 4 1/2" W x 1 3/16" D
24 V Systems • Not for 2 Stage Heat Pumps

EXCLUSIVE 3 WAY GUARANTEE 1. 30 day money back no hassle guarantee. 2. One year money back performance guarantee. If you don't save at least the cost of the unit in 1 year. MAGIC STAT will give you a full refund. 3. Three year warranty on parts and workmanship. Full details with each MAGIC STAT. (Guarantees apply to complete units only.)

KCS ELECTRONICS CORPORATION
P.O. BOX 33205
PHOENIX, AZ 85015
(602) 274-2885
Call or write for **FREE** Semiconductor Parts & Products Catalog

CIRCLE 83 ON FREE INFORMATION CARD

MARCH 1984

DIGI-KEY CORPORATION 800-346-5144

In Mass., As. No. Coll. 2-18-80-0074

QUALITY - Name brand products from nationally recognized manufacturers. **SERVICE** - Computerized order processing and inventory control. **SAVINGS** - Volume Discounts • OEM Quality Pricing • Toll Free 800 Number

VISA

RATED CIRCUITS

Part No.	Part Name	Part No.	Part Name
100-111	100-111	100-111	100-111
100-112	100-112	100-112	100-112
100-113	100-113	100-113	100-113
100-114	100-114	100-114	100-114
100-115	100-115	100-115	100-115
100-116	100-116	100-116	100-116
100-117	100-117	100-117	100-117
100-118	100-118	100-118	100-118
100-119	100-119	100-119	100-119
100-120	100-120	100-120	100-120
100-121	100-121	100-121	100-121
100-122	100-122	100-122	100-122
100-123	100-123	100-123	100-123
100-124	100-124	100-124	100-124
100-125	100-125	100-125	100-125
100-126	100-126	100-126	100-126
100-127	100-127	100-127	100-127
100-128	100-128	100-128	100-128
100-129	100-129	100-129	100-129
100-130	100-130	100-130	100-130
100-131	100-131	100-131	100-131
100-132	100-132	100-132	100-132
100-133	100-133	100-133	100-133
100-134	100-134	100-134	100-134
100-135	100-135	100-135	100-135
100-136	100-136	100-136	100-136
100-137	100-137	100-137	100-137
100-138	100-138	100-138	100-138
100-139	100-139	100-139	100-139
100-140	100-140	100-140	100-140
100-141	100-141	100-141	100-141
100-142	100-142	100-142	100-142
100-143	100-143	100-143	100-143
100-144	100-144	100-144	100-144
100-145	100-145	100-145	100-145
100-146	100-146	100-146	100-146
100-147	100-147	100-147	100-147
100-148	100-148	100-148	100-148
100-149	100-149	100-149	100-149
100-150	100-150	100-150	100-150

TEXAS INSTRUMENTS I.C. SOCKETS

Standard 16-pin DIP sockets for Texas Instruments integrated circuits. Available in various materials and finishes.

SOLDER TAIL DIP SOCKETS

- Standard profile
- Minimum mounting and processing requirements
- 200V surge test
- 200V surge test

WIRE WRAP DIP SOCKETS

- Standard profile
- Minimum mounting and processing requirements
- 200V surge test
- 200V surge test

NEW KIT 250 DISC CAPACITORS

250 Disc Capacitors, 1.5V, 100V, 1000V, 10000V. Available in various values and tolerances.

NEW KIT 250 DISC CAPACITORS

250 Disc Capacitors, 1.5V, 100V, 1000V, 10000V. Available in various values and tolerances.

NEW KIT 250 DISC CAPACITORS

250 Disc Capacitors, 1.5V, 100V, 1000V, 10000V. Available in various values and tolerances.

NEW KIT 250 DISC CAPACITORS

250 Disc Capacitors, 1.5V, 100V, 1000V, 10000V. Available in various values and tolerances.

NEW KIT 250 DISC CAPACITORS

250 Disc Capacitors, 1.5V, 100V, 1000V, 10000V. Available in various values and tolerances.

NEW KIT 250 DISC CAPACITORS

250 Disc Capacitors, 1.5V, 100V, 1000V, 10000V. Available in various values and tolerances.

MOLEX I.C. SOCKET PINS

Standard Molex I.C. socket pins for various integrated circuits. Available in various materials and finishes.

SUPER STRIPS

Standard Super Strips for various integrated circuits. Available in various materials and finishes.

TEXAS INSTRUMENTS GOLD EDGEBOARD CONNECTORS

Standard Texas Instruments Gold Edgeboard connectors for various integrated circuits. Available in various materials and finishes.

PANASONIC V SERIES

Standard Panasonic V Series capacitors for various applications. Available in various values and tolerances.

PANASONIC TSW Series

Standard Panasonic TSW Series capacitors for various applications. Available in various values and tolerances.

PANASONIC TSW Series

Standard Panasonic TSW Series capacitors for various applications. Available in various values and tolerances.

MOLEX I.C. SOCKET PINS

Standard Molex I.C. socket pins for various integrated circuits. Available in various materials and finishes.

SUPER STRIPS

Standard Super Strips for various integrated circuits. Available in various materials and finishes.

TEXAS INSTRUMENTS GOLD EDGEBOARD CONNECTORS

Standard Texas Instruments Gold Edgeboard connectors for various integrated circuits. Available in various materials and finishes.

PANASONIC V SERIES

Standard Panasonic V Series capacitors for various applications. Available in various values and tolerances.

PANASONIC TSW Series

Standard Panasonic TSW Series capacitors for various applications. Available in various values and tolerances.

PANASONIC TSW Series

Standard Panasonic TSW Series capacitors for various applications. Available in various values and tolerances.

DIGI-KEY Corporation

Volume Discount

DIGI-KEY Stocks Most A.P. Products

TEXAS INSTRUMENTS GOLD EDGEBOARD CONNECTORS

Standard Texas Instruments Gold Edgeboard connectors for various integrated circuits. Available in various materials and finishes.

PANASONIC V SERIES

Standard Panasonic V Series capacitors for various applications. Available in various values and tolerances.

PANASONIC TSW Series

Standard Panasonic TSW Series capacitors for various applications. Available in various values and tolerances.

PANASONIC TSW Series

Standard Panasonic TSW Series capacitors for various applications. Available in various values and tolerances.

The Dig-Key volume discount and service charges are based on the net amount of the order. The net amount is the total amount of the order after all discounts and before all charges. The net amount is the total amount of the order after all discounts and before all charges. The net amount is the total amount of the order after all discounts and before all charges.

SERVICE CHARGES VOLUME DISCOUNT

Order Total	Service Charge	Volume Discount
\$ 0.00 - \$ 9.99	Add \$2.00	0.00%
\$ 10.00 - \$24.99	Add \$3.00	1.00%
\$ 25.00 - \$49.99	Add \$4.00	2.00%
\$ 50.00 - \$99.99	Add \$5.00	3.00%
\$ 100.00 & Up	No Charge	4.00%

RADIO-ELECTRONICS

CIRCLE 65 ON FREE INFORMATION CARD

DIGI-KEY CORPORATION 800-346-5144

VLSI
NATIONAL
AAV0 & P
ARR'S & C
OF MACHIN
CA 95051

QUALITY - Name brand products from nationally recognized manufacturers.
SERVICE - Computerized order processing and inventory control.
SAVINGS - Volume Discounts • DEM Quantity Pricing • Toll Free 800 Number

SILICON RECTIFIERS ZENER DIODES



Part No.	Max. Avg. Forward Current (I _F)	Max. Reverse Current (I _R)	Max. Reverse Voltage (V _R)	Max. Forward Voltage (V _F)
1N4001	1.0	5.0	50	1.0
1N4002	1.0	5.0	100	1.0
1N4003	1.0	5.0	200	1.0
1N4004	1.0	5.0	400	1.0
1N4005	1.0	5.0	600	1.0
1N4006	1.0	5.0	800	1.0
1N4007	1.0	5.0	1000	1.0

SILICON ZENER DIODES



Part No.	Max. Power Dissipation (P _D)	Max. Zener Current (I _Z)	Max. Zener Voltage (V _Z)	Max. Reverse Current (I _R)
1N4733	0.5	25	3.3	5.0
1N4734	0.5	25	4.7	5.0
1N4735	0.5	25	6.2	5.0
1N4736	0.5	25	8.2	5.0
1N4737	0.5	25	10	5.0
1N4738	0.5	25	15	5.0
1N4739	0.5	25	20	5.0
1N4740	0.5	25	30	5.0
1N4741	0.5	25	40	5.0
1N4742	0.5	25	50	5.0
1N4743	0.5	25	75	5.0
1N4744	0.5	25	100	5.0
1N4745	0.5	25	150	5.0
1N4746	0.5	25	200	5.0
1N4747	0.5	25	300	5.0
1N4748	0.5	25	400	5.0
1N4749	0.5	25	500	5.0
1N4750	0.5	25	600	5.0

BAZILARON LED DISPLAY

Part No.	Max. Power Dissipation (P _D)	Max. Forward Current (I _F)	Max. Forward Voltage (V _F)	Max. Reverse Voltage (V _R)
1N4148	0.1	20	1.7	5.0
1N4149	0.1	20	1.8	5.0
1N4150	0.1	20	1.9	5.0
1N4151	0.1	20	2.0	5.0
1N4152	0.1	20	2.1	5.0
1N4153	0.1	20	2.2	5.0
1N4154	0.1	20	2.3	5.0
1N4155	0.1	20	2.4	5.0
1N4156	0.1	20	2.5	5.0
1N4157	0.1	20	2.6	5.0
1N4158	0.1	20	2.7	5.0
1N4159	0.1	20	2.8	5.0
1N4160	0.1	20	2.9	5.0
1N4161	0.1	20	3.0	5.0
1N4162	0.1	20	3.1	5.0
1N4163	0.1	20	3.2	5.0
1N4164	0.1	20	3.3	5.0
1N4165	0.1	20	3.4	5.0
1N4166	0.1	20	3.5	5.0
1N4167	0.1	20	3.6	5.0
1N4168	0.1	20	3.7	5.0
1N4169	0.1	20	3.8	5.0
1N4170	0.1	20	3.9	5.0
1N4171	0.1	20	4.0	5.0
1N4172	0.1	20	4.1	5.0
1N4173	0.1	20	4.2	5.0
1N4174	0.1	20	4.3	5.0
1N4175	0.1	20	4.4	5.0
1N4176	0.1	20	4.5	5.0
1N4177	0.1	20	4.6	5.0
1N4178	0.1	20	4.7	5.0
1N4179	0.1	20	4.8	5.0
1N4180	0.1	20	4.9	5.0
1N4181	0.1	20	5.0	5.0

NATIONAL Semiconductor



79F02
Voltage Regulator
Negative Voltage Regulator
Max. Output Current: 100mA
Max. Output Voltage: -2.8V to -18V
Max. Input Voltage: -18V to -30V
Max. Power Dissipation: 500mW
Max. Junction Temperature: 175°C

79F02

Part No.	Max. Output Current (I _O)	Max. Output Voltage (V _O)	Max. Input Voltage (V _I)	Max. Power Dissipation (P _D)
79F02	100	-2.8 to -18	-18 to -30	500

79F02



79F02

Part No.	Max. Power Dissipation (P _D)	Max. Forward Current (I _F)	Max. Forward Voltage (V _F)	Max. Reverse Voltage (V _R)
1N4148	0.1	20	1.7	5.0
1N4149	0.1	20	1.8	5.0
1N4150	0.1	20	1.9	5.0
1N4151	0.1	20	2.0	5.0
1N4152	0.1	20	2.1	5.0
1N4153	0.1	20	2.2	5.0
1N4154	0.1	20	2.3	5.0
1N4155	0.1	20	2.4	5.0
1N4156	0.1	20	2.5	5.0
1N4157	0.1	20	2.6	5.0
1N4158	0.1	20	2.7	5.0
1N4159	0.1	20	2.8	5.0
1N4160	0.1	20	2.9	5.0
1N4161	0.1	20	3.0	5.0
1N4162	0.1	20	3.1	5.0
1N4163	0.1	20	3.2	5.0
1N4164	0.1	20	3.3	5.0
1N4165	0.1	20	3.4	5.0
1N4166	0.1	20	3.5	5.0
1N4167	0.1	20	3.6	5.0
1N4168	0.1	20	3.7	5.0
1N4169	0.1	20	3.8	5.0
1N4170	0.1	20	3.9	5.0
1N4171	0.1	20	4.0	5.0
1N4172	0.1	20	4.1	5.0
1N4173	0.1	20	4.2	5.0
1N4174	0.1	20	4.3	5.0
1N4175	0.1	20	4.4	5.0
1N4176	0.1	20	4.5	5.0
1N4177	0.1	20	4.6	5.0
1N4178	0.1	20	4.7	5.0
1N4179	0.1	20	4.8	5.0
1N4180	0.1	20	4.9	5.0
1N4181	0.1	20	5.0	5.0

79F02

Part No.	Max. Power Dissipation (P _D)	Max. Forward Current (I _F)	Max. Forward Voltage (V _F)	Max. Reverse Voltage (V _R)
1N4148	0.1	20	1.7	5.0
1N4149	0.1	20	1.8	5.0
1N4150	0.1	20	1.9	5.0
1N4151	0.1	20	2.0	5.0
1N4152	0.1	20	2.1	5.0
1N4153	0.1	20	2.2	5.0
1N4154	0.1	20	2.3	5.0
1N4155	0.1	20	2.4	5.0
1N4156	0.1	20	2.5	5.0
1N4157	0.1	20	2.6	5.0
1N4158	0.1	20	2.7	5.0
1N4159	0.1	20	2.8	5.0
1N4160	0.1	20	2.9	5.0
1N4161	0.1	20	3.0	5.0
1N4162	0.1	20	3.1	5.0
1N4163	0.1	20	3.2	5.0
1N4164	0.1	20	3.3	5.0
1N4165	0.1	20	3.4	5.0
1N4166	0.1	20	3.5	5.0
1N4167	0.1	20	3.6	5.0
1N4168	0.1	20	3.7	5.0
1N4169	0.1	20	3.8	5.0
1N4170	0.1	20	3.9	5.0
1N4171	0.1	20	4.0	5.0
1N4172	0.1	20	4.1	5.0
1N4173	0.1	20	4.2	5.0
1N4174	0.1	20	4.3	5.0
1N4175	0.1	20	4.4	5.0
1N4176	0.1	20	4.5	5.0
1N4177	0.1	20	4.6	5.0
1N4178	0.1	20	4.7	5.0
1N4179	0.1	20	4.8	5.0
1N4180	0.1	20	4.9	5.0
1N4181	0.1	20	5.0	5.0

Silicon Transistors

Part No.	Max. Power Dissipation (P _D)	Max. Forward Current (I _F)	Max. Forward Voltage (V _F)	Max. Reverse Voltage (V _R)
1N4148	0.1	20	1.7	5.0
1N4149	0.1	20	1.8	5.0
1N4150	0.1	20	1.9	5.0
1N4151	0.1	20	2.0	5.0
1N4152	0.1	20	2.1	5.0
1N4153	0.1	20	2.2	5.0
1N4154	0.1	20	2.3	5.0
1N4155	0.1	20	2.4	5.0
1N4156	0.1	20	2.5	5.0
1N4157	0.1	20	2.6	5.0
1N4158	0.1	20	2.7	5.0
1N4159	0.1	20	2.8	5.0
1N4160	0.1	20	2.9	5.0
1N4161	0.1	20	3.0	5.0
1N4162	0.1	20	3.1	5.0
1N4163	0.1	20	3.2	5.0
1N4164	0.1	20	3.3	5.0
1N4165	0.1	20	3.4	5.0
1N4166	0.1	20	3.5	5.0
1N4167	0.1	20	3.6	5.0
1N4168	0.1	20	3.7	5.0
1N4169	0.1	20	3.8	5.0
1N4170	0.1	20	3.9	5.0
1N4171	0.1	20	4.0	5.0
1N4172	0.1	20	4.1	5.0
1N4173	0.1	20	4.2	5.0
1N4174	0.1	20	4.3	5.0
1N4175	0.1	20	4.4	5.0
1N4176	0.1	20	4.5	5.0
1N4177	0.1	20	4.6	5.0
1N4178	0.1	20	4.7	5.0
1N4179	0.1	20	4.8	5.0
1N4180	0.1	20	4.9	5.0
1N4181	0.1	20	5.0	5.0

79F02

Part No.	Max. Power Dissipation (P _D)	Max. Forward Current (I _F)	Max. Forward Voltage (V _F)	Max. Reverse Voltage (V _R)
1N4148	0.1	20	1.7	5.0
1N4149	0.1	20	1.8	5.0
1N4150	0.1	20	1.9	5.0
1N4151	0.1	20	2.0	5.0
1N4152	0.1	20	2.1	5.0
1N4153	0.1	20	2.2	5.0
1N4154	0.1	20	2.3	5.0
1N4155	0.1	20	2.4	5.0
1N4156	0.1	20	2.5	5.0
1N4157	0.1	20	2.6	5.0
1N4158	0.1	20	2.7	5.0
1N4159	0.1	20	2.8	5.0
1N4160	0.1	20	2.9	5.0
1N4161	0.1	20	3.0	5.0
1N4162	0.1	20	3.1	5.0
1N4163	0.1	20	3.2	5.0
1N4164	0.1	20	3.3	5.0
1N4165	0.1	20	3.4	5.0
1N4166	0.1	20	3.5	5.0
1N4167	0.1	20	3.6	5.0
1N4168	0.1	20	3.7	5.0
1N4169	0.1	20	3.8	5.0
1N4170	0.1	20	3.9	5.0
1N4171	0.1	20	4.0	5.0
1N4172	0.1	20	4.1	5.0
1N4173	0.1	20	4.2	5.0
1N4174	0.1	20	4.3	5.0

ATTENTION TECHNICIANS

ARE YOU TIRED
of being

"only a serviceman"
or
"just a technician"?

THE LETTERS "CET"
AFTER YOUR NAME SPELLS
"PRIDE"

TRY IT.

Take pride in
your profession—
Decide to be a CET



For information about... Exam dates,
requirements, study guides.

Other: _____
Send to NESDA/ISCET
2708 W. Berry St.
Fort Worth, TX 76109
(817) 921-9101

Name _____

Address _____

City _____ St. _____ Zip _____

AMAZING DEVICES

PHASORS
PERSONAL DEFENSE AND PROPERTY PROTECTION
UTILIZE SPACE AGE TECHNOLOGY.
CAUTION THESE DEVICES CAN BE HAZARDOUS AND MAY SOON
BE ILLEGAL.
POCKET PAIN FIELD GENERATOR — IPG50
Assembled \$59.50
IPG5 Plans \$7.00 IPG5K Kit/Plans \$39.50
PHASOR PAIN FIELD CROWD CONTROLLER — PPF10
Assembled \$250.00
PPF1 Plans \$15.00 PPF1K Kit/Plans \$175.00
BLASTER — Provides a plasma discharge capable of puncturing
a can.
BLS10 Assembled \$79.50
BLS1 Plans \$10.00 BLS1K Kit/Plans \$59.50
SHOCKER/PARALYZING DEVICE — Very intimidating and
effective.
SHG60 Assembled \$99.50
SHG6 Plans \$10.00 SHG6 Kit/Plans \$79.50

LASERS
RUBY LASER RAY GUN — Intense visible red beam burns and
welds hardest of metals. MAY BE HAZARDOUS.
RUBALIT Parts Available for Completing Device \$15.00
CARBON DIOXIDE BURNING, CUTTING LASER — Produces
a continuous beam of high energy. MAY BE HAZARDOUS.
LCS All Parts Available for Completing Device. \$15.00
VISIBLE LASER LIGHT GUN — Produces intense red beam for
sighting, spotting, etc. Hand held complete.
LHG3 Plans \$10.00 (Kit & Assembled Units Available)
IR PULSED LASER RIFLE — Produces 15-30 watt infra-red
pulses at 200-2000 per sec.
LRG3 All Parts & Diodes Available \$10.00
BEGINNERS LOW POWER VISIBLE LASER — Choices of
red, yellow, green — provides an excellent source of monochromatic
light.
LHC2 Plans \$5.00 LHC2 Kit \$29.50

SECURITY
SNOOPER PHONE — Allows user to call his premises and listen
in without phone ever ringing.
SNP20 Assembled \$89.50
SNP2 Plans \$9.00 SNP2K Plans/Kit \$59.50
LONG RANGE WIRELESS MIKE — Manufacture device clearly
transmits w/over one mile. Super sensitive, powerful.
MFT1 Plans \$7.00 MFT1K Kit/Plans \$39.50
WIRELESS TELEPHONE TRANSMITTER — Transmits both
sides of phone conversation over one mile. Shuts off automatically.
VWPM5 Plans \$8.00 VWPM5K Plans/Kit \$34.50
TALK & TELL AUTOMATIC TELEPHONE RECORDING
DEVICE — Great for monitoring telephone use.
TAT20 Assembled \$24.50
TAT2 Plans \$5.00 TAT2K Kit/Plans \$14.50

Our phone is open for orders anytime. Technicians are available 9-11
a.m., Mon-Thurs for those needing assistance or information. Send for
free catalog of hundreds more similar devices. Send check, cash,
MO, Visa, MC, COD to: INFORMATION UNLIMITED
DEPT. RB, P.O. Box 716, Amherst, N.H. 03001 Tel: 603-573-4730

CIRCLE 9 ON FREE INFORMATION CARD

TOLL FREE ORDERS • 1-800-826-5432

(IN CALIFORNIA 1-800-258-6949)
INFORMATION • (213) 380-5500

**SOLID STATE
RELAYS**
2 AMP
MOTOROLA
MP 12002
RATED
CONTROL — 3-6 VDC
LOAD — 120VAC 2 AMPS
TTL COMPATIBLE
SIZE: 3 1/2" x 1 1/2" x 1 1/2" HIGH
\$3.50 EACH 10 FOR \$32.00

10 AMP
TELEDYNE P/N 619-1
CONTROL
3.32 VDC
LOAD: 10 AMP
140 VAC
\$9.50 EACH

**EDGE
CONNECTORS**
22/44 22/44 GOLD PLATED
CONTACTS
156 CONTACT SPACING
\$2.00 EACH 10 FOR \$18.00

28/56
28/56 GOLD PLATED CONTACTS
156 CONTACT SPACING
\$2.50 EACH 10 FOR \$22.00

50/100 MICRO PLASTIC
MP 0175-50 DS 1
STANDARD 5.000 CONNECTOR
125 SPACING GOLD PLATED
PC MOUNT
\$3.75 EACH 10 FOR \$35.00

MULTI-SWITCHES
5 STATION INTERLOCKING
3, 2PDT AND 2, 6PDT SWITCHES ON FULLY
INTERLOCKING ASSEMBLY 3/4" BETWEEN
MOUNTING CENTERS \$2.50 EACH
5 STATION NON-INTERLOCKING
SAME AS ABOVE, EXCEPT EACH SWITCH
OPERATES INDEPENDENTLY \$2.50 EACH

SEND FOR LARGER NEW 48 PAGE CATALOG

**COMPUTER
GRADE
CAPACITORS**

1700 mfd. 150 VDC \$2.00
2 1/2" DIA. x 4 3/4" HIGH
3,600 mfd.
40VDC \$1.00
1 3/8" DIA. x 3" HIGH
6,400 mfd.
60 VDC \$2.50
1 3/8" DIA. x 4 1/2" HIGH
22,000 mfd. 15 VDC
2" DIA. x 2 1/2" HIGH \$2.00
22,000 mfd. 40 VDC
2" DIA. x 8" HIGH \$3.00
24,000 mfd. 30 VDC
1 3/8" DIA. x 4" HIGH \$3.80
31,000 mfd. 15 VDC
1 3/4" DIA. x 4" HIGH \$2.50
72,000 mfd. 15 VDC
2" DIA. x 4" HIGH \$3.50
180,000 mfd. 6V
2 1/2" DIA. x 4 1/2" HIGH \$1.50

CLAMPS TO NY CAPACITORS 90 50

MINIATURE TOGGLE SWITCHES
ALL ARE RATED 5 AMPS @ 125 VAC

S.P.D.T.
(on-on)
PC STYLE
NON-THREADED
BUSHING
\$1.00 EACH
10 FOR \$7.00

S.P.D.T.
(on-on)
SOLDER LUG
TERMINALS
\$1.00 EACH
10 FOR \$7.00
100 FOR \$60.00

S.P.D.T.
(on-off-on)
SOLDER LUG
TERMINALS
\$1.00 EACH
10 FOR \$7.00
100 FOR \$60.00

S.P.D.T.
(on-off-on)
NON-THREADED
BUSHING
PC STYLE
\$1.00 EACH
10 FOR \$7.00

S.P.D.T.
(on-on)
PC LUGS
THREADED
BUSHING
\$1.00 EACH
10 FOR \$7.00
100 FOR \$60.00

D.P.D.T.
(on-on)
SOLDER LUG
TERMINALS
\$2.00 EACH
10 FOR \$19.00
100 FOR \$180.00

ALL ELECTRONICS CORP.
ALL ELECTRONICS CORP.

805 S. VERMONT AVE. P.O. BOX 20406 LOS ANGELES, CA 90008

QUANTITY DISCOUNTS AVAILABLE
CREDIT CARD ORDERING AVAILABLE
VISA, MC, COD, DISCOVER
NO C.O.D.

CIRCLE 12 ON FREE INFORMATION CARD

FINEST QUALITY

Government Approved QQ-S-571e

SOLDER

**SPECIAL
FOR THE MONTH**

SN 60/40 Rosin Core (RA)



One lb. Reels
16 swg (.064) \$7.95
18 swg (.048) \$8.45
19 swg (.040) \$8.95
20 swg (.036) \$9.45
21 swg (.032) \$9.95

SN 62 (2% Silver) Eutectic Rosin Core

21 swg (.031) \$19.95

Plus FREE Desoldering Wick
with each pound of solder

FREE Freight On All Orders Over \$25
Under \$25 add \$2.50 per order. Minimum order \$10

Check Money Order Master Charge Visa

N.Y. State residents add appropriate sales tax.

To place your order call:
TOLL FREE 800-645-4808

In NYS (516) 334-2660 No COD's accepted

SolderCraft™
P.O. Box 668 Jericho, N.Y. 11753

CIRCLE 58 ON FREE INFORMATION CARD

MICRO MART

608 Central Ave.
Westfield, N.J. 07080
(201) 684-6008

UMF-TV PREAMP

(As featured in Radio Electronics March
Magazine, 1982)
This inexpensive antenna mounted preamp
can add more than 25 dB of gain to
your system. Lots of satisfied customers
and repeat orders for this high quality kit
which includes all component parts, PC
BC Case, Power Supply and Balun \$34.50
Assembled Version \$67.50

ATTENTION TV SERVICE TECHS

(Special New IC Purchase)

28 Pin luminance/chroma in-
tegrated circuit as used in

CTC-108 (1982) chassis. Equi-
valent to IC U-701. Replaces

PCA #145868. MICRO-MART #6008

Price: \$10.95 (1-4)

\$9.95 (5-9), \$8.95 (10 pcs)

REPLACEMENT IC BARGAINS

Any of the following for \$1

221-42, 221-69, 221-96,

221-105, 221-106, 5604 (ECG
Equiv. 714), 76-2 (ECG

Equiv. 742), LM110, LM1800
Zen 221-140C (ECG 845) \$4.95

23C1172B Toshiba (ECG 238) 2.49
RECTANGULAR LED's 10/1.25, 100/10.50

Terms: MICRO-MART accepts Visa, MC and telecheck. COD's
Minimum order \$10.00. Shipping — U.S. orders, \$2.00.
Canada and other countries \$3.50
NJ residents add 5% sales tax.

MICRO-MART • 608 CENTRAL AVE.,
WESTFIELD, NJ 07080 • (201) 684-6008

CIRCLE 24 ON FREE INFORMATION CARD

RAMSEY

THE FIRST NAME IN ELECTRONIC TEST GEAR

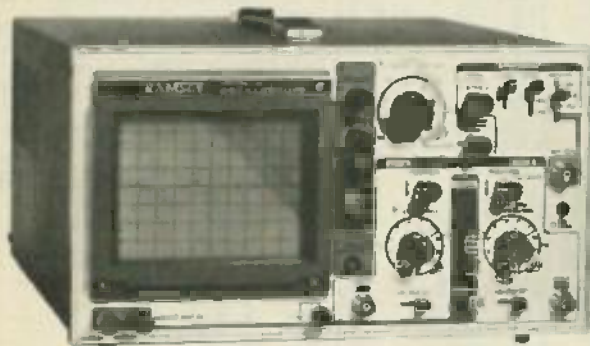

NEW FROM RAMSEY 20 MHz DUAL TRACE OSCILLOSCOPE

Unsurpassed quality at an unbeatable price, the Ramsey oscilloscope compares to others costing hundreds more. Features include a component testing circuit that will allow you to easily test resistors, capacitors, digital circuits and diodes • TV video sync filter • wide bandwidth & high sensitivity • internal graticule • high quality rectangular CRT • front panel trace rotator • Z axis • high sensitivity x-y mode • very low power consumption • regulated power supply • built-in calibrator • rock solid triggering • high quality hook-on probes

\$399.95 high quality hook-on probes included



RAMSEY D-1100 VOM-MULTITESTER

Compact and reliable, designed to service a wide variety of equipment. Features include • mirror back scale • double-jeweled precision moving coil • double overload protection • an ideal low cost unit for the beginner or as a spare back-up unit

\$19.95

test leads and battery included

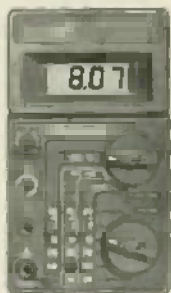

RAMSEY D-2100 DIGITAL MULTITESTER

A compact easy to use unit designed to operate like a pro. Featuring • 3 1/2 digit LCD • low BAT. indicator • all range overload protection • overrange indication • auto-polarity • Transistor Tester • dual-slope integration • vinyl carrying case

\$54.95

test lead leads, battery & vinyl carrying case included

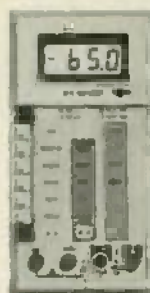

RAMSEY D-3100 DIGITAL MULTIMETER

Reliable, accurate digital measurements at an amazingly low cost • In-line color coded push buttons, speeds range selection • abs plastic tilt stand • recessed input jacks • overload protection on all ranges • 3 1/4 digit LCD display with auto zero, auto polarity & low BAT. indicator

\$59.95

test leads and battery included



CT-70 7 DIGIT 525 MHz COUNTER

Lab quality at a breakthrough price. Features • 3 frequency ranges each with pre amp • dual selectable gate times • gate activity indicator • 50mV @ 150 MHz typical sensitivity • wide frequency range • 1 ppm accuracy

\$119.95

wired includes AC adapter

CT-70 kit \$99.95
BP-4 nicad pack 8.95



CT-90 9 DIGIT 600 MHz COUNTER

The most versatile for less than \$300. Features 3 selectable gate times • 9 digits • gate indicator • display hold • 25mV @ 150 MHz typical sensitivity • 10 MHz timebase for WWV calibration • 1 ppm accuracy

\$149.95

wired includes AC adapter

CT-90 kit \$129.95
OV-1 0.1 PPM oven timebase 59.95
BP-4 nicad pack 8.95



CT-125 9 DIGIT 1.2 GHz COUNTER

A 9 digit counter that will outperform units costing hundreds more. • gate indicator • 24mV @ 150 MHz typical sensitivity • 9 digit display • 1 ppm accuracy • display hold • dual inputs with preamps

\$169.95

wired includes AC adapter

CT-125 kit \$149.95
BP-4 nicad pack 8.95

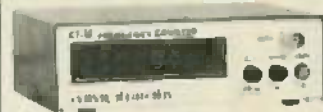

CT-50 8 DIGIT 600 MHz COUNTER

A versatile lab bench counter with optional receive frequency adapter, which turns the CT-50 into a digital readout for most any receiver • 25 mV @ 150 MHz typical sensitivity • 8 digit display • 1 ppm accuracy

\$169.95

wired

CT-50 kit \$139.95
RA-1 receiver adapter kit 14.95

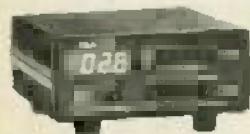

DM-700 DIGITAL MULTIMETER

Professional quality at a hobbyist price. Features include 26 different ranges and 5 functions • 3 1/2 digit, 1/2 inch LED display • automatic decimal placement • automatic polarity

\$119.95

wired includes AC adapter

DM-700 kit \$99.95
MP-1 probe set 4.95

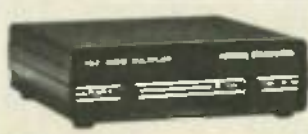

PS-2 AUDIO MULTIPLIER

The PS-2 is handy for high resolution audio resolution measurements, multiplies UP in frequency • great for PL tone measurements • multiplies by 10 or 100 • 0.01Hz resolution & built-in signal preamp/conditioner

\$49.95

wired includes AC adapter

PS-2 kit \$39.95



PR-2 COUNTER PREAMP

The PR-2 is ideal for measuring weak signals from 10 to 1,000 MHz • flat 25 db gain • BNC connectors • great for sniffing RF • ideal receiver/TV preamp

\$44.95

wired includes AC adapter

PR-2 kit \$34.95



PS-1B 600 MHz PRESCALER

Extends the range of your Present counter to 600 MHz • 2 stage preamp • divide by 10 circuitry • sensitivity: 25mV @ 150 MHz • BNC connectors • drives any counter

\$59.95

wired includes AC adapter

PS-1B kit \$49.95

ACCESSORIES FOR RAMSEY COUNTERS

Telescopic whip antenna—BNC plug .. \$ 8.95
High impedance probe, light loading .. 16.95
Low pass probe, audio use .. 18.95
Direct probe, general purpose use .. 13.95
Tilt ball, for CT-70, 90, 125 .. 3.95



PHONE ORDERS CALL
716-586-3950

TELEX 466735 RAMSEY CI

TERMS: • satisfaction guaranteed • examine for 10 days; if not pleased return in original form for refund • add 6% for shipping and insurance to a maximum of \$10.00 • overseas add 15% for surface mail • COD add \$2.50 • orders under \$10.00 add \$1.50 • NY residents add 7% sales tax • all kits have a 90 day parts warranty. All wired units have 1 year parts and labor warranty.



RAMSEY ELECTRONICS, INC.
2575 Baird Rd.
Penfield, N.Y. 14526

MARCH 1984

HOME COMPUTER ACCESSORIES

KEYBOARDS - POWER SUPPLIES

DISK DRIVES AND CABLE

VOICE SYNTHESIZER FOR APPLE AND COMMODORE



Over 250 word vocabulary... Over 250 word vocabulary... Over 250 word vocabulary...

APPLICATIONS: Security Warning, Teletext/Teletype, Handicap Aid, Tutoring, Instrumentation, Games

The JE520 series SYNTHESIZER can plug right into your computer and allow you to enhance almost any application...

Part No. Description Price

JE520CM	For Commodore 64 & VIC-20	\$114.95
JE520AP	For Apple II, II+, and IIx	\$149.95



JE664 EPROM PROGRAMMER

8K to 64K EPROMS - 24 & 28 Pin Packages

Programs and Validates EPROMs... Programs and Validates EPROMs...

The JE664 EPROM Programmer... The JE664 EPROM Programmer...

JE664-A 17000 Programmer \$995.00

JE664 - 82520 INTERFACE OPTION... JE664 - 82520 Interface Option...

FOR A LIMITED TIME A SAMPLE OF SOFTWARE WRITTEN IN BASIC FOR THE TRS-80, MODEL I, II, & III COMPUTER WILL ALSO BE PROVIDED

JE664-ARS Diskette Prog. \$695.00 \$1195.00

EPROM ADAPTER MODULES... EPROM Adapter Modules...

Part No.	Description	Price
JE664-ARS	Diskette Prog. \$695.00	\$1195.00
JE664-ARS	Diskette Prog. \$695.00	\$1195.00
JE664-ARS	Diskette Prog. \$695.00	\$1195.00

4-Digit Fluorescent Alarm Clock Kit

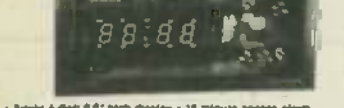

Bright 4-digit 0.5" high display... Bright 4-digit 0.5" high display...

The JE750 Clock Kit is a versatile 12-hour digital clock with 24-hour alarm... The JE750 Clock Kit is a versatile 12-hour digital clock...

JE750 Alarm Clock Kit \$29.95

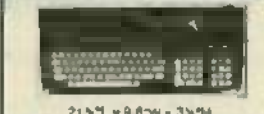

106-Key 8-Bit Serial ASCII Keyboard

Micro-Switch 106-Key Keyboard 8-Bit Serial ASCII

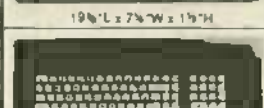

SMK 103-Key Unencoded Keyboard



Power/Mate Corporation REGULATED POWER SUPPLY

Power/Mate Corporation REGULATED POWER SUPPLY

Switching Power Supply for APPLE II, II+ & IIx

POWER SUPPLY @ 5VDC @ 7.5 AMP, 12VDC @ 1.5 AMP SWITCHING

POWER SUPPLY 4-Channel Switching

DISKETTES AND ACCESSORIES

Part No.	Description	Price
JE664-ARS	Diskette Prog. \$695.00	\$1195.00
JE664-ARS	Diskette Prog. \$695.00	\$1195.00
JE664-ARS	Diskette Prog. \$695.00	\$1195.00

DISKETTE ACCESSORIES

Part No.	Description	Price
JE664-ARS	Diskette Prog. \$695.00	\$1195.00
JE664-ARS	Diskette Prog. \$695.00	\$1195.00
JE664-ARS	Diskette Prog. \$695.00	\$1195.00

10.00 Minimum Order - U.S. Funds Only... 10.00 Minimum Order - U.S. Funds Only...

MasterCard JAMECO ELECTRONICS VISA

1355 SHOREWAY ROAD, BELMONT, CA 94002

3/24 PHONE ORDERS WELCOME - (415) 592-8097 Telex: 176043

8" FLOPPY DISK DRIVE



The FDD100-8 8" Floppy Disk Drive... The FDD100-8 8" Floppy Disk Drive...

FDD100-8 \$169.95 ea.

5 1/4" APPLE™ Direct Plug-In Compatible Disk Drive

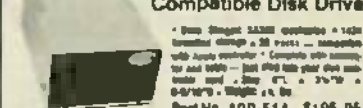

5 1/4" TEAC DISK DRIVE

5 1/4" SHUGART DISK DRIVE

5 1/4" PANASONIC DISK DRIVE

SIGNAL CABLES

Drive Style	Part No.	1.0	3.0
8 1/4" M	S34-36-C	7.95	7.25
8 1/4" N	S34-80-C	8.95	8.38
8" M	S50-36-C	10.35	9.95
8" N	S50-80-C	12.49	10.95

Power Cable Kits

Part No.	Description	Price
JE664-ARS	Diskette Prog. \$695.00	\$1195.00
JE664-ARS	Diskette Prog. \$695.00	\$1195.00
JE664-ARS	Diskette Prog. \$695.00	\$1195.00

UV-EPROM Eraser



DE-4 UV-EPROM Eraser \$79.95

UVS-11EL Replacement Bulb \$18.95

SPARTAN Electronics Inc



CALL (516) 499-9500 MAIL

6094 Jericho Tpke. Commack, N.Y. 11725

Philips Remote Cable Converter

CTC9R
 • Micro computer technology • Quartz controlled IC's lock in picture & prevent drift • 60 channel functions • Programmable line cut off • 24 hour LED digital clock • Favorite channel memory & recall • Still scan • Wireless hand held video and transmitter system • Automatic line lock • Adaptable to any brand television • One year warranty service

\$139.95

COMPUTER CARE KIT

The Preventative maintenance kit for the office and home computer
 Contains Precision Diode Zero Charge Anti-Static Screen and Keyboard cleaner Zero Charge Anti-Stat

\$18.95

SGL WABER \$35.95

Protect your computer and electronic equipment from voltage spikes

DG115P
 DG115S (6 Outlet) \$45.95

WINEGARD FM CAR ANTENNA BOOSTER

Amplifies FM radio signals an average of 10dB (3 times) Improves car radio reception and prevents range to allow greater selection of stations. Switch and indicator light attaches to lower edge of dash. 24' cable with Motorola plugs provided. Visible to mounting. Great for window antennas.

\$29.95

REFURBISHED MONITORS

9", 12", Commercial Grade as low as **\$39.95**

BECKMAN CIRCUITMATE 20

8 functions and 30 ranges - Diode transistor test function - auto-polarity, auto-zero, and auto-decimal - 10 Amps AC and DC Current Capability - Transistor Gain Test (hFE) - Conductance

\$64.95

Jerrold 36 Channel Remote CATV Converter

w/on/off Fine Tuning \$94.95
 58 Channel Wireless \$109.95

40 Channel VHF to UHF Block Converter

28.95 Ea.
 24.95 4 & up
 Deluxe Version - Features fine tuning knob, matching X former & 2 cables \$38.95

AUTO ALARM SYSTEMS

Keyless Automatic Passive
 -arms when ignition is turned off
 -automatic turn-off and reset timer

\$64.95

2000 Auto Watchman

Prevents use of master keys or the removal of ignition lock to start vehicle
 -protects all foreign and American cars

\$34.95

Volume Discounts

Min. Order \$25.00
 International shipping Add \$7.00
 Prices subject to change without notice
 COD 7.00 Extra
 Add \$ shipping for monitors

50 to 75.00	\$2.50
76.00 to 250.00	\$4.50
251.00 to 500.00	\$6.00
501.00 to 750.00	\$8.50
751.00 to 1000.00	\$12.00
Over 1000.00	\$17.50

(516) 499-9500 Mon Th 9-8 Tu W F Sa 9-6 9:30-5

ADVERTISING INDEX

RADIO-ELECTRONICS does not assume any responsibility for errors that may appear in the Index below.

Free Information Number	Page	
46	Acorn	94
3	Active Electronics	116
80	Advanced Computer Products	117
7	Advance Electronics	12-15,33
12	All Electronics	124
67	ASIC Sales	81
77	Appliance Service	94
87	AP Products	29
32	Bay State Electronics	94
72	BBC	27
100	Beckman Instruments	30
16	B&K	96
—	Bullet	111
—	C&D	100
18	CEL	28
34	Chaney	108
37	Chemtronics	99
—	CIE	84-87
64	Circuit Specialists	106
—	Contmand Productions	83
35,86	Communications Electronics	2,32
68	CPU	116
—	Daetron	99
92	Diamondback	111
53	Direct Video	98
65	Digitek	122,123
11	Digitron	116
99	Dokay	118,119
54	DTI	96
59	EICO	95
81	Electra	Cover2
8	Electronic Book Club	89
70	Electronic Industries	100
6	Electronic Specialists	108
74	Electronic Surplus	102
39	Electronix	108
—	Fluke Manufacturing	7
40	Firestik	95
—	Fordham Radio	42,75,Cover4
76	Formula	120
96	Global Specialties	81
—	Goldsmith	106
—	Grantham College of Engineering	24
75	Haltronix	110
15,97	Heath	23,91
85	Hickok	83
—	Hitech	103-105
—	ICS	40,101
28	Instrument Mart	26
41	Jameco	126,127
38	Jan Crystal	95
49	JDR	112-115
69	Jensen	94
4	J&W	98
63	Kashiwagi	94
83	KCS	121
48	Kikusui	25
93	McIntosh Labs	95
66	MFJ	116
24	Micro Mart	124
95	Mouser	81
90	Network Sales	121
—	Newtone Electronics	101
—	NRI	16-19
—	NTS	34-37
98	OK Industries	9
62	Optoelectronics	41
52	Paia	77
22	Panavise	77
29	Philips Tech Electronics	121
73	Pomona	31
43	PTS	93
61	Radio Shack	107
79	Ramsey	125
17	Random Access	94
—	RCA	1,39
19	Regency	21
27	RF Electronics	109
44	Sams Book Store	Cover3
9	Scientific Systems	124
60	SEI	110
82	Sinter	22
14	Solder Absorbing Technology	94
58	Solder Craft	124
36	Spartan Electronics	128
—	Tektronix	5
45	Trio-Kenwood	20
91	VIZ	79
13	Westech	109
—	Zenith	38

THE BEST PLACE TO BUY, SELL OR TRADE NEW AND USED EQUIPMENT

NUTS & VOLTS MAGAZINE
 BOX 1111-E • PLACENTIA, CA 92670
 (714) 632-7721

Join Thousands of Readers Nationwide Every Month

ONE YEAR U.S. SUBSCRIPTIONS
 \$7.00 - 1st Class • \$13.00 - 1st Class
 \$25.00 - Lifetime - 1st Class

NUTS & VOLTS
 MAIN BOARD COMPUTERS SOFTWARE SCANNERS • OPTICAL TEST EQUIPMENT MICROPROCESSORS SATELLITE AUDIO VISUAL NEW PRODUCTS COMPONENTS • TEST EQUIPMENT ELECTRONIC PUBLICATIONS PLANS • SERVICES

A SINGER'S DREAM!

REMOVES VOCALS FROM RECORDS!

Our VOCAL ELIMINATOR can remove most or virtually all of a lead vocal from a standard stereo record and leave most of the background untouched. Record with your voice or perform live with the backgrounds. Used in Professional Performance yet connects easily to a home component stereo system. Not an equalizer! We can prove it works over the phone. Write or call for a free brochure and demo record.

Write to: **LT Sound**, Dept. R-1, P.O. Box 338 Stone Mountain, GA 30086
 In Georgia Call (404) 493-1258
TOLL FREE: 1-800-241-3005 - Ext. 72

RADIO-ELECTRONICS

Sams Books For A Down-To-Earth Look at Video,



Whoever On Earth You Are.

If you're an engineer working with video, a service technician brushing up on repair and installation, or a musician who wants to tune in more than MTV, you need Sams books. Because when it comes to video technology, Sams knows all about it.

People trust Sams for books that are easy to read and understand, no matter what the subject is. Fact is, Sams has been a leading publisher of technical books since 1946.

So turn to Sams and get in tune with today's video technology. Here are the books you need:

THE SATELLITE TV HANDBOOK shows you how to legally and privately cut your cable TV costs in half, see TV shows that may be blacked out in your city, pick up live, unedited network shows, start a mini-cable system in your apartment or condo, plug into video-supplied college courses, and more. Also covers how to buy, build and aim your own satellite antenna, and includes a handy guide to all satellite-programming. No. 22055, \$16.95.



For a down-to-earth look at video, get the books you need from Sams today. Visit your local Sams dealer. Or call Operator 103 at 317-298-5566 or 800-428-SAMS

THE BIRDS OF BABEL—SATELLITES FOR THE HUMAN WORLD explains how satellites work and how they are changing our lives. It looks at the social and political importance satellites have in science, law, medicine, finance and other fields, as it investigates the domestic and international issues surrounding their use. No. 22033, \$12.95.

INTRODUCTION TO SATELLITE TV provides an engrossing insight into the technical side of satellite TV. So if you want to purchase a home satellite system, or you already own one, you need this book. With it you'll learn about receivers, antennas, mounts, feeds, amplifiers, converters, and more. No. 21978, \$9.95.

THE HOME VIDEO HANDBOOK (3rd Edition) shows you how to simply and successfully enjoy your home TV camera, videocassette recorder, videodisc system, large-screen TV projectors, home satellite TV receiver, and all their accessories. Also tells you how to hook everything up and how to buy the best equipment. No. 22052, \$13.95.

SAMS™

What Technology Is All About.

HOWARD W. SAMS & CO., INC.
4300 West 62nd Street, P.O. Box 7092, Indianapolis, IN 46206

Offer good in USA only. Prices and availability subject to change without notice. In Canada, contact Lenbrook Electronics, Markham, Ontario L3R 1H2.

Win a complete home satellite receiving unit from Sams Satellite Sweepstakes. Coming to your Sams dealer SOON!

CIRCLE 44 ON FREE INFORMATION CARD

High Performance
VIDEO EQUIPMENT
at Down-to-Earth Prices



**NEW! BP VIDEO COLOR PROCESSOR/
 RF CONVERTER/
 STABILIZER/3-WAY
 DISTRIBUTION
 AMPLIFIER**

Comparably priced at \$299.95
OUR PRICE

\$189⁹⁵



Corrects video signal directly into tape not just on playback. Luminance meter monitors brightness levels for quality recordings. Can also be used between video cameras and VCR, VCR and VCR and from VCR to TV during playback mode. Corrects off-color tapes. Center detent, luminance, chroma, phase and audio controls. Stabilizer for removing copyguard.

**SPECIAL! BP STABILIZER/IMAGE ENHANCER/
 RF CONVERTER/VIDEO
 FADER/2-WAY
 DISTRIBUTION
 AMPLIFIER**

Comparably priced at \$189.95

\$119⁹⁵
OUR PRICE



Contains five units in one: stabilizer (video guard remover), image enhancer, video to RF converter, video fader, and dual output distribution amplifier. Stabilizer will correct entire range of copy guard distortion such as jitter, vertical roll or black bar traveling through picture. Enhancer will provide best picture at your preference. RF Converter allows TV set to receive video and audio signals from image enhancer, guard stabilizer, video camera, computer, VCR, etc. The direct video signal from any component can be fed into the V-1880 and converted to a usable RF signal that can go to your TV antenna terminals. Video Fader used to produce fade ins and outs.

**NEW! BP TV TO STEREO AUDIO
 ADAPTOR/ENHANCER**

Comparably priced much higher

OUR PRICE \$19⁹⁵



Easily connects to any TV and Stereo Amplifier for simulated stereo sound. Makes taping TV Audio simple - TV can be located any distance from stereo. Delivers two channels of simulated stereo. Comes with noise eliminator and special output level controls. Frequency response: 50 Hz - 15,000 KHz.

QUALITY PERFORMANCE • IMMEDIATE DELIVERY • LOW PRICES

FORDHAM
 260 Motor Parkway, Hauppauge, N.Y. 11788

Master Charge	N.Y. State residents add	ADD FOR SHIPPING AND INSURANCE:
VISA	appropriate sales tax	\$0 to \$250.00 \$4.50
Money Order		\$251.00 to \$500.00 \$6.50
Check		\$501.00 to \$750.00 \$8.50
		\$751.00 to \$1000.00 \$12.50
		over \$1000.00 \$15.00
COD's extra (required 25% deposit)		

Compare, then call **TOLL FREE**
800/645-9518
 In N.Y. State call 800/832-1446