

48784

**SPECIAL  
TEAR OUT SECTION  
COMPUTER DIGEST**

\$1.75 JUNE 1984

# Radio- Electronics.

COMPUTERS - VIDEO - STEREO - TECHNOLOGY - SERVICE

**THIS MONTH!  
SPECIAL SECTION  
SATELLITE TV RECEPTION**

**Don't trust the weatherman!**  
Build our solid-state barometer  
with LED display and predict the  
weather yourself

**Is satellite TV reception for you?**  
Everything you need to know about  
satellite TV but didn't know who  
to ask.

**What's all the DBS hoopla about?**  
A look at direct broadcast satellite service  
and what it means to you.

**Stop Wasting Time!** Build R-E's  
exhaust analyzer and use it to  
tune up your car. It's easy. It's  
accurate! It works!



GERMSBACK

**PLUS:**

- ★ Hobby Corner
- ★ Equipment Reports
- ★ Drawing Board
- ★ Service Clinic
- ★ New Idea
- ★ State-Of-Solid-State





Drop-proof



Overload-proof



Contamination-proof

# Oops proof.

Now there's a new breed of Beckman Industrial Corporation hand-held DMMs tough enough to withstand accidental drops, input overloads and destructive environments.

The new HD100 and HD110 DMMs are drop-proof, packed with overload protection and sealed against contamination. You won't find a more rugged meter than our HDs.

## Drop Proof

Constructed of double-thick thermoplastics, the HD100 series DMMs resist damage even after repeated falls. All components are heavy-duty and shock mounted.

## Contamination Proof

The HD series meters are designed to keep working even around dirt, heavy grime, water and oil. The special o-ring seals, ultrasonically-welded display window and sealed input jacks protect the internal electronics of the HD meters. The oops-proof meters are sealed so tightly, they even float in water.

## Accidental Overload Protection

All DC voltage inputs are protected up to 1500 Vdc or 1000 Vrms. Current ranges are protected to 2A/600V with resistance ranges protected to 600 Vdc. Transient protection extends up to 6KV for 10 microseconds.

## More Meter for Your Money

For starters you can get 2000 hours of continuous use

from a common 9V transistor battery. You can run in-circuit diode tests and check continuity. You even

get a one year warranty.

The 0.25% basic dc volt accuracy HD meters serve you with 7 functions and 27 ranges. The HD 110 also gives you 10 AMPS ac and dc. With one simple turn of the single selector switch, you can go directly to the function and range you need. There's less chance of error.

Also available is the electrical service kit. It includes the meter of your choice, a current clamp, deluxe test leads and a heavy-duty case designed to carry both meter and accessories, conveniently.

Feature for feature you can't find a more dependable meter with prices starting at just \$169 (U.S. only).

To locate your nearest distributor, write Instrumentation Products Division, Beckman Industrial Corp. A Subsidiary of Emerson Electric Company, 630 Puente Street, Brea, CA 92621 (714) 773-8453.



CIRCLE 100 ON FREE INFORMATION CARD

***Beckman Industrial!***<sup>™</sup>

# Where's Your **ELECTRONICS** Career Headed?

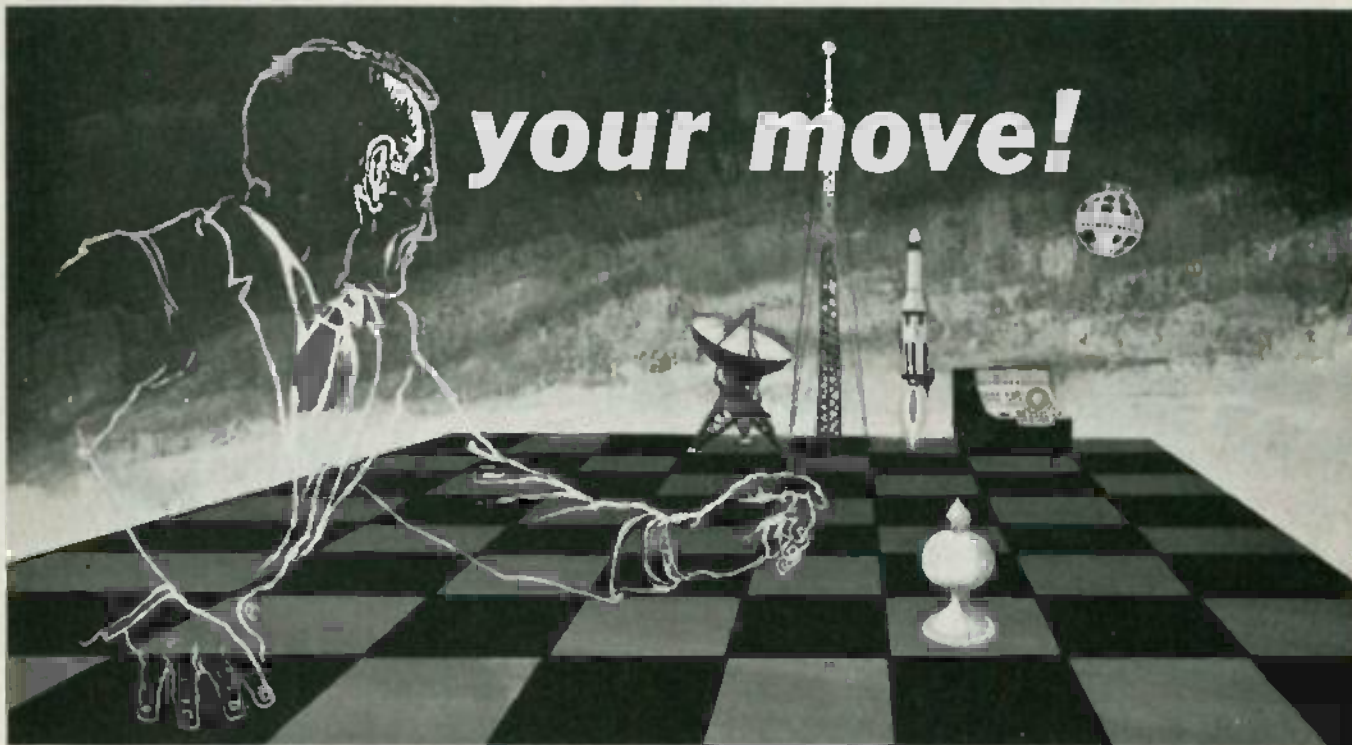

## The Move You Make Today Can Shape Your Future

Yes it's your move. Whether on a chess board or in your career, you should plan each move carefully. In electronics, you can *move ahead* faster and further with a

## B. S. DEGREE

Put professional knowledge and a COLLEGE DEGREE in your electronics career. Earn your degree through independent study at home, with Grantham College of Engineering. No commuting to class. Study at your own pace, while continuing your present job.

The accredited Grantham non-traditional degree program is intended for mature, fully employed workers who want to upgrade their careers . . . and who can successfully study electronics and supporting subjects through

### INDEPENDENT STUDY, AT HOME

Free Details Available from:

**Grantham College of Engineering**  
2500 South La Cienega Blvd.  
P. O. Box 35499  
Los Angeles, CA 90035

### Independent Home Study Can Prepare You

Study materials, carefully written by the Grantham staff for independent study at home, are supplied by the College, and your technical questions related to those materials and the lesson tests are promptly answered by the Grantham teaching staff.

### Recognition and Quality Assurance

Grantham College of Engineering is accredited by the Accrediting Commission of the National Home Study Council.

We are located at 2500 S. LaCienega Blvd., Los Angeles, California, but for faster response please use our mailing address: P. O. Box 35499, Los Angeles, CA 90035.

**Grantham College of Engineering** 6-84  
P. O. Box 35499, Los Angeles, CA 90035

Please mail me your free catalog which explains your B.S. Degree independent-study program.

Name \_\_\_\_\_ Age \_\_\_\_\_

Address \_\_\_\_\_

City \_\_\_\_\_ State \_\_\_\_\_ Zip \_\_\_\_\_



# Last night Mark Davis started over from scratch. Without wasting so much as a lead wire.

Some day Mark will be working on bigger projects. But right now, he's learning. Fortunately, the new ACE 109 solderless breadboard from A P PRODUCTS, just made learning a lot more affordable.



**ACE 109 SOLDERLESS BREADBOARD**  
**PRICED UNDER \$20!**  
• SUGGESTED U.S. RESALE PRICE

The ACE 109 is the newest, lowest priced All Circuit Evaluator in the A P PRODUCTS line. It has a universal matrix of 840 solderless plug-in tie-points. And is ideal for designing, testing and modifying small circuits. ACE 109 has three, standard 5-way binding posts for easy access to power sources.

With an ACE 109, there's no wiring, soldering or desoldering. Just plug in your components and interconnect them with ordinary solid hook-up wire. If you want to make a circuit change, just unplug the components involved and start over. It's just that easy.

Every ACE breadboard makes circuitry easy, fast, flexible. Now A P PRODUCTS has made it even more affordable. The ACE 109 is priced under \$20!

Look for the complete line of ACE breadboards and other A P PRODUCTS at your favorite electronics distributor. For the name of the A P PRODUCTS distributor nearest you, call Toll-Free: (800) 321-9668. (In Ohio, call collect (216) 354-2101.) Make the A P connection.



## SPECIAL FEATURE

- 45 **RECEIVING SATELLITE TELEVISION**  
Learn about satellite TV and the components that make up a home TVRO system. **Martin Clifford**
- 47 **ALL ABOUT SATELLITE TV**
- 51 **THE DISH**
- 61 **SATELLITE RECEIVERS**
- 67 **FROM FEEDHORN TO RECEIVER**
- 75 **DIRECT-BROADCAST SATELLITES**

## BUILD THIS

- 41 **SOLID-STATE BAROMETER**  
Make your own weather predictions with this fun project. **Sudhir M. Gupta**
- 78 **HOME CONTROL COMPUTER**  
Part 3. We wrap up our look at a control computer that's ideal for home-control applications. **Steven E. Sarns**
- 81 **AUTOMOTIVE EXHAUST ANALYZER**  
Part 2. A useful test instrument that helps get your car ready for those tough emissions tests. **Philip M. Van Praag**

## TECHNOLOGY

- 4 **VIDEO ELECTRONICS**  
Tomorrow's news and technology in this quickly changing industry. **David Lachenbruch**
- 14 **SATELLITE/TELETEXT NEWS**  
The latest happenings in communications technology. **Gary M. Arlen**

## CIRCUITS AND COMPONENTS

- 38 **NEW IDEAS**  
Turn-signal alarm
- 86 **HOBBY CORNER**  
Finding replacement parts. **Earl "Doc" Savage, K4SDS**
- 88 **DRAWING BOARD**  
Smoothing out the sinewave-generator output. **Robert Grossblatt**
- 90 **DESIGNER'S NOTEBOOK**  
Charging indicators. **Robert Grossblatt**
- 92 **STATE OF SOLID STATE**  
Regulator IC's. **Robert F. Scott**

## VIDEO

- 94 **SERVICE CLINIC**  
Fixing half of a computer. **Jack Darr**
- 95 **SERVICE QUESTIONS**  
Radio-Electronics' Service Editor solves technicians' problems.

## EQUIPMENT REPORTS

- 26 **Triplet Model 3500 Autoreange Digital Multimeter**
- 29 **Beta Electronics Pro-Kit 1 PC-Board Fabrication Kit**

## DEPARTMENTS

- |                                 |                  |
|---------------------------------|------------------|
| 8 Advertising and Sales Offices | 98 Market Center |
| 129 Advertising Index           | 31 New Products  |
| 130 Free Information Card       | 6 What's News    |
| 15 Letters                      |                  |

## ON THE COVER

Satellite TV offers a lot of attractions, what with its promise of nearly unlimited viewer selection of TV programming. But is it for you? This month, **Radio-Electronics** turns its attention to satellite-TV, with a special section devoted, among other things, to home reception of satellite signals. It all begins on page 45.

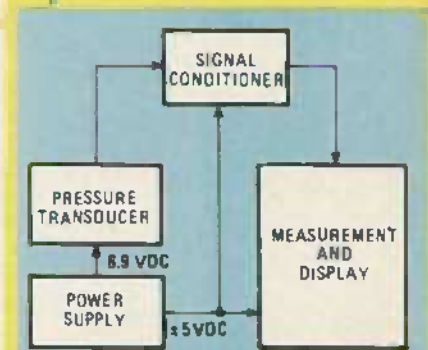

**BEFORE WEATHER SATELLITES**, perhaps the most useful tool for weather prediction was the barometer. In this issue, we show you a solid-state barometer that you can build. The story starts on page 41.

## COMING NEXT MONTH On Sale June 21

- **Energy Meter.** This useful project will help you get the most out of your air conditioning system.
- **Interfacing the ZX81.** Put your Timex/Sinclair computer to work with this practical interface.
- **A Unique Ammeter.** Here's a DC clamp-on ammeter you can build.
- **Repairing PC Boards.** Fixing those broken PC boards is easier than you think.
- **And lots more!**

Radio-Electronics, (ISSN 0033-7862) Published monthly by Gernsback Publications, Inc., 200 Park Avenue South, New York, NY 10003. Second-Class Postage Paid at New York, N.Y. and additional mailing offices. One-year subscription rate: U.S.A. and U.S. possessions, \$14.97, Canada, \$17.97, Other countries, \$22.47 (cash orders only, payable in U.S.A. currency). Single copies \$1.75. © 1984 by Gernsback Publications, Inc. All rights reserved. Printed in U.S.A.

**POSTMASTER:** Please send address changes to RADIO-ELECTRONICS, Subscription Dept., Box 2520, Boulder, CO 80322.

A stamped self-addressed envelope must accompany all submitted manuscripts and/or artwork or photographs if their return is desired should they be rejected. We disclaim any responsibility for the loss or damage of manuscripts and/or artwork or photographs while in our possession or otherwise.

# VIDEO ELECTRONICS

DAVID LACHENBRUCH  
CONTRIBUTING EDITOR

## COMPATIBLE HDTV

A compatible high-definition widescreen TV system has been proposed by North American Philips and Philips of the Netherlands. In the American version, a standard 525-line picture would be received on the basic TV channel, while a second channel would be used to supply the extra scanning lines required for the higher-definition picture, as well as the additional information for the two ends of the expanded screen, whose proportion would be 1.78 to 1. Philips says its research has shown that 657 lines, non-interlaced, at 60 fields, or 120 frames-per-second, would be the optimum for HDTV.

Philips has developed a solid-state CCD frame-store that it says could be produced economically, and has demonstrated what it calls HQT<sub>V</sub> (*High Quality TV*), which could be developed in the TV set from a standard 525-line picture. The receiver would convert the 30-frame interlaced picture to a 60-frame non-interlaced one, using special line-averaging techniques in areas where motion is displayed. That gives the impression of virtually doubled vertical resolution, completely eliminating the picture's line structure, as well as line crawl, line flicker and cross-color. Philips says its HQT<sub>V</sub> system will be used in its TV receivers "sooner rather than later," although HDTV probably will have to wait for some form of standardization. HDTV probably will see its first use via DBS or cable TV, where spectrum isn't a major consideration.

Some aspects of Philips' frame-store system could show up quite soon in TV sets—perhaps within two years. Using a partial frame store, it's expected to add a picture-in-picture feature to some sets, superimposing a second color picture in the corner of the screen. Philips also likes the idea of what it calls "MPIC" (for *Multiple Picture In-Picture*), providing up to nine pictures on a single screen to let the viewer see at a glance what programs are available at any time. Philips says the 9-picture display could be accomplished with only two tuners in the set by a scanning technique, but with lower resolution than normal full-screen pictures. The full-frame store, when available, will also provide still-framing of TV pictures and digital noise elimination.

## MULTICHANNEL TV SOUND

All indications are that the FCC will soon permit the broadcasting of supplementary multiplexed sound channels along with the TV picture. The two major benefits of that authorization will be the availability of stereophonic sound and a separate audio channel that can be used for bilingual translations, program commentary on a different educational level, or even descriptions of the on-screen action for the blind.

A four-year, industry-wide engineering study under the control and influence of the EIA tested three proposed multichannel TV-sound (MTS) systems and three companding (or noise-reduction) systems and chose an FM-AM system developed by Zenith, along with the dbx companding system, to recommend to the FCC. Also tested were transmission systems proposed by the EIA, Japan, and by Telesonics Corporation, as well as companding systems by Dolby Labs and CBS (the CX system, used for noise reduction on videodiscs). The winning Zenith system is similar to the current broadcast FM-stereo system, but the addition of companding will avoid the reduction in coverage area for stereo sound, which occurs in FM broadcasts, as well as reducing unwanted noise.

In proposing MTS, the Commission indicated that it intended to adopt the "marketplace approach"—permitting transmission in any and all technically sound systems—as it did in AM stereo more than two years ago. Fearing a repetition of the problem of AM stereo, which still has relatively little broadcasting and almost no audience, the EIA made specific recommendations that it hopes will serve as a *de facto* standard should the FCC stick to its marketplace policy for TV sound.

TV-set manufacturers are already tooling for stereo versions. Some recently introduced sets incorporate plugs for stereo decoders. It's expected that high-end sets will include both stereo and A-B switching, the latter for the so-called "separate audio program" (bilingual, etc.), which can be broadcast simultaneously with stereo. Some medium-priced sets designed for regions with large foreign-speaking populations may have the A-B switch without the stereo feature. The inauguration of MTS is also expected to result in the availability of component hi-fi tuners that include the "TV-stereo" band, as well as stand-alone "converters" that are basically stereo radios incorporating TV audio.

R-E

# Tek's best-selling 60 MHz scopes: Now 25 ways better for not a penny more!

Now Tek has improved its 2213/2215 scopes with brighter displays. Greater accuracy. And more sensitive triggering. At no increase in price.

The 60 MHz 2213 and dual time base 2215 have been the most popular scopes in Tektronix history. Now, Tek introduces an "A" Series update with more than 25 specification and feature enhancements — things you have asked for such as single sweep — all included at no added cost.

A brighter display and new vertical amplifier design provides sharp, crisp traces.

That makes the 2213A/2215A a prime candidate for tasks like TV troubleshooting and testing, where fast sweeps are typical.

New features include 10 MHz bandwidth limit switch, separate A/B dual intensity controls (2215A only), and power-on light: additions customers have suggested for



1-800-426-2200

giving these scopes the final measure of convenience.

Triggering, sweep accuracy, CMRR and many more major specifications are better than ever. Check the performance chart: not bad for scopes already considered the leaders in their class!

The price: still \$1200\* for the 2213A, \$1450\* for the 2215A. Or, step up to the 100 MHz 2235 for just \$1650\*! You can order, obtain literature, or get expert technical advice, through Tek's National Marketing Center. Direct orders include operator manuals, two 10X probes,

15-day return policy, world-wide service back-up and comprehensive 3-year warranty.

Talk to our technical experts.

Call toll-free:  
**1-800-426-2200**  
Ext. 185.

In Oregon call collect:  
(503) 627-9000 Ext. 185.

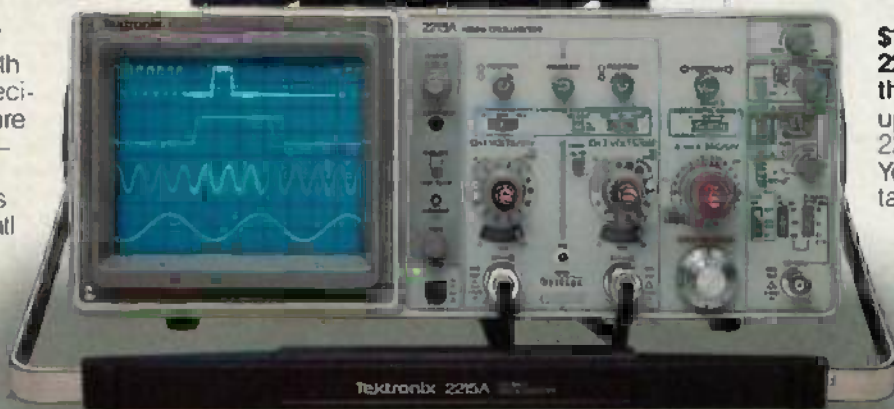

Specification enhancement	2213/2215 "A" Series	2213/2215
CRT brightness	14 kv accel. potential	10 kv accel. potential
Vertical accuracy	3%, 0° to 50°C	3%, +20° to 30°C
Chop rate	500 kHz	250 kHz
Input capacitance	20 pF	30 pF
CMRR	10 to 1 at 25 MHz	10 to 1 at 10 MHz
Channel isolation	100:1 at 25 MHz	Not specified
A Trigger sensitivity (int)	0.3 div at 5 MHz	0.4 div at 2 MHz
TV triggering	1.0 div compos. sync	2.0 div compos. sync
Sweep accuracy (in 10X)	4%, 15° to 35°C	5%, 20° to 30°C
Delay jitter	20,000 to 1 (2215A) 10,000 to 1 (2213A)	10,000 to 1 (2215) 5,000 to 1 (2213)
Holdoff Range	10:1	4:1

\*Price FOB, Beaverton, OR  
All scopes are UL listed and CSA approved. 3-year warranty includes CRT and applies to 2000 family oscilloscopes purchased after 1/1/83

# WHAT'S NEWS

## Radio anechoic chamber tests 1990 antennas

A unique new facility at the National Aeronautics and Space Administration's Lewis Research Center is designed to test the sophisticated antennas envisioned for the communications satellites of the 1990's. It is intended to measure the electric fields very close to the antenna—the so-called near field.

That testing is part of a broad Lewis effort to design, build, launch, and conduct experiments with an advanced communications satellite operating in the higher 30 gigahertz range during this de-

cade. Such a satellite will require a larger, more complex antenna than present types. But conventional far-field testing for such antennas requires a separation of many miles between transmitter and antenna, making measurements difficult, costly and impractical.

In the near-field environment, very precise measurements can be made of the beam pattern close to the antenna, even just a few feet away. From those measurements, far-field patterns—such as would be produced on earth by an antenna thousands of miles away in space—can be determined accurately.

The new near-field facility at

Lewis is enclosed by walls 40 feet high, covered by thousands of small pyramids of specially coated foam material, which absorb stray microwave reflections much as reflected sound is absorbed by the similar-looking acoustic anechoic chambers.

A small probe or scanner measures the antenna field as it moves up and down on a 22-foot tower mounted on a carriage that moves across the chamber on rails, acquiring data over a surface area 22 square feet. Laser beams check the precise alignment of the moving systems. The probe can be moved to within a few thousandths of an inch over the entire 22 x 22-foot scan area, making it possible to make measurements on antennas up to 60 gigahertz.

Antennas on present satellites have very wide beams, covering an area the size of the United States with two or three single beams. The technology Lewis is working on is to design antennas that will have a great many non-interfering beams. That will greatly increase traffic-carrying capacity per satellite—the more beams there are, the more channels of different information that can be transmitted simultaneously.

## Blind reading service is going national

*In Touch*, a New York closed-circuit network that provides a free reading service to the "print-handicapped," announces plans to extend its services to the whole country. Satellite Syndicated Systems, Inc., of Tulsa, OK, is donating its Transponder 3 on Satcom IV for distribution of the free reading service to all parts of the United States. It will be available without charge to all cable systems and FM stations that wish to make use of it.

*In Touch* broadcasts 24 hours a day on weekdays and 14 hours a day on weekends. The service is provided by more than 300 volunteers, who read from seven selected newspapers and a wide variety of magazines. Part of the material is first read on tape (for the overnight and some of the weekend broadcasts). Not only do the visually handicapped find this ser-

vices valuable, but also quadriplegics and victims of strokes or cerebral palsy who are not able to hold or turn the pages of printed matter.

The effort is supported entirely by voluntary contributions, not only to purchase supplies and support the full-time staff of five—all of whom are visually handicapped—but to supply free receivers to those who may need them.

*In Touch* is located at 322 West 48 St., New York, NY 10036. The phone number is 212-586-5588.

## RCA Americom to launch three more satellites

RCA American Communications, Inc., has filed with the FCC a plan to launch and operate three new hybrid communications satellites, or, at the company's option, three co-located C-band and Ku-band spacecraft, in the 1989-1992 time frame.

The Ku-band portion of the new service would be provided by sixteen 50-watt transponders on each spacecraft. The C-band portion would be provided by twenty-four 10-watt solid-state power amplifiers.

The company has requested orbital slots of 61, 63, and 65 degrees in the orbital arc. Spacecraft in those slots can provide service to the contiguous 48 states plus the Caribbean basin, specifically Puerto Rico and the U.S. Virgin Islands.

## Competing mobile groups agree in Minneapolis-St. Paul

MCI/Cellcom, Metro Mobile CTS, and Cellular Mobile Systems of Minnesota have combined their cellular applications in the Minneapolis-St. Paul area. The partnership includes all the applicants for the non-telephone company cellular franchise in Minneapolis-St. Paul. The group expects to receive a construction permit by the end of the year.

Under the agreement, MCI/Cellcom will take an 83 percent interest in the partnership, Metro Mobile will take 10 percent, and Cellular Mobile Systems 7 percent.

If granted a construction permit

*continued on page 8*



TECHNICIAN AT NASA'S LEWIS RESEARCH CENTER, CLEVELAND, adjusts a laser interferometer in the Center's new near-field antenna test facility. The precise measurements that can be made in this near-field environment permit accurate calculations of far-field beam patterns originating thousands of miles distant. The sharp pyramids—of foam material that absorbs microwave energy—prevent signals from being reflected and confusing the measurements.



# The Digital vs. Analog battle is over.

**\$85\*** buys you the new champion. **The new Fluke 70 Series.**

They combine digital and analog displays for an unbeatable two-punch combination.

Now, digital users get the extra resolution of a 3200-count LCD display.

While analog users get an analog bar graph for quick visual checks of continuity, peaking, nulling, and trends.

Plus unparalleled operating ease, instant autoranging, 2,000+ hour battery life and a 3-year warranty.

All in one meter.

Choose from three new models. The Fluke 73, the ultimate in simplicity. The feature-packed Fluke 75. Or the deluxe Fluke 77, with its own multipurpose protective holster and unique "Touch Hold" function (patent pending) that captures and holds readings, then beeps to alert you.

Each is Fluke-tough to take a beating. American-made, to boot. And priced to be, quite simply, a knockout.

For your nearest distributor or a free brochure, call toll-free anytime **1-800-227-3800, Ext. 229**. From outside U.S., call 1-402-496-1350, Ext. 229.

**FROM THE WORLD LEADER IN DIGITAL MULTIMETERS.**

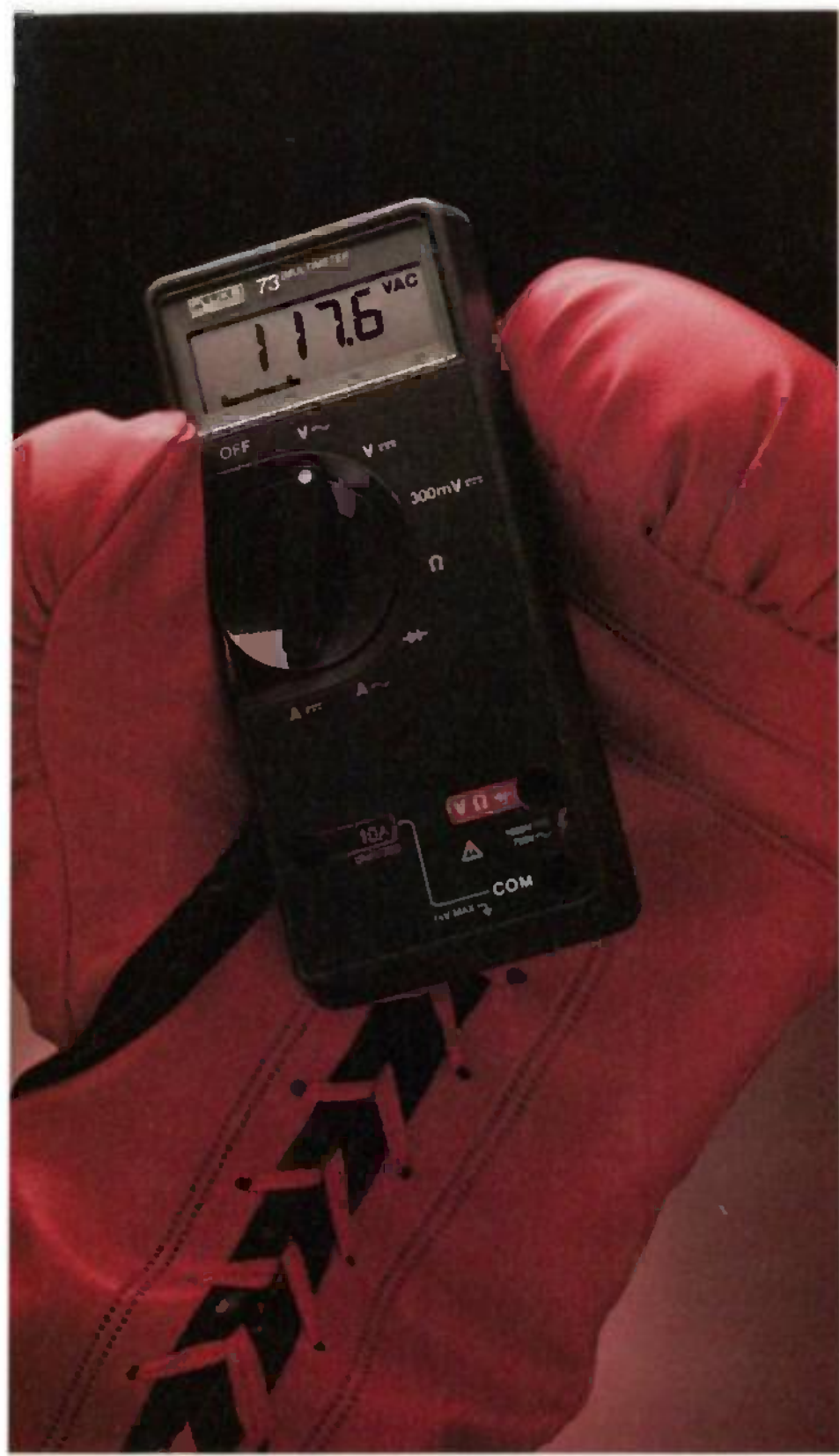

#### Fluke 73

\$85\*  
Analog/digital display  
Volts, ohms, 10A, diode test  
Autorange  
0.7% basic dc accuracy  
2000+ hour battery life  
3-year warranty



#### Fluke 75

\$99\*  
Analog/digital display  
Volts, ohms, 10A, mA, diode test  
Audible continuity  
Auto-range/range hold  
0.5% basic dc accuracy  
2000+ hour battery life  
3-year warranty



#### Fluke 77

\$129\*  
Analog/digital display  
Volts, ohms, 10A, mA, diode test  
Audible continuity  
"Touch Hold" function  
Auto-range/range hold  
0.3% basic dc accuracy  
2000+ hour battery life  
3-year warranty  
Multipurpose holster

\* Suggested U.S. list price, effective October 1, 1983.



# WHAT'S NEWS

continued from page 6

by the FCC, the partnership expects that its 12-cell system could be built in nine months.

## Voice warning system for auto drivers

A system that tells a driver in English when his oil is running low or his parking brake is on, and warns him of 12 other possible problems, is being marketed by Audio Systems Inc. (114B Royce St. Los Gatos CA. 95030). The device can even be set up to report the fuel level at a desired time daily, or when the fuel drops to a given level.

The circuit-monitoring unit consists of a complete package from National Semiconductor Corp., and includes the company's MM54104 Speech Synthesizer, which produces a high-quality female voice.

The system can be fitted into cars already in use. A car owner can install it in his or her car's electrical system in about an hour, or have it installed by a garage that specializes in automotive electronics, says the president of Audio Systems.

The suggested price of the Voice Warning System is \$184.95.

## Camcorder marks Kodak's entry into TV imaging

Kodak, long-time leader in the optical imaging field, is now entering the video-recording market with an 8-mm camera/recorder (camcorder) which combines in one unit a camera and a video tape recorder, and weighs only a little over five pounds. Kodak is also introducing a wide range of video tapes.

Two camcorders make up the

Kodavision 2000 series: the manual-focus 2200 and an auto-focus 2400, which also adds several other features, including pushbutton fade-in/out control and back-light control. Both use an f/1.2, 6:1 power-zoom lens and an electronic viewfinder. Picture quality is claimed to be extremely high, "at least equal in quality to that displayed from 1/2-inch systems." The 8-mm video cassettes are only slightly larger than audio tape cassettes.

An interesting feature of the new series is the playback equipment, the "cradle," which is connected to the user's TV. The camcorder is placed in it to play back the recording, with the camera's motor driving the tape, while its battery is being recharged by the cradle.

Tentative list prices are \$1,599 for the camcorder 2200, \$1,899 for the 2400, and \$199 for the cradle.

## NEMA makes Tech Alert available to nonmembers

Since June 1973, the National Electrical Manufacturers Association (NEMA) has been publishing for its members *Tech Alert*, a bi-monthly newsletter on trends and events in plant automation and high-tech systems. Now *Tech Alert* is available to nonmembers as well.

The newsletter presents in a concise and readable form, a summary of some of the leading-edge issues relating to the complex automation process.

It spotlights emerging or critical technologies, and tells where to go for more information. It tells what is happening within NEMA and its Automated Systems Program; and in other organizations, national and international, that are working on technology issues.

*Tech Alert* covers state-of-the-art topics and critical legislative and regulatory issues relating to technology, and provides a continuing glossary of "technical terms" to help nontechnical managers understand the jargon of high technology.

For those who would like a free subscription, write *Tech Alert*, NEMA, 2101 L Street, N.W., Washington, D.C. 20037. R-E



THE KODAVISION 2400 "CAMCORDER" combines video camera and recorder, with a cassette little larger than an audio tape cassette. Extremely portable and maneuverable, the 8-mm unit weighs only a little over 5 pounds.

# Radio-Electronics

A  
GERNSBACK  
PUBLICATION

Hugo Gernsback (1884-1967) founder  
M. Harvey Gernsback, editor-in-chief  
Larry Steckler, CET, publisher  
Arthur Kleiman, editor  
Carl Leron, WB2SLR, associate editor  
Brian C. Fenton, assistant technical editor  
Robert A. Young, assistant editor  
Jack Darr, CET, service editor  
Robert F. Scott, semiconductor editor  
Herb Friedman, communications editor  
Earl "Doc" Savage, K4SDS, hobby editor  
Gary H. Arlen, contributing editor  
David Lachenbruch, contributing editor  
Lou Frenzai, contributing editor  
Ruby M. Yee, production manager  
Robert A. W. Lowndes, production associate  
Dianne Osias, production assistant  
Joan Roman, circulation director  
Arlene R. Fishman, advertising coordinator

Cover photo by Robert Lewis  
Radio-Electronics is indexed in *Applied Science & Technology Index* and *Readers Guide to Periodical Literature*

Gernsback Publications, Inc.  
200 Park Ave. South  
New York, NY 10003  
Chairman of the Board, M. Harvey Gernsback  
President, Larry Steckler

ADVERTISING SALES 212-777-6400

Larry Steckler  
Publisher

## EAST SOUTHEAST

Stanley Levitan  
Radio-Electronics  
200 Park Ave. South  
New York, NY 10003  
212-777-6400

## MIDWEST/Texas/Arkansas/Okla.

Ralph Bergen  
Radio-Electronics  
540 Frontage Road—Suite 325  
Northfield, Illinois 60093  
312-446-1444

## PACIFIC COAST

Mountain States  
Marvin Green  
Radio-Electronics  
15335 Morrison St., Suite 227,  
Sherman Oaks, CA 91403  
818-986-2001

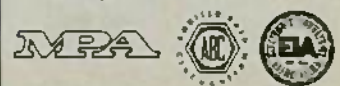

# AN INNOVATIVE 20 MHz OSCILLOSCOPE THAT EMPHASIZES OPERABILITY

## \$535\*

The SS-5702 has flexibility and power which make it ideal for the maintenance and troubleshooting of TVs, VTRs, audio equipment and a wide range of other electronic systems by hobbyist as well as professionals. At the top of its class, the SS-5702 uses a 6-inch rectangular, parallax-free CRT.

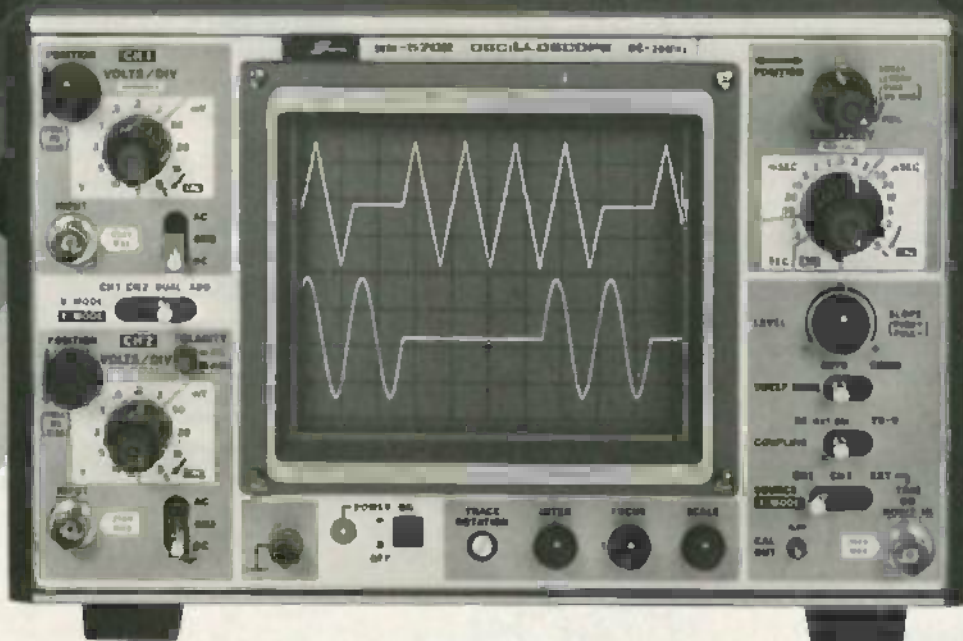

## IWATSU SS-5702 DC-20 MHz OSCILLOSCOPE

IWATSU makes more than 20 oscilloscopes as well as an impressive lineup of other instruments including logic analyzers and digital memory scopes. The fastest oscilloscope has a maximum frequency of 350 MHz. And the same technological expertise and product quality that make this super high-frequency oscilloscope possible are incorporated in the SS-5702.

- 6-inch rectangular, parallax-free CRT
- TV-V trigger
- Variable sweep length
- Double Lissajous figure
- 1 mV/div to 10 V/div sensitivity
- 100 ns/div to 0.2 s/div sweep
- Differential input with ADD mode
- DC operation (optional)

\* User price, including probes.



**IWATSU INSTRUMENTS INC.**  
120 COMMERCE ROAD, CARLSTADT, N J 07072 PHONE: (201) 935-5220, TWX: 710-989-0255

■ In Canada: ATELCO, 3400 Pharmacy Avenue, Unit 1, Scarborough, Ontario, M1W 3J8. Phone (416) 497-2208, TWX 610-492-0122

CIRCLE 51 ON FREE INFORMATION CARD

JUNE 1984



V-151F

**FEATURES**

- 1mV/div high sensitivity design. Effective for measurement of weak signals.
- Employs TV sync separator circuitry with one touch synchronization of both TV horizontal and vertical signals.
- Delayed sweep function with one touch control 10x magnification.
- Trace rotation system for easily adjusting trace inclination caused by terrestrial magnetism.
- Fine adjusting click positioning function enhances measuring efficiency.
- Signal output: Vertical output terminal to Frequency Counter, etc.
- Z axis input provided — possible to use as CRT display.
- One touch shifting of waveform slopes for easy observation of rise and fall of waves.



MODEL 302F

DUAL TRACE  
W/DELAY

All HITACHI Oscilloscopes feature 2 year parts & labor warranty.

**HITACHI  
30 MHz  
SCOPE**

**\$549<sup>95</sup>**

Price does not include probes. Probes \$50. a pair when purchased with scope. \$15. shipping within continental U.S.

**HITACHI**

**\$329<sup>95</sup>**

**15 MHz  
TRIGGERED SCOPE**

QUANTITIES ARE LIMITED

**SPECIFICATIONS**

Vertical Deflection Sensitivity	5mV/div to 5V/div ±5%, 10 calibrated steps 1mV/div to 1V/div ±8% (When using x5 amplifier) Uncalibrated continuous control between steps 1: < 2.5 (provided with click positioning function)
Bandwidth	DC to 15MHz, -3dB (at 4 div) DC to 7MHz, -3dB (at 4 div) (When using x5 amplifier) 24ns. (for x5) 70ns typ
Rise Time Signal Delay Line Max. Input Voltage Input Coupling Input Impedance Operating Modes X-Y Operation	600Vp-p or 300V (DC + AC peak, at 1kHz) AC, GND, DC Direct: 1M ohm, approx. 30pF Single trace External trigger input: X axis, Vertical input: Y axis X axis: approx. 200mV/div, Y axis: same as Vertical input DC to 10kHz within 3" DC to 500kHz, -3dB 4 div or more
Sensitivity	20mV/div or more (terminated into 50Ω) 50Hz to 5MHz, -3dB Approx. 50Ω
Horizontal Deflection Trigger Modes Trigger Source Trigger Coupling TV Sync Internal External Trigger Sensitivity	AUTO, NORM, TV (+), TV (-) LINE, EXT AC TV sync-separation circuit 1 div or more (TV sync-signal) 1Vp-p or more (TV sync-signal)
AUTO Low Bandwidth Trigger Slope External Trigger Input	Frequency Internal External 20Hz to 2MHz 0.5div 200mV 2 to 15MHz 1.5div 800mV
Sweep Time	30Hz ± input impedance: approx. 1M ohm, 30pF or less Max. input voltage: 100V (DC + AC peak at 1kHz) 0.2µs/div to 0.2s/div, ±5% 19 calibrated steps Uncalibrated continuous control between steps 1: < 2.5 (provided with click positioning function)
Sweep Time Magnifier Max. Sweep Time	10 times (±7%) 100ns/div (20ns/div and 50ns/div, not calibrated)
Amplitude Calibrator Waveform Voltage	Approx. 1kHz ±10% (typ), square wave 0.5V ±5%
Power Requirements	100/120/220/240V ±10% 50 to 60Hz, approx. 40W
Dimensions	Approx. 275(W) x 190(H) x 400(D) mm
Weight	Approx. 8.5kg

Price does not include probe. Probe \$20. when purchased with oscilloscope.

Full 2 year parts & labor warranty.

**WE CARRY A FULL LINE OF HITACHI OSCILLOSCOPES**

**ORDERING INFORMATION**

We don't just take orders, we ship them  
*Advance Electronics* endeavors to keep everything we advertise in stock for immediate delivery.



- Mastercharge & Visa shipped within 24 hours.
  - Bank checks or Money Orders shipped within 24 hours.
  - Personal checks — please allow 3 weeks for check to clear.
  - All prices plus shipping charges. Please call for appropriate charges. Use our toll free number.
  - New York State residents add appropriate sales tax.
  - PRICES SUBJECT TO CHANGE WITHOUT NOTICE.
- Quantities are limited

V-422

**\$599<sup>95</sup>**DC to 40 MHz,  
1mV/div, dual-trace,  
DC offset function

V-222

**\$499<sup>95</sup>**DC to 20 MHz,  
1mV/div, dual-trace,  
DC off. func., Alt.  
magnify function

V-212

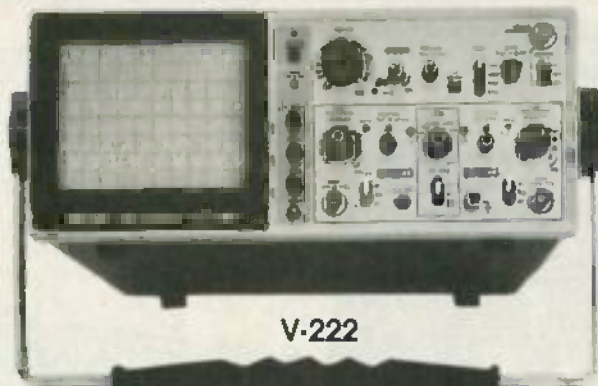
**\$439<sup>95</sup>**DC to 20 MHz,  
1mV/div, dual-tracePRICES DO NOT INCLUDE  
PROBES. PROBES \$50. A PAIR  
WHEN PURCHASED WITH SCOPE.  
\$15 SHIPPING WITHIN  
CONTINENTAL U.S.

V-222

## HI-PERFORMANCE PORTABLE OSCILLOSCOPES

ALL FEATURE 6" RECTANGULAR CRT  
Full 2 year parts & labor warranty.

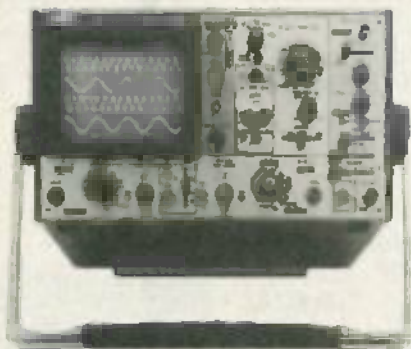

## HITACHI 100MHz QUAD TRACE DELAYED SWEEP OSCILLOSCOPE

- Large 6" rectangular CRT with internal graticule.
- 20kV acceleration potential.
- 500  $\mu$ V/div high sensitivity.
- Quad-trace.
- Equipped with delayed sweep function.
- Simultaneous enlarged waveform (delayed sweep) and entire original waveform (Main sweep) displayed on the CRT. (Alternate sweep function)
- Single sweep function.
- TV sync separator circuitry with one touch synchronization of both TV horizontal and vertical signals.

V-1050F

**\$1,249<sup>95</sup>**

- Large 6" rectangular CRT with internal graticule.
- 10 kV acceleration potential.
- 1 mV/div high sensitivity.
- Triple trace.
- Equipped with delayed sweep function.
- Single sweep function.
- Automatic focus circuit eliminates loss of focusing.

## HITACHI 60MHz DUAL TRACE DELAYED SWEEP OSCILLOSCOPE

V-650F

**\$939<sup>95</sup>**

TOLL FREE HOT LINE  
**800-223-0474**

212-730-7030

26 WEST 46th STREET, NEW YORK, N.Y. 10036

THE TEST EQUIPMENT SPECIALISTS

# ADVANCE ELECTRONICS



- 77
- 0.3% Accuracy
  - Manual or Autorange
  - 10A + mA Range
  - Beeper
  - "Touch-Hold" Function

**\$129<sup>00</sup>**

WE CARRY A FULL LINE OF FLUKE MULTI-METERS. IN STOCK NOW

# FLUKE 70 SERIES MULTIMETERS

- Analog Display • Rotary Knob • Volts AC & DC • Resistance to • 32 MΩ • 10 Amps • Diode Test • 3200 Counts • Fast Autoranging • Function Annunciators In Display • Power-Up Self Test • 2000+ Hour Battery Life w/ Power Down "Sleep Mode" • New Test Leads • VDE & UL Approval



**\$99<sup>00</sup>**

75

- 0.5% Accuracy
- Manual or Autorange
- 10A + 300 mA Range
- Beeper



**\$85<sup>00</sup>**

73

- 0.7% Accuracy
- Autorange Only
- 10 Amp Only



4 1/2 DIGIT MULTIMETERS

**\$349<sup>00</sup>**

MODEL 8060A



- Frequency measurements to 200KHz
- dB measurements
- Basic dc accuracy 0.4%; 10μV, 10 nA and 10 mΩ sensitivity
- Relative measurements
- True RMS
- High-speed Beeper



70 MHz Dual Time Base SCOPE

MODEL 1570

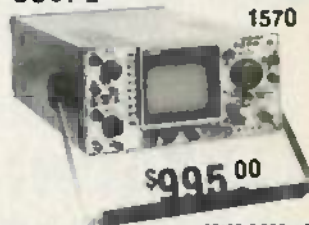

**\$995<sup>00</sup>**

PRICE DOES NOT INCLUDE PROBES

- 1mV/division sensitivity to 70 MHz
- 500 μV/division cascade sensitivity
- Four-Input operation provides trigger view on 4 separate inputs
- Alternate time base operation
- Switching power supply delivers best efficiency and regulation at lowest weight!

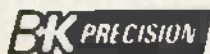

POWER SUPPLIES



**\$299<sup>95</sup>** MODEL 1601

- Isolated 0-50VDC, continuously variable; 0-2A in four ranges
- Fully automatic shutdown, adjustable current limit
- Perfect for solid state servicing



**\$329<sup>95</sup>** MODEL 1650

- Functions as three separate supplies
- Exclusive tracking circuit
- Fixed output 5VDC, 5A
- Two 0 to 25VDC outputs at 0.5A
- Fully automatic, current-limited overload protection



INDUSTRIAL TRANSISTOR TESTER



**\$199<sup>95</sup>**

MODEL 520B

- Now with HI/LO Drive
- Works in-circuit when others won't
- Identifies all three transistor leads
- Random lead connection
- Audibly and visually indicates GOOD transistor



FUNCTION GENERATORS

**\$189<sup>95</sup>** MODEL 3010

- Sine, square and triangle output
- Variable and fixed TTL outputs
- 0.1 Hz to 1MHz in six ranges
- Push button range and function selection
- Typical sine wave distortion under 0.5% from 1 Hz to 100kHz

MODEL 3020 **\$319<sup>95</sup>**

SWEEP FUNCTION

- Four Instruments in one package. — sweep generator, function generator, pulse generator, tone-burst generator
- Covers 0.02Hz-2MHz
- 1000:1 tuning range
- Low-distortion high-accuracy outputs



CAPACITANCE METERS

**\$199<sup>95</sup>** MODEL 830

- Automatically measures capacitance from 0.1pF to 200mF
- 0.1pF resolution
- 0.2% basic accuracy
- 3 1/2 digit LCD display



**\$159<sup>95</sup>** MODEL 820

- Resolves to 0.1pF
- 4 digit easy-to-read LED display
- Fuse protected against charged capacitors
- Overrange Indication

# BECKMAN'S CIRCUITMATE® ALL UNDER \$100

AVAILABLE NOW...

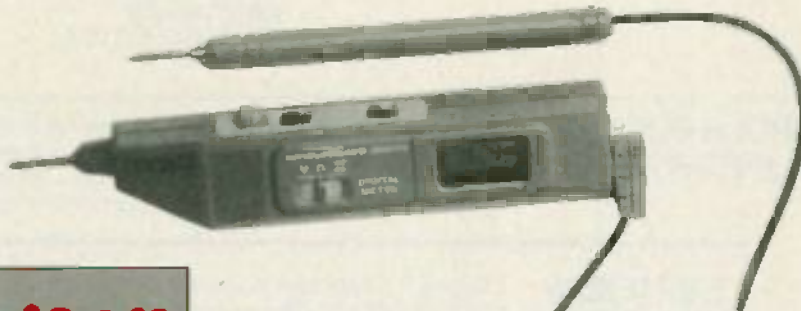

Circuitmate DM 20—  
3½-digit, pocket-size  
multimeter; 0.8% Vdc  
accuracy, diode test,  
hFE test, conductance,  
10 amps AC and DC  
ranges, auto-polarity  
auto-zero, auto-  
decimal

**\$64<sup>95</sup>**

The DM73 is the smallest digital  
multimeter on the market. Its probe-style  
design makes it ideal for taking  
measurements in hard-to-reach test areas.



Circuitmate DM-25—  
3½ digit, pocket-size  
multimeter; 0.5% Vac  
accuracy, diode test,  
capacitance, continuity  
beeper, conductance,  
10 amps AC and DC  
ranges, auto-polarity,  
auto-zero, auto-  
decimal

**\$79<sup>95</sup>**

**\$63<sup>95</sup>**

- Small Size
- Complete  
Autoranging
- "Touch Hold"
- Audible  
continuity  
checking



Circuitmate DM-40 —  
3½-digit multimeter;  
0.8% Vdc accuracy,  
diode test, auto-  
polarity, auto-zero,  
auto-decimal

**\$69<sup>95</sup>**



The DM 77 gives you  
the convenience of  
autoranging plus 10  
amps ac/dc  
measurement  
capability. You simply  
select the function  
you want, and the  
DM 77 automatically  
sets the required  
range.



Circuitmate DM 45 —  
3½-digit multimeter;  
0.5% Vdc accuracy,  
diode test, continuity  
beeper, 10 amps AC  
and DC ranges, auto-  
zero, auto-polarity,  
auto-decimal

**\$89<sup>95</sup>**

**\$76<sup>95</sup>**

TOLL FREE HOT LINE  
**800-223-0474**

26 WEST 46th STREET, NEW YORK, N.Y. 10036  
212-730-7030

THE TEST EQUIPMENT SPECIALISTS

**ADVANCE  
ELECTRONICS**

# SATELLITE/TELETEXT NEWS

GARY ARLEN  
CONTRIBUTING EDITOR

## WPIX BECOMES SUPERSTATION

WPIX-TV, the popular New York City television Channel 11, is becoming the newest satellite superstation, transmitted nationwide via a transponder on Westar 6. WPIX, with its full complement of New York-area sports events, movies, and other programming, will be beamed by United Video, the same satellite carrier that made WGN-TV, Chicago, into a superstation.

## ESPN MAY SCRAMBLE

ESPN, the mostly sports network on Satcom 3R, may begin scrambling its satellite transmission by year's end. The company is in the preliminary stages of analyzing how, or if, it could begin encoding its signals; it would be the first ad-supported cable/satellite network to install such scrambling to prevent reception by unauthorized earth stations. ESPN claims that pickups by home and apartment earth stations diminishes the value of its programming to cable-TV operators who pay for the 24-hour channel. HBO is already well along on scrambling tests, and Showtime cable/pay TV network is considering a scrambling system.

## SKY-HIGH PREDICTIONS

More than 550,000 backyard earth stations will be installed this year, twice the number set up during 1983, according to a forecast by KLM Electronics President Peter Dalton, an official of the home earth-station association. SPACE. If Dalton's prediction comes true, upwards of 875,000 dishes will be in place by the end of 1984, including units at apartments, schools, and office buildings, as well as home satellite receivers. The price is now averaging about \$2,500 apiece. (That's down from last year's \$3,000 average.)

## PLAYING MUSICAL ORBIT SLOTS

The FCC has shifted several orbit assignments for domestic satellites in an effort to head off interference problems of C-band and Ku-band birds. Westar 5 (the C-band bird which malfunctioned after launching from the February Shuttle) still has rights to 91° west longitude; Westar 3, which had been in that slot, shifts to 81°, and Westar 2 continues operating from current 78.5°. SBS 4, a digital-data satellite, will operate in the same slot in Ku-band. AT&T's Comstar D3 will move from 88.5° to 86°, and GTE Spacenet satellite—due to launch this summer—will go into the 89° slot.

## DBS DRIVES

United Satellite Communications Inc. has accelerated its direct-broadcasting satellite activities, introducing a five-channel service in Washington, Cincinnati, Richmond, and Harrisonburg (VA) so far this year. (Its first site was Indianapolis in late 1983.) USCI expects that by the end of the year 200,000 homes will have signed up to use the pay-TV service, which comes in via Canada's Anik II bird. Subscribers pay \$300 for installation then \$40 per month for service and equipment rental. Customers are also allowed to purchase receivers for \$700 then pay only \$25 per month. USCI plans to expand in 1986 to a higher-powered Ku-band bird allowing coverage of all U.S. homes.

Meanwhile, Satellite Television Co., the Comsat DBS subsidiary, is firming up plans for its late-'84 launch. Toshiba and ANCOM (a venture of Alcoa and NEC) have developed the equipment package, which costs about \$350 to \$450 per home. STC plans to charge about \$15 to \$20 per month for its 3-channel service.

## OLYMPIC TELETEXT

Olympic visitors in Los Angeles this summer will be able to use teletext on KTTV Channel 11, a Metromedia station, to look up late results from the Games, find out about road conditions to the scattered events, and even get tips about other area activities. Two hundred teletext receivers, made by Zenith and Sanyo, will be placed in hotel lobbies, travel centers, and other public sites around L.A. The project is part of a test by Metromedia and other supporters of the World System Teletext format (which is incompatible with the technology that CBS and NBC are using).

Sanyo's plunge into teletext carries added significance, because it will build an integrated set with decoder; the company has also been actively involved in related text services, notably as sole maker of TeleCaptioning decoders used for closed-captions of TV shows. R-E



# LETTERS

Address your comments to: Letters, **Radio-Electronics**,  
200 Park Avenue South, New York, NY 10003

## DIGITAL PANEL METERS

I have been following the articles on digital panel meters with interest. In the March, 1984 issue, I was particularly interested in the precision thermometer, since I am in the process of building several for automatic controls in my hybrid solar house. I am using both the LM3911 and LM335 sensors. Even though the latter is called a precision temperature sensor, it really doesn't do any better than that claimed for the one in Ray Marston's article, "How to Use Digital Panel Meters."

There is one flaw in the calibration procedure that I would like to point out, however. It is a shame to build such a potentially accurate thermometer and then calibrate it erroneously. Water does not boil at 100 degrees C, except at 760 mm of mercury atmospheric pressure. The boiling point drops about 1 degree for each thousand feet of elevation; in



Denver, for example, climatic conditions will cause the boiling point to vary about 1/2 degree above and below the average for the particular altitude.

If the thermometer is calibrated to read boiling at 100 degrees, and the altitude is appreciably higher than sea level, the thermometer will still be reasonably accurate in the lower

quarter of its range. But if one wants the best accuracy, or is going to use it at higher than normal weather temperatures, I suggest that it would be better to adjust the boiling point downward at the rate of 1 degree-per-thousand feet of elevation. If higher accuracy is required, one should take into account both altitude and current barometric pressure. The details are beyond the bounds of this letter. Or one could better calibrate the thermometer immersed in a mixture of liquid and frozen chemical of known freezing point, exactly as with water for the 0 (zero)-degree calibration. Or what is even simpler yet, immerse it in a liquid held essentially at a steady temperature that is monitored with a good lab thermometer.

KENNETH E. STONE  
Cherryvale, KS

*continued on page 22*

## PRINTED CIRCUIT KITS MAKE CARDS QUICKLY



### ONLY Vector kits contain:

- Positive photo-resist coated AND uncoated copper laminate—no messy photo-reversal—no spraying, dipping, or baking.
  - 4 types of art aids: rub transfers, ink, tape, cut and peel—use 1 or all.
  - 1:1 circuit art rub transfers—IC sets, pads, lines, connectors, symbols, letters, and numbers.
  - Everything included—just add water and sunlamp or bright sunshine.
  - Liquid etchant and developer—no dry chemical mixing problems.
- AND
- Process choices—make circuit on copper and etch for 1 card.
- Make circuit on film, expose, develop and etch for 1 or many cards.

ART AIDS + mylar film + sunlamp + developer & etchant = 1 or many PC's  
+ card + etchant = 1PC

32XA1 kit makes 1 PC cards, \$30.59, 32X1 starter kit makes 2 cards, \$21.11  
If not available locally, factory order—include \$3.00 shipping, U.S. only  
Prices subject to change without notice

830177

Vector Electronic Co., 12460 Gladstone Av., Sylmar, CA 91342

CIRCLE 59 ON FREE INFORMATION CARD

ANNOUNCEMENT OF OUR NEW ARRIVAL

SEND FOR OUR  
ELECTRONIC COMPONENTS CATALOG

"ALWAYS IN STOCK"

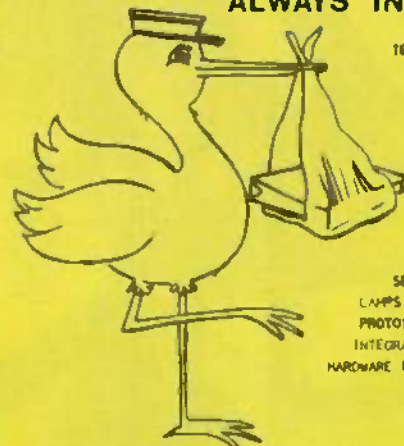

TEST EQUIPMENT  
WIRE & CABLE  
CONNECTORS  
RESISTORS  
BATTERIES  
SWITCHES  
FANS  
FUSES  
CABINETS  
TERMINALS  
CAPACITORS  
SEMI CONDUCTORS  
LAMPS & INDICATORS  
PROTOTYPING BOARDS  
INTEGRATED CIRCUITS  
HARDWARE & ACCESSORIES

CALL TOLL-FREE

IN MICHIGAN  
1-800-432-4364

NATIONAL WATS  
1-800-952-9232

**Tubergen**

TUBERGEN & ASSOCIATES, INC.  
3124 N. STATE ST.  
ZEELAND, MI 49464

STOCKING DISTRIBUTORS OF ELECTRONIC COMPONENTS

JUNE 1984

15

# *COMPUTERS ARE CREATING JOBS FOR NRI-TRAINED PEOPLE.*

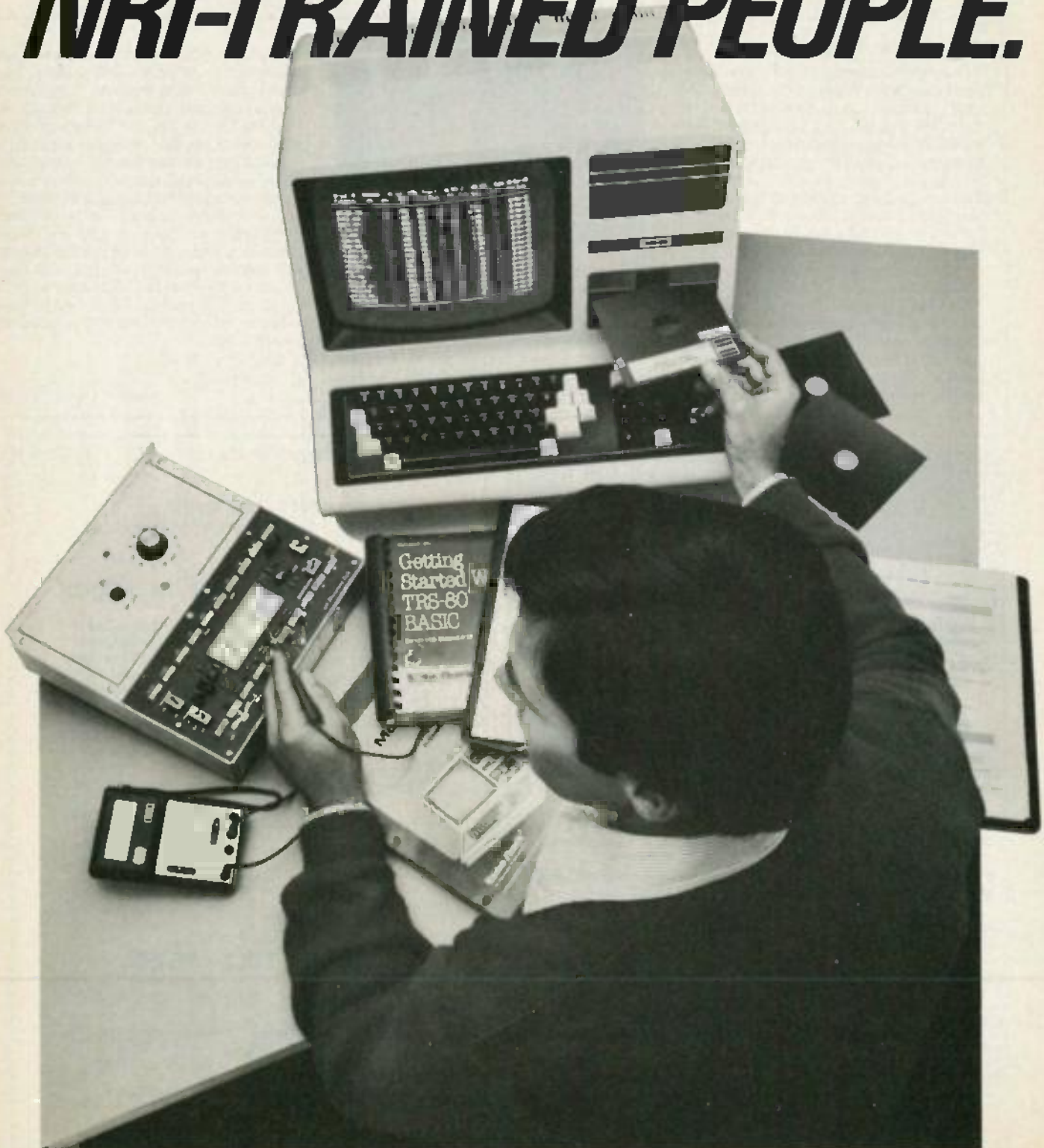

**IF YOU'RE SERIOUS ABOUT MAKING MONEY IN MICRO-COMPUTERS, NRI IS SERIOUS ABOUT SHOWING YOU HOW.**

The U.S. Department of Labor projects job openings for qualified computer technicians will soon double. International Resource Development, Inc., estimates a 600% increase in these jobs in a decade. And most of these will be new jobs, created by the expanding role of computers.

**NEVER HAS THERE BEEN A FASTER-GROWING FIELD OF TECHNOLOGY.**

Many people are afraid of losing their jobs to computers, but thousands of jobs will be created for those who are prepared to meet the challenge.

With NRI training, you'll be prepared. You can have a profitable, exciting future as an expert who can handle the operational, programming and technical aspects of all kinds of microcomputers and micro-processors.

**LEARN IN YOUR SPARE TIME.**

NRI trains you in your own home, at your convenience...no classroom schedule to meet, no need to quit your job. As a class of one with complete course materials and the backing of a staff of professional electronics instructors, you'll get extraordinary hands-on training on the latest model in the most popular line of microcomputers: the new TRS-80™ Model 4, with disk drive for greater memory capacity. The TRS-80 Model 4 complete with advanced features

TRS-80 is a trademark of the Radio Shack division of Tandy Corp.



*Your NRI course will include the new TRS-80 Model 4 with Disk Drive or the TRS-80 Color Computer with NRI Computer Access Card...plus a professional LCD multimeter, NRI Discovery Lab and hundreds of demonstrations and experiments. It's all yours to keep.*

that are built right in...features that are offered as options on other microcomputers. Designed to perform diverse personal and business functions and to accept the most software, the TRS-80 Model 4 is a great computer to learn on...and it's yours to keep, along with the disk drive!

**LEARN HOW TO USE, PROGRAM AND SERVICE STATE-OF-THE-ART MICROCOMPUTERS.**

Through your carefully designed NRI course, you'll get a wealth of practical experience. You'll build circuits...from the simplest to the most advanced...with your NRI Discovery Lab.® You'll use a professional 4-function LCD digital multimeter for analysis and troubleshooting.

With NRI training you'll explore your computer's registers, memory and input-output ports. You'll even write programs to control the circuits you've designed and built. You'll perform hundreds of challenging experiments, always backed by a full-time faculty ready to help you personally.

When your NRI training is complete, you'll be a computer technician, ready for your first job — servicing, testing or programming all types of microcomputers — in a rewarding and challenging new career.

**THE CATALOG IS FREE. THE TRAINING IS PRICELESS.**

Send the postpaid card today for your FREE 104-page catalog. It's a valuable guide to opportunities and training in the high-tech revolution.



*For greater computer memory capacity, a double density disk drive is included.*

You'll see how easily you become part of the growing high-tech world of microcomputers.

If the card has been removed, please write to us today.



**NRI School of Electronics**  
McGraw-Hill Continuing  
Education Center  
3939 Wisconsin Avenue  
Washington, D.C. 20016

*We'll give you tomorrow.*

# UNGAR DESOLDERING & SOLDERING

## Special Pricing... Special Free Offer

### Hot VAC Desoldering System



Model 4000

Built-in vacuum pump eliminates the need for shop air. Compact design and portability make it ideal for use at any location where there is an AC electrical plug-in outlet.  
**Self-Contained, Super-Quiet Air Pump:** The vacuum pump is not only virtually maintenance free, it is remarkably quiet. The pump operates only when the handle switch is actuated.  
**Temperature Control:** Variable solid-state control that adjusts the tip temperature from 500° - 1000° F. An electric circuit assures that transient spikes are fully suppressed thereby making the system safe for desoldering voltage-sensitive components.

Reg \$599.95  
**OUR SPECIAL PRICE**

**\$379<sup>95</sup>**

### Electronic Temperature Controlled Soldering System with Built-in Controller



Model 9100

Includes: Base unit with built-in controller, micro-size handle with THERMO-DURIC heater, 1/16" #9012 screwdriver tip, sponge and tip tray, sponge, and Iron Holder. A low cost alternative in an operator-adjustable, temperature controlled soldering system.  
 • Electronic, closed-loop temperature control for maximum precision • Temperature is operator adjustable from 400° F to 600° F • Continuous, variable control so you can select the exact temperature you need • Neon "on-off" light • Iron Holder can be right- or left-hand mounted to accommodate all operators.

**OUR SPECIAL PRICE** **\$89<sup>95</sup>**

**FREE UNGAR 9100**  
 with purchase of  
 Ungar 4000

TOLL FREE (800) 645-9518

**FORDHAM**

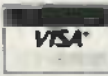

260 Motor Parkway, Hauppauge, N.Y. 11788

In N.Y. State 800-832-1446  
 • VISA • COD • Master Charge  
 • Money Order N.Y. State residents add appropriate sales tax.  
 • Check  
 COD's extra (required 25% deposit!)

ADD FOR SHIPPING AND INSURANCE  
 \$250.00 ..... \$4.50  
 \$251.00 to 500.00 ..... 6.50  
 501.00 to 750.00 ..... 8.50  
 751.00 to 1000.00 ..... 12.50  
 over 1000.00 ..... 15.00

# FORDHAM DISCOUNTS DISCOUNT PRICES ON HITACHI SCOPES

We will beat any advertised price

**SPECIAL OFFER!**  
 For a limited time only

### 35 MHz DUAL TRACE SIGNAL DELAY LINE

Vertical sensitivity 5m V/div to 5V/div and 1m V/div to 1 V/div with 5X amplifier • Trigger modes Automatic, Normal, TV (+), TV (-).

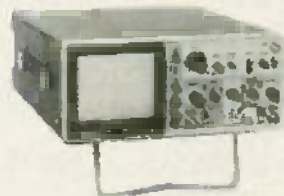

V-355F

REG \$895  
**OUR PRICE**

**\$599<sup>95</sup>**

WITH PROBES

### 60 MHz DUAL TRACE DELAYED SWEEP

High sensitivity • 1 mV/div (10 MHz) • 5 ns/div sweep rate  
 • 3rd channel display (trigger view) • Variable trigger hold-off  
 • Full TV triggering • Single sweep • Automatic locus correction.

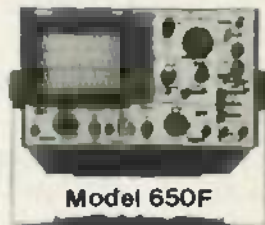

Model 650F

**OUR PRICE**  
**\$995**  
 WITH PROBES

### 100 MHz QUAD TRACE DELAYED SWEEP

Large, bright 8x10 cm screen  
 • Quad trace operation/Ch1, Ch2, A trigger and B trigger • High sensitivity 500 μ V/div (5 MHz)  
 • Full TV triggering.



Model V-1050-F

**OUR PRICE**  
**\$1299<sup>95</sup>**  
 WITH PROBES

TOLL FREE (800) 645-9518

**FORDHAM**



260 Motor Parkway, Hauppauge, N.Y. 11788

In N.Y. State 800-832-1446  
 • VISA • COD • Master Charge  
 • Money Order N.Y. State residents add appropriate sales tax.  
 • Check  
 COD's extra (required 25% deposit!)

ADD FOR SHIPPING AND INSURANCE  
 \$250.00 ..... \$4.50  
 \$251.00 to 500.00 ..... 6.50  
 501.00 to 750.00 ..... 8.50  
 751.00 to 1000.00 ..... 12.50  
 over 1000.00 ..... 15.00

# SUPERSALE

We will beat any advertised price

## BECKMAN Circuitmate® DMM

MODEL DM73  
**\$69<sup>95</sup>**

• Smallest digital multimeter on the market • Probe-style design makes it ideal for taking measurements in hard-to-reach test areas



**\$64<sup>95</sup>**

• 3 1/2-digit pocket-size multimeter • 0.8% Vdc accuracy • diode test • hFE test • conductance • 10 amps a.c. and DC ranges • Autopolarity • Auto Zero • Auto-decimal



**\$79<sup>95</sup>**

MODEL DM25

• 3 1/2-digit pocket-size multimeter • 0.5% Vdc accuracy • diode test • capacitance • continuity beeper • conductance • 10 amps AC and DC ranges • auto-polarity • auto-zero • auto-decimal



## B&K PRECISION 100 MHz FREQUENCY COUNTER

MODEL 1803  
REG. \$169.95  
**OUR PRICE \$144<sup>50</sup>**



• 5 Hz to 100 MHz range • 8 digit LED display • Leading zero blanking • Low pass filter • BNC Connector Input • Overflow indicator • Battery or AC powered • Charger/AC Adaptor included with Model 1803

## NTSC COLOR BAR GENERATOR MODEL 1251

REG. \$995.00  
**OUR PRICE \$849<sup>95</sup>**



• Generates a wide variety of test signals and patterns for comprehensive testing and adjustment of virtually all types of television and video equipment • Video patterns include standard NTSC color bars, -IWO and staircase at two levels of burst phase chrominance • A full assortment of convergence patterns, raster colors gated or full field multiburst

## HITACHI PORTABLE OSCILLOSCOPES

MODEL V-222 (20 MHz)  
REG. \$895.00

MODEL V-422 (40 MHz)  
REG. \$895.00



## CALL FOR SPECIAL PRICING

• New series of scopes provides high performance and light weight • Large 6-inch rectangular, internal grayscale CRT • Autolocus circuit and scale illumination • DC offset function • Voltage and frequency reading outputs • High accuracy - ±3% • High sensitivity - 1 mV/div

## BP DIGITAL CAPACITANCE METER

MODEL DCM-601  
REG. \$149.95

**OUR PRICE \$79<sup>95</sup>**



• Digital display easy and correct readout • High accuracy 100 PPM 0.5% • LS-circuit provides high reliability and durability • LCD display provides low power consumption

## FORDHAM 550 MHz FREQUENCY COUNTER

MODEL FM-8  
REG. \$199.95  
**OUR PRICE \$149<sup>95</sup>**



• 8-digit high frequency counter with a switch selectable input using single BNC • Completely assembled • Pre-Calibrated, Pre-tested

## LEADER NTSC WAVEFORM MONITOR

MODEL LBO-5860  
REG. \$2050.00  
**OUR PRICE \$1850**



Permits displaying vertical interval test and reference signals by front panel line selector.

## NTSC VECTORSCOPE

MODEL LVS-5850  
REG. \$2050.00  
**OUR PRICE \$1850**



Convenient method for observing and measuring the relative phase and amplitude of chrominance signal components

## FLUKE 70 73

• Analog Display • Rotary Knob • Volts AC & DC • Resistance to 32 MΩ • 10 Amps • Diode Test • 3200 Counts • Fast Autoranging • Function annunciators in Display • Power Up Self Test • 2000+ Hour Battery Life w/Power Down "Sleep Mode" • New Test Leads • VDE & UL Approval

**\$79<sup>95</sup>**

• 0.7% Accuracy • Autorange Only • 10 Amp Only



75  
**\$95<sup>00</sup>**

• 0.5% Accuracy • Manual or Autorange • 10A • 300 mA Range • Beeper



77  
**\$125<sup>00</sup>**

• 0.3% Accuracy • Manual or Autorange • 10 A • 300mA Range • Beeper • "Touch-Hold" Function



## VIZ DC TRIPLE POWER SUPPLY

MODEL WP-708  
REG. \$479.95

**OUR PRICE \$399<sup>95</sup>**



• Dual DC Voltmeter • Triple DC Power Supply • Three separate completely isolated DC power supplies, two 0-20V @ 0.2A, one fixed 5V @ 4A

## WELLER SOLDERING STATION

MODEL EC1000  
OUR PRICE  
**\$109<sup>95</sup>**

• Identical to the EC2000 except LED Digital temperature readout • The EC1000 is dial controlled



## SOLDERING STATION

MODEL EC2000  
OUR PRICE  
**\$139<sup>95</sup>**

• Continuously variable tip temperature from 350 to 850 F • Positive temperature coefficient sensor inside the tip provides temperature feedback to maintain tip temperature at set point



# FORDHAM

260 Motor Parkway, Hauppauge, N.Y. 11788

• Master Charge • VISA • COO • Money Order • Check

• N.Y. State residents add appropriate sales tax.

ADD FOR SHIPPING AND INSURANCE:  
\$0-\$250.00 ..... \$ 4.50  
\$251.00 to \$ 500.00 ..... \$ 6.50  
\$501.00 to \$ 750.00 ..... \$ 8.50  
\$751.00 to \$1000.00 ..... \$12.50  
over \$1000.00 ..... \$15.00

**TOLL FREE (800) 645-9518**  
in N.Y. State call 800-832-1446

Free Catalog on Request

JUNE 1984

21

## LETTERS

continued from page 15

### THE COUNTDOWN CONTROVERSY

After reading Jack Darr's June 1983 article on countdown circuits and L.D. Smithley's letter concerning the same, I did some research to clear up the confusion in my mind and hope that the results of my research will help give other readers of *Radio-Electronics* a clearer view of how countdown circuits function.

As Mr. Smithley said, the ratio of 15,750 to 60 (or 262.5) is not directly compatible with counting. The same goes for the present day

15,734 Hz (horizontal) to 59.94 Hz (vertical)—it's still not compatible. To allow countdown by a whole number it is necessary to begin with 31,468 Hz which is twice 15,734 Hz, and then break it down to the horizontal and vertical rate with the dividers.

For this discussion we will use RCA's CTC 99/101 color-TV chassis. IC V-400 performs those operations by using a master-clock VCO, which oscillates at 31,468 Hz. Its output is divided by 525 to obtain vertical pulses and by 2 to obtain horizontal pulses.

Mr. Smithley was right in stating that: "Perhaps the circuit is doing something that it is not telling him". Also, Jack Darr did a good job describing the operation, except for that one minor detail, which is understandable when

you consider how difficult it can be to find all of the information on new circuits. I love your magazine and Jack's articles.

STEVEN JAY BABBERT  
Worthington, OH

### CORRECTION

I was extremely pleased to see my article, "Instrument Landing Systems," in the March 1984 issue of your magazine. I would like to point out one correction, however.

On page 52, fourth line from the bottom of the first column, the text reads: "feet in width at the outer marker or 3°."

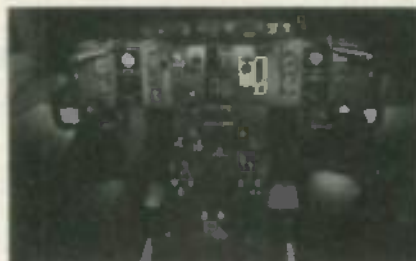

In the original manuscript, that line read: "feet in width at the landing threshold or 3°."

That makes quite a difference in the structure of the radiated signal, and may cause some of our technicians to write in for clarification.

Thanks again for publishing my article, and I hope to send you another one soon.

BILL SEWELL  
Schaumburg, IL

### POSITIVE AGREEMENT

I couldn't agree more with the reader who wrote, "Stay as you are," in the March 1984 Letters column.

I am especially interested in video and related projects. As a continuance of exploration of cable-television methods, I would like to suggest an article and kit on how stereo music is transmitted and received over cable, i.e. MTV. Thank you for a fine "one-of-a-kind" magazine.

JOHN R. DEAN  
Thiells, NY

### SUPERSTATION SATELLITE

I was very surprised to read the report published under "Satellite/Teletext News" in the January 1984 issue of *Radio-Electronics*. That is because the EBU has no plans whatsoever "to launch a multinational satellite-superstation during 1984."

The report appears to confuse a number of separate developments making use of the European Communications Satellite System, only one of which involves the EBU. That is, the contract concluded between the EBU and Eutelsat for a ten-year lease of two transponders in the Eutelsat F-2 satellite. Those transponders will be used exclusively, to enable certain of the point-to-point international television circuits, whose use is coordinated by the EBU, to be transferred from the existing terrestrial facilities—which should occur during the second half of 1984.

Those circuits are used only for the exchange of programs and news items between the broadcasting stations and networks that are members of the EBU, known as Eurovi-

# IT'S HERE!

IT'S FREE . . .



## . . . AND IT'S YOURS!

Consolidated Electronics has a catalog that's sure to please you. We've slashed 80% of our prices in this catalog. We at CEI are so sure that you'll find our quality parts dependable that we've put a **TWO YEAR WARRANTY** on everything. Not only that, CEI is offering **FREE** shipping and handling. Just call us **TOLL FREE** for details.

**CALL TOLL FREE TODAY!**

**1-800-543-3568**

NATIONAL WATS

**1-800-762-3412**

OHIO WATS

705 WATERVLIET AVE., DAYTON, OHIO 45420  
IN DAYTON • (513) 252-5662

TELEX NO. 288-229

CIRCLE 18 ON FREE INFORMATION CARD

sion. Access to them by third parties is not permitted. I should be very grateful if you would inform the readers of **Radio-Electronics** of those facts, as soon as possible, and inform me of the source of your report, so that I may take steps to prevent the circulation of further such errors.

R. GRESSMAN, DIRECTOR  
European Broadcasting Union (E.B.U.)

Something was apparently lost in the translation about European satellite activities. In using usually reliable information about satellite developments in Europe, the misinterpretation that Mr. Gressman suggests, crept into the report. With so many countries planning satellite services—including several multinational projects—it's possible that EBU's role was improperly stated. Thank you for setting the record straight, and I look forward to hearing more from EBU about European satellite activities.—Gary Arlen.

### ADDITIONS TO POWERLINE TRANSIENT SUPPRESSOR

I'd like to congratulate Mr. Herb Friedman on a fine article, "Build this Powerline Transient Suppressor", in the September 1983 issue.

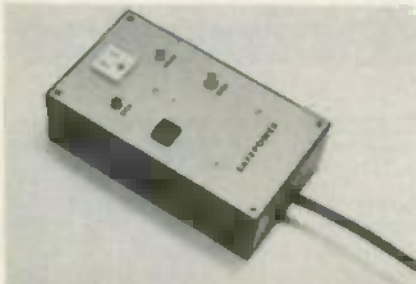

My two units (for two computers) are built inside a surplus Executone telephone desk-top machine. I made two small additions: a) added MOV's from "hot" 115-volts AC to ground and from "neutral" to ground, to guard against transients. b) added a 4-amp fuse in series with the power-input line.

My units have been up and running for 4 months without incident, and have worked beautifully under field conditions. Total cost \$25.00. Keep up the good work.

WEI-LI  
Seattle, WA

### SCHEMATIC NEEDED

On the fifth of October, 1982, I purchased an IBM Selectric-Redatron-I/O Printer/Typewriter from a company called Computer Products & Peripherals Unlimited (CPU), for my then new, VIC-20. Being very new to computers, I paid the \$25.00 for the interface kit and an extra \$120.00 for the "tested & operational" machine. Unfortunately, the machine was neither, and the kit consisted of one IC and some illegible photocopies.

The company did make partial repairs, but the machine still is not usable. I can not afford to throw away over \$450.00, so I would like to contact anyone who has built the interface and is willing to help out with the schematic or layout. Please contact me for details and costs. Thank you,  
EUGENE WITHROW  
254 Harken Street  
Mansfield, OH

# PROBES FOR SALE

FROM THE BEST SOURCE FOR OSCILLOSCOPE PROBES AND DMM/VOM TEST LEAD SETS.

- Low Cost
- High Quality
- Excellent Performance
- Slender, Flexible Cable
- Wide Range of Choice
- Switchable X1 and X10 Attenuation Factor
- 100 MHz Bandwidth

MODEL SP100  
**\$41<sup>00</sup>**



**TEST PROBES, INC.** **TPI** Your Probe Specialists  
COLINE U.S. SALES & STOCKING SOURCE  
P.O. BOX 2113, LA JOLLA, CALIFORNIA 92038 (619) 458-4197

CIRCLE 62 ON FREE INFORMATION CARD

**FREE**

## McIntosh STEREO CATALOG and FM DIRECTORY



Get all the newest and latest information on the new McIntosh stereo equipment in the McIntosh catalog. In addition you will receive an FM station directory that covers all of North America.

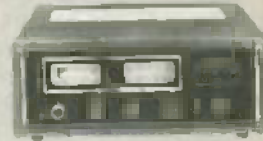

**SEND TODAY!**

McIntosh Laboratory Inc. RE  
East Side Station P.O. Box 96  
Binghamton, N.Y. 13904-0096

NAME \_\_\_\_\_  
ADDRESS \_\_\_\_\_  
CITY \_\_\_\_\_ STATE \_\_\_\_\_ ZIP \_\_\_\_\_

If you are in a hurry for your catalog please send the coupon to McIntosh. For non rush service send the Reader Service Card to the magazine.

CIRCLE 93 ON FREE INFORMATION CARD

# Diskette Users...

When you've heard from all the animals in the diskette zoo, but you need fast delivery and high quality diskettes...



## Call Communications Electronics

Diskette order desk  
**800-521-4414**  
 In Canada 800-265-4828



**Choose your brand**  
**Choose your price**

**Super Disk**  
 diskettes for as low as  
**\$0.99 each**

**Wabash**  
 diskettes for as low as  
**\$1.14 each**

**BASF**  
 diskettes for as low as  
**\$1.69 each**

Product Description	Super Disk Part #	CE quant. 100 price per disk (\$)	Wabash Part #	CE quant. 100 price per disk (\$)	BASF Part #	CE quant. 100 price per disk (\$)
8" SSSD IBM Compatible 128B/S, 28 Sector	_____	_____	F111	1.89	_____	_____
8" SSSD Shugart Compatible, 32 Hard Sector	_____	_____	F31A	1.89	_____	_____
8" SSDD IBM Compatible (128 B/S, 28 Sectors)	_____	_____	F131	2.29	_____	_____
8" DSDD Soft Sector (Unformatted)	_____	_____	F14A	2.89	_____	_____
8" DSDD Soft Sector (256 B/S, 28 Sectors)	_____	_____	F144	2.69	_____	_____
8" DSDD Soft Sector (612 B/S, 15 Sectors)	_____	_____	F145	2.69	_____	_____
8" DSDD Soft Sector (1024 B/S, 8 Sectors)	_____	_____	F147	2.69	_____	_____
5 1/4" SSSD Soft Sector w/Hub Ring	6431	1.19	M11A	1.34	_____	_____
5 1/4" SSSD Same as above but bulk product	6437	0.99	M11AB	1.14	_____	_____
5 1/4" SSSD 10 Hard Sector w/Hub Ring	_____	_____	M41A	1.34	_____	_____
5 1/4" SSDD Soft Sector w/Hub Ring	6481	1.44	M13A	1.59	54974	1.89
5 1/4" SSDD Same as above, but bulk product	6487	1.24	M13AB	1.39	_____	_____
5 1/4" SSDD Soft Sector Flippy (use both sides)	_____	_____	M:18A	2.59	_____	_____
5 1/4" SSDD 10 Hard Sector w/Hub Ring	_____	_____	M43A	1.59	_____	_____
5 1/4" DSDD Soft Sector w/Hub Ring	6491	1.94	M14A	2.09	54980	2.44
5 1/4" DSDD Same as above, but bulk Product	6497	1.74	M14AB	1.89	_____	_____
5 1/4" DSDD 10 Hard Sector w/Hub Ring	_____	_____	M44A	2.09	_____	_____
5 1/4" DSDD 16 Hard Sector w/Hub Ring	_____	_____	M54A	2.09	_____	_____
5 1/4" DSDD Soft Sector w/Hub Ring (96 TPI)	8501	2.84	M18A	2.99	54992	3.34
3 1/2" SSDD Soft Sector micro-floppy	_____	_____	_____	_____	_____	_____

**For more information about this brand call:**

**Lifetime warranty**  
 For more info on Super Disk call  
**800-521-4414**  
 In Michigan 313-973-1111

**6 year warranty**  
 For more info on Wabash call  
**800-323-9868**  
 In Illinois 312-593-6363

**Lifetime warranty**  
 For more info on BASF call  
**800-343-4600**  
 In Massachusetts 617-271-4000



## CE... your best source for diskettes

For you the diskette buyer, it's a jungle out there. There are so many different brands to choose from, you need to go on a safari to find a good brand at a reasonable cost. Fortunately, CE has already hunted for the best diskettes and offers you an excellent choice at a CE price. To save you even more, CE also offers bulk product where 100 diskettes are packed in the same box without envelopes or labels. Since we save packaging costs, these savings are passed on to you. Diskette envelopes are also available from CE. These super strong and tear resistant Tyvek® envelopes are only \$15.00 per 100 pack. Use order # TE-5 for a 100 pack of 5 1/4" diskette envelopes.

## Quantity Discounts Available

Our diskettes are packed 10 disks to a carton and 5 or 10 cartons to a case. The economy bulk pack is packaged 100 disks to a case without envelopes or labels. Please order only in increments of 100 units for quantity 100 pricing. With the exception of bulk pack, we are also willing to accommodate your smaller orders. Quantities less than 100 units are available in increments of 10 units at a 20% surcharge above our 100 unit price. **Quantity discounts** are also available. Order 300 or more disks at the same time and deduct 1%; 500 or more saves you 2%; 1,000 or more saves 3%; 2,000 or more saves 4%; 5,000 or more saves 5%; 10,000 or more saves 6%; 50,000 or more saves 7%; 100,000 or more saves 8%; 500,000 or more saves 9% and 1,000,000 or more disks earns you a 10% discount off our super low quantity 100 price. Almost all our diskettes are immediately available from CE. Our efficient warehouse facilities are equipped to help us get you the quality product you need, when you need it. If you need further assistance to find the flexible diskette that's right for you, call the appropriate manufacturers compatibility hotline telephone number listed at the bottom of this ad. Dealer inquiries invited.

## Buy your diskettes from CE with confidence

To get the latest delivery of your diskettes, phone your order directly to our order desk and charge it to your credit card. Written purchase orders are accepted from approved government agencies and most well rated firms at a 10% surcharge for net 10 billing. For maximum savings, your order should be prepaid. All sales are subject to availability, acceptance and verification. All sales are final. All prices are in U.S. dollars. Prices, terms and specifications are subject to change without notice. Out of stock items will be placed on backorder or substituted for equivalent product at no extra cost to you unless CE is instructed differently. A \$5.00 additional handling fee will be charged for all orders with a merchandise total under \$50.00. All shipments are F.O.B. CE warehouse in Ann Arbor, Michigan. COO terms are available. In U.S. UPS areas for \$5.00 extra, and are payable with cash or certified check.

For shipping charges add \$8.00 per 100 diskettes and/or any fraction of 100 8-inch diskettes, or \$6.00 per 100 diskettes and/or any fraction of 100 5 1/4-inch mini-diskettes for U.P.S. ground shipping and handling in the continental U.S. UPS 2nd day air rates are three times continental U.S. rates. For Canada, Puerto Rico, Hawaii, Alaska, or APO/FPO delivery, shipping charges are three times continental U.S. rates.

**Mail orders to:** Communications Electronics, Box 1002, Ann Arbor, Michigan 48106 U.S.A. If you have a Visa or Master Card, you may call and place a credit card order. Order toll-free in the U.S. Dial 800-521-4414. In Canada, order toll-free by calling 800-265-4828. If you are outside the U.S. or in Michigan dial 313-973-8888. Telex anytime 810-223-2422. Order today.

Copyright © 1984 Communications Electronics™

Ad #050184



## Computer Products Division

818 Phoenix □ Box 1002 □ Ann Arbor, Michigan 48106 U.S.A.  
Call TOLL-FREE 800-521-4414 or outside U.S.A. 313-973-8888

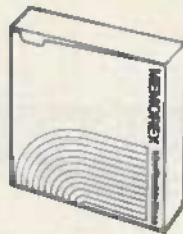

**Verbatim**  
diskettes for as low as  
**\$1.79 each**

**3M**  
diskettes for as low as  
**\$1.84 each**

**Memorex**  
diskettes for as low as  
**\$1.84 each**

**TDK**  
diskettes for as low as  
**\$2.09 each**

**Fuji**  
diskettes for as low as  
**\$2.99 each**

Verbatim Part #	CE quant. 100 price per disk (\$)	3M Part #	CE quant. 100 price per disk (\$)	Memorex Part #	CE quant. 100 price per disk (\$)	TDK Part #	CE quant. 100 price per disk (\$)	Fuji Part #	CE quant. 100 price per disk (\$)
_____	_____	85SS0	1.94	3082	1.94	F1-S	2.69	FD1S-128N	2.99
_____	_____	_____	_____	3015	1.94	_____	_____	_____	_____
_____	_____	8SSDD	2.39	3090	2.39	_____	_____	_____	_____
_____	_____	8DSDD	2.89	3102	2.89	F2D-S	3.29	FD20	4.59
_____	_____	_____	_____	_____	_____	_____	_____	_____	_____
_____	_____	8DSDD-1024	2.89	3104	2.89	F2D-S1024	3.29	FD2D-1024	4.59
_____	_____	_____	_____	_____	_____	_____	_____	_____	_____
28820	1.79	5SSDD-RH	1.84	3481	1.84	M1D-S	2.09	M01D	2.99
_____	_____	_____	_____	_____	_____	_____	_____	_____	_____
28821	2.54	5DSDD-RH	2.59	3491	2.59	M2D-S	2.84	MD2D	3.19
_____	_____	_____	_____	_____	_____	_____	_____	_____	_____
28823	3.44	5DSDD-96RH	3.49	3501	3.49	M2DX-S	3.89	MO2D-96TPI	4.49
_____	_____	_____	_____	8100	3.74	_____	_____	_____	_____

### Lifetime warranty

For more info on Verbatim call

**800-538-8589**

In California 408-245-4400

### Lifetime warranty

For more info on 3M call

**800-328-9438**

In Minnesota 612-736-9524

### 5 year warranty

For more info on Memorex call

**800-448-1422**

Monday-Friday 9am-4pm ET

### Lifetime warranty

For more info on TDK call

**800-645-6571**

In New York 516-625-0100

### Lifetime warranty

For more info on Fuji call

**800-223-6535**

In New York 212-736-3335

CIRCLE 35 ON FREE INFORMATION CARD



volts AC. Its DC and AC current ranges are 20 mA, 200 mA, and 10 amps. And its resistance ranges are 200, 2K, 20K, 200K, and 2 megohms. A low-power-ohms measurement mode is also offered, with ranges of 2K, 20K, 200K, and 2 megohms. In that mode, you can measure in-circuit resistances that are shunted by a silicon diode or other such junction device without turning on the junction. (The maximum open-circuit voltage is less than .4 volt in the LPR mode.)

Another good way to get an idea of the capabilities of the 3500 is to take a look at the face of the unit and its controls. A 10-mm, 3½-digit LCD readout dominates the top half the unit, while a large rotary switch (which lets you choose voltage, resistance, or one of three current ranges) dominates the bottom half. Three push-push switches are located beneath the display. The first lets you choose AC or DC modes (when measuring voltage or current) or normal or low-power ohms (when measuring resistance). The second button, RANGE SELECT, lets you choose the proper resistance or voltage range. (When first turned to the VOLT or OHM mode, the unit is in its auto mode until the RANGE SELECT button is pressed. The current ranges are chosen only with the rotary switch.) The third button, ZERO ADJUST, is used to zero the resistance reading when

the leads are shorted together. It can also be used in the voltage or current modes to make offset measurements (as long as the two least-significant digits are less than 19).

Three input jacks are centered at the bottom of the unit. The only time the leads have to be changed is when making current measurements in the 10-amp mode. All of the jacks are of the recessed safety type.

The accuracy specifications of the 3500 should suit the professional as well as the hobbyist. When measuring DC voltage, your measurements will be, at worst, accurate to within .75% of the reading  $\pm 1$  digit (when the meter is correctly calibrated). For AC voltage measurements, the worst-case specification is 1% of the reading,  $\pm 3$  digits (for signals between 40 and 500 Hz). In either resistance mode, you can expect your measurements to be accurate within 1.5%,  $\pm 1$  digit. The accuracy of the 3500 drops when measuring current: 1.7%  $\pm 1$  digit DC, 1.7%  $\pm 3$  digits AC.

If you plan to make in-circuit measurements with your multimeter, there are some additional specifications that you should look at. One of those is the input impedance, which is at least 10 megohms on all voltage ranges. When making current measurements, the voltage drop

across the instrument is, at worst, 2/10 volt. For in-circuit resistance measurements, the open-circuit voltage drop across the leads is important. That voltage is less than .4 volt in the low-power-ohms mode, and less than 1.5 volts in the high-power-ohms mode.

#### User features

The most "user-friendly" feature of the 3500 is its autorange capability. When making voltage or resistance measurements, there is no need to select a measurement range. However, you can, as we mentioned earlier, select ranges manually by depressing the RANGE SELECT button. When you do that, the AUTO annunciator will disappear from the display. As you step through the ranges, the decimal point on the display will change, as will the unit annunciator.

One advantage of using the manual range mode is that the meter's response time is improved for some measurements. For example, while the response time when making resistance or AC voltage measurements is 5 seconds (maximum) in the autorange mode, it is only 3 seconds (maximum) in the manual mode. The response time for DC voltage measurements is the same in either the auto or manual modes, about 3 seconds maximum. The maximum response time for current mea-

## High Quality. Low<sup>est</sup> Prices.



### MODEL DM-6500 AUTORANGING DMM

Priced at only

**\$75**

There's no sacrificing quality, even at this low price. And check out these features:

- Autoranging
- Shock Resistant
- Continuity Buzzer
- Fuse Protection
- Safety Construction

#### RANGES

DC Volts:  
200m/2/20/200/1000V  
AC Volts:  
2/20/200/600V  
AC/DC Current  
200 mA/10A  
Resistance:  
200/2k/20k/200k/2000k $\Omega$

### MODEL DM-6590 ELECTRO-PROBE™ DMM

Lowest price available!

**\$63<sup>75</sup>**

#### Including case

The hottest new instrument to hit the market. Contains features such as:

- Autoranging
- Data Hold Button
- Shock Resistant Housing
- Continuity Buzzer
- 200 hr. Battery Life

#### RANGES

AC/DC Volts: 2/20/200/500V  
Resistance: 2k/20k/200k/2000k $\Omega$

For more information on the DM-6500 and DM-6590 see your local distributor or contact A.W. Sperry Instruments Inc., P.O. Box 9300, Smithtown, N.Y. 11787. Phone: 800-645-5398 Toll-Free (N.Y., Hawaii, Alaska call collect 516-231-7050).



**A.W. SPERRY INSTRUMENTS INC.**  
**The Measurable Advantage.**

CIRCLE 17 ON FREE INFORMATION CARD

JUNE 1984

27

surements is about 3 seconds for DC and 5 seconds for AC current. (Remember, autorange capability is not available for current measurements.)

A useful "extra" feature of the 3500 is its audible tone. In the voltage or current modes the tone is used (along with a blinking initial "1" in the display) to indicate that the tester is overranged. In the resistance mode, the tone is used for a continuity indicator—it will sound when the two least-significant digits are less than 19 (in any range). Those of you who find those tones annoying will be happy to know that the feature can be turned off.

### Protection

No matter how careful you are, it's all too easy to put excessive voltage across the meter probes. For example (although no-one likes to admit it), almost everyone has at one time or another tried to measure a voltage with a multimeter that was in its resistance mode. That is, of course, why manufacturers design protection circuits into their meters. For voltage measurements, the 3500 is protected up to 1000-volts DC and 600-volts AC. In the resistance and current modes, the unit is protected up to 250 volts AC. As for other types of protection, its rugged plastic case

should protect it against rough handling.

The 3500 requires 2 "AA" cells—you can expect 300 hours of operation from two alkaline batteries. A low-battery indicator appears in the display when there are less than about 50-hours of operating life remaining.

Triplet		3500												
OVERALL PRICE														
EASE OF USE														
INSTRUCTION MANUAL														
PRICE/VALUE														
		1	2	3	4	5	6	7	8	9	10			
		Poor		Fair			Good			Excellent				

# Radio-Electronics

SPECIAL REPORT  
BUILT THIS ROBOT FOR UNDER \$400



BUILD THIS ROBOT FOR UNDER \$400

**AVAILABLE—COMPLETE for the FIRST TIME!**

## BUILD YOUR OWN ROBOT!

Send today for your 52-page (8½ x 11") booklet containing complete reprints of all eleven articles in the Build Your Own Robot series by Jim Gupton.

This all-inclusive reprint gives you all the data you need to build your own Robot.

■ TELLS EVERYTHING YOU NEED TO KNOW to build the Unicorn-1 Robot without the need for an engineering degree or special equipment. The robot is fully mobile with manipulator arms to grasp, lift and carry.

■ MANIPULATOR ARMS and end-effectors (hands) are what enable the robot to perform useful tasks. Details of construction techniques and considerations are fully explained.

■ MOBILITY BASE is not a lunar space station. It is the drive system that permits the robot to move from here to there. Full construction details along with a discussion of power sources is included.

■ THE BODY—FRAME AND ROTATION MECHANISM. This is the part that makes Unicorn-1 look like a robot. Wood and Formica are the materials for the body. Motors and gears are what make it function.

■ COMMUNICATIONS. How you can tell your robot what to do. Preprogramming techniques...radio control...computer control are all detailed.

■ SENSORS. How to add sensors so your robot doesn't bump into things.

The instruction manual that's supplied with the meter is adequate. It includes—along with a listing of specifications and instructions—a parts list, schematic, and a parts-placement diagram.

The 3500 has a suggested price of \$140, which is about what you'd expect to pay for an instrument with similar specifications. It comes equipped with two test probes with screw-on alligator clips. Other accessories are also available, including a temperature probe, two high-voltage probes (6 kV and 30 kV), a 20-amp external shunt, and a variety of carrying cases. You'll probably want to get one of the cases—the 3½ x 6 x 1½-inch unit is too large for a shirt pocket. R-E

### Beta Electronics Pro-Kit I PC-Board Fabrication Kit

*Using a stencil is the best way to make a group of printed-circuit boards that use the same circuit pattern.*



CIRCLE 102 ON FREE INFORMATION CARD

MOST OF THE CONSTRUCTION PROJECTS presented in the pages of Radio Electronics require the use of a printed-circuit board. Even when it's not mandatory, it's

### Radio-Electronics

Robot Reprints  
200 Park Ave. South  
New York, N.Y. 10003

I want to order \_\_\_\_\_ reprints @ \$12.00 plus \$1.00 postage and handling for U.S., Canada and Mexico.  
Add 9% sales tax for New York State residents only.  
U.S. Funds Only.

I want to order \_\_\_\_\_ reprints @ \$12.00 plus \$3.00 Air Postage and handling for all other countries.  
U.S. Funds Only.

Allow 6-8 weeks for delivery.

We do not bill, check must be enclosed.

Please print

(Name)

(Street address)

(City)

(State)

(Zip)

6-84

usually a good idea to use one—PC boards can reduce wiring errors and make troubleshooting easier. But if a prepared board isn't available, what do you do?

One solution might be to make your own, using a PC-board fabrication kit such as *Pro-Kit 1* from Beta Electronics (2081-A 3rd Street, Riverside, CA 92057). The kit is best suited for making more than one board at a time—once you've done one board, it's not much more work to do twenty more. That makes *Pro-Kit 1* well suited for club or school projects that require many boards of the same type. But because the results from *Pro-Kit 1* are close to professional quality, you could even use it in business applications.

### The process

*Pro-Kit 1* uses a screening method (the same method that's used professionally): you first make a stencil (photographically) of your PC-board layout and apply resist ink to a copper-clad board using the stencil—but it's not as easy as all that, as you'll see as we go through the process step by step.

Once you have your artwork completed, you'll need a right-reading emulsion positive which is used to expose the stencil material in the contact printer that's included with the kit. (The stencil material can be exposed in direct sunlight, or under a sun lamp.) After exposing the stencil material, you have to develop it, rinse it, and then place it on the screen.

	Beta Electronics	Pro-Kit 1
OVERALL PRICE	1 2 3 4 5 6 7 8 9 10	1 2 3 4 5 6 7 8 9 10
EASE OF USE	1 2 3 4 5 6 7 8 9 10	1 2 3 4 5 6 7 8 9 10
INSTRUCTION MANUAL	1 2 3 4 5 6 7 8 9 10	1 2 3 4 5 6 7 8 9 10
PRICE/VALUE	1 2 3 4 5 6 7 8 9 10	1 2 3 4 5 6 7 8 9 10
	Poor Fair Good Excellent	

After blotting up the excess water with newspaper, block-out is applied around the stencil material. That, when dry, will prevent the resist ink from flowing through the screen. (It helps to save ink and keeps the work area cleaner.)

When everything is dry (about 2 hours later), you can pull off the stencil material—but all that is removed is the plastic sheet—the emulsion stays on the screen in the area where you want the copper removed (and prevents the resist ink from being applied to the copper). The combination of the block-out and emulsion on the screen makes up the stencil.

Now that the stencil is all prepared, you place your copper-clad board under the screen and then pour resist ink on the screen and "pull" it over the stencil.

When the resist dries, you can etch the board. All that's left to do is to clean up.

### The advantage of screening

You might wonder what the advantage of the *Pro-Kit* method is. After all, you could have gotten the same results, with fewer steps by using a photo-resist method. But what if you wanted to make another board? If you used a photo-resist method, you'd have to expose another board and worry about the exposure times, rinsing, etc. And if you wanted to expose five more boards, you'd have to do the same thing five times more. With *Pro-*

*Kit 1*, all you'd have to do is to place another copper-clad board under the screen and "pull" some more ink over it—you no longer have to worry about exposure times. Beta claims that, with practice (a lot of practice, as far as you could tell), you should be able to get enough speed to print 75 or more of the same images in one setup. (If you let the screen sit too long, the ink will dry on the screen. But even if that happens, and you still want to print the image more, you can use lacquer thinner to clean off the ink without disturbing the stencil.)

*continued on page 40*

# Look for trouble ...and find it.

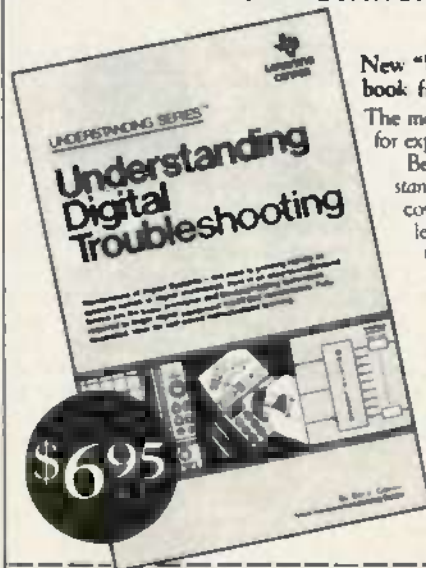

### New "Understanding Digital Troubleshooting" book from TI.

The move is on to digital circuits, increasing the need for expert maintenance and repair troubleshooting. Before trouble finds you, get the new TI Understanding Series Digital Troubleshooting book. The book covers basic concepts and operating principles and leads you through to accurate troubleshooting techniques.

This 264 page book is filled with the latest information, clear illustrations and self-help tests. It's everything you need to find trouble in digital systems.

Order your copy today.

## TEXAS INSTRUMENTS

Creating useful products and services for you.

Please send me:	Quantity	Price
<b>Understanding Series™ Titles:</b>		
<input type="checkbox"/> Understanding Digital Troubleshooting—(LCB0036)	_____	@ \$6.95
<input type="checkbox"/> Understanding Solid-State Electronics—3rd edition (LCB3361)	_____	@ \$6.95
<input type="checkbox"/> Understanding Digital Electronics—(LCB3311)	_____	@ \$6.95
<input type="checkbox"/> Understanding Microprocessors—(LCB4023)	_____	@ \$6.95
<input type="checkbox"/> Understanding Calculator Math—(LCB3321)	_____	@ \$6.95
<input type="checkbox"/> Understanding Communications Systems—(LCB4521)	_____	@ \$6.95
<input type="checkbox"/> Understanding Computer Science—(LCB471)	_____	@ \$6.95
<input type="checkbox"/> Understanding Optics—(LCB472)	_____	@ \$6.95
<input type="checkbox"/> Understanding Automotive Electronics—(LCB5771)	_____	@ \$6.95
<input type="checkbox"/> Understanding Electronic Security Systems—(LCB7201)	_____	@ \$6.95
<input type="checkbox"/> Understanding Electronic Control of Energy Systems—(LCB6642)	_____	@ \$6.95
<input type="checkbox"/> Understanding Telephone Electronics—(LCB7141)	_____	@ \$6.95
<input type="checkbox"/> Understanding Electronic Control of Automation Systems—(LCB6641)	_____	@ \$6.95
<b>Self Study Courses:</b>		
<input type="checkbox"/> AC Audio (LCB6651)/AC Text (LCW8168)	_____	@ \$24.95
<input type="checkbox"/> DC Audio (LCB5922)/DC Text (LCW8161)	_____	@ \$24.95
<input type="checkbox"/> Learning Center Library Catalog (CM-708L)	_____	Free

Mail to:

Texas Instruments  
P.O. Box 3640, M/S 54  
Dallas, Texas 75285

Add \$1.25 per book for postage and handling. Prices subject to change without notice.

Enclose check or money order with sales tax (except AK, DE, NH, OR). Foreign orders must be in U.S. dollars and include shipping charges. No phone orders, please.

Name \_\_\_\_\_

Address \_\_\_\_\_

City \_\_\_\_\_

State \_\_\_\_\_

Zip \_\_\_\_\_

72336 © 1984 TI

RE684

## CALL NOW AND RESERVE YOUR SPACE

- 6 x rate \$605 per each insertion.
- Reaches 235,323 readers.
- Fast reader service cycle.
- Short lead time for the placement of ads.
- We typeset and layout the ad at no additional charge.

Call 212-777-6400 to reserve space. Ask for Arline Fishman. Limited number of pages available. Mail materials to: mini-ADS, RADIO-ELECTRONICS, 200 Park Ave. South, New York, NY 10003.



**MAE-3, YAGI MICROWAVE ANTENNA** — High quality up to 60 dB gain 1.9-2.5 GHz-50 mile range possible clear TV picture, pre assembled probe with down converter, 1.9-2.5GHz, power supply and RF amplifier, 1.9-2.5GHz, 30dB gain, with co-ax cable included. All mounting hardware, for fast and easy installation. Special \$89.95. Available by phone or mail order only. Check or money order. 5% Shipping and Handling on all orders. **KASHIWAGI ELECTRONICS CORP.**, 3555 So. Highland Suite 14 Las Vegas, Nevada 89103. 702-367-1241.

CIRCLE 63 ON FREE INFORMATION CARD



Introducing a Stereo Synthesizer with the performance and features enthusiasts demand. Unique circuitry produces a dramatic stereo effect from mono sources while enhancing depth and definition. Usable with TV's, VTRs, or in broadcast, studio, or live situations. Order 3 ways: Assembled w/case \$199.95; Kit w/case \$149.95; Board only \$39.95. Includes extensive literature package, warranty, and MONEY-BACK GUARANTEE. Checks, MC VISA. Free kit catalogue. **RODCAR Electronic Sales**; 9983 Monroe Dr., Dallas, TX 75220; 214-351-9895.

CIRCLE 74 ON FREE INFORMATION CARD



**SUBSCRIPTION TV MANUAL.** This information packed book details the methods used by subscription TV companies to scramble and descramble video signals. Covers the Sinewave, Gated Pulse, SSAVI system, and the methods used by most cable companies. Includes circuit schematics, theory, and trouble shooting hints. Only \$12.95 plus \$1.50 first class P&H. Info \$2.00, refundable. **RANDOM ACCESS**, Box 41770-R, Phoenix, AZ 85080.

CIRCLE 31 ON FREE INFORMATION CARD

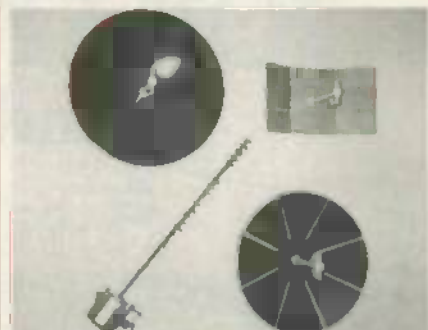

Bring in those hard to get channels with these low priced amateur microwave T.V. receivers. New wide band multi channel reception in the 2.1-2.9 GHz range. 100% legal for ITFS channels. We stock all types. Complete systems from \$43.95 in quantity. Every item fully guaranteed. Free shipping. Phone or mail order only. C D O's accepted. **H.M.R. Sales**, 221 East Camelback, Suite 1, Phoenix, Arizona 85012. Phone 602-993-0398.

CIRCLE 38 ON FREE INFORMATION CARD



**SATELLITE CONTROL CABLE—NEMAL ELECTRONICS** has designed a new series of combination cables for TVRO installations. These cables provide all necessary wires for signal, motor and receiver power and sense circuits together in one direct burial jacket. **TYPE-1** RG-59 + 9 conductor (2-18gu) \$495/1000', **TYPE-2** RG-59 + 11 conductor (2-12gu) \$689/1000', **TYPE-3** dual RG-59 + 11 conductor (2-12gu) \$879/1000', all made with milspec RG59, 96% copper shield, tinned drain wires. Over 500 types of cable, connectors. **SMATV** products in stock. Authorized distributor **Kings-Amphenol-Columbia**. **NEMAL ELECTRONICS Inc.**, 12240 N.E. 14th Ave., N. Miami, FL 33161 (305) 893-3924.

CIRCLE 84 ON FREE INFORMATION CARD



**THE High Performance Kit Company!** Quality components and SOTA designs make these audio kits superior performers. Reviewed in **AUDIO, SILE SOUND**, **THE AUDIO AMATEUR**, and cover of **POPULAR ELECTRONICS**. A partial list of audio kits include: Parametric Equalizer, Analog Delay/Ambience Extractor, Tape Noise Reduction, Moving Magnet, and Moving Coil Phono Preamps. Call or write for literature with full specifications. **PHOENIX SYSTEMS, INC.-RE2**, PO BOX 628, Manchester, Ct. 06040, (203) 643-4484.

CIRCLE 82 ON FREE INFORMATION CARD



**MINIATURE 1/4W 5% CARBON FILM RESISTORS** offer superior overall performance characteristics compared to carbon composition resistors - at significant cost savings! EIA color coding. 1 ohm thru 10 megohm. \$3.75 per hundred per value. Mastercard, Visa, American Express, accepted. Please add \$2.00 for shipping. California residents add 6% Sales Tax. No C.O.D. **ACORN INDUSTRIAL ELECTRONICS P.O. Box 10846**, SANTA ANA Ca. 92711. 1300-D E. Edinger Ave., Santa Ana, Ca. 92705. (714) 547-8424.

CIRCLE 46 ON FREE INFORMATION CARD



**SHEET METAL WORKER—The 24" TRIOK** is a Press Brake, Shear and Slip-roll machine-perfect for research and development or maintenance shops. Over a thousand machines world wide in little to the largest companies. For free literature on this and our other sheet metal working machines contact **PACIFIC ONE CORPORATION**, 513 Superior Ave. Suite K408, Newport Beach, CA 92663, (714) 645-5962.

CIRCLE 14 ON FREE INFORMATION CARD



**ONE MAN CRT FACTORY**, easy operation. Process new or rebuild old CRT's for TV's, bus. machines, monitors, scopes, etc. Color, b&w, 20mm, foreign or domestic. 3x6 ft. space required. Profits?? Average CRT rebuilding cost — \$5. Sell for \$100 = \$95 profit; x 5 CRT's = \$475 daily; x 5 days = \$2375 weekly profit. Higher profits outside U.S.A. Investigate this opportunity today. We service the entire world. Write or call: **CRT Factory, 1909 Louise St., Crystal Lake, Il. 60014, (815) 459-0666.**  
**CIRCLE 89 ON FREE INFORMATION CARD**

## CALL NOW AND RESERVE YOUR SPACE

- 6 x rate \$605 per each insertion.
- Reaches 235,323 readers.
- Fast reader service cycle.
- Short lead time for the placement of ads.
- We typeset and layout the ad at no additional charge.

Call 212-777-6400 to reserve space. Ask for Arline Fishman. Limited number of pages available. Mail materials to: mini-ADS, RADIO-ELECTRONICS, 200 Park Ave. South, New York, NY 10003.



**FREE 1984 ELECTRONIC TOOL & INSTRUMENT CATALOG** is packed with over 5,000 quality technical products for assembling, testing and repairing electronic equipment. All products fully illustrated with photographs, detailed descriptions and pricing to allow for easy ordering by phone or mail. Most orders are shipped within 24 hours. 100% satisfaction guarantee. **CONTACT EAST, 7 Cypress Drive, Burlington, MA 01803. (617)272-5051.**

**CIRCLE 50 ON FREE INFORMATION CARD**

# NEW PRODUCTS

For more details use the free information card inside the back cover

**SCANNER**, the Bearcat model *CP 2100*, is the first scanner radio designed as a peripheral for today's personal computers; it is available in versions that are compatible with the IBM PC, Atari 800, Apple II and IIe, Osborne, and Commodore 64 personal computers.

The model *CP 2100* can monitor police and

fire calls, emergency transmissions, Coast Guard rescues, aircraft communications, and amateur-radio transmissions in the 10, 6, 2 and .7 (70cm) meter bands. Each of its 200 channels can be programmed to display the source and location of a transmission, 10-codes, and phone numbers. Whenever a broadcast is monitored, the information pro-



**CIRCLE 121 ON FREE INFORMATION CARD**

grammed into the channel will automatically appear on the screen.

The Bearcat *CP-2100's* basic package includes the radio, AC adaptor, plus a special telescoping whip antenna with a 20' coaxial cable and mating BNC connectors. Custom 5¼-inch program diskette, custom interface cable, and manual are packaged separately

for compatibility with different models of computers. Software can be user-modified to suit individual needs.

The Bearcat model *CP 2100*, including both hardware and software packages, has a suggested list price of \$499.95.—**Electra Company, 300 County Line Road, Cumberland, IN 46229.**

**OSCILLATOR**, model 4400A, has a 3-digit frequency selector that eliminates any need for a frequency counter for most applications. It covers a frequency range from 1Hz to 100kHz.



**CIRCLE 122 ON FREE INFORMATION CARD**

The nearly distortion-free sinewave (.001%) provides a source for measuring the distortion of audio-preamplifiers, power amplifiers, communications systems, etc. It also provides a 7-volt RMS output with a 3-position pushbutton attenuator, calibrated in 20-dB steps, along with a 30-dB vernier, giving a total dynamic range of 90 dB. The model 4400A is priced at \$695.00.—**Krohn-Hite Corporation, Avon Industrial Park, Bodwell St., Avon, MA 02322.**

**CORDLESS PHONES**, model *FCT-246*, model *FCT-266*, and model *FCT-346* (shown in photo) all feature circuitry that provides se-

curity against unauthorized use, and eliminates interference and false ringing. The three models also feature selectable guard-tone frequencies and a handset that operates at the maximum range allowed by the Federal Communications Commission: up to 1500 feet.

The model *FCT-246* features a 3-position sentry switch, touch-button dialing, fast-number redial, and paging from the base to the handset. It is priced at \$129.95.

The model *FCT-266* adds selectable pulse or tone dialing to provide access to long-distance networks, such as MCI, SPRINT, etc. It is priced at \$149.95.

The model *FCT-346* features continuous-monitor digital-security coding to guard



CIRCLE 123 ON FREE INFORMATION CARD

against unauthorized use and false ringing, and a range selector for choosing normal or extended range. Pulse or tone dialing allows for access to long-distance networks, and two-way intercom between the cordless handset, and a conventional handset plugged into the base is featured.—**Fanon**, 15300 San Fernando Mission Blvd., Mission Hills, CA 91345.

**LCR BRIDGES**, model 4225 (shown) and model 4210 are second-generation models claimed to be great improvements over earlier bridges.

The model 4225 is a portable micro-processor-controlled, AC-powered component bridge with automatic or manual component-display selection, and three operating frequencies. With a basic accuracy of 0.25% over a wide component-value range, it is capable of displaying D and Q values for reactive components. It uses a touch-sensitive keypad, is operated in four-terminal mode

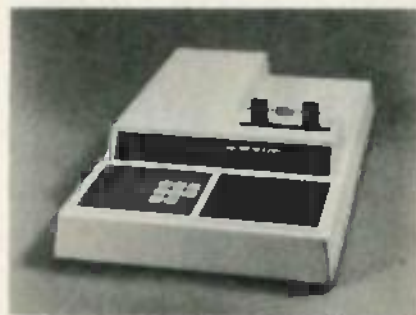

CIRCLE 124 ON FREE INFORMATION CARD

from a built-in test fixture, and is capable of single-shot or continuous measurements. The model 4225 carries a suggested list price of \$1195.00.

The model 4210 offers accuracy of 0.10% and numerous options; it shares the features of the model 4225. The most important option is the complete systems capability through the RS-232 output and the IEEE-488 bus. Complete remote command and data transfer allows the instrument to play a key data-acquisition role in automated parts handling, component evaluation, and other applications requiring program control of a high-accuracy bridge. The model 4210 is priced at \$1995.00.—**Wayne Kerr, Inc.**, 400 West Cummings Park, Woburn, MA 01801.

**CONTACT BURNISHERS**, the P-4 and P-6 are pocket-pen type burnisher/cleaners for the communications, telephone, and electronics industries. They are designed for all-type contacts: silver, platinum, gold, palladium, tungsten, molybdenum, and all other precious-metal contacts. The burnishers are light, and the flexibility of the blades can be adjusted by varying its depth in chuck.

The burnishers are non-residual, leaving no grit or dust on the contact. Their insulated caps permit working on "live" contacts. They have interchangeable blades made of stainless steel, with an abrasive coating of aluminum oxide that insures minimum contact wear.

The burnishers are 5½ inches in length, ¾-inch in diameter, and are available in two types. The P-6 pen has 12 blades 3.16-inches wide, 1¼ inches long, and .007 inch thick for

## AN INNOVATIVE 20 MHz OSCILLOSCOPE THAT EMPHASIZES OPERABILITY \$535\*

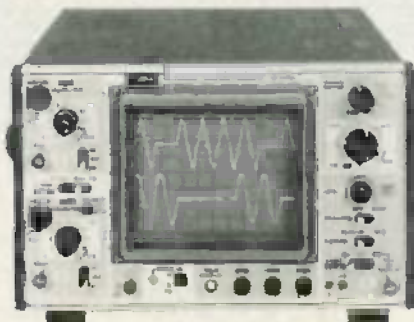

### IWATSU SS-5702 DC-20 MHz OSCILLOSCOPE

- 6-inch rectangular, parallax-free CRT
- TV-V trigger
- Variable sweep length
- Double Lissajous figure
- 1 mV/div to 10 V/div sensitivity
- 100 ns/div to 0.2 s/div sweep
- Differential input with ADD mode

\*User price, including probes.



The Professional Test Equipment Source

**The Instrument Mart**

295 Community Drive, Great Neck, New York 11021  
(516) 487-7430 Outside N.Y. (800) 645-6535

Sales, Service, Rental/Leasing Programs  
... and Pre-Owned Test Equipment also Available



CIRCLE 28 ON FREE INFORMATION CARD





line contacts and relays. The P-4 pen also has 12 blades, and is 1/4-inch wide, 1 1/4 inches long, and .007 inch thick for industrial con-

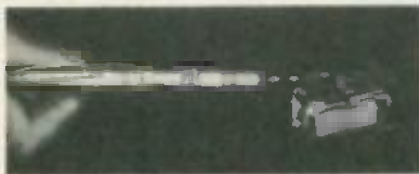

CIRCLE 125 ON FREE INFORMATION CARD

tacts and relays. Both are priced at \$5.70 each.—Jonard Industries Corp., Precision Tools Division, 134 Marbledale Road, Tuckahoe, NY 10707.

**MICROPHONE**, model PZM-180, is a general-purpose microphone suitable for applications such as conferences, interviews, group



CIRCLE 126 ON FREE INFORMATION CARD

discussions, home-video productions, broadcast news and sports, and music recordings. It uses the "Pressure Recording Process," in which a miniature condenser-microphone capsule is arranged very close to a sound-reflecting plate or boundary. The capsule is mounted in the "pressure zone" just above the boundary—a region where sound coming directly from the sound source combines in-phase with sound reflected off the boundary. That eliminates phase interference between direct and reflected waves, resulting in cleaner reproduction.

An integral handle allows the microphone to be hand-held, stand-mounted, or simply laid on any hard surface.

The model PZM-180 can be phantom-powered or battery-powered; it requires no external power-supply interface. It is supplied with a battery for powering and a windscreens to reduce pickup of wind noise and breath "pops." Self-contained electronics adapt the unit for phantom powering, and connecting the microphone to a phantom-power supply disconnects the internal battery.

The suggested retail price of the model PZM-180 is \$169.00.—Crown International, 1718 W. Mishawaka Road, Elkhart, IN 46517.

**MULTIMETER**, the B&K-Precision model 2804, is a 3-1/2-digit auto/manual, handheld digital multimeter featuring 0.7% DC accuracy; diode test; audible-continuity check, and 10-amp current range.

DC voltage ranges are 200 mV, 2000 mV, 20 V, 200 V, and 1000 V. AC voltage ranges are 2000 mV, 20 V, 200 V, and 750 V. Input

impedance is 10 megohms. Resistance ranges are 200 ohms, 2000 ohms, 20 Kilohms, 200 Kilohms, 2000 Kilohms and 20 megohms. DC and AC current ranges are 200 mA and 10A.



CIRCLE 127 ON FREE INFORMATION CARD

The diode test measures the forward voltage drop of a semiconductor junction at 0.6 mA; continuity checks are done through audible tones. The model 2804 is priced at \$60.00; that price includes test leads, spare fuse, two AA batteries, and an instruction manual.—B&K-Precision Dynascan Corporation, 6460 West Cortland Street, Chicago, IL 60635. R-E

**SURPLUS BARGAINS**

**G.E. "Terminet 1200" featuring:**  
110, 300, & 1200 Baud (11, 30 & 120 cps), full KSR & RS-232-C I/O, compact table-top configuration upper & lower case continuous band, made in USA by General Electric, tested and operational.

**CRT Terminals** Built by a major OEM, these terminals include 3 microprocessor boards (Interface, CPU & CRT) plus composite video & switching power supply 48K or roms, "Ergonomic" design and more. Experimenter special, includes Data Keyboard, RS-232 I/O plus much more. Seems to be quite powerful.

**Parallel, TTL Input I/O "Selectric" TYPEWRITER/PRINTER** These machines have built-in driver and decoder circuitry and take TTL levels. 6-bit character, plus a 4-bit function input signals. Easily driven by most any micro. Use as a typewriter (with add'l "repeat" circuitry) or as a KSR I/O printer or both. "Table Top" style case.

**9" Composite Video Input CRT Monitor** Requires approx. 12 VDC @ 1-2A VDC in attractive case. With schematics.

**Shugart SA-400 "Mini-Floppy" Drives** Model SA-400, used, whole, untested, less power supply & case. Data and schematics included. Removed from Equipment.

Circle 125 on Free Information Card

Only!!  
\$349.<sup>00</sup>  
Plus Shipping  
120 CPS!  
RS-232

Only!!  
\$289.<sup>00</sup>  
Plus Shipping

Only!!  
\$329.<sup>00</sup>  
Plus Shipping  
TESTED AND OPERATIONAL!

Only!!  
\$89.<sup>00</sup>  
Plus Shipping

Only!!  
\$119.<sup>00</sup>  
Plus Shipping

Computer Products & Peripherals Unlimited

WAREHOUSE 18 Granite St. Haverhill, Mass. 01830  
MAIL ORDERS: Box 204 Newton, New Hampshire 03858  
617/372-8637  
Sorry No Collect Calls  
MasterCard & VISA Accepted

**THE SA-7 DESOLDER STATION**

- Self-contained vacuum pump—No shop air required.
- Pistol grip iron for easy handling.
- Temperature controlled heater.
- Heavy duty suction with newly designed cylinder pump.
- Long life 30W ceramic heating element.
- Replacement tips available.
- Straight flow through design.
- Simple filter replacement.

The lightweight pistol grip shaped desolder iron allows for maximum comfort and board accessibility while desoldering. Powerful self-contained cylinder vacuum pump is built for long life industrial performance and yet requires no shop air. The straight flow-through design prevents clogging, and the see-thru solder collector is easy to clean and replace. The unit also features a built in tip cleaning rod stored conveniently in the handle. The SA-7 series offers a compact size styling, accessible tool holder and simple trigger actuated operation. Some of the key design and IC controlled ceramic heater allows adjustment of tip temperature for widest variety of desoldering applications. These desolder systems are designed to meet the most rigorous production desoldering applications including research, manufacturing, repair, etc.

**DAVLE TECH INC**  
ELECTRONIC TOOLS & ACCESSORIES

2-05 BANTA PLACE  
FAIRLAWN, NJ, 07410  
TEL: 201-796-1720  
TELE: 968771

JUNE 1984

# If you have put off learning more electronics for any of these reasons, act now!

- I don't have the time.*
- High school was hard for me and electronics sounds like it may be hard to learn.*
- I can't afford any more education.*
- I have a family now.*
- I'm here. You're there. I've never learned that way before. I'm not sure it will work for me.*

**Read the opposite page and see how you can get started today!**

**Be honest with yourself. Are the reasons really excuses? You already know enough about electronics to be interested in reading this magazine. So why not learn more? If you need encouragement, read on and see how excuses can be turned into results.**

**You don't have the time.**

Be realistic. All you have in life is a period of time. Use it. Try to know more tomorrow than you do today. That's the proven way to success.

**Electronics sounds like it may be hard to learn.**

You already know something about electronics or you wouldn't be reading this. Now, build on that. CIE Auto-Programmed® Lessons help you learn. Topics are presented in simple, logical sequence. All text is clear and concise for quick, easy understanding. You learn step by step, at your own pace. No classes to attend. Nobody pressures you. You *can* learn.

**You can't afford any more education.**

Actually, you can't afford NOT to gain the skills that can put you ahead of the others. It makes sense to invest in yourself through education — learning a skill. If you are not able to pay full tuition now, convenient monthly payments can be arranged.

**You have a family now.**

All the more reason why you have the responsibility to advance yourself. For the sake of your family. Do you want them to have what you had or have *more* than you had? The choice is yours. Electronics is a rewarding career choice. CIE can help you to get started on that career.

**You're there. We're here. How does CIE help you learn?**

First, we *want* you to succeed. You may study at home, but you are not alone. When you have a question about a lesson, a postage stamp gets you your answer fast. You may find this even better than having a classroom teacher. CIE understands people need to learn at their own pace. When CIE receives your completed lesson before noon, it will be graded and mailed back to you the same day with appropriate instructional help. Your satisfaction with your progress comes by return mail. That's how CIE helps you learn.

**NOW, IF YOU AGREE CIE TRAINING CAN WORK FOR YOU, HOW ELSE CAN CIE HELP YOU?**

CIE is one of the largest independent home study schools in the world that specializes in electronics. Although "big" does not always mean "best," it is evidence that CIE is a strong, successful institution with the people and resources to help you succeed.



**Step-by-step learning includes "hands-on" training.**

The kind of professional you want to be needs more than theory. That's why some of our courses include the Personal Training Laboratory, which helps you put lesson theory into actual practice. Other courses train you to use tools of the trade such as a 10MHz, solid-state, triggered-sweep oscilloscope. Or a Digital Learning Laboratory to let you apply the digital theory that's essential today for anyone who



wants to keep pace with electronics in the eighties. Or a Microprocessor Training Laboratory you learn to program and interface with displays, memories, switches, and more.

**Your credentials can impress employers.**

One of the best credentials you can have in electronics — or any other career field — is a college degree. That's why CIE gives you the opportunity to earn an Associate in Applied Science in Electronics Engineering Technology. Any CIE career course can offer you credit toward the degree...more than half the number needed in some cases.

You can also prepare for the government-administered FCC (Federal Communications Commission) Radiotelephone License, General Class. It can be a real mark in your favor...government-certified proof of your specific knowledge and skills.

**Find out more! Today. Now.**

There's a card with this ad. Fill it in and return. If some other ambitious person has already removed it, use the coupon.

You'll get a copy of CIE's free school catalog, along with a complete package of personal home study information.

For your convenience, we'll try to arrange for a CIE representative to contact you to answer any questions you may have.

If you are serious about a rewarding career, about learning electronics or building on your present skills, your best bet is to go with the electronics specialists — CIE. Mail the card or coupon today or write CIE (please mention the name and date of this magazine), 1776 East 17th Street, Cleveland, Ohio 44114.

This could be the best decision you've made all year.

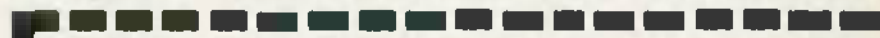

**CIE** Cleveland Institute of Electronics, Inc.  
1776 East 17th Street, Cleveland, Ohio 44114

Accredited Member National Home Study Council

YES...I want to learn from the specialists in electronics — CIE. Send me my FREE CIE school catalog...including details about the Associate Degree program... plus my FREE package of home study information.

Print Name \_\_\_\_\_

Address \_\_\_\_\_ Apt. \_\_\_\_\_

City \_\_\_\_\_ State \_\_\_\_\_ Zip \_\_\_\_\_

Age \_\_\_\_\_ Area Code/Phone No. \_\_\_\_\_ / \_\_\_\_\_

Check box for G.I. Bill bulletin on Educational Benefits:  Veteran  Active Duty

**MAIL TODAY!**

RE-86

# RCA Salute to SPRING

**FREE**  
**Nipper**  
**Baseball**  
**Cap...**



... with purchase of 35 fast moving  
RCA SK Replacement Semiconductors.

Let's play ball! When you purchase 35 of RCA's fastest moving SK replacement semiconductors, we'll give you a deluxe corduroy baseball cap (adjustable to fit your size) absolutely FREE.

All you have to do is see your participating RCA SK Distributor and purchase the SKCAP 84 Kit and receive the FREE Nipper baseball cap. Packed with the cap are eight hard-hitting SK cartons containing:

QTY	Stock Number
6	SK3444/123A
6	SK3466/1097
5	SK3100/519
4	SK3051/156
4	SK3024/128
4	SK3025/129
3	SK3854/123AP
3	SK3054/196



**RCA**  
SK Replacement  
Solid State

See your participating RCA SK Distributor, and score big with RCA's reliable solid state replacements.  
RCA Distributor and Special Products Division, Deptford, NJ 08096

# NEW IDEAS

## Turn-signal alarm

HOW OFTEN HAVE YOU FOLLOWED THE CAR in front of you and noticed that its turning signal was flashing without purpose. Perhaps you, too, have left your turning signal on by mistake. The clicking sound of the interrupter in many cars is almost inaudible; therefore, it's difficult to know whether the signal cut-off has taken effect. At other times steering turns are so gradual that the cancellation switch fails to do its job. A brute-force solution to making the interrupter more noticeable is to connect a buzzer between the two terminals of the turn flasher relay (located under the dashboard). However, that may prove annoying to the occupants of the car—making the cure worse than the "disease."

A more practical way of dealing with the problem would be to provide a tone circuit with a reasonable delay so that the tone signal is activated only after the turn signal is left on for an excessively long time. That's the approach taken by the circuit described in here. If you've been having a problem with leaving your turning signal on, perhaps this circuit will interest you.

### How it works

Figure 1 shows a circuit that can be used to tell the driver of a vehicle when his or her turning signal is left on for too long. The circuit consists of IC1, a 555 timer; transistor Q1, an MPS3702 PNP preamp/driver; PBI, a piezoelectric buzzer (such as Radio Shack's 273-065); along with an assortment of resistors, capacitors, and diodes. The 555 is connected in the monostable mode, requiring only a momentary negative pulse at pin 2 to trigger the timing cycle.

Power for the circuit is picked off the flasher relay and applied to IC1, pin 8, through diode D1. The negative pulse is provided by an initially discharged capacitor C2. After the initial triggering, the voltage across C2 rises as it becomes charged through R4, a 10,000-ohm resistor. That prevents subsequent interference with the delay function due to false triggering.

Capacitor C3 and resistor R1 determine the delay. With the component values shown, a delay of about one minute will be provided before the intermittent tweet sound generated by the circuit begins. If

higher values are used for C2 and R1, a longer delay time will result. The light-emitting diode, LED1, provides a voltage drop to assure complete transistor blocking during the off periods of the flasher. Alternatively, two diodes in series can be used.—Walter K. MacAdam

### NEW IDEAS

This column is devoted to new ideas, circuits, device applications, construction techniques, helpful hints, etc.

All published entries, upon publication, will earn \$25. In addition, for U.S. residents only, Panavise will donate their model 333—The Rapid Assembly Circuit Board Holder, having a retail price of \$39.95. It features an eight-position rotating adjustment, indexing at 45-degree increments, and six positive lock positions in the vertical plane, giving you a full ten-inch height adjustment for comfortable working.



I agree to the above terms, and grant Radio-Electronics Magazine the right to publish my idea and to subsequently republish my idea in collections or compilations of reprints of similar articles. I declare that the attached idea is my own original material and that its publication does not violate any other copyright. I also declare that this material has not been previously published.

Title of Idea

Signature

Print Name

Date

Street

City

State

Zip

Mail your idea along with this coupon to: New Ideas Radio-Electronics, 200 Park Ave. South, New York, NY 10003

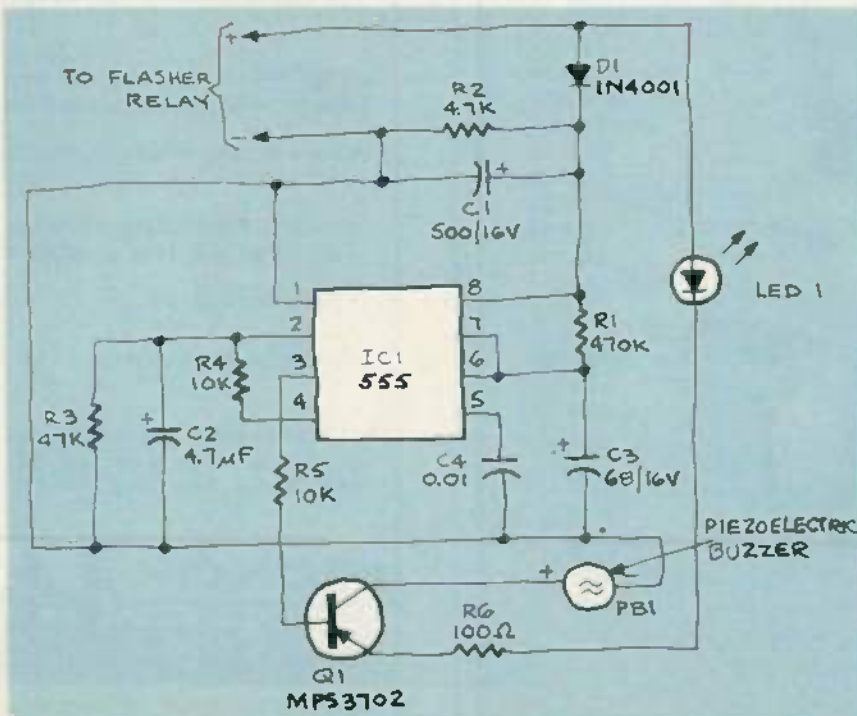

FIG. 1

## EQUIPMENT REPORTS

continued from page 30

Another advantage of the screening method is that it can be used for things other than applying resist ink to copper-clad boards. For example, you can (using the appropriate ink) print component legends on PC boards, or the legends on the front panel of your next project, or use it to print the PC-board solder mask. And you can use it for non-electronics hobbies too. For example you can print posters or de-

signs on fabric (but you'll probably need a vacuum-frame contact printer for best results).

Of course, there are some disadvantages to this method as well. It can be very messy, and it takes quite a lot of practice to get consistently good results. That's why our rating chart shows only a "fair" mark for "Ease of Use." Of course there's no easy way to make PC boards—until you get the hang of things. The *Pro-Kir* takes a bit longer to learn than other methods, but it can do more as well.

Another disadvantage to the kit is that  
*continued on page 93*

## Electronic Troubleshooting

# WINNER



Hickok's MX333 with VARI-PITCH® and LOGI-TRAK®

Instantaneous VARI-PITCH speeds:

- Voltage tracing
- Troubleshooting in hard-to-reach locations
- Tuning type adjustments
- Resistance checks
- Digital logic troubleshooting

And . . . Detects signal characteristics and abnormalities not possible with digital or analog meters.

LOGI-TRAK replaces the best 100MHz logic probes and offers:

- Eyes on the probe tip, HI/LO indication
- Instant identification of marginal states and fault conditions
- 100MHz response
- 5n sec pulse detection

LISTEN to what the MX333 can do for you. Ask about our NO RISK 30 day Free Trial.

**HICKOK**  
the value innovator 

THE HICKOK ELECTRICAL INSTRUMENT CO.  
10514 Dupont Avenue • Cleveland, Ohio 44108  
(216) 541-8080

The Professionals' Choice

# PTS

## "I get all the modules I need in one stop . . ."

PTS makes my job easier with 'one stop shopping'. All the modules and tuners I need are available right behind the counter. I can get fast, 8 hour rebuilding, or I can make a quick exchange at over 1500 distributors throughout the country."

Try PTS rebuilt modules and tuners for:

- Fast 8 hour rebuilding service
- Full year limited warranty
- Availability at over 1500 authorized stocking distributors
- Quality rebuilds that meet or exceed original manufacturers' specs
- One stop shopping for all makes/all models

PTS CORPORATION  
P.O. Box 272  
Bloomington, IN 47402  
(812) 824-9331

For your free copy of the PTS Price and Technical Information Guide write:

CIRCLE 43 ON FREE INFORMATION CARD

CIRCLE 85 ON FREE INFORMATION CARD

# BUILD THIS

## Solid State BAROMETER

Measuring and charting the atmospheric pressure has long been recognized as an effective way to make weather forecasts. Now you can build this state-of-the-art barometer and make your own weather predictions.

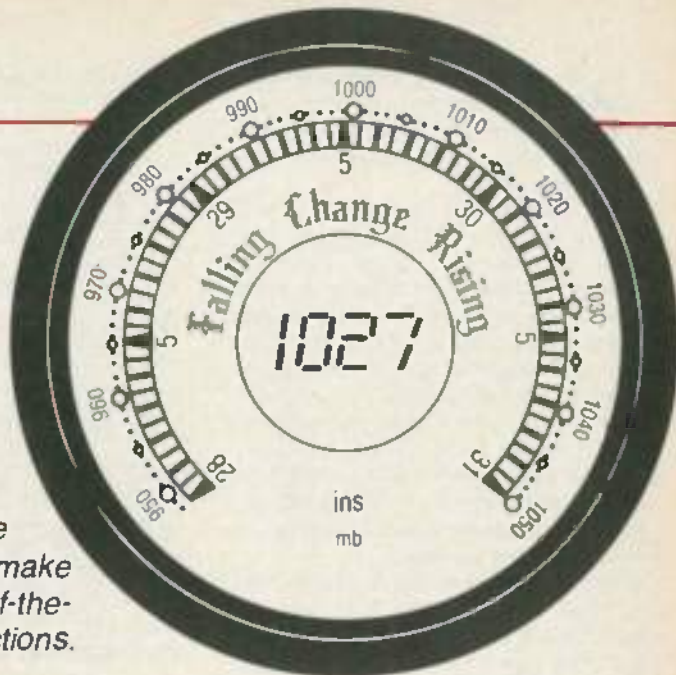

SUDHIR K. GUPTA

BEFORE WEATHER SATELLITES CAME INTO use, the barometer was perhaps the most useful instrument for providing information about future changes in the weather. Both mercury and aneroid barometers have long been used to measure the atmospheric pressure. But we're going to show you a new type of barometer—a barometer that uses a state-of-the-art solid-state pressure transducer and gives a digital readout of atmospheric pressure.

The barometer that we'll build can be thought of as being made up of four basic building blocks. As shown in Fig. 1, they include the pressure transducer, power supply, signal conditioner, and the measurement-and-display section. Let's look at each separately.

### The pressure transducer

A transducer is a device which transforms one form of energy to a different form of energy. In this barometer, we'll be using a pressure transducer that converts barometric pressure into electrical signals. The transducer is made by SenSym (1255 Reamwood Ave. Sunnyvale, CA 94809) and is shown in Fig. 2. It is an absolute-pressure device. That is, it measures pressure relative to a vacuum. (Another pressure-transducer type is the gage type, which measures pressure relative to ambient pressure.)

The transducer's sensing circuitry is deposited on a silicon chip that has a cavity etched out to form a diaphragm. On the top of the diaphragm (the "exposed" side) is the pressure-sensing circuitry. The other side of the diaphragm is a vacuum. Figure 3 shows the structure of the device along with the transducer's pinout and its schematic.

Changes in ambient pressure affect the deflection of the sensing diaphragm. The

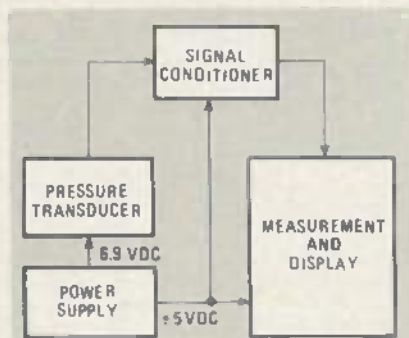

FIG. 1—THE SOLID-STATE BAROMETER can be thought of as being made up of four blocks of circuitry.



FIG. 2—THE LX0503A pressure transducer is ideal for barometric applications.

resistance of the piezoresistive elements changes as the pressure changes, and thus the output voltage changes. The voltage on pin 6 ( $V_1$ ) increases with an increase in pressure. The voltage on pin 5 ( $V_2$ ) decreases (or goes negative) with increasing

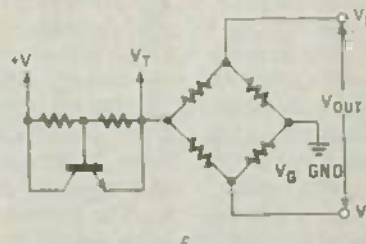
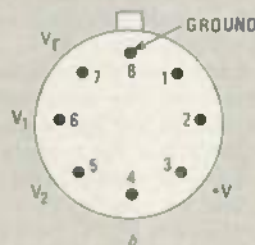
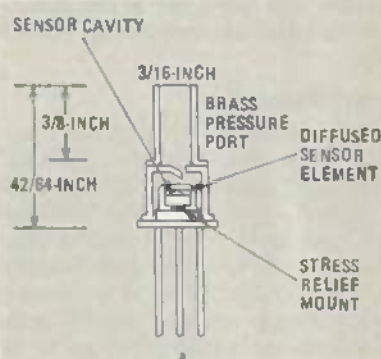

FIG. 3—THE STRUCTURE of the LX0503A is shown in a and its pinout is shown in b. The schematic of the device is shown in c. We will not use the  $V_r$  pin, which is normally used for temperature compensation.

pressure.

The signal-conditioner section is necessary to provide zero and offset corrections for the transducer output. The signal

from the transducer (about 40 millivolts) is amplified to about 1 volt. That corresponds to a display of 100 kilopascals (abbreviated kPa). We'll discuss that unit, and others, shortly.

We want the power-supply section to provide +5 volts DC for the signal-conditioning and measurement section as well as 6.9 volts DC for transducer excitation. Therefore we can use an AC adapter that provides 8–11 volts DC. Such adapters are readily available from many sources, including Radio Shack. The adapter's output is filtered and regulated by IC3, a 7805 5-volt regulator. A monolithic voltage converter, IC4 (an ICL7660 from Intersil) provides –5 volts DC. Finally, a Zener diode is used to provide 6.9 volts DC to the transducer.

The measurement-and-display section is based on a single-IC A/D converter from Intersil: their ICL7106. The author's prototype used Intersil's ICL7106 EV panel-meter evaluation kit for a display. It is capable of displaying 199.9 millivolts or 1.999 volts full-scale. In our application, the full-scale reading is set to 1.999 volts.

### Circuit description

Conventionally, the pressure transducer is powered by a 10–15-volt DC power supply, and a 6.9-volt Zener diode is shunted across the supply terminals (pins 3 and 8). That provides an excitation voltage of 6.9 volts DC. Unfortunately, when that is done, there is a common-mode voltage of about 1.8 volt DC at the signal-output terminals (pins 5 and 6). We do not want the small transducer output signal of 30–40 millivolts to ride on such a large common-mode signal.

To get around that problem, we can either use an expensive instrumentation amplifier with large common-mode rejection ratio (CMRR), or we can play a trick. That is, we can use a bipolar supply of  $\pm 5$  volts DC instead of a 10–15 volt DC supply. As shown in Fig. 4, we can connect pin 3 directly to +5 volts DC and we can connect pin 8 through a dropping resistor to –5 volts DC. (We can obtain the –5 volts from the ICL7660 that we discussed earlier; the power-supply schematic is shown in Fig. 5. The ICL7660, incidentally, is listed in this year's Radio Shack catalog.) A precision Zener reference across pins 3 and 8 regulates the voltage to 6.9 volts DC. That technique reduces the common-mode voltage to a mere 100 millivolts. Now it is feasible to use a conventional op-amp (like the LM324) as a differential amplifier.

One quarter of that quad op-amp (IC1-a) is used as a differential amplifier. It amplifies the input signal by a factor of about 22. We use IC1-b, another section of the LM324 quad op-amp to introduce the offset that will be required to calibrate the barometer. The signal is further ampli-

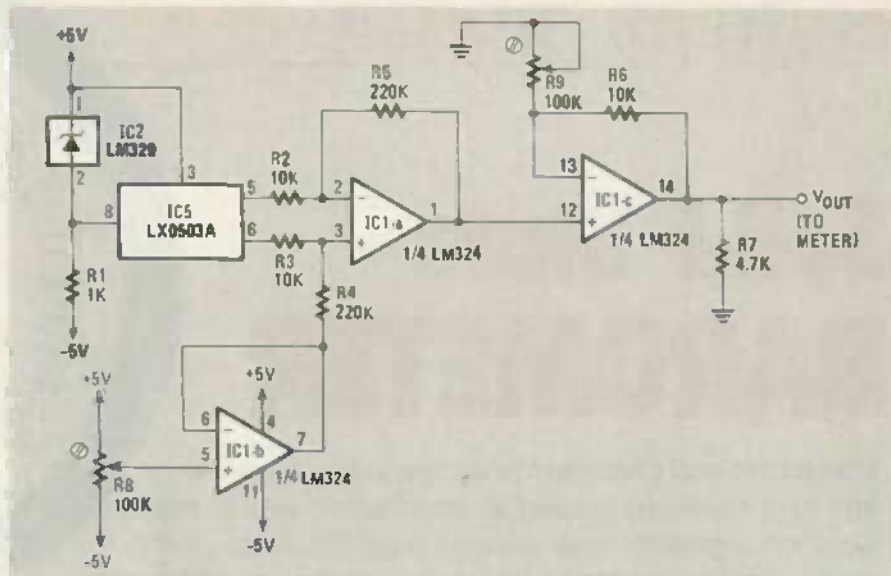

FIG. 4—A ZENER DIODE is used to regulate the transducer's input voltage to 6.9 volts.

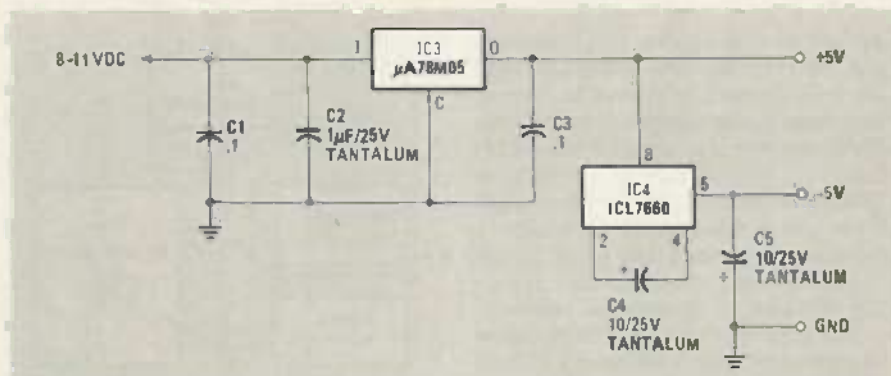

FIG. 5—THE POSITIVE 5-volt supply is easily converted to a bipolar supply by using the ICL7660 voltage converter.

fied by IC1-c to about 1 volt. That gives us a scaling factor of 10 millivolts per kilopascal.

### Scaling the display

Barometric pressure is expressed in a variety of units, including pounds-per-square-inch (psi), bars, millibars, pascals, inches of mercury, atmospheres, torr, etc. Table 1 is a conversion chart to help you convert from one unit to another. To use that chart, look across the top for the unit you want to convert from then look down the side for the unit you want to convert to. Multiply the units you have by the conversion factor indicated by the table, and your answer will be in the units you want.

Because we are using a 3½-digit display, the maximum resolution is obtained when the pressure is displayed in kilopascals (millibar/10) or millibars. A barometric scale of 95 kilopascal (28 inches of mercury) to 105 kilopascal (31 inches of mercury) more than covers the useful barometric pressure range. You may think that using the unit of pascal (a unit that you've probably never heard of) is not a

good idea. However, that's not necessarily so. The pascal is the standard unit for pressure or stress in the International System of Units (SI). ANSI (the American National Standards Institute) has adopted the pascal as its standard pressure unit. It is equal to one newton per square meter (N/m<sup>2</sup>). Weather reports often give barometric readings in millibars as well as in inches of mercury just as they give temperature readings in both Fahrenheit and Celsius. Conversion from kilopascals to millibars is simply a matter of multiplying by a factor of 10.

### Construction

The project is built in two parts: the transducer/power-supply board, and the display board. A suggested layout for a printed-circuit transducer board is shown in Fig. 6. A parts-placement diagram is shown in Fig. 7. However, it's not really necessary to use a PC board. It is just as well to use perforated construction board and point-to-point wiring. We do, however, recommend that you use IC sockets for all IC's.

As we mentioned before, the display



## PARTS LIST

All resistors 1/4 watt, 5% unless otherwise noted

R1—1000 ohms

R2,R3,R6—10,000 ohms

R4,R5—220,000 ohms

R7—4700 ohms

R8,R9—100,000 ohms, multiturn trimmer potentiometer

### Capacitors

C1,C3—0.1  $\mu$ F, ceramic disc.

C2—1  $\mu$ F, 25 volts, tantalum

C4,C5—10  $\mu$ F, 25 volts, tantalum

### Semiconductors

IC1—LM324 quad op-amp.

IC2—LM329 6.9-volt precision voltage reference

IC3— $\mu$ A78M05 5-volt regulator (Fairchild) or similar

IC4—ICL7660 voltage converter (Intersil)

IC5—LX0503A pressure transducer (SenSym)

**Miscellaneous:** IC sockets PC or perforated construction board, Intersil evaluation board ICL 7106 EV kit or any meter with a 2-volt range, AC adapter, 8–11 volts DC

section of the author's prototype is based upon an evaluation board from Intersil—their ICL 7106 EV kit. That was used as a dedicated display. If you want to avoid the expense of that kit (about \$35), you can use an ordinary digital voltmeter or even an analog meter with a full-scale range of 2 volts DC.

If you do use the Intersil evaluation board, follow the instructions that are supplied with it to set the full-scale display to 2.000 volts. Keep in mind that there is no need to use a battery to power the ICL 7106 EV—the transducer/power-supply board generates  $\pm 5$  volts that can be used for powering the display board. Connect +5 volts to the v+ input on the evaluation board and -5 volts to the v- input. We should note here that the current drain from the +5-volt supply should be limited to a few milliamps. Otherwise, degradation of -5-volt supply will result. You

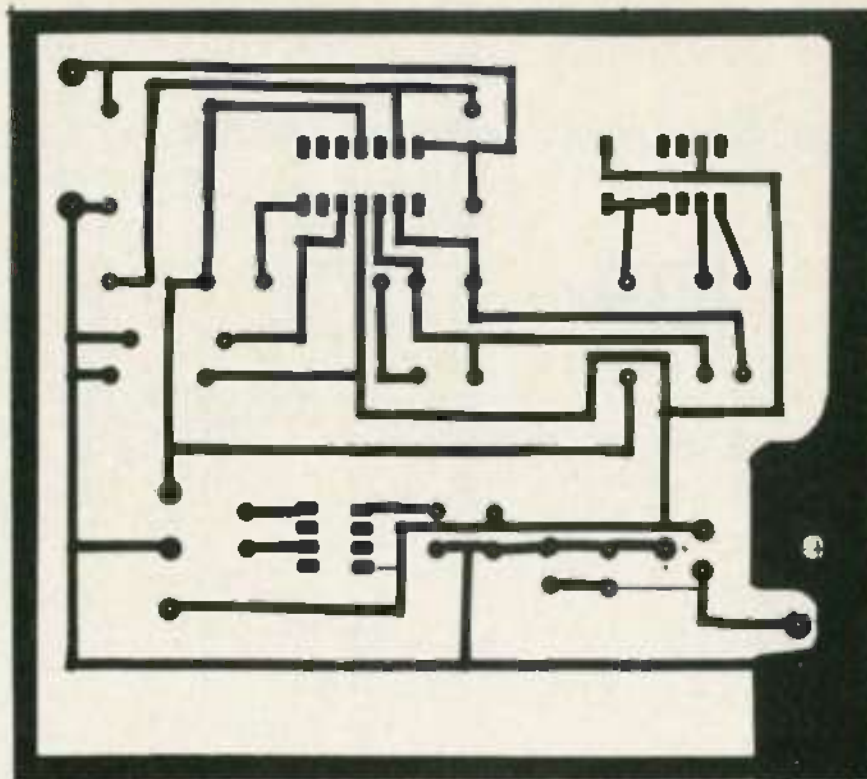

FIG. 6—FOIL PATTERN for the barometer is shown full-size above. The layout is not critical, and point-to-point wiring can be used—but be sure to use a socket for the transducer.

should, however, have no problem powering the display.

As we mentioned before, the use of IC sockets is strongly recommended. The pressure transducer can be installed in an eight-pin socket. But don't install it—or any IC's—yet. First install all resistors, capacitors, potentiometers, and IC sockets. Check for solder bridges and clean all of the flux off the board. If you used point-to-point wiring, be especially careful of cold-solder joints. When you have double-checked your work, you can install all the IC's except the transducer.

Apply 8–11 volts DC to the transducer/power-supply board and check for  $\pm 5$  volts DC at the output indicated in the parts-placement diagram of Fig. 7. Also check for 6.9 volts DC at the transducer socket. Bend the transducer pins, recheck the orientation, turn off the power, and install it in the socket. If you wish, you may install the transducer remotely and connect it to the transducer board through a four-wire shielded cable.

You can mount the unit in just about any cabinet, but you should keep the transducer outside the cabinet, or make

TABLE 1—CONVERSION FACTORS

	PSI	PASCAL	kPa	MILLIBAR	in.Hg	mm Hg	ATM	TORR
PSI	1	$1.4504 \times 10^{-4}$	0.1450	$1.4504 \times 10^{-2}$	0.49118	$1.9337 \times 10^{-2}$	14.696	$1.9337 \times 10^{-2}$
PASCAL	$6.8946 \times 10^3$	1	1000	.100	$3.3865 \times 10^3$	133.32	$1.0132 \times 10^5$	133.32
kPa	6.8946	$1 \times 10^3$	1	10	3.3865	0.13332	$1.0132 \times 10^2$	0.13332
MILLIBAR	68.946	$1 \times 10^{-2}$	10	1	33.865	1.3332	$1.0132 \times 10^3$	1.3332
in.Hg	2.0359	$2.9529 \times 10^{-4}$	0.2953	$2.9529 \times 10^{-2}$	1	$3.9368 \times 10^{-2}$	29.920	$3.9368 \times 10^{-2}$
mm Hg	51.714	$7.5006 \times 10^{-3}$	7.5006	0.75006	25.401	1	760.00	1
ATM	$6.8045 \times 10^{-2}$	$9.8692 \times 10^{-6}$	$9.8692 \times 10^{-3}$	$9.8692 \times 10^{-4}$	$3.3422 \times 10^{-2}$	$1.3158 \times 10^{-3}$	1	$1.3158 \times 10^{-3}$
TORR	51.714	$7.5006 \times 10^{-3}$	7.5006	0.75006	24.401	1	760	1

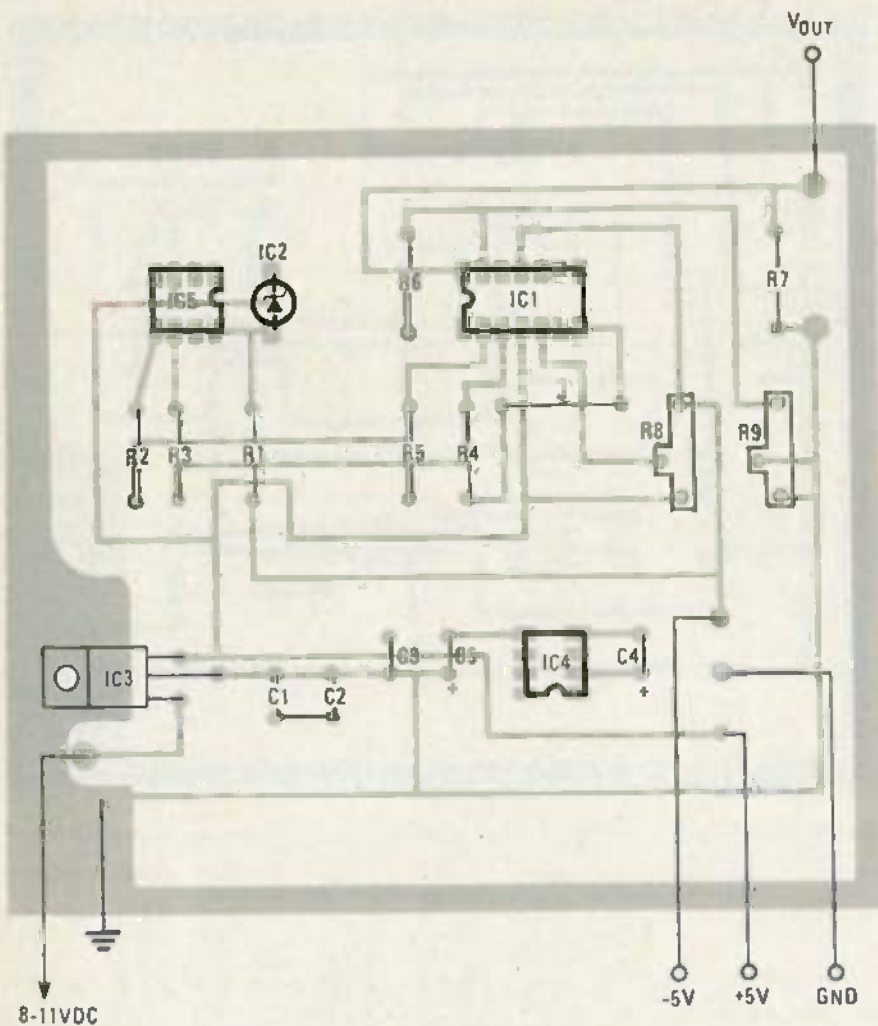

FIG. 7—THE PARTS-PLACEMENT diagram for the foil pattern shown in Fig. 6.

sure that your cabinet is not-tight fitting. The best place to mount the unit is in an old anroid barometer. Then you not only have an interesting conversation piece, but you can also use the old barometer's pressure scale as a conversion scale!

#### Transducer Calibration

A typical transducer requires a two-point calibration to correct for offset and gain over the entire operating range. In the case of this barometer, the actual operating range is limited to  $\pm 5\%$  of the top of the scale (95 – 105 kPa). Therefore, a single-point calibration performed at the middle of the range (100 kPa) may be acceptable. So that we can please everyone, we'll discuss both methods.

Before doing any calibration, switch the unit on and let it warm up for about an hour. Set potentiometer R8 to its middle position. Obtain the barometric pressure (using the local weather forecast or a barometer that you know to be accurate). Using Table 1, convert the barometer's reading to kilopascals or millibars. (The closer the reading is to 100 kilopascals, the better.) All that is to be done for sin-

gle-point calibration is to adjust potentiometer R9 until the meter displays the barometric pressure.

If you can, it is best to use two-point calibration. That's because a typical transducer requires an offset correction as well as slope correction.

As a first step, perform the single-point calibration that we just discussed and leave the unit operating over a period of a few days. Try to obtain two readings: one at the low end of the scale (around 98 kPa) and the other at the high end of the scale (around 102 – 104 kPa). On both those days, note the actual barometric pressure as well as the corresponding meter readings. We'll use a little mathematics to arrive at the calibration values. Following are some sample calibrations.

Let the old barometric pressure,  $P_1 = 98$  kPa and the corresponding meter reading,  $M_1 = 972$  mV.

Let the present barometric pressure,  $P_2 = 102.5$  kPa and the present meter reading,  $M_2 = 1030$  mV.

The change in barometric pressure is  $P_2 - P_1 = 102.5 - 98$  kPa = 4.5 kPa

The change in the meter reading is, of

#### How to use your barometer to predict the weather.

Although some of you will build this barometer simply because you enjoy building electronic projects, many more will actually want to use it to predict the weather. So that you can do that, here's a crash course on what barometric-pressure changes usually mean.

High-pressure cells generally bring fair weather. In the northern hemisphere, the air circulation is clockwise and winds are usually light. The temperature can be warm or cold, but will remain constant for relatively long periods of time.

Low-pressure cells generally bring cloudy weather, with rain or snow. In the northern hemisphere, the air circulation is counter clockwise, and winds are usually strong. Tropical lows are warm, but other lows are cold, or change to cold.

A steady barometer usually indicates unchanging weather for one or two days.

Any rapid fall usually indicates that rain or unsettled weather is on its way. (A rapid rise or fall in barometric pressure is generally considered to be 0.05 to 0.09 inches (0.16–0.30 kPa) over 3 hours.) The lower the pressure before the rapid change, the sooner the rain will approach. For example, if the pressure is 29.8 inches (100.9 kPa) and falling rapidly, a severe storm will pass within a few hours. A rapid rise signals that the storm is ending, and clear and colder weather is on its way.

A suggestion to make the barometer more useful is to interface it with a computer (such as the control computer that concludes with Part 3 in this month's issue). Then you could automatically chart the changes in pressure and record the highs and lows that occur. We'd like to hear about your successes (and failures).

course,  $M_2 - M_1 = 1030 - 972$  mV = 58 mV.

The generated slope is  $\Delta M/\Delta P$  or  $(M_2 - M_1)/(P_2 - P_1) = 58/4.5$  mV/kPa or 12.88 mV/kPa.

The slope that we require is 10 mV/kPa. Therefore, the change in the gain required is  $10/12.88 = 0.776$ .

What we are going to do is to reduce the gain generated by the op-amp by a factor of 0.776. An example of how to do that follows.

Measure the voltage at the output of IC1-a. We'll call it  $V_1$ . Presume that  $V_1 = 755$  millivolts. Then the gain of IC1-c =  $M_2/V_1 = 1030/755$ . The required gain, however, is  $1030/755 \times 0.776 = 1.059$ . So the required output at IC1-c is  $1.059 \times V_1 = 1.059 \times 755 = 799$  mV.

Adjust the gain potentiometer, R9, until the meter reads 799. Now adjust the offset potentiometer, R8 until the meter reads 1025 millivolts, corresponding to the present barometric pressure. That completes the calibration. Now you can substitute your own values in the calculations and perform the calibration on your digital barometer. R-E

**Radio  
Electronics**

**RECEIVING**

JUNE 1984

# **Satellite**<sup>®</sup> **TELEVISION**



**All About  
Satellite TV**

**The Dish**

**From Feedhorn  
To Receiver**

**Direct  
Broadcast  
Satellites**

**Satellite  
Receivers**

# The First Name In Satellite TV...

When you invest in a **DRAKE** Earth Station Receiver, you've chosen the very finest. Elegantly designed with the latest engineering concepts in solid-state techniques, every **DRAKE** is characterized by superb performance and versatility. **DRAKE**... world-class leader in satellite television reception.



**ESR240 EARTH STATION RECEIVER**

- Infrared Remote Control
- Digital Channel Readout
- Preset 6.2/6.8 and Variable Audio Tuning

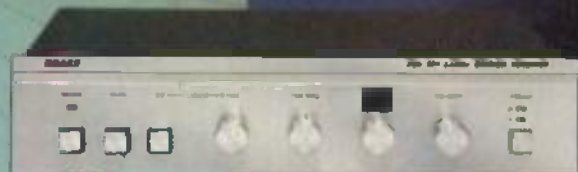

**ESR324 EARTH STATION RECEIVER**

- Digital Channel Readout
- Detent Channel Tuning
- Preset 6.8 and Variable Audio Tuning

## ...The Last Word In Performance!



540 Richard Street, Miamisburg, Ohio 45342, USA  
Phone: (513) 866-2421  
Telex: 288-017

MEMBER OF  
**SPACE**

CIRCLE 48 ON FREE INFORMATION CARD



# All About Satellite TV

*In this article we'll look at how satellite TV works, and answer many of the most popular questions concerning it.*

THE BASIC PROBLEM OF TELEVISION IS NOT ITS PRODUCTION BUT its delivery. For instance, terrestrial broadcast TV has a lot going against it. It is most suitable when the transmitting and home TV-antennas can "see" each other, with no intervening objects between them. Unfortunately, there are a wide variety of intervening objects around to cause problems, including hills or mountains, and man-made structures such as buildings or bridges. Another source of problems is the curvature of the earth.

The way to avoid the problems caused by intervening objects and the earth's curvature is to place the transmitting and/or receiving antennas high enough. In the early days of TV, there were suggestions about putting the transmitting antenna aboard a plane. Later on, receiving antennas were placed on a mountain top or other high location, with the received signals delivered to paying subscribers via cable. Known as CATV (Community Antenna Television) such a set up became the ancestor of cable TV.

There is a more practical way of getting a TV transmitting-antenna high enough and that's by putting it on a satellite. Doing that offers a lot of advantages. For one thing, the curvature of the

## Radio Electronics RECEIVING A Satellite TELEVISION

MARTIN CLIFFORD

earth, a limiting factor in terrestrial transmissions, doesn't affect satellite signals as much. Also, large buildings, bridges, mountains and hills can not come between satellite signals and their destination, so those causes of signal ghosts are eliminated. Another factor to consider is that satellite television-signals are transmitted at microwave frequencies ranging from 3.5-6 GHz (C-band) to 12-14 GHz (Ku-band). At those frequencies, signals are relatively immune to atmospheric, and are not bothered by sunspot activity. Thus, if good quality receiving equipment is used, you can expect television pictures produced by satellite transmissions to be of nearly studio-monitor quality.

In the rest of this article, we are going to attempt to answer some of the questions you may have had concerning satellite TV. We are going to look at some of the things you should consider when buying or setting up a receiving system, and also learn what some of the terminology often used when describing satellite-TV means.

### Earth stations and TVRO's

Television programs are produced on earth, radiated to a satellite and are then retransmitted back to earth. Any two-way communications between the ground and the satellite must be handled by an earth station, a facility equipped for both transmission and reception. A receive-only arrangement, such as an in-home installation, is a TVRO, or TeleVision Receive Only setup.

### Geosynchronous orbits

For satellite TV to be practical, some way must be found to keep the satellite at the same position relative to the ground at all times. That is done by placing the satellite at a distance from the earth such that its orbital speed is zero in relation to the rotational speed of the earth. The distance for such an orbit is 22,279 statute miles (a statute mile is 5,280 feet). That distance is from the satellite to a spot on the equator directly below it. Satellites in such an orbit are geosynchronous (or geostationary), having an orbital speed synchronized with the daily rotational period of the earth (23 hours, 56 minutes, 4 seconds). See Fig. 1.

A geosynchronous orbit is a parking place for satellites, and, like parking places anywhere, are in limited supply. North American satellites are put in orbit above the earth's equator, in what is

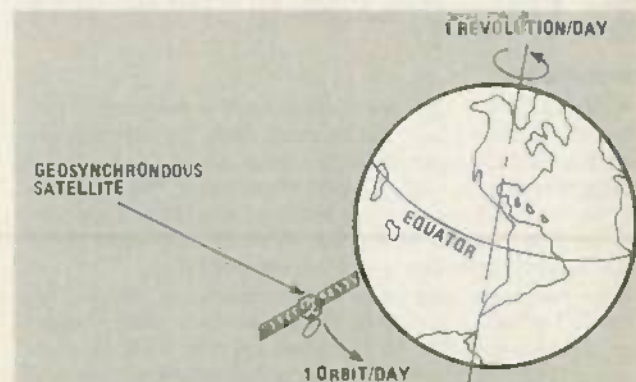

FIG. 1—A GEOSYNCHRONOUS SATELLITE has an orbital speed equal to the rotational period of the earth. To an observer on the ground it appears to always be in the same place.

known as the equatorial plane, between 79° west longitude and 143° west longitude. Right now there are 16 U.S. and Canadian satellites in orbit, the FCC has authorized 20 more U.S. satellites by 1986. See Fig. 2.

### Identifying satellites

Satellites can be identified in many ways: by designation, by name, by position, or by any combination of those. Satellite names and designations are usually followed by a number or letter to indicate which member of the satellite family it is. Sometimes a higher number is used to identify a satellite, but there is no lower number, meaning that a new satellite has been sent up as a replacement. For example, Westar 2 is a substitute for the formerly existing Westar 1. The working lifetime expectancy of a satellite is from 7 to 10 years.

### Satellite separation

Presently, satellites are spaced about 4° apart, with the exception of two Canadian satellites that are spaced 4.5° apart. That translates to a distance of approximately 1838 miles. Of course, satellites are subject to the gravitational pull of solar system planets so they do not follow a smooth path. Instead, they may have a wobble of as much as 60 miles, an insignificant percentage of the 164,884 miles traveled each day. In order to place more satellites in orbit in the equatorial plane, efforts are now being made to reduce spacing distance. We'll see the importance of spacing a little later on in this article.

### Tilt angle

The tilt angle, or orbital inclination, is the tilt the satellite assumes with respect to the equatorial plane, with the equatorial plane being an imaginary, two-dimensional flat surface bisecting the earth at the equator and extending into space. Tilt can be controlled from the earth by radio, with the signals being used to cause a hydrogen-peroxide-ignited/hydrazine-fueled thruster to fire in a computer-programmed sequence.

Satellites aren't put into space and then left to chance. Station keeping, using a satellite's telemetry tracking command subsystem, is needed to maintain the satellite's position with respect to the earth. There are three axes of motion along which a satellite can move, but each of those can be independently earth-controlled. Flywheels on the satellite supply a counter torque to any thrust or attempted movement from the desired position, supplemented by the firing of small rockets.

### Operating power

The power for operating the electronics gear aboard a satellite is obtained from batteries. Satellites are equipped with wing-like structures, which are deployed when the satellite reaches orbit, on which are mounted solar cells that are used to convert solar energy to electricity that is used to charge the batteries (see Fig. 3). Since the position of the sun with reference to the satellites keeps changing, the panels are adjusted so as to keep them at right angles to the sun.

### Transponders

A satellite is not a passive relay station. It does not simply reflect television signals, but receives them, processes them, downconverts them, and retransmits them. Aboard each satellite are a number of transponders, a type of transceiver that is capable receiving signals from earth and retransmitting them. Transponders not only transmit video, but also both mono and stereo audio, telephone messages, news reports, and data.

The average operating power of a transponder is 5 watts. That is the DC power delivered to the RF power-amplifier output stage. One exception is the Canadian satellite, Anik D, positioned at 104.5° west, which uses an average operating power of 11.5 watts. Note that larger amounts of power are available and could be used. The reason it is not is that transmissions from C-band satellites fall in the same microwave-frequency range used

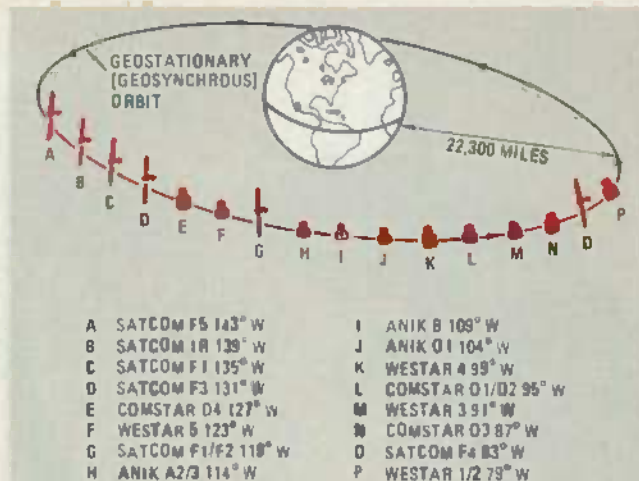

FIG. 2—NORTH-AMERICAN SATELLITES, and their positions in the equatorial plane, are shown here.

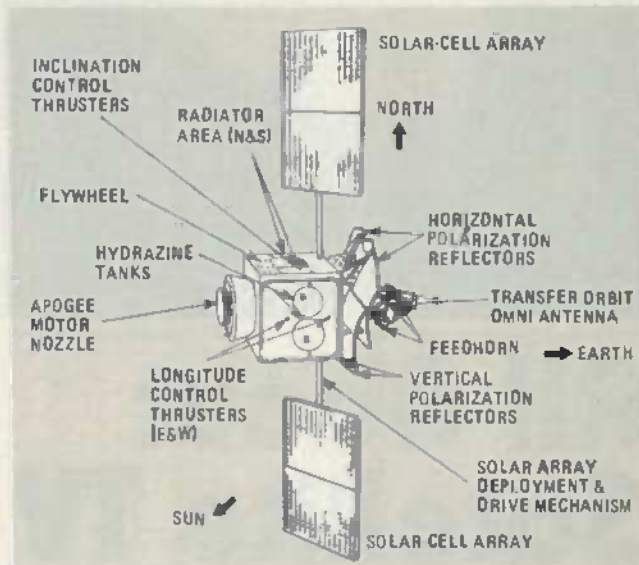

FIG. 3—A TYPICAL TV SATELLITE. Note the wing-like structures which contain the solar cells used to charge the batteries used for power.

by AT&T for the transmission of telephone communications and if higher power levels were used, interference with those communications could occur.

When signals are transmitted to a satellite, that is called the *uplink*. Uplink transmissions use the frequency band from 5.925 to 6.425 GHz. In the satellite, the signals are downconverted to a frequency range between 3.7 and 4.2 GHz and retransmitted to earth; that retransmission is called the *downlink*. See Fig. 4.

The number of transponders on a satellite is related to bandwidth requirements. For video use, the bandwidth requirement of a transponder is 40 MHz (36 MHz plus a 4-MHz guard band). With a total bandwidth availability of 500 MHz (that total is calculated by subtracting the lower frequency limit from the upper one), that would permit  $500/40 = 12$  transponders only. Yet, a typical satellite will have 24, not 12 transponders. As we'll see shortly, signal polarization is taken advantage of to squeeze in the extra transponders.

Note that not all satellites have the same number of transponders. Typically, North American satellites will have either 12 or 24. But some satellites have 6 or 10 transponders. And in the 12-GHz-, or Ku-band (also known as the K Band), there are satellites with as many as 32 transponders.

### Signal polarization

As indicated above, the total available bandwidth would seem

# Radio Electronics RECEIVING Satellite TELEVISION

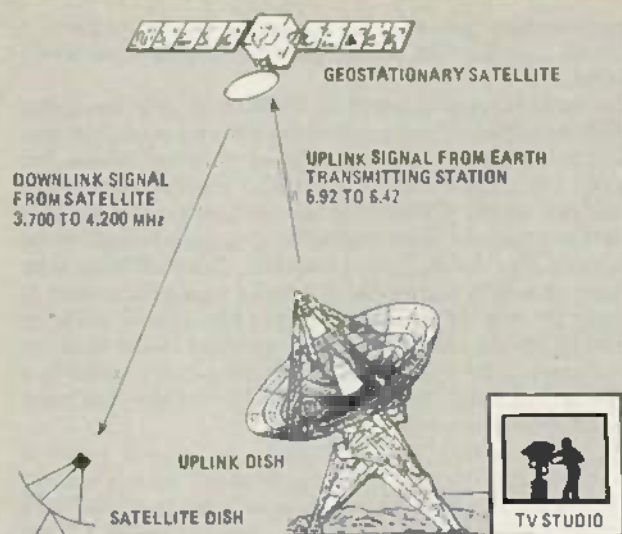

FIG. 4—TELEVISION PROGRAMMING is uplinked from earth to an orbiting satellite. The satellite then downconverts them and downlinks them for reception on earth.

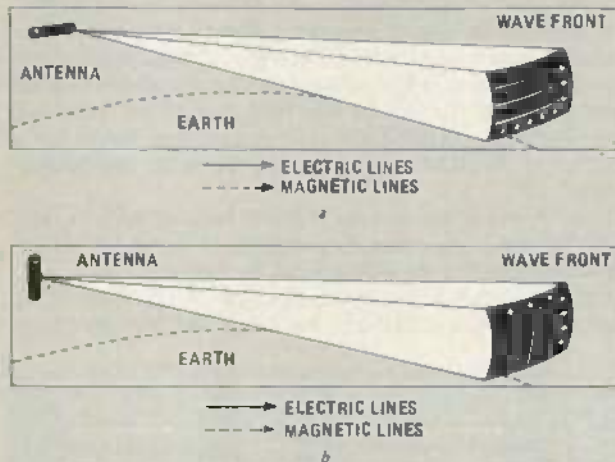

FIG. 5—WAVE POLARIZATION. A horizontally polarized wave is shown in a; a vertically polarized wave is shown in b.

TABLE 1—CHANNEL ASSIGNMENTS

CHANNEL	OPERATING FREQUENCY (MHz)
1	3720
2	3740
3	3760
4	3780
5	3800
6	3820
7	3840
8	3860
9	3880
10	3900
11	3920
12	3940
13	3960
14	3980
15	4000
16	4020
17	4040
18	4060
19	4080
20	4100
21	4120
22	4140
23	4160
24	4180

to limit the number of transponders per satellite to a maximum of 12. Additional transponders are accommodated by alternating the polarization of the signals they transmit.

A radio wave, and that, of course, includes television signals as well, consists of a pair of fields—an electric field and a magnetic field—at right angles to each other (see Fig. 5). The polarization of a wave is described by the direction of the electric field. North American satellites use horizontal and vertical polarization. In addition, other types of polarization are used. Those are right-hand circular and left-hand circular. Most international satellites use circular polarization.

With alternating polarization, 24 rather than 12 transponders can be used. That's because the signals from the adjacent transponders are 90° out-of-phase and thus they do not interfere with each other even though their frequencies overlap. Because of that overlap in frequency, the technique of using alternating polarization is termed *frequency reuse*.

Polarization is one method of allowing the same frequencies to be reused. Another is by separating the satellites by a sufficient distance in the sky. That's the reason for the 4° spacing between satellites we discussed earlier. Table 1 is a listing of channel allocations for a 24-transponder satellite. The frequencies listed are those of the unmodulated carrier. Each transponder is identified by a channel number, and every satellite having the same channel numbers uses the same frequencies. That is possible, of course, only if the satellite spacing is adequate to prevent interference.

Generally, if a pair of satellites are adjacent, one satellite will have all its odd-numbered channels vertically polarized while the other satellite will have all its odd-numbered channels horizontally polarized. Alternating polarization is used only if a satellite is equipped with 24 transponders. If a satellite has only 12 transponders, all transmissions will be horizontally polarized; that is true regardless of whether the channel in question is odd or even numbered.

### Translation frequency

The frequency difference between an uplink signal and its corresponding downlink signal is always 2.2 GHz. Thus an uplink signal with a frequency of 5.92 GHz will be downlinked by its transponder at 3.72 GHz. That 2.2 GHz relationship holds true for every uplink and downlink pair and is called the translation frequency.

### Space loss and power

With a distance of 22,300 miles to travel, the downlink signal is heavily attenuated by the time it reaches earth, with a loss of about 196 dB and an approximate signal strength of  $0.5 \times 10^{-20}$  watts. That is less than the thermal noise level that is present at the ground.

Space loss also strongly effects the uplink signal. The RF signal power at the uplink antenna ranges from about 400 watts to 1 kilowatt. However, that is multiplied by the gain of the uplink dish, which is commonly on the order of 50 dB, to give us the effective radiated power, sometimes referred to as *Effective Isotropic Radiated Power (EIRP)*. A gain of 50 dB translates into a power ratio of 100,000. Thus, if the RF signal power is 400 watts, and the power ratio is 100,000, then the EIRP is  $400 \times 100,000 = 40,000,000$  watts. However, due to the effect of space loss, the received signal at the satellite is on the order of microwatts.

## Footprint and boresight point

The EIRP of the downlink signal is its terrestrial strength and can be plotted on a map in terms of dBW (decibels referred to 1 watt). Such a diagram, called a footprint, is shown in Fig. 6. The actual shape of the footprint will vary with each transponder. The center of the pattern is the area of maximum signal strength and is called the boresight point.

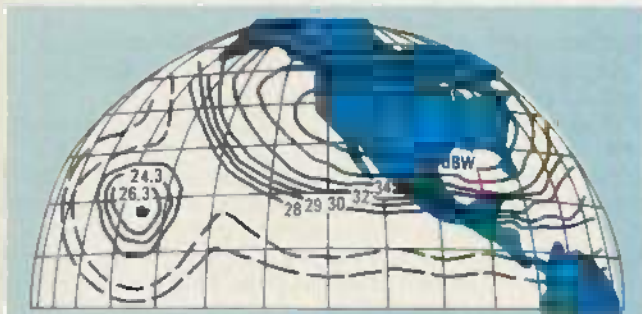

FIG. 6—THE FOOTPRINT of a TV satellite. The boresight point is the area of maximum signal strength.

## Signal processing

Uplinking a video signal to a satellite and then re-transmitting that signal by a transponder isn't a simple matter of signal transmission. Since the signal will need to make a round trip of about 44,600 miles, some signal processing is needed.

Signal processing isn't a new concept. For example, standard FM broadcast signals are processed by pre-emphasis (a method of boosting the high-frequency component of the signal) prior to being broadcast. Similarly, the audio waveform of a satellite-TV signal undergoes pre-emphasis prior to uplinking. The purpose is to improve the signal-to-noise ratio, since the FM demodulator in the satellite receiver is noisier at the high-frequency end. Compensation for pre-emphasis is supplied in the in-home satellite receiver subsequent to demodulation by a de-emphasis network. Following pre-emphasis the audio signal is frequency modulated onto a subcarrier whose center or resting frequency is somewhere between 5 MHz and 8 MHz. Representative audio subcarrier frequencies are 5.6-, 5.8-, 6.0-, 6.12-, and 6.4-MHz.

Another signal processing method used prior to transmitting the uplink signal is dithering of the video. That is done by adding an energy-dispersal waveform to the video signal; that added signal is a triangular wave having a frequency of 30 Hz, which is the television-receiver frame rate. Its effect is to produce a more uniform dispersal of the video-signal energy, thus eliminating, or at least minimizing, video-signal energy concentration. (That helps to reduce interference to terrestrial microwave links.) In the satellite receiver in the TVRO home station, the effect of that dithering action is countered by a video-clamping network.

Subsequent to processing, both the audio and video are used to modulate a selected carrier frequency in the uplink C-band. Prior to delivery to the microwave transmitting antenna, the modulated signal is strengthened by an RF power amplifier.

The signal from the antenna is reflected by a parabolic dish to a selected satellite. Usually, the dish delivers its signals to a single satellite, and so once the dish is properly aligned on a line-of-sight basis with its selected satellite, it is fastened into a permanent position. Dishes used for transmission are much larger than those used in TVRO setups and a dish diameter, or aperture, of 30 feet is not uncommon. Large-aperture dishes are desirable since the gain of a dish is directly dependent on its diameter.

## The TVRO system—an overview

At the transponder, the uplink signals are downconverted and re-transmitted to earth. On the ground, a TVRO system, such as the one shown in Fig. 7, picks up the video and sound signals, possibly selecting them from one or more satellites, and ul-

timately delivers them to a video monitor or the VHF input of a television receiver. The signals are then displayed on either Channel 3 or 4.

The most conspicuous part of the TVRO is the dish, most often a parabolic reflector comparable to the reflector used in an auto headlight. Although commonly referred to as an antenna, the dish is simply a signal reflector, although it is an important part of the antenna system. The dish has just one function and that is to focus the signals of a single satellite to some point forward of the dish, generally a distance of just a few feet. That focal point is the entrance to a short rectangular or tubular waveguide (which is just another type of transmission line, like coaxial cable or twinlead). The concentrated signal is gathered by the feedhorn (the entrance of the waveguide) and passed a short distance to a small length of metal, often no more than 1-inch long—that piece of metal is the antenna probe.

The signal voltage developed across the antenna probe is immediately delivered to a low-noise amplifier, often referred to as an LNA. The amplifier is a broadband type that uses GaAsFET and bipolar transistors. The output of the LNA is fed to a downconverter.

The downconverter, as its name implies, reduces or downconverts the frequency of the C-band signals. Signals of lower frequency can be connected by a cable to following components with lower losses than if microwave signals were used. The frequency conversion process is akin to that used in all super-heterodyne receivers in which a local oscillator produces a signal whose frequency is made to beat with that of the incoming signal. The output of the downconversion process usually has a frequency of 70 MHz and can be regarded as an intermediate frequency (IF).

The LNA and downconverter, whether separate units or integrated, are generally mounted on or near the frame supporting the dish and must be shielded against the weather.

From the output of the downconverter, the 70 MHz IF is brought via coaxial cable into the home and delivered to a



FIG. 7—BLOCK DIAGRAM of a typical TVRO setup.

satellite receiver. In the receiver, the signal is amplified and then demodulated into the original baseband audio and video.

The baseband audio and video signals are then remodulated, either by a separate remodulator unit or one that is integrated into the receiver. Demodulation is required since both video and audio are frequency modulated and cannot be used "as is" by the input of the television receiver. The RF carrier used in the remodulator is the carrier frequency of either VHF channel 3 or channel 4. The output of the remodulator is exactly like that of a terrestrial TV-broadcast. That is, it follows the NTSC standard (at least in North America) and uses AM for video and FM for audio. The audio and video signals are then supplied to the antenna input terminals of a television receiver, which can treat them exactly like a terrestrial broadcast.

The final link in the TVRO setup is the television receiver. The finest TVRO system cannot produce a quality picture if the receiver is inadequate.

## Licensing

No FCC license is required for a TVRO setup, although one was once mandatory. On October 10, 1979, the FCC rescinded its licensing mandate for TVRO systems. As a result, it is legal to install and operate TVRO equipment. R-E



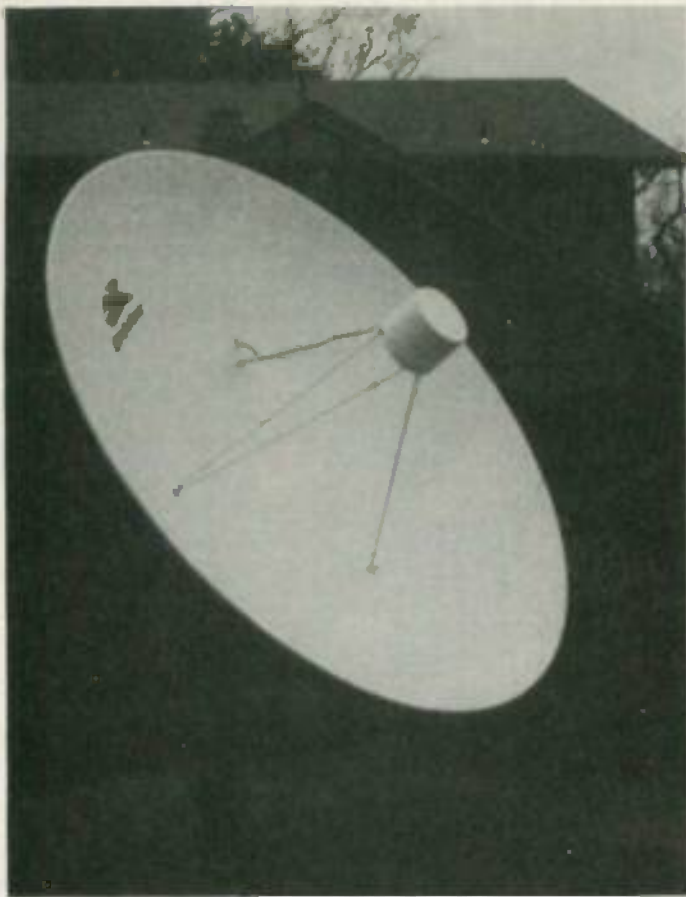

MARTIN CLIFFORD

Earth and the satellite; that distance is 22,300 miles. Because of a satellite's low EIRP and because of the tremendous distance involved, by the time the signal reaches the TVRO dish it is down by a factor of about  $10^{20}$ . As a consequence the received signal is practically non-existent, as it is literally buried in thermal noise at the earth's surface.

### Shape of the dish

Most TVRO dishes are parabolic, although some are spherical. A spherical dish is merely a section of the surface of a sphere, but things get a little more complicated when you are dealing with a parabola. In a parabolic dish, a curve drawn across the surface from any point on the perimeter of the dish to a point directly opposite it will yield a parabola. In geometry, such a curve can be obtained by sending a plane through a cone such that the plane is parallel to an element of the cone. Thus, a parabola is a conic section. A parabola can also be derived mathematically from the formula  $Y^2 = 4f \times D$ , where Y is the distance of the curve from its center, f is the focal length, and D is the desired diameter.

### Dish construction

All dishes are made of stainless steel or aluminum, but since they are exposed to the elements, they must be treated with a rust preventive, usually by using a bonding process, or coated with a substance such as fiberglass. That is important since the oxidation of a dish surface results in pits that deform the shape of the dish and can produce inaccurate reflections causing signal loss at the feedhorn. The coating that covers the metallic surface of the dish is a type that is heat absorptive rather than reflective. The objective is to direct as little heat as possible toward the feedhorn. A dish can be stamped from a single sheet of metal or can be petallized (made up of sections), and can be solid or made of wire mesh. The petallized form, whether solid or mesh, makes shipping easier, but requires assembly at the site. A petallized dish is

# The Dish

*One of the most important, and most conspicuous parts of a TVRO system is the dish. In this article we'll look at satellite-TV dishes, including what they do and some things to consider when selecting one for your system.*

THE DISH, EASILY THE MOST CONSPICUOUS COMPONENT IN A TVRO system, has a double function: to gather in as much signal energy as possible, usually from a single satellite, and to focus that energy on the entrance to the feedhorn. A dish, then, such as the one shown in Fig. 1, is just a large-sized, passive, signal reflector.

The downlink signal to be picked up by a dish is very weak, far weaker than the uplink transmission. The DC input power to an uplink final stage ranges from about 400 watts to a kilowatt; the input power to a satellite's transponder is often 5 watts. Another reason that the downlink signal is far weaker than the uplink is that the dish of an earth station supplying an uplink signal is much larger than the dish of a TVRO. Gain, of course, depends on the size of the dish. Thus, while the gain of an earth-station dish used for transmitting is more than 50 dB, the gain of a TVRO dish is about half of that.

Both the uplink and downlink signal suffer from space loss, which is also called spreading loss. That loss is approximately 200 dB and is proportional to the distance squared between the

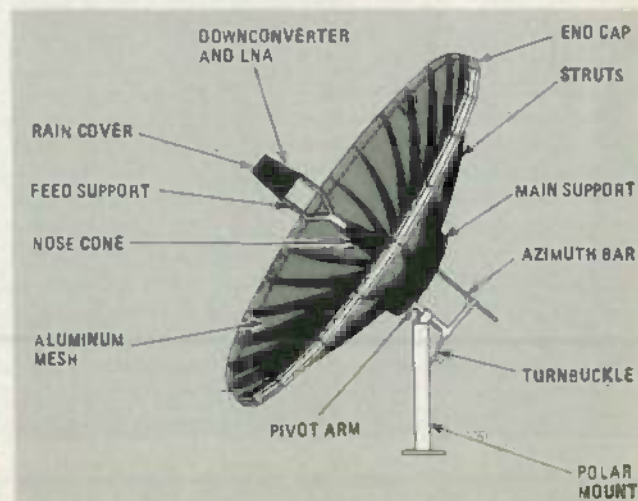

FIG. 1—A TYPICAL WIRE-MESH satellite dish is shown here on a polar mount.

# Build your own IBM compatible - and save hundreds of dollars.

## HEATH PROUDLY ANNOUNCES THE NEW HS-151 DESKTOP AND HS-161 PORTABLE COMPUTERS.

The world's largest library of PC software has IBM's name on it. But if that's not the name you want on your computer, you don't have to be left out anymore. Now you can run that software on a new machine that feels superior and friendly.

Superior, because it performs. Friendly, because you can build this complex computer from a simple kit.

Can you do it? 85% of our first-time customers ask the same. And the answer is 100% yes. You can.

In fact, you should build it. There's no better introduction to computers in general and the Heath PC's in particular. So, glance at the clear, simple steps that can lead to your own PC. And imagine the fun you'll find along the way.

### EVEN OPENING THE BOX IS A PLEASURE!



Getting your PC kit is exciting... and reassuring. Because, as soon as you open it, you'll know it's been designed by experts. Even the box works well. Everything is packed in sections so you build from one organized section at a time. Parts stay stored in the box until needed.

Except for some very simple tools, we include everything. You'll find a soldering guide for mistake-free work. Even an extra circuit board for practice soldering.

### PROCEED ONE STEP AT A TIME. BUILD CONFIDENCE... AND AN ADVANCED COMPUTER... FROM A SIMPLE KIT.

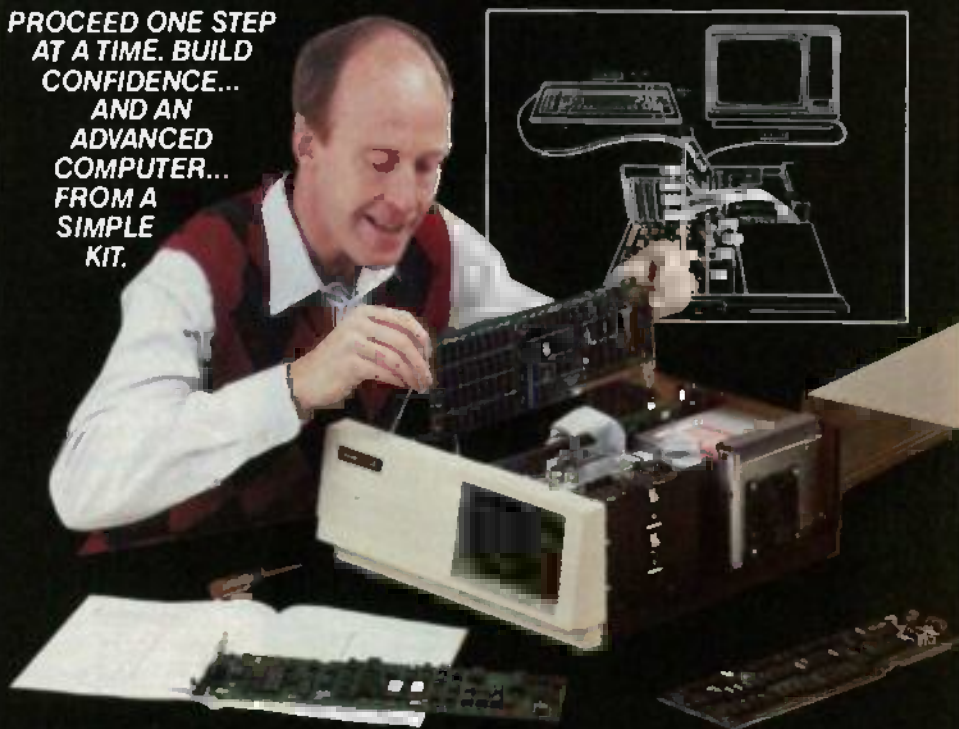

The two main circuit boards come to you as they are shown here. Pre-assembled. They're not only completed...they're also factory-tested so you know they work. And you don't have to bother with complicated testing equipment.



If all of that is done, then what's to build? We do ask you to build some of smaller boards, plus install any optional memory you've ordered. Then you'll connect the sockets and wiring harnesses between components.

You'll build the chassis from pre-formed subassemblies. The keyboard is already assembled; just put the cover on. Then, finally, bolt the power supply in place. We help you by writing the world's best instruction manuals. And we illustrate those manuals

because one picture may be worth all the words needed to explain a dozen steps. The simpler the better.

The process is exciting because each finished step is its own reward. And every step brings you nearer your completed computer.

### EXPERT ADVICE AND TROUBLE-SHOOTING ARE JUST A PHONE CALL AWAY.

You are never alone in this process. If there is ever any question, call our Service Line. You'll reach a trained consultant whose specialty is talking sense, not jargon.

Your computer will work. Our entire business depends on that. And we'll do whatever's necessary to make our simple pledge come true: "We Won't Let You Fail."



**A LITTLE WONDER,  
AND A LOT OF PRIDE...**



Then the moment of truth. Plug It in. Slide in the included test disk. Odds are the only problem will be contain-

ing the pride you feel when your new computer comes to life.

**YOU'VE BUILT IT. YOU'LL  
KNOW HOW TO USE IT.**

You now possess the highest quality personal computer...with up to 320K RAM, a professional keyboard and dual 360K disk drives.

Your machine is truly complete. It's color capable and MS-DOS\* is included.

And, because it's IBM compatible, your new machine can work with all that's worthwhile in software. Better yet, with the money saved by building a kit, think of all the peripherals and software you can buy!

\*MS-DOS is a registered trademark of Microsoft Corporation

**FOR COMPUTING  
ON THE GO...  
THE HS-161  
PORTABLE.**



The HS-161 has the same features as the HS-151. Amber Monitor included. Convenient keyboard folds up, two disk drives fold down.



HS-151 Desktop PC with standard floppy disk drive or optional hard disk.

**Get more information  
on the most rewarding  
personal computers...**

**Heathkit<sup>®</sup>**  
Heath  
Company



Get your **FREE**  
**HEATHKIT CATALOG**

Mail this coupon to:  
Heath Company, Dept. 020-184  
Benton Harbor, MI 49022

Name \_\_\_\_\_

Address \_\_\_\_\_

City \_\_\_\_\_

State \_\_\_\_\_ Zip \_\_\_\_\_

CP-229

CIRCLE 15 ON FREE INFORMATION CARD

also easier to handle if the unit is to be moved to a new site.

Another consideration is wind loading. The shape of a dish is such that it offers maximum obstruction to wind gusts, and it must be able to withstand those without being nudged out of position. Wire-mesh screens have a higher wind-loading tolerance than those that have solid surfaces. Size for size, the mesh types are lighter, since they do not have the added weight of a fiberglass coating. Solid structures can also accumulate water, and in freezing weather the water can form ice. Another disadvantage of the fiberglass coated dish is that, if improperly cured, the covering material can warp.

### Focal length and focal point

The focal length of a dish is the distance from the center of the dish to the focal point, a small area where the reflected signal energy is concentrated. The entrance to the waveguide feedhorn is at the focal point. See Fig. 2.

### Positioning the dish

Since the parabolic dish is made to face a selected satellite, some provision must be made for turning the dish if reception from more than one satellite is wanted.

To be able to "see" a selected satellite, a parabolic dish must be able to move horizontally and vertically. The horizontal movement is variously known as the angle of rotation, bearing, the angle of azimuth, or simply azimuth. The reference point for the azimuth is the true North Pole, not the magnetic one. The azimuth of the true North Pole is 0° (or 360°).

The vertical motion of a dish is its elevation, with the earth as a reference at zero degrees, as shown in Fig. 3. The maximum elevation of a dish is 90° and is along a line that is perpendicular to the earth. At 90°, the signal-collecting surface of the dish faces straight upward into the sky.

Since all the satellites are in the equatorial plane, the elevation of a dish depends on its location. Along the equator the elevation would be such that the dish points straight upward. Farther north or south the angle of elevation decreases. Typically it ranges from about 5° to 70°.

The orbital path of the satellites around the earth is a circle surrounding the earth, parallel to the equator, 23,000-miles high. North American satellites occupy a small part of that circle, and are located in an arc from 72° west to 143° west longitude. Just as the hub of a wheel has a small motion compared to its rim, the movement in azimuth of a dish is measured in inches even though the satellite are separated by thousands of miles. If a parabolic dish is to pick up more than one satellite, it must turn in an arc that follows the path of the satellites. Closer to the equator that tracking path is more circular; farther north it is more elliptical.

### Dish VSWR

Although a dish simply transfers the signals it receives from a satellite, focusing them on the feedhorn, it can be regarded as the first stage of the TVRO; that is, as the signal source. But not all of the picked up energy is focused on the feedhorn, and as a consequence there is an energy loss, with some of the signal energy being returned to the dish. Ultimately, the unused signal energy is dissipated in heat.

The relationship between the signal energy delivered to the feedhorn and that which is not used is the Voltage Standing Wave Ratio (VSWR). A typical value for the VSWR is 1:2, but the closer the VSWR is to unity (1:1), the better. With a VSWR of 1:1, the optimum amount of signal energy is accepted by the feedhorn.

### Illumination

The relationship between the dish and the feedhorn is a critical one. For one thing, the dish must "see" the feedhorn, which is another way of saying that the feedhorn must be at the focal point. Similarly, the feedhorn must see the full surface area of the

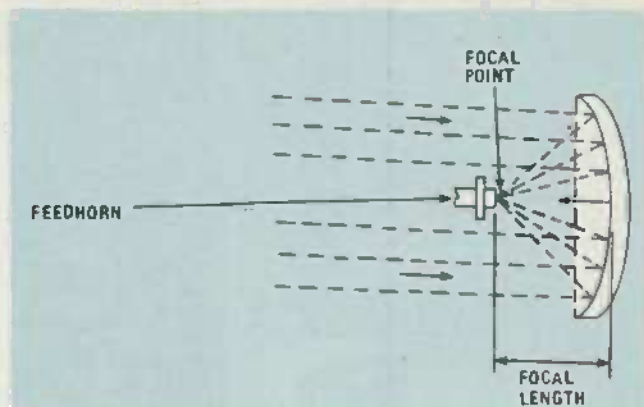

FIG. 2—THE FOCAL LENGTH of a dish is the distance from the surface of the dish to the focal point of the reflected signals.

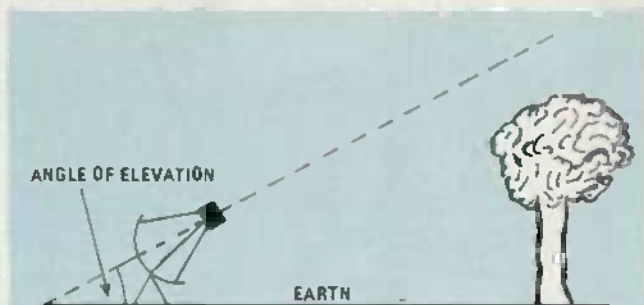

FIG. 3—THE ANGLE OF ELEVATION is taken with reference to the earth.

dish, not too little nor too much. The ideal set up is one in which the dish is fully "illuminated" and the feedhorn receives signals from every section of the dish. A partially illuminated dish is one in which the full reflective surface of the dish isn't used so that the feedhorn doesn't receive an adequate amount of signal. Another possibility is the "viewing" of the area beyond the perimeter of the dish; that condition is known as spillover. With spillover the feedhorn receives all of the reflected signal, but the signal-to-noise ratio is worsened since the region beyond the perimeter of the dish contributes noise, but no signal. See Fig. 4.

### Dish gain

Dish gain is directly related to dish aperture and generally ranges between 35 and 45 dB for a TVRO dish. Gain is a variable and is usually higher at the high-frequency end of the C-band. Specification sheets do not emphasize that point and often supply only the highest gain-value. The gain of a 6-foot dish is at best about 35 dB, with an increase in gain of approximately 1 dB for each additional foot in dish aperture. That applies to dishes in the 6-foot to 11-foot range. Once the aperture gets beyond 11 feet, gain continues to increase, but at a rate of about 1/2-dB-per-foot-increase in aperture.

The gain of a dish also depends on how well the surface of the dish adheres to its intended curvature, and whether that curve is parabolic or spherical. Warp, corrosion, and deformation caused by stress put on the dish surface, as well as debris collected on it, all contribute to loss of gain.

### Noise

There are two important electrical-noise sources that affect TVRO systems. One of those is thermal energy, the energy supplied by the sun. Noise caused by thermal energy is sometimes called space noise. The earth is also a secondary noise-generator, acting as a heat-energy reservoir during daylight hours and releasing that stored energy after sunset. That energy can affect signals in the C-band, particularly when the elevation of the dish is low.

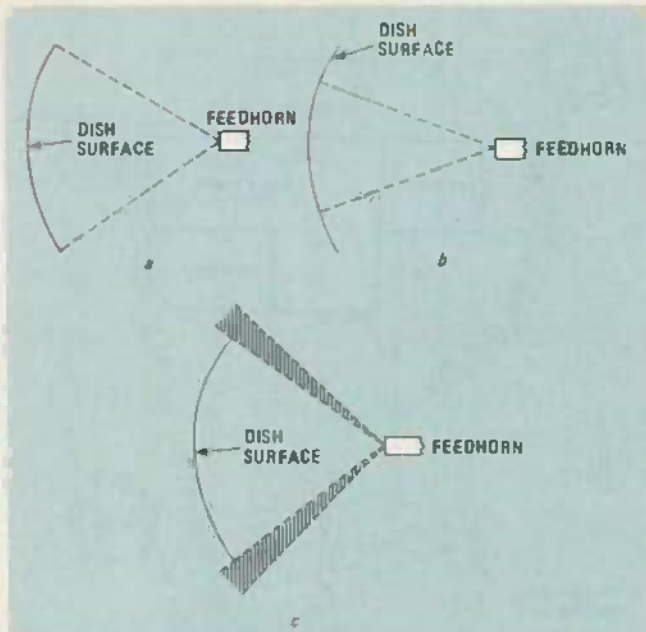

FIG. 4—DISH ILLUMINATION. A fully illuminated dish is shown in a, one with insufficient illumination is shown in b, and one with spillover is shown in c.

Noise can also be generated by solid-state components such as diodes and transistors. The noise generated by those devices is known as shot-effect noise and is caused by random movement of electrons, which increases with temperature. Transistors for the first active component following the dish, the low-noise amplifier (LNA), are GaAs FET's, which are noted for their low noise-level compared to other transistors.

### Noise figure

The noise figure, abbreviated as NF, is a comparison of the signal-to-noise ratio at the output of a component with reference to the signal-to-noise ratio at its input. Wide-band amplifiers are more subject to high noise-levels since they are capable of including a greater range of noise frequencies. Such amplifiers also have fairly low gain, and so the amount of noise compared to signal level tends to be higher.

### Noise and the picture

Noise, carried through and amplified by a TVRO, can affect the picture in several ways. Noise in the chroma portion of a picture can consist of colored dots or small rectangular streaks that can vary in intensity. That type of noise is sometimes referred to as "confetti" or "sparklies." The luminance portion of a picture can also show the effects of noise. Noise there appears as the black and white particles known as snow. Noise in the picture can be caused by inadequate signal-levels or by electrical interference that's overriding the signal level. Noise can also affect the sound portion of the video signal, showing up as mainly as hiss.

### Carrier-to-noise ratio

Abbreviated as C/N, the carrier-to-noise ratio is a comparison of the power contained in the downlink signal to the amount of noise, with the result supplied in decibels. Obviously, the higher the carrier and the lower the noise, the better the picture.

### Beamwidth

A dish has the capacity to accept some signals and reject others, although it can not select certain transponders of one satellite while rejecting the signals of other transponders of the same satellite. Instead, a dish has the ability to respond to one selected satellite while rejecting the signals of other satellites.

That is an important characteristic since all satellites use the same downlink frequencies. In order for a TVRO system to process signals from several satellites, it is necessary to re-aim the dish.

Beamwidth is a measure of a dish's ability to select the signals from one satellite while rejecting those from others. The narrower the beamwidth, the more selective the dish. One of the advantages of dishes having larger apertures is that they are more selective.

### The shroud

A few dishes are equipped with a metallic ring mounted around the perimeter. That ring is called the shroud. Measuring from a minimum of 6 inches to as much as 18 inches, and mounted at a right angle with the surface area of the dish, its purpose is to block interfering signals from arriving at the sides.

### Reception window

A small movement of the dish in any direction, either in elevation or in azimuth, or both, is equivalent to a large motion in outer space. As a result, even a small change in the position of the dish can produce a weakening of the received signal or its complete loss. There is, however, a small area, called the reception window, through which the dish can be moved without seriously affecting reception. The reception window can be visualized as being parallel to the dish and located a few feet away from it. See Fig. 5.

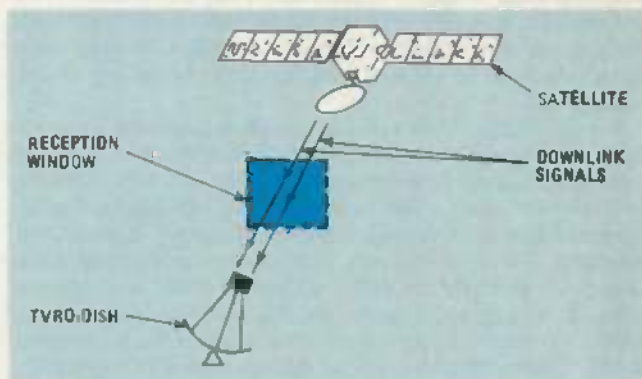

FIG. 5—BEST SATELLITE-TV RECEPTION occurs when signals are received through a small reception window.

### The spherical dish

Although a parabolic dish is the more widely used in TVRO installations, a spherical dish does have some significant advantages. One of those is that its signal reflection accuracy can be excellent, with a sharper area of focus than that of a parabolic reflector.

Also, unlike the parabolic dish which must be precisely pointed at a selected satellite, the spherical dish (sometimes also called a circular dish) does not need to face a satellite directly. In fact, it can be as much as 20° off of a direct line and still produce a usable signal. The result is the spherical dish can focus on several satellites simultaneously; the focal point for each satellite will, of course, be at a different location as shown in Fig. 6.

The spherical dish is generally a fixed-in-position type, con-

sequently its support can be made quite substantial and may be desirable in areas where wind loading is a significant factor. It is also a suitable type where signal pickup from two adjacent satellites is all that is wanted.

The chief disadvantage of the spherical dish, and one that has diminished its popularity for TVRO systems, is its very long focal length, often 12 to 20 feet.

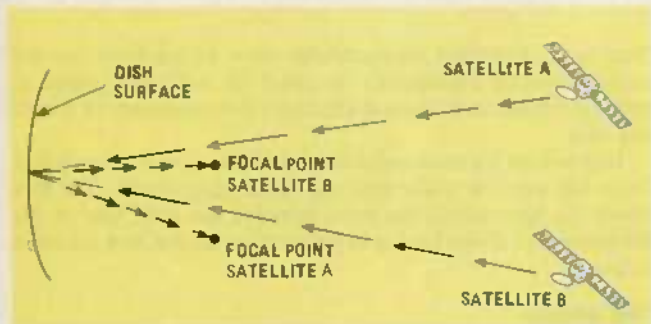

FIG. 6—A SPHERICAL DISH can receive signals from more than one satellite, with each satellite having its own independent focal point.

### Mounts for parabolic dishes

The mount used for a dish has two functions: the first and more obvious is that it must support the dish, an important consideration but particularly so in areas having occasionally strong winds. The other requirement is that the dish must face a selected satellite.

The simplest support is the fixed mount. Its chief advantage is that it is permanently fixed in position, requiring no further adjustment once good signal reception is established. Further, such a mount can be reinforced so as to tolerate substantial wind. The most serious disadvantage is that the dish is restricted to pickup from one satellite only. In some instances that may be desirable, as in the case of a newspaper using the services of just one satellite, or a cable-TV earth station that communicates with and receives signals from a designated satellite. In some areas signal blockage by trees or buildings permits the use of one satellite only.

For the average TVRO owner, though, a preferable mount is the Az/El type. The Az/El (AZimuth/Elevation) has two axis of movement: azimuth and elevation. Adjustments in positioning can be made along either axis and those adjustments can be handled either manually or by motorized control, at the dish or remotely. The difficulty with such mounts is that making a change in azimuth can affect a change made in elevation. However, with an Az/El mount, the dish can be made to point at a number of satellites and if a record is made of the positioning points, moving the dish from one satellite to another is possible, but tedious.

The most popular mount for TVRO installations is the polar mount. With the polar mount, just the angle of azimuth needs to be changed, with adjustments in elevation being made automatically. A support of that kind can be controlled at the dish site or remotely from the home.

### TVRO site selection

A prime requirement for a TVRO system is a clear line of sight to a minimum of one, and preferably more, satellites in geosynchronous orbit. The dish must have a clear view of a certain portion of the southern horizon with no buildings, hills, or trees blocking the downlink microwave-signals.

A preliminary examination of a proposed site for dish will sometimes quickly determine if a TVRO system is feasible. A good way to make that examination is to make a preliminary site overview sketch as shown in Fig. 7. Note the variety of factors taken into account in that sketch. Among the things often over-

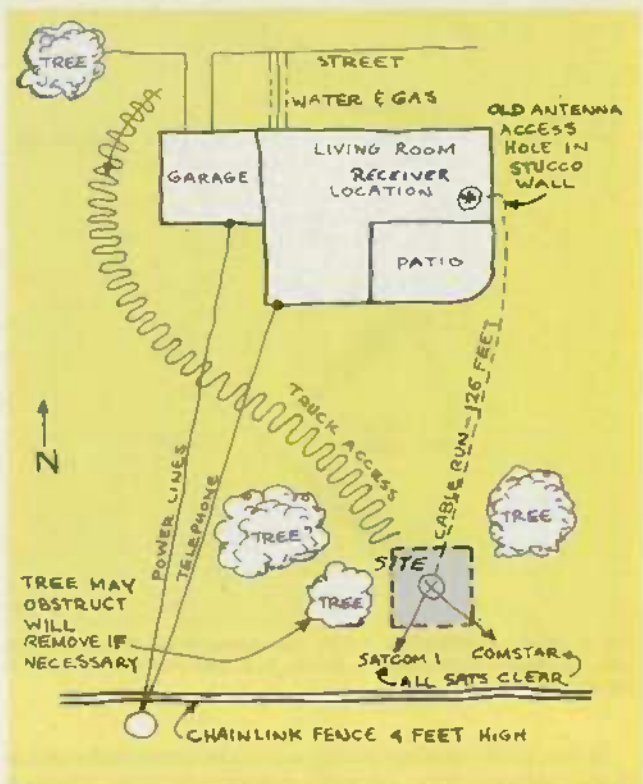

FIG. 7—A SITE SURVEY SKETCH. Note the variety of factors that the survey should account for.

looked are the connections between the dish and the house. Your sketch should indicate the length of coaxial cable that needs to be run from the site to the satellite receiver in the home. Make allowance for the fact that the receiver may be on an upper floor or in a room not immediately adjacent to where the cable enters. A good installation technique is to route all connections between the dish and the house through PVC pipe that's buried underground. Special sealants are available for closing the entrance and exit of the pipe to prevent water entry.

Another factor to be considered while doing your site survey is the fact that the dish will need to be supported not only in terms of weight but also wind stress. Thus, a concrete pad, which involves the mixing and pouring of one or more cubic yards of cement, is needed.

If a preliminary site survey is satisfactory, the next step is to use a site tester. The site tester shown in Fig. 8 is one of various types that can be used. The device looks like a miniature telescope, but it does not have a lens. Instead, it has an elevation plate calibrated in degrees, a bubble glass to help you keep it level, and a built-in compass. The device is used to give a prior indication of what satellites can be viewed and what obstruction (i.e. tree) removals may be necessary.

Here are some factors to consider when selecting a site. Not only must the dish have a clear line of sight to the satellites, but there should be no overhead power-lines since the electrical noise produced by those can override the signals. The selected site should be clear of existing underground installations: phone lines, power lines, storm drains, etc. It is also advisable to check with municipal or township authorities to learn if there are any restrictions on satellite-dish installation. In some instances, it may be necessary to obtain the cooperation of neighbors for tree removal or site clearance.

Following pickup by the dish the signals will be processed by equipment mounted on or near the dish, but ultimately the signals will need to be brought into the home. The maximum distance between the dish and the home should be about 300 feet, but remember that the shorter the cable, the less the signal loss.

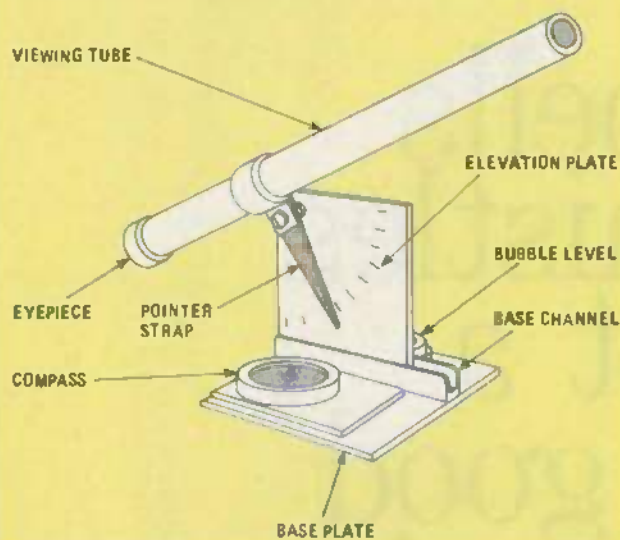

FIG. 8—IF THE RESULTS of the site survey are satisfactory, the next step is to use a site tester such as the one shown here.

There is always the possibility of microwave telephone-interference since phone companies operate over the same frequency range as satellite-TV signals. That is not a problem, unless the dish site is in the path of such transmissions.

In addition to the information given by the site tester, it is necessary to know the azimuth and elevation heading of the various satellites for any particular dish site. That information is often available in the form of a computer printout from dish manufacturers. There are also commercial services that supply such data. The azimuth and elevation readings, plus the information from the site tester, will give you a preliminary indication of which satellites will be available at the selected site.

#### Foundation types

We mentioned earlier that a concrete pad or foundation is required in a TVRO installation. There are several types of foundations. One type consists of a single slab of reinforced concrete (see Fig. 9). Its advantage is that it distributes the weight of the dish and the forces pushing against it over a large area. The slab mount may be necessary in area where the soil is loose or where there is a drainage problem. When installing that type of foundation, it will be necessary to construct forms to hold the cement and it is also advisable to use a gravel base before pouring the cement. The single pole support of the polar mount must be imbedded in the center of the cement slab and must be absolutely vertical. The depth of the pole in the cement should be at least two feet. As the pole is pushed into the gravel base and as the cement is poured, make repeated checks of the pole using a large bubble glass to make sure the pole is vertical. The concrete base itself has no kind of orientation. Its only functions are to supply support and rigidity for the mount.

After the cement has been poured, it should be allowed to cure. The cement should be watered lightly about once or twice a day, but the dish should not be mounted, preferably for a week. How fast the cement will cure will depend on the ambient temperature and moisture content of the air. Cement should not be poured if there are predictions of rain.

Another type of foundation is the pier mount, shown in Fig. 10. A pier mount is used where a low frost line prevents the use of a slab. An X-frame consisting of a series of wooden beams can be used as a dish support, supplemented by a concrete pad. The footing supplied by the pier resists movement in any direction.

The choice of the type of foundation is often dictated by conditions at the sight. If the site is very rocky it may not be possible to drill pier holes and so a slab foundation may be

necessary, especially since it can be poured directly over rock. If you need help in installing the foundation, some small

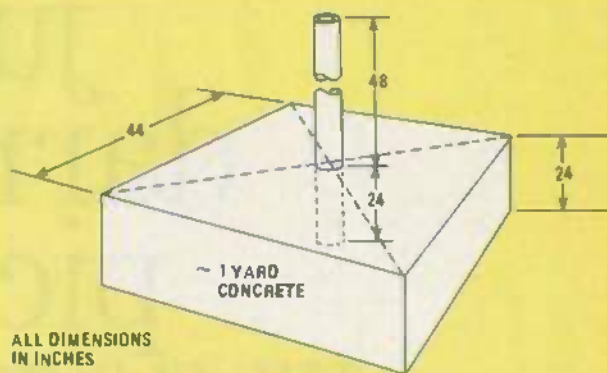

FIG. 9—A SINGLE SLAB concrete foundation for a polar mounted satellite dish.

contractors who are experienced in working with house foundations can be consulted and in some instances they will take on the job. In addition, manufacturers of dishes often supply suggestions about dish supports, complete with plans and dimensions.

#### The dish and its environment

A dish is not an object that can be readily concealed. For that reason there may be some apprehension on the part of family members or neighbors about its appearance. The usual location

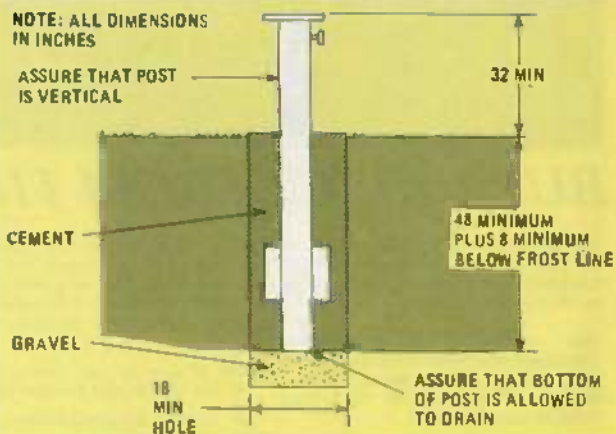

FIG. 10—PIER MOUNTS can be used where a low frost line makes using a slab foundation impractical.

for a dish is somewhere near the rear of the house, generally in an area that isn't otherwise used. A dish can be situated in a tree or shrub area provided that none of those obstruct the front of the dish as it sweeps through its arc.

From a low-noise viewpoint, the higher the dish is in the air, the better. There are instances of roof mounts, but generally those are in commercial applications. The roof must be strong enough not only to support the dish but the wind force to which the dish is subjected. Such installations require the approval of town or city authorities. In some instances it may be necessary to obtain a variance to avoid violating local building codes. R-E

no bells  
no whistles  
just a  
darn good  
picture!

**THE ELECTRONIC RAINBOW**  
Satellite Receiver MODEL ERI 7000



**BUY DIRECT FROM THE FACTORY... AND SAVE!!**

Now-a-days everybody's talking price. The ERI 7000 Satellite Receiver is just what the low-budget system installer needs, without sacrificing picture quality.

Many satellite receiver manufacturers camouflage their receivers operating ability with lots of lights, meters, dancing numbers, whistles, and bells. We at Electronic Rainbow think the...

1. Picture Quality
2. Serviceability
3. Value for the Money Spent

are the most important features.

The ERI 7000 is a satellite receiver with few frills, just a darn good picture at a price you can afford.

We know maintenance is often a problem. Our modular construction is the most advanced system on the market today. When something goes wrong, unplug the section with the problem and insert a new module.

In a few minutes your ERI 7000 is back in business. All other receivers are subject to sending the receiver to a service center or back to the factory. This takes weeks of turn around time and you have a very upset customer.

Ease of operation and simplicity of design the ERI 7000 Satellite Receiver features:

- L. E. D. Bar Signal Strength Indicator
- Fully Tunable Audio
- Polarity Selector
- Full Band Variable Frequency Tuning

Every dealer can do most of the repairs themselves. The receiver is made-up of 4 plug in modules.

1. Power Supply Module
2. 70 MHz Amp. Module
3. Video Module
4. Audio Module

With this superior design and engineering, you can expect years of trouble free performance.

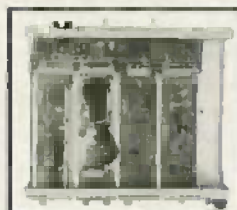

Inside the ERI-7000

**MAIL ORDER SPECIAL!**

**ERI-7000**

Satellite Receiver . . . . \$425.00  
LNA 100<sup>®</sup> . . . . . \$349.00

**COMBINATION SPECIAL \$674.00**

**SAVE \$75.00**



Visa & Master Card Accepted  
**TO ORDER CALL 800-428-3500**



Information Call 317-291-7262

**ELECTRONIC RAINBOW**

6254 LaPas Trail • Indianapolis, IN 46268

CIRCLE 20 ON FREE INFORMATION CARD



MARTIN CLIFFORD



# Satellite Receivers

*Along with the satellite dish, antenna, and downconverter, the satellite receiver is an important part of any TVRO system.*

THE SATELLITE RECEIVER IS ONE OF THE FEW PARTS OF A TVRO system that is located indoors. Its main function is to convert signals from the LNA so that they're compatible with your TV or video monitor.

One of the first specifications that you'll notice about the receiver is the number of channels it can receive. A receiver with 24-channel capability is best, even though not all satellites have 24 transponders (some are equipped with 12 or even fewer). There are some satellite receivers designed for single-channel input. Those are called *dedicated* satellite receivers and are not for general home use. (They are usually used commercially to pick up, for example, news from one satellite or programs from a cable company's single satellite.) The use of a dedicated satellite receiver does have its advantages, though. Because you only want to receive one channel, the receiver is a fixed-tuned type. So the tuning control, once set, seldom requires readjustment. A fixed mount for the dish is generally used with such receivers, so once the dish's azimuth and elevation are set to focus on a particular satellite, adjustments are no longer required.

The second type of receiver (and the one commonly used with in-home TVRO systems) is known as a *frequency-agile* satellite receiver because it has the capability of tuning from one channel to the next. Such a receiver is shown in Fig. 1.

### Tuning frequency-agile receivers

The first step in tuning the in-home satellite receiver is to make sure that the dish is facing the selected satellite. Then you must select (using a rotary dial or a pushbutton selector) one channel from among the 12 or 24 offered by the satellite.

The receiver will also be equipped with a control (usually labeled V/H or VERT/HORIZ) that lets you select between signals that are vertically or horizontally polarized. Although the polarity of many channels are published, using the v/h control is so quick and easy that you may not want to bother using the published information. No matter what, you'll be right half the time!

### The double-conversion receiver

The output of a C-band LNA consists of audio and video signals that are frequency modulated onto a microwave carrier in the downlink frequency band (3.7 to 4.2 GHz). From there they are fed either to an external downconverter or directly to a receiver.

In the double-conversion (or dual-conversion) receiver, there is no external downconverter—the signals are brought directly from the LNA into the receiver as shown in Fig. 2. In that arrangement, all of the downconversion is handled directly in the receiver itself. That's a bit of a disadvantage—bringing the microwave signal from the antenna to the receiver requires special, expensive coaxial cable. Signal losses become very critical.

The first downconversion is accomplished by a mixer/local oscillator arrangement. The first mixer is used to *heterodyne* the downlink signal and the first-local-oscillator signal, producing an IF of 1100 MHz. (Heterodyne means to mix two frequencies together to produce sum and difference frequencies.) The selection of the IF or Intermediate Frequency is arbitrary and is a manufacturer's choice, but 1100 MHz is typical.

Like all IF stages, the first IF is an active filter, and supplies not only selectivity but gain as well. Although the diagram shows a single block, the IF section consists of a number of stages.



FIG. 1—SATELLITE TV RECEIVER. Features of this unit (KLM Sky Eye V11X) include variable speed scanning for fast scanning of the satellites or frame-by-frame viewing of each of the 24 transponders of a satellite. Note that this receiver uses an external downconverter, shown beside it.

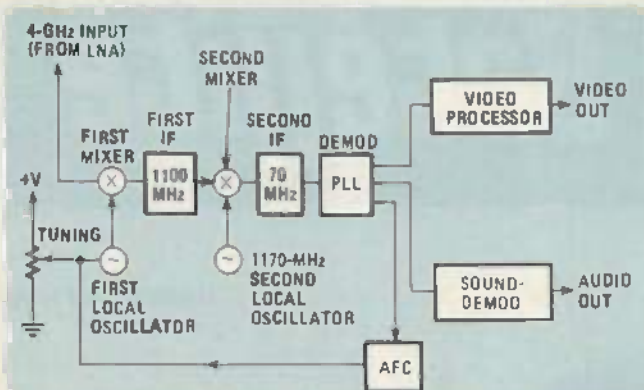

FIG. 2—A DUAL-CONVERSION SATELLITE RECEIVER takes the 4-GHz input from the LNA and uses two local-oscillator/mixer combinations to convert it to a 70-MHz signal that is then demodulated.

The bandwidth of the modulating waveform for both the uplink and downlink signals is 36 MHz. Technically, that should be the bandwidth of the IF stages. But in many receivers, the bandwidth is restricted to 28–30 MHz. There's a good reason for doing that—it results in an improved signal-to-noise ratio (S/N). By narrowing the bandpass of the IF, noise on the outer limits of the bandpass is rejected. At the same time the gain of the IF amplifiers is increased because of the narrower band. However, in narrowing the bandpass of the IF, some picture quality is sacrificed. But because of the increased S/N, that's a tradeoff that seems worthwhile.

Following the 1100-MHz IF section, the signal is sent to another mixer/local-oscillator circuit, known appropriately as the second mixer/second local oscillator. The local oscillator here is at a frequency that is 70 MHz higher than that of the first IF, namely 1170 MHz. The output of this circuit is a second IF of 70 MHz. As we'll see shortly, that is the same frequency as the output of an external downconverter.

In a double-conversion arrangement, the change in carrier frequency is accomplished in two steps, with both of these steps taking place in the in-home receiver. While the double-conversion setup does make use of two local oscillators (a first and a second), only the first local oscillator is tunable. Since the IF remains the same for any of the 24 channels tuned in, the second local oscillator is a fixed-tuned type.

While this type of double-conversion receiver eliminates the need for an external downconverter, we have a problem of bringing the microwave signals in from the outdoor LNA—because of the very high frequencies of those signals, cable losses become a serious problem unless special, expensive coaxial cable is used. Therefore, dual-conversion receivers that use external downconverters are much more popular.

### External dual downconversion

Even though the downconverting circuitry is located in a separate, externally mounted component, we can (and will) still think of the satellite-receiver/external-downconverter system as an integrated unit. The first part consists of dual mixers/local-oscillator circuitry and the second part consists of demodulators and amplifiers.

The only major difference between this type of system and the system that we looked at previously is that it's housed in two separate cabinets, one of them outdoors. In a typical setup, the dish-mounted downconverter first changes the downlink band from 3.7–4.2 GHz to 850 MHz and then, using a second local oscillator/mixer arrangement, has another downconversion step resulting in a 70 MHz carrier. That setup is shown in Fig. 3. That 70-MHz IF output is then brought to the in-home receiver using standard RG-59/U coaxial cable. That's the real advantage of this system. (Remember the problems we had with the coaxial cable when all downconversion was handled indoors.)

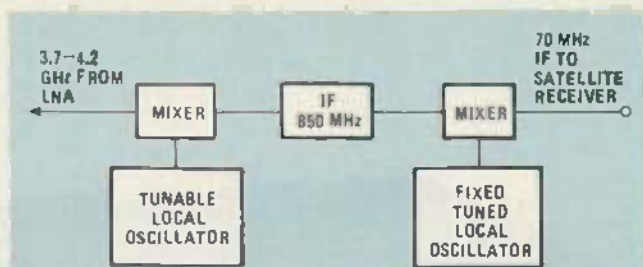

FIG. 3—BASIC ARRANGEMENT of dual-downconversion component, mounted outdoors.

### Single downconversion

Another popular receiver used today is the single-downconversion type, as shown in Fig. 4. In that type of system, all of the downconversion takes place in an externally located component.

A disadvantage of single-conversion receivers is that of *image signals* that can be produced by the single downconversion

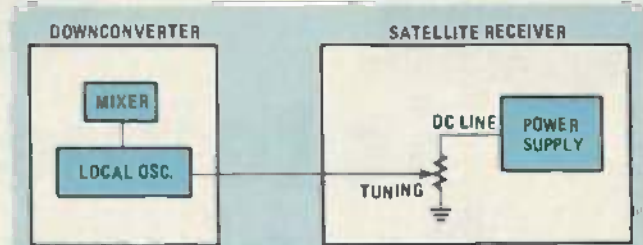

FIG. 4—IN SINGLE-CONVERSION SYSTEM using an external downconverter, the local oscillator is tuned by DC voltage from a power supply in the satellite receiver.

process. To minimize that possibility, single-conversion satellite receivers may be equipped with an image-reject mixer.

### Tuning

In an ordinary (superheterodyne) AM or FM receiver, tuning is done by varying the frequency of the local oscillator and the RF amplifier (if present). For satellite-signal reception, the LNA can be considered to be the RF amplifier, but it's not tunable. As shown in Fig. 4, tuning is done by changing the local-oscillator frequency by varying its DC voltage. The local oscillator, then, is also known as a voltage-controlled oscillator (VCO). For double-conversion units, only the voltage of the first local oscillator is changed, as shown in Fig. 5. While the IF of 70 MHz is close to the frequency of one of the low-band VHF channels, it is not suitable as is for input to the antenna terminals of the TV receiver because the video is frequency modulated—it is incompatible with NTSC standards.

To meet the processing requirements of the television receiver, it is first necessary to recover the original baseband signals, and then to remodulate them, using frequency modulation for the sound and amplitude modulation for the video. The carrier frequency selected is usually that of VHF channel 3 or channel 4.

During the uplink transmission process, a *dithering* technique was used, a method of pre-emphasizing the higher-frequency components of the video signal. Its function is to compensate for a characteristic of video demodulators, whose noise output is greater at the upper end of the video band. Because the dithering technique shifts the 6-MHz satellite signal up and down the 36-MHz satellite-transponder spectrum (thus spreading out the transmission energy over a wide frequency band), it also can reduce the interference to/from terrestrial microwave links. To counter the effects of dithering, a video de-emphasis filter circuit, called a clamp, is used. Clamping is essential to prevent the picture from flickering at the rate of 30 Hz.

### The audio signals

Just as a terrestrial TV signal uses a subcarrier to carry the

# Radio Electronics RECEIVING a Satellite TELEVISION

colorburst signal at 3.58 MHz, the subcarrier technique is also used by the downlink transmission. The sound subcarriers can be at 5.6, 5.8, 6.2 or 6.8 MHz. The satellite receiver will be equipped with a control to permit subcarrier tuning by means of a tunable audio demodulator. The sound output will be mono, but stereo can be had through the use of a pair of audio demodulators, one for left channel sound, the other for right channel sound. Some receivers, such as the one shown in Fig. 6, are equipped with a pair. Others require an add-on component.

The audio demodulators are equipped with filters so as to select the correct audio subcarrier. The frequency range of the audio is from 15 Hz to 15 kHz, comparable to that of terrestrial FM broadcasts. Some satellite transponders supply audio information only and that is always stereo.

## Remodulation

The demodulators recover the original video and audio baseband signals, and these are then remodulated in the proper NTSC format onto either VHF channel 3 (60 MHz-66 MHz) or VHF

channel 4 (66 MHz-72 MHz). The output of the remodulator is connected to the antenna input terminals of a television receiver.

In some instances, the satellite receiver and the remodulator are integrated, forming a single unit. However, there are some satellite receivers not equipped with a remodulator. The integrated type is obviously more convenient.

## Features

You cannot say that satellite receivers are all alike any more than you can say that all hi-fi receivers are alike. Let's look at some of the differences in the features of satellite receivers, starting with tuning.

Various tuning methods are used in satellite receivers. Continuously tuned dials are available as are detent or click-stop types. The dial can simply be a rotary type with channel numbers around the knob. It could also be a linear, illuminated slide-rule type marked with channel numbers. (To avoid crowding, only even or odd-numbered channels from 1 to 24 may be indicated, but that does not mean all the channels cannot be received.)

Some receivers will offer a digital readout of the channel number. And some offer a tuning meter that indicates signal strength. The tuning meter is helpful in several ways. If the satellite receiver uses continuous tuning (as opposed to detent tuning), it can aid in tuning accuracy indicating when maximum signals are being received. It can also be used to help peak the picture when making azimuth and elevation adjustments of the dish. If the receiver isn't equipped with a tuning meter, the picture, as seen on the television screen, can be used instead, but the tuning meter is a much better approach. The tuning meter also supplies an indication of the comparative signal strengths of the various transponders.

A Surface Acoustic Wave (SAW) filter is used in modulators, receivers, demodulators, converters, decoders, and signal processors. The advantage of a SAW filter is that it is capable of delivering an almost ideally shaped IF bandpass waveform (see Fig. 7) to the input of the video demodulator, without the need for special alignment. At all operating frequencies and bandwidths, SAW filters can have a very flat response over the passband region, with a variation of less than  $\pm 0.5$  dB. The problem in using a SAW filter is that it has a high insertion loss, usually around 30 dB, but that can be overcome through the use of additional IF amplifier stages. The use of a SAW filter, plus the need for extra stages of IF amplification, adds to the cost of the receiver, but the result is pictures that are less noisy and have greater freedom from interference. Unlike other filter types, SAW filters do not require fine tuning or adjustments.

SAW filters are made on various piezoelectric substrates, the two most common being lithium niobate (LiNbO<sub>3</sub>) and ST-quartz. A major advantage SAW filters over L-C filters with comparable shape factors is that SAW filters fit easily on a printed-circuit board because they are small and are packaged in sealed containers.

There are two major types of SAW filters. The first is a SAW transversal filter. Those filters can be designed over a wide range of center frequency, bandwidth and temperature requirements, have excellent passband behavior and stopband rejection. They can be used in a wide range of signal-processing applications. The second type is a SAW resonator filter. They are used for narrow-band circuitry in the 30-MHz to 1-GHz (or higher) range.

Video-output terminals are often included in the satellite

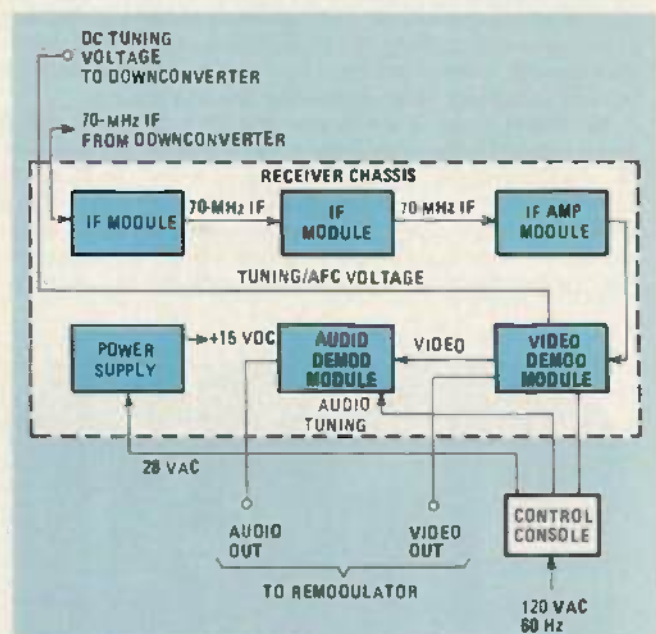

FIG. 5—THE BASEBAND SIGNALS ARE RECOVERED signals prior to remodulation.

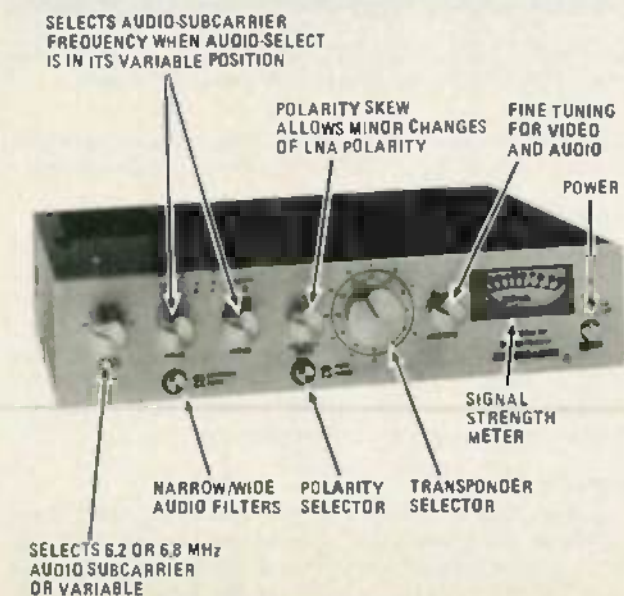

FIG. 6—FRONT PANEL CONTROLS of satellite receiver.

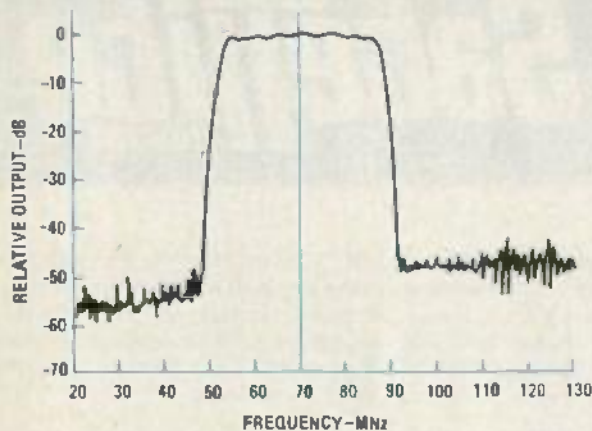

FIG. 7—SHARPNESS OF RESPONSE of SAW filter used in an IF stage. Note the center frequency of 70 MHz.

receiver. That's important if you plan to use the baseband audio and video signals for your VCR, for example. The output impedance is usually 75 ohms and can be handled by coaxial cable such as RG-59U. From that terminal, the signals can be led into an external modulator, or, as an alternative, supplied to a videocassette recorder. Since these units are equipped with a modulator section, the use of a separate modulator will not be required.

The receiver may be equipped with a baseband-signal-level control. The signal level should be 1.25 volts, peak-to-peak. A simple way of adjusting that control is to display a picture on the TV set and then set the control for the best results. If the picture tears or skews, the signal level is too high. If the picture seems to be weak, the video signal level is inadequate. In either case, variation of the control should improve the picture.

The channel-calibration control is often mounted on the rear apron of the receiver. It is used to make sure tuning is correct, regardless of the quality of the picture. When making adjustments, the channel-calibration control takes precedence. It is the first one adjusted. Once tuning accuracy is established, make signal level adjustments if required.

Remote control is a feature that some satellite receivers come equipped with. Being able to select any one of 24 transponders from your chair is certainly a convenience. It isn't necessary, of course, but...

The line tuning control is used for producing a peak picture. However, it is difficult to adjust the tuning control and get observable results unless you have a test pattern to look at. Motion in the picture makes peaking very difficult.

A video-inversion switch can be useful. Some satellites use signal scrambling in an effort to make sure that only paying subscribers of cable TV can watch their programs. One way of doing that is to invert the video signal. Some satellite receivers are equipped with a decoder which is, in effect, a video inverter. The video inverter is useful only if signal inversion is the type of scrambling used.

Speed scanning is a method in which satellite channels are tuned in automatically. Scanning can be single-speed or two-speed. With single-speed scanning all the channels are displayed, successively at a constant rate. The problem with this type of scanning is that there may not be enough time to view a picture and make a decision to watch or to manually override the scanning action. As a solution to this problem some satellite receivers have two speed scan, a technique in which the scanning action becomes much slower when tuning across an active channel, supplying the opportunity for a longer look at the picture. Scanning is much more rapid between channels.

Audio selection is desirable because there are four basic formats used by satellite transponders for the transmission of audio signals. Those include mono (single channel) sound, ma-

trix stereo, discrete stereo, and multiplex stereo. However, the sound, whether mono or stereo is ultimately delivered to a television receiver, but that receiver most likely has only single-channel capability. Further, television sound is not only mono but, with most TV's, it has exceptionally poor quality. However, there are several ways of overcoming the sound limitations of the TV set. The decision to transmit mono or stereo audio is not determined by the transponder, but is decided upon at the time of transmission of the uplink signal.

### Stereo synthesizer

Even if a satellite's transponder transmits only mono, it is possible to change it into a synthetic form of stereo by using an add-on stereo synthesizer. However, stereo sound isn't automatically hi-fi sound, but is a step on the way to achieving more realistic sound. Used along with a hi-fi system, the synthesizer can yield good results.

### Stereo processor

A stereo processor is another TVRO add-on component. Unlike the stereo synthesizer, it is capable of supplying true stereophonic sound (as long as the satellite is transmitting stereo information). A stereo processor may also be equipped with one or more headphone jacks, permitting listening privacy.

The tuning range of the processor is from 5.5 MHz to 8.0 MHz, permitting the selection of any of the audio subcarriers of the downlink signal. In some stereo processors, the IF bandwidth is selectable and can be either 150 kHz or 500 kHz. With a narrow bandwidth, gain is increased—that's desirable under conditions of low-signal strength. At the same time, the narrow bandpass reduces the noise level, some musical information can



TWO-CHANNEL SOUND. Some receivers can have stereo capability added to them through the addition of an external stereo demodulator.

be lost. Conversely, a wider bandpass means gain is lowered, the noise level may be higher, but all of the music will be heard.

### Tunable audio

Since, with terrestrial TV, sound is an automatic accompaniment of the picture, the concept of tunable audio may initially appear to be somewhat strange. With a satellite receiver equipped with a tunable audio feature it is possible to listen to a musical program without watching a picture. The audio-tune control on the front panel of the satellite receiver can be used to optimize sound pickup or for the selection of a sound-only program available on some transponders.

### Remote control

If you have a fixed-mount dish, you don't have to worry about adjustment—once you have the azimuth and elevation set and the dish is focused correctly on a desired satellite. With the polar mount, the dish can be aimed either at the dish site or from the home. Dish position control from the home is the more desirable

TABLE 1—VIDEO SATELLITES

Position	Existing	Mid-84	Late-84
143°W	F5	F5	F5
139°W	F1R	F1R	F1R
134°W	G1	G1	G1
131°W	F3	F3	F3
127°W	D4	D4	D4
123°W	W5	W5	W5
119°W	F1/F2	S1	S1
117.5°W	AC3	AC3	AC3
114°W	A3	A3	A3
112.5°W	AC2	AC2	AC2
109°W	AB	AB	AB
106°W			GSA1
104°W	AD1	AD1	AD1
103°W			GSA2
99°W	W4	W4	W4
95°W			T302
95°W	D1/D2	D1/D2	D1/D2
91°W	W3	W3	W3
87°W	D3	D3	D3
83°W	F4	F4	F4
79°W	W1/2	W1/2	W1/2
76°W	T301	T301	T301
74°W		G2	G2
72°W		F2R	F2R
70°W			S2

Note: Satellites are identified as follows:

A = ANIK (Telesat Canada), D = COMSTAR (Comsat),  
 F = SATCOM (RCA American), G = GALAXY  
 (Hughes), GS = GSTAR (GTE), S = SPACENET (GTE  
 Spacenet), T = TELSTAR (AT&T), W = WESTAR  
 (Western Union)

not only for convenience, but also for quick and accurate adjustment from one satellite to another.

The remote control unit is a memory device. Once the position of the dish has been entered into the memory, the dish can always be made to return to a specified position.

Since more satellites are being lofted (See Table 1 for a list), the remote control memory should have a capacity exceeding that of the present satellite population. It is possible to get a remote dish-control console that can program and recall up to 50 satellite positions. The component may also have a digital selection and readout panel to keep the viewer advised of the dishes position during programming, recall, or manual control. Other features could include single-knob polarity control and full east-west manual control with travel readout.

### Switching

TV receivers are now being used as display devices for a variety of video products including terrestrial TV broadcasting, satellite TV, videocassette recorders, videodisc players, and videogames. Switching from one of these program sources to the other can be bothersome because of the tangle of wires that is sure to result when you start switching cables from one unit to another. An alternative method, and an easier one, is to use a video switcher. The simplest is an A/B switcher, but that has only a two program source capability (for switching between cable TV and your satellite receiver, for example). A better add-on component would be a switcher that can handle four, five, or



SOME RECEIVERS, such as the one shown here, are intended for dedicated operation. They are set at the factory for only one transponder.

# Radio Electronics RECEIVING Satellite TELEVISION

even more different signals.

Video switchers are passive devices and all of them have a certain amount of insertion loss, that is, they will produce some small decrease in signal strength. For the average signal source that has adequate level that's not a problem. But for marginal signals it may mean the difference between a viewable and a non-viewable picture. There may also be the possibility of signal leakage from one program channel to another, so good channel isolation is essential.

### The television receiver

For a TVRO system, the television receiver is the final step in a long link of components, starting with the dish, the feed, the LNA, the downconverter, the satellite receiver, plus the possible inclusion of some add-on devices. The total cost of a TVRO setup depends on a number of variables, beginning with the type and size of the dish, but can easily be several thousand dollars or more.

Although it isn't generally regarded as such, the television receiver is an integral part of every TVRO arrangement. Possibly because of the cost of a TVRO installation, the usual tendency is to "make do" with the existing TV set. Whether such a decision is a wise one or not depends directly on the TV receiver. A satellite system can deliver superb pictures with a quality comparable to that of a studio monitor. The TV set should have good field interface and good horizontal and vertical resolution. Connecting a TVRO system to a television receiver having poor or just average picture quality just doesn't make economic sense. A



FIG. 8—IF A NUMBER OF TV SETS are to be connected to the remodulator, or remodulator-equipped satellite receiver, a line amplifier may be required. The line amplifier connects to a signal splitter whose output feeds the antenna input terminals of the TV sets.

TVRO can also be used with a projection unit or a monitor.

### Multiple-set operation

The output of the remodulator in the satellite receiver is the equivalent of a VHF channel 3 or 4 signal. That signal can be fed into one or more television receivers with the help of a signal splitter, a type of balun, a balanced-to-unbalanced transformer.

If the output of the satellite is to drive a number of TV sets, it may be necessary to use a line amplifier inserted between the satellite receiver and the input to the television sets. The output of the line amplifier is brought into the splitter and from the splitter to each of the TV receivers. (See Fig. 8)

One of the problems in connecting the satellite receiver to one or more television sets is that while the output of the receiver is 75 ohms, the input to the VHF terminals of a television receiver can be either 75 ohms or 300 ohms. For 75-ohm inputs coaxial cable is used; for 300 ohm inputs twinlead is required.

Unfortunately, there is no standardization and so the input at the VHF antenna terminals can be either 75 or 300 ohms. Therefore, the input to the signal splitter will be 75 ohms but its output may present a problem. You will need an output for every television set to be used. But not all the outputs will be the same, it depends on the input impedance requirements of each television set.

R-E

MARTIN CLIFFORD



# From Feedhorn To Receiver

*Getting the satellite-TV signals from the dish to the receiver is not a simple matter. In this article, we'll look at the components between the dish and the receiver, including the feedhorn, waveguide, LNA, and downconverter, and the important roles they play in a TVRO system.*

WE'VE ALREADY LOOKED AT THE DISH, AND SAW THAT ITS JOB IS to gather the signal from a satellite and focus it on a feedhorn. The feedhorn is the first of a series of important stages in the processing of a satellite signal for use by a satellite receiver. In this article we'll be looking at those stages—the feedhorn, waveguide, LNA, and downconverter—and see how they work and why they are so important.

## Feedhorns

The relationship between the dish and the feedhorn is very straightforward. The dish must collect as much signal energy as possible and focus as much of it as possible onto the feedhorn. In turn, the feedhorn must "see" the maximum surface area of the dish—not too much or too little.

There are several different feedhorn arrangements. The most popular and widely used is the prime-focus feedhorn, so-called since the feedhorn is placed directly at the focal point of the signals. That is an easy, economical arrangement, but it does mean that the positioning of the feedhorn with respect to the dish is critical. Misalignment degrades the signal-to-noise ratio.

The entrance to the feedhorn may be equipped with a series of concentric rings. Such a prime-focus feedhorn is known as a scalar feedhorn (see Fig. 1) and the rings are used to help direct microwave signals that are in the general area of the feedhorn into the opening of the waveguide. Most of the energy reflected by the dish comes from the inner three-fourth's of the surface area, thus the area of the dish nearest its perimeter is the least effective in terms of signal reflecting. That doesn't mean that that area of the dish is wasted, for it does work as a shield against the pickup of thermal noise. The advantage of the scalar feedhorn is that it gathers more signals from near the perimeter of the dish.

Another type of feedhorn arrangement is known as a Cassegrain system (see Fig. 2). It uses two reflectors. One of those is the dish itself, with another, secondary reflector positioned at the focal point. That second reflector has a surface in the shape of a hyperbola and because of its shape it is called a hyperboloidal subreflector. The subreflector, positioned at the focal point of the dish, reflects the signals it receives from the dish through an opening in the center of the dish, to the LNA, which is mounted at the rear of the dish.

A Cassegrain system has a higher ratio of dish gain to temperature and in that respect is superior to the prime-focus feedhorn, but the system costs more and is more difficult to adjust. However, a prime-focus feedhorn does supply better side lobe performance. Since the secondary reflector is in the path of incident signals from a satellite there is a certain amount of signal loss, which is known as aperture blockage.

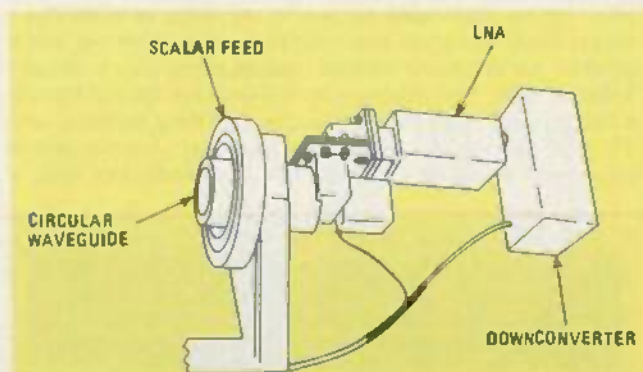

FIG. 1—A SCALAR FEEDHORN is a prime focus feedhorn whose entrance features concentric rings to help gather the reflected signal.

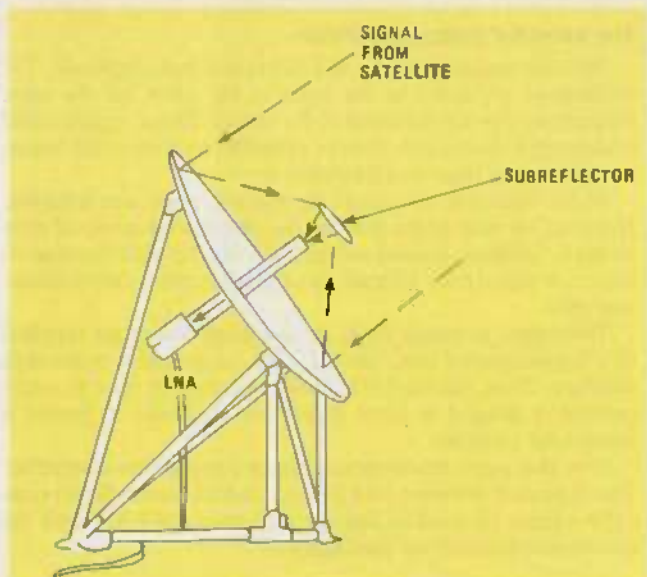

FIG. 2—IN THE CASSEGRAIN SYSTEM, the signal is reflected through an opening in the center of the antenna to the LNA, which is mounted in the rear.

There are various ways of overcoming the design faults of the Cassegrain system. One technique is to use a larger dish to compensate for aperture-blockage losses. The Cassegrain system is used in commercial applications, but rarely in home TVRO's.

### Waveguides

Just as the signals picked up by a TV antenna need to be delivered to the input of the TV receiver, so must the signals concentrated at the feed be delivered to an antenna (remember, the dish itself is just a reflector, not an antenna). That is the opposite of TV broadcasting in which the signal is picked up by the antenna and then delivered to a receiver. In satellite TV, the signal is first delivered to the transmission line, here a waveguide, and it is the waveguide that supplies the signal to the antenna.

A waveguide is used instead of coaxial cable or twin lead since it performs more efficiently at microwave frequencies. Thus, it has a lower dielectric loss than coaxial cable. In coax, the dielectric is a plastic material; in waveguide it is air and air has a very low amount of signal loss in the GHz region.

As the frequency of a current is increased, it tends to flow closer to the surface of its conductor. That is known as skin effect, and because of it the current behaves as though the volume of the conductor had been reduced. A waveguide is quite like a solid conductor, except that the unused inner portion of the conductor has been removed. In appearance it resembles a rectangular or circular pipe as shown in Fig. 3. The waveguide not only confines the signal but protects it from external electrical disturbances.

Technically, the entire length of waveguide used to conduct the signals to the antenna probe is the feedhorn, but through common usage the word feedhorn is often used to indicate the entrance area of the waveguide, or the signal focal point.

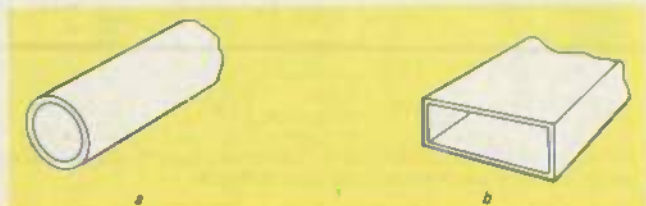

FIG. 3—A WAVEGUIDE may be cylindrical, as shown in a, or rectangular, as shown in b.

### Impedance

Just as it is for coaxial cable, twin lead, and all other types of transmission line, the impedance of a waveguide is a function of its construction. The impedance at the entrance to the waveguide, the feedhorn, is referred to as the open air impedance of the waveguide. For maximum transfer of signal energy, the open air impedance of the waveguide should match the impedance of free space. That can be done by flaring the waveguide at its end, an arrangement that is sometimes called a horn antenna, or more simply (and more correctly) a horn. Actually, the horn is a transformer or impedance-matching device. Horns are available in various shapes, but most often they are cones or pyramids.

### The antenna

The antenna (see Fig. 4) is inside the waveguide at the end farthest from the focal point. Because of the extremely short wavelengths involved, the antenna, sometimes called an antenna probe or simply a probe, is quite small, measuring about 1-inch. The antenna is connected to a small section of coaxial cable for input to the LNA. The coaxial cable used is an unbalanced type whose center or "hot" lead is connected to one end of the antenna, while its "cold" or ground lead is attached to the metal frame of the waveguide.

The antenna probe is cut so that it is broadly resonant at the downlink C-band frequencies. Its length and shape are critical since it must favor satellite signals over the wide-band noise that's at a much higher level.

### Signal polarization

The process of signal selection begins with the antenna probe. If a particular satellite is equipped with 24 transponders and each of those is functioning simultaneously, 24 different channels of programming will be delivered to the antenna.

If 24 channels are delivered to the antenna, 12 of those channels will be horizontally polarized; 12 will be vertically polarized. There are various techniques that can be used for separating vertically or horizontally polarized signals.

One simple method is to rotate the antenna probe so it is positioned either vertically or horizontally, which can be easily done using a servo motor that's controllable from indoors. A dual-polarization antenna feed can also be used. That type of feed uses the principle of Faraday rotation in which an axial magnetic field is applied to a waveguide containing ferrite material. The ferrites, made of zinc oxide, manganese oxide, ferric oxide, and nickel are used in a circular waveguide, with a current-carrying coil wound around the ferrite. The magnetic field around the coil can change the polarization of the signal.

Of course a pair of antenna probes can be used—one for horizontally polarized signals, the other for vertically polarized ones—with the probes mounted at right angles. Switching from one probe to the other is a simple matter.

Another method for the selection of polarized signals is to use a dual-section LNA, with one section for vertically polarized signals; the other for horizontally polarized.

### The LNA

The signal from the antenna probe is delivered via coaxial cable to the low-noise amplifier (LNA), a solid-state amplifier. The LNA is mounted in some sort of waterproof housing since it is located outdoors, usually as part of the feed system. A broadband, non-tunable amplifier, an LNA has an overall amplification factor of about 100,000.

The LNA not only amplifies the signal but any noise delivered to its input. In addition, the LNA generates some noise of its own. LNA's are rated in Kelvins (formerly called degrees Kelvin), and the lower the rating, the lower the noise supplied by it.

Another important LNA specification is the ratio of signal level to noise level, G/T, and is known as its figure of merit. The noise developed by an LNA can be expressed either in Kelvins or decibels.

### LNA noise figure

If an LNA has a noise figure of 1.5 dB, that means that it will add that amount of electrical noise to what's present at the input. However, noise level and LNA gain are independent; the noise level does not affect the gain, which is more dependent on frequency. Thus, an LNA having a noise figure of 1.5 dB could have a gain variation of as much as 5 to 6 dB at different frequencies. Specification sheets that indicate a single gain figure usually supply the optimum one. In some, the gain is indicated as a range; possibly from 47 to 53 dB. When the gain is indicated as a number, such as 100,000, that is a power ratio and is 100,000 to 1, which is equivalent to 50 dB.

### Noise factor

The noise factor of an LNA,  $f$ , is the ratio of the signal-to-noise at the input compared to the signal-to-noise at the output.

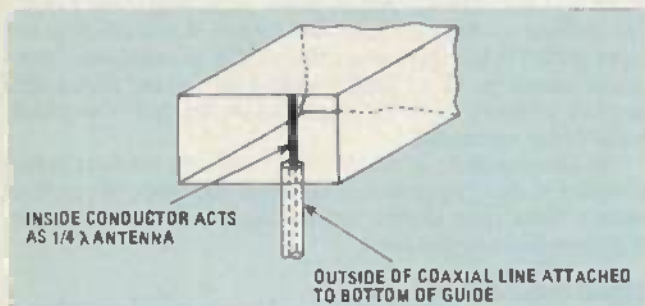

FIG. 4—THE ANTENNA, or antenna probe, is located at the end of the waveguide and is cut to be resonant at the C-band downlink frequencies.

### Other LNA's

LNA's ordinarily use two different types of transistors—GaAs FET's and bipolar transistors. There are two other types of LNA's, but those are not used in home TVRO's. One is the uncooled parametric amplifier. It is more expensive, but capable of producing less noise than an ordinary LNA. That amplifier, also known as an electronically cooled preamp or a non-cryogenically cooled preamp, is essential in areas where the signal level is too low to satisfactorily drive a GaAs FET preamp.

The most expensive of the LNA's is the cryogenically cooled parametric amplifier, ordinarily used in military or industrial installations. The name of the amplifier is derived from the fact that it is cooled almost to absolute zero. A complex amplifier, it requires constant maintenance.



AN LNA, or Low Noise Amplifier, is a broadband, non-tunable amplifier with an overall gain of about 100,000.

### The need for downconversion

The only change made by an LNA is in signal amplitude. The frequencies presented to the input of the LNA are the same frequencies that are delivered at the output. Those signals could be delivered via coaxial cable to a satellite receiver in the home, for subsequent input to a television set.

At one time that was indeed the procedure that was followed. However, because of the fact that the frequencies involved were so high, ordinary coaxial cable could not be used because of excessive signal loss. Instead, an expensive cable, called heliaz, was used.

These days, to reduce costs, the downlink signals are supplied to a downconverter that, like the LNA, is mounted on the dish structure. Thus, like the LNA, the downconverter must be waterproofed or housed in some waterproof enclosure to protect it against the elements.

Note that some receivers include an integral downconverter. That approach, however, is of limited usefulness as ordinary coax cable cannot be used to link the dish-mounted LNA with the downconverter/receiver combination.

### The downconverter

Basically, the downconverter is the equivalent to the front end of a superheterodyne receiver, consisting of a mixer and a local oscillator. The output of that mixer-local oscillator arrangement is an intermediate frequency (IF) and, for TVRO systems, is generally 70 MHz (see Fig. 5).

In a superheterodyne receiver, the mixer and local oscillator circuits are tuned simultaneously so that the IF is always constant. The downconverter is also tuned, but since it is located outdoors, close to the LNA, tuning is done remotely. The downconverter oscillator/mixer circuits are tuned by a VCO—a Voltage Controlled Oscillator. The voltage required for tuning is furnished by the satellite receiver and is about 8 volts DC. The satellite receiver may have a tuning dial permitting selection of a transponder of a satellite.

Note that the tuning dial of the in-home satellite receiver does not select the satellite. Satellite selection is usually done by moving the dish, either manually or by a remotely controlled motor, so that the dish "sees" the selected satellite. If a pair of satellites, possibly adjacent, have 24 transponders, all of those transponders use the same C-band frequencies. Signal selection, then, is a two-step process: first, by narrowing the number of channels from 24 to 12 by choosing either horizontally or vertically polarized signals, and then narrowing the choice to a single transponder's signals by using a mixer/local oscillator circuit in the downconverter.

### The LNC

The low-noise amplifier and the downconverter are separate components, but they can be integrated into a single unit that performs both functions and is known as a low-noise converter (LNC). There are several advantages to using an LNC. The need for a cable link between the LNA and the downconverter is eliminated. The two components are mounted on a common chassis and are put into a single waterproof enclosure. As a result, installation is simplified and manufacturing costs are



FIG. 5—IN A DOWNCONVERTER, the downlink signal is mixed with the output of a local oscillator to produce a 70-MHz IF.

lowered. The use of an LNC also reduces mounting time since just one component requires installation instead of two. Of



Radio  
Electronics

# Satellite

RECEIVING  
TELEVISION

course, there are some disadvantages as well. With a separate LNA and downconverter, it is possible to replace either one of these units if it fails or the system is upgraded. Also, troubleshooting is often simplified with separate components.

### Line amplifier

The output frequency of the downconverter is commonly 70 MHz, a frequency that can be readily handled by standard coaxial cable. But coax, just like any other type of cable, does cause a certain amount of signal attenuation per unit length.

The output of the downconverter supplies the signal that is to be fed into the input of the satellite receiver. But the downconverter is outdoors; the satellite receiver indoors. The distance between the two can be as much as 100 feet or more. Whether such lengths of connecting cable are tolerable or not depends on the initial signal strength. If signal losses are too great and result in a weak picture, a line amplifier (see Fig. 6) can be used. A line amplifier is a broadband, fixed-tuned, solid-state amplifier. It can be positioned in the home, contains its own power supply, receives its input signal from the downconverter, and supplies its output to the satellite receiver.

Technically, it would be desirable to connect the line amplifier as close to the output of the downconverter as possible, but that

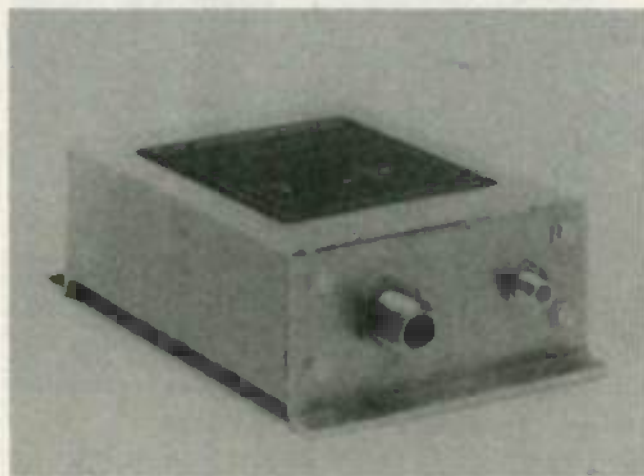

A DOWNCONVERTER IS USED TO convert the high-frequency downlink signals to ones with a lower frequency. Doing that allows standard coax cable to be used.

presents practical difficulties. The amplifier would need to be waterproofed and it would need to be supplied with DC operating voltages from the satellite receiver, or else contain its own AC power-supply.

Even if the signal strength is adequate for one TV, a line amplifier may be required if more than one receiver is to be operated.

### Block downconversion

The downconverter, as indicated earlier, is used to supply the signals of a single transponder—that is, a single video channel—to the in-home satellite receiver. However, there is an alternative approach called block downconversion in which all the channels presented at the input of the downconverter are handled simultaneously. That technique is favored by hotels, motels, and high-rise apartment houses as a way of permitting individual channel selection. The advantage is that such an arrangement requires just a single dish and a single LNA.

With block downconversion, the entire downlink band from 3.7 GHz to 4.2 GHz is converted to an intermediate frequency. There is no standardization or even a consensus as to what that IF should be: it could be 500 MHz, 1,000 MHz, etc.

In block downconversion, as in single-channel downconversion, the input is 12 channels only, assuming that all 12 channels are operating simultaneously. The difference is that the block



FIG 6—IF SIGNAL STRENGTH is inadequate, or if more than one satellite receiver is to be used, a line amplifier can be placed between the downconverter and the receiver.

downconverter works on all of the channels input; the single downconverter on just one channel at a time.

With block downconversion, the signal can be delivered to a group of satellite receivers, with each having its own mixer/oscillator circuit for the selection of a wanted channel.

### The downconverter output signal

The output of the single-channel downconverter consists of the composite-video signal modulated onto a 70-MHz carrier. The only effect of downconversion is to change the very-high-frequency C-band carrier to one having a lower frequency.

Not only do those two signals, video and audio, remain unchanged, but the method of modulation originally used, frequency modulation for both video and audio, remains the same. Essentially what we have then going into the receiver is a 70-MHz RF carrier that is frequency modulated for both video and audio. The receiver must demodulate the signal and remodulate it so that compatible with your TV (AM video, FM audio).

### Cables

Generally, the coaxial cable used to carry the IF signals from the output of the outdoor downconverter to the in-home satellite receiver will be RG-59/U, which has a characteristic impedance of 75 ohms. That impedance is based on the physical structure of the cable and is independent of its length. For distances greater than 300 feet, RG-11/U cable should be used.

The wires used to deliver DC power to the LNA and the downconverter should be 20-gauge for distances up to 300 feet, 18-gauge for distances of 300 to 500 feet, and 16-gauge for distances between 500 and 1,000 feet.

Instead of running separate DC lines and coaxial cable between the satellite receiver and dish-mounted components, all of the conductors can be housed within one covering, an arrangement known as a siamese cable.

The connecting coax cable should be long enough to join the components but without sharp bends. Any excess length of cable should be cut away. Use a drip loop at the point where the cable enters the home. A drip loop is formed by bending the cable into a "U" shape and then having the cable enter the home at a slight upward angle. Using a drip loop will prevent rain water, etc. from entering the house by following the cable.

There are some types of coaxial cable designed to be run underground, but standard coax needs to be encased in PVC pipe for that type of installation. A pipe having an inside diameter of about 3/4-inch should be satisfactory. Such pipe is available in 10-foot lengths, and the lengths can be joined by threaded sleeves. Put the coaxial cable and the DC power lines through the pipe sections before joining them, and then make sure each of the sleeves is tight. As an added precaution against water infiltration, coat the ends of each sleeve with a sealant. And, after connecting the coaxial cable at both ends, cover the entry areas of the cable into the pipe with sealant.

R-E

# In Computer Electronics...

# NTS INTRONIC™ HOME TRAINING GIVES YOU THE EDGE

**The competition for High-Technology careers is strong, and the rewards are great. Give yourself the edge you need by training with NTS.**



NTS INTRONIC home training provides you with a special kind of "Hands-On" experience that prepares you better, develops your skills faster. You advance as quickly as you wish, working with actual circuits, diagrams, schematics, and state-of-the-art hardware. There are a dozen different NTS programs in electronics to help you develop and reach your potential. They range from basics to advanced areas in several fields. And the ALL-NEW NTS course catalog spells it all out. It's free, and does not obligate you in any way. Send for it today.

## **A GROWTH INDUSTRY**

High-Technology is a growth industry. The evidence is clear, and most observers predict a steady expansion due to a relatively strong flow of investment capital into computers, electronics and precision instruments. Sales of computers alone will reach an estimated ten million units this year. This means challenges and new

employment opportunities, especially in servicing and maintenance. Computer servicing skills can best be learned by working directly on field-type equipment. NTS electronic hardware is selected and developed especially for the training program with which it is associated. You learn by doing, by assembling, by performing tests and experiments, covering principles of computer electronics, microprocessor troubleshooting, and circuitry.

## **MICROCOMPUTERS**

NTS offers three programs in computer electronics. You will receive training covering solid-state devices, digital logic circuitry, and the fundamentals of the computer itself. Instruction includes micro-control technology and detailed operation of microcomputers. These courses will prepare you for entry-level in many facets of the computer industry such as field service and customer engineering as well as programming. In addition to written texts your course includes the NTS/HEATH disc-drive computer which you assemble as part of the training process. The assembly and use of the computer will serve to reinforce practical application of principles.

## MICROPROCESSOR TECHNOLOGY

The field of industrial and microprocessor technology encompasses the application of electronic microprocessor control principles. Your course takes you from fundamentals of digital electronics and associated circuitry through the application of the microprocessor as a control device. You will learn how to move and manipulate instructions and information. The microprocessor trainer included in your course is a microcomputer system designed as a practical tool for learning the use of software and hardware techniques utilized in the linking of microprocessors to various systems.

## DIGITAL ELECTRONICS

The NTS Compu-Trainer is a fascinating solid-state device which you will build in order to perform over ninety logic circuit experiments. These experiments serve to emphasize an area of electronics which is essential to the understanding of state-of-the-art control equipment; they are also extremely important to those wanting to pursue a career in computer servicing. Separate courses involving the Compu-Trainer are also available in Microcomputer Servicing and Digital/Analog Electronics.

## ROBOTICS & VIDEO TECHNOLOGY

Other NTS courses cover a wide range of specialization. In Robotics, the NTS/Heath Hero I is included to train you in robotic applications in

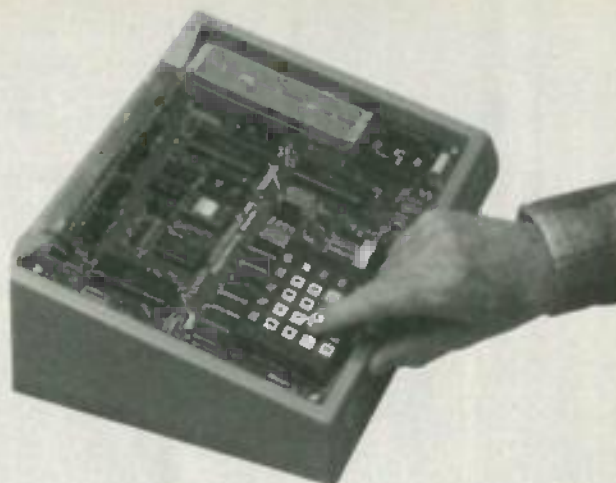

manufacturing processes. In Video technology, a new course features the advanced NTS/Heath Z Chassis "Smart Set" color TV with computer space command remote control and space phone. This is an excellent program for those interested in a career in video servicing with microcomputer basics.

## EARN CEU CREDITS

America's Industrial giants are turning more and more frequently to home study as an effective way to upgrade employee skills. You benefit from the experience NTS has gained in its 79 years as a leader in technical training. The skills and experience gained in the building of kits and test equipment provide you with training that cannot be duplicated. And, depending on the program you select, you can earn up to 30 CEU credits for successful completion. Complete details included in the catalog.



Use the mail-in card or fill out and mail the coupon. Indicate the field of your choice (One, only please.) FREE full color catalog will be sent to you by return mail.



NO OBLIGATION NO SALESMAN WILL CALL

**NTS NATIONAL TECHNICAL SCHOOLS**

TECHNICAL TRADE TRAINING SINCE 1905  
 Student and Home-Study Schools  
 So. Figueroa St., Los Angeles, CA 90037

**NATIONAL TECHNICAL SCHOOLS** Dept. 206 064  
 4000 South Figueroa Street, Los Angeles, CA 90037

Please send FREE color catalog on course checked below

- |                                                         |                                               |
|---------------------------------------------------------|-----------------------------------------------|
| <input type="checkbox"/> Robotics                       | <input type="checkbox"/> Computer Electronics |
| <input type="checkbox"/> Digital Electronics            | <input type="checkbox"/> Video Technology     |
| <input type="checkbox"/> Auto Mechanics                 | <input type="checkbox"/> Home Appliances      |
| <input type="checkbox"/> Air Conditioning/Solar Heating |                                               |

Name \_\_\_\_\_ Age \_\_\_\_\_  
 Address \_\_\_\_\_ Apt. \_\_\_\_\_  
 City \_\_\_\_\_ State \_\_\_\_\_  
 Zip \_\_\_\_\_ Phone (\_\_\_\_) \_\_\_\_\_

- Check if interested ONLY in classroom training in Los Angeles  
 Check if interested in G.I. Bill information

**We Bring You the World**

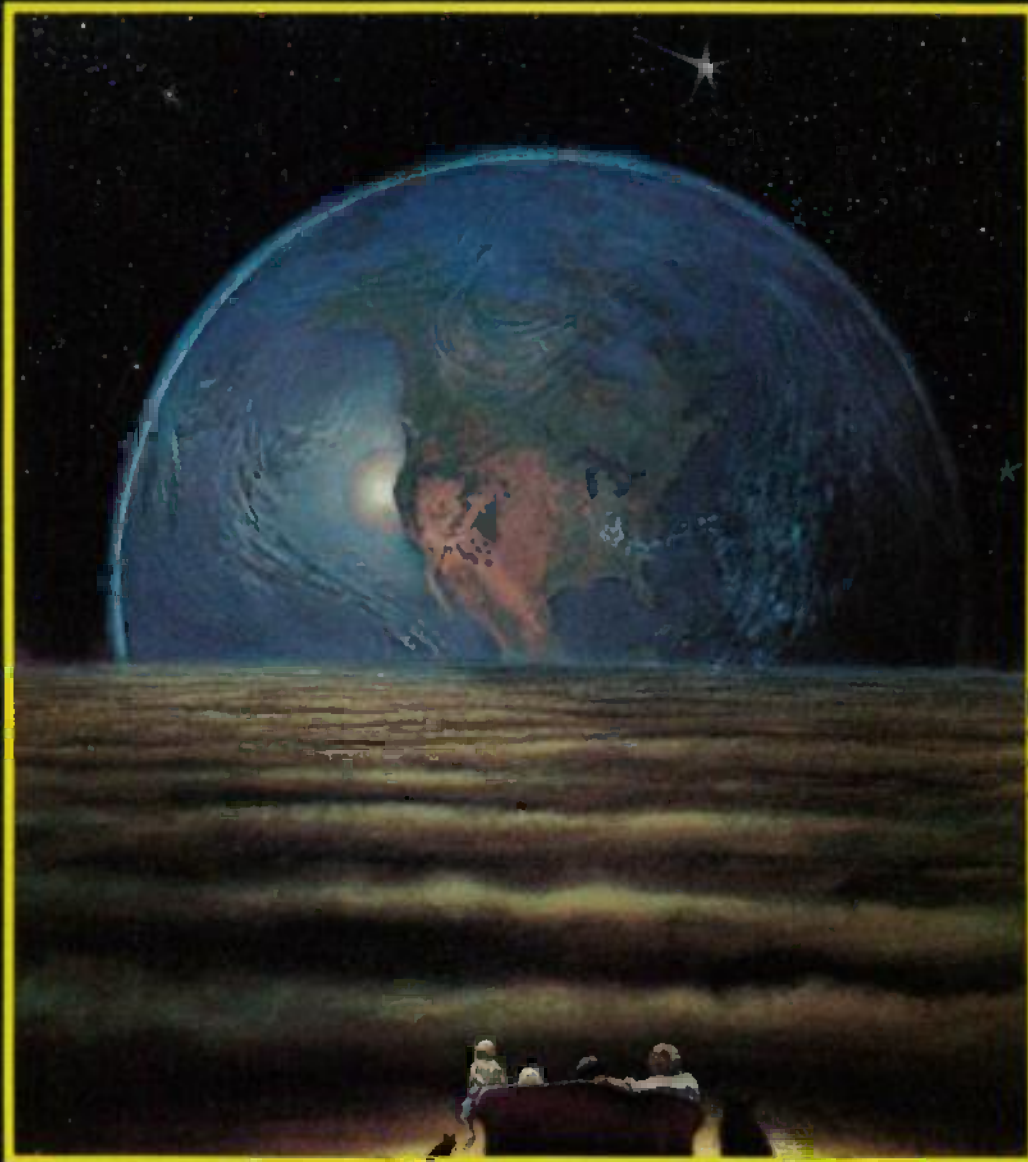

The fastest growing, most complete  
video programming log for satellite television.  
Satellite TV Week gets it straight —  
bringing information to  
industry, dealers and viewers.

 **Satellite TV Week**

P.O. Box 308, Fortuna, California 95540  
800-358-9997 or in CA 800-556-8787  
707-725-2476

CIRCLE 69 ON FREE INFORMATION CARD



# Direct Broadcast Satellites

*If you've ever wanted to watch satellite-broadcast television—but were put off by the high price of receiver systems and the large antenna dish required—then DBS is for you!*

MANY PEOPLE WATCH TELEVISION SIGNALS THAT ARE BROADCAST from satellites—either through a cable TV system or by using their own TVRO. But there are many more people who *don't* watch any TV received from a satellite, even though they want to. For those people, the new DBS (Direct Broadcast Satellite) service might be the answer. But before we talk about DBS, let's take a look at some of the problems associated with C-band satellite reception now—the problems that DBS may solve.

Cable TV is the most popular method for watching satellite transmissions. But cable-TV services aren't uniformly distributed throughout the nation. That's because, in order to be profitable, a cable system must be located in an area of sufficient population density. So for many people, a TVRO installation is the only alternative.

With almost 20 North American satellites now in geosynchronous orbit and more planned, and with each of those having 12 to 24 transponders, the number of possible viewing choices with a TVRO is larger than VHF and UHF terrestrial

## Radio Electronics RECEIVING **Satellite** TELEVISION

MARTIN CLIFFORD

television programs combined. But while a TVRO installation presents an interesting and exciting possibility, and while the number of TVRO users is growing, there are a few problems that are keeping many people away. The first of those is the cost—which can easily reach several thousand dollars or more. The second is the size of the dish. While there are some dishes that have an aperture of just 6 feet, there is no question that a larger dish supplies more gain. (A six-foot dish will not work well enough in most areas—it depends on the strength of the signal available at the proposed site.) But even a six-foot dish is too large to install in many cases.

### The DBS system

So if you are not serviced by cable TV and if the number of broadcast TV stations that you can receive is limited to one or two (that includes several million homes in the U.S.), then you should look into the new DBS (Direct-Broadcast Satellite) services—they will increase your viewing variety. Let's see how DBS works and what it has to offer.

The DBS service will not use the C band. Instead, direct-broadcasting satellites will use the higher-frequency Ku band (11.7–12.7 GHz). Like the satellites that supply video services in the C band, satellites for the Ku band (sometimes also called the K band) will be geostationary with one, or possibly two, orbital slots per time zone. Each direct-broadcasting satellite will have transponders with a three- or four-program capability.

While the DC input power for C band transponders is 5 watts, power for K band satellites will be higher, possibly ranging as much as 160 watts, with a minimum suggested 40 watts. (But as we'll discuss shortly, the only existing direct-broadcasting service uses less than that.) Because of the higher power, there will be fewer transponders per satellite. The energy for the transponders is obtained from large photovoltaic panels (sunlight-to-electricity transducers) spread out from the satellite.

### Size of the dish

The size of the dish required for DBS reception is smaller than that used for C-band signals. The dish size ranges from about 2 feet to 4 feet. The smaller size is not due to the higher frequency of the K band—it is solely because of the increased transponder power. (The antenna probe, which measures about 1/4 inch, is slightly smaller than one for the C band.) Because of the smaller dish size, the gain of K-band dishes will be much less than that of the larger sized C-band dishes. But, again, the higher transponder power will compensate for that.

There are many arguments that can be put forth in favor of small dishes. They are certainly less noticeable and are easier to install, so they're not as likely to upset your neighbors. They are easier to pack and ship, so instead of being transported in palletized form (sections), as many C-band dishes are, K-band



**THE MAIN ADVANTAGE OF DBS** is that smaller dishes can be used because of the high power of the satellite transponders. That means that you can receive DBS programming even in a city.

dishes are single-unit types. Also because the dish is smaller, it is easier to manufacture to a true parabolic shape and it can hold that shape better since there will be less stress on it. K-band dishes don't need to tolerate the high wind-load factor that is so significant with C-band types. And, because of their reduced size and weight, they will lend themselves more readily to roof mounting or possibly even window mounting.

Because there will be fewer satellites on the K band (at least at the start), it is possible that fixed-mount dishes will be popular. But whether a fixed or polar mount is used, the problem of "seeing" a satellite will remain. Although some projections have been made about using a window-type installation, there are several possible problems with that. The first is that even a dish with just an two foot aperture will still require a substantial amount of support. And, of course, if the window doesn't face in the in the right direction, you won't receive a thing.

If the DBS dish is to be roof-mounted, and is not a fixed-position type, it will need to be remotely controlled. Even though the dish is much smaller than one used for C-band reception, the roof itself may still need to be reinforced. That's not only because it will have to withstand not only the weight of the dish but the wind force as well. It is possible that many municipalities will require an installation permit and the setup may need approval by a building inspector.

#### The DBS market

What is the market for DBS TV—who will watch the new

service? To answer that question, we'll have to look at the television services that are now available. Those services include broadcast TV, cable TV, and SMATV (Satellite Master Antenna Television). Let's see how each of those compare to DBS.

Broadcast television is the most popular system available—and it will continue to be so. That doesn't mean that it doesn't have its problems. For example, the number of channels is limited. But in most areas, the problem isn't the lack of available channels—it's the number of stations that is limited. Another important shortcoming of broadcast terrestrial TV is that the quality of reception in both sparsely populated rural areas and congested city areas can be rather poor. Those problems are, of course, what brought about the growth of cable TV and other alternatives such as MDS (Multipoint Distribution Service) and broadcast subscription TV.

Cable TV will be more of a competitor against DBS services than will broadcast TV. Presently, about 60-million homes are wired for cable. Would DBS give those homes enough of an incentive to switch? Most people would base their decision on two main factors: Which is a better bargain? Which service gives



**THE DBS ANTENNA DISH** is hardly noticeable in the photo above. Note that even the standard TV antenna is larger!

better programming or a greater variety of programming?

The answers to those questions are not easy—especially since there is now only one DBS service (which we'll get to shortly) in operation. (Of course, many people with C-band TVRO systems will insist that they are watching DBS right now—but we mean Ku-band signals that are meant specifically for direct-to-home broadcasts.) Most cable systems offer more than 30 channels, and those that don't are being upgraded. It is unlikely that DBS will offer that many. Also, the backbone of most cable systems is standard broadcast TV and local programming—something that DBS is also unlikely to offer. Of course, the price of the systems has to be considered. Cable subscribers usually have only a nominal installation fee to pay to start up. DBS will have a much higher cost, approaching that of a C-band setup. And in most cases there will also be a monthly fee to pay.

From what we have said so far, it seems that DBS will have a

The following companies have expressed an interest in direct broadcasting by satellite and have applied to the FCC.

**Advance Incorporated**  
1835 K Street, NW  
Suite 404 Washington, DC 20006

**CBS**  
51 West 52 Street  
New York, NY 10019

**Direct Broadcast Satellite Corporation (DBSC)**  
Suite 520E  
7315 Wisconsin Ave.  
Washington, DC 20014

**Focus Broadcast Satellite Company**  
Suite 825  
One Commerce Plaza  
Nashville, TN 37239

**Graphic Scanning**  
99 West Sheffield Ave.  
Englewood, NJ 07631

**RCA**  
David Samoff Research Center  
Princeton, NJ 08540

**Satellite Television Corporation (STC)**  
1301 Pennsylvania Ave, NW  
Washington, DC 20004

**United Satellite Communications, Inc. (USCI)**  
1345 Avenue of the Americas  
New York, NY 10105

**United States Satellite Broadcasting Company (USSB)**  
3415 University Ave.  
St. Paul, Minnesota 55114

**Video Satellite Systems**  
29201 Telegraph Road, Suite L-8  
Southfield, MI 48034

**Western Union**  
1828 L Street, NW  
Washington, DC 20036

hard time competing against cable TV. But we can't forget that there are millions of homes that don't have cable available and that many cable services offer only a minimum of programming. And because there is only one DBS service in operation, we're not sure just how much new or different programming will be transmitted.

SMATV is the another service that will compete with DBS for viewers. (SMATV is used by apartment buildings, etc. to distribute programming to tenants. It's sort of an "in-house" cable system.) One advantage that DBS will offer over C-band SMATV is a smaller sized dish and a presumably less expensive TVRO setup. But until we know for sure what programming will be available, it's hard to determine which will find more favor with SMATV operators.

#### FCC approval

K-band usage for satellite signal transmissions has been approved by the FCC. And, just as no licensing is required by the FCC for C-band TVRO's, there will be no licensing needed for the K band.

# Radio Electronics RECEIVING Satellite TELEVISION

It was less than four years ago that the first company (STC) filed with the FCC for a DBS system and the FCC proposed interim DBS rules. Those interim rules were approved about a year later, after the Regional Administrative Radio Conference in Geneva (RARC-83) in June, 1983. One advantage of the late happenings is that DBS will be able to apply advanced technology and learn from experience acquired with C-band TVRO systems. We should note that existing dishes for the C band will be usable for the K band, but all other components will need to be modified or replaced. For joint C-band and K-band operation it is possible that integrated LNA's, downconverters and satellite receivers may be made available.

#### Recent developments

The first direct-to-home satellite service is now broadcasting to homes in the eastern half of the U.S. (not including the area of Georgia, Alabama, and Florida). The system, owned by United Satellite Communications Inc. or USCI (1345 Avenue of the



ARTIST'S REPRESENTATION OF THE HIGH-POWERED direct-broadcasting satellite that STC plans to use in 1986 to beam programming to both the Eastern and Central time zones. Each of the two satellites will carry three channels and will transmit 200-watt signals.

Americas, New York, NY 10105) expects to expand by the end of this year to cover the entire west coast (in addition to the 26 states east of the Rocky Mountains from Maine to Tennessee that it now serves). That will happen when USCI switches its service (from the ANIK C2 satellite that it is now using, which has a transponder power of 15 watts) to the GSTAR A2 satellite, which has a transponder power of 20 watts. After the switch, 82% of all homes with television would have the service available. The dish that's required ranges in size from 2 1/2 to 4 feet, depending on the location.

In January of this year, an agreement was reached that made Radio Shack the exclusive retail sales agent for USCI. RCA Service Company will install and service the receiving equipment. The cost for the service includes a installation fee of \$300 and a monthly fee of \$39.95 that covers programming, rental, and maintenance. However, you can buy the receiving equipment for \$995. (That includes installation and one year of service and programming.)

Satellite Television Corporation (STC), who filed the first application to build a DBS system, expects to be broadcasting later this year (in the fall). They plan to offer a five-channel pay-TV system to the northeastern U.S. (from Norfolk, VA to Burlington, VT and from the coast west to Pittsburgh, PA).

STC plans to expand their service in 1986 with a 6-channel pay-TV system to the eastern half of the U.S. They plan to use 200-watt travelling-wave tubes (a special vacuum tube for amplifying microwave signals).

R-E

# BUILD THIS

# HOME CONTROL COMPUTER

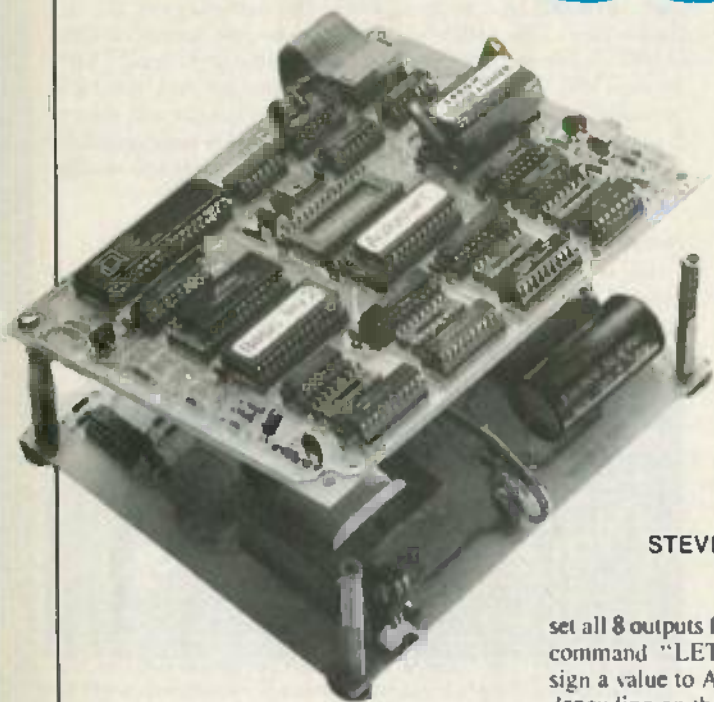

In this concluding part of our look at a control computer you can build, we'll finish our discussion of the I/O systems and show you a sample application for the unit.

STEVEN E. SARNS

**Part 3** AS WE PROMISED LAST time, we'll start this month with a look at the byte-wide I/O port.

The 8-bit parallel I/O port is the easiest to design. All that is required for inputs is to enable 8 buffers onto the data bus for each port. That job is done by IC2 and IC3, which are 74LS541 buffers. For outputs, all we have to do is to latch the status of the data bus, for which we use IC6 and IC7, 74LS377 D-type flip-flops.

While the byte-wide port is best suited to data transfer, it is possible to use it for bit-wise control as well—but it's not always easy to isolate the single bit that's of interest. In the case of input testing, it involves a mathematical process called *bit masking*. If the output port is used for single-bit control, a record of the state of the port must be maintained in the program so that the proper output word can be formed, that will toggle the desired bit but leave all of the other bits unchanged.

The same simple software commands used for the bit addressable ports are used to control the 8-bit parallel ports. For example, "OUT(16,0): OUT(16,255)" will

set all 8 outputs first to zero then to 1. The command "LET A=INP(16)" will assign a value to A in the range of 0 to 255 depending on the status of the 8 inputs.

## Analog Inputs

Most natural processes appear to us as analog or continuous-time functions. The temperature, pressure, humidity, sound levels, and light levels surrounding you are analog quantities. But the measuring process can convert the analog function into a discrete digital function. For example, we know that the temperature does not change in steps. But if your thermometer is only accurate to one-half degree, then the temperature will appear to change in 1/2-degree steps. If you used a thermometer with higher resolution, you could extend the number of digits used to express the temperature. But no matter how accurate the thermometer, you cannot express the temperature exactly.

In order for the computer to be able to "understand" analog quantities, they have to be converted into digital quantities. That's the purpose of the analog-to-digital (A/D) converter.

The first parameter used to describe our A/D converter is the number of bits the result will be—the resolution of the measurement. The smallest increment or change of the result is always one *least-*

*significant-bit (LSB)*. An 8-bit conversion resolves to one part in 256. The next parameter is the *span* of the conversion. That is the physical range that is represented by the zero and full-scale values of the A/D output. Thus, if our 8-bit converter had a span from 0° to 255°, each bit of output would represent one degree. If the span were reduced to 125°, each bit would represent 1/2°. The number of bits of the conversion determines the resolution of the converter. The span of the conversion determines the resolution of the physical quantity. Increasing the number of bits or decreasing the span will increase the resolution of the result.

The accuracy of the A/D conversion takes into account not only repeatability, but the absolute accuracy of the output compared to the input. That is really a measure of the accuracy of the standard used during the conversion process. If a reference diode defines full-scale as 2.55 volts, and if that reference should drift to 2.56 volts, then 2.56 volts will be required at the A/D input to produce a result at the output of 255. That potential source of inaccuracy can be eliminated by using a technique called *ratiometric measurement*. Ratiometric measurements are made using the same source for both the reference and the transducer. Thus any variations will be present in both and will cancel out.

The last parameter we should consider is the number of channels—the number of inputs that can be connected to the A/D converter. Obviously with 2 A/D converters, we can measure 2 different points.



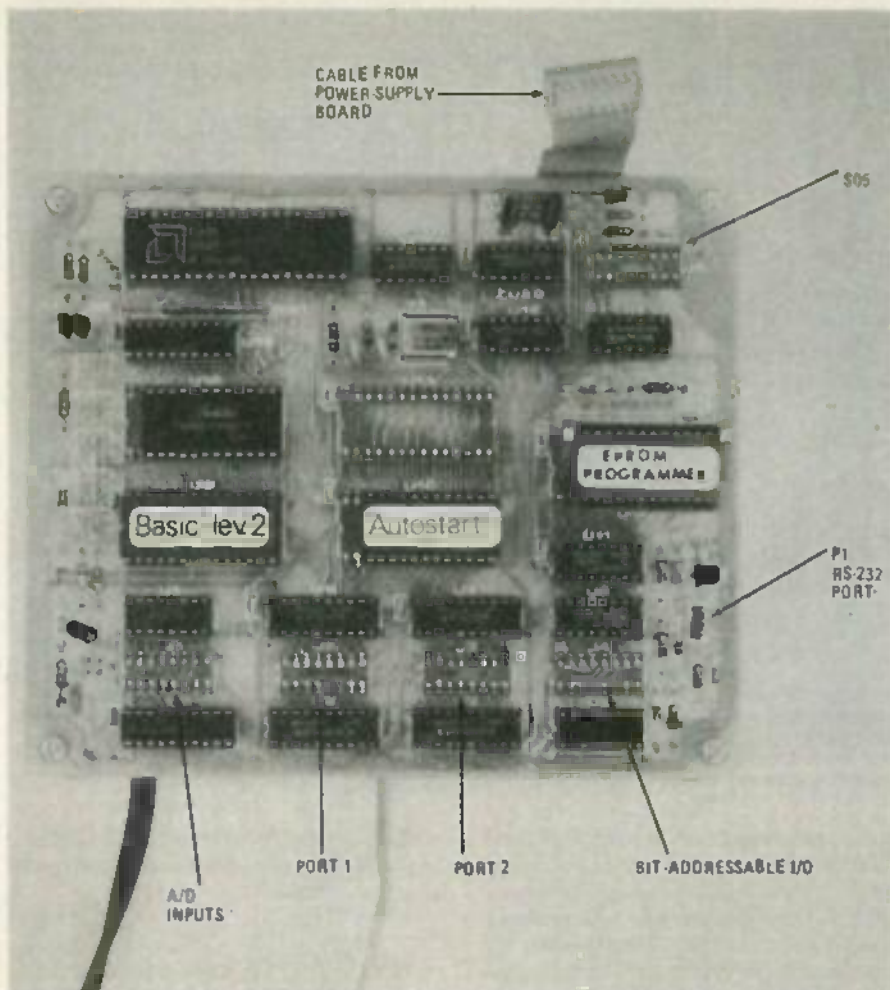

COMPUTER BOARD. Note how the 24-pin devices are plugged into the 28-pin sockets leaving pins 1 and 2 empty.

However, by equipping a single A/D converter with an analog input multiplexer we can also measure several points (but not simultaneously).

There are two common methods of performing the conversion. The first is called integration. The input voltage causes a proportional input current to charge a capacitor to a specific voltage level. The time required to charge the capacitor is inversely proportional to the input voltage. The second method is called successive approximation (SAR). In that method, the analog input is compared to the output of a digital to analog (D/A) converter. The D/A converter is adjusted until its output matches the unknown analog input. The input to the D/A converter that produces the match becomes the output of the A/D converter.

The number of tries before a match is made is never more than the number of bits of resolution. Thus an 8-bit A/D will find a match in no more than 8 tries.

Integrating A/D's are very accurate but slow. Twelve- and 14-bit conversions take tens of milliseconds. Successive approximation (SAR) A/D's are fast, but are not as accurate. Eight-bit conversions may take only a few microseconds.

The A/D converter selected for our computer is IC1, the ADC0805 from National Semiconductor. That 8-bit SAR converter can span input voltages as low as .25 volts. Provision has been made for ratiometric or absolute conversion. The converter has true differential inputs and zero-offset adjustment. An analog multiplexer is included in the circuit that accommodates up to 8 input channels.

The ADC0805 is designed to be used with microprocessors, so all we have to do is to connect it to the data and control buses.

A conversion is initiated by writing (anything) to the A/D converter. The result will be available by the time BASIC interprets the next program statement. The channel-select controls of the input multiplexer (IC5 pins 9, 10, and 11) are connected to three outputs of the 8-bit port at SO2. That doesn't mean that you have to use the port, only the A/D converter—it can be used for data transfer. The only requirement is that the multiplexer's control inputs be stable when the A/D converter is making a measurement.

Using the A/D converter is a simple 1-2-3 procedure. First, select the channel (using the 8-bit output port). Second,

write to the A/D to start the conversion. Third, read the result. In BASIC, we could write:

```
10 OUT(16,0)
20 OUT(32,0)
30 PRINT INP(32)
```

Line 10 selects channel 0, line 20 writes a zero to the A/D to start conversion, line 30 prints the result.

### Digital-to-analog conversion

Most of the same parameters that we noted for A/D conversion also apply in D/A conversion. Although the control computer doesn't have D/A capabilities, they can be added with very little effort. As shown in Fig. 13-a, a simple resistor-capacitor network is the only hardware required. Remember the description of the SAR A/D converter? We can implement a D/A converter in a similar manner with the components we have on the board

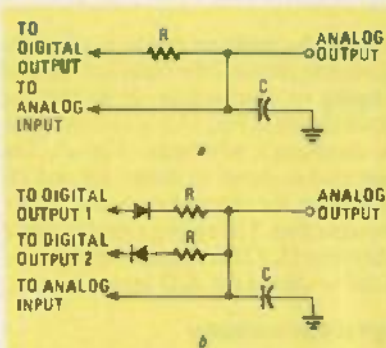

FIG. 13—TWO SIMPLE D/A circuits. The circuit shown in b is also shown in Fig. 1, the schematic of the computer. The values of the components depend on your particular application.

and some software.

One of the bit-addressable outputs and one input of the A/D converter must be dedicated to each D/A channel. The digital output is used to charge a capacitor through a resistor, and the A/D input measures the voltage on the capacitor. That measured voltage is compared to the desired value (which is stored in the program). If the voltage is too low, the output is turned on. If the voltage is too high, the output is turned off. The selection of the R-C time constant, and the frequency that the output is corrected by the program, determine the accuracy of that simple approach.

The major limitation of that approach is that the ripple and response time of the circuit are directly related. If minimum ripple is required, a long response time is the result. That can be avoided with a slightly more sophisticated circuit, such as the one shown in Fig. 13-b.

That circuit uses one bit-addressable output to charge the capacitor and another to discharge it. When the voltage is correct, the capacitor is neither being charged nor discharged. Thus, the only contribution to ripple is the discharge current imposed by the load. The response

A BASIC interpreter for the control computer is available (see Ordering Information). BASIC I can operate on 26 variables, and includes commands such as:

LIST	NEW
RUN	LET
IF	FOR/NEXT
GOTO	GOSUB/RTN
PRINT	INPUT
STOP	REM
XMIT	PEEK
POKE	INP
OUT	

The BASIC II operating system includes all that is contained in BASIC I. In addition, it can operate on 52 variables and 1 array, and contains about twice as many commands. Those extra commands include FILL, STAT, DUMP, EPROM (which programs an EPROM with the current program) MOD, ONERROR, and many others.

time can be made as fast as it takes the software to decide if the capacitor requires charging or discharging. Note that the circuit shown in Fig. 13-b is also shown in the computer's schematic (Fig. 1). The open circles shown at diodes D1 and D2 (or R2) are for connection to the bit-addressable port. The analog signal is output at SO1 pin 15. (That output also gets connected to one of the A/D inputs.)

#### Digital thermometer

As an example of the simplicity and flexibility that smart control can provide, we'll look at how we could use the control computer to measure the temperature. The first step is to select the transducer. There are several options. We could use National Semiconductor's LM335, which has a linear output of 10 mV/°C. Another

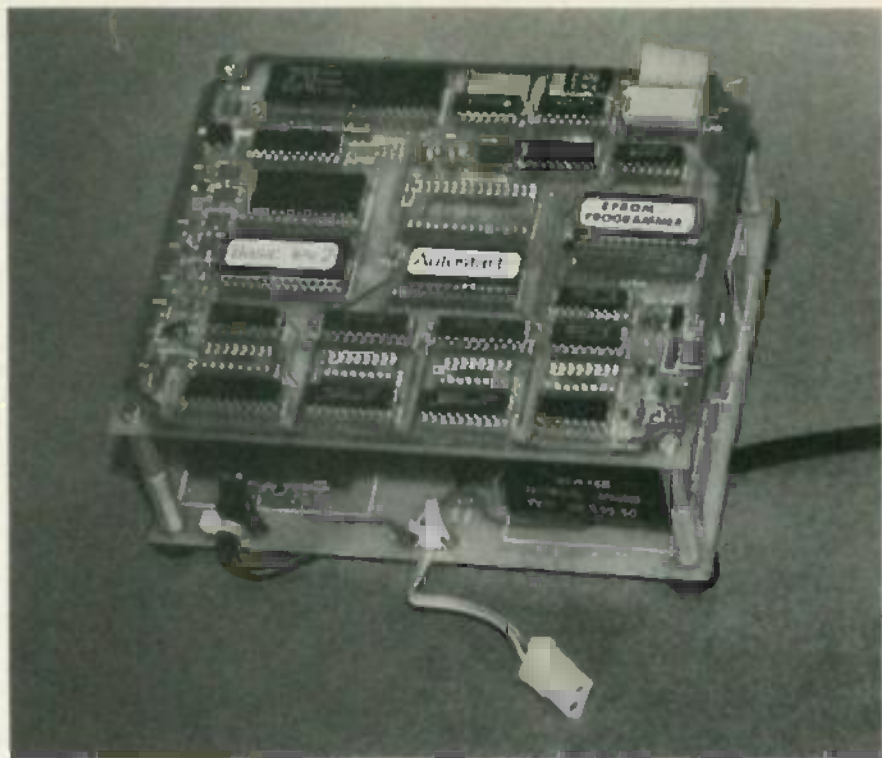

THE FINISHED PRODUCT. The hinged spacers at the rear of the board let you tilt the computer board up, giving you easy access to both boards, while keeping the size of the system down.

possible choice is Analog Devices' AD590, which has a current output that is also a linear function of temperature. Both of those devices can be connected directly to one of the A/D converter's input channels and the result can be scaled to read degrees. But suppose you just reach into the junk box and come out with an unmarked, unknown thermistor. You can connect it to the input of the A/D converter with a pull up resistor to +5VDC. Using IF statements, your program can find the correct temperature:

```
100 OUT(16,0):REM CHANNEL 0
    CONNECTED TO THER-
    MISTOR
110 OUT(32,0):REM START CON-
    VERSION
120 LET A = INP(32):REM ASSIGN
    RESULT TO A
200 IF A = 0 PRINT "45"
201 IF A = 1 PRINT "44"
202 IF A = 2 PRINT "42"
```

```
455 IF A = 255 PRINT "5.8"
500 PRINT "DEGREES"
510 GOTO 100
```

Although that program will make any professional programmer shudder, it works, it's simple, and it doesn't require hours of debugging. One of the features that makes this computer so powerful is that it can be up-and-running in a minimum of development time.

Now, suppose we wanted the output of our digital thermometer to go to a DVM instead. The simple D/A plus the pull-up

resistor for the thermistor are all that is required. The software to drive that circuit is just as simple:

```
700 OUT(16,1): REM A/D CHAN-
    NEL 1
710 OUT(32,0): REM START CON-
    VERSION
720 LET B = INP(32): REM D/A
    OUTPUT VOLTAGE IS
    STORED IN B
740 REM VARIABLE C CONTAINS
    DESIRED OUTPUT
750 REM RC IS CONNECTED TO
    BIT ADDRESSABLE OUTPUT
    0
770 IF B < C OUT(0,1): REM
    CHARGE UP CAPACITOR
780 IF B > C OUT(0,0): REM DIS-
    CHARGE CAPACITOR
```

If you wanted to compute the average temperature since the unit was turned on:

```
800 LET D = D + 1: REM THE
    NUMBER OF SAMPLES
810 LET E = E + A : REM THE AC-
    CUMULATED TEM-
    PERATURES
820 LET F = E/D: REM THE AVER-
    AGE TEMPERATURE
```

That illustrates the advantages of smart control over a traditional thermistor/linearizer/meter approach. Although more complex initially, the control computer is unlimited in its adaptability.

Of course, now that you have the temperature information inside the computer, you can use this data to control any of the outputs. Those can control your home heating system etc. R-E

#### ORDERING INFORMATION

The following are available from Vesta Technology, Inc., 2849 W. 35th Ave., Denver, CO 80211: KIT 1: Kit of all parts needed to control 7 LS-TTL outputs, monitor 7 inputs, program EPROM's, RS-232 serial port, and 2K RAM (does not include operating system—see below), \$99.95; Operating systems contained in ROM: BASIC I operating system, \$12.95; BASIC II operating system, \$29.95; Forth operating system, \$79.95; Assembled, tested, and burned-in control computer with BASIC II operating system, \$279; RS-232 cable, \$24.95; 2716 EPROM, \$6.95; Power-supply/BSR-IIlink kit, including all components, \$59.95; Assembled, tested, and burned in power supply, \$109. Add \$6 for shipping, handling and insurance.

# BUILD THIS

# AUTOMOTIVE EXHAUST ANALYZER

*Build this useful automotive test instrument and stop guessing about your car's emissions.*

PHILIP M. VAN PRAAG

**Part 2** LAST TIME WE INTRODUCED you to a device for analyzing your car's exhaust emissions. This month, we'll show you how to build and use the unit.

Figure 11 is the parts-placement diagram for the display board; Fig. 12 is the parts-placement diagram for the TCC board. Note that the four-conductor cable on the TCC board (Fig. 12) is installed on the foil side. Be careful to orient all IC's, diodes, and polarized capacitors as shown. Use a 25-watt iron with a fine pointed tip, and .030-inch solder.

One point should be made here about the resistors. Note that the majority are precision 1% units. Such resistors are now available from a number of sources, including Digi-Key (Highway 32 South, PO Box 677, Thief River Falls, MN 56701). A less expensive alternative for those who have well stocked junkboxes is to test more common 5% resistors with a DMM until ones with the precise value called for are found.

Study Figs. 11 and 12 before starting construction of the boards, and decide upon a method of attack for inserting the components. Although individual styles differ, the following sequence should work well. The idea here is that by sequencing the parts installation according to the height of the components, several similar components can be inserted on the board before the board is inverted and the parts soldered in place. That should speed things up a bit.

First, install the horizontal-mount fixed ¼-watt resistors, slightly bending the leads after insertion to avoid misposition-

ing when the board is inverted for soldering. (To help in troubleshooting, should it become necessary, orient the resistors so that all the first bands point in the same direction. That also



makes the project look a lot neater.) After soldering the resistors in place, trim the leads flush with the solder mounds. Next, install the IC sockets, making sure that the notch, or dot, on one end of the socket is aligned with pin 1. Note that the

IC's themselves, with the exception of IC1, are not to be installed now. As IC1 is a voltage regulator, it is not socketed. Instead, solder that device directly to the board at this time. Then mount the diodes making sure that they are oriented properly. Next, install the capacitors beginning with the physically smaller types. Next, mount the trimmer potentiometers: R24, R26, and R32. Then mount transistors Q1-Q5.

The function switch (S2) shaft must be trimmed to a ½-inch length. When that has been done, mount it on the PC board, but only after the cabinet top has been drilled and can be used to check switch alignment. That is important since the switch cannot be moved once it is soldered in place. If it is crooked when installed, it will not allow the top to be attached properly. Set the switch into the board (noting the rotational alignment shown by the tab position in Fig. 6-b). It may be necessary to straighten some of the contacts before it can be smoothly inserted. The switch should be inserted in the board to a depth such that about ¼-inch of the solder contacts protrude out beyond the bottom of the board. Then lightly solder one or two contacts and temporarily install the PC board in the cabinet bottom. Check to see that the top cover will fit without binding at the switch shaft clearance hole. When satisfied, remove the PC board and complete the contact soldering.

The four-conductor cable interface between the display unit and the conversion box is made using a modular telephone-extension cable with plug and receptacle assembly. Cut a 9-inch section of the cable at the plug end, and use that to connect the

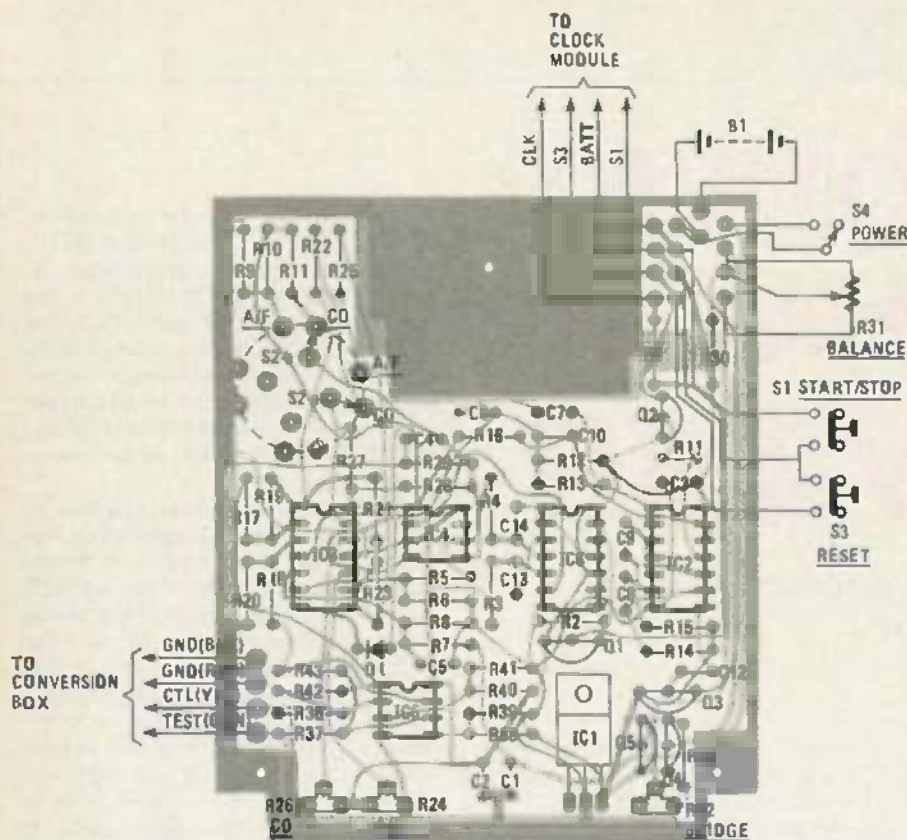

FIG. 11—PARTS PLACEMENT DIAGRAM for the display board. Study the board carefully before beginning construction.

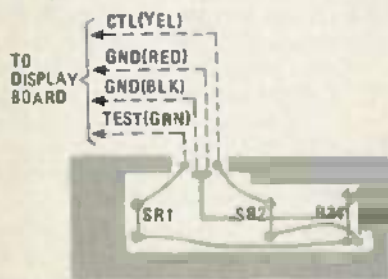

FIG. 12—THE FOUR-CONDUCTOR CABLE is installed on the foil side of the TCC board. Note that Fig. 10 shows an "X-ray" view of the board, not the foil-side as was stated last month.

PC boards. Figures 11 and 12 show how the boards are interconnected. The color scheme indicated is not mandatory, but following it will minimize any chance of confusion. Note that the receptacle is mounted on the conversion box and wired to the TCC board. Doing that allows the conversion box to be disconnected from the display unit when not in use.

Turning to the off-board components, use small-gauge, color-coded wires for the connections to S1 and S3. Twist them rather tightly to prevent spurious ignition-noise pick-up that otherwise could occur with some automobiles. (The noise pick-up would cause erratic timer triggering and occasional faulty display readings.)

When construction of the display board is complete, clean off all solder-flux residue with isopropyl alcohol or commercial spray flux-remover. If using a commercial flux remover be sure to read the directions as some of those are harmful to plastics.

### Conversion box preparation

Figure 13-a shows the conversion-box preparation details for the box available from the supplier mentioned in the parts list. Also shown is the probe and tubing assembly (Fig. 13-b). The probe is built using  $\frac{1}{8}$ -inch outside diameter (O.D.) copper tubing, with an alligator clip added to make sure that the probe remains in the auto-exhaust pipe when it is placed there. A 48-inch length of  $\frac{3}{8}$ -inch I.D. (Inside Diameter),  $\frac{1}{2}$ -inch O.D., vinyl tubing connects the probe to the conversion box. (Note that if you purchase the complete kit from the source mentioned in the parts list, all cutting and drilling will already have been done.)

A 2-inch copper tube stub (see Fig. 13-c) is needed to attach the vinyl tubing to the conversion box. Crimp a  $\frac{1}{16}$ -inch length of one end in a vise to obtain the flattened dimensions indicated. Then drill a  $\frac{1}{32}$ -inch hole where shown. Insert a No. 6 flat washer ( $\frac{3}{8}$ -inch O.D.,  $\frac{1}{2}$ -inch thick) into the flattened portion when assembling as discussed below. Flattening of the stub and inserting the washer cre-

ates a controlled inlet aperture. That aperture limits the exhaust-gas flow rate into the conversion box, ensuring adequate gas cooling before exposure to the TCC.

Velero strips can be used to allow attachment of the conversion box to the automobile. First, glue the "fabric" portion of the strip to the back of the conversion box. Then, double-sided carpet tape can be applied to the mating Velero strip for attachment to the bumper. (Never stick the tape onto a painted portion of the car, as the paint is likely to come off when removing the strip later on.)

Figure 14 shows the component and board placement within the conversion box. As shown, the sensors should be mounted  $\frac{1}{4}$ -inch above the PC board. Plastic spray-bottle caps (with approximate dimensions as shown) should then be glued to the board over the sensor assemblies. Try to center the caps around the sensor fixtures. Silicone glue may be used, although 3M windshield adhesive (available at automotive-parts stores) is even more effective. Apply the glue to the mating surfaces only. When the caps are in place, coat the outer cap and the board surfaces with additional glue to be certain of a good seal. Once the glue is firm, melt a hole into the test-sensor cap where shown in Figure 14. (The hole should face the side of the conversion box that contains the strain-relief/cable assembly.) Holding a  $\frac{1}{4}$ -inch diameter screw with a pair of pliers, heat the screw with a candle flame and use it to melt a hole through the plastic. The cap/board assembly should then be silicone glued to the side and bottom of the conversion box. Be sure to use ample amounts of silicone glue around the control sensor, as it is vital that no exhaust gas be allowed to reach it.

Assemble the tube stub as shown in Fig. 14 using four 6-32 nuts to space the stub from the side edge. Don't forget to place a No. 6 washer inside the flattened tube end before tightening the outside 6-32 nut. When the four "spacer" nuts are snug, tighten the outside nut with a small wrench or pliers until the tube end is compressed against the washer inside the tube. Thus, gas will be allowed into the box only at the top and bottom of the washer, and to a small degree through the outer sides.

### Battery operation

Two self-contained batteries are used by the unit. One is a hearing-aid type 1.5-volt cell. The other is a common 9-volt transistor-radio-type battery. The 1.5-volt cell is used in the timer module and its life expectancy is over one year.

The 9-volt battery powers all of the remaining circuitry. Current drain is rather high due to the required thermistor heating. Therefore, the unit should only be turned on when exhaust measurements are needed. Also, when replacing the bat-

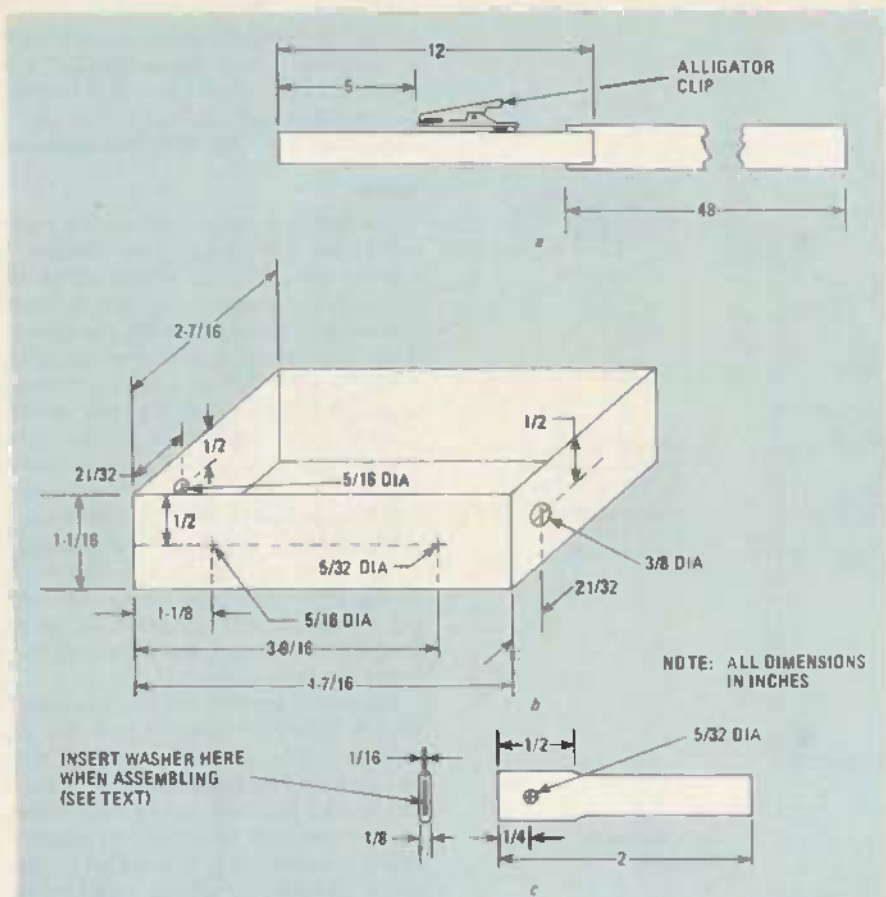

FIG. 13.—DETAILS for preparing the conversion box (a), the probe and tubing assembly (b), and a tube stub (c).

All resistors 1%, 1/4-watt unless otherwise noted

R1—100,000 ohms, 5%  
 R2, R12—4700 ohms, 5%  
 R3, R4, R13—R16—10,000 ohms, 5%  
 R5, R6, R8, R22—4870 ohms  
 R7—8450 ohms  
 R9—47,500 ohms  
 R10—4640 ohms  
 R11, R23—30,900 ohms  
 R17, R18—20,500 ohms  
 R19, R20—100,000 ohms  
 R21—46,400 ohms  
 R24—50,000 ohms, miniature potentiometer, linear taper, vertical PC-board mount  
 R25—4530 ohms  
 R26—10,000 ohms, miniature potentiometer, linear taper, vertical PC-board mount  
 R27—14,300 ohms  
 R28—6810 ohms  
 R29—11,900 ohms  
 R31—1000 ohms, miniature potentiometer, linear taper, panel mount, with SPST switch (S4)  
 R32—300 ohms, miniature potentiometer, linear taper, vertical PC-board mount  
 R33—221 ohms  
 R34, R35—105 ohms  
 R36, R37—22,100 ohms  
 R38, R40—226,000 ohms  
 R39—152,000 ohms  
 R41—143,000 ohms

#### PARTS LIST

R42, R43—210,000 ohms  
**Capacitors**  
 C1—C5, C7—C9, C13—0.1  $\mu$ F, ceramic disc  
 C6, C11, C12—100 pF, ceramic disc  
 C10—0.01  $\mu$ F, mylar  
 C14—0.05  $\mu$ F, ceramic disc  
**Semiconductors**  
 IC1—LM340T-5 or 78M05 +5 volt regulator  
 IC2, IC6—74C00 CMOS quad NAND gate  
 IC3—LM324 quad operational amplifier  
 IC4—TL507C A/D converter  
 IC5—ICL7621DCPA dual operational amplifier  
 Q1—Q5—2N3904 NPN silicon transistors  
 D1—1N914 or 1N4148 general purpose diode  
 SR1, SR2—G126 precision matched thermistor pair (Fenwal Electronics, 63 Fountain St., Framingham, MA 01701)  
 TM1—timer module, model U01 sport stopwatch (Armitron Corporation, 29-10 Thompson Ave., Long Island City, NY 11101)  
 S1, S3—SPST momentary normally open pushbutton (C & K 8631 or equivalent)  
 S2—4PDT rotary, panel mount  
 S4—SPST potentiometer switch, part of R31  
 B1—9-volt battery

tery, be sure that the unit is off (to prevent damage).

#### Checkout and calibration

The following calibration/test procedures are performed with the probe exposed to ambient air-conditions only. Do not allow exposure to exhaust gas at this time. Double-check all connections and component orientation. Do not install the IC's into the sockets yet. (Only IC1, which is soldered in place, should be installed to this point.)

If you haven't re-installed the timer battery yet, do so now, and verify that all that all of the timer's functions operate as described in its owners booklet. With no external power applied to the unit, all timer functions should be just as they would be normally. If that is not the case, do not proceed until you have isolated and corrected the problem. Try disconnecting the four wires from the display PC board. If operation returns to normal, then something is probably miswired in the Q1, Q2, or Q3 circuitry. If timer operation is still faulty, then either the wire connections on the timer board are bad (for example, solder bridging across two circuit paths) or the timer module is bad.

Before connecting the conversion-box cable to the display unit, apply power via S4. Check the voltage at IC12. It should be +5 volts. Leave the power applied for a few minutes, then touch IC1. It should be just slightly warm, not hot. If all is

Miscellaneous: PC boards, display and conversion-box cabinets, IC sockets, 9-volt battery terminal clip, modular telephone extension cord, 25 feet, with plug and receptacle (MCM TA625 or equivalent), vinyl thin-wall tubing (3/8-inch I.D., 1/2-inch O.D., 48-inch length), copper tubing (3/8-inch O.D., 1/2-inch wall thickness, 14-inch length), spray bottle caps (see text), alligator clip, cable strain-relief (3/8-inch mounting hole), silicone glue, Velcro strip (1 1/2 inches wide by 3 inches long), double-sided carpet tape, 30 gauge wire, 8-conductor ribbon cable, knobs, hardware, etc.

The following are available from PVP Industries, P.O. Box 35667, Tucson, AZ 85740: Etched and drilled epoxy-glass PC boards for display cabinet and conversion box for \$14.95; SR1, SR2 sensor pair for \$22.95; PC board set, both cabinets (not drilled), timer module, front panel decal for display cabinet, and modular extension cord for \$49.95; complete kit of all parts (except glue and battery), including pre-drilled cabinets for \$98.95; completely assembled, calibrated, and tested unit for \$129.95. The above prices are postpaid in the continental U.S. Arizona residents add 5% sales tax. Readers of Radio-Electronics are invited to send a SASE to the above address to receive free updates on this project, along with user tips as they become available.

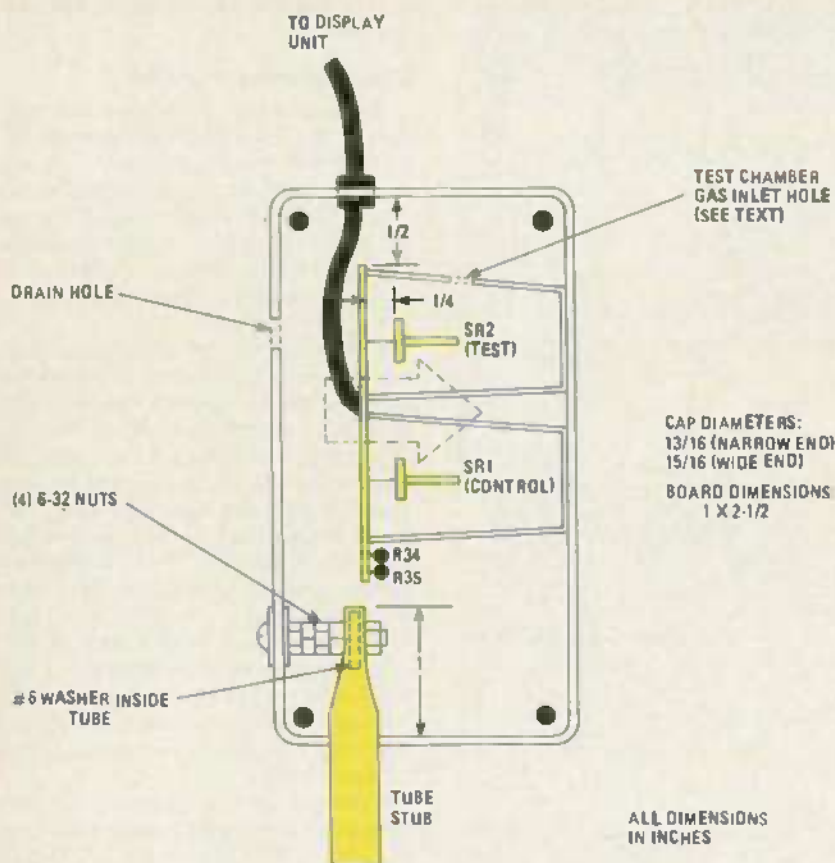

FIG. 14—THE TCC BOARD is mounted inside the conversion box. Note that all exhaust tests are made with the conversion box oriented as indicated by the arrow.

well, remove power, connect the conversion-box cable, and install the remaining IC's. Then set the BALANCE CONTROL (R31) and trimmer potentiometers R24, R26, and R32 to their midpoint positions, and set the FUNCTION to the CO position.

If the timer had been in the normal clock mode, you must change it to timer mode by holding S3 depressed for a few seconds until the display changes to all zeros. Now re-apply power. After several seconds, the display should begin to respond to the initiation of tests about every two seconds.

If the word LAP appears on the display (below the two smaller digits on the right), that means the count/reset sequence is out of step. That may occasionally happen after power up. Simply depress the TIMER switch one time. That should clear the counting abnormality within two or three test cycles.

Now proceed with the calibration process, as follows. Again, be certain that there is no exhaust gas near the conversion box, and that its temperature is stable. Also, orient the conversion box as shown in Fig. 14. (That is the orientation that will be used during actual exhaust testing.)

1. Connect a DVM between the display-board pads for the green and yellow leads to the TCC board. Adjust R32 for a

reading of exactly 0 volts. There will be some settling time required, so leave the DVM connected for about 30 seconds.

2. Adjust R26 for a display of 4.0%. Take your time in doing that step as it is rather critical. Make the adjustment in small increments until the reading changes with each test cycle. If movement in one direction doesn't produce a display change, go back to midrange and try the other direction. When you do start seeing a change, continue to adjust, but in even smaller increments, until the display reads 4.0 consistently on several subsequent tests.

3. Switch to the A/F mode, and adjust R24 for a 13.1 display. Follow the procedure outlined in the previous step.

That completes the checkout and calibration process. The settings of R24, R26, and R32 should not require readjustment under normal circumstances. The BALANCE control should give you enough of an adjustment range to compensate for any subtle variations due to component aging or imbalances at particular ambient temperatures.

**WARNING:** Exhaust gas is poisonous! Do NOT ever perform any exhaust-gas tests in an enclosed or poorly ventilated area! Even being inside a car with the windows rolled up is no as-

surance of safety. While the system itself is designed so that gas is sampled and converted to an electrical signal outside the car, exhaust gas can seep into the car in many other ways. Do NOT take chances!

### Setup

The first step is to attach the conversion box to the rear-bumper area. Choose a position that allows the tubing and probe to reach the exhaust tailpipe without stretching or sharply bending the tubing. Also, observe the mounting direction as outlined earlier. Velcro strips may be used to attach the box, but they may not be suitable for all applications. Other alternatives may be necessary, such as masking tape. An especially sturdy mounting is not needed unless the unit is to be used while driving, in which case adequate means must be provided to prevent a change of position or the device even falling off the car. Do not attach the probe until after the balance operation described below has been performed.

Before the unit can be used, two things must be allowed to happen: One is that the engine must be allowed to reach its normal operating temperature (about 10 minutes in mild weather), and the other is that the test unit must be allowed to stabilize (about 1 minute). If you warm up the car while allowing the unit to stabilize, be sure that no exhaust gas is allowed to reach the conversion box until after the balance operation is performed. Also, never start the engine while the probe is inserted in the tailpipe, as the initial surge of exhaust is extremely "dirty," and could coat the TCC, altering the unit's accuracy. A small piece of tape may be placed over the conversion-box gas-inlet stub and drain hole during warmup to ensure that exhaust gas will not enter at that time.

In use, all functions are displayed when the timer is in the stopwatch mode. If the timer is in the clock mode, depress the MODE switch for a few seconds until the display reads all zeros. That can be done whether or not power has been applied. In fact, if power is not applied, the unit can be used as an ordinary stopwatch. Once power is applied and the unit is placed in the STOPWATCH mode, the display should begin to change in response to each test cycle.

The unit uses the three rightmost display digits for readout, with an assumed decimal point between the rightmost two digits. Thus, a 13.4 display in the A/F mode indicates a 13.4 air/fuel ratio while a 036 display in the CO mode indicates a CO content of 3.6%.

To activate the unit, rotate the BALANCE control from its off position to about mid-range. As explained above, allow a brief warmup period. That allows time for pre-heating the TCC sensors, and generally allows the system to become acclimated to ambient conditions in the test environ-

ment. Once the display stabilizes, adjust the BALANCE control for a reading of 4.0 in the CO mode or 13.1 in the A/F mode.

When the engine is running at normal operating temperature, insert the probe into the tailpipe, and attach the tubing to the conversion box. There will be a very brief response lag-time encountered as the display changes to reflect the thermal conductivity of the gas sample. (Note that a new sample test is performed about every two seconds.) It is normal for some fluctuation "drift" in adjacent readings, particularly if the engine is idling rough, or if the engine system routinely changes idle speed, timing, or carburetor mixture in response to engine temperature.

If your automobile has a catalytic converter, accurate readings can best be obtained by sensing the exhaust gas before the converter. While some autos have a port available for this testing, it will probably be necessary to remove the exhaust-gas recirculation (EGR) valve and insert the probe at that point in the system. (It will then be necessary to close off the EGR line to the intake manifold to ensure accurate readings.) The catalytic converter changes much of the hydrocarbons and CO into water and carbon dioxide. That "new" gas/vapor mixture presents a different composite thermal conductivity to the TCC, thus affecting accuracy.

#### Adjustments.

When making adjustments, be sure to allow time for the display to respond. It takes time for the engine system to stabilize on the new setting(s), and then it takes a short time for unit to respond to the different exhaust-gas content. If the unit is to be used on more than one vehicle during a session, allow several minutes for remaining exhaust to clear the conversion box before connecting it to the next vehicle. When making adjustments that typically have a broad range, it is best to make small incremental changes, pausing after each and then noting the display. That method makes it easy to "zero-in" on the optimum setting without losing control; that is, getting things so far out of adjustment that the engine dies, or that it is difficult to return to the original settings.

The following emission-related component topics are intended for general information only. Specific adjustments for your auto should be made in accordance with the auto makers' prescribed methods. Occasionally, emissions tuneup procedures and data will be included on decals in the engine compartment. Otherwise, consult an appropriate service manual for details. It is a good idea to take a CO reading before making any repairs or adjustments so that you can later measure your progress by "before/after" comparison.

It is wise to begin by checking the igni-

tion components: replace, clean, or re-gap spark plugs as needed; set point dwell and ignition timing to manufacturer specifications; check spark plug wires; and clean/inspect distributor cap.

Equipment added to modern automobiles to reduce emissions include (in part) the following items. They should be inspected, cleaned, replaced, or adjusted as recommended by the auto maker.

1. Air-Inlet temperature damper (routes preheated air to carburetor during engine warmup).
2. Air pump (pumps air into exhaust manifold area to improve combustion efficiency).
3. Charcoal vapor-evaporator (routes stored fuel vapor to carburetor).
4. EGR (routes portion of exhaust back to carburetor).
5. PCV (Positive Crankcase Ventilation system—routes "blow-by" gases back to carburetor, and allows fresh air to enter crankcase).
6. Spark-timing advance (three common types: deceleration-vacuum control, transmission-gear-shift control, and engine temperature thermostat-vacuum control).
7. Thermostat-engine coolant (higher temperature thermostats being used).

Proper carburetor operation is vital to minimizing exhaust pollutants. All passages and internal/external components must be clean, and gaskets must be secure to prevent air or fuel leaks. Once that has been accomplished, the various adjustments must be set to the manufacturer's instructions. Those adjustments typically include float, choke, throttle, and air/fuel mixture, but may include other things, such as multi-carburetor synchronization. While "in the old days" simple cookbook adjustment procedures could be given (for example: "tighten down mixture screw, then back off 3 turns..."), today that is just not possible. The importance of using a CO meter and strictly following the auto makers' adjustment instructions is no better exemplified than with the carburetion setup.

#### Readings

As mentioned earlier, auto makers typically provide emissions-adjustment information in the engine compartment. That information often includes CO and A/F readings that should be attainable if all systems are functioning properly. Tune-up manuals will also provide that information. Of course, it is also important to know your state's prescribed maximum CO limits for your make, engine, and year auto. Those limits vary considerably.

In Arizona, for example, a 1972 Ford Pinto with a 4-cylinder engine is allowed 6% CO maximum. A 1981 Dodge Aries, also with a 4-cylinder engine, is only allowed 1.5% CO maximum. A 1973 12-cylinder Jaguar XKE is allowed 5.5% CO.

Some auto types seem to be rather amenable to achieving even very stringent requirements, while others (like the Jaguar mentioned above) just barely squeak by relaxed requirements, and then only after considerable effort. In general, however, 10- or 15-year-old cars should be able to deliver about 3%–4% CO, while the very latest cars should be down to about 1%.

Air/fuel ratio measurements are especially meaningful when making carburetor adjustments. Once again, it is important to consult the manufacturer's data for recommended procedures and readings. It can be injurious to the engine valve system, for example, to set the mixture too lean. The few pennies saved in fuel will be more than offset by subsequently having to repair burned valves, due to excessive combustion temperatures. Air/fuel readings above about 14.0 indicate a lean mixture (i.e., more air, less fuel) while readings below about 12.0 indicate a rich mixture.

The advantage of using the unit while driving is to verify A/F carburetor settings and general carburetor/accelerator pump response under actual operating conditions. At cruising speeds, with a light engine load, the A/F reading will normally be a little leaner (by about .3 or .4) than when the auto is stationary. After sudden, brief acceleration the reading should diminish considerably, then gradually rise back to nominal. Service data for your auto should provide specific load readings.

#### Suspicious readings

Sooner or later, you will probably encounter readings that just don't seem to make sense. There can be many sources of inaccuracy, but first it is important to determine the general cause. There are three general causes to consider: the automobile, the setup, or the unit itself. Once the general cause is found, the specific problem is much easier to track down.

One common auto symptom is the carburetor-mixture control not having any effect on CO readings. That is a "normal" occurrence if the carburetor needs overhauling. What has happened is that blockages or leaks in the carburetor have disrupted normal operation enough to make the relatively minor mixture-screw changes ineffective. It is also possible that the air filter is clogged. To verify, note the A/F reading, then remove the air-cleaner element, re-attach the air-cleaner cover, and retest. If A/F ratio is now more than .2 or .3 higher than before, the filter probably needs replacing.

Another source of potential trouble from the automobile, as mentioned earlier, is "swamping out" of the TCC due to an unusually dirty exhaust blast, such as that which would occur if the engine is started with the probe attached. Swamp-

*continued on page 96*

# HOBBY CORNER

## Finding replacement parts

EARL "DOC" SAVAGE, HOBBY EDITOR

TWENTY OR SO YEARS AGO, WHEN commercially available amateur-radio setups began to appear in large quantities, the number of ham operators who simply bought transmitter/receiver units and turned them on began to increase at an exponential rate. Prior to that time, most hams built their own installations, or at least knew enough about them to repair and modify them whenever the need arose. So they, the old timers, made disparaging references to the new breed of hams—they were called "appliance operators." Not so long ago, the computer hobby went through a similar change. Not only is it no longer necessary to build a computer to have one, but most computerists have no interest in knowing how their machines work. In fact, the vast majority of computer owners today are essentially "appliance operators."

The purpose of reviewing that bit of history is not to start an argument—neither side is any better than the other. However, those and other similar changes have created a problem that many electronics enthusiasts encounter frequently. That is, we start to build or modify some device and discover that the parts we need are hard, if not impossible, to find. That's partially because many parts distributors

carry more sub-assemblies than discrete components. The reason behind that is that these days the repairman usually replaces a complete sub-assembly (or board) rather than the parts themselves. It's quicker and cheaper to do things that way—at least they say it's cheaper!

You really can't blame the stores and mail-order houses for the change; simple economics was the deciding factor in making that adjustment. There is more profit in selling manufactured sub-assemblies than there is in selling parts unless the volume purchased is quite large. And therein lies the root of the problem, but knowing the cause doesn't affect a cure—it's still hard to find the parts. That's true whether you do business with the very large parts dealers or the "mom-and-pop"-type operations, which have low overhead. We know it's difficult, not only from personal experience but because a week doesn't go by without receiving a letter from someone saying that he can't find a source for a certain coil, transformer, or whatever. So, for David Barger (NY), Jerome Roach (CA), D. C. Hoffman (PA), Chris Miller (Ontario), Chauncey Albright (NY), and the rest of you out there who have had difficulty in locating the needed parts, here are some old methods and a new one that has proven quite valuable.

### Helpful hints

If you're building a device from a construction article, first check to see if the author has made arrangements to offer a parts kit. Often a source of partial or complete kits is listed with the article. That may be the best way to go when you need all or almost all of the parts. The second approach to the parts problem is to check the local Radio Shack store or their catalog. If they carry the necessary parts, then you've saved yourself a lot of time. But if that turns out to be dead end, the next step is to check the back-page ads and the classified section of current and past issues of *Radio Electronics* for suppliers. Most suppliers will send along a current catalog when you order something, and continue to do so once you are on their mailing lists. Still others will send their catalogs to you just for the asking. (I don't know about you, but I never throw out a

catalog until a replacement comes along.) Assuming the worst case, it's then time to start writing letters of inquiry to supply houses (a task that's all too familiar to me). In the past that has been like shooting in the dark, but now some light has been shed on the subject.

A fellow by the name of Edward A. Hall has written a 125-page book—*The Buyers' Guide to Radio and Electronic Parts*. That guide goes a long way in letting you know which distributors carry what items. The book contains listings for hundreds of parts, ranging from actuator-to-yoke and it also lists over 85 companies that carry each item. A special section in the back of the book gives supplier mailing addresses, telephone numbers, catalog costs, and minimum order amounts. (I've found it to be quite helpful.) If you feel that the guide would be of benefit to you: it's available for \$6.95 postage paid from Hayward Products, 39 Sunset Court, St. Louis, MO 63121. (And I don't own a bit of stock in the company!) How times have changed!



FIG. 1

Speaking of changing times, you may be interested in a little conversation piece in my workroom. It is nothing more than a small wooden base holding a tube, a transistor, and an IC. The sketch in Fig. 1 gives you an idea of what it looks like. My non-technical friends are amazed when I answer their questions about it, and I'm sometimes tempted to cheat a bit by replacing the puny 68L7 with an old transmitting tube! Of course, you could have a series of such eye-openers: How about a 5R4 and a solid state rectifier, or an OA3 and a Zener diode? There are all kinds of interesting possibilities.

### Inquiries

Whenever I have the occasion to thumb through my *Radio Electronics* magazine

### AN INVITATION

To better meet your needs, "Hobby Corner" has undergone a change in direction. It has been changed to a question-and-answer form. You are invited to send us questions about general electronics and its applications. We'll do what we can to come up with an answer or, at least, suggest where you might find one.

If you need a basic circuit for some purpose, or want to know how or why one works, let us know. We'll print those of greatest interest here in "Hobby Corner." Please keep in mind that we cannot become a circuit-design service for esoteric applications; circuits must be as general and as simple as possible. Please address your correspondence to:

Hobby Corner  
Radio-Electronics  
200 Park Ave. South  
New York, NY 10003



file, I am impressed anew with the variety and scope of the subjects that have been covered (or uncovered) over the years. A back-issue file is a valuable resource of circuits, ideas, and construction data. When you are looking for information, check through your back-issue file. You'll almost always find that the time was well spent.

For instance, one reader—James Lewis (NJ)—is looking for a voltage/spike suppressor for his equipment. Well, James, take a peek at page 57 of the September 1983 issue. There you'll find a great construction article entitled "Powerline Transient Suppressor" by Herb Friedman. That suppressor takes care of four line problems: RF interference, line transients, surges, and interruptions of service. (Well, it doesn't prevent interruptions but it does keep down troubles when service is resumed.) Another reader, S. M. Harmon (PA), will have to look back a bit farther to find an answer to his question. That reader is a teacher who wishes to add some tunes to his math games. He says the mini-player piano of a few months ago is overkill for his needs. You're in luck, Mr. Harmon. You can find just such a monophonic "tune maker" circuit in the "Hobby Corner" columns of the January and February 1979 issues of *Radio Electronics*.

Those of you who have written about sequential turn-signals for your cars and other uses of "chase" circuits, may wish to check the March, 1978 installment of "Hobby Corner." To operate that circuit with high-current devices (tail lights, 110-volt lights, etc.) just hang one or two TTL relays, or transistor switches on the outputs in place of the LED's.

#### Antenna measurements

Antennas can make or break any kind of radio installation. That is especially true of transmitting antennas. What is especially exasperating about them is that they can look great but perform like a willow twig, or worse.

It is axiomatic that the more you know about antennas, the more you realize you don't know! To make matters more com-

plicated, the usual DC and AC test instruments are of little value in making antenna measurements. Typically, AC instruments function adequately only up to a few hundred Hertz, at best. They are all but worthless when dealing with devices in the kHz and MHz ranges.

Andrew Mazzella has asked how he can test his antenna without lowering it or climbing up a long ladder. Well, the first thing we have to tell you is that there are many things you need to know about a given antenna that can't be learned by bringing it down or going up to it, unless you have special instruments.

The primary question about an antenna is: What is its resonant frequency? Fortunately, that can be determined from the ground, as it were, with any of three instruments. Two are quite reliable but the third will mislead you, given half a chance.

The one which you must use with great care is the grid dip meter. The method and degree of coupling to the antenna is quite critical to getting useful and accurate readings. In spite of that, the grid dip meter is used often because it does not require an external source of RF energy. The other two instruments that will give you the needed information on your antenna are an SWR bridge and an RF impedance bridge. R-E

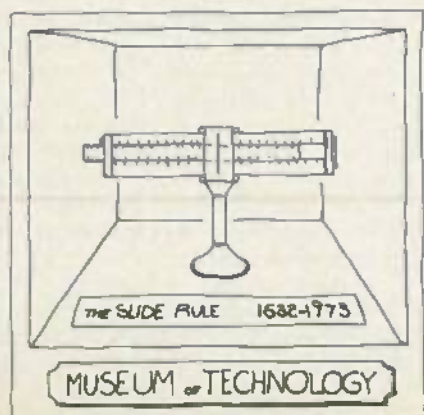

## SUPER LONG PLAY TAPE RECORDERS

10 Hour Model — \$95.00\*  
14 Hour Model — \$159.00\*

Modified Panasonic Slimline, high quality AC-DC Recorders provide 5 or 7 continuous hours of quality recording & playback on each side of cassette for a total of 10 or 14 hours depending on model. Built-in features include • Voice level control • Digital counter, etc. TOK DC 180 Cassette Furnished.



### PHONE RECORDING ADAPTER

Records calls automatically. All Solid state connects to your telephone jack and tape recorder. Starts recording when phone is lifted. Stops when you hang up. \$24.50\* FCC APPROVED



VOX VOICE ACTIVATED CONTROL SWITCH  
Solid state. Self contained. Adjustable sensitivity. Voices or other sounds automatically activate and control recorder. Uses either recorder or remote mike. \$24.95\*



Add for ship & hdlg. Phone Adapter & Vox \$1.50 ea. Recorders \$4.00 ea. Cal. Res. add tax. Mail order, VISA M/C, CODs OK. Money Back Guarantee. Qty. disc. avail. Dealer inquiries invited. Free data. AMC SALES INC. Dept. A 9335 Lubec St., Box 928, Downey, CA 90421 (213) 889-8519

CIRCLE 67 ON FREE INFORMATION CARD

SEE YOUR DEALER TODAY

FROM



HERE'S A TIP THAT'S PERFECT!

AM/FM AUTO RADIO AND CB

## 'Firestik' II

GOLDEN SERIES

BARE-HANDS TUNABLE "NO TOOLS NEEDED" HIGH PERFORMANCE ANTENNAS

ALSO ANTENNAS FOR CORDLESS TELEPHONES MONITOR SCANNERS

Dealer & Distributor Inquiries Invited SEND FOR FREE CATALOG

Firestik Antenna Company  
2614 East Adams/Phoenix, AZ 85034

Name \_\_\_\_\_  
Street \_\_\_\_\_  
City \_\_\_\_\_  
State \_\_\_\_\_ Zip \_\_\_\_\_

Serving the CB and Communications Market Since 1962.

5-YEAR REPLACEMENT WARRANTY

CIRCLE 40 ON FREE INFORMATION CARD

# Be an FCC LICENSED ELECTRONIC TECHNICIAN!

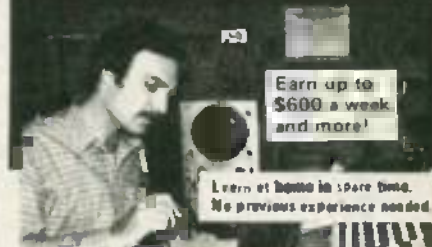

No costly School. No commuting to class. The Original Home-Study course that prepares you for the FCC Radiotelephone license exam in your spare time! An FCC Government license is your "ticket" to thousands of exciting jobs in Communications, Radio & TV, Mobile two-way, Microwave, Computers, Radar, Aerospace and more. You don't need a college degree to qualify, but you do need an FCC License. No need to quit your job or go to school! You learn how to pass the FCC License exam at home at your own pace with this easy-to-understand, proven course. It's easy, fast and low cost! GUARANTEED PASS. You get your FCC License or money refunded. Write for free details. Soon you could be on your way to being one of the highest workers in the electronics field. Send for FREE facts now. MAIL COUPON TODAY!

### COMMAND PRODUCTIONS

FCC LICENSE TRAINING, Dept. 90  
P.O. Box 2223, San Francisco, CA 94126  
Rush FREE facts on how I can get my FCC License in spare time. No obligation. No salesman will call.

NAME \_\_\_\_\_  
ADDRESS \_\_\_\_\_  
CITY \_\_\_\_\_ STATE \_\_\_\_\_ ZIP \_\_\_\_\_

CIRCLE 23 ON FREE INFORMATION CARD

JUNE 1984

87

# THE DRAWING BOARD

## Smoothing out the sinewave-generator output

ROBERT GROSSBLATT

ANYONE WHO GETS INTERESTED IN ELECTRONICS and gets really hooked on it will progress through a number of clearly recognizable steps. In the beginning, you buy light-dimmer kits and burn your eyes out trying to read obscure directions written in muddy print. The next step is to buy components and, armed with a chart that lists the resistor color code and a soldering iron, burn your components up trying to build a light dimmer of your own design. Somewhere around here you begin to understand that there's more to electronics than Ohm's law, and you begin to read.

Now, we're all familiar with the truth of Grossblatt's 12th Law: He who doesn't have his head in a book has his head in something else. But the more general the rule, the more exceptions there are to it, and that applies here as well. After you've plowed through enough abstracts and journals, you'll learn how to apply Grossblatt's 27th law: What is written on paper is not carved in stone.

The difference between theory and practice is the difference between brain damage and common sense. The difficult task of plowing through countless reams of paperwork filled with obscure equations can often be eliminated by taking a look at the original problem on a different-color paper or walking away and letting your subconscious take over.

The perfect example of that is the problem facing us at the moment—finding the resistor values for our digital sinewave generator. There are three ways to go about finding the answer. 1) Trial and error. 2) Mind-warping math. 3) Common sense. The first one is OK, but only gives answers for a particular application. The second is OK for people who wear a bathing suit with shoes and socks. That leaves us with the third.

Believe me when I tell you that the standard method for calculating the resistor values involves math so hairy... well, even with a lot of equipment it would be difficult. The Fourier transforms and Fibonacci numbers are the easy part. The hard parts can only be solved using a variable interossiter. (Do any of you remember what that is or know how to spell it?)

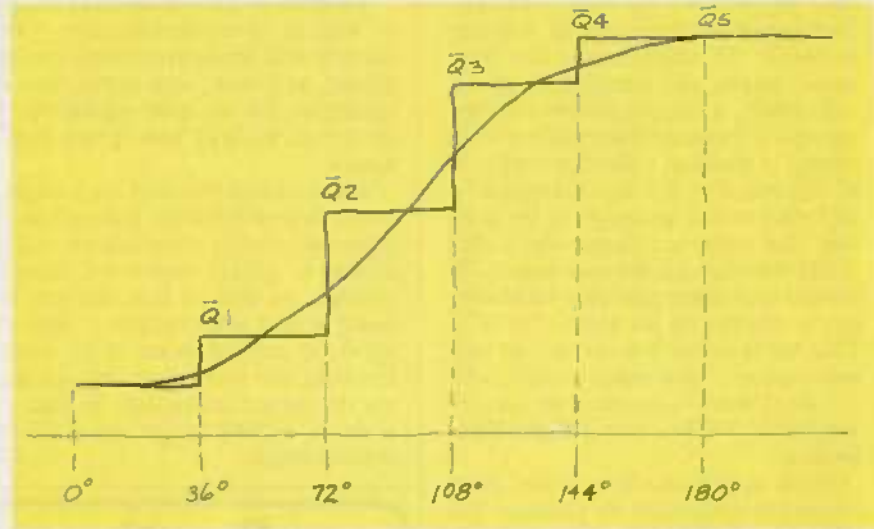

FIG. 1

TABLE 1

OUTPUT	ANGLE	SINE	NORMALIZED VALUE
$\bar{Q}_1$	36°	0.588	1.617
$\bar{Q}_2$	72°	0.951	1.000
$\bar{Q}_3$	108°	0.951	1.000
$\bar{Q}_4$	144°	0.588	1.617
$\bar{Q}_5$	NOT USED		

FIG. 2

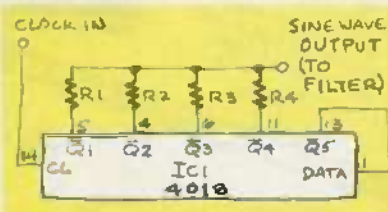

FIG. 3

### Getting around the math

But seriously folks, the math is both complicated and unnecessary. We can get within several decimal places of the calculated values by using common sense and a bit of elementary arithmetic. Let's take a good look at the problem. Figure 1 shows the circuit we're going to use; Fig. 2 shows 180 degrees of the waveform that we want, and a couple of helpful hints.

You'll remember that we're not using

the  $Q_5$  output of the 4018 because it's a quick and dirty way to make the waveform conform more closely to a sinewave. The resistors on the remaining outputs will determine the shape of the wave we generate but—and this is important—we still have to allow for the time used by the  $Q_5$  output. In other words, no matter how many 4018 outputs we decide to use, it's still going to take 5 incoming clock-pulses to make the 4018 repeat itself. That means any calculations that we do have to take into account the fact that there will be 5 discrete 4018 output states for each 180 degrees of the sinewave.

In practical terms, each incoming clock pulse will control 36 degrees ( $180/5$ ) of the sinewave.  $Q_1$  will determine the amplitude of the sinewave 36° into the cycle.  $Q_2$  will determine the amplitude of the sinewave at 72°, and so on until we get to

# COMPUTER DIGEST

VOL. 1 No. 2 June 1984

NEW KIND OF MAGAZINE FOR ELECTRONICS PROFESSIONALS

**PC JR VS NEW TRANSPORTABLE...**  
**A BRAND NEW IBM COMPUTER THAT YOU CAN CARRY WITH YOU WHEREVER YOU GO. HERE'S A COMPARISON BETWEEN THE NEW TRANSPORTABLE AND THE PC JR.**

## CP/M FOR BEGINNERS...

**DON'T BE AFRAID OF USING CP/M. IT'S A TERRIFIC OPERATING SYSTEM ONCE YOU UNDERSTAND HOW TO USE IT.**



## GRAPHICS SOFTWARE...

**FROM PAINTING PICTURES TO DRAWING PIE-CHARTS ON YOUR TERMINAL'S SCREEN OR DOT MATRIX PRINTER.**

A  
GERNSBACK  
PUBLICATION

# Radio-Electronics Software Store

New for our readers....A mallorder source of software for Atari 400, Atari 800, IBM P C, Commodore VIC-20, Apple II, and other personal computer systems.

## IBM PC



**FLIGHT SIMULATOR** by Microsoft ... List \$49.95. Our price ... \$43.00. Highly accurate simulation of flight in a single-engine aircraft. Working instruments. Out the window graphics. Real-time flight conditions. (IBM P C, 64k, color graphics, disc)

**EASYWRITER II** by Information Unlimited ... List \$350.00. Our price ... \$300.00. Turns your computer into a word processor. You see everything on the screen. There are no imbedded commands. (IBM P C, disc)

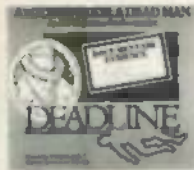

**DEADLINE** by Infocom ... List \$49.95. Our price ... \$43.00. A locked door. A dead man. You have 12 hours to solve the mystery. One false move, and the killer strikes again. (IBM P C, 48k, disc)

**ALGEBRA**, Vol. 1 by Eduware ... List \$39.95. Our price ... \$34.00. A first year algebra tutorial covering definitions, number line operations, sets, etc. (IBM P C, 48k, color graphics, disc)



**MICRO TERMINAL** by Microcom ... List \$94.95. Our price ... \$83.00. Allows access to remote mainframes and minis, information data banks, and other personal computers. (IBM P C, disc)

**PC TUTOR** by Comprehensive Software ... List \$79.95. Our price ... \$69.00. Interactive program teaches you how to use your IBM Personal Computer, including hardware and software. (IBM P C, 64k, disc)



## APPLE



**PRISONER2** by Interactive Fantasies ... List \$32.95. Our price ... \$28.00. Escape is hardly possible. The island keeps you under surveillance. Just try and get out! (Apple II, 48k, disc)

**PRISONER2** by Interactive Fantasies ... List \$39.95. Our price ... \$34.00. (Atari disc)

**THE MASK OF THE SUN** by Ultrasoft Inc. ... List \$39.95. Our price ... \$34.00. An animated adventure through a series of hi-res screens. An ultimate adventure challenge. (Apple II, 48k, disc)



**MASTERTYPE** by Lighting Software ... List \$39.95. Our price ... \$34.00. A typing instruction system in an exciting hi-res game format. Learn to type while battling waves of attacking enemy words. (Apple II, 48k/64k, disc)

**THE GRAPHICS MAGICIAN** by Penguin Software ... List \$59.95. Our price ... \$53.00. Make your own animated graphics. Handles up to 32 independent objects. Stores hundreds of color pictures. (Apple II, 48k, disc)



**RENDEZVOUS** by Eduware ... List \$39.95. Our price ... \$34.00. In four phases, simulates an actual space-shuttle flight from Earth Liftoff through Orbital Rendezvous and Approach to Alignment Docking with a space station. Hi-res graphics (Apple II, disc)

**SAT WORD ATTACK SKILLS** by Eduware ... List \$49.00. Our price ... \$43.00. A tutorial for mastering vocabulary, deciphering new or unfamiliar words, and taking tests. (Apple II, disc)



## COMMODORE VIC-20



**PIPES** by Creative Software ... List \$39.95. Our price ... \$34.00. Connect a pipeline from the water supply tank to every house. Watch out for leaks. Use as little pipe as possible. 5 skill levels. (Commodore VIC-20 cartridge)

**SHAMUS** by Human Engineered Software ... List \$39.94. Our price ... \$34.00. Only you can stop the Shad-ows mad reign of terror. Two levels with 20 rooms each. A joystick challenge. (Commodore VIC-20 cartridge)



**HOUSEHOLD FINANCE** by Creative Software ... List \$17.95. Our price ... \$15.00. Home utility program records and analyzes your monthly income, expenses and budget in 16 categories. (Commodore VIC-20 tape cassette)

**HOME OFFICE** by Creative Software ... List \$29.95. Our price ... \$25.00. Combines VICPRO, a flexible and efficient word processor with VICDATA a powerful and sophisticated information storage and retrieval system. (Commodore VIC-20, cassette tape, 8k additional memory required)



## ATARI



**SUBMARINE COMMANDER** by Thom EMI ... List \$49.95. Our price ... \$43.00. A submarine patrol simulator to hunt and destroy enemy ships. 9 skill levels. Plug-in cartridge. (Atari Cartridge 400/800)

## APPLE

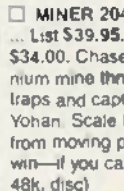

**MINER 2049** by MicroLab ... List \$39.95. Our price ... \$34.00. Chase into a Uranium mine thru 10 levels of traps and capture Yukon Yohan. Scale ladders, jump from moving platforms, and win—if you can. (Apple II, 48k, disc)



## Radio-Electronics Software Store

200 Park Avenue South  
New York, NY 10003

Number of items ordered

Total Price of Software ..... \$ .....

Sales Tax (NY State Residents Must Include) .....

Shipping (\$2.00 per item) .....

TOTAL ENCLOSED (Sorry, No COD's) ..... \$ .....

Name \_\_\_\_\_

Address \_\_\_\_\_

City \_\_\_\_\_ State \_\_\_\_\_ ZIP \_\_\_\_\_

SORRY - NO CREDIT CARD OR COD ORDERS

# CONTENTS

COMING  
NEXT  
MONTH

Vol. 1 No. 2

June 1984

## 6 IBM PCjr Versus The Portable

An in-depth look at two of IBM's newest computers. Included is a look at the similarities and differences between the two machines.

Marc Stern

## 10 CP/M For Beginners

Part 2. This month, we'll turn our attention to one of the most important CP/M utility programs: PIP. Herb Friedman.

## 14 Computer Graphics

With the proper software, it's possible to add the tremendous power of graphics to any personal computer. In this article, we'll take a look at some of what is available, and see what those programs can, and can not, do. Herb Friedman

## 4 Editorial

## 5 New Products

First there was the ZX80, the machine that set the computer industry on its ear. Now Clive Sinclair is at it again with his latest entry, the QL. Find out how it stacks up against the competition in next month's issue.

## Computer telecommunications

has received a lot of attention in the last year or so, but what exactly is it, and where does the average hobbyist fit in? Those are just some of the topics our look at telecommunications will cover.

## Handling large amounts of data,

or writing long reports or papers, is done much faster when done on a computer. Getting a printout of your work, however, is an entirely different matter. Losing use of your computer for minutes, or sometimes hours, while reams of paper are fed through even the fastest printers is unproductive, frustrating, and annoying. Next time, we'll find out all about how you can put an end to all of that by adding a printer buffer to your computer system.

## ON THE COVER

Add a solid graphics software package to a computer and it becomes easy to prove the cliché "a picture is worth a thousand words." Learn all about some popular graphics software, and how they can make your computer "speak volumes," beginning on page 14.

The illustration on our cover was created on a Heath/Zenith Z100 computer using a graphics software package called Autocad.

**COMPUTER DIGEST**  
NEW KIND OF MAGAZINE FOR ELECTRONICS PROFESSIONALS

**PC Jr VS NEW TRANSPORTABLE...**  
A BRAND NEW IBM COMPUTER THAT YOU CAN CARRY WITH YOU WHEREVER YOU GO. HERE'S A COMPARISON BETWEEN THE NEW TRANSPORTABLE AND THE PC Jr.

**CP/M FOR BEGINNERS...**  
Don't be afraid of using CP/M. It's a realistic step-by-step guide to help you understand how to use it.



**GRAPHICS SOFTWARE...**  
From plotting pictures to drawing pictures on your terminal's screen, see how easy it is.

# EDITORIAL

## CAVEAT EMPTOR!

Money is tight. Nobody had to tell you that. All you have to do is to open your wallet or look at the balance in your checkbook. The things you want are harder and harder to come by. So you have to decide which things are necessities and which are luxuries. But it goes beyond that. Your purchases have to be exact and correct. There is no room for mistakes.

That's why a magazine like **ComputerDigest** becomes increasingly important to you. Not only do you learn what new products are available to you, but you'll also learn how well they perform, and whether or not they will be precisely what you want and need for your own computer system. In a tight-money situation, there's no room to buy, try, and discard. Your purchase must work for you the way you want it to, or you've lost your money.

The other thing that happens in that sort of situation, is that a lot of manufacturers compete for the bucks you've got to spend. Now competition is good for everybody. It keeps prices within reason, provides innovative products, and the industry continues to move forward. Yes, that's all to the good. Unfortunately, not all of the manufacturers can hold out in a highly-competitive market, and there's always a dropping by the wayside. If you buy a product and that manufacturer fails, you might wind up with a totally worthless guarantee.

What does it all mean? You've simply got to be a careful consumer! Before you make any purchase, you must be certain that you want and need the product that you're contemplating. Having made the decision to buy, you've got to use a careful process of elimination to select the manufacturer you want to deal with, and then pick that specific product of that specific manufacturer. When you've nailed down the manufacturer and model number, you go out shopping for price, and we hope, you'll deal with a local distributor who has an untainted reputation in addition to fair prices.

When you finally do make a purchase, we recommend that you stop shopping. Too many people waste time after a purchase, trying to verify that they made the right buy, after it's too late!

We started out by saying *Caveat Emptor*. It's Latin for "Let the Buyer Beware."

We at **ComputerDigest** are trying to help. We're working your side of the street. We'd like to hear from you, too. Got any specific problems or questions? If we don't have the answers, we'll know where to get them; and while all mail will be answered, we'll publish the letters that we think are most interesting. So do let us hear from you.

And hey... THANKS!

BYRON G. WELS  
EDITOR

# COMPUTER DIGEST

**Hugo Gernsback** (1884-1967)  
founder

**M. Harvey Gernsback**, editor-in-chief

**Larry Steckler**, CET, publisher

**Art Kleiman**, editorial director

**Byron G. Wels**, editor

**Brian C. Fenton**, technical editor

**Carl Laron**, associate editor

**Robert A. Young**, assistant editor

**Ruby M. Yee**, production manager

**Robert A. W. Lowndes**, production  
associate

**Dianne Osias**, production  
assistant

**Joan Roman**, circulation director

**Arline R. Fishman**,  
advertising coordinator

---

Gernsback Publications, Inc.  
200 Park Ave. South  
New York, NY 10003  
Chairman of the Board,  
M. Harvey Gernsback  
President; Larry Steckler

## ADVERTISING SALES 212-777-6400

Larry Steckler  
Publisher

### EAST/SOUTHEAST

Stanley Levitan  
Radio-Electronics  
200 Park Ave. South  
New York, NY 10003  
212-777-6400

### MIDWEST/Texas/Arkansas/Okla.

Ralph Bergen  
Radio-Electronics  
540 Frontage Road—Suite 325  
Northfield, Illinois 60093  
312-446-1444

### PACIFIC COAST Mountain States

Marvin Green  
Radio-Electronics  
15335 Morrison St., Suite 227,  
Sherman Oaks, CA 91403  
818-986-2001

# COMPUTER PRODUCTS

For more details use the free  
information card inside the back cover

**DUSTCOVER**, the *Copy Cover*, is a combination dust-cover and copy holder. Manufactured from clear lucite, when down, it protects keyboards from dust and dirt; when it is flipped up (see photo) it becomes a copyholder that accommodates documents and computer printouts that measure up to 11 x 16 inches.

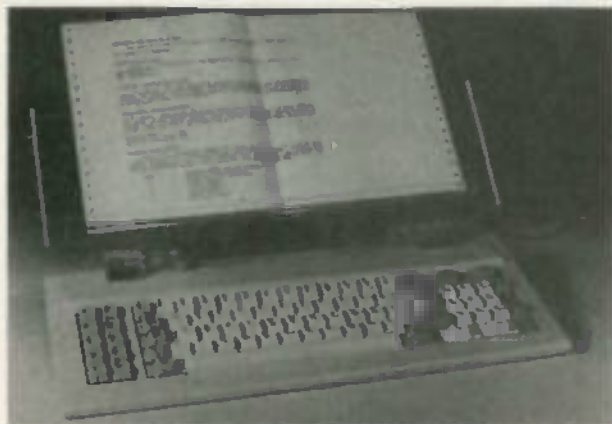

CIRCLE 110 ON FREE INFORMATION CARD

The *Copy Cover* clips on and off in seconds. Each unit is custom-fit and versions are available for most popular computer models, including IBM PC, XT, jr—Apple—Radio Shack's *Color Computer*—TI 99—Commodore 64, VIC-20, DEC Rainbow 100—Columbia—Kaypro, and many other models. There is also a special version available for the portable Radio Shack model 100 and the NEC 8201. During the special introductory offer period, the *Copy Cover* is priced at \$39.95.—**C-Thru Products**, 6351 Lk. Worth Road, Lk. Worth, FL 33463, Suite 111.

**SOLDERLESS EXPERIMENTER SYSTEM**, the *eZ Board*, provides a method for building experimental add-ons to interface with personal computers.

Features of the system include a glass epoxy circuit board mounted with a set of solderless breadboarding units for building circuits; four separate distribution buses with 50 tie-in points, each of which can be used for power, ground, clock lines, reset, and more.

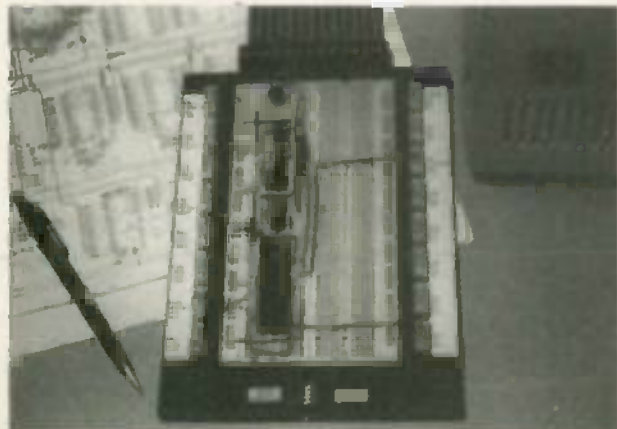

CIRCLE 112 ON FREE INFORMATION CARD

There is an array of tie-point blocks from which each pin of the computer's bus system (I/O channel) is clearly labelled and is easily accessible. A four-position DIP switch is mounted on the board. Each switch position connects to a set of tie-block sockets on either side, to aid in the development and analysis of experimental circuits. A flat ribbon cable connects the board to the computer's bus expansion slot.

Versions are available for IBM, Apple, and Commodore machines, as well as for hardware compatible models. The entire system, including cable and connectors, is priced at \$174.95 each, plus \$5.00 for shipping.—**Sabadia Export Corporation**, 3920 E. Coronado Street, Suite 206, Anaheim, CA 92807.

**COIN-EVALUATION PROGRAM**, *Coins*, automatically evaluates 1600 common American coins. Non-standard coins can also be listed and maintained, so that numismatists can determine the current market value of their collections. The package provides for special reports that show yearly purchases and sales, as well as a complete inventory

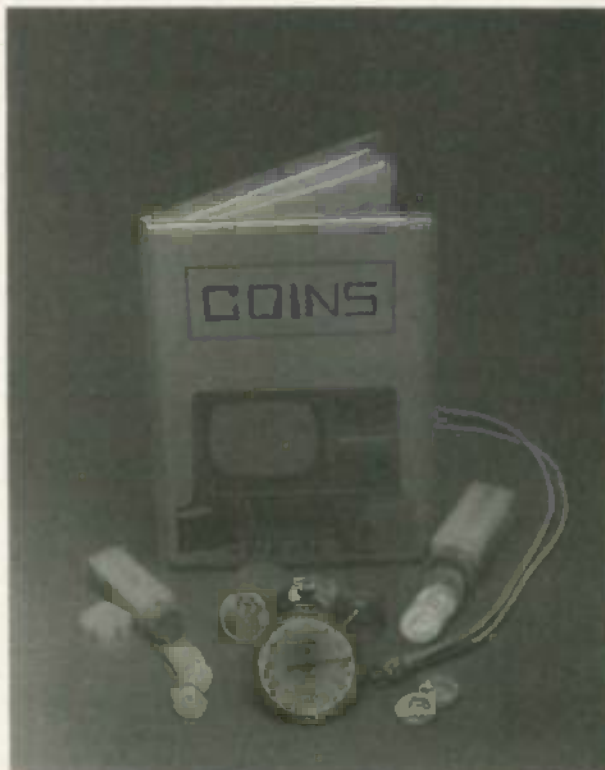

CIRCLE 113 ON FREE INFORMATION CARD

Optional quarterly update diskettes that will be available reprice the collection per current market values. IBM PC/XT/jr, Apple II/II + IIe, and TRS-80 models I/III versions, including a 44-page manual and program diskette with latest value file are available at \$95.00. (Previews Packs—manual only—are available for \$10.) Add \$2.50 for shipping and handling. MC/VISA order are acceptable; California residents are asked to please add 6% sales tax.—**Compu-Quote**, 6914 Berquist Avenue, Canoga Park, CA 91307.

# IBM PCjr VERSUS THE PORTABLE

MARC STERN

*Here we'll look at IBM's Portable PC and the PCjr to see if there are any similarities.*



FIG. 1—THE NEW IBM PORTABLE personal computer features 256K of user memory and a single disk drive.



FIG. 2—THE IBM PCjr. The version shown here features a single disk drive, two cartridge slots, and a cordless keyboard.

■When IBM made its decision to enter the microcomputer market in 1981 with its Personal Computer (PC), it was generally considered a way of getting its foot in the door. The giant computer maker was dipping its toe—so to speak—into the waters of this market to see if it was right for the corporation.

The fact that this entry was rather cautious was hardly surprising because this area of the computer market was a giant unknown for IBM. Look at the original offering and you'll see what we mean.

It used an 8088 microprocessor—a proven device—which had a 16-bit internal architecture, but an 8-bit data bus. The computer used 16K static RAM IC's to provide a total of 64K of RAM on the motherboard; a cassette recorder interface, and a detachable 83-key keyboard. That combination is hardly what one would call revolutionary.

To upgrade this system, you had to buy special-purpose accessory boards that plugged into the motherboard (system board of the computer) and you had to buy a separate display device to see the system's output and that device needed a special plug-in card so it would work, too.

This, again, was hardly a new trend in the microcomputer world. Apple had been doing it successfully for four years before IBM jumped into it.

Like Apple, though, IBM used a cagey marketing strategy, one which was totally out of character with the company's traditional policy of in-house development, it made its system and bus architecture public, publishing a detailed "Technical Reference Manual." This manual allowed developers of non-IBM-developed accessory boards, peripherals and software to have a look at the memory and input/output (I/O) structure of the system and to develop products for it. IBM even went so far as making most of its Basic Input/

Output System (BIOS) software public, with the exception of some proprietary Read-Only Memory (ROM) calls, so that anything developed for the IBM PC was compatible not only with the basic system, but other accessory devices and with IBM-developed products.

For IBM it was quite a daring maneuver, on the face of it. But, think about it for a moment. With its original minimal PC, it had very little at stake. If the market for the IBM PC failed to develop, the company was out the development costs of the basic system and for some tooling. Since the corporation relied so heavily on outside vendors, though, much of the development cost would be borne by third parties and they would be the ones who would have had to absorb any failure.

However, as we all know, the IBM-PC hardly failed at all. Almost at once, the market for this system began to skyrocket—even with the minimal level of hardware and software that was originally out there—and soon the IBM-PC became an industry standard. Almost immediately, a widespread network of hardware and software suppliers jumped on the bandwagon, providing IBM users with a wide array of accessory devices and software. Even IBM joined its own bandwagon by providing more and more IBM-packaged material for the PC.

Yet, IBM remained cautious, even though its market share in the microcomputer world soon approached and surpassed 20 percent. Some said this was due to IBM's fear of an anti-trust action if it came to dominate too much of the market. However, it is probably truer to say that it was a result of IBM's native business conservatism. It wanted to be sure the PC phenomenon was more than just a flash in the pan. And, while it took more than a-year-and-a-half for it to be convinced of



the success of the PC, the corporation eventually began turning out upgrades and additions to the PC line.

First came the PC-XT, an upgraded IBM Personal Computer that used 64K RAM IC's to provide a maximum of 256K on the motherboard and a 10-megabyte hard disk. Then came other upgrades to this system, the PC-XT/3270, IX and more. Each of these systems had more power and functionality. Some could be tied into a network of terminals, while others could support the UNIX operating system.

Eventually, as it had done in the mainframe computer world, IBM offered a full lineup of business-oriented systems, ranging from the basic PC—now called the PC1—to the full-blown PC-XT/IX. It is now even beginning to offer a small computer system for the scientific and engineering world, based on its S-9000 MC-68000 microcomputer, called the S2.

However, if you look at all of the additions to the line, you will see there were still two crucial areas in which IBM had no entries, the home computer and portable computer realms. The first of these gaps was filled in November, 1983 with the introduction of the IBM PCjr shown in Fig. 1. (see March **Radio Electronics** for a description of PCjr). The second obvious gap was filled in February, 1984 with the introduction of the IBM Portable Personal Computer (see Fig. 2). This now makes IBM competitive in all areas of the microcomputer market, with the exception of the lap or kneetop computer area and it is more than likely that this gap will be filled before long.

### Compatibility Across Board

Perhaps one of IBM's shrewdest moves with all of its entries in the small computer world is the use of a common microprocessor and system architecture across the line. This assures compatibility from the low end to the high end and it further means that users will be able to migrate from one system to a higher-powered system as their needs change.

More important for the user, though, is the fact that the software base won't become obsolete simply by upgrading to a different IBM computer. Because the system architecture and disk format is the same, a program that runs on the PCjr will run on the PC and will run on the PC-XT and so on, provided, of course, that you use DOS 2.1.

This type of compatibility solves one of the long-time complaints in the microcomputer world—incompatibility of operating environments.

Since IBM has become so powerful in the microcomputer world, there are now many PC-compatible systems on the market that will emulate the IBM product and can use some of the same software. Some of them are so compatible that they will act the same as a PC and will run even IBM's proprietary software. This means compatibility across a great number of machines. However, there are varying levels of compatibility and you do have to check to find out just how compatible an IBM-compatible computer is.

For IBM, though, the compatibility between its systems means it can keep users "in-house" as they upgrade in their microcomputer needs.

With all of this background set out, let's take a detailed look at the Portable PC and PCjr.

### Portable PC

Like all the IBM Personal Computers, the Portable PC uses an Intel-designed 8088 microprocessor that runs at 4.7 MHz. This microprocessor has a 16-bit internal architecture—16 registers for storage and data and it handles data internally in 16-bit chunks—two 8-bit digital words at a time.

However, to get its data from the rest of the system, it must make two 8-bit data fetches. The reason is the 8088 microprocessor only has an 8-bit data path (bus). This means that before it can take any action on a digital instruction, it must send for 8 bits of data, store them temporarily, and then ask for the remaining 8 bits of the instruction. This does slow response time somewhat.



The PCjr's entry level model is packaged with software that's especially designed for users with little or no computer experience.

Included with the Portable PC, is a standard 256K of user memory (RAM). This means this portable will be able to run even the most memory-hungry programs. (Many 16-bit programs written now rely on a minimum system configuration of 128K of RAM and some even require 256K. The reasoning behind them is that memory is cheap and it is far better for program response to load the entire program in RAM, rather than relying on constant disk access every time something new is needed by the program.) This level of RAM is expandable to a maximum of 512K.

Interestingly, this is only half of the amount of RAM that a 16-bit microprocessor such as the 8088 can address. In reality, it can address up to megabyte of RAM. However, because of system constraints, at the moment, this is limited to 640K on the PC.

The Portable PC weighs about 30 pounds and folds



**FOR A WIDE VARIETY** of home and classroom applications, the PCjr can be used with the IBM Compact Printer. For instance, when used with the appropriate software, that combination can be used by students to produce reports, essays, etc.



**WHEN USING IBM's Personal Computer Disk Operating System 2.1**, the PCjr's enhanced model is compatible with a wide variety of business and personal-productivity programs available for other IBM computers.

into a 20 x 17 x 8-inch package. It features the same type of 83-key, firm-touch keyboard that is used by the larger members of the IBM Personal Computer family.

Unlike the other members of the PC family, this system comes with a built-in 9-inch, high-resolution amber monitor that is capable of displaying graphics. It is capable of displaying the industry standard 80-columns by 25-lines and this makes this system ideal for professional use.

This system also offers a standard color-graphics monitor adapter card so this system can be used for color graphics work and is compatible with the latest version of the IBM disk operating system—2.1.

Since it is compatible with DOS 2.1, it indicates this system comes equipped with a disk drive—you don't need DOS if you don't have a disk drive—and it does. The standard disk drive is a slimline (half-height) double-sided, double-density unit that is capable of 360K of storage. A second drive is available as an option.

There are also five expansion slots on the motherboard, which, again, shows the heritage of the Portable PC—an open system architecture that you can fill in yourself. It does add to the initial \$2,795 price for the one-drive system. An additional drive is \$425, while a serial communications port is about \$100, and a parallel printer port so you can use your Portable PC with a printer, is about another \$150. The 256K memory addition option costs anywhere between \$400 and \$900, depending on where you get the 64K 250 ns RAM IC's required.

It also boosts the cost of this system to about what you'd expect to pay retail for a similarly equipped two-drive IBM-PC1 desktop model. However, you do get the advantage of portability.

#### **Portable versus PCjr**

As we noted earlier, the portable plugs one of the holes in IBM's small computer lineup, while PCjr plugs the other hole at the low end of the line.

Like the Portable, PCjr uses an 8088 microprocessor and, like the Portable, that processor runs at 4.7 MHz.

However, it's there that the similarities stop and the contrasts begin.

Perhaps the first and biggest contrast is the price of the respective units. Where the Portable costs nearly \$3,000, the PCjr is available in its base form for \$669. This system includes 64K of RAM; a connector with a built-in RF modulator for a television set; a detachable keyboard; a connector for a cassette player so you can store data and load programs from tape, and Cartridge BASIC.

A more fully configured version—\$1,889—includes the basic PCjr and 128K of RAM—the maximum allowed, versus the 512K possible with the Portable; the keyboard and a 360K slimline drive; the TV connector; the disk operating system; VisiCalc; Cartridge BASIC, and a word-processing program.

A fully configured system—\$3,252—adds a high-resolution color display; connector for the display; internal modem; parallel printer adapter; graphics printer; Cartridge BASIC; the disk operating system, and a spreadsheet program.

As you can see, both systems are comparable in price when fully configured and both have about the same capability at that level. However, the Portable is a much more expensive machine in its basic form than the \$1,889 PCjr and the Portable weighs much more, 30 pounds versus 11 pounds. However, it must be remembered that the Portable has much more metal in its construction than the nearly all-plastic PCjr.

Junior also has some standard features that are extra-cost options on the Portable or any other PC in the IBM product line. For instance, it features the built-in video adapter; a serial port, and a joystick adapter. It also features ROM software cartridge slots, another feature the larger PC lacks.

Where PCjr differs markedly is in its keyboard; system architecture and audio.

For starters, rather than employing the much more expensive, full-travel 83-key PC keyboard, Junior sports a 62-key cordless keyboard. It does support all of the same key functions as the bigger keyboard, but relies on dual-function keys to achieve them. Further, it lacks

any functions keys and has no numeric keypad.

The lightweight keyboard should be a long-lived, fairly indestructible unit because of its construction. When you look at it, the first thing you notice are the calculator-type keys IBM used. The rationale for this is that since this is primarily aimed at the home market and everyone in the family will be using it, it doesn't have to have a full, professional-style keyboard.

Undemeath those keys is a rubber liner, that not only protects the inner workings of the keyboard from spills and other household disasters, but also provides them with the ability to return after being pushed. Each key has a corresponding dome impressed on the rubber liner and beneath this dome is a little circle of carbon that presses a contact and completes the key signal.

That signal travels through the keyboard's circuits to an infrared emitter/transmitter, the other highlight of this keyboard. It is this transmitter that links the keyboard with the system unit. The system box contains an infrared detection circuit that reads the keyboard codes sent to it and they are translated into the proper system codes so they can be displayed on the display tube.

IBM says this keyboard can be used up to 20 feet away from the system box, but provides an optional cable (at extra cost) to tie the keyboard to the system box, should there be other infrared-emitting devices in the area. If there are, it is possible the keyboard codes will be scrambled. PCjr is the first home computer on the market to use this technology.

Another important area of difference between the keyboards of the Portable and the PCjr is direct memory access (DMA). The Portable has it, while Junior doesn't. Because there is no direct memory access from the keyboard, the microprocessor must stop whatever it is doing whenever it needs more data or when it must write data to a disk or tape. This means there can be no keyboard input when Junior is handling a read or write-to-disk operation because the micro is totally absorbed with that operation. The keyboard is disabled, in fact, during information transfers.

This contrasts markedly with the Portable which uses DMA. This means you can continue to use the keyboard when a disk drive is accessed and you will not lose any keystrokes because they remain resident in the keyboard's memory-buffer area in RAM. It also means the processor can run at full speed in all actions because it doesn't have to devote its full attention to just one task.

### System-Level Differences

There are also key differences at the system level that make the Portable and Junior stand apart. For starters, Junior can't use an 8087 co-processor chip for number crunching, as the Portable can. This immediately eliminates some software from the PCjr's repertoire.

Another difference is the level of RAM expandability. Where the Portable can be expanded up to 512K, Junior can only be expanded to 128K. This immediately limits the number of programs that can be used on the program. (To better illustrate this, let's say you have a PCjr with 128K of RAM. This RAM must set apart 16K for the video memory—the color display requires this—

and 24K for the operating system—we're assuming a disk drive is being used. This means you've used up 40K of RAM before you load your program. Now, assume you load a 64K program into memory. This leaves only 24K of user memory for actual work, which isn't much. So, you are limited in the range of programs you can use.)

Another key difference is the amount of Read-Only Memory (ROM) and what the system does with it. In Junior, there is 64K of ROM. This is taken up by a minimal level of BASIC called Cassette BASIC, the BIOS and built-in diagnostics. In the Portable, the BIOS takes up BK of ROM and the same level of BASIC takes up about another 32K of ROM. That's all there is. In Junior, the other 24K is taken up by disk operating routines that are handled from a program disk by the Portable.

Finally, the PCjr is capable of generating a three-voice sound, compared with the single-channel sound capability of the rest of the PC line. This is thanks to the Texas Instruments large-scale integration audio function IC that is used in Junior.

### Compatibility

Since it uses the same disk format—the way a disk is set up to handle data—and the same disk size, it is theoretically possible to use any IBM-compatible program with Junior. However, as we noted earlier, its memory limits dictate which ones can be used. Further, since there is only one disk drive available, it must act in place of two drives with some programs and that can also rule it out, unless you can reconfigure the program to work with one drive.

Yet, it should be possible to use many programs with Junior, provided they meet these criteria.

Overall, the IBM Portable PC and Junior are about as different as day is from night. The Portable is aimed at the more serious professional user or student, while the Junior is aimed at the home environment. However, in their own ways each system is as powerful as the other and, since they are nearly totally compatible, you can easily move from one to the other, allowing for easy migration as your needs change. Both systems should do well in their markets. ◀▶



# CP/M FOR BEGINNERS

HERB FRIEDMAN

## NOTE

To avoid computer commands and statements which confuse the user, punctuation will be shown outside the quotation marks even when convention calls for them to be inside the marks. Also, capitalized words within the "<" and ">" symbols mean a specific key; i.e., <ENTER> is the key marked ENTER or RETURN (carriage return), while <CONTROL> means the key or keys on your computer which function as a single CONTROL key. While CP/M commands can be either in upper or lower case or a combination of case, for uniformity they will be shown in upper case only. For example, the command LOAD = load = LoAd = LoAd, etc.

## PART 2

*Even if you learn nothing else about CP/M, you should learn how to use the PIP and STAT utilities.*

■The point is open to debate, but for the applications-oriented user of the modern personal computer, the very keystone of CP/M is a utility program supplied with CP/M called PIP—an acronym for *Peripheral Interchange Program*.

In plain terms, PIP is the equivalent of the function "COPY TO". When we say PIP a program, we are in effect saying that we have loaded a program into the computer's memory that permits us to copy a program, data, or just a single character from one piece of hardware to another.

PIP came about because the kind of computer for which CP/M was originally intended could accommodate many different user-selectable I/O (input/output) devices generically called "peripherals", and PIP provided the means whereby data could be exchanged among the various devices.

To digress for a moment, keep in mind that each peripheral accommodated by CP/M is identified for I/O by a "colon". For example, the control terminal is CON:, the printer is LST:, the disk drives are A:, B:, C:, etc. Except for one specific case, without the colon CP/M has no idea what device is to be used. (We'll get to the exception later.) Many newcomers to CP/M have difficulty with CP/M because they forget about the colon, or inadvertently substitute ";" or "\*" because of the keyboard layout. Without the colon, PIP will not work.

PIP works this way. Let's assume for a moment that after years of effort you have written a program called

FUTURE.COM which foretells the future. It is located on a disk in drive A:. You are ready to have the computer tell you what horses will win tomorrow at Hialeah, but you're afraid to run the program for fear it will crash and years of effort will be wiped out; so you want to make a backup copy in disk drive B:. You do it with PIP. The command line "PIP B:=A:FUTURE.COM" will cause the program PIP to load into the computer's memory, auto-run and copy to disk drive B: the FUTURE.COM program from drive A:, then return you to the CP/M command prompt "A>".

By now you should have guessed that under PIP the "=" character means "from". You should also recognize that copies have the same filename as the original, unless specifically changed. For example, the command "PIP B:MAKEMONI.COM=A:FUTURE.COM" will result in disk B: having the file MAKEMONI.COM, which is a mirror image of FUTURE.COM except for the filename.

At this point some of you old hands at CP/M are probably ready to take pen in hand to write in that there is no need to identify the control (default) disk drive, that the proper entry when A: is the control (default) drive is "PIP B:=FUTURE.COM" rather than "PIP B:I.COM=A:FUTURE.COM".

You are correct, of course. The control drive is the exception we mentioned earlier. If no device is specified CP/M assumes you mean the default drive, which is drive A:, or whatever you select as the control drive. Unfortunately, many newcomers to CP/M get

confused as to when to specify the control device. The fewest difficulties arise if the control drive is always entered where it would normally be assumed. It does no harm to enter the control drive.

Another example of PIP will serve to clarify its power and then we can move on. If we enter the command "PIP LST:=CON:" what we are saying is copy to the line printer (LST:) from the control console (CON:). What we type on the keyboard will go to the printer and will be printed on a sheet of paper. Logically, this "connection" will last to the end of time, so how do we free the printer from the keyboard? With a <CONTROL>-Z, PIP's command for "bail out". When PIP receives a <CONTROL>-Z it terminates a copy function.

### Multiple file operations

When we use a single command line for PIP, such as "PIP B:=A:FUTURE.COM", we are returned to the CP/M command prompt (the "A>") when the copy is completed. However, if we have several disk files to transfer it's possible to "lock" the computer in the PIP mode and simply issue a series of "copy" commands.

To enter a "locked" PIP mode type "PIP <ENTER>". The screen will return the asterisk symbol ("\*"), which we call a "star" when talking in CP/Mese. (CP/Mese being a foreign language slightly more difficult to understand than Chinese.) When the star is on the screen we can transfer data by simply typing the desired copy command, such as "B:=A:FUTURE.COM". When the copy is completed the star reappears on the screen and you can enter another direct copy command, such as "LST:=CON:" which causes the lineprinter to print whatever is entered on the keyboard. A <CONTROL>-Z returns control to PIP and the star appears.

When all the copies have been completed, a keyboard <CONTROL>-C terminates PIP and returns the computer to the CP/M command prompt ("A>"). The entire sequence for three file copies might appear on the screen as:

```
A> PIP <ENTER>
* B:=A:FUTURE.COM <ENTER>
* C:WORDSTAR.DOC=B:TEXTFILE.TXT <ENTER>
* LST:=CON: <ENTER>
Your typed text appears here and goes to the printer.
<<CONTROL>-Z>
* <CONTROL>-C <ENTER>
A>
```

Notice that while the <ENTER> key must be depressed to enter each copy command which is self-completing, a <CONTROL>-Z is required to terminate/complete the keyboard entry mode.

When you want all the user files on a disk PIP'd to another disk, you can avoid entering a command line for each file by using PIP's universal "copy everything" command called "STAR-DOT-STAR", meaning "\*.\*". The command "PIP B:=A:\*.\*" will result in every user file on disk B: being copied to disk A:.

Let's take a break and try to work out a few unusual applications of PIP. For a refresher, remember we said PIP will always assume the control drive. Figure this one out: "PIP LST:=FUTURE.DAT. If you said a disk text data file on the command drive will be copied on the

printer you've got a decent grasp of PIP. (If FUTURE.DAT was a binary, rather than a text file, the print would consist of "garbage".)

Here's a more difficult one. "PIP B:DOCUMENT.TXT =CON:". This PIP command will produce a text disk file called DOCUMENT.TXT on drive B: as you type on the control console's keyboard. You would enter a <CONTROL>-Z to indicate the text is completed and you wanted to terminate PIP and return to the "A>" CP/M prompt (or whatever you're using for the command drive).

### PIP options

PIP has a whole slew of options which are appended within bracket symbols to the end of the PIP command. (Remember, you must use brackets, "[ and ]", not parenthesis.) Some are useful for the average user, others are intended primarily for programmers and other computer science types. We shall cover only the most important applications-oriented options. First off, there is the V-option, which checks a destination disk file against the original. It takes somewhat longer for the PIPing to finish, but you can be certain you have a glitch-free copy. The V-option is entered thusly: "PIP B:=A:FUTURE.COM[V]".

CP/M has things called "hidden" files, which you don't normally see displayed when you call for a directory listing. To copy a hidden file you must use the R-option, which you can simply tack on to any other option within the brackets. For example, a PIP command might be: "PIP C:=B:HIDENFIL.COM[VR]", meaning, copy the hidden file B:HIDENFIL.COM on drive C: and also verify the the copy. Other useful options are listed in your CP/M manual, but one of the most useful, the G-option, is often not understood by newcomers to CP/M.

The G-option means "get"—get a file from a user area from 1 to 15. In the last installment of this article, we showed how user files are used to avoid directory clutter; that related disk files could be assigned with a software "tag" to specific user areas. It is the G-option that permits you to copy tagged disk files. For example, assume you have concealed your spreadsheet data in B: drive USER 5 under the filename MULTIPLN.DAT, but you now need to integrate some of its data into a report you're preparing with your word processor in drive A: USER 0. This is where the G-option comes in.

If you enter the command "PIP A:=B:MULTPLN.DAT" CP/M will have no idea what you're talking about because all drives operate in the same user area as the control drive, and there is no spreadsheet datafile in the USER 0 area of drive B: But if your command is "PIP A:=B:MULTIPLN.DAT[G5] you will copy the datafile to A: because "[G5] tells PIP to get the disk file from USER 5. Sneaky, no? Problem is, the author of CP/M did not include a function that works the other way. You cannot use PIP to move a disk file to another user area. For example, assume you have your crystal ball program FUTURE.COM on disk A: USER 0, the default user area, and you want to conceal it from general view in USER 8. It can't be done with a straight PIP command because, except for special versions of PIP used for hard disk computers, PIP will not copy to a user area. If you enter the USER 8 area you still can't copy because

PIP does not exist in USER 8. This is called „...being caught between a rock, a hard place, and a somewhat sloppy disk operating system.”

What you must do is create a copy of PIP in USER 8. (If you say the disk will now have two PIP programs, one tagged USER 0 and the other USER 8 you have a solid grasp of CP/M.) Creating a copy of PIP in USER 8 is a simple enough procedure that you don't have to understand. It's like using a housekey. The key opens the lock but you don't have to understand how the lock works to be able to get into your home.

It can be done this way. Place the disk with the program FUTURE.COM and PIP in drive A:. Place a disk with the CP/M utility DDT.COM in drive B:. In response to the A> CP/M prompt enter "B:DDT PIP.COM", which tells the computer to load DDT from drive B: and process PIP from drive A:.

The screen will show:

```
DDT VERS 2.2
NEXT PC
xxxx xxxx (xxxx is a Hex number)
```

The "-" is your prompt. Type "G0" <ENTER>. Then type "USER 8" <ENTER>. Then type "SAVE 29 PIP.COM" <ENTER>. The entire sequence will appear on the screen as:

```
A>B:DDT PIP.COM
DDT VERS 2.2
Next PC
xxxx xxxx
-G0
A>USER 8
A>SAVE 29 PIP.COM.
```

If you have any problem running PIP in USER 8 substitute the command "SAVE 30 PIP.COM". You will be left in USER 8. A DIR command will show PIP.COM in the directory, which you can now use to move FUTURE.COM from USER 0. But remember, you will need the "get" tag for PIP. To copy the program you will use the command "PIP A: = A:FUTURE.COM[G0]". (If you can understand this the first time around you are going to be a whiz at CP/M.) To help those of you having some difficulty understanding what is being done, the command line means: "Copy to the USER 8 area of A: the program FUTURE.COM from the USER 0 area of the same disk (A:)."

Your disk will now contain two copies of PIP.COM and two of FUTURE.COM. You can erase PIP.COM from USER 8 and FUTURE.COM from USER 0.

If you plan on extensive use of the user areas, life will be much easier in general if you prepare a sysgened (system) disk having PIP.COM utility in all the planned user areas, perhaps 0 through 6, or 8. In this way, if you're in a user area and you want to copy or move a program you can pop your "PIP" disk into drive B: or C:, or whatever, and instantly use PIP from any user area without having to go through the DDT routine each time. In my own case I have a disk with PIP, STAT, and XDIR (a public domain extended directory) in each user area.

## The STAT command

The CP/M utility "STAT" serves two purposes. In the first instance it means "statistics", and will provide information on individual files or the disk itself. It tells you how many records are used for each disk file, the file size (in increments of 2K), how much storage is available on the entire disk itself, and how much is left. The problem with STAT is it provides information on only one file or drive at a time. On the other hand, a public domain program called XDIR (get a copy from a friend) serves as both a directory and universal STAT command, simultaneously providing statistics on all the files and the entire disk itself.

Figures 1, 2 and 3 illustrates the difference. Figure 1 is a standard directory listing of a disk. Figure 2 is the

```

A:DIR
A: POWER   COM : CONFIG   COM : DISK76C  COM : DISK740  COM
A: D       COM : PIPKAY   COM : FORMAT   COM : INTERCHG  COM
A: HEALINK COM : MODEM   COM : PIP      COM : STAT    COM
A: SUBMIT  COM : SYSGEN   COM : SUB      COM : XDIR    COM

```

FIG. 1—A STANDARD CP/M DIRECTORY listing will produce a display similar to this one.

```

STAT.POWER.COM

Recs  Bytes  Est Acc
  116   166   1 R/W A:POWER.COM
Bytes Remaining On A: 76k

```

FIG. 2—THE STAT COMMAND of a file listed in the directory displays the statistics of the particular program and the available disk storage space.

display when a STAT is taken on the POWER.COM file. Note the display shows how many bytes remain on the disk. Figure 3 is the display using XDIR (extended directory); it presents a directory, all the important statistics on each user file, and a lot of meaningful statistics on the disk itself.

```

A:XDIR
Extended Directory version 3.5

CONFIG .COM 10k
D       .COM  6k
DISK740 .COM  4k
DISK76C .COM  4k
FORMAT .COM  6k
INTERCHG.COM  4k
HEALINK .COM  2k
MODEM .COM  2k
PIP .COM  2k
PIPKAY .COM  8k
POWER .COM 16k
STAT .COM  6k
SUBMIT .COM  2k
SYSGEN .COM  2k
XDIR .COM  4k
SUB    .COM  2k

Disk A: 2k blocks
Size= 170k, 16 Files, Used= 94k, Space= 76k

```

FIG. 3—XDIR, a public domain CP/M utility combines the DIR and STAT commands and produces an alphabetized listing that also contains the file and disk statistics.

You found an error! The files only add up to 90K but the disk statistics shows 94K used! The "missing" 4K are the invisible system files, the ones not listed by the directory.

Figure 4 is an unusual kind of extended directory: the "STAT'd" screen display produced by the D.COM file used by Kaypro. It also shows the length of each file and the disk statistics, but notice it subtracts the system files from the total disk capacity. It displays the available capacity as 166K rather than 170K. The numbers are slightly different but the end result is the same.

STAT also works as an "assign" function. Among other things STAT can assign a file or a disk to be read only, or read/write. For many newcomers to CP/M, the most intriguing function is STAT's ability to assign different peripherals as I/O devices.

As we mentioned earlier, CP/M was intended to work with many peripherals. In actual fact, CP/M recognizes only the disk drives and four "logical" devices: LST: (list device for output, i.e., a printer); PUN: (punch device for data input); RDR: (reader for data input); and CON: (control terminal). In order to get the data in and out of the desired peripherals, which are called "physical" devices, the peripheral itself must be assigned to function as one of the four recognized devices, what CP/M calls the "logical" device.

CP/M supports twelve physical devices, though the modern personal computer might support only four to eight of them. The physical devices include the CRT: (video display terminal), UC1: (user defined console), a TTY: (teletype terminal or printer), and assorted user-installed I/O devices such as PTR: (paper tape reader), PTP: (paper tape punch), UR1: (user defined tape reader), UP1: (user defined punch), UL1: (user defined list device).

Each manufacturer more or less decides for himself what physical devices will be allowed and whether they will be serial or parallel input, or both, or IEEE. Often, a manufacturer will assign several "physical" devices to the same I/O port. For example, TTY:, UR1:, UL1: and CRT: might all reference the same serial port. Regardless which you selected you would end up on the serial I/O. It is the STAT function that selects the logical-physical relationship. For example, one popular computer allows the user to select one of four physical devices as a logical device. They are:

```
CON: = TTY: CRT: BAT: UC1:
LST: = TTY: CRT: LPT: UL1:
RDR: = TTY: PTR: UR1: UR2:
PUN: = TTY: PTP: UP1: UP2:
```

What this chart shows are the four possible peripherals that can be assigned to each logical function. To keep things simple, the manufacturer will probably have CP/M recognize TTY: BAT: UC1: PTR: and UL1: as the serial RS-232C I/O, LPT:, the line printer, as either serial or parallel, and UP1 as parallel. Actually, he can allow whatever assignments he wants to permit. (The user will not have 12 individual I/O ports to worry about.)

Every desktop computer has default device assignments which can be changed by the user

through the STAT command. For example, "STAT CON:=TTY:" will cause a connected teletypewriter to function as the control terminal, while a "STAT CON:=UC1:" will permit any terminal connected to the serial I/O to function as the control terminal because the manufacturer decided UC1: will represent the RS-232 port on his computers.

Similarly, "STAT LST:=LPT:" will use the parallel printer as the printer, while "STAT LST:=UP1:" uses a serial printer connected to the serial port as the listing device.

For each computer, the "STAT VAL:" command results in a listing of all the possible device assignments for a particular computer, while "STAT DEV:" lists the current device assignments, as illustrated in Figs. 5 and 6.

While many of the PIP and STAT functions appear formidable the first few times you try to understand or use them—you actually can use them without understanding anything about them, their mystery tends to vanish when you spend an evening or so experimenting "hands on". You can't break anything if

```

ADD
  name  Ext Bytes  Name  Ext Bytes  Name  Ext Bytes  Name  Ext Bytes
CONF10 COM 100K  FDRMAT COM  AK  PIP  COM  BK  SUBP11 COM  2K
D      COM  AK  INTERCHGCOM  AK  PIPEAT COM  BK  SYSGEN COM  2K
D16x740 COM  AK  MERLIN COM  2K  POWER COM  1AK  1DIR COM  AK
D16x740 COM  BK  MODEN COM  BK  STAT COM  AK  1SUB COM  2K
16 Files, occupying 90K of 166K total capacity
112 directory entries and 76K bytes remain on A:

```

FIG. 4—KAYPRO'S D.COM combined DIR and STAT utility provides almost the same information as XDIR. The major difference being the way the disk statistics are presented.

```

A>STAT VAL:
Temp R/D Disk: d:=R/D
Set Indicator: d:filenam.typ sR/O sR/W sSYS sDIR
Disk Status : DSK: d:DSK:
User Status : USR:
10byte Assign:
CON: = TTY: CRT: BAT: UC1:
RDR: = TTY: PTR: UR1: UR2:
PUN: = TTY: PTP: UP1: UP2:
LST: = TTY: CRT: LPT: UL1:

```

FIG. 5—AMONG OTHER TIDBITS of information about the disk, the command STAT VAL: shows the possible physical device assignments for CP/M's four logical devices. For example, the CON: (control terminal) cannot be assigned to LPT: (the printer), or whatever is considered UL1: CON: can only be TTY:, CRT:, BAT:, or UC1:.

```

A>STAT DEV:
CON: 1= TTY:
RDR: 1= TTY:
PUN: 1= TTY:
LST: 1= LPT:

```

FIG. 6—THE STAT COMMAND displays the actual logical/physical assignments in use.

you make a mistake; all you can do is erase disk files, so just make certain you don't have your only copy of FUTURE.COM in the disk drive when you give PIP and STAT that "Old Hand's-On Try". ◀▶

# COMPUTER GRAPHICS

The best way to convey a lot of information quickly is through computer graphics.

HERB FRIEDMAN

■Among the most eye catching computer screen displays is anything having to do with graphics. Whether it's row after row of three-dimensional bars that look more like skyscraper buildings, multi-colored pies with a slice cut out, or just irregular lines that rise and fall as they interlace with other lines, graphic displays are unusual, attractive, and do catch our attention; so much so that personal computers and their software are often touted or sold on the basis of their graphics capabilities.

For example, ask your local computer store salespersons to demonstrate Lotus 1-2-3 and they will probably bring up some form of spreadsheet display, then exclaim "Watch this!" as they touch a few keys, and suddenly the screen transforms into a bar graph representation of the data. A most impressive demonstration because it proves the old cliché that "A picture is worth a thousand words."

Or maybe you're shopping for a printer. It's a safe bet that somewhere along the line the graphics capabilities of various dot-matrix printers will be prominently mentioned, and in most—if not all—instances the graphics will be discussed in terms of bar and pie charts, not computer art.

Unfortunately, what you see is often not what you get when it comes to graphics and the lesser-cost computer systems, those we call the home-and-family or small business systems. There are inherent limitations in both the computers and printers which restrict what, or how much data can be graphically displayed, or the manner in which it's displayed. Then again, there is also the cost of the software itself. Decent graphics—other than conventional bar charts—require some rather sophisticated programming, and even not-so-good graphics software doesn't come cheap. Depending on how much performance is being offered for the money, a low-cost software package can range from "not bad" to "downright rotten", with "not bad" the more common level of performance.

## Bar charts

Take, for example, the bar charts mentioned earlier. Bar charts are relatively easy to program in BASIC, so even budget software can accommodate some form of automatic data-to-graphics conversion. The EASY FINANCE I software for the Commodore 64 computer is a good illustration of low-cost bar-charting. The program itself is primarily intended to resolve typical home-and-family financial situations, such as the

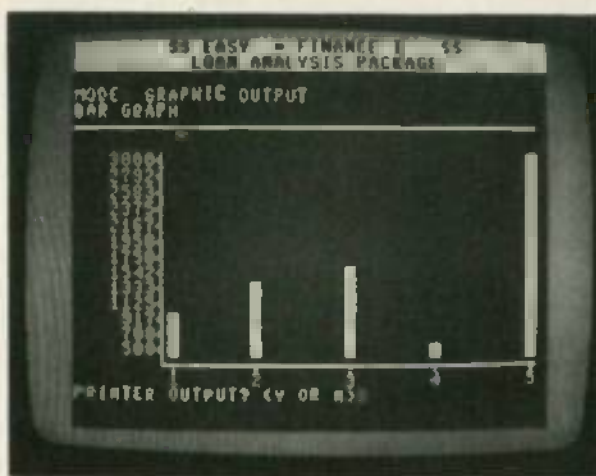

FIG. 1—EVEN A SIMPLE BAR GRAPH makes data easy to comprehend.

difference in monthly payments depending on the size and interest rate of a mortgage; the size of monthly payments on financed shop test equipment; the actual interest charged by the bank on a family or business loan; how much interest your money earns depending on the interest rate, frequency of compounding, etc. While all the information displayed on the screen can be printed, EASY FINANCE I will permit the user to convert charted data such as the screen display shown in Fig. 1 into bar graphs. Considering that the program sells for less than \$20, that's a lot of performance for the price.

Most inexpensive computers such as the Commodore 64 and the Radio Shack Color Computer support graphics. Unfortunately, the same cannot usually be done with a somewhat more expensive computer because, unless retrofitted with hardware, they usually will not support a meaningful graphics display. The typical CP/M computers, at best, support limited graphics: a bar this way, a line that way, a triangle, a rectangle—altogether, not enough for a precise or meaningful graphics-screen display. Oh, there will be something on the screen, but a meaningful display must be printed using a matrix printer.

Many programmers recognize the limitation of computers not having specific graphics capability and don't even try for a screen display, even for those computers having limited screen-graphics capability. Instead, the effort goes into providing notably good printer output from standard printers. The DATA PLOT software (Lark Software, 7 Cedars Rd., Caldwell, NJ 07006) is a good example of low-cost software giving noteworthy performance by limiting itself to doing a particular job well. DATA PLOT is specifically intended only for the printing of line, multi-line and scatter charts. To this end it will read data directly from values entered into disk file via a word processor, or directly from a spreadsheet or other datafile. After the titles, headings, etc. are prepared, all output shifts directly to the printer, where a chart is printed that is precisely the specified size (in inches), with the titles also precisely positioned because their positions are also specified in inches, rather than guesstimated by the cursor position. For extreme title-positioning accuracy—the equal of



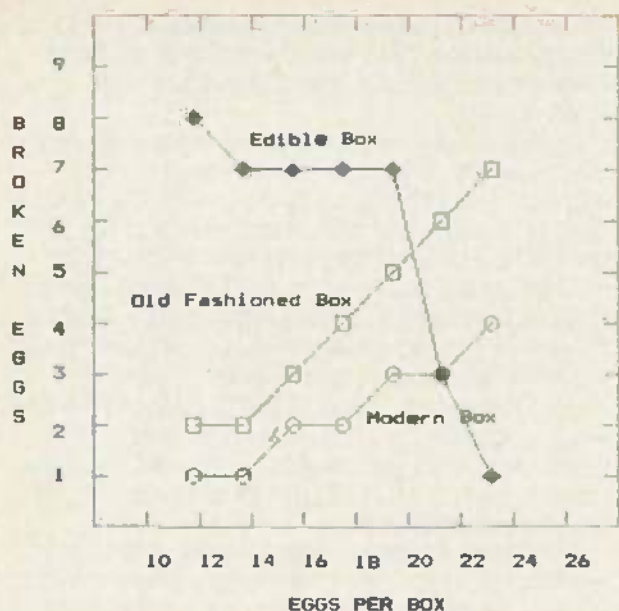

FIG. 2—OUTPUT FROM DATA PLOT shows how much you can convey with just a simple line chart.

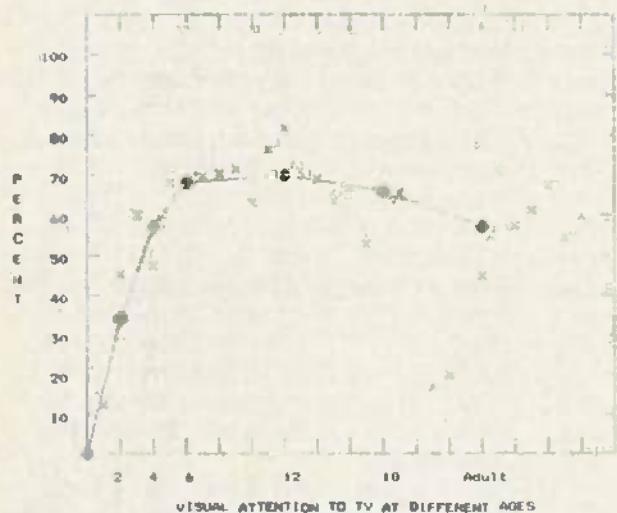

FIG. 3—A MIXED GRAPH of lines and unconnected points produced by DATA PLOT. It's almost impossible to convey the meaning of the data with just words.

typesetting—the user can make a print, measure dimensions on the print, and then go back to the program and specify precisely where the titles are to be located within a tenth of an inch.

Another extra feature of DATA PLOT is that the "points" for each line can have a different size, shape or shading, making it easy to follow which line goes where. This kind of detail is possible only on moderately expensive computers (such as the IBM) or through a printout when using a low-cost computer. Examples of the DATA PLOT output are shown in Figs. 2 and 3.

An unusual example of sophisticated graphics for budget computers is Radio Shack's "GRAPHICS PAK" for their Color Computer. GRAPHICS PAK provides line, bar and even pie charts. It can stack several charts on a single bar, group bars, create multi-color pie charts, and even create a pie chart with a displaced wedge.

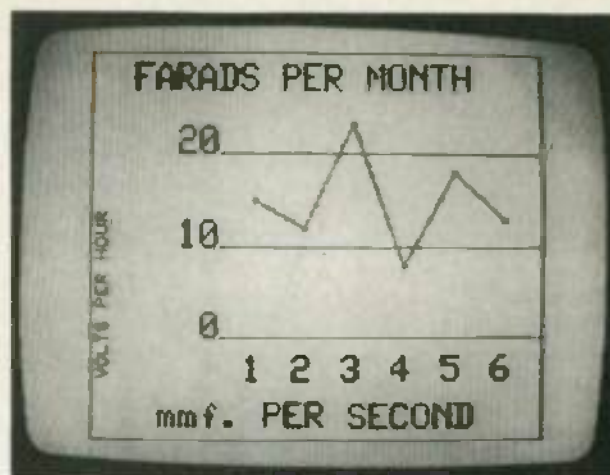

FIG. 4—TYPICAL OF GRAPHICS PAK, this Color Computer display can be edited and re-edited until the desired graph is obtained. GRAPHICS PAK is considered by many to be the best low-cost graphics instructional aid.

The screen displays can be in moderately high definition 2-color or low definition 4-color. While the graphics can be printed out, at the time this article was prepared it was possible using only two specific Radio Shack printers, one a monochrome (one color) matrix "line printer", the other a color "pen plotter" using a "print head" holding four (including black) colored pens. Unfortunately, the color printer utilizes a narrow width paper which must be pasted on a larger sheet if incorporated into reports.

Naturally, one doesn't expect gold-plated performance from a budget priced computer. While you can save the "charts" on cassette tape, each must be initially created by directly entering the data on the keyboard. GRAPHICS PAK does not read data files so it cannot automatically extract data from spreadsheets, word-processed tables, etc.

Storage and printer limitations aside, however, if you need a decent screen display for your own viewing, for photography, or for demonstration in a classroom, a showcase, or whatever, the GRAPHICS PAK /CoCo package does the job well. Figure 4 shows the kind of photo record you can get from GRAPHICS PAK using a low-cost Polaroid camera.

### Graphics and CP/M

The same kind of multi-chart capability as GRAPHICS PAK—but with printing and automatic calculations—is available for CP/M computers through several programs, one of the best known being GRAFIKS 2.0. (Robonics, 936 Hermosa Ave., Hermosa Beach, CA 90254). GRAFIKS 2.0 creates multi-bar, line and pie charts. It will accept input directly from the keyboard or it will read data from files, such as a SuperCalc data file, and it even permits overlays of one chart on another. Typical of the better graphics software, GRAFIKS 2.0 will do automatic scaling. Even if you make an error in data entry, such as entering percentages that do not add up to the whole of a pie, GRAFIKS will attempt to correct the users "errors" by converting to percentages of a whole, providing decimal values if necessary. It will also solve algebraic equations and plot the results (such as a sinewave).

SEA URCHINS vs. BARNACLES

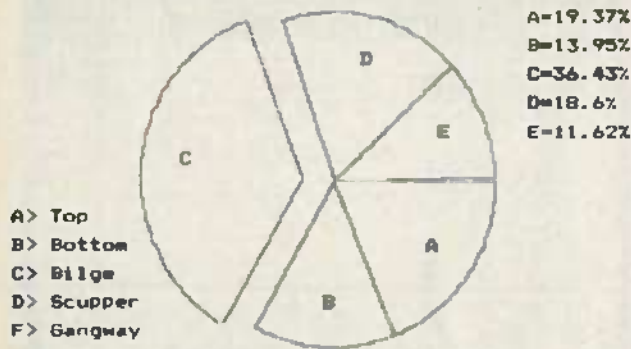

FIG. 5—PIE CHART FROM GRAFIKS. 2.0. The pie chart is produced by most graphics software.

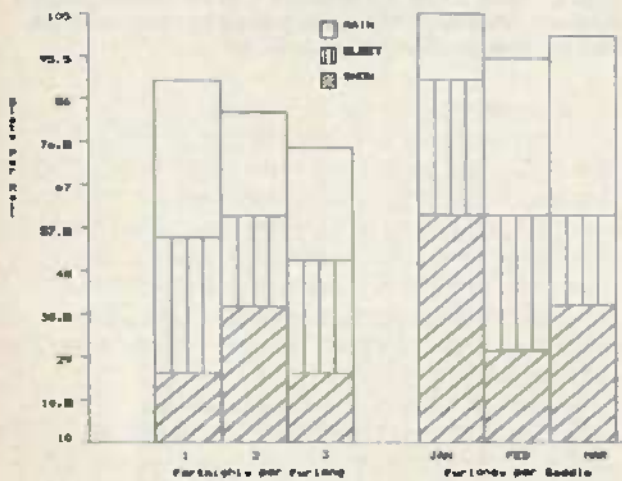

FIG. 6—BAR CHART FROM GRAFIKS. 2.0. The keyed legends and automatic scaling of the bar chart is "heavyweight" performance.

Because of the graphics limitations of unenhanced CP/M, the GRAFIKS 2.0 screen display only serves as a reference for making rough evaluations of the graphics display and for the positioning of labels and titles. Unlike the precise title positioning of DATA PLOT, the GRAFIKS 2.0 labels are positioned on the screen with guesstimates; final positioning can be corrected after the first print is made. Figures 5 and 6 show some of the flexibility of a full-featured graphics program such as GRAFIKS 2.0.

Because graphics printout is highly dependent on the printer being used, it's important that you are certain the software will work with your printer. As a general rule, graphics software will be available in several versions to accommodate the popular printers, or will be provided with several user-selected "drivers" for a broad selection of printers. Even then you must be careful. For example, much of the graphics software is intended for printout on an Epson MX-80 printer or one of its clones. There are, however, at least three versions of the MX-80: the original model, the Graftrax model (which provides backspacing), and the Graftrax-Plus model (backspacing and a bagful of bells and whistles). As a general rule, a printer must backspace or it cannot create graphics with most of the lower priced software. Radio Shack, as mentioned earlier, is in a

whole different ballpark with its graphics software and they are limited to their own printers, one of which does not use standard paper, for printouts from GRAPHICS PAK.

DATA PLOT can use several printers and either Epson Graftrax model. GRAFIKS 2.0, however, which will utilize both Graftrax Epson printers, works differently. A Graftrax model repositions (homes) the print head full left before each and every tick (mark) on the paper; the wear on the positioning motor for a single printout is severe, and one can actually sense that the motor is slowing. The Graftrax-Plus printers, on the other hand, allow the head to track directly across the paper, printing each tick in sequence without homing the print head. In addition to saving wear on the head positioning motor, Graftrax-Plus printers take minutes to create a graph that would take almost an hour on the non-Graftrax-Plus MX-80.

Admittedly, it's hard to determine how your printer will function with a particular graphics program before you buy the program. Since rarely, if ever, is software returnable if not originally defective, it's worth the extra effort to find out if the software will deliver optimum performance with your printer before you buy.

If you need a high definition graphics screen display from a home/business computer in addition to, or in place of, a printout, there's really not much you can do. While the Atari and Commodore computers have the capability for acceptable screen display the software selection doesn't exist (not much demand to start with). If you have a Radio Shack Model III computer you have lucked out. Radio Shack has a high definition retrofit, for which there is presently a limited selection of stand-alone software; it's really intended for use from within a BASIC program. If you need stand-alone software the GRAFYX SOLUTION retrofit (Micro-Labs, Inc. 902 Pinecrest, Richardson, TX 75080) is probably what you need. That aftermarket device consists of a small board that plugs into the Model III: it provides a 512 x 192 dot display.

The GRAFYX can be utilized directly from a BASIC program (either commercial or user-written), or through pre-written software from Micro-Labs that is specifically written for use with GRAFYX. Among the Micro-Labs software is BIZGRAPH, which creates three dimensional bar graphs, and line and shaded-area charts and charts integrating both presentations, and pie charts.

We have touched briefly on some of the highlights of graphics software for the the lower cost computers. If there is one general rule we can apply to graphics software it's that the most important feature, the one you are actually spending the money for, probably isn't in the package you're preparing to buy. Either it won't create a desired type of screen display, or you don't have the right printer, or the chart you want is too large for your purpose, or one of a hundred other things. If a particular graphics function is important to you, do not trust to the opinions of the computer store's sales force (who haven't the vaguest idea how most of the software they sell works). If they can't or won't give you a demonstration of the precise functions you need using exactly the peripherals you have, then check, double-check and finally triple-check with the software's publisher. ◀▶

Q5. Even though we're not using it, we still have to allow for the time it takes for the 4018 to cycle through it.

Make sure you understand that!

Translating that bit of common sense to actual resistor values is really simple. We look up the sine of the angles we're interested in and generate a table like that shown in Fig. 3. We already know the angles we want—they're listed together in the appropriate column in the table. The last column translates that data into something that's easier for us human beings to use. All that we've done is to make the relative proportions a bit more evident by dividing all the sine values into .951.

So, you may well ask, what do we have to do next?

Well, believe it or not, that's all we have to do! All our work is done and the only arithmetic (as opposed to mathematics) we have left is some multiplication. What the last column in the table is telling us is that in order to generate a sine wave using 4 of the outputs from 5 daisy-chained flip-flops, the resistor values have to be in the proportions indicated. Pick a convenient value for  $R_2$  and  $R_3$ , do the arithmetic, and you've got your resistor values! Of course, you might have a hard time finding standard-value resistors in the right ratios but that's a common problem—and, naturally enough, it has a common solution. You can use precision resistors if you're rich enough, or trimmers if you're not. In any event, we've got it made!

I know you haven't seen the math we managed to avoid doing, so you can't appreciate the kind of work we saved. What we've done is a classic example of how a common-sense approach to a problem can eliminate a lot of effort and keep the men in the white coats from your door. Let's go through the reasoning behind all that and make sure we understand it.

If the data is recirculated in the 4018, 5 incoming clock cycles have to pass before the output states start to repeat. One complete cycle of the 4018's outputs will be needed for each half of the sine wave we want to generate, regardless of how many of the outputs we actually use. That means that each incoming clock pulse will come when the sine wave we want to generate has advanced *one fifth of half its full cycle* or 36 degrees (180/5).

The amplitude of the sine wave at any point on the curve can be found by looking up the sine of the angle. Once we've listed all the ones we need, we can find the ratios of the resistors we need to generate the wave. See that? It is simple!

If you decide you want to use more flip-flops in the sine wave generator that you build, you'll have to recalculate the resistor values. Just go through the same reasoning we outlined and you won't have any problems.

From a practical point of view, I would recommend that you standardize the

lowest value resistor at 10K or so and use trimmers to get the other values that you'll need. Just measure the 10K resistors to get the *exact* value, and do the arithmetic to find out where to set the trimmers. Set them out of the circuit and use a bit of nail polish to lock them in place before you put them on the board.

There are other parts to this sine wave generator we're slowly designing: the input clock, frequency selector, and the output filter. The most interesting one is the input clock. With a little bit of thought, we can make it variable so that the frequency selector can be something as simple as a potentiometer. That was one of our original design criteria.

Since we've already seen that the input clock has to run ten times faster than the maximum sine wave frequency we want to produce (remember—the 4018 is set up to divide by ten), we need a clock that can be tuned over a 1000:1 range with a twist of the wrist. There are a couple of things that come to mind that will fill the bill, but we ought to think about refinements such as crystal control of the frequency, stability, low-power requirements, and all those other good things.

And that brings us to next month, when we'll start on all that and see if we can put the whole circuit together in the real world. R-E

## CABLE TV

### CONVERTERS DESCRAMBLERS

Largest Selection  
of Equipment Available  
\$ Buy Warehouse Direct & Save \$



36 channel  
converter  
\$4595

36 channel  
wired remote  
converter  
only  
\$8895



Send \$2 for complete catalog  
of converters and unscramblers

Quantity Discounts • Visa • MasterCard  
Add 5% shipping — Mich. residents add 4% sales tax

C&D Electronics, Inc.  
P.O. Box 21, Jenison, MI 49428  
(616) 669-2440

## CABLE TV

Buy Direct & Save

### SUPER SPECIALS

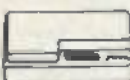

40 CHANNEL  
CONVERTER  
\$2995

Advanced Solid State design and circuitry allows you to receive mid & super band channels. Restores programming to Video Recorders.



36 CHANNEL  
REMOTE CONTROL  
CABLE CONVERTER  
\$6995

JERROLD 400  
THE ULTIMATE CABLE TV  
CONVERTER

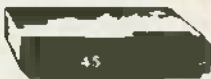

60 CHANNEL  
INFRARED  
REMOTE  
CONTROL  
\$12995

Send \$5 for Complete Catalog

DIRECT VIDEO SALES

P.O. BOX 1329  
JEFFERSONVILLE, INDIANA 47130

CALL  
1-812-282-4766

CIRCLE 53 ON FREE INFORMATION CARD

### 9 reasons why the real pros prefer Endeco desoldering irons



- Operates at 120v, 40w, idles at 20w for longer tip life
- Flexible, burn resistant Neoprene cord set
- Cool, unbreakable polycarbonate handle
- Exclusive bracket insures alignment, prevents damage
- Safety light in handle tells when it's on
- Stainless steel construction
- Temperature control Low, high or off.
- Eight tip sizes. Comes with .063 I.D.
- Converts to soldering iron with 1/4" shank type tip

See your distributor or write

Enterprise Development Corp.

5127 E. 65th St. • Indianapolis, IN 46220  
PHONE (317) 251-1231

CIRCLE 97 ON FREE INFORMATION CARD

JUNE 1984

89

# DESIGNER'S NOTEBOOK

## Charging indicators

ROBERT GROSSBLATT

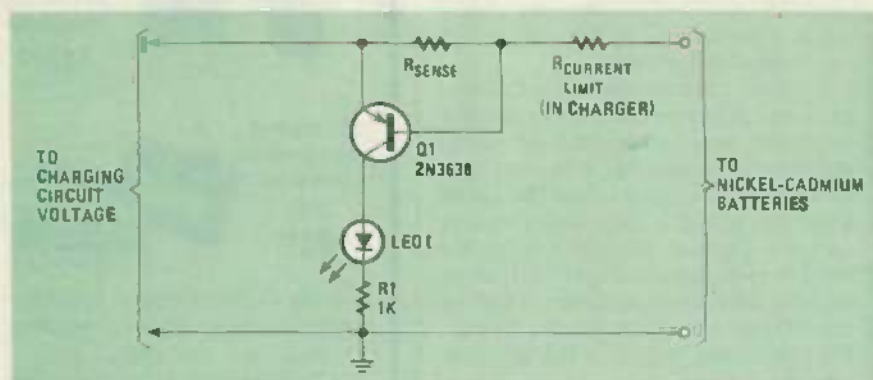

FIG. 1

THE ATTRACTIVENESS OF NICKEL-CADMIUM or NiCd batteries for use as power sources, has caused them to begin showing up in many electronic parts catalogs and advertisements. Because they're still relatively expensive when compared with alkaline units, the advertisers in the back of this and other electronics publications offer them at a considerable discount; usually at least 30% off the regular price. And though nickel-cadmium batteries don't have the staying power of alkaline cells, being able to recharge them several times makes them extremely attractive for use in battery-powered devices. Also, they provide a constant voltage over the life of the charge, are relatively trouble free, and the charging circuitry for them is easy to design. All in all, if you take good care of them, they'll take good care of you.

However, one constant source of irritation in using NiCd cells has, paradoxically, nothing to do with the batteries. The problem that we're referring to has to do with the charger, or more specifically the charging indicator. The irritation comes from the fact that the indicators are often misleading—they show that the charger is plugged in, but tell you nothing as to whether or not the batteries are actually taking a charge. And that's not all: There's a second source of trouble as well. Let's assume that your charging circuitry doesn't include some sort of automatic changeover to trickle charge after the batteries have reached a certain charge level. If you keep pumping current into them at the same rate, you stand a good chance of blowing them up. Though NiCd cells may

be available at discount prices, they're still not exactly cheap enough to destroy.

This month's circuit, shown in Fig. 1, is deceptively simple—it only calls for a handful of parts. But believe me when I say that it can save you a whole bunch of time, trouble, and, most important, money. It gives you a way to make sure that the batteries are really charging and also tells you when they're fully charged.

### How it works

In the schematic shown in Fig. 1, transistor Q1 has its base-emitter junction connected across the sensing resistor ( $R_{\text{SENSE}}$ ) on the line carrying the charging current. (Note that  $R_{\text{CURRENT LIMIT}}$  is a part of the charger itself.) When the batteries are put on charge, current flows through the sensing resistor causing a voltage drop to be developed across it, and the resulting voltage turns on the transistor. With the transistor turned on, current flow through it causes the LED to turn on. However, the LED won't light unless the batteries are taking a charge! Sounds simple doesn't it?

Another feature of the circuit is that if the right value is chosen for the sensing resistor, the LED will extinguish when the batteries are fully charged, because of a change in current flow through the circuit. Now, if the LED were part of some optoisolator arrangement, you could automatically increase the charger's current limiting resistor and cut the charge down to a trickle. Not bad for a handful of parts—and cheap ones at that!

We can't give you a value for the sens-

ing resistor, because that depends on the amount of current needed to charge the batteries. However, calculating the resistance value needed is a piece of cake. Because we're using a silicon PNP transistor, it's going to take a voltage drop of about .65 volt to turn it on. The next thing you'll need to know is the charge rate of your unit. (Many chargers have their charge current and voltage printed on the wall transformer.) Once you have that information, the arithmetic is simple. The correct value for the sensing resistor can be found through the simple application of Ohm's law:

$$E = IR$$

$$R_{\text{SENSE}} = .65V / I_{\text{CHARGE}}$$

The value needed will typically be between 60 and 200 ohms.

Since the current-limiting resistor is usually much larger than 200 ohms, you can ignore the current limiting that the sensing resistor does. But try to keep that value as close to the calculated value as possible, because you want the transistor to turn off when the charging current starts to drop. If you're only interested in making sure that the batteries are really charging, you can forget the sensing resistor and put the transistor right across the current-limiting resistor. The parts for the circuit should cost you less than 50 cents and considering the price of NiCd batteries, that's a really cheap insurance policy!

R-E

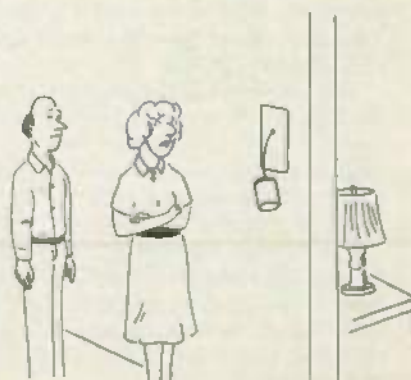

"I don't think I'm going to like that new long-distance saving service."

# Here's why we're Number One.

When it comes to logic probes, more people purchase Global Specialties! Because you can spend twice as much and not get the speed, precision, flexibility and accuracy offered by our four logically-priced probes—including our remarkable new 150 MHz ECL Probe. Not to mention the versatility, reliability and durability we've become famous for.

But we don't stop there. When it comes to logic testing, Global Specialties does the *complete* job. With our DP-1 auto-sensing digital signal injector—for fast, easy stimulus-response testing at an economical \$83.00\*. Plus a line of multi-channel Logic Monitors that provide an inside picture of circuit activity at up to 40 nodes simultaneously. And each product has an idea-filled applications manual—as well as an unmatched line of highly-functional accessories, to extend its versatility still more.

With Global Specialties, there's no need to compromise on performance. Or value. Discover for yourself why we're the number-one logical choice!



Easy-to-use Memory and Pulse functions

Full readout indications—HI, LOW PULSE

Overload and AC-line-protected high-impedance input  
Linear input impedance eliminates errors due to non-uniform loading

Complete line of interchangeable probe tips and grounding wires, including easy clip, banana plug, alligator clip jumpers and variety of power cords

True multi-family performance:  
DTL, TTL, CMOS,  
Or ECL!

Interchangeable thin-profile power cords (instead of awkward, heavy or coiled cords)

Unsurpassed reliability—Performance Proven

All specs conservative and guaranteed

Half the price for equal (or better) performance

Circuit-powered with reverse-voltage protection

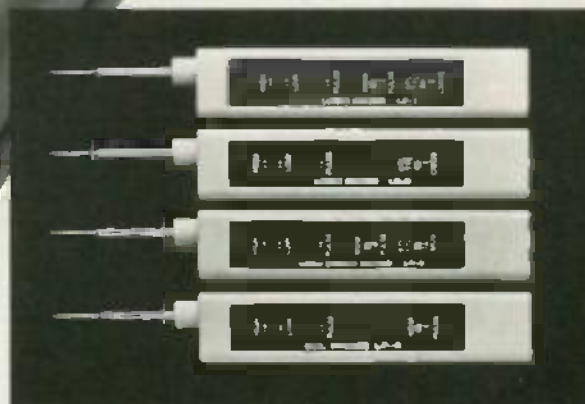

**Standard LP-1**, only \$50.00\*, with latching memory—captures pulses as fast as 50 nsec, to 10MHz, guaranteed  
**Economy LP-2**, \$32.00\*, guaranteed to 50 nsec, 1.5 MHz  
**High-speed LP-3** with memory, only \$77.00\*, guaranteed to 10 nsec (6 nsec, typical) and 50 MHz!  
**New ECL LP-4**, \$150.00\*: the new industry standard—with memory, guaranteed to 4 nsec (2 nsec, typical) at 150 MHz!  
 \*LP-4 probe exclusively for use with ECL. For DTL, TTL or CMOS, select LP-1, -2 or -3.

Compact, high-impact, human-engineered case

70 Fulton Terr., New Haven, CT 06509 (203) 624-3403, TWX 710-465-1227  
 OTHER OFFICES: San Francisco (415) 648-0611, TWX 910-372-7992  
 Europe: Phone Saffron-Walden 0799-21682, TLX 817477  
 Canada: Len Finkler Ltd., Downsview, Ontario

## GLOBAL SPECIALTIES CORPORATION

\*Suggested U.S. resale. Prices, specifications subject to change without notice. © Copyright 1981 Global Specialties Corporation.

CIRCLE 33 ON FREE INFORMATION CARD

JUNE 1984

91

# STATE OF SOLID STATE

## Regulator IC's

ROBERT F. SCOTT, SEMICONDUCTOR EDITOR

MENTION VOLTAGE REGULATORS when talking to a group of knowledgeable electronics buffs and you're sure to be met with "So what," "What's new?" or some other similar remark indicating uninterest. After all, most electronics technicians and experimenters consider the

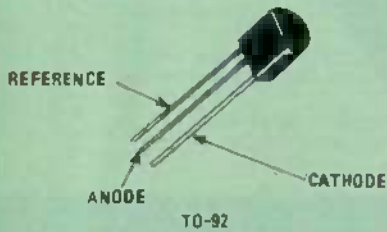
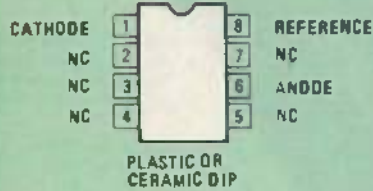

FIG. 1

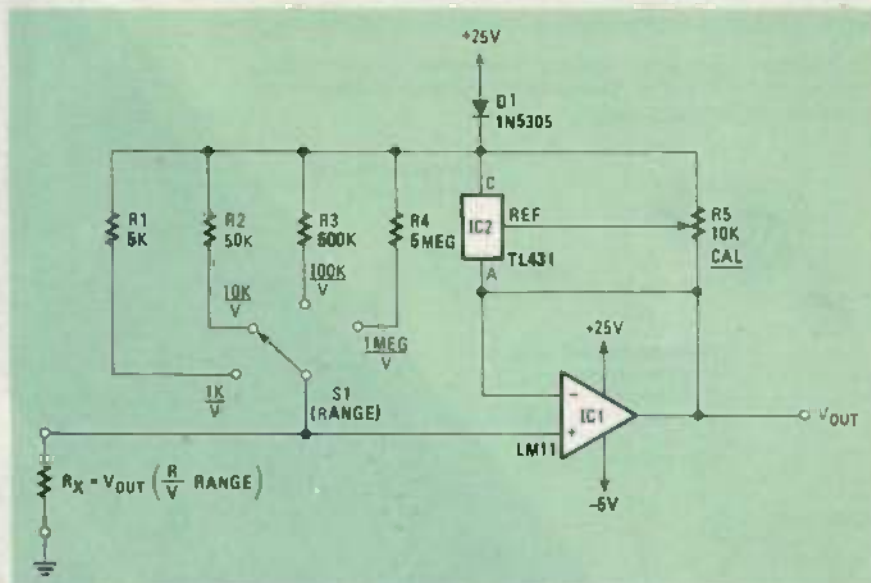

FIG. 3

voltage regulator to be a simple 3-terminal device that outputs a specified voltage that's lower than its supply voltage. Your "know-it-all" friends wouldn't be so smug had they read Motorola's data sheet

on the TL431 adjustable-shunt regulator (introduced by Texas Instruments and now second-sourced by Motorola).

The TL431 is a precision adjustable-  
*continued on page 97*

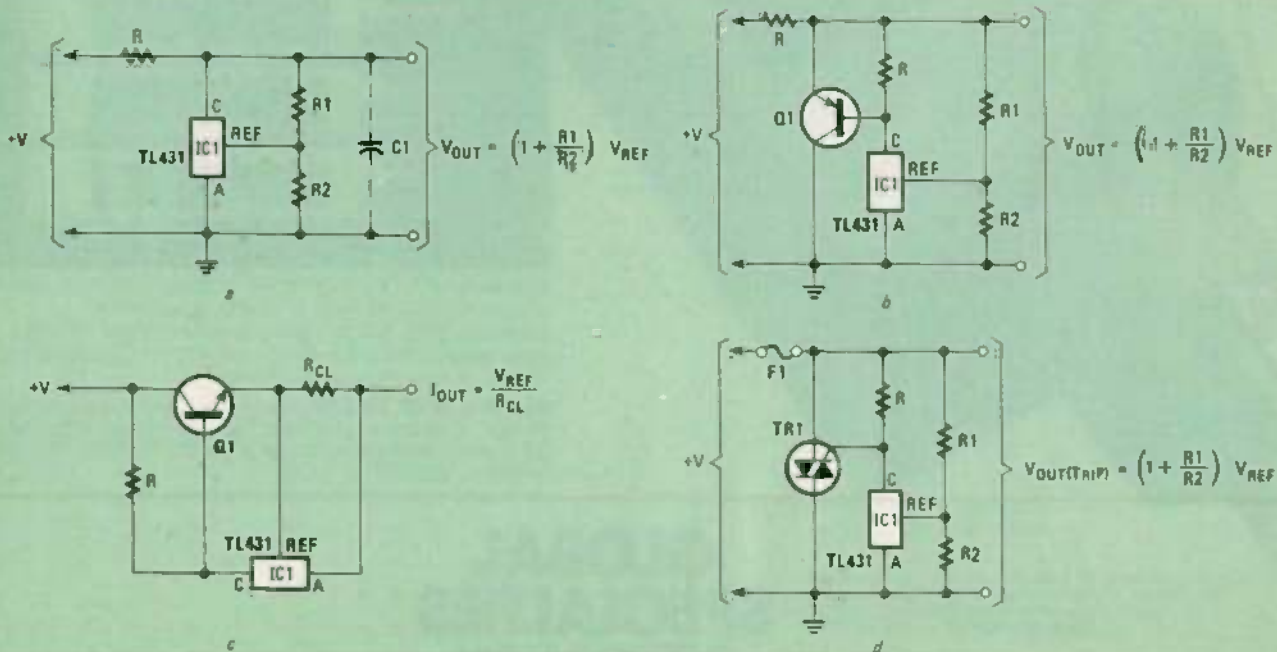

FIG. 2

## EQUIPMENT REPORTS

continued from page 40

you'll be working with some dangerous chemicals. Of course that's true whenever you make a PC board, but there are more of them in *Pro-Kit I*. The only chemicals that don't have to be mixed are the resist ink and block-out. The etchant (ammonium persulfate), ink stripper (trisodium phosphate), and developer (chemical name not given) must be mixed with water.

The developer for the photostencil film comes as two packages of powder which must be mixed together with one gallon of distilled water. Unfortunately, you must discard the solution at the end of the day. (If stored, it forms a powerful gas.) But the manual gives instructions for making 2 cups of developer at a time.

### What you get

Let's see what is contained in *Pro-Kit I*: a workboard and a screen (15 × 15 inches); a 12 × 12-inch contact printer (a felt-covered wood base with a glass cover); photostencil material (8 × 42 inches); a squeegee for ink pulls; a spreader for block-out; an 8 × 12 inch plastic tray for developing and etching, stencil developer (two packages of powder that are mixed with water), two single-sided copper clad boards (4 × 12 and 6 × 12 inches), and two double-sided copper-clad boards (4 × 12 and 6 × 12 inches).

The instruction manual is 16 pages and is—as its introduction states—written with the hobbyist in mind. The manual isn't perfect, but it's much better than most. It's amply illustrated and is laid out in a logical and organized manner. What is missing from the manual is a brief overview of the process before the step-by-step instructions. If you're unfamiliar with silk-screening, you'll have to read through the manual a few times to get the idea of it. We did like to see the following note at the beginning: "Practice makes perfect...the more you use your kit, the better your results will be."

With *Pro-Kit I*, you can make near-professional-quality PC boards. It's not suited for the casual hobbyist, but if you're a serious hobbyist, and make a lot of PC boards, then *Pro-Kit I* might be a good way to go—especially if you make a few boards of the same pattern. If you don't make a lot of boards, then the \$99.95 cost is probably too expensive.

Beta Electronics offers a copper-plating and solder-plating service at \$.05 per square inch (\$3 minimum). They will also drill your board for \$.04 per hole and can produce your photography (\$5 for 5 × 7 inch artwork), and they can do the complete fabrication of your PC board (\$75 minimum).

R-E

Now we can detect a breast cancer smaller than this dot.

At such an early stage, your chances of living a long, healthy life are excellent. But we need your help. The only proven way to detect a cancer this small is with a mammogram. A mammogram is a low-radiation x-ray of the breast capable of detecting a cancer long before a lump can be felt. If you're over 50, a mammogram is recommended every year. If you're between 40 and 50, or have a family history of breast cancer, consult your doctor. In addition, of course, continue your regular self-examinations.

American Cancer Society



# THE RIGHT STUFF.

The growth of NTE quality replacement parts has been nothing short of astronomical. And the proof is in our new 1984 Replacement Master Guide, destined to be the standard directory for technicians across the country. In excess of 3,000 quality NTE types are cross-referenced to more than 220,000 industry part numbers.

#### YOU'LL FIND ALL THE RIGHT STUFF FOR REPLACEMENT, MAINTENANCE AND REPAIR:

- Transistors
- Thyristors
- Integrated Circuits
- Rectifiers and Diodes
- High Voltage Multipliers and Dividers
- Optoelectronic Devices
- Zeners
- Microprocessors and Support Chips
- Memory IC's
- Thermal Cut-Offs
- Bridge Rectifiers
- Unijunctions
- RF Transistors
- Microwave Oven Rectifiers
- Selenium Rectifiers
- NEW! The Protector 6000™ Transient Voltage Protection Strip

Look for our Replacement semiconductors in the bright green polybags and cartons that list rating limits, device type, diagrams and competitive replacement right on the package. NTE quality parts are available from your local NTE distributor and come backed by our exclusive two-year warranty. Ask for your FREE NTE Replacement Master Guide and take off with NTE!



NEW-TONE ELECTRONICS, INC.  
44 FARRAND STREET • BLOOMFIELD, NEW JERSEY 07003  
(FORMERLY TCG)

JUNE 1984

93

# SERVICE CLINIC

## Fixing half a computer

JACK DARR, SERVICE EDITOR

I CONTEND THAT WE CAN FIX COMPUTERS! Half of one anyhow! The half that I'm talking about is the display section. All computers have two main sections; the computing circuits to do the actual work, and the readout so that we can see what the computer has done. Most display units are nothing more than a CRT in a box, along with DC supplies and video amplifiers—sound familiar? It should, since it's nothing more than the back half of a TV set. Still, many computer manufacturers are a little secretive about them. For instance, I recently called up one of the largest video-monitor manufacturers and all I got was shuffled around from phone to phone, and finally wound up in Publications. And when I asked the young lady if I could borrow a service manual for the display unit, I was informed (in very snooty tones) that they didn't want any "ham-handed" service technician, using a pair of glass pliers and a blowtorch, fooling around inside their delicate machinery. I didn't tell her that I worked with delicate circuits every day; I just quietly hung up and went away. However we did get the data needed from another, more obliging source.

There are two basic types of computer monitor; the raster-scan type and the X-Y or vector monitor. Let's look at the raster-scan monitor first.

### Raster-scan monitor

The raster-scan monitor is more or less a modified TV set. It get the same symptoms as a TV: no raster, no vertical scan, etc. So simply check the same things in the monitor that you would normally check if you were working on a TV set. The display's input (video) signal comes from the computer's output, and is easily traced with a scope. The display unit will contain at least one video-amplifier stage; or three, (for the RGB signals) if it's a color monitor. All the associated DC power supplies, including the high-voltage (about 14,000 volts) and the low-voltage DC supplies, are derived from the flyback. A crosshatch pattern from a dot/bar generator can be used for troubleshooting. The setup adjustments on raster-scan monitors and all of the controls are exactly the same, so we'll say no more about that.

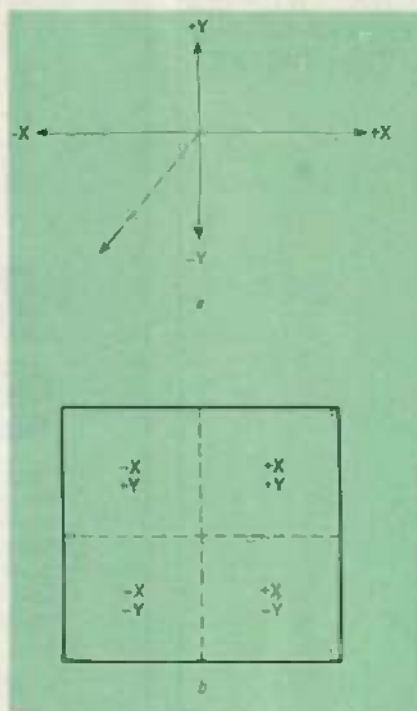

FIG. 1

### Vector monitor

The vector type monitor may seem new to some of you, but it really isn't! The reason that it isn't new is that all scopes are X-Y monitors! Figure 1-a shows what X-Y means: as shown, the X dimension means horizontal axis and Y is the vertical axis. The X-Y monitor differs from the raster-scan type in that it draws its output on the screen in a different way. Instead of the scan starting in the upper left corner, it starts in the middle of the screen, with the screen remaining dark until a signal is received.

Another important difference in the X-Y monitor is that the signal is not fed into the CRT grid, as in the raster-scan type. That signal has nothing to do with the flyback. Instead, the signal (a deflection signal) is fed to the yoke so that it moves the spot as needed to produce the "vectors." The screen is divided into four quadrants, as shown in Fig. 1-b; spot movement in a lateral direction is called X and vertical movement is called Y. Each quadrant is the vector sum of the X and Y voltages: the sum draws the pattern. Also

shown here, is how the different quadrants are identified. For instance, the upper half of the screen is the positive Y axis and the lower half is the negative Y. Right of the center line is the positive X axis and the opposite for the left. Once again, look at Fig. 1-b: The upper right quadrant is called +X/+Y and the lower left is called the -X/-Y. The other two quadrants are identified in the same way with their respective positive and negative X/Y axes. There are three separate amplifiers for the video section, consisting of the X and Y amplifiers, which drive their respective X-Y yoke windings. The third amplifier is the Z or video amplifier, which provides and brightness for the picture. The X and Y video amplifiers are generally powered by plus and minus 25-volt supplies and the video stages by a +90-volt supply.

When a positive voltage is applied to the Y axis, the spot (video) moves up as the voltage is increased, and down as the negative voltage on that axis is increased. In the same manner, when a positive voltage is applied to the X axis, the spot moves right and the reverse is true for a negative voltage. If the voltage on both the X axis and Y axis is negative, spot movement is in the direction of the dotted line (see Fig 1-a). Now that we've seen how those two monitors differ, let's look at some failure symptoms associated with the vector type.

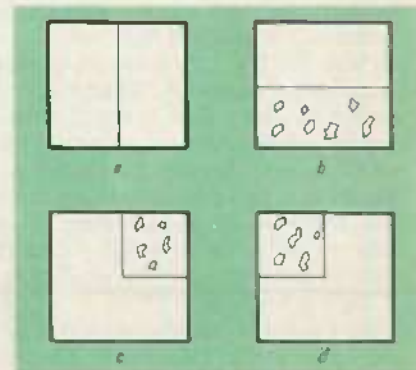

FIG. 2

### Failure symptoms

Figure 2 shows some possible symptoms of failure in the different sections of



a vector-type monitor. The patterns shown here also suggest the probable cause of the problem. For example, Fig. 2-a shows a blank screen with a vertical line down the center; here the most likely cause would be the X amplifier (horizontal) or the power supply to it. What the figure shows is that, for some reason, there is no positive or negative voltage applied to the X axis. Patterns on the lower half of the screen only (see Fig. 2-b) indicate a malfunction in the Y amplifier or its power supply.

The next one, Fig. 2-c, with a pattern showing in the upper right corner is a bit more tricky. Here, what you need to know is what voltages would cause the picture to move in that direction and which are missing to cause the imbalance. In this case, either the X or Y amplifiers, or the -25-volt supply could be the cause of the problem. A proper blend of all voltages should pull the picture to the center of the screen. The final pattern (Fig. 2-d) shows a screen with the pattern in the upper left corner; can you figure that one out? (Hint: the problem could be in the X or Y amplifier, or the +25 volt supply.)

As you can see, the problems associated with that type monitor can be figured out with a bit of careful thought. Just as with all other raster-scan problems, look to see what is there and what isn't. A lot of the hassle can be taken out of troubleshooting with the oldest trick in the book—check the power supply first. Many times you may not have to go any farther! Remember that the correct interpretation of the symptoms will cut down on your repair time.

Although the symptoms and diagrams used in our discussion are for a particular make monitor, they should be useful in the repair of other makes. They should at least help enough to get you headed in the right direction. Monitors were chosen for this month's discussion because they have the components that operate under the most stress; and are therefore, most likely to fail.

With all the personal computers in use today, someone's gotta fix 'em, and we can do the job better than anyone else. Happy computer-fixing!! R-E

## SERVICE QUESTIONS

### NO COLOR

*I have no color on a Quasar DT5979 chassis. I've replaced the color circuit, IC601, but that did no good. The voltages and waveforms on IC601 seem OK. Any ideas?—A.P., Swedesboro, NJ*

If all voltages and all waveforms on

IC601 were OK, you would have no problem. You had better double-check your measurements. Pin 1 of IC601 is your input. Pins 6, 8, and 10 are your outputs. In between, there are lots and lots of parts that need to be checked out, including capacitors, coils, resistors, and a crystal, X601. Don't overlook any of them!

### SHUTDOWN PROBLEMS

*I'm having a shutdown problem with a GE EC-C chassis—there's too much high voltage. With my variable transformer set at 60-volts AC, I get 28,000 volts. When I increase the line voltage to 70-volts AC,*

*the high voltage rises to 30,000, and the set shuts down. I have replaced the sweep, high-voltage shutdown, and PSR modules.—D.D., Sheridan, WY*

The shutdown systems are apparently doing their jobs. The trick now is to bring down the high voltage. If the retrace capacitors—those connected between the collector and emitter of the output transistor—are open, it could cause the high voltage to go wild. You can use regular capacitors with a high-voltage rating to check it out; but as for a replacement, use only exact replacements because they are specially designed to do the job. R-E

# Radio-Electronics

SPECIAL REPRINT  
BUILD A BACKYARD SATELLITE TV RECEIVER



**Sixth Printing: Sold Out!**  
**Seventh Printing—Just Off Press!**  
**Reprints Now Available!**

## Don't miss out again!

Send away today for your 36-page booklet containing a complete reprint of all seven articles in the series on Backyard Satellite TV Receivers by Robert B. Cooper Jr.

This all-inclusive report gives you all the data you need to build your own Backyard Satellite TV Receiver.

- TELLS ALL ABOUT domestic satellite communications, with full details on how you can pull those elusive TV signals from space.
- LEGAL REQUIREMENTS, technical specifications, and how you, the

home constructor, can meet them. Find out what mechanical and electronics skills you need.

- RECEIVER CHARACTERISTICS, technical details and specifications, along with examples of actual receivers built at comparatively low cost.

- ANTENNA DESIGN, and exactly how you can build a spherical antenna, while keeping total earth-station cost for the complete system under \$1,000.

- THE FRONT END is critical when you build your own system. We help you explore several different ap-

proaches to making one that will work for you.

- RECEIVER-SYSTEM hardware and how it goes together to bring you direct-from-satellite TV reception in your own home.

To order your copy:

Complete coupon and enclose it with your check or money order for \$7.00. Plus \$1.00 for postage and handling. We will ship your reprint within 6 weeks of receipt of your order. All others add \$4.00 for postage. New York State residents must add 5% sales tax.

**Radio Electronics**

Satellite TV Reprints  
45 East 17th Street  
New York, N.Y. 10003

Please print

Name

Street address

City

State

Zip

I want \_\_\_\_\_ reprints @ \$7.00 each, plus \$1. Handling & Postage.  
I have enclosed \$ \_\_\_\_\_ . N.Y. State residents must add sales tax.

NO PREVIOUS EXPERIENCE NECESSARY

# BECOME YOUR OWN COMPUTER EXPERT



## LEARN HOW TO USE A COMPUTER

Now you can LEARN EVERYTHING you ever wanted to know about microcomputers, applications, operations and programming. UNDERSTAND computer talk and WRITE professional BASIC programs. Use and modify any of thousands of readily available home or business programs for your own special needs. Programs like word processing, data base management, bookkeeping, mailing lists, graphics and hundreds more!

**LEARN AT YOUR OWN PACE IN YOUR SPARE TIME**  
Our (quicker independent) study program allows you to learn at your own pace. In your spare time, in the privacy of your own home. No classes to attend. And our expert instructors will provide you with one-on-one counseling.

**LEARN EVEN BEFORE YOU DECIDE ON A COMPUTER**  
Everything is explained in clear easy-to-understand language. You will enjoy learning to use a computer—EVEN IF YOU DON'T OWN ONE. Learn to program from the first lesson, programs that will run on any personal computer you choose: IBM, APPLE, COMMODORE, TRS, TI and more.

**LEARN AT HOME. TAKE IT TO WORK**  
Programming is the best way to learn to use computers and we can show you the best and most economical way to learn programming!  
Send today for your free information package. No obligation will call.

**halix** CENTER FOR COMPUTER EDUCATION  
INSTITUTE 1743 So Vermont Ave. Los Angeles, CA 90008

HALIX INSTITUTE CENTER FOR COMPUTER EDUCATION  
DEPT. 49-5  
1743 SO VERMONT AVE.  
LOS ANGELES, CA 90008

YES! Send me information on how I can learn about computers and programming at home.

Name \_\_\_\_\_ Age \_\_\_\_\_

Address \_\_\_\_\_

City \_\_\_\_\_ State \_\_\_\_\_

I already have a computer available.

Model \_\_\_\_\_

## EXHAUST ANALYZER

continued from page 85

ing can also occur if an adjustment is made, while testing, that causes a very dirty exhaust. Swamping typically is manifested by a suspiciously low CO reading, or a suspiciously high A/F reading. (In extreme cases, the CO reading may "attempt" to reach zero. When that happens, the display will stop updating entirely. The display will remain "frozen" until the TCC clears—typically 10–15 minutes after the offending gas mixture is removed.) The best way to correct that is to shut off the engine and allow the TCC to "breathe" ambient air for 15 minutes or so. Another solution is to deliberately force a rich mixture situation (such as by temporarily blocking part of the air intake to the carburetor) until the CO percentage swings up a few percent (or the A/F reading is down considerably); then allow normal air flow and check the reading after about a minute. If it returns to the same super-low CO, or super-lean A/F, then that's most likely the real situation, unless one of the remaining two possible trouble areas is at fault.

If the setup is suspected, re-check the setup conditions mentioned earlier. It is important that all conditions be met, such

as positioning of the conversion box and allowing sufficient time for the system to stabilize before balancing and then beginning the test. It is also possible that accuracy could be affected if a significant temperature change occurs in the conversion box area after balancing has been performed. An example of that might be if the sun came out from behind a cloud and significantly changed the ambient temperature conditions around the conversion box. Although immune to subtle changes in ambient temperature due to the "control" sensor presence, very large temperature-changes can cause a shift in the balance point. To re-balance, the TCC needs to again "breathe" ambient air for several minutes; then reset the BALANCE control.

A particularly perplexing symptom is where the display is erratic; that is, where the unit is obviously performing tests, but with significantly different readings on each trial. Verify that swamping or improper setup is not influencing the readings by shutting off the engine and observing the readings over several minutes, making sure that the conversion box remains in the same position and ambient temperature. If the readings remain erratic, there is a problem with the unit's electronics. But, if the readings stabilize, there is either something wrong with the setup or you have a really weird exhaust mixture.

The whole business of emissions testing is very tricky. Those of you who own "marginal" cars (remember that Jaguar we mentioned?) know what we mean. Each emission test can bring new surprises—sometimes good, sometimes bad. The same car, with the same tank of gas, with the same emission settings, can produce different readings at different times. There always are reasons, but sometimes they can be quite difficult to determine. In states such as Arizona that allow "conditioning mode" testing if the initial test fails, the auto is run at accelerated engine speeds, in gear on rollers, for about 30 seconds and is then retested—often with dramatically lower readings. Everything is exactly the same as before, except that some of the excess combustion byproducts (built up, perhaps, during the long wait in line to be tested) have been blown out.

The message here is: Don't be alarmed if any particular readings appear to be somewhat different from the last readings taken. To best determine the state of exhaust emissions, you really need to average the readings. In particular, take note of subtle changes in test conditions that can affect the results. Paying attention to those details will improve the overall usefulness of the unit and rectify the emissions from your automobile, thus improving the quality of air we breathe—and that's what it's all about! R-E

# cable TV

## DESCRAMBLER PARTS

We stock the exact parts and PC Board for Radio Electronic's February Article on building your own Cable TV Descrambler.

**#701 PARTS PACKAGE \$29.95**  
Includes all resistors, capacitors, diodes, transistors, integrated circuits, coils and IF transformers (BKAN-K5552AXX).

**#702 PC BOARD \$16.95**  
Etched and drilled silk-screened PC Board as shown in article.

**BOTH #701 & #702 \$39.00**  
Add \$2.50 Postage & Handling



Orders only 1-617-339-6714  
1-617-339-5372

# J & W ELECTRONICS, INC.

P.O. Box 52  
Cumberland, RI 02864

CIRCLE 45 ON FREE INFORMATION CARD

## ACTIVE RECEIVING ANTENNA

Gives excellent reception, 50 KHz to 30 MHz.

Now MFJ-1024 Active Receiving Antenna mounts outdoors away from electrical noise for maximum signal.

Gives excellent reception of 50 KHz to 30 MHz signals. Equivalent to wire hundreds of feet long. Use any SWL, MW, BCB, VLF or Ham receiver.

High dynamic range RF amplifier. 54 in. whip, 50 foot coax. 20 dB attenuator prevents receiver overload. Switch between two receivers. Select auxiliary or active antenna Gain control. "ON" LEO. Remote unit, 3x2x4 in. Control, 8x2x5 in. 12 VDC or 110 VAC with optional adapter. MFJ-1312, \$9.95.

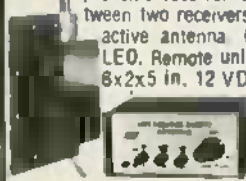

**\$129.95**  
\$4.00 shipping

Order from MFJ and try it. If not delighted, return within 30 days for refund (less shipping).

One year unconditional guarantee.

Order today. Call TOLL FREE 800-647-1800.

Charge VISA, MC, or mail check, money order.

Write for free catalog. Over 100 products.

**CALL TOLL FREE 800-647-1800**

Call 601-323-5869 in Miss., outside continental USA, tech/order/repair info. TELEX 53-4590.

# MFJ ENTERPRISES, INCORPORATED

Box 494, Mississippi State, MS 39762

CIRCLE 66 ON FREE INFORMATION CARD

RADIO-ELECTRONICS

## STATE OF SOLID STATE

continued from page 92

shunt regulator, whose output is programmable from 2.5 to 36 volts, using only two external resistors. The current range of that device is from 1 mA to 100 mA, with a low dynamic-impedance of typically 0.22 ohms. Its internal temperature compensation ensures stable operation with a temperature coefficient of 55 ppm/°C. The TL431 is available in three temperature ranges: -55 to +125°C, -40 to +85°C, and 0 to 70°C. Two case styles are available: an 8-pin plastic or ceramic DIP, or the TO-92 case (see in Fig. 1).

Some typical applications for the TL431 are shown in Fig. 2: Figure 2-a shows a shunt regulator; 2-b is a high-current shunt regulator; 2-c shows a constant-current source, and 2-d shows a triac crowbar circuit. Figures 3 and 4 show two of the more unusual applications for this regulator IC. In Fig. 3, the TL431 is teamed up with an LM11 (precision low-drift op-amp) to form a linear ohmmeter. The schematic in Fig. 4 shows an unusual phono amplifier using the TL431. The circuit shown there resembles a vacuum-tube cathode follower or a solid-state emitter follower with the unit's reference electrode corresponding to the grid or base in triode devices. The output of the crystal phono-cartridge (typically 2 volts) modulates the reference voltage. That, in turn, modulates the TL431 cathode-to-anode voltage ( $V_{CA}$ ) and the audio output is then coupled to the speaker through an output transformer. Prices for the TL431 start at \$0.52 and can range up to \$3.42 depending on the temperature range and case style. Complete specifications for the IC, along with numerous application diagrams, are available from Motorola Semiconductor Products, PO Box 20912, Phoenix, AZ 85036.

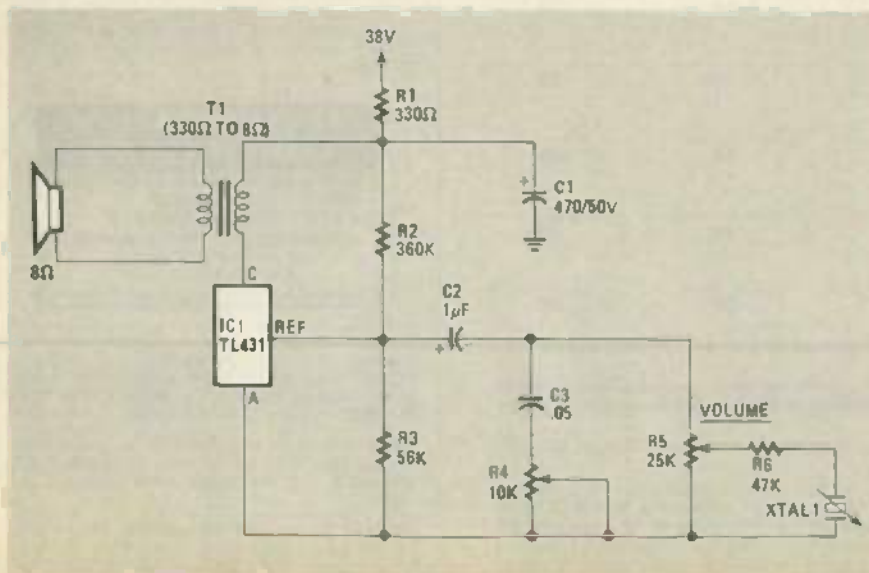

FIG. 4

## Designers' guide

*Designer's Guide—Small-Signal, Low-Noise Transistors* is a 126-page data and applications manual covering the TRW line of transistors for receiver and RF circuitry. The manual includes a cross-reference listing nearly 100 competitive transistors and 22 TRW substitutes or equivalents. Also included in the manual are packaged outline drawings with dimensions, complete technical data on the 22 TRW transistors, and application notes including schematics and PC-board patterns. The manual is available from the Semiconductor Division, TRW Electronics Components Group, 14520 Aviation Blvd., Lawndale, CA 90260.

## New semiconductor databook

The new 588-page RCA *CMOS-LSI Databook*, No. SSD-260A, provides technical information on the company's line of CMOS-LSI products. That databook includes information on such devices as the 1800-series and 6805-series of microprocessor products, a series of general-purpose CMOS memories. Also included are RCA alternate-source types for the industry.

The introduction is the "General Guide" to RCA CMOS-LSI products. It points out currently available package options and summarizes the basic features in each product category. In addition, the various IC's are classified according to product type and function.

Five separate data sections provide ratings, electrical characteristics, significant features, and user information for: 1800-series microprocessors and microcomputers, 1800-series memories, 1800-series peripherals, general-purpose memories, and 6805-series LSI products. The *CMOS-LSI Databook* is available from RCA distributors or RCA (Solid State Division, Box 3200, Somerville, NJ 08876) priced at \$7.00. R-E

# Radio-Electronics Software Store

New for our readers...A mail order source of software from Apple

Home Business	Recommended List Price	Was Pay
<input type="checkbox"/> Barn Street Writer (Broderbund)	\$69.95	\$49.95
<input checked="" type="checkbox"/> <b>Chess II (Atari-Tate) (Disk)</b>	70.00	40.00
<input type="checkbox"/> <b>Money Accountant (Comshare) (Software) (Disk)</b>	74.95	49.95
<input type="checkbox"/> <b>Star Achievement (Comshare Software) (Disk)</b>	88.95	39.95
<input type="checkbox"/> <b>Wordstar - the CP/M card (Micropro Int.) (Disk)</b>	812.00	385.00
<input type="checkbox"/> PFS: Flo RE - II - (Software Publishing) (Disk)	125.00	85.00
<input type="checkbox"/> PFS: Grant RE - II - (Software Publishing) (Disk)	125.00	85.00
<input type="checkbox"/> PFS: Report RE - II - (Software Publishing) (Disk)	125.00	85.00
<input type="checkbox"/> Visicat RE (Visicon) (Disk)	250.00	179.95
<b>Solo/Share</b>		
<input type="checkbox"/> <b>Mastering the SAT (CBS Software) (Disk)</b>	150.00	110.00
<input type="checkbox"/> <b>Success: Addition Subtraction (CBS Software) (Disk)</b>	24.95	19.95
<input type="checkbox"/> <b>Success: Multiplication Division (CBS Software) (Disk)</b>	24.95	19.95
<input type="checkbox"/> <b>Ballistics (Designers) (Disk)</b>	39.95	29.95
<input type="checkbox"/> <b>Algebra I (Eduware) (Disk)</b>	39.95	29.95
<input type="checkbox"/> <b>Rocky's Boots (The Learning Company) (Disk)</b>	49.95	39.95
<input type="checkbox"/> <b>Apple's Rainbow (The Learning Company) (Disk)</b>	29.95	24.95
<input type="checkbox"/> <b>Master Type (Lighting Software) (Disk)</b>	39.95	29.95
<input type="checkbox"/> <b>Master Type (Scarborough Systems) (Disk)</b>	39.95	29.95
<input type="checkbox"/> <b>Alphazoo (Sonnaxer Software) (Disk)</b>	29.95	24.95
<input type="checkbox"/> <b>Undercomp (Sonnaxer Software) (Disk)</b>	29.95	24.95
<input type="checkbox"/> <b>Story Machine (Sonnaxer Software) (Disk)</b>	34.95	29.95
<input type="checkbox"/> <b>The Graphics Magician (Penguin Software) (Disk)</b>	59.95	42.50
<input type="checkbox"/> <b>Get Word Attack (Eduware) (Disk)</b>	49.00	35.00
<b>Entertainment</b>		
<input type="checkbox"/> <b>Choplifer (Broderbund) (Disk)</b>	34.95	29.95
<input type="checkbox"/> <b>Little Runner (Broderbund) (Disk)</b>	34.95	25.95
<input type="checkbox"/> <b>Zaxxon (Dassoft) (Disk)</b>	38.95	29.95
<input type="checkbox"/> <b>Zaxxon II (Dassoft) (Disk)</b>	38.95	29.95
<input type="checkbox"/> <b>Zaxxon III (Dassoft) (Disk)</b>	38.95	29.95
<input type="checkbox"/> <b>Phantom II (Interactive Fantasies) (Disk)</b>	32.95	25.95
<input type="checkbox"/> <b>The Maze Of The Sun (UltraSoft) (Disk)</b>	39.95	29.95
<input type="checkbox"/> <b>Warrior 88-888 (Micropro) (Disk)</b>	39.95	29.95
<input type="checkbox"/> <b>Wizardry: Praying Grounds (Sir-Tech Software) (Disk)</b>	49.95	39.95
<input type="checkbox"/> <b>Wizardry: Knight of Diamonds (Sir-Tech Software) (Disk)</b>	34.95	27.95
<input type="checkbox"/> <b>Fight Simulator II (Strategic Corporation) (Disk)</b>	33.50	25.95
<input type="checkbox"/> <b>Temple of Apeah (Elys. Inc.) (Disk)</b>	39.95	29.95
<input type="checkbox"/> <b>Rendezvous (Eduware) (Disk)</b>	39.95	29.95

Radio-Electronics Software Store  
200 Park Avenue South  
New York, NY 10003

Number ordered

Total Price \$ \_\_\_\_\_

Sales Tax (NY State Residents only) \_\_\_\_\_

Shipping and Handling (R2.00 per item) \_\_\_\_\_

TOTAL ENCLOSED \$ \_\_\_\_\_

Name \_\_\_\_\_

Address \_\_\_\_\_

City \_\_\_\_\_ State \_\_\_\_\_ Zip \_\_\_\_\_

**SORRY - NO CREDIT CARD OR COD ORDERS**

# MARKET CENTER

## FOR SALE

**CABLE TV SECRETS**—the outlaw publication the cable companies tried to ban. HBO, Movie Channel, Showtime, descramblers, converters, etc. Suppliers list included. Send \$8.95 to **CABLE FACTS**, Box 711-R, Palaskala, OH 43062.

**RESISTORS** ¼ W & ½ W 5% 3 cents, 1% Metal-films, precision custom wirewounds, \$1.00 refundable to: **JR INDUSTRIES**, 5834-B Swancreek, Toledo, OH 43614.

**FREE** catalog featuring scanner accessories, carrier/subcarrier detectors, voice scramblers, unusual kits. **CAPRI ELECTRONICS**, Route 1R, Canon, GA 30520.

**THE Intelligence Library**—Restricted technical information & books on **electronic surveillance, surveillance device schematics, lock-picking, investigation, weapons, identification documents, covert sciences**, etc. The best selection available. **Free brochures**. **MENTOR**, (Dept. Z), 135-53 No. Blvd., Flushing, NY 11354.

**MILITARY** communications radios: **CPRC-26** Canadian manpack radio, compact size, transmits-receives 42-54 MHz FM, 6 channels, with battery box, antenna, handset crystal: \$22.50 apiece, \$42.50 pair. **PRC-510** backpack radio (Canadian version of U.S. PRC-10), transmits-receives 38-54 MHz FM continuous tuning, with headset, antenna, battery box: \$39.50, \$77.50 pair. **ARC-27** aircraft guard receiver, 220-250 MHz AM single channel: \$12.50 mint. 45-day replacement guarantee. Schematics included. Add \$5 unit shipping. **BAYTRONICS**, Dept. RE, Box 591, Sandusky, OH 44870.

**CABLE TV** equipment, notch filters for "beeping" channels. Information \$1.00. **GOLDCOAST**, PO Box 63 6025 RE, Margate, FL 33063.

**FORTY-nine** educational electronics kits with self-learning project manual. Details \$2.00 refundable with order. **TRIANGLE ELECTRONICS**, 89 Arkay Drive, Hauppauge, NY 11788.

**RF parts Motorola transistors**. MRF454 \$16.50, MRF455 \$13.50. Catalog available. **RF PARTS CO.**, 1320 Grand, San Marcos, CA 92069. (619) 744-0720.

## World's Most Remarkable Radar Jammer!

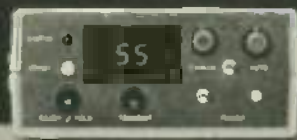

Causes speed radar guns and devices to read out your choice of either a percentage of your true speed when in automatic mode (adjustable 10% speed; 70 mph, auto reads out for 70%, speed displayed = 37 mph), or the speed that you dial in when in manual mode. Transmits only in the presence of speed radar, or by manual override. Operates on both X and K bands. **WARNING!** The device described in the literature is not legal to use against police radar, and is not FCC approved.

For complete literature and plan package send \$14.95 to: **Phillips Instrument Design Co., Inc.**, 9500 S.W. Barbur Blvd., Suite #100 B, Portland, Oregon 97219.

**DESCRAMBLERS** for downconverters, high gain. Send \$1.00. **RB ELECTRONICS**, PO Box 643, Kalamazoo, MI 49005.

**PICTURE flyer** lists quality electronics surplus at low prices. Since 1970. Send for the last 3 issues. **STAR-TRONICS**, Box 683, McMinnville, OR 97128.

**UP** to \$500.00 per month. Sell computer software in your home. Write to: **COMPUTER SERVICES**, PO Box 7748, Tucson, AZ 85725.

**CABLE-TV** products Jerrold, Hamlin, and Oak converters. Send \$3.00 for information. **ADDITIONAL OUTLET CORP.**, 111 E. Commercial Blvd., Ft. Lauderdale, FL 33334.

**RECONDITIONED test equipment** \$1.00 for catalog. **JAMES WALTER TEST EQUIPMENT**, 2697 Nickel, San Pablo, CA 94806.

**POLICE** code unscramblers, other scanner accessories, telephone recording device. **DNE, Inc.**, Rt. 7, Box 257E, Hot Springs, AR 71901 (501) 623-6027.

**NEW!... repair any TV... easy.** Anyone can do it. Write. **RESEARCH**, RR No. 3, Box 601BR, Colville, WA 99114.

**EXACT** same PCB and Toko coil set (no. 4) for descrambler in February article only \$15.00 shipping \$2.00. **JIM RHODES**, 1025 Ransome Lane, Kingsport, TN 37660.

**CONVERTERS** all types for all systems, lowest prices anywhere, quantity discounts, dealer inquiries accepted. Send \$1.00 for catalog. **PG VIDEO CORP.**, PO Box 296, Latham, NY 12110 (518) 274-6593.

## REVERBERATION FOR ORGANS

Solid state with controls for reverberation and room size. **EVERY ORGAN SHOULD OWN ONE.** Send for free flyer.

**DEVTRONIX ORGANS, INC.**  
6101 WAREHOUSE WAY  
SACRAMENTO, CALIFORNIA 95826 Dept. B

**COMPUTER** tools, unique accessories and computer add-ons, and software for C-64 Atari, Apple, IBM-PC. Also large selection of electronics components. Write for free catalog. **TOOLS FOR COMPUTERS**, PO Box 727, New Rochelle, NY 10801.

**SAVE 50%** off on electronics parts, supplies, and components. All major brands. Write **S/B ELECTRONICS**, 419 7th Street, Imperial Beach, CA 92032.

**DELUXE** Cable/UHF converters. All systems. Zenith S5AV1-1 \$225.00, SB-3 \$89.95, N-12 \$79.95. \$2.00 catalog. **PRECISION VIDEO**, PO Box 1323, Elgin, IL 60121.

To run your own Classified ad, put one word on each of the lines below and send this form along with your check for \$2.15 per word (minimum 15 words) to:

Radio-Electronics, 200 Park Avenue South, N.Y., N.Y. 10003

### ORDER FORM

PLEASE INDICATE in which category of classified advertising you wish your ad to appear. For special headings, there is a surcharge of \$20.00.

( ) Plans/Kits ( ) Business Opportunities ( ) For Sale  
( ) Education/Instruction ( ) Wanted ( ) Satellite Television

Special Category: \$20.00

PLEASE PRINT EACH WORD SEPARATELY, IN BLOCK LETTERS.

1	2	3	4	5
6	7	8	9	10
11	12	13	14	15
16	17	18	19	20
21	22	23	24	25
26	27	28	29	30
31	32	33	34	35

PLEASE INCLUDE FOR OUR FILES YOUR PERMANENT ADDRESS AND PHONE NUMBER.

**CLASSIFIED COMMERCIAL RATE** for firms or individuals offering commercial products or services) \$2.15 per word prepaid (no charge for zip code)...MINIMUM 15 WORDS. 5% discount for 6 issues, 10% for 12 issues within one year, if prepaid.

**NON-COMMERCIAL RATE** (for individuals who want to buy or sell a personal item) \$1.50 per word prepaid...no minimum.

**ONLY FIRST WORD AND NAME** set in bold caps. Additional bold face (not available as all caps) at 20¢ per word. All copy subject to publisher's approval. **ADVERTISEMENTS USING P.O. BOX ADDRESS WILL NOT BE ACCEPTED UNTIL ADVERTISER SUPPLIES PUBLISHER WITH PERMANENT ADDRESS AND PHONE NUMBER.** Copy to be in our hands on the 20th of the third month preceding the date of the issue (i.e., August issue closes May 20th). When normal closing date falls on Saturday, Sunday, or a holiday, issue closes on preceding working day.

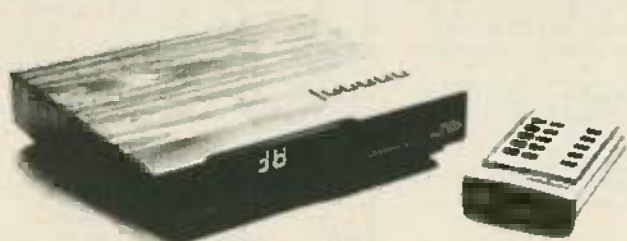

# CABLE-TV PRICE SLASH!

QTY.	ITEM	REG.	NOW	QTY.	PRICE
1...	JERROLD 400 CONVERTER (DRX-3) 58 Ch. ...	\$109.00	\$ 90.00	.....	.....
10...	JERROLD 400 CONVERTERS (DRX-3) 58 Ch. ...	\$ 80.00 ea.	\$ 65.00 ea.	.....	.....
1...	JERROLD 450 CONVERTER (DRZ-3) 66 Ch. ....	\$134.00	\$105.00	.....	.....
10...	JERROLD 450 CONVERTERS (DRZ-3) 66 Ch. ...	\$110.00 ea.	\$ 90.00 ea.	.....	.....
1..	*JERROLD STARBASE Ch. #_____	\$ 97.00	\$ 89.00	.....	.....
10..	*JERROLD STARBASE Ch. #_____	\$ 63.00 ea.	\$ 52.00 ea.	.....	.....
1..	*MINICODE (N-12) Ch. #_____	\$ 97.00	\$ 89.00	.....	.....
10..	*MINICODE (N-12) Ch. #_____	\$ 63.00 ea.	\$ 52.00 ea.	.....	.....
1..	*MINICODE (N-12) VARISYNC Ch. #_____	\$119.00	\$ 99.00	.....	.....
10..	*MINICODE (N-12) VARISYNC Ch. #_____	\$ 69.00 ea.	\$ 59.00 ea.	.....	.....
1..	*C-1000 DELUXE (ZENITH COMPATIBLE SYSTEM) Ch. #_____	\$260.00	\$225.00	.....	.....
5..	*C-1000 DELUXE (ZENITH COMPATIBLE SYSTEM) Ch. #_____	\$220 ea.	\$185.00 ea.	.....	.....
1...	MLD1200-3 .....	\$129.00	\$ 99.00	.....	.....
10...	MLD1200-3 .....	\$ 85.00 ea.	\$ 55.00 ea.	.....	.....

\*ALL UNITS AVAILABLE WITH CHANNEL 3 OUTPUT. STARRED UNITS ALSO AVAILABLE WITH CHANNEL 2 OUTPUT. PLEASE SPECIFY CHANNEL PREFERENCE ON THESE UNITS. ACTUAL FACTORY EQUIPMENT.

Name \_\_\_\_\_ Sub-Total .....

Street \_\_\_\_\_ Shipping .....

City/State/Zip \_\_\_\_\_ TOTAL .....

Phone Number Area Code \_\_\_\_\_ Number \_\_\_\_\_

Add \$2.00 per unit shipping or call for specifics.

Payment is accepted by money order, certified check or wire transfer only, unless prior arrangements have been made.

### MUST BE SIGNED AND RETURNED WITH YOUR ORDER

*I understand that the purchase of these cable T.V. products does not authorize their use on any cable T.V. system. I agree to obtain the proper authorization from local officials or cable company officials in my area.*

Signed \_\_\_\_\_

Sale of Descramblers may be prohibited in some states. If in doubt, please check with your local authorities.

**Transamerican Cable Distributors**  
449 BROADWAY AVE. • BEDFORD, OHIO 44146 • (818) 956-5839

# WERSI electronics

## ORGAN & PIANO KITS

### ALPHA DX 300



fully  
DIGITAL  
RS232  
Interface

For Free Sound Info  
Call 1-800-233-3865  
or write WERSI USA  
Dept. M B.P.O. Box 5318  
Lancaster, PA 17601

**CHANNEL 3**—60dB notch filter 63.5MHz. \$32.00.  
CROSLY, Dept 763, Box 840, Champlain, NY  
12919.

**APPLE** twin computers. Accessories. We service.  
Winter sale catalog. PINCOR, 530 Palace, Aurora,  
IL 60506 (312) 896-0015.

**WHOLESALE** indoor antenna \$14.00. Master video  
control center \$30.00. (212) 897-0509. D&WR,  
68-12 110 St., Flushing, NY 11375.

**INDIVIDUAL** photofact folders. Nos. 201 to 1300  
\$3.00 first-class postpaid. LBT, 414 Chestnut Lane,  
East Meadows, NY 11554.

**TUBES**—All types, discount prices. Many antique  
and hard-to-find types. Send \$1.00 for 16-page catalog.  
We buy antique tubes. **ANTIQUE ELECTRONIC SUPPLY**, 1725 W. University, Tempe, AZ  
85281.

**COMMODORE/VIC-20** bargains. Programs, supplies,  
peripherals, battery backup, game accessories,  
hardware. Free catalog. **CREATIVE**, PO 4253,  
Thousand Oaks, CA 91360.

**BEST** prices: CB equipment, scanners, radar detectors,  
telephones. Free list. **CBS**, 1587 Central  
Ave., Yonkers, NY 10710.

**TI-99/4A BASIC** programs written to your specifications  
by Engineer, Mathematical, scientific specialty  
Description, listing, cassette. Write for sample  
quote. **AL TEMPS, ENT.**, 720 Smithtown Ave.,  
Bohemia, NY 11716.

**SINE** wave descramblers (Deluxe II) built and tested  
\$219.00 plus \$6.95 shipping. Money orders (no  
shipping to Calif.) or send \$2.00 for information.  
**ADVANCE ELECTRONICS**, Dept. X, PO Box 3298,  
Culver City, CA 90231.

**CONNECTORS**—audio, co-axial, aviation, computer,  
industrial, and many other types. Send \$2.00 for  
complete price list and ordering information.  
Largest inventory in country. **CONNECTOR TECHNOLOGY INC.**, 5A Veronica Ave., Somerset, NJ  
08873.

**RARE** parts and surplus electronics bargains. RF,  
linear, digital computers, robotics. Free catalog.  
**OOO BALL ELECTRONICS**, PO Box 879R, Ouncanville,  
TX 75116.

**PRINTED-circuit** artwork, design layout quality,  
prompt. Send schematic. **SOMMER CIRCUIT DESIGN**,  
1227 Kimber, Wooster, OH 44691. Visa/MasterCard.

**VCR** protective cover clear vinyl 18 1/2 x 15 1/2 x 5  
beautifully made \$11.95. **WINDOW MOODS**, 8228  
Scotts Level Road, Baltimore, MD 21208.

**POWER** supplies. New. Xentek triple output.  
5Vat5A and +/-12V at 1.5A, each. 35.00 each.  
Eipac triple output 5Vat3A and +/-12V at 1.5A each.  
\$30.00 each. Eipac switching P.S. 5Vat30A \$50.00  
each. Call after 8:00PM E.S.T. (516) 747-4109.

**CORCOM** power line filters No 6J4 \$5.00 each.  
**Fans. Pewee Boxer** 3.125" square. Model  
PWS2142FL-M \$7.00 each. Call after 6:00 PM  
E.S.T. (516) 747-4109.

## NEW! MULTI-CHANNEL MICROWAVE

Complete Antenna Systems from '69<sup>95</sup>

Full 800 Mhz Range  
Tune 1.9-2.7 Ghz  
Includes all  
ITFS Channels

DEALERS WANTED

COD's and Credit Card  
Orders call TOLL FREE  
1-800-247-1151

**GALAXY ELECTRONICS**  
6009 N. 61 Avenue  
Glendale, AZ 85301  
1-602-247-1151



**SHUGART SA1002** 8" hard disk drives new—  
\$269.00 each. \$100, IBM, Heath, SS-50, TRS-80I,  
Apple II interfaces available. Controller, \$331.00.  
**DIGITAL SEARCH** (803) 877-9444.

**AUTOMOTIVE** security catalog. 1984 24-page  
color catalog. \$2.00. ASE, PO Box 382, Plainview,  
NY 11803.

**OVER 1200** electronics parts, kits, and computer  
Products. Lowest prices. Send \$1.00 (redeemable)  
for catalog. Stamp brings flyer **DAYTAP ELECTRONICS**,  
3029 N. Wilshire, Arlington Hts., IL  
60004.

**ELECTRONIC** surveillance! Incredible manual,  
"Homebrew Bugging" reveals secret techniques  
used by Professionals (schematics included)—  
\$15.00. Send \$3.00 for amazing catalog. **A.T.I.S.**,  
Dept. R, 61 Gatchell St., Buffalo, NY 14212.

**COMPUTERS**, clones, drives, monitors, expansions,  
software. Bargain Prices—directory of manuf-  
acturers in Taiwan, Hong Kong \$4.00. **MULTITEK**,  
Box 25, Allentown, PA 18105.

**MUSICAL** electronics & home recording. Schematics  
and "how to". Bi-monthly \$12.00/year. Sample  
issue \$2.50. **POLYPHONY**, Box 20305,  
Oklahoma City, OK 73156.

**DESCRAMBLERS** Jerrold type as seen in Feb.  
issue, parts kit and top quality PC board, only  
\$30.00. Money order ships immediately **HI-Q**, Box  
2830, Trenton, NJ 08619.

**PLANS & KITS**  
**PRINTED-circuit** boards. Quick prototypes, production,  
design, reflow solder and print or  
description for quote to **KIT CIRCUITS**, Box 235,  
Clawson, MI 48017.

**CABLE TV** converters and equipment. Plans and  
parts. Build or buy. For information send \$2.00. **C & B ELECTRONICS**, PO Box 21, Jenison, MI 49428.

## FREE KIT Catalog

FUNCTION GENERATOR KIT \$59.95 contains  
Auto-Ranglar, Cap-meter kit \$79.95  
TEST & EXPERIMENTER'S EQUIP.  
Phone 209-772-2076  
Write or Phone for FREE CATALOG  
**DAGE SCIENTIFIC INSTRUMENTS**  
BOX 144 VALLEY SPRINGS, CA 95252

**TUSA**  
A WHOLE NEW WORLD OF TV TRAINING WITH TUSA'S  
NEW MODEL CTV-40 40 CHANNEL CABLE TV CONVERTER  
...  
NOW \$28.95

**UHF TUNERS**  
Give Stop Detent! Tuning  
model Excellent for applications  
...  
WHILE THEY LAST  
\$3.95 ea.  
10 or more \$2.99 ea.

**POPULAR IC'S**  
TOP QUALITY  
NO SECONDARY  
...  
THE ORIGINAL, NE 664 IS NOW BACK IN STOCK!  
\$2.88 Each

**7-ELEMENT**  
75 OHM UHF YAGI ANTENNAS  
...  
NOW! \$16.95  
EACH

**SANYO UHF VARIATOR TUNERS**  
75 Ohm Input - 45 MHz Output  
For Channels 14-83  
...  
NOW! \$16.95  
EACH

**POPULAR MICROWAVE PARTS**  
...  
WHILE THEY LAST!  
\$13.95 ea.

**NEW 1984 B&K AUTOMANUAL RANGING MULTIMETER**  
...  
SPECIAL PRICE!  
\$94.00 ea.

**JEEROLD 400 DIGITAL CATV CONVERTER**  
...  
SPECIAL PRICE!  
\$119.95 ea.  
1 or more \$104.95 ea.

**PROJECT BOXES**  
...  
\$12.50 ea.  
4 or more \$10.95 ea.  
10 or more \$9.95 ea.

**PHONE-A-Tenna**  
...  
\$37.95

**COLORMAX 36 CHANNEL REMOTE CATV CONVERTER**  
...  
\$69.95 ea.  
8 or more \$64.95 ea.

**SURPLUS SYLVANIA UHF VARIATOR TUNERS**  
...  
WHILE THEY LAST!  
\$13.95 ea.

**DELUXE A-B SWITCHES**  
...  
\$5.95 ea.  
10 or more \$5.50 ea.

**ORDER NOW**  
TOLL FREE  
800-854-4655  
OUTSIDE CALIFORNIA  
714-635-5090  
INSIDE CALIFORNIA

**R.F. ELECTRONICS**  
1085-C N. STATE COLLEGE BLVD., DEPT. R  
ANAHEIM, CALIFORNIA 92806

OPEN  
TUES - FRI  
9-6  
SAT 10-6  
CLOSED SUN & MON

SEND  
NO POSTAGE  
NECESSARY  
IF MAILED  
IN THE  
UNITED STATES

PERSONAL CHECKS HELD FOR CLEARANCE — NO MINIMUM ORDER  
ALL PREPAID ORDERS 7 LBS OR LESS MUST INCLUDE \$2.50 SHIPPING & HANDLING — SHIPPED SAME DAY RECEIVED

RADIO-ELECTRONICS

# RAMSEY

## THE FIRST NAME IN ELECTRONIC TEST GEAR

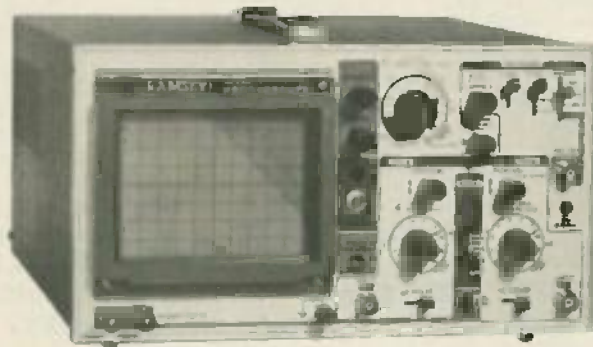

### NEW FROM RAMSEY-20 MHz DUAL TRACE OSCILLOSCOPE

Unsurpassed quality at an unbeatable price, the Ramsey oscilloscope compares to others costing hundreds more. Features include a component testing circuit that will allow you to easily test resistors, capacitors, digital circuits and diodes • TV video sync filter • wide bandwidth & high sensitivity • internal graticule • high quality rectangular CRT • front panel trace rotator • Z axis • high sensitivity x-y mode • very low power consumption • regulated power supply • built-in calibrator • rock solid triggering • high quality hook-on probes

**\$399.95** high quality hook-on probes included

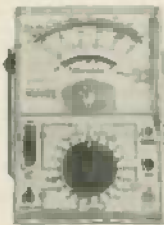

#### RAMSEY D-1100 VOM-MULTITESTER

Compact and reliable, designed to service a wide variety of equipment. Features include • mirror back scale • double-jeweled precision moving coil • double overload protection • an ideal low cost unit for the beginner or as a spare back-up unit.

**\$19.95**

test leads and battery included



#### RAMSEY D-2100 DIGITAL MULTITESTER

A compact easy to use unit designed to operate like a pro. Featuring • 3 1/2 digit LCD • low BAT. indicator • all range overload protection • overrange indication • auto-polarity • transistor tester • dual-slope integration • vinyl carrying case

**\$54.95**

test leads, battery & vinyl carrying case included



#### RAMSEY D-3100 DIGITAL MULTIMETER

Reliable, accurate digital measurements at an amazingly low cost • in-line color coded push buttons, speeds range selection • abs diastict tilt stand • recessed input jacks • overload protection on all ranges • 3 1/2 digit LCD display with auto zero, auto polarity & low BAT. indicator

**\$59.95**

test leads and battery included



#### CT-70 7 DIGIT 525 MHz COUNTER

Lab quality at a breakthrough price. Features • 3 frequency ranges each with pre amp • dual selectable gate times • gate activity indicator • 50mV @ 150 MHz typical sensitivity • wide frequency range • 1 ppm accuracy

**\$119.95**

wired includes AC adapter

CT-70 kit ..... \$99.95  
BP-4 nicad pack ..... 8.95



#### CT-90 9 DIGIT 600 MHz COUNTER

The most versatile for less than \$300. Features 3 selectable gate times • 9 digits • gate indicator • display hold • 25mV @ 150 MHz typical sensitivity • 10 MHz timebase for WWV calibration • 1 PPM accuracy

**\$149.95**

wired includes AC adapter

CT-90 kit ..... \$129.95  
OV-1 0.1 PPM oven timebase ..... 59.95  
BP-4 nicad pack ..... 8.95



#### CT-125 9 DIGIT 1.2 GHz COUNTER

A 9 digit counter that will outperform units costing hundreds more. • gate indicator • 25mV @ 150 MHz typical sensitivity • 9 digit display • 1 ppm accuracy • display hold • dual inputs with preamps

**\$169.95**

wired includes AC adapter

BP-4 nicad pack ..... 8.95



#### CT-50 8 DIGIT 600 MHz COUNTER

A versatile lab bench counter with optional receive frequency adapter, which turns the CT-50 into a digital readout for most any receiver • 25 mV @ 150 MHz typical sensitivity • 8 digit display • 1 ppm accuracy

**\$169.95**

wired

CT-50 kit ..... \$139.95  
RA-1 receiver adapter kit ..... 14.95

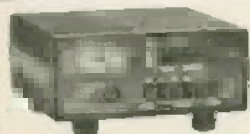

#### DM-700 DIGITAL MULTIMETER

Professional quality at a hobbyist price. Features include 26 different ranges and 5 functions • 3 1/2 digit, 1/2 inch LED display • automatic decimal placement • automatic polarity

**\$119.95**

wired includes AC adapter

DM-700 kit ..... \$99.95  
MP-1 probe set ..... 4.95



#### PS-2 AUDIO MULTIPLIER

The PS-2 is handy for high resolution audio resolution measurements. multiplies up in frequency • great for PL tone measurements • multiplies by 10 or 100 • 0.01 Hz resolution & built-in signal preamp/conditioner

**\$49.95**

wired

PS-2 kit ..... \$39.95

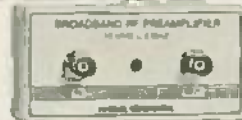

#### PR-2 COUNTER PREAMP

The PR-2 is ideal for measuring weak signals from 10 to 1,000 MHz • flat 25 db gain • BNC connectors • great for sniffing RF • ideal receiver/TV preamp

**\$44.95**

wired includes AC adapter

PR-2 kit ..... \$34.95

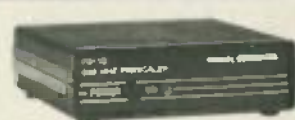

#### PS-1B 600 MHz PRESCALER

Extends the range of your present counter to 600 MHz • 2 stage preamp • divide by 10 circuitry • sensitivity, 25mV @ 150 MHz • BNC connectors • drives any counter

**\$59.95**

wired includes AC adapter

PS-1B kit ..... \$49.95

#### ACCESSORIES FOR RAMSEY COUNTERS

Telescopic whip antenna—BNC plug .. \$ 8.95  
High impedance probe, light loading .. 16.95  
Low pass probe, audio use .. 16.95  
Direct probe, general purpose use .. 13.95  
Tilt ball, for CT-70, 90, 125 .. 3.95



PHONE ORDERS CALL  
**716-586-3950**  
TELEX 466735 RAMSEY CI

TERMS • satisfaction guaranteed • examine for 10 days; if not pleased, return in original form for refund • add 6% for shipping and insurance to a maximum of \$10.00 • overseas add 15% for surface mail • COD add \$2.50 (COD in USA only) • orders under \$15.00 add \$1.50 • NY residents add 7% sales tax • 90 day parts warranty on all kits • 1 year parts & labor warranty on all wired units

**RAMSEY**

RAMSEY ELECTRONICS, INC.  
2575 Baird Rd.  
Pentfield, N.Y. 14626

JUNE 1984

**NEW!... repair any TV... easy.** Anyone can do it. Write **RESEARCH**, RR No.3, Box 601BR, Colville, WA 99114.

**MOST advanced sine converter descrambler available.** PCB and plans \$15.00. **JIM RHODES**, 1025 Ransome Ln., Kingsport, TN 37660.

**RF MODULATORS**  
for the video industry



Specialize modulators from channel 1 thru UHF. Kits & assembled models by all manufacturers...including our new Apple-variant designed to mount into computer. Also an extensive line of monitors, cameras and kits. **FREE CATALOG**

PHONE (602) 961-3711  
**ATV Research**  
13-RE BROADWAY  
DARTMOUTH CITY, NH 03812

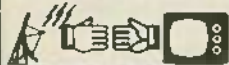

**PSST!** Hey, wanna make professional-quality printed-circuit boards? One or more in only 60 minutes. Simple, inexpensive new system. Free 1984 catalog. **PINCOR**, 530 Palace, Aurora, IL 60506 (312) 896-0015.

**HI-FI speaker kits, auto speaker systems and raw drivers** from the world's finest manufacturers. For beginners and experts. **A&S SPEAKERS**, Box 7462R, Denver, CO 80207 (303) 399-8609.

**REPAIRS** of all converters and cable boxes with prompt service. Deluxe sinewave kits \$95.00, 90% complete also available (quantity discounts) UHF converters of all types available. Send SASE (54 cents postage) for information. 1-(312) 637-4408. **HIGGINS ELECTRONICS**, 6014 W. Nelson, Chicago, IL 60641.

**ELECTRONIC touch light control pad.** Write for free brochure. **EXOTIC IDEAS**, PO Box 446, Lake Bluff, IL 60044

**ENJOY satellite television.** Save money with easy, guaranteed, do-it-yourself antenna plans kits. Electronics knowledge not necessary. Send \$1.00 for catalog. **GFI-ZZ**, Box 9108, Missoula, MT 59807.

**SCHEMATICS, plans, parts, lists**, for all electronics. Modern and late. Send \$2.00 (refundable with order) to **ELECTRONICS**, PO Box 9606, Detroit, MI 48209.

**UP/down digital counter, four-digit display** for satellite tracker. Easy plans, parts list. \$3.00. **SATELLITE TRACKER**, Route 9, Box 37, Hickory, NC 28601.

 **WRITE FOR McGEE'S SPEAKER & ELECTRONICS CATALOG**

**1001 BARGAINS IN SPEAKERS**

Tel.: 1 (816) 842 5092

1901 MCGEE STREET KANSAS CITY, MO. 64108

**CATALOG:** Hobby, CB, broadcasting! Linears, transmitters, bugs, scramblers, downconverters, antennas, modifications, more! **PANAXIS**, Box 130-F6, Paradise, CA 95969.

200 electronics kits, projects, plans. Send stamp for list. **MATCO ELECTRONICS**, Box 316R, Cadillac, MI 49601.

**WARN** animals of the approach of your car at a safe distance. Emits ultrasonic sound. Plans \$5.00. **D.R. OBENOUR**, Box 44, Sand Creek, MI 49279.

**SATELLITE TELEVISION**



**HOW to build a satellite-TV LNA, downconverter, receiver!** Save hundreds! Satisfaction guaranteed! Free information! Send stamped envelope: **XANDI**, Box 25647, Dept. 21X, Tempe, AZ 85282.

**GEARMOTORS** for motorized satellite antenna projects. 110VAC, 101RPM, reversible, straight, or right angle. \$32.50 plus \$4.00 shipping. **TEM**, 22518 97th, Corcoran, MN 55374 (612) 488-8014.

**Satellite Descrambler**

For West Star 5

Movies Movies Movies

Send \$5.00 for information  
Modern Technology   
P.O. Box 419 D1   
Boston, Ma. 02186

**BUSINESS OPPORTUNITIES**

**MECHANICALLY** inclined individuals desiring ownership of small electronics manufacturing business—without investment. Write: **BUSINESSSES**, 92-R, Brighton 11th, Brooklyn, NY 11235

**BIG PROFITS ELECTRONIC ASSEMBLY BUSINESS**

Start home spare time investment knowledge or experience unnecessary. **BIG DEMAND** assembling electronic devices. Sales handled by professionals. Unique business opportunity

**FREE:** Complete illustrated literature  
BARTA, RE-O Box 248  
Walnut Creek, Calif. 94597

 **Active**



1984 Mail Order Catalog

The One Stop Electronic Shop!

Call Toll FREE 1-800-343-0874

In the United States:

<b>Mall Orders</b> P.O. Box 8000 Westborough, Mass. 01581 (Mass) (617) 366-0500	<b>Boston</b> 133 Flanders Road Westborough, Mass. 01581 (617) 366-9684	<b>Seattle</b> 13107 Northup Way Bellevue, Wash. 98004 (206) 881-8191
---------------------------------------------------------------------------------------------	-------------------------------------------------------------------------------------	-----------------------------------------------------------------------------------

In Canada:

<b>Montreal</b> 5651 Rue Ferrier Montréal, Quebec H4P 1N1 (514) 731-7441	<b>Toronto</b> 14 Carlton Street Toronto, Ontario M5B 1K5 (416) 977-7692	<b>Downsview</b> 86 St. Regis Cr. N. Downsview, Ontario M3J 1Y8 (416) 630-0400
<b>Ottawa</b> 1023 Merivale Road Ottawa, Ontario K1Z 6A6 (613) 728-7900	<b>Calgary</b> 3220-5th Ave. N.E. Bay 2 Calgary, Alberta T2A 5N1 (403) 235-5300	<b>Vancouver</b> 3070 Kingsway Vancouver, B.C. V5R 5J7 (604) 438-3321

Visit your nearest Active store, call, write or circle the Reader Service Card for your copy of Active's new catalog.

CIRCLE 77 ON FREE INFORMATION CARD



# WE HAVE QUALITY PARTS, DISCOUNT PRICES AND FAST SHIPPING!

### TRANSFORMERS

120 volt primaries

5 & VOLTS @ 750 MA	\$3.00
8 VOLTS @ 160 MA	\$1.25
12 VCT @ 200 MA	\$2.00
18 & V @ 3 AMPS	\$6.50
18 V @ 850 MA	\$4.50
18 VOLTS @ 1 AMP	\$4.50
24 VOLTS @ 250 MA	\$2.50
24 VCT @ 1 AMP	\$4.50
42 VCT @ 1.2 AMP	\$4.50

### MULTI-SWITCHES

3 STATION NON-INTERLOCKING

3 - 2PDT SWITCHES EACH OPERATES INDEPENDENTLY

1 1/2" BETWEEN MOUNTING CENTERS \$1.75 EACH

5 STATION INTERLOCKING

MADE BY ALPS

3 - 2PDT AND 2 - 6PDT SWITCHES ON FULLY INTERLOCKING ASSEMBLY

3 1/2" BETWEEN MOUNTING CENTERS \$2.50 EACH

5 STATION NON-INTERLOCKING

SAME AS ABOVE, EXCEPT EACH SWITCH OPERATES INDEPENDENTLY \$2.50 EACH

### HELPING HAND

WILL HOLD P.C. BOARD OR OTHER SMALL ITEMS AND ALLOW BOTH YOUR HANDS FREEDOM TO WORK

\$6.50 EACH

### MIKE CONNECTOR

3 CONDUCTOR IN-LINE PLUG AND CHASSIS MOUNT JACK TWIST LOCK STYLE. SAME AS SWITCHCRAFT 12CL5M

\$2.50 PER SET

### METER

0 - 15 V.D.C.

THIS 2-1/4" SQUARE METER MEASURES 0-15 VDC

\$4.50 EACH

### SUB-MINIATURE D TYPE CONNECTOR

SOLDER TYPE SUB-MINIATURE CONNECTORS USED FOR COMPUTER HOOP UPS

DB-15 PLUG	\$2.75
DB-15 SOCKET	\$4.00
DB-15 HOOD	\$1.50
DB-25 PLUG	\$2.75
DB-25 SOCKET	\$3.50
DB-25 HOOD	\$1.25

### "PARALLEL" PRINTER CONNECTOR

SOLDER STYLE 35 PIN MALE USED ON "PARALLEL" DATA CABLES

\$5.50 EACH

### LIGHTS

#### GRAIN OF WHEAT

##### T1 SIZE

125" DIA (3.15mm)

3 for 8 VOLTS 3 for \$1.00  
Rated 55ma @ 5 VOLTS

5 for 12 VOLTS 3 for \$1.00  
Rated 55ma @ 8 VOLTS

12 for 24 VOLTS 3 for \$1.00  
Rated 45ma @ 14 VOLTS

##### T1 SIZE WITH WIRE LEADS

3 for 8 VOLTS 2 for \$1.00  
Rated 55ma @ 5 VOLTS

5 for 12 VOLTS 2 for \$1.00  
Rated 55ma @ 8 VOLTS

17 for 24 VOLTS 2 for \$1.00  
Rated 45ma @ 14 VOLTS

##### T1 - 3/4 SIZE WITH WIRE LEADS

183" DIA (4.14mm)

3 for 8 VOLTS 2 for \$1.00  
Rated 45ma @ 5 VOLTS

5 for 12 VOLTS 2 for \$1.00  
Rated 55ma @ 8 VOLTS

12 for 24 VOLTS 2 for \$1.00  
Rated 45ma @ 14 VOLTS

### NEON W/ RESISTOR

DIRECT OPERATION

7 for \$1.00 FROM 120 VOLT

### 120V INDICATOR

NEON INDICATOR RATED 120 V 1/2 W MOUNTS IN 5/16" HOLE. RED LENS

75¢ EACH  
10 FOR \$7.00  
100 FOR \$65.00

### SOLDERING IRON STAND

SPRING STEEL IRON HOLDER ON WEIGHTED BASE

\$5.00 EACH

### BATTERY OPERATED SMOKE DETECTOR

BRK MODEL #79R  
UL APPROVED  
9 VOLT BATTERY OPERATION FOR CEILING OR WALL MOUNT

\$8.00 EACH 2 FOR \$15.00

### WALL TRANSFORMER

ALL ARE 115 VAC PLUG IN

4 VDC @ 70 MA	\$3.00
8 VDC @ 100 MA	\$3.50
9 VDC @ 500 MA	\$5.00
9 VDC @ 725 MA	\$3.00
14 VDC @ 300 MA	\$3.50
15 VAC @ 300 MA	\$3.00
16.3 VAC @ 10 VA	\$3.50
17 VAC @ 500 MA	\$4.00

### SPRING LEVER TERMINALS

TWO COLOR CODED TERMINALS ON A STURDY 2 3/4" x 3 3/4" BAKELITE PLATE GREAT FOR SPEAKER ENCLOSURES OR POWER SUPPLIES

\$1.00 EACH 10 FOR \$9.00

### 2 CHANNEL LIGHT ORGAN

EASILY HOOKS INTO STEREO SPEAKERS AND ALLOWS 110 VAC LIGHTS TO DANCE WITH MUSIC. TWO SEPARATE 110 VAC OUTPUTS FOR HIGH AND LOW FREQUENCY AUDIO SIGNALS. USE TWO ORGANS FOR STEREO

\$6.50 PER UNIT  
COLOR LIGHT STRING AVAILABLE \$1.75 EA

### EDGE CONNECTORS

ALL ARE 150" SPACING

15 PIN GOLD SOLDER EYELET \$1.75 EACH

15/30 GOLD SOLDER EYELET \$2.00 EACH

18/36 GOLD SOLDER EYELET \$2.00 EACH

### 22/44 TIN

P.C. STYLE NO MOUNTING EARS

\$1.50 EACH 10 FOR \$14.00

22/44 GOLD P.C. STYLE \$2.00 EACH 10 FOR \$18.00

### 28/56 GOLD

28/56 GOLD PLATED CONTACTS 156 CONTACT SPACING

\$2.50 EACH 10 FOR \$22.00

50/100 GOLD STANDARD 5.100 CONNECTOR 125" SPACING GOLD PLATED P.C. MOUNT

\$3.75 EACH 10 FOR \$35.00

### SWITCHES

#### MINI-PUSH BUTTON

5 PBT MOMENTARY NORMALLY OPEN 1/4" BUSHING

35¢ EACH  
10 FOR \$3.25  
100 FOR \$30.00

SPECIFY COLOR RED BLACK WHITE GREEN YELLOW

#### KEY SWITCH

8 PBT 4 AMPS @ 125 VAC KEY REMOVES BOTH POSITIONS

\$3.50 EA

#### LIGHTED PUSH BUTTON

RED LIGHTED 120 VAC 10 AMP 5 PBT

"POWER" PRINTED ON FACE MOUNTS IN 7/8" SQUARE HOLE

\$1.50 EA 10 FOR \$13.50

## FREE! FREE! FREE! SEND FOR NEW LARGER! 48 PAGE CATALOG FREE! FREE! FREE!

### BCD DIP SWITCH

10 POSITION ROTARY SCREW DRIVER ADJUST FITS 6 PIN DIP

\$1.85 EACH

### LINE CORDS

#### TWO WIRE

8 18ga TWO WIRE 3 FOR \$1.00

#### THREE WIRE

18 INCH 18ga THREE WIRE 2 for \$1.00

8 FOOT 18ga THREE WIRE \$2.00 EACH

### ROTARY SWITCH

#### 1 POLE 6 POSITION

1 1/4" DIA x 1 1/2" HIGH

75¢ EACH 10 FOR \$6.00

### COMPUTER GRADE CAPACITORS

2,000 mfd. 200 VDC	\$2.00
1 3/4" DIA - 5" HIGH	
3,600 mfd. 40 VDC	\$1.00
1 3/8" DIA - 3 3/4" HIGH	
6,400 mfd. 60 VDC	\$2.50
1 3/8" DIA - 4 1/4" HIGH	
21,000 mfd. 50 VDC	\$4.00
2 1/2" DIA - 8" HIGH	
22,000 mfd. 40 VDC	\$3.00
2" DIA - 8" HIGH	
31,000 mfd. 15 VDC	\$3.00
1 1/4" DIA - 4" HIGH	
44,000 mfd. 35 VDC	\$2.50
2" DIA - 5" HIGH	
72,000 mfd. 15 VDC	\$3.50
2" DIA - 4 3/8" HIGH	
185,000 mfd. 6 VDC	\$1.50
2 1/2" DIA - 4 1/2" HIGH	

CLAMPS TO BIT CAPACITORS FOR 50

### SLIDE POTS

100K linear tape 2" LONG

1 5/8" TRAVEL 75¢ EACH

500K linear taper 2 7/8" LONG

1 3/4" TRAVEL 75¢ EACH

DUAL 100K audio taper 3 1/2" LONG

2 1/2" TRAVEL \$1.50 EACH

### L.E.D.'S STANDARD JUMBO DIFFUSED

RED 10 FOR \$1.50  
GREEN 10 FOR \$2.00  
YELLOW 10 FOR \$2.00

### KEY ASSEMBLY

#### 5 KEY

\$1.00 EACH

CONTAINS 5 SINGLE-POLE NORMALLY OPEN SWITCHES MEASURES 3 3/4" LONG

#### 6 KEY

\$1.25 EACH

CONTAINS 6 SINGLE-POLE NORMALLY OPEN SWITCHES MEASURES 4 1/4" LONG

### SOLID STATE RELAYS

#### 2 AMP

MOTOROLA AMP 12DD2 RATED CONTROL - 3 & 6VDC LOAD - 120VAC 2 AMPS TTL COMPATIBLE SIZE 1 1/2" x 1 1/2" x 1 1/2" HIGH

\$3.50 EACH 10 FOR \$32.00

### RELAYS

#### MINIATURE 6 VDC RELAY

SUPER SMALL SPOT RELAY. GOLD COBALT CONTACTS

RATED 1 AMP AT 30 VDC HIGHLY SENSITIVE. TTL DIRECT DRIVE POSSIBLE. OPERATES FROM 4.2 TO 8 V. COIL RES 220 OHM

1 3/16" x 13/32" x 7/16" AROMAT + RSD-6V

\$1.50 EACH 10 FOR \$13.50

### CRYSTALS

CASE STYLE MC33/U

2 MHZ COLORBURST 3579-545 KC

\$3.50 EACH \$1.00 EACH

### METAL OXIDE VARISTOR

GE # V82A12 50 VOLTS NOMINAL D.C. VOLTAGE 5/8" DIAMETER

2 FOR \$1.50

### FLASHER LED

5 VOLT OPERATION RED JUMBO SIZE \$1.00 EACH

### BI POLAR LED

2 FOR \$1.70

### SUB MINI LED

078" x 098" RED 10 FOR \$1.00  
200 FOR \$10.00  
GREEN 10 FOR \$1.50

### TRANSISTORS

2N1706	8 for \$1.00
2N2222A	4 for \$1.00
PN2222	8 for \$1.00
2N2904	4 for \$1.00
2N2906	8 for \$1.00
2N2907	4 for \$1.00

### 2K 10 TURN MULTI-TURN POT

SPECTROL #MOD 534-7167

\$5.00 EACH

### 13 VDC RELAY

CONTACT S.P.N.C. 10 AMP @ 120 VAC ENERGIZE COIL TO OPEN CONTACT

COIL 13 VDC 650 OHMS

SPECIAL PRICE \$1.80 EACH

### MINIATURE TOGGLE SWITCHES

ALL ARE RATED 5 AMPS @ 125 VAC

#### S.P.D.T. (on-on)

PC STYLE NOW THREADED BUSHING 75¢ EACH 10 FOR \$7.00

#### S.P.D.T. (on-off-on)

PC LUGS THREADED BUSHING \$1.00 EACH 10 FOR \$9.00

#### S.P.O.T. (on-off-on)

SOLDER LUG TERMINALS \$1.00 EACH 10 FOR \$9.00

#### S.P.D.T. (on-on)

PC LUGS THREADED BUSHING \$1.00 EACH 10 FOR \$9.00

#### D.P.D.T. (on-on)

SOLDER LUG TERMINALS \$1.00 EACH 10 FOR \$9.00

### LED HOLDERS

TWO PIECE HOLDER FOR JUMBO LED

10 FOR 65¢ 200 FOR \$10.00

### POWER SUPPLY W/ PRE-AMP

THIS SUPPLY WAS USED TO POWER AN 8 TRACK CASSETTE UNIT IT WILL SUPPLY APPROX 18 VDC AND INCLUDES A SMALL PRE-AMP TO BOOST SIGNAL LEVEL. RCA PLUGS FOR LINE IN/OUT

\$4.50 EACH

### 4 PDT RELAY

14 pin style 1.3 amp contacts 24 volt a.c. coil 120 volt a.c. coil

Used but fully tested \$1.70 EACH

specify coil voltage

LARGE QUANTITIES AVAILABLE

SOCKET'S FOR RELAY 90¢ each

### 4 PDT RELAY

14 pin style 1.3 amp contacts 24 volt a.c. coil 120 volt a.c. coil

Used but fully tested \$1.70 EACH

specify coil voltage

LARGE QUANTITIES AVAILABLE

SOCKET'S FOR RELAY 90¢ each

### MINIATURE TOGGLE SWITCHES

ALL ARE RATED 5 AMPS @ 125 VAC

#### S.P.D.T. (on-on)

PC STYLE NOW THREADED BUSHING 75¢ EACH 10 FOR \$7.00

#### S.P.D.T. (on-off-on)

PC LUGS THREADED BUSHING \$1.00 EACH 10 FOR \$9.00

#### S.P.O.T. (on-off-on)

SOLDER LUG TERMINALS \$1.00 EACH 10 FOR \$9.00

#### S.P.D.T. (on-on)

PC LUGS THREADED BUSHING \$1.00 EACH 10 FOR \$9.00

#### D.P.D.T. (on-on)

SOLDER LUG TERMINALS \$1.00 EACH 10 FOR \$9.00

### PHOTO-FLASH CAPACITORS

35 MFD 330 VOLT 1 1/2" x 5/8" DIA 45¢ EACH... 10 FOR \$4.00

170 MFD 330 VOLT 1 1/2" x 7/8" 2 FOR \$1.50 10 FOR \$7.00

750 MFD 330 VOLT 2" HIGH x 1 1/4" DIA \$1.25 EACH 10 FOR \$11.00

### POWER SUPPLY W/ PRE-AMP

THIS SUPPLY WAS USED TO POWER AN 8 TRACK CASSETTE UNIT IT WILL SUPPLY APPROX 18 VDC AND INCLUDES A SMALL PRE-AMP TO BOOST SIGNAL LEVEL. RCA PLUGS FOR LINE IN/OUT

\$4.50 EACH

### 4 PDT RELAY

14 pin style 1.3 amp contacts 24 volt a.c. coil 120 volt a.c. coil

Used but fully tested \$1.70 EACH

specify coil voltage

LARGE QUANTITIES AVAILABLE

SOCKET'S FOR RELAY 90¢ each

### 4 PDT RELAY

14 pin style 1.3 amp contacts 24 volt a.c. coil 120 volt a.c. coil

Used but fully tested \$1.70 EACH

specify coil voltage

LARGE QUANTITIES AVAILABLE

SOCKET'S FOR RELAY 90¢ each

### MINIATURE TOGGLE SWITCHES

ALL ARE RATED 5 AMPS @ 125 VAC

#### S.P.D.T. (on-on)

PC STYLE NOW THREADED BUSHING 75¢ EACH 10 FOR \$7.00

#### S.P.D.T. (on-off-on)

PC LUGS THREADED BUSHING \$1.00 EACH 10 FOR \$9.00

#### S.P.O.T. (on-off-on)

SOLDER LUG TERMINALS \$1.00 EACH 10 FOR \$9.00

#### S.P.D.T. (on-on)

PC LUGS THREADED BUSHING \$1.00 EACH 10 FOR \$9.00

#### D.P.D.T. (on-on)

SOLDER LUG TERMINALS \$1.00 EACH 10 FOR \$9.00

### PHOTO-FLASH CAPACITORS

35 MFD 330 VOLT 1 1/2" x 5/8" DIA 45¢ EACH... 10 FOR \$4.00

170 MFD 330 VOLT 1 1/2" x 7/8" 2 FOR \$1.50 10 FOR \$7.00

750 MFD 330 VOLT 2" HIGH x 1 1/4" DIA \$1.25 EACH 10 FOR \$11.00

TOLL FREE ORDERS ONLY  
1-800-826-5432  
(ORDER ONLY)  
(IN CALIFORNIA: 1-800-258-6666)  
ALASKA HAWAII  
OR INFORMATION  
12131 380 8000

# ALL ELECTRONICS CORP.

905 S. Vermont Ave. P.O. BOX 20406 Los Angeles, Calif. 90006

QUANTITIES LIMITED  
MINIMUM ORDER \$10.00  
USA \$2.50 SHIPPING  
FOREIGN ORDERS  
INCLUDE SUFFICIENT  
SHIPPING  
CALIF RES ADD 6.12%  
NO COD'S

**ELECTRONIC KITS  
FROM HAL-TRONIX**

2304 MHz DOWN CONVERTERS TUNES IN ON CHANNELS 2 TO 7 ON YOUR OWN HOME T.V HAS FREQUENCY RANGE FROM 2000 MHZ TO 2500 MHZ EASY TO CONSTRUCT AND COMES COMPLETE WITH ALL PARTS INCLUDING A DIE-CAST ALUM CASE AND COAX FITTINGS. REQUIRE A VARIABLE POWER SUPPLY AND ANTENNA (Antenna can be a dish type or coffee can type depending on the signal strength in your area.)

2304 MOD 1 (Basic Kit) \$19.95  
(Less case & springs)

2304 MOD 2 (Basic Pre-amp) \$29.95  
(Less case & springs)

2304 MOD 3 (Hi-Gain Pre-amp) \$39.95  
(Includes case & springs)

POWER SUPPLY FOR EITHER MODEL ABOVE IS AVAILABLE COMES COMPLETE WITH ALL PARTS. CASE, TRANSFORMER, ANTENNA SWITCH AND CONNECTORS (Kit) \$24.95  
Assembled..... \$34.95

Slotted Microwave Antenna For Above Downconverters..... \$39.95

**PREAMPLIFIERS**

HAL PA-19—1.5 mhz to 150 mhz 19db gain operates on 8 to 16 volts at 10ma. Complete unit \$8.95

HAL PA-14—3 mhz to 1.4 ghz 10 to 12 db gain operates on 8 to 16 volts at 10 ma. Complete unit \$12.95

(The above units are ideal for receivers, counters, etc.)

16 LINE TOUCH TONE DECODE KIT WITH P.C. BOARD AND PARTS..... \$69.95

12 LINE TOUCH TONE DECODE KIT WITH P.C. BOARD AND PARTS..... \$39.95

16 LINE ENCODER KIT, COMPLETE WITH CASE, PAD AND COMPONENTS..... \$39.95

12 LINE ENCODER KIT, COMPLETE WITH CASE, PAD AND COMPONENTS..... \$29.95

Complete Sets of P.C. Boards Available For: Unicorn Robot Project and Heart-A-Matic Project.  
**MANY, MANY OTHER KITS AVAILABLE**

Send 30 second phone or 3-4 S&S for information and list of other kits. Technical literature. 1-4 copies for phone 3-93 249-1142



**Hal-TRONIX**  
P.O. Box 1101  
Southgate, MI 48193

SHIPPING CHARGES OVER \$50 WILL BE SHIPPED POSTPAID SECURE ON OTHER WIRELESS ADDITIONAL CHARGES ARE REQUIRED FOR CABLES LESS THAN 50 FEET PLEASE INCLUDE ADDITIONAL \$1.50 PER FOOT FOR REMOTE AND BULKY CHARGES

**CIRCLE 75 ON FREE INFORMATION CARD**

48K computer US\$380.00 and hundreds Apple-compatible softwares. Details US\$1.00. **RELIANT** PO Box 33610, Sheungwan, Hongkong

E-Z learn security-alarm systems—business terrific. Information 2.00. **SECURITY**, PO Box 1456-E, Grand Rapids, MI 49501.

64K 6502 Z80 dual Processor computer US\$420.00. Hundreds Apple-compatible softwares Details US\$1.00. **RELIANT**, PO Box 33610, Sheungwan, Hongkong.

YOUR own radio station! AM, FM, cable, licensed, unlicensed, transmitter kits! Write: **BROADCAST-ING**, Box 130-F6, Paradise, CA 95969.

VIDEO game repair business. Start your own. Information parts list \$5.00. **BEST ELECTRONICS**, 4440 Sheena, Phoenix, AZ 85032

TECHNICAL writers make big money... writing short sentences! Free details: **TEK PUBS**, Box 2458-E, Oroville, CA 95965.

**EDUCATION & INSTRUCTION**

EARN your university degree through evaluation assessment of existing education, experience, achievements. Call, (614) 863-1791, or write, **ASSESSMENT**, Box 13130R, Columbus, OH 43213.

FCC general radiotelephone license. Home study. Fast, inexpensive! Free details. **COMMAND**, D-91, Box 2223, San Francisco, CA 94126.

E-Z learn security-alarm systems. Employment—business terrific. Information \$2.00. **SECURITY**, PO Box 1456-SW Grand Rapids, MI 49501.



**LEARN HOW TO USE A COMPUTER**

Train at home in spare time! Computer Programming... computer applications... computer games! No previous experience needed! Now you can learn it all! Learn how to use different programs, budgeting, bookkeeping, expenses, investments, interest, taxes, shopping lists, vacation planning, addresses, phone numbers, even foreign languages and graphics. Everything explained in easy-to-understand language with step-by-step directions. **ICS COMPUTER TRAINING**, Dept. 0684 Scranton, PA 18513

**WANTED**

WANTED: Old Western Electric & RCA tubes, speakers, amps, McIntosh, Marantz, tube amps, old Thorens, JBL, Altec, Garrard. (713) 728-4343. **MAURY CORB**, 11122 Atwell, Houston TX 77096.

INVENTIONS, ideas, new products wanted for presentation to industry and exhibition at national technology exposition. Call 1-800-528-6050. Arizona 1-800-352-0458. X831.

HALLICRAFTERS S-40, S-52, S-77. Any condition. Paying \$20.00-\$40.00 each. **FALA ELECTRONICS**, Box 04134-2, Milwaukee, WI 53204.

HEATHKIT IG 102 RF generator. Write: **LPH**, Box 3551, Ontario, CA 91761



**START MAKING MONEY IN COMPUTER REPAIR**

Train at home in spare time. No previous experience needed. Experts show you what to do, how to do it! Even beginners can learn how to repair small computers. Everything explained in easy-to-understand language. You learn by doing with tools and materials included in your course. Easy home-study plan shows how you can get in on ground floor of this fast-growing business.

**MAIL COUPON TODAY!**

There's no obligation and no salesman will call.

**SCHOOL OF COMPUTER REPAIR, Dept. OE 054**  
Scranton, Pennsylvania 18515

Yes! I want to get into computer repair. Rush me free facts and color brochure.

Name: \_\_\_\_\_ Age: \_\_\_\_\_  
Address: \_\_\_\_\_  
City/State/Zip: \_\_\_\_\_

THE BEST PLACE TO BUY, SELL or TRADE NEW and USED EQUIPMENT

**NUTS & VOLTS MAGAZINE**  
BOX 11114 • PLACENTIA, CA 92670  
(714) 832-7731

Join Thousands of Readers Nationwide Every Month

ONE YEAR U.S. SUBSCRIPTIONS  
\$7.00 - 1st Class • \$12.50 - 1st Class

☐ \$25.00 - Lifetime - 3rd Class

**NUTS & VOLTS**  
HARD-TO-FIND COMPONENTS  
SOFTWARES  
SCANNERS • OPTICS  
TEST EQUIPMENT  
RECORDERS  
SATELLITES  
AUDIO VISUAL  
NEW PRODUCTS  
COMPONENTS • SETS  
ANTHONY ELECT.  
PUBLICATIONS  
PLANS • SERVICES

**CB EQUIPMENT**

**PALOMAR** Pride electronics— exclusive repair facility. Service—update—improvements on these and similar equipment. **PALOMAR-PRIDE REPAIR**, 1320 Grand, San Marcos, CA 92069 (619) 744-0720.

**CB MODIFICATIONS**

Increase Channels, range, privacy! We specialize in frequency expanders, speech processors, FM converters, PLL & silder tricks, how-to books, plans, kits. Expert mail-in repairs & conversions. 16-page catalog \$2.

**CBC INTERNATIONAL**, P.O. BOX 31500RE, PHOENIX, AZ 85046 (602) 996-8700

**TI-99/4A SOFTWARE**

TI-99 4A owners. Get your free catalog of new, exciting, low cost software. **DYNA**, Box 690, Hicksville, NY 11801.

**SCANNERS**

SCANNERS— discount prices Bearcat BC-100 \$279.99; Bearcat 210XL \$214.99; Bearcat 300 \$335.99; Regency MX3000 \$186.99; JIL SX100 \$138.99; JIL SX200 \$269.99; Bearcat 20 20 \$275.99; Spectrum radar detector \$214.99; plus \$3.00 shipping. Free discount catalog. Lowest prices anywhere on scanners, radar detectors, marine radios, two-way accessories. **SCANNER WORLD**, 10-RE New Scotland, Albany, NY 12208 (518) 436-9606.

**REEL-TO-REEL TAPES**

**AMPEX** professional series open reel tape, 1800- or 2400-foot on 7-inch reels, used once. Case of 40, \$45.00. 10 1/2 x 3600 feet and cassettes available. MasterCard Visa. **VALTECH ELECTRONICS**, Box 6-RE, Richboro, PA 18954 (215) 322-4866.

**HOME ROBOTS**

**WORLD'S** largest supplier of home robot kits, parts, and publications. Catalog \$5.00. Design handbook \$15.00. Complete kits \$129.95. **ROBOT SHOP**, Dept. 10, PO Box 582, El Toro, CA 92630.

**SINE WAVE PROBLEMS?**

**MANUAL** includes trouble shooting, alignment, antenna hookup, improvements, theory. \$8.00. **SIGNAL**, Box 2512-R, Culver City, CA 90231.

**SPECIAL TEST EQUIPMENT**

WOULD you like an easier way to fix stereo and sound systems? One technician did. He developed the **Fastest**, saving many hours of bench time. You, too, can build the **Fastest** from easily obtainable parts and save yourself thousands of dollars a year in time. Nothing like it. You can test stereo receivers, amplifiers, preamplifiers, record changers, turntables, tape decks, tape players, speakers, and microphones. Build your **Fastest** from easily followed instructions. Set of plans only \$9.95 prepaid. Send today to **DRURY ELECTRONICS**, 9847 St. Charles Road, St. Ann, MO 63074.

**AMAZING DEVICES**

**PHASORS**

PERSONAL DEFENSE AND PROPERTY PROTECTION UTILIZE SPACE AGE TECHNOLOGY. CAUTION THESE DEVICES CAN BE HAZARDOUS AND MAY SOON BE ILLEGAL

POCKET PAIN FIELD GENERATOR — IPG50  
Assembled..... \$59.50  
IPGS..... Plans..... \$7.00 IPGSK..... Kit/Plans..... \$39.50

PHASOR PAIN FIELD CROWD CONTROLLER — PPF10  
Assembled..... \$250.00  
PPF1..... Plans..... \$15.00 PPF1K..... Kit/Plans..... \$175.00

BLASTER — Provides a plasma discharge capable of puncturing a can  
BLS10..... Assembled..... \$79.50  
BLS1..... Plans..... \$10.00 BLS1K..... Kit/Plans..... \$59.50

SHOCKER/PARALYZING DEVICE — Very intimidating and effective  
SHG60..... Assembled..... \$99.50  
SHGS..... Plans..... \$10.00 SHG6K..... Kit/Plans..... \$79.50

**LASERS**

RUBY LASER RAY GUN — Intense visible red beam burns and welds hardest of metals. **MAY BE HAZARDOUS.**  
RUB3All Parts Available for Completing Device \$15.00

CARBON DIOXIDE BURNING, CUTTING LASER — Produces a continuous beam of high energy. **MAY BE HAZARDOUS.**  
LCS. All Parts Available for Completing Device \$15.00

VISIBLE LASERLIGHT GUN — produces intense red beam for lighting, spotting, etc. Hand held complete  
LOUS. Plans \$10.00 (Kit & Assembled Units Available)

PULSED LASER RIFLE — Produces 15-30 watt infra red pulses at 200-2000 per sec.  
LRG3..... All Parts & Diodes Available..... \$10.00

BEGINNERS LOW POWER VISIBLE LASER — Choice of red, yellow, green — provides an excellent source of monochromatic light.  
LHC2..... Plans..... \$5.00 LHC2K..... Kit..... \$29.50

**SECURITY**

SNOOPERPHONE — Allows user to call his premises and listen without phone ever ringing  
SNP20..... Assembled..... \$39.50  
SNP2..... Plans..... \$9.00 SNP2K..... Plans/Kit..... \$59.50

LONG RANGE WIRELESS MIKE — Miniature device clearly transmits well over one mile. Super sensitive, powerful  
MFT1..... Plans..... \$7.00 MFT1K..... Plans/Kit..... \$39.50

WIRELESS TELEPHONE TRANSMITTER — Transmits both sides of phone conversation over one mile, shuts off automatically  
VWPM5..... Plans..... \$8.00 VWPM5K..... Plans/Kit..... \$34.50

TALK & TELL AUTOMATIC TELEPHONE RECORDING DEVICE — Great for monitoring telephone use  
TAT20..... Assembled..... \$24.50  
TAT2..... Plans..... \$5.00 TAT2K..... Plans/Kit..... \$14.50

Our phone is open for orders anytime. Technicians are available 9-11 a.m. Mon-Thurs for those needing assistance or information. Send for free catalog of hundreds more similar devices. Send check, cash, MO Visa, MC, COD to. **INFORMATION UNLIMITED**  
DEPT RR, P.O. Box 716 Amherst N.H. 03031 Te 603 673 4730

**CIRCLE 88 ON FREE INFORMATION CARD**

# MAKE RADIO SHACK YOUR PARTS PLACE™

Low Prices!

First Quality!

No Mail Order Hassles!

## Power Transformers

120VAC Primaries

Type	Volts	Current	Cat. No.	Each
Mini	6.3	300 mA	273-1384	2.50
Mini	12.6	300 mA	273-1385	2.79
Mini	25.2	300 mA	273-1386	2.99
Mini	12.6 CT	450 mA	273-1385	3.59
Mini	25.2 CT	450 mA	273-1386	3.99
Std.	6.3	1.2 A	273-050	3.79
Std.	12.6 CT	1.2 A	273-1505	3.99
Std.	25.2	1.2 A	273-1490	4.39
H-D	12.6 CT	3.0 A	273-1511	5.99
H-D	25.2 CT	2.0 A	273-1512	6.29
H-D	16.0 CT	2.0 A	273-1515	6.99

## Low-Profile DIP Sockets

Quality non-wicking sockets for PC use. Low-resistance contacts.

Type	Cat. No.	Price
8-Pin	276-1995	2/59
14-Pin	276-1999	2/89
16-Pin	276-1998	2/89

Type	Cat. No.	Each
18-Pin	276-1992	49
20-Pin	276-1991	59
24-Pin	276-1989	79
28-Pin	276-1997	89
40-Pin	276-1996	99

## Replacement Transistors



Type	Cat. No.	Each
2N1305	PNP 276-2007	1.19
MPS222A	NPN 276-2009	.79
PN2484	NPN 276-2010	.89
MPS3904	NPN 276-2016	.69
TIP31	NPN 276-2017	.99
TIP3055	NPN 276-2020	1.59
MPS2907	PNP 276-2023	.79
MJE34	PNP 276-2027	1.49
2N3053	NPN 276-2030	.89
MPS3638	PNP 276-2032	.79
TIP120	NPN 276-2068	1.29
2N3055	NPN 276-2041	1.99
MJ2955	PNP 276-2043	2.19
2N4124	NPN 276-2057	.59
2N4401	NPN 276-2058	.59
MPSA06	NPN 276-2059	.59
MPSA13	NPN 276-2060	.59
MPSA42	NPN 276-2061	.69
MU4891	UJT 276-2029	.99
2SD313	NPN 276-2048	1.79
2SC945	NPN 276-2051	.79
2SC1308	NPN 276-2055	7.95
2N3819	N-FET 276-2035	.99
MPF102	N-FET 276-2062	.99

## Tantalum Capacitors

- 20% Tolerance
- Standard IC Pin Spacing



µF	WVDC	Cat. No.	Each
0.1	35	272-1432	.49
0.47	35	272-1433	.49
1.0	35	272-1434	.49
2.2	35	272-1435	.59
10	16	272-1436	.69
22	16	272-1437	.79

## Ceramic Disc Capacitors

Low As **39¢** Pkg. of 2



For RF, bypass and coupling. HI-Q. Moistureproof coating. 50 WVDC minimum.

µF	Cat. No.	Pkg. of 2	µF	Cat. No.	Pkg. of 2
4.7	272-120	.39	.001	272-126	.39
47	272-121	.39	.005	272-130	.39
100	272-123	.39	.01	272-131	.39
220	272-124	.39	.05	272-134	.49
470	272-125	.39	1	272-135	.49

## Dual Switched Filter

Slashed 51%

Reg. 7.99 **388**



20-Pin

MF10. Versatile CMOS building block for active filters—eliminates the need for expensive, close-tolerance parts. High performance, yet very easy to use. Hams—build a CW/SSB audio bandpass filter or a RTTY demodulator with a minimum number of parts! Center frequencies up to 20 kHz. Single or split supply. With data.

276-2329 Sale 3.88

## SPST DIP Switches



For digital or low current applications. Mount in DIP sockets or on PC boards. Style may vary.

8-Position. Fits 16-pin DIP socket, 275-1301 ..... 1.99  
4-Position. Fits 8-pin DIP socket, 275-1304 ..... 1.49

## Computer Connectors

Repair or make your own RS-232 cables and joystick extension cords and save!

Type	Positions	Cat. No.	Each
ID Card Edge	34	276-1564	4.95
ID Card Edge	50	276-1566	4.95
Card Edge Socket	44	276-1551	2.99
Solderless Sub-D Male	25	276-1559	4.99
Solderless Sub-D Female	25	276-1565	4.99
Solder Sub-D Male	9	276-1537	1.99
Solder Sub-D Female	9	276-1538	2.49
Hood for Above	9	276-1539	1.99
Solder Sub-D Male	15	276-1527	2.49
Solder Sub-D Female	15	276-1528	3.49
Hood for Above	15	276-1529	1.99
Solder Sub-D Male	25	276-1547	2.99
Solder Sub-D Female	25	276-1548	3.99
Hood for Above	25	276-1549	1.99

## Communications ICs

Type	Cat. No.	Each
AY-3-1015 UART	276-1794	5.59
AY-5-8116 Baud Rate Gen.	276-1795	8.95
XR 2206 AFSK Generator	276-2336	5.95
XR 2211 Decoder/PLL	276-2337	5.95
5089 Modem Tone Encoder	276-1301	3.99

## ¼-Watt, 5% Resistors

39¢ Pkg. of 5

Ohms	Cat. No.	Ohms	Cat. No.
10	271-1301	10k	271-1335
100	271-1311	15k	271-1337
150	271-1312	22k	271-1339
220	271-1313	27k	271-1340
270	271-1314	33k	271-1341
330	271-1315	47k	271-1342
470	271-1317	68k	271-1345
1k	271-1321	100k	271-1347
1.8k	271-1324	220k	271-1350
2.2k	271-1325	470k	271-1354
3.3k	271-1328	1 meg	271-1356
4.7k	271-1330	10 meg	271-1365
6.8k	271-1333		

## Semiconductor Reference Guide 349

1984 Edition. Cross-reference and substitution section lists 80,000 types and low-cost Radio Shack replacements. Data on Shack transistors, ICs, SCRs, LEDs, diodes, opto devices. Illustrated. 272 pages 276-4007 3.49



## 4000-Series CMOS ICs

With Pin-Out and Specs



Type	Cat. No.	Each
4001	276-2401	.79
4011	276-2411	.79
4013	276-2413	.99
4017	276-2417	1.49
4023	276-2423	.99
4049	276-2449	.99
4066	276-2466	.99

## TTL Digital ICs

In Stock at Low Prices!

Type	Cat. No.	Each
7400	276-1801	.59
7404	276-1802	.79
7408	276-1822	.79
7447	276-1805	1.19
7490	276-1808	.89

## Operational Amplifiers



Type	Cat. No.	Each
741 (Single)	276-007	.79
MC1458 (Dual)	276-038	.99
LM324 (Quad)	276-1711	1.29
TL082 (Dual)	276-1715	1.89
TL084 (Quad)	276-1714	2.99
LM3900 (Quad)	276-1713	1.39
LM339 (Quad)	276-1712	1.49

## Voltage Regulator ICs



Type	Adjustable	Cat. No.	Each
LM723	0 to 40 VDC	276-1740	.89
LM317T	1.2 to 37 VDC	276-1778	2.79
Type	Fixed Output	Cat. No.	Each
7805	+5 VDC	276-1770	1.59
7812	+12 VDC	276-1771	1.59
7815	+15 VDC	276-1772	1.59
7905	-5 VDC	276-1773	1.59
7912	-12 VDC	276-1774	1.59

A DIVISION OF TANDY CORPORATION

# Radio Shack®

OVER 8800 LOCATIONS WORLDWIDE

Prices apply at participating Radio Shack stores and dealers  
CIRCLE 61 ON FREE INFORMATION CARD

# 4164

64K DYNAMIC  
200 NS

# \$595

# TMM2016

2KX8 STATIC  
200 NS

# \$415

## STATIC RAMS

2101	256 x 4 (450ns)	1.95
5101	256 x 4 (450ns) (cmos)	3.95
2102-1	1024 x 1 (450ns)	.80
2102L-4	1024 x 1 (450ns) (LP)	.90
2102L-2	1024 x 1 (250ns) (LP)	1.45
2111	256 x 4 (450ns)	2.40
2112	256 x 4 (450ns)	2.90
2114	1024 x 4 (450nt)	8/9.95
2114-2S	1024 x 4 (250ns)	8/10.95
2114L-4	1024 x 4 (450ns) (LP)	8/12.95
2114L-3	1024 x 4 (300ns) (LP)	8/13.45
2114L-2	1024 x 4 (200nt) (LP)	8/13.95
TC5514	1024 x 4 (850ns) (cmos)	2.40
TC5516	2048 x 8 (250ns) (cmos)	6.95
2147	4096 x 1 (55ns)	4.55
TMS4044-4	4096 x 1 (450ns)	3.40
TMS4044-3	4096 x 1 (300ns)	3.90
TMS4044-2	4096 x 1 (200ns)	4.40
MK4118	1024 x 8 (250ns)	9.95
TMM2016-200	2048 x 8 (200ns)	4.15
TMM2018-150	2048 x 8 (150ns)	4.95
TMM2016-100	2048 x 8 (100ns)	6.15
HM6116-4	2048 x 8 (200ns) (cmos)	4.75
HM6116-3	2048 x 8 (150ns) (cmos)	4.95
HM6116-2	2048 x 8 (120ns) (cmos)	6.95
HM6116LP-4	2048 x 8 (200ns) (cmos) (LP)	5.85
HM6116LP-3	2048 x 8 (150nt) (cmos) (LP)	6.95
HM6116LP-2	2048 x 8 (120ns) (cmos) (LP)	10.85
Z-6132	4096 x 8 (300ns) (Qstat)	34.95
HM6264	8192 x 8 (150ns) (cmos)	46.95

LP Low Power Qstat Quasi-Static

## EPROMS

1702	256 x 8 (1us)	4.50
2708	1024 x 8 (450ns)	3.95
2750	1024 x 8 (450ns) (5v)	5.95
2716	2048 x 8 (450ns) (5v)	3.95
2716-1	2048 x 8 (350nt) (5v)	8.95
TMS2516	2048 x 8 (450ns) (5v)	5.50
TMS2716	2048 x 8 (450ns)	7.95
TMS2532	4096 x 8 (450ns) (5v)	5.95
2732	4096 x 8 (450nt) (5v)	4.95
2732-250	4096 x 8 (250ns) (5v)	8.95
2732-200	4096 x 8 (200ns) (5v)	11.95
2732A-4	4096 x 8 (450ns) (8v) (21vPGM)	6.95
2732A	4096 x 8 (250ns) (5v) (21vPGM)	9.95
2732A-2	4096 x 8 (200ns) (5v) (21vPGM)	13.95
2764	8192 x 8 (450ns) (5v)	6.95
2764-250	8192 x 8 (250ns) (5v)	7.95
2764-200	8192 x 8 (200ns) (5v)	19.95
TMS2564	8192 x 8 (450ns) (5v)	14.95
MCM60764	8192 x 8 (450ns) (5v) (24 pin)	39.95
MCM60764	8192 x 8 (350ns) (5v) (24 pin)(pw dn.)	42.95
27128	14384 x 8 (300ns) (5v)	29.95

8v Single 5 volt Supply 21vPGM Program at 21 Volts

## CRYSTALS

32.766 khz	1.95
1.0 mhz	3.95
1.8432	3.95
2.0	2.95
2.097152	2.95
2.4576	2.95
3.2768	2.95
3.579545	2.95
4.0	2.95
4.50	2.95
5.0688	2.95
5.185	2.95
5.7143	2.95
8.0	2.95
8.144	2.95
8.5536	2.95
8.0	2.95
10.0	2.95
10.738835	2.95
14.31818	2.95
15.0	2.95
18.0	2.95
17.430	2.95
18.0	2.95
18.432	2.95
20.0	2.95
22.1184	2.95
32.0	2.95

## CMOS

4000	29	4520	1.19
4001	25	4531	.95
4002	25	4532	1.95
4006	.89	4538	1.95
4007	29	4539	1.95
4008	.95	4541	2.04
4009	.30	4543	1.19
4010	.45	4553	5.79
4011	25	4555	.95
4012	25	4556	.95
4013	30	4581	1.95
4014	.79	4582	1.95
4015	39	4584	.75
4016	.39	4585	.75
4017	.69	4702	12.95
4018	.79	74C00	.35
4019	.39	74C02	.35
4020	.75	74C04	.35
4021	.70	74C08	.35
4022	.79	74C10	.35
4023	.29	74C14	.59
4024	.65	74C20	.35
4025	.29	74C30	.35
4026	1.05	74C32	.39
4027	.45	74C42	1.29
4028	.88	74C48	1.99
4029	.79	74C73	.65
4030	.38	74C74	.65
4034	1.95	74C76	.80
4035	.85	74C83	1.95
4040	.75	74C85	1.95
4041	.75	74L44	.39
4042	.69	74C89	4.50
4043	.85	74C90	1.19
4044	.79	74C93	1.75
4046	.85	74C95	.99
4047	.95	74C107	.89
4049	.35	74C150	5.75
4050	.35	74C151	2.25
4051	.79	74C154	3.25
4052	.70	74C187	1.75
4060	.89	74C180	1.10
4066	.39	74C181	1.10
4068	.39	74C182	1.19
4069	.39	74C183	1.19
4070	.35	74C184	1.39
4071	.29	74C185	2.00
4072	.29	74C173	.70
4073	.29	74C174	1.19
4075	.29	74C175	1.19
4076	.79	74C192	1.49
4078	.29	74C193	1.49
4081	.29	74C195	1.39
4082	.29	74C200	5.75
4085	.85	74C221	1.75
4086	.95	74C244	2.25
4093	.49	74C373	2.45
4098	2.49	74C374	2.45
4099	1.95	74C901	.39
14409	12.95	74C902	.35
14410	12.95	74C903	.85
14411	11.95	74C905	10.95
14412	12.95	74C906	.95
14419	7.95	74C907	1.00
14433	14.95	74C908	2.00
4502	.95	74C909	2.75
4503	.65	74C910	0.95
4508	1.95	74C911	0.95
4510	.85	74C912	0.95
4511	.85	74C914	1.95
4512	.85	74C915	1.19
4514	1.25	74C918	2.78
4515	1.79	74C920	17.95
4516	1.55	74C921	15.95
4518	.89	74C922	4.49
4519	.39	74C923	4.95
4520	.79	74C925	8.95
4522	1.25	74C926	7.95
4526	1.25	74C928	7.95
4527	1.95	74C929	19.95

## \*\*\* HIGH-TECH \*\*\*

**HM6264** HITACHI 8K x 8 STATIC RAM

- Fast—150 ns
- +5V Supply
- 28 Pin—Compatible w/2764 EPROM
- Low Power CMOS (TTL Compatible)
- 200 mW Operation / 0.1 mW Standby (LP)

HM6264P-15 \$39.95 HM6264LP-15 \$49.95

## \*\*\* SPOTLIGHT \*\*\*

- + Computer managed inventory — virtually no back orders!
- + Very competitive prices!
- + Friendly staff!
- + Fast service — most orders shipped within 24 hours!

## UARTS

AY3-1014	6.95		
AY3-1013	3.95		
AY3-1015	6.95		
PT 1472	8.95		
TR1602	3.95		
2350	9.95		
2651	8.95		
IM6402	7.95		
IM6403	8.95		
INS8250	10.95		
4049	.35	74C150	5.75
4050	.35	74C151	2.25
4051	.79	74C154	3.25
4052	.70	74C187	1.75
4060	.89	74C180	1.10
4066	.39	74C181	1.10
4068	.39	74C182	1.19
4069	.39	74C183	1.19
4070	.35	74C184	1.39
4071	.29	74C185	2.00
4072	.29	74C173	.70
4073	.29	74C174	1.19
4075	.29	74C175	1.19
4076	.79	74C192	1.49
4078	.29	74C193	1.49
4081	.29	74C195	1.39
4082	.29	74C200	5.75
4085	.85	74C221	1.75
4086	.95	74C244	2.25
4093	.49	74C373	2.45
4098	2.49	74C374	2.45
4099	1.95	74C901	.39
14409	12.95	74C902	.35
14410	12.95	74C903	.85
14411	11.95	74C905	10.95
14412	12.95	74C906	.95
14419	7.95	74C907	1.00
14433	14.95	74C908	2.00
4502	.95	74C909	2.75
4503	.65	74C910	0.95
4508	1.95	74C911	0.95
4510	.85	74C912	0.95
4511	.85	74C914	1.95
4512	.85	74C915	1.19
4514	1.25	74C918	2.78
4515	1.79	74C920	17.95
4516	1.55	74C921	15.95
4518	.89	74C922	4.49
4519	.39	74C923	4.95
4520	.79	74C925	8.95
4522	1.25	74C926	7.95
4526	1.25	74C928	7.95
4527	1.95	74C929	19.95

## GENERATORS BIT-RATE

MC14411	11.95
BR1941	11.95
4702	12.95
COM5016	16.95
COM8116	10.95
MM5307	10.95

## FUNCTION

MC4024	3.95
LM565	1.49
XR2206	3.75
8038	3.95

## MISC.

UPD7201	29.95
TMS99532	29.95
ULN2803	2.40
3242	7.95
3341	4.95
MC3470	4.95
MC3480	3.00
11C90	13.95
95H90	7.95
2513-001 UP	9.95
2513-002 LOW	9.95

## CLOCK CIRCUITS

MM5314	4.95
MM5369	3.95
MM5375	4.95
MM58167	12.95
MM58174	11.95
MMS832	3.95

## KEYBOARD CHIPS

AYS-2376	11.95
AYS-3600	11.95
AYS-3600 PRO	11.95

## DYNAMIC RAMS

TMS4027	4096 x 1 (250ns)	1.99
UPD411	4096 x 1 (300ns)	3.00
MM5280	4096 x 1 (300ns)	3.00
MK4108	8192 x 1 (200ns)	1.95
MM5298	8192 x 1 (250ns)	1.85
4116-300	16384 x 1 (300ns)	8/11.75
4116-250	16384 x 1 (250ns)	8/7.95
4116-200	16384 x 1 (200ns)	8/12.95
4116-150	16384 x 1 (150ns)	8/14.95
4116-120	16384 x 1 (120ns)	8/29.95
2118	16384 x 1 (150ns) (5v)	4.95
MK4332	32768 x 1 (200ns)	9.95
4164-200	65536 x 1 (200ns) (5v)	5.95
4164-150	65536 x 1 (150ns) (5v)	6.95
MCM6665	65536 x 1 (200ns) (5v)	8.95
TMS4164-15	65536 x 1 (150ns) (5v)	8.95

5V single 5 volt supply

## 6800

68000	49.95
6800	2.95
6802	7.95
6803	19.95
6805	13.90
6806	14.95
6809E	11.95
6809	2.95
6820	4.35
6821	2.95
6828	14.95
6840	12.95
6843	34.95
6844	25.95
6845	14.95
6847	19.95
6850	3.25
6852	6.75
6860	7.95
6875	8.95
6880	2.25
6883	22.95
68047	24.95
68488	19.95
6800 - 1MHZ	
68800	10.95
68802	22.25
68809E	29.95
68809	29.95
68810	6.95
68821	6.95
48840	19.95
68845	18.95
68850	5.95
68800 - 2MHZ	

## 6500

55
----

**2114** 450 NS **8/\$995**

**2114** 250 NS **8/\$1095**

### 74LS00

74LS00 .24	74LS179 .88
74LS01 .25	74LS174 .55
74LS02 .25	74LS175 .35
74LS03 .25	74LS181 2.15
74LS04 .24	74LS189 8.95
74LS05 .25	74LS190 .89
74LS08 .26	74LS191 .89
74LS09 .29	74LS192 .79
74LS10 .25	74LS193 .79
74LS11 .35	74LS194 .69
74LS12 .35	74LS195 .89
74LS13 .45	74LS196 .79
74LS14 .59	74LS187 .79
74LS15 .35	74LS221 .89
74LS20 .25	74LS240 .95
74LS21 .29	74LS241 .99
74LS22 .25	74LS242 .99
74LS26 .29	74LS243 .99
74LS27 .29	74LS244 1.29
74LS28 .35	74LS245 1.49
74LS30 .25	74LS247 .75
74LS32 .29	74LS248 .99
74LS33 .55	74LS249 .99
74LS37 .35	74LS251 .59
74LS38 .35	74LS253 .59
74LS40 .25	74LS257 .59
74LS42 .49	74LS258 .59
74LS47 .75	74LS259 2.75
74LS48 .75	74LS260 .59
74LS49 .75	74LS266 .55
74LS51 .25	74LS273 1.49
74LS54 .29	74LS275 3.35
74LS55 .29	74LS279 .49
74LS63 1.25	74LS280 1.99
74LS73 .39	74LS283 .89
74LS74 .35	74LS290 .89
74LS75 .39	74LS293 .69
74LS76 .39	74LS295 .99
74LS78 .49	74LS298 .89
74LS83 .89	74LS299 1.75
74LS85 .89	74LS323 3.50
74LS86 .39	74LS324 1.75
74LS90 .55	74LS352 1.29
74LS91 .89	74LS353 1.29
74LS92 .55	74LS363 1.35
74LS93 .55	74LS364 1.95
74LS95 .75	74LS365 .49
74LS96 .89	74LS366 .49
74LS107 .39	74LS367 .45
74LS109 .39	74LS368 .45
74LS112 .39	74LS373 1.39
74LS113 .39	74LS374 1.39
74LS114 .39	74LS375 .95
74LS122 .45	74LS377 1.39
74LS123 .79	74LS378 1.19
74LS124 2.90	74LS379 1.35
74LS125 .49	74LS385 3.90
74LS126 .49	74LS386 .45
74LS132 .59	74LS390 1.19
74LS133 .59	74LS393 1.19
74LS136 .38	74LS395 1.19
74LS137 .99	74LS399 1.49
74LS138 .55	74LS424 2.95
74LS139 .55	74LS447 .95
74LS145 1.20	74LS490 1.95
74LS147 2.48	74LS626 3.99
74LS148 1.35	74LS640 2.99
74LS151 .55	74LS645 2.20
74LS153 .55	74LS648 1.69
74LS154 1.90	74LS649 1.89
74LS155 .69	74LS670 1.49
74LS156 .89	74LS674 14.95
74LS157 .85	74LS682 3.20
74LS158 .59	74LS683 3.20
74LS160 .89	74LS684 3.20
74LS161 .85	74LS685 3.20
74LS162 .89	74LS688 2.40
74LS163 .85	74LS689 3.20
74LS164 .89	81LS95 1.89
74LS165 .95	81LS96 1.49
74LS166 1.95	81LS97 1.49
74LS168 1.75	81LS98 1.49
74LS189 1.75	25LS2921 2.80
74LS170 1.49	25LS2569 4.25

### 74S00

74S00 .32	74S132 1.24	74S225 7.95
74S02 .35	74S133 .45	74S240 2.20
74S03 .35	74S134 .50	74S241 2.20
74S04 .35	74S135 .89	74S244 2.20
74S05 .35	74S138 .85	74S251 .95
74S08 .35	74S139 .85	74S253 .95
74S09 .40	74S140 .85	74S257 .95
74S10 .35	74S151 .95	74S258 .95
74S11 .35	74S153 .95	74S260 .79
74S15 .35	74S157 .95	74S273 2.45
74S20 .35	74S189 .95	74S274 19.95
74S22 .35	74S161 1.95	74S275 19.95
74S30 .35	74S182 1.95	74S280 1.95
74S32 .40	74S183 1.95	74S287 1.99
74S37 .88	74S188 3.95	74S288 1.90
74S38 .85	74S189 3.95	74S289 6.89
74S40 .35	74S174 .95	74S301 6.95
74S51 .35	74S175 .85	74S373 2.45
74S64 .40	74S181 3.95	74S374 2.45
74S65 .40	74S182 2.95	74S381 7.95
74S74 .50	74S188 1.95	74S387 1.95
74S85 1.99	74S189 6.95	74S412 2.98
74S86 .60	74S194 1.49	74S471 4.95
74S112 .50	74S195 1.49	74S472 4.95
74S113 .60	74S196 1.49	74S474 4.95
74S114 .55	74S197 1.49	74S482 15.25
74S124 2.75	74S201 6.95	74S570 2.95
		74S571 2.85

### VOLTAGE REGULATORS

7805T .75	7905T .85
78M05C .35	7908T .85
7808T .75	7912T .85
7812T .75	7915T .85
7815T .75	7924T .85
7824T .75	
7905K 1.49	7908K 1.49
7812K 1.38	7915K 1.49
7815K 1.38	7924K 1.49
7824K 1.39	79L05 .79
78L05 .69	79L12 .79
78L12 .69	79L15 .79
78L15 .69	LM323K 4.95
78H05K 9.95	UA78540 1.95
78M12K 8.95	

C. T. - TO-220 K - TO-3  
L - TO-92

### 7400

7400 .19	74123 .49
7401 .19	74125 .45
7402 .19	74126 .45
7403 .19	74132 .45
7404 .18	74136 .50
7405 .25	74143 4.95
7406 .29	74145 .60
7407 .29	74147 1.75
7408 .24	74148 1.20
7409 .19	74150 1.35
7410 .19	74151 .55
7411 .25	74153 .85
7413 .55	74154 1.25
7414 .49	74155 .75
7416 .25	74157 .55
7417 .25	74159 1.65
7420 .19	74160 .85
7421 .35	74161 .69
7425 .29	74163 .69
7427 .29	74164 .85
7430 .19	74165 .85
7432 .29	74166 1.00
7437 .29	74167 2.95
7438 .29	74170 1.65
7442 .49	74173 .75
7445 .89	74174 .89
7446 .89	74175 .89
7447 .69	74177 .75
7448 .69	74181 2.25
7451 .23	74184 2.00
7473 .34	74185 2.00
7474 .33	74191 1.15
7475 .45	74192 .78
7476 .35	74193 .78
7482 .95	74194 .85
7483 .50	74195 .85
7485 .59	74197 .75
7488 .35	74198 1.35
7489 2.18	74221 1.35
7490 .35	74246 1.35
7492 .50	74247 1.25
7493 .35	74259 2.25
7495 .55	74273 1.95
7497 2.75	74278 1.25
74100 1.75	74279 1.75
74107 .30	74366 .65
74109 .45	74367 .85
74118 1.55	74368 .95
74121 .29	74393 1.35
74122 .45	

### BYPASS CAPS

.01 UF DISC	100/6.00
.01 UF MONOLITHIC	100/12.00
1 UF DISC	100/6.00
1 UF MONOLITHIC	100/15.00

### EPROM ERASERS SPECTRONICS CORPORATION

Timer	Capacity Chip	Intensity (uW/Cm <sup>2</sup> )		
PE-14	9	8,000	83.00	
PE-14T	X	9	8,000	119.00
PE-24T	X	12	9,800	175.00
PL-265T	X	30	9,600	285.00
PR-125T	X	25	17,000	349.00
PR-320T	X	42	17,000	595.00

### DATA ACQUISITION

ADC0800	15.55	DAC0808	2.95
ADC0804	3.49	DAC1020	8.25
ADC0809	4.49	DAC1022	5.95
ADC0817	9.95	MC1408L8	1.95
DAC0800	4.95	MC1408L8	2.95

### INTERFACE

8T28	1.59
8T28	1.89
8T95	.89
8T96	.89
8T97	.89
8T98	.89
DM8131	2.95
DP8304	2.29
DS8833	2.25
DS8835	1.99
DS8836	.99
DS8837	1.65
DS8838	1.30

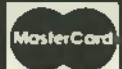
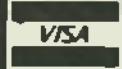

### CONNECTORS

RS232 Male	2.50
RS232 Female	3.25
RS232 Hood	1.25
S-100 ST	3.95

### EXAR

XR 2206	3.75
XR 2207	3.75
XR 2208	3.75
XR 2211	5.25
XR 2240	3.25

### INTERSIL

IJCL7105	9.95
IJCL7107	12.95
IJCL7550	2.95
IJCL8038	3.95
IJCM7207A	5.59
IJCM7208	15.95

### 9000

9316	1.00
9334	2.50
9368	3.95
9401	9.95
9601	.75
9602	1.50
96S02	1.95

### LINEAR

LM101 .34	LM240 (see 7800)	LM555 .99	LM1558H 3.10
LM301M .79	LM348 .99	LM556 1.49	LM1800 2.37
LM307 .85	LM350K 4.95	LM557 .89	LM1812 8.25
LM308 .48	LM350T 4.80	NE570 3.95	LM1830 3.50
LM308H 1.15	LM358 .69	NE571 2.95	LM1871 5.49
LM309H 1.95	LM359 1.79	NE590 2.50	LM1872 5.49
LM309K 1.25	LM378 3.75	NE592 2.75	LM1877 3.25
LM310 1.75	LM379 1.95	LM709 .58	LM1889 1.95
LM311 .94	LM378 2.50	LM710 .75	LM1896 1.75
LM311M .69	LM379 4.50	LM711 .79	ULN2003 2.49
LM312M 1.75	LM380 .89	LM723 .49	LM2877 2.05
LM317K 3.95	LM380H-8 1.10	LM723H 55	LM2878 2.25
LM317T 1.19	LM381 1.60	LM733 .98	LM2900 .85
LM318 1.48	LM382 1.60	LM741 35	LM2901 1.00
LM318M 1.59	LM383 1.95	LM741H.14 35	LM3900 .59
LM319H 1.90	LM384 1.95	LM741N 40	LM3908 1.25
LM319 1.25	LM386 .89	LM747 .69	LM3909 .98
LM320 (see 7800)	LM387 1.40	LM748 .59	LM3911 2.25
LM322 1.65	LM389 1.35	LM1014 1.19	LM3914 3.95
LM323K 4.95	LM390 1.95	LM1303 1.95	LM3915 3.95
LM324 .59	LM392 .89	LM1310 1.49	LM3916 3.95
LM329 .65	LM393 1.29	MC1330 1.89	MC4024 3.95
LM331 3.95	LM394M 4.80	MC1349 1.89	MC4044 4.50
LM334 1.19	LM399M 5.00	MC1350 1.19	RC4136 1.25
LM335 1.40	NE331 2.95	MC1358 1.69	RC4151 3.95
LM336 1.75	NE355 .34	MC1372 .69	LM4250 1.75
LM337K 3.95	NE356 .95	LM1414 1.59	LM4500 3.25
LM337T 1.95	NE358 1.50	LM1458 .59	RC4558 .89
LM338K 8.95	NE581 24.95	LM1488 .89	LM13080 1.29
LM339 .99	NE584 2.95	LM1489 .89	LM13600 1.49
		LM1496 .85	LM13700 1.49

### RCA

CA 3023	2.75	CA 3082	1.65
CA 3039	1.29	CA 3083	1.55
CA 3046	1.25	CA 3086	.80
CA 3059	2.90	CA 3089	2.99
CA 3080	2.90	CA 3096	3.48
CA 3065	1.75	CA 3130	1.30
CA 3080	1.10	CA 3140	1.15
CA 3081	1.63	CA 3146	1.85
CA 3160	1.19		

### TI

TL494	4.20	75365	1.95
TL496	1.65	75450	.59
TL497	3.25	75451	.39
75107	1.49	75452	.39
75110	1.95	75453	.39
75150	1.95	75454	.39
75154	1.95	75491	.79
75188	1.25	75492	.79
75189	1.25	75493	.89
75494	.89		

### BI FET

TL071	.79	TL084	2.19
TL072	1.19	LF347	2.19
TL074	2.18	LF351	.60
TL081	.79	LF353	1.00
TL082	1.19	LF355	1.10
TL083	1.19	LF356	1.10
LF357	1.40		

### DIP SWITCHES

4 POSITION	.85
5 POSITION	.90
6 POSITION	.90
7	

**2716** 16K EPROMS **\$395** EA

**4116** 250 NS **8/\$795**

**BARGAIN HUNTERS CORNER**

**D-SUBMINIATURE CONNECTORS**

**DB25P** 25 PIN MALE **10/19.95**  
**DB25S** 25 PIN FEMALE **10/24.95**  
**HOOD25** GREY HOOD **10/9.95**

**CENTRONICS CONNECTORS**

**CEN36** 36 PIN MALE **5.95**

**IC SOCKETS**

**14 PIN** STLOW PROFILE **100/7.95**  
**16 PIN** STLOW PROFILE **100/7.95**

**SPECIALS END 5/31/84**

**TRANSISTORS**

2N918	50	MPS3706	.18
MPS918	25	2N3772	1.85
2N2182	75	2N3903	.25
2N2218	50	2N3904	.10
2N2218A	50	2N3906	.10
2N2219	50	2N4122	.25
2N2219A	50	2N4123	.25
2N2222	25	2N4249	.25
PN2222	.10	2N4304	.75
MPS2389	.25	2N4401	.25
2N2484	.25	2N4402	.25
2N2905	50	2N4403	.25
2N2907	.25	2N4857	1.00
PN2907	.125	PN4916	.25
2N3055	.79	2N5086	.25
3055T	.89	PN5129	.25
2N3393	.30	PN5139	.25
2N3414	.25	2N5209	.25
2N3563	40	2N6028	.35
2N3565	.40	2N6043	1.75
PN3565	.25	2N6045	1.75
MPS3638	.25	MPS-A05	.25
MPS3640	.25	MPS-A06	.25
PN3643	.25	MPS-A55	.25
PN3644	.25	TIP29	.65
MPS3704	.15	TIP31	.75
		TIP32	.79

**IC SOCKETS**

8 pin ST	1.99	100
14 pin ST	.13	.11
18 pin ST	.15	.12
18 pin ST	.17	.13
22 pin ST	.20	.18
20 pin ST	.29	.27
22 pin ST	.30	.27
24 pin ST	.30	.27
28 pin ST	.40	.32
40 pin ST	.49	.39
64 pin ST	4.25	call
ST = SOLDER TAIL		
8 pin WW	.59	.49
14 pin WW	.69	.52
18 pin WW	.69	.56
18 pin WW	.99	.90
20 pin WW	1.09	.95
22 pin WW	1.39	1.28
24 pin WW	1.49	1.35
28 pin WW	1.89	1.49
40 pin WW	3.89	1.80
WW = WIREWRAP		
16 pin ZIF	5.95	call
24 pin ZIF	7.95	call
28 pin ZIF	8.95	call
ZIF = TEXT TOOL		
(Zero Insertion Force)		

**DISK DRIVES TANDON**

**TM100-1** 5 1/4" (FOR IBM) 55/DD **229.00**  
**TM100-2** 5 1/4" (FOR IBM) 08/DD **259.00**  
**SHUGART**  
**SA 400L** 5 1/4" (40 TRACK) 55/DD **199.95**  
**MPI**  
**MP-52** 5 1/4" (FOR IBM) 06/DD **249.00**

NOTE: Please include sufficient amount for shipping on above items.

**CABINETS FOR 5 1/4" DISK DRIVES**

**CABINET #1 \$29.95**

- DIMENSIONS 8 1/2" x 5 1/4" x 3 1/4"
- COLOR MATCHES APPLE
- FITS STANDARD 5 1/4" DRIVES, INCL. SHUGART
- INCLUDES MOUNTING HARDWARE AND FEET

**CABINET #2 \$79.00**

- COMPLETE WITH POWER SUPPLY, SWITCH, LINE COORD, FUSE & STANDARD POWER CONNECTOR
  - DIMENSIONS 11 1/2" x 5 1/4" x 3 1/4"
  - +5V @ 1 AMP, +12V @ 1.5 AMP
  - FITS STANDARD 5 1/4" DRIVES
  - PLEASE SPECIFY GRAY OR TAN
- NOTE: Please include sufficient amount for shipping on above items.

- ★ Computer managed inventory — virtually no back orders!
- ★ Very competitive prices!
- ★ Friendly staff!
- ★ Fast service

**ORDER TOLL FREE**  
**800-538-5000**  
**800-662-6279**  
 (CALIFORNIA RESIDENTS)

**NEW UN-USED MUFFIN FANS**

4.68" Square **14.95**  
 3.125" Square **14.95**

**HEAT SINKS**

TO-3 style **.95**  
 TO-220 style **.35**

**SWITCHES**

SPOT mini-toggle **1.25**  
 DPDT mini-toggle **1.50**  
 SPST mini-pushbutton **.39**

**OPTO-ISOLATORS**

4N26	1.00	MCA-7	4.25
4N27	1.10	MCA-255	1.75
4N28	.69	IL-1	1.25
4N33	1.75	ILA-30	1.25
4N35	1.25	ILQ-74	2.75
4N37	1.25	H11C5	1.25
MCT-2	1.00	TIL-111	1.00
MCT-6	1.50	TIL-113	1.75

**DIODES**

1N751	5.1 volt zener	.25
1N759	12.0 volt zener	.25
1N4148	(1N914) switching	25/1.00
1N4004	400PIV rectifier	10/1.00
KBP02	200PIV 1.5amp bridge	.45
KBP04	400PIV 1.5amp bridge	.55
VM48	Dip-Bridge	.35

**EDGE-CARD CONNECTORS**

S-100 ST	3.95
S-100 WW	4.95
72 pin ST	6.95
72 pin WW	7.95
50 pin ST	4.95
44 pin ST	2.95
44 pin WW	4.95

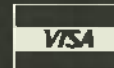

**RESISTORS**

1/4 WATT 5% CARBON FILM ALL STANDARD VALUES FROM 1 OHM TO 10 MEG OHM  
 50 PCS. SAME VALUE **.025**  
 100 PCS. SAME VALUE **.02**  
 1000 PCS. SAME VALUE **.015**

**D-SUBMINIATURE**

DESCRIPTION	SOLDER CUP		RIGHT ANGLE PC SOLDER		IDC RIBBON CABLE		HOODS	
	MALE	FEMALE	MALE	FEMALE	MALE	FEMALE	BLACK	GREY
ORDER BY	DBxxP	DBxxS	DBxxPR	DBxxSR	IDBxxP	IDBxxS	HOOD-B	HOOD
CONTACTS 9	2.06	2.66	1.65	2.18	3.37	3.69	---	1.60
15	2.69	3.63	2.20	3.03	4.70	5.13	---	1.80
25	2.50	3.25	3.00	4.42	6.23	6.84	1.25	1.25
37	4.80	7.11	4.83	6.19	9.22	10.06	---	2.95
50	6.06	9.24	---	---	---	---	---	3.50

For order instructions see "IDC Connectors" below.

**MOUNTING HARDWARE 1.00**

**RIBBON CABLE**

CONTACTS	SINGLE COLOR		COLOR CODED	
	1"	10"	1"	10"
10	.50	4.40	.83	7.30
16	.55	4.80	1.00	8.80
20	.65	5.70	1.25	11.00
25	.75	6.60	1.32	11.60
26	.75	6.60	1.32	11.60
34	.98	8.60	1.65	14.50
40	1.32	11.60	1.92	16.80
50	1.38	12.10	2.50	22.00

**IDC CONNECTORS**

DESCRIPTION	SOLOER HEADER	RIGHT ANGLE SOLDER HEADER	WW HEADER	RIGHT ANGLE WW HEADER	RIBBON HEADER SOCKET	RIBBON HEADER	RIBBON EDGE CARD
ORDER BY	IDHxxS	IDHxxSR	IDHxxW	IDHxxWR	IDSxx	IDMxx	IDExx
CONTACTS 10	82	85	1.86	2.05	1.15	---	2.25
20	1.29	1.35	2.98	3.28	1.86	5.50	2.36
26	1.68	1.76	3.84	4.22	2.43	6.25	2.65
34	2.20	2.31	4.50	4.45	3.15	7.00	3.25
40	2.58	2.72	5.26	4.80	3.73	7.50	3.80
50	3.24	3.39	6.63	7.30	4.65	8.50	4.74

ORDERING INSTRUCTIONS: Insert the number of contacts in the position marked "xx" of the "order by" part number listed. Example: A 10 pin right angle solder style header would be IDH10SR.

© Copyright 1984 JDR Microdevices

CIRCLE 49 ON FREE INFORMATION CARD

# FOR APPLE COMPUTER USERS



## JDR Microdevices

THOUSANDS SOLD!

### JDR 16K RAM CARD FOR APPLE II+

- Expand your 48K Apple to 64K
- Fully compatible with Apple Language System -- Use in place of Apple Language card
- Highest quality card features: gold edge connector, sockets for all IC's.
- 2 YEAR WARRANTY

Kit with Instructions ..... \$40.95 **\$44.95**  
Bare PC Card ..... \$14.95

### GET SLIM IN 1984! JDR HALF-HEIGHT DISK DRIVE

- 35 Track if used with Apple Controller
- 40 Track Controller and DOS Available (Call for Price)

**\$209.95**



### MA SYSTEMS FD-35 DISK DRIVE

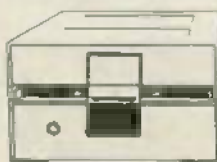

**\$199.95**

- Shugart Mechanism -- Made In U.S.A.
- Direct Replacement for Apple Disk II
- Compatible with Apple Controller or other Apple compatible Controllers
- Specially designed electronics with low power consumption
- DOS 3.3 and 3.2 compatible
- One Year Warranty

### CONTROLLER CARD

\$69.95

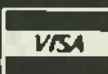

### APPLE COMPATIBLE POWER SUPPLY

- Use To Power Apple Type Systems
- +5V @ 4A +12V @ 2.5A
- -5V @ .5A -12V @ 5A
- Instructions and Apple Power Connector Included.

**\$79.95**

### BMC BMX-80 PRINTER

- 80 CPS Dot Matrix Printer
- Prints Bi-Directional in 40, 80, 71 or 142 Columns in Normal, Double Width or Compressed Text.
- Print Superscript As Well As Superb Graphics in Character or Bit Image



**\$279**

### micromax

#### VIEWMAX-80 NOW ONLY \$159.95

- 80 Column Card for Apple II+
- Video Soft Switch
- Inverse Video
- 2 Year Warranty

#### VIEWMAX-80e NEW \$129.95

- 80 Column Card for Apple IIe
- 64K RAM Expandable to 128K
- 64K RAM Upgrade \$47.60

#### GRAPHMAX \$129.95

- Hi Resolution Graphics
- Printer Card
- Centronics Parallel Interface
- Zoom, Rotation and More

Graphmax with Color Option ..... **149.95**

### NASHUA DISKETTES 5 1/4" WITH HUB RING

MD1 SOFT SECTOR, SS/SD	19.95
MD1D SOFT SECTOR, SS/DD	26.25
MD2D SOFT SECTOR, OS/DD	30.75
MD2F SOFT SECTOR, DS/QUAD DENSITY	45.00
MD110 10 SECTOR HARD, SS/SD	19.95
MD210D 10 SECTOR HARD, OS/DD	30.75
8" WITHOUT HUB RING	
FD1 SOFT SECTOR, SS/SD	24.75
FD1D SOFT SECTOR, SS/DD	30.00
FD2D SOFT SECTOR, DS/DD	36.75

### VERBATIM DATALIFE DISKETTES

SS/DD SOFT SECTOR  
**\$29.95**  
SS/DD 10 HARD SECTOR  
**\$29.95**

### 5 1/4" DISKETTE FILE

- ATTRACTIVE FUNCTIONAL DISK STORAGE SYSTEM
  - 75 DISK STORAGE CAPACITY
  - MOLDED FROM DURABLE SMOKED PLASTIC WITH FRONT CARRYING HANDLE
- \$16.99**

### OTHER ACCESSORIES FOR APPLE II

- THUNDERCLOCK \$129.95
- Real-Time Clock Calendar
- Software Included
- Mountain Software Compatible
- BSR Control Options Available
- KRAFT JOYSTICK \$39.95

### MONITORS

#### BMC MONITOR STAND MODEL PA-900

Your Display Will Tilt & Swivel **\$29.95**

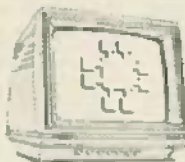

#### MONOCHROME

BMC BM 12AUW GREEN 12"	\$89.95
BMC BM 12EUY 18 MHZ AMBER	\$139.95
BMC BM 12EUN 18 MHZ HIGH RES GREEN	\$115.00
NEC JB1201M - 20 MHZ GREEN	\$169.00
ZENITH ZVM-121 - 15 MHZ GREEN	\$99.00

#### COLOR

BMC BM-AU9191U COMPOSITE 13" ..... **\$279.00**

NO C.O.D. ORDER PLEASE

### VISIT OUR RETAIL STORE

HOURS: M-W-F, 9-5 T-Th., 9-9 Sat. 10-3

PLEASE USE YOUR CUSTOMER NUMBER WHEN ORDERING

TERMS: Minimum order \$10. For shipping and handling include \$2.50 for UPS Ground and \$3.50 for UPS Air. Orders over 1 lb. and foreign orders may require additional shipping charges -- Please contact our sales department for the amount. CA residents must include 6% sales tax. Bay Area and LA residents include 3 1/2%. Prices subject to change without notice. We are not responsible for typographical errors. We reserve the right to limit quantities and to substitute manufacturers. All merchandise subject to prior sale.

© Copyright 1984 JDR Microdevices



## JDR Microdevices

1224 S. BasCom Avenue, San Jose, CA 95128  
800-538-5000 • 800-662-6279 (CA)  
(408) 995-5430 • Telex 171-110

Apple is a trademark of Apple Computer Corporation

CIRCLE 49 ON FREE INFORMATION CARD

JUNE 1984

109

**MICRO-PROFESSOR**  
 THE Z-80 BASED  
**MICROCOMPUTER**  
 A superb learning tool for students, Instructors, hobbyists.

Nothing else needed. Just plug in and start learning! Complete experimenters manual, easy instructions 18 experiments. Fully expandable for Z80-CTC, Z80-PIO, EPROM, Breadboarding and prototyping. Invest with confidence. Now only \$129.95, two for only \$239.95. 2KB BASIC interpreter now available, only \$19.00. Full money back guarantee!

**Plus-FREE GIFT**  
 Check this box for FREE Z-80 Microprocessor Programming and Interfacing textbook when you order within 7 days. \$12.95 value.

**ETRONIX**  
 Dept. RE004  
 14800 N.E. 40th  
 Redmond, WA 98052

For immediate action call TOLL FREE  
**1-800-426-1044**

NAME \_\_\_\_\_  
 ADDRESS \_\_\_\_\_  
 CITY \_\_\_\_\_ ST \_\_\_\_\_ ZIP \_\_\_\_\_  
 VISA  MASTERCARD  EXP \_\_\_\_\_  
 ACCT NO \_\_\_\_\_

CIRCLE 39 ON FREE INFORMATION CARD

**Call or Write Us for Your Crystals**  
 - just one or hundreds -  
 for Communications  
 for Industrial Use  
 for Your Technology

You will get

- Cost Savings
- Prompt Service
- High Stability

**JAN CRYSTALS**  
 Serving Crystal Users Since 1958

**JAN CRYSTALS**  
 P.O. Box 16017, Fort Myers,  
 Florida 33906 All Phones  
 (813) 936-2397

CIRCLE 30 ON FREE INFORMATION CARD

# SUMMERTIME, AND THE LIVIN' AIN'T EASY.

Especially for one person like yourself who's trying to do the work of three. So why not hire one or two of the thousands of young disadvantaged people looking for work this summer. Hiring them can also help you get as much as an 85% tax credit on the first \$3,000 in wages you pay to one of these summer employees. For further information, write the National Alliance of Business at P.O. Box 7207, Washington, D.C. 20044. And support your local summer-jobs-for-youth programs. Make living in the summertime easy.

**LET'S GET ALL OF AMERICA WORKING AGAIN.**

**Ad Council** A PUBLIC SERVICE OF THIS PUBLICATION & THE ADVERTISING COUNCIL

**POPULAR CHIPS**

NE564	2.75
LM 301	.49
LM 565	.95
MC 1330	1.25
MC 1350	1.15
MC 1459	.49
MC 1496	1.00
LM 1889	1.75
7805	.80
7808	.50
7812	.80
7815	.80
7818	.80
MV 2109	.69
2N2222	.30
MC 1349	1.79

**SPECIALS ON PRIME IC's**

NE564	\$2.75 ea. 10/\$25, 100/\$195
LM1889	\$1.75 ea. 10/19.50, 100/\$150
MC1496	\$1.00 ea. 10/\$9, 100/\$75

**MISC. SPECIALS**

2200 mfd 40V Axial Cap 79¢
470 mfd 16V Radial Cap 10/1.00
10 mfd 35V Radial Cap 12/1.00
7808 6 volt Regulator 49¢
28 Pin IC Socket 10/1.00

## NETWORK SALES, INC.

**DELUXE PARTS ASSORTMENTS**

**a1 Resistors & Trimpots**  
 60 1/2 watt 5% resistors & 5 PT-15 10K trimpots, 1 each - 51, 75, 100, 470, 1.5K, 3.0K, 51K, 470K, 13-1.2K, 2-220, 3-100K, 6-330, 8-12K, 7-910, 9-3.3K, & 14-4, 7K.  
**\$4.50 ea. 10/40.00**

**a2 Capacitor "A"**  
 Monohydrus - 1-560pf, 7- 1 mfd & 1-22 mfd Silver Micas - 2-10pf, & 1 each of 42pf, 110pf, 560pf, 1200pf, 3000 or 3300pf.  
**\$4.95 ea. 10/45.00**

**a3 Capacitor "B"**  
 Mylar 4- 001, 2- 047, 29- 01, Radial Mylar 3-10 mfd 16V, 1-1000 mfd 50V, 1-2200 mfd 35V, Disc Caps 1 each of 5, 12, 27, 36, 110, 330pf, 2-120pf, 3-39pf, 3-220pf, and 1 Varl Cap 5-35pf.  
**\$7.50 ea. 10/70.00**

**a4 Coils & Chokes**  
 1 each of 15, 33, and 100 (uh) micro henries Chokes - 1-variable RF coil 100µ as #49A537MPC)  
**\$3.25 ea. 10/30.00**

**a5 IC's Sockets, & Semis**  
 1 each of NE564, LM565, MC1330, MC1350, MC1496, LM1689, 7812, 7815, 2N2222A, MV2109, neat sink 2-MC1458, 4-1N4002, 4-8 pin, 2-14 pin, 1-18, & 1-18 pin socket.  
**\$13.50 ea. 10/125.00**

**a6 Misc Hardware**  
 LED & holder, fuse & holder, line cord, grommet SPST switch, DPDT switch, 2-F81 conn. & lugs, knob, 4-species 8-screws & nuts, 2-RC-174, matching Transformer w/out.  
**\$8.95 ea. 10/57.50**

**POWER TRANSFORMERS**

Prn 115V AC
Sec. 24 volts @ 350 A
Dim. 2 1/2 x 1 1/2 x 2 H
<b>\$1.95 ea. 10/\$15.00 100/\$125.00</b>

**ASTEC VIDEO MODULATOR**  
 Video & Audio Inputs  
 Chan 3 or 4 Output  
 Model UM1285-8  
 W/specs. \$8.25



**UHF TUNER**  
 Mechanical Detent Tuning  
 Chan 14-83, 12 VDC, 300 Ohm input  
 45 MHZ output **\$2.95 ea. 4/10.00**

**SILVER MICA CAPS**  
 10 PF, 43 PF, 110 PF, 560 PF,  
 1200 PF **35¢ ea. 10/3.00, 100/25.00**  
 3000 PF **80¢ ea. 10/7.00, 100/69.00**

**VOLUME DISCOUNT**

5 10.00 - 499.00 NET	1000.00 - 4999.00 -5%
500.00 - 999.00	-2% 5000.00 & up -10%

**T<sup>9</sup> CONNECTORS**

F-59 20¢ ea. 10/1.50, 100/10.00
F-61 35¢ ea. 4/1.00, 100/22.00
F-81 35¢ ea. 3/1.00, 100/29.00

**10 TURN POT**  
 10K ohm Panel Mt.  
**\$4.95**



**MATCHING TRANSFORMERS**  
 UHF/VHF  
 75/300 Outdoor/Indoor  
 300/75 Push-on/Indoor  
 Your choice **89¢ ea. 10/7.00, 100/55.00**



**SOLID CARBIDE PC DRILL**  
 #55 1/8 in. SHANK FOR  
 USE WITH DREMEL TOOL  
 Special 79¢ ea. 10/5.00



**RF COIL**  
 Same as #49A537MPC  
**\$1.25 ea. 10/10.00**

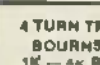

**UHF AMP KIT**  
 25db Gain stripline PC board  
 using (2) BFR-90's  
 Complete (no enclosure) **\$10.95**  
 Power supply for above **\$3.49**

**THUMBWHEEL TRIMMER POTS**  
 VERTICAL MOUNT  
 OHMS 500 1K, 2K, 5K, 10K, 25K  
 50K, 100K, 200K, 500K, 1 MEG.  
 4/100 100/\$20.00

**FUNCTION GENERATOR KIT**  
 Uses XR-2208 IC 1 Hz to 100 kHz  
 Complete with PC Board & all parts except  
 power supply and enclosure **\$19.95**

**BYPASS CAP SPECIAL**  
 1 MFD - 50VDC **100/\$5.00 1000/37.50**

**VERNIER PANEL POTS**  
 Multi-Turn, 1/2" shaft  
 500 ohm, 1K, or 10K **\$4.49**



**BRIDGE RECTIFIERS**

35A 200 PIV \$2.00
25A 100 PIV \$1.50
3A 400 PIV \$1.00



**MTLAR CAPS**  
 50 volts

.001 mfd	10¢ ea.
.01 mfd	100/7.00
.047 mfd	1000/48.00



**DIGITAL VOLTMETER KIT**  
 3 DIGIT 0 to 99.9 VDC  
 Uses CA3161E & CA3162E  
 Complete with PC Board and parts, except  
 power supply and enclosure. **\$24.95**

**4 TURN TRIM POTS**  
 BOURNS #33398  
 1K - 5K R/A - 10K  
**99¢ ea.**

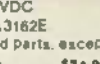

**RF COIL**  
 Same as #49A537MPC  
**\$1.25 ea. 10/10.00**

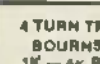

**NETWORK SALES, INC.**  
 2343 W. BELMONT AVE.  
 CHICAGO, IL. 60618  
 312/248-3202

**TERMS** Visa, M.C., Check, Money Order or COD (add. \$3.00). Min. Order \$10.00. Add \$2.50 S&H for USA. Ill. add 8% Tax. **MAIL ORDER ONLY.** Prices subject to change without notice.

Phone Orders Welcome. QUANTITIES MAY BE LIMITED

©COPYRIGHT 1984 NETWORK SALES, INC.

CIRCLE 90 ON FREE INFORMATION CARD

www.americanradiohistory.com





# FORMULA INTERNATIONAL INC.

12603 Crenshaw Blvd., Dept. B, Hawthorne, CA 90250

For Information (213) 973-1921 • Orders Only (outside Calif.) (800) 672-8758



## MARK IV — 15 STEP LED POWER LEVEL INDICATOR KIT

This new stereo indicator kit consists of 30 4-color LEDs (15 per channel) to indicate the sound level output of your amplifier from -36dB to +30dB. Comes with a well designed silk screen printed plastic panel and has a selector switch to allow floating or gradual output indicating. Power supply @ 6-12VDC with THG on board input sensitivity controls. This unit can work with any amplifier from 1W to 200W. Kit includes 70 pcs driver transistors, 38 pcs matched 4-color LEDs, all electronic components, PC Board and front panel. **MARK IV KIT \$31.80**



No FCC License Required  
**OUR PRICE \$46.50**  
Additional Microphone (Transistor Available @ \$24.00 ea., 10URA 97MS-41



## CRYSTAL CONTROLLED WIRELESS MICROPHONE SYSTEM

Transmitter, P.E.T. mic for nat. 30KHz-18KHz response. Xtal controlled 49MHz AM Band for drift-free performance. 100mW output (range approx. 1/4 mile) for reliable long range transmission. Powered by a 9V radio battery. Receiver, Xtal controlled locks on 49MHz transmitter signal. On panel VU meter, monitors the signal strength from the microphone. Standard phone jack outlet connection to a P.A. or other phone input. 9V battery included. This professional set is ideal for on stage, in field, church, in house or outdoor use.

49MHz transmitter signal. On panel VU meter, monitors the signal strength from the microphone. Standard phone jack outlet connection to a P.A. or other phone input. 9V battery included. This professional set is ideal for on stage, in field, church, in house or outdoor use.



## pinecom™ DP-64



- Dual Processor (6502 and Z80A)
- Detached Keyboard
- 64K RAM Expandable to 192K
- 25 Function Key Keyboard
- Auto Repeat Keys w/Upper/lower Case
- 2 Slim Disk Drives (optional)
- 100% Apple II Compatible
- 40/80 Column Display (optional)
- Runs Both Apple Soft and CP/M Software

Model DP-64 **\$650<sup>00</sup>**  
Fully Assembled...

TA-1000  
KIT  
\$51.95  
Power  
Transformer  
\$24.00 ea.



## 100W CLASS A POWER AMP KIT

Dynamic Bias Class "A" circuit design makes this unit unique in its class. Crystal clear, 100 watts power output will satisfy the most picky fans. A perfect combination with the TA-1020 low THD stereo pre-amp.

Specifications - Output power 100W RMS into 8Ω, 125W RMS into 4Ω - Frequency response 10Hz-100KHz - THD less than 0.01% - S/N ratio better than 80dB - Input sensitivity 1V max. - Power supply = 40V @ 5A.

## LOW THD DC STEREO PRE-AMP KIT TA-1020

Incorporates brand new DC design that gives a frequency response from 0-100KHz ±0.5dB. Added features like tone defeat and loudness control let you tailor your own frequency response to eliminate 60Hz hum/bustlers!

Specifications - THD TH less than 0.005% - Frequency response DC to 100KHz ±0.5dB - RIAA deviation ±0.2dB - S/N ratio better than 70dB - Sensitivity: Phone 2mV 47KΩ, Aux (00mV 100KΩ) - Output level 1.5V - Max output 15V - Tone controls: Bass ±10dB @ 50Hz, Treble ±10dB @ 15KHz - Power supply ±24VDC @ 0.5A. Kit comes with regulated power supply. As you need is a 48VCT transformer @ 0.5A.

Only \$44.50  
Transformer  
\$4.50 ea.



## pinecom™

### Pioneer of Low Cost Apple\* Compatible Computer



### Now with New Improved Keyboard and 64K RAM

No Copyright Problems!

Compare These Features with Our Competitors:

- Powerful Utility Program (100% Apple Compatible)
- 68-Key Upper & Lower Case Keyboard with Numeric Keypad
- 25 Pre-programmed Function Keys
- 2 Speed Auto Repeat Function
- 64K User Memory—expandable to 192K
- 5A Switching Power Supply (110/220VAC)
- All ICs Are Socketed for Easy Service
- Nation-wide Dealer Network for Convenient Technical Support

And best of all, the price  
Assembled and Tested is just.....

# \$499<sup>00</sup>



## TA-322 30 WATTS TOTAL 15W + 15W STEREO AMP KIT

This is a solid state all transistor circuitry with on board stereo pre-amp for dual microphone or phone input. Power output employs a heavy duty Power Hybrid IC. Few built on board controls for volume, balance, treble and bass. Power supply requires 48VCT 2.5A transformer. THD of less than 0.1% between 100Hz-10KHz at full power (15 Watts + 15 Watts loaded into 8Ω).

## MAGNETIC HEAD EQUALIZER

Standard RIAA curve for all kinds of magnetic heads. 3 stages crossover circuit for best results. Output voltage guaranteed to be stable without any oscillation. Power Supply 24 V.D.C.



MODEL: MA-142  
Part #370-370.....\$6.95 ea.

## PROFESSIONAL REGULATED VARIABLE DC POWER SUPPLY KIT

All solid state circuitry with high efficiency power transistor 2SD368 and IC voltage regulator MC1728. Output voltage can be adjusted from 0-30V at 1A current limited or 0-15V at 2A current limited. Internal resistance is less than 0.005Ω, ripple and noise less than 1mV, dual on panel meters for voltage and current reading, also with on board LED and audible over load indicator. Kit comes with pre-drilled PC Board, instructions, all necessary electronic components, transformer and a professional looking metal cabinet. The best project for school and the most useful instrument for repairman. Build one today!



Model TR88A  
0-15VDC @ 2A  
Model TR88B  
0-30VDC @ 1A  
\$59.50 per Kit

## 60W + 60W O.T.L. AMP

Stereo pre-amp - tone control - power amp. All in one unit, fully assembled! Competed in 800 7-14N-3215. Can be used like most cabinets. Power transistors using 2SC1087 & 2 to give a max output of 60W + 60W (8Ω).  
- Frequency response 20Hz-85KHz (1dB) - Total harmonic distortion 0.02% (1KHz) - Signal Noise Ratio 88 dB (open loop) - Temp control, 100 Hz ± 16 dB 10 Hz ± 14dB - Dynamic range: 60 dB - Power Supply 48V-70V 5 Amp - Filter Capacitor 4700µF 75V or better

MODEL:  
SA-4520



Part #370-0350.....\$39.95 ea.  
1 Transformer Part #370-0230...\$22.50 ea.  
2 Filter Capacitor 4700µF 70V \$6.50 ea.

## STEREO MIC. AND ECHO MIXER FOR STEREO AMPLIFIER SYSTEM

The circuitry employs all integrated circuits. SBD type echo circuit, echo time can be adjusted (max. 30 Msec.) Also with a microphone preamp on the board. Fully assembled.



MODEL: MX205  
Part #370-0360.....\$29.95 ea.

## LOW T.I.M. TRANSISTORS 100W + 100W

Employs Hitachi low noise J.C. for pre-amp. Max output 16 V.P.P. (non distortion) with hi-low filter, and tone defeat circuit - Rear power amp with short circuit protection - Great heat sink for maximum results - Tone controls ±14dB - All components (except pots for volume and tone controls) are pre-assembled, the quality is guaranteed. - Power supply DC @ 35V-50V



MODEL: SA802C  
Part #370-0340.....\$45.00  
POWER TRANSFORMER  
(68V-80V CT 6 AMP)  
Part #670-0220.....\$24.50

SEND ONE DOLLAR  
FOR OUR DETAIL CATALOG

Shipping & Handling Charges	Under \$50.00	Over \$50.00
Purchase	10%	5%
	15%	10%
	25%	20%

Minimum Order \$10.00/Calif. Residents add 6.8% Sales Tax. Phone Orders Accepted on VISA or MC ONLY. NO C.O.D.'s. Prices subject to change without notice.



STORE HOURS  
MON-FRI-10-7  
SAT-10-6

\*Apple and Apple II are the trademark of APPLE COMPUTERS, INC.

CIRCLE 76 ON FREE INFORMATION CARD

# DIGI-KEY CORPORATION

10000 Ash St., Col 216-0110-0076

**QUALITY** - Name brand products from nationally recognized manufacturers.  
**SERVICE** - Computerized order processing and inventory control.  
**SAVINGS** - Volume Discounts • Q&M Quality Pricing • Toll Free 800 Number

### INTEGRATED CIRCUITS

Part No.	Manufacturer	Price
7400	Philips	1.50
7401	Philips	1.50
7402	Philips	1.50
7403	Philips	1.50
7404	Philips	1.50
7405	Philips	1.50
7406	Philips	1.50
7407	Philips	1.50
7408	Philips	1.50
7409	Philips	1.50
7410	Philips	1.50
7411	Philips	1.50
7412	Philips	1.50
7413	Philips	1.50
7414	Philips	1.50
7415	Philips	1.50
7416	Philips	1.50
7417	Philips	1.50
7418	Philips	1.50
7419	Philips	1.50
7420	Philips	1.50
7421	Philips	1.50
7422	Philips	1.50
7423	Philips	1.50
7424	Philips	1.50
7425	Philips	1.50
7426	Philips	1.50
7427	Philips	1.50
7428	Philips	1.50
7429	Philips	1.50
7430	Philips	1.50
7431	Philips	1.50
7432	Philips	1.50
7433	Philips	1.50
7434	Philips	1.50
7435	Philips	1.50
7436	Philips	1.50
7437	Philips	1.50
7438	Philips	1.50
7439	Philips	1.50
7440	Philips	1.50
7441	Philips	1.50
7442	Philips	1.50
7443	Philips	1.50
7444	Philips	1.50
7445	Philips	1.50
7446	Philips	1.50
7447	Philips	1.50
7448	Philips	1.50
7449	Philips	1.50
7450	Philips	1.50
7451	Philips	1.50
7452	Philips	1.50
7453	Philips	1.50
7454	Philips	1.50
7455	Philips	1.50
7456	Philips	1.50
7457	Philips	1.50
7458	Philips	1.50
7459	Philips	1.50
7460	Philips	1.50
7461	Philips	1.50
7462	Philips	1.50
7463	Philips	1.50
7464	Philips	1.50
7465	Philips	1.50
7466	Philips	1.50
7467	Philips	1.50
7468	Philips	1.50
7469	Philips	1.50
7470	Philips	1.50
7471	Philips	1.50
7472	Philips	1.50
7473	Philips	1.50
7474	Philips	1.50
7475	Philips	1.50
7476	Philips	1.50
7477	Philips	1.50
7478	Philips	1.50
7479	Philips	1.50
7480	Philips	1.50
7481	Philips	1.50
7482	Philips	1.50
7483	Philips	1.50
7484	Philips	1.50
7485	Philips	1.50
7486	Philips	1.50
7487	Philips	1.50
7488	Philips	1.50
7489	Philips	1.50
7490	Philips	1.50
7491	Philips	1.50
7492	Philips	1.50
7493	Philips	1.50
7494	Philips	1.50
7495	Philips	1.50
7496	Philips	1.50
7497	Philips	1.50
7498	Philips	1.50
7499	Philips	1.50
7500	Philips	1.50

### TEXAS INSTRUMENTS I.C. SOCKETS

NEW KIT 150 I.C. SOCKETS \$35.00

Part No.	Price
TS-100	1.50
TS-101	1.50
TS-102	1.50
TS-103	1.50
TS-104	1.50
TS-105	1.50
TS-106	1.50
TS-107	1.50
TS-108	1.50
TS-109	1.50
TS-110	1.50
TS-111	1.50
TS-112	1.50
TS-113	1.50
TS-114	1.50
TS-115	1.50
TS-116	1.50
TS-117	1.50
TS-118	1.50
TS-119	1.50
TS-120	1.50
TS-121	1.50
TS-122	1.50
TS-123	1.50
TS-124	1.50
TS-125	1.50
TS-126	1.50
TS-127	1.50
TS-128	1.50
TS-129	1.50
TS-130	1.50
TS-131	1.50
TS-132	1.50
TS-133	1.50
TS-134	1.50
TS-135	1.50
TS-136	1.50
TS-137	1.50
TS-138	1.50
TS-139	1.50
TS-140	1.50
TS-141	1.50
TS-142	1.50
TS-143	1.50
TS-144	1.50
TS-145	1.50
TS-146	1.50
TS-147	1.50
TS-148	1.50
TS-149	1.50
TS-150	1.50

### NEW KIT 150 I.C. SOCKETS \$35.00

NEW KIT 150 I.C. SOCKETS \$35.00

### NEW KIT 150 I.C. SOCKETS \$35.00

NEW KIT 150 I.C. SOCKETS \$35.00

### NEW KIT 150 I.C. SOCKETS \$35.00

NEW KIT 150 I.C. SOCKETS \$35.00

### WIRE WRAP DIP SOCKETS

NEW KIT 150 WIRE WRAP DIP SOCKETS \$35.00

Part No.	Price
WW-100	1.50
WW-101	1.50
WW-102	1.50
WW-103	1.50
WW-104	1.50
WW-105	1.50
WW-106	1.50
WW-107	1.50
WW-108	1.50
WW-109	1.50
WW-110	1.50
WW-111	1.50
WW-112	1.50
WW-113	1.50
WW-114	1.50
WW-115	1.50
WW-116	1.50
WW-117	1.50
WW-118	1.50
WW-119	1.50
WW-120	1.50
WW-121	1.50
WW-122	1.50
WW-123	1.50
WW-124	1.50
WW-125	1.50
WW-126	1.50
WW-127	1.50
WW-128	1.50
WW-129	1.50
WW-130	1.50
WW-131	1.50
WW-132	1.50
WW-133	1.50
WW-134	1.50
WW-135	1.50
WW-136	1.50
WW-137	1.50
WW-138	1.50
WW-139	1.50
WW-140	1.50
WW-141	1.50
WW-142	1.50
WW-143	1.50
WW-144	1.50
WW-145	1.50
WW-146	1.50
WW-147	1.50
WW-148	1.50
WW-149	1.50
WW-150	1.50

### TEXAS INSTRUMENTS GOLD LOGBOARD CONNECTORS

NEW KIT 150 GOLD LOGBOARD CONNECTORS \$35.00

Part No.	Price
TL-100	1.50
TL-101	1.50
TL-102	1.50
TL-103	1.50
TL-104	1.50
TL-105	1.50
TL-106	1.50
TL-107	1.50
TL-108	1.50
TL-109	1.50
TL-110	1.50
TL-111	1.50
TL-112	1.50
TL-113	1.50
TL-114	1.50
TL-115	1.50
TL-116	1.50
TL-117	1.50
TL-118	1.50
TL-119	1.50
TL-120	1.50
TL-121	1.50
TL-122	1.50
TL-123	1.50
TL-124	1.50
TL-125	1.50
TL-126	1.50
TL-127	1.50
TL-128	1.50
TL-129	1.50
TL-130	1.50
TL-131	1.50
TL-132	1.50
TL-133	1.50
TL-134	1.50
TL-135	1.50
TL-136	1.50
TL-137	1.50
TL-138	1.50
TL-139	1.50
TL-140	1.50
TL-141	1.50
TL-142	1.50
TL-143	1.50
TL-144	1.50
TL-145	1.50
TL-146	1.50
TL-147	1.50
TL-148	1.50
TL-149	1.50
TL-150	1.50

### NEW KIT 150 WIRE WRAP DIP SOCKETS \$35.00

NEW KIT 150 WIRE WRAP DIP SOCKETS \$35.00

### NEW KIT 150 WIRE WRAP DIP SOCKETS \$35.00

NEW KIT 150 WIRE WRAP DIP SOCKETS \$35.00

### NEW KIT 150 WIRE WRAP DIP SOCKETS \$35.00

NEW KIT 150 WIRE WRAP DIP SOCKETS \$35.00

### NEW KIT 150 WIRE WRAP DIP SOCKETS \$35.00

NEW KIT 150 WIRE WRAP DIP SOCKETS \$35.00

### POWER AC

NEW KIT 150 POWER AC \$35.00

### NEW KIT 150 POWER AC \$35.00

NEW KIT 150 POWER AC \$35.00

### NEW KIT 150 POWER AC \$35.00

NEW KIT 150 POWER AC \$35.00

### NEW KIT 150 POWER AC \$35.00

NEW KIT 150 POWER AC \$35.00

### NEW KIT 150 POWER AC \$35.00

NEW KIT 150 POWER AC \$35.00

### NEW KIT 150 POWER AC \$35.00

NEW KIT 150 POWER AC \$35.00

### NEW KIT 150 POWER AC \$35.00

NEW KIT 150 POWER AC \$35.00

### NEW KIT 150 POWER AC \$35.00

NEW KIT 150 POWER AC \$35.00

### NEW KIT 150 POWER AC \$35.00

NEW KIT 150 POWER AC \$35.00

### NEW KIT 150 POWER AC \$35.00

NEW KIT 150 POWER AC \$35.00

### NEW KIT 150 POWER AC \$35.00

NEW KIT 150 POWER AC \$35.00

### NEW KIT 150 POWER AC \$35.00

NEW KIT 150 POWER AC \$35.00

### NEW KIT 150 POWER AC \$35.00

NEW KIT 150 POWER AC \$35.00

### NEW KIT 150 POWER AC \$35.00

NEW KIT 150 POWER AC \$35.00

### NEW KIT 150 POWER AC \$35.00

NEW KIT 150 POWER AC \$35.00

### NEW KIT 150 POWER AC \$35.00

NEW KIT 150 POWER AC \$35.00

### NEW KIT 150 POWER AC \$35.00

NEW KIT 150 POWER AC \$35.00

### NEW KIT 150 POWER AC \$35.00

NEW KIT 150 POWER AC \$35.00

**DIGI-KEY CORPORATION**  
 Volume Discount  
 DIGI-KEY Stocks Meet A.P. Products

Quantity	Price
1-10	\$1.50
11-50	\$1.40
51-100	\$1.30
101-500	\$1.20
501-1000	\$1.10
1000+	\$1.00

**SERVICE CHARGES VOLUME DISCOUNT**

Order Total	Service Charge	Volume Discount
\$0.00 - \$99.99	\$2.00	0%
\$100.00 - \$499.99	\$3.00	2%
\$500.00 - \$999.99	\$4.00	4%
\$1000.00 - \$4999.99	\$5.00	6%
\$5000.00 - \$9999.99	\$6.00	8%
\$10000.00 & Up	\$7.00	10%

RADIO-ELECTRONICS

# DIG-KEY CORPORATION

# 800-346-5144

**QUALITY** — Name brand products from nationally recognized manufacturers. **SERVICE** — Computerized order processing and inventory control. **SAVINGS** — Volume Discounts • GEM Quantity Pricing • Toll Free 800 Number

### SHOULDER RECTIFIERS ZENER DIODES

... [Detailed list of diode specifications including part numbers, ratings, and prices]

### 3 AMP BRIDGE RECTIFIERS

... [Detailed list of bridge rectifier specifications]

### 1500V ZENER DIODES

... [Detailed list of high-voltage zener diode specifications]

### NATIONAL SEMICONDUCTORS

... [Detailed list of National Semiconductor products including diodes and rectifiers]

### GI-CLOCK IN

... [Detailed list of clock components and related parts]

### REPAIR KIT

... [Detailed list of repair kit components]

### 1/4 WATT RESISTORS

... [Detailed list of resistor specifications]

### REPAIR KIT

... [Detailed list of repair kit components]

### REPAIR KIT

... [Detailed list of repair kit components]

### REPAIR KIT

... [Detailed list of repair kit components]

### REPAIR KIT

... [Detailed list of repair kit components]

### alpha

... [Detailed list of Alpha brand electronic components]

### REPAIR KIT

... [Detailed list of repair kit components]

### NOW AT DIG-KEY 1.5 to 25 Amp 10 to 400 PPV/Lag

... [Detailed list of power supply and transformer specifications]

### 1/4 WATT RESISTORS

... [Detailed list of resistor specifications]

### REPAIR KIT

... [Detailed list of repair kit components]

### REPAIR KIT

... [Detailed list of repair kit components]

### REPAIR KIT

... [Detailed list of repair kit components]

### REPAIR KIT

... [Detailed list of repair kit components]

**HANDLING CHARGES VOLUME DISCOUNT**

\$ 0.00 to 9.99	4.44	\$ 50.00 to 99.99	10.00
\$ 10.00 to 24.99	5.50	\$ 100.00 to 249.99	12.00
\$ 25.00 to 49.99	6.50	\$ 250.00 to 499.99	14.00
\$ 50.00 to 99.99	7.50	\$ 500.00 to 999.99	16.00
\$ 100.00 to 249.99	8.50	\$ 1000.00 & up	18.00

... [Additional shipping and handling information]

CIRCLE 65 ON FREE INFORMATION CARD

CPU'S & SUPPORT CHIPS table with columns for part numbers and prices.

EPOXY GLASS VECTOR BOARD table with columns for SCR's and TRIAC's.

TRANSISTOR SPECIALS table listing various transistor models and prices.

SHIFT REGISTERS and ROM's table listing various integrated circuits.

C/MOS table listing various CMOS integrated circuits.

TTL IC SERIES table listing various TTL integrated circuits.

LINEAR CIRCUITS table listing various linear ICs.

74S SERIES table listing various 74S series integrated circuits.

74LS SERIES table listing various 74LS series integrated circuits.

TOGGLE SWITCHES table listing various toggle switch models.

4164-2 - \$6.25, 4164-15 - 100/\$660.00, 4116-3 - 100/\$100.00

74LS SERIES table listing various 74LS series integrated circuits.

DIP SWITCHES table listing various DIP switch models.

REGULATORS table listing various voltage regulator ICs.

TANTALUM CAPACITORS table listing various tantalum capacitor values.

WIRE WRAP SOCKETS table listing various wire wrap socket models.

REGULATORS table listing various voltage regulator ICs.

TANTALUM CAPACITORS table listing various tantalum capacitor values.

POSTAGE RATES table listing shipping and handling charges.

REGULATORS table listing various voltage regulator ICs.

TANTALUM CAPACITORS table listing various tantalum capacitor values.

G.T.E. ELECTRONIC SUPPLY advertisement with logo, contact information, and service guarantees.

SOLID STATE SALES advertisement with contact information and shipping details.



# POPULAR TELEVISION CIRCUITS

## New! SAT-X PROCESSOR

Digital Circuitry



- KSD-2412 Sat Process Kit \$348.95 + \$7.95 S/H
- PCS-3000 Sat Process PCB \$78.00 + \$4.00 S/H

### GATED SYNC SUPER BOARD

- KGS-3080 Gated Sync Kit \$149.95 + \$5.95 S/H
- PCG-7000 Gated Sync PCB only \$30.00 + \$3.00 S/H



### SINEWAVE SUPER BOARD

- KSW 1483 Sinewave Kit \$119.95 + \$5.95 S/H
- KSD 1484 Sinewave Minut PCB \$99.95 + \$5.95 S/H
- PCS 6252 Sinewave PCB only \$20.00 + \$3.00 S/H

State of the art technology brings you this superior Sinewave or Gated Sync Superboard. It has no internal connection to T.V. RF modulator built on the board. AGC for stability and tunes the entire band with a varactor tuner and multi-turn pot. A high quality plated thru circuit board with silk-screened parts layout, easy to follow, fully illustrated instructions and quality parts make this kit easy to assemble. The beautifully finished cabinet will add a touch of class to the many hours of enjoyment you will receive building and using this kit.

## ZENITH M1/FV-5 OR W1/FV-5 SYSTEMS



- KZW 2083 M1 FV-5 Kit \$234.95 + \$6.95 S/H
- KZW 2083 W1 FV-5 Kit \$199.95 + \$6.95 S/H
- KZO 2084 FV-5 only \$149.95 + \$6.95 S/H
- PCZ 8000 FV-5 PCB only \$30.00 + \$3.00 S/H
- ZMO \$151 M1 Module only \$88.95 + \$5.95 S/H
- WMD 9151 W1 Module only \$58.95 + \$4.95 S/H

This advanced baseband video inversion/sync suppression system which is most often used nationwide is one of our most popular kits. It features AGC for stability, RF modulator built on the board, no internal connection to T.V. and full band variable tuning. High quality parts, fully illustrated instructions, prepunched cabinet and plated-through/solder-masked P.C. board make this kit a breeze to assemble. The M1 varactor tuner board is assembled and tested and need only be interconnected to the FV-5 board. The completed circuitry is then placed in the beautifully finished cabinet. Place your order today.

M1 & FV-5 used as a system

UNSURE? Order any manual for only \$9.95 post paid. Refundable with order of full kit.

# SATELLITE TELEVISION



## COMPLETE SYSTEMS

- SCS 5800 \$1148.95 FOB  
58" Fiberglass Dish  
70K LNA & Servo Feed  
Miste Receiver & 100' of Cable
- SCS 6600 \$1248.95 FOB  
58" Stainless Dish  
70K LNA & Servo Feed  
Miste Receiver & 100' of Cable
- SCS 0010 \$1499.95 FOB  
10' Aluminum Mesh Dish  
70K LNA & Servo Feed  
Miste Receiver & 100' of Cable



- FEATURES**
- Signal Strength Carrier Level Meter
  - Crystal Controlled Video Modulator
  - Detent Channel Tuning with Fine Tune
  - Scan Mode on Front
  - Polarity Selector on Front
  - Decoder Output—5 Pin DIN
  - Block Down Converter (Mounts on LNA)

Complete Systems are everything you need for an operating system except your television, a 3 1/2" pipe installed in concrete (where your dish will be installed) and installation labor.

## COMPONENTS

- SAD 0010  
10' Aluminum Mesh Dish  
\$859.95 FOB
- SFD 8000  
8' Fiberglass Dish  
\$449.95 FOB
- SFD 8000  
8' Fiberglass Dish  
\$349.95 FOB
- SSD 8600  
5 1/2" Stainless Dish  
\$359.95 FOB
- SFD 8800  
58" Fiberglass Dish  
\$299.95 FOB
- SFH 0100  
Single Feed  
\$17.95 + \$4.95 S/H
- SFH 0200  
Dual Feed  
\$149.95 + \$4.95 S/H
- SFH 0300  
D.C. Motor Feed  
\$179.95 + \$4.95 S/H
- SFH 0400  
Servo Feed  
\$144.95 + \$4.95 S/H
- SRM 2000  
Miste Receiver  
\$349.95 + \$8.95 S/H
- SLA 1000  
LNA 100K  
\$349.95 + \$8.00 S/H
- SLA 0700  
LNA 70K  
\$449.95 + \$8.00 S/H
- SAC 1200  
Actuator 12 Position  
\$299.95 + \$12.95 S/H

## MICROWAVE PROBE



2 GHz  
20" DISH  
ALUMINUM



- MSR 2000 SKY RANGER  
\$89.95 + \$5.95 S/H
- MLR 2100 LONG RANGER  
\$89.95 + \$5.95 S/H
- KMP 2030 Micro Probe Kit  
\$24.95 + \$3.00 S/H
- MPD 2000 Micro 20" Dish  
\$14.95 + \$5.95 S/H
- PCM 2000 Micro PCB only  
\$4.95 + \$3.00 S/H
- MPS 1218 Micro Power Supply  
\$24.95 + \$3.00 S/H

## OTHER ITEMS

- RFM-3040 RF Modulators  
\$24.95 + \$3.00 S/H
- UAA-1000 UHF Amplifier Kit  
\$19.95 + \$3.00 S/H



• HOBBY USE ONLY. NOT FOR UNAUTHORIZED RECEPTION OF TV SIGNALS.  
 \* AVAILABLE BY MAIL ONLY. \* SEND FOR INFORMATION ON OTHER ITEMS.  
 \* COMPLETE REPAIR SERVICE. \* CHECKS HELD 3 WEEKS FOR CLEARANCE.

4218 S. 36TH PL., PHOENIX, ARIZONA 85040

ORDERS ONLY: (800) 243-6700

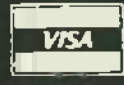

**WESTECH**  
**WESTECH ELECTRONICS**  
 (602) 437-0100

7400

Number of Pins of each U.L.S. for every package group.

MICROPROCESSOR COMPONENTS

Digitalker

Table listing various 7400 series components with columns for Part No., Description, and Price.

Table listing various 74LS series components with columns for Part No., Description, and Price.

Table listing various 74S/PROMS series components with columns for Part No., Description, and Price.

Table listing various 74S/PROMS series components with columns for Part No., Description, and Price.

Table listing various MICROPROCESSOR CHIP components with columns for Part No., Description, and Price.

Table listing various 3800A SERIES components with columns for Part No., Description, and Price.

Table listing various 74S/PROMS series components with columns for Part No., Description, and Price.

Table listing various 74S/PROMS series components with columns for Part No., Description, and Price.

Table listing various 74S/PROMS series components with columns for Part No., Description, and Price.

DT1050 — Applications: Teaching aids, appliances, clocks, automotives, telecommunication, language translators, etc.

DT1050 Digitalker™ \$34.95 ea.
NM54104 Processor Chip \$14.95 ea.

DT1057 — Expands the DT1050 vocabulary from 137 to over 260 words. Includes 2 ROMs. 8000 SPS.
Part No. DT1057 \$24.95 ea.

INTERISIL

Table listing various INTERISIL components with columns for Part No., Description, and Price.

30009 1983 INTERISIL Data Book (1983) \$29.95

Table listing various 74HC High-Speed CMOS components with columns for Part No., Description, and Price.

Table listing various LINEAR components with columns for Part No., Description, and Price.

Table listing various LINEAR components with columns for Part No., Description, and Price.

RADIO-ELECTRONICS

\$10.00 Minimum Order — U.S. Funds Only
California Residents Add 8% Sales Tax
Shipping — Add 5% Plus \$1.50 Insurance
Send S.A.S.E. for Monthly Sales Flyer!



1355 SHOREWAY ROAD, BELMONT, CA 94002
624 PHONE ORDERS WELCOME — (415) 592-8097 Telex: 176043
CIRCLE 41 ON FREE INFORMATION CARD



# DON'T BLAME THE SOFTWARE!

Our Isolators eliminate equipment interaction, clean up interference, curb damaging power line spikes and lightning bursts.



**ISO-1 ISOLATOR**  
3 isolated sockets; quality spike suppression; basic protection... \$81.95

**ISO-3 SUPER-ISOLATOR**  
3 dual isolated sockets; suppressor; commercial protection..... \$122.95

**ISO-17 MAGNUM ISOLATOR**  
4 quad isolated sockets; suppressor; laboratory grade protection... \$213.95

ESP Electronic Specialists, Inc.  
171 S. Main, North, MA 01760 (617) 655-1632  
Toll Free Order Desk 1-800-225-4876  
MasterCard, VISA, American Express

CIRCLE 6 ON FREE INFORMATION CARD

**FREE GIANT CATALOG**

Send for our FREE 1984 catalog of electronic components, kits, IC's, computer software, computer peripherals and unique items.

**PARTS SUPER SPECIALS!**

<p><b>MICRO MINATURE SPEAKER</b> 1/2" dia. 8 Ohm 100mW C6517 \$4.95</p>	<p><b>BESTER KIT TYPE SOLID STATE</b> 4000 Hz 100mW C6518 \$1.00</p>
<p><b>NOISE EFFECT SIMULATOR KIT</b> 1000 Hz 100mW C6519 \$4.95</p>	<p><b>SOLID CARBIDE PC DRILL BIT</b> 1/8" dia. C6520 \$1.25 EACH</p>
<p><b>BOX OF RESISTORS</b> 1000 1/4W 1% 100 Ohm C6521 \$5.95</p>	<p><b>BOX OF CAPS</b> 1000 1/4W 5% 100pF C6522 \$5.95</p>
<p><b>VALUABLE MEMORIAL PACKAGE</b></p> <p>1000 1/4W 5% 100 Ohm resistors, 1000 1/4W 5% 100pF capacitors, 1000 1/4W 5% 100 Ohm resistors, 1000 1/4W 5% 100pF capacitors, 1000 1/4W 5% 100 Ohm resistors, 1000 1/4W 5% 100pF capacitors.</p>	
<p><b>1700V SURGE PROTECTOR LIGHT KIT</b> 1700V Surge Protector C3071 \$9.99</p>	<p><b>PAC TEC ELECTRONIC ENCLOSURE</b> 1/2" x 1/2" x 1/2" (C6000) \$4.95</p>
<p><b>3 CHANNEL COLOR ORGAN KIT</b> 1000 1/4W 5% 100 Ohm C6523 \$9.95</p>	<p><b>FASCINATION STAR KIT</b> 1000 1/4W 5% 100 Ohm C6524 \$4.95</p>
<p><b>NEGATIVE ION GENERATOR BOARD</b> 1000 1/4W 5% 100 Ohm C6525 \$4.95</p>	<p><b>CHANEY INC.</b> P.O. Box 27038 Denver, Colorado 80277 303 751 6750</p>

Send for our free catalog of unique items

CIRCLE 34 ON FREE INFORMATION CARD

A Time to Remember

Remember family or friends with Special Occasion, Get Well or Memorial cards.



**American Heart Association**

WE'RE FIGHTING FOR YOUR LIFE

## SEI, Inc.

641 Academy Drive • Northbrook, Illinois 60062

For information (312) 564-0104 • To order outside Illinois 1-800-323-1327

### SOLID STATE STEREO REVERBERATION AMPLIFIER

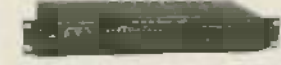

Specifications • Total harmonic distortion less than 0.5% • Frequency response 10Hz to 50K Hz ±10dB • 5/8" Ribbon 500Ω • Reverberation time 0 to 3 sec • Input 150mW 50Ω ohm • Max. input 2V • Accepts input from tape, phono or bus • Includes and LED Reverb Level display. Kit comes with all electronic components, transformer and instructions and 1/2" rack mount cabinet.

Model TA-2400 ..... \$89.95

### AMATEUR MICROWAVE Receiver System 1.9-2.5 GHz



### MICROWAVE RECEIVER SYSTEM

• Commercial grade construction • Slotted Parabolic aluminum reflector antenna • High gain 50 dB • Line of sight distance 45 miles • Complete system, power supply, cable assembled, reflector antenna, and downconverter • Downconverter mounted in attractive cabinet  
90 day warranty on PS-5!  
\$5 Assembled ..... \$109.95  
Kit Form ..... \$ 79.95

### Microwave Preamp NEW KIT

Use with PS-3 Kit. Adds 20-25 db gain to boost reception distance.  
• Low Noise  
• High Gain  
• Can be used with all existing slot high board receivers!  
1.9-2.5 GHz Freq. Range  
PS-4 (Kit) ..... \$34.95

### SOLID STATE STEREO GRAPHIC EQUALIZER PRE AMP KIT



Specifications • Total Harmonic Distortion Less than 0.05% • Intermodulation Distortion (IMD) 78dB • 1/2" SMP/E Method Less than 0.02% • Frequency Response Overall 10Hz to 100KHz ±0.2dB 1dB • RIAA Curve Deviation (Phono) ±0.2dB -0.2dB (30Hz to 15KHz) • Channel separation (at rated output) 1KHz) • Phono Tuner, Aux and Tape Monitor better than 70dB • Input sensitivity and impedance (1KHz for rated output)  
Phono 2MV 47K ohms Aux 130MV 50K ohms Tuner 130MV 50K ohms Tape 130MV 50K ohms Graphic Equalizer Control 10 Band Slide Control Frequency Bands: 31 3Hz 63Hz 125Hz 250Hz 500Hz 1KHz 2KHz 4KHz 8KHz 16KHz also with on panel selector for Phono Tuner, Aux 1 and Aux 2 Power Supply 157 VAC Kit comes with all electronic components, transformer, instructions and a 1/2" rack mount type metal cabinet.

TA-2500 (KIT) ..... \$119.00

### 20 STEP LED POWER LEVEL INDICATOR KIT

This new stereo level indicator kit consists of 40 3-color LED's to indicate sound level output of your amplifier from -57 dB to 0 dB. Comes with an attractive silk screen printed panel. Hiss selector switch to allow floating or gradual output indicating. Kit includes all parts. Front panel and power supply.

TY-45 (KIT) \$34.95

### SPY EAR

A very popular device designed to listen to sounds & voices through doors or 3 1/2" thick concrete walls. Piece listening sensor against wall and telephone in ear. Adjust volume control. Clearly hear things you may not want to!  
CM-8 ..... \$89.95

### INFRA-RED REMOTE CONTROL SWITCH KIT



Infra-red Remote Control switch can be used to control appliances up to 500 W.

The TK-41 has effective control up to 10 meters. No antenna needed. Features delay IC controller which excludes interferences from light or AC pulse signal.

TK-41 Kit ..... \$24.95

### STEREO AMP KIT 160 Watt Total 80W + 80W

This is a solid state all transistor circuitry on board stereo amplifier. Power output employs 2 pairs of matching Darlington transistors. THD less than 0.5% between DC to 200 KHz. Power supply requires 30 VCT 2 amp • FMR

TA-802 \$39.95  
Transformer (optional) \$9.95

### LOW THD DC STEREO PRE-AM KIT TA-2800

Incorporates state of D.C. design that gives a frequency response from 0Hz - 100KHz ± 5dB. Features tone defest switch. Built-in triple midrange bass balance • Contains quad BJT op-amp to develop THD of 0.05% at rated output • Input sensitivity phono 2.5 mV tuner aux tape play 100mV 100K • Power supply - 15 volt DC at 2A. Kit comes with regulated power supply. all you need is 15-30 VCT 2 amp XFMR

TA-2800 ONLY \$44.50  
XFMR \$4.50 ea.

### UHF TV PREAMP



FEATURES:  
• 25 db gain  
• Kit

Your reception will dramatically improve! This unit will enable you to pull in signals you never knew were there! For both indoor and outdoor use. Input and output impedance 75 ohm. No adjustment. Easy assembly.

JH-0 KH ..... \$23.95



### TA-1500 200 WATT CHANNEL STEREO AMP & PREAMP KIT

More power for stereo blast! 100 watts/channel, stereo preamp built-in. Treble, midrange, bass, mic volume. Balance and volume are standard controls on the preamp. Mic input allows you to use R as a P.A.  
Specifications: 100 W x 2 into 8 Ohms Freq Range 0-100KHz ± 3dB THD: 0.1% S/N Ratio: 80 dB Sensitivity: 3 mu into 42K Power Requirements: 24-40 VAC

TA-1500 ..... \$72.00

### 160 WATT DC STEREO AMP/PREAMP KIT

The TA-800 is an 80 watt/channel preamp and power amp with tone control, high, middle and bass controls. Volume and balance control are built-in. On board power supply requires only 80 volt CT XFMR. Specifications: 50W x 2 into 8 Ohms Freq. Range: 0Hz-100 KHz ± 3dB THD: 0.1% S/N Ratio: 80 dB Sensitivity: 3 mu into 47 K. Power Requirements: 24-40 VAC

TA-800 ..... \$65.00

Add 10% shipping on orders under \$35.00. Orders over \$35.00, add 5%.  
Catalog-\$1.00. Visa & Mastercharge accepted.



CIRCLE 60 ON FREE INFORMATION CARD

RADIO-ELECTRONICS





# Electronics Paperback Books

## Quality Paperbacks at Affordable Prices



**35 SOLDERLESS BREADBOARD PROJECTS BOOK-1, \$5.75.** Whenever possible the same parts are used in several projects. Even a first-time builder can complete these circuits.

**HOW TO GET YOUR ELECTRONIC PROJECTS WORKING, \$6.00.** Helps troubleshoot and repair home-built projects of every description.

**MINI-MATRIX BOARD PROJECTS, \$6.95.** A variety of projects that can all be built upon a mini-matrix board that has 10 strips and is 24 holes long.

**MODERN CHIP PROJECTS, \$6.95.** Wide range of special VLSI IC and circuits including in-line, in-packet, in-chip, input impedance, etc.

**MULTI-CIRCUIT BOARD PROJECTS, \$6.95.** 27 tiny simple projects that can all be built on a single printed-circuit board. All are powered by a 9V battery.

**IC PROJECTS FOR BEGINNERS, \$5.00.** Inexpensive digital and linear ICs are used to assemble the selection of circuits intended for the beginner.



**ART OF PROGRAMMING THE 1K Z801, \$6.25.** Topics include bit screen, sorting, PEEK & POKE and actual working programs.

**THE 6809 COMPANION, \$6.95.** Written for the average assembly language programmer. A discussion of 6809 features & reference work for the 6809 programmer.

**ART OF PROGRAMMING THE 1K Z801, \$6.00.** How to use the features of the Z801 in programs that fit the 1K machine and are still fun to use.

**INTRODUCTION TO BASIC PROGRAMMING TECHNIQUES, \$5.00.** Based on author's own experience in learning BASIC and helping others to learn its program.

**A MICROPROCESSOR PRIMER, \$4.95.** Prerequisite to computing for the beginner. Step-by-step explains computer operations and assembly.

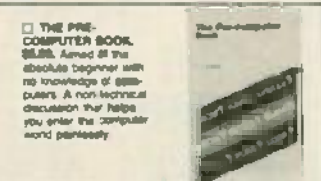

**THE PRE-COMPUTER BOOK, \$6.95.** Aimed at the absolute beginner with no knowledge of computers & non-technical discussion that helps you enter the computer world painlessly.

**AN INTRODUCTION TO VIDEO, \$6.95.** Perfect for the person just about to buy a VCR. Discusses pros & cons of the various features, video disc, videotex, tape copying and more.



**BASIC & PASCAL, \$4.95.** Teaches BASIC & Pascal and develops programs in both languages simultaneously.

**FIRST BOOK OF TRANSISTOR EQUIVALENTS & SUBSTITUTES, \$3.75.**

**PRACTICAL COMPUTER EXPERIMENTS, \$4.50.**



**POWER SUPPLY PROJECTS, \$4.95.** Contains designs and construction details for almost 80 power supply projects around the home.

**ELECTRONIC TIMERS PROJECTS, \$5.00.** Simple circuits that have numerous applications around the home.

**REMOTE CONTROL PROJECTS, \$4.95.** Radio-control infra-red, visible light & ultrasonic systems are all included, along with methods of achieving them.

**ELECTRONIC TEST EQUIPMENT CONSTRUCTION, \$4.95.** Construction details of a wide range of test equipment the experimenter can build at home.

**COUNTER DRIVER & NUMERICAL DISPLAY PROJECTS, \$4.95.** Features applications & projects using various types of numerical-display devices.

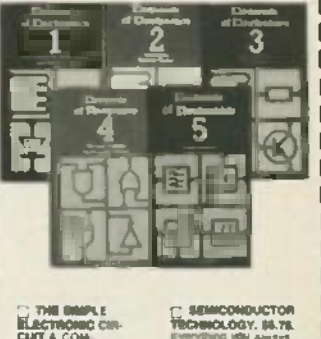

**PRACTICAL ELECTRONIC BUILDING BLOCKS—Book 1, \$4.95.** All electronics circuits consist of simple building blocks. When you know how to make the blocks you can easily create your own projects.

**PRACTICAL ELECTRONIC BUILDING BLOCKS—Book 2, \$6.95.** Circuits that process signals. Combines with those in Book 1.

**SPECIAL OFFER Book 1 & Book 2, PRACTICAL ELECTRONIC BUILDING BLOCKS, \$8.95.** Shipping included. Save \$1.75.

**RADIO CONTROL FOR BEGINNERS, \$4.50.**

**ELECTRONIC HOUSEHOLD PROJECTS, \$4.95.**

**ELECTRONIC MUSIC PROJECTS, \$4.95.**

**POPULAR ELECTRONIC PROJECTS, \$3.75.**

**PROJECTS IN OP-AMP ELECTRONICS, \$6.95.**

**RADIO CIRCUITS USING IC'S, \$4.95.**

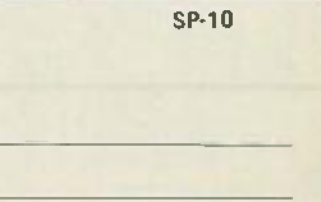

**THE SIMPLE ELECTRONIC CIRCUIT COOKBOOK, \$6.75.** All the fundamental theory needed to build a full understanding of the simple electronic circuit and its components.

**SEMICONDUCTOR TECHNOLOGY, \$6.75.** Everything you always needed to know about solid-state devices in one volume.

**ALTERNATING CURRENT THEORY, \$6.75.** Alternating current theory without which there can be no comprehension of speech, music, radio or television.

**CRYSTAL SET CONSTRUCTION, \$4.95.** Packed full of easy-to-duplicate designs for crystal radio receivers.

**COMMUNICATIONS, \$7.95.** Covers most modern communication systems. Line, microwave, submarine, satellite, digital, multiplex, radio & video.

**AN INTRODUCTION TO RADIO CIRCUITS, \$6.95.** Llama, to your home, to broadcast engineering thousands of miles away. Tells how you can do it.

**CRYSTAL SET CONSTRUCTION, \$4.95.** Packed full of easy-to-duplicate designs for crystal radio receivers.

**LONG DISTANCE TV RECEPTION (TYD) FOR THE ENTHUSIAST, \$6.95.** Practical & authoritative introduction to the unusual aspect of electronics.

**AN INTRODUCTION TO RADIO CIRCUITS, \$6.95.** Llama, to your home, to broadcast engineering thousands of miles away. Tells how you can do it.

**THE SIMPLE ELECTRONIC CIRCUIT COOKBOOK, \$6.75.** All the fundamental theory needed to build a full understanding of the simple electronic circuit and its components.

**SEMICONDUCTOR TECHNOLOGY, \$6.75.** Everything you always needed to know about solid-state devices in one volume.

**COMMUNICATIONS, \$7.95.** Covers most modern communication systems. Line, microwave, submarine, satellite, digital, multiplex, radio & video.

**FIRST BOOK OF 16-PI-SPEAKER ENCLOSURES, \$4.95.**

**SOLID STATE NOVELTY CIRCUITS, \$3.50.**

**35 TESTED TRANSISTOR PROJECTS, \$4.25.**

ELECTRONIC TECHNOLOGY TODAY INC.  
P.O. Box 240, Massapequa Park, NY 11762

SP-10

Number of books ordered

Total Price of Books ..... \$ .....

Sales Tax (NY State Residents) .....

Shipping (75c 1st two books, 30c ea additional) .....

TOTAL ENCLOSED ..... \$ .....

Name .....

Address .....

City ..... State ..... ZIP .....

# CABLE TV CONVERTERS



**A**  
**LCC-91**  
TV Remote Controller

**A. JERROLD LCC-91**

- Remote Control Lets You Change TV Channels From the Comfort of Your Chair
- Turn Your TV Set On and Off Without Touching the Dial
- 66 Channel Capacity
- Lighted Digital Display On the Converter Indicates the Channel
- Simple Do It Yourself Installation In Minutes
- Works With All TV Models and Compatible With All Cable Systems
- Guaranteed One Year By More Than 300 General Instrument Warranty Stations



**B**  
**LCC-58** (Formerly Model DRX-105)  
TV Remote Controller

**B. JERROLD LCC-58**

- Remote Control Lets You Change TV Channels From the Comfort of Your Chair
- Turn Your TV Set On and Off Without Touching the Dial
- 58 Channel Capacity
- Lighted Digital Display On the Converter Indicates the Channel
- Simple Do It Yourself Installation In Minutes
- Works With All TV Models and Compatible With All Cable Systems
- Guaranteed One Year By More Than 300 General Instrument Warranty Stations

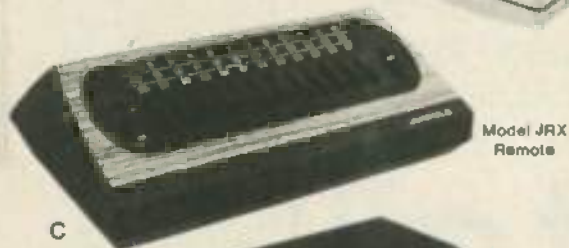

Model JRX Remote

**C. JERROLD #JRX-3**

- 37 Channel Capability
- Cord Type Remote Control
- Remote Channel Selection
- Remote-Fine Tuning

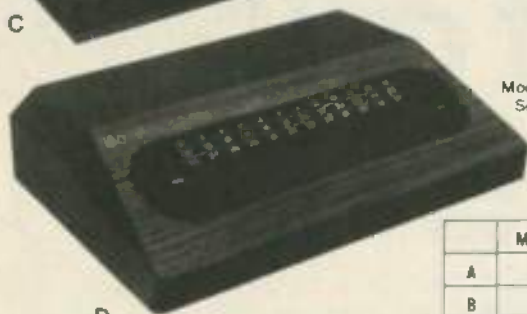

Model JSX Set-10P

**D. JERROLD #JSX-3**

- 37 Channel Converter
- Set-Top Model

	MANUFACTURE	MODEL #	RETAIL
A	JERROLD	LCC-91	129.00
B	JERROLD	LCC-58	119.00
C	JERROLD	300 JRX-3	79.00
D	JERROLD	300 JSX-3	69.00

LARGE QUANTITY DEALERS INVITED. SPECIAL PRICING ARRANGED.

**G M HIGH TECH**  
"Your Cable Warehouse"

P.O. Box 624412  
Miami, Florida 33269  
305-651-2637

CIRCLE 26 ON FREE INFORMATION CARD

# Radio-Electronics

STOP WRONG NUMBERS!  
BUILD A TELEPHONE ADD-ON

\$1.75 MAR. 1984

COMPUTERS • VIDEO • STEREO • TECHNOLOGY • SERVICE

Build this deluxe  
**VIDEO TEST GEN**  
with gen lock, multiburst, and more

Who's in control?  
**JET-BANDING SYSTEMS**  
How life, work

Will this work with a PC?  
**COMPUTER COMPATIBILITY**  
Know before you buy

Build an  
**AUDIO GENERATOR**  
with digital frequency display

How to design  
**POWER SUPPLIES**  
to fit your needs



PLUS  
★ Radio Corner ★ Equipment Reports ★ Design Board  
★ Service Clinic ★ News/Logs ★ State-Of-Solid-State

This will be coming to you when you subscribe to **Radio-Electronics:**

• **HELPFUL CONSTRUCTION ARTICLES** . . .

- Test Equipment
- Hi-Fi Accessories
- Telephone Accessories
- Music Synthesizers
- Computer Equipment
- Automotive Equipment
- Intruder Alarms
- Home & Car
- Video Accessories

• **NEWS ON NEW TECHNOLOGY** . . .

- Computers
- Microprocessors
- Satellite TV
- Teletext
- Automotive Electronics
- Speech Synthesizers
- IC Applications

• **FASCINATING "HOW TO DO IT" ARTICLES** . . .

- Build Your Own Projects
- Make Your Own PC Boards
- Wiring Techniques
- Soldering and Desoldering
- Design and Prototyping

• **HOW YOU AND THE COMPUTER CAN BE FRIENDS** . . .

- Getting Started
- Programs, Circuit Design, Games
- A/D-D/A Interfacing
- Peripheral Equipment

• **NEW AUDIO DIMENSIONS FOR YOUR PLEASURE** . . .

- Noise-Reduction Devices
- How to Connect that Extra Add-On
- Hi-Fi Accessories
- New Technology

• **TV WONDERS FOR YOUR FUTURE** . . .

- Latest Receivers and Circuits
- The Home Entertainment Center
- Projection TV Today
- Satellite TV Receivers
- Jack Darr's Monthly Service Clinic
- Service Problems and Solutions

• **AND you also get these regular MONTHLY FEATURES:**

- **LOOKING AHEAD** by Dave Lachenbruch
- **HOBBY CORNER** by "Doc" Savage
- **STATE-OF-SOLID-STATE** by Bob Scott
- **WHAT'S NEWS**, new products, stereo news
- **VIDEOGAMES**, new products, game reviews
- **and NEW IDEAS STEREO PRODUCTS NEW COMPUTER PRODUCTS FOR HOMEJOB and MUCH MORE!**

**Radio-Electronics covers all aspects of the fast moving electronics field . . . featuring COMPUTERS • VIDEO • STEREO TECHNOLOGY • SERVICE COMMUNICATIONS • PROJECTS**

# Get it all!

Subscribe today to **Radio-Electronics**. Don't miss a single issue and . . . you save as much as \$31.03 off the newsstand price.

When you select one of the subscription offers listed on the handy coupon—you'll be assured of having your copy reserved, even if it sells out on the newsstand. Make sure you get **all the excitement in every issue of Radio-Electronics, every month, by filling in and mailing the coupon, today.**

Mail to: **Radio-Electronics**  
P.O. Box 2520, Boulder, CO 80322

- 1 year—12 issues only \$11.97 (You save \$9.03 off newsstand price.)
- 3 years—(Save More)—36 issues—\$31.97 (Save \$31.03 off the newsstand price.)

**Every Month!**  
**Get the Best—Mail Today!**

- Payment Enclosed
- Bill Me

Name \_\_\_\_\_ (please print)

Address \_\_\_\_\_

City \_\_\_\_\_ State \_\_\_\_\_ Zip Code \_\_\_\_\_

Offer Valid in U.S. Funds Only  
Allow 6-8 weeks for delivery of first issue

Canada—Add \$3.00 per year  
All other countries—Add \$7.50 per year



**NEW!**

**The complete BREADBOARDING SOURCE at the lowest prices ANYWHERE!**

### HB-0100 Buss Strip



Each buss strip contains four groups of labeled contact points (25 per group) providing multipoint distribution for Vcc, ground and signal paths. When interconnected, HB-0100's can simulate Micro-Processor's data or address busses simplifying ROM, RAM, UART, etc. to processor interconnects.

Competition Price: \$3.00!  
**\$2.25**

HB-0100

### HB-1000 Socket

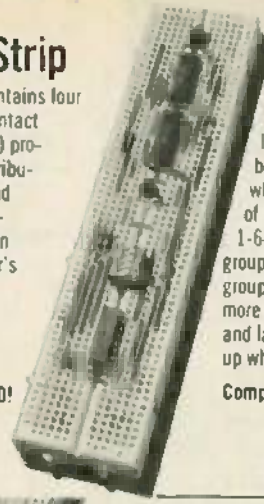

With HANDY sockets, breadboarding is easy because you always know where you're at. Each group of 5 contacts is labeled from 1-64 and each position within a group is labeled from a-j. With 64 groups of 5 contacts each you have more than enough room for infield and lab mock-ups that always come up when you least expect them.

Competition Price: \$12.50!  
**\$9.95**

HB-1000

### HB-1210

One socket and one buss strip with self-adhesive backing and metal ground plate. Big nine 14-pin DIP capacity.

Competition Price: \$18.50!  
**\$13.95**

HB-1210

### HB-1110

One socket and two buss strips with self-adhesive backing and metal ground plate. Big nine 14-pin DIP capacity.

Competition Price: \$15.49!  
**\$11.95**

HB-1110

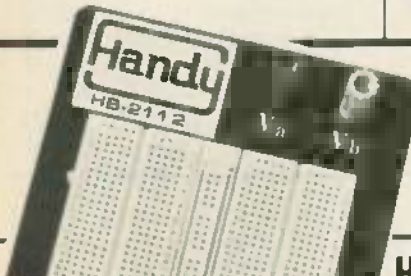
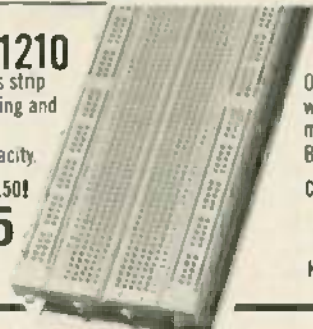

### HB-2112

A compact breadboard ideal for beginners, students, professionals and hobbyists. It's quick and easy to use and immediately becomes the most useful tool on your workbench. Includes: • 2 sockets • 1 buss strip • 2 binding posts and is mounted on an 8.7"x5.4" aluminum ground plate. 18 14-Pin DIP capacity.

Competition Price: \$24.95!  
**\$24.95**

HB-2112

**ORDER NOW!**

### HB-2313

Holds enough IC's to meet any quick-fix situation. Includes: • 2 sockets • 3 buss strips • 3 binding posts and is mounted on an 8.7"x5.9" aluminum ground plate. 18 14-Pin DIP capacity.

Competition Price: \$51.50!  
**\$31.00**

HB-2313

### HB-3514

Ideal for light industrial as well as secondary level educational and hobbyist experimentation. Includes: • 3 sockets • 5 buss strips • 4 binding posts and is mounted on a 9.4"x7.7" aluminum ground plate. 27 14-Pin DIP capacity.

Competition Price: \$66.00!  
**\$47.95**

HB-3514

### HB-4714

Largest HANDY breadboard available today. Complete PCB or even system mock-ups can easily fit on this breadboard. This high capacity, heavy duty board is a must for Industrial users where time is money ... Great for advanced educational and hobbyist applications. Includes: • 4 sockets • 7 buss strips • 4 binding posts and is mounted on a 10.3"x9.5" aluminum ground plate. Giant 36 14-Pin DIP capacity.

Competition Price: \$89.00!  
**\$63.95**

HB-4714

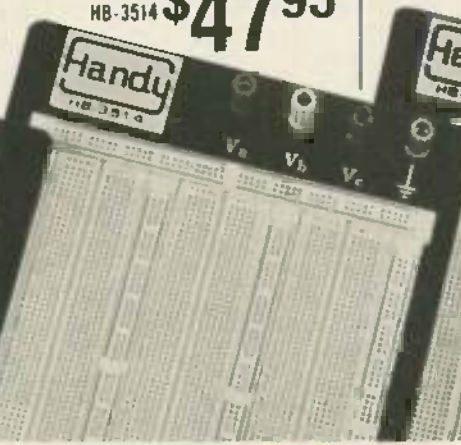

Mail Orders: Please add \$3 (Canada & Int'l add \$5) to cover cost of shipping/handling.  
Charge Cards: (Min. \$15). Please include Acct. No., Exp. Date, Bank No. (M/C only) and your signature.  
Checks: Drawn in U.S. Dollars on U.S. banks only.  
Conn. Residents: Add 7% Sales Tax. Sorry! No C.O.D. orders.

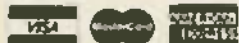

To order... call **1-800-34-HANDY**  
...charge with VISA, MasterCard or American Express.  
All items off-the-shelf for immediate shipment!

a division of RSP Electronics Corp.

7 Business Park Drive • P.O. Box 699 • Branford, CT 06405 • (203) 488-6603 • TWX: (910) 997-0684  
Easy Link Mail Box: 62537580 • CompuServe: 71346, 1070  
U.S. and Canadian Distributor inquiries welcomed.

CIRCLE 95 ON FREE INFORMATION CARD

JUNE 1984

127

# SPARTAN Electronics Inc



CALL (516) 499-9500 MAIL

6094 Jericho Tpke. Commack, N.Y. 11725

## Philips Remote Cable Converter

CTCOR  
 • More computer technology • Quietly controlled IC's lock in picture & prevent drift • 60 channel sections • Programmable line 60 & 61 • 7.1 laser LED 8000 clock • Favorite channel memory & recall thru scan • Wireless hand held "plug-in" transmitter system • Automatic line lock • Accepts to any brand television • One year warranty limited

**\$139.95**

**SGL WABER \$35.95**  
 Protect your computer and electronic equipment from voltage spikes  
 DG115P  
 DG115S (6 Outlet) \$45.95

**WINEGARD FM CAR ANTENNA BOOSTER**  
 Amplifies FM radio signals an average of 100% (3 times), improves car radio reception and extends range to allow greater selection of stations. Switch and indicator light attaches to lower edge of dash. 24' cable with Motorola plug provided. Installs in minutes. Great for satellite antennas.

226 95

**REFURBISHED MONITORS**  
 9" and 12" Bell & Howells or GBC Commercial Grade as low as  
 \$10.00 off with a purchase of 2 refurbished monitors  
**\$39.95**

**BECKMAN CIRCUITMATE DM73**  
 • .5% basic Vdc Accuracy probe-sized dmm  
 • 4 ac dc voltage ranges (autoranging)  
 • 4 resistance ranges (autoranging)  
 • continuity beeper  
 • "touch hold" button  
 Other Circuitmate Meters Available.

**\$63.95**

**Jerrold 58 Channel Wireless Remote Converter \$109.95**  
**Jerrold 36 Channel Remote CATV Converter w/on/off Fine Tuning \$94.95**

**40 Channel VHF to UHF Block Converter**  
 28.95 Ea.  
 24.95 4 & up  
 Deluxe Version - Features fine tuning knob, matching X former & 2 cables \$38.95

**BEFORE YOU PAY \$5 FOR A TELEPHONE SERVICE CALL. TEST IT YOURSELF**  
**EX PRECISION**  
 Telephone Line Analyzer Model #1042  
 — Tests telephone line functions that affect telephone operation  
 — Verifies ring and ring voltage levels  
 — Checks condition of telephone line from central office to user's telephone jack  
 — Verifies telephone line polarity that can affect specially designed telephones

**\$19.95**

**PROFESSIONAL TELEPHONE PRODUCT TESTER**  
**EX PRECISION**  
 Features: MODEL 1045  
 • Provides basic operation tests for twisted pair telephone measuring resistance and equipment status  
 • Checks telephone line polarity and identifies shorts to ground  
 • Verifies number tones and selected for push or touch tone telephones  
 • Provides line and normal dial ring test procedure  
 • Verifies the voice line DTMF (Dual Tone Multiple Frequency) tones and checks remote ring voltage

**\$335.95**

Dealers: McGraw-Hill, Visa, MC, BAC, Amex. All above prices include 4% cash discount. C.O.D. money order, check Add for shipping.

**Volume Discounts**  
 Min. Order \$25.00  
 International shipping Add'l  
 Prices subject to change without notice  
 C.O.D. 2.00 Extra  
 Add'l shipping for monitors

to 75.00	\$2.50
76.00 to 250.00	\$4.50
251.00 to 500.00	\$6.00
501.00 to 750.00	\$8.50
751.00 to 1000.00	\$12.00
Over 1000.00	\$12.50

(516) Mon Th Tu W F Sa  
 499-9500 9-8 9-6 9:30-5

## ADVERTISING INDEX

RADIO-ELECTRONICS does not assume any responsibility for errors that may appear in the index below.

Free Information Number	Page		
46	Acorn	30	Phoenix Systems
77	Active Electronics	102	Professional Video
80	Advanced Computer Products	121	PTS
—	Advance Electronics	10-13	Radio Shack
12	All Electronics	103	Ramsey
67	AMC Sales	87	Random Access
87	AP Products	2	RCA Dis. and Special Prod.
17	AW Sperry	27	RF Electronics
100	Beckman Instruments	Cover 2	RL Drake
16	B&K	Cover 3	Rodear Electronic Sales
—	C&D	89	RSP Handy
18	CEI	22	Sams Book Store
—	Chaney	120	Satellite T.V. Week
—	CIE	34-37	Scientific Systems
23	Command Productions	87	SEI
35	Communications Electronics	24-25	Sinter
50	Contact East	31	Solid State Sales
68	CPU	33	Spartan Electronics
89	CRT	31	Tektronix
10	Dalbani	123	Test Probes Inc.
65	Digitkey	112-113	Texas Instruments
11	Digitron	122	TransAmerican Cable
53	Direct Video	89	Tubergen and Assoc.
99	Dokay	119	Vector Electronics
54	DTI	33	Westech
20	Electronic Rainbow	60	WM B Allen
6	Electronic Specialists	120	
97	Enterprise Development	89	
39	Etronix	110	
40	Firestik	87	
—	Fluke Manufacturing	7	
76	Fordham Radio	20,21	
33	Formula	111	
26	Global Specialties	91	
—	GM Highteck	125	
—	Grantham College of Engineering	1	
—	GTE Electronic Supply	114	
75	Haltix	96	
15	Halttronix	104	
85	Heath	52-55	
38	Hickok	40	
28	HMR Sales	30	
51	Instrument Mart	32	
41	Iwatsu	9	
5	Jameco	116,117	
42	Jan Crystal	110	
49	Javanco	122	
4	JDR	106-107	
63	J&W	96	
83	Kashiwagi	30	
93	KCS	122	
66	McIntosh Labs.	23	
94	MFJ	96	
84	Mouser	118	
90	Nemal	30	
—	Network Sales	110	
—	Newtone Electronics	93	
—	NRI	16-19	
14	NTS	70-73	
52	Pacific One	30	
29	Paia	109	
—	Philips Tech Electronics	122	

### MOVING?

Don't miss a single copy of **Radio-Electronics**. Give us:

Six weeks' notice

Your old address and zip code

Your new address and zip code

ATTACH LABEL HERE

name (please print)

address

city state zip code

Mail to: Radio-Electronics  
 SUBSCRIPTION DEPT., P.O. BOX 2520,  
 BOULDER, COLO. 80322

# NEW! The first complete line of telephone testers designed for the phones you service.

From B&K-PRECISION, the Test Instruments Group of Dynascan Corporation...  
 makers of Cobra Telephone products

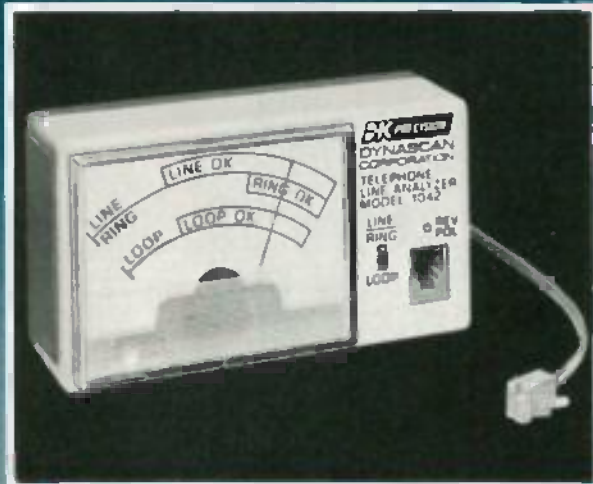

For quick line checks

## the telephone line analyzer

Allows you to quickly determine if the problem is in the phone itself or in the phone company lines. Tests for telephone line and ringing circuit operation and for defects in the telephone line cord. Small, compact, fast and easy to use. No external power required. No batteries to replace. Blister packed for quick merchandising; the Model 1042 sells itself at a suggested retail price of **\$19.95**



For comprehensive performance tests

## the telephone product tester

An in-shop or in-store tester that can be a profit source when you charge for telephone testing. A great way to instantly check-out customer returns. Tests corded and cordless phone operation and automatic phone dialers for all basic functions: defects in line and hand set cords, tone or pulse dial operation, ringing circuit operation, sound volume and voice quality. Can also be used by non-technical personnel to screen returns before giving them to repair technicians. Statistics show that over half the returns are good. Model 1045 - **\$395**

## FOR MORE COMPLETE TESTING

Coming soon!  
 The Model 1047 cordless telephone tester allows full radio frequency testing and alignment of base and portable units of cordless phones, without expensive signal generators and deviation meters.

Coming soon!  
 The Model 1050 telephone analyzer combines the features of the 1045 and 1047 for full analyzing and servicing of corded and cordless phones, answering machines and automatic dialers.

Don't miss out on this expanding new service market!  
**LEARN MORE AT YOUR LOCAL B&K-PRECISION DISTRIBUTOR**

**BK PRECISION** DYNASCAN CORPORATION

6460 West Cortland Street • Chicago, Illinois 60635 • 312/889-9087

International Sales, 6460 W. Cortland St., Chicago, IL 60635

Canadian Sales, Atlas Electronics, Ontario

South and Central American Sales, Empire Exporters, Plainview, NY 11803

CIRCLE 16 ON FREE INFORMATION CARD

# Sams IBM® Books. Programming Guides That Speak Your Language,

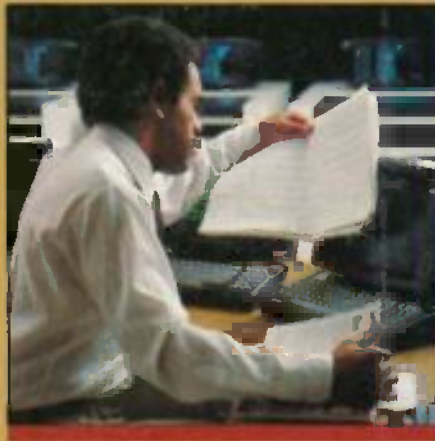

## Whatever Language You Speak.

If you're a computer novice curious about PC DOS, a businessman beginning to learn BASIC, or a new PCjr™ owner interested in assembler language programming, you need Sams books. Because when it comes to programming on the IBM PCs, Sams knows all about it.

Fact is, Sams has been a leading technical publisher since 1946. People trust Sams for books that are easy to understand and use. You can, too.

So if you want to learn more about programming on your IBM, get these books from Sams:

**BASIC PROGRAMMING WITH THE IBM PCjr** that shows how to program the PCjr in BASIC, and how to use the many advanced BASIC features unique to the computer. Contains a BASIC tutorial, programming hints and many useful programs. No. 22359, \$12.95.

**ASSEMBLER LANGUAGE PROGRAMMING: THE IBM PCjr** shows how to program Junior in 8088 assembler language, how to control its video, keyboard, disk, and other



hardware. Contains machine-language tutorial, exploitation hints and simple programs. No. 22360, \$12.95. (NOT SHOWN)

**8088 ASSEMBLER LANGUAGE PROGRAMMING: THE IBM PC** explains assembler language programming, PC system hardware, the 8088 microprocessor, PC architecture, and more. No. 22024, \$15.95.

**PC DOS COMPANION** basic hardware and software concepts, PC DOS, the computer terms and shows how PC DOS works, how to apply DOS commands, prepare floppy and hard disks, and more. No. 22039, \$15.95.

**INTERFACING TO THE IBM PERSONAL COMPUTER** presents detailed technical and operational theory on interfacing the PC with a variety of hardware. Includes many design tips, examples, 8088/8086 ASM subroutines and example program functions. No. 22027, \$15.95.

**AVAILABLE SOON**  
**USER'S GUIDE FOR THE IBM PCjr**, No. 22302, \$14.95.

So for IBM programming guides that speak your language, get the books you need from Sams today. Visit your local Sams dealer. Or call OPERATOR 100 at 1-7-298-5566 or 1-800-428-SAMS.

**SAMS™**

What Technology Is All About.

HOWARD W. SAMS & CO., INC.  
4300 West 62nd Street, P.O. Box 7092,  
Indianapolis, IN 46206

Offer good in USA only. Prices and availability subject to change without notice. In Canada, contact Lanbrook Electronics, Markham, Ontario L3R 1M2. IBM is a registered trademark of International Business Machines Corporation. PCjr is a trademark of International Business Machines Corporation.

CIRCLE 25 ON FREE INFORMATION CARD