

PROJECTS, COMPUTERS, HI-FI, CB, TV

\$1.00 ■ SEPT. 1977

Radio-Electronics

THE MAGAZINE FOR NEW IDEAS IN ELECTRONICS

CORE MEMORIES

HOW THEY WORK
YOU CAN USE THEM

BURGLAR ALARM

KEEP THEM OUT
BUILD IT NOW

FREQ COUNTER

30-MHz, 5 DIGITS
FOR CAR OR HOME

DIGITAL THERMOMETER

2-DIGIT DISPLAY EASY TO BUILD

CB TESTING

WHAT TO TEST
HOW TO MEASURE



A
GERNSBACK
PUBLICATION

PLUS

BACK HARR'S SERVICE CLINIC ★ COMPUTER CORNER ★

STATE-OF-SOLID-STATE ★

CLOCK ★ HI-FI LAB TEST REPORTS ★



503196 DRK 64504090 14 A JUN78
LLOYD DARKNELL DR
6450 HYATLEWOOD CA 95129
SAN JOSE
67126

Fill your needs from these 3 winning lines from Mallory.

Each of these Mallory lines of components is bubble-packed, easily identified. Almost all feature basic specs and/or instructions on the back of the cards.

Mallory EPC components consist of the most popular products for technicians, hobbyists and audio enthusiasts.

Mallory PTC semiconductors are of the highest quality. They fill a wide range of consumer and industrial applications. A convenient cross-referencing catalog permits fast selection.

Mallory crimp-type solderless terminals meet virtually all popular applications.

For all the facts and pricing, see your Mallory distributor. Or write Mallory Distributor Products Company, a division of P. R. Mallory & Co. Inc., Box 1284, Indianapolis, Indiana 46206. (317) 856-3731.



Mallory crimp type solderless terminals.

Popular components in Mallory Electronic Parts Center (EPC).

Mallory PTC semiconductors.

MALLORY

Capacitors • Controls • Fastening Devices • Resistors • Security Products • Semiconductors • Solderless Terminals • Switches

CIRCLE 40 ON FREE INFORMATION CARD

Understanding Digital Electronics

New teach-yourself courses

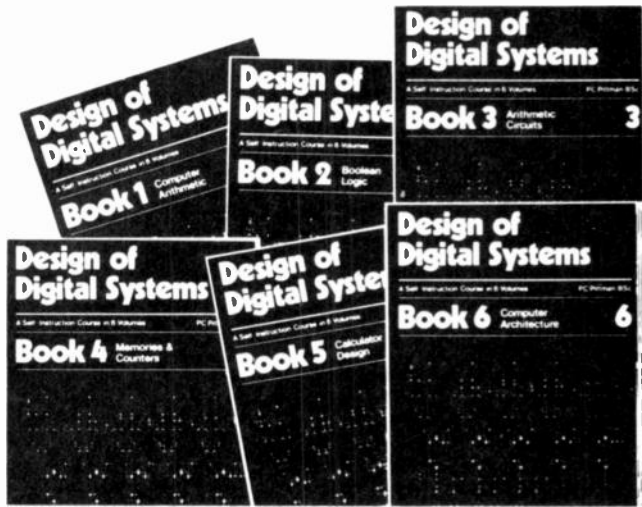

Design of Digital Systems is written for the engineer seeking to learn more about digital electronics. Its six volumes — each 11-1/2" x 8-1/4" are packed with information, diagrams and questions designed to lead you step-by-step through number systems and Boolean algebra to memories, counters and simple arithmetic circuits, and finally to a complete understanding of the design and operation of calculators and computers.

The contents of Design of Digital Systems include:

Book 1 Octal, hexadecimal and binary number systems; conversion between number systems; representation of negative numbers; complementary systems; binary multiplication and division.

Book 2 OR and AND functions; logic gates; NOT, exclusive-OR, NAND, NOR and exclusive-NOR functions; multiple input gates; truth tables; De Morgans Laws; canonical forms; logic conventions; Karnaugh mapping; three-state and wired logic.

Book 3 Half adders and full adders; subtractors; serial and parallel adders; processors and arithmetic logic units (ALUs); multiplication and division systems.

Book 4 Flip flops; shift registers; asynchronous and synchronous counters; ring, Johnson and exclusive-OR feedback counters; random access memories (RAMs) and read only memories (ROMs).

Book 5 Structure of calculators; keyboard encoding; decoding display data; register systems; control unit; program ROM; address decoding; instruction sets; instruction decoding; control program structure.

Book 6 Central processing unit (CPU); memory organization; character representation; program storage; address modes; input/output systems; program interrupts; interrupt priorities; programming; assemblers; computers; executive programs; operating systems and time sharing.



Digital Computer Logic and Electronics is designed for the beginner. No mathematical knowledge other than simple arithmetic is assumed, though the student should have an aptitude for logical thought. It consists of four volumes — each 11-1/2" x 8-1/4" — and serves as an introduction to the subject of digital electronics. Everyone can learn from it — designer, executive, scientist, student, engineer.

Contents include: Binary, octal and decimal number systems; conversion between number systems; AND, OR, NOR and NAND gates and inverters; Boolean algebra and truth tables; De Morgans Laws; design of logic circuits using NOR gates; R-S and J-K flip flops; binary counters, shift registers and half adders.

In the years ahead the products of digital electronics technology will play an important part in your life. Calculators and digital watches are already commonplace. Tomorrow a digital display could show your automobile speed and gas consumption; you could be calling people by entering their name into a telephone which would automatically look up their number and dial it for you.

These courses were written by experts in electronics and learning systems so that you could teach yourself the theory and application of digital logic. Learning by self-instruction has the advantages of being faster and more thorough than classroom learning. You work at your own pace and must respond by answering questions on each new piece of information before proceeding.

After completing these courses you will have broadened your career prospects and increased your fundamental understanding of the rapidly changing technological world around you.

The six volumes of Design of Digital Systems cost only: **\$19⁸⁸**

And the four volumes of Digital Computer Logic and Electronics cost only: **\$14⁸⁸**

But if you buy both courses, the total cost is only: **\$29⁹⁰**

a saving of over: **\$5⁰⁰**

SEVEN-DAY MONEY-BACK GUARANTEE: If you are not satisfied with your Cambridge course, return it within 7 days for a full refund.

To order your books, complete the order form below and send it together with your check or money order to GFN Industries, Inc., 6 Commercial Street, Hicksville, N.Y. 11801.

To: GFN INDUSTRIES, INC.

6 COMMERCIAL STREET, HICKSVILLE, NY 11801

Please send me:

Sets of Design of Digital Systems \$19.88 _____

Sets of Digital Computer Logic & Electronics \$14.88 _____

Sets of both courses \$29.90 _____

Sales tax (N.Y. residents) _____

Shipping and handling \$2.50 per set _____

Enclosed is check/mo (payable to GFN Industries, Inc.)

Total \$ _____

Name _____

Address _____

City/State/Zip _____

Prices include overseas surface mail postage.

RE9B



NO ONE PUTS A TURNTABLE ON TOP OF A SPEAKER, RIGHT?

We realize no sane person ever puts their turntable even close to their speakers, but we did it to prove a point.

Which is, it's now possible to build turntables that effectively deal with that unbearable "howl" known as mechanical and acoustic feedback.

The first of these new turntables are the Kenwood KD-3055 and KD-2055.

How did we do it?

With a special base made of an anti-resonance concrete so dense it absorbs vibrations from the speakers and the floor before they get to our new S-shaped tone arm.

To prove it, we did the unheard of.

We put the turntable right on the speaker box. The worst place for vibrations. Then we turned up the music.

Nothing happened. No howl. No screech. Just music, loud and clear.

To make a believer out of you, ask your Kenwood dealer for a demonstration comparing the Kenwoods with any other turntable in the store.

And once you've made the comparison based on performance, make a comparison based on price.

The semi-automatic KD-2055 is only \$150.* The fully-automatic KD-3055, only \$190.*

And that's amazing, right?



KENWOOD

For the Kenwood dealer nearest you, see your Yellow Pages, or write Kenwood, 15777 S. Broadway, Gardena, CA 90248

*Nationally advertised value. Actual prices are established by Kenwood dealers.

Cartridge not included.

Radio-Electronics®

THE MAGAZINE FOR NEW IDEAS IN ELECTRONICS

Electronics publishers since 1908

SEPTEMBER 1977 Vol. 48 No. 9

BUILD ONE OF THESE

- 33 **2-Digit Electronic Thermometer**
Covers a 100°F range; costs about \$50. by **Walter Sikonowiz**
- 36 **Electronic Security System**
Protect yourself and your property with this versatile system. by **C.D. Wadsworth**
- 40 **10-Function Digital Clock**
Part II: Construction details for a clock that tells time and date; has an alarm, acts as a countdown timer and more. by **Jeffrey G. Mazur**
- 43 **CB Frequency Counter**
For base or mobile installations. by **George Santi**

CB RADIO

- 51 **Testing CB Transceivers**
24 tests that really tell you how a CB radio performs. by **Robert Constantine**

COMPUTERS

- 54 **Core Memories**
Magnetic cores are available surplus. Here's a look at what they are and how they work. by **Martin A. Sala**
- 78 **Computer Corner**
Moving data inside the machine. by **David Larsen, Peter Rony and Jon Titus**

HIGH FIDELITY STEREO

- 59 **Pulse-Width Modulation for Hi-Fi**
Greater efficiency, smaller size and less weight are the advantages. Now see how these amplifiers work. by **Len Feldman**
- 62 **R-E Lab Tests Kenwood KA-8300**
Power amplifier earns an "Excellent." by **Len Feldman**
- 68 **R-E Lab Tests Epicure PR-4**
Really fine preamp earns its "Excellent." by **Len Feldman**

TEST EQUIPMENT

- 56 **All About RF Signal Generators**
Part II: Types available, how they work, specifications, features and applications. by **Charles Gilmore**

TELEVISION

- 81 **Service Clinic**
Attacking the intermittent. by **Jack Darr**
- 82 **Service Questions**
R-E's Service Editor solves reader problems
- 84 **Step-By-Step Troubleshooting**
Antennas and TV reception. by **Stan Prentiss**

GENERAL ELECTRONICS

- 4 **Looking Ahead**
Preview tomorrow; today! by **David Lachenbruch**
- 70 **State Of Solid State**
Add vibrato, an SCR array, and an ultra-stable oscillator. by **Karl Savon**
- 72 **Hobby Corner**
Working with breadboards. by **Earl Savage**
- 80 **Today's Semiconductors**
News of new solid-state devices. by **Karl Savon**

EQUIPMENT REPORTS

- 22 **TeleMatic KC-702 CrysMate Crystal Tester**
- 24 **Clarcothane Cleaning Solvent**
- 24 **OK Machine WSU-30 Wire-Wrap Tool**
- 26 **Polaris TPS-225 DC Power Supply**
- 102 **JFD FM500 Amplified FM Antenna**
- 104 **VIZ 534A VoltOhmyst V**

DEPARTMENTS

- | | |
|-------------------------------------|---------------------------|
| 108 Advertising Index | 103 New Books |
| 12 Advertising Sales Offices | 6 New & Timely |
| 14 Letters | 94 New Products |
| 105 Market Center | 99 Next Month |

ON THE COVER

Electronic thermometer sits in a bed of ice cubes while accurately presenting the internal temperature of one cube—2-digit display measure 0 to 99°F. See page 33 and build your own

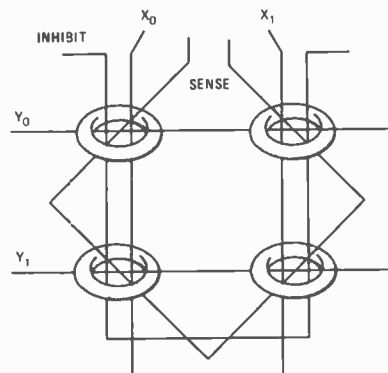

CORE MEMORIES ARE GREAT for the computer hobbyist if he understands how they work. . . . see page 54

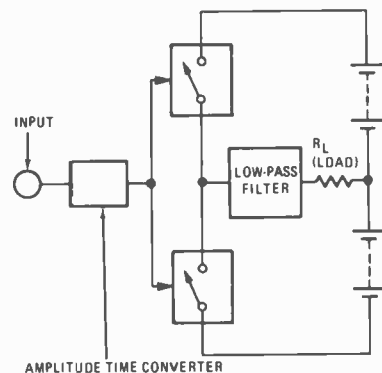

PULSE-WIDTH MODULATION amplifier looks like this. To find out how it works see page 59

Radio-Electronics, Published monthly by Gernsback Publications, Inc., 200 Park Avenue South, New York, NY 10003. Phone: 212-777-6400. Second-class postage paid at New York, NY and additional mailing offices. One-year subscription rate. U.S.A., U.S. possessions and Canada, \$8.75 Pan-American countries, \$10.25. Other countries, \$10.75. Single copies \$1.00 © 1977 by Gernsback Publications, Inc. All rights reserved. Printed in U.S.A.

Subscription Service: Mail all subscription orders, changes, correspondence and Postmaster Notices of undelivered copies (Form 3579) to Radio-Electronics Subscription Service, Box 2520, Boulder, CO 80322

A stamped self-addressed envelope must accompany all submitted manuscripts and/or artwork or photographs if their return is desired should they be rejected. We disclaim any responsibility for the loss or damage of manuscripts and/or artwork or photographs while in our possession or otherwise

As a service to readers, Radio-Electronics publishes available plans or information relating to newsworthy products, techniques and scientific and technological developments. Because of possible variances in the quality and condition of materials and workmanship used by readers, Radio-Electronics disclaims any responsibility for the safe and proper functioning of reader-built projects based upon or from plans or information published in this magazine.

looking ahead

Picture IC? It's only a matter of time and effort—not technological breakthrough—before a thin-film transistorized color TV panel will be able to do the work of today's bulky picture tube. That's the opinion of Dr. T.P. Brody, head of a research team on electroluminescent displays at Westinghouse Research Laboratories in Pittsburgh. Dr. Brody's team already has demonstrated a thin-film panel $\frac{1}{8}$ -inch thick that can display a monochrome picture in real time, with no visible smear and with grey-scale rendition.

The panel was originally designed for alphanumeric display, but its grey-scale capability convinced the team to explore its TV possibilities. As Westinghouse describes it, the current panel is actually a giant integrated circuit measuring six inches square. It has 12,000 glowing picture elements in a 110×110 -element format. These elements themselves are phosphor dots that light up when electricity passes through them. The matrix of dots is produced by vacuum-depositing thousands of tiny interlocked thin-film circuits onto a glass substrate, coating the circuits with a phosphor film and sealing the "sandwich" with a glass cover-plate. Each element consists of two thin-film transistors, a storage capacitor and a phosphor overlay. The transistorized matrix permits separate elements to be energized without activating others in the same row or column.

Although the current panel has low resolution, the research team is now working on a 262-line display designed especially for television experimentation. Remaining work, in addition to improving resolution, will be developing thin-film driver circuitry, developing color capability and removing blemishes. Color phosphors are already available, but Dr. Brody says development of a color panel will take "several more years of concentrated effort."

Star is born: It looks like the biggest new-product launching since color TV. Fifteen entries are at the starting gate for the all-industry debut of the home video recorder this fall. Although Sony has been offering its *Betamax* for about two years, and Quasar has been shipping its *Great Time Machine* in quantity for some six months, the big push is about to start, with 15 different brand names on three different types of Japanese videocassette recorders.

The latest to announce are Magnavox and Sylvania, both choosing the Matsushita-made VHS, which gets up to four hours recording onto a single cassette of half-inch tape. This is the same system adopted by RCA and Panasonic, and has partial compatibility with versions to be offered by JVC, Hitachi, MGA and Sharp. The latter machines provide two-hour capability on the same cassette, while the former have a 2/4-hour switch for full-speed or half-speed recording. *Betamax*-compatible VTRs, all providing 2-hour recording on a single cassette, will be offered by Sony, Zenith, Sanyo, Toshiba, Pioneer and Aiwa. Quasar will continue to offer its *Great Time Machine*, which is not compatible with the other two standards.

Sales are expected to be limited by supply for the rest of this year and at least a part of next. RCA estimates that the American public will buy about 250,000 units of all makes in 1977 and 750,000 next year. The going price is expected to remain at the \$1000-and-up level until the shortage is over and competition erodes pricing.

Accessories: The videocassette recorder is a television accessory that costs more than the TV set. But the VTR is going to have its own accessories that will cost more than the recorder. JVC has already introduced what it calls the first home color TV camera. As a home product, it's priced at a rather steep \$1500 and up. That's a bargain as color cameras go, the lowest-priced unit ever introduced. It uses a single vidicon tube, has a built-in microphone, and the \$1500 version has an optical viewfinder and 25-mm lens, along with a control unit, that provides automatic color correction for a variety of light conditions. Higher-priced versions will be available with electronic viewfinders and zoom lenses. But that's not all—even the accessory has an accessory. JVC will offer a "telecine attachment," which converts the camera into a film or slide scanner to permit users to transfer their own home movies or slides onto videocassettes. It's a prism arrangement that uses any projector and the JVC camera to make a film scanner; it's expected to cost around \$100.

And another accessory: Sony has confirmed our report of last month that it will offer a black box to convert its *Betamax* video recorder into—of all things—an audio recorder. But it undoubtedly will be the best audio recorder you ever heard, using pulse code modulation (PCM) with practically no distortion, zero crosstalk, zero wow and flutter, and virtually uniform audio frequency response. It's scheduled to be available here in about a year at approximately \$1300—about the same price as *Betamax* itself.

Cassette games: Most programmable video games announced to date have used ROM's for programming. Now there's a discernible trend toward a switch to audio cassettes. Cassette-programmed video game/computer systems already have been introduced by Microelectronics Corp. and a few others. General Instrument and EMI of England have announced the most comprehensive cassette-program plans to date. GI is making the electronics, EMI is doing the programming. Cassettes have many advantages in home computer/game programming, according to GI. A standard C-60 cassette can store 1.5-million bits on one side, or 3-million bits if both sides are used—compared with about 160,000 for a ROM. To develop a programmed ROM requires about three months and a run of perhaps 10,000 or more is needed to make a profit. A cassette can be programmed in three to five days and runs can be as short as 300 to 500.

A cassette program can provide audio instruction—an important factor in such computerized courses as

continued on page 98

Tuner Service Corporation

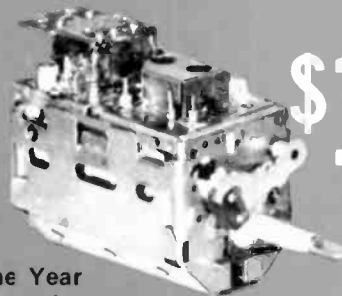
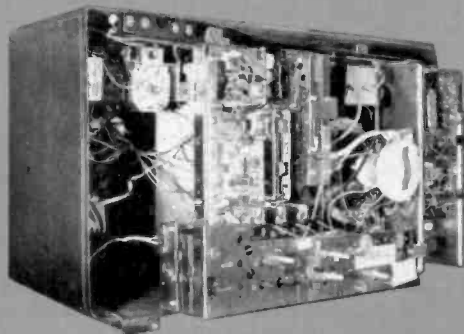

\$10⁹⁵
U.S.A. ONLY

Major Parts and Shipping Charged at Cost

One Year Guarantee

MODULE REPAIRS

TSC has been repairing private brand TV modules for over 3 years.

Expanded facilities now include modules for

- RCA
- GE
- ZENITH
- W. T. GRANT
- J. C. PENNEY
- WESTERN AUTO
- GAMBLES

as well as Zenith IF subchassis.

For free Price List and complete information write or phone; TSC HEADQUARTERS, BLOOMINGTON, IND. or any of the TSC locations listed below.

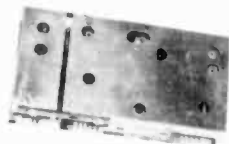
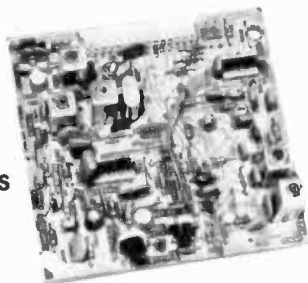

PROVIDES YOU WITH A COMPLETE SERVICE FOR ALL YOUR TELEVISION TUNER REQUIREMENTS.

TUNER REPAIRS

VHF OR UHF ANY TYPE.....(U.S.A.) \$10.95
UHF/VHF COMBINATION.....(U.S.A.) \$17.95

MAJOR PARTS AND SHIPPING CHARGED AT COST

- FAST, EFFICIENT SERVICE AT ANY OF THE CONVENIENTLY LOCATED SERVICE CENTERS LISTED BELOW.
- ONLY ORIGINAL FACTORY PARTS USED
- All tuners ultrasonically cleaned, repaired and realigned.

EXACT REPLACEMENT

- Exact Replacement Tuners are available at a cost of \$14.95 and up.(U.S.A. Only)
- Send in your original tuner for comparison purposes to any of the Centers listed below.

UNIVERSAL REPLACEMENT

- UNIVERSAL REPLACEMENT TUNER \$13.95.....(U.S.A. Only)
- This price buys you a complete new tuner built specifically for this purpose.
- All shafts have a maximum length of 10 1/2" which can be cut to 1 1/2".
- Specify heater type parallel and series 450 mA or 600 mA.

FLASH

NOW AVAILABLE—TUNER SERVICE PARTS CATALOG OF ALL SARKES TARZIAN VHF AND UHF TUNERS, INCLUDING EXPLODED VIEW DRAWINGS. OVER 200 PAGES. ORDER YOUR COPY TODAY. SEND \$2.50 WITH ORDER TO BLOOMINGTON HEAD OFFICE.

SAME DAY SERVICE — ONLY ORIGINAL FACTORY PARTS USED



WATCH US GROW

HEADQUARTERS	BLOOMINGTON, INDIANA 47401	537 South Walnut Street	Tel. 812/334-0411
ARKANSAS	LITTLE ROCK, ARKANSAS 72204	4208-C Ashe Ave.	Tel. 501/661-0393
ALABAMA	BIRMINGHAM, ALABAMA 35212	5623 1st Avenue North	Tel. 205/592-8150
CALIFORNIA	NORTH HOLLYWOOD, CALIF. 91601	10654 Magnolia Boulevard	Tel. 213/769-2720
	SAN MATEO, CALIF. 94402	608 S. Amphlett Boulevard	Tel. 415/348-3292
	MODESTO, CALIF. 95351	123 Phoenix Avenue	Tel. 209/521-6051
FLORIDA	TAMPA, FLORIDA 33606	1506 Cypress Street	Tel. 813/259-0324
	FT. LAUDERDALE, FLORIDA 33309	3518 N.W. 10th Avenue	Tel. 305/556-4882
GEORGIA	ATLANTA, GEORGIA 30310	848 Evans Street S.W.	Tel. 404/758-2232
ILLINOIS	URBANA, ILLINOIS 61801	908 E. Main Street	Tel. 217/384-2052
	SP. OKIE, ILLINOIS 60078	5110 West Brown Street	Tel. 312/675-0230
INDIANA	INDIANAPOLIS, INDIANA 46204	112 West W. Clair Street	Tel. 317/632-3493
KENTUCKY	LOUISVILLE, KENTUCKY 40205	2244 Taylorsville Road	Tel. 502/452-1191
LOUISIANA	SHREVEPORT, LOUISIANA 71104	2423 Southern Ave.	Tel. 519/221-3027
MASSACHUSETTS	SPRINGFIELD, MASSACHUSETTS 01108	405 Dickinson Street	Tel. 413/788-8206
MISSOURI	ST. LOUIS, MISSOURI 63132	9577 Page Avenue	Tel. 314/429-0633
NEVADA	LAS VEGAS, NEVADA 89102	114 South Casino Center Blvd.	Tel. 702/384-4235
NEW JERSEY	TRENTON, NEW JERSEY 08638	1139 Pennsylvania Avenue	Tel. 609/393-0999
	JERSEY CITY, NEW JERSEY 07307	454 Central Avenue	Tel. 201/792-3730
	ROCHESTER, NEW YORK 14615	37 Pullman Avenue	Tel. 716/647-9180
NORTH CAROLINA	GREENSBORO, NORTH CAROLINA 27405	2914 East Market Street	Tel. 919/273-6276
OHIO	CLEVELAND, OHIO 44109	4525 Pearl Road	Tel. 216/741-2314
OREGON	PORTLAND, OREGON 97210	1732 N.W. 25th Ave., P.O. Box 3078	Tel. 503/222-9059
PENNSYLVANIA	PITTSBURGH, PENNSYLVANIA 15209	515 Grant Avenue	Tel. 412/621-4004
TENNESSEE	MEMPHIS, TENNESSEE 38111	3158 Barrow Avenue	Tel. 901/458-2355
TEXAS	DALLAS, TEXAS 75218	11540 Garland Road	Tel. 214/327-8413
CANADA	ST. LAURENT, QUEBEC H4N-2L7	305 DeCarle Boulevard	Tel. 514/748-8803
	CALGARY, ALBERTA T2H-1Y3	P.O. Bdx 5823, Stn. "A"	Tel. 403/243-0971

If you want to branch out into the TV Tuner Repair Business write to the Bloomington Headquarters about a franchise.

CIRCLE 14 ON FREE INFORMATION CARD

The positive aspects of negative-ion generators

Ever since 1932, when an RCA scientist accidentally discovered that an electrostatic generator in his laboratory was releasing positive and negative ions and causing dramatic mood swings in his fellow workers, the topic has intrigued scientists. Studies here and abroad showed that atmospheric ions, those billions of electrically charged particles in the air all around us, had definite effects not only on personal well-being but also on an individual's capacity to recover from illness and disease.

For example, it has been noted that sometimes before a storm many people complain of fatigue and other symptoms; cattle also grow restless. What happens is that the air retains an excess of positive ions, causing distress and discomfort to both humans and animals. Observations made at the University of California at Berkeley and at the Hebrew University in Israel have shown that before a storm many "weather sensitive" people display moderately acute respiratory problems, migraines, nausea and vomiting. Negative-ion generation was able to reduce these symptoms. Burn victims, post-operative patients and persons suffering from depression have also been successfully treated by means of a negative-ion generator.

This generator is an electronic device housed in a small metal box. With a flip of a switch, a fan begins to turn releasing a flow of negative ions. The air begins to smell sweet and the patient feels better. Naturally enough after this discovery, negative-ion generators proliferated on the commercial market. Because fantastic claims were made for their therapeutic benefits, they were completely discredited. However, in the light of continuing laboratory experiments, negative-ion generators have now not only become "respectable," they have opened up a vista of unlimited possibilities.

While there is still much to be learned about atmospheric ions, it has been predicted that in a few years we will be able to control the ion level indoors as we regulate temperature and humidity, thereby helping us all to lead happier, healthier lives.

New mobile phone network permits more subscribers

The Illinois Bell Telephone Company of Chicago is presently testing a unique mobile telephone network that can service a greater number of subscribers. They have devised a system in which metropolitan areas are divided into circular cells about 1½ miles wide. Each cell is served by a radio telephone station, with power supplied from a single transmitter in the Chicago loop area. The stations, in turn, are controlled by a central computer.

The way it works is this: As the mobile phone user moves from area to area, he is "handed off" from one station to another. The quality and strength of his signal is measured at five-second intervals to determine whether to maintain the connection at the current station or switch to the next.

A Bell spokesman stated that the 1½-mile spacing had proved feasible in a series of tests in New Jersey, specifically Newark. In the Newark test, transmissions were made from a computer-equipped van, with interference being provided by other van-mounted transmitters placed wing-fashion around the 1½-mile cell test area.

Seizing upon the idea, other companies have requested permission to make similar tests. In the Washington, DC, area, the American Radio Telephone Service, Inc., plan to use a Motorola cellular system called Dynatac, in which hand-held as well as mobile phones are envisioned. Harris Corporation, another major electronics company, has petitioned the FCC for permission to test a digital transmission system using a single central station and remote-relay antennas. The on-off digital code of the computer would be used to generate the signals. The radio channel would be shared by sampling mobile telephone transmissions many times per second; this sharing system is called time-division multiple access.

It is felt that the cellular system, by allowing a greater re-use of radio frequencies, will accommodate many more mobile telephone users in urban areas, with enough traffic to justify installing the cells.

Alternate to CB radio for small business communicators

The small business that has been attempting to use CB communications but finds crowding intolerable now has an alternate in a new line, Motorola's *MOXY*,



MOTOROLA MOXY mobile radio

that is intermediate in price between CB and current FM business radio, yet offers the advantages of the latter.

Crowding is reduced and reliability increased because each business user is assigned his own frequency. In addition, he can order a PL (Private Line) or DPL (Digital Private Line) squelch to screen out messages on his channel that are not intended

for him.

The *MOXY* mobile radios are available in UHF, high band and low band. Power outputs range from 10 to 25 watts. They are less than 3 inches high, 7 inches wide and 11 inches long, weighing less than 3 pounds, thus can be installed easily in cars, trucks or tractors.

Plate-glass speaker can replace conventional systems

This is the success story of two acoustical-equipment makers, Les Barcus and John Berry, who, while tinkering around in their plant lab one day, wired an electronic sound energizer to a piece of ordinary window glass. Presto—a speaker, which has turned out to be a revolutionary device—the AudioPlate.

The AudioPlate is made of a 5- by 7-inch sheet of glass, ¼-inch thick, with a 1-inch energizer bonded to the back. The device projects sound of such clarity that conventional precise speaker arrangement may become a thing of the past. The manufacturers claim it can produce sound in its upper ranges up to 250,000 hertz, more than ten times that of most speakers. No one is really quite sure how it works. One theory has it that the energizer bends the glass, causing wave disturbances in it, which then disturbs the air sufficiently to produce sound.

Barcus-Berry, Inc., has already provided franchised distributors in the U.S. and abroad with public-address systems incorporating the AudioPlate, and hope to make a low-price model available to the hi-fi market before long.

Contest turns up wide range of new microprocessor applications

An agricultural monitor and controller and a system for monitoring electroencephalograms (EEG's) more easily during surgical operations were the first and second prize winners in the Schweber Electronics first annual Microprocessor Competition. This competition, according to Seymour Schweber, president of the company, is to "inspire people to narrow the gap between today's challenges and tomorrow's realities."

The agricultural monitor and controller, which won a \$1,000 first prize for Peter J. Prossen of Prossen Industries, Westminster, CA, is described as part of a system to optimize irrigation practices, reduce the cost of irrigation and irrigation labor, and minimize water waste. Data measured include root stress, transpiration rate, temperature, rainfall, and various irrigation system pressures and flow rates.

Second prize went to John Doyle of Ottawa, Canada, who worked with the Ottawa General Hospital to develop his

Continued on page 12

Vaco.



Super Case II No. 70380



Super Zip No. 70390

Meet the Super Family!

Our original Super Case was such a success that you asked for more. So here they are!

Super Case II includes 45 professional problem-solving tools from screwdrivers and nutdrivers to hex keys, testers, wire cutters, wrenches and pliers . . . plus a super-handy solderless connector kit complete with crimping tool. Super Zip is a compact zipper case assortment of 36 of our most popular tools and components. All professional quality. And all with a full lifetime warranty.

For a full color brochure on all three SUPER CASES, just write:

Vaco Products Company, 510 N. Dearborn St.,
Chicago, Illinois 60610.

CIRCLE 20 ON FREE INFORMATION CARD

Introductory Feature with Super Case II



As a special introductory bonus, we're including the super-size No. 4900-63 metal box solderless terminal kit (complete with crimping tool) in place of the standard service kit. Super!

NRI BRINGS "POWER-ON"
 TRAINING TO YOUR HOME...
 FOR QUICKER, EASIER
 LEARNING AND
 FASTER EARNING

NRI FIRSTS

First and only school with designed-for-learning Quadraphonic Audio Center with four SP14 speaker systems. This solid state SQ™ system is designed so that you perform meaningful experiments at every stage of assembly . . . for thorough training in audio technology.



™Trademark of CBS, Inc

You get trouble-shooting experience from the chassis up . . . with NRI's unique training equipment.

The "firsts" described here are typical of NRI's over 63 years of leadership in electronics home training. When you enroll as an NRI student, you get the technical knowledge and the priceless confidence of "hands-on" experience sought by employers in communications, TV-audio servicing, computers, and industrial and military electronics. NRI training is designed for your education . . . from the educator-acclaimed Achievement Kit sent the day you enroll, to bite-size, well illustrated, easy-to-read lessons programmed with designed-for-learning training equipment.

NRI Firsts make learning at home fast and fascinating. More than a million have come to NRI for home training. Professional TV/Audio technicians who learned their profession through home training rate NRI as first choice by far, over any other school.

SEND FOR THE FREE FULL-COLOR CATALOG . . . for full details on NRI home training. There is no obligation . . . *no salesman will call.*

First with an electronics Discovery Lab™. This self-contained advanced solid-state lab gives you fast, hands-on access to fully-powered semiconductor circuitry. NRI is the only school with all these modern solid state component experiments in: bipolar and field effect transistors, Zener diodes, light-emitting diodes, SCR's and phototransistors.

™McGraw Hill CEC

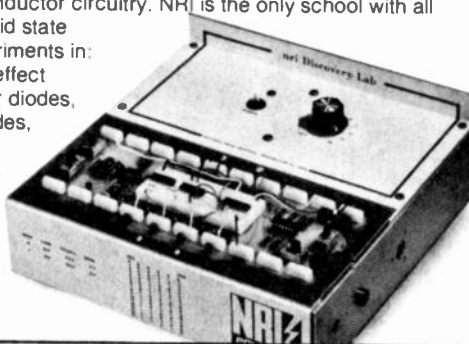

First and only school with new Optical Transmission System engineered to allow you to analyze digital and analog signal transmission via light beam. Systems you build use LED and phototransistor technology, simulating basic principles of laser communications as used in video disc home entertainment systems.

First and only school with designed-for-learning 25" diagonal solid state Color TV complete with cabinet. This solid state set was designed by NRI's own engineers from the chassis up so that students can perform over 25 in-set experiments during construction, including valuable "Power-On" trouble-shooting.

First and only school with a portable CMOS digital frequency counter engineered by NRI to give you experience in the newest types of digital systems coming into expanded use in consumer electronics.



First and only school with an Antenna Applications Lab engineered to give you a thorough understanding of practical communications antenna requirements. You assemble and test several different types of antennas and matching sections, measuring gain and radiation patterns.



First and only training with an actual programmable digital computer to give you the only home training in machine-language programming . . . essential to trouble shooting digital computers. Extra Memory Expansion Kit doubles memory size for practice in advanced programming techniques.

First and only school with a solid state regulated power supply engineered by NRI to give you experience with modern power supply designs; to give you a premium power supply for your NRI Transceiver, or to use in trouble-shooting mobile equipment.



First and only school with designed-for-learning, 400-channel, digitally-synthesized VHF Transceiver to give you the only fully-up-to-date 2-meter equipment for complete training in commercial, amateur, and CB communications. The design incorporates circuitry and components representative of the latest state of the art. Circuitry is on five plug-in circuit cards to take full advantage of NRI "Power-On" training.

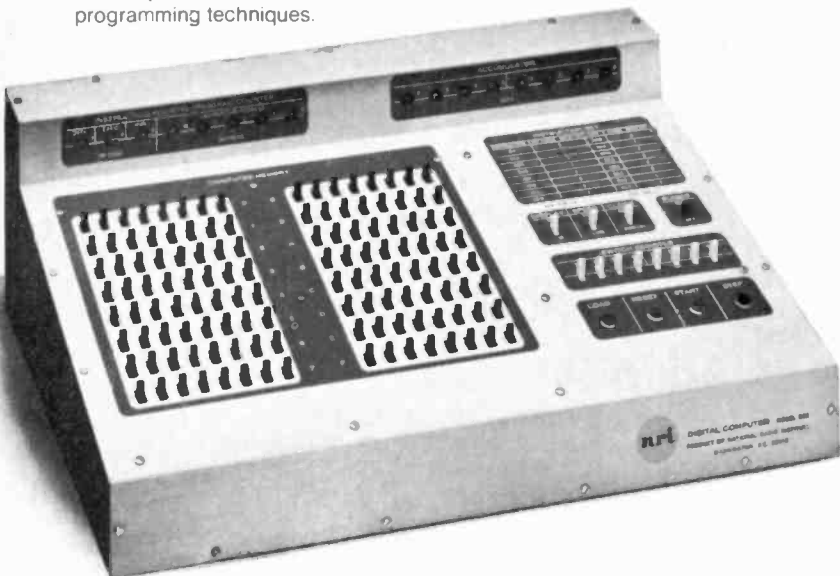

If card is missing, write to:

NRI Schools
 McGraw Hill Continuing
 Education Center
 3939 Wisconsin Ave.
 Washington, D.C. 20016

EEG monitor. He received \$500 for his entry.

Third and fourth prizes, both of \$250, were tied between Dr. Jay S. Karmarker, electronic systems consultant of Santa Clara, and Derek McClure, of Wetaskiwin, CA. Dr. Karmarker designed a drug interaction computer that can determine the compatibility of various drugs. McClure's entry was an audiometric instrument with which a patient can test himself after minimal instruction from a technician. The fifth prize, also of \$250, went to David B. Herburg, Nirmal Ratnakumar and Peter Lobban, all of Stanford University, who cooperated on a microprocessor controller for an epitaxial reactor. There were also five honorable mentions.

The competition will be an annual one. For information on entries, contact Mel Kutzin, MPU Center, Schweber Electronics, Westbury, NY 11590, phone 516-334-7474.

Planet Jupiter emits intense radiation field

Pioneer I and Pioneer II space probes have confirmed that the planet Jupiter is emitting radiation into a vast region of space. The radiation consists of high energy electrons that are emitted from a specific region of the planet's magnetic field. These high-energy electrons are apparently accelerated by the planet's magnetic field in the same manner as those signals generated by distant pulsars.

At the spring meeting of the American Geophysical Union in Washington, DC, Dr.

John A. Simpson of the University of Chicago and others discussed the significance and implications of these findings. Physicists have long determined that pulsars, which are "hotspots" that spin at incredibly fast rates, release highly charged electronic particles that are responsible for much of the electromagnetic radiation that bombards the earth from all directions in the universe. Although Jupiter's spin rate is much slower, the planet is now believed to have features in common with pulsars.

Dealer training program draws record crowd

This past April, Downstate Communications, Inc. sponsored their second, highly successful dealer training seminar at Southern Illinois University, Carbondale, IL. DOW-COM president Craig Martin was enthusiastic about the turnout. It was "like a mini PC-77," he said, citing attendance by dealers and manufacturers from many areas.

Thirty-six manufacturers set up booths featuring mainly CB's and related equipment. In addition, a morning seminar was addressed by speakers drawn from industry leaders. Adding spice to the proceedings were door prizes. The grand prize of a Browning Golden Eagle CB radio was won by Mark Chaffee. Lee Kitay of Pittsburgh, PA, won a base-station antenna for having "travelled the farthest distance." The day ended in an appropriately festive fashion with a dinner party for the manufacturers hosted by DOW-COM's Craig Martin for the participants.

R-E

Radio-Electronics®

Hugo Gernsback (1884-1967) founder
M. Harvey Gernsback, KOD-6694
editor-in-chief and publisher
Larry Steckler, KTX-3644, CET, editor
Robert F. Scott, CET, W2PWG,
KXK-8533, technical editor
Arthur Kleiman, KTZ-3288,
managing editor

Jack Darr, CET service editor
Leonard Feldman
contributing high-fidelity editor
Karl Savon, semiconductor editor
David Lachenbruch, contributing editor
Earl R. Savage, K4SDS, hobby editor
Vincent P. Cicenica, production manager
Dale Allinson, production assistant
Harriet I. Matysko, circulation director
Sheila Wertling, circulation assistant
Arline R. Bailey, advertising coordinator

Cover design by Louis G. Rubsamen

Cover photo by Walter Herstatt

Radio Electronics is a member of the *Institute of High Fidelity* and is indexed in *Applied Science & Technology Index* and *Readers Guide to Periodical Literature*.



Radio-Electronics magazine is published by Gernsback Publications, Inc.
200 Park Ave. S., New York, NY 10003
(212) 777-6400

President: M. Harvey Gernsback
Vice President: Larry Steckler
Treasurer: Carol A. Gernsback
Secretary: Bertina Baer

ADVERTISING SALES

EAST

Stanley Levitan, KZA-5580
Radio-Electronics
200 Park Ave. South
New York, NY 10003
(212) 777-6400

MIDWEST/Texas/Arkansas/Okla.

Ralph Bergen, KXD-8396
Jim Reilly
The Ralph Bergen Co.
6319 N. Central Ave.
Chicago, IL 60646
(312) 792-3646

PACIFIC COAST Mountain States

Jay Eisenberg, KYF-3277
J.E. Publishers Representative Co.,
8732 Sunset Blvd.,
4th Floor,
Los Angeles, CA 90069
(213) 659-3810
Sales Mart Building
1485 Bayshore Blvd., Box 140
San Francisco, CA 94124
(415) 467-0125

SOUTHEAST

J.E. Publishers Representative Co.,
214-387-2424



GRAND PRIZE WINNER at the dealer training program is Mark Chaffee (center). He is shown being presented with a Browning Eagle by Gardiner Greene (left), president of Browning Laboratories, Inc.

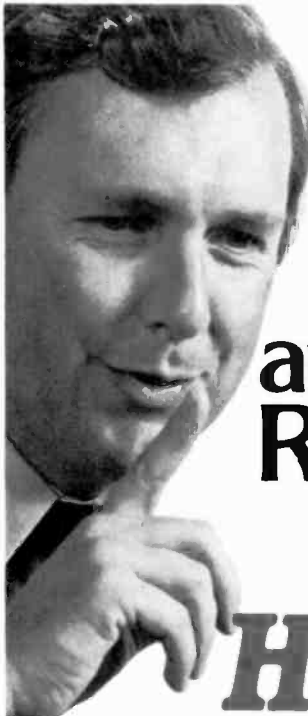

You've got a secret

with the amazing Realistic® One-Hander™



How's a CB bandit going to take your CB if he doesn't even know you've got one? That's the secret of the One-Hander. Since all controls you need are in the palm-sized handset, you can mount the tiny transceiver case permanently out of sight — in the glovebox, under dash or seat, even in the trunk using a special extension cable. When you leave your vehicle, unplug the handset and lock it up or take it with you. The One-Hander is safer and easier to use while driving — no reaching and fumbling around to make adjustments. Built-in noise blanker and limiter chop out ignition-type noise. Two ceramic filters and push-pull audio circuitry. Improved auto-modulation for FULL talk power, always. With mounting bracket, cables for 12 VDC positive or negative ground. Thieves hate the Realistic One-Hander. But you'll love it. Just 169.95* at your nearby Radio Shack.

1½x5¼x7" case with selector switch for handset speaker, built-in speaker, or optional external speakers.



ALL THE CONTROLS ARE IN THE MIKE

- ✓ Push-to-Talk Switch
- ✓ Speaker and Mike
- ✓ Channel Selector with LED Indicator
- ✓ Volume On/Off Control
- ✓ Variable Squelch
- ✓ 5' Coiled Cord



Trunk-mount your One-Hander: Special 16½-foot cable runs from trunk under carpet to plug-in jack on dash. Everything's hidden! Cable (21-600) just 29.95*.



FREE! New '78 Catalog
Come in for your copy and see what's *really* new in electronics. 164 pages, 100 in full color. 2000 exclusive items.

SOLD ONLY WHERE YOU SEE THIS SIGN:

Radio Shack®

A TANDY COMPANY • FORT WORTH, TEXAS 76107
OVER 5000 LOCATIONS IN NINE COUNTRIES

*Prices may vary at Individual stores and dealers.

INTRODUCING THE FAST WORKING COUNTERS FROM HICKOK.



Four affordable, deluxe
counters — one for every need.

MODEL 380. 1 Hz to 80 MHz. 10 ppm	\$269
MODEL 380X. 1 Hz to 80 MHz. 1ppm	\$419
MODEL 385. 1 Hz to 512 MHz. 10ppm	\$545
MODEL 385X. 1 Hz to 512 MHz. 1ppm	\$699

Perfect for communications, CB, audio and digital work, servicing and laboratory applications.

Full 7-digit display with automatic decimal, full autoranging. SPEED READ mode updates display 5 times each second to aid tuning and adjustments.

Resolution is 1 Hz to 10 MHz. and 10 Hz to 80 MHz. Models 385, 385X feature a built-in prescaler to take you all the way to 512 MHz. Models 380X, 385X incorporate temperature compensated crystal oscillators with 1 ppm accuracy.

See these exciting new counters at your distributor now!

HICKOK

the value innovator

INSTRUMENTATION & CONTROLS DIVISION
THE HICKOK ELECTRICAL INSTRUMENT CO.
10514 Dupont Avenue • Cleveland, Ohio 44108
(216) 541-8060 • TWX: 810-421-8286
CIRCLE 25 ON FREE INFORMATION CARD

letters

TRANSDUCERS

I have an answer to the letter that appeared in the May 1977 issue asking for information on dashboard digital readouts for drag races and rallies.

For position transducers, linear accelerometers, precision pendulums and gyroscopes, write to: Humphrey Instruments, 9212 Balboa Ave., San Diego, CA 92123. Other temperature transducers can be obtained from: Omega Engineering, Inc., Box 4047, Springdale Station, Stamford, CT 06907.

MARK POLLARD
Boulder, CO

2650 NEWSLETTER

We are announcing the 2650 Computer User Notes, a six-issue-per-year newsletter supporting the 2650 microcomputer system from Central Data Company (Radio-Electronics; April, May, June 1977 issues.)

Unlike previous computer newsletters, this publication will be professionally typeset with normal-sized print, display-size headlines, and pictures. Subscriptions are \$5 in the U.S. and Canada, \$10 foreign, from 2650 Computer User Notes, Box 158, San Luis Rey, CA 92068.

The new 2650 microprocessor system described in *Radio-Electronics* is just the sort of powerful, cost-effective, versatile (the S100-bus option, for instance) machine people have long wanted. Personally, I have been waiting three years for something sensible to come along—and this is it. An associate and I are ordering three of them. We're going to use them to edit newsletter copy and drive typesetting equipment (which includes a simple Lexitron/IBM-Executive strikeon machine and a Photon 713-20 phototypesetter). We'll also use the computer to keep track of subscriptions.

The first issues of the newsletter will be heavily concerned with the problem of getting up and running home-assembled boards. We will be advising of software availability, programming problems, solving the bottleneck of low-cost high-speed mass storage, and multiprocessing with other processors (thus stretching software availability). User applications will be a prime interest.

BILL McLAUGHLIN, Editor
San Luis Rey, CA

CORRECTION

The transistor types are incorrectly labeled in the schematic and parts list of the Electronic Music Box in the June issue. The author originally specified transistor Q1 as being any general-purpose PNP silicon device with H_{fe} greater than 50. Similarly, Q2-Q5 were specified as being general-purpose NPN silicon transistors. Thus, Q1 is a 2N3906 and Q2-Q5 are 2N3904's.

RINGBACK

Your article telling how to build a tele-switch for your home (April 1977 issue) didn't mention one important misconception about phone company equipment.

Ringback, the intermittent sound you hear in the earpiece after dialing, has no correlation with the number of rings occurring at the other end. The signal you hear is generated by equipment in your local phone company switching office. Even if the call were made within the same switching office, the ringback is sent out to you, the caller, only for your benefit so as to create a false sense of security that indeed the call has gone through.

A situation could come up where you think you've allowed your phone to ring once only, but it may have rung as many as three times, or not at all, depending on the equipment, or, I should say, on its availability at the moment it generates ring and ringback.

JONAS R. BIELKEVICIUS
Greenbelt, MD 20770

ELECTRONIC ROULETTE

I was very pleased with your construction article, "Build Electronic Roulette" in the December 1976 issue. I used the circuits shown to build a similar unit. I found a few errors that other readers should take note of before building the unit.

The first is on page 73. IC6 is shown having pin 1 connected to LED 28. This is incorrect. IC6 was inserted in the wrong direction in Fig. 3. Turn IC6 around so pin 1 goes to LED 17, pin 2 will go to LED 18, etc. *NOTE, the location of pin 1 of IC6 on page 72 is correct.* The schematic shows pins 2 and 3 of IC2 and IC3 shorted together. This does not appear in the foil pattern and must be included on the printed circuit board, otherwise, the counters will never reset. Add a line on the foil pattern from pin 2 to pin 3 on both IC2 and IC3.

Next, the oscillator shows the top of R1, R3, and R4 connected to the positive side of the 5-volt power supply. On the foil pattern, extend the line at the top of R3 to R1 respectively. No oscillation will occur if this is not done. The foil pattern shows pin 18 of IC7 connected to pin 4 of IC4-b, and pin 19 of IC7 connected to pin 5 of IC4-c. Change pin 18 from pin 4, IC4-b to pin 5, IC4-c, and change pin 19 from pin 5, IC4-c to pin 4, IC4-b. Once done, the foil pattern will match the schematic.

Finally, two incorrect numbers on the schematic. The first on IC5. Pin 23 appears in two places. The one labelled on input AO is correct. Change input A3 from pin 23 to pin 20. The next is on IC3. Pin 12 should be connected to pin 1 instead of pin 2. The foil pattern is correct, however, for both of these points on the schematic.

continued on page 16

New SIMPSON 5" Dual-Trace 15 Mhz Scope

with triggered sweep. Reliable, versatile
and easy to use. It's your best scope buy.



MODEL 452 \$635

- For design, development and service of digital circuitry, communications, audio, TV equipment . . . in lab, shop or field.
- Differential vertical amplifier stages provide wide DC to 15 MHz bandwidth with smooth rolloff useable thru 27 MHz.
- Reliable integrated circuitry, all-solid-state (except CRT)
- Triggering — internal, external, TVV, TVH, VITS
- Automatically shifts between CHOP and ALTERNATE as you change sweep time.
- 24 nanosecond rise time
- Front-panel X-Y operation, dual matched vertical amplifiers.
- Displays CH A, B, A&B, A + B, A-B
- 0.5V peak-to-peak 1kHz square wave calibrator
- Voltage-calibrated vertical and horizontal inputs (eleven steps in 1-2-5 sequence)
- X5 magnification
- Human-engineered front panel controls

See Your Local Electronics Distributor or Write for Bulletin T-837.



SIMPSON ELECTRIC COMPANY
853 Dundee Avenue, Elgin, Illinois 60120
(312) 697-2260 • Cable SIMELCO • Telex 72-2416

KATY INDUSTRIES



INDUSTRIAL
EQUIPMENT
GROUP

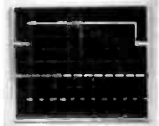

Check logic
including
countdowns and PLL

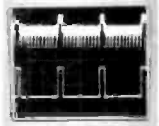

Display composite
video and AGC pulse

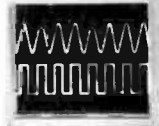

Display op-amp
input/output, A/D
converter

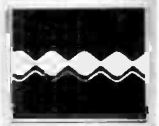

27 MHz "CB"
envelope and
modulating signal

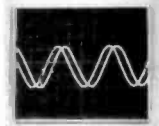

Check phase shift
and distortion in
amplifiers

LETTERS

continued from page 14

In addition to these corrections, I came up with a small modification. If a variable time constant is desired, replace R1 with a 0-500K potentiometer. Taper and type are not critical. Also, if the oscillation does not come to a smooth stop at the end of a spin, it can be eliminated by increasing the value of C1 to 3000 μ F, and replacing C2 with a 220 μ F 16-volt, electrolytic capacitor.

MIKE TORTORELLA
Essex Junction, VT

2650 COMPUTER QUESTIONS & ANSWERS

With reference to the article on the 2650 microcomputer on page 31 of the April issue, I have a few questions. For instance, in being capable of 16 lines of 80 characters, is it also the limit of the PC board memory? Do you have to transfer this to the tape before you can prepare another format? How many of these sets will a 30-minute tape take? Can you recall from the tape any portion from any part of the tape, or do you have to start at the beginning? What about a printout, can you add on a page printer, and, if so, what kind?

RAUL YZAGUIRRE
Premont, TX

The 80-character by 16-line display is indeed limited by the display memory. You can store any memory locations onto the cassette, and load them back again without

running through the cassette from the beginning. A 30-minute tape will hold about 300,000 bytes of data (234 screens full). We have a teletype line printer hooked to it (300 LPM), and it works very well.—Jeff Roloff

In the April and May issues, pictured along with the 2650 computer article, is an ASCII encoded keyboard, which is used to input data to the computer. Nothing is mentioned in the article as to where this unit can be purchased, or any of the circuitry involved with it.
RONALD P. LE BLANC
Kincheloe AFB, MI

You can purchase any ASCII keyboard for use with our board. We, however, don't sell any. We have heard that Radio-Shack keyboards work well.—Jeff Roloff

MUSIC GENERATOR

With respect to my article on constructing a music generator in the June 1977 issue, the construction details were reproduced very faithfully, with the following exceptions:

The transistor type numbers are all interchanged on the schematic and parts list. NPN's are 2N3904, PNP's 2N3906. On the schematic, IC11-b in the Pitch Scaler should be $\frac{1}{2}$ 4013; IC4-b in the Duration Scaler should have output pin No. 4.

Also, a small metal shield should be placed, with appropriate insulation, over R1 and soldered to the frame of S1, which, in turn, is grounded.

Additionally, credit should be given to Richard F. Voss, IBM, Yorktown Heights, NY, for the original research on the subject done at the Physics Department of the University of California at Berkeley, and for the introductory portion of the article. His name should have been included as co-author of the article.

RAYMOND A. CHAMBERLIN
Berkeley, CA

R-E

Thanks to you
it works...
FOR ALL OF US



United Way

advertising contributed for the public good. 

Treat yourself to a new direct reading DVM today.



DVM35

POCKET PORTABLE
ANALOG REPLACEMENT
3-digit, 1% DCV,
Battery or AC
Only \$134



DVM36

LAB ACCURATE
POCKET PORTABLE
3½ digit, .5% DCV,
Battery or AC
Only \$158



DVM32

BENCH & FIELD MASTER
3½ digit, .5% DCV,
Battery or AC
Only \$198



DVM38

"PRIME" STANDARD
AT YOUR FINGERTIPS
3½ digit, .1% DCV,
Auto-Ranging
Only \$348

A COMPLETE LINE OF DVMs TO FILL YOUR EVERY NEED OR WANT.

You can be sure more times in more circuits, under more adverse conditions, with greater versatility, accuracy, and meter protection than any other digital multimeters on the market today; and for less money too. 10 Day Free Trial: Try any of these famous DVMs for 10 days. If the DVMs in use don't prove exactly what we say, return them to your Sencore FLPD Distributor.

Want more information? We would like to tell you all about the Sencore DVMs by sending you a 24-page Sencore News, a six-page brochure, and the name of your nearest Sencore Distributor today... simply write or circle reader's service number.

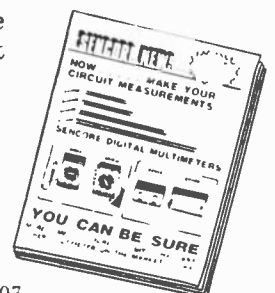

3200 Sencore Drive, Sioux Falls, SD 57107

CIRCLE 4 ON FREE INFORMATION CARD

Why you should buy a digital multimeter from the leader in digital multimeters.

If you're shopping for your first multimeter, or moving up to digital from analog, there are a few things you should know.

First, look at more than price. You'll find, for instance, that the new Fluke 8020A DMM offers features you won't find on other DMMs at any price. And it's only \$169.*

Second, quality pays. Fluke is recognized as the leading maker of multimeters (among other things) with a 30-year heritage of quality, excellence and value that pays off for you in the 8020A.

Third, don't under-buy. You may think that a precision 3½-digit digital multimeter is too much instrument for you right now. But considering our rapidly changing technology, you're going to need digital *yesterday*.

If you're just beginning, go digital.

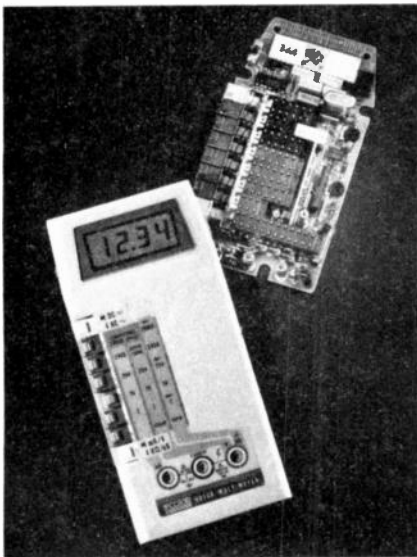

Why not analog? Because the 8020A has 0.25% dc accuracy, and that's *ten*

times better than most analog meters.

Also, the 8020A's digital performance means things like 26 ranges and seven functions. And the tougher your home projects get, the more you need the 8020A's full-range versatility and accuracy. The 8020A has it; analog meters don't.

If you're a pro.

You already know Fluke. And you probably own a benchtop-model multimeter.

Now consider the 8020A: smaller in size, but just as big in capability. Like 2000-count resolution and high-low power ohms. Autozero and autopolarity. And the 8020A is MOV-protected to 6000V against hidden transients, and has overload protection to 300V ac.

Nanosiemens?

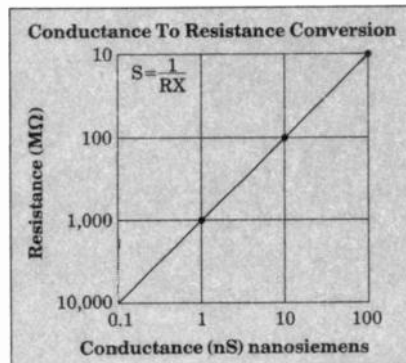

Beginner or pro, you'll find the meter you now have can't measure nanosiemens. So what? With the 8020A *conductance* function, you can measure the equivalent of 10,000 megohms in nanosiemens. Like capacitor, circuit board and insulation leakage. And, you can check transistor gain with a simple, homemade adapter. Only with the 8020A, a 13-oz. heavyweight that goes where you go, with confidence.

What price to pay.



\$169.*

Of course, you can pay more. Or less. In fact, you could pay almost as much for equally compact but more simplistic meters, and get far less versatility. And, the 8020A gives you the 'plus' of custom CMOS LSI chip design, and a minimum number of parts (47 in all). All parts and service available at more than 100 Fluke service centers, worldwide. Guaranteed, for a full year.

Rugged. Reliable. Inexpensive to own and to operate; a simple 9V battery assures continuous use for up to 200 hours.

Where to buy.

Call (800) 426-0361 toll free. Give us your chargecard number and we'll ship one to you the same day. Or, we'll tell you the location of the closest Fluke office or distributor for a personal hands-on feel for the best DMM value going.

*U.S. price only

Fluke 8020A DMM for Home Electronics Experts: \$169



You gotta shop around.

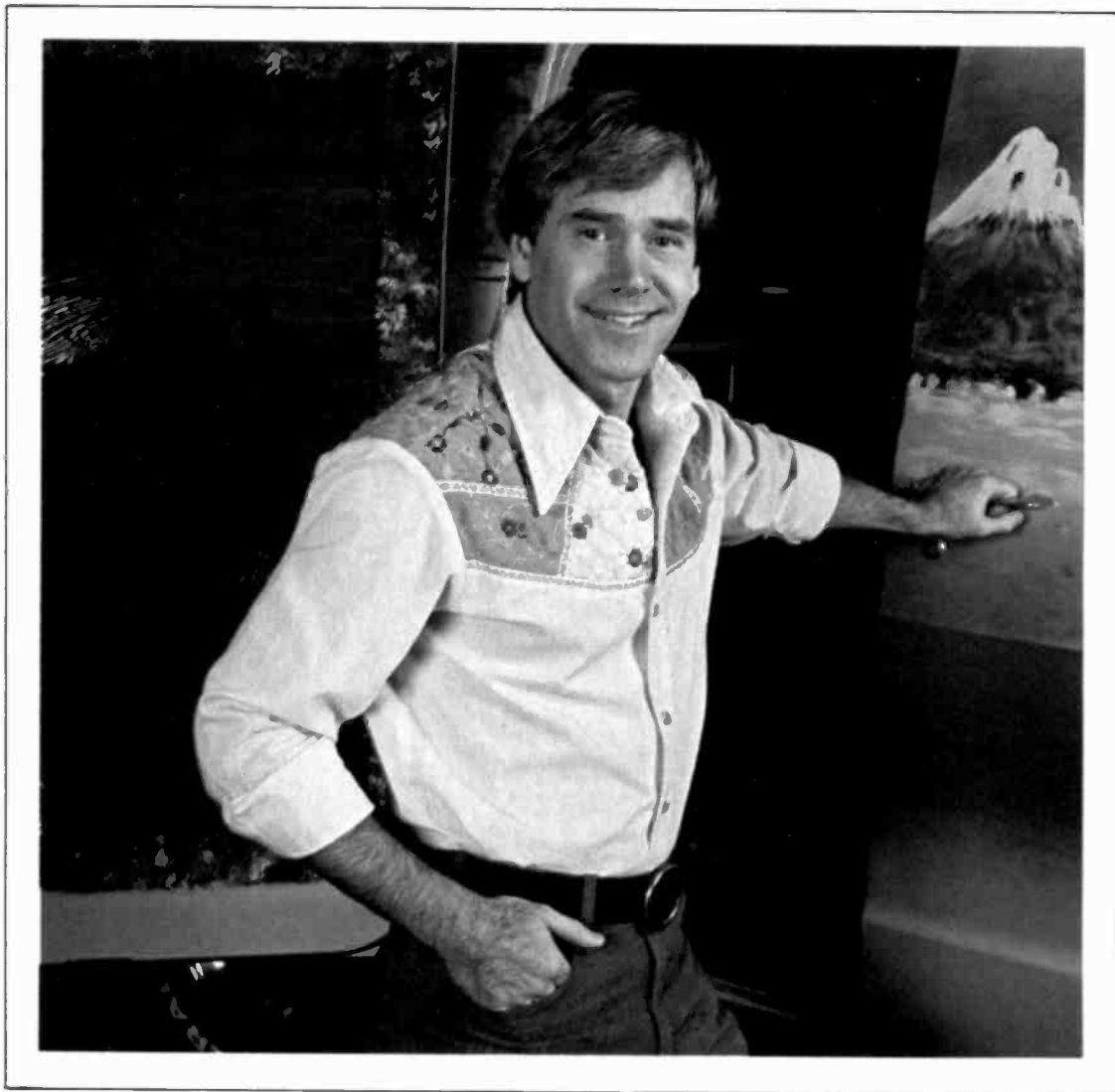

**When you do, you'll probably pick CIE.
You can't afford to settle for
less when it comes to something like
electronics training that could
affect your whole life.**

When you shop around for tires, you look for a bargain. After all, if it's the same brand, better price—why not save money?

Education's different. There's no such thing as "same brand." No two schools are alike. And, once you've made your choice, the training you get stays with you for the rest of your life.

So, shop around for your training. Not for the bargain. For the best. Thorough, professional training to help give you pride and confidence.

* * *

If you talked to some of our graduates, chances are you'd find a lot of them shopped around for their training. They pretty much knew what was available. And they picked CIE as number one.

Why you should shop around yourself.

We hope you'll shop around. Because, frankly, CIE isn't for everyone.

There are other options for the hobbyist. If you're the ambitious type—with serious career goals in electronics—take a close look at what we've planned for you at CIE.

What you should look for first.

Part of what makes electronics so interesting is it's based on scientific discoveries—on ideas! So the first thing to look for is a program that starts with ideas and builds on them!

That's what happens with CIE's Auto-Programmed® Lessons. Each lesson takes one or two principles and helps you master them—before you start using them!

How practical is the training?

This is the next big important question. After all, your career will be built on what you can do—and on how well you do it.

Here are ways some of CIE's troubleshooting programs help you get your "hands-on" training...

With CIE's Experimental Electronics Laboratory...



you learn and review the basics—perform dozens of experiments. Plus, you use a 3-in-1 precision Multimeter to learn testing, checking, analyzing!



When you build your own 5 MHz Triggered-Sweep, Solid-State Oscilloscope you take your first real professional step. You use it as a doctor uses an X-ray machine—to "read" waveform patterns... lock them in... study, understand and interpret them!

When you get your Zenith 19-inch Diagonal Solid-State Color TV you

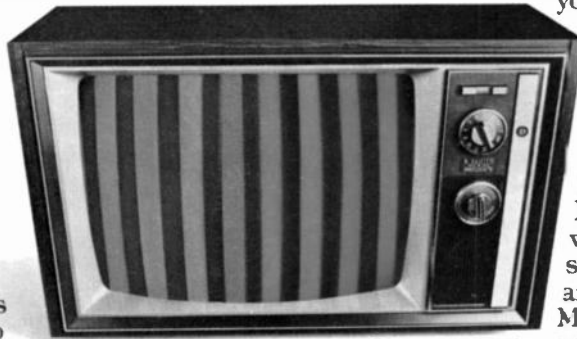

Pattern simulated.

apply your new skills to some real on-the-job-type troubleshooting! You learn to trace signal flow... locate malfunctions... restore perfect operating standards—just as with any sophisticated electronics equipment!



When you work with a completely Solid-State Color Bar Generator—actually a TV signal transmitter—you study up to ten different patterns on your TV screen... explore digital logic circuits... observe the action of a crystal-controlled oscillator!

Of course, CIE offers a more advanced training program, too. But the main point is

simply this:

All this training takes effort. But you'll enjoy it. And it's a real plus for a troubleshooting career!

Do you prepare for your FCC License?

Avoid regrets later. Check this out before you enroll in any program.

For some troubleshooting jobs, you must have your FCC License. For others, employers often consider it a mark in your favor. Either way, it's government-certified proof of specific knowledge and skills!

More than half of CIE's courses prepare you for the government-administered FCC License exam. In continuing surveys, nearly 4 out of 5 CIE graduates who take the exam get their Licenses!

Shop around... but send for CIE's free school catalog first!

Mail the card. If it's gone, cut out and mail the coupon. If you prefer to write, mention the name and date of this magazine. We'll send you a copy of CIE's FREE school catalog—plus a complete package of independent home study information! For your convenience, we'll try to have a representative contact you to answer your questions. Mail the card or coupon—or write: CIE, 1776 East 17th St., Cleveland, OH 44114.

CIE Cleveland Institute of Electronics, Inc.

1776 East 17th Street, Cleveland, Ohio 44114
Accredited Member National Home Study Council

YES... I'm shopping around for the **right** kind of career training in electronics troubleshooting—and CIE sounds well worth looking into. Please send me my FREE CIE school catalog—including details about troubleshooting courses—plus my FREE package of home study information! RE-17

Print Name _____

Address _____ Apt. _____

City _____

State _____ Zip _____

Age _____ Phone _____
(area code)

Check box for G. I. Bill information:
 Veteran Active Duty

Mail today!

equipment reports

TeleMatic KC-720B CrysMate Crystal Tester



CIRCLE 90 ON FREE INFORMATION CARD

AN INSTRUMENT THAT WILL TEST RF CRYSTALS can be very useful. The TeleMatic Co., 2849 Fulton St., Brooklyn, NY 11207 made one quite a while ago. I have used it many times with good results. Now, they have introduced a "bigger and better" model, the CrysMate model KC-720B. It has the same features as the original plus some new ones. It checks

crystals for activity, as the older one did. You plug the crystal into the front-panel socket. If it is good, an indicator light tells you so.

The new model also has a HI-LO switch. If the crystal is suspected of being low in activity or "weak" and the front-panel HI indicator light comes on, switch to LO. If the light goes out, this crystal should be suspected.

The crystal socket has the standard 1/2-inch (8-mm) pin spacing. This will fit the majority of crystals found in color TV, CB, etc. For crystals in larger cases, solder two short pieces of stiff No. 20 wire to two mini-clips and use these to hook it up. Keep the leads as short as possible to hold down the stray capacitance.

Many crystals work in a "third overtone" mode. If the crystal under test is one of these, a frequency counter or calibrated radio receiver will read the fundamental, since this has the highest amplitude output. A 15-MHz third-overtone crystal will read 5 MHz, etc. With an accurately calibrated receiver, you can tune a surprising number of harmonics. We have picked up good usable signals from a 1.0-MHz crystal as high as the 10th harmonic and, in some cases, even higher. (Keep this

handy in your shirt pocket to check the tracking of a short-wave receiver; a beep every 1.0 MHz will tell how well the receiver dial tracks the actual frequency. Other frequencies may be used, of course.) You can use the same setup to find the frequency of unknown crystals. Tune for the strongest and lowest-frequency signal. This will be the fundamental.

To put an odd-ball marker frequency on a sweep-alignment curve, just feed the RF output of the CrysMate into the external-marker jack of the sweep generator. Most have this jack, but if yours doesn't, the signal can be coupled into the IF input with a couple of turns of insulated wire.

With the proper crystals, you can calibrate CB or amateur radios for frequency, band-edge, etc. Crystals in the set can be checked against replacements to make sure they are good or bad. In most cases, the CrysMate's RF output will be high enough to drive a frequency counter.

If you're using the CrysMate as a frequency standard, or making calibration adjustments

continued on page 24

Connect with a little help from A.P.

Intra-Connector

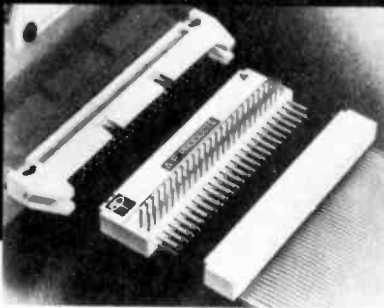

Intra-Switch



Intra-Connector and Intra-Switch do for flat cable systems what our IC Test Clips do for DIPs, which can do a lot for you.

Intra-Connector mates in-line with standard double row socket connectors. It has one set of female contacts, but two sets of male, at right angles. So it provides instant line-by-line probeability, and, allows for attachment of test probes, components or an additional connector.

Intra-Switch plugs right in line, too. But small, dependable slide switches are built

right in to switch each line, independently. So it's great for diagnostic and quality testing, terrific for programming or selective line inhibiting.

Intra-Connector and Intra-Switch are available in 20, 26, 34, 40 and 50 contact versions at the dealer or distributor in your area who stocks our Faster and Easier Line. You can locate him by calling our toll-free number, 800-321-9668.

**Faster and easier
is what we're all about.**



AP PRODUCTS INCORPORATED

Box 110 • 72 Corwin Dr., Painesville, OH 44077 • (216) 354-2101 TWX: 810-425-2250

LOOK AT ALL YOU GET!

1,862 nuts, bolts, screws, and other fasteners • Heavy-duty, all-steel cabinet, 12"W. x 5½"D. x 9"H. • 25 pre-printed I.D.I. labels • 51 individual compartments • 25 high-impact plastic bins, 2"W. x 5½"D. x 1½"H.

HEAD STYLES INCLUDED



THREADS INCLUDED



DIAMETERS INCLUDED



LENGTHS INCLUDED

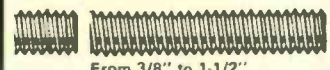

<p>168 SHEET METAL SCREWS: 6 Sizes (Panhead)</p>	<p>168 WOOD SCREWS: 6 Sizes (Flathead)</p>	<p>68 MACHINE SCREWS: 2 Diameters, 3 Lengths of Each Diameter (Hex Head)</p>	
<p>312 MACHINE SCREWS: 3 Diameters, 4 Lengths of Each Diameter (Roundhead)</p>	<p>274 HEX NUTS: 5 Sizes</p>	<p>Only \$24.95 plus \$3.90 shipping and handling Half the price you'd pay at a hardware store!</p>	<p>92 COTTER PINS: 4 Sizes</p> <p>WASHERS: 3 Styles, 4 Sizes of Each Style</p>

Just about every nut, bolt, screw, washer, and cotter pin you'll ever need - nearly 2,000 pieces - all in one, organized steel cabinet.

- Now . . . your own hardware store for home, shop, or office!
- 1,862 fasteners total - all high-quality, zinc plated (rust-resistant) steel.
- No more piece-at-a-time trips to the hardware store.
- Heavy-duty, all-steel cabinet, high-impact plastic bins and bin dividers, printed I.D. labels.
- Truly a \$50 value.
- Unconditional 30-day money back guarantee.
- The most important tool in your workshop.
- The hit of the Minneapolis Buldard's Show. As featured by the editors of: MECHANIX ILLUSTRATED, POPULAR SCIENCE, WORKBENCH, FAMILY HANDYMAN, HOT ROD AND OTHERS.

Now you can have just the right nut, bolt, screw, washer, or cotter pin at your fingertips . . . whatever the job! And for an almost unbelievable low price!

With the NUT & BOLT SHOP - a complete size range of just about every kind of hardware you'll ever need. All organized in one all-steel, 25-tray, 51-bin cabinet. Perfect for auto repair. Home projects and hobbies. Office maintenance. And industrial shop use. Great as a gift, too!

No more time-consuming trips to the hardware store. No more less-than-professional looking repair jobs. No more searching through old coffee cans of fasteners.

Order today! Send check, money order, or company purchase order for just \$24.95 (plus \$3.90 shipping and handling) to DRI INDUSTRIES, 7246 Washington Ave. So., Eden Prairie, MN 55343. If you're not completely satisfied - if you're not truly amazed at all you get - return it within 30 days for a full refund. No questions asked! And keep the FREE \$2.50-value wall chart for your trouble!

- 24-HOUR SERVICE -

CREDIT CARD BUYERS

Call our 24-hour toll-free number for immediate service 800-325-6400 (In Missouri, call 800-342-6600)



30-DAY UNCONDITIONAL MONEY BACK GUARANTEE

DRI INDUSTRIES, Dept. RE-9
7246 Washington Ave. So., Eden Prairie, MN 55343

I WISH TO ORDER ___(QTY.) NUT & BOLT SHOP(S):

I have enclosed my check, money order, or company purchase order for \$24.95 + \$3.90 ea. (Minn. residents add 4% sales tax).

I wish to charge it to (Check One): American Express VISA Diners Club Master Charge/Bank No.

CARD NO. _____ EXP. DATE _____

SIGNATURE X _____

NAME _____

ADDRESS _____

CITY _____ STATE _____ ZIP _____

OUR CUSTOMERS ARE AMAZED AT THE VALUE!

"I don't see how you make a profit at such a low cost! I found it much more than I expected!"

M. D. Dorsette, Rockville, Maryland
"An excellent buy. At retail prices, would have cost far more . . . usually a minimum of 3c to 5c a piece!"

G. L. Steiger, Enfield, Connecticut
"Quality is excellent. Great for do-it-yourselfers . . . and convenient!"

G. R. Dalmadge, Sunnyvale, California
"I've priced these items separate - it would have cost far more for them (at a hardware store)."

J. D. Russell, Cicero, Illinois

FREE 17½" x 24" wall-size Specifications Chart - a \$2.50 value. Tells you everything you need to know for a quick professional job every time. What thread types and head styles are available. What size nut and wrench to use. What size "starting" and "tapping" holes to drill. When to use what kind of washer. Instantly measures sizes. And much, much more. Yours FREE just for trying the Nut & Bolt Shop!

CIRCLE 104 ON FREE INFORMATION CARD

LEARN AVIATION ELECTRONICS

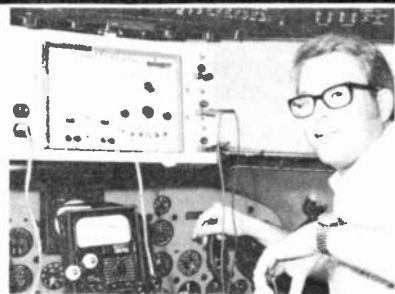

at the School
of Aeronautics,
Florida Institute
of Technology.

Prepare for a **REAL** job in just 2 years and earn a **COLLEGE DEGREE** at the same time.

FAA publications identify that by 1977 the **AVIATION INDUSTRY** will need **230% MORE AVIONICS TECHNICIANS**.

Half the costs of airplanes today is in electronics, including navigation systems . . . instruments . . . communications systems . . . and control systems.

We teach you in our laboratories . . . classrooms . . . and on our aircraft the theory of radio communications and how to flight check and repair all related equipment.

Our placement record of graduates is **100%**. . . Make your time and money spent **REWARDED** by a job in your field.

The **SCHOOL OF AERONAUTICS** operates one of the largest flight training programs in the **WORLD** and we are an "accredited University".

Classes starting September . . . January . . . June.

To learn more about our aviation electronic programs, check the reader service card or write direct to:

The School of Aeronautics, Florida Institute of Technology, P.O. Drawer 1839, Melbourne, Florida 32901
Att: Director of Admissions

CIRCLE 18 ON FREE INFORMATION CARD

EQUIPMENT REPORTS

continued from page 22

where it must be on quite a while, set the switch to the LO position. The RF output will usually be ample; this reduces the battery drain quite a bit.

Model KC-720B is very compact, comes in a 3.5 by 6-inch plastic case just a bit over an inch deep. It is completely self-contained, powered by one standard 9-volt battery. It will operate at full output over a range down to 7.5 volts under load. Battery life in the original model was good, and should be good here since the basic circuitry is the same. The only limitations are that low-frequency crystals may not oscillate, or not oscillate with enough output to light the indicator lamp. This could be checked with a scope on the RF output terminals or on the calibrated receiver.

This instrument can also be used to put markers for each VHF channel on a TV tuner output curve! By using the 4.5-MHz marker provided on most sweep generators, you can check the response curve for each channel. Very handy for those "I got a problem only on Channel 6" jobs! R-E

Clarcothane Cleaning Solvent



CIRCLE 91 ON FREE INFORMATION CARD

EVER SINCE CARBON-TETRACHLORIDE WAS banned, we have been looking for something that would do the same job in cleaning up electronic apparatus, removing grease, etc. Clarkson Laboratories, Inc., Camden, NJ, has come up with *Clarcothane*. The full name is "1,1 trichloroethane."

It comes in the familiar 16-ounce aerosol can, with a long needle so you can get into tight places. The odor is considerably more pleasant than carbon-tet, and it seems to do the same job very well. We tried it on a couple of PC boards, controls and other items; it cleaned them nicely. It's a very good grease-remover and evaporates quickly.

The manufacturer says that it does not cause a toxic buildup in the body, and that it is completely safe on electrical parts and insulation. It will not burn, and has no flash point.

The familiar warning on the can tells you to "avoid prolonged breathing of the vapors," etc. and also states that "certain plastics" may

be "softened." We tried it on several plastics but found no bad effects. R-E

OK Machine and Tool WSU-30 Wire-Wrapping Tool



CIRCLE 92 ON FREE INFORMATION CARD

WIRE WRAPPING HAS BEEN USED IN THE DIGITAL field for many years, and the wire-wrap tool has become a mainstay of the computer serviceman's tool kit. Design and debugging of systems with complex interconnection patterns requires a wiring technique that lends itself to rapid assembly and modification. Wire wrapping is used because it makes quick, reliable, neat connections without the danger of burning insulation or splashing solder among hundreds or thousands of closely spaced terminals and components.

Recently, hobbyists have been exposed to the wire-wrapping technique. They work with systems built up of 8 to 40 pin-integrated circuits which multiply to high total pin counts. So it's really not unusual to have inexpensive wire-wrap tools designed specifically for the hobbyist.

The Hobby-Wrap-30 Wire-Wrapping/Stripping/Unwrapping Tool (model WSU-30) is made by the OK Machine and Tool Corporation that also makes a complete industrial line of manual and powered wire-wrap equipment.

The WSU-30 is an amazingly simple yet effective tool. Two tubular extensions of different length are axially mounted to an easily gripped hex-shaped center handle. The handle has a V-shaped wire stripper blade that removes the insulation from No. 30 (0.25-mm) wire. The stripped end of the wire is inserted in the small hole closest to the perimeter of the end of the longer tool extension. A slot along the length of the extension acts as a reservoir for the wire about to be wrapped.

The center hole at the same end is slid over a 0.025-inch square wire-wrap terminal, and the tool rotated clockwise for 10 turns. As the tool is turned, the wire is forced against the terminal and is deformed at the post corners for a low-resistance electrical connection. The tool is then lifted from the terminal.

The WSU-30 has an unwrapper in its shorter extension. A central hole at this end fits over the terminal as on the wrap end, where a

continued on page 26

ok® wire wrapping center ok®

ANOTHER UNIQUE PRODUCT
**DESIGNED, MANUFACTURED
AND MARKETED WORLDWIDE**
BY
OK MACHINE & TOOL CORPORATION

1

BATTERY WIRE-WRAPPING TOOL MODEL BW-630



\$34.95*

STRIP / WRAP / UNWRAP TOOL MODEL WSU-30

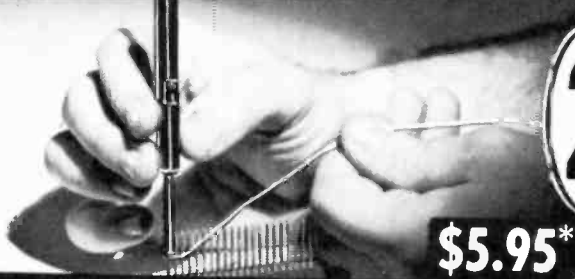

\$5.95*

2

ANOTHER UNIQUE PRODUCT
**DESIGNED, MANUFACTURED
AND MARKETED WORLDWIDE**
BY
OK MACHINE & TOOL CORPORATION

ANOTHER UNIQUE PRODUCT
**DESIGNED, MANUFACTURED
AND MARKETED WORLDWIDE**
BY
OK MACHINE & TOOL CORPORATION

3

WIRE DISPENSER MODEL
WD-30-B



THE DISPENSER WHICH
CUTS AND STRIPS
THE WIRE

\$3.45*

DIP IC INSERTION TOOL WITH PIN STRAIGHTENER
MODEL INS-1416

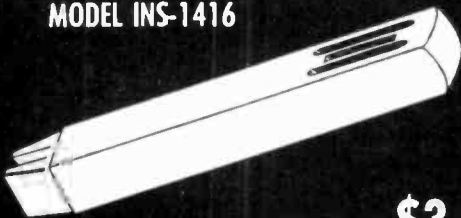

\$3.49*

4

ANOTHER UNIQUE PRODUCT
**DESIGNED, MANUFACTURED
AND MARKETED WORLDWIDE**
BY
OK MACHINE & TOOL CORPORATION

ANOTHER UNIQUE PRODUCT
**DESIGNED, MANUFACTURED
AND MARKETED WORLDWIDE**
BY
OK MACHINE & TOOL CORPORATION

5

WHAT'S ? NEXT

* MINIMUM ORDER \$25.00, SHIPPING CHARGE \$1.00, N.Y. CITY AND STATE RESIDENTS ADD TAX

OK MACHINE & TOOL CORPORATION

3455 Conner St., Bronx, N.Y. 10475 ■ (212) 994-6600 ■ Telex 125091

recessed notch traps the end of the wire. The wire is loosened and unwrapped when the tool is rotated counterclockwise, opposite to the original wrapping direction.

I used the *WSU-30* to wire an IC wiring panel. I found its very low mass and sound performance make it a useful tool; one that does its job effectively without getting in your way. I also had a couple of chances to try the unwrapper to fix a couple of errors.

The *WSU-30* Wire-Wrapping Tool sells for \$5.95 and is available from local electronic suppliers, or direct from OK Machine and

Tool Corporation, 3455 Corner Street, Bronx, NY 10475. The *WK-2-B* Wire-Wrapping Kit includes a tool, a 50-foot spool of Kynar wire and an assortment of 1-, 2-, 3- and 4-inch pre-stripped wires for about \$12. **R-E**

Polaris TPS-225 DC Power Supply

THE POLARIS CO. HAS QUITE A FEW SMALL, handy test instruments. Their latest is the *model TPS-225* DC power supply. A bench DC power supply can be used to power small radios, CB sets, or even TV modules for out-of-set servicing.

The *TPS-225* is completely isolated from the AC line. So, it can be used as either a positive or negative voltage supply. It's rated at up to 25 volts at a maximum current of 250 mA. The DC voltage is well-filtered, and can be continuously regulated from 0 up to 25

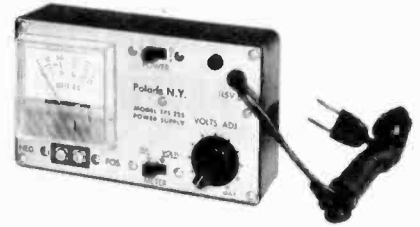

CIRCLE 93 ON FREE INFORMATION CARD

volts. An internal solid-state regulator controls the voltage and also protects against shorts in the load. A short does no damage to either the equipment or the power supply; when the short is removed, the output voltage comes right back.

A panel meter reads the voltage or current; selection is by means of a slide switch conveniently located at the bottom of the panel. The voltage is adjusted by a control at the right, and the DC voltage is taken off at two screw terminals on the left.

The variable-voltage output can be used, for example, in servicing small and medium power stereo amplifiers. After output transistor replacement, just lift the set's own DC power supply and hook in the *TPS-225*. Turn the *VOLTS ADJUST* control to zero and set the *METER* switch to *MA*. Now bring the DC voltage up slowly without applying an input signal to the amplifier and observe the current being drawn on the meter. This is the key to the operation of the output stage. If it's too high, a problem still exists, usually in the bias. The instrument will supply ample current to check even fair-sized amplifiers, if you check one channel at a time. This can take the place of a variable-voltage line transformer and can be a great transistor saver.

The experimenter can use this unit for powering various solid-state projects; its usefulness is limited only by the ingenuity of the technician. For example, we had a question the other day: "Just how much current does this (color demodulator) IC draw?" By lifting the +24-volt supply lead and using the *model TPS-225* in its place, we could have had the answer instantly. Normal current in this case happened to be 22 mA, and this handy little instrument would have been a great help! It's also reasonably priced. For more information write: Polaris Co., 2849 Fulton St., Brooklyn, NY 11207. **R-E**

This ONE Wiring Tool Does The Work Of FIVE



- ① Long Nose Plier
- ② Wire Stripper
- ③ Wire Cutter
- ④ Bolt Cutter
- ⑤ Wire Crimper

It strips wire without damaging the conductor. Cuts machine bolts without damaging threads. Cuts wire with a clean, scissors action. Crimps both insulated and non-insulated wire to make permanent, solderless connections. Its lean plier-nose pulls wire, loops wire ends, loosens and tightens small nuts. Blue dipped plastic cushion grips are kind to hands. Tough, durable, precision made to CHANNELLOCK standards. Length 8¼ inches.

The No. 908 WIRE TOOL by CHANNELLOCK. Ask your tool supplier for it. Write for free catalog information. CHANNELLOCK, INC., Meadville, Pa. 16335.

CHANNEL LOCK

No. 908—G WIRE TOOL
Meet The Family • Send For Free Catalog.



"Myron dear, Mummy wishes you wouldn't sit around in front of the tube all day."

The most important piece of audio equipment you'll ever own.

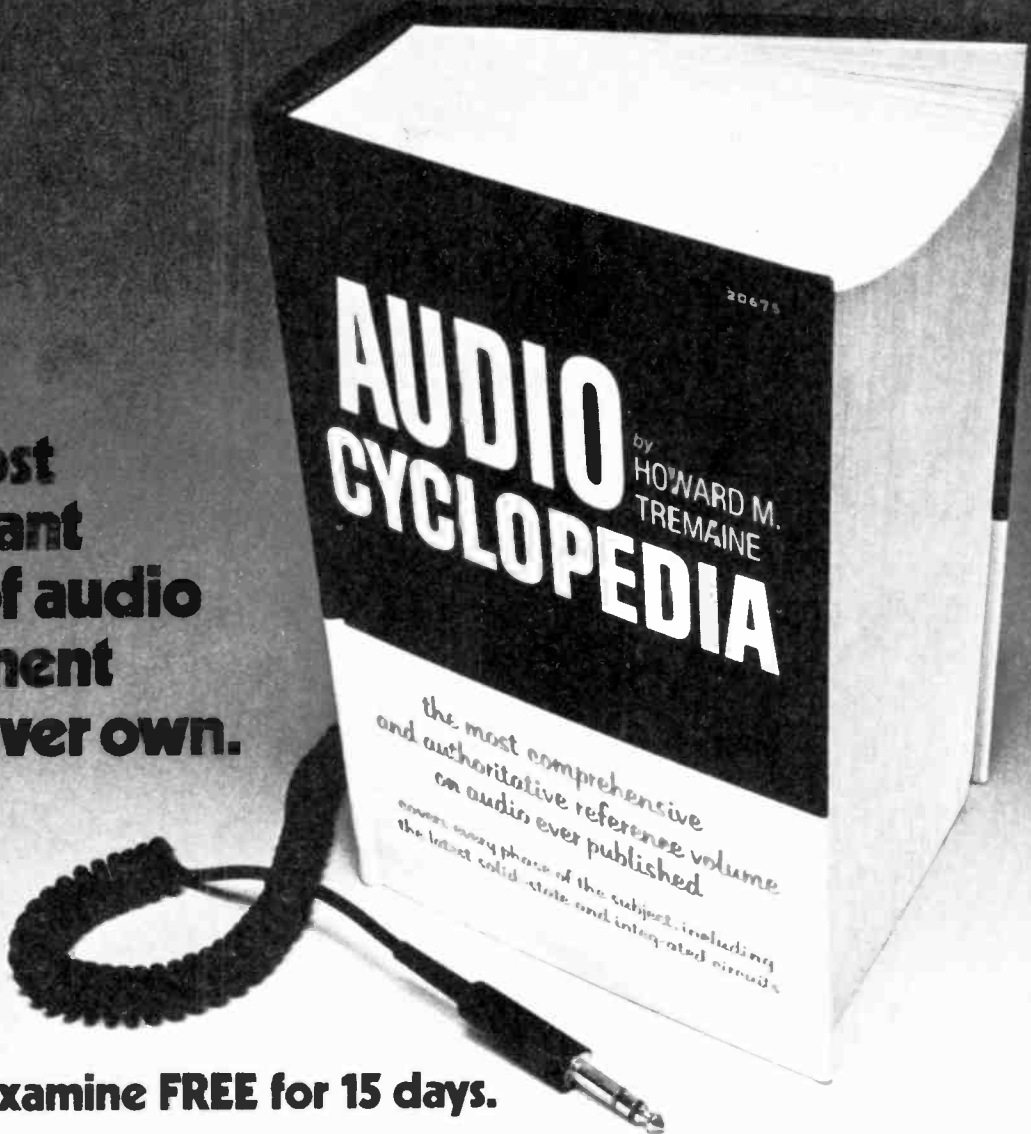

Yours to examine FREE for 15 days.

25 FACT-FILLED CHAPTERS ARRANGED IN "EASY-TO-FIND" QUESTION AND ANSWER FORM

- Basic Principles of Sound
- Acoustics, Studio techniques, and Equipment
- Constant-Speed Devices, Motors, and Generators
- Microphones
- Attenuators
- Equalizers
- Wave Filters
- Transformers and Coils
- Sound Mixers
- VU and Volume Indicator Meters
- Vacuum Tubes, Transistors, and Diodes
- Audio Amplifiers
- Disc Recording
- Cutting Heads
- Recording and Reproducing Styli
- Pickups
- Magnetic Recording
- Optical Film Recording
- Motion Picture Projection Equipment
- Loudspeakers, Enclosures, Headphones, and Hearing Aids
- Power Supplies
- Test Equipment
- Audio-Frequency Measurements
- Installation Techniques
- General Information, Charts and Tables

Be our guest. Examine the AUDIO CYCLOPEDIA free for 15 days. You'll find out why it is considered the most comprehensive and authoritative book ever written on the subject. And you'll get a FREE \$3.50 bonus book to keep no matter what!

The AUDIO CYCLOPEDIA is literally a one-book audio library. It has long been considered "the bible" by amateur stereo buffs as well as professional technicians. That's why you'll find it in constant use not only in home workshops and at stereo centers, but also in recording studios, broadcast booths and concert halls.

This giant reference book is over 3" thick,

and packed with 1,757 illustrated pages. It features 3,645 questions and answers and a 50 page "instant-find" index for subject identification. It is truly the big one in audio electronics and it puts all the information you'll ever need right at your fingertips, chapter by chapter.

Send for the AUDIO CYCLOPEDIA today. If you don't agree that it's the most important piece of audio equipment you own, just return it within 15 days. You won't owe a cent. And no matter what you decide, you'll get a free \$3.50 copy of *The ABC's of Tape Recording* to keep just for mailing the coupon.

FREE-BOOK FREE-TRIAL COUPON



Save postage & handling costs. Full payment enclosed (plus tax where applicable). 15-day return privilege still applies.

Yes, please rush me the AUDIO CYCLOPEDIA (#21455) for my free trial. I understand if not completely satisfied, I may return it within 15 days, and owe nothing. Otherwise, it's mine to keep for only \$34.00 plus postage and handling and local taxes (where applicable). **And, whatever I decide, a copy of "The ABC's of Tape Recording" (valued at \$3.50) is mine free!**

Name _____
 Address _____
 City _____
 State _____ Zip _____

Mail to Audel
 4300 W. 62nd Street
 Indianapolis, Indiana 46206
 A Division of Howard W. Sams & Co., Inc. EC-33

Learn electronics easier... with HEATHKIT®

MONEY-BACK GUARANTEE

We're so confident you will enjoy and benefit from these five courses, that if for any reason you are dissatisfied, we will refund the full purchase price of the course text material.

Unique Heathkit Electronics Courses are designed to provide you with a complete overview of basic and advanced electronics.

You learn at your own pace, without pressure or deadlines, and all material is presented in a clear, logical, step-by-step fashion. It's the ideal, effective way to learn about electronics if you're a beginner, or to "brush up" on the latest techniques and theory.

Courses start as low as **\$39⁹⁵** (less trainer)

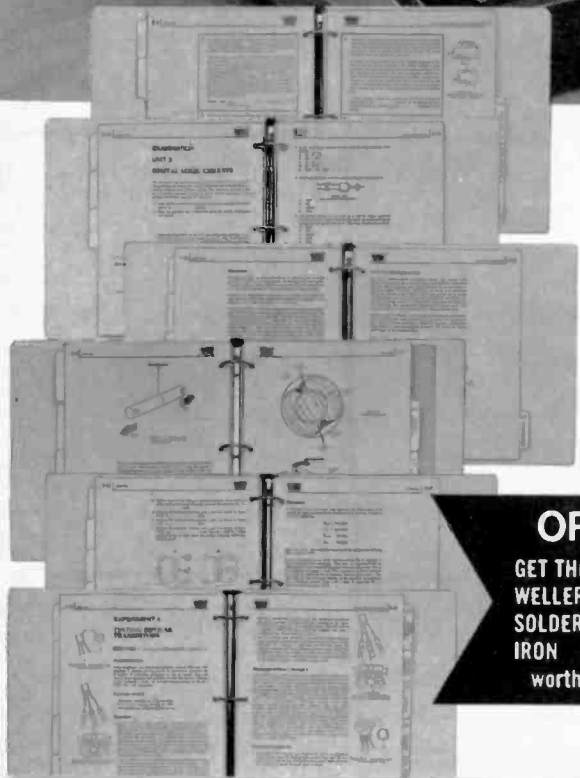

Thousands of people just like you have already learned electronics the easy Heathkit way — and you can, too. The secret is our efficient approach to self-learning with easy, step-by-step "programmed" instructions; audio records to introduce and reinforce key concepts; self-evaluation quizzes to test your understanding; and interesting experiments that let you learn the easy "hands-on" way. All you need is a record player, small tools and a VOM. The optional Heathkit experimenter/trainer is specifically designed to help you do the experiments in each course, and when you finish the course, you can use it to design and breadboard your own circuits. After completing each course, you can take the optional final exam (passing grade 70%) and receive both a Certificate of Achievement and Continuing Education Units, a nationally recognized way of acknowledging participation in non-credit adult education.

ORDER NOW—GET THESE BONUS SAVINGS!

GET THIS
WELLER
SOLDERING
IRON
worth

FREE!
WITH YOUR ORDER
A 40-watt
iron for easy
kitbuilding

Buy Any Single Course
with Trainer and —

SAVE \$9⁹⁵

Buy Courses 1 thru 4
with Trainer and —

SAVE \$24⁹⁵

faster...at lower cost... Learn-at-home Courses!

COURSE 1: DC Electronics

An ideal introduction to electronics. Covers current, voltage, resistance, magnetism, Ohm's law, electrical measurements, DC circuits, inductance and capacitance. Discusses matter, atoms, current, flow, voltage rises and drops, series and parallel connections, magnetic fields, voltage dividers, network theorems, more. Includes text, records and 56 parts for 20 different experiments. Average completion time, 20 hours. 2.0 Continuing Education Units and certificate for passing optional final exam.

Course EE-3101 39.95

COURSE 3: Semiconductor Devices

Essential for understanding latest solid-state equipment. Covers fundamentals, diodes, zener diodes, special diodes, bipolar transistor operation and characteristics, FET's, thyristors, integrated circuits and optoelectronics. Discusses holes, current flow, N and P types, biasing, tunnels and varactors, PIN, IMPATT, gain, cutoff and leakage current, SCR's, bi-directional triodes, light sensitive and light emitting devices, more. Includes text, records and 27 parts for 11 different experiments. Average completion time, 30 hours. 3.0 Continuing Education Units and certificate for passing optional final exam.

Course EE-3103 35.95

COURSE 2: AC Electronics

Provides an understanding of most commonly used circuits. Covers alternating current, AC measurements, capacitive and inductive circuits, transformers and tuned circuits. Discusses waveforms, period and frequency, meters, scopes, series and parallel circuits, RC filters, dividers, phase shifts, reactance, vectors, transformer theory and characteristics, series and parallel resonance, more. Includes text, records and 16 parts for 8 different experiments. Average completion time, 15 hours. 1.5 Continuing Education Units and certificate for passing optional final exam.

Course EE-3102 39.95

COURSE 4: Electronic Circuits

Outstanding explanations of basic circuits. Covers basic amplifiers, special purpose amplifiers, operational amplifiers, power supplies, oscillators, pulse circuits, modulation and demodulation. Discusses amplifier functions and configurations, class of operation, audio characteristics, video amplifiers, buffers, IF's, rectifiers, voltage multipliers, voltage regulation, basic oscillators, RC waveshaping, clipping, AM, FM and SSB, modulation fundamentals and more. Assumes knowledge of courses 1 through 3 or equivalent and requires an oscilloscope for some experiments. Includes text, records and over 110 parts for 18 different experiments. Average completion time, 30 hours. 3.0 Continuing Education Units and certificate for passing optional final exam.

Course EE-3104 49.95

LEARN DIGITAL TECHNIQUES

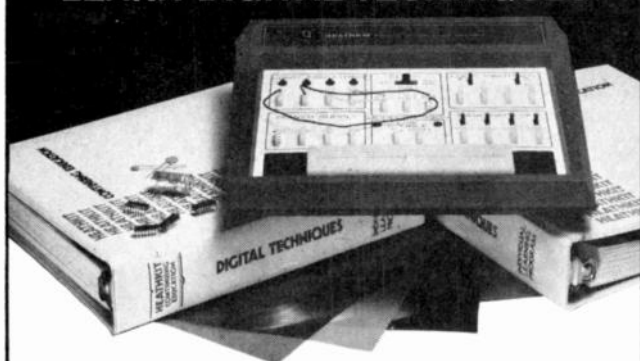

Our most advanced self-learning course prepares you for the world of computers and microprocessors, with particular emphasis on circuit design. Covers digital fundamentals, semiconductor devices for digital circuits, digital integrated circuits, Boolean algebra, flip-flops and registers, sequential logic circuits, combinational logic circuits, digital design and digital applications. Discusses TTL, ECL, CMOS, PMOS, NMOS; integrated circuits; SSI, MSI and LSI; ROM's, PLA's, microprocessors,

computers and more. Assumes completion of Heathkit courses 1 through 4 above, or equivalent knowledge. The special digital techniques experimenter/trainer helps you perform all the experiments in the course, and when you complete the course, build and design your own circuits. Course includes text, records and 44 parts for 24 different experiments. Average completion time, 40 hours. 4.0 Continuing Education Units and a certificate for passing final exam.

ORDER DIGITAL TECHNIQUES PROGRAM AND TRAINER \$109⁹⁵

HEATH IM-17 VOLT-OHM METER

All Electronic Learning Programs require a VOM to make electrical measurements. We suggest the Heath IM-17 as the ideal "all-purpose" unit. All solid state with FET input for better accuracy. Portable battery operation, zero and ohms adjust, accessory probe jack. Comes with DC polarity switch, three test leads; batteries not included. Easy 3 hour assembly.

ORDER KIT IM-17 \$32⁹⁵



HEATHKIT EXPERIMENTER/TRAINER

For use with Heathkit Electronics Courses 1 through 4 — helps you perform all the experiments quickly and easily. Has solderless breadboarding sockets, dual variable power supply for positive and negative voltages, sine and square wave signal source, center-tapped line transformer. After you complete the course, the trainer is ideal for experimenting and breadboarding with your own circuit designs.

Kit ET-3100 \$59⁹⁵

HEATH

Schlumberger

Order Form/Agreement

Heath Company, Dept. 020-331
Benton Harbor, Michigan 49022

Please send me items checked below and include FREE \$7.95-value Weller Soldering Iron (GDP-1105).

- Send one course (checked below) with the *Experimenter/Trainer* (ET-3100) at the special price of only \$89.95 plus \$3.00 shipping and handling.
- DC (EE-3101) AC (EE-3102) Semiconductors (EE-3103)
- Send me the *Electronic Circuits Course* (EE-3104) with the *Experimenter/Trainer* (ET-3100) at the special price of only \$99.95 plus \$3.00 shipping and handling.
- Send all four of the courses above (EE-3101, 3102, 3103, 3104) with the *Experimenter/Trainer* at the special price of just \$199.95 plus \$4.50 shipping and handling.

In addition, please send the following courses (less trainer):

- DC (EE-3101) AC (EE-3102) Semiconductors (EE-3103) for just \$39.95 plus \$1.50 shipping and handling each.
- Electronics Circuits (EE-3104) for just \$49.95 plus \$1.50 shipping and handling.
- Send me the *Digital Techniques Course* (EE-3201) with its *Experimenter/Trainer* (ET-3200) for only \$109.95 plus \$3.00 shipping and handling.
- Also send me that IM-17 VOM kit for just \$32.95 plus \$1.50 shipping and handling.

Michigan residents add 4% sales tax.

I enclose check money order for \$_____ ; or, Charge to my:

- BankAmericard Acct. No. _____ Exp. Date _____
- Master Charge Acct. No. _____ Exp. Date _____
- If Master Charge, include Code No. _____

Signature: X _____

Name (please print) _____

ADDRESS _____

CITY _____ STATE _____ ZIP _____

Radio Electronics ED-105A

IF YOU'RE NOT DESIGNING WITH A CSC PROTO-BOARD, LOOK AT ALL YOU'RE MISSING.

Utility—Models are available with or without built-in regulated power supplies (fixed or adjustable).

Economy—Eliminate heat and mechanical damage to expensive parts. Save money by re-using components.

Versatility—Use with virtually all types of parts, including resistors, capacitors, transistors, DIP's, TO-5's, LED's, transformers, relays, pots, etc. Most plug in directly, in seconds.

Durability—All Proto-Board models are carefully constructed of premium materials, designed and tested for long, trouble-free service.

Expandability—Proto-Board units can be instantly interconnected for greater capacity.

Visibility—All parts are instantly and easily visible, for quick circuit analysis and diagramming.

Speed—Assemble, test and modify circuits as fast as you can push in or pull out a lead. Save hours on every project.

Adaptability—Use in design, packaging, inspection, QC, etc. Works with most types of circuits, in many, many applications.

Flexibility—Use independently, or in conjunction with other accessories, such as scopes, counters, CSC Proto-Clip™ connectors, Design Mate™ test equipment, etc. One Proto-Board unit can serve a thousand applications.

Accessibility—All parts are instantly and easily accessible, for quick signal tracing, circuit modifications, etc.

Variety—A wide variety of models are available with capacities ranging from 630 to 3060 solderless tie-points (6 to 32 14-pin DIP's), to fit every technical and budget requirement.



Whatever type of electronic circuits you work with, you can do more in less time with CSC's solderless Proto-Board systems. As fast and easy as pushing in or pulling out a lead, you can design, test and modify circuits at will. Components plug into rugged 5-point terminals, and jumpers, where needed, are lengths of #22 AWG solid wire. In the same time you took to read this ad, you could be well on your way to assembling a new circuit. For more information, pick up your phone and call your dealer—or order direct.

CSC PROTO-BOARD SOLDERLESS BREADBOARDS

MODEL NUMBER	NO. OF SOLDERLESS TIE-POINTS	IC CAPACITY (14-PIN DIP'S)	MANUFACTURER'S SUGG. LIST	OTHER FEATURES
PB-6	630	6	\$15.95	Kit—10-minute assembly
PB-100	1060	10	19.95	Kit—with larger capacity
PB-101	940	10	29.95	8 distribution buses, higher capacity
PB-102	1240	12	39.95	Large capacity, moderate price
PB-103	2250	24	59.95	Even larger capacity; only 2.7¢ per tie-point
PB-104	3060	32	79.95	Largest capacity; lowest price per tie-point
PB-203	2250	24	75.00	Built-in 1%-regulated 5V, 1A low-ripple power supply
PB-203A	2250	24	120.00	As above plus separate 1/2-amp +15V and -15V internally adjustable regulated power supplies

See your CSC dealer or call 203-624-3103 (East Coast) or 415-421-8872 (West Coast) 9 AM to 5 PM local time. Major credit cards accepted. Add \$2.50 for shipping and handling in the U.S. and Canada on direct orders of \$50.00 or less; \$3.00 for orders over \$50.00. On all foreign orders add 15% to cover shipping and handling.

CONTINENTAL SPECIALTIES CORPORATION



EASY DOES IT

44 Kendall Street, Box 1942
New Haven, CT 06509 • 203-624-3103 TWX: 710-465-1227
West Coast: 351 California St., San Francisco, CA
94104 • 415-421-8872 TWX: 910-372-7992
Canada: Len Finkler Ltd; Ontario
Mexico: ELPRO, S.A., Mexico City, 5-23-30-04

© 1976 Continental Specialties Corp.
Prices and specifications subject to change without notice.

SEE US AT WESCON SHOW BOOTH #'s 1114, 1116, 1118
CIRCLE 1 ON FREE INFORMATION CARD

CONSTRUCTION

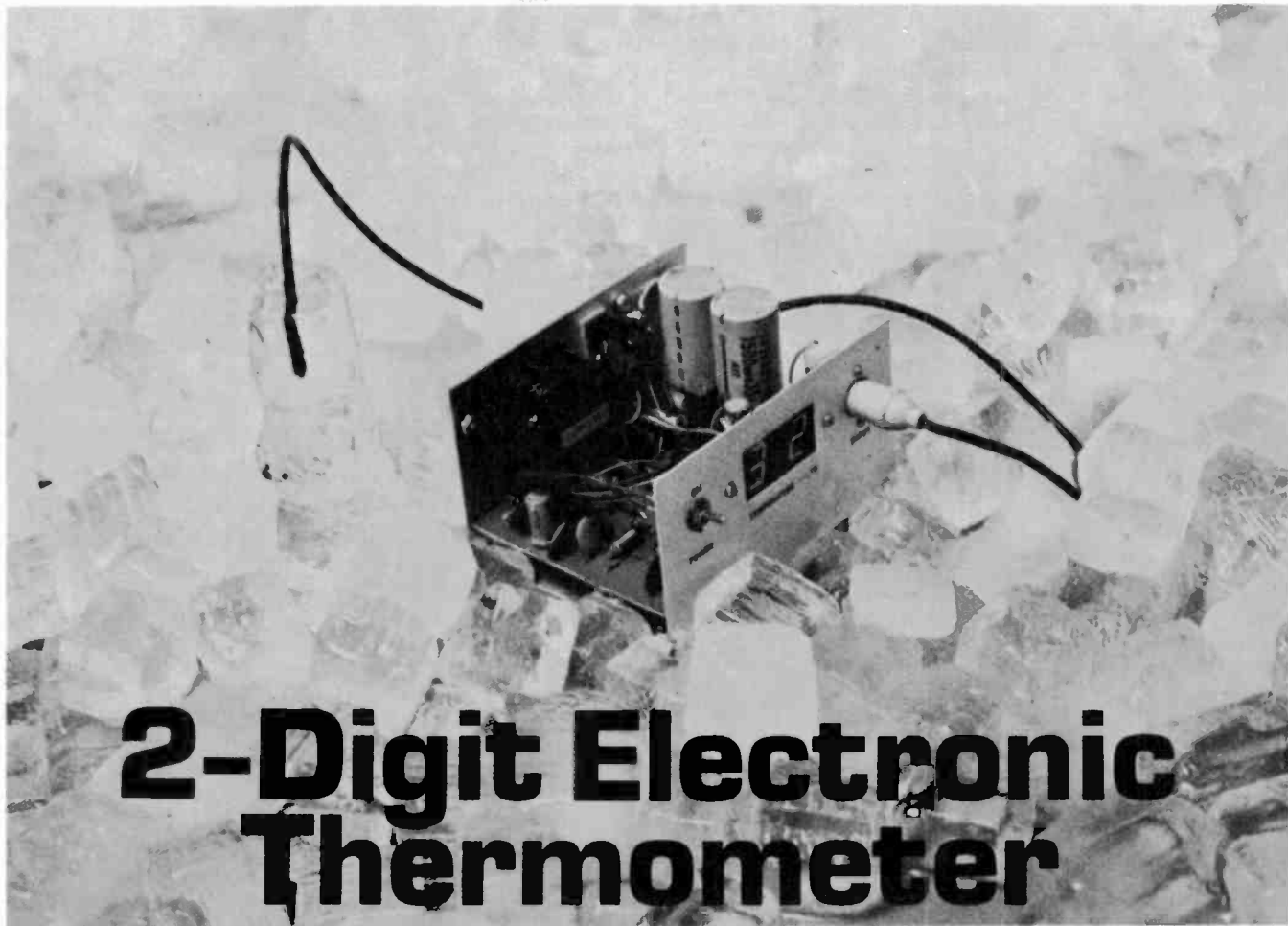

2-Digit Electronic Thermometer

Measure temperature easily with this electronic thermometer. It has a 2-digit LED display and covers a 100° F. range

WALTER SIKONOWIZ

HERE'S A DIGITAL THERMOMETER THAT MEASURES FROM 0° TO 99°F and displays the temperature on a 2-digit LED display with 0.6-inch high digits. The unit is relatively simple and should cost about \$50 to build. The accuracy is such that readings will off by -2° at 30°F and +2° at 70°F. Restricting the temperature range and recalibrating the unit should yield better accuracy. However, the thermometer may be best suited to remote monitoring of outdoor temperatures requiring the 0° to 99°F temperature range.

About the circuit

The thermometer circuit combines two functional modules: The first module is a thermistor/resistor network whose output voltage is a nearly linear function of temperature over the 0° to 99°F range; the second module is a two-decade A/D converter. The maximum output of the temperature-sensing network is 2.2 volts, which is slightly less than the maximum voltage that the A/D converter will accept.

The block diagram (Fig. 1) and timing waveforms (Fig. 2) show how the circuit operates. During the display interval,

when the output of monostable IC4 is high, the converter is inactive while the last conversion is being displayed. In this inactive state, the output of oscillator IC1 is inhibited, staircase generator IC2 is reset to zero and the displays are visible. The output of IC4 remains high for about 1 second, then drops for the duration of the conversion interval. When the output of IC4 goes low, it generates a negative pulse that clears the counters.

During the conversion interval, which can last a maximum of 10 milliseconds, the display is blanked. This rapid blanking cannot be seen and the rapid display changes that would occur during clocking of the counters remain invisible.

There is a delay of about 100 μ s before the first clocking edge (negative) appears at the output of IC1. This delay permits the negative pulse to clear the counters. Each clocking edge from IC1 increments the counters and causes the staircase to increase by one step.

Comparator IC3 monitors the output voltage of the temperature-sensing network as well as the staircase-generator output. As soon as the staircase output exceeds the output of the

temperature-sensing circuitry, IC3's output drops low and triggers IC4. Before another clocking edge can arrive, the oscillator is inhibited and the staircase generator is reset. The displays are also unblanked and show the count accumulated in the counters. When IC4's output again drops low, the whole process is repeated.

The schematic diagram is shown in Fig. 3. A 10-kHz multi-vibrator is formed by IC1, R2, R3, R4 and C10. When base drive is present, Q1 shorts out C10 and inhibits the multi-vibrator output. This method of inhibiting has another effect: The oscillator cannot operate until 100 μ s after base drive is removed from Q1. The reason is that C10 must charge to its operating potential through R4. This allows time for the

counters to be cleared.

Operational amplifier IC2 generates the positive-going staircase. Resetting the staircase generator is performed by FET Q2 which shorts out capacitor C14. If you cannot obtain the 2N4393 FET specified for Q2, you can substitute another, but test it to be sure it has a pinch-off voltage of less than 4.5 volts.

The output of IC2 couples to pin 3 of comparator IC3, while pin 2 receives the output signal of the temperature-sensing network. Capacitor C16 filters out any noise that might be picked up by the thermistor and its input leads. The comparator's output signal (at pin 7) couples to monostable IC4, whose own output is available at pin 3.

As can be seen in Fig. 3, IC4's output drives Q1's base, Q2's gate, the blanking terminals of display drivers IC7 and IC8 (pin 4), as well as a differentiator composed of R19, C19 and D9. The output spike from the differentiator clears counters IC5 and IC6. The output of oscillator IC1 goes to inverter Q4, which drives the clock input of the first counter. The four outputs of each counter go to a decoder/driver IC (either IC7 or IC8). Then R23 through R36 couple the driver outputs to the display digits. Finally, feedback from IC4's output to pin 6 of

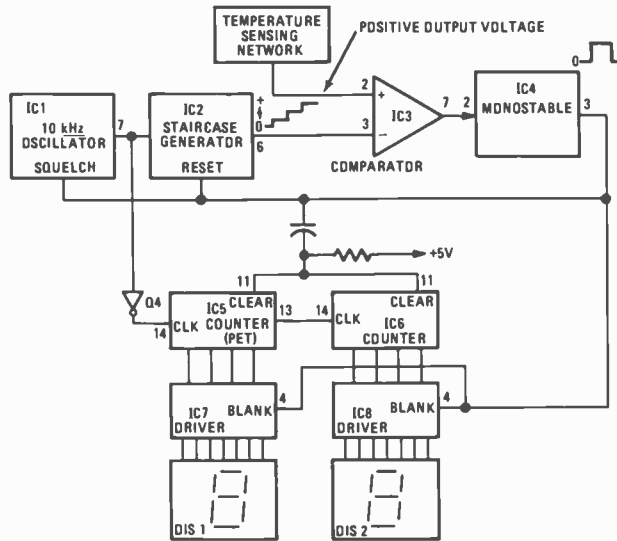

FIG. 1—DIGITAL THERMOMETER uses simple 2-digit A/D converter.

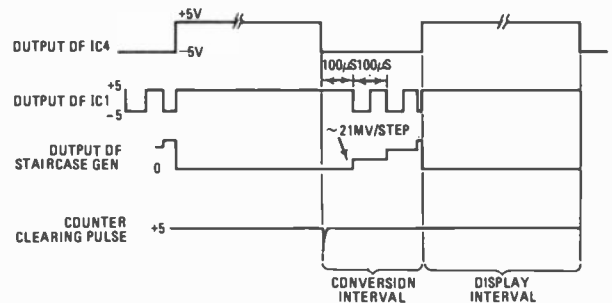

FIG. 2—TIMING WAVEFORMS of the thermometer circuit.

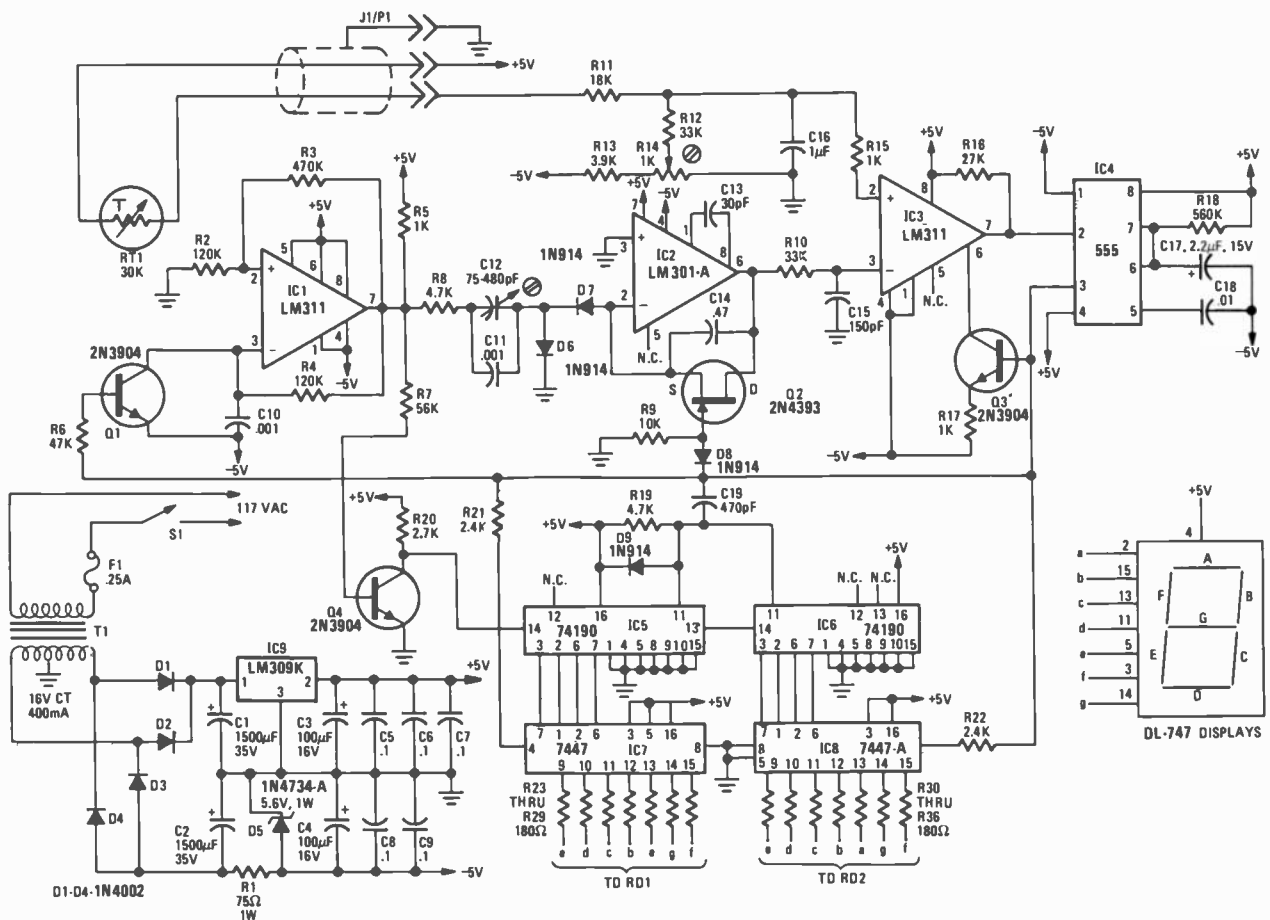

FIG. 3—COMPLETE SCHEMATIC. Power is supplied by IC regulator.

IC3, by way of Q3, eliminates an undesirable condition that results when pin 2 of IC3 is at a potential of 0 volts or less.

Construction

When constructing the thermometer be sure to include ceramic bypass capacitors for the power supply. The case should be made of metal and connected to the system ground. If the voltage regulator, IC9, is bolted directly to the chassis, with only a layer of silicone grease intervening, it will eliminate the need for a heatsink. Due to the many IC's used, it will probably be most convenient to use a PC board. The foil pattern is shown in Fig. 4 and the component overlay is shown in Fig. 5.

Two-conductor shielded cable, such as Belden No. 9452, is used to connect the thermistor to the rest of the circuitry. The shield should be connected to ground, while the two central conductors connect the thermistor to the positive supply and to R11. Use a 3- or 5-prong DIN plug-and-socket set with the shielded cable. Do not substitute for RT1, a 30K Fenwal

UUT43J1 precision thermistor. Use 5% resistors for R11 and R12; these two resistors, along with R13 and R14, were chosen especially to complement the thermistor. The combination provides the most linear voltage-vs.-temperature response over the 0°-to-99°F range, as shown in Fig. 6.

The thermistor assembly should be weatherproofed against environmental extremes. First insulate the exposed thermistor leads with heat-shrinkable tubing, then use Epoxy cement to seal any remaining areas where water could seep in. Since the thermistor is only 0.1-inch in diameter and thus relatively fragile, it should be mounted safely. For example, it could be put into a small plastic pill bottle, in which numerous large air holes have been punched. When mounting the thermistor outdoors, place it where summer sun and winter ice cannot damage it.

The power transformer for the thermometer is a 16-volt center-tapped 400 mA unit. If you cannot find a similar transformer, you can order one directly from the company listed in the parts list. Capacitors C11 and C14 should be polystyrene

PARTS LIST

All resistors 1/4 watt, 5% unless noted.

- R1—75 ohms, 1 watt
- R2, R4—120,000 ohms
- R3—470,000 ohms
- R5, R15, R17—1000 ohms
- R6—47,000 ohms
- R7—56,000 ohms
- R8, R19—4700 ohms
- R9—10,000 ohms
- R10, R12—33,000 ohms
- R11—18,000 ohms
- R13—3900 ohms
- R14—1000-ohm multiturn trimmer
- R16—27,000 ohms
- R18—560,000 ohms
- R20—2700 ohms
- R21, R22—2400 ohms
- R23-R36—180 ohms
- RT1—30,000 ohms precision thermistor (Fenwal UUT43J1. Write to: Customer Service, Fenwal Electronics, Framingham, MA 01701, for name and address of their distributor in your area.)

- C1, C2—1500 μ F, 35 volt, electrolytic
- C3, C4—100 μ F, 16 volt, electrolytic
- C5-C9—0.1 μ F, ceramic
- C10, C11—1000 pF, polystyrene
- C12—75-480 pF trimmer (Arco 466)
- C13—30 pF, polystyrene
- C14—0.47 μ F, polystyrene
- C15—150 pF, polystyrene
- C16—1 μ F, paper
- C17—2.2 μ F, 15 volt, tantalum
- C18—.01 μ F, ceramic
- C19—470 pF, ceramic
- D1-D4—1N4002
- D5—1N4734A, 5.6 volt, 1 watt
- D6-D9—1N914

- IC1, IC3—LM311 voltage comparator
- IC2—LM301A op-amp
- IC4—555 timer
- IC5, IC6—74190 synchronous up/down counter with mode control
- IC7, IC8—7447A BCD-to-seven segment decoder/driver
- IC9—LM309K voltage regulator, 5 volt
- F1—1/4 amp
- J1—3-pin DIN jack
- P1—DIN plug
- Q1, Q3, Q4—2N3904
- Q2—2N4393
- S1—SPST toggle
- T1—16 volt, center-tapped, 400 mA (Signal No. 241-4-16. Available from Signal Transformer, 1 Junius St., Brooklyn, NY 11212. \$3.70 each, plus postage.)
- DIS 1, DIS 2—DL-747 (Litronix seven-segment display.)
- Misc.—Case, 2-conductor shielded cable (Belden No. 9452 or equal), miscellaneous hardware.

FIG. 4—FOIL PATTERN, shown half size.

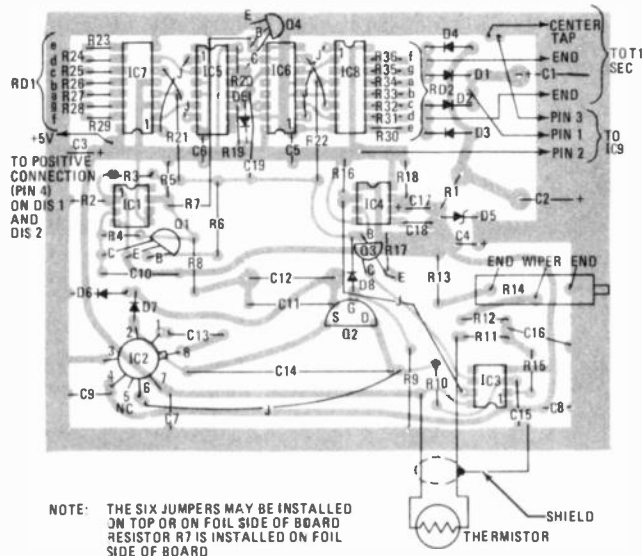
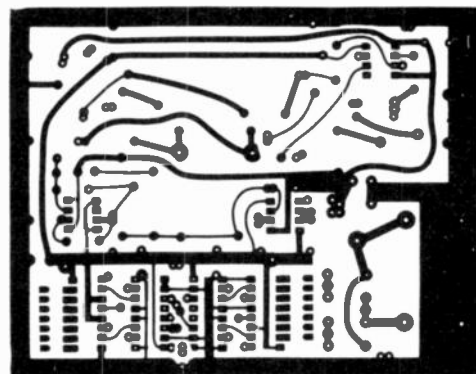

FIG. 5—COMPONENT PLACEMENT diagram.

types to assure low leakage, high stability and precise capacitance values. Finally, the display pinouts are for Litronix DL-747's; others can be used, but the pin connections may be different.

Calibration

After construction, only the circuit calibration remains to be done. To adjust R14, use a 287K 1% metal-film resistor. Thermistor resistance at 0°F is theoretically 288K \pm 1.5%; the precision resistor is a very close match. By using the precision resistor, you can obtain an accurate 0°F temperature reference for the circuit at the point where RT1 would normally be inserted. Apply power to the thermometer, and connect a high-imped-

continued on page 99

BEAT THE BURGLAR!

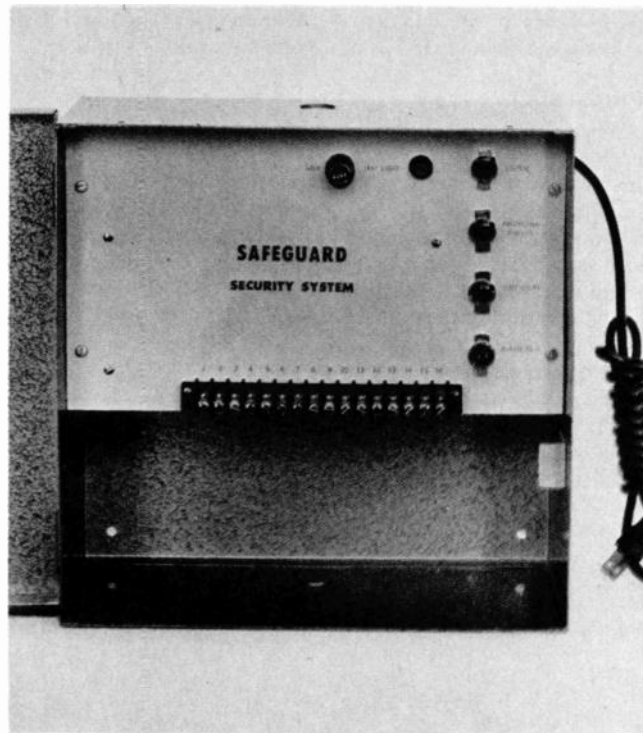

Build This Electronic Security System

Protect yourself and your property with this versatile multi-featured security system.

C. D. WADSWORTH

THE SOLID-STATE SYSTEM DESCRIBED here provides all the features and versatility of the most advanced security systems in the \$500.00 to \$800.00 category at a parts cost that should not exceed \$65.00.

Special features of this security system include:

System test light that turns on any time the protective circuit is broken. Prevents false alarms—automatically indicates any tampering with circuit.

Automatic exit time delay. Just turn the system on; now you have three minutes before it activates the protective circuit. This eliminates the outside key-lock switch (which is hard to install) and there is nothing outside to be picked or tampered with.

Automatic accessory control to provide house power to turn on lights, siren, or other accessories.

Automatic entrance time delay. When you enter the building, just walk to the master control and turn the system off. There is an adjustable time delay of 10 to

45 seconds before the alarm sounds. You set this re-entry time to suit your needs—it's fully adjustable.

Day-Night circuit to switch in or out part of the alarm circuit to suit your changing needs.

Entrance-Exit time delay turn-off. This single switch eliminates the time delays

so you get immediate response (alarm) when an intruder breaks in—to protect you while at home.

Automatic alarm turn-off. 8 to 10 minutes after the alarm starts it shuts itself off and automatically resets itself (just in case the burglar returns). This could be a very attractive feature for your neighbors if you decided to leave home for two

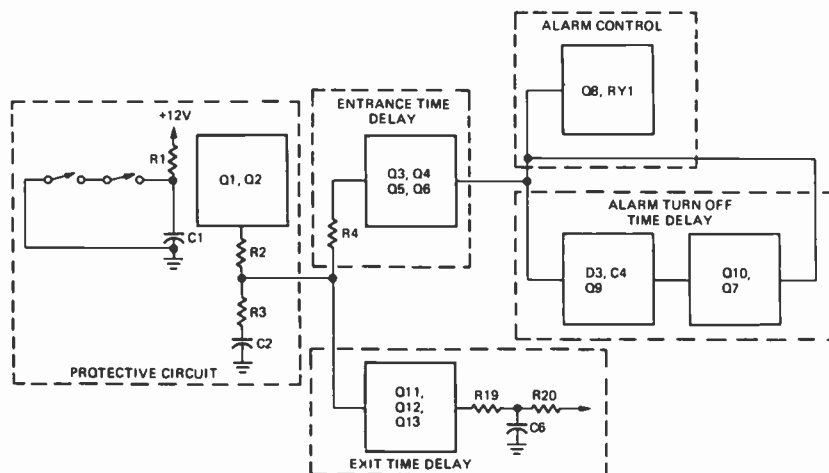
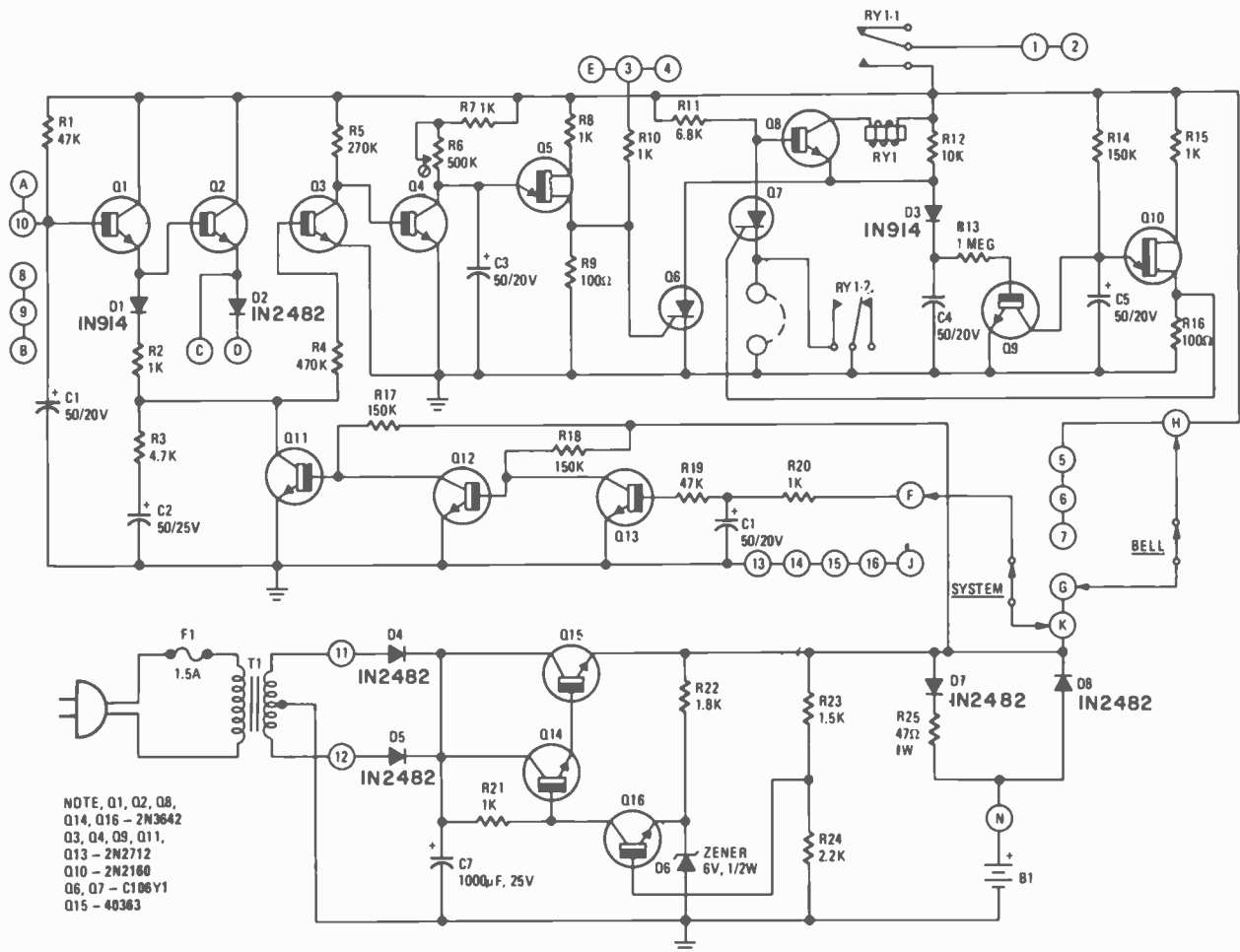

FIG. 1—BLOCK DIAGRAM DIVIDES the circuit up into its functioning sections, shows what transistors belong in each, and indicates connections to protective switches.



NOTE: Q1, Q2, Q8, Q14, Q16—2N3642
 Q3, Q4, Q9, Q11, Q13—2N2712
 Q10—2N2160
 Q6, Q7—C106Y1
 Q15—40363

FIG. 2—COMPLETE CIRCUIT DIAGRAM of the Safeguard Security System.

PARTS LIST

All resistors are 1/4-watt, 10%, unless noted.

- R1, R19—47,000 ohms
- R2, R7, R8, R10, R15, R20, R21—1,000 ohms
- R3—4,700 ohms
- R4—470,000 ohms
- R5—270,000 ohms
- R6—500,000-ohm, 1/4 W, vertical-mount subminiature trimmer (Mallory MTC 55L1 or equal)
- R9, R16—100 ohms
- R11—6,800 ohms
- R12—10,000 ohms
- R13—1 megohm
- R14, R17, R18—150,000 ohms

- R22—1,800 ohms
- R23—1,500 ohms
- R24—2,200 ohms
- R25—47 ohms, 1W
- C1, C2, C3, C4, C5, C6—50 μF, 20V
- C7—1,000 μF, 25V
- D1, D3—1N914
- D2, D4, D5, D7, D8—1N2482, 1A, 200 PIV
- D6—Zener, 6V, 1/2 W, 10%
- Q1, Q2, Q8, Q14, Q16—2N3642
- Q3, Q4, Q9, Q11, Q12, Q13—2N2712
- Q5, Q10—2N2160
- Q6, Q7—C106Y1 (G-E)
- Q15—40363 (RCA)
- B1—batteries, (3) 4.5V alkaline rechargeable (RCA VS1563)

- F1—fuse, 1.5A
- RY1—Relay, DPDT, 12V DC, PC board mount (Potter Brumfield R10-E2-Y2)
- L1—10V DC (Eldema ICE 5913)
- Misc.—16-conductor terminal strip (Cinch 16-140-Y), four SPDT toggle switches, metal spacers, panel, grommets, battery clips, key lock, metal cabinet.

Note: The following items are available from Electronic Products Co., Box 160412, Sacramento, CA 95816: Circuit board No. 627, \$9.20. Complete kit of all parts, circuit board, panel, metal cabinet and instructions. No. 627K, \$65.00 plus postage for 10 lbs.

weeks and the alarm tripped while you were gone.

Automatic stand-by power in case the normal house power is interrupted for any reason. Rechargeable batteries are a feature and the recharging circuitry is built in and fully automatic.

Provision for fire sensors and panic button.

How it works

The block diagram of Fig. 1 shows the functions of the various parts of the

circuit. The complete schematic appears in Fig. 2.

When protective circuit switches (Fig. 1) are closed, the base of Q1 is held at ground potential and the transistor remains off. When the protective circuit is broken, the bias provided by R1 turns on Q1 and charges C2 through R2 and R3. The only discharge path for C2 is through R3, R4, and the base-emitter junction of Q3. This causes Q3 to turn on, bringing the base of Q4 to ground potential and turning Q4 off. With Q4 off C3 (Fig. 2) is allowed to charge through R6 and R7 to the point where

unijunction transistor Q5 fires and turns on SCR Q6. The R-C time constant of R6R7/C3 is the re-entry time delay.

The exit time delay is provided by the system switch (closed when system is off) which charges C6. Transistors Q11, Q12, and Q13 hold C2 at ground potential until C6 discharges through R19 and the base-emitter junction of Q13.

The 10-minute alarm turn-off works as follows: Transistor Q8 is held "on" by R11. However, relay RY1 cannot turn on because the emitter of Q8 does not have a complete path to ground until SCR Q6 is turned on. When Q6 turns on, RY1 acti-

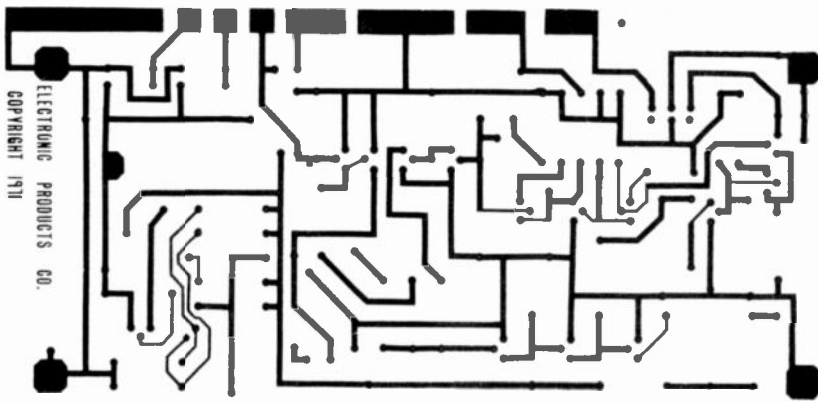
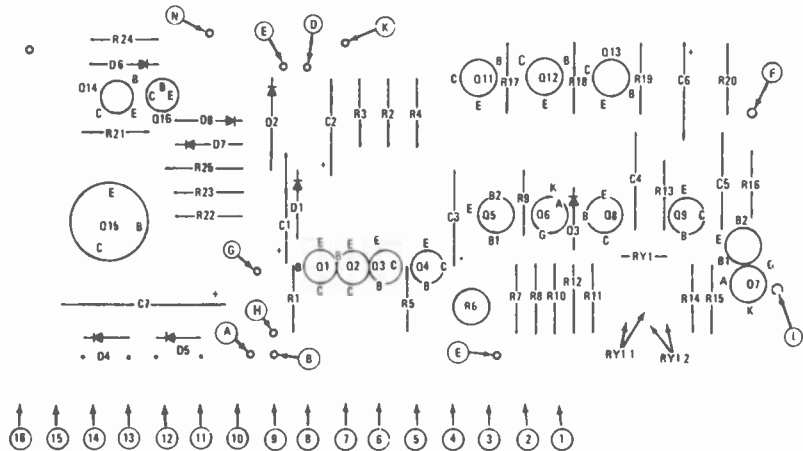

FIG. 3—PRINTED CIRCUIT BOARD, reduced to one-half its actual dimensions.



NOTE:
*THESE TERMINALS CAN BE USED FOR 2 MORE DIODES TO MAKE FULL-WAVE BRIDGE WHEN CENTER-TAPPED TRANSFORMER IS NOT AVAILABLE

FIG. 4—COMPONENT PLACEMENT diagram.

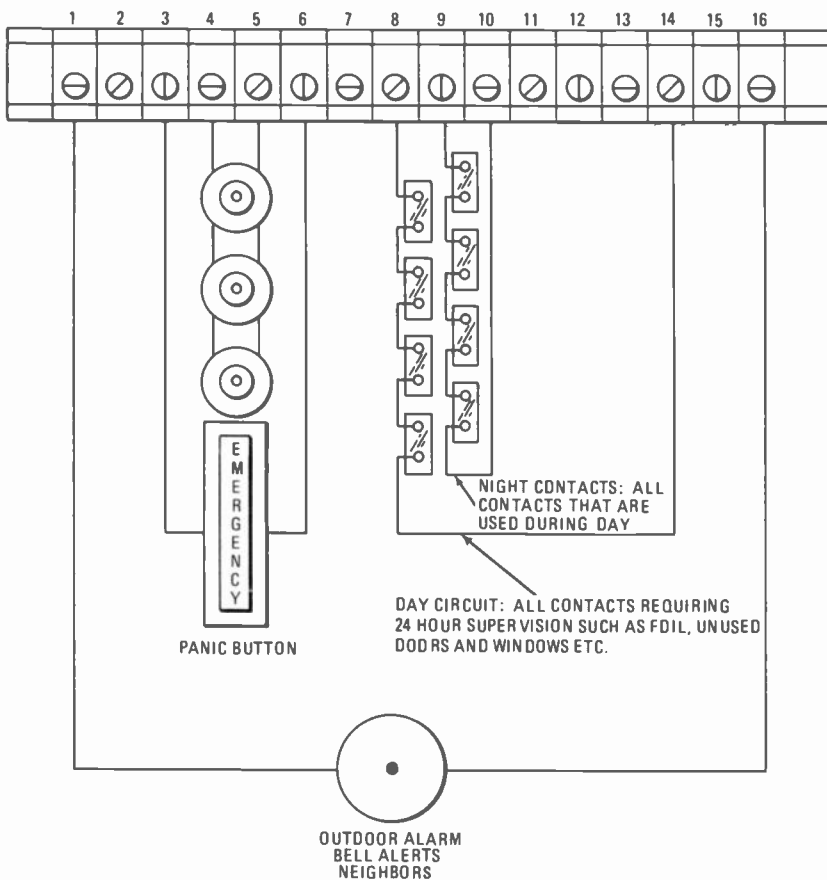

FIG. 5—THE TERMINAL STRIP. Numbers along top match circled numbers in schematic.

vates closing switches RY1-1 and RY1-2 and the alarm sounds. Prior to activation of Q6, capacitor C4 was charged to full potential through R12 and D3. When Q6 activates, it also back-biases diode D3 and the only discharge path for C4 is through R13 and the base-emitter junction of Q9. With Q9 on, C5 cannot charge and will remain at ground potential. When C4 has discharged, Q9 turns off. C5 charges through R14 and fires unijunction Q10 which triggers the SCR 7. Negative bias is then applied to Q8's base through Q7 and RY1-2. Q8 turns off, RY1 turns off, Q6 turns off because there is no longer a conductive path except through R12, which does not pass enough current to keep it turned on. When RY1 deactivates, switch RY1-2 opens, which turns off Q7. All components are now in the same active state as before the alarm.

The power supply design is straightforward and easy to follow. No heat sink is required for Q15 if the components specified are used. Batteries charge through D7 until their voltage is equal to the supply voltage, at which time diode D7 becomes back-biased, preventing further charging. R25 is a current-limiting resistor to protect the batteries. Diode D7 remains back-biased until supply voltage falls below battery voltage, at which point the batteries then supply power to the circuit.

Putting it together

Construction is straightforward and parts layout is not critical except in the SCR gate circuit, in which leads should be kept as short as possible. If you plan to etch and drill your own circuit board, the layout and parts placement are shown in Fig. 3 and Fig. 4.

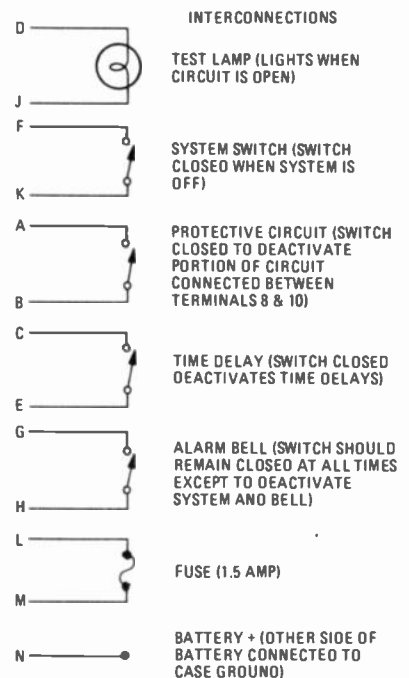
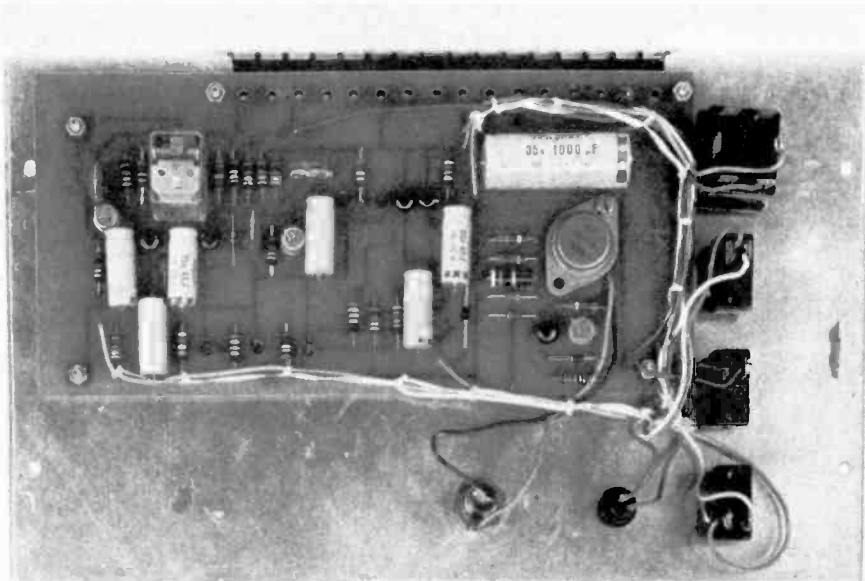
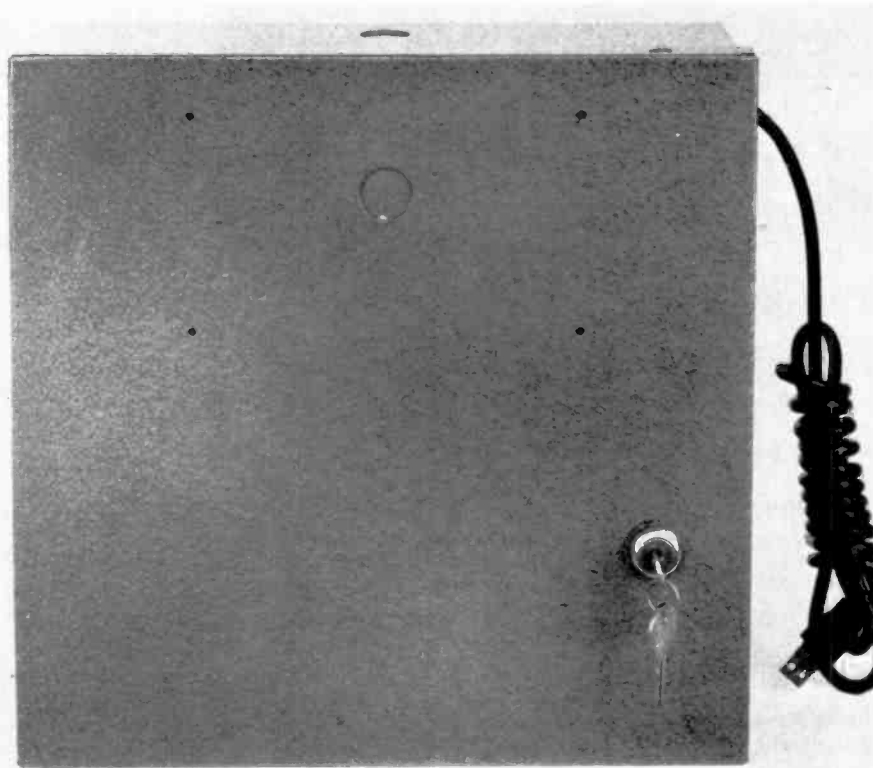

FIG. 6—INTERCONNECTIONS to items on panel. Letters match those on schematic.



REAR VIEW OF CONTROL PANEL shows circuit board and switches. Terminal strip is mounted on bottom edge of PC board.



THE ELECTRONIC SECURITY SYSTEM is housed within a steel enclosure. A key lock prevents tampering.

Insert resistors and capacitors in board and solder, then insert diodes and transistors and solder. This helps prevent excessive heat on the semiconductors. Next, connect the terminal strip to the foil side of the printed circuit board with 4-40 machine screws. Use one 4-40 nut and three washers as spacers between the terminal strip and the printed-circuit board so the ends of the leads on the terminal strip do not quite pass through the board. The metal leads on the terminal strip can now be soldered to the printed-circuit board.

The numbered locations on the schematic correspond with the pin numbers of the terminal strip (Fig. 5) and the printed circuit board layout. The lettered locations on the schematic and the printed circuit board layout are the interconnections for the test lamp, fuse, and switches and are detailed in Fig. 6.

Connect wires for the switches, fuse, and light to the printed circuit board, mount the board on the back of the metal panel, using 4-40 machine screws and two 4-40 nuts as spacers. Check to be sure that no leads from printed-circuit board or the terminal strip touch the metal panel. Mount the fuse, light and switches, dress wires around edge of printed-circuit board and connect to appropriate points. Mount transformer in cabinet with the center tap of the transformer secondary going to cabinet ground.

The connections for the various sensors to the terminal strip are detailed in Fig. 5. Remember when checking this system out, capacitor C2 must become fully discharged between tests. So you must turn the SYSTEM switch on between tests and wait the full 3 minutes (exit time) before the next test. Turning the BELL switch off will *not* discharge C2. Unless you turn the SYSTEM switch off and then back on you may get a false alarm.

Special Note: The time before the alarm turns itself off may be reduced or increased by changing the value of R13 and to some extent by changing the value of R14. Experiments with R13 show it can be increased to 5 megohms providing the beta of Q9 (the particular 2N2712 you use for this function) is not drastically different from normal for this unit.

For accessory control (house lights, siren, etc.) connect a 12-volt relay to terminals 2 and 15. **R-E**

Students to learn programming with hand-held calculators

A course for teaching fundamental programming with small calculators to students in high school was described to the recent annual conference of the National Council of Teachers of Mathematics by speakers from Texas Instruments.

Designed by the University of Denver Mathematics Laboratory and oriented to a series of motivational activity lessons, the

course materials have been tested with both teachers and students. The format allows a teacher to move the students into simple straightforward programming quickly. They then proceed to advanced program techniques involving conditional and unconditional transfers, loops and subroutines. At each of these points the teacher selects applications or problem situations at various mathematical levels, to help the students understand the concepts covered.

The great advantage of the hand-held calculator as a learning tool is that it is readily available to teachers and students who would otherwise have to wait, after writing programs, for access to larger computers. Also, the initial and continuing costs for a computer-based course would be orders of magnitude greater than for one that uses calculators.

The course will be available late in 1977. Contact your local TI dealer or write: TI, Box 5012, Dallas, TX 75222

Build This



10 Function Digital Clock

Part II. *Construction details for a multi-function digital clock that provides a simultaneous display of the time, date, alarm and countdown timer*

JEFFREY G. MAZUR

LAST MONTH, IN THE FIRST PART OF THIS article, we provided the complete schematic diagram and a detailed description of how the circuit worked. This month, the article concludes with the foil patterns and construction details.

Construction

The clock is built on two separate printed circuit boards. A double-sided board holds all the clock circuitry, and a single-sided one contains the readouts. The foil patterns for the main board are shown in Figs. 5 and 6. The foil pattern for the display board is shown in Fig. 7. The two boards are connected by a 32-conductor cable. Since there are many connections on both sides of the clock

board as well as feed-through holes for interconnecting the two sides, plated-through holes are a must on this board.

Mount the power transformer directly on the clock board or, for a slimmer package, use a wall-type AC adapter transformer. If the adapter is used, the

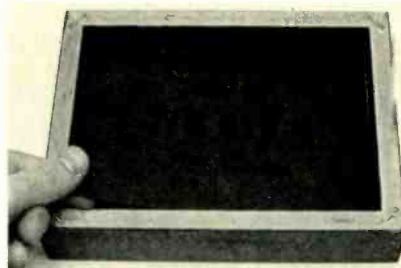

AFTER MOUNTING red plastic to the front of the frame, add a piece of black cardboard with cutouts for the displays.

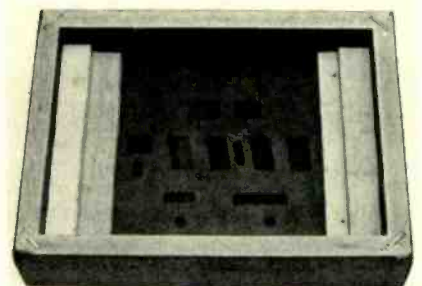

MOUNT SUPPORTS for the two PC boards for the proper spacing.

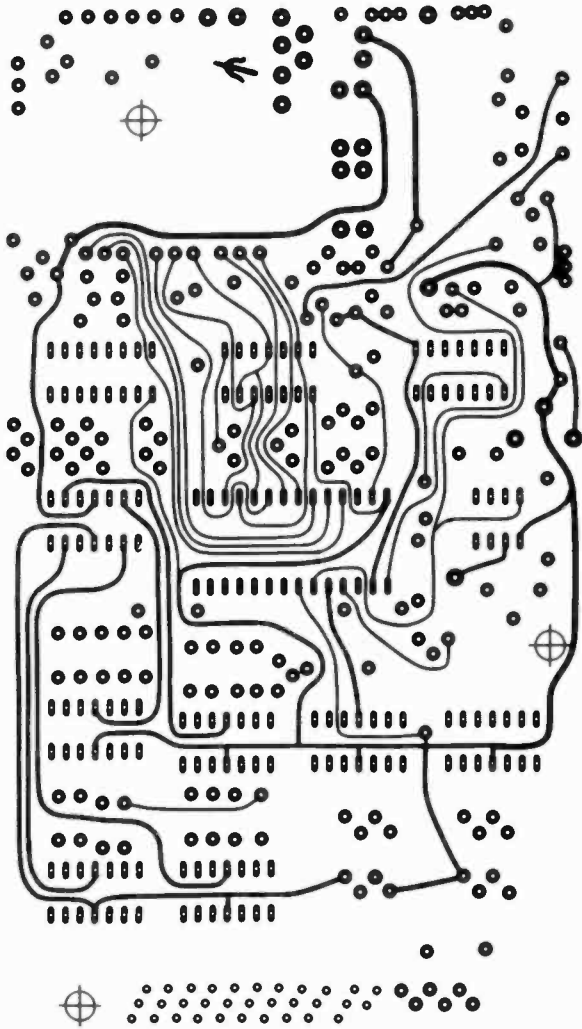

FIG. 5—FOIL PATTERN of component side of double-sided clock board. Actual board measures 7 × 4 inches.

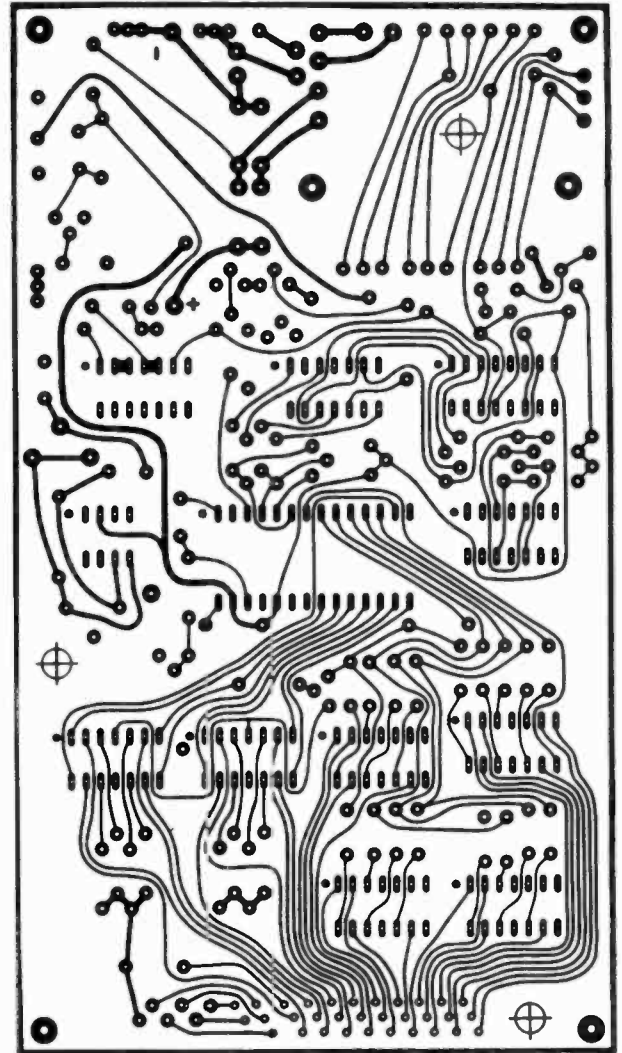

FIG. 6—FOIL PATTERN of bottom side of double-sided clock board.

two boards fit neatly into a standard 5 × 7-inch picture frame.

Before starting construction, decide on which options will be used. If a 24-hour format is desired, install D28. (See Fig. 8.) Resistors R17, R18, R26, transistor Q2 and the AM/PM digits can then be omitted if desired. For crystal timebase operation, omit R1, D1 and C2. If the power-line frequency (50 or 60 Hz) is going to be used as the timebase, *do not* install IC12. For 50-Hz operation, add D29. Temporarily place a jumper where resistor R5 would normally go. The com-

ponent placement diagram for the display board is shown in Fig. 9. Mount the small alarm and timer displays on Molex pins to raise them up to the same height as the other displays. This gives a uniform appearance and reduces parallax problems when mounting the board behind the front panel. Make the front panel by cutting holes in a piece of black cardboard and mounting it to a solid piece of red plastic.

Mount the remaining components, including the 28-pin socket for IC11. Do not install IC11 at this time. Connect the

display board to the clock board using ribbon cable. Then wire up all switches, being careful to install the diodes connected to them properly. Mount the TIME SET/DATE SET switch on the back or where it won't be accidentally moved. Mount the rest of the switches on the front, back or sides.

Check the boards carefully for shorts and proper component polarity. When everything looks in order, remove IC11 from its protective carrier and carefully install it in its socket. Then apply power. The display may register all 8's; this is a

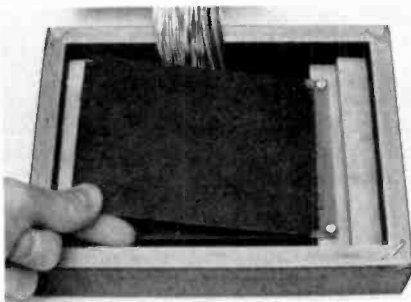

INSULATE the back of the display board with a piece of cardboard.

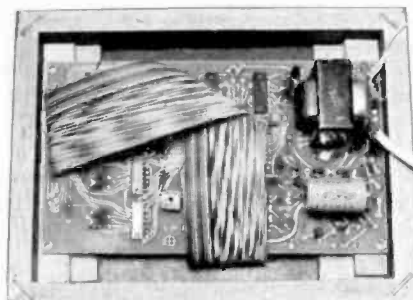

CLOCK BOARD is mounted over the display board.

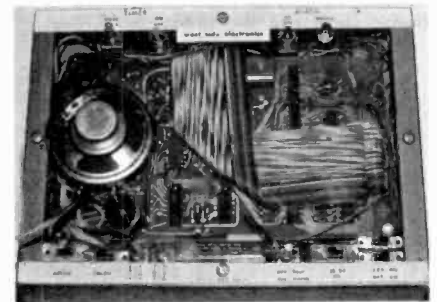

REAR VIEW of completed clock with clear plastic rear cover.

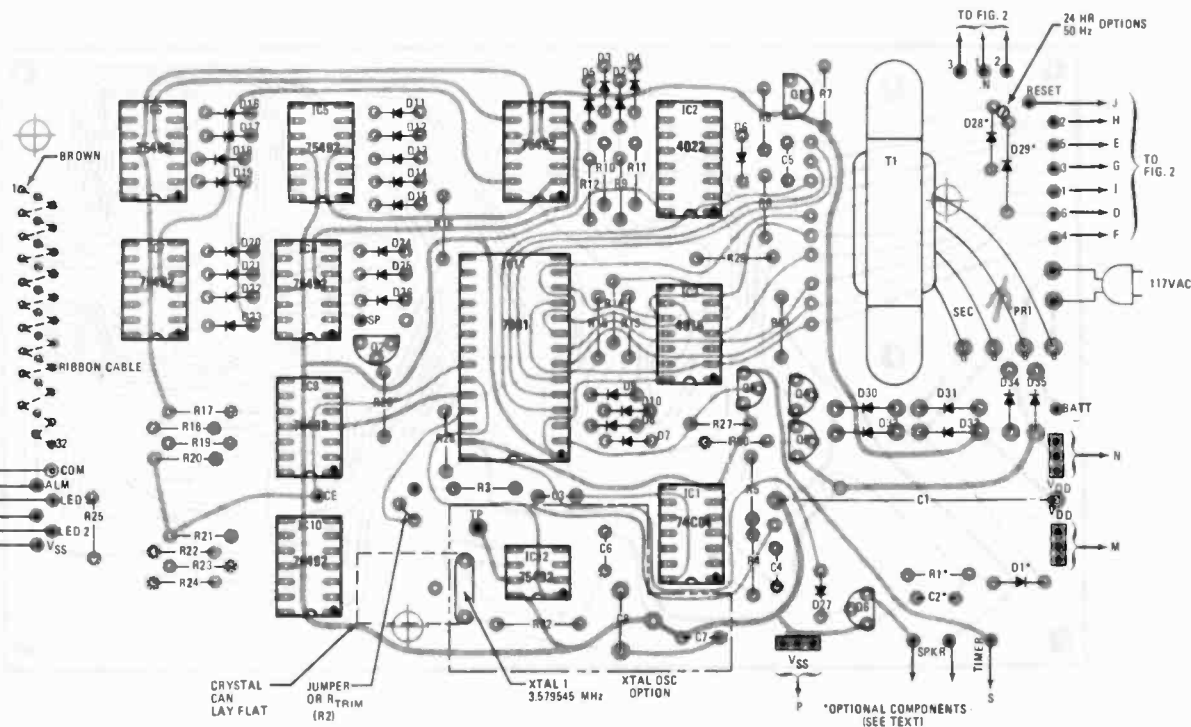

FIG. 8—COMPONENT PLACEMENT diagram of clock board.

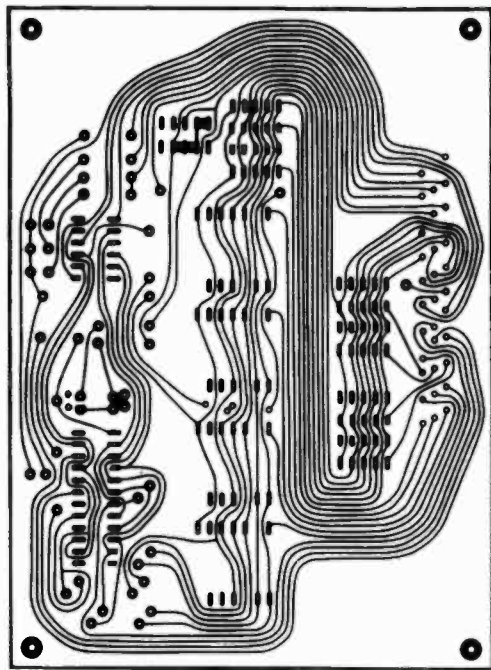

FIG. 7—FOIL PATTERN of single-sided display board. Actual board measures 4 × 5½ inches.

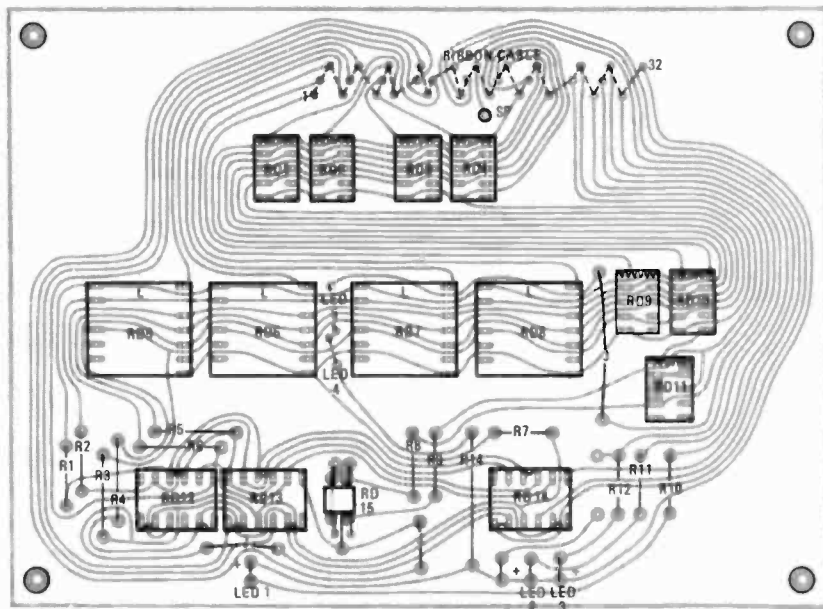

FIG. 9—COMPONENT PLACEMENT diagram of display board.

normal reaction. Set the date, time, alarm and timer displays using the SET and MINUTES/HOURS advance switches. Setting the time will automatically set the seconds to zero. The seconds will hold at zero until switching to another mode. This permits you to synchronize the clock to a standard time source such as the phone company. When setting one of the functions (time, alarm, date, etc.), all but the time display will be blanked.

If there is any flicker in the display or in certain segments, the external multi-

plexing frequency or the blanking time may be off. The output of the scanning oscillator (IC1) should be about 140 Hz. If this checks OK, then increase the value of capacitor C5 (blanking time) until no misreading occurs.

If the crystal timebase option is not used, the clock will revert to its internal backup oscillator in case of a power failure. This oscillator can be adjusted by replacing the jumper at R5 with a 5K potentiometer or a selected resistor. The value of R5 should be such that the DI output of the 7001 (pin 8) is 1.05 kHz for

60-Hz or 875 Hz for 50-Hz operation. For short power interruptions (up to several hours), use a 9-volt battery. For longer protection, use eight AA-cells or a 12-volt lantern battery depending on available space. If rechargeable cells such as Ni-Cad's are used, then a trickle charge can be obtained by adding a resistor across D35. For DC operation in a car, boat, etc., connect the power across C1 (omit T1). Use a 9-volt backup battery to take over if the vehicle battery drops too low, for instance during starting.

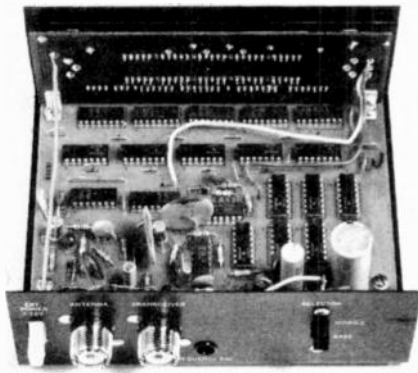

Build 30-MHz CB

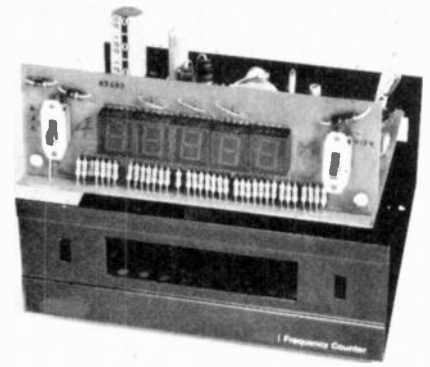

FREQUENCY COUNTER

Two circuit boards make this an easy unit to assemble. An accessory power supply adds line voltage operation

THERE IS ONLY ONE WAY THAT A CB OPERATOR can be certain that his CB transmitter is always operating on frequency, and that's by monitoring its output with a frequency counter whenever he is on the air. The frequency counter described in this article makes it easy for the CB'er to do just that. It can be used in the car with a mobile unit or at home with a base station.

The counter reads frequencies over a range of 5 Hz to 30 MHz. The display

GEORGE SANTI

consists of five large (1½-inch high), bright LED readouts. A mode switch lets you select kHz or MHz readings. Once installed, the unit works automatically when you transmit. And while you're listening, only the decimal point of the display remains lit, reducing current drain to less than 70 mA.

For CB'ers, all 40 CB channels are

covered. The unit can be mounted in a car and the frequency counter connects between the CB transmitter and the antenna by using standard SO-239 in-line connectors.

To use the counter with a base station, an additional 117-volt AC supply is needed. A schematic for such a supply is shown and an assembled version is available as described in the parts list.

Amateur radio operators can also use the counter to check their transmissions on all bands through 10 meters. Obviously, this is particularly important if he is using a VFO.

For experimenters, this counter offers an inexpensive accurate (± 10 PPM) test instrument. It can be driven directly with 5-volt TTL signals.

SPECIFICATIONS

INPUT SENSITIVITY: 500 mV RMS-DC to 3MHz, 500 mV RMS linearly increasing to 5 VRMS-3 MHz to 27 MHz.

IMPEDANCE: 22,000 ohms at low frequencies, 200 ohms at 27 MHz.

FREQUENCY RANGE: 5 Hz to 30 MHz.

DISPLAYS: Five 0.5" high LED's

OVERLOAD: Diodeprotected input

ACCURACY: ± 1 digit \pm time base stability

READOUT: kHz or MHz

TIMEBASE CRYSTAL FREQUENCY: 10 MHz, ± 10 PPM accuracy, ± 1 PPM stability

POWER REQUIREMENTS: 8-14 VDC at 1.2A. For base-station operation use 117 VAC regulated power supply (minimum 1.5A rating)

DIMENSIONS: 2½" H, 5½" W, 6¼" D

WEIGHT: 1.6 pounds

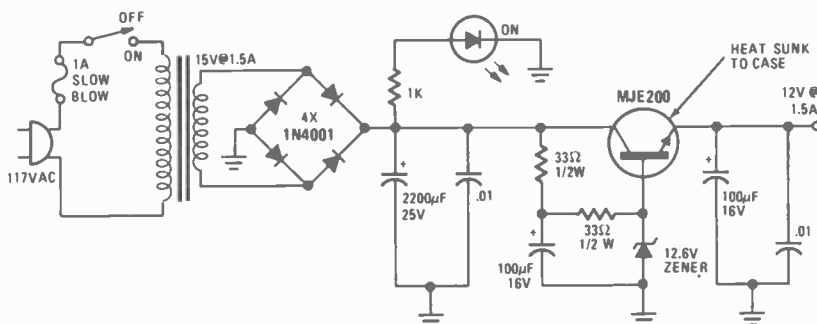

POWER SUPPLY provides 12 volts DC to operate the frequency counter off the 117-volt AC line.

Building your counter

The unit is easy to build. All parts with the exception of front and rear panel switches and connectors mount on the two circuit boards. One board is the main circuitry, the other houses the display devices. Both boards are one-sided and the foil patterns printed here are actual size. Boards are also available from the supplier listed in the parts list.

The resistors mounted on the display board have only one lead connected to that board. The other end of these resistors mate with matching holes in the main circuit board and interconnect the two boards. Once soldered into place, the two boards sit at right angles to each other and are firmly fastened together.

No special construction tips are needed. But do take care not to let solder blobs short foils, especially when soldering the IC pins into place.

One point; you might want to try

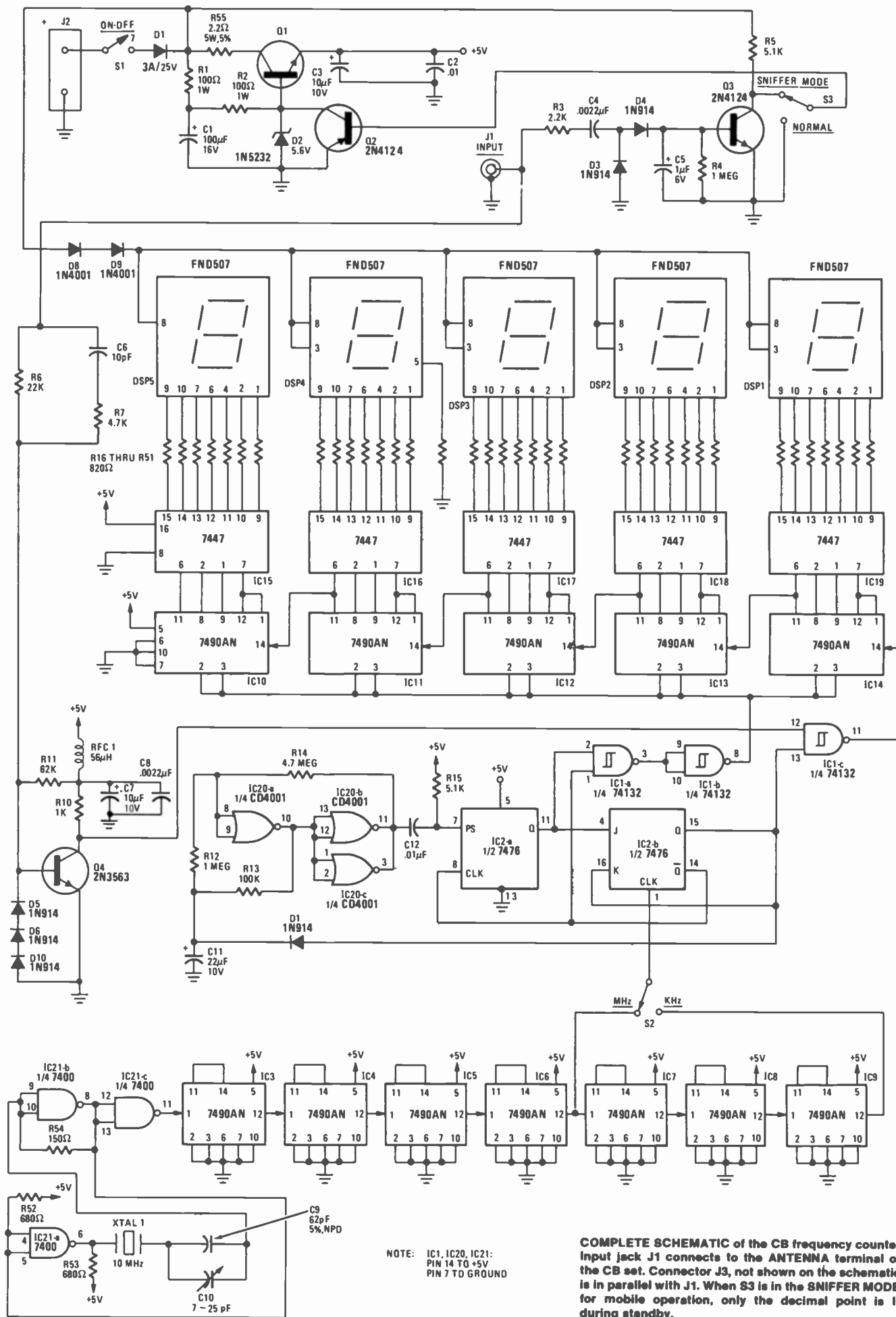

NOTE: IC1, IC20, IC21:
PIN 14 TO +5V
PIN 7 TO GROUND

COMPLETE SCHEMATIC of the CB frequency counter. Input jack J1 connects to the ANTENNA terminal on the CB set. Connector J3, not shown on the schematic, is in parallel with J1. When S3 is in the SNIFFER MODE, for mobile operation, only the decimal point is lit during standby.

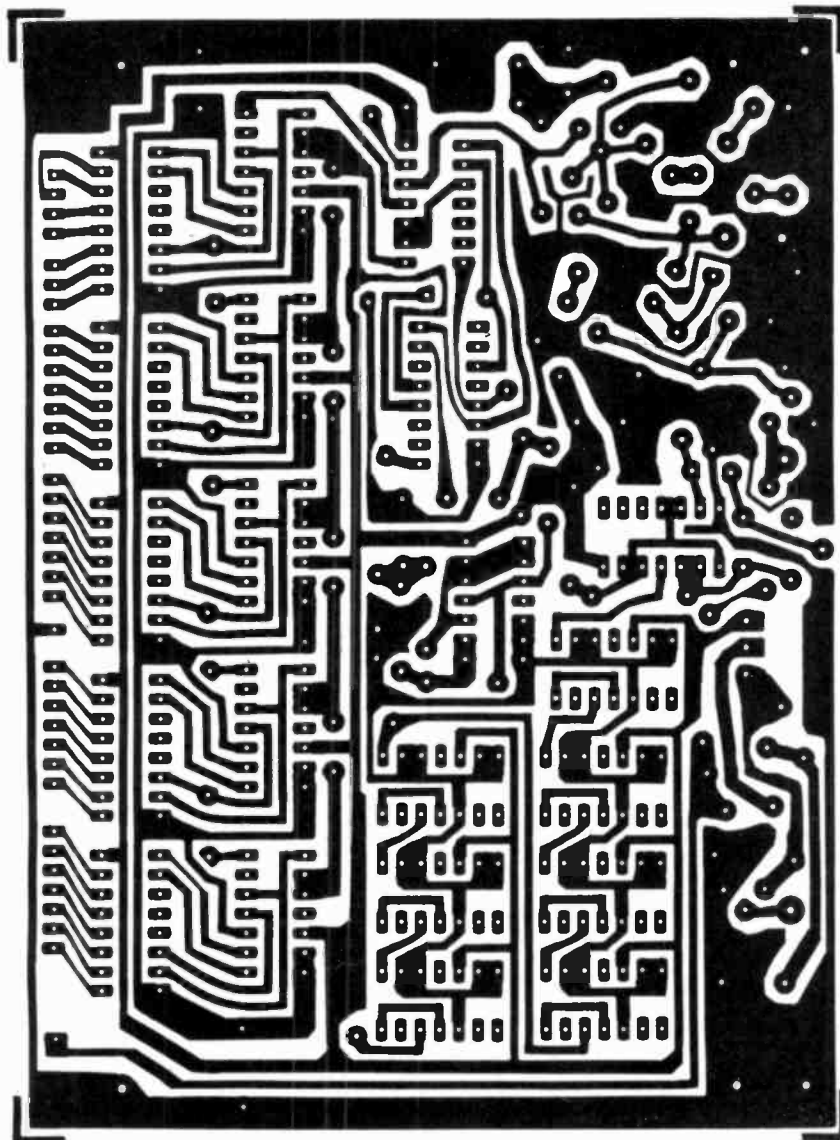

FULL SIZE FOIL PATTERN for the main circuit board of the CB frequency counter. This one-sided board should be relatively easy to make.

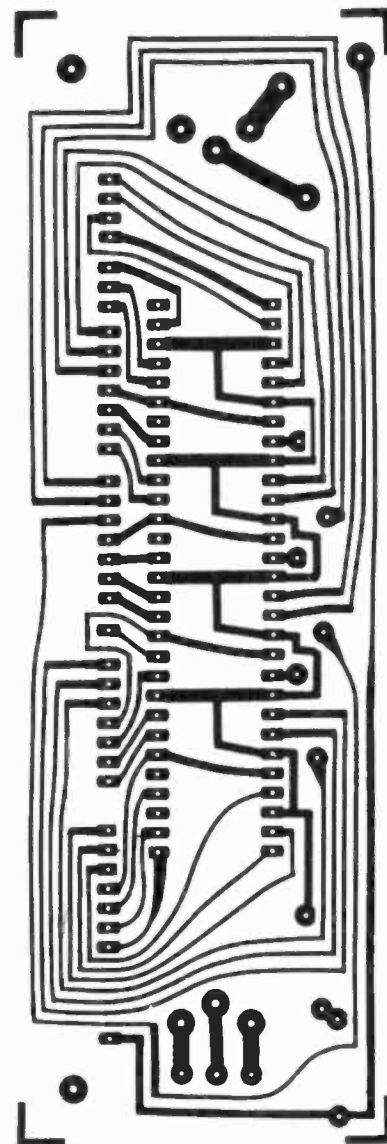

FULL SIZE FOIL pattern for the display board makes it easy to duplicate.

PARTS LIST

All resistors 1/4-watt 5% unless noted

R1, R2—100 ohms, 1W, 10%
 R3—2200 ohms
 R4, R12—1 megohm
 R5, R15—5100 ohms
 R6—22,000 ohms
 R7—4700 ohms
 R8, R9—not used
 R10—1,000 ohms
 R11—62,000 ohms
 R13—100,000 ohms
 R14—4.7 megohms
 R16 thru R51—820 ohms (35 resistors)
 R52, R53—680 ohms
 R54—150 ohms
 R55—2.2 ohms, 5W, 5%

Capacitors

C1—1,000 μ F, 16V, electrolytic
 C2, C12—.01- μ F disc
 C3, C7—10 μ F, 10V, electrolytic
 C4, C8—.0022- μ F disc
 C5—1 μ F, 6V, electrolytic
 C6—10-pF disc
 C9—62-pF, 5% NPO, disc
 C10—7-25-pF trimmer (Erie)
 C11—22- μ F 10V, electrolytic

Diodes

D1—3A, 25V or higher power rectifier
 D2—1N5232B, 5.6V Zener diode
 D3, D4, D5, D6, D7, D10—1N914
 D8, D9—1N4001
 DSP1, DSP2, DSP3, DSP4, DSP5—
 FND507 (0.5-inch high 7-segment LED
 display 15mA per segment)
 F1—3A 3AG
 J1—coax connector
 J2, J3—2 connector male power jack
 RFC1—56- μ H choke

Integrated circuits

IC1—74132—Quad 2-input NAND
 Schmitt Trigger
 IC2—7476—Dual J-K Master-Slave flip-
 flop
 IC3 thru IC14—7490AN—Decade Counter
 IC15 thru IC19—7447 BCD-to-seven-
 segment decoder drive
 IC20—CD4001—Quad 2-input NOR gates
 IC21—7400—Quad 2-input NAND gate
 Q1—2N40631
 Q2, Q3—2N4124
 Q4—2N3563
 S1—SPST switch

S2, 3—SPDT switch
 XTAL1—10 MHz \pm 10 PPM.
 Circuit Boards
 Case
 Hardware

The following parts are available from
 Guardsman Electronics, Box 215,
 Brooklyn, NY 11207.

Etched and drilled circuit boards
 (2); \$11.00 postage prepaid.
 10-MHz crystal; \$3.50 postage paid.
 Trimmer capacitor; \$6.50 postage
 paid.

Set of 2 circuit boards, crystal and
 trimmer capacitor; \$19.00 postage
 paid.

Complete kit of all parts including
 custom cabinet; \$59.95 plus \$1.50
 postage and handling.

Assembled unit; \$99.95 plus \$1.50
 postage and handling.

Power supply (assembled) 13.6VDC,
 2.5A, \$18.00 postage prepaid.

continued on page 50

Be the “New Professional” in electronics

**CREI trains you at home
for one of the most important
career levels in electronics—
plus offers you special
arrangements for engineering
degrees**

Most people think there are only two levels of careers in electronics: the technician level and that of the degree engineer.

There is, however, a third and very important level. It is that of the engineering technician or *practical* engineer. The growing importance of this career level has created what might well be called the “New Professional” in electronics.

If you look at the various levels of employment in electronics, you will understand why this “New Professional” is so important.

The average technician is a person who has had vocational training in electronics. He understands the basic principles of electronics so he can troubleshoot, repair and maintain equipment. He usually works under close supervision in performing his duties.

The engineer has college training in electronics. He usually supervises technician personnel and is responsible for planning and developing of electronic equipment and systems. Frequently, however, engineers are more heavily trained in the scientific principles of electronics and less in their practical application.

The engineering technician, by contrast, is a specialist in the practical application of electronics. His training usually consists of a two-year college program in electronic engineering technology. In many organizations, the engineering technician handles several of the responsibilities of the degree engineer. He often has the title of engineer.

CREI programs are designed to give you at home the same level and depth of training you receive in a two-year college program in electronic engineering technology. CREI programs are, in fact, more extensive than you will find in many colleges. And CREI gives you the opportunity to specialize in your choice of the major fields of electronics.

Unique Design Lab

CREI gives you both theory and practical experience in circuit design with its Electronic Design Laboratory Program. The professional equipment included in this program allows you to construct, test out and correct the circuits you design until you have an effective circuit.

This Lab Program helps you understand advanced electronics. It also gives you practical experience in many other important areas of electronics, as in pro-

Career Training at Home

totype construction, breadboarding, test and measurement procedures, circuit operation and behavior, characteristics of electronic components and how to apply integrated circuits.

Only CREI offers the unique Lab Program. It is a complete college Lab and, we believe better than you will find in most colleges. The "Lab" is one of the factors that makes CREI training interesting and effective. And the professional equipment in this program becomes yours to keep and use throughout your professional career after you complete the training.

Engineering Degree

CREI offers you special arrangements for earning credit for engineering degrees at certain colleges and universities as part of your home study training program. An important advantage in these arrangements is that you can continue your full time job while "going to college" with CREI. This also means you can apply your CREI training in your work and get practical experience to qualify for career advancement.

Wide Program Choice

CREI gives you a choice of specialization in 14 areas of electronics. You can select exactly the area of electronics best for your career field. You can specialize in such areas as computer electronics, communications engineering, microwave, CATV, television (broadcast) engineering and many other areas of modern electronics.

Free Book

In the brief space here, there isn't room to give you all of the facts about CREI college-level, home study programs in electronics. So we invite you to send for our free catalog (if you are qualified to take a CREI program). The catalog has over 80, fully illustrated pages describing your opportunities in advanced electronics and the details of CREI home study programs.

Qualifications

You may be eligible to take a CREI college-level program in electronics if you are a high school graduate (or the true equivalent) and have previous training or experience in electronics. Program arrangements are available depending upon whether you have extensive or minimum experience in electronics.

Send for this **FREE** Book describing your opportunities and CREI college-level programs in electronics



Mail card or write describing qualifications to

CREI **CAPITOL
RADIO
ENGINEERING
INSTITUTE**

McGraw-Hill Continuing Education Center
3939 Wisconsin Avenue Northwest
Washington, D.C. 20016

Accredited Member National Home Study Council

GI Bill

CREI programs are approved for training of veterans and servicemen under the G.I. Bill.



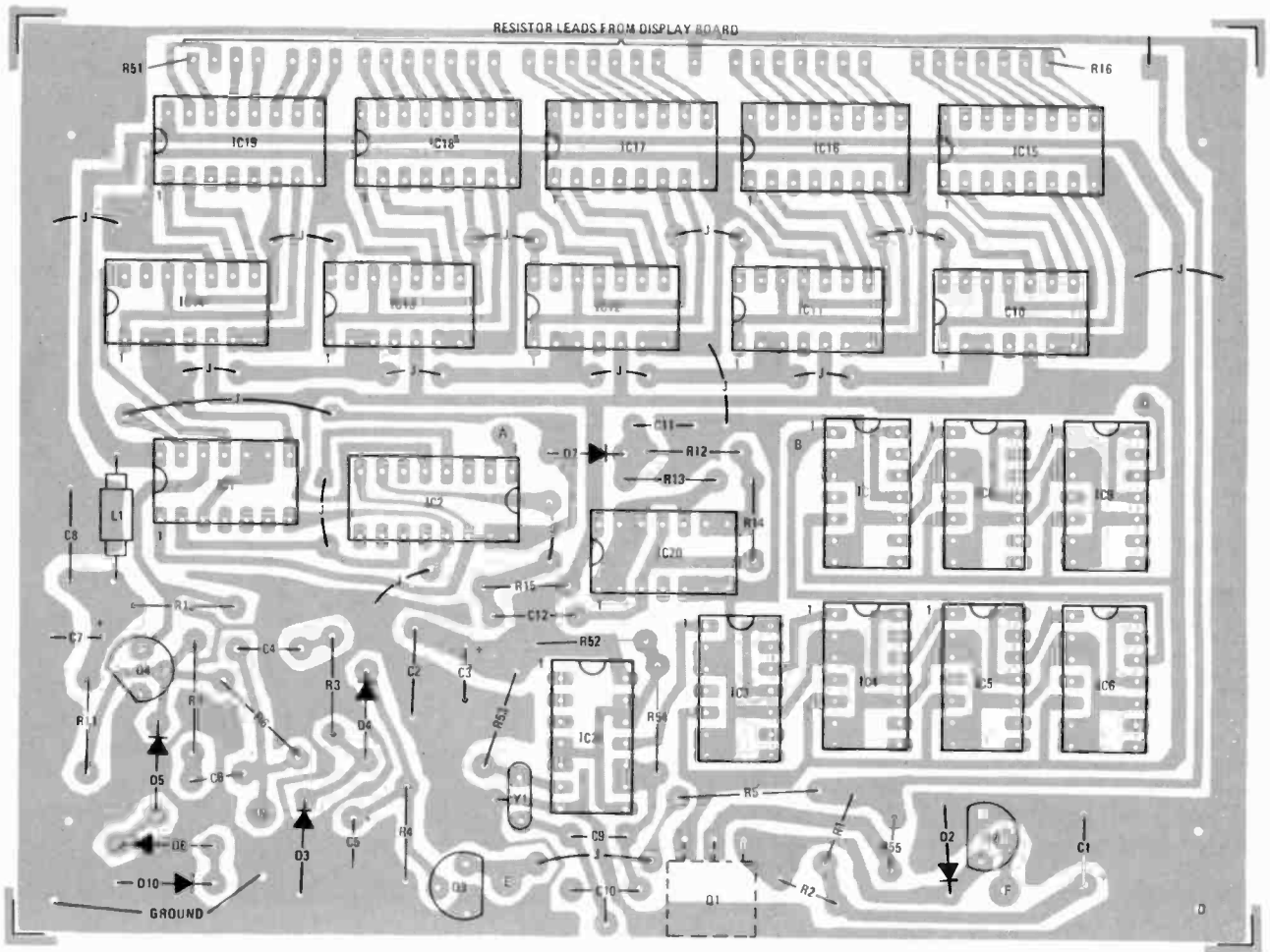
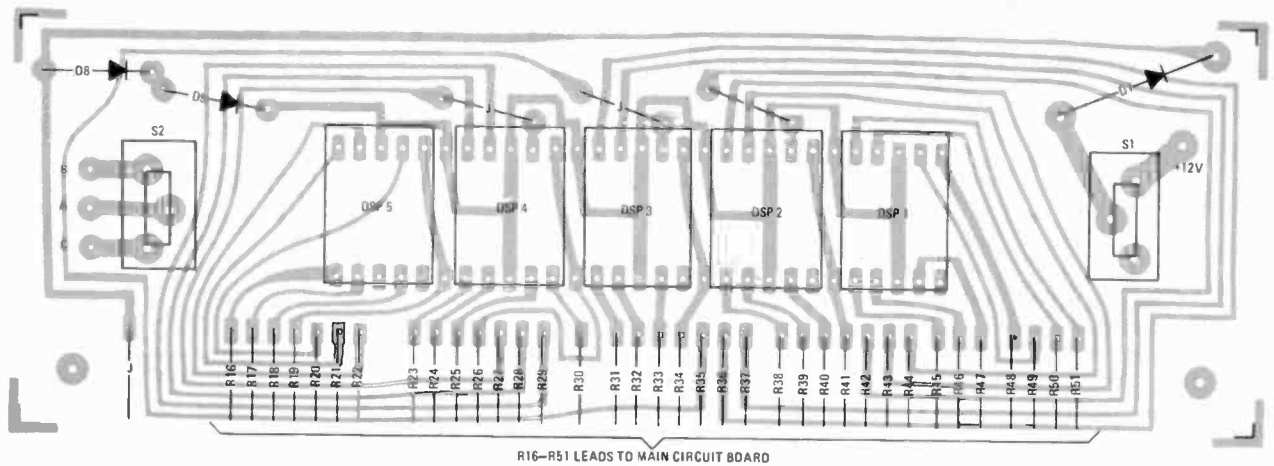

PARTS PLACEMENT DIAGRAMS shows exact positions for parts mounting on both the main and display circuit boards.

continued from page 45

using IC sockets. Don't do it for this project if you intend to use the counter in a vehicle. Over a period of time the vibration will loosen the IC's and the counter will suffer from all kinds of strange problems. However, if you are using the counter with a base station, you can use IC sockets if you wish.

Installation

Installing the counter in a car is a relatively simple matter. It can be installed in

any convenient location using mounting brackets. The most convenient location is usually under-dash as close to your CB rig as possible.

After mounting, the next step is to connect the counter to the car's 12-volt electrical system. To do this, assuming a negative-ground electrical system, connect the negative lead from the counter to the metal frame of the car and the positive lead to a fuse in the fuse box. If you would like the counter to turn off with the ignition switch, tie into a fuse that handles a switched accessory. For posi-

tive-ground electrical systems, reverse the connections.

Connect the antenna to the coaxial connector marked **ANTENNA** on the back panel of the counter and the CB rig to the one marked **TRANSCIVER**. Finally, place the slide switch on the back panel in the **MOBILE** position and your all set.

A base installation is basically the same, minus the mounting headaches. Power is taken from the separate power supply.

We think you'll find this an interesting and useful project.

R-E

THE BASIC CLASS-D CITIZENS RADIO service has been around for many years, existing mostly as the refuge of gypsy cabs, toy-like hand helds and would be Hams. However, the explosion in popularity begun by truckers during the 1974-75 oil shortage and the 55-MPH speed limit has brought a tremendous influx of users with little or no previous two-way radio experience and a great many questions.

Adding to the confusion is the similar influx of CB manufacturers each elbowing for their share of the market the boom created. Many of them with the usual kind of over-zealous claims that seem to flourish in any gold rush economy. The fact that most CB sets are sold through non-technical retailers such as department and discount stores, automotive stores and truck stops, and marine hardware stores and tackle shops only compounds the confusion over quality and value even further.

Especially in the area of measuring and predicting performance in the real world, meaningful information has been non-existent. As any field service technician would be quick to point out, measurements made on the sterile bench of the testing laboratory can seem to be distantly related phenomena when compared to actual performance in the hostile environment of mobile, portable and marine service.

Mobile and marine service are especially demanding of a set's electrical and mechanical stability, and circuits and components designed to be economical performers in the living room or office are frequently disappointing and often unreliable when in equipment intended for use in the field, car or boat.

CB electronics in particular suffer in this respect because they must be built to an attractive price for one of the most competitive markets in the electronics industry. Frequently, the most unfortunate consequence of this is a lavish distribution of the manufacturing budget towards those aspects of appearance that enhance a product's appeal on the retailer's shelf, invariably at the expense of more sturdy internal construction that might enhance environmental and mechanical stability or assure long term durability.

Temperature & performance

Temperature stability is one of the most frequently overlooked causes of poor communication. In the United States, seasonal temperature extremes of 0°F to 125°F in direct sun surface temperatures are not at all uncommon. Yet many CB rigs currently in production will not operate over this range without drifting beyond legal (and useable) frequency tolerance.

Likewise a transceiver, to be trustworthy, must be able to operate under the widest power supply voltage variations

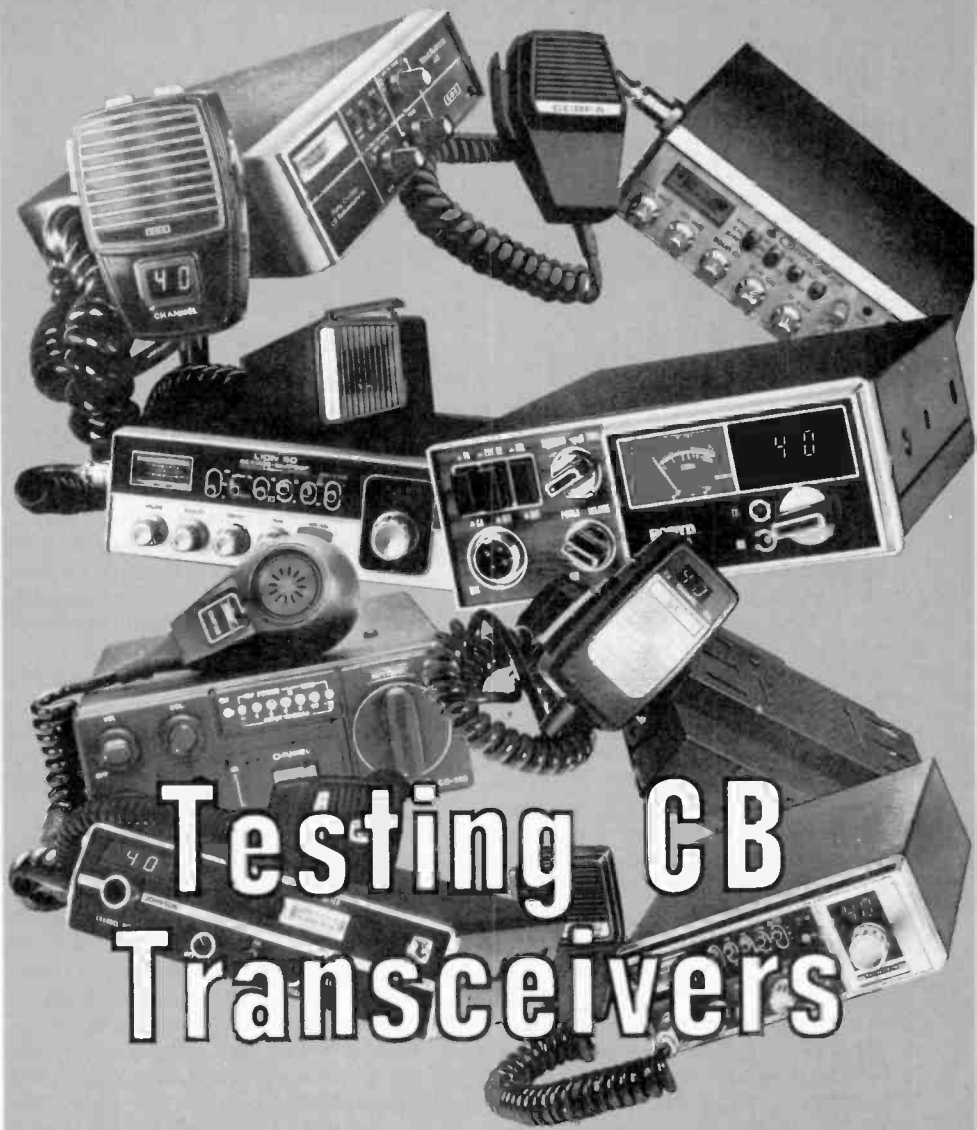

Testing CB Transceivers

If we wanted to find the very best CB transceiver, what tests should we make? Here are 24 that really tell you how a CB radio performs.

ROBERT J. CONSTANTINE





COBRA 29XLR



SBE TOUCH/COM 40



PEARCE-SIMPSON LION 40

experienced. A typical automotive electrical system in good condition delivers about 13.6VDC when the engine is running. But dead batteries or defective voltage regulators can extend this optimum voltage into a range with a low of 11.0VDC and a high of 16.0VDC. A motorist stuck in a blizzard or on a desert road might find his battery too dead to restart his engine but still charged enough to deliver 3A to his CB. But if his transmitter has drifted between channels it will not get a call through and may be worse than useless.

Temperature and supply voltage, however, are two variables that are frequently overlooked when specifying and purchasing equipment. Also ignored is mechanical stability. The tremendous vibration experienced by equipment bolted to transmission humps and under dashboards can do more than just shake a flimsy radio apart in time. It can also cause the transmitted carrier to be modulated in amplitude or frequency. The former being the cause of the annoying rumble or roar heard on some signals. The latter being a violation of FCC regulations.

(If we were going to test every new CB set before we purchased it, we would use the list of tests that follows. In the issues to come, Radio-Electronics will publish test reports on CB radios. These reports will include actual lab measurements of some of the more vital performance specifications covered in the following text. All of these measurements will be made in our lab and will accurately reflect the performance of the equipment that we test.—Editor)

The tests

1. Carrier Frequency Error. In this test we check the actual carrier frequency of each channel in the radio when transmitting into a 50-ohm dummy load at room temperature (70°F) and nominal supply

voltage (13.6 VDC for mobiles, 117 VAC for base stations) to see how carefully the crystals are selected and aligned. Results will be listed for the greatest error above and/or below any assigned frequency.

2. Carrier Frequency Change with Temperature. Holding the voltage constant we measure the maximum excursion in each direction as the entire chassis is first chilled from +70°F to 0°F and then heated to +125°F over a period of approximately four hours on channel 9.

3. Carrier Frequency Change with Voltage. Holding the temperature constant at 70°F we vary the supply voltage from 11 to 16 VDC for mobiles and 100 to 130 VAC for base stations while measuring the maximum excursion in frequency of channel 9 to test the set's regulation.

4. Carrier Frequency—Worst Case. In this rigorous test we sweep the voltage ranges in test No. 3 at each 20°F increment in test No. 2 and measure the worst excursion of channel 9 in each direction. Any transceiver that remains within the .005% tolerance (approximately 1850 Hz) prescribed by the FCC during this test must be very well regulated and temperature compensated.

5. AM Carrier Power Output—Unmodulated. At nominal temperature and voltage we will measure the average carrier power into a 50-ohm load of each channel and report the highest and lowest readings. A difference of more than a few percent between these two may indicate an output network that is too selective or parasitic resonances elsewhere in the exciter.

6. AM Modulation Percentage. We measure the percentage of 1000-Hz sinusoidal audio modulation relative to the

carrier power on each channel to insure that the modulator has enough power to fully swing the output symmetrically about the average value. Non-symmetrical irregularities are reported.

7. Mechanical Modulation. In this test, the chassis is clamped to a shake table and vibrated separately in each of three crossed axes with the mike audio terminals shorted while the output of the transmitter is observed for variations in amplitude or frequency. The presence of either will indicate loosely mounted components or poor solder joints. The vibration will sweep from 20 Hz to 2000 Hz at approximately 5 G's (sinusoidal).

8. Speech Processor Effectiveness. On sets with built in speech processing circuitry such as audio compressors or RF clippers we attempt to give a figure of merit as to their value. At nominal conditions on channel 9 we adjust external 600-Hz sinusoidal audio modulation to provide as close to 100% modulation as the modulation limiter will allow. We then monitor the output for any increases in average envelope power that can be obtained by increasing the audio input to saturation. We report the improvement in dB obtained to guide the user in evaluating manufacturers claims of superior "Talk Power". This test measures only average power however and this is not a complete indication of improved intelligibility as other factors of circuit design which determine the number of distortion products (unavoidably generated as part of the compression process) that fall within the RF passband will determine total articulation gains.

9. Harmonic and Spurious Suppression. This expresses in dB relative to a 1000-Hz 100% modulated carrier any harmonically or non-harmonically related signal within the range of 500 KHz to 400 MHz. These signals, if present, cause



RAY JEFFERSON CB845



RCA CB CO-PILOT 14T275



SHAKESPEARE 740



ROBYN DG-130D



XTAL XCB-40



JOHNSON MESSENGER 4170

interference with other services—especially TV and FM radio. Therefore they are particularly interesting to base-station operators who must peacefully co-exist with their non-CB neighbors. The current FCC standard is -60dB but a proposal to increase this to -100dB may be enacted (this will affect manufacturers only and existing equipment will be unaffected).

10. Opposite Sideband Suppression (SSB only). We measure the amount of unwanted sideband content in a 1500 Hz to determine the amount of harmful interference to users of the other half channel and the amount of power lost to the selected sideband. This suppression is determined by the IF filter and a good figure aids the receiver too.

11. Carrier Suppression (SSB only). The amount of residual carrier present in the output represents power robbed from the desired sideband's P.E.P. and can cause aggravating interference to distant SSB users. We measure this also in dB below the P.E.P. in the same two-tone conditions as used in test No. 10. A poor rating means a defective balanced modulator or poor shielding.

12. Peak Envelope Power—P.E.P. (SSB only). The power output is measured under the same conditions as in test No. 5 except using the above described two-tone modulation and a detector that responds to the peak value of the RF envelope—not the average. Legally limited to 12 watts, radios with properly adjusted Automatic Level Control should approach this closely.

13. Sensitivity. Under nominal conditions of temperature and supply voltage, a 1000-Hz 50% modulated RF signal is injected at the antenna terminals with the transceiver in the receive mode. The amount of this standard signal in microvolts (μV) necessary to produce ten times (20 dB normalized) the audio output voltage at the speaker terminals that the

random air noise produces is termed its 20 dB S+N to N sensitivity. This is a direct measure of how weak a signal can be easily heard. Measurements made at a lower ratio such as 10 dB will yield a lower (better) figure but do not represent "armchair copy" legibility.

14. Squelch Sensitivity. Using the same conditions of standard modulation but advancing the squelch control just to the point of quieting the air noise, the RF input signal is measured that just breaks the squelch open. This shows how weak a signal can be heard while still enjoying the advantages of squelched operation.

15. Sensitivity—Tight Squelch. The sensitivity measurement taken under standard conditions but with the squelch control fully advanced. For purposes of local operation, this shows how strong a signal can be excluded.

16. Sensitivity—Image Channel. The process of mixing in all superheterodyne receivers produces a second undesirable channel in which signals may be received if not filtered out completely. We will measure the standard signal strength necessary on this image channel required to produce the same audio output as on the desired channel. Expressed in microvolts, it is a measure of the effectiveness of the RF and IF filtering and shielding.

17. Sensitivity—IF. Measuring the susceptibility of a radio to receive undesirable signals directly into its intermediate frequency we have a figure that can guide us away from a set with some strange responses. Interstage shielding is the culprit in most cases and is difficult to remedy.

18. Dynamic Range. To measure the dynamic range or ration of the weakest signal to the strongest signal a receiver can accommodate, we inject two equal level standard signals whose difference in frequency is equal to 27.065 MHz (Channel 9). Any overloading in the

protection diodes, RF amplifier stage, mixer or IF stages before the filter will cause non-linear operation of that stage with a subsequent mixing of the two signals. We use test frequencies of 27.935 MHz and 55 MHz to include frequencies both inside and outside the RF bandpass to mimic the most troublesome type of interference—between other CB stations and local TV stations. The signals will be increased until cross modulation is observed on channel 9 and the difference in microvolts with test No. 13 expressed as dB.

19. Selectivity. This test measures a set's ability to discriminate against signals on the channel immediately adjacent to the one in use. Signals displaced by the 10-kHz channel spacing both above and below are separately injected and adjusted to produce the same audio output as a $10\text{-}\mu\text{V}$ signal on channel 9. The lower level in dB relative to $10\text{ }\mu\text{V}$ is reported.

20. Bandwidth Shape Factor. This tests the steepness of the skirt of the receiver's filter response and is vital for judging how well a set rejects interference from stations that are off frequency. We will measure the frequency off the carrier at which the receiver's response is 6dB down from its peak value and the frequency at which it is 60dB down. The smaller over the larger gives a simple numerical figure of merit. Sets with expensive multi-section crystal type or mechanical filters in the IF will shine here and should be highly prized because this is perhaps the most important single specification for today's crowded channels.

21. Noise Suppressor Effectiveness. We will inject a train of $25\text{-}\mu\text{S}$ pulses with a risetime of 2 nS into the antenna and measure the reduction, again in dB, with the filter switch on and off. These pulses simulate typical ignition noise and noise blankers that block an IF gate

continued on page 99



GEMTRONICS GTX-77



AUDIOVOX MCB-5000



SONY ICB-2500

Core Memories— How they work

With inexpensive core memories flooding the surplus market, it's a wonder that they haven't appeared in more hobby computer systems. Here's a look what they are and how they work

MARTIN A. SALA

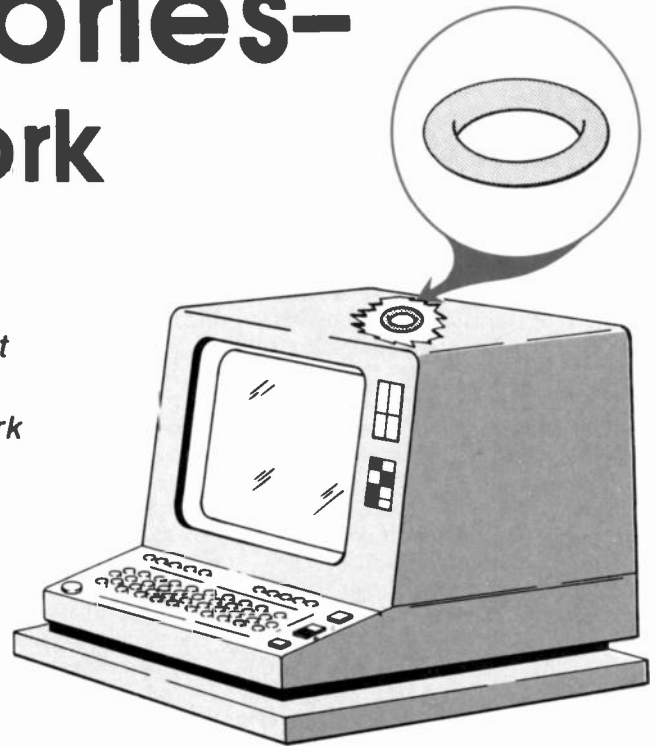

THE MAGNETIC CORE IS ONE OF THE LEAST expensive and fastest means of storing data in a computer system. Magnetic core memories are *static*: they hold data when power is removed, don't have to be refreshed periodically and are usually of the random access (RAM) variety.

The actual method of storing ones and zeros in a core is simple. The basic core element is shown in Fig. 1. By passing conductors through the center of the ferrite cores and passing a current through the conductors in a set direction, a magnetic field is created that magnetizes the core. A logic 1 has then been written when the core is magnetized. (This process is similar to the one used in making permanent magnets.)

Just the opposite is done to read or clear a core. A current is sent through in the opposite direction, and consequently cancels any previous fields in the core. To read a core, an extra winding must be added: the *sense* winding.

When a core holds a logic 1 (is magnetized) the *read* current causes the magnetic flux to collapse and induce a voltage in the *sense* winding. If the core had held a logic 0 (been unmagnetized), no voltage would have been induced in the *sense* winding.

This method is basically the idea, but is much too simple to function in a real computer system. The type we shall be concerned with is known as the 3-D, 4-wire. Three-D means a three-dimensional array consisting of planes of cores arranged in an X-Y format in which the total number of words is equal to the number of cores per plane. (The number of bits per word is equal to the number of planes.) Four-wire signifies that four wires pass through each core. They are: *X Drive*, *Y Drive*, *Inhibit* lines and the *Sense* windings. (See Fig. 2.)

When a *read/write* (R/W) current passes through both X and Y drive lines, a core is magnetized (or demagnetized). If there is current on one drive line through one or many cores, those cores will not switch; it takes the sum of both

X and Y currents to switch a core. The current on one line is known as the *half current*.

This half current is used to write a logic 0 into a core, with the help of the *Inhibit* lines. As a core is selected, an equal but opposite current on the *Inhibit* line cancels out the current on the *Drive* line parallel to it and thus creates a half current. Remember, the drive lines only select the core to be written—it is the *Inhibit* lines that determine whether or not the core will be logic one or zero. During the read cycle,

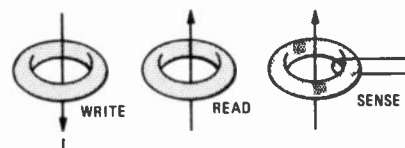

FIG. 1—ELEMENT OF CORE MEMORY. Current passing through the wire magnetizes the ring (core) when a strong enough current flows. A current in the opposite direction breaks down the magnetic field, producing a pulse of current in the *Sense* winding.

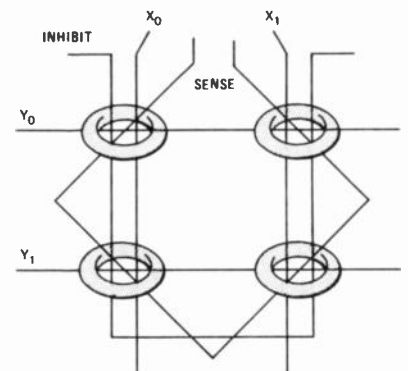

FIG. 2—HOW THE CORES ARE WIRED. The four wires are X-drive, Y-drive, Inhibit and Sense. There will be 64 X and 64 Y drive lines in a 4096-core plane (X_0 to X_{64} , etc.).

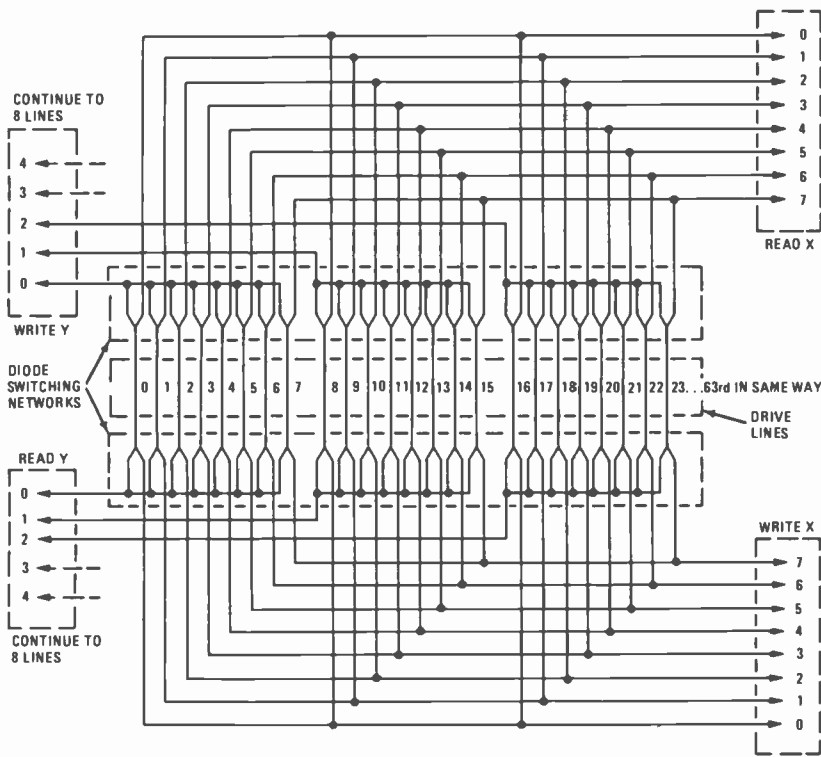

FIG. 3—A MEMORY CORE ASSEMBLY. There are no less than seven pieces of equipment in the circuitry shown here; the core stack itself, the two diode steering units and four switching units.

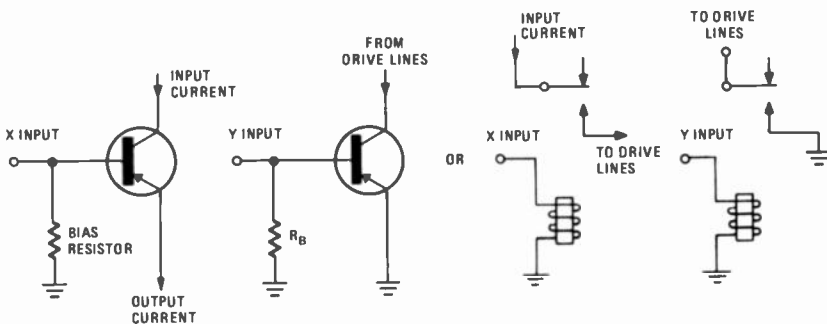

FIG. 4—TWO SWITCHING SYSTEMS. The actuating signals come from the address decoder, the output is to the drive lines.

the drive currents are reversed and cause the magnetic field stored in the core to collapse and create a voltage on the *Sense* winding.

Core memory design

Memories of the core type are basically easy to design. Circuitry is usually straightforward, with simple timing methods. All that one needs to service a core memory is an oscilloscope, a VOM and sometimes a signal generator.

One can start a core system with a stack of core planes with the desired

number of bits and words. Try to obtain the core stack parameters (current values for the Drive and Inhibit lines, etc.). Input/output designations for the core stack are also necessary—the experimenter will be lost if he doesn't know what all the leads on the package are for.

Mount the core stack in a place relatively free from magnetic fields (away from motors, generators, solenoids and the like) and where cool air may circulate freely—continued use heats the Drive lines.

In the 4096-core unit partially illus-

trated in Fig. 3, there are 64 X-drive lines and 64 Y-drive lines. (Fig. 3 shows only eight of one of these sets of lines.) One of each must be selected to switch a core. An Address unit supplies the information as to which drive lines are to be selected and in which mode (*Read*, *Write*, etc.). One of the simplest circuits incorporates a steering network to partially decode the address and steer the currents in the proper direction for *read* or *write*. Figure 3 shows that by selecting one X and one Y input, any one of 64 lines may be picked. The input lines to the diode decoders are numbered 0 to 7 X and Y. (Only one of these sets of lines is shown, to keep the circuit as simple as possible.) It is when one of eight X lines and one of eight Y lines are picked that a specific drive line is enabled.

Switching a core

It takes a specific amount of current to switch a core. This current is switched on and off at the diode decoders desired by the X and Y circuits. They are usually made up of single transistors biased so that they turn on and off at logic 1 and 0. Logic 1 is normally 4 volts, logic 0 is 1.4-volts TTL (transistor-transistor logic) levels. See Fig. 4.

There are two sets of X and Y circuits. One sends current down the drive lines in one direction to write; the other in the opposite direction for the read operation. While transistors are most commonly used, one may use any desired technique: relays, switches, diodes, even vacuum tubes (all have been used) and need not incorporate the TTL methods described here.

So far the cores, mounted in their planes and assembled into stacks, the diode decoders and the switch and sink circuits have been discussed. How the cores receive their signals, how they are directed to certain cores in the stack, how they are called for and how information is restored to a core after it is destroyed by reading are still to be learned. R-E

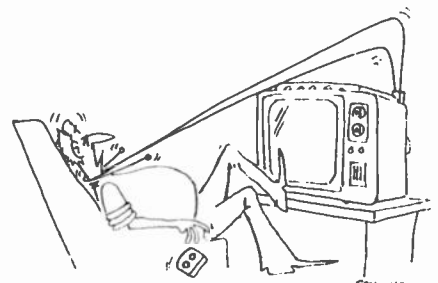

all about RF signal generators

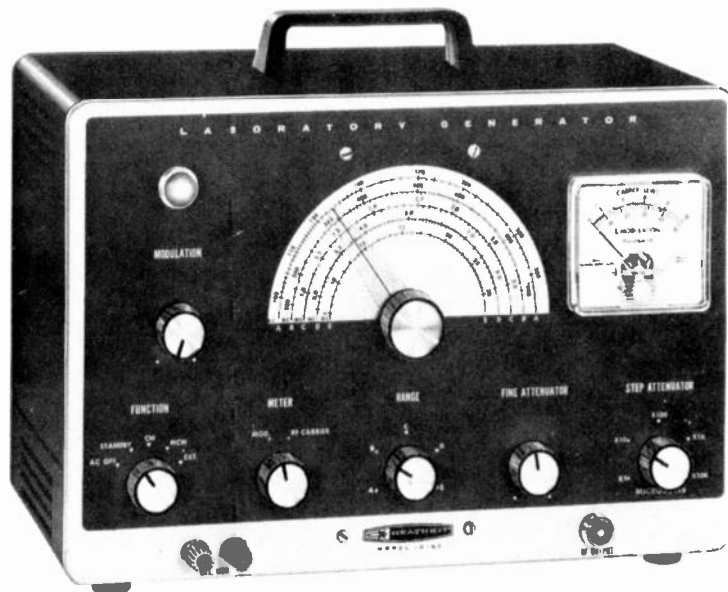

PART II—An in-depth look at the different types currently available, including how they work, their specifications, features and applications

CHARLES GILMORE*

LAST MONTH WE EXAMINED THE BASICS OF RF signal generators and the types of oscillator circuits that are commonly used. This time we continue our study of how RF signal generators work.

Modulators

As indicated last month, AM normally takes place at the output amplifier or a special modulator prior to the amplifier. Some of the earlier laboratory generators were MOPA (Master Oscillator Power Amplifier) designs. Modulation was applied directly to the oscillator itself. Generally, it is very difficult to AM an oscillator without also creating some FM. Most of the older vacuum-tube RF signal generators used grid modulation of the power amplifier. Frequently the total percentage of modulation you can get from a particular signal generator is limited not only by the modulator, but also by the power amplifier itself. This is especially true at high output levels.

The more modern, all solid-state generators, use diode modulators between the buffer and the output amplifier. Frequently the amplitude modulator has a wider dynamic range than needed to provide maximum percentage of modula-

tion required by the generator. This wider dynamic range, combined with DC coupling, permits the modulator to modulate the RF carrier with audio frequencies and also to vary the gain of the RF carrier as part of the automatic level-control (ALC) circuitry.

When the modulator is used for both automatic level control and modulation, the modulator has two inputs. One of these is AC coupled and its input signals are the internal tones generated by the modulator oscillators. The other input is a DC level derived from the automatic level control monitoring circuits.

Most signal generators provide two internal tones, one at 400 Hz, the other at 1 kHz. The two-tone modulation signal source normally consists of one of the common RC oscillator circuits. The amplitude of the audio oscillator may be continuously varied from zero to an amount which produces the maximum permissible modulation. Variation is controlled with a modulation level control on the front panel of the RF generator.

There are two ways to get a metered indication of the percentage of AM. The first, and simplest, is commonly used in the lower cost RF generators. The modulating signal supplied to the modulated circuits is sampled and applied to a full-

wave rectifier. The output of the full-wave rectifier is applied to a DC meter that reads in percent of modulation. Such a system is relatively accurate if the modulation percentage does not change with changes in RF frequency, or modulating frequency.

The second form of indicating the amplitude modulation percentage is somewhat more complex but eliminates problems encountered with the simpler form. As you can see in Fig. 8, this system uses a wideband diode detector that monitors the output of the power amplifier. This output is filtered so no RF signal remains, leaving only the modulating waveform. This detected signal is applied to an AC voltmeter made up of a wideband fixed-gain amplifier and high-impedance, wideband, stable AC metering circuits.

The system eliminates problems encountered in the first method of monitoring as it measures the actual amount of modulating signal retrieved from the RF carrier. Frequently a more highly-filtered signal is also taken from this detector, as shown by the dotted line in Fig. 8. This signal is also applied to the modulator, forming the automatic level controls. The filtering on this line completely eliminates all RF carrier and

*Manager Design Engineering, Heath Co., Benton Harbor, MI.

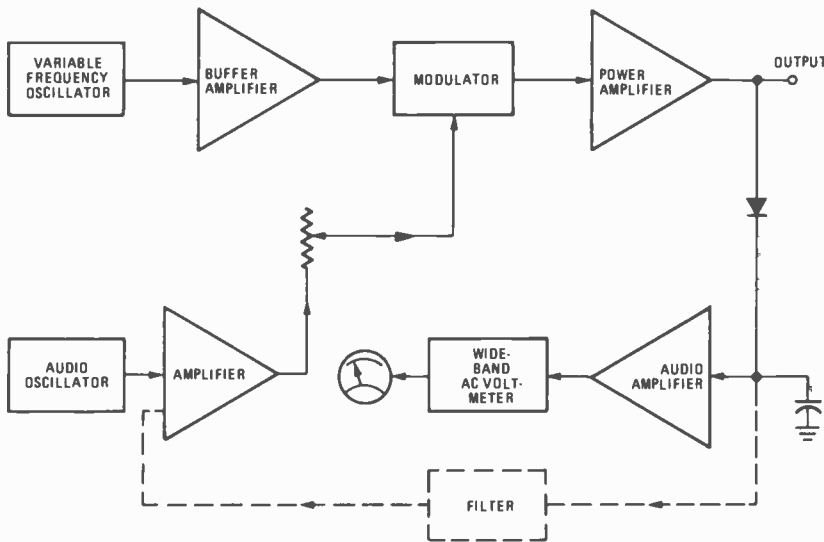

FIG. 8—AMPLITUDE MODULATION METER indicates the modulation percentage directly. The circuit is built around a diode detector.

modulation. The line, therefore, responds only to long-term variations in output level.

A modulator normally has three sources of input when automatic leveling is used—the automatic leveling input, the internal audio tones, and a source of external audio modulation. The automatic leveling input is always connected, regardless of the modulating mode. The user, however, may choose between one of the two modulating sources—either the internal oscillator or the external input.

Frequency modulation is done by direct modulation of the oscillator. In vacuum tube generators, a reactance modulator is common. It is a form of amplifier applied across the resonance circuits of an oscillator. Signals applied to the input of the reactance modulator appear as a change of reactance to the tuned circuit. This changes the oscillator frequency. The reactance modulator is a direct-coupled device so it not only responds to audio-frequency modulating signals, but to DC-controlled signals as well. For this reason, the reactance modulator can provide limited electronic frequency control.

In solid-state oscillator design, the reactance amplifiers are normally replaced by a variable-capacitance diode. It is direct-coupled as well, and performs the same function.

The amount of deviation is of greatest concern to the person using an FM signal generator. Wideband discriminators are not readily available to monitor the RF output of the generator and indicate the amount of deviation. Therefore, we use a method similar to the first method described for monitoring amplitude modulation to determine deviation. An AC voltmeter, calibrated in kHz of deviation, is connected to the output of the modulating amplifier.

Special circuits compensate the signal from the modulation amplifier before it

reaches the modulator. They adjust the signal amplitude so that deviation produced by the signal of given amplitude from the modulating amplifier is consistent with band changes and as the RF generator is tuned across the band. Without such circuitry, the deviation meter is valid only at the calibration frequency. At all other frequencies, the deviation is either greater or less than indicated. If automatic leveling circuitry is incorporated into the FM generator, an AM modulator is connected at all times. It is usual for generators of this nature to be

the output of the signal generator must be reduced to an extremely low but known output level. The output attenuator must have valid calibration over extremely wide ranges of attenuation and frequency. Typically, output attenuators found on RF signal generators have at least 100 dB of attenuation. Attenuations of 120 dB to 140 dB are common.

There are two basic forms of attenuator—the piston attenuator and the step attenuator. The piston attenuator has been used for many years, and is being replaced by the step attenuator on newer designs. The piston attenuator (see Fig. 9) consists of a pickup loop and an impedance-matching network. This assembly is withdrawn into the metallic tube to increase attenuation. The exact amount of attenuation depends upon the position of the pickup loop within the tube. Theoretical attenuation is 32 dB each time the piston travels a length equal to the diameter of the tube. The diameter is based on the highest generator frequency so the tube always acts as a waveguide operating below cutoff frequency. For high levels of signal amplitude, the amount of attenuation is no longer uniform with displacement and the calibration marks on the dial no longer have uniform spacing.

Resistors R_1 , R_2 , and capacitor C_1 act as an impedance-matching network to match the loop impedance at all frequencies to the 50-ohm output of the generator. The impedance compensating network connects to a flexible coaxial

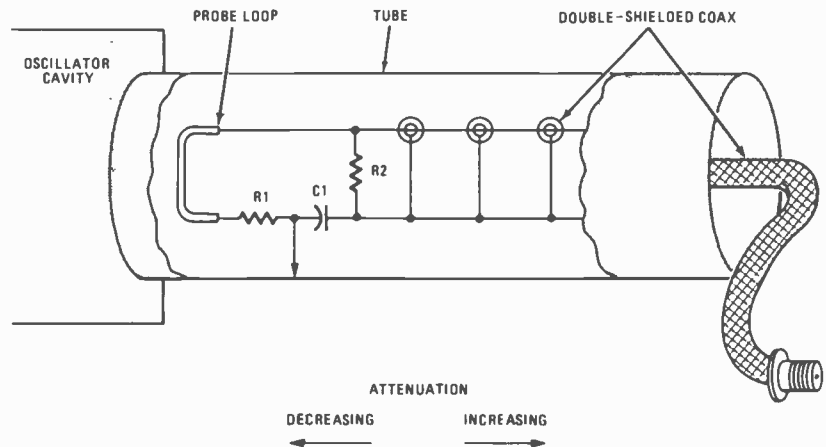

FIG. 9—PISTON ATTENUATOR consists of a pickup loop and an impedance-matching network. The attenuation is determined by the position of the pickup loop.

able to supply both AM and FM signals.

Attenuators

The output attenuator of an RF signal generator is one of the more critical components in determining its usefulness. A signal generator with a poor RF attenuator or, for that matter, one with high leakage and a good RF attenuator, is of little value in many applications. For example, to measure receiver sensitivity,

transmission line, that feeds the generator output connector. This is normally a double-shielded coaxial cable to maintain a high degree of shielding.

The step attenuator commonly consists of a number of 50-ohm pi attenuators, as shown in Fig. 10. Each of these can be given different amounts of attenuation depending on the resistor values. A series of four or more such attenuators, each having a minimum attenuation of 10 dB, may be switched in and out through a

switching sequence similar to that shown in Fig. 10. This results in attenuations from 0 dB to the required maximum attenuation in 10-dB steps.

Because this attenuator is not continuously variable as is the piston attenuator, a fine attenuation control or vernier usually accompanies it. Today, circuit designers frequently combine the DC output of a vernier control with the other modulator signals. This signal is very similar to the automatic level control signals. In some lower-frequency lower-

seen by the oscillator.

Output level meter

Most RF signal generators have an output level meter. It is driven by a wide-band RF voltmeter that monitors the output amplifier. The metering circuitry may be combined with the automatic leveling circuits if they exist in the generator. Occasionally dual meters are provided on an RF signal generator, but most generators switch select the metering function between the RF level and

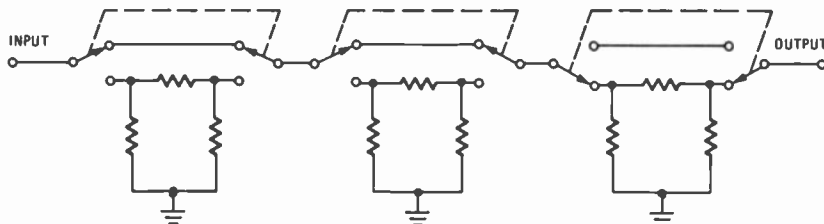

FIG. 10—STEP ATTENUATOR consists of many pi-type attenuators that are switched in or out of the main signal path.

cost generators, the variable resistance element is placed at the output of the power amplifier. In this configuration the variable element provides variable attenuation of the RF carrier.

The output amplifier

Most new signal generators have some form of amplifier between the oscillator and the output attenuator. Within this group of generators, a large percentage have more than one amplifier. The final output amplifier is assigned the task of supplying the required maximum output level to the desired output impedance, usually 50 ohms, over a wide range of frequencies. These amplifiers normally come in two forms. The tuned amplifier is quite popular with vacuum-tube signal generator designs. The output impedance of vacuum-tube amplifiers is high, thus making the matching network for broadband design extremely complex. Although this imposes no particular user restrictions, it does require additional cost in design and manufacture of the generator.

The advent of low-cost wideband low-output impedance, solid-state power amplifiers permits using a broadband amplifier at the output stage of the RF signal generator. This is the amplifier most commonly used today. The broadband, solid-state power amplifier can now be made more efficient and with a much higher degree of linearity and, therefore, with lower harmonic distortion and intermodulation distortion products, and at a lower cost than its tuned vacuum-tube counterpart.

There are some generators that use no power amplifier or buffer. These normally decouple the oscillator from the load with attenuation networks. The attenuation network, of course, substantially reduces any reflected change in load, as

modulation percentage.

The RF voltmeter used for output level monitoring is confined to a single amplitude range, normally no more than 1 decade.

Specifications

Specifications supplied for any particular RF signal generator are generally quite involved. A full understanding of these specifications is a must, if you are to make significant measurements. However, simple servicing and experimental projects can be undertaken without such an in-depth knowledge. The most important specifications to understand are those which differentiate the low-cost generator from the laboratory or high-quality service generator. These specifications are primarily in areas of attenuation, frequency stability, and frequency range, with secondary differences appearing in the area of signal purity and modulation characteristics.

Frequency range

One of the most important and definitely application-oriented specifications of the RF generator is its frequency range. The generator designed for use in the laboratory may not be suitable for VHF mobile servicing, and neither of these generators may be suitable for accurate analysis of 88- to 108-MHz commercial FM receivers. Frequency range is specified by noting the lowest and highest frequencies within the generator's capabilities.

Be careful when reviewing the specifications of low-cost signal generators, because the frequency range may include harmonic usage of lower range fundamental signals. For example, the Heathkit IG-102 RF signal generator is a low-cost generator with an upper fundamental frequency of 110 MHz. However,

general operation is specified to 220 MHz by the use of harmonics. This characteristic is not used on the higher-cost generators. Although there are no truly typical ranges for RF signal generators, two types of generators do stand out. The first is the AM-HF (High Frequency) generator. The frequency range of typical units in this class lie between 50 kHz and 100 MHz. The second is the AM or AM/FM VHF generator. The frequency range of typical units in this class lie between 10 MHz and 500 MHz.

Frequency bands

Frequency bands indicate the number of switch settings the operator must make to cover the entire frequency range of the generator. The band specifications also indicate the frequency break points between bands.

Normally, the exact break points are not very important to the operator. However, some specialized applications may require the generator to be continuously tunable from one frequency to another. The generator must not have a band change within this range. Most generators have some tuning capability beyond their indicated absolute band limits. This is usually not more than a few percent at each end, but does insure a complete overlap from one band to another. The actual break points of the bands are primarily dependent upon the starting frequency and the tuning range of the generator.

Not all generators are continuously tunable. Many of those designed for specific applications, such as communications servicing, have segmented bands—they cover only those frequencies of interest to the user and do not continuously tune frequencies in between those of interest. For example, a communications oriented generator has one band from 25 to 54 MHz to cover low-band 2-way FM and the 6-meter amateur band. A second band covers 132 to 175 MHz and includes the 2-meter amateur band and the VHF 2-way radio communications band. A third band covers 420 to 550 MHz which includes the $\frac{3}{4}$ -meter amateur band and the UHF 2-way communications band. Such a generator may also have a signal source at 455 kHz for IF and discriminator alignment. This source has limited or no attenuation or modulation capabilities.

Other generators may have an extremely limited range of frequencies if they are designed for servicing a particular type of equipment. For example, generators designed exclusively for the commercial FM receiver market may only cover 88 to 108 MHz.

The tuning method

Most RF generators have switch-selected band changes and both coarse and fine variable controls within the

continued on page 92

Greater efficiency, smaller size and less weight are the advantages of the pulse-width modulated amplifier. Here's a look at how these amplifiers work

LEN FELDMAN
CONTRIBUTING HI-FI EDITOR

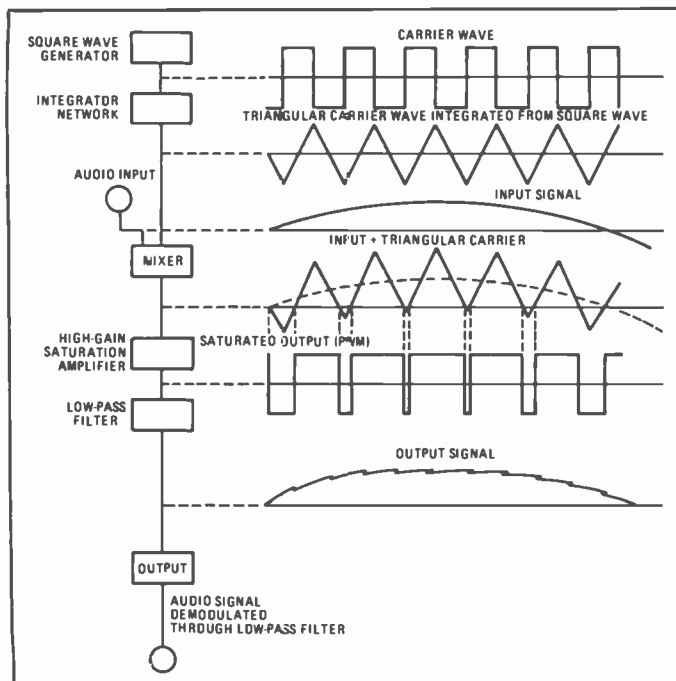

Pulse-Width Modulation For HI-FI

LONG AGO, IN THE DAYS WHEN A TEN watts-per-channel output power capability for an amplifier was considered the requirement for true high-fidelity music reproduction, little attention was paid to amplifier efficiency. This is especially true in vacuum-tube amplifiers, where the additional power dissipation in the vacuum-tube heaters lowers efficiency even further.

In low-powered amplifiers (whether tube-type or solid-state), Class-A operation (in which the output devices or stages draw constant, full current regardless of the input audio signal) can still be found in mini-powered output stages of car radio amplifiers. Class-A operation is also found in a few medium-powered high-fidelity amplifiers where manufacturers and users are willing to sacrifice efficiency for low distortion and the total absence of crossover distortion.

As audio power needs grew (largely because of the increased popularity of smaller, lower-efficiency speakers) the design trend in high-fidelity amplifiers shifted to Class B. In Class-B audio amplifiers, the output devices conduct for approximately one-half of the input waveform cycle, and total current drawn by the output stages varies in proportion to the output power delivered to the loads. While the Class-B circuit is therefore much more efficient as a converter of DC power to audio power, its effi-

ciency is greatest—around 70% or so—only when it is delivering its maximum rated power output to the load, as shown in Fig. 1. Since, under musical listening conditions, the average power delivered to the load may be some 10 or more dB lower than maximum (10%), even the more efficient Class-B circuit ends up with an *average* efficiency of around 20%. Translated to typical wattage values, that means that when a 200-watt-(rated) per-channel Class-B amplifier is delivering 20 watts-per-channel, 100 watts of input power must be supplied by the power supply—hardly a very efficient use of energy!

There is a more efficient audio amplifier circuit, known as Series E or Class G. This circuit is embodied in Hitachi's *model SR-903* stereo receiver that uses a smaller heat sink and has less overall weight as compared with other receivers

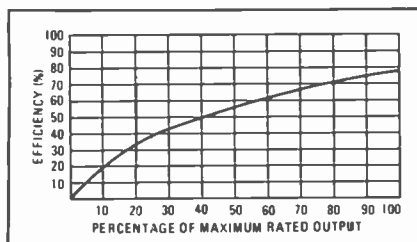

FIG. 1—EFFICIENCY of Class-B amplifier is greatest when it's delivering maximum rated output power.

using the more conventional Class-B amplifier-design approach. But long before Hitachi developed the Class-G circuit, other researchers were exploring still another means of improving audio-amplifier efficiency. Class-D or "switching" amplifiers have been discussed in the audio literature since the early 1960's. Now, Sony Corporation of Japan has shown promising prototypes of a stereo amplifier that uses Class-D amplification or, more properly, pulse-width modulation, for significantly higher efficiency than can be obtained either in Class-B or Class-G amplifier operation.

How pulse-width modulation works

The theory of operation of a pulse-width modulation (PWM) amplifier is illustrated in its simplest form in Fig. 2. The audio input signal, having a continuously varying waveform amplitude, is converted to a series of pulses whose width is proportional to the instantaneous amplitude of the audio waveform itself. Some have theorized that the PWM amplifier is "digital," but a clear distinction must be made between true digital amplification and pulse-width modulation. In true analog/digital conversion, the "bit-code" appearing at the output of the A/D converter would determine the instantaneous amplitude of the input audio waveform. In a true PWM amplifier, the number of pulses per second ap-

pearing at the output of the amplitude-time converting circuit is *fixed*, and it is the varying width of successive pulses that conveys the audio waveshape.

Figure 2 shows that the converted

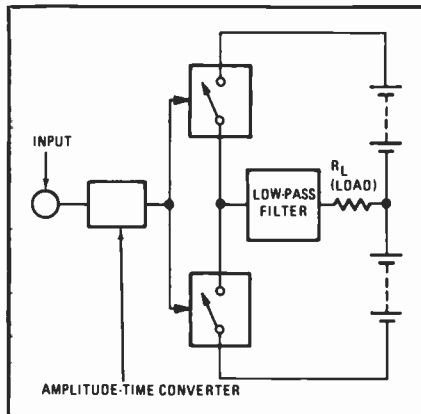

FIG. 2—CIRCUIT CONFIGURATION of a PWM amplifier.

pulse signals control the switching elements of the final power stage, the output of which is passed through a low-pass filter and on to the load. Since the final power stage is either in the saturated "on" mode or the totally "off" mode, there is theoretically no loss of energy in the operation of the circuit.

Figure 3 is a block diagram of each stage of the PWM amplifier. Alongside each stage is shown the waveform relating to that stage. In the Sony prototype PWM amplifier, a squarewave generator is used as the source of the fixed-frequency carrier. The squarewave frequency, which in this case is crystal-controlled, is around 500 kHz. The squarewave carrier is next converted to a triangular wave by means of an integrating circuit. This triangular waveshape and the input audio signal are mixed together and the resulting waveform is passed on to a saturating high-gain amplifier to obtain a series of pulses whose repetition rate is still the same 500 kHz, but the pulse width is in direct proportion to the amplitude of the audio input signal. The variable width pulses are then amplified by a pulse power-amplification stage and "demodulated" by a low-pass L-C type filter.

Amplitude-time converter

Figure 4 shows the basic configuration of the amplitude-time converter in greater detail. Since it is desirable to apply overall negative feedback to this type of amplifier (for the same reasons that negative feedback is used in conventional Class-A or Class-B amplifiers), the pulse-width modulated output is fed through a phase-inverter circuit and an integrator circuit, the combination of which provides a 6 dB-per-octave increase in the frequency response. To compensate for this rising frequency-response and its accompanying 90-degree phase delay, the audio input signal itself

also has to be passed through an integrating circuit.

The total negative feedback applied to the PWM amplifier decreases with increasing frequency. For a 500-kHz carrier frequency, the negative feedback versus audio signal frequency is shown in Fig. 5. From this graph we see that the distortion-reducing benefits of overall loop feedback diminish at the high-

adversely affecting high-frequency audio response.

As the carrier frequency is increased, however, high-speed switching capability of the power output devices become a problem. A very high carrier frequency requires devices with good high-frequency characteristics and high power capability. Since the vertical field effect transistor (V-FET) does not exhibit signifi-

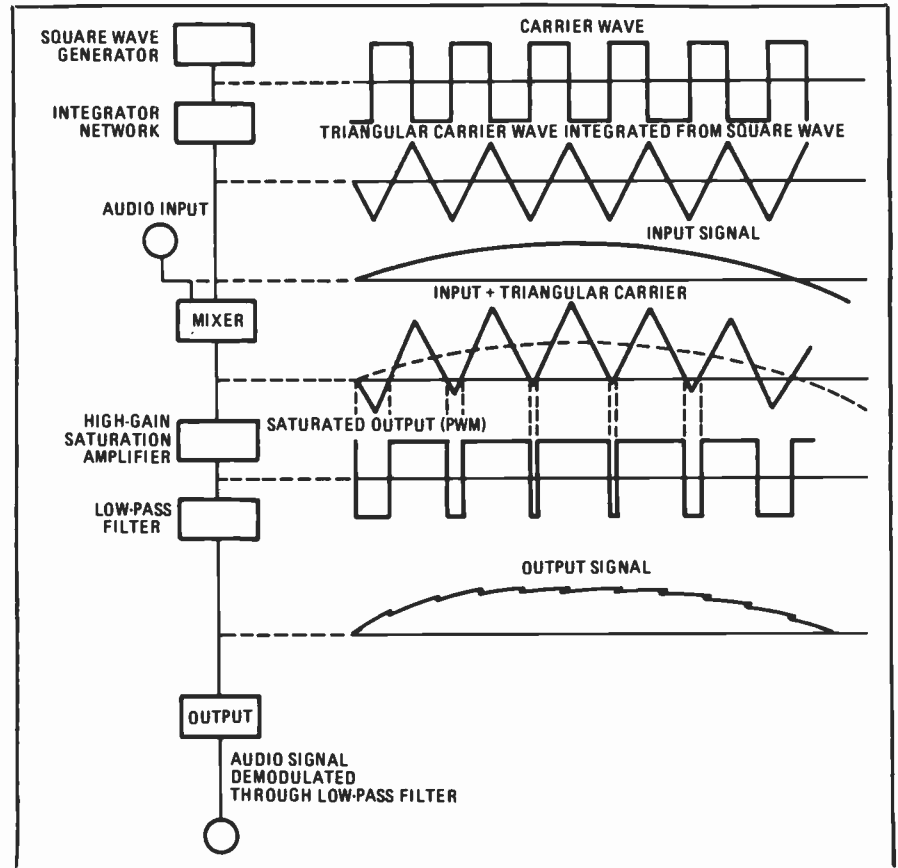

FIG. 3—CIRCUIT WAVEFORMS and block diagram of a PWM amplifier.

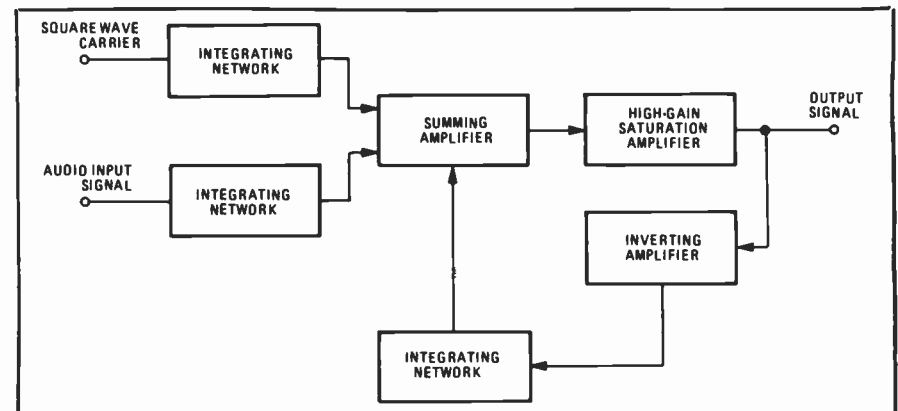

FIG. 4—AMPLITUDE-TIME CONVERTER provides a pulse-width modulated output in accordance with an analog input.

frequency end of the audio spectrum. The higher the carrier frequency, the greater the amount of negative feedback that can be applied for lowering distortion. Higher carrier frequency also allows greater suppression of the carrier and its sideband components (shown in Fig. 6) for a given low-pass filter without that filter

cant storage time in pulse response and has excellent risetime and falltime characteristics, Sony found it especially useful for pulse-width modulation amplifier applications. In addition, since both N- and P-channel FET's are available, the drive circuit for a V-FET final power output stage can be relatively simple and

does not require a phase inverter stage.

Figure 7 shows the static characteristics of one of the two types of V-FET's used in Sony's prototype PWM amplifier (at $V_{gs} = 0$). The device shows good linearity from the forward to reverse range, which means that it can be regarded as a pure resistive component whose saturation resistance is the value of resistance seen when it is in the "on" state. This low saturation resistance also means that the return current generated

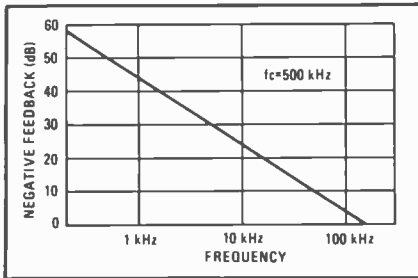

FIG. 5—NEGATIVE-FEEDBACK characteristic of PWM amplifier.

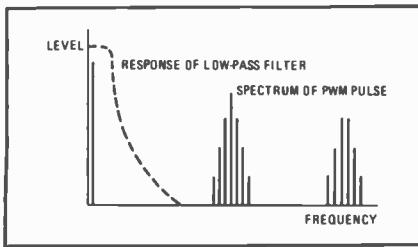

FIG. 6—FREQUENCY SPECTRUM of PWM pulse falls farther outside the response of a low-pass filter as the carrier frequency is increased.

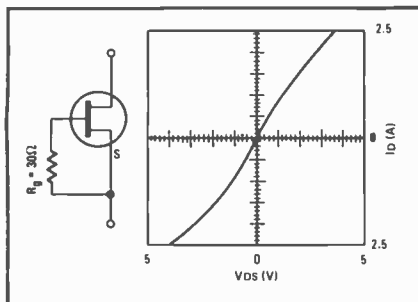

FIG. 7—CHARACTERISTIC CURVE of a V-FET.

by the inductive component of the low-pass filter network that follows (in the output circuit) can be easily dissipated within the V-FET.

A PWM amplifier

Figure 8 shows Sony's first prototype PWM amplifier. In this unit, a 500-kHz carrier frequency is used. While a low-pass filter just ahead of the output terminals effectively removes the carrier components from the audio signal, a fair amount of RF energy exists inside the chassis itself. This RF energy must be prevented from radiating outside the chassis and, for that reason, extensive shielding is used. The shielded chassis is of cast aluminum to reduce the number of welded or soldered joints that would

act as "radiating antennas" at this high frequency.

One of Sony's local engineers disclosed that the company hopes to be able to increase the carrier frequency used in their PWM amplifiers in the near future. To obtain the benefits of a higher carrier-frequency (increased feedback at the high end of the audio spectrum and resulting lower distortion), it will be necessary to come up with "faster" switching devices for the output switching stages of the amplifier. Already, Sony is developing MOSFET's that can handle the power for such output applications.

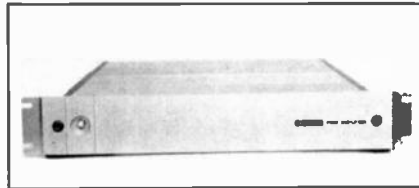

FIG. 8—PROTOTYPE PWM AMPLIFIER manufactured by Sony.

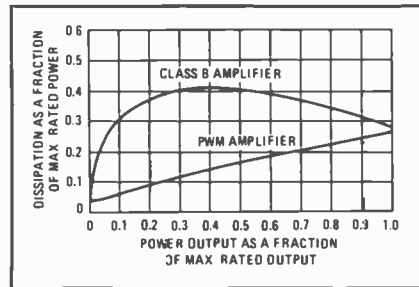

FIG. 9—POWER DISSIPATION of a conventional Class-B amplifier and the new PWM amplifier.

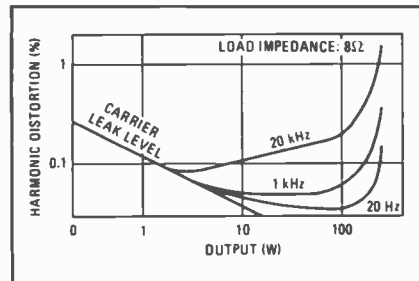

FIG. 10—HARMONIC DISTORTION characteristic of the PWM amplifier.

With increased amplifier efficiency comes lower internal power dissipation. The relative dissipation of a Class-B amplifier and that of the prototype PWM amplifier are compared in Fig. 9. The horizontal axis of the curve represents fractions of rated output while the vertical axis is calibrated in terms of internal power dissipation divided by the maximum rated output. In a Class-B amplifier, the poorest dissipation occurs between 0.2 and 0.7 of full-rated amplifier output (the range of power output most typically used). In the case of the PWM amplifier, dissipation increases linearly as a function of the actual output divided by the rated output and approaches that of a Class-B amplifier only when full-rated output is delivered.

The total harmonic distortion versus power output for the prototype amplifier, taken at frequencies of 20 Hz, 1 kHz and 20 kHz, is shown in Fig. 10. As stated before, the THD tends to increase at the higher audio frequencies.

Sony admits that some of the published distortion specs of the prototype PWM amplifier are not as good as those of some conventional hi-fi audio amplifiers. However, they maintain that the "softer" overload characteristic of the design (as in the more gradual rise of THD beyond 100-watts output shown in Fig. 10) results in a "warmer," less-strident sound, even when more power is required beyond published ratings. This contrasts with the steep rise in THD (and sharp clipping) characteristic of conventional Class-B amplifiers when they are driven beyond overload. Sony believes the PWM amplifier will find immediate acceptance in sound-reinforcement applications, and that shortly thereafter, as faster switching devices are perfected, the new technique will find equal application in super-high-fidelity audio amplifiers. R-E

New practice CET test available

An addition to the series of training course texts for CET's (*Radio-Electronics*, April 1977, page 95) is the *Journeyman Communications Electronics Option*. Questions similar to those in actual CET examinations are asked on AM, FM, sideband, transmitters, receivers, transistors and other subjects likely to be covered in the actual examination. Answers to all the questions (which are multiple-choice) are in the back of the book, as well as instructions on taking CET tests.

The series of practice CET Test monographs now numbers six: *Associate*, *Audio Journeyman*, *Consumer Journeyman* and *Industrial Journeyman* levels, as well as the present text. For digital servicing, *Servicing Logic Circuits* is available. All the monographs may be obtained from Bank Wilson Services, P.O. Box 3321, Warren, OH 44485. Price per volume, \$3.00 for members, \$4.00 for non-members.

Sylvania's service manager named dealers' man-of-the-year

John Borlaug, National Service Manager of GTE-Sylvania, was named the Time/NARDA Man of the Year at the NARDA national convention in Atlanta last spring. The award is presented annually by *Time*, the weekly newsmagazine, and the recipient is selected by the board of directors of NARDA (National Association of Retail Dealers of America).

The award was made for Mr. Borlaug's work, as chairman of the Electronic Industries Association (EIA) sub-committee on warranty, in bringing about industry-wide agreement on a standard service warranty. The accomplishment was hailed by some as a breakthrough in the service industry, and was one that was reached only after great effort on Mr. Borlaug's part. R-E

Radio-Electronics



CIRCLE 99 ON FREE INFORMATION CARD

Tests Kenwood KA-8300

LEN FELDMAN
CONTRIBUTING HI-FI EDITOR

THE LATEST HIGH-POWERED AMPLIFIER FROM Kenwood Electronics, the model KA-8300, is one of the four new integrated amplifier models that were introduced late last year. Its front panel layout is shown in Fig. 1. Despite the apparent lack of clutter on this elegantly styled panel, there are more obvious and hidden features to discuss than immediately meet the eye. Those two prominent illuminated meters at the upper left, for example, are peak-reading power output meters. Instead of wiggling minimally as do many power meters now featured on many basic power amplifiers and some receivers, these meters are augmented by a two position METER RANGE switch that alters their full-scale reading from 100 watts to 3 watts. Readings can be clearly interpreted all the way from full power output down to 10 milliwatts.

Controls along the upper right section of the panel include step-type BASS and TREBLE controls, a mono/stereo MODE pushbutton and the program INPUT SELECTOR switch. The large controls at the center of the panel are dual-concentric VOLUME and BALANCE, and the VOLUME control has 41 discrete click-stop positions for easy resettability of preferred listening levels. To the left of these major controls, under the power meters, are a POWER on/off toggle switch, PHONE jack, a power-on indicator light, SPEAKER selector switch (up to three sets of speakers can be connected to the KA-8300, with the first two sets selectable singly or together and the third set selectable only by itself), a three position LOUDNESS switch (OFF, plus two degrees of loudness compensation) and a three position PRESENCE switch (that adds a boost in overall response centered either at 800 Hz or at 3 kHz).

Controls to the right of the VOLUME and BALANCE pair include two TURNOVER switches for bass and treble controls (with a tone-defeat position and selectable 150 Hz or 400 Hz turnover for bass; 3 kHz and 6 kHz for treble), low- and high-cut FILTER pushbutton switches, TAPE DUBBING and TAPE MONITORING switches (which permit taping through from one deck to another while listening to any other program source).

Figure 2 shows the layout of the rear panel of the KA-8300 as well as the variety of associated equipment that can be used with it. In addition to the usual low- and high-level inputs (there are two pairs for phono), tape record outputs and a DIN combination socket

which parallels the "Tape B" monitor circuitry, the unit is equipped with preamplifier output and main amplifier input jacks that are combined or separated by means of a slide switch, shipped with a retainer that keeps the switch in the NORMAL (combined) position. Speaker terminals are of the knurled screw type that, when loosened, permit direct insertion of stripped speaker wires without twisting.

Two chassis ground terminals are located adjacent to the two pairs of phono input jacks. The left and right ends of the rear panel are equipped with projecting structures that permit the user to stand the amplifier upright on its rear for easy handling and also prevent pushing the unit too close to a rear surface (wall or rear of custom cabinet), thus protecting rear connectors, plugs and cables—a nice

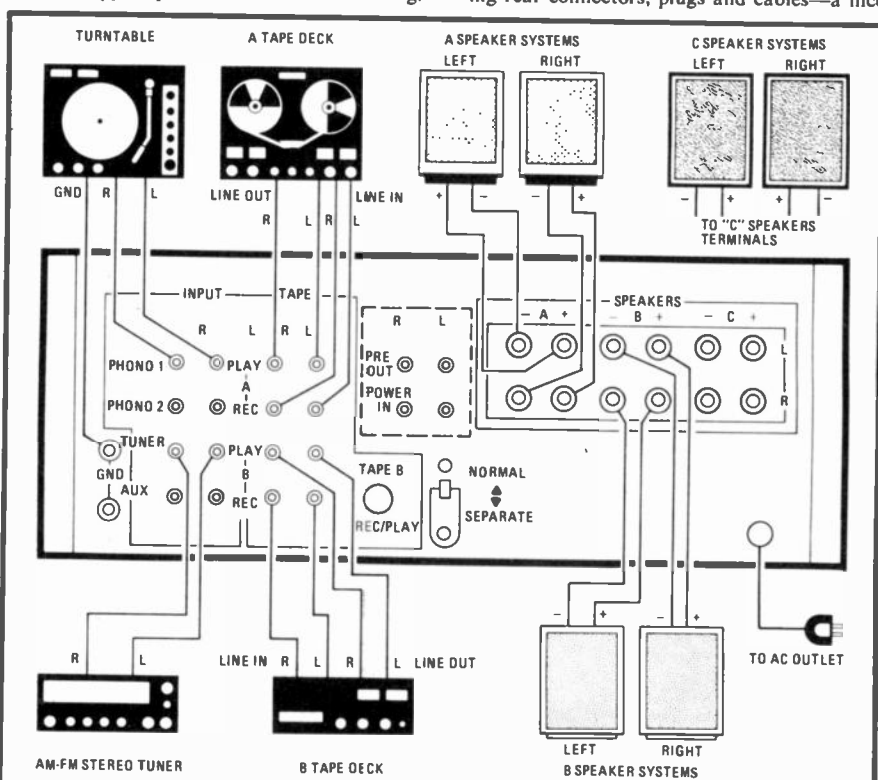

MANUFACTURER'S PUBLISHED SPECIFICATIONS:

Power Output: 80 watts-per-channel, minimum continuous power, 8 ohm loads, from 20 Hz to 20 kHz. **Rated Harmonic Distortion:** 0.1% (0.04% at 1 watt). **IM Distortion:** 0.1% (0.04% at 1 watt). **Damping factor:** 50 at 8 ohms. **Residual Noise,** main amplifier: 100 dB. **Input Sensitivity:** Phono 1 & 2: 2.5 mV; Tuner, Aux, Tape: 150 mV. **Signal-to-Noise Ratio (A-weighted):** Phono: 72-dB below 5 mV; High Level: 90 dB. **Phono Overload:** 260 mV. **Frequency Response:** Phono: RIAA ± 0.3 dB; High Level: 20 Hz to 40 kHz, +0, -0.5 dB. **Bass Control Range:** ± 7.5 dB at 100 Hz or 40 Hz (depending upon turnover frequency selected); **Treble Control Range:** ± 7.5 dB at 10 kHz or 20 kHz. **Bass and Treble Turnover Frequencies:** 400 Hz, 150 Hz, 3 kHz and 6 kHz. **Low Filter Cutoff:** -3 dB at 40 Hz, 12 dB-per-octave. **High Filter Cutoff:** -3 dB at 8 kHz, 12 dB-per-octave. **Presence Control Range:** +6 dB at 800 or 3000 Hz. **Power Requirements:** 120 V, 60 Hz, 550 watts (maximum). **Dimensions:** 16 $\frac{1}{8}$ " W by 5" H x 14 $\frac{1}{8}$ "-inches D. **Net Weight:** 35.3 lbs. **Suggested Retail Price:** \$449.95.

**TABLE I
AMPLIFIER PERFORMANCE MEASUREMENTS**

	R-E Measurement	R-E Evaluation
POWER OUTPUT CAPABILITY		
RMS power/channel, 8-ohms, 1 kHz (watts)	99.0	Excellent
RMS power/channel, 8-ohms, 20 Hz (watts)	88.0	Excellent
RMS power/channel, 8-ohms, 20 kHz (watts)	86.0	Very good
RMS power/channel, 4-ohms, 1 kHz (watts)	110.0	Excellent
RMS power/channel, 4-ohms, 20 Hz (watts)	103.0	Good
RMS power/channel, 4-ohms, 20 kHz (watts)	100.0	Good
Frequency limits for rated output (Hz-kHz)	12-30	Excellent
DISTORTION MEASUREMENTS		
Harmonic distortion at rated output, 1 kHz (%)	0.02	Excellent
Intermodulation distortion, rated output (%)	0.06	Very good
Harmonic distortion at 1 watt output, 1 kHz (%)	0.04	Good
Intermodulation distortion at 1 watt output (%)	0.04	Good
DAMPING FACTOR, AT 8 OHMS		
	55	Very good
PHONO PREAMPLIFIER MEASUREMENTS		
Frequency response (RIAA \pm ___dB)	0.2	Excellent
Maximum input before overload (mV)	270	Superb
Hum/noise referred to full output (dB) (at rated input sensitivity)	68 (unweighted)	Very good
HIGH LEVEL INPUT MEASUREMENTS		
Frequency response (Hz-kHz, \pm ___dB)	15-55, 1.0	Excellent
Hum/noise referred to full output (dB)	86 (unweighted)	Very good
Residual hum/noise (min. volume) (dB)	100	Excellent
TONAL COMPENSATION MEASUREMENTS		
Action of bass and treble controls	See Fig. 4	Excellent
Action of secondary tone controls	See Fig. 5	Superb
Action of low frequency filter(s)	See Fig. 6	Excellent
Action of high frequency filter(s)	See Fig. 6	Excellent
COMPONENT MATCHING MEASUREMENTS		
Input sensitivity, phono 1/phono 2 (mV)	2.3/2.3	
Input sensitivity, auxiliary input(s) (mV)	150	
Input sensitivity, tape input(s) (mV)	150	
Output level, tape output(s) (mV)	150	
Output level, headphone jack(s) (V or mW)	50 mW (8 ohms)	
EVALUATION OF CONTROLS, CONSTRUCTION AND DESIGN		
Adequacy of program source and monitor switching		Excellent
Adequacy of input facilities		Excellent
Arrangement of controls (panel layout)		Superb
Action of controls and switches		Excellent
Design and construction		Very good
Ease of servicing		Good
OVERALL AMPLIFIER PERFORMANCE RATING		
		Excellent

**TABLE II
OVERALL PRODUCT ANALYSIS**

Retail price	\$449.95
Price category	Medium
Price/performance ratio	Excellent
Styling and appearance	Excellent
Sound quality	Superb
Mechanical performance	Excellent

Comments: As many of the features normally found only on integrated amplifiers find their way into all-in-one receivers, makers of separate amplifiers are hard-pressed to find new features and performance levels that will justify the purchase of a separate amplifier or tuner. Kenwood seems particularly skillful in this, and, in the KA-8300 they have come up with a great number of features which, though extremely useful, manage to leave the front panel of the unit with a totally uncluttered look that would not intimidate even the audio neophyte. The dual-position loudness control is a welcome addition, in that it permits proper operation of this often misused circuit for a variety of program source levels. The novel presence switch, with its selectable center frequencies is another innovation that appealed to us greatly in our listening tests and, of course, the power meters, with their two expanded scales permit their use at lowest and loudest listening levels. Kenwood's "tape through" feature, which permits dubbing from deck to deck while listening to other program sources, has been copied by other manufacturers since being introduced some years ago, but it is still a most welcome feature.

As for the sound delivered by this carefully designed and assembled integrated amplifier, it is clean and authoritative, suggesting a power output capability far in excess of that actually measured. In our view, Kenwood continues to be one of the lower-profile companies amongst the "big four", whose products deserve serious consideration from audiophiles who are ready to step up from an all-in-one receiver to a system comprised of separate components. Our test sample exceeded its published or claimed performance by a wide margin and, more important, it delivered sound that to our ears was equal to that produced by some of the more esoteric (and expensive) products which are currently being favored by some audiophiles. Construction is impeccably executed.

touch that we have not seen before.

Internal construction and circuitry

The main filter capacitors clearly visible in the Fig. 3 are 15,000 μ f each and are located

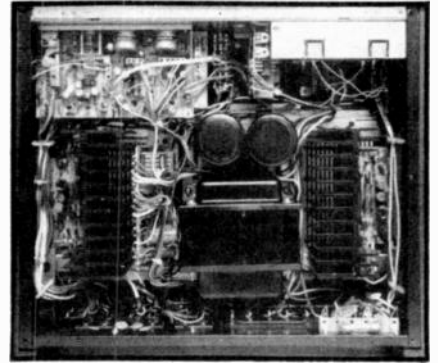

near a massive, cool-running power transformer near chassis-center. A predriver Class-A stage is used in the main amplifier section for reduced crossover distortion and direct coupled, complementary symmetry circuitry is used in the power output stages. High precision resistors and capacitors are used in the phono equalizer circuit. Volume control takes place at two points in the circuit: before and after the tone control section for best signal-to-noise ratios at all listening levels.

The model KA-8300 has two kinds of protection circuits—one for the amplifier stages and one for connected speakers. The relay circuit that protects the speakers also provides a 4-second time delay on amplifier turn-on, preventing thumps and pops during power supply stabilization. Tone control circuits in this amplifier employ separate active amplifiers for bass and treble to reduce interaction effects and, like many other controls on the KA-8300, are directly mounted to their respective printed-circuit modules for a minimum of conventional circuit wiring. Kenwood maintains that this careful layout results in lower hum and less high-frequency attenuation.

Laboratory measurements

Generally speaking, the performance claims made for the KA-8300 integrated amplifier by its makers are conservatively stated. Our measured results, listed in Table I, may be readily compared with Kenwood's published specifications. Kenwood could easily have rated this amplifier at 85 watts-per-channel over the full

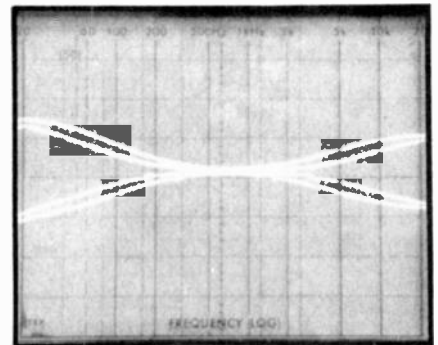

audio band and still conformed with FTC requirements. At the 80-watt level, the power band extended from 12 Hz to 30 kHz, as opposed to the nominal 20 Hz to 20 kHz

The better the training the better you'll

Send for
FREE
illustrated
career
guide

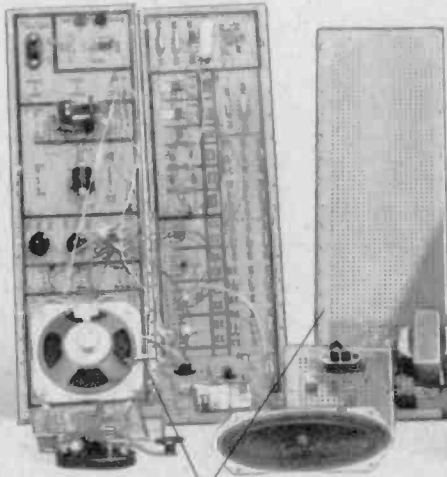
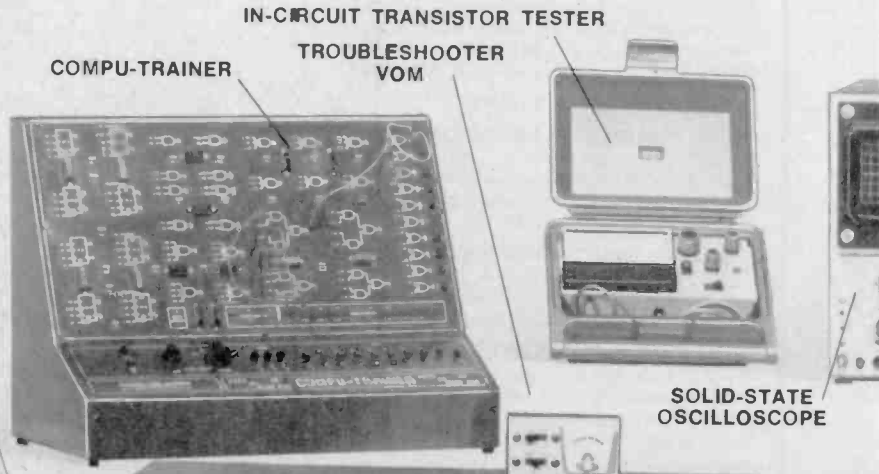
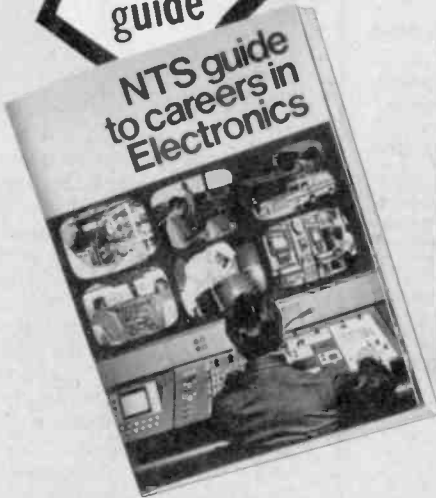

As an NTS student you'll acquire the know-how that comes with first-hand training on NTS professional equipment. **Equipment you'll build and keep.** Our courses include equipment like the **NTS/Heath GR-2001 computerized color TV (25" diagonal)** with varactor diode tuning and digital read-out channel selection; (optional programming capability and digital clock avail.).

Also pictured above are other units — 5" solid state oscilloscope, vector monitor scope, solid-state stereo AM-FM receiver with twin speakers, digital multimeter, and more. It's the kind of better equipment that gets you better equipped for the electronics industry.

This electronic gear is not only designed for training; it's field-type — like you'll meet on the job, or when you're making service calls. And with NTS easy-to-read, profusely illustrated lessons you learn the theory behind these tools of the trade.

Choose from 12 NTS courses covering a wide range of fields in electronics, each complete with equipment, lessons, and manuals to make your training more practical and interesting.

Compare our training; compare our lower tuition. We employ no salesmen, pay no commissions. You receive all home-study information by mail only. All Kits, lessons, and experiments are described in full color. Most liberal refund policy and cancella-

and the equipment be equipped.

**COMPARE OUR
KITS AND LESSONS.
COMPARE OUR
TUITION.**

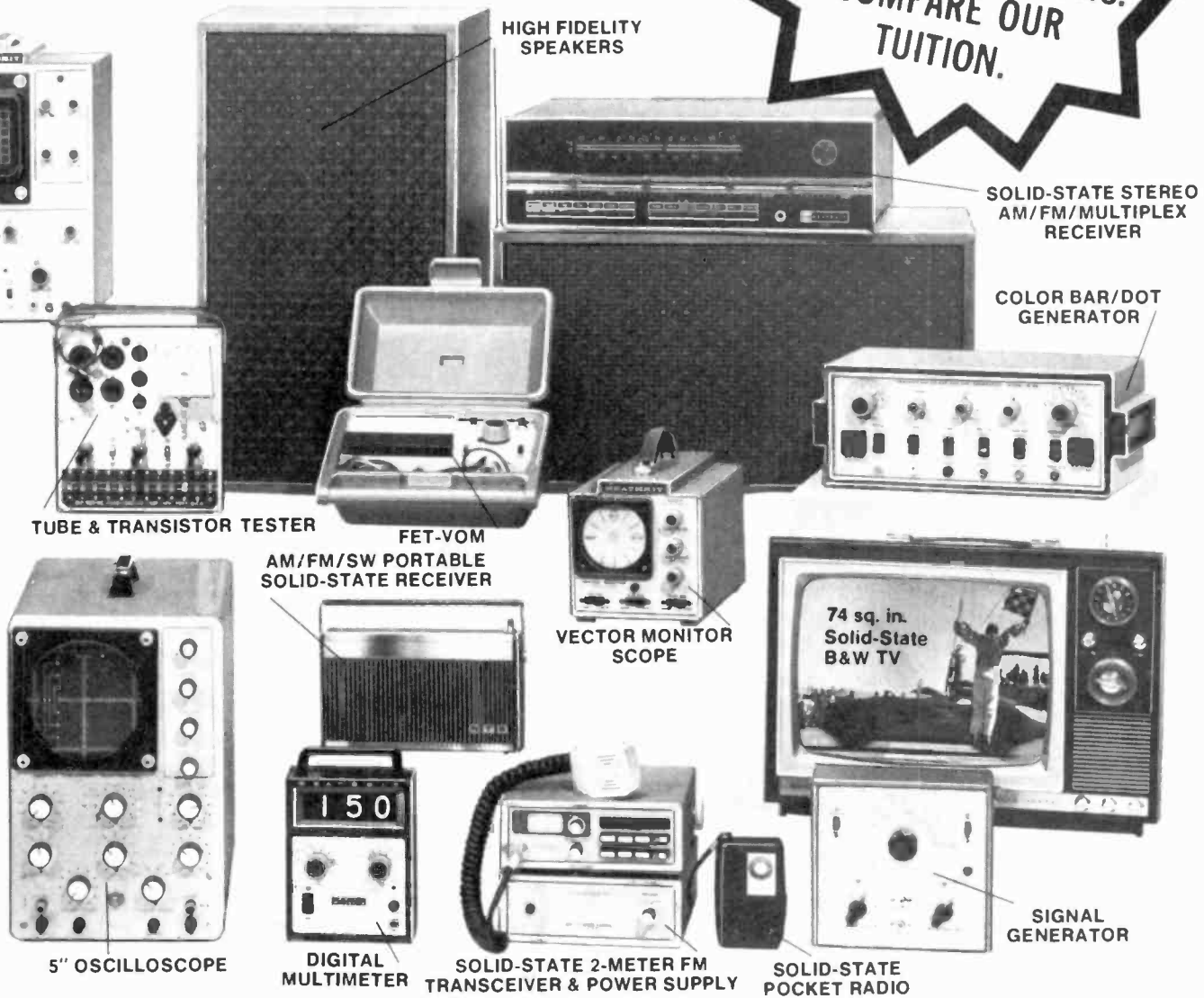

tion privileges spelled out. Make your own comparisons, your own decision. Mail card today, or clip coupon if card is missing.

NO OBLIGATION. NO SALESMAN WILL CALL

APPROVED FOR VETERAN TRAINING

Get facts on new 2-year extension

NATIONAL TECHNICAL SCHOOLS

TECHNICAL-TRADE TRAINING SINCE 1905
Resident and Home-Study Schools
4000 So. Figueroa St., Los Angeles, Calif. 90037

NATIONAL TECHNICAL SCHOOLS Dept. 206-097
4000 South Figueroa St., Los Angeles, Calif. 90037
Please send FREE Color Catalog and Sample Lesson.
NO OBLIGATION. NO SALESMAN WILL CALL.

<input type="checkbox"/> Color TV Servicing	<input type="checkbox"/> Electronics Technology
<input type="checkbox"/> B & W TV and Radio Servicing	<input type="checkbox"/> Computer Electronics
<input type="checkbox"/> Electronic Communications	<input type="checkbox"/> Basic Electronics
<input type="checkbox"/> FCC License Course	<input type="checkbox"/> Audio Electronics Servicing

NAME _____ AGE _____
ADDRESS _____ APT # _____
CITY _____ STATE _____

Please fill in Zip Code for fast service _____
 Check if interested in G.I. Bill Information.
 Check if interested ONLY in classroom training in Los Angeles.

claimed. The frequency response of the high-level inputs was within 1 dB from 15 Hz to 55 kHz and RIAA phono equalization was accurate over the entire curve to within ± 0.2 dB. Phono overload measured 170 millivolts while unweighted signal-to-noise, referred to rated sensitivity of 2.5 mV, measured a very satisfactory 68 dB.

The action of the BASS and TREBLE controls, in each of their selectable turnover modes, is shown in the spectrum-analyzer photo of Fig. 4, while the selectable PRESENCE control response range is shown in Fig. 5. The response of the high- and low-cut filters is compared with the flat response setting of the amplifier in Fig. 6. The two choices of center frequency for the PRESENCE control permit an added degree of flexibility when using this feature. The filters have a 12 dB-per-octave slope with turnover points well positioned for elimination of noise and rumble with minimum degrada-

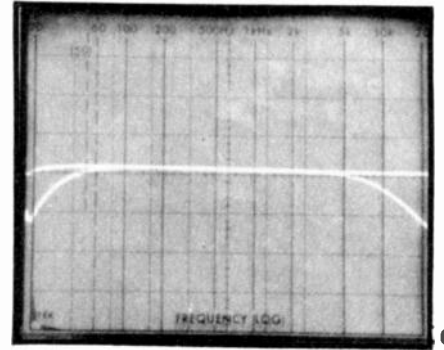
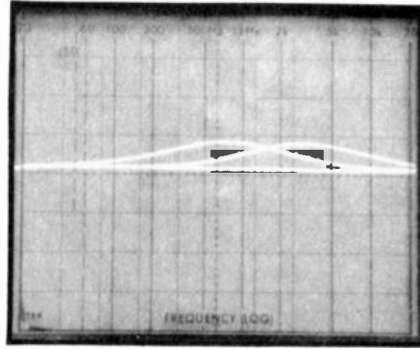

tion of musical content when they are used.

A summary of our reaction to the KA-8300 as well as overall comments regarding this top amplifier from Kenwood will be found in Table II, together with our overall product evaluation. For the demanding audiophile who

is not quite prepared to invest in audio components in the \$1000-plus category but still demands excellent sound reproduction and the flexibility offered only by a well designed integrated amplifier, the Kenwood KA-8300 might well be a good choice. **R-E**

Epicure PR-4 Preamp



CIRCLE 101 ON FREE INFORMATION CARD

LEN FELDMAN
CONTRIBUTING HI-FI EDITOR

EPICURE PRODUCTS, INC., HAS ESTABLISHED A good reputation for itself in the high-fidelity loudspeaker field since its inception in 1967. The first electronic product introduced by the company under the Epicure label (they also market speakers under the EPI brand name) was their rack-mountable *model 1* power amplifier, rated at 125 watts-per-channel. *Model PR-4* is intended as a companion unit for that basic power amplifier, although of course it would function well when used with any other high-quality basic audio power amplifier.

The front panel, shown in Fig. 1, is completely free of any rotary controls and uses pushbuttons and slide potentiometers for all control functions. Finished in black with walnut-finish end pieces, the sole indicator light to appear when power is applied is the illuminated word EPICURE at the upper center of the panel. Individual bass and treble slider controls for each channel are paired so they can be moved together or singly at the left of the panel. The top group of four pushbuttons take care of low- and high-cut filter activation, selection of the tone control turnover points and tone defeat. The tone control turnover-point pushbutton has two positions—"9 dB" and "18 dB." These, we suppose, denote the maximum boost or cut attainable from the tone controls at some extreme frequency. A more understandable designation would have been the frequencies of turnover of the bass and treble circuits (approximately 400 Hz or 80 Hz for the BASS controls; 1.5 kHz and 5 kHz for the TREBLE controls). With this single-button arrangement, it is not possible to select the "9-dB" action for the bass while

MANUFACTURER'S PUBLISHED SPECIFICATIONS:

Rated Output: 2.5 volts. **Frequency Response:** 20 Hz to 20 kHz, ± 0.25 dB. **Harmonic Distortion at Rated Output:** 0.005%. **IM Distortion at Rated Output:** 0.005%. **Phono Input Sensitivity:** 1.5 mV. **High-Level Input Sensitivity:** 100 mV. **Phono Overload:** 150 mV. **Maximum Output:** 7 volts into 100K ohms; 3.5 volts into 600 ohms. **Filter Cut-Off Frequencies:** Low: 50 Hz at 12 dB per octave; High: 7.5 kHz at 12 dB per octave. **Overall Dimensions:** 15½ wide \times 5 high \times 8-inches deep. **Shipping Weight:** 19 lbs. **Suggested Retail Price:** \$450.

TABLE I
PREAMPLIFIER PERFORMANCE MEASUREMENTS

	R-E Measurement	R-E Evaluation
DISTORTION MEASUREMENTS:		
Harmonic distortion at rated output, 1 kHz (%)	0.005	Excellent
IM distortion at rated output (%)	0.01	Very good
Harmonic distortion at 1V output, 1 kHz (%)	0.027	Noise limited
IM distortion at 1V output (%)	0.007	Excellent
PHONO PREAMPLIFIER MEASUREMENTS		
Frequency response (RIAA \pm dB)	0.1	Superb
Maximum input before overload (mV)	80.0	See text
Hum/noise referred to full output (dB) (at rated input sensitivity)	71.0	Unweighted
HIGH-LEVEL INPUT MEASUREMENTS		
Frequency response (Hz-kHz, \pm dB)	13-55	Excellent
Hum/noise referred to full output (dB)	88.0	Very good
Residual hum/noise (Min. volume) (dB)	96.0	Very good
TONAL COMPENSATION MEASUREMENTS		
Action of bass and treble controls	See Fig. 5	Excellent
Action of low-frequency filter(s)	See Fig. 6	Very good
Action of high-frequency filter(s)	See Fig. 6	Very good
COMPONENT MATCHING MEASUREMENTS		
Input sensitivity, phono 1/phono 2 (mV)	1.6-3.3 / 1.6-3.3	
Input sensitivity, auxiliary input (s) (mV)	250	
Input sensitivity, tape input(s) (mV)	250	
Output level, tape output(s) (mV)	250	
Output level, headphone jack(s) (V or mW)	N/A	
EVALUATION OF CONTROLS, CONSTRUCTION AND DESIGN		
Adequacy of program source and monitor switching		Very good
Adequacy of input facilities		Excellent
Arrangement of controls (panel layout)		Superb
Action of controls and switches		Good
Design and construction		Excellent
Ease of servicing		Excellent
OVERALL AMPLIFIER PERFORMANCE RATING		
		Excellent

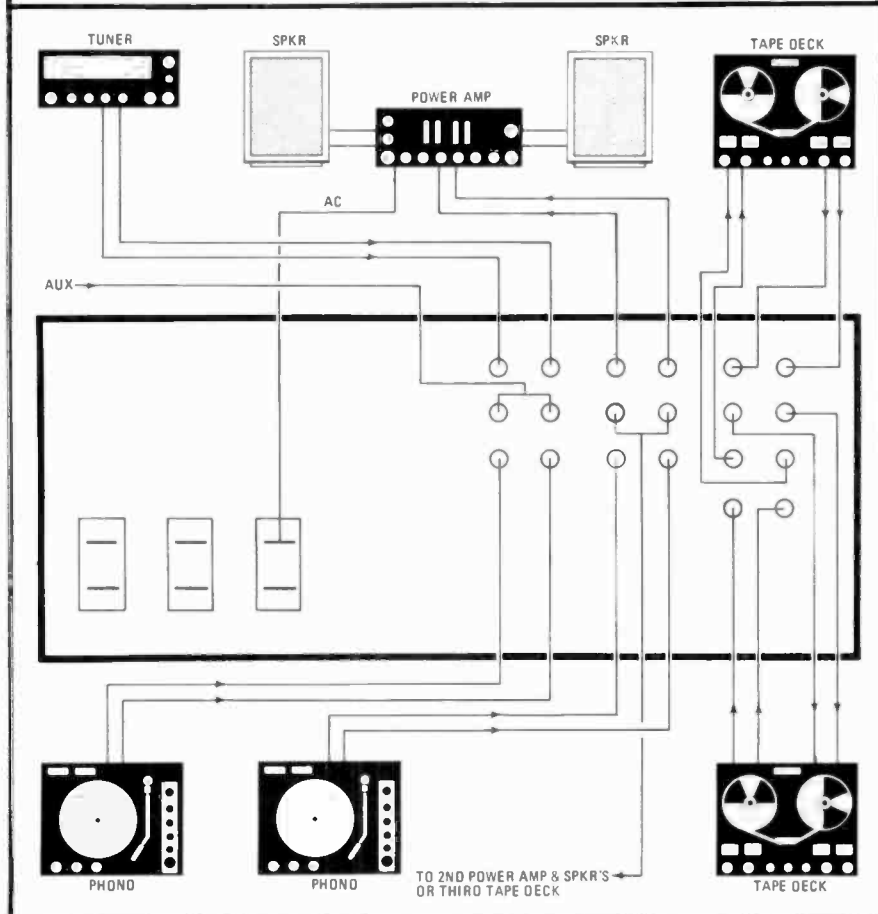

TABLE II OVERALL PRODUCT ANALYSIS

Retail price	\$450.00
Price category	Medium/high
Price/performance ratio	Very good
Styling and appearance	Very good
Sound quality	Excellent
Mechanical performance	Very good

Comments: Epicure Products, Inc., seems to have adopted a middle-of-the-road approach in designing this preamplifier/control unit. While some manufacturers of "esoteric" preamps have been abandoning tone controls altogether (in the belief that the "true" audiophile would not want them in his or her system), Epicure has not only included bass and treble controls but has made them extremely versatile. Nevertheless, they do provide full bypassing of these controls for the purists among their customers. The emphasis on high performance in the phono-equalizer section seems to have paid off, for although the overload capability of the phono section is not the highest we have measured in recent months, we did not encounter any distortion problems while listening to a variety of wide dynamic range recordings. The ability to individually adjust the input sensitivity of each pair of phono inputs, and the fact that fully separate low-level gain stages are used for those two pairs is well worth the extra cost.

Except for the inclusion of those tone controls, Epicure seems to lean towards the increasingly popular "no frills" approach for better preamplifiers. The unit performed extremely well in our listening tests, is beautifully engineered and constructed and, with its high output capability, will provide plenty of headroom when used with any of the better, high-powered basic power amplifiers now available, including Epicure's own matching model 1 stereo power amplifier. Prospective purchasers may take issue with the front-panel styling of the model PB-4 (it is a bit drab) but can hardly question the internal construction and layout, which is up to military grade standards. We have categorized this preamplifier as being in the medium-to-high price range. However, there are competitive preamplifiers on the market which offer no better sound reproduction and fewer control features.

2 choosing the "18-dB" curve for the treble, since the control switch affects both ends of the spectrum.

Four buttons below those just described handle two tape monitor circuits and permit dubbing from one tape deck to another. Five more pushbuttons at the upper right are designated PROGRAM MODE and select either stereo, reverse, mono, left-only or right-only; while below these, six more pushbuttons are used for PROGRAM SOURCE selection (a pair of separate phono inputs, two tape play pushbuttons, aux and tuner). The single button at the lower right turns on power to the unit, while the paired slide controls at the extreme right act as individual channel gain controls, thereby eliminating the need for the more common balance control.

The rear panel of model PR-4 (see Fig. 2) has two unswitched and one switched AC receptacles, a line fuseholder, chassis ground terminal and the usual array of input jacks and tape record output jacks. Two pairs of output jacks make it simple to feed a pair of stereo power amplifiers or a single power amplifier and a tape deck for recording program material that has been altered by the tone controls and filters. Below each pair of phono inputs are pairs of recessed screwdriver adjustment controls to set the sensitivity of each phono input pair to match levels of other program sources. The variety of equipment that can be connected to the Epicure model PR-4 preamplifier/control is shown in Fig. 3.

Figure 4 shows an internal view of model PR-4. Two glass-epoxy circuit boards contain-

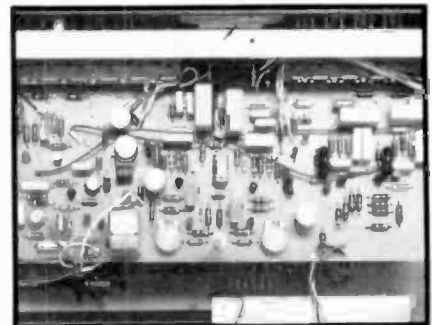

ing nearly all the parts required are mounted at right angles to each other and interconnected by a multiconductor ribbon cable. The entire power supply (including a hum-bucking toroid power transformer) is mounted in its own separate shielded enclosure clearly visible at the lower left in Fig. 4.

The phono stages use a two-stage voltage amplifier in a DC-stabilized feedback pair, followed by a single-stage unity-gain buffer amplifier. Auxiliary phono inputs are grounded when not in use. It should be emphasized that two completely separate equalizer-preamplifier sections are used in this unit requiring no low-level input switching. The master volume control sliders are located ahead of the high-level stage, which provides a high overload capability for all high-level program sources. A buffer amplifier precedes the two-pole low and high-pass active filter circuits, followed by another buffer stage. Baxandall-type bass and treble controls, and a line amplifier that provides 20 dB gain from high-level inputs to outputs. According to Epicure, the wide bandwidth of this amplifying section (100 kHz for the -3 dB point) coincides with the small-signal high-frequency response so that the amplifier barely enters slew-rate limi-

continued on page 91

state of solid state

A look at an interesting circuit that adds a vibrato effect to musical passages; plus an SCR array and an ultra-stable oscillator. **KARL SAVON** SEMICONDUCTOR EDITOR

TREMOLO AND VIBRATO CIRCUITS ARE POPULAR with musicians. Some want to hook them up to their electronic organs and guitars. Others want to play tape recorders or radios through them.

The effects of the tremolo and vibrato circuits are related; they both add some form of modulation to the original music. Both modulate the original music source with a low-frequency (usually sub-audio) control

signal to give a pleasing "wobulation" to the music. It is most effective when the music source is purely tonal in nature with only the attack and decay envelope shapes of specific instruments.

Tremolo is amplitude modulation. The frequency of the source is unaffected. Only its amplitude wavers, usually following the sinusoidal envelope of the modulating signal. Tremolo is relatively easy to implement with

fairly simple circuitry. Lower-cost electronic instruments that include either of the two effects will invariably use tremolo—it's less expensive.

Vibrato is the more pleasing of the effects. We recognize it as the frequency modulation mastered by the professional vocalist. Inevitably it is often combined with a secondary amplitude modulation. Electronic organs sometimes go to great expense and extremes to produce vibrato mechanically. The most notable are the moving baffle and rotating speaker systems, where the sound source is physically moved. Some achieve true Doppler effects by changing the distance between

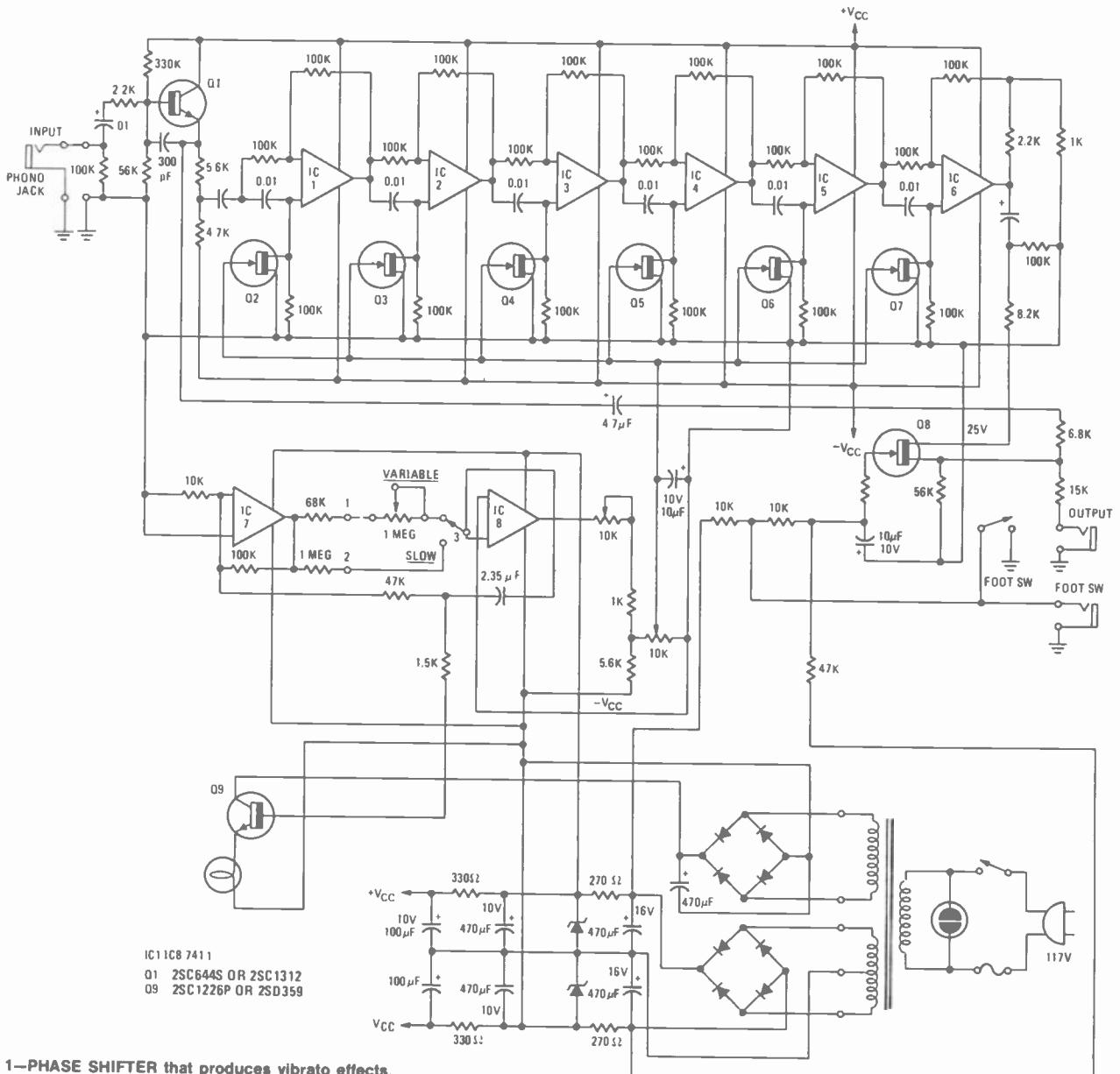

FIG. 1—PHASE SHIFTER that produces vibrato effects.

the source and the listener. At least one manufacturer uses undriven speakers as mechanical counterweights. When the modulation frequency is very low and the proper tonal quality is synthesized, the effect takes on the sound of a carillon.

Musical phase shifter

One way to produce a true vibrato is to phase-modulate the music source. Frequency is the rate of change of phase. If the phase is varied as a sine function, the frequency of the output will change at the same rate as the phase modulation with a cosine function. You may ask, "Isn't it simpler to frequency-shift the oscillator itself in the case of an electronic instrument tone generator?" Well maybe—but be careful. Whenever you design an oscillator to be frequency-shifted, its stability suffers as a rule. The act of building a frequency-shift system by its nature introduces sources of instabilities for undesirable shifts in frequency.

By phase-modulating the buffered oscillator output, the stability is unaffected. The frequency of the vibrato output will vary around the rock-stable original frequency.

This method is one that has been proven in the FM radio broadcast field. FM stations must hold their carrier frequencies to very tight standards. But they of course must find some way to modulate the carrier in frequency. Phase modulation is the answer. In this case the audio modulation signal is not just a simple low-frequency tone, but the entire audio baseband, and a conversion must be made so the effect of the phase modulation will be to produce a change in frequency

proportional to the audio amplitude.

Dan Shannon of Brownsville, Texas, sent in the elegant vibrato circuit drawn in Fig. 1, an electronic phase-shifter that produces a true vibrato effect, pure frequency modulation without attendant amplitude modulation. It has eight op-amps, two bipolar transistors, and seven N-type FET's. He supplied no specifications, but the circuit does not look unduly critical and will probably work with a wide range of standard parts.

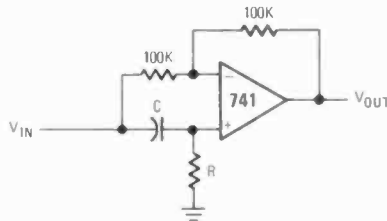

FIG. 2—A PHASE SHIFTER STAGE.

The signal from the input jack feeds the base of emitter follower Q1. The signal splits two ways, one path feeds the string of six phase-shifting 741 op-amps. A typical stage looks like the one in Fig. 2. Because of the op-amp's very high negative-feedback gain, let's make the familiar and reasonable assumption that the signal input at both the inverting and non-inverting inputs are equal in amplitude and phase. The inverting input then has a signal level equal to $1/2 (V_{in} + V_{out})$. The non-inverting input is fed through a phase-shift

network that consists of capacitor C and resistor R. This works out to $V_{in} (j\omega RC / (1 + j\omega RC))$, where j represents a 90° reactive phase-shift for sinewave inputs and $\omega = 2\pi f$ (f is the frequency of the input signal). Now this must equal the non-inverting input so with some algebraic juggling you end up with $V_{out} = V_{in} (1 - j\omega RC) / (1 + j\omega RC)$.

I've bothered to go into this much detail because this result is a very interesting circuit response. It can also be produced with a passive non-amplifying circuit, but there will be a loss of gain through it. First of all the magnitude of the gain or the signal output for the 741 phase-shifter remains fixed as the frequency changes. The stage gain is flat across the band.

These types of circuits are called all-pass networks because of their flat signal transmission.

How about phase? $\Delta\phi = \tan^{-1}2\omega RC$. In Fig. 1, R is made up of a fixed 100K resistor and the variable resistance of an FET. At any particular frequency the phase shift is a function of R or the control voltage of the FET. Though the phase shift changes with frequency, the function is linear. The output will be delayed in time but undistorted in waveform. Cascading the six stages multiplies the phase shift and increases the phase sensitivity of the circuit.

The output of the phase-shift chain is combined with a portion of the input from the emitter of Q1. FET Q8 is a transmission gate operated by a foot switch to turn the vibrato on and off as desired. Switched off, the unshifted signal path continues to provide a

continued on page 104

The complete VOM line.



WV-518B
\$39.95



- All ranges and functions fuse-protected against burnout, (Except 5A ac/dc current ranges)
- Taut-band meter with 30,000 Ω /Vdc sensitivity
- New, modern styling, tilt stand, high-impact case

VIZ makes the industry's most complete line of VOMs.

From our \$9.95 Handyman VOM, all the way to our new \$267.00 3½-digit autopolarity multimeter, VIZ VOMs and VoltOhmysts® are rugged, stable, and designed for long life and top-notch service.

There's a VIZ VOM to fit your need.

See them at your VIZ distributor.

VIZ Test Instruments Group

of VIZ Mfg. Co.

335 E. Price St., Phila. PA 19144

© VIZ

6822

Formerly
VIZ
Instruments

hobby corner

Part II. Homebrew breadboard that's inexpensive, easy to build and versatile. The basic design can be easily modified.

EARL R. SAVAGE, K4SDS.

IN LAST MONTH'S COLUMN, WE PROVIDED schematics for several of circuits of the breadboard system. This month, the column concludes with the rest of the schematics and the construction details.

Pulsar switch

The trouble with the logic switches previously described is that they tend to "bounce" when making or breaking a connection. In fact, all mechanical switches have contact bounce. It usually doesn't matter because you don't care if something is turned on and off five or ten times very rapidly every time you throw the switch. In some circuits this bouncing can cause serious problems.

Suppose you are working with counters, for example, and you use one of the logic switches for a trigger. You throw the switch from LO to HI and the counter shows that you did it *eight times*. Surely that is no way to test a counter circuit!

The pulser switch (See Fig. 6) is "bounceless." The mechanical switch S1 is not connected to the output. Instead, it causes the two gates (7400) to change the state of the output. The gates don't bounce.

The two LED's, one red and one green, indicate the state of the output (LO or HI). Switch S1 is an SPDT type that was not used in the prototype. The prototype used two normally open momentary SPST pushbutton switches instead. Either arrangement is satisfactory.

Pulse generator

After the power supply, without which none of these circuits would operate, the pulse generator (See Fig. 7) is the most useful device in the breadboard. A pulse generator is often called a clock because its output "clocks" back and forth between a LO and HI level.

The generator is a 555 timer IC with an approximate squarewave output. The frequency is changed by selecting various capacitors with switch S1. The four values shown produce pulses at rates of about 0.1, 1, 10 and 100 pulses-per-second. These have been found adequate to meet all needs to date. Of

course, you may change the values or increase or decrease the number of frequencies available.

The LED is included in order that the operation and state of the output of the clock can be monitored directly. This is an advantage when working with some types of circuits. Note, too, that the stated frequencies are only approximations because resistors R1 and R2, and the timing capacitors are not precision units. All you need is to be in the right ballpark—the expense of precision is unjustifiable.

Construction

Construction is greatly simplified by using a plastic parts box (6 × 11 × 2-inches) instead of a conventional metal cabinet. Mounting holes and even rectangular openings for the slide switches are easily made and there is no worry about insulating parts from the chassis. There are, however, disadvantages.

The box is clear plastic and it would be confusing at best to look through the panel! This was solved by painting the *inside* of the box *after* making all the holes but *before* mounting the parts. In fact, I made the various sections different colors—red, yellow, black, white, blue, silver.

The greatest disadvantage of this box

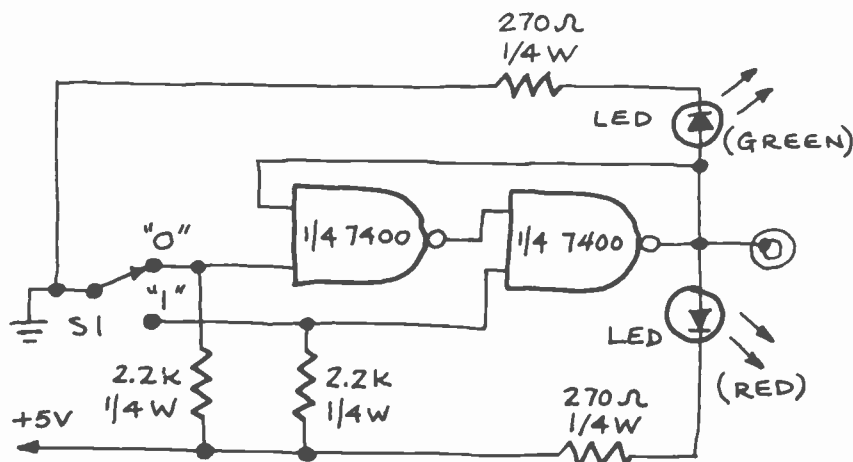
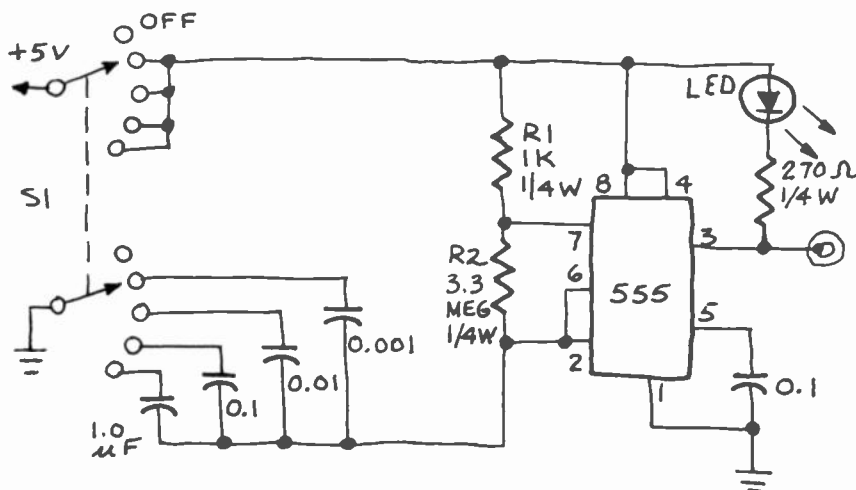

FIG. 6—PULSE SWITCH provides bounceless switching.



NOTE: S1, DPS POS (NON-SHORTING)

FIG. 7—PULSE GENERATOR produces squarewaves at frequencies of 0.1, 1, 10 and 100 hertz.

stopped most conveniently by putting an SPDT switch on pin 4 of the 555 circuit. When pin 4 is grounded, the counter stops; when it is connected to V_c (+5), the counter runs.

The 7490 circuit can be reset to 0 by connecting pins 2 or 3 to V_c ; it can be reset to 9 by also connecting pins 6 or 7 to V_c . The reset and start/stop functions can be combined in a single DPDT switch.

Things to try

1. You can have an audible time sig-

nal by connecting a Sonalert between pin 3 of the 555 circuit and ground. If the Sonalert is connected between pin 11 of the 7490 and ground, it will sound a tone warning at count 8.

2. A second digit can be added so that the counter indicates up to 99 intervals. This will require a second 7490 circuit and four LED's for binary; or a second 7490, a 7448 circuit and a 7-segment digital unit for Arabic. In either case, connect the input (pin 14) of the second 7490 to pin 11 of the first 7490. Of

course, a third, fourth and more digits can be added similarly.

3. A common anode digit and a 7447 circuit can be substituted for the 7448 and common-cathode digit.

4. Follow the 7490 with a 74145 (BCD-to-decimal decoder-driver) and 10 LED's to make a 0-to-9 sequential light counter. If interval T is made short, the light will appear to sweep up the line of LED's.

Troublesome circuits

If you have trouble with any of these circuits, there could be three causes:

1. You may have made a wiring error, which is easy to correct unless something went up in smoke when you applied power. That's why wiring should *always* be checked before throwing the ON switch—we all make wiring errors from time to time.

2. One of the components may be bad or it may have a value outside of acceptable tolerance. Since sometimes this information is difficult to find, we'll try to call your attention to any parts that seem critical.

3. Typographical errors do occur on rare occasions. This is a toughie to correct in your project. About all we can say is that a correction will be printed as soon as possible.

continued on page 89

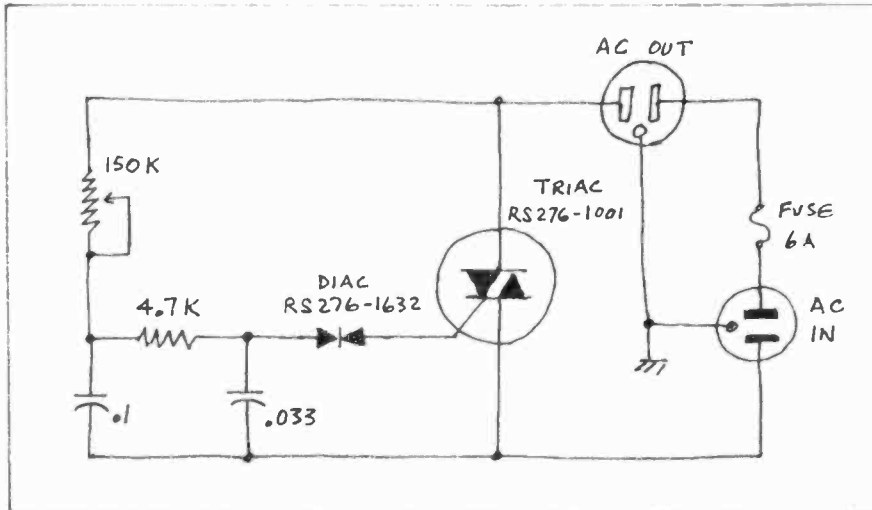

FIG. 5

ok® wire wrapping center ok®

NEW HOBBY WRAP MODEL BW 630



Battery
wire
wrapping
tool

\$34.95
ONLY
COMPLETE WITH BIT
AND SLEEVE

STRIP/WRAP/UNWRAP TOOL MODEL WSU-30



\$5.95*

RIBBON CABLE ASSEMBLY

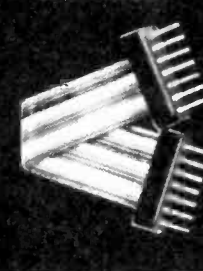

DIP SOCKETS

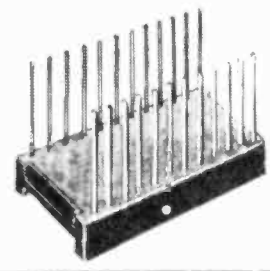

DIP IC INSERTION TOOL WITH PIN STRAIGHTENER



MODEL
INS-1416

\$3.49*

WIRE DISPENSER MODEL WD-30-B



\$3.45*

PRE-CUT PRE-STRIPPED WIRE

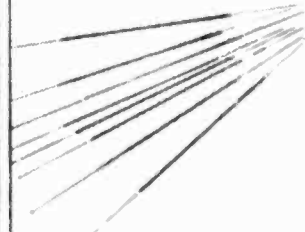

WIRE WRAPPING KIT

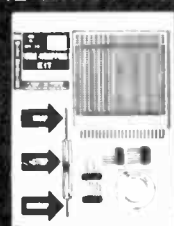

\$15.45*

*MINIMUM ORDER \$25.00. SHIPPING CHARGE \$1.00. N.Y. CITY AND STATE RESIDENTS ADD TAX

OK MACHINE AND TOOL CORPORATION

3455 CONNER STREET, BRONX, NEW YORK, N.Y. 10475 U.S.A.
PHONE (212) 994-6600 TELEX NO 125091

CIRCLE 15 ON FREE INFORMATION CARD

Heathkit®

FALL 1977

New THE HEATHKIT COMPUTERS

The "total system" computer products for home, hobby, educational and business applications. With powerful software to get you up and running fast, superior documentation and service support, sensational low prices too. They're the ones you've been waiting for! See pages 2-14.



H8 8-bit Digital Computer, pages 4-5

H10 Paper Tape Reader/Punch, page 9

H11 16-bit Digital Computer, pages 6-7

H9 Video Terminal, page 8

Plus the world's largest selection of quality easy-to-build electronic kits

Heath-recommended electronic products



Video Recorder, page 99



Telephone Answerer, page 76



Indoor Greenhouse, page 78

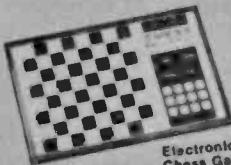

Electronic Chess Game, page 77

© 1977 Heath Company
See Index on page 2

New Kit Products for FALL



Active Audio Processor, page 39



Low-Priced Oscilloscope, page 68



Electronic Digital Scale, page 104



FET Multimeter, page 60

HEATHKIT MAIL ORDER CATALOG 817

"Heath" and "Heathkit" are registered trademarks of Heath Company

FREE!

The NEW Heathkit catalog introducing our complete line of personal computers and many more, exciting, fun-to-build electronic kits

NEW! H8 8-Bit Digital Computer

This 8-bit computer based on the famous 8080A microprocessor features a Heathkit exclusive "intelligent" front panel with octal data entry and control, 9-digit readout, a built-in bootstrap for one-button program loading, and a heavy-duty power supply with enough capacity for plenty of memory and I/O interfaces. It's easier and faster to use than most other personal computers and it's priced low enough for any budget.

NEW! H11 16-Bit Digital Computer

Heath, the world's largest kit manufacturer, and Digital Equipment Corporation, the leader in minicomputer systems, combine to bring you today's most sophisticated personal computer. Features include DEC's 16-bit LSI-11 CPU, 4096 x 16 read/write MOS memory expandable to 20K (up to 32K words total), priority interrupt, DMA operation and more. Complete systems software for fast and efficient operation is included!

NEW! H9 Video Terminal

This full ASCII terminal system features a bright 12" CRT, with both long and short-form displays, all standard serial interfaces, plus a fully wired and tested control board. Has auto-scrolling, cursor with full positioning controls, full-page or line-erase modes, a transmit page function, and a plot mode for simple curves and graphs. The H9 is compact, attractive and easy to build. It's compatible with all Heathkit computers as well as most others through standard interfacing.

NEW! H10 Paper Tape Reader/Punch

Complete mass-storage peripheral using low-cost paper tape. Features a solid-state recorder with stepper motor drive, totally independent punch and reader modes and a copy mode for fast, easy tape duplication. Reads at 50 characters per second, punches at 10 characters per second. For use with Heathkit computers and most others.

Other Heathkit computer products include a cassette recorder/player for mass storage, teleprinter, self-instructional programming courses, a complete library of the latest computer books, plus software, memory expansion cards, I/O cards and lots more — everything you need to make Heath your personal computing headquarters!

NEW! Kit products for fall

An exciting selection of new kits includes an active audio processor to give your present hi-fi system better dynamic range and reduced noise levels, a new medium-power stereo FM-AM receiver, an electronic digital scale that shows you weight in big, bright easy-to-read numbers, and new test instruments including a low-priced precision oscilloscope and an easy-to-use FET multimeter.

NEW! Heath-recommended electronic products

These unique new products are recommended by Heath because of their excellent quality and outstanding value. The Sony Betamax™ videotape recording system using exclusive ultra-compact 2-hour Sony cartridges; an electronic greenhouse with automatic temperature and humidity controls; a microcomputer based electronic chess game; and a sophisticated multi-cartridge microprocessor-based video game. All are high quality, fully assembled, tested and priced low to give you the kind of value you expect from Heath.

PLUS nearly 400 other superb, easy-to-build, money-saving products. You'll find a complete line of digital electronic clocks and weather instruments, plus useful and unique items for your car, home or office. There are many more exciting products to read about too! Home convenience items like a practical freezer alarm, a touch-control light switch, intercoms and a unique programmable doorbell. Automotive instruments and accessories, marine equipment, model aircraft Radio Control gear, security systems and more. Plus our world-famous Amateur Radio equipment and test and service instruments.

These are among the nearly 400 quality, fun-to-build kits described in this new Heathkit catalog. Kits for every interest. All with the world-famous Heathkit assembly manual — a step-by-step instruction guide that makes kitbuilding easy and leaves nothing to chance. And all backed by our "We won't let you fail!" promise. Find out about the satisfaction, savings and FUN of kitbuilding.

Send for your
FREE copy today!

HEATH Schlumberger	Heath Company, Dept. 010-330 Benton Harbor, Michigan 49022
Please send me my FREE Heathkit Catalog. I am not on your mailing list.	
Name _____	
Address _____	
City _____	State _____
CL-637	Zip _____

computer corner

DAVID LARSEN, PETER RONY, and JONATHON TITUS*

MOST MICROCOMPUTERS MANIPULATE INFORMATION eight bits at a time. For example, the 8080A microprocessor can move the eight bits from internal register to internal register, from internal register to memory, and between the accumulator and an external I/O device. It can also perform arithmetic and logic operations, the former including add, subtract, and compare, and the latter including AND, OR, EXCLUSIVE-OR, and COMPLEMENT. In this column, logic operations will be explored.

The basic rules governing one-bit logic operations are truth tables. A truth table can be defined as a tabulation that shows the relation of all output logic levels of a digital circuit to all possible combinations of input logic levels in such a way as to characterize the circuit functions completely.¹ The truth tables for the AND, OR, EXCLUSIVE-OR, and COMPLEMENT operations are:

AND			OR		
B	A	Q	B	A	Q
0	0	0	0	0	0
0	1	0	0	1	1
1	0	0	1	0	1
1	1	1	1	1	1

EXCLUSIVE-OR			COMPLEMENT	
B	A	Q	A	Q
0	0	0	0	1
0	1	1	1	0
1	0	1		
1	1	0		

These truth tables are called *one-bit tables* because data words A and B each contain only a single bit.

In discussing logic instructions, it is useful to employ *Boolean symbols*. Such symbols originate from the subject of *Boolean algebra*, which is the mathematics of logic systems. Alphabetic symbols such as A, B, C, . . . , Q are used to represent logic variables and 1 and 0 to represent logic states. This particular form of mathematics was originated in England by George Boole in 1847. It did not become widely used until 1938, when Claude Shannon adapted it to analyze multi-contact networks for telephone networks.

What should be learned about Boolean algebra are the basic Boolean symbols that are used in Boolean algebra computations, and thus all digital logic. These symbols include the following:

- + which means *logical addition* and is given the name OR
- which means *logical multiplication* and is given the name AND
- ⊕ which is given the name *EXCLUSIVE-OR* or XOR
- ̄A which means *negation* and is given the name NOT

The negation symbol is a solid bar over a logical variable such as A, B, . . . , Q. Thus, the Boolean statement for a two-input AND gate is $Q = A \cdot B$, or simply $Q = AB$, where the equality symbol means that the variables or groups of variables on either side of the "=" symbol are the same, i.e., both are in the same logic state. It is useful to summarize the symbol operations for the three gates that are being considered:

AND		OR		EXCLUSIVE-OR		COMPLEMENT		
0	• 0	=	0	0	+	0	=	0
0	• 1	=	0	0	+	1	=	1
1	• 0	=	0	1	+	0	=	1
1	• 1	=	1	1	+	1	=	1
0	⊕ 0	=	0	0	=	1		
0	⊕ 1	=	1	1	=	0		
1	⊕ 0	=	1					
1	⊕ 1	=	0					

Multibit logic operations are treated as many one-bit logic operations. No new principles of logic are involved. The corresponding bits of one binary word logically operate on the corresponding bits of the second binary word to produce an overall multibit logic result. The length of the binary words can be any number of bits: two bits, eight bits, thirty-two bits, etc. Since the 8080A microprocessor performs multibit logic operations on eight-bit words (bytes), all of the examples will involve full bytes.

Consider the eight-bit logic variable, A. The individual bits in this variable are labeled as A7, A6, A5, A4, A3, A2, A1 and A0, with A0 being the least significant bit (the 2⁰ bit) and A7 being the most significant bit (the 2⁷ bit). Also consider the eight-bit logic variable, B, that has individual bits that are labeled as B7, B6, B5, B4, B3, B2, B1 and B0. The logic operation, $A \cdot B = Q$, means the following eight one-bit logic operations:

A0 • B0	=	Q0	A4 • B4	=	Q4
A1 • B1	=	Q1	A5 • B5	=	Q5
A2 • B2	=	Q2	A6 • B6	=	Q6
A3 • B3	=	Q3	A7 • B7	=	Q7

The result of the logic operation is the logic variable Q that has a least significant bit of Q0 and a most significant bit of Q7. In other

words, *multibit logic operations are performed bit-by-bit via a series of one-bit logic operations.* It is easier to perform multibit logic operations if the multibit binary words are placed one under the other. Thus, if $A = 11011111_2$ and $B = 00100011_2$, then $A \cdot B$ is

$$\begin{array}{r} 11011111_2 \\ \cdot 00100011_2 \\ \hline 00000011_2 \end{array}$$

or $Q = 00000011_2$. In performing a logical AND, the relationships $0 \cdot 1 = 0$ and $1 \cdot 1 = 1$ were used in deriving the final result. (The subscript 2 reiterates the fact that a bit takes only two values.)

One of the more important uses for multibit logic operations is in situations in which the on-off state of external devices must be monitored. Consider the following system of eight devices:

Bit position	Device	Logic state information
Bit 0	pressure sensor	1 = pressure above set-point 0 = pressure at or below set-point
Bit 1	temperature sensor	1 = temperature above set-point 0 = temperature at or below setpoint
Bit 2	velocity sensor	1 = velocity above set-point 0 = velocity at or below set-point
Bit 3	flow rate sensor	1 = flow rate above set-point 0 = flow rate at or below set-point
Bit 4	concentration sensor	1 = concentration above set-point 0 = concentration at or below setpoint
Bit 5	Valve A	1 = valve A open 0 = valve A closed
Bit 6	Valve B	1 = valve B open 0 = valve B closed
Bit 7	Power	1 = power on 0 = power off

The group of eight bits is called the *status byte* for our system of eight devices. At any instant

* This article is reprinted courtesy of American Laboratories. Dr. Rony, Department of Chemical Engineering, and Mr. Larsen, Department of Chemistry, are with the Virginia Polytechnic Institute & State University. Mr. Titus is president of Tychon, Inc., a microcomputer consulting firm in Blacksburg, Virginia.

of time, the status byte will have a specific value. For example, the status byte 11100010₂ signifies that the pressure is at or below the setpoint, the temperature is above the setpoint, the velocity is at or below the setpoint, etc. There are 2⁸ or 256 possible combinations.

The importance of logic instructions in a digital computer is that they permit the determination of the following characteristics about the external devices listed above:

- Which devices are on, open or above the setpoint?
- Which devices are off, closed, or at or below the setpoint?
- Since the last time we checked, which devices have gone from on to off, open to closed, or above the setpoint to at or below the setpoint?
- Since the last time we checked, which devices have gone from off to on, closed to open, or at or below the setpoint to above the setpoint?

In other words, using logical instructions, not only can the current state of the external devices be determined but also what changes have occurred since the last time that the devices were interrogated. Since it is not clear how this is done logically, a specific example based upon the eight devices described above should help.

Assume all eight devices have just been interrogated and the current status byte is found to be 11101010₂, where the least significant bit, bit 0, is on the far right. One second ago, the status byte was 11101001₂. What is the current state of each device, which devices have changed state during the last second, and in which direction? The steps to be employed

to answer such questions are as follows:

STEP 1. Examine the current status byte. Determine the status of each external device from the logic state of its status bit.

The current status byte (CSB) is 11101010₂. From this value, it is concluded that the pressure, velocity and concentration sensors are all at or below their respective setpoints; the temperature and flow rate sensors are above their respective setpoints; and that valve A, valve B and power are all on.

STEP 2. Perform an EXCLUSIVE-OR operation between the prior status byte (PSB) and the current status byte (CSB). A logic 1 in the result indicates that the logic state of that device has changed.

The logic operation to be performed is

$$PSB \oplus CSB = Q1$$

where PSB = 11101001₂, CSB = 11101010₂, and Q1 is the result of the EXCLUSIVE-OR operation. Thus,

11101001	PSB
\oplus 11101010	CSB
00000011	Q1

and Q1 = 00000011₂. Only the pressure and temperature sensors have changed state.

STEP 3. Perform an AND operation between Q1 and the prior status byte (PSB). A logic 1 in the result indicates a de-

vice that has changed state from logic 1 to logic 0.

The logic operation to be performed is

$$PSB \cdot Q1 = Q2$$

where PSB = 11101001₂, Q1 = 00000011₂, and Q2 is the result of the AND operation. The following is obtained:

11101001	PSB
\cdot 00000011	Q1
00000001	Q2

and thus can conclude that the pressure sensor has changed from being above the setpoint to now being at or below the setpoint (logic 1 to logic 0 transition).

STEP 4. Negate (or COMPLEMENT) Q2, then AND this complemented result with Q1. A logic 1 in the result indicates a device that has changed state from logic 0 to logic 1.

The logic operation that is now to be performed is

$$\overline{Q2} \cdot Q1 = Q3$$

Since Q2 is 00000001₂, the complemented value of Q2 must be 11111110. The result of the AND operation is obtained as follows,

11111110	$\overline{Q2}$
\cdot 00000011	Q1
00000010	Q3

The result, Q3 = 00000010₂, leads to the *continued on page 89*

LCR-740
LCR BRIDGE



LEADER
Instruments Corp.

- Highly accurate 3 unit digital readout.
- Measures inductance (L), Capacitance (C), and Resistance (R), within $\pm 0.5\%$ accuracy.

Designed for project engineering, educational and service use where highly accurate L, C and R readings are of utmost importance. The LCR-740 operates on one 9V battery, measures inductance resistance and capacitance within $\pm 0.5\%$ accuracy. Dependable, portable, it has a 3 unit digital readout plus an 8 step inductance range; an 8 step capacitance range; and an 8 step resistance range.

TO ORDER CALL COLLECT 212-687-2224

ADVANCE ELECTRONICS

54 West 45 Street, New York, N.Y. 10036 212-687-2224

THE TEST EQUIPMENT SPECIALISTS

EIGHT INSTRUMENTS IN ONE



- Out-of-Circuit Transistor Analyzer
- Dynamic In-Circuit Transistor & Radio Tester
- Signal Generator
- Signal Tracer • Voltmeter
- Milliammeter
- Battery Tester
- Diode Checker

Transistor Analyzer Model 212

Factory Wired & Tested—\$30.57
Easy-to-Assemble Kit—\$20.36

YOU DON'T NEED A BENCH FULL OF EQUIPMENT TO TEST TRANSISTOR RADIOS! All the facilities you need to check the transistors themselves — and the radios or other circuits in which they are used — have been ingeniously engineered into the compact, 6-inch high case of the Model 212. It's the transistor radio troubleshooter with all the features found only in more expensive units. Find defective transistors and circuit troubles speedily with a single, streamlined instrument instead of an elaborate hook-up.

Features:
Checks all transistor types — high or low power. Checks DC current gain (beta) to 200 in 3 ranges. Checks leakage. Universal test socket accepts different base configurations. Identifies unknown transistors as NPN or PNP.

Dynamic test for all transistors as signal amplifiers (oscillator check), in or out of circuit. Develops test signal for AF, IF, or RF circuits. Signal traces all circuits. Checks condition of diodes. Measures battery or other transistor-circuit power-supply voltages on 12-volt scale. No external power source needed. Measures circuit drain or other DC currents to 80 milliamperes. Supplied with three external leads for in-circuit testing and a pair of test leads for measuring voltage and current. Comes complete with instruction manual and transistor listing.

EMC, 625 Broadway, New York 12, N. Y.

Send me FREE catalog of the complete value-packed EMC line, and name of local distributor.

NAME _____ RE-9

ADDRESS _____

CITY _____ ZONE _____ STATE _____

EMC

ELECTRONIC MEASUREMENTS CORP.
625 Broadway, New York, N. Y. 10012

Today's Semiconductors

KARL SAVON
SEMICONDUCTOR EDITOR

THE DATA SHEET FOR THE RCA CA3160 BIMOS operational amplifier (File Number 976) describes a device similar to the earlier CA3130 but with internal compensation. This means that in a host of applications you don't have to figure out the value of capacitors or more complex compensation networks to stop your favorite circuit from oscillating.

CA3160 application

Suppose you have a microcomputer or some kind of counter hooked up as a music generator or in a measurement system and you would like to convert its 8-bit parallel output into an analog voltage. Digital-to-analog converters tend to get complicated and expensive, but the one shown in Fig. 1 is neither. This circuit has nine parallel inputs labelled MSB1 to LSB9, from the most significant to least significant bits. The converter uses an R-2R precision resistor network to weight the various binary inputs to produce the DC output voltage. Speed is a virtue of this type of converter since there are no closed-loop comparisons or sequencing operations to slow things down. It's simply a matter of reading the parallel inputs and the time it takes the switches to settle and the circuit capacitance to charge.

The CA3160 in Fig. 1 acts as a voltage follower that takes the output of the resistor network and buffers it to feed the system output. To maintain converter accuracy, it is vital not to load the resistor network. It doesn't take much to disturb the DC output voltage. The situation is similar to measuring with a DC

voltmeter. If the meter does not have a sufficiently high input impedance, it will load the finite impedance of the circuit and destroy the measurement accuracy.

The circuit uses five IC's; three CD4007's that serve as switches; the CA3160 voltage follower; and a CA3085 voltage regulator to supply a stable reference voltage. The system output cannot be any better than the reference voltage since all other errors are added to it.

The CD4007's are really COS/MOS amplifier stages. The input to each inverter amplifier is connected to each of the 9 digital inputs, and each corresponding output feeds one of the converter resistors. Starting at the most significant bit, notice that until you reach R7, the resistors keep doubling in value. Eight 806K's in parallel are about 100K; the next group on terminals 1 and 5 of IC3 combine to 100K, etc. A voltage on the most significant bit has the largest influence due to its lowest series resistance to the common output bus. As you move in the direction of the less significant bits, doubling the resistance value reduces their influence by one-half.

Assume for the moment that you are dealing with two input bits. These binary inputs are weighted in powers of two so that the most significant bit has a weight of 2 and the least significant bit has a weight of 1. If both bits are 0, the binary number is 0 and a 0-volt output is produced. If the least significant bit is a 1 and the most significant bit is a 0, the binary number is 1 and the output is one-fourth the reference voltage. A logic 1 on

the most significant of the two bits and a logic 0 on the other equals a 2, which produces an output of one-half the reference voltage. Both bits at a logic 1 level produce an output equal to three-fourths of the reference voltage. By weighting each input in binary fashion, the converter produces equal steps from 0 to three-fourths of the reference voltage. The same pattern holds for the 9-bit converter except the range of output steps is from 0 to 511.

The circuit should double the resistance value down to the end of the chain, but this would require a resistance range of 256 to 1, which creates some real practical problems. By inserting the 1556-ohm series resistance, the total converter network resistance range is limited to only 16:1, a much more manageable figure. The actual choice of resistor values is a compromise between speed and accuracy. The larger the resistance the slower the R-C time constants, and the smaller the resistors the larger the effect of the 250-ohm output resistance of the CD4007's.

Resistors R8 and R9 combine to form a 1.612 megohm resistance. The voltage swing at its upper end has a specific, voltage influence on network output. Resistor R5, the next one in the chain, must have exactly one-half this influence. If we separate R5 from the resistors to its left, we can draw the equivalent circuit shown in Fig. 2. If the circuit is opened at point x, the voltage at that point will change by

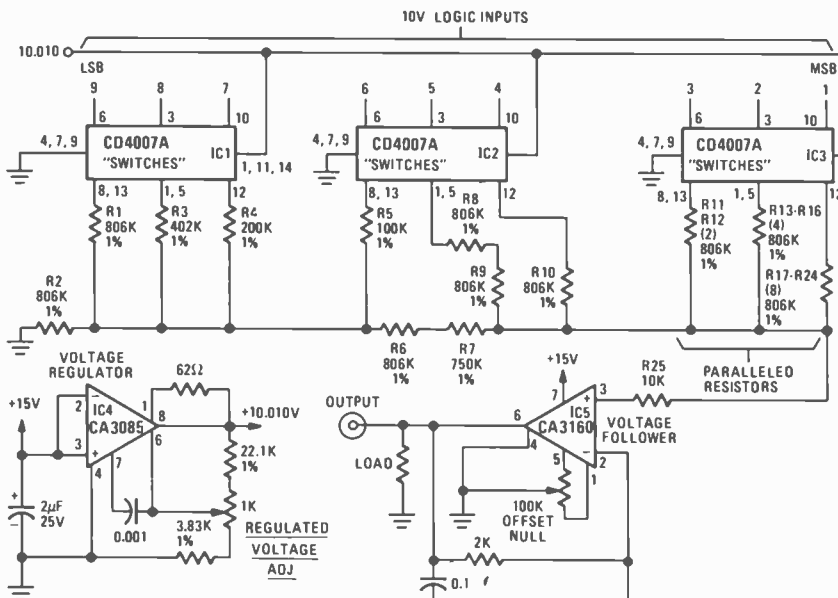

FIG. 1—DIGITAL-TO-ANALOG CONVERTER using the RCA CA3160 as a voltage follower.

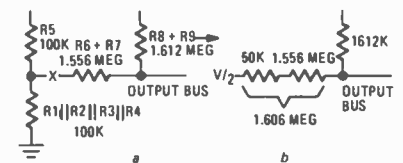

FIG. 2—EQUIVALENT CIRCUIT of the ladder network shown in Fig. 1 is shown in a. Simplifying the equivalent circuit yields the circuit shown in b.

one-half the supply when the top of R5 is switched. The resistance of this circuit is the parallel value of the two 100K resistances, or 50K. Added to the 1556 ohms resistance, the total resistance comes to 1606 ohms, similar to the R8 and R9 resistance.

The ladder network uses 1% metal film resistors. The most significant bits are assembled with parallel and series 806K resistors from the same lot. Paralleling resistors increases the probability of a good match between the components. The regulated voltage is adjusted higher than 10 volts to 10.01 volts to compensate for the loading of R2 to ground. R-E

Attacking the intermittent. *Logic can win the battle.*

JACK DARR, SERVICE EDITOR

INTERMITTENTS ARE THE BANE OF OUR existence. They're responsible for more frustration, bad language, and monetary loss than anything else. Nobody ever made money on an intermittent. There aren't any hard and fast ways of handling them (especially "fast") but there are ways that can help; two of them. You could call them active and passive.

The passive method means "set it up on the bench and let it play till it cuts out." This can take up a lot of time since the stock intermittent will usually play indefinitely on the bench. (I may hold the U.S. record! I watched one set for more than 120 hours without catching it acting up; all summer, in fact.

Since surveys show that long delays in getting sets repaired and returned are a major cause of "consumer complaints" (even more than high service charges!) this method isn't too good.

The active way is best. "Don't just sit there; DO SOMETHING!" Attack it. Intermittents can be classified, and this gives us a place to start. There are two kinds; intermittent shorts or opens. Shorts are a bit easier. They can often be located from the burnt resistors or other signs of damage. Intermittent opens are another thing. They interrupt circuits causing the loss of signal, sync, sweep, and, in the easier ones, a loss of voltage. However, the nature of the fault will lead us to the *function* that is affected.

Intermittents are caused by one of three things:

This column is for the service technician's problems—TV, radio, audio or industrial electronics. We answer all questions submitted by service technicians on their letterheads individually, by mail, and the more interesting ones will be printed here.

If you're really stuck, write us. We'll do our best to help you. Don't forget to enclose a stamped, self-addressed envelope. If return postage is not included we cannot process your question. Write: Service Editor, Radio-Electronics, 200 Park Avenue South, New York, NY 10003

Thermal: some part gets hot enough to open, change value, etc.

Physical: a bad *connection* somewhere that makes and breaks.

Voltage: the least frequent but still possible. Certain voltages go out of tolerance causing trouble. Solid-state sets with automatic hold-down circuits are quite prone to this. Either of the first two things can cause this, so this is really a "subclass "

There is no definite line of demarcation between these, of course. For example, a thermal might be a burnt resistor that is cracked. Thermal expansion can make it open, and it can also be made to act up by jarring the chassis. So, don't freeze on any single attack; be flexible. Use them all at once if necessary!

A "thermal" resistor, in this sense, means one that changes in value when it gets hot. It may even open entirely. This definitely includes those types which are supposed to change, such as thermistors. These may be changing too much or not enough. Now let's see about methods of attack.

Check the *characteristics* of the intermittent fault. If the trouble shows up within the first 8 to 10 minutes of operation, this could be a thermal resistor in a current-carrying circuit. Plate or collector load resistor, etc. The heat that makes it go bad is developed in the resistor itself from the current. This could be called a "conduction" thermal. Such resistors usually heat up enough during the first few minutes to go bad.

If the resistor is used in a "dry" circuit, with practically no normal current-flow, it too can be thermal. In this case, it is heated by radiation of heat from nearby parts or from the chassis. It could be called a "radiation" thermal. (The heat is "conducted" through the chassis, but let's not mention that; we'll be confused enough as it is!)

The main characteristic of such thermals is the much longer time-constant. This is normally at least an hour and may be far longer. These little gems are the ones that act up in the cabinet and just won't show up at all with the chassis out of the case, or even with the back off!

Where to start

Now, to the attack. If the problem shows these signs of being thermal, locate the function or circuit which is affected. For example; the problem is a sudden loss of picture and sound leaving a clean raster. Here we have three suspects; tuner, IF and AGC. Eliminate the tuner by checking with a tuner-substituter. Eliminate the AGC by clamping it. This leaves us with the IF strip. (Unless the previous tests showed that the trouble was in one of the first two. We should be so lucky?)

How do we attack? We've agreed that this shows signs of being thermal. So we heat things up or cool them off to see if we can *make* the problem show up. You can use a heat-gun, such as the Wahl *Thermal-Spot*, to heat up individual parts. You can also hold the tip of a soldering iron on the part long enough to warm it up. If this doesn't make it happen, try the opposite; cool things off with freeze-spray.

These tests are very useful for finding things like thermal transistors, of which there are quite a few. (I have a pet on my bench: At room temperature it works perfectly. Warm it or cool it only a very few degrees, and out it goes, only to come back when it returns to room temperature!)

These things are also useful for finding drifting resistors that cause such things as a gradual loss of vertical sync, color, etc. Heat or cool them while watching the screen. If you do find one, replace it and then check all of the others in the circuit. There may be more than one.

The physical or "jar-intermittent" can be made to show up by jarring the cabinet (the famous "Punt" treatment.) These shouldn't be too hard to find, but of course often are. If you can make it act up by jarring the cabinet, note which function is affected. This tells you where to start. Go to the area of this circuit and start tapping things *very lightly*. Use an insulated tool. Something like a plastic screwdriver is my favorite. You can tap with the end or hit harder with the handle if necessary. The part that is causing the problem will be the most sensitive to tapping. Use a very light touch until you find a place where only a very light tap will make it act up.

Bad solder joints are one common cause. Hairline cracks in PC board con-

ductors are another. (These can *also* be thermal, when the board warms and expands.) Small electrolytic capacitors are another common cause. And do *not* overlook dirty tube-socket or other plug-in contacts. If you can get it pinned down to only a small area but can't *see* the one that is bad (not uncommon), you're justified in "shotgunning" this.

Remelt and add fresh solder to all of the joints in this area. This normally won't involve more than about a dozen at the most. This catches a good many of them though you never know just which one it was. (Who cares?)

The last class involves voltages. If they are high or low, they can cause intermittents. It may be the AC line voltage or one of the DC power supply voltages. A variable-voltage transformer is invaluable here. You can run the AC line voltage up or down to see if this makes the problem show up.

Look for "common-cause" circuitry. For example, many solid-state sets have a regulated low-voltage DC power supply. It feeds the horizontal output stage that in turn develops other low-voltage DC supplies. An intermittent condition in the primary DC supply will cause all of the rest to go bad, apparently affecting a great many circuits at the same time.

In one set, an intermittent Zener clamp in the low-voltage regulator let the output voltage go too high. This made the high-voltage rise, triggering the high-voltage shutdown circuit (which it was supposed to do). In cases like this, always go back far enough to make sure that the fault is not in circuits such as the DC low-voltage regulator and not in the high voltage at all. All of these regulated low-voltage supplies are critical.

All intermittents are annoying, and some can be infuriating. These are the "touchy" ones. The problem shows up; but touch any point in the circuit with a test-lead and it promptly goes back to working perfectly. There is an attack for these, too. One way is to use your scope, but do not make actual contact with the circuit. Hold the probe tip near, but NOT touching, the circuit. By increasing the vertical gain, you can get a pickup pattern and see whether a signal is present at certain points.

Another way is to connect a high-impedance voltmeter to test points, with the power *off*. When the set is turned on, you will be able to see the reading without causing the transient that shocks it back into operation. Still another way is to open the supply circuit and insert a milliammeter or ammeter. The current drain will give you a better idea of the nature of the fault; short or open. Use your ingenuity, and you will find numerous other ways of making tests in cases like this.

I might say in closing that I feel well-qualified to discuss the subject. Right now, my TV is intermittent, my *car* is

intermittent, and I've got a flashlight that's not working all that well. Just as soon as I get this done, I'm going to have to go to work. **R-E**

reader questions

VERTICAL SYNC PROBLEM

Thank you for your suggestions on the vertical sync problem in this Wards Airline GEN-12440A, (Sams 1143). The horizontal sync was good, but the vertical weak. We found both capacitors C406 and C413 open. Replacing them cured the trouble. Now tell me how I got horizontal sync through capacitor C406?—R.S., Littleton, CO.

This is simple. (Note how simple all of these problems are, *after* they're solved.) Both of these are 3.3- μ F electrolytic capacitors. They lose capacitance where a paper capacitor can't; it's either good or open.

Capacitor C406 is the coupling capacitor, and it had enough capacitance left to let the high-frequency horizontal sync get through, though it reduced the vertical sync amplitude. (Vertical sync works on amplitude.) Capacitor C413 is the screen grid bypass on the sync-separator 6GH8, and if it's open, you'll get quite a bit of degeneration and a loss of gain.

AGC PROBLEM

Here's one for your collection. I apparently had AGC problems in this Sears 529.7246 chassis. The set had a raster, but no snow or sound. Adjusting the AGC control had no effect. Checking DC voltages, I found No. 1 B+ source to the tuner read zero. This comes from the cathode of the 50C5 audio output tube. Read this voltage (from underside of chassis) and *it* was zero. Replaced 50C5 tube and still nothing.

Looking at the top side, I saw that the 50C5 and a pair of 12AV6's weren't lit. Since they use a series heater string, I'd assumed that all of the tubes were lit. Turns out that these three are fed through a 300-ohm 10-watt dropping resistor all by their little selves. This resistor is R231, even though the parts lists says C231. It was open and replacing it fixed the set.

Thanks to Joe Witt, of Maxi-Watt Electronics, Vineland, NJ.

RELAYS CHATTER ON PEAKS

Here's one for you on ham gear. I'm trying to drive a Heath SB-230 linear amplifier with a Hallicrafters SR-150 transceiver. This works well in all bands except the 7-MHz band, but here the relays chatter and cut out on voice peaks. Happens only in PTT (Push-to-talk). This must be RF getting in, but so far I can't find it.—F.K., Raytown, MO.

Speaking from a background of almost complete ignorance on actual amateur gear, I can give you a couple of ideas. You noted that the relay driver tube grid varied when the relay chatters. Try connecting a diode from this grid to ground, anode grounded. The idea of this is to clip the negative going peaks of the interfering signal and help hold the plate current steadier. Also, add more bypassing to ground on this grid.

(Feedback: "Tried diode to ground. It works. Fantastic!")

FUSE BLOWS

The 2.5 fast-blow fuse that supplies the +145 volts to the flyback in this Magnavox T982-12, blows within 30 seconds after turn-on. I've changed the horizontal output transistor, tripler and the flyback, and it still blows. It makes a perfect picture till the fuse goes. What's going on here?—B.H., Decatur, GA.

After the things you've changed, nothing. Hi! Seriously, something *else* is causing this, but what? I hunted through the schematic for about 15 minutes and finally came up with a good possible. This same fuse is also connected to a pulse supply that develops +250 volts. This is what took me so long; I couldn't find out where that 250 volts went.

Finally stumbled over it. This is the DC bias applied to the picture tube heater, and nothing else. You have a diode and a couple of electrolytic capacitors in that circuit. If any of these are bad, the fuse could blow; just disconnect the +250 volts and see.

HIGH-VOLTAGE ARCING

The high-voltage arcs all around the back of the picture tube in this Zenith 21X1C36. I can see arcs and flashes all around it. Sometimes the picture goes out of focus and then goes out. I suspect the picture tube but I'm not sure. How can I verify this?—J.H., Houston, TX.

This is one of those "might be the picture tube; might not" things. There *is* one way to tell. Hook the chassis up to a test jig! If you get the same symptoms, this is some kind of oddball problem in the grounding of the dag coating, etc. If this clears all symptoms up, the original is bad.

VOLTAGE-DEPENDENT RESISTOR

Where can I find a VDR used in a Motorola TS-597C? It's the one connected between the +250-volt source and the brightness control. The part number is 6C66263A08. Can't find it anywhere around here, even in the factory parts catalogue!—R.A., Thibodaux, LA.

This VDR can be replaced with an Oneida GB-308. This is rated 1.0 mA at 110-120 volts. This one will also replace an RCA 114862. Oneida parts are available at a lot of radio-TV supply houses. Their address is 853 North Cottage St., Meadville, PA 16335. **R-E**

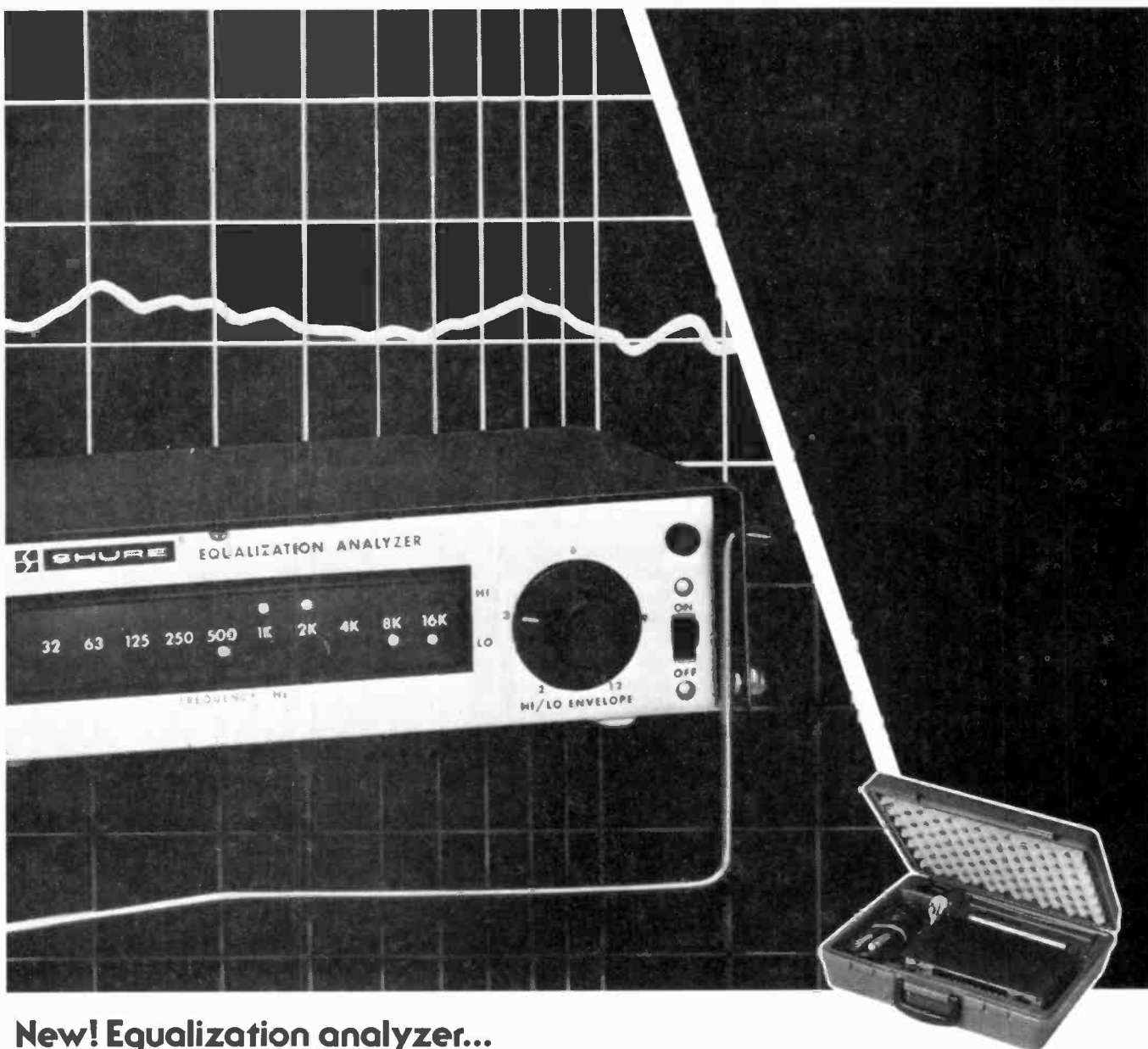

New! Equalization analyzer...

Balance a system...Balance a budget.

Quick and accurate adjustment of sound system frequency response is finally within the reach of most budgets. The Shure M615AS Equalization Analyzer System is a revolutionary breakthrough that lets you "see" room response trouble spots in sound reinforcement and hi-fi systems—without bulky equipment, and at a fraction of the cost of conventional analyzers.

The portable, 11-pound system (which includes the analyzer, special microphone, accessories, and carrying case) puts an equal-energy-per-octave "pink noise" test signal into your sound

system. You place the microphone in the listening area and simply adjust the filters of an octave equalizer (such as the Shure SR107 or M610) until the M615 display indicates that each of 10 octaves are properly balanced. You can achieve accuracy within ± 1 dB, without having to "play it by ear."

Send for complete descriptive brochure AL558.

Shure Brothers Inc.
222 Hartrey Ave.
Evanston, IL 60204

In Canada:
A. C. Simmonds & Sons Limited

TECHNICORNER

The M615 Analyzer's display contains 20 LEDs that indicate frequency response level in each of 10 octave bands from 32 Hz to 16,000 Hz.

A rotary hillo envelope control adjusts the HI LED threshold relative to the LO LED threshold. At minimum setting, the resulting frequency response is correct within ± 1 dB. Includes input and microphone preamplifier overload LEDs. A front panel switch selects either flat or "house curve" equalization.

The ES615 Omnidirectional Analyzer Microphone (also available separately) is designed specifically for equalization analyzer systems.

 **SHURE**[®]

MANUFACTURERS OF HIGH FIDELITY COMPONENTS, MICROPHONES, SOUND SYSTEMS AND RELATED CIRCUITRY.

CIRCLE 69 ON FREE INFORMATION CARD

step by step

Antennas and transmission lines. Improve reception with the right antenna system. STAN PRENTISS

THIS SERIES HAS NEVER DISCUSSED ANTENNA and transmission line characteristics, so a short discussion might be helpful to many—both in and out of the TV business—who are contemplating new installations.

Be assured there's more to retrieving a signal from the air than meets the eye, especially if you take time to ask: What "makes" this or that antenna or lead-in the best? You'll find that worthwhile products can almost always be judged fairly by their manufacturing specifications, especially if the maker has a history of reliability. Manufacturers of the better product lines, of course, usually make detailed specifications, such as antenna polar and gain graphs of transmission-line shielding and loss characteristics, available.

Obviously, prairie and mountain folk 100 miles from the nearest transmitter require antennas with very high gain and the best available 300-ohm "dry" transmission line for maximum signal pickup. Perhaps even a very high mast or tower with variable elevation and directional devices may be in order. The special circumstances and special needs are normally well known in the individual localities and need no discussion here. What we do wish to review and comment upon, however, are the vast numbers of installations within 50 miles of TV stations that probably would respond with a 25- to 50-percent improvement in signal pickup if installers would adhere to solid fundamentals.

Broadcast signals

Broadcast stations are power limited—if you didn't already know—to prevent such problems as co-channel and adjacent-channel interference. In the northeast United States, the VHF stations must begin cutting back power when their towers have risen 1,000 feet above the average surrounding terrain. UHF cutbacks begin at 2,000 feet everywhere, while VHF around the Gulf coast and the remainder of the U.S. can have transmitters reaching 2,000 feet, the same as UHF, before power is curtailed. Broadcast power is also limited to 100 kilowatts for Channels 2 through 6; 316 kilowatts for Channels 7 through 13;

and 5 megawatts for all UHF stations. Stations within 250 miles of the Canadian border are normally limited to 1 megawatt.

Received signals

Television signals between 54 and 890 MHz are broadcast virtually line-of-sight—especially signals in the 470-890 MHz spectrum. This energy consists of electromagnetic waves that are horizontally polarized. The radiator (broadcast antenna) length is inversely proportional to frequency. Naturally, what is broadcast can also be received, but FM and TV receiving antennas are far different from broadcast antennas because they must handle a much broader range of signals and do not require heavy castings for large power dissipation. And while broadcast antennas are very specially de-

signed by teams of highly specialized engineers, receiving antennas may or may not be (depending on the company) so their characteristics are worth looking into. True, you do need structural strength in any receiving antenna to withstand winds of at least 75 MPH, as little wind resistance as possible, exterior coatings that will not succumb to salt spray, soot and other undesirable accumulations which tend to form leakage paths that reduce efficiency and signal pickup. You would also like as many transmission-attracting elements as possible. The *Yagi* is the best example of an antenna using a combination of parasitic and driven arrays. Parasitic elements help supply unidirectional patterns to aid both directivity and selective gain.

Some companies make a *Log Periodic* antenna, whose principles were first discovered by an antenna research group at the University of Illinois in 1954. But it's only been since 1963 that log periodics,

continued on page 86

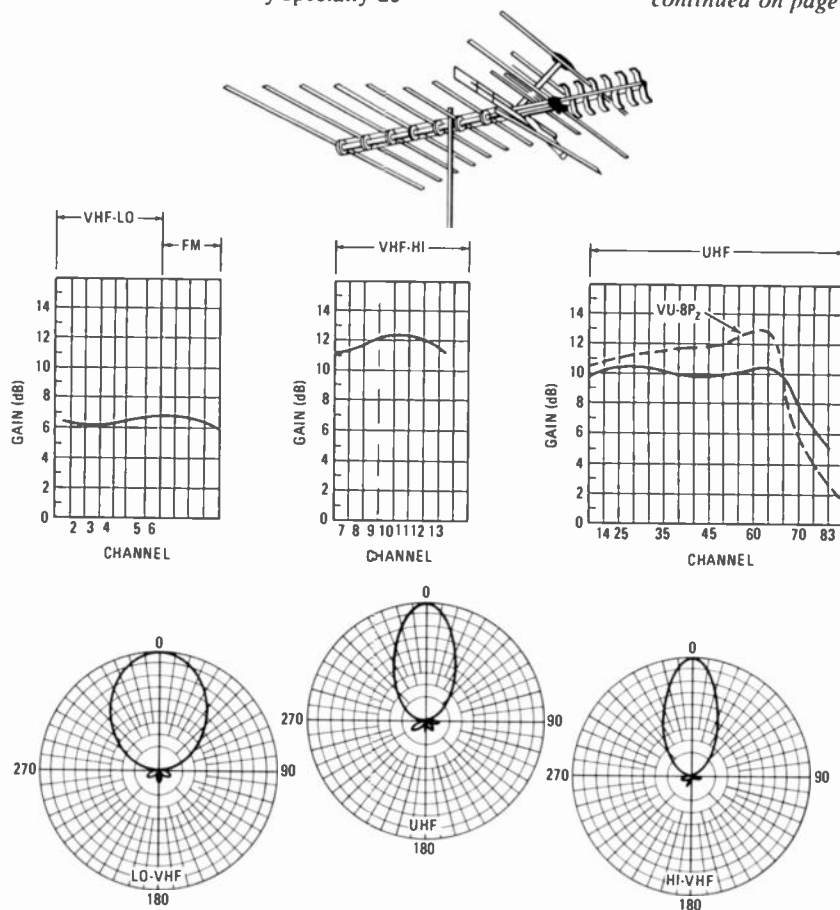

FIG. 1—THREE TYPICAL POLAR PATTERNS for a fringe-area antenna.

An Extraordinary Offer to introduce you to the benefits of Membership in

ELECTRONICS BOOK CLUB

take any **3** of these unique electronics books (value to \$51⁷⁵) for only **99¢** each

with a Trial Membership in the Book Club that guarantees to save you 25% to 75% on a wide selection of electronics books

All two-book sets count as only one of your three Selections.

1080-200 p.—Tower's International Transistor Selector—2nd Edition (\$9.95) 7"×10"



861-252 p.—Display Electronics (\$8.95)

743-224 p.—Electronic Music Circuit Guidebook (\$9.95)

563/636-344 p.—TWO BOOKS—Beginner's Guide to TV Repair & Installing TV and FM Antennas (\$15.90)

800-602 p.—Master Handbook of 1001 Practical Electronic Circuits (\$12.95)

785-294 p.—Microprocessor/Microprogramming Handbook (\$9.95)

754-238 p.—Practical CB Radio Troubleshooting and Repair (\$8.95)

913-476 p.—The Complete Handbook of Electrical & House Wiring (\$10.95)

780/790-350 e.—TWO BOOKS—111 Digital & Linear IC Projects & 21 Simple Transistor Radios You Can Build (\$15.90)

905-294 p.—Build-It Book of Digital Electronic Timepieces (\$9.95)

909-140 p.—How to Build Metal/Treasure Locators (\$7.95)

919-434 p.—Color TV Trouble Factbook—Problems & Solutions (\$9.95)

841-238 p.—Build Your Own Working Robot (\$8.95)

582-444 p.—Commercial FCC License Handbook (\$9.95)

101-416 p.—Electronic Circuit Design Handbook (\$17.95) 8 1/2"×11"

May we send you your choice of these 3 practical, time-and-money-saving books as part of an unusual offer of a Trial Membership in Electronics Book Club?

Here are quality hardbound volumes, each especially designed to help you increase your know-how, earning power, and enjoyment of electronics. Whatever your interest in electronics, you'll find Electronics Book Club offers practical, quality books that you can put to immediate use and benefit.

This extraordinary offer is intended to prove to you, through your own experience, that these very real advantages can be yours... that it is possible to keep up with the literature published in your areas of interest, and to save substantially while so doing. As part of your Trial Membership, you need purchase as few as four books during the coming 12 months. You would probably buy at least this many anyway... without the substantial savings offered through Club Membership.

To start your Membership on these attractive terms, simply fill out and mail the coupon today. You will receive the 3 books of your choice for 10-day inspection. **YOU NEED SEND NO MONEY!** If you are not delighted, return the books within 10 days and your Trial Membership will be cancelled without cost or obligation.

ELECTRONICS BOOK CLUB, P.O. Box 10, Blue Ridge Summit, Pa. 17214

Facts About Club Membership

- The 3 introductory books of your choice carry publishers' retail prices of up to \$51.75. They are yours for only 99¢ each (plus postage and handling) with your Trial Membership.
- You will receive the Club News, describing the current Selection, Alternates and other offerings, every 4 weeks (13 times a year).
- If you want the Selection, do nothing; it will be sent to you automatically. If you do not wish to receive the Selection or if you want to order one of the many Alternates offered, you simply give instructions on the reply form (and in the envelope) provided, and return it to us by the date specified. This date allows you at least 10 days in which to return the form. If, because of late mail delivery, you do not have 10 days to make a decision and so receive an unwanted Selection, you may return it at Club expense.
- Personal service for your account—no computer's used!
- To complete your Trial Membership, you need buy only four additional monthly selections or alternates during the next 12 months. You may cancel your Membership any time after you purchase these four books.
- All books—including the introductory Offer—are fully returnable after 10 days if you are not completely satisfied.
- All books are offered at low Member prices, plus a small postage and handling charge. Prepaid orders shipped postpaid.
- Continuing Bonus: If you continue after this Trial Membership, you will earn a Dividend Certificate for every book you purchase. Three Certificates, plus payment of the nominal sum of \$1.99, will entitle you to a valuable Book Dividend of your choice which you may choose from a list provided Members.

ELECTRONICS BOOK CLUB

P.O. Box 10
Blue Ridge Summit, Pa. 17214

Please open my Trial Membership in ELECTRONICS BOOK CLUB and send me the 3 books circled below. I understand the cost of the books I have selected is only 99¢ each, plus a small shipping charge. If not delighted, I may return the books within 10 days and owe nothing, and have my Trial Membership cancelled. I agree to purchase at least four additional books during the next 12 months, after which I may cancel my membership at any time.

101	563/636	510/628	582	743
780/790	754	785	800	841
861	905	909	913	919
			1010	

Name _____ Phone _____

Address _____

City _____

State _____ Zip _____

(This offer valid for new Members only. Foreign and Canada add 10%) RE-97

CIRCLE 39 ON FREE INFORMATION CARD

with their different length dipoles—each half-wave resonant at its own specific frequency—have been used extensively in consumer electronics. In the graphs of Fig. 1 you will note gains of 6 dB (as compared with a folded dipole—since an antenna has no actual gain of its own) for the low VHF band (and FM), between 11 and 12 dB for the higher VHF band, and a nominal gain of 10 dB for UHF channels 14 through 68. (Channels 69 through 83 are now ordinarily used only by translators and land mobile.) Now, take a quick look at the polar patterns (shown in Fig. 1) with their large front lobes and small side and back lobes and let's investigate these. An example will help illustrate what we mean.

Polar patterns

The polar pattern in Fig. 2 is drawn in 90-degree quadrants with the three inside circles representing 3, 10, and 20-dB losses. The 3-dB half-power point occurs about 15 degrees on either side of zero (the antenna's front lobe beamwidth is 30 degrees). That's what the antenna "sees" when pointed toward a transmitter. Obviously, this is somewhat narrow, and a beamwidth of 60 degrees would be more appropriate for metropolitan or suburban reception.

The real problems with this pattern are the back and side lobes that deliver a front-to-back ratio of only 13 dB—not especially good; 20 dB would be considerably more satisfactory. Unfortunately, these side lobes permit interfering frequencies (including ghosts) to enter almost the entire back area of the array, with only the area between the forward horizontal 35- and 90-degree markers free from spurious signals because of antenna rejection. In the broad, composite patterns of Fig. 1, the front-to-back ratio is at least 20:1 (26 dB), with insignificant back lobes, and beamwidths that range from some 60 degrees in the low VHF band, to about 30 degrees in the high VHF and UHF bands where directivity is somewhat more important.

Surprisingly, the characteristics in Fig. 2 are not all that bad. For had this pattern been broadened to at least a 60-degree beamwidth, it would probably make a good metropolitan antenna if there were no tall buildings or hills to induce reflected images. So tailoring an antenna for each location can not only improve your installation immensely, but often save the customer considerable cash when elaborate antenna systems are not needed. Of course, if you're right next to some television broadcast or other interfering transmitter, you'll have to use a high gain, narrow beamwidth antenna with rotor and, perhaps, pad it resistively to reduce excess gain. In any circum-

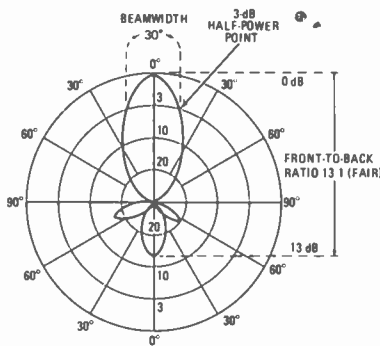

FIG. 2—30-DEGREE BEAMWIDTH ANTENNA, with rather large side and rear lobes.

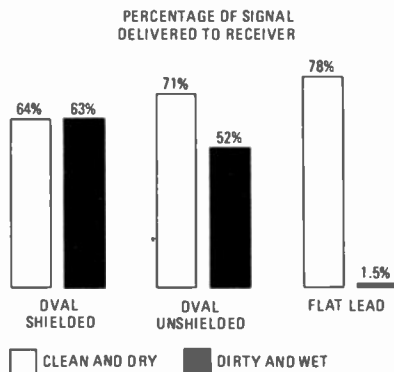

FIG. 3—TRANSMISSION LINE EFFICIENCY, for shielded and unshielded types. Note that the best line when dry is the worst one wet.

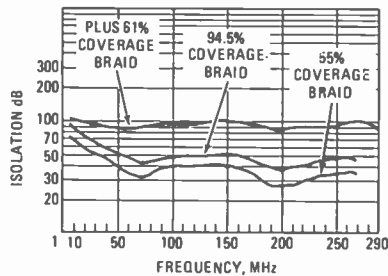

FIG. 4—DIFFERENCES IN ISOLATION for three types of shielding. Bottom, 55% coverage braid; middle, 94.5% coverage braid; top, dual-foil laminate plus 61% coverage braid.

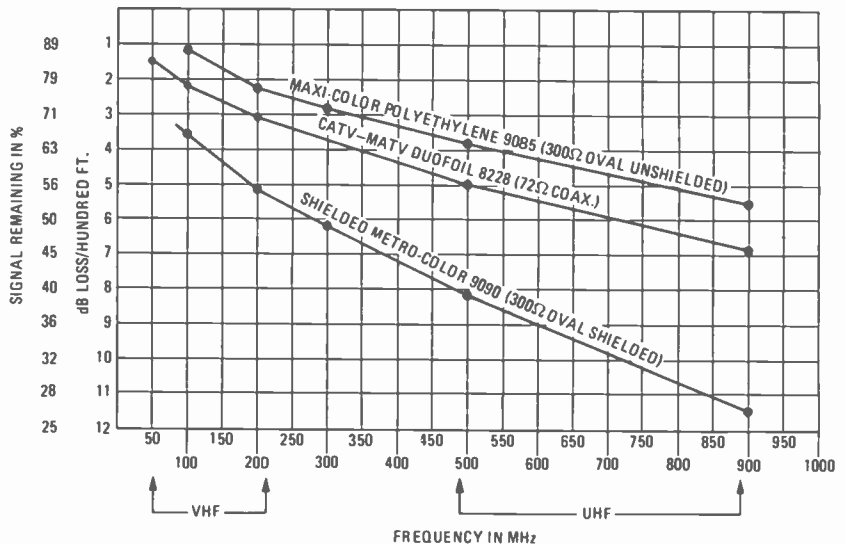

FIG. 5—LOSSES IN TRANSMISSION LINES. Top, low-loss oval unshielded line; middle, low-loss shielded 75-ohm coax; bottom, high-quality shielded 300-ohm lead. Characteristics of the 9283 are similar to those of the 8228 (middle curve).

stances, know your area characteristics, consult the manufacturer's gain and polar patterns, and install an antenna that is adequate for the particular location. Don't guess!

Transmission lines

Just as important as antennas are transmission lines; if the two aren't matched, the resulting standing-wave ratio (SWR) can generate unacceptable losses, line interference and all sorts of nasty signal reflections and attenuation. SWR—for your information—is the difference (quotient) between the maximum and minimum currents (or voltages) across any single or multiple conductor. The incident (outgoing) and reflective (incoming) signals will form stationary valleys and energy peaks to distort incoming information one way or another. Certainly the best insurance against a high SWR is to terminate the line in its characteristic impedance, so no energy will be reflected back from load to source. Therefore, both antenna and receiver should always present a correct impedance match to any and all transmission lines.

Unfortunately, not all transmission cables are alike, as is evident in Fig. 3. This chart shows both shielded and unshielded 300-ohm lead-in characteristics under dirty-wet and good-dry conditions. Note that flat lead when old and wet is a drastic attenuator and really should be used only indoors, being especially vulnerable when allowed to lie on metal, gutters, or roofs. Adequately shielded cable can touch other objects, but should not be permitted to contact rooftops or other places that collect either water or dirt.

Coaxial cable versus twin lead is an old subject of discussion that often fails to take into consideration so many of the

continued on page 88

The J.M.J. DIGITAL DISPLAY BEZEL FOR APPEARANCE AND PERFORMANCE!

Now you can add a truly professional appearance to your digital projects and improve their performance as well. . . With the JMJ BEZEL. It will vastly improve the readability of the display and put a finishing touch on any front panel. And that's important, for obviously, the display is the most looked-at feature on any piece of digital equipment.

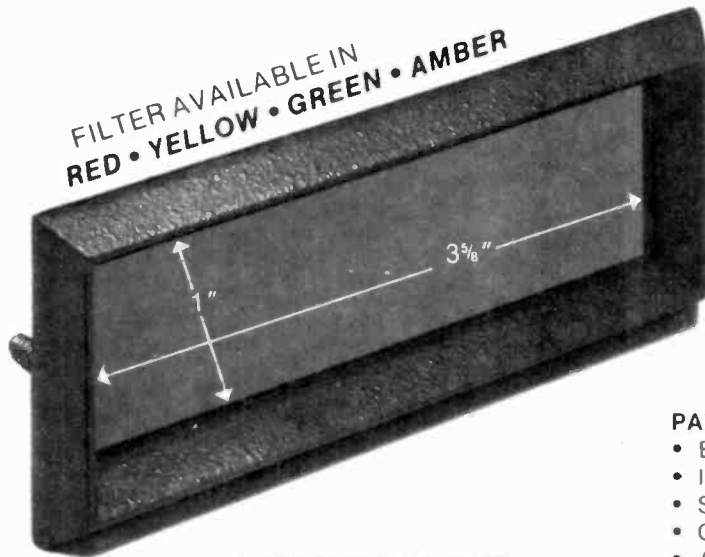

UNIVERSAL SIZE
HANDLES MOST REQUIREMENTS

\$4.95 EACH

(Please order by color)

PATENTED CHROMAFILTER® SCREEN

- Eliminates glare and reflections
- Improves contrast and readability
- Scratch resistant—easily cleaned
- Out-performs circular polarized types
- Available in four colors

DIE CAST METAL FRAME

- Nonreflective black finish
- Durable—heat resistant
- Integral 6-32 mounting studs
- No exposed hardware
- Mounts in panels up to 3/16" thick
- Includes all hardware and a special template for easy installation.

® Panelgraphic Corp., W. Caldwell, N.J.

DEALERS INQUIRIES INVITED

ATTENTION CLOCK BUILDERS

Adapters for mounting clock modules and clock displays directly to the JMJ-BEZEL. Assures perfect alignment and simplifies mounting (*Please Order by Number*).

\$.69 ea.

ADAPTER #1 (Fits the following)

National	Liton	Texas Inst.	Bowmar
MA 1001	LT 601	TIL 364	Opti-Stick
MA 1002	LT 442	thru	
NSB5917	LT 446	TIL 372	
NSB5921	LT 447		
NSB5922			

ADAPTER #2 (Fits the following)

National	Liton
MA 1010	LT 701
MA 1012	
MA 1013	

ADAPTER-3 (Universal Mount) For mounting any PC Board to the JMJ-BEZEL (Requires two mounting holes in PC Board).

TERMS: Minimum Order \$4.95
Add \$1.00 for Postage & Handling
N.J. Residents Add 5% Sales Tax
Send Check or M.O. — No COD's

NAME		
ADDRESS		
CITY	STATE	ZIP
___ J.M.J. BEZELS at \$4.95 EA. (COLOR: _____)		
___ ADAPTERS at \$.69 EA. (NUMBER: _____)		
POSTAGE & HANDLING		1.00
5% N.J. SALES TAX		
AMOUNT ENCLOSED		
J.M.J. TECHNICAL PRODUCTS, INC. BOX 26, KENDALL PARK, N.J. 08824		

CASTLE

THE TUNER PIONEERS

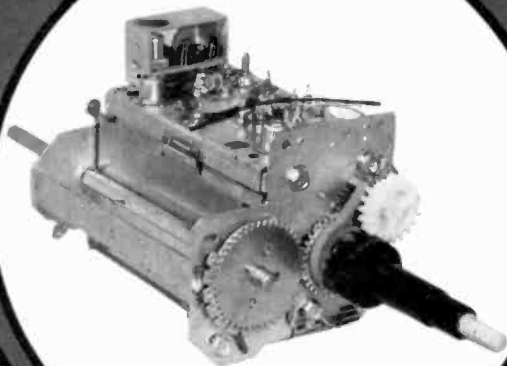

**Professional
Expertise Backed
By 25 Years Of Tuner
Service Experience . . .**

Castle has been in the business of repairing TV tuners longer than anyone. When you send your customers' defective tuners to Castle, you can be assured of receiving reliable, quality service.

Each tuner is ultrasonically cleaned. Our technicians analyze the defects, document the repair performed and return the tuner to you in a protective package. Workmanship and parts are backed by a one year limited warranty.

Consider Castle's Services

**TUNER REPAIR
\$12.95**

Any make or model. Tubes and transistors extra. Send defective tuners directly to Castle. Remove all accessories.

U/V COMBO... \$20.95

**CASTLE REPLACEMENT TUNERS
\$17.95**

In-stock replacement tuners, engineered by Castle for a wide variety of makes and models, provide original or improved performance. Purchase outright—no exchange required.

**TUNER EXCHANGE/REBUILDING
VHF \$21.95 UHF \$17.95**

When the original tuner is unfit for repair and a stock replacement is not available, the tuner can be exchanged for an exact replacement, rebuilt to original specifications, or tailored to a custom order.

All prices are f.o.b. our plant.



CASTLE TUNER SERVICE

CHICAGO, IL 60645
5744 North Western Avenue
Phone 312-728-1800

SAN JOSE, CA 95112
466 Reynolds Circle
Phone 408-289-1117

CIRCLE 63 ON FREE INFORMATION CARD

STEP BY STEP TROUBLESHOOTING

continued from page 86

new advances in transmission line use and construction. The Belden Corp., for instance, has recently developed an outstanding new CATV drop cable, the 9283, consisting of polyester film with aluminum foil bonded to the polyester core, and either a tinned copper or aluminum braid cover. Belden's tests (Fig. 4) show that with aluminum inner foil laminate plus 61 percent braid cover, there is 100-dB isolation from external interference. The cable, of course, is usable for home TV installations as well as CATV. There's a little cost differential, but the price spread between the *best* 300-ohm line and this cable isn't overwhelming either.

Figure 5 shows the attenuation characteristics (both the dB loss and percentage of signal remaining) for comparable 8228 cable (without the addition of extra braid), as compared with both unshielded and shielded 300-ohm standard TV transmission lines. Note that the 8228 cable is within approximately 1.5 dB of Belden's best unshielded—the 9085—over the entire frequency range. (Losses of the 9283 are almost identical with those of the 8228.) Then add 0.5 dB for each top (antenna) and bottom (receiver) matching transformer (balun), and you have a difference total of 2.5 dB. Will this do your metropolitan-suburban job of keeping interference to a minimum as well as passing excellent signals? Try it within 50 miles or less of the transmitter and you will be more than pleasantly surprised. Further, the total electromagnetic field will be contained in the coax; SWR will be low because of the matching transformers, and you'll have considerably better UHF and improved VHF reception as a result. **R-E**



"Uncle Bill, Mother, Sis! Let us have our honeymoon before Fred gets to your TV sets!"

HOBBY CORNER

continued from page 73

You will notice that nothing has been said about a circuit being bad in the first place. That's because everything you see in this column has been checked out and built at least on a breadboard. *Any exceptions will be clearly marked "UNTESTED."*

Iron temperature control

Do you have a light dimmer or motor speed control on your workbench? Of course, it's handy for slowing down the drill or grinder when working in soft materials such as plastic. But at our workbench the soldering iron is usually connected to it.

Just having one all-purpose soldering iron instead of two or three for various uses can cause trouble with many solid-state circuits because excess heat can quickly ruin a part or even a circuit board. However, you can keep your iron at just the right temperature with a dimmer/speed control.

The control shown in Fig. 5 can be assembled quickly and easily. Be sure to provide a good heat sink for the triac. Although the 6-amp unit specified can readily handle any normal electronics iron, you might want to use the control with something heavier.

Once you use the dimmer/speed control with your iron you'll find you destroy fewer parts and boards and your iron and tip will last longer.

New CB guide

For beginning CB'ers, Radio Shack has published a second edition of *All About CB Two-Way Radio* (RS #68-1046). This updated nontechnical guide covers such topics as how CB got started, types of radios and antennas, how to set up fixed and mobile stations, FCC rules and regulations and plenty of ideas on using CB. **R-E**

Please remember that we want to hear from you—your needs, suggestions, ideas and circuits. Drop us a note. *73, Doc*



"Hey, Ed. He says he's your Uncle Charlie about a 10-30."

TESTING CB RADIOS

continued from page 53

completely during a noise pulse become apparent by their vastly improved performance over simple noise clippers.

22. Audio Output Power. At the level at which the audio output contains 10% distortion or full volume, whichever is greater, we will measure the AC voltage across the speaker terminals and, using the speaker's characteristic impedance, calculate the audio power in watts.

23. Public Address Output Power. We measure the power in watts directly into 8 ohms at the P.A. jack.

24. Power Drain. Measured in 6 watts at nominal line voltage in receive mode with audio squelched off.

The tests **Radio-Electronics** will use as a part of our CB Equipment Reports are conducted by an independent testing laboratory using the highest quality test equipment. We will from time to time add new tests if they are needed to rate as yet unknown features and delete those tests that do not seem important any longer. We will test at least two transceivers each month and may review an important new accessory occasionally if it requires a technical critique that fits our format. The actual tests will be performed on equipment supplied to us by the respective manufacturer and it is expected that they will be representative of the models in production. **R-E**

COMPUTER CORNER

continued from page 79

conclusion that the temperature sensor has changed from at or below the setpoint to above the setpoint (logic 0 to logic 1 transition).

The reason that such a series of logical operations is performed is to determine what type of corrective actions to apply to the system if it is not operating properly. If the temperature is below its setpoint, a heater may have to be turned on. If the concentration of a reactant is too high, valve B may have to be turned off to temporarily halt the flow of reactant into the system. If the pressure is above the setpoint, an emergency condition may exist and the power may have to be turned off for the entire system. With a properly interfaced microcomputer, all such decisions are easily and quickly made under software control and the necessary corrective actions initiated. However, mechanical and electromechanical devices typically have response times that are much longer than the decision times for a microcomputer. These response times must be taken into account in software design, and are important considerations in the field of digital controls. A discussion of response times is beyond the current scope of this column. **R-E**

REFERENCES:

1. GRAF, R. F., *Modern Dictionary of Electronics*, Howard W. Sams & Co., Indianapolis, 1972.

Autoranging Frequency Counting to 60 MHz with 1Hz Resolution



B&K-PRECISION MODEL 1801 \$200

- For laboratory, production line or maintenance applications
- Automatic ranging, 20 Hz to 40 MHz is guaranteed... readout to 60 MHz is typical
- Reliable TTL circuitry updates the six-digit display five times per second
- Resolution to 1 Hz obtained by suppressing digits above 1 MHz when switching to 1 SEC mode



MHz display of
3.579548 MHz input (AUTO mode)

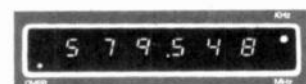

KHz display of overflow of
3.579548 MHz input (1SEC mode)

- Available for immediate delivery, from local B&K PRECISION distributors
- 10-day free trial offer

B&K PRECISION
DYNASCAN
CORPORATION

6460 West Cortland Avenue
Chicago, Illinois 60635 • 312/889-9087

In Canada: Atlas Electronics Ontario
Intl. Sys. Empire Exp. 270 Newtown Rd. Plainville, LI, NY 11803

CIRCLE 61 ON FREE INFORMATION CARD



TUN-O-POWER OUTLASTS 3 CANS OF ORDINARY TUNER SPRAY



AND TUN-O-POWER KEEPS TUNERS WORKING BETTER, LONGER!

A one second blast of TUN-O-POWER has more cleaning and lubricating power than a three to five second blast of any ordinary tuner spray. That's why one can of TUN-O-POWER outlasts three cans of ordinary spray.

DRY TEFLON MAKES THE DIFFERENCE

Economy isn't TUN-O-POWER's only advantage. It works better too. Ordinary tuner cleaner-lubricants are made with petroleum based grease. Grease attracts dust and gums up.

TUN-O-POWER is made with dry TEFLON. It keeps contacts clean and corrosion-free, while maintaining smooth-as-silk detent action.

Try it. You'll love it.

CHEMTRONICS
INCORPORATED

45 HOFFMAN AVE., HAUPPAUGE, N.Y. 11787 • (516) 582-3322

CIRCLE 73 ON FREE INFORMATION CARD

new books

INTERFACE INTEGRATED CIRCUITS HANDBOOK, National Semiconductor Corp., 2900 Semiconductor Drive, Santa Clara, CA 95051. 464 pp. 6 1/4 × 9 in. Softcover \$4.00.

This handbook gives specifications on the complete line of interface products—peripheral/power drivers, level translators/buffers, line drivers and receivers, memory and clock drivers, sense amplifiers, display drivers and optocouplers. The text is supported by graphs, charts and diagrams. Also included is a 72-page section of application notes on such topics as transmission lines, data transmission and high noise environments and driving gas discharge, and LED displays.

NOVICE AND GENERAL CLASS AMATEUR LICENSE Q & A MANUAL, by Marvin Tepper. Hayden Book Co., Inc., 50 Essex St., Rochelle Park, NJ 07662. 182 pp. 6 × 9 in. Softcover \$6.35.

The ideal guide for anyone preparing to take an FCC Novice, Technician, Conditional or General Class amateur radio licensing exam. The book is brief and has FCC-type answers for each question and then explains most answers in detail. There are also chapters on the types of amateur licenses, FCC exam procedures, schedules, fees and locations, how to learn code, how to take the code in written exams, how to operate an amateur radio station and the latest FCC rules and regulations.

CB TESTING

continued from page 53

completely during a noise pulse become apparent by their vastly improved performance over simple noise clippers.

22. Audio Output Power. At the level at which the audio output contains 10% distortion or full volume, whichever is greater, we will measure the AC voltage across the speaker terminals and, using the speaker's characteristic impedance, calculate the audio power in watts.

23. Public Address Output Power. We measure the power in watts directly into 8 ohms at the P.A. jack.

24. Power Drain. Measured in 6 watts at nominal line voltage in receive mode with audio squelched off.

The tests **Radio-Electronics** will use as a part of our CB Equipment Reports are conducted by an independent testing laboratory using the highest quality test equipment. We will from time to time add new tests if they are needed to rate as yet unknown features and delete those tests that do not seem important any longer. We will test at least two transceivers each month and may review an important new accessory occasionally if it requires a technical critique that fits our format. The actual tests will be performed on equipment supplied to us by the respective manufacturer and it is expected that they will be representative of the models in production.

R-E

burglar-fire alarm catalog

FREE!

MORE THAN
900 PRODUCTS

detectors,
controls,
sounders,
locks,
tools



EVERYTHING NEEDED TO PROTECT HOME, BUSINESS, INSTITUTION

Huge selection of high quality professional alarm products. 64 fact-filled pages with detailed specs, diagrams, technical notes.

Products range from basic switches, controls, bells, sirens to most sophisticated detectors — radar, modulated or passive infrared, microwave, ultrasonics, ion, data links using pulse code multiplex, FSK radio, automatic phone dialers, leased line connections and display panels. Full selection of tools, relays, wire, foil, terminals, books.

WRITE FOR FREE CATALOG TODAY!

(Outside U.S., send \$1.00.)



mountain west alarm
box 10780 • phoenix, az 85064

(602) 263-8831

CIRCLE 21 ON FREE INFORMATION CARD

**"My father built this
Schober Organ
for me!"**



You'd be proud to buy her an organ this good...but how would you feel if you'd also built it? It's a special kind of satisfaction. The gift of a lifetime of magnificent music, crafted with your own hands!

And you can do it! You need no prior electronic or mechanical abilities. Just the capacity to follow instructions. Every step is clearly detailed, every component is supplied. You'll find the assembly process as enjoyable as the music which follows!

And what music! For this is a truly fine instrument you will build. Far superior to most 'ready-made' organs...easily comparable to others at twice the price. Kit costs range from \$650 to \$2850 for all basic components, and you can purchase it in sections to spread costs out...or have two-year time payments.

Just send the coupon for the fascinating Schober color catalog (or enclose \$1 for a record that lets you hear as well as see the quality of Schober).

The Schober Organ Corp., Dept. RE-166
43 West 81st Street, New York, N.Y. 10023

Please send me Schober Organ Catalog.
 Enclosed please find \$1.00 for 12-inch L.P. record of Schober Organ music.

NAME _____

ADDRESS _____

CITY _____ STATE _____ ZIP _____

CIRCLE 32 ON FREE INFORMATION CARD

RE TESTS EPICURE PR-4

continued from page 69

tation before it becomes response-limited. This power bandwidth (at 7 volts RMS output) translates to a slew-rate of 4.8 volts-per-micro-second. Design has stressed minimization of transient intermodulation, and subsequent bench and listening tests attest to its success.

Laboratory measurements

Table I summarizes the results obtained in measuring the performance of the *model PR-4*. Distortion at rated output was so low that our readings were undoubtedly influenced by the residual test-oscillator distortion.

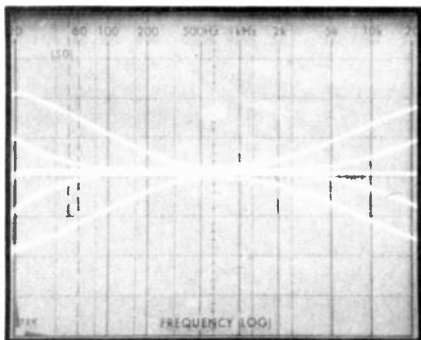

5

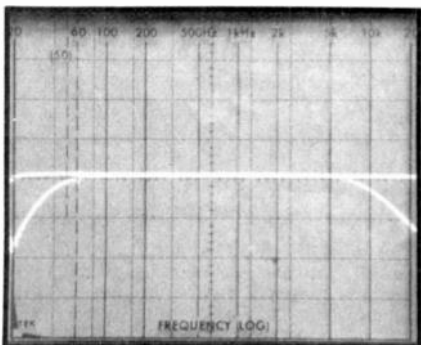

6

The overload readings obtained for the phono input, although short of the 150 mV claimed, are actually referred to an input sensitivity of 1.5 mV. Translated to the more usual 2.5-mV input sensitivity of most phono input stages, the overload capability increases to around 133 mV and, referred to the *model PR-4*'s least sensitive phono input settings, the figure becomes 175 mV.

The dual ranges of the BASS and TREBLE tone controls were plotted using our spectrum analyzer; results are displayed in Fig. 5. Low- and high-cut filter action is similarly plotted in Fig. 6. As for the signal-to-noise ratio in phono, our measurements are referred to a 1.5-mV input, whereas the published specification is based on a 5.0-mV input.

Summary

The overall product analysis of the Epicure *model PR-4* is found in Table II. In actually using the preamplifier for listening and tape recording, we were pleased to see that the mode pushbuttons do not affect the tape outputs, so that signals available for recording are always stereo, even if a mono pushbutton is selected via the front panel. When this preamplifier was used together with a direct-coupled power amplifier, the transient response was extremely good and phono equalization was just about perfect.

R-E



Before
you buy
stereo
headphones,
get
some
good
advice.

Theirs:

Julian S. Martin

HI-FI STEREO BUYERS' GUIDE, March-April, 1976

"Superb from every viewpoint. An outstanding achievement in headphone design. One of the most comfortable."

The Len Feldman Lab Report

TAPE DECK QUARTERLY, Winter, 1975

"Response of these phones extends uniformly from 20 Hz to over 22,000 Hz with no more than ± 2 dB variation over this entire range...this is nothing short of incredible."

New Equipment Reports

HIGH FIDELITY, January, 1976

"The sound quality the AT-706 presents [to you] is exceptional: very wide range and smooth...Within this excellent operating range the sound is exceedingly clean and open...an extremely fine stereo headset."

If you asked the critics they'd tell you to listen critically to a variety of products before you buy. We agree. Because the more carefully you listen, the more you'll be impressed by the sound of Audio-Technica.

AT-706

Electret Condenser

Stereo Headset \$129.95

Our finest Personal Transducer



audio-technica

® INNOVATION □ PRECISION □ INTEGRITY

AUDIO-TECHNICA U.S., INC., Dept. 97E, 33 Shiawassee Avenue, Fairlawn, Ohio 44313
Available in Canada from Superior Electronics, Inc.



RECYCLE YOUR DUDS

9 OUT OF 10 TV SHOPS HAVE THEM!

DOES YOURS?

TV modules are doing little more than collecting dust in service shops all over the country. Check your shop! Whether you have one or 101, they are worth good money. PTS wants to buy or trade your TV modules for instant cash or credit!

CREDIT: With each tuner you send to any PTS Servicenter for repair, include one TV module and get a \$4 credit toward your repair charges.

CASH: If you have a quantity of TV modules, send us a list of brand and model numbers and we'll advise you of the value . . . for instant cash!

Acceptable brands are Admiral, GE, Magnavox, Montgomery Ward, Philco, Quasar, RCA, Sears/Warwick, Sylvania and Zenith. Do not include ceramic encapsulated, broken or cannibalized modules. PTS reserves the right to reject any or all modules.

For your convenience, PTS has more than 44 company-owned servicenters.

PTS ELECTRONICS, INC.
PRECISION TUNER SERVICE
P.O. BOX 272 • BLOOMINGTON, IN 47401 • 812-824-9331
CIRCLE 62 ON FREE INFORMATION CARD

RF SIGNAL GENERATORS

continued from page 58

band. The fine control may be mechanical or electronic. The method of tuning may be of concern if the requirement for extreme frequency settability exists. An electronic vernier or a direct coupled variable capacitor vernier provides the lowest backlash method of fine frequency adjustment. The indicated difference between the two dial points required to get the same frequency when tuning from opposite directions is referred to as backlash. It makes setting an exact frequency quite difficult. Backlash can make it impossible to set a frequency at the same point on the dial when increasing frequency as when decreasing frequency.

A fine frequency control which is simply an edge-drive on a large coarse frequency control, or other forms of mechanical frequency vernier are much more inclined to have a high degree of backlash.

Frequency accuracy and readout

The expected accuracies, specified as a percentage of reading on band-switched LC oscillators, do not vary widely and figures such as $\pm 4\%$ are found on the lowest-cost generators, and only $\pm 1\%$ on some of the best. Frequency readout on such generators is normally on a circular or slide-rule dial. Each band has its own calibration. Dial calibration takes care of stray capacitance and inductance that may affect calibration.

If the generator has a digital readout, calibration accuracy becomes entirely different. The designer is no longer dependent upon the repeatability of various capacitors. The accuracy now becomes the accuracy of the digital frequency meter. This is almost entirely the accuracy of the crystal time base. Typical accuracies for digital frequency meters installed in RF signal generators are in the area of plus-minus one part per million ($\pm 0.0001\%$). This results in approximately a ten thousandfold increase in accuracy.

Frequency stability

The frequency-stability specification covers a multitude of small variations. Each of the various frequency stability specifications presume independence from the effects of any other specification. Therefore, the total frequency stability specification of the generator must take into consideration the actual operating environment and not just any one single spec.

Frequency stability is normally defined for five different conditions. The two major ones are time and temperature. Stability with respect to time may be given for both short interval (10 minutes) and long interval (a few hours). It is usually given as a percentage of

Want to cut out a career as a two-way radio technician?

MTI offers the only training for professional FM two-way radio available. Qualified technicians are employed in government, industry, and public service. But training is your key.

You could cut out a career as a two-way radio technician by cutting out this coupon. We'll send you information on how you can learn more about this specialized field, at home.

Name _____

Address _____

City/State/Zip _____

I am a veteran or serviceman on active duty. JJ3



formerly

MOTOROLA TRAINING INSTITUTE

College Hill, Summerdale, Pennsylvania 17093

CIRCLE 37 ON FREE INFORMATION CARD

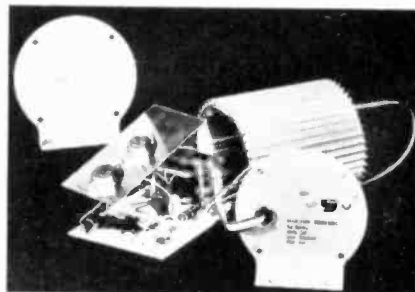

FROM KIT TO CAR IN 80 MINUTES!

Electronic ignition is "in." Update your car with the TOPS in power, efficiency and reliability — the TIGER SST capacitive discharge ignition (CD).

The TIGER delivers everything other CD's promise — and more: quicker starting, more power, more gas mileage, tune-ups eliminated, lifetime plugs and points, reduced repairs and pollution.

The TIGER can be built and installed in your car in 80 minutes. The TIGER is unique!

The TIGER comes with a switch for TIGER or standard ignition for 12V negative ground only.

Simpli-Kit \$21.95

POST PAID U.S.A.

WE ACCEPT:
Mastercharge or BankAmericard.
Send check or money order with order to:

Tri-Star Corporation

DEPT. FF, P.O. Box 1727
Grand Junction, Colorado 81501

CIRCLE 8 ON FREE INFORMATION CARD

frequency setting per unit time. Drifts of 50 PPM/10 minutes are common on older generators with an order of magnitude improvement on newer generators. Long-term drifts may lie between 1 kHz and 10 kHz per hour for older generators. Once again, an order of magnitude improvement may be expected from newer generators.

Temperature stability is given as a percentage per degree centigrade. One degree centigrade is approximately 2°F at normal working conditions. The practical concern is change in frequency for change in temperature, rather than change in absolute calibration.

Two less important specs covering frequency stability indicate percentage frequency change due to load changes, and due to line voltage changes. The band-switched LC oscillator often includes a stability specification for the time interval immediately following bandswitch operation. This specification may be read as a settling time.

Like all other specifications, these improve with generators of greater cost and lessen with generators of lower cost. On low-cost generators the specifications are frequently omitted.

Resettability

The resettability specification indicates the percentage of desired frequency to which a generator may be returned if it is set back to the same mark on the dial.

Amplitude range

Amplitude range is usually specified in both voltage and dBm. The minimum amplitude of generator output determines the suitability for testing radio receivers. There are few receivers that do not require a generator output that is substantially less than 1 μ V (frequently as low as 0.1 μ V) for making sensitivity checks. Simple receiver alignment and basic troubleshooting may be carried out at levels considerably in excess of the 1- μ V level.

As noted, the output level specifications are usually given in both volts across 50-ohms and dBm (decibels relative to 1 milliwatt). Zero dBm is 223.6 mV, 1 μ V is -127 dBm, and 0.1 μ V is -127 dBm. The maximum obtainable signal from a signal generator varies from 100,000 μ V (0.1 volt or -7 dBm) to 3 V (+22 dBm). A maximum output of 1 V or +13 dBm is common.

The variation in output level is often a function of both price and frequency. VHF generators offer 1 V in modern designs and 100,000 μ V output is common on older designs. HF generators usually offer a 3-V output on medium and upper price generators. Levels in excess of 100,000 μ V are usually not necessary for radio receiver servicing. The high output levels may be required for research work or situations where

continued on page 100

MEET OUR FAMILY of GRABBERS



MODEL 4233 MICRO GRABBER
Tests high density packaging



MODEL 3925 MINI GRABBER
Tests conventional packaging



MODEL 4011 THREADED GRABBER
Accepts 6-32 threaded leads

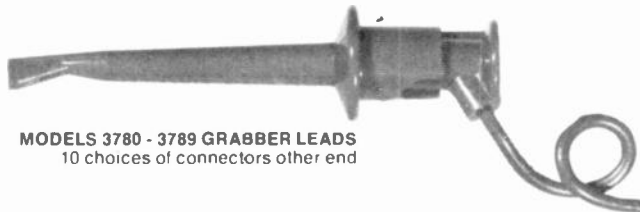

MODELS 3780 - 3789 GRABBER LEADS
10 choices of connectors other end



MODEL 4225 MAXI GRABBER
Tests high rise packaging

All Grabbers shown actual size

Our Grabber family is five years old now, and we're adding new members to keep pace with the complexities of state-of-the-art electronic packaging. Grabber is our name for a series of test clips designed to simplify testing of electronic packages from conventional components to maximum density DIP's. They're rugged, dependable, versatile, and very easy to use. Write for our catalog and get the complete story on the whole family of Grabbers. Find out why they are your best solution to your electronic testing problems.

**AVAILABLE THROUGH YOUR
FAVORITE ELECTRONIC
PARTS DISTRIBUTOR**

ITT POMONA ELECTRONICS

1500 East Ninth St., Pomona, Calif. 91766
Telephone (714) 623-3463. TWX: 910-581-3822



CIRCLE 57 ON FREE INFORMATION CARD

new products

More information on new products is available from manufacturers of items identified by a Free Information number. Free Information Card follows page 108.

40-CHANNEL AM/CB TRANSCEIVER, model Malibu 40, is a rugged, economical set suitable for installation in commercial and pleasure vehicles. Features phased-locked-loop circuitry, 4-



pole ceramic bandpass filter, easy-to-read channel numbers, microphone, adjustable squelch and volume controls, and backlit RF power-out/"S" meter. Suggested price: \$159.95.—SBE, Inc., Dept. P, 220 Airport Blvd., Watsonville, CA 95076

CIRCLE 80 ON FREE INFORMATION CARD

AUDIO THROUGH VHF/UHF FREQUENCY COUNTER, model FC45, is highly sensitive, with 25 mV average throughout band, with pickup loop; all direct-reading, 8-digit display; crystal checker; and all testing leads. The unit comes with optional prescaler, model PR 47, and power



adapter, model PA202, for use with other frequency counters. Accuracy is better than FCC requirements on all bands including UHF. Price: Frequency counter, \$395; prescaler, \$125; power adapter, \$9.95.—Sencore, Inc., 3200 Sencore Drive, Sioux Falls, SD 57107

CIRCLE 81 ON FREE INFORMATION CARD

VOLTAGE SPIKE PROTECTOR, model GESP-752, limits voltage transients that might damage equipment. It plugs into a 120-volt grounded AC

receptacle and protects TV's, stereos and other sensitive electronic equipment against lightning strikes that cause high-voltage surges. Contained within is a varistor that permits only a safe voltage level to enter protected equipment and does not interfere with normal current flow, or add to energy cost. Available from manufacturers' tube



products distributors. Suggested retail, \$9.95.—G-E, Tube Products Dept., Louisville, KY 40205

CIRCLE 82 ON FREE INFORMATION CARD

HOLE-DRILLING KIT, model Conecut 3420, contains two drill bits, cutting compound and fiber hole gauges. It is particularly adapted for easy CB antenna installation, plumbing, electrical and hobby uses. Holes can be drilled in thin material,

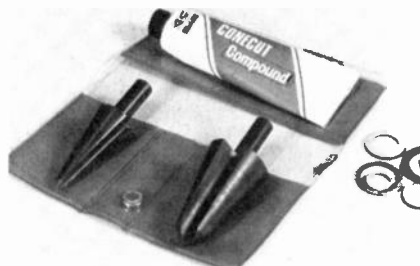

such as steel, sheet metal and formica, among others.—GC Electronics, 400 So. Wyman St., Rockford, IL 61101

CIRCLE 83 ON FREE INFORMATION CARD

KEYBOARD ENCODER KIT, Archer model 277-117, contains printed-circuit board with instruction manual and parts. Completed encoder can be used to provide inputs to many devices requiring ASCII-encoded alpha-numerical characters. Kit comes with repeat key, negative-going/posi-

tive-going data-valid strobe, latch outputs, shift and shift-lock capability, true or false outputs and six extra control keys. Circuit board with parts



and assembly manual: \$14.95. All parts, except hardware and case: \$57.80.—Radio Shack, 2617 W. 7th St., Fort Worth, TX 76107

CIRCLE 84 ON FREE INFORMATION CARD

RADAR DETECTOR, BEARTECTOR PR-7 Series II, resists extreme temperature and input voltage variations and interference generally found in automotive environments. The unit features a front-panel "running light" to indicate when device is working, volume and squelch controls are similar to CB equipment. Mounts on dash with self-adhesive Velcro pads for easy removal to



guard against theft. Power cord plugs into cigarette lighter socket. The Series II measures 4 1/2 X 6 X 3 1/2 inches, power from +12 or -12 volts. Unit carries a full 90-day parts and labor warranty and is available through CB and electronics dealers and distributors.—Prime Electronics, Inc., 8605 Quivira Rd., Lenexa, KS 66215

CIRCLE 85 ON FREE INFORMATION CARD

CATHODE-RAY OSCILLOSCOPE, Miniscope MS-15, weighs only 3 pounds and measures 2.7 X 6.4 X 7.5 inches. Other features are a 15-MHz

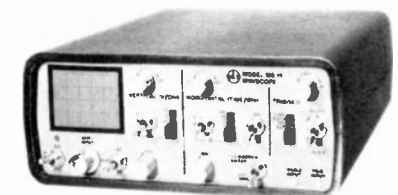

bandwidth, 0.25-inch division spacing and a graticulated rectangular viewing area 4 divisions high by 5 divisions wide. Also provided are internal/external triggering with automatic and line synchronization modes and horizontal input; 12 vertical

gain settings from 0.01 to 50 volts per division; 21 time-base settings from 0.2 ms to 0.5 sec. per division, and optional 10:1 probe and carrying case. Power is from batteries or AC line. Price: \$289.—Non-Linear Systems, Inc., P.O. Box N, Del Mar, CA 92014

CIRCLE 86 ON FREE INFORMATION CARD

RMS VOLTMETER/AMPLIFIER, model 9601A, is a general-purpose instrument for use in high-risk areas such as power-generating stations. Measures and amplifies AC voltages of 10 Hz-1 MHz



and over. Basic reading accuracy is ±3%. Battery operating time is 8 hours continuous from 0°-5° C and 4 hours at -40° C; AC power is 115 volts or 230 volts RMS ± 10% at 47-420 Hz.

Accessories include retractable tip, ground cable, spare fuse, AC power cable, test probe and

manual. The instrument weighs 9.5 lbs and measures 7¼ × 8¼ × 6-inches. Priced at \$995.—Ballantine Laboratories, P. O. Box 97, Boonton, NJ 07005.

CIRCLE 87 ON FREE INFORMATION CARD

PRECISION LOAD SYSTEM, model 240, is designed specifically for use as a dummy load for audio equipment. It can provide 4-, 8-, 16-ohm, 1% loads, with power-dissipation capability at 250 watts per channel at 8 ohms, and 500 watts

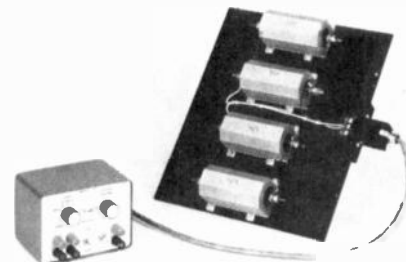

at 4 or 16 ohms. Unit has speaker-monitoring capability. Load resistors are heat-sink-mounted, with an impedance-matched cable/connector to control unit permitting out-of-way placement. Price: \$275.—BPI-Audio Test Instruments, 7853 Balboa Ave., San Diego, CA 92111

CIRCLE 88 ON FREE INFORMATION CARD

VOM PACKAGE, model 100-T, comes in a leather carrying case complete with VOM, temperature probe, VOM leads, a clamp-on AC ammeter, and a plug-in separator for standard-line-cord current readings.

The model 390 VOM includes five AC/DC ranges for 0-1200 volts; four DC milliamp ranges



Includes Functional Tilt Stand!

NEW EICO 270 3½ DIGIT DMM KIT ONLY \$79.95

Introductory Offer—FREE AC ADAPTOR

The first and only lab accuracy portable DMM Kit featuring MOS/LSI IC economy and reliability. Measures DC/AC Volts, Kilohms, DC/AC milliamps in 21 ranges. Polarity indicators and overload protection are provided, and 0.5 inch LED displays give easiest-to-read digital readout to 1999. The 270 features a basic 0.5% DC accuracy, 10 Meg-ohm input impedance, low voltage drop in all current ranges and automatically-flashing overrange indicator. **Assembled \$109.95**

FREE '78 EICO CATALOG

Check reader service card or send 75¢ for first class mail. See your local EICO Dealer or call (212) 272-1134, 9:00 a.m.-5:00 p.m. EST. Major credit cards accepted.

EICO—283 Malta St., Brooklyn, N.Y. 11207



CIRCLE 76 ON FREE INFORMATION CARD

SYSTEM 5000

The New Programmable Clock Kit from Digital Concepts. \$29.95



SYSTEM 5000 features a 1.5" LED digital display, 12 push buttons, and a 12-hour timer. It includes a carrying case, a power cord, and a user manual. Price: \$29.95.

SYSTEM 5000 features a 1.5" LED digital display, 12 push buttons, and a 12-hour timer. It includes a carrying case, a power cord, and a user manual. Price: \$29.95.

SYSTEM 5000 features a 1.5" LED digital display, 12 push buttons, and a 12-hour timer. It includes a carrying case, a power cord, and a user manual. Price: \$29.95.

FEATURES AND SPECIFICATIONS		
Timekeeping Function	Display	General
• 12 H. Dig. Hrs.	• 1.5" Dig. Freq. Exp.	• 1.5" Dig. Hrs. Exp.
• 12 H. Dig. Min.	• 1.5" Dig. Temp. C.	• 1.5" Dig. Temp. F.
• 12 H. Dig. Sec.	• 12 H. Dig. Day of Week	• 1.5" Dig. Day of Week
• 12 H. Dig. AM/PM	• 1.5" Dig. Month	• 1.5" Dig. Month
• 12 H. Dig. Alarm	• 1.5" Dig. Year	• 1.5" Dig. Year
• 12 H. Dig. Alarm	• 1.5" Dig. Power On	• 1.5" Dig. Power On
• 12 H. Dig. Alarm	• 1.5" Dig. Power Off	• 1.5" Dig. Power Off

RELAY OPTION — \$4.00

QUARTZ TIME BASE OPTION — \$6.95

SWITCH OPTION — \$3.75

CASE OPTION — \$11.00

ORDER THIS EXCITING KIT TODAY AND PUT ELECTRONIC TIMEKEEPING TO WORK FOR YOU!

digital concepts

Digital Concepts Corporation • 241 Route 46
Saddle Brook, New Jersey 07662 • (201) 845-7101

CIRCLE 41 ON FREE INFORMATION CARD



Clever Kleps

Test probes designed by your needs—Push to seize, push to release (all Kleps spring loaded).

- Kleps 10** Boathook clamp grips wires, lugs, terminals. Accepts banana plug or bare wire lead. 4¼" long. **\$1.39**
- Kleps 20** Same, but 7" long. **\$1.49**
- Kleps 30** Completely flexible. Forked-tongue gripper. Accepts banana plug or bare lead. 6" long. **\$1.79**
- Kleps 40** Completely flexible. 3-segment automatic collet firmly grips wire ends, PC-board terminals, connector pins. Accepts banana plug or plain wire. 6¼" long. **\$2.59**
- Kleps 1** Economy Kleps for light line work (not lab quality). Meshing claws. 4½" long. **\$.99**
- Pruf 10** Versatile test prod. Solder connection. Molded phenolic. Doubles as scribing tool. "Bunch" pin fits banana jack. Phone tip. 5½" long. **\$.89**

All in red or black - specify. (Add 50¢ postage and handling). Write for complete catalog of - test probes, plugs, sockets, connectors, earphones, headsets, miniature components.

Available through your local distributor, or write to:

RYE INDUSTRIES INC.
127 Spencer Place, Mamaroneck, N.Y. 10543
In Canada: Rye Industries (Canada) Ltd.

CIRCLE 38 ON FREE INFORMATION CARD

CIRCLE 38 ON FREE INFORMATION CARD



Price: \$79 each.—Edmund Scientific Co., 555 Edscorp Bldg., Barrington, NJ 08007

CIRCLE 97 ON FREE INFORMATION CARD

CB HEADPHONE, CB-MET, is the first to incorporate power-mike circuitry, with power assist from a self-contained preamp and variable-gain adjust control. Specifications also include 8-ohm anti-blast earphone circuitry matched to external



speaker jack. Unit output is -45 dB re 1 volt. Powered by one AA cell, unit also includes safety switch. Suggested price: \$60.—Superex Electronics Corp., 151 Ludlow St., Yonkers, NY 10705

CIRCLE 98 ON FREE INFORMATION CARD

CB FILTER CABLE reduces harmonic interference to TV channels 2, 5, 6 and 9. Connected between CB transceiver and antenna at trans-



ceiver antenna terminal, cable comes in 6-foot and 18-foot lengths.—Vitek Electronics, Inc., 200 Wood Ave., Middlesex, NJ 08846.

CIRCLE 102 ON FREE INFORMATION CARD

CPU BOARD is S-100 bus-compatible for use with a motherboard and bus peripherals, or can replace existing CPU board and front panel to operate as a minicomputer. Features two oper-

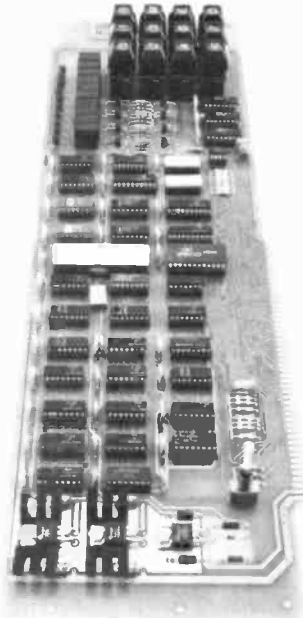

ating modes: one allows user to step through program while unit is running; other mode prevents microcomputer from shutting off after HALT instruction. Buffering assures proper data transfer and Schottky IC's reduce power consumption. The kit is \$250; assembled, \$325.—Morrow's Micro-STUFF, P.O. Box 6194, Albany, CA 94706.

CIRCLE 103 ON FREE INFORMATION CARD



NEW EICO 700 FREQUENCY COUNTER KIT \$69⁹⁵

At last! A digital counter every CB'er/Hobbyist can afford. Exclusive transmitter-Keyed "sniffer" circuit activates counter only on transmit, giving accurate readout of channel frequency. Standard coax connectors and mounting brackets make mobile installation a snap. IC Digital circuitry. Freq. range: 5 Hz-27 MHz (all 40 CB channels) Accuracy: ± 1 PPM ± 1 Digit. Readout: Five 0.5" LED Displays; 10 MHz crystal oscillator KHz/MHz Timebase switch; Compact design: 2 $\frac{3}{8}$ "H x 6 $\frac{1}{8}$ "W 5 $\frac{3}{8}$ "D. **Assembled \$99.95**

FREE '78 EICO CATALOG

Check reader service card or send 75¢ for first class mail. See your local EICO Dealer or call (212) 272-1134, 9:00 a.m.-5:00 p.m. EST. Major credit cards accepted.

EICO—283 Malta St., Brooklyn, N.Y. 11207



CIRCLE 77 ON FREE INFORMATION CARD

REVOLUTIONARY NEW CB ANTENNA TUNERS

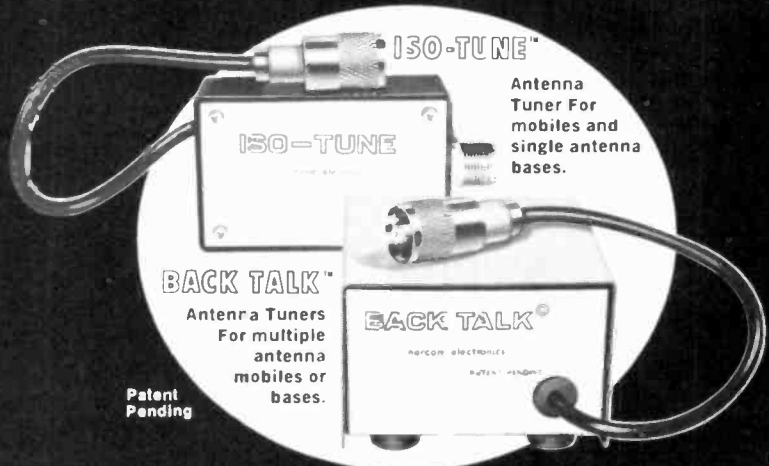

ISO-TUNE™
Antenna
Tuner For
mobiles and
single antenna
bases.

BACK TALK™
Antenna Tuners
For multiple
antenna
mobiles or
bases.
Patent
Pending

MAKE 4 WATTS SOUND LIKE 20... SAFELY

ISO-TUNE and BACK TALK antenna tuners do more to help. They'll tune to the lowest SWR... even on 40. Reception will be far and clear. They feature a unique exclusive Isolated Tuned Circuitry. They'll out-perform anything on the market. They protect against power blowback, coax shorts, ground loops, accidental grounding. Coax lengths unimportant. Maximum radiated signals. Greatly reduced TVI.



NORCOM ELECTRONICS, INC.

A DIVISION OF IDEAS INC.

SALES OFFICE: 23611 Chagrir Blvd. • Beachwood, Ohio 44122 • Phone: 216/831-5005

NE-4863

CIRCLE 72 ON FREE INFORMATION CARD

If you like our chemicals, you'll love our solder.

That's because we make it the same way we make our chemicals—with "Total Control."

We control its quality at every step from pure raw tin to hermetically sealing every spool to prevent contamination. That's why Chemtronics solder is so pure it exceeds Federal and Milspecs. And it's why Chemtronics solder takes high temperatures, yet flows evenly at low temperatures. Good flow gives *you* control. No crumbling, no beading, no cold joints. Instead, a bright, strong bond.

Unlike ordinary solders, Chemtronics solder won't sputter or spatter. On old soldered joints, it works in and makes a solid connection.

You know us for our chemicals. Now try us for our solder. Ask your distributor for Chemtronics "Total Control" solder. For valuable tips on soldering, use the Reader Service number below.

 **CHEMTRONICS**
INCORPORATED
45 Hoffman Ave.
Hauppauge, N.Y. 11787



LOOKING AHEAD *continued from page 4*

language, which EMI plans to introduce. In addition, cassette-programmed games and educational material can provide a recording feature—for example, an on-screen TV drawing made using the game/computer may be preserved for posterity (or to show Mom when she gets home). Probably the most important advantage of all is cost—the more comprehensive cassette programs are expected to retail for \$5 or less, as compared with \$20 for ROM programs. The GI-EMI computer system is expected to be available to manufacturers early next year, with some end-products to show up in time for the Christmas 1978 market.

In the meantime, about a dozen companies are expected to field various video game/computer systems this year, featuring such diversions as space war, tank battles, aerial dogfights, auto racing, blackjack, chess, quizzes of all kinds, and even the beginnings of a video quick-reference encyclopedia.

Big as life: Projection TV isn't very big—as a business, that is. Although there may be more than 50 companies assembling projection sets, their total output has been small to date. The largest company in the field is still Advent, which, unlike most other entities, markets a unit with specially designed electronics and three projection tubes and lenses. Major American television manufacturers have all looked into this business and decided to stay out. Sony has a single-tube projector that it appears to be phasing out. If American manufacturers are shunning the three-tube projector, Japanese TV makers seem to be taking strong interest, with three such units due from major companies within the next year. Panasonic has quietly shown some of its dealers a three-tube system designed in a one-piece cabinet with a screen five feet in diameter. MGA (Mitsubishi) may offer a two-piece system with six-foot screen in the United States before Christmas. Sony is working on a three-tube system, presumably for introduction next year. Does all this Japanese activity mean the American manufacturers will come along after all, as they did in VTR?

CB bargains: The CB manufacturers haven't yet overcome the problems created by the shock of transition from 23 to 40 channels, and the result is some almost unbelievable bargains in transceivers. The 23-channel units haven't yet been cleared from the pipelines—as a glance at the ads will show—and some have been advertised recently as low as \$49.95, far below the cost of manufacture. Unfortunately for the industry—but fortunately for the consumer—the price-cutting has spread to 40-channel units as inventories rise, and even these can sometimes be spotted at half their list prices. Industry sources predict an almost certain shakeout among manufacturers, and an eventual adjustment of supply to demand, which will mean a gradual increase in prices.

If you already own a CB, there's a bright side to the picture for you, too. Along with prices of new transceivers, the "fence" prices for stolen CB's have declined to such a low point that it's hardly worth the effort to break into cars any more. Why would anybody try to steal 'em from cars when you can just about steal 'em from dealers—legally?

DAVID LACHENBRUCH
CONTRIBUTING EDITOR

next month

OCTOBER 1977

■ Build The Flanger

It's an add on to your electronic music system that produces a very special effect.

■ Car Clocks Roundup

Everything you ever wanted to know about electronic, digital readout car clocks.

■ Vari-Proportional Amplifier

New kind of high-efficiency amplifier that you'll want to know about

■ CB Antennas

Pro and cons . . . When to use which kind . . . Getting out . . . And more

PLUS

Hobby Corner, Computer Corner, Jack Darr's Service Clinic, State Of Solid State, Equipment Reports, and much more.

ELECTRONIC THERMOMETER

continued from page 35

ance voltmeter to read the voltage with respect to ground at pin 2 of IC3. Adjust R14 until you get a 0-volt reading on the voltmeter's most sensitive scale.

The second part of the calibration, the adjustment of C12 requires a 16.7K, 1% metal-film resistor. As before, connect the precision resistor into the circuit in place of RT1. Adjust C12 so that the display just changes from "99" to "0."

If you neither have nor want to buy a 16.7K precision resistor, the following procedure can be followed: Using a standard, accurate thermometer as a reference, fill a large bowl with hot and cold tap water to 99°F, stir carefully during this process. Plug the thermistor assembly into the thermometer, and immerse the waterproofed thermistor in the water. Adjust C12 to obtain a reading of "99." The thermometer is now ready to be used. At temperatures below 0°, the display will remain at 0. On the other hand, a temperature of 105°F appears as "5." However, the thermometer's accuracy is rapidly degraded as the temperature rises above 100°. **R-E**

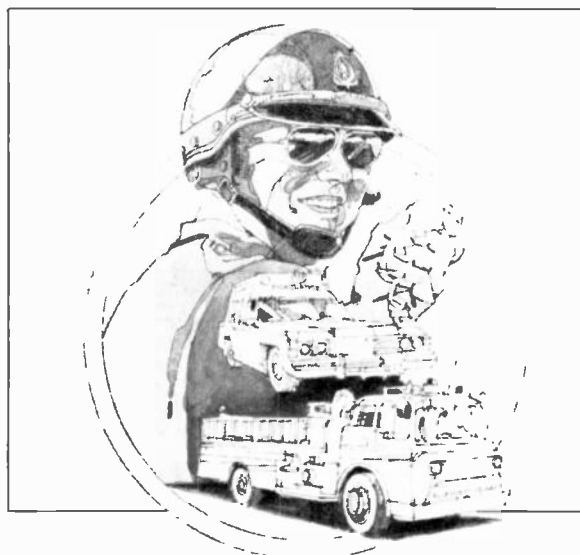

INTERNATIONAL FM 2400CH

FREQUENCY METER for testing mobile transmitters and receivers



- Tests Predetermined Frequencies 25 to 1000 MHz
- Extended Range Covers 950 MHz Band
- Pin Diode Attenuator for Full Range Coverage as Signal Generator
- Measures FM Deviation

The FM-2400CH provides an accurate frequency standard for testing and adjustment of mobile transmitters and receivers at predetermined frequencies.

The FM-2400CH with its extended range covers 25 to 1000 MHz. The frequencies can be those of the radio frequency channels of operation and/or the intermediate frequencies of the receiver between 5 MHz and 40 MHz.

Frequency Stability: $\pm .0005\%$ from +50° to +104°F.

Frequency stability with built-in thermometer and temperature corrected charts: $\pm .00025\%$ from +25° to +125° (.000125% special 450 MHz crystals available).

Self-contained in small portable case. Complete solid state circuitry. Rechargeable batteries.

FM-2400CH (meter only)	\$595.00
RF crystals (with temperature correction)	24.00 ea.
RF crystals (less temperature correction)	18.00 ea.
IF crystals	catalog price



International Crystal Manufacturing Company, Inc.

10 North Lee Oklahoma City Oklahoma 73102

CIRCLE 34 ON FREE INFORMATION CARD

THE PAIA 8700 COMPUTER/CONTROLLER

An exceptional price on an applications oriented 6503 based micro-processor system



\$149.95

THE IDEAL, LOW COST SOLUTION TO IMPLEMENTING THOSE WILD COMPUTER BASED CONTROL SYSTEMS YOU'VE BEEN DREAMING OF!

PAIA software currently available or under development includes: Music synthesizer interface; Home applications package including: multi-zone fire/burglar alarm, real time clock, energy saving heat/air conditioning control, computer generated "door-bell"; Model road controller and more.

8700 COMPUTER/CONTROLLER KIT \$149.95 (requires 5v. @ 1.2A.; 12v. @ 150 ma.)

Shipped direct from PAIA (add \$3.00 postage) Also available at FULL LINE computer stores

DETAILS IN OUR FREE CATALOG

PAIA • DEPT. 9R • 1020 W. Wilshire Blvd. • Oklahoma City, OK 73116

CIRCLE 12 ON FREE INFORMATION CARD

★ FREE! ★

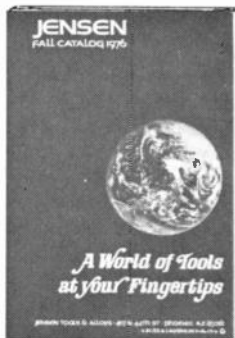

NEW CATALOG OF HARD-TO-FIND PRECISION TOOLS

Jensen's new 128-page catalog is jam-packed with more than 2800 quality items. Your single source for hard-to-find precision tools used by electronic technicians, scientists, engineers, instrument mechanics, schools, laboratories and government agencies. This wanted catalog also contains Jensen's world-famous line of more than 40 tool kits. Plus 10 pages of useful "Tool Tips" to aid in tool selection. Send for your free copy today!

JENSEN TOOLS AND ALLOYS
4117 N. 44th Street, Phoenix, Arizona 85018

A BLISS & LAUGHLIN industry

CIRCLE 24 ON FREE INFORMATION CARD

RF SIGNAL GENERATORS

continued from page 93

receivers are tested for overload and intermodulation distortion.

Accuracy

Output amplitude accuracy at any particular attenuator setting is specified as plus-minus a number of decibels. Common values for this specification are ± 3 dB for the very poorest of generators to better than ± 1 dB for extremely good generators. It is well to remember that while ± 1 dB sounds like a good figure, it is equivalent to saying $\pm 10\%$, and ± 3 dB is a little less than $\pm 30\%$. High accuracy attenuations at UHF and substantial amounts of attenuation at UHF are extremely difficult to obtain, and even more difficult to validate.

Accuracy of the output amplitude is even further influenced by other parameters. One of these is accuracy of the output leveling circuitry. Once again, the accuracy of output leveling is usually given as plus-minus a number of decibels. If the signal generator does not use automatic leveling, then the output attenuator is only accurate if the signal generator has been "red-lined." [Red-lining is manually leveling the generator, usually by adjusting an output amplitude control until the output level meter needle is resting on a reference mark (red line).]

Output impedance

Output impedance is given in ohms and indicates the characteristic impedance of transmission line the generator is intended to drive. Almost all generators are 50 ohms, with the exception of those designed for television work, which are 75 ohms. The output impedance specification may include a VSWR (Voltage Standing Wave Ratio) specification, indicating the accuracy of the 50-ohm spec. If the generator load is a pure resistance at the characteristic impedance of the transmission line, the VSWR of the generator output is of little or no significance. Most generators, due to attenuator design, only specify output amplitude accuracy when the generator is driving a non-reactive load at the specified output impedance.

Leakage

The leakage specification should, in many ways, be combined with the output attenuator specification. It is the leakage specification that indicates the ultimate level below which reducing the output attenuator may produce no further decrease in the signal supplied to the load. Frequently the output leakage specification is rated in μV , as it indicates the ability of the generator to make receiver sensitivity measurements. For example, a generator may be specified as being able to make 0.1 μV measurements.

In the case of an extremely low-cost generator, although the attenuator and variable level control may be set for less than 1- μV output, the leakage specification indicates the generator can only make receiver sensitivity measurements of 5 μV or greater.

There may be a high degree of attenuation beyond which the attenuator itself may no longer supply increased attenuation. This is to say, some signals directly bypass the attenuator and appear at the output. This problem is different than a leakage problem.

A leakage specification only indicates the presence of signals in the area of the generator. A receiver may be a substantial distance from the generator, fed signals through a long coaxial cable, having known loss and good shielding, and receiver sensitivity measurements can be made.

to be continued

BETTER THAN A THIRD HAND!



PANAVISE TILTS, TURNS, AND ROTATES TO ANY POSITION. IT HOLDS YOUR WORK EXACTLY WHERE YOU WANT IT.

PanaVise has great strength yet is gentle enough to firmly hold delicate objects.

Quite possibly the finest new tool you will buy this year, PanaVise is built to exacting professional standards. We guarantee it!

Illustrated is the Electronics Vise Model 396. Three other bases and a wide variety of heads are available. All interchangeable! Buy a basic unit, then add on to create your system.

Available through your dealer. Write for a free catalog.

PANAVISE® Dept. 5E
10107 Adella Ave., South Gate, CA 90280
In Canada: 25 Toro Rd., Downsview, Ont. M3J 2A6

CI A Division of Colbert Industries
CIRCLE 27 ON FREE INFORMATION CARD

Service Questions

INTERMITTENT HIGH VOLTAGE

The high voltage in this CTC-17X RCA would pop on and off, but only at very short intervals, separated by long periods of working perfectly. In my first letter, you suggested several places to check. I finally found that the color-difference amplifiers and the blanker tubes were the cause; their plate voltages all went to full B+.

You'd suggested the common cathode resistor R728 as one possibility. It checked good. Then I got to wondering why the blanker plate also went to B+. After some hours, I soldered the ground strap between the PW-700 board and chassis, near R728, and cured the problem.

Further checking showed why. This same strip is also the ground return for the heaters of the difference-amplifier tubes and the blanker. When the heaters went out, the plates went to B+! Thanks.—R.W., Toms River, NJ.

HORIZONTAL "SAG" IN RASTER

This is a funny problem. In this Bradford WTG-53421 TV, the raster will show a horizontal sag about 20 minutes after you put the back on the cabinet. Before this, it works fine. This has to be a heat problem, but where?—W.O., Solon, OH.

You are so right; this has to be a thermal problem. From past experience with problems of funny-shaped rasters, I'd suspect a filter capacitor that is opening up when hot. I've seen rasters shaped like butterflies, hourglasses and lots more.

Try waiting till the "thing" appears, then spray coolant on each of the filter capacitors. Alternately, blow hot air on them, one at a time, with the back off. This should help catch it. The basic cause of this is oddball feedback through the DC power supply.

HORIZONTAL-OUTPUT CURRENT RUNAWAY

This Admiral 12H10 chassis came in with no drive on the horizontal-output tube. A plate resistor was open in the horizontal oscillator. Now the breaker trips after about 15 seconds. Horizontal-output cathode current starts out at 200 mA, then after about 5 seconds rapidly climbs to 400 mA and then the breaker trips.

I tried unhooking the picture tube; everything was fine; 24 kV, 220 mA steady. Then I tried the chassis on the test jig and got the same results—runaway after 5 seconds. Replaced flyback and yoke, thinking of shorted turns—no good. Any ideas will be more than welcome.—J.H., Winston-Salem, NC.

One correction: if the flyback or horizontal winding of the deflection yoke is shorted, you'll have excessive cathode current even with the picture tube disconnected. Since the thing shows the same symptoms on its own tube and a test jig, it seems to be something in the picture tube bias.

Go and check the bias voltages on the picture tube. A good picture tube can be driven to 4–5 mA of beam current, and the maximum output of the average high-voltage circuit is quite a bit less than that. It seems that two picture tubes are showing you the same symptom, and the bias would be the most likely thing. Grids too far positive or cathodes too far negative are one and the same problem.

SPEED CONTROL PROBLEM

This Sony 800B tape recorder was plugged in wrong. Now it runs at 15 IPS at all times! I found a tantalum capacitor that was causing the difference-amplifier transistor to turn off. Replaced it. Now the transistor is turned on at all times. What else?—V.C., Lansing, MI.

Be sure that you replaced that tantalum capacitor with the right polarity. Putting these in backward builds up some very peculiar troubles that weren't there to start with. Also, check ALL transistors in that voltage-regulator circuitry. R-E



UNIVERSAL TEST RIG

DOES IT ALL



\$229.95

PJS-298

C.R.T. Included

- 33KV Leaded Glass CRT
- 40KV Meter
- Build-In Speaker
- Obsolete-Proof

The PJS-298 Universal Test Rig for tube and Solid State TVs designed for servicing high voltage chassis. Built-in speaker for convenient audio checking, 40KV-50Ua sensitivity meter constant monitoring of the anode voltage. Up-dating is accomplished by means of plug-in modules. (Extension cables included).

FOR FAST TROUBLE SHOOTING . . .

"FERRET" TV MINI-ANALYZER



\$99.95

SG-785

- VHF/UHF Subber
- I.F. - Video Trouble Shooter
- Convergence Generator
- Dots and Cross-Hatch Patterns

The "FERRET" is a multi-functional instrument for fast, efficient trouble-shooting and adjustment of all Color and B&W tvs. It is ideal for both shop and field work. (Cables included.)

Telematic 108-02 Otis Ave., Corona, N.Y. 11368

CIRCLE 74 ON FREE INFORMATION CARD

FREE catalog

of over
2000
small tools,
measuring
instruments,
and supplies



- ELT.
- COL.
- DRILLS
- FILM LOADERS
- PS. PAGES. GRAVERS
- GRINDERS. HAMMERS
- INCLINOMETERS. JACKS
- KNIVES. LATHES. LEATHER
- ETTES. LOUPES. MINIATURE
- TOOLS. METRIC TOOLS. MULTI
- TESTERS. NEGATIVE FILES
- NIPPERS. OILERS. PIN VISES
- PLIERS. PROBES. RIFFLERS
- SCISSORS. SNARES. SOLDER
- ING SUPPLIES. TEST INSTRU
- MENTS. TWEEZERS. VIEWERS
- VISES. WRENCHES
- ADH. ABRASIVES
- G. BOOKS
- LIMATORS
- EPOXIES
- CALIPERS



National Camera
2000 West Union Ave. Dept. GBF
Englewood, Colo., U.S.A. 80110

CIRCLE 13 ON FREE INFORMATION CARD

Try this exciting new hobby! Build your own electronic concert organ. It's easy. No technical knowledge required. Just follow the clearly pictured instructions of the famous Wersi do-it-yourself system. Choose from seven different models. Send \$2.00 (refundable) with coupon for colorful 104 page catalog.

WERSI



Wersi Electronics, Inc.
Dept. 24, Box 5318
1720 Hempstead Road
Lancaster, PA 17601

Enclosed is \$2.00 for my copy of your 104 page catalog.

Name _____
Address _____
City _____ State _____ Zip _____

CIRCLE 64 ON FREE INFORMATION CARD

equipment reports

JFD Electronics FM-500 Amplified FM Antenna



CIRCLE 95 ON FREE INFORMATION CARD

A WELL DESIGNED AND PROPERLY INSTALLED FM antenna makes the difference between poor and good stereo and monaural FM reception. Many attempts have been made to replace an outdoor rooftop antenna with a compact electronic device like the one described in this report. Unlike many of the others, this one works. Measuring only 1 1/2 inches in diameter, 1 1/2 inches thick and weighing 1 1/2 pounds, the FM-500 uses solid state circuitry to amplify both monaural and stereo FM signals. The antenna itself can be placed right on top of the FM receiver or tuner, or can be mounted on a wall indoors, hidden in an attic, or even mounted outdoors. However, for outdoor installation, a separate mounting kit is required.

Inside the FM-500 is an omni-directional condensed element whose balanced output is fed directly into a low-noise, solid state preamplifier. The element is a modified dipole formed in a manner so that its radiation pattern is changed from that of the basic figure eight dipole's shape, to a nearly circular pattern. The output of the element connects directly to the input of the broadband, tuned preamplifier with a medium 10-dB gain. A low-noise bipolar transistor gives the lowest possible noise figure. The amplified output of the antenna preamp section is then fed along a shielded coaxial cable transmission line to the power supply/balan unit. The signal is converted from the unbalanced coaxial line to a balanced 300-ohm twin lead output for easy connection to the antenna input terminals of the FM receiver.

The power supply for the antenna is a transformer type unit that provides 15 volts DC to the preamp and duplexes this voltage on the same coax cable that carries the FM/RF signal to the receiver. The power supply uses

only 1.4 watts so the unit can be operated continuously and both use less than 75 cents worth of electricity per year.

The overall antenna system is omnidirectional. It has a nominal gain of 8 dB over a reference dipole. The system noise figure is less than 5 dB for a 200 kHz bandwidth. The photographs compare the response of the FM-500 antenna mounted outdoors with a JFD Model AFM150 turnstile antenna mounted outdoors. The parameters of the display are

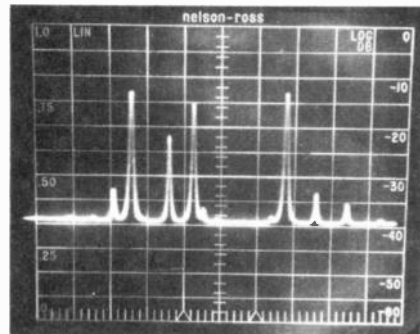

a

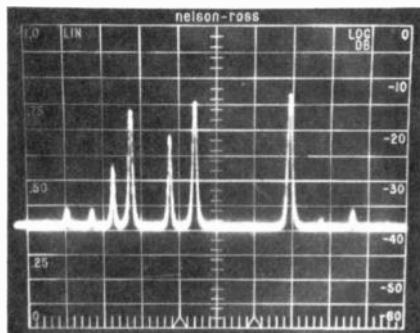

b

RELATIVE STRENGTHS OF SIGNALS received with JFD AFM150 turnstile FM antenna outdoors (a) and FM-500 antenna indoors (b).

sweep width 20 MHz (2 MHz/CM). Center frequency 98 MHz, vertical scale, log dB scale, zero dB reference line is 0 dB Mv. As you can see, performance of the FM-500 is more than adequate. Where it is possible to install a conventional outdoor, FM antenna, do so. But when you can't you will find great improvement in your FM reception when you use the FM-500 in place of an indoor or built-in antenna for FM.

R-E

(continued on page 104)

new books

WORLD RADIO TV HANDBOOK, 31st Annual Edition—1977, by Jana Frost. Billboard Publications, Inc., 2160 Paterson St., Cincinnati, OH 45124, and Gilfer Associates, Box 239, Park Ridge, NJ 07656. 480 pp. plus 48-page insert, *Listen to the World*. 5 1/2" x 9 in. Softcover \$10.95.

Truly a master guide for users of international radio and television, this book contains exact information on worldwide shortwave, longwave and medium-wave stations. The *Table of Contents* lists 224 countries ranging from Afars and Issas to Zambia. In the *General Index* are such topics as "Broadcasts in English," "Abbreviations," "DX Clubs," "HF Broadcast Reception Conditions for 1977," "Most Suitable Broadcasting Bands for 1977," "Shortwave Stations of the World," and "World Time Charts and Tables."

The coverage of long- and medium-wave stations (150 to 1,600 kHz) is broken down into five geographical zones. Stations are listed according to frequency, kilowatt power, country and station location. Shortwave stations are listed alphabetically by country. Also covered are call letters, frequency, mailing address, names and positions of principals, program schedules, principal languages, and scores to the stations' musical signature.

The insert *Listen to the World* introduces the beginner to the material he'll need as a serious listener and covers such current topics as the sunspot minimum and how to listen to clandestine stations.

SOLID-STATE CIRCUIT TROUBLESHOOTING GUIDE, by Art Margolis. TAB Books, Blue Ridge Summit, PA 17214. 224 pp. 5 1/2" x 8 1/2" in. Softcover \$4.95; hardcover \$7.95.

This is a new printing of an old book, but it's certainly worth mentioning again. This practical guide book, once and for all, will help clear up any misunderstandings readers may have about solid-state circuits. The first four chapters discuss the various types of solid-state devices—diodes, transistors, FET's, integrated circuits and silicon controlled rectifiers. Then, getting into the real meat of the subject, the author describes how these devices work in typical circuits the reader is likely to encounter, and shows how to go about finding faulty components.

Individual chapters are devoted to RF amplifiers, IF amplifiers, audio and video amplifier circuits, power amplifiers, oscillators, converters, remote control circuits, sync separators and power supply circuits. In each instance, the author takes the reader through typical circuits, describing how each type works and how the truest professional approaches a troubleshooting problem so as to solve it in the quickest and best possible manner.

GAMES WITH THE POCKET CALCULATOR, by Sivasailan Thiagarajan and Harold D. Stolovitch. Dymax, Box 310, Menlo Park, CA 94025. 47 pp. 10 3/4" x 8 1/4" in. Softcover \$2.00.

The two dozen calculator games in this book all involve an element of conflict and competition, and all share the following features: An inexpensive calculator with a 6-digit display will work fine; all the games permit people at different levels to compete on equal grounds; a single instrument can be shared by friends and opponents; the games are fast-paced and permit immediate replay without loss of interest; and the two dozen games have sufficient variety to intrigue those who love numbers and those who hate them.

Each game is described in a consistent format that interweaves a complete sample game along with the rules to provide concrete illustrations. All the games emphasize mental manipulation and use the calculator to provide immediate feedback and reinforcement, which facilitates learning of number facts and principles. All the games have been repeatedly tried and tested by various interested groups.

BROADCAST ENGINEERING & MAINTENANCE HANDBOOK, by Patrick S. Finnegan. TAB Books, Blue Ridge Summit, PA 17214. 532 pp. Hardcover \$19.95.

This data-packed reference work for broadcast engineers, technicians and managers gives timely maintenance tips, installation techniques and measurement methods for the entire broadcast chain. The same approach used to design a system is incorporated in understanding and troubleshooting it. The thrust of this book is how-to-do-it information that can be put to immediate use. All the procedures an engineer needs are included, from simple tasks like inspecting a transmitter building to running a proof of performance.

Separate chapters cover AM and FM transmitters, inspections, antennas, automation and how to get the most out of the station's test equipment. One big chapter tells how all the standard electronics techniques are adapted to broadcasting and another chapter gives complete coverage to installation. A book within a book tells how to maintain tape machines, adjust equalization, align, bias, and more. Also, there is plenty of hard-to-find, practical information about program automation equipment.

GENERAL TELEVISION SERVICER

... the concept that is changing the course of television servicing.

The new model General Television Servicer now includes 4.5 Mhz sound carrier, Blue Raster, Green Raster and Color Trio as well as the old favorites from the original General Television Servicer (Model ATC-10): i.e., 3.58 Monitor, Vector, Color Bars (6th bar marker), Hatchdots, Gray Quad, Red Raster, Crystal controlled RF, Wide range RF/IF attenuator, Video and IF outputs for signal injection, Interlace, and more.

The above listed features clearly show why the General Television Servicer does much more than an ordinary color bar pattern generator; it cuts service time and makes every job easier from a simple house call to the toughest dog! That's why the GTS-10 is the biggest bargain in TV service equipment today.

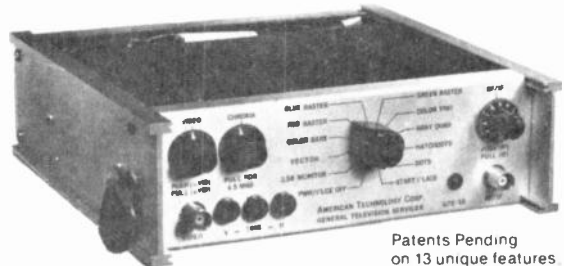

Patents Pending on 13 unique features.

Write for comprehensive 6-page full color brochure that describes these and many more features.

Telephone orders on VISA or Master Charge accepted for same day shipment.

30 day money back guarantee

2 year factory warranty against all failures in normal use.

ATC

AMERICAN TECHNOLOGY CORPORATION
225 Main Street, Dept. 9C
Canon City, Colorado 81212
(303) 275-8991

CIRCLE 29 ON FREE INFORMATION CARD

MATHEMATICS ELECTRONICS ENGINEERING MATHEMATICS ADVANCED MATHEMATICS

These unusual courses are the result of many years of study and thought by the President of Indiana Home Study, who has *personally* lectured in the classroom to *thousands* of men, from all walks of life, on mathematics, and electrical and electronic engineering.

You will have to see the lessons to appreciate them!

NOW you can master mathematics and electronics and actually *enjoy* doing it!

WE ARE THIS SURE:—you order your lessons on a money-back guarantee.

In plain language, *if you aren't satisfied you don't pay*, and there are no strings attached.

Write today for more information and your outline of courses.

You have nothing to lose, and everything to gain!

**The INDIANA
HOME STUDY INSTITUTE**
P.O. BOX 1189
PANAMA CITY, FLA 32401

CIRCLE 22 ON FREE INFORMATION CARD

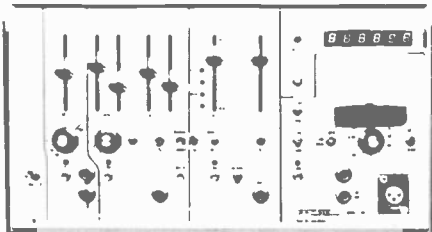

MODEL 101 AUDIO TEST SYSTEM consists of two sine/square/triangle function generators, pulse generator, frequency counter and AC voltmeter. As a system it will generate a frequency response plot on an X-Y recorder or scope.

Time base generator offers symmetrical or independent control of the positive and negative sides of the ramp providing a duty cycle of 1% to 99%. Frequency range is .002 Hz to 100k Hz. Amplitude is 16 Vpp into 500 Ohms with ± 5 VDC offset. The time base output drives the X axis of an X-Y recorder. Manual mode provided for setup.

Audio sweep generator provides manual frequency adjustment or log/linear sweep of 20 Hz to 20k Hz. Blanking mode provides zero reference line on an X-Y recorder or tone burst. Amplitude is 16 Vpp into 500 Ohms or 10 Vpp into 8 Ohms.

Pulse generator frequency range is .002 Hz to 800k Hz. Pulse width is adjusted independent of frequency from 4 seconds to 40 nanoseconds. Outputs are complementary TTL.

AC Voltmeter has full scale sensitivities from 1 mV to 250 V. Fast/slow, peak/true RMS and log/linear modes are provided. Output drives Y axis of X-Y recorder.

Frequency counter is 6 digit, line triggered, and reads either internal or external. Sensitivity is 100 MV peak at 20k Hz. 1/2 sec. update. 50/60 Hz.

Dimensions: 8x14x3. Shipping weight: 9 lbs.
\$650. Stock to 30 days. Warranty: 1 year, 3-year \$60.

FIDELITY SOUND

1894 Commercenter W. #105
San Bernardino, Ca 92408
(714) 889-7623

CIRCLE 3 ON FREE INFORMATION CARD

EQUIPMENT REPORTS *continued from page 102*

VIZ WV-534A Voltohmyst V



CIRCLE 94 ON FREE INFORMATION CARD

THE VIZ MFG. CO. HAS RECENTLY DEVELOPED the Voltohmyst V, model WV-534A, which sells for \$150. This compact, versatile autopolarity analog meter reads up-scale on all DC voltages and current measurements. The reading polarity is shown on a small separate meter just below the main movement. Because you never have to reverse the test leads, it's also possible to read a greater number of ranges with the same number of range switch positions.

The Voltohmyst V has nine AC/DC 0.05- to 500-volt ranges; a 1500-volt range available at a special jack; and eight 0.15-amp to 500-mA current ranges, also both AC or DC. A 1.5-amp range has its own jack. All voltage

and current ranges are read on only the 0-to-50 and 0-to-15 meter scales. The scales are *linear*, with no crowding at either end.

Resistance is read in seven ranges—from $R \times 1$ to $R \times 1$ megohm. Either HI (1.5 volt applied) or LO (50 mV) can be used on any range. For quick transistor checking, hook the test prods to any two leads and note the reading. To reverse polarity, just pull out the OHMS ADJUST knob.

The autopolarity feature can be used to advantage in tests that require reading a dip, or even in such zero-crossing tests as adjusting a discriminator. Just set the Voltohmyst V to about half-scale, and then tune for a reading that drops to zero and rises again. The polarity meter will indicate which is which.

The high frequency range of the Voltohmyst V makes it useful for audio-frequency-response testing. The input circuitry is frequency-compensated from 1 dB to 50 kHz.

A dB scale reads 0 dB for 1 mV (dBm) across 600 ohms. Calibration is +6, -20 dB, which is read directly on the AC, 0-1.5-volt range. A calibration chart for the other AC voltage ranges is given in the manual.

The circuitry is powered by 8 AA-cell batteries, plus a 1.5-volt "C" cell for the ohms ranges. If alkaline batteries are used, they can be recharged by the WG-479 AC adapter, which plugs into the side of the case.

The Voltohmyst V is housed in a rugged light blue plastic case containing all the test leads and the WG-479.

The scale reduction allowing the use of larger figures makes it easy to read. All controls are easily accessible, and a high-voltage probe, WG-411A, is available as an accessory. **R-E**

STATE OF SOLID STATE *continued from page 71*

vibrato-free output.

IC7 and IC8 is an oscillator circuit that controls the amount of phase shift. The output of IC8 feeds control FET's Q2 through Q7. The shift rate of the system is determined by the frequency of the oscillator, which has both a variable and fixed-rate mode. Visual indication of the vibrato rate is provided by the incandescent lamp driven by power transistor Q9 switched by the oscillator output from IC8.

Bridge rectifiers complete the circuit by providing the positive and negative voltages for the op-amps as well as the other circuitry.

High-power transistors from TRW

Three new gold-metallized transistors from TRW are believed to be the highest power-rated equivalent devices commercially available. The PT9780, 9785, and 9790 are rated from 12 to 50 volts and 100 to 150 watts. Gain is 13 to 15 dB at full rated power.

They are designed for single-sideband applications in military, amateur, and marine radio equipment.

The transistors are available from stock and sell for \$41.85 to \$52.10 each in 100 quantities.

TRW has also updated their RF semiconductor catalog. The 16-page catalog includes HF, UHF, VHF, SSB, and microwave transistors. Also detailed are mobile power amplifier and CATV amplifier modules. For more information write to: TRW Semiconductors, 14520 Aviation Blvd., Lawndale, CA 90260.

Little Dipper™

NEW!

- FASTEST manual device available
- Will not wear out
- Safe—gentle on devices
- Adjustable
- Easy to use

LOADS from any surface or magazine

FREE CATALOG
Distributors Wanted

ALIGNS leads

INSERTS with no stress

TECHNI-TOOL INC.

Apollo Road, Plymouth Meeting, Pa. 19462
(215) 825-4990 Telex 83-4763

CIRCLE 71 ON FREE INFORMATION CARD

market center

CLASSIFIED COMMERCIAL RATE (for firms or individuals offering commercial products or services). \$1.40 per word (no charge for zip code) . . . minimum 15 words.

NONCOMMERCIAL RATE (for individuals who want to buy or sell personal items) 85¢ per word . . . no minimum.

ONLY FIRST WORD AND NAME set in bold caps. Additional bold face (not available as all caps) at 10¢ per word. Payment must accompany all ads except those placed by accredited advertising agencies. 5% discount for 6 issues, 10% for 12 issues within one year, if paid in advance. All copy subject to publisher's approval. Advertisements using P.O. Box address will not be accepted until advertiser supplies publisher with permanent address and phone number. Copy to be in our hands on the 26th of the third month preceding the date of the issue (i.e., August issue closes May 26). When normal closing date falls on Saturday, Sunday or a holiday, issue closes on preceding working day.

BUSINESS OPPORTUNITIES

50% royalties when manufactured. Need designer for digital product. Best design selected. \$2.00 for description and theory. **CHRIS TREWHELLA**, 5A Wendy Lane, Burnt Hills, NY 12027

HIGHLY PROFITABLE

ONE-MAN ELECTRONIC FACTORY

Investment unnecessary, knowledge not required, sales handled by professionals. Ideal home business. Write today for facts! **Postcard will do. Barta-BU, Box 248, Walnut Creek, CA 94597.**

CAFM station. No investment! Excellent income! Others operate for you. Details free. **CAFM, Box 5516-FI, Walnut Creek, CA 94596**

EDUCATION & INSTRUCTION

TELEPHONE bugged? Don't be Watergated! Countermeasures brochure \$1.00. **NEGEYE LABORATORIES**, Box 547-RE, Pennsboro, WV 26415

F.C.C. EXAM MANUAL

PASS FCC EXAMS! Memorize, study—Tests Answers for FCC 1st and 2nd class Radiotelephone licenses. Newly revised multiple choice questions and diagrams cover all areas tested in FCC exams, plus Self-Study Ability Test. \$9.95 postpaid. Money back guarantee.



COMMAND PRODUCTIONS P.O. BOX 26348 E
RADIO ENGINEERING DIV. SAN FRANCISCO, CALIF. 94126

GRANTHAM's FCC License Study Guide—377 pages, 1465 questions with answers/discussions—covering third, second, first radiotelephone examinations. \$13.45 postpaid. **GSE PUBLICATIONS**, 2000 Stoner, Los Angeles, CA 90025

PLANS & KITS

67 KHz SCA kits for extended FM reception. Includes drilled bakelite case, 110 volt power supply parts, wired and tested PC board. Quality products. \$47.50. Fully wired \$60.00. **MUSIC ASSOCIATED**, 65 Glenwood Rd., Upper Montclair, NJ 07043 (201) 744-3387

BI-LINEAR amplifier, 2-30 MHz, 60-150 watt. Construction plans. \$3.00. **WILSON**, Box 5516-FI, Walnut Creek, CA 94596



YES, YOU CAN BUILD AN ELECTRONIC ORGAN

That has a PIPE ORGAN SOUND

With **DEVTRONIX** easy to build assemblies. Own the ultimate in organ design & sound at 1/3 the cost of commercial organs

BROCHURE AND DEMO RECORD \$1.00



Devtronix Dept. B
ORGANS, INC. 5872 Amapala Dr.
San Jose, CA 95129

TV-GAMES: many circuits. Complete copies of original patents. Set \$9, postpaid. **SANRO**, Box 5511, San Jose, Calif. 95125

FREE KIT Catalog

STOP! Take a minute & let us send our latest kit catalog. If you like, send us the name & address of a friend who may also be interested and we'll include to you our booklet "How to build electronic thermometer" contains **TEST & EXPERIMENTER'S EQUIP.**

DAGE SCIENTIFIC INSTRUMENTS
BOX 1054R LIVERMORE CA 94550

PRINTED circuit boards from artwork, magazine layouts. Fast service. **OMEGA ENTERPRISES**, Box 48239, Niles, IL 60648

Toshiba Transistor Amplifier Module

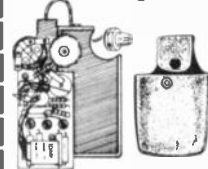

XM-670

499
Reg. 6.99

- Experimenters Delight
- 100's of Uses •Some Marred & Soiled

BSR

METROTEC

Smoke

& Fire

Detector

XM-646

1499
Reg. 19.99

- Protect Your Family From Fire and Killer Gases
- 117 VAC Powered

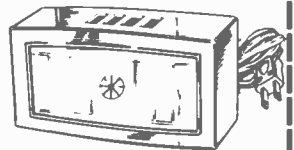

NICKEL CADMIUM "AA" Pen-Lite Cells



\$1 BA-341
Ea.

- 1.2 Volt Rechargeable
- For Radios and Calculators Etc.

	Reg.	Now
AM Pushbutton Auto Radio-New, AU-580	10.99	9.99
Sonar 30-50 MHz (3-Ch.) plus AM std. Broadcast Pocket Receiver, RA-577	39.00	29.99
Sonar 150-174 MHz. (3-Ch.) plus AM std. Broadcast Pocket Receiver, RA-422	39.00	29.99
Electronic Camera Shutter Assembly, XM-637	1.49	1.49
Singer 12 Digit MOS Calculator Chip with Data Sheet, XM-635	2.90	2.29
UHF Varactor Tuner, Data Incl., XM-676	1.99	1.49
Electronic "Choo-Choo" Module for Model Railroad, AM-549	1.99	.99
Siphon Pump-6 ft. Squeeze Type, XM-67559	.39
6 VDC to 12 VDC Converter, AU-297	16.00	7.00
4 Channel Converter for Car Stereo, HF-216	7.90	2.00
Timing Motor 1 Rev. Every 4 Hours 120 VAC., MO-407	1.69	.99
Teletchron Digital Clock Movement, 1 1/2" Numerals, 117 VAC., 60 Hz. Removed from Equip., SW-853	5.99	4.99
2 1/2" 60 Ohm Speaker, SP-435	1.19	.69
AM-FM-IMPX Receiver Chassis, Solid State 11-12 VAC Input. Tape Out Jacks, RA-574	9.99	7.99
Universal AC Adapter, 117 VAC Input, 6-7.5 and 9 VDC Output @ 300 Ma., BA-159	7.00	4.99

FREE CATALOG

Olson
electronics
260 S. FORGE ST.
DEPT. L3AKRON, OHIO 44327

NAME _____
ADDRESS _____
CITY _____ STATE _____
ZIP _____ Send Olson Cat

ENCLOSE POSTAGE AND SALES TAX

QTY.	STK. #	Description	Price Ea.	Total

CIRCLE 70 ON FREE INFORMATION CARD

BUILD YOUR OWN SPEAKERS AND SAVE UP TO 50%

Send for our free fact-packed 44-page catalog manual and learn how to assemble your own multi-element stereo speakers from scratch or from kits. Our catalog includes chapters on circuit construction, x-over, enclosures, midrange, woofers, tweeters and horns. Write us today!

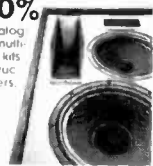

SPEAKERLAB
Dept. RE-A, 5500 35th N E
Seattle, Washington 98105

POWERFUL hearing aid with "electret" microphone. Complete kit \$45.00. **GOLDEN ENTERPRISES**, Box 1282-R, Glendale, AZ 85311

1702A, 2708, EPROM programmers, video display board, 6502 CPU board, all plug compatible to SWTPC 6800, usable on others. Board and documentation \$29.00 each. **F & D Associates**, New Plymouth, OH 45654

FREQUENCY counter: 300 MHz, crystal timing, lab quality .00003% accuracy, 9-18 vdc supply, internal batteries, 4" X 2" X 4 1/4". Plans only: \$5.00. Kits: 30 MHz, \$100.00 - 300 MHz, \$120.00. **E & J PRODUCTS**, Box 5516-FI, Walnut Creek, CA 94596

FOR SALE

FREE catalog. IC's, Semi's. CORONET ELECTRONICS, 649A Notre Dame W., Montreal, Que., Canada, H3C-1H8. US Inquiries.

FREE Send For CORNELL'S New Color Catalog 48 Pgs. New Items

(CORNELL TUBES!)

33¢ per tube **36¢ per tube**

ORDER FREE IF NOT SHIPPED IN 24 HOURS

4215 E. UNIVERSITY AVE. SAN DIEGO, CALIF. 92105

COMPUTER WAREHOUSE STORE

Dept. R
P. O. Box 68, Kenmore Station
Boston, MA 02215
617-261-2700

★ ONE DAY SHIPMENT ★



GREEN PHOSPHOR VIDEO MONITOR
\$150 + \$25 Shipping & Handling

16 MHz bandwidth, Standard Raster Scan, 24 Lines x 80 char.

THOUSANDS OF KITS AND PERIPHERALS

SPECIAL DISCOUNTS!
If you buy used equipment peripherals at the same time you buy our kit(s):
20% off Kit Price if over \$900
10% off Kit Price if over \$250
5% off Kit Price if over \$95
(\$200 Maximum Discount)

SEND \$1 FOR OUR CATALOG
Describes complete line of Kits & Units. Full About Hobby Microcomputers, Largest Selection of Computer Books, Microprocessor Comparison Chart and MUCH MORE

NAME brand digital/analog test equipment. Discount prices. Free catalog. **SALEN ELECTRONICS**, P.O. Box 82, Skokie, IL 60076

MAKE professional-quality PC boards with silk-screen techniques. Complete step by step information. \$4.95 Postpaid. **TERRATRONIC RESEARCH**, Box 513S, Quincy, IL 62301

PICTURE TUBE MACHINE
We buy and sell NEW and USED CRT rebuilding machinery. **COMPLETE TRAINING. Buy with CONFIDENCE from the ORIGINAL MFR.**

For complete details send name, address, zip to:
LAKESIDE INDUSTRIES
3520 W. Fullerton Ave.
Chicago, Ill. 60647
Phone: 312-342-3399

FREE catalog. Solar cells, NiCad's, kits, calculators, digital watch modules, ultrasonics, strobes, LED's, transistors, IC's, unique components. **CHANEY'S**, Box 27038, Denver, CO 80227

CARBON film resistors—1/4W, 5% (1-4M7 ohms) 3.5¢ each. 50¢/value—\$0.85. Postage, handling \$1.00. Send 25¢ for catalog, sample, specifications. **COMPONENTS CENTER**, Box 134R, New York, NY 10038

Burglar. Smoke Fire Alarm Catalog

• Billions of dollars lost annually due to lack of protective warning alarms.

FREE CATALOG Shows you how to protect your home, business and person. Wholesale prices. Do-it-yourself. Free engineering service.

Burdex Security Co.

Box 82802 RE-097 Lincoln, Ne. 68501

RECONDITIONED test equipment. \$0.50 for catalog. **WALTER'S TEST EQUIPMENT**, 2697 Nickel, San Pablo, CA 94806

MANUALS for Govt. surplus radios, test sets, scopes. List 50¢ (coin). **BOOKS**, 7218 Roanoke Drive, Washington, D.C. 20021

AMAZING ELECTRONIC PROJECTS and PRODUCTS:
Lasers Super Powered, Burning, Cutting, Rifle, Pistol, Pocket. See in Dark—Shotgun Directional Mike—Unscramblers—Giant Tesla—Stunwand—TV Disrupter—Energy Producing, Surveillance, Detection, Electrifying, Ultrasonic, CB, Auto and Mech. Devices. Hundreds More—All New Plus INFO UNLTD PARTS SERVICE. Catalog \$1. Information Unlimited, Box 626, Lord Jeffery Court, Amherst, N.H. 03031.

PRINTED circuit supplies. A process that always works. Send stamp. **CIRCOLEX**, Box 198, Marcy, NY 13403

Same day shipment. First line parts only. Factory tested. Guaranteed money back. Quality IC's and other components at factory prices.

INTEGRATED CIRCUITS

7400	7401	7402	7403	7404	7405	7406	7407	7408	7409	7410	7411	7412	7413	7414	7415	7416	7417	7418	7419	7420	7421	7422	7423	7424	7425	7426	7427	7428	7429	7430	7431	7432	7433	7434	7435	7436	7437	7438	7439	7440	7441	7442	7443	7444	7445	7446	7447	7448	7449	7450	7451	7452	7453	7454	7455	7456	7457	7458	7459	7460	7461	7462	7463	7464	7465	7466	7467	7468	7469	7470	7471	7472	7473	7474	7475	7476	7477	7478	7479	7480	7481	7482	7483	7484	7485	7486	7487	7488	7489	7490	7491	7492	7493	7494	7495	7496	7497	7498	7499	7500
------	------	------	------	------	------	------	------	------	------	------	------	------	------	------	------	------	------	------	------	------	------	------	------	------	------	------	------	------	------	------	------	------	------	------	------	------	------	------	------	------	------	------	------	------	------	------	------	------	------	------	------	------	------	------	------	------	------	------	------	------	------	------	------	------	------	------	------	------	------	------	------	------	------	------	------	------	------	------	------	------	------	------	------	------	------	------	------	------	------	------	------	------	------	------	------	------	------	------	------	------

P.O. Box 4430E Santa Clara, CA 95054
(408) 988-1540



QUEST ELECTRONICS

7400	7401	7402	7403	7404	7405	7406	7407	7408	7409	7410	7411	7412	7413	7414	7415	7416	7417	7418	7419	7420	7421	7422	7423	7424	7425	7426	7427	7428	7429	7430	7431	7432	7433	7434	7435	7436	7437	7438	7439	7440	7441	7442	7443	7444	7445	7446	7447	7448	7449	7450	7451	7452	7453	7454	7455	7456	7457	7458	7459	7460	7461	7462	7463	7464	7465	7466	7467	7468	7469	7470	7471	7472	7473	7474	7475	7476	7477	7478	7479	7480	7481	7482	7483	7484	7485	7486	7487	7488	7489	7490	7491	7492	7493	7494	7495	7496	7497	7498	7499	7500
------	------	------	------	------	------	------	------	------	------	------	------	------	------	------	------	------	------	------	------	------	------	------	------	------	------	------	------	------	------	------	------	------	------	------	------	------	------	------	------	------	------	------	------	------	------	------	------	------	------	------	------	------	------	------	------	------	------	------	------	------	------	------	------	------	------	------	------	------	------	------	------	------	------	------	------	------	------	------	------	------	------	------	------	------	------	------	------	------	------	------	------	------	------	------	------	------	------	------	------	------

Digital Thermometer \$65.00
General purpose or medical 32-230 F. Disposable probe cover = 2 accuracy. Completely assembled w/compact case.

Not a Cheap Clock Kit \$17.45
Includes everything except case. 2-PC boards. 6-50' LED Displays. 5314 clock chip, transformer, all components and full instructions. Same clock kit with 80' displays. \$22.75

Digital Temperature Meter Kit
Indoor and outdoor. Automatically switches back and forth. Beautiful 50' LED readouts. Nothing like it available. Needs no additional parts for complete, full operation. Will measure -100° to +200°F, air or liquid. Very accurate complete instructions. \$39.95

Clock Calendar Kit \$29.95
C77015 direct drive chip displays date and time on 6' LEDs with AM-PM Indicator. Alarm/doze feature. Includes buzzer. Complete with all parts, power supply and instructions. Less case. \$5.00

1977 IC Update Master
Manual. Complete integrated circuit data selector from all manufacturers. 1,234 page master reference guide to the latest IC's including microprocessors and consumer circuits. 17,000 cross references for easier sourcing of hard to get parts. Special pricing: \$24.95, with free update service thru 1977. Domestic postage \$2.00. Foreign \$6.00.

2.5 MHz Frequency Counter Kit
As low as 10 Hz. 6-50' digits with PC board and full instructions. \$40.00

30 MHz Frequency Counter Kit
Same basic CMOS counter as above plus level controls and dual FET inputs. Prescalable to 200 MHz with PC board and full instructions. \$55.00 Fully wired and tested. \$75.00

Function Module, Card Kit
Converts any frequency counter into 3 1/2 digit DVM, digital thermometer, pulse & square generator from 10 Hz to 100 kHz. Complete kit minus power supply. \$25.00

Stopwatch Kit \$26.95
Full six digit battery operated. 2-5 volts. 3.2768 MHz crystal accuracy. Times to 59 minutes, 59 seconds, 99 1/100 sec. Times standard, split and Taylor. 7205 chip, all components minus case. Full instructions. White or black plexiglass case. \$5.00

Volt/ohm Probe
Batt. oper. AC/DC to 125 V. 2 pos. volt. and 2 neg. volt. plus continuity. Stainless steel, pocket size. comp. assem \$34.95

60 Hz Crystal Time Base Kit \$4.75
Converts digital clocks from AC line frequency to crystal time base. Outstanding accuracy. Kit includes: PC board, MMS369, crystal, resistors, capacitors and trimmer.

Home Alarm Kit \$18.75
Designed for use with electronic siren module. AC power, battery backup, entry delay. Instant alarm for night use. NO/NC circuits. Test and arm indicators. 2 amp switching capability. All parts with complete Instructions minus power supply. Electronic siren module kit. \$2.75

Variable Power Supply Kit
0-12 VOC @ 1/2A bench supply. Less than .1% line, load regulation. Remote sense capability. Constant voltage/circuit limit. Can be modified for other V/A ranges. Complete with board and transformers. \$19.95 Same supply at 1 amp \$22.50

Cosmac 'ELF' Kit RCA CMOS Expandable Microcomputer. **New PC board with monitor on PROM included.** No hard wiring required. All on board including power supply. Complete kit of parts with new assembly manual. \$109.00 Includes audio amplifier & speaker. All in stock, immediate delivery. Board only \$14.95 Special case with front panel \$15.00

Auto Clock Kit \$15.95
DC clock with 4-50' displays. Uses National MA1012 module with alarm option. Crystal time base PC boards and full instructions. Add \$3.95 for a beautiful dark gray case ready to install. This is the best value available anywhere!

TERMS: \$5.00 min. order U.S. Funds. Calif residents add 6% tax. BankAmericard and Master Charge accepted. Shipping charges will be added. FREE: Send for your copy of our 1977 QUEST CATALOG. Include 13¢ stamp.



NEW LSI TECHNOLOGY
FREQUENCY COUNTER

TAKE ADVANTAGE OF THIS NEW STATE-OF-THE-ART COUNTER FEATURING THE MANY BENEFITS OF CUSTOM LSI CIRCUITRY. THIS NEW TECHNOLOGY APPROACH TO INSTRUMENTATION YIELDS ENHANCED PERFORMANCE, SMALLER PHYSICAL SIZE, DRASTICALLY REDUCED POWER CONSUMPTION [PORTABLE BATTERY OPERATION IS NOW PRACTICAL], DEPENDABILITY, EASY ASSEMBLY AND REVOLUTIONARY LOWER PRICING!

SIZE:
3" High
6" Wide
5 1/2" Deep

1 3/4 LBS.
COLOR:
BLACK



FACTORY DIRECT PRICES

KIT #FC-50 C	60 MHZ COUNTER WITH CABINET & P.S.	\$99.85
KIT #PSL-350	350 MHZ PRESCALER [NOT SHOWN]	23.95
KIT #PSL-650	650 MHZ PRESCALER [NOT SHOWN]	29.95
MODEL #FC-50WT	60 MHZ COUNTER WIRED, TESTED & CAL.	165.95
MODEL #FC-50/600WT	600 MHZ COUNTER WIRED, TESTED & CAL.	199.95

KIT #FC-50C IS COMPLETE WITH PREDRILLED CHASSIS ALL HARDWARE AND STEP-BY-STEP INSTRUCTIONS. WIRED & TESTED UNITS ARE CALIBRATED AND GUARANTEED. PRESCALERS WILL FIT INSIDE COUNTER CABINET.

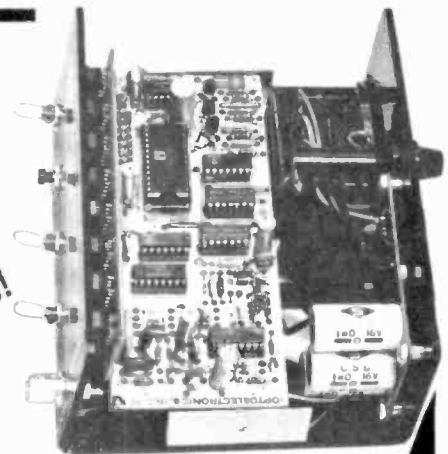

4" DIGITS!

FEATURES AND SPECIFICATIONS:

DISPLAY: 8 RED LED DIGITS .4" CHARACTER HEIGHT
GATE TIMES: 1 SECOND AND 1/10 SECOND [AUTO DEC. PT. PLACEMENT]
RESOLUTION: 1 HZ AT 1 SECOND, 10 HZ AT 1/10 SECOND.
FREQUENCY RANGE: 10 HZ TO 60 MHZ [65 MHz TYPICAL].
SENSITIVITY: 10 MV RMS TO 50 MHZ, 20 MV RMS TO 60 MHz TYP.
INPUT IMPEDANCE: 1 MEGOHM AND 20 PF.
[DIODE PROTECTED INPUT FOR OVER VOLTAGE PROTECTION.]
ACCURACY: ± 1 PPM [± .0001%] AFTER CALIBRATION TYPICAL.
STABILITY: WITHIN 1 PPM PER HOUR AFTER WARM UP [0.001% XTAL]
IC PACKAGE COUNT: 8 [ALL SOCKETED].
INTERNAL POWER SUPPLY: 5.2 V DC AT 800 MA. REGULATED.
POWER CONSUMPTION: 4 WATTS
INPUT CONNECTOR: BNC TYPE

PLEXIGLAS CABINETS



Great for Clocks or any LED Digital project Clear-Red Chassis serves as Bezel to increase contrast of digital displays.

CABINET I

3"H, 6"W, 5 1/2"D
2 1/2"H, 5"W, 4"D
3"x6"x1/8"

Black, White or Clear Cover
\$6.50 ea
95¢ ea. 4/\$3

SEE THE WORKS Clock Kit
Clear Plexiglas Stand

- 6 Big 4" digits
- 12 or 24 hr. time
- 3 set switches
- Plug transformer
- all parts included

Plexiglas is Pre-cut & drilled
Kit #850-4CP

Size: 6"H, 4 1/2"W, 3"D
\$23.50 ea. 2/\$45.

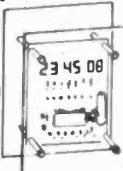

A SUPER CLOCK!

60 HZ.

XTAL TIME BASE:
Will enable Digital Clock Kits or Clock-Calendar Kits to operate from 12V DC
1" x 2" PC Board
Power Req. 5-15V (2.5 MA TYP.)
Easy 3 wire hookup
Accuracy ± 2PPM
#TB-1 (Adjustable)
Complete Kit \$4.95
Wir & Cal \$9.95

SPECIAL PRICING!

PRIME - HIGH SPEED RAM
21L02-3 400 NS
LOW POWER - FACTORY FRESH
1-24 \$1.95 ea 100-199 \$1.60 ea
25-99 1.75 ea 200-499 1.45 ea
OVER 500 PCS. \$1.39 ea.

6-DIGIT LED CLOCK CALENDAR KIT
DATE-TIME-SNOOZE ALARM & MORE... KIT 7001

FOR THE BUILDER THAT WANTS THE BEST. FEATURING 12 OR 24 HOUR TIME — 29-30-31 DAY CALENDAR. ALARM, SNOOZE AND AUX. TIMER CIRCUITS

Will alternate time (8 seconds) and date (2 seconds) or may be wired for time or date display only, with other functions on demand. Has built-in oscillator for battery back-up. A loud 24 hour alarm with a repeatable 10 minute snooze alarm, alarm set & timer set indicators. Includes 110 VAC/60Hz power pack with cord and top quality components through-out.

KIT - 7001B WITH 6 - .5" DIGITS	\$39.95
KIT - 7001C WITH 4 - .6" DIGITS & 2 - .3" DIGITS FOR SECONDS	\$42.95
KIT - 7001X WITH 6 - .6" DIGITS	\$45.95

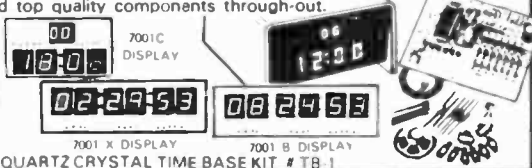

KITS ARE COMPLETE (LESS CABINET)

ALL 7001 KITS FIT CABINET I AND ACCEPT QUARTZ CRYSTAL TIME BASE KIT #TB-1

PRINTED CIRCUIT BOARDS for CT 7001 Kits sold separately with assembly info. PC Boards are drilled Fiberglass, solder plated and screened with component layout.

Specify for 7001

B, C or X - \$7.95

AUTO BURGLAR ALARM KIT



AN EASY TO ASSEMBLE AND EASY TO INSTALL ALARM PROVIDING MANY FEATURES NOT NORMALLY FOUND. RELESS ALARM HAS PROVISION FOR POS & GROUNDING SWITCHES OR SENSORS. WILL PULSE HORN RELAY AT 1/2 RATE OR DRIVE SIREN. KIT PROVIDES PROGRAMMABLE TIME DELAYS FOR EXIT ENTRY & ALARM PERIOD UNIT MOUNTS UNDER DASH. REMOTE SWITCH CAN BE MOUNTED WHERE DESIRED. CMOS RELIABILITY RESISTS FALSE ALARMS & PROVIDES FOR ULTRA DEPENDABLE ALARM DO NOT BE FOOLED BY LOW PRICES! THIS IS A TOP QUALITY COMPLETE KIT WITH ALL PARTS INCLUDING DETAILED DRAWINGS AND INSTRUCTIONS OR AVAILABLE WIRED AND TESTED

KIT #ALR-1 \$9.95
#ALR-1WT WIRED & TESTED \$19.95

VARIABLE REGULATED 1 AMP POWER SUPPLY KIT

- VARIABLE FROM 4 TO 14V
 - SHORT CIRCUIT PROOF
 - 723 IC REGULATOR
 - 2N3055 PASS TRANSISTOR
 - CURRENT LIMITING AT 1 Amp
- KIT IS COMPLETE INCLUDING DRILLED & SOLDER PLATED FIBERGLASS PC BOARD AND ALL PARTS (LESS TRANS. FORMER) KIT #PS-01 \$6.95
TRANSFORMER 24V CT will provide 300MA. at 12V and 1 Amp at 5V. \$3.50

MOBILE LED CLOCK

12/24 HR 4" DIGITS!

MODEL 12 VOLT AC or DC POWERED #2001



- 6 JUMBO .4" RED LED'S BEHIND RED FILTER LENS WITH CHROME RIM
 - SET TIME FROM FRONT VIA HIDDEN SWITCHES • 12/24-Hr. TIME FORMAT
 - STYLISH CHARCOAL GRAY CASE OF MOLDED HIGH TEMP. PLASTIC
 - BRIDGE POWER INPUT CIRCUITRY — TWO WIRE NO POLARITY HOOK-UP
 - OPTIONAL CONNECTION TO BLANK DISPLAY [Use When Key Off in Car, Etc.]
 - TOP QUALITY PC BOARDS & COMPONENTS - INSTRUCTIONS.
 - MOUNTING BRACKET INCLUDED
- KIT #2001 COMPLETE KIT \$2995 EA 3 OR MORE \$2795 EA. #AC-1 [Less 9V. Battery] 115 VAC Power Pack \$250 EA.
ASSEMBLED UNITS WIRED & TESTED \$3995 EA. OR \$3795 EA. [LESS 9V. BATTERY] Wired for 12-Hr. Op. If not otherwise specified.

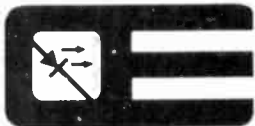

OPTOELECTRONICS, INC.

BOX 219 • HOLLYWOOD, FLA. 33022 • (305) 921-2056
STORE: 823 S. 21 AVE

WE PAY ALL SHIPPING IN CONTINENTAL USA — OTHERS ADD 5% [10% FOR AIRMAIL]



ORDER BY PHONE OR MAIL
COD ORDERS WELCOME
Orders Under \$15 Add \$1.00 Handling
Fla. Res. Please Add 4% Sales Tax.

SEPTEMBER 1977

Test Equip. Special Discount Prices



BLUE LATERAL MAGNET/PURITY RING	1.79
COLOR DELAY LINE	1.69
ZENITH STICK RECTIFIER #103-215.....	5.95
ZENITH TRIPLER # 212-109	3.95
RCA COLOR POWER TRANSFORMER #26R150	9.95
2—COLOR BURST CRYSTALS (3579.545KC).....	1.89
3—COLOR TV RECTIFIERS 6500KV	1.95
5—DUAL DIODES (Common or Series)	2.49
3—ZENITH VIDEO AMP. #121-743	2.00
3—ZENITH VIDEO DRIVER #121-952	1.29
TACHOMETER 2 1/4" SQ. PANEL METER	2.00
7 TUBE AM FM STEREO AMP. with tubes	9.95
6—SILICON RECT. 1 Amp. 1000 Piv	1.00
6—SILICON RECT. 2 Amp 1000 Piv	1.49
DELUXE PILLOW SPEAKER	2.29
3—POLARIZED CHEATER CORDS	1.00
4—TV ALIGNMENT KIT	1.00
6—TV ALIGNMENT KIT	2.79
VU "T" METER (0-20db Scale)	1.00
100' GREY SPEAKER WIRE	2.00
CO-AX CABLE -50' 2.69 250'	10.00
3" X 5" SPEAKER.....	1.49
6" X 9" SPEAKER 10 oz.	5.50
8" SPEAKER 10 oz.	5.50
6" X 9" SPEAKER 20 oz.	10.95
2" X 6" SPEAKER.....	1.95
3" TWEETER.....	1.49
STEREO HEADPHONE	5.95
100' 300 OHM-100 Mill-antenna wire	2.95
RCA 110° FLYBACK TRANS. (Blk & Wht)	3.95
110° YOKE (Blk & wht)	4.95
90° COLOR YOKE	7.95
70° CDLOR YOKE RCA type	5.95
70° COLOR CRT BOOSTER.....	3.95
90° COLOR CRT BOOSTER.....	4.50
BEHIND THE SET ANTENNA	2.95
UHF TUNERS	2.95
UHF TUNERS GE TYPE.....	3.95
PHILCO UHF/VHF TUNERS (Trans)	9.95
GE TV TUNER (Series EP86X11)	7.95
WAHL CORDLESS SOLDER IRON	17.95
MONO PHONO TONE ARM	1.69
3—UHF ANT. LOOP	1.79
B&K-280 3 DNG. MULTIMETER	84.95
BSR RECORD CHANGER	24.95
10-ASSTD. CIRCUIT BREAKERS	4.95
HEP-707 TRANSISTOR	2.29
2-HEP S0015 TRANSISTOR	1.00
HEP S5004 TRANSISTOR	1.00
HEP S5011 OR S5012	1.00
TRANSISTORS SK3006, SK3018, SK3020	1.00 ea
" SK3122, SK3124	1.00 ea
" SK3009, SK3024, SK3040	1.00 ea
GE IC3 or IC 4	1.00 ea
5—12BH7 Westinghouse Tubes	2.95
SOLID STATE DC POWER SUPPLY 12V.....	19.95
5—ANTENNA MATCHING TRANS (72 to 300 Ohm)	5.95
TRANSISTOR RADIO as is	1.50
TAPE RECORDERS as is	4.00
TRANSISTORS ECG-108, ECG116, ECG123A	1.00 ea
" ECG160, ECG-121, ECG 128	1.00 ea
TRANSISTOR SPECIAL ECG 154	1.00
TUNER SPRAY 16 oz. can	1.59
75 —ASSTD. 1/2W RESISTORS	1.29
100— " 1/4W	1.00
200— " 1/2W " short leads.....	1.00
70 — " 1W	1.29
35 — " 2W	1.29
50 — " CERAMIC COND.	1.00
SHARP FLYBACK 8FT592	2.00
5—10K—2 WATT BIAS POTS	1.00
3 SPEAKER 7 WAY SEL. SW.,	1.00
10—MINI ELEC. COND. for transistor radios.....	1.00
CONVERG. RECTIFIER 4 cell	1.00
10-456KC IF TRANSFORMERS	1.00
RONETTE STEREO CARTRIDGE	2.00
10—ASSTD VOLUME CONTROLS	1.00
20—ASSTD. WIRE WOUND RESISTORS	1.00
TV DAMPER DIODE RCA Type	1.95
VARCO STEREO CARTRIDGE TN4B	2.95

Minimum Order \$5.00 Immediate Delivery

BROOKS RADIO & TV CORP.
529 Columbus Ave., New York, N.Y. 10024
TELEPHONE 212-874 5600

ADVERTISING INDEX

RADIO-ELECTRONICS does not assume any responsibility for errors that may appear in the index below.

Free Information Number	Page
19 AP Products	22
42 Advance Electronics	79
5 Allison.....	96
29 American Technology.....	103
Audio-Technica	91
61 B & K-Div. of Dynascan	89
63 Castle Electronics.....	88
9 Channellock	26
73,79 Chemtronics	90, 98
CIE-Cleveland Institute of Electronics ..	18-21
6 Cobra-Div. of Dynascan	Cover IV
1 Continental Specialties.....	32
CREI-Div. of McGraw-Hill Continuing Education	46-49
41 Digital Concepts	95
104 DRI	23
30 Edmund Scientific.....	126
76,77 EICO	95,97
39 Electronics Book Club.....	85
EMC-Electronic Measurements.....	79
3 Fidelity Sound.....	104
18 Florida Institute of Technology	24
33 Fluke	17
GFN Industries	1
48 Grantham College of Engineering	96
GTE-Sylvania-Consumer Renewal	Cover III
100 Heath	74-77,28-31
25 Hickok Electrical Instruments	14
22 Indiana Home Study.....	104
34 International Crystal	99
24 Jensen Tools & Alloys.....	100
35 JMJ Technical Products	87
Kenwood Electronics	2
40 Mallory Distributor Products	Cover II
37 MTI	92
21 Mountain West Alarm Supply	90
13 National Camera Supply	102
National Radio Institute (NRI)-Div. of McGraw-Hill Continuing Education Center	8-11
National Technical Schools.....	64-67
72 Norcom Electronics.....	97
26,15 OK Machine & Tool.....	25,73
12 PAIA.....	100
62 PTS Electronics	92
27 Panavise-Div. of Colbert Industries	100
57 Pomona Electronics.....	93
Radio Shack	13
38 Rye Industries	95
H.W. Sams	27
32 Schober Organ.....	90
4 Sencore	16
69 Shure Brothers.....	83
7 Simpson Electric.....	15
71 Techni-Tool	104
74 Telematic-Div. of UXL	101
8 Tri-Star.....	92
14 Tuner Service.....	5
31 VIZ Mfg.....	71
20 Vaco.....	7
64 Wersi Electronics	102
78 Wintek	96

MARKET CENTER

60 Active Electronics.....	118
American Used Computer	106
53 AVR Electronics.....	112
49 Babylon Electronics.....	120
Karel Barta	105

Free Information Number Page

36 Brooks Radio & TV	108
Burdex Security.....	106
CFR Associates	105
Command Productions	105
Cornell	106
Dage Scientific Instruments	105
43 Delta Electronics	114
Devtronix Organ Products	105
Digi-Key	123
54 Electronic Warehouse	114
65 EtcO Electronics	115
Exper-Tronix.....	112
44 Fordham Radio Supply	114
55 Formula International	119
47 Godbout Electronics	122
Information Unlimited.....	106
International Electronics	113
10,11 James Electronics	116,117
Lab Science	112
Lakeside Industries.....	106
59 Meshna	112
45 New-Tone	122
70 Olson	105
51 Optoelectronics.....	107
17 Page Digital Electronics	114
46 Parasitic Engineering	122
16 Printronix	112
28 Poly Paks	121
52 Quest	106
67 Radio Hut	125
68 SD Sales	124
23 JB Saunders	111
58 Solid State Sales.....	118
Speakerlab	106
75 Trico Electronics	120

MOVING?

Don't miss a single copy of **Radio-Electronics**. Give us:

Six weeks' notice

Your old address and zip code

Your new address and zip code

ATTACH LABEL HERE

name (please print) #
address
city state zip code

Mail to: Radlb-Electronics
SUBSCRIPTION DEPT., P.O. BOX 2520,
BOULDER, COLO. 80322

All Orders Processed Same Day!

If We Have An Out-Of-Stock Item, You Are Notified Immediately.

Remember!! Our prices in May and June Radio-Electronics are still good.

MODU-CLOCK

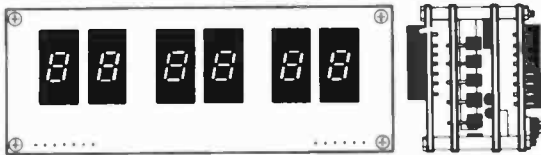

* High quality printed circuit board project. --No parts included.

THOUSANDS SOLD NATIONALLY!!!!

DESIGN UTILIZES:
6-Digit LED (Men 7, DL 707, etc.)
MM5314 Clock Chip
Can be built for AC or DC operation.
Drilled, etched and plated boards.
CMOS timesave option.

The ultimate 6-digit clock project. Unique architecture allows versatile construction. All boards are 1.5" x 4" and mount behind each other. All connections are brought to the board's edges.

AC Version (3 board set)
Readout Board
Clock Board
Power Board
Complete Instructions and Parts List.
ONLY \$4.95

AC/DC Version (4 board set)
Readout Board
Clock Board
Power Board
Timesave board
Complete Instructions and Parts List.
ONLY \$5.95



DIGIT-MODULE STRIP

DM 5 STRIP
5 digit strip for use with FND 500/507 LED readouts. Dim 1" x 3.5"
\$2.25/strip

DECADE COUNTER MODULE

DCM-1



Versatile decade counter board. Utilizes a 7447 decoder-driver and a 7490 decade counter. Directly drives common anode LED readouts. Designed to be used in conjunction with our DM-5 and DM-8 digit modules. All connections brought to board's edge. **ONLY 70¢ ea 10 for \$6.00**

6 DIGIT READOUT BOARDS

Multiplexed connections for clocks, counters, etc. See notes for mounting.

Part No. Use with Price Dim
DB 63 FND 357 \$2.25 1.5" x 4"
DB 67 DL 707, MARI 1 type etc. 1.5" x 4" \$2.25
DB 65 FND 500/507/510 \$3.00 1.5" x 5"

DIGIT-MODULES

Versatile boards for mounting and wiring LED displays. For clocks, counters, timer etc.

Part No. Use with Price Dim
DM 5 FND 500/507 .50 7" x 1"
DM 8 FND 800/807 .70 1" x 1.5"

ALARM CLOCK MODULE

displays Hours, Minutes, and Seconds

FEATURES:

- GIANT .7 INCH RED LED READOUTS
- COMPLETE FACTORY TESTED MODULES
- SPECIAL TRANSFORMER
- SECONDS DISPLAY
- BRIGHTNESS CONTROL
- 12 OR 24 HOUR OPTION
- SLEEP AND SNOOZE TIMERS
- PRESETTABLE 59 MINUTE SLEEP TIMER
- 9 MINUTE SNOOZE ALARM
- AM - PM INDICATOR
- COMES COMPLETE WITH 6 PAGE INSTRUCTION BOOKLET



NEW!!!

SATISFACTION GUARANTEED!!!!

THE ULTIMATE CLOCK PROJECT!!
Order Now!
ONLY \$12.95
3 for \$34

Data sheets. Specifications. Applications information. New TTL Data Book. Only \$4.95



Five more valuable reference aids.

- The Optoelectronics Data Book, 368 pages, \$2.95.
- The Semiconductor Memory Data Book, 275 pages, \$2.95.
- The Transistor and Diode Data Book, 1,248 pages, \$4.95.
- The Linear Control Circuits Data Book, 368 pages, \$2.95.
- The Power Semiconductor Data Book, 516 pages, \$3.95.

The newest edition of the TTL Data Book for Design Engineers. Detailed specifications on over 900 TTL device types. Standard TTL, high technology, Schottky clamped TTL, pin assignment drawings of all TTL types. The most complete book on TTL logic written by the same company that invented the IC.

A must for every scientist, engineer, and technician!!!!

The TTL Data Book, second edition, 832 pages, \$4.95

WIRE DISPENSER

- 50 FT. ROLL OF 30 AWG. KYNAR WIRE-WRAPPING WIRE
- CUTS THE WIRE TO LENGTH
- STRIPS 1 INCH OF INSULATION

AVAILABLE IN FOUR COLORS

- WD-30-B BLUE WIRE
 - WD-30-Y YELLOW WIRE
 - WD-30-W WHITE WIRE
 - WD-30-R RED WIRE
- \$3.45 EACH**

MODEL WD-30



COOKBOOKS



• **CMOS COOKBOOK** by Don Lancaster, pub. Howard W. Sams Company. Another gem from Don Lancaster, author of the famous RTL and TTL Cookbooks. The CMOS Cookbook details the application of CMOS, the low power logic family suitable for most applications presently dominated by TTL. The book follows the style of the original Cookbooks. Eight chapters cover all facets of CMOS logic, and the work is prefaced by 100 pages detailing the characteristics of most CMOS circuits. The CMOS Cookbook is required reading for every serious digital experimenter. \$9.95

• **TTL COOKBOOK** by Donald Lancaster, describes the use of a standard television receiver as a microprocessor CRT terminal. Explains and describes character generation, cursor control and interface information in typical, easy-to-understand, Lancaster style. This book is a required text for both the microcomputer enthusiast and the amateur RTTY operator who desires a quiet alternative to noisy teletype machines. \$9.95

• **TTL COOKBOOK** by Donald Lancaster. Explains what TTL is, how it works, and how to use it. Discusses practical applications, such as a digital counter and display system, events counter, electronic stopwatch, digital voltmeter, and a digital tachometer. 336 pages, 5 1/2 x 8 1/2, softbound. \$9.95

• **IC OP-AMP COOKBOOK** by Walter G. Jung. Covers not only the basic theory of the IC op amp in great detail, but also includes over 250 practical circuit applications, liberally illustrated. 592 pages, 5 1/2 x 8 1/2, soft bound. \$12.95

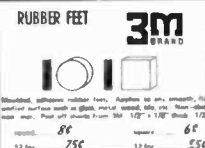

SATISFACTION GUARANTEED!!!!

Catalog-In-A-Box™

JBS EXCLUSIVE!

NEW!!!

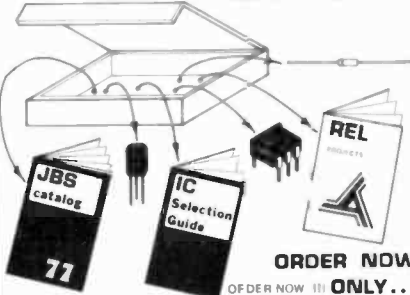

Each CATALOG-IN-A-BOX™

Contains:

- Samples of transistors, IC's, caps, resistors. Worth over \$1.00 in merchandise.
- JBS GIANT full-line catalog with outstanding buys on electronics.
- IC selection guide. Handy selection and pricing guide for digital and linear IC's.
- REL projects catalog.

Just send \$2.00 cash, check or M.O. for immediate delivery. No minimum order for CATALOG-IN-A-BOX™.

ORDER NOW!! \$2.00

ORDER NOW!!! ONLY.....
Limit One Per Customer Please.
ORDER TODAY!!!
You must be satisfied or your money back.

Our Third Big Year Serving The Scientist, Engineer, OEM Manufacturer And Hobbyist. Highest Quality Merchandise! Fastest Service!

Customer Satisfaction Guarantee

We specialize in fast, prompt service with total customer satisfaction!! All items are guaranteed for 30 days from date of shipment, provided that no user inflicted damage has occurred.

STORE HOURS: 9:30 - 5:30 Weekdays
9:30 - 3:00 Saturdays

JBS ELECTRONICS, inc.
3050 VALMONT BOULDER, COLO. 80301
(303) 442-1212

TERMS

ALL PRICES SUBJECT TO CHANGE WITHOUT NOTICE
ALL MERCHANDISE SUBJECT TO PRIOR SALE
POSTAGE & HANDLING ADD \$1
3 1/2% STATE TAX (COLO. RES.)
MINIMUM ORDER \$5.00
NC COD'S

© COPYRIGHT 1977 JBS

CIRCLE 23 ON FREE INFORMATION CARD

CATCH-A-PULSE II[®] LOGIC PROBE

10 Nsec SPEED AT
3.5 to 15V LEVELS
ONLY \$39.95

Compatible with RTL, DTL, TTL, CMOS, MOS, and Microprocessors using a 3.5 to 15V power supply. Thresholds automatically programmed. Automatic resetting memory. No adjustment required. Visual indication of logic levels, using LEDs to show high, low, bad level or open circuit logic and pulses. Highly sophisticated, shirt-pocket portable (protective tip cap and removable coil cord). Eliminates need for heavy test equipment. A definite savings in time and money for engineer and technician.

- 10 Nsec pulse response
- Open circuit detection
- Multi-family
- Replaceable tip & cord
- High input impedance
- Pulse stretching

Send \$39.95
(Calif. residents add
6% sales tax) to:



Pat. Pend. Dealer inquiries welcome
ELECTRONICS

Box 19299, San Diego, CA 92119
(714) 447-1770

CIRCLE 53 ON FREE INFORMATION CARD



AM/FM RADIO \$10

Plugs into wall, add your 2 speakers and you're ready to go. Calibrated s/o motion am/fm tuning dial. Has stereo amps for use with phono or tape inputs to give stereo output. Solid state new.



UNIVERSAL POWER SUPPLY

Operates on 115 or 230V. Output by switches 4.5VDC, 6 VDC, 7.5VDC or 9 VDC. Also has universal 4 way output plug to fit most any device. Good for 300 MA. \$6.00 each 3 for \$15.00.

CHARACTER GENERATOR CHIP
Memory is 512X5 produces 64 five by seven ASCII characters. New by National, w/specs \$6.00

TOUCHSTONE ENCODER CHIP
Compatible w/Bell system. Ideal for repeater work. W/specs \$6.00

SMOKE - FIRE - INTRUDER ALARM
12 VDC w/ 5 inch loud bell, w/instructions.

Fine biz. for car, camper, boat, home
W/ instructions \$22.00

customer pays all postage

MESHNA, PO BOX 62, E. Lynn Ma 01904

RADIO-ELECTRONICS

112 CIRCLE 59 ON FREE INFORMATION CARD

RESISTORS

*1/2 Watt 5% Carbon Film 10 of each value

Brand New O.E.M. Quality Resistors

10 12 15 18 22 27 33 39 47 56 68 82

100 120 150 180 220 270 330 390 470 560 680 820

1K 1.2K 1.5K 1.8K 2.2K 2.7K 3.3K 3.9K 4.7K 5.6K 6.8K 8.2K

10K 12K 15K 18K 22K 27K 33K 39K 47K 56K 68K 82K

100K 120K 150K 180K 220K 270K 330K 390K 470K 560K 680K 820K 1M

610 \$15.95

Mini Toggle Switches 8/\$6.50 or \$0.90 each

Dry Etchant, just add water.

4 packets-each makes 1 qt. \$3.95

Many other items: Calc. Keyboards, Transistors, Diodes, Rams, Roms, and many more MOS I.C.'s.

Send \$0.25 for flyer to:

SENO CHECK OR MONEY ORDER
INDIANA RES ADD 4%
EXPENTRONIX Co. P.O. Box 1087
Hammond, Ind. 46320
SHIPPING & HANDLING

SUPREME Electronic's new catalogue is ready. Send \$1.00 (refundable) to our new address: P.O. Box 58276, Postal Stn. L, Vancouver, B.C. V6P 6E3

POWERFUL, adjustable, regulated, three output power supply and 900 easily removable parts in complete **Cartrivision** television recorder electronic assembly with documentation. Perfect for **Microprocessor, IC, transistor, television, CB** radio applications. \$24.95 total. BankAmericard, Master Charge. Free brochure. **MADISON ELECTRONICS, INCORPORATED**, 369, D101, Madison, AL 35758. Satisfaction guaranteed.

VIDEO tape recorders: Norelco LDL 1000/52 records and plays on 1/2-inch tape. Guaranteed perfect: \$260.00, UPS postage paid. **GORDON K. KAPES**, 1127 Ridgewood Drive, Highland Park, IL 60035

NEW! Electronics catalog. Rush \$1.00. Refundable with first order. **HOBBIE-TRONICS**, 4950 Clearwood Way, Sacramento, CA 95841

TELEPHONE recording equipment and other 'unusual' electronic devices. Free information. **GARRISON**, Box 128, Kew Gardens, New York, 11354

NOW!

The PTX
Logic Probe
Only \$12.95
and a new
Low Cost
Board

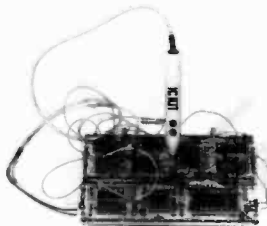

All of our boards feature—
• Numbered tie points and colored plugs.
• Solid printed circuit boards.
• Reusable parts.

Our original board handles 10 IC's in sizes from 14-40 pin DIP shown above. Kit includes: Board, plugs, sockets & eyelets. Only \$36.25—Order # 141

NEW from Printronix—a very low cost board!
Our new board can handle 10 IC's and included with the board are sockets, plugs, even wire. Only \$12.95—Order # 171

A complete package for the Experimenter including one of the above PTX kits and 3 specially selected books: Basic Digital Electronics, OP AMP Circuit Design and Applications, Optoelectronics Guidebook—with tested projects. With kit # 141—\$49.95-Order # 151. With kit # 171—\$26.95-Order # 181.

Also New—a low cost logic probe!
Good for TTL & C MOS integrated circuits, includes two VLED's and case. Kit-\$12.95—Order # 271
Assembled-\$17.95—Order # 261

Books of interest!
Programming Microprocessors-Order # 985—\$6.95. Master Handbook of 1001 Practical Electronic Circuits-Order # 800—\$9.95. Microprocessor/Microprogramming Handbook-Order # 785—\$6.95. Computer Programming Handbook-Order # 752—\$8.95.

PRINTRONIX
1361 Flatbush Ave.
Bklyn, N.Y. 11210

ALL items are postpaid
N.Y. City & State
residents add tax

CIRCLE 16 ON FREE INFORMATION CARD

EC-101 CURVETRACER

STILL BY FAR THE LOWEST COST FULL FUNCTION CURVE TRACER ON THE MARKET. ATTACHES TO YOUR SCOPE IN SECONDS. USED BY EDUCATORS, PROFESSIONALS AND HOBBYISTS ALL OVER THE WORLD. 30 DAY MONEYBACK GUARANTEE.

lab science

STILL ONLY \$39.50
ADD \$2 P.H. SALES TAX

PO BOX 1972, BOULDER, COLO. 80306

NEGATIVE ion generator. Revitalize yourself with invigorating "ionized" air. **GOLDEN ENTERPRISES**, Box 1282-RE, Glendale, Arizona 85311

DETECT/destroy hidden "bugs," wiretaps. Complete line countersurveillance equipment. **GOLDEN ENTERPRISES**, Box 1282-RE, Glendale, Arizona 85311

FREE catalog of electronic parts, kits, semi's, spectacular savings. **DIAMONDBACK**, Box 194R, Spring Valley, IL 61362

CONNECTORS, audio and RF and accessories. Low prices. Free catalog. **COAKIT**, Box 101G, Dumont, NJ 07628

CLOSEOUT on entire inventory of electronic parts, kits. Send stamp. **C.F. ENTERPRISES**, 8905 Holly, Kansas City, MO 64114

CARTRIVISION owners! Sony color tuner modulator plugs into video recorder. Record off channels not viewed. Record without television on. Play into any TV without interfacing. \$250.00 (specify channel 3/4). **D.H.V., INC.**, Box 12, Langhorne, PA 19047

CANADIAN electronics surplus catalog mailed anywhere in the world. Jam packed with exciting items and unusual and hard to find parts for hobbyist, industry and schools. Thousands of super surplus bargains in parts, semis, kits, test gear, tubes, accessories, CB, telephones, calculators, etc. Over 100 top name stereo brands discounted. Amazing values for everyone. We are big buyers of factory clearouts, distress merchandise and government surplus. Rush \$1. **ETCORE**, 521 5th Ave., NYC 10017

SAVE on television tuner repairs, tuner parts, modules and test equipment. \$1.50 refundable catalog. **OZ'S TUNER SERVICE**, Box 2464, La Puente, CA 91746

United Way

Thanks to you
it works...

FOR ALL OF US

advertising contributed for the public good

INTERNATIONAL ELECTRONICS UNLIMITED

10% OFF WITH \$25 ORDER
15% OFF WITH \$100 ORDER

THESE DISCOUNTS APPLY TO TOTAL OF ORDER — SPECIALS INCLUDED

TTL					
7400	.13	7451	.17	74151	.89
7401	.16	7453	.17	74154	1.20
7402	.15	7454	.17	74155	.97
7403	.15	7460	.17	74156	.97
7404	.16	7464	.35	74157	.99
7405	.19	7465	.35	74158	1.79
7406	.20	7470	.30	74160	1.23
7407	.28	7472	.30	74161	.97
7408	.18	7473	.35	74162	1.39
7409	.19	7474	.28	74163	1.09
7410	.16	7475	.49	74164	.99
7411	.25	7476	.30	74165	.99
7413	.43	7483	.68	74166	1.25
7414	.65	7485	.88	74170	2.10
7416	.35	7486	.40	74173	1.49
7417	.35	7489	2.25	74174	1.23
7420	.16	7490	.43	74175	.97
7422	.30	7491	.75	74176	.89
7423	.29	7492	.48	74171	.84
7425	.27	7493	.40	74180	.90
7426	.26	7494	.78	74181	2.45
7427	.29	7495	.79	74182	.79
7430	.20	7496	.79	74184	1.90
7432	.23	74100	.90	74185	2.20
7437	.25	74105	.44	74187	5.75
7438	.25	74107	.37	74190	1.15
7440	.15	74121	.38	74191	1.25
7441	.89	74122	.38	74192	.95
7442	.59	74123	.65	74193	.85
7443	.73	74125	.54	74194	1.25
7444	.73	74126	.58	74195	.74
7445	.73	74132	.89	74196	1.25
7446	.81	74141	1.04	74197	.73
7447	.79	74145	1.04	74198	1.73
7448	.79	74150	.97	74199	1.69
7450	.17	74151	.79	74200	5.45

LOW POWER					
74L00	.29	74L51	.29	74L90	1.40
74L02	.29	74L55	.29	74L91	1.20
74L03	.23	74L71	.29	74L93	1.50
74L04	.29	74L72	.45	74L95	1.50
74L06	.29	74L73	.56	74L98	2.25
74L10	.29	74L74	.56	74L164	2.25
74L20	.29	74L78	.75	74L165	2.30
74L30	.29	74L85	1.09		
74L42	1.39	74L86	.65		

LOW POWER SCHOTTKY					
74LS00	.36	74LS32	.38	74LS95	2.09
74LS02	.36	74LS40	.45	74LS107	.59
74LS04	.36	74LS42	1.40	74LS164	2.20
74LS08	.36	74LS74	.59	74LS193	2.20
74LS10	.36	74LS90	1.30	74LS197	2.20
74LS20	.36	74LS93	1.30		

HIGH SPEED					
74H00	.25	74H22	.25	74H61	.25
74H01	.25	74H30	.25	74H62	.25
74H04	.25	74H40	.25	74H74	.39
74H08	.25	74H50	.25	74H101	.58
74H10	.25	74H52	.25	74H102	.58
74H11	.25	74H53	.25	74H103	.68
74H20	.25	74H55	.25	74H106	.72
74H21	.25	74H60	.25	74H108	.72

CMOS					
4000A	.26	4018A	1.39	4066A	.89
4001A	.25	4020A	1.72	4068A	.44
4002A	.25	4021A	1.18	4069A	.44
4006A	1.35	4022A	.94	4071A	.26
4007A	.26	4023A	.25	4072A	.35
4008A	1.52	4024A	.89	4073A	.39
4009A	.57	4025A	.25	4075A	.39
4010A	.54	4027A	.59	4078A	.39
4011A	.29	4028A	.98	4082A	.35
4012A	.25	4030A	.44	4151A	1.56
4013A	.45	4035A	1.27	4152A	1.56
4014A	1.27	4040A	1.39	4154A	2.10
4015A	.47	4042A	1.47		
4016A	.44	4049A	.59		
4017A	1.01	4050A	.59		

CALCULATOR CHIPS					
CTS502	12 digit, 4 function fixed decimal battery operation — 40 pin				1.95
CTS505	12 digit, 4 function plus memory, fixed decimal — 20 pin				2.49
MM5725	8 digit, 4 function, floating decimal 18 pin				1.98
MM5736	6 digit, 4 function, 9V battery operation — 18 pin				2.95
MM5738	8 digit, 5 function plus memory and constant floating decimal, 9V battery operation — 24 pin				3.95
MM5739	9 digit, 4 function, 9V battery operation — 22 pin				3.95

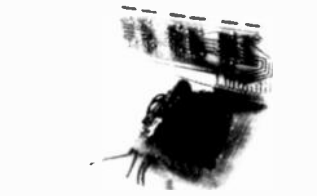

6 Digit Clock Kit
MM5314 with 6 NS71 .27" displays 2 P.C. boards — Display board may be remote. Internal or wall transformer can be used. 50-60 Hz, 12-24 hour. Includes all necessary transistors, resistors, capacitors, diodes, 3 switches and complete assembly instructions.

CK6-3 \$14.95

MM 5330
4 1/2 DIGIT DVM LOGIC \$6.95

LH 0070
BCD BUFFERED REF. \$6.95

MM 5616
QUAD BI-LATERAL SWITCH \$1.25

IC SOCKETS					
Solder Tail - low profile					
8 pin	\$.17	24 pin	.42		
14 pin	.20	28 pin	.59		
16 pin	.22	40 pin	.64		
18 pin	.29				

SPECIAL DEVICES					
372 AF-IF Strip Detector DIP				2.93	
546 AM Radio Receiver Subsystem DIP				.75	
1310 FM Stereo Demodulator DIP				2.90	
1496 Balanced Modulator-Demodulator				.99	
1800 Stereo Multiplexer DIP				2.48	
ULN2208 FM Gain Block 34dB (typ) mDIP				1.18	
ULN2209 FM Gain Block 48dB (typ) mDIP				1.35	
2513 Character Generator 648x5 DIP-24				10.20	
3046 Transistor Array DIP-14				.73	

LINEAR CIRCUITS					
100	\$ 71	171	2.42	723	.62
301	.29	176	.68	733	.87
302	.53	180	1.10	739	1.09
304	.80	180-8	1.25	741	.32
305	71	181	1.75	747	71
307	.26	182	1.75	748	.35
308	.89	183	2.95	1458	.62
309A	1.35	180	2.95	1800	2.48
110	1.07	550	.79	1900	.49
111	.95	555	.45	524	.71
119	1.11	556A	1.19	7525	.98
1201	1.39	560	3.39	8038	4.25
1204	1.39	562	3.39	8864	2.25
122	1.70	565	1.18	75150	1.75
124	1.52	566	1.95	75451	.35
139	1.58	567	1.95	75452	.35
140A	1.69	709	.26	75453	.35
1401	1.49	710	.35	75491	71
172	2.91	711	.26	75492	.80

DISCRETE LED's					
ME4	INFRARED CLEAR DOME 170"				.28
MV10B	CLEAR DOME .170"				.25
MV50	CLEAR — AXIAL .09"				.12
MV50	RED — AXIAL .09"				.12
NBL100	RED .19"				.12
RL209	RED DIFF. SUBMINIATURE .12"				.12
RLT-T1-03	WHITE DIFF. SUBMINIATURE NO FLANGE .12"				.15
RLC-200	RED DIFF. CURRENT REG. .190"				.25
RLC-201	RED DIFF. CURRENT REG. CONST. BRIGHTNESS 4.5-12.5V				.25
RLC-4403	RED DIFF. FULL FLOOD .190"				.15
GREEN	SPOT .190"				.18
CLEAR	POINT .190"				.15

LED S					
DL10A	RED CA .27" LHD				\$1.89
DL707	RED CA .30" RHD				1.49
DL507	RED CA .50" RHD				1.49
FND359	RED CC .375" RHD				.89
DL702	RED CC .30" LHD				1.39
NSN74R	RED CC .30" RHD				1.49
DL500	RED CC .50" RHD				1.49
MAN5	GREEN CA .37" LHD				1.39
MAN8	YELLOW CA .27" LHD				1.39
MAN82	YELLOW CA .3" LHD				1.89
MAN66	RED CA .6" LHD				2.19
DL747	RED CA .6" LHD				2.39

MEMORIES					
1101	\$.69				
1103	.69	3G1	mDIP	.19	
1702A	5.95	723		.49	
		733	TO-S	.59	
5262	.99	300-8	mDIP	1.09	
74S200	3.25	565		1.49	
		739		.89	
82S23	2.75	75491	mDIP	.59	
93410	1.39	75150		.99	

SPECIALS					
7410	Triple 3 input NAND gate			.12	
7438	Quad 2 input NAND buffer (o.c.)			.17	
7442	BCD to decimal decoder			.30	
7453	Exp. AND-OR-INVERT gate			.14	
7474	Dual D flip-flop			.19	
7493	4 Bit binary counter			.35	
74121	One shot			.29	
74153	Dual four-input multiplexer			.69	

CENTRAL PROCESSING UNIT					
8008	\$16.95				
8080A	\$16.95				

CALCULATOR DISPLAY					
		9 MAN 3 M			
		ON PC BOARD			
					99¢

KEYBOARD					
		20 KEYS			
		2 SLIDE SW			
		3 x 3			\$.99

RESISTOR KIT						
Carbon Film .5%						
1 4 or 1 2 watt						
2200 resistors 44 values						
supplied in a 15 drawer						
60 compartment storage						
cabinet — table or wall						
mount Ready to use						
1.5	47	470	3.9K	33K	150K	1.0M
3.3	68	680	4.7K	39K	220K	1.5M
6.8	100	1.0K	6.8K	47K	330K	2.2M
10	150	1.5K	10K	68K	470K	3.3M
15	220	2.2K	15K	100K	680K	4.7M
22	270	2.7K	22K			
36	330	3.3K	27K			

UART					
AYS1013A	\$6.95				

CLOCK CHIPS					
MM5314	6 digit multiplexed 12-24 Hr, 50-60 Hz 24 pin				4.45
MM5316	4 digit, 12-24 Hr, 50-60 Hz, alarm 40 pin				4.95
S375AA	4-6 digit, 12 hour, 60 Hz snooze alarm brightness control capability, alarm tone output — 24 pin				4.95
CT7001	6 digit, 12-24 Hr, 50-60 Hz, alarm, timer and date circuits — 28 pin				6.95

SHIFT REGISTERS					
2502	1024 bit MULT DYN 16 pin				\$2.95
2504	1024 bit MULT DYN 8 pin				2.95
2511	Tri-State Dual 50-100-200 bit				
	STATIC 14 pin				2.95
2518	Hex 32-bit STATIC 16 pin				2.95
2519	Hex 40-bit STATIC 16 pin				2.95
2527	Dual 256 bit STATIC 8 pin				2.95
2532	Quad 80 bit STATIC 16 pin				3.95
5013	1024 bit accum. Dynamic 8 pin				1.75
5016	500/512 bit Dynamic 8 pin				1.59

OPTO ISOLATORS		
----------------	--	--

ETCO[®] ELECTRONICS

\$1,000,000 SURPLUS SALE

BARGAIN BUYS



INCREDIBLE!
ON THE FRITZ CALCULATOR BLITZ!
2.95
10/24.95
SU279A

The factory says "It doesn't pay to repair 'em" so ETCO buys 'em cheap! Be smart - take 'em apart. Fix them if you can, or give 'em to the kids! Order now, while we have stock.

2,000 AVAILABLE!

"SEE" MUSIC IN FLASHING COLOR!
The DEK/ite 3-CHANNEL, 1200 WATT COLOR ORGAN KIT!

400 watts per channel. A unique DEK/ite of quality parts for easy construction of your own high powered color organ. Use with home music system, PA or music amplifiers. Complete with French, English instructions. KT185A

21.95



6" dia. 8-TRACK BELTS TR121A **29¢**

2N4339 F.E.T. N-channel, equiv. ECG133 DS157A **29¢**
100/19.95

RCA 370A 40 watt POWER TRANSISTOR - DS160A **29¢**

1.5A/200 Volt BRIDGE RECTIFIER - DS159A **69¢**

PaIr PHILIPS AC187/AC188 power transistors w/ heat sinks PT168A **69¢**

7A/600 Volt SCR (TO-66) DS158A **1.99**

GE "D" SIZE NI-CAD BATTERY - BA363A **3.99**

NE-2 NEON BULBS BB125A **7¢** ea.

THERMOSTATIC APPLIANCE SWITCH - SU017A **69¢**

6-piece ALIGNMENT TOOL SET - TL004A **69¢**

100 asst. METAL FILM CAPACITORS - PT167A **6.95**

10 asst. THERMISTORS PT166A **1.49**

JUMBO INCANDESCENT NUMERIC READOUT MODULE

10/ \$29.95 **3.49** EA.
800 AVAILABLE!

Bold 1" numerals. Dialco No. 710-0300-005. Utilizes seven No. 344 10 volt bulbs to achieve brilliant white characters. Overall height 1 1/2". Displays 10 numbers, 10 letters. DS161A

SURPLUS 9V - 200 MA. BATTERY ELIMINATOR TRANSFORMER
3,000 AVAILABLE!

99¢ EA.
10/8.95 100/69.95

117 VAC in and 9 volts at 200 ma. out a second winding provides 20 volts output with a center tap. Originally used in the construction of small DC power supplies. Size 1 1/2" x 1 1/2" x 1 1/2". XF103A

21,000 AVAILABLE! DELUXE SOLDERLESS BANANA PLUGS

10/2.49 **29¢** EA.
100/19.95

Possibly the best banana plug on the market today. Quick permanent solderless connections are easily and quickly made - repair when necessary is easy. Red MS059A Black MS060A

TO-3 TRANSISTOR SOCKET **25,000 AVAILABLE!**

SAVE! 4¢ EA.
MS055A
100/3.69 1000/29.95

CLOSE-OUT!

SUPER TINY ELECTRET MIKE CAPSULE!

NEW 3.49 EA.
10/29.95 **1,500 AVAILABLE!**

ONLY 10mm DIAMETER! Here is a super tiny very sensitive electret mike capsule you can use to build hidden mikes, experimental sound pickups, repair and modernize old mikes. 10mm dia., 9 1/2mm long. 35-15,000 Hz. 500 ohms. Operates on 1 1/2 - 9 vdc. 400 ua. drain. MP028A

PRICE BREAK! 10 1/2" PROFESSIONAL NAB HUB METAL REELS

4.95 EA.
3/12.95 10/39.95 100/295.00

Beautiful reels as removed from active service by a national radio network. Used but in excellent condition and fully guaranteed. Standard NAB hub. TR574A

FACTORY SURPLUS! THREE TRANSISTOR AF AMPLIFIER

What a price! Brand new - shipped with schematic diagram - lots of useful 8 ohm output, hi-Z input for crystal phono or microphone cartridge. The 10k control alone is worth our low price! Operates well on 6 VDC. PK032A

49¢ EA.
100/39.95 **10,000 AVAILABLE!**

5,000 AVAILABLE! BRASS TELEPHONE QUALITY PHONE PLUG

Standard 1/2" phone plug of far superior construction - all brass. Telephone company quality, solder lugs, cord anchoring device. MS140A

99¢ EA. **VALUE**

1,000 AVAILABLE! JUMBO MONAURAL PHONE PLUG A \$1.00 VALUE!

SURPLUS SALE! **29¢** EA.
MS070A

10 EA.

Surplus! 12 VOLT MINI PIGTAIL BULB

10/0.79 100/5.95 1000/49.95 **16,000 AVAILABLE!**

3/8" overall diameter. Ideal for model building and custom illumination jobs. Brand new factory surplus. Stock up while we have them. BB079A

QUANTITY PRICES

CANADIANS

Advertised merchandise is available at our Canadian stores at the same price as in U.S.A.

- * MONTREAL, QUEBEC
- * POINTE CLAIRE, QUEBEC
- * TORONTO, ONTARIO (coming soon)

OEM's / Manufacturers / Distributors: Special wholesale quantity prices. Write listing quantity desired for quote.

SURPLUS WANTED

We are large quantity buyers of just about anything interesting. Write us today with your listing to: Att: Marvin Birnbaum.

RUSH \$1.00 to: ETCO ELECTRONICS, Dept. OX, 521 5th Ave., NYC, N.Y. 10017

\$1 NEW SURPLUS CATALOG \$1

JUST OFF THE PRESS!

New 64 page bargain packed electronic parts and surplus catalog. Thousands of exciting surplus items and hard to find parts for OEM, schools, hobbyist and industry. FREE copy with each order from this ad.

NAME.....

ADDRESS.....

ETCO[®] ELECTRONICS

CANADIAN MAILORDER CENTER
183G Hymus Blvd. Pointe Claire, Quebec H9R 1E9

USA MAILORDER CENTER
521 Fifth Ave., New York, N.Y. 10017.

MERCHANDISE SUBJECT TO PRIOR SALE. PRICES SUBJECT TO CHANGE WITHOUT NOTICE.
Full remittance with each order, or BANKAMERICARD, MASTERCHARGE, VISA or CHARGEX. Add 10% for postage and handling (excess refunded).

7400N TTL

SN7400N	16	SN7495A	25	SN74154N	1.00
SN7401N	16	SN7496A	22	SN74155N	0.99
SN7402N	21	SN7497A	45	SN74156N	0.99
SN7403N	16	SN7472N	37	SN74157N	0.99
SN7404N	16	SN7473N	37	SN74160N	1.25
SN7405N	24	SN7474N	32	SN74161N	0.99
SN7406N	20	SN7475N	56	SN74162N	1.10
SN7407N	29	SN7476N	32	SN74163N	1.10
SN7408N	25	SN7479N	5.00	SN74164N	1.10
SN7409N	25	SN7480N	5.00	SN74165N	1.10
SN7410N	18	SN7482N	98	SN74166N	1.25
SN7411N	30	SN7483N	7.00	SN74167N	2.10
SN7412N	33	SN7485N	89	SN74170N	2.10
SN7413N	45	SN7486N	39	SN74172N	0.95
SN7414N	70	SN7488N	3.50	SN74173N	1.50
SN7415N	35	SN7489N	2.49	SN74174N	1.25
SN7417N	35	SN7490N	45	SN74175N	1.50
SN7420N	21	SN7491N	75	SN74176N	0.90
SN7421N	33	SN7492N	49	SN74177N	0.90
SN7422N	49	SN7493N	49	SN74180N	0.99
SN7423N	37	SN7494N	79	SN74181N	2.49
SN7425N	29	SN7495A	79	SN74182N	0.95
SN7426N	29	SN7496N	89	SN74184N	1.95
SN7427N	37	SN7497N	4.00	SN74185A	2.20
SN7429N	42	SN74100N	3.00	SN74186N	15.00
SN7430N	26	SN74101N	2.99	SN74187N	6.00
SN7432N	31	SN74121N	1.00	SN74188N	3.95
SN7437N	27	SN74122N	39	SN74190N	1.19
SN7438N	27	SN74123N	50	SN74191N	1.25
SN7439N	25	SN74125N	60	SN74192N	0.99
SN7440N	15	SN74126N	60	SN74193N	0.99
SN7441N	69	SN74132N	1.09	SN74194N	1.25
SN7442N	59	SN74136N	55	SN74195N	0.75
SN7443N	75	SN74141N	1.15	SN74196N	1.25
SN7444N	75	SN74142N	4.00	SN74197N	0.75
SN7445N	75	SN74143N	4.50	SN74198N	1.75
SN7446N	81	SN74144N	4.50	SN74199N	1.75
SN7447N	69	SN74145N	1.15	SN74200N	5.99
SN7448N	79	SN74147N	2.35	SN74279N	0.90
SN7449N	25	SN74148N	2.00	SN74280N	6.00
SN7451N	27	SN74150N	1.00	SN74281N	7.99
SN7453N	27	SN74151N	7.99	SN74285A	6.00
SN7454N	20	SN74153N	8.99	SN74367N	7.75

Timeband by FAIRCHILD

Watches

Men's & Ladies

- Solid State
- Displays hour, minute, second, month & day
- Free set of replacement batteries
- Choose LED or LCD styles
- One year factory warranty

T249 White w/bracelet \$19.95

T248 Yellow w/bracelet \$22.95

T237 White w/bracelet \$22.95

T236 Yellow w/bracelet \$25.95

Ladies LCD

TC425 White w/strap \$29.95

TC424 Yellow w/strap \$34.95

LADIES LED

TC437 White w/bracelet \$29.95

TC436 Yellow w/bracelet \$34.95

LADIES LED

T325 White w/strap \$24.95

T324 Yellow w/strap \$27.95

WIRE WRAP CENTER

HOBBY-WRAP TOOL-BW-630

- Battery Operated (Size C)
- Weights ONLY 11 Ounces
- Wraps 30 AWG Wire onto Standard DIP Sockets (.025 inch)
- Complete with built-in bit and sleeve

\$34.95 (batteries not included)

WIRE-WRAP KIT — WK-2-W

WRAP • STRIP • UNWRAP

- Tool for 30 AWG Wire
- Roll of 50 Ft. White or Blue 30 AWG Wire
- 50 pcs. each 1", 2", 3" & 4" lengths — pre-stripped wire.

\$11.95

WIRE WRAP TOOL WSU-30

WRAP • STRIP • UNWRAP - \$5.95

WIRE WRAP WIRE — 30 AWG

25 ft. min. \$1.25 50 ft. \$1.95 100 ft. \$2.95 1000 ft. \$15.00

SPECIFY COLOR — White - Yellow - Red - Green - Blue - Black

WIRE DISPENSER — WD-30

- 50 ft. roll 30 AWG KYMAR wire wrap wire **\$3.45 ea.**
- Cuts wire to desired length
- Strips 1" of insulation Specify — Blue-Yellow-White-Red

HEAT SINKS

205-CB Beryllium Copper w/Black finish for TO-5 **\$1.25**

291-36H Aluminum for TO-220 Transistors & Regulators **\$1.25**

680-75A Black Anodized Aluminum for TO-3 **\$1.50**

401-A Black Anodized Aluminum — predrilled mounting holes for TO-3 **\$1.75**

DIP SWITCHES SPST Slide Action

- #206-4 (8 pin dip) 4 switch unit **\$1.95 ea.**
- #206-7 (14 pin dip) 7 switch unit **\$1.75 ea.**
- #206-8 (16 pin dip) 8 switch unit **\$2.25 ea.**

TV GAME CHIP SET — \$14.95

Includes AY-3-8500-1 chip and 2.010 mhz crystal — purchased separately would cost \$18.95

ZENERS — DIODES — RECTIFIERS

TYPE	VOLTS	W	PRICE	TYPE	VOLTS	W	PRICE
1N4745	3.3	400m	41.00	1N4005	50	1.0	10.00
1N4754	5.1	400m	41.00	1N4006	50	1.0	10.00
1N752	5.6	400m	41.00	1N4007	1000	1.0	10.00
1N753	6.2	400m	41.00	1N4008	50	200m	6.00
1N754	6.8	400m	41.00	1N4184	75	10m	15.00
1N959	8.2	400m	61.00	1N4184	35	10m	12.00
1N958	15	400m	41.00	1N4305	75	25m	20.00
1N5232	5.6	500m	28	1N4734	5.6	1w	28
1N5234	6.2	500m	28	1N4735	6.2	1w	28
1N5235	6.8	500m	28	1N4736	6.8	1w	28
1N5236	7.5	500m	28	1N4738	8.2	1w	28
1N4556	25	40m	61.00	1N4742	12	1w	28
1N4558	150	7m	61.00	1N4744	15	1w	28
1N4654	180	10m	61.00	1N1183	50	1.0	1.60
1N4601	50	1.0AMP	121.00	1N1184	100	1.0	1.70
1N4002	100	1.0AMP	121.00	1N1185	150	1.0	1.80
1N4003	200	1.0AMP	121.00	1N1186	200	1.0	1.80
1N4004	400	1.0AMP	121.00	1N1188	400	1.0	3.00

SCR AND FW BRIDGE RECTIFIERS

TYPE	VOLTS	W	PRICE	TYPE	VOLTS	W	PRICE
C360	15A @ 400V	SCR	1.95				
C36M	35A @ 200V	SCR	5.00				
2N2328	1.5A @ 200V	SCR	5.00				
MDA 980-1	12A @ 50V	FW BRIDGE RECT.	1.95				
MDA 980-3	12A @ 50V	FW BRIDGE RECT.	1.95				

TRANSISTORS

TYPE	PRICE	TYPE	PRICE
2N2907	45.00	2N4339	45.00
2N2908	45.00	2N4340	45.00
2N2909	45.00	2N4341	45.00
2N2910	45.00	2N4342	45.00
2N2911	45.00	2N4343	45.00
2N2912	45.00	2N4344	45.00
2N2913	45.00	2N4345	45.00
2N2914	45.00	2N4346	45.00
2N2915	45.00	2N4347	45.00
2N2916	45.00	2N4348	45.00
2N2917	45.00	2N4349	45.00
2N2918	45.00	2N4350	45.00
2N2919	45.00	2N4351	45.00
2N2920	45.00	2N4352	45.00
2N2921	45.00	2N4353	45.00
2N2922	45.00	2N4354	45.00
2N2923	45.00	2N4355	45.00
2N2924	45.00	2N4356	45.00
2N2925	45.00	2N4357	45.00
2N2926	45.00	2N4358	45.00
2N2927	45.00	2N4359	45.00
2N2928	45.00	2N4360	45.00
2N2929	45.00	2N4361	45.00
2N2930	45.00	2N4362	45.00
2N2931	45.00	2N4363	45.00
2N2932	45.00	2N4364	45.00
2N2933	45.00	2N4365	45.00
2N2934	45.00	2N4366	45.00
2N2935	45.00	2N4367	45.00
2N2936	45.00	2N4368	45.00
2N2937	45.00	2N4369	45.00
2N2938	45.00	2N4370	45.00
2N2939	45.00	2N4371	45.00
2N2940	45.00	2N4372	45.00

CAPACITOR CORNER

TYPE	VOLTS	PRICE	TYPE	VOLTS	PRICE
10 pF	.05	04	03	001µF	.05
22 pF	.05	04	03	004µF	.05
47 pF	.05	04	03	01µF	.05
100 pF	.05	04	03	022µF	.06
220 pF	.05	04	03	047µF	.06
470 pF	.05	04	03	1µF	.09

CHANNEL F™ FAIRCHILD VIDEO ENTERTAINMENT SYSTEM

\$159.95

- Freeze Action • Speed Option
- Automatic time and scorekeeping
- Battery-free AC operation
- Dual controls with 8-way action
- Built-in Pro Hockey and Tennis games
- Easy hook-up on any B/W or Color TV
- Factory warranty

Channel F — additional cartridges — \$17.95 ea.

0813 — Backjack (1 or 2 players)
0814 — Solitaire (1 or 2 players)
0819 — Drag strip (1 or 2 players)
0820 — Maze (2 players)
0811 — Tic-Tac-Toe/Shooting Gallery
0812 — Desert Fox/Shooting Gallery
0815 — Spacewar! (2 players)
0816 — Magic Numbers (computer logic)
0822 — Baseball (2 players)

DISCRETE LEDS

TYPE	POLARITY	HT	TYPE	POLARITY	HT
KC209	Red	10.81	KC111	Red	10.81
KC209	Green	4.81	KC111	Green	4.81
KC209	Orange	4.81	KC111	Yellow	4.81
KC209	Yellow	4.81	KC111	Orange	4.81

DISPLAY LEDS

TYPE	POLARITY	HT	TYPE	POLARITY	HT
MAN 1	Common Anode	270 2 95	MAN 3640	Common Cathode orange	300 1 75
MAN 2	5 x 7 Dot Matrix	300 4 95	MAN 4710	Common Anode-Red	400 1 95
MAN 3	Common Cathode	125 3/16 00	DL701	Common Anode-Red	300 99
MAN 4	Common Cathode	187 1 95	DL704	Common Cathode	300 99
MAN 7	Common Anode	300 1 25	DL707	Common Anode	300 99
MAN 7G	Common Anode-green	300 1 95	MAN 4740	Common Anode-Red	400 1 50
MAN 7V	Common Anode-yellow	300 1 95	DL741	Common Anode	600 1 50
MAN 52	Common Cathode	300 99	DL 740	Common Cathode	600 2 49
MAN 64	Common Anode-red	400 99	DL 747	Common Anode	600 2 25
MAN 74	Common Cathode	300 1 50	DL 338	Common Cathode	110 30
MAN 82	Common Anode-yellow	300 99	FND70	Common Cathode	250 75
MAN 84	Common Cathode	300 99	FD503	Common Cathode	500 1 00
MAN 3620	Common Anode-orange	300 1 75	FND507	Common Anode	500 1 00

FCS 8000A — 3 1/2 Digit — .8" Display

NEW! 25 Pin version with color & amp/mv indicator

• Connects almost one for one with 3817, 3817A or D. (3817 available at \$5.00 each)

• Typical segment current 8mA except color. 10 hrs. @ .5 amp 10 min. @ 1 g which are 16 mA

• Forward voltage drop 1.5 volts

\$4.95 EA.

MAXIMUM FORWARD CURRENT — 25 mA

HP 5082-7300 Series — Multi-Digit

- 1/2" Ht. • Common Cathode • Dip Package
- 3 to 5 volts @ 5 mils per segment
- 7 segment Monolithic • Red Display

2 Digit **\$.79**
3 Digit **\$.89**
4 Digit **\$.99**
5 Digit **\$ 1.19**

IC SOLDERTAIL — LOW PROFILE (TIN) SOCKETS

Pin	1-24	25-49	50-100	Pin	1-24	25-49	50-100
8 pin	\$1.17	16	15	24 pin	\$3.38	37	36
14 pin	20	19	18	28 pin	45	44	43
16 pin	22	21	20	36 pin	60	59	58
18 pin	24	23	22	40 pin	63	62	61
22 pin	27	26	25	28 pin	5.99	90	81
16 pin	30	27	25	36 pin	1.39	1.26	1.15
18 pin	35	32	30	40 pin	1.59	1.45	1.30
24 pin	49	45	42				

SOLDERTAIL STANDARD (TIN)

Pin	1-24	25-49	50-100	Pin	1-24	25-49	50-100
8 pin	\$5.20	27	24	24 pin	\$7.70	63	57
14 pin	35	32	29	28 pin	1.10	1.00	90
16 pin	38	35	32	36 pin	1.75	1.40	1.26
18 pin	52	47	43	40 pin	1.75	1.59	1.45

SOLDERTAIL STANDARD (GOLD)

Pin	1-24	25-49	50-100	Pin	1-24	25-49	50-100
8 pin	\$4.45	41	37	24 pin	\$1.05	95	85
14 pin	39	38	37	28 pin	1.40	1.25	1.10
16 pin	43	42	41	36 pin	1.59	1.45	1.30
18 pin	75	68	62	40 pin	1.75	1.55	1.40

WIRE WRAP SOCKETS (GOLD) LEVEL #3

Pin	1-24	25-49	50-100	Pin	1-24	25-49	50-100
8 pin	\$4.45	41	37	24 pin	\$1.05	95	85
14 pin	39	38	37	28 pin	1.40	1.25	1.10
16 pin	43	42	41	36 pin	1.59	1.45	1.30
18 pin	75	68	62	40 pin	1.75	1.55	1.40

50 PCS. RESISTOR ASSORTMENTS \$1.25 PER ASST.

ASST.	RESISTORS	WATTAGE	PRICE
ASST. 1	5 ea. 20 OHM 10 OHM 15 OHM 18 OHM 22 OHM 27 OHM 33 OHM 39 OHM 47 OHM 56 OHM		

CRYSTALS

THESE FREQUENCIES ONLY

Part #	Frequency	Case Style	Price
CY1A	1.000 MHz	HC33/U	\$5.95
CY2A	2.000 MHz	HC33/U	\$5.95
CY2D1	2.010 MHz	HC33/U	\$1.95
CY3A	4.000 MHz	HC18/U	\$4.95
CY7A	5.000 MHz	HC18/U	\$4.95
CY12A	10.000 MHz	HC18/U	\$4.95
CY14A	14.31818 MHz	HC18/U	\$4.95
CY19A	18.000 MHz	HC18/U	\$4.95
CY22A	20.000 MHz	HC18/U	\$4.95
CY30B	32.000 MHz	HC18/U	\$4.95

EXAR

XR-2206KB Kit \$29.95 Special XR-2206KA Kit \$19.95

WAVEFORM GENERATORS

XR-205	\$8.40	XR-555CP	\$ 9.99
XR-2206CP	4.49	XR-320P	1.55
XR-2207CP	3.85	XR-555CP	1.85

MISCELLANEOUS

XR-2211CP	\$6.70	XR-2240CP	3.25
XR-4136	99	PHASE LOCKED LOOPS	
XR-1310CP	\$3.20	XR-1468	3.85
XR-1310EP	3.20	XR-1468	5.80
XR-1800P	3.20	XR-1489	4.80
XR-2567	2.99	XR-2208	5.20
		XR-567CT	1.95

CONNECTORS

PRINTED CIRCUIT EDGE-CARD

156 Spacing-Tin-Double Read-Out

Biturcated Contacts — Fts .054 to .070 P.C. Cards

15/30	PINS (Solder Eyelet)	\$1.95
18/36	PINS (Solder Eyelet)	\$2.49
22/44	PINS (Solder Eyelet)	\$2.95
50/100	PINS (Wire Wrap)	\$6.95
50/100A (1.00 Spacing)	PINS (Wire Wrap)	\$6.95

25 PIN-D SUBMINATURE

DB25P	PLUG	\$3.25
DB25S	SOCKET	\$4.95

3 1/2" DIGIT DVM KIT

This 0-2 VDC .05 per cent digital voltmeter features the Motorola 3 1/2 digit DVM chip set. It has a 4" LED display and operates from a single +5V power supply. The unit is provided complete with an injection molded black plastic case complete with Bezels. An optional power supply is available which fits into the same case as the 0-2V DVM allowing 117 VAC operation.

A. 0-2V DVM with Case \$49.95
B. 5V Power Supply \$14.95

Etching Kits

32 X A-1 — P.C. Etch Materials Kit enough for 5 circuit boards \$29.95 ea.

27 X A-1 — Etched Circuit Kit Complete kit — only add water \$ 9.95 ea.

Plugboards

3662 — 6.5 X 4.5 X 1/16 Epoxy glass P-Pattern-4: P.C. Tabs spaced 156 \$ 6.95 ea.

22/44 — Mating connector for plugboard — 22 pin double readout \$ 2.95 ea.

8800V — Universal Microcomputer Processor plugboard — Epoxy Glass — complete with heatsink and mounting hardware \$19.95 ea.

1/16 VECTOR BOARD

P-Part No.	Hole Spacing		L	W	1	2-Up	Price
	O.T.	P-Part No.					
PHENOLIC	64P14 062333P	4.50	6.50	1.72	1.54		
	169P14 021333P	4.50	17.00	3.69	3.32		
EPOXY GLASS	64P14 062	4.50	6.50	2.07	1.86		
	64P14 062	4.50	8.50	2.56	2.31		
	169P14 062	4.50	17.00	5.04	4.53		
	169P14 062	8.50	17.00	9.23	8.26		
	169P14 062C1	4.50	17.00	6.80	6.12		

SLIT-W-RAP WIRE WRAP TOOL

- Slits and opens insulation exposing bare wire
- No pre-cutting or pre-stripping.
- Comes complete with two - 100 ft spools #28 AWG wire Model P180 \$24.50

HEXADECIMAL ENCODER 19-KEY PAD

- 1 - 0
- ABCDEF
- Return Key
- Optional Key (Period)
- Key

\$10.95 each

63 KEY KEYBOARD

This keyboard features 63 unimicro-coded SPST keys, unattached to any kind of P.C.B. A very strong molded plastic 13" x 4" base suits most applications.

\$24.95

HD0165 16 LINE TO FOUR BIT PARALLEL KEYBOARD ENCODER \$7.95

TOOLS

A97MS — Diagonal Cutter - 4" semi-flush cut \$8.50 ea.

A11DM — Chain Nose Pliers - 4 1/2" long 7.50 ea.

T-6 — Wire Stripper - #16 to #26 gauge 3.75 ea.

55B — Wire Stripper - #10 to #20 gauge 2.50 ea.

CS-8 — Cutter-Crimper Tool - 8 1/2" long 8.50 ea.

Nippling Tool — Cuts, Trims or Notches Metal up to #18 gauge 6.95 ea.

Nibbling Tool- Replacement Punch 3.75 ea.

PERMACEL® P-29 PLUS Electrical Tape - All Weather 1/2" wide x 66 ft. 1.99/roll \$6.95/10 roll package

MICROPROCESSOR COMPONENTS

8080A CPU	\$19.95	8228 System Controller - Bus Driver	\$10.95
8212 8 Bit Input/Output	4.95	MC6800L 8 Bit MPU	35.00
8214 Priority Interrupt Control	15.95	MC6820L Periph. Interface Adapter	15.00
8216 Bi-Directional Bus Driver	6.95	MC6810A1 128 x 8 Static RAM	6.00
8224 Clock Generator/Driver	10.95	MC6830L8 1024 x 8 Bit ROM	18.00
CDP1802 - with user manual	39.95	Z80 CPU	49.95

CPU S

8080 Super 8008	24.95	1101 256 x 1 Static	\$ 4.49
8080A Super 8008	19.95	2101 256 x 4 Static	5.95
2650 8 BIT MPU	26.50	2102 1024 x 1 Static	17.75
		2107 5280 4096 x 1 Dynamic	4.95
		2111 256 x 4 Static	6.95
		2489 16 x 1 Static	2.49
		8101 256 x 4 Static	6.95
		8111 256 x 4 Static	6.95
		8599 16 x 4 Static	2.49
		91102 1024 x 1 Static	2.29
		1200 256 x 1 Static	8.49
		93421 256 x 1 Static	2.29
		1MM5282 2K x 1 Dynamic	2 for 7.95

SRS

2504 1024 Dynamic	\$ 3.95		
2518 Hex 32 BIT	7.00		
2519 Hex 40 BIT	4.00		
2524 512 Dynamic	2.49		
2525 1024 Dynamic	6.00		
2527 Dual 256 BIT	3.95		
2528 Dual 512 BIT	1.00		
2532 Dual 85 BIT	3.95		
2533 1024 Static	Special 5.95		
3341 F16	6.95		
74LS670 16 x 4 Reg	3.95		

RAM S

1702A 2048	FAMOS	\$ 5.95
5203 2048	FAMOS	11.95
82523 32 x 8	Open C	00.00
825123 32 x 8	Tristate	00.00
74S267 1024	Static	1.95
3889 256 x 4	Static	1.95
2708 8K	Eplrom	20.95
6301-1 1024	Tri-State Bipolar	3.40
6301-1 256	Open Collector Bipolar	2.95
6331-1 256	Tri-State Bipolar	4.95

UART'S

AY-5-1013 30K Baud	\$5.95		
--------------------	--------	--	--

ROM'S

2513(2140) Char. Gen. upper case	\$ 9.95		
2513(3021) Char. Gen. lower case	9.95		
2516 Char. Gen.	10.95		

SPECIAL REQUESTED ITEMS

FCM3817	\$ 5.00	675	8197	2.80
AY-3-8500-1	\$16.95	675	3341	6.05
MC3081P	3.50	CD4508	9.99	3.95
MC4016P (74416)	7.50	CD4520	17.50	9.25
MC1558	3.50	MC1561	17.50	19.95
MC1562	14.50	MC1571	17.50	17.50
CD4059	9.95	MC1575	17.50	17.50
CD4070	9.95	MC1575	17.50	17.50
MC14409	14.95	MC14419	14.95	14.95
MC14410	14.95	ICM7045	24.95	22.00
		ICM7208	22.00	14.95
		ICM7209	7.50	7.50
		HD0165	7.50	7.50

PARATRONICS

Featured on February's Front Cover of Popular Electronics

Logic Analyzer Kit MODEL 100A

\$189.00/Kit

- Analyzes any type of digital system
- Checks data rates in excess of 8 million words per second
- Trouble shoot TTL, CMOS, DTL, RTL, Schottky and MOS families
- Displays 16 logic states up to 8 digits wide
- See ones and zeros displayed on your CRT, octal or hexadecimal format
- Tests circuits under actual operating conditions
- Easy to assemble — comes with step-by-step construction manual which includes 80 pages on logic analyzer operation.

• Some applications are:
 — Troubleshooting microprocessor address, instruction, and data flow
 — Examine contents of ROMs
 — Tracing operation of control logic
 — Checking counter and shift register operation
 — Monitoring I/O sequences
 — Verifying proper system operations during testing

TRIGGER EXPANDER — Model 10 Add 16 additional bits — Connects direct to Model 100A (Optional baseplate permits mounting to 100A for integrated unit) (Baseplate — \$12.00) Model 10 — \$229.00

BUGBOOK

Continuing Education Series

BUGBOOK I & II - Basic concepts of TTL Logic — over 90 experiments \$17.00/set

BUGBOOK IIa - Introduces UART — recommended for RTTY enthusiast \$5.00/book

BUGBOOK III - Explores 8080 chip — introduces Mark 80 Microcomputer \$15.00/book

555 TIMER APPLICATIONS SOURCEBOOK WITH EXPERIMENTS — over 100 design techniques \$6.95/book

CMOS - M-DESIGNERS PRIMER AND HANDBOOK a complete CMOS instruction manual \$6.00

Introductory Offer — all 6 books (worth \$49.95) SPECIAL - \$42.95

CONTINENTAL SPECIALTIES

PROTO BOARD 6 \$15.95 (6" long X 4" wide)

Other CS Proto Boards

PB100 - 4.5" x 6"	\$ 19.95
PB101 - 5.8" x 4.5"	29.95
PB102 - 7" x 4.5"	39.95
PB103 - 9" x 6"	59.95
PB104 - 9.5" x 8"	79.95
PB203 - 9.75 x 6 1/2 x 2 1/2	75.00
PB203A - 9.75 x 6 1/2 x 2 1/2	120.00 (includes power supply)

PROTO CLIPS

14 PIN	\$4.50
16 PIN	4.75
24 PIN	8.50

DESIGN MATES

DM1 - Circuit Designer	54.95
DM2 - Function Generator	69.95
DM3 - RC Bridge	59.95

MAX-100 Frequency Counter 20 MHz-100MHz — 8 digit — 6" LED Available September 15, 1977 \$134.95

Logic Monitor \$84.95 for TTL, HTL, TTL or CMOS Devices

QT PROTO STRIPS

QT-595	QT-185
QT-598	QT-125
QT-475	QT-85
QT-478	QT-355
QT-358	QT-358

QT type #holes price

QT-595	590	12.50
QT-598	bus strip	2.50
QT-475	470	10.00
QT-478	bus strip	2.25
QT-355	350	8.50
QT-358	bus strip	2.00
QT-185	180	4.75
QT-125	120	3.75
QT-85	80	3.25
QT-75	70	2.00

Experimenter 300 \$ 9.95
 Experimenter 600 \$10.95

\$5.00 Minimum Order — U.S. Funds Only California Residents — Add 6% Sales Tax

Spec Sheets - 25¢ — Send 35¢ Stamp for 1977A Catalog Dealer Information Available

James ELECTRONICS

1021-A HOWARD AVE., SAN CARLOS, CA. 94070
 PHONE ORDERS WELCOME — (415) 592-8097
 All Authorized Prices Good Through September

Timeband Digital Alarm Clocks

A Division of Fairchild Camera and Instrument Corporation

• 24-hour alarm
 • Doze Button
 • 100% Solid State
 • Large Red Led Display
 • 1.0" height
 • AM/PM indicator
 • Seconds display at touch of button
 • Power failure indicator
 • One year factory warranty

C-500 - Ivory Case \$16.95
 C-500B - Ebony Case \$19.95

C-2111 Woodgrain Case \$19.95

Timeband LAMP CLOCK

by FAIRCHILD

- 24 hour alarm
- Doze button
- Alarm-on indicator
- 1" high Red LED Display
- AM/PM Indicator
- High intensity lamp
- Lamp shuts off when collapsed

Model C-590 (Ivory) \$29.95

DIGITAL AUTO INSTRUMENT SEVEN DIFFERENT INSTRUMENTS!

MEETS OR EXCEEDS ORIGINAL AUTOMOTIVE SPECS

PLEASE specify which one of the seven models you want when ordering — these do not all come in one unit. Each model must be bought separately.

1 TACHOMETER 0-9900 RPM 4, 6 or 8 Cylinders 3 Pen-usage Low Fuel Indicator	2 WATER TEMP 100-250°F	3 FUEL LEVEL 3 Pen-usage Low Fuel Indicator	4 SPEEDOMETER* 0-99 MPH
5 OIL PRESSURE 0-80 PSI	6 OIL TEMP 200-350°F	7 BATTERY MONITOR -1 Volts From 11-15 VDC	

BRIGHT YELLOW ORANGE 3" x 1" FD DISPLAY!

Kit includes case, bracket and all components — complete
 Nothing else to buy! 12 Volt NEG GND
 DIMENSIONS: 4 1/2" x 4" x 2"
 *Add \$10.00 for required speed transducer.
 KIT: \$49.95
 ASSEMBLED: \$59.95

DIGITAL STOPWATCH

- Bright 6 Digit LED Display
- Times to 99 minutes 59.99 seconds
- Crystal Controlled Time Base
- Three Stopwatches in One
- Times Single Events — Split & Taylor
- Size 4.5" x 2.15" x .90 (4 1/2 ounces)
- Uses 3 Penrite Cells

Kit — \$39.95
 Assembled — \$49.95
 Heavy Duty Carry Case \$5.95

Stop Watch Chip Only (7205) \$19.95

QUARTZ DIGITAL AUTO CLOCK OR EXPANDED TIMER!

Elapsed Timer: Hrs, Mins and Secs
 12 or 24 Hr Capacity
 Simple Reset - Start Pushbutton Control

Complete kit includes mounting bracket, case and all components, nothing else to buy. Features MMS314 chip. Large 4" LED's. Accuracy better than 1 min. per month internal battery backup. 12 volt non polar operation.

DIMENSIONS 4 1/2" x 4" x 2"
 12 or 24 HOUR MODE

Kit: \$29.95
 Assembled: \$39.95
 CASE ONLY (includes hardware, mounting bracket and bezel) \$6.50

JE700 CLOCK

The JE700 is a low cost digital clock, but is a very high quality unit. The unit features a simulated readout case with dimensions of 6 x 2 1/2 x 1. It utilizes a MAN72 high brightness readout and the MMS314 clock chip.

12 or 24 Hour
 115 VAC
\$17.95

DIGITAL CLOCK KIT — 3 1/2" INCH DIGITS

4 DIGIT KIT \$49.95
 4 DIGIT ASSEMBLED \$59.95
 6 DIGIT KIT \$69.95
 6 DIGIT ASSEMBLED \$79.95

This clock features big 3 1/2" high digits for viewing in offices, auditoriums, etc. Each digit is formed by 31 bright 0.2" LEDs. The clock operates from 117 VAC, has either 12 or 24 hr. operation. The 6 digit version is 27" x 3 1/2" x 1 1/2" and the 4 digit is 18" x 3 1/2" x 1 1/2". Kits come complete with all components, case and transformer.
 Specify 12 or 24 Hour When Ordering

JE803 PROBE

The Logic Probe is a unit which for the most part is indispensable in trouble shooting logic families. TTL, DTL, RTL, CMOS. It derives the power it needs to operate directly off of the circuit under test drawing a scant 10 mA max. It uses a MAN72 readout to indicate any of the following states by these symbols: (H) 1 (LOW) 0 (PULSE) P. The Probe can detect high frequency pulses to 45 MHz. It can't be used at MOS levels or circuit damage will result.

\$9.95 Per Kit
 printed circuit board

T²L 5V 1A Supply

This is a standard TTL power supply using the well known LM309K regulator to provide a solid 1 AMP of current at 5 volts. We try to make things easy for you by providing everything you need in one package, including the hardware for only

\$9.95 Per Kit

CIRCLE 11 ON FREE INFORMATION CARD

LINESARS		CMOS		CMOS		CMOS		TEXAS INSTRUMENTS								
SH0002CH	LMH002CH	5.40	LM710CH	5.55	LM711CH	5.55	LM3046N-14	5.2	CD4000BE	13	CD4052BE	1.15	74C14/40014PC	75	L.C. SOCKETS	
SH2001CH	LM710CH	5.55	LM711CH	5.55	LM3046N-14	5.2	CD4001BE	16	CD4053BE	89	74C85/40085PC	1.20	74C85/40085PC	1.20	(Low Profile Solder Tall)	
LM300H	LM715CH	3.85	LM308E	59	LM3089	1.98	CD4002BE	16	CD4055BE	1.29	80C97/40097PC	65	80C97/40097PC	65	Description Unit	
LM301AH	LM720CN-14	79	LM3089	1.98	LM3032N	65	CD4006BE	99	CD4060BE	99	80C98/40098PC	65	80C98/40098PC	65	Price	
LM301AN-8 (Mini Dip)	LM723CH	29	LM3032N	65	LM3401N	65	CD4007BE	16	CD4066BE	59	74C160/40160PC	1.50	74C160/40160PC	1.50	8 Pin DIL (C840802) .15	
LM302H	LM723CN-14	2.25	LM3401N	65	LM3403N	1.20	CD4008BE	80	CD4068BE	24	74C161/40161PC	1.50	74C161/40161PC	1.50	14 Pin DIL (C841402) .18	
LM304H	LM725CH	79	LM3403N	1.20	LM3900N	54	CD4009BE	37	CD4069BE	24	74C162/40162PC	1.50	74C162/40162PC	1.50	16 Pin DIL (C841602) .19	
LM305H	LM726CH	79	LM3900N	54	LM4136N	1.20	CD4010BE	37	CD4070BE	24	74C163/40163PC	1.50	74C163/40163PC	1.50	18 Pin DIL (C841802) .29	
LM306H	LM727CH	1.10	LM4136N	1.20	RC4131N-8 (Mini Dip)	80	CD4011BE	16	CD4071BE	24	74C174/40174PC	1.40	74C174/40174PC	1.40	20 Pin DIL (C842002) .35	
LM307H	LM733CN-14	36	RC4131N-8 (Mini Dip)	80	RC4151N-8 (Mini Dip)	5.00	CD4012BE	16	CD4072BE	29	74C175/40175PC	1.40	74C175/40175PC	1.40	22 Pin DIL (C842202) .34	
LM307N-8 (Mini Dip)	LM734CN-14	35	RC4151N-8 (Mini Dip)	5.00	8700CJ	9.65	CD4013BE	29	CD4073BE	29	74C192/40192PC	1.50	74C192/40192PC	1.50	24 Pin DIL (C842402) .34	
LM308H	LM739CN-14/LM381	.89	8700CJ	9.65	8701CN	22.85	CD4014BE	74	CD4075BE	29	74C193/40193PC	1.50	74C193/40193PC	1.50	40 Pin DIL (C844002) .65	
LM308N	LM740CH/NE536T	.79	8701CN	22.85	8702CN	29.50	CD4015BE	74	CD4076BE	98	74C194/40194PC	1.40	74C194/40194PC	1.40		
LM309H	LM741CH	.79	8702CN	29.50	8703CJ	11.10	CD4016BE	29	CD4078BE	24	74C195/40195PC	1.40	74C195/40195PC	1.40		
LM309K (T03)	LM741CN-14	1.45	8703CJ	11.10	8704CJ	13.95	CD4017BE	79	CD4081BE	24						
LM310H	LM741CN-8 (Mini Dip)	1.25	8704CJ	13.95	8705CN	29.50	CD4018BE	79	CD4082BE	29	SG3501AT	3.60	±5V Dual Tracking Regulator			
LM311H	LM747CN-14	.79	8705CN	29.50	8750CJ	11.50	CD4019BE	38	CD4085BE	75	SG3524T	7.25	Switching Regulator Converter			
LM312H	LM747CH	1.55	8750CJ	11.50	9400CJ	5.95	CD4020BE	84	CD4086BE	75	SG4501T	1.80	±15V Dual Tracking Regulator			
LM318H	LM748CN-8 (Mini Dip)	1.25	9400CJ	5.95	SN72L044N	2.30	CD4021BE	89	CD4087BE	1.15	RC4194TK	3.95	Variable Dual Tracking Regulator ±35V ±9.5V			
LM323K	LM748CH	5.60	SN72L044N	2.30	TL080CP	1.49	CD4022BE	89	CD4088BE	39	RC4195T	2.35	Fixed ±15V Dual Tracking Regulator T05			
LM324N	LM749CN-14	1.25	TL080CP	1.49	TL082CP	1.29	CD4023BE	16	CD410BE	1.05	RC4195TK	3.15	Fixed ±15V Dual Tracking Regulator T066			
LM339N	LM750CN-14	.79	TL082CP	1.29	TL083CN	1.65	CD4024BE	67	CD411BE	1.25	78H05KC	6.35	5 Amp 5 Volt Positive Regulator T03			
LM341H	LM776CH	.99	TL083CN	1.65	TL081CP	.69	CD4025BE	16	CD412BE	69	7800 Series	.99	Positive Voltage Regulators (Plastic) 1 amp			
LF355L	LM777CH	1.49	TL081CP	.69	TL082CP	1.29	CD4026BE	1.39	CD414BE	2.50	T0-20 / LM340T		5, 6, 8, 12, 15, 18, 24 Volts			
LF356L	LM791KC	1.49	TL082CP	1.29	TL083CN	1.65	CD4027BE	.38	CD415BE	2.50	7800 Series	1.39	Positive Voltage Regulator 1/2 Amp			
LF357L	LM796CH/MC1496G	1.75	TL083CN	1.65	TL084CN	1.69	CD4028BE	.74	CD416BE	84	T0-5 / LM340H	1.49	Positive Voltage Regulator 1 Amp			
LM358P	LM1312N-14	.65	TL084CN	1.69	TL089CL/HA2905	14.50	CD4029BE	.78	CD418BE	84	7800 Series	1.29	Positive Voltage Regulator 1 Amp			
LM376N-8 (Mini Dip)	LM1436CH	.99	TL089CL/HA2905	14.50	TL182CN/DG182	1.98	CD4030BE	.37	CD419BE	79	T0-3 / LM340K	.29	Positive Voltage Regulator 100 MA			
LM393P	LM1437N-14	.75	TL182CN/DG182	1.98	TL185CN/DG185	1.98	CD4031BE	1.60	CD420BE	79	7810L AWC Series		2.6, 5, 6, 2, 8, 12, 15 Volts			
LM555N-8 (Mini Dip)	LM1458H	.34	TL185CN/DG185	1.98	TL188CN/DG188	1.50	CD4032BE	2.95	CD422BE	1.98	7900 Series	1.25	Negative Voltage Regulator 1 Amp			
LM556N-14	LM1458N-8 (Mini Dip)	.75	TL188CN/DG188	1.50	TL497CN	1.98	CD4033BE	1.60	CD424BE	1.50	T0-20 / LM320T	1.35	Negative Voltage Regulator 1/2 Amp			
LM702CH	LM1488D	.69	TL497CN	1.98	ULN2001AN	1.10	CD4034BE	2.95	CD426BE	1.25	7900 Series	1.75	Negative Voltage Regulator 1 Amp			
LM706APC	LM1489D	1.75	ULN2001AN	1.10	ULN2002AN	1.10	CD4035BE	98	CD428BE	2.50	T0-3 / LM320K	1.20	Negative Voltage Regulator			
LM709CN-8 (Mini Dip)	LM1489AD	.37	ULN2002AN	1.10	ULN2003AN	1.10	CD4040BE	.99	CD429BE	1.50	78MGT2C	1.20	Dual In Line Adjustable 4 Terminal Positive Voltage Regulator			
LM709CN-14	LM1495N-14	.28	ULN2003AN	1.10	ULN2004AN	1.10	CD4041BE	.67	CD431BE	1.25	79MGT2C	1.20	Dual In Line Adjustable 4 Terminal Negative Voltage Regulator			
LM709CH	LM1496N-14	.49	ULN2004AN	1.10			CD4042BE	.58	CD433BE	1.25	78GU1 T0-20	1.45	1 Amp Adjustable Positive Voltage Regulator			
							CD4043BE	.45	CD435BE	1.20	79GU1 T0-20	1.25	1 Amp Adjustable Negative Voltage Regulator			
							CD4044BE	.45	CD455BE	.75	78GC T0-3	1.80	1 Amp Adjustable Positive Voltage Regulator			
							CD4046BE	2.45	CD456BE	.75	79GKC T0-3	2.10	1 Amp Adjustable Negative Voltage Regulator			
							CD4047BE	2.45	CD4581BE	2.25						
							CD4049BE	.34	CD4582BE	.95						
							CD4050BE	.34	CD4585BE	1.80						
							CD4051BE	.89								

CMOS		CMOS		CMOS	
CD4000BE	13	CD4052BE	1.15	74C14/40014PC	75
CD4001BE	16	CD4053BE	.89	74C85/40085PC	1.20
CD4002BE	16	CD4055BE	1.29	80C97/40097PC	65
CD4006BE	99	CD4060BE	.99	80C98/40098PC	65
CD4007BE	16	CD4066BE	.59	74C160/40160PC	1.50
CD4008BE	80	CD4068BE	.24	74C161/40161PC	1.50
CD4009BE	37	CD4069BE	.24	74C162/40162PC	1.50
CD4010BE	.37	CD4070BE	.24	74C163/40163PC	1.50
CD4011BE	16	CD4071BE	.24	74C174/40174PC	1.40
CD4012BE	16	CD4072BE	.29	74C175/40175PC	1.40
CD4013BE	29	CD4073BE	.29	74C192/40192PC	1.50
CD4014BE	74	CD4075BE	.29	74C193/40193PC	1.50
CD4015BE	74	CD4076BE	.98	74C194/40194PC	1.40
CD4016BE	29	CD4078BE	.24	74C195/40195PC	1.40
CD4017BE	79	CD4081BE	.24		
CD4018BE	79	CD4082BE	.29		
CD4019BE	38	CD4085BE	.75		
CD4020BE	84	CD4086BE	.75		
CD4021BE	89	CD4087BE	1.15		
CD4022BE	89	CD4088BE	.39		
CD4023BE	16	CD410BE	1.05		
CD4024BE	67	CD411BE	1.25		
CD4025BE	16	CD412BE	.69		
CD4026BE	1.39	CD414BE	2.50		
CD4027BE	.38	CD415BE	2.50		
CD4028BE	.74	CD416BE	84		
CD4029BE	.78	CD418BE	84		
CD4030BE	.37	CD419BE	79		
CD4033BE	1.60	CD420BE	.79		
CD4034BE	2.95	CD422BE	1.98		
CD4035BE	98	CD424BE	1.50		
CD4040BE	.99	CD426BE	1.25		
CD4041BE	.67	CD428BE	1.50		
CD4042BE	.58	CD431BE	1.25		
CD4043BE	.45	CD433BE	1.20		
CD4044BE	.45	CD455BE	.75		
CD4046BE	2.45	CD456BE	.75		
CD4047BE	2.45	CD4581BE	2.25		
CD4049BE	.34	CD4582BE	.95		
CD4050BE	.34	CD4585BE	1.80		
CD4051BE	.89				

CMOS		CMOS		CMOS		TEXAS INSTRUMENTS	
74C14/40014PC	75	74C85/40085PC	1.20	80C97/40097PC	65	L.C. SOCKETS	
80C98/40098PC	65	74C160/40160PC	1.50	74C161/40161PC	1.50	(Low Profile Solder Tall)	
74C162/40162PC	1.50	74C163/40163PC	1.50	74C174/40174PC	1.40	Description Unit	
74C175/40175PC	1.40	74C192/40192PC	1.50	74C193/40193PC	1.50	Price	
74C194/40194PC	1.40	74C195/40195PC	1.40				
VOLTAGE REGULATORS							
SG3501AT	3.60	±5V Dual Tracking Regulator					
SG3524T	7.25	Switching Regulator Converter					
SG4501T	1.80	±15V Dual Tracking Regulator					
RC4194TK	3.95	Variable Dual Tracking Regulator ±35V ±9.5V					
RC4195T	2.35	Fixed ±15V Dual Tracking Regulator T05					
RC4195TK	3.15	Fixed ±15V Dual Tracking Regulator T066					
78H05KC	6.35	5 Amp 5 Volt Positive Regulator T03					
7800 Series	.99	Positive Voltage Regulators (Plastic) 1 amp					
T0-20 / LM340T		5, 6, 8, 12, 15, 18, 24 Volts					
7800 Series	1.39	Positive Voltage Regulator 1/2 Amp					
T0-5 / LM340H	1.49	Positive Voltage Regulator 1 Amp					
7800 Series	1.29	Positive Voltage Regulator 100 MA					
T0-3 / LM340K	.29	Positive Voltage Regulator 100 MA					
7810L AWC Series		2.6, 5, 6, 2, 8, 12, 15 Volts					
7900 Series	1.25	Negative Voltage Regulator 1 Amp					
T0-20 / LM320T	1.35	Negative Voltage Regulator 1/2 Amp					
7900 Series	1.75	Negative Voltage Regulator 1 Amp					
T0-3 / LM320K	1.20	Negative Voltage Regulator					
78MGT2C	1.20	Dual In Line Adjustable 4 Terminal Positive Voltage Regulator					
79MGT2C	1.20	Dual In Line Adjustable 4 Terminal Negative Voltage Regulator					
78GU1 T0-20	1.45	1 Amp Adjustable Positive Voltage Regulator					

NEW!

ELECTRONIC TOUCH ORGAN KIT

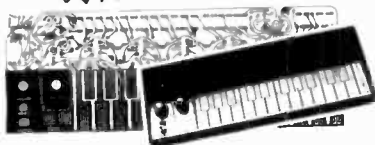

Fantastic new design uses CMOS I.C. and a total of 39 semi-conductors to give a touch control keyboard, all the electronic parts in one PC Board. This organ is easy to build, yet has features like a full two-octave range touch keyboard, variable tremolo; two voices; built-in I.C. amplifier with volume control, complete with speaker and a specially designed plexi-glass case.

BATTERIES NOT INCLUDED *Ideal kit for beginner or gift for children

\$24.50 ea.

SLIM LINE CALCULATOR

6 Functions with % and memory
8 Digits LED display
*One full year guarantee
Special Price Only
\$8.50 Ea.



BATTERIES NOT INCLUDED

CALCULATOR with STOPWATCH

6 Functions with % and memory
8 Digits big green display
*Built-in X'tal controlled stop watch count to 1/10 of a second.
Special Price Only
\$16.50 Ea.



BATTERIES NOT INCLUDED

I.C. TEST CLIPS

Same as the E-Z clips
With 20" Long Leads
In Black and Red Colors
\$1.75 Per Pair



5W AUDIO AMP KIT

2 LM 380 with Volume Control
Power Supply 6~18V DC
only \$5.00 ea.



Multi-Color LED Indicator
Red-Green Colors in one LED
with Plastic Housing
99¢ Ea.
Voltage 2V 20 MA per LED



TIMER KIT

Time Controlled from 1-100sec.
Ideal to be used as time delay unit for burglar alarm, photo service, and other purposes.
Max. loading 110V, 2 AMP.
Supply voltage 12-18V D.C.
\$11.50 each



FT-90 ELECTRONIC IC TIMER

ELECTRONIC ALARM SIREN

COMPLETE UNIT
Ideal for use as an Alarm Unit, or hook up to your car back-up to make a reverse indicator
Light Output up to 130 dB.
Voltage Supply 6~12V **\$7.50**



AU-999

19 KEY HEXADECIMAL KEY PAD

• 1-0 • Homekey
• ABCDEF • ←→ Key
SPECIAL \$10.50 ea.
Low Cost Hexadecimal 16 Key Pad



Designed for Calculator
Can be used for Computer
Data Entry Pad or Digital Lock
All key tops blank with superb
good touch feeling \$0.95 ea.

DIGITAL ELECTRONIC LOCK KIT

for auto ignition, entry door, burglar, alarm, etc.
CMOS I.C. 4 Digits Programmable to
IN CIRCUIT Any Combination
\$6.50 ea.
400A RELAY AND KEY PAD NOT INCLUDED



POWER SUPPLY KIT

0-35V D.C. REGULATED
Uses UA723 and ZN3055 Power
TR output can be adjusted from
0-35V, 2 AMP. Complete with PC
board and all electronic parts.
038 POWER SUPPLY **\$9.50 each**
Transformer for Power Supply, 2 AMP 24V \$3.90 ea.



EDGE CONNECTORS (IMSA1 Type)

Dual 50 (100 pin)
0.125 spacing wire-wrap
\$4.50 EACH



DB25 Type CONNECTOR

Male **\$3.40 each**
Female **\$3.75 each**
Plastic Housing for Connector **\$1.00 each**

MULTI-COLOR RIBBON CABLES

Type	Conductors	Avg	Price Per Ft.
A	15	20	0.40
B	12	24	0.40
C	18	24	0.45
D	26	26	0.50
E	13	30	0.25
F	22 prs.	26	0.40

red/white twisted prs.
(over 50 ft. per type-less 15%)

QUARTZ CRYSTALS

1 MHz	\$4.95
2 MHz	\$5.25
4 MHz	\$5.25
10 MHz	\$5.25
3.579 MHz	\$1.25

Color TV Type



TV Games



Direct Sales Only
\$29.50

FEATURES:
• 4 Games—Tennis, Hockey, Racquet Handball and Single Handball.
• Auto counter display on the screen.

CB MICROPHONE

500 MIC for CB Unit
Talk Switch with Connector and Cord
\$2.50 each
CLOSE OUT SALE



TV GAME MODULATOR UNIT

FCC Approved
For channel 3 and 4
With Dec. Coil
ONLY \$4.50



TI 1955
Alternative AY38500-1
6 Game (28 Pin Dip)
TV Game Chip with Data
Tennis, Squash, hockey,
practice & 2 shooting.
Special Only \$11.00
PC Board for TV game with Data \$2.50 ea.
Switch Box between Game & TV \$1.25 ea.

WIRE WRAPPING TOOL

\$33.50
Wire Wrapping in Bulk
100' **\$2.00**
500' **\$8.50**



CLOCK KIT MOST POPULAR MMS314 KIT

WITH A NEW CASE
4 features: 12 1/2 hr. Display
50 60 Hz input 6 Digits Readout
Kit Includes: Grey Color Plastic Case
MMS314 Clock Chip, PC Board and Transistor forms, 6 Green Color 0.3" Tube Readouts
All other transistor Drivers and other Components
Special Only \$14.95 ea.



SAE DIP SWITCHES

Part No. 1004 692 4KSPST SW
100R 692 8KSPST SW
4 Toggle SPST Switches on a Mini DIP
(8 units) Only \$1.50 ea.
3 Toggle SPST Switches on a DIP
(16 pins) Only \$2.60 ea.



MINI-MINI TOGGLE SWITCH

Half size of submini toggle switch
rated 3 amp 125V AC contact
1-9 10-99
MS-2432P SPST 0.90 0.80
MS-244 SPDT 1.00 0.90
MS-245 DPDT 1.20 1.10
LARGE QUANTITY AVAIL
FOR OEM

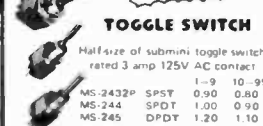

SUBMINIATURES TOGGLE SWITCHES

SPDT On/Off **\$1.30 ea.**
DPDT On/Off **\$1.50 ea.**
SPDT On/Off **\$1.75 ea.**
Mini Size Rocker Type
Also Available at the Same Price



JOY STICK

4 100K Volume pot in one unit, vary resistance proportional to the angle of the stick. Perfect for electronic games or model remote control
only \$7.50

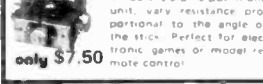

PUSH-BUTTON SWITCH

N/Open Contact
Color: Red, White, Blue, Green, Black. **4/\$1.00**
N/Close also Available **50¢ ea.**
LARGE QTY. AVAILABLE



SOLID STATE ELECTRONIC BUZZER

First design for digital buzzer. Sized from 0-10 but can be etched and your own size without time base
only \$3.80 ea.



MINIMUM ORDER \$10.00. Call for California residents add 6% sales tax. All orders add 10% postage for out of state. Overseas countries add 15% of total order for postage. SEND CHECK OR MONEY ORDER TO



FORMULA INTERNATIONAL INC.

12603 CRENSHAW BOULEVARD • HAWTHORNE, CALIFORNIA 90250

For more information please call (213) 679-5162

STORE HOURS 10-7 Monday - Saturday



MA1003, 12V DC CLOCK MODULE

Built in X'TAL controlled time base. Protected against automotive volt transients. Automatic brightness control with 0.3" green color display. Display turnoff with ignition "OFF".
\$23.50 EACH



BONUS SALE

With a \$25 prepaid order get an int'l data catalog
With a \$50 prepaid order get the 8080 user manual

8K RAM BOARD

FULLY ASSEMBLED & TESTED, JUST PLUG IT IN - 64 21L02's (in sockets)
ALTAIR & IMSAI 8080 COMPATIBLE, ON BOARD REGULATORS, FULLY BUFFERED

\$189.95

WHO NEEDS A KIT? BUY IT, PLUG, & GO

CARBON FILM RESISTORS

High quality .25W 5% ALL STANDARD VALUES FROM 2.7Ω to 22MΩ STOCKED IN DEPTH
each 100's \$1.60 1000's \$1.40
10% 40% \$1.60 \$1.40 - per value
no mix of values

RESISTOR ASSORTMENTS

LEADS TRIMMED FOR PRINTED CIRCUIT BOARD
200 1/4W 5% \$2-
200 1/2 5% \$2-

-SUPER SPECIALS-

74S206 DIP 256x1 45NS RAM	\$.90
934101 " " "	.90
LM308AH OP-AMP w/pwr.	.90
1A776 " " PROGRAMMABLE	.90
78L05 1092 1A + REGULATOR	.30
78L12 " " "	.30
78L24 " " "	.30
MM5369 CRYSTAL OSC. TIME BASE	1.75
MM5058 1024 BIT STATIC S.R. MINI.	2.00
LM300 ADJUSTABLE REGULATOR	.60
LM723 " " "	.50
747 DUAL OP-AMP	.50
ZENER 16V 1W on tape	.10
DIAC 27 VOLT TRIGGER DIODE	.20
CERAMIC FILTER 10.7 MHz.	1.25
7812 TO-3 1amp REGULATOR	.69
78M05 10220 .5A	.69

IC SOCKETS

SOLDER TAIL TIN		WIRE WRAP TIN (3)	
Pins	ea.	Pins	ea.
8	25	14	45
14	25	16	48
16	27	24	75
24	50		
28	80		
40	99		

500 \$4.75 5K \$38
1K 8.50 10K 70
2K 16 50K 325

14Pin \$3.49
TEST CLIP

RCA NUMITRON

DR2010 5 VOLT
7 SEGMENT DISPLAY

\$4 each - 5 for \$16
10 for \$30
100 for \$250

CAPACITORS -

ALUMINUM			
MF	VV	PKG.	EA.
1000	35	pcb	49
1000	16		35
470	35		35
80	40		25
600	360	photo	95
1800	25	axial	55
1000	16		35
220	25		25
50	50		20
4	50		15

1000's \$4.00

DIPPED TANTALUM			
MF	VV	EA.	TEN
4.7	35	.25	2.25
6.8	6	.25	2.25
10	25	.25	2.25
15	35	.25	2.50
22	50	.30	2.50
33	10	.30	2.50

-SWITCHES-

RED PUSH BUTTON
N.O. MOMENTARY
CONTACT, 1/4" HOLE

30¢ each	
8	\$ 2
100	22
1000	195

actual size

MINI MINI TOGGLE

EXTRA SMALL D.P.D.T.
3A 125VAC CONTACTS

each \$1.50

8 - 10.
100 - 95.

actual size

ONE AMP OP-AMP

HIGH POWER AMPLIFIER IN A TO-3 CASE. REPLACEMENT FOR NATIONAL LM0021

\$4.50 5/\$20

POTTER BRUMFIELD

Type KHP Relay
4 PDT 3A Contacts

24VDC COIL
650 ohms

120VAC
10.5MA

\$1.60 ea.

DIP TRIMMER

12 TURN 1/4"x1/4"x1/4"
5K or 200K only
mfg. DALE

\$1.50 TEN FOR \$4

150 Mhz Prescaler

Use your low frequency counter to measure VHF or UHF frequencies. This kit will divide the input signal by ten (10 or 100 with 650MHz option)
Kit contains drilled circuit board, 2 MC10131 IC's, all parts needed and instructions.

150/170MHz KIT \$12.95
650MHz option w/11C90 IC.....\$29.95
-requires 5v at app. -2A, power supply and case are not part of kit---

SUPER LED'S

This family of LED's are mounted on a TO-18 header with a 6/32 threaded stud to secure to a heat sink... TWO AMPERES max. continuous current rating (with heat sink). LED's can be pulsed at up to 25A with low duty cycle. Data supplied w/order

ME2 Infra Red w/low lens
ME5 Infra Red w/high lens
MV4 Visible Red w/low lens
MV4H Visible Red w/high lens

\$2.99 ea.

BRIDGE RECTIFIER

25AMP
cosmetic rejects
(scratches)
tested

100PIV - \$1.35 10-\$12
500PIV - 1.75 10-14

PO BOX 41778
Sacramento, Ca.
95841
916 334 2161

Money back guarantee - \$5 minimum order, we pay post on orders for \$10 or more. All payment must be in U.S. funds. Foreign orders must include post BAC & MC are not prepaid orders and shipping is added

4811 MYRTLE AVE

BABYLON ELECTRONICS

BANKAMERICARD

TRICO TRICO TRICO TRICO TRICO TRICO TRICO

6 DIGIT LOW COST FREQUENCY COUNTER KIT COMPARE and SAVE!

Frequency Range = 100Hz - 30MHz Min.
Sensitivity = 15mV Typical
Features: x'tal time base, all TTL circuitry for easy service. Regulated Power Supply for stability, FET Input stage provides High Impedance, all IC's socketed, tin plated & silk screened P.C. Board for easy assembly. Kit includes: Detailed Instructions, 22ICs with sockets, x'tal, regulator IC, transformer, 2 P.C. Boards, Line cord and all parts.



KIT # 250-30A \$54.95

HERE'S A MUST FOR THE EXPERIMENTER!



2-20V @ 1.3A Continuously Variable Power Supply Kit. Kit Includes: P.C. Board, Transformer, Power Transistor, Heat Sink, IC Regulator & all the parts with detailed instruction.

KIT # T-658 \$10.95

WOW! LOOK AT THIS!

5V 10A Power Supply Kit for your TTL Circuits!

Kit Includes: Extra Large Heat Sink, Power Tr., IC Regulator, P.C. Board, with OVP Circuitry.

KIT # T-500 \$7.95

With Optional X'former, Rectifiers and Filtering Capacitor. \$17.95

Put Your CB or Ham Gear in your House with this Power Supply Kit

13.8V @ 3.5A with OVP

Kit Includes: P.C. Board, Transformer, Power Transistor, IC Regulator, Extra Large Heat Sink, all the parts and detailed instruction.

KIT # T-700 \$13.95

6-DIGIT AUTO CLOCK KIT WITH ALARM

Features:

- A. Fairchild 0.5" FND 500 Series Display
- B. Display Board may be remote
- C. X'tal time base
- D. P.C. Boards, speaker, IC's and all parts.
- E. Detailed Instructions

\$19.95
KIT # TC-1100

Stereo Power Amplifier

Output Power = 4.5W/Channel
Input Sensitivity = 25mV
Supply Voltage = 6 - 14V D.C.
Speaker Impedance = 4 - 8 Ohm
only \$11.95

4 or 6 Digit Alarm Clock Kit

Features:

- A. Fairchild 0.5" FND500 series Display
- B. Display Board may be remote
- C. P.C. Boards, Transformer, Speaker and all the parts needed (less case)
- D. Detailed Instructions

12 Hr. 6-Digit \$16.50 4-Digit \$14.95
6-Digit-24 Hr. \$14.95 (no alarm)

TTL 5V 12V 1 AMP Supply Kit

This is a standard TTL Power Supply using the WELL KNOWN LM340T Regulator I.C. to provide a solid amp of current @ 5V or 12V. Kit includes: all components except transformer.

\$3.95

Q.8" 4 Digit Jumbo Display Alarm Clock Kit

Features:

- A. Fairchild 0.8" FSC8000 Display Array
- B. Fairchild Super-Chip - F-3817PC
- C. P.C. Board, Transformer, Speaker and all parts included (less case)
- D. Detailed Instructions

\$19.50

TRANSISTORS		TANTALUM CAPACITORS		TRANSFORMERS	
GENERAL PURPOSE				All inputs 110 V AC	
NPN 10/\$1.00		1µ 35V	.15	40 V C.T. 10A	\$14.50
PNP 10/\$1.00		1µ 10V	.15	30V C.T. 20A	\$13.50
BOURNS		3.3µ 35V	.20	24V 1.3A	\$3.50
MINIATURE TRIMMERS		10µ 50V	.35	2.4 6.3-12V 1A 4 In 1	\$3.50
3292X 2K 55¢ ea.		22µ 35V	.25	28V C.T. 0.6A	\$2.00
or 10 for \$5.00					
330PP 2K 75¢ ea.					
or 10 for \$6.75					
INTER-COM BOARD		MINIATURE TOGGLE SWITCH		WIRE-WRAP TOOLS from OK	
Fully assembled. Works on 9-15V D.C. 2 speakers make it work. With Schematic ONLY \$3.00		SPDT \$1.10		Hobby Wrap - 30 \$5.45	
		DPDT \$1.45		Hobby Wrap-Model BW 630 Bat- tery Op. (less batt.) \$30.95	
		DPDT Center off \$1.45			
COMPUTER GRADE CAPACITORS		THIS MONTH'S SPECIALS!		L.E.D.	
10,000 µF 50V \$3.95		LM741 CH - To - 5 30		0.25" Red 25µ 10 for \$1.75	
11,500 µF 25V \$3.50		9 ft. 2 Wire Line Card .45 ea. or 10/4 00		0.25" Green 30µ 10 for \$2.50	
30,000 µF 15V \$3.50		LM340T-12 80		0.125" Red 20µ 10 for \$1.75	
100,000 µF 5V \$2.00		LM340T-6 80		0.5" FN0503 C.C. \$1.00	
32,000 µF 25V \$3.95		AN214 4.5W Power I.C. with Spec. 2.95		0.5" FN0507 C.A. \$1.00	
30,000 µF 15V \$3.00				0.8" FSC8000 C.C. \$5.00	
63,000 µF 15V \$3.50					
		OPEN FRAME POWER SUPP.		I.C. SOCKETS	
		5V @ 3A with OVP 115V AC input \$17.50		14 Pin Lo pro \$.30	
				14 Pin Standard Gold 35	
				14 Pin Wire Wrap Gold 45	
				16 Pin Lo pro 35	
				16 Pin Wire Wrap Gold 50	
				22 Pin Lo pro 45	
				24 Pin Lo pro Open Frame 45	
				24 Pin Standard Gold 100	
				40 Pin Lo pro Open Frame 55	

TERMS: Money Back Guarantee
CALIF. RESIDENTS ADD 6% SALES TAX
Please add \$1.00 for postage inside Calif., \$2.00 for Out of State, Overseas add 10% of order
Minimum Order \$5.00 C.O.D. \$20.00 (\$1.00 handling)
STORE HOURS: Mon-Sat., 10-7

PHONE 714/821-0234

TRICO ELECTRONIC SUPPLIES

Please send your check or money order to:
P.O. Box 4208, Anaheim, Ca. 92803
Visit our new location at:
2795 W. Lincoln Ave., Suite L, Anaheim, Ca. 92801

Watch for our supermarket bargains each month!

any way you look at it

POLY PAKS® IS THE WORLD'S LARGEST ELECTRONIC SUPERMARKET

DISCOUNT SEP. 77 RADIO ELECTRONICS SPECIALS

FEATURING THE BARGAINS OF THE MONTH!!!!

\$5.50 TV GAME JOY STICK

Includes four 100K pots
For TV & computer games
and quadrophonic balancing
1 1/2 x 1 1/2 x 1". With
1" handle. Wt. 2 ozs.
Cat. No. 9R3808



RCA High quality "POCKET" VOM

Model WV 539A. Features:
1% precision movements
diode protected against
burnout. Measures DC volts
0-15-150-1000; AC volts
0-15-150-1000; DC current
0-150ma; resistance X1000.
Sensitivity 1000 ohms/volt.
AC/DC. Uses penlite cell.
not included. Size 2 1/2 x
3 1/2 x 1 1/2". Wt. 5 ozs.
Cat. No. 9R3921

\$8.88

SPECIAL THIS AD G-E "BLUE" FLUORESCENT READOUTS

Bright blue 7-segment characters, 0.57" high 1.6V filament, 24V characters. Common cathode. Fits standard 3-pin tube socket. Driven directly by MM5316. Wt. 3 ozs. Cat. No. 9R3684

\$1.00 each

MM5316 Clock Chip — \$2.95
Cat. No. 9R1759

6-DIGIT CAR CLOCK KIT

For auto, plane, boat, truck, etc. Top quality & accuracy at the lowest price! Displays hours, minutes & seconds in 12 hour format. Controls for fast & slow set. Attractive grey cabinet with chrome-trimmed red lens. Only 4 x 4 1/2" (Complete "Clock" kit, 12 VDC, Wt. 14 ozs.)

\$2200 KIT
REG. \$26.88

- Crystal controlled time base
- Easy to assemble and install!
- Bright RED 0.35" LED digits!

Cat. No. 9R3852

J. C. PENNEY'S S-track TAPE TRANSPORT

Excellent replacement or design your own quality tape system! Automatic or manual track selection with program indicator lights. Player shuts off automatically when tape is removed. Built-in low-distortion preamp and wow free motor. With input & output cables. Requires external power supply. With instruction manual. Wt. 4 lbs. Cat. No. 9R3010

\$12.95

- 115 VAC fan-cooled motor
- Slides easily into modular cabinet
- Shielded preamp

SPECTROL "SKINNY-TRIMS" 3/8" Sq. POTENTIOMETERS

Choose ANY 3 FOR **\$1.19**

- 9R3863 25 Turn upright, type 63
- 9R3864 25 Turn flat, type 64
- 9R3866 Single turn flat, type 63

3 1/8" square. Screwdriver shaft. 20% tolerance. Built-in trimmer. PC leads. Order by Cat. No. and Value.

CODE:
*Available in all types
**Available in Cat. No. 9R3863 only.

WIN

We know we have the lowest prices!!

BUY 10 **15% OFF**
BUY 100 **25% OFF**

Order by Cat. No. 9R1981

Type	Sale	A Type No	
SN7400	\$0.14	SN74141	.92
SN7401	14	SN74145	.89
SN7403	14	SN74150	.99
SN7404	17	SN74151	.63
SN7405	19	SN74152	.63
SN7406	19	SN74154	.69
SN7407	24	SN74155	.78
SN7408	17	SN74156	.68
SN7409	24	SN74157	.69
SN7410	14	SN74158	.78
SN7411	19	SN74159	.87
SN7412	19	SN74160	.89
SN7413	39	SN74161	.95
SN7414	61	SN74162	.67
SN7415	24	SN74163	.87
SN7416	24	SN74164	.95
SN7417	24	SN74165	.95
SN7418	24	SN74166	1.15
SN7419	24	SN74167	1.19
SN7420	14	SN74168	.95
SN7421	26	SN74169	.77
SN7422	26	SN74170	.99
SN7423	14	SN74171	1.49
SN7424	24	SN74172	.63
SN7425	24	SN74173	1.88
SN7426	24	SN74174	.95
SN7427	24	SN74175	1.69
SN7428	24	SN74176	1.39
SN7429	24	SN74177	1.39
SN7430	14	SN74178	1.69
SN7431	24	SN74179	1.15
SN7432	24	SN74180	1.15
SN7433	24	SN74181	1.15
SN7434	24	SN74182	1.69
SN7435	24	SN74183	1.69
SN7436	24	SN74184	1.89
SN7437	24	SN74185	1.89
SN7438	24	SN74186	1.89
SN7439	24	SN74187	1.89
SN7440	24	SN74188	1.89
SN7441	24	SN74189	1.89
SN7442	24	SN74190	1.89
SN7443	24	SN74191	1.89
SN7444	24	SN74192	1.89
SN7445	24	SN74193	1.89
SN7446	24	SN74194	1.89
SN7447	24	SN74195	1.89
SN7448	24	SN74196	1.89
SN7449	24	SN74197	1.89
SN7450	24	SN74198	1.89
SN7451	24	SN74199	1.89
SN7452	24	SN74200	1.89
SN7453	24	SN74201	1.89
SN7454	24	SN74202	1.89
SN7455	24	SN74203	1.89
SN7456	24	SN74204	1.89
SN7457	24	SN74205	1.89
SN7458	24	SN74206	1.89
SN7459	24	SN74207	1.89
SN7460	24	SN74208	1.89
SN7461	24	SN74209	1.89
SN7462	24	SN74210	1.89
SN7463	24	SN74211	1.89
SN7464	24	SN74212	1.89
SN7465	24	SN74213	1.89
SN7466	24	SN74214	1.89
SN7467	24	SN74215	1.89
SN7468	24	SN74216	1.89
SN7469	24	SN74217	1.89
SN7470	24	SN74218	1.89
SN7471	24	SN74219	1.89
SN7472	24	SN74220	1.89
SN7473	24	SN74221	1.89
SN7474	24	SN74222	1.89
SN7475	24	SN74223	1.89
SN7476	24	SN74224	1.89
SN7477	24	SN74225	1.89
SN7478	24	SN74226	1.89
SN7479	24	SN74227	1.89
SN7480	24	SN74228	1.89
SN7481	24	SN74229	1.89
SN7482	24	SN74230	1.89
SN7483	24	SN74231	1.89
SN7484	24	SN74232	1.89
SN7485	24	SN74233	1.89
SN7486	24	SN74234	1.89
SN7487	24	SN74235	1.89
SN7488	24	SN74236	1.89
SN7489	24	SN74237	1.89
SN7490	24	SN74238	1.89
SN7491	24	SN74239	1.89
SN7492	24	SN74240	1.89
SN7493	24	SN74241	1.89
SN7494	24	SN74242	1.89
SN7495	24	SN74243	1.89
SN7496	24	SN74244	1.89
SN7497	24	SN74245	1.89
SN7498	24	SN74246	1.89
SN7499	24	SN74247	1.89
SN7500	24	SN74248	1.89
SN7501	24	SN74249	1.89
SN7502	24	SN74250	1.89
SN7503	24	SN74251	1.89
SN7504	24	SN74252	1.89
SN7505	24	SN74253	1.89
SN7506	24	SN74254	1.89
SN7507	24	SN74255	1.89
SN7508	24	SN74256	1.89
SN7509	24	SN74257	1.89
SN7510	24	SN74258	1.89
SN7511	24	SN74259	1.89
SN7512	24	SN74260	1.89
SN7513	24	SN74261	1.89
SN7514	24	SN74262	1.89
SN7515	24	SN74263	1.89
SN7516	24	SN74264	1.89
SN7517	24	SN74265	1.89
SN7518	24	SN74266	1.89
SN7519	24	SN74267	1.89
SN7520	24	SN74268	1.89
SN7521	24	SN74269	1.89
SN7522	24	SN74270	1.89
SN7523	24	SN74271	1.89
SN7524	24	SN74272	1.89
SN7525	24	SN74273	1.89
SN7526	24	SN74274	1.89
SN7527	24	SN74275	1.89
SN7528	24	SN74276	1.89
SN7529	24	SN74277	1.89
SN7530	24	SN74278	1.89
SN7531	24	SN74279	1.89
SN7532	24	SN74280	1.89
SN7533	24	SN74281	1.89
SN7534	24	SN74282	1.89
SN7535	24	SN74283	1.89
SN7536	24	SN74284	1.89
SN7537	24	SN74285	1.89
SN7538	24	SN74286	1.89
SN7539	24	SN74287	1.89
SN7540	24	SN74288	1.89
SN7541	24	SN74289	1.89
SN7542	24	SN74290	1.89
SN7543	24	SN74291	1.89
SN7544	24	SN74292	1.89
SN7545	24	SN74293	1.89
SN7546	24	SN74294	1.89
SN7547	24	SN74295	1.89
SN7548	24	SN74296	1.89
SN7549	24	SN74297	1.89
SN7550	24	SN74298	1.89
SN7551	24	SN74299	1.89
SN7552	24	SN74300	1.89
SN7553	24	SN74301	1.89
SN7554	24	SN74302	1.89
SN7555	24	SN74303	1.89
SN7556	24	SN74304	1.89
SN7557	24	SN74305	1.89
SN7558	24	SN74306	1.89
SN7559	24	SN74307	1.89
SN7560	24	SN74308	1.89
SN7561	24	SN74309	1.89
SN7562	24	SN74310	1.89
SN7563	24	SN74311	1.89
SN7564	24	SN74312	1.89
SN7565	24	SN74313	1.89
SN7566	24	SN74314	1.89
SN7567	24	SN74315	1.89
SN7568	24	SN74316	1.89
SN7569	24	SN74317	1.89
SN7570	24	SN74318	1.89
SN7571	24	SN74319	1.89
SN7572	24	SN74320	1.89
SN7573	24	SN74321	1.89
SN7574	24	SN74322	1.89
SN7575	24	SN74323	1.89
SN7576	24	SN74324	1.89
SN7577	24	SN74325	1.89
SN7578	24	SN74326	1.89
SN7579	24	SN74327	1.89
SN7580	24	SN74328	1.89
SN7581	24	SN74329	1.89
SN7582	24	SN74330	1.89
SN7583	24	SN74331	1.89
SN7584	24	SN74332	1.89
SN7585	24	SN74333	1.89
SN7586	24	SN74334	1.89
SN7587	24	SN74335	1.89
SN7588	24	SN74336	1.89
SN7589	24	SN74337	1.89
SN7590	24	SN74338	1.89
SN7591	24	SN74339	1.89
SN7592	24	SN74340	1.89
SN7593	24	SN74341	1.89
SN7594	24	SN74342	1.89
SN7595	24	SN74343	1.89
SN7596	24	SN74344	1.89
SN7597	24	SN74345	1.89
SN7598	24	SN74346	1.89
SN7599	24	SN74347	1.89
SN7600	24	SN74348	1.89
SN7601	24	SN74349	1.89
SN7602	24	SN74350	1.89
SN7603	24	SN74351	1.89
SN7604	24	SN74352	1.89
SN7605	24	SN74353	1.89
SN7606	24	SN74354	1.89
SN7607	24	SN74355	1.89
SN7608	24	SN74356	1.89
SN7609	24	SN74357	1.89
SN7610	24	SN74358	1.89
SN7611	24	SN74359	1.89
SN7612	24	SN74360	1.89
SN7613	24	SN74361	1.89
SN7614	24	SN74362	1.89
SN7615	24	SN74363	1.89
SN7616	24	SN74364	1.89
SN7617	24	SN74365	1.89
SN7618	24	SN74366	1.89
SN7619	24	SN74367	1.89
SN7620	24	SN74368	1.89
SN7621	24	SN74369	1.89
SN7622	24	SN74370	1.89
SN7623	24	SN74371	1.89
SN7624	24	SN74372	1.89
SN7625	24	SN74373	1.89
SN7626	24	SN74374	1.89
SN7627	24	SN74375	1.89
SN7628	24	SN74376	1.89
SN7629	24	SN74377	1.89
SN7630	24	SN74378	1.89
SN7631	24	SN74379	1.89
SN7632	24	SN74380	1.89
SN7633	24	SN74381	1.89
SN7634	24	SN74382	1.89
SN7635	24	SN74383	1.89
SN7636	24	SN74384	1.89
SN7637	24	SN74385	1.89
SN7638	24	SN74386	1.89
SN7639	24	SN74387	1.89
SN7640	24	SN74388	1.89
SN7641	24	SN74389	1.89
SN7642	24	SN74390	1.89
SN7643	24	SN74391	1.89
SN7644	24	SN74392	1.89
SN7645	24	SN74393	1.89
SN7646	24	SN74394	1.89
SN7647	24	SN74395	1.89
SN7648	24	SN74396	1.89
SN7649	24	SN74397	1.89
SN7650	24	SN74398	1.89
SN7651	24	SN74399	1.89
SN7652	24	SN74400	1.89
SN7653	24	SN74401	1.89
SN7654	24	SN74402	1.89
SN7655	24	SN74403	1.89
SN7656	24	SN74404	1.89
SN7657	24	SN74405	1.89
SN7658	24	SN74406	1.89
SN7659	24	SN74407	1.89
SN7660	24	SN74408	1.8

GODBOUT

BILL GODBOUT ELECTRONICS
BOX 2353, OAKLAND AIRPORT, CA 94614

TERMS: Prices good through end of magazine cover date. Cal res add tax. BankAmericard®/VISA®/Mastercharge® orders (\$15 min) call (415) 562-0636, 24 hrs. Allow up to 5% shipping (more for power supplies); excess refunded. COD orders OK with street address.

ADD 24K OF MEMORY TO YOUR COMPUTER — \$450

Now you can buy 3 of our popular 8K ECORAM II™ boards for \$450. Features? All static design (eliminates dynamic timing hassles); tri-state outputs; configured as two separate, independent 4k blocks with individual protect for each block; zero wait states (4 MHz 2-80s; use 1 wait state, implemented on board); provides vector interrupt if write attempted in protected block. Fully buffered. Fully socketed. True low power.

- *SPC-24 Three 8K ECORAM II kits..... \$450.00
- *CK-008 8K ECORAM II (kit form)..... \$163.84
- *CK-010 Same but assembled, tested, 1 yr warr. \$188.50
- *CK-007 4k ECORAM II (kit form)..... \$100.00
- *CK-009 Same but assembled, tested, 1 yr warr. \$120.00

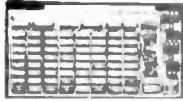

12V 8A supply - \$39.95

Less case, hardware. Please add sufficient postage.

SPECIALS: *SPC22, PRIME 8080A \$12.95 *SPC24, 2708 \$25

MOTHERBOARDS Interdesign 1101 10 slot \$90 pulse generator 18 slot \$124

ONLY \$88 FOR QUALITY TEST EQUIPMENT. 0.1Hz-20Hz; 100% to 90% duty cycle; ports to minimize buss problems; file and rechargeable.

FOR MORE DETAILS, COMPONENTS + MUCH MORE...

SEND FOR OUR FLYER

CIRCLE 47 ON FREE INFORMATION CARD

1 out of 2 who have it don't know it...



21 million Americans have high blood pressure. But 50 percent of those who have it, don't know it.

When blood pressure goes higher than it should, and stays high, it sets the stage for heart attack or stroke.

Most cases of high blood pressure can be controlled with drugs and other advances in treatment. That's why you should see your doctor regularly. Only he can tell if you need help.

A public service message from your Heart Association



\$699. Now or never.

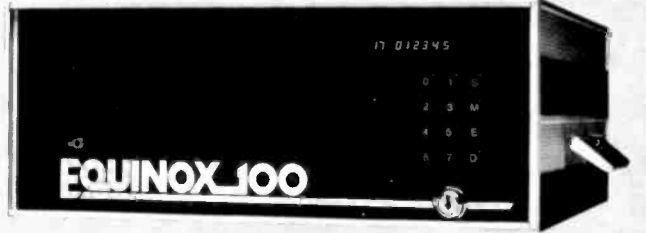

Price increases \$100 on Oct. 15, 1977.

Equinox 100™ is The Frontrunner in S-100 personal computers... because it gives you full front panel access to all CPU registers and register pairs, I/Os and memory locations via octal 12-key keyboard and digital LED readout... single-step and programmable Slow-Step™... no-crash 26-amp constant voltage power supply... 20-slot shielded and actively terminated busboard... and more!

Order your Equinox 100™ kit at your local personal

computer store, by direct mail or by phone. But you must order before Oct. 15, 1977 to save \$100.

For \$699, it's now or never.

ORDER: At your computer store

WRITE: P.O. Box 6314, Albany, CA 94706

CALL: BAC/MC orders to 800-648-5311

EQUINOX 100

The Frontrunner from Parasitic Engineering

See us at the Atlantic City show!

CIRCLE 46 ON FREE INFORMATION CARD

CB SPECIALS—R.F. DRIVERS—R.F. POWER OUTPUTS—FETS

2SC481 1.85	2SC767 15.75	2SC866 5.85	2SC1449-1 1.60	40081 1.50
2SC482 1.75	2SC773 .85	2SC1013 1.50	2SC1475 1.50	40082 3.00
2SC495 1.10	2SC774 1.75	2SC1014 1.50	2SC1678 5.50	2SC608 4.85
2SC502 3.75	2SC775 2.75	2SC1017 1.50	2SC1679 4.75	SK3046 2.15
2SC517 4.75	2SC776 3.00	2SC1018 1.50	2SC1722 2.15	SK3047 3.75
2SC614 3.80	2SC777 4.75	2SC1173 1.25	2SC1760 2.15	SJ2095 3.50
2SC615 3.90	2SC778 3.25	2SC1226A 1.25	2SC1816 5.50	SK3048 3.25
2SC616 4.15	2SC779 2.50	2SC1237 4.50	2SC1908 7.70	SK3054 1.25
2SC617 4.25	2SC798 3.10	2SC1239 3.50	2SC1957 1.50	2SK19 1.75
2SC699 4.75	2SC781 3.00	2SC1243 1.50	2SF8 3.00	2SK30 1.00
2SC710 7.0	2SC789 1.00	2SC1306 4.75	HEP-S 3001 3.25	2SK33 1.20
2SC711 7.0	2SC796 3.15	2SC1306-1 4.90	2SD235 1.00	2SK33 1.20
2SC735 7.0	2SC799 4.25	2SC1307 5.75	MRFB004 3.00	
2SC756 3.00	2SC802 3.75	2SC1307-1 6.00	4004 3.00	3SK40 2.75
2SC765 9.50	2SC803 4.00	2SC1377 5.50	4005 3.00	3SK45 2.75
2SC766 10.15	2SC839 .85	2SC1449 1.30	40080 1.25	3SK49 2.75

JAPANESE TRANSISTORS

2SA52 .60	2SB187 .60	2SC458 .70	2SC815 .75	2SC1569 1.25
2SA316 .75	2SB235 1.75	2SC460 .70	2SC828 .75	2SC1756 1.25
2SA473 .75	2SB303 .65	2SC478 .80	2SC829 .75	
2SA483 1.95	2SB324 1.00	2SC491 2.50	2SD30 .95	
2SA489 .80	2SB337 2.10	2SC497 1.60	2SC839 .75	
2SA490 .70	2SB367 1.00	2SC515 .80	2SD45 2.00	
2SA505 .70	2SB370 .65	2SC535 .75	2SD65 .75	
2SA564 .50	2SB405 .85	2SC536 .65	2SD68 .90	
2SA628 .65	2SB407 1.65	2SC537 .70	2SD72 1.00	
2SA643 .85	2SB415 .85	2SC563 2.50	2SD88 1.50	
2SA647 2.75	2SB461 1.25	2SC605 1.00	2SD151 2.25	
2SA673 .85	2SB463 1.65	2SC620 .80	2SD170 2.00	
2SA679 3.75	2SB471 1.75	2SC627 1.75	2SD180 2.75	
2SA682 .85	2SB474 1.50	2SC642 3.50	2SD201 1.95	
2SA699 1.30	2SB476 1.25	2SC643 3.75	2SD218 4.75	
2SA699A 1.75	2SB481 2.10	2SC644 .70	2SD300 2.50	
2SA705 .55	2SB492 1.25	2SC681 2.50	2SD313 1.10	
2SA815 .85	2SB495 .95	2SC684 2.10	2SD315 .75	
2SA816 .85	2SB507 .90	2SC687 2.50	2SD318 .95	
	2SB511 .70	2SC696 2.35	2SD341 .95	
		2SC712 .70	2SD350 3.25	
2SB22 .65		2SC713 .70	2SD352 .80	
2SB54 .70	2SC206 1.00	2SC732 .70	2SD380 5.70	
2SB56 .70	2SC210 1.10	2SC737 .70	2SD389 .90	
2SB77 .70	2SC261 .65	2SC733 .70	2SD-390 .75	
2SB128 2.25	2SC291 .65	2SC739 .70	2SD437 5.50	
2SB135 .95	2SC320 2.00	2SC715 1.75		
2SB152 4.50	2SC352 .75	2SC762 1.90	MPS-U31 4.00	
2SB173 .55	2SC353 .75	2SC783 1.00	MPS8000 1.25	
2SB175 .55	2SC371 .70	2SC784 .70		
2SB178 1.00	2SC372 .70	2SC785 1.00		
2SB186 .60	2SC394 .70	2SC793 2.50		

POWER-TRANSISTORS HIGH-VOLT. TV. TYPE

BU204 1300V 3.90	BU207 1300V 5.40	2SC1172B 1100V 4.25
BU205 1500V 4.70	BU208 1500V 6.25	2SC1308 1100V 4.95
BU206 1700V 5.90	2SC1170 1100V 4.00	2SC1325 1100V 4.95

OEM SPECIALS

1N270 .10	2N960 .55	2N2219A .30	2N2913 .75	2N3740 1.00	2N4401 .20
1N914 .10	2N962 .40	2N2221 .25	2N2914 1.20	2N3771 1.75	2N4402 .20
	2N967 .50	2N2221A .30	2N2916A 3.65	2N3772 1.90	2N4403 .20
2N173 1.75	2N1136 1.35	2N2222 .25	2N3019 .50	2N3773 3.00	2N4409 .20
2N178 .90	2N1142 2.25	2N2222A .30	2N3053 .70	2N3819 .32	2N4410 .25
2N2327A 1.15	2N1302 1.25	2N2270 .40	2N3054 .70	2N3823 .70	2N4416 .75
2N334 1.20	2N1305 .75	2N2322 1.00	2N3055 .75	2N3856 .20	2N4441 .85
2N336 .90	2N1377 .75	2N2323 1.00	2N3227 1.00	2N3866 .85	2N4442 .90
2N338A 1.05	2N1420 .20	2N2324 1.35	2N3247 3.40	2N3903 .20	2N4443 1.20
2N398B .90	2N1483 .95	2N2325 2.00	2N3250 .50	2N3904 .20	2N4452 .55
2N404 .75	2N1540 .90	2N2326 2.85	2N3375 6.50	2N3905 .20	2N5061 .30
2N443 1.75	2N1543 2.70	2N2327 3.80	2N3393 .20	2N3906 .20	2N5064 .50
2N456 1.10	2N1544 .80	2N2328 4.20	2N3394 .17	2N3925 3.75	2N5130 .20
2N501A 3.00	2N1549 1.25	2N2329 4.75	2N3414 .17	2N3954 3.50	2N5138 .15
2N508A 4.45	2N1551 2.50	2N2368 .25	2N3415 .18	2N3954A 3.75	2N5138 .15
2N555 .45	2N1552 3.25	2N2369 .25	2N3416 .19	2N3955 2.45	2N5198 3.75
2N652A .85	2N1554 1.25	2N2484 .32	2N3417 .20	2N3957 1.25	2N5294 .50
2N677C 6.00	2N1557 1.15	2N2712 .18	2N3442 1.85	2N3958 1.20	2N5296 .50
	2N1560 2.80	2N2894 .40	2N3553 1.50	2N4037 .60	2N5306 .20
2N706B .40	2N1605 .35	2N2903 3.30	2N3563 .20	2N4093 .85	2N5354 .20
2N711 .50	2N1613 .30	2N2904 .25	2N3565 .20	2N4124 .20	2N5369 .20
2N711B .60	2N1711 .30	2N2904A .30	2N3638 .20	2N4126 .20	2N5400 .40
2N718 .25	2N1907 4.10	2N2905 .25	2N3642 .20	2N4141 .20	2N5401 .50
2N718A .30	2N2060 1.85	2N2905A .30	2N3643 .15	2N4142 .20	2N5457 .35
2N720A .50	2N2102 .40	2N2906 .25	2N3645 .15	2N4143 .20	2N5458 .30
2N918 .35	2N2218 .25	2N2906A .30	2N3646 .14	2N4220A .45	C103Y .25
2N930 .25	2N2218A .30	2N2907 .25	2N3730 1.50	2N4234 .95	C103d .40
2N956 .30	2N2219 .25	2N2907A .30	2N3731 2.75	2N4400 .20	C106b1 .50

SILICON UNIUNIONS		INTEGRATED CIRC.		RECTIFIERS	
2N2646 .50	2N4871 .50	UA703C .40			10 100
2N2647 .60	2N4891 .50	709C OP. AMP. .25		IN4001 .60	5.00
2N6027 .55	2N4892 .50	741C OP. AMP. .25		IN4002 .70	6.00
2N6028 .70	2N4893 .50	740 .15		IN4003 .80	7.00
DE537 .25	2N4894 .50	TA7061P 3.50		IN4004 .90	8.00
2N2160 .65	MU10 .40	TA7205P 8.00		IN4005 1.00	9.00
2N4870 .50		UPC1001h2 6.00		IN4006 1.10	10.00
		Ne555 1.25		IN4007 1.20	11.00

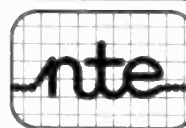

New-Tone Electronics
P.O. Box 1738 A
Bloomfield, N.J. 07003
Phone: (201) 748-6171

ALL PARTS GUARANTEED

N.J. residents add 5% sales tax. Minimum order \$5.00. All orders add \$1.00 postage. Dealers write or phone for discount prices.

CIRCLE 45 ON FREE INFORMATION CARD

DIGI-KEY CORPORATION

Quality Electronic Components

DON'T FORGET OUR DISCOUNTS WHEN COMPARING PRICES MICROPROCESSORS

Best Values Yet!

8080A	8-BIT CPU, 2 USEC CYCLE	\$12.95
8212	8-BIT I/O PORT	\$ 3.95
8216	BI-DIRECTIONAL BUS DRIVER	\$ 4.25
8224	CLOCK GENERATOR	\$ 3.95
8228	SYSTEM CONTROLLER	\$ 6.95
8251	COMMUNICATIONS INTERFACE	\$12.95
8255	PERIPHERAL INTERFACE	\$11.95
1702A	2K EPROM (256x8)	\$ 6.95
2708	8K EPROM (1Kx8)	\$29.50
2102-1	1K RAM 500 NS.	\$ 1.79
5C/MP	5 VOLT 5C/MP CPU	\$ 9.95
2650	MICROPROCESSOR 1.25 MH-2 CLOCK 40 DIL.	\$24.95

DIAMOND

See Our Catalog For More Diamond Tool

4 1/4" Length **MS54 \$6.58**

ACE 200-K

Part No. 923333 \$18.95

• Two 5-way binding posts
• Size: 4 9/16" by 5 9/16"
• Kit form - lowest cost

778 SOLDERLESS PLUG-IN TIE POINTS CAPACITY UP TO 8 16-PIN DIP's

ok

Dig-Key Stocks the Entire AP Line

WSU-30 Regular Wrap... \$5.95
WSU-30M Modified Wrap... \$6.95

CLOCK MODULES

The MA1002 and MA1010 comes clock modules by National Semiconductor are fully assembled and tested clocks using a 4 digit LED display and an MOS integrated circuit on the same board. Simply connect switches and our special transformer and you have a fully functioning clock.

The MA1003 clock module is a fully assembled and tested 17 hour clock using a high brilliance green fluorescent display and crystal time base making it perfect for use as a time portable clock. It operates directly from 17 volts DC so no transformer is needed. Our price includes three push button switches for setting the time.

MA1002A	1 1/2" x 17" Hour	\$10.50	MA1010A	1 1/2" x 17" Hour AM	\$13.00
MA1002A SET	1 1/2" x 17" Hour	\$13.95	MA1010A SET	1 1/2" x 17" Hour AM	\$16.45
MA1002C	1 1/2" x 17" Hour	\$10.50	MA1010C	1 1/2" x 17" Hour AM	\$13.00
MA1002C SET	1 1/2" x 17" Hour	\$13.95	MA1010C SET	1 1/2" x 17" Hour AM	\$16.45
MA1003	17 Hour Clock with Switches	\$24.95			

8080A CHIP SET

ONE EACH 8080A, 8212, 8224 and 8228 PLUS SIXTEEN 2102-1's — ALL FOR

\$49.95

PRICE BREAKTHROUGH ON 74LS'

74LS00	28	74LS00	28	74LS00	57	74LS157	75	74LS248	79
74LS01	28	74LS02	33	74LS03	28	74LS04	57	74LS249	79
74LS02	28	74LS03	33	74LS03	28	74LS04	102	74LS253	84
74LS03	28	74LS38	33	74LS107	39	74LS161	102	74LS257	75
74LS04	29	74LS40	28	74LS109	39	74LS162	102	74LS258	75
74LS05	29	74LS41	28	74LS112	39	74LS163	102	74LS266	39
74LS08	29	74LS47	28	74LS113	39	74LS164	102	74LS283	79
74LS09	29	74LS48	28	74LS114	39	74LS168	114	74LS290	65
74LS10	28	74LS51	28	74LS125	49	74LS169	114	74LS293	65
74LS11	28	74LS54	28	74LS126	49	74LS170	114	74LS365	67
74LS12	28	74LS55	28	74LS132	81	74LS173	134	74LS366	67
74LS13	47	74LS57	28	74LS134	39	74LS174	106	74LS367	67
74LS14	102	74LS74	39	74LS138	73	74LS175	84	74LS368	67
74LS15	28	74LS75	53	74LS140	118	74LS186	39	74LS369	39
74LS16	28	74LS76	39	74LS151	75	74LS191	118	74LS670	234
74LS21	28	74LS78	39	74LS153	75	74LS196	86	81LS95	77
74LS22	28	74LS83	39	74LS154	110	74LS197	86	81LS96	77
74LS26	33	74LS86	39	74LS155	75	74LS197	86	81LS97	77
74LS27	33	74LS156	75	74LS156	75	74LS197	86	81LS98	77

STRIPS — WRAPS — UNWRAPS

TOTALLY ASSEMBLED CRT AT LOWER THAN KIT PRICE

CRT TERMINAL \$895.00 MANUAL ONLY \$2.00

Bishop Graphics 5" x 6" 1A Scale PC

The Dig-Key Catalog features many more quality Bishop Graphics products.

No. 3365 \$12.50

MA1002 0.5" High Digits

Actual Size: 1.375" x 3.05"

MA1010 0.84" High Digits

Actual size: 1.75" x 3.75"

INTEGRATED CIRCUITS TTL, CMOS, LINEAR

7400	21	7476	32	74181	215	4012	23	4520	114
7401	21	7480	70	74182	219	4013	40	4527	168
7402	21	7481	70	74183	219	4014	80	4528	80
7403	21	7483	70	74185	219	4015	96	4585	123
7404	21	7485	89	74188	350	4016	40	7102-1	179
7405	21	7485	89	74189	350	4017	105	8306A	1295
7406	25	7489	219	74190	223	4018	105	CA3046	1295
7407	25	7490	44	74191	323	4019	23	LM2111N	125
7408	21	7491	70	74192	88	4020	114	LM309K	180
7409	21	7492	44	74193	88	4021	114	LM309M	180
7410	21	7493	44	74194	88	4022	96	LM340T-5	125
7411	21	7494	70	74195	88	4023	23	LM340T-6	125
7412	21	7495	70	74196	88	4024	84	LM340T-8	125
7413	25	7497	89	74197	88	4025	22	LM340T-12	125
7414	29	74100	128	74198	149	4026	168	LM340T-15	125
7415	29	74107	30	74199	149	4027	40	LM340T-18	125
7417	25	74109	33	74201	100	4028	89	LM340T-24	125
7418	25	74125	48	74202	67	4029	114	LM3900M	69
7419	25	74126	48	74203	67	4030	23	LM3900N	69
7420	21	74127	44	74205	67	4031	151	MC1456V	100
7421	25	74128	44	74206	67	4032	151	MC1458V	53
7422	35	74129	61	74207	67	4033	151	MC1469P	115
7423	35	74130	61	74208	67	4034	114	NE530T	324
7424	35	74131	61	74209	67	4035	114	NE540L	204
7425	35	74132	61	74210	67	4036	114	NE540V	48
7426	35	74133	61	74211	67	4037	114	NE556A	88
7427	35	74134	61	74212	67	4038	114	NE556B	383
7428	35	74135	61	74213	67	4039	114	NE560B	128
7429	35	74136	61	74214	67	4040	114	NE566V	136
7430	35	74137	61	74215	67	4041	79	UA709CV	44
7431	35	74138	61	74216	67	4042	79	UA710CA	44
7432	35	74139	61	74217	67	4043	79	UA711CA	53
7433	30	74140	130	74218	67	4044	186	UA723CA	60
7434	25	74141	136	74219	67	4045	186	UA733CA	75
7435	25	74142	136	74220	67	4046	158	UA711CV	44
7436	25	74143	136	74221	67	4047	158	UA712CV	44
7437	25	74144	136	74222	67	4048	158	UA727CV	70
7438	25	74145	136	74223	67	4049	158	UA780CV	48
7439	25	74146	136	74224	67	4050	158	UA780CV	48
7440	25	74147	136	74225	67	4051	158	UA780CV	48
7441	25	74148	136	74226	67	4052	158	UA780CV	48
7442	25	74149	136	74227	67	4053	158	UA780CV	48
7443	25	74150	136	74228	67	4054	158	UA780CV	48
7444	25	74151	136	74229	67	4055	158	UA780CV	48
7445	25	74152	136	74230	67	4056	158	UA780CV	48
7446	25	74153	136	74231	67	4057	158	UA780CV	48
7447	25	74154	136	74232	67	4058	158	UA780CV	48
7448	25	74155	136	74233	67	4059	158	UA780CV	48
7449	25	74156	136	74234	67	4060	158	UA780CV	48
7450	25	74157	136	74235	67	4061	158	UA780CV	48
7451	25	74158	136	74236	67	4062	158	UA780CV	48
7452	25	74159	136	74237	67	4063	158	UA780CV	48
7453	25	74160	136	74238	67	4064	158	UA780CV	48
7454	25	74161	136	74239	67	4065	158	UA780CV	48
7455	25	74162	136	74240	67	4066	158	UA780CV	48
7456	25	74163	136	74241	67	4067	158	UA780CV	48
7457	25	74164	136	74242	67	4068	158	UA780CV	48
7458	25	74165	136	74243	67	4069	158	UA780CV	48
7459	25	74166	136	74244	67	4070	158	UA780CV	48
7460	25	74167	136	74245	67	4071	158	UA780CV	48
7461	25	74168	136	74246	67	4072	158	UA780CV	48
7462	25	74169	136	74247	67	4073	158	UA780CV	48
7463	25	74170	136	74248	67	4074	158	UA780CV	48
7464	25	74171	136	74249	67	4075	158	UA780CV	48
7465	25	74172	136	74250	67	4076	158	UA780CV	48
7466	25	74173	136	74251	67	4077	158	UA780CV	48
7467	25	74174	136	74252	67	4078	158	UA780CV	48
7468	25	74175	136	74253	67	4079	158	UA780CV	48
7469	25	74176	136	74254	67	4080	158	UA780CV	48
7470	25	74177	136	74255	67	4081	158	UA780CV	48
7471	25	74178	136	74256	67	4082	158	UA780CV	48
7472	25	74179	136	74257	67	4083	158	UA780CV	48
7473	25	74180	136	74258	67	4084	158	UA780CV	48
7474	25	74181	136	74259	67	4085	158	UA780CV	48
7475	25	74182	136	74260	67	4086	158	UA780CV	48
7476	25	74183	136	74261	67	4087	158	UA780CV	48
7477	25	74184	136	74262	67	4088	158	UA780CV	48
7478	25	74185	136	74263	67	4089	158	UA780CV	48
7479	25	74186	136	74264	67	4090	158	UA780CV	48
7480	25	74187	136	74265	67	4091	158	UA780CV	48
7481	25	74188	136	74266	67	4092	158	UA780CV	48
7482	25	74189	136	74267	67	4093	158	UA780CV	48
7483	25	74190	136	74268	67	4094	158	UA780CV	48
7484	25	74191	136	74269	67	4095	158	UA780CV	48
7485	25	74192	136	74270	67	4096	158	UA780CV	48
7486	25	74193	136	74271	67	4097	158	UA780CV	48
7487	25	74194	136	74272	67	4098	158	UA780CV	48
7488	25	74195	136	74273	67	4099	158	UA780CV	48
7489	25	74196	136	74274	67	4100	158	UA780CV	48
7490	25	74197	136	74275	67	4101	158	UA780CV	48
7491	25	74198	136	74276	67	4102	158	UA780CV	48
7492	25	74199	136	74277	67	4103	158	UA780CV	48
7493	25	74200	136	74278	67	4104	158	UA780CV	48
7494	25	74201	136	74279	67	4105	158	UA780CV	48
7495	25	74202	136	74280	67				

S.D. SALES CO. P.O. BOX 28810 -G DALLAS, TEXAS 75228

★ Imsai - Altair "A" Compatible Kits ★

Z-80 CPU KIT COMPLETE - \$149. kit

Z-80 Chip & Manual \$49.95

Z-80 Manual - \$7.50 Separately

From the same people who brought you the \$89.95 4K RAM KIT. We were not the first to introduce an Imsai/Altair compatible Z-80 Card, but we do feel that ours has the best design and quality for the lowest price!
The advance features of the Z-80 such as an expanded set of 158 instructions, 8080A software compatibility, and operation from a single 5VDC supply, are all well known. What makes our card different is the extra care we took in the hardware design. The CPU card will always stop on an NMI state. We also generate TRUE SYNC on card, to insure that the rest of your system functions properly. Dynamic memory refresh and NMI are brought out for your use. Believe it or not, not all of our competitors have gone to the extra trouble of doing this. As always this kit includes all parts, all sockets, and complete instructions for ease of assembly. Because of our past experience with our 4K kit we suggest that you order early. All orders will be shipped on a strict first come first served basis. Dealers inquiries welcome on this item. Kit includes Zilog Manual and all parts. Kit shipped with 2 MHz crystals.

THE WHOLE WORKS
\$89.95

4K LOW POWER RAM BOARD KIT

Imsai and Altair 8080 plug in compatible. Uses low power static 21L02-1 500 ns. RAM'S. Fully buffered, drastically reduced power consumption, on board regulated, all sockets and parts included. Premium quality plated through PC Board.
For 250 ns RAM's add \$10.00

NEW! DESIGN CONSOLETTA KIT - \$89.95

S.D. Sales announces the inexpensive way to beat the wire wrap jungle. Our latest kit gives you 124 solderless quick connect terminals, enough for eight 16 pin IC's and provides 50 x 8 common buss matrix. Has regulated +5VDC and +/- 15VDC, all at 1 AMP. Voltage regulation at 100%. Also includes a pulse generator variable from 10hz to 50mhz and .01 sec. to 100 nano seconds. Generator output is +5V. In kit form only and includes all parts, sockets; front panel measures 7 1/4" x 8 1/4", and hardware, case not available.

CAR/BOAT KIT
\$34.95

Music to your Ears!

New Item!

MUSICAL HORN

Musical Horn Kit for car, boat, or home. Plays any tune from Mozart to Led Zepplin. Change tunes in seconds; complete solid state electronics. Standard or custom tunes available at \$6.95 each (you supply us with the sheet mus c - we supply electronics for your favorite tune.) One song supplied with original order. Standard tunes available: DIXIE - EYES OF TEXAS - ON WISCONSIN - YANKEE DOODLE DANDY - NOTRE DAME FIGHT SONG - PINK PANTHER - AGGIE WAR SONG - ANCHORS AWAY - NEVER ON SUNDAY - BRIDGE OVER RIVER OUI - CANDY MAN.

HOME KIT
\$26.90

Home kit includes speaker which operates from your door bell. When door bell is pushed your favorite tune is played. Car/boat kit DOES NOT include speaker. Uses standard Bohm PM speaker. Allow 4 weeks delivery on both kits.

Limited Quantity!
\$9.95 kit

6 DIGIT ALARM CLOCK KIT

We made a fantastic kit even better. Redesigned to take advantage of the latest advances in IC technology. Features: Litronix Dual 1/2" displays, Mostek 50250 super clock chip, single I.C. segment driver, SCR digit drivers. Greatly simplified construction. More reliable and easier to build. Kit includes all necessary parts (except case). For P.C. board add \$3.00; AC XFMR add \$1.50. Do not confuse with Non-Alarm kits sold by our competition! Eliminate the hassle - avoid the 5314!
NEW! WITH JUMBO LED READOUTS!

1000 MFD Filter Caps
Rated 35 WVDC Up-right style with PC leads. Most popular value for hobbyists.

4/\$1.00

SLIDE SWITCH Assortment
Our best seller. Includes miniature and standard sizes, single and multi-position units. All new.

12/\$1.00

POWER RESISTOR 15 OHM 25W BY CLAROSTAT

75¢ ea.

RESISTOR ASSORTMENT
1/4W 5% & 10% PC leads. A good mix of values! Special!

200/\$2.

P.C. LEAD DIODES
1N4148/1N914
100/\$2.

1N4002 - 1A
100 PIV
40/\$1.

Just received a good mixed lot of National TD-92 plastic transistors. PNP & NPN, even a few FET's. 40-50% yield. Untested Asst.

500/\$3.

DISC CAP ASSORTMENT
P.C. Leads. At least 10 different values. Includes .001, .01, .05 plus other standard values.

60/\$1.00

AMD-1702A
Huge Factory Purchase

FACTORY PRIME UNITS! BRAND NEW!

1.5 Micro-Seconds Access Time.

10/\$40. \$4.95 ea.

★ *Special!* ★

3.579545 MHz Time Base Crystal \$1.25

28 PIN SOCKETS
3 for \$1.00

11,000 MFD 50WVDC Computer Grade Cap \$3.00 each

39 MFD 16 V Mallory Electrolytic 15 for \$1.00

FACTORY PRIME!
21L02-1

Not only are our RAM'S faster than a speeding bullet but they are now very low power. We are pleased to offer prime new 21L02-1 Low Power and Super Fast RAM'S. Allows you to STRETCH your power supply farther and at the same time keep the wait light off!

500ns 8/\$12.95
250ns 8/\$15.95

IC'S REMOVED FROM PC BOARDS
ALL TESTED;
FULL SPEC.

Great Buy!

IC's from XEROX

1402 A Shift Regulator - 50c
MH0025CN - 55c

7400 - 9c
7402 - 9c
7403 - 9c
7406 - 11c
7407 - 11c
7410 - 9c
7416 - 13c
7420 - 9c

7430 - 9c
7440 - 9c
7437 - 10c
7438 - 10c
7451 - 9c
7474 - 16c
7475 - 24c
7486 - 16c

7493 - 26c
74121 - 22c
74123 - 32c
74151 - 9c
74155 - 22c
74193 - 35c
8233 - 35c
Intel - 1302 - 45c

MOS 6 DIGIT UP/DOWN COUNTER

40 PIN DIP. Everything you ever wanted in a counter chip. Features: Direct LED segment drive, single power supply (12 VDC TYPE), six decades up/down, pre-loadable counter, separate pre-loadable compare register with compare out-put. BCD and seven segment outputs, internal scan oscillator, CMOS compatible, leading zero blanking, 1MHZ. count input frequency.

\$12.95 Exclusive! \$12.95

CALL IN YOUR BANK-AMERICARD OR MASTER CHARGE ORDER IN ON OUR CONTINENTAL UNITED STATES TOLL FREE WATTS LINE:

1-800-527-3460

Texas Residents Call Collect:

214/271-0022

TERMS:

Money Back Guarantee!

NO COD'S. TEXAS RESIDENTS ADD 5% SALES TAX. ADD 5% OF ORDER FOR POSTAGE & HANDLING. ORDERS UNDER \$10.00 ADD 75c. FOREIGN ORDERS - U.S. FUNDS ONLY!

Orders over \$15. - Choose \$1. FREE MERCHANDISE!

CIRCLE 68 ON FREE INFORMATION CARD

Radio Hut

Money back guarantee. NO COD'S. Texas residents add 5% sales tax. Add 5% of order for postage and handling. Orders under \$15.00 add 75 cents. Foreign orders add 10% for postage.

For your convenience, call your BankAmericard or Master Charge orders in on our Toll Free Watts Line: 1-800-527-2304. Texas residents call collect: 1-214-271-8423.



P. O. Box 38323R
Dallas, Texas 75238



Memorex computer boards with IC's, diodes, transistor, etc. 5 Boards containing 100 - 200 IC's
ONLY \$ 4.25

BRIDGE RECTIFIERS		
6 Amp	50V	1.10
10 Amp	50V	1.25
25 Amp	50V	1.39

RESISTORS
Over 50,000,000 in stock

130 ohm	22K ohm
470 ohm	27K ohm
1680 ohm	33K ohm
1K ohm	39K ohm
12K ohm	43K ohm
27K ohm	47K ohm
33K ohm	82K ohm
47K ohm	100K ohm
68K ohm	150K ohm
10K ohm	220K ohm
20K ohm	

1.8W only
1.2W only
All resistors are E.C. type and are not puller's
100 min. order for each value
NO MIX 100/99

MK 5005
4 digit counter/latch decoder; 7 segment output only. 24 pin dip with specs.
\$ 8.00 EACH

UNSCRAMBLER KIT
for all Scanners
• Tunes easily
• Full instructions included
• Easy to install
• 3 1/2" x 3 1/2" x 1 1/2"
Only \$19.95

PLASMA DISPLAY KIT

Kit Includes: 12 digit display .4" Character Power supply for display above Complete specs for hookup.
Line cord Not Included. **ONLY \$ 3.95**



SPECIAL DEVICES

82S23	2.19
2513	10.00
2102-1	.99
1101A	.75
1103A	1.10
8T13	1.50
8T97	1.25
MM5233	1.50
300KC xtal	1.50

REGULATORS

7805	7818
7806	7824
7808	7905
7812	7912
7815	7915
Your Choice \$.95	

READOUTS

Best Value!

FND70 .4"C.C. .59
FND800 .8"C.C. 1.69
TI 6 digit array C.C. 3/1.00
MAN 8 .3"CA Yellow .89
LT767 .7" C.C. 4 digit stick \$ 3.95

WATERGATE SPECIAL

Telephone Relay automatically starts and stops tape recorder. No batteries required. Kit complete with drilled P.C. Board.
Parts and Case **ONLY \$ 10.95**

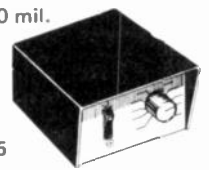

VARIABLE POWER SUPPLY KIT NO. 1

*Continuously variable from 5V to 20V
*Excellent regulation up to 500 mil.
*4400 Mfd of filtering
*Drilled fiberglass PC Board
*One hour assembly
*Kit includes all components
*Case Included **ONLY \$ 10.95**

VARIABLE POWER SUPPLY KIT NO. 2

Same as above but with 1 amp output, also with case. **ONLY \$ 13.95**

CLOCK KIT



Kit includes
• LT701 clock module
• Power Supply
• Punched Case
• 12 hour operation only
Complete except for line cord
LT701E 12 hour clock
LT701G 24 hour clock
ONLY \$ 14.95

BATTERY CLIPS

Standard 9V battery clip with 4-1/2" tinned leads. 25/\$1.00

TRANSISTORS DIODES

*MJE1103	3/1.00
MJ3001	1.30
2N2222	6.1.00
2N2369	6/1.00
2N2905	4/1.00
*2N2907	15/1.00
2N3906	6/1.00
2N4400	6/1.00
2N4443 SCR	3/1.00
IN4004	15/1.00
IN4007	10/1.00
IN4148 - (IN914)	20/1.00
3N201 VHF Pre amp	.80
D40C1 Power Dar.	8/1.00
EN930	.20
IN746	.25

*House numbered and P.C. Lead

T T L

7400	.17	7473	.21
7401	.17	74H74	.45
7402	.17	7474	.35
7403	.17	7475	.55
74H04	.25	7476	.35
74504	.30	7480	.45
7404	.17	7483	.76
7406	.25	7485	.89
7408	.17	7486	.35
7409	.17	7490	.71
7410	.17	7491	.71
7411	.25	7492	.71
7413	.45	7493	.67
7420	.17	7494	.90
7421	.17	7495	.71
7423	.35	7496	.85
7425	.25	74100	.96
7427	.17	74123	.61
7430	.25	74125	.44
7432	.30	74141	.71
7437	.35	74145	.97
7438	.35	74151	.71
7440	.17	74153	.81
7442	.60	74154	.97
7443	.60	74161	.91
7444	.65	74163	1.05
7446	.85	74164	1.05
74L47	1.75	74174	.91
7447	.81	74175	1.40
7448	.81	74180	.76
7450	.20	74181	2.25
7451	.17	74191	1.20
7453	.17	74192	1.20
7454	.17	74193	.95
7470	.35	74S195	1.05
7472	.21	74195	.65

SOCKETS

14 pin	.22
16 pin	.25
18 pin	.25
24 pin (ww only)	.95
28 pin	.35
40 pin	.50

CMOS SALE

CD4000	.16
CD4001	.16
CD4002	.16
CD4007	.16
CD4009	.45
CD4010	.45
CD4011	.16
CD4012	.16
CD4013	.29
CD4014	.75
CD4015	.75
CD4016	.29
CD4017	.80
CD4018	.80
CD4019	.39
CD4020	.85
CD4021	.90
CD4029	.99
CD4024	.70
CD4025	.19
CD4027	.39
CD4028	.75
CD4041	.69
CD4042	.59
CD4030	.16
CD4034	2.30
CD4035	.99
CD4040	1.00
CD4041	.69
CD4042	.59
CD4043	.60
CD4044	.59
CD4046	.90
CD4047	.59
CD4049	.35
CD4050	.35
CD4051	.90
CD4053	.90
CD4058	.90
CD4056	1.00
CD4058	.90
CD4060	1.00
CD4066	.69
CD4069	.30
CD4071	.16
CD4076	.99
74C04	.29
74C107	.29
CD4116	.39
CD4507	.40
CD4512	.50
CD4516	.85
CD4518	.85
CD4520	.85

L S

74LS00	.26	74LS145	1.00
74LS02	.26	74LS151	.70
74LS03	.26	74LS153	.70
74LS04	.30	74LS155	.69
74LS05	.32	74LS156	.76
74LS08	.26	74LS157	.95
74LS09	.26	74LS158	.85
74LS10	.26	74LS160	.85
74LS11	.35	74LS161	.85
74LS12	.35	74LS162	.85
74LS13	.58	74LS163	.85
74LS14	1.05	74LS163	.85
74LS15	.26	74LS168	.85
74LS20	.24	74LS169	.85
74LS21	.35	74LS170	2.00
74LS22	.35	74LS171	2.10
74LS26	.35	74LS174	1.00
74LS27	.35	74LS175	1.00
74LS30	.34	74LS190	.95
74LS32	.35	74LS191	.95
74LS37	.33	74LS192	.85
74LS38	.38	74LS193	.95
74LS40	.34	74LS194	.95
74LS42	.80	74LS195	.95
74LS51	.26	74LS196	.85
74LS54	.26	74LS197	.85
74LS55	.26	74LS251	.85
74LS73	.75	74LS253	.85
74LS74	.49	74LS257	.85
74LS76	.49	74LS258	.85
74LS86	.45	74LS260	.26
74LS90	.85	74LS266	.26
74LS92	1.00	74LS279	.55
74LS93	1.00	74LS290	.75
74LS109	.49	74LS293	.75
74LS112	.49	74LS295	.95
74LS113	.40	74LS298	.95
74LS114	.40	74LS365	.55
74LS125	.55	74LS366	.55
74LS132	.65	74LS367	.55
74LS136	1.00	74LS368	.55
74LS133	.35	74LS390	1.75
74LS136	.39	74LS393	1.45
74LS138	.85	74LS670	3.25
74LS139	.85		

ORDER BY PHONE. Charge your order to BankAmericard or Master Charge.
USE OUR TOLL FREE WATTS
1-800-527-2304

60 Hz L(•)(•)K

Crystal Time Base Kit - Kit enables a MOS clock circuit to operate from a DC power source. Ideal for car, camper, van, boat, etc.
60Hz output with an accuracy of .005% (typ.) Low power consumption 2.5 ma (typ.). Small size will fit most any enclosure. Single MOS IC oscillator/divider chip 5-15 volts DC operation.
ONLY \$ 5.95
2 for \$10.00

NOW! For the Dallas Area Residents.
Come Visit Our Retail Store.
3717 Lincoln Court, Garland, Texas
Tues. - Fri. 10 AM to 6 PM
Sat. 10 AM to 3 PM
CLOSED MONDAY

In replacement parts nothing is foreign to us.

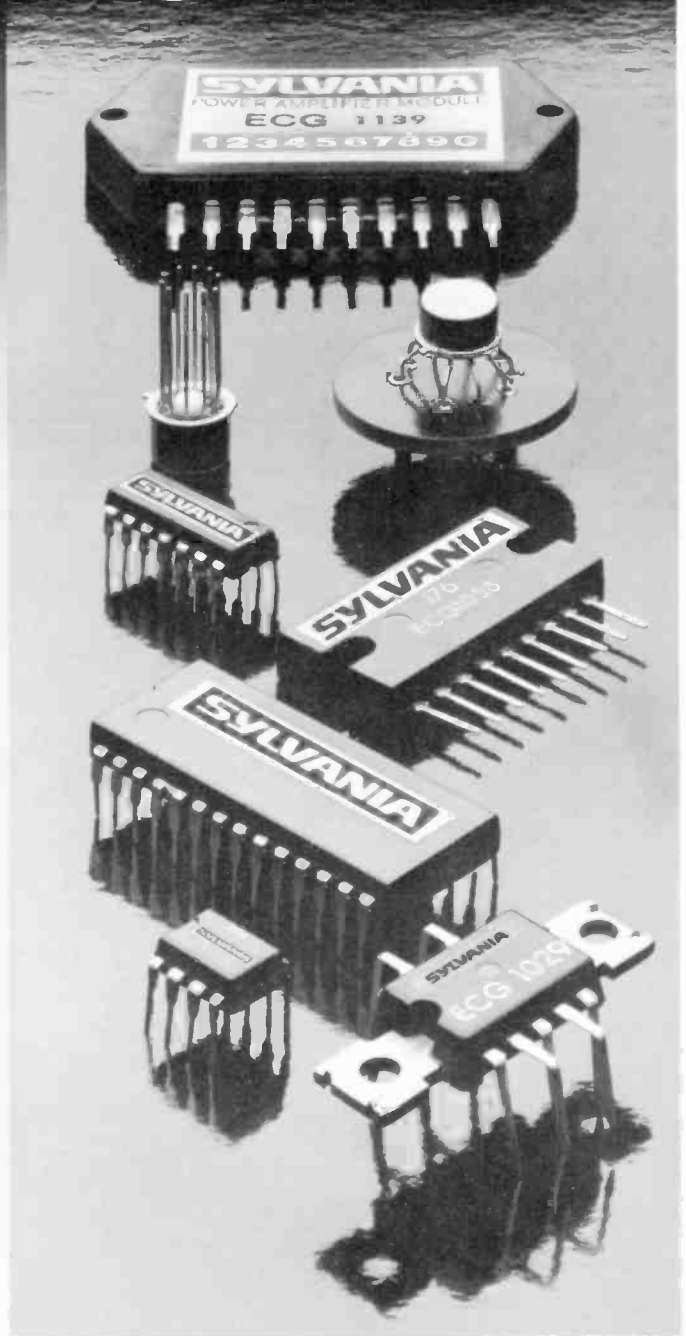
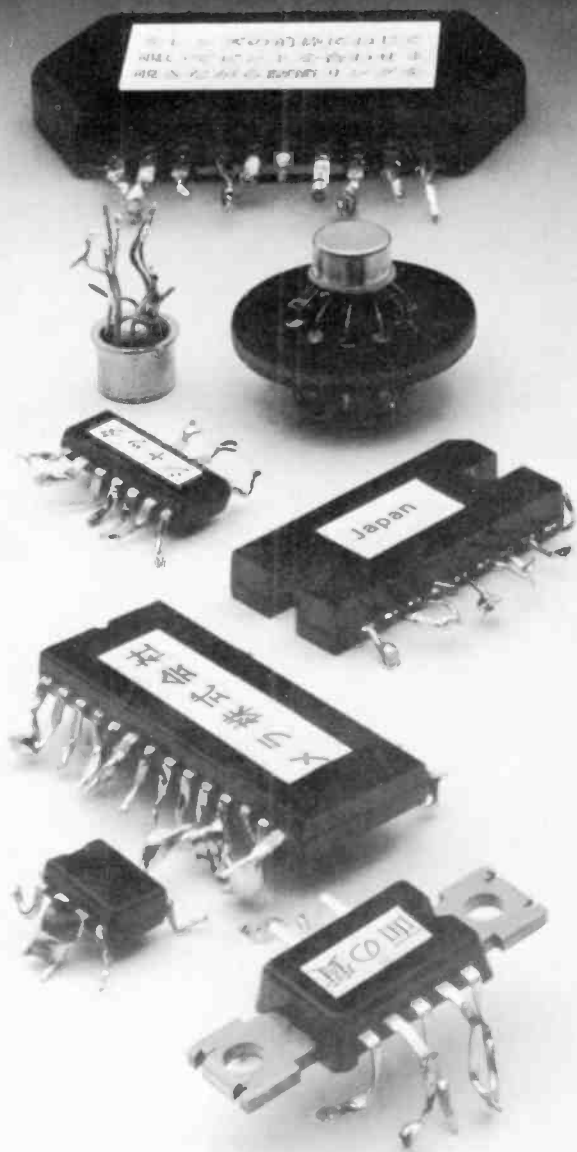

We know the problems in finding the right semiconductor replacements for imported TV, CB and other electronic equipment.

That's why we have a line of thick-film modules and ICs that will replace over 3,000 devices in 139 brands of foreign-made equipment.

And we've made them easy to find in two ways. One is through our new Module and IC Replacement Guide that cross references the original part number with

our ECG® semiconductor part number.

The other way we've made it easy is by making sure your local Sylvania distributor has access to a full stock of semiconductor replacements.

Pick up a copy of the replacement guide at your distributor today, so you'll be able to pick up all the parts you need in just one stop tomorrow.

GTE SYLVANIA

Introducing the mobile that can move you out of the world of the ordinary and into the world of the serious CB'er. The Cobra 138XLR Single Sideband. Sidebanding puts you in your own private world. A world where there's less congestion. More privacy. More time to talk.



It's all possible because instead of 40 channels you get your choice of 120 channels. Both AM and SSB. And instead of 4 watts of legal power you get 12 watts of legal power. So you get almost double the range of AM.

With the 138XLR Single Sideband there's less background noise and less interference. So there's cleaner, clearer reception. Because like all Cobras, the 138XLR SSB is engineered to punch through loud and clear. Even in crowded metropolitan areas.

And like all Cobras it comes equipped with such standard features as an easy-to-read LED channel indicator. Switchable noise blanking and limiting. An RF/signal strength meter. And Cobra's exclusive DynaMike gain control.

You'll find the 138XLR SSB wherever Cobras are sold. Which is almost everywhere. Because Cobra's got a nationwide network of dealers and Authorized Service Centers offering sales, installation, service and advice. So come on in. And move on up.



Punches through loud and clear.

Cobra Communications Products
DYNASCAN CORPORATION
 6460 W. Cortland St., Chicago, Illinois 60635

Write for color brochure
 EXPORTERS: Empire • Plainview, N.Y. • CANADA: Atlas Electronics • Toronto

UPWARD MOBILITY.



CIRCLE 6 ON FREE INFORMATION CARD