

Radio-^{IND}Electronics®

THE MAGAZINE FOR NEW IDEAS IN ELECTRONICS

BUILD ONE OF THESE

- ★ Gas Sensor Alarm
- ★ New TV Games
- ★ 8080 Microcomputer

LEARN SOMETHING NEW

- ★ Komputer Korner
- ★ Microphones For Pro Sound
- ★ Hobby Computer Convention

TELEVISION

- ★ CB & TV Interference
- ★ Service Problems & Solutions
- ★ Equipment Reports

HI-FI-STEREO

- ★ New Digital Expander
- ★ R-E Lab Test Reports
- Tandburg Tape Deck
- Pioneer Receiver

Build this
BRAINWAVE MONITOR
Control Video & Sound
On Your TV Screen





**BACK YOUR
PROMISES**

WITH A PTS GUARANTEE

PTS—Precision Tuner Service—has grown up with the tuner repair business. Today, with more than 40 service centers in the U.S. and Canada, TV servicing dealer/agents know we're always a step ahead of the others. It takes only 1 working day to repair 95% of all the various types of tuners we receive. Our one year guarantee on tuner repair—and module overhaul too—is as important to your customers as it is to you. Not only do we use only original parts! We test, retest and air test our work. Would you believe we repair more tuners than all other tuner repair companies combined.



PTS ELECTRONICS, INC.

PRECISION TUNER SERVICE

Consult the white pages of your telephone directory for the address and number of your nearest PTS Service Center. General Headquarters: Bloomington, IN - Birmingham - Phoenix - Los Angeles - San Diego - Sacramento - Arvada (CO) - Jacksonville - Tampa - Indianapolis - Davenport (IA) - Kansas City (KS) - Metairie (LA) - Silver Spring (MD) - Boston - Springfield (MA) - Detroit - Grand Rapids (MI) - Minneapolis - St. Louis - E. Paterson (NJ) - Buffalo (NY) - Syracuse (NY) - Charlotte (NC) - Cincinnati - Columbus (OH) - Cleveland - Oklahoma City - Portland (OR) - Pittsburgh - Philadelphia - Montreal - Memphis - Nashville (TN) - Houston - Longview (TX) - Salt Lake City - Norfolk - Seattle - Milwaukee.

Circle 1 on reader service card

The small wonder



of the micro-World

Measuring just 11" wide x 11" deep x 5" high, and weighing a mere 7 pounds, the Altair™ 680b is a complete, general-purpose computer.

The secret to this revolutionary, small computer is its CPU board. This double-sided board fits along the bottom of the Altair case and plugs directly into the front panel board. It contains the new 6800 microprocessor, 1,024 bytes of RAM memory, a 256 byte PROM monitor, provisions for 768 bytes of additional PROM or ROM, and a single Interface port with a Motorola ACIA serial interface adapter which can be configured either RS-232 or TTY. A five level Baudot interface option is also available.

The Altair 680b can be programmed from front panel switches, or it can be interfaced to a video display terminal, or teletypewriter. Three additional circuit boards can be plugged inside the Altair 680b for further memory and interface expansion. The first of these boards now under development is an 8K RAM memory board.

Software already developed includes a resident two pass assembler and 8K BASIC. The Altair 680b is also compatible with Motorola 6800 software.

The Altair 680b is ideal for hobbyists who want a powerful computer system at an economic price. Altair 680b owners qualify for membership in the Altair Users Group, and like other Altair owners, they receive a complimentary subscription to **Computer Notes** and complete factory support.

PRICES:

Altair 680b kit with complete, easy-to-understand assembly manual, operator's manual, and programming manual \$466
 Assembled Altair 680b \$625
 Baudot option \$ 42
 8K RAM memory board and software prices to be announced soon.

MAIL THIS COUPON TODAY

Enclosed is a check for \$ _____

BankAmericard # _____ or Master Charge # _____

Altair 680b Kit Assembled
 enclose \$8 for postage and handling

Please send free information package.

NAME _____

ADDRESS _____

CITY _____ STATE & ZIP _____

Price, specifications subject to change. Please allow up to 60 days for delivery.



2450 Alamo SE/Albuquerque, NM 87106, 505-243-7821

NOTE: Altair is a trademark of MITS, Inc.

Pocket CB

New integrated circuit technology and a major electronic breakthrough brings you the world's smallest citizens band transceiver.



The PocketCom measures approximately 3/4" x 1 1/2" x 5 1/2" and easily fits into your shirt pocket. The unit can be used as a personal communications link for business or pleasure.

SMALL ENOUGH FOR YOUR POCKET

Scientists have produced a personal communications system so small that it can easily fit in your pocket. It's called the PocketCom and it replaces larger units that cost considerably more.

MANY PERSONAL USES

An executive can now talk anywhere with anybody in his office, his factory or job site. The housewife can find her children at a busy shopping center. The motorist can signal for help in an emergency. The salesman, the construction foreman, the traveler, the sportsman, the hobbyist—everybody can use the PocketCom—as a pager, an intercom, a telephone or even a security device.

LONG RANGE COMMUNICATIONS

The PocketCom's range is limited only by its 100 milliwatt power and the number of metal objects between units or from a few blocks in the city to several miles on a lake. Its receiver is so sensitive, that signals several miles away can be picked up from stronger citizens band base or mobile stations.

VERY SIMPLE OPERATION

To use the PocketCom simply turn it on, extend the antenna, press a button to transmit, and release it to listen. And no FCC license is required to operate it. The PocketCom has two Channels—channel 14 and an optional second channel. To use the second channel, plug in one of the 22 other citizens band crystals and slide the channel selector to the second position. Crystals for the second channel cost \$7.95 and can only be ordered after receipt of your unit.



The PocketCom components are equivalent to 112 transistors whereas most comparable units contain only twelve.

A MAJOR BREAKTHROUGH

The PocketCom's small size results from a breakthrough in the solid state device that made the pocket calculator a reality. Mega scientists took 112 transistors, integrated them on a micro silicon wafer and produced the world's first transceiver linear integrated circuit. This major breakthrough not only reduced the size of radio components but improved their dependability and performance. A large and expensive walkie talkie costing several hundred dollars might have only 12 transistors compared to 112 in the Mega PocketCom.

BEEP-TONE PAGING SYSTEM

You can page another PocketCom user, within close range, by simply pressing the PocketCom's call button which produces a beep tone on the other unit if it has been left in the standby mode. In the standby mode the unit is silent and can be kept on for weeks without draining the batteries.

SUPERIOR FEATURES

Just check the advanced PocketCom features now possible through this new circuit breakthrough: 1) Incoming signals are amplified several million times compared to only 100,000 times on comparable conventional systems. 2) Even with a 60 decibel difference in signal strength, the unit's automatic gain control will bring up each incoming signal to a maximum uniform level. 3) A high squelch sensitivity (0.7 microvolts) permits noiseless operation without squelching weak signals. 4) Harmonic distortion is so low that it far exceeds EIA (Electronic Industries Association) standards whereas most comparable systems don't even meet EIA specification. 5) The receiver has better than one microvolt sensitivity.



EXTRA LONG BATTERY LIFE

The PocketCom has a light-emitting diode low-battery indicator that tells you when your 'N' cell batteries require replacement. The integrated circuit requires such low power that the two batteries, with average use, will last weeks without running down.



The PocketCom can be used as a pager, an intercom, a telephone or even a security device.

MULTIPLEX INTERCOM

Many businesses can use the PocketCom as a multiplex intercom. Each employee carries a unit tuned to a different channel. A stronger citizens band base station with 23 channels is used to page each PocketCom. The results: an inexpensive and flexible multiplex intercom system for large construction sites, factories, offices, or farms.

NATIONAL SERVICE

The PocketCom is manufactured exclusively for JS&A by Mega Corporation. JS&A is America's largest supplier of space-age products and Mega Corporation is a leading manufacturer of innovative personal communication systems—further assurance that your modest investment is well protected. The

PocketCom should give you years of trouble-free service, however, should service ever be required, simply slip your 5 ounce PocketCom into its handy mailer and send it to Mega's prompt national service-by-mail center. It is just that easy.

GIVE IT A REAL WORKOUT

Remember the first time you saw a pocket calculator? It probably seemed unbelievable. The PocketCom may also seem unbelievable so we give you the opportunity to personally examine one without obligation. Order only two units on a trial basis. Then really test them. Test the range, the sensitivity, the convenience. Test them under your everyday conditions and compare the PocketCom with larger units that sell for several hundred dollars.

After you are absolutely convinced that the PocketCom is indeed that advanced product breakthrough, order your additional units, crystals or accessories on a priority basis as one of our established customers. If, however, the PocketCom does not suit your particular requirements perfectly, then return your units within ten days after receipt for a prompt and courteous refund. You cannot lose. Here is your opportunity to test an advanced space-age product at absolutely no risk.

A COMPLETE PACKAGE

Each PocketCom comes complete with mercury batteries, high performance Channel 14 crystals for one channel, complete instructions, and a 90 day parts and labor warranty. To order by mail, simply mail your check for \$39.95 per unit (or \$79.90 for two) plus \$2.50 per order for postage, insurance and handling to the address shown below. (Illinois residents add 5% sales tax). But don't delay.

Personal communications is the future of communications. Join the revolution. Order your PocketComs at no obligation today.

\$39.95 NATIONAL INTRODUCTORY PRICE

Credit Card Buyers Call Toll Free

JS&A NATIONAL SALES GROUP

DEPT. RA JS&A Plaza
Northbrook, Illinois 60062
CALL TOLL-FREE .. 800 325-6400
In Missouri call ... 800 323-6400

©JS&A Group, Inc., 1976

Radio-Electronics®

THE MAGAZINE FOR NEW IDEAS IN ELECTRONICS

Electronics publishers since 1908

JULY 1976 Vol. 47 No. 7

SPECIAL FEATURES

- 32 **CB Base Antennas**
Selecting the best possible antenna to fit your needs. **by Robert F. Scott**
- 40 **First World Altair Computer Convention**
Hobbyists arrived from all over the U.S. and from foreign countries to talk computers.

BUILD ONE OF THESE

- 36 **Mindpower: Alpha**
A biofeedback device that monitors alpha waves and displays their presence on your TV screen.
- 46 **Gas Sensor**
Measures the relative concentration of deoxygenizing gases. It may save your life. **by Cass Lewart**
- 56 **Great Games You Play On Your TV**
Part II: How it works and the foil patterns. **by Ray Pichullo**
- 48 **8080 Microcomputer**
Part III: Conclusion, with a description of the 8080A microprocessor and how the Dyna-Micro works. **by John Titus**

GENERAL ELECTRONICS

- 4 **Looking Ahead**
Tomorrow's news today. **by David Lachenbruch**
- 22 **Computer Korner**
A look at the 8080 microprocessor. **by Peter Rony, David Larsen & John Titus**
- 26 **State-Of-Solid-State**
New developments in solid-state electronics. **by Karl Savon**

HI-FI AUDIO STEREO

- 43 **Digital Reverb**
A new device that turns your home into a concert hall. **by Len Feldman**
- 49 **R-E Lab Tests Tandberg 10XD**
Reel-to-reel stereo tape deck that really rates. **by Len Feldman**
- 51 **R-E Lab Tests Pioneer SX-1250**
The most powerful receiver in the world. **by Len Feldman**
- 53 **Mics For Pro Sound Systems**
How to select a microphone for a professional sound system. **by Joe Black**

TELEVISION

- 59 **Step-By-Step Troubleshooting**
DC power supplies. **by Jack Darr**
- 62 **Service Clinic**
How to cure CB interference. **by Jack Darr**
- 64 **Reader Questions**
R-E's Service Editor solves reader problems.

DEPARTMENTS

- | | |
|------------------------------|-------------------------|
| 110 Advertising Index | 6 New & Timely |
| 12 Advertising Sales Offices | 72 New Products |
| 14 Letters | 90 Next Month |
| 93 Market Center | 113 Reader Service Card |

ON THE COVER

Mindpower: Alpha is no ordinary brainwave monitor. It displays the presence of alpha waves on a TV screen in either of two possible modes. Use it to train yourself to relax. To get started on this project turn to page 36.

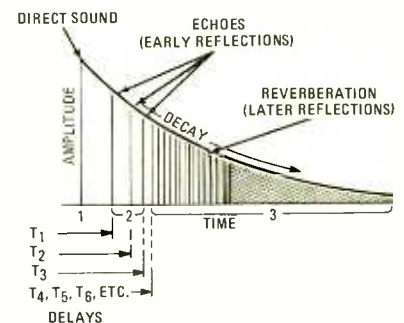

A NEW DIGITAL REVERB unit that can turn your home into a concert hall. For a complete description, turn to page 43.

WHAT! NO CLOCKS

Last month we reported that this issue would feature two construction projects—a countdown timer and a digital clock. We are sorry to report that both these projects experienced difficulty and we had to delay publication. The countdown timer will run in the August, 1976, issue and the digital clock will run in a near future issue.

Radio-Electronics, Published monthly by Gernsback Publications, Inc., 200 Park Avenue South, New York, NY 10003. Phone: 212-777-6400. Second-class postage paid at New York, NY and additional mailing offices. One-year subscription rate: U.S.A., U.S. possessions and Canada, \$8.75. Pan-American countries, \$10.25. Other countries, \$10.75. Single copies 75c. © 1976 by Gernsback Publications, Inc. All rights reserved. Printed in U.S.A.

Subscription Service: Mail all subscription orders, changes, correspondence and Postmaster Notices of undelivered copies (Form 3579) to Radio-Electronics Subscription Service, Boulder, CO 80302.

A stamped self-addressed envelope must accompany all submitted manuscripts and/or artwork or photographs if their return is desired should they be rejected. We disclaim any responsibility for the loss or damage of manuscripts and/or artwork or photographs while in our possession or otherwise.

As a service to readers, Radio-Electronics publishes available plans or information relating to newsworthy products, techniques and scientific and technological developments. Because of possible variances in the quality and condition of materials and workmanship used by readers, Radio-Electronics disclaims any responsibility for the safe and proper functioning of reader-built projects based upon or from plans or information published in this magazine.

looking ahead

New CB licenses

The FCC is now issuing temporary CB licenses to all transmitter purchasers, enabling them to go on the air immediately—and legally—right after the purchase. The temporary permit is supplied by the dealer at the time of purchase, and is good for 60 days from the date a permanent-license application is mailed to the FCC. The applicant derives his own temporary call sign, consisting of the letter K followed by the initials of his first and last names and his ZIP code.

By mid-April, the FCC was receiving an average of 500,000 CB license applications a month. The backlog of unopened mail at its Gettysburg, PA, license-processing center was about 2½ weeks and it was taking seven weeks from the time the application was mailed to Gettysburg to receipt of a permanent license.

30-inch color tube

The largest picture tube ever produced in quantity is the new giant Sony Trinitron direct-view color tube that measures 30-inches diagonally. The measurements of the picture are 21.1 × 27.2 inches or approximately 575 square-inches in area, 82.5% larger than the 25-inch color tube (315 square-inches). The tube will be offered in Japan this fall in a television console at about \$5,000 and in a monitor at approximately \$3,300. Both units are designed for use with Sony's U-Matic and Betamax videocassette recorders. The tube may be offered in U.S.-market TV receivers later.

Old-timers will recall another 30-inch television set that hit the market a long time ago. This was the DuMont Royal Sovereign, introduced in 1951, sporting a giant 30-inch round black-and-white tube with a picture measuring around 550 square inches. Between 500 and 1,000 of these sets were sold before they

were obsoleted by the 27-inch rectangular tube that briefly reigned as the largest "industry-standard" black-and-white picture tube.

VIR TV

A line of television receivers whose chroma and tint are adjusted by the TV station has been introduced by General Electric. The sets have a special circuit that makes automatic adjustments based on the standard color burst and chrominance elements of the vertical interval reference (VIR) signal which is rapidly becoming a standard feature of broadcast transmission.

The VIR signal has been approved by the FCC for insertion in line 19 of the blanking period between television frames. The signal contains references for luminance amplitude, black-level amplitude and sync amplitude as well as chrominance amplitude and color-burst amplitude and phase. At any point of origination—from videotape recorder to transmitter—the color, brightness and contrast of the picture may be maintained at the proper level by restoring the reference signal to its exact specifications.

All three commercial TV networks as well as the Public Broadcasting System are now inserting the VIR signal in their pictures, as are many videotape production houses and independent stations. It is estimated that perhaps 50% of all television stations now use the VIR signal for picture adjustment, and it's hoped that eventually all stations will make use of it. Adjustment at the station is usually manual, although automatic adjustment equipment is available from Tektronix.

The new G-E sets automatically track the color portions of the reference signal by means of a 5-in. × 5-in. circuit-board containing five specially developed IC's. A pilot light indicates when the VIR signal is present. The automatic correction may be over-

ridden by a defeat switch. The special VIR feature is included in one 19-inch set designed to sell for about \$550 and four 25-inch consoles in the \$775-to-\$800 price range. The automatic circuitry adds an estimated \$30 to \$50 to the retail price. Although the VIR signal could also be used to automatically adjust the contrast-brightness ratio, G-E has decided that these settings should be left to the viewer's own preference.

Another new feature in G-E's 1977 line is the first 25-inch color-picture tube with in-line gun. The new tube has a standard dot-type mask (as opposed to the slot masks in most in-line tubes) with a new electron gun designed to provide a finer spot size, overcoming the major problem of in-line guns in large-size picture tubes.

CB expansion

The eagerly awaited expansion of the 27-MHz Class-D Citizens band has been postponed again, as reported here last month. The FCC says it could come by January 1—although some veteran FCC-watchers caution against expecting anything before next April. The hold-up in expansion is an investigation of interference problems—particularly intermodulation (IM). The FCC stressed that expansion in the current 27-MHz band is only an interim step to relieve the immediate problem of congestion, and that it is studying "long-term needs of the general public for personal radio communications." It's generally believed that the ultimate home for personal radio will be further upstairs in the spectrum, possibly around 600 MHz.

The Commission indicated that the present 23 channels on 27 MHz would be expanded to about 58 conventional AM channels—or possibly 99, 105 or 115 through various combinations of amplitude modulated and single sideband channels.

Videodisc postponed

Once again the videodisc is sliding over the horizon into the further future. The plans of both RCA and Philips (Magnavox) to begin marketing in 1976 apparently have been shelved for at least a year. Although both companies have produced a number of players and are convinced that this can easily be translated to mass production and are setting up disc production facilities, they are going slow on plans for market introduction—presumably waiting more for a better economic climate than for any technical breakthrough.

RCA has an in-home test project well under way in Indianapolis, and Magnavox is believed to be starting a similar program in Fort Wayne. The tests, which involve the placement of players in consumer homes, are designed to determine reliability, ease of operation and consumer reaction to the new video medium.

We recently visited RCA's videodisc mastering and duplication facilities in Indianapolis, and there is no doubt this company has a serious commitment to the new product. Specialized equipment there has the capability of producing nearly 6,000,000 two-sided 12-inch discs (playing time is one hour) per year on a two-shift basis. Mastering has already started on the first of 250 or so initial video programs. RCA President Anthony Conrad estimates that marketing of player and discs will start on a regional basis some time between mid and late 1977.

Philips and its subsidiary Magnavox are quieter about their plans, but they seem to be headed for a 1977 introduction date as well. MCA Disco-Vision is now in the process of mastering the forerunners of an anticipated 1,000 initial programs on 30-minute optical discs for the Philips player.

DAVID LACHENBRUCH
CONTRIBUTING EDITOR

TUNER SERVICE CORPORATION

SUBSTITUNER



JUST
\$44.95
U.S.A. ONLY
WITH CABLES

ONE YEAR
GUARANTEE

STILL ONLY



\$9.95
U.S.A. ONLY

FEATURES

- A UHF Tuner with 70 channels which are detented and indicated just like VHF channels.
- A VHF Hi Gain Solid State Tuner.
- AC Powered.
- 90 Day Warranty.

Demonstrate the **SUBSTITUNER** to your customers and show improved reception with their TV sets.

You may place your order through any of the Centers listed below.

PROVIDES YOU WITH A COMPLETE SERVICE FOR ALL YOUR TELEVISION TUNER REQUIREMENTS.

REPAIR

VHF OR UHF ANY TYPE (U.S.A. ONLY) \$ 9.95
UHF/VHF COMBINATION (U.S.A. ONLY) \$15.00

MAJOR PARTS AND SHIPPING CHARGED AT COST

- Fast, efficient service at our conveniently located Service Centers.
- All tuners are ultrasonically cleaned, repaired, realigned, and air tested.

REPLACE

UNIVERSAL REPLACEMENT TUNER \$12.95 (U.S.A. ONLY)

- This price buys you a complete new tuner built specifically by Sarkes Tarzian Inc. for this purpose.
- All shafts have a maximum length of 10 1/2" which can be cut to 1 1/2".
- Specify heater type parallel and series 450 mA or 600 mA.

CUSTOMIZE

- Customized tuners are available at a cost of only \$15.95. With trade-in \$13.95. (U.S.A. ONLY)
- Send in your original tuner for comparison purposes to any of the centers listed below.



WATCH US
GROW

HEADQUARTERS	BLOOMINGTON, INDIANA 47401	537 South Walnut Street	Tel. 812-334-0411
ARIZONA	TUCSON, ARIZONA 85713	1528 S. 6th Ave	Tel. 602-791-9243
CALIFORNIA	NORTH HOLLYWOOD, CALIF. 91601	10654 Magnolia Boulevard	Tel. 213-769-2720
	BURLINGAME, CALIF. 94010	1924 Marsten Road	Tel. 415-347-5228
	MODESTO, CALIF. 95351	123 Phoenix Avenue	Tel. 209-521-8051
FLORIDA	TAMPA, FLORIDA 33606	1505 Cypress Street	Tel. 813-253-0324
	MIAMI, FLORIDA 33159	7641 N.W. 7th Avenue	Tel. 305-754-1352
	FT. LAUDERDALE, FLORIDA 33315	1045 W. 23rd Street, Bay 16	Tel. 305-524-0914
GEORGIA	ATLANTA, GEORGIA 30310	646 Evans Street, S.W.	Tel. 404-758-2232
ILLINOIS	CHAMPAIGN, ILLINOIS 61820	405 East University Street	Tel. 217-356-6400
	DOLTON, ILLINOIS 60419	1507-09 E. 142 Street	Tel. 312-841-4444
	SKOKIE, ILLINOIS 60076	5110 West Brown Street	Tel. 312-675-0230
INDIANA	INDIANAPOLIS, INDIANA 46024	112 West St. Clair Street	Tel. 317-632-3493
KENTUCKY	LOUISVILLE, KENTUCKY 40205	2244 Taylorsville Road	Tel. 502-452-1191
LOUISIANA	SHREVEPORT, LOUISIANA 71104	3025 Highland Avenue	Tel. 318-221-3027
MARYLAND	BALTIMORE, MARYLAND 21215	5505 Reisterstown Rd., Box 2624	Tel. 301-358-1186
MASSACHUSETTS	SPRINGFIELD, MASSACHUSETTS 01108	405 Dickinson Street	Tel. 413-788-8206
MISSOURI	ST. LOUIS, MISSOURI 63132	9577 Page Avenue	Tel. 314-429-0633
NEVADA	LAS VEGAS, NEVADA 89102	1412 Western Avenue No. 1	Tel. 702-384-4235
NEW JERSEY	TRENTON, NEW JERSEY 08638	1139 Pennsylvania Avenue	Tel. 609-393-0999
	JERSEY CITY, NEW JERSEY 07307	547-49 Tonnesle Ave., Hwy. 1 & 9	Tel. 201-792-3730
NEW YORK	ROCHESTER, NEW YORK 14615	37 Pullman Avenue	Tel. 716-647-9180
NORTH CAROLINA	GREENSBORO, NORTH CAROLINA 27401	2914 East Market Street	Tel. 919-273-6276
OHIO	CINCINNATI, OHIO 45216	7450 Vine Street	Tel. 513-821-5080
	CLEVELAND, OHIO 44109	4525 Pearl Road	Tel. 216-741-2314
	PORTLAND, OREGON 97210	1732 N.W. 25th Avenue, P.O. Box 10141	Tel. 503-222-9059
OREGON	PITTSBURGH, PENNSYLVANIA 15209	515 Grant Avenue	Tel. 412-821-4004
PENNSYLVANIA	MEMPHIS, TENNESSEE 38111	3158 Barron Avenue	Tel. 901-458-2355
TENNESSEE	DALLAS, TEXAS 75218	11540 Garland Road	Tel. 214-327-8413
TEXAS	NORFOLK, VIRGINIA 23513	3295 Santos Street	Tel. 804-855-2518
VIRGINIA	ST. LAURENT, QUEBEC; CALGARY, ALBERTA		
CANADA			

IF YOU WANT TO BRANCH OUT INTO THE TV TUNER REPAIR BUSINESS, WRITE TO THE BLOOMINGTON HEADQUARTERS ABOUT A FRANCHISE.

Circle 2 on reader service card

Two Bell scientists honored for semiconductor research

William G. Pfann and Henry C. Theurer have been named by the American Physical Society as the winners of the Society's International Prize for New Materials. The prize is awarded for outstanding achievement in research and carries a \$2,500 award for each recipient. The two Bell scientists were cited "for their outstanding work on the development of methods for purifying semiconductors and growing epitaxial crystals from the vapor phase. This effort has been of vital importance in the growth of semiconductor technology."

Mr. Pfann invented the zone refining method (**Radio-Electronics**, December 1972, page 36) to make the ultra-pure germanium that made the first transistors possible. Mr. Theurer invented the floating zone refining method that improved ordinary zone refining and eliminated the need for a crucible. It was used to make ultra-pure silicon, the basic material for field-effect transistors and for most of the transistors used today. Theurer also invented a process for preparing ultra-pure silicon tetrachloride, which Bell Labs used to make the first successful epitaxial crystals for transistors. These developments were all quickly adopted by the semiconductor industry and since then have been extended to other fields.

Vertical interval test signal for automatic color correction

With the anchoring of VIRS (Vertical Interval (Color) Reference Signal) on line 19 by the FCC, a completely automatic color television receiver becomes possible. Although some manufacturers insist they can regulate chroma, color sync and luminance signals in their receivers without recourse to outside signals, others are enthusiastic about the proposed new approach.

Bill Quinn, manager at General Electric, Portsmouth, VA, says "Broadcasting VIRS offers an excellent tool for the receiver manufacturers, networks and local broadcast stations to ensure that the customer receives and maintains a picture of the quality seen by the studio camera."

According to Quinn, to make VIRS work in TV receivers, the circuitry must locate and identify line 19; gate out the black-reference and white-reference levels, chroma and burst; correlate the amplitude of the 3.58-MHz chroma in the luminance part of the signal with the luminance reference to insure the proper relationship between luminance and chroma; establish the black level for the picture-tube cutoff; and correct differentially the phase errors between the

chrominance reference and the corresponding frequency in the receiver-regenerated subcarrier.

One drawback is that the FCC has not yet made it mandatory to broadcast the VIRS, though manufacturers tend to believe it will become a federal regulation.

Footstep detector patented

Two Honeywell engineers have invented a seismic human footstep detector to be used in intruder alarms. Vibration and sound detectors have been used in intrusion alarms in the past, but have had the weakness that they would respond to many other signals than human footsteps.

According to Patent 3,992,663, issued to Roger A. Lubke and Charles P. Varcicka and assigned to Honeywell, Inc., the human footstep does not normally exceed 250 milliseconds in duration and successive footsteps occur within a period of less than 1.6 seconds. With this basic data, the device is able to determine whether the vibrations—picked up by a geophone—are human footsteps or not. If they fit the specifications, an alarm is sounded.

Newest transatlantic cable carries 4,000 conversations

Second step in the laying of the world's largest capacity transatlantic cable began early last spring when the Bell System's cable ship *Long Lines* began to lay the deep-sea portion of the cable. The work began last August when the French



UNDERWATER SEA PLOW is suspended from the stern of the French cable ship *Vercors*, that has plowed under—in a trench about two feet deep—the parts of the transatlantic cable that lie in shallow water on the continental shelves off the U.S.A. and France.

cable ship *Vercors* plowed under the shallow-water portions, burying 111 nautical miles of cable between the Rhode Island shore and the edge of the conti-

mental shelf. It then laid a similar section off the French coast. The cable was buried about two feet deep with the special plow, designed by Bell Laboratories, that forms part of the equipment of the *Vercors*. This prevents damage from fishing vessels or anchoring ships.

The entire cable system, called TAT-6, will extend 3,379 nautical miles (3,891 land miles) from Green Hill, Rhode Island, to the French coastal town of St. Hilaire. It will be able to carry 4,000 telephone conversations simultaneously—more than twice the capacity of any transatlantic cable now in service—and will also carry data, telex and other forms of communications.

Repeaters, each weighing more than 600 pounds, spaced every 5.1 nautical miles (roughly every 6 miles) along the cable will amplify the signals so that they will arrive at their destination with approximately the same strength they started with.

The system was developed as a joint engineering project by groups from the British Post Office, the French Ministry for Posts and Telecommunications and AT&T.

Cable-TV companies in struggle against pirate program tappers

Hundreds of thousands of homes in the United States are connected illegally to local cable-TV distribution systems, says the president of a national cable-TV company. These free riders are enjoying their programs at the expense of the viewers who do pay, and endangering the very existence of some of the companies by denying them revenues they would receive if the free-riders paid for the services they are receiving.

The recent expansion of Pay-TV has aggravated the situation by increasing the incentive to rob the cable. The companies' costs have also increased by the fees they have to pay to transmit the programs, and these costs must be paid back in customer rental fees if the companies are to survive.

Some cable companies use special security forces to track down illegal connections. In Manhattan, for example, Teleprompter Corp. employs a force of 30 persons to trap thieves who tap into apartment building connection boxes. The security system is paying for itself—Teleprompter reports that 25 percent of the persons disconnected decide to pay for the service.

On another front, prosecutions are being initiated against concerns that sell the converters that change the shortwave transmissions from the cable companies to an unused local VHF channel. State

(continued on page 12)

Famous Realistic® CB

PRICE CUT



YOU GET ALL THESE QUALITY FEATURES

- ✓ Full 23-channel coverage
- ✓ Built-in noise limiter
- ✓ Dual conversion receiver
- ✓ Lighted channel selector
- ✓ Modulation indicator light
- ✓ Plug-in dynamic mike
- ✓ Fits any vehicle or boat
- ✓ Positive or negative ground
- ✓ Complete mounting hardware

Specifications

Sensitivity for 10 dB S+N/N: 0.5 μ V
Selectivity at -6 dB: 6 kilohertz
Adjacent Channel Rejection: 50 dB
Audio Power: 3 watts maximum
Power Requirement: 12 volts DC

Reduced so you can easily afford to put more fun and safety into traveling. Call ahead for road and weather information. Radio for help. Use it for business. Get one for your wife's car for extra protection and companionship. Ceramic filtered IF circuitry for minimum interference. Silicon transistors for superior stability and reliability. 1 1/2 x 5 1/4 x 7 7/8" small. And our lower price will help pay for your (Archer®) antenna. Realistic transceivers are sold and serviced only by Radio Shack — leading the way in quality CB since 1960. Ask for 21-168.



Use Your Credit Card
at participating stores

SOLD ONLY WHERE YOU SEE THIS SIGN:

Radio Shack®

A TANDY CORPORATION COMPANY
4600 LOCATIONS • 50 STATES • 9 COUNTRIES

* At Participating Stores and Dealers.
Prices and products may vary in Canada.

Circle 3 on reader service card

Three different schools give you this 25" DIAGONAL hobby-kit Color TV...

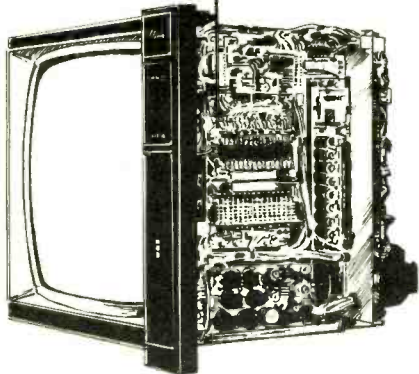

No other home training school gives you both an exclusive solid state color TV, and an SQ® Quadraphonic Receiver complete with four speakers . . . all in one course. You get both for hundreds of dollars less than the combined tuition cost of TV and Audio courses at another school. And only NRI's Master Course in Color TV/Audio servicing lets you train on equipment specifically designed for training with exclusive "power-on" features.

NRI doesn't give you hobby kits or commercial sub-assemblies. We invested the time and money to design equipment with learning in mind.

It's the only way you can (1) get the feel of typical commercial circuitry, (2) learn bench techniques while building complete units from the "ground" up, (3) perform over 35 "in-set" experiments during construction, and (4) end up with a 25" diagonal solid-state color TV with console cabinet and a 4-channel quadrasonic Audio Center.

NRI passes the savings on to you

NRI can save you money because our engineering eliminates the cost of buying from an outside source. We pay no salesman's commission. Students are enrolled by mail only. The savings are passed on to you in the form of low tuition fees, extras like the TV's console cabinet and the four speaker Quadrasonic System; a 5" triggered sweep

Only NRI gives you this 25" DIAGONAL designed-for-learning Color TV...

oscilloscope, CMOS digital frequency counter, and an integrated circuit color TV pattern generator. Where NRI supplies a professional color

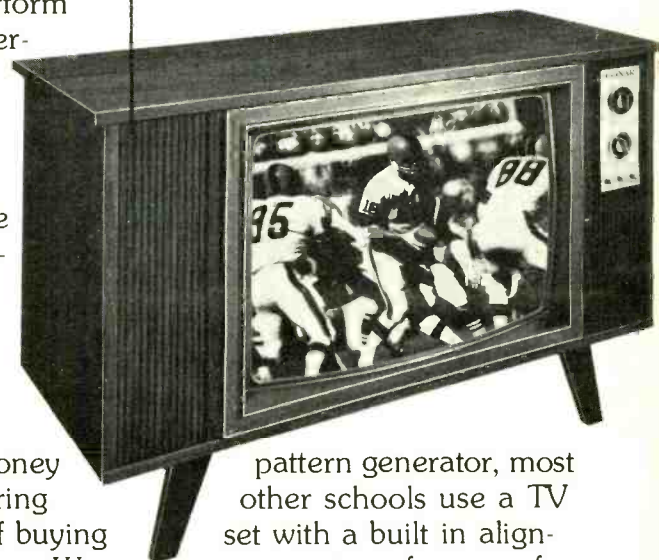

pattern generator, most other schools use a TV set with a built in alignment generator of no use for servicing other sets. Only NRI designs, engineers, and supplies training kits specifically for learning and professional use. You can pay hundreds of dollars more for a similar course and not get a nickel's worth more in training and equipment.

...plus complete Quadraphonic Audio Center!

More know-how per dollar

That's what it all boils down to, the quality of training you get for the money you spend. In our 62-year history, more than a million students have come to NRI and we're fully approved for career study under the G.I. Bill. We must be teaching something right. Some of those "right" things are bite-size lessons to ease understanding and speed learning . . . personal consultation, and prompt grading of all tests . . . a full-time staff of engineer/instructors to help if you need it . . . plenty of kits and experiments to give you hands-on training . . . and fully professional

programs oriented to full or part-time career needs.

Widest Choice of Courses with Communications, CB, Digital Computer, and other careers.

NRI offers not one, but five excellent TV/Audio servicing courses so you can tailor your training to your budget.

Or you can study other opportunity fields like Digital Computer Electronics, Citizens Band Radio, Communications, Aircraft or Marine Electronics, Mobile Radio, and more. Send

for our free catalog and see for yourself that no one gives you more training and equipment for your dollar. There's no obligation, and no salesman will call.

If card is missing, write to:



NRI SCHOOLS
McGraw-Hill Continuing
Education Center
3939 Wisconsin Avenue,
Washington, D.C. 20016

laws are also coming into play against cable pirates. More than a dozen states have passed theft-of-service laws—some of which provide jail sentences as well as fines. In Wilmington, DE, several members of the local police force were found enjoying cable-TV without pay. A number of converters stolen from the local cable company had been recovered by one of the officers, who turned in a number and gave the rest to his friends. He was indicted on 10 criminal charges.

Most severe sentence reported so far was a 45-day jail sentence imposed on an Iliion, NY, man who connected his girlfriend's TV set to the local cable.

In spite of the partial successes against the pirates, there are still a number of difficulties including the uncertainty of the legality of making and selling converters that can be used for illegal purposes only, and the fact that perfectly legal equipment can in some cases be used to receive such signals. The struggle is crucial according to the cable companies, and on its success may depend the future expansion of cable TV—particularly pay-TV, the viewers of which tripled in number last year from 160,000 to more than a million.

Maritime satellite provides instant ship-shore radio ties

MARISAT, the world's first commercial telecommunications satellite was launched into synchronous orbit over the equator at 15 degrees West longitude. Its



MARISAT, being checked out at the Hughes Aircraft Co. plant in California, where it was built for Comsat General Corp. A Hughes technician is using a theodolite to check out its vertical and horizontal alignment.

twin was launched into orbit over the Pacific at 176 degrees East longitude. The satellites will provide "a new clear voice for ships." Ship captains have in the past

waited as long as 8 to 20 hours for messages by ordinary shortwave radio, troubled as it is by severe fading, interference, atmospheric and propagation difficulties.

The new satellite technique assures instant communication by voice, telex, facsimile and data communications, both for the international merchant marine and the U.S. Navy. Three channels are provided, one in the UHF range for the Navy and two in the gigahertz region—L-band for merchant vessels and C-band between shore stations and the satellite.

Lighter weight, lower costs in new Zenith picture tube

Zenith has demonstrated to TV manufacturers a new 19-inch color tube expected to reduce cost as well as weight. The tube has a unique slot-type shadow-mask assembly two pounds lighter than previous masks. It is made by multi-stage mask forming dies to achieve a self-supporting mask that eliminates the conventional mask frame and can be inserted with automatic equipment.

Another weight-reducing concept is a "skirtless" faceplate panel that eliminates the heavy molded glass flanges of current tubes. The new faceplate panel, with an unground seal edge, can be joined easily with a newly designed funnel shaped for maximum strength.

The new tube has a deflection angle of 100 degrees, a small neck in-line high resolution gun and a smaller spot. It is 2.5 inches shorter than older 19-inch Zenith picture tubes.

Two CB stations silenced

Val G. Hodges of York, PA, was fined \$200 and received a suspended 60-day sentence, and James R. Laden of Anchorage, AK, lost his license for violation of FCC regulations.

Hodges was operating a mobile without a license. He was tracked down by direction-finding equipment, which made the final positive identification of his operation from a vehicle in violation of a previous cease and desist order. Six pieces of radio transmitting equipment, including two illegal linear amplifiers, were seized.

Laden (KHO-4585) was found guilty of transmitting communications to another station on a frequency reserved for intrastation communication, for failing to identify his station, and of refusing to permit an inspection of his station by FCC personnel. His conduct, the judge stated, was further aggravated by "misrepresentation" and lack of the truthfulness and candor required to qualify to be or remain an FCC licensee. **R-E**

Radio-Electronics®

Hugo Gernsback (1884-1967) founder

M. Harvey Gernsback
editor-in-chief and publisher

Larry Steckler, CET, editor

Robert F. Scott, W2PWG, CET,
technical editor

Arthur Kleiman, associate editor

Jack Darr, CET service editor

Leonard Feldman
contributing high-fidelity editor

David Lachenbruch, contributing editor

Karl Savon, semiconductor editor

Vincent P. Cicenia, production manager

Harriet I. Matysko, circulation director

Sheila Wertling, circulation assistant

Arline R. Bailey, advertising coordinator

Cover design by Louis G. Rubsamen

Cover photo by Walter Herstatt

Radio Electronics is a member of the *Institute of High Fidelity* and is indexed in *Applied Science & Technology Index* and *Readers Guide to Periodical Literature*.



Radio-Electronics magazine is published by Gernsback Publications, Inc. 200 Park Ave. S. New York, NY 10003 (212) 777-6400

President: M. Harvey Gernsback

Vice President: Larry Steckler

Treasurer: Carol A. Gernsback

Secretary: Bertina Baer

ADVERTISING SALES

EAST

Stanley Levitan, Sales Manager

Radio-Electronics
200 Park Ave. South
New York, NY 10003
(212) 777-6400

MIDWEST/Texas/Arkansas/Okla.

Ralph Bergen
Jim Reilly
The Ralph Bergen Co.
6319 N. Central Ave.
Chicago, IL 60646
(312) 792-3646

PACIFIC COAST Mountain States

Jay Eisenberg
J.E. Publishers Representative Co.,
8732 Sunset Blvd.,
4th Floor,
Los Angeles, CA 90069
(213) 659-3810
Sales Mart Building
1485 Bayshore Blvd., Box 140
San Francisco, CA 94124
(415) 467-0125

SOUTHEAST

J. E. Publishers Representative Co.
(214) 387-2424

NEW 3½ Digit Multimeter from B&K-PRECISION



B&K PRECISION MODEL 283—\$170

**...you'll want it for its features
...but it's the price that will sell you!**

- High intensity LED display is easily read from at least 6 feet in the brightest room.
- Measures AC and DC voltage, AC and DC current and resistance.
- 0.5% DC accuracy.
- 100% overrange (1000 scale reads to 1999).
- Automatic polarity.
- Automatic decimal point.
- Flashing overrange indication on display.
- Four voltage ranges to 1000V
- Four current ranges to 1000mA.
- Six resistance ranges to 10 meg.
- In-circuit resistance measurements at voltage levels below conduction threshold of semiconductors.
- Overload protection on all ranges.

Complete new circuitry makes the Model 283 the most dependable and versatile 3½ digit multimeter you can buy. The extra-bright display allows you to use it where other units would cause reading problems. The selectable "low ohms" function permits accurate measurement of semiconductor shunted resistors.

An optional, internal battery pack (BP-83, \$50.00) provides 8 hours of continuous use on one overnight charging and charges when the Model 283 is in use on 115/230VAC.

Thoughtful, convenience features like a side carrying handle, tilt stand and detachable line cord add to its usefulness.

Your B&K-PRECISION distributor has them in stock and will be glad to demonstrate its features to you. Call him, or write for additional information.

B&K PRECISION
PRODUCTS OF DYNASCAN

6460 W. Cortland Avenue
Chicago, IL 60635 312/889-8870

In Canada: Atlas Electronics, Toronto

Circle 4 on reader service card

THE CURVE TRACER THAT WON'T COLLECT DUST.

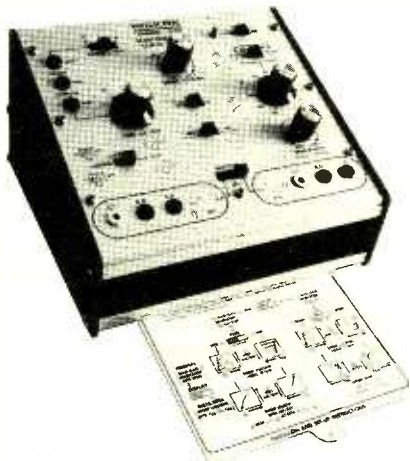

The Hickok Model 440 semiconductor curve tracer is all purpose and convenient to use. It's the ideal instrument for testing, evaluating, classifying and matching all types of transistors, FET's and diodes. You'll get stable, full range dynamic displays that you can accurately scale right from the screen.

- Pull-out card for easy, fast set-up and operation.
- Set-up marks for rapid set-up of 80% of tests.
- Unique INSTA-BETA display takes the guesswork out of transistor and FET parameter measurement.
- In-or-out of circuit testing.
- A full range professional tracer at a price you can afford.

The Model 440 is the most modern, versatile tracer available. See it at your Hickok distributor or send for our technical bulletin.

\$179⁰⁰

HICKOK

the value innovator

INSTRUMENTATION & CONTROLS DIVISION
THE HICKOK ELECTRICAL INSTRUMENT CO.
10514 Dupont Avenue • Cleveland, Ohio 44108
(216) 541-8060 • TWX: 810-421-8286

Circle 7 on reader service card

letters

ASCII TO BAUDOT

I would like to call attention to two important corrections that were omitted from the "ASCII To Baudot" article (*R-E*, March 1976).

First: In Table I, word 31, Bell should be removed and replaced with a Null, and no bits should be shown programmed. The code as shown is the same as letter "S".

Second: On the schematic diagram (Fig. 1), pin 3 of IC2-a should be shown connected to pin 15 (not 11) of IC7. We must detect a change in bit 6 instead of bit 7 or else a CR or LF will shift us to LETTERS with no way to output FIGURES.

Printed-circuit boards from Southwest Technical Products are correct. It should also be pointed out that the kit of all parts includes the PC board.
ROGER L. SMITH

TI CALCULATORS

Many of your readers probably have the SR-52 or SR-51 calculators which are manufactured by Texas Instruments, Inc. Both of these calculators have fully addressable memories which are accessible from the keyboard that are not mentioned in the respective owner's manuals.

For the SR-51, memories 1, 2, 3, 4, 5, 6, 7, 8, and 9 are available. Care should be exercised in using memories 4-9 since they are used during various calculations, chiefly for linear regression.

On the SR-52, memories 60-69 are the operational registers and are directly accessible from the keyboard. With care, some of these registers can be used for data storage—depending on the number of pending operations required. Registers 70-79 are used for program storage. Each of the registers 70-97 corresponds to 8 programming steps, i.e. register 70 corresponds to program steps 000-007. If all programming steps are not required, registers 70-97 are available for data storage.

Care must be exercised in using registers 70-97 for data storage since these registers can be written over when loading a program from magnetic cards. Registers 98 and 99 are also available on the SR-52. These registers are not destroyed by loading magnetic cards, internal operations, etc. Registers 60-69 are cleared by pressing the CLR key. Registers 70-99 can be cleared by storing 0 in them or overwriting them with new data.

Access to the memories on the SR-51 is provided by following STO or RCL by the numbers 1-9. Memories on the SR-52 are accessed by STO or RCL followed by the appropriate two digit number. It should be noted that register arithmetic can be done in any of the

registers mentioned for the SR-52.

It should be re-emphasized that extreme care must be taken to avoid losing data stored in these memory registers. With proper precautions the capabilities of both of these calculators is greatly enhanced.

I read your magazine every month and find it very interesting. Keep up the good work.

THOMAS S. COX
Greenville, SC

MICROCOMPUTER/TV INTERFACE

I can't understand it!! There are so many computer hobbyists without any I/O. And yet we can find no circuit that will take our 8 bit output and put it on our TV screen.

There are many TV typewriters, TV games and TV graphics (most in the range of \$160-\$300). Where is the circuit (inexpensive) that will accept 8-bits of x, y, brightness (whatever the TV will need) and convert it to video for my portable TV?

My 6800 is waiting as are many others!! This circuit would be more versatile than a dedicated TV typewriter or game.

Let the computer owner build it to fit into his system to accommodate his needs. Let him decide on where the memory shall reside.

There is a need!!!! See what you can do!!!!

PAUL HYDE JR.
Milwaukee, WI

We agree. There is a definite need for an inexpensive project of this kind. If any of our readers have any ideas, circuits, etc., please forward them. We are interested.—Editor

LOW-FREQUENCY METER

Ever since the calculator on a chip came out a few years ago, I've been waiting for someone to come out with a kit for a high-accuracy low-frequency meter. Using a crystal-controlled timebase, it would count the number of crystal oscillations between input pulses. The calculator chip would then divide this number into an appropriate constant to obtain the display output. For example, with a 1-MHz timebase and a 60-Hz input, the counter would count to 16,666. This could be entered into the calculator as 16.666 ms. Then dividing 16.666 into 1,000 (the constant for hertz output), the meter (digital display of course) would display 60.00. With a .01% crystal, this reading is approximately $\pm .01$ Hz. To obtain RPM, the constant would be 60,000 and the display would read 3600 RPM.

The uses for low-frequency meters are quite extensive: tachometers, tuning mu-

(continued on page 16)

In receiving tubes, the only full line is now our line.

Sylvania makes the broadest line of receiving tubes in the world—from Nuvistor to power tubes.

And we sell more of them in the U.S. than anyone else.

That means your best bet for all tube needs is your local Sylvania full-line distributor. He's part of the largest distributor network devoted to electronic components.

He carries the most complete line available and he also has our line of business builder ad mats, service aids, signs and displays—plus tube caddies to make your job easier.

And don't forget, every Sylvania tube you buy gives you another point towards a bigger premium in our "rally 'round the tab!" award program.

For the most complete line of tubes and complete information on other Sylvania services, see your local distributor today.

GTE SYLVANIA

GTE Sylvania, Electronic Components Group, 100 First Ave., Waltham, MA. 02154

LETTERS

(continued from page 14)

sical instruments, measuring a heart beat or even setting a mechanical time-piece by measuring the time between ticks. In the case of heart beat or ticks of a clock, the meter might be arranged to take an average over four or five or more input pulses. The meter would still be faster and more accurate than meters that use long pulse counting periods or pulse insertion methods.

Now the processor on a chip is available at quite reasonable prices, and it seems this device would make simpler the implementation of the meter.

If such a kit already exists, I would appreciate knowing about it. If not, it might be a good idea for a construction project for your magazine.

DOUGLAS GORGEN

Apt. 202-A

548 W. Johnson St.

Madison, WI 53703

IC BREADBOARD

Enclosed you will find a photograph of my finished IC Breadboard Prototyping system (R-E, February 1975 issue). After 5 months of construction and wiring and all, I finally finished it. I changed several things from the suggested layout but I tried to stick with the general format of your article.

Some innovations I put in were: a built-in 3" speaker on the bottom of the cabinet and a pair of terminals (banana

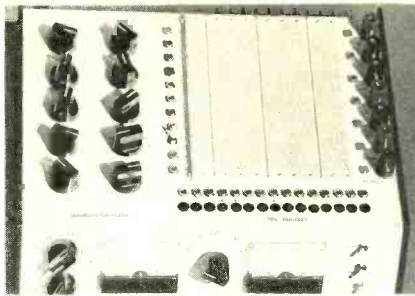

jacks) on rear panel for a scope—these jacks are interconnected to pin jacks to left of breadboarding socket through a rotary switch to make testing circuit conditions much easier. I added an external position to the voltmeter in the meter section and I included an AM/FM modulation type generator using two XR205's enabling me to have 2 separate signals if I choose. There are +5 and +12 volt pin outs too.

I priced the nearest thing to what I had constructed and it cost well over \$1400 and it fell way short of the capabilities of my system. I think this system is worth close to \$2000 and it only cost me about \$180. That's a bargain. Keep up the fine projects.

DONALD MAHARAS

Everett, WA

CALCULATOR/STOPWATCH

Regarding the article on Build a Calculator/Stopwatch (R-E, November, 1975 and February, 1976.) I had a National Semiconductor model 600 calculator which had the right components to at-

tempt the conversion, so I decided to attempt it.

The parts were procured for the added circuit and put together. When wiring the circuit I found that the driver IC was wired entirely different than the one shown in the article. After figuring out the correct combination of which driver went to which digit (new pin numbers are shown in circles on diagram), I wired in the Stopwatch unit and it worked fine. I adjusted it to within .03 seconds in 2 minutes.

Fine, but when I went to use the calculator I found that when entering 8 from the keyboard, a zero was automatically displayed and also stored in the register. This caused some head scratching since all other functions of the calculator performed normally. Through some consultation with local engineers, it was decided to try breaking the foil from pin 1 of the 5736 IC to the keyboard and connect the keyboard side to pin 14 of the driver IC. After accomplishing this, the calculator worked properly (including the 8) and the stopwatch ran fine.

Maybe other readers have run into this same problem and have wondered what to do. Also, since I could not find a source for the MC14571, I used a N4081 which seems to be an exact replacement. (MC14571 was a Motorola developmental type number. The production type number is MC14081. The RCA equivalent is CD4081.—Editor)

I enjoy your magazine very much—keep up the good work.

BILL WAINES

**Tear
'n
Share**

RCA
Electronic
Components
Trade Mark(s)® Registered
Marca(s) Registrada(s)



Regulation of cable-TV rates now being checked by FCC

The Federal Communications Commission has ordered an inquiry into the process by which cable-TV subscription rates are regulated. At present, most of these rates are set by the municipalities in which the cable systems are located.

The FCC reported that the inquiry does not indicate any immediate intended change in the present system of largely local regulation. One of the reasons suggested for the investigation was concern by some cable companies over what they considered "unreasonable delays" in considering requests for rate increases.

Circularly polarized antennas improve TV pictures

Results of an extensive FCC-authorized test of circularly polarized TV antennas were reported to the recent NAB convention in Chicago by Peter K. Onnigian of Jampro Antenna Co.

The test results, Mr. Onnigian reported, indicate that TV pictures on home receivers are "significantly improved" when the signal is transmitted with a circularly polarized antenna. Ghosts are eliminated while snow and signal fading are reduced.

The tests were carried out at TV Station KLOC (UHF) in Modesto, California. Test results have been submitted to the FCC for analysis. Jampro has had long experience in designing and manufacturing circularly polarized FM broadcast antennas. R-E

CSC'S NEW DESIGN-MATE 4. AN 8-FUNCTION DIGITAL PULSE GENERATOR FOR LESS THAN MOST DVM'S.

Wherever you need crisp, clean, fast output pulses compatible with virtually all logic families and discrete circuits, Design-Mate™ 4

is the logical choice. It produces symmetrical and unsymmetrical pulses ranging from 0.5Hz to 5MHz. And has a 100mV—10V variable output, with rise/fall times of less than 30 nanoseconds plus TTL sink output for up to 40 loads. Pulse width and spacing are independently-controllable from 100 nanoseconds to 1 second (10⁷:1 duty cycle) in seven overlapping ranges. And with the DM-4 you can select continuous operation, manual one-shot or external triggering to 10MHz with synchronous output gating. And a lot more. Which adds up to a high quality clock source, delayed pulse generator, synchronous clock source, manual system stepper, pulse stretcher, etcetera, etcetera . . . minus the 'high quality' price tag.



For more information, see your CSC dealer. Or write for our catalog and distributor list.

CONTINENTAL SPECIALTIES CORPORATION



EASY DOES IT

44 Kendall Street, Box 1942
New Haven, CT 06509 • 203-624-3103 TWX: 710-465-1227
West Coast office Box 7809, San Francisco, CA
94119 • 415-421-8872 TWX: 910-372-7992
Canada: Len Finkler Ltd., Ontario

© Continental Specialties Corp. 1976

Circle 6 on reader service card

Just Tear and Get your Share.

RCA's Super Prize Program is Back by Popular Demand! As before, just save your RCA entertainment receiving tube carton ends and color picture tube warranty serial number stickers* — to earn valuable awards:

- Lots of great merchandise premiums. Choose from a wide selection for yourself, your family, or your home.



- Money-saving discount certificates, good toward purchases of more RCA receiving and color picture tubes.

Pick up your copy of the RCA "Tear and Share '76" Prize Book, saver envelope and gift order form at your participating RCA distributor. You have until November 30, 1976 to tear 'n share in RCA's bonanza of great gifts. RCA Distributor and Special Products Division, Cherry Hill, N.J. 08101.



*Save the receiving tube carton end that is *not* marked with the tube type number, and the warranty serial number sticker that appears above the warranty envelope on the upper right hand corner of the color picture tube carton. *One* warranty serial number sticker is equal in value to 20 receiving tube carton ends.

RCA

We'd like to compare our But there's no

Send for
FREE
illustrated
career
guide

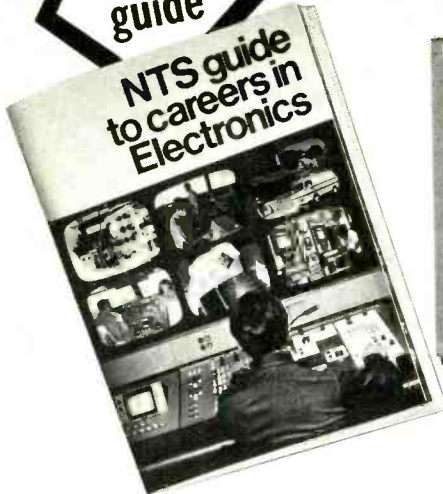

COMPU-TRAINER

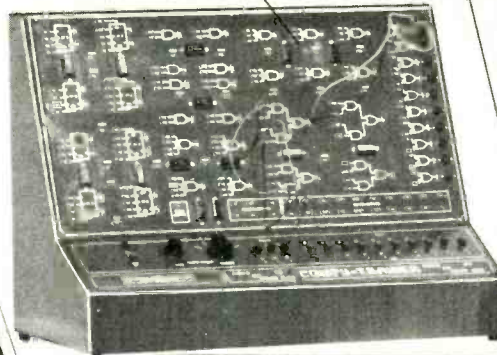

IN-CIRCUIT TRANSISTOR TESTER

TROUBLESHOOTER
VOM

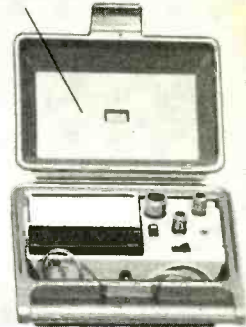

SOLID-STATE
OSCILLOSCOPE

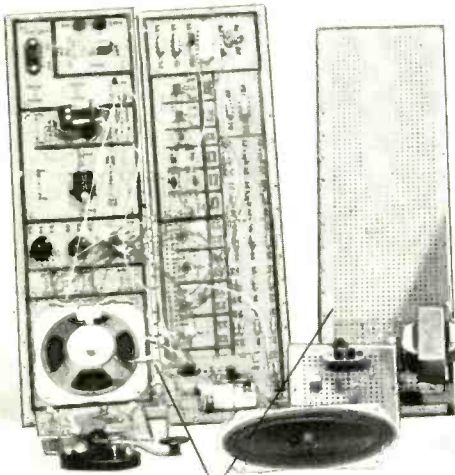

ELECTRO-LAB



(Simulated TV Reception)

COMPARE OUR TRAINING PROGRAMS: NTS Electronics programs are considerably different from those of other schools, and, we believe, better designed to prepare you for entry-level opportunities in the field of your choice. For example, our Master Course in Electronics Technology includes over 170 lessons; another school offers fewer than half that many in a course with the same title. Our course includes 26 kits to build an Electro-Lab, a Solid-State Digital Computer-Trainer with transistor-diode logic circuits; a 5" wide-band solid-state Heath Oscilloscope; a Heath FET-VOM, and slide rule. Their course offers 10 kits to build a private label VOM and 2 experimental circuit chassis.

And even though you need an oscilloscope to perform their experiments, they don't provide it. You have to buy your own. And their course does not even include a Digital

Computer-Trainer. The closest thing to our program they offer costs over \$200 more than ours. Another school's course in Electronics Technology offers even fewer lessons, and kits to build only a VOM. That's all. Think it over, and check it out, course by course, program by program. There's no comparison.

COMPARE OUR EQUIPMENT: NTS selected Heath equipment because of Heath's international reputation as a prime designer of commercial and professional electronic equipment in kit form. Cooperation between Heath and NTS assures you of highest quality components, design, function and training. What's more, Heath equipment is the kind you'll meet in the field - not limited to training only. For instance, the Heath GR 2000 25" (diagonal) Color TV included in our Color TV courses is acclaimed as ahead of its time in features and engineering. And the Heath AM-FM

school to other schools. comparison.

COMPARE OUR
KITS AND LESSONS.
COMPARE OUR
TUITION.

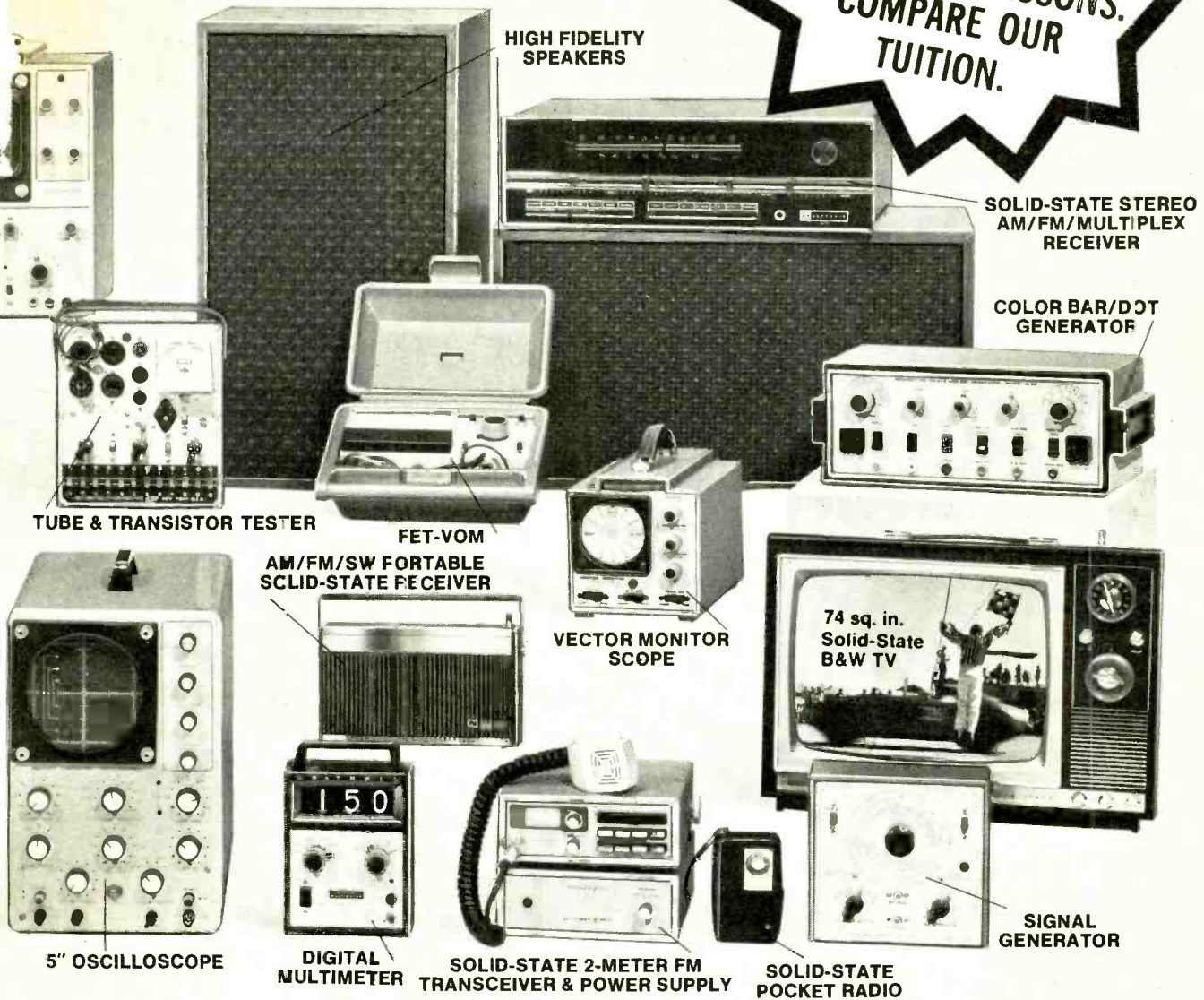

Multiplex/Receiver offered in our Audio course is a 30-Watts-RMS-per-channel set that's designed for true High Fidelity performance, not built for training only. As for reliability, that's another word for Heath.

The same holds true for Heath Oscilloscopes, FET-VOM, Digital Multimeter, In-Circuit Transistor Tester, Solid-State 2-Meter FM Transceiver, and much more included in over a dozen NTS courses. Check it out! There's just no comparison.

COMPARE OUR LOW TUITION: We employ no salesmen, pay no commissions. You receive all home study information by mail. All kits, lessons and experiments are fully described in our Catalog and all equipment needed for your training is included in the tuition price. Nothing extra to buy for your training with NTS. Liberal refund policy and cancellation privileges spelled out.

Make your own comparisons. Check the number of lessons, check the subjects covered and check the amount and value of training equipment you will receive for your tuition dollars. Then make your own decision. Mail card today, or write for FREE Electronics catalog if card is missing. **FIND OUT!**

NO OBLIGATION. NO SALESMAN WILL CALL
APPROVED FOR VETERAN TRAINING

Get facts on new 2-year extension

NATIONAL TECHNICAL SCHOOLS

TECHNICAL-TRADE TRAINING SINCE 1905
Resident and Home-Study Schools
4000 So. Figueroa St., Los Angeles, Calif. 90037

The IMSAI 8080.

A commercial yet personally affordable computer.

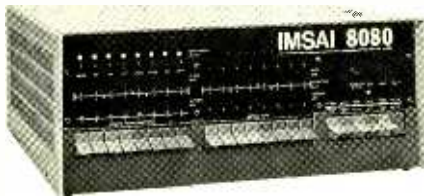

If you thought you could never afford a computer at home, think again. The IMSAI 8080 is built for rugged industrial performance. Yet its prices are competitive with Altair's hobbyist kit. Fully assembled, the 8080 is \$931. Unassembled, it's \$599.

The IMSAI 8080 is made for commercial users, and it looks it. Inside and out. The cabinet is attractive, heavy gauge aluminum. The heavy duty lucite front panel has an extra 8 program controlled LED's. It plugs directly into the Mother Board without a wire harness. And rugged commercial grade paddle switches are backed up by reliable debouncing circuits.

The system is optionally expandable to a substantial system with 22 slots in a single printed circuit board. And the durable card cage is made of commercial-grade anodized aluminum.

The IMSAI 8080 power supply produces a true 28 amp current, enough to power a full system. You can expand to a powerful system with 64K of software protectable memory plus an intelligent floppy disk controller. You can add an audio tape cassette input device, a printer plus a video terminal and a teletype. And these peripherals will function with an 8-level priority interrupt system. BASIC software is available in 4K, 8K and 12K.

Get a complete illustrated brochure describing the IMSAI 8080, options, peripherals, software, prices and specifications. Send one dollar to cover handling to IMS. The IMSAI 8080. From the same technology that developed the HYPERCUBE Computer architecture and Intelligent Disk systems.

Dealer inquiries invited.

IMS

IMS Associates, Inc.
14860 Wicks Boulevard
San Leandro, CA 94577
(415) 483-2093

Dept. RE-7

KOMPUTER KORNER

DAVID LARSEN, PETER RONY,
and JOHN TITUS*

THIS MONTH WE WILL DISCUSS THE 8080 microprocessor. Will cover the 8080's hardware architecture and in a future column we will discuss its instruction set and programming characteristics. This should provide us with enough information to begin discussing various programming techniques illustrated with examples using the 8080.

Background

The 8080 microprocessor was introduced by Intel Corporation in late 1973. It is a direct descendant of the Intel 8008

9 μ s). The 8080 requires an external two-phase clock and power supplies of +5, +12, and -12, all referenced to ground.

The 8080 must be supported by various peripheral circuits if it is to be made into a useful system. This interface is accomplished using an 8-bit data bus, a 16-bit address bus, and ten timing and control signals (six outputs and four inputs). The bus structure and control signals allow the 8080 to be interfaced to a wide variety of memory and I/O devices. All outputs and inputs (except for the clocks) are capable of directly interfacing one TTL

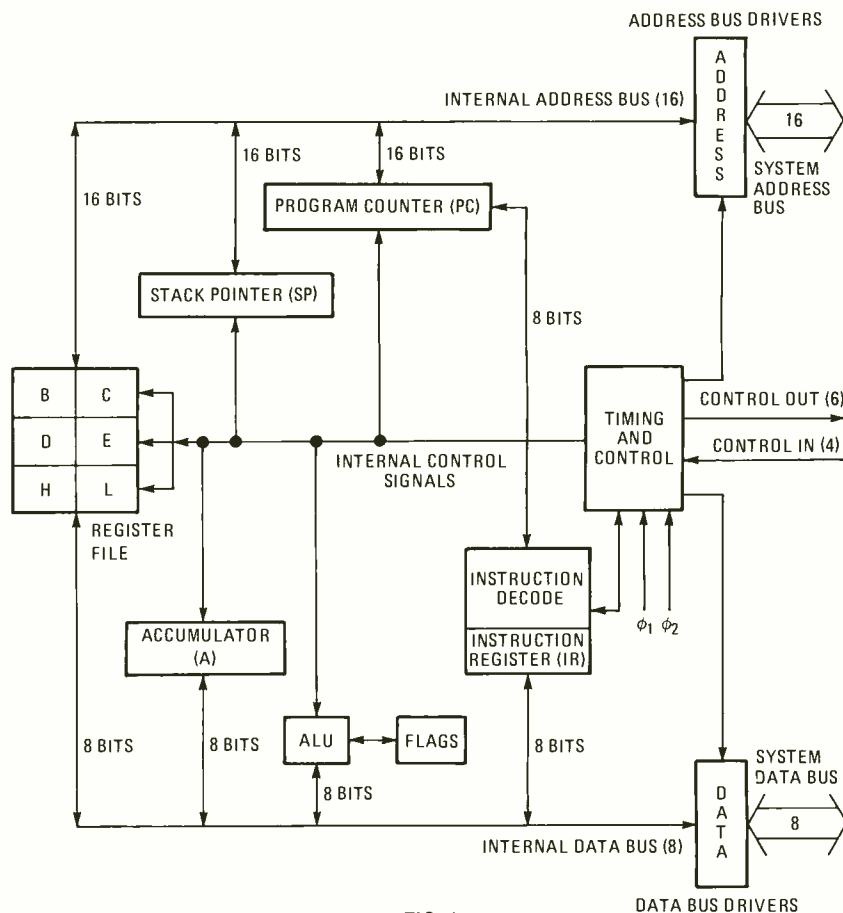

FIG. 1

and it was developed to provide additional features and corrections to limitations imposed on the 8008 by process and packaging constraints. The 8080 is an 8-bit parallel microcomputer central processing unit, fabricated on a single integrated circuit using an n-channel MOS process. It has a basic machine cycle time of 500 ns, with instruction execution times ranging from 4 to 18 machine cycles (2 μ s to *This article is reprinted courtesy of American Laboratories.

load. In addition, the address and data busses are both three-state. This provides for bi-directional data transfers using the normal high or low states. The third is a high impedance "floating" state that permits multiple devices to be wired in parallel to the bus.

Architecture

A block diagram of the 8080's basic architecture is shown in Fig. 1. With the
(continued on page 24)

FREE

The world's largest catalog
of easy-to-build, money-saving
electronic kits



- Power Supplies • Oscilloscopes • Frequency Counters
- VTVM's and VOM's • Ham Radio Gear • Color TV's
- Hi-Fi Components • Electronic Clocks • Electronics Learning Programs
- Auto, Fishing, Marine and Aircraft Accessories — over 400 kits in all!

Every Heathkit product comes with a fully-illustrated, step-by-step assembly manual that tells you everything you need to know to make kitbuilding fun and easy. Thousands of people have discovered the satisfaction — and savings — of handcrafting a fine piece of electronic equipment. You can build it better...let us show you how.

Send for your FREE Catalog today! ►
Heath Company, Dept. 20-19, Benton Harbor, Michigan 49022

HEATH	
Schlumberger	
Heath Company, Dept. 20-19 Benton Harbor, Michigan 49022	
NAME _____	
ADDRESS _____	
CITY CL-601	STATE _____ ZIP _____

Circle 100 on reader service card

KOMPUTER KORNER

(continued from page 22)

exception of its internal register file and separate address and data buses, the architecture is fairly conventional. From a user standpoint, the areas that are of most interest to us are the registers, memory addressing modes, instruction set and basic timing and control sequences. These are the features that have the most effect on how we will be able to use the processor in practical systems.

Registers

The 8080 provides an interesting internal register structure. The user accessible registers are organized into three 16-bit general-purpose registers (BC, DE, and HL), a 16-bit stack pointer (SP), a 16-bit program counter (PC), and an eight-bit accumulator. There are also five processor flags that are treated together as a register by certain instructions.

The three 16-bit general-purpose registers are designed so that they can also be used as six independent 8-bit registers for a number of operations. The internal organization of the 8080 makes this feature significant. The 8080 uses an 8-bit word (byte) as its basic memory data elements. However, it addresses memory with a 16-bit memory address. To do this, the 8080 is effectively divided internally into an eight-bit "data side" and a 16-bit "address side". Now, one of the most important measure of any computer's flexibility is

(continued on page 87)

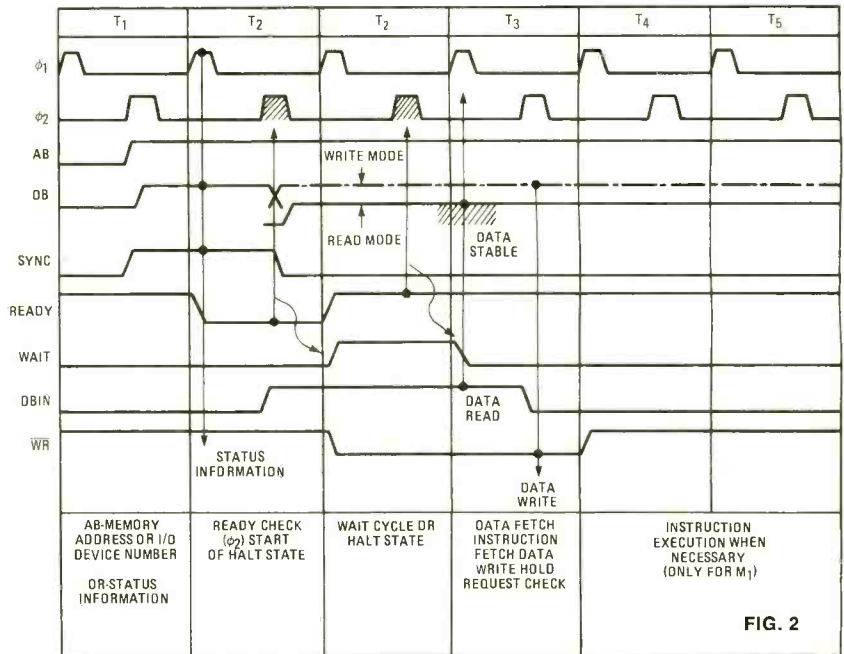
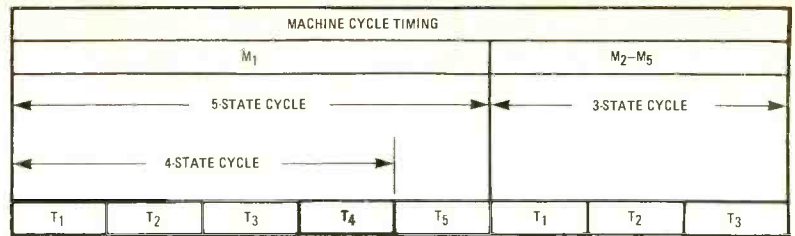

FIG. 2

TIGER .01

Introduced three years ago, our "Tiger .01" is still one of the finest amplifiers available in its power class. This amplifier introduced our 100% complementary circuit which has become a standard feature in many of the better amplifiers. This combined with an output triple produces a circuit that can honestly be rated as having less than .01% IM distortion at any level up to 60 Watts. Relatively low open loop gain and a conservative amount of negative feedback results in clean overload characteristics and good TIM characteristics.

Other features are volt-amp output limiting, plus three fuses and an overheat thermostat. Despite the "budget" price an output meter is standard equipment. Each channel measures 4¼ x 5 x 14. Four will mount in a standard width relay rack for four channel systems.

SPECIFICATIONS

60 Watts—4.0 or 8.0 Ohm load Minimum RMS from 20 Hz to 20 KHz with less than .05% Total Harmonic Distortion.

IM Distortion less than .01%
 Damping Factor 50 or greater 20 Hz to 20,000 Hz.
 Hum and Noise -90 dB

207/B Amplifier (single channel) \$110.00 Ppd
 # 207/B Amplifier — Kit \$ 77.50 Ppd

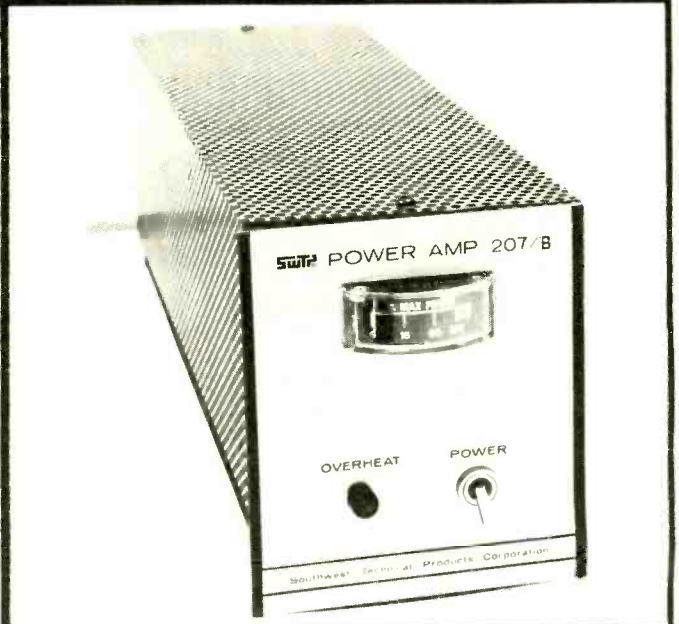

Southwest Technical Products Corp.
 219 W. Rhapsody, Dept. FM
 San Antonio, Texas 78216

16 ways to move ahead in electronics!



Choose the one that's just right for you...the one that can make your future more rewarding...more secure...more enjoyable...starting now! These ways to move ahead are yours from Electronics Technical Institute...the finest electronics home study courses and programs ever offered!

Fundamental Electronics

Get a solid foundation for entering the fast-moving world of electronics where today is great, and tomorrow will be greater. Learn it the simple, easy, step-by-step, programmed way called *Autotext*, exclusive with ETI!

Electronics Drafting

Learn a vitally needed specialty that translates new technological concepts and developments to the practical drawing board. Become a specialist-in-demand, through ETI's training. Learn it at home...get your future moving now!

Color TV Servicing

There's a real future waiting for the established color television technician. You become that technician through this program that takes you step-by-step to *theoretical and practical* mastery of color TV. Get your tomorrow started today!

Master TV/Radio Servicing

Here is true "master" preparation for a career that can take you as far as you want to go into radio and television servicing, both black and white, and color. The helpful, practical ETI way can be your way to more money, security, success!

Communications

ETI's communications program opens up a whole range of career development possibilities in electronics. Solid-state receivers, solid-state audio equipment, communications equipment, CATV, as well as preparation for FCC-licensed positions in commercial broadcasting and mobile communications. You can find a real future here!

Industrial Electronics

You open great career opportunities through this program, as instrumentation technician, electronic equipment maintenance technician, electronic calculating machine technician and audio technician. It also prepares you to move into and up in communications, automation and industrial electronics!

Digital Technology

Join the digital revolution which is radically altering our lives today and tomorrow. Get solidly trained in the new digital specialties that can lead to a real future as a digital control technician, electronic calculating machine technician, field representative, computer sales representative, manufacturer's representative.

Electronics Technology

Learn electronics across the board! You'll be ready for real career advancement with training that can lead to technical positions in communication, automation and industrial electronics, and can also help you in sales positions, management and administration.

Computers

ETI offers training opportunities in Computer Technology and Computer Programming. Learn at home, and get ready to enter a field where incredible developments are sure to continue. It's practical, useful—the step-by-step ETI way!

Advanced Electronics

Want greater challenges and career advancement? This course is for you. It can be valuable preparation not only for a technical career, but also for the fields of sales, management and administration. Make your move now!

Digital Electronics—Advanced

Here's a special course for those already in the field of digital electronics, ready to move into more advanced areas. This is how to move up in sales, management and administration. Here's your tomorrow!

Black and White TV Servicing—Advanced

This can be your own "advance" course to black-and-white TV competence from A to Z. You'll construct a receiver yourself, if you wish. A key to lifetime success!

Industrial Instrumentation—Advanced

Move up in the world...the wonderful electronics world! This course opens up a whole range of careers in the industrial field, as instrumentation technician, laboratory technician, process control technician or electronic calculating machine technician. Get ready...and go!

Color TV Servicing—Advanced

Here is the "graduate" course in color TV for those who already know television fundamentals. You'll learn color TV from top to bottom, build your own set if you choose. A great way to build your future!

Solid-State Electronics—Advanced

Applications of transistors are increasing all the time and the transistor may be a breakthrough

comparable in importance to the development of nuclear energy. Solid-state can mean your solid career development, too, through ETI!

FCC License Preparation

Here is real down-to-earth practical preparation to take your 3rd, 2nd or 1st class Federal Communication Commission Radio-telephone License examinations. Get yourself ready now for any of the FCC-licensed positions involving broadcasting, mobile communications, microwave communications links, marine communications equipment or in many other positions in solid-state, communications, CATV. Get ready for tomorrow...today!

Get all the facts...free!

Send the coupon now for ETI's colorfully illustrated new

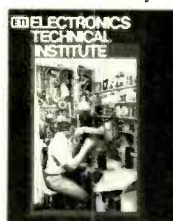

44-page catalog giving you all the details. You owe it to yourself. There's no obligation, and no salesman will call. Send for yours today!

Electronics Technical Institute

Division of Technical Home Study Schools

Electronics Technical Institute, Dept. 2-479-076
Little Falls, New Jersey 07424

Send me the Electronics Technical Institute Catalog.

Name _____ (please print)
Address _____
City _____ State _____ Zip _____

Interested in another field? Check the Technical Home Study School program that interests you most. No salesman will call. PLEASE CHECK ONLY ONE.

- | | |
|---|--|
| <input type="checkbox"/> Typewriter and Office Machine Repair | <input type="checkbox"/> Locksmithing |
| <input type="checkbox"/> Upholstery and Decorating | <input type="checkbox"/> Legal Investigation |
| <input type="checkbox"/> Accident and Insurance Claim Adjusting | <input type="checkbox"/> Security/Alarm Business |
| <input type="checkbox"/> Outdoor Careers in Conservation | <input type="checkbox"/> Photography |
| <input type="checkbox"/> Check here for information on Veterans Benefits. | |
| <input type="checkbox"/> Check here for information on learning by cassettes. | |

NEW!
TeleMatic
SONY
PICTURE TUBE
BRIGHTENER



The option to replacing expensive Sony color picture tubes. (For most popular models.)

Another first from the pioneers in service test equipment.

FOR MORE INFORMATION WRITE:

TeleMatic J-6
 2862 Fulton Street
 Brooklyn, NY 11207

NAME _____
 ADDRESS _____
 CITY _____ STATE _____ ZIP _____
 My supplier is: _____

SOLD THROUGH DISTRIBUTORS ONLY

RADIO-ELECTRONICS

State of SOLID STATE

A novel battery-monitor circuit from Intersil plus new releases from RCA and Motorola

KARL SAVON
 SEMICONDUCTOR EDITOR

EVERY ONCE IN A WHILE I SEE A CIRCUIT so free of nuances that its simplicity is a joy to behold. Intersil's ICM7201 is nothing much more than a Schmitt trigger that is adaptable to the majority of rechargeable battery powered equipment. It is a four-terminal circuit mounted in a TO-72 can.

The circuit in Fig. 1 will sense the

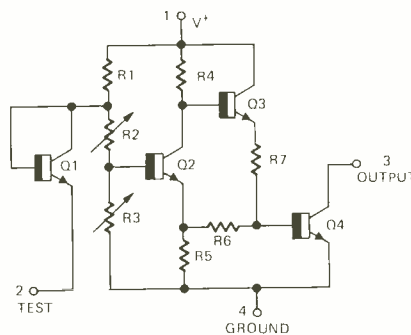

FIG. 1—INTERASIL BATTERY MONITOR.

charge-level of a 3-cell series-connected nickel-cadmium battery pack. The battery voltage is applied directly across pins 1 and 4. When the battery voltage falls below a preset threshold, pin 3 is switched to ground by turn-on of Q4. Design center trigger points of the circuit are 2.9 and 3.1 volts. The 0.2-volt hysteresis between the two voltages is the noise margin that prevents the output indicator from flashing intermittently, or being only partially energized as the voltage reaches one of the trigger points. The collector of Q4 can be connected to trigger an audible alarm with extra parts, but the simplest hookup is to an LED that will light at the lowered voltage as the batteries become depleted.

The fully charged voltage of a single cell Ni-Cad is 1.3 adding up to 3.9 volts for the three. When the rated ampere-hour capacity has been drained from the cell its voltage drops to 1.1 volts at the 10-hour discharge rate. A voltage of 2.9 for three cells, or .967 volt for one, is the cutoff voltage at some higher discharge rate. There is no easy way to de-

termine the ampere-hour capacity between the fully-charged and cutoff points. The voltage discharge characteristic is nearly flat until it nears full discharge.

Connecting the batteries to the 7201 first turns on transistors Q3 and Q4 as pin 1 quickly rises and passes through $2V_{be}$ (about 1.2 volts). The conduction path is through R4, the base-to-emitter of Q3, R7, and the base-to-emitter of Q4. Q2 is still off and does not divert any current. Above this point the emitter of Q2 sees the 0.6-volt Q4 junction through R6 and ground through R5. Voltage divider R1, R2, R3, drops $V+$ by a ratio less than one: $A = R3/(R1 + R2 + R3)$. When A times $V+$ minus the V_{be} of Q2 exceeds BV_{be} where $B = R5/(R5 + R6)$, Q2 turns on. This is set up to be the 3.1-volt point, which is still below the voltage of a partially charged 3-cell battery pack. Q2 now conducts current and its collector begins to fall below $V+$, reducing the current in Q3. Q3 had been supplying a portion of the current in R5. As it turns off, Q2 must pick up the extra current, further dropping its collector voltage. The action continues in regenerative fashion until Q3 is turned off. Q4 goes off at the same time and the circuit is in the "charged battery" state. Q2 and Q3 are the conventional Schmitt trigger circuit. Both devices are in a non-inverting DC loop. Q2 operates as a grounded-base DC amplifier and Q3 as an emitter follower. The loss of the contributing emitter current of Q3 accounts for the circuit hysteresis or voltage lag before the circuit will switch back when the battery voltage drops 0.2 volt.

What has happened is that the emitter of Q2 previously saw a voltage higher than ground, BV_{be} , through the Thevenin equivalent parallel resistance of R5 and R6. Now with Q2 on and Q3 off, the emitter of Q2 sees a lower voltage, namely ground, through R5 alone. $AV+$, the base voltage of Q2, must now drop below one V_{be} before Q2 starts turning off and the loop becomes regenerative in the reversed sense.

Putting it into numbers, at 3.1 volts: $V_{high}A - V_{be} = V_{be}B$ or $B = 4.17 A$.
 (continued on page 28)

Logic Probe 1 is a compact, enormously versatile design, test and troubleshooting tool for all types of digital applications. By simply connecting the clip leads to the circuit's power supply, setting a switch to the proper logic family and touching the probe tip to the node under test, you get an instant picture of circuit conditions.

LP-1's unique circuitry—which combines the functions of level detector, pulse detector, pulse stretcher and memory—makes one-shot, low-rep-rate, narrow pulses—nearly impossible to see, even with a fast scope—easily detectable and visible. HI LED indicates logic "1", LO LED, logic "0", and all pulse transitions—positive and negative as narrow as 50 nanoseconds—are stretched to 1/3 second and displayed on the PULSE LED.

By setting the PULSE/MEMORY switch to MEMORY, single-shot events as well as low-rep-rate events can be stored indefinitely.

While high-frequency (5-10MHz) signals cause the "pulse" LED to blink at a 3Hz rate, there is an additional indication with unsymmetrical pulses: with duty cycles of less than 30%, the LO LED will light, while duty cycles over 70% will light the HI LED.

In all modes, high input impedance (100K) virtually eliminates loading problems, and impedance is constant for all states. LP-1 also features over-voltage and reverse-polarity protection. Housed in a rugged, high-impact plastic case with strain-relieved power cables, it's built to provide reliable day-in, day-out service for years to come.

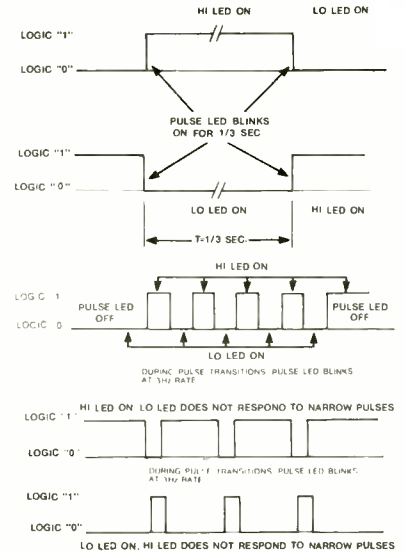

CSC'S MULTI-FAMILY LOGIC PROBE 1. AT \$44.95, IT DIGS UP A LOT OF INFORMATION WITHOUT BURYING YOUR BUDGET.

HI/LO LED's—Display level (HI-logic "1", LO-logic "0") of signal activity at node under test

PULSE LED—Lets you know what's going on—and off. Indicates positive and negative pulse and level transitions. LP-1 stretches pulses as narrow as 50 nanoseconds to full 1/3 sec. (3Hz pulse rate)

PULSE/MEMORY Switch—PULSE position detects and stretches pulses as narrow as 50 nanoseconds to 1/3 sec. Switch to MEMORY and it stores single shot and low-rep-rate events indefinitely; HI/LO LED's remain active

Logic Family Switch—TTL/DTL or CMOS matches Logic "1" and "0" levels, for greater versatility. High Input Impedance—100K virtually eliminates circuit loading problems and is constant in both "0" and "1" states. CMOS position also compatible with HTL, HiNIL and MOS logic

Non-corrosive nickel-plated probe tip and clip leads—For reliable contacts and maximum life

Rugged high impact plastic case—Built to take it in the lab or in the field

Protected—Features built-in reverse polarity and over-voltage protection; strain-relieved power cable

\$44.95 Price tag—Costs so little it can be your personal property



For more information, see your distributor or write for our catalog and distributor list.
44 Kendall St., Box 1942 New Haven, CT 06509 • 203-624-3103 TWX: 710-465-1227 West Coast office:
Box 7809, San Francisco, CA 94119 • 415-421-8872 TWX: 910-372-7992 Canada: Len Finkler Ltd., Ontario

Circle 9 on reader service card

© 1976, Continental Specialties Corp

JULY 1976

STATE OF SOLID STATE

(continued from page 26)

From the 2.9 volt point: $A \times 2.9 = 0.6$, $A = 0.207$ and $B = 4.17 \times 0.207 = 0.862$, giving a feel for what these resistor ratios have to be. A more complete analysis would include the effects of base currents and the exact points at which the loop gain is high enough to be regenerative. Pin 2 is a test point that is pulled down through diode-connected Q1 to simulate a reduced battery voltage on the Q2 base divider. If the sensing circuit is working properly it will switch and turn on Q4, activating the low-battery alarm.

RCA's gold chip

RCA has announced a tri-metal pro-

cess, similar to Bell Telephone Labs beam-lead construction. Changes have been made so the RCA method is simpler and more cost-effective for plastic DIP's. Significantly, the chip protection takes place on the silicon wafer before the pellets are encapsulated.

Tri-metal is short for Silicon Nitride Passivated Trimetal. Conventional integrated circuits use a layer of aluminum, evaporated on the chip surface, to interconnect all the devices, thereby wiring the circuit. Moisture may leak in where the leads penetrate the plastic package or it can seep through the plastic material itself. Insulating layers of aluminum oxides and hydroxides form, creating open circuits, which cause malfunction. There are other failure mechanisms besides this

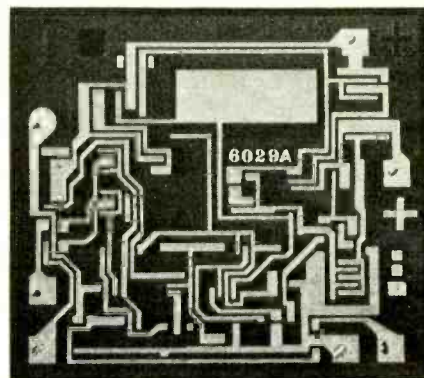

PHOTOMICROGRAPH OF CA741CG CHIP shows gold metallization in all light areas of photo, instead of the older-process aluminum.

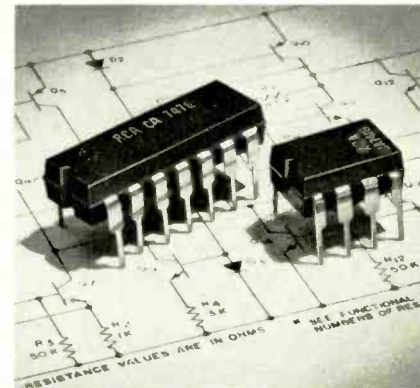

TWO NEW IC'S, CA741CG AND CA741G.

electrolytic corrosion. "Purple plague" is a compound that forms at high temperatures between the dissimilar gold bond wire and aluminum metallization. The junction becomes brittle and may eventually break open. Electromigration is the physical movement of metal at high temperature and current densities above $10A/cm^2$. The surface of an IC is a series of hills and valleys over which the aluminum is evaporated. Poor step coverage is a common problem that will produce cracks where the metal is thin, high contact resistance, and high current density areas.

Figure 2 shows the IC surface after

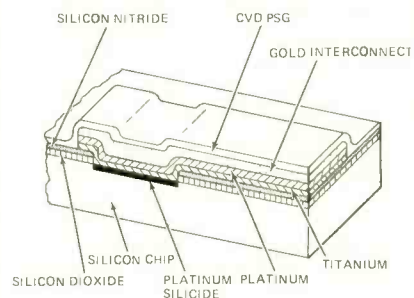

FIG. 2—RCA'S LAYER-BUILT CHIP.

fabrication by the Gold Chip process. Up to the final silicon nitride and metallization steps, circuit production is the same as the aluminum-metallization process. The similar procedure makes cost differences minimal and the circuits will be sold at the same price as the standard versions.

After completing device diffusions with an SiO_2 layer, a silicon nitride layer hermetically seals all device junctions.

(continued on page 89)

Den nya handic 2305 Basstationen har sensationell prestanda!

In the USA this means: "The new Handic 2305 Base Station is a spectacular performer!"

- ◆ Built-in "Priority Channel" can be switched on so that a pre-selected channel (i.e. Emergency CH-9) will override any other channel being used.
- ◆ Full 23-CH operation on 110VAC or 12VDC.
- ◆ Selectivity — 90dB at $\pm 10KHz$.
- ◆ Sensitivity — $0.5\mu V$ at 10dB S/N.
- ◆ Built-in PA Facility.
- ◆ Automatic Gain Control.
- ◆ Automatic Noise Limiter Switch.
- ◆ Selective Call Facility.
- ◆ Built-in SWR Bridge and Illuminated S/R F Meter.
- ◆ Complete with 'Mic', AC cable, crystals for 23-Chan's; jacks for Selective Call, external speaker, PA speaker and hand-held telephone.

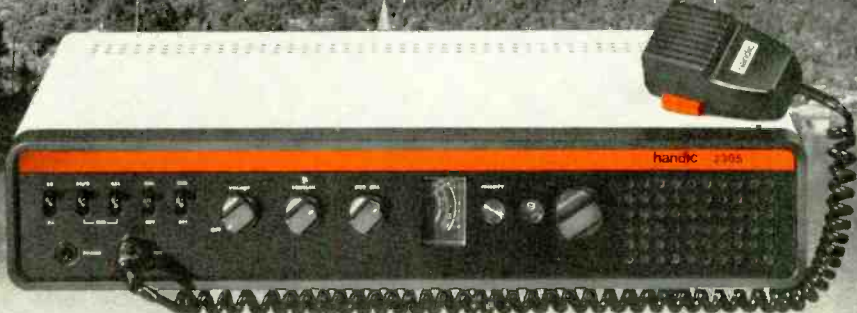

Handic CB radios include: mobile/base transceivers; hand-held personal portable CB systems; scanners with FM radio option; antennas; microphones; selective call; and a full line of accessories.

Send For FREE Catalog!



handic U.S.A. inc.

14560 N.W. 60th Ave., Kennedy Bldg.,
Miami Lakes, Fla. 33014 (305) 558-1522

In Canada: Scotcomm Radio Inc., Chomedey, Laval, Quebec



THE DEPENDABLE CB FROM SWEDEN

Circle 16 on reader service card

ONE RIG DOES IT ALL!

Tube and Solid State

THE UNIVERSAL
PJS-298

33KV LEADED GLASS 19" CRT

EIA recommended to protect against
dangerous X-radiation

A MUST FOR TODAY'S SERVICING

ACCESSORIES INCLUDE:

- CRT 90° Extension
- Yoke Extension
- Transverter
- Convergence Load
- Universal Yoke
- Convergence Assembly
- Blue Lateral Assembly
- Anode Extension

SOLD THROUGH DISTRIBUTORS ONLY

PLEASE SEND ME MORE INFORMATION

J-6

NAME _____

ADDRESS _____

CITY _____ STATE _____ ZIP _____



33KV

BUILT-IN SPEAKERS

Easy audio checking

40 KV METER

50aU sensitivity monitoring

FRONT CONNECTORS

Convenient cable plug-in

OBSOLETE PROOF

Plug in modules for up dating

~~\$298-98~~ VALUE

SPECIAL INTRODUCTORY OFFER

\$229.95

COMPLETE WITH CRT

Telematic

2468 FULTON ST., BROOKLYN, NY 11207

Circle 10 on reader service card

Wilson

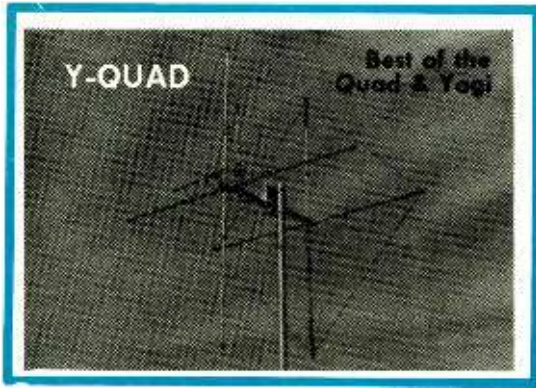

Y-QUAD

Best of the Quad & Yagi

• WINNING COMBINATION •

The Y Quad combines the best of the Quad & Yagi designs giving one of the best performing switchable polarity lightweight antennas on the market. Uses a Quad Reflector and Yagi driven element.

• ANGLE OF RADIATION •

The Quad Reflector assures low angle of radiation even at low heights for real long distance performance.

• FRONT TO BACK •

The Quad Reflector gives an excellent front to back ratio of 25-30 dB along with a forward gain of 10.5 dB.

• DUAL POLARITY •

This feature gives considerable improvement in the following types of communications:

- A. Maximum transmission to either base or mobile stations.
1. Mobile antennas are invariably vertically pol-

arized antennas. Switching to the vertical mode of the Y Quad allows effective communications with these mobiles.

2. Base to base transmissions are most effective using horizontal polarization.

B. Line of sight transmission

1. By shifting polarity, you shift the signal 90° thereby reducing the received signal in the opposite polarity by as much as 20 dB. Good gain with other station is still maintained if polarity is matched with yours.
2. Good front to back and front to side rejection of unwanted signals in both polarities.

• SPECIFICATIONS •

- Gain 10.5 dB
- Front to back ratio 25/30 dB
- Boom length, 6 ft.
- Weight, 12 lbs.
- Horizontal or vertical polarity
- IMP 50 Ω Gamma Match
- Power capability, 2,000 watts
- Can be turned with small TV rotor
- Fiberglass Spreader

Wilson Electronics Corp.

SHOOTING STAR

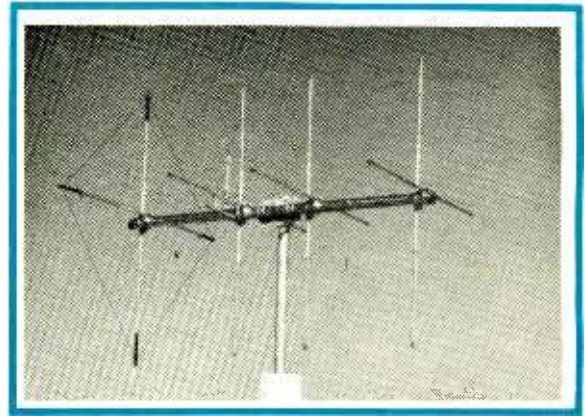

The 8 Element Shooting Star was developed to fill the need for a top performing, high quality, dual polarity antenna at a reasonable price. Its design is the same as antennas used to bounce signals off the moon using ½ wave dipole and quad reflector.

With dual polarity you can switch to vertical and work the mobiles or local stations and when things get rough, switch to horizontal and eliminate interference as much as 25 dB.

The design uses a scientifically matched boom of 16' and precision spacing to give the very best gain and front to back combination possible. A quad type reflector is used to increase gain and improve front to back ratio. Gamma matches are used to obtain the best impedance match, eliminating coils which burn out, allowing a 2 KW power handling capability.

The mechanical construction is superior to other antennas, as we use extruded aluminum boom to element clamps which do not require drilling holes in the elements. All aluminum tubing is heavy wall aircraft type. Uses same construction as the famous Laser beams.

- Gain - 14.5 dB
- SWR - 1.3 to 1
- Impedance - 50-52 Ohms
- Power Handling Capabilities - 2,000 watts
- Front to Back Ratio - 38 dB
- Vertical - Horizontal Separation - 25 dB
- Weight - 29 lbs.
- Boom - 2'
- Recommended Rotor - CD44 or Ham II
- Fiberglass Spreader

ALPHA V58

5/8 Wave Ground Plane

The Alpha V58 is a full 5/8 wave ground plane with four full size radials, using a loop for loading which eliminates the need for a coil that could easily burn out. The use of DC ground reduces the static noise and gives a cleaner received signal.

Superior to all other verticals. Wilson uses a new "Adjustable Capacitive Coupling System" in the V1 & V58, to enable you to achieve a flat 1.1 to 1 SWR in the widest range of installations.

- Gain 5.14 dB
- 4 full length radials
- Loop loading
- 1.1 to 1 SWR
- No coils to burn out
- Will handle 2,000 watts
- Height, 21 ft.
- Weight, 7 lbs.
- New radial hub design

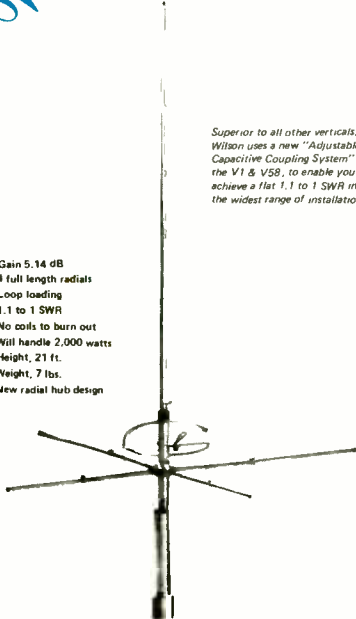

V1

5/8 Wave Ground Plane Without Radials

Our V1 is a 5/8 wave vertical ground plane without radials.

It's the perfect antenna campers and mobilers like to have for portable operation. It is quick & easy to set up or take down. Be on the air in less than 5 minutes after arriving at your camping spot.

- Gain 3 dB
- No radials
- Loop loading
- 1.1 to 1 SWR
- No coils to burn out
- Will handle 2,000 watts
- Height, 21 ft.
- Weight, 5 lbs.



Ideal for campers or portable operation

WILSON ELECTRONICS' SUPER LASER 500

THE MOST POWERFUL AND DIRECTIVE CB ANTENNA IN THE WORLD

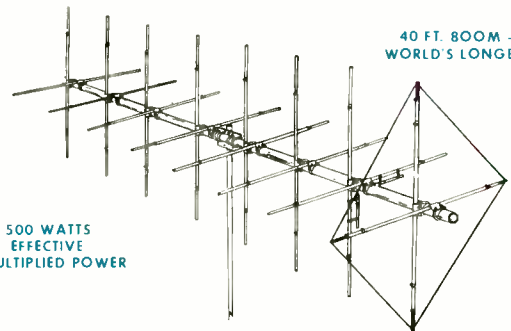

40 FT. BOOM - WORLD'S LONGEST

500 WATTS EFFECTIVE MULTIPLIED POWER

The Super Laser's tremendous Gain and Directivity, with the great rejection of unwanted signal, will enable you to hear and talk to stations that before were just noise in the pile of heterodynes. Your normal CB rig will develop an effective power of 500 watts, and the received signals will pop in loud and clear.

Now When You Hit That Mike, Others Will Listen They'll Have To - You Offer No Choice!

- You've seen advertisements telling of the Cadillac of antennas. Well, here's the Rolls Royce of CB Antennas
1. World's longest boom - 40 ft
 2. World's most powerful - 500 W of Effective Multiplied power
 3. World's most directive - unbelievable
 4. World's best F/B Ratio & Side Rejection - fantastic 50 dB.
 5. World's most rugged construction - special aircraft aluminum

And the list continues on

Ask one of the staff at Wilson Electronics what he

ELECTRICAL	
Gain	18 dB
F/B Ratio	up to 50 dB
Side Rej	up to 50 dB
SWR	1.3 to 1 or less
Polarity	Horizontal or Vertical
Power	2 KW

thinks of the Super Laser, and his answer will be "FAN TASTIC!" That pretty well describes this antenna.

The unique method of gain and directivity of The Super Laser will take a normal transmitter (even though it will handle 2 KW) and produce an Effective 500 Watts of Multiplied Power!

The Super Laser has adjustable Gamma Matches to obtain the lowest SWR for Horizontal or Vertical Polarization. The boom, 40 ft. of 3" OD, with 5/8" elements of quality heavy wall aircraft aluminum, produce an assembled antenna weighing 70 lbs. with a wind survival of over 90 mph.

With this kind of strength and durability we recommend using the following with The Super Laser:
Mast - 2" OD
Tower - Rohn 25G, Consolidated HD 18 or Equivalent
Rotor - Rotor Brake or Prop Pitch

MECHANICAL	
Boom	40 ft. 3" OD aluminum
Elements	5/8 inch aircraft quality aluminum
Weight assembled	70 lbs
Quad Reflector for improved Gain & F/B	New Fiberglass Spreaders

Wilson Electronics Corp.

NEW LONG BOOM 12 ELEMENT LASER BEAM

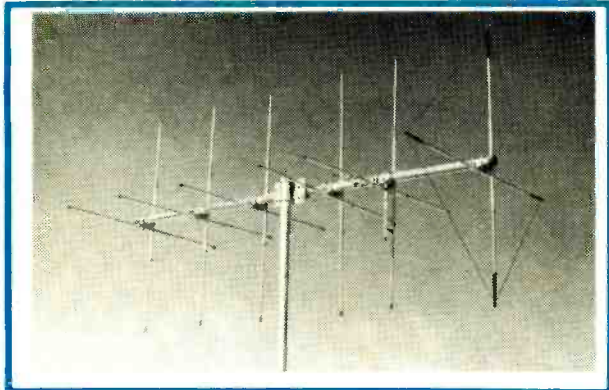

31 FT. BOOM 400 WATTS EFFECTIVE POWER

The new 12 Element Laser has been expanded to achieve the maximum forward gain and front to back ratio covering a wide range of installations. This is achieved by the unique use of a Quad Reflector and Yagi Parasitic elements. There are six elements horizontal and six elements vertical, scientifically spaced, on a new 31 ft. boom. The 12 Element Laser has been tested and proven. It is second only to the Super Laser 500. The same top quality aircraft aluminum that has made Wilson Electronics famous, is used in the new 12 Element Laser.

MECHANICAL SPECIFICATIONS

- Boom Length 31 ft.
- Longest Element 17.5 ft.
- Elements Aircraft type aluminum
- Element Mounts Aluminum extrusions
- Quad Reflector Wire 14 GA. Copper Stranded
- Boom 2" OD
- Weight 45 lbs.
- Fiberglass spreaders
- Recommended Rotator Ham II

ELECTRICAL SPECIFICATIONS

- Gain 17 dB
- Front to back ratio up to 40 dB
- Side Rejection up to 45 dB
- Horizontal or Vertical Polarization
- Power Capability 2,000 watts
- Adjustable Gamma Matches for Horizontal & Vertical
- SWR 1.3 to 1 or less
- 400 Watts effective multiplied power

Wilson V QUAD BEAM VQ2

The Modern Successor to the Quad

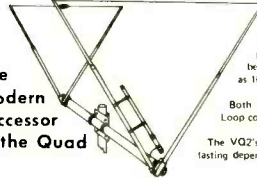

Now the Wilson VQ2 Quad offers CBers the advantages of both horizontal and vertical polarizations with only one coax feed line. The new V configuration gives outstanding gain and pinpoint rejection. Experienced CBers know how annoying fading due to polarization loss can be. With the dual polarity of the VQ2 Quad signal fading is reduced as much as 10 dB.

Both horizontal and vertical polarization is achieved through unique V Quad Loop configuration.

The VQ2's rugged mechanical structure of top grade aluminum tubing assures long lasting dependable service. Handles up to 2,000 watts with maximum power transfer.

MECHANICAL SPECIFICATIONS

- Boom length, 6 ft.
- Element length, 12 ft.
- Accepts up to 1.5/8 in. mast
- Wind survival, 100 mph.
- Net weight, 7.5 pounds

ELECTRICAL SPECIFICATIONS

- Gain, 10.5 dB
- F/B Ratio, 25 dB
- Side Rejection, 40 dB
- SWR, 1.3:1 or less
- Polarization Vert. and Horiz.
- Impedance, 50 ohms

Stacking Kit includes Boom, Hardware and Coax Network.

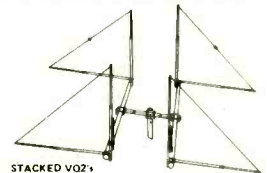

STACKED VQ2's

Wilson "MAXIMUM" ANTENNAS

The new "Maximum" antennas are tunable from 26.5 to 30 MHz in either the horizontal or vertical position. This is possible by adjusting the element lengths to the specific frequency between 26.5 and 30 MHz.

The mechanical construction is superior to other antennas as we use extruded aluminum boom to element clamus which do not require drilling holes in the elements. All aluminum tubing is heavy wall aircraft type.

All Wilson CB Beams have the following common features:

- Taper Swaged Tubing
- Full Compression Clamps
- No Holes Drilled in Elements
- 2" or 3" Aluminum Booms
- Adjustable Gamma Match 52 Ω
- Quality Aluminum
- Handle 2kw
- Heavy Extruded Element to Boom Mounts



M106C

MECHANICAL	M106C	M106C	M105C	M103C
Boom Length	40'	31'	26'	11'8"
Boom OD	3"	2"	2"	1 1/2"
No. of Elements	8	6	5	3
Longest Element	19'	19'	19'	19'
Turn Radius	24'	17'	15'	10'
Surface Area	4 sq. ft.	3 sq. ft.	2.5 sq. ft.	1.5 sq. ft.
Wind Survival	100 mph	100 mph	100 mph	100 mph
Weight	80 lbs.	36 lbs.	24 lbs.	12 lbs.
Rotator	H.D.	H.D.	6000	T.V.
Stacking Kit	N/A	MBSK	MBSK	VQ2SK

ELECTRICAL	M106C	M106C	M105C	M103C
Tuning (MHz)	26.5-30	26.5-30	26.5-30	26.5-30
Gain (dBi)	18	17	15.5	11
Front To Back (dB)	50	31	31	25
SWR	1.5:1 or less	1.5:1 or less	1.5:1 or less	1.5:1 or less
Power Capabilities	2,000 watts	2,000 watts	2,000 watts	2,000 watts

SEE YOUR FAVORITE DEALER OR DISTRIBUTOR

Wilson Electronics Corporation



4288 S. POLARIS, LAS VEGAS, NEVADA 89103
(702) 739-1931

Circle 11 on reader service card

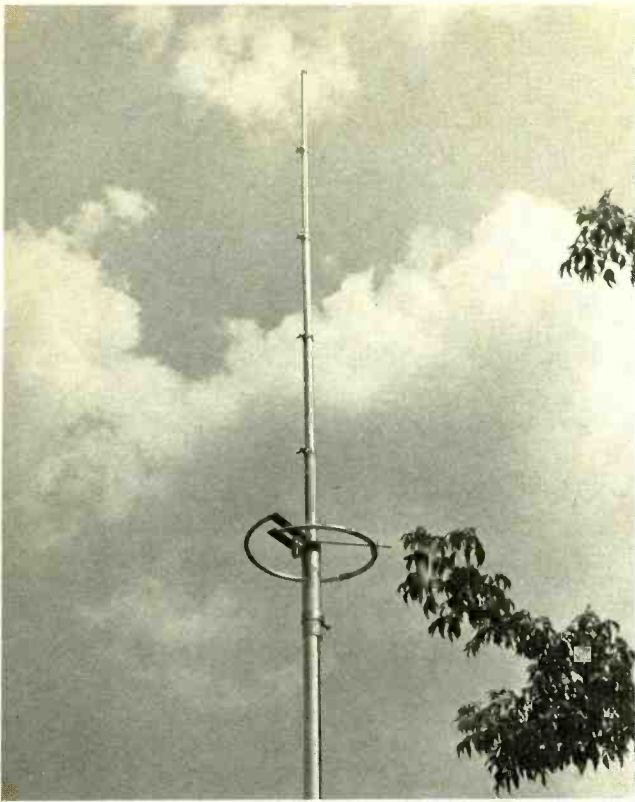

Selecting Station

Selecting the best possible is a difficult choice. and specifications that

GETTING MAXIMUM RANGE FROM CB EQUIPMENT is a never-ending quest for many operators. With maximum legal power output limited to 4 watts, the only way a CB'er can be assured of maximum communications range is to use the most efficient base antenna installation he can afford.

This means selecting the antenna that is best for typical operating conditions and then installing it within the limits set by the FCC. The factors to be considered are antenna polarization, vertical radiation angle, directivity and gain.

Perhaps one of the first things that anyone should consider in connection with 2-way communications antennas is based on the principal of *reciprocity*. In effect, this states that polarization, gain, directivity, radiation angle and all other characteristics are the same whether the antenna is transmitting or receiving.

Polarization

When power is fed to a transmitting antenna, it radiates *magnetic* and *electric* fields that are at right angles to each other. The electric (or electrostatic) field components are always—at least as far as CB antennas are concerned—in the same plane as the radiator. Thus, a vertical antenna such as a mobile whip or vertically oriented Yagi will radiate a vertically polarized signal. Similarly, an antenna with elements parallel to the earth radiates a horizontally polarized signal. (As an example, TV and FM antennas in the U.S. are horizontally polarized. However, recent announcements indicate that the U.S. TV standard may be changed to circular polarization to minimize aircraft-flutter, ignition interference and other problems.)

For the most reliable contacts between two CB stations using ground-wave communications—as intended by the FCC—both should use antennas with the same

polarization. An antenna with one type of polarization will still pick up signals of the opposite polarization but with much lower efficiency. Usually, cross-polarization results in a signal loss of around 20 dB—3 to 4 “S” units on your receiver. Generally, base antennas are vertically polarized to provide the best communications to and from mobile units that use vertical whips.

Vertical radiators

The basic vertically polarized CB antenna is the quarter-wavelength ground-plane type. It consists of a one-quarter wavelength radiator cut from aluminum or copper tubing (one-quarter wavelength is approximately 108 inches at 27 MHz) and a ground plane composed of three or four quarter-wavelength radials mounted horizontally at the base of the radiator. The radiator and ground plane are insu-

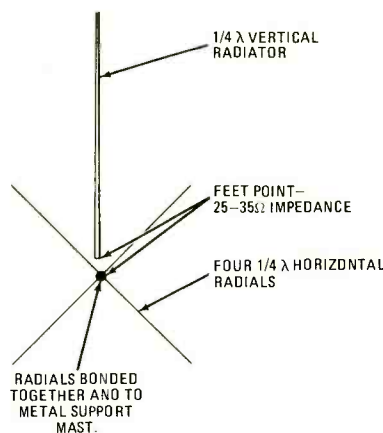

FIG. 1—DIAGRAM OF A TYPICAL GROUND-PLANE. Some have three radials.

lated from each other and used as the connecting points for the coaxial feed line as shown in Fig. 1.

The feed-point impedance is generally between 25 and 35 ohms. Most CB transceivers are designed to match 50–52-ohm antenna systems so some means must be

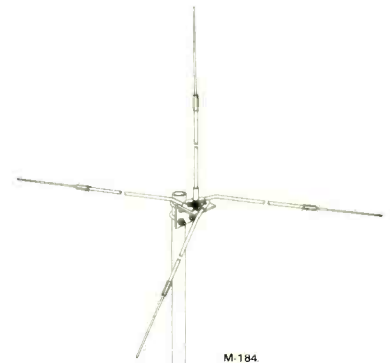

FIG. 2—DROOPING RADIALS raise antenna feed-point impedance to 50 ohms to match the coaxial transmission line.

provided to raise the feed-point impedance to about 50 ohms to match the coax transmission line. One method is to tilt the radials downward at about 35 degrees as in the Antenna Specialists model M-184 (Fig. 2). Another method of providing a match between the antenna and 50-ohm line is to use a *beta match* as in the Hy-Gain GP-54 and the Breaker model 11-101 (Fig. 3).

The vertical radiator has an omnidirectional horizontal pattern. That is, it radiates, or receives signals, equally in all directions. In free-space—where proximity to earth does not affect feed-point impedance—the pattern resembles a doughnut as in Fig. 4. In practical applications, a quarter cross-section of a ground-plane radiation pattern is shown in Fig. 5-a. The

CB Base Antennas

antenna to fit your needs
Here's a rundown of the factors
should be considered

ROBERT F. SCOTT
TECHNICAL EDITOR, KXK-8533

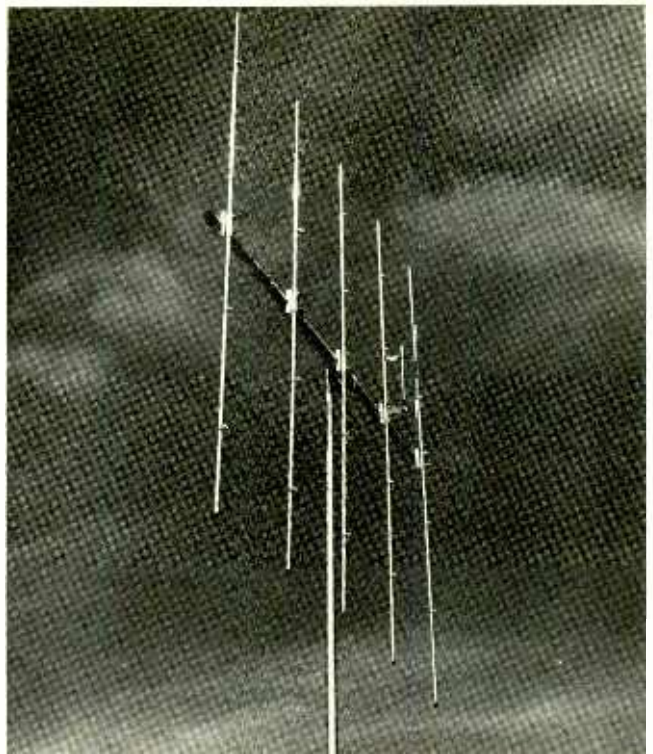

concentric half-circles represent signal strength at various angles to the horizon and distances from the antenna.

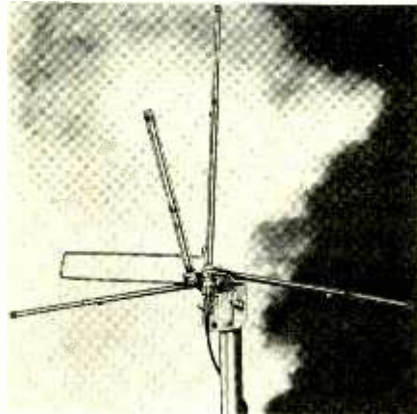

FIG. 3—THE BETA MATCH—it looks like the slide portion of a trombone—is one method of matching a ground-plane antenna to 50-ohm coax when the radials are horizontal.

AXIS OF
VERTICAL ANTENNA

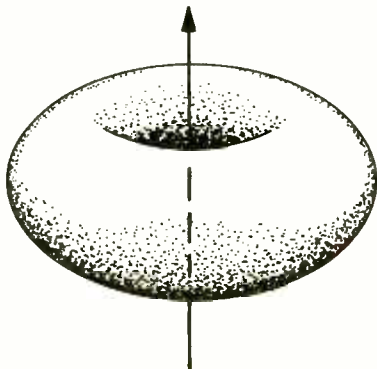

FIG. 4—FREE-SPACE HORIZONTAL PATTERN of a vertical quarter-wave length antenna such as a ground-plane type.

The quarter-wavelength ground-plane antenna is generally inexpensive and has a relatively high angle of radiation—an appreciable amount of power is radiated at an angle of about 50 degrees above the horizon. It is the standard or basis for comparing the performance of all other vertically polarized antennas. Its gain is *unity* or 0 dB.

Gain vertical antennas

An antenna is not an amplifier so it cannot radiate more power than is fed to it by the transmitter. Thus, a CB antenna cannot legally radiate more than 4 watts. However, a gain-type antenna can provide nearly 4 dB gain (2.5 times the power) over a quarter-wave type by concentrating the radiated energy at a lower and more useful angle. This is accomplished by lengthening the radiator. Figures 5-b and 5-c compare the vertical radiation patterns of half-wave and five-eighths wavelength radiators to the quarter-wave ground-plane. Figure 6 shows these patterns superimposed on a representation of the earth's surface to show the effective gain and coverage of each type.

The five-eighths wavelength antenna provides the greatest gain. As length is increased beyond five-eighths wavelength, the energy in the low-angle lobe drops drastically and much of the power is radiated at around 80 degrees.

The basic half-wave vertical has a gain of approximately 1.8 dB over a ground-plane. It does not require radials in most installations but some designs use short radials as a part of the impedance-matching system and to decouple the coax shield from the field of the antenna. (Coax shielding that absorbs energy from the antenna is a common cause of TVI and RF feedback in the CB shack.)

Figure 7 shows two common methods of connecting the low-impedance coax

feedline to a half-wave base-fed radiator. Fig. 7-a shows the coax tapped onto the 50-ohm point on a 27-MHz tuned coil at the base of the radiator. Fig. 7-b shows the version of the resonant circuit used by Cush-Craft. The parallel-resonant circuit is horizontal like a ground plane. The single-turn coil is tapped at the 50-ohm point to match the transmission line.

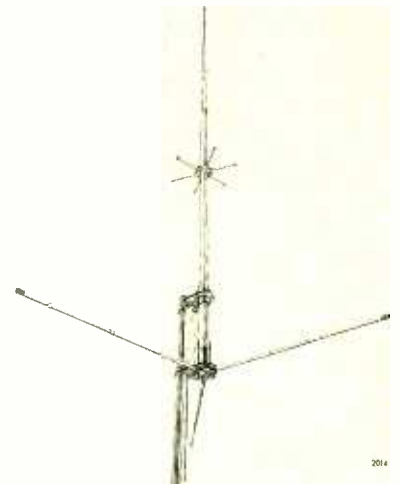

FIVE-EIGHTHS WAVELENGTH colinear-type vertical from Hustler. The model 27-T has short stub radials that help lower the vertical radiation angle.

Figure 8 shows the basic construction of the Cush-Craft gamma loop matching network used in the new CX-1000 antenna. The variable capacitor consists of a piece of dielectric sleeving between two telescoping sections of vertical tubing.

The five-eighths wavelength vertical provides a gain of nearly 4 dB over a ground plane and also eliminates the need for radials. Some manufacturers vary the

basic configuration by using short stubby radials at about half-way up the radiator (as in the Hustler *Trumpet* model 27-T, see photo) and/or small loops or radials at the tip to further lower the radiation angle and thus provide greater gain. The Hy-Gain *CLR* series of five-eighths wavelength verticals has a matching coil and three one-quarter wavelength radials at the base and a "top hat" consisting of three short radials to lower the radiation angle and provide a gain of approximately 3.4 dB. Another approach to the design is Mosley's *Devant Special* with its gamma match and "top hat" radials. The tapped matching coil and the gamma impedance-matching section permit the whole antenna to operate at DC ground potential, thus providing lightning protection and a reduction in atmospheric and precipitation static:

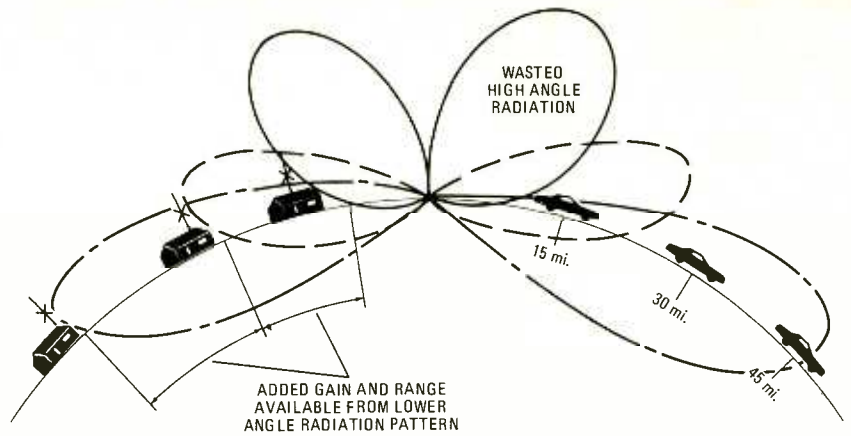

FIG. 6—RADIATION PATTERNS of antennas in Fig. 5 superimposed on representation of earth's surface to show how quarter-wave ground-plane wastes energy in high-angle radiation while longer verticals have increased communications range through their lower angles of radiation.

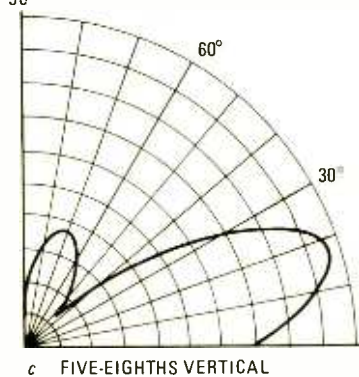
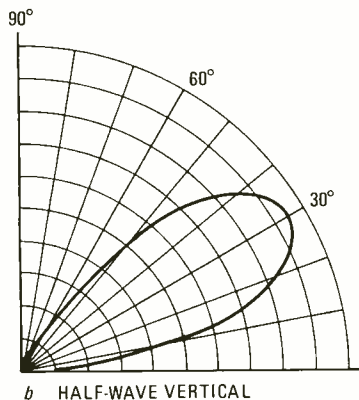
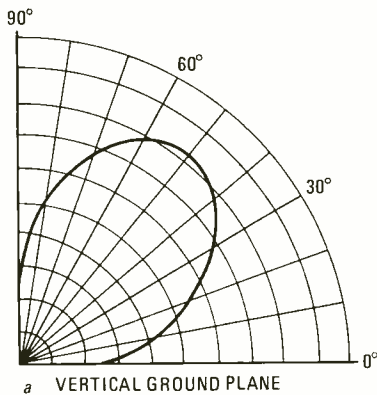

FIG. 5—VERTICAL RADIATION PATTERNS from three popular types of CB antennas. The five-eighths wavelength vertical (c) provides highest gain through its lower angle of radiation.

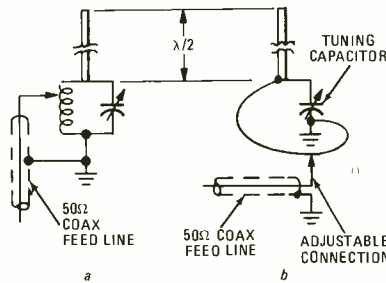
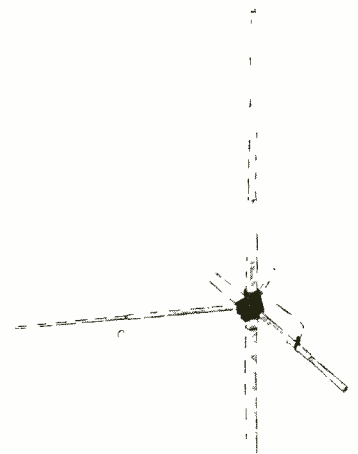

FIG. 7—TWO COMMON METHODS OF FEEDING HALF-WAVE VERTICALS. The method at (a) uses a tapped coil in a resonant circuit at the antenna base. The second method (b) uses a tuned circuit with a single-turn helical coil mounted horizontally.



GAMMA MATCH in the Mosley *Devant* series of base-station antennas. The *Devant Special* has "top-hat" radials for low angle of radiation.

Rotatable vertical beams

The most common uni-directional beam antennas consist of three to five vertical elements in a Yagi configuration so it looks like a "real wild" TV antenna standing on end. In these beam or directive antennas, gain is realized by the ability to concentrate all the energy in a narrow signal beam that can be directed to a specific area or point. This type of antenna consists of a half-wave *radiator* or *driven element*, a slightly longer *reflector* and one or more shorter elements called *directors*. The directors point in the direction of maximum radiation. The beam antenna must be rotated when 360° coverage is desired. Two identical Yagis can be mounted on a cross boom to provide a very narrow horizontal beam with a gain of 3 dB over a single Yagi of the same type.

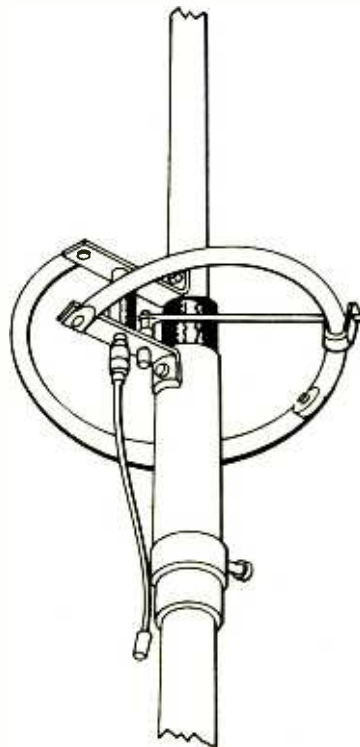

FIG. 8—BASIC CONSTRUCTION of the Gamma-loop matching system used in Cush-Craft verticals such as the new CX-1000.

Beam antennas can provide nearly 13 dB of gain, depending on the number of elements and their configuration. Figure 9 shows how stacking two simple Yagis horizontally can sharpen the horizontal radiation pattern and increase gain by 3 dB.

Figure 9-a is the pattern of a single vertical Yagi and Fig. 9-b shows the response of two identical Yagis stacked horizontally as in Hy-Gain's *Super Duo Beam SDB-6*. This antenna has a gain of 12.7 dB (18.6 power multiplication factor), providing an effective radiated power of 74.4 watts from a 4-watt CB transceiver. Front-to-back ratio is 23 dB. A similar model, Cush-Craft's CB-2KD, is shown in Fig. 10.

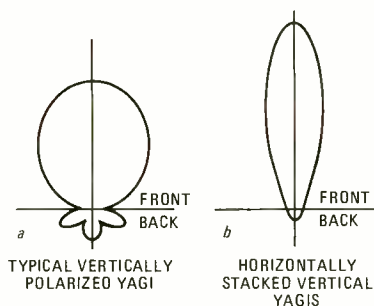

FIG. 9—STACKING ANTENNAS HORIZONTALLY (side-by-side) provides a 3-dB gain due to narrowing of the horizontal pattern.

Most CB antenna manufacturers such as Hy-Gain, New-Tronics (Hustler) and Mosley supply stacking kits so you can add a second Yagi to your array if you need a narrower beam or an additional 3 dB gain.

We mentioned earlier that cross-polarization between transmitting and receiving antennas results in about 20 dB attenuation in the received signal. Thus, in point-to-point applications where beam antennas can be used to an advantage, you might consider using horizontally polarized Yagis to reduce interference from CB stations in the beam's path that are using vertical polarization. Thus, horizontal polarization can be used to advantage between base stations but will prove to be a disadvantage when either base needs to contact a mobile unit.

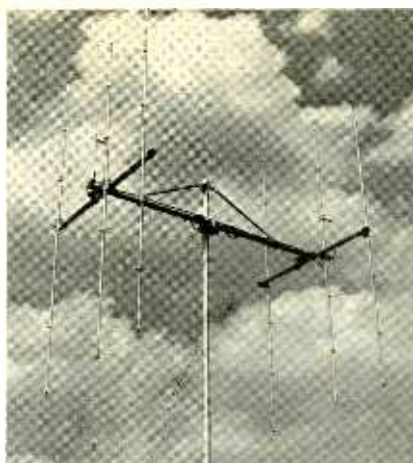

FIG. 10—SIX-ELEMENT ARRAY from Cush-Craft is made by mounting two 3-element Yagi's side-by-side on a cross boom.

For this reason, several manufacturers have developed dual-polarity CB antennas consisting of two Yagis on the same boom. The elements of one are horizontal; the other's are vertical. Typical antennas of this type are the Avanti *Moonraker*, Cush-Craft *Superfire* (see photo) and Mosley's *Saser*. The Hy-Gain approach to dual polarization is the two-element model *Eliminator II* quad. Antenna polarization is selectable through switching from the operating position.

Another advantage of selectable polarization is the ability to avoid interference from distant CB stations whose signals arrive at your antenna after being bounced between the ionosphere and earth. These "long-hop" or "skip" signals often undergo polarity reversals as they are reflected off the earth or ionosphere. Thus, when "skip" comes in, you can polarize your antenna system for minimum interference.

Large rotatable beam antennas like those just discussed have several disadvantages. Among them are high installation

cost—you need a tower and heavy-duty rotator, TV-grade components won't do—and you need a *large* cleared area to accommodate the beam's turning radius with sufficient clearance from trees, power lines and your neighbor's property.

Fixed steerable arrays

This type of beam antenna—called a phased-array—has the advantages of a rotary beam while eliminating the need for a sturdy tower and rotator. It consists of vertical radiators spaced either one-quarter or one-half wavelength apart and fed through phasing harnesses to provide the desired directivity pattern. For example, two ground-plane antennas one-half wavelength apart and fed through equal-length transmission lines will radiate two narrow beams at right angles to the plane of the antennas as in Fig. 11-a. When the an-

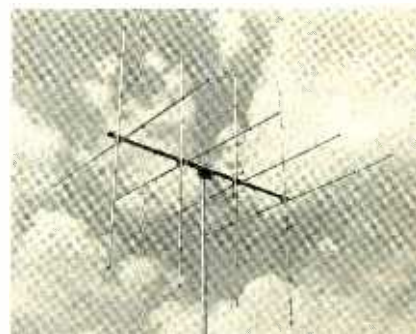

DUAL POLARIZATION results when two Yagis are mounted at right angles on a common boom. This Cush-Craft Superfire has a quad-type reflector for a superior front-to-back ratio.

tennas are excited (fed) in-phase, radiation is *broadside* to the plane of the antennas with a gain of about 3.85 dB over a single ground-plane. Half-power beam width is about 60°.

If the phasing harness adds one half-
(continued on page 75)

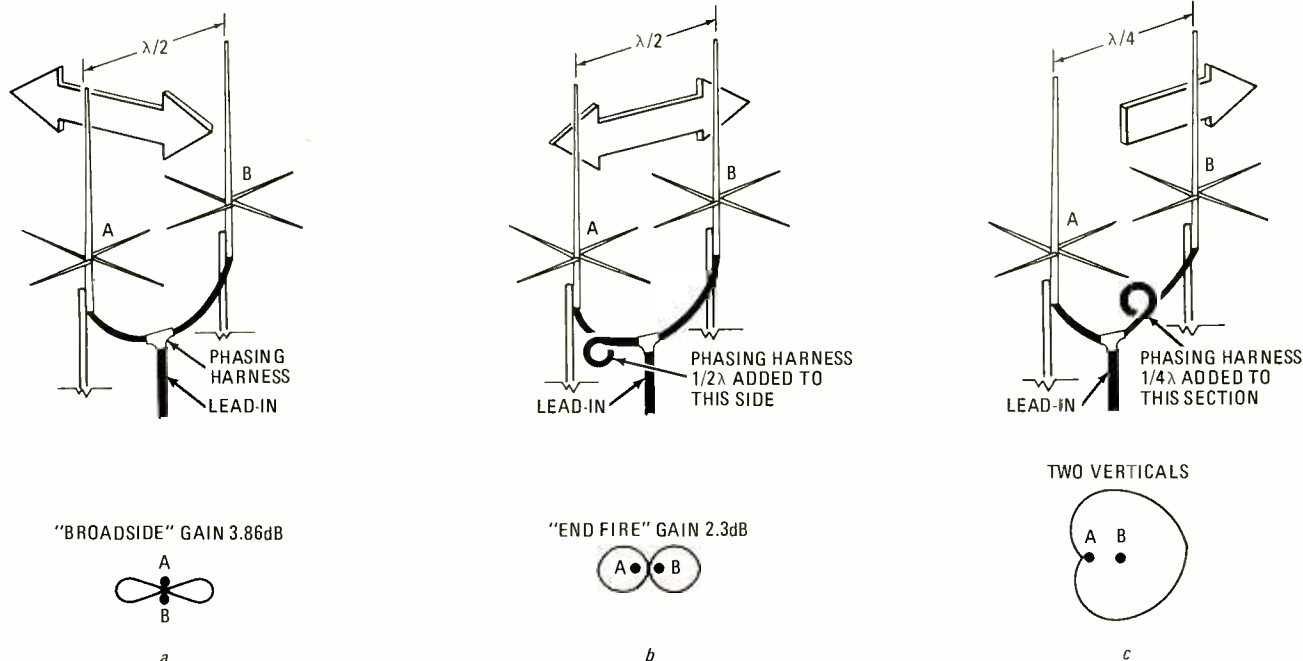

FIG. 11—TWO FIXED GROUND-PLANE ANTENNAS can be used as a bi-directional or cardioid-type omnidirectional beams. Directivity is determined by the phase of the signals fed to the two radiators. Typical radiation patterns are shown.

MIND POWER: ALPHA

Build this biofeedback device that displays the presence of alpha waves on a TV screen. You can use it to learn how to control your alpha waves and gain from the benefit of the relaxation that comes with it

DEvised BY SCIENTISTS, RATHER THAN YOGIS, ALPHA-WAVE biofeedback is a technique of *mental training*, through which the brain and the body are made to link-up more closely, so that the physiologic sources of stress come under the control of the mind.

If that seems a bit too much to grasp on the first pass, consider this: Since birth, your mind has gradually "learned" to control many of your body's important functions. Most have come naturally, like learning to stand erect, to walk, to throw a ball, ride a bicycle, to speak, to type, and countless others. Yet, there are several functions in which the body apparently acts *independently* of the mind. The heartbeat, respiration, digestion and certain glandular functions are representative of these *autonomous functions*. So, too, are the reactions of small muscle masses surrounding the tiny blood vessels of the body. When these tense under stress, blood pressure goes up.

What has this to do with alpha wave biofeedback? Well, research over the past two decades has suggested that if we can get the brain to downshift from its usual *high-gear state*, to the "idling" state, in which a recording of brain wave activity shows a predominance of *alpha waves*, a host of beneficial physiologic changes take place. A feeling of well-being and general comfort spreads throughout the body as muscles slacken, heart-rate and respiration slow down, body temperature eases and the body enters into a longed-for state of relaxation. The body is essentially responding to a *mental state* of relaxation. Obviously, therefore, a feedback link *does* exist between the brain and "involuntary" body functions. To strengthen that link, an outside training instrument is needed. Using it, the mind can be made aware of its success in achieving the alpha state, and, the accompanying beneficial physiologic responses serve as a "reward" to the mind, thus inspiring the continuation of the alpha state.

Such an instrument is *Mindpower: Alpha*. It is a *true* alpha-wave biofeedback instrument that incorporates an electroencephalographic "front-end," designed to amplify and selectively process the tiny potential indicative of the brain's "idling" state, as picked up by headband electrodes. It also includes the circuitry for converting these potentials into signals, that exert control over *both auditory and visual* stimulus devices. In the auditory sense, *Mindpower: Alpha* provides an audible tone indication when the user's mind is generating alpha waves. However, *Mindpower: Alpha* also includes the circuitry to convert alpha waves into *signals that control a video display on a television screen!*

Why? Well, if it is possible to train the mind to generate the waves of relaxation in quiet meditation, with eyes

NOTE

Mindpower: Alpha is an intriguing device for entertainment and experimentation in video biofeedback. It is not a therapeutic instrument, neither is it suggested as a cure for individuals suffering from psychological or physiological disorders.

closed, does it not make sense that the mind can be trained to the extent that the waves of relaxation can be generated with *eyes open*? After all, the things that cause *stress* and *anxiety* to arise in our minds are largely *visual* in nature. We *see* emotion-charged situations that cause our bodies to tense-up. We *read* words that produce anxiety. We respond to television news programs, in which the visual input sometimes elicits responses from us which can only be classed as preparation for *fight* or *flight*.

And so, it is only natural that the brain should "communicate" with and train itself, through our powerful visual sensors: the eyes. But, to do so, an external instrument is needed to "close the loop." That instrument is the combination of *Mindpower: Alpha* and your television set.

The Mindpower: Alpha biofeedback loop

The brain is totally dependent upon its sensors for information. The eyes, ears, nose, mouth, skin, and the proprioceptors within the body's muscles supply the basic data inputs through which the brain is informed, educated, and on which it bases its executive functions. But, our sensors are mostly directed to the external world, rather than to our internal environment. We have no built-in means to see or hear what is happening within our bodies. Without a mirror, we cannot even look into our own eyes!

Yes, once information about what is going on inside the body or mind can be brought outside ourselves, where our sensors can detect it, a main-line path is opened to the information-hungry brain. With that link established, the executive power of the mind can begin to go to work on itself.

Mindpower: Alpha is designed to detect and amplify the tiny bioelectric signals produced by your brain's activity. From the full spectrum of the brain waves, it filters-out everything but the alpha waves (slow 8 to 13-Hz variations) and converts these into signals that control an audio "beeper" and a video display created by a symbol generator. (The symbol is a white rectangle on a black field.) The beeper sounds each time a significant amount of alpha appears in your brain-wave spectrum, thus feeding back to your brain via the ears.

©Copyright 1976, National Mentor Corp. All rights reserved. Pat. Pend.

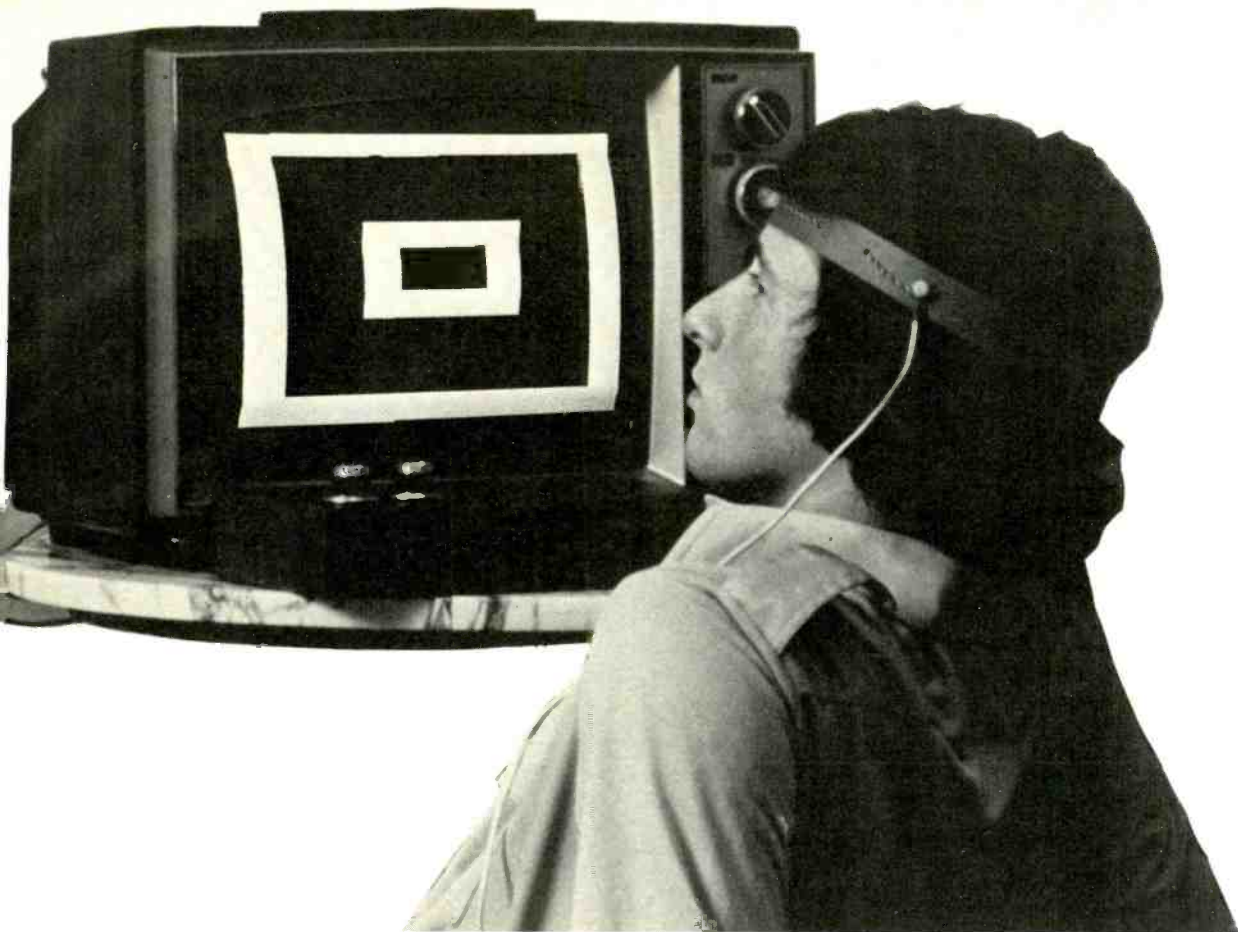

Part of the price we pay for the comfort and convenience of living in an advanced, industrialized society is the acceptance of a high degree of *anxiety* and *stress*. Sociologists, psychiatrists, and medical investigators agree that the forces of our complex, technologic, and ever-changing society hammer away incessantly on the individual. Shock waves of change and new crisis wash over us so rapidly that, scarcely have we prepared ourselves to deal with a problem, when suddenly, it mutates or disappears, leaving us confronted by a new threat. In rapid succession, we find ourselves buffeted by an Energy Crisis, Inflation, Recession, Shortages, Lay-offs, Corruption in High Government, and the countless smaller forces in our daily lives which keep us constantly "on-edge" and defensively anxious.

This anxiety and the stress of being always ready to ward off the blow of some new crises can have fearfully great effects upon our health *and* our ability to lead a "normal" life. Extreme, prolonged stress is believed to be linked to high blood pressure, increased incidence of heart attacks and strokes, and serious deterioration of important organs of the body. What's more, constant stress and anxiety exert a debilitating effect on the *mind* as well as the body. That "always tired" feeling—the inability to hold a problem in focus and think through a solution—both may have the same malevolent origin: *constant stress!*

Small wonder that Transcendental Meditation (TM) has found so many new converts in our overwrought society. Combining the mysticism of the East with varied exercises in meditation, TM seems to have proven helpful to many people in the relief of stress. Unfortunately, the technique is long in learning for many people and requires a daily regimen of meditation which some busy people find as hard to swallow as their dentist's demand for thrice-daily brushing!

However, there is another approach to stress—relief, relaxation, and the rejection of anxiety. This article will show you how to build an Alpha-Wave trainer to help you learn how to control these stresses with your own MINDPOWER.

Meanwhile, the alpha has a *direct visual impact* on the video display. In Mode 1, where the rectangle is normally stationary, when alpha occurs, the rectangle shrinks. Steady alpha will reduce it to a small dot at the screen center. When alpha stops, the rectangle grows again, until it fills the screen, or until reappearance of alpha reverses the process.

In Mode 2, the rectangle is always moving, originating as a dot at the screen center and automatically growing outward until it passes beyond the extreme edges of the screen, only to reappear at the screen center and start travelling outward again. In this mode, the occurrence of alpha slows or stops the rectangle's inexorable travel. Prolonged alpha will even back it down to a dot and hold it there!

The implications of this instrument are apparent. By feeding back success at alpha generation to the brain which is producing it, more and stronger alpha should be produced. With time and practice, it should be possible to extend the periods of alpha and, it may ultimately be possible for the user to generate the waves of relaxation *at will!* In effect, here is the prospect for developing a new retaliatory response to everyday stress, and to increasing the power of the mind to overcome anxiety.

Understanding your brain waves

More properly called the EEG (electroencephalogram), brain waves are neither incomprehensibly medical nor mystical. However, to properly understand the workings of *Mindpower: Alpha*, you must have a fair grasp of these simple facts.

The adult human brain contains some 12 billion neurons—specialized nerve cells that are densely packed to form an organ that weighs scarcely more than three pounds and fits easily into the limited space within the human skull. All of the brain's neurons exhibit *bioelectrical* activity: the production of small varying potentials associated with their functioning. Such a dense population of active neurons might be compared to a crowd of noisy spectators in a football

stadium, and the shouts of individual spectators likened to the changing potentials of individual neurons. Just as it would be hard to single-out a conversation within the noisy environment of the crowd, it is also practically impossible to single-out the electrical activity of just a few neurons in their "noisy" environment.

But just as the overall noise of the crowd is audible outside the stadium, so also are the gross changes of the bioelectric potentials detectable outside the brain, on the surface of the forehead and scalp. And, just as you, standing outside, might easily detect rhythmic chants of the crowd in the stadium without knowing specifically what is being said, so also can we detect rhythmic variations in the gross bioelectric activity of large neural masses of the brain by strategically placing electrodes on the forehead and scalp.

Early in this century, medical researchers discovered that the brain generates a broad spectrum of rhythmically varying electrical waves. Though very low in amplitude (on the order of 10 microvolts in averaging amplitude), these potentials are detectable at the skin surface of the forehead and scalp. At first, the waves appeared to be completely random—rather like the noise of the football stadium crowd. But, through patient research, investigators were able to separate

the dominant bands of brain-wave rhythms into these four:

delta (δ): 1–3 Hz

theta (θ): 4–7 Hz

alpha (α): 8–13 Hz

beta (β): 13–30 Hz

Further research has shown that psychological and physiological states affect the frequency content of the brain waves. Thus, when we are in deep sleep, the brain generates delta waves. Day-dreaming and problem solving brings up the theta waves. Fear, anger and intense concentration increase the beta waves. But a state of relaxation and tranquility bring up the alpha waves. A graphic recording of the brain waves produces a chart that is called an electroencephalogram. (EEG, for short).

The waves are recorded by placing electrodes on the forehead and scalp, and by measuring the instantaneous *potential difference* between selected pairs of electrodes. Thus, for example, the potential detected at the right frontal lobe of the brain may be differentially measured with respect to the potential present at the rear of the skull, opposite the left occipital lobe of the brain. The two electrodes, connected to a carefully designed high-gain differential amplifier that rejects common-mode voltages (60-Hz pickup, im-

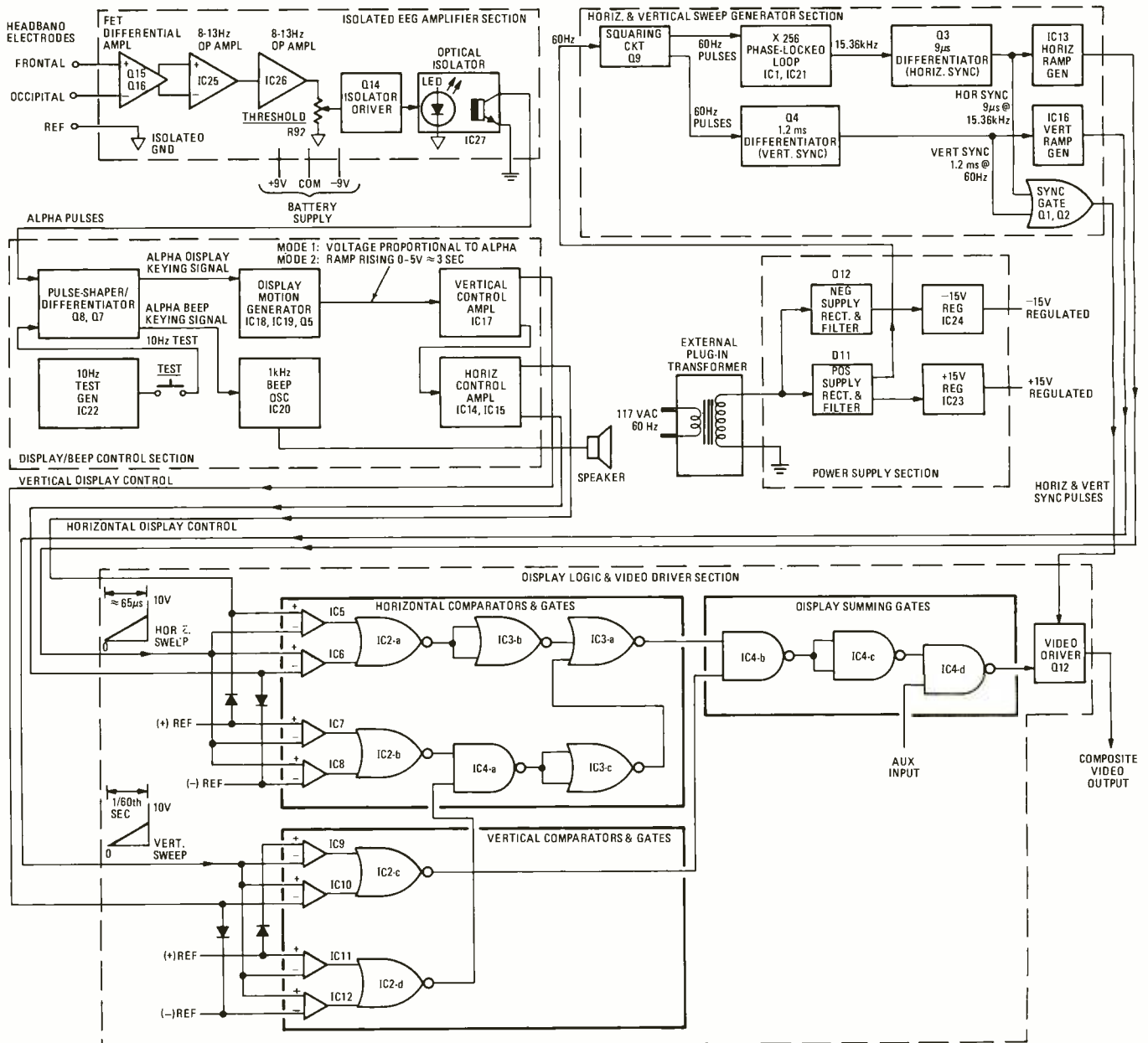

FIG. 1—MINDPOWER: ALPHA, block diagram. The device displays a pattern on a TV screen in accordance with the amount of alpha waves detected.

PARTS LIST

All resistors 1/4-watt 10% unless noted

R1, R2, R14, R16, R20, R28, R32, R45, R46, R64—10,000 ohms
 R3, R4, R41, R42, R47, R68, R72, R73—10,000 ohms, 5%
 R5, R31—2700 ohms
 R6—27,000 ohms
 R7, R8, R48—30,000 ohms, 5%
 R9, R10, R12, R13—3 megohms, 5%
 R11—3900 ohms
 R15, R53, R63, R65, R74, R75, R77, R78, R79, R80, R88—4700 ohms
 R17—820,000 ohms
 R18—22 ohms
 R19, R36, R52—56,000 ohms
 R21, R39, R44, R59, R76, R91—15,000 ohms
 R22, R34, R51—100,000 ohms
 R23, R25, R26, R33, R81, R82, R83, R84, R86—22,000 ohms
 R24—47,000 ohms
 R27—3300 ohms
 R29—10 megohms
 R30—1.5 megohms
 R35—750,000 ohms
 R37—20,000 ohms, 5%
 R38—4700 ohms, 5%
 R40, R89—1000 ohms
 R43—15,000 ohms, 5%
 R49—120,000 ohms
 R50—39,000 ohms
 R54, R57, R58, R60, R61—5600 ohms
 R55, R62—33,000 ohms
 R56—220,000 ohms, 5%
 R66, R71—13,000 ohms, 5%
 R67—220,000 ohms
 R69—12,000 ohms, 5%
 R70—7500 ohms, 5%
 R85—12,000 ohms
 R87—240 ohms
 R90—200 ohms
 R92—10,000 ohms, linear potentiometer

All capacitors 25V or more unless noted

C1, C2—0.47 μ F, 100 V, 10%

C3, C4, C5, C6—0.033 μ F, disc, 10%
 C7, C8, C20—5 μ F, electrolytic
 C9, C15, C29, C30—10 μ F, 25V, electrolytic
 C10, C12, C14, C19—1 μ F, 100V, 20%
 C11, C23—0.1 μ F, 100V, 10%
 C13, C26, C27—0.01 μ F, disc
 C16—(see text)
 C17, C18—2000 μ F, 50V, electrolytic
 C21—0.082 μ F, disc, 10%
 C22—0.33 μ F, 100V, 10%
 C24—0.015 μ F, disc, 10%
 C25—0.0068 μ F, disc, 10%
 C28—150 pF, disc
 C29, C30—10 μ F, 25V, electrolytic
 *C31, C32—10 μ F, 25V, electrolytic
 *If required (see text)

Transistors*

Q1, Q2, Q3, Q4, Q5, Q7, Q8, Q9, Q10, Q11, Q12, Q13—2N4401
 Q6—2N4403
 Q14—2N5524
 Q15—SE4021

Diodes*

D1 through D19—1N3064
 D20—1N5240, 10V, 10% Zener

Integrated Circuits*

IC1—CD4046AE (CMOS)
 IC2, IC3—CD4001AE (CMOS)
 IC4—CD4011AE (CMOS)
 IC5, IC6, IC7, IC8, IC9, IC10, IC11, IC12—LM311N (voltage comparator)
 IC13—LM318N (op amp)
 IC14, IC15, IC16, IC17, IC18, IC19, IC25, IC26—LM307N (op amp)
 IC20, IC22—NE555 (programmable timer)
 IC21—CD4040AE (CMOS)
 IC23—MC7815 (+15V regulator)
 IC24—MC7915 (−15V regulator)
 IC27—MCT-2 photocoupler

Miscellaneous

Printed circuit board (2 sided, plated through holes)
 Plastic case
 Miniature speaker, 8-ohms
 Headband assembly
 Battery clips
 Battery connectors
 BATT1, BATT2—9-volt alkaline batteries
 Transformer
 S1—3-pole, double throw slide
 S2—N.O. single pole pushbutton (or slide)
 S3—dpst slide
 S4—spst slide
 IC sockets
 Misc hardware

*Do not substitute

The following items are available from National Mentor Corp., Box 53, Wykagyl Station, New Rochelle, NY 10804

Circuit board. 2-sided, plated through holes. Order part number NM-P108: \$34.50

Transformer. Order part number NM-T6: \$17.50

Headband. Order part number NM-HA39: \$9.50

Case, punched and drilled. Order part number NM-C56: \$14.75

Set of all semiconductors including 27 IC's and 35 transistors and diodes. Order part number NM—Semis 1: \$99.50

Complete set of all parts needed to build Brainwave: Alpha: \$265.00.

All prices include postage and insurance in the continental United States.

pinging noise voltages, etc.) produce a signal that shows the predominant make-up of the brain waves across the greatest mass of the brain, traversing the frontal, temporal, parietal, and occipital lobes. In effect, such a signal describes the principal state of the brain's major, distinguishable lobes, thus providing a useful index of brain-wide mental state.

How it works

A simplified functional block diagram of *Mindpower: Alpha* is shown in Figure 1. There are five principal sections, enclosed by dashed lines. These are: the horizontal and vertical sweep generators, the display logic and video driver, the isolated EEG amplifier, the display beep control section, and the power supply.

Because *Mindpower: Alpha* creates a video display that is then acted upon by control signals developed from an alpha wave input, the most logical starting point is the horizontal and vertical sweep generators section.

To establish a field for producing a display on a TV screen, it is necessary to sweep the CRT electron beam both horizontally and vertically on the screen face. The horizontal sweep must produce 256 left-to-right lines (one-half frame), moving vertically from top to bottom of the screen within 1/60th of a second. Each line must be written within 65 microseconds. The flyback time between lines must thus be less than nine microseconds. To develop this basic field, the horizontal and vertical sweep generators receive a 60-Hz AC input signal from the AC power supply. This signal is squared by transistor Q9. This stage provides 60-Hz pulse outputs to the two sweep generators. Horizontal sweep is obtained with a X 256 phase-locked loop (IC1, IC21), that multiplies the input to an output of 15.36 KHz. This output

is differentiated by Q3, and is applied to the horizontal ramp generator, IC13. This stage produces a ramp voltage rising from 0 to 10 volts in 65 microseconds. Its output is applied to the horizontal comparators and gates of the display logic and video driver section.

Since the vertical sweep rate is synonymous with the line frequency, the pulse output of Q9 is simply differentiated to produce pulses which control the vertical ramp generator, IC16. The output of this stage is a ramp voltage rising from 0 to 10 volts in 1/60th of a second (16.7 milliseconds), and is applied to the vertical comparators and gates of the display logic and video driver section. Sync pulses to determine field timing are provided by sync driver Q1, Q2 to video driver Q12.

The two ramp voltages provided from these earlier stages are used to produce a rectangular display by comparing their instantaneous voltage levels against reference voltage levels in horizontal comparators IC5 through IC8 and vertical comparators IC9 through IC12. These develop beam control signals which determine the point on each line where the CRT electron beam will be turned-on and shut-off. However, since it is desired to produce a rectangle display rather than a cross-hatch, we must use logic to eliminate those line segments which lie *outside* the rectangle's confines. This function is performed by gates IC2, 3, and 4. The result is a white rectangle on a dark field, sized (in Mode 1) to fill about 75% of the screen's usable area. This video signal is applied to the television set by video driver Q12.

Having established the basic display, all we now need is a way to vary the *size* of the display. This is done by the display/beep control section. Vertical control amplifier IC17

(continued on page 91)

MITS

WORLD ALTAIR

COMPUTER CONVENTION

THE FIRST WORLD ALTAIR COMPUTER CONVENTION WAS HELD March 26-28 at the Airport Marina Hotel in Albuquerque, NM. Successful? Was it ever! Over 700 participants from 46 states and 7 foreign countries gathered to talk computers, exchange information, ask questions, participate in seminars, match their system against other systems in a demonstration contest and see many different systems in operation.

MITS sponsored the convention and they plan to make it an annual event. Seminars were presented by MITS' engineers and software developers.

Saturday night's event was a discussion led by a group of



GUEST SPEAKERS at Awards Banquet are, from left to right, Lou Fields (Vice President of Southern California Computer Society), Manfred and Virginia Peschke (publishers of Byte), David Ahl (publisher of Creative Computing) and Larry Steckler (Editor of Radio-Electronics).

guest speakers. The theme of the discussion was the future of computers in general and its effect upon hobbyists in particular. The group of speakers included Ted Nelson (author of *Computer Lib*), David Ahl (*Creative Computing*), Carl Helmers (*Byte Magazine*), Larry Steckler (**Radio-Electronics**) and Les Solomon (*Popular Electronics*) among others.

The highlight of the convention was the awards banquet held Sunday where the winners of the demonstration contest were announced. The grand prize, a complete Altair floppy-disc system, was awarded to Don Alexander of Columbus,



BILL GATES, one of the writers of Altair Basic, presents a general software seminar.



SEMINARS were interesting and well attended, as can be seen from the above photograph.



CARL HELMERS of Byte receives trophy from Lou Fields, Vice President of Southern California Computer Society, in recognition of Byte's contribution to the home computer field.

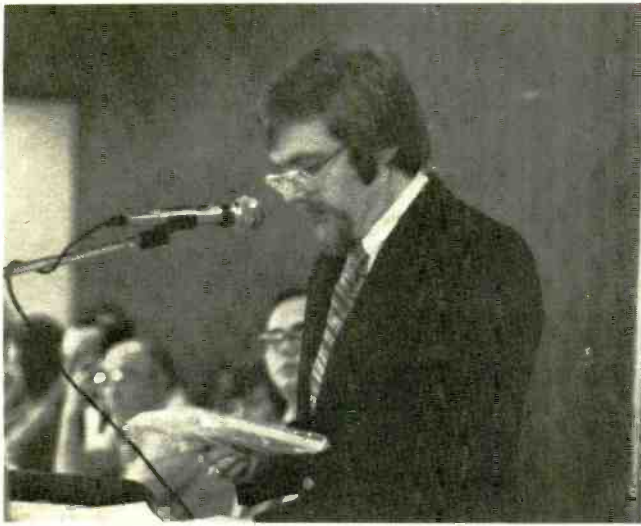

PAUL ALLEN, director of software at MITS, announces the winners of the software contest at the Awards Banquet.

OH, for his computer-controlled amateur radio station. The system consisted of an Altair 8800 with 8K of memory, an ASCII keyboard, a video display, Baudot Teletype and stan-



DON ALEXANDER receives Grand Prize, a complete Altair floppy-disc system, for his amateur radio station.



GRAND PRIZE WINNER Don Alexander demonstrating his computer-controlled amateur radio station.

dard transmitter and receiver. The system was designed to transmit and receive messages in a radio Teletype contest. The Altair was used for ASCII to BAUDOT translation, cross-checking calls for duplication, transmitting the time and message number of a transmission and generating a hard-copy printout of all exchanges. Mr. Alexander devel-

oped his own software and wrote the assembler and editor in addition to building the hardware.

The competition resulted in a tie for second place. Randy Miller of Tempe, AZ, with a computer chess demonstration and Wirt and Valerie Atmar of Las Cruces, NM, with a speech synthesizer, were the second place winners. Both winners received an Altair 8800B.

Third place was awarded to Danny Kleinman, Steve Grumette and Mike Gilbert of Los Angeles, CA, for their



NORMAN TILBURY AND BARBRA SOLOMON demonstrating Daylight Savings Company system.

backgammon game. The software was written in Altair Basic and displayed by a Cromemco TV Dazzler. An Altair 16K static-memory card was the prize.

The winners of the MITS' yearly software contest were also announced at the banquet. James Gerow of Houston, TX, took first place for the Best Program and Lee M. Eastburn of Langdon, MD, won the top prize in the subroutine category.



WINNERS OF THE DEMONSTRATION CONTEST are, from left to right, Randy Miller (second place), Danny Kleinman, Steve Grumette and Mike Gilbert (third place).

This was the first computer convention of its kind and you had to be there to experience the enthusiasm. Computer hobbyists brought just about everything with them to the convention—from Teletypes to floppy discs. Have you ever walked through the halls of a hotel in the early hours of the morning and heard Teletypes clanking away? The era of the home computer system is definitely upon us and we would like to add our support to MITS and hope their plans for an annual convention develops into a reality in time for next year's convention. **BRAVO MITS!**

R-E

State of SOLID STATE

A new semiconductor transistor-like device from G-E that operates beyond 3 GHz, new memory devices and power Schottky diodes are featured this month

KARL SAVON
SEMICONDUCTOR EDITOR

GENERAL ELECTRIC HAS A NEW SOLID-STATE device designed for operation beyond the present 3-gigahertz limitation of present transistors. Seven times higher frequency range will be possible with the new triode. The CATT (Controlled Avalanche Transit Time) triode combines transistor and IMPATT diode features.

Radar and communications equipment design should be simplified by the G-E development. The CATT could play an important role in increasing activity in the less crowded upper portion of the radio spectrum.

Just like conventional transistors, the low power input signal feeds the emitter-base junction, injecting carriers into the base region. The base-collector depletion region has an IMPATT diode profile with the avalanche zone close to the base.

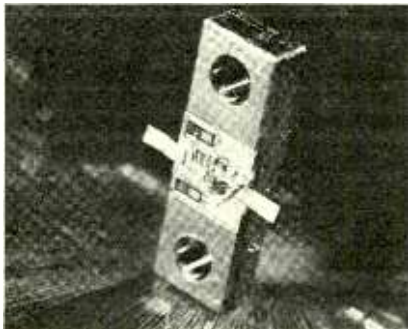

G-E's TRANSISTOR-LIKE CATT TRIODE, shown mounted for operation in a microstrip circuit, can operate at as much as seven times the frequency of conventional transistors.

Computer simulation was used in the development of the triode. So far devices have been operated between 2 and 3 GHz with 12 watts output, 13 dB gain, and 30% collector efficiency.

General Electric Company, Research and Development Center, P.O. Box 8, Schenectady, NY 12301.

Memories

TI and Signetics have introduced new memory products.

Texas Instruments has the TMS4033, 4044, and 4045 types organized as 1024 1-bit words. Their access times are 450, 650,

and 1000 nanoseconds. N-channel silicon gate technology is used and they are fully compatible with the 74 TTL series. The price of the TMS4035NL is \$13.36 in 100 quantities.

Signetics' 82S10 open collector and 82S11 tri-state output is a 1024 x 1 bipolar RAM. It is the fastest 1024 bit bipolar random-access-memory on the market

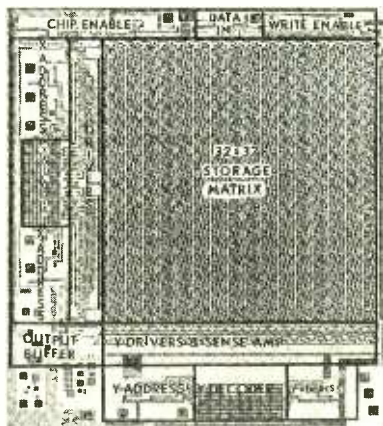

SIGNETICS 82S10 bipolar random-access memory.

with a 30-ns typical access time. Schottky processing and dual-layer metalization is used. It surpasses other high speed 1024 bit RAM's, whether ECL or quasi-static N-channel, as well as standard 256-bit TTL RAM's. Performance is at the same level as 256-bit ECL RAM's and specially selected TTL RAM's. Typical input currents are 10 microamps giving a reduction in fan-in. This specification lets a single TTL gate drive many paralleled address and control inputs, well beyond the normal fanout of 10. The 82S10 and 82S11 can be used in high-speed main frame, cache memory, buffer storage and writeable control storage applications.

TRW power Schottky diodes

All the energy converted from the AC power line to DC voltages passes through the power-supply rectifier diodes. Power dissipation in the diodes is often substantial. A 1-volt forward diode drop at 10 amps is 10 watts of unproductive dissipation. Efficiency is poorer at the lower

power-supply voltages because a larger proportion of the voltage appears across the diodes. Many logic, computer, and industrial systems use 5 volt supplies at large currents.

Schottky diodes have forward drops that are less than half the comparable normal silicon junction drops, and wasted power drops in the same proportion. Not only does power supply efficiency leap upward, but the entire cost picture improves. The devices shrink in size because of the reduction in thermal resistance requirements. System cooling and heat exchange needs are less demanding.

TRW has added the new SD-41 30-amp device to their already existing SD-51 60-amp device. Early Schottky rectifiers had problems at high temperatures and high reverse-voltages. But the SD-41 has a maximum forward voltage drop of only 0.55 volt at 30-amps and an unprecedented 125°C case temperature. The SD-41 is rated at a maximum reverse-current of 100-mA at 125°C and 35 volts. Non-repetitive 500-amp peak forward-current surges cause it no harm. Reverse recovery-time is under 10 nanoseconds.

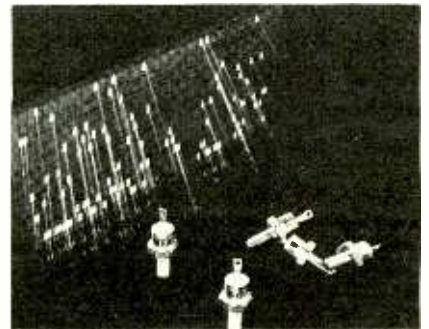

TRW POWER SEMICONDUCTORS' 30-amp Schottky diode.

Schottky's have metal-to-silicon junctions instead of conventional PN junctions. TRW credits much of the superior performance of their power Schottky line to a new structure that uses a proprietary metalization technique for the interface in the silicon-to-metal junction.

TRW's SD-41 comes in a JEDEC DO-4 case and is priced at \$5 each in production quantities.

R-E

DIGITAL REVERB FOR TODAY'S HI-FI SYSTEMS

A new digital time-delay system that brings the spaciousness associated with a concert hall into the living home

LEN FELDMAN
CONTRIBUTING HI-FI EDITOR

EVEN AN UNTRAINED LISTENER CAN easily distinguish the differences between music in a spacious concert hall and the same music reproduced over an audio system in a home listening environment. The concert hall has richness and depth because of the blending of the direct sounds coming from the performers on stage with indirect sounds reflected in a variety of complex patterns from the sides and rear of the hall. These reflected sounds arrive fractions of a second later than the direct sounds and, though they may not be perceived as separate sounds by our ears, are responsible for the listener's ability to perceive—even with eyes closed—that the musical event is taking place in a spacious environment.

Earliest recording experiments with 4-channel sound attempted to recreate this feeling of spaciousness or ambience by using the added pair of back channels to record and reproduce random reflections picked up at some point far removed from the sound itself. Less dramatic, perhaps, than later "surround sound" quadraphonic recordings (in which primary musical information reaches the listener from every direction), the "ambience" approach to 4-channel sound soon gave way to more "gimmicky" musical effects. At a recent electronic industry exhibition in Chicago, we were introduced to a newly developed digital time delay system which, to our ears, seemed more able to recreate the spaciousness of a concert hall than any quadraphonic approach we had heard before. Designated the *Model One Digital Time-Delay System* by its makers, Audio Pulse (a division of Hybrid Systems, Inc.), this unusual device synthesizes the live listening experience by adding multiple continuous time delays to the original content of a stereo recording or broadcast. The delayed reverberant

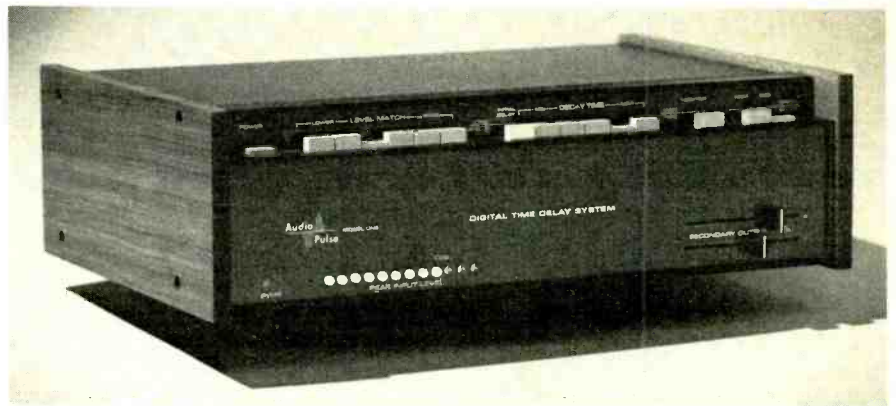

AUDIO PULSE MODEL ONE time-delay system eliminates the disadvantages inherent in mechanical delay lines.

signal is fed to a separate stereo amplifier and heard over a second set of speakers to the sides or rear of the listener's usual seating area. The number, length and combination of time delays can be varied, so that the blend of direct and indirect sound in a listening room can be varied to suit different kinds of music and listening requirements. Fig. 1 shows how the time-delay unit would be hooked into an ordinary stereo component system. Superficially the setup resembles the familiar 4-channel array, but that's where the similarity ends.

Digital design comes to audio

Nor is Audio-Pulse's time delay system a new-fangled version of the old mechanical "reverb" units which employed springs as transducers and were moderately popular in the earlier days of high-fidelity and stereo. Such spring devices were noted for adding a "twangy" coloration to delayed or reverberant signals produced by them, and, in any event, delay effects were at best random, incapable of being varied, and certainly unrelated to what takes place in a large concert hall.

The Audio-Pulse unit can be thought of as a miniature computer containing an electronic model of acoustic space. Using various components to be described, the system converts input audio signals to digital pulses with an analog-to-digital (A/D) converter. Once in digital form, signals can be delayed by selected amounts of time, added or mixed together at selectable amplitudes and finally reconverted by a digital-to-analog (D/A) converter and reinserted into the audio reproduction chain through the extra pair of amplifier and speaker channels.

The idea of electronic digital time delay for audio is not, in and of itself, new. Such devices as the *Cooper Time Cube* have been in use in professional recording studios for some time. Their drawback, from the home user's point of view, has been their cost, which can mount up to several thousands of dollars because of the complexity of the circuits involved. While the Audio Pulse unit employs the equivalent of 150,000 transistors (most of which are reduced to integrated circuitry), its advanced encoding process and decoding process has made possible the introduc-

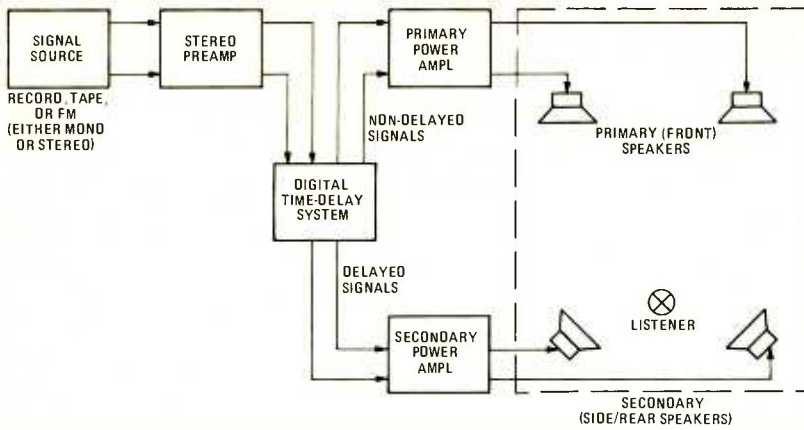

FIG. 1—THE DIGITAL TIME DELAY is inserted in the rear-speaker circuit of a four-speaker system, after the stereo preamp.

tion of this device at a cost of under \$600.00.

This time delay system is a unity-gain device. It contains level-matching input and output circuitry to enable the line-level audio signals to be matched to the dynamic range of the digital encoders for optimum signal-to-noise ratio. Selecting the optimum gain is simplified by a sensitive, frequency-controlled, front panel 3-color, 12-LED display which continuously shows the peak signal levels at the encoder inputs.

Circuit description

A simplified block diagram (Fig. 2) will aid in understanding the operation of the digital time delay system. In each channel, the incoming audio signal is fed to a buffer stage and then to an active filter, which attenuates frequencies above 8 kHz. This deliberate roll-off is introduced because it has been found that in actual concert halls the reverberant-field energy rolls off rapidly at high frequencies. The filtered audio signal then goes on to a pre-emphasis/compression circuit used as a noise reduction encoder, somewhat analogous to Dolby (but with different characteristics specifically matched to the behavior of the encode-decode system which follows.)

The audio signal in each channel is converted to digital pulses by an analog-to-digital (A/D) converter. This particular A/D circuit is a new one employing *Delta Modulation With Memory*, which will be explained in detail shortly, and which was developed expressly for this instrument. The A/D encoding takes place at regular intervals defined by the "clock". In the LONG position of the front panel INITIAL DELAY switch, encoding occurs at a rate of 250,000 pulses per second. In the SHORT position of the switch, the encoding interval is about 2.5 microseconds, yielding 400,000 pulses per second.

At either rate, the two channels of pulses are fed into two serial memories consisting of a total of thirty-seven 1,000-bit shift registers. In either channel, as each clock pulse occurs, a data pulse from the encoder enters the first shift register and all the data pulses in the memory are shifted by one bit. Pulses emerge from the opposite end of the shift register bank after a time delay that is simply the clock interval multiplied by the number of shift register bits. In addition to this full delay, a briefer partially delayed signal is obtained by tapping the shift register memory at about one-third its length.

The fully and partially delayed pulse trains then go to the digital-to-analog (D/A) converters to be decoded back into audio waveforms. The decoders also operate on the Delta Modulation principle and complement the A/D converters precisely.

Fully and partially delayed audio signals are fed to a variable mixer. Here, relative proportions of partial and full delays are controlled by a bank of selectable DELAY TIME switches on the front panel. Increasing the proportion of the fully-delayed signals lengthens the reverberant decay time and *vice versa*.

A dynamic expansion/de-emphasis circuit restores the signal to its original dynamic range and frequency spectrum balance while reducing noise and distortion introduced by the digital encoding and decoding process. An active filter, similar to the one used at the input, smoothes out the signal and reduces residual noise beyond 8 kHz while limiting reverberated signals to that bandwidth. The delayed output from each channel is fed back and mixed into the input of the opposite channel, where it is further delayed and then fed back to the input of its original channel, and so on. In addition to these cross-channel recycling loops there are also recycling loops within each channel (not shown in Fig. 2). As each delayed signal is recycled it is mixed into the input at a reduced level, corresponding to the attenuation of a sound wave as it is reflected from the walls of a concert hall. As a result, the composite output signal following an input transient contains dozens of delayed signals, decaying exponentially in amplitude, very much like the actual reverberant decay of sound that takes place in a real concert hall, as illustrated in Fig. 3.

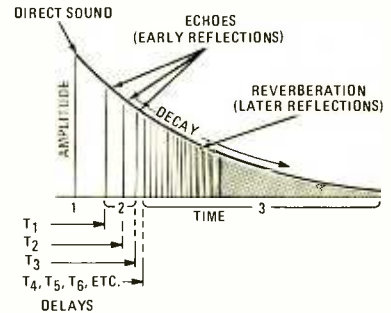

FIG. 3—THE DELAY APPROXIMATES the reverberation in an actual concert hall, as represented in this drawing.

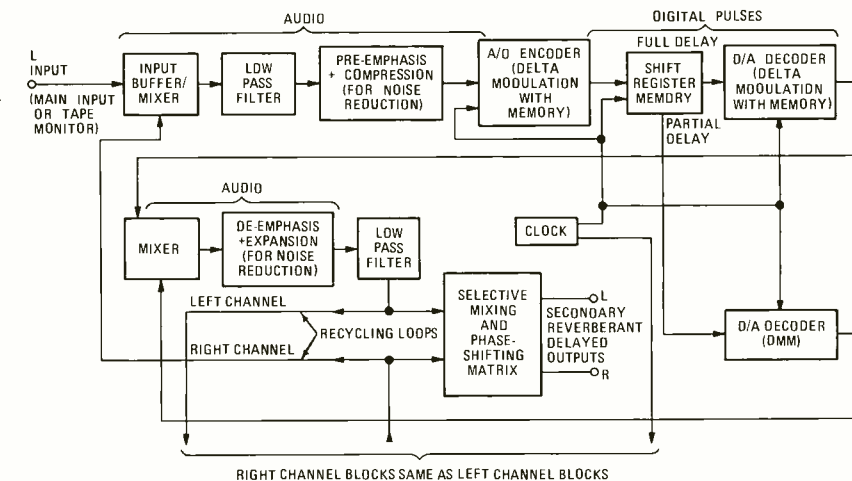

FIG. 2—HOW THE SYSTEM WORKS—a simplified block diagram of the operation.

In a real concert hall or any other large acoustic space, reverberant-field energy arriving at a listener's two ears is largely incoherent and random-phase in character, with little or no left-right symmetry. So, the Model One contains active signal processing output circuits following the digital time delay circuitry. These include a phase-shifting

network whose purpose is to insure that the delayed signals will have the spacious, non-localizable character of actual reverberant-field energy in an acoustic space. At the same time, these extra circuits solidify the bass energy in the sound field by minimizing low-frequency cancellations due to the standing waves in listening rooms of typical size.

Delta modulation with memory

As mentioned earlier, the most important element in this time delay audio system is a new form of analog-to-digital converter which Audio Pulse calls "Delta Modulation With Memory" (DMM). Unlike conventional pulse code modulation (PCM) encoders, which digitally encode the amplitude of audio waveforms, the DMM encoder is a waveform slope detector, which digitally encodes the moment-to-moment *changes* in the audio signals applied to it. To understand its operation, refer to Fig. 4, which is a detail of the more generalized central blocks of Fig. 1 (A/D encoder, shift register memory and D/A encoder).

The core of the digital DMM encoder is a comparator IC. The comparator is essentially a high gain open-loop operational amplifier in disguise. It has two inputs ("sig" and "ref") and one output. This comparator is a binary, or digital device in that it is capable of only two output levels of

voltage. If the audio signal voltage is greater than the reference voltage, output of the comparator is equal to the power supply voltage (corresponding to a "1" logic state). When audio signal level is less than reference voltage level, comparator output instantly flips to 0 volts (corresponding to a "0" logic state).

In the DMM circuit developed by Audio Pulse, the reference voltage supplied to the comparator is not a fixed level; rather, it is a rising or falling voltage ramp. The ramp generator is part of a feedback loop that varies the comparator reference voltage in an attempt to track the incoming audio signal voltage. Thus, the comparator's binary output is essentially an error signal continuously indicating whether the ramp generator's voltage is above or below the audio waveform voltage. Generation of the reference voltage is the key to the DMM encoder's operation.

At regular intervals of a few microseconds (as determined by the clock signal), the comparator's "up" or "down" output state is transferred into a short-term digital memory. This memory contains several storage cells (the exact number remains a proprietary secret with Audio Pulse, for the moment) which retain logic "1"'s and "0"'s generated during an equal number of previous clock intervals. The contents of the memory comprise an n-bit digital code ("n" being the number of cells) which describes recent history of the audio signal waveform. At each clock interval this group of logic pulses is fed to a weighting network whose output controls the ramp generator. The ramp generator produces a rising or falling voltage ramp whose polarity and slope are selected in accordance with the control signal produced by the weighting network.

The weighting network uses the pattern from the digital memory to predict what the audio waveform slope will be during the forthcoming clock interval, and it causes the ramp generator to produce a voltage ramp whose slope approximately leads the predicted audio waveform slope. The comparator then generates an "up" or "down" binary output, depending upon whether ramp voltage rises above or falls below audio waveform voltage during the next clock interval.

The serial pulse train that results is then time-delayed by sequential shift through the shift registers. The output pulse train from the delay shift register is identical in every way to the pulse train generated by the encoder section except for its time delay.

When the delayed pulse train reaches the decoder, it is fed into a multiple-bit digital memory which is identical to

that used in the encoder section. In each clock interval, pulses in the DMM decoder memory comprise an n-bit digital code identical to that previously found in the encoder. The pulse group is fed to a weighting network (also identical to that in the encoder) whose output controls another ramp generator. The delayed pulse train causes the decoder's ramp generator to reconstruct audio waveforms, segment by segment. The low-pass filter removes the sharp corners of the reconstructed waveform, resulting in a smooth and undistorted delayed replica of the original audio signal.

While delta modulators have been available for several years and, unlike PCM encoders, cannot be overloaded by low-frequency or mid-frequency signals (unless they exceed the encoder's power supply voltage), the simpler form of basic delta modulator was subject to severe slew-rate limitations and had a constricted high-frequency dynamic range. The development which made the Audio Pulse Model One practical was the new form of delta modulator with short-term memory which has just been described. The encoder's slew-rate is effectively quadrupled in this approach, providing ample dynamic range for high-frequency transients.

What is most exciting about this new device is that, in our opinion, it provides a level of sonic realism that serious audiophiles have sought for a long time (and have not been able to find in any available quadraphonic system, as presently offered). While it does call for a second stereo amplifier and pair of speakers, the performance requirements for those extra pieces of equipment do not seem to be as critical as they are for quadraphonic reproduction. Since bandwidth of the reverberant sound signals is deliberately restricted to reproduce the narrower bandwidth of reflected sound, the second pair of speakers not be ultra-wide range. And since the device requires no special program material (it even does some remarkable "space expanding" when reproducing older, monophonic program sources), it won't become obsolete or incompatible.

Evaluative listening test

We first heard the Audio Pulse Model One in a listening room which was, if anything, smaller than most people's living rooms. Speakers driven by the Model One and its second stereo amplifier were mounted fairly high on the side walls of the room parallel to our front-to-back listening point. The most amazing thing about what we heard is the fact that one is not conscious of the presence of those

(continued on page 108)

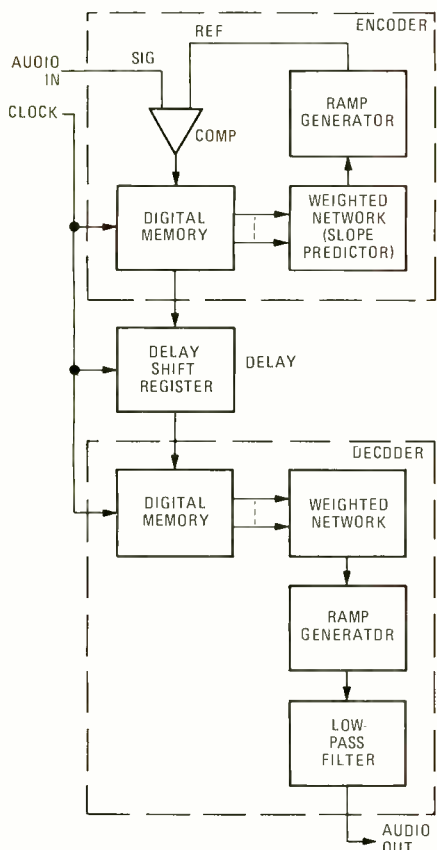

FIG. 4—DIGITAL MODULATION WITH MEMORY circuit is an expansion of the encoder, delay and decoder blocks shown in Fig. 1.

Build A Gas Sensor

This simple device measures the concentration of various noxious gases



THE GAS SENSOR gives a direct readout of the relative concentrations of noxious gas.

CASS R. LEWART

THE GAS SENSING INSTRUMENT DESCRIBED in this article can detect and measure low concentrations of various noxious gases in your car or boat and can possibly give you a warning before it is too late. The instrument is based on an inexpensive semiconductor device called the Taguchi Gas Sensor (TGS).

Sensor operation

The TGS sensor changes its resistance as a function of minute quantities of a deoxidizing gas that is present. Typical gases detected by this device are carbon monoxide, gasoline or alcohol vapors, propane, methane and hydrogen. The TGS sensor consists of a combination of n-type metal oxides, such as tin, zinc and ferric oxides, that decrease their electrical resistance with an increasing concentration of a deoxidizing gas.

The sensor has an amazing range of sensitivity to gas concentration. Depending on external circuitry, it can detect concentrations of a few parts-per-million, but it can also be used to measure high gas concentrations encountered in the exhaust of an automobile. Due to this wide sensitivity range, the instrument can be used to check the inside of a boat, car or trailer for escaping gasoline vapors, carbon monoxide or exhaust fumes. It can also be used for automobile tune-ups. Because of the wide variety of gases to which

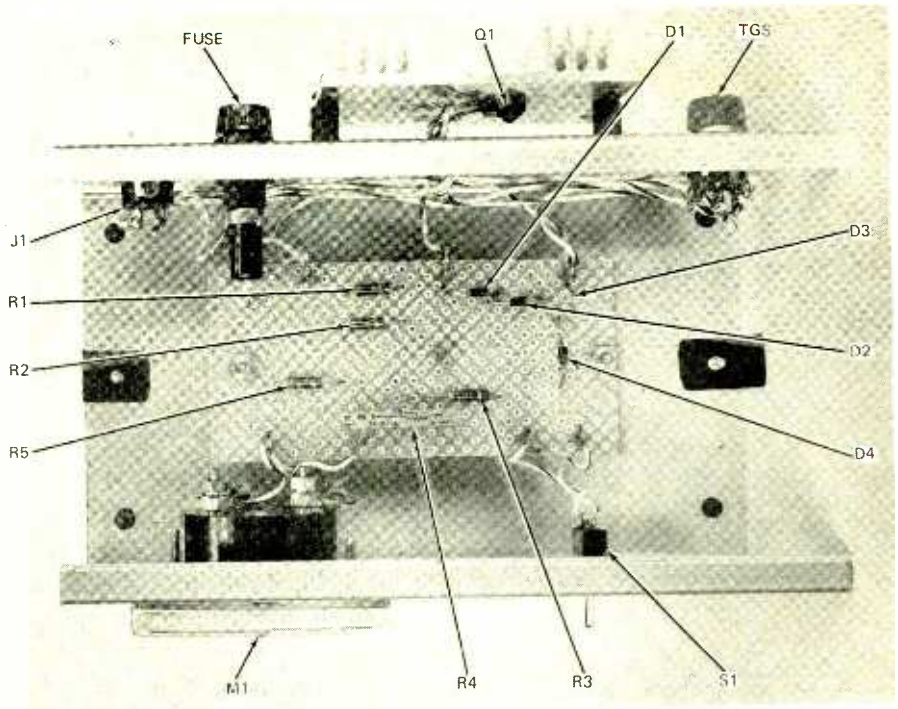

the TGS sensor responds, the readings of the instrument can only be interpreted in a qualitative, comparative way.

If you observe the meter needle jumping as the TGS sensor approaches a pipe joint, you will know that gas is escaping. If the inside of your car, boat or trailer gives a higher meter reading than the fresh air, you will know that a problem exists. However, there is no way to translate the meter readings directly into gas concentration because the sensitivity of the TGS sensor is different for various gases.

Circuit description

The circuit consists of a regulated voltage supply for the TGS sensor and of a resistance-indicating meter that has its own regulated voltage supply. A higher than normal concentration of a noxious gas lowers the TGS resistance between pins 1, 2 and 3, 4 and causes the meter reading to increase.

The TGS sensor requires approximately 1 volt at 0.4 ampere to operate. This voltage is derived from a 12-volt automobile or boat battery by the voltage regulator consisting of the transistor Q1 and three diodes as shown in Fig. 1. The voltage drop across diodes D1, D2 and D3 (approximately 1.7 volts) minus the voltage drop across the base-emitter junction of Q1 (0.7 volts) provides the required regulated voltage of 1 volt for the TGS sensor.

Then Zener diode D4 supplies a constant voltage for the resistance-indicating meter circuit making it independent of battery fluctuations. The initial adjustment consists of connecting points A and B with a jumper wire and rotating R4 to read full scale on the meter. Switch S1 shunts resistor R5 across the metering circuit, thus giving a LOW and HIGH sensitivity range of gas concentration. A 0.75-ampere fuse is recommended to protect the circuit.

The normal reading on the meter after the initial warm-up of 5–10 minutes is 0.3–0.6 mA on the HIGH sensitivity setting and 0.1–0.3 mA on the LOW setting. You can test the circuit by putting a drop of gasoline on your finger, bringing it close to the TGS sensor and watching the meter needle deflect. The meter should then register close to its maximum reading. After the sensor detects a high gas concentration, it takes several minutes after the gas removal until the reading goes back to normal.

Construction

Wiring of the circuit is not critical, however, we would recommend the parts layout shown. Mount the meter in a metal cabinet. Depending on the intended use you can mount the TGS sensor on the cabinet or in a separate housing connected with a 3-wire extension cord to the main circuit. The TGS sensor will fit into a 7-pin miniature

PARTS LIST

All resistors are 1/2-watt, 10%, unless noted.

R1—1000 ohms
R2—150 ohms
R3—6800 ohms
R4—5000-ohm potentiometer
R5—680 ohms

D1, D2—1N914 diode (HEP154, HEPR0050, or equal)

D3—1N34 diode (HEP134, HEPR9134, or equal)

D4—9-volt, 1-watt Zener (HEP104, HEPR0412, or equal)

Q1—2N5190 transistor (HEP701, HEPS5000, or equal)

S1—SPST switch

J1—Male 2-conductor connector

M1—1-mA meter (Calectro D1-912 or equal)

TGS—TGS gas sensor, order from Southwest Technical Products, Dept. RE, 219 West Rhapsody, San Antonio, TX 78216. \$6.25 postpaid.

Metal cabinet—8 × 4 × 6" (Lafayette Radio Electronics, catalog no. 12-R-03074V, or equal)

Misc.—Heat sink (Radio Shack no. 276-1361 or equal), 7-pin tube socket, Vector board, fuse, hardware.

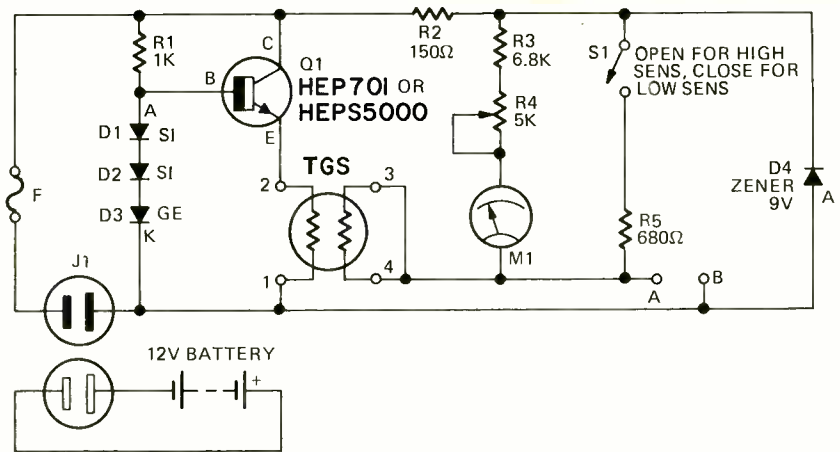

FIG. 1—GAS SENSOR is built around sensing element that changes resistance in accordance with gas concentration.

tube socket with only 4 pins being used. The input pins 1 and 2 and output pins 3 and 4 of the sensor are interchangeable.

The power transistor Q1 dissipates approximately 4 watts and should be mounted on a heat sink outside the cabinet. Use fiber spacers to mount the heat sink to the cabinet. Check diodes D1, D2 and D3 before connecting the unit to the cigarette lighter in your car. An open or reversed diode may destroy the sensor.

R-E

Public Broadcasting Service wants captioned video

A petition recently filed with the FCC by Public Broadcasting Service asks that video scanline 21 be permitted to carry captions so that deaf viewers may read the titles and some of the information content of the program they are watching. This, it is estimated, would help 13.7 million hard-of-hearing television viewers. Station WETA, channel 36, near Washington, DC, has been given permission to test the system.

Home decoders for these captions are expected to cost less than \$100, and since they have been developed under federal funding, their designs will be available to all manufacturers.

An important by-product of the proposal is a special "ghost excisor" that cancels secondary bounce reflections. Engineers suspect that this excisor could be developed to the point that all video ghosts could be curtailed or eliminated.

Public Broadcasting Service would use satellite relays

The FCC has been asked to approve a plan for linking the Public Broadcasting System (PBS) stations by satellite instead of by leased land-lines as at present. Economy (savings of \$1 million per year), better reception and more flexibility in programming are cited as advantages of the proposed system. The plan, approved by the annual conference of PBS members held in Los Angeles last February, would provide three two-way channels. Under the present system, programs are sent out over a single line for live broadcast or taping for later use by

the receiving station. The three-channel system would have far more flexibility and capacity (comparable to that of a three lane, two-way highway as opposed to a one-lane, one-way road).

With three channels, PBS could send out two programs at the same time giving its stations a chance to select. Programs could also be originated from various points and individual stations would even be able to exchange programs. While all these types of transmission are technically possible with leased lines, the excessive costs make them practically unattainable.

Quality would be better since signals can deteriorate when sent long distances in 30-mile jumps by microwave, and reception would be more uniform—each station would receive practically the same signal.

Western Union is prepared to offer three two-way channels on its Westar satellite, and Collins Radio has bid for the construction of earth stations at about \$100,000 each.

X-ray tomography patent to Maryland doctor

Patent 3,922,582 has been issued to Dr. Robert S. Ledley, of Georgetown University Medical School, for an X-ray machine that scans any organ, or the whole body, and immediately displays a cross-section of the area scanned.

Tomography, a technique that has attracted the attention of several scientific journals recently, is performed by what one reviewer called the "barbecue" method. However, instead of rotating the body being scanned, the X-ray tube is

rotated around the body. On the opposite side, a group of X-ray detectors—with sensitivity far surpassing that of any X-ray film—is rotated. The area of interest is in the center of the plane of rotation. Scanning signals are fed continuously into a computer that generates—as soon as the scanning is complete—a cross-section picture of the scanned area on a color television receiver.

The cross-section picture (tomograph) shows the exact location of any object in the plane being scanned. Thus a brain tumor or other object can be located for surgery. Much lower-voltage (softer) X-rays can be used with this technique, reducing the amount of radiation the patient receives. Resolution down to one millimeter is possible (this is good in X-ray photography!). This makes it possible to see such details as a clogged coronary artery that would be difficult or impossible to see in an ordinary X-ray photograph.

Cost is also high—about 20 times that of an ordinary X-ray machine. In spite of that, about four dozen of the machines are already in use.

Smokey ticketed by FCC

The FCC hands out hundreds of fines each week—to amateurs and CB'ers. The difference is that this particular fine goes to a police station in Marlton, New Jersey. Their police radio station, call sign KFR-661, was in "repeated violation of Section 1.89 of the rules by failing to reply to official communications." The fine was set at fifty dollars.

R-E

build an 8080 microcomputer

The first two parts of this article (May and June, 1976) described the Dyna-Micro and presented the construction details.

This third and concluding part of the article discusses the 8080A and describes how the Dyna-Micro works.

The 8080A microprocessor

The 8080A microprocessor is an eight-bit parallel central processing unit (CPU). Unlike the earlier 8008 and 8008-1, the 8080A is a more powerful, easy to use device. The 8008 was an 18-pin device and many things were multiplexed on the same bus. The 8080A is a 40 pin package that offers many advantages over the earlier devices:

- A simplified bus that has separate address (16 bits) and data (8 bits) buses.
- Three state and TTL compatible buses.
- Simplified control.
- Improved interrupt and stack.
- More instructions.

While the power and clock requirements for the 8080A are more complex than for the 8008, they are easily met.

How the Dyna-Micro works

The Dyna-Micro uses the same basic computer functions found in most other computers, large or small. These are:

- Central processing unit (CPU)
- Memory (R/W and PROM)
- Control Logic
- Input/Output Control
- Clock and power supplies

The 8080A has 24 output-lines, 16 of which are used for address information and eight of which are a bi-directional data bus taking data to and from the CPU. The data flow on the data bus is controlled by the \overline{DBIN} (Data Bus IN) signal from the 8080A chip on pin 17. Two bus buffers, Intel type 8216, are used to boost or buffer the data bus outputs and to protect the 8080A's inputs. The \overline{DBIN} signal switches the 8216 IC's for either input or output of data on the bus.

The system's operation is controlled by signals from the 8080A at various times as synchronized by the clock frequency. An Intel 8224 clock chip with a 6.75-MHz crystal is used to provide the 750-kHz MOS clock levels to the 8080A. These clocks are slightly out of phase and do not overlap. While the 8080A chip can operate at frequencies up to 2 MHz, the Dyna-Micro's clock

has been set to 750 kHz so that it will work with the relatively slow 1702A type PROM's. You can increase the speed of the Dyna-Micro by using a higher-frequency crystal. The 8224 chip divides the crystal's frequency by nine, so an 18 MHz crystal will give the 2 MHz output needed for the highest operating speed.

The clock chip also synchronizes the READY input with the clock so that system can slow down for slow memories and I/O devices. The RESET input from the R key is also input to the 8224 IC where it, too, is synchronized to the clock and output to reset the 8080A.*

The 8080A's data bus will also contain some STATUS information that is used by the control logic section to synchronize its control operations. The STATUS information is output and is available when the SYNC signal is output from the 8080A. The 8224 clock IC gates the SYNC pulse from the 8080A with the main system clock to provide a very short STSTB (Status Strobe) signal that 'catches' the status information in the SN74174 latch. The status information indicates data output, data input, halt condition, memory read, memory write and a special condition that signals the start of the next instruction, M1. Four of these status signals are gated with other system signals to provide the \overline{IN} , \overline{OUT} , \overline{MW} and \overline{MR} signals used throughout the Dyna-Micro. These signals are used as indicated below:

- \overline{IN} and \overline{OUT} —used to synchronize data flow to (\overline{IN}) and from (\overline{OUT}) the 8080A CPU. They are used with external devices for data transfer.
- \overline{MR} and \overline{MW} —used to indicate to the memory that the computer is executing a Memory Read or a Memory Write.
- \overline{INTA} —indicates that the computer has acknowledged an interrupt.
- HALT and \overline{ML} —latched and provided for the user. These are not used in the Dyna-Micro, but are described in the experiment modules and are available for your use.

When the 8080A addresses memory, one and only one address must be specified on the 16-bit address lines. Since the 1702A and the 8111-2 memories only have eight lines to address their 256 locations, the remaining eight lines must be used to select one and only one

*For more information about these signals and IC's, see the *8080 Microcomputer System User's Manual*, Sept. 1975 from Intel Corp., 3065G Bowers Ave., Santa Clara, CA 95051.

of the memory blocks. We can select from two blocks of PROM, two blocks of R/W or possibly no blocks on the Dyna-Micro if we have expanded the memory off the PC board.

Address lines A0 through A7 are applied directly to the memory IC's on the Dyna-Micro card. Address lines A10 through A15 are gated in a six input NOR gate IC13. When this gate's output is a logic 1, it indicates that we are selecting one memory location within the first 1024 locations. Address lines A10–A15 are equal to logic 0. This would be one of the locations in either R/W or PROM, since these are located within the first 1024 locations. If the NOR gate produces a logic 0, at least one of the address inputs (A10–A15) must be at a logic 1, indicating that we are now addressing memory outside the blocks on the Dyna-Micro. Address bits A8 and A9 and the memory read signal (\overline{MR}) are gated together in an SN74LS155 decoder to select the proper block of the four possible on the Dyna-Micro card. The 8111-2 memories input the memory read and memory write signals to control the flow of data from and to the CPU. The 1702A PROM has only a chip-select input, so the memory read synchronizing signal is used in the SN74LS155 to gate data from the 1702A onto the bus at the correct time. Table V shows the memory selection.

TABLE V—MEMORY SELECTION

NOR Output	A9	A8	\overline{MR}	Memory
0	X	X	X	NONE
1	0	0	0	PROM 0
1	0	1	0	PROM 1
1	0	0	1	NONE
1	0	1	1	NONE
1	1	0	X	R/W 2*
1	1	1	X	R/W 3*

* \overline{MR} and \overline{MW} applied independently to the 8111-2 chips.

X = Don't care condition, logic 0 or logic 1.

Data flows to and from the memory on the bidirectional data bus and the 16-bit address bus specifies each location. This address bus is also used to help control the flow of data to and from external devices. The eight least-significant or LO address bits can specify one of 256 possible peripheral devices. The address bits are decoded in

(continued on page 85)

Radio-Electronics

Tests Tandberg 10XD

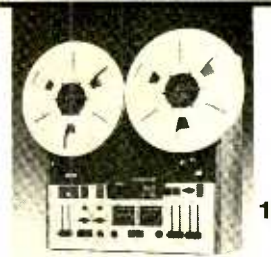

LEN FELDMAN

CONTRIBUTING HI-FI EDITOR

TANDBERG STATES QUITE SIMPLY THAT their new model 10XD is the best tape deck they have ever produced. That's quite a statement for a highly respected company that has been designing and manufacturing tape recorders and tape decks almost as long as that type of product has been available for home and professional studio use. By the time we were finished with our tests and evaluations we were ready to agree and to go even a bit further. The Tandberg 10XD may well be among the few best tape decks ever produced by any home tape deck manufacturer!

It is a credit to the industrial designers of this flexible unit that its front panel seems to be remarkably simple in layout and ideally organized as to its control functions. The complete unit is shown in Fig. 1 while a closeup of the lower control-

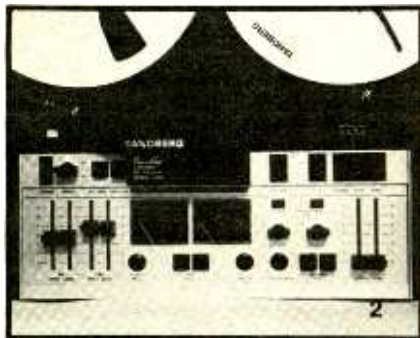

section is shown in Fig. 2. We'll deal with the transport, tape paths and tape guidance system presently. For the moment, let's examine those tastefully designed controls. A rocker switch below the left tape reel turns-on power, indicated by a green lamp just above it. Next is a SPEED selector knob for the three available speeds, followed by a reel-size selector button and an EDIT/CUE button. When

this button is depressed, the user can hear sounds recorded on the tape even when the transport is in either of its fast wind modes or when tape is moved by hand for precise editing. Below the right take-up reel is a 4-digit tape counter.

Transport mode selection buttons are located beneath the digit counter and there are no restrictions on the sequence of buttons depressed. The RECORD button also sets tape in motion, thereby acting in lieu of a pause control which this machine does not possess as such. Since recording can only take place if one or both of the RECORD SELECT buttons (elsewhere on the panel) is activated, a measure of safety (against inadvertent recording or erasure) is also provided. Tiny lights beneath each of the transport keys become illuminated indicating the mode of transport motion that is in progress, while the RECORD key is totally illuminated in red whenever it is depressed.

The lower section of the front panel contains a pair of record level meters that also read during playback. The meters are peak-reading and are inserted in the circuit chain beyond the record equalization circuits. Furthermore, a 0-dB reading on these meters corresponds to a +6 VU record level in terms of NAB standards, so that in reality the machine has a good deal more headroom than one might at first suppose. To the left of the meters are individual slide controls for each channel's microphone and line inputs. Microphone input jacks (that are balanced and have a self-adjusting sensitivity feature that is dependent upon the impedance of the microphone used) and the record select buttons are located below the two meters. The lower right section of the panel contains HEADPHONE jack, SOURCE/TAPE switches, OUTPUT LEVEL slide controls, a three position SOUND-ON-SOUND switch and a DOLBY selector switch with positions for NORMAL Dolby encoding or decoding, FILTER, and DOLBY FM (used for recording a Dolbyized FM program).

Lights located above the two last switches turn on when either sound-on-sound or Dolby operation is selected.

A photo of the rear panel is shown in Fig. 3. It contains the usual LINE IN and

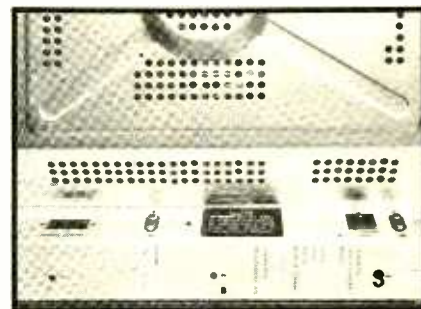

LINE OUT jacks, a DIN connector (that Tandberg prefers to label RADIO), and a REMOTE CONTROL socket for connection of an available accessory that permits complete remote operation of the transport system in any mode.

Internal features

While the visible features and controls of the Tandberg 10XD are certainly impressive enough, a real appreciation of the engineering that went into this unit can only be gained by exploring the not-so-obvious built-in features. Covering them all is beyond the scope of this report, but a few of the more important ones will be touched upon briefly. Consider, for example, the photo in Fig. 4. It is a closeup



view of the head area with tape-head covers removed. What is unusual is the pair of heads that traverse the tape path from either side. These are the record and bias head, positioned on opposite sides of the tape. The technique is called cross-field recording and with it, Tandberg maintains that the tape can accept much stronger signals than with conventional techniques in which bias and recording signals are applied via a single recording head.

A simplified block diagram of the 10XD is shown in Fig. 5. The operation of the tape transport is controlled elec-

MANUFACTURER'S PUBLISHED SPECIFICATIONS:

Tape Speeds: 15, 7½, 3¾ IPS. **Speed Tolerance:** ±0.3%. **Wow-And-Flutter (WRMS):** (15 IPS) 0.04%; (7½ IPS) 0.06%; (3¾ IPS) 0.11%. **Frequency Response** (±2.0 dB): (15 IPS) 30-25000 Hz; (7½ IPS) 30-22000 Hz; (3¾ IPS) 40-18000 Hz. **S/N:** (unweighted) 56 dB; (unweighted, with Dolby) 60 dB. **Crosstalk Attenuation:** (mono) 60 dB; (stereo) 50 dB. **Harmonic Distortion:** (0 dB Record Level) 2.0%. **Mic Input Sensitivity:** Automatically adjusted for mic impedance; balanced mic inputs. From 1 mV to 130 mV. **Line Input Sensitivity:** Automatically adjusted from 100 mV to 5 V. **Line Output Level:** 1.5 V at 150-ohms load. **Dimensions:** 17¾" (45.1 cm) high by 17¼" (43.5 cm) wide by 7¼" (18.4 cm) deep. **Weight:** 36 lbs. (16.3 Kg). **Suggested Retail Price:** \$1299.00.

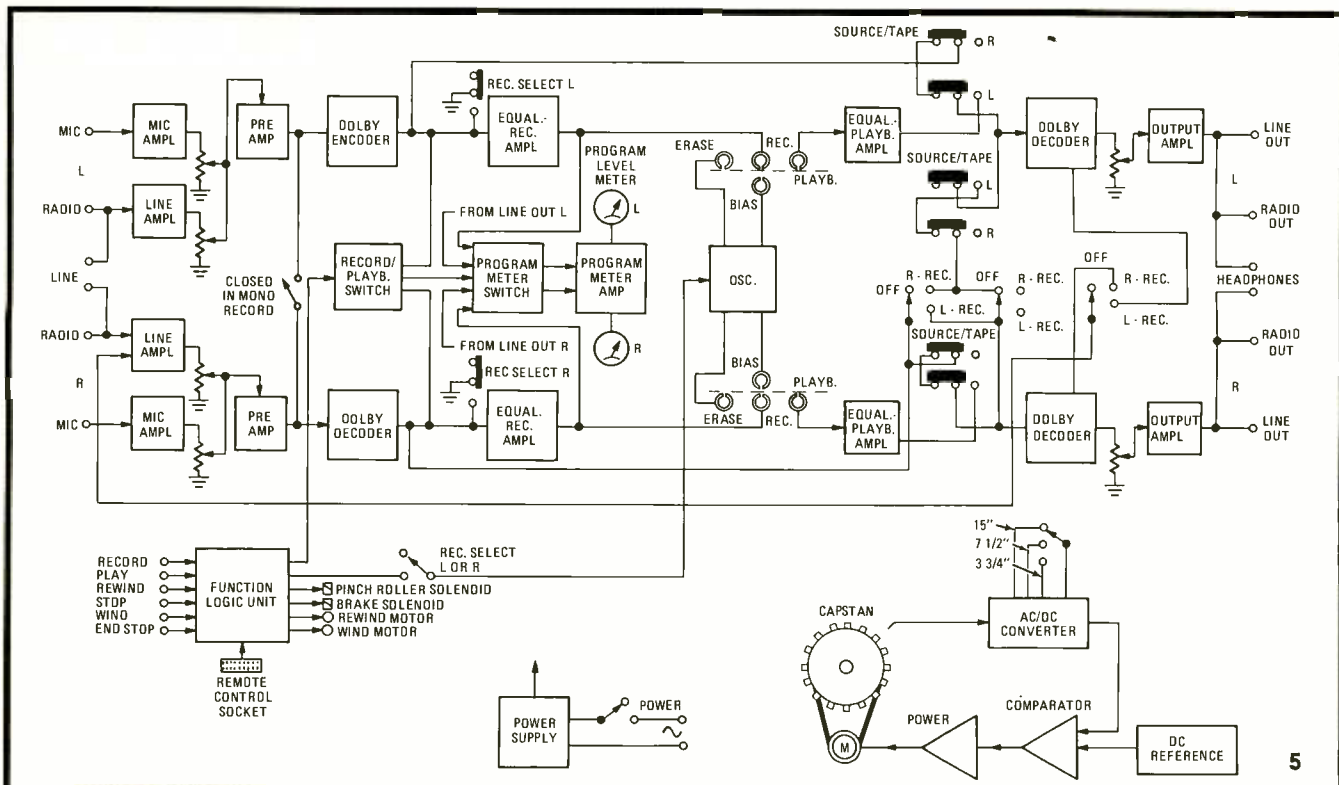

tronically. Of the three motors used in this model, the two reel-motors are connected directly to the reel hubs while the third motor drives the tape capstan. The capstan motor is a servo-controlled brushless DC motor.

The 10XD is equipped with photoelectric stop. The tape passes between a lamp and a photo transistor. At the end of the tape (or if a transparent leader passes through the tape path) the tape drive stops automatically and the pinch roller is retracted from the tape. The operation of the transport logic control is such that regardless of the order that the mode buttons are depressed, the electronic control and tape tension-adjusting system ensures that tape travel is always correct and the tape is never stretched or in any way damaged. Controlled braking is also accomplished electronically. A light-emitting diode and a photo-transistor sense whether the right reel-motor is rotating or not and sends the information to the logic control. At the instant when that reel motor stops, the logic control dictates that information and permits the tape recorder to go into playback with practically no delay.

In the 10XD, power from the capstan motor is transferred by a belt to the flywheel. This keeps the capstan motor far away from the tape heads to avoid interference pickup and provides a simple and stable power transfer system.

Additional features of the 10XD include automatic adjustment of the tape tension as the tape is transferred from one reel to another. What Tandberg calls "flying start" electronic editing permits the user to go directly from the play mode to the record mode while the tape is running, thereby permitting precision editing or recording revisions. As far as we know, the 10XD is probably the only high-speed (15 IPS) machine that has as flexible a Dolby system. For example, the 10XD

TABLE I
RADIO-ELECTRONICS PRODUCT TEST REPORT

Manufacturer: **Tandberg**

Model: **10XD**

OPEN-REEL TAPE DECK MEASUREMENTS

FREQUENCY RESPONSE MEASUREMENTS

STANDARD TAPE

Frequency response @ 15 IPS (Hz-kHz ± - dB) 29-27, 2-dB
 Frequency response @ 7½ IPS (Hz-kHz ± - dB) 32-22.5, 2-dB
 Frequency response @ 3¾ IPS (Hz-kHz ± dB) 35-18, 2-dB

CRO₂ TAPE

Frequency response @ 15 IPS (Hz-kHz ± - dB) N/A
 Frequency response @ 7½ IPS (Hz-kHz ± - dB) N/A
 Frequency response @ 3¾ IPS (Hz-kHz ± dB) N/A

DISTORTION MEASUREMENTS (RECORD/PLAY)

Harmonic distortion @ -10 VU (highest speed) (%) 0.9%
 Harmonic distortion @ -3 VU (highest speed) (%) 0.7%
 Harmonic distortion @ 0 VU (highest speed) (%) 0.5%
 Harmonic distortion @ +3 VU (highest speed) (%) 0.7%
 Recording level for 3% THD (dB VU/dB meter) +8/+2

SIGNAL-TO-NOISE RATIO MEASUREMENTS

Best S/N ratio, standard tape (dB) 61 dB weighted
 Best S/N ratio, CRO₂ tape (dB) N/A

MECHANICAL PERFORMANCE MEASUREMENTS

Wow-and-flutter @ 15 IPS (% WRMS) 0.017
 Wow-and-flutter @ 7½ IPS (% WRMS) 0.025
 Wow-and-flutter @ 3¾ IPS (% WRMS) 0.07
 Rewind time, 1800' tape (seconds) 90 sec.

COMPONENT MATCHING CHARACTERISTICS

Microphone input sensitivity (mV) 0.5mV/600 ohm (see text)
 Line input sensitivity (mV) 180
 Line output level (mV) 180
 Phone output level (mV or mW) 5 mW/8 ohm (see text)
 Bias frequency (kHz) Approx. 125

TRANSPORT MECHANISM EVALUATION

Action of transport controls **Excellent**
 Tape guidance system **Excellent**
 Absence of mechanical noise **Very good**
 Tape head accessibility **Good**
 Construction and internal layout **Excellent**
 Evaluation of extra features, if any **Excellent**

OVERALL TAPE DECK PERFORMANCE RATING

Superb

can be used with any tuner or receiver equipped with 25 microsecond de-emphasis to decode FM Dolby broadcasts even if you do not wish to record them.

Laboratory measurements

Some of the most important performance measurements taken for the 10XD in our laboratory are listed in Table I and these may be compared with published claims of the manufacturer. Note that we have used a 2.0 dB roll-off point in specifying frequency response simply because that is what Tandberg did. Were we to specify the 3 dB roll-off points (as most other tape deck manufacturers do), high-end response would extend even further than the impressive figures shown. Figure 6 is a plot of frequency response taken at

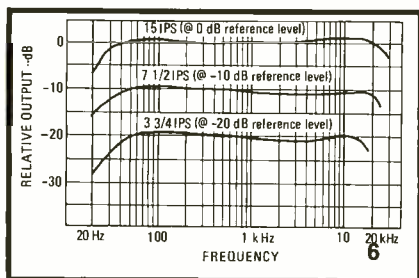

the three transport-speeds. Maxell UD tape was used in all of these measurements. It should also be noted that 0 dB on the Tandberg's own meters really corresponds to +6 VU based upon NAB standards. This demonstrates the outstanding characteristics of the cross-field recording technique insofar as recording level capabilities without tape saturation are concerned.

As for wow-and-flutter, the readings shown are the lowest we have ever observed for a consumer-intended tape deck. Distortion at all levels observed was far below that conservatively listed by Tandberg, rising to 3% at +8 VU (+2 VU on Tandberg's meters).

A word of clarification is needed with regard to the single signal-to-noise measurement of 61 dB (weighted) that we show for this unit. First, the measurement was made without Dolby. With Dolby, the S/N would increase to around 66 or 67 dB as a single meter reading. If one

TABLE II
RADIO-ELECTRONICS PRODUCT TEST REPORT

Manufacturer: **Tandberg**

Model: **10XD**

OVERALL PRODUCT ANALYSIS

Retail price	\$1299.00
Price category	High
Price/performance ratio	Excellent
Styling and appearance	Superb
Sound quality	Excellent
Mechanical performance	Superb

Comments: It is difficult to come up with the proper superlatives with which to summarize this report. The Tandberg 10XD is certainly that company's best effort to date. We have never measured a machine with lower wow-and-flutter, or lower distortion at high recording levels. As we recall, Tandberg was the first company to prove to the world that high-fidelity recording results could be obtained even at low 3¾ IPS speeds and it is altogether fitting that they should have included that non-professional speed in this thoroughly professional deck. No doubt Tandberg's cross-field biasing technique has much to do with the amazing frequency response achieved at that slow speed, but the transport mechanism together with its governing electronic and logic control is as much a masterpiece of design as are the purely electronic elements that govern recording quality. The Dolby noise reduction system incorporated in this machine almost seems unnecessary—especially when the machine is used at its highest 15 IPS speed, but of course it provides the usual improvement in signal-to-noise and if users intend to make dubbings or re-recordings from master tapes originally recorded on the 10XD, those extra dB's of signal-to-noise capability really make a difference as each successive dubbing adds its own noise contribution. The Tandberg 10XD is adjusted to be used with low-noise, high-output tape and, since there are no selectable bias or EQ positions (other than those that are automatically adjusted as speeds are changed), a user would be well advised to use only that type of tape if best results are desired. Action of the logic-controlled transport is just about as perfect as anyone would desire and we have not seen a faster "start up" on any consumer machine. Pauses between fast and play modes are just long enough to prevent tape damage, but not so long as to negate the advantages of this fully-automated fool-proof automated transport system. All in all, we shall be most reluctant to part with this magnificent example of open-reel tape deck technology.

were to use IEC A weighting in making the S/N measurement, the reading would be further increased to around 65 dB without Dolby and more than 72 dB with Dolby! Tandberg gives all these S/N numbers in their data sheet and our observations came out a bit better than the numbers they quote in every instance using our tape sample (Maxell UD).

Using the Tandberg 10XD

In its advertising literature, Tandberg suggests that the quality of the recorder can best be judged subjectively by switching from "source" to "tape" while making a recording. (This can be done without

interrupting the tape recording process) and that is just one of the things we tried while using the machine for more than a week. The point of this test is to try to determine any difference between the source material (which should be of highest fidelity to begin with) and the recorded version of it. Suffice it to say, we could tell no difference at even the slowest speed of 3¾ IPS!

Tandberg has a winner here—and the serious recordist has a new machine to consider—one that sells for but a fraction of the total cost of those studio or professional tape recorders that it comes close to equalling. **R-E**

Pioneer Model SX-1250

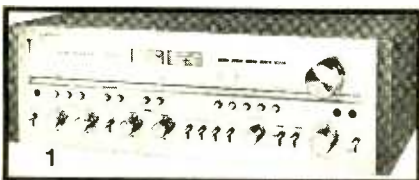

PIONEER BILLS THEIR NEWEST TOP-OF-THE-line receiver as the most powerful in the world—and that it certainly is. But it is also a superior piece of equipment from several other viewpoints, and one that will appeal to the audio enthusiast who re-

quires high power but hasn't the room or the funds to purchase a two-piece or even a three-piece high-fidelity configuration.

The front panel of the SX-1250 (shown in Fig. 1) is styled very much like that of Pioneer's separate tuners (and the front panels of many other new products made in Japan), in that it has abandoned the black-out dial approach that had become almost standard for most receivers in the last decade. Now, the linearly calibrated FM dial and AM dial scales are highly visible even when the unit is turned off. Both tuning and signal-strength meters are centrally positioned above the dial

scales and these meters are flanked with a series of colored rectangles containing legends that illuminate to denote the speaker system (or systems) in use, program source selected and reception of a stereo FM signal. The dial pointer itself is smoothly guided along the bottom edge of the sloped (for easy viewing) dial scales by means of a massive flywheel-tuning knob arrangement that is about the smoothest we have ever twirled.

A series of pushbuttons just below the dial area select one or two out of three possible pairs of speaker systems, actuate low- and high-cut filters, turn FM muting

on and off, permit audible observations of multipath interference and select the various program inputs. The usual phone jack (at the left) and a pair of left- and right-channel microphone input jacks are also in line with these buttons.

The lower section of the panel contains six rotary-controls and nine toggle-switches. Pioneer's novel twin-bass and twin-treble control arrangement has been carried over from earlier receivers and affords a degree of tone control not possible with simple, single bass and treble control arrangements. The toggle switch between these pairs of controls defeats the tone control action entirely when desired. Other rotary controls are the usual BALANCE control and a step-type master VOLUME control calibrated in dB down to -70. TWO TAPE MONITOR switches are augmented by a TAPE DUPLICATE switch (enabling tape dubbing from either tape deck connected to the other) and a fourth toggle switch labelled ADAPTOR that is in reality a third circuit interruption point suitable for connection of a four-channel adaptor or even a third tape deck or other accessory. LOUDNESS, stereo/mono MODE and audio MUTING switches plus a main POWER on/off switch complete this most carefully thought out from panel layout.

The rear panel, shown in Fig. 2, has three sets of spring-loaded SPEAKER termi-

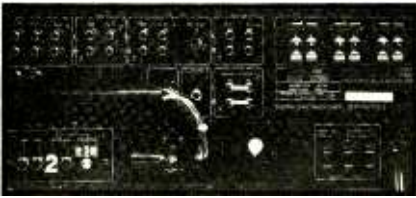

nals for connection of as many speaker pairs (only two of which may be heard at any one time), the usual PHONO inputs (two phono pairs of jacks), high-level AUX inputs, TAPE and ADAPTOR inputs and outputs and a pair of jumpers that interconnect the preamplifier output and amplifier input circuits. Antenna connection facilities include 300-ohm and 75-ohm coaxial for FM, plus external AM and ground terminals. A pivotable AM ferrite-bar antenna is included, as are three convenience AC outlets (one switched) and an FM detector output jack for possible use with future FM 4-channel adaptors.

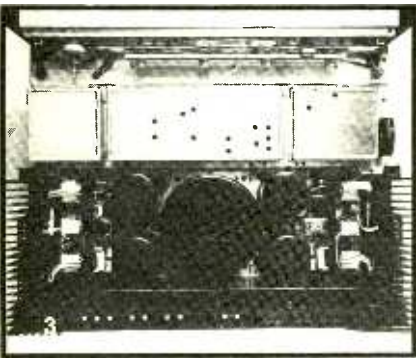

There is also a slide switch that selects 75- μ s or 25- μ s FM deemphasis (the latter required for Dolby FM listening if you have an accessory Dolby decoder). A DIN socket parallels the TAPE 2 input and output jacks.

MANUFACTURER'S PUBLISHED SPECIFICATIONS

FM TUNER SECTION:

Usable Sensitivity: 8.7 dBf (1.5 μ V) mono; 14.5 dBf (2.9 μ V) stereo. **50-dB Quieting Sensitivity:** 11.5 dBf (2.05 μ V) mono; 36 dBf (34.5 μ V) stereo. **S/N Ratio:** (mono): 80 dB; (stereo): 74 dB. **THD:** (1 kHz): 0.1% mono; 0.20% stereo; (100 Hz): 0.1% mono; 0.25% stereo; (6 kHz): 0.3% mono; 0.3% stereo. **Capture Ratio:** 1.0 dB. **Selectivity:** 83 dB. **Spurious and Image Rejection:** 110 dB. **IF Rejection:** 120 dB. **AM Suppression:** 60 dB. **Muting Threshold:** 13 dBf (2.45 μ V). **Stereo Separation:** (1 kHz): 50 dB; (30 Hz to 15 kHz) 35 dB. **Sub-carrier and SCA Rejection:** 74 dB.

AM TUNER SECTION:

IHF Sensitivity: 15 μ V external antenna; 300 μ V/m internal antenna. **Selectivity:** 40 dB. **S/N Ratio:** 55 dB. **Image Rejection:** 65 dB. **IF Rejection:** 85 dB.

AMPLIFIER AND PREAMPLIFIER SECTION:

Power Output: 160 watts per channel minimum continuous power into 8 ohms, 20 Hz to 20 kHz at no more than 0.1% total harmonic distortion; 200 watts into 4 ohms, same conditions. **IM Distortion:** 0.1%. **Damping Factor:** 30. **Input Sensitivities:** phono 1 & 2: 2.5 mV; mic: 6.5 mV; Tape and Aux: 150 mV. **Phono Overload:** 500 mV. **Frequency Response:** (phono): RIAA \pm 0.2 dB; (high level inputs): 10 Hz to 50,000 Hz, +0, -1 dB. **Tone Control Range:** (main bass): \pm 10 dB @ 100 Hz; (sub-bass): \pm 5 dB @ 50 Hz. (main treble): \pm 10 dB @ 10 kHz; (sub-treble): \pm 5 dB @ 20 kHz. **Filters:** (low): 30 Hz; (high): 8 kHz (both 12 dB/octave). **S/N:** (phono): 75 dB weighted. (high level): 90 dB weighted.

GENERAL SPECIFICATIONS:

Power Consumption: 1200 watts. **Dimensions:** 21 $\frac{1}{8}$ " W \times 7 $\frac{3}{8}$ " H \times 18 $\frac{3}{4}$ " D. **Weight:** 64 $\frac{1}{4}$ lbs. **Suggested Price:** \$900.00.

TABLE I

RADIO-ELECTRONICS PRODUCT TEST REPORT

Manufacturer: **U.S. Pioneer Electronics**

Model: **SX-1250**

OVERALL PRODUCT ANALYSIS

Retail price	\$900.00
Price category	High
Price/performance ratio	Very Good
Styling and appearance	Excellent
Sound quality	Excellent
Mechanical performance	Excellent

Comments: The enormous power output capability of the Pioneer SX-1250 places it in a class by itself as far as integrated receivers are concerned. But the Pioneer SX-1250, in our view, was not designed or conceived simply to produce "brute force" power. Its FM tuner section proved, in many respects, to be equal to or even better than the best separate tuner made by Pioneer. We are firm believers in the importance of high phono-overload capability, and the 500+ millivolt input capability of the preamplifier section of this receiver, coupled with its extremely accurate RIAA equalization make its preamp performance as good as many preamp sections we have measured on separate control units or integrated amplifiers. All of which raises the question, once more, as to whether there is a meaningful reason these days to opt for "separates." As far as we know, this is also the first high-powered receiver that uses two independent power supply transformer windings for the high-voltage output stages, an innovation that we have seen and admired in separate power amplifiers. Low-frequency reproduction superiority was clearly discernible and, we think, attributable at least in part to this feature.

We are indeed sorry that the people at Pioneer have misinterpreted the newly approved Tuner Measurement Standards (with respect to the relationship between dBf power numbers and previously used microvolts) both in their instruction manual and in their advertising literature and hope that future printings will correct these errors. We question, too, Pioneer's "need" to quote usable sensitivity at 1.5 microvolts (8.7 dBf) since, in production, it will be difficult if not impossible for them to maintain that ultra low figure consistently. All of which does not detract from the fact that this is a receiver having a most sensitive tuner section, an excellent and flexible preamplifier section, and a power amp section that should have no difficulty in driving even the lowest efficiency speakers around too high, clean sound levels.

Construction and circuit description

A view of the SX-1250 chassis with cabinet cover removed is shown in Fig. 3. Visible is a massive toroidal-core power transformer with separate windings for powering the left and right channels and flanking this transformer are dual pairs of 22,000- μ F filter capacitors for each voltage polarity of each separate channel. Not

visible, because of extensive use of shield covers, are the circuitry of the FM and AM sections of the receiver. Five-gang tuning is used in the FM front-end while three gangs are employed in the AM section. Dual gate MOSFET's are used for two RF amplifiers and mixer and the local oscillator is equipped with a buffer stage to increase oscillator stability. Four phase-

(Continued on page 00)



microphones in pro sound systems

Microphones are an important part of the professional sound system. Here's the ins and outs of selecting the right one

JOE BLACK*

IT IS VITAL TO EVERY SOUND SYSTEM that the proper microphone be used. For no matter how good the amplifier, no matter how well laid out the speakers, no matter how beautiful the auditorium or restaurant or meeting room or nightclub, the wrong microphone will destroy all the previous planning.

Yet, selecting a microphone can be easy if it is approached in a logical, step-by-step fashion. The procedure is simple and breaks down into four basic areas: (1) pick-up patterns (2) frequency response (3) the type of microphone and (4), last but not least, price.

Pick-up patterns

There are three basic types of microphone sensitivity patterns. Unidirectional, omnidirectional, bidirectional. The unidirectional picks up sound mainly from the front and at the same time suppresses sound and noise coming from the back. The most generally useful unidirectional pick-up pattern is the cardioid, meaning heart-shaped. This pattern successfully suppresses rear sounds by at least seventy percent, while picking up sound from the front over a broad area. Sounds 120° to 180° off-axis are almost entirely suppressed, but you must be sure to check the pattern of the particular microphone you plan to use to determine the exact cut-off angle. A typical pattern of a uni-

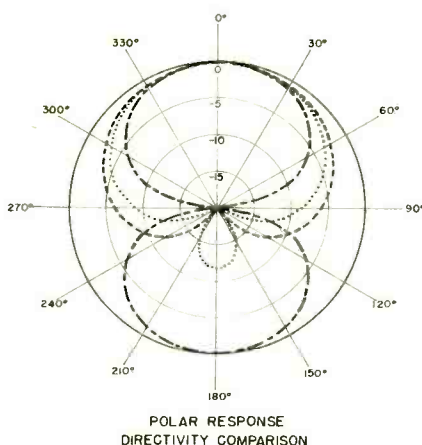

directional cardioid microphone is shown in Figure 1.

The cardioid microphone is most commonly used to solve feedback problems. Because of its reception pattern (the rear of the microphone rejecting sound) it can be easily positioned so that sound projecting from the speakers of the system cannot re-enter the microphone and produce feedback. As a result, performers can work much further away from unidirectional microphones than they can with omnidirectional mi-

UNIDIRECTIONAL

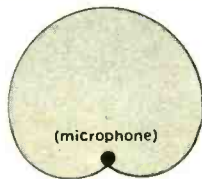

UNIDIRECTIONAL CARDIOD microphone has a typical pick-up pattern as shown.

crophones, because amplifier gain can be set to a higher level without encountering feedback.

The use of the unidirectional microphone also reduces the affects of audience noises; coughing, shuffling feet, etc. Because of the wide reception area, it is also convenient to use for a fixed installation in front of an individual performer or even a small group. To cover a large group, multiple unidirectional microphones are necessary.

Omnidirectional microphones pick up sounds from all directions and with almost equal sensitivity. A typical omnidirectional pattern is shown in Figure 2. For all practical affects these microphones are non-directional. They can be hand held, stand mounted or worn

OMNIDIRECTIONAL



OMNIDIRECTIONAL MICROPHONE has a typical pick-up pattern as shown.

around the performer's neck. These are perhaps the most commonly used microphones, and probably account for the largest number of microphones in use.

Omnidirectional microphones are great in applications where feedback or audience noise is no great problem. Since these microphones are extremely

*We wish to thank Shure Brothers Inc., Evanston, IL for providing the materials used to develop this article.

versatile, and many of them are thin, long, probe type units, they are perfect for walk-around and interview situations.

The bidirectional microphone (its pattern is shown in Figure 3 picks up sound from both front and back, but

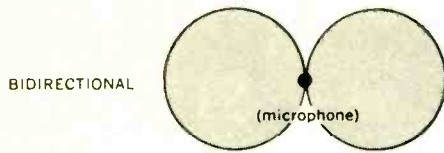

BIDIRECTIONAL MICROPHONE has a typical pick-up pattern as shown.

suppresses the reception of audio signals from the side, the top and the bottom. This category of microphones is perfect when two performers or groups are positioned on opposite sides of the same microphone. It permits that same freedom of movement that you get when you use unidirectional microphones, yet helps solve feedback problems caused by rooms that have hard, reflective ceilings, or in set-ups where the loudspeakers are mounted directly over or to one side of the microphone.

Frequency response

Once you have decided on the kind of pick-up pattern your application demands, it's time to decide on the frequency response required. Because the fidelity of reproduction is not always the prime requirement. The frequency response of a microphone should be tailored to the application. For example: if you are going to do recording, broadcasting, or need a PA system that can handle quality music, you've got to look for a wide-range frequency response, and here your microphone must deliver a minimum of 50 to 15000 Hz. And the response has got to be both flat and smooth over that range. The best types of microphones for such an application are ribbon and dynamic types. On the other hand, if all we need is a quality public address system for voice and music, but total frequency response is not needed, we can get by with a microphone that only covers 70 to 10,000 Hz. It, like the wide range microphone, should have a flat response. It could be slightly rising, but definitely must have no prominent peaks. There are three types of microphones that can be used in this type of application. They are: ribbon, dynamic, and some of the better crystal or ceramic units.

If all we are concerned with is indoor paging systems and public address systems for voice only, a frequency response from 200 to 5000 Hz is more than enough. Again, it is desirable to have a response curve that is slightly rising and it must have no prominent peaks. For this kind of application, again, we can use ribbon, dynamic, and

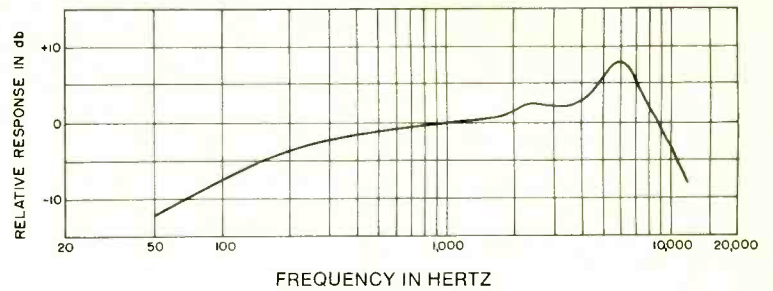

A

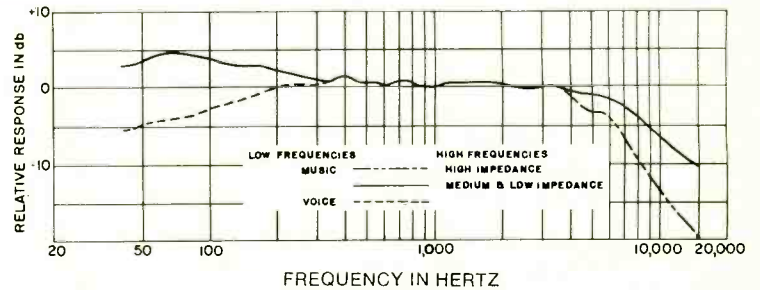

B

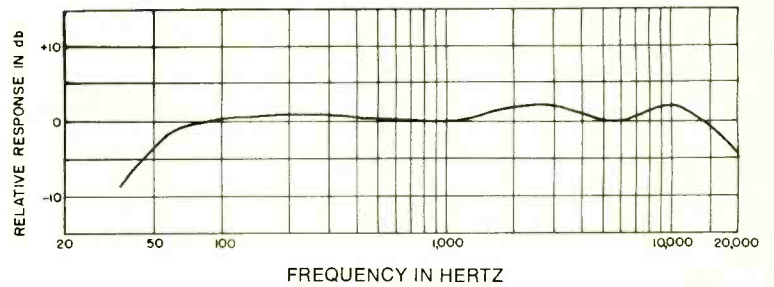

C

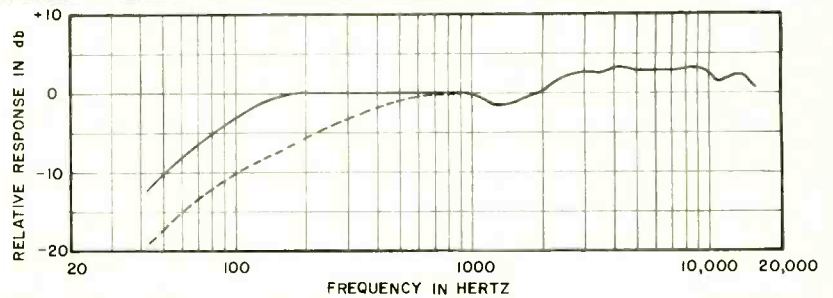

D

FREQUENCY RESPONSE AND PICK-UP PATTERNS for three different microphone-types. (A) Dynamic Lavelier. (B) Bidirectional Ribbon. (C) Omnidirectional Dynamic. (D) Unidirectional Dynamic.

some the better crystal or ceramic microphones, but we can also use some controlled-magnetic mikes.

The final application area is for outdoor paging systems or systems that are installed in noisy locations, such as in a factory or warehouse. These systems are normally used only for voice, and the requirement here is maximum intelligibility of what is being said. Ideally, the response requirements should be limited, and the range of 300

to 3500 Hz is ideal. The response curve should be rising and should show a peak in the 2000 to 3500-Hz region. This peak is not mandatory, as in some situations it is not necessary, but it is helpful in improving intelligibility under the circumstances outlined. These microphones are available in controlled magnetic, dynamic, carbon, and some ceramic units.

In general, the more extended the frequency response of the microphone,

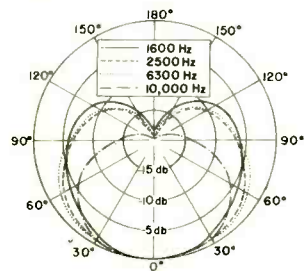
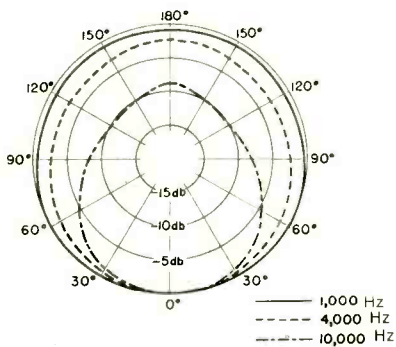
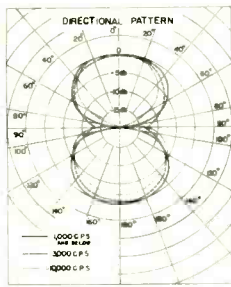
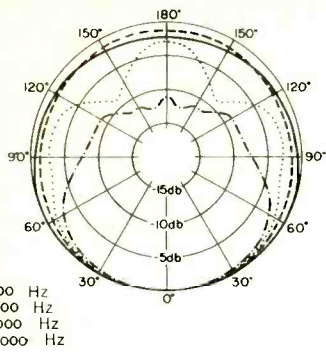

the more faithful the reproduction. Therefore, the more important reproduction quality is, the better and wider and flatter the frequency response you should look for.

A true high-fidelity microphone will deliver a response that is very smooth. When you look at its response curve, you should see no obvious abrupt peaks or valleys of output at any frequency. A mike that does this results in a smooth frequency curve and good hi-

fidelity type quality reproduction.

A flat frequency response curve, as we all know, is one that shows no change in the output signal over the frequency range. This means that that microphone responds equally well at any frequency, and as we so well know, this is an absolute must for hi-fidelity reproduction.

While we know that microphones that have the widest frequency range, coupled with the smoothest and flattest frequency response curves, will give the best fidelity, they are not necessarily best for every application.

For example, we often deliberately use a microphone that has a shaped response plus peaks in some area of the frequency curve so that we can add presence and improve intelligibility in systems used for paging and communications use.

Types of microphones

We will not attempt to present here a course on microphones, but instead will briefly summarize the five major types of microphones used in pro sound systems. These are ceramic, ribbon, controlled magnetic, dynamic, and crystal types.

Ceramic microphones are quite similar to crystal microphones in design. The difference is that the ceramic microphone uses a man-made ceramic element. These microphones are economical, and are better than crystal types for outdoor use since they are not affected by high temperature extremes and humidity changes. These mikes have a high output-impedance too. Overall, whenever price becomes an important factor, ceramic microphones should be used. They are available in both omnidirectional and unidirectional units. All tend to be economical and rugged.

The ribbon microphone offers the great advantage of virtually uniform frequency response. It is definitely among the very best microphones available. It is extremely rugged for normal use indoors, offers adjustable impedance and is great for use wherever the quality of frequency response is the first consideration, such as in broadcasting, professional recording or PA systems intended to carry good music. They can be found in both unidirectional and bidirectional versions. They are excellent for music, but are not recommended for outdoor use, however, they can be used outdoors if protected against wind and environmental conditions.

The controlled-magnetic microphone uses a balanced armature, and as a result, is rugged, stable and delivers high signal-output. This type of microphone was originally developed for the military to combine the advantages of carbon and dynamic microphones with

none of the disadvantages. It has the ability to directly supply any needed impedance without using a transformer, and controlled magnetic microphones tend to be modestly priced and deliver dependable performance over a long life time.

These microphones can be used indoors or outdoors; in fact, wherever rugged performance must be coupled with a reasonable price and frequency response. They are ideal for paging, language labs, portable PA systems, and are normally available only in omnidirectional types.

The dynamic or moving-coil microphone is available in a wide range of types, styles, and prices. The better dynamic units are among the very best microphones for frequency response, flat response up to 20,000 Hz is not unusual.

These dependable units should be used where unusual performance coupled with ruggedness and reliability are required. These encompass broadcasting and better-quality public address systems. The dynamic microphone tends to be superior in frequency response to ceramic, crystal, carbon, and controlled magnetic units are available in both directional and omnidirectional versions.

The crystal microphone offers good quality at a low price. Response is normally somewhat limited, usually to somewhere around 10,000 Hz at the top. Sealed crystals used in some microphones makes it possible to use the crystal microphone in applications where high humidity could otherwise cause a problem. However, high temperature, such as indirect sunlight, over a prolonged period will normally require the use of another type of microphone. Crystal microphones provide high impedance and are primarily used where price is a limiting factor.

Price is always a consideration

Microphones vary from the very inexpensive to the very expensive, but compared to the total cost of a sound system, the microphone is often the lowest priced single item in the system. Despite this, the function of the microphone is critical. Actually, no sound system can be any better than the microphone that does the original conversion from sound into electrical impulses. If you want to make comparisons, the unidirectional cardioid microphones tend to be the most expensive, however, there are first rate omnidirectional and bidirectional microphones that can cost just as much as the unidirectionals. If economy is the major factor, you've got to look at crystal, ceramic or controlled magnetic units. Where quality is the most important factor, a ribbon or dynamic microphone becomes a must. **R-E**

Build This Great TV Game

Part II. With on-screen digital scoring and a unique alternate "bumper" game, this ping-pong game can be played by two or four people, or it can be set to play a perfect game against you or itself

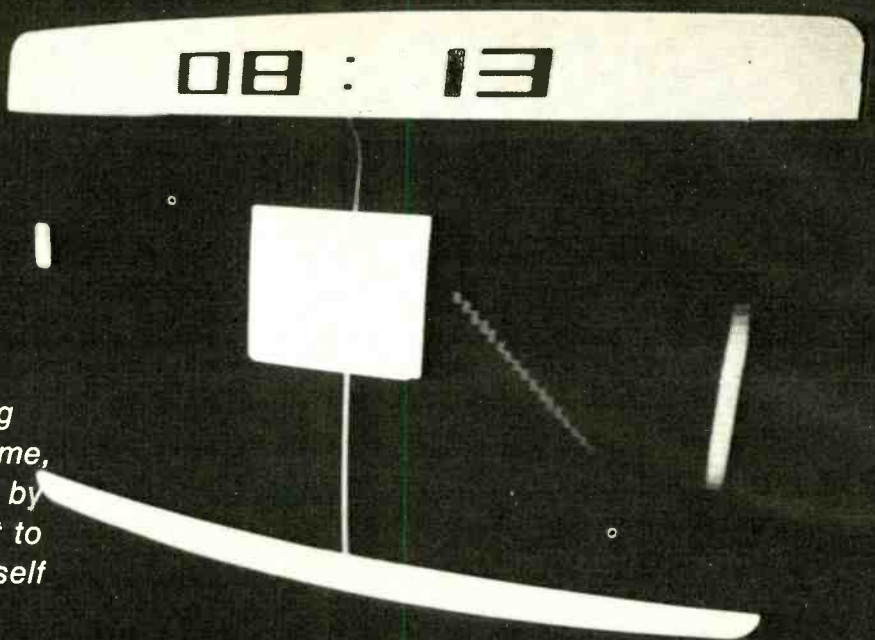

THE FIRST PART OF THIS ARTICLE (JUNE, 1976) presented the schematic and began the discussion of how the circuit works.

This second part of the article concludes the discussion of the main circuit board and presents the foil patterns.

Generating the ball

In a manner somewhat similar to that used to produce the paddles, we generate the ball. Two comparators are used to determine the vertical and horizontal coordinates of the ball. The actual position of the ball is set by the voltages appearing on the collectors of transistors Q3 and Q4.

Q3 determines the vertical position and Q4 the horizontal position. When the horizontal ramp voltage reaches the voltage of Q3, pin 14 of IC6-d goes low, producing a negative pulse at pin 11 of IC5-d. These two pulses are AND'ed by IC5-d to produce a positive pulse at the output pin 13 of IC5-d. This signal is the ball signal that is displayed on the screen via IC13.

Since the ball is always in motion, it is apparent that the voltages on Q3 and Q4 are constantly changing. The direction (positive or negative) of that change is determined by the state of two flip-flops, IC9-a and IC10-a. The signal at pin 5 of IC9-a determines the ball's vertical direction. The signal at pin 9 of IC10-a determines its horizontal direction. The rate of change (ball speed) is determined by the rate at which the two capacitors C5 (vertical) and C14 (horizontal) are charging or discharging.

Let us assume for the purpose of this description that the ball on the screen is moving diagonally from the upper left to the lower right corner. When this is happening, the voltage on the collectors of Q3 and Q4 are both increasing in the positive direction and flip-flops IC9-a and IC10-a are both in the set state.

Now the ball reaches the bottom bound-

ary, and must rebound back into the playing field. The ball is made to rebound simply by changing its vertical direction; since IC9-a controls ball vertical direction, all that is required is to reset IC9-a. This resetting is done by the signal from pin 8 of IC7-c. The inputs of this gate are the signals from pin 9 of IC7-c and pin 10 of IC7-c. The ball signal is on pin 9 of IC7-c and the bottom boundaries on pin 10 of IC7-c.

If the ball and bottom boundary both occur at the same time (the ball has reached the boundary), both of these inputs will be high, causing their AND'ed output to go low. This output signal goes to the direct clear input of IC9-a causing the flip-flop to reset, which in turn reverses the direction of the charge on C5 and Q3, thereby reversing the vertical direction of the ball.

The top boundary rebound functions in a similar manner. The ball is AND'ed with the top boundary signal at pin 3 of IC7-b. When a coincidence occurs at the top boundary, IC9-a is set, causing the ball to reverse direction downwards. (Diode D2 connected to pin 14 of IC4-d and pin 1 of IC7-b is part of the video circuit and allows the score to be displayed in the top boundary area and has no function in the rebound circuit.)

Horizontal direction of the ball is controlled by IC10-a and Q4/C14 in a similar manner. Horizontal direction is reversed only in an instance where the ball strikes a paddle (or the bumper). Horizontal direction is reversed by resetting IC10-a. This is controlled by the output at pin 6 of IC7-a and pin 6 of IC8-a, which are AND'ed outputs of the ball and right paddle and left paddle, respectively.

They are used to direct set or direct clear IC10-a in the same manner as IC9-a is controlled for vertical direction. Additionally, the output from pin 8 of IC8-b is

the ORED signal from either paddle which indicates a paddle hit. The signal is used for the audio as well as in the ball angle randomizer circuit.

When the ball is hit

When the ball rebounds from a paddle, several other things take place. The ball may or may not change speed or angle. Whether or not it does is determined in the ball-hit randomizer circuit. This circuit is a pseudo-random pattern generator that gives ten different combinations to determine the ball's speed and angle. The ten combinations are provided by IC20, a counter, that is clocked at the horizontal sync rate (15,750 Hz). Thus, the four outputs (A, B, C, D) are changing at rates of 7875, 3937, 1968 and 984 times per second.

When a paddle-hit occurs, the four sections of IC21 are enabled by the paddle-hit signal, and at that instant the pattern contained in IC20 is applied to the clock inputs of four flip-flops [IC9 (a and b) and IC22 (a and b)].

If the respective output of the pattern happens to be low at the time of the hit, the corresponding flip-flops will toggle. As a result pin 5 of IC9-a, which controls vertical direction, may reverse if the signal at pin 12 of IC20 happened to be low at the time of the hit, and so on for pin 5 of IC22-a and pin 9 of IC22-b.

The signal from pin 5 of IC22-a controls vertical speed. The signal from pin 9 of IC22-b is used to allow a nearly horizontal shot. When set, it causes the signal at pin 11 of IC8-d to continuously toggle IC9 at a 7875 Hz rate. Thus the ball will travel nearly horizontally because the signal at pin 5 of IC9-a will be rapidly setting and resetting during the ball's travel across the screen, preventing capacitor C14 from either charging or discharging and the ball from changing its vertical direction.

PARTS LIST

All resistors 1/4-watt 5% unless noted

R1, R2, R9, R57, R77, R78, R80, R81, R82, R83—5000 ohms, trimpot
R3, R45—2000 ohms
R4, R7, R10, R12, R16, R19, R21, R24, R25, R28, R30, R52, R64, R70, R74—1000 ohms
R5, R6, R13, R20, R22, R23, R27, R32, R42, R54, R58—10,000 ohms
R8, R17—15,000 ohms
R11, R26, R60—47,000 ohms
R14, R15, R18, R29, R31, R39, R40, R41, R48, R53, R56, R71—5100 ohms, R33—3.3 megohms
R34, R65, R66, R68, R69, R76—470,000 ohms
R35, R38—1000 ohms, trimpot
R36, R37, R47, R61, R73—510 ohms
R43—20,000 ohms nominal (V sync)
R44—30,000 ohms nominal (H sync)
R46—15 ohms
R49, R59, R62—100,000 ohms
R50, R51—75,000 ohms (or 68,000 or 82,000 ohms)
R55, R72—200 ohms
R63—50,000 ohms, trimpot (or 100,000 ohms, trimpot)
R67—Not used
R75—1200 ohms
R79—1000 ohms, optional, see text
R84, R85, R86, R87, R88—5000 ohms, potentiometer linear taper (or any value between 5000 and 25,000 ohms)

All capacitors 15 volts or more

C1—2000 pF, temp stab polystyrene
C2—1.0 or 1.2 μ F, temp stab tantalum
C3—0.2 μ F, dipped tantalum
C4—not used
C5, C14, C33, C42—10 μ F, axial
C6, C32—1000 μ F, radial
C7—.001 μ F
C8, C18—0.1 μ F, dipped tantalum
C9, C35, C36—270 pF
C10, C12, C44, C47, C48—1 μ F, axial

C11, C13, C19—500 pF or 470 pF
C15, C16—0.47 μ F, dipped tantalum
C17—1 μ F, dipped tantalum
C20, C22, C23, C24, C38, C39—.01 μ F
C21, C26, C27, C28, C29, C30, C31—.05 μ F
C25—not used
C34, C37—100 pF
C40, C41, C46—.005 μ F
C43—2.2 μ F, dipped tantalum
C45—100 μ F, radial
C49—6.8 μ F, tantalum
C50—not used

Diodes

D1 to D8—1N4148 (or any signal diode)
D9 to D12—not used
D13 to D23—1N4148 (or any signal diode)
D24, D25—1N4148 (optional for low-resistance joystick)

Transistors

Q1 to Q6—2N2222

Integrated Circuits

IC1, IC11, IC26—555
IC2—7404
IC3, IC7, IC8, IC14, IC15, IC18, IC19—7400
IC4, IC6—339
IC5—7402
IC9, IC22—74C74
IC10, IC17—7474
IC12—4066
IC13—7423
IC16—7420
IC20—74C90
IC21—74C00
IC23, IC24—74C04
IC25—74C10
IC27—LM309 (5v, 1A regulator)

Switches

S1—spst toggle
S2, S3—spdt toggle
S4—spst N.O. momentary push button
SPKR—4 to 8 ohms, 2 1/4 inch diameter

The following items are available from Visulex, P.O. Box 4204, Mountain View, CA 94040. Also available from Technology Trends, P.O. Box 732, Manhasset, NY 11030

Main circuit board, with pre-aligned horizontal and vertical sync oscillators soldered in place. Includes circuitry (but not components) for ball, paddle and boundary display, sound effects, computer-control module, paddle size selector, ball speed/angle randomizer, game action electronics for bumper and power filters. Order Kit MB-3: \$29.50

Component kit for main board. Contains all additional ICs, IC sockets, transistors, resistors, diodes, trimpots and 5V regulator Order kit MBK-3: \$48.50

Assembled and tested main board. Order MBA-3: \$105.00

On screen scoring circuit board, including LSI character display generator IC. Order kit SB-3: \$18.75

Component kit for scoring board contains all additional ICs, IC sockets, res-

sistors, capacitors, diodes and trimpots. Order kit SBK-3: \$20.50

Assembled and tested scoring board. Order SBA-3: \$55.00

Accessory kit contains parts for external game control. Includes paddle potentiometers for horizontal and vertical motion, 6-wire cables for remote use of paddle motion potentiometers, paddle size potentiometer, switches for computer control and game selection, score reset push button, speaker and hook-up wire, knobs. Order kit AK-3; \$25.75

Power supply, 12 volts DC. Powers the entire game including scoring module. Order kit PS-3; \$8.70

Cases. Including main cabinet plus remote player control boxes. Order kit CC-3: \$22.50

The Everything Package. Supplies everything needed. Includes CP-3, MB-3, MBK-3, SB-3 SBK-3 AK-3, PS-3 and CC-3. Order EP-3: \$162.50

Ball speed

Should the ball encounter either the top or bottom boundary in this mode, the signal at pin 9 of IC22-b will be cleared through diodes D17 or D18 and the ball will rebound off the boundary. The two diodes, D15 and D16 that connect to pin 3 of IC21-a and pin 11 of IC8-d are simply an OR gate to allow either gate to clock pin 3 of IC9-a.

Ball speed is controlled in both the vertical and horizontal directions. As was previously mentioned, the signal from pin 9 of IC9-b controls the horizontal speed while the signal at pin 5 of IC22-a controls the vertical speed. The element that determines the speed is IC12, a bilateral switch.

You will recall from the previous discussion that ball speed is a function of the charge rates of capacitors C5 and C14. These rates are determined by resistors R11 and R50. The values of these components were selected to produce the slower ball speeds. When the faster ball speed has been selected, an additional resistance R49 (or R51) is switched across the appropriate resistor by IC12, under the control of the signal from pin 9 of IC9 or pin 5 of IC22. This additional resistance effectively lowers the value of R11 (or R50) thereby increasing the ball's speed.

The computer-controlled paddles, a special feature of this machine and not to our knowledge seen elsewhere operates via IC12 too. By means of the external SPDT switches, the vertical paddle position voltage on pin 4 of IC4 and pin 6 of IC4 can be determined by either the player potentiometer or the computer control circuitry.

Recall the previous discussion of how the vertical position of the ball is determined by the voltage appearing on the collector of Q3. If this same voltage were applied to the paddle vertical position input, then the paddle should have the same vertical position as the ball. This is exactly the case. Instead of the player potentiometer determining the vertical position of the paddle, then, a paddle is slaved to the ball. Thus, the paddle tracks the ball motion and always has the same vertical position as the ball.

Since there are two paddles, it is necessary to select which one is to be slaved to the ball. This selection is done via the remaining two sections of IC12 and is controlled by IC10. When the ball is travelling toward the left side, the left hand paddle is slaved to the ball. When IC10 caused the ball to reverse direction, the other paddle becomes selected at that time.

Registering a point

A miss is detected by two end boundaries which are generated by IC15 and IC16, although not displayed on the screen. The left-hand boundary is generated by stretching the width of the horizontal sync pulse to about 8 microseconds through pins 11 and 8 of IC15; and then by AND'ing with the ball signal from pin 13 of IC5, the left-hand signal from pin 9 of IC10, and the inverted ball horizontal position signal from Q4 (also pin 11 of IC6) via pin 3 of IC15.

Coincidence of all four input signals on IC16 (ball presence, ball on left, ball going left, very near edge of screen) constitutes

10 INCHES

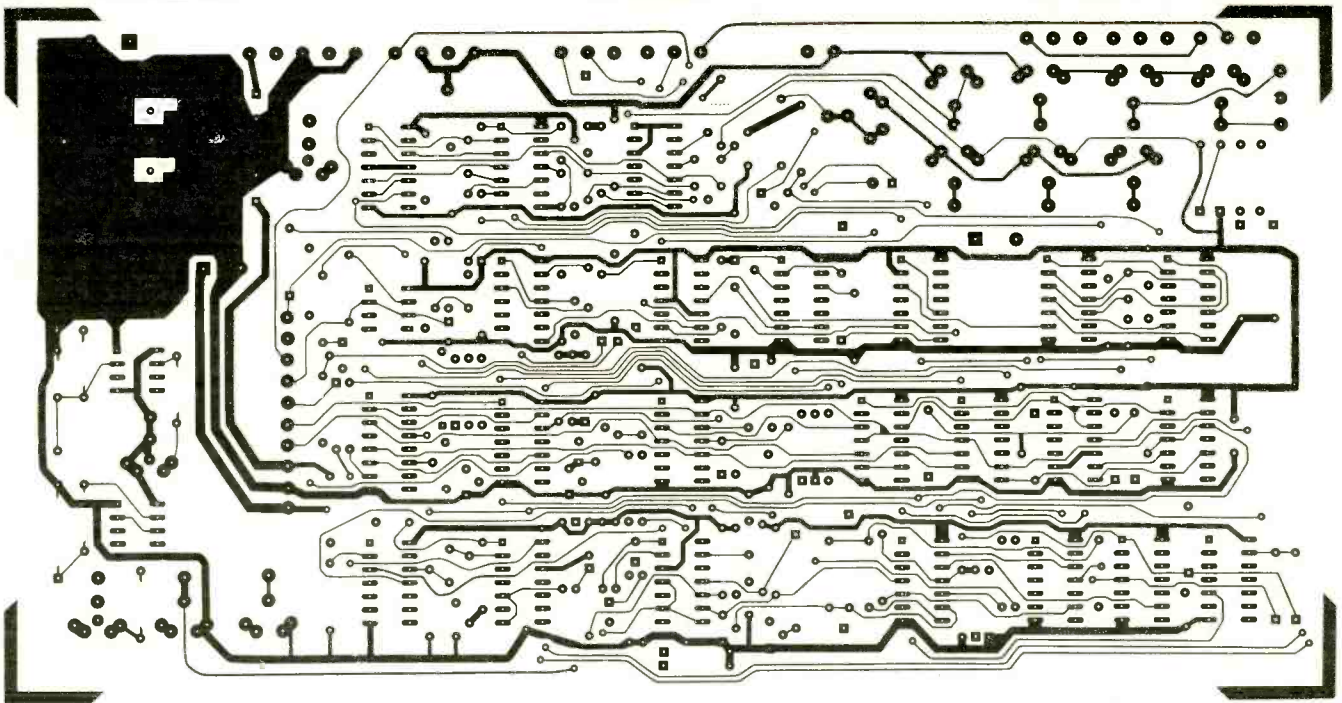

MAIN CIRCUIT BOARD FOIL PATTERN shown from component side of double-sided board.

10 INCHES

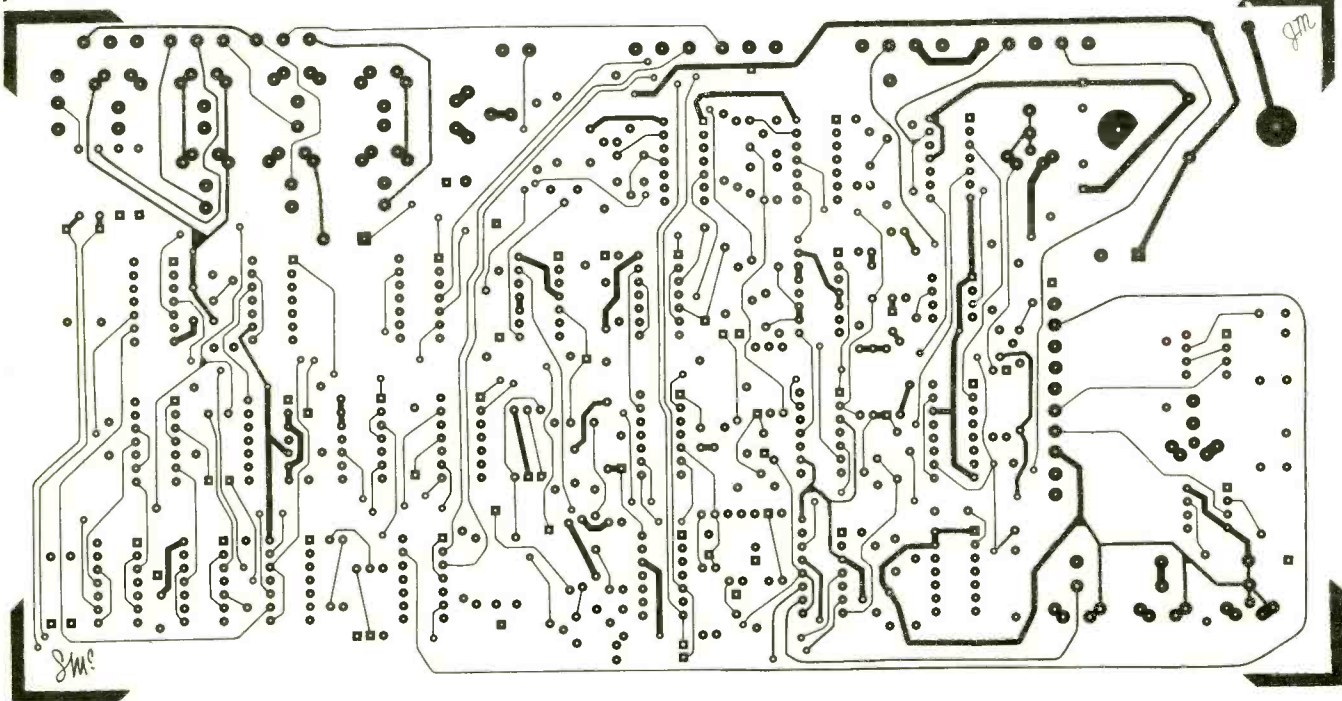

MAIN CIRCUIT BOARD FOIL PATTERN shown from bottom side of double-sided board.

a miss. The output pin 8 of IC16 goes low, through IC15 which is used as an OR gate and sets pin 5 of IC17, which indicates a miss. Similarly, a right hand miss is detected by pin 6 of IC16, which detects ball off the screen to the right at the beginning of the next scan line.

With pin 5 of IC17 set, pin 5 is high, which allows capacitor C17 to start charging. When C17 reaches the required level, IC11, the re-serve timer generates a re-serve signal. The signal resets pin 5 of IC17 and also clocks pin 9 of IC10 causing the ball to reverse direction horizontally.

In addition, with the occurrence of a miss signal pin 5 of IC9 is cleared from pin 6 of IC17, which causes the ball to return to the top of the screen. You will note that the ball always re-serves from either the upper right or upper left corner.

In the August issue we will present the description of the second game "Bumper" and the remaining construction information, which will include the parts location diagram. This article has required more space than we originally expected, but we want to present all the information we have. R-E



"Rampart, this is three. I have a mahogany patient, about four years old, picture weak, stand by for vital signs."

Step-by-step

TV Troubleshooters Guide

DC power supplies—how they work and how to troubleshoot and repair them

JACK DARR
SERVICE EDITOR

WHAT! DO A WHOLE TROUBLE-SHOOTING article on the DC power supply? Yes, SIR! This is a vital part of all electronics equipment. It is also the first thing that should be checked in any halfway logical approach to troubleshooting. If you have no DC power supply, none of the other stages can work at all. Besides, the DC power supply gives us a large percentage of the service jobs we run into.

Most of the circuits used are simple, and "stock". But a large part of the mail we get shows that this circuitry isn't all that clear to too many of us. In addition to the regular problems, it can give us some real headaches, with the cause too often unsuspected. Let's look over these circuits.

How do they work?

The stock AC-to-DC power supply is very simple. We feed an AC voltage to rectifier, which converts it to pulsating DC. The pulsations (ripple) are filtered out and we wind up with a nice smooth DC voltage. The DC voltage output is determined by the AC input voltage.

The simplest circuit is the half-wave rectifier of Fig. 1. The AC line voltage is fed directly to the rectifier diode. We come

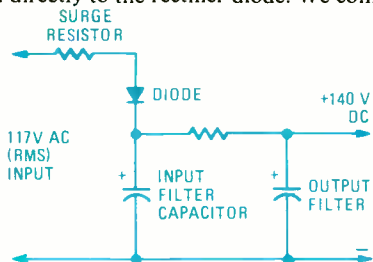

FIG. 1—HALF-WAVE rectified DC supply.

out with a series of pulses at 60 Hz; the polarity of these pulses is determined by the polarity of the diode. In tube sets, polarity is always positive; in transistor sets it can be either + or -.

Let's pause for a moment here and go over something that puzzles a lot of novices. Our AC input voltage here is 117 volts AC RMS. The DC output voltage is +140 volts. Are we getting something for nothing? No! the *apparent* gain of voltage is simply due to the way we read these voltages! Our AC voltmeter is calibrated in RMS, which is roughly 70% of the *peak* voltage. When the AC is rectified, we come out with a series of pulses, but these go to the peak value of the AC. Fig. 2 shows this relationship. These pulses are fed into the input filter capacitor and charge it up to peak voltage, and we could see a DC

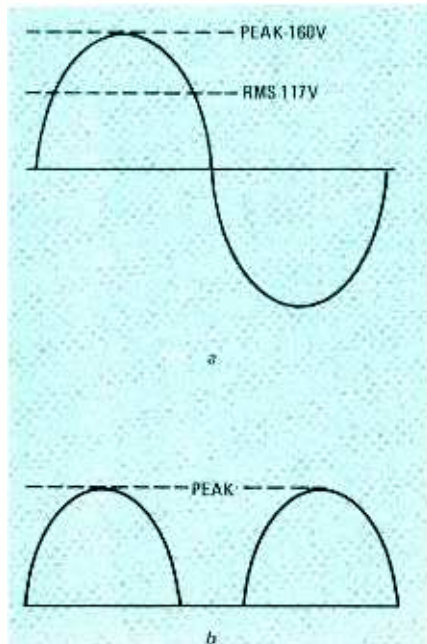

FIG. 2—IN- AND OUTPUT VOLTAGES. At a, 160-volt peak, 117-volt RMS ingoing AC voltage; at b, positive-going half cycles with 160 volts peak coming out of rectifier.

output voltage of about 160 volts, if there were no load at all on it. When we load the power supply, we are actually drawing out the charge that we put into the input filter capacitor. So, the voltage goes down somewhat. This capacitor is sometimes called a "reservoir" capacitor, for it acts like one.

The next most common type of supply is the full-wave rectifier. Fig. 3 shows a typical circuit. This type is generally used with a power transformer, with a center-tap in the high-voltage winding. The cathodes of the diodes are tied together for the + DC voltage, and the center-tap of the transformer secondary is the minus terminal, usually grounded. (If you put a resistor in series with this CT lead, you can

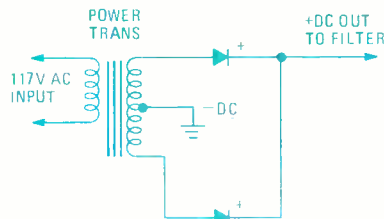

FIG. 3—THE FULL-WAVE RECTIFIER. Diode cathodes are plus, the center tap of the secondary winding is the minus terminal.

develop a negative voltage across it. Lots of older sets used this circuit.)

The voltage output here has the same ratio as the first circuit. The DC voltage output is higher than the AC RMS input. Just as before, we can get a negative voltage by reversing the diodes (and the filter capacitors!) In tube type TV sets, the DC voltage will run from about 300 to 400 volts, always positive to ground. In solid-state TV sets, you may see voltages or either or both polarities. Voltages will be lower.

The "bridge" rectifier

If we use four diodes hooked up as a "full-wave bridge" (Fig. 4) we can save some money. The secondary doesn't need

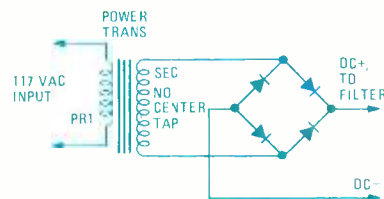

FIG. 4—THE FULL-WAVE BRIDGE uses a smaller transformer, but needs four diodes.

to be center-tapped, and it doesn't have to be twice the DC voltage. It can be the same (well, approximately). For a +300-volt DC output, a full-wave rectifier transformer would have to be 270-0-270 volts AC, or "270 volts each side of center tap". Using a full-wave bridge rectifier, we need only a 270-volt winding. The common-cathode connection of the bridge is the + terminal and the common-anode connection the -.

We can get DC voltage of any polarity we need by grounding the appropriate terminal of the bridge.

Voltage doublers

A popular circuit for line-operated DC power supplies is the half-wave voltage doubler of Fig. 5. A polarized electrolytic capacitor is connected directly to the AC line input. (This confuses people, but wait. This capacitor does *not* have ac on it.) Two diodes are used; they are called the series diode and the shunt diode. A filter capacitor is connected across the output.

Here's how it works: During the first negative-going half-cycle of the AC input voltage, input capacitor C1 charges up to the peak voltage, because diode D2 is conducting. During the positive-going half-cycle, D2 is cut off, but D1 (series diode) is conducting. So, the charge on the capaci-

tor C1 is fed through D1, in addition to the charge developed by the positive-going half-cycle. This action charges C2 (filter capacitor) to double the applied AC line voltage. C3 then discharges into the load,

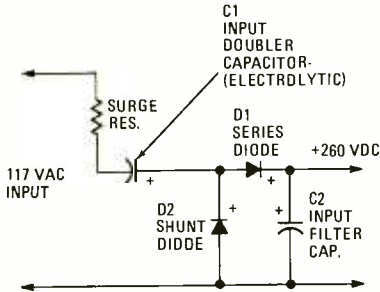

FIG. 5—VOLTAGE DOUBLER. This half-wave doubler is common in line-powered TV sets and many low-priced radios.

to give us a DC output voltage of about 260. Because of the presence and hookup of the diodes, C1 never actually has AC applied to it, though it does look like it! For reference, remember how a diode conducts: Fig. 6.

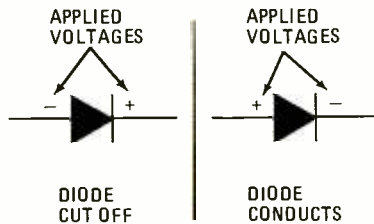

FIG. 6—WHEN CATHODE IS POSITIVE, diode is cut off; when negative, it conducts.

The full-wave voltage doubler

Another form of this circuit is shown in Fig. 7. It is called a full-wave voltage doubler. You'll find this circuit in sets with power transformers, because the AC input must be isolated. The basic action is the

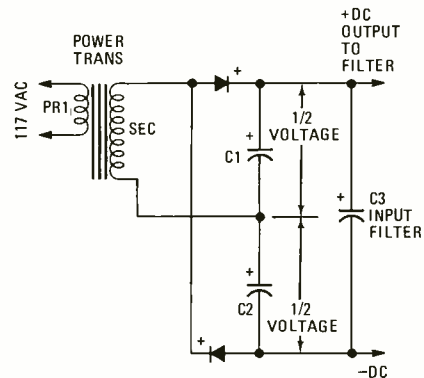

FIG. 7—FULL-WAVE DOUBLER requires a power transformer, two doubler capacitors.

same as in the half-wave type. The only difference is that each diode charges one of the doubler capacitors while it is conducting; one on each half-cycle, so that we use them both. In effect, the doubler capacitors are charged in parallel, then discharged in series. So, we get double the input voltage again.

The "identifier" for this circuit is the low side of the ac line. Note that it goes to the junction of the two doubler capacitors and nowhere else! C3 is the filter capacitor.

Table I is a fault-chart giving the typical reactions to various faults in each of the rectifier circuits. Each one has its own peculiarities. These are valuable clues to the actual part causing the trouble.

The filter circuit

The "DC output" of each of these rectifier circuits still consists of pulses of current or voltage. This has too much ripple in it; we've got to get rid of it before we can use the DC. So, we "filter" it out. The stock filter circuit is called a "pi-filter"

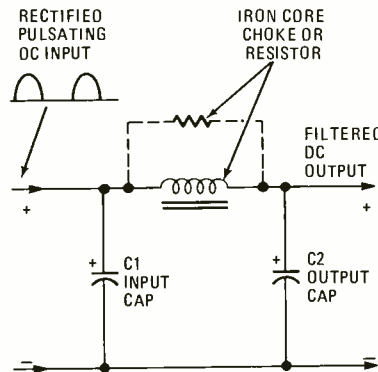

FIG. 8—THE PI-SECTION FILTER is used by the majority of power supplies.

from its resemblance to the Greek letter. Fig. 8 shows it. C1 is the input-filter capacitor, and C2 the output-filter capacitor. This circuit is still used in many TV sets.

In others, we use what is known as "brute force" filtering—we use capacitors so big that they simply swamp out the ripple. A resistor often replaces the filter choke. All of these reduce ripple in two ways: We treat the rectifier output as two voltages; one, the DC voltage we want, the other, a small AC voltage riding on top of the DC. The filter choke opposes the AC by inductive action. The filter capacitors provide a very low-impedance path to ground for AC only. So, the ripple flows through the filter capacitors to ground. These capacitors are so big they give the DC power supply lines a "zero impedance to ground." REMEMBER THAT! For the purists, this impedance isn't actually zero. It's something like 0.0000001 ohm or so in a well-designed filter.

Power supply protection

Most power supplies are protected

against short circuits. (All of them should be.) Fuses and circuit-breakers will be found in both primary and secondary circuits. There are two types of fuses; the "fast blow", with a simple link, and the slow-blow. The last has a tiny heating element in series; it can withstand short current surges without opening up. Both fuses and circuit-breakers must always be replaced with exactly the same kind originally used. One common mistake is to put in a larger fuse. This can allow serious damage to happen to the set, unless the circuit trouble that blew the original fuse is cleared!

Testing and test equipment

The DC power supply can be tested with only a few pieces of test equipment. A good AC/DC voltmeter is essential. A DC milliammeter can be very helpful. For some tests, a wattmeter is a time-saver, for reading the input power. Finally, the scope. We'll go into the uses of each in a minute.

Power supply testing can be very simple; just turn the set on and read the DC voltage under normal load. If it is up to the value shown on the schematic, fine. This is also a pretty good indicator of conditions in the whole set. If the DC voltage is normal, most of the thing is OK. If it's below normal, you may have an overload somewhere. If it's above normal, you have an open circuit somewhere.

There are only two types of faults in DC power supplies. One is "weak supply"; the thing won't supply enough current for normal operation, so down goes the DC voltage. The other one is overload; some stage or part is drawing for too much current. This too pulls the DC voltage down. However, in the last one, something will usually get hot.

There is one easy way to tell which of these faults you have. Read the input wattage with a wattmeter. For example: the set has a normal input of 150 watts. You can get this figure from the service data, or by looking at the rating-plate on the chassis. You have low DC voltage. Plug the television receiver into the wattmeter and turn it on.

A reading of say about 75 watts means that you have something weak, or open. A reading of 250 watts means that something is leaky; about 400 watts means that you've got a big fat short somewhere! This should be the first step in the actual diagnosis. More on this useful instrument later.

TABLE I—FAULT CHART

Circuit	DC Voltage Low	No DC Voltage
Half-Wave	Open input filter capacitor	Open diode, open surge resistor, shorted input capacitor
Full-Wave	Open input filter capacitor	Open diodes, or shorted input filter
Full-Wave Bridge	Open input filter capacitor (NOTE: one diode in bridge open will not reduce DC voltage by very much, but will increase ripple)	Shorted filter capacitor
Half-Wave Doubler	Open input filter capacitor	Open input doubler capacitor, diode or surge resistor
Full-Wave Doubler	Open input filter, one diode open; one doubler capacitor open	Shorted filter capacitor

Weak supply problems

Let's take the easy one first, the weak supply. In half-wave and full-wave circuits, a low-emission rectifier tube or selenium rectifier can cause it. For a quick check, just shunt a silicon diode across the original rectifier. If the DC voltage comes up, replace the old one. The same symptom can be caused by a low-capacitance or open input-filter capacitor. Since it acts as a reservoir to hold the charge, the DC voltage drops when it loses capacitance. Here again, just shunt another capacitor across the suspected one. If the DC voltage comes up, that was it.

In both half-wave and full-wave voltage doublers, low or open capacitors will reduce the DC voltage. In the half-wave circuit, the input doubler (not the filter,

the doubler capacitor) can reduce the DC output to almost nothing if it opens. Clue: there will be very little AC voltage on the rectifier side of this capacitor. In the full-wave doublers, if either one of the doubler capacitors opens, down goes the voltage. Clue: half normal output DC voltage across one of the capacitors, very little across the other. It is a good idea to replace both of them. They must be matched.

NOTE: do not bridge large electrolytic capacitors across others in transistor power supplies, with power on. This causes a large transient, and can damage transistors. Turn the power off first.

In a full-wave bridge rectifier circuit, an open input-filter capacitor will drop the voltage; same reason. If one of the

diodes in the bridge should open, the DC voltage will not drop by very much, but the ripple will go up quite a lot.

Overloads and shorts

An overload is just that. Something is trying to draw far too much current from the DC power supply. Typical symptoms are low DC voltage and something getting very hot (like the power transformer). The input power reading will be well above normal, and fuses or circuit breakers will open up.

This can be caused by a shorted part in the DC power supply itself. Silicon diodes should be checked; you can do that with an ohmmeter. All good silicon diodes should show a high resistance one way and a much lower one with the ohmmeter prods reversed. A shorted one will usually read almost zero both ways.

Electrolytic filter capacitors can short. These too can be checked with the ohmmeter. Hint: electrolytic capacitors will show a low resistance if the ohmmeter polarity is reversed; always reverse the ohmmeter prods. In a full-wave bridge rectifier circuit, you will probably get a low ohms reading both ways! One of the diodes will always be forward biased and conducting. For a definite check, lift the DC output lead of the bridge, and repeat the resistance check.

Electrolytic capacitors can develop high leakage, causing an overload. The clue to this is a "hot can" in the can-types. Normally, electrolytics should not be warm, unless there is a hot tube nearby. If the can is hot, leakage is too high.

Breaker tripping

Circuit-breaker tripping is often the sign of an overload. Note that I didn't say "always." The breaker may be tripping on too little current. To check, let it trip; then clip a duplicate breaker across its terminals, and turn the set on again. If this one trips, then you do have an overload. There are several other tests, as usual. You can connect an AC ammeter across the terminals of the breaker and read the actual AC current being drawn.

Power transformer shorted?

In quite a few cases, we have trouble finding out whether the short is in the load circuits or in the power transformer itself. It's not too hard to tell. One good check is to disconnect all loads from the secondaries, plug it in and let it sit for about 15 minutes. If it isn't shorted, the case will still be at room temperature. If there is an internal short, the case will be pretty hot. The wattmeter can be used here; a good transformer, with no load, will show a very small reading, about 5 watts or less, with a wattmeter in its primary. This is the "iron loss" of the transformer. Note: the wattmeter used for this test must be the "true wattmeter" or dynamometer type with a current coil and voltage coil. You can identify one by the fact that the meter has four terminals.

You can make an "emergency wattmeter" by connecting a 1-ohm resistor in series with the AC circuit, and then hooking an AC voltmeter across the

(continued on page 108)

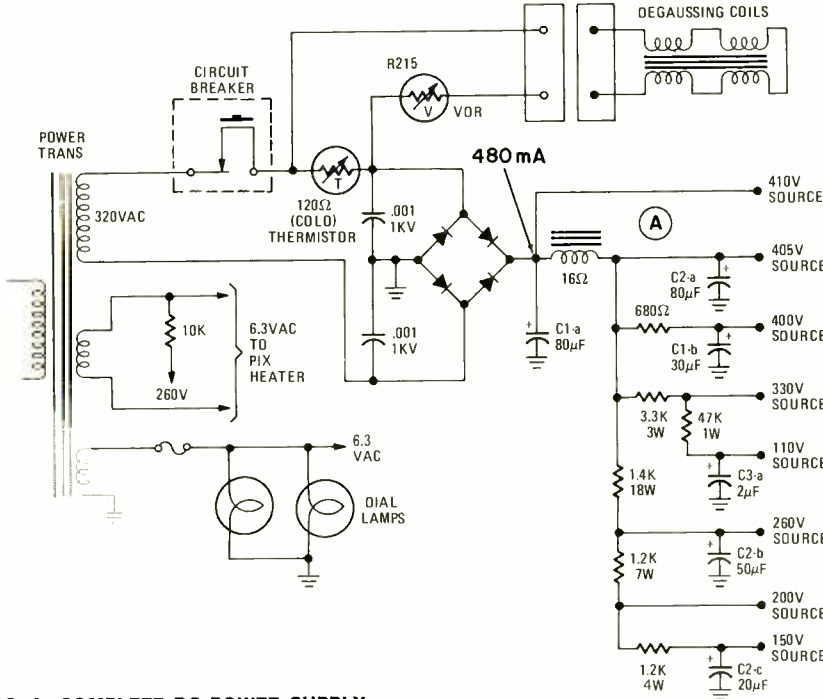
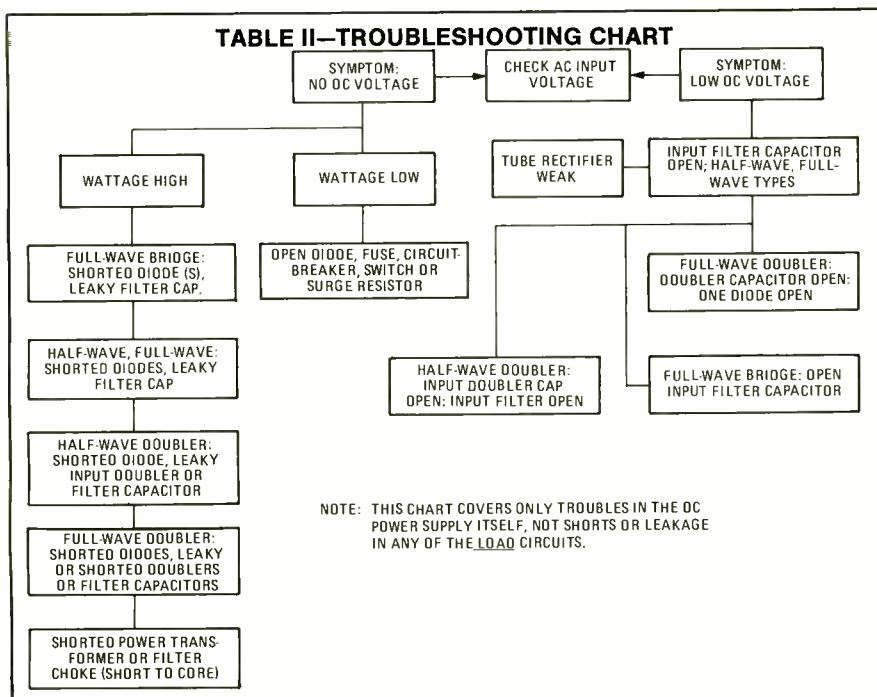

FIG. 9—COMPLETE DC POWER SUPPLY.



R-E's Service Clinic

CB in hi-fi and TV

How to cure
CB interference

JACK DARR
SERVICE EDITOR

WITH THE RECENT INCREASE OF CB radios, we're beginning to get the kind of complaints that we got on ham transmitters. These complaints are in regards to interference with other services—radio, TV, stereo, hi-fi and musical instrument amplifiers, as well as PA systems.

The problems in TV are beats and lines on the screen and garbled voice signals in the sound. In audio amplifier systems, it's different. The interference is usually loud and clear. Speaking of loud, one reader says that it almost broke windows in his home—he had a 500-watt amplifier!

The cause is usually unmistakable. When your stereo suddenly booms out "Big Bad Bertha to Poopdeck Pete. Is Smokey in sight?", there isn't much doubt! However, before I get run over by a 16-wheeler, let me say this in self-defense. Hardly *any legally operated* CB radio will cause this severe interference. Not in a properly designed radio, stereo, TV or PA system.

Causes

People say, "But this is an RF signal. How can it get into my audio amplifier?" Easy. The input of a modern audio amplifier is pretty sensitive. When there is a strong RF signal at the input, it can be demodulated by the first preamplifier stage. After this, it's audio and goes sailing right on through. Transistor stages are especially prone to this. Any of the junctions can act as a diode detector. A tube stage will do the same thing in a slightly different way.

In fact, this is a well-known servicing trick. I have used it for many years in testing audio amplifiers, particularly PA systems. I just connect a TV an-

tenna to the input (see Fig. 1). Any antenna with continuity will do, an open-end type like a simple dipole will make it hum very badly. If the amplifier is working, it will sit there and "radio" all day. This works in any place with a fairly strong local radio station.

That's what happens in audio amplifiers, we'll get to the TV later. Now, how can we stop this? The cure is fairly simple; just kill the RF signal at the input of the amplifier. All we need to do is add a simple filter to eliminate the RF. This should have no effect on the audio signals. The simplest way of doing this is to connect a small bypass capacitor, say 250 pF, from the base of the first preamp stage to ground. This will look like a dead short to the RF and a very high resistance to the audio signals. The 250-pF capacitor has 650,000-ohms reactance at only 1.0 kHz, but only 200 ohms at 27 MHz. Be sure to use the shortest possible leads and connect it directly from the base of the transistor to ground, as shown in Fig. 2.

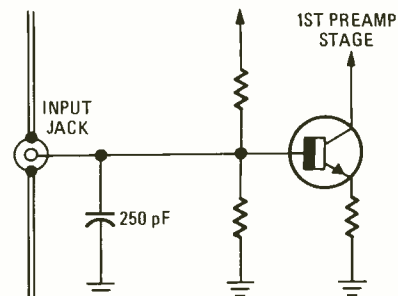

FIG 2

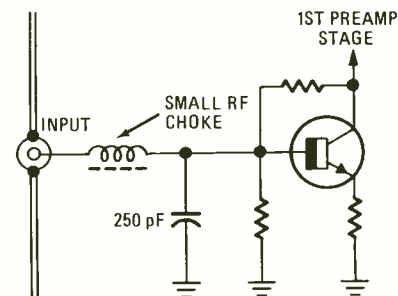

FIG 3

If this helps but doesn't cure the problem, add a small RF choke in series with the lead from the audio input to the base of the transistor. Figure 3 shows the addition of the RF choke. Here we're taking advantage of

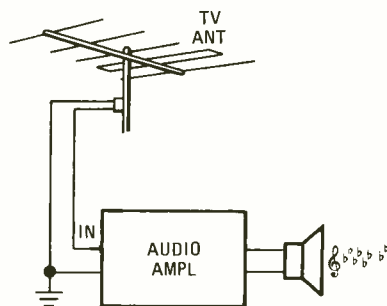

FIG 1

REPLY COUPON

Expires 9/30/76

This column is for your service problems—TV, radio, audio or general and industrial electronics. We answer all questions individually by mail, free of charge and the more interesting ones will be printed here.

If you're really stuck, write us. We'll do our best to help you. *This coupon must accompany all questions. No reproductions or facsimile will be accepted.* Don't forget to enclose a stamped, self-addressed envelope. If return postage is not included, we cannot process your question. Write: Service Editor, Radio-Electronics, 200 Park Ave. South, N.Y. 10003.

the opposite characteristics of a coil to a capacitor. A 1.0 millihenry choke has only 31.4-ohms reactance at 5,000 Hz, but almost 200,000 ohms at 27 MHz. If you still need more attenuation, you can convert this into the familiar pi-type filter by adding another capacitor to ground at the input jack (see Fig. 4.)

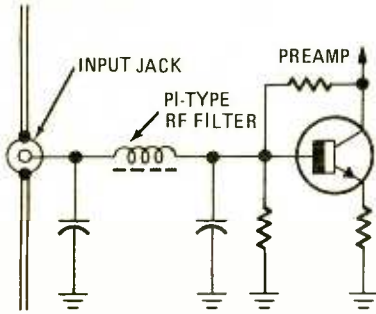

FIG 4

If you want to do a little extra work, you might even try tuning this filter to 27 MHz! Or, rig up a parallel-resonant circuit and put this in series with the input lead. Ordinarily, this isn't needed.

Shielding

Oddly enough, this kind of interference will be found even though all leads are shielded. I don't really understand this, but it happens. The RF signal may be coming into the chassis on the AC lines. This could be cured by the same basic method. Bypass the AC line to chassis right at the point where it enters. It might be that the shielding braid on audio cables, though adequate for audio, isn't "tight" enough for RF. In difficult cases, you might try adding a "bottom plate" to the amplifier chassis. A piece of aluminum foil held by the mounting bolts will do nicely.

CB in the TV

Now we come to a more difficult type of CB interference—in TV sets. The typical symptom will be beats in the picture, sometimes these will be in the form of a typical 120-Hz humbar. There will be two bands of wiggles across the picture, sometimes affecting the color, sync, etc. In most cases, you'll be able to hear garbled voice signals along with the TV sound.

Here we have several possibilities. One, the 27-MHz RF signal may be getting into the tuner. The signal can beat with the TV station signal or the local oscillator, or simply develop its own harmonic beats in the mixer. TV RF stages are not noted for sharp selectivity. If they were, they wouldn't work. If there is a 2nd harmonic developed in the mixer, it would produce some dandy beats, sidebands, etc., right in the middle of the TV's bandpass!

A less common but possible place for RF pickup might be in the IF input. The 2nd harmonic would be developed in the 1st IF stage. This is one place

MODEL 6000 BOOSTER AMPLIFIER



KIT
\$49.50

MAY BE CONNECTED TO THE OUTPUT OF ANY CAR STEREO OR RADIO UNIT. WILL DELIVER A POWERFUL 60W (30W PER CHANNEL) OUTPUT AT LESS THAN 3% THD. FREQUENCY RESPONSE FLAT FROM 50-20000 HZ. EASY TO ASSEMBLE KIT, COMPLETE WITH ALL PARTS, ENCLOSURE.

MODEL 4000 TONE CONTROL



KIT
\$32.50

WILL WORK WITH EITHER THE MODEL 6000 OR 3000 BOOSTER AMPLIFIER. FEATURES FULL RANGE BASS, MID, TREBLE CONTROLS, PUSHBUTTON CONTROL FOR TAPE HISS FILTER, HEADPHONE JACK. CONNECTS BETWEEN CAR STEREO OUTPUT AND EITHER OF THE TWO BOOSTER AMPLIFIERS. WILL NOT WORK BY ITSELF OR OTHER MAKE BOOSTER AMPLIFIERS. EASY TO ASSEMBLE KIT, COMPLETE WITH ALL PARTS, KNOBS, ENCLOSURE.

MODEL 3000 BOOSTER AMPLIFIER



KIT \$36.50

- * FULL 30W (15W PER CHANNEL)
- * LESS THAN 3% THD.

Jandy International

2001 North Buena Vista Burbank, Calif. 91504 Phone (213) 841-3440

Description	Price Each	Total

(Calif. residents add 6% sales tax.)

My check or M.O. for \$ _____ is enclosed.

Charge your purchase Master Charge* BankAmericard

Acct. No.

*Interbank No. Expiration Date
(4 digits above your name)

X _____
Sign Your Name as it appears on your Bank Credit Card

To Avoid Delay—Print Clearly

Mr., Mrs., Miss _____
First Middle Last

Street _____

City _____

State _____ Zip _____

SATISFACTION GUARANTEED OR YOUR MONEY BACK!

Circle 13 on reader service card

AUTOMOTIVE STEREO BOOSTER KITS

where we might get better results by shielding. The coupling from the tuner to chassis is through an RF coaxial cable. If the IF stage is properly shielded, as is customary, pickup in this area should be very rare.

In the large combination sets with TV and a stereo amplifier, we could get pickup directly on the audio system input. If this happens, the cures mentioned can be used.

Tuned traps

In cases where you're almost certain that the problem is caused by RF pickup on the lead-in, you should be

able to minimize it with tuned traps. A high-pass filter can be connected between the lead-in and TV input terminals. If this is efficient enough, it should be able to reduce all RF signals below about 40 MHz. You can get these already made, but get a good one. I have tried some of the cheaper ones. I couldn't even tell they were in there!

The FCC

In most cases, complaining to the FCC won't do a great deal of good. At least not immediately. The FCC is overloaded right now. You should exhaust all local alternatives first. For one rea-

son, (I repeat) it is possible for a perfectly legal CB transmitter to cause some interference to a radio, TV or audio amplifier that isn't properly designed to reduce RF pickup at its input. The better amplifiers do have this protection built-in. For consumers, the first step should be to check with your radio-TV technician. He can probably help the situation with some of the things mentioned.

A good CB transmitter doesn't radiate enough 2nd harmonic signal to give any trouble. FCC type-acceptance specifications require that the 2nd harmonic emission be held to a very low level—60 dB down or more. It is possible for 2nd harmonics to be bothersome, but in most cases these are generated inside your own set!

Another good way to get help is to contact the head of the local CB or amateur radio club. These groups are interested in clean interference-free operation and reception.

Listen carefully to any interfering transmissions. Make notes of any handles used, or even a call-sign. See if you can get any idea of the location of the station. When you get some information, ask the CB'ers to check it out. When you have something to go on, then write or call the nearest FCC Field Office, giving dates, places, type of interference and so on.

Speaking to the electronics technicians, check up on cases of CB interference in your area. Eliminating this is often quite simple and can provide a good source of extra business. Follow the suggestions given and you may be able to help clear up the problem. Technicians, listeners and CB clubs working together can help clean up this particular kind of noise pollution. **R-E**

reader questions

INSTRUMENTATION PROBLEM

I'm having difficulty in trying to fix a black-and-white Zenith. After tube changes, the raster came back. Now I have some very unusual readings! The grid of the horizontal-output tube ought to be -39 volts, and I read a +100 volts. The horizontal oscillator grid ought to be -70 volts, and I get +125 volts. Others are also off. The only voltages I get that are normal are the boost at +680 volts and B+ of 260 volts. I've changed some capacitors and resistors, but I still can't get any change in these readings. What else can I try?—G.S., Baton Rouge, LA.

We have a couple of contradictory statements here! If you *do* have a raster, a picture, and a boost voltage of +680 volts (normal), this set is work-



This Helper Goes 'Round The Corner To Get To Work

When you've got to go 'round an obstacle in order to get to the job, reach for this bent nose helper. Long, fine pointed nose. Precision matched, serrated jaws. Drop forged of high grade steel with full polished, high luster finish. Blue dipped plastic cushion grips optional. All of the painstaking attention to details you expect—and get—in tools by CHANNELLOCK.

CHANNELLOCK, INC., • Meadville, Pa. 16335

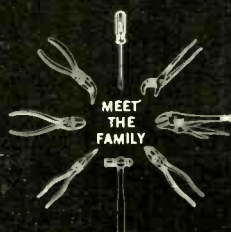

Send For Our Free Catalog

CHANNEL LOCK

No. 386 Curved Long Nose Plier

Circle 15 on reader service card

ing! It couldn't possibly work with the grid voltages you read. So, I think the first thing to try would be another *voltmeter*. For a crystal-ball guess, your voltmeter is giving you incorrect readings because of the presence of high pulse voltages. I've had this happen to me. You need a bypass capacitor across something to prevent this.

AUDIO POWER MODULES

I've just gotten hold of some RCA HC2500 100-watt power amplifier modules. What would be the best way to get a 200-watt power output from these? Could I use one of these as a booster for another?—D.K., Commack, NY.

You can't increase the power output of these above the rating. However, you could easily get a 200-watt total output by using two modules, each driving its own speaker system, and feeding the inputs in parallel. The power supply would have to be beefed up to handle the extra current drain, of course.

ODDBALL SYMPTOMS

This set came in with no high voltage. I found a short between the horizontal and vertical windings of the deflection yoke. Replacing this, I put my DC milliammeter in the cathode circuit of the horizontal output tube. Now I get some very odd reactions! There's a chirping in the flyback and it loses horizontal sync, then there is a frying in the flyback. Current through the output stage decreases and the high-voltage goes down.

I checked several things, including the filter capacitor—no help. I accidentally grabbed the leads to the meter and the high-voltage came back! I found that I could twist these and it came back to almost normal. Taking the meter out, it works fine. What's going on here?—R.O., Daly City, CA.

You're getting some kind of screw-ball feedback due to pulse voltage across your milliammeter! When you grabbed the leads, you added some shunt capacitance. Add a 0.5 μ F capacitor right across the meter and you won't have this trouble any more.

RCA TRANSISTOR NUMBERS

I'm not having any luck crossing the IF transistors from an RCA CTC-38 against the substitution guides! Especially the 3536, AGC; 3535, 1st IF, and 3576 3d video IF. Any ideas?—C.R., Clymer, PA.

Try using the stock numbers. In the RCA SPG-202R *Transistor Manual*, the ones you're looking for are on page 110. AGC transistor, 124573 = SK-3122. The 1st and 2d IF, 124757 = SK-3117. The 3d IF 124754 = SK-3132. The secret is to keep looking until you have found all of the numbers that start with "124."

R-E

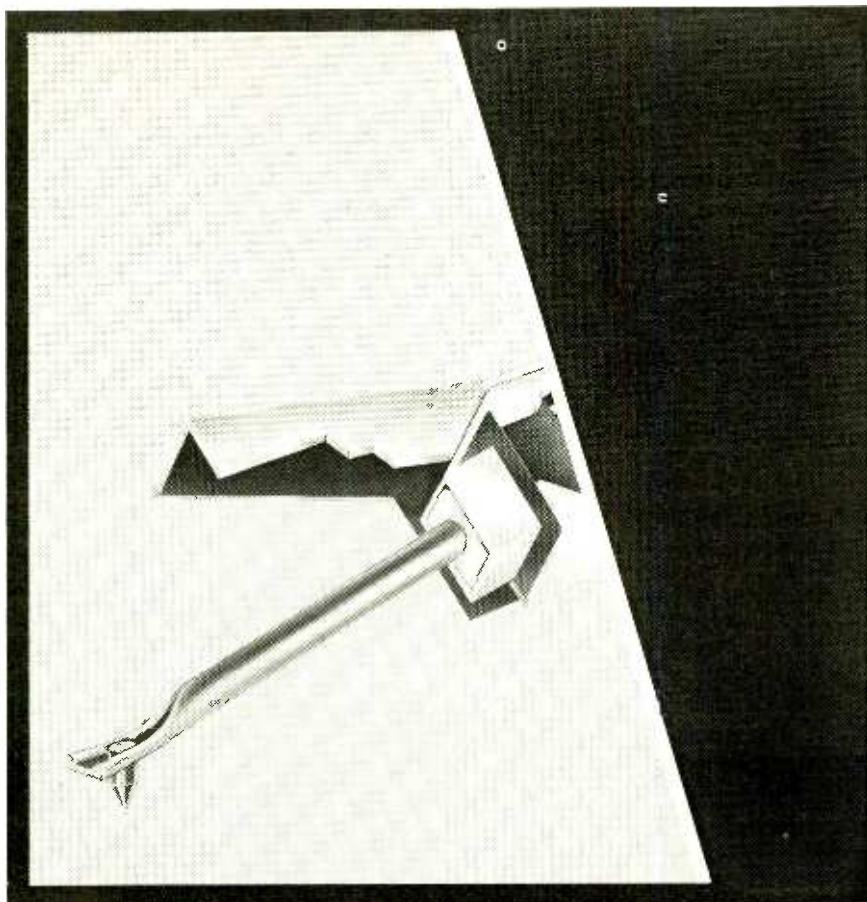

This...protects your most expensive hi-fi investment.

Recognizing that a penny saved is a penny earned, may we suggest that trying to economize by putting off the replacement of a worn stylus could be like throwing away five dollars every time you play a record. (Multiply that by the number of records you own!) Since the stylus is the single point of contact between the record and the balance of the system, it is the most critical component for faithfully reproducing sound and protecting your record investment. A worn stylus could irreparably damage your valuable record collection. Insure against this, easily and inexpensively, simply by having your dealer check your Shure stylus regularly. And, when required, replace it immediately with a genuine Shure replacement stylus. It will bring the entire cartridge back to original specification performance. Stamp out waste: see your Shure dealer or write:



Look for the name SHURE on the stylus grip and the words "This Stereo Dynetic® stylus is precision manufactured by Shure Brothers Inc." on the box.

Shure Brothers Inc.
222 Hartrey Ave., Evanston, IL 60204
In Canada: A. C. Simmonds & Sons Limited



Manufacturers of high fidelity components, microphones, sound systems and related circuitry.

Circle 17 on reader service card



The Stax SRX-III is quite simply the finest sound reproduction system you can buy. Period.

Much better than any speaker system at any price. Literally the standard for "other" headphone manufacturers.

Compare the facts you can measure: flat frequency response from 25 - 30,000 Hz (± 1.5 dB); distortion is essentially unmeasurable.

Now compare the facts that really matter. The SRX-III is entirely hand assembled and evaluated by the family company who created the first electrostatic headphone. A company dedicated to research — to ultimate sound. So every SRX is the product of detailed effort. Even the low mass diaphragms are individually paired — both by electronic testing and by listening.

Listen to an SRX system with program material you "know". You will be in the front row — the same room — the recording studio. You will hear perfection. The truest, clearest, most transparent reproduction ever possible. A reality now at audio dealers nationwide.

STAX

Backed by **American Audioport, Inc.**
909 University
Columbia, Mo. 65201



Circle 18 on reader service card

HI-FI TEST REPORTS

continued from page 52

linear ceramic filters, two IC's and an LSI circuit are employed in the FM-IF section.

The multiplex decoder section uses the now-popular phase-locked-loop IC circuit plus low-pass output filtering for extra subcarrier suppression. FM muting employs a reed relay for positive action at the threshold signal level. The AM circuit uses an IC to replace most discrete components. The phono equalizer-preamp section uses a three-stage direct-coupled circuit powered by relatively high (± 49 volts) supply voltages for high overload characteristics. A dual-polarity supply is used to power the tone control stages, too.

A two-stage class-A differential amplifier is used as the input stage of the power amplifier section that is entirely DC-coupled and the output section (drivers and outputs) consists of a three-stage Darlington direct-coupled circuit with power transistors arranged in a parallel push-pull circuit. The electronic protec-

tion circuitry of the SX-1250 uses a power relay which also delays turn on until the supply voltage has been stabilized. A block diagram of the entire receiver (one amplifying-channel only) is shown in Fig. 4, while Fig. 5 shows the variety of auxiliary equipment that may be connected to the unit.

FM performance measurements

A summary of FM performance measurements measured in our lab is listed in Table II. We feel that Pioneer "pushed" sensitivity specs just a bit too far in their published literature. While a given number of receivers may well meet the 1.5 μ V (8.7 dBf) usable sensitivity figure claimed, that is so difficult to maintain consistently in production that the company would have been well advised to settle for a 1.7 μ V (10 dBf) claim—which is what we measured for our sample—rather than risk failing to meet what is at best an unimportant spec.

We have also advised Pioneer that their interpretation of the new dBf notations in their literature is *not* correct. In our list of Manufacturer's Published Specs shown

TABLE II
RADIO-ELECTRONICS PRODUCT TEST REPORT

Manufacturer: **U.S. Pioneer Electronics**

Model: **SX-1250**

FM PERFORMANCE MEASUREMENTS

SENSITIVITY, NOISE AND FREEDOM FROM INTERFERENCE

	R-E Measurement	R-E Evaluation
IHF sensitivity, mono: (μ V) (dBf)	1.7 (10.0)	Excellent
Sensitivity, stereo (μ V) (dBf)	3.0 (14.9)	Very good
50 db quieting signal, mono (μ V) (dBf)	2.4 (13.0)	Very good
50 db quieting signal, stereo (μ V) (dBf)	50.0 (39.3)	Poor
Maximum S/N ratio, mono (dB)	81	Superb
Maximum S/N ratio, stereo (dB)	73	Excellent
Capture ratio (dB)	1.0 dB	Excellent
AM suppression (dB)	58 dB	Very good
Image rejection (dB)	Greater than 100	Excellent
IF rejection (dB)	Greater than 100	Excellent
Spurious rejection (dB)	Greater than 100	Excellent
Alternate channel selectivity (dB)	81 dB	Very good

FIDELITY AND DISTORTION MEASUREMENTS

Frequency response, 50 Hz to 15 kHz (\pm dB)	+0, -1.0	Very good
Harmonic distortion, 1 kHz, mono (%)	0.14	Very good
Harmonic distortion, 1 kHz, stereo (%)	0.20	Very good
Harmonic distortion, 100 Hz, mono (%)	0.12	Excellent
Harmonic distortion, 100 Hz, stereo (%)	0.20	Excellent
Harmonic distortion, 6 kHz, mono (%)	0.14	Excellent
Harmonic distortion, 6 kHz, stereo (%)	0.24	Superb
Distortion at 50 dB quieting, mono (%)	0.6	Very good
Distortion at 50 dB quieting, stereo (%)	0.25	Very good

STEREO PERFORMANCE MEASUREMENTS

Stereo threshold (μ V) (dBf)	4.0 (17.4)	Very good
Separation, 1 kHz (dB)	48	Excellent
Separation, 100 Hz (dB)	42	Excellent
Separation, 10 kHz (dB)	36	Superb

MISCELLANEOUS MEASUREMENTS

Muting threshold (μ V) (dBf)	2.0 (11.4)	Excellent
Dial calibration accuracy (\pm kHz @ MHz)	-300 kHz	Fair

EVALUATION OF CONTROLS, DESIGN, CONSTRUCTION

Control layout	Excellent
Ease of tuning	Superb
Accuracy of meters or other tuning aids	Very good
Usefulness of other controls	Excellent
Construction and internal layout	Excellent
Ease of servicing	Good
Evaluation of extra features, if any	Very good

OVERALL FM PERFORMANCE RATING

Excellent

separately, we have *correctly* specified the dBf versus microvolt readings. Pioneer, for example, interpreted 8.9 dBf *correctly* but paranthetically called that reading equivalent to 3.0 μ V across a 300 ohm input impedance when, in fact, it corresponds to 1.5 μ V across that impedance. All other microvolt readings (listed alongside the dBf figures in Pioneer's literature) are equally in error by two-to-one, or 6 dB. We give Pioneer an "A" for effort in hastening to try to conform to the newly accepted measurements and notations but suggest that they re-read the standards very carefully. If you happen to pick up a spec sheet for any new 1976 Pioneer receiver or tuner, simply divide the " μ V" notations that you will find listed near the dBf notations by two to get the right microvolt equivalent!

Nearly all of the measured results regarding FM performance were either very good or excellent, with the exception of 50 dB quieting in stereo which, on our sample, required a signal input of 39.3 dBf (50.0 μ V/300 ohms). The various rejection ratios (image, IF and spurious) were, in fact, so superior that we could not measure them accurately with our lab equipment that had a 100-dB limit. Distortion readings in both mono and stereo were very good to excellent and we were particularly impressed with the low THD reading (0.24%) at the high-frequency test point in stereo where THD usually tends to get out of hand because of beat frequencies. Separation was also excellent both at mid frequencies and at the audio

frequency extremes. Dial calibration was off by a consistent 300 kHz across the dial which simply means that the dial pointer needed to be shifted slightly (and is not indicative of mis-alignment of the RF section).

Amplifier and preamplifier measurements

The power amplifier was subjected to the usual one hour preconditioning tests with no resulting heat problems or thermal cutout. The SX-1250 is one of very few receivers that boast a 4-ohm power rating these days, since at 4-ohms considerably more current is delivered by the output circuits than is true under 8-ohm loads and not many receivers can pass the stringent FTC burn-in requirements when so loaded. Maximum power-output ratings were exceeded moderately under 8-ohm conditions before reaching the low 0.1% rated THD figure, and by a wider margin under 4-ohm load conditions. These and other results are listed in Table III. The IM distortion at rated power was almost as low as the THD, measuring only 0.095%. At the one-watt level, where many amplifiers tend to show higher or rising distortion, both THD and IM were still low.

Hum and noise for both phono and high-level inputs was very low, as would be expected from a receiver of this quality. But even more surprising was the incredible overload capability of both phono inputs which measured 540 milli-

continued on page 82



You can build a better organ than you can buy!

A magnificent Schober Electronic Organ

What a marvelous way to put your special talents to work! With our Schober Electronic Organ Kits and your skill, you can build yourself some very special satisfaction, and a lifetime of great music!

Schober Organs are literally far superior to comparably-priced "ready-made" units. You could actually pay twice as much and get no better organ... and miss the fun of assembling it yourself. A PC board at a time, component by component, you'll assemble your own "king of instruments." And when you're done, you'll wish there was more to do. And there is! For then, Schober will help you learn to play, even if you've never played a note before!

Schober Organ Kits range from \$650 to \$2850, and you can purchase in sections to spread costs out... or have two-year time payments.

Just send the coupon for the fascinating Schober color catalog (or enclose \$1 for a record that lets you hear as well as see Schober quality.)

The Schober Organ Corp., Dept. RE-152
43 West 61st Street, New York, N.Y. 10023

- Please send me Schober Organ Catalog.
 Enclosed please find \$1.00 for 12-inch L.P. record of Schober Organ music.

NAME _____
ADDRESS _____
CITY _____ STATE _____ ZIP _____

Circle 19 on reader service card

Why ACE solderless breadboards are more reliable than others.

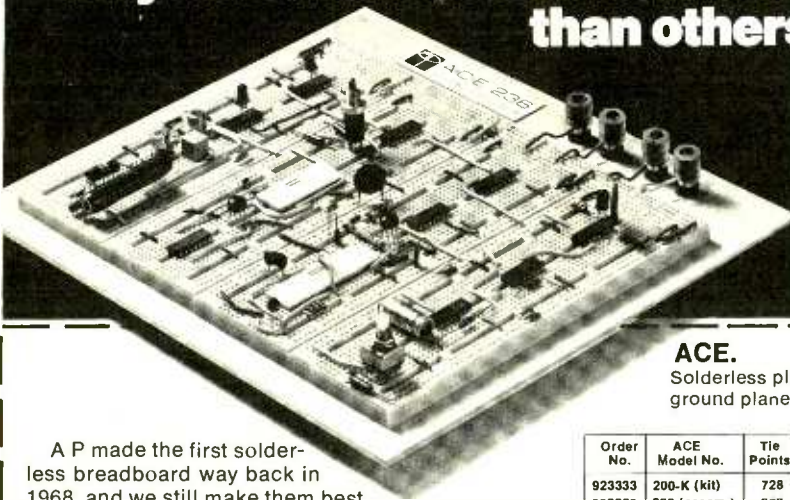

ACE.
Solderless plug-in tie points,
ground plane and binding posts.

A P made the first solderless breadboard way back in 1968, and we still make them best. Because our experience taught us to avoid the pitfalls that can mean circuit errors. We do it by paying attention to details. Like using non-corrosive nickel-silver in our frankly superior terminals. And like using a vinyl-insulated back that prevents short circuiting. That's why you can count on the reliability of our solderless boards when you specify A P ACE All Circuit Evaluator Boards, Super Strips™, Terminal and Distribution Strips.



A P PRODUCTS INCORPORATED
Box 110-R Painesville, OH 44077 (216) 354-2101 TWX: 810-425-2250

Order No.	ACE Model No.	Tie Points	DIP Capacity	No. Buses.	No. Posts	Board Size (Inches)	Price Each	Gly.	Total
923333	200-K (kit)	728	8 (16's)	2	2	4-9/16x5-9/16	\$18.95		
923332	208 (assem.)	872	8 (16's)	8	2	4-9/16x5-9/16	28.95		
923334	201-K (kit)	1032	12 (14's)	2	2	4-9/16x7	24.95		
923331	212 (assem.)	1224	12 (14's)	8	2	4-9/16x7	34.95		
923326	218 (assem.)	1760	18 (14's)	10	2	6-1/2x7-1/8	46.95		
923325	227 (assem.)	2712	27 (14's)	28	4	8x9-1/4	58.95		
923324	236 (assem.)	3648	36 (14's)	36	4	10-1/4x9-1/4	79.95		

Total for merchandise

Sales Tax (OH and CA)

Shipping (see table)

TOTAL ENCLOSED

Credit Card Number _____

4 Numbers Above Name (MC) Good Thru _____

Signature _____

Print Name _____

Address _____

City _____ State _____ Zip _____

- Check or M.O. enclosed
 Charge BAC
 Charge MC
 Send catalog

Shipping/Handling

Up to \$10.00 \$1.00
10.01 to 25.00 1.50
25.01 to 50.00 2.00
50.01 to 100.00 2.50
100.01 to 200.00 3.00

Orders subject to acceptance at factory.

Company PO's FOB Painesville
No COD orders

DEALER INQUIRIES INVITED.

Circle 20 on reader service card



1 CC Form 70-A
August 1974

The United States of America NUMBER
PI-24-14355

FEDERAL COMMUNICATIONS COMMISSION

RADIO TELEPHONE OPERATOR LICENSE

FIRST CLASS
(General Radiotelephone Certificate)

This certifies that JOHN R. BOE

SEX	HEIGHT	WEIGHT	COLOR EYES	COLOR HAIR	DATE OF BIRTH
M	5' 11"	185	BLUE	BROWN	02 MONTH 22 DAY 1946

IS A LICENSED RADIO OPERATOR, AUTHORIZED, SUBJECT TO ANY SPECIAL ENDORSEMENT PLACED HEREON, TO OPERATE THE CLASSES OF LICENSED RADIO STATIONS FOR WHICH THIS CLASS OF LICENSE IS VALID UNDER THE ORDERS, RULES AND REGULATIONS OF THE FEDERAL COMMUNICATIONS COMMISSION, ANY STATUTE OF THE UNITED STATES AND ANY TREATY TO WHICH THE UNITED STATES IS A PARTY.

THIS LICENSE IS GRANTED UNDER THE AUTHORITY OF THE COMMUNICATIONS ACT OF 1934 AS AMENDED AND THE TERMS AND CONDITIONS THEREOF AND OF ALL LEGISLATIVE ACTS, EXECUTIVE ORDERS, AND TREATIES TO WHICH THE UNITED STATES IS SIGNATORY, AND ALL ORDERS, RULES AND REGULATIONS OF THE FEDERAL COMMUNICATIONS COMMISSION, WHICH ARE BINDING UPON RADIO OPERATORS, AND ARE MADE A PART HEREOF AS THOUGH SPECIFICALLY SET OUT IN FULL HEREIN.

NEITHER THIS LICENSE NOR THE RIGHTS CERTIFIED TO HEREIN SHALL BE ASSIGNED OR OTHERWISE TRANSFERRED TO ANY OTHER PERSON.

PLACE AND DATE OF ISSUANCE: WASHINGTON, D.C. MARCH 31, 1975

DATE AND TIME OF EXPIRATION: MARCH 31, 1980 AT THREE O'CLOCK A. M. EASTERN STANDARD TIME

SPECIAL ENDORSEMENT:

SHP RADIAR ENDORSEMENT WASHINGTON, D.C. MARCH 31, 1975

Paul J. Harris
Assistant Director
Federal Communications Commission

John R. Boe
Licensee

SPECIMEN

NOT VALID UNTIL SIGNED

CIE's Warranty says a lot to you!

A lot about CIE's FCC License training programs...and a lot more about our school.

Our FCC License Warranty means just what it says. If you enroll in any CIE career course that includes FCC License preparation and successfully complete your training . . . you'll pass the Government FCC exam. We *warrant* that you'll succeed.

CIE can make this no-nonsense warranty because we're confident of our in-depth career training programs. You see, we have *specialized exclusively* in Electronics education-by-mail for more than 40 years. Just Electronics. And, the courses we offer today are the result of these years of teaching experience and proven methods of training.

Our courses of study are written in easy-to-understand language, so you can progress at your own learning pace, at home, in your spare time. And, there are never any classrooms to attend.

CIE courses challenge your thinking . . . help you develop your understanding of important electronics theories and applications . . . enable you to learn new skills and knowledge. Our courses are thorough. They have to be.

You see, we're training you for a career in Electronics. And, if an FCC "ticket" is part of your goal, you'll have to pass a tough licensing exam administered by the Federal Communications Commission (an agency of the U.S. Government). And you'll be prepared.

CIE is willing to warrant that you will pass! The reason is . . . we have every reason to expect that *you will* do exactly that. Based on a series of continuing surveys, *close to 9 out of 10 CIE grads pass* their FCC exams!

What's a license worth?

An FCC License can be worth a lot if you're interested in any area of Electronics involving communications. In some fields, federal law requires that you must have one. And, even in careers where a license is not required, it is

Government certification of certain electronics knowledge and skills.

What about other CIE courses?

In every CIE career course, you'll find the same time-tested instructional techniques that have made CIE's FCC License preparation programs so successful.

Each CIE career course is built on the principle that the best way for you to *learn* and *retain* what you've learned is to *explain*; then to *check* your understanding; then to *reinforce* your comprehension with practical applications. In some courses, you will perform experiments and tests with your CIE Experimental Electronics Laboratory using authentic electronic components and gear. And, if you select a course that includes Color TV technology, you will not only build and keep a 25" diagonal Color TV which features digital circuitry . . . you'll also learn how to troubleshoot your TV.

The CIE course you select (beginner, intermediate, or advanced college-level), will be a complete educational program, designed by *experts* to give you the best in Electronics home-study education.

Send for FREE school catalog

Discover more about the career opportunities open to people with electronics training. *Learn* how CIE career courses can help you build new skills and knowledge and prepare you for a meaningful, rewarding career. Whether you are just starting out in Electronics or are a college-trained engineer in need of updating, (or anywhere in between), CIE has a course designed for *you*. And, more than half of CIE's career courses include FCC License preparation.

Send today for our FREE school catalog and booklet on FCC License information. For your convenience, we will try to have a representative call to assist in course selection. Mail reply card or coupon to CIE . . . or write: Cleveland Institute of Electronics, Inc., 1776 East 17th Street, Cleveland, Ohio 44114. Do it TODAY.

G.I. Bill benefits

All CIE *career* courses are approved for educational benefits under the G.I. Bill. If you are a Veteran or in service now, check box for G.I. Bill information.

CIE's FCC LICENSE WARRANTY OF SUCCESS

CIE warrants that when you enroll in any CIE course which includes FCC License preparation, you will, upon successful completion of the course and the FCC License material, pass the Government FCC Examination for the License for which your course prepared you. If you do not pass the appropriate FCC Examination, you will be entitled to a full refund of an amount equal to the cash price for CIE's "First Class FCC License Course," No. 3. This warranty will remain in effect from the date of your enrollment to 90 days after the expiration of the completion time allowed for your course.



Dr. G. O. Allen President

CIE Cleveland Institute of Electronics, Inc.
1776 East 17th Street, Cleveland, Ohio 44114
Accredited Member National Home Study Council

Yes, I want your FREE school catalog and career information package today. RE-78

I am especially interested in:

- | | |
|--|--|
| <input type="checkbox"/> Electronics Technology | <input type="checkbox"/> Industrial Electronics |
| <input type="checkbox"/> FCC License Preparation | <input type="checkbox"/> Electronics Engineering |
| <input type="checkbox"/> Color TV Maintenance | <input type="checkbox"/> Other _____ |
| <input type="checkbox"/> Mobile Communications | _____ |

Print Name _____

Address _____

Apt. _____

City _____

State _____

Zip _____

Age _____

Check box for G.I. Bill information. Veteran On Active Duty

new products

More information on new products is available from the manufacturers of items identified by a Reader Service number. Use the Reader Service Card inside the back cover.

ELECTRONICS TOOL SET. The model 250K is a 12-piece starter tool set for electronic technicians and kit builders in a compact plastic carry case with storage tray. Included are the Weller® UL listed 25-watt iron with two 750°F. tips, soldering aid tool and 10 oz.



of resin core solder. From Xcelite®, 4" long-nose pliers, diagonal cutters and wire strippers, all with Poly-Cushion grips, a ¼" nutdriver, and both slotted and Phillips head screwdrivers with chrome vanadium steel blades and plastic handles.—Weller-Xcelite Electronics Div., The Cooper Group, Apex, NC 27502.

Circle 31 on reader service card

MINIATURE NEEDLE-TIP TEST PROBE with a miniature banana plug 48 inches long. Model 4071-48 includes a sharp, replaceable needle tip that easily pierces varnish or plat-

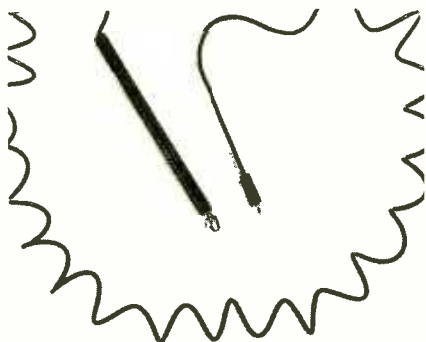

ing to give a good electrical reading. Tough thermoplastic is molded directly onto the probe tip and wire lead, providing a strong,

reliable integral unit.

The pin tip plug is .080 inches in diameter, made of gold-plated brass. The stack-up is of beryllium copper spring, gold-plated, and accepts .080 inches diameter pin. Operating temperatures are from -25°C to +105°C. \$2.50.—ITT Pomona Electronics, 1500 E. 9th St., Pomona, CA 91766.

Circle 32 on reader service card

25-WATT POWER AMPLIFIER, model F62500, is a compact monitor power amplifier for recording and broadcast studios and for commercial-sound and sound-reinforcement applications. It fills the need for an amplifier with higher power output than the company's 10-watt model 610 (shown), but with lower power than the company's 70-watt model 870 monitor amplifier. One important application of the new amplifier is for use by disc jockeys who want more headset sound than can be provided by lower-power units while monitoring a record.

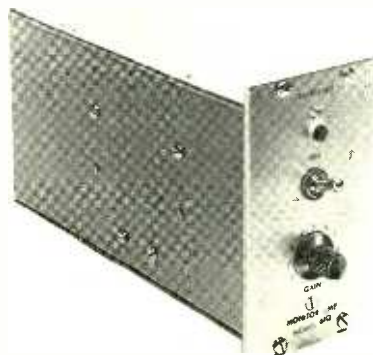

The unit is completely self-contained with a built-in 110 to 120 volt AC, 50 to 60 Hz power supply. Operating from a standard 600-ohm audio line, the amplifier readily drives an 8- or 16-ohm monitor loudspeaker. The model F62500 is housed in a compact chassis with brushed-aluminum front panel. Up to five of these amplifiers can be mounted in the company's 662 PM 5¼ by 19 in. rack-mounting frame.

Some important specifications of the amplifier are: power output (8-ohm load), 25 watts continuous; power output (16-ohm load), 15 watts continuous; harmonic distortion at full power, 0.4 percent; frequency response, ±1 dB from 20 to 20,000 Hz, hum and noise, 85 dB below rated output; and input voltage for full output, 0.4 volt.—Robins Industries, 75 Austin Blvd., Commack, NY 11725.

Circle 33 on reader service card

TOOLS FOR CABLE INSTALLATION. The D'versaBit combines a long flexible spring-steel shaft with high-quality drill bits in a

tool system that reduces the time required for in-wall cable installations. The tools can be used for rapid installation of coaxial and electrical cable within all type of building walls. A standard quarter-inch drill is used to drive the tools.

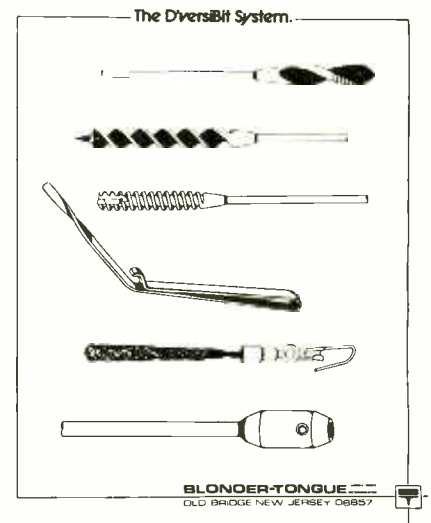

The various items making up the system include: a ½-inch auger bit with a 54-in. flexible shaft for easy starting and a clean entrance hole; a ½-inch carbide-tipped masonry bit with a 54-in. flexible shaft for drilling cement blocks and plaster; and a ½-inch combination bit with a 54-in. flexible shaft for greater durability and general-purpose use. Also available is a special alignment tool to guide and hold steady the D'versaBit flexible shafts; a line-recovery pulling-grip attachment for drawing RG-59 and RG-6 coax cable through the drilled holes; and a 54-in. extension attachment.

Installers of burglar and fire alarms, TV cables, telephone lines and electrical power lines will find the new tool system indispensable for quick and easy installations.—Blonder-Tongue Labs, 1 Jake Brown Rd., Old Bridge, NJ 08857.

Circle 34 on reader service card

AM/FM STEREO RECEIVER, model 331. Tuner section uses circuit-board module construction, has frequency-linear variable



capacitor, a low-noise MOSFET to improve sensitivity, and heavy sintered alloy flywheel

for smooth tuning. There is also a sensitive tuning meter and a blackout dial face. Two ceramic filters and IC's deliver first rate performance. The model 331 is rated at 12 watts-per-channel, minimum RMS power with both channels driven into 8 ohm speakers over a bandwidth of 40 Hz to 20,000 Hz with no more than 1.0% THD. Power bandwidth is 40 Hz to 20,000 Hz at or below rated minimum RMS power output and total harmonic distortion. Frequency response at 1-watt output is 25 Hz to 30,000 Hz, +2 dB, -3 dB. IHF sensitivity is 2.5 microvolts, signal-to-noise ratio is better than 65 dB, selectivity is better than 60 dB, capture ratio less than 1.5 dB. \$200.00—Sansui Electronics Corp., 55-11 Queens Blvd., Woodside, NY 11377.

Circle 35 on reader service card

ALL-WEATHER OUTDOOR SPEAKER, the Kriket KC-45 is built for external mounting



on boats, sports vehicles, tractors, or any mobile application. Designed to look good

Money Generator

PAT. PEND.



ATC-10 GENERAL TELEVISION SERVICER

- Extra wide range RF/IF attenuator for testing receiver sensitivity.
- GRAY QUAD pattern for gray scale tracking checks/adjustments.
- COLOR BARS pattern with 6th bar marked to make your job easier.
- 3.58 MONITOR pattern for oscillator frequency checks with no need to short the AFPC test point.
- RED RASTER pattern for checking and adjusting purity at the flip of a switch.
- High level, 75 ohm video output.
- 2 year factory warranty.
- 30 day money back guarantee.

Versatile

Next time you're repeatedly switching static and dynamic convergence patterns, think how much easier the composite HATCH-DOTS pattern below would make your job. It can also perform size, linearity, pincushion and centering checks. It's only one of several unique patterns produced by the ATC-10 that can save you time, trouble and most important - money. We'd love to show you how. Write us.

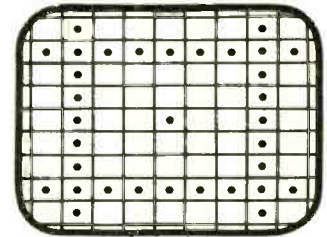

American Technology Corporation

225 Main Street, Dept. 7C, Canon City, Colorado 81212

Circle 22 on reader service card

Consumer Tested Remedy for Sick Car Performance Sparks New Life in Pre-1975 Cars.

Owners of pre-1975 cars get better performance with less maintenance when they install one of the Mark Ten C.D. Electronic Ignition Systems. In fact, thousands of users testify the Mark Ten has noticeably improved their automobile's performance. As a California doctor stated after using the Mark Ten for 95,000 miles. "... I can 'feel' the difference in performance between my conventional ignition and the Mark Ten..."



Mark Ten Systems* spark each plug with 50,000 to 60,000 volts in secondary output compared to a mere 25,000 volts in standard and most pointless systems. This means dramatic increases in acceleration and general engine performance, and substantial increases in gasoline mileage. Points will last the lifetime of the rubbing block. Spark plug life is extended three to ten times due to the hot spark generated by the Mark Tens, which eliminates fouling and cleans dirty plugs. And the Mark Ten Systems virtually eliminate at least 2 out of 3 tuneups! Look at what Delta Customer P.S. from New York wrote, "... I might add that I had another unit of yours that has been on three cars so far. Each of the cars was driven about 50,000 miles

before it was turned in. *Not one of the cars ever had a new set of points, new plugs or a tune-up.*

Now its on the fourth car with 20,000 miles on it and going strong." The result? BIG SAVINGS!

Send today for your copy of the new Delta brochure and learn how a Mark Ten System can spark your car into new life.

*Only Delta Products offers a full line of C.D. ignitions: The Mark Ten and Mark Ten B, available assembled or in kit form; and the Mark Ten C, assembled only.

DELTA PRODUCTS, INC.

P.O. Box 1147
Grand Junction, Colo. 81501
(303) 242-9000 Dept. RE

I want to know more about Mark Ten CDI's. Send me complete no-nonsense information on how they can improve the performance of my car.

Name

Address

City State Zip

Circle 23 on reader service card

and keep operating during all weather conditions, the *Kriket KC-45* is carefully crafted with an impact-resistant, Duralex cover for rugged dependability.

Kriket KC-45 outdoor speaker specifications: power handling, 5 watts, 9 watts program, 13 watts peak. Frequency response: 150 Hz—10,000 Hz. Impedance: 8 ohms. Shipping weight: 2 lb. 6 oz.—**Acoustic Fiber Sound Systems, Inc.**, P.O. Box 18228, Indianapolis, IN 46218.

Circle 36 on reader service card

TURNTABLE. The *FONS CO-30* transcription is a precision engineered device for those who demand top performance and reliability.

It comes standard without a pickup arm. High-performance arms, available from a number of manufacturers, can be used with the *FONS*. Pre-cut mounting boards are available for the turntable. For the purchaser

who likes to "do it himself", the blank board that is standard on the *CO-30* may be custom drilled. For those who prefer a turntable with an arm already installed, the *FONS* also comes equipped with a factory-installed SME arm.

Among the outstanding features of the *FONS* is the individually and continuously variable three-speed (33 $\frac{1}{3}$, 45, 78 rpm) speed control allowing total speed variation from 29 to 100 rpm. Aside from accurately playing records, the wide range of speed allows the user the ability to play records at varying speeds for "in home" recording effects or for listening to older off speed records.

The drive system consists of a DC servo control motor with tachometer generator coupled to a high mass, anodized aluminum platter by means of a precision belt. This, along with the full electronic speed control insures an accurate speed regardless of

power supply fluctuations.

Another benefit of the high torque motor/drive system is a platter run up time of .66 of a revolution (1.7 seconds) to 33 $\frac{1}{3}$ rpm.

The "instant speed" features make the turntable ideal for recording studio use, and production wherein tight cueing of records is desirable. Rumble is typically —79dB and wow and flutter is better than $\pm 0.4\%$.



The base incorporates the *FONS* anti-feedback phase cancellation suspension system. The unit comes with a walnut base and hinged, smoked plexiglass dust cover. Approximately \$300.00. The turntable is manufactured in Scotland by Fergus-Fons and distributed by **Audio Dimensions**, 4 Riverstone Drive, Weston Ontario M9P 2R6 Canada.

Circle 37 on reader service card

CAR FM SIGNAL BOOSTER, the *Stereo One*, is designed to help eliminate signal fade and flutter associated with weak-signal FM reception. The *Stereo One* can be used with any auto AM/FM radio without adverse effect on normal AM/FM operation. The circuit more than triples the received signal in the "on" mode to provide clear, crisp FM reception in fringe signal areas. The booster does not overload in strong-signal metropolitan areas.



The *Stereo One* is a 2-piece unit consisting of the amplifier that mounts close to the auto radio and the ON-OFF control switch that self-mounts on the dash in any convenient location. The control switch includes an LED "on" indicator.—**The Finney Co.**, 34 W. Interstate St., Bedford, OH 44146. **R-E**

Circle 38 on reader service card

EDLIE'S BARGAIN BONANZA ONLY HIGHEST QUALITY PRODUCTS

- SPECIAL BUY** AMPEX 60 minute cassette tapes only .99¢ each 3 for \$2.69 12 for only \$8.99
- Single conductor SHIELDED WIRE #22 Gauge good for Microphone or stereo cable. Gray color only 25 Ft for \$1.00 100 foot for only \$3.39 Same wire as above with 2 conductors and two shields 25 ft for \$1.25 100 foot for only \$4.39
- (P017) COPPER CLAD BOARDS! Copper on one side, 1/16" thick. Excellent quality for either production or experimental work. B) 4"x16 1/2" .99¢ ea. 3/\$2.69 D) 8"x16 1/2" \$1.19 ea. 3/\$2.99 E) 6 3/8"x17 1/2" \$1.19 ea. 3/\$2.99
- (P134) 8 ROTARY SWITCHES Some multiple gang. \$1.00
- (P128) 13 MINIATURE ELECTROLYTIC CAPACITORS \$1.00 Axial & upright, popular values.
- (P144) TRANSISTOR REPAIR KIT \$1.19 Various parts used to repair transistorized devices.
- (P336) TO—3 TRANSISTOR SOCKETS 12 for \$1.00
- (P164) 4 ROLLS OF WIRE \$1.00 Approx. 25 ft. per roll, 20-28ga.
- (P140) TAPE RECORDER SPARE PARTS KIT \$2.95 Parts for repairing most tape recorders: capacitors, meter, pilot lamp, jacks, and MUCH MORE.
- (P167) 10 MINIATURE POTENTIOMETERS \$1.00
- (P182) 2 MISC METERS \$1.00 Miniature.
- (P156) 60 DISC CAPACITORS \$1.00 Asst. from .0001 to .1, most 600V, Z5U, NPO, N750, etc.

SURPLUS TUBES
All guaranteed for 1 full year.
ANY 3 FOR \$1.25

Acquired from U.S. Defense depots or removed from equipment (new and used). These are laboratory tested and guaranteed for one full year. Most are of such standard makers as RCA, GE, etc.

3A4	6AQ7	6DE4	12AE7
3AF4	6AT6	6DR7	12AL5
3BN6	6AU6	6DW4	12AU7
3DG4	6AV6	6EB8	12AV6
3KT6	6AX4	6EM7	12BE6
3Q4	6AX5	6GF7	12BH7
4BC5	6AY3	6GH8	18FV6
4BN6	6BA6	6K6	25L6
4BU8	6BG6	6K11	35EH5
4BZ7	6BJ8	6LB6	36AM3
5V6	6BQ6	6SN7	50A5
6AF4	6BZ6	6T8	50L6
6AG5	6CB6	6W4	
6AG7	6CG7	6X4	
6AL5	6CM7	10EW7	

- (P147) 4 lb. GRAB BAG SPECIAL \$1.00 Full of exotic and exciting electronics parts.
- (P155) TUBE BONANZA! \$1.00 20 asst. popular tubes, untested.
- (P142) 50 PRECISION RESISTORS \$1.00 All 1%, 1/2w and 1w, low and high ohmages.
- (P150) 15 HI-FI KNOBS \$1.00 Every one superb! Purchased from Harmon, Kardon, Fisher, etc.
- (P102) CALCULATOR KEYBOARD \$2.95 Wild Rover C-1380. Can be used with CT5001. 4 function, clear, clear entry and constant. 7 cm x 9 cm.
- (P175) 70 1/2w CARBON RESISTORS \$1.00 Asst. values. Some 5%.
- (P154) 150 CUT LEAD RESISTORS \$1.00 Carbon, all leads long enough for soldering.
- (P149) 20 POLYSTYRENE TOP GRADE CAPACITORS \$1.00
- (P132) 20 DUAL POTS \$1.00

MONEY BACK GUARANTEE
Terms: Minimum order \$4.00. Include postage. Either full payment with order or 20% deposit, balance C.O.D.

WRITE FOR FREE 1976 VALUE PACKED CATALOG
Listing thousands of components, tubes, resistors, IC's, kits, test equipment.

BONUS FREE CAPACITOR KIT With Every \$5 Purchase

THIS MONTH'S SPECIALS!

- 74\$15 Schottky 3 inp pos AND. O.C. 45¢
- 739 Dual lo-noise pre-amp 85¢
- P8815A Dual 4 inp. NOR 2 for \$1.00

TTL

<input type="checkbox"/> 7400	16¢	<input type="checkbox"/> 7446	80¢
<input type="checkbox"/> 7401	18¢	<input type="checkbox"/> 7447	80¢
<input type="checkbox"/> 7402	23¢	<input type="checkbox"/> 7448	80¢
<input type="checkbox"/> 7403	23¢	<input type="checkbox"/> 7473	49¢
<input type="checkbox"/> 7404	23¢	<input type="checkbox"/> 7474	49¢
<input type="checkbox"/> 7405	23¢	<input type="checkbox"/> 7475	85¢
<input type="checkbox"/> 7406	23¢	<input type="checkbox"/> 7476	53¢
<input type="checkbox"/> 7410	23¢	<input type="checkbox"/> 7490	79¢
<input type="checkbox"/> 7411	27¢	<input type="checkbox"/> 7492	79¢
<input type="checkbox"/> 7413	40¢	<input type="checkbox"/> 7493	69¢
<input type="checkbox"/> 7420	23¢	<input type="checkbox"/> 7495	79¢
<input type="checkbox"/> 7430	23¢	<input type="checkbox"/> 74121	57¢
<input type="checkbox"/> 7440	30¢	<input type="checkbox"/> 74122	57¢
<input type="checkbox"/> 7442	\$1.12	<input type="checkbox"/> 74123	67¢

- LINEARS**
- LM309K 5v la reg. \$1.15
 - 555 Timer 75¢
 - 556 Dual 555 \$1.00
 - 566 Function gen. \$1.75
 - 567 Tone decoder \$1.95
 - 741 comp. op amp 39¢
 - 2102 1024 bit RAM \$4.95
 - 8038 volt cont OSC \$4.25

- CLOCK CHIPS WITH DATA**
- (MM5314) 6 dig clock \$4.95
 - CT 7001 Alarm & Date \$5.95

- LED'S**
- (P223) 10 Asst LEDs \$1.00
 - (P242) 5 Jumbo Green LEDs \$1.00
 - (P242) 5 Med Yellow LEDs \$1.00
 - (P001) 5 Jumbo Red LEDs \$1.00
 - (P011) 5 Med Red LEDs \$1.00
 - (P012) 5 Mini Red LEDs \$1.00
 - (P293) DL707 (equiv.) 7 seg red LED, .3" char, comm anode \$1.00
 - (P007) DL747 7 seg red LED, .6" char, comm anode \$1.95
 - (P013) MAN 5 (equiv.) 7 seg green LED, .27 char, comm anode \$1.49
 - (P006) D.L. 704 (equiv.) same as D.L. 707 except comm-cath \$1.35

- IC BREADBOARDS & TERMINALS**
Boards have .042 holes. Made of 1/16" polyester glass.
- (PB663) 3"x4" 94¢
 - (PB664) 3"x6" \$1.29
 - (PB665) 4"x6" \$1.65
 - (PB666) 4"x8" \$2.12
- Push-in terminals
- (PP6601-20) pkg 20, 90¢
 - (PP6601-100) pkg 100, \$2.89
- Push-in flanged pins
- (PB6602-20) pkg 20, 90¢
 - (PB6602-100) pkg 100, \$2.98
- Push-in flea clips
- (PB6603-20) pkg 20, 90¢
 - (PB6603-100) pkg 100, \$2.89
 - (P008) 14 pin DIP sockets 3 for \$1.00
 - (P1104) IC REMOVAL AND INSERTION TOOL \$4.95 "Pul-n-ser-tic" extracts and inserts ICs without damage.

CB ANTENNAS

(continued from page 35)

wavelength to the feed line to one of the verticals, the array provides an *end-fire* bi-directional pattern along the plane of the antennas as in Fig. 11-b. End-fire gain is 2.3 dB and beamwidth is about 80°. Note that broadside operation provides more gain while end-fire operation provides wider lobes.

When two identical vertical antennas are spaced one-quarter wavelength apart and fed 90° out-of-phase (by adding one-quarter wavelength to the feed line to one antenna) the radiation pattern is uni-directional in the shape of a cardioid with 120° beamwidth, 30 dB attenuation to the rear and 20 dB attenuation to the sides. Radiation is in the direction of the out-of-phase antenna (Fig. 11-c).

When three identical ground-plane verticals are spaced one-quarter wavelength apart and excited directly, 90° out-of-phase, the cardioid radiation pattern has a half-power beamwidth of 60°. This pattern can be switched in either direction. Inserting a one-quarter wavelength section in the feed line to one vertical causes the array to "fire" in the direction of that particular element. By using three radiators one-quarter wavelength (9 feet) apart in the form of a triangle, it is possible to steer the 60° cardioid pattern around the horizon in six steps while providing 4.5 dB over a single vertical radiator.

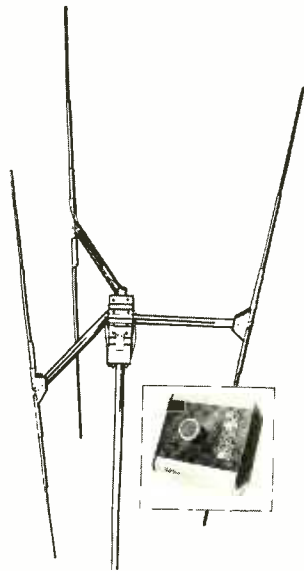

FIG. 12—THIS THREE-ELEMENT PHASED ARRAY—Antenna Specialists' Super Scanner MS119—provides 360° directivity by selecting one vertical dipole as the radiator and using the other two as reflectors.

The switching system—usually controlled from the operating desk—selects the two radiators to be directly excited and the other that is to be fed with a 90° phase shift. This permits the beam to be switched to any one of six positions. A letter to the engineering department of most antenna makers will bring application notes and engineering reports that will make it easy for you to design your own steerable vertical array.

MEET OUR FAMILY OF HIGH VOLTAGE TEST PROBES

In 1967 we introduced the first high voltage test probe with a built-in meter. It became so popular that we have been adding new models ever since. Now there are five different versions to satisfy the demands of radio, television, appliance, audio, and electrical repair men in a wide variety of high voltage testing applications.

The five models are briefly described below. Our general catalog contains complete applications information, illustrations, specifications, and prices. Write for your free copy.

MODEL 4242—42,000 volts DC.
Negative ground.

MODEL 3157—15,000 volts DC.
Negative ground.

MODEL 4312—15,000 volts DC.
Positive ground.

MODEL 3163—6,000 volts DC.
Negative ground.

MODEL 3200—10,000 volts AC.

**AVAILABLE THROUGH YOUR
FAVORITE ELECTRONIC PARTS DISTRIBUTOR**

ITT POMONA ELECTRONICS

1500 East Ninth St., Pomona, Calif. 91766
Telephone (714) 623-3463, TWX: 910-581-3822



Circle 25 on reader service card



Who needs a \$50 ladder?

You do, if you're an electronic professional. Both your livelihood and your personal safety depend upon your tools, so it makes no sense to economize on something as important—and as susceptible to accidents—as a ladder. Inexpensive ladders may be OK for people who use them only occasionally. But regular use, stress, and exposure can require an ordinary ladder to be replaced every year or so. **And that is expensive!**

It's economically sounder to spend a little more now for a Perma Power Professional Ladder with its unconditional twelve year guarantee. You'll probably never have to buy another ladder! Perma Power aluminum ladders have so many special safety and construction features, they'll take all the punishment you can give them—and then some. And they carry the ANSI Type I Heavy Duty rating, which means they are well able to carry your weight as well as the weight of the tools you use in your work.

Perma Power Ladders unconditionally guaranteed for 12 years!

Perma Power aluminum straight and extension ladders are available only from your electronic parts distributor. Ask him to show you their many special features, or write for free ladder literature.

PRODUCTS OF **Chamberlain**
Chamberlain Manufacturing Corporation
Perma Power Division
5740 North Tripp Avenue
Chicago, Illinois 60646
Circle 26 on reader service card

Electrically steerable antenna systems based on the phased array are the *Super Scanner* model MS119 by Antenna Specialists and the *Turner Ultra Kicker*. The *Super Scanner* (Fig. 12) consists of three elements mounted 120° apart on a bracket that mounts on a mast. Predetermined lengths of coaxial cable connect each element to a set of switching relays. The relays switch the cables so one element becomes the radiator while the other two are electrically lengthened to act as reflectors. All points of the compass can be covered by switching the 120° cardioid through three positions. The control switch has a OMNI/MONITOR position that provides an omnidirectional pattern for use when on stand-by or monitoring. When a call comes in, the operator turns the selector switch for the strongest signal.

Selecting your base antenna

Carefully consider your requirements before you select an antenna for your base. (If you have received your license and are anxious to get on the air, then obtain an inexpensive ground plane while you analyze your needs. A coffee break or jam-boree is a good place to get an inexpensive antenna. Be wary if offered a phased-array beam at a bargain price. The relay switching box is generally jammed with coax coils that make up the half-wave or quarter-wave phasing sections. Many a CB'er and a few hams have been known to lop off the "extra" coax for use in a mobile installation or other application. If any of the phasing lines are shortened or removed, the system won't work right and you'll have to purchase new phasing networks—if you are smart enough to figure out why the antenna array won't work.)

Factors to be considered are desired range, terrain, elevation above mean ground level, weather conditions (if your winters are severe with heavy icing, you'll need a rugged system) and cost. A simple ground-plane will do for local contacts in fairly open terrain and residential areas. A half-wave antenna provides a little more range and is relatively free from precipitation static and man-made interference.

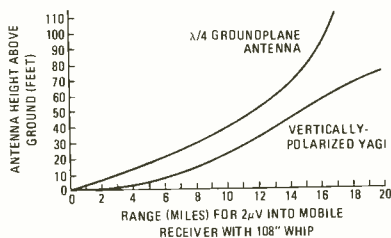

FIG. 13—HOW HEIGHT AND ANTENNA-TYPE affect the communications range. The curves are based on developing a 2- μ V signal in a 108-inch mobile whip.

Use a beam if you need extended range or the ability to "punch" a signal into normally "dead spots" where signals are attenuated by terrain or tall buildings. Figure 13 (prepared from material developed by International Crystals Corp.) interference on their TV or radio. You may be innocent but you'll have a heck of a time proving it to him. Many neighbors antenna height above mean terrain level

FREE catalog
over 2000
unique tools,
handy kits,
precision
instruments,
technical
supplies.

Over 24 years of service to the world's finest craftsmen and technicians.

A carefully selected and tested assortment of unique, hard-to-find tools, clever gadgets, precision instruments, bargain kits. One-stop shopping for the technician, craftsman, hobbyist, lab specialist, production supervisor. Many tools and measuring instruments available nowhere else. One of the most unusual and complete tool catalogs anywhere. Get your copy of the NC FLASHER today.

National Camera
2000 West Union Ave., Dept. GBA
Englewood, Colorado 80110
(303) 789-1893

Circle 27 on reader service card

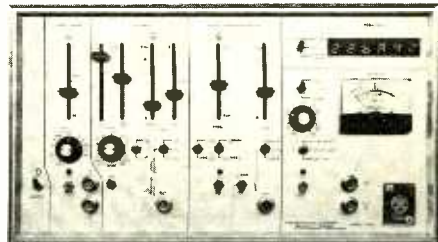

MODEL 100 AUDIO RESPONSE PLOTTING SYSTEM and general purpose sweep/tone burst/pulse generator consists of two sine/square/triangle function generators, pulse generator, frequency counter and peak amplitude measurement sections. It is primarily intended to generate a frequency response plot on an X-Y recorder or scope.

Time base generator offers symmetrical or independent control of the positive and negative sides of the ramp providing a duty cycle of .7% to 99.3%. Frequency range is .0035Hz to 100kHz. Amplitude is 15Vpp into 500 ohms with \pm 5VDC offset. The time base output drives the X axis of an X-Y recorder.

Audio sweep generator provides manual frequency adjustment or log/linear sweep of 20Hz to 20kHz. Blanking mode produces zero reference line on X-Y recorder or tone burst. Amplitude is 15 Vpp into 500 ohms or 10 Vpp into an 8 ohm speaker.

Pulse generator frequency range is .0035Hz to 525kHz. Pulse width is adjusted independent of frequency from 4 seconds to 40 nanoseconds. Outputs are complimentary TTL.

Peak amplitude measurement section measures internal or external signals from mike to power amp level. Amplitude output drives Y axis of X-Y recorder.

Frequency counter is 6 digit, line triggered, and reads either internal or external. Sensitivity is 50 mv peak at 20kHz.

Dimensions: 8 x 14 x 3. Warranty: 1 year. \$525, stock to 30 days.

FIDELITY SOUND

9764 Vine St.
Bloomington, CA 92316

Circle 28 on reader service card

and the horizontal scale shows how far away each antenna will put a 2- μ V signal into a 108-inch mobile whip.

Remember, if you use a beam and intend to do a lot of monitoring, you may miss an incoming call if the antenna is not aimed in the right direction. Too, before considering one of the really big rotary beams, give a thought to your neighbors. Many, seeing your big antenna, will immediately blame you for all the interference on their TV or radio. You may be innocent but you'll have a heck of a time proving it to him. Many neighbors will suspect anything unusual sprouting from your roof but won't give a second thought to a couple of verticals in your back yard. Don't ask for trouble.



NO RADIALS ARE USED on this Hy-Gain 488 antenna. It consists of a 70.5-inch fiberglass mast topped by a 52-inch stainless steel whip. Ratchet-type base permits mounting on flat or sloping surface.

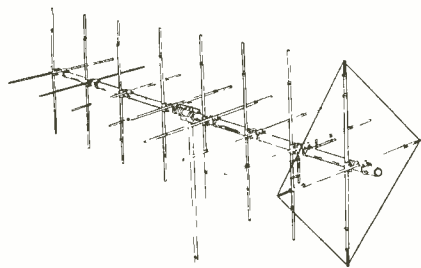

WILSON ELECTRONICS' SUPER LASER 500 is a 16-element dual-polarized array on a 40-foot boom. It features 18-db gain.

If you need more information on antennas, there are lots of good books in your local library and on the shelves of a good book store. A glance through them will enable you to select one on your level. For a good, easy-to-understand treatment on antennas, take a look at *The ARRL Antenna Book* published by The American Radio Relay League. Another one of interest is *The Truth About CB Antennas* by Orr and Cowan.

Another good way to separate truth from scuttlebutt is to arrange for your CB club to have a speaker from the engineering staff of one of the leading antenna makers. Some distributors have knowledgeable field agents that will be happy to speak on antennas at your next club meeting. Beware of a lot that you'll hear about antennas over the air. The best antenna in the world won't be satisfactory if it is not properly installed or if the owner expects too much from it. **R-E**

SOLID STATE...BREAKERLESS ELECTRONIC IGNITION.

The BEST...The ULTIMATE of All Ignition Systems

'OPTO-ELECTRIC'



★ **No Breaker-Points or Condenser to EVER wear out or need any maintenance**



★ **Once installed and properly timed your Distributor will give you CONTINUOUS PEAK PERFORMANCE!**



● The Allison OPTO-ELECTRIC System ELIMINATES the Points and Condenser, replacing them with an OPTO-Electronic Trigger, using a Light-Emitting Diode and Phototransistor. This System operates on a BEAM of LIGHT. There is NO "Breaker-Point Wiper-Arm" to wear down. Point bounce and erosion are completely eliminated thereby giving longer Timing ACCURACY than any System using "Mechanical" Breaker-Points. (and No Timing Fluctuation as with Magnetic Impulse Units). ACCURATE Timing gives the BEST in Engine EFFICIENCY and that's the name of the Game for the BEST in GAS MILEAGE and ECONOMY.

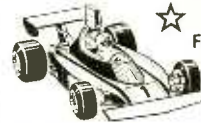

★ **PROVEN RELIABILITY**
Factory Tested to 15,000 RPM
Road and Race PROVEN
(Opto-Electric Systems Won at INDY Two Years in a Row)

● The Allison's "Built-in" DWELL never needs adjustment. It is PRE-SET to supply the OPTIMUM Performance at BOTH High and Low speeds. The RPM capability of the "OPTO-ELECTRIC" unit exceeds that of any known automotive internal combustion engine. Positive spark intensity and duration helps eliminate "misfire" and extends the Spark-Plug life.

● The Allison "OPTO-ELECTRIC" was engineered to OUTLAST the LIFE OF YOUR CAR. Only the Highest Grade Solid-State Components are used. UNAFFECTED by Moisture or Vibration! Easier engine starting under ANY Weather Condition. Solid, DEPENDABLE PERFORMANCE.

★ Installed in your Distributor in same location as Points. **COMPLETE INSTRUCTIONS FURNISHED.**
(Not Necessary to Dismantle your Distributor)



● **America's Oldest and Largest Manufacturer of Opto-Electronic Ignition Systems.**

ALLISON Our BEST Salesmen are the USERS of our ALLISON System!
AUTOMOTIVE COMPANY 1267 - E9 East EDNA PL., COVINA, CAL. 91722

★ **ORDER with CONFIDENCE**
FACTORY-BACKED 10-YEAR
Free Repair or Replacement on ANY Defects in Materials or Workmanship

★ **SAVE! ORDER FACTORY DIRECT**

● Send Check or M O
State Make, Year, Engine Size, (4, 6, or 8-cylinder)

● You may use your **MASTER CHARGE** or **BANKAMERICARD**
Send us (1) Your Number, (2) Interbank No., (3) Exp. Date
MC or BA Card Holders, ORDER by TOLL FREE PHONE
(800) 423-6525, Ext. 2 (When in Continental U.S.A.)

★ Before Buying any other Type ignition system
Send Postcard for our FREE BROCHURE.

★ If you have already installed a "Capacitive-Discharge" Ignition
Modernize and Increase its Efficiency
CONVERT YOUR "C-D" UNIT TO BREAKERLESS!
Opto-Electric "TRIGGER UNIT" . . . Only \$34.95

Only **\$59.95**
COMPLETE
(Calif. Res. and Tax)
...that's EVERYTHING!
Including
Postage & Insurance.

Circle 29 on reader service card



WORLD'S SMALLEST RECHARGEABLE CALCULATOR...\$19.95!

Does Everything Big Ones Do

Small but mighty! 8-digit, 4-function electronic calculator even has automatic % key . . . for only \$19.95. Take it anywhere. Carry it in your pocket or purse — it's 2/3 the size of a pack of cigarettes. This 3 1/2-ounce dynamo features floating decimal, constant key, lead zero depression, clear entry, more! At Edmund's low price, the unit comes with a Ni-Cad rechargeable battery pack that can plug into any AC outlet. No need for special recharging adapters. Calculator overall is just 2 x 3 1/2 x 1/8" with plenty of room for most fingers. *Another Edmund first with advanced technology.* **\$19.95** ppd.
STOCK NO. 1945EH..... Only \$19.95 ppd.

GIANT FREE CATALOG!

NEW 172 Pages
Over 4,500 Un-usual Bargains for Hobbyists, Schools, Industry



JUST CHECK COUPON!

EDMUND SCIENTIFIC CO.
300 EDSCORP BUILDING
Barrington, N. J. 08007
(609) 547-3488

America's Greatest
Science • Optics • Hobby Mart

COMPLETE AND MAIL COUPON NOW

EDMUND SCIENTIFIC CO. 300 Edscorp Bldg., Barrington, N. J. 08007

SEND FREE 172 PAGE CATALOG "EH"
 Charge my BankAmericard
 Charge my Master Charge

Interbank No. _____
Card No. _____
Expiration Date _____
30-DAY MONEY-BACK GUARANTEE. You must be satisfied or return any purchase in 30 days for full refund

Send me: _____
ELECTRONIC CALCULATOR(S)
@ \$19.95 ea. (No 1945EH) \$ _____
Service and handling charge \$ _____ \$1.00
Enclosed is check, m o in amount of \$ _____
Signature _____
Name _____ Please print
Address _____
City _____ State _____ Zip _____

HELPING TO DEVELOP AMERICA'S TECHNOLOGY FOR OVER 30 YEARS.

Circle 30 on reader service card

JULY 1976

77

If you can't go to college for your career in electronics -read this!

**CREI brings college-level training
to you with eight educational
advantages, including special
arrangements for engineering degrees**

The best way to qualify for top positions and top pay in electronics is obviously with college-level training. The person with such training usually steps more quickly into an engineering level position and is paid considerably more than the average technician who has been on the job several years.

A regular college engineering program, however, means several years of full-time resident training—and it often means waiting several years before *you can even start your career*. This, of course, is difficult if you must work full time to support yourself and your family.

If your career in electronics is limited without college-level training, take a look at the advantages a CREI home study program can offer you.

1. Convenient Training

CREI brings the college to you. Through the convenience of home study, you receive exactly the same level of training you will find in any college or university offering programs in electronic engineering technology. With CREI, however, you can "go to college" whenever you have spare time at home or on the job.

2. Specialized Programs

With CREI, you enjoy the advantage of *specialized* training. That is, your program will include only those courses directly applicable to your career in electronics. We omit such courses as English, social studies and other subjects, which are usually required in resident schools. Therefore, with CREI, you move ahead faster to the more interesting and useful part of your training.

3. Practical Engineering

CREI programs give you a *practical engineering* knowledge of electronics. That is, each part of your training is planned for your "use on the job." By using your training, you reinforce the learning process. And by demonstrating your increased knowledge to your employer, you may qualify for faster career advancement.

4. Engineering Degrees

CREI offers you a number of special arrangements for earning engineering degrees at recognized colleges and universities. You can earn college credit while you are taking your CREI program or apply later, whatever is best for your career plans.

Mail This Card for
free CREI
CATALOG

80 page, full color book describes over 16 college-level electronics engineering programs. (For high school grads or equivalent only.) Check area of interest:

- | | |
|---|---------------------------------------|
| <input type="checkbox"/> Communications | <input type="checkbox"/> Broadcast TV |
| <input type="checkbox"/> Computers | <input type="checkbox"/> Cable TV |
| <input type="checkbox"/> Microwave | <input type="checkbox"/> Other |
- 2

Name

Address

City State ZIP

Phone Age

Employed by

Type of Present Work

If you have previous training in electronics, check here
For GI Bill Information, check here

Accredited Member National Home Study Council

CREI CAPITOL
RADIO
ENGINEERING
INSTITUTE

E1407G

McGraw-Hill Continuing Education Center
Washington, D. C. 20016

Radio
Electronics

Mail This Card for
free CREI
CATALOG

80 page, full color book describes over 16 college-level electronics engineering programs. (For high school grads or equivalent only.) Check area of interest:

- | | |
|---|---------------------------------------|
| <input type="checkbox"/> Communications | <input type="checkbox"/> Broadcast TV |
| <input type="checkbox"/> Computers | <input type="checkbox"/> Cable TV |
| <input type="checkbox"/> Microwave | <input type="checkbox"/> Other |
- 1

Name

Address

City State ZIP

Phone Age

Employed by

Type of Present Work

If you have previous training in electronics, check here
For GI Bill Information, check here

Accredited Member National Home Study Council

CREI CAPITOL
RADIO
ENGINEERING
INSTITUTE

E1407G

McGraw-Hill Continuing Education Center
Washington, D. C. 20016

Radio
Electronics

FIRST CLASS
Permit No. 20-R
Washington, D. C.

BUSINESS REPLY MAIL

No Postage Stamp Necessary If Mailed in the United States

Postage will be paid by

ARRRRI
CAPITOL
RADIO
ENGINEERING
INSTITUTE

McGraw-Hill Continuing Education Center
3939 Wisconsin Avenue
Washington, D. C. 20016



FIRST CLASS
Permit No. 20-R
Washington, D. C.

BUSINESS REPLY MAIL

No Postage Stamp Necessary If Mailed in the United States

Postage will be paid by

ARRRRI
CAPITOL
RADIO
ENGINEERING
INSTITUTE

McGraw-Hill Continuing Education Center
3939 Wisconsin Avenue
Washington, D. C. 20016



Career Training at Home

5. Unique Laboratory

Only CREI offers you the unique Electronic Design Laboratory Program. This complete college laboratory makes learning advanced electronics easier and it gives you extensive practical experience in many areas of engineering, including design of electronic circuits. No other school offers this unique program. It is a better "Lab" than we have found in many colleges. And the professional equipment included in the program becomes yours to keep and use throughout your professional career.

6. Wide Program Choice

CREI gives you a choice of specialization in 14 areas of electronics. You can select exactly the area of electronics best for your career field. You can specialize in such areas as computer electronics, communications engineering, microwave, CATV, television (broadcast) engineering and many other areas of modern electronics.

7. Prepared by Experts

Experts in industry and technical organizations of government develop CREI programs. Each part of your training is developed by a recognized expert in that area of electronics. That means you get the most up-to-date and practical instruction for your career.

8. Industry Recognition

That CREI training is recognized by industry and government is evident from the fact CREI provides training to advanced technical personnel in over 1,700 technical organizations. Many subsidize the training of their employees with CREI. If there is any question about the advantages of CREI training for you, ask your employer or any engineer to evaluate the outline of a CREI program for you.

Other Advantages

Of course, there are many other advantages to CREI training. For example, throughout your training, CREI's staff gives you personal instruction for each step of your program. And in many industrial areas, both in the U. S. and abroad, CREI Field Service Representatives provide a number of important personal services for your training and your career.

FREE Book

There isn't room here to give you all of the facts about career opportunities in advanced electronics and how CREI prepares you for them. So we invite you to send for our free catalog (if you are qualified). This fully illustrated, 80 page catalog describes in detail the programs, equipment and services of CREI.

Qualifications

You may be eligible to take a CREI college-level program in electronics if you are a high school graduate (or the true equivalent) and have previous training or experience in electronics. Program arrangements are available depending upon whether you have extensive or minimum experience in electronics.



Send for this **FREE Book** describing your opportunities and CREI college-level programs in electronics

Mail card or write describing qualifications to

CREI **CAPITOL
RADIO
ENGINEERING
INSTITUTE**

McGraw-Hill Continuing Education Center
3939 Wisconsin Avenue Northwest
Washington, D.C. 20016

Accredited Member National Home Study Council

GI Bill

CREI programs are approved for training of veterans and servicemen under the G.I. Bill.



JULY 1976

Does your computer talk to you?

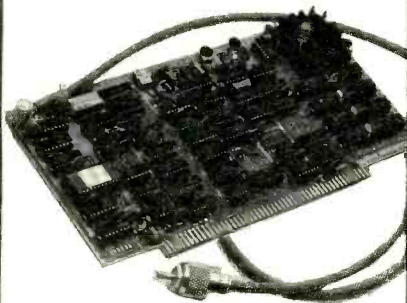

The intelligence of your 8080 system is only as great as its capacity to communicate. Processor Technology's VDM-1 will function as a highly cogent link to that intelligence. This **ultra-high speed output device** plugs into your Altair or IMSAI to provide fast, versatile human interface. It generates 16 lines of display: 64 characters each, **both upper and lower case**. 1024 bytes of random access memory are on the card. The VDM-1 scrolls upwards or downwards, up to a top speed of **2000 lines per minute!** Any combination of cursors (up to 1024) can be displayed as black-on-white or vice versa — perfect for video games. The VDM-1 will work with any standard video monitor, or your own TV set can be easily modified. The module comes with **free terminal mode software**, for teletype replacement when used with BASIC or assemblers.

Our detailed VDM-1 Owner's Manual is available for \$4, refundable with purchase of the VDM-1. **Kit Price:** (eff. 7/1/76): **\$199** (premium grade, low profile IC sockets included).

Write Us,
about our other
plug-in modules,
compatible with
the 8800 system.

**Processor
Technology**
6200-P Hollis Street
Emeryville, CA 94608

Circle 61 on reader service card

HI-FI TEST REPORTS

continued from page 67

volts, the highest we have ever recorded for an all-in-one receiver we tested.

The complete range of tone control action, in discrete 2 dB increments, is shown in Figs. 6 and 7. There are several nice things worth mentioning about the tone

control system. For one thing, the rotary controls have distinct "stops" so that any of the curves shown in Figs. 6 and 7 (or combinations of both) can be reliably duplicated exactly. In addition, the sub-bass and sub-treble controls permit adjustment of the frequency extremes without affecting mid-range tones. Single or combined use of main and/or sub controls affords an unusually great choice of pre-

continued on page 84

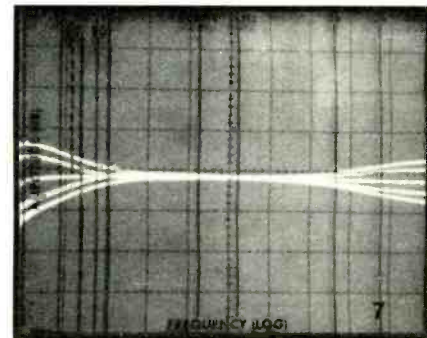
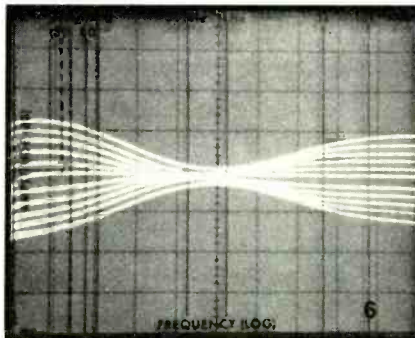

TABLE III

RADIO-ELECTRONICS PRODUCT TEST REPORT

Manufacturer: **U.S. Pioneer Electronics**

Model: **SX-1250**

AMPLIFIER PERFORMANCE MEASUREMENTS

	R-E Measurement	R-E Evaluation
POWER OUTPUT CAPABILITY		
RMS power/channel, 8-ohms, 1 kHz (watts)	169.0	Very good
RMS power/channel, 8-ohms, 20 Hz (watts)	166.0	Excellent
RMS power/channel, 8-ohms, 20 kHz (watts)	167.0	Excellent
RMS power/channel, 4-ohms, 1 kHz (watts)	235.0	Excellent
RMS power/channel, 4-ohms, 20 Hz (watts)	232.0	Superb
RMS power/channel, 4-ohms, 20 kHz (watts)	200.00	Good
Frequency limits for rated output (Hz-kHz)	15-20	Very good
DISTORTION MEASUREMENTS		
Harmonic distortion at rated output, 1 kHz (%)	0.077	Excellent
Intermodulation distortion, rated output (%)	0.095	Very good
Harmonic distortion at 1 watt output, 1 kHz (%)	0.018	Excellent
Intermodulation distortion at 1 watt output (%)	0.002	Excellent
DAMPING FACTOR, AT 8 OHMS	30	Good
PHONO PREAMPLIFIER MEASUREMENTS		
Frequency response (RIAA \pm ___ dB)	0.2	Excellent
Maximum input before overload (mV)	540	Superb
Hum/noise referred to full output (dB) (at rated input sensitivity)	75 (weighted)	Excellent
HIGH LEVEL INPUT MEASUREMENTS		
Frequency response (Hz-kHz, \pm ___ dB)	11-54	Excellent
Hum/noise referred to full output (dB)	85 (weighted)	Very good
Residual hum/noise (min. volume) (dB)	96 (weighted)	Very good
TONAL COMPENSATION MEASUREMENTS		
Action of bass and treble controls	See Fig. 6	Excellent
Action of secondary tone controls	See Fig. 7	Excellent
Action of low frequency filter(s)	See Fig. 8	Very good
Action of high frequency filter(s)	See Fig. 8	Very good
COMPONENT MATCHING MEASUREMENTS		
Input sensitivity, phono 1/phono 2 (mV)	2.2/2.2	
Input sensitivity, auxiliary input(s) (mV)	150	
Input sensitivity, tape input(s) (mV)	150	
Output level, tape output(s) (mV)	N/A	
Output level, headphone jack(s) (V or mW)		
EVALUATION OF CONTROLS, CONSTRUCTION AND DESIGN		
Adequacy of program source and monitor switching		Very good
Adequacy of input facilities		Excellent
Arrangement of controls (panel layout)		Very good
Action of controls and switches		Excellent
Design and construction		Very good
Ease of servicing		Good
OVERALL AMPLIFIER PERFORMANCE RATING		Very good

MONEY SAVING BUYS

FREE \$1 BUY WITH EVERY 10 YOU ORDER
Only applies to "\$1" Buys

FREE GIFT WITH EVERY ORDER

CANADIANS: Ordering is easy—we do the paperwork—try a small order

RCA 110° FLYBACK TRANSFORMER
We scooped the Market. Latest type standard for all 110° TV's (Blk. & Wht.). RCA's design of large Coil produces 18kv assuring adequate width incl. Schematic Diagram application for any TV.
List price \$13.90 395
Your price 295
10% off in lots of 3.



- 110° TV DEFECTION YOKE for all types TV's Incl schematic 495
- "COMBINATION SPECIAL" 695
- RCA 110° FLYBACK plus 110° DEFECTION YOKE
- 90° FLYBACK TRANSFORMER for all type TV's (Blk. & Wht.) 295
- 70° FLYBACK TRANSFORMER for all type TV's (Blk. & Wht.) 200
- 70° TV DEFECTION YOKE for all type TV's (Blk. & Wht.) 200
- OLYMPIC & SHARP FLYBACK Part #8PT592 Equip. Stancor #HO-408—Thorlaxson #Fly339 200
- 90° COLOR YOKE For all Rectangular 19 to 25" Color CRT's 795
- 70 COLORE YOKE For all round color CRT's 595
- DELMONICO NIVICO COLOR FLYBACK Part #A20411-B 795
- WESTINGHOUSE FM TUNER #476-V-015D0 1 Transistor 399
- WESTINGHOUSE FM TUNER (12D Tube) 100
- UHF TUNER—Transistor Type Used in all TV sets 295
- G.E. UHF TUNER—TRANSISTOR Type Model #85X4 395
- ADMIRAL TV TUNER Model #94C393 1 (2HA5-4LJ8) Model #194C441-3 (Transistor) 795
- WELLS GARDNER TUNER Part #7A 120-1 (4GS7-2HA7 Tubes) 795
- G.E.—TV TUNER (2GK5-4LJ8) Model #8E1 86X1 795
- PHILCO UHF/VHF TUNER Transistorized 995
- 100° GRI SPEAKER WIRE 200
- 2 Cond., mini zip, 101 uses
- UNIVERSAL TV Antenna Back of set mounting . . . 5 section rods 299
- BLUE LATERAL Magnet Assy. Replacement for most color TV's 179
- 5-10K—2 WATT BIAS POTS Used in solid state application 100
- COLOR CONVERGENCE Assy. Universal type—good for most sets 249
- 3 SPEAKER—7 WAY SELECTOR SWITCH Wall Mount 100
- 7 TUBE AM-FM STEREO 995
- AMPLIFIER CHASSIS. Completely assembled—with tubes AS 1S needs slight adjustments 100
- 10-MINI ELECTROLYTIC COND For Transistor & miniature work MATCHED PAIRS 100
- TRANSISTORS NPN & PNP (2N252-2N2904) (2N2222-2N2907) Each set 100
- ZENITH TV TUNER Model 175-1164 & 175-1151 (Parallel) Model 175-1120 & 175-1118 (Series) 995
- 2 COLOR-TV CRT SOCKETS Wired leads for all color TV's 100
- 35-Assorted RADIO KNOBS All standard types \$20 value 100
- 20-TV KNOBS 100
- POPULAR TYPES Mostly Selector & Fine Tuning 25—Clock & Radio KNOBS most popular types 100
- 20-Vertical Linearity KNOBS Long shank . . . Front mount assortment 100
- 20-Vertical Linearity KNOBS Side mount . . . Standard Sizes 100
- MERCURY COMPACT TUBE TESTER Model #990 Miniature-sized Specia Saver Full sized in performance 4995
- TELMATIC Tuner-Mate KT-730 Portable "Substi-Tuner"—Instant Tuner Check 4250
- TELEMATIC Test Jig Model—EJ-190—Master Rigs—4995
- Combo Rigs—Econo Rigs

GE NI-CAD RECHARGEABLE BATTERIES
CHARGER & ANY 2 BATTERIES \$12.95
2-AA BATTERIES \$5.95 Pair
2-C BATTERIES \$6.25 Pair
2-D BATTERIES \$6.50 Pair
1000 Recharges guaranteed

MARKET SCOOP COLUMN

- ZENITH SILICON STICK RECTIFIER, PART #103-215 — 45K PIV, also used in Electrohome, Motorola, E.D.I. 595
- CONVERGENCE RECTIFIER—For COLOR TV 4 Cell—Used in RCA—Philco—Zenith, etc. 100
- 3-ZENITH VIDEO 200
- AMPLIFIER PART #121-743 100
- 2-SILICON NPN TRANSISTOR HEP-S0015 . . . List \$1.75 100
- 1-SILICON NPN TRANSISTOR (SK3534—HEP S5004) 100
- 5-ZENIER DIODE 1N4757A . . . 1 Watt—50 V 4—ASST. PHILCO SWITCHES 259
- PUSH—PUSH TYPE #TV2-3-4, & Sig. Sw. With knobs latest type 100
- POWER TRANSFORMER (PT-49)—110V Pri.—12V Sec. Used in many transistor 229
- 35kV complete 2
- COMPLETE CONVERGENCE ASSY.—Inc. Yoke, Board & Plug Conn. Adaptable to most 90° sets 395
- COLOR DELAY LINE—Used in most color sets 169
- SILICON NPN HV TRANSISTOR RCA—SK-3021—Hep-240 100
- RCA—SK-3026—Hep-241 100
- Transistor Specials—Your Choice SK3006, SK3018, SK3020 SK3122, SK3124 100
- Transistor Specials—Your Choice SK3009, SK3024, SK3040 198
- WAHL-CORDLESS SOLDER IRON Complete with Auto Charger—Fast Heating—Compact 100
- 5-Audio Output TRANSFORM Sub-min for Trans Radios 5—1 F. Coil TRANSFORMERS 45kV for Transistor Radios 100
- 6" UNIVERSAL SPEAKER Top quality Special buy EA 159
- 10" UNIVERSAL SPEAKER Large Magnet—Top quality 495
- 8" UNIVERSAL SPEAKER Large Magnet—Special Buy 299
- 2 1/2"x4" SPEAKER Special Buy 10 for \$5 EA 69
- 4"x6" "QUAM" 16 OHM SPK. Large magnet . . . Special Buy (10 for \$15.00) 179
- 8" HEAVY DUTY 10 OZ. SPEAKER Ceramic Type—8 ohm 1" 8"x9" Heavy Duty 10 oz. Speaker Ceramic Type . . . 8 ohm 550
- 3-ELECTROLYTIC CONDENSERS. 100/80/20 MFD—300 Volts 200
- Top Brand Silicon RECT. 1 amp., 100V PIV 100
- IC4 and IC3 Integrated Circuit Used in Scott—Fisher etc. 100
- RONETTE Stereo Cartridge latest dual sapphire flipover type Stereo Headphones Hi-Fi Quality 200
- . . . Complete with Stereo plug 395
- 10—STANDARD TRANSISTORS NPN & PNP 2N404, 2N414, etc. 100
- 15—Mini 456KC IF Transformers PC 1/2"x1/2"—good value 100
- 7—ASSORTED VOLUME CONTROLS with switch 100
- 10—ASSORTED VOLUME CONTROLS less switch 100
- 15—ASST. ROTARY SWITCHES All popular types—\$20 value 100
- DELUXE PILLOW SPEAKERS With plug & volume control 249
- 2-12BH7 RCA TUBES 100
- 10—ASST DIODE CRYSTALS 1N34, 1N48, 1N60, 1N64, etc. 100
- TUBE & CONTINUITY CKR. Model FT425 (Tests fuses, heaters, lamps, etc.) 198
- TUBE SPECIAL—IN LOTS OF 5 295
- 2CY5—5U8—12BD6—12BH7—18FY6 2

SHANNON MYLAR RECORDING TAPE

3 1/4" — 600'	.78
5" — 600'	.82
5" — 900'	.90
5" — 1200'	1.49
5" — 1800'	1.89
7" — 1200'	.97
7" — 1800'	1.32
7" — 2400'	1.99
7" — 3600'	3.49

CASSETTE C-60 \$9
CASSETTE C-90 1.19
CASSETTE C-120 1.97
8-Track — 64 Min. 1.29
8-Track — 80 Min. 1.59
8-Track — Clegner 1.49

3" TAPE REEL09
3 1/4" TAPE REEL12
5" TAPE REEL29
7" TAPE REEL35

Test Equip. Special Discount Prices

- BK** **TECO**
Leader
SENCORE
- TRANSISTOR RADIO asst type good, bad, broken, as-is, potluck 150
- TAPE RECORDER assorted types good, bad broken, as-is, potluck 400
- 200 ASST. 1/2 W RESISTORS Top Brands, Short Leads, Excellent Selection 100
- 75-ASST 1/4 WATT RESISTORS stand, choice ohmages, some in 5% 100
- 100-ASST 1/2 WATT RESISTORS stand, choice ohmages, some in 5% 100
- 70-ASST 1 WATT RESISTORS stand, choice ohmages, some in 5% 100
- 35-ASST 2 WATT RESISTORS stand, choice ohmages, some in 5% 100
- 50-PRECISION RESISTORS asst. list-price \$50 less 98% 100
- 20-ASSORTED WIREWOUND RESISTORS, 5, 10, 20 watt 100
- 250-ASST SOLDERING LUGS best types and sizes 100
- 250-ASST WOOD SCREWS finest popular selection 100
- 250-Asst Self Tapping SCREWS #6, #8, etc. 100
- 100-ASST 6/32 SCREWS and 100-6/32 HEX NUTS 100
- 100-ASST 8/32 SCREWS and 100-8/32 HEX NUTS 100
- 100-ASST 2/56 SCREWS and 100-2/56 HEX NUTS 100
- 100-ASST 4/40 SCREWS and 100-4/40 HEX NUTS 100
- 100-ASST 5/40 SCREWS and 100-5/40 HEX NUTS 100
- 500-ASSORTED RIVETS most useful selected sizes 100
- 100-ASST RUBBER BUMPERS for cabinet bottoms—other uses 100
- 100-ASST RUBBER GROMMETS best sizes 100
- 1-KENWOOD TWEETER Special Buy—4" Round 479
- 10-ASST SLIDE SWITCHES SPST, SPDT, DPDT, etc. 100
- 25-SYLVANIA HEAT SINKS For Transistors 100
- 20-ASSORTED TV COILS I.F. VIDEO, sound radio, etc. 100
- 1-ELECTROLYTIC COND. 200/300/100/100 MFD—25V 100
- 1-ELECTROLYTIC COND 100 MFD—300V 100
- 3-ELECTROLYTIC COND 20/20 MFD—450V 100
- 40-ASST. TUBE CARTONS Most popular types 100
- 2-ELECTROLYTIC Condensers 300 mfd-200V. 300/60 mfd-150V 100
- 4-ELECTROLYTIC COND 75/30mfd—150V 100
- ELECTROLYTIC CONDENSERS 200/200 mfd—200V 100
- 2-ELECTROLYTIC COND 1000 mfd.—25V 100
- 50-ASST. CERAMIC CONDENSERS Most desirable values 100
- 2 COLOR-TV CRT SOCKETS Wired leads, for all color TV's 100
- 3-RCA 110° CRT SOCKETS Wired leads, for all TV's 100
- 4-36" Hi-Fi CABLES RCA Molded Phone plug at one end stripped and tinned leads on other end 100
- 3-Polarized CHEATER CORD Grey 100
- 70° COLOR TUBE BRIGHTNER 395
- 90° COLOR TUBE BRIGHTNER 495
- 5-PNP TRANSISTOR general purpose, TO-5 case 100
- 5-NPN TRANSISTORS general purpose, TO-5 case 100
- 25-ASSORTED TRANSISTORS big factory scoop—sold as-is 100
- 5-9 VOLT MOTORS Excellent for hobbyist 100
- 2-ELECTROLYTIC CONDENSERS Axial leads—500—25V TACOMETER 2 1/4" Sq. Panel 200
- Meter 1-VDC, full scale 33 Ohm coil resistance 0-6000 R.P.M. 299
- 1-CASSETTE type dynamic Mike with universal plugs—200 Ohms 200
- 10-SETS PHONO PLUGS & PIN JACKS RCA type 100
- STANDARD TUNER—Transistor (Guided Grid) 100
- 4 Channel closed circuit 100

KLEPS "CLEVER" TEST PRODS

- "Third-hand" test prods, reach into out of way places - Insulated - cannot slip - accommodates bare wire or banana plug—no soldering.
- PRUF 10—Versatile Test Probe 89
 - KLEPS 10 Boathook Clamp 4 1/4" long 139
 - KLEPS 20—Boathook Clamp 7" long 149
 - KLEPS 30—flexible-forked Tongue 6" long 179
 - KLEPS 40 FLEXIBLE-PC Board Terminals 6 1/4" long 259
 - KLEPS I-ECONOMY Kleps for Light Work 99
 - KANDU—Printed Circuit Kit Trace & Etch your own circuits—easy to use instructions 995
 - SOLID STATE STEREO DISCO MIXER Features talkover—Q'ing both channels—slide control SPECIAL PRICE 13995
 - HIGH VOLTAGE POWER TRANSISTOR Equip. HEP 707 . . . List price \$16.00 229
 - 1—VARCO STEREO CARTRIDGE Model TN4B with holder 295
 - 2-ELECTROLYTIC CONDENSERS 80/100/50 MFD—160V 100
 - 2-ELECTROLYTIC COND 200/30/4—mfd—350V 100
 - 3-ELECTROLYTIC COND 100 mfd.—100V, 50 mfd.—75V 100
 - 2-ELECTROLYTIC COND 40 mfd—500V, 40 mfd—400V 100
 - 8-MINI PILOT BULBS With 3" Leads—6.3V 30MA (5000 Hrs.) 100
 - 8-MINI PILOT BULBS With 12" Leads—6.3V, 150MA (5000 Hrs.) 100
 - 32-TEST PROD WIRE DELUXE QUALITY red & black—COLOR POWER TRANSFORMER RCA 2BR150 special 2-Colorburst Quartz-Crystal For most color TV sets 3579.545 KC 5 ASST GLOBAL VARISTOR Popular replacements for most COLOR TV COLOR-TV RECTIFIER—Used in most color sets—6500 kv 3 for 195
 - 4—TV ALIGNMENT TOOLS most useful assortment of 100
 - 4—TV ALIGNMENT TOOLS For Color TV #2 149
 - 6—TV COLOR ALIGNMENT TOOLS Most popular type 279
 - TV TWIN LEAD-IN 300 ohm 500'—\$7 100'—\$1.50, 50' CO-AX cable RG59U (Black) 269
 - 250'—\$10, 100'—\$4.50, 50' 5-DUAL DIODE—MOST POPULAR TYPES Common cathode or Series connected 250
 - 15-DIPPED MYLAR CAP. 01—600V 100
 - 15-DIPPED MYLAR CAP. 0033—600V 100
 - 15-DIPPED MYLAR CAP. 0033—1000V 100
 - 15-DIPPED MYLAR CAP. 047—400V 100
 - 15-Molded Tubular Capacitors 056—400V 100
 - 15-DIPPED MYLAR Condensers 0039—400V 100
 - 6-TRANSISTOR RADIO EAR-PIECES wires complete with plug 7-TV ELECTROLYTIC CONDENSERS desirable types 100
 - 25—.0033 DISC CERAMIC CAPACITORS C. R. L. 100
 - 50-ASST. TERMINAL STRIPS all types, 1-lug to 6-lug 100
 - UNIVERSAL 4" PM SPEAKER Top Quality 100
 - ZENER DIODE * MOTOROLA HEP 103 1 Watt—6.2 Volts CAR POWER ADAPTOR 12 Volt in—6V, 7.5V 9 Volt Out—300MA 495
 - 50-ASST. TUBULAR CONDENSERS Popular values 100
 - 25' Shielded MIKE CABLE Grey 25/1 100
 - 50-ASSORTED FUSES Popular asstd. ampere ratings 100
 - 35-RADIO & TV SOCKETS all type 7 pin, 8 pin, 9 pin, etc. 100
 - 1-5"x7" UNIVERSAL SPK. (10-20-40 OHM Imped.) 295
 - 4-50' HANKS Hook-Up Wire assorted colors 100
 - VU "M" PANEL METER 0-20 db Scale 129
 - 10-ASST RADIO & TV TUBES Every Tube a good number 100
 - UHF or VHF Matching Trans. Simple Foot-proof installation 100
 - TV DAMPER DIODE Single—Replace RCA part #135932 \$3.95 3995
 - 12" UNIVERSAL SPEAKER Top Quality . . . Large Magnet 795
- Minimum Order \$5.00

IMMEDIATE DELIVERY . . . Scientific light packing for safe delivery at minimum cost.
HANDY WAY TO ORDER . . . Send check or money order, add extra for shipping. Lists of new offers will be returned in your order.
Please specify refund on shipping overpayment desired: CHECK POSTAGE STAMPS MERCHANDISE (our choice) with advantage to customer

BROOKS RADIO & TV CORP., 529 Columbus Ave., New York, N.Y. 10024 TELEPHONE 212-674 5600

Circle 62 on reader service card

JULY 1976 83

FREE EICO CATALOG

346 Ways To Save On Instruments, Burglar Alarms, Automotive & Hobby Electronics!

The more you know about electronics, the more you'll appreciate EICO. We have a wide range of products for you to choose from, each designed to provide you with the most pleasure and quality performance for your money. The fact that more than 3 million EICO products are in use attests to their quality and performance.

"Build-it-Yourself" and save up to 50% with our famous electronic kits.

For latest EICO Catalog on Test Instruments, Automotive and Hobby Electronics, Eicocraft Project kits, Burglar-Fire Alarm Systems and name of nearest EICO Distributor, check reader service card or send 50¢ for fast first class mail service.

EICO—283 Malta Street,
Brooklyn, N.Y. 11207

Leadership in creative electronics
since 1945.



Circle 63 on reader service card

HI-FI TEST REPORTS

continued from page 82

cise tone control settings. Filter responses are combined (low cut and high cut) in Fig. 8 and cut-off points (-3 dB) were precisely at the frequencies specified, with slopes in both instances at 12 dB per octave as claimed.

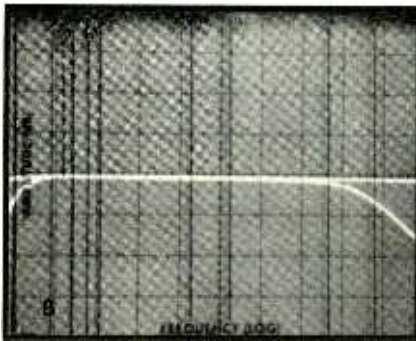

A summary of our reactions to the SX-1250 will be found in Table I. We were especially pleased with the price and with all the controls on the panel of the receiver and particularly so with that master VOLUME control. Those multiple, well defined steps of attenuation are extremely practical to use and give the receiver a professional feel besides. The tape monitoring facilities, coupled with the tape DUPLICATE feature will appeal to anyone owning more than one tape deck, regardless of the tape format, and the extra ADAPTOR jacks make it easy to add a Dolby decoder without having to give up one of the other tape monitor circuits for this purpose.

FM reception was excellent and that audible multipath indicator really works (as we proved by deliberately rotating our outdoor antenna to a less-than-optimum position). This multipath-minimizing scheme is actually easier to use than some of the visual indicators (meters or scopes) that have been used for this purpose.

AM reception was better than average, with considerably less variation of output level with change in signal strengths than we are accustomed to hearing on AM sections of all-in-one hi-fi receivers.

But by far the most impressive thing about the SX-1250 is its unbelievably high power-output capability. We were fortunate in having a brand new pair of full-range electrostatic speakers in the lab at the time we were testing this receiver. These speakers, while extremely smooth and well balanced in response, are notoriously inefficient and require lots of power to produce reasonable sound levels in a large listening room. They posed no problem whatever for this high powered Pioneer receiver. With conventional dynamic speaker systems of varying efficiencies, there were times when we felt that the bass reproduction could have been a bit tighter, but this is largely a matter of personal taste. \$900.00 may seem like quite a lot of money to spend for an all-in-one receiver, but if you try to assemble this much power and equivalent performance using "separates" you will quickly conclude that the new Pioneer SX-1250 is a bargain at that!

R-E



**save on gas!
save on tune-ups!
save on maintenance!**

Electronic ignition is "IN"! So says Detroit.

Update your car with either a TIGER CD or a TIGER I breakerless system.

Enjoy the benefits of better gas mileage, quicker starting, elimination of tune-ups, 50,000 miles on points and plugs, and reduced maintenance expenses.

TIGER MAX CD	\$69.95
TIGER 500 CD	59.95
TIGER SST CD	42.95
SIMPLIKIT CD	31.95
TIGER I	45.95

Postpaid U.S.A. only.

Tri-Star Corporation

Dept. WW, P.O. Box 1727
Grand Junction, Colorado 81501

Circle 64 on reader service card

VISTA DIGITAL CROSSHATCH

Gives professional, accurate Color T.V. convergence. Digital IC's coupled with a crystal time-base oscillator provide precise horizontal & vertical lines at broadcast frequencies. Accurate 8 x 7 dot or crosshatch pattern A.C. power 2 x 3 3/4 x 6 in. Wt. 24 oz. Fits in tool kit.

COMES COMPLETE WITH ALL PARTS, CASE, CRYSTAL AND GUIDE TO ASSEMBLY & USE.

KIT
\$31.95

COMPLETELY
ASSEMBLED
\$41.95

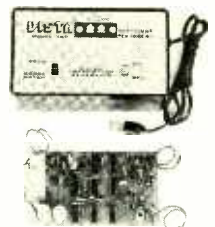

Shipping Prepaid in USA
NY State Add Sales Tax

PHOTOLUME CORP.
118 EAST 28 STREET
NEW YORK, N.Y. 10016

Circle 65 on reader service card

BUILD A COMPUTER

(continued from page 48)

the Dyna-Micro to select one of four possible onboard devices. These are the three groups of LED's and the keyboard. Address bits A3-A7 are all gated together in IC17, an OR gate made from a series of open-collector inverters in an SN74LS05 chip. If the 8-bit LO address specifies a value

**TABLE VI—ON-BOARD I/O
DEVICE DECODER**

OR Gate	A2	A1	A0	Device
1	X	X	X	NONE
0	0	0	0	LED Port 0, Keyboard
0	0	0	1	LED Port 1
0	0	1	0	LED Port 2
0	0	1	1	} Available for user
0	1	0	0	
0	1	0	1	
0	1	1	0	
0	1	1	1	

X = Don't care condition. Can be either a logic 1 or a logic 0.

greater than seven, the OR gate's output becomes a logic 1. Address bits A0-A2 are used in IC18, an SN74L42 decoder chip to provide a one-out-of-eight code for devices 0 to 7. The OR gate's output is used to enable the decoder for the device coded 0-7, but to disable it for other codes. The decoding scheme is shown in Table VI.

You will notice that device-code 0 selects both the LED PORT 0 and INPUT PORT 0 (the keyboard.) How can the computer output and input data at the same time. It can't, and some means must be used to distinguish between them. The Control Logic section outputs two control signals, \overline{IN} and \overline{OUT} that indicate whether data will be input to the CPU or output to an external device. Both signals are exclusive, never taking place at the same time. The pulses are generated by the 8080A and the Control Logic section under control of the software. Only when we execute an I/O type instruction will either of these signals be generated. The device codes for the SN7475 latches are gated with the \overline{OUT} signal in IC19, and the \overline{IN} signal is gated with the keyboard device code in the DM8095 buffer chip associated with the keyboard, IC31. Data is input or output only when we have a valid device code and the presence of either the \overline{IN} or \overline{OUT} signals. R-E

**Red Cross.
The Good
Neighbor.**

SUPER SIGNAL SOURCE!



L-15 PULSE-SWEEP FUNCTION GENERATOR

\$55 KIT \$75 ASSEMBLED (+ \$2.00 P&H)

FOR: Designers, Service Techs, anyone working with electronics!

FEATURES: 1Hz to 100KHz in 5 ranges, at constant amplitude • Sine and triangle adjustable to 20vp-p into 600 ohms • Sine distortion is .5% typical • Voltage controlled sweep of sine and triangle waves • TTL square wave has a fully adjustable pulse and drives 600 ohms • Frequencies of lower than 1Hz and greater than 100KHz are obtainable • short proof and guaranteed for 1 full year • Small, only 3" H x 6 1/4" W x 4" D • State-of-the-art design!

DEALER INQUIRIES INVITED

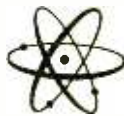

HELECTRONIX
8100 St. Clair Ave.
N. Hollywood, CA 91605
(213) 767-5624

Circle 66 on reader service card

MATHEMATICS ELECTRONICS ENGINEERING MATHEMATICS ADVANCED MATHEMATICS

These unusual courses are the result of many years of study and thought by the President of Indiana Home Study, who has personally lectured in the classroom to thousands of men, from all walks of life, on mathematics, and electrical and electronic engineering.

You will have to see the lessons to appreciate them!

NOW you can master mathematics and electronics and actually enjoy doing it!

WE ARE THIS SURE:—you order your lessons on a money-back guarantee.

In plain language, if you aren't satisfied you don't pay, and there are no strings attached.

Write today for more information and your outline of courses.

You have nothing to lose, and everything to gain!

**The INDIANA
HOME STUDY INSTITUTE**

P.O. BOX 1189
PANAMA CITY, FLA 32401

Circle 67 on reader service card



Model AT6003 TRI-CAPSULE \$9.95

**Our neat little cartridge
holder...it was a great
idea in its time.**

When we designed our cartridge holder, it wasn't uncommon for an enthusiast to have several cartridges. Perhaps one for stereo, one for four-channel, and maybe an old favorite for special records.

But with our new UNIVERSAL cartridges, this handy little idea may well be doomed. Because one UNIVERSAL cartridge is just fine, thank you, for both stereo and four-

channel. New records and old.

If you're from the old school, ask one of our dealers to show you our holder. It can protect as many as three cartridges in their shells, while you play a fourth. But then ask to hear one of our UNIVERSAL models. There are four to choose from. And any one of them may be all you'll need to own for every record in your library.



audio-technica.
INNOVATION □ PRECISION □ INTEGRITY

AUDIO-TECHNICA U.S., INC., Dept. 76E, 33 Shiawassee Ave., Fairlawn, Ohio 44313
Available in Canada from Superior Electronics, Inc.

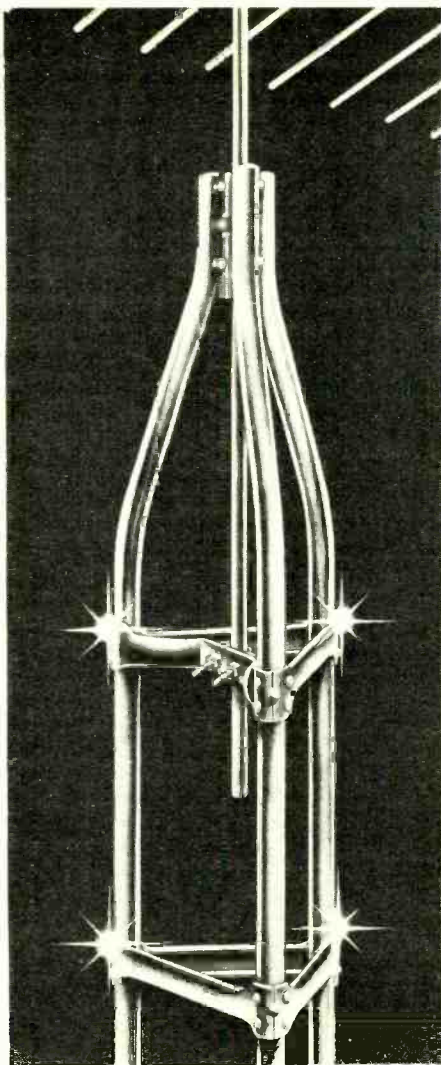

JERROLD TOWERS ARE STRONGER AND EASIER TO ERECT!

Competitive towers use 18 gauge steel, but Jerrold Towers are made of 16 gauge, pregalvanized high strength steel, which is 20% stronger.

Our tubular towers utilize a unique "Everdur" welding process to join cross-braces to tower legs. Our open channel leg towers use X braces that are riveted in the center, as well as at the ends, for extra durability. (Competitive antennas are riveted only at the ends.)

Further, all Jerrold Tower sections are PRECISION BUILT for extremely ACCURATE FIT. Thus, they go up faster and easier.

Once you try Jerrold Towers, you won't be satisfied with anything less.

JERROLD



a GENERAL INSTRUMENT company

Horsham, Pa. 19044 • (215) 674-4800

Circle 68 on reader service card

KOMPUTER KORNER

(continued from page 24)

the ease with which it can manipulate addresses as data and convert data into addresses. Were it not for the 8080's ability to use the register file on either the "data" or "address" side, its ability in this area would be severely limited. As it is, we have the option of using the registers either way, with conversion between the two being readily accomplished using the instruction set. This makes this register structure much more versatile than its simple appearance would first indicate. It also makes this organization much more useful than having either three 16-bit registers or six 8-bit registers.

The stack pointer (SP) is a special type of memory address register. It maintains the address of a special region in read/write memory called, appropriately, the stack. The stack operates as a LIFO (last in, first out) memory buffer. Certain 8080 instructions cause the contents of the internal registers to be transferred into or out of the stack. When this happens, the stack pointer is automatically incremented or decremented so that it always contains the address of the top (last in) element in the stack. This makes it easy to save and restore the registers during program operation. All you have to remember is to take the data out of the stack in the opposite order that it was placed into it. This ease of saving the register contents and status makes the stack architecture very powerful, particularly for interrupt and subroutine programming. Ways to take maximum advantage of a stack will be mentioned in later columns.

The program counter (PC) is used to determine the address in memory where the next instruction or data is to be found. In normal, sequential instruction execution, the program counter is incremented-by-one everytime an instruction- or data-byte is fetched from memory. Certain instructions, however, can cause the contents of the program counter to be modified in various ways. When this is done, program execution is transferred to the location specified by the new contents of the program counter. This is known as a program branch or jump. Program branches can be either unconditional or conditional. An unconditional branch is always executed, no matter what the state of the processor is when the instruction is executed. A conditional branch, on the other hand, will only execute if the state of the processor matches some specified condition. (For example, branch if the carry flag is set.) If the condition is not met, the processor ignores the branch instruction and continues executing where it is. Conditional branching is the way that any computer is able to make decisions based on the results of operations.

The eight-bit accumulator (A) is used in a variety of ways. For all 8-bit operations with ALU, the accumulator holds one of the operands and receives the result of the operation. For I/O operations, the accumulator serves as the I/O register with all data transferred to or from the various I/O devices passing through it. It serves as the primary memory data regis-

FREE burglar — fire alarm catalog



over 500
systems,
detectors,
controls,
souncers,
tools, locks,
supplies

TO PROTECT HOMES, BUSINESSES, INDUSTRY

Huge selection of hard-to-find security equipment from stock. 96 fact-filled pages loaded with 100's of highest quality professional alarm products, technical notes, diagrams.

ONE-STOP SUPERMARKET SELECTION INCLUDES:

ultrasonics, radar, infrared, undercarpet mats, magnetic contacts, smoke & heat detectors; Controls; Alarms; bells, sirens, phone dialers, lights, guard panels. Large selection of tools, relays, wire, holdup alarms, books. Fills need for industry, alarm cos., businesses, homes, institutions. Order your copy today.



mountain west alarm
4215 n. 16th st.
phoenix, az. 85016
(602) 263-8831

Circle 69 on reader service card

the audio amateur ?

Old George Frederic would today doubtless compose a Royal Fire and Water Works salute to the prowess of Audio Amateur magazine readers who design, build and customize their transmission lines and electrostatic speakers, 900 w. electrostatic amps, mixers, pre-amps and more.

Free prospectus on joining the jolly group of subscribers.

the Audio Amateur Box 176R
Peterborough, N. H.
03458

Craig Stark of STEREO REVIEW says:
"Top quality, only U.S. publication devoted to the serious audiophile constructor."

Name
Street
City State
Zip

Circle 70 on reader service card

ter with most memory-to-CPU and CPU-to-memory data transfers taking place through it. It is obvious that the accumulator is a very busy register. If there is one place that the 8080 might be subject to criticism, it is that the accumulator is overworked. In programs requiring many I/O and memory transfers, the accumulator can become the bottleneck.

Memory addressing modes

With its 16-bit address bus fully decoded, the 8080 is capable of directly addressing 65,536 bytes of memory. To access all this memory, the 8080 provides three basic modes of memory addressing—direct, register indirect, and immediate. Direct addressing instructions contain the address of the memory location that contains data to be used in an operation in the second and third bytes of the instruction. Register indirect addressing instructions use the contents of one of the 16-bit registers (BC, DE, HL, or SP) to specify the memory location that contains the data to be used in the operation. Immediate addressing instructions contain the actual data to be used in the operation in the second and, if necessary, third bytes of the instruction.

Of the three address modes, the register indirect mode is the most versatile. It allows us to use the various instructions that manipulate the registers to form addresses for memory references.

Timing and control

The timing and control section of the 8080 decodes instructions, senses the state of the control inputs, and generates a sequence of control signals for both the processor and the external devices attached to the control output lines. The 8080 instructions are one-, two-, or three-bytes long, depending on the function performed. The first byte is always decoded to provide the operation to be executed. For two-byte instructions, the second byte provides either immediate data or an I/O address. For three-byte instructions bytes two and three provide either double-length immediate data or a memory address.

To decode and execute these multiple byte instructions, the 8080 uses from one to five machine cycles (M_1 – M_5). Each machine cycle consists of from three to five states (T_1 – T_5). All instructions require a four- or five-state first machine cycle, M_1 . Additional cycles, if required, are all three-states long. A general timing waveform is shown in Fig. 2.

During the first machine cycle (M_1), one instruction is fetched from memory, decoded, and either fully or partially executed. This is accomplished during four or five machine-states. During state T_1 , the processor sends the SYNC signal to indicate the start of a machine cycle, places the processor status word on the data bus, places the memory address contained in the program counter on the address bus, and enters state T_2 . This sequence causes the memory to decode the address on the address bus and place the contents of the location referenced on the data bus. The 8080 uses state T_2 to wait for the data from the memory. At maximum speed it will remain in state T_2 approximately 500 ns. However, if the READY signal is low at

SPHERE

THE COMPUTER PEOPLE WITH THE LINE OF COMPLETE, VERSATILE, EXPANDABLE, EASY-TO-USE, COMPUTERS...

introduces to you, another great feature...

▶▶ The 4K ROM BOARD ◀◀

A 4000 bytes Read Only Memory (ROM) board featuring:

INSTANT CALL UP as you turn the power on. (No more tedious programming of the most used programs.)

NO LOSS OF PROGRAM as the power is turned off. (Your PROGRAM is always there.)

A MEMORY BOARD designed to use the I702A programmable ROMs. (256 bytes per ROM)

A BOARD completely assembled and tested with the SOCKETS for the PROMS already mounted.

SIMPLY PLUG IN ONE OF THE APPLICATIONS PROMS available from SPHERE or insert your own specially programmed prom and with power-on immediately begin playing that computer game or using your own application.

THE 4K ROM BOARD may be plugged right in to the standard SPHERE computer bus cable.

TWO SPECIALLY PROGRAMMED ROMS NOW AVAILABLE FROM SPHERE are:

The GAME OF LIFE (1 chip) \$30.00 This program provides either a generation at a time solution or a continuous dynamic solution of the LIFE algorithm. Available in V3A, V3N, SDOS version

TELETYPE HANDLER (1 chip) \$30.00 Allows paper tape transmission of data on teletype. Available in V3A, V3N versions.

Contact SPHERE for special programming prices and arrangements.

4K ROM BOARD (w/o roms) \$156.00
unprogrammed ROMS \$15.00

WHAT A POWERFUL, VERSATILE, EXPANDABLE, EASY-TO-USE, COMPUTER YOU HAVE WHEN... YOU GET IT ALL TOGETHER FROM SPHERE... THE COMPUTER PEOPLE! !

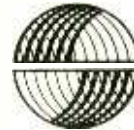

SPHERE
CORPORATION

940 North 400 East · North Salt Lake, Utah 84054

(801) 292-8466

Circle 71 on reader service card

THINKING ABOUT YOUR OWN COMPUTER?

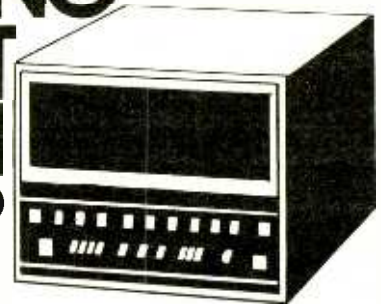

Join over 50,000 avid readers of BYTE, the magazine with rich, professionally edited articles on micro-computers... for building, expanding and having downright fun with your own system. You'll reread super articles on...

- detailed hardware/software designs by successful experimenters and hobbyists
- editorial on the fun of computers... electronic music, video games, hobbyist control systems, ideas for ham radio, model railroading and lots more
- reviews of upcoming general purpose systems
- tutorial background and sources full of ideas for home computers and computer science
- ads by firms with computer products you want
- club information and social activities

SUBSCRIBE TO BYTE NOW! IT'S FUN... AND GLICHE-PROOF!

Send this coupon for a trial subscription to BYTE. Get your first issue by return mail. Read it from cover-to-cover. If it isn't everything you want, just write "CANCEL" on the bill and return it to us. The first copy is yours to keep.



BYTE PETERBOROUGH, NH 03458

Please enter my trial subscription to BYTE...

\$12 One Year \$22 Two Years \$30 Three Years

I understand you will send the first issue by return mail and bill me later. If I don't like BYTE, I just write "CANCEL" across the invoice and return it. I will not be charged.

Name (Please Print) _____

Address _____

City _____

State _____

Zip _____

Circle 72 on reader service card

Antenna^{incorporated}

U.S. MANUFACTURERS OF
THE BEST IN
CITIZENS BAND
ANTENNAS



SEVENTY-FIVE
MODEL 22630
5/8 WAVE LENGTH
GAIN BASE STATION
\$39.95

HOWITZER
MODEL 22530
1/4 WAVE LENGTH
BASE STATION
\$14.25

Antenna, Incorporated

23850 Commerce Park Road, Cleveland, Ohio 44122
(216) 464-7075

In Canada: E.S. Gould Marketing Co., Ltd.
109 Montee De Liesse - Montreal, Quebec H4T 1S9 Canada
Antenna, Incorporated, International Division
P.O. Box 1002 - Rockville Centre, New York 11571

Circle 73 on reader service card

We carry
**B&K, EICO,
RCA, FLUKE,
SENCORE,
SIMPSON,
HICKOK and
LEADER.**

We sell them
at *% off.

*Our prices are so low the manufacturers forbid us to advertise them. Write and find out how much you can save

Complete line of tubes,
tools and electronic supplies

FREE CATALOG
FORDHAM
RADIO SUPPLY CO., INC.

558 Morris Ave., Bronx, N.Y. 10451
Tel: (212) 585-0330

Circle 74 on reader service card

the end of this time, the 8080 issues the WAIT signal high (indicating it is not executing) and enters the WAIT state (an extension of T_2). The processor remains in the WAIT state until the READY line is again high, at which time it resets the WAIT signal low and enters state T_3 . Thus by controlling the READY line, peripherals and memories of varying speeds can be synchronized with the 8080. Once in state T_3 , the 8080 loads the contents of the data bus into the instruction register. The instruction is then decoded and executed during states T_4 and, if necessary, T_5 . If the instruction executed was a 1-byte instruction, the processor then enters state T_1 of cycle M_1 for the next instruction. Otherwise, it enters state T_1 of cycle M_2 for the current instruction.

For instructions requiring more than one machine cycle, cycles M_2 — M_5 provide additional times for the 8080 to transfer data or addresses between the various internal registers and memory or I/O devices. Cycles M_2 — M_5 are all three states long and all operate according in the same general sequence. During state T_1 , the processor issues the SYNC signal, places the processor status word onto the data bus, places some address information onto the address bus and enters state T_2 . The address information placed onto the address bus will depend upon the instruction being executed. It can be a memory address (specified by the contents of register BC, DE, HL, PC, or SP) or the address of an I/O device specified by an IN or OUT instruction. (In the case of I/O addresses, the same 8-bit I/O address appears on both A_0 — A_7 and A_8 — A_{15} .) Once in state T_2 , the processor waits for the READY line to indicate that the memory I/O device is prepared for the data transfer. State T_3 is then entered and the required data transfer is performed. The DBIN and WR signals are used to indicate to peripherals and memory whether the 8080 is accepting input data or writing output data. If execution of the current instruction is complete, the processor enters cycle M_1 of the next instruction. Otherwise it continues executing with the next cycle of the current instruction.

8080 MANUFACTURERS

Advanced Micro Devices
901 Thompson Road
Sunnyvale, CA 94086

Intel Corporation
3065 Bowers Ave.
Santa Clara, CA 95051

NEC Microcomputers, Inc.
5 Militia Drive
Lexington, MA 02173

Texas Instruments
P.O. Box 1443
Houston, TX 77001

Conclusion

The hardware architecture of the 8080 is obviously too complex to be treated thoroughly in this short space. Hopefully this brief overview will give you enough information to follow and understand references made to the various registers and other structures that will occur in later columns.

R-E

- A TOTALLY NEW CONCEPT IN MUSICAL INSTRUMENTS



OZ IS...
POLYTONIC
WITH 7 OCTAVE RANGE,
BUILT IN SPEAKER AND AMP,
LED STATUS INDICATORS &
UNIQUE PRESSURE SENSITIVE
PITCH BENDER. OZ CAN BE
USED ALONE OR INTERFACE
TO ANY SYNTHESIZER
INCLUDING THE GNOME
MICRO-SYNTHESIZER!
UNDER \$80.00 IN KIT FORM.
CALL OUR 24HR. DEMO-LINE
(405) 843-7396
FREE CATALOG

F&A ELECTRONICS, INC.
DEPT. 6-R

1020 WEST WILSHIRE BLVD.
OKLAHOMA CITY, OK 73116

Circle 75 on reader service card

Build your own...
HOME TV GAME
with **SUPER
PONG** KITS

available from... **technology trends**

PC board kits, component kits, and accessory kits available in various combinations to fit the hobbyist's particular needs and skills. Prices from \$18.75. Circle reader service for complete information or send \$6.00 for manual.

Send \$6⁰⁰
for 40 PAGE MANUAL
Construction Plans and Parts List

Technology Trends

P.O. BOX 732, MANHASSET, NY 11030

Send me the 40 page construction manual for which I enclose \$6.00 (check or money order only).

Name.....

Address.....

New York residents add City and/or State Sales Tax

Circle 76 on reader service card

STATE OF SOLID STATE

(continued from page 28)

tions. At this point the chip has been protected from the hostile environment. What remains are the steps to metallize the wafer and bond to the package terminals so that this environmental screen is maintained.

Contact windows in the silicon dioxide are next opened up with conventional photomask operations. The wafer is sputtered with platinum and sintered in, forming platinum silicide low-resistance contacts. Titanium and platinum layers are sputtered on next. The platinum is etched with the metallization interconnect pattern and a gold layer electrolytically plated onto the platinum. So the three layers of the tri-metal process are titanium, platinum, and gold. The titanium layer has very good adherence to the silicon nitride contact areas. Platinum, the middle layer, is a diffusion barrier between the titanium and gold. Gold has very low resistivity, does not corrode and is perfect as a bonding surface for the connecting wires. The last wafer step is silicon dioxide passivation to protect against damage during handling in the wafer testing, pellet separation, and packaging steps.

RCA says that the product passed 5,000 hours of a standard 15-volt reverse bias test at 85 degrees C and 85% humidity life test with *no failures*. One hundred percent failure of standard product with aluminum metallization occurs within 1,500 hours; a strong contrast.

The price schedule for the 741CG and 747G op-amps is \$.50 and \$1.50 respectively at the 100 to 999 level. Other prices in the same quantity are: CA324G Quad Op-Amp, \$2.50; CA3724G High-Current NPN Transistor Array, \$1.50; and the CA339G Quad Voltage Comparator, \$2.25.

Let's hope that your next TV set with its probable complement of a half-dozen IC's will be closer to par with that communications satellite in the sky with its unserviceable electronics package.

New Motorola releases

Motorola's CMOS MSI logic line has two new additions. They are the MC14560 NBCD Adder and the MC14561 9's Complementer.

The MC14560 is a 4-bit binary full-adder. It adds two 4-bit Natural Binary Coded-Decimal words (NBCD). This term refers to the normal 8-4-2-1 weighting convention.

An NBCD word at the data input of the MC14561 is transferred to its output terminals either complemented or uncomplemented as instructed by the complement control input. Putting the two IC's together gives a 4-Bit NBCD Adder/Subtractor.

The circuits are mounted in either ceramic or plastic DIPs and are grouped into two operating temperature ranges. The MC14560CP is a plastic -40 to +85°C unit which sells for \$4.71 in small quantities. In the same lowest cost package and temperature range, the MC14561 goes for \$1.45.

Motorola is also moving ahead with LSI MOS. Their new MCM6590L is a 2048 by 8 bit read only memory useful as a look-

up table, for program storage, and in display terminals. The 16K ROM is mask programmable. Six conversion codes are factory programmed into the MCM6591L version. They are ASCII to and from Selectric (IBM), EBCDIC, and a modified 8 bit Hollerith. The same chip also has 128 USACII characters in mixed character fonts of 5 x 7 and 7 x 7 dot matrixes. They cost \$23.95 each in 24 pin ceramic DIP packages in 100 quantities.

In the linear market, Motorola has the new MPC900 Negative Voltage Regulator. It covers a range of -4 to -30 volts at load currents up to 10 amps. These ratings do not lean on any external transistors since the MPC900 power dissipation rating is 100 watts. The regulator's TO-3 style package plugs into a novel tube socket. Price is \$20.66 each in small quantities.

For more information on any of these new products, write to: Technical Information Center, Motorola Inc., Semiconductor Products Division, P.O. Box 20294, Phoenix, AZ 85036.

New microprocessor

MOS Technology has announced an 8-bit microprocessor, the MCS6501, first of a family. It is plug-compatible with the Motorola M6800. The new device uses N-channel, silicon gate, ion implanted, depletion load technology. It operates from a single 5-volt supply.

MOS Technology says the MCS6501 combines the compatibility of the M6800 bus system, the ready and indirect memory access of the 8080 and the on-chip clock of the F-8.

True address indexing, two types of indirect addressing and two index registers are powerful features. It is designed for cost effectiveness with a price of under \$20 in quantity.

Software plans include an efficient Cross Assembler and a Fortran-like software emulator.

R-E

"Happy Birthday
to Me!"



Don't let America celebrate
its 200th alone.

Find out how you can volunteer
to invite the world to our
party.

Contact:

**American Field Service
International Scholarships
Department 1776**

313 E. 43rd St., N.Y., N.Y. 10017

LEARN AVIATION ELECTRONICS



at the School
of Aeronautics,
Florida Institute
of Technology.

Prepare for a REAL job in just
2 years and earn a COLLEGE
DEGREE at the same time.

FAA publications identify that
by 1977 the AVIATION IN-
DUSTRY will need 230% MORE
AVIONICS TECHNICIANS.

Half the costs of airplanes to-
day is in electronics, including
navigation systems . . . in-
struments . . . communica-
tions systems . . . and control
systems.

We teach you in our labora-
tories . . . classrooms . . .
and on our aircraft the theory
of radio communications and
how to flight check and repair
all related equipment.

Our placement record of grad-
uates is 100%. . . . Make
your time and money spent
REWARDED by a job in your
field.

The SCHOOL OF AERONAU-
TICS operates one of the larg-
est flight training programs in
the WORLD and we are an
"accredited University".

Classes starting September
. . . January . . . June.

To learn more about our avia-
tion electronic programs,
check the reader service card
or write direct to:

**The School of Aeronautics,
Florida Institute of Tech-
nology, P.O. Drawer 1839,
Melbourne, Florida 32901
Att: Director of Admissions**

Circle 77 on reader service card

NEW! An absolutely LEGAL way to Pull In Distant, Weak CB Signals!



- MAKES INCOMING CB SIGNAL VOLTAGE 10 TIMES STRONGER
- PERMITS "WALL-TO-WALL" CB RECEPTION FROM MUCH GREATER DISTANCES
- MAY BE USED WITH BOTH AM AND SSB
- FAIL-SAFE. AUTOMATICALLY BY-PASSED WHEN TURNED OFF AND WHEN TRANSCEIVER TRANSMITS
- CAN BE USED WITH NEG. OR POS. GND
- CONNECTS EASILY BETWEEN CB XCVR & ANTENNA



Our business is improving yours!
Circle 78 on reader service card

next month

AUGUST 1976

■ CB Transceiver Roundup

What's new and available in CB gear. We look at the equipment and the features. We've included the new products our editors have seen at both the Personal Communications show in Las Vegas and the NEWCOM show in New Orleans.

■ Digital Clock Kits—1976

A special survey of the 35 different digital clock kits you can buy today. We examine how they work, list their specifications and tell you where you can get them.

■ New Digital Clock Module

Just announced by National Semiconductor, here's a preview of a new digital clock module that requires only the addition of a power supply and switches (and a case) to make a complete electronic digital clock.

■ Mindpower: Alpha

Unique brainwave monitor that has visual feedback. This month we get into the circuitry and take a look at the circuit boards.

■ Darkroom Countdown Timer

A digital darkroom timer that you set by using a calculator-type keyboard. It counts down and you can add an audio tone to the seconds.

PLUS

State-Of-Solid-State

Jack Darr's Service Clinic

Komputer Korner

Hi-Fi Lab Test Reports

Looking Ahead

Equipment Reports

EIGHT INSTRUMENTS IN ONE



- Out-of-Circuit Transistor Analyzer
- Dynamic In-Circuit Transistor & Radio Tester
- Signal Generator
- Signal Tracer • Voltmeter
- Milliammeter
- Battery Tester
- Diode Checker

Transistor Analyzer Model 212

Factory Wired & Tested—\$26.95
Easy-to-Assemble Kit—\$17.95

YOU DON'T NEED A BENCH FULL OF EQUIPMENT TO TEST TRANSISTOR RADIOS! All the facilities you need to check the transistors themselves — and the radios or other circuits in which they are used — have been ingeniously engineered into the compact, 6-inch high case of the Model 212. It's the transistor radio troubleshooter with all the features found only in more expensive units. Find defective transistors and circuit troubles speedily with a single, streamlined instrument instead of an elaborate hook-up.

Features:

Checks all transistor types — high or low power. Checks DC current gain (beta) to 200 in 3 ranges. Checks leakage. Universal test socket accepts different base configurations. Identifies unknown transistors as NPN or PNP.

Dynamic test for all transistors as signal amplifiers (oscillator check), in or out of circuit. Develops test signal for AF, IF, or RF circuits. Signal traces all circuits. Checks condition of diodes. Measures battery or other transistor-circuit power-supply voltages on 12-volt scale. No external power source needed. Measures circuit drain or other DC currents to 80 milliamperes. Supplied with three external leads for in-circuit testing and a pair of test leads for measuring voltage and current. Comes complete with instruction manual and transistor listing.

EMC, 625 Broadway, New York 12, N. Y.

Send me **FREE** catalog of the complete value-packed EMC line, and name of local distributor.

NAME _____ RE-7

ADDRESS _____

CITY _____ ZONE _____ STATE _____

EMC

ELECTRONIC MEASUREMENTS CORP.
625 Broadway, New York, N. Y. 10012

and horizontal control amplifier IC14, IC15, provide control voltages to the horizontal and vertical comparators that can vary the "detect" points of the stages with respect to the horizontal and vertical ramp inputs. Since this determines the coordinates at which the electron beam will turn-on and shut-off, the apparent size of the rectangle is determined by the respective levels of the display control signals.

As we have now established the method for producing and sizing the on-screen display, let us now examine the method by which the minute alpha wave potentials produced by the brain achieve control of the display.

The *Mindpower: Alpha* user wears an elastic headband that places three electrodes against the skin of the forehead and scalp. Two of these lie opposite the brain's right frontal lobe and left occipital lobe, thus establishing differential signal-measuring points that traverse most of the brain's neural mass. These two electrodes provide the differential input to an FET differential amplifier, comprising Q15 and Q16. The third electrode connects to the isolated ground of the EEG amplifier, establishing a neutral reference on the skin of the skull that aids in the elimination of stray signal pickup. The FET-input stage provides extremely high common-mode rejection and a high input impedance, thus making it a most efficient processor of the very low-level brain wave signals obtainable at the cranial skin surface and picked up by the head-band electrodes.

All front-end stages of the unit are operated from a dual 9-volt battery power supply for user safety, and the amplified output of the EEG amplifier is safely isolated from the remaining stages by means of a photo-isolator (IC27). This ensures complete user safety.

The amplified neurological potentials of the FET input stage are applied to cascaded operational amplifier stages IC25 and IC26, that are optimized for response to signals in the 8- to 13-Hz alpha wave frequency range. Overall gain of the amplifier is approximately 100,000 and output appears across threshold control R92. This control can be set so that amplified alpha waves of increasing level are required to achieve audible or visual response. The selected alpha voltage is applied to isolator driver Q14. It drives the light-emitting diode section of optical isolator IC27. Hence, as alpha wave bursts are detected and amplified, IC27 converts these to light pulses which are transmitted across a space to a phototransistor. This, in turn, provides the alpha pulse to pulse shaper/differentiator Q8, Q7, in the display/beep control section (that is transformer-powered from the AC line).

The output signal of the isolated EEG amplifier section, for a given signal input, is a train of about-equal amplitude pulses, which are differentiated and applied to both 1-KHz beep oscillator IC20, and display motion generator IC18, IC19, Q5. The differentiated pulses key IC20 on and off so that an audible indication of alpha occurrence is provided to the user by the speaker. (This can be silenced by opening a switch.) The pulses also control the display motion generator's response in either of two ways, depending upon the units selected mode.

In Mode 1 (fixed display), incoming alpha pulses subtract from a fixed reference voltage, so that the display motion generator produces an output causing the display rectangle to shrink in size in proportion to the alpha produced. Return to normal size is automatic, if alpha is not sustained. In Mode 2 (moving display), the generator produces a rising ramp voltage which can be reduced by the arrival of an alpha wavetrain. This makes it possible for the user to hold the display "in check" on screen, or to move it down to smaller size by sustained alpha. Failure to sustain alpha causes the display to grow in size.

R-E

Put Professional Knowledge and a **COLLEGE DEGREE** in your Electronics Career through **HOME STUDY**



Earn Your **DEGREE**

by correspondence, while continuing your present job. No commuting to class. Study at your own pace. Learn from complete and explicit lesson materials, with additional assistance from our home study instructors. Advance as fast as you wish, but take all the time you need to master each topic. Profit from, and enjoy, the advantages of independent study.

The Grantham correspondence degree program in electronics is comprehensive. It begins with basics, written in very simple language, and continues through the B.S.E.E. degree level. Throughout the entire program, heavy emphasis is placed on clear explanations written in great detail, progressing from the simple to the complex, in easy steps.

Our free bulletin gives complete details on the curriculum, the degrees awarded, the requirements for each degree, and how to enroll.

GRANTHAM SCHOOL OF ENGINEERING

2000 Stoner Ave., Los Angeles CA 90025

● Telephone (213) 477-1901 ●

Worldwide Career Training thru Home Study

Mail the coupon below for free bulletin.

Grantham School of Engineering RE 7-76
2000 Stoner Ave., Los Angeles, CA 90025

I have been in electronics for _____ years. Please mail me your free bulletin which gives details concerning your electronics degree programs.

Name _____ Age _____

Address _____

City _____ State _____ Zip _____

Circle 79 on reader service card



INTERNATIONAL FM 2400CH

FREQUENCY METER for testing mobile transmitters and receivers



- Tests Predetermined Frequencies 25 to 1000 MHz
- Extended Range Covers 950 MHz Band
- Pin Diode Attenuator for Full Range Coverage as Signal Generator
- Measures FM Deviation

The FM-2400CH provides an accurate frequency standard for testing and adjustment of mobile transmitters and receivers at predetermined frequencies.

The FM-2400CH with its extended range covers 25 to 1000 MHz. The frequencies can be those of the radio frequency channels of operation and/or the intermediate frequencies of the receiver between 5 MHz and 40 MHz.

Frequency Stability: $\pm .0005\%$ from $+50^\circ$ to $+104^\circ\text{F}$.

Frequency stability with built-in thermometer and temperature corrected charts: $\pm .00025\%$ from $+25^\circ$ to $+125^\circ$ (.000125% special 450 MHz crystals available).

Self-contained in small portable case. Complete solid state circuitry. Rechargeable batteries.

FM-2400CH (meter only) \$595.00
 RF crystals (with temperature correction) ... 24.00 ea.
 RF crystals (less temperature correction) 18.00 ea.
 IF crystals catalog price

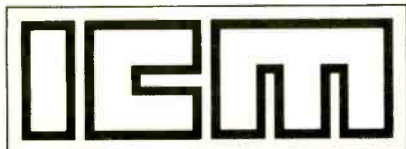

International Crystal Manufacturing Company, Inc.
 10 North Lee, Oklahoma City, Oklahoma 73102

Circle 80 on reader service card

VERTICAL JITTERS

This Magnavox IT5502 has a bad vertical jitter and intermittent roll. I've checked tubes and changed the 17JZ8 twice. Scope seems to show everything OK around the vertical circuits. It's not the 2.0- μF capacitor in the AGC; I changed that! Where to go from here?—E.D., Tappan, NY.

Go to the DC power supply. Scope all of the DC supply lines feeding the sync separator. You may find some vertical-frequency pulses floating around. If so, one of the electrolytic filter capacitors isn't doing its job.

(Field Feedback: Right! A 200- μF electrolytic that reads less than 80- μF isn't too good. That did it.)

SAME PROBLEM, TWO TV SETS

I've got an Admiral PG910 and an RCA 172-A049 with the same problem. No high voltage. All of the DC voltages in both of them check out, including the boost. What have I done wrong?—M.B., Jackson, MS.

If your boost voltage is up to normal, you must have the right amount of driving pulse to the flyback. So, this will almost have to be something in the high-voltage rectifier tubes, sockets or the heater wiring to them. For a quick check, try replacing the tube with one of the solid-state rectifiers such as RCA SK-3067 or SK-3068. If this gives you high voltage, OK.

FLOATING COLOR BARS

I asked for help on finding the cause of two floating bars of color in the picture, on an Admiral. You suggested several things, but your post-script was the right one. The auto-degauss coil was bad. Glad you had that last-minute thought!—L.B., Wallkill, NY.

So am I!

R-E



GO DIGITAL, GO DANAMETER®

(The New VOM For Today's Needs.)

- 0.25% Accuracy
- Full Overload Protection
- Really Drop-Proof
- Full One Year Battery Life



Dana Laboratories, Inc.

2401 Campus Dr, Irvine, Ca 92715, (714) 33-1234

Circle 81 on reader service card

COMPLETE ALARM CLOCK

- * 4 Digits 0.5" LED with brightness control
- * 12 Hour display with AM/PM indication
- * True 24 hour alarm with repeatable snooze
- * Power failure indication for power interrupt



MODEL EC 400
(Not a Kit)
Only \$22.50

NEW CLOCK KITS!



MODEL OC1032
JUMBO DIGITS
ALARM CLOCK
1.2" Bright Yellow
Color Readouts

Features: 12/24 Hour Display, 24 Hour Alarm Set, 10 Min Snooze Switch, AM/PM Indicator
Kit Includes: Woodlike Color Plastic Case, 4 Digit 1.2" Neon Display with AM/PM, TMS 3834 Alarm Chip, 2 pcs. double sided PC Boards, 16 transistors, all other components, Transformer and speaker

SPECIAL \$35.90

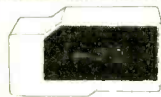

MODEL OC1030
4 DIGIT
ALARM CLOCK KIT
0.5" Green Color
Readouts

Features: 12/24 Hour Displays, 24 Hour Alarm Set, 10 Min Snooze Switch, AM/PM Display.
Kit Includes: Orange Color Plastic Case, 0.5" LD8132 Green Color Readouts PC boards with transformer, all electronic parts with speaker.

Only \$28.50

THE MOST POPULAR



MM5314 KIT

WITH A NEW CASE!!
Features: 12/24 Hour Display
50/60 HZ Input 6 Digits Readout
Kit Includes: Grey Color Plastic Case
MM5314 Clock Chip PC Boards and Transformer, 6 Green Color 0.3" Tube Readouts, All other transistor Drivers and other Components.

Special Only \$19.95 ea.

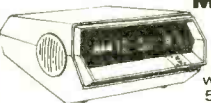

MODEL CT7001
Drive 6
Fairchild FND
0.5" Red LED
with MONTH & DATE
50/60HZ and ALARM

Only \$28.50 ea.
(without case)

COMPUTER KEYBOARDS



Standard Teletype Keyboards with gold plated contact switches. All switches are independent and allow you to connect into any form of output.

Only \$22.50

MODEL B SPECIAL ONLY \$16.50 ea.

Fully ASCII decoded with electronic parts TTL logic. Used but all in good condition.

ROCKWELL A4001 I.C.

ELECTRONIC SLIDE RULE SCIENTIFIC CALCULATOR KIT !!

Kit Includes: Rockwell A4001 IC
HP 9 Digit LED Readouts
Complete Keyboard with Case
PC Board with all Electronic Parts
Instructions and Batteries



SPECIFICATION

- * 9-digit HP Red Led Displays
- * 8 digits capacity for data entry or results (10⁻⁸ ~ 10⁸)
- * Full floating point
- * Dome keyboard for excellent response and preventing double entry input

BASIC FUNCTION

- * Algebraic mode operation
- * Constant operations
- * Repeat Operations
- * Chain operations
- * Change sign operation
- * Display and Y register exchangeable
- * One accumulating memory
- * Display and memory exchangeable

SPECIAL FUNCTION

- * Trigonometric functions (sin, cos, tan)
- * Inverse trigonometric functions (sin⁻¹, cos⁻¹, tan⁻¹)
- * Radian or degree selectable
- * π constant
- * Logarithms (ln, log)
- * Anti logarithms (e^x)
- * Power functions (y^x)
- * Reciprocal (1/x)
- * Square root (\sqrt{x})
- * Display recall

AC adapter for the unit
\$4.50 ea.
* postage \$1.50 per unit.

ONLY \$28.50

Dimension: 32.5mm(H) x 77mm(W) 145mm (L)
1 9/32 in (H) x 3 1/32 in (W) x 5 23/32 in (L)

50 UA PANEL METER



First designed for metal Finder. Scaled from 0-10 but can be erased and your own scale put on top. Brand new in box Only \$3.80 ea.



TRANSFORMERS

- 12V AC 300 MA output Wall Type Autotier (designed for clock with limited space) \$2.50 ea
- 12V 0.12V or 24V 1 Amp output \$2.25 ea
- 0.08V 12V 300 MA output (for our fluorescent tubes) \$2.50 ea
- 12V CT 500MA output \$1.50 ea

- 0.3V 12V 24V 500MA output (for CT 7001 Drive- LD 8132 Readouts) 2.50 ea
- 0-15V 160V 150MA output (for Gas discharge Readouts) 1.00 ea

NEW ITEMS

- MM 5330 4 1/2 Digits DVM Chip \$12.50 ea
- T1 TMS 2901 Static USACI: 64 x 5 x 7 Character Generator \$8.50 ea
- Morotopia MC1733 Video Amp IC \$1.20 ea
- LM 566 Vcn Controlled Oscillator \$1.60 ea
- NE 540L Power Driver \$2.00 ea
- LM 339 Quad Comparator \$1.70 ea
- UA 739 Dual Low Noise Pre Amp \$1.00 ea
- NE 8038 Wave Form Generator \$4.50 ea
- 1702A Erasable Rom \$3.50 ea
- 2102 1 RAMS 256x1 \$2.60 ea
- 1M 3900 Quad Op Amp \$0.50 ea
- 75491 Quad Seg Drivers \$0.50 ea
- 75492 Hex Digit Drivers \$0.50 ea
- Bridge Rectifier 1.5 Amp 200V \$0.60 ea
- Bridge Rectifier 25 Amp 200V \$2.50 ea
- IN 4002 Rectifier 1 Amp 100V 12 for \$1.00

AUTO ALARM KIT



The Crenshawer Auto Alarm is an electronic, self controlled auto protection system, normally mounted within the ignition box of an automobile. Two minutes after turning off the ignition, the alarm automatically turns itself "on". When the auto is re-ignited, the horn will sound after a 10-15 second entry delay. The automobile owner, by inserting the ignition key, will activate the alarm. Once activated, the alarm will sound for two minutes before automatically turning off. The alarm then resets and is ready to again protect the vehicle from unwanted entry.

FEATURES: Simple installation 5 wires. Automatically turns on when auto is parked. Adjustable entry time. Extended exit time to allow for uncrushed exit from vehicle. Numerous applications include protection of boats, campers, trailers, motorcycles, trucks. Cannot be deactivated by "hot wiring" an auto. Cannot be turned off without ignition key. Negative ground only.
ONLY \$10.00 per kit Completed Unit \$16.00

LED READOUTS



Fairchild I SC 8000
0.8" Red 1 LD 3 Digits with AM PM
Direct Drive by MM 5316 or Fairchild 3817
\$10.50 ea.

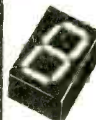

JUMBO LED

Fairchild FND 800
0.8" Common Cathode Red Color
ONLY \$3.50 ea.

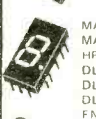

- MAN 74 Red \$1.00
- MAN 84 Yellow \$1.50
- HP 0 3 Red \$1.20
- DL 747 RZ D \$2.50
- DL 727 Double Digit \$2.50
- DL 707 0.3 Red \$1.30
- FND 70 0.25 Red \$0.60
- FND 503 0.5 Red \$1.60
- FLV 50 Submini Red \$0.15 ea
- FLV 209 Mini Red \$0.15 ea
- Jumbo Red \$0.15 ea
- Jumbo Green \$0.25 ea
- Jumbo Orange \$0.25 ea

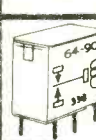

12 VDC Relay
SPDT 1amp
\$1.25 ea.

DIRECT DRIVE LED!!
F3817 Alarm Clock Chip by Fairchild
4 digit 24 hour Alarm
\$4.95 ea.

Ni-Cd Rechargeable Batteries
4AA size to a pack (1.25V ea.)
Only \$2.50 per pack

COMPUTER GRADE CAPACITOR

- 15500 MFD 75V-DC \$4.95 ea.
- 5600 MFD 60V-DC \$1.25 ea.

SAE DIP SWITCHES



Part No 1004 692 4xSPST SW
1008 692 4xSPST SW
4 Toggle SPST Switches on a Mini DIP (8 pins) Only \$1.50 ea
8 Toggle SPST Switches on a DIP (16 pins) Only \$2.60 ea

SUBMINIATURES TOGGLE SWITCHES



SPDT On-None-On \$1.30 ea
DPDT On-None-On \$1.50 ea

ECCO BCD THUMBWHEEL SWITCHES

- 8 positions \$1.25 ea
- 10 positions \$2.15 ea
- 12 positions \$2.50 ea

QUARTZ CRYSTALS

1 MHz Composite Crystals \$4.25 ea
3.58 MHz Color TV Crystals \$1.25 ea
Use with Nation MM 5369 to make a perfect time base for clock.

NEW!
NATIONAL MM 5369 17 STAGE PROGRAMMABLE OSC/DIVIDER generate A 60 Hz reference Frequency with a 3.58 MHz Color TV X-TAL in Mini DIP Package
ONLY \$2.25 ea.

NEW ALARM CLOCK CHIPS

MM 5375 Series by National 24 pin package Multiplex output with brightness control.
ONLY \$3.50 ea. Data .25 ea.

FEATURE	OPTION	PART			
		AA	AB	AC	AD
Input Frequency	60 Hz 50 Hz	X	X	X	X
Time Display	12 Hour 24 Hour	X	X	X	X
Duplicate Register	Alarm Counter Date Counter Minute Timer Second Timer	X	X	X	X
Alarm Signal	Tone DC Level	X	X	X	X
Alarm Output	Modulated @ 20Hz Not Modulated	X	X	X	X
Alarm at Power Failure	ON OFF	X	X	X	X
Segment Driver Polarity	Via for Display Vid for Display	X	X	X	X
AM or PM Indication	Off during time display Displayed at all times	X	X	X	X

MINIMUM ORDER \$10.00. California residents add 6% sales and 1.50 to cover postage and handling.
Out-of-state and overseas countries add \$2.50.

SEND CHECK OR MONEY ORDER TO:



FORMULA INTERNATIONAL INC.

12603 CRENSHAW BOULEVARD • HAWTHORNE, CALIFORNIA 90250

For more information please call (213) 679-5162

STORE HOURS 10-7 Monday - Saturday

market center

CLASSIFIED COMMERCIAL RATE (for firms or individuals offering commercial products or services). \$1.40 per word... minimum 15 words.

NONCOMMERCIAL RATE (for individuals who want to buy or sell personal items) 85¢ per word... no minimum.

ONLY FIRST WORD AND NAME set in bold caps. Additional bold face (not available as all caps) at 10¢ per word. Payment must accompany all ads except those placed by accredited advertising agencies. 10% discount on 12 consecutive insertions, if paid in advance. All copy subject to publisher's approval. Advertisements using P.O. Box address will not be accepted until advertiser supplies publisher with permanent address and phone number. Copy to be in our hands on the 26th of the third month preceding the date of the issue (i.e. August issue closes May 26). When normal closing date falls on Saturday, Sunday or a holiday, issue closes on preceding working day.

EDUCATION & INSTRUCTION

FREE educational electronics catalog. Home study courses. Write to: **EDUKITS WORKSHOP**, Dept. 281G, Hewlett, NY 11557

ELECTRONICS DESIGN NEWSLETTER

★ Logic Design Techniques
★ Digital & Linear Design Theory & Procedures
★ Construction Projects

Learn Design Techniques!
Write for FREE CATALOG of parts & kits

Subscription \$6 Sample Copy \$1

VALLEY WEST Box 2119-L Sunnyvale, CA 94087

GRANTHAM'S FCC License Study Guide—377 pages, 1465 questions with answers/discussions—covering third, second, first radiotelephone examinations. \$9.95 postpaid.
GSE PUBLICATIONS, 2000 Stoner, Los Angeles, CA 90025

TELEPHONE bugged? Don't be Watergated! Countermeasures brochure \$1.00. **NEGEYE LABORATORIES**, Box 547-RE, Pennsboro, WV 26415

F.C.C. EXAM MANUAL

PASS FCC EXAMS! Memorize, study—Tests—Answers for FCC 1st and 2nd class Radiotelephone licenses. Newly revised multiple choice questions and diagrams cover all areas tested in FCC exams, plus Self-Study Ability Test. \$9.95 postpaid. Money-back guarantee.

Tests—Answers for FCC First and Second Class Commercial License

COMMAND PRODUCTIONS P.O. BOX 26348 E
RADIO ENGINEERING DIV SAN FRANCISCO, CAL 94126

FOR SALE

TV picture tubes—Over 1700 types of B-W and Color at the lowest prices. **ALLIED SALES**, Dept. 32, Pimento, IN 47866. 812-495-6555

FREQUENCY directories! Police, fire, other services! Retail sales & dealer inquiries invited. Send postage stamp for catalog. **CRB RESEARCH**, Box 56-RE, Commack, NY 11725

OWN YOUR OWN PICTURE TUBE REBUILDING BUSINESS

With Lakeside Industries re-building equipment you can rebuild any picture tube!

For complete details send name, address, zip code to
LAKESIDE INDUSTRIES
3520 W Fullerton Ave
Chicago, Ill. 60647
Phone: 312-342-3399



ELECTRONIC test equipment and surplus parts excess to my needs. Send SASE for list. **BRIAN KENT**, 22 Wake Ct., Eatontown, NJ 07724

Red Cross. The Good Neighbor.

NEW adjustable three-output regulated power supply, plus 900 parts worth \$400.00 list. Solid-state **Cartrivision** television recorder electronic unit. Schematics, parts cross reference. **Heathkit** television transistor substitution. Power CB radios, microprocessors. \$17.95 plus \$3.50 S & H, USA. Free brochure. Master Charge, Bank-Ameri-card. **MADISON ELECTRONICS COMPANY, INC.**, Box 369, D101, Madison, AL 35758

LED watches—\$25.95—add \$1.00 postage, flyer 13¢. **LYNDALL DISTRIBUTORS**, Box 1394, Scottsdale, AZ 85252

CARBON film resistors—1/4 W, 5% 10—4.7 megohms for 3 1/2¢ each. Fifty per value \$0.85. Discounts available. Free samples/specifications. Other quality components. \$1.00 postage. **COMPONENTS CENTER**, Box 134R, New York, NY 10038

RADIO & TV tubes 36¢ each. One year guaranteed. Plus many unusual electronic bargains. Free catalog. **CORNELL**, 4217-E University, San Diego, CA 92105

CASSETTES/LABELS

Plain white cassette labels. Norelco cassette cleaners, famous brand cassettes. Send for open reel and cassette discount catalog. 1-9 10-99 100 1000 10M

Cassette Labels .02 .015 .01 .005
Norelco Cassette Cleaner .65 .60 .55 .50 .45
10" Fiberglass used 3/4" Hole .50 .40 .35 .30

Plus Postage by Weight and Zone. Minimum Order \$5.00
OPEN REEL STEREO TAPE BUYERS!

We've Got the "Spirit" The Prices And The Address To Prove It
Saxitone's Bicentennial Tape Shoppe
1776 Columbia Rd., N.W., Wash. D.C. 20009

CANADIAN discount and factory clearouts catalog. Top brand stereo equipment, calculators, test gear, CB & communications, telephones. Factory dumps—government surplus. Amazing bargains. Unusual items. Rush \$1.
ETCO-RE, 521 5th Ave., NYC, 10017

COMPUTERS—Hexadecimal calculator: \$35.95. Octal calculator: \$14.95. Literature free. **RADIX PRECISION**, Box 13861-R, Atlanta, GA 30324

B&K test equipment. 15% discount. Free shipping. Free catalog. **SPACETRON**, Box 84C, Broadview, IL 60153

JAPANESE transistors. All transistors original factory made. Free catalog. **WEST PACIFIC ELECTRONICS**, P.O. Box 25837, W. Los Angeles, CA 90025



CLOCK KIT \$14.00

Includes all parts with MM5316 chip, transformer, drilled & etched PC board, all except case. #SP-284 \$14 or 2/\$25

ASCII KEYBOARD, brand new w/paperwork \$45.00

AA NICAD CELLS brand new \$1.25 each 9/\$9.00

C-MOS LINEAR all brand new RCA

301	\$.60	747	\$.82	CLOCK CHIPS
307	.52	748	.96	MM5314 \$3.00
324	1.80	1458	.96	MM5316 3.00
339A	1.60	3401	.80	
741	.50	555	.60	7001 8.00

POWER SUPPLY KIT

Puts out 24-12-6 volt DC 2 amps. Includes xfmr, line cord, filter, silicon bridge. #PK-2B \$9.00

B & L HELIUM NEON GAS LASER

Fully assembled, runs on 115 volts AC. Less Laser tube. \$15.00

POWER AMP TRANSFORMER \$9.00
115 volts input, output of 96 VCT 2 amps. \$9.00 each 3/\$25

Please add shipping cost on above.

FREE catalog

Meshna SURPLUS ELECTRONIC MATERIAL
P.O. Box 62
19 ALLERTON STREET
E. LYNN MASS. 01904

Circle 82 on reader service card

CLOCKS

GIANT NIXIE CLOCK — 4 digits — 2.5" displays. Line frequency operated. Uses opto-isolators for drivers. Complete kit includes circuit board set, instructions, and all parts except case. Complete kit — only \$29.95 ppd.

6 digit AUTOMOTIVE CLOCK KIT complete with a **CRYSTAL TIMEBASE** accurate to .01 percent. 12 volts d.c. operation — built in noise suppression and voltage spike protection. Readouts blank when ignition is off — draws 25 mA in standby mode. Has .3 in. readouts. Use it in your car or for all applications where a battery-operated clock is needed. Approximate size 3" x 3.5" x 1.75"

WITH BLACK PLASTIC CASE \$34.95 ppd.
WITHOUT CASE \$29.95 ppd.
ASSEMBLED AND TESTED \$45.95 ppd.

CMOS CRYSTAL TIMEBASE KITS with .01 percent accuracy. 5-15 v.d.c. operation. Draws only 3 mA at 12 volts. Single I.C. — very small size — the P.C. board is 7/8" x 1-5/8". Choose a main output of 50 or 100 Hz., 60 Hz., 500 or 1000 Hz., or 1 Hz. Several related frequencies are also available on each board, in addition to the main ones listed above. Be sure to specify the Frequency you want. All kits are \$10.95 ppd.

Flyer available — write for it or circle the reader service card.

NEXUS TRADING CO.
Box 3357
San Leandro, Ca 94578

Circle 83 on reader service card

2 in 1

5 x 4 x 2 1/2"

Display counter module 4 x 5
All other modules 3 x 5 inches



FREQUENCY COUNTER - MULTIMETER

\$89.95

- MODULES**
- (1) DECADE COUNTER MODULE \$27.95
4 digit 7 seg LED TTL circuitry (flashed display version available add 6.95)
 - (2) TIME BASE DIVIDER CHAIN MODULE 21.95
1MHz crystal controlled oscillator. 5 decade divider. 1MHz, 100KHz, 10KHz, 1KHz, 100Hz, 10Hz, 1Hz outputs. Accuracy better than .001%. Module contains dual JK Flip Flop for stopwatch timer application.
 - (3) FREQUENCY COUNTER GATE MODULE 16.95
Schmidt trigger input requires IV. 1 Hz range to 30MHz. Has 1 stage shortky prescaler extending freq. range to 100MHz.
 - (4) DIGITAL MULTIMETER MODULE 29.95
(See frequency counter digital multimeter specs for ranges and spec.)
(a) DVM module (DC volt & current)
(b) AC converter OHM module (AC volt & current, OHM)
 - (5) CAPACITANCE COUNTER MODULE 19.95
100pF to 100MF ± 1% typically. Requires Freq. counter system (6)
 - (6) FUNCTION GENERATOR MODULE 19.95
1Hz to 1MHz. Simultaneous sine, square, triangle wave. Adjustable duty cycle. Less than 1% Distortion. 0.1% linearity. Can be modulated
- SYSTEMS**
- (A) FREQUENCY COUNTER - DIGITAL MULTIMETER 89.95
(Also stopwatch, timer, crystal calibrator)
Consists of module (1), (2), (3), (4)
Digital Multimeter, 11 MEG OHM input impedance on all ranges
100% over-range, i.e., 0.1 999 on 0.1 000V range
AC & DC voltage range: 0.1 000V, 10 00V, 100 0V, 1000V
AC & DC current range: 0.1 000mA, 10 00mA, 100 0mA, 1000mA
OHMS range 0 100 0HM, 10K, 1MEG
All attenuating & short network of precision resistors
Accuracy ± 1 count ± 1% (flashed display version available add 6.95)
 - (B) FREQUENCY COUNTER - consists of Modules (1), (2), and (3) 59.95
 - (C) STOPWATCH-TIMER TIME BASE (4 digit) 47.95
Consists of module (1) and (2) Time range from 10us to 9999 seconds - 166.66 msec two count gate. Start & Stop.
 - (D) POWER SUPPLY 22.95
± 15V at 500ma and 5V at 1.5amp. Use for more than 4 digit.
- *NEW*** 6 Digit Frequency Counter - Digital Multimeter. Kit - 100MHz base 50MΩ 1MEG input. Complete Kit \$179.95 (can be expanded to 7 or 8 digits)
Write for information.

Systems do not include hardware such as rotary switches, etc. 1 Add \$1.50 Postage & Handling - Power Supply \$1.50 additional California Resident add 6% tax ALL MODULES ASSEMBLED AND TESTED Please allow 2 weeks for scheduling & delivery SEND CHECK OR MONEY ORDER TO

LIN CORPORATION

15311 S. Broadway
Gardena, California 90248
(213) 532-8809
Hours 10:4-3:30

DESCRAMBLERS: Several professional models that work with all scanners. Tone encoders/decoders, Scanmate, AAPP, radar detectors, Big Ears, alarms, books, kits, parts. Catalog 25 cents: **KRYSTAL KITS**, Box 445, Bentonville, AR 72712

PRINTED CIRCUIT

Positive Acting Photo Resist; Carbide bits; Bubble etchers; Artwork; Epoxy Glass Boards.

Send stamp & address label for flyer
TRUMBULL

833 Balra Dr., El Cerrito, CA 94530

SURPRISE! Build inexpensively, the most unusual test instruments, futuristic gadgets using numerical readouts. Catalogue free! **GBS**, Box 100B, Greenbank, WV 24944

SEMICONDUCTOR and parts literature, **J. & J. ELECTRONICS**, Box 1437R, Winnipeg, Manitoba, Canada, U.S. Inquiries Invited.

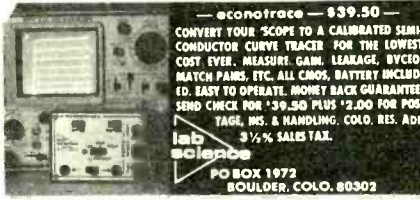

MANUALS for Govt. surplus radios, test sets, scopes. List 50¢ (coin). **BOOKS**, 7218 Roanne Drive, Washington, DC 20021

PARTS! **CORNELL TUBES!**
Send For FREE
CORNELL'S New Color Catalog
43 pgs. New Items
33¢ per tube
36¢ per tube
ORDER FREE IF NOT SHIPPED IN 24 HOURS
4215 E. UNIVERSITY AVE. SAN DIEGO, CALIF. 92105

FREE catalog, ultrasonic devices, LED's, transistors, IC's, strobe lights, UART's, memories, digital thermometers, unique components. **CHANEY'S**, Box 15431, Lakewood, CO 80215

FREE catalog. IC's, Semi's. **CORONET ELECTRONICS**, 649A Notre Dame W., Montreal, Que. Canada, H3C-1H8. US Inquiries.

WANTED

QUICK cash . . . for electronic equipment, components, unused tubes. Send list now! **BARRY**, 512 Broadway, New York, NY 10012, 212 Walker 5-7000

TV games kits P/C boards
Send for your information packet today - which also includes circuit functions, component line-up, and accessories. Information Packet \$1.00 (refundable with order).
visulex P. O. Box 4204R Mountain View, CA 94040

BUSINESS OPPORTUNITIES

LEARN basic digital troubleshooting by correspondence. Information free. **EDUCATIONAL TECHNOLOGIES**, Department RE, Box 224, Reynoldsburg, OH 43068

HIGHLY PROFITABLE ONE-MAN ELECTRONIC FACTORY
Investment unnecessary, knowledge not required, sales handled by professionals. Ideal home business. Write today for facts! Postcard will do. **Barta-BE**, Box 248, Walnut Creek, CA 94597.

EMPLOYMENT OPPORTUNITY

CALIFORNIA companies hiring electronic engineers, technicians. Current employment bulletin \$3.00. **DYNAMICS**, Box 1867-RA, Covina, CA 91722

CB SPECIALS-R.F. DRIVERS-R.F. POWER OUTPUTS-FETS

2SC481 1.85	2SC767 15.75	2SC866 5.85	2SC1449-1 1.60	40081 1.50
2SC482 1.75	2SC773 .85	2SC1013 1.50	2SC1475 1.50	40082 3.00
2SC495 1.10	2SC774 1.75	2SC1014 1.50	2SC1678 5.50	2SC608 4.85
2SC502 3.75	2SC775 2.75	2SC1017 1.50	2SC1679 2.15	SK3046 2.15
2SC517 4.75	2SC776 3.00	2SC1018 1.50	2SC1728 2.15	SK3047 3.75
2SC614 3.80	2SC777 4.75	2SC1173 1.25	2SC1760 2.15	ST2095 3.50
2SC615 3.90	2SC778 3.25	2SC1266A 1.25	2SC1816 5.50	SK3048 3.25
2SC616 4.15	2SC797 2.50	2SC1237 4.50	2SC1908 .70	SK3054 1.25
2SC617 4.25	2SC798 3.10	2SC1239 3.50	2SC1957 1.50	2SK19 1.75
2SC699 4.75	2SC781 3.00	2SC1243 1.50	2SF8 3.00	2SK30 1.00
2SC710 .70	2SC789 1.00	2SC1306 4.75	2SF8 3.00	2SK30 1.00
2SC711 .70	2SC796 3.15	2SC1306-1 4.90	HFP-S 3001 3.25	2SK33 1.20
2SC735 .70	2SC799 4.25	2SC1307 5.75	MRF8004 3.00	3SK40 2.75
2SC756 3.00	2SC802 3.75	2SC1307-1 6.00	4004 3.00	3SK45 2.75
2SC765 9.50	2SC803 4.00	2SC1377 5.50	4005 3.00	3SK49 2.75
2SC766 10.15	2SC839 .85	2SC1449 1.30	40080 1.25	3SK49 2.75

JAPANESE TRANSISTORS

2SA52 .60	2SB187 .60	2SC458 .70	2SC815 .75	2SC1569 1.25
2SA316 .75	2SB235 1.75	2SC460 .70	2SC828 .75	2SC1756 1.25
2SA473 .75	2SB303 .65	2SC478 .80	2SC829 .75	
2SA483 1.95	2SB324 1.00	2SC491 2.50	2SC830 1.60	2SD30 .95
2SA489 .80	2SB337 2.10	2SC497 1.60	2SC839 .85	2SD45 2.00
2SA490 .70	2SB367 1.60	2SC515 .80	2SC945 .65	2SD65 .75
2SA505 .70	2SB370 .65	2SC535 .75	2SC1010 .80	2SD68 .90
2SA564 .50	2SB405 .85	2SC536 .65	2SC1012 .80	2SD72 1.00
2SA628 .65	2SB407 1.65	2SC537 .70	2SC1051 2.50	2SD88 1.50
2SA643 .85	2SB415 .85	2SC563 2.50	2SC1061 1.65	2SD151 2.25
2SA647 2.75	2SB461 1.25	2SC605 1.00	2SC1079 3.75	2SD170 2.00
2SA673 .85	2SB463 1.65	2SC620 .80	2SC1096 1.20	2SD180 2.75
2SA679 3.75	2SB471 1.75	2SC627 1.75	2SC1098 1.15	2SD201 1.95
2SA682 .85	2SB474 1.50	2SC642 3.50	2SC1115 2.75	2SD218 4.75
2SA699 1.30	2SB476 1.25	2SC643 3.75	2SC1166 .70	2SD300 2.50
2SA699A 1.75	2SB481 2.10	2SC644 3.75	2SC1170 4.00	2SD313 1.10
2SA705 .55	2SB492 1.25	2SC681 2.50	2SC1172B 4.25	2SD315 1.75
2SA815 .85	2SB495 .95	2SC684 2.10	2SC1209 .55	2SD318 .95
2SA816 .85	2SB507 .90	2SC687 2.50	2SC1213 .75	2SD341 .95
	2SB511 .70	2SC696 2.35	2SC1226 1.25	2SD350 3.25
2SB22 .65		2SC712 .70	2SC1243 1.50	2SD352 8.00
2SB54 .70	2SC206 1.00	2SC713 .70	2SC1293 .85	2SD380 5.70
2SB56 .70	2SC240 1.10	2SC732 .70	2SC1308 4.75	2SD389 .90
2SB77 .70	2SC261 .65	2SC733 .70	2SC1347 .80	2SD390 7.50
2SB128 2.25	2SC291 .65	2SC739 .70	2SC1383 .75	2SD437 5.50
2SB135 .95	2SC320 2.00	2SC715 1.75	2SC1409 1.25	
2SB152 4.50	2SC352 .75	2SC762 1.90	2SC1410 1.25	MPS-U31 4.00
2SB173 .55	2SC353 .75	2SC783 1.00	2SC1447 1.25	
2SB175 .55	2SC371 .70	2SC784 .70	2SC1448 1.25	
2SB178 1.00	2SC372 .70	2SC785 1.00	2SC1507 1.25	
2SB186 .60	2SC394 .70	2SC793 2.50	2SC1509 1.25	

POWER-TRANSISTORS HIGH-VOLT. TV. TYPE

BU204 1300V 3.90	BU207 1300V 5.40	2SC1172B 1100V 4.25
BU205 1500V 4.70	BU208 1500V 6.25	2SC1308 1100V 4.95
BU206 1700V 5.90	2SC1170 1100V 4.00	2SC1325 1100V 4.95

OEM SPECIALS

1N270 .10	2N960 .55	2N2219A .30	2N2913 .75	2N3740 1.00	2N4401 .20
1N914 .10	2N962 .40	2N2221 .25	2N2914 1.20	2N3771 1.75	2N4402 .20
	2N967 .50	2N2221A .30	2N2916A 3.65	2N3772 1.90	2N4403 .20
2N173 1.75	2N1136 1.35	2N2222 .25	2N3019 .50	2N3773 3.00	2N4409 .20
2N178 .90	2N1142 2.25	2N2222A .30	2N3053 .30	2N3819 .32	2N4410 .25
2N327A 1.15	2N1302 .25	2N2270 .40	2N3054 .70	2N3823 .70	2N4416 .75
2N334 1.20	2N1305 .30	2N2322 1.00	2N3055 .75	2N3856 .20	2N4441 .85
2N336 .90	2N1377 .75	2N2323 1.00	2N3227 1.00	2N3866 .85	2N4442 .90
2N338A 1.05	2N1420 .20	2N2324 1.35	2N3247 3.40	2N3903 .20	2N4443 1.20
2N398B .90	2N1483 .95	2N2325 2.00	2N3250 .50	2N3904 .20	2N4452 .55
2N404 .30	2N1540 .90	2N2326 2.85	2N3375 6.50	2N3905 .20	2N5061 .30
2N443 1.75	2N1543 2.70	2N2327 3.80	2N3393 .20	2N3906 .25	2N5064 .50
2N456 1.10	2N1544 .80	2N2328 4.20	2N3394 .17	2N3925 3.75	2N5130 .20
2N501A 3.00	2N1549 1.25	2N2329 4.75	2N3414 .17	2N3954 3.50	2N5133 .15
2N508A .45	2N1551 2.50	2N2368 2.5	2N3415 .18	2N3955A 3.75	2N5138 .15
2N555 .45	2N1552 3.25	2N2369 .25	2N3416 .19	2N3955 2.45	2N5198 3.75
2N652A .85	2N1554 1.25	2N2484 .32	2N3417 .20	2N3957 1.25	2N5294 .50
2N677C 6.00	2N1557 1.15	2N2712 1.18	2N3442 1.85	2N3958 1.20	2N5296 .50
2N706 .25	2N1560 2.80	2N2894 .40	2N3553 1.50	2N4037 .60	2N5306 .20
2N706B .40	2N1605 .35	2N2903 3.30	2N3563 .20	2N4093 .85	2N5354 .20
2N711 .50	2N1613 .30	2N2904 .25	2N3565 .20	2N4124 .20	2N5369 .20
2N711B .60	2N1711 .30	2N2904A .30	2N3568 .20	2N4126 .20	2N5400 .40
2N718 .25	2N1707 4.10	2N2905 .25	2N3642 .20	2N4141 .20	2N5401 .50
2N718A .30	2N2060 1.85	2N2905A .30	2N3643 .15	2N4142 .20	2N5457 .35
2N720A .50	2N2102 .40	2N2906 .25	2N3645 .15	2N4143 .20	2N5458 .30
9N1918 .35	2N2218 .25	2N2906A .30	2N3646 .14	2N4220A .45	C103y .25
2N930 .25	2N2218A .30	2N2907 .25	2N3730 1.50	2N4234 .95	C103d .40
2N956 .30	2N2219 .25	2N2907A .30	2N3731 2.75	2N4400 .20	C106d1 .50

SILICON UNIJUNCTIONS		INTEGRATED CIRC.		RECTIFIERS	
2N2646 .50	2N4871 .50	UA703C .40		10	100
2N2647 .60	2N4891 .50	709C OP. AMP. .25		IN4001 .60	5.00
2N6027 .55	2N4892 .50	741C OP. AMP. .25		IN4002 .70	6.00
2N6028 .70	2N4893 .50	7400 .15		IN4003 .80	7.00
D5E37 .25	2N4894 .50	7404n .18		IN4004 .90	8.00
2N2160 .65	MU10 .40	7430n .19		IN4005 1.00	9.00
2N4870 .50		9700,74LS00 .35		IN4006 1.10	10.00
		74h55n .35		IN4007 1.20	11.00



New-Tone Electronics
P.O. Box 1738 A
Bloomfield, N.J. 07003
Phone: (201) 762-9020

ALL PARTS GUARANTEED AND TESTED ON PREMISES.

N.J. residents add 5% sales tax. Minimum order \$5.00. All orders add \$1.00 postage. Dealers write or phone for discount prices.

Circle 86 on reader service card

VIDEO CAMERA KIT

A UNIQUE ALL SOLID STATE CAMERA KIT
FEATURING A . . . 100 x 100 BIT
SELF SCANNING CHARGED
COUPLED DEVICE

INCLUDES THE FOLLOWING
UNIQUE FEATURES . . .
FOUND IN FAR MORE
EXPENSIVE CAMERAS
IF AVAILABLE

- LOW VOLTAGE SUPPLY (DR. BATTERIES) 5 AND 15 VOLTS
- SENSITIVE TO INFRARED AS WELL AS VISIBLE LIGHT
- MAY BE USED FOR IR SURVEILLANCE WITH AN IR LIGHT SOURCE
- EXCELLENT FOR STANDARD SURVEILLANCE WORK BECAUSE OF ITS LIGHTWEIGHT AND SMALL SIZE
- ALL COMPONENTS MOUNTED ON TWO PARALLEL 3 1/2" SINGLE SIDED BOARDS TOTAL WEIGHT UNDER 2 LBS
- MAY BE WIRED BY PERSON WITH SOME TECHNICAL EXPERIENCE IN 4-6 HRS



SUPER UNBELIEVABLE
ONLY \$225.00

ADD \$2.00 POSTAGE AND HANDLING, PLUS \$6.00 FOR ALL ILL. STATE RES. (OPTIONAL)

SCHEMATIC FOR
COMPUTER
INTERFACE
SUPPLIED

MAY BE USED
WITH AMATEUR
RADIO FOR VIDEO

USED FOR CHARACTER
RECOGNITION
FOR COMPUTERS
WITH EXTERNAL
CIRCUITS

MAY BE USED IN
A VACUUM, UNDER
WATER, HIGH
ALTITUDE, AND
IN MAGNETIC
ENVIRONMENT
BECAUSE THERE
IS NO HIGH
VOLTAGE OR
MAGNETIC
DEFLECTION

WE SUPPLY ALL
SEMICONDUCTORS,
BOARDS, DATA SHEETS,
DIAGRAMS, RESISTORS
AND CAPACITORS

SORRY, WE DO NOT SUPPLY
THE CASE, BATTERIES
(OR SUPPLY) THE LENS
(NOT SUPPLIED) DEPENDS
UPON THE USER

VERAS-8 MICROPROCESSOR KIT

IS ONE OF THE MOST ADVANCED MCU
SYSTEMS ON THE MARKET TODAY FOR ONLY
\$159.00

- This three chip 8-bit microprocessor system has the following advantages:
- 1) Driven by a -5 and -12 volt power supply.
 - 2) Two I/O ports on the CPU chip, and ROM, making 32 instructions lines.
 - 3) 64 bytes of fast RAM scratchpad built into the CPU chip.
 - 4) A built-in clock generator and power-on reset built into the CPU chip.
 - 5) A programmable interval timer built into the ROM chip.
 - 6) 60% of the instructions are 1 byte.
 - 7) TTL I/O compatibility.
 - 8) Consumes less than 300mw of power per chip.
 - 9) A local interrupt with automatic address vector.
 - 10) Expandable to 64K bytes (2102 1 1/2 of memory).
 - 11) 20 mil tooth and RS-232C included.
 - 12) minimum freq response 1 MHz.
 - 13) 22 pin edge for easy servicing.

The VERAS-8 Kit has enough parts and instructions to demonstrate microprocessor programs up to 1K byte, and to debug those programs.

We supply:

- 1) 3850 CPU
- 2) 3851 A FAH BUG (or enhanced) storage unit, provides the programmer with all its I/O addresses, and allows the programmer to display or alter memory, and register contents via a teletype terminal
- 3) 3853 Static memory interface
- 4) 2102
- 5) Plus CMOS gates and buffers, PC card, instruction manuals, programming guide.

4K MEMORY KIT \$159.00

- Memory Kit: Our unique memory card features:
- 1) On-board octal buffer, outputs buffered
 - 2) On-board decoder for any four of 64 pins
 - 3) Address buffered
 - 4) 4K bytes of 2102 1 1/2 static RAM's
 - 5) No on-board regulator to cause heat problems.
 - 6) Only 15 volt supply needed

The memory card, like other computer cards, has a 44 pin gold plated edge (156 spacing). This feature makes the system completely stackable to save space, service problems, and hard wiring. It will also allow plug-in capability for our other cards when they become available.

EXPANDER BOARD

This board will expand the memory capability to 16 kilobytes with full buffering. Individual power terminals for each memory card are on board. This system can be expanded to the full 64 kilobytes of memory by adding expander cards into this one with the 44 pin connector options.

EXPANDER KIT WITH ONE EDGE CONNECTOR \$59.00

To the best of our knowledge, ours is the only kit on the market designed for easy expansion to full memory capability. Extra 44 Pin Connectors \$2.50 ea.

ALTAIR 8800 & IMSAI 8080 plug-ins, low prices *** 8K Memory, static, exceptionally low power, fast no wait or refresh states, low price. *** Prototyping Board. *** Extender Card. *** 8800 Octal Encoder *** IC Sockets TL. *** Microprocessor Coding Form Pads. Send for latest information and low prices * **ELECTRONIC CONTROL TECHNOLOGY**, Box 6, Union, NJ 07083

A COMPUTER SYSTEM CHEAPER THAN A KIT

PDP8 4K w/ASR33 & CAB \$1595
ALSO FOR SALE: DEC • DG • CAI • HP • MICRO • SEL • WANG • XLO
MODULES • PERIPHERALS
ELECTRONIC COMPONENTS
— 90-DAY WARRANTY —
617-261-1100
AMERICAN USED COMPUTER CORP.
Box 68, Kenmore Station, Boston, Mass. 02215
member COMPUTER DEALERS ASSOCIATION

New Canadian Magazine, "Electronics Workshop," \$5.00 yearly, sample \$1.00. ETHCO, Box 741 "A," Montreal

ETCH PC boards cheaply in seconds. Engineer's new method reduces etching time by 90%. Send \$1.00 for etching details. GRISSON, 1955 Stearnle, Long Beach, CA 90815

DELUXE LARGE DISPLAY CLOCK KITS

* 6 Digit, 8" Characters — Only \$44.95 — Bright & Clear — Easily Read 50' Away — All Parts Supplied, Even Nuts & Screws — No Transistors, Only Integrated Circuits — AM-PM Indicator — 3 Way Intensity Contr. — One Section Display.
Easy to Assemble. Send Check or Money Order for \$44.95 + \$1.00 for Postage, IL Res. Add 5% Sales Tax. Money Back Guarantee. Alarm Option. Add \$5.00. Complete Assembly w/Alarm — \$79.95. Clocks Unlimited, 416 Firestone Dr., Hoffman Estates, IL 60195. (312) 279-8434.

RECORDS-TAPES! Discounts to 73%; all labels; no purchase obligations; newsletter; discount dividend certificates; 100% guarantees. Free details. **DISCOUNT MUSIC CLUB**, 650 Main St., Dept. 3-776, New Rochelle, NY 10801

SAVE ELECTRIC POWER!

Save up to 80% electrical power with this unique, inexpensive, portable, permanent and legal method applicable for shops, homes, factories, businesses, farms, sites. 100% Refund Guaranteed if not scientifically sound or if it employs gimmicks.

CONSUMERTRONICS CO.

Information \$1.00

P.O. Box 542 Alamogordo, N.M. 88310

µP/TERMINAL: including keyboard, video, µP, 2 tape decks, power supply. Ready to go! Guaranteed, \$695.00. Add-on robot device prints thru IBM Selectric; \$395.00. Info: CFR, Box #F, Newton, NH 03858, supply limited

ELECTRONIC

MUSIC SYNTHESIS/ANALOG PROCESSING

- PLANS & KITS
- CIRCUIT THEORY
- INDUSTRIAL R&D TECHNIQUES
- PARTS & COMPONENTS

featuring: STATE-OF-THE-ART technology, and

professional-lab quality designs at LOW COST

BUILD: • Ultra wide range universal V.C.O.

• Voltage controlled filters & amplifiers

• Joystick controlled filters & faders

• plus MUCH MUCH MORE

Free Information... send self addressed, stamped envelope to

CFR ASSOCIATES

P.O. Box F Newton, N.H. 03858

"the oldest name in synthesis for the experimenter"

MAGNETS. All types. Specials-20 disc, or 10 bar, or 2 stick, or 8 assorted magnets, \$1.00. MAGNETS, Box 192-F, Randelstown, MD 21133

RECONDITIONED test equipment. \$0.50 for catalog. WALTER'S TEST EQUIPMENT, 2697 Nickel, San Pablo, CA 94806

INTEL 8080 CPU	\$29.50
2518-HEX 32 BIT SR	\$6.00
8008 8 BIT MICRO PROCESSING CHIP (with Data Book)	\$19.00
2102-1 1024 BIT RAM	\$ 2.60
5202A UV PROM	\$12.50
MM5203 UV PROM	\$12.50
1702A UV PROM	\$12.50
5204-4K PROM	\$24.95
MINIATURE MULTI-TURN TRIM POTS 100, 50K, 10K, 25K, 50K, 100K, 200K, \$75 each	\$32.00
MULTI-TURN TRIM POTS Similar to Bourns 3010 style 3/16"x5/8"x1-1/4", 50, 100, 1K, 10K, 50K ohms	\$1.50 ea.
3/5400 ea.	3/\$4.00
LIGHT ACTIVATED SCR'S TO-18, 200V 1A.	\$ 1.75

PRINTED CIRCUIT BOARD

4-1/2"x6-1/2" SINGLE SIDED EPOXY BOARD 1/16" thick, unetched	\$50 ea.	5/\$2.20
VECTOR BOARD 1" SPACING 4.5" x 6" SHEET		\$1.50

4 WATT IR LASER DIODE \$7.95

2N 5460 P FET	\$.45
2N 5457 N FET	\$.45
2N 4891 UJT.	\$.45
T1S 43 UJT	\$.35
ER 900 TRIGGER DIODES	4/\$1.00
2N 6028 PROG. UJT	\$.65

VERIPAX PC BOARD

This board is a 1/8" single sided paper epoxy board, 4 1/2"x6 1/2" thick, and ETCHED which will hold up to 21 single 14 pin IC's or 8, 16, or LSI DIP IC's with buses for power supply connector. \$5.25

MV 5691 YELLOW-GREEN BIPOLAR LED	\$1.25
MT-2 PHOTO TRANS	\$.60
RED, YELLOW, GREEN OR AMBER LARGE LED'S	ea. \$.20
14 PIN DIP SOCKETS	\$.35
16 PIN DIP SOCKETS	\$.35
MOLEX PINS 100/50/8.00	\$3.00
8 PIN MINI DIP SOCKETS	\$.30
10 WATT ZENERS 3.9, 4.7, 18 OR 22V	ea. \$.60
1 WATT ZENERS 4.7, 5.6, 10, 12, 15, 18 OR 22V	ea. \$.25

Silicon Power Rectifiers

PRV 1A 3A 12A 50A 125A	
100 06 14 .30 .80 3.70	
200 07 .20 .35 1.15 4.25	
400 09 .25 .50 1.40 6.50	
600 11 .30 .70 1.80 8.50	
800 15 .35 .90 2.30 10.50	
1000 20 .45 1.10 2.70 12.50	

REGULATED MODULAR POWER SUPPLIES

+ - 15 VDC AT 100ma	
115VAC INPUT	\$27.95
5VDC AT 1A, 115VAC INPUT	\$24.95
12 VDC AT .5A	\$24.95
IN 4148 (IN914)	15/\$1.00

SILICON SOLAR CELLS

2 1/4" diameter	
5V at 500 ma. . . . \$5.00 ea., 6/\$27.50	

Terms: FOB Cambridge, Mass. Send Check or Money Order. Include Postage, Minimum Order \$5.00, C/P'S \$20.00

TRANSISTOR SPECIALS

2N3585 NPN Si TO-66	\$.95
2N3772 NPN Si TO-3	\$ 1.60
2N4908 PNP Si TO-3	\$ 1.00
2N6055 NPN Si TO-3 Darlington	\$ 1.30
2N5086 PNP Si TO-92	4/\$ 1.00
2N4998 PNP TO-66	\$.60
2N404 PNP GE TO-5	5/\$ 1.00
2N3919 NPN Si TO-3 RF	\$ 1.50
MPS4 13 NPN Si TO-92	3/\$ 1.00
2N3767 NPN Si TO-66	\$.70
2N2222 NPN Si TO-18	5/\$ 1.00
2N3055 NPN Si TO-3	\$.80
2N3904 NPN Si TO-92	5/\$ 1.00
2N3906 PNP Si TO-92	5/\$ 1.00
2N5296 NPN Si TO-220	\$.50
2N6109 PNP Si TO-220	\$.55
2N3866 NPN Si TO-5 RF	\$.75
2N3638 PNP Si TO-5	5/\$ 1.00
2N6517 NPN TO-92 Si	3/\$ 1.00

TANTULUM CAPACITORS

22UF 35V 5/\$1.00	6.8UF 35V 3/\$1.00
47UF 35V 5/\$1.00	33UF 25V \$.40
68UF 35V 5/\$1.00	30UF 6V 5/\$1.00
1UF 35V 5/\$1.00	150UF 20V \$.50
47UF 35V 4/\$1.00	
CT7001 ALARM CLOCK CHIP	\$ 5.75

NATIONAL MOS DEVICES

MM1402-3-20	MM5057-4-00
MM1403-3-20	MM5058-4-95
MM1404-2-50	MM5060-4-95
MM5013-7-75	MM5061-4-30
MM5016-3-50	MM5595-6-25
MM5017-4-75	MM5596-6-25
MM5055-4-00	MM5210-1-95
MM5056-4-00	MM5260-2-95

TTL IC SERIES

7400-25	7442-50	74126-90
7400-16	7445-80	74150-100
7401-16	7446-90	74151-80
7402-16	7447-87	74153-79
7403-20	7448-80	74154-105
7404-20	7449-35	74155-100
7405-22	7473-40	74161-100
7406-35	7474-35	74164-105
7407-33	7475-50	74165-105
7408-22	7476-35	74165-105
7409-25	7480-48	74173-135
7410-16	7483-80	74174-100
7411-25	7485-95	74177-100
7412-30	7486-45	74180-100
7413-60	7489-20	74181-210
7416-33	7491-79	74190-115
7417-33	7492-55	74191-110
7420-16	7493-55	74192-75
7426-35	7494-80	74193-95
7430-16	7495-80	74194-125
7432-30	7496-73	74195-74
7437-29	74107-34	74196-110
7438-29	74121-50	74283-150
7440-18	74123-70	75324-175
7440-18	74125-70	75491-60
7441-82	74125-70	75492-60

MINIATURE DIP SWITCHES

CTS 206-4 Four SPST switches in one minidip package	\$1.80
CTS 206-8 Eight SPST switches in a 16 pin DIP package	\$2.75
AT-5 1013-30K ser/par., par/ser., uni-versal UAHT.	\$8.50

ALCO MINIATURE TOGGLE SWITCHES

MTA 106 SPDT	\$1.20
MTA 206 DPDT	\$1.70

C/MOS (DIODE CLAMPED)

74C02-30	4016-50	4035-125
74C01-30	4017-110	4042-75
4001-24	4018-120	4046-220
4002-24	4019-50	4047-220
4006-30	4022-100	4049-50
4007-30	4023-25	4050-50
4009-50	4024-85	4055-195
4010-50	4025-25	4066-110
4011-25	4027-55	4071-25
4012-25	4028-95	4077-25
4013-35	4029-125	4081-25
4015-110	4030-95	4076-120

LED READOUTS

FND 500-5" C.C.	\$1.75
HF 7740-3" C.C.	\$1.40
MAN-4-25" C.C.	\$1.20
MAN-7-3" C.C.	\$1.25
DL747-6" C.A.	\$1.95
NS 33-3 dig. array	\$1.35

Full Wave Bridges

PRV 2A	6A	25A	
200	95	1.25	2.00
400	1.15	1.50	3.00
600	1.25	1.75	4.00
GD 110 LINEAR 256 X1 BIT SELF SCANNING CHARGED COUPLED DEVICE			\$125.00

SANKEN AUDIO POWER AMPS
Si 1010 G 10 WATTS \$ 6.90
Si 1020 G 20 WATTS \$13.95
Si 1050 G 50 WATTS \$24.95

LINEAR CIRCUITS

LM 309K 5V 1A REGULATOR	\$1.00
723 - 40 + 40V/V REGULATOR	\$.54
301/748-Hi Per. Op. Amp.	\$.25
320T5, 12, 15, OR 24V NEGATIVE REG.	\$1.35
741A OR 741C OP AMP	\$.35
710 COMPARATOR	\$.32
307 OP AMP	\$.25
CA 304T Hi Per. Op. Amp.	\$.95
CA 304T 5, 6, 8, 12, 15, 18, 24V POS REG. TO 220	\$1.20
101 OPER. AMP. HI PERFORM.	\$.75
LM 308 OPER. Amp., Low Power	\$1.05
747 - DUAL 741	\$.65
655 - DUAL TIMER	\$.95
537 PRECISION OP AMP	\$1.70
540-70W POWER DRIVE	\$2.75
LM 3900 - QUAD OP AMP	\$.49
LM 324 - QUAD 741	\$1.50
560 - PHASE LOCK LOOP	\$2.00
561 - PHASE LOCK LOOP	\$2.00
565 - PHASE LOCK LOOP	\$1.50
566 FUNCTION GEN.	\$1.65
567 - TONE DECODER	\$1.75
LM 1310N FM STEREO DEMOD.	\$2.75
8038 IC VOLTAGE CONT. OSC.	\$3.90
LM 370 - AGC SQUELCH AMP.	\$1.15
555 - 2us - 2 HR. TIMER	\$.53
553 QUAD TIMER	\$2.50
FCD 810 OPTO-ISOLATOR	\$.80
1458 DUAL OP AMP	\$.55
LM 380 - 2W AUDIO AMP	\$1.95
LM 377 - 2W Stereo Audio Amp.	\$2.50
LM 381 - STEREO PREAMP	\$1.20
LM 382 - DUAL AUDIO PREAMP	\$1.25
LM 311 - HI PER. COMPARATOR	\$.95
LM 319 - Dual Hi Speed Comp.	\$1.10
LM 339 - QUAD COMPARATOR	\$1.40

TRIACS

PRV 1A 3A 12A 50A 125A	
100 40 70 1.30 4.0 50 1.20	
200 70 110 1.75 60 70 1.60	
400 110 1.60 2.60 100 120 2.20	
600 170 2.30 3.60 150 3.00	

SCR'S

Send 25c for our catalog featuring Transistors and Rectifiers 145 Hampshire St., Cambridge, Mass.

ZENER DIODES 500 mW - 5%

V	1.9 10up	V	1.9 10up
IN5223B	2.7 45 40	IN5246B	16 45 40
IN5224B	2.8 45 40	IN5247B	17 45 40
IN5225B	3.0 45 40	IN5248B	18 45 40
IN5226B	3.3 45 40	IN5249B	19 45 40
IN5227B	3.6 45 40	IN5250B	20 45 40
IN5228B	3.9 45 40	IN5251B	22 45 40
IN5229B	4.3 45 40	IN5252B	24 45 40
IN5230B	4.7 45 40	IN5253B	25 45 40
IN5231B	5.1 45 40	IN5254B	27 45 40
IN5232B	5.6 45 40	IN5255B	28 45 40
IN5233B	6.0 45 40	IN5256B	30 45 40
IN5234B	6.5 45 40	IN5257B	33 45 40
IN5235B	6.8 45 40	IN5258B	36 45 40
IN5236B	7.5 45 40	IN5259B	39 45 40
IN5237B	8.2 45 40	IN5260B	43 45 40
IN5238B	8.7 45 40	IN5261B	45 45 40
IN5239B	9.1 45 40	IN5262B	51 45 40
IN5240B	10 45 40	IN5263B	56 55 50
IN5241B	11 45 40	IN5264B	60 55 50
IN5242B	12 45 40	IN5265B	62 55 50
IN5243B	13 45 40	IN5266B	68 55 50
IN5244B	14 45 40	IN5267B	75 55 50
IN5245B	15 45 40		

7400N TTL

1.9 10up	1.9 10up	1.9 10up	
7400N	1.4 13	7410N	40 30
7401N	18	7411N	45 75
7402N	18	7412N	42 38
7403N	18	7413N	44 40
7404N	21	7414N	55 50
7405N	22	7415N	44 74
7406N	36	7416N	80 72
7407N	36	7417N	80 72
7408N	24	7418N	98 96
7409N	28	7419N	82 76
7410N	22	7420N	80 72
7411N	26	7421N	80 72
7412N	34	7422N	80 72
7413N	45	7423N	80 72
7414N	58	7424N	80 72
7415N	35	7425N	80 72
7416N	35	7426N	80 72
7417N	35	7427N	80 72
7418N	30	7428N	80 72
7420N	15	7429N	80 72
7421N	30	7430N	80 72
7422N	50	7431N	80 72
7423N	37	7432N	80 72
7424N	30	7433N	80 72
7425N	28	7434N	80 72
7426N	28	7435N	80 72
7427N	28	7436N	80 72
7428N	40	7437N	80 72
7430N	26	7438N	80 72
7432N	32	7439N	80 72
7433N	34	7440N	80 72
7437N	29	7441N	80 72
7438N	29	7442N	80 72
7439N	44	7443N	80 72
7440N	17	7444N	80 72
7441N	85	7445N	80 72
7442N	40	7446N	80 72
7443N	72	7447N	80 72
7444N	72	7448N	80 72
7445N	90	7449N	80 72
7446N	90	7450N	80 72
7447N	98	7451N	80 72
7448N	98	7452N	80 72
7449N	14	7453N	80 72
7450N	14	7454N	80 72
7451N	14	7455N	80 72
7452N	14	7456N	80 72
7453N	14	7457N	80 72
7454N	14	7458N	80 72
7455N	20	7459N	80 72
7456N	11	7460N	80 72

HIGH SPEED TTL

74A00N	33	74A01N	33
74A02N	33	74A03N	33
74A04N	33	74A05N	33
74A06N	33	74A07N	33
74A08N	33	74A09N	33
74A10N	33	74A11N	33
74A12N	33	74A13N	33
74A14N	33	74A15N	33
74A16N	33	74A17N	33
74A18N	33	74A19N	33
74A20N	33	74A21N	33
74A22N	33	74A23N	33
74A24N	33	74A25N	33
74A26N	33	74A27N	33
74A28N	33	74A29N	33
74A30N	33	74A31N	33
74A32N	33	74A33N	33
74A34N	33	74A35N	33
74A36N	33	74A37N	33
74A38N	33	74A39N	33
74A40N	33	74A41N	33
74A42N	33	74A43N	33
74A44N	33	74A45N	33
74A46N	33	74A47N	33
74A48N	33	74A49N	33
74A50N	33	74A51N	33

LOW POWER TTL

74L00N	24	74L01N	34
74L02N	24	74L03N	34
74L04N	24	74L05N	34
74L06N	24	74L07N	34
74L08N	24	74L09N	34
74L10N	24	74L11N	34
74L12N	24	74L13N	34
74L14N	24	74L15N	34
74L16N	24	74L17N	34
74L18N	24	74L19N	34
74L20N	24	74L21N	34
74L22N	24	74L23N	34
74L24N	24	74L25N	34
74L26N	24	74L27N	34
74L28N	24	74L29N	34
74L30N	24	74L31N	34
74L32N	24	74L33N	34
74L34N	24	74L35N	34
74L36N	24	74L37N	34
74L38N	24	74L39N	34
74L40N	24	74L41N	34
74L42N	24	74L43N	34
74L44N	24	74L45N	34
74L46N	24	74L47N	34
74L48N	24	74L49N	34
74L50N	24	74L51N	34

74LS00

1.9 10up	1.9 10up	1.9 10up	
74LS00N	36	74LS01N	36
74LS02N	36	74LS03N	36
74LS04N	36	74LS05N	36
74LS06N	36	74LS07N	36
74LS08N	36	74LS09N	36
74LS10N	36	74LS11N	36
74LS12N	36	74LS13N	36
74LS14N	36	74LS15N	36
74LS16N	36	74LS17N	36
74LS18N	36	74LS19N	36
74LS20N	36	74LS21N	36
74LS22N	36	74LS23N	36
74LS24N	36	74LS25N	36
74LS26N	36	74LS27N	36
74LS28N	36	74LS29N	36
74LS30N	36	74LS31N	36
74LS32N	36	74LS33N	36
74LS34N	36	74LS35N	36
74LS36N	36	74LS37N	36
74LS38N	36	74LS39N	36
74LS40N	36	74LS41N	36
74LS42N	36	74LS43N	36
74LS44N	36	74LS45N	36
74LS46N	36	74LS47N	36
74LS48N	36	74LS49N	36
74LS50N	36	74LS51N	36

SCHOTTKY TTL

74S00N	44	74S01N	44
74S02N	44	74S03N	44
74S04N	44	74S05N	44
74S06N	44	74S07N	44
74S08N	44	74S09N	44
74S10N	44	74S11N	44
74S12N	44	74S13N	44
74S14N	44	74S15N	44
74S16N	44	74S17N	44
74S18N	44	74S19N	44
74S20N	44	74S21N	44
74S22N	44	74S23N	44
74S24N	44	74S25N	44
74S26N	44	74S27N	44
74S28N	44	74S29N	44
74S30N	44	74S31N	44
74S32N	44	74S33N	44
74S34N	44	74S35N	44
74S36N	44	74S37N	44
74S38N	44	74S39N	44
74S40N	44	74S41N	44
74S42N	44	74S43N	44
74S44N	44	74S45N	44
74S46N	44	74S47N	44
74S48N	44	74S49N	44
74S50N	44	74S51N	44

9300 SERIES

9300PC	\$1.00	9301PC	2.30
9302PC	1.20	9303PC	1.50
9304PC	1.50	9305PC	2.00
9306PC	2.00	9307PC	2.50
9308PC	2.50	9309PC	3.00
9310PC	3.00	9311PC	3.50
9312PC	3.50	9313PC	4.00
9314PC	4.00	9315PC	4.50
9316PC	4.50	9317PC	5.00
9318PC	5.00	9319PC	5.50
9320PC	5.50	9321PC	6.00
9322PC	6.00	9323PC	6.50
9324PC	6.50	9325PC	7.00
9326PC	7.00	9327PC	7.50
9328PC	7.50	9329PC	8.00
9330PC	8.00	9331PC	8.50
9332PC	8.50	9333PC	9.00
9334PC	9.00	9335PC	9.50
9336PC	9.50	9337PC	10.00
9338PC	10.00	9339PC	10.50
9340PC	10.50	9341PC	11.00
9342PC	11.00	9343PC	11.50
9344PC	11.50	9345PC	12.00
9346PC	12.00	9347PC	12.50
9348PC	12.50	9349PC	13.00
9350PC	13.00	9351PC	13.50
9352PC	13.50	9353PC	14.00
9354PC	14.00	9355PC	14.50
9356PC	14.50	9357PC	15.00
9358PC	15.00	9359PC	15.50
9360PC	15.50	9361PC	16.00
9362PC	16.00	9363PC	16.50
9364PC	16.50	9365PC	17.00
9366PC	17.00	9367PC	17.50
9368PC	17.50	9369PC	18.00
9370PC	18.00	9371PC	18.50
9372PC	18.50	9373PC	19.00
9374PC	19.00	9375PC	19.50
9376PC	19.50	9377PC	20.00
9378PC	20.00	9379PC	20.50
9380PC	20.50	9381PC	21.00
9382PC	21.00	9383PC	21.50
9384PC	21.50	9385PC	22.00
9386PC	22.00	9387PC	22.50
9388PC	22.50	9389PC	23.00
9390PC	23.00	9391PC	23.50
9392PC	23.50	9393PC	24.00
9394PC	24.00	9395PC	24.50
9396PC	24.50	9397PC	25.00
9398PC	25.00	9399PC	25.50
9400PC	25.50	9401PC	26.00
9402PC	26.00	9403PC	26.50
9404PC	26.50	9405PC	27.00
9406PC	27.00	9407PC	27.50
9408PC	27.50	9409PC	28.00
9410PC	28.00	9411PC	28.50
9412PC	28.50	9413PC	29.00
9414PC	29.00	9415PC	29.50
9416PC	29.50	9417PC	30.00
9418PC	30.00	9419PC	30.50
9420PC	30.50	9421PC	31.00
9422PC	31.00	9423PC	31.50
9424PC	31.50	9425PC	32.00
9426PC	32.00	9427PC	32.50
9428PC	32.50	9429PC	33.00
9430PC	33.00	9431PC	33.50
9432PC	33.50	9433PC	34.00
9434PC	34.00	9435PC	34.50
9436PC	34.50	9437PC	35.00
9438PC	35.00	9439PC	35.50
9440PC	35.50	9441PC	36.00
9442PC	36.00	9443PC	36.50
9444PC	36.50	9445PC	37.00
9446PC	37.00	9447PC	37.50
9448PC	37.50	9449PC	38.00
9450PC	38.00	9451PC	38.50
9452PC	38.50	9453PC	39.00
9454PC	39.00	9455PC	39.50
9456PC	39.50	9457PC	40.00
9458PC	40.00	9459PC	40.50
9460PC	40.50	9461PC	41.00
9462PC	41.00	9463PC	41.50
9464PC	41.50	9465PC	42.00
9466PC	42.00	9467PC	42.50
9468PC	42.50	9469PC	43.00
9470PC	43.00	9471PC	43.50
9472PC	43.50	9473PC	44.00
9474PC	44.00	9475PC	44.50
947			

XR FUNCTION GENERATOR

XR-2206KA ... SPECIAL ... \$16.95. Includes monolithic function generator IC, PC board, and assembly instruction manual.
XR-2206KB ... SPECIAL ... \$26.95. Same as XR-2206KA and includes external components for PC board.

HIGH QUALITY CARBON FILM RESISTORS

From 10 ohm to 10 megohms. . . % Watt % . . \$1.69 per 100
Only in multiples of 100 per value - 150 different values in stock

OHM	OHM	OHM	OHM	OHM	OHM
10	100	1K	10K	100K	1M
11	110	1.1K	11K	110K	1.1M
12	120	1.2K	12K	120K	1.2M
13	130	1.3K	13K	130K	1.3M
15	150	1.5K	15K	150K	1.5M
16	160	1.6K	16K	160K	1.6M
18	180	1.8K	18K	180K	1.8M
20	200	2K	20K	200K	2M
22	220	2.2K	22K	220K	2.2M
24	240	2.4K	24K	240K	2.4M
27	270	2.7K	27K	270K	2.7M
30	300	3K	30K	300K	3M
33	330	3.3K	33K	330K	3.3M
36	360	3.6K	36K	360K	3.6M
39	390	3.9K	39K	390K	3.9M
43	430	4.3K	43K	430K	4.3M
47	470	4.7K	47K	470K	4.7M
51	510	5.1K	51K	510K	5.1M
56	560	5.6K	56K	560K	5.6M
62	620	6.2K	62K	620K	6.2M
68	680	6.8K	68K	680K	6.8M
82	820	8.2K	82K	820K	8.2M
91	910	9.1K	91K	910K	9.1M

PULSE GENERATOR

Interdesign 1101: 0.1Hz - 2MHz, 0.5V Output, var. width, line or battery operation . . . \$159.00

SPDT MINIATURE TOGGLE SWITCH

105D . . . 115V . . . 5A Rating . . . \$0.95

MM5316 DIGITAL ALARM CLOCK CIRCUIT

Price . . . 1-4, \$4.95 . . . 5 up, \$4.50

PICO-PAC POWER SUPPLIES - ADTECH

Model No.	Output Vdc	Amps	1-4	5 up
APSS-3	5	3.0	1.00	
APSS-16	12	1.5	1.00	
APSS-15	15	1.5	\$29.95	\$28.60
APSS-24	24	1.0		
APSS-28	28	0.8		
APSS-5	5	6	\$48.45	\$46.05
APSS-12	12	4		
APSS-15	15	3		
APSS-24	24	2.2		
APSS-28	28	2		
APSS-10	5	10		
APSS-12	12	7		
APSS-15	15	6	\$72.25	\$68.65
APSS-24	24	5		
APSS-28	28	4		

Only 1.70" x 1.00" x 0.85" high. This, of course, results in a real cost saving. Set $\pm 5\%$, 9 models: V mAdc V mAdc
8 115 18 50
10 100 70 35
12 90 22 25
15 70 24 15
\$39.80 each

CMOS/LSI FROM STANDARD MICROSYSTEMS

COM2502	UART - Ceramic	\$13.20
COM2502P	UART - Ceramic	14.20
COM2502H	UART - Cer High Speed	14.20
COM2502HP	UART - Plastic High Speed	9.00
COM2017	UART - Ceramic	13.20
COM2017P	UART - Plastic	8.00
COM2017H	UART - Cer High Speed	14.20
COM2017HP	UART - Plastic High Speed	9.00
COM2601	USRT	30.00
COM5016	Dual Baud Rate Gen	12.00
COM5016T	Dual Baud Rate Gen	14.20
KR022A	Keyboard Encoder ROM	20.00
NMX5010	10 Channel Multiplexer	12.00
CAL1022	12-Digit Printing Calculator	60.00

CONTINENTAL SPECIALTIES

PROTO BOARDS

Build & test circuits as fast as you think!

PB-6	6 IC cap breadboard kit	\$15.95
PB100	10 IC cap breadboard kit	18.95
PB101	10 14-DIP cap, 5-way post, 940 solderless tie points, 5.8 x 4.5"	29.95
PB102	12 14-DIP cap, like PB101 with 1,240 tie points, 7.0 x 4.5"	39.95
PB103	24 14-DIP cap., 4.5 way points, 2,250 tie points, 6.0 x 9.0"	59.95
PB104	32 14-DIP cap., 3060 solderless tie points, 8.0 x 9.75"	79.95

LOGIC MONITOR 1

Simultaneously displays static and dynamic logic states of DTL, TTL, HTL or CMOS DIP ICs. Pocket size. \$84.95

LOGIC MONITOR 2

Automatically and accurately displays static and dynamic logic states of digital ICs. Selectable threshold control. \$124.95

LOGIC PROBE LP-1

Compact, circuit-powered multifunction logic probe. Multi-family compatibility, DTL/TTL/HTL/CMOS. Traces logic levels and pulses through digital circuitry. \$44.95

PROTO-CLIP

For power-on/hands-off signal tracing. Bring IC leads up from PC board surface for fast troubleshooting.

PC14	14 pin	\$4.50
PC16	16 pin	4.75
PC24	24 pin	8.50

SOCKETS & BUS STRIPS

Plug-in, wire, test, modify or expand without patch cords or solder. Snap together to form breadboard needed.

PN/Description	L	Hole-to-Hole Term's	Price
QT595 Socket 6.5"	6.2"	1"	\$12.50
QT598 Bus 6.5"	6.2"	2"	2.50
QT475 Socket 5.3"	5.0"	94	10.00
QT478 Bus 5.3"	5.0"	16	2.25
QT355 Socket 4.1"	3.8"	12	0.50
QT358 Bus 4.1"	3.8"	12	0.00
QT185 Socket 2.4"	2.1"	36	4.75
QT125 Socket 1.8"	1.5"	24	3.75
QT85 Socket 1.4"	1.1"	16	3.25
QT75 Socket 1.3"	1.0"	14	3.00

PROTO BOARDS

With built-in regulated short-proof power supplies

PB203	5V, 1 amp regulated power supply	\$ 75.00
PB203A	5V, 1 amp and 2.15V, 1/2 amp regulated power supply	120.00

DESIGN MATES

DESIGN MATE 1 . . . CIRCUIT DESIGNER

With built-in, regulated, metered power supply to design unusual circuits fast. \$49.95

DESIGN MATE 2 . . . FUNCTION GENERATOR

Complements Design Mate 1. Produces clean, accurate wave forms with variable amplitude and frequency controls. \$64.95

DESIGN MATE 3 . . . R/C BRIDGE

Saves design time by measuring and selecting capacitors and resistors to better than 5% instantly! \$54.95

DESIGN MATE 4 . . . MULTIPURPOSE PULSE GENERATOR

With the precision and versatility of a laboratory instrument, ideal wherever a source of clean, fast output pulses compatible with virtually all logic families and discrete circuits is needed. \$124.95

BREADBOARD JUMPER WIRE KIT

Each kit contains 350 wires cut to 14 different lengths from 0.1" to 5.0". Each wire is stripped and leads are bent 90° for easy insertion. Wire length is classified by color coding. All wire is solid tinned 22 gauge with PVC insulation. The wires come packed in a convenient plastic box. BK-1.....\$9.95

NEW FROM PLESSEY RADIO COMMUNICATIONS

Plessey SL1600 Radio Communications Circuits are used in all types of military, commercial and amateur radio systems. These same devices are now available in economical, easy-to-use plastic minidip packages. Now you can afford to make extensive use of Plessey circuits in the design of synchronous, superhet, SSB and multimode receivers, transmitters and transceivers.

92 PAGE APPLICATIONS MANUAL

Contains Circuit Data, System Design and Technical Data for SL1600 series integrated circuits . . . \$1.95

LOW COST INTEGRATED CIRCUITS FOR RADIO COMMUNICATIONS

A TYPICAL TRANSCIVER SYSTEM

SSB transmitters and receivers of the same type contain many identical components. Therefore, by a little signal switching, it is possible to make one set of filters and SL1600 devices perform alternately as a transmitter and as a receiver - i.e. as a transceiver. This, of course, results in a real cost saving. Details on SL1600 devices (which in any case are relatively inexpensive) and on filters (which are not!) systems of this type are described in detail in the 92-page applications bulletin described here. Order your copy today!

SL1600 SERIES

Low-cost plastic Mini-dip packaged ICs for radio communications

SL1610C	RF voltage amplifier	\$2.03
SL1611C	RF voltage amplifier	2.03
SL1612C	RF voltage amplifier	2.03
SL1613C	RF limited amplifier/detector	2.45
SL1620C	Voice operating gain adjusting device	2.58
SL1621C	AGC generator	2.58
SL1622C	AF amplifier & logod	3.01
SL1623C	AM detector, AGC amplifier, & SSB demodulator	3.01
SL1624C	Multimode detector	2.91
SL1630C	Microphone/headphone amplifier	2.10
SL1640C	Double-balanced modulator	2.03
SL1641C	Double-balanced modulator	2.03

SP8000 SERIES HIGH SPEED DIVIDERS

-5 to 125°C

SP8600A	250MHz - 4	\$25.20
SP8601A	150MHz - 4	15.75
SP8602A	500MHz - 2	35.00
SP8640A	200MHz - 10/11	26.25
SP8641A	250MHz - 10/11	31.50
SP8642A	300MHz - 10/11	52.50
SP8655A	200MHz - 32	35.00
SP8656A	500MHz - 10/11	42.00
SP8690A	200MHz - 10/11	35.00
SP8695A	200MHz - 10/11	35.00
SP8695B	200MHz - 10/11	35.00
SP8695C	200MHz - 10/11	35.00
SP8695D	200MHz - 10/11	35.00
SP8695E	200MHz - 10/11	35.00
SP8695F	200MHz - 10/11	35.00
SP8695G	200MHz - 10/11	35.00
SP8695H	200MHz - 10/11	35.00
SP8695I	200MHz - 10/11	35.00
SP8695J	200MHz - 10/11	35.00
SP8695K	200MHz - 10/11	35.00
SP8695L	200MHz - 10/11	35.00
SP8695M	200MHz - 10/11	35.00
SP8695N	200MHz - 10/11	35.00
SP8695O	200MHz - 10/11	35.00
SP8695P	200MHz - 10/11	35.00
SP8695Q	200MHz - 10/11	35.00
SP8695R	200MHz - 10/11	35.00
SP8695S	200MHz - 10/11	35.00
SP8695T	200MHz - 10/11	35.00
SP8695U	200MHz - 10/11	35.00
SP8695V	200MHz - 10/11	35.00
SP8695W	200MHz - 10/11	35.00
SP8695X	200MHz - 10/11	35.00
SP8695Y	200MHz - 10/11	35.00
SP8695Z	200MHz - 10/11	35.00

2N125	1.40	2N1534	1.00	2N2527	5.40
2N173	2.15	2N1540	1.05	2N2538	4.40
2N293	.60	2N1543	3.40	2N2600	7.00
2N321	.50	2N1544	1.40	2N2605	.49
2N324	.55	2N1549	1.80	2N2605A	.58
2N336	1.00	2N1551	3.90	2N2606	3.05
2N388A	.82	2N1552	3.95	2N2606	2.05
2N388	8.00	2N1554	1.90	2N2646	0.00
2N398B	1.00	2N1557	1.70	2N2647	1.50
2N404	.30	2N1613	4.00	2N2648	3.90
2N417	.85	2N1617B	2.30	2N2658	6.90
2N458	1.40	2N1620	1.30	2N2708	3.00
2N491	4.90	2N1711	.40	2N2712	.30
2N497	1.10	2N1715	.70	2N2713	.14
2N508A	.40	2N1720	4.80	2N2714	.44
2N511A	3.50	2N1722	3.60	2N2715	.14
2N512B	2.90	2N1707	4.80	2N2716	.20
2N514	6.90	2N1924	1.25	2N2754	94.00
2N555	.60	2N1934	9.30	2N2802	9.70
2N552A	.50	2N1930	.75	2N2823	3.90
2N671C	5.50	2N2060	2.50	2N2850	116.00
2N681	2.80	2N2081A	2.00	2N2851	3.00
2N683	2.90	2N2100	2.90	2N2880	10.90
2N697	.25	2N2102	.45	2N2893	3.50
2N697A	.50	2N2143	1.50	2N2893	9.70
2N699	.66	2N2147	1.40	2N2894	5.00
2N700	3.50	2N2148	.68	2N2895	1.00
2N705	.60	2N2152	3.00	2N2903	4.10
2N706	.30	2N2160	1.50	2N2904	.36
2N706B	.40	2N2192A	.66	2N2904A	.38
2N711	.34	2N2193	.44	2N2905	.36
2N711B	.60	2N2197	2.40	2N2905A	.36
2N718	.28	2N2217	.80	2N2906	2.00
2N718A	.31	2N2218	.25	2N2906A	.21
2N741	2.80	2N2218A	.28	2N2907	.16
2N744	.35	2N2219	.40	2N2907A	.16
2N829	2.80	2N2219A	.36	2N2911	21.00
2N834	.35	2N2221	.44	2N2913	.89
2N859	7.90	2N2221A	.25	2N2925	.20
2N884	2.90	2N2222	.40	2N2926	.14
2N918	.40	2N2222A	.26	2N2947	14.40
2N929	.26	2N2289	3.60	2N2949	5.90
2N930	.28	2N2300	5.90	2N2950	6.40
2N960	.45	2N2392	4.40	2N2959	9.00
2N962	.45	2N2326	3.30	2N2969	30.90
2N967	.48	2N2356	5.90	2N3019	5.90
2N976	1.70	2N2356A	6.90	2N3022	17.90
2N984	.95	2N2359	15.90	2N3053	.34
2N1035	1.80	2N2368	.28	2N3054	.80
2N1132	.30	2N2369	.28	2N3055	.94
2N1136	1.40	2N2369A	.28	2N3060	2.95
2N1139	1.80	2N2370	.40	2N3130	4.00
2N1143	1.90	2N2440	3.45	2N3202	15.90
2N1168	.65	2N2465	7.40	2N3209	.89
2N1204	1.40	2N2468	1.00	2N3227	2.30
2N1302	.50	2N2475	.54	2N3247	3.80
2N1303	.60	2N2476	.79	2N3252	8.00
2N1305	.50	2N2484	.25	2N3307	8.50
2N1377	1.40	2N2492	4.00	2N3308	6.50
2N1404	.48	2N2509	.95	2N3309	7.10
2N1408	.60	2N2512	1.90	2N3322	1.15
2N1420	.50	2N2518	5.90	2N3324	8.00
2N1485	2.60	2N2526	4.40	2N3325	.70

PREMIUM QUALITY TRANSISTORS

IF IT ISN'T INDUSTRIAL QUALITY OR BETTER, WE WON'T SELL IT TO YOU.

2N3375	5.50	2N3570	2.10	2N3866	1.25	2N4125	.25
2N3390	.40	2N3570	2.10	2N3877	.42	2N4126	.25
2N3391	.41	2N3571	3.90	2N3900	.38	2N4141	.26
2N3392	.20	2N3572	2.60	2N3908	.22	2N4142	.17
2N3393	1.80	2N3584	1.80	2N3909	.20	2N4143	.16
2N3394	.22	2N3614	1.10	2N3910	.22	2N4200A	1.00
2N3395	.24	2N3616	1.24	2N3911	.18	2N4224	1.25
2N3396	.26	2N3617	2.40	2N3912	1.20	2N4225	3.75
2N3397	.28	2N3634	7.90	2N3921			

SOLVE YOUR TEST CONNECTION PROBLEMS WITH E-Z-HOOK

E-Z Hooks have been designed and field tested throughout the industry to save time and money in commercial electronic production and servicing. The spring-loaded hook attaches firmly, yet so gently it will not damage component — frees hands while testing. Durably constructed and fully insulated to a single contact point assuring true readings. Meets exacting laboratory and space age computer technology requirements. AVAILABLE IN 10 RETMA COLORS: Red, black, blue, green, orange, yellow, white, violet, brown or gray. The most unique field-serviceable test connectors available. Fast, safe, sure and trouble-free. NOW AVAILABLE FROM ANCRONA . . . the source you can trust for fine quality, industrial-grade electronic components and accessories.

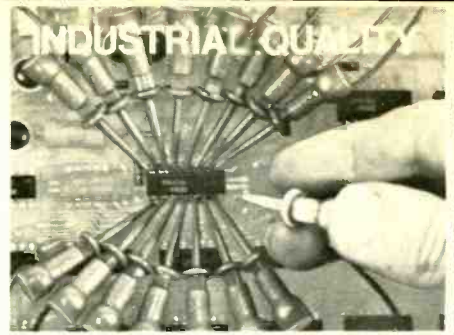

Specify color.

Order No.	Length	Price
204-12W*	12"	\$1.60
204-24W*	24"	1.60

Jumper with XM Micro Hooks

Order No.	Length	Price
204XM-12*	12"	\$1.70
204XM-24*	24"	1.70

Specify color.

EXTRA LONG MINI HOOK
ORDER P/N XL-1

XL-1 Mini Hook (5.0" long) combines all the proven features of the X100W with an extra long body. It will make safe, short-free test connections in card racks and through deep wiring nest up to 4". \$1.25 ea.

Jumper, XM Micro Hook to Banana Plug

Order No.	Length	Price
201XM*	32"	\$1.40

Specify color.

MICRO HOOK

XM Micro Hook (1.75" long, < 1 gram) for difficult IC Testing. Permits hookups to delicate wires where weight and leverage may damage component. . . \$.80 ea.

Specify color. ORDER P/N XM

Jumper with XL-1 Mini Hooks

Order No.	Length	Price
204XL1-12	12"	\$2.80
204XL1-24	24"	2.80

Specify color.

Jumper X-100W Mini Hook** to Stacking Banana Plug

Order No.	Length	Price
201W*	32"	\$1.35

Specify color.

MINI HOOK

X100W Mini Hook (2.25" long) combines rugged construction, miniature size and Finger-eze Hypo Action for all the best test connections. Hook is large enough for component leads, yet small enough to get into tight places. . . . \$.75 ea.

Specify color. ORDER P/N X100W

Jumper, XL-1 Mini Hook** to Stacking Banana Plug

Order No.	Length	Price
201XL-1*	32"	\$1.95

Specify color. **Square hole tip for hooking laterally to leads or vertically over square wire-wrap pins.

Prices effective through July 31, 1976.
Minimum order \$10.00. Add \$1.00 to cover postage and handling. California residents add 6% sales tax. PLEASE VISIT OUR ELECTRONIC STORES

ARIZONA	CALIFORNIA	CANADA
4518 East Broadway Tucson, Arizona 85711	11080 Jefferson Blvd. Culver City, CA 90230	1300 E. Edinger Ave. Santa Ana, CA 92705
		5556 Fraser Street Vancouver, B.C. V6W 2Z4

SEND CHECK OR MONEY ORDER TO:
ANCRONA CORP.
Mail order: P.O. Box 2208R, Culver City, CA 90230. Phone order: (213) 641-4064
Prices may vary at over-the-counter locations.

NEW FROM Verowire® WIRING SYSTEM
WIRING PEN — The wiring pen with self-contained spool of poly-urthane lacquer insulated copper wire is used to route and wrap onto component leads, terminal pin, etc. Connections are completed by soldering which melts the insulation and at the same time makes a permanent solder joint.

Wiring pen with unique integral spring wire clamp for wire retention advancement and retraction. With spool . . . \$7.99 each.

ADDITIONAL WIRE SPOOLS — Package of 2 spools (120 meters) of 34 AWG wire . . . \$2.68

Circle 91 on reader service card

DIGITAL REVERB

(continued from page 45)

second speakers. One hears only expanded space as the buttons on the device are successively depressed—from shortest time delay interval to maximum delay. We were able to easily duplicate acoustic space ranging from a "nightclub" environment to a spacious cathedral-like sound.

According to the inventors of the device, this first version of the time delay system is a "high end" product intended for use with relatively high-priced stereo component systems. There was more than a hint, however, that other products are planned—also based upon digital time delay principles. In our own view, a device of this kind (suitably proportioned downward in size, price and features) might make a wonderful addition to a car stereo system, for example. When we offered this suggestion to the people at Audio Pulse, they smiled slyly—as if they knew something and we didn't—and they very probably do! R-E

STEP-BY-STEP

(continued from page 61)

resistor. You'll read 1.0 volt for each 1.0 ampere flowing. This type will *not* give you an accurate reading on an unloaded power transformer, which is a pure inductive load. You will see a reading of about 35-40 watts on a *good* transformer. However, this trick is reasonably accurate on a fully loaded power transformer.

"Load-shedding"

Power companies use a trick called "load-shedding" to locate a short. They disconnect all the loads and then put them back one at a time. The one that trips the breaker is the bad one. You can do the same thing, if necessary. Disconnect the high-current loads; in a hybrid or tube TV, these are the horizontal output stage, vertical output stage and audio output stage. The other stages normally take only small currents.

You can make this easier by opening the main DC power supply lead at the filter output and hooking in a DC milliammeter. This is point A in Fig. 9, a typical TV power supply circuit from a Sams Photofact schematic. Note that they show the *normal* load current; this is found on all Sams schematics, and should be used on all. Note this current; if it's far too high, disable the high current stages one at a time, and you'll be able to tell which one is faulty.

In transistor power supply stages, particularly in high-powered audio ampli-

fiers, you'll see two current readings. One will be the resting or "no-signal" current. The other will be the full-volume current, and will be much greater. This is typical of class-B output stages.

"Visible symptoms"

In TV sets, there will often be visible symptoms of power-supply trouble. One of these is the small raster; it will be pulled in on both sides, top and bottom. This shows that neither the horizontal or vertical sweeps have full output. The cause is something common to both, meaning the DC power supply.

Another visible symptom is "hum-bars" in the raster. Fig. 10 shows how these look. In sets with full-wave rectifier circuits, the hum (ripple) has a frequen-

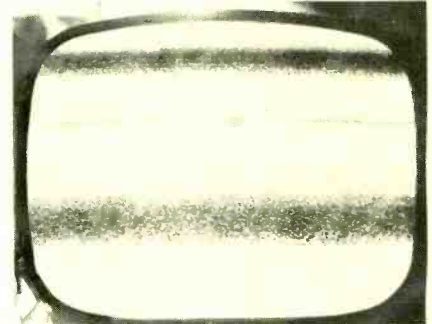

FIG. 10—OPEN FILTER CAPACITOR is the commonest reason for these hum bars.

cy of 120 Hz; so you see two hum-bars on the raster. In sets with half-wave power supplies, the ripple is at 60 Hz, so (Continued on page 108)

Thanks to you it works...

FOR ALL OF US

Ad advertising contributed for the public good



United Way

S. D. SALES CO. P. O. BOX 28810 DALLAS, TEXAS 75228

ALARM CLOCK KIT SIX DIGIT LED

Thousands of hobbyists have bought and built our original clock kit and were completely satisfied. But we have received many requests for an alarm clock kit with the same value and quality that you have come to expect from S.D. So, here it is!

THE KIT INCLUDES:

- 1 Mostek 50252 Alarm Clock Chip
- 6 Hewlett Packard .30 in. common cathode readouts.
- 15 NPN Driver Transistors
- 2 Switches for time set
- 2 Slide Switches for alarm set and enable
- 1 Filter Cap
- 4 IN4002 Rectifiers
- 1 IN914 Diode
- 1 .01 Disc Cap
- 15 Resistors
- 1 Speaker for alarm
- 1 LED lamp for PM indicator.

\$9.95

PCB - 3.00
VFMR - 1.50

60 Hz. Crystal Time Base FOR DIGITAL CLOCKS S. D. SALES EXCLUSIVE!

\$5.95

KIT FEATURES:

- A. 60 Hz output with accuracy comparable to a digital watch.
- B. Directly interfaces with all MOS clock chips.
- C. Super low power consumption (1.5 Ma typ.)
- D. Uses latest MOS 17 stage divider IC.
- E. Eliminates forever the problem of AC line glitches.
- F. Perfect for cars, boats, campers, or even for portable clocks at ham field days.
- G. Small size, can be used in existing enclosures.

BUY TWO FOR \$10.00

Kit includes crystal, divider IC, P.C. Board plus all other necessary parts and specs.

MOS 4 DIGIT COUNTER IC

All in one 28 PIN DIP. 4 Decade counters, latches, MUX circuits, display decoders, etc. Features: 5VDC operation, 25 MW power consumption, BOTH 7 segment and BCD outputs. Perfect for DVM's, frequency meters, tach's, etc. Can be cascaded for more digits. #5002 - \$8.95.

8008-1 MICRO PROCESSOR

New Units. High speed 8008. Almost twice as fast as units sold by others. Still a very versatile and widely used MPU. No data book, only pinout date included at this price. \$12.50 LIMITED QTY.

1101 A RAM IC

256 XI BITS. Perfect for 8008 or small systems such as telephone dials that do not require a lot of memory. Special 59c. 8 FOR \$4.

C & K MINI TOGGLE SWITCH

#7103 SUB MINI SPDT Center OFF. Special - 99c.

TTL IC'S

7400 - 19c	7420 - 19c	74153 - 75c	74154 - 1.00
7402 - 19c	7432 - 34c	7437 - 39c	74157 - 75c
7404 - 19c	7485 - 95c	7438 - 39c	74161 - 95c
74204 - 29c	7486 - 45c	7447 - 85c	74164 - 1.10
7406 - 29c	7490 - 65c	7448 - 85c	74165 - 1.10
7408 - 19c	7492 - 75c	7473 - 39c	74174 - 95c
74504 - 44c	7495 - 75c	7474 - 35c	74181 - 2.50
7410 - 19c	74121 - 38c	7475 - 69c	74191 - 1.25
7411 - 29c	74123 - 65c	7476 - 35c	74192 - 1.25
7413 - 50c	74141 - 75c	7483 - 95c	74193 - 1.00

2102 1K RAM's - 8 FOR \$12.95

New units _____ We bought a load on a super deal, hence this fantastic price. Units tested for 500NS Speed.

MOTOROLA RTL IC'S

Brand new, factory prime. Hard to find, but still used in a variety of projects. (See the RTL Cookbook by Howard W. Sams.)

MC724P-59c	MC780P-89c	MC791P-69c
MC725P-59c	MC785P-49c	MC792P-59c
MC764P-49c	MC787P-89c	MC799P-59c
MC767P-69c	MC788P-49c	MC9704P-89c
MC771P-49c	MC789P-59c	MC9709P-69c
MC775P-89c	MC790P-89c	MC9760P-69c

MV-50 TYPE LED'S

by LITRONIX
10 for \$1
Factory Prime!

3 DIGIT LED ARRAY - 75c

by LITRONIX
DL33MMB. 3 MAN-3 Size Readouts in one package. These are factory prime, not retested rejects as sold by others. compare this price! 75c 3 for \$2.



SALE ON CUT LEAD SEMICONDUCTORS

Leads were cut for PCB insertion. Still very useable.

1N914/1N4148	100/\$2
1N4002 1 Amp 100 PIV	40/\$1
1N4745A 16V 1W Zener	20/\$1
EN2222 NPN Transistor	25/\$1
EN2907 PNP Transistor	25/\$1
2N3904 NPN Driver Xstr.	25/\$1
2N3392 GE Pre-amp Xstr.	25/\$1
C103Y SCR. 800MA. 60V.	10/\$1

**ALL NEW.
UNUSED.
SOME ARE
HOUSE #**

SLIDE SWITCH ASSORTMENT

Our best seller. Includes miniature and standard sizes, single and multi-position units. All new, first quality, name brand switches. Try one package and you'll reorder more. Special - 12 for \$1 (Assortment)



DISC CAP ASSORTMENT

PC leads. At least 10 different values. Includes .001, .01, .05, plus other standard values.
60 FOR \$1



UPRIGHT ELECTROLYTIC CAPS

47 mfd 35 V-10/\$1 68 mfd 25V-8/\$1
Brand new by Sprague. PC leads.

RESISTOR ASSORTMENT

1/4 W 5% and 10%. PC leads
A good mix of values. 200/\$2



1000 MFD FILTER CAPS

Rated 35 WVDC. Upright style with P.C. leads. Most popular value for hobbyists. Compare at up to \$1.19 each from franchise type electronic parts stores. S.D. Special 4 for \$1



FAIRCHILD BIG LED READOUTS

A big .50 inch easy to read character. Now available in either common anode or common cathode. Take your pick. Super low current drain, only 5 MA per segment typical.

**YOUR
CHOICE**

FND - 510	Common Anode	
FND - 503	Common Cathode	\$1.50 ea. 6 for \$7.50

DUAL 741C (5558) OP AMPS

Mini dip. New house numbered units
by RAYTHEON.
4 FOR \$1

FET'S BY TEXAS INSTRUMENTS — SPECIAL 5 for \$1

#TIS-75 but with an internal house number. TO-92 plastic case. N. Channel, Junction type FET.

We do not sell junk. Money back guarantee on every item. No C.O.D. Texas Res. add 5% tax. Postage rates went up 30%! Please add 5% of your total order to help cover shipping.

S. D. SALES CO.

P. O. BOX 28810
DALLAS, TEXAS 75228

ORDERS UNDER \$10

ADD 75c HANDLING.

ORDERS OVER \$15 CHOOSE \$1 FREE MERCHANDISE

NEW

wafers are meant to be inserted in a .063" maximum thickness board and have .043" diameter pins on .156" centers.

CATALOG NUMBER	DESCRIPTION	PRICES	
		1-10	11-99
13-0001	12 pos. rt. angle connector	60	50
13-0002	12 position wafer	60	50
13-0003	9 pos. rt. angle connector	60	50

SPECIAL!
1000 Molex IC terminals for \$7.50
2000 for \$13.50

SPECIAL!
Motorola 741 Mini Dip 35¢-10 for \$3.00

ELECTROLYTIC CAPACITORS
PLEASE ORDER IN MULTIPLES OF 5 PER ITEM
RADIAL LEADS

(uF)	WORKING VOLTS DC	PRICE
10	16, 35, 50	.16
20	16, 35, 50	.16
30	16	.16
50	16, 35	.22
100	16, 35, 50	.25
200	16	.22
500	16	.34
1000	16	.52
2200	16	.80

NE501A 2.80
NE555A .50
A710CA .60
A741V .40
A747CA 1.10
A748CV .74
A723CA 1.00
MC1468L 3.90

Red Led & Mtg. Hardware
T1-3/4
1-10 11-100
.35 .29

MINIATURE FILM CAPACITORS

VALUE (uF)	PRICE TABLE		
	1-14	15-50	51-100
.001	.10	.10	.05
.0047	.10	.10	.05
.01	.10	.10	.05
.05	.19	.17	.15
1	.20	.18	.16
.22	.25	.23	.21

These units are made by International Components Corp. All units 100V

FIXED POWER SUPPLY KITS

Specifications	F0510	F1210	F1510
Input Voltage (50-500Hz)	105-125v	105-125v	110-125v
Output Voltage	5v ± 5%	12v ± 5%	15v ± 5%
Output Current (T _a = 25° C)	1.5A Max.	1.5A Max.	1.1A Max.
PRICE	\$14.00	\$14.50	\$14.50

INDEFINITE SHORT CIRCUIT PROTECTION. Price includes Pre-drilled G10 Board, All Parts and Transformer.

DISPLAY BEZELS

CATALOG NUMBER	FILTER COLOR	PRICE	DIMENSION
		1.28	C
905-60	Red	\$2.75	1.37
910-60	Red	2.80	2.00
915-60	Red	2.90	3.00
920-60	Red	2.90	4.00
920-70	Amber	2.95	4.00

These bezels are heat resistant plastic with a black matte finish. Filters are circular, polarized type.

SOCKETS
LOW PROFILE
These sockets are from TI

NUMBER OF PINS	\$99	100
8	.21	.18
14	.25	.20
16	.28	.24
24	.40	.35
28	.50	.45

TRANSISTORS

2N3638A	P	5	TO-92	25
2N2222A	N	5	TO-18	20
2N5133	N	05	TO-18	25
2N5494	N	7	TO-220	105
2N4401	N	60	TO-92	60
2N4403	P	60	TO-92	30
TIP32	P	3	TO-220	105

TRIMMER POTENTIOMETERS
These are 5/8" diameter thumbwheel trimmer potentiometers

BAG OF 50 MOLEX PIN NESTERS
7 pin style \$2.00
8 pin \$2.25

MOLEX IC TERMINAL

100 for \$1.00	300 for \$2.60	500 for \$4.20
200 for \$1.80	400 for \$3.40	600 for \$5.00
700 for \$5.80	900 for \$7.40	
800 for \$6.60	1,000 for \$8.20	

Real of 50,000 \$ 270.00

REGULATOR CIRCUITS

MC7805CP	5 volt regulator @ 1.5A max.	1.99
MC7812CP	12 volt regulator @ 1.5A max.	2.00
MC7815CP	15 volt regulator @ 1.5A max.	2.00

16 Page Catalog 25¢

DIODES

1N4001	10/\$1.00
1N4002	10/\$1.00
1N4148	10/\$1.00
1N5401	5/\$2.00 (3A, 1000V)

1N746-759A \$3.00ea

TERMS \$10.00 Min. Order. Orders less than \$25.00 add \$1.00 postage & handling. Money charge & Bank Americard

TRACY DESIGN CORP.
15870 SCHAEFER • DETROIT, MI. 48227 • (313) 838-2501

C-MOS PROBE

will convert your voltmeter into a sensitive FET INPUT millivoltmeter. Complete kit \$11.25 plus shipping. Also - Temp Meters - Power Supplies - Design Consoles.



Send for FREE CATALOG

SCIENTIFIC INSTRUMENTS
BOX 1054R • LIVERMORE • CA 94550

PLANS & KITS

CB'ers—"triple your power" using new 46' all-directional CB antenna!!! Plans \$2.—**ASTROBEAM-9**, 704 Edwards, Visalia, CA 93277

KITS. Beginner digital electronics. Electronic games. From \$7.75. Send stamp. **NBL-E**, Box 1115, Richardson, TX 75080

ELECTRONIC kits for home or school project. Select from over 50 kits. Many under \$5.00. Send \$1.00 for catalog. Refundable with first order. **GRAYMARK**, 1751 McGaw Ave., Dept. 51, Irvine, CA 92714

AMAZING ELECTRONIC PROJECTS and PRODUCTS:

Lasers Super Powered, Burning, Cutting, Rifle, Pistol, Pocket. See in Dark—Shotgun Directional Mike—Unscramblers—Giant Tesla—Stunwand—TV Disrupter—Energy Producing, Surveillance, Detection, Electrifying, Ultrasonic, CB, Auto and Mech. Devices, Hundreds More—All New Plus INFO UNLTD PARTS SERVICE. Catalog \$1. Information Unlimited, Box 626, Lord Jeffery Court, Amherst, N.H. 03031.

BUILD that electronic organ you always wanted at a price you can afford. Third edition of "Organ Builder's Guide," pictured product kit line, circuits, block diagrams, design rationale using IC divider and independent generators with diode keying. \$3.00 Postpaid. Also, free brochure on keyboards. **DEVTRONIX ORGAN PRODUCTS**, Dept. B, 5872 Amapola Drive, San Jose, CA 95129

ANALOG adjustable modem kit, TTL compatible, +5 -9 volts, 110 TTY, clock output standard, \$35.00, **E. CADOTTE**, 1027 Windhill Circle, Knoxville, TN 37919

NEW BUILD YOUR OWN DIGIKIT™ Electronic Games

Each DIGIKIT Game is Quick, Easy & Fun to Build, Fun-to-Play, and Includes:

- All PRE-TESTED, "state-of-the-art" 100% warranted parts
- PREDRILLED PC boards for quick easy installation of digital components
- Complete professional assembly instructions
- Detailed schematic diagram and assembly drawing
- IC logic diagrams
- Exclusive... screened film top Panel overlay for professional appearance

Reaction TENNIS

Like Tennis, this is a game of timing. LED's firing in sequence show the flight of the ball. Player receiving serve must react in time to return the shot. Change speeds to fast or slow.

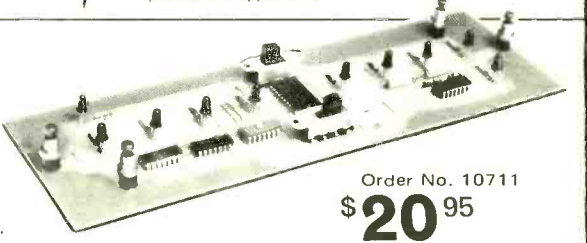

Order No. 10711
\$20⁹⁵

SLOT MACHINE

An electronic "push button bandit." 3 LED's read out: C for Cherry, O for Orange, L for Lemon and P for Plum. Hit any three alike, and you win. Oscillates at different rates, so game cannot be "fixed"

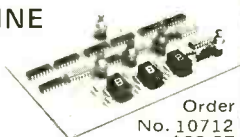

Order No. 10712
\$22.95

ROTATING DICE

The new electronic "shape" for dice. Two counter-rotating circles flash sequential LED's. Stop the movement, and add the values of both circles (2 thru 12) to read your roll. Works like a pair of dice.



Order No. 10708
\$14.95

7-LIGHT DICE-A PAIR

A roll of the dice with all possible outcomes (2 thru 12) at the push of a button. 14 LED's represent spots on dice. Use to play MONOPOLY, LIFE, electronic "craps", any game that requires a roll of the dice.



Order No. 10710
\$14.95

HEADS & TAILS

Great for making decisions that require a Heads or Tails and Yes or No outcome. It's fun, foolproof and honest... only one of two random flashing LED's remain lit to indicate decision.

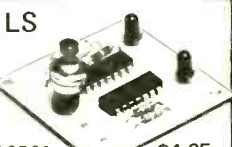

Order No. 10701
\$4.95

SPINNER

10 sequentially lit LED's fire in a circle. Push the button and only one LED stays lit. Designed to indicate the number of moves in games that require a numbered spinner.

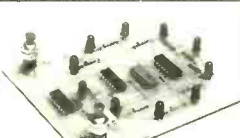

Order No. 10705
\$11.95

MATCH BOX

Two players each control 2 LED's that flash randomly. Call odd or even before you begin. Start the LED's and take your chances. Stop the LED's and remaining lit LED's indicate odd or even.



Order No. 10703
\$6.95

7 SEGMENT DICE-A PAIR

Read a roll of the dice as a digital display. 1 thru 6 on each die. Ideal for board games that call for a pair of dice.



Order No. 10707
\$14.95

UNIVERSAL 5-VOLT DC POWER SUPPLY

Perfect Power source for all DIGIKIT electronic games, and most other TTL IC projects.



Order No. 10713
\$6.95
±15 Volt DC Power Supply Order No. 10715 \$17.95

Order Your DIGIKITS Today! California residents add 6% sales tax. Add \$1 postage & handling on orders under \$10. Phone Orders - Call (213) 993-1311. Send Check or Money Order to: **DIGIKIT ENTERPRISES, INC.** Dept. RE 776 20450 Plummer St., Chatsworth, CA 91311

Indicate quantity and order no.
Min. Charge \$15.
Include all card No's.

FREE! DIGIKIT CATALOG Send for your copy.

GODBOUT

BILL GODBOUT ELECTRONICS
BOX 2355, OAKLAND AIRPORT, CA 94614

TERMS-add 50¢ to orders under \$10. Cal res add tax. For Mastercharge® or BankAmericard® call (415) 357-7007, 24 hrs SORRY, NO COD ORDERS

VECTOR DOES IT AGAIN! 'SLIT-N-WRAP' \$24.50

FROM THE PEOPLE WHO BROUGHT YOU VECTORBOARD...THE WIRE PENCIL...THE ALTAIR PROTOTYPE BOARD...AND NOW, THE "SLIT-N-WRAP". A SPEEDY MANUAL WRAPPING DEVICE WHICH SUPPLIES INSULATED WIRE (#28 GA.) FROM A SPOOL DIRECTLY TO WRAP POSTS WITHOUT ANY PRE-STRIPPING OR PRECUTTING. SAY GOODBYE TO PRE-MEASURING, TOO. THE SECRET? A TINY SLIT IN THE WIRE EXPOSES COPPER TO THE WRAP POST. WITH TOOL, INSTRUCTIONS, 200' OF WIRE. ADD 1 LB. SHPNG.

an alarming clock kit only \$15.95

4 BIG 1/2" DIGITS---SQUINT NO MORE! Snooze function, timed turnoff, speaker included for alarm beeps; transformer, circuit board, and 7 pushbutton switches included in the kit. Opto-isolator for alarm and sleep out (so you can trigger triacs and play other games). Readouts may be removed. Use with 60 Hz time base for battery operation. +1 lb. shpng.

Crystals

\$4.95 EACH. Excellent for frequency calibrators, hams, or computer bugs. Series mode fundamental operation, wire leads. Choose from:
4 MHz (PACE clock frequency), 5 MHz, 8 MHz, 10 MHz, 12 MHz, 15 MHz, 18 MHz (8080 clock frequency), and 20 MHz. **CAVE** sky

NEW! Low-cost, full feature 4kx8 kit

ALTAIR 8800/MSAI PLUG-IN COMPATIBLE. Buffered addresses--data out--and data in lines, 0 wait states, 1A typ power, sockets for all ICs, low power Schottky TTL support ICs, onboard regulation, lots of bypassing, DIPswitch address select, documentation, and a quality double-sided board...
\$99.95

FREE FLYER

Circle the reader service no. below, and you'll receive our flyer listing lots of stuff.

ECONORAM™

Circle 96 on reader service card

"Gentlemen, start your cassettes"

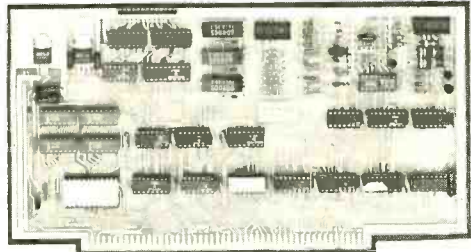

NON-VOLATILE, MASS STORAGE FOR YOUR ALTAIR 8800/MSAI...
This is a complete, well thought out complement to your microcomputer. With on board RAM, regulators, various options (see below), and most of all...a 4K EROM which contains the software required to make the board SMART.
FREE: Ask for Product Bulletin #1, which describes the unique virtues of this board. Or send \$4.95 for the documentation (instructions, logic print, applications, annotated listing, more). If you just can't wait, here are the prices:
BASIC BOARD (talks to 2 machines).....\$96.00
EXTRA CASSETTE CHANNEL (talk to 3 machines)....add \$6.00
GENERAL PURPOSE, 8 BIT I/O PORT.....add \$6.00
TTY/RS-232 INTERFACE.....add \$12.00
(These are kit prices; write for prices on wired units.)

MORROW'S Micro-STUFF

BOX 6194
ALBANY,
CA 94706

WE PAY POSTAGE
CALIFORNIANS ADD
STATE SALES TAX
NO CODS **CAVE** sky

Circle 97 on reader service card

Spring-Pac super SALE! \$1.98

Each pac only
All pacs are first quality (no fallout), tested and guaranteed.

Memory pac MM5016 MOS TO-5 512 BIT shift registers from NATIONAL - with data \$1.98	Flip-Flop pac 10 assorted Flip-Flops, Dual JK's, RST's, and low power FF's, with data \$1.98	Comparator pac 5 assorted DIP's--LM311, 710, 711, with data \$1.98
TTL Gates 15 assorted DIP's 7400 series-7420, 7430, 7440, etc...All prime, marked parts, with data \$1.98	LED pac 10 assorted discrete LED's-green, red, and infra-red, with data. \$1.98	Transistor pac 40 assorted TO-92 plastic transistors--PNP's and NPN's, mostly Fairchild house marked. \$1.98
Regulators 4 LM723 DIP variable regulators, 2-40V, with data \$1.98	Diodes 100 Germanium computer signal diodes with leads trimmed for PCB mounting. \$1.98	Resistors 100 1/4 watt 5% resistors of any single standard value from 2.7 ohm to 1M ohm \$1.98
Linear pac 8 assorted linears in mini-DIP or TO-5*741 op amp, LM307 op amp, LM 703 RF-IF amp, with data and circuits \$1.98	DIP RC Network 50 assorted 14 and 16 pin IC packages containing precision resistors and capacitors-no data available \$1.98	Switches 8 SPST momentary contact push button N.O. Red button fits in approx. 1/8" panel, with lock washer and mounting nut. \$1.98

LED Display pac
2 DL33 - 3 digits each, approximately .1" magnified digits in a 12 pin DIP, with data
\$1.98

Buy 5 pacs for \$9.90 and pic-a-pac for **10¢**

The above are special offerings from Babylon Electronics, and will be shipped third class. See bottom of ad for ordering instructions.

Specials		EMOS		TTL				
DIP TRIMMER -12 turn trim pots which plug into a DIP socket -5K and 200K -1/4" x 1/2" x 1/8" -4 leads spaced .3" x .2"	CD4001	\$.29	CD4023	.29	74001	\$.20	74L54S	.25
	CD4002	.29	CD4024	1.50	74H00	.25	74L55	.25
	CD4009	.59	CD4025	.34	7401	.14	7460	.16
	CD4010	.59	CD4030	.65	74H01	.25	74L71	.20
	CD4011	.29	74C20	.65	7402	.25	7472	.40
	CD4013	.69	74C42	2.00	7404	.25	74L72	.60
	CD4015	1.98	74C157	2.50	74H04	.30	7473	.35
	CD4016	.69	74C195	1.00	7405	.30	74L73	.75
	CD4019	.69			7406	.40	7474	.45
					7408	.30	74H74	.75
				7410	.12	7475	.8-	
				7413	.75	7476	.35	
				7417	.40	74L78	.70	
				7420	.12	7480	.50	
				74L20	.25	7483	.70	
				74H20	.18	7489	2.00	
				74H22	.30	7490	.70	
				7430	.10	7492	.35	
				74H30	.30	7493	1.00	
				74L30	.30	7495	.65	
				7440	.10	74L95	1.00	
				74H40	.22	74107	.25	
				7442	1.00	74123	.75	
				7447	1.50	74145	1.25	
				7450	.10	74155	.90	
				74H50	.30	74174	1.00	
				7451	.10	74180	1.00	
				74H51	.25	74192	1.00	
				7453	.10	74193	1.00	
						75492	1.00	

SPACE AGE CLOCK KIT
Instructions & parts - 12 or 24 hour format.
Four digit clock kit includes all parts for complete clock: 3 1/2" x 2":
-END 70 readouts
-MM5314 clock chip & all transistors, etc.
-extruded aluminum case
-cord with transformer plug
\$16.95

POTTER BRUMFIELD
Type KHP Relay
4 PDT 3A Contacts

24V DC . \$1.50 (650 coil)
120V AC . \$1.75 (10.5 MA coil)

Mail orders to: **BABYLON ELECTRONICS**
P.O. Box 41778, Sacramento, CA 95841
Phone (916) 334-2161
TWX # 910-367-3521

Send a stamp for our flyer listing more money-saving bargains!

All IC's are new and fully tested. Leads are plated with gold or solder. Due to increased costs, orders under \$7.00 add \$1.00 postage and handling. Residents of California add sales tax. Orders shipped promptly. \$10 minimum order on C.O.D.'s.

MONEY BACK GUARANTEE ON ALL GOODS!

JULY 1976

7400N TTL

SN7400N	13	SN7453N	27	SN74150N	100
SN7401N	16	SN7454N	20	SN74151N	79
SN7402N	21	SN7455A	25	SN74153N	89
SN7403N	16	SN7456N	22	SN74154M	128
SN7404N	16	SN7470N	45	SN74155N	99
SN7405N	24	SN7471N	69	SN74156N	99
SN7406N	20	SN7472N	37	SN74157N	99
SN7407N	29	SN7473N	37	SN74180N	125
SN7408N	25	SN7474N	32	SN74181N	99
SN7409N	25	SN7475N	50	SN74183M	99
SN7410N	16	SN7476N	32	SN74184N	110
SN7411N	30	SN7479N	50	SN74185N	110
SN7412N	33	SN7480N	50	SN74186N	110
SN7413N	45	SN7482N	85	SN74187N	510
SN7414N	30	SN7483N	70	SN74170N	210
SN7415N	35	SN7485N	89	SN74172N	180
SN7417N	35	SN7486N	59	SN74173N	150
SN7420N	21	SN7488N	350	SN74174N	125
SN7421N	33	SN7489N	225	SN74175N	99
SN7422N	49	SN7490N	45	SN74176N	50
SN7423N	37	SN7491N	75	SN74177N	90
SN7425N	29	SN7492N	49	SN74180N	99
SN7426N	29	SN7493N	49	SN74181N	210
SN7427N	37	SN7494N	79	SN74182N	95
SN7429N	42	SN7495N	79	SN74184N	195
SN7430N	26	SN7496N	99	SN74185N	220
SN7432N	31	SN7497N	430	SN74186N	99
SN7433N	27	SN74100N	100	SN74187N	600
SN7434N	27	SN74107N	39	SN74190N	125
SN7439N	25	SN74121N	39	SN74191N	119
SN7440N	15	SN74122N	39	SN74192N	89
SN7441N	89	SN74123N	70	SN74193N	85
SN7442N	59	SN74125N	60	SN74194N	125
SN7443N	75	SN74126N	60	SN74195N	60
SN7444N	75	SN74132N	109	SN74196N	125
SN7445N	75	SN74134N	110	SN74197N	125
SN7446N	81	SN74141N	115	SN74198N	175
SN7447N	69	SN74142N	400	SN74199N	75
SN7448N	79	SN74143M	150	SN74200N	559
SN7450N	26	SN74145N	115	SN74201N	90
SN7451N	27	SN74147N	235	SN74202N	179
		SN74148N	200	SN74204N	600
		SN74149N	200	SN74205N	600

MANY OTHERS AVAILABLE ON REQUEST
20% Discount for 100 Combined 7400's

CMOS

CD4000	25	74C04N	75
CD4001	25	74C01N	65
CD4002	25	74C02N	65
CD4006	25	74C06N	65
CD4007	25	74C042N	215
CD4009	59	74C044N	150
CD4010	59	74C046N	115
CD4011	25	74C047N	65
CD4012	25	74C049N	200
CD4013	47	74C050N	125
CD4016	56	74C051N	290
CD4017	135	74C053N	300
CD4019	55	74C056N	215
CD4020	149	74C066N	325
CD4022	125	74C069N	325
CD4023	125	74C072N	300
CD4024	150	74C073N	300
CD4025	25	74C074N	260
CD4027	69	74C075N	275
CD4028	165	74C076N	275
CD4029	290	74C077N	450
CD4030	85	74C078N	56

LINEAR

LM300H	80	LM1351N	165
LM300A	36	LM1414N	175
LM300B	75	LM1458C	65
LM300H	100	LM1496N	95
LM300S	95	LM1556V	85
LM300CN	100	LM2188N	295
LM300H	100	LM2601N	69
LM300CN	100	LM3005N	55
LM300H	110	LM3005N	50
LM309K	99	LM3009N	29
LM310CN	115	LM3555N	185
LM311CN	90	MC5558V	100
LM311CN	90	LM7525N	90
LM318CN	150	LM7529N	125
LM319	130	MC8038	495
LM3190	900	LM75450N	49
LM320K-5	135	75451CN	39
LM320K-12	135	75452CN	39
LM320K-15	135	75453CN	39
LM320T-5	175	75454CN	39
LM320T-12	175	75455CN	39
LM320T-15	175	75456CN	39
LM323K-5	995	75457CN	79
LM324N	180	RC3 LINEAR	180
LM339N	170	CA3023	215
LM340K-5	195	CA3025	225
LM340K-12	195	CA3029	135
LM340K-15	195	CA3026	145
LM340K-24	195	CA3028	145
LM340K-30	195	CA3029	145
LM340K-48	195	CA3031	280
LM340K-60	195	CA3032	280
LM340K-75	195	CA3033	280
LM340K-12	175	CA3034	280
LM340K-15	175	CA3035	280
LM340K-24	175	CA3036	280
LM340K-30	175	CA3037	280
LM340K-48	175	CA3038	280
LM340K-60	175	CA3039	280
LM340K-75	175	CA3040	280
LM340K-12	155	CA3041	280
LM340K-15	155	CA3042	280
LM340K-24	155	CA3043	280
LM340K-30	155	CA3044	280
LM340K-48	155	CA3045	280
LM340K-60	155	CA3046	280
LM340K-75	155	CA3047	280
LM340K-12	135	CA3048	280
LM340K-15	135	CA3049	280
LM340K-24	135	CA3050	280
LM340K-30	135	CA3051	280
LM340K-48	135	CA3052	280
LM340K-60	135	CA3053	280
LM340K-75	135	CA3054	280
LM340K-12	115	CA3055	280
LM340K-15	115	CA3056	280
LM340K-24	115	CA3057	280
LM340K-30	115	CA3058	280
LM340K-48	115	CA3059	280
LM340K-60	115	CA3060	280
LM340K-75	115	CA3061	280
LM340K-12	95	CA3062	280
LM340K-15	95	CA3063	280
LM340K-24	95	CA3064	280
LM340K-30	95	CA3065	280
LM340K-48	95	CA3066	280
LM340K-60	95	CA3067	280
LM340K-75	95	CA3068	280
LM340K-12	75	CA3069	280
LM340K-15	75	CA3070	280
LM340K-24	75	CA3071	280
LM340K-30	75	CA3072	280
LM340K-48	75	CA3073	280
LM340K-60	75	CA3074	280
LM340K-75	75	CA3075	280
LM340K-12	55	CA3076	280
LM340K-15	55	CA3077	280
LM340K-24	55	CA3078	280
LM340K-30	55	CA3079	280
LM340K-48	55	CA3080	280
LM340K-60	55	CA3081	280
LM340K-75	55	CA3082	280
LM340K-12	35	CA3083	280
LM340K-15	35	CA3084	280
LM340K-24	35	CA3085	280
LM340K-30	35	CA3086	280
LM340K-48	35	CA3087	280
LM340K-60	35	CA3088	280
LM340K-75	35	CA3089	280
LM340K-12	15	CA3090	280
LM340K-15	15	CA3091	280
LM340K-24	15	CA3092	280
LM340K-30	15	CA3093	280
LM340K-48	15	CA3094	280
LM340K-60	15	CA3095	280
LM340K-75	15	CA3096	280
LM340K-12	5	CA3097	280
LM340K-15	5	CA3098	280
LM340K-24	5	CA3099	280
LM340K-30	5	CA3100	280
LM340K-48	5	CA3101	280
LM340K-60	5	CA3102	280
LM340K-75	5	CA3103	280
LM340K-12	3	CA3104	280
LM340K-15	3	CA3105	280
LM340K-24	3	CA3106	280
LM340K-30	3	CA3107	280
LM340K-48	3	CA3108	280
LM340K-60	3	CA3109	280
LM340K-75	3	CA3110	280

KITS EXAR IC'S

XR-2206KA	SPECIAL \$17.95		
Includes monolithic function generator IC, PC board, and assembly instruction manual.			
XR-2206KB	SPECIAL \$27.95		
Same as XR-2206KA above and includes external components for PC board.			
STEREO DECODERS			
XR-555CP	\$6.99	XR-1310P	\$3.20
XR-320P	1.55	XR-1310EP	3.20
XR-556CP	1.85	XR1800P	3.20
XR-2556CP	3.20		
XR-2240CP	3.25		
WAVEFORM GENERATORS			
XR-205	8.40		
XR-2207CP	3.85		
MISCELLANEOUS			
XR-210	5.20		
XR-215	6.60		
XR-567CP	1.95		
XR-2261P	6.70		
XR-2261P	2.99		
XR-2267CP	3.79		
XR-4136	2.00		

DATA HANDBOOKS

7400	Pin-out & Description of 5400/7400 IC'S	\$2.95
CMDS	Pin-out & Description of 4000 Series IC'S	\$2.95
LINEAR	Pin-out & Functional Description	\$2.95
ALL THREE HANDBOOKS \$6.95		

CONSUMER ELECTRONICS

exelar



DIGITAL WATCH
This watch is manufactured by National Semiconductor. It provides 5 functions: hours, minutes, seconds, date, A.M. indicator dot. Accuracy is assured to 5 seconds per month by precision quartz crystal. If something should go wrong with the watch, repair is assured within 48 hours after it is received. Complete with steel black leather band.

ES4-YR
3 CRIMON GOLD PLATE BEZEL
\$29.95
NOT A KIT

Novus



DIGITAL ALARM CLOCK
This digit Novus Alarm Clock is a very reliable and smartly styled unit. It provides such features as an alarm settable in any minute of the day, a 7 minutes snooze alarm, a power failure indicator, and even an A.M., P.M. indicator.

NOT A KIT **\$19.95**

OPTO ELECTRONICS

XCITON LITRONIX MONSANTO

DISCRETE LEADS

R - RED
G - GREEN
Y - YELLOW
O - ORANGE

XC209R	5/S1	XC526R	5/S1	XC111R	5/S1
XC209G	4/S1	XC526G	4/S1	XC111G	4/S1
XC209Y	4/S1	XC526Y	4/S1	XC111Y	4/S1
XC209O	4/S1	XC526O	4/S1	XC111O	4/S1

125" dia. 185" dia. 190" dia.

XC220R 5/S1 XC566R 5/S1 MV50 5/S1
XC220G 4/S1 XC566G 4/S1 085" dia. Micro
XC220Y 4/S1 XC566Y 4/S1 red red
XC220O 4/S1 XC566O 4/S1 6/S1

DISPLAY LEADS

FND503	FND70	DL707	DL338
MAN 2	MAN 3	MAN 4	MAN 7

TYPE	POLARITY	HT	PRICE	TYPE	POLARITY	HT	PRICE
MAN 1	COMMON ANODE	270	\$3.25	MAN 74	COMMON CATHODE	300	\$1.50
MAN 2	5 x 7 DOT MATRIX	200	4.95	DL707	COMMON ANODE	300	1.50
MAN 3	COMMON CATHODE	125	79	COMMON ANODE	600	2.25	
MAN 4	COMMON CATHODE	187	1.95	DL750	COMMON CATHODE	600	2.49
MAN 7	COMMON ANODE	300	1.50	DL338	COMMON CATHODE	110	1.25
MAN 7G	COMMON ANODE GREEN	300	2.50	FND503	COMMON CATHODE	250	50
MAN 7Y	COMMON ANODE YELLOW	300	2.50	FND507	COMMON CATHODE	500	1.75
MAN 7Z	COMMON ANODE	300	50	FND507	COMMON ANODE	500	1.75

IC SOLDERTAIL — LOW PROFILE (TIN) SOCKETS

8 pin	1.24	25-49	50-100	1.24	25-49	50-100
14 pin	20	19	18	28 pin	45	44
16 pin	22	21	20	36 pin	60	59
18 pin	29	28	27	40 pin	63	62
22 pin	37	36	35			

SOLEDAERTAIL STANDARD (TIN)

14 pin	\$27	25	24	28 pin	99	90	81
16 pin	30	27	25	36 pin	1.39	1.26	1.15
18 pin	35	32	30	40 pin	1.59	1.45	1.30
24 pin	49	45	42				

SOLEDAERTAIL STANDARD (GOLD)

8 pin	\$30	27	24	24 pin	\$70	63	57
14 pin	35	32	29	28 pin	110	100	90
16 pin	38	35	32	36 pin	1.75	1.40	1.26
18 pin	52	47	43	40 pin	1.75	1.59	1.45

WIRE WRAP SOCKETS (GOLD) LEVEL #3

10 pin	\$45	41	37	24 pin	\$105	95	85
14 pin	39	38	37	28 pin	140	125	110
16 pin	43	42	41	36 pin	1.59	1.45	1.30
18 pin	75	68	62	40 pin	1.75	1.55	1.40

50 PCS. RESISTOR ASSORTMENTS \$1.75 PER ASST.

ASST. 1	5 ea.	10 OHM	12 OHM	15 OHM	18 OHM	22 OHM	5
---------	-------	--------	--------	--------	--------	--------	---

CRYSTALS

THESE FREQUENCIES ONLY

Part #	Frequency	Case/Style	Price
CY1A	1.000 MHz	HC33/U	\$4.95
CY2A	2.000 MHz	HC33/U	\$4.95
CY3A	4.000 MHz	HC18/U	\$4.95
CY7A	5.000 MHz	HC18/U	\$4.95
CY12A	10.000 MHz	HC18/U	\$4.95
CY14A	14.31818 MHz	HC18/U	\$4.95
CY19A	18.000 MHz	HC18/U	\$4.95
CY22A	20.000 MHz	HC18/U	\$4.95
CY30B	32.000 MHz	HC18/U	\$4.95

CLOCK CHIPS — CALCULATOR CHIPS

MMS309	6 Digit, BCD Outputs, Reset Pin.	\$5.95
MMS311	6 Digit, BCD Outputs, 1 or 24 Hour	4.95
MMS312	4 Digit, BCD Outputs, 1 PPS Output	4.95
MMS313	6 Digit, BCD Outputs, 1 PPS Output	4.95
MMS314	6 Digit, 12 or 24 Hour, 50 or 60 Hz	4.95
MMS316	4 Digit, Alarm, 1 PPS Output	6.95
MMS318	Video Clock Chip. For Use With MMS841	9.95
CT7001	6 Digit, Calendar, Alarm, 12 or 24 Hour	6.95

CALCULATOR CHIPS

MMS725	6 Digit, Four Function, Less Decimals	\$2.95
MMS738	8 Digit, 5 Function, +, -, x, /, %	2.95
MMS739	8 Digit, 4 Function, Floating Decimal	2.95
CT5001	12 Digit, 4 Function	3.95
CT5005	12 Digit, 4 Function with Memory	4.95
CT5000	12 Digit, 4 Function and %	7.95

MISC. MEMORY

MMS320	TV Camera Sync Generator	\$19.95
MMS330	4 1/2 Digit DVM Chip	9.95
MMS369	60 Hz Timebase Circuit From 3.58 MHz	5.00
MMS341	Video Generator For MMS318	18.00
MC1408-L7	7 Bit Digital to Analog Converter	9.95
MK5007	4 Decade Counter with Latches	10.95
LD110L1111	3 1/2 Digit DVM Chip Set	25.00
95H90	100 MHz — 10 Counter For Prescalers	13.95

Filament Transformers

1/2" or 3/4" Dia. Secondary 50 or 60 Hz

Type	Secondary	Primary	Watt	Cap. or Load	Case Dimensions	Mounting Dimensions	Wt.	Price
F-7X	1.00	115	100	1.00	1.50 x 1.50 x 1.50	2.10 x 1.10	3.10	5.10
F-13X	1.00	115	150	1.50	1.50 x 2.00 x 1.50	2.10 x 1.10	3.10	3.80
F-14X	1.00	115	200	1.50	1.50 x 2.00 x 1.50	2.10 x 1.10	3.10	4.15
F-16X	1.00	115	250	1.50	1.50 x 2.00 x 1.50	2.10 x 1.10	3.10	5.35
F-25X	1.00	115	350	1.50	1.50 x 2.00 x 1.50	2.10 x 1.10	3.10	6.25
F-40X	1.00	115	500	1.50	1.50 x 2.00 x 1.50	2.10 x 1.10	3.10	7.00
F-45X	1.00	115	500	1.50	1.50 x 2.00 x 1.50	2.10 x 1.10	3.10	7.50
F-54X	1.00	115	500	1.50	1.50 x 2.00 x 1.50	2.10 x 1.10	3.10	8.50

Add 50¢ Postage

VECTOR WIRING PENCIL



Vector Wiring Pencil P173 consists of a hand held featherweight (under one ounce) tool which is used to guide and wrap insulated wire, fed off a self-contained replaceable bobbin, onto component leads or terminals installed on pre-punched "P" Pattern Vectorboards. Connections between the stranded wire and component leads, pads or terminals are made by soldering. Complete with 250 FT of red wire. **\$9.50**

REPLACEMENT WIRE — BOBBINS FOR WIRING PENCIL

W36-3-A-Pkg. 3	250 ft. 36 AWG GREEN	\$2.40
W36-3-B-Pkg. 3	250 ft. 36 AWG RED	\$2.40
W36-3-C-Pkg. 3	250 ft. 36 AWG CLEAR	\$2.40
W36-3-D-Pkg. 3	250 ft. 36 AWG BLUE	\$2.40

1/16 VECTOR BOARD

Part No.	Material	4.50	6.50	1.72	1.54
PHENOLIC	64P41 062XXXP	4.50	6.50	1.72	1.54
	169P41 02AXXP	4.50	6.50	1.72	1.54
EPOXY GLASS	84P44 062	4.50	6.50	2.07	1.86
	169P44 062	4.50	6.50	2.07	1.86
EPOXY GLASS COPPER CLAD	169P44 062C1	8.50	17.00	8.23	8.06
	169P44 062C2	8.50	17.00	6.80	6.12

VECTOR TERMINALS

Series	Gold	Tinned	Post Size	Gold	25 pcs	50 pcs
T44	T44-1	T44	025 sq	1.50	1.00	2.75
T46	T46-1	T46	028 sq	1.75	1.25	3.00
T49	T49A	T49	025 sq	1.75	1.25	3.10
T42-1	PKG 100	Terminals	\$3.50 C	\$13.00 M		

DIP SWITCH

These switches feature seven SPST side switches in a molded chip. They are ideally suited for microprocessor applications. **\$1.95**

100 PER STRIP

MOLEX PINS

Intended for use as an inexpensive substitute for IC sockets. Also perfect for use as board connectors and in subassemblies.

SPECIAL — 100/1.49 — 1000/12.00

64 KEY KEYBOARD

The ideal item for the real homebrew computer hobbyist. This keyboard features 64 unencased SPST keys, unattached to any kind of P.C.B. A very solid molded plastic 13" x 4" base suits most applications. **\$24.95 ea.**

JOYSTICK

These joysticks feature four 100K potentiometers, that vary resistance proportional to the angle of the stick. Sturdy metal construction with plastics components only at the movable joint. Perfect for electronic games and instrumentation. **\$9.95 ea.**



MICROPROCESSOR COMPONENTS

8080 SUPPORT DEVICES

8080A	8212	8 BIT INPUT/OUTPUT PORT FOR 8080	\$ 5.95	8080	
\$37.95	8224	CLOCK GENERATOR AND DRIVER FOR 8080	12.95	\$24.95	
	8228	SYSTEM CONTROLLER AND BUS DRIVER FOR 8080	12.95		

CPU'S		RAM'S				
8008	8 BIT CPU	\$19.95	2601	256 x 1	Static	\$ 5.00
8080	Super 8008	24.95	1101	256 x 1	Static	\$ 2.25
8080A	Super 8008	37.95	1103	1024 x 1	Dynamic	2.95
2504	1024 Dynamic	\$ 9.00	2101	256 x 1	Static	6.95
2518	Hex 32 BIT	7.00	2102	1024 x 1	Static	1.95
2519	Hex 40 BIT	4.00	2107	4096 x 1	Dynamic	19.95
2524	512 Dynamic	2.95	2111	256 x 4	Static	7.95
2525	1024 Dynamic	6.00	7010	1024 x 1	Static	29.95
2527	Dual 256 BIT	3.95	7489	16 x 4	Static	2.49
2529	Dual 512 BIT	4.00	8101	256 x 4	Static	7.95
2532	Quad 80 BIT	3.95	8599	16 x 4	Static	3.49
2533	1024 Static	7.95	91102	1024 x 1	Static	2.49
3341	Flip	6.95	74200	256 x 1	Static	6.95
74LS670	16 x 4 Reg	3.95	93410	256 x 1	Static	1.75
UART'S		PROM'S				
AY-5-1013	30K Baud	\$ 6.95	1702A	2048	Famos	\$15.95
2513	Char. Gen.	\$11.00	82523	2048	Famos	14.95
7488	Random Bits	3.00	82523	32 x 8	Open C	5.00
2516	Char. Gen.	13.00	745287	1024	Trislate	5.00
					Static	7.95

2K RAM SPECIAL

MMS262 Fully Decoded 2Kx1 Dynamic RAM. All inputs except clocks are TTL compatible. Provides a 635 ns minimum access time, and requires +5, +6.5, and -15V power supply. Low power provides non-volatile memory using battery back up. **\$0.99 ea. (0.05 cents per bit)**

Special Requested Items

RC4194	Dual Track V Reg	\$ 5.95	N8797	\$ 2.00	Mk5007	\$10.95	MC4044	\$ 4.50
RC4195	±15V Track Reg	3.25	4024P	2.25	8203	5.95	LM3909	1.25
7368B	Decoder	2.95	DM8130	3.25	8287	2.75	MMS320	19.95
LD110/111	DVM Chip Set	25.00	9322	1.30	8288	1.15	4072AE	45.45
CA3130	Super CMOS Op Amp	1.49	MC14016	5.6	8826	3.00	7422	1.50
MC1408L7	D/A	9.95	2525	6.00	8680	80	7487	4.00
73341	FIFO	6.95	2527	3.95	45-11AE	2.50	74186	5.00
MMS841	Character Gen.	18.00	CD5418	2.50	XR4136	2.00	74279	90
AYS-9100	Push Button Dialer	17.50	MMS309	5.95	4566AE	3.00		

WE'LL BE HAPPY TO QUOTE ON YOUR SPECIAL PARTS —

Continental Specialties

PROTO BOARD 100

For the economy-minded experimenter...

Here's a low cost, yet 10 IC capacity breadboard kit with all the quality of Q1 sockets and the best of the Proto Board series. Complete down to the last nut, bolt and screw. Includes Q1 255 Sockets. 1 Q1 255 Bus Strip, 2 1/2 way binding posts, a nut/bolt screw, nuts, bolts and easy assembly instructions.

Proto Board 100
Range 3 255 sockets
16 points (4 5 way
binding posts, 12 1 pin
DIP capacity, 1/8" long
1 1/8" wide) **79.95**

Proto Board 100
Range 3 255 sockets
16 points (4 5 way
binding posts, 12 1 pin
DIP capacity, 1/8" long
1 1/8" wide) **79.95**

Proto Board 100
Range 3 255 sockets
16 points (4 5 way
binding posts, 12 1 pin
DIP capacity, 1/8" long
1 1/8" wide) **79.95**

Proto Board 100
Range 3 255 sockets
16 points (4 5 way
binding posts, 12 1 pin
DIP capacity, 1/8" long
1 1/8" wide) **79.95**

Proto Board 100
Range 3 255 sockets
16 points (4 5 way
binding posts, 12 1 pin
DIP capacity, 1/8" long
1 1/8" wide) **79.95**

Proto Board 100
Range 3 255 sockets
16 points (4 5 way
binding posts, 12 1 pin
DIP capacity, 1/8" long
1 1/8" wide) **79.95**

Proto Board 100
Range 3 255 sockets
16 points (4 5 way
binding posts, 12 1 pin
DIP capacity, 1/8" long
1 1/8" wide) **79.95**

Proto Board 100
Range 3 255 sockets
16 points (4 5 way
binding posts, 12 1 pin
DIP capacity, 1/8" long
1 1/8" wide) **79.95**

Proto Board 100
Range 3 255 sockets
16 points (4 5 way
binding posts, 12 1 pin
DIP capacity, 1/8" long
1 1/8" wide) **79.95**

Proto Board 100
Range 3 255 sockets
16 points (4 5 way
binding posts, 12 1 pin
DIP capacity, 1/8" long
1 1/8" wide) **79.95**

Proto Board 100
Range 3 255 sockets
16 points (4 5 way
binding posts, 12 1 pin
DIP capacity, 1/8" long
1 1/8" wide) **79.95**

Proto Board 203

For the economy-minded experimenter...

Here's a low cost, yet 10 IC capacity breadboard kit with all the quality of Q1 sockets and the best of the Proto Board series. Complete down to the last nut, bolt and screw. Includes Q1 255 Sockets. 1 Q1 255 Bus Strip, 2 1/2 way binding posts, a nut/bolt screw, nuts, bolts and easy assembly instructions.

Proto Board 203
Range 3 255 sockets
16 points (4 5 way
binding posts, 12 1 pin
DIP capacity, 1/8" long
1 1/8" wide) **39.95**

Proto Board 203
Range 3 255 sockets
16 points (4 5 way
binding posts, 12 1 pin
DIP capacity, 1/8" long
1 1/8" wide) **39.95**

Proto Board 203
Range 3 255 sockets
16 points (4 5 way
binding posts, 12 1 pin
DIP capacity, 1/8" long
1 1/8" wide) **39.95**

Proto Board 203
Range 3 255 sockets
16 points (4 5 way
binding posts, 12 1 pin
DIP capacity, 1/8" long
1 1/8" wide) **39.95**

Proto Board 203
Range 3 255 sockets
16 points (4 5 way
binding posts, 12 1 pin
DIP capacity, 1/8" long
1 1/8" wide) **39.95**

Proto Board 203
Range 3 255 sockets
16 points (4 5 way
binding posts, 12 1 pin
DIP capacity, 1/8" long
1 1/8" wide) **39.95**

Proto Board 203
Range 3 255 sockets
16 points (4 5 way
binding posts, 12 1 pin
DIP capacity, 1/8" long
1 1/8" wide) **39.95**

Proto Board 203
Range 3 255 sockets
16 points (4 5 way
binding posts, 12 1 pin
DIP capacity, 1/8" long
1 1/8" wide) **39.95**

Proto Board 203
Range 3 255 sockets
16 points (4 5 way
binding posts, 12 1 pin
DIP capacity, 1/8" long
1 1/8" wide) **39.95**

Proto Board 203
Range 3 255 sockets
16 points (4 5 way
binding posts, 12 1 pin
DIP capacity, 1/8" long
1 1/8" wide) **39.95**

Proto Board 203
Range 3 255 sockets
16 points (4 5 way
binding posts, 12 1 pin
DIP capacity, 1/8" long
1 1/8" wide) **39.95**

AUTOTEL™

WARNING LIGHTS ARE NOT ENOUGH



AN AUDIBLE ALARM INDICATING POTENTIAL ENGINE DAMAGE

AUTOTEL is an efficient (15 ma current standby) device by which every owner of an automobile, truck or vehicle equipped with indicator lights for temperature and oil pressure can be assured of a reliable warning before an impending failure. AUTOTEL, by means of an audible signal (70 db pulsing) immediately warns the vehicle operator of a malfunction or failure, allowing time to correct and prevent major engine failures. It is programmed so there is no sound during normal operating conditions. AUTOTEL features CMOS circuitry, packaged in a 2 1/2" sq x 7/8" case. The kit comes complete with all components, hardware and case to hook directly into your car's warning light system.

\$14.95 Assembled \$9.95 Per Kit

IME 3 1/2 DIGIT DVM KIT

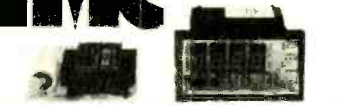

This 0-2 VDC .05 per cent digital voltmeter features the Motorola 3 1/2 digit DVM chip set. It has a 4 LED display and operates from a single -5V power supply. The unit is provided complete with an injection molded black plastic case complete with Bezels. An optional power supply is available which fits into the same case as the 0-2V DVM allowing 117 VAC operation.

A. 0-2V DVM with Case \$49.95
B. 5V Power Supply \$14.95

JE700 CLOCK

The JE700 is a low cost digital clock, but is a very high quality unit. The unit features a simulated wall-clock case with dimensions of 6 1/2" x 2 1/2" x 1 1/2". It utilizes a MAM72 high brightness readout, and the MMS314 clock chip.

115 VAC \$19.95

Liquid Crystal Temperature Display

Six Digit Light Emitting Diode Display

This clock makes an attractive addition to any desk. It has an extruded, black anodized aluminum case. It displays hours, minutes, and seconds with .11 inch displays, and comes complete with a liquid crystal thermometer. It operates off 115 VAC at 50 or 60 Hz. **\$24.95**

KIT - ALL COMPONENTS & CASE \$34.95 WIRED & ASSEMBLED \$39

HP7730
 .33 in. high red very bright 25mA per seg. Common anode. **\$1.20**

DL727
 One of our best readouts 5 in. high, 20mA per segment. Common anode. **\$3.75**

**FND807 ANODE
 FND 800 CATHODE**

8 in. High. The Best on the market. Ideal for large readout application. **\$4.95**

25 in high orange digit. 160v dc. Free socket. **\$2.50**

FND503
 \$1.60
 5/\$7.50

TI
 Fully multiplexed common cathode. Goldplated. Idea for mini 6 digit clock. **\$1.30**

LEDS
 Mini red 12
 Jumbo red 15
 Jumbo green 20
 Jumbo yellow 25

BURROUGHS 12 DIGIT
\$4.95

DL33
 If you like an array of displays, we have it. Common cathode. **\$1.45**

4 & 6 DIGIT PC BOARDS

PC Board for 4 digit display FND 800 or 807	\$2.75
PC Board for 6 digit display FND 800 or 807	\$3.50
PC Board for 4 digit display MAN series or DL707	\$1.75
PC Board for 6 digit display MAN series or DL707	\$2.25
PC Board for 4 digit display FND503	\$2.00
PC Board for 6 digit display FND503	\$3.00
PC Board for 4 digit display DL747	\$2.50
PC Board for 6 digit display DL747	\$3.00
PC Board for 4 digit display DL727	\$2.25
PC Board for 6 digit display DL727	\$3.00
PC Board for 4 digit display FND70	\$1.75

All PC display boards are multiplexed for adding additional digits.



SAVE! 4-DIGIT ALARM CLOCK

KIT NO. 1 \$13.95
 (with PC Board)

FEATURES:
 Direct drive display outputs, * Current control regulation-on chip, * Low power brightness control-on chip, * RFI eliminating slowup circuitry, * Sleep Radio feature, * 24 hr. snooze alarm, * Independent digit setting, * Non multiplexed output circuitry 12VAC CT 1/2 amp transformer for Kit No. 1 **\$2.00**

***KIT NO. 2**
 Complete kit with components, PC Board, Transformer, wood grain case and filter for display window. Includes .25 in. readouts. **\$21.50**

KIT NO. 3
 Complete kit with components, PC Board, Transformer, wood grain case, and filter for display window. Includes 5 inch readouts. **\$22.50**

* Components for Kit No. 2 or Kit No. 3 sleep radio feature, add \$.95



LSI INTEGRATION

MM5316 4-6 digit alarm clock 40 pin dip w/spec.	\$ 4.25
7002 4 digit counter/latch decoder; 7 segment and BCD outputs. 28 pin dip w/spec.	\$12.50
7005 4 digit counter/latch decoder; 7 segment output only. 24 pin dip w/spec.	\$ 9.50
7007 4 digit counter/latch decoder with BCD output only. 16 pin dip w/spec.	\$ 7.00
70250 4-6 digit alarm clock 28 pin dip w/spec.	\$ 5.50
PC Board for 70250	\$ 4.25
70380 4 digit non-multiplexed radio alarm clock featuring direct drive display output 40 pin dip w/spec.	\$3.50
PC Board for 70380	\$ 3.75
8008 8 bit parallel CPU	\$19.50
2102 1K static RAM for 8008	\$ 2.25
MM5203 2K UV erasable PROM	\$12.25
75491 segment driver	\$ 0.35
75492 digit driver	\$ 0.45
7020 6 function calculator chip with direct segment drive. 8 digit	\$ 2.25

GE TRANSISTOR ASSORTMENT
 T098 cased Darling, SCR's, NPN, PNP, ect.

50 for \$0.95
 100 for \$1.75
 300 for \$5.00

TTL BOARDS

MEMDREX computer boards with TTL's Diodes and Transistors, etc.

5 Boards containing 150-250 IC's **\$3.95**

GOT A CASE? HERE'S THE CURE!

Ideal for Frequency counter case function generator, etc. Overall height 4", length 12", width 7 1/2".

(Includes top, bottom, and hardware.)



\$5.95

MASTER II

LIGHTS MUSIC 60 WATT COLOR ORGAN

Completely self contained unit with 120 volt power cord included. **\$1.50**

ALTAJ ELECTRONICS
 P.O. 80X 38544R Dallas, Texas 75238
 TERMS: Check or money order. No COD
 Telephone (214) 278-3561
 Texas Residents Add 5%

THE KING OF ALTAJ INTRODUCING: TANYA
 (60 Hz. Crystal Time Base)

ADDITIONAL FEATURES:
 1.) Low Power Consumption
 2.) Directly Interfaces with King MOS Clock Chip.
 3.) 60 Hz output with crystal time base accuracy
 4.) Ideal for Cars, Boats, & Campers.



Kit includes All Components, P.C. Board, and Instructions for Interfacing with "THE KING" 6-Digit Alarm Clock.

DELILA APPLIANCE STARTER \$9.95

(Example) Set your alarm for 7: a.m., set timer for 15 min. At exactly 7 a.m., the appliance will start; at 7:15 your clock alarm will wake you.

Kit includes all components, PC Board and instructions for interfacing with THE KING 6-digit alarm clock. Addition Number 2

FATIMA 4-DIGIT TEMP. KIT \$19.95

Features 4-digit temperature display; fahrenheit or centigrade; complete C-Mos application; uses 7002 4-digit counter.

Kit includes all components, PC Board and instructions for interfacing with THE KING 6-digit alarm clock. Addition Number 1

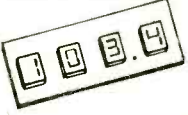

THE KING \$23.50 6-DIGIT ALARM CLOCK

THE KING FEATURES:

- 6 digit, 12 hr. 60 cycle or 24 hr. 50 cycle alarm clock.
- Time sharing capability for display of additional information
- Single 12v. supply and a minimum of interface components.
- AM-PM and automatic power fail indications.
- 10 minute snooze
- Intensity control of LEDs.

Kit No. 70250 1R (Red readouts)
 Kit No. 70250 1G (Green readouts)
 Kit No. 70250 1Y (Yellow readouts)
 Kit No. 70250 2R (DL727 readouts) **\$28.50**
 Kit No. 70250 3R (FND807 readouts) **\$29.50**

All kits include components, PC Boards; Transformer, case, and construction manual.

TTL

7400 -21	7447 .94	74151 -.80
7402 -21	7448 .94	74153 .94
7404 -21	7453 .21	74154 -1.00
7406 -29	7473 .42	74161 1.04
7408 -21	7474 .42	74163 1.24
7410 -21	7476 .70	74164 -1.94
7413 -54	7478 .44	74165 -1.54
7420 -21	7483 .90	74174 -1.34
7427 -29	7490 .74	74175 1.44
7430 -21	7492 .80	74181 -2.80
7437 -44	7493 .80	74192 1.30
7438 -39	7495 .80	74193 -1.30
7440 -21	7496 .80	74195 .84
7442 -.74	74121 .43	74197 .84
	74123 .80	

CMOS

4000 .24	4018 -1.49	4035 1.39
4001 -24	4019 -.59	4037 4.50
4002 .24	4020 -1.59	4040 -1.59
4006 1.49	4021 -1.49	4041 -.89
4007 -24	4022 -1.19	4042 -.79
4008 -1.15	4023 -.24	4043 -.80
4009 .59	4024 -.99	4044 -.59
4010 -.55	4025 -.24	4047 -.59
4011 -24	4026 -1.49	4049 -.59
4012 -.24	4027 -.59	4050 -.59
4013 -.59	4028 -.99	4065 -.99
4014 -1.49	4029 -1.39	4077 -.39
4015 -1.19	4030 .49	74C92 .29
4016 .59	4032 -.24	74C04 -.29
4017 -1.29	4033 -1.49	74C107 -1.29
	4034 -3.25	

CONTINENTAL SPECIALTIES

THE ONE SOURCE FOR EVERYTHING NEW IN BREAD BOARDING



CSC 100



Proto Board

\$29.95

CSC 101

Write for our FREE Brochure

LINEARS

555 Timer Mini dip	0.65
8038 Functional generator	4.25
RCA 3043 FM IF, Aud Preamp	1.20
565 Phase Lock Loop	1.95
567V Tone Decoder	1.50
LM723 Pos. Volt. Reg.	0.55
LM309 5v. Lamp Reg	1.10
LM380 2w. Audio Amp. 8 pin dip	1.00
LM741 Operational Amp.	0.25

TRANSISTORS-DIODES

RCA200V 115W T05 NPN	1.25
GE D40C1 NPN Darl	0.25
2N4443SCR 400-8A T0220	0.65
2N2222 NPN Gen Ampl.	0.20
2N3904 NPN Driver	0.15
2N3906 PNP Comp. 2N3904	0.15
2N4400 NPN Low level noise	0.20
2N5401 PNP Nixie driver	0.25
1N4004 400PIV	15 for 1.00
1N4007 4000PIV	10 for 1.00
1N746 3.3 Zen	4 for 1.00
1N4148 Switch	20 for 1.00

LOOK!

From Altaj to you, a special offer.

Power Supply Kit: 5 Volt 1 Amp. Reg.
 Line regulation .005%
 Load regulation 50mV

Kit includes Components, PC Board, Transf., Fuse, Pilot Light
 Nothing else to buy: **\$5.50**

MSI

Wise move



MODULAR SCIENTIFIC INSTRUMENTATION

Now you can build some of the most advanced digital electronic instruments with our new series of low-cost modular scientific kits. These kits will expand the range of your electronic applications enormously—and all at a surprisingly low cost.

The heart of the system is our 4-digit Decade Counter (Kit 012) which features a full 4 digit LED readout (you choose the size best suited to your application). Combine this with a 5-volt regulated power supply (Kit 030) and you have the basis of a wide range of sophisticated electronic instruments, including:

- A Digital Voltmeter (DVM) ... Kit 012 + Kit 030 + Kit 017
- Frequency Counter..... Kit 012 + Kit 030 + Kit 016 + Time Base
- RPM Counter..... Kit 012 + Kit 030 + Kit 020 + Kit 018

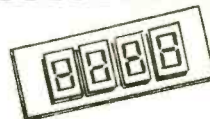

4-DIGIT DECADE COUNTER KIT

\$19.95
KIT 012

One chip 4 digit decade counter kit, with both 7 segment and BCD output.

1. Chip features internal oscillator for scanning speed.
2. Overflow and count extent outputs.
3. Transfer, reset, count, blanking and true compliment control inputs.
4. PC Boards can be cascaded to 8-12 16, etc. digits.
5. Kit includes counter chip, drive circuit for 4 cathode type displays and PC Board. (For readout board see (FND70-FND503)

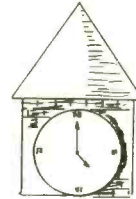

TIME BASES

1 Mhz crystal chain time base divider. Outputs; 1Mhz-100Khz-10Khz-1Khz-100Hz-10Hz-1Hz-0.1Hz. Accuracy better than .005% with proper adjustment.

Kit 013 complete CMOs with PC board \$15.75
Buffer Circuit for TTL Interfacing

Kit 014 Same as Kit 013, but with TTL..... \$13.75

Kit 015 50Hz or 60Hz chain time base using line frequency as reference. Accuracy 0.1-0.05%. Outputs 10Hz-1Hz-0.1Hz. Complete with CMOs shaping circuit and PC Board..... \$9.75

Kit 019 Same as Kit 015, but with TTL and 60Hz only..... \$7.75

Kit 018 60Hz chain time base using line frequency for Kit 020 RPM counter.

*Outputs: .6 sec. = 100th of RPM
6 sec. = 10th of RPM
60 sec. = full revolution
\$9.75

KIT 016 FREQ. COUNTER

Features FET input front end with trigger circuit for measuring complex waveforms. Measures from 0.1Hz to 10MHz when used with Kit 015 or 019. Measures from .01Hz to 35MHz when used with Kit 013 and 014. **\$24.50**

KIT 017 DVM

1.999V as basic, with polarity indication. 1 M ohm input impedance and accuracy to 1% if properly adjusted. **\$13.50**

KIT 020 RPM COUNTER

Counts from 1 to 100,000 RPM. RPM counter kit contains components and PC board. **\$8.95**

KIT 030 POWER SUPPLY

*Input voltage: 25V max. *Output current: 1 amp max. *Load regulation: 50mV. *Output voltage: 5V. *Line regulation: .01%. (requires 8-20V transformer) **\$4.55**

(Contains all parts except transformer)

ALTAJ ELECTRONICS

P.O. BOX 38544R, Dallas, Texas 75238

TERMS: Check or money order. No COD.
Telephone (214) 278-3561
Texas Residents Add 5%

MSI CLUB

Send for your membership card to the Modular Scientific Instrumentation Club and receive a big 10% off on future purchases of M.S.I. kits. Send \$3.00 with your name and address. We will promptly send your very own registered membership card. Don't miss out on the savings. Write now.

Memberships valid for one year from date of registration.

NEW MANAGEMENT!

- * Free Postage
- * No Minimum Order
- * 48 Hour Service
- * 24 Hour Phone Service



WE ARE EAGER TO SERVE YOU!

Circle 101 on reader service card

P.O. Box 4430E Santa Clara, CA 95054

TERMS: \$5.00 min. order U.S. funds
Calif. residents add 6% tax.

FREE: Send for your copy of
our 1976 QUEST CATALOG.

Include
\$.13¢ stamp.

Same day shipment

First line parts only. Factory tested. Guaranteed money back. Quality IC's and other components at factory prices.

INTEGRATED CIRCUITS

7400 TTL	SN74LS00N	1 10
SN7400N	17 SN74LS05N	1 89
SN7404N	19 SN74LS107N	52
SN7408N	23 SN74LS132N	1 50
SN7410N	17 SN74LS151N	1 28
SN7416N	39 SN74LS157N	1 40
SN7420N	37 SN74LS160N	2 05
SN7430N	17 SN74LS175N	2 85
SN7438N	37 SN74LS192N	2 60
SN7440N	17 SN74LS197N	2 00
SN7447N	78 SN74LS259N	2 20
SN7450N	17 SN74LS290N	2 00
SN7473N	36 SN74LS670N	3 50
SN7474N	39	
SN7475N		
SN7489N		
SN7490N		
SN7492N		
SN74107N		
SN74121N		
SN74123N		
SN74145N		
SN74150N		
SN74154N		
SN74157N		
SN74161N		
SN74174N		
SN74175N		
SN74181N		
SN74190N		
SN74192N		
SN74251N		
SN74259N		
SN74500N		
SN74504N		
SN74508N		
SN74510N		
SN74520N		
SN74538N		
SN74547N		
SN74574N		
SN74590N		
SN74592N		
SN74594N		
SN74595N		

DISPLAY LEADS

NE556A	1 00	MAN1	CA	270	1 80
NE567	1 85	MAN3	CC	125	30
NE567V	1 75	MAN4	CC	187	1 95
SN754500CN	47	MAN7	CA	300	1 35
SN754510CN	39	MAN7Z	CA	300	1 35
SN754520CN	39	MAN7A	CA	300	1 35
SN754530CN	37	DL707	CA	300	1 35
SN754540CN	37	DL727	CA	500	2 55
		DL747	CA	600	2 00
		FND503	CC	500	1 75
		FND510	CA	500	1 75

MOS/MEMORY RAM

CD34001	42	FND503	CC	500	1 75
CD4001	25	FND510	CA	500	1 75
CD4011	25				
CD4012	25				
CD4013	75	2102		2 75	
CD4015	50	2102-1		2 75	
CD4017	2 00	2102-2		2 75	
CD4020	2 30	21L02		2 75	
CD4027	55	2107		18 50	
CD4030	55	2112-2		7 90	
CD4049	82				
CD4050	62	4YS 1013		6 20	
CD4071	40				
CD4072	40				
CD4082	45	8700CN		16 00	
CD4511	2 20				
CD40132	3 00				
1702A	13 00				
NB8203	2 90				
NB82123	2 90				
NB82126	4 85				
NB82295	2 75				
NB180A	2 75				
NB190A	2 75				
8080	4 50				
8080A	39 50				

MICRO-PROCESSOR

8080 4.50
8080A 39.50



DELTA ELECTRONICS CO.

P.O. BOX 2, AMESBURY, MASS. 01913

7400 series TTL PARTS SPECIAL

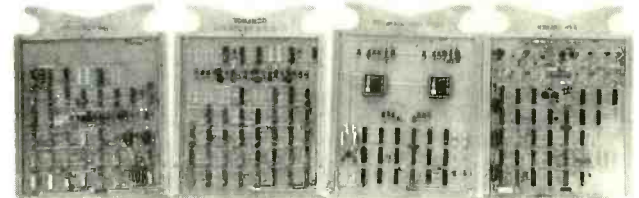

These boards are loaded with 7400 series TTL ICs, which are easily removed for reuse. Shown above is a representative sample of these 7 1/2" x 8" computer boards. We select 2 boards and guarantee at least 60 ICs, but most will have more than 70. These ICs, mostly made by T.I., are gates, counters, flip flops, one-shots, decoders, shift registers, etc. Less than .10 per IC, many of which sell for over \$1.00. Shipping weight 2 lbs./set of 2 boards.

STOCK NO. R5409 2 board set \$5.00, 5 boards/10.00



1 AMP DC PANEL METER

HOYT 0 to 1 amp DC panel meter. Clear plastic case, 2 3/8" x 2 5/8", mounts in 2 1/4" dia. hole. Black scale on white face. 1 lb. **STOCK NO. R5408 \$4.95 ea, 3/14.00**

ELECTRONIC TIMER

A sophisticated timer used to time "Instant Pictures". Range .5 sec. to 2 min., adjustable with potentiometer. Operates from 3 v. source. Time indicated by a small bulb, which could be replaced by a reed relay or SCR to control other equipment. All units tested, with data. **STOCK NO. R6312 \$1.75 each, 4/6.00**

Send for latest free catalog. Minimum order \$5, phone orders welcome: (617) 388-4705. Include sufficient postage; excess will be refunded. BANKAMERICARD & MASTERCARD welcome, ALL numbers needed for processing. Minimum charge \$15.

Liteguard Warning System \$7.95

Won't let you leave your car with the lights on. One year warranty. Save many \$ on dead batteries and costly service calls \$7.95. Two for \$15.00

Not a Cheap Clock \$17.45

Includes everything except case. 2-PC boards, 6-50 LED Displays, 5314 clock chip transformer, all components and full instructions.

IC UPDATE MASTER MANUAL

Complete IC data from all Manufacturers. 14,000 cross references. \$30.00 complete with quarterly update service. For Domestic Air, add \$2.00. Foreign \$6.00.

Miles Per Gallon Circuit

As described Jan. 1976 EDN mag. Digital Flow sensor \$29.50. Speed transducer \$8.00. CMOS rate multipliers \$19.95. 2-50 in. displays \$2.50.

Circle 103 on reader service card

Circle 104 on reader service card

STEP-BY-STEP

(continued from page 100)

you'll see only one hum-bar. Same cause; probably an open filter capacitor in the DC power supply. A related symptom is the "floating bar": a horizontal bar about an inch high, which drifts up or down in the picture. It may be light or dark. This is caused by *insufficient* filtering in the DC power supply. The bar comes from the normal pulse of current drawn by the vertical output stage once each field. It gets back into the DC power supply, if the filters don't have enough capacitance to get rid of it, you'll see it in the picture. Cure: check filter capacitors. If necessary, ADD more capacitance! The orig-

inal design may have been a little short of capacitance to start with.

Other troubles

One problem is actually caused by failure of a part in the DC power supply. However, it fools a lot of us if we forget it! This is the sudden appearance of multiple symptoms; loss of sync or instability; AGC problems, color problems, and so on. What does it is "non-zero impedance to ground" in the filter circuits! One of the electrolytic capacitors has developed high power factor, etc., and isn't doing the job. So, this lets a great many different *signals* show up on the DC power supply lines, and you have the mother and father of all *feedback loops!* Only one tool in the shop will catch

this, and that is the scope. In a normally operating DC power supply, you should see absolutely no signals of any kind on the DC supply lines: scope's vertical gain set high. Whenever you run across multiple-symptom problems, always scope the filter capacitors *first*. If you see any kind of signal, replace them.

Hint: if you find a bad section in a multiple electrolytic, always replace the whole thing. Don't hook a replacement across the bad section. Whatever happened inside the can to make that one section go bad will get the rest very soon, and you'll have a call-back.

To sum up:

The DC power supply is an ideal subject for logical step-by-step test methods. You start out with the primary voltage supply, then check the DC voltage output, then the current drain. You simply walk it out, one step at a time. Follow the Trouble-Free Chart, and checking will be much easier. **R-E**

MDA...

Dedicated to the idea that "No disease is incurable... there are only diseases whose cures are yet to be found." Support the research programs of the **Muscular Dystrophy Association**

Olson ELECTRONIC PARTS AND ACCESSORIES

- TL-477. Soldering Iron 2.99
- VC-274. 12-Pc. Volume Control Kit 49c
- XM-501. 40-Pc. Terminal Strip 79c
- XM-370. 7 Seg. L.E.D. Display 1.29
- TR-446. 25-Pc. Ass'td. SCR 1.49
- SW-555. 90-120 V AC Relay 59c
- SW-156. Ctr.-Off Toggle Switch DPDT. Pkg. 2 2.49
- SW-460. 3 Button Push Switch 29c
- SW-636. Thermostatic Switch 50-600 NO 39c
- SW-752. Unimax 15A Switch SPST 49c
- SW-587. 5A Toggle SPST NO 39c
- SW-431. Phone Type Lever Switch 4 SPST 62c
- SW-632. Reed Switch W/Magnet SPST. Pkg. 10 1.29
- MO-359. 1/30 RPM Timing Motor 120V AC 49c
- TT-092. 2500 OHM Output Transformer 64c
- TF-047. 6 V 1/2 A. Filament Transformer 44c
- TF-050. 12V 2A Filament Transformer 47c
- KN-030. 25-Pcs. Assorted Knobs 49c
- ME-182. 0-1 Ma Panel Meter 1 3/8" Mtg. Hole 89c
- ME-205. 0-200 UA. Panel Meter 1 5/16 x 5/8" 74c

Send to: Olson Electronics, Dept. LN 260 S. Forge St., Akron, Ohio 44327. Allow For Postage. COD 20% Deposit. Residents of the following states please add Sales Tax: Ca. 5%, Fl. 4%, Ga. 3%, Il. 4%, Ky. 5%, Ma. 5%, Mi. 4%, Mo. 3%, N.Y. 4%, Oh. 4%, Pa. 6%, Tx. 4%.

FREE! Please send me Olson catalog CB catalog Both. Print

NAME _____
ADDRESS _____
CITY _____
STATE _____ ZIP _____

QUALITY ELECTRONIC COMPONENTS

NEW DISCOUNT SCHEDULE SAVES YOU EVEN MORE!

AMD 8080A \$34.95 2102 \$1.99

MICROPROCESSOR 1024 Bit Random Access Memory 500 ns Typical, 1000 ns Max Access Time

INTEGRATED CIRCUITS — TTL, CMOS, LINEAR & MOS

7400	21	7473	30	74174	98	4001	23	4073	23
7401	21	7474	30	74175	98	4002	23	4075	23
7402	21	7475	30	74176	79	4006	23		
7403	21	7476	32	74177	79	4007	23	4082	23
7404	21	7480	70	74180	70	4008	79	4502	79
7405	21	7482	70	74181	215	4009	44	4510	114
7406	25	7483	70	74182	79	4010	44		
7407	25	7485	89	74184	219	4011	23	4514	280
7408	21	7486	28	74185	219	4012	23	4515	280
7409	21	7488	219	74188	350	4013	40	4516	123
7410	21	7490	44	74189	350	4014	96	4518	114
7411	21	7491	70	74190	123	4015	96	4520	114
7412	21	7493	44	74191	123	4016	40	4522	146
7413	25	7493	44	74192	88	4017	105	4528	88
7414	89	7494	70	74193	88	4018	105	4585	123
7415	25	7495	70	74194	88	4019	88	4590	123
7417	25	7496	70	74195	88	4020	114	LM324N	128
7420	21	74100	128	74196	88	4021	114	LM3401-5	125
7421	25	74107	30	74197	88	4022	96	LM3401-6	125
7423	35	74109	43	74198	149	4023	88	LM3401-8	125
7425	35	74121	35	74199	149	4024	84	LM3401-12	125
7426	25	74122	44	74201	109	4025	23	LM3401-15	125
7427	35	74123	61	74202	58	4026	123	LM3401-18	125
7428	28	74125	40	74365	67	4027	40	LM3401-24	125
7430	21	74126	40	74366	67	4028	89	LM3900N	88
7432	25	74132	70	74367	67	4029	14	MS361	324
7433	30	74133	88	74368	67	4030	23	MS401	104
7437	25	74145	70	75150	131	4033	151	NESS5V	48
7438	25	74147	163	75450	88	4034	350	NESS5A	88
7440	71	74148	130	75451	61	4035	14	NESS5B	383
7441	88	74150	116	75452	61	4040	114	NESS1B	383
7442	53	74151	70	75453	61	4041	79	NESS2B	383
7443	63	74153	65	75454	61	4042	79	NESS5A	125
7444	63	74154	103	75491	88	4043	70	NESS4V	128
7445	70	74155	70	75492	84	4044	70	NESS7V	128
7446	70	74156	70	75493	109			uA709CV	44
7447	70	74157	70	75494	119	4049	40	uA710CA	44
7448	70	74160	88	8093	40	4050	40	uA711CA	44
7450	21	74161	88	8094	40	4051	26	uA723CA	60
7453	21	74162	88	8095	67	4052	126	uA741CV	44
7454	21	74163	88	8096	67	4053	126	uA742CV	44
7460	21	74164	88	8097	67	4060	158	uA748CV	49
7470	30	74166	126	8098	67	4066	79	MC1458B	53
7472	30	74170	244	82525	219	4031	23	2102	265
		74175	162	4000	23	4072	23	8080A	49.55

AP SUPER STRIP II—Universal Breadboarding

Element with 840 Solderless Plug-In Tie-Points

\$17.00

IC TEST CLIPS

- 14 pin TC-14 \$4.50
- 16 pin TC-16 \$4.75
- 24 pin TC-24 \$13.85
- TC-16
- TC-24

In a hurry? Try these high-performance All-Circuit Evaluators

obsoletes ordinary breadboards

All solderless plug-in tie-points

7 models for fast building and testing of circuits

On all models... simply plug in your components and interconnect with 22-ga. solid wire. All models accept all DIP's, TO-18's and discrete with leads up to .032" diameter.

Multiple buses can easily be linked for power and ground distribution, reset and clock lines, shift command, etc. Buses: gold-anodized aluminum. Terminals: non-corrosive nickel-silver. Four rubber feet included.

ACE Model No.	Tie Points	DIP No. No.	Capacity Buses Posts	Board Size (Inches)	Price Each
200-K (kit)	728	8 (16's)	2	4-9/16x5-9/16	\$18.95
208 (assem.)	872	8 (16's)	2	4-9/16x5-9/16	\$28.95
203-C (kit)	12 (14's)	2	2	4-9/16x7	\$24.95
212 (assem.)	1224	12 (14's)	8	4-9/16x7	\$49.95
215 (assem.)	1760	18 (14's)	10	6-1/2x7-1/8	\$69.95
227 (assem.)	2712	27 (14's)	28	8-9/16x14	\$99.95
228 (assem.)	3648	36 (14's)	36	10-1/4x14-1/4	\$79.95

BISHOP GRAPHICS Printed Circuit Drafting

Aids are now available from Dig-Key

DATA BOOKS

- TTL IC's - 592 pages \$4.00
- INTERFACE IC's - 464 pages \$4.00
- LINEAR IC's - 704 pages \$4.00
- VOLTAGE REGULATORS - 128 pages \$3.00
- CMOS IC's - 256 pages \$3.00
- LINEAR APPLICATIONS - 432 pages \$4.00
- TRANSISTORS - 288 pages \$3.00
- MEMORY IC's - 592 pages \$3.00

SILICON TRANSISTORS

MPS518, MPS930, MPS222A, MPS2369A, MPS2712, MPS2907A, MPS3392, MPS3393, MPS3394, MPS3395, MPS3365, MPS3638, MPS368A, MPS368B, MPS3641, MPS3642, MPS3645, MPS3646, 2N3904, 2N3906, 2N4124, 2N4126, 2N4128, 2N4130, 2N4132, 2N4134, 2N4136, 2N5087, 2N5089, 2N5129, 2N5133, 2N5134, 2N5137, 2N5138, 2N5139, 2N5210, 2N5964, 16, 51, 55/10, 513, 60/100 of some part no.

MPP102. 36 \$30.60/C 2N5457 48 \$41.00/C MPA513 28 \$24.00/C 2N3055 99 \$85.00/C

ELECTROLYTIC CAPACITORS

Radial Lead	Axial Lead	Axial Lead			
1uf/50v	.08 65/10	1uf/50v	.11 90/10	47uf/25v	.17 130/10
2.2uf/50v	.08 65/10	2.2uf/50v	.12 90/10	100uf/16v	.17 130/10
3.3uf/50v	.08 65/10	3.3uf/25v	.12 95/10	100uf/10v	.20 155/10
4.7uf/25v	.08 65/10	3.3uf/50v	.12 100/10	100uf/50v	.29 230/10
4.7uf/50v	.08 70/10	4.7uf/25v	.11 90/10	220uf/16v	.20 155/10
10uf/25v	.08 65/10	4.7uf/50v	.12 95/10	220uf/25v	.29 230/10
10uf/50v	.10 75/10	10uf/25v	.11 100/10	330uf/16v	.29 230/10
22uf/25v	.09 70/10	10uf/50v	.12 100/10	330uf/25v	.32 255/10
22uf/50v	.12 100/10	10uf/50v	.14 115/10	470uf/16v	.32 255/10
100uf/16v	.09 75/10	22uf/25v	.12 100/10	470uf/25v	.37 300/10
100uf/50v	.11 85/10	22uf/50v	.13 105/10	1000uf/16v	.39 315/10
1000uf/25v	.13 110/10	33uf/25v	.12 100/10	1000uf/25v	.56 450/10
		33uf/50v	.14 115/10	2200uf/16v	.62 495/10
		47uf/16v	.14 115/10		

DISC CAPS

100pf/500v	.04 36/10	1N5226B	3.3v 15 511/C	1N5226B	7.5v 15 511/C
220pf/500v	.04 36/10	1N5227B	4.7v 15 511/C	1N5227B	8.7v 15 511/C
470pf/500v	.04 36/10	1N5228B	3.9v 15 511/C	1N5228B	8.7v 15 511/C
1000pf/500v	.04 37/10	1N5229B	4.3v 15 511/C	1N5229B	9.1v 15 511/C
2200pf/500v	.04 37/10	1N5230B	4.7v 15 511/C	1N5230B	11v 15 511/C
4700pf/500v	.04 32/10	1N5231B	5.1v 15 511/C	1N5241B	11v 15 511/C
10uf/500v	.06 31/10	1N5232B	5.6v 15 511/C	1N5242B	12v 15 511/C
01uf/500v	.03 24/10	1N5233B	6.0v 15 511/C	1N5243B	13v 15 511/C
02uf/25v	.03 28/10	1N5234B	6.2v 24 111/C	1N5244B	14v 15 511/C
047uf/25v	.05 42/10	1N5235V	6.8v 15 511/C	1N5245B	15v 15 511/C
1uf/25v	.08 62/10				

1/4 WATT ZENER DIODES

CMOS DATABOOK \$1.50

Specifications and pin-outs for 80 different 4000 series parts

REED RELAYS

1.5 Amp SPST N.O. Contacts

4.8v Coil	\$1.70	\$125/C
6.0v Coil	\$1.70	\$125/C
12v Coil	\$1.70	\$125/C
24v Coil	\$1.70	\$125/C

I.C. SOCKETS

8 Pin Solder Tab	17
14 Pin Solder Tab	20
16 Pin Solder Tab	22
18 Pin Solder Tab	29
24 Pin Solder Tab	38
28 Pin Solder Tab	45
40 Pin Solder Tab	63
8 Pin Wire-Wrap	24
14 Pin Wire-Wrap	26
16 Pin Wire-Wrap	30
18 Pin Wire-Wrap	60
24 Pin Wire-Wrap	86
28 Pin Wire-Wrap	123
40 Pin Wire-Wrap	100

RESISTOR ASSORTMENTS

5 ea. all 10% 1/4 W. Val. from 2.2 to 22 meg (425 pcs) \$12.00

5 ea. all 10% 1/2 W. Val. from 10 to 5.6 meg (150 pcs) \$12.00

SILICON DIODES

1N4148	40/10	3.50/C	1N4000A	70/10	5.95/C
1N4001	64/10	5.50/C	1N4005	82/10	7.05/C
1N4002	66/10	5.50/C	1N4006	90/10	7.75/C
1N4003	66/10	5.80/C	1N4007	99/10	8.60/C

VOLUME DISCOUNT SCHEDULE

Merchandise Total	Discount	Merchandise Total	Discount
\$ 0.00-5 9.99	NET	\$ 100.00-599.99	LESS 15%
\$ 10.00-24 9.99	LESS 5%	\$ 500.00-999.99	LESS 20%
\$ 25.00-99 9.99	LESS 10%	\$ 1000.00 & up	LESS 25%

— Then Add the Standard Charge Below

STANDARD SHIPPING/HANDLING CHARGE

If your merchandise total after discount is between:

\$ 0.00-4 9.99	add \$2.00	\$ 50.00-99 9.99	add \$0.25
\$ 5.00-24 9.99	add \$0.75	\$ 100.00 & up	No Charge
\$ 25.00-99 9.99	add \$0.50		

Includes shipping & insurance to USA & Canada

COB ORDERS ACCEPTED FOR SAME DAY SHIPMENT—CALL 218-681-6674

HARDWARE

2-56 1/4 Screw	99/C 7.20/M
2-56 1/2 Screw	99/C 7.65/M
4-40 1/2 Screw	55/C 3.60/M
4-40 3/4 Screw	60/C 4.05/M
6-32 1/4 Screw	65/C 4.40/M
6-32 1/2 Screw	75/C 4.85/M
8-32 3/8 Screw	90/C 5.85/M
2-56 Hex Nut	55/C 3.60/M
4-40 Hex Nut	55/C 3.75/M
6-32 Hex Nut	60/C 4.00/M
8-32 Hex Nut	60/C 4.15/M
No. 2 Lockwasher	85/C 5.75/M
No. 4 Lockwasher	45/C 3.00/M
No. 6 Lockwasher	45/C 3.00/M
No. 8 Lockwasher	45/C 3.00/M

Send for free catalog or mail orders service card.

"Only Quality Components Sold!"

DIGI-KEY CORPORATION

Thief River Falls, MN 56701

RADIO-ELECTRONICS

VIDEO GAME KIT

FIVE GAMES TO PLAY

A CHALLENGE TO BUILD, A CHALLENGE TO PLAY.

This is a unit featuring a true "state of the art" design. It is something you will be proud to show your friends.

With a basic knowledge of electronic circuitry, this kit can be assembled and playing in just a few hours. If you have trouble, test facilities are available at nominal cost to remedy the problem.

FEATURES

- 1 Unique curve button adds extra thrill and skill to game.
- 2 Disappearing score - allows full vision of playing field when ball is in action.
- 3 16 different angles of deflection for the ball compared to 3 with most competitive designs.
- 4 Fast action paddles.
- 5 Commercial quality design.

PRICES FOR THE UNITS ARE:

VK-1	PC board only Includes parts list & wiring diagram.	25.00 net
VK-2	PC board with parts Includes PC board, 78 IC's (those necessary are pre-programmed), resistors & capacitors to stuff the board.	125.00 net
VK-3	Hardware, wire, controls, switches Does not include housing or case.	17.50 net
VK-4	RF Module To convert video signal to TV receiver signal eliminates internal "wire in" on TV set. This unit can be used with other manufactured or kit type video games.	22.50 net
VK-5	Power Supply Kit	12.50 net
	Trouble shoot & Test Buyer assembled set	25.00 net
	Preassemble & Test	75.00 plus components

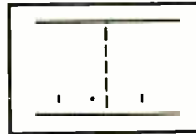

GAME 1

Let's start with a Tennis "MATCH". Fun for all, particularly beginners. This is the game that started the craze.

Scores to 12 points

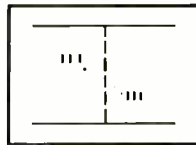

GAME 2

Then go to the "PRO MATCH". You'll need 3 paddles to return the ball on this one, almost as fast as a Hockey Puck. A challenge for the 2 players this is designed for.

Scores to 12 points.



GAME 3

Now to deflate the ego's of the "Pros" put them to a "GRAVITY MATCH". A bouncing ball adds more fun and excitement plus it plays havoc with the skill of the 2 players.

Scores to 12 points.

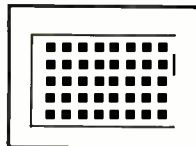

GAME 4

WIPE OUT I

A game for a single player. Test your reflexes and see how many squares you can knock out. As your score increases so does the speed of the ball.

Top Score is 2400 points in 6 tries.

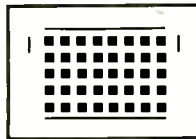

GAME 5

WIPE OUT II

If you can't beat the machine by yourself, get someone to help you. Together you can (that is it is possible to) score 2800 points in 6 tries.

All games have sound.

C-MOS

34001	FSC Quad 2-Input NOR Gate	1.00
4000	Dual 3-Input NOR Gate/Invert	3/1.00
4001	Quad 2-Input NOR Gate	3/1.00
4002	Dual 4-Input NOR Gate	3/1.00
4006	18-bit St. Shift Register	1.50
4007	Dual Comp Pair + Inverter	1.25
4008	4-bit Full Adder	1.25
4009	Hex Buffer/Inverter	2/1.50
4010	Hex Buffer/Converter	2/1.50
4011	Quad 2-Input NAND Gate	3/1.00
4012	Dual 4-Input NAND Gate	3/1.00
4013	Dual Type D FlipFlop	2/1.00
4014	8-bit St. Shift Register	1.25
4015	Dual 4-bit Static Shift Reg	1.25
4016	Quad Analog SW/Quad Multi	1.00
4017	Decade Counter/Divider	1.25
4018	Divide by N Counter	1.25
4019	Quad AND-OR select gate	1.50
4020	14-bit Binary Counter	1.40
4021	8-bit St. Shift Register	1.50
4022	Octal Counter/Divider	1.25
4023	Triple 3-Input NAND Gate	3/1.00
4024	7 Stage Ripple Counter	1.00
4025	Triple 3-Input NOR Gate	3/1.00
4027	Dual J-K FlipFlop	2/1.25
4028	BCD to Decimal Bi. Octal Dec	1.25
4029	4-bit BIN/BCD UP/DN CTR	1.90
4030	Quad Exclusive OR Gate	2/1.25
4032	Triple Serial Adder (pos.)	1.50
4033	Decade counter/divider	2.00
4035	4-bit Parallel IN&OUT Shift Reg.	1.45
4040	12-Binary Counter	1.50
4041	OD True/Comp Buffer	1.45
4042	Quad Latch	1.00
4043	Quad 3-state NOR R/S latch	1.50
4044	Quad 3-state NAND R/S latch	1.25
4049	Hex Inverter/Buffer	1.00
4050	Hex Non Inverting Buffer	1.00
4051	8 Input Analog Multi	1.50
4052	Diff 4 Input Analog Mk.	1.50
4053	Triple 2 channel Mltplx.	1.50
4066	Quad Bilateral Sw.	1.00
4068	8 Input NAND	2/1.00
4069	Hex Inverter	1.00
4070	Quad Exclusive OR	1.00
4071	Quad 2 Input OR Gate	1.00
4077	Quad Exclusive OR	1.00
4081	Quad 2 Input AND Gate	1.00
4402		1.00
4403		1.00
4404		1.00
4412		1.00
4416		2.00
4426		2.00
4508		2.60
4510		1.75
4511	BCD TO 7 Seg. Latch/DEC	2.00
4512	8 Input Multiplexer	1.50
4518	Dual 4 Bit Decade Counter	1.50
4520	Dual 4 Bit Binary Counter	1.65
4528	Dual One Shot	1.50

LINEAR IC's

308K	5-V Reg	1.25
310H	V Fol	1.95
310 M	F o l	2.25
311H	V Comp	1.25
311M	V Comp	1.25
311N	V Comp	1.50
312H	Op Amp	2.00
318H	HI Per Op Amp	2.00
320T-5V	Neg Reg	1.75
320T-6V	Neg Reg	1.75
320T-8V	Neg Reg	1.75
320T-12V	Neg Reg	1.75
320-15V	Neg Reg	1.75
320T-18V	Neg Reg	1.75
324N	Quad Op Amp	2.50
339N	Lo V Quad Comp	1.50
340T-5V	Pos Reg	1.75
340-8V	Pos Reg	1.75
340T-12V	Pos Reg	1.75
340T-15V	Pos Reg	1.75
340T-18V	Pos Reg	1.75
370N	AGC/Sig Amp	1.75
373N	AM/FM IF Dat	2.00
380M	Audio Amp	1.00
380N	Audio Amp	1.00
381N	Dual Pre Amp	1.50
531H	Op Amp	2.00
555M	Timer	2/1.25
556N	Dual Timer	1.35
565M		2.00
567M	Tone Decoder	2.50
702H	Linear	1.50
703H	RF/IF Amp	1.50
709H	Op Amp	1.25
709N	Op Amp	2/1.25
710H	V Comp	1.00
711H	Dual Comp	1.00
711N	Dual Comp	1.00
723H	V Reg	2/1.25
723 N	Reg	2/1.25
725H	Ins Op Amp	3.75
733H	Dif Vid Amp	1.00
733N	Dif Vid Amp	1.00
739N	Dual Aud Pre Amp	1.00
740H	FET Op Amp	7.00
741H	Op Amp	2/1.00
741M	Op Amp	2/1.00
747H	Dual Op Amp	1.00
747N	Dual Op Amp	1.00
748H	Op Amp	3/1.25
748M	Op Amp	3/1.25
749N	Dual Aud Pre Amp	1.50
760N	Dif V Comp	3.00
761N	Gain Cont IF Amp	2.00
909H	Buffer	3.00
1458M	Dual Op Amp	2/1.15
2900N	Quad Amp	1.00
3069N	TV Snd Sys	2/1.50
3900N	Quad Amp	2.00
4136N	Quad 741	2.00
4558M	Dual 741	1.00

TTL IC's

Low Power	
74L00	3/1.25
74L02	3/1.25
74L03	2/1.00
74L04	3/1.25
74L10	3/1.25
74L20	3/1.25
74L30	3/1.25
74L42A	2.25
74L51	3/1.25
74L54	3/1.25
74L55	3/1.25
74L71	2/1.25
74L73	2/1.00
74L75	2/1.25
74L86	2/1.35
74L90	1.50
74L93	1.50
74L95	1.50
74L98	4.50
74L122	1.00
74L123	1.00
74L154	2.00
74L157	1.75
74L154	2.00
74L191	2.00
74L192	2.50
74L193	2.50

IC Sockets

	Low Pro	Standard	Wire Wrap
10	—	4/1.00	—
14	4/1.00	4/1.25	3/1.00
16	4/1.25	3/1.00	3/1.25
24	3/1.00	3/1.25	2/1.25
28	—	3/1.25	2/1.25

POTENTIOMETER ASSORTMENT

10	(each different)	1.00
MC1303L Dual Stereo PreAmp 1.00		

DIODES

1N4148 Switching Diode 20/1.00 100/4.00

Zeners

400MW 5%

1N746A	3.3V	7/1.00	100/11.00
1N747A	3.6V	7/1.00	100/11.00
1N748A	3.9V	7/1.00	100/11.00
1N749A	4.3V	7/1.00	100/11.00
1N750A	4.7V	7/1.00	100/11.00
1N751A	5.1V	6/1.00	100/13.00
1N752A	5.6V	6/1.00	100/13.00
1N753A	6.2V	6/1.00	100/13.00
1N754A	6.8V	6/1.00	100/13.00
1N755A	7.5V	6/1.00	100/13.00
1N756A	8.2V	5/1.00	100/15.00
1N757A	9.1V	5/1.00	100/15.00
1N758A	10V	5/1.00	100/15.00
1N759A	12V	5/1.00	100/15.00

1N4728-57 Series

1 Watt 5% Zeners				
5/1.00 or 100/15.00				
Any 1 Voltage Listed Below				
3.3V	5.6V	10V	18V	33V
3.6V	6.2V	11V	20V	36V
3.9V	6.8V	12V	22V	39V
4.3V	7.5V	13V	24V	43V
4.7V	8.2V	15V	27V	47V
5.1V	9.1V	16V	30V	51V

RESISTORS

1/4W 5% 100/\$1.95

Asst. 1	
10 each of 10, 18, 20, 36, 75, 180, 360, 2.4K, 3.3K and 18K Ohm Values.	
Asst. 2	
10 each of 5.6, 18, 27, 180, 200, 270, 360, 10K, 470K and 8.2M Ohm Values.	
Asst. 3	
10 each of 10, 18, 51, 180, 360, 1.8K, 3.3K, 18K, 470K, and 1.8M Ohm Values.	
Asst. 4	
10 each of 11, 20, 30, 75, 240, 360, 820, 1.1K, 3.3K, and 120K Ohm Values.	
Asst. 5	
10 each of 10, 18, 75, 150, 180, 270, 330, 910, 4.7K, and 470K Ohm Values.	
Asst. 6	
10 each of 13, 24, 27, 33, 39, 43, 56, 62, 75, 160, and 200 Ohm Values.	
Asst. 7	
10 each of 240, 300, 510, 1.3K, 1.6K, 3.0K, 3.9K, 59K, 560K, and 8.2M Ohm Values.	

TERMS:

10% Discount over \$50 - Parts Only
\$1 Minimum per line item
Add \$1 for postage & Insurance

Top Quality Products
at these low, low prices.



JADE Co
P.O. Box 4246 -Torrance, Ca. 90510
Telephone 213-320-1250



Give us your name & address. We will send our catalogue.

TERMS:

California Residents add 6% Sales Tax
BoFA & M.C. accepted on orders over \$20
C.O.D.'s accepted

Satisfaction Guaranteed
or your Money Refunded.

**ALL MERCHANDISE IS
COMMERCIAL QUALITY, FULLY
TESTED AND MARKED**
(No barrel stock except as noted)

**7400N TTL
SN7400N SERIES**

7400	.23	7427	.35	7486	.47	74157	1.35
7401	.23	7430	.24	7490	.75	74163	1.60
7402	.25	7432	.47	7493	.85	74163	1.50
7404	.25	7437	.47	74107	.46	74164	1.79
7405	.27	7438	.47	74121	.52	74174	1.50
7406	.40	7440	.26	74122	.87	74175	2.10
7408	.27	7442	.99	74123	.95	74176	1.80
7410	.25	7450	.27	74150	1.56	74177	1.80
7416	.44	7473	.44	74151	1.05	74180	1.10
7417	.62	7474	.40	74153	1.30	74191	1.75
7418	.26	7475	.80	74154	2.00	74192	1.40
7420	.27	7476	.57	74155	1.39	74194	1.50
7425	.40	7483	1.35			74195	1.75

CMOS

CD 4001 SERIES

4001	.29	4023	.29	74C04N	.83
4007	.29	4025	.34	74C10N	.72
4009	.59	4029	1.50	74C20N	.72
4010	.59	4049	.79	74C42N	2.37
4011	.29	4050	.65	74C74	1.26
4013	.69	74C00N	.43	74C107N	1.38
4016	.69	74C02N	.60	74C161	3.58
4017	1.75				

LINEAR & MISC. IC'S

LM741CH	.28	INTEL-2102	3.00
LM723CH	.45	NE555B	.68
LM309K	1.50		

TRIM POTS (per our choice) 14/8.99

1 POLE 7 POS. MIN. SWT. 1.15

KITS EXAR IC'S

XR555CP	1.07	XR1310P	3.20
XR556CP	1.85	XR210	5.20
XR2240CP	4.80	XR215	6.60
XR205	8.40	XR567CP	1.75
XR100K	80.00		

POWER RECTIFIERS

VOLTS	1.5A	3A	10A	20A	30A
100	.09	.14	.30	.40	.56
200	.10	.20	.35	.47	.80
400	.11	.25	.50	.52	.98
600	.12	.30	.70	.91	1.20
800	.15	.35	.90	1.17	1.52
1000	.20	.45	1.10	1.43	1.90

NPN & PNP SIL. TRANSISTORS

2N2220 (TO-46)	.21 ea. or 5/98
2N3903	.20 ea. or 5/98
2N3904	.22 ea. or 5/98
2N3905	.20 ea. or 5/98
2N3906	.22 ea. or 5/98

ZENERS 1/2 W.

Any voltage, 5% Tol., 3 to 200V .22 ea.

ZENERS 1 W.

Any voltage, 5% Tol., 3 to 200V .27 ea.

G.P. SIL. DIODES

1N456	.13 ea. or 100/11.00
1N457	.14 ea. or 100/11.80
1N458	.15 ea. or 100/12.50
1N459	.16 ea. or 100/13.00

LED DISPLAYS

CC or CA red, green or yellow, small or large numbers—Small-\$1.79 Large-\$2.99

SWITCHING DIODES

(SPECIAL PRICE)

1N4148	35/1.00	1N914B	15/1.00
--------	---------	--------	---------

BARREL STOCK SPECIAL

1N4001-4007 type. No shorts, no opens, all more than 50V. 60/1.98

NPN SIL TO-92 TRANSISTORS 20/1.00

NOTE: Barrel Stock products carry no guarantee and are unmarked.

Min. Order—\$5.00. Add .50 for postage and handling. Please send check or money order with purchase order. Calif. residents add 6% sales tax. Write for large quantity prices.

ELECTRONIC MATERIALS CO.

Div. PC & B Industries, Inc.
1877 West Carson Street
Torrance, Ca. 90501
(213) 328-8532

ADVERTISING INDEX

RADIO-ELECTRONICS does not assume any responsibility for errors that may appear in the index below.

READER SERVICE CARD NO. PAGE

26	Allison Automotive Co.	77
18	American Audioport	66
22	American Technology Corp. ...	73
73	Antenna, Inc.	88
20	AP Products	67
70	Audio Amateur	86
	Audio Technica U.S., Inc.	85
4	B & K, Division of Dynascan Corp.	13
62	Brooks Radio & TV Corp. ...	83
72	Byte Publications, Inc.	87
109	Castle Electronics, Inc. ... Cov. IV	
15	Channellock, Inc.	64
78	Chemtronics	90
21	CIE, Cleveland Institute of Electronics	68-71
6,9	Continental Specialties Corp.	17,27
	CREI, Division of McGraw- Hill Continuing Education	78-81
81	Dana Laboratories, Inc.	92
23	Delta Products	73
24	Edlie Electronics	74
30,111	Edmund Scientific	77,112
63	EICO, Electronic Instrument, Inc.	84
8	Electronics Technical Institute, Division of Technical Home Study Schools	25
	EMC, Electronics Measurement Corp.	90
28	Fidelity Sound	76
77	Florida Institute of Technology	89
74	Fordham Radio Supply Co.	88
79	Grantham School of Electronics	91
5	GTE Sylvania— Electronic Components	15
16	Handic of U.S.A.	28
100	Heath Co.	23
66	Helectronix	85
7	Hickok Electrical Instruments Co.	14
	IMS	22
67	Indiana Home Study Institute	85
80	International Crystal Mfg. Co.	92
13	Jandy International	63
68	Jerrold	86
	JS&A National Sales Group ...	2
	MTS, Micro-Instrumentation Telemetry Systems, Inc.	1
69	Mountain West Alarm Co.	86
27	National Camera Co.	76
	National Technical Schools ...	18-21
	NRI, Division of McGraw-Hill Continuing Education Center	8-11
75	PAIA Electronics, Inc.	88
26	Perma Power	76
65	Photolume Corp.	84
25	Pomona Electronics	75
61	Processor Technology Corp. ...	82
1	PTS Electronics, Inc. Cov. II	
3	Radio Shack	7
	RCA—Distributor & Special Products Division	16-17
110	SBE	Cov. III
19	Schober Organ Corp.	67
17	Shure Brothers	65
12	Southwest Technical Products .	24
71	Sphere Corp.	87
76	Technology Trends	88
10,14	Telematic, Inc.	26,29

READER SERVICE CARD NO. PAGE

64	Tri-Star Corp.	84
2	Tuner Service Corp.	5
11	Wilson Electronics Corp. ...	30-31

MARKET CENTER

101	Altaj	106,107
	American Used Computer	96
89,90,91	Ancrona	98,99,100
	Babylon Electronics	103
	Barta	95
	CFR Associates	96
	Clocks Unlimited	96
	Command Productions	93
	Consumertronics Co.	96
	Cornell Electronics	95
	Dage Scientific Instruments ...	102
104	Delta Electronics	107
92	Digi-Key	108
85	Digikit, Division of Bishop Graphics, Inc.	102
107	Electronic Materials	100
84	Formula International	94
96	Bill Godbout Electronics	103
	Information Unlimited, Inc. ...	102
108	International Electronics Unlimited	111
106	Jade	109
98,99	James Electronics	104,105
	Lab Science	95
	Lakeside	93
82	Meshna Electronics, John Jr. ...	93
97	Morrow's Micro-Stuff	103
86	New-Tone Electronics	95
83	Nexus Trading	93
105	Olson Electronics	100
88	Poly Paks	97
103	Quest	107
	Saxitone	93
93	SD Sales	101
87	Solid State Sales	96
95	Stanley Lin	95
94	Tracy Design Corp.	102
	Trumbull	95
	Valley West	93
	Visulux	95

MOVING?

Don't miss a single copy of **Radio-Electronics**. Give us:

Six weeks' notice

Your old address and zip code

Your new address and zip code

ATTACH LABEL HERE

name (please print)

address

city state zip code

Mail to: Radio-Electronics
SUBSCRIPTION DEPT., BOULDER, COLO.
80302

PACKAGE OF TEN — DEDUCT 15%

PACKAGE OF ONE HUNDRED — DEDUCT 25%

TTL

7400	.16	7451	.20	74153	1.14
7401	.18	7453	.20	74154	1.29
7402	.17	7454	.20	74155	1.23
7403	.18	7460	.20	74156	1.23
7404	.22	7464	.40	74157	1.14
7405	.22	7465	.40	74158	2.06
7406	.40	7470	.35	74160	1.60
7407	.40	7472	.35	74161	1.44
7408	.21	7473	.40	74162	1.71
7409	.22	7474	.40	74163	1.60
7410	.18	7475	.66	74164	1.83
7411	.29	7476	.45	74165	1.83
7413	.63	7483	.91	74166	1.71
7414	.81	7485	1.27	74170	2.65
7416	.40	7486	.46	74173	1.71
7417	.40	7489	2.48	74174	1.86
7420	.18	7490	.59	74175	1.60
7422	.30	7491	1.12	74176	1.02
7423	.33	7492	.82	74171	.97
7425	.31	7493	.69	74180	1.04
7426	.30	7494	1.08	74181	3.43
7427	.33	7495	.91	74182	.91
7430	.23	7496	.91	74184	2.29
7432	.26	74100	1.50	74185	2.29
7437	.40	74105	.51	74187	4.50
7438	.40	74107	.46	74190	1.35
7440	.20	74121	.48	74191	1.35
7441	1.13	74122	.52	74192	1.25
7442	.89	74123	.69	74193	1.19
7443	1.00	74125	.62	74194	1.25
7444	1.00	74126	.72	74195	1.02
7445	1.02	74132	1.02	74196	1.44
7446	1.07	74141	1.20	74197	1.02
7447	1.02	74145	1.20	74198	2.06
7448	1.20	74150	1.12	74199	2.06
7450	.20	74151	.91	74200	5.90

LOW POWER

74L00	.29	74L51	.33	74L90	1.71
74L02	.29	74L55	.38	74L91	1.67
74L03	.29	74L71	.29	74L93	1.94
74L04	.29	74L72	.45	74L95	1.94
74L06	.29	74L73	.56	74L98	3.21
74L10	.29	74L74	.56	74L164	3.21
74L20	.38	74L78	.91	74L165	3.21
74L30	.38	74L85	1.44		
74L42	1.71	74L86	.79		

LOW POWER SCHOTTKY

74LS00	.36	74LS32	.38	74LS95	2.09
74LS02	.36	74LS40	.45	74LS107	.59
74LS04	.36	74LS42	1.40	74LS164	2.20
74LS08	.38	74LS74	.59	74LS193	2.20
74LS10	.36	74LS90	1.30	74LS197	2.20
74LS20	.36	74LS93	1.30		

HIGH SPEED

74H00	.25	74H22	.25	74H61	.25
74H01	.25	74H30	.25	74H62	.25
74H04	.25	74H40	.25	74H74	.39
74H08	.25	74H50	.25	74H101	.39
74H10	.25	74H52	.25	74H102	.49
74H11	.25	74H53	.25	74H103	.58
74H20	.25	74H55	.25	74H106	.58
74H21	.25	74H60	.25	74H108	.60

SCHOTTKY

74S00	.38	74S08	.52	74S22	.38
74S02	.45	74S10	.38	74S32	.52
74S03	.38	74S20	.38	74S74	.38
74S04	.45				

8000 (NATIONAL)

8091	.61	8220	1.49	8811	.65
8092	.61	8230	2.19	8812	1.02
8095	1.25	8288	1.49	8822	2.19
8121	.80	8520	1.16	8830	2.19
8123	1.43	8552	2.19	8831	2.19
8130	1.97	8563	.62	8836	.29
8200	2.33	8810	.70	8880	1.19
8214	1.49				

8000 (SIGNETICS)

8263	5.79	8267	2.59		
------	------	------	------	--	--

9000

9002	.40	9309	.79	9601	.89
9301	1.03	9312	.79	9602	.79

DTL

930	.15	937	.15	949	.15
932	.15	944	.15	962	.15
936	.15	946	.15	963	.15

6 DIGIT LED CLOCK KIT

INCLUDES:
MM5314 clock circuit
6 FND70 LED displays (.250" red 7 segment)
All necessary transistors, resistors & capacitors
1 double-sided PC board accommodates LED's & clock circuitry
Schematic & instructions
Does not include 12V-300 ma transformer, switches & case \$12.95

QUANTITY DISCOUNT NOT APPLICABLE ON THIS ITEM

DATA SHEETS ON REQUEST. ADD \$10 EACH IF ITEM IS PRICED BELOW \$100 EACH

IC SOCKETS

Solder Tail - low profile

8 pin	\$.19	24 pin	.45
14 pin	.22	28 pin	.59
16 pin	.24	40 pin	.69
18 pin	.35		

WIRE WRAP - gold plate

14 pin	.59		
--------	-----	--	--

CMOS

4000A	.30	4018A	1.39	4066A	1.02
4001A	.29	4020A	1.49	4068A	.51
4002A	.29	4021A	1.39	4069A	.51
4006A	1.55	4022A	1.10	4071A	.30
4007A	.30	4023A	.29	4072A	.40
4008A	1.79	4024A	1.02	4073A	.45
4009A	.66	4025A	.29	4075A	.45
4010A	.62	4027A	.68	4078A	.45
4011A	.33	4028A	1.13	4082A	.40
4012A	.29	4030A	.51	4518A	1.89
4013A	.52	4035A	1.46	4528A	1.84
4014A	1.49	4040A	1.39	4585A	2.10
4015A	1.49	4042A	1.69	4901A	.45
4016A	.56	4049A	.68		
4017A	1.19	4050A	.68		

74C00	.25	74C74	1.20	74C162	2.93
74C02	.30	74C76	1.54	74C163	3.06
74C04	.51	74C107	1.30	74C164	3.06
74C08	.78	74C151	3.00	74C173	2.61
74C10	.40	74C154	3.62	74C195	2.66
74C20	.40	74C157	2.02	80C95	1.35
74C42	1.55	74C160	2.85	80C97	1.13
74C73	1.20	74C161	2.93		

CALCULATOR CHIPS

CT15002	12 digit, 4 function fixed decimal — battery operation 40 pin	2.79
CT15005	12 digit, 4 function plus memory, fixed decimal 28 pin	2.99
MM5725	8 digit, 4 function, floating decimal 28 pin	1.98
MM5736	6 digit, 4 function, 9V battery operation 18 pin	3.95
MM5738	8 digit, 5 function plus memory and constant floating decimal, 9V battery operation 24 pin	4.50
MM5739	9 digit, 4 function, 9V battery operation 22 pin	5.35

MEMORIES

1101	1.50	5262	2.25
1101	1.95	82523	3.69
1702A	14.95	F91410	1.95
2102	2.95	7489	2.48
5203	10.95	74182	5.95
5260	1.95	74200	5.90
5261	2.19		

CLOCK CHIPS

MM5311	\$4.45	MM5314	4.45
MM5312	3.95	MM5316	5.39
MM5313	4.45	CT7001	7.95

POCKET CALCULATOR

5 function plus constant — addressable memory with individual recall — 8 digit display plus overflow — battery saver — uses standard or rechargeable batteries — all necessary parts ready to assemble form instructions included.

Calc. Kit, Kit only	\$10.95
Batteries (alkaline, disp.)	2.00
Adapter 60Hz	3.95
Kit, Batteries & Adapter	15.95

QUANTITY DISCOUNT NOT APPLICABLE ON THIS ITEM

TANALUM CAPACITORS

SOLID-DIPPED +20%

1 mid 35V .25 ea.	6.8 mid 6V .30 ea.
.33 mid 35V .25 ea.	6.8 mid 50V .40 ea.
1 mid 35V .25 ea.	10 mid 25V .40 ea.
2.2 mid 20V .25 ea.	15 mid 10V .40 ea.
2.2 mid 35V .30 ea.	33 mid 10V .40 ea.
4.7 mid 16V .30 ea.	47 mid 6V .40 ea.

SHIFT REGISTERS

MM5013	1024 bit accum. dyn. 8 pin	1.75
MM5016	500/512 bit dyn. 8 pin	1.59
SLS-4025	Quad 25 bit 2504	1.29
2504	1024 bit multiplexed dyn 8 pin	4.95

UNIVERSAL BREADBOARD

Silver plated copper circuit board 1-1/8" x 3-1/8" 2 rows of 27 holes for DIP IC's — space for transistors, resistors & capacitors. Versatile and simple for breadboarding IC circuits. \$1.50 ea.

CT5005 CALCULATOR CHIP

12 digit — 4 function with memory \$1.39

7001 CLOCK CHIP

4-6 digit, 12-24 hr. alarm, timer and date circuits — with data \$6.95

DVM CHIP 4 1/2 DIGIT

MM5330 — P channel device provides all logic for 4 1/2 digit volt meter. 16 pin DIP with data \$12.95

ALARM CLOCK CHIP

MS5375AA 4-6 digit, 12 hour, 60Hz snooze alarm, brightness control capability, alarm tone output 24 pin DIP \$4.95

RESISTOR KIT

CARBON FILM ± 5% 1/4 WATT — 01255
1/4 WATT — 01905

455 RESISTORS 44 VALUES SUPPLIED IN A 15 DRAWER CABINET — TABLE OR WALL MOUNT. READY TO USE \$24.95 ea.



JULY SPECIALS

1103	Memory	10/\$10.00	100/\$88
5260	"	10/\$11.90	100/\$104
5261	"	10/\$11.90	100/\$104
5262	"	10/\$13.90	100/\$122
5002	Calculator Chip	10/\$11.90	100/\$104
5005	"	10/\$13.90	100/\$122
5738	"	10/\$20.00	100/\$176
309K	5V Regulator	10/\$10.00	100/\$89
741	Operational Ampl.	10/\$2.50	100/\$22
3900	Quad Amplifier DIP	10/\$3.20	100/\$29
74123	Dual Monostable Multivibrator	10/\$5.60	100/\$50
MAN 1	Display	10/\$11.90	100/\$104

RESISTOR ASSORTMENT

R (OHMS)

QTY	R	QTY	R	QTY	R	QTY	R	QTY	R	QTY	R	QTY	R	QTY	R
1.5	5	68	5	10K	20	10K	20	100K	20	1.5M	5				
3.3	5	100	15	10K	10	15K	10	150K	10	2.2M	5				
6.8	5	150	10	2.2K	20	22K	10	220K	10	3.3M	5				
10	10	220	10	2.7K	10	27K	10	270K	5	4.7M	5				
15	5	270	5	3.3K	10	33K	20	330K	10						
22	5	330	10	3.9K	10	39K	10	470K	10						
33	5	470	20	4.7K	20	47K	20	470K	10						
47	10	680	10	6.8K	10	68K	10	1.0M	20						

MISC DEVICES

ULN 2208	FM gain block 34dB mDIP	1.39
ULN2209	FM gain block 48dB mDIP	1.59
2513	64 x 8 x 5 character generator	11.00
CA 3046	Transistor array 14 pin DIP	.86

LINEAR CIRCUITS

300	Pos V Reg (super 723) TO-5	\$.82
301	Hi Perf Op Amp mDIP TO-5	.33
302	Volt follower TO-5	.61
304	Neg V Reg TO-5	.92
305	Pos V Reg TO-5	.82
307	Op AMP (super 741) mDIP TO-5	.30
308	Micro Pwr Op Amp mDIP TO-5	1.02
309K	5V 1A regulator TO-3	1.35
310	V Follower Op Amp mDIP	1.23
311	Hi Perf V Comp mDIP TO-5	1.09
319	Hi Speed Dual Comp DIP	1.30
320T	Neg Reg 5, 12, 15 TO-22	

LIVE IN THE WORLD OF TOMORROW... TODAY!

And our FREE 164 PAGE CATALOG is packed with exciting and unusual values in electronic, hobby and science items — plus 4,500 finds for fun, study or profit... for every member of the family.

A BETTER LIFE STARTS HERE

SAVE 50%!

8 X 20 MONOCULAR

Fantastic bargain! Top quality Spy Scope, a \$30 value, now offered at \$14.95! Our special purchase saves you 50% and you get 100% coated optics: 393 ft. field of view. Only 2 oz.—stores in pocket, purse, glove compartment. Fits in your palm—peer into hard-to-see places without letting subject know you're spying. Great for birders and race fans; inclcs. neck strap, leatherette 3 1/2 x 1 1/2 x 2" case. Beautiful brushed metal finish. Buy two—one for a gift!



Stock No. 1568EH \$14.95 Ppd.

GOES 3000 RPM IN BRIGHT SUN!

Handsome new aluminized version of Crooke's Radiometer demonstrates solar energy... by continuous vane-spinning up to 3000 rpm... & gives you fascinating "fisheye" hemispherical mirror to see all around you. Even works by light-bulb or infrared (cigarette), but most fun is sun. Your own solar engine to show light-stimulated molecular activity. Req. no fuel, lubrication or repairs; partial vacuum; 4 vanes spin. "Silvering" on 1/2 of glass globe. Great conversation piece!



No. 60,529EH (5" HIGH, 3" DIA.) \$4.75 Ppd.

AN ALPHA MONITOR FOR \$34.95?

Yes, because you built it! Use your ability to tune in your brainwaves, an aid to relaxation, concentration. Kit inclcs. everything you need (except 9v trans. batt.) to own: a portable self-cont. BIOFEEDBACK unit for a pittance; steth. earphones, electrode headband; solid-state circuitry; 5 microvolt sensitivity, more! Compl. assembly instructions & op. manual. With basic electronics knowledge, you can do it!



No. 61,069 EH (KIT) \$34.95 Ppd.
No. 71,809 EH (FULLY ASSEMBLED) \$55.00 Ppd.

FLYWHEEL GENERATED FLASHLIGHT

Never needs batteries! Lights the way free by using flywheel energy. Each time you squeeze handle the alternator generator spins, flywheel disengages from the clutch, and your flashlight lights for about 2 seconds. By continuous squeezing (generating a soft hum), the light stays bright. Energy-saving 6-oz. flashlight pays for itself many times over. And demonstrates flywheel generator principle. Never buy flashlight batteries again!

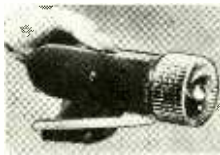

No. 61,086 EH (2x5 1/2") \$14.95 Ppd.

WHEN YOU COME TO PHILADELPHIA BE SURE TO SEE
★ FREE BICENTENNIAL LIGHT SHOW ★
IN BARRINGTON N.J. ONLY 10 MINUTES AWAY AT
EDMUND FACTORY STORE

WOW! TR METAL DETECTOR: \$69.95

Super-sensitive transmitter/receiver unit at a never-before price, w/feats. of \$150 types. Terrific selectivity—10-turn (not just 90°) metal/mineral tuner! 6" waterproof search coil finds a cent at 6"; telescoping adjust. shaft

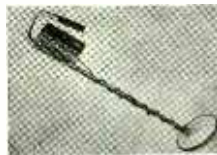

gives 44" lgth.; 1/4" stereo earphone jack; all metal constr. Perfect balance & feather light, it inclcs. 8 "AA" batteries. Lifetime warranty!
No. 80,251EH (JUST 38 OZ.) \$69.95 Ppd.
STARTERS' BFO CHALLENGER I (32 OZ.)
No. 80,222EH (ALUMINUM CONSTR.) \$39.95 Ppd.

SAVE ON DIGITAL MULTIMETERS!

Get superior .1% accuracy with under-\$200 professional Electronic Digital Multimeter comparable to units at \$320 up! Fast, one-hand op'n. Measures AC, DC voltages from .001V to 750V, resistances from 1 ohm to 19.99 megohms.



Feats.: 3 1/2 digit LED display; autorangeing; autopolarity; auto decimal; overload indicator. Inclcs. AC adaptor/charger, NiCd batts., case, op. manual.
No. 72,199EH (10 1/2 OZ.) \$199.95 Ppd.
WITH TEMPERATURE MEAS. PROBE
No. 72,198EH (°C, VDC, VAC, OHMS) \$259.95 Ppd.

PRO ELECTRONIC SOUND CATCHER

Parabolic mike w/18 3/4" transparent reflecting shield & 2 IC's in amplifier magnifies signals 100x that of omni-direction mikes. Catch sounds never before heard! Highest signal to noise ratio poss. Earphones, tape recorder output,



tripod socket; req. two 9V trans. batt. (not incl.).
No. 1649EH (5 1/2 LB.) \$299.00 Ppd.
LOW COST MODEL: NO EARPHONES, ELECTR. CIRC.
No. 1665EH \$149.95 Ppd.
LOWER SENSITIVITY ECON. MOD. W/O ELECTR.
No. 80,242EH \$89.50 Ppd.

PORTABLE SOLAR WATER HEATER

In under 3 hours on a 70° day this 12x19" vinyl heater will heat your 10 quarts of water to over 100°! No fire or fuel—just sun. USE IT ANYWHERE for showers, laundry, dishwashing; or as solar energy demonstrator. Just fill, place on flat surface with clear side exposed to sun. Heat sensor changes color to indicate cold, warm, hot. Plastic bar for easy carrying, suspending. Water funnels into 29" flexible hose with aluminum spray-head. Has on/off valve.



No. 72,176EH (FOLDABLE; 12 OZ.) \$9.50 Ppd.

KNOW YOUR ALPHA FROM THETA!

For greater relaxation, concentration, monitor your Alpha/Theta brainwaves w/ audible or visible signal on Biosone II. Has 3 feedback modes, outputs to monitor logic signal, filter sel. feedback, broad sensitivity control; other professional feats. of \$200-up units. Easily operated 4-lb. portable has total brainwave monitoring capability! Req. 2 9v tr. batteries.



No. 1668EH (9 1/2 x 5 5/8 x 4 1/4") \$149.95 Ppd.
LOW COST STARTERS' UNIT (PORTABLE)
No. 71,809EH (4 1/2 x 2 3/4 x 4 1/4") \$ 55.00 Ppd.



MAIL COUPON FOR GIANT FREE CATALOG!

172 PAGES • MORE THAN 4500 UNUSUAL BARGAINS

Completely new 1976 edition. New items, categories, illustrations. Dozens of electrical and electromagnetic parts, accessories. Enormous selection of Astronomical Telescopes. Unique lighting and ecological items. Microscopes, Binoculars, Magnifiers, Magnets, Lenses, Prisms. Hard-to-get surplus bargains. Ingenious scientific tools. 1000's of components.

EDMUND SCIENTIFIC CO.
300 Edscorp Building, Barrington, N.J. 08007
Please rush Free Giant Catalog "EH".

Name _____
Address _____
City _____ State _____ Zip _____



COMPLETE AND MAIL WITH CHECK, M. O. OR CHARGE NO.
EDMUND SCIENTIFIC CO. 300 Edscorp Building, Barrington, N.J. 08007
(609) 547-3488

How Many Stock No. _____ Price Each _____ Total _____

PLEASE SEND GIANT FREE CATALOG "EH"

Charge my BankAmericard *

Charge my Master Charge *

Interbank No. _____

My Card No. Is _____

Card Expiration Date _____

30-DAY MONEY-BACK GUARANTEE.

You must be satisfied or return any purchase in 30 days for full refund. *\$15.00 minimum



enclose check money order for TOTAL \$ _____

Add Handling Charge \$1.00

Signature _____

Name _____

Address _____

City _____ State _____ Zip _____

RADIO-ELECTRONICS

Introducing... SBE Touch/Com

The mike that does it all!

SBE adds the ultimate touch of sophistication to CB with the new SBE Touch/Com. It puts all the functions of CB two-way radio communication in the palm of your hand. Change channels, adjust volume and squelch, receive or transmit... all with the flick of a finger on the mike. It features up/down two-speed channel selection and a bright base-station-size LED digital channel readout for fast identification.

The Touch/Com, with the circuitry of the now-famous Formula D, incorporates all of SBE's most advanced CB technology: digital synthesis to cover all 23 channels with a single crystal; phase-lock-loop circuitry for "on-target" frequency stability; positive or negative ground for RV, boat and truck voltage systems; dual conversion for sharp selectivity and rejection of adjacent channel interference. The Touch/Com also features delta tune: crisp, clear audio output; a large, combination power output/"S" meter, night-lighted for easy viewing.

SBE'S finest CB—now made unquestionably the best by the unique convenience of Touch/Com.



SBE-32CB

SBE Better Communications through Creative Technology

For information write: SBE, Inc., 220 Airport Blvd., Watsonville, CA 95076

INTERNATIONAL OFFICES: E. S. Gould Marketing Co. Ltd., Quebec, Canada/Linear Systems, S.A., Geneva 1, Switzerland
Circle 110 on reader service card

You enjoyed the **TIMESAVING** advantages of the previous models of the Castle Subber® analyst . . . **NOW** you will want to move up to this superior, redesigned model . . . our best yet!

SUBBER®

Mark IV-CUV

*UHF-VHF tuner
and i-f analyst*

net \$64.95



If you haven't joined the ranks of thousands of professional technicians using this **TIMESAVING** instrument . . . **NOW** is your opportunity to own the latest model boasting these improved features:

- **TUNES ALL VHF & UHF CHANNELS.** Use where prime signals are on either VHF or UHF . . . or both.
- **ELECTRONIC FINE TUNING.** Smooth, exact tuning ensures precise setting for ease in testing color receivers.
- **DUAL 40MHz IF OUTPUT JACKS.** Select Hi or Lo impedance output for best coupling match to circuit being substituted . . . tube or transistor.
- **BATTERY CONDITION INDICATOR.** IC comparator driven LED shows when inbuilt 9v transistor batteries require replacement. Battery & 120-vac line powered.

The Mark IV-CUV tunes all 82 VHF & UHF channels for substitution tests of the tuners and entire i-f system of any 40MHz TV receiver. Permits signal injection after the agc controlled stages for the high speed agc system analyzing procedure invented by Castle . . . the first practical method for analyzing agc system defects without confusion.

Mark IV-C

The Mark IV-C tunes all 12 VHF channels for substitution injection tests of the VHF tuner, UHF tuner and entire i-f system of any 40MHz TV receiver.

- **ELECTRONIC FINE TUNING.** Battery & 120-vac line powered.
- **DUAL 40MHz IF OUTPUT JACKS.**
- **BATTERY CONDITION INDICATOR.**

net \$54.95



Made in USA.

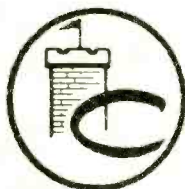

See your stocking distributor . . . or write for more details and complete specifications.

CASTLE ELECTRONICS, INC.

5715 N. Western Ave., Chicago, Illinois 60645 Phone: (312) 728-1800

In Canada: Len Finkler Ltd., Ontario

Circle 109 on reader service card