

NEW CB TEST GEAR

75¢ ■ APR. 1976

Radio-^{IND}Electronics®

THE MAGAZINE FOR NEW IDEAS IN ELECTRONICS

BUILD ONE OF THESE

- ★ Tach & Overspeed Circuits
- ★ Bardot to ASCII Converter
- ★ Serial Interface for TVT-II

TELEVISION

- ★ 30-Channel MATV Systems
- ★ Jack Darr's Service Clinic
- ★ Service Problems & Solutions
- ★ Equipment Reports

HI-FI-STEREO

- ★ Speed Stereo Test Time
- ★ R-E's Lab Tested Reports:
Fuji Tape Cassette
Harman-International Basic Amp

LEARN SOMETHING NEW

- ★ Komputer Korner
- ★ All About Garage Door Openers
- ★ Looking Ahead

LEINSBACK
ELECTRONIC ACTION

You've Got Us Where You Want Us

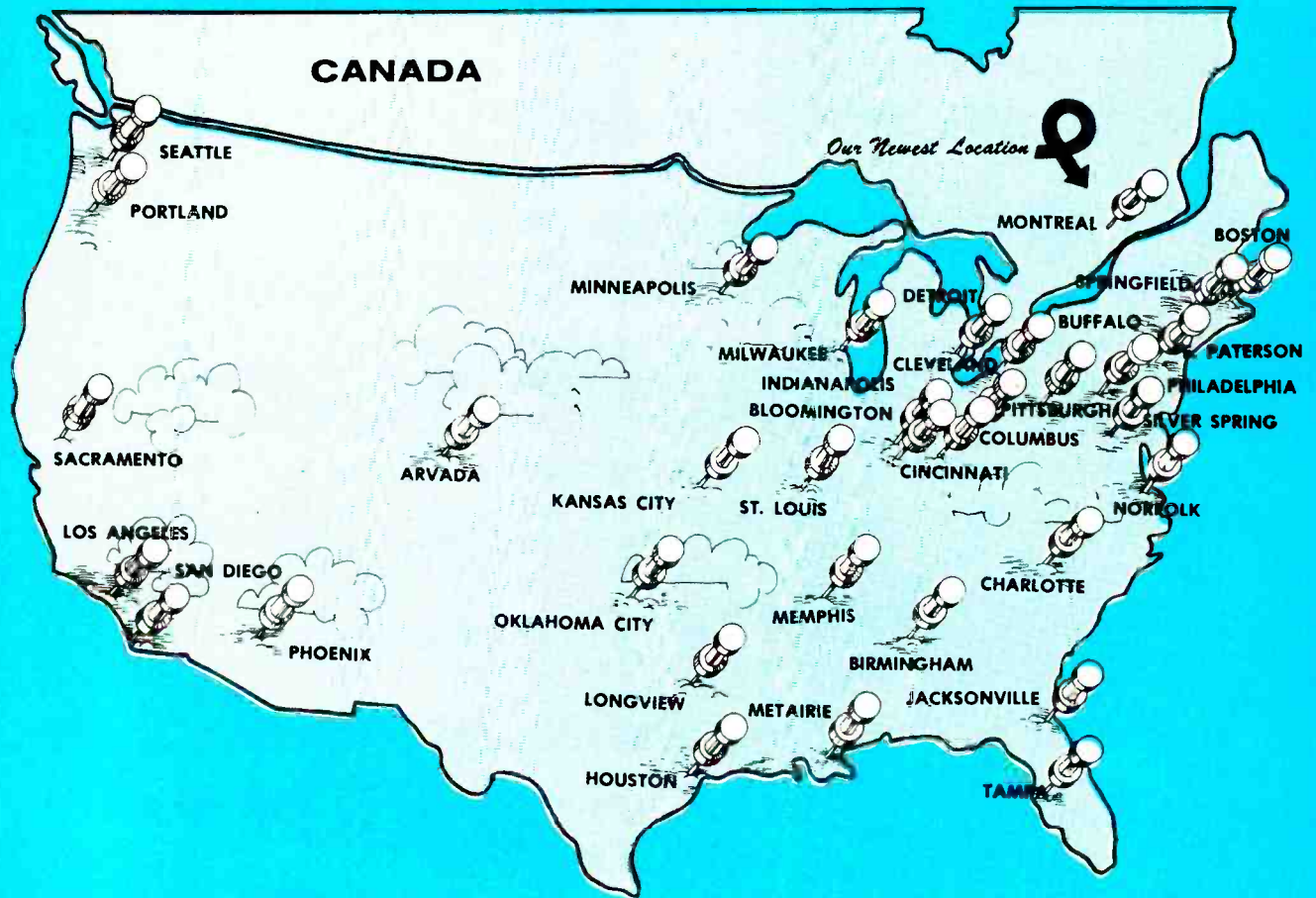

Even though we're the world's largest tuner repair service, recommended by more TV manufacturers than any other company, we think small. Really! We could put the whole thing under one roof. Instead, we have 35 small service centers across the country, staffed by more than 200 professional technicians. Why? Service for one thing . . . same-day

service. Bring us a tuner . . . any tuner . . . at 8 a.m. and it's repaired and tested by 4 p.m. Then there's quality . . . original parts, and once repaired, it's good as new. Oh sure, being the world's largest is something we're proud of. But we also like the fact that with 35 service locations, we can be small enough to give every tuner repair job a personal as well as a professional touch.



ELECTRONICS, INC.

PRECISION TUNER SERVICE

Consult the white pages of your telephone directory for the address and telephone number of the PTS center nearest you.

Circle 1 on reader service card

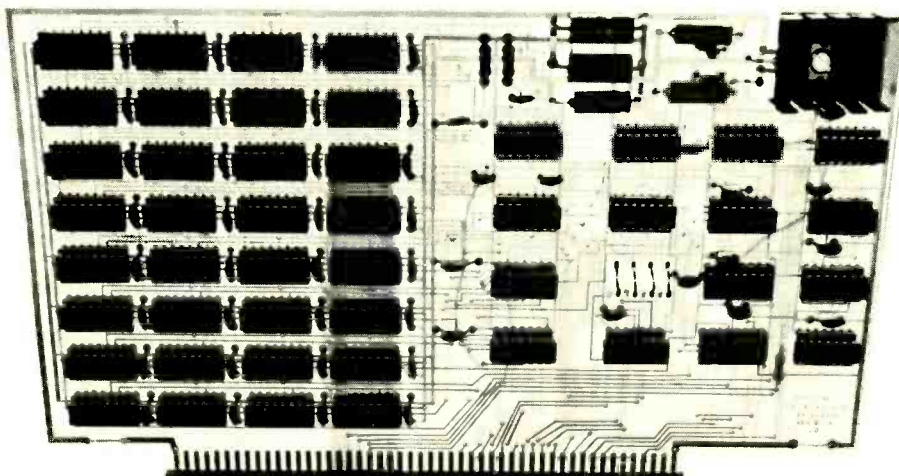

The One and Only

Altair® 4K Static.

Altair 4K Static from MITS is unquestionably the finest 4K static memory available anywhere. It is also the fastest.

Altair 4K Static uses Intel 2102 A-4 memory chips which have a worst case access of 450 nanoseconds at 70°C. At normal system temperatures the access times are typically less than 300 nanoseconds.

Altair 4K Static is fully isolated from the system bus by Schmitt™ triggers. Thus, the excessive capacitive loading caused by other 4K static memories is eliminated. Use of these triggers on all Altair 4K static inputs greatly reduces noise. Internal data collection nodes also use Schmitt triggers, which prevents internal data bus noise from being transmitted to the system data bus.

Altair 4K Static is the only 4K static supported by MITS. Owners of Altair 4K Static are eligible to qualify for discounts on AltairBASIC and other MITS products.

Altair 4K Static is the only 4K static that comes with all the required Altair hardware including edge connectors and card guides.

Altair 4K Static is the answer for Altair owners who need static memory for special applications such as the TV Dazzler from Commodore.

PRICES:

Altair 4K Static Kit	\$159
Altair 4K Static Kit with 2K Memory	\$134
Chip set to convert 2K to 4K	\$ 45

SPECIAL—Altair Documentation Notebook. Contains catalog, price sheet, Computer Notes newspaper, Software Information Package, technical data on Altair hardware, list of authorized Altair dealers, list of computer clubs, survey of home computing market, and much more. All in top quality three ring binder. Only \$5 plus \$1 for postage and handling. Offer expires April 30, 1976.

MAIL THIS COUPON TODAY

Enclosed is check for \$ _____
 BankAmericard # _____ or Master Charge # _____
 Altair 4K Static Altair 2K Static
 Include \$3 for postage and handling
 Please send me the Altair Documentation Notebook. Enclosed is \$5 plus \$1 for postage and handling.
 Please send free catalog and price sheet.

NAME _____
 ADDRESS _____
 CITY _____ STATE & ZIP _____

MITS/2450 Alamo SE/Albuquerque, NM 87106/505-262-1951

Prices, delivery and specifications subject to change.

mits

2450 Alamo SE/Albuquerque, NM 87106/505-262-1951

Circle 2 on reader service card

John Buckner, independent installer says:
**"Winegard Chromstar
 has proved it does
 a beautiful job."**

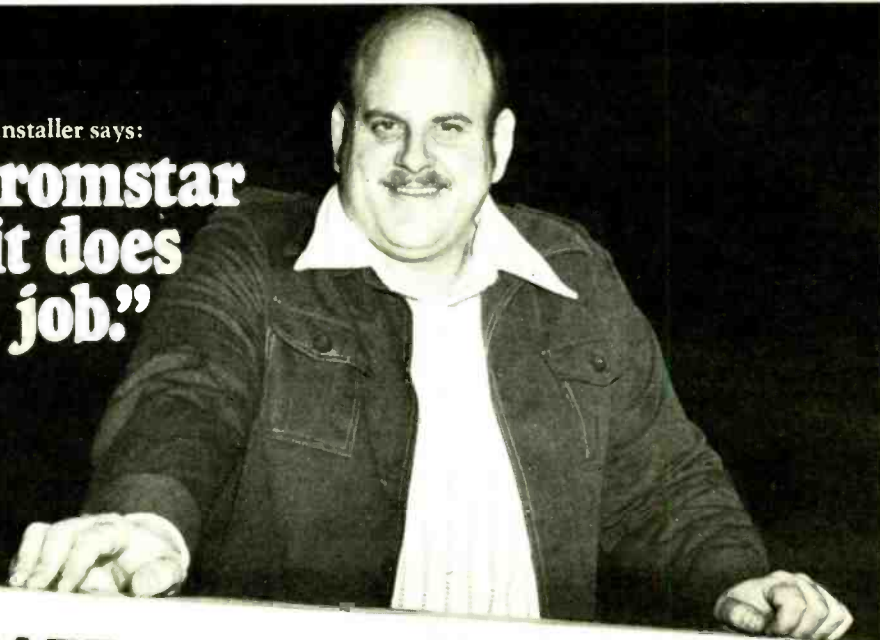

WINEGARD
Chromstar tv antenna

"... quality of Winegard products,
 ... far surpasses other brands ..."

"We depend on the Winegard Chromstar
 Antenna for quality color reception."

"... tremendously pleased with the
 reception the Winegard Chromstar
 antenna gets in our area."

Get all the facts from your Winegard Distributor.
 Free Spec Charts on all models.

These statements are from John A. Buckner, President of Buckner Co., Lyndon, Kentucky, who adds in his letter,* "We have a unique situation in the Louisville area, with all television signals coming from a ridge west of town, and their power output varying greatly. We have two VHF stations — Ch. 3 and 11 — and four UHF stations — Ch. 15, 32, 41, and 68. We must cover a broad range of signals, and an even wider variation of power output levels from these stations. The Winegard Chromstar antenna has proved to us and our customers that it does a beautiful job."

*A copy of Mr. Buckner's letter will be sent to you on request.

LOOK TO CHROMSTAR FOR QUALITY AND PERFORMANCE

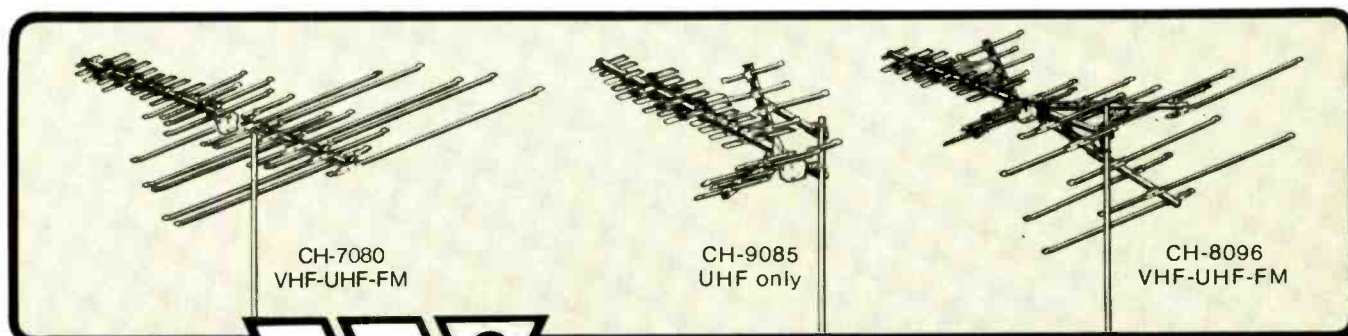

WINEGARD[®]
 COMPANY
 3000 Kirkwood • Burlington, Iowa 52601

TV ANTENNAS MORE PEOPLE LOOK UP TO.

Circle 3 on reader service card

Radio-Electronics®

THE MAGAZINE FOR NEW IDEAS IN ELECTRONICS

Electronics publishers since 1908

APRIL 1976 Vol. 47 No. 4

SPECIAL FEATURES

- 33 **CB Test Gear**
What's available and how to use it effectively. **by Jack Darr**
- 50 **All About Garage Door Openers**
Photo story shows how to install and service these electronic devices. **by Lee Stral**

BUILD ONE OF THESE

- 37 **Tach and Overspeed Circuits**
A variety of practical circuits you can add to your car. **by R. M. Marston**
- 57 **Baudot to ASCII Converter**
A practical project for the computer hobbyist. **by Roger Smith**
- 60 **Serial Interface Add On For TVT-II**
Another add-on board to extend the capabilities of your TV Typewriter. **by Ed Colle**

GENERAL ELECTRONICS

- 4 **Looking Ahead**
Preview of tomorrow's news today. **by David Lachenbruch**
- 18 **Komputer Korner**
The anatomy of a microcomputer. **by Peter Rony, Jon Titus & David Larsen**

TELEVISION

- 40 **30-Channel MATV Systems**
How they work and how they are set up. **by Bert Wolf**
- 63 **Service Clinic**
Horizontal oscillators. **by Jack Darr**
- 64 **Reader Questions**
R-E's Service Editor solves reader problems.

HI-FI STEREO AUDIO

- 43 **Speed Audio Test Time**
Follow these tried & tested techniques to minimize audio test time. **by Len Feldman**
- 53 **R-E Test Fuji FX 60**
A report on a new cassette tape. **by Len Feldman**
- 55 **R-E Tests Harman-Kardon Citation 16**
Basic power amplifier runs through our laboratory. **by Len Feldman**

DEPARTMENTS

- | | |
|-------------------------------------|--------------------------------|
| 112 Advertising Index | 79 New Literature |
| 12 Advertising Sales Offices | 74 New Products |
| 14 Letters | 93 Next Month |
| 96 Market Center | 115 Reader Service Card |
| 6 New & Timely | |

ON THE COVER

A modern CB test bench might look like this one, fully equipped with the latest test gear specifically designed for speedy servicing of CB transceivers. Note the B&K model 1049 CB Servicemaster that works in combination with existing test gear. See our story on CB test gear on page 33



GARAGE DOOR OPENERS can be money makers. To see how to install them turn to the story on page 50.

Radio-Electronics, Published monthly by Gernsback Publications, Inc., 200 Park Avenue South, New York, NY 10003. Phone: 212-777-6400. Second-class postage paid at New York, NY and additional mailing offices. One-year subscription rate: U.S.A., U.S. possessions and Canada, \$8.75. Pan-American countries, \$10.25. Other countries, \$10.75. Single copies 75c. © 1976 by Gernsback Publications, Inc. All rights reserved. Printed in U.S.A.

Subscription Service: Mail all subscription orders, changes, correspondence and Postmaster Notices of undelivered copies (Form 3579) to Radio-Electronics Subscription Service, Boulder, CO 80302.

A stamped self-addressed envelope must accompany all submitted manuscripts and/or artwork or photographs if their return is desired should they be rejected. We disclaim any responsibility for the loss or damage of manuscripts and/or artwork or photographs while in our possession or otherwise.

As a service to readers, Radio-Electronics publishes available plans or information relating to newsworthy products, techniques and scientific and technological developments. Because of possible variances in the quality and condition of materials and workmanship used by readers, Radio-Electronics disclaims any responsibility for the safe and proper functioning of reader-built projects based upon or from plans or information published in this magazine.

looking ahead

Microcam

Also on the broadcast front, helping CBS cover the political conventions this summer will be the first electronic camera claimed to be smaller and lighter than a film camera. The culmination of many years of increasing miniaturization of television cameras for use in "electronic newsgathering," the Microcam was developed by Thomson-CSF Laboratories (formerly CBS Labs) under a CBS contract, but will be offered to all broadcasters later this year.

The camera is a full-featured studio-quality color unit using three Plumbicon pickup tubes, but weighs only eight pounds. An accompanying control unit with battery can be belt-mounted and adds another three pounds, for 1½ hours' operation. The camera can operate on flashlight batteries in an emergency. Its developers claim it is one-half the weight and size and requires one-half the power of the nearest competitive electronic camera. An added feature is its adaptability to charge-coupled semiconductor pickup devices, when they are available, as substitutes for tubes—which could further reduce the size, weight and power requirements.

More TV games

There are going to be plenty of video game attachments on the market this year, according to plans now being made. In addition to those mentioned last month, these companies are also planning to enter the TV game field: APF Electronics, a leading calculator supplier, is expected to field a tennis-football-squash-handball game this summer, to sell at about \$80. Dyn Electronics plans a Ping Pong and tennis wireless game at less than \$70 by about the same time. Gran Prix, an importer, hopes to have a hockey-tennis-Ping Pong attachment in the \$50-

to-\$60 range. The toy manufacturers are eyeing the field, too. Coléco will soon display a game using General Instrument's six-game chip at \$50 to \$70. Mego's, which makes Star Trek and other action games, will have a \$50 chip-controlled unit soon. Ideal, Mattel, Kenner and Aurora—all leading toy makers—are looking closely at the field and could move in soon.

Historic plant closed

When RCA ends receiving tube manufacture July 30, it will be a sentimental occasion tinged with history. Its plant in Harrison, NJ, was originally built by Thomas A. Edison in 1882 to produce electric light bulbs. General Electric acquired it in 1892 and continued to make bulbs there until 1918, when it started output of radio tubes. The Harrison plant was an important source of tubes for RCA Radiola radios throughout the '20's and was sold by G-E in 1930 to the RCA Radiotron Company, a subsidiary of RCA.

The plant is being closed because of the sharp decline in demand for receiving tubes in the face of the shift to solid-state devices. Industry-wide sales of receiving tubes have declined from 442,000,000 in 1966 to about 80,000,000 in 1975—the latter figure being less than RCA alone sold in the heyday of receiving tubes. RCA's move leaves G-E and Sylvania as the sole U.S. manufacturers of receiving tubes. RCA will continue to market RCA tubes made by others.

Computerized slides

Today, when you see a still picture (such as a station identification) on television, you're usually looking at a 35-mm slide. Later this year, you may be seeing the product of a computer. Ampex and CBS have developed the first practical broadcasting device

to use digital recording techniques for video images—the Electronic Still Store system, or ESS. ESS converts any video signal (from film, tape or live camera) into digital form and stores it on a standard magnetic computer disc pack.

Up to 1500 still frames can be stored on a single disc, to be selected for readout, in any order, from a bulk memory with an access time of less than 100 milliseconds. The system has three modes of operation—record, reproduce and rearrange. In the latter mode, selected stills may be arranged in any order for sequential programming. One of the most attractive features of the system is that the discs have virtually unlimited shelf storage life, helping to alleviate the always-acute storage problem at TV stations. CBS will take delivery of the first ESS unit around midyear.

Videodisc standards

The home videodisc came closer to reality as three major developers of optical disc systems agreed on standards for interchangeability of video records. Prime movers in the agreement were Philips and MCA. Both had agreed to merge their similar but different systems. Also participating in the standardization move but without committing themselves on production of the optical system was Zenith, and the French electronics combine Thomson-CSF is expected to join in.

The resulting specifications theoretically supply everything a manufacturer needs to know to build an optical videodisc player or make a disc. Among the specs selected: (1) 1800 rpm in a counterclockwise direction as viewed from the objective lens (underneath the discs in the prototypes already demonstrated). (2) The disc plays from the inside out. (3) Two basic disc sizes—12 and 8 inches. (4) Both rigid and flexible discs, the former 1.1-mm thick, the latter 0.2-mm. (5) Two sound chan-

nels, at 2.3 and 2.8 MHz on the carrier. (6) Direct NTSC encoding, frequency-modulated.

The last specification—direct NTSC encoding—came as something of a surprise, as previous demonstration optical disc systems have used separate luminance and chrominance signals, encoded in a non-standard manner. The direct encoding will simplify the electronics in the player and should result in a better picture.

The interchangeability pact, of course, doesn't include the RCA capacitance disc system, which is basically incompatible with the optical design, despite reports that some sort of playable signal has been obtained optically from an RCA disc. So it still appears that two systems will fight it out in the marketplace.

364,000,000 TV sets

While we're on a statistical kick, we can't resist noting that by latest count there were approximately 364,000,000 television sets in use in the world, and that color sets passed the 100,000,000 mark during 1975. Of the 146 countries with television stations, the United States has by far the most sets—57,700,000 color and 63,400,000 monochrome, for a total of 121,000,000. That's an average of 1.7 sets per American home. In terms of color sets in use, Japan (with 19,800,000 sets) is second to the U.S.; the United Kingdom is third with 6,820,000, followed by West Germany with 4,350,000 and Canada with 4,100,000. In monochrome, the Soviet Union is second with around 50,000,000 (this includes some color sets—no breakdown is available). Others in order are West Germany (13,250,000), Italy (12,450,000), France (12,000,000) and the United Kingdom (10,900,000).

by DAVID LACHENBRUCH
CONTRIBUTING EDITOR

Find semiconductors fast.



With the new, updated Mallory PTC Semiconductor Product Guide.

Instead of looking all over for replacement semiconductors, just open the guide.

There's new indexing and cataloging for fast, easy access to the electrical and physical parameters of each PTC product. Plus, a listing of thousands of semiconductors, each cross-referenced to Mallory PTCs.

It's the authoritative source-book and cross-reference for transistors, zener diodes, diodes, high-voltage rectifiers, color crystals, integrated circuits, field-effect transistors.

Now it's easier than ever to get Mallory performance and reliability in your semiconductor replacement parts.

See your Mallory distributor or give him a call, today.

MALLORY

MALLORY DISTRIBUTOR PRODUCTS COMPANY

a division of P. R. MALLORY & CO. INC.
Box 1284, Indianapolis, Indiana 46206; Telephone: 317-856-3731

Batteries • Capacitors • Controls • Security Products • DURATAPE® • Resistors • Semiconductors • SONALERT® • Switches • Fastening Devices
DURATAPE® and SONALERT® are registered trademarks of P. R. Mallory & Co. Inc.

Circle 4 on reader service card

APRIL 1976 5

Quadriphonic broadcasting now feasible, says committee

The National Quadriphonic Radio Committee, sponsored by the Consumer Electronics Group of the Electronic Industries Association, has reported to the FCC that quadriphonic broadcasting is compatible with existing systems and with the FCC's allocation plan. It also reported that it can be carried out with commercially available equipment, or equipment well within present technology.

The report was the result of a 45-month study of quadriphonic broadcasting. The committee studied five proposed systems and conducted subjective and objective tests to determine the compatibility, feasibility and practicality of the system. The tests consisted of subjective listening, closed-circuit and over-the-air broadcast tests in both home and mobile situations.

The Committee made it clear that the report was not intended to recommend or propose a specific system, but to assist the FCC in issuing a public notice for proposed rules that would establish a standard for quadriphonic FM broadcasting.

New guide for WWV/WWVH issued by National Bureau of Standards

"The Use of NBS High Frequency Broadcasts for Time and Frequency Calibrations," is the title of the new guide published by NBS for all who use WWV or WWVH for getting standard time and frequencies or for more specialized uses.

In addition to discussing the widespread use of the signals for standard time and frequency information, the authors place special emphasis on using WWV/WWVH signals to measure time or set clocks with an accuracy of ± 100 microseconds, or to calibrate frequency to a few parts in 10^{10} . Specific suggestions are given on making observations, optimizing reception and measurement conditions, and using such items of equipment as oscilloscopes, delay circuits and time-interval counters.

Dimensions and construction details for several antennas are given, and instructions for measuring or computing receiver and propagation delays, great circle distances and incident wave angles.

The guide, identified as NBS Technical Note 668, is obtainable from the Superintendent of Documents, Government Printing Office, Washington, DC 20402, for \$1.05.

Sixty-one seconds make a minute

For the fourth year in succession, the official time and frequency stations WWV at Boulder, CO; WWVH at Maui, HI; and WWV's low-frequency supplements

(WWVB and WWVH) welcomed in the New Year with a 61-second minute. The extra second was added to the last minute of the last day of the old year. Thus December 31 was actually the longest day of the year—24 hours and one second long.

The extra second was a time correction. The Earth has recently been slowing down in its annual circular tour and the added second has been necessary to keep our clocks from running ahead of the sun. The difference is not important to the average individual—at the present rate it would be 60 years before we would have to set the clocks back one minute—but is taken into account by astronomers, navigators and other specialized groups.

Since the National Bureau of Standards started making these corrections in 1972, five seconds have since been added—the first in June of that year, and the other four as "leap seconds" at the end of the last minute of each year.

New communications satellite doubles previous capabilities

"A new generation of satellites," providing low-cost communications unmatched by any other carrier, according to RCA Communications president Howard R. Hawkins, was launched last December 12.

Satcom I will serve the whole 50 states of the USA, it will maintain a 22,300-mile-



RCA SATCOM-1 SPACECRAFT, shown above as it would look if the photographer could get near enough to take a picture, is equipped with 24 transponders—double the communications capacity of any conventional satellite now in orbit. The solar panels have 71 square-feet of silicon cells always oriented toward the sun.

high orbit over the equator at a point approximately south of Los Angeles. Its 24 channels give it twice the communications capacity of earlier satellites.

Each of these 34-MHz channels is designed to carry 1,000 voice-grade circuits, one FM/color TV transmission or 64 million bits-per-second of computer data. The antenna directs all 24 channels to Alaska and the continental United States, and couples 12 channels to the Hawaii spot beam. A special modification of the Thor-Delta launch vehicle, providing 30 percent more power than earlier rockets, was necessary to put the one-ton satellite into orbit.

The craft is powered by a combination of solar-array panels and three nickel-cadmium batteries, with a maximum power of 740 watts. Its life period, with continuous full power, is designed to be eight years.

M. Harvey Gernsback now Fellow of the Radio Club of America

The Editor-in-Chief and Publisher of *Radio-Electronics* was elevated to the status of Fellow of the Radio Club of America, for "contributions to Signal Corps publication during World War II and in electronics publication to the present," at the Club's annual meeting last November 21.

At the same meeting, Dr. Henri Busignes, chief scientist emeritus of ITT, also a Fellow of the Club, was awarded the highest honor of the association—the Armstrong Medal—for his military and civilian work in automatic direction finding, electronic navigation systems and moving-target radar. Edgar F. Johnson, head of the radio company that bears his name, received the Club's Sarnoff Citation for his services to radiomen, particularly amateurs, and his influence on radio since 1920.

A special feature of the meeting was the presentation of a charter to the Club's Section 1, Washington, DC, the first local section in the Club's 66-year history. It was announced that Section 2, the California Section of the Club, would be chartered at a semi-annual meeting and banquet in Washington late in March.

Science depends on engineers says Bell's James B. Fisk

"It takes a lot of engineering to make the fullest use of research," Dr. James B. Fisk, recently retired President and Chairman of the Board of Bell Laboratories, told a recent meeting of the National Academy of Engineers at Washington, DC.

Dr. Fisk, in a speech accepting the Academy's Founders Medal, cited the

(Continued on page 12)

JBL Loudspeaker Components



Twelve brand new pages. Forty-seven JBL components — dividing networks, lenses, horns, transducers, everything.

Lots of these goodies have never been available as individual components before. (They've been performing inside JBL's newest professional studio monitors.)

Write us. We'll send you the catalogue, free, along with the name and location of your nearest

authorized JBL Loudspeaker Components Dealer.

He's important. Besides all those components he's got a fresh supply of the new JBL Enclosure Construction Kits that tell you everything you need to know about building your own JBL enclosure.

Fill out this coupon and send it along to JBL, the people who wrote the book on sound.



3249 Casitas Avenue
Los Angeles 90039

Gentlemen:
I can't beat the price. Send me the book.

Name _____
Address _____
City _____ State _____ Zip _____

James B. Lansing Sound, Inc.
High fidelity loudspeakers
from \$99 to \$3210.

RE-4

The real way to learn digital electronics!

NRI is the only school to train you at home on a real digital computer.

Learn computer design, construction, maintenance and programming techniques on your own programmable digital computer.

Qualified technicians are urgently needed for careers in the exciting new field of digital

and computer electronics . . . and the best way to learn digital logic and operations is now available to you in NRI's Complete Computer Electronics course.

This exclusive course trains you at home on your own digital computer! This is no beginner's "logic trainer", but a complete programmable digital computer that contains a memory and is fully automatic. You build it yourself and use it to define and flow-chart a program, code your program, store your program and data in the memory bank. Press the start button and the computer solves your problem and displays the result instantly.

The NRI digital computer is one of 10 kits you receive in the NRI Complete Computer Electronics Course. You build and use your own TVOM, and experiment with NRI's exclusive electronics lab. You perform hundreds of experiments, building hundreds of circuits, learning organization, operation, troubleshooting and programming.

New NRI Memory Expansion Kit

The Model 832 NRI Digital Computer now comes with a new Memory Expansion Kit. Installed and checked out in 45 minutes, it doubles the size of the computer's memory, significantly increasing the scope and depth of your knowledge of digital computers and programming. With the large-scale IC's you get the only home training in machine language programming . . . experience essential to troubleshooting digital computers.



Only NRI offers you five TV/Audio Servicing Courses



NRI can train you at home to service TV equipment and audio systems. You can choose from 5 courses, starting with a 48-lesson basic

course, up to a Master Color TV/Audio Course, complete with 25" diagonal solid state color TV and a 4-speaker SQ® Quadraphonic Audio System. NRI gives you both TV and Audio servicing for less than you'd pay for either course at the next leading home study school!

All courses are available with low down payment and convenient monthly payments. All courses provide professional tools and "Power-On" equipment along with NRI kits engineered for training. With the Master Course, for instance, you build your own 5" wide-band triggered sweep solid state oscilloscope, TV color pattern generator, CMOS digital frequency counter, and NRI "Discovery" electronics lab.



*trademark of CBS, Inc.

NRI's complete communication course includes your own professional 500-channel VHF transceiver



NRI prepares you for a career in the rapidly expanding field of communications . . . a field destined to double in the next decade! You can train at home for one of the thousands of service and maintenance jobs opening in Citizens Band, AM and FM transmission and

reception, TV broadcasting, microwave systems, teletype, radar, marine electronics, mobile communications, and aircraft electronics. You train on your own 500-channel, digitally-synthesized VHF Transceiver and AC power supply; CMOS digital frequency counter; with bite-size lessons leading to your FCC radiotelephone license and the communications field of your choice.



You pay less with NRI training and you get more for your money.

NRI employs no salesmen, pays no commissions. We pass the savings on to you in reduced tuitions and extras in the way of professional equipment, testing instruments, etc. You can pay more, but you can't get better training.

More than one million students in 62 years have learned at home the NRI way.

Mail the insert card and discover for yourself why NRI is the recognized leader in home training. No salesman will call. Do it today and get started on that new career.

APPROVED FOR CAREER TRAINING UNDER GI BILL
Check box on card for details.

MAIL THE INSERT CARD FOR YOUR
FREE NRI CATALOG No salesman will call



NRI SCHOOLS
McGraw-Hill Continuing Education Center
3939 Wisconsin Avenue,
Washington, D.C. 20016

transistor, which required an entire organization to develop practical uses after it was discovered, as a particularly apt example. A "happy blending of basic science with the ingenious skills of the design, development and manufacturing engineers," he said, "has enabled us to do things widely beneficial to people."

"Breakthrough" World War DF presented to Smithsonian

The Smithsonian Institution has received the precursor model of an invention that was a decisive factor in defeating Hitler's submarine "wolfpacks" in the most critical days of World War II. Known as the "Huff-Duff" instant radio direction-finder, it was presented to the Institution by its inventor, Dr. Henri G. Busignies, chief scientist emeritus of ITT.

The German submarine reported to home base with a radio technique designed to make detection impossible. The messages were recorded, then the submarine surfaced and sent everything in a "squirt" that might last less than a second. Ordinary direction finders were helpless against this technique.

The "Huff-Duff" scanned the whole horizon like a fast radar, making more than one 360° scan during even the shortest transmission. The strength of signals received from any direction was displayed on a cathode-ray (picture) tube. Since the signals were strongest when the antenna was pointed in the direction of the incoming signal, the resulting patterns was described as "an electronic finger pointing" at the submarine source. Cross bearings from two stations receiving the signals pinpointed

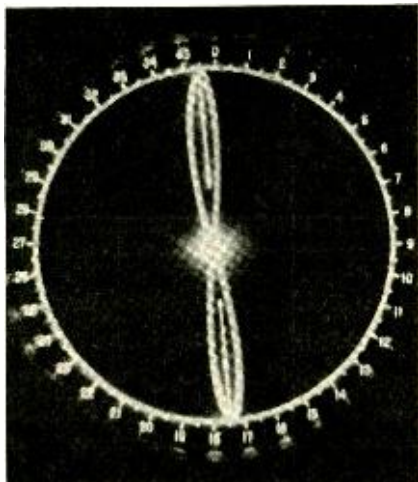

SUBMARINE AT 355 DEGREES, says the electronic finger of the Huff-Duff display. Pictures like these meant destruction to the German submarine "wolfpacks" of World War II.

the position of the sub. Air and Navy forces were then dispatched to "search and destroy," and merchant convoys warned of the danger area.

German submarine losses rapidly increased to 40 per month, and Allied convoy ship losses dropped to an astounding 2 percent of those at the height of the submarine campaign.

Six youthful members of 4-H get Westinghouse scholarships

Projects ranging from bringing a juke box back to life to constructing an electric automobile won \$800 scholarships for six 4-H members at the 54th National 4-H Congress in Chicago last December. The scholarships were from Westinghouse Electric Corp., sponsor of the 4-H Electric Program Contest.

The electric car, built from a \$15 junked automobile, was the project of 16-year-old Randy Atkins, Cedar Bluff, VA. His car cruises 60 to 70 miles between charges and can travel at 55 miles per hour. It is powered by eight 6-volt batteries.

Lynn Ann Goddard, 18, won her scholarship by organizing a 4-H electric club for younger members and teaching them the rudiments of electrical maintenance (her own field of expertise), electrical theory and electrical safety.

A versatile battery charger built from parts out of a power scrubbing machine was the entry of E. Michael Krenzer, 16, Spencerport, NY, while Andrew J. Kutlik, also 16, Lodi, CA, designed and built an electric combination lock and alarm system.

William C. Padgett, Jr., 18, Walterboro, SC, submitted a juke box that was originally discarded. He raised the value from zero to \$650 with an expenditure of \$35 in parts and a great deal of time. The prize-winning entry of Norman Shubert, 18, Danube, CA, was a synchronous converter and transformer.

Brazil's color TV system good for both PAL and NTSC

Brazil exhibited a new television system, PAL/M, at the International Telecommunications Exhibition in Geneva last Fall. The PAL/M system has the same high quality of the German PAL delay-line system, while being compatible with the American NTSC system.

The Brazilians suggest that their solution to the "which system" problem may be the answer for some countries who have not decided which system to adopt, but may have pilot transmitters or large numbers of receivers using the NTSC system, which was the first to be widely used but does not reproduce color with the same fidelity as PAL.

Radio-Electronics®

Hugo Gernsback (1884-1967) founder

M. Harvey Gernsback
editor-in-chief and publisher

Larry Steckler, CET, editor

Robert F. Scott, W2PWG, CET,
technical editor

Arthur Kleiman, associate editor

Jack Darr, CET service editor

Leonard Feldman
contributing high-fidelity editor

David Lachenbruch, contributing editor

Karl Savon, semiconductor editor

Vincent P. Cicenia, production manager

Donna L. Glass, production assistant

Harriet I. Matysko, circulation director

Sheila Wertling, circulation assistant

Arline R. Bailey, advertising coordinator

Cover design by Louis G. Rubsamen

Radio Electronics is a member of the *Institute of High Fidelity* and is indexed in *Applied Science & Technology Index* and *Readers Guide to Periodical Literature*.



Radio-Electronics magazine is published by Gernsback Publications, Inc.
200 Park Ave. S. New York, NY 10003
(212) 777-6400

President: M. Harvey Gernsback

Vice President: Larry Steckler

Treasurer: Carol A. Gernsback

Secretary: Bertina Baer

ADVERTISING SALES

EAST

Stanley Levitan, Sales Manager
Radio-Electronics
200 Park Ave. South
New York, NY 10003
(212) 777-6400

MIDWEST/Texas/Arkansas/Okla.

Ralph Bergen
Jim Reilly
The Ralph Bergen Co.
6319 N. Central Ave.
Chicago, IL 60646
(312) 792-3646

PACIFIC COAST Mountain States

Jay Eisenberg
J.E. Publishers Representative Co.,
8732 Sunset Blvd.,
4th Floor,
Los Angeles, CA 90069
(213) 659-3810
Sales Mart Building
1485 Bayshore Blvd., Box 140
San Francisco, CA 94124
(415) 467-0125

SOUTHEAST

J. E. Publishers Representative Co.
(214) 387-2424

16 ways to move ahead in electronics!



Choose the one that's just right for you... the one that can make your future more rewarding, more secure, more enjoyable... starting now! These ways to move ahead are yours from Electronics Technical Institute... the finest electronics home study courses and programs ever offered!

Fundamental Electronics

Get a solid foundation for entering the fast-moving world of electronics where today is great, and tomorrow will be greater. Learn it the simple, easy, step-by-step, programmed way called *Autotext*, exclusive with ETI!

Electronics Drafting

Learn a vitally needed specialty that translates new technological concepts and developments to the practical drawing board. Become a specialist-in-demand, through ETI's training. Learn it at home... get your future moving now!

Color TV Servicing

There's a real future waiting for the established color television technician. You become that technician through this program that takes you step-by-step to *theoretical and practical* mastery of color TV. Get your tomorrow started today!

Master TV/Radio Servicing

Here is true "master" preparation for a career that can take you as far as you want to go into radio and television servicing, both black and white, and color. The helpful, practical ETI way can be your way to more money, security, success!

Communications

ETI's communications program opens up a whole range of career development possibilities in electronics. Solid-state receivers, solid-state audio equipment, communications equipment, CATV, as well as preparation for FCC-licensed positions in commercial broadcasting and mobile communications. You can find a real future here!

Industrial Electronics

You open great career opportunities through this program, as instrumentation technician, electronic equipment maintenance technician, electronic calculating machine technician and audio technician. It also prepares you to move into and up in communications, automation and industrial electronics!

Digital Technology

Join the digital revolution which is radically altering our lives today and tomorrow. Get solidly trained in the new digital specialties that can lead to a real future as a digital control technician, electronic calculating machine technician, field representative, computer sales representative, manufacturer's representative.

Electronics Technology

Learn electronics across the board! You'll be ready for real career advancement with training that can lead to technical positions in communication, automation and industrial electronics, and can also help you in sales positions, management and administration.

Computers

ETI offers training opportunities in Computer Technology and Computer Programming. Learn at home, and get ready to enter a field where incredible developments are sure to continue. It's practical, useful—the step-by-step ETI way!

Advanced Electronics

Want greater challenges and career advancement? This course is for you. It can be valuable preparation not only for a technical career, but also for the fields of sales, management and administration. Make your move now!

Digital Electronics—Advanced

Here's a special course for those already in the field of digital electronics, ready to move into more advanced areas. This is how to move up in sales, management and administration. Here's your tomorrow!

Black and White TV Servicing—Advanced

This can be your own "advance" course to black-and-white TV competence from A to Z. You'll construct a receiver yourself, if you wish. A key to lifetime success!

Industrial Instrumentation—Advanced

Move up in the world... the wonderful electronics world! This course opens up a whole range of careers in the industrial field, as instrumentation technician, laboratory technician, process control technician or electronic calculating machine technician. Get ready... and go!

Color TV Servicing—Advanced

Here is the "graduate" course in color TV for those who already know television fundamentals. You'll learn color TV from top to bottom, build your own set if you choose. A great way to build your future!

Solid-State Electronics—Advanced

Applications of transistors are increasing all the time and the transistor may be a breakthrough

comparable in importance to the development of nuclear energy. Solid-state can mean your solid career development, too, through ETI!

FCC License Preparation

Here is real down-to-earth practical preparation to take your 3rd, 2nd or 1st class Federal Communication Commission Radio-telephone License examinations. Get yourself ready now for any of the FCC-licensed positions involving broadcasting, mobile communications, microwave communications links, marine communications equipment or in many other positions in solid-state, communications, CATV. Get ready for tomorrow... today!

Get all the facts... free!

Send the coupon now for ETI's colorfully illustrated new 44-page catalog giving you all the details. You owe it to yourself. There's no obligation, and no salesman will call. Send for yours today!



Electronics Technical Institute

Division of Technical Home Study Schools

Electronics Technical Institute, Dept. 2-479-046
Little Falls, New Jersey 07424

Send me the Electronics Technical Institute Catalog.

Name _____ (please print)
Address _____
City _____ State _____ Zip _____

Interested in another field? Check the Technical Home Study School program that interests you most. No salesman will call. PLEASE CHECK ONLY ONE.

- | | |
|-------------------------------------------------------------------------------|--------------------------------------------------|
| <input type="checkbox"/> Typewriter and Office Machine Repair | <input type="checkbox"/> Locksmithing |
| <input type="checkbox"/> Upholstery and Decorating | <input type="checkbox"/> Legal Investigation |
| <input type="checkbox"/> Accident and Insurance Claim Adjusting | <input type="checkbox"/> Security/Alarm Business |
| <input type="checkbox"/> Outdoor Careers in Conservation | <input type="checkbox"/> Photography |
| <input type="checkbox"/> Check here for information on Veterans Benefits. | |
| <input type="checkbox"/> Check here for information on learning by cassettes. | |

Circle 5 on reader service card

letters

NEW AUTOMATIC IN-CIRCUIT SEMICONDUCTOR TESTING AND LEAD IDENTIFICATION



for
all bipolar transistors
(including hard-to-
check Darlington's),
FET's, SCR's,
diodes.

Model 520B
Semiconductor Tester
\$160.00

New HI/LO power drive circuitry permits accurate testing of even more transistors and other semiconductors in circuits with shunt resistance as low as 10 ohms and shunt capacitance up to 15 μ F. New low power drive automatically identifies base, emitter and collector leads, in or out of circuit.

Test takes 9 seconds or less. Audio tone and LED's indicate GOOD/BAD, NPN-OK or PNP-OK.

Ideal for production line, inspection, and field service applications.

Contact your local distributor for a demonstration or write for detailed brochure.

BK PRECISION
PRODUCTS OF DYNASCAN

1801 West Belle Plaine Avenue
Chicago, Illinois 60613 312/525-3990

In Canada: Atlas Electronics, Toronto

HELP!

I must say that you have a very fine magazine. I enjoy it very much. The departments, Service Clinic, Service Notes, and Letters are a lot of help.

Would you please print a request for help? I have this old Stewart-Warner radio that I would like to restore. I would like to ask for anything that would be of help to me. Old service notes, schematic, circuit diagrams, etc. The information on the set describes it as a Stewart-Warner Speedometer Corp., item "900 series", model 801, series B.
ARNOLD AMERSON
130 Alves Lane, Apt. #1
Pittsburgh, CA 94565

Sorry Mr. Amerson. We opened our archives, but no luck. We did discover, however, a tremendous amount of dust.

Okay readers; dust off your files and see if you can help. Send any information you can dig up on this radio directly to Mr. Amerson.—Editor

DIGITAL STOPWATCH

Reader John Morse, of Bridgeport, CT, tells us that he has come across two versions of the Novus Mathbox model 650 calculator—one of several models recommended in the November issue as the basis for a digital stopwatch. One version—obviously the one used in the stopwatch shown in the article—has the IC's mounted on a PC board. The second, and presumably a later version, has all the electronic components potted into a glob on the back of the read-out. This one is unsuitable for use in the construction of the stopwatch.

You can probably identify the two versions by opening the battery compartment and pulling out the battery holder. You'll see either the PC board or the glob on the back of the read-out. Mr. Morse also mentioned that in the model 650 Mathboxes he's seen, versions with the PC board have serial numbers beginning with "1" while the serial numbers on the others begin with "2".—Editor

*** TO RADIO ELECTRONICS ***

THANK YOU FOR THE WONDERFUL
& EXCITING PROJECT I EVER BUILD
IT TOOK ME A YEAR TO GATHER
REASONABLE PRICE PARTS. ALONG
WITH THE TV TYPEWRITER I ALSO
PUT TOGETHER THE R.E. *UART*

MY NEXT PROJECT WILL BE THE
*** 8080 SYSTEM ***

ORVILLE B. JUGARAP
41-576 INOAOLE ST.
WAIMANALO, HAWAII

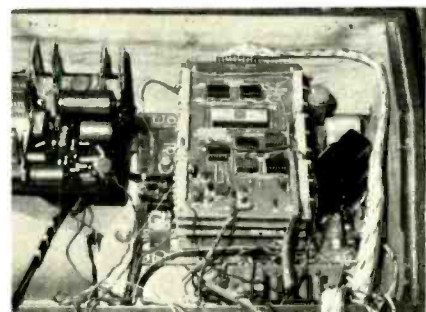
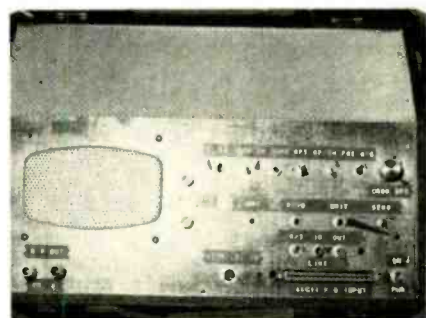

SX-70 BATTERIES

I look forward to every issue of your magazine as I have for the past ten years. As a hobbyist I particularly enjoy your hobby oriented projects. I would like to pass this item on to your other readers.

One asset other experimenters may have overlooked is the battery that comes with every pack of Polaroid SX-70 film. The battery measures 1/10" x 3 1/2" x 4 1/4" and is easily removed from the disposable pack after the last picture has been taken. The 6-volt cell, in its own protective pack, has two openings where you can solder on leads. With two silicon diodes in series it provides 5 volts for digital IC work. Four batteries provide ± 12 volts for op-amp projects. They can even be series-strung to replace expensive 22.5 and 67.5 volt batteries in tube and transistor applications.

One bonus they provide is that they come from the camera at a consistent 6.23 volts (checked with an accurate source) which provides for a calibration

(continued on page 16)

The Black Watch kit

At \$29.95, it's

★**practical**—easily built by anyone in an evening's straightforward assembly.

★**complete**—right down to strap and batteries.

★**guaranteed.** A correctly-assembled watch is guaranteed for a year. It works as soon as you put the batteries in. On a built watch we guarantee an accuracy within a second a day—but building it yourself you may be able to adjust the trimmer to achieve an accuracy within a second a week.



The Black Watch by Sinclair is unique. Controlled by a quartz crystal . . . powered by two hearing aid batteries . . . it's also styled in the cool prestige Sinclair fashion: no knobs, no buttons, no flash . . . just touch the front of the case to show hours and minutes and minutes and seconds in bright red LEDs.

The Black Watch kit is unique, too. It's rational—Sinclair have reduced the separate components to just four.

It's simple—anybody who can use a soldering iron can assemble a Black Watch without difficulty. From opening the kit to wearing the watch is a couple of hours' work.

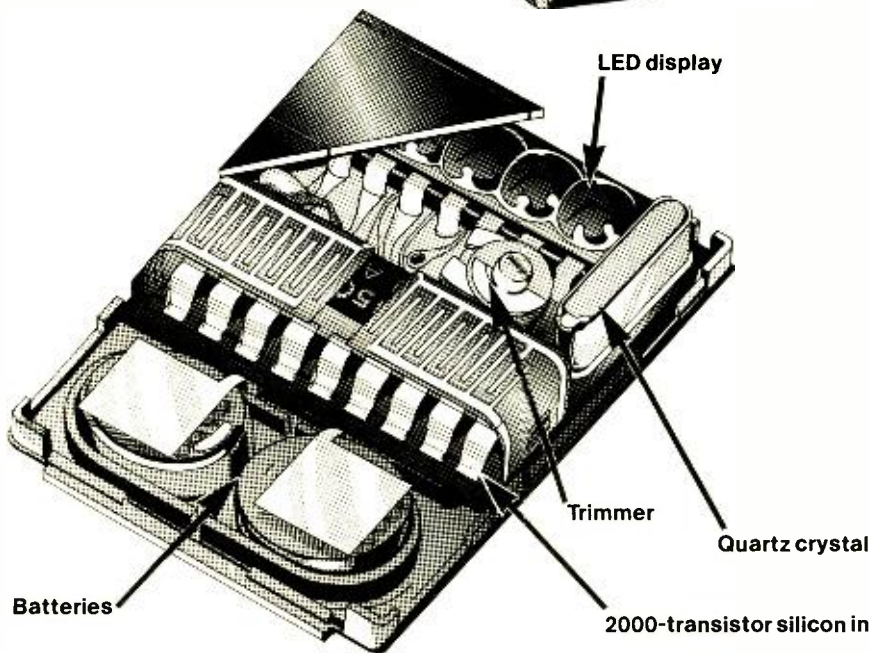

Complete kit \$29.95!

The kit contains

1. printed circuit board
 2. unique Sinclair-designed IC
 3. encapsulated quartz crystal
 4. trimmer
 5. capacitor
 6. LED display
 7. 2-part case with window in position
 8. batteries
 9. battery-clip
 10. black strap (black stainless-steel bracelet optional extra—see order form)
 11. full instructions for building and use.
- All you provide is a fine soldering iron and a pair of cutters.

Take advantage of this no-risks, money-back offer today!

The Sinclair Black Watch is fully guaranteed. Return your kit within 10 days undamaged and we'll refund the cost of your kit without question.

sinclair
SINCLAIR RADIONICS

375 Park Avenue
New York, N.Y. 10022

Please send me _____ Sinclair Black Watch kit(s) at \$29.95 (Plus \$2.50 per unit, shipping and handling). Stainless steel band \$4.00. Available assembled kit \$49.95.

Enclosed is my check for _____

Name _____

Address _____

Mail to: Sinclair Radionics Inc., RE-4 375 Park Ave., New York, N.Y. 10022
N.Y. Residents add sales tax.

LETTERS

(continued from page 14)

check on test equipment. Their flat shape allows them to be used in many projects where standard batteries with their bulky holders would not fit. Their shelf life and current capacity make these a valuable power source that are presently being thrown in the garbage by the million.

2nd LT. KENNETH M. SCHULTZ
Goodfellow Air Force Base
San Angelo, TX

MORE HI-FI

I think your in-depth hi-fi test reports are very good. My only criticism is that there aren't more test reports in each

issue. I realize that with the proliferation of equipment available—it is impossible to cover everything. I do appreciate the fact that you are testing items other than receivers, turntables, etc. I especially appreciate your rear-view photo and the Overall Product Analysis.

I, personally, would like to see in-depth reports on several of the many system add-ons for improving dynamic range and increasing the S/N ratio.

I am learning more about audio and what the specifications mean all the time—my education coming mainly from reading reports and studying the explanations and comments made regarding specs in the reports.

I got turned on to Len Feldman via *Rolling Stone*. He really knows hi-fi and

more important, he obviously loves to talk about it and explain it to others. Many equipment reports appearing in other magazines seem to go out of their way not to criticize any product. I like the way your reports take a stand on the competitive value of an item.

Keep up the good work.
BILL HATCHEL
Hayward, CA

Thanks for your comments concerning our hi-fi test reports. They are well noted. But perhaps now is a good time for an explanation of our editorial policy.

We too would like to devote more space and cover more equipment than we presently do. Each month we find it increasingly difficult to "squeeze" the vast amount of information in our test reports into the available number of pages. But we would also like to increase the number of construction, educational and service oriented articles as well.

If Radio-Electronics was a magazine devoted to one specialized area (high-fidelity, for example), the decision would be easy—but it isn't. Radio-Electronics is a diversified magazine covering many specialized areas in electronics. We cannot devote more space to one specialized area without sacrificing the others.

Your comments, however, DO COUNT! We must have the support of our readers. Write to us, let us know about what you would like to see appear.—Editor

KOMPUTER KORNER

Computer Korner is one of the best ideas the editors have had for quite some time. Microcomputers and microprocessors are being widely used now, and this type of information should be of great value to your readers.

The reason I read *Radio-Electronics* is to become more informed about new electronic developments. When I read a good informative story published in an electronics magazine it makes a favorable and lasting impression. Computer Korner is exactly that type of story.

My congratulations go to Tim Barry for the fine job he is doing on Computer Korner, and I sincerely hope to see more information of this type on microprocessors and microcomputers in the months to come.

DAVID H. SCOTT
Mt. Home, ID

I thought all our ideas are "best" ideas! Oh well.

Computer Korner is a monthly column that we hope will be with us for a long time. Although we are publishing only one column per month, there are two different Computer Korner columns. One column, as you noted, is being written by Tim Barry. The second column is the result of the combined efforts of John Titus, David Larsen and Peter Rony. Watch for them both.—Editor

R-E

DON'T MISS THEM!

This month's hi-fi test reports include the new Fuji FX-C60 cassette tape and the Harman-Kardon Citation 16 power amplifier. Turn to pages 53 and 55, respectively, for the complete story and full specifications.

Den nya handlic 2305 Basstationen har sensationell prestanda!

In the USA this means: "The new Handlic 2305 Base Station is a spectacular performer!"

- Built-in "Priority Channel" can be switched on so that a pre-selected channel (i.e. Emergency CH-9) will override any other channel being used.
- Full 23-CH operation on 110VAC or 12VDC.
- Selectivity — 90dB at ± 10 KHz
- Sensitivity — $0.5\mu V$ at 10dB S/N.
- Built-in PA Facility.
- Automatic Gain Control.
- Automatic Noise Limiter Switch.
- Selective Call Facility.
- Built-in SWR Brdge and Illuminated S/R/F Meter.
- Complete with 'Mic', AC cable, crystals for 23-Chan's; jacks for Selective Call, external speaker, PA speaker and hand-held telephone

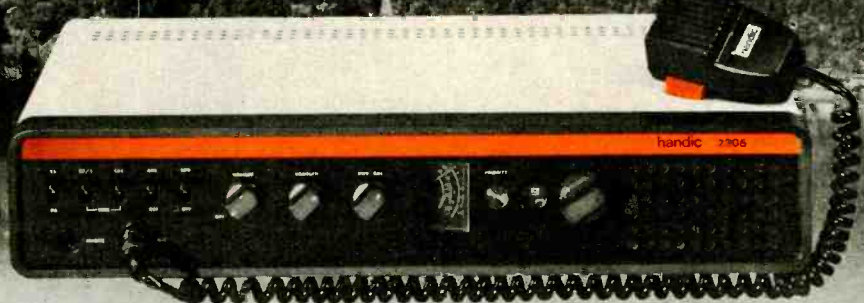

Handlic CB radios include: mobile/base transceivers; hand-held personal portable CB systems; scanners with FM radio option; antennas; microphones; selective call; and a full line of accessories

Send For FREE Catalog!



handlic U.S.A. inc.

14560 N.W. 50th Ave., Kennedy Bldg.,
Miami Lakes, Fla. 33014 (305) 558-1522
In Canada: Scotcomm Radio Inc., Chomedey, Laval, Quebec



THE DEPENDABLE CB FROM SWEDEN

THE YOUNGEST REVOLUTIONARY



From the deep jungles of jumbled software, from the rivers of mysterious circuits, he came. Mini-Micro Designer. He was tough and smart. And he glowed with purpose. To teach the people microcomputers.

Learn from the leader in the modern electronics revolution. E&L's Mini-Micro Designer (MMD-1) comes with a series of educational "modules" that teach you how to design and use a microcomputer. And you get complete documentation and full software support. MMD-1 features the 8080A central processor chip, direct keyboard entry of data/instructions, LED status indicators, and all the apparatus needed to make your first microcomputer. Novice or expert, MMD-1 gets you into action fast. Put a revolutionary on your side. Send for more information today.

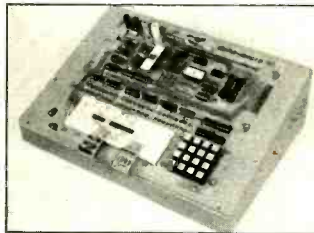

Prices start at \$125 in kit form.

CIRCUIT DESIGN, INC.

Division of E&L Instruments
P.O. Box 24
Shelton, Conn. 06484

Circle 8 on reader service card

ONCE YOU HOOK UP WITH US, YOU'RE HOOKED.

Your watch and wallet will tell you why, once you've used our QT solderless breadboarding Sockets and Bus Strips.* Because of the time and money you'll save by eliminating soldering, desoldering and resoldering on every circuit you design or test.

With the QT system, you can instantly connect and reconnect all kinds of components—as fast as you can push in (or pull out) a lead. Durable 5-point terminals provide fast, easy interconnections between components... and jumpers, where necessary, are lengths of #22 AWG solid wire.

You'll save money because components can be reused again and again, with no heat to damage delicate semiconductors. You can start off inexpensively—as little as \$3.00** for a compact socket with 70 solderless tie-points—and expand with interlocking units to any size you need.

Problem is, once you see how much time, money and aggravation our QT system saves, you'll never want to breadboard any other way.

(For more information, see your CSC dealer.

or write for our catalog and distributor list.)

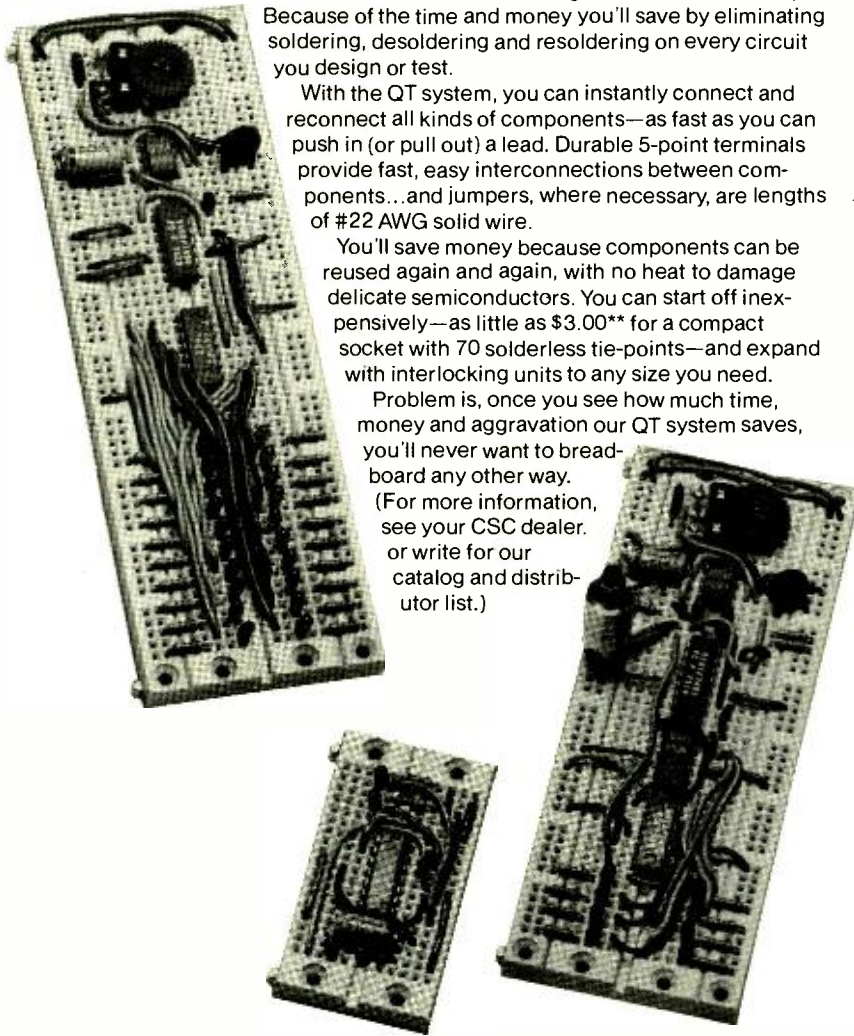

CONTINENTAL SPECIALTIES CORPORATION



EASY DOES IT

44 Kendall Street, Box 1942
New Haven, CT 06509 • 203-624-3103 TWX: 710-465-1227
West Coast office: Box 7809, San Francisco, CA
94119 • 415-421-8872 TWX: 910-372-7992
Canada: Len Finkler Ltd., Ontario

© 1976, Continental Specialties Corp.

*U.S. Pat. No. D 235,554

**Manufacturer's suggested list QT-7S.

Prices and specifications subject to change without notice.

Circle 9 on reader service card

KOMPUTER KORNER

Microcomputer anatomy and the way it communicates to the outside world is described this month.

**PETER RONY, JOHN TITUS,
and DAVID LARSEN***

* This article is reprinted courtesy American Laboratories

IN THIS COLUMN WE WILL DISCUSS THE "anatomy" of a typical microcomputer system. (See Fig. 1, page 24.) This system is based upon the 40-pin 8080 microprocessor chip and possesses all of the minimum requirements for a computer.

- It can input and output data.
- It contains an arithmetic/logic unit (ALU), located within the 8080 chip, that performs the arithmetic and logical operations.
- It contains "fast" memory (speed is an important requirement for a functional computer these days).
- It is programmable, with the data and program instructions capable of being arranged in any sequence desired.
- It is digital.

Memory

Lets first consider the data communication between the 8080 central processing unit (CPU) and memory. The following definitions^{1,2} will be useful in the ensuing discussion:

memory—Any device that can store bits in such a manner that a single bit or group of bits can be accessed and retrieved.

memory cell—A single storage element of memory.

memory word—A group of bits occupying one storage location in a computer. This group is treated by the computer circuits as an entity, by the control unit as an instruction, and by the arithmetic unit as a quantity. Each bit is stored in a single memory cell.

memory address—The storage location of a memory word.

memory data—The memory word occupying a specific storage location in memory, or the memory words collectively located in memory.

random access memory—A memory into which bits can be written (stored) and then read out again (retrieved).

read-only memory—A memory that can be repeatedly read out, but cannot be written into.

programmable read-only memory—A read-only memory that is field programmable by the user.

volatile memory—In computers, any memory that can store information only as

(continued on page 22)

Introducing the fast working counters from Hickok.



MODEL 380
80 MHz,
\$259



MODEL 385
512 MHz,
\$499

**Four affordable, deluxe counters —
one for every need.**

How would you like a 512 MHz counter for hundreds of dollars less than comparable equipment? Or a low priced 80 MHz counter with a fast updating SPEED READ mode, that displays 7 digits, autoranges, and delivers 1 Hz resolution through 10 MHz? Hickok has four new counters that do all this and more.

Model 380 1 Hz to 80 MHz, 10 ppm \$259

Guaranteed 80 MHz response.
Resolution is 1 Hz to 10 MHz and 10 Hz to 80 MHz.
10 ppm accurate time base to meet FCC requirements for CB applications.
Autoranging selects best gate time, 1 sec. or 0.1 sec.
SPEED READ mode updates display 5 times per second (0.1 sec. gate) for fast response while tuning.

Model 380X 1 Hz to 80 MHz, 1 ppm \$385

Offers all of the above plus a 1 ppm accurate temperature compensated crystal oscillator (TCXO). Meets FCC requirements for all communications servicing.

Model 385 1 Hz to 512 MHz, 10 ppm \$499

Guaranteed 512 MHz response with built-in prescaler.
Autoranging and auto-decimal in direct and prescaled modes.
Switch-selectable 1 Megohm or 50 ohm inputs.

Resolution is 1 Hz through 10 MHz, 10 Hz through 80 MHz, and 100 Hz through 512 MHz.

Model 385X 1 Hz to 512 MHz, 1 ppm \$625

Offers all of the above with a 1 ppm accurate temperature compensated crystal oscillator (TCXO).

PLUS: Models 380 and 385 have switch-selectable external time base oscillator inputs. Models 380X and 385X offer high stability time base oscillator output @ 1 MHz (An "X" model can drive up to four 380 or 385 models — providing 1 ppm accuracy to all 5 units).

These counters are perfect for communications setup and servicing, digital watch service, CB, broadcasting, audio and digital work, educational and laboratory applications.

See these new counters at your distributor now!

HICKOK

the value innovator

INSTRUMENTATION & CONTROLS DIVISION
THE HICKOK ELECTRICAL INSTRUMENT CO.
10514 Dupont Avenue • Cleveland, Ohio 44108
(216) 541-8060 • TWX: 810-421-8286

Circle 10 on reader service card



Wm. De
Electrical

NORRISTOWN

Electric HEATING CONTRACTOR
FLAMELESS
ELECTRIC HEAT
FOR COMPLETE COMFORT AND CONVENIENCE

CALL US FOR...
AND AN...

“Learn an honest trade,” my old man used to say to me, “and you’ll never have to knuckle under to any man.”

(A TRUE STORY)

Bill DeMedio of Conshohocken, Pa., has it made. At 26, he’s a licensed master electrician. The top of a trade where there aren’t enough good men to go around.

But more important, Bill’s his own boss and calls his own shots. “I just went into my own business. And even before the sign on my truck was dry, I got my first big job.

“The contractor for a new group of houses asked me to do the wiring. And there’s bound to be more work from him and other builders.

“If it wasn’t for my ICS training as an electrician, I’d still be in some dead-end job—hating what I was doing, taking orders from everyone, and never getting any thanks for it.

“As a master electrician, you’re the boss on the job—even when you’re working for someone. You get respect, good money, and like my old man said, you don’t have to take baloney from anyone.”

Bill De Medio is one of our outstanding graduates. He’s hard working. He’s in a growing field. And he has good training.

Of course, we can’t promise you’ll be as successful as Bill—no school can guarantee jobs for its graduates. But ICS *can* give you the first-rate training you need—especially if you’re interested in one of the growing careers where ICS concentrates its training.

AN IDEAL WAY TO LEARN

As an ICS student, you study at home, on your own schedule. You waste no time traveling to and from class. And you never have to miss a paycheck.

But you’re never alone. If you ever want to talk to an instructor, you can call ICS from anywhere in the continental United States, using our toll-free Dial-a-Question® service.

Since 1890, millions of men and women around the world have turned to ICS for career training.

More than 70 of America’s largest 100 corporations (including Gulf Oil, Bethlehem Steel, 3M, Westinghouse, and International Paper) use ICS training for their own employees.

And the ICS Center for Degree Studies is authorized by the Pennsylvania Department of Education to grant the Associate in Specialized Business degree in Accounting and Business Management, and the Associate in Specialized Technology degree in Civil, Mechanical, Electrical, and Chemical Engineering Technologies.

These degree programs are not mere stepping-stones to higher education nor are they intended for transfer toward advanced degrees. They are practical, career-oriented programs designed to help you reach your objectives without further academic training.

If you already have some college education, you may be able to receive advanced standing toward your degree. With a degree from ICS, you’ll be able to apply with pride for jobs that call for career training.

FREE DEMONSTRATION LESSON

No one can promise you success, but if you *want* more—more money, more security, more day-to-day satisfaction and more future—our free Career Booklet and free Demonstration Lesson can help you get started in the right direction.

Remember, it’s your life. You might as well make the most of it.

© 1975 Intext, Inc. E

FOR A FREE CAREER BOOKLET & DEMO LESSON, CHECK BELOW.

- | | |
|-----------------------------------------------------------|-----------------------------------------------------|
| <input type="checkbox"/> Electrician | <input type="checkbox"/> Automotive Mechanics |
| <input type="checkbox"/> Engineering | <input type="checkbox"/> Business Management |
| <input type="checkbox"/> Accounting | <input type="checkbox"/> Civil Engineering |
| <input type="checkbox"/> Drafting | <input type="checkbox"/> Interior Decorating |
| <input type="checkbox"/> Electronics Technician | <input type="checkbox"/> Construction Electrician |
| <input type="checkbox"/> TV Service & Repair | <input type="checkbox"/> Appliance Service & Repair |
| <input type="checkbox"/> Surveying & Mapping | <input type="checkbox"/> Income Tax |
| <input type="checkbox"/> Diesel Mechanic | <input type="checkbox"/> Motel/Restaurant Mgt. |
| <input type="checkbox"/> Air Conditioning & Refrigeration | <input type="checkbox"/> Mechanical Engineering |
| | <input type="checkbox"/> High School |

EARN A DEGREE WITHOUT GOING TO COLLEGE

The ICS Center for Degree Studies is authorized by the Pennsylvania Department of Education to offer career programs at home leading to Associate in Specialized Business and Associate in Specialized Technology degrees. For information, check the field of your choice below.

- | | |
|----------------------------------------------|-----------------------------------------------------------------------|
| Business Programs: | Engineering Technologies: |
| <input type="checkbox"/> Accounting | <input type="checkbox"/> Civil <input type="checkbox"/> Electrical |
| <input type="checkbox"/> Business Management | <input type="checkbox"/> Mechanical <input type="checkbox"/> Chemical |

Name _____ Age _____

Address _____

City _____

State _____ Zip _____

Phone _____

ICS

XA915Q

INTERNATIONAL CORRESPONDENCE SCHOOLS
SCRANTON, PA. 18515

VETERANS: TAKEN FOR CAREER PURPOSES, ICS PROGRAMS QUALIFY FOR V.A. BENEFITS. CANADIAN RESIDENTS USE SCRANTON, PA. ADDRESS FOR SERVICE FROM ICS CANADIAN, LTD. IN HAWAII 931 UNIVERSITY AVE., HONOLULU, HAWAII 96814.

At 26, Bill De Medio has more freedom, more security, and gets more respect than guys twice his age. (Photograph by Frank Cowan.)

MEET OUR family of shielded "BLACK BOXES"

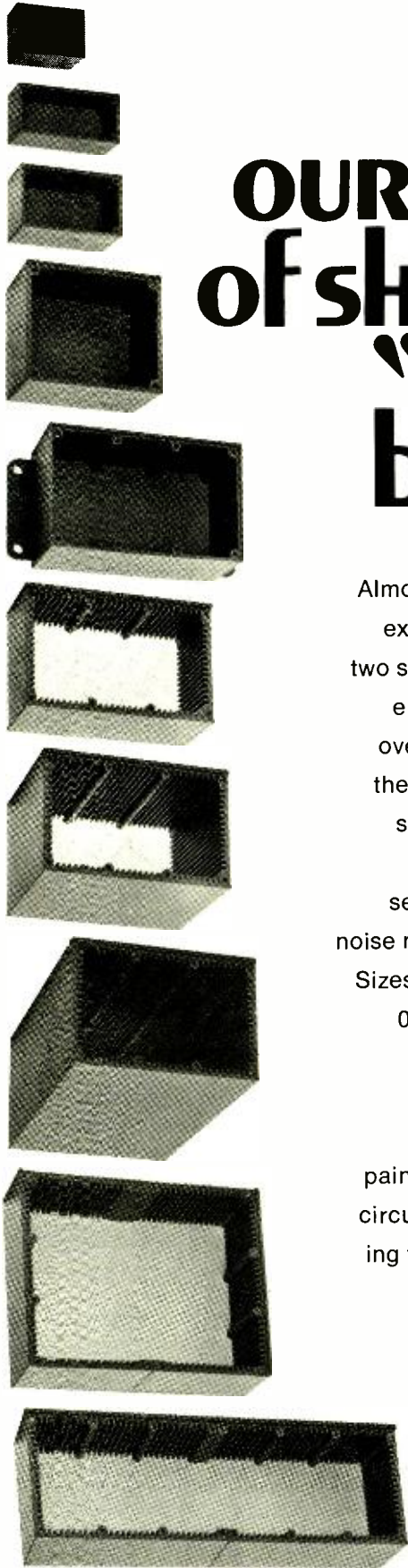

Almost 10 years ago (1966 to be exact) we introduced our first two series of shielded electronic enclosures. They became an overnight success. Since then the demand for different sizes, shapes and applications has increased our family to ten series of models, each with a noise rejection greater than 70db.

Sizes range from 1.50" x 1.13" x 0.88" to 4.13" x 2.68" x 6.0"; in blank versions or with a complete choice of coaxial connectors; painted or unpainted; with or without printed circuit card guides; with mounting flanges or bottom mounting plates. All models supplied with aluminum covers and mounting screws.

AVAILABLE THROUGH YOUR
FAVORITE ELECTRONIC
PARTS DISTRIBUTOR

ITT POMONA ELECTRONICS

1500 East Ninth St., Pomona, Calif. 91766
Telephone (714) 623-3463, TWX: 910-581-3822



Circle 11 on reader service card

long as power is applied to the memory.
read—To transmit data from a memory to some other device.

write—To transmit data into a memory from some other device. A synonym is *store*.

The 8080 microprocessor uses 8-bit words that are stored in memory by a 16-bit memory address bus. The memory address bus determines a specific storage location in memory. Therefore, $2^{16} = 65,536$ different memory locations can be accessed by the microprocessor. This memory access is direct, which means that you don't have to engage in any special tricks or digital electronic gimmicks to access any given memory location within the 65,536 possible locations. Forty-pin integrated circuit chips do have their advantages, and this is one of them. The total memory capacity of the 8080 microprocessor is known in the trade as "64K." This is far more memory than you will ever need for most applications, but it is nice to know that you have such power in reserve.

Data is transferred between the 8080 CPU and the memory via 8-bit input and output buses, both of which are shown in Fig. 1. By "input," we mean "input into the CPU." The term "output" is defined in a similar fashion. Our point of reference is always the CPU. Data leaving the CPU is always considered to be "output data;" data entering the CPU is always considered "input data." In the figure, we have indicated that the input and output data is transferred between the *accumulator* and memory. This is frequently the case, but in a more detailed look at the 8080 chip, you will discover that data stored in memory is transferred to other internal *registers* within the 8080 chip as well. The most obvious such register is the *instruction register*, from which the decoding of the instruction occurs. Other registers, known as *general purpose registers*, are classified by the letters B, C, D, E, H, and L.

The accumulator register is the heart of the entire microcomputer. Arithmetic and logic operations are always performed to or on the eight bits of data present in the accumulator. All input and output data passes through the accumulator with the aid of two computer instructions called *IN* and *OUT*.

Between the 8080 CPU and memory there is a single output line called memory *READ/WRITE*. When this line is at a logic 1 level, you are able to read data into the CPU either from memory or from an external device. When this line is at a logic 0 level, you are able to write data from the CPU into memory or an external output device.

As a final point, you can use any type of "fast," digital electronic memory device, including random access memory (RAM), read-only memory (ROM), and programmable read-only memory (PROM). What do we mean by "fast" memory? Simply that the memory can perform either a read or write operation during a single microcomputer instruction.

(continued on page 24)

Everything you need to know about CB is in this new book by Radio Shack

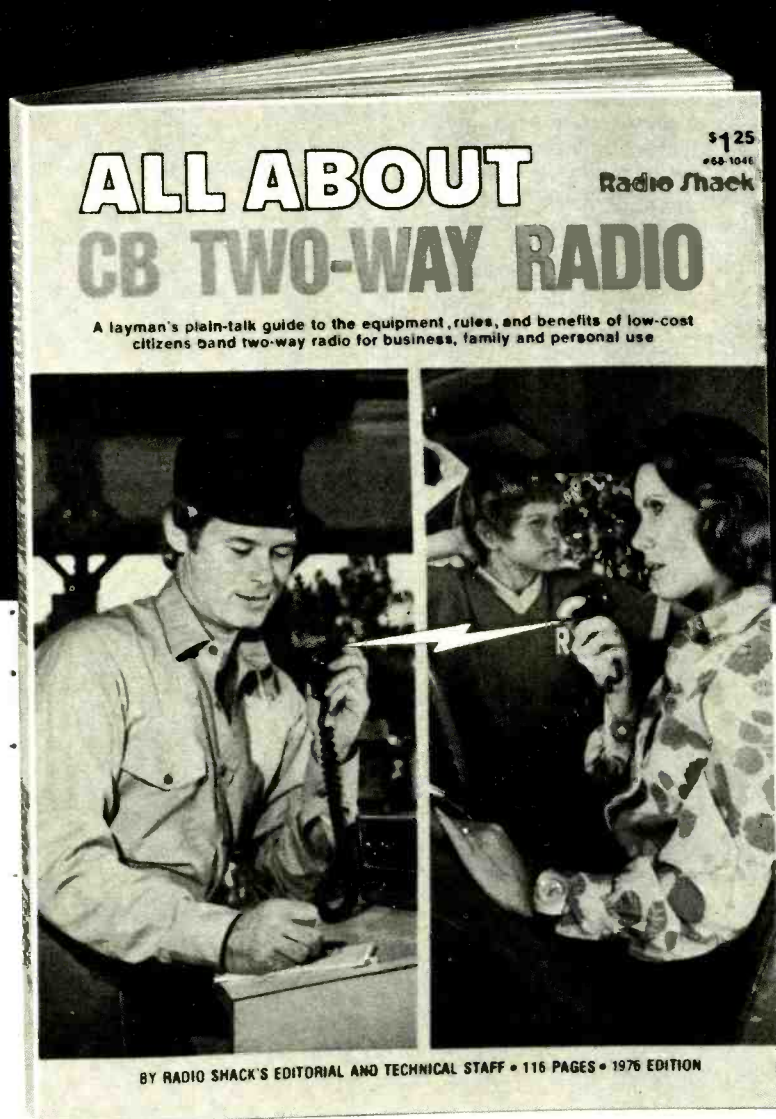

SPECIAL INTRODUCTORY OFFER!

Reg. \$1.25 CB Book

25¢

* WITH THIS COUPON

Offer Good at: Participating Radio Shack Stores and Dealers

NONE SENT BY MAIL 705

9 Plain-Talk Chapters:

- Personal Two-Way Communications
 - Taking the Mystery Out of CB
 - Parts of the System
 - How Far You Can Expect to Talk
 - Equipment Selection
 - Installation
 - FCC Regulations
 - CB Tomorrow
 - Detailed Glossary
- Plus —
- 10-Codes ■ CB Slang
 - FCC Field Offices
 - Over 100 Pictures

Our just-published 116-page CB pocket-size book is available now at Radio Shack stores at a "give-away" price of just 25¢, prior to its listing in our catalog at \$1.25. If you're into CB 2-way radio or getting in (as who isn't!) you'll want this book to avoid costly errors.

Edited by the folks who started our famous Realistic® CB line in 1959, it's authoritative, very easy to read, and tells all about CB for business, family and personal use. *Get your \$1-off copy—bring this coupon to any nearby participating Radio Shack store or dealer TODAY!

Radio Shack® LEADING THE WAY IN CB SINCE 1959
A TANDY COMPANY

Circle 12 on reader service card

APRIL 1976

KOMPUTER KORNER

(continued from page 22)

tion. A typical 8080 microcomputer system operates at a clock rate of 2-MHz and a read or write operation takes only 3.5 μ s. Thus, RAM, ROM and PROM all need an access time of about one to two microseconds to allow you to take full advantage of the maximum clock speed. Slower semiconductor memories can be used, but the microcomputer will have to "wait" while a read or write operation is completed.

Data output

The 8-bit output bus between the 8080 CPU and memory also serves as the output data bus to an external output device. When you provide output to an external device, there are several important points that you must remember:

- You must select the specific output device that will receive 8-bits of data from the CPU.

- You must indicate to this device when output data is available on the output data bus.

- The device must capture this output data in a very short period of time, typically 1.5 μ s.

The third point is perhaps the most important. Keep in mind that the microcomputer is operating at a clock rate of 2 MHz. Each computer instruction is executed in a very short period of time, which ranges from 2 μ s to 9 μ s. Thus, accumulator data designated as "output data" to an external device is not available for very long. You must capture it while it is available. We will discuss the techniques that you should use in a subsequent column; this topic is certainly among the most in-

teresting topics that can be discussed in the area of computer interfacing.

Data input

The basic considerations that apply to data output also apply to data input to the CPU from an external device. Thus:

- You must select the specific device that will transmit 8-bits of data to the CPU.

- You must indicate to this device when the CPU is ready to acquire the input data.

- You must insure that the CPU acquires this data in a very short period of time, typically 1.5 μ s.

Input/output device addressing

The 16-bit memory address bus is time shared so that it can provide, at certain times, an 8-bit device identification number called a *device code*. Eight bits of information allow you to decode $2^8 = 256$ different devices. When used in conjunction with 2 output-function pulses called IN and OUT, the microcomputer system can address 256 different input devices and 256 different output devices. We might point out here that a "device" can be a complex machine such as a teletype, a CRT display, or a simple device such as a single integrated circuit chip. This is another interesting topic for discussion that we shall reserve for a subsequent column.

Microcomputer interrupt

Not shown in Fig. 1 is a single input line to the microcomputer that generates (continued on page 30)

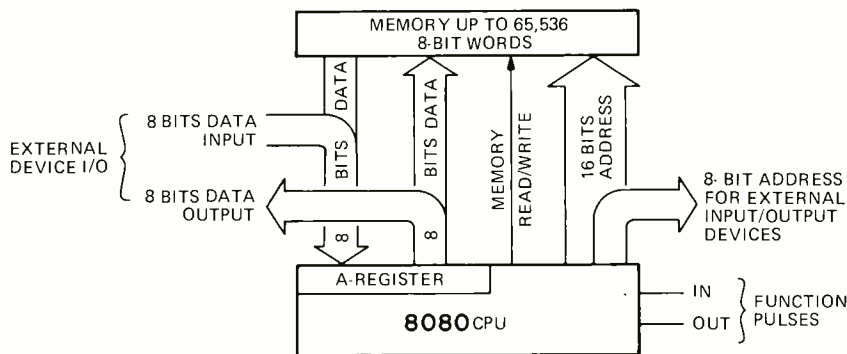

FIG. 1

Semiconductors made very, very easy.



How to stock 300 instead of 112,000. All it takes is RCA's "Top of the Line" SK Series 1976 Replacement Guide. Our most comprehensive list to date of transistors, rectifiers, thyristors and integrated circuits — 300 RCA types to replace 112,000 in entertainment or industrial equipment.

Excellent Product. Excellent Catalog. As a product, RCA SK replacement semiconductors measure up to strict AQL standards. As a catalog, our 1976 Replacement Guide is a thorough, accurate informational source, representing thousands of engineering man-hours.

Get the "top of the line" now. With RCA's SK Series and RCA's SK Replacement Guide. Contact your RCA Distributor. Or send \$1.00 (check or money order) to RCA Distributor and Special Products Division, P.O. Box 85, Runnemede, N.J. 08078.

RCA SK Replacement Semiconductors



Until now, the toughest part of CB servicing was getting the part.

Sylvania's ECG™ semiconductor replacement line has 138 devices for the transistors, diodes, rectifiers, integrated circuits and modules you need for Citizen's Band repairs.

And they're all at your Sylvania Distributor.

That means you can spend your time in the shop instead of in search of the right parts house. It can also make the difference between turning away a potential customer, and turning out a profitable repair job.

The latest ECG Semiconductor Replacement Guide and Supplement cross-references CB devices by original manufacturer's part numbers. In practically all cases, you'll find a direct replacement, not a part that's "something like" the original.

So don't waste valuable time hunting for parts when you can have ECG's electronics supermarket right in your own shop.

We're helping you make it.

GTE SYLVANIA

Circle 13 on reader service card

Who builds the best electronics around?

You Do! when you build these exciting Heathkit products... all in our new spring catalog



Our sensational Modulus™...the music system with total flexibility for your changing listening needs



The GB-1201 programmable digital stopwatch lets you keep track of time...for rallies, races, trips, efficiency studies

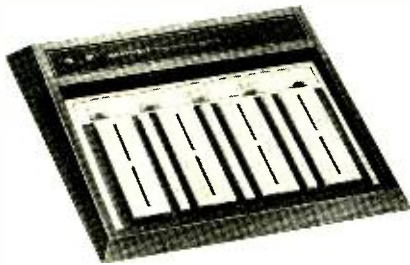

ET-3300 Lab Breadboard... makes circuit design and development fast and easy



IO-4550 Dual-Trace DC to 10 MHz scope... featuring brighter trace and faster writing speed



HW-2021 Hand-held 2-meter transceiver... 1 watt out, 5 receive and 10 transmit channels

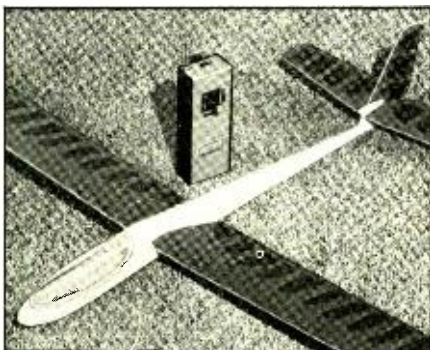

A complete line of Radio Control devices and systems... and a sleek new glider to go with them!

IT-5230 CRT Tester/ Rejuvenator handles the new IN-LINE COLOR tubes without adapters

IT-7400 Digital IC Tester...for RTL, DTL, TTL, CMOS, others...real versatility for your bench

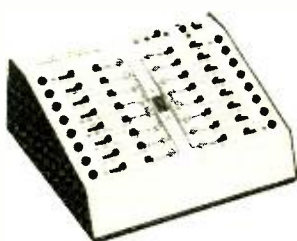

HEATHKIT

The Pioneer Spirit made America Great. Self-reliance, independence, individual participation. You get a sense of that spirit when you build a Heathkit product. Declare your independence now.

SPRING 1976

1. New - V-C Slider
2. New - CRT Tester
3. New - Digital Stopwatch
4. New - Programmable Power Transformer
5. New - Digital IC Tester
6. New - Digital IC Tester
7. Programmable Stopwatch

PLUS...over 100 other products in our new Spring Catalog

© 1976 Heath Company. See index on page 8. Heathkit, Modulus, and Rejuvenator are registered trademarks of Heath Company.

Who learns electronics the easy, effective, low-cost way?

You Do! when you study using the exclusive Heathkit Individual Learning Programs.

What better way to learn electronics than from people whose *business depends* on making it as easy to understand and work with as possible?

These Heathkit Individual Learnings Programs will give you a thorough background in basic electronics, while letting you study and learn at your own pace. There are four programs presently available: DC electronics, AC electronics, Semiconductor devices, and for the advanced, Digital Techniques. Each program includes a text written by the same people who write the world-famous Heathkit instruction manuals, audio records to reinforce and "personalize" text materials, and parts for hands-on experiments using low-cost electronic trainers which provide signal sources, power supplies and controls. Find out more about them, send for the FREE catalog below.

**HEATHKIT
CONTINUING
EDUCATION**

FREE! Read all about them!

The new Spring '76 Heathkit catalog describes those kits above, plus over 400 other money-saving electronic kits that are easy and fun to build! Send coupon or postcard today for your FREE copy.

Heath Company, Dept. 20-16, Benton Harbor, Michigan 49022

Complete, accurate, HONEST descriptions of over 400 electronic kits including:

- Automotive, Aircraft and Boating Aids
- Test Instruments
- Stereo Hi-Fi Components
- Amateur and Shortwave Radio
- Color TV • Security Systems
- Educational Self-Study

Use coupon or postcard today!



HEATH Schlumberger	Heath Company, Dept. 20-16, Benton Harbor, Michigan 49022
Please indicate area of interest:	
<input type="checkbox"/> Color TV <input type="checkbox"/> Hi-Fi <input type="checkbox"/> Automotive	
<input type="checkbox"/> Test Equipment <input type="checkbox"/> Amateur <input type="checkbox"/> Shortwave	
<input type="checkbox"/> Security <input type="checkbox"/> Self-Study	
Send me my FREE Heathkit Catalog.	
Name _____	
Address _____	
City _____	State _____
CL-593	Zip _____

Circle 100 on reader service card

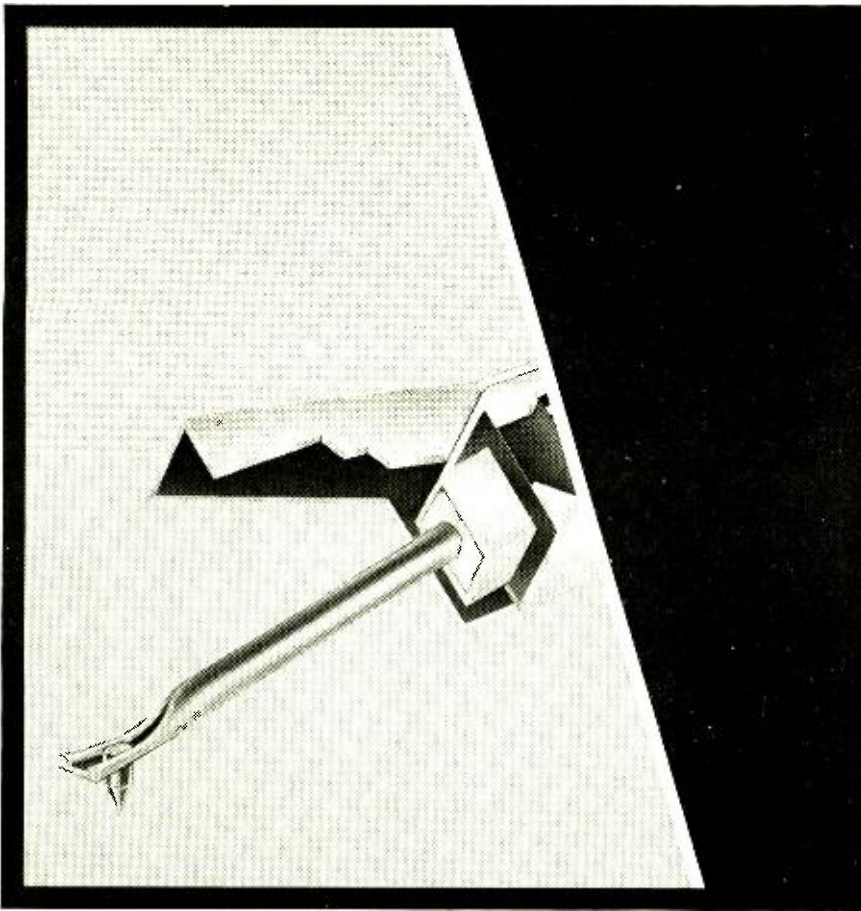

This...protects your most expensive hi-fi investment.

Recognizing that a penny saved is a penny earned, may we suggest that trying to economize by putting off the replacement of a worn stylus could be like throwing away five dollars every time you play a record. (Multiply that by the number of records you own!) Since the stylus is the single point of contact between the record and the balance of the system, it is the most critical component for faithfully reproducing sound and protecting your record investment. A worn stylus could irreparably damage your valuable record collection. Insure against this, easily and inexpensively, simply by having your dealer check your Shure stylus regularly. And, when required, replace it immediately with a genuine Shure replacement stylus. It will bring the entire cartridge back to original specification performance. Stamp out waste: see your Shure dealer or write:

Shure Brothers Inc.
 222 Hartrey Ave., Evanston, IL 60204
 In Canada: A. C. Simmonds & Sons Limited



* FREE! 1976 Stereo Directory & Buying Guide with the purchase of a Shure V-15 Type III, or the M95 series, M75 Type II or M91 series of cartridges. Simply send us your warranty card with the notation "Send Free Buying Guide." Hurry—offer subject to supply.

Circle 14 on reader service card

KOMPUTER KORNER

(continued from page 24)

a program interrupt during microcomputer operation. Such an interrupt would be generated by an external device that wishes to transfer data to or from the computer. This particular topic is quite complex and it will be a number of months before we tackle it in this column.

The above is about the best that we can do to describe the general "anatomy of a microcomputer in one thousand words or less. Microcomputers are fascinating machines. They are small and relatively inexpensive, so one is less likely to be intimidated by them. They are far simpler than their minicomputer and computer counterparts and can be readily repaired by the simple process of chip substitution.

R-E

References

1. Graf, R. F., *Modern Dictionary of Electronics*, Howard W. Sams & Co., Inc., Indianapolis, IN, 1972.
2. Blukis, J. and Baker, M., *Practical Digital Electronics*, Hewlett-Packard Co., Santa Clara, CA, 1974.

Computer calls to computer via amateur radio satellite

Two North American radio amateurs have made the first claimed remote access of a computer, not only through a two-way radio link but also via an amateur communications relay satellite.

An "execute program" command was transmitted by WB4BWK, W. Franklin Mitchell, Jr., Due West, SC, to VE2BYG/3, Randall S. Smith, Barrie, Ontario, via the AMSAT/OSCAR 7 satellite. On reception, it executed the stored program which consisted of a message from VE2BYG/3 to WB4BWK. The data was transmitted in ASCII code at a rate of 110 baud (110 units per second). The FCC has granted a waiver to hams interested in computers and radioteletype, permitting them to transmit ASCII-coded information by way of the satellite.

Calculators good for kids say mathematics teachers

The little hand-held electronic calculator, which formerly aroused some doubts in the minds of educators, is now acclaimed as a "valuable instruction aid" by the National Council of Teachers of Mathematics. "In the classroom," reads the Council's policy statement, "the calculator should be used in imaginative ways to reinforce learning and to motivate the learner as he becomes proficient in mathematics."

According to articles in *Arithmetic Teacher* and *Mathematics Teacher*, organs of the Council, important teaching uses of the calculator are to encourage inquisitiveness and creativity, to promote independent problem solving, to solve problems that would be impractical to attempt with pencil and paper, and to decrease the time needed to handle difficult computations. The little computers can also be used more prosaically to solve consumer problems and to verify the results of pencil-and-paper calculations.

R-E

ONE RIG DOES IT ALL!

Tube and Solid State

THE UNIVERSAL
PJS-298

33KV LEADED GLASS 19" CRT

EIA recommended to protect against
dangerous X-radiation

A MUST FOR TODAY'S SERVICING

ACCESSORIES INCLUDE:

- CRT 90° Extension
- Yoke Extension
- Transverter
- Convergence Load
- Universal Yoke
- Convergence Assembly
- Blue Lateral Assembly
- Anode Extension

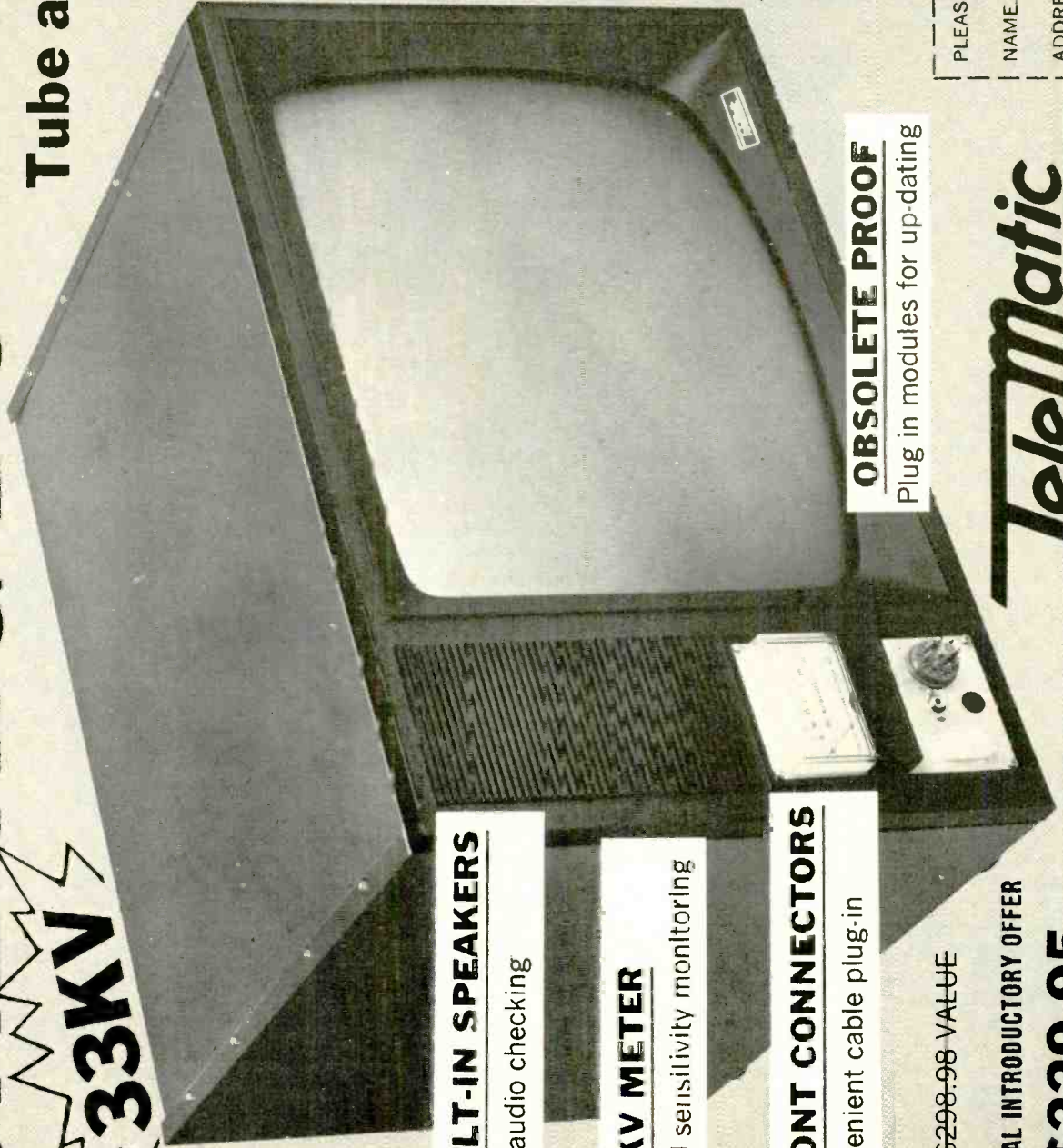

BUILT-IN SPEAKERS

Easy audio checking

40 KV METER

50aU sensitivity monitoring

FRONT CONNECTORS

Convenient cable plug-in

\$298-98 VALUE

SPECIAL INTRODUCTORY OFFER

\$229.95

COMPLETE WITH CRT

OBSOLETE PROOF

Plug in modules for up-dating

Telematic

24-68 FULTON ST., BROOKLYN, NY 11207

Circle 15 on reader service card

PLEASE SEND ME MORE INFORMATION

NAME _____

ADDRESS _____

CITY _____

STATE _____

ZIP _____

BIG HELP FOR SMALL BUCKS.

Used to be, filling your bench with really good test equipment meant emptying your wallet. Because you had to pay a price for quality and versatility. A high price.

Not anymore. CSC's ingenious new Design Mate™ line of test equipment combines performance high enough for most lab applications with the kind of versatility and economy everyone can afford. Thanks to a number of new design concepts and manufacturing techniques.

Proof? Check the specs and prices below, then visit your CSC dealer for a demonstration. Or write for our catalog and distributor list.

CONTINENTAL SPECIALTIES CORPORATION



EASY DOES IT

44 Kendall Street, Box 1942
New Haven, CT 06509 • 203-624-3103 TWX: 710-465-1227
West Coast office: Box 7809, San Francisco, CA
94119 • 415-421-8872 TWX: 910-372-7992
Canada: Len Finkler Ltd., Ontario

© 1976, Continental Specialties Corporation
*Manufacturer's suggested list
Prices and specifications subject to change without notice.

**Design Mate 1 Breadboard/
Power Supply. \$49.95***

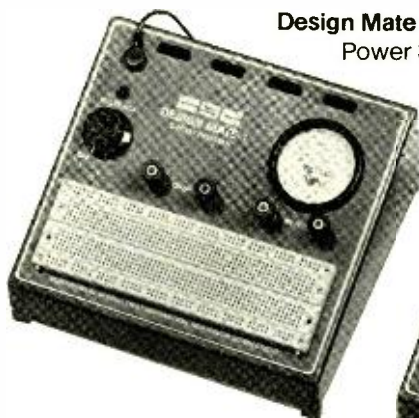

**Design Mate 2 Wide-Range
Function Generator. \$64.95***



**Design Mate 3 Precision
R/C Bridge. \$54.95***

New CB Test Gear

Using the new CB test gear is easy and CB service is a whole new field for the consumer electronics technician. Consider getting started now

JACK DARR
SERVICE EDITOR

THE CITIZENS BAND HAS LITERALLY EXPLODED! For the last year or so, the sales of CB radios have soared to astronomical figures. A recent report (R-E January 1976) said that they had reached a level of 100,000 units a month, and the only reason they weren't selling more was that the setmakers couldn't keep up. The FCC has a tremendous backlog of license applications (about 350,000).

So there they are, "out there", and someone has to service them. The regular two-way radio repair shops can't keep up with the vast numbers of jobs. This makes it a lucrative field for the consumer electronics men. Only a few added test instruments will be needed. Most of them aren't hard to fix, with proper equipment.

The only new thing will be transmitter servicing. And with the right instruments, this isn't too tough. The transmitters and receivers are crystal-controlled, which makes frequency calibration very simple. Receivers are straight single conversion or dual conversion superheterodynes, with only one new circuit, the squelch. We'll cover the typical circuits, test equipment and methods, and the legal requirements of CB radio servicing, and show you some of the ways to make this easier.

To repair the transmitters, a technician must hold an FCC Operator's License of at least a Second Class Radiotelephone grade, or higher. To get one you must pass the FCC test (which isn't any tougher than the CET test!) For a very helpful book on this, get a copy of Edward M. Noll's "Radio Operator's License Handbook, 3d Edition" (Sams, 21112). It explains all of the Rules and Regulations ("R&R"'s) and gives sample questions with the answers. For a higher Class, "First Class Radiotelephone License Handbook" by the same author (Sams 21144), which covers First and Second Class 'phone license material.

The FCC requires that you have a copy of "FCC Rules and Regulations (R&R's), Part 95" in your possession. This, with some Amendments, covers Citizens Band operation, and tells you what you can and can not do, and so on. This is available from the Superintendent of Documents, U.S. Government Printing Office, Washington, D.C. 20402 for a "nominal fee".

The most important thing in the R&R's is the statement that "Only those persons properly licensed are permitted to make repairs or adjustments which may result in illegal operation." What this means in English is that the transmitter must be on-

frequency within the stated tolerance, and must not radiate a higher rf power than the license calls for. The original CB radios used a rating of "5 watts input" meaning 5 watts input power to the final rf stage. The rule now is "4 watts (of rf power) input to the antenna", which is about the same thing.

If you're interested, "input power" is figured by reading the voltage and current of the final rf stage, and then multiplying to get $W=EI$. We now have direct-reading rf power meters, and the power measurements are as easy as reading the battery voltage with a VOM! Fig. 1 shows one of the new CB test instruments. We'll be talking about these and several others as we go.

The rule about radiation of too much rf power isn't hard to comply with! In most cases, the problems we find are *too little* rf output. Off-frequency operation is very



FIG. 1—WATTMETER MONITORS transceiver power output and antenna standing wave ratio. This unit has three power scales.

unlikely. With crystal control, the only thing that could cause this would be a bad crystal. This would throw the transmitter so far off that it wouldn't work at all.

(There is one thing that can result in illegal operation! This is the use of a "PEP Booster" (PEP = Peak Envelop Power) of 50 watts rating that raises the transmitter output to that figure. These are completely illegal, and woe be to the CB operator caught using one! The FCC does monitor the CB bands, and the use of such a thing can mean a stiff fine.)

No periodic frequency checks or logs are required, as in commercial two-way radio service. However, for best operation, the frequency of both receiver and transmitter should be *checked* each time the set is serviced. Another new instrument that makes this really a snap is the digital frequency counter, such as the Simpson 7026 in Fig. 2. All you do is push the but-

ton, and these instruments give you a direct readout of the operating frequency down to the least significant digit. Frequency tolerance for the CB band is .005% or 50 parts per million which is easy to get with modern crystals. This is roughly ± 135 hertz.

The CB radio

Most of the CB sets you'll see will be



FIG. 2—FREQUENCY COUNTERS like this one read CB frequencies to an accuracy within 0.1 Hz.

"transceivers" (transmitter and receiver in a single case, sharing not only the power supply but quite a few circuits as well). I believe that the majority of these are mobile units with a 12 volt dc power supply. There are ac-powered base station units, but a lot of these are identical to the mobiles, with the addition of only a 12 volt dc power supply from the AC line.

There are quite elaborate versions, some costing as much as a commercial two-way radio. The vast majority, though, will be the simpler ones used in cars and trucks. Solid-state circuitry is almost universal, because of the space saving. Some of these units are amazingly compact, though they have all of the functions of the bigger ones.

There are three main groups of frequencies used. The "27-MHz band" has 23 channels, and this is where most of the activity is. A band of frequencies around 72 MHz is used for radio control of models, and there is a "UHF Band" from 462.55 MHz to 467.725 MHz. Amplitude modulation is used almost exclusively.

Transmitter testing

This is the part that will be new to most technicians. However, with the proper instruments, it isn't at all difficult. If you

know the fundamentals of the operation, no problems. Let's review a few of the basic principles.

The rf circuits of the transmitter put out a radio-frequency signal at the carrier frequency. The first check is for correct frequency; just feed the signal to a dummy load, couple the frequency counter to this and push the transmit button. Read the channel frequency from the counter readout. Channel 5, for instance, is 27.015 MHz.

Next we check the rf power output. This, too, is a cinch with the right instruments. The SWR/rf power meter of Fig. 1 will give you a direct reading. Fig. 3 shows another type, with a digital readout, that does not require a direct connection to the transmitter.

For bench tests, the rf is fed into a "dummy load". This is a resistance with 50 ohms impedance (the characteristic impedance of most CB transmitters). Thank goodness for a standard!

By coupling a "linear detector" to the dummy load, the rf signal and modulation can be read on an oscilloscope. Fig. 4 shows the schematic of such a detector; it must be built into a shielded case (A "Band-Aid" can is very handy, and common!)

There are a couple of reactions that can be of a lot of help. Let's go over them quickly. The reading you see on the rf power meter, without talking into the mike, is the unmodulated carrier power. It would look something like Fig. 5 if you had a 50 MHz scope, which isn't necessary. To make this useful for communications, we must "add intelligence" to it; or, "modulate" the carrier with an audio frequency.

Maximum modulation should be just a little below 100%. Fig. 6 shows an rf carrier with about 95% modulation. Notice that the peak value of the rf waves is just about twice the peak of the unmodulated carrier. This happens because we are adding the power in the modulating signal



FIG. 3—FIELD STRENGTH METER with digital output. It has a frequency range of 2 to 1100 MHz.

to that of the rf carrier.

Let's say that the rf signal in Fig. 5 has an amplitude of 5 volts peak. Now if we modulate this with a 5-volt peak audio signal, the voltage on peaks will be doubled, because the two voltages (of the same polarity) will add. So, the peaks of the full-modulated signal in Fig. 6 will be 10 volts, and the carrier will be driven down to almost zero at points where the modulating voltage is opposite-polarity.

Would you like a fine simple test for

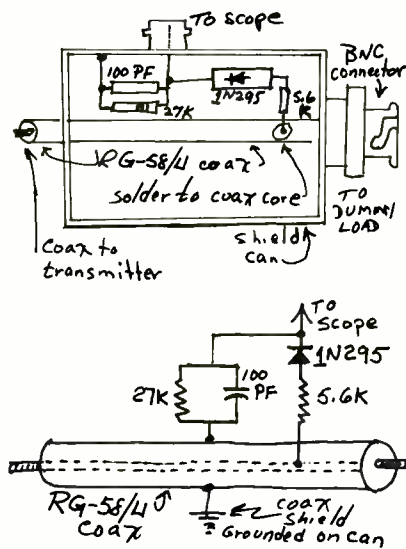

FIG. 4—LINEAR DETECTOR CIRCUIT. Use this to read the modulation of the transmitter and detect any sign of distortion. A sinewave input must be used.

this? Good; we have one. Just push the transmit button. Note the rf power reading. Now whistle loudly into the mike and watch the meter. If the reading goes up roughly 22%, you are getting 100% modulation! (It doesn't come out double because the peak reading we just gave is voltage, and this is a power reading.)

There is one more, before we leave this section. If you whistle into the mike and

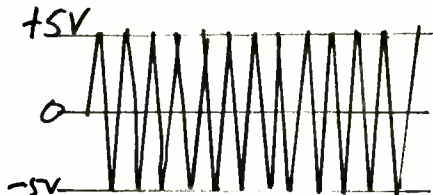

FIG. 5—UNMODULATED RF CARRIER with positive and negative peak voltages of 5 volts. You see this when you key the rig.

the power reading goes down look out. This means that you are over-modulating the rf carrier, and actually losing power output. There will also be quite a bit of distortion. Why? Fig. 7 shows the answer. Let's say that you have the same 5-volt peak rf, but that your modulation is 8 volts peak. On the cancel-peaks, the rf carrier will be driven "below zero", as shown. So, you actually do not get as much rf power out as before, and the recovered audio will be distorted. In actual CB transmitters, this is usually due to a drop in the rf power output, rather than to an increase in audio modulating voltage. You come out with the same condition; too much modulating signal for the amount of rf. Common causes are mistuning of the rf final amplifier stage ("final"), mismatch to the antenna, and so on.

Now what if the modulator does get weak? This can happen if the mike is defective or if a driver stage in the transmitter has a bad transistor. Now the carrier will be under-modulated. The audio will be "clear but weak". The rf power meter will not show the normal rise in

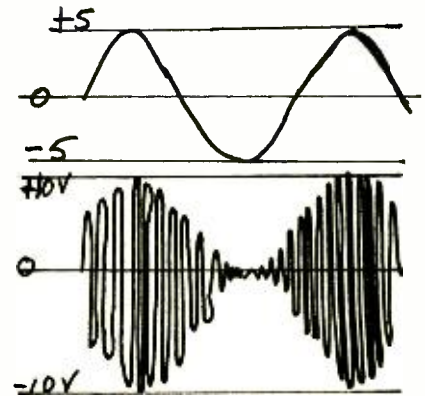

FIG. 6—(top) AUDIO MODULATING signal, also positive and negative volts peak. (bottom) 100% modulated rf signal. Note that where modulation and rf voltages add, we get peaks of +10 and -10 volts. This is voltage; the power increases by about 22%.

power with modulation, but it will not go down.

In the typical CB transmitter, the modulator stage is also the receiver audio output, so that any problems such as this will show up in the receiver too. (One "goody" for doing this is an open emitter bypass capacitor in the audio driver stage! This reduces the gain and causes quite a bit of distortion; check this with a scope on the emitter. Should be no signal present at all.)

Final tests

For the best results, the CB transmitter should be checked with the antenna normally used; on the vehicle, etc. If there is any trouble in the antenna, it will show up as a loss of rf power output. (And with only 4 watts of rf, we can't put up with

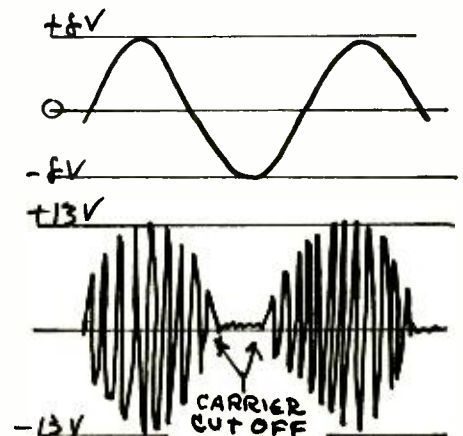

FIG. 7—EXCESS MODULATION voltage or low RF voltage causes overmodulation, and loss of RF power output.

any loss at all!) One common cause of this is "standing waves" on the transmission line.

What's a "standing wave?" When the transmitter sends out an rf signal, it travels to the antenna through the transmission line. If the line, and the antenna, are per-

fectly *matched*, the antenna absorbs all of the rf power. (Where does it go? It radiates off into space as an electrical field. This is the only "one-way circuit" in electronics!)

However, if the antenna or transmission line isn't matched to the transmitter output stage, there will be a *reflection* of power from the antenna back to the transmitter! One cycle of rf will go down the line, bounce off the mismatch, and start back toward the transmitter. On the way, it will meet other cycles of rf coming from the transmitter. The two will add and cancel, and the result will be rf signals that simply run back and forth in the transmission line.

This does nothing at all for the total rf power output, since these standing waves represent precious rf power. They are called "Voltage Standing Waves" and the voltage standing wave ratio is a measure of the efficiency of any transmitter-antenna system. The abbreviation for this is VSWR or "Viz-War" if you want to call it that.

How do we check for this condition? (Are you ready for this one?) You read it on a VSWR Meter! This is a special rf power meter, which can be switched so that it reads "forward power" or normal rf output, or reversed so that it reads power *coming back* from the antenna. It is calibrated so that it reads the VSWR directly as a ratio. Such an instrument is shown in Fig. 8. This can be connected in series with the transmission line to the antenna and left there. In the FORWARD position, it will tell the operator whether he's "getting out" or not.

Standing-wave problems are often caused by improper tuning of the final in the transmitter. Most of the CB antennas used are well-built commercial designs, that have very low VSWR's. A VSWR of 1:1 is "perfect", and anything above this should be checked out. If you do run into problems, there is a little device called an "Antenna Matcher" which can help: Fig. 9. It can be installed in the transmission line, tuned up and left there.

A quick check of transmitter adjustments can be made, in the vehicle, with a simple rf detector, of the type shown in Fig. 10. It is just a radiation detector. You set it near the antenna and push the transmit button. Then, check all of the rf tuning adjustments on the transmitter. Set these for a peak on the rf meter, and there you are.

This is one fast way of catching any defective stages in the transmitter. If *any* of these adjustments fail to show a definite *peak*, that stage has a problem! After using such an instrument for only a little while, you'll be able to get a very good idea of whether this transmitter is putting out normal rf power. Set the meter about the same distance from the antenna each time, and the rf reading will be close to the same.

Summing up on the transmitters, the final in a CB transmitter is something of a "broadband" affair. Since it isn't possible to provide really sharp tuning adjustments for each of the 23 channels, the finals are "peaked" somewhere near the center of the band.

So make your tuning adjustments on Channel 11 or 12; then check for rf output



FIG. 8—STANDING-WAVE-RATIO bridge reads relative forward power or reflected power and SWR.

on Channel 1 and Channel 23 to make sure that something isn't causing too much of a "droop" in the curve. Since the whole CB Class-D band is only 300 kHz from one end to the other, it's not impossible to get good results over the whole band.

Checking receivers

The typical CB receiver will be crystal-controlled. This makes it handy. You don't need a very accurately calibrated rf signal generator for alignment work! Just tune the signal generator for maximum output through the front end, and there you are.



FIG. 9—ANTENNA TUNER for 27-MHz Citizens band offers improved operation of CB transceivers and reduces harmonic radiation and television interference. It can tune the transmission line to a 1:1 SWR.

For sensitivity tests, the generator should have an accurately-calibrated output attenuator. Most of the better CB receivers have astonishingly good sensitivity, often down around 1.0 microvolt or better.

The receiver's RF amplifier stage is also somewhat wideband, but the sensitivity is attained in the IF stages. Many of them use dual-conversion IF's, with the first one up around 10 MHz, and the second down around 455 kHz. Both oscillators will be crystal-controlled for stability.

The squelch circuit

There is one circuit used in all CB receivers that isn't common in the broadcast types. This is the "squelch". This circuit does just what its name implies; it squelches the "blow" or hiss that would be heard in the absence of an incoming signal. (In the very first two-way police radios, it wasn't used. The constant roar drove the poor officers mad, so they simply turned the volume down. So they missed a lot of calls. This spurred the development of a working squelch circuit.)

The operation of a squelch circuit is simple. The most common type uses a high

bias on one of the audio preamplifier stages. This cuts off the tube/transistor, so that there is no sound in the speaker. The RF and IF stages are still picking up the random noise or blow. This is rectified, and used to maintain the cutoff bias.

When a signal is picked up, these stages will "quiet" because the signal overrides the random noise. This drop in the noise voltage causes the squelch circuit to develop a bucking voltage which "opens" the audio stage by cancelling the cut-off bias; the signal goes through.

In case you're wondering how the set can tell the difference between the noise and the signal, this, too, is fairly simple! The noise is "white noise", or random samples of all kinds of frequencies, mostly very high. So, we pick off only the very high-frequency signals and use them to hold the squelch off. The voice signals are,

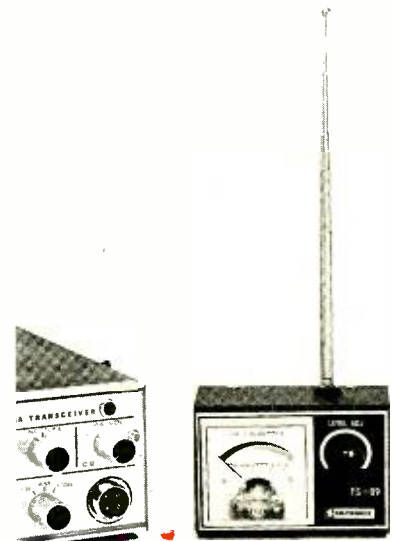

FIG. 10—FIELD STRENGTH METER indicates relative field strength of CB antenna power over a frequency range of 1.5 to 200 MHz. A 7-ounce instrument.

by comparison, very low frequencies, so they have no effect on the squelch circuit itself.

Most problems in the squelch circuits will be due to weak tubes, leaky transistors, bad resistors, and so on. A very good check for the condition of this circuit is just turning the squelch control. If this will "break" (let the speaker blow) somewhere near the center of rotation, the squelch is in pretty good shape.

If you must turn it all the way to one end, and then it barely breaks the squelch, something has drifted off value, and will cause trouble very soon. If the squelch won't break at all, you may have trouble in the RF or IF stages, or in the controlled stage. Check the dc voltages with and without an input signal, and it shouldn't take long to pin down the guilty part.

Odds and ends

Watch out for "Unauthorized Repairs"! Quite a few CB operators are amateurs. I don't mean amateur operators—I mean amateur *technicians*! When you get one of these sets, look it over very carefully. Check the type and *location* of all tubes and transistors. This kind of thing isn't hard to spot if you're looking for it, but it can really throw you a curve if you're

not really on your toes.

One set came in with simply awful sensitivity on the receiver. The rf tube was checked, and found to be perfectly good, also brand new. After much digging around, we noticed that the dc voltages around this tube socket were in very funny places for the tube in use. It turned out that the original tube was a dual-triode. The one in it was a triode-pentode. You may find a transistor installed backward, or npn's used where a pnp should be, and all sorts of goodies like that.

This brings up a very important point—service data. With the right service data, we would have caught the tube substitution instantly; it wasn't there (at the time! It is now). You can get full service data for all of the U.S. makes of CB sets in Sams Photofact "CB Radio Series" of manuals. This will save a great deal of time in checking parts, locating tuning adjustments, and many other things.

Check that voltage regulator!

Like all other electronic equipment, CB radios have their own peculiar problems. Since the majority of them are solid-state, and also used in vehicles, the car's electrical system must be in good shape. If the trouble is blown rf or audio transistors, etc., check the vehicle's voltage regulator.

It must never be higher than 13.8 volts with the engine running at cruising speed. If this voltage goes up to 15.5 or 16 volts, look out. Many operators have a habit of making long transmissions without letting up on the key. This normally heats up

output and audio transistors, and if the supply voltage is too high, can lead to failure due to overheating of the junctions.



AUTORANGING FREQUENCY COUNTER is great for CB service work. You only have to turn it on and select the mode.

In some sets, these transistors are not derated enough to begin with, and a 30 to 40% increase in the supply voltage can drive them into breakdown.

In certain sets, the rf output transistors will have to be replaced by the exact equivalents, due to socket or basing problems. Many of these are EIAJ types, such as 2SC1173, and others which do not as yet have U.S. exact duplicates. Mostly, the cases won't fit, and the extra wiring needed to convert may upset the stray capacitance of the final, and cause tuning problems. This will soon be remedied, I'm sure, but for now you may have to dig up exact duplicates. The back pages of *Radio-Electronics* are a good place for this! There are quite a few semiconductor supply houses listed in here who stock these special types of CB transistors.

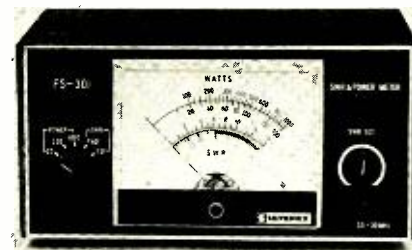

WATTMETER MONITORS transceiver power output and antenna standing wave ratio. The unit has a flat response directional coupler independent of frequency from 3.5 to 30 MHz. Three power reading scales cover 0 to 1000 watts. Expanded range calibration of the SWR scale permits direct reading of from 1:1 to 3:1 SWR.

Final notes

In general, the TV technician who wants to get into CB radio work won't have too many problems. Practically all of his regular test equipment can be used, with only a few instruments added. As I said before, the FCC license test isn't any harder than the CET tests. You don't have to make periodic frequency checks; the only thing you might do here, if you do make a frequency check, is to note it on the statement, with the date and results. (You charge for this, of course!)

So, there you are. As so many of the CB operators say today "Arkie to Screw-driver-Jockey—Out!". **R-E**

Electronic games on home TV making a sudden upsurge

According to a number of dealers, electronic TV games became an important factor in toy departments for the first time last Christmas season. Odyssey, a Magnavox product, was introduced three years ago, but felt its first heavy demand last year with the result that the company's production lines worked full time to fill Christmas orders. Odyssey was described in full in the December, 1975 issue of this magazine (page 29) with block diagrams of the circuitry.

Another company, Broadmoor, puts out a game that requires a modified TV set, since the game signals are injected into the video circuitry. It plays hockey and tennis. Atari, maker of sports-arcade electronic games, produces a very popular game called Pong.

Coding system to combat video tape pirating

A device to prevent illegal copying of videotapes has been developed by Goldmark Communications Corp., Byron Motion Pictures and Teletronics International, three organizations working in the television and motion picture field.

Called "Stop-Copy," the system uses a specially devised technique to code the magnetic tape electronically. The special coding permits a program to be played through the videocassette, but if an attempt is made to record the program on another videocassette recorder, the coding prevents video recording and the result is a blank copy. While the

"Stop-Copy" system is not yet compatible with all types of video recorders, a more completely compatible type is under development.

The developers warn that although the present device is successful in prevent-

ing ordinary illegal duplication, it could possibly be circumvented by a skilled electronic technician. More sophisticated technology may be required to deter the professional who decides to engage in program pirating.

COMPUTERIZED NEWSPAPER MAKEUP



MODERN NEWSPAPERS have replaced the traditional type-case and blue pencil with computerized composition and electronic-display editing. The above scene at the *Minneapolis Star and Tribune* is typical. Display ads are set up with the help of a Raytheon 1,000-line television screen and solid-state memory composition system. Items can be set up or erased either by the keyboard or with an "electric pencil" applied directly to the face of the tube. What the pencil crosses out is erased in the computer and can be replaced by material typed in from the keyboard. Display type of different sizes and faces can be selected and typed in almost as easily as typing one size and face on a standard typewriter.

**BUILD FOR
YOUR CAR**

Tachometer and Over-Speed Alarms

*The versatile CD4001 IC
is the heart of these
practical tachometer and over-
speed alarm circuits that
you can build and connect
to any vehicle with a 6- or
12-volt electrical system*

R. M. MARSTON

MANY MODERN SEMICONDUCTOR DEVICES have practical applications in automobiles. One of the most useful devices is the CD4001 COS/MOS digital integrated circuit. The CD4001 is an inexpensive and readily available quad 2-input NOR gate that features near-infinite input impedance, a low output impedance, near-zero quiescent current consumption, and the ability to operate from any supply source in the range of 5 to 15 volts.

The CD4001 is very versatile and can readily be made to act in a variety of gate, logic, inverter, and multivibrator roles. In this first part of this 2-part story, we show how you can use a single CD4001 IC to make an inexpensive but highly efficient precision tachometer or RPM meter for your car.

In Part 2 of the series, we'll go on to show how the basic tachometer circuit can be expanded so that it also acts as a precision red-line or over-speed alarm. This alarm generates an audio/visual output when the engine or vehicle speed exceeds a pre-set limit.

The tachometer and over-speed alarm circuits can be used on any gasoline-powered vehicle having a 12-volt electrical system. If required, the tachometer circuit can also be used on vehicles with 6-volt electrical systems by using a simple adapter device that is also described in this article. Before looking at the first of these circuits, let's digress a little and take a brief look at the characteristics of the CD4001 integrated circuit that forms the basis of these designs.

The CD4001 IC

The CD4001 COS/MOS digital IC is a quad 2-input NOR gate. The basic circuit and pin connections of the device are shown in Fig. 1. A full description of this unit was given in the September 1974 issue of *Radio-Electronics*. For our present purpose, it is sufficient to know that each of the four gates of the device features a

near-infinite input impedance, a low output impedance, near-zero quiescent current consumption, and the ability to operate from any supply source in the range 5 to 15 volts.

If a rising or falling voltage is applied to the input of a COS/MOS digital IC element, the output of the device remains unaffected until the input signal reaches a value known as the *transition voltage*, at

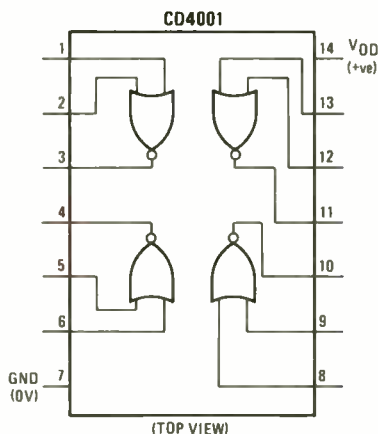

FIG. 1—LOGIC DIAGRAM and pin connections of the CD4001 quad 2-input NOR gate.

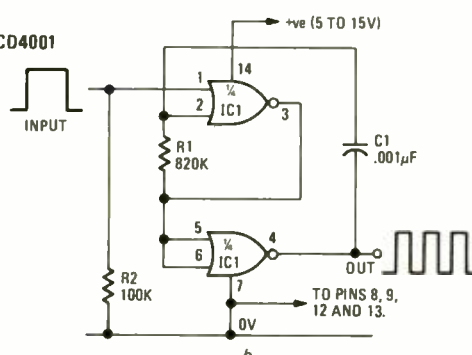
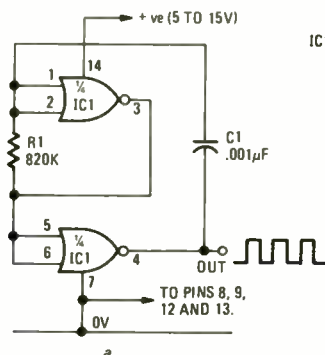

FIG. 4—ASTABLE MULTIVIBRATOR circuits operating at 800 Hz are shown. Circuit shown in a is a simple astable while circuit shown in b must be gated to operate.

which point the output may switch rapidly from one logic state to the other. The transition voltage of a device is usually specified as a percentage of its supply voltage: The CD4001 has a typical transition voltage value of 50% of its supply voltage, the actual production spread limits being 30% to 70%.

The CD4001 is a very versatile device. Each logic element of the CD4001 can be used as a NOR gate by using the connections shown in Fig. 2. A NOR gate provides a low (logic 0) output if either input is high (logic 1). Alternatively, the NOR gates can be used as NOT elements or simple pulse inverters by using the connections shown in Fig. 3. A NOT element provides a low output when the input is high, and vice versa. Note when using this device (and all other COS/MOS digital integrated circuits), that the unused input pins of the IC must be disabled by connecting them to one of the circuit supply lines.

Any two or more gates of a CD4001 IC can be cross-coupled to make a highly efficient version of any one of the three basic types of multivibrator. Figure 4-a shows the connections for making a simple 800-Hz astable multivibrator or square-wave generator that operates whenever its power supply is connected, and Fig. 4-b shows a gated version of the same basic circuit. The Fig. 4-b circuit can be gated on by applying the full positive supply voltage to pin 2 of the IC, and can be gated off by reducing the voltage on pin 2 to zero.

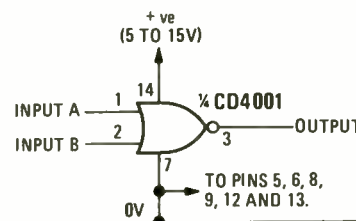

FIG. 2—A NOR GATE is obtained by connecting one of the gates of the CD4001 as shown.

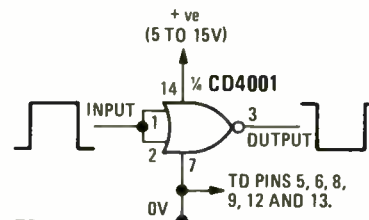

FIG. 3—A PULSE INVERTER is obtained by connecting one of the gates of the CD4001 as shown.

Figure 5 shows how two of the gates of a CD4001 can be cross-coupled to form a monostable multivibrator. An outstanding feature of this particular circuit is that it can be triggered by any input waveform shape, irrespective of its rise-time or duration. The duration can be longer or shorter than that of the actual output pulse. The shape of the output pulse is independent of the shape of the trigger signal. The output pulse of the circuit is actually initiated at the moment that the input trigger signal rises above the transition voltage. The circuit is unaffected by input voltages that fall below the transition voltage.

Finally, Fig. 6 shows how the monostable multivibrator described above can be used as a simple but very accurate linear-scaled analogue frequency meter, giving a full-scale reading of 1-kHz on an

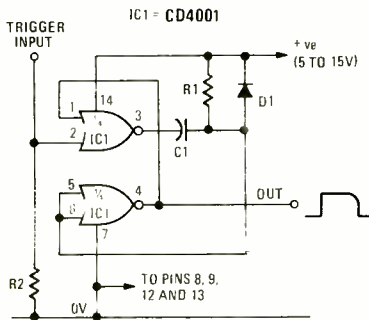

FIG. 5—MONOSTABLE MULTIVIBRATOR provides an output pulse when it is triggered.

inexpensive 1-mA moving-coil meter.

Here, the input trigger signals are fed to the gate-A—gate-B monostable circuit via the Q1 preamplifier and via the gate-D inverter stage. The output pulses of the monostable are fed to the 1-mA meter via gate C and current-limiting resistor R8. The supply line of the circuit is stabilized at 6.8 volts by the R9—D2—C4 network. Consequently, a current pulse of fixed amplitude and fixed length is fed to the meter each time the monostable is triggered.

The average current flowing in the meter in the above circuit is equal to the product of the peak pulse current and the pulse length and the repetition frequency of the pulse. In practice, the circuit gives a peak pulse current of approximately 2 mA and has a pulse length of 0.5 ms, so the meter reads its full-scale value of 1 mA at 1 kHz, and reads 0.5 mA at 500 Hz and 0.1 mA at 100 Hz. The circuit thus acts as a linear-scale frequency meter.

Note that the meter in this circuit can not be damaged by applying too high an input frequency, since the maximum meter current is limited to 2 mA by R8, and all 1 mA moving-coil meters can withstand this magnitude of overload quite easily.

The Fig. 6 circuit can be made to read precisely 1 kHz at full scale by simply feeding an accurate 1 kHz signal to its input and adjusting R6 for the full-scale reading. The linearity of the circuit is equal to that of the basic meter. The circuit can be triggered from any input waveform shape, and has an input sensitivity

of approximately 100 mV RMS and an input impedance of about 10,000 ohms.

The circuit can be made to read alternative full-scale frequency values by altering the values of C3 and/or R6—R7. Higher frequencies can be obtained by reducing the values of these components, and vice versa. The circuit gives a useful performance up to frequencies of a few hundred kHz.

The Fig. 6 circuit can easily be adapted to function as a tachometer, and forms the basis of the tachometer and red-line or over-speed alarm circuits described in this article.

A high-performance tachometer

Fig. 7 shows how the Fig. 6 circuit can be adapted for use as a tachometer or RPM-meter on vehicles equipped with 12-volt electrical systems. Circuit operation relies on the fact that a vehicle's contact breaker (breaker points) develops a waveform with a basic frequency that is directly proportional to the engine's RPM. In the Fig. 7 circuit, this waveform is picked up and used to trigger a monostable multivibrator. The output frequency of the multivibrator is indicated on a 1-mA meter in the same way as the Fig. 6 circuit. In this case, however, the meter is calibrated directly in RPM rather than in frequency.

The interesting technical feature of the Fig. 7 circuit is the method of converting the basic contact breaker signal into a form suitable for triggering the COS/MOS monostable multivibrator. Fig. 8 shows the actual waveforms that are obtained in different parts of the circuit when it is connected to a 4-cylinder engine at 3000 RPM. Note particularly the details of the contact breaker signal appearing at point "A" of the circuit.

As the contact breaker first opens, the ignition coil is thrown into oscillation at a frequency of approximately 10 kHz. In the first half-cycle of this oscillation, a peak signal of about 250 volts is developed across the contact breaker. This peak voltage drops rapidly to about 30 volts as ionization takes place across the vehicle's spark plug gap. After 1.5 ms or so, the ionization process ceases and the coil again goes into oscillation.

This time the coil oscillates at a frequency of about 2.5 kHz. As this oscillation dies away the contact breaker voltage

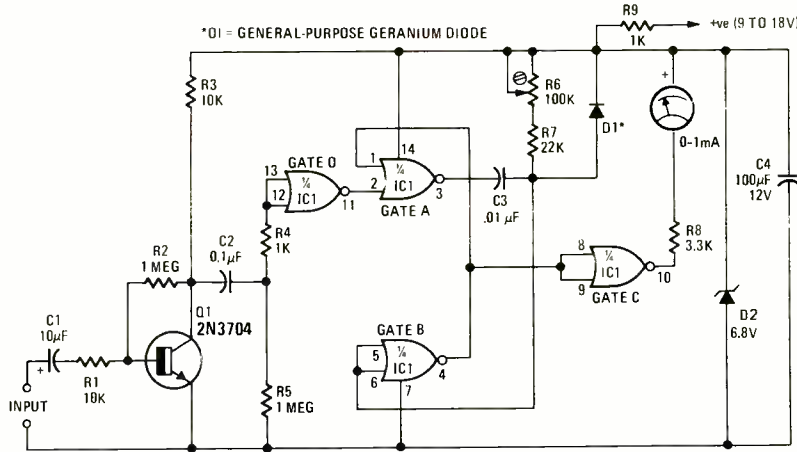

FIG. 6—LINEAR SCALE analog frequency meter has a 1 kHz full-scale reading.

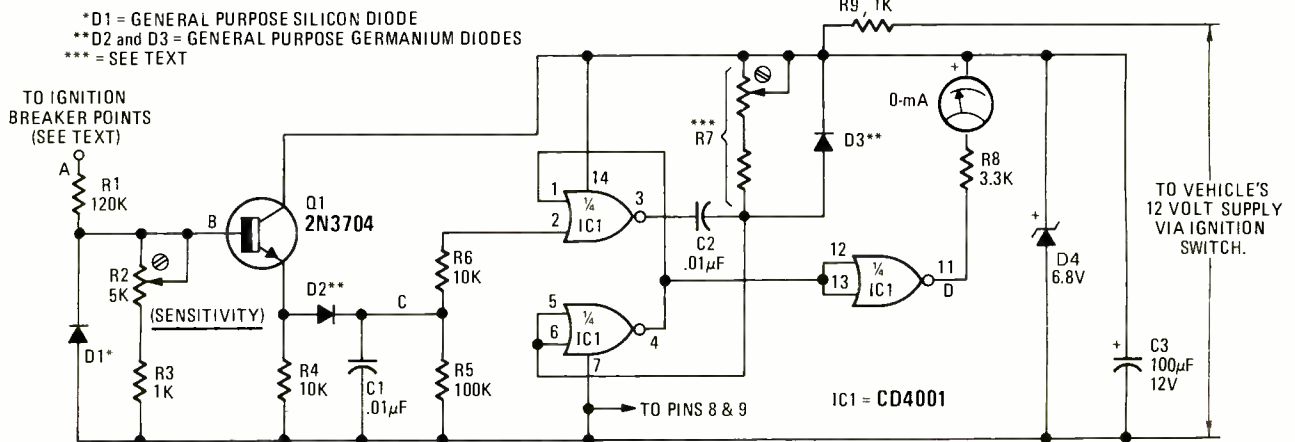

FIG. 7—TACHOMETER CIRCUIT can be used on any car equipped with a 12-volt electrical system.

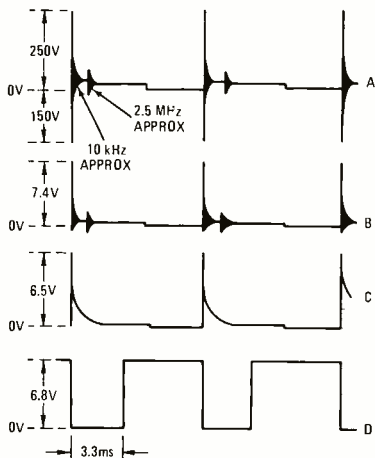

FIG. 8—VOLTAGE WAVEFORMS obtained from tachometer circuit when it is connected to a 4-cylinder engine operating at 3000 RPM.

$$f = \frac{\text{RPM} \times N}{120} \quad (4\text{-CYCLE ENGINES})$$

$$\text{OR}$$

$$f = \frac{\text{RPM} \times N}{60} \quad (2\text{-CYCLE ENGINES})$$

WHERE 'N' = NUMBER OF CYLINDERS

$$R7 \approx \frac{73,000,000}{N}$$

WHERE R7 = OHMS

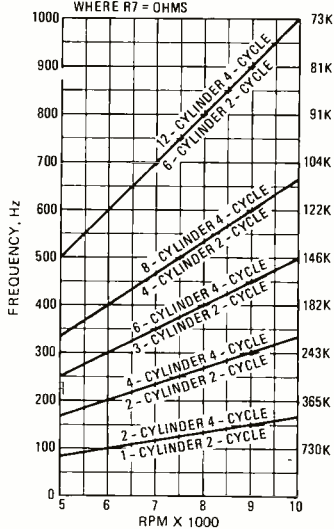

APPROXIMATE (±50%) R7 VALUE NEEDED FOR SELECTED f.s.d. METER READINGS WHEN C2 = .01 μF.
NOTE: R7 VALUE CAN BE REDUCED BY A FACTOR OF TEN IF C2 IS INCREASED TO 0.1 μF.

FIG. 9—RELATIONSHIP between frequency, RPM and the value of R7 needed to provide full-scale readings for different types of engines. The value of C2 is .01 μF.

stabilizes at the vehicle's battery voltage of roughly 12-volts. Eventually, the contact breaker closes again, and the voltage falls to zero. When the contact breaker reopens, another high-voltage oscillation is initiated, and the waveform repeats.

Thus, the contact breaker signal is quite complex and contains a variety of frequency and voltage components. To trigger the tachometer, we need to detect the basic contact breaker frequency but reject all the transient oscillatory voltages. The Fig. 7 circuit achieves this as follows:

First, the basic contact breaker signal is applied to the base of emitter follower Q1 via voltage divider R1—R2—R3 and diode D1. The voltage divider reduces the amplitude of the signal by a factor of about 40, and the diode eliminates the negative parts of the signal at point "B" of the circuit. Any positive portions of the signal at point "B" that significantly exceeds the 6.8 volt

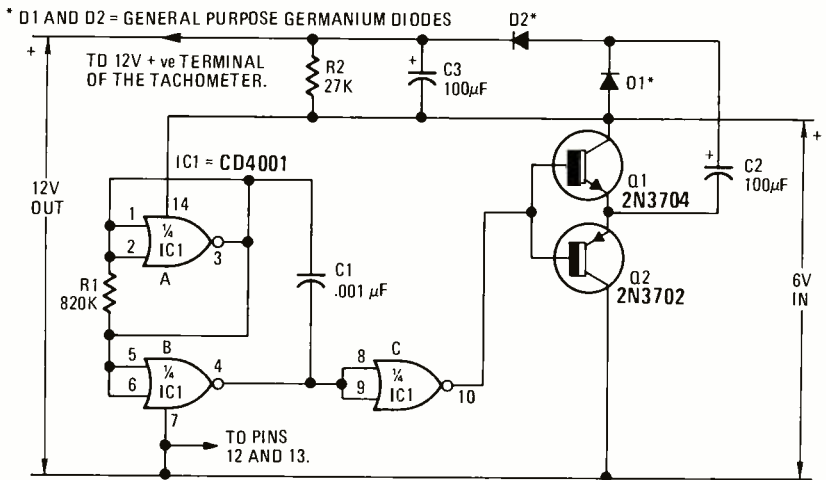

FIG. 10—6-to-12 VOLT converter enables the tachometer circuit to be used with cars equipped with 6-volt electrical systems.

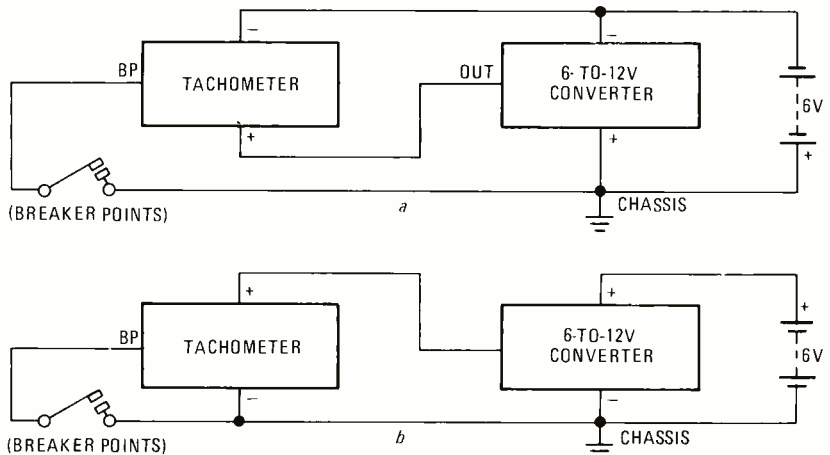

FIG. 11—METHOD OF CONNECTING tachometer to 6-volt systems via the converter on cars with + ground is shown in a and - ground is shown in b.

Zener-stabilized supply of Q1 causes the base-collector junction of the transistor to become forward biased, so positive signals are automatically clipped at about 7.4 volts at point "B" of the circuit.

The signal appearing at the emitter of Q1 is similar to that of the base, except that approximately 600 mV is subtracted from all parts of the waveform by the forward-biased base-emitter junction of the transistor. This waveform is fed to a peak-detecting time-constant circuit formed by D2—C1 and R5, with the result that a pulse waveform with a short rise-time and a relatively long fall-time is developed at point "C" of the circuit. This waveform is used to trigger the monostable multivibrator via R6.

Note that, since the monostable is fired by a positive-going transition voltage with a nominal value of 3.4 volts (= 50% of the 6.8-volt supply), and since the input attenuator provides a division factor of about 40, the monostable actually triggers at the moment that the contact breaker signal rises to approximately 126 volts. This occurs as the breaker points first open. The monostable is thus triggered synchronously with the contact breaker, but is unaffected by voltage transients with a magnitude lower than 126 volts or so. The Fig. 7 circuit thus acts as a versatile and accurate tachometer or RPM meter.

The tachometer circuit can be fitted to any vehicle having a 12-volt electrical system, irrespective of the systems polarity. The supply leads for the tachometer are connected to the vehicle's battery via the ignition switch, and the circuit's input terminal is connected to a suitable pick-up point. On vehicles with conventional ignition systems, the terminal is connected to the contact breaker. On vehicles fitted with capacitor-discharge ignition systems, the terminal should be connected to the high-voltage output point of the C—D ignition unit.

Before attaching the unit to the car, it must first be calibrated to give the appropriate full-scale RPM readings for the particular vehicle in question. The procedure here is to first decide the full-scale RPM reading that is required, and then consult the graph of Fig. 9 to find the frequency that corresponds to that reading on that particular vehicle.

Thus, a frequency of 333 Hz corresponds to a reading of 10,000 RPM on a 4-cylinder 4-cycle engine. The output of a square wave generator set to this frequency, with a peak amplitude of approximately 6.8 volts, is then connected to the input of the tachometer circuit after first setting potentiometer R2 to its maximum value. Then adjust R7 to give the full-scale

(continued on page 82)

Inside 30 Channel MATV Systems

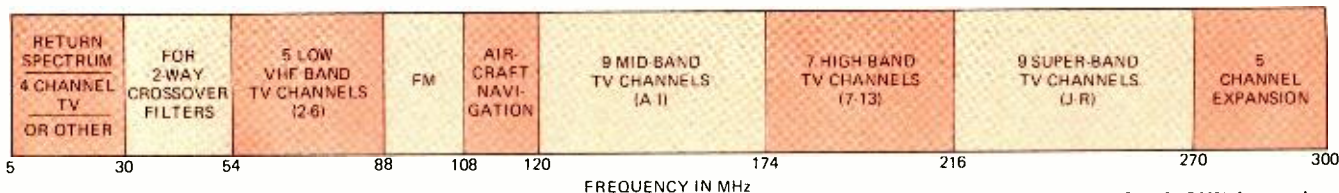

FIG. 1—FREQUENCY SPECTRUM for modern CATV systems.

The demand for more channels in master-antenna TV distribution systems increases as such systems are specified for new hotels, apartment complexes and shopping centers. Here are how the wideband systems work.

BERT WOLF*

THE NEW TREND IN MATV (MASTER Antenna TV) systems is toward more channels and more services. Like CATV (Cable TV) systems, MATV has been moving steadily toward more program choice over the past 26 years.

For a long time, systems were confined to the low VHF band (channels 2 thru 6). Then, new equipment permitted systems to carry the high VHF band (7 thru 13) channels. Once the technology permitted adjacent-channel operation, systems carrying up to 12 VHF channels were possible.

However, 12 channels were still not enough. Modern CATV systems use the midband (120 MHz to 174 MHz) and the super-band (216 MHz to 300 MHz), giving them 30 to 35 channel capability without UHF distribution. CATV systems convert UHF channels to lower frequencies to reduce cable attenuation and the high costs of UHF signal distribution. Figure 1 shows the spectrum for today's CATV systems.

Modern cable-TV systems typically exceed 12-channel capability and the FCC currently requires a minimum of 20-channel capability in the 100 largest TV markets. They also require 2-way capability, at least on a non-voice basis. Two-way capability typically involves the use of the sub-channel band (5-30 MHz) for return information.

Many MATV systems are now being designed to carry over 20 channels so that they can accept a CATV feed. Other MATV systems are being de-

signed for more than 12 channels to accommodate all the available off-air channels plus local closed-circuit TV channels. As a result, there is a growing requirement for MATV systems with a capability of over 20 channels.

Equipment requirements

Most passive MATV equipment (splitters, tap-offs, etc.) in use over the past 10 years are capable of passing the entire VHF spectrum (54 to 216 MHz). For an all-channel MATV system to be CATV compatible, all equipment must be capable of passing 5 to 306 MHz to include the whole spectrum shown in Fig. 1.

The most critical piece of active equipment for a 30-channel system is the internal distribution amplifier. Figure 2 shows a typical MATV amplifier capable of covering the entire 5 to 306 MHz spectrum. An important feature of amplifiers designed to handle mid-band channels is that they must use

push-pull circuitry. This is essential to eliminate second-order distortion.

Second order distortion is not important in ordinary MATV amplifiers. This is because of the standard VHF frequency assignments established by the FCC. Take any pair of picture carrier-frequencies in the VHF band (channels 2 thru 13) and you will find that neither their sum nor their difference frequencies (which are generated when two frequencies are mixed) fall within the VHF low-band (channels 2 thru 6) or the VHF high-band (channels 7 thru 13). Similarly all of the second harmonics of the low VHF band carriers (except channel 6 sound carrier) fall between the two VHF bands.

Figure 3 shows the spectrum obtained when 12 continuous-wave signals on the VHF picture carrier-frequencies were sent through a broadband VHF amplifier. Notice that none of the beats or harmonics are in a position to cause interference.

When it comes to the mid-band, however, second-order distortion becomes a very important factor. Mid-band channels are in the portion of the spectrum most affected by second-order distortion. Push-pull circuitry cancels second-order distortion, making it possible to carry these extra channels.

Figure 4 is a functional block diagram of the output section of a typical push-pull RF amplifier. The first hybrid inverter splits the input signal into two equal portions. It sends half of the sig-



FIG. 2—JERROLD MODEL IDA-45 30-channel amplifier with 2-way capability.

*V.P. & General Manager, Jerrold Electronics DSD Division.

FCC CATV TECHNICAL STANDARDS

	FCC CATV STANDARD
Channel Capacity	20 channels, minimum, in top 100 markets
Subscriber Tap Level Range	0 dB mV to 12 dB mV
Limit Between Adjacent Channels	3 dB maximum
Limit Between Non-Adjacent Channels	12 dB maximum
Visual To Aural Carrier Ratio	-13 dB to -17 dB
Signal-To-Hum	5%, -26 dB maximum
Channel Frequency Response	± 2 dB max., -1 to +4 MHz of visual carrier
Carrier-To-Noise	36 dB minimum*
Carrier Interference	46 dB minimum
Isolation Between Outlets	18 dB minimum*
System Radiation Limits below 54 MHz	15 μV/meter @ 100 feet
54 to 216 MHz	20 μV/meter @ 10 feet
Above 216 MHz	15 μV/meter @ 100 feet
2-way Capacity	at least non-video capacity

*Jerrold 30 Channel Standard is identical to FCC CATV Standard except that Jerrold requires a carrier-to-noise of 50 dB minimum and the Isolation Between Outlets to be 18 dB minimum. (Required to limit noise addition to incoming signal to less than 0.5 dB, if incoming C/N is 40 dB or less.)

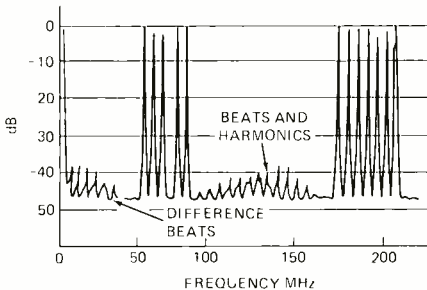

Fig. 3—FREQUENCY SPECTRUM of 12 continuous-wave signals with appreciable 2nd-order distortion.

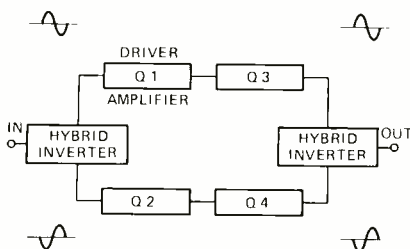

FIG. 4—PUSH-PULL AMPLIFIER eliminates 2nd-order distortion.

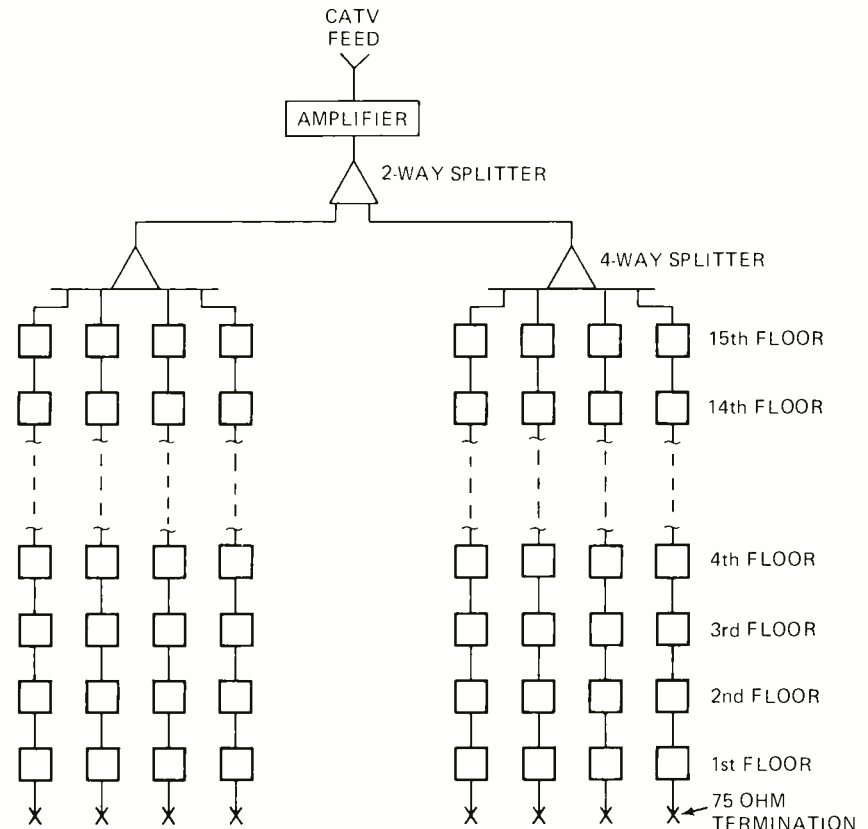

FIG. 5—CONVENTIONAL MATV RISER system has high distribution losses.

nal in-phase to driver amplifier Q1. The phase of the other half of the signal is inverted 180 degrees and sent to driver amplifier Q2. Transistors Q1 and Q2 are a matched-pair arranged in a common-emitter configuration.

The second hybrid inverter inverts the signal from Q4 and then combines it with the signal from Q3. A push-pull RF amplifier provides exactly the same advantages as a push-pull audio amplifier. Even harmonics are mixed at exactly the same amplitude, but 180° out of phase. Therefore, they cancel each other and the second-order harmonic distortion is eliminated.

For large MATV systems, high-output capability is very important. Output capability is related to the number of channels carried by the amplifier and the amount of cross-modulation distortion that can be tolerated. MATV amplifiers should be rated at 0.15% cross-modulation (-57 dB) or better if they are to accept a CATV feed or if cascading is required. In systems where no amplifier cascading is required, 0.5% cross-modulation (-46 dB) is generally considered tolerable.

Typical 30-channel MATV systems

A typical MATV system is shown in Fig. 5. Observe that the risers go from apartment to apartment. There is no direct access to each apartment and therefore no direct control over a cable

TV connection without entering an apartment. At that point it is still impractical to discontinue service without affecting the other sets on the same riser. Another problem with the conventional riser system shown in Fig. 5 is that distribution losses are high.

A better way to do the job is shown in Fig. 6. This system uses one central core riser with horizontal feeders. Notice that this system does provide direct access to every subscriber at the central core. Further, only one line extender is required, rather than eight. Electrical contractors are accustomed to running conduit for vertical risers and it will take time before specifications can be changed to accommodate a central-core horizontal-feeder system.

In many instances, 30-channel MATV systems will be two-stage affairs. The first stage is to build a self-contained, fully functional system that provides excellent quality and program variety. The second stage is to interface the MATV system with the CATV system as soon as a CATV feed becomes available. By planning ahead, you protect the system from obsolescence. When CATV comes to the area, no rewiring or extra equipment will be required.

Even if a CATV feed never becomes available, a 30-channel MATV system can still deliver excellent services. In

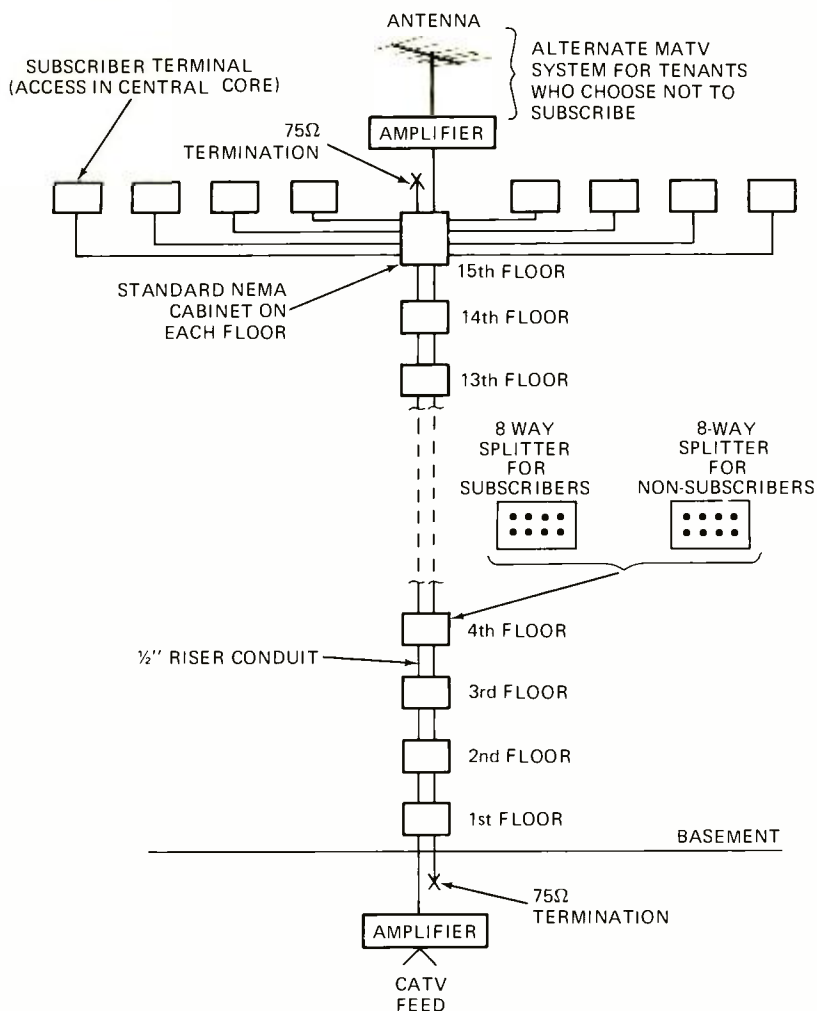

FIG. 6—CENTRAL CORE RISER system has a single vertical riser.

addition to all available off-the-air channels, many other program sources are possible. Premium movies are becoming commonplace in hotels and motels. They may soon be available to residents in suitably equipped apartment house complexes, condominiums, housing developments and trailer parks as well.

Closed-circuit TV channels are being used both for security and entertainment. Some systems, for example, use one CCTV channel to watch the front door and another channel to see who is in the elevator. CCTV channels are also useful for time-message-weather-music, watching swimming pools and recreation areas.

Hospitals, nursing homes and medical schools often use converters to provide restricted access to certain programs. Anyone connected to the system can watch entertainment programs, but only authorized personnel equipped with converters can watch televised operations and medical training programs telecast on sub-, mid- and super-band channels.

The two-way capability of MATV systems may eventually be used to monitor fire and burglar alarms, polling, shop-at-home services, student response systems, etc. The possibilities are mind boggling.

We have the technology for 30-channel MATV systems right now. They cost a little more than conventional MATV systems, but they are obsolescence-proof. **R-E**

Substitutes For Transistors

We have a machine of Japanese manufacture, with a solid-state control unit. A copy of the schematic is attached (see diagram). The transistors actually used are noted beside the symbols. It is still working, but I'd like to have information as to substitutes available in this country, before they blow out.—W.A., Conyngham, PA.

There is a wise move. After an unknown device has blown, it's very difficult to get any exact data on it. I've noted possible substitutes on the diagram, where I could get the data. There are a couple of things that you will have to verify; see the "notes" marked.

1. The Zener diode. No listing on a 1S234, but this is obviously a Zener. Read the DC voltage across it. This will give you the correct rating.

2. These are SCR's. There are many of these available. To get the correct

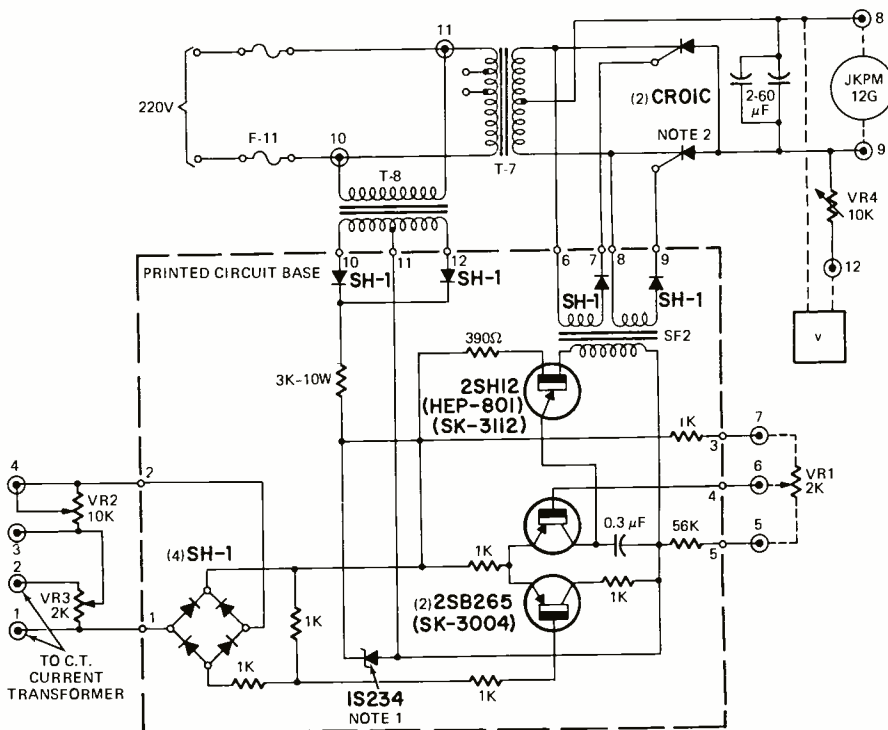

ratings, measure the maximum voltage across them. Also, open the circuit and insert a milliammeter (ammeter?) and see what the maximum current is.

Note this on the schematic, as well as the normal DC voltages on all of the transistors. "SH-1" and -2 are common silicon diodes, I'm pretty sure. **R-E**

CUTTING AUDIO TEST TIME

New audio test equipment reduces measurement time while increasing measurement accuracy. Here's what this new equipment is all about.

LEN FELDMAN
CONTRIBUTING HI-FI EDITOR

IT TAKES A TECHNICIAN ABOUT TEN MINUTES to plot the frequency response of an audio amplifier, using a fixed-frequency audio oscillator and an AC VTVM, if you count the time needed to transcribe the thirty or more readings from the meter to a piece of semi-log graph paper. The same task can be performed in a few seconds using a modern audio sweep generator, a chart recorder and/or a storage oscilloscope equipped with an audio frequency graticule.

The very best distortion analyzers, equipped with automatic nulling and even automatic level set (such as the Sound Technology 1700A described in the October issue of R-E) can provide a single reading of total harmonic distortion in less than five seconds. However, distortion analyzers cannot tell you what harmonics make up the total distortion and what the contribution of each of those harmonics

is. It has become increasingly apparent in recent years that a single figure of THD does not provide us with enough information to determine the "audible annoyance factor" of that distortion. High-order harmonics are known to be more bothersome, subjectively, than simple second- or third-order harmonic distortion.

Rumble meters, used to measure rumble of turntable systems, give a single figure (in dB) of signal-to-noise ratio but the reading does not tell us the frequency or frequencies of the offending noise. Is it primarily sub-sonic rumble (in the 5 to 30 Hz range) or is it caused by multiples and sub-multiples of the rotation frequency of synchronous motors used to drive the turntable (usually at 1800 RPM, or, 30 Hz)?

With the development of audio sweep generators some years ago, there began a steady but growing trend towards simplification, automation and reduction of the time required to make many of the audio test measurements we have mentioned. Audio sweep generators, such as the IEC Model F-34 shown in Fig. 1, use a voltage-controlled oscillator (VCO). The output frequency of the VCO depends upon the instantaneous voltage applied to a varactor diode—a diode whose effective capacitance varies with DC voltage applied to it. Such diodes serve as the frequency-determining capacitance in oscillator circuits. A change of voltage of as little as 5 volts can cause the frequency of oscillation to change over a wide range.

An elementary system of sweep frequency analysis is shown in block diagram form in Fig. 2. The sawtooth generator

develops the ramp voltage required to sweep the VCO over its desired range of audio frequencies. The ramp or triangular voltage is also applied to the horizontal input of an oscilloscope to develop a horizontal trace in synchronism with the changing audio frequencies. Output from the oscillator is applied to the amplifier under test and output of the amplifier is displayed vertically on the oscilloscope.

The oscilloscope photo of Fig. 3 shows the response of an audio amplifier over the range from 300 Hz to 20,000 Hz when the high-cut filter of the amplifier is switched into the circuit. The upper trace is the input signal, unvarying in amplitude over the specified range, while the lower trace is a display of the output of the amplifier under test. Frequency sweep in this case was linear, but if the ramp voltage

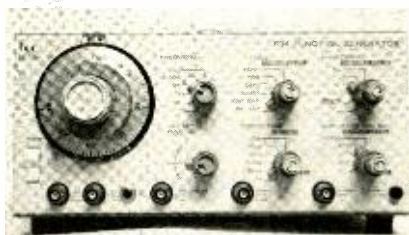

FIG. 1—IEC MODEL F34 function generator delivers square waves, triangular waves, pulses and tone bursts.

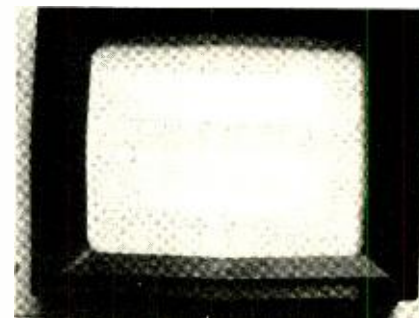

FIG. 3—SWEEP GENERATOR output is shown in upper trace. Frequency response of amplifier with high-cut filter turned on is shown in lower trace.

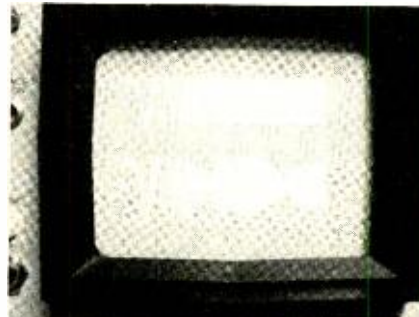

FIG. 4—FREQUENCY RESPONSE of an audio system with two notch filters is shown in the lower trace. Upper trace shows output of sweep generator.

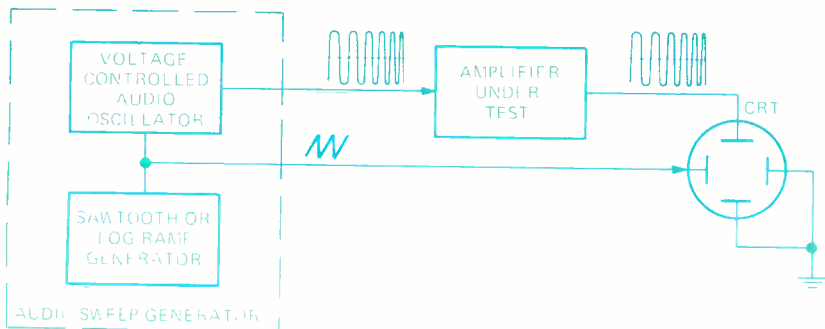

FIG. 2—AUDIO SWEEP GENERATOR is used to display the frequency response of an amplifier on a CRT.



FCC Form No. 1
April 1975

NIMHFD
PI-24-14355

The United States of America
FEDERAL COMMUNICATIONS COMMISSION

RADIO TELEPHONE OPERATOR LICENSE
FIRST CLASS
(General Radiotelephone Certificate)

This certifies that JOHN R. DOE

SEX	WEIGHT	HEIGHT	COLOR EYES	COLOR HAIR	DATE OF BIRTH
M	6 1/2	185	BLUE	BROWN	MONTH 02 DAY 22 YEAR 1946

IS A LICENSED RADIO OPERATOR, AUTHORIZED, SUBJECT TO ANY SPECIAL ENDORSEMENT PLACED HEREON, TO OPERATE THE CLASSES OF LICENSED RADIO STATIONS FOR WHICH THIS CLASS OF LICENSE IS VALID UNDER THE ORDERS, RULES AND REGULATIONS OF THE FEDERAL COMMUNICATIONS COMMISSION, ANY STATUTE OF THE UNITED STATES AND ANY TREATY TO WHICH THE UNITED STATES IS A PARTY.

THIS LICENSE IS GRANTED UNDER THE AUTHORITY OF THE COMMUNICATIONS ACT OF 1934 AS AMENDED, AND THE TERMS AND CONDITIONS THEREOF AND OF ALL LEGISLATIVE ACTS, EXECUTIVE ORDERS AND TREATIES TO WHICH THE UNITED STATES IS SIGNATORY, AND ALL ORDERS, RULES AND REGULATIONS OF THE FEDERAL COMMUNICATIONS COMMISSION, WHICH ARE BINDING UPON RADIO OPERATORS, ARE MADE A PART HEREOF AS THOUGH SPECIFICALLY SET OUT IN FULL HEREIN.

NEITHER THIS LICENSE NOR THE RIGHTS CERTIFIED TO HEREIN SHALL BE ASSIGNED OR OTHERWISE TRANSFERRED TO ANY OTHER PERSON.

PLACE AND DATE OF ISSUANCE: WASHINGTON, D.C. MARCH 31, 1975

DATE AND TIME OF EXPIRATION: MARCH 31, 1980 AT THREE O'CLOCK A.M. EASTERN STANDARD TIME

SPECIAL ENDORSEMENT:
SHIP HADAN ENDORSEMENT WASHINGTON, D.C. MARCH 31, 1975

Paul J. Harris
Issuing Officer
Federal Communications Commission

John R. Doe
Signature

SPECIMEN
NOT VALID UNTIL SIGNED

CIE's Warranty says a lot to you!

A lot about CIE's FCC License training programs...and a lot more about our school.

Our FCC License Warranty means just what it says. If you enroll in any CIE career course that includes FCC License preparation and successfully complete your training... you'll pass the Government FCC exam. We *warrant* that you'll succeed.

CIE can make this no-nonsense warranty because we're confident of our in-depth career training programs. You see, we have *specialized exclusively* in Electronics education-by-mail for more than 40 years. Just Electronics. And, the courses we offer today are the result of these years of teaching experience and proven methods of training.

Our courses of study are written in easy-to-understand language, so you can progress at your own learning pace, at home, in your spare time. And, there are never any classrooms to attend.

CIE courses challenge your thinking... help you develop your understanding of important electronics theories and applications... enable you to learn new skills and knowledge. Our courses are thorough. They have to be.

You see, we're training you for a career in Electronics. And, if an FCC "ticket" is part of your goal, you'll have to pass a tough licensing exam administered by the Federal Communications Commission (an agency of the U.S. Government). And you'll be prepared.

CIE is willing to warrant that you will pass! The reason is... we have every reason to expect that *you will* do exactly that. Based on a series of continuing surveys, *close to 9 out of 10 CIE grads pass* their FCC exams!

What's a license worth?

An FCC License can be worth a lot if you're interested in any area of Electronics involving communications. In some fields, federal law requires that you must have one. And, even in careers where a license is not required, it is

Government certification of certain electronics knowledge and skills.

What about other CIE courses?

In every CIE career course, you'll find the same time-tested instructional techniques that have made CIE's FCC License preparation programs so successful.

Each CIE career course is built on the principle that the best way for you to *learn* and *retain* what you've learned is to *explain*; then to *check* your understanding; then to *reinforce* your comprehension with practical applications. In some courses, you will perform experiments and tests with your CIE Experimental Electronics Laboratory using authentic electronic components and gear. And, if you select a course that includes Color TV technology, you will not only build and keep a 25" diagonal Color TV which features digital circuitry... you'll also learn how to troubleshoot your TV.

The CIE course you select (beginner, intermediate, or advanced college-level), will be a complete educational program, designed by *experts* to give you the best in Electronics home-study education.

Send for FREE school catalog

Discover more about the career opportunities open to people with electronics training. *Learn* how CIE career courses can help you build new skills and knowledge and prepare you for a meaningful, rewarding career. Whether you are just starting out in Electronics or are a college-trained engineer in need of updating, (or anywhere in between), CIE has a course designed for *you*. And, more than half of CIE's career courses include FCC License preparation.

Send today for our FREE school catalog and booklet on FCC License information. For your convenience, we will try to have a representative call to assist in course selection. Mail reply card or coupon to CIE... or write: Cleveland Institute of Electronics, Inc., 1776 East 17th Street, Cleveland, Ohio 44114. Do it TODAY.

G.I. Bill benefits

All CIE *career* courses are approved for educational benefits under the G.I. Bill. If you are a Veteran or in service now, check box for G.I. Bill information.

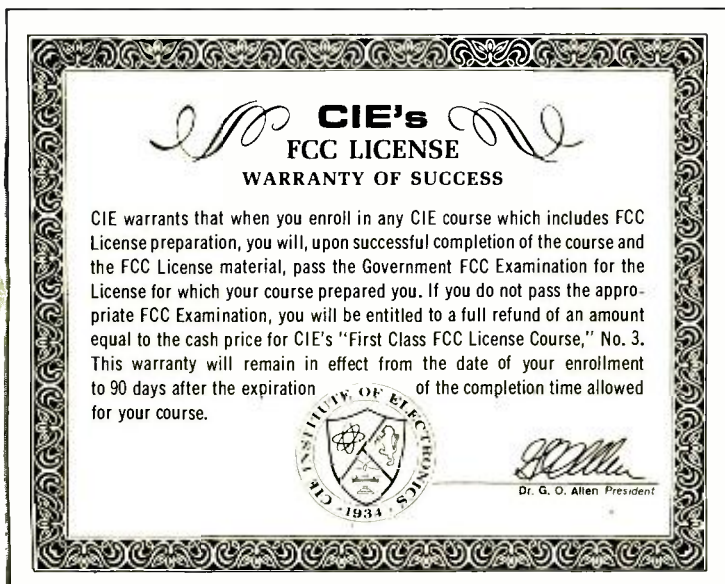

CIE Cleveland Institute of Electronics, Inc.
1776 East 17th Street, Cleveland, Ohio 44114
Accredited Member National Home Study Council

Yes, I want your FREE school catalog and career information package today. RE-69

I am especially interested in:

<input type="checkbox"/> Electronics Technology	<input type="checkbox"/> Industrial Electronics
<input type="checkbox"/> FCC License Preparation	<input type="checkbox"/> Electronics Engineering
<input type="checkbox"/> Color TV Maintenance	<input type="checkbox"/> Other _____
<input type="checkbox"/> Mobile Communications	_____

Print Name _____

Address _____ Apt. _____

City _____

State _____ Zip _____ Age _____

Check box for G.I. Bill information. Veteran On Active Duty

used to control the oscillator and the horizontal scope trace had been logarithmic, the display could have been made similar to the more familiar frequency plots of audio products. Vertical amplitude in Fig. 3 is also represented linearly, but again, insertion of a linear-to-log amplifier ahead of the connection to the scope's vertical plates could have altered the display so that it could be calibrated in dB's.

The oscilloscope photo of Fig. 4 shows the effect on response of a given amplifier when two notch filters are inserted in series with the sweep signal at frequencies of 2 kHz and 12 kHz. Notch filters are often used in sound reinforcement work to can-

cel audio feedback at specific frequencies. With such a convenient display available, it becomes easy to "tune" the filters to the exact desired frequency or, conversely, to read off the exact center, frequency of the filters after they have been tuned. To convert this display to the more familiar "single line" frequency plot, it is only necessary to add a wide-band amplitude detector, as shown in Fig. 5. The detector converts the sweeping audio frequencies into "average amplitude" and the oscilloscope photo of Fig. 6 (converted to dB as well) is equivalent to that of Fig. 4 but more easily interpreted.

A unit that combines all these functions

plus more is Fidelity Sound's model 100 Audio Frequency Plotting System, shown in Fig. 7. This test equipment consists of two sine/square/triangle function generators, a pulse generator, frequency counter and peak amplitude measurement sections. The equipment is primarily intended to generate a frequency response plot on an X-Y chart recorder or on an oscilloscope. Its audio sweep generator provides manual frequency adjustment or log/linear sweep from 20 Hz to 20 kHz. The peak amplitude measurement section measures internal or external signals from microphone levels all the way up to power amplifier output levels. The frequency counter has a 6-digit display and reads either internal or externally connected frequencies. This system sells for \$525.

Low-frequency spectrum analyzers

Recently, two well known manufacturers of sophisticated test equipment have introduced low-frequency spectrum analysis equipment that could revolutionize and simplify audio equipment testing beyond the hopes of audio technicians and engineers. Spectrum analysis—or the investigation of signals in the frequency domain, as opposed to time domain observations on an oscilloscope—has been used in the radio-frequency region for years. With improvements in filter design, integrated circuits, circuit stability and reduced noise and oscilloscope storage techniques, it is now possible to display audio system performance in terms of spectral or frequency content.

The basic approach to audio spectrum analysis is shown in the block diagram of Fig. 8. The system operates as if it were a wide-range, tunable band-pass filter, controlled by the output voltage of the self-contained audio sweep generator. An incoming signal enters the first mixer through a low-pass input filter. The other input to the heterodyne mixer is the output of a VCO. The output frequency of the VCO varies upward from the center frequency of the intermediate amplifier. Sweep range is adjusted to correspond to the portion of the audio spectrum to be examined. When the frequency difference between the input signal frequency and the VCO frequency equals the IF center frequency, the signal is detected and appears as a vertical deflection on the CRT.

Changing the bandwidth of the IF bandpass filter changes the analyzer's resolution. The narrower the IF bandwidth, the longer the time required for the filter to reach a stable output. This characteristic imposes limitations on the rate at which a given range of frequencies can be swept. The entire spectrum of interest cannot be observed simultaneously, as it can when an oscilloscope is used in the time domain.

Two different methods are used to overcome this viewing problem. A storage CRT may be used as a display mechanism. Using a storage scope, the sweep can be slowed down as much as needed, depending upon filter bandwidth, and the resulting curve can be stored and displayed on the CRT face almost indefinitely for detailed examination. This is the approach taken by Tektronix in their 5L4N Spectrum Analyzer. The analyzer itself is a plug-in module, shown in Fig. 9, and it

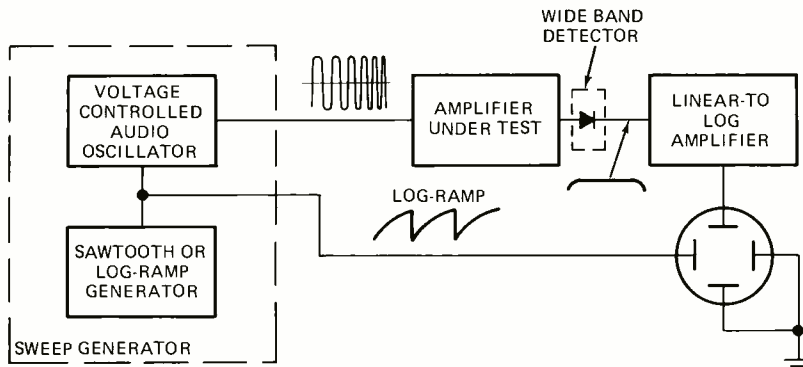

FIG. 5—CONVENTIONAL SEMI-LOG frequency response display can be obtained with the setup shown.

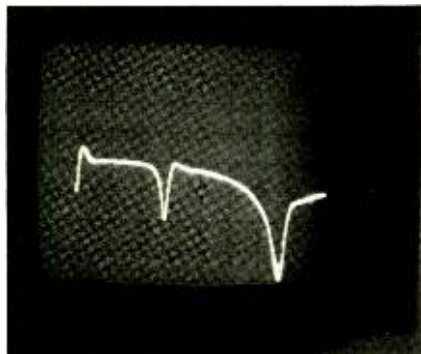

FIG. 6—FREQUENCY RESPONSE of amplifier with vertical axis of oscilloscope calibrated in dB.

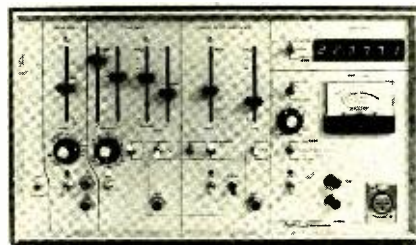

FIG. 7—FIDELITY SOUND MODEL 100 combines function sweep generator with frequency counter and amplitude meter.

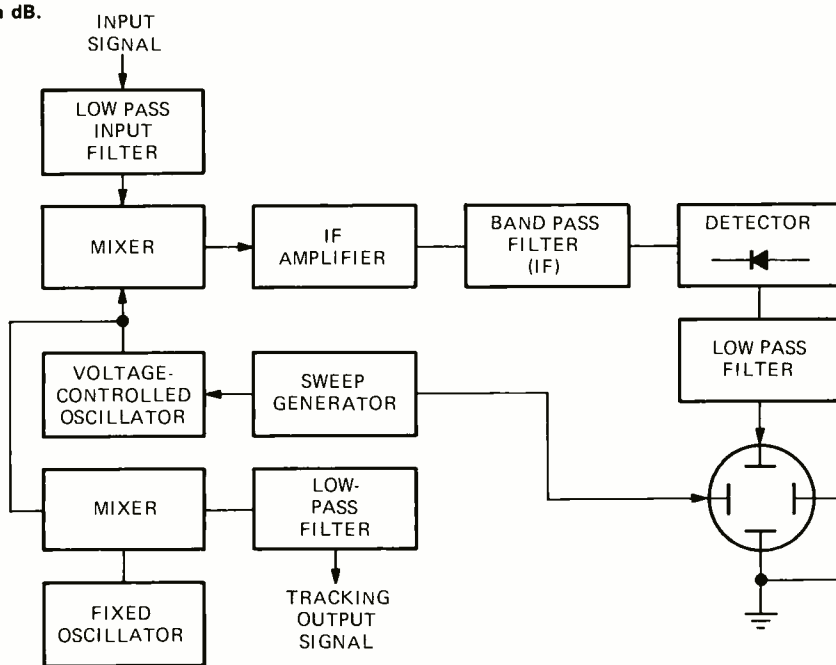

FIG. 8—LOW-FREQUENCY spectrum analyzer system.

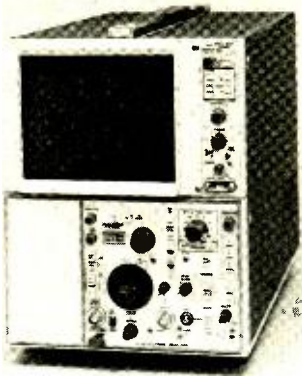

FIG. 9—TEKTRONIX MODEL 5L4N plug-in module spectrum analyzer.

closely to the IF frequency at every instant of time. The one-piece HP 3580A is shown in Fig. 11. The tracking generator output (see Fig. 10) is connected to the input of the circuit to be tested, while the output of the test circuit is connected to the analyzer's input terminals. The resulting single-line trace on the oscilloscope represents the frequency response of the circuit under test.

Applications of spectrum analysis

Tektronix has published a most informative booklet, entitled "The Tektronix Cookbook of Standard Audio Tests." Of course, the booklet emphasizes the use of their 5L4N Spectrum Analyzer, but it is a storehouse of useful information regarding audio amplifier testing. Using just the spectrum analyzer (complete with storage

sweeps from one end of the audio spectrum to the other, distinct "blips" will be displayed at those frequencies where signals appear. By setting a zero-dB reference for the fundamental signal, the presence of all order harmonics is not only seen visually, but their amplitude, in dB, is instantly readable from the analyzer as shown in Fig. 12. To arrive at a conventional measurement in total percentage of distortion, simply add the various harmonic components together using the proper correction factors when adding "dB" numbers. A handy table is supplied in the Tektronix booklet for this purpose. Harmonic contributions that are 6-dB or more lower than the major harmonic contribution can be ignored in determining the total harmonic distortion.

With greater emphasis on performance

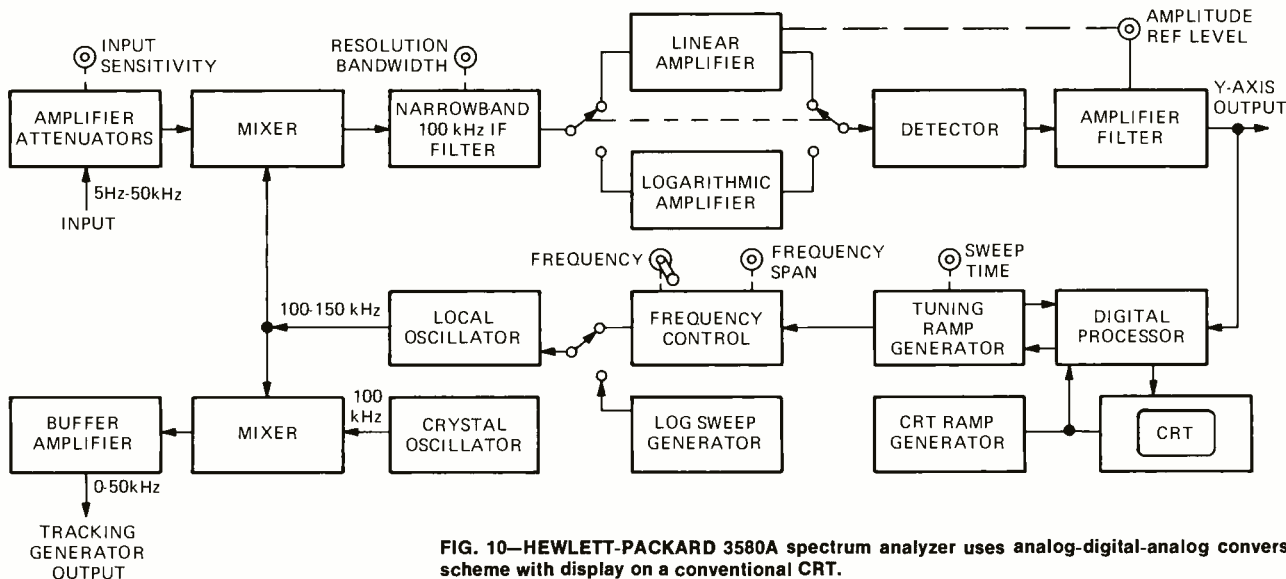

FIG. 10—HEWLETT-PACKARD 3580A spectrum analyzer uses analog-digital-analog conversion scheme with display on a conventional CRT.

can be used with any one of many oscilloscope main-frame and plug-in units in that company's 5100 series of oscilloscope products. Optional plug-ins are available to convert the storage oscilloscope to time domain use for such applications as real-time storage of non-recurring signals such as musical energy frequency distribution, noise, etc. With these additional plug-ins, the storage scope can then be used as an ordinary oscilloscope, with the added advantage of being able to examine a permanently stored waveform trace at will.

The second approach to overcoming the slow-sweep rate of narrow-bandwidth filter spectrum analyzers involves the conversion of the vertical input signals from analog form to digitalized data. This digitalized data is recurrently circulated in a shift register and, as each digital word is recirculated, it is reconverted to its analog value and displayed on the face of an ordinary oscilloscope having normal persistence.

A block diagram of the Hewlett-Packard Model 3580A, which uses this analog-digital-analog display method is shown in Fig. 10. With the exception of the different display method, the basic scheme is similar to other traditional spectrum analyzers. The output of a fixed-frequency oscillator (100 kHz) is mixed with the output of a VCO. The output of the mixer is fed through a low-pass filter that provides a signal whose frequency corresponds

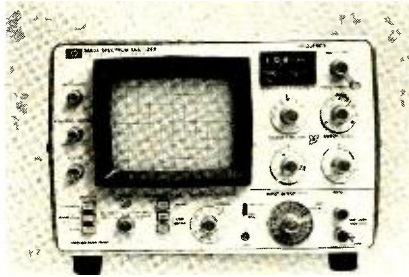

FIG. 11—HEWLETT-PACKARD MODEL 3580A low-frequency spectrum analyzer.

scope mainframe) and a separate audio oscillator, plus load resistors and matching pads you can easily build yourself, the booklet lists the following audio performance tests that can be easily made with this equipment: Power Output, Frequency Response, Harmonic Distortion, Distortion vs. Output, IM Distortion, Power Bandwidth, Damping Factor, S/N Ratio, Square Wave Response, Crosstalk, Sensitivity and Transient Intermodulation Distortion.

Referring back to the question of harmonic content, it should be obvious that spectrum analysis will not only show distortion but will "break up" that distortion into its various harmonic components. If a single frequency signal is applied to the amplifier under test and the analyzer

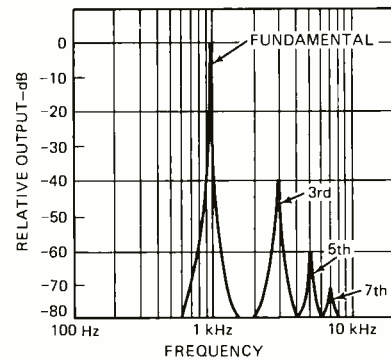

FIG. 12—1-kHz OUTPUT SIGNAL from an amplifier is displayed on a spectrum analyzer as a fundamental plus the odd-order harmonics.

specifications in high-priced audio equipment, the need for performance verification increases and test instruments such as spectrum analyzers, though relatively expensive (the Hewlett-Packard unit costs about \$4500.00, while the elements needed to put together the Tektronix system run just under \$4000.00), are likely to find their way onto the test benches of hi-fi company engineering departments and better-equipped hi-fi service centers. They may well pay for themselves in a relatively short time in terms of the test time and measurement time they can save.

R-E



Installing Garage Door Openers

THE NEXT TIME YOU'RE ON A SERVICE CALL, SEE IF YOUR CUSTOMER has a garage-door opener. If your customer does not, you have the opportunity to make that service call more lucrative by selling and installing an automatic garage-door opener.

Today's garage-door openers are easy to install because manufacturers have replaced the lollipop rail with the split rail. The lollipop rail is a long, one-piece rail used to guide the opener's drive chain and door arms. The one-piece design is awkward, if not downright difficult to store and carry. The newer split-rail comes in pieces and is ready to bolt together at the installation site. It's as strong as the lollipop rail and allows for smaller packages for easy storage and carrying.

Because of this new, compact packaging, more electronic distributors are carrying garage door-openers in stock. This means you can easily pick up one or two openers at your distributor and keep them in your car trunk, ready to go when your customer needs one. And with this ready

availability of openers from a wholesale source, you won't have much money tied up in inventory.

Installation is fast and goof-proof, taking less than two hours and using common tools. Most likely, you already carry most of the necessary tools for a garage-door opener installation. All you need is a screwdriver, pliers, wire cutters, adjustable end wrench, claw hammer, socket wrench, electric drill and stepladder. Everything else you need, from hardware to wire to lubricant, is generally included in the garage-door opener package.

Installation

There are three basic steps to installing a modern garage-door opener—assembling the unit, attaching the unit to the garage, and installing the radio controls. It's that simple, and just about that easy, especially since car installation of the transmitter is eliminated by the use of portable solid-state transmitters.

The first step is assembling the unit (top left) This begins with the assembly of the split rail. Most manufacturers use a three-piece rail that easily bolts together.

Attach the drive-chain sprocket bracket (top right) to the rail next, making certain the bracket and the rail are aligned.

The trolley assembly (lower left), the piece that connects the ends of the chain and actually pulls the garage-door open, slides onto the rail.

The rail is next attached to the power head (lower right). Place the power head on the package in which the system came to avoid scratching the cover. For extra convenience, a support may be placed under the sprocket bracket. Align the two holes in the motor end of the rail with the holes in the power head chassis and bolt the rail to the power head.

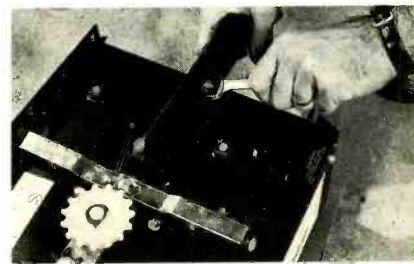
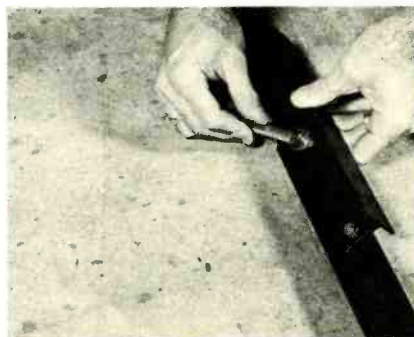

Installing electronic garage-door openers has always been profitable. Solid-state electronics and new mechanical designs have made the job easier and more lucrative. Here's how it's done, step-by-step

LEE PHILIP STRAL

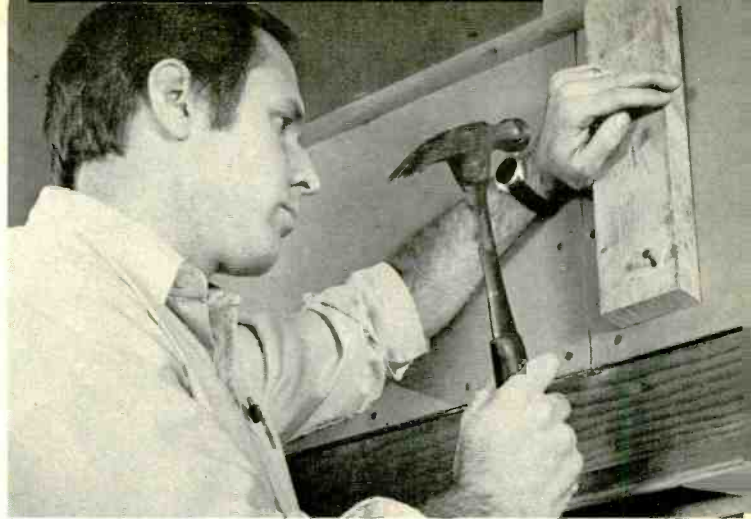

Attaching the opener to the garage begins with the installation of the header bracket on the vertical center-line of the garage door on the header wall above the door. If there is no stud on the header wall behind the center line, nail a 2 × 4 to reinforce the bracket.

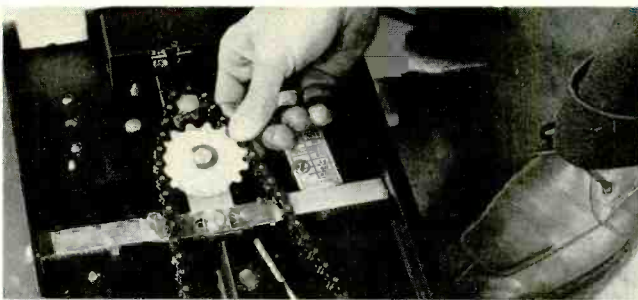

The drive chain is installed once the rail is attached to the power head. This is accomplished by first looping the drive chain over the sprocket wheel on the power head.



Next, mount the header bracket to the header wall along the vertical center-line of the garage door.

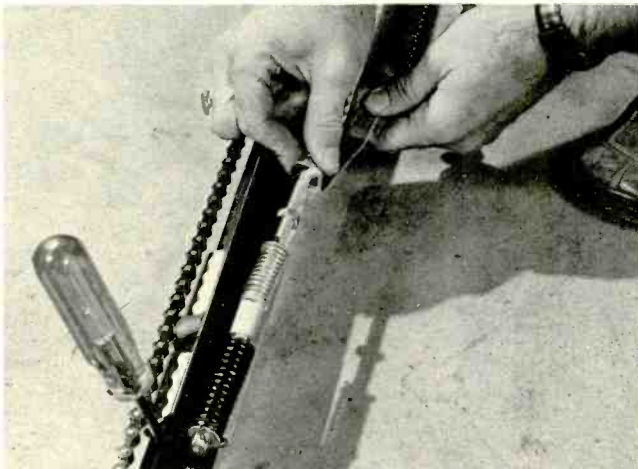

Next, attach the drive chain to the trolley. First insert a screwdriver in the hole in the front end of the rail and slide the trolley up to the screwdriver. Thread a nut onto the trolley stud and fasten one end of the chain to the trolley.



With the power head still on the packaging material, raise the rail and attach it to the bracket.

Next, raise the power head onto a stepladder and open the garage door, making sure the door clears the rail. To properly position the unit, place a 2 × 4 on edge along the top section of the door, resting the rail on the piece of wood. The 2 × 4 is not a necessity, but it is convenient for establishing an ideal door-to-rail distance.



Then, extend the chain around the idler sprocket wheel and forward to the trolley, being sure the teeth of each sprocket wheel engage the chain. Connect the end of the chain to the trolley and the unit is now ready to attach to the garage.





Hanging brackets are used to secure the power head to the garage. Measure the distance between the opener and the garage ceiling and cut both hanging brackets just beyond that length. Notch the ends of the bracket and bend them so the bracket hole is flush against the garage ceiling. Fasten the hanging brackets, first to the chassis, then to the roof supports.

After the opener is secured, close the garage door and attach the emergency release cord to the trolley release lever. Attach the straight door-arm to the trolley assembly on the rail and connect the curved door-arm in the vertical opening of the straight door-arm and, before temporarily connecting the two, find the best location for the door bracket on the garage door.

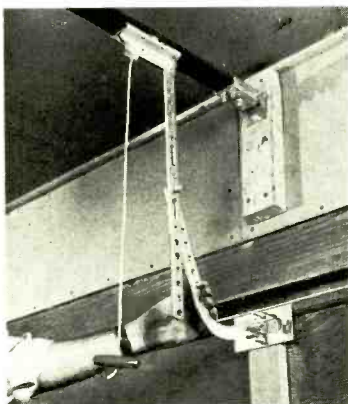

Ideally, the bracket should be in horizontal line with the top rollers of the door. When this is not possible, place the bracket as close to this alignment as possible, but within the upper eight inches of the top section of the door. When the best location for the door bracket is found, press the garage door snugly against the floor, mark the door bracket locations on the door and bolt the bracket in place.

Pull the emergency release cord and slide the trolley back from the door. Mark where the curved door-arm meets the bottom of the vertical opening on the straight door-arm and connect the curved and straight door-arms.

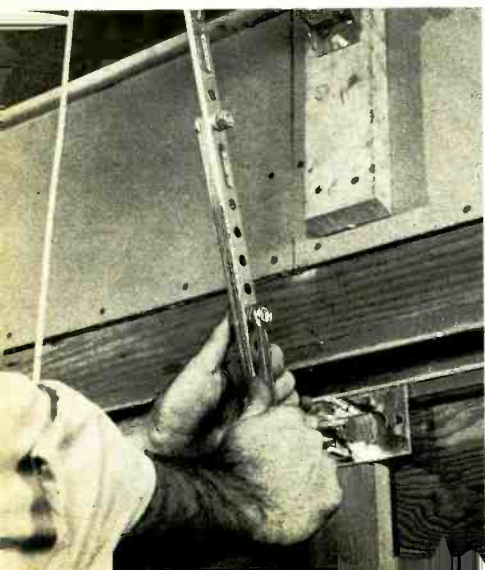

Installing the radio controls, once the most difficult part of the job, is now the easiest. Modern garage-door openers no longer require wired-in transmitter installation in the car. Instead, a compact, battery operated transmitter just clips to the sunvisor.

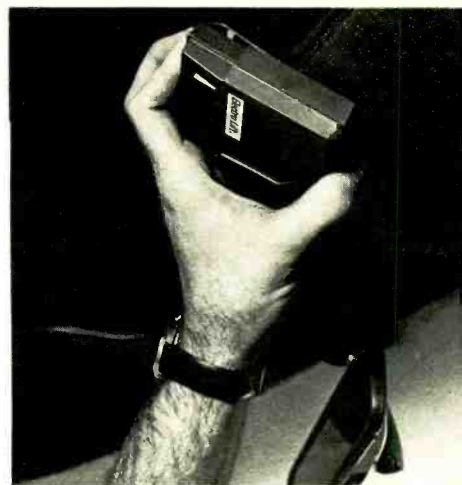

The receiver, also compact, easily attaches to the interior wall of the garage. (On some units, it's housed within the power head.) The antenna plugs into the receiver.



The receiver connects to the power head by running wires from the receiver, up the wall and across the ceiling to the power head.

Attach the wires to the power head and then to the receiver.

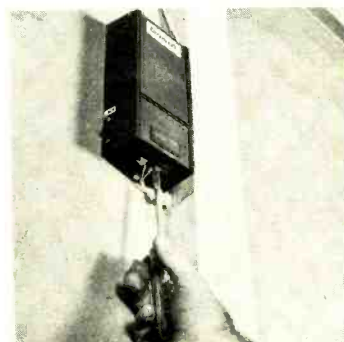

After this is done, just connect the power and the installation is complete.

Installing a garage door opener can make a service call more lucrative. So, too, can recommending accessories to go along with the opener.

(continued on page 92)

Radio-Electronics



Tests Fuji Model FX C-60 Tape

LEN FELDMAN

CONTRIBUTING HI-FI EDITOR

ALL OF OUR HIGH-FIDELITY EQUIPMENT REPORTS to date have concerned themselves with the electronic hardware used to reproduce music in the home. An equal partner in the sound reproduction process is so-called "software"—the tapes and discs that we use as program sources. While few of us have any control over the quality of the discs we buy (choosing a recording ordinarily involves musical tastes rather than technical quality considerations), we can exercise a measure of selectivity when it comes to selecting the raw tape to be used on our open-reel or cassette tape decks.

Tape characteristics do vary greatly from brand to brand and from formulation to formulation. In attempting to test any tape, and especially cassette tapes, one has to establish not only reference levels of performance, but a standard tape deck whose performance capability does not become the limiting factor in the measurements made. In this, and any future cassette tape evaluations, we selected the Nakamichi model 1000 cassette deck because of our previous experience with this machine. It is capable of delivering uniform frequency response at the relatively slow cassette speed out to at least 20,000 Hz. Its bias is set such that Nakamichi's own EX tape will deliver 0-dB playback level (as indicated on its self-contained

level meters) for 0-dB input recording level at mid-frequencies. Under these calibrated conditions, the reference Nakamichi tape (EX C-60) tested on the reference deck at a record level of -20 dB resulted in a response curve that was down 3 dB at 21.0 kHz.

Without altering any bias calibration settings, we ran a response curve of the new Fuji FX C-60 tape, a photo of the cassette is shown in Fig. 1. Fuji is perhaps best known in this country and abroad for its photographic film products, but we learned that the company has also been manufacturing video tape and related products for some years. According to their descriptive literature, Fuji FX tapes are made with a gamma-ferric formulation, using particles which the company calls Pure Ferrix. The size of the particles is said to be 0.4 microns with a length to width ratio of 8:1. Be that as it may, the results of our frequency response tests are shown in Fig. 2. The first thing we noted

SUMMARY OF MANUFACTURER'S SPECIFICATIONS:

PHYSICAL PROPERTIES

Width Tolerance: +0.00, -0.05 mm. **Length:** 90 m (295.28"). **Breaking Strength:** 1.4 kg (3.09 lbs). **Yield Strength:** 0.6 kg (1.32 lbs). **Maximum Elongation:** 30%. **Residual Elongation:** 0.02%. **Surface Resistance:** 1.7×10^9 ohms. **Thickness:** Backing, 12 μ ; Coating, 6 μ ; Overall, 18 μ . **Width:** 3.81 mm (0.150").

MAGNETIC PROPERTIES:

Coercivity: 345 oersteds. **Retentivity:** 1520 gauss. **Saturation Flux-density:** 1820 gauss.

ELECTRO-MAGNETIC PROPERTIES:

Operating Bias Current: 105%. **Sensitivity (333 Hz):** +1.0 dB. **Sensitivity Uniformity:** (333 Hz) 0.3 dB. **Relative Frequency Response (10 kHz):** +2.2 dB. **Output fluctuation (8 kHz):** 0.3 dB. **Maximum Output Level:** +4.0 dB at 333 Hz. **Signal-to-Noise Ratio (1000 Hz):** 58 dB. **Erasure Effect:** (1000 Hz): 76 dB. **Print-through (1000 Hz):** 56 dB.

RADIO-ELECTRONICS PRODUCT TEST REPORT

Manufacturer: **Fuji Photo Film U.S.A., Inc.**

Model: **FX-60 Cassette Tape**

OVERALL PRODUCT ANALYSIS

Retail Price	\$3.50
Price Category	Medium
Price/Performance Ratio	Excellent
Styling and Appearance	-
Sound Quality	Very Good
Mechanical Performance	Excellent

Comments: In addition to our laboratory testing, we used several of the new Fuji FX-60 cassettes to record a variety of program material, including music, test tones of sustained duration and voice. Playback of constant level recorded tones resulted in no audible variation in output level over a period of some ten minutes and there were no "drop-outs" during this same time period, indicating a high degree of consistency and uniformity in tape formulation and ferric coating. As with any tape product, results will depend partly upon the bias conditions, equalization and overall quality of the machine with which the tape is used. However, the greater output at upper-mid to high frequencies of this new tape formulation should find favor with many cassette deck owners who seek better high-frequency response without sacrificing signal-to-noise capability or low distortion.

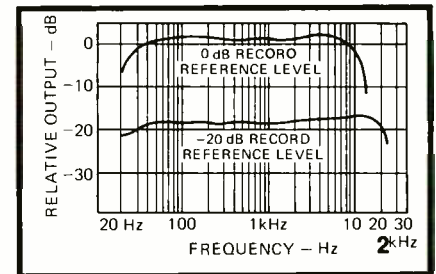

was that for the same 0-dB recording level used with our reference tape, the Fuji sample delivered an output level of +1.5 dB, consistent with its claims for higher output. The response curve shows a slight rising characteristic above 3000 Hz. This rising response will be welcomed by owners of cassette decks that tend to roll-off response long before our reference deck and will lend a measure of "brightness" to resultant recordings. The -3-dB point using our reference deck occurred at a frequency of 21.5 kHz, a shade better than the reference tape.

Next, we measured distortion at several recording levels. At the 0-dB record level, THD measured just over 1.0%. The 3.0% distortion level occurred at a recording level of +7.5 dB, which means that the FX tape offers excellent "headroom" or dynamic range capability. At recording

levels lower than -3 dB, THD readings become rather meaningless since the distortion meter begins to integrate residual noise into the single reading.

From a system point of view, the other important electrical characteristic that requires measuring is signal-to-noise ratio. Two methods were used in our tests. The unweighted S/N measurement that takes into account noise at all frequencies resulted in a reading of -51 dB below the 3.0% distortion level. By installing an "A" weighting network between the output terminals of the deck and the meter, the reading improved to -58 dB. The "A" weighting network takes into account the audible effect of wideband noise that tends to be less bothersome when the noise consists of low frequencies. By way of comparison, our reference tape, tested under the same

conditions, had a headroom of +6.0 dB (for 3% THD) and an "A" weighted signal-to-noise ratio of 55 dB when measured under the same conditions.

Mechanical considerations

The two halves of the new Fuji FX cassette package are held together with five tiny Philips head screws. The cassette package itself is precision molded and dimensional tolerances of our samples were extremely well maintained. The reference Nakamichi deck used in our tests is one of the few available that has three separate heads. It is therefore necessary to align the record head with respect to the playback head when a new cassette is inserted. This is easily accomplished by means of a tiny control that is rotated until a pair of LED indicators blink on and off equally. Nor-

mally, the adjustment is made before starting recording and re-checked from time to time during passage of the tape to make certain that variations in tape positioning have not taken place. We found no substantial difference in the alignment settings indicating a high degree of accuracy for both the precision tape and the package that contains it.

Based upon our tests, we would conclude that Fuji Film has developed an excellent cassette tape suitable for use by serious home recordists. We understand that there are plans afoot for the company to introduce a line of open-reel tapes as well as additional formulations of cassette tape. If the excellent quality of this first variety is carried over into these additional lines we should be hearing more about Fuji tape products in the future. **R-E**

Harman-Kardon Citation 16

JOINING THOSE COMPANIES WHO SPECIALIZE in high-powered, high-priced, super-performing basic power amplifiers is Harman-Kardon, with their impressive looking Citation 16, shown in Fig. 1. The massive rack-mountable front panel of this amplifier is highlighted by brushed aluminum covering most of its lower section, and a series of colored LED display lamps that are arranged in a pattern slanting from center upward to the left and to the right. Each set of eight LED's is arranged to flash successively, from the lowest to the highest depending upon the instantaneous power delivered by the amplifier to each speaker. Calibration of these lights is in dB, from 0 dB down to -30 dB. The 0-dB point corresponds to different power levels, depending upon the setting of a rotary control at the center of the unit. One position of this control is used to test all the lamps, while another position can turn off the display entirely, if desired. The lower two-position control sets the display sensitivity for 4 ohm or 8 ohm loads. Table I, reproduced from a card supplied with the amplifier, shows the wide range of display levels available—all the way from 0.0039 watts to 160 watts. Thus, the LED display can be used to indicate power even when listening at moderate or background music levels. Separate neon indicator lights adjacent to the power on/off switch shows the user that both channels are being powered.

The rear panel of the Citation 16 (see Fig. 2) contains the left and right phono-plug inputs and the instrument-type output terminals nestled between dual-banks

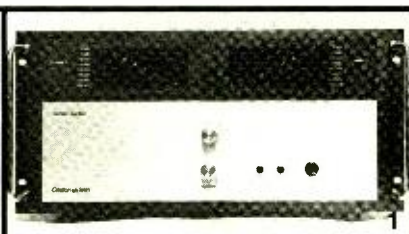
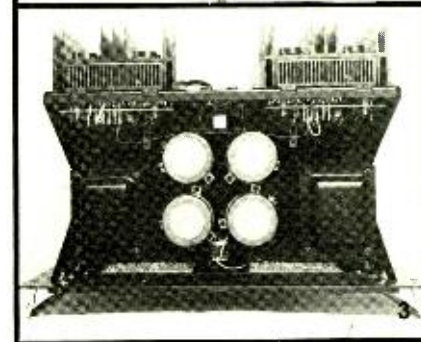
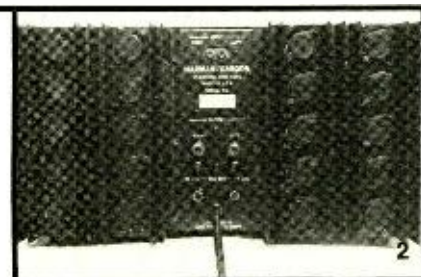

TABLE I

display setting	display setting			
	•	••	•••	••••
0 db	4W	16W	64W	160W
-3 db	2	8	32	80
-6 db	1	4	16	40
-9 db	.5	2	8	20
-12 db	.25	1	4	10
-18 db	.0625	.25	1	2.5
-24 db	.0156	.0625	.25	.625
-30 db	.0039	.0156	.0625	.1562

of ten transistors each, mounted on heat sinks to the left and right of the input and output terminals. Eight transistors are used in the output stages of each channel, while the remaining pair are drivers. Separate 4 ampere line-fuses are provided for



each channel since this amplifier uses two completely separate power supply systems, including two identical power transformers that can be seen in the photo of the internal layout of the amplifier, Fig. 3.

Circuit highlights

Individual circuit board modules (for each channel) include a driver board, an LED display board and an output heat-sink assembly. In addition, a small relay printed-circuit board delays turn-on of the amplifier for about one second to prevent "pops" or power bursts from reaching the speakers.

Each of the two independent power supplies delivers two sets of voltages: ± 60 volts to power the output and driver stages and ± 12 volts to drive the LED display circuits.

The driver board provides circuitry for gain and drive and also includes circuitry used in a current-foldback protection arrangement that protects the amplifier from damage due to short circuits or overloads at the output. The electronic

MANUFACTURER'S PUBLISHED SPECIFICATIONS:

Power Output: 150 watts-per-channel minimum continuous power, driven into 8 ohm loads from 20 Hz to 20 kHz. **Rated Harmonic Distortion:** Less than 0.05% from 1 watt to 150 watts at any frequency from 0.5 Hz to 20 kHz. **IM Distortion:** Less than 0.05% from 0.015 watts to 150 watts. **Frequency Response:** From 0.5 Hz to 120 kHz at 1 watt into 8 ohms. **Hum and Noise:** Better than 100 dB below 150 watts. **Damping Factor:** 300. **Square Wave Risettime:** 3 microseconds. **Slew Rate:** Greater than 30 volts-per- μ s. **Input Impedance:** 10,000 ohms. **Input Sensitivity:** 1.25 volts for 150 watts. **Phase Shift:** Less than 0.5 degrees at 20 Hz; less than 12 degrees at 20 kHz. **Dimensions:** 9 1/8" high \times 19 1/8" wide \times 13 1/2" deep. **Weight:** 55 pounds. **Suggested Retail Price:** \$795.

protection circuit insures the passage of full load-current when an 8 or 4 ohm load is present, but senses the presence of a short circuit and reduces the current level to a point where the transistor thermal dissipation is in a safe area. The circuit is designed so that the amplifier will deliver 11.1 amps peak current required for a 250 watt output into 4 ohm loads, but delivers progressively less current as the load impedance is reduced from 4 ohms to zero ohms, at which time maximum current is limited to approximately 8 amperes.

The amplifier can also be driven in a bridge mode (that is, monophonically) by rearranging the connection of two internal jumpers. In this mode, the channel identified as "A" is driven with the input signal and connection to a single speaker is made by connecting its terminals to each of the positive output terminals of the amplifier. Under these conditions, the Citation 16 can deliver approximately 500 watts of power to a 4 ohm load!

The technical manual supplied with the unit goes into great detail regarding the circuit design, explaining what Harman-Kardon believes to be the importance of fast risetime and good slew-rate and detailing how these criteria were met in the design. Each driver board uses a balanced IC for an input stage plus ten bipolar transistors.

Laboratory measurements

A summary of significant laboratory measurements made on the Citation 16 power amplifier is listed in Table II. The amplifier delivered far more power at mid-frequencies and at the frequency extremes than its conservative rating would suggest. Note, too, that while no "official" power rating is listed by the manufacturer for 4-ohm operation, we were able to read an output of over 250 watts-per-channel when a 4-ohm load was connected, at the 20 Hz extreme. This measurement was obtained after first subjecting the amplifier to the usual pre-conditioning test at one third rated power for one hour. No thermal shutdown of the amplifier occurred at any point in all of our various tests.

While most manufacturers rate the power bandwidth for full power output at from 20 Hz to 20 kHz, the Citation 16 delivered full power (150 watts-per-channel into 8 ohms, both channels driven) all the way down to below 10 Hz (the limit at which our distortion analyzer can read THD) and up to 59 kHz.

Reducing the output power to the published rated power output of 150 watts-per-channel, THD measured 0.003% at mid-frequencies, while IM was a low 0.04% at this same power level. Though not shown in Table II, we also measured THD at 150 watts output at the frequency extremes and, amazingly, the THD at 20 Hz was as low as that measured at mid frequencies, while at 20 kHz, THD still measured a very low 0.03% for one channel and 0.02% for the other.

It is difficult to confirm a damping factor as high as that claimed by Harman-Kardon (300) but we were able to measure in excess of 200 for this parameter. Residual hum and noise bettered claims of the manufacturer by a full 6

TABLE II		
RADIO-ELECTRONICS PRODUCT TEST REPORT		
Manufacturer: Harman-Kardon	Model: Citation 16	
AMPLIFIER PERFORMANCE MEASUREMENTS		
POWER OUTPUT CAPABILITY	R-E Measurement	R-E Evaluation
RMS power/channel, 8-ohms, 1 kHz (watts)	194	Superb
RMS power/channel, 8-ohms, 20 Hz (watts)	183	Excellent
RMS power/channel, 8-ohms, 20 kHz (watts)	180	Excellent
RMS power/channel, 4-ohms, 1 kHz (watts)	272	Superb
RMS power/channel, 4-ohms, 20 Hz (watts)	259	Excellent
RMS power/channel, 4-ohms, 20 kHz (watts)	218	Excellent
Frequency limits for rated output (Hz-kHz)	Under 10 to 59	Superb
DISTORTION MEASUREMENTS		
Harmonic distortion at rated output, 1 kHz (%)	0.003	Excellent
Intermodulation distortion, rated output (%)	0.04	Very good
Harmonic distortion at 1 watt output, 1 kHz (%)	0.005	Superb
Intermodulation distortion at 1 watt output (%)	0.01	Very good
DAMPING FACTOR, AT 8 OHMS	Over 200	Excellent
FREQUENCY RESPONSE AT 1 WATT/CH (Hz-kHz ±__ dB)	4-60, 0.5	Excellent
HUM & NOISE, REFERRED TO 150 WATTS (dB)	106 dB	Excellent
INPUT SENSITIVITY FOR FULL OUTPUT (mV)	1200	

dB, measuring 106 dB on each channel.

We applied a portion of the output of one channel of the amplifier to our spectrum analyzer when the amplifier was just beginning to clip with a 1000 Hz input signal (at an output power level of 195 watts into an 8 ohm load) and examined the harmonic distortion content. Results are shown in the scope photo of Fig. 4.

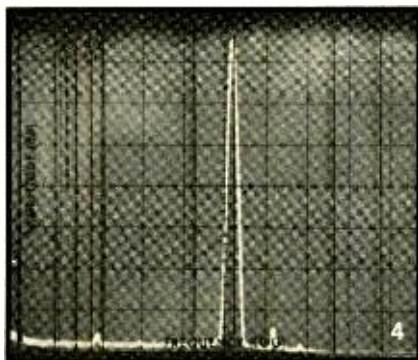

the right of the fundamental 1 kHz signal can be seen a second harmonic component which is 72 dB below the fundamental (corresponding to approximately 0.025%), while the barely perceptible third harmonic contribution is down about 75 dB (equivalent to a distortion of 0.0177%).

Since Harman-Kardon emphasizes the importance of square wave response in evaluating amplifier performance, we decided to put the Citation 16 to this test as well. Figure 5 shows scope photos of input (upper trace) and output square wave signals applied to the amplifier at frequencies of 100 Hz (Fig. 5-a), 1 kHz (Fig. 5-b) and 10 kHz (Fig. 5-c). There is virtually no evidence of overshoot or tilt in any of these traces.

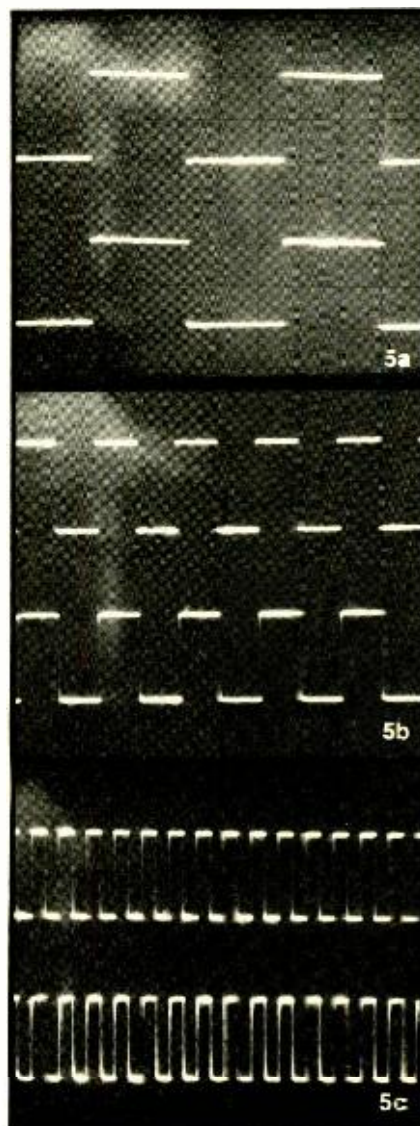

APRIL 1976

TABLE III
RADIO-ELECTRONICS PRODUCT TEST REPORT

Manufacturer: **Harman-Kardon**

Model **Citation 16**

OVERALL PRODUCT ANALYSIS

Retail price	\$795.00
Price category	High
Price/performance ratio	Very good
Styling and appearance	Excellent
Sound quality	Excellent
Mechanical performance & layout	Excellent

Comments: It is clear that the designers of this new Citation amplifier were intent upon producing the most reliable and rugged power amplifier they knew how to make. Harman-Kardon's design philosophy regarding bandwidth and phase response is well known for audiophiles. They believe in wide-as-possible bandwidth—far beyond audible limits, and have incorporated that philosophy in this design. While we do not propose to get involved in this age old debate (there are equally respected manufacturers who differ violently with this concept, and maintain that extended bandwidth offers no audible benefit to the consumer and costs involved in extending bandwidth might be put to better use), we can only judge the results by what we heard during our listening tests. Sound reproduction, using the Citation 16 hooked up to a pair of low-efficiency speakers capable of response down to below 30 Hz was so clean and transparent as to defy description.

As for reliability and fool-proof design, the Citation 16 can operate into short circuits, unloaded operating conditions, and the kinds of reactive loads presented by electrostatic and other esoteric speaker designs.

The LED power display is effective and provides the more serious and technically oriented audiophile with a very accurate and continuous means of monitoring power fed to the loudspeakers. We suspect that Harman-Kardon's profit margin on the Citation 16 will not be eroded by their very generous two-year service warranty on parts and labor.

Summary

In addition to subjecting the amplifier to the laboratory tests described, we spent a great deal of time listening to the amplifier connected to several pairs of our favorite speakers. Our conclusions are summarized in Table III. Certainly, just under \$800.00 is a lot of money for a power amplifier and there are other basic amplifiers around that provide as much power (or more) for less money. In our opinion, however, power output alone is not the sole criterion for judging this kind of component. Reliability, durability and just plain excellence of reproduced sound must play a part in the selection process too. Harman-Kardon seems to have taken all these factors into account—and more—in producing this latest unit in the respected Citation series

R-E

PICTURE RUNS SIDEWAYS!

The picture runs sideways in this Curtis-Mathes 56M-5748; just like a vertical roll, but crosswise. Now and then it will lock in, then start sliding again. The horizontal hold will stop it, but it slips again in a minute or two. Three shops have said this is a lemon. —L.B., El Paso, TX.

Well, there's an old saying that I just made up: "When you get a lemon, make lemonade!" Joking (?) aside, we have a couple of facts. First, we know the horizontal oscillator is running pretty well because the picture is straight-sided and you can tell that there is only one picture present. However, you do not have any horizontal sync to speak of. The oscillator is free-wheeling.

Ground the AFC grid of the horizontal oscillator tube. This should have some effect on the picture. If it doesn't, turn it off and see if this grid shows a short to ground! (Frankly, from the description, that's what it sounds like!) Another possible cause of this is an open socket contact on the AFC grid of the horizontal oscillator tube. I had a set of another make with this problem and it was hard to catch. (It was trying to tell me what it was, but I didn't listen).

Check out the entire horizontal AFC

circuit including the diode unit, all resistors and capacitors, and check continuity on the little ceramic capacitor that couples the horizontal sync from the sync-separator to the diode unit. If this is open, you could get exactly the same symptoms.

PHOTOSENSITIVE TRANSISTOR!

We had a mysterious hum in a small transistor amplifier. Checking filters did not help. We finally found that you could cover one of the transistors with your fingertips, and the hum stopped! Or, turn out the bench lights! The transistor was a little plastic TO-92 case, but it was a light brown instead of the normal black.

Investigation and checking with the maker disclosed that this was actually the cause. The fix? Cover the transistor case with black tape. All transistor junctions are photosensitive, and the case of this one let in just enough of the fluorescent light to make it hum.

Thanks to Charles Varble, Chart TV, St. Louis, for this cute one!

SAME WAVEFORM GRID AND CATHODE?

I've been all over the place in this Admiral 8T950 color set, trying to find out why I can't get enough height. I need about three inches at bottom of

the raster. All of the parts in the output circuit have been checked, and the tube changed. I see one funny thing. I get the normal waveform on the output sync tube grid, but I also get the same waveform on the cathode. That isn't right, is it?—J.M., Pettus, WV.

No, sir! This cathode is well by-passed! Whenever you see the same waveform with almost the same amplitude on both grid and cathode of an amplifier tube, you've got a terrific *degeneration* that reduces the gain of the stage very badly. The normal cathode waveform should be a distinct parabola with a P-P amplitude of about 11 volts. Check that 50- μ F electrolytic capacitor that bypasses the cathode. I'll bet you it's open. (I won! It was.)

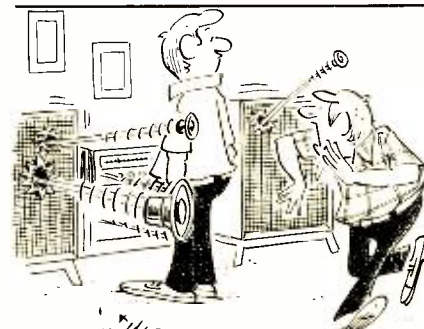

"I said, 'turn down the volume!'"

BAUDOT to ASCII

Build this converter so you can use your
Baudot or other teletypewriter as
an input device for the TV Typewriter

ROGER L. SMITH

LAST MONTH WE DESCRIBED AN ASCII to Baudot converter that let you connect your TV Typewriter or Mark 8 Mini-computer to a teletypewriter for hard-copy print-out. Now, we show how to use your teletypewriter as an input device.

BAUDOT to ASCII converter

The BAUDOT to ASCII conversion circuit may not be necessary for your application if all you wanted was a print-out device. However, if you intend to use your BAUDOT Teletype (or Kleinschmidt or Creed) machine for an input device, or if you are a ham operator and want to receive the BAUDOT RTTY signals on your TV Typewriter, you will want the BAUDOT to ASCII converter also.

The BAUDOT to ASCII conversion is simpler in that extra characters (shifts) don't need to be generated. The incoming serial BAUDOT data is clocked into the shift register IC13 (see Fig. 1). The leading "space" pulse starts the clock, which is stopped when this bit reaches flip-flop IC14-b. Gates IC19 and IC21 determine if the character is a LETTERS or FIGURES shift character and sets or resets flip-flop IC17-a accordingly. The proper PROM (IC20 or IC22) is then selected and the correct ASCII output character appears for the equivalent BAUDOT inputs. The shift inputs will generate a null.

Notice that the output ASCII data is not valid until the "data ready" line goes high ("1"). If your set-up requires a logic "0" signal for "data ready", use the \bar{Q} output (IC15-a pin 4). This line will remain high for 10-ms during which time the device being driven gates in the ASCII character. The PROM truth tables for IC20 and IC22 are shown in Tables I and II. These tables are on pages 00 and 00.

Adjustment

If you build the BAUDOT to ASCII Converter, you will need to adjust the oscillator (IC18). With all circuits hooked up (see Fig. 2), set the oscillator to a high rate (200K trimmer near minimum), and while typing a "K", adjust the oscillator until the "K" is received on the ASCII device. Keep turning the trimmer until you get a "Q", then back off half-way. Notice that if you are using *both* boards, you must add a suitable switch to change connections to pin 23 of the timing board when connecting the TV Typewriter I.

The boards are well suited for use with either TV Typewriter. If you are using the Model CT-1024 (Terminal System Kit from Southwest Technical Products) you can cut off the excess portion of the circuit board. Connection to a regular ASCII-encoded keyboard or Ham radio gear is also possible so long as the devices provide the proper "data ready" signals. The use

of these boards with the Mark-8 Mini-computer or other minicomputers is appealing. Output from the computer can then be the normal ASCII (as it would probably be for other output devices). Computer memory would not be used up in storing the codes, timing would be handled by the converter board and the software program would be simplified. **R-E**

CONNECTION OF BAUDOT TO ASCII CONVERTER

TV Typewriter I

On the timing board, cut the foil connection to pin 23. The REPEAT switch becomes the RECEIVE/NORMAL switch. (Substitute suitable switch if both boards in this article are to be used.

Add Molex pins and jumpers as shown in Fig. 4-a.

Note: CR and LF are not stored in TV Typewriter.

TV Typewriter II (CT-1024)

Add Molex plug P1 (09-52-3151) and wire the pins as shown in Fig. 4-b.

Note: CR and LF are not stored in TV Typewriter.

Minicomputer Connections

Connect as shown in Fig. 4-c.

Ham radio connections

Follow the schematic and observe power connections.

ADDITIONAL PARTS FOR ASCII TO BAUDOT CONNECTION

TV Typewriter I:

Quantity	Type
1	74123 dual monostable IC
1*	2524 512-bit shift register IC
3	2200 ohms, 1/4 W resistor
1*	6800 ohms, 1/4 W resistor
2	220 pF disc capacitors
1*	SPST switch
6	Molex connector (part #09-52-3103)
60	Molex pins 3/4-inch (part #08-54)

TV Typewriter II (CT-1024):

Quantity	Type
1*	2102 1024-bit memory
1	330 ohm, 1/4 W resistor
1	.1 uF disc capacitor
1	Molex 15-pin connector (part #09-52-3151)
15	Molex pins 3/4-inch (part #08-54)
1*	SPST switch

ADDITIONAL PARTS FOR BAUDOT TO ASCII CONNECTION

TV Typewriter I:

Quantity	Type
6	Molex connectors (part #09-52-3103)
60	Molex pins 3/4-inch (part #08-54)

TV Typewriter II (CT-1024):

Quantity	Type
1	Molex connector (part #09-52-3151)
15	Molex pins 3/4-inch (part #08-54)

*These parts *not* required if you can set your Teletype margins to 32 spaces and you have automatic CR and LF.

ASCII TO BAUDOT CORRECTION

Mr. Roger Smith called our attention to several discrepancies in his article "ASCII to BAUDOT" in the March issue. They are as follows:

The schematic in Fig. 1 shows a connection between pin 3 of IC2-a and pin 2 of IC5-a. This connection is in error. Pin 2 of IC5-a should connect only to pin 11 of IC7. Pin 3 of IC2-a should connect to the top end of C1 at the junction of the lines to pin-15 IC7 and pin-4 IC9-a.

In Table 1, delete the 1's from the B₂ and B₀ output columns for word 31. Delete "BELL" and substitute "NULL."

PARTS LIST BAUDOT TO ASCII CONVERTER

R22, R24—330 ohms, ¼ watt
 R23—1000 ohms, ¼ watt
 R25-R31, R35—2200 ohms, ¼ watt
 R32—100,000 ohms, ¼ watt
 R33—200,000 ohm, trimmer
 R34—33,000 ohms, ¼ watt
 R36—20,000 ohms, ¼ watt
 R37—100 ohms, ¼ watt
 C21, C27-C30—.1 µF, disc
 C22—.1 µF, 10%, ceramic
 C23—1 µF, 50 volt, electrolytic (upright)
 C24—.01 µF, disc
 C25—100 pF, disc
 C26—.001 µF, disc
 C31—10 µF, 25 volt, electrolytic
 IC13—74194
 IC14, IC17—7474
 IC15—74123

IC16—7404
 IC18—555 timer
 IC19, IC21—7430
 IC20, IC22—8223 32 × 8 PROM
 See Connection Details for listing of additional parts

The following items are available from Southwest Technical Products Co., 219 W. Rhapsody, San Antonio, TX 78216:

A kit of all basic parts (order additional parts separately) for the BAUDOT To ASCII Converter for \$19.50 postpaid.

Etched and drilled printed circuit board for the BAUDOT To ASCII Converter for \$4.35 postpaid.

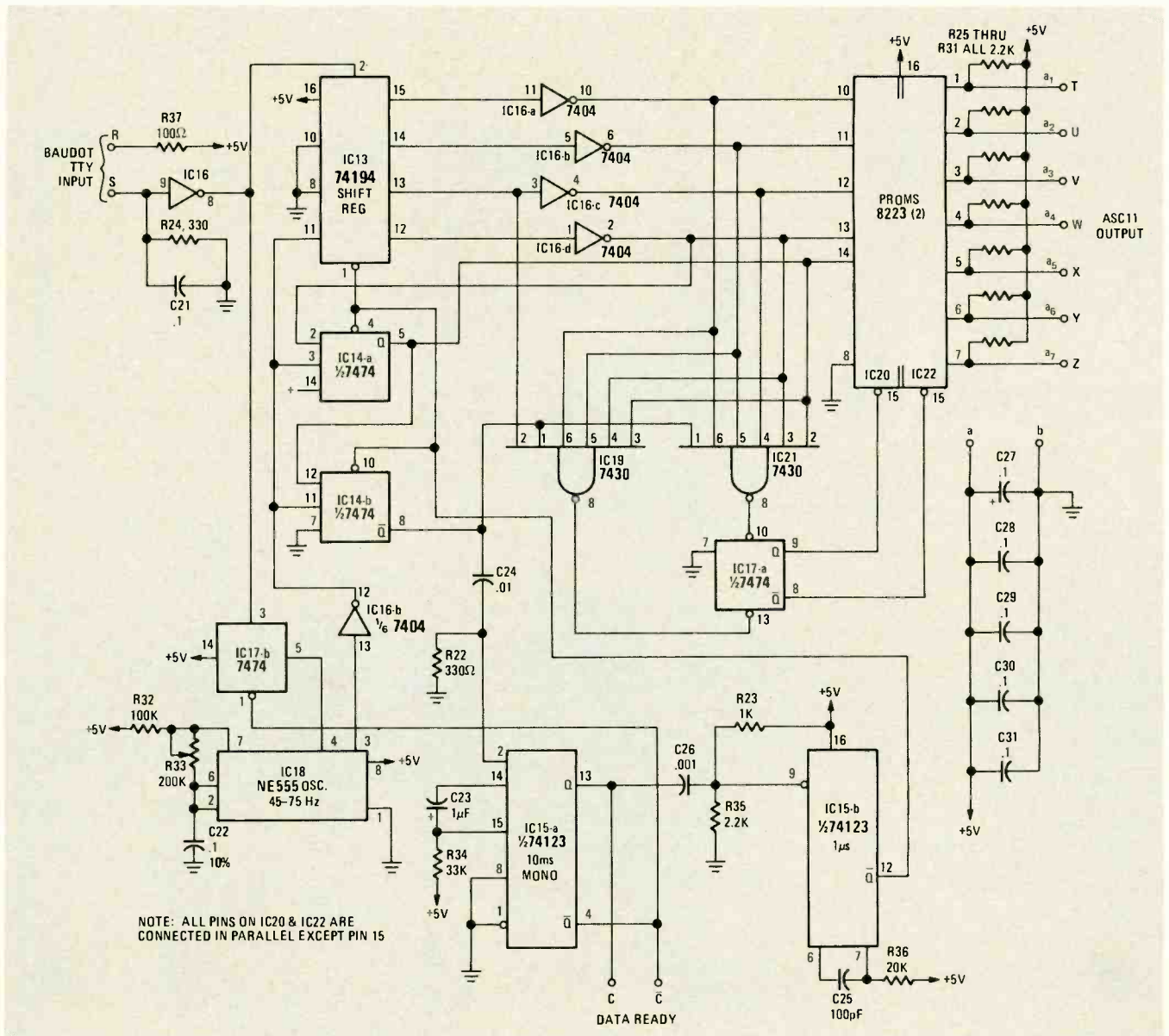
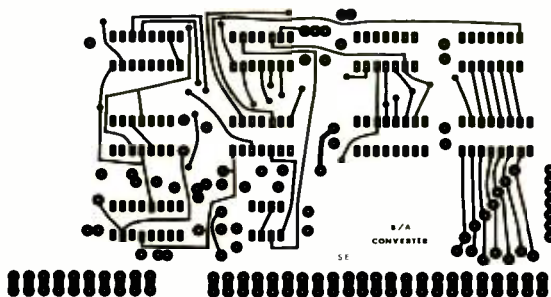
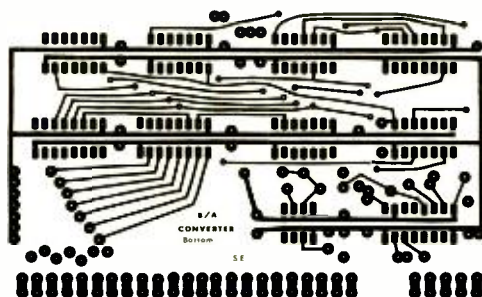

FIG. 1—BAUDOT TO ASCII CONVERTER schematic diagram.



BAUDOT TO ASCII CONVERTER printed circuit board foil pattern. Component side of double-sided board is shown 1/2-size.



BAUDOT TO ASCII CONVERTER printed circuit board foil pattern. Bottom-side of double-sided board is shown 1/2-size.

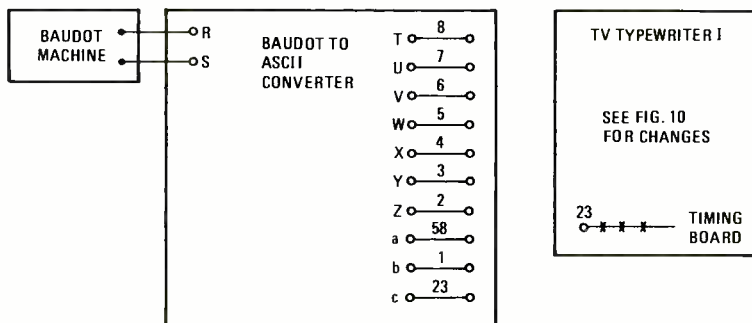

NOTE: THE CR AND LF ARE NOT STORED FOR THIS CONFIGURATION.

a

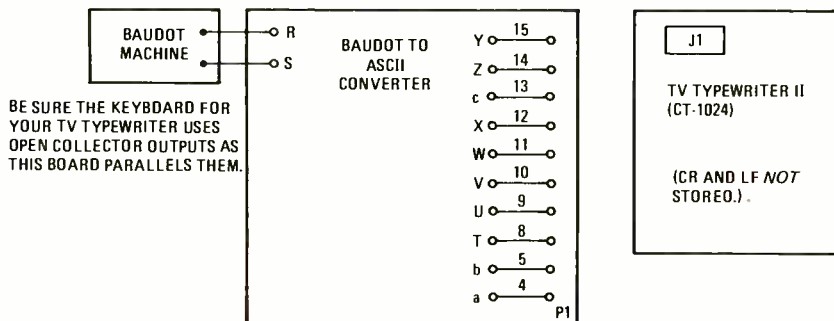

MOUNT P1 IN FIRST 15 HOLES IN BOTTOM RIGHT EDGE OF BOARD. TRIM BOARD.

b

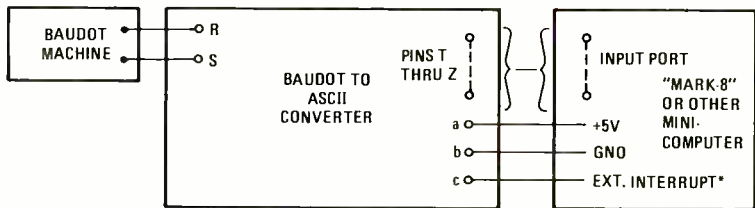

*IF INTERRUPT TIMING IS USED.

c

FIG. 2—BAUDOT TO ASCII CONVERTER connections to TV Typewriter I are shown in a, TV Typewriter II are shown in b, and mini-computer is shown in c.

All other necessary construction and descriptive material on this project appeared in the February 1976 issue under the title "ASCII To Baudot Converter" and this material should be scanned if any further details are needed.

Elsewhere in this issue, on page 82 you will find the component-layout diagram for the printed-circuit board and Charts I and II, which are the Truth Tables for the type 8223 PROM used for IC20 and IC22. We do hope that you have enjoyed this project along with the others in this series of ad-ons to TV Typewriter II. R-E

VERTICAL SWEEP GONE

This little Airline portable, a GEN-3267A, has got us going. No vertical sweep. Still, we can drive it with a B & K Analyst, clear black to the pin-10 grid of the 17J28, and get sweep. Everything else is fine, but no vertical sweep.—O.W., Durant, OK.

This has just got to be something in the feedback loop, from plate of the output section to grid of the input section. This is what makes the circuit oscillate. Take it out, and all you have is a two-stage R-C coupled amplifier. If you can get sweep by feeding a drive signal to the input grid, the "amplifier" part is OK.

Suggestion: feed your drive signal to the input grid. Now follow it with a scope, from the output plate back to the input grid. Something in there will be open.

SHORTED CRT IN SCOPE

(This is the end result of quite a bit of correspondence about a problem of severe blooming in the CRT of an Eico 460 oscilloscope. The reader wrote:)

Thank you for the hints about the trouble in my scope. I finally found that the DC voltage on the grid and cathode of the CRT were both the same. This was caused by an internal short between these elements. I blew this out by discharging a 40-μF capacitor across them.—S. Goldhor, Hayward, CA.

Serial Interface for TV II

To connect TV Typewriter II to a telephone or other two-wire system or to a magnetic-tape memory you need an adequate modem. Here's how to build one

ED COLLE

FOR THE TV TYPEWRITER II TO COMMUNICATE via a two-wire system, a phone line or a magnetic-tape data storage system, the parallel ASCII data must be broken down into sequential one-bit-at-a-time form both when coming out of the keyboard and going into the terminal. The serial interface or UART (Universal Asynchronous Receiver/Transmitter) provides this conversion from the parallel form into a series of properly timed one's and zero's including not only the serial data, but the start, stop and parity bits as well. The reverse is true during the receive mode. The baud rate or speed at which the serial data is transmitted or received can be selected from 110, 150, 300, 600 or 1200 baud with a single-pole rotary switch. There is a provision for "echo off" where the data is transmitted to the receiver, but is not put up on the screen until it is transmitted back by the receiver and displayed by the terminal; or "echo on" where the data is transmitted and simultaneously put up on the screen and is not echoed back by the receiver.

The input/output connections are type RS-232 compatible which will attach directly to most couplers and data sets, however, to record on or playback from magnetic tape it will be necessary to build some kind of FSK encoder/decoder system to get the digital data on and off the tape since this is not provided by the interface. Data to be transmitted can either be provided by the screen-read

board or the keyboard. The interface normally monitors the keyboard, however, a "ready to send" command from the screen board locks out the keyboard and allows the screen-read board to transmit its data.

The entire circuit is built on a 3 3/8" X 9 1/2" circuit board that is plugged onto the main board at connector strips J1 and J2 just behind the cursor and screen-read boards. Switch connections to the serial

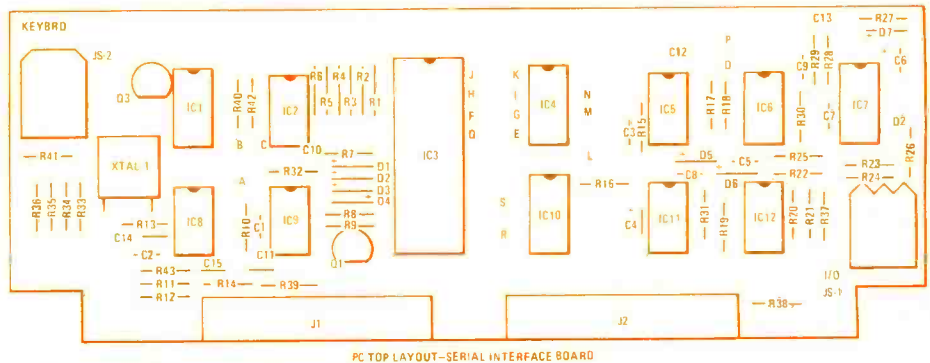

FIG. 2—COMPONENT PLACEMENT diagram.

SPECIFICATIONS

Receive Format:	E1A RS-232 and TTL compatible with a mark equal to + 1.5 to - 25 volts and a space equal to + 3 to + 25 volts. The range from + 1.5 to + 3 is the hysteresis region.
Input Impedance:	1800 ohms
Transmit Format:	E1A RS-232 with a mark equal to - 4.7 volts and a space equal to + 4.7 volts (2000-ohm load)
Baud Rates	
Standard:	110 baud
Optional:	110, 150, 300, 600, 1200—selectable
Stop Bits:	Automatic selection of 2 stop-bits for 110 baud and 1 stop-bit for 150, 300, 600 and 1200 baud
Parity	
7 bit:	odd, even, none
8 bit:	no parity (bit 8 programmable to a 0 or 1)

PARTS LIST

Serial Interface Board—110 baud

All resistors are 1/4-watt, 10%, unless noted

R1-R7, R16, R24—22,000 ohms
 R8, R15, R17, R20-R22, R29, R31, R37, R39, R42—1000 ohms
 R9, R27—47,000 ohms
 R18, R38—12,000 ohms
 R19—2000 ohms
 R23—3900 ohms
 R25—27 ohms
 R26—2700 ohms
 R28—5600 ohms
 R30—330 ohms
 C3—470 pF capacitor
 C4, C6—33 μF, 25 volt electrolytic
 C5—.01 μF capacitor
 C7—100 pF capacitor
 C8—.001 μF capacitor
 C9—330 pF capacitor
 C10-C13—0.1 μF capacitor
 D1-D7—1N4148 silicon diode
 Q1—2N5210 silicon transistor
 Q2—PNP general purpose transistor, gain = 100, maximum V_{ce} = 40 volts
 IC2—7493 counter
 IC3—S1883 UART
 IC4, IC10—74157 data selector
 IC5—74132 quad NAND gate
 IC6—7400 quad NAND gate
 IC7—74123 dual one-shot
 IC9—7474 dual type-D flip-flop
 IC11—7404 hex inverter
 IC12—7403 quad open collector NAND gate

PARTS LIST

150, 300, 600, 1200 baud option

All resistors are 1/4-watt, 10%, unless noted

R10—180 ohms
 R11, R13—1800 ohms
 R12, R14—470 ohms
 R32-R36, R40, R41—1000 ohms
 R43—2700 ohms
 C1, C14—300 pF capacitor
 C2—50 pF capacitor
 C15—.005 μF capacitor
 Q3—2N5210 silicon transistor
 IC1—7497 rate multiplier
 IC8—7404 hex inverter
 XTAL 1—307.200 kHz series resonant crystal

The following items are available from Southwest Technical Products Corp., 219 West Rhapsody, San Antonio, TX 78216.

CT-S Serial Interface Kit	\$39.95
S1-b Serial Interface Circuit	\$11.75
Other add-ons for TVT-II include:	
Screen Read Board Kit	\$17.50
(September 1975 issue)	
Manual Cursor Kit	\$11.50
(November 1975 issue)	

interface board are provided by a 12-pin connector (J1) while the keyboard is plugged into another 12-pin connector (J2) rather than J9 of the main terminal board as is done if the interface board is not used.

How it works

The serial interface circuit has been designed around a single UART chip that actually does most of the work. The other circuitry on the interface board interfaces

the chip itself to the circuitry on the main terminal board. The schematic diagram appears in Fig. 1.

During the transmit mode, both the outputs from the keyboard and the screen-read board are fed into data selectors IC4 and IC10. These data selectors select either one of the two sets of inputs with the input from the screen-read board taking priority. Normally the keyboard is selected as the input. However, if the screen-read board starts to send data, the incoming

low-to-high transition at J2 pin-13 triggers IC7-a, a retriggerable 350 ms one-shot. This selects the screen-read inputs and locks out the keyboard by driving pin 1 of IC4 and IC10 low. It also blocks any data from being received during a screen read operation if the jumper from S to R is installed by forcing pin 8 of IC9-a low. This gates the "output data available" line into the "reset data available" line of the UART chip. Since the keyboard and receiver are disabled for at least 350 ms after

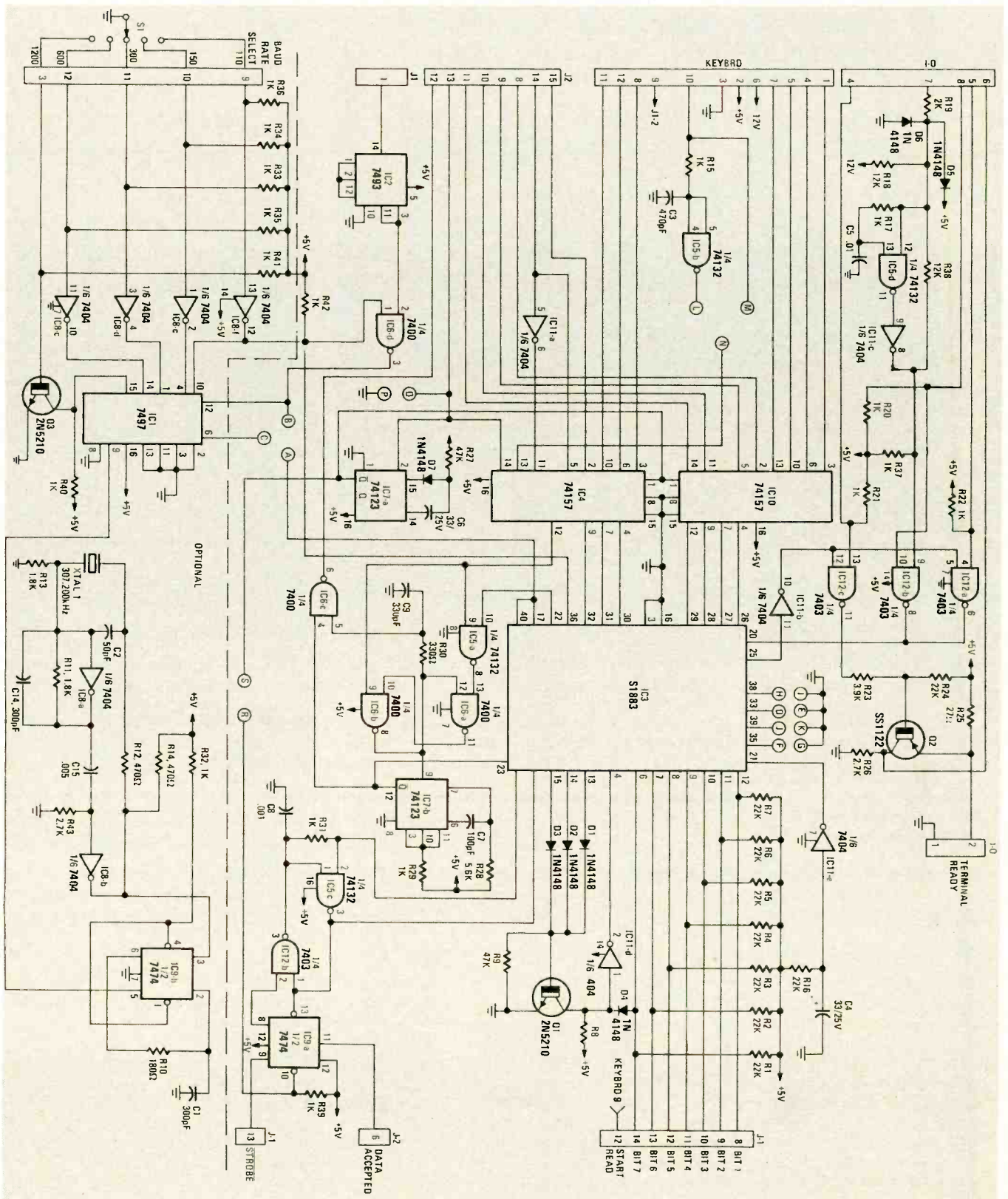

FIG. 1—SERIAL INTERFACE OPTION for TV Typewriter II.

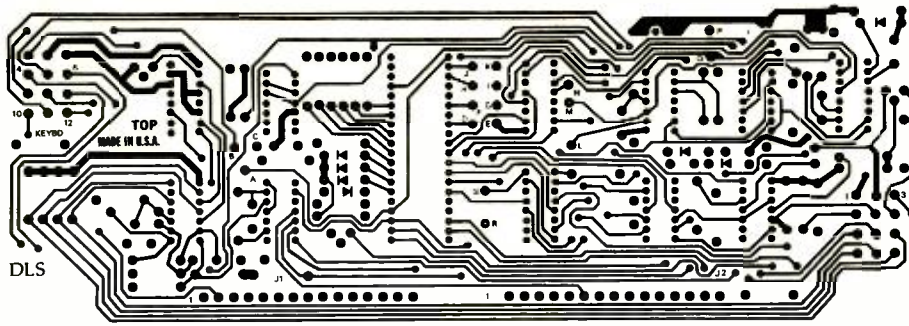

FIG. 3—FOIL PATTERN of component side of double sided board shown 1/2 size.

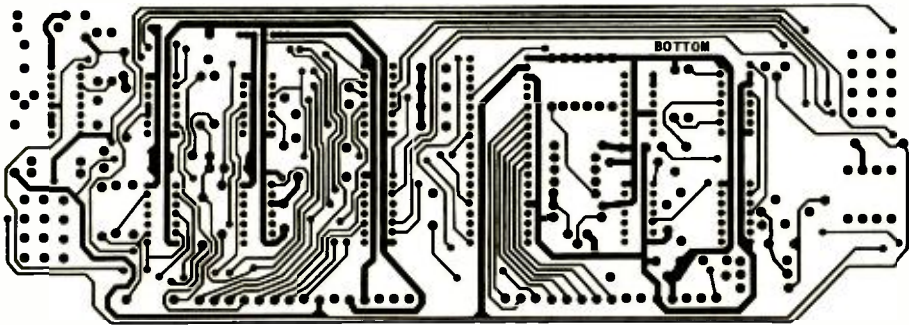

FIG. 4—FOIL PATTERN of foil side of double sided board shown 1/2 size.

each character is dumped during a screen-read operation, there may be problems with a computer sending a return message too soon after the screen-read operation is completed, especially when using high baud rates. In these situations, you may not want to lock out the receiver during a screen-read transmission and can omit the jumper between points S and R. You must be sure, however, that the TV Typewriter II is not in the echo mode and that the computer does not attempt to send data to it until the screen dump has been completed. This is indicated by an "!" transmission if the auto-stop function on the screen read-board is being used.

Regardless of whether the data to be transmitted comes from the screen-read board or the keyboard, it exits from the data selector IC4 pin-12 to IC5-a pin 9 where it is gated with the transmitter buffer empty output from the UART chip, IC3 pin 22. When IC3 pin 22 goes high, it sets the output of the AND gate latch (IC6 pin 11) high. Each time this (IC6-a and IC6-b) latch is set, a 250-ns pulse is generated that loads the data at the output of the IC4 and IC10 data selectors into the input buffer of the UART chip. At the trailing edge of the same pulse, a pulse is supplied to the screen read board until it resets and forces IC6-a pin 9 low which resets the (IC6-a and IC6-b) latch. This reset pulse that is sent to the screen-read board allows it to find and store its next character until the UART transmitter buffer is ready for it. This double buffering enables the transmitter to transmit at up to 1200 baud without gaps or hesitations.

The serial data leaves the UART chip, (IC3 pin 25) and is gated with the transmitter on/off input at IC12-c. Transistor Q2 then converts the serial TTL level output to RS-232 format.

During the receive mode, the incoming RS-232 serial data is converted into TTL compatible levels by a Schmitt trigger circuit consisting of IC5-d and its related components. The output at IC11-c pin 8 is then gated and fed into the serial input terminal of the UART chip (IC3 pin 20.) When the UART chip sees the stop bits of the character being received, output data available line changes to logic "1" (IC3 pin 19). If IC9-a pin 8 is at a logic "1" level, it means the terminal already has a character awaiting loading and is not ready to accept the new character waiting in the receiver data holding registers. When the character in the terminal's register is finally loaded, the character accepted line feeding IC9-a (pin 11) changes to a logic "0" and toggles IC9-a forcing pin 8 low. This permits IC12 to pulse the output of IC5-c low clearing the output data available line and generating a negative going keypress strobe to load the new character into the terminal's data registers. Note that the keypress strobe jumper of the main terminal board must be wired for a negative strobe when the serial interface is being used.

If an error is detected by the UART chip, it drives one of three IC3 outputs high. IC3 pin 14 changes to a logic "1" if a stop bit does not follow after the start bit and the correct number of data bits. IC3 pin 13 changes to a logic "1" if there is a parity error received. IC3 pin 15 changes

(continued on page 80)

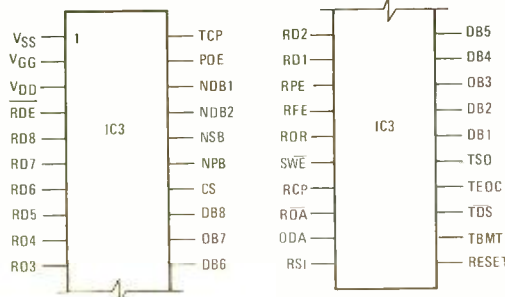
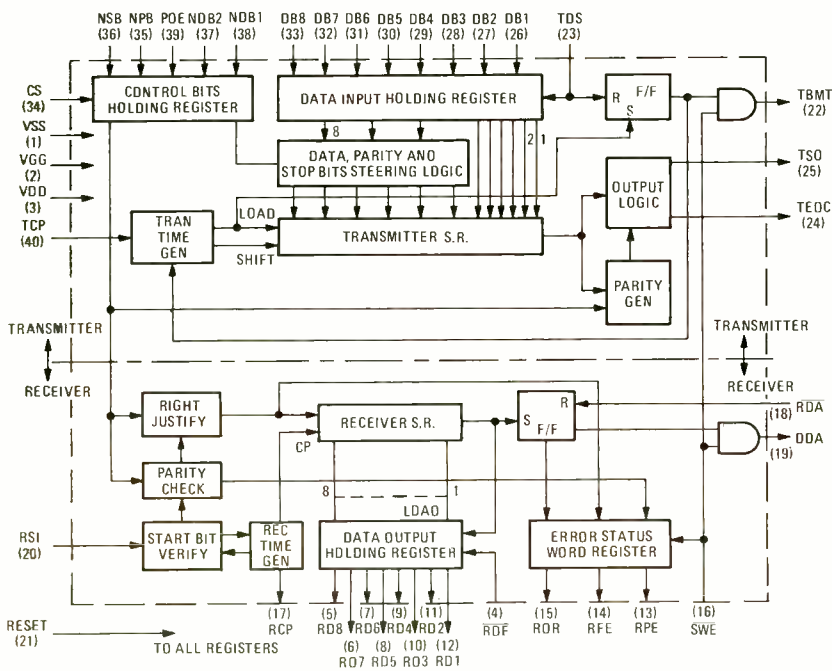

R-E's Service Clinic

Horizontal oscillators

Oddball symptoms

by JACK DARR
SERVICE EDITOR

THE RECENT SERVICE CLINIC ABOUT horizontal oscillator circuits got quite a bit of mail. Mainly requests for more information on this circuit. So, here it is. Let's look at some of the oddball symptoms you will find. With a little cool, logical thinking, you can get a handle on any of them.

OK, here's one; an oldie. When the antenna signal is applied to the receiver, the horizontal oscillator runs and you get a raster. Horizontal hold isn't too good. Turn to a dead channel or remove the antenna signal and out goes the raster and high voltage! Or, just the opposite. Raster off-channel, no raster with an antenna signal. (*Not* to be confused with an AGC blackout. If this happens, you do have high-voltage, but the tube is cut-off.) Weird, eh? Not too. The problem is in the *horizontal AFC*.

Why? Because the *only* difference between the two conditions is the presence or absence of the horizontal *sync*. In the first case, the horizontal oscillator will run when there is sync, but won't run without it. In the opposite case, the oscillator will run if the sync is not present; when the sync appears, this throws the oscillator so far off that it dies!

The major cause of this is a defective AFC diode unit. Sometimes due to a bad part in the anti-hunt circuit, etc., but mostly the diodes. To check, kill the AFC and see if this will keep the oscillator running, on- and off-channel.

In one really wild case, in an old Philco, the horizontal sync wasn't too bad but the vertical sync was terrible. After checking out the vertical circuits, I finally found that the ground-side of the *horizontal AFC* diode was shorted! This was pulling down the amplitude of the composite sync and upsetting the vertical oscillator first.

Another puzzler (unless you know it's there) comes up in sets using only the boost for the plate voltage supply of the horizontal oscillator. Figure 1 shows a typical example, an Admiral T2H-1A chassis. The complaint is often "no raster" or "narrow raster".

The horizontal oscillator plate voltage will be well below normal. Here, note that there is no direct path from the horizontal oscillator supply back to the B+. Oh, no? There is, if you'll trace it out. When the set is turned

on, the DC voltage appears immediately, since solid-state diodes are used in the DC power supply. However, the damper tube must warm up enough to conduct current before any DC voltage shows up on the oscillator.

Without any output signal from the horizontal output stage, only the B+ voltage appears on the damper cathode.

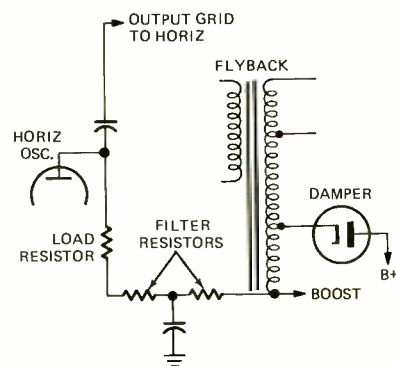

FIG 1

This is connected to the oscillator plate through two resistors. There will be enough voltage to *start* the oscillator. Once it starts running, it drives the horizontal output stage, producing a flyback pulse. This pulse is rectified by the damper tube, producing a much higher voltage, and everything starts to work.

If you have this kind of trouble, check the *boost* voltage. The boost capacitor is returned to ground instead of to B+. It develops about +340 volts DC. If you measure only the B+ voltage of about +135 volts, you have no boost at all. A good check for this is to drive the horizontal output with a substitute drive signal.

If the boost voltage and high-voltage appears, then you have some problem in those resistors feeding the horizontal oscillator. If you still have no boost, check things like the boost capacitor, the horizontal winding of the deflection yoke, and the damper and horizontal output tubes. In one odd variation of this, I found 0 V DC on the damper cathode. This turned out to be an open cathode connection inside the damper tube! You should see the B+ voltage here before the horizontal output tube starts to work.

In another queer case, in an RCA CTC-53, the raster and high-voltage

This column is for your service problems—TV, radio, audio or general and industrial electronics. We answer all questions individually by mail, free of charge and the more interesting ones will be printed here.

If you're really stuck, write us. We'll do our best to help you. Don't forget to enclose a stamped, self-addressed envelope. If return postage is not included, we cannot process your question. Write: Service Editor, Radio-Electronics, 200 Park Ave. South, N.Y. 10003.

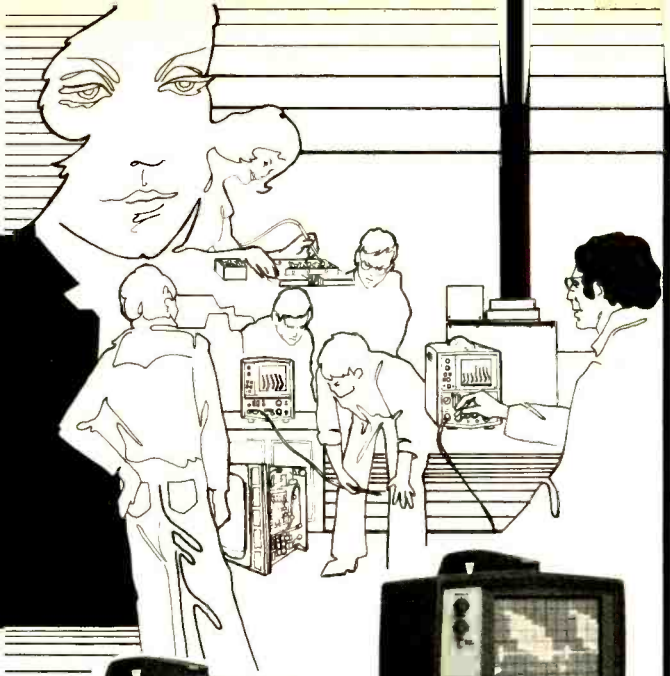

ANNOUNCING the TEKTRONIX T900 Oscilloscopes

from \$695
probes included and more...

Here's important news for engineers, technicians and educators who want the quality, reliability and support associated with TEKTRONIX Oscilloscopes - all at a moderate price. T900* Oscilloscopes are an entirely new line designed for cost savings without sacrifice of basic performance.

This New Line Includes:

- T921—Dc to 15 MHz; single-trace, mono time-base \$ 695**
- T922—Dc to 15 MHz; dual-trace, mono time-base \$ 850**
- T932—Dc to 35 MHz; dual-trace, mono time-base \$1050**
- T935—Dc to 35 MHz; dual-trace, dual time-base with delayed sweep \$1250**
- T912—(Storage model) Dc to 10 MHz, dual-trace mono time-base . . \$1195**

Easy to Use

T900 Oscilloscopes are simple to use. All have a large, bright (8 x 10 cm) crt, beam finder, single knob trigger control, delay line to enable viewing of waveform leading edge, automatic selection of tv line or frame display and functionally color-coded control panels. Convenience is also enhanced by a full complement of accessories including 10X probes (included in price), optional scope stand, camera, rain jacket and more . . . T900 Oscilloscopes are easy to handle and fit into small spaces. They weigh only 15-18 lbs. and measure only 7" x 10" x 19".

Tektronix Support

T900 Oscilloscopes are warranted against defective materials and workmanship for one year. There are over 37 service centers and 50

field offices across the U.S. Whenever you need help in the selection, operation, application or servicing of T900 Oscilloscopes your local field engineer is available to help you . . . no extra charge . . . just extra value.

For a copy of the new T900 Brochure (includes complete specifications), or ordering information write to Tektronix, Inc., P.O. Box 500, Beaverton, Oregon 97077. For immediate information call your local Tektronix field engineer or Tektronix, Inc. (503) 644-0161 extension T900.



TEKTRONIX®

committed to
technical excellence

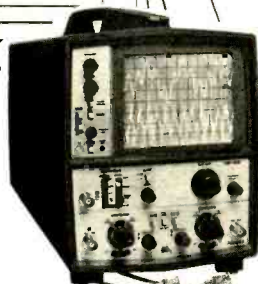

T912



T921

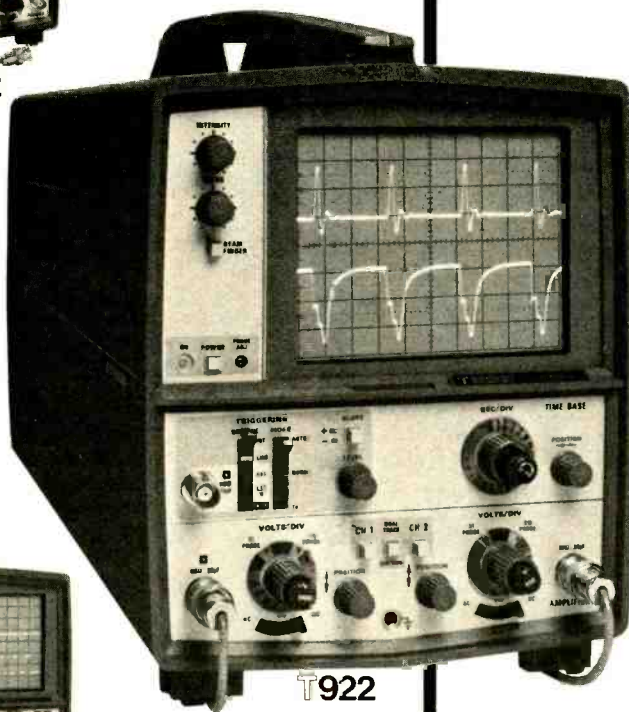

T922



T935



T932

*Available presently in U.S.A. only.
**U.S.A. price FOB Beaverton, Oregon.

Circle 18 on reader service card

There is only
one

2-WAY

RADIO HOME STUDY COURSE

exclusively devoted
to professional FM radio equipment

We don't know how many
TV repairman or
other people there are
in electronics
who would like to move up to
professional FM two-way radio.

Nor do we know how many
servicemen and installers
there are
already in the field
who want to expand
and upgrade their knowledge.

But we do know how many
home study schools
cater exclusively
to both these groups.

ONE!

Please send me more information.

Name _____

Address _____

Code _____

- I am a former MTI student.
 I am presently in the military.
 I am a veteran.

MTI

Formerly

MOTOROLA TRAINING INSTITUTE

Summerdale, PA 17093
(717) 732-3636

Circle 19 on reader service card

READER QUESTIONS

(continued from page 64)

mal, full picture. Tried the old one; same thing. Picture pulled in and current went up. Now you tell me what happened —R.B., Santa Ana, CA.

Rubbing the crystal ball, the Swami replies: "From past experience, I'd say that the 6HV5 tube had a very bad case of *grid emission*. I have seen the same symptoms when a horizontal output tube developed this trouble, but I've never seen it happen in a regulator tube. Anything can happen, can't it?" Thanks. This could happen in any set using this type of high-voltage regulator; so, try a new tube to make sure!

MORE ON PM MAGNET ERASURE

I have a letter from Mr. William A. Manly, Director Product Development of the Cobaloy Co., Arlington, TX, 76011, with some very useful data on erasing tapes with a PM magnet. The original was in answer to R. G. of Baltimore in the Oct. 75 issue of **R-E**. I said that I didn't think it would hurt. Mr. Manly warns that this might be bad advice, depending on the intended use of the erased tapes. For ordinary low-fi, voice and similar applications, OK. But—now I quote:

"It's true that this erasure method will not result in any permanent damage to the tape or the recorder. A tape thus erased, however, will have a very high level of *background noise* on it (the so-called "DC noise") some 6 to 20 dB above the true (bulk-erased) background noise. Such a tape will have a tendency to magnetize the heads of any machine it's used on. If the heads are magnetized, they will tend to erase the short wavelengths of any tape containing information subsequently played on the machine. None of this makes any great difference to the inexpensive machine that employ DC erase and biasing, but I suspect that if R.G. is using 10.5-inch reels as he says, he could well be using a pretty good machine and these considerations would definitely apply.

"For voice-only and other undemanding uses, DC erase is fine. I would not recommend it for any high-quality use where quality of recording is a consideration. By the way, the field of such a strong magnet should be kept well away, at least three feet, from any tape containing data that he wishes to keep. It will not only erase the signals, but a lower intensity exposure to powerful magnetic fields will cause print-through to appear on the tape."

Thank you very much, sir! I intended the original reply to say something like that, but I didn't get it in plainly enough. I appreciate the information and it will be duly filed for the next question on the subject.

ODD VOLTAGES

This G-E T2250-H radio runs for 10 minutes then stops. I can't make sense out of the DC voltages! Any helpful hints?—S.C., Mentone, CA.

The power supply in this set is unusual. For one thing, be sure that you have the correct schematic; Sams 1038 shows both early and late production runs. There is some difference! When it stops, check the detector to see if you have a signal. If you do, the problem is in the audio stages. If you don't, the problem is in the IF or front end. (Feedback: reader found out that he was using the early production schematic on a late production chassis! Also, the audio output transistors were intermittently opening up!)

NO HV REGULATION

I really need help with this Zenith 14A10C29 color TV. I have no high-voltage regulation at all. The high-voltage varies from 20 kV to 30 kV with the setting of the brightness control. Not much change in picture size, but I do lose focus. All tubes have been subbed in the high-voltage and video circuits. The horizontal output tube grid-drive and cathode current is normal. Voltages on the high voltage regulator tube are off, but I can't find any bad parts in there.—D.B., Portsmouth, VA.

The 6HV5 high-voltage regulator grid-voltage comes from the boost, through several resistors and a VDR. You have undoubtedly checked the resistors, but a VDR is usually "checkable" only by substitution! Be sure that you get the correct one; this is a Zenith 63-8161.

(Feedback: that was it!)

OUTPUT TUBE HOT

The 6LF6 horizontal output tube in this Motorola TS-929 gets red hot; intermittently, of course. When this happens, the grid bias on the 6LF6 goes to zero. The bias comes from the FA panel. I've changed all the tubes on this panel, no help. Output transformer and yoke checked out. Any solution will be appreciated.—C.F., Pineview, GA.

I think you have the key clue; the zero bias on the 6LF6. Scope the FA panel output. If this signal is still present there while the 6LF6 grid drops to zero, you have an intermittent open in one of the *connectors* between the FA panel and the horizontal output. Sometimes one of the contact pins will be pushed back to the point where it makes intermittent contact with the board or plug.

OUTPUT TUBE CUT OFF

The horizontal oscillator is working in this Zenith 14A9C50. The screen grid of the 6LB6 reads +300 volts or more! No, it's not the screen bypass or
(continued on page 68)

C-MOS

Table of C-MOS components including part numbers, quantities, and prices.

DTL IC's

Table of DTL IC components including part numbers, quantities, and prices.

LINEAR IC's

Table of Linear IC components including part numbers, quantities, and prices.

JADE Co

Offers Top Quality Products at these low, low prices. Satisfaction Guaranteed or your Money Refunded.

MEMORY

Table of Memory components including part numbers, quantities, and prices.

CHIPS

Table of Chip components including part numbers, quantities, and prices.

IC Sockets

Table of IC Sockets including Low Pro, Standard, and Wire Wrap options.

WANT TO PLAY VIDEO GAMES ON YOUR OWN TV?

Write us today for a free catalogue with complete listing of video games and other kits along with all I.C.'s, Discretes, Diodes, Resistors, pots, hardware, grab bags - you name it.

TTL IC's

Table of TTL IC components including part numbers, quantities, and prices.

TTL IC's

Table of TTL IC components including part numbers, quantities, and prices.

TTL IC's

Table of TTL IC components including part numbers, quantities, and prices.

TTL IC's

Table of TTL IC components including part numbers, quantities, and prices.

PLIERS

Table of Pliers including 7" Needle Nose and 4 1/2" Round Nose types.

SWITCHES

Table of Switches including V3-101-D8 and 3115MS56 types.

RESISTORS

Table of Resistors including 1/4W 5% and 100 Ohm values.

Or get any of the following assortments for only \$1.95. Each assortment consists of 10 resistors from the 10 different Ohm value groups listed.

DIODES

Table of Diodes including 1N4148 Switching Diode, Zeners, and Bridge Rectifiers.

TRANSISTORS

Table of Transistors including 2N718, 2N910, and 2N3692 types.

SCR's

Table of SCR's including 1 0 Amp and 4 0 Amp types.

Terms: 10% Discount over \$50 - \$1 Minimum per line item. Add \$1.00 for postage and insurance. California residents add 6% Sales Tax. No C.O.D.'s. BankAmericard & MasterCard accepted on orders over \$20 or send check or money order to:

JADE Co

P.O. Box 4246-Torrance, Ca. 90510 Telephone 213-320-1250 Data Sheets \$.25 each Prices effective through April 30, 1976



NO strings attached

Visit Booths G23 & G25
NEW/COM '76



NEW Weller® CORDLESS SOLDERING IRON... GOES ANYWHERE

Weller's WC-100 . . . the professional quality, feather-light cordless. Lets you make connections anywhere. Without AC cord and outlet.

Fingertip touch on exclusive sliding safety switch activates long-life, nickel-cadmium battery. Heats tip to over 700°F in 6 sec. Locks in "off" position to prevent accidental discharge in use or while restoring energy with fast-power recharger (UL listed).

Simple, instant change to any of 4 tips . . . for any job. Built-in light focuses on tip and work area.

Get this! It's at your dealer or distributor now . . . waiting for you. Need more info first? Request literature.

Weller-Xcelite Electronics Division



The Cooper Group

P. O. BOX 728,
APEX, NORTH CAROLINA 27502

Circle 21 on reader service card

READER QUESTIONS

(continued from page 66)

resistor; I read -110 volts on the control grid! When I touch my scope probe to the 6LB6 grid, the raster comes back, full-screen. Otherwise, no raster at all. Get out the crystal ball, I need it!—R.D., Guttenberg, NJ.

You're so right; that output tube is firmly cut off by that much negative grid voltage. What you are probably doing with the scope probe is bleeding off enough of this to let the tube conduct. (This can happen if the grid resistor is completely open; even the high impedance of a FETVM will give it enough drop to let it work).

Trace the high-voltage hold-down circuit back over to the high-voltage regulator. You'll see a VDR in shunt to ground, a pulse-coupling capacitor to the flyback, and then a diode back to B+ connected to the cathode of the 6HV5. One of these parts is bad, causing the circuit to develop far too much negative voltage.

LOSS OF VERTICAL SWEEP

I noticed an item in the October issue of **R-E** on loss of vertical sweep. I just had a novel case in a CTC-25 RCA! The symptom was a lot of B+ on the grid of the 6GF7 vertical output tube. Started with heavy foldover and finally killed the oscillator. The tube conducted so heavily that it melted solder on the terminal strip where R164 and R165 are; these are the cathode resistors, near the 6JE6.

This was traced to an insulation breakdown in the SERVICE switch. Pin 2 of this had +405 volts on it and it was leaking to pin 7, which goes to the grid of the vertical output tube. (Thanks very much to Donald A. Donadio, Winston-Salem, NC!)

ODDBALL AFT PROBLEM

This one happened to me! The set was an RCA CTC-28E and it had AFT problems all over the place. At times the AFT wouldn't work on the low channels, then it would act up on the high channels. Voltage tests and a sweep test showed that the AFT seemed to be pretty close to normal. Marker right on crossover, etc. The set did not work too badly without AFT.

After some scratching of head, I finally decided to check the alignment. The only thing I could see was that the color looked a bit low on the curve, with the pix carrier a bit high. Would moving these help? You're darn right! Now the AFT works on low channels but not on highs!

The tuner showed a decided instability on 7 and 11. So, I ran a neutralization alignment on it. That did it, for the high channels. (The tipoff symptom on this is a "hot leadin" on a high chan-

nel; touch it and you'll see beats in the picture. This seems to always show a need for neutralization).

YOKE RETURN CAPACITOR BURNING

The yoke-return capacitor (C228) has burned up three times on this CTC-40 RCA. Originally the boost rectifier was shorted, too. Now we get good color, plenty of sweep, but the capacitor keeps burning up. What's the reason for this?—A.M., Morgan Hill, CA.

The reason this capacitor burning up is that it's carrying too much current for its voltage rating. RCA is now sending out special capacitors for this. I'd replace it with one of them. Early models used two 1.5- μ F capacitors in this position, in parallel.

You might check the waveform on this capacitor; this should be only about 35 volts P-P. You shouldn't get more than this if your sweep is normal.

GREEN STRIPE AT LEFT

After replacing several tubes, the raster and picture on this RCA CTC-22 reappeared. However, I have a small green stripe on the left side of the screen. All voltages are OK. However, scoping the control grids, I found a positive going spike in the waveform right after the horizontal blanking pulse. It was 35 volts P-P!

Someone had replaced the clamp diode on the green amplifier output with an ordinary silicon rectifier. I tried other diodes on hand, and each one showed a change in the spike! Any ideas?—E.S., Niagara Falls, ON.

Yep; if you can't get an exact duplicate of the original diode, use some kind of "fast-recovery" diode. RCA SK-3127, etc. These have a recovery time of less than 1.0 microsecond, and ought to help. There are several of these; use the one that will hold the applied DC voltage and have a very fast recovery.

HIGH CATHODE CURRENT

I can't get the 21JS2 cathode-current down far enough to suit me on this Motorola TS-925. It's working pretty well as far as the high-voltage and sweep are concerned, but I have an uneasy feeling that it might not stand up for too long in this shape. Do you have any suggestions on this?—J.B., Greenup, KY.

Adjust the horizontal efficiency coil for a dip. If this still doesn't bring the cathode current of the 21JS6 down far enough, try reducing the screen-grid voltage on this tube. You can cut this down until you begin to lose width or high-voltage.

(Field feedback; it worked! Dropped 21JS6 screen grid from 220 volts to about 175, and it works fine!) **R-E**



CD-4 DEMOMULATOR



TRUE FOUR CHANNEL SOUND

Southwest Technical Products is proud to offer the most advanced CD-4 demodulator available. Our new CD-4 has characteristics superior to anything previously available thanks to the QSI-5022 integrated circuit used in the unit. This IC and the balance of the circuit was designed by Quadracast Systems Inc. under the direction of Mr. Lou Dorren. The QSI-5022 contains all the sub-system functions needed to demodulate a CD-4 disc, from the phono cartridge input to the output drive for the four power amplifiers. It may be used with either an RIAA equalized magnetic cartridge, or a semiconductor cartridge with flat equalization.

INEXPENSIVE

Now anyone can afford to add discrete true 4 channel sound to their system. You no longer need be satisfied with matrix techniques that produce acoustical enhancement, but not true 4 channel sound. The Southwest Technical Products CD-4 demodulator when added to your system will produce four channel sound from a CD-4 encoded disc that will equal, or surpass anything you can buy—no matter what the price.

EASY INSTALLATION

The SWTPC demodulator connects

between the cartridge and the volume-tone control portion of your system. If you did not want tone controls, actually all that would be needed in addition to our CD-4 demodulator would be volume controls for the front and rear amplifiers. The demodulator is self powered from any 115 Volt 60 Cycle line. When normal stereo discs are played on your system a muting system automatically turns off the rear channels. A manual override 2 or 4 channel selector switch is provided on the rear panel.

SIMPLE CONSTRUCTION

As shown in the photograph, the vast majority of the parts mount on the epoxy-fibreglass circuit board. Part numbers and package outlines printed on the top of the board make proper assembly quite simple. Anyone with a minimum of electronic experience should be able to assemble this project without any problems. A copy of the article describing the CD-4 demodulator and assembly instructions are supplied in the kit.

CD-4 Demodulator Kit.....\$50.00 ppd

CD-4 CARTRIDGE

For those who do not already own a CD-4 cartridge, we are offering the "Technics" EPC-451C semiconductor

strain-gauge cartridge at a special low price when purchased with our new CD-4 demodulator kit. This cartridge features a Shibata-type stylus and excellent response out to 50 kHz. This eliminates any chance of "carrier drop-out", or "carrier crosstalk" which result in abnormal noise or distorted sound. The EPC-451C produces a high output (about 30 times that of an average magnetic cartridge) and does not pick up hum from magnetic, or electrostatic fields. Easily replaced stylus.

EPC-451C CD-4 Cartridge.....\$25.00 ppd

TEST RECORD

Lou Dorren has recorded a special test record for Southwest Technical Products Corp. that will allow you to properly adjust your CD-4 demodulator for the best possible sound. This special test and demonstration record is yours for only \$5.00 when purchased with the CD-4 demodulator kit.

CD-4 Test Record.....\$5.00 ppd

WANT MORE INFORMATION?

Send the coupon below and \$0.50 and we will send you by return mail a copy of the article describing our new CD-4 kit along with our catalog of other kit projects.

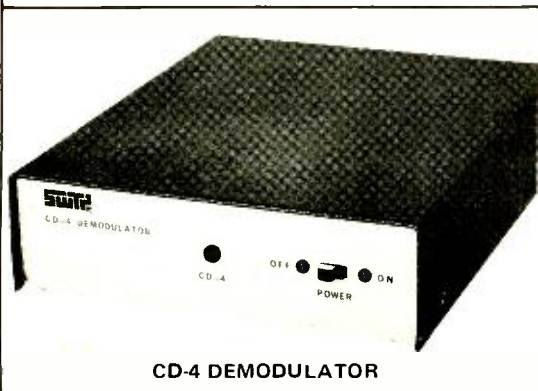

MAIL THIS COUPON TODAY

Enclosed is \$ _____ or BAC # _____
 or Master Charge # _____ Bank # _____ Expire Date _____
 CD-4 Demodulator Kit Cartridge Test Record

NAME _____

ADDRESS _____

CITY _____ STATE _____ ZIP _____

\$0.50 Enclosed for catalog & CD-4 Data

Southwest Technical Products Corp., Box 32040, San Antonio, Texas 78284

The better the training the better you'll

Send for
FREE
illustrated
career
guide

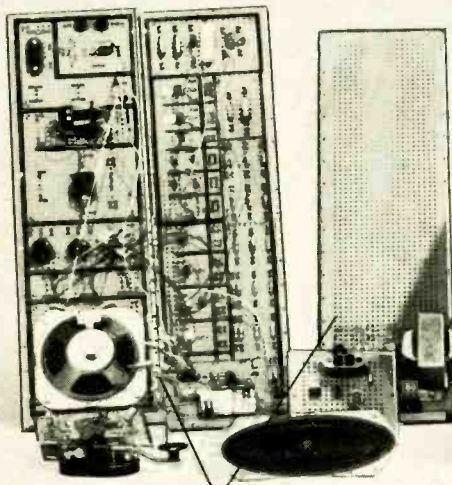
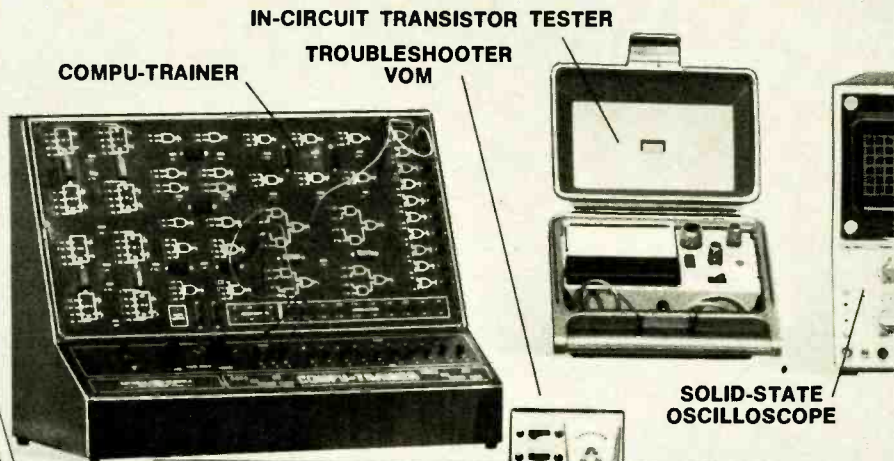
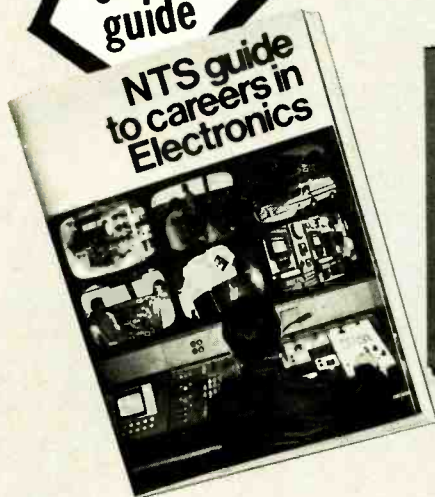

ELECTRO-LAB



(Simulated TV Reception)

As an NTS student you'll acquire the know-how that comes with first-hand training on NTS professional equipment. **Equipment you'll build and keep.** Our courses include equipment like the **NTS/Heath Digital GR-2000 Solid State color TV** with first-ever features like silent varactor diode tuning; digital channel selection, (with optional digital clock), and big 315 sq. in. ultra-rectangular screen.

Also pictured above are other units — 5" solid state oscilloscope, vector monitor scope, solid-state stereo AM-FM receiver with twin speakers, digital multimeter, and more. It's the kind of better equipment that gets you better equipped for the electronics industry.

This electronic gear is not only designed for training; it's field-type — like you'll meet on the job, or when you're making service calls. And with NTS easy-to-read, profusely illustrated lessons you learn the theory behind these tools of the trade.

Choose from 12 NTS courses covering a wide range of fields in electronics, each complete with equipment, lessons, and manuals to make your training more practical and interesting.

Compare our training; compare our lower tuition. We employ no salesmen, pay no commissions. You receive all home-study information by mail only. All Kits, lessons, and experiments are described in full color. Most liberal refund policy and cancella-

and the equipment be equipped.

COMPARE OUR
KITS AND LESSONS.
COMPARE OUR
TUITION.

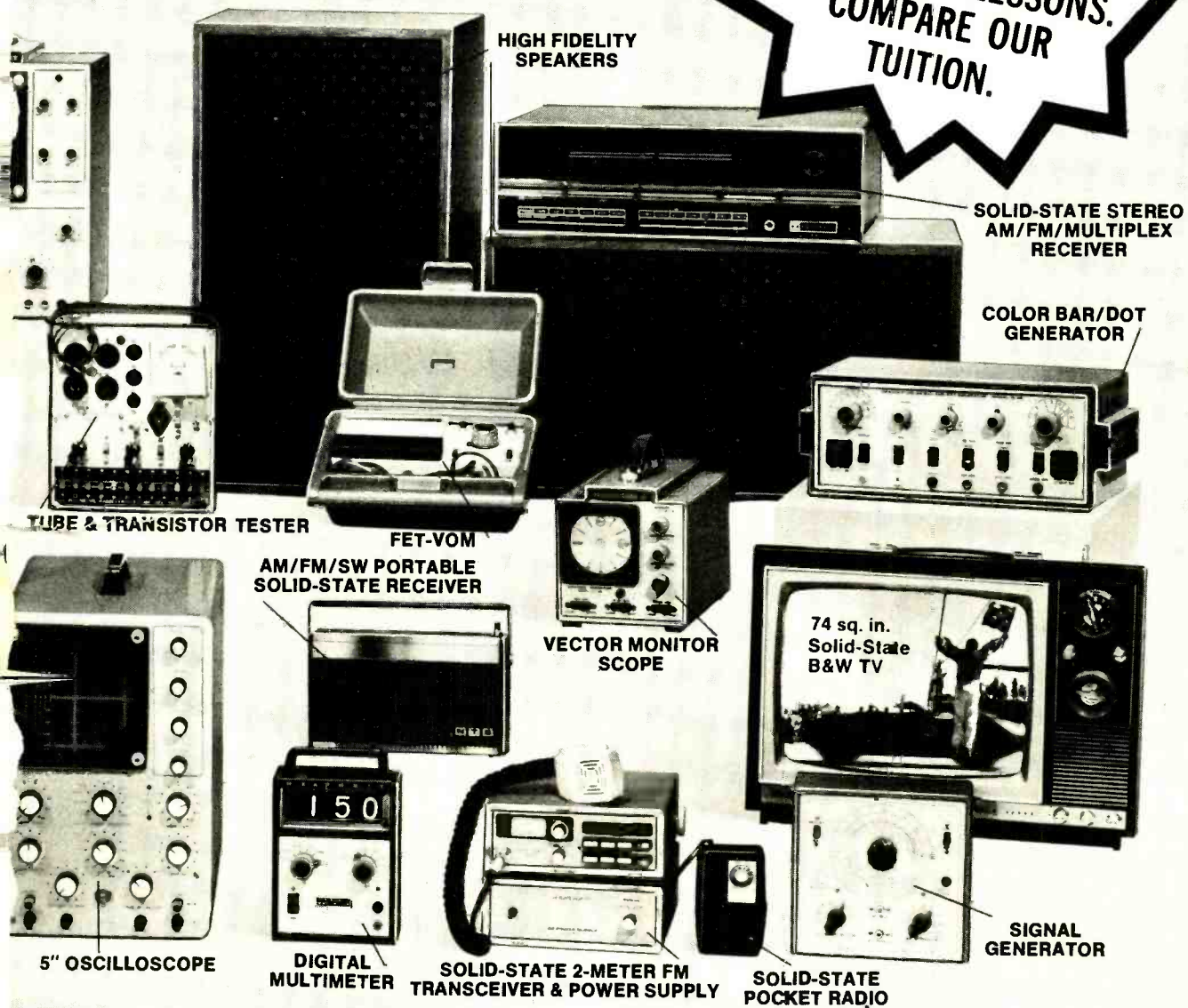

tion privileges spelled out. Make your own comparisons, your own decision. Mail card today, or clip coupon if card is missing.

NO OBLIGATION. NO SALESMAN WILL CALL

APPROVED FOR VETERAN TRAINING

Get facts on new 2-year extension

NATIONAL TECHNICAL SCHOOLS

TECHNICAL-TRADE TRAINING SINCE 1905

Resident and Home-Study Schools

4000 So. Figueroa St., Los Angeles, Calif. 90037

NATIONAL TECHNICAL SCHOOLS Dept. 206-046
4000 South Figueroa St., Los Angeles, Calif. 90037

Please send FREE Color Catalog and Sample Lesson.
NO OBLIGATION. NO SALESMAN WILL CALL.

- | | |
|-------------------------------------------------------|------------------------------------------------------|
| <input type="checkbox"/> Color TV Servicing | <input type="checkbox"/> Electronics Technology |
| <input type="checkbox"/> B & W TV and Radio Servicing | <input type="checkbox"/> Computer Electronics |
| <input type="checkbox"/> Electronic Communications | <input type="checkbox"/> Basic Electronics |
| <input type="checkbox"/> FCC License Course | <input type="checkbox"/> Audio Electronics Servicing |

NAME _____ AGE _____

ADDRESS _____ APT # _____

CITY _____ STATE _____

Please fill in Zip Code for fast service _____

- Check if interested in G.I. Bill information.
 Check if interested ONLY in classroom training in Los Angeles.

Fast, Fool-proof TV Alignment

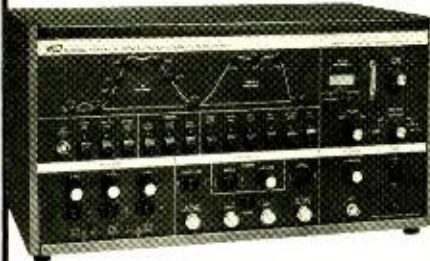

B&K-PRECISION SWEEP/MARKER GENERATOR

Model 415, \$485

With the B&K-PRECISION Model 415 you can complete a TV alignment in about the time you would spend hooking up the instruments for conventional alignment procedures. It's ideal for testing adjacent channel interference in CATV installations, too.

Everything you need is built into the Model 415—sweep and marker generators, a marker adder and three bias supplies. The 10 crystal-controlled IF markers can be shown either vertically or horizontally on your scope, and they light up on the front panel IF response and chroma bandpass diagrams as you use them.

Proper set alignment is assured and is almost automatic when you follow the Model 415's programmed alignment procedures.

Contact your local B&K-PRECISION distributor for a demonstration, or write for detailed information on how the Model 415 can save you time and increase your profits.

B&K PRECISION
PRODUCTS OF DYNASCAN

1801 W. Belle Plaine Ave.
Chicago, IL 60613 • (312) 525-3990
In Canada: Atlas Electronics, Toronto

Circle 6 on reader service card

new products

More information on new products is available from the manufacturers of items identified by a Reader Service number. Use the Reader Service Card inside the back cover.

CURVE TRACER, Cobra model CT-751, provides a quick and easy way of checking transistors, diodes, IGFET's, LED's, Zeners, photocells, selenium rectifiers, capacitors, and controls. The instrument produces a clearly defined waveform on any general purpose oscilloscope. Identifies NPN and PNP

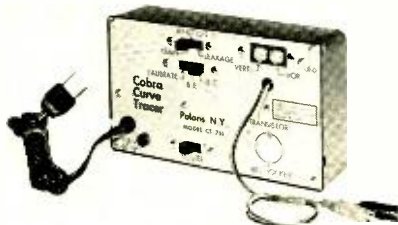

devices for polarity and function and a unique switching system makes it easy to perform tests without need to change or reverse connections. A transistor socket plus test leads provide maximum versatility. Complete with easy-to-follow instructions and sample waveform chart. Operates on 105-125V 60Hz. Measures only 6" x 3" x 1½".—Polaris New York, 2862 Fulton Street, Brooklyn, NY 11207.

Circle 31 on reader service card

AUDIO FREQUENCY RESPONSE PLOTTING SYSTEM, model 100, consists of two sine, square, and triangle function generators, pulse generator, frequency counter and peak amplitude measurement sections. It is primarily intended to generate a frequency response plot on an X-Y recorder or scope.

The time base generator offers symmetrical or independent control of the positive and negative sides of the ramp providing a duty cycle of 0.7% to 99.3%. Frequency range is .0035 Hz to 100 kHz. Output amplitude is 15 volts peak-to-peak into 500 ohms with ±5 volt DC offset. The time base output drives the X axis of an X-Y recorder.

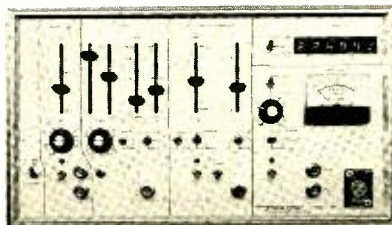

The audio sweep generator provides manual frequency adjustment or log/linear sweep of 20 Hz to 20 kHz. Blanking mode produces zero reference line on X-Y recorder. Output is 15 VP-P into 500 ohms or 10 VP-P into an 8-ohm speaker.

The pulse generator frequency range is .0035 Hz to 525 kHz. Pulse width is adjusted independent of frequency from 4 seconds to 40 nanoseconds. Outputs are complimentary TTL.

The peak amplitude measurement section measures internal or external signals from mike to power-amplifier level. Amplitude output drives Y axis of X-Y recorder.

The 6" digit frequency counter is line triggered and reads either internal or external signals. Sensitivity is 50-mV peak at 20 kHz. Dimensions: 8 x 14 x 3 inches. Price; \$525. Warranty: 1 year.—Fidelity Sound, 9764 Vine Street, Bloomington, CA 92316.

Circle 32 on reader service card

TV SIGNAL INDICATOR, the model 200 *Levelite*, is a totally new type of equipment that can be used to make rapid go-no-go tests on home TV installations and MATV systems. It checks signal levels at the antenna, preamplifier, splitter, tapoff or the 300-ohm terminals at the back of the TV set. Three adapters provide for connections to F-, G- and autoplug-type fittings and 300-ohm terminal screws.

Signals fed into the *Levelite* are amplified and detected to develop a DC voltage. This DC voltage, amplified by an IC, drives an LED. (It works from composite signals on



TV channels 7 through 13 only due to the possibility of erroneous indications from FM signals in the 88-108-MHz band.)

The device has two LED's. The green indicates the presence of signal; the red shows battery power. The brightness of the green LED provides an indication of signal strength. The brightness threshold of the green LED is selected by a two-position range switch. In the DISTANT position, the green LED lights when the signal is -6 dBmV (500 μV) or greater. In the LOCAL position, the LED lights dimly when the signal is ±6 dBmV (2000 μV) or greater. From dimmest glow to maximum brightness is about 4 dB. Operated easily with one hand, the model L-200 operates over a range of 20°F to 100°F.—Jerrod Electronics Corp., 200 Witmer Rd., Horsham, PA 19044.

Circle 33 on reader service card

REPAIR MODULES PARTS KIT. The most needed parts kit enables a servicer to repair rather than change a defective solid-state module. The kit contains the solid-state devices which, in G-E's experience, are the most frequently needed for in-home repair of any G-E modular color solid-state chassis produced from 1961.

The kit has a cross reference chart and location diagram to expedite part location in the box. The parts are individually packaged and marked with the exact catalog number to further simplify identification. Also contained in the modular chassis kit is a *Module Repair Digest* identifying those components



which are the most likely cause of failure. With this digest, the technician can choose between repairing or replacing a failed module. The kits also show basing diagrams for listing transistors.

The parts kit (EP50X16) is now available from General Electric at a price approximately on-half the sum of the regular individual parts prices. For further information contact your nearest G-E zone office or Regional Parts Center.

Circle 34 on reader service card

ELECTRONIC ORGAN KIT, this organ has two manuals, each with a complement of 61 keys and can produce a variety of tonal effects, suitable for popular, classical or liturgical music.



The average price of a kit with optional accessories is about \$2500.—**Schober Organ Corporation**, 43 West 61st Street, New York, NY 10023.

Circle 35 on reader service card

DIGITAL MULTIMETER DVM34, a portable DVM for service applications with a 3½-digit LED display and long battery life. The unit features a basic 0.1% accuracy, 15-megohm input impedance. Five-function unit measures



from 100 microvolts to 2000 VDC, 100 microvolts to 1000 VAC, 10 milliohms to 20 megohm, and 100 nanoamps to 2A AC and DC. 50 kV DC voltage capabilities are available with an optional 1%, 50-kV high-voltage probe. High

and low-power ohms function provides increased accuracy when measuring resistance in solid-state circuits. Auto-ranging circuit automatically steps down to the next lowest range on AC and DC volts, whenever the reading is "180" or less. Price: \$295. High voltage adaptor probe: \$25.00.—**Sencore Inc.**, 3200 Sencore Drive, Sioux Falls, SD 57107.

Circle 36 on reader service card

POWER AMPLIFIER dual-channel 2400/XXIV. A professional stereo power amplifier in a 19"



rack mount with handles and anodized black face plate. The amplifier delivers 200 watts RMS per channel, both channels driven into four or eight ohms from 20 Hz to 20 KHz with no more than 0.5% total harmonic distortion. Maximum harmonic and intermodulation distortion 0.05%, input sensitivity 1.5 volts, RMS ± 0.25 dB frequency response (20 Hz to 20 KHz) at rated power and better than -100-dB noise level below rated power.—**S.A.E. Scientific Audio Electronics Inc.**, 701 East Macy Street, Los Angeles, CA 90014.

Circle 38 on reader service card

INFRARED TRANSMITTER IS76. Infrared transmitter intended for use with a TV set, that can be adapted to a variety of output characteristics to permit wireless broadcast of audio to a remote headphone. The complete system consisting of the IS76 transmitter, IE76 receiver and DT444 headphone

GET FAMILIAR WITH MICROCOMPUTERS AT MICROCOST.

\$229.

The EBKA FAMILIARIZOR is a complete microcomputer system. No expensive terminal is required. Everything is built-in to a single PC board, including a hexadecimal keyboard and display.

Easy-to-understand Hardware and Programming Manuals guide you every step of the way. You will gain a practical knowledge of microprocessing, plus invaluable "hands-on" experience. All at microcost.

The heart of the EBKA FAMILIARIZOR is a MOS TECHNOLOGY 6502 Microprocessor, an eight bit processor that can address up to 65K bytes of memory. On-board memory consists of 1K bytes of RAM for user programs and two eight bit ports (one input and one output). A 256 byte monitor program, supplied in one 1702A erasable PROM, enables you to load, examine, run, debug and modify your own programs. Each function can be implemented at any address in memory. Breakpoints can be entered at any location in your program to display internal registers or branch to a separate routine.

You may also expand the capabilities of your FAMILIARIZOR in easy, inexpensive stages. To store your own programs in PROM, the PC board is designed to accept three additional 1702A PROMS (768 bytes). A low cost PROM programmer is also available. The system bus allows easy expansion. Add-on memory, interface and special function cards are available.

Whether you're a beginner or an experienced engineer, EBKA offers you a microcost way to get familiar with microcomputers. Order your EBKA FAMILIARIZOR today.



ORDER FORM

Please send me:

- Complete 6502 FAMILIARIZOR Kit\$229
- Assembled\$285
- IC Socket Kit\$14.50
- Power Supply\$58
- Check here if you wish to receive literature on the complete EBKA line.

Oklahoma residents, add sales tax.

Make payable and mail to:

EBKA INDUSTRIES INC.
6920 Meirose Lane 405/787-3671
Oklahoma City, Oklahoma 73127

- Enclosed is my check or money order for \$ _____
- Charge my Bank Americard or Master Charge exp. date _____

Account No. _____

M.C. Bank No. _____

Signature _____

Name _____

Address _____

City, State, Zip _____

Circle 23 on reader service card

works on a carrier frequency of 95 kHz, is frequency modulated, and covers a frequency range of at least 40 to 10,000 Hz with less

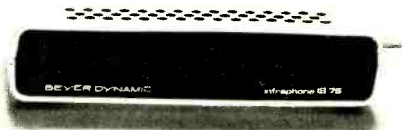

than 1.5% distortion. The transmitter is \$92.50, the receiver is \$76.00, the headphones, \$119.50.—**Revox Corporation**, 155 Michael Drive, Syosset, NY 11791.

Circle 39 on reader service card

MICROCOMPUTER, Altair 680, based on the 6800 microprocessor IC. Specifications include MPU 8-bit parallel processor, 16-bit

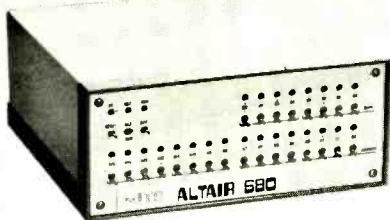

address bus, ability to address 65K bytes memory, 72 basic instructions, 4 microsecond cycle time. Memory 1K RAM built-in on main circuit board, plus built-in provisions for an additional 1K ROM or PROM. Built-in I/O port and interface circuitry on main printed circuit board can be set up for RS232 or for 20 mA or 60 mA current loop TTY. Optional

software includes PROM monitor, assembler, debug, and editor. Available full front panel model, \$345 as a kit, \$420 assembled. Altair's 680 MPU board only: \$195 as a kit, \$275 assembled.—**MITS, Inc.**, 6328 Linn, N.E. P.O. Box 8636, Albuquerque, NM 87108.

Circle 37 on reader service card

SOLDERING IRON, model WP-25 pencil-type iron with stainless-steel barrel and heat-shield handle. 25-watt iron has a nominal temperature range of 840-degrees F is 7%”

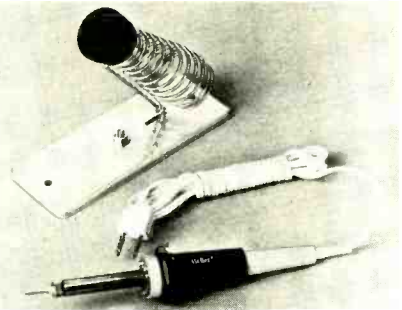

long and weighs 1 3/4 oz. Available with both two- and three-wire cords, and in a 40-watt model WP-40 with a temperature range of 950-degrees F.—**Weller-Xcelite Electronics Division**, The Cooper Group, Apex, NC 27502.

Circle 40 on reader service card

POWER AMPLIFIER KIT, model UK 192, delivers 50-watts continuous power output minimum per channel at 1% total harmonic distortion. Frequency response is within 2 dB

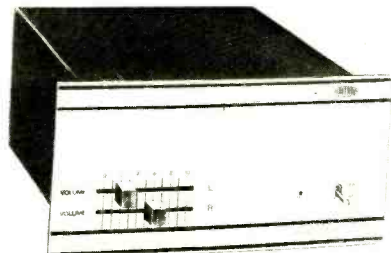

from 8 to 80,000 Hz. Input sensitivity is 1 volt for full power output. Input impedance is 1000 ohms and output impedance is 4 ohms. \$139.95 in kit form.—**Amroncraft Kits Ltd.**, One West 13 Street, New York, NY 10011.

Circle 41 on reader service card

CD-4 DEMODULATOR KIT, model 5022, complete with case and power supply, inserts between phono cartridge and the four discrete inputs of any quadriphonic system. The switch on the back of the case defeats the



quadriphonic functions, allowing stereo records to be played as well. An indicator light on the front panel shows when CD-4 records are playing. The demodulator is priced at \$50.00, and a model EPC-451C semi-conductor strain gauge cartridge is also available for \$25.00. A CD-4 test record is available at an additional cost of \$5.00.—**Southwest Technical Products Corp.**, Box 32040, San Antonio, TX 78284.

Circle 42 on reader service card

MINI-TERMINAL, model B-R-B, video terminal displays 1280 ASCII dot matrix characters in 16 lines. Unit features selectable standard baud rates from 110 to 9600, RS-232 serial data interface, backspace capability, ultra-

Soundcraftsmen THE PERFECT PRE-AMP

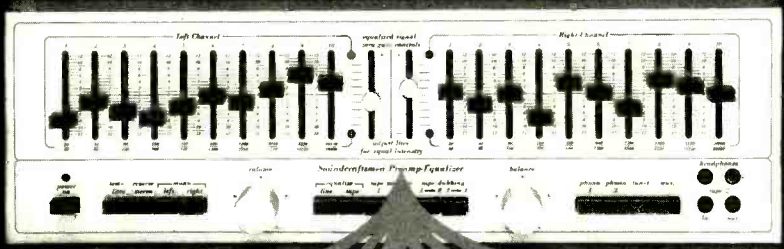

FOR THE GREAT NEW SUPER-POWER AMPS!

For a SUPER-SYSTEM, match the 2217 with any of these TRUE "State-of-the-Art" amps



- PHASE LINEAR • SAE • CROWN • DYNACO • AUDIO RESEARCH • CITATION • ESS • MARANTZ • SONY • KENWOOD • BOSE • QUATRE • BGW •

"FANTASTIC! I CAN HARDLY BELIEVE MY EARS... VERY VERSATILE & CLEAN-SOUNDING AND I REALLY LIKE THE SWITCHABLE PATCHING."

SPECIAL FEATURES

- ALL PUSHBUTTONS INTERLOCKED to prevent inadvertent program destruction • DISCRETE-OCTAVE EQUALIZATION CONTROL of ten octaves on each channel. ±12db each octave • FULL-SPECTRUM LEVEL CONTROL for each channel • AUTOMATIC CONTINUOUS MONITORING by light emitting diodes for visual warning of overload in output circuits • VISUAL ZERO-GAIN EQUALIZATION BALANCING on music, white noise or pink noise • SELECTION OF TEST LITES on or off • TAPE DUBBING BETWEEN TWO MACHINES, with optional simultaneous equalizing and monitoring • DOUBLE-DUBBING into two recorders simultaneously • SEPARATE SYSTEM-SELECTION enables full use of all other functions during the dubbing operation • LINE OR TAPE equalization selector • AUTOMATIC EQUALIZER-DEFEAT when line or tape equalizer is not in use • FRONT PANEL TAPE input-output jacks for easy 2nd and 3rd tape recorder hookup access • TAPE MONITORING of either tape at any time • TWO stereo headphone jacks • MONO SELECTOR for left, right or both channels to both outputs • REVERSE-STEREO mode • TWO low-level phono inputs • FOUR independent phono preamps • SIX A/C outlets, 4 switched, 2 unswitched • ELECTRO-PLATED FERROUS CHASSIS — (eight sections) — provides optimum shielding to minimize magnetic field-coupling • SINGLE-POINT system ground connector minimizes ground-loops • TWO REGULATED power supplies

(CUSTOMER COMMENT CARDS ARE ON FILE AT SOUND-CRAFTSMEN)
 "FANTASTIC! I CAN HARDLY BELIEVE MY EARS... VERY VERSATILE & CLEAN-SOUNDING AND I REALLY LIKE THE SWITCHABLE PATCHING."
 Fantastic unit! I'm glad my first audio system feature is in control.
 Please let me suggest improvements, changes, or additions.
 I've bought 3 more units for my own use.

case list any suggested improvements, changes, or additions.
YOU MUST BE KIDDING!

GUARANTEED SPECIFICATIONS

- FREQ. RESPONSE — Hi-level: ±1/2 db, 5 Hz to 100 KHz
- FREQ. RESPONSE — Phono: ±1/2 db, 20 Hz to 20 KHz
- THD: less than .05% at 1 volt (Typ. .01% at 1 volt)
- IM: less than .05% at 1 volt (Typ. .01% at 1 volt)
- PHONO INPUT CAPABILITY: 105mm
- SIGNAL TO NOISE — Hi-level: 100 db below full output
- SIGNAL TO NOISE — Phono: 84 db below a 10mm input
- SIGNAL TO NOISE — Equalizer: 106 db @ full output
- GAIN — Phono: 63 db
- GAIN — Hi-level: 21 db
- OUTPUT IMPEDANCE: 800 ohms
- EQUALIZER LEVEL: Zero gain controls for left and right continuously variable, for unity gain compensation
- INDIVIDUAL OCTAVE CONTROL RANGE: Minimum ±12 db (Typ. ±14 db), each octave centered at 30, 60, 120, 240, 480, 960, 1920, 3840, 7680, and 15,360 Hz
- MAX. OUTPUT SIGNAL: Variable master volume control allows adjustment of optimum output to match amplifier
- GOLD SWITCHES: All contacts are gold plated for low-noise, long life, and resistance to oxidation and corrosion
- CIRCUIT BOARDS: Military grade G-10 glass epoxy
- RESISTORS: Low-noise selected carbon film
- CABINET SIZE: 7 1/4" x 20" x 11 1/4" deep
- SHIPPING WEIGHT: 28 lbs.
- MADE IN U.S.A. Includes cabinet of rack mounts.

PE2217 — \$499.50

FREE!

THE "WHY'S AND HOW'S OF EQUALIZATION," an easy to understand explanation of the relationship of acoustics to your environment. This 6 page booklet also contains many unique ideas on "How the Soundcraftsmen Equalizer can measurably enhance your listening pleasures." How typical room problems are eliminated by Equalization, and a "10-point self-rated Equalization Evaluation Check List."

Soundcraftsmen EQUALIZERS

NOW YOU CAN MAKE YOUR SYSTEM SOUND EXACTLY THE WAY YOU WANT IT TO SOUND! In a few minutes, YOU can accurately "tune" the frequency response of YOUR stereo system and room environment to a flat ±2 db! All you need are YOUR OWN EARS and the Soundcraftsmen Equalizer (WITH ITS STEP-BY-STEP INSTRUCTION RECORD) to transform any stereo system and room environment into an acoustically-perfect concert hall! Or, to provide any special acoustical effects you desire! The Soundcraftsmen Equalizer enables YOU to instantly compensate for frequency response variations, IN SYSTEM AND ROOM.

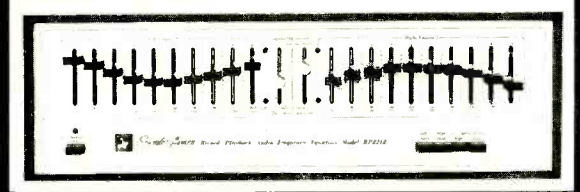

- GUARANTEED to enhance and improve any fine system!**
- RP2212** Illustrated above... **\$349.50**
- 20-12** Same specs as RP2212, except no L.E.D.'s, no Tape Equalize on front... **\$299.50**
- Both models include cabinet or rack mounts.

Just plug 2 cables into your receiver's tape monitor jacks, and you are ready to enjoy a new experience in musical enjoyment!

Soundcraftsmen • 1721 Newport Circle, Santa Ana, California 92705 Prices and specifications subject to change without notice.

Circle 17 on reader service card

RADIO-ELECTRONICS

reliable detachable keyboard, half and duplex operation, and composite video put. Board only model for custom designs



and suitcase model also available. Complete unit \$875.—Wintek Corporation, 902 N. 9th Street, Lafayette, IN 47904

Circle 43 on reader service card

TOGGLE SWITCHES, subminiature double pole, double-throw vertical mounting model AV2, is only 1.373 inches long. Minimum electrical life is 100,000 make-and-break cy-

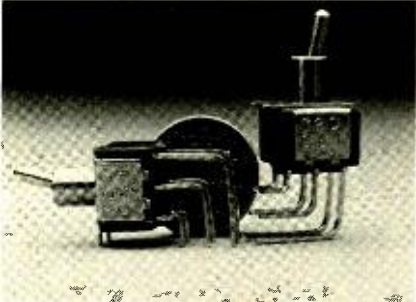

cles, minimum insulating resistance is 1000 megohms, minimum dielectric strength is 1000 volts RMS at sea level.—C & K Components Inc., 103 Morse Street, Watertown, MA 02172.

Circle 44 on reader service card

FUNCTION GENERATOR, Design Mate 2, three waveform function generator provides a short-proof output amplifier, that delivers both variable signal amplitudes and constant



output impedance. Completely wired, tested and calibrated, useful for testing audio amplifiers, op-amps and educational laboratory designs. Complete with instruction manual, application notes and operation theory, \$64.95.—Continental Specialties Corp., 44 Kendall Street, Box 1942, New Haven, CT 06509.

Circle 45 on reader service card

MOUNT 'N LOCK Model ML-1 is designed for easy mounting and removal of electronic equipment, such as radio transceivers, scanners, depth finders, tape players and many other similar devices in cars or boats. They offer maximum security after installation and all mounting hardware is completely inaccessible until equipment is removed. Mount

OUR PROTO-CLIP™ CAN PAY FOR ITSELF THE 1ST TIME YOU USE IT.

The reason's as simple as the time you'll save testing, signal tracing or wiring in DIP's. Not to mention the cost of IC's ruined by accidental shorts. A Proto-Clip is the foolproof, short proof way to bring up leads from crowded circuit boards. Its patented, molded design and unique gripping teeth free hands for other work. Built to withstand tough day-to-day use, CSC clips are available with or without cable for 14-, 16-, and 24-pin DIP's, starting at \$4.50* For more information, see your dealer or write for our full-line catalog and distributor list.



CONTINENTAL SPECIALTIES CORPORATION



44 Kendall Street, Box 1942
New Haven, CT 06509 • 203-624-3103
TWX: 710-465-1227
West Coast office: Box 7809,
San Francisco, CA 94119 • 415-421-8872
TWX: 910-372-7992
Canada: Len Finkler Ltd., Ontario

U. S. Pat No. 3,914,007
*Mfr's sugg. retail

© 1975, Continental Specialties Corp.

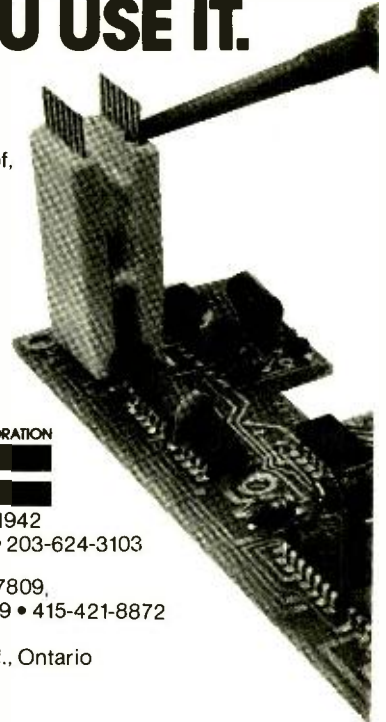

Circle 25 on reader service card

Sphere Offers You A Real Computer!

A REAL COMPUTER IS:

1. A SYSTEM: One that begins at the beginning with an attractive chassis to put everything in and consists of:
 - A. CPU—To give the greatest computing power for the lowest cost ever. Motorola 6800 Microprocessor. The most advanced microprocessor available today.
 - 1K PROM...The Computer Operating Program turns on instantly.
 - 4K RAM...For storage and operating capacity for many programs.
 - REAL TIME CLOCK...To program and monitor events outside and inside the computer.
- B. CRT—To display in human language on video everything going on inside the computer. (512 characters total in 16 lines by 32 characters.)
- C. KEYBOARD—So you can talk to your Computer as fast as you can type. (72 keys of alpha-numeric style typewriter keyboard.)

2. AND A REAL COMPUTER ALLOWS YOU TO: Record and reload programs and data with inexpensive audio cassette recorder.
 - D. SIM BOARD—So you can interface to teletype, audio cassette recorders and phone. (RS232c, TTL, TTY at 60ma and 20ma (Teletype), Modem, and 2 cassette recorders.
3. A REAL COMPUTER ALLOWS YOU TO: Adj more memory so you can do more processing and have more storage space.
 - E. 16K MEM BOARD—About 20 pages of close type-written material (more memory up to 64K is available if needed.)
4. A REAL COMPUTER ENDS UP BY ALLOWING YOU TO: Remember huge quantities of information, and then print it out on paper when you need reports, records, checks, P.O.s, Invoices, etc., etc., etc.
 - F. PIM BOARD—To interface the computer with the line printer and floppy disk storage.
 - G. FLOPPY DISK—To remember 1/2 million characters (about 150 pages of typed material) on line with the computer.
 - H. LINE PRINTER—To print 65 lines per minute on 8 1/2" wide paper up to 4 legible copies.

THAT'S A COMPUTER!!!!

Please Contact One Of Our Distributors—

Computer Way—Huntington Beach, California
Bargain Electronics—LaMeda, California
Comput-O-Mat Systems—Rye, New York
The Computer Workshop, Inc.—Montgomery County, Maryland
Computer Mart Corporated—Boston, Massachusetts
The Computer Mart of New York—New York City, New York
Comunicacions S.A.—San Jose, Costa Rica
Computer Country—Denver, Colorado



SPHERE CORPORATION

791 South 500 West Bountiful, Utah 84010
(801) 292-8466

IMPROVE ANY BRAND TEST RIG

SERVICE SOLID STATE

ON ANY TEST RIG

with the **PLUG IN TRANSVERTER NO WIRING**



TeleMatic

ADD-A METER TO YOUR RIG

HVM - 3900

\$33.00



- MONITORS ANODE VOLTS
- CONVENIENT MOUNTING
- SIMPLE INSTALLATION

TeleMatic

ADD-A FOCUS SUPPLY

SERVICES THE NEW LOW FOCUS VOLTAGE TV's.



FVS - 3950

\$22.95

- ADJUSTABLE
- SAFETY LIGHT
- E-Z HOOK-UP

TeleMatic

ADAPTORS YOKE-CONVERGENCE ADAPTOR

FOR ALL BRANDS TV.

FREE



CROSS REFERENCE CHARTS WRITE...

TeleMatic

2862 Fulton Street
Brooklyn, N.Y. 11207

Name _____

Street _____

City _____

State _____

Zip _____

My Supplier is: _____

SOLD THROUGH DISTRIBUTORS ONLY

Circle 26 on reader service card

'n Lock is adjustable to fit any size equipment of any depth and any height and widths

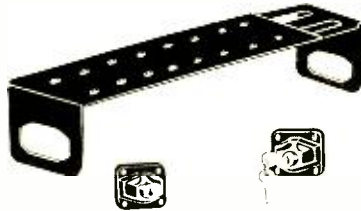

of 5 1/4" to 11".—**South Shore Trading Corp.**, 1311 Bellmore Avenue, North Bellmore, NY 11710.

Circle 46 on reader service card

CB RADIO, Messenger 130A. 23-channel unit has a PA function and includes the option of private listening with automatic speaker silencing when the handset is lifted from its



cradle. Operates with either positive or negative ground electrical systems and features improved receiver noise suppression circuitry. Price: \$199.95.—**E. F. Johnson Company**, Waseca, MN 56093.

Circle 47 on reader service card

NEW PLIERS. A new chain-nose plier, features an extra long reach and includes serrated jaws for positive pulling or side holding grip, or drawing and looping of wire. The thin chain nose head allows for working

Hunter Tools



- drop forged top quality steel
- precision ground finish
- cushioned vinyl grip

in close quarters or reaching way back into assemblies. The cushioned handle gives a firm but comfortable grip.

This tool is a proven electricians' favorite, with unlimited household and hobby uses. Hunter's long-reach chain-nose plier is available boxed or packaged on a 5 1/8" x 9 7/8" color-coded card. Being blister packed onto a card of this size makes this tool practically shoplifter proof.—**Hunter Tools**, Marshall Industries, 9674 Telstar Ave., El Monte, CA 91731.

Circle 48 on reader service card

TOOL ORGANIZER, molded of tough urethane, is ideal for holding a large selection of small tools. When set up next to work bench, keeps tools out of grit and grime of tool box.



One piece unit has no stitching, seams, flaps or rivets. Five year guarantee, \$12.75.—**Platt**, 2301 South Prairie Avenue, Chicago, IL 60616.

Circle 49 on reader service card **R-E**

BETTER THAN A THIRD HAND!



#315

#300

PANAVISE TILTS, TURNS, AND ROTATES TO ANY POSITION. IT HOLDS YOUR P.C. BOARD EXACTLY WHERE YOU WANT IT.

Quite possibly the finest new tool you will buy this year. PanaVise is built to exacting professional standards. We guarantee it!

Illustrated is P.C. Board Holder #315 in the #300 Base. This combination has exclusive multiple positioning ability. Boards are gently but firmly locked in place with one arm spring loaded to facilitate quick board changes.

Three other bases and a wide variety of heads are available. All interchangeable! Buy a basic unit, then add on to create your system.

FREE Write for the latest PanaVise catalog, prices, and dealer listing.

Available through your dealer.

PANAVISE® Dept. 5E

A Division of Colbert Industries

10107 Adella Ave., South Gate, CA 90280

Circle 68 on reader service card

FREE catalog

over 2000



unique tools,
handy kits,
precision
instruments,
technical
supplies.

Over 24 years of service to the world's finest craftsmen and technicians.

A carefully selected and tested assortment of unique, hard-to-find tools, clever gadgets, precision instruments, bargain kits. One-stop shopping for the technician, craftsman, hobbyist, lab specialist, production supervisor. Many tools and measuring instruments available nowhere else. One of the most unusual and complete tool catalogs anywhere. Get your copy of the NC FLASHER today.



National Camera
2000 West Union Ave., Dept. GBA
Englewood, Colorado 80110
(303) 789-1893

Circle 27 on reader service card

new lit

All booklets, catalogs, charts, data sheets and other literature listed here with a Reader Service number are free. Use the Reader Service Card inside the back cover.

GENERATORS AND MEASUREMENT EQUIPMENT. Here is an 80-page catalog listing all Wavetek function and sweep function generators, sweep signal generators, television test equipment, phase meters, transmission level test sets, plus accessories and options. Many standard and not so conventional instruments can be found in the pages of this catalog along with much useful information on how to use this equipment to speed servicing. More than 50 different instruments are described and illustrated.—**Wavetek, P.O. Box 651, San Diego, CA 92112.**

Circle 50 on reader service card

CITIZENS BAND CRYSTALS. An 8-page folder listing a large variety of standard-channel and special-frequency crystals made to fit most Citizens band transceivers. Many types of crystals are illustrated and a page of typical transistorized oscillator circuits is included.—**JAN Crystals, 2400 Crystal Drive, Ft. Myers, FL 33901.**

Circle 51 on reader service card

BEST IN NEW ELECTRONICS BOOKS!

- Master Hdbk of 1001 Pract. Electr. Circ's 602 p. 1250 il. \$9.95
- CB Radio Operator's Guide. 256 p. 139 il. \$5.95
- Build Your Own Working Robot. 238 p. 117 il. \$5.95
- Microprocessor/Microprogramming Handbook 294 p. \$6.95
- CB Radio Schematic/Service Manual. Vol. 3. 200 p. \$5.95
- CB Radio Schematic/Service Manual. Vol. 2. 200 p. \$5.95
- CB Radio Schematic/Service Manual. Vol. 1. 200 p. \$5.95
- Digital Logic: Processors, Memories & Interfaces. 294 p. \$6.95
- Zenith Color TV Schematic/Service Manual. Vol. 4. 196 p. \$5.95
- Introduction to Medical Electronics. 320 p. 126 il. \$7.95
- Modern Electronics Math. 602 p. 424 il. \$9.95
- Impedance 196 p. 90 il. \$5.95
- Aviation Electronics Handbook 406 p. 227 il. \$8.95
- Switching Regulators & Power Supplies 252 p. 128 il. \$6.95
- RCA Color TV Schematic/Service Manual. vol. 5. 196 p. \$5.95
- Central Htg./Air Conditioning Repair Guide. 320 p. 285 il. \$6.95
- MOSFET Circuits Guidebook 196 p. 104 il. \$4.95
- Microelectronics 266 p. 228 il. \$5.95
- Build-It Book of Miniature Test/Meas. Instr. 238 p. 151 il. \$4.95
- 21 Simple Transistor Radios You Can Build. 140 p. 122 il. \$3.95
- Op Amp Circuit Design & Applications. 280 p. 239 il. \$6.95
- Digital Logic Electronics Handbook 308 p. 226 il. \$6.95
- Troubleshooting with the Dual-Trace Scope. 224 p. 252 il. \$5.95
- Electronic Conversions, Symbols & Formulas. 224 p. \$4.95
- RC Modeler's Handbook—Gliders/Sailplanes. 196 p. \$4.95
- Electronic Music Circuit Guidebook 224 p. 180 il. \$6.95
- TV Schematics: Reading Between the Lines. 252 p. 188 il. \$5.95
- Ham Novice Class License Study Guide. 224 p. 57 il. \$5.95
- Ham General Class License Study Guide. 448 p. 125 il. \$7.95
- Ham Advanced Class Lic. Study Guide. 252 p. 109 il. \$5.95
- Advanced Applics. for Pocket Calculators. 304 p. 275 il. \$5.95
- TV Troubleshooter's Handbook 448 p. over 300 il. \$4.95
- Radio Control for Models. 350 p. 417 il. \$6.95
- Tower's International Transistor Selector. 140 p. \$4.95
- CATV Circuit Engineering. 294 p. 138 il. \$14.95
- Handbook of Multichannel Recording. 322 p. 196 il. \$7.95
- 111 Digital & Linear IC Projects. 210 p. 275 il. \$5.95
- Integrated Circuits Guidebook. 196 p. 119 il. \$5.95
- Jack Darr's Service Clinic No. 3. 252 p. 124 il. \$4.95
- 4-Channel Stereo—From Source to Sound. 252 p. 102 il. \$4.95
- Color TV Studio Design & Operation. 168 p. 69 il. \$9.95
- Practical CB Radio Troubleshooting/Repair. 210 p. 166 il. \$5.95
- Computer Programming Handbook. 518 p. 114 il. \$8.95
- Auto Electronics Simplified. 256 p. 202 il. \$5.95
- The Complete Auto Electric Handbook. 210 p. 139 il. \$5.95
- Color TV Case Histories Illustrated. 238 p. 219 il. \$5.95
- The Home Appliance Clinic. 195 p. 61 il. \$4.95
- Amat. Filmmaker's Hdbk. Sound Sync/Scoring. 210 p. \$5.95
- The Complete FM 2-Way Radio Handbook. 294 p. 111 il. \$6.95
- Directional Broadcast Antennas. 210 p. 60 il. \$12.95
- Troubleshooting With EVM & Scope. 238 p. 185 il. \$5.95

SEND NO MONEY! We'll invoice you on 10-DAY FREE TRIAL. Clip entire ad to order. 100% guaranteed or your money refunded.

TAB BOOKS DEPT RE-46 P.O. BOX 40
BLUE RIDGE SUMMIT, PA. 17214

Circle 28 on reader service card

MARKET SCOOP COLUMN

- HIGH VOLTAGE POWER TRANSISTOR Family. HEP 707. List price \$16.00. **2 29**
- 3-ZENITH VIDEO **2 00**
- AMPLIFIER PART #121-743 **2 00**
- 2-SILICON NPN TRANSISTOR HEP-80015. List \$1.75 **1 00**
- 1-SILICDN NPN TRANSISTOR (SK3534-HEP 85004) **1 00**
- 6-2 DIODES **1 00**
- 1N4751A 1 Watt-50 V **1 00**
- 4-ASSTD. PHILCO SWITCHES—PUSH—PUSH TYPE #TV2-3-4, & Sig. Sw. With knobs latest type. **2 59**
- POWER TRANSFORMER (PT-48)—110V Pri.—12V Sec. Used in many transistor Power supplies. **2 29**
- COMPLETE CONVERGENCE ASSY.—Inc. Yoke, Board & Plug Conn. Adaptable to most 90" sets. **3 95**
- COLOR DELAY LINE—Used in most color sets. **1 69**
- Silicon NPN HV TRANSISTOR RCA—SK-3021—Hep-240 **1 00**
- RCA—SK-3026—Hep-241 **1 00**
- Transistor Specials—Your Choice SK3006, SK3018, SK3020 **1 00**
- SK3122, SK3124 **1 00**
- Transistor Specials—Your Choice SK3009, SK3024, SK3040 **1 98**
- WAHL-CORDLESS SOLDER IRON Complete with Auto Charger, Fast Heating-Compact **1 79**
- 5-Audio Output TRANSFORM Sub-min for Trans Radios **1 00**
- 5-1 F. Coil TRANSFORMERS **1 00**
- 456-kc for Transistor Radios **1 00**
- 6" UNIVERSAL SPEAKER Top quality Special buy **EA.**
- 10" UNIVERSAL SPEAKER Large Magnet—Top quality **4 95**
- 8" UNIVERSAL SPEAKER Large Magnet—Special Buy **2 99**
- 2 1/2" 4" SPEAKER Special Buy 10 for \$5 **EA.**
- 4"x6" "QUAM" 16 Ohm SPK. Large magnet... Special BUY (10 for \$15.00) **1 79**
- 8" HEAVY DUTY 10 OZ. SPEAKER Ceramic Type—8 Ohm 1-6" of Heavy Duty 10 oz. Speaker Ceramic Type... 8 Ohm **4 50**
- 3-ELECTROLYTIC CONDENSERS. 100/80/20 MFD—300 Volts **2 00**
- 6-Top Brand SILICON RECT. 1 amp., 1000 PIV. **1 00**

IMMEDIATE DELIVERY... Scientific light packing for safe delivery at minimum cost.

HANDY WAY TO ORDER... Send check or money order, add extra for shipping. Lists of new offers will be returned in your order.



Please specify refund on shipping overpayment desired: CHECK POSTAGE STAMPS MERCHANDISE (our choice) with advantage to customer

BROOKS RADIO & TV CORP., 529 Columbus Ave., New York, N.Y. 10024 TELEPHONE 212-674 5600

- COLOR-TV RECTIFIER—Used in most color sets—6500 kv 3 for... **1 95**
- 4 - TV ALIGNMENT TOOLS most useful assortment #1 **1 00**
- 4 - TV ALIGNMENT TOOLS For Color TV #2 **1 49**
- 6 - TV COLOR ALIGNMENT TOOLS Most popular type **2 79**
- TV TWIN LEAD-IN 300 ohm 500'—\$7 100'—\$1.50. 50' CO-AX CABLE RG59U (Black) **1 00**
- 250'—\$10. 100'—\$4.50. 50' 5-DUAL DIODE—MOST POPULAR TYPES Common cathode or Series connected **2 50**
- 15-DIPPED MYLAR CAP. .01—400V **1 00**
- 15-DIPPED MYLAR CAP. .033—600V **1 00**
- 15-DIPPED MYLAR CAP. .0033—1000V **1 00**
- 15-DIPPED MYLAR CAP. .047—400V **1 00**
- 15-Molded Tubular Capacitors .056—400V **1 00**
- 15-DIPPED MYLER Condensers .0039 400V **1 00**
- 25-ASSORTED TRANSISTORS big factory scoop—sold as-is **1 00**
- 5-9 VOLT MOTORS Excellent for hobbyist **1 00**
- 100' GREY SPEAKER WIRE 2 Cond., mini zip, 101 uses **2 00**
- 1 -VARCO STEREO CARTRIDGE Model TN48 with holder **2 95**
- 2-ELECTROLYTIC CONDENSERS 80/100/60 MFD—160V **1 00**
- 2-ELECTROLYTIC COND 200/30/4—mfd—350V **1 00**
- 3-ELECTROLYTIC COND 100 mfd—100V 50 mfd—75V **1 00**
- 2-ELECTROLYTIC COND 40 mfd—500V. 40 mfd—400V **1 00**
- 8-MINI PILOT BULBS With 8" Leads—6.3V 30MA (5000 Hrs) **1 00**
- 8-MINI PILOT BULBS With 12" Leads—6.3V, 150MA (5000 Hrs.) **1 00**
- 32-TEST PROD WIRE DELUXE QUALITY red & black **1 00**
- 1-COLOR POWER TRANSFORMER RCA 26R150... special **6 95**
- 2-Colorized Quartz-Crystal For most color TV sets 3579.545 KC **1 89**
- 5 ASST GLOBAL VARISTOR Popular replacements for most COLOR TV **1 00**
- TACHOMETER 2 1/4" Sq. Panel Meter 1-VDC, full scale 33 Ohm coil resistance 0-6000 R.P.M. **2 00**
- 1-CASSETTE type dynamic Mike with universal plugs—200 Ohms **2 99**

- VU 1" PANEL METER 0-20 db Scale **1 29**
- RCA 110" FLYBACK TRANSFORMER. For Blk. & Wht. sets —18KV Part #8E7592. Incl. schem. **3 95**
- 110" TV DEFECTION YOKE for all types TV's incl schematic **4 95**
- "COMBINATION SPECIAL" RCA 110" FLYBACK plus 110" DEFECTION YOKE **6 95**
- 90" FLYBACK TRANSFORMER for all type TV's (Blk. & Wht.) **7 95**
- 70" FLYBACK TRANSFORMER for all type TV's (Blk. & Wht.) **2 00**
- 70" TV DEFECTION YOKE for all type TV's (Blk. & Wht.) **2 00**
- OLYMPIC & SHARP FLYBACK PART #8E7592 Equiv. Sinter #H10-403—Thorndarson #Fly339 **2 00**
- 90" COLOR YOKE For all Rectangular 19 to 25" Color CRT's **7 95**
- 70" COLOR YOKE For all round color CRT's **5 95**
- DELMONICO NIVICO COLOR FLYBACK Part #A2041-B **7 95**
- WESTINGHOUSE FM TUNER #476-V-015D0 1 Transistor **3 99**
- WESTINGHOUSE FM TUNER (12T8 Tube) **1 00**
- UHF TUNER—Transistor Type Used in all TV sets **2 95**
- G.E. UHF TUNER—TRANSISTOR TYPE Model #85N4 **3 95**
- ADMIRAL TV TUNER Model #94C093-1 (2HA5-4LJ8) **7 95**
- Model #T94C41-3 (Transistor) **7 95**
- WELLS GARDNER TUNER Part #7A 120-1 (4G8T-2HA7 Tubes) **7 95**
- G.E. TV TUNER (2GK5-4LJ8) Model #EP 86x11 **7 95**
- PHILCO UHF/VHF TUNER Transistorized **9 95**
- Model #F ANTENNA General replacement for any set **1 00**
- UNIVERSAL TV Antenna Back of set mounting... 6 section rods **2 99**
- BLUE LATERAL Magnet Assy. Replacement for most color TV's **1 79**
- 5-10K—2 WATT BIAS POTS Model # assembled—with 10hrs COLOR CONVERGENCE ASSY. **1 00**
- Universal type—good for most sets **2 49**
- 3 SPEAKER—7 WAY SELECTOR SWITCH Wall Mount **1 00**
- 7 TUBE AM-FM STEREO AMPLIFIER CHASSIS. (Completely assembled—with 10hrs AS IS needs slight adjustments) **12 50**
- 10-MINI ELECTROLYTIC COND For Transistor & miniature work **1 00**

Test Equip. Special Discount Prices

- 
- 
- Leader SENCORE**
- TRANSISTOR RADIO asst type good, bad, broken. as-is, potluck **1 50**
 - TAPE RECORDER assorted types good, bad broken, as-is, potluck **4 00**
 - 200 ASST. 1/2 W RESISTORS Top Brands, Short Leads. Excellent Selection **1 00**
 - 75-ASST 1/2 WATT RESISTORS stand. choice ohmages, some in 5% **1 00**
 - 100-ASST 1/2 WATT RESISTORS stand. choice ohmages, some in 5% **1 00**
 - 70-ASST 1 WATT RESISTORS stand. choice ohmages, some in 5% **1 00**
 - 35-ASST 2 WATT RESISTORS stand. choice ohmages, some in 5% **1 00**
 - 50-PRECISION RESISTORS asst. list-price \$50 less 98% **1 00**
 - 20-ASSORTED WIREWOUND RESISTORS, 5, 10, 20 watt **1 00**
 - 250-ASST SOLDERING LUGS best types and sizes **1 00**
 - 250-ASST WOOD SCREWS finest popular selection **1 00**
 - 250-Asst Self Tapping SCREWS #6, #8, etc. **1 00**
 - 100-ASST 6/32 SCREWS and 100-6/32 HEX NUTS **1 00**
 - 100-ASST 8/32 SCREWS and 100-8/32 HEX NUTS **1 00**
 - 100-ASST 2/56 SCREWS and 100-2/56 HEX NUTS **1 00**
 - 100-ASST 4/40 SCREWS and 100-4/40 HEX NUTS **1 00**
 - 100-ASST 5/40 SCREWS and 100-5/40 HEX NUTS **1 00**
 - 400-ASSORTED RIVETS most useful selected sizes **1 00**
 - 100-ASST RUBBER BUMPERS for cabinet bottoms—other uses **1 00**
 - 100-ASST RUBBER GROMMETS best sizes **1 00**
 - 1-KENWOOD TWEETER Special Buy—4" Round **4 79**

Minimum Order \$5.00

Circle 29 on reader service card

GENERATION-III



FROM: **PAIA**

THIRD GENERATION MUSIC SYNTHESIZER KITS from PAIA feature state-of-the-art design still at incredibly low prices.

Have you seen "POLYPHONY"? ... The PAIA User's Group magazine. Information for musicians, from musicians. Write today for your free sample issue.

24 HR. DEMO LINE (405) 843-7396

FREE CATALOG

PAIA ELECTRONICS, INC.
DEPT. 3-R
1020 W. WILSHIRE BLVD.
OKLAHOMA CITY, OK 73116

Circle 30 on reader service card

FREE burglar — fire alarm catalog



over 500 systems, detectors, controls, sounders, tools, locks, supplies

TO PROTECT HOMES, BUSINESSES, INDUSTRY

Huge selection of hard-to-find security equipment from stock. 96 fact-filled pages loaded with 100's of highest quality professional alarm products, technical notes, diagrams.

ONE-STOP SUPERMARKET SELECTION INCLUDES:

ultrasonics, radar, infrared, undercarpet mats, magnetic contacts, smoke & heat detectors; Controls; Alarms: bells, sirens, phone dialers, lights, guard panels. Large selection of tools, relays, wire, holdup alarms, books. Fills need for industry, alarm cos., businesses, homes, institutions. Order your copy today.



mountain west alarm
4215 n. 16th st.
phoenix, az. 85016
(602) 263-8831

Circle 61 on reader service card

SERIAL INTERFACE

(continued from page 62)

to a logic "1" if there is a condition where the receiver is being sent characters faster than it can accept them. If any one of these three error conditions occurs, transistor Q1 turns on and presents a "?" to the terminal as an error indication for the character(s) for which the error was received.

The standard baud rate for the unit is 110 baud and is derived from the 15,840 Hz phase-locked oscillator on the main board that is brought in through pin 1 of J1. The 15,840 clock frequency is divided-by-nine by IC2 to produce 1760 Hz required by the UART chip for 110 baud. For higher baud rates, a crystal oscillator with a 307.200 kHz crystal is required as well as IC1 and IC8. Inverters IC8-a and IC8-b form an oscillator with a frequency of 307.200 kHz that is fed to flip-flop IC9-b pin 4 where it is divided by two and in turn fed to a programmable divider, IC1 pin 9. By selecting correct inputs of this integrated circuit, the correct output frequency necessary for each baud rate can be easily set. A five position rotary switch can be attached at jack J1 that grounds the selected baud rate line providing easy selection of either 110, 150, 300, 600 or 1200 baud. The 110-baud input inverter (IC8-f) also drives the stop bit select line of the UART chip, IC3 pin 36, to select the correct number of stop bits for 110 baud operation.

A terminal ready signal is provided at J1 pin 2 to tell external devices when the terminal is powered up, however, this output is a sense line only and should not be loaded when anything sourcing or sinking a current of more than 5 mA.

A power-up reset is provided by IC11-e to clear the registers inside the UART chip when power is applied to the terminal.

Construction

It is not very difficult to assemble the unit, just be sure to orient all of the integrated circuits, diodes, electrolytic capacitors, transistors, and connectors as shown in Fig. 2. Note that the connectors are notched and must be installed exactly as shown in the drawing. The foil pattern of the component side of the double sided printed circuit board is shown in Fig. 3, while the foil pattern of the foil side of the board is shown in Fig. 4. If you use the 150, 300, 600 or 1200 baud option, install the parts used for the crystal controlled oscillator and its related circuitry. Also attach a jumper between points A and C on the interface board. The various baud rates are selected by grounding the appropriate pin of connector J1. If you are not using the optional baud rates and wish to use the standard 110 baud then attach a jumper between points A and B instead of A and C on the interface board.

Without the screen-read board inserted on the TV Typewriter II main terminal board it will be necessary to jumper point O to P on the interface board. With the screen-read board installed on the main terminal board, omit the jumper.

If you want to guarantee that the receiver remains off during a screen-read

MACHINE LANGUAGE PROGRAMMING FOR THE "8008" AND SIMILAR MICROCOMPUTERS

READ IT FOR 15 DAYS! MONEY-BACK GUARANTEE

- Detailed presentation of "8008" codes
- Flow Charts • Mapping
- Floating-point Package
- Basic programs: loops, counters, masks
- Multiple-precision arithmetic
- Debugging • Organizing Tables
- Editing/Assembling • Math operations
- I/O, Real-Time Programming
- Maximizing memories • And lots more

19⁹⁵ ppd.



Here's the detailed, basic manual you need to develop today's machine language programs. 170 pages. Illustrated. Easy-to-read, understand. Most techniques applicable to other microcomputers, e.g. 8080, etc. Floating-point arithmetic package is worth the price alone.

Order today! Read the manual for 15 days. If not completely satisfied, return it in salable condition, for full refund.

SCELBI COMPUTER CONSULTING INC.
1322 Rear Boston Post Rd., Milford, CT 06460.

Circle 62 on reader service card

VISTA DIGITAL CROSSHATCH

Gives professional, accurate Color T.V. convergence. Digital IC's coupled with a crystal time-base oscillator provide precise horizontal & vertical lines at broadcast frequencies. Accurate 8 x 7 dot or crosshatch pattern A.C. power 2 x 3/4 x 6 in. Wt. 24 oz. Fits in tool kit.

COMES COMPLETE WITH ALL PARTS, CASE, CRYSTAL AND GUIDE TO ASSEMBLY & USE.

KIT
\$31.95

COMPLETELY ASSEMBLED
\$41.95



Shipping Prepaid in USA
NY State Add Sales Tax

PHOTOLUME CORP.
118 EAST 28 STREET
NEW YORK, N.Y. 10016

Circle 63 on reader service card

dump, you will probably want to jumper point S to R on the interface board. If high baud rates are used and/or the turn-around time from whatever feeds the terminal is fast you may have to omit this jumper. If so, you must be sure the terminal is not in the echo mode and that whatever feeds the receiver of the terminal doesn't transmit during the time a screen-dump operation takes place.

It is also necessary to program the interface board for the correct parity and number of bits to be handled. The transmit and receive formats are identical and are programmed with jumpers as follows:

Odd parity, no bit 8—jumper J to K and jumper I to H

Even parity, no bit 8—jumper I to H
No parity, no bit 8—jumper G to F and jumper I to H

No parity, bit 8 = 1—jumper G to F
No parity, bit 8 = 0—jumper G to F and jumper E to D

The appropriate keypressed strobe jumper should be installed. If your keyboard's strobe is positive going and narrow or if it is negative going and the data is held for at least 100 nanoseconds after the trailing edge of the strobe pulse, solder a jumper wire between pads L and N. Almost all keyboards will work in this configuration. Jumpering pad M to N instead is used for positive edge level triggering where the pulse is clean and there is no ringing. The board must not be wired for a positive keypressed strobe (M to N) if the screen-read board is used.

Before plugging the interface board into the main terminal board, be sure to insert the indexing key in J2 pin 2 to prevent the board from being plugged in backwards. Then orient the interface board so its component side is toward the center of the main terminal board and plug it into connectors J1 and J2.

Input/output and control lines for the interface are accessed thru connector J1. J1 pin 7 is the RS-232 compatible input and J1 pin 6 is the RS-232 compatible output. Pin 2 of J1 is a terminal ready status line that is high when power is applied to the terminal. You must be sure not to draw more than 5 mA from this pin when sensing this line. J1 pin 5, pin 4 and pin 8 control the receiver off, transmitter off and echo off, respectively. Grounding the respective control line shuts off the selected function and J1 pin 1 is ground. Note that when the serial interface board is used, the keyboard must be plugged into jack J2 on the interface rather than the J9 connector on the main terminal board on the chassis.

Checkout and use

The easiest way to check the unit out is to operate it in the echo mode and the receiver and transmitter switched off. This should display everything that is typed on the screen where it can be seen and checked. Since this mode uses both the transmit and receive circuitry, it is a good way to check everything on the interface for proper operation. If you have any problems, remove power and check carefully for assembly errors. If you find it necessary to troubleshoot the circuit, you will need an oscilloscope, a good background in digital theory and a thorough knowledge of how the unit operates. **R-E**

MORROW'S Micro-STUFF

BOX 6194
ALBANY,
CA 94706

"I have a tremendous amount of fun creating these products and I'm happy to be able to offer them to you." --- George Morrow

Intelligent Cassette Interface
ALTAIR 8800/IMSAI owners: talk to 3 cassette machines for mass storage. Uses industry standard bi-phase recording method. THIS KIT IS SMART! Includes its own software and data buffers (512 bytes of ROM + 512 bytes of RAM) so you can get going as soon as you connect power. With sockets, board, parts, even a cassette. **\$72.00**

8080 Micro Processor Board
8080 based microcomputer system on a board. You get: *512 bytes of RAM (expands to 1K; just add ICs) *512 bytes of ROM (expands to 4K) *data & address buffers *xtal clock *TTL support ICs *16 key keyboard + nine 7 segment displays, so you can painlessly load and examine memory. OPTIONS: Cassette interface (+\$30), editor/assembler (+99), RS-232/TTY interface (+\$20). COST-EFFECTIVE & PROVEN. **\$139.95**
Less pwr supply.

We even have parts:
2502 UART \$3.75
TMS8080 \$27.95
WE PAY POSTAGE--Cal res add tax--no CODs.
FIND OUT MORE: circle the reader service #

Circle 64 on reader service card

DELUXE DIGITAL COLOR CONVERGENCE GENERATOR

10 ROCK SOLID PATTERNS
ALL IC COUNTDOWN CIRCUITS
QUARTZ CRYSTAL OSCILLATORS
2 FULL YEARS' WARRANTY

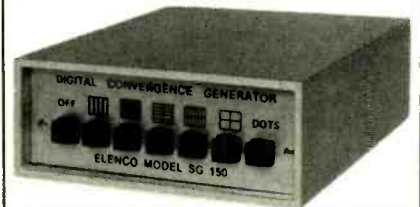

MODEL SG-150 \$75⁹⁵



MODEL SG-100
ONLY \$59⁹⁵

2 Patterns: 20 x 16 Crosshatch, 320 Dots, weight only 17 oz.

WRITE OR CALL FOR DETAILS
ELENCO ELECTRONICS INC.

1928 Raymond Dr., Northbrook, IL 60062
(312) 564-0919

Circle 65 on reader service card

SOLID STATE...BREAKERLESS ELECTRONIC IGNITION.

The BEST...The ULTIMATE of All Ignition Systems

ALLISON 'OPTO-ELECTRIC'



★ No Breaker-Points or Condenser to EVER wear out or need any maintenance.



★ Once installed and properly timed your Distributor will give you CONTINUOUS PEAK PERFORMANCE!



● The Allison OPTO-ELECTRIC System ELIMINATES the Points and Condenser, replacing them with an OPTO-Electronic Trigger, using a Light-Emitting Diode and Phototransistor. This System operates on a BEAM of LIGHT. There is NO "Breaker-Point Wiper-Arm" to wear down. Point bounce and erosion are completely eliminated thereby giving longer Timing ACCURACY than any System using "Mechanical" Breaker-Points. (and No Timing Fluctuation as with Magnetic Impulse Units) ACCURATE Timing gives the BEST in Engine EFFICIENCY, and that's the name of the Game for the BEST in GAS MILEAGE and ECONOMY.

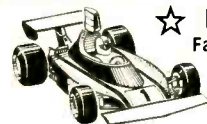

★ PROVEN RELIABILITY
Factory Tested to 15,000 RPM
Road and Race PROVEN
(Opto-Electric Systems Won at INDY Two Years in a Row)

★ ORDER with CONFIDENCE...
FACTORY-BACKED 10-YEAR
Free Repair or Replacement on ANY
Defects in Materials or Workmanship.

Only \$59⁹⁵
COMPLETE
(Calif. Res. add Tax)
...that's EVERYTHING!
including Postage & Insurance.

★ SAVE! ORDER FACTORY DIRECT

● Send Check or M.O.
State Make, Year, Engine Size. (4, 6, or 8-cylinder).

● You may use your MASTER CHARGE or BANKAMERICARD. Send us (1) Your Number, (2) Interbank No., (3) Exp. Date MC or BA Card Holders. ORDER by TOLL FREE PHONE: (800) 423-6525, Ext. 2. (When in Continental U.S.A.)

★ Before Buying any other Type ignition system
Send Postcard for our FREE BROCHURE.

★ If you have already installed a "Capacitive-Discharge" Ignition Modernize and Increase its Efficiency...
CONVERT YOUR "C.O." UNIT TO BREAKERLESS!
Opto-Electric "TRIGGER UNIT"... Only \$34.95.

● America's Oldest and Largest Manufacturer of Opto-Electronic Ignition Systems.



ALLISON
AUTOMOTIVE COMPANY 1267 - E9 East EDNA PL., COVINA, CAL. 91722

Our BEST Salesmen are the USERS of our ALLISON System!

Circle 66 on reader service card

free

BA 1976 catalog



244 PAGE
RADIO, TV &
ELECTRONICS
CATALOG

Your buying guide for Everything in Electronics... Stereo, Hi-Fi, TV's, Radios, Tape Recorders, CB, Kits, Tools, Books and Electronic Parts.

**WRITE FOR YOUR
FREE COPY NOW!**

burstein - applebee

DEPT. RE-4 3199 MERCIER ST.
KANSAS CITY, MO. 64111

NAME _____
ADDRESS _____
CITY _____
STATE _____ ZIP _____

**"My father built this
Schober Organ
for me!"**



You'd be proud to buy her an organ this good... but how would you feel if you'd also built it? It's a special kind of satisfaction. The gift of a lifetime of magnificent music, crafted with your own hands!

And you can do it! You need no prior electronic or mechanical abilities. Just the capacity to follow instructions. Every step is clearly detailed, every component is supplied. You'll find the assembly process as enjoyable as the music which follows!

And what music! For this is a truly fine instrument you will build. Far superior to most "ready-made" organs... easily comparable to others at twice the price. Kit costs range from \$650 to \$2850 for all basic components, and you can purchase it in sections to spread costs out... or have two-year time payments.

Just send the coupon for the fascinating Schober color catalog (or enclose \$1 for a record that lets you hear as well as see the quality of Schober).

The Schober Organ Corp., Dept. RE-149
43 West 61st Street, New York, N.Y. 10023

- Please send me Schober Organ Catalog.
- Enclosed please find \$1.00 for 12-inch L.P. record of Schober Organ music.

NAME _____
ADDRESS _____
CITY _____ STATE _____ ZIP _____

Circle 67 on reader service card

BAUDOT TO ASCII (continued from page 59)

TABLE I
TRUTH TABLE FOR 8223 PROM—TO BE USED AS IC22
Check that the symbols given here agree with your machine

WORD	INPUTS							OUTPUTS							SYMBOL
	A ₄	A ₃	A ₂	A ₁	A ₀	ENABLE	B ₇	B ₆	B ₅	B ₄	B ₃	B ₂	B ₁	B ₀	
0	0	0	0	0	0	0	0								Null
1	0	0	0	0	1	0	0	1	1	1					T
2	0	0	0	1	0	0	0				1	1			CR
3	0	0	0	1	1	0	0	1			1	1	1	1	C
4	0	0	1	0	0	0	0		1						Space
5	0	0	1	0	1	0	0	1		1					H
6	0	0	1	1	0	0	0	1			1	1	1		N
7	0	0	1	1	1	0	0	1			1	1		1	M
8	0	1	0	0	0	0	0				1		1		LF
9	0	1	0	0	1	0	0	1			1	1			L
10	0	1	0	1	0	0	0	1	1				1		R
11	0	1	0	1	1	0	0	1				1	1	1	G
12	0	1	1	0	0	0	0	1			1			1	I
13	0	1	1	0	1	0	0	1	1						P
14	0	1	1	1	0	0	0	1					1	1	C
15	0	1	1	1	1	0	0	1	1		1	1			V
16	1	0	0	0	0	0	0	1				1		1	E
17	1	0	0	0	1	0	0	1	1	1			1		Z
18	1	0	0	1	0	0	0	1				1			D
19	1	0	0	1	1	0	0	1					1		B
20	1	0	1	0	0	0	0	1	1				1	1	S
21	1	0	1	0	1	0	0	1	1	1				1	Y
22	1	0	1	1	0	0	0	1				1	1		F
23	1	0	1	1	1	0	0	1	1	1					X
24	1	1	0	0	0	0	0	1						1	A
25	1	1	0	0	1	0	0	1	1			1	1	1	W
26	1	1	0	1	0	0	0	1			1		1		J
27	1	1	0	1	1	0	0								Null
28	1	1	1	0	0	0	0	1	1		1		1		U
29	1	1	1	0	1	0	0	1	1					1	Q
30	1	1	1	1	0	0	0	1			1		1	1	K
31	1	1	1	1	1	0	0								Null
ALL	x	x	x	x	x	1	1	1	1	1	1	1	1	1	

TACHOMETER AND SPEED ALARMS (continued from page 39)

reading on the meter.

Note that R7 comprises a fixed and a variable resistor in series. The graph of Fig. 9 shows the approximate total value of R7 that is needed to give full-scale meter readings at particular frequencies when C2 has a value of .01 μF. Note that, if preferred, C2 can be increased to 0.1 μF and the R7 value can then be reduced by a factor of ten.

Once the unit has been attached to the car, the SENSITIVITY control R2 should be adjusted to slightly above the minimum

value at which triggering can be reliably obtained without interference from spurious signals. The setting up procedure is then complete, and the tachometer is ready for use. The tachometer can readily be transferred from one vehicle to another by simply adjusting R7 to give the required full-scale RPM reading, and adjusting the R2 SENSITIVITY control to suit the individual vehicle.

A 6-to-12 volt converter

Figure 10 shows the circuit of a simple 6-to-12 volt converter that can be used to enable the tachometer circuit to operate

TABLE II
TRUTH TABLE FOR 8223 PROM—TO BE USED AS IC20
 Check that the symbols given here agree with your machine

WORD	INPUTS							OUTPUTS							SYMBOL
	A ₄	A ₃	A ₂	A ₁	A ₀	ENABLE	B ₇	B ₆	B ₅	B ₄	B ₃	B ₂	B ₁	B ₀	
0	0	0	0	0	0	0									Null
1	0	0	0	0	1	0			1	1			1	1	5
2	0	0	0	1	0	0						1	1		CR
3	0	0	0	1	1	0			1	1	1			1	9
4	0	0	1	0	0	0			1						Space
5	0	0	1	0	1	0			1				1	1	#
6	0	0	1	1	0	0			1		1	1			.
7	0	0	1	1	1	0			1		1	1	1		.
8	0	1	0	0	0	0					1		1		LF
9	0	1	0	0	1	0			1		1			1)
10	0	1	0	1	0	0			1	1			1		4
11	0	1	0	1	1	0			1			1	1		&
12	0	1	1	0	0	0			1	1	1				8
13	0	1	1	0	1	0			1	1					0
14	0	1	1	1	0	0			1	1	1		1		:
15	0	1	1	1	1	0			1	1	1		1	1	;
16	1	0	0	0	0	0			1	1			1	1	3
17	1	0	0	0	1	0			1				1		"
18	1	0	0	1	0	0			1				1		\$
19	1	0	0	1	1	0			1	1	1	1	1	1	?
20	1	0	1	0	0	0						1	1	1	Bell
21	1	0	1	0	1	0			1	1		1	1		6
22	1	0	1	1	0	0			1				1		!
23	1	0	1	1	1	0			1		1	1	1	1	/
24	1	1	0	0	0	0			1		1	1		1	—
25	1	1	0	0	1	0			1	1			1		2
26	1	1	0	1	0	0			1			1	1	1	'
27	1	1	0	1	1	0									Null
28	1	1	1	0	0	0			1	1		1	1	1	7
29	1	1	1	0	1	0			1	1				1	1
30	1	1	1	1	0	0			1		1				(
31	1	1	1	1	1	0									Null
ALL	x	x	x	x	x	1	1	1	1	1	1	1	1	1	

(continued on page 86)

on vehicles equipped with 6-volt electrical systems. Circuit operation is quite simple. Gates A and B of the CD4001 IC are wired as a simple astable multivibrator or square-wave generator that operates at about 800 Hz. The output of the astable multivibrator is fed to complementary emitter-follower stage Q1-Q2 via a spare inverter-connected gate of the IC. The output of the emitter follower is fed to a voltage-doubler circuit comprising C2-D1-D2-C3 and R2. The output of the circuit is taken from this voltage-doubler stage.

In practice, a vehicle equipped with a 6-volt electrical system generates approxi-

mately 7-volts under actual running conditions, and the converter gives a nominal output of about 11-volts to the tachometer under this condition. This output voltage is more than adequate for driving the tachometer circuit.

Figs. 11-a and 11-b show how the converter and the tachometer can be connected to vehicles having either a positive ground or a negative ground electrical system.

In the concluding part of this article, we'll show how the basic tachometer circuit can be expanded so that it also acts as a red-line or over-speed alarm. **R-E**

FREE EICO CATALOG

346 Ways To Save On Instruments, Burglar Alarms, Automotive & Hobby Electronics!

The more you know about electronics, the more you'll appreciate EICO. We have a wide range of products for you to choose from, each designed to provide you with the most pleasure and quality performance for your money. The fact that more than 3 million EICO products are in use attests to their quality and performance.

"Build-it-Yourself" and save up to 50% with our famous electronic kits.

For latest EICO Catalog on Test Instruments, Automotive and Hobby Electronics, Eicocraft Project kits, Burglar-Fire Alarm Systems and name of nearest EICO Distributor, check reader service card or send 50¢ for fast first class mail service.

**EICO—283 Malta Street,
Brooklyn, N.Y. 11207**

Leadership in creative electronics since 1945.



Circle 69 on reader service card



INTERNATIONAL FM 2400CH

FREQUENCY METER for testing mobile transmitters and receivers



- Tests Predetermined Frequencies 25 to 1000 MHz
- Extended Range Covers 950 MHz Band
- Pin Diode Attenuator for Full Range Coverage as Signal Generator
- Measures FM Deviation

The FM-2400CH provides an accurate frequency standard for testing and adjustment of mobile transmitters and receivers at predetermined frequencies.

The FM-2400CH with its extended range covers 25 to 1000 MHz. The frequencies can be those of the radio frequency channels of operation and/or the intermediate frequencies of the receiver between 5 MHz and 40 MHz.

Frequency Stability: $\pm .0005\%$ from $+50^\circ$ to $+104^\circ\text{F}$.

Frequency stability with built-in thermometer and temperature corrected charts: $\pm .00025\%$ from $+25^\circ$ to $+125^\circ$ (.000125% special 450 MHz crystals available).

Self-contained in small portable case. Complete solid state circuitry. Rechargeable batteries.

FM-2400CH (meter only) \$595.00
 RF crystals (with temperature correction) ... 24.00 ea.
 RF crystals (less temperature correction) 18.00 ea.
 IF crystals catalog price

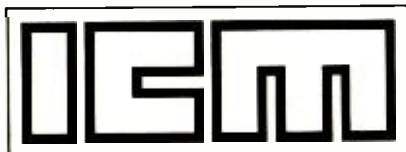

International Crystal Manufacturing Company, Inc.

10 North Lee, Oklahoma City, Oklahoma 73102

Circle 70 on reader service card

READER QUESTIONS

(continued from page 68)

OUTPUT TUBE OVERHEATING

The 6BQ5 output tubes in one channel of this Truetone DC5941 amplifier get red hot after about 10 minutes. I tried new tubes; no luck. Is there a Sams folder on this chassis?—J.M., Birmingham, AL.

Look in Sams Photofact 466-4. This is an Airline, but the same amplifier. The overheating problem is probably due to a bias defect. If the cathode resistor and bypass capacitor are OK, then the coupling capacitor from the driver is probably leaky. Pull the 6BQ5 tubes, turn the set on, and read the DC voltage on the grids of the 6BQ5's. This voltage should be zero. If you read any positive voltage, the coupling capacitor is leaking.

SUBSTITUTE TRANSISTOR

I need a substitute for the output transistor in a Bendix 248 automobile radio. The number on it is 4080187-0507 and I can't find that either! Help!—R.S., Sacramento, CA.

There's a trick in looking up part numbers in transistor guides. Look for the first two digits; in this case "40". The computer that sorts out the numbers "keys" on the first two digits.

In this case, RCA lists an SK-3024 as an exact replacement for that long numbered transistor.

SEVERE JITTER

The picture in this RCA CTC-51K is very unstable. Severe horizontal jitter that causes double images, and a vertical jitter at the same time. This is affected by both brightness and contrast controls. Horizontal sync range on hold control very small. Why?—J.M., Hatfield, AR.

After you check the horizontal AFC diodes and so on,

For
faster
service

USE
ZIP
CODE

on
all
mail



save on gas!
save on tune-ups!
save on maintenance!

Electronic ignition is "IN"! So says Detroit.

Update your car with either a TIGER CD or a TIGER I breakerless system.

Enjoy the benefits of better gas mileage, quicker starting, elimination of tune-ups, 50,000 miles on points and plugs, and reduced maintenance expenses.

TIGER MAX CD	\$69.95
TIGER 500 CD	59.95
TIGER SST CD	42.95
SIMPLIKIT CD	31.95
TIGER I	45.95

Postpaid U.S.A. only.

TRI-Star Corporation

Dept. WW, P.O. Box 1727
 Grand Junction, Colorado 81501

Circle 74 on reader service card

try checking the plate load resistor of the horizontal oscillator! This is R40, and should be 220K. In one known case, this dropped to about 40K and caused the same symptoms you have. Oddly enough, there was plenty of sweep and high voltage, but it was very unstable. Apparently the horizontal oscillator was hunting very rapidly and upsetting the sync keying pulses, etc. Quick-check; horizontal oscillator plate voltage will be very high, almost 400 volts instead of normal +225 volts.

UHF SNIVETS

I've got a couple of oddball problems in this Quasar TS-934. There are severe snivets on UHF, clean on VHF. The UHF picture and sound go out shortly after turn-on. The other one: I replaced the Z-panel DC regulator. After taking the UHF tuner out, I checked the 20-volt source and it was only 12 volts. I adjusted it to 20 volts as instructed, and the video and sound went out! Are these connected?—J.L., Fairfield, CA.

Your snivets could be caused by corona to the metal ring around the 6LF6 tube. This has happened. Move the ring so that it's nearer the bottom of this tube.

Voltage problem: it is possible that raising the 20 volt line to normal could have caused the AGC to cut off the IF. Run this voltage up to the normal level and then reset the IF and RF AGC controls. That ought to do it.

TUNER DRIFT

This Admiral 3L36 has a very severe tuner drift. After it warms up it may drift one whole channel. Tuner tubes checked and replaced, no help. Where to look?—M.W., El Cajon, CA.

"Drift" is something that changes the tuner oscillator frequency. (Fine basic statement!) Not apt to be a coil, but very apt to be a capacitor. In this tuner, they use a transistor with one terminal clipped, apparently as a varactor diode. This would be a very good "suspect"; try warming it up or cooling it off and see if this won't show up something.

DISAPPEARING DIODE!

I can't find the 22-volt Zener diode, Y404, in this G-E 19QA chassis! It's not on the power-supply board, although the symbol is there. In the photo of this board in Sams 1388-3, it's also gone. Shows it on the schematic, though. The 22.7 volt source shows a very low resistance. Help!—L.C. Mena, AR.

It's still in the circuit, but not where you'd expect. Follow the line from the power-supply board down to a terminal strip on the back of the flyback cage; right under the sticker saying "19QA Chassis." It's underneath this board! Also, it's probably shorted if you're reading a low resistance on the 22.7-volt line.

WINDOW-SHADE PROBLEM

I have an odd brightness problem in this Zenith 20X1C38. Everything is normal except that the picture is dark at the top and bottom is too bright. When the brightness control is turned, the picture gets dark from the top down, like pulling a window shade down. Any assistance will be appreciated!—R.S., Aurora, CO.

You've got it; you've even got the right name for it. This is a classic case of "window-shade." It's caused by a shorted blanking diode in the vertical blanking circuitry. This will probably be the one connected to the green-white wire from the secondary of the vertical output transformer to the emitter of the 1st video amplifier transistor. There are two more to the same point; check them all for luck.

DIODE BLOWING

This Sears 528.40720320 color set came in with the horizontal output transistor, vertical output transistor and diode
(continued on page 87)

Put Professional Knowledge and a COLLEGE DEGREE in your Electronics Career through HOME STUDY

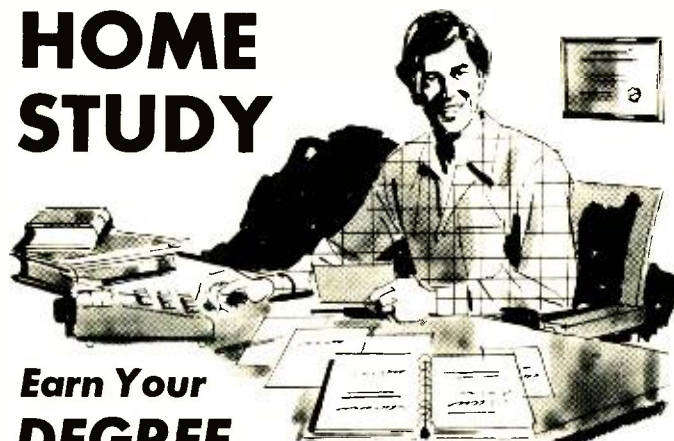

Earn Your DEGREE

by correspondence, while continuing your present job. No commuting to class. Study at your own pace. Learn from complete and explicit lesson materials, with additional assistance from our home study instructors. Advance as fast as you wish, but take all the time you need to master each topic. Profit from, and enjoy, the advantages of independent study.

The Grantham correspondence degree program in electronics is comprehensive. It begins with basics, written in very simple language, and continues through the B.S.E.E. degree level. Throughout the entire program, heavy emphasis is placed on clear explanations written in great detail, progressing from the simple to the complex, in easy steps.

Our free bulletin gives complete details on the curriculum, the degrees awarded, the requirements for each degree, and how to enroll.

GRANTHAM SCHOOL OF ENGINEERING

2000 Stoner Ave., Los Angeles CA 90025

● Telephone (213) 477-1901 ●

Worldwide Career Training thru Home Study

Mail the coupon below for free bulletin.

Grantham School of Engineering RE 4-76
2000 Stoner Ave., Los Angeles, CA 90025

I have been in electronics for _____ years. Please mail me your free bulletin which gives details concerning your electronics degree programs.

Name _____ Age _____

Address _____

City _____ State _____ Zip _____

Circle 71 on reader service card

**MATHEMATICS
ADVANCED MATHEMATICS
ELECTRONICS
ENGINEERING MATHEMATICS**

These unusual courses are the result of many years of study and thought by the President of Indiana Home Study, who has *personally* lectured in the classroom to *thousands* of men, from all walks of life, on mathematics, and electrical and electronic engineering.

You will have to see the lessons to appreciate them!

NOW you can master mathematics and electronics and actually *enjoy* doing it!

WE ARE THIS SURE:—you order your lessons on a money-back guarantee.

In plain language, *if you aren't satisfied you don't pay*, and there are no strings attached.

Write today for more information and your outline of courses.

You have nothing to lose, and everything to gain!

**The INDIANA
HOME STUDY INSTITUTE**
P.O. BOX 1189
PANAMA CITY, FLA 32401

Circle 72 on reader service card

**Some stores
sell test
equipment
at discount
prices.**

**At Fordham
we discount
their discount
prices.**

B&K, EICO, RCA, SENCORE
FLUKE, HICKOK, LEADER
and SIMPSON

Complete line of tubes,
tools and electronic supplies

**FREE CATALOG
FORDHAM**

RADIO SUPPLY CO., INC.

558 Morris Ave., Bronx, N.Y. 10451
Tel: (212) 585-0330

Circle 73 on reader service card

BAUDOT TO ASCII
(continued from page 83)

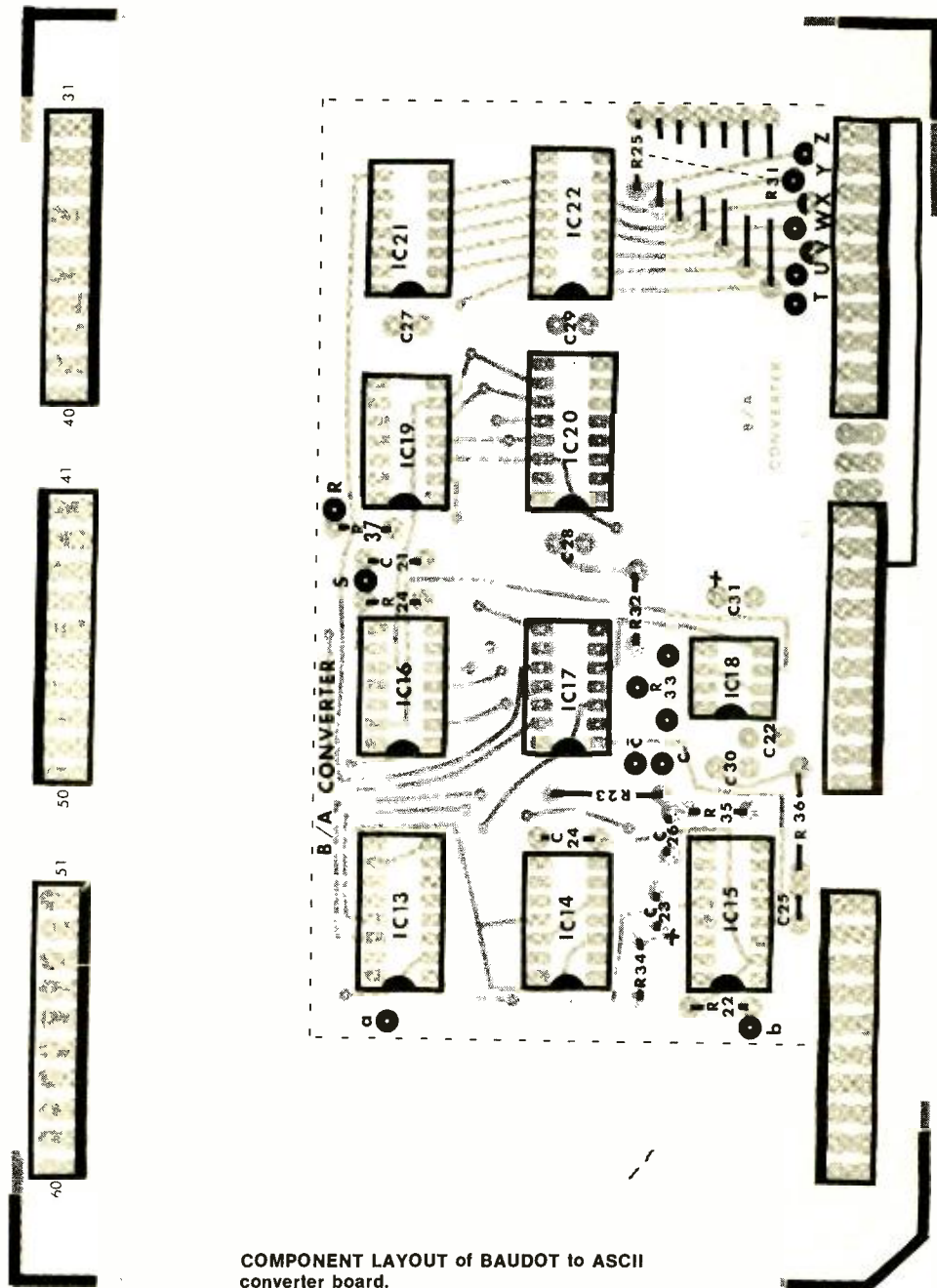

COMPONENT LAYOUT of BAUDOT to ASCII
converter board.

AN INTERMITTENT FLYBACK!

The reader wrote that he had two symptoms; a vertical shrink and roll, and then the raster went black. Since these aren't normally from the same cause, I investigated. In this chassis the vertical oscillator is fed from boost. So, I suggested checking the boost. If this dropped, it could cause these two symptoms.

He wrote back, and said "Since this showed up only at the customer's house, I figured he had excessive line voltage that was causing the flyback to break down. So, I raised the line voltage, on the bench, and out it went. Cool it off and it came back!

"I replaced the flyback, and cured the trouble. First intermittent I ever saw like this, in a flyback!" (Thanks to Jack Mandik, Evanston, IL.)

Thanks, Jack. Me too.

FLAT-TOPPING OF GRID-DRIVE

(Reader had previously written about problems in his scope. These were solved, then he wrote;) "Thanks for detailed suggestions regarding problems in Silvertone 7174. I used the scope, and sure enough, the grid-drive waveform on the 31JS6 tube flattened very decidedly when the trouble showed up. Replacing this tube cleared up the problem."
R-E

READER QUESTIONS

(continued from page 85)

D773 shorted. Replaced all of these, plus the fuse, and everything worked well. Current through 1.5-A fuse 800 mA. Then diode D773 shorted again! Took it out and fed the vertical module from a 20 volt DC power supply. Current drain of vertical section is 550 mA, and it played for hours.

Tried another diode, and it overheated. Tried feeding 60 Hz AC through it, and it overheated again! Something is odd here. What's going on?—F.A., Orlando, FL.

The crystal ball says that the vertical module is all right; not overloading the power supply. Since it will work "for hours" on an outboard DC power supply, and draw what sounds like about normal current, this much ought to be OK.

From the schematic (Sams 1443-2) this diode and the 3300- μ F filter-capacitor provide the +21.6 volt source that drives the vertical module. However, the drive waveform is 15,750 Hz! So, feeding the circuit with 60 Hz AC might keep the diode on too long and make it overheat. (Guess!)

More derating of this diode would be one way of helping. Try something like an RCA SK-3081, 1000 volts at 2.0 A. Alternate, do what several manufacturers have done in similar cases; parallel two diodes to raise the current handling ability. Won't take long to find out!

FOCUS VOLTAGE DROPS TO ZERO

If I disconnect the lead from the tube-base, pin 9, the focus voltage reads OK. If I reconnect the lead, the focus voltage drops to zero. Raster goes dark. Is the picture tube shorted? If so, can it be repaired?—B.C., Thurmont, MD.

The chances are that you do have a short in the focus electrode! With zero focus-voltage, the raster will go out. You might try this; disconnect the focus lead from the tube—leave the other leads and the high-voltage connected. Turn the set on and see what voltage, if any, you read on the open pin-9 lead. This might tell you something about where the short is. For instance, if you get about 750-800 volts, the focus would be shorted to one of the screens. You might blow the short out by discharging an electrolytic capacitor between the base pins. No guarantee on this, of course!

SYNC PROBLEM

I've got what looks like a sync problem in this RCA KCS-141 chassis. The voltages around the sync-separator seem to be pretty close. Changed the tube and checked capacitors. The voltage on the plate of the AGC keyer goes off now and then; sometimes to +15 volts. I could use some ideas!—L.P., Houston, TX.

There is one problem that I've run across on several occasions in this chassis. Check the voltage divider made up of R17 (12K, 2-watt) and R101 (47K, 2-watt) between the

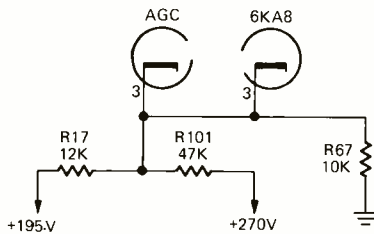

+195 volt and +270 volt lines. This sets the cathode voltage on both the AGC keyer and sync separator stages. If either one of these resistors opens or changes in value, it'll cause trouble in both AGC and sync. You'll have to break the circuit to get a valid reading of either one of these. Wouldn't hurt to check R67 (10K) to ground from this point as well.

(continued on page 95)

The Money Generator



GENERATES MONEY FOR YOU!

It's a DOG FIGHTER, TOO!

The Model ATC-10 is much more than a color bar pattern generator. It should be called a portable multi-purpose TV diagnostic and servicing aid, but that's too much of a mouthful. We would have nicknamed it the Dog Fighter (instead of the Money Generator), but that might be misinterpreted to mean that it's only useful in the shop. The versatile ATC-10, a portable, moderately-priced instrument, combines the most essential features of a color bar pattern generator, a TV "analyzer," and a substitute tuner plus several brand new "dog fighting" and timesaving innovations. With all this extra versatility, however, the ATC-10 is human engineered with only four simple-to-master controls.

Two illustrated brochures describe the ATC-10. The first brochure describes the many unique and unusual features which make the ATC-10 a "dog fighter" and a time-saver. The second brochure compares the money-making potential of the ATC-10 with 18 competitive models. It includes a comprehensive chart which compares the features of 19 makes and models, lists the estimated timesaving potential of these 33 respective performance features, and then calculates the money making potential of the various models. We think you are in for some surprises, such as the potential of the ATC-10 for returning its \$299.95 purchase price in as little as three or four months.

These brochures are yours for the asking — write direct for immediate reply.

American Technology Corporation

225 Main, Dept. 4C, Canon City, CO 81212

Circle 75 on reader service card

2 ACE KITS
ALL-CIRCUIT EVALUATOR
for fast, solderless, plug-in circuit building and testing
Just plug in any components with leads to .032 dia. Interconnect with solid wire up to 20 ga. Assembled models tool

Order No.	ACE Model No.	Tie Points	DIP Capacity	No. Buses	No. Posts	Board Size (Inches)	Price Each
923333	200-K (kit)	728	8 (16's)	2	2	4-9/16 x 5-9/16	\$18.95
923332	208 (assem.)	872	8 (16's)	8	2	4-9/16 x 5-9/16	28.95
923334	201-K (kit)	1032	12 (14's)	2	2	4-9/16 x 7	24.95
923331	212 (assem.)	1224	12 (14's)	8	2	4-9/16 x 7	34.95
923326	218 (assem.)	1760	18 (14's)	10	2	6-1/2 x 7-1/8	46.95
923325	227 (assem.)	2712	27 (14's)	28	4	8 x 9-1/4	59.95
923324	236 (assem.)	3648	36 (14's)	36	4	10-1/4 x 9-1/4	79.95

Gold-anodized aluminum base/ground; non-corrosive nickel-silver terminals; 4 rubber feet.

SEND ORDERS TO: **A P PRODUCTS INCORPORATED**
Box 110-R, Painesville, OH 44077

DEALER INQUIRIES INVITED

QTY	PART NO.	\$ EACH	\$ TOTAL

ACCOUNT NUMBER _____

NAME (PRINT) _____ ADDRESS _____ CITY _____ STATE _____ ZIP _____

SIGNATURE _____

PRINT NAME _____

SHIP TO: _____

Merchandise Total _____
Sales Tax (OH & CA) _____
Shipping (see below) _____
TOTAL ENCLOSED _____

SHIPPING/HANDLING: Up to \$10.00 \$1.00; \$10.01 to \$25.00 1.50; \$25.01 to \$50.00 2.00; \$50.01 to \$100.00 2.50; \$100.01 to \$200.00 3.00

ORDERS SUBJECT TO ACCEPTANCE AT FACTORY
Company P.O.'s F.O.B. Painesville

APRIL 1976

If you can't go to college for your career in electronics -read this!

CREI brings college-level training to you with eight educational advantages, including special arrangements for engineering degrees

The best way to qualify for top positions and top pay in electronics is obviously with college-level training. The person with such training usually steps more quickly into an engineering level position and is paid considerably more than the average technician who has been on the job several years.

A regular college engineering program, however, means several years of full-time resident training—and it often means waiting several years before you can even start your career. This, of course, is difficult if you must work full time to support yourself and your family.

If your career in electronics is limited without college-level training, take a look at the advantages a CREI home study program can offer you.

1. Convenient Training

CREI brings the college to you. Through the convenience of home study, you receive exactly the same level of training you will find in any college or university offering programs in electronic engineering technology. With CREI, however, you can “go to college” whenever you have spare time at home or on the job.

2. Specialized Programs

With CREI, you enjoy the advantage of *specialized* training. That is, your program will include only those courses directly applicable to your career in electronics. We omit such courses as English, social studies and other subjects, which are usually required in resident schools. Therefore, with CREI, you move ahead faster to the more interesting and useful part of your training.

3. Practical Engineering

CREI programs give you a *practical engineering* knowledge of electronics. That is, each part of your training is planned for your “use on the job.” By using your training, you reinforce the learning process. And by demonstrating your increased knowledge to your employer, you may qualify for faster career advancement.

4. Engineering Degrees

CREI offers you a number of special arrangements for earning engineering degrees at recognized colleges and universities. You can earn college credit while you are taking your CREI program or apply later, whatever is best for your career plans.

Career Training at Home

5. Unique Laboratory

Only CREI offers you the unique Electronic Design Laboratory Program. This complete college laboratory makes learning advanced electronics easier and it gives you extensive practical experience in many areas of engineering, including design of electronic circuits. No other school offers this unique program. It is a better "Lab" than we have found in many colleges. And the professional equipment included in the program becomes yours to keep and use throughout your professional career.

6. Wide Program Choice

CREI gives you a choice of specialization in 14 areas of electronics. You can select exactly the area of electronics best for your career field. You can specialize in such areas as computer electronics, communications engineering, microwave, CATV, television (broadcast) engineering and many other areas of modern electronics.

7. Prepared by Experts

Experts in industry and technical organizations of government develop CREI programs. Each part of your training is developed by a recognized expert in that area of electronics. That means you get the most up-to-date and practical instruction for your career.

8. Industry Recognition

That CREI training is recognized by industry and government is evident from the fact CREI provides training to advanced technical personnel in over 1,700 technical organizations. Many subsidize the training of their employees with CREI. If there is any question about the advantages of CREI training for you, ask your employer or any engineer to evaluate the outline of a CREI program for you.

Other Advantages

Of course, there are many other advantages to CREI training. For example, throughout your training, CREI's staff gives you personal instruction for each step of your program. And in many industrial areas, both in the U. S. and abroad, CREI Field Service Representatives provide a number of important personal services for your training and your career.

FREE Book

There isn't room here to give you all of the facts about career opportunities in advanced electronics and how CREI prepares you for them. So we invite you to send for our free catalog (if you are qualified). This fully illustrated, 80 page catalog describes in detail the programs, equipment and services of CREI.

Qualifications

You may be eligible to take a CREI college-level program in electronics if you are a high school graduate (or the true equivalent) and have previous training or experience in electronics. Program arrangements are available depending upon whether you have extensive or minimum experience in electronics.

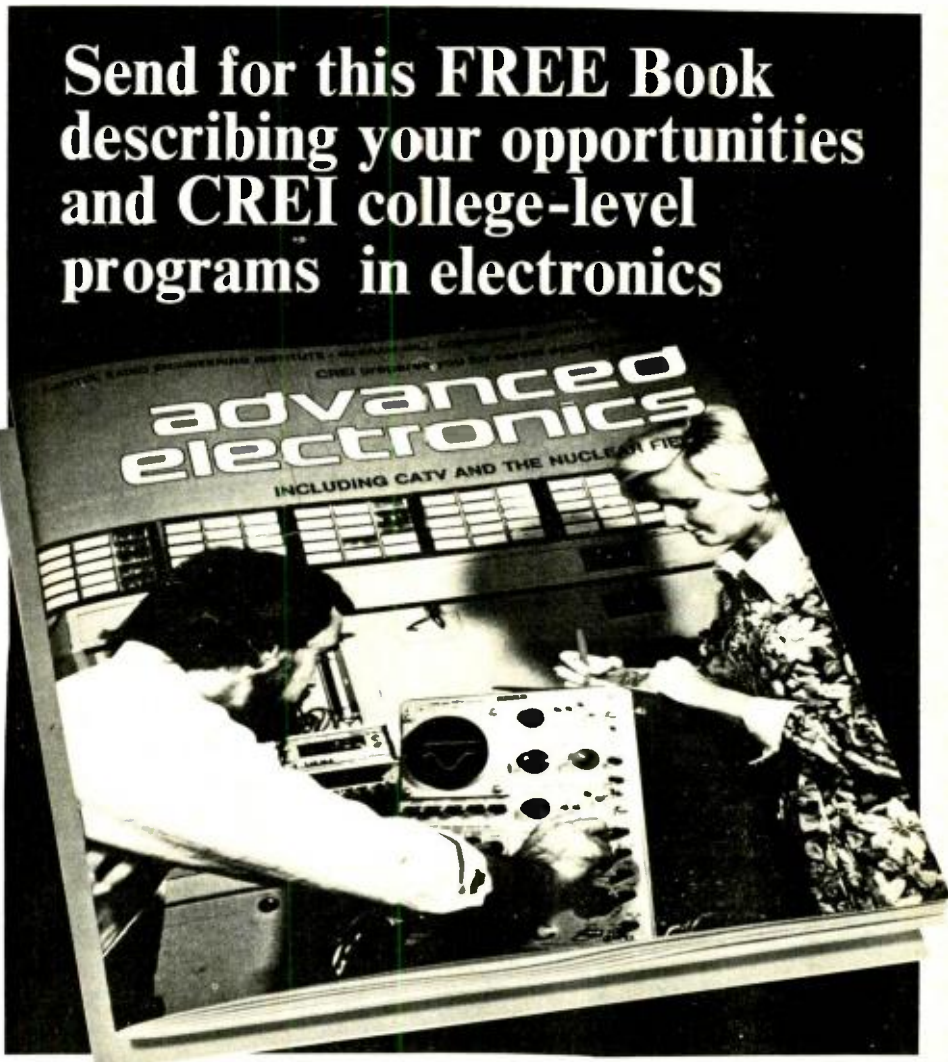

Mail card or write describing qualifications to

CREI **CAPITOL
RADIO
ENGINEERING
INSTITUTE**

McGraw-Hill Continuing Education Center
3939 Wisconsin Avenue Northwest
Washington, D.C. 20016

Accredited Member National Home Study Council

GI Bill

CREI programs are approved for training of veterans and servicemen under the G.I. Bill.



APRIL 1976

GARAGE DOOR OPENER

(Continued from page 52)

Now that many families are two-car families, the first accessory that comes to mind is an extra transmitter. Since manufacturers generally include only one transmitter per unit, the convenience and need for an extra transmitter for the second car cannot be overstated.

Another item in demand is an outdoor key-switch control. The key-switch installs in the garage door and allows the homeowner to unlock and

open the garage door with a key instead of having to use the transmitter. Suppose the homeowner is outside and the car is in the garage. With the key switch the homeowner can easily open the garage door. This is particularly important if the garage is a main access route to the home.

A third accessory is a wall button for operating the garage door from a second location, such as the kitchen. This allows the homeowner to open and close the garage door without having to use the transmitter or walk into the garage to operate the switch on the receiver.

Service is easy

Servicing the garage door opener is usually easier than installing it. Most manufacturers use solid-state radio controls to provide years of service without worrying about vacuum tubes burning out. The greatest number of reported problems (inadequate distance or failure to operate) are corrected by replacing the battery in the transmitter.

The only regular maintenance the garage door opener requires is lubrication of the rail. This is done only once a year with a light, spray lubricant.

Door force and opener-limit adjustments are usually made at the factory, but because garage doors vary, extra adjustment may have to be made after the opener is installed. If the door reverses itself at any point in travel, the door force must be adjusted.

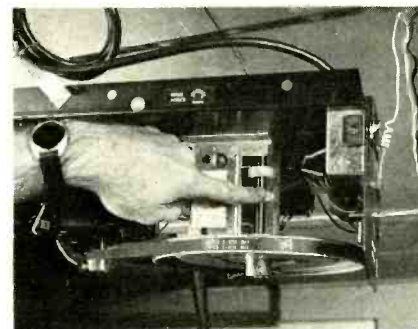

If the door does not open fully, the opener limits need adjustment. Slide the power head chassis-cover forward. Adjustments are made by turning the large plastic limit nuts up or down a threaded shaft located just behind the motor. One complete revolution of the limit nut equals three inches of trolley travel. All adjustments require complete turns.

There are other minor problems that occasionally develop and these are usually attributable to even more minor causes, many requiring only minor electrical adjustments. For example:

- If the power head completely stops, check the electrical supply. Specifically, check for loose plugs, a blown fuse or circuit breaker and power shutoff.
- If the garage-door operates from the wall switch but not from the transmitter, it is most likely because the battery in the transmitter is dead.
- If the unit turns on but does not lift the door, the door may have been accidentally locked. All locks should be deactivated.
- If the garage light does not turn on when the door opens, check the bulb, socket and socket wires.

Installing garage-door openers are easy, lucrative and does not require a large capital investment in inventory. Don't overlook this possibility to expand your business.

R-E

APRIL 1976

Super Specials!

AT ALL ALLIED WAREHOUSES

20,000 OHMS/VOLT 25-RANGE MULTITESTER

This multitester has a range switch with "off" position and a 3-color meter for easy readings. DC/V. 0 to 1200 in 7 ranges. AC/V. 0 to 1200 in 5 ranges. DC Current. 0-60 μ A, 0 to 300mA in 3 ranges. Resistance. 0.5k-50k-500k-5 meg. Decibels. -20 to +63 in 5 ranges. Output jack. zero adjust. test leads. battery. instructions included. 5x3 $\frac{3}{4}$ x1 $\frac{1}{2}$ Shpg. wt. 1 lb. 910-4522 Each 17.95



DO-IT-YOURSELF PANEL METER

Custom design your own meter face. 34 microamps for full deflection. 1.5k coil resistance. Deviation from linearity is less than 1/2% of full scale. Mounting holes width 1". Panel dimensions are 2 $\frac{3}{4}$ x3".

910-0999 Each 2.95

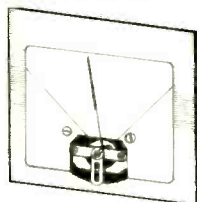

Now 17.95

Was 20.95

MINI-SIZE MODULAR PRINTED CIRCUIT REED RELAYS

Now 2.25
Was 6.02

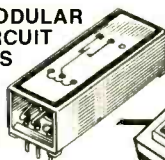

Relays have integrally molded bobbin and term. board. Welded capsule leads and support term. Contact load rating: 3 VA Max. @ 0.25 A Max. or 28 VDC Max. Resistive. Typical life at rated load: 10 M operation — longer at reduced load.



SPST "SLIDELITE" SWITCH HAS SNAP-IN INSTALLATION

Designed for snap-in panel mounting. SPST switch is rated at 6.0 amps AC or 1.0 amp DC at 125V. Neon lamp with 1/2W series resistor for 125 VAC. Wire leads 6" long. 1 $\frac{25}{64}$ " long x 1 $\frac{1}{32}$ " wide x 2 $\frac{1}{32}$ " deep. 844R7501 Each 1.07

Now 1.07

Was 2.25

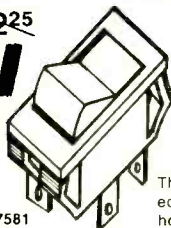

SNAP-IN ROCKER SWITCH

25¢ Each in Lots of 10

This SPDT rocker switch is an economical buy for the electronics hobbyist who has a limited budget. Easy to install, no drilling or screws required. Simply snap switch into place. White plastic housing. 10 amps at 70 volts, 4 amps at 120 volts. UL listed. 1 $\frac{1}{16}$ " long x 7 $\frac{1}{16}$ " wide x 9 $\frac{1}{16}$ " deep. (1 $\frac{1}{16}$ " deep including prongs.) MINIMUM ORDER OF 10. 910-0300 10 for 2.50

Stock No.	Allied Type No.	Coil Data		EACH
		VDC	Ohms	
703-2014	AMP2014	5	450	2.25
703-2011	AMP2011	6	70	2.25
703-2012	AMP2012	12	300	2.25

THREE ALLIED LOCATIONS TO SERVE YOU

GARDEN GROVE, CALIFORNIA. 12311 Industry Street, Garden Grove, California 92641. (714) 894-7581

ELGIN, ILLINOIS. 1355 Sleepy Hollow Road, Elgin, Illinois 60120. (312) 697-8200

FORT WORTH, TEXAS. 401 E. 8th Street, Fort Worth, Texas 76102. (817) 336-5401

YOUR SOURCE FOR P&B RELAYS

AME Potter & Brumfield

ALLIED ELECTRONICS

A DIVISION OF TANDY CORPORATION

next month

MAY 1976

■ Build An 8080 Computer

It's faster and is easier to build than the Mark 8 that started the whole hobby computer craze. Build this machine, complete on a single circuit board, for \$350 including software package.

■ More Tach & Overspeed circuits

Handy devices to add to your car. They are all solid-state circuits and easy to build. Most important of all they make practical additions.

■ MATV Equipment & Accessories

A roundup of what's new in this growing industry. Take a look at the equipment and how it is being used today.

■ Phase Linear Speakers

A new speaker system answers the problem of phase linearity in speaker design. Len Feldman explains how it works.

PLUS

State of Solid State

Step-By-Step Troubleshooting Charts

Equipment Reports

Hi-Fi Lab Test Reports

Jack Darr's Service Clinic

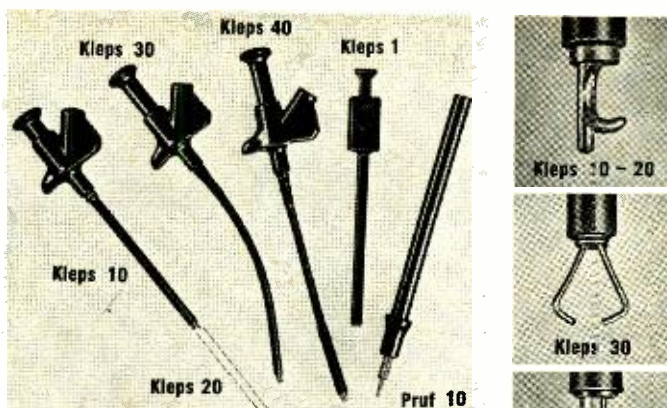

Clever Kleps

Test probes designed by your needs — Push to seize, push to release (all Kleps spring loaded).

Kleps 10. Boathook clamp grips wires, lugs, terminals. Accepts banana plug or bare wire lead. 4¾" long. **\$1.39**

Kleps 20. Same, but 7" long. **\$1.49**

Kleps 30. Completely flexible. Forked-tongue gripper. Accepts banana plug or bare lead. 6" long. **\$1.79**

Kleps 40. Completely flexible. 3-segment automatic collet firmly grips wire ends, PC-board terminals, connector pins. Accepts banana plug or plain wire. 6¼" long. **\$2.59**

Kleps 1. Economy Kleps for light line work (not lab quality). Meshing claws. 4½" long. **\$.99**

Pruf 10. Versatile test prod. Solder connection. Molded phenolic. Doubles as scribing tool. "Bunch" pin fits banana jack. Phone tip. 5½" long. **\$.89**

All in red or black - specify. (Add 50¢ postage and handling).

Write for complete catalog of - test probes, plugs, sockets, connectors, earphones, headsets, miniature components.

Available through your local distributor, or write to:



RYE INDUSTRIES INC.

130 Spencer Place, Mamaroneck, N.Y. 10543

In Canada: Rye Industries (Canada) Ltd.

Circle 77 on reader service card

Accuracy like a VTVM... Convenience like a VOM...

NEW BATTERY-OPERATED FET
SOLID-STATE VOLT-OHMMETER #116

Easy-to-build KIT

\$36.90 =116K

Factory-Wired & Tested

\$49.49 =116W

Now you can get all the benefits of a VTVM (laboratory accuracy, stability and wide range) but with its drawbacks gone: no plugging into an AC outlet, no waiting for warm-up, no bulkiness. New Field Effect Transistor (FET) design makes possible low loading, instant-on battery-operation and small size. Excellent for both bench and field work.

Compare these valuable features:

- High impedance low loading: 11 meg-ohms input or DC, 1 megohm on AC
- 500-times more sensitive than a standard 20,000 ohms-per-volt VOM
- Wide-range versatility: 4 P-P AC voltage ranges: 0-3.3, 33, 330, 1200V; 4 RMS AC voltage ranges: 0-1.2, 12, 120, 1200V; 4 DC voltage ranges: 0-1.2, 12, 120, 1200V; 4 Resistance ranges: 0-1K, 0-100K, 0-10 meg., 0-1000 meg.; 4DB ranges: -24 to +56DB.

Sensitive easy-to-read 4½" 200 micro-amp meter. Zero center position available. Comprises FET transistor, 4 silicon transistors, 2 diodes. Meter and transistors protected against burnout. Etched panel for durability. High-impact bakelite case with handle useable as instrument stand. Kit has simplified step-by-step assembly instructions. Both kit and factory-wired versions shipped complete with batteries and test leads. 5¼"H x 6¾"W x 2¾"D. 3 lbs.



Send FREE catalog of complete EMC line and name of nearest distributor.

RE-4

Name _____

Address _____

City _____

State _____ Zip _____

EMC

ELECTRONIC MEASUREMENTS CORP.
625 Broadway, New York, N.Y. 10012

APRIL 1976

93



endeco soldering & desoldering equipment

SOLDERING IRONS

Pencil style. Safety light. Two heats — 20w and 40w. 6 tips. Unbreakable handle. 2 and 3 wire neoprene cords.

DESOLDERING IRONS

Pencil style. Safety light. Some operate at 40w, idle at 20w. 8 tip sizes. 2 and 3 wire neoprene cords.

SOLDERING & DESOLDERING KITS

Everything needed to solder or desolder or both. All in a handy lifetime metal box with hasp.

See your distributor or write...

Enterprise Development Corp.

5127 E. 65th St. • Indianapolis IN 46220
PHONE (317) 251-1231

Circle 78 on reader service card

PONG GAME - This kit generates adjustable ball and paddles, adjustable upper and lower court boundaries, audio sound effects, and a non-numeric score indicator on your TV set. Includes controls to allow horizontal and vertical paddle movement. Although the kit consists of standard TTL parts, it is fairly complex and requires some knowledge of electronics to build it and access to an O-scope to adjust it. The kit comes complete with an etched and drilled, double-plated-through P.C. board, instructions, and all parts including control pots, but less case.

TV Pong Game Kit \$59.95 ppd.

6 digit AUTOMOTIVE CLOCK KIT complete with a CRYSTAL TIMEBASE accurate to .01 percent. 12 volts d.c. operation — built in noise suppression and voltage spike protection. Readouts blank when ignition is off — draws 25 mA in standby mode. Has .3 in. readouts. Use it in your car or for all applications where a battery-operated clock is needed. Approximate size 3" x 3.5" x 1.75"

WITH BLACK PLASTIC CASE \$34.95 ppd.
WITHOUT CASE \$29.95 ppd.
ASSEMBLED AND TESTED \$45.95 ppd.

CMOS CRYSTAL TIMEBASE KITS with .01 percent accuracy, 5-15 v.d.c. operation. Draws only 3 mA at 12 volts. Single I.C. — very small size — the P.C. board is 7/8" x 1-5/8". Choose a main output of 50 or 100 Hz., 60 Hz., 500 or 1000 Hz., or 1 Hz. Several related frequencies are also available on each board, in addition to the main ones listed above. Be sure to specify the Frequency you want. All kits are \$10.95 ppd.

NEXUS TRADING CO

Box 3357 San Leandro, Ca 94578

Circle 110 on reader service card

COMPUTER TERMINAL SPEAKS JAPANESE



JAPANESE TEACHERS AND STUDENTS inspect a new computer terminal that prints out information in Japanese characters, it is being demonstrated for them by Frank Taylor of the Raytheon Data Systems plant in Norwood, MA. The audience is part of a 36-person delegation sent by the Japanese Institute for Cultural Studies, who are on a month-long cultural exchange as guests of Boston University. Half the group are teachers of English and business in the Japanese public school system; others are Japanese college students who are continuing their education in the United States.

Newest equatorial satellite will study communications

The Communications Technology Satellite (CTS) launched from Cape Canaveral, January 13, is the focal point of an international venture into the study of space communications, in which NASA and three American universities are involved.

Besides communications research, CTS will carry out a variety of education, health-care and community service demonstrations in remote areas.

Research of millimeter reception is one of the main projects for the satellite, according to information from the News Bureau of Ohio State University, one of the schools taking part in the study. (The other two are the Virginia Polytechnic Institute and the University of Texas.) The millimeter band offers great advantages, among them being inexpensive receivers, compact antennas and a fantastic signal capacity.

A second important objective of the project is a quantitative study of scintillation—the atmospheric turbulence that causes stars to twinkle. An understanding of scintillation might be useful in studying a number of not entirely understood effects on communication, such as some types of fading and possibly the sunrise effect—that sudden change in signal strength at sunrise or sunset.

Ohio State University is receiving the signals from the satellite with the antenna consisting of four dishes in a "self-phased" array. Each dish measures only a meter in diameter. Although the satellite is "fixed" in position above the equator at 116° west longitude, its position varies slightly because of variations in the earth's rotational pattern. The ground station tracks the satellite by measuring the difference in signal strength as received by each of the dishes and using the result to "phase" the antenna to aim it at the satellite. The physical array remains stationary—all the tracking is accomplished electronically.

R-E

MINI-BAR[®] color generator

\$89.50

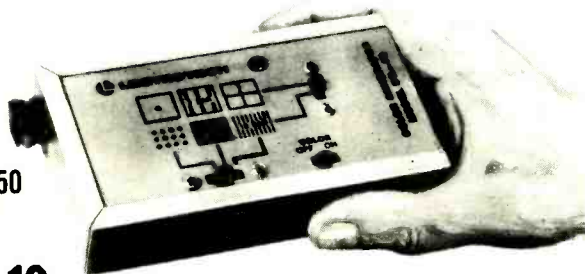

BG-10 battery-operated, fits in shirt pocket!

No AC plug in . . . automatic on & off with LED indicator . . . fast, easy hook-up with coaxial cable . . . all essential patterns . . . • Low power consumption for extended battery life (Uses inexpensive 9 volt batteries) • Shuts off when not in use • Enclosed RF cable compartment • Size: 5 1/2" x 3" x 1 1/8". Only 12 ounces • TV station type sync signals • CMOS LSI IC for all counting functions . . . no internal adjustments • RF output on Ch. 3, 4 or 5.

BG-10 (less battery) \$89.50
CC-1 Carrying Pouch \$ 2.95



See your distributor or write

LECTROTECH, INC.

5810 N. Western Ave.,
Chicago, Illinois 60659
(312) 769-6262

Circle 79 on reader service card

2
+2
5

Double
check
your
tax
return.

Errors
delay
refunds!

Internal
Revenue
Service

READER QUESTIONS

(continued from page 87)

POWER FILTER OUT

I can't get anything through the active power-filter circuit in this Philco B311 TV. The collector voltage is 19.5, the base voltage also 19.5, and the emitter voltage is zero. If I connect an external 12-volt supply to the emitter, the set works fine. I've changed the transistor, the resistor and the capacitor, but nothing helps. Why isn't the transistor turning on?—D.R., Rockwood, MI.

You're right; that's wrong! The transistor is definitely not conducting at all. The base circuit here is from the V_{cc} supply, through VR3, R85 and the base-emitter junction of Q100. Since you have (wisely) tried a new transistor and

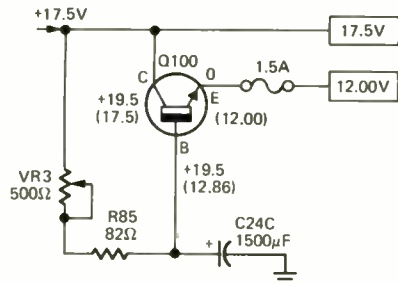

NOTE: PART NUMBERS ARE FROM SAMS 1334-3.

parts, that clears that much up. The emitter circuit returns through the load circuits. The load circuits are clear because they'll work with an external power supply.

So! This leaves us with only one good suspect; the transistor socket, the wiring, and so on. Take your DC voltage readings right on the pins of the transistor itself, and see if you get something open!

NO TINT CONTROL

Due to an accidental short while plugging in some controls, the tint control, transformer, and a couple of resistors blew up in this Penncrest 2890. These were replaced. Now I have good color, flesh tones, and so on, but the tint control has no effect at all! What do you think?—A.T., Benton, IL.

I think you still have something wrong in or around the tint control circuit itself. Since the control and the transformer were replaced, this would leave only the cable from chassis to control. This is probably one of those tiny coax cables we see so often of late. The initial short may have blown the center conductor open or caused the coax to short. Disconnect it and check. Check the tiny choke marked L503; this may have been burnt when the short hit.

GEAR TOOTH JITTER

This Wards Airline GEN-17148B has a problem with horizontal stability. Vertical lines are "rippled" (the old "gear-tooth" effect) and the horizontal hold control has very little hold-range. The picture won't jump to a double image, though. I've bridged electrolytic filters without any luck. Where to go now?—M.R., Gregory, MI.

Try grounding the pin-2 grid of the 6FQ7 horizontal oscillator tube, and see if you can juggle the hold control to make a single picture without the gear-tooth effect. If you can, this trouble is in one of two places. It may be a badly unbalanced AFC diode unit or a loss of the horizontal sync pulse feeding the diodes. You have the typical symptoms—narrow hold range, etc.

If the gear-tooth effect isn't cleared up by this, check the anti-hunt network capacitors (below the AFC diode unit on the schematic; Sams Photofact SED in 1288.) One of these parts may be open.

R-E

Mark Ten Electronic Ignitions put lightning under the hood.

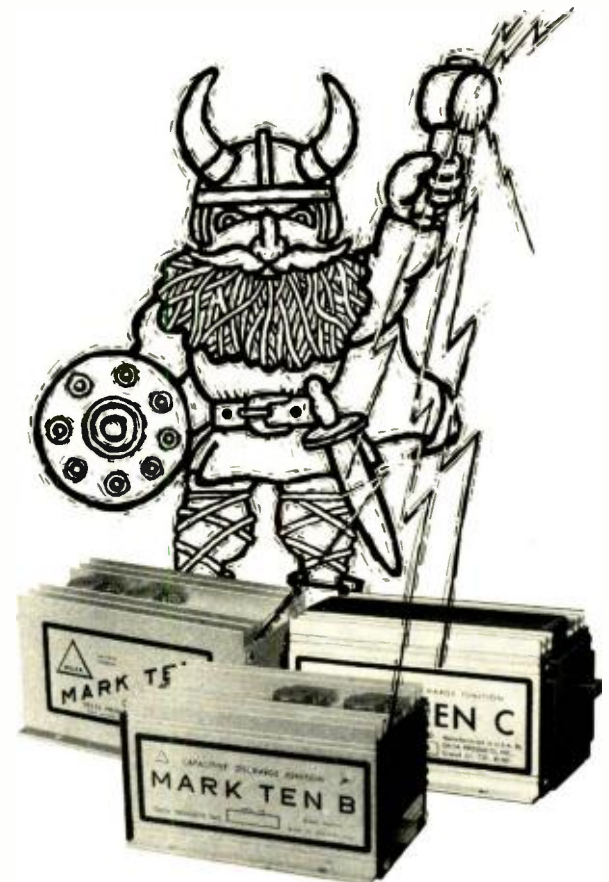

It's like having a bolt of lightning under the hood of your car when you feel it burst into action. And that's not all you'll feel with one of Delta's three HOT, HOT ignition systems. You'll feel the contentment of knowing your car will start INSTANTLY no matter how hot or cold the weather, the relief of fast, safe entry onto teaming freeways with POWERFUL ACCELERATION, and the satisfaction of pocketing all that money you'll save, not only from INCREASED GAS MILEAGE, but from all the TUNE-UPS you can forget about (at least 2 out of 3). And that's just for starters. Send today for free, color brochure jam-packed with helpful facts on how Delta's Mark Ten, Mark Ten B and Mark Ten C Capacitive Discharge Electronic Ignitions can help make driving a better experience for you.

I want to know more about Mark Ten DCI's. Send me complete nonsense information on how they can improve the performance of my car.

Name _____

Address _____

City _____ State _____ Zip _____

DELTA PRODUCTS, INC.

P.O. Box 1147, Grand Junction, Colo. 81501
(303) 242-9000 Dept. RE

Circle 80 on reader service card

APRIL 1976

55



POLY PAKS
CELEBRATES THE
BICENTENNIAL WITH A
"ONE-CENT" ANNIAL

HONEST "ABE" SALE

Order by Cat. No. 4R1983 & Type. No. below

Type	Sale	2 for	Type	Sale	2 for
SN7400	.22	.23	SN7490	1.00	1.01
SN7401	.22	.23	SN7491	.91	.92
SN7402	.22	.23	SN7494	.82	.83
SN7403	.22	.23	SN7495	.85	.87
SN7404	.24	.25	SN7496	.88	.87
SN7405	.38	.37	SN7498	1.50	1.51
SN7407	.46	.47	SN74112	.89	.90
SN7408	.22	.23	SN74120	1.29	1.30
SN7409	.82	.81	SN74126	1.29	1.30
SN7410	.22	.23	SN74132	1.95	1.98
SN7411	.27	.28	SN74140	2.60	2.61
SN7414	2.78	2.78	SN74141	1.12	1.13
SN7416	.44	.45	SN74145	1.69	1.70
SN7417	.62	.63	SN74146	3.28	3.26
SN7420	.22	.23	SN74150	1.32	1.33
SN7421	.88	.86	SN74153	1.10	1.11
SN7423	.47	.48	SN74154	1.53	1.54
SN7425	.37	.38	SN74155	1.39	1.40
SN7428	.27	.28	SN74156	1.38	1.40
SN7430	.22	.23	SN74157	1.09	1.10
SN7432	.34	.37	SN74158	1.55	1.56
SN7437	.42	.43	SN74160	1.58	1.60
SN7438	.42	.43	SN74161	1.90	1.91
SN7440	.22	.23	SN74163	1.80	1.81
SN7442	.97	.98	SN74164	1.79	1.80
SN7443	.97	.98	SN74165	1.79	1.80
SN7444	.97	.98	SN74166	1.85	1.86
SN7446	.97	.98	SN74173	1.69	1.70
SN7448	1.10	1.11	SN74174	1.42	1.43
SN7447	1.10	1.11	SN74175	1.45	1.46
SN7448	1.10	1.11	SN74176	1.85	1.86
SN7450	.22	.23	SN74177	1.89	1.90
SN7451	.27	.28	SN74179	2.50	2.51
SN7453	.22	.23	SN74180	2.45	2.46
SN7454	.22	.23	SN74181	2.75	2.76
SN7455	.22	.23	SN74182	1.09	1.10
SN7456	.22	.23	SN74184	2.18	2.20
SN7457	.44	.45	SN74185	2.75	2.76
SN7458	1.00	1.01	SN74191	2.78	2.78
SN7460	.84	.85	SN74183	2.18	2.20
SN7482	.99	1.00	SN74194	2.19	2.20
SN7483	.99	1.00	SN74195	.88	.90
SN7485	1.41	1.42	SN74196	2.18	2.20
SN7486	.47	.48	SN74197	2.25	2.28
SN7488	2.95	3.98	SN74198	2.25	2.28
SN7489	2.28	2.26	SN74199	2.25	2.28

MINIMUM ORDER — \$6.

Phone: Wakefield, Mass. (617) 245-3829

Terms: Add postage. Rated: net 30

POLY PAKS
P.O. BOX 942R LYNNFIELD, MASS. 01940

C.O.D.'s MAY
BE PHONED

Circle 84 on reader service card

DISPLAYS

9 digits mini OPTOSTICK 1/8" car. ht. red semi-circle \$3.95 ea.

9 digits micro OPTOSTICK 1/8" car. ht. clear lenses

3" Height LED \$1.20 ea.

Red EAN 72 C.A., EAN 74 C.C.

Yellow EAN 82 C.A., EAN 84 C.C.

LED DISCRETE LAMPS

.125" DIA. and .190" Red, Yellow, Green 5 for \$1.00

SAME DAY SERVICE

SEND FOR OUR FREE COMPONENTS CATALOG.

Transistors, Tubes, I.C., Resistors, Capacitors, etc.

LOW, LOW, LOW PRICES

Special of the month

10 position single deck rotary switch, 1 1/4" shaft by oak mfg. 39 ea - 4 for \$1.00

Minimum order: \$5.00 - Add .50c for postage and handling.

California residents add 6% sales tax.

Mail order to: Electronic Warehouse Inc.
1603 Aviation Blvd. - Dep. E
Redondo Beach, CA 90278
(213) 376-8005

Circle 85 on reader service card

market center

CLASSIFIED COMMERCIAL RATE (for firms or individuals offering commercial products or services). \$1.40 per word . . . minimum 15 words.

NONCOMMERCIAL RATE (for individuals who want to buy or sell personal items) 85¢ per word . . . no minimum.

ONLY FIRST WORD AND NAME set in bold caps. Additional bold face (not available as all caps) at 10¢ per word. Payment must accompany all ads except those placed by accredited advertising agencies. 10% discount on 12 consecutive insertions, if paid in advance. All copy subject to publisher's approval. Advertisements using P.O. Box address will not be accepted until advertiser supplies publisher with permanent address and phone number. Copy to be in our hands on the 26th of the third month preceding the date of the issue (i.e. August issue closes May 26). When normal closing date falls on Saturday, Sunday or a holiday, issue closes on preceding working day.

BUSINESS OPPORTUNITIES

HIGHLY PROFITABLE ONE-MAN ELECTRONIC FACTORY

Investment unnecessary, knowledge not required, sales handled by professionals. Ideal home business. Write today for facts! Postcard will do. Barta-BD, Box 248, Walnut Creek, CA 94597.

TV shop for sell, netting \$25,000.00 yearly, 1-3 man operation, well established. Houston, TX 713-661-2541

OWN YOUR OWN PICTURE TUBE REBUILDING BUSINESS

With Lakeside Industries re-building equipment you can rebuild any picture tube!

For complete details send name, address zip code to

LAKESIDE INDUSTRIES
3520 W Fullerton Ave.
Chicago, Ill. 60647
Phone 312-342-3399

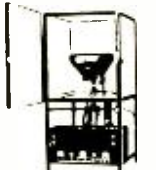

EDUCATION & INSTRUCTION

MICROPROCESSOR, M6800 Instructional Lab-Preprogrammed, includes CPU, DEBUG ROM, RAM, ACIA, PC BOARD, Teletype provision; expandable; with Programming/Application Manuals; \$19.00 kit; money order, B/Acard, Master Charge. **COMPUTER SYSTEMS**, 18430 Morang, Detroit, MI 48205 (313) 779-8700

DIGITAL Design Newsletter design, theory, construction, kits. Sample \$1.00. **ROM ASSOCIATES**, Box 296R, Weston, MA 02193

F.C.C. EXAM MANUAL

PASS FCC EXAMS! Memorize, study—Tests—Answers for FCC 1st and 2nd class Radiotelephone licenses. Newly revised multiple choice questions and diagrams cover all areas tested in FCC exams, plus Self-Study Ability Test. \$9.95 postpaid. Money-back guarantee.

Tests—Answers for FCC First and Second Class Commercial Licenses

COMMAND PRODUCTIONS P.O. BOX 26348 E
RADIO ENGINEERING DIV SAN FRANCISCO, CAL 94126

MANUALS for Govt. surplus radios, test sets, scopes. List 50¢ (coin). **BOOKS**, 7218 Roanne Drive, Washington, DC 20021

Be Coin Machine Mechanic ... in 4 Months

(Pinball, Juice Box, Vending Machines)

CASINO TRAINING CENTER
2454 Industrial Blvd., Las Vegas, NV 89102 Resident School

Name _____ Age _____

Address _____

City _____ State _____ Zip _____

Phone () _____ 76-4-36

FREE educational electronics catalog. Home study courses. Write to: **EDUKITS WORKSHOP**, Dept. 278G, Hewlett, NY 11557

ELECTRONICS DESIGN NEWSLETTER

- ★ Logic Design Techniques
- ★ Digital & Linear Design Theory & Procedures
- ★ Construction Projects

Learn Design Techniques!

Win for FREE CATALOG of parts & kits

Subscription \$6 Sample Copy \$1

VALLEY WEST Box 2119-L Sunnyvale, CA 94087

TELEPHONE bugged? Don't be Watergated! Countermeasures brochure \$1.00. **NEGEYE LABORATORIES**, Box 547-RE, Pennsboro, WV 26415

FCC License Study Guide. New, 377 pages. Includes 1465 FCC-type questions, with answers and discussions, covering third, second, and first class radiotelephone exams. \$8.95 postpaid. **GSE PUBLICATIONS**, 2000 Stoner Ave., Los Angeles, CA 90025

FOR SALE

ALTAIR 8800 software, Games, Pictures, Business and Engineering packages, hardware kits. Send \$1 for catalog. **SRI**, PO Drawer C, Marcy, NY 13403



Red Cross. The Good Neighbor.

MEASURE AC current using your VOM. \$7.95 0-12 amp adapter plugs into VOM receptacles. Also available: Power factor measurement adapter—\$17.95. Send for details. **I.R.C.** Box 262, Massapequa, NY 11758

— econotrace —

EQUIP YOUR LAB OR SHOP WITH A GENUINE QUALITY SEMICONDUCTOR CURVE TRACER. MEASURE BETA, LEAKAGE, BVCEO, NOISE, MATCH PAIRS, ETC. USES LATEST CMOS CIRCUITRY. COMPLETE WITH BATTERY. COMPARES WITH TRACERS SELLING FOR \$150.00 OR MORE AND EASIER TO OPERATE. SEND CHECK FOR \$34* PLUS \$1** FOR POSTAGE & HANDLING. COLD RES. ADD 3 1/2% SALES TAX. MONEY BACK GUARANTEE.

lab science

PO BOX 1972 BOULDER, COLO. 80302

ELECTRONIC Bargains! New and surplus parts. Catalog 25¢, refundable w/order. **ATLANTIS**, Box 12654R, Tucson, AR 85711

JAPANESE transistors. All transistors original factory made. Free catalog. **WEST PACIFIC ELECTRONICS**, P. O. Box 25837, W. Los Angeles, CA 90025

4 DIGIT ALARM CLOCK

\$15.95

KIT No. 1 (with PC Board)

Features the only LED direct drive clock chip on the market. Kit includes all parts (except transformer) for a 4-digit alarm clock kit. Uses 25 inch LED readouts.

Transformer for Kit No. 1 \$ 2.00

Kit No. 2 - Complete Kit With Woodgrain Case and Display Window\$21.50

Kit No. 3 - Same as Above but with 1/2 inch Readouts\$22.50

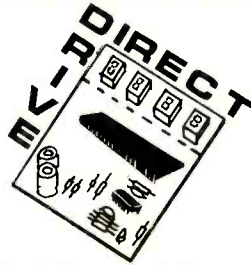

THE KING OF ALTAJ



Follow the King in future issues, and he will introduce a series of fantastic Maidens representing sophisticated circuits designed Especially for the KING.



DIGITAL ALARM CLOCK

THE KING-FEATURES:

- 1.) 6 digit, 12 or 24 hour, 50 or 60 cycle alarm clock
- 2.) Time sharing capability for display of additional information
- 3.) Built-in alarm generator and automatic output for intensity control of LED's.
- 4.) Single 12v supply and a minimum of interface components.
- 5.) AM-PM and automatic power failure indications.
- 6.) 10 minute snooze.
- 7.) Complete data and construction manual enclosed.



\$ 23.50

Kit No. 70250 1R (Red readouts)
Kit No. 70250 1Y (Yellow readouts)\$23.50
Kit No. 70250 1G (Green readouts)\$23.50
Kit No. 70250 2R (DL727 readouts)\$28.50
Kit No. 70250 3R (DL747 readouts)\$28.50

Upon conclusion of our introductions you will have the most advanced timepiece on the market. Watch next issue for the King's first addition to his harem.

DL747

Jumbo 6 in. high, and only 20mA per segment. Common Anode

2.75

DL707

Red, 30 in. high 15mA per segment Common anode

1.25

727

Common Anode

One of our best Read-outs, 5 in. high, 20mA per segment

3.75

NEW HP7730

33 in. high read very bright readout, 25mA per segment Common Anode

1.20

FND503

We like it, you will love it, our new .5 in. common cathode type by Fairchild.

1.45

BURROUGHS 12 DIGIT DISPLAY

25 in. high, Orange digits ionization voltage 160V DC. We will encl. a free socket as a bonus.

3.25

5FOR-750

1.60

TEXAS INSTRUMENTS 6 DIGIT DISPLAY.

A perfect choice for your mini 6 digit clock or why not a stop watch Fully multiplexed, common cathode. 1 Class and goldplated.

1.30

MAN'S GREEN MAN'S RED MAN'S YELLOW

Why not make a clock in 3 diff. colors, we tried it and it looks nice. 27 in. high digit. Common Anode

1.25

LEDs

Mini Red 12 cents ea
Jumbo Red 15 cents ea
Jumbo Green 20 cents ea
Jumbo Yellow 25 cents ea

LSI INTEGRATION

MM5314	4-6 digit digital clock 24 pin dip w/spec.	\$ 3.75
MM531R	4-6 digit alarm clock 40 pin dip w/spec.	\$ 4.25
7002	4 digit counter/latch decoder; 7 segment and BCD outputs, 28 pin dip w/spec.	\$12.50
7005	4 digit counter/latch decoder; 7 segment output only .24 pin dip w/spec.	\$ 9.50
7007	4 digit counter/latch decoder with BCD output only. 16 pin dip w/spec.	\$ 7.00
70250	4-6 digit alarm clock 28 pin dip w/spec.	\$ 5.50
70380	4 digit non-multiplexed radio alarm clock featuring direct drive display output 40 pin dip w/spec.	\$ 6.50
PC Board for 70250		\$ 4.25
PC Board for 70380		\$ 3.75
PC Board for 5 Displays type Man or DL707		\$ 2.25
PC Board for 4 Displays type FND503		\$ 2.00
PC Board for 6 DL747 or 3 DL 727		\$ 3.00

TTL C-MOS

7400-16	
7402-16	
7404-16	
7406-24	CD4000-24
7408-16	CD4001-24
7410-16	CD4002-24
7413-49	CD4006-1.49
7413-49	CD4007-24
7420-16	CD4008-1.15
7427-24	CD4009-59
7430-16	CD4011-24
7437-39	CD4012-24
7438-36	CD4013-59
7440-16	CD4014-1.49
7442-69	CD4015-1.19
7447-89	CD4016-59
7448-89	CD4017-29
7453-37	CD4018-1.49
7473-37	CD4019-59
7474-37	CD4020-1.59
7475-65	CD4021-1.49
7476-39	CD4022-1.19
7483-85	CD4023-24
7490-69	CD4024-99
7492-75	CD4025-24
7493-75	CD4026-1.49
7495-75	CD4027-59
7496-75	CD4028-99
74121-38	CD4029-1.39
74123-75	CD4030-49
74151-75	CD4032-24
74153-89	CD4033-1.49
74154-95	CD4035-1.39
74161-99	CD4040-1.59
74163-1.19	CD4041-89
74164-1.89	CD4042-79
74165-1.49	CD4044-59
74174-1.29	CD4049-59
74175-1.39	CD4050-59
74181-2.75	CD4066-99
74192-1.25	CD4077-39
74193-1.25	74C02-29
74195-79	74C04-29
74197-79	74C107-1.29

TRANSISTORS

2N3055 NPN	115W TO3 Power	0.85
RCA 200V	115W TO3 Power	1.25
GE D40C	NPN Darlingtion. Cut leads	0.25
2N4443 SCR	400V x 8Amp. 10220	0.55
2N2222 NPN	Gen. Amplification	0.20
2N2924 NPN	Gen. Amplification	0.15
2N3904 NPN	Driver	0.15
2N3906 PNP	Complimentary 2N3904	0.15
2N4400 NPN	Low level noise	0.20
2N4402 PNP	Complimentary 2N4400	0.25
2N4249 PNP	Low noise, High gain	0.25
2N4969 NPN	Similar to 2N2221	0.20
2N5401 PNP	Nixie driver 160V	0.25



LINEAR'S

555 Timer	Mini dip. Low Price	0.45
553 Timer	Quad. 14 pin dual.	2.25
8038	Function Generator	4.25
RCA 3043	FM, IF, Audio Preamp.	1.20
565	Phase Locked Loop.	0.95
567V	Tone Dec. Phase Locked Loop.	1.50
LM 723	Pos. Voltage Regulator	0.55
LM 309	5 Volt 1 Amp. Regulator	1.10
LM 741	Operational Amplifier	0.25
LM 324	Quad Operational Amp.	0.95

LOOK!

From Altaj to you, a special offer.

Power Supply Kit: 5 Volt 1 Amp, regulated, Lineregulation 005% Loadregulation 50mV.

Kit includes: Components, PC board, Transf., Fuse, Pilot Light.

Nothing else to buy: \$ 5.50

CPU'S

8008	8 bit parallel CPU	19.50
2102	1K Static RAM for 8008.	2.25
MM5203	2K UV. erasable PROM.	12.25

6 Function Calculator

Chip 7020 with direct Segment Drive .8 digit.

Priced to Sell: \$ 2.25

RCA 3062

Photodetector with power-amplifier.

\$ 2.25

LED Driver ICs

75491	Segment	.35
75492	Digit.	.45

CAPS

Tantalum	1 uF	10V	20% tol.	0.20
Tantalum	4.7 uF	10V	20% tol.	0.25
Electrolytic	10 uF	25V	PC.	0.15
Electrolytic	50 uF	25V	Ax.	0.20
Electrolytic	100 uF	15V	PC.	0.20
Electrolytic	200 uF	15V	PC.	0.25
Electrolytic	470 uF	16V	Ax.	0.30
Electrolytic	1000 uF	16V	PC.	0.35
Electrolytic	2000 uF	16V	PC.	0.45
Electrolytic	1500 uF + 2000 uF			
dual 30 Volt metal can, twist				0.85
Electrolytic	300 uF	250V	PC.	0.45
Ceramic Discs	01uF	25V		0.05
Ceramic Discs	68PF	50V		0.05
Ceramic Discs	220PF	50V		0.05
Dipped Mica	150PF	100V	5%	0.10

LIGHTS - \$1.50

MUSIC

60 Watt COLOR ORGAN.

Completely self-contained unit, with 120 volt power cord included.

TTL BOARDS

MEMOREX computer boards with TTLs, Diodes and Transistors, etc.

5 Boards containing 150 - 250 ICs. \$ 3.95

TRANSFORMERS

No 1.	8V	5 Amp	1.05
No 2.	12V. CT.	5 Amp	2.00
No 3.	10V	3 VCT - 1 Amp.	1.95

DIODES

1N4004	400P.V	15 for 1.00
1N4007	1000P.V	10 for 1.00
1N746	3.3V Zen.	4 for 1.00
1N4148	Switch	20 for 1.00

FM Transformers. \$1.00

Includes FORD 19 KHZ, 38 KHZ, Osc. Coils, etc. Used in AM-FM car radios. All New 10 PC. ASSMT.

FREE! 9 Volt Batterv with \$10.00 or more purchase

CSC 100 NEW Proto Board

\$ 19.95 (Complete Kit) (Allow 2 weeks for Delivery)

Altaj Electronics Now offers a full line of Continental Specialties Proto Boards, Quick Sockets, Clips, Design Mates, Monitors, etc.

ALTAJ THANKS YOU

GE Transistor Assortment

T098 cased Darlingtons, SCRs, NPN, PNP, etc. Sample test shows very high yield.

50 for	95
100 for	1.75
300 for	5.00

Satisfaction Guaranteed

ALTAJ ELECTRONICS

P.O. Box 38544R, Dallas, Texas 75238

TERMS: Check or money order. No COD.

Telephone (214) 278-3561

Texas Residents Add 5%

NEW

Wafers are meant to be inserted in a .063" maximum thickness board and have .043" diameter pins on .156" centers.

CATALOG NUMBER	DESCRIPTION	PRICES	
		1-10	11-99
13-0001	12 pos. rt. angle connector	.60	.55
13-0002	12 position wafer	.60	.55
13-0003	9 pos. rt. angle connector	.60	.55

SPECIAL!
1000 Molex IC terminals for \$7.00

POWER SUPPLY CORDS
Gray \$1.45 ea.

2N3904 15¢

LINEAR

NE501A	2.80
NE555A	.50
A710CA	.60
A741V	.40
A747CA	1.10
A748CV	.74
A723CA	1.00
MC1468L	3.90

Red Led & Mfg. Hardware
7-1-3/4
1-10 11-100
.35 .29

MINIATURE FILM CAPACITORS

VALUE (uF)	1-14	15-50	51-100
.001	.10	.10	.06
.0047	.10	.10	.06
.01	.10	.10	.06
.05	.19	.17	.15
.1	.24	.21	.20
.22	.28	.26	.25

These units are made by International Components Corp. All units 100 V

FIXED POWER SUPPLY KITS

Specification:	F0610	F1210	F1510	DIGITAL CIRCUITS
Input Voltage (50-500Hz)	105-125V	105-125V	110-125V	7400 .34
Output Voltage	5v ± 5%	12v ± 5%	15v ± 5%	7402 .34
Output Current (I _a = 25°C)	1.5A Max.	1.5A Max.	1.1A Max.	7404 .34
PRICE	\$14.00	\$14.50	\$14.50	7410 .34
				7411 .34
				7413 .75
				7416 .54
				7417 .54
				7420 .42
				7447 .140
				7473 .52
				7475 .85
				7476 .62
				7490 .92
				7492 .92
				7493 .92
				74121 .70
				74192 2.20

INDEFINITE SHORT CIRCUIT PROTECTION Price includes Fixed Resistor G10 Board All Parts and Transformer

DISPLAY BEZELS

CATALOG NUMBER	FILTER COLOR	PRICE	DIMENSION 1/2" C	These bezels are heat resistant plastic with a black matte finish. Filters are circular polarized type
905-60	Red	\$2.50	1.37	7420 .42
910-60	Red	2.55	2.00	7447 .140
915-60	Red	2.65	3.00	7473 .52
920-60	Red	2.70	4.00	7475 .85
920-70	Amber	2.70	4.00	7476 .62

5 For Green
4 For Red
Add A
G to Part number

SOCKETS
LOW PROFILE
These sockets are from TI

NUMBER OF PINS	599	100
14	.25	.20
16	.28	.24
24	.40	.33
28	.45	.45

TRANSISTORS

2N3638A	P	5	TO-92	.25
2N2222A	N	5	TO-18	.20
2N5133	N	.05	TO-18	.25
2N5494	N	7.00	TO-220	1.05
2N4401	N	6.00	TO-92	.60
2N4403	P	6.00	TO-92	.30
TIP32	P	3.00	TO-220	1.05

TRIMMER POTENTIOMETERS
These are 5/8" diameter thumbwheel trimmer potentiometers.

BAG OF 50 MOLEX PIN NESTERS
7 pin style \$2.00
8 pin \$2.25

MOLEX IC TERMINAL
100 for \$1.00 300 for \$2.80 500 for \$4.20
200 for \$1.80 400 for \$3.40 800 for \$5.00
700 for \$5.80 900 for \$7.40
800 for \$6.60 1,000 for \$8.20
Reel of 50,000 \$ 270.00

REGULATOR CIRCUITS

MC7805CP	5 volt regulator @ 1.5A max	1.95
MC7812CP	12 volt regulator @ 1.5A max	2.00
MC7815CP	15 volt regulator @ 1.5A max	2.00

16 Page Catalog 25¢

DIODES

1N4001	10/51.00
1N4002	10/51.00
1N4148	10/51.00
1N5401	5/52.00
(3A, 100PVS)	

1N 746-739A \$ 3.00

TRACY DESIGN CORP.
15870 SCHAEFER • DETROIT, MI 48227 • (313) 838-2501

WHY rent extension telephones? Save hundreds of dollars by connecting your own legally. New FCC ruling, effective April 1st, eliminates monthly rentals completely. Details, \$1.00. QVTS, Box 29002-X, Queens Village, NY 11429

Govt. SURPLUS ELECTRONIC EQUIPMENT CATALOG

New ITEMS . . . New BARGAINS!
FREE UPON REQUEST!
If you haven't received our new Catalog, write for free copy today. Address: Dept. RE

FAIR RADIO SALES

1016 E. EUREKA • Box 1105 • LIMA, OHIO • 45802

DESCRAMBLERS: Several professional models that work with all scanners. Tone encoders/decoders, Scanmate, AAPP, radar detectors, Big Ears, alarms, books, kits, parts. Catalog 25 cents; **KRYSTAL KITS**, Box 445, Bentonville, AR 72712

SEMICONDUCTOR and parts literature, J. & J. ELECTRONICS, Box 1437R, Winnipeg, Manitoba, Canada, U.S. Inquiries Invited.

SURPRISE! Build inexpensively, the most unusual test instruments, futuristic gadgets using numerical readouts! Catalogue free! **GBS**, Box 100B, Greenbank, WV 24944

NEW Canadian Magazine, "Electronics Workshop", \$5.00 yearly, sample \$1.00. **ETHCO**, Box 741 "A", Montreal.

MICRO MINI MIKE
WIRELESS MICROPHONE

World's smallest; solid state, completely self-contained. Picks up and transmits most sounds without wires up to 350 ft. through FM Radio. Use as mike, amp., alarm & alert sys., hot line, etc. Money back guar. B/A, M/C cds, COD ok. \$14.95 plus \$1.00 post. & hdg. Calif. res. add tax. **AMC SALES**, Dept. 19, Box 928 Downey, CA. 90241.

ALTAIR 8800 users. 8K Memory Board kit clocked static, exceptionally low power, fast no wait states or refresh, low price. **Prototyping Board 8800** bus compatible. **8800 Octal Encoder Board** kit does not require additional I/O board or software. Send for our latest information and low prices. **ELECTRONIC CONTROL TECHNOLOGY**, Box 6, Union, NJ 07083

FREE catalog. Ultrasonic devices, LED's transistors, IC's, keyboards, digital thermometers, unique components. **CHANEY'S**, Box 15431, Lakewood, CO 80215

A COMPUTER SYSTEM CHEAPER THAN A KIT

PDP8 4K w/ASR33 & CAB ...\$1800
ALSO FOR SALE: DEC • DG • CAI • HP • MICRO • SEL • WANG • XLO
MODULES • PERIPHERALS
ELECTRONIC COMPONENTS
— 90-DAY WARRANTY —
617-261-1100
AMERICAN USED COMPUTER CORP.
Box 68, Kenmore Station, Boston, Mass. 02215
member COMPUTER DEALERS ASSOCIATION

RECONDITIONED test equipment. \$0.50 for catalog. **WALTER'S TEST EQUIPMENT**, 2697 Nickel, San Pablo, CA 94806

RECEIVING tubes: 50% off list price, new, in factory cartons. **Power supplies:** 6 or 12 volts, 3 amperes, filtered, fused, assembled, case size 5x4x3, \$14.95. **Regulated power supply subassemblies:** \$7.95 + \$1.00 per ampere to 20 amperes (—less transformer). Free price list. Include postage. **MICBERSON-D**, SW 115 State, Pullman, WA 99163

CARBON film resistors—1/4W, 5% 10—4.7 megohms for 3 1/2¢ each. Fifty per value \$0.85. Discounts available. Free samples/specifications. Other quality components. \$1.00 postage. **COMPONENTS CENTER**, Box 134R, New York, NY 10038

Red Cross. The Good Neighbor.

CITIZEN band base antenna, four elements, absolutely complete, 8.6 decibel gain, only \$49.95 prepaid. Send no money, we ship COD. Ten day return privilege. **GOTHAM**, 2051 N.W. 2 Ave., Miami, FL 33127

PRINTED CIRCUIT
Positive Acting Photo Resist; Carbide bits; Bubble etchers; Artwork; Epoxy Glass Boards.
Send stamp & address label for flyer
TRUMBULL
833 Balra Dr., El Cerrito, CA 94530

CANADIAN discount and factory clearouts catalog. Top brand stereo equipment, calculators, test gear, CB & communications, telephones. Factory dumps—government surplus. Amazing bargains. Unusual items. Rush \$1. **ETCO-RE**, 521 5th Ave., NYC, 10017

RECORDS-TAPES! Discounts to 73%; all labels; no purchase obligations; newsletter; discount dividend certificates; 100% guarantees. Free details. **DISCOUNT MUSIC CLUB**, 650 Main St., Dept. 4-26, New Rochelle, NY 10801

FREE catalog. IC's, Semi's. **CORONET ELECTRONICS**, 649A Notre Dame W., Montreal, Que. Canada, H3C-1H8. US Inquiries.

CASSETTES/LABELS
Plain white cassette labels. Norelco cassette cleaners, famous brand cassettes. Send for open reel and cassette discount catalog. 1-9 10-99 100 1000 10M
Cassette Labels .02 .015 .01 .005
Norelco Cassette Cleaner .65 .60 .55 .50 .45
10" Fiberglass used 3/4" Hole .50 .50 .40 .35 .30
Plus Postage by Weight and Zone. Minimum Order \$5.00
OPEN REEL STEREO TAPE BUYERS!
We've Got the "Spirit" The Prices And The Address To Prove It
Saxitone's Bicentennial Tape Shoppe
1776 Columbia Rd., N.W., Wash. D.C. 20009

FREE catalog. Ultrasonic devices, LED's transistors, IC's, keyboards, digital thermometers, unique components. **CHANEY'S**, Box 15431, Lakewood, CO 80215

Olson ELECTRONIC PARTS AND ACCESSORIES

Reg. Sale

TA-854	40 Min. 8 Track Tape	1.29	.89c
TA-855	80 Min. 8 Track Tape	1.59	1.09
TA-879	3 Pak C-60 Cassette	1.49	.99c
PL-233	Pkg. 5 Red LED	1.19	.69c
XM-501	Pkg. 40 Terminal Lugs	1.30	.59c
XM-367	Mechanical 4 Digit Counter	1.49	.69c
TT-092	2500 Ohm Output Transformer	1.09	.69c
SW-581	117 VAC Solenoid	1.49	.79c
TR-446	Pkg. 25 Asstd. SCR	2.69	.99c
XM-343	7 Segment 6" LED Display	5.00	1.99

Send to: Olson Electronics, Dept. LJ260 S. Forge St., Akron Ohio 44327. Allow for Postage, C.O.D. 20% Deposit. Ohio Residents Add 4% Sales Tax.
FREE! Ask for our Catalog when you Order

NEW CLOCK KITS!



MODEL OC1032

JUMBO DIGITS
ALARM CLOCK
1.2" Bright Yellow
Color Readouts

Features: 12/24 Hour Display, 24 Hour Alarm Set, 10 Min Snooze Switch, AM/PM Indicator

Kit Includes: Woodlike Color Plastic Case, 4 Digit 1.2" Neon Display with AM/PM, TMS 3834 Alarm Chip, 2 pcs. double sided PC Boards, 16 transistors, all other components, Transformer and speaker

SPECIAL \$35.90

THE MOST POPULAR

MM5314 KIT



WITH A NEW CASE!!
Features: 12/24 Hour Display
50/60 HZ Input 6 Digits Readout

Kit Includes: Grey Color Plastic Case MM5314 Clock Chip PC Boards and Transformer, 6 Green Color 0.4" Tube Readouts, All other transistor Drivers and other Components.

Special Only \$19.95 ea.



MODEL OC1030

4 DIGIT
ALARM CLOCK KIT
0.5" Green Color
Readouts

Features: 12/24 Hour Displays, 24 Hour Alarm Set, 10 Min Snooze Switch, AM/PM Display.

Kit Includes: Orange Color Plastic Case, 0.5" LO8132 Green Color Readouts PC boards with transformer, all electronic parts with speaker.

Only \$28.50



MODEL TMS

6 DIGIT ALARM
CLOCK KIT

Special Only \$23.50 ea.

Kit includes all electronic parts and case but no speaker



MODEL CT7001

WITH ALARM
MONTH and DATE

CLOCK KIT

use 0.5" LED Displays

without case **Only \$28.50 ea.**

CT Case \$7.50 Additional

* * NEW ITEMS * *

National MM5330 4 1/2 digits DVM chip \$12.50 ea.
TI TMS2501 Static USASCII 64 x 5 x 7 character generator \$8.50 ea.
Motorola MC 1733 Video Amp. I.C. \$1.20 ea.
Monsanto MAN5491 Bipolar Led Orange or Green .50 ea.
LM 566 Voltage Controlled Oscillator \$1.60 ea.

ROCKWELL A4001 I.C.

ELECTRONIC SLIDE RULE SCIENTIFIC CALCULATOR KIT !!

Kit Includes:

Rockwell A4001 IC
HP 9 Digit LED Readouts
Complete Keyboard with Case
PC Board with all Electronic Parts
Instructions and Batteries

SPECIAL FUNCTION

- Trigonometric functions (sin, cos, tan)
- Inverse trigonometric functions (sin⁻¹, cos⁻¹, tan⁻¹)
- Radian or degree selectable
- π constant
- Logarithms (ln, log)
- Anti logarithms (e^x)
- Power functions (y^x)
- Reciprocal (1/x)
- Square root (\sqrt{x})
- Display recall

SPECIFICATION

- 9-digit HP Red Led Displays
- 8 digits capacity for data entry or results
- (10⁸ ~ 10⁸)
- Full floating point
- Dome keyboard for excellent response and preventing double entry input

BASIC FUNCTION

- Algebraic mode operation
- Constant operations
- Repeat Operations
- Chain operations
- Change sign operation
- Display and Y register exchangeable
- One accumulating memory
- Display and memory exchangeable

AC adapter for the unit

\$4.50 ea.

* postage \$1.50 per unit.



Dimension: 32.5mm(H) x 77mm(W) 145mm (L)
1 9/32 in (H) x 3 1/32 in (W) x 5 23/32 in (L)

ONLY \$28.⁵⁰

LINEAR I.C.

LM 309K	5V 1A Regulator	1.00
LM 340T	Pos. 1A V. Regulator (5V, 6V, 12V, 15V.)	1.00
LM 380	2W Audio Amp	.80
LM 381	Lo Noise Pre Amp	1.00
LM 555	Timer Mini Dip	.55
LM 556	Dual 555 Timer	.85
LM 565	Phase Locked Loop	1.50
LM 567	Tone Decoder	1.50
UA 709	Operational Amp	.20
UA 741	Comp Op Amp	.25
LM 747	Dual 741 Op Amp	.55
LM 1458	Dual Comp Op Amp	.55
LM 3900	Quad Op Amp	.50
DM 8864	9 Digit Led Driver	1.40
75492	HEX MOS to Led Digit Drivers	.60
75491	Quad Seg. Drivers	.60

POWER HYBRID CIRCUITS By RCA (HC2500)



High power output: up to 100W (rms)
High output current: 7 A (peak)
Stability with resistive or reactive loads
Single or split power supply
(30 to 75V, single, +15 to +37.5, split)

Only \$8.75 Ea.

PLASMA GAS DISCHARGE JUMBO 1.2 READOUTS DISPLAYS



Bright Orange Color for
Clocks, Supply Voltage
170V D.C.

ONLY \$11.90 each.

Transformer for the above readouts \$1.00 ea.

WIRE WRAP I.C. SOCKETS

by ITT CANNON
14 pins or 16 pins, Gold plated 3 Level size
SPECIAL - 10 for \$4.00

TRANSFORMERS



12V AC 300 MA output Wall
Type Adapter (designed for
clock with limited space) \$2.50ea

12V-0-12V- or 24V 1 Amp out-
put \$2.25ea



0-0.8V-12V 300 MA output (for
our fluorescent tubes) \$2.50ea

18V 1 amp output \$2.50ea

0-3V-12V-24V 500MA output
(for CT 7001 Drive LD 8132 Readouts) 2.50 ea

0-15V-160V 150MA output
(for Gas discharge Readouts) 1.00 ea

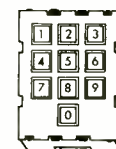

TOUCH TONE KEYBOARD

no electronic parts
10 key switches only
LIMITED QUANTITY
Only \$4.50 ea.

MINIMUM ORDER \$10.00. California residents add 6% sales and 1.00 to cover postage and handling.

Out-of-state and overseas countries add \$2.00.

SEND CHECK OR MONEY ORDER TO:

FORMULA INTERNATIONAL INC.

12603 CRENSHAW BOULEVARD • HAWTHORNE, CALIFORNIA 90250

For more information please call (213) 679-5162

STORE HOURS 10-7 Monday - Saturday

Circle 89 on reader service card

PLANS & KITS

TV-GAMES, construction plans: **Pong** series — 5 game set \$5.00, big 12 game set \$12.00. **Jaws-2** and **Space Race**—both games for \$8.00. **Pinball 1 & 2**—both for \$8.00. Full descriptions and specs—\$1.00. **ADVANCED ELECTRONICS**, P.O. Box 1128, Cupertino, CA 95014

TV Ping Pong game. Plays through your set's antenna terminals: **Plans \$3.25**. **ARS SYSTEMS**, Box 1922, Sunnyvale, CA 94088

MUSIC SYNTHESIS/ANALOG PROCESSING

BUILD: • Ultra wide range universal V.C.O.
WRITE: • Voltage controlled filters & amplifiers
NOW: • Joystick controlled filters & tapers

Free information... send self addressed, stamped envelope to



C.F.R. ASSOCIATES

P.O. Box F Newton, N.H. 03858

"the oldest name in synthesis for the experimenter"

AMAZING ELECTRONIC PROJECTS and PRODUCTS:

Lasers Super Powered, Burning, Cutting, Rifle, Pistol, Pocket. See in Dark—Shotgun Directional Mike—Unscramblers—Giant Tesla—Stunwand—TV Disrupter—Energy Producing, Surveillance, Detection, Electrifying, Ultrasonic, CB, Auto and Mech. Devices. Hundreds More—All New Plus **INFO UNLTD PARTS SERVICE**. Catalog \$1. Information Unlimited, Box 626, Lord Jeffrey Court, Amherst, N.H. 03031.

C/MOS probe converts your voltmeter into FET input millivoltmeter. Free catalog. **DAGE SCIENTIFIC INSTRUMENTS**, Box 1054R, Livermore, CA 94550

Send for your information packet today—which also includes circuit functions, component line-up, and accessories. Information Packet \$1.00 (refundable with order).

visulex P.O. Box 4204R Mountain View, CA 94040

RADIO & TV tubes 36¢ each. One year guaranteed. Plus many unusual electronic bargains. Free catalog. **CORNELL**, 4217-E University, San Diego, CA 92105

BUILD YOUR OWN TV CAMERA!

THE ECONOMICAL ANSWER TO HOME MONITORING OF NURSERIES, ENTRANCES, DRIVEWAYS, BUSINESS and INDUSTRIAL SURVEILLANCE...TV AMATEUR TV PLUS HUNDREDS OF OTHER APPLICATIONS. MODEL XT-1A. SERIES 0 KIT FORM \$185; ASSEMBLED \$215. SOLID-STATE WORKS ON ANY TV SET. OPTIONAL SOUND KIT \$25.95. PHONE or WRITE for catalog. Dial 802-987-3771

BOX 453-RE ATV Research DAKOTA CITY, NE 68731

FREE plans for building electronic thermometer with control. Send **SASE**. **DAGE SCIENTIFIC INSTRUMENTS**, Box 1054, Livermore, CA 94550

BUILD that electronic organ you always wanted at a price you can afford. Third edition of "Organ Builder's Guide," pictured product kit line, circuits, block diagrams, design rationale using IC divider and independent generators with diode keying. \$3.00 Postpaid. Also, free brochure on keyboards. **DEVTRONIC ORGAN PRODUCTS**, Dept. B, 5872 Amapola Drive, San Jose, CA 95129

ALTAIR 8800 OWNERS

Is your Altair: • Slow to start-up
• Writing all 0's or 1's into memory
• Having troubles running BASIC

Our 'CPU Clock Fix-kit' may solve your problems. Good clock pulses are a must. Send for your kit today!

Brochure available. **PARASITIC ENGINEERING**
P.O. Box 6314, Albany, Ca. 94706

WANTED

QUICK cash... for electronic equipment, components, unused tubes. Send list now! **BARRY**, 512 Broadway, New York, NY 10012, 212 Walker 5-7000

On all models... simply plug in your components and interconnect with 22-gauge solid wire. All models accept all DIP's, TO-5's and discretes with leads up to .032" diameter.

VIATRON terminal. Unused, consists of keyboard, micro-processor, control panel, video display, 2 built-in tape decks, power supply. Operates on 115v AC 60 cycle. Unused but in storage for 4 years. Due to storage, may require some work. Sold "as is" FOB Lynn, Mass. Ship wgt. 160 lbs. Has memory, automatic input/output under program control, tape search, key verification, tape validation, etc.

Send for informative data brochure. Limited quantity. \$425.00 FOB Lynn, Mass.

JOHN MESHNA JR.
P.O. BOX 62
E. LYNN, MASS. 01904

Meshna

Circle 91 on reader service card

QUALITY ELECTRONIC COMPONENTS

NEW DISCOUNT SCHEDULE SAVES YOU EVEN MORE!

8080A \$39.95 2102 \$1.99
MICROPROCESSOR 1024 Bit Random Access Memory
0-70°C 480 ns Clock Period 500 ns Typical, 1000 ns Max Access Time

INTEGRATED CIRCUITS — TTL, CMOS, LINEAR & MOS

7400 .21	7473 .30	74174 .93	4001 .23	4073 .23	723
7401 .21	7474 .30	74175 .93	4002 .23	4075 .23	723
7402 .21	7475 .49	74176 .79	4006 .123	4081 .23	723
7403 .21	7476 .32	74177 .93	4007 .23	4082 .23	723
7404 .21	7480 .70	74180 .70	4008 .79	4502 .79	79
7405 .21	7482 .70	74181 .215	4009 .44	4510 .114	1.14
7406 .25	7483 .70	74182 .79	4010 .44	4511 .105	1.05
7407 .25	7485 .89	74184 .219	4011 .23	4514 .280	2.80
7408 .21	7486 .28	74185 .219	4012 .23	4515 .280	2.80
7409 .21	7489 .219	74188 .350	4013 .40	4516 .123	1.23
7410 .21	7490 .44	74189 .350	4014 .56	4518 .114	1.14
7411 .21	7491 .70	74190 .123	4015 .96	4520 .114	1.14
7412 .21	7492 .44	74191 .123	4016 .40	4527 .168	1.68
7413 .25	7493 .44	74192 .88	4017 .105	4528 .88	88
7414 .89	7494 .70	74193 .88	4018 .105	4585 .123	1.23
7416 .25	7495 .70	74194 .88	4019 .23	LM309K .128	1.28
7417 .25	7496 .70	74195 .88	4020 .114	LM324N .128	1.28
7420 .21	74100 .128	74196 .88	4021 .114	LM3401-5 .125	1.25
7421 .25	74101 .30	74197 .88	4022 .96	LM3401-6 .125	1.25
7423 .25	74109 .33	74198 .149	4023 .23	LM3401-8 .125	1.25
7425 .25	74121 .33	74199 .149	4024 .84	LM3401-12 .125	1.25
7426 .25	74122 .44	74201 .109	4025 .23	LM3401-15 .125	1.25
7427 .33	74123 .61	74202 .109	4026 .168	LM3401-18 .125	1.25
7428 .28	74125 .40	74365 .67	4027 .40	LM3401-24 .125	1.25
7430 .21	74126 .40	74366 .67	4028 .89	LM3900N .88	88
7432 .25	74127 .44	74367 .67	4029 .114	NE5361 .324	3.24
7433 .30	74141 .88	74368 .67	4030 .23	NE5401 .204	2.04
7437 .25	74145 .70	75510 .31	4033 .151	NE555V .48	48
7438 .25	74147 .163	75510 .31	4034 .56	NE560A .88	88
7440 .21	74148 .30	75511 .61	4035 .114	NE560B .383	3.83
7441 .88	74150 .116	75512 .61	4040 .114	NE601B .383	3.83
7442 .53	74151 .70	75513 .61	4041 .79	NE62B .383	3.83
7443 .63	74152 .63	75514 .61	4042 .79	NE64V .125	1.25
7444 .63	74154 .03	75515 .61	4043 .79	NE66V .128	1.28
7445 .70	74155 .70	75516 .61	4044 .70	NE67V .136	1.36
7446 .70	74156 .70	75517 .61	4045 .70	UA795CV .44	44
7447 .70	74157 .70	75518 .119	4049 .40	UA710CA .44	44
7448 .70	74160 .88	8093 .40	4050 .40	UA711CA .53	53
7450 .21	74161 .88	8094 .40	4051 .76	UA723CA .60	60
7452 .21	74162 .88	8095 .40	4052 .87	UA728CV .44	44
7454 .21	74163 .88	8096 .67	4053 .72	UA747CA .70	70
7460 .21	74164 .96	8097 .67	4060 .158	UA748CV .49	49
7470 .30	74166 .128	8098 .67	4066 .79	UA749CV .49	49
7472 .30	74170 .128	82525 .219	4071 .23	7102 .265	2.65
	74173 .142	82525 .219	4072 .23	8080A .49.95	49.95

AP SUPER STRIP II—Universal Breadboarding
Element with 840 Solderless Plug-in Tie-Points
\$17.00

IC TEST CLIPS
14 pin TC-14 \$4.50
16 pin TC-16 \$4.75
24 pin TC-24 \$13.85 TC-16 TC-24

In a hurry? All-Circuit Evaluators
obsoletes ordinary breadboards
All solderless plug-in tie-points

7 models for fast building and testing of circuits

On all models... simply plug in your components and interconnect with 22-gauge solid wire. All models accept all DIP's, TO-5's and discretes with leads up to .032" diameter.

Multiple buses can easily be linked for power and ground distribution, reset and clock lines, shift command, etc. Bases: gold-anodized aluminum. Terminals: non-corrosive nickel-silver. Four rubber feet included.

ACE Model No.	Tie Points	DIP No.	No. Buses	Board Size (Inches)	Price Each
200-K (Ver)	728	8 (16x4)	2	2 4-9/16x5-9/16	\$18.95
208 (Assm)	812	8 (16x4)	8	2 4-9/16x5-9/16	28.95
201-K (Kit)	1032	12 (14x4)	2	2 4-9/16x7	24.95
212 (Assm)	1224	12 (14x4)	8	2 4-9/16x7	34.95
218 (Assm)	1760	18 (14x4)	10	2 6-1/2x7-1/8	46.95
227 (Assm)	2712	27 (14x4)	28	4 8-9/16x14	90.95
236 (Assm)	3648	36 (14x4)	36	4 10-1/2x9-1/4	79.95

BISHOP GRAPHICS Printread Circuit Drafting
Aids are now available from DigI-Key

CMOS DATABOOK \$1.50
Specifications and pin-outs for 80 different 4000 series parts

MONSANTO MAN 64 AL 1702 AQ
ERASEABLE PROM WITH QUARTZ WINDOW
60¢ \$13.50

REED RELAYS
1.5 Amp SPST N.O. Contacts

4.8v Coil \$1.70 \$125/C
6.0v Coil \$1.70 \$125/C
12v Coil \$1.70 \$125/C
24v Coil \$1.70 \$125/C

1/4 WATT 5% CARBON FILM RESISTORS
5¢ each in multiples of 5 per value
\$1.70/100 of same value. 10 ohm to 1.0 meg

SILICON TRANSISTORS

MPS918, MPS930, MPS2222A, MPS2369A, MPS2712, MPS2907A, MPS3392, MPS3393, MPS3394, MPS3395, MPS3563, MPS3565, MPS3568, MPS3640, MPS3641, MPS3642, MPS3643, MPS3645, MPS3646, MPS3904, MPS3906, 2N4126, 2N4126, 2N4401, 2N4403, 2N4410, 2N4888, 2N5067, 2N5069, PMS129, PMS133, PMS134, PMS137, PMS138, PMS139, PMS210, PMS596A 16, \$1.55/100. \$13.60/100 of same part.

MPS1702 36x30 60°C 2N5457 .48 \$41.00/C MPA543 28 \$24.00/C 2N3055 .99 \$85.00/C

I.C. SOCKETS

8 Pin Solder Tab	17
14 Pin Solder Tab	20
16 Pin Solder Tab	22
18 Pin Solder Tab	28
24 Pin Solder Tab	39
28 Pin Solder Tab	45
40 Pin Solder Tab	63
8 Pin Wire-Wrap	24
14 Pin Wire-Wrap	26
16 Pin Wire-Wrap	30
18 Pin Wire-Wrap	60
24 Pin Wire-Wrap	86
28 Pin Wire-Wrap	123
40 Pin Wire-Wrap	170

RESISTOR ASSORTMENTS

5¢ ea. all 10% 1/4 W. Val. from 2.2 to 22 meg (425 pcs) \$12.00
5¢ ea. all 10% 1/4 W. Val. from 10 to 5.0 meg (350 pcs) \$12.00

ELECTROLYTIC CAPACITORS

— Radial Lead — — Axial Lead — — Axial Lead —

1uf/50v .08	65/10	1uf/50v .11	90/10	47uf/25v .17	1.30/10
2.2uf/50v .08	65/10	2.2uf/50v .12	90/10	100uf/16v .17	1.30/10
3.3uf/50v .08	65/10	3.3uf/50v .12	90/10	100uf/25v .20	1.55/10
4.7uf/25v .08	65/10	3.3uf/50v .12	100/10	100uf/50v .29	2.30/10
4.7uf/50v .08	70/10	4.7uf/25v .11	90/10	220uf/16v .20	1.55/10
10uf/15v .10	75/10	4.7uf/35v .12	95/10	220uf/25v .29	2.35/10
10uf/50v .09	70/10	10uf/25v .12	100/10	330uf/25v .32	2.55/10
22uf/25v .12	100/10	10uf/50v .12	115/10	470uf/16v .32	2.55/10
100uf/16v .39	75/10	22uf/16v .12	1.00/10	470uf/25v .37	3.00/10
100uf/16v .11	85/10	22uf/25v .13	1.05/10	1000uf/16v .39	3.15/10
100uf/25v .13	110/10	33uf/16v .12	1.00/10	1000uf/25v .56	4.50/10
		33uf/25v .14	1.15/10	2200uf/16v .62	4.95/10
		47uf/16v .14	1.15/10		

HARDWARE

2-56 1/4 Screw	99/C	7.20/M
2-56 1/2 Screw	99/C	6.65/M
4-40 1/4 Screw	55/C	3.60/M
4-40 1/2 Screw	60/C	4.05/M
6-32 1/4 Screw	65/C	4.40/M
6-32 1/2 Screw	75/C	4.85/M
8-32 3/8 Screw	90/C	5.85/M
2-56 Hex Nut	55/C	3.60/M
4-40 Hex Nut	55/C	3.75/M
6-32 Hex Nut	60/C	4.00/M
8-32 Hex Nut	60/C	4.15/M
No. 2 Lockwasher	85/C	5.75/M
No. 4 Lockwasher	85/C	3.00/M
No. 6 Lockwasher	45/C	3.00/M
No. 8 Lockwasher	45/C	3.00/M

Send for free catalog or mail orders "Only Quality Components Sold!"

DISC CAPS

100uf/500v .04	36/10
220uf/500v .04	36/10
470uf/500v .04	36/10
100uf/500v .06	37/10
220uf/500v .04	37/10
470uf/500v .04	37/10
01uf/500v .06	50/10
01uf/500v .03	24/10
02uf/25v .03	28/10
04uf/25v .05	42/10
1uf/25v .08	62/10

1/2 WATT ZENER DIODES

1N5226B 3.3v	15 \$11/C	1N5236B 7.5v	15 \$11/C
1N5227B 3.6v	15 \$11/C	1N5237B 8.2v	15 \$11/C
1N5228B 3.9v	15 \$11/C	1N5238B 8.7v	15 \$11/C
1N5229B 4.3v	15 \$11/C	1N5239B 9.1v	15 \$11/C
1N5230B 4.7v	15 \$11/C	1N5240B 10v	15 \$11/C
1N5231B 5.1v	15 \$11/C	1N5241B 11v	15 \$11/C
1N5232B 5.6v	15 \$11/C	1N5242B 12v	15 \$11/C
1N5233B 6.0v	15 \$11/C	1N5243B 13v	15 \$11/C
1N5234B 6.5v	15 \$11/C	1N5244B 14v	15 \$11/C
1N5235B 6.8v	15 \$11/C	1N5245B 15v	15 \$11/C

DIGI-KEY CORPORATION
P.O. Box 677 Thief River Falls, MN 56701

RADIO-ELECTRONICS

5% OFF ON ORDERS OVER \$50.00
 10% OFF ON ORDERS OVER \$100.00
 15% OFF ON ORDERS OVER \$250.00

TTL

7400	.14	7451	.17	74154	1.25
7401	.16	7452	.17	74155	1.07
7402	.15	7460	.17	74157	.99
7403	.16	7464	.35	74158	1.79
7404	.19	7465	.35	74160	1.39
7405	.19	7470	.30	74161	1.25
7406	.35	7472	.30	74162	1.49
7407	.35	7473	.35	74163	1.39
7408	.18	7474	.35	74164	1.59
7409	.19	7475	.57	74165	1.59
7410	.16	7476	.39	74166	1.49
7411	.25	7483	.79	74170	2.30
7413	.55	7485	1.10	74173	1.49
7416	.35	7486	.40	74174	1.62
7417	.35	7489	2.48	74175	1.39
7420	.16	7490	.59	74176	.89
7422	.26	7491	.97	74177	.84
7423	.29	7492	.71	74180	.90
7425	.27	7493	.60	74181	2.98
7426	.26	7494	.94	74182	.79
7427	.29	7495	.79	74184	2.29
7430	.20	7496	.79	74185	2.29
7432	.23	74100	1.30	74187	5.95
7437	.35	74105	.44	74190	1.35
7438	.35	74107	.40	74191	1.35
7440	.17	74121	.42	74192	1.25
7441	.98	74122	.45	74193	1.19
7442	.77	74123	.85	74194	1.25
7443	.87	74125	.54	74195	.89
7444	.87	74126	.63	74196	1.25
7445	.89	74141	1.04	74197	.89
7446	.93	74145	1.04	74198	1.79
7447	.89	74150	.97	74199	1.79
7448	1.04	74151	.79	74200	5.90
7450	.17	74153	.99		

LOW POWER TTL

74100	\$.25	74151	\$.29	75190	\$1.49
74102	.25	74155	.33	74191	1.45
74103	.25	74171	.25	74193	1.69
74104	.25	74172	.39	74195	1.69
74106	.25	74173	.49	74198	2.79
74110	.25	74174	.49	74164	2.79
74120	.31	74178	.79	74165	2.79
74130	.33	74185	1.25		
74142	1.49	74186	.69		

HIGH SPEED TTL

74H00	\$.25	74H21	\$.25	74H55	\$.25
74H01	.25	74H22	.25	74H60	.25
74H04	.25	74H30	.25	74H61	.25
74H08	.25	74H40	.25	74H62	.25
74H10	.25	74H50	.25	74H72	.39
74H11	.25	74H52	.25	74H74	.39
74H20	.25	74H53	.25	74H76	.49

8000 SERIES

8091	\$.53	8214	\$1.49	8811	\$.59
8092	.53	8220	1.49	8812	.89
8095	1.25	8230	2.19	8822	2.19
8121	.80	8520	1.16	8830	2.19
8123	1.43	8551	1.39	8831	2.19
8130	1.97	8552	2.19	8836	.25
8200	2.33	8554	2.19	8880	1.19
8210	2.79	8810	.69	8263	5.79
				8267	2.59

9000 SERIES

9002	\$.35	9309	\$.79	9601	\$.89
9301	1.03	9312	.79	9602	.79

CMOS

4000A	\$.26	4017A	1.19	4066A	.89
4001A	.25	4020A	1.49	4068A	.44
4002A	.25	4021A	1.39	4069A	.44
4006A	1.35	4022A	1.10	4071A	.26
4007A	.26	4023A	.25	4072A	.35
4008A	1.79	4024A	.89	4073A	.39
4009A	.57	4025A	.25	4075A	.39
4010A	.54	4027A	.59	4078A	.39
4011A	.29	4028A	.98	4081A	.26
4012A	.25	4030A	.44	4082A	.35
4013A	.45	4035A	1.27	4528A	1.60
4014A	1.49	4042A	1.47	4585A	2.10
4015A	1.49	4049A	.59		

74C00	\$.22	74C74	\$1.04	74C162	\$2.93
74C02	.26	74C76	1.34	74C163	2.66
74C04	.44	74C107	1.13	74C164	2.66
74C08	.68	74C151	2.61	74C173	2.61
74C10	.35	74C154	3.15	74C195	2.66
74C20	.35	74C157	1.76	80C95	1.35
74C42	1.61	74C160	2.48	80C97	1.13
74C73	1.04	74C161	2.93		

POCKET CALCULATOR

5 function plus constant — addressable memory with individual recall — 8 digit display plus overflow — battery saver — uses standard or rechargeable batteries — all necessary parts in ready to assemble form — instructions included.

Calc. Kit, Kit only	\$10.95
Batteries (alkaline, disp.)	2.00
Adapter 60Hz	3.95
Kit, Batteries & Adapter	15.95



MARKED — NO FACTORY LOGO GUARANTEED FUNCTIONAL

7400	\$.10	7420	\$.11	7460	\$.11
7402	.10	7437	.20	7474	.25
7403	.11	7440	.11	7493	.39
7404	.12	7445	.49	7496	.49
7406	.20	7450	.11	74195	.59
7408	.12	7453	.11		
7410	.11	7454	.11		

TTL

74132	\$.89				
74H101	.58				
74H102	.58	741500	\$.36		
74H103	.63	741502	.36		
74H106	.63	741504	.36		
74H108	.63	741508	.38		
		741510	.36		

SCHOTTKY

74500	\$.38	741532	.38
74502	.45	741540	.45
74503	.38	741574	.59
74504	.45	741590	1.30
74508	.52	741593	1.30
74510	.38	741595	2.09
74520	.38	7415107	.59
74522	.38	7415164	2.20
74532	.52	7415193	2.50
74574	.38		

LINEARS

546	AM radio receiver subst. DIP	\$.75
733	DHL video AMPL TO-5	.89
5556/MC1456	Int. compensated Op Amp mDIP	1.59
7525	Dual core mem. sense AMPL DIP	.98
CA3046	Transistor array 14 pin DIP	.89

LED's

MV10B	Red TO 18	\$.22
MV50	Axial leads	.18
MV5020	Jumbo Vis. Red (Red Dome)	.22
	Jumbo Vis. Red (Clear Dome)	.22
ME4	Intra red diff. dome	.54
MAN1	Red 7 seg. .270"	2.19
MAN2	Red alpha num. .32"	4.39
MAN4	Red 7 seg. .190"	1.95
MAN5	Green 7 seg. .270"	3.45
MAN6	.6" high solid seg.	4.25
MAN7	Red 7 seg. .270"	1.19
MAN3	Red 7 seg. .127"	.29
MAN8	Yellow 7 seg. .270"	3.45
MAN66	.6" high spaced seg.	3.75
MCT2	Opto-iso transistor	.61

MULTIPLE DISPLAYS

NSN33	3 digit .12" red led 12 pin fis IC skt.	\$1.79
HP45082	5 digit .11 led magn. lens	
7405	com. cath	3.49
HP5082	4 digit .11 LED magn. lens comm. cath.	3.25
FNA37	9 digit 7 seg led RH dec. clc. magn. lens	4.95
SP-425-09	9 digit .25" neon direct interface with MOS/LSI, 180 VDC, 7 seg.	1.79

SHIFT REGISTERS

MM5013	1024 bit accum. dynamic mDIP	\$1.75
MM5016	500/512 bit dynamic mDIP	1.59
SL5-4025	QUAD 25 bit	1.29

DTL

930	\$.15	937	.15	949	.15
932	.15	944	.15	962	.15
936	.15	946	.15	963	.15

APRIL SPECIALS

ALARM CLOCK CHIP

MMS375AA 4-6 digit, 12 hour, 60Hz snooze alarm, brightness control capability, alarm tone output 24 pin DIP \$4.95

8038 FUNCTION GENERATOR

Voltage controlled oscillator — sine, square, triangular output. 16 pin DIP with data \$3.95

7001 CLOCK CHIP

4-6 digit, 12-24 hr. alarm, timer and date circuits — with data \$6.95

6 DIGIT LED CLOCK KIT

INCLUDES: MM5314 clock circuit, 6 FND70 LED displays (.250" red 7 segment), All necessary transistors, resistors & capacitors, 1 double sided PC board accommodates LED's & clock circuitry, Schematic & instructions, Does not include 12V-300 ma transformer, switches & case \$11.95

CLOCK CHIPS WITH LED's

CT7001 4-6 digit, 12-24 hour clock with alarm, timer & date circuits plus 4 MAN 66.6" LED display \$14.95 above items plus 2 MAN 1 for date \$17.95

MMS314 clock chip 12-24 hour 4-6 digits Plus choice of 6 MAN 5 green 7 SEG LED .27" 6 MAN 7 red 7 SEG LED .27" 6 MAN 8 yellow 7 SEG LED .27" \$9.95

UNIVERSAL BREADBOARD

Silver plated copper circuit board 1-1/16" x 5-1/16", 2 rows of 27 holes for DIP IC's — space for transistors, resistors & capacitors. Versatile and simple for breadboarding IC circuits \$1.50 ea. 50 pcs. 1.00 ea.

UV ERASABLE PROM

1702A — 2048 bit static PROM 256x8 elect programmable & erasable TTL/DTL comp. \$14.95

METAL FILM RESISTORS

QTY	PRICE EACH	PRICE MINIMUM 10 PER VALUE	PRICE MINIMUM 100 PER VALUE
0 - 10	\$2.20		
10 - 100	.20	\$.15	
100 - 1000		.10	\$.09
1000 -		.10	.08

RESISTANCE (OHMS)

22.6	71.5	182	887	11.8K	40.2K
23.7	78.7	187	1.15K	13.0K	45.3K
25.5	84.5	191	1.5 K	15.0K	48.7K
30.9	105	205	2.49K	18.2K	54.9K
34.8	110	232	3.57K	19.1K	60.4K
40.2	115	243	4.75K	19.6K	64.9K
45.3	137	499	5.49K	22.6K	69.8K
51.1	147	604	6.04K	24.9K	84.5K
61.9	158	715	7.15K	28.0K	
64.9	178	806	8.25K	37.4K	

MISC. DEVICES

2513	64 x 8 x 5 character generator	\$11.00
2602	1024-bit static RAM, N-channel DTL/TTL compatible	3.95
F93410	256 bit RAM	2.19
MV5020	Jumbo green	.22
XC209-R	.125" red LED	.15
L100	Red LED	.15
L101	Red LED	.15

MEMORIES

1101	256 bit RAM MOS	\$ 1.50
1103	1024 bit RAM MOS	3.95
1702A	2048 bit static PROM UV eras.	17.95
2102-2	1024 bit static RAM	4.25
5203	2048 bit UV eras PROM	17.95
5260	1024 bit RAM	2.49
5261	1024 bit RAM	2.69
5262	2048 bit RAM	5.95
7489	64 bit ROM TTL	2.48
82523	Programmable ROM	3.69
74200	256 bit RAM tri-state	5.90

CALCULATOR & CLOCK CHIPS

5001	12 DIG 4 funct fix dec	\$2.49
5002	Same as 5001 exc btry power	2.79
5005	12 DIG 4 funct w/mem	2.99
MMS5725	8 DIG 4 funct chain & dec	1.98
MMS5736	18 pin 6 DIG 4 funct	4.45
MMS5738	8 DIG 5 funct K & mem	5.35
MMS5739	9 DIG 4 funct (btry sur)	5.35
MMS5311	28 pin BCD 6 dig mux	4.45
MMS5312	24 pin 1 pps BCD 4 dig mux	3.95
MMS5313	28 pin 1 pps BCD 6 dig mux	4.45
MMS5314	24 pin 6 dig mux	4.45
MMS5316	40 pin alarm 4 dig	5.39

Satisfaction guaranteed. Shipment will be made via first class mail in U.S., Canada and Mexico within 5 days from receipt of order. Add \$.50 to cover shipping and handling for orders under \$25.00. Minimum order \$5.00. California residents add sales tax.

INTERNATIONAL ELECTRONICS UNLIMITED

P.O. BOX 1708/ MONTEREY, CA. 93940 USA
 PHONE (408) 659-3171

CRYSTALS

Part #	Frequency	Case Style	Price
CV1A	1 000 MHz	HC33/U	\$4.95
CV2A	2 000 MHz	HC33/U	\$4.95
CV3A	3 000 MHz	HC18/U	\$4.95
CV7A	5 000 MHz	HC18/U	\$4.95
CV12A	10 000 MHz	HC18/U	\$4.95
CV19A	18 000 MHz	HC18/U	\$4.95
CV22A	20 000 MHz	HC18/U	\$4.95
CV30B	32 000 MHz	HC18/U	\$4.95

AVAILABLE IN THESE FREQUENCIES ONLY

CLOCK CASES

Nicely styled cases complete with red bezel for use in such applications as desk clocks, car clocks, alarm clocks, instrument cases.

DIMENSIONS: W-4" L-4" H-2"

\$5.95

64 Key Keyboard

\$24.95

This keyboard is composed of 64 Magnetic Reed Switches, in one molded unit. It is unencased with each SPST switch brought out to two pins.

HD0185 Keyboard Encoder ROM **\$7.95**

DIGITAL WATCH READOUT

FOR USE WITH WATCHES: DVMS, COUNTERS, ETC.

\$1.95

MOS LSI DEVICES

CLOCK CHIPS

MM5309	6 Digit BCD Outputs, Reset Pin	\$5.95
MM5311	6 Digit, BCD Outputs, 12 or 24 Hour	4.95
MM5312	4 Digit, BCD Outputs, 1 PPS Output	4.95
MM5313	6 Digit, ICD Outputs, 1 PPS Output	4.95
MM5314	6 Digit, 12 or 24 Hour, 50 or 60 Hz	4.95
MM5316	4 Digit, Alarm, 1 PPS Output	6.95
MM5318	Video Clock Chip, For Use With MM5841	9.95
CT7001	6 Digit, Calendar, Alarm, 12 or 24 Hour	6.95

CALCULATOR CHIPS

MM5725	8 Digit, Four Function, Less Decimal	\$2.95
MM5726	8 Digit, 5 Function	2.95
MM5739	8 Digit, 4 Function, Floating Decimal	2.95
CT5001	12 digit 4 Function	3.95
CT5005	12 digit 4 Function with Memory	5.95
CT5030	12 digit 4 Function and 2	7.95

MISC. MOS

MM5007	Complete 4 Digit Counter	\$10.95
L5110/0L111	3 1/2 Digit Voltmeter Chip Set	\$29.00
MC1408.7	7 Bit Digital To Analog Conv	9.95
MM5320	TV Camera Sync Generator	19.95
MM5841	Video Generator For MM5318	18.00

DL728

The DL728 is a dual 0.5" common cathode red display. It is ideal for use with clock chips, as segments are already multiplexed.

\$2.95

1 1/4" x 1 1/2" XFEMERS

That were designed for clock type applications. 110 Vac primary @ 60 Hz. Secondary: 8-10 Vac @ 30 mA-50 mA. 50 Vac @ 30 mA-50 mA. E-relet for miniature power supplies & gas discharge displays.

SPECIAL \$1.79

1/16 VECTOR BOARD

0.1" Hole Spacing P-Pattern

Part No.	Length	Width	Price
PHENOLIC			
16P44 062XXP	4.50	6.50	1.72 1.54
16P44 02XXP	4.50	17.00	3.69 3.32
16P44 062	4.50	6.50	2.07 1.86
16P44 062	4.50	8.50	2.56 2.31
16P44 062	4.50	17.00	5.04 4.53
16P44 062	8.50	17.00	9.23 8.26
16P44 062C1	4.50	17.00	6.80 6.12

EPOXY GLASS COPPER CLAD

VECTOR WIRING PENCIL

Vector Wiring Pencil (VWP) consists of a hand held feather-weight (under one ounce) tool which is used to guide and wrap insulated wire. Fed off a self-contained replaceable bobbin, onto component leads or terminals installed on pre-punched "P" Pattern Vectorboard. Connections between the wrapped wire and component leads, pads or terminals, are made by soldering. Complete with 250 Ft of red wire.

Special \$7.95

REPLACEMENT WIRE — BOBBINS FOR WIRING PENCIL

W36-3-A-Pkg	3	250 Ft.	36 AWG GREEN	\$2.40
W36-3-B-Pkg	3	250 Ft.	36 AWG RED	\$2.40
W36-3-C-Pkg	3	250 Ft.	36 AWG CLEAR	\$2.40
W36-3-D-Pkg	3	250 Ft.	36 AWG BLUE	\$2.40

9V BATTERY CLIP

STANDARD CLIP FOR USE WITH 9V TRANSISTOR BATTERIES WITH 4" LEADS

97.99

TERMINAL STRIPS

THREE TERMINAL STRIPS, WITH CENTER TERMINAL USED FOR MOUNTING

15/\$1.00

MOLEX PINS

PINS USED AS INEXPENSIVE SUBSTITUTE FOR SOCKETS

SPECIAL	100/1.49
SPECIAL	1000/12.00

MICROPROCESSOR COMPONENTS

CENTRAL PROCESSOR UNITS

Each processor feature a 2µs instruction cycle, and are brand new from the manufacturer. The 8080 is a 2nd generation processor, and the 8080A is a 2 1/2 generation microprocessor.

8080 \$24.95

8080A \$39.95

Direct Replacement For Intel C8080

2K RAM SPECIAL

MM5262 Fully decoded 2Kx1 dynamic RAM. All inputs except clocks are TTL compatible. Provides a 635 ns minimum access time, and requires a +5, +8.5, and -15V power supply. Low power provides non-volatile memory using battery back-up.

\$0.99 ea. (0.05 cents per bit)

CPU'S	Price	RAM'S	Price
8 Bit CPU	\$19.95	256K1	\$2.25
Super 8008	\$24.95	1024X1	2.95
Super 8008	\$39.95	2101	6.95
		2102	2.49
		1024X1	19.95
		4096X1	7.95
		256K4	29.95
		16K4	2.49
		16K4	7.95
		256K4	2.95
		16K4	3.99
		1024X1	2.75
		256K1	6.95
		256K1	1.75
		DYNAMIC	2.95

BUILD YOUR OWN JOLT MICROCOMPUTER IN JUST 3 HOURS OR LESS FOR \$159.95.

A COMPLETE MICROCOMPUTER IN A SINGLE CPU KIT INCLUDES: • An MOS Technology MCS6502 NMOS microprocessor • 512 bytes of program RAM, and 64 bytes of interrupt vector RAM • 1K bytes of mask programmed ROM containing DEMON, a powerful debug monitor • 26 programmable I/O lines • Internal RC clock, or crystal controlled clock with user supplied crystal • Serial I/O ports for a teleprinter current loop driver/receiver, or an EIA standard driver/receiver • Expandable address and data buses • Hardware interrupt • Control panel/interface lines available on card connector • Complete assembly manuals and sample programs

JOLT ACCESSORY KITS

JOLT RAM Card — Fully static 4,096 bytes of RAM with 1 microsecond access time and on-board decoding. **\$199.95**

JOLT I/O Card (Peripheral Interface Adapter) — 2 PIA LSI chips, 32 I/O lines, four interrupt lines, on-board decoding and standard TTL drive. Fully programmable. **\$99.50**

JOLT Power Supply — Operates at +5, +12 and -10 voltages. Supports JOLT CPU, 4K bytes of RAM and JOLT I/O card — or CPU and 8 I/O cards. **\$99.95**

JOLT +5V Booster Option — Fits onto JOLT Power Supply card. Supports CPU, 8K bytes RAM and 8 I/O CPU and cards. **\$24.95**

JOLT Universal Card — Same size (1 1/4" x 7") same form factor as other JOLT cards. Completely blank drilled to accept 14, 16, 24 or 40 pin sockets. **\$24.95**

JOLT Resident Assembler — Fully symbolic, single pass resident assembler, all microprocessors compatible with timesharing assemblers. Delivered on four 1702A PROMS, ready for plugging into JOLT PROM card. **\$149.95**

JOLT 1702A PROM CARD — Sockets for 2,048 bytes of PROM memory. Place anywhere in memory with jumper selectable addresses. **\$99.95**

30 AWG WIRE WRAP WIRE

AWG	COLOR	25 FT. MIN.	50 FT.	100 FT.	1000 FT.
30 AWG	WHITE	\$2.10	\$2.75	\$3.50	\$24.00
30 AWG	YELLOW	2.10	2.75	3.50	24.00
30 AWG	RED	2.10	2.75	3.50	24.00
30 AWG	GREEN	2.10	2.75	3.50	24.00
30 AWG	BLUE	2.10	2.75	3.50	24.00
30 AWG	BLACK	2.10	2.75	3.50	24.00

26 AWG RIBBON CABLE

CONDUCTORS	1-9 H	10-24 H	25-99 H	100 H
10	39	29	25	23
20	58	49	45	43
26	69	59	55	52

6' 2 CONDUCTOR POWER CORDS 125V @ 5A

3/1\$

THREE CONDUCTOR POWER SUPPLY CORDS

NUMBER	LENGTH	AWG	O. D.	RATING	COLOR	PRICE
17236	6	18(41X34)	265	1250W	BLACK	Special 79 ea
17237	6	18(41X35)	253	1250W	GREY	1.25
17238	6	18(41X34)	265	10A-125V	BLACK	Special 99 ea
17239	6	18(41X34)	253	10A-125V	GREY	1.30
17000	4	18(41X34)	253	10A-125V	BLACK	59

Satisfaction Guaranteed. \$5.00 Min. Order. U.S. Funds. California Residents — Add 6% Sales Tax — Data Sheets 25c each. Send a 13c stamp (postage) for a FREE 1976 Catalog

JAMES

P.O. BOX 822, BELMONT, CA. 94002
PHONE ORDERS — (415) 592-8097

JE SERIES KITS

JE700 CLOCK

The JE700 is a low cost digital clock, but is a very high quality unit. The unit features a simulated walnut case with dimensions of 6" x 2 1/4" x 1 1/8". It uses a MAN72 High Brightness resect and the MM5314 clock chip.

12 in. 24 Hour

115 VAC—**\$17.95**

JE803 PROBE

The Logic Probe is a unit which is for the most part indispensable in trouble shooting logic families. TTL, DTL, RTL, CMOS. It derives the power it needs to operate directly off of the circuit under test, drawing a scant 10 mA max. It uses a MM5314 output to indicate any of the following states by these symbols: (H) = HIGH, (L) = LOW, (P) = PULSE, (C) = CAN'T BE USED at MOS levels, or circuit damage will result.

\$9.95 Per Kit printed circuit board

JOYSTICK

These joysticks feature four 100K potentiometers, that vary resistance proportional to the angle of the stick. Study metal construction with plastics components only at the movable joint. Perfect for electronic games and instrumentation.

\$9.95 ea

ELECTRONIC CRAPS

Electronic craps is an entirely electronic game featuring a dice "roll down", 14 LED's form two dice that roll when activated by a push button switch. Dimensions are 6 1/2" x 3 1/2" x 1 1/2".

\$19.95

ELECTRONIC ROULETTE

This kit comes complete with all components, including the case and the cord. Electronic Roulette, is entirely electronic, and features 32 D's that form a wheel, that is actuated, by a push button switch. Dimensions are 6 1/2" x 6 1/2" x 1 1/2".

\$29.95

Semiconductor Specials

2N2222 — NPN Si, High Frequency switching transistor (typically 250 MHz) 0.5W, HFE = 100. Vceo 30V **75/5.00**

4N3055 — Same as T03 CAN 2N3055 except that base and emitter leads have solder lugs. **5.99**

1N4308 — Excellent signal diode for uses in digital switching circuits 80 PRV @ 200 mA. **20/\$1.00**

MCT2E — NPN Opto Isolator which provides 2500 VDC isolation. **\$2.95**

7N4123 — NPN Si, high frequency switching transistor. With an HFE = 120, it is ideally suited for most digital applications. **85/1.00**

RL4403 — Red 2' LED with 2 piece plastic mounting. **3/51.00**

74S287 — Outstanding 256 x 4 TTL PROM. Tri-state outputs provide easy bussing. Access time of 40 ns. **\$7.95**

CA3081 — Common Emitter H.V. 7 transistors in a 16 PIN package. Ideal for segment drivers. **\$1.75**

CA3082 — Common Collector H.V. NPN transistor array, packaged 7 transistors to each O.I.P. Excellent in uses with incandescent displays. **\$2.00**

PROTO BOARD 6

The PB-6 lets the user test and build circuits without soldering or patch cords. All interconnections between components are made with common #22 AWG hook-up wire. This quality breadboarding kit includes 630 component tie points at less than 2.5c each. It measures 6" long by 4" wide. Designed specially to Breadboard Microprocessor Circuits.

\$15.95

PROTO BOARD 100

A low cost, big 10 IC capacity breadboard kit with all the quality of DT Board series — complete down to the last nut, bolt and screw. Includes 2 07-35S Sockets, 1 QT-358 Bus Strip, 2 5-way binding posts, 4 rubber feet, screws, nuts, bolts, and easy assembly instructions.

SPECIAL \$17.95

7400N TTL

SN7400N	.13	SN7453N	.27	SN74150N	1.13
SN7401N	.16	SN7454N	.41	SN74151N	1.25
SN7402N	.21	SN7455A	.22	SN74152N	1.35
SN7403N	.16	SN7456N	.22	SN74154N	1.25
SN7404N	.16	SN7470N	.45	SN74155N	1.21
SN7405N	.24	SN7471N	.69	SN74156N	1.30
SN7406N	.45	SN7472N	.39	SN74157N	1.30
SN7407N	.45	SN7473N	.37	SN74158N	1.75
SN7408N	.25	SN7474N	.32	SN74159N	1.45
SN7409N	.25	SN7475N	.59	SN74163N	1.35
SN7410N	.16	SN7476N	.32	SN74164N	1.65
SN7411N	.30	SN7479N	5.00	SN74165N	1.65
SN7412N	.43	SN7480N	.50	SN74167N	1.70
SN7413N	.85	SN7482N	1.75	SN74167N	1.50
SN7414N	.70	SN7483N	1.15	SN74170N	3.00
SN7415N	.43	SN7485N	1.12	SN74172N	18.00
SN7417N	.25	SN7486N	.45	SN74173N	1.70
SN7418N	.25	SN7488N	3.50	SN74174N	1.95
SN7420N	.21	SN7489N	3.00	SN74175N	1.55
SN7421N	.39	SN7490N	.49	SN74176N	.90
SN7422N	1.50	SN7491N	1.20	SN74177N	.90
SN7423N	.37	SN7492N	.85	SN74180N	1.05
SN7425N	.43	SN7493N	.57	SN74181N	3.55
SN7426N	.31	SN7494N	.91	SN74182N	.95
SN7427N	.37	SN7495N	.91	SN74184N	2.30
SN7428N	.42	SN7496N	.42	SN74185N	2.30
SN7429N	.26	SN7497N	4.00	SN74186N	5.00
SN7432N	.31	SN74100N	1.00	SN74187N	1.60
SN7437N	.47	SN74107N	.49	SN74190N	5.00
SN7438N	.40	SN74120N	.45	SN74191N	1.50
SN7439N	.25	SN74122N	.49	SN74192N	1.19
SN7440N	.21	SN74123N	.70	SN74193N	.99
SN7441N	1.10	SN74125N	.60	SN74194N	1.45
SN7442N	1.08	SN74126N	.81	SN74195N	1.00
SN7443N	1.05	SN74132N	3.00	SN74196N	1.25
SN7444N	1.10	SN74136N	1.80	SN74197N	2.00
SN7445N	1.10	SN74141N	1.15	SN74198N	2.25
SN7446N	1.15	SN74142N	4.00	SN74199N	2.25
SN7447N	.79	SN74143N	4.50	SN74200N	7.00
SN7448N	.89	SN74144N	4.50	SN74209N	.80
SN7450N	.26	SN74145N	1.15	SN74215N	2.50
SN7451N	.27	SN74147N	3.00	SN74248N	6.00
SN7452N	.27	SN74148N	2.50	SN74285N	6.00

MANY OTHERS AVAILABLE ON REQUEST
20% Discount for 100 Combined 7400s

CMOS

CD4000	.25	74CD04N	.75
CD4001	.25	74CD05	.65
CD4002	.25	74CD09	.65
CD4003	2.50	74CD10	.85
CD4007	.25	74CD42	2.15
CD4009	.59	74CD44	1.90
CD4010	.59	74CD46	1.50
CD4011	.25	74CD47	1.15
CD4012	.25	74CD49	2.75
CD4013	.47	74CD50	1.25
CD4016	.56	74CD51	2.90
CD4017	.35	74CD52	3.00
CD4019	.55	74CD59	2.15
CD4020	1.49	74CD66	3.25
CD4022	.25	74CD69	3.25
CD4023	.25	74CD71	3.00
CD4024	1.50	74CD72	.75
CD4025	.25	74CD81	2.60
CD4027	.69	74CD85	2.75
CD4028	1.65	74CD87	2.75
CD4029	2.90	74CD90	2.75
CD4030	.65	74CD92N	5.50

LINEAR

LM300A	.80	LM135T	1.65
LM301A	3.10	LM141A	1.65
LM302A	.75	LM1458C	.85
LM303A	1.00	LM1496N	.85
LM305A	.95	LM1555V	.85
LM309A	.35	LM210N	2.95
LM309H	1.00	LM2091N	2.85
LM309CN	1.00	LM3065N	.55
LM309H	1.10	LM3090N	.55
LM309N	1.10	LM3095N	.60
LM309M	1.15	LM350D	1.85
LM310CN	.90	LM350L	6.00
LM311N	.90	LM355N	1.00
LM312CN	1.25	LM355V	2.20
LM319N	.30	LM358D	2.20
LM319D	.90	LM358B	2.20
LM320K-5	1.35	LM358P	.495
LM320K-12	1.35	LM359A	.99
LM320K-15	1.35	LM359N	1.25
LM320T-5	.75	LM359D	.39
LM320T-8	.75	LM359N	.39
LM320T-12	.75	LM359N	.39
LM320T-15	.75	LM359N	.39
LM324K-5	1.60	LM3909N	.89
LM324N	1.80	LM3909N	.89
LM329N	1.75	LM3909N	.89
LM330K-5	1.95	LM3909N	.89
LM330K-12	1.95	LM3909N	.89
LM330K-15	1.95	LM3909N	.89
LM330N	1.95	LM3909N	.89
LM340T-5	1.75	LM3909N	.89
LM340T-8	1.75	LM3909N	.89
LM340T-12	1.75	LM3909N	.89
LM340T-15	1.75	LM3909N	.89
LM340T-18	1.75	LM3909N	.89
LM340T-24	1.75	LM3909N	.89
LM340T-30	1.75	LM3909N	.89
LM340T-36	1.75	LM3909N	.89
LM340T-42	1.75	LM3909N	.89
LM340T-48	1.75	LM3909N	.89
LM340T-54	1.75	LM3909N	.89
LM340T-60	1.75	LM3909N	.89
LM340T-66	1.75	LM3909N	.89
LM340T-72	1.75	LM3909N	.89
LM340T-78	1.75	LM3909N	.89
LM340T-84	1.75	LM3909N	.89
LM340T-90	1.75	LM3909N	.89
LM340T-96	1.75	LM3909N	.89
LM340T-102	1.75	LM3909N	.89
LM340T-108	1.75	LM3909N	.89
LM340T-114	1.75	LM3909N	.89
LM340T-120	1.75	LM3909N	.89
LM340T-126	1.75	LM3909N	.89
LM340T-132	1.75	LM3909N	.89
LM340T-138	1.75	LM3909N	.89
LM340T-144	1.75	LM3909N	.89
LM340T-150	1.75	LM3909N	.89
LM340T-156	1.75	LM3909N	.89
LM340T-162	1.75	LM3909N	.89
LM340T-168	1.75	LM3909N	.89
LM340T-174	1.75	LM3909N	.89
LM340T-180	1.75	LM3909N	.89
LM340T-186	1.75	LM3909N	.89
LM340T-192	1.75	LM3909N	.89
LM340T-198	1.75	LM3909N	.89
LM340T-204	1.75	LM3909N	.89
LM340T-210	1.75	LM3909N	.89
LM340T-216	1.75	LM3909N	.89
LM340T-222	1.75	LM3909N	.89
LM340T-228	1.75	LM3909N	.89
LM340T-234	1.75	LM3909N	.89
LM340T-240	1.75	LM3909N	.89
LM340T-246	1.75	LM3909N	.89
LM340T-252	1.75	LM3909N	.89
LM340T-258	1.75	LM3909N	.89
LM340T-264	1.75	LM3909N	.89
LM340T-270	1.75	LM3909N	.89
LM340T-276	1.75	LM3909N	.89
LM340T-282	1.75	LM3909N	.89
LM340T-288	1.75	LM3909N	.89
LM340T-294	1.75	LM3909N	.89
LM340T-300	1.75	LM3909N	.89
LM340T-306	1.75	LM3909N	.89
LM340T-312	1.75	LM3909N	.89
LM340T-318	1.75	LM3909N	.89
LM340T-324	1.75	LM3909N	.89
LM340T-330	1.75	LM3909N	.89
LM340T-336	1.75	LM3909N	.89
LM340T-342	1.75	LM3909N	.89
LM340T-348	1.75	LM3909N	.89
LM340T-354	1.75	LM3909N	.89
LM340T-360	1.75	LM3909N	.89
LM340T-366	1.75	LM3909N	.89
LM340T-372	1.75	LM3909N	.89
LM340T-378	1.75	LM3909N	.89
LM340T-384	1.75	LM3909N	.89
LM340T-390	1.75	LM3909N	.89
LM340T-396	1.75	LM3909N	.89
LM340T-402	1.75	LM3909N	.89
LM340T-408	1.75	LM3909N	.89
LM340T-414	1.75	LM3909N	.89
LM340T-420	1.75	LM3909N	.89
LM340T-426	1.75	LM3909N	.89
LM340T-432	1.75	LM3909N	.89
LM340T-438	1.75	LM3909N	.89
LM340T-444	1.75	LM3909N	.89
LM340T-450	1.75	LM3909N	.89
LM340T-456	1.75	LM3909N	.89
LM340T-462	1.75	LM3909N	.89
LM340T-468	1.75	LM3909N	.89
LM340T-474	1.75	LM3909N	.89
LM340T-480	1.75	LM3909N	.89
LM340T-486	1.75	LM3909N	.89
LM340T-492	1.75	LM3909N	.89
LM340T-498	1.75	LM3909N	.89
LM340T-504	1.75	LM3909N	.89
LM340T-510	1.75	LM3909N	.89
LM340T-516	1.75	LM3909N	.89
LM340T-522	1.75	LM3909N	.89
LM340T-528	1.75	LM3909N	.89
LM340T-534	1.75	LM3909N	.89
LM340T-540	1.75	LM3909N	.89
LM340T-546	1.75	LM3909N	.89
LM340T-552	1.75	LM3909N	.89
LM340T-558	1.75	LM3909N	.89
LM340T-564	1.75	LM3909N	.89
LM340T-570	1.75	LM3909N	.89
LM340T-576	1.75	LM3909N	.89
LM340T-582	1.75	LM3909N	.89
LM340T-588	1.75	LM3909N	.89
LM340T-594	1.75	LM3909N	.89
LM340T-600	1.75	LM3909N	.89
LM340T-606	1.75	LM3909N	.89
LM340T-612	1.75	LM3909N	.89
LM340T-618	1.75	LM3909N	.89
LM340T-624	1.75	LM3909N	.89
LM340T-630	1.75	LM3909N	.89
LM340T-636	1.75	LM3909N	.89
LM340T-642	1.75	LM3909N	.89
LM340T-648	1.75	LM3909N	.89
LM340T-654	1.75	LM3909N	.89
LM340T-660	1.75	LM3909N	.89
LM340T-666	1.75	LM3909N	.89
LM340T-672	1.75	LM3909N	.89
LM340T-678	1.75	LM3909N	.89
LM340T-684	1.75	LM3909N	.89
LM340T-690	1.75	LM3909N	.89
LM340T-696	1.75	LM3909N	.89
LM340T-702	1.75	LM3909N	.89
LM340T-708	1.75	LM3909N	.89
LM340T-714	1.75	LM3909N	.89
LM340T-720	1.75	LM3909N	.89
LM340T-726	1.75	LM3909N	.89
LM340T-732	1.75	LM3909N	.89
LM340T-738	1.75	LM3909N	.89
LM340T-744	1.75	LM3909N	.89
LM340T-750	1.75	LM3909N	.89
LM340T-756	1.75	LM3909N	.89
LM340T-762	1.75	LM3909N	.89
LM340T-768	1.75	LM3909N	.89
LM340T-774	1.75	LM3909N	.89
LM340T-780	1.75	LM3909N	.89
LM340T-786	1.75	LM3909N	.89
LM340T-792	1.75	LM3909N	.89
LM340T-798	1.75	LM3909N	.89
LM340T-804	1.75	LM3909N	.89
LM340T-810	1.75	LM3909N	.89
LM340T-816	1.75	LM3909N	.89
LM340T-822	1.75	LM3909N	.89
LM340T-828	1.75	LM3909N	.89
LM340T-834	1.75	LM3909N	.89
LM340T-840	1.75	LM3909N	.89
LM340T-846	1.75	LM3909N	.89
LM340T-852	1.75	LM3909N	.89
LM340T-858	1.75	LM3909N	.89
LM340T-864	1.75	LM3909N	.89
LM340T-870	1.75	LM3909N	.89
LM340T-876	1.75	LM3909N	.89
LM340T-882	1.75	LM3909N	.89
LM340T-888	1.75	LM3909N	.89
LM340T-894	1.75	LM3909N	.89
LM340T-900	1.75	LM3909N	.89
LM340T-906	1.75	LM3909N	.89
LM340T-912	1.75	LM3909N	.89
LM340T-918	1.75	LM3909N	.89
LM340T-924	1.75	LM3909N	.89
LM340T-930	1.75	LM3909N	.89
LM340T-936	1.75	LM3909N	.89
LM340T-942	1.75	LM3	



PROGRAMMABLE COUNTER

A brand NEW, working 2 digit programmable counter with 2 Nixie tube readouts. Set desired count with 10 position switches, and the

logic will count up, giving an output at the preset number. The board contains 2 7490 counters, 2 74141 decoders, a PUT, and many transistors, caps, etc. With schematic. Many uses. 4 1/4" x 10 1/2", 1 lb. **STOCK NO. R6275 \$7.95 each, 2/15.00**



LONG HANDLE TOGGLE SWITCHES

Miniature toggle switches with 3/4" long handle. Both are SPDT, PC contacts, made by ALCO or C&K. ALCO series MST 105 or C&K series 710X. With hardware.

on-none-on **STOCK NO. R6276 \$1.25 ea, 5/5.00**
on-off-on **STOCK NO. R6277 \$1.25 ea, 5/5.00**

ROTARY SWITCHES

CENTRALAB rotary switches, 3/8" bushing mount, phenolic base.



1 section, 4 pole, 2 position **STK. NO. R6222 .75 ea, 5/3.00**
3 section, 3 pole, 11 position **STK. NO. R6278 \$1.50 ea, 4/5.00**

GENERAL PURPOSE LOCK



This general purpose lock finds many uses. Mounts in 3/4" dia. hole; up to 1/2" thick panels. The "hook" catches any 1/4" bolt. Key removable in both positions. With 2 keys. Extra keys .25 each.

STOCK NO. R5384 \$1.50/set, 4/5.00

Send for new 88 page Catalog 16, better than ever. **MASTERCHARGE & BANKAMERICARD** now accepted. Minimum cash order \$5, minimum charge order \$15. Phone orders accepted. Include sufficient postage, excess refunded.



DELTA ELECTRONICS CO.

BOX 1, LYNN, MASSACHUSETTS 01903
Phone (617) 388-4705

Circle 95 on reader service card

This month's special

TERMS:

\$5.00 min. order U.S. funds.
Calif. residents add 6% tax.



Electronic Watch Kit \$24.95

5 function LED. Large readout unmagnified. Easy to solder and assemble.

M5 Large numeric readout \$24.95

M8 Alpha/Numeric readout \$27.95

Finished modules also available

Watch Case & Strap Handsomely styled

C6 All metal \$15.50 C7 Leather (watch case) \$14.00

Same Day Shipment. First line parts only. Guaranteed satisfaction. Listed below is just a small sample of the complete lines available. A broad line of IC's at low factory prices. Try us. You'll like the quality and the service!

74LS00 TTL	7403	14	MOS/MEMORY	LINEAR
74LS00	29	7405	2102P	2 50
74LS02	29	7406	2102-2P	2 60
74LS04	35	7408	6331J	
74LS10	29	7423	82S123	2 90
74LS74	45	7436	8223	3 10
74LS90	99	7447	1404AT	1 80
74LS93	99	7473		
74LS107	47	7474		
74LS151	1 14	7476		
74LS157	1 14	7490		
74LS163	1 89	7493		
		74107		
		74154		
		74157		
		74163		
		74192		
		74197		
		74198		
		74199		
		74200		
		74201		
		74202		
		74203		
		74204		
		74205		
		74206		
		74207		
		74208		
		74209		
		74210		
		74211		
		74212		
		74213		
		74214		
		74215		
		74216		
		74217		
		74218		
		74219		
		74220		
		74221		
		74222		
		74223		
		74224		
		74225		
		74226		
		74227		
		74228		
		74229		
		74230		
		74231		
		74232		
		74233		
		74234		
		74235		
		74236		
		74237		
		74238		
		74239		
		74240		
		74241		
		74242		
		74243		
		74244		
		74245		
		74246		
		74247		
		74248		
		74249		
		74250		
		74251		
		74252		
		74253		
		74254		
		74255		
		74256		
		74257		
		74258		
		74259		
		74260		
		74261		
		74262		
		74263		
		74264		
		74265		
		74266		
		74267		
		74268		
		74269		
		74270		
		74271		
		74272		
		74273		
		74274		
		74275		
		74276		
		74277		
		74278		
		74279		
		74280		
		74281		
		74282		
		74283		
		74284		
		74285		
		74286		
		74287		
		74288		
		74289		
		74290		
		74291		
		74292		
		74293		
		74294		
		74295		
		74296		
		74297		
		74298		
		74299		
		74300		
		74301		
		74302		
		74303		
		74304		
		74305		
		74306		
		74307		
		74308		
		74309		
		74310		
		74311		
		74312		
		74313		
		74314		
		74315		
		74316		
		74317		
		74318		
		74319		
		74320		
		74321		
		74322		
		74323		
		74324		
		74325		
		74326		
		74327		
		74328		
		74329		
		74330		
		74331		
		74332		
		74333		
		74334		
		74335		
		74336		
		74337		
		74338		
		74339		
		74340		
		74341		
		74342		
		74343		
		74344		
		74345		
		74346		
		74347		
		74348		
		74349		
		74350		
		74351		
		74352		
		74353		
		74354		
		74355		
		74356		
		74357		
		74358		
		74359		
		74360		
		74361		
		74362		
		74363		
		74364		
		74365		
		74366		
		74367		
		74368		
		74369		
		74370		
		74371		
		74372		
		74373		
		74374		
		74375		
		74376		
		74377		
		74378		
		74379		
		74380		
		74381		
		74382		
		74383		
		74384		
		74385		
		74386		
		74387		
		74388		
		74389		
		74390		
		74391		
		74392		
		74393		
		74394		
		74395		
		74396		
		74397		
		74398		
		74399		
		74400		
		74401		
		74402		
		74403		
		74404		
		74405		
		74406		
		74407		
		74408		
		74409		
		74410		
		74411		
		74412		
		74413		
		74414		
		74415		
		74416		
		74417		
		74418		
		74419		
		74420		
		74421		
		74422		
		74423		
		74424		
		74425		
		74426		
		74427		
		74428		
		74429		
		74430		
		74431		
		74432		
		74433		
		74434		
		74435		
		74436		
		74437		
		74438		
		74439		
		74440		
		74441		
		74442		
		74443		
		74444		
		74445		</



These smiles depend on you

Muscular dystrophy can destroy smiles as it destroys every voluntary—and ultimately—every involuntary muscle in the body.

Physical therapy, summer camps and counseling keep children with dystrophy smiling while MDA scientists search for a cure.

MDA needs your support to keep them smiling. And that will make you smile too.

MDA

Muscular Dystrophy Association
810 Seventh Avenue
New York, NY 10019

VIDEO CAMERA KIT

A UNIQUE ALL SOLID STATE CAMERA KIT
FEATURING A...100 X 100 BIT
SELF SCANNING CHARGED
COUPLED DEVICE

INCLUDES THE FOLLOWING
UNIQUE FEATURES
FOUND IN FAR MORE
EXPENSIVE CAMERAS
IF AVAILABLE

- LOW VOLTAGE SUPPLY (OR BATTERIES) - 5 AND +15 VOLTS
- SENSITIVE TO INFRARED AS WELL AS VISIBLE LIGHT
- MAY BE USED FOR SURVEILLANCE WITH AN IR LIGHT SOURCE
- EXCELLENT FOR STANDARD SURVEILLANCE WORK BECAUSE OF ITS LIGHT WEIGHT AND SMALL SIZE
- ALL COMPONENTS MOUNTED ON TWO PARALLEL 3" X 5" SINGLE SIDED BOARDS. TOTAL WEIGHT UNDER 2 LBS.
- MAY BE WIRED BY PERSON WITH SOME TECHNICAL EXPERIENCE IN 4-6 HRS



SUPER UNBELIEVABLE
ONLY
\$225.00

ADD \$2.00 POSTAGE AND HANDLING. PLUS \$8.00 FOR ALL IC SOCKETS (Optional)

MAY BE USED
WITH AMATEUR
RADIO FOR VIDEO

USED FOR CHARACTER RECOGNITION FOR COMPUTERS WITH EXTERNAL CIRCUITS

MAY BE USED IN A VACUUM, UNDER WATER, HIGH ALTITUDE, AND IN MAGNETIC ENVIRONMENT BECAUSE THERE IS NO HIGH VOLTAGE OR MAGNETIC DEFLECTION

WE SUPPLY ALL SEMICONDUCTORS, BOARDS, DATA SHEETS, DIAGRAMS, RESISTORS AND CAPACITORS

SORRY, WE DO NOT SUPPLY THE CASE, BATTERIES (OR SUPPLY THE LENSES (NOT SUPPLIED) DEPENDS UPON THE USER

F8 MICROPROCESSOR KIT

WE'VE GOT THE F8 MICROPROCESSOR KIT, ONE OF THE MOST ADVANCED MCU SYSTEMS ON THE MARKET TODAY FOR ONLY \$179.00

This three chip microprocessor system has the following advantages:

- 1) Driven by a +5 volt +12 volt power supply
- 2) Two I/O ports on the CPU chip, and ROM making 32 bidirectional lines
- 3) 64 bytes of fast RAM scratchpad built into the CPU chip
- 4) A built-in clock generator and power-on reset built into the CPU chip
- 5) A programmable internal timer built into the ROM chip
- 6) 80% of the instructions are 1 byte
- 7) TTL I/O compatibility
- 8) consumes less than 300mw of power per chip
- 9) A local interrupt with automatic address vector
- 10) expandable to 64K bytes (2 1024 2's) of memory

The F8 Kit has through parts and instructions to demonstrate microprocessor programs up to 1K byte, and to debug those programs

We supply:

- 1. 3850 CPU
- 2. 3851 FAIR RUG programmed storage unit provides the programmer with all its I/O subroutine and allows the programmer to display or alter memory, and register contents via a teletype terminal
- 3. 3852 Static memory interface
- 8. 2102 2 Plus CMOS gates and buffers, PC card, instruction manuals, programming guide, and time sharing guide

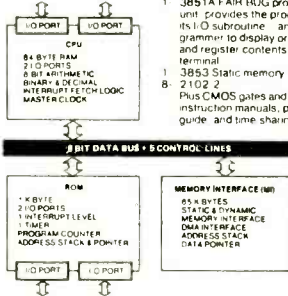

- INTEL 8080 CPU \$37.50
- 8008 8 BIT MICRO PROCESSING CHIP (with Data Book) \$19.00
- 2102 2 1024 BIT RAM \$ 2.95
- 5202A UV PROM \$12.50
- MM5203 UV PROM \$12.50
- 1702A UV PROM \$12.50
- 5204 4K PROM \$24.95
- MINIATURE MULTI-TURN TRIM POTS 100, 500 \$1.50 ea.
- 5K 10K, 25K 50K 100K 200K \$3/2.00
- MULTI-TURN TRIM POTS Similar to Bourns 3010 style 1/4", 1/2", 3/4", 1" x 1/4", 50, 100, 1000 ohms \$1.50 ea.
- LIGHT ACTIVATED SCR's TO: 1B, 200V, 1A \$1.75

- ### TRANSISTOR SPECIALS
- 2N3585 NPN Si TO-66 \$ 95
 - 2N3772 NPN Si TO-3 \$1.80
 - 2N4901 PNP Si TO-3 \$ 85
 - 2N5086 PNP Si TO-92 4.51 00
 - 2N4898 PNP TO-66 \$ 60
 - 2N404 PNP GE TO-5 \$ 51 00
 - 2N3913 NPN Si TO-3RF \$ 51 00
 - MPS13 NPN Si TO-92 \$ 31 00
 - 2N3767 NPN Si TO-66 \$ 70
 - 2N2222 NPN Si TO-18 \$ 51 00
 - 2N3055 NPN Si TO-3 \$ 80
 - 2N3904 NPN Si TO-92 \$ 51 00
 - 2N3906 PNP Si TO-92 \$ 51 00
 - 2N5296 NPN Si TO-220 \$ 50
 - 2N6109 PNP Si TO-220 \$ 55
 - 2N3866 NPN Si TO-5 \$ 75
 - 2N3638 NPN Si TO-5 \$ 51 00
 - 2N6517 NPN TO-92SL \$ 1.00

- ### C/MOS (DIODE CLAMPED)
- 74C02 - 26 4013 - 45 4028 - 95
 - 74C10 - 30 4015 - 14 4029 - 120
 - 4001 - 24 4017 - 15 4030 - 49
 - 4002 - 24 4018 - 14 4035 - 150
 - 4006 - 135 4019 - 50 4042 - 75
 - 4007 - 24 4022 - 14 4046 - 275
 - 4009 - 50 4023 - 24 4047 - 350
 - 4010 - 50 4025 - 24 4050 - 49
 - 4011 - 24 4026 - 190 4055 - 195
 - 4012 - 24 4027 - 55 4066 - 100
- ### FND 505 5°C C
- HP 7740 3°C C \$1.75
 - MAN-4 25°C A \$1.40
 - MAN-7 3°C A \$1.25
 - DL 747 6°C C \$1.95
 - NS 33-3 digit array \$1.35

- ### PRINTED CIRCUIT BOARD
- 4 1/2" x 6" SINGLE SIDED EPOXY BOARD, thick prepreg \$5/2.20
 - VECTOR BOARD 1" SPACING 4 1/2" x 6" SHEET \$1.50

- ### 4 WATT IR LASER DIODE \$7.95
- 2N5480 P-CELL \$ 45
 - 2N 5487 N-FET \$ 45
 - 2N 4891 UJT \$ 45
 - 1T5 43 UJT \$ 35
 - ER 900 TRIGGER DIODES 4/51 00
 - 2N 6028 PROG UJT \$.85

- ### VERIPAX PC BOARD
- This board is a 1/2" single sided paper epoxy board, 4 1/2" x 6", DRILLED and ETCHED which will hold up to 21 single 14 pin IC's or 8, 15, or 15i DIP IC's with buses for power supply connector. \$5.25
- MV 5691 YELLOW-GREEN \$1.25
 - BIPOLAR LED \$1.25
 - MT 2 PHOTO TRANS \$.80
 - RED YELLOW, GREEN OR AMBER LARGE LED's \$.20
 - 14 PIN DIP SOCKETS \$.35
 - 16 PIN DIP SOCKETS \$.38
 - MOLEX PINS 100 \$1.00
 - 8 PIN MINI DIP SOCKETS \$.30
 - 10 PIN TO 5 TEFLOX PC SOCKETS \$.80
 - 10 WATT ZENERS 3.9, 4.7, 12, 18, OR 22V \$.80
 - 1 WATT ZENERS 4.7, 5.6, 10, 12, 15, 18 OR 22V \$.25

- ### Silicon Power Rectifiers
- | PRV | 1A | 3A | 12A | 50A | 125A |
|------|----|----|-----|-----|-------|
| 100 | 06 | 14 | 30 | 80 | |
| 200 | 07 | 20 | 35 | 115 | 4.25 |
| 400 | 09 | 25 | 50 | 140 | 6.50 |
| 600 | 11 | 30 | 70 | 180 | 8.50 |
| 800 | 15 | 35 | 90 | 230 | 10.50 |
| 1000 | 20 | 45 | 110 | 275 | 12.50 |

- ### REGULATED MODULAR POWER SUPPLIES
- + - 15VDC AT 100ma
 - 115VAC INPUT \$24.95
 - 5VDC AT 1A, 115VAC INPUT \$24.95
 - 12V 5A \$24.95
 - IN 4148 (IN914) \$15/1.00
 - 1103 1024 bit RAM \$2.75
 - NEC 6003 2048 bit RAM \$8.00
 - 1101 256 bit RAM \$1.40
 - 7489 RAM \$2.30
 - 7 POLE 1 THROW TO 5 MINATURE ROTARY SWITCH \$1.15
 - 5-30V LOW CURRENT.

- ### TANTULUM CAPACITORS
- 22UF 35V 5/51 00 68UF 35V 3/51 00
 - 47UF 35V 5/51 00 33UF 75V \$.40
 - 68UF 35V 5/51 00 30UF 6V 5/51 00
 - 1UF 35V 5/51 00 150UF 20V 5.50
 - 4.7UF 35V 4/51 00

- ### TTL IC SERIES
- 74100 - 26 7476 - 35
 - 7400 - 14 7480 - 48
 - 7401 - 15 7483 - 75
 - 7402 - 15 7488 - 105
 - 7403 - 15 7486 - 34
 - 7404 - 18 7490 - 49
 - 7405 - 18 7491 - 79
 - 7406 - 35 7492 - 49
 - 7407 - 33 7493 - 49
 - 7408 - 18 7495 - 74
 - 7409 - 18 7496 - 79
 - 7410 - 15 7410 - 34
 - 7411 - 25 7412 - 38
 - 7412 - 30 74123 - 74
 - 7413 - 45 74125 - 54
 - 7414 - 45 74126 - 54
 - 7416 - 33 74150 - 92
 - 7417 - 33 74151 - 69
 - 7420 - 15 74153 - 79
 - 7425 - 27 74154 - 105
 - 7426 - 24 74155 - 105
 - 7427 - 27 74157 - 75
 - 7430 - 15 74161 - 95
 - 7432 - 24 74164 - 110
 - 7437 - 29 74165 - 110
 - 7443 - 28 74173 - 136
 - 7444 - 15 74175 - 95
 - 7441 - 95 74177 - 75
 - 7442 - 59 74181 - 230
 - 7445 - 79 74192 - 110
 - 7446 - 87 74193 - 110
 - 7447 - 87 74194 - 115
 - 7448 - 95 74195 - 74
 - 7449 - 28 74196 - 74
 - 7473 - 34 75324 - 175
 - 7474 - 35 75491 - 110

- ### ALCO MINATURE TOGGLE SWITCHES
- MTA 106 SPDT \$1.20
 - MTA 206 DPDT \$1.70

- ### Full Wave Bridges
- | PRV | 1A | 6A | 25A |
|-----|------|------|------|
| 200 | 95 | 1.25 | 2.00 |
| 400 | 1.5 | 1.50 | 3.00 |
| 600 | 1.35 | 1.75 | 4.00 |

- ### SANKEN AUDIO POWER AMPS
- Si 1010 G 10 WATTS \$ 6.90
 - Si 1020 G 20 WATTS \$13.95
 - Si 1050 G 30 WATTS \$24.95

- ### LINEAR CIRCUITS
- LM 309K 5V 1 REGULATOR \$1.00
 - 723 - 40 - 40V REGULATOR \$.54
 - 301 748 HI Per Op Amp \$.28
 - 320T 5 12 15 OR 24V NEGATIVE REG \$1.50
 - 741A or 741C OP AMP \$.31
 - 709 - OPER AMP \$.25
 - 307 OP AMP \$.95
 - CA 3047 HI PER OP AMP \$1.95
 - CA 3089 FM IF SYSTEM \$3.25
 - 340T 5, 8, 12, 15, 18, 24V POS REG TO 220 \$1.20
 - 101 OPER AMP HI PERFORM \$.75
 - LM 308 Oper Amp Low Power \$1.05
 - 747 - DUAL 741 \$.65
 - 556 - DUAL TIMER \$2.80
 - 537 - PRECISION OP AMP \$2.50
 - 540 70W POWER DRIVER \$2.49
 - LM 3900 - QUAD OP AMP \$.49
 - LM 324 - QUAD 741 \$1.50
 - 560 - PHASE LOCK LOOP \$2.50
 - 561 - PHASE LOCK LOOP \$2.50
 - 865 - PHASE LOCK LOOP \$1.50
 - 566 FUNCTION GEN \$2.50
 - 567 - TONE DECODER \$1.50
 - LM 1310N FM STEREO DEMOD \$2.75
 - 8038 IC VOLTAGE CONT OSC \$3.90
 - LM 370 - AGC SQUELCH AMP \$1.15
 - 555 - 2 us - 2 HR TIMER \$.55
 - 553 QUAD TIMER \$3.50
 - FCD 810 OPTO-ISOLATOR \$.80
 - 1458 DUAL OP AMP \$.55
 - LM 380 - 2W AUDIO AMP \$.80
 - LM 377 - 2W Stereo Audio Amp \$2.50
 - LM 381 - STEREO PRE AMP \$1.00
 - LM 382 - DUAL AUDIO PREAMP \$1.00
 - LM 311 - HI PER COMPARTOR \$.95
 - LM 319 - Dual H Speed Comp \$1.10
 - LM 339 - QUAD COMPARTOR \$1.25

- ### TRIACS SCR'S
- | PRV | 1A | 10A | 25A | 15A | 6A | 35A |
|-----|-----|-----|-----|-----|-----|-----|
| 100 | 40 | 70 | 130 | 40 | 50 | 120 |
| 200 | 70 | 110 | 175 | 60 | 70 | 160 |
| 400 | 110 | 160 | 260 | 100 | 120 | 220 |
| 600 | 170 | 230 | 360 | 150 | 300 | |

SGS-ATES AUDIO AMPLIFIERS LOTS OF WATTS IN LESS SPACE FOR A WIDE RANGE OF APPLICATIONS 10 WATT



Type	Supply Voltage (V)	Power (W)	PRV (V)	QRL (Ω)	BVcc (V)	Closed-Loop Gain Range (dB)	Key Features	Price
TAA 611812	5 to 15	115	8	12	9	28 to 53		\$1.95
TAA 621A11	6 to 27	2.80	8	18	12	30 to 57		3.00
TAA 621A12	6 to 27	1.40	8	12	12	30 to 57		1.80
TBA 641811	6 to 18	2.20	4	9	14	30 to 46		3.00
TBA800	5 to 30	4.70	8	18	18	30 to 53	Wide Supply Voltage Range	2.55
TBA 810A5	4 to 20	2.50	4	9	14	28 to 51	Thermal Shut-Down	3.00
TBA820	3 to 16	.75	4	6	6	30 to 52	Low Voltage Operation	1.65
TCA830	5 to 20	2.00	4	9	12	28 to 51	Thermal Shut Down	2.25
TCA940	6 to 24	6.50	8	20	28	28 to 51	Fully Protected	4.50
TOA 2020	±18	10.00	4	215	40		Fully Protected	7.80

Minimum Order \$10.00. Add \$1.00 for Postage. Data Sheets \$.25 ea.

IF IT ISN'T INDUSTRIAL QUALITY OR BETTER, WE WON'T SELL IT TO YOU.

SEND CHECK OR MONEY ORDER TO:
ANCORNA CORP.
P.O. BOX 2208R
CULVER CITY, CA 90230 • (213) 641-4064

HOBBY/WORKSHOP WALL STORAGE CENTERS

These high-quality, exceptionally convenient units are perfect for the hobbyist or handyman with lots of tools and no place to store them. Also ideal for storage of small parts, hardware and components. Budget priced complete with pegboard wall.

WWSC3 HOBBY STORAGE CENTER
\$29.95

WWSC5 TRADESMAN STORAGE CENTER
\$69.95

WWSC4 HANDYMAN STORAGE CENTER
\$48.50

ADD \$1.00 TO COVER POSTAGE

WE OFFER ONLY THE
FINEST QUALITY PRODUCTS AVAILABLE

SEND CHECK OR MONEY ORDER TO:
ANCORNA CORP.
P.O. BOX 2208R
CULVER CITY, CA 90230 • (213) 641-4064

RADIO-ELECTRONICS

Terms: FOB Cambridge, Mass. Send Check or Money Order. Include Postage. Minimum Order \$5.00, COD'S \$20.00



SOLID STATE SALES
P. O. BOX 74 D
SDMERVILLE, MASS. 02143 TEL. (617) 547-4005

WE SHIP OVER 95%
OF OUR ORDERS THE
DAY WE RECEIVE THEM

Circle 99 on reader service card

Circle 102 on reader service card

INDUSTRIAL QUALITY

E-Z-HOOK®

E-Z Hooks have been designed and field tested throughout the industry to save time and money in commercial electronic production and servicing. The spring-loaded hook attaches firmly, yet so gently it will not damage component — frees hands while testing. Durably constructed and fully insulated to a single contact point assuring true readings. Meets exacting laboratory and space age computer technology requirements. **AVAILABLE IN 10 RETMA COLORS:** Red, black, blue, green, orange, yellow, white, violet, brown or gray. The most unique field-serviceable test connectors available. Fast, safe, sure and trouble-free. **NOW AVAILABLE FROM ANCRONA** ... the source you can trust for fine quality, industrial-grade electronic components and accessories.

SOLVE YOUR TEST CONNECTION PROBLEMS WITH E-Z-HOOK®

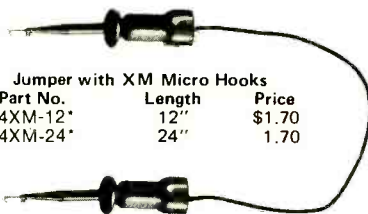

Jumper with XM Micro Hooks

Part No.	Length	Price
204XM-12*	12"	\$1.70
204XM-24*	24"	1.70

MICRO HOOK



XM Micro Hook (1.75" long, <1 gram) for difficult IC Testing. Permits hookups to delicate wires where weight and leverage may damage component. **\$.80 ea.**

MINI HOOK



X100W Mini Hook (2.25" long) combines rugged construction, miniature size and Finger-eze Hypo Action for all the best test connections. The hook is large enough for component leads, yet small enough to get into tight places. **\$.75 ea.**

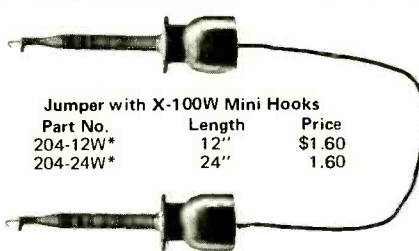

Jumper with X-100W Mini Hooks

Part No.	Length	Price
204-12W*	12"	\$1.60
204-24W*	24"	1.60

EXTRA LONG MINI HOOK



XL-1 Mini Hook (5.0" long) combines all the proven features of the X100W with an extra long body. It will make safe, short-free test connections in card racks and through deep wiring nest up to 4". **\$1.25 ea.**

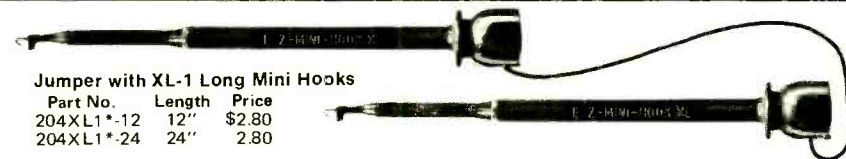

Jumper with XL-1 Long Mini Hooks

Part No.	Length	Price
204XL1*-12	12"	\$2.80
204XL1*-24	24"	2.80



Jumper, XM Micro Hook to Banana Plug

Part No.	Length	Price
201XM*	32"	\$1.40



Jumper, XL-1 Long Mini Hook to Stacking Banana Plug**

Part No.	Length	Price
201XL-1*	32"	\$1.95

*Specify color. **Square hole tip for hooking laterally to leads or vertically over square wire-wrap pins.

ANCRONA . . . YOUR FIRST SOURCE FOR INDUSTRIAL QUALITY ELECTRONIC COMPONENTS AND ACCESSORIES

Prices effective through April 30, 1976
 Minimum order \$10.00. Add \$1.00 to cover postage and handling.
 California resident add 6% sales tax.

SEND CHECK OR MONEY ORDER TO:



Mail order: P.O. Box 2208R, Culver City, CA 90230. Phone order: (213) 641-4064
 Visit our Electronic Shop: 11080 Jefferson Blvd., Culver City, CA
 (Studio Village Shopping Center)
 Prices may vary at over-the-counter locations.



Jumper X-100W Mini Hook to Stacking Banana Plug**

Part No.	Length	Price
201W*	32"	\$1.35



DIPPED TANTALUM CAPACITORS

MFD	WVDC	1-9	10 up	50 up	MFD	WVDC	1-9	10 up	50 up
.1	35	30	25	20	4.7	35	40	32	26
.15	35	30	25	20	6.8	35	40	32	26
.22	35	30	25	20	10.0	16	38	30	24
.33	35	30	25	20	10.0	35	40	32	26
.47	35	30	25	20	15.0	35	95	64	56
.68	35	30	25	20	22.0	16	40	32	26
1.0	35	30	25	20	22.0	16	40	32	26
1.5	35	30	25	20	33.0	20	95	64	56
2.2	20	30	25	20	47.0	20	1.40	1.05	90
3.3	35	38	30	24	68.0	16	1.40	1.05	90

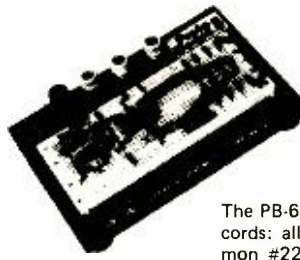

CONTINENTAL SPECIALTIES

PROTO BOARD 6 \$15.95

The PB-6 lets the user test and build circuits without soldering or patch cords: all interconnections between components are made with common #22 AWG hook-up wire. This quality breadboarding kit includes 630 component tie points at less than 2.5c each. It measures 6" long by 4" wide. Designed specially to Breadboard Microprocessor Circuits.

DIODES

1N78	.30	1N3595	.95
1N416	.40	1N3600	.15
1N456A	.50	1N3604	.15
1N457	.30	1N3717	5.00
1N459A	.25	1N4099	1.95
1N463A	.25	1N4148	.10
1N538	.65	1N4154	.10
1N547	.40	1N4246	.45
1N645	.95	1N436A	5.00
1N751A	.30	1N4735A	.50
1N753A	.28	1N4742A	.40
1N823	.70	1N4744A	.40
1N825	.95	1N4752	.40
1N929	4.10	1N4817	.16
1N914	.10	1N4820	.20
1N1731	1.70	1N4864	1.30
1N1275	5.50	1N5054	.25
1N2821	2.40	1N5062	.25
1N2989	1.90		

EXAR SPECIAL

TONE DECODER

XR567CN (8 PIN)

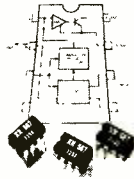

1 PC	\$1.70
10 UP	1.40
25 UP	1.20
100 UP	1.10
500 UP95

High Quality CARBON FILM RESISTORS

from 10 ohm to 10 megohms

1/4 Watt 5%

\$1.69 per 100

Only in multiples of 100 per value
• 150 different values in stock

OHM	OHM	OHM	OHM	OHM	OHM	OHM	OHM	OHM	OHM	OHM
10	100	1K	10K	100K	1M	33	330	3.3K	33K	3.3M
11	110	1.1K	11K	110K	1.1M	36	360	3.6K	36K	3.6M
12	120	1.2K	12K	120K	1.2M	39	390	3.9K	39K	3.9M
13	130	1.3K	13K	130K	1.3M	43	430	4.3K	43K	4.3M
15	150	1.5K	15K	150K	1.5M	47	470	4.7K	47K	4.7M
16	160	1.6K	16K	160K	1.6M	51	510	5.1K	51K	5.1M
18	180	1.8K	18K	180K	1.8M	56	560	5.6K	56K	5.6M
20	200	2K	20K	200K	2M	62	620	6.2K	62K	6.2M
22	220	2.2K	22K	220K	2.2M	68	680	6.8K	68K	6.8M
24	240	2.4K	24K	240K	2.4M	75	750	7.5K	75K	7.5M
27	270	2.7K	27K	270K	2.7M	82	820	8.2K	82K	8.2M
30	300	3K	30K	300K	3M	91	910	9.1K	91K	9.1M

XR FUNCTION GENERATOR

XR-2206KA SPECIAL \$16.95
Includes monolithic function generator IC, PC board, and assembly instruction manual.

XR-2206KB SPECIAL \$26.95
Same as XR-2206KA and includes external components for PC board.

PULSE GENERATOR



Interdesign 1101: 0.1Hz width, 0.5V Output, var. width, line or battery operation. \$159.00

SPDT MINIATURE TOGGLE SWITCH

115V 5A RATING
105D \$.95

PLESSEY ICs

SL610C	RD amplifier	\$4.07
SL611C	RF amplifier	4.07
SL612C	IF amplifier	4.07
SL613C	Limiting amp/det.	8.66
SL620C	VOGAD	6.15
SL621C	AGC generator	6.15
SL622C	AF amp/VOGAD sidetone amplifier	15.21
SL623C	AM det./AGC amp/SSB demod.	11.19
SL624C	Multimode det. AF amp.	5.70
SL630C	AF amplifier	3.85
SL640C	DBL bal. modulator	7.55
SL641C	Receiver mixer	7.55
SL645C	Square law device	7.55
SL650B	Mod./phase loc. loop	10.86
SL650C	Mod./phase loc. loop	6.80
SL651B	Mod./phase loc. loop	12.06
SL651C	Mod./phase loc. loop	7.56

2N125	1.40	2N1534	1.00	2N2538	2.40
2N173	2.15	2N1540	1.05	2N2600	7.00
2N293	.80	2N1543	3.40	2N2605	.49
2N321	.50	2N1544	1.40	2N2608A	.58
2N324	.55	2N1549	1.80	2N2606	3.50
2N336	1.00	2N1551	3.90	2N2647	1.30
2N338A	.82	2N1552	3.90	2N2648	3.90
2N388A	.82	2N1554	1.90	2N2658	6.90
2N389	8.90	2N1557	1.70	2N2708	.25
2N393	3.70	2N1613	.40	2N2712	.30
2N398B	1.00	2N1671B	2.30	2N2713	.14
2N404	.30	2N1693	13.90	2N2714	.40
2N417	.85	2N1711	.40	2N2715	.18
2N456	1.30	2N1716	.70	2N2718	.18
2N491	4.90	2N1720	4.80	2N2754	94.00
2N497	1.10	2N1893	.36	2N2802	9.70
2N508A	.40	2N1907	4.80	2N2833	3.90
2N511A	.50	2N1924	1.25	2N2850	112.50
2N512B	.90	2N1934	9.30	2N2857	3.00
2N514	6.90	2N1990	.75	2N2880	10.90
2N525A	.50	2N2060	2.05	2N2893	9.70
2N527C	5.60	2N2080	4.90	2N2894	.45
2N581	2.00	2N2081A	2.50	2N3395	2.40
2N583	2.90	2N2100	2.90	2N3396	.26
2N597	.25	2N2102	.45	2N3397	.28
2N597A	.60	2N2143	1.50	2N3398	.25
2N609	.56	2N2147	1.40	2N3414	.32
2N670	3.50	2N2148	.68	2N3415	.20
2N705	.60	2N2152	3.00	2N3416	.20
2N706B	.40	2N2192	.60	2N3417	.38
2N711	.34	2N2192A	.66	2N3418	.16
2N711B	.60	2N2193	.44	2N3419	.16
2N718	.28	2N2197	2.40	2N3420	.98
2N718A	.31	2N2217	.80	2N3421	.16
2N720A	.50	2N2218	.25	2N3422	1.15
2N741	2.80	2N2218A	.28	2N3423	1.15
2N744	.28	2N2219	.28	2N3424	1.15
2N829	2.80	2N2219A	.36	2N3425	1.15
2N834	.35	2N2221	.24	2N3426	1.15
2N859	7.90	2N2221A	.25	2N3427	1.15
2N894	2.90	2N2222	5.90	2N3428	1.15
2N918	.40	2N2225	.26	2N3429	1.15
2N929	.26	2N2229	1.10	2N3430	1.15
2N930	.28	2N2270	.40	2N3431	1.15
2N960	.45	2N2289	3.60	2N3432	1.15
2N962	.45	2N2290	5.90	2N3433	1.15
2N967	.48	2N2297	.95	2N3434	1.15
2N976	1.70	2N2323	1.90	2N3435	1.15
2N984	.95	2N2326	3.30	2N3436	1.15
2N1035	1.80	2N2327	4.20	2N3437	1.15
2N1132	.30	2N2356A	6.90	2N3438	1.15
2N1136	1.40	2N2359	15.90	2N3439	1.15
2N1137A	1.80	2N2368	.29	2N3440	1.15
2N1143	1.90	2N2369	.22	2N3441	1.15
2N1168	.65	2N2375	5.90	2N3442	1.15
2N1204	1.40	2N2382	4.40	2N3443	1.15
2N1302	.50	2N2440	3.45	2N3444	1.15
2N1303	.60	2N2465	7.40	2N3445	1.15
2N1305	.50	2N2468	1.00	2N3446	1.15
2N1307	.65	2N2475	.50	2N3447	1.15
2N1377	1.40	2N2476	.79	2N3448	1.15
2N1404	.48	2N2483	.28	2N3449	1.15
2N1408	.60	2N2484	.25	2N3450	1.15
2N1420	.50	2N2492	4.00	2N3451	1.15
2N1486	2.60	2N2516	5.90	2N3452	1.15
2N1521	4.80	2N2526	4.40	2N3453	1.15
2N1523	6.00	2N2527	5.40	2N3454	1.15

PREMIUM QUALITY TRANSISTORS

IF IT ISN'T INDUSTRIAL QUALITY OR BETTER, WE WON'T SELL IT TO YOU.

2N3391A	.20	2N3570	5.50	2N3705	.32	2N3856	.28	2N4037	.70
2N3392	.20	2N3571	3.90	2N3706	.21	2N3858	.28	2N4045	1.90
2N3393	.20	2N3572	2.60	2N3707	.18	2N3859	.26	2N4058	.25
2N3394	.20	2N3573	2.20	2N3708	.12	2N3860	.29	2N4059	.24
2N3395	.24	2N3584	1.80	2N3709	.22	2N3861	1.25	2N4062	.25
2N3396	.26	2N3614	1.10	2N3710	.20	2N3866	1.25	2N4066	.25
2N3397	.28	2N3616	1.24	2N3711	.20	2N3867	.42	2N4068	1.10
2N3398	.25	2N3617	2.40	2N3712	.18	2N3868	.38	2N4073	1.05
2N3399	.32	2N3618	7.90	2N3713	.20	2N3869	.30	2N4123	.20
2N3410	.20	2N3619	1.80	2N3714	.22	2N3870	.22	2N4124	.20
2N3411	.20	2N3620	1.80	2N3715	.50	2N3871	.22	2N4125	.25
2N3412	.38	2N3621	1.90	2N3716	1.80	2N3872	.22	2N4126	.25
2N3413	1.60	2N3622	1.60	2N3717	2.00	2N3873	.22	2N4127	.25
2N3414	.98	2N3623	1.60	2N3718	3.15	2N3874	.22	2N4128	.25
2N3415	1.70	2N3624	1.10	2N3719	2.00	2N3875	.22	2N4129	.25
2N3416	2.15	2N3625	4.70	2N3720	3.50	2N3876	.22	2N4130	.25
2N3417	8.90	2N3626	6.10	2N3721	1.20	2N3877	.22	2N4131	.25
2N3418	1.45	2N3627	9.20	2N3722	2.30	2N3878	.22	2N4132	.25
2N3419	1.85	2N3628	6.50	2N3723	3.30	2N3879	4.40	2N4133	.25
2N3420	2.00	2N3629	9.90	2N3724	3.00	2N3880	5.80	2N4134	.25
2N3421	6.40	2N3630	4.20	2N3725	.25	2N3881	2.70	2N4135	.25
2N3422	6.40	2N3631	4.40	2N3726	3.00	2N3882	2.90	2N4136	.25
2N3423	3.90	2N3632	1.20	2N3727	3.15	2N3883	2.90	2N4137	.25
2N3424	2.90	2N3633	1.35	2N3728	8.00	2N3884	8.00	2N4138	.25
2N3425	1.80	2N3634	1.75	2N3729	10.40	2N3885	1.45	2N4139	.25
2N3426	1.50	2N3635	1.60	2N3730	1.09	2N3886	1.09	2N4140	.25
2N3427	1.60	2N3636	1.20	2N3731	1.35	2N3887	1.20	2N4141	.25
2N3428	1.90	2N3637	1.20	2N3732	1.40	2N3888	1.40	2N4142	.25
2N3429	.26	2N3638	.21	2N3733	.69	2N3889	1.39	2N4143	.25
2N3430	.28	2N3639	.22						

CONTINENTAL SPECIALTIES

PROTO BOARDS

Build & test circuits as fast as you think!
PB100 10 IC cap breadboard kit, 4.5 x 6.0 x 1.35" \$19.95
 10 14-DIP cap, 5-way post, 940 solderless \$29.95
 tie points, 5.8 x 4.5"
PB102 12 14-DIP cap., like PB101 with 1,240 tie \$39.95
 points, 7.0 x 4.5"
PB103 24 14-DIP cap., 4 5-way posts, 2,250 tie \$59.95
 points, 6.0 x 9.0"
PB104 32 14-DIP cap., 3060 solderless tie points, \$79.95
 8.0 x 9.76"



LOGIC MONITOR

Simultaneously displays static and dynamic logic states of DTL, TTL, HTL or CMOS DIP ICs. Pocket size. \$84.95.

PROTO-CLIP

For power-on/hands-off signal tracing. Spring leads up from PC board surface for fast trouble-shooting. PC14 4-pin \$4.50
 PC16 16-pin 4.75

SOCKETS & BUS STRIPS

Plug-in with test, mount or expand without patch cords or solder. Snap together to form breadboard needed.

PN/Description	L. Hole-to-Hole	Term's	Price
OT585 Socket	6.5"	2"	2.50
OT475 Socket	5.3"	5.0"	94
OT478 Bus	5.3"	5.0"	16
OT358 Socket	4.1"	3.8"	12
OT358 Bus	4.1"	3.8"	12
OT185 Socket	2.4"	2.1"	36
OT125 Socket	1.8"	1.5"	24
OT75 Socket	1.3"	1.0"	14

7400N TTL

7400N	\$ 12	7442N	58	7497N	5.00	74164N	1.10
7401N	15	7443N	74	74100N	1.10	74165N	1.10
7402N	14	7444N	77	74104N	1.20	74166N	1.28
7403N	15	7445N	77	74105N	1.50	74170N	2.05
7404N	16	7446N	83	74107N	.33	74173N	1.34
7405N	19	7447N	72	74109N	74	74174N	1.25
7406N	29	7448N	80	74111N	1.20	74175N	.95
7407N	29	7449N	14	74111N	1.20	74176N	.90
7408N	18	7451N	14	74116N	2.00	74177N	.90
7409N	20	7453N	14	74121N	.36	74178N	.90
7410N	16	7454N	14	74122N	.38	74179N	2.50
7411N	24	7455N	20	74123N	.70	74181N	.95
7412N	33	7460N	14	74125N	.47	74181N	2.39
7413N	44	7470N	26	74126N	.53	74182N	.70
7414N	95	7472N	26	74128N	.84	74184N	1.84
7415N	30	7473N	37	74132N	1.10	74185N	2.20
7416N	33	7473N	33	74136N	.75	74188N	.75
7418N	25	7475N	50	74141N	1.20	74190N	1.20
7420N	13	7476N	32	74145N	.91	74191N	1.20
7421N	33	7480N	48	74147N	2.40	74192N	.96
7422N	50	7481N	20	74148N	2.00	74193N	.95
7423N	37	7482N	98	74150N	1.00	74194N	1.10
7425N	23	7483N	70	74151N	.80	74195N	.74
7426N	23	7484N	3.00	74152N	1.40	74196N	.99
7427N	25	7485N	90	74153N	.79	74197N	.78
7428N	33	7486N	1.50	74154N	.70	74198N	1.40
7430N	20	7489N	2.20	74155N	.97	74199N	1.60
7432N	24	7490N	48	74156N	.95	74200N	5.60
7433N	36	7491N	78	74157N	.74	74221N	1.75
7437N	29	7492N	49	74158N	1.60	74251N	1.50
7438N	29	7493N	79	74160N	2.45	74272N	2.45
7439N	38	7494N	72	74161N	.99	74279N	.94
7440N	16	7495N	80	74162N	1.25	74293N	1.00
7441N	87	7496N	70	74163N	.98	74298N	1.98

HIGH SPEED TTL

74H00N	33	74H20N	33	74H52N	.36	74H73N	.80
74H01N	25	74H21N	33	74H53N	.36	74H74N	.80
74H02N	33	74H22N	33	74H54N	.36	74H76N	.80
74H03N	33	74H23N	33	74H55N	.36	74H102N	.75
74H08N	40	74H40N	36	74H60N	.36	74H103N	.90
74H10N	33	74H50N	36	74H71N	.75	74H106N	.95
74H11N	33	74H51N	36	74H72N	.75		

LOW POWER TTL

74L00N	24	74L10N	24	74L51N	.34	74L90N	1.62
74L02N	24	74L20N	33	74L73N	.43	74L93N	1.51
74L03N	39	74L21N	3.33	74L74N	.90	74L95N	1.62
74L04N	33						

74LS00

1-9 10up	1-9 10up	1-9 10up	1-9 10up			
74LS00	38	74LS54	55	74LS160	3.00	2.90
74LS01	50	74LS56	39	74LS161	3.00	2.90
74LS02	39	74LS73	65	74LS162	2.25	2.20
74LS03	39	74LS74	65	74LS163	2.25	2.20
74LS04	45	74LS76	65	74LS164	2.25	2.20
74LS05	45	74LS78	92	74LS174	2.20	2.15
74LS08	39	74LS95	2.19	74LS175	2.40	2.35
74LS09	45	74LS107	65	74LS181	3.69	3.65
74LS10	39	74LS109	65	74LS190	2.85	2.80
74LS11	42	74LS112	65	74LS191	2.85	2.80
74LS15	57	74LS113	92	74LS193	2.85	2.80
74LS20	39	74LS114	92	74LS194	2.25	2.20
74LS21	56	74LS123	1.30	74LS195	2.25	2.20
74LS22	60	74LS125	1.30	74LS251	2.06	2.00
74LS27	45	74LS139	2.00	74LS253	2.42	2.40
74LS29	39	74LS151	1.55	74LS257	1.89	1.85
74LS32	45	74LS153	1.89	74LS258	2.06	2.00
74LS38	53	74LS157	1.59	74LS260	5.00	.44
74LS51	39	74LS158	1.89			

SCHOTTKY TTL

74S00	44	74S32	80	74S113	1.50	74S174	3.30
74S01	76	74S40	65	74S114	1.20	74S175	2.90
74S02	60	74S50	76	74S133	8.00	74S181	6.00
74S03	75	74S51	80	74S138	2.20	74S189	4.40
74S04	55	74S60	80	74S139	2.20	74S194	3.80
74S05	76	74S64	80	74S140	8.00	74S195	3.80
74S08	80	74S65	80	74S151	2.20	74S251	2.20
74S09	76	74S74	90	74S153	3.40	74S253	2.40
74S10	55	74S76	115	74S160	3.40	74S257	2.40
74S11	65	74S78	115	74S162	3.00	74S260	2.40
74S15	76	74S85	6.10	74S163	2.90	74S262	1.20
74S20	65	74S86	2.50	74S161	4.00	74S280	5.70
74S21	76	74S112	1.00	74S172	6.00	74S289	4.00
74S30	80						

9300 SERIES

9300PC	\$1.00	9318PC	2.30	9366PC	1.75	93L18	3.50
9301PC	1.20	9321PC	1.20	93L00	1.50	93L21	1.50
9304PC	1.60	9322PC	1.30	93L01	1.60	93L22	1.80
9306PC	6.90	9326PC	2.00	93L02	1.60	93L23	2.80
9308PC	2.50	9328PC	2.50	93L09	1.80	93L28	3.70
9309PC	1.60	9334PC	2.95	93L10	2.80	93L34	4.00
9310PC	1.50	9338PC	3.30	93L11	4.20	93L38	6.20
9311PC	2.30	9340PC	5.00	93L12	1.80	93L40	6.50
9312PC	1.20	9341PC	4.10	93L14	1.70	93L41	2.50
9314PC	1.30	9342PC	1.15	93L16	3.20	93L60	3.00
9316PC	1.50	9360PC	1.75	93L18	3.50	93L66	2.70

WAVEFORM GENERATOR KIT
EXAR XR205K \$25.00

Here's a highly versatile lab instrument at a fraction of the cost of conventional unit. Kit includes 2 XR205 IC's, data & applications, PC board (etched and drilled, ready for assembly) and detailed instructions.

LINEAR IC'S

H-TO-5	N-DIP	M-MINI-DIP	D-CER-DIP	K-TO-3	
LM105H	3.90	LM311H	1.20	LM710CH	90
LM108H	4.90	LM312D	90	LM710CN	90
LM114H	3.00	LM313M	1.75	LM711CH	90
LM300H	1.20	LM313Z	1.75	LM711CN	90
LM300N	1.20	LM318H	1.50	LM715CH	3.50
LM301AH	.50	LM318M	2.40	LM715CD	6.60
LM301AM	.80	LM322N	1.60	LM723CH	6.00
LM301AN	1.10	LM331N	1.25	LM723CN	6.50
LM301M	.95	LM336K	2.40	LM725CH	1.50
LM302N	1.40	LM336K	2.20	LM725CD	5.00
LM302H	1.30	LM320SK	2.90	LM733CH	1.40
LM303AH	.70	LM320ST	2.50	LM733CD	3.50
LM305H	.85	LM320-12K	2.90	LM733CN	1.50
LM305AH	1.05	LM320-12T	2.50	LM741CH	4.00
LM308N	1.00	LM340-8K	2.60	LM741CD	1.25
LM308H	.95	LM340-8K	2.60	LM741CN	.30
LM307H	.60	LM340-8K	2.60	LM747CH	.75
LM307M	1.50	LM340-12K	2.60	LM747CN	.90
LM308H	.85	LM340-15K	2.60	LM748CM	.55
LM308AH	5.00	LM340-18K	2.60	LM777CH	2.15
LM308D	2.25	LM340-24K	2.60	LM777CN	2.10
LM308M	1.00	LM556CM	.70	LM3046CN	.95
LM309H	1.75	LM556CM	1.30	LM3054CN	1.50
LM309K	1.50	LM567CM	1.70	SG4501T	2.40
LM310H	1.50	LM567CN	1.70	SG4501C	2.40
LM310M	1.80	LM709CN	.75	LM5000K	7.50

C-MOS

P/N	1-9 10up	P/N	1-9 10up	P/N	1-9 10up
4000AE	24	4027AE	55	4070AE	60
4001AE	24	4028AE	55	4071AE	25
4002AE	24	4029AE	1.25	4072AE	34
4004AE	4.00	4030AE	4.40	4073AE	38
4006AE	1.24	4032AE	2.00	4074AE	38
4007AE	2.73	4035AE	1.25	4076AE	1.24
4008AE	1.79	4040AE	1.58	4077AE	.70
4009AE	59	4041AE	1.82	4078AE	.38
4010AE	50	4042AE	78	4079AE	.25
4011AE	24	4043AE	85	4082AE	34
4012AE	24	4044AE	80	4095AE	2.00
4013AE	45	4047AE	2.75	4098AE	1.30
4014AE	1.45	4048AE	1.43	4099AE	2.90
4015AE	1.24	4049AE	58	40707AE	50
4016AE	50	4050AE	58	40508AE	2.20
4017AE	1.15	4051AE	1.49	4510AE	1.45
4018AE	1.24	4052AE	1.49	4514AE	5.00
4019AE	50	4053AE	1.49	4515AE	5.00
4020AE	1.45	4054AE	1.95	4516AE	1.75
4021AE	1.38	4056AE	1.99	4518AE	1.28
4022AE	1.05	4063AE	2.50	4520AE	1.28
4023AE	24	4066AE	1.10	4528AE	1.59
4024AE	88	4068AE	50	4585AE	2.05
4025AE	24	4069AE	44	4911AE	43

INDUSTRIAL QUALITY COMPONENTS

We've been buying and selling top quality components for nearly ten years. Our annual volume exceeds \$3 million. We handle only original parts, from the world's leading manufacturers and our customers include some of the largest and most quality-conscious companies. Now you can take advantage of our component buying skills and power and select from a broad range of advanced circuits.

FIRST QUALITY ONLY

MICROPROCESSOR SPECIAL
8080A \$38.50

INTERSL 8038 PRECISION WAVEFORM GENERATOR & VCO

For simultaneous sine, square and triangular waveforms <1001 Hz to 1MHz.

Part No: 8038CCPD \$3.90 \$3.70

1-AMP RECTIFIERS

1N4001	1.00	100	6000
1N4002	1.10	800	7000
1N4003	1.20	900	8000
1N4004	1.30	1000	9000
1N4005	1.40	1100	10000
1N4006	1.50		

Spring-Pac super SALE! ^{Each pac only} \$1.98

All pacs are first quality (no fallout), tested and guaranteed.

Memory pac 4 MM5016 MOS TO-5 512 BIT shift registers from NATIONAL - with data \$1.98	Flip-Flop pac 10 assorted Flip-Flops, Dual JK's, RST's, and low power FF's, with data \$1.98	Comparator pac 5 assorted DIP's--LM311, 710, 711, with data \$1.98
TTL Gates 15 assorted DIP's 7400 series-7420, 7430, 7440, etc... All prime, marked parts, with data \$1.98	LED pac 10 assorted discrete LED's-green, red, and infra-red, with data. \$1.98	Transistor pac 40 assorted TO-92 plastic transistors--PNP's and NPN's, mostly Fairchild house marked. \$1.98
Regulators 4 LM723 DIP variable regulators, 2-40V, with data \$1.98	Diodes 100 Germanium computer signal diodes with leads trimmed for PCB mounting. \$1.98	Resistors 100 1/2 watt 5% resistors of any single standard value from 2.7 ohm to 1M ohm \$1.98
Linear pac 8 assorted linears in mini-DIP or TO-5*741 op amp, LM307 op amp, LM 703 RF-IF amp, with data and circuits \$1.98	DIP RC Network 50 assorted 14 and 16 pin IC packages containing precision resistors and capacitors-no data available \$1.98	Switches 8 SPST momentary contact push button N.O. Red button fits in approx. 1/4" panel, with lock washer and mounting nut. \$1.98

LED Display pac
 2 DL33 - 3 digits each, approximately .1" magnified digits in a 12 pin DIP, with data
\$1.98

Buy 5 pacs for **\$9.90** and **10¢** pic-a-pac for

The above are special offerings from Babylon Electronics, and will be shipped third class. See bottom of ad for ordering instructions.

Specials

DIP TRIMMER -12 turn trim pots which plug into a DIP socket -5K and 200K -1/2" x 1/2" x 1/2" -4 leads spaced .3" x .2" Each \$.65 10 for \$4.95	CMOS CD4001 \$.29 CD4023 .29 CD4002 .29 CD4024 1.50 CD4009 .59 CD4025 .34 CD4010 .59 CD4030 .65 CD4011 .29 74C20 .65 CD4013 .69 74C42 2.00 CD4015 1.98 74C157 2.50 CD4016 .69 74C195 1.00 CD4019 .69	TTL 7400 \$.20 7453 \$.10 74H00 .25 7454 .20 7401 .14 74LS4 .25 74H01 .25 74LS5 .25 7402 .25 7460 .16 7404 .25 74L71 .20 74H04 .30 7472 .40 7405 .30 74L72 .60 7406 .40 7473 .35 7408 .30 74L73 .75 7410 .12 7474 .45 7413 .75 74H74 .75 7417 .40 7475 .80 7420 .12 7476 .35 74L20 .25 74L78 .70 74H20 .18 7480 .50 74H22 .30 7483 .70 7430 .10 7489 2.00 74H30 .30 7490 .70 74L30 .30 7492 .35 7440 .10 7493 1.00 74H40 .22 7495 .65 7442 1.00 74L95 1.00 7447 1.50 74107 .25 7450 .10 74145 1.25 74H50 .30 74155 .90 7451 .10 74174 1.00 74H51 .25 74180 1.00 75492 1.00 74193 1.50
-----------------------------------------------------------------------------------------------------------------------------------------------------------------------	----------------------------------------------------------------------------------------------------------------------------------------------------------------------------------------------------------------------------------------	-------------------------------------------------------------------------------------------------------------------------------------------------------------------------------------------------------------------------------------------------------------------------------------------------------------------------------------------------------------------------------------------------------------------------------------------------------------------------------------------------------------------------------------------------------------------------------------------------------------------------------------------------------------------------------------

25K Trimmer
 Printed Circuit Board Type Each \$.20 10 for \$1.50

TRANSISTOR
 2N3904 - HEP736
 TO92 PLASTIC - NPN
 300 MW - 60V - 3100-300
 NEW - FAIRCHILD - MARKED
 EACH \$.15 10 for \$1.00

1 AMP RECTIFIER
 1N4007 SALE EACH \$.13 10/ \$1.00

NPN TO3 POWER TRANSISTORS
 2N3055: PD-115W; VCE-60V; HFE-50; FT-30K.
 Each \$.90 10 for \$6.95
 410 (RCA) 200V-10A
 2N3772 70V-30A (max.)
 Each \$1.75 10 for \$15.00

More Memories
 93410-256x1 RAM, fully decoded, high speed (40 ns) open collector output. 16 pin DIP with data.
 ONLY \$2.25 10/\$18.95
 1702-2048 BIT PROM. 2K static units. Ultra-violet light erasable.
 EACH \$9.95

SPACE AGE CLOCK KIT
 Instructions & parts - 12 or 24 hour format.
 Four digit clock kit includes all parts for complete clock: 3 1/2" x 2"; -FND 70 readouts -MM5314 clock chip & all transistors, etc.
 -extruded aluminum case -cord with transformer plug
\$16.95

POTTER BRUMFIELD
 Type KHP Relay
 4 PDT 3A Contacts

120V AC (10.5 MA coil)
\$1.75

Send a stamp for our flyer listing more money-saving bargains!

Mail orders to: P.O. Box 41778 Sacramento, CA 95841 Phone (916) 334-2161 TWX # 910-367-3521

BABYLON ELECTRONICS
 MONEY BACK GUARANTEE ON ALL GOODS!

All IC's are new and fully tested. Leads are plated with gold or solder. Due to increased costs, orders under \$7.00 add \$1.00 postage and handling. Residents of California add sales tax. Orders are shipped within 2 workdays - kits are shipped within 10 days. \$10 minimum order on C.O.D.'s.

FOR YOUR CAR, VAN...! SON of a CHEAP CLOCK & time base kit \$23.50!

A DIGITAL CLOCK IN YOUR VEHICLE---AT A SPECIAL COMBINATION PRICE! The clock features .3 inch readouts, bright digits, sockets for readouts and IC, choice of display modes, and so on. Our time base provides stable 60 Hz timing pulses: just the thing to free your clock from its dependence on the AC line. It's a miser with power consumption, and accurate to within .01% or better. Our data shows how to run your clock & time base from a 12 volt battery, blanking the readouts when not in use, remoting readouts, and more.

TOP QUALITY "CHERRY" DATA SWITCH
 Their price \$1.29 ea.

10,000 µf PERFECT TONIC FOR SUPPLIES WITH A FARAD DEFICIENCY.
 10 WVDC, \$1.25 EACH.

39 µf Tantalum 10V 4/\$1.00

SPST PUSHBUTTON SWITCHES, momentary contact; many uses. 4 for \$1.00.

SWITCHES: 5/\$1.00 SWITCH/KEYTOP combination 5/\$1.25. KEYTOPS WHILE THEY LAST! SORRY, NO CHOICE OF LEGEND.

91L02 SPECIAL \$2.35
 ANOTHER "WHILE-THEY-LAST" SPECIAL: **LOW POWER NMOS 1K RAMS!**

5V 5A microprocessor power supply
 Also +12V @ 1/2A and -12V @ 1/2A, plus an adjustable negative bias supply. Crowbar overvoltage protected; fold back current limiting; 5V regulation 1% or better. TOP QUALITY COMPUTER SUPPLY KIT, w/ HARDWARE & CHASSIS--less line cord. \$44.95 + 8 lbs shpng.

NAKED RAM
 \$79.95. 4K by 8 RAM kit, JOLT plug-in compatible or use with other bi-directional buss systems. No buffers---just cost-effective & reliable storage.

BILL GODBOUT ELECTRONICS***BOX 2355**OAKLAND AIRPORT, CA 94614. Terms: Add 50¢ to orders under \$10. Add shipping where shown. Cal res add tax. Mastercharge/BankAmericard: (415) 357-7007, 24 hrs.

Circle 106 on reader service card

Your Altair Deserves Our Mother.

Every Altair owner eventually wants to acquire full sixteen card capacity. Our Mother Board makes this possible in just one installation, while actually increasing the overall reliability and durability of your system.

The rugged MB-1 is a full 1/8" thick, with a sturdy 16-slot card guide assembly that mounts directly onto the chassis. Because the MB-1 is one solid piece, you won't have to solder 300 tiny wires in four separate installations. And, you'll get our exclusive bus terminator, providing greater reliability by terminating signals with the correct impedance. If you already have an 88EC installed, our compatible MB-12 (replacing 3 88EC's) is available for the same price. \$70, postpaid. (Master Charge accepted.)

Both you and your Altair deserve the MB-1.

Write us. For details on our other compatible 8800 plug-in modules.

Processor Technology
 6200-R Hollis Street Emeryville, CA 94608

RADIO-ELECTRONICS

**HEWLETT
PACKARD**



H. P. IS BACK!

No Rejects or Retests here — You Want Quality? You have it with this popular 0.3" L.E.D. by Hewlett Packard. Fits Standard I.C. Socket. Right hand DP.
5082-7740 — Common Cathode \$1.25
6 for \$6.00



FAIRCHILD BIG LED READOUTS

A big .50 inch easy to read character. Now available in either common anode or common cathode. Take your pick. Super low current drain, only 5 MA per segment typical.

FND - 510 Common Anode **YOUR CHOICE**
FND - 503 Common Cathode **\$2 ea.**

DO YOU NEED A LARGE COMMON ANODE READOUT AT A FANTASTIC PRICE?

S. D. presents the MAN-64 by Monsanto - .40 inch character. All LED construction - not reflective bar type, fits 14 pin DIP. Brand new and factory prime. Left D.P.
\$1.50 ea. 6 for \$7.50



HIGH V. TRANSFORMER Primary 117V, two secondaries:
24 VAC 500 MA 175 VAC 100 MA. \$1.25 ea.

2102 1K RAM's - 8 FOR \$12.95

New units ——— We bought a load on a super deal, hence this fantastic price.
Units tested for 500NS Speed.

INTEL 1702A 2K ERASEABLE PROM'S \$6.95

We tell it like it is. We could have said these were factory new, but here is the straight scoop. We bought a load of new computer gear that contained a quantity of 1702A's in sockets. We carefully removed the parts, verified their quality, and are offering them on one heck of a deal. First come, first served. Satisfaction guaranteed.

SIGNETICS 1K P-ROM

82S129. 256 X 4. Bipolar, much faster than MOS devices. 50 NS. Tri-state outputs. TTL compatible. Field programmable, and features on chip address decoding. Perfect for microprogramming applications. 16 pin DIP. With specs. \$2.95 ea.

PROMS!



\$2.95

PROFESSIONAL QUALITY STEREO HEADPHONES

Here is the kind of super deal that S. D. is famous for. Treat your ears to a super sound at a super price. Soft padded ear cushions, lightweight, fully adjustable headband, long coiled cord, wide response. \$6

NEW IN ORIGINAL FACTORY BOXES

INSTRUMENT KNOBS

Black with brushed aluminum insert. Medium size, very attractive style.
SPECIAL 5 FOR \$1

MV-50 TYPE LED's
by LITRONIX
10 for \$1
Factory Prime!

3 DIGIT LED ARRAY — 75c

by LITRONIX
DL33MMB. 3 MAN-3 Size Readouts in one package. These are factory prime, not retested rejects as sold by others. compare this price! 75c 3 for \$2.



SALE ON CUT LEAD SEMICONDUCTORS

Leads were cut for PCB insertion. Still very useable.

- 1N914/1N4148 100/\$2
- 1N4002 1 Amp 100 PIV 40/\$1
- 1N4745A 16V 1W Zener 20/\$1
- EN2222 NPN Transistor 25/\$1
- EN2907 PNP Transistor 25/\$1
- 2N3904 NPN Driver Xstr. 25/\$1
- 2N3392 GE Pre-amp Xstr. 25/\$1
- CT103Y SCR. 800MA. 60V. 10/\$1

**ALL NEW.
UNUSED.
SOME ARE
HOUSE #**

NATIONAL MM5375AA ALARM CLOCK CHIP

Second generation alarm chip. Six digits, internally generates alarm tone, snooze, power failure indicator, etc. Very easy to use. Outperforms older types like 5316, 5370, etc. Perfect for use with our HP 5082-7740 LED readouts. S.D. SPECIAL PRICE: \$3.50

WITH DATA

MOSTEK MK50380 DIRECT DRIVE ALARM CHIP

Drives LED readouts direct, eliminates transistor or IC interface circuitry. 4 digit output is non-multiplexed to eliminate RFI in clock radio applications. Has sleep and snooze features. 40 pin DIP. Makes a JUMBO alarm clock by using our FND 503 readouts. We show you how.

INTRODUCTORY PRICE: \$3.95

SLIDE SWITCH ASSORTMENT

Our best seller. Includes miniature and standard sizes, single and multi-position units. All new, first quality, name brand switches. Try one package and you'll reorder more. Special — 12 for \$1 (Assortment)



DISC CAP ASSORTMENT

PC leads. At least 10 different values. Includes .001, .01, .05, plus other standard values.
60 FOR \$1



UPRIGHT ELECTROLYTIC CAPS

47 mfd 35 V-10/\$1 68 mfd 25V-8/\$1
Brand new by Sprague. PC leads.

1000 MFD FILTER CAPS

Rated 35 WVDC. Upright style with P.C. leads. Most popular value for hobbyists. Compare at up to \$1.19 each from franchise type electronic parts stores. S.D. Special 4 for \$1



RESISTOR ASSORTMENT

1/4 W 5% and 10%. PC leads.
A good mix of values. 200/\$2



LARGE SIZE LED LAMPS

Similar to MV5024. Prime factory tested units. We include plastic mounting clips which are very hard to come by.
Special 5 for \$1



VERNIER DIAL

From a close out of metal detector manufacturer. 1/2 Turn, 8 to 1 ratio. Internal stops easily removed to make unit multi-turn.

LIMITED QUANTITY - \$.99 EACH

741C OP AMPS

Prime, factory tested and marked. Full spec on all parameters. Not re-tested, functional only, units as sold by others.
741 CH - TO-5 8 Lead Metal Can 3/\$1
741CV - 8 Lead Mini Dip 4/\$1



DUAL 741C (5558) OP AMPS

Mini dip. New house numbered units by RAYTHEON.
4 FOR \$1

FET'S BY TEXAS INSTRUMENTS — SPECIAL 5 for \$1

#TIS-75 but with an internal house number. TO-92 plastic case. N. Channel, Junction type FET.

Signetics, TRI-State Hex Buffer. MOS and TTL interface to TRI-State Logic.
Special: \$1 **8T97B**

TRANSISTORS
2N3904 - NPN
2N3906 - PNP
8 for \$1

TI POWER TRANSISTORS

TIP29 NPN Silicon. TO-220. 4/\$1

CT-5005
WITH FOUR-
FUNCTION MEMORY!

CALCULATOR CHIP

By CalTex. 12 Digits.
With Specs. \$1.49
Factory prime. Not retested

We do not sell junk. Money back guarantee on every item. No C.O.D. Texas Res. add 5% tax. Postage rates went up 30%! Please add 5% of your total order to help cover shipping.

S. D. SALES CO.

P.O. BOX 28810
DALLAS, TEXAS 75228

HIGHEST QUALITY PARTS Fully Guaranteed

7400N TTL SN 7400N SERIES

7400	.18	7438	.38	74151	1.05
7401	.18	7440	.20	74153	1.20
7402	.19	7442	.99	74154	1.35
7404	.19	7450	.22	74155	1.10
7405	.29	7473	.42	74157	1.10
7406	.35	7474	.42	74161	1.30
7408	.23	7475	.80	74163	1.50
7410	.18	7476	.49	74164	1.50
7416	.35	7483	.99	74174	1.50
7417	.40	7486	.42	74175	1.55
7418	.25	7490	.70	74176	1.10
7420	.20	7493	.85	74177	1.15
7425	.40	74107	.32	74180	.90
7427	.34	74121	.50	74191	1.40
7430	.24	74122	.47	74192	1.40
7432	.27	74123	.89	74194	1.30
7437	.43	74150	.99	74195	.90

CMOS CD 4001 SERIES

4001	.25	4049	.65
4007	.25	4050	.65
4009	.59	74C00N	.39
4010	.59	74C02N	.55
4011	.25	74C04N	.75
4013	.47	74C10N	.65
4016	.56	74C20N	.65
4017	1.25	74C42N	2.15
4023	.25	74C74	1.15
4025	.25	74C107N	1.25
4029	1.30	74C161	3.25

LINEAR & MISC. IC'S

LM741CH	.28	INTEL-2102	3.00
LM723CH	.45	NE555B	.68
LM309K	1.50		

TRIM POTS (per our choice) 14/8.99

1 POLE 7 POS. MIN. SWT. 1.15

KITS EXAR IC'S

XR555CP	1.07	XR1310P	3.20
XR556CP	1.85	XR210	5.20
XR2240CP	4.80	XR215	6.60
XR205	8.40	XR567CP	1.75
XR100K	80.00		

POWER RECTIFIERS

VOLTS	1.5A	3A	10A	20A	30A
100	.09	.14	.30	.40	.56
200	.10	.20	.35	.47	.80
400	.11	.25	.50	.52	.98
600	.12	.30	.70	.91	1.20
800	.15	.35	.90	1.17	1.52
1000	.20	.45	1.10	1.43	1.90

NPN & PNP SIL. TRANSISTORS

2N2220 (TO-46)	.21 ea. or 5/ 98
2N3903	.20 ea. or 5/ 98
2N3904	.22 ea. or 5/ 98
2N3905	.20 ea. or 5/ 98
2N3906	.22 ea. or 5/ 98

ZENERS 1/2 W.

3V, 3.3V, 3.9V, 4.7V, 5.1V, 5.6V, 6.2V, 6.8V, 8.2V, 15V	.22 ea. or 5/ 99
---------------------------------------------------------	------------------

ZENERS 1W.

3.3V, 5.1V, 6.2V, 6.8V, 15V	.27 ea. or 4/ 99
-----------------------------	------------------

G.P. SIL. DIODES

1N456	.13 ea. or 100/11.00
1N457	.14 ea. or 100/11.80
1N458	.15 ea. or 100/12.50
1N459	.16 ea. or 100/13.00

RECTIFIERS

1N4001	.08 ea. or 100/ 6.00
1N4002	.09 ea. or 100/ 7.00
1N4003	.10 ea. or 100/ 8.00
1N4004	.11 ea. or 100/ 9.00
1N4005	.12 ea. or 100/10.00
1N4006	.13 ea. or 100/11.00
1N4007	.15 ea. or 100/12.00

LED DISPLAYS

CC or CA red, green or yellow, small or large numbers — Small - \$1.79 Large - \$2.99

SWITCHING DIODES (Special Price)

1N4148 35/1.00	1N914B 15/1.00
----------------	----------------

EM PAK SPECIAL

1N4001-4007 type. No shorts, no opens, all more than 50V. 60/1.98

NPN SIL TO-92 TRANSISTORS 20/1.00

NOTE: EM PAK products carry no guarantee and are unmarked. All other products are marked and fully guaranteed.

Min. Order — \$5.00. Please send check or money order with purchase order. Calif. residents add 6% sales tax. Write for large quantity prices.

ELECTRONIC MATERIALS CO.

Div. PC & B Industries, Inc.
1877 West Carson Street
Torrance, Ca. 90501
(213) 328-8532

Circle 108 on reader service card

ADVERTISING INDEX

RADIO-ELECTRONICS does not assume any responsibility for errors that may appear in the index below.

READER SERVICE CARD NO. PAGE

66	Allied Electronics	92
75	Allison Automotive Co.	81
76	American Technology Corp.	87
6	AP Products	87
6	B & K, Division of Dynascan Corp.	14,74
29	Brooks Radio & TV Corp.	79
	Burstein-Applebee	82
83	Castle TV Tuner Service	Cov. IV
111	CIE, Cleveland Institute of Electronics	44-47
9,20,25	Continental Specialties Corp.	18,32,77
	CREI, Div. of McGraw-Hill Continuing Education Center	88-91
80	Delta Products	95
8	E & L Instruments, Inc.	17
23	Ebka Industries, Inc.	75
24	Edlie Electronics	64
81	Edmund Scientific	114
69	EICO, Electronic Instrument, Inc.	83
65	Elenco	81
5	Electronics Technical Institute, Division of Technical Home Study Schools	13
	EMC, Electronics Measurement Corp.	93
78	Enterprise Development Corp.	94
73	Fordham Radio Supply Co.	86
71	Grantham School of Electronics	85
13	GTE Sylvania Electronic Components	25
7	Handic	16
26-29	Heath Co.	100
10	Hickok Electrical Instrument Co.	19
	ICS, International Correspondence Schools	20,21
72	Indiana Home Study Institute	86
70	International Crystal Mfg. Co.	84
	J. B. Lansing Sound, Inc.	7
16	Jade Co.	67
79	Lectrotech, Inc.	94
4	Mallory Distributor Products	5
2	MITS, Micro-Instrumentation Telemetry Systems, Inc.	1
64	Morrors Mini Stuff	81
61	Mountain West Alarm Supply Co.	80
19	MTI, Motorola Training Institute	66
27	National Camera	79
	National Technical Schools	70-73
	NRI, Div. of McGraw-Hill Continuing Education Center	8-11
110	Nexus Trading Co.	94
30	PAIA Electronics, Inc.	80
68	Panavise, Div. of Colbert Ind.	78
63	Photolume Corp.	80
11	Pomona Electronics	22
1	PTS Electronics, Inc.	Cov. II
12	Radio Shack	23
	RCA—Solid State Division	24
77	Rye Industries	93
82	SBE	Cov. III
62	Scelbi Computer	80
67	Schober Organ Corp.	82
14	Shure Brothers	30
	Sinclair Radionics, Inc.	15
17	Soundcraftsmen	76
22	Southwest Technical Products	69
	Sphere Corp.	77
28	Tab Books	79
15,26	Telematic	31,78

READER SERVICE CARD NO. PAGE

18	Tektronix, Inc.	65
74	Tri-Star	84
21	Weller-Xcelite Electronics Div.	68
3	Winegard	2

MARKET CENTER

98	Active Electronics	105
86	Altaj	96
	AMC Sales	98
	American Used Computer Corp.	98
101-105	Ancrona Corp.	106-109
	ATV Research	100
	Babylon Electronics	110
	Karel Barta	96
	Casino Training Center	96
	CFR Associates	100
	Command Productions	96
95	Delta Electronics	104
90	DiGi-Key	100
108	Electronic Materials	112
85	Electronic Warehouse	96
	Fair Radio Sales	98
89	Formula International	99
106	Bill Godbout Electronics International	110
	Information Unlimited, Inc.	100
92	International Electronics Unlimited	101
93,94	James Electronics	102,103
	Lab Science	96
	Lakeside Industries	96
91	Meshna Electronics, John Jr.	100
97	New-Tone Electronics	104
88	Olson Electronics	98
84,109	Poly Paks	96,113
	Processor Technology Corp.	110
96	Quest	104
	Saxitone Tape Sales	98
107	SD Sales	111
99	Solid State Sales	106
	Sphere Corp.	96,98
87	Tracy Design	98
	Trumbell	98
	Valley West	96
	Visulex	100
	W. & Associate	100

MOVING?

Don't miss a single copy of **Radio-Electronics**. Give us:

Six weeks' notice

Your old address and zip code

Your new address and zip code

ATTACH
LABEL
HERE

name (please print)

address

city state zip code

Mail to: Radio-Electronics
SUBSCRIPTION DEPT., BOULDER, COLO.
80302

Poly Pak's

100'S OF BARRELS PURCHASED!
BUY 'EM FROM THE "BARREL" AND SAVE!

Your choice of any kit

\$1.98

SMALL PARTS BARREL

EXCLUSIVE 'BARREL'

THE BIGGEST INFLATION-FIGHTING VALUE EVER!

TEST 'EM YOURSELF 'N SAVE!

Every kit carries money back guarantee.

For the first time anywhere, Poly Pak merchandisers introduce a new way in buying the economical way. Raw

stock from the "barrel". Remember the "good ole days"? They're back again. The same way merchandisers throughout the United States buy from various factories... their overruns in barrels. Poly Pak has done the same. Therefore you are getting the same type of material as the RE-TESTERS DO!

BARREL KIT #1 SN7400 DIP IC'S 75 for \$1.98 Marked 14 and/or with 16 pin dips, may include gates, registers, flip flops, counters. Who knows! GUARANTEED SATISFACTION! Cat.No.4R2415 Untested.	BARREL KIT #2 LINEAR OP AMPS DIP'S 75 for \$1.98 Un tested May include: 09's, 741's, 703's, 680 series, 555 included marked and unmarked. Cat.No.4R2416	BARREL KIT #3 1N4148/914 SWITCHING DIODES 100 for \$1.98 You never saw this before. Imagine famous switching diodes at these prices! Cat.No.4R2418 Untested.	BARREL KIT #4 "4000" RECTIFIERS 100 for \$1.98 Un tested. These are the famous micro miniature rectifiers of the 1N4000 series. May include 25, 50, 100, 200, 400, 600, 800 and 1000 volters. Cat.No.4R2417	BARREL KIT #5 SCRS, TRIACS, QUADRACS 40 for \$1.98 All the famous plastic power triac type. Raw factory stock! All the 10 amp types. Cat.No.4R2419 Untested.	BARREL KIT #7 VOLUME CONTROL BONANZA! 40 for \$1.98 100% Good Singles, duals, variety of values, styles, big ones — small ones. Cat.No.4R2421	BARREL KIT #8 SUBMINIATURE IF TRANSFORMERS 100 for \$1.98 Amazing. Includes 45Kcs, osc, antenna, who knows? From transistor radio manufacturers. Cat.No.4R2422
BARREL KIT #10 ROMS-REGISTERS 50 for \$1.98 Un tested 28 to 40 pin devices, marked. Internal factory numbers. (to Cat.No.4R2424)	BARREL KIT #12 POWER TAB TRANSISTORS 40 for \$1.98 PNP, plastic TO220 type. Assorted 2N numbers. Cat.No.4R2426 Untested.	BARREL KIT #13 RESISTOR NETWORKS 60 for \$1.98 Un tested. By Corning Glass, in 14-pin dip packs. Cat.No.4R2427	BARREL KIT #14 PRECISION RESISTORS 100% good 200 for \$1.98 Cat.No.4R2428 Marked and unmarked 1/4, 1/2, 2 watts.	BARREL KIT #15 MOSFET TRANSISTORS 60 for \$1.98 All 4 leaders TO-18 case. Includes DHF transistors too! Cat.No.4R2429	BARREL KIT #17 LINEAR & 7400 DIPS Un tested 100 for \$1.98 Marked and unmarked. Internal numbers of raw factory stock. Cat.No.4R2431	BARREL KIT #18 ZENER-RECTIFIER MIX 200 for \$1.98 Subminiature. DO7's, includes asst. zeners and rectifiers. It's mixed at the factory. We cannot separate. Cat. 4R2432 Untested.
BARREL KIT #19 DIPPED MYLARS 60 for \$1.98 Finest capacitors made. Shiny finish. Imagine factory dumping 'em in barrels. Cat.No.4R2597 100% good.	BARREL KIT #20 LONG LEAD DISCS 150 for \$1.98 Factory distributor stock "auction sale". Prime. Mostly 1/2 watters. 1% to 5% tol. & a barrel of values. Cat.No.4R2598 100% good	BARREL KIT #24 HIGH VOLTAGE RECTIFIERS 160 for \$1.98 Un tested. Up to 12,000 volts. 4 mils. epoxy, axial leads. Cat.No.4R2602	BARREL KIT #25 METAL CAN TRANSISTORS 100 for \$1.98 Includes TO-5, TO-18, TO-18, etc. assorted 2N numbers unmarked etc. Cat.No.4R2603	BARREL KIT #26 PLASTIC TRANSISTORS 100 for \$1.98 Un tested. Type TO-92 (TO-18). all manufacturers variety of 2N's. Cat.No.4R2604	BARREL KIT #28 CERAMIC CAPACITORS 200 for \$1.98 Not only do the barrels contain dogbones, but factory dumped. Erie Central. molded types too! Cat.No.4R2606 100% good.	BARREL KIT #29 VITAMIN Q CAPS 75 for \$1.98 100% good. Every type of oil-impregnated caps, some worth \$2. But the "ole barrel" sale gives you the bargain-of-a-lifetime. Cat.No.4R2607
BARREL KIT #30 TRANSFORMERS 250 for \$1.98 250 for \$1.98 You'll get even amount. 100% 1/4, 100% 1/2 watters. Cat.No.4R2608 100% good	BARREL KIT #31 METALIC RESISTORS 100 for \$1.98 100% good. Made mostly by Corning, the finest resistor made. Mostly 1/2 watters. 1% to 5% tol. & a barrel of values. Cat.No.4R2609	BARREL KIT #32 WITH A HOLE IN IT 50 for \$1.98 Un tested. Can't name factory but we bought barrels of 26 watters with hole in middle. PNP's and NPN's.	BARREL KIT #34 TUBE SOCKETS 100 for \$1.98 Good ole tube sockets. still in demand! Barrels and barrels. 1" 5", 7", 8", 9, even computer types. Cat.No.4R2612 100% good.	BARREL KIT #35 NEON LAMPS 40 for \$1.98 100% good. Famous NE-2's. All prime, but factory made millions and barreled 'em. Your advantage. Cat.No.4R2613	BARREL KIT #36 GERMANIUM DIODES 200 for \$1.98 Un tested. Famous maker, popular item. Never grows old. But this is the way the RE-TESTERS buy 'em from the factories. Cat.No.4R2614	BARREL KIT #37 1 AMP "BULLET" RECTIFIERS 100 for \$1.98 Famous style, asst. voltages, silicon, axial, includes 1KV. Cat.No.4R2615
BARREL KIT #38 2 AMP RECTIFIERS 75 for \$1.98 Un tested. "CYLINDER" type, silicon. Mallory, includes all voltages up to 1KV. Axial leads. Cat.No.4R2616	BARREL KIT #39 2N3055 HOBBY TRANSISTORS 15 for \$1.98 100% good. From factory to you, these fallouts of the famous 2N3055. We have 10 barrels. Cat.No.4R2617	BARREL KIT #40 PNP HIGH-POWER TRANSISTORS 20 for \$1.98 Popular germanium TO-3 case units, now available at "good ole barrel" prices. Cat.No.4R2618 100% good.	BARREL KIT #42 "GLASS 4000" RECTIFIERS 150 for \$1.98 Un tested. Just in! 1N4000 silicon rectifiers in epoxy, now in glass encased at barrel prices \$50 to 1000's too! Cat.No.4R2620	BARREL KIT #46 G.E. 3.5 WATT AMPLIFIERS 25 for \$1.98 Un tested. Hobby type, factory fallouts, we purchased them in barrels. These are unknowns. Cat.No.4R2624	BARREL KIT #49 QUADS! QUADS! 50 for \$1.98 LM 3500 Un tested. 4 mirror op amps in one package. Why the factory barreled these we don't know. Cat.No.4R2627	BARREL KIT #80 SIGNAL SILICON DIODES 200 for \$1.98 Includes many, many types of switching, signal silicon types, all axial leads. Some may be zeners. Cat.No.4R2628 Untested.
BARREL KIT #51 HOBBY OPTO COUPLERS 40 for \$1.98 Un tested. We bet 1000's unknown both the sensor or transmitter may be good or both. WE DON'T KNOW! We don't know the type. 1600's isolation. Cat.No.4R2629	BARREL KIT #52 DISCS! 500 for \$1.98 Cat.No.4R2630 100% good The bargain of a lifetime! First time ever offered by Poly Paks for the economy-minded bargain hunters.	BARREL KIT #53 JUMBO RESISTOR PAK 100-pc. \$1.98 Cat.No.4R2721 Assortm metal films, precision, carbons, metal oxide powers, from 1/8 watt to 7 watts. Color coded & 100% good. Worth \$10.	BARREL KIT #55 3 DIGIT READOUTS 15 for \$1.98 National cleaned its warehouse... now we have barrels of NSN-38 type. Un tested. Cat.No.4R2723	BARREL KIT #57 HI-POWER RECTIFIERS 15 for \$1.98 50-Amp studs; 6, 12, 24, 48V. 100% material. Factory rectifier "line" rejects. Cat.No.4R2725 100% good.	BARREL KIT #58 SLIDE SWITCHES 30 for \$1.98 All shapes, sizes, spst, dpdt, momentaries, etc. Tremendous shop pak for 100's of switching projects. Cat.No.4R2726 100% good.	BARREL KIT #59 POWER TRANSISTORS 40 for \$1.98 15 watt Bendix B-5000 pellet transistors; nnn, all good, purchased from a pretester, have millions of 100% good. Cat.No.4R2727
BARREL KIT #60 DTL'S IC'S 75 for \$1.98 Un tested. This is prime barrel material. Who wants DTL's? 950, 930, 910's. Your gain is our loss. They're marked too. Cat.No.4R2728	BARREL KIT #61 POLYSTYRENE CAPS 100% good 100 for \$1.98 Finest cap made. As a gambler, we bought 10 barrels from factory, mixed values; all good. Cat.No.4R2729	BARREL KIT #65 MIXED READOUTS 30 for \$1.98 Factory returns — such numbers as MAN-4's, MAN-7's, MAN-5's. 11 barrels & no time to separate. Cat.No.4R2733 Untested.	BARREL KIT #67 2-WATT AMPLIFIERS 50 for \$1.98 Un tested. Buy from the barrel 'n save! LM-38 types in dip packs. Are they good? We don't want to find out. We got millions. Cat.No.4R2734	BARREL KIT #68 2 WATERS 100 for \$1.98 100% good. Nobody seems to want 'em! So many suppliers don't count, but they're 'em in the barrel. It's a lil' gold mine. All marked. Cat.No.4R2735	BARREL KIT #71 CAPACITOR SPECIAL 100 pcs. \$1.98 Emptied stockrooms into barrels of mylars, poly's, mica's, muldies, plastics, ceramics, discs, etc. Nifty 100% good. Cat.No.4R2738	BARREL KIT #73 TRANSISTOR ELECTROS 50 for \$1.98 "buggy" as why the factories dump 'em in barrels. We don't wish to separate wide asst voltages & values up to 300 mF. Cat.4R2747
BARREL KIT #75 400MW ZENERS 100 for \$1.98 Factory out of biz! Amazing offer: 6, 8, 10, 12 to 15V. You test. Hermetically sealed glass pak. Double plug. Cat.No.4R2740 Untested.	BARREL KIT #76 1-WATT ZENERS 100 for \$1.98 Un tested. Factory same as 400-mw's. Never-to-see-again offer: 6, 8, 10, 12, 15V. under glass. Double plug. Cat.No.4R2741	BARREL KIT #77 "BROWN" BODY TRANSISTORS 40 for \$1.98 G-E D-40 series has hi-voltage, Darlingtons, hi-current, npn's. Factory line discontinued. Power tabs. Cat.No.4R2742 Untested.	BARREL KIT #78 "RED" BODY TRANSISTORS 40 for \$1.98 D-42 series. You test—go into your own biz! High current, hi-V. NPN. Un tested. Cat.No.4R2743	BARREL KIT #81 SUBMINI RESISTORS 200 for \$1.98 100% good. PC, upright type, color coded. 1/8 watt. Asst voltages. Come to us in a barrel. Cat.No.4R2746	BARREL KIT #82 8000 SERIES ICS 50 for \$1.98 By National. From factory to you. Assortment of popular series factory fallouts, overruns. Un tested. Cat.No.4R2634	BARREL KIT #83 LM-340T VOLTAGE REGULATORS 15 for \$1.98 Un tested. Factory rejected them for length of leads. May include 5, 6, 8, 12, 15, 18, 24 volts. Power tab. Cat.No.4R2635
BARREL KIT #84 25 for \$1.98 "THE CLAW". 6x 15 mils. LED hobby or experimental use, for understanding the working of "mini" or calculator readouts. A segment may be missing. No. 4R2679	BARREL KIT #86 HOBBY LEDS 40 for \$1.98 Un tested. Wow! A Litronics dump of all kinds of mixed discrete LEDs, shapes, colors, good, poor, etc. Cat.No.4R2859	BARREL KIT #87 NATIONAL IC BONANZA 100 for \$1.98 Factory dumps into barrels. Types 8000, 7400 series, DTL's, ROM's, registers, clock & calc. chips, linears, etc. Cat.No.4R2860 Untested.	BARREL KIT #109 TERMINAL STRIPS 150 for \$1.98 Wide asst. of terminal strip connectors, from 1 contact up. Strip manufacturers barrel dump is your gain. Wt. 1 lb. Cat.No.4R3136	BARREL KIT #110 SUPPRESSOR DIODES 50 for \$1.98 Cat.No.4R3137 Keeps ignition noises out axial. Un tested, but the of your eqpt., car, industrial, etc. Double plug.	BARREL KIT #99 PHOTO ELECTRIC CELLS 10 for \$1.98 Assst. Op types, CDS types. Mixed by factory. Big job for us to separate. 100% good. Cat.No.4R3052	BARREL KIT #102 CLOCK CHIPS 5 for \$1.98 No. 4R3055 National is dumping! MM-5316 — what's wrong with 'em, we don't know, but we got barrels. Hobby special. Wt. 2 oz.
BARREL KIT #104 SLIDE VOLUME CONTROLS 10 for \$1.98 Cat.No.4R3057 Used in hi-fi, volume control maker unknown. Asst. values, what a buy. Worth \$1 ea. We've got barrels of 100% material.	BARREL KIT #107 SQUARE OHMS 60 for \$1.98 Cat.No.4R3096 Factory people are sometimes "squares" when they mope prime square ohms mix 'em up in barrels. Asst. values watts. Wt. 1 lb.	BARREL KIT #108 TO-5 PLASTIC TRANSISTORS 40 for \$1.98 Cat.No.4R3101 Includes PNP, NPN, 2N-3638, 2N3641, 2N5000 series, etc. Un tested, but guaranteed to a 60% yield.	BARREL KIT #116 BUTTONS 'N FEEDTHRU'S 100 for \$1.98 100% good. Truthfully you're a small fortune. Wide asst. of button-feedthru caps! HUNTS TAKE NOTE! RE, UHF, etc. Wt. 1 lb. Cat.No.4R3143	BARREL KIT #111 MULTI DIGIT READOUTS 8 for \$1.98 Cat.No.4R3138 Includes 3 digit readouts to USA for "dump". Un tested.	BARREL KIT #112 MICRO MINI LEDS 40 for \$1.98 In the tiny leds, axial, upright of Monsanto, Litronics, variety of colors. Yield 50% or better. Cat.No.4R3139	BARREL KIT #113 STABISTORS 50 for \$1.98 Cat.No.4R3140 Regulator, sensing and computer circuitry. Axial double plug type. Discontinued factory line. PIV 20 volts. 90% yield. U test 'n save!

Terms: Add postage. Rated: net 30
Phone: Wakefield, Mass. (617) 245-3829
Retail: 16-18 Del Carmine St., Wakefield.

C.O.D.'S MAY BE PHONED

POLY PAKS
P.O. BOX 942R LYNNFIELD, MASS. 01940

MINIMUM ORDER — \$6.00

For free information on products advertised or mentioned in the editorial pages of this issue...

Use one of these Reader Service Cards

HERE'S HOW:

1. Circle the number on the attached postcard that corresponds to the number at the bottom of each advertisement or editorial item of interest.
2. Detach the postcard. Fill in your name and address and mail.
3. Be sure to print or type your name and address. Be sure to include zip code.

IMPORTANT:

The Clinton, Iowa Reader Service address is a data processing center which handles only Reader Service literature request cards. All other mail sent there may be delayed in reaching the proper department. For subscription problems (missing copies, change of address, etc.) write Radio-Electronics Subscription Service, Boulder, Colorado 80302. Address all other correspondence to Radio-Electronics, 200 Park Avenue South, New York, New York 10003.

RADIO-ELECTRONICS READER SERVICE

N476

The numbers I have circled below indicate the material I would like to receive:

1	2	3	4	5	6	7	8	9	10	11	12	13	14	15
16	17	18	19	20	21	22	23	24	25	26	27	28	29	30
31	32	33	34	35	36	37	38	39	40	41	42	43	44	45
46	47	48	49	50	51	52	53	54	55	56	57	58	59	60
61	62	63	64	65	66	67	68	69	70	71	72	73	74	75
76	77	78	79	80	81	82	83	84	85	86	87	88	89	90
91	92	93	94	95	96	97	98	99	100	101	102	103	104	105
106	107	108	109	110	111	112	113	114	115	116	117	118	119	120

Reader Service available to U.S.A. and Canadian readers only

NAME _____

ADDRESS _____

CITY _____ STATE _____ ZIP _____

Cards without Zip Codes will not be processed

Void after June 30, 1976

RADIO-ELECTRONICS READER SERVICE

N476

The numbers I have circled below indicate the material I would like to receive:

1	2	3	4	5	6	7	8	9	10	11	12	13	14	15
16	17	18	19	20	21	22	23	24	25	26	27	28	29	30
31	32	33	34	35	36	37	38	39	40	41	42	43	44	45
46	47	48	49	50	51	52	53	54	55	56	57	58	59	60
61	62	63	64	65	66	67	68	69	70	71	72	73	74	75
76	77	78	79	80	81	82	83	84	85	86	87	88	89	90
91	92	93	94	95	96	97	98	99	100	101	102	103	104	105
106	107	108	109	110	111	112	113	114	115	116	117	118	119	120

Reader Service available to U.S.A. and Canadian readers only

NAME _____

ADDRESS _____

CITY _____ STATE _____ ZIP _____

Cards without Zip Codes will not be processed

Void after June 30, 1976

FIRST CLASS
PERMIT 597
BOULDER, COLO.

BUSINESS REPLY MAIL

no postage stamp necessary if mailed in the United States

POSTAGE WILL BE PAID BY

Radio-Electronics

**SUBSCRIPTION SERVICE
BOULDER, COLORADO 80302**

For new ideas in electronics read Radio-Electronics

PLACE
STAMP
HERE

Radio-Electronics

READER SERVICE

P.O. Box 2707

Clinton, Iowa 52732

PLACE
STAMP
HERE

Radio-Electronics

READER SERVICE

P.O. Box 2707

Clinton, Iowa 52732

Subscribe today to the magazine which keeps you up-to-date with the newest ideas and innovations in electronics. (If you already are a subscriber, do a friend a favor and pass this subscription card along to him.)

check offer preferred

1 Year — 12 issues **ONLY \$8.75** 2 Years — 24 Issues **SAVE MORE \$16.50**
(You save \$1.50 over newsstand)

3 Years — 36 Issues **GREATER SAVINGS \$24.50**
(You save \$2.50 over newsstand prices)

Payment enclosed Bill Me Check here if you are extending or
renewing your subscription

Check here if this is a new subscription

Name _____

Address _____

City _____ State _____ Zip _____

IMPORTANT

Canada same as U.S.A. Extra Postage: Pan American \$1.50 per year, all other foreign \$2.00 per year.

N4046

www.americanradiohistory.com

During the next 12 months

Radio-Electronics will carry up-to-the minute articles on:

- solid-state technology
- color TV • stereo
- test equipment • radio
- computers • careers
- industrial electronics
- servicing TV-radio-stereo
- experimenter circuits
- exceptional construction projects

Don't take a chance on missing even one issue. Subscribe now and save!



NEW IDEAS AND INNOVATIONS IN ELECTRONICS

The newest ideas and innovations in electronics appear in Radio-Electronics. Keep up-to-date!

Subscribe Today!

To SBE technology

is not just another word

SBE brings computer-age technology to two-way radio communications in developing the newest, the most advanced, the most exciting personal communications equipment available today.

FORMULA D, for example, is SBE's sophisticated new 23-channel citizens band mobile AM two-way radio. With a single crystal, it offers advanced digital techniques, combined with phase-lock-loop (PLL) circuitry, to synthesize frequencies covering all 23 transmit and receive channels. Tolerances are closer. Stability is better. And performance exceeds the best that crystal-controlled two-way radio could ever provide.

FORMULA D is but the first of a whole new generation of sophisticated, digitally-synthesized personal communications equipment being developed by SBE to keep you ahead in the exciting new advances planned for citizens band communications.

The same creative approach to technology as exemplified by FORMULA D is reflected in other SBE products—a full line of communications equipment that includes citizens band, land mobile, marine and special application.

Discover how you can benefit from SBE's advanced technology.



Better Communications through Creative Technology

For information write: SBE, Inc., 220 Airport Blvd., Watsonville, CA 95076

INTERNATIONAL OFFICES: E. S. Gould Marketing Co. Ltd., Quebec, Canada/Linear Systems S.A. Geneva 1, Switzerland

Circle 82 on reader service card

www.americanradiohistory.com

The Tuner People

... offer something

NEW

Custom Service

*... for the
Professional*

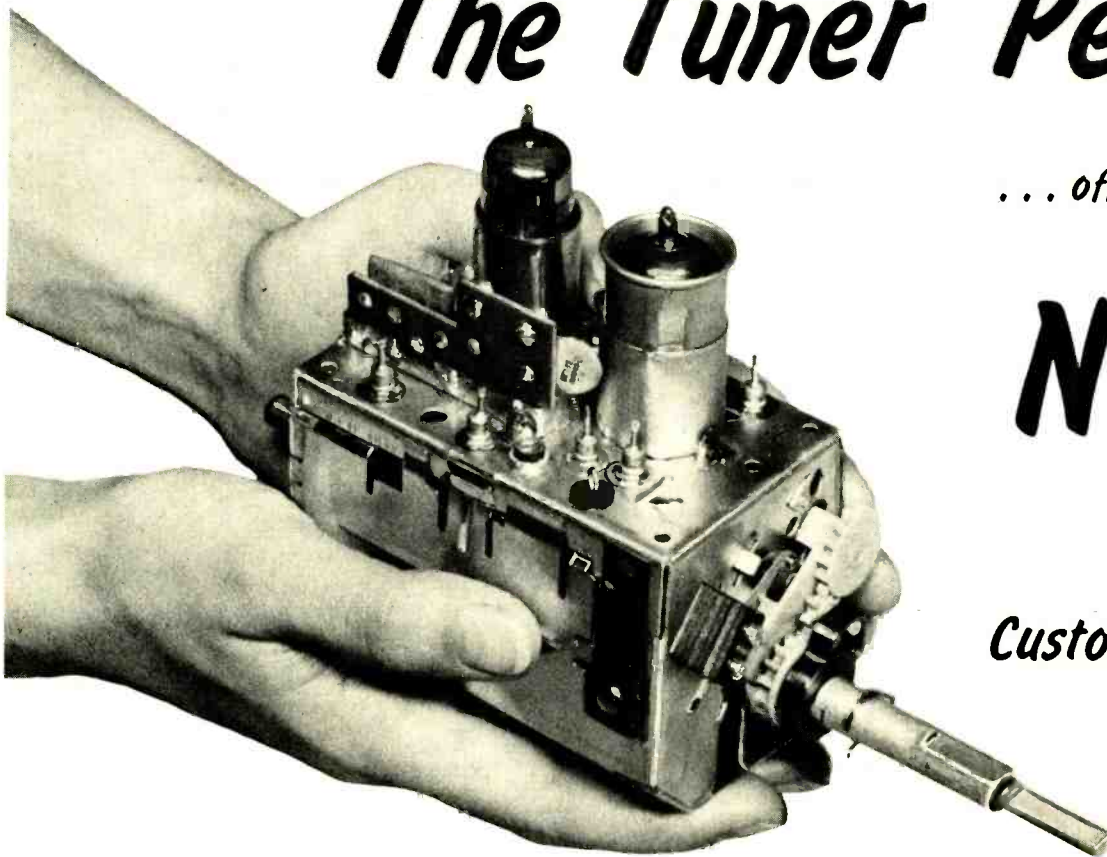

Yes! Castle, the pioneer of TV Tuner overhauling, gives you 25 years of expertise and professional experience behind every tuner processed under our new Custom Service.

Each order is handled on an individual basis with documentation of performance and service recorded for each tuner. This Custom Service guarantees you expert analysis of the tuner; precise, skilled alignment . . . and no harmful, unusual cleaning processes. Your need to return for further service in warranty is reduced to an absolute minimum . . . when you receive the tuner under Castle's Custom Service you know that it is right!

What does this Custom Service cost?

Castle Custom Overhaul Service.

Individual overhauling of any TV Tuner, tubes and transistors extra.

\$12.95

Send defective tuner only to Castle, remove ALL accessories.

Castle Custom Stock Replacement Tuners.

Engineered by Castle to provide exact replacement . . . giving original, or improved performance. Purchase outright — no exchange required — send for list of tuners available.

\$17.95

Castle Custom Exchange Replacement Service and Custom Rebuilding.

This is a custom service offered when the original tuner is unfit for overhaul and a Castle Custom Stock Replacement is not available. Each tuner is exchanged for an exact replacement tailored to custom order; or the original tuner is professionally rebuilt to perform to original specifications. All inclusive price.

VHF \$21.95

UHF \$17.95

REMEMBER . . . Castle Custom Service is as near as your Post Office. All prices are f.o.b. our plant. We will ship C.O.D.



CASTLE TV TUNER SERVICE

5715 N. Western Ave., Chicago, Ill. 60645 • Ph. (312) 728-1800

Circle 83 on reader service card