

Lowdown on electronic burglar alarms

60c ■ NOV. 1970

Radio-Electronics^{IND}

FOR MEN WITH IDEAS IN ELECTRONICS

New FM tuner One IC replaces entire I. F. strip

- No tuned circuits
- High linearity
- Low distortion
- Phase-locked loop

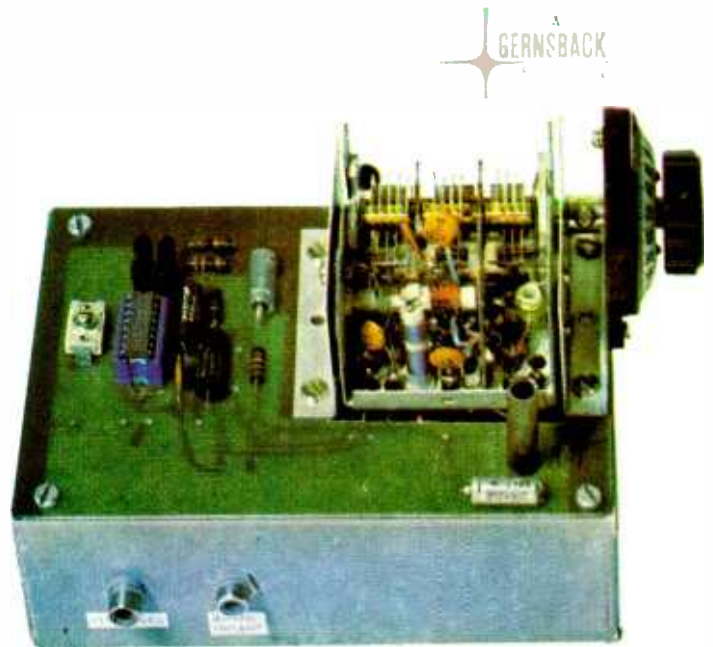

Build with IC's 3-way Waveform Generator

- Sinewaves
- Squarewaves
- Triangular waves
- All solid state

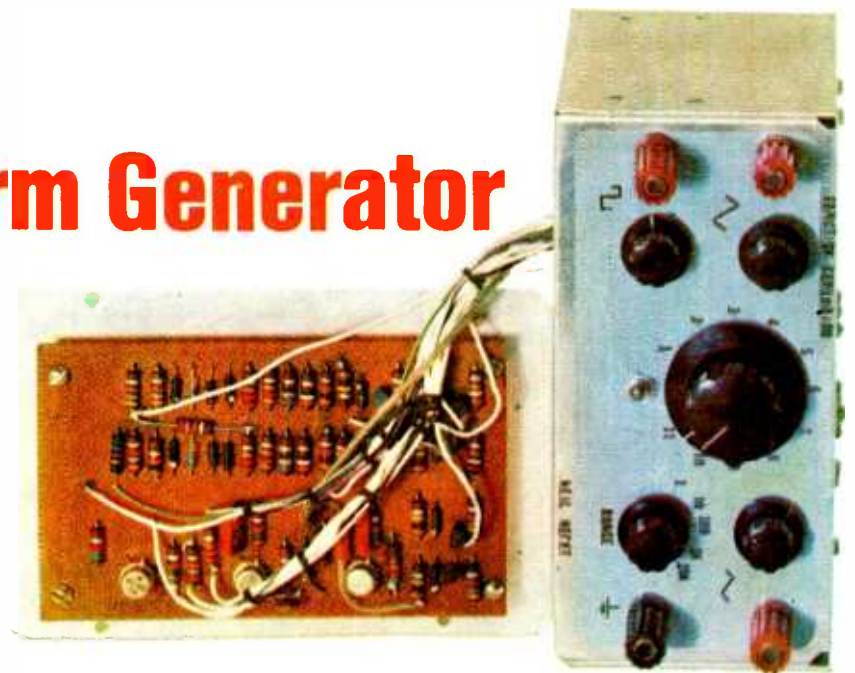

PLUS

30 Experimenter's IC Circuits ■ Jack Darr's Service Clinic ■
Careers In Computers ■ Putter With The PUT

Be creative - and thrifty too!

Save up to 50% with EICO Kits and Wired Equipment.

NEW "TREASURE HUNTER" KIT

Finds metals, pipes several inches underground. EICO TH-30 Solid State Treasure Hunter locates iron, steel, tin, gold, silver, copper etc. Beep pitch increases as you near object.

Battery operated. \$29.95.

NEW "BULLHORN" KIT

Carries your voice up to 400 feet. EICO BH-16 Solid State Bullhorn. 2½ lbs. light, is perfect for all outdoors, camping, sports. Battery-operated. \$15.95.

NEW EICOCRAFT

The electronic science project kits for beginners, sophisticates, educators. 42 kits to date.



FM Wireless Mike \$9.95.

8 NEW EICOCRAFT KITS

Automotive "LIGHTGUARD" • "VARIVOLT" DC Power Supply • "MOODLITE" Light Dimmer Control • "VARASPEED" Motor Speed Control • "LIGHTSHOW" Sound/Lite Translator • "ELECTRIC FIESTA" Audio Color Organ • "SUPER MOODLITE" Remote Control Light Dimmer • "ELECTROPLATER" From \$2.50 to \$14.95.

NEW "FLEXI-CAB"

Build your own custom designed cabinet in minutes!

Give your EICOCRAFT and other projects that finished professional look with decor-styled FLEXI-CAB vinyl clad steel cabinets. Fast, easy, push-together assembly. 3-sizes from \$3.49.

COLOR IMAGES

Electronic Art in Motion.

"CHROMA-CUBE"

Classic white 18" Cube features a fantastic audio-responsive light display.

"CELESTIAL LITES"

Constantly flowing color images move in rhythm to music. 24" x 24" x 6".

"LIGHT FANTASTIC"

Translucent dome provides 3-dimensional world of ever changing light patterns in response to music. 38" high.

NOW YOU CAN SEE THE MUSIC YOU HEAR. Sound n' Color

Color Organs, Translators, Strobes

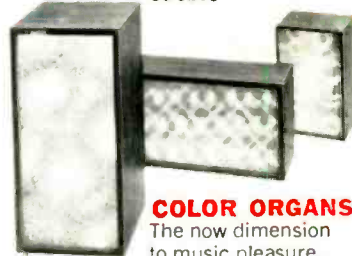

COLOR ORGANS

The new dimension to music pleasure.

EICO all electronic solid-state Audio-Color Organs transform sound waves into moving synchronized color images.

MODEL 3450 Giant (30" x 12" x 10") 4-Channels. Kit \$79.95, Wired \$109.95.

MODEL 3445 (24" x 12" x 10") 4-Channels. Kit \$64.95, Wired \$99.95.

MODEL 3440 (10" x 15" x 16") 3-Channels. Kit \$49.95.

Wired \$79.95. Other models to choose, from \$19.95 and up.

TRANSLATORS

The electronics you need to create audio-stimulated light displays.

MODEL 3460 1 Channel. Kit \$24.95, Wired \$39.95.

MODEL 3465 3 Channel. Kit \$39.95, Wired \$69.95.

STROBE LITES

Burst of white light flash in cadence of each beat of audio.

Model 3470 Adjustable Rate. Kit \$29.95, Wired \$44.95

Model 3475 Audio Actuated. Kit \$39.95, Wired \$59.95.



NEW cortina2 STEREO KITS

The lowest-priced component quality high fidelity!

EICO 3780 50-Watt Silicon Solid State FET AM-FM Stereo Receiver. Kit \$109.95, Wired \$169.95



EICO 3080 50-Watt Silicon Solid State Stereo Amplifier. Kit \$69.95, Wired \$109.95



EICO 3300 Silicon Solid State FET AM-FM Stereo Tuner. Kit \$69.95, Wired \$109.95

NEW SOLID STATE TEST INSTRUMENTS

The first and only solid state test equipment guaranteed for 5 years!

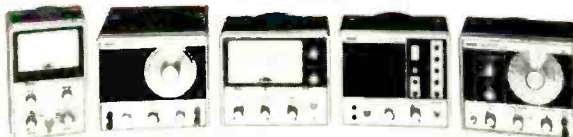

EICO 240 Solid State FET-TVM. Kit \$59.95, Wired \$79.95.

EICO 379 Solid State Sine/Square Wave Generator. Kit \$69.95, Wired \$94.50.

EICO 242 Solid State FET-TVOM. Kit \$69.95, Wired \$94.50.

EICO 150 Solid State Signal Tracer. Kit \$49.95, Wired \$69.95.

EICO 330 Solid State RF Signal Generator. Kit \$59.95, Wired \$84.50.

FREE 1970 EICO CATALOG

Send me FREE catalog describing the full EICO line of 200 best buys, and name of nearest dealer.

Name _____

Address _____

City _____ State _____ Zip _____

EICO Electronic Instrument Co., Inc.
283 Malta Street, Brooklyn, N.Y. 11207



AUTOMOTIVE

EICO 889 Solid State Capacitive Ignition System.

Boost gas mileage up to 25%, life of points, plugs to 100,000 miles; Kit \$29.95, Wired, \$39.95.



EICO 888 Solid State Universal Engine Analyzer. Tunes and troubleshoots your car/boat engine, the totally professional way. Kit \$49.95, Wired \$69.95.

Put More "GO POWER" into Your Electronics Career —

MOVE AHEAD from Technician to ENGINEER

by studying at home with

GRANTHAM SCHOOL OF ENGINEERING

"the college that comes to you"

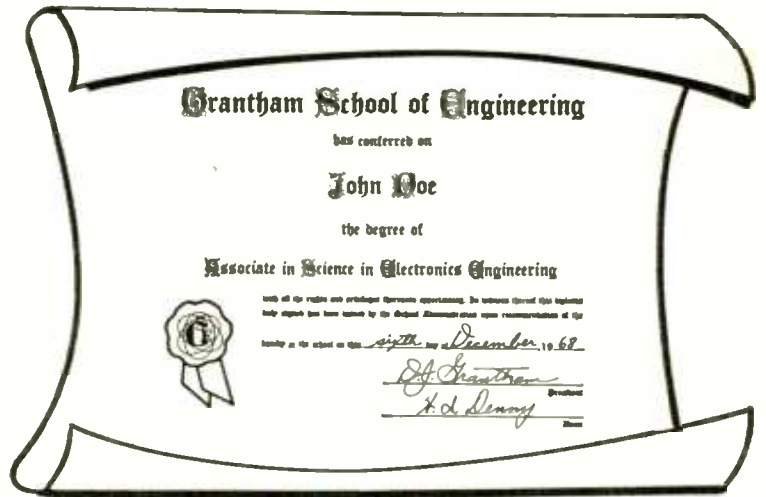

Earn a DEGREE in Electronics Engineering

The GRANTHAM educational program in ELECTRONICS ENGINEERING is designed to upgrade electronics technicians to the engineering level, mostly by home study.

While you continue your present employment, you can really learn electronics engineering and earn an ACCREDITED DEGREE. Upgrade your income and prestige by upgrading your electronics education at the college level.

GRANTHAM'S strong-foundation educational program in electronics engineering is designed especially for the working technician. This program, offered mostly by home-study, leads to non-obsolete skills—to skills based on reasoning—and leads to the DEGREE of Associate in Science in Electronics Engineering (the ASEE Degree).

This accredited degree program consists of four "correspondence semesters" of 100 lessons each, a total of 400 lessons. All except the last ten of these lessons are completed entirely by correspondence. However, after you have completed Lesson 390 you must then attend a two-week Graduation Seminar at the School. It is during this attendance that you complete Lessons 391 thru 400 and receive your ASEE Degree.

Accreditation and G.I. Bill Approval

Grantham School of Engineering is accredited by the Accrediting Commission of the National Home Study, is approved under the G.I. Bill, and is authorized under the laws of the State of California to grant academic degrees.

Grantham School of Engineering

• Established in 1951 •

1505 N. Western Ave.
Hollywood, Calif. 90027

Telephone:
(213) 469-7878



What's in Your Future —

The Same Old Job, or Success in Engineering?

Where will you be five years from today? Are you headed for real advancement in electronics, or in a rut? The experience you have as a technician is valuable; it gives you a head start toward a better future. But to get ahead and stay ahead, experience must be supplemented with more education in electronics and such allied subjects as mathematics, physics, computers, and engineering design.

The Grantham educational program in electronics engineering is not for beginners. Every point is explained just as carefully as if you were a beginner, but the important difference is that while the beginner would need extensive laboratory training, you (as an experienced technician working with modern equipment) do not require such training and should not waste your time doing the same laboratory experiments that beginners must perform. This program in engineering is designed, written, and taught for and to experienced technicians, and beginners are not accepted for enrollment.

• Mail the coupon below for our free Bulletin •

Grantham School of Engineering RE-11-70

1505 N. Western Ave., Hollywood, Calif. 90027

Gentlemen:

Please send me your free Bulletin which gives complete details on the Grantham educational program leading to the Associate Degree in Electronics Engineering. I understand no salesman will call.

Name _____

Address _____

City _____ State _____ Zip _____

I have been in electronics for _____ years.

NEW & TIMELY

Volume 41 Number 11

RADIO-ELECTRONICS . . . FOR MEN WITH IDEAS IN ELECTRONICS

November 1970

TV PICTURES ON A DISC

Thin plastic disc rotates at 1500 rpm, floats on air and produces TV pictures. Made by AEG-Telefunken, the unit looks a lot like a conventional record player. The unit shown handles only black-and-white, but color is in the works. For more details see Looking Ahead on page 4. ★

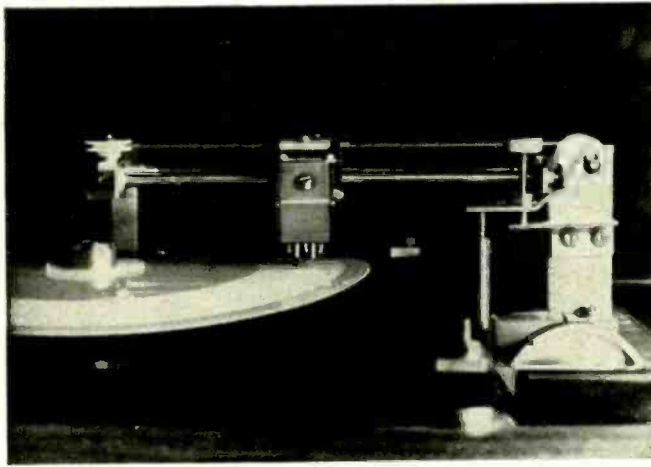

BATTERY-POWERED CONTINUOUS LASERS

MURRAY HILL, N.J.—A new laser, smaller than a grain of sand, that can be powered by ordinary dry-cell batteries, has been built by Bell Laboratory Scientists. It emits a beam of near-visible infrared light.



Designed by Izuo Hayashi and Morton Panish, the new laser is a semiconductor device that operates continuously at normal room temperature (75-80°F). This is about the average operating temperature of typical transmission equipment used in communications systems.

In the past, the heat generated in semiconductor lasers was too great to permit operation at room temperature for more than a fraction of a second at a time without destroying the semiconductor itself. Even when these lasers were mounted on heat sinks, room-temperature operation was limited to about 1/10,000 second.

By building a new semiconductor laser structure the designers eliminated the need for additional cooling.

The new semiconductor laser consists of four layers of semiconductor materials. Two of the layers, each about 60 millionths of an inch thick, confine laser light to a thin central layer of the structure. This layer, called the active region is about 20 millionths of an inch thick.

Laser activity, effectively confined to such a small region, can be produced with much less current, resulting in less heating. This makes the continuous laser operation possible. ★

Supermagnets To Speed Tomorrow's Transit

MENLO PARK, CALIF.—A new rapid transit vehicle which can race along an invisible magnetic "track" at over 300 miles-an-hour is under study at Stanford Research Institute. The new transit mode would use the tremendous power of superconducting magnets to lift the weight of the vehicle off its track and propel it to extremely high speeds.

Key to the system is magnetic levitation, a phrase which refers to the use of magnetic repulsion to lift the vehicle free of any physical

inventing the time-consuming auto trip between airport and downtown destinations this new transit system could compete with airliners operating in high-density travel corridors.

SRI researchers reasoned that a transit vehicle carrying powerful superconducting magnets could be levitated as much as a foot above a metal-lined roadway. The same magnet forces could be used to keep the car centered in the roadway.

The suspended vehicle could be propelled by linear-

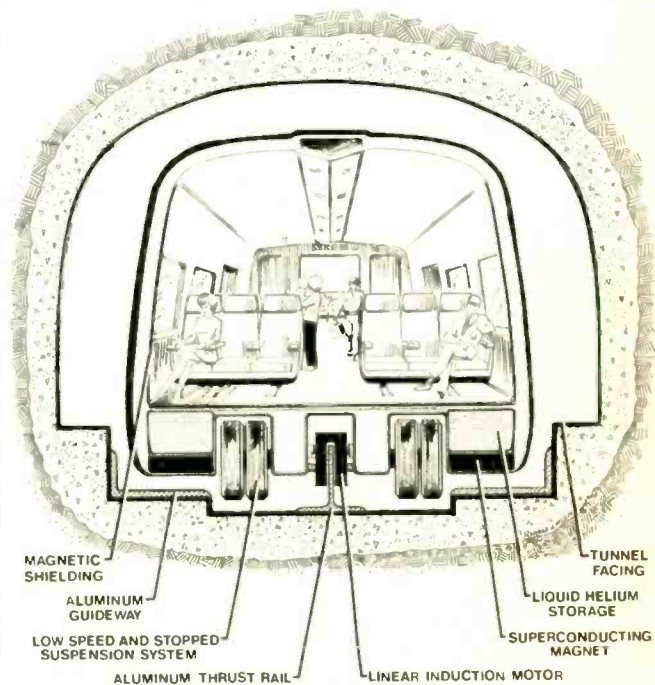

support, allowing it to achieve very high speeds easily and economically. Pushed by linear induction motors, which also use magnetic forces, the vehicle could travel at high speed in virtual silence.

Operating between downtown urban centers such a vehicle could whisk passengers between New York and Washington in about an hour. The trip between downtown San Francisco and downtown Los Angeles could be made in about 1-1/2 hours. By elim-

ination motors. They use magnetic power, are silent, and produce no contaminating exhaust.

In theory the only limit to the speed of such a vehicle would be the resistance of the surrounding air. This could be solved by having the vehicle run in a tunnel from which enough air had been removed to create a partial vacuum. Passengers in the vehicle would be as comfortable as those riding in the pressurized cabin of an airliner. (continued on page 12)

Radio-Electronics

FOR MEN WITH IDEAS IN ELECTRONICS

November 1970 • Over 60 Years of Electronics Publishing

SPECIAL FEATURES

- Alarms Stop Burglars** **33** Bill Gracie
Lowdown on today's burglar alarms
- New IC Replaces FM I.F. Strip** **59** Larry Steckler
Phase lock loop is coming
- Burglar Alarm Manufacturers** **94**

BUILD ONE OF THESE

- 30 IC Circuits** **37** R.M. Marston
More ways to use the CA 3018
- Putter With The PUT** **50** R.W. Fox
11 more ways to use the programmable unijunction transistor
- 3-Way Waveform Generator** **62** Neil Heckt
IC unit delivers sinewaves, square waves, rectangular waves

TELEVISION

- In The Shop** **17** Jack Darr
Up-down-positive-negative
- Kwik-Fix Troubleshooting Charts** **41** Forest Belt
Sound i.f. and quadrature detector
- Equipment Report** **82** Warren Roy
GBC closed circuit TV system
- Service Clinic** **86** Jack Darr
R-E's service editor answers your questions

GENERAL ELECTRONICS

- Looking Ahead** **4** David Lachenbruch
with future overtones
- Editorial** **6** Robert F. Scott
Getting parts for construction articles
- Careers In Computers** **52** George G. Garmus
New jobs for trained technicians
- R-E Reference Manual** **54** Tom Haskett
Power tools for you
- Computer Logic Course Review** **88** John Williams

DEPARTMENTS

- | | | |
|--------------------------------------------------|------------------------------------|----------------------------------------|
| CB Troubleshooter's Casebook 96 | New Books 83 | New Semiconductors 91 |
| Coming Next Month 84 | New Literature 85 | New & Timely 2 |
| Correspondence 18 | New Products 72 | Try This One 92 |

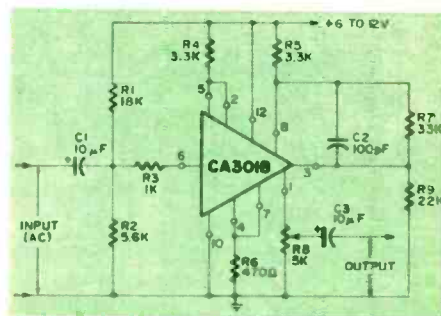

The CA3018 has four transistors inside its case. Here are more ways to put it to work for you. . . . see page 37



Computer technicians are in demand. Discover the opportunities in this exciting growing industry. . . . see page 52

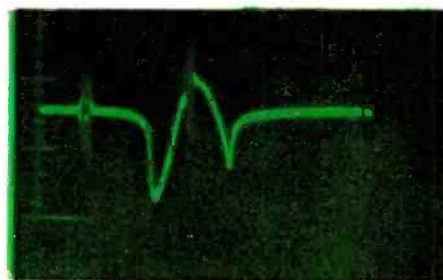

Kwik-Fix waveforms like this one will help you make quadrature repairs a cinch. For complete details see page 41

RADIO-ELECTRONICS, NOV. 1970, Vol. 41, No. 11
 Published monthly by Gernsback Publications, Inc., at Ferry St., Concord, N. H. 03302
 Editorial, Advertising, and Executive offices: 200 Park Ave. S., New York, N.Y. 10003. Subscription Service: Boulder, Colo. 80302.
 Second-class postage paid at Concord, N. H. Printed in U.S.A. One-year subscription rate: U.S. and possessions, Canada, \$6.
 Pan-American countries, \$7.50. Single copies 60¢. © 1970 by Gernsback Publications, Inc. All rights reserved.
 POSTMASTER: Notices of undelivered copies (Form 3579) to Boulder, Colo. 80302.



Radio-Electronics is indexed in Applied Science & Technology Index (formerly Industrial Arts Index)

LOOKING AHEAD

Volume 41 Number 11

RADIO-ELECTRONICS . . . FOR MEN WITH IDEAS IN ELECTRONICS

November 1970

by **DAVID LACHENBRUCH**
CONTRIBUTING EDITOR

Video disc system

A new entry in the videoplayer sweepstakes has some engineers very excited. It's the long-rumored video disc system developed by German manufacturer AEG-Telefunken with British Decca and demonstrated recently in Berlin. The playback unit looks, at first sight, like a conventional phonograph. The grooved discs are extremely thin flexible plastic records measuring eight and 12 inches in diameter, and playing for five and 12 minutes respectively in black-and-white. (See photo in *New & Timely*, page 2.)

Each disc contains from 120 to 140 grooves per millimeter, and spins at 1,500 revolutions per minute, producing one frame per revolution. On the turntable, the discs ride on a cushion of air, and a new type of pickup responds to the variations in groove elevation. Telefunken is developing longer-playing discs, a disc changer and a system which plays back in color.

American engineers who witnessed the Berlin demonstration say picture quality was very good. Among the claimed advantages of the disc system over other videoplayer techniques: (1) Economy—discs may cost five dollars each, or less; players would be priced somewhere between \$140 and \$280. (2) Fast duplication—discs may be pressed in a conventional manner, about 1,000 in 12 minutes. (3) Playback ease—the phonograph is still the most familiar type of playback equipment, and the consumer would not have the problem of learning new procedures for playing visual material.

For color consistency

A new series of signals is going out over the air along with color TV broadcasts. It's an experimental system being tested by the television broadcasters as part of an all-out effort to achieve uniformity in color from program-to-program, scene-to-scene and channel-to-channel.

On selected programs of all three networks, a test is being made of the use of part of the "vertical interval" between frames to transmit reference signals for contrast, tint and color intensity. The vertical interval reference signals are inserted in line 20 of field 1. If the tests work out, stations will be supplied with a method for absolute calibration of equipment to produce uniformity in colors. This and other procedures and standards being developed by a top-level engineering committee representing TV broadcasters, set manufacturers, film and tape companies and the telephone company, eventually could lead to color uniformity so good that the tint control could be eliminated from color TV receivers. At least, that's the hope of the engineers.

Standard amplifier measurements

The rule faced by the purchaser of high-fidelity equipment—particularly the unknowledgable one—has always been "let the buyer beware." Claims for amplifier power, in particular, have been difficult or impossible to compare. There have been several so-called "standard" ways of measuring—the Institute of High Fidelity (IHF) standard, the Electronic Industries Association (EIA) "music power" standard, and something that some manufacturers dreamed up and called "peak music power." Generally, the IHF standard was designed to apply to audio component ampli-

fiers, the EIA and "peak" standards to packaged consoles—and there was no real way for the layman to compare various equipment.

Finally, after some 15 years of discussion and debate, a standard system for describing audio amplifier power appears to be in sight. The EIA has modified its system to the point where it would be compatible with the IHF system. Under the proposal, which had not yet been officially approved by EIA members at press time, all manufacturers would use the same measurements and terminology.

The original EIA "music power output" (MPO) standard, developed in 1960, specified five percent total harmonic distortion. The new proposed standard permits the manufacturer to use any total harmonic distortion level he wishes, but not to exceed five percent. In addition, the EIA has changed test procedures, renamed MPO "momentary power output" and added a continuous power output test and rating procedure.

EIA's proposed new rule also includes definitions and procedures for establishing rated intermodulation distortion, intermodulation distortion-low level, frequency response, channel separation, signal-to-noise ratio, input overload margin, input impedance, output impedance, damping factor and tracking error.

The EIA-IHF efforts to arrive at a common standard were accelerated by a new move by the Federal Trade Commission to step in and police amplifier output claims through a new Trade Regulation Rule. The proposed rule is still in exploratory stages but would require that manufacturers use standard measurements whenever they made claims for amplifier power. EIA and IHF hope that the FTC will accept their proposed joint standard, giving it—in effect—the force of law, and ending at least some of the confusion in the amplifier "horsepower race."

Home videoplayer sweepstakes

Keep your eye on the hot home video-player field. It could end up as biggest boom—or biggest bust—in the history of consumer electronics. It appears that almost everybody has a system, and hardly any one is compatible with any other. In addition to the Telefunken system described above, it's believed that some 20 or more different systems will have been exposed before the year is over. Among non-compatible approaches are RCA's holographic-tape Selecta-Vision, CBS's electronically-recorded EVR film, Sony's Video-cassette magnetic tape system, and other non-compatible tape approaches by Cartridge Television (Cartrivision), Ampex, Arvin, Philips and others. In addition there is the ABTO color-encoded film system, plus electronically-scanned Super-8 systems introduced by several manufacturers.

As each new system is introduced, the question of standards becomes more urgent. The promising new field of pre-recorded audio-visual records for the home is in danger of strangling on consumer confusion over the multiplicity of systems. How many years would audio recording have been set back if there had been introduced simultaneously cylinder recordings in eight different speeds, discs which played clockwise and discs which played counter-clockwise in five different speeds, magnetic tapes in four widths, grooved tapes recorded by four different non-compatible methods and optical film recordings in several configurations? It's enough to bring back vaudeville, band concerts in the park and other innocent non-electronic diversions.

R-E

RADIO-ELECTRONICS

NOW you can measure resistors accurately

IN CIRCUIT!

in solid state devices



FE20 HI-LO
with hi-voltage probe and large
six-inch meter **\$129.50**



FE21 HI-LO
with 4½-inch
meter **\$99.50**

WITH THE NEW HI-LO FIELD EFFECT MULTIMETERS

USES ONLY .08 VOLTS TO POWER OHMMETER TO PREVENT TRANSISTORS FROM CONDUCTING AND UPSETTING READINGS

Look at these extra features to see why the Hi-Lo meter belongs on your want list:

- Unbelievable specifications of 15 megohm input impedance on DC and 12 megohms on AC
- Laboratory accuracy of 1.5 percent on DC and 3 percent on AC
- 9 DC voltage ranges from as low as .1 volts full scale to 1000 volts
- 3 hi-voltage ranges of 3 KV, 10 KV and 30 KV
- 9 DC zero center ranges from .05 volts to 500 volts . . . a must for delicate transistor bias measurements
- 7 resistance ranges from 1000 ohms full scale to 1000 megohms
- 9 DC current ranges from 100 microamps to 1 amp
- Automatic built-in battery test . . . never a worry about rundown batteries, just push the switches under the meter and read.
- Standard .6 amp fuse to protect the ohms and milliamps scales if voltage or overload is accidentally applied. No more need to return the meter to factory for repair . . . just replace the fuse.
- Special probe with 100K isolation resistor in probe to prevent AC pickup or to prevent loading oscillator circuits. Leave in normal position for most tests.

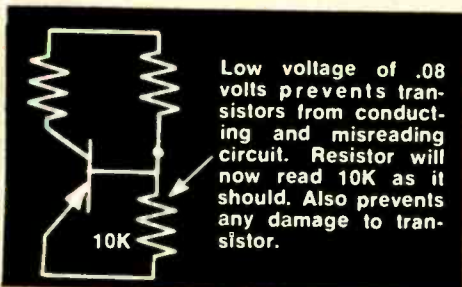

Here is why you should have both Hi and Lo battery voltages for correct in-circuit resistance measurements in solid state circuits:

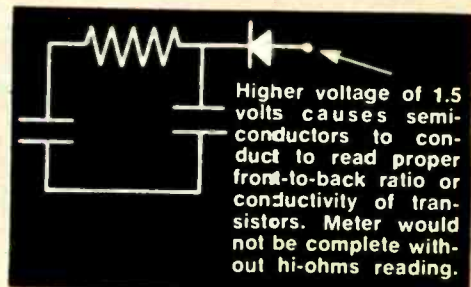

SENCORE INC. 3200 Sencore Drive • Sioux Falls, South Dakota 57107
Circle 3 on reader service card

Editorial — TO THE CONSTRUCTOR

FROM DAY TO DAY, OUR PERSONAL EXPERIENCES AND CALLS and letters from you indicate that it is becoming increasingly difficult to obtain all the parts needed to complete any, except the simplest of construction projects. With present-day construction techniques tending toward increased use of semiconductors, printed circuits and miniaturization, it is often impossible to substitute more-readily available components.

Take, for example, a magazine article describing a photoelectric control unit with a PC board laid out to accept a particular relay and power transformer. Its cabinet is just large enough to house the electronic circuitry. You, like most readers, want to build the unit exactly as the author described it. The relay, transformer and cabinet—the critical parts in this project—are all standard replacement or consumer-type items listed in manufacturers' catalogs but you can expect some difficulty in obtaining at least one of these parts. This is especially true when you try to buy them locally.

Most of you go to local electronics parts houses for components for your projects. There are three basic types of parts suppliers. One is set up to serve the local TV and radio service industry or possibly the needs of nearby electronics or industrial plants. This type of dealer stocks only those parts experience has shown can be sold fast and with the least difficulty. The variety of components often needed by experimenters and other nonprofessionals are not carried in stock. Experimenters, CB'ers and do-it-yourselfers are not welcome because they often ask for assistance or advice which the dealer is not prepared (or able) to give.

The second type of parts house specializes in hi-fi or CB gear and stocks only those IC's, transistors, tubes, resistors, capacitors and other components that might be required to maintain the equipment it sells. You may find "blister packs" of general-purpose semi-conductors and other components for beginning students and experimenters but you are not likely to find all the parts needed for an advanced construction project.

Mail-order houses—the third type—are generally the best source of parts for advanced construction projects. Most of these serve all phases of the electronics industry, schools and experimenters and are more likely to have the

parts you need in stock. If a component is out of stock, they can supply it without undue delay. Note well that not all mail-order dealers carry all brands of components and some will carry the full line of a particular manufacturer while others do not.

More and more parts manufacturers are gearing their product and sales toward the industrial market and sell only through wholesale (OEM-type) distributors. With the exception of some mail-order houses many distributors are basically wholesalers who have a minimum-order sales policy. That is, they don't accept orders totaling less than a specific amount—usually \$8 to 10. RADIO-ELECTRONICS has turned down many articles on equipment requiring a special but inexpensive part obtainable only through sources which have a minimum-order figure many times the value of that part. If a special part for a construction project cannot be readily obtained at reasonable cost, there is no place for that story in RADIO-ELECTRONICS.

If you want to complete your construction projects without the frustration of not being able to locate a critical component, you will have to rely more and more on mail-order houses. Naturally, you will have to await the arrival of the parts from the mail-order house but this is not nearly as frustrating as waiting for one part ordered through a local dealer.

I have nothing against local dealers. It is just that most are specialists who do not stock the type of parts required for many of your projects.

If you enjoy constructing your own electronic gear from magazine articles, here are a few tips we hope will enhance your enjoyment of future projects.

(1) Before beginning a construction project from a magazine, read the article and parts list again. Then, go over it once more. Often, in your anxiety to get started, you overlook authors' or editors' notes on obtaining a particular part.

(2) Obtain catalogs from at least six mail-order houses. Study them until you are familiar with the types and brands of components listed in each.

(3) When ordering, follow instructions to the letter. List page and stock numbers and a description of each

(continued on page 14)

Radio-Electronics

HUGO GERNSBACK (1884-1967)
founder

M. HARVEY GERNSBACK,
editor and publisher

LARRY STECKLER, managing editor

Robert F. Scott, W2PWC
senior technical editor

Jack Darr, service editor

I. Queen, editorial associate

Matthew Mandl, contributing editor

David Lachenbruch, contributing editor

Joan Washington, editorial assistant

Vincent P. Cicenia, production manager

Barbara Rosefelt, production assistant

H. Matysko, circulation

Cover by Harry Schlack

RADIO-ELECTRONICS is published by Gernsback Publications, Inc. 200 Park Ave. South New York, N.Y. 10003 (212) 777-6400

President: M. Harvey Gernsback
Secretary: Bertina Baer

ADVERTISING SALES EAST

Stanley Levitan, Eastern Sales Mgr. N.Y.C. (212) 777-6400

MIDWEST/Texas/Arkansas/Okla.

Ralph Bergen, 6319 N. Central Ave. Chicago, Ill. 60646 (312) 792-3646

PACIFIC COAST/Mountain States

J. E. Publishers Representative Co., 8560 Sunset Blvd., Suite 601 Los Angeles, Calif. 90069 (213) 659-3810
420 Market St. San Francisco, Calif. 94111, (415) 981-4527

SOUTHEAST

E. Lucian Neff Associates
25 Castle Harbor Isle
Fort Lauderdale, Florida 33308
(305) 566-5656

SUBSCRIPTION SERVICE: Send all subscription orders and correspondence to RADIO-ELECTRONICS, Subscription Department, Boulder, Colo. 80307

MOVING? For change of address, at least six weeks, furnishing both the old and new addresses and if possible attaching label from a recent issue below. Otherwise please print clearly your name and address exactly as it appears on your label.

ATTACH LABEL HERE

name (please print)

address

city

state

zip code

Mail to: RADIO-ELECTRONICS
SUBSCRIPTION DEPT., BOULDER, COLO. 80302

RADIO-ELECTRONICS

TUNER GONE TO SEED?

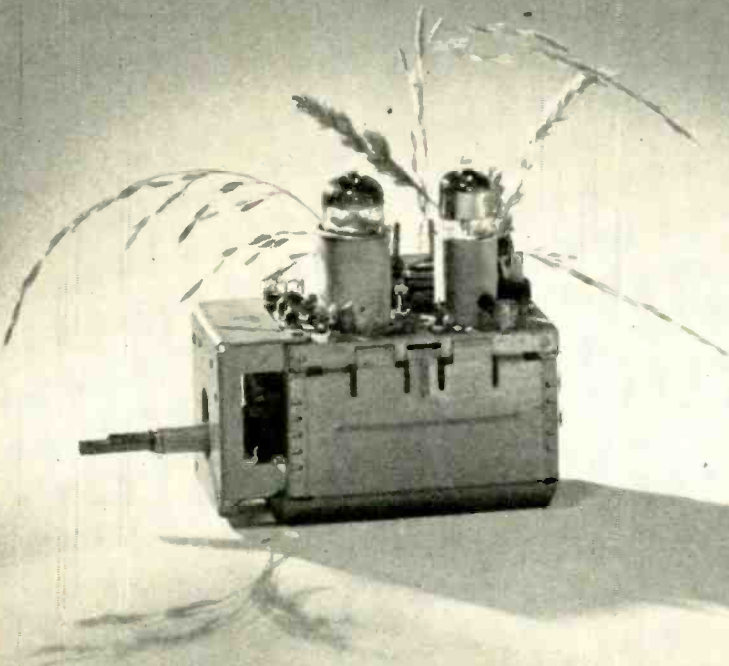

REACH FOR CHROMA FOAM!

New Chroma Foam cleans up the cruddiest tuners with its unique green foaming action!

Chroma Foam's exclusive Poly-Solaxan Silicone Base contains hollow abrasive particles that burnish delicate gold and silver contacts, then collapse to prevent damage. Moreover, Chroma Foam doesn't drip, dry, cake or run, yet provides permanent lubrication without detuning the most sensitive equipment!

That's why we dare to claim that Chroma Foam is second to none. It took years to develop a miracle time and money saver, so you can work miracles in minutes!

The rest of our new miracle service chemical line

50 BELOW Circuit Cooling Spray...cools to at least 20 degrees below any other spray on the circuit. TAPE HEAD CLEANER-penetrates deep to clean and protect tape heads, reduce noise and improve fidelity. TUNER CLEANER-dispenses under 80 pounds pressure to do the job of an ultrasonic bath.

Special Intro Offer: Your first 5 can order of Channel Master service chemicals comes packed in a free metal tote box with fold out storage tray...Grab onto one!



CHANNEL MASTER

DIV. OF AVNET, INC., ELLENVILLE, N.Y. 12428

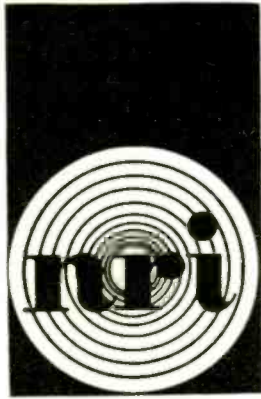

GET A FASTER START IN THE COURSE YOU CHOOSE WITH NRI'S REMARKABLE ACHIEVEMENT KIT

When you enroll with NRI we deliver to your door everything you need to make a significant start in the Electronics field of your choice. This remarkable, new starter kit is worth many times the small down payment required to start your training. And it is only the start . . . only the first example of NRI's unique ability to apply 50 years of home-study experience to the challenges of this Electronics Age. Start your training this exciting, rewarding way. No other school has anything like it. What do you get? The NRI Achievement Kit includes: your first set of easy-to-understand "bite-size" texts; a rich, vinyl desk folder to hold your training material in orderly fashion; the valuable NRI Radio-TV Electronics Dictionary; important reference texts; classroom tools like pencils, a ball-point pen, an engineer's ruler; special printed sheets for your lesson answers—even a supply of pre-addressed envelopes and your first postage stamp.

Learning electronics at home is faster, easier, more interesting with new achievement kit

Only NRI offers you this pioneering method of "3 Dimensional" home-study training in Electronics, TV-Radio . . . a remarkable teaching idea unlike anything you have ever encountered. Founded more than half a century ago—in the days of wireless—NRI pioneered the "learn-by-doing" method of home-study. Today, NRI is the oldest, largest home-study Electronics school. The NRI staff of more than 150 dedicated people has made course material entertaining and easy to grasp. NRI has simplified, organized and dramatized subject matter so that any ambitious man—regardless of his education—can effectively learn the Electronics course of his choice.

DISCOVER THE EXCITEMENT OF NRI TRAINING

Whatever your reason for wanting knowledge of Electronics, you'll find the NRI "3 Dimensional" method makes learning exciting, fast. You build, test, experiment, explore. Investigate NRI training plans, find out about the NRI Achievement Kit. Fill in and mail the postage-free card. No salesman will call. NATIONAL RADIO INSTITUTE, Electronics Division, Washington, D. C. 20016



ELECTRONICS COMES ALIVE AS YOU LEARN BY DOING WITH CUSTOM TRAINING EQUIPMENT

Nothing is as effective as learning by doing. That's why NRI puts so much emphasis on equipment, and why NRI invites comparison with equipment offered by any other school, at any price. NRI pioneered and perfected the use of special training kits to aid learning at home. You get your hands on actual parts like resistors, capacitors, tubes, condensers, wire, transistors and diodes. You build, experiment, explore, discover. You start right out building your own professional vacuum tube voltmeter with which you learn to measure voltage and current. You learn how to mount and solder parts, how to read schematic diagrams. Then, you progress to other experimental equipment until you ultimately build a TV set, an actual transmitter or a functioning computer unit (depending on the course you select). It's the practical, easy way to learn at home—the priceless “third dimension” in NRI's exclusive Electronic TV-Radio training method.

SIMPLIFIED, WELL-ILLUSTRATED “BITE-SIZE” LESSON TEXTS PROGRAM YOUR TRAINING

Lesson texts are a necessary part of training, but only a part. NRI's “bite-size” texts are as simplified, direct and well-illustrated as half a century of teaching experience can make them. The amount of material in each text, the length and design, is precisely right for home-study. NRI texts are programmed with NRI training kits to make things you read come alive. As you learn, you'll experience all the excitement of original discovery. Texts and equipment vary with the course. Choose from major training programs in TV-Radio Servicing, Industrial Electronics and Complete Communications. Or select one of seven special courses to meet specific needs. Check the courses of most interest to you on the postage-free card and mail it today for your free catalog.

Available Under
**NEW
GI BILL**

If you served since
January 31, 1955, or
are in service, check GI
line in postage-free card.

custom training kits “bite-size” texts

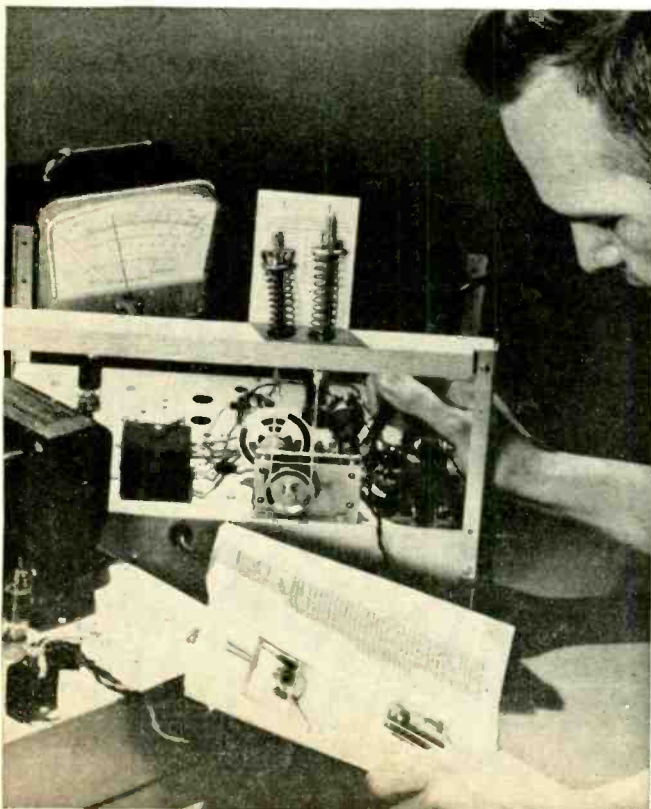

Here's A Little Item That Will Get You Out Of Many A Tight Spot

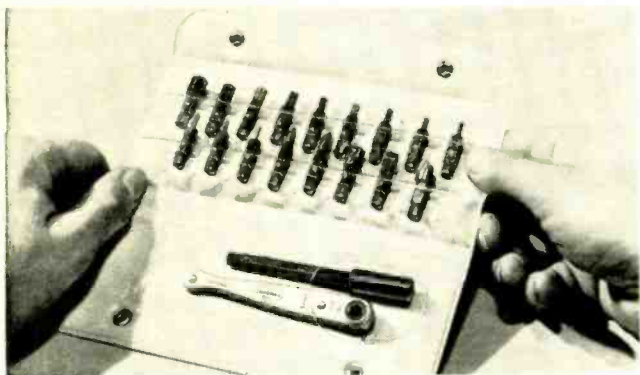

**HANDLE ONLY 3 $\frac{3}{4}$ " LONG—
18 Degree Working Arc.**

Stainless steel Midget Ratchet handle, 17 Drivers, 3 $\frac{3}{4}$ " extension, two slotted and two Phillips bits, 12 hexagonal bits from 0.050 to 5/16", one square adapter for $\frac{1}{4}$ " wrench sockets—all in pocket-sized vinyl case.

You may purchase from your local
Supply-House or direct from

THE CHAPMAN MANUFACTURING CO.

Manufacturers of Midget Ratchet Offset
Screwdrivers for over 25 years.

30 Saw Mill Road, Durham, Conn. 06422

Circle 5 on reader service card

Kit #4320
complete \$10.00



Accuracy like a VTVM... Convenience like a VOM...

NEW BATTERY-OPERATED FET SOLID-STATE VOLT-OHMMETER #116

Easy-to-build KIT

\$29⁹⁵ #116K

Factory-Wired & Tested

\$39⁹⁵ #116W

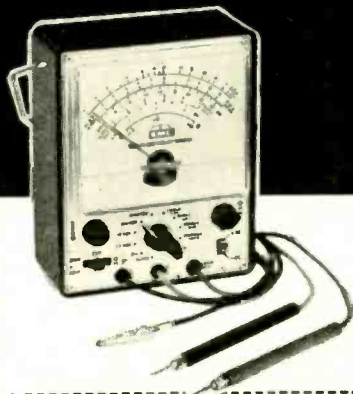

Now you can get all the benefits of a VTVM (laboratory accuracy, stability and wide range) but with its drawbacks gone: no plugging into an AC outlet, no waiting for warm-up, no bulkiness. New Field Effect Transistor (FET) design makes possible low loading, instant-on battery-operation and small size. Excellent for both bench and field work.

Compare these valuable features:

- High impedance low loading: 11 meg-ohms input on DC, 1 megohm on AC
- 500-times more sensitive than a standard 20,000 ohms-per-volt VOM
- Wide-range versatility: 4 P-P AC voltage ranges: 0-3.3, 33, 330, 1200V; 4 RMS AC voltage ranges: 0-1.2, 12, 120, 1200V; 4 DC voltage ranges: 0-1.2, 12, 120, 1200V; 4 Resistance ranges: 0-1K, 0-100K, 0-10 meg., 0-1000 meg.; 4DB ranges: -24 to +56DB.

Sensitive easy-to-read 4 $\frac{1}{2}$ " 200 micro-amp meter. Zero center position available. Comprises FET transistor, 4 silicon transistors, 2 diodes. Meter and transistors protected against burnout. Etched panel for durability. High-impact bakelite case with handle useable as instrument stand. Kit has simplified step-by-step assembly instructions. Both kit and factory-wired versions shipped complete with batteries and test leads. 5 $\frac{1}{4}$ "H x 6 $\frac{3}{4}$ "W x 2 $\frac{7}{8}$ "D. 3 lbs.

Send FREE catalog of complete EMC line and name of nearest distributor. RE-11

Name _____

Address _____

City _____

State _____ Zip _____

EMC

ELECTRONIC MEASUREMENTS CORP.
625 Broadway, New York, N.Y. 10012

Export: Pan Mar Corp. 1270 8 way N.Y. N.Y. 10001

New & Timely

(continued from page 2)

SRI scientists call their concept MAGLEV (for Magnetic Levitation). They first worked it out two years ago in a theoretical design for an experimental rocket sled ca-

pable of speeds above 6,000 miles an hour. The magnetically-suspended sled, freed of friction and weight, was designed to be accelerated along a special track to tremendous speeds by a fast-burning rocket motor. ★

ZENITH SUBSCRIPTION TV APPROVED BY FCC

CHICAGO, ILL.—Zenith Radio Corporation's Phonevision system for over-the-air subscription TV (STV) is the first system granted technical approval by the Federal Communications Commission. Joseph S. Wright, Zenith's board chairman, said, "With FCC technical approval, Teco, Inc., Zenith's licensee for commercial development of Phone-

vision in North America, is in a position to implement plans to introduce this new box office TV service."

Under the FCC rules for over-the-air STV, it was noted, no station application for regular STV broadcasting can be granted unless the station has an agreement to use an FCC-approved system. ★



ELECTRONIC HOME TV BOX OFFICE—Zenith's subscription TV (STV) decoder is part of the first STV system to receive FCC technical approval. This compact solid state unit can enable subscribers to see first run movies, blacked-out sports events, Broadway shows and others features not available on advertising-sponsored TV, for a modest charge. To select an STV feature, the subscriber uses a subscriber "ticket" and dials a simple code.

Electrons Control Body Temperature

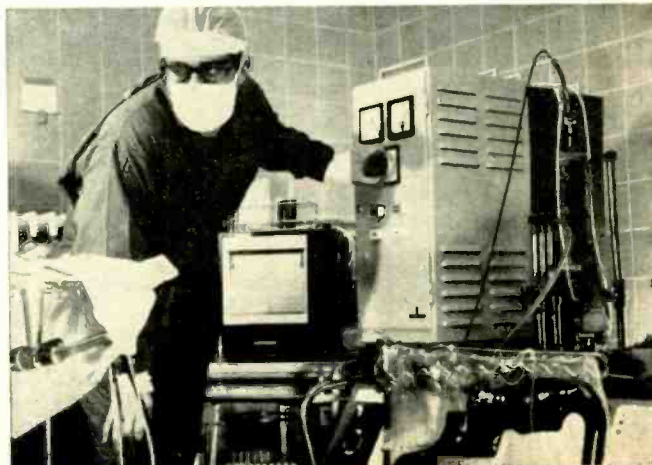

ERLANGEN, GERMANY—Operations on the heart and aorta are generally performed with

the aid of a heart-lung machine. This ensures a proper supply of oxygen and keeps

Circle 6 on reader service card →

THE CALECTRO SUPERMARKET

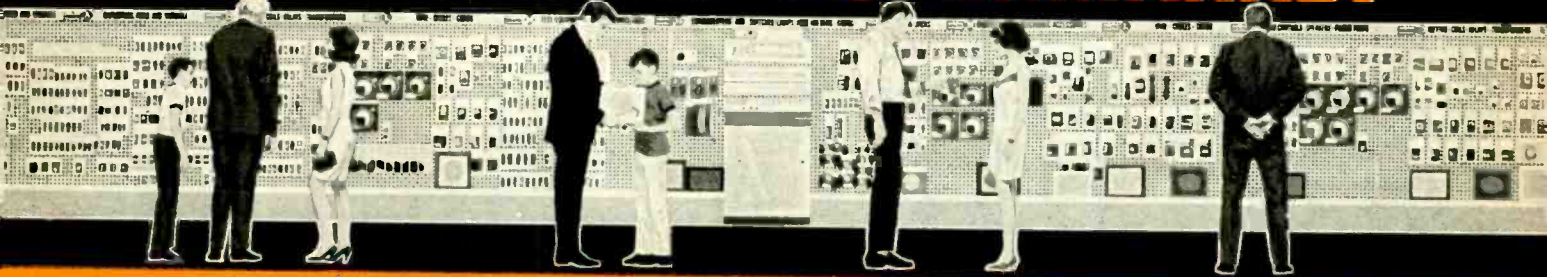

EVERYTHING IN ELECTRONICS!



VARIABLE BALANCE STEREO HEAD PHONE

Unique "Sound Level" control on each earpiece permits adjustment. Frequency range: 20 to 20,000 + cps. 6½' cord with stereo plug. Impedance 4 to 16 ohms. Cat. No. Q4-132 \$17.95 Net



HOBBYIST'S SOLDERING AND TOOL KIT

Diagonals, long nose pliers, soldering iron and solder, solder aid tool, heat-sink, and screwdriver. A deal gift item. Cat. No. H3-378 \$7.95 Net.



TAPE RECORDER MICROPHONE

Outstanding performance on music and speech for the price. Low impedance matches late model solid state recorders. Removable desk stand; 4½' cord with dual plugs that fit most models. Freq. Response: 100-8k Hz. Output: -77 dB. Impedance: 200 ohms. Cat. No. Q4-146 \$4.95 Net

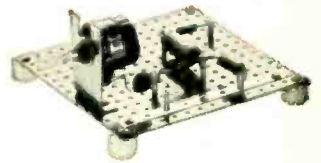

EXPERIMENTER'S CIRCUIT BOARD KIT

Contains a 3¼" x 4" perforated board, 15 terminals (No. J4-636) and 4 mounting feet w/screws. Build small circuits, hobby and science projects, etc. Cat. No. J4-660 \$9.98 Net

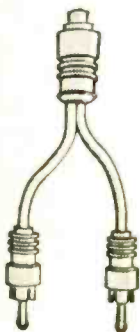

AUDIO ADAPTORS

"Y" Audio Adaptor has a phono pin jack on one end and dual phono pin plugs on the other. Cat. No. Q4-288 \$.99 Net



TWO STATION WIRELESS INTERCOM

Just plug into any electrical outlet. Completely portable. Expand system anytime with additional units. Two unit system complete in display pack. Cat. No. N4-110 \$34.95 Net



MINIATURE LAMPS

Type PR2 • 2.5 volt • 0.50 amp • Cat. No. E2-430 • Pkg. of 2 \$2.29 Net
Type PR3 • 3.6 volt • 0.50 amp • Cat. No. E2-431 • Pkg. of 2 \$2.29 Net

STANDARD 1000 VOLT CAPACITOR

High quality, compact and reliable.

RESISTORS

Attractively packaged 2 per pack, showing values, color codes and formulas.



THE "GC CALECTRO HOBBYIST HANDBOOK"

The "GC Calectro Hobbyist Handbook" is available at your nearest Calectro Electronic Supermarket. One is located near you. WRITE TODAY and we'll rush you the name and address of your nearest Calectro Supermarket.



CALECTRO

G-C ELECTRONICS
A DIVISION OF
HYDROMETALS, INC.



400, SO. WYMAN ST. ROCKFORD, ILLINOIS 61101

COLOR ORGAN

ONE KILOWATT - FOUR CHANNELS

ULTRA - COMPACT - LOW COST



Build Dancing Colored Lighting Displays That Leap And Sparkle In Ever Changing Color Combinations Of Red, Blue, Green And Yellow. Displays Which Dance In Rhythm And Intensity According To The Frequency Content Of The Musical Input Taken From The Loudspeaker Terminals Of Any Audio Amplifier.

YEAR ROUND ENJOYMENT

Hi-Fi Enhancement — Lawn Parties — Musical Groups — Display Advertising — Spectacular Christmas Displays.

- Features: Tunable Active R-C Filters For Frequency Separation
- All Silicon Solid State Design
- Walnut Wood Grain Panel — Compact Bakelite Case That Measures Only 7 $\frac{3}{4}$ " x 4 $\frac{1}{2}$ " x 2 $\frac{1}{2}$ " Deep.

Easy to Assemble Printed Circuit Board Kit — \$49.95
Factory Assembled — \$65.00

Add \$2.00 For Handling And Shipping Costs
N. J. Residents Add 3% Sales Tax
(Payment Must Accompany Order)

Scarpa Laboratories, Inc.

formerly Edison Instruments, Inc.
46 Liberty Street • Metuchen, N. J. 08840
(201) 549-4260

Circle 7 on reader service card

UNEXCELLED! THE UVM ANTENNA

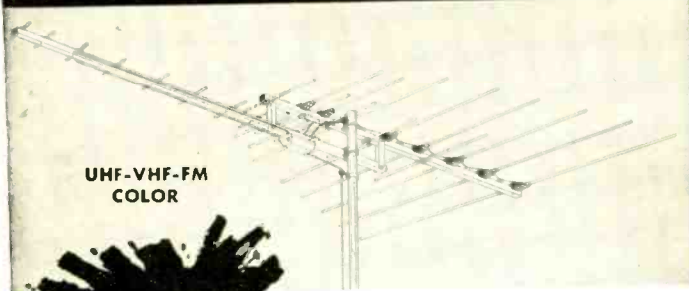

UHF-VHF-FM
COLOR

**COMPLETELY
NEW!**

Combination
UHF-VHF-FM Antennas

for superior performance.

Tuned and engineered featuring a LOG PERIODIC VHF section incorporating a PATENTED MAGNETIC WAVE design for UHF. Discriminate between desired signal and unwanted noise. An absence of minor lobes and extremely high front to back ratio are characteristics of these antennas. Mechanical features include all new fittings and special alloy aluminum tubing for added strength. Six models available.

Write or phone for complete information.

S & A ELECTRONICS, INC.

210 W. Florence St. Phone (419) 693-0528 Toledo, Ohio 43605

Circle 8 on reader service card

New & Timely

(continued from page 12)

the patient's blood circulation intact. In special cases it is advantageous to lower the temperature of the patient's body during such complicated operations to reduce metabolism as much as possible and thus any post-operative consequences.

Scientists of the Siemens Research Centre in Erlangen (Federal Republic of Germany) have developed a continuous-flow heat exchanger of stainless steel (capacity 190 ml) which is fitted with Sirigor cooling blocks (Peltier elements).

A Peltier element consists of two semi-conductor legs of which the one is of the n-type and the other of the p-type. The two legs are connected at the face end by a copper strap. If dc flows in a given direction through the

Peltier element, the copper strap absorbs thermal energy from the immediate surroundings, and cools off. The thermal energy absorbed by the cold side of the element—boosted by the current input—is given off on the other side of the element. The Peltier element thus "pumps" thermal energy from its cold to its warm side. The direction of the heat transfer can be reversed by reversing the direction of the current. A Sirigor cooling block is made up of several Peltier elements connected meander-fashion in series. Although the elements are connected in series electrically, they are in parallel thermally so that all the cold copper straps are on the one side and all the warm ones on the other side of the cooling block.

R-E

Editorial (continued from page 6)

item when asked for on the order blank. Failure to do this will delay your order. Parts are frequently stocked in bins by catalog number, not by name, brand or part number. If you omit catalog numbers, someone will have to find time to look up the numbers and perhaps rewrite your order in a way that it can be handled by workers in the stockroom. In many cases, the person filling your order may not be able to tell a resistor from an i.f. transformer.

(4) Read new-literature columns in this and other magazines and write for catalogs and data sheets from components manufacturers. Many contain substitution guides, dealer and distributor listings and a wealth of technical information that will prove useful when selecting parts for future projects. You should have catalogs from at least two makers of each type of common electronic component.

(5) Pay particular attention to the parts list when planning a construction project from an old issue. Some parts which were readily available at time of publication may have been discontinued and there may not be an acceptable substitute. If there is any indication of special components in the device, check with the manufacturer or listed source of supply before purchasing any of the more readily available components.

(6) Don't rush headlong into a construction project whose operation depends on a special surplus component such as a meter, relay, transformer or filter network. Make sure that the part is available before you begin. The source may have "dried up" and there is no commercial equivalent available.

Construction projects can be fun when you know the ropes. Follow the tips above and then dig in and tackle some of the equipment on the following pages.

Robert F. Scott

SENIOR TECHNICAL EDITOR

RADIO-ELECTRONICS



**B & K Precision
Model E-200D RF Generator**



**B & K Precision
Model E-310B Sine/Square
Wave Generator**

NEW GENERATION FROM B&K

Go ahead. Compare them with any others. These new all solid state Precision generators from B&K do more things and do them better. Because B&K makes products that really work.

Take the Model E-200D RF generator, for instance. You get wide-range coverage from 100 KHz to 216 MHz in 5 bands. A completely shielded RF output provides continuously variable monitored attenuation . . . calibrated to less than a microvolt on fundamentals to 54 MHz. And built-in crystal calibration assures you of frequency accuracy.

You get a giant 5" vernier dial with anti-backlash 12:1 gear ratio. So it's easy to obtain and repeat the results you want.

Or consider the Model E-310B. This new sine/square wave generator gives you step attenuation of both outputs.

And a variable control lets you adjust continuously from maximum down to less than 0.25 millivolt.

It also features extended frequency ranges: 20 Hz to 2 MHz for sine wave, 20 Hz to 200 KHz for square wave. Plus constant-voltage output over each band and band-to-band.

Both new generators are based on earlier models that made us famous. Now you can have all the additional benefits only transistors make possible.

See the new solid state generation from B&K at your local distributors. Or write us for complete details.

B & K Precision MODEL E-200D RF GENERATOR \$159.95

Other features:

- Four outputs: unmodulated RF, modulated RF (400Hz), externally modulated RF, 400 Hz audio signal.
- Covers full VHF TV range; can be used as crystal-calibrated marker (100 KHz to 54 MHz on fundamentals, 54 to 216 MHz on harmonics).
- FM and TV channels identified on dial.
- Three-wire AC line cord.
- RF cable.

B & K Precision MODEL E-310B SINE/SQUARE WAVE GENERATOR \$119.95

Other features:

- All solid state—100% silicon transistors.
- Continuously variable output control plus accurate 6-step attenuator for precise voltage division of both sine and square wave outputs.
- Fast square wave rise time (less than 100 nanoseconds).
- Wide range permits low frequency RF applications.
- Large 5" dial with vernier tuning for maximum accuracy
- Three-wire AC line cord.



Products of DYNASCAN CORPORATION
1801 W. Belle Plaine, Chicago, Ill. 60613
The professional test equipment

When your servicemen
have to solder,
make sure they...

SOLDER ONCE SOLDER WELL SOLDER WITH WELLER!



WELLER SPECIALIZES IN SERVICE SOLDERING TOOLS. Today's electronic products such as computers, office equipment, instruments, radios, televisions, hi-fi sets and other sophisticated equipment are manufactured with the use of highly specialized soldering tools - to assure optimum results. But . . . what about specialized soldering tools when these products require service soldering? Whether the servicing is done in a plant, shop or right in the field, you should get the same quality solder connection that your product received on the production line. Are your servicemen

equipped with soldering tools that perform as well as those in your production line? If not they should be . . . it's costing you money!

Weller, world's largest manufacturer of soldering tools, offers a line of soldering tools designed specifically for servicing electronic products and equipment. Each Weller soldering tool is built to allow your serviceman to solder just once . . . solder fast . . . solder well. See that he solders with one or more of the following Weller Service Tools . . .

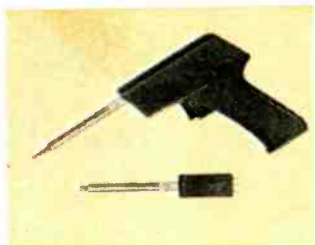

TEMPMATIC

- CONTROLLED, INTERCHANGEABLE PLUG-IN POWERHEADS - provide proper tip size, temperature, and capacity for any soldering job . . . big or small.
- PERMANENT-TYPE PLATED TIP - eliminates frequent tip changes.
- FAST HEATING - 8 seconds or less.
- LIGHTWEIGHT - no transformer.
- PISTOL GRIP - trigger operated.
- PORTABLE - for field or bench operation.



MODEL W-TCP-L

- CONTROLLED OUTPUT - provides proper temperature and capacity for any soldering job.
- EASY, QUICK CHANGE TIPS AND ACCESSORIES - maximum flexibility.
- ISOLATED LOW VOLTAGE SUPPLY - eliminates voltage damage to sensitive components.
- FAST RECOVERY - for maximum soldering efficiency.
- FLEXIBLE NON-BURNING CORD SET.
- IDEAL FOR BENCH OPERATION.



MODEL W-MCP

- SOLID STATE MINIATURE SIZED TOOL - for micro soldering and easy access to tight work areas.
- UNIQUE DESIGN - outperforms all other micro soldering tools.
- VARIETY OF INTERCHANGEABLE TIPS - micro sizes for miniature work.
- FIXED TEMPERATURE ELEMENT - assures proper tip temperature for the job.
- ISOLATED LOW VOLTAGE SUPPLY - eliminates voltage damage to sensitive components.
- FLEXIBLE NON-BURNING CORD SET.
- FOR BENCH OR FIELD OPERATIONS.



MODEL W-PS

- IDEAL FOR SIMPLE SERVICE SOLDERING.
- SMALL, HANDY (7-7/8" long) - easy to use and store.
- USEFUL IN CROWDED WORK AREAS.
- VARIETY OF EASY CHANGE WELLERCOTE TIPS - performs many soldering jobs, will not freeze, longer life.
- PORTABLE - for field or bench use.

CONTACT THE DISTRIBUTOR, LISTED AT RIGHT, FOR ASSISTANCE IN THE SELECTION OF YOUR TOOLS AND ACCESSORIES.



Weller

INDUSTRIAL SOLDERING TOOLS

A DIVISION OF  COOPER INDUSTRIES, INC.

100 WELLCO ROAD, EASTON, PA. 18042 • 215 • 258-5371

PARTICIPATING WELLER DISTRIBUTORS

State	City	Distributor
AL	Opelika	Southern Elec. Corp.
	Tuscaloosa	Radio Parts Co.
AZ	Phoenix	Dalis Elec. Supply
AR	Little Rock	Carlton-Bates Co.
CA	El Monte	Claude Michael, Inc.
	Fresno	Dunlap Elec.
	Glendale	R. V. Weatherford Co.
	Inglewood	Newark Elec. Co., Inc.
	Los Angeles	Acme Industrial Supply Co.
	Los Angeles	Radio Products Sales, Inc.
	Palo Alto	Zack Elec.
	Sacramento	Dunlap Elec.
	San Diego	Claude Michael, Inc.
	San Francisco	Zack Elec.
	San Jose	Dunlap Elec.
	Santa Ana	Hurley Elec.
	Stockton	Dunlap Elec.
	Sunnyvale	Claude Michael, Inc.
CO	Denver	Electronic Parts Co.
CT	Waterbury	Bond Radio Elec., Inc.
DE	Wilmington	Radio Elec. Svc. Co., Inc.
FL	Miami	Elec. Equipment Co., Inc.
	Orlando	Hammond Elec.
GA	Atlanta	Jackson Elec.
	Atlanta	Specialty Dist. Co., Inc.
IL	Chicago	Allied Radio Corp.
	Chicago	EDI Elec. Dist., Inc.
	Chicago	Newark Elec. Corp.
	Harvey	The George Co.
	Peoria	Klaus Radio
	Rockford	J & M Elec., Inc.
IN	Indianapolis	Graham Elec. Supply Co.
	Indianapolis	RA-DIS-CO, Inc.
KY	Louisville	P. I. Burks & Co., Inc.
	Louisville	Peerless Elec. Equip. Co.
LA	Baton Rouge	Davis Whsle. Elec. Sup. Co.
	New Orleans	Columbia Radio & Sup. Co.
ME	Portland	DeMambo Radio Sup. Co., Inc.
MD	Baltimore	D & H Distributing Co.
	Bethesda	Empire Elec. Supply Co.
	Rockville	Pioneer-Standard
	Rockville	Capitol Radio Whslers., Inc.
MA	Boston	DeMambo Radio Sup. Co., Inc.
	Newton	Cramer Electronics, Inc.
	Worcester	DeMambo Radio Sup. Co.
MI	Adrian	Wedemeyer Elec. Sup. Co.
	Ann Arbor	Wedemeyer Elec. Sup. Co.
	Detroit	Radio Specialties Co.
	Jackson	Wedemeyer Elec. Sup. Co.
	Lansing	Wedemeyer Elec. Sup. Co.
	Oak Park	Newark-Detroit Elec., Inc.
MN	Saint Paul	Ragon Electronics, Inc.
MS	Jackson	Risher Radio Sup. Co., Inc.
MO	Kansas City	Beaver Drill & Tool Co.
	Kansas City	Burstein-Applebee Co.
	Saint Louis	Divine Industrial Elec., Inc.
NB	Lincoln	Scott Elec. Supply Corp.
NH	Reno	Dunlap Electronics
NV	Manchester	DeMambo Radio Sup. Co., Inc.
NJ	Hillside	Raysons Supply Co.
	Paterson	Roberts Tool & Supply Co.
	Saddle Brook	Thermotronics Co.
	Springfield	Federated Purchaser, Inc.
NM	Albuquerque	Electronic Parts Co.
NY	Bronx	Electronic Tool Co.
	Farmingdale, L.I.	Arrow Electronics, Inc.
	Farmingdale, L.I.	Harrison Radio Corp.
	Farmingdale, L.I.	Claude Michael, Inc.
	Long Island City	H. L. Dalis, Inc.
	New York City	Newark Elec. Center, Inc.
	Plainview, L.I.	Morris Abrams, Inc.
	White Plains	Westchester Elec., Inc.
	Yorkville	Valley Elec. Labs, Inc.
NC	Raleigh	S'teast'n Radio Sup. Co., Inc.
OH	Cincinnati	United Radio, Inc.
	Cleveland	Pioneer-Standard
	Columbus	Hughes-Peters, Inc.
	Dayton	Pioneer-Standard
OK	Oklahoma City	Trice Wholesale Elec.
	Oklahoma City	Wholesale Elec. Supply, Inc.
	Tulsa	Trice Wholesale Elec.
OR	Portland	United Radio Supply, Inc.
PA	Allentown	A. A. Peters, Inc.
	Harrisburg	Pyttronic Industries, Inc.
	Philadelphia	Philadelphia Elec., Inc.
	Philadelphia	Radio Electric Svc. Co., Inc.
	Philadelphia	Simco Electronics, Inc.
	Pittsburgh	Cameradio Company
	Pittsburgh	RPC Electronics
	Reading	The Geo. D. Barbey Co., Inc.
	Scranton	Pursell Electronics Co.
	Warrington	U. S. Equipment
RI	Providence	DeMambo Radio Sup. Co., Inc.
SC	Columbia	Dixie Radio Supply Co., Inc.
TN	Knoxville	McClung Appliances
	Memphis	Elec. Comm. Whslers.
	Nashville	Electra Distributing Co.
TX	Austin	Hargis-Austin, Inc.
	Corpus Christi	Modern-Electrotex
	Dallas	Claude Michael, Inc.
	Dallas	Wholesale Elec. Supply Co.
	El Paso	Midland Specialty Co.
	Houston	Sterling Electronics Corp.
	San Antonio	Modern-Electrotex
UT	Salt Lake City	Standard Supply Co.
VA	Arlington	Arlington Elec. Whslers., Inc.
	Norfolk	Priest Electronics, Inc.
WA	Seattle	Seattle Tool & Sup. Co., Inc.
	Seattle	Western Electronics Co.
WV	Charleston	Mountain Elec.-Chemcity
WI	Madison	Satterfield Electronics

Circle 10 on reader service card

In the Shop . . . With Jack

By JACK DARR
SERVICE EDITOR

Up-Down-Positive-Negative

For a long time, old-timers like me have said that a voltage "going up" means it goes more positive, and "going down" means it goes more negative. This worked fine with tubes because plate voltages were always positive and that's what we did most of the work with. Now, we've got to change our "thinking!"

We've got to learn to think "goes more positive" or "goes more negative." This is true even in tube circuits used nowadays, let alone solid-state stuff. And, the way we *think* about the circuits determines the speed with which we can analyze their operation and find faults in them! You do not do this with voltmeters or any kind of test equipment. You do this with that mass of blue mud between your ears! The proper thinking-methods will speed up the process of getting the information, forming a conclusion, and making the diagnosis.

There are circuits we work with every day that demand this type of thinking. The bias on color picture tubes is a good example. How many times have you been fooled by a "no raster" symptom, only to find out (sometimes very painfully) that there *was* plenty of high voltage after all? A biased-off picture tube has a dark screen, but lots of high voltage on the ultor to bite unwary fingertips.

All of these things can be traced back to circuit reactions as simple as current flowing through a resistor—Ohm's Law. In the video output stage used in millions of color TV sets, the voltage on the video output tube plate and CRT cathode are determined by the amount of current flowing through the plate load resistor. (Incidentally, we can still say "up" and "down" speaking of current, no matter which way it's flowing!)

If the video output tube plate current increases, the voltage at the plate goes more negative. So the cathode of the picture tube goes more negative since it is directly coupled to the plate.

A negative-going voltage on the cathode of all vacuum tubes is the same as a positive voltage on the grid. (We're assuming now that the grid voltage is fixed.) The important relationship here is the voltage between cathode and grid (*not to ground*). This determines the conduction of the tube. So if the cathode goes toward a greater negative voltage, the grid-cathode voltage has gone more positive. Result; the raster gets brighter (more beam current).

A positive-going cathode voltage has the opposite effect—the grid has been

made more negative with respect to the cathode and beam-current is reduced. A dimmer raster results.

There's a dandy example of the value of thinking of the circuit reactions in terms of "positive-going" or "negative-going" instead of "up" or "down". The terms will remind you of the *effect* that the voltage-changes have on the circuit operation. You can get the same effects in the CRT grid circuits, of course. A more positive plate voltage on a color-difference amplifier tube (directly coupled to one CRT grid) makes that grid more positive. What does a more

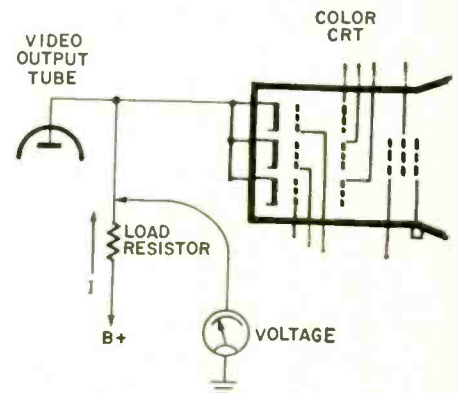

positive grid voltage do in all tubes? Makes them conduct more current. In this case the raster will be brighter, because the CRT is being biased to draw more beam current.

This kind of thinking can be most helpful in solid-state circuits. Why? Because we can find transistors with "negative plate voltages"! The collector voltage of a pnp transistor in a common-emitter circuit *is* negative. If this transistor conducts more heavily, draws more current through its load resistor, the voltage will go more positive. (Oh yes it will too. Assume that the normal collector voltage was -15 volts, from a -20 volt supply through a load resistor. If this changes to -5 volts, a -5 volt reading is 10 volts more positive than -15 volts, isn't it?)

In cases like this, you might have a -20 volt supply, with only 5 volts dropped across the load resistor in normal operation. This leaves us -15 volts on the collector. A higher collector current might cause a 15-volt drop across the load resistor, leaving us only -5 volts on the collector. This is a *symptom*, not a *cause*. The cause is whatever is making this transistor draw three (continued on page 86)

C

orrespondence



PROGRESS WITH SCR'S

It is noted that the Noteworthy Circuits item, "Portable SCR Tester," in the March 1970 RADIO-ELECTRONICS (page 94) reproduces, with editorial changes, GE Application Note 201.3.

Our policy is to request that our application notes not be copied without permission. New product introductions constantly require updating of circuits, and when requests are received to publish circuits disclosed in our publications, it affords us an opportunity to inform the author of the most recent advances in the art.

Our suggestion for replacing the C5U SCR described is to employ a C106Q (any type 1-4). For the electronic hobbyist, it may be convenient to pick up a GEMR-5.

CAROL O. THOMAS

Patent Attorney

General Electric Co.

We appreciate the suggested update for the SCR tester, it will aid our readers. Our normal procedure is to credit sources of information that appear in RADIO-ELECTRONICS. The oversight in this instance was due to the absence of any credit or reference to General Electric in our file copy.

FORGOTTEN AMMETER

The autotransformer story by James Squires (Sept. 1970) was of interest because I don't believe a technician's bench should be without one.

However, after reading the item, there was one item that should have been included in the circuit—an ac ammeter. The ammeter is necessary to know the power drawn by the unit under repair, and quickly lets you know if there's a short in the work.

Use an ac ammeter and voltmeter with a Variac variable line transformer built into my bench, connected to an output plug. By starting the transformer at zero, I've saved many receivers from burning with this rig. I advise anyone building one of these units to wire in the ammeter. I wired a shunted switch across mine so it reads to 2 and 20 amps.

PETER LEGON

Malden, Mass.

(continued on page 24)

RADIO-ELECTRONICS



When one gun fades restore color balance with a Perma-Power single-brite COLOR GUN CONTROL

One Color Weak
Other Guns OK

Use SINGLE-BRITE

All Colors Fade
From Tube Aging—

Add COLOR-BRITE

MODEL
B-150

Here's a unique new product that lets you restore color picture balance when a single gun weakens. You just adjust the bias between the G1 and G2 grid leads of the weakened gun, permitting color intensity variation as needed for a balanced picture. Installation is easy . . . just two simple connections, no soldering. Now available at your parts distributor.

\$800 Suggested List Price

CHAMBERLAIN MANUFACTURING CORPORATION
845 Larch Avenue • Elmhurst, Illinois 60126 • Phone: (312) 279-3600

Circle 11 on reader service card

Clever Kleps

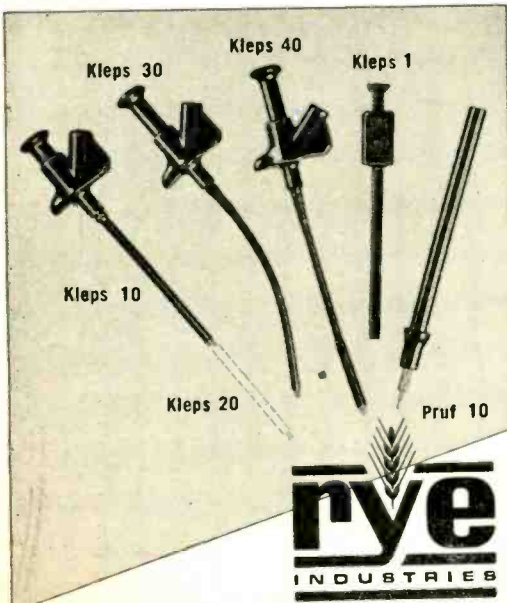

Test probes designed by your needs—
Push to seize, push to release (all Kleps spring loaded).

Kleps 10. Boathook type clamp grips wires, lugs, terminals. Accepts banana plug or bare wire lead. 4 3/4" long. **\$1.19**

Kleps 20. Same, but 7" long. **\$1.39**

Kleps 30. Completely flexible. Forked-tongue gripper. Accepts banana plug or bare lead. 6" long. **\$1.47**

Kleps 40. Completely flexible. 3-segment automatic collet firmly grips wire ends, PC-board terminals, connector pins. Accepts banana plug or plain wire. 6 3/4" long. **\$2.39**

Kleps 1. Economy Kleps for light line work (not lab quality). Meshing claws. 4 1/2" long. **\$.99**

Pruf 10. Versatile test prod. Solder connection. Molded phenolic. Doubles as scribing tool. "Bunch" pin fits banana jack. Phone tip. 5 1/2" long. **\$.79**

All in red or black — specify.

For additional information, write for our complete catalog of — test probes, plugs, sockets, connectors, earphones, headsets, and miniature components.

Available through your local distributor, or write to:
RYE INDUSTRIES, INC.
129 Spencer Place, Mamaroneck, N.Y. 10543

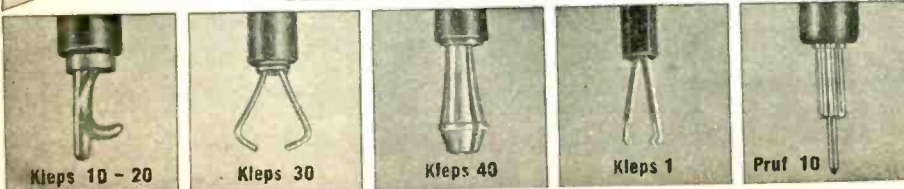

Circle 12 on reader service card

A COMPLETE VIDEOTAPE SYSTEM FOR ONLY \$650!

Buy a GE* Videotape Deck at the ridiculous price of \$297.50 and get 65% off on a GBC Viewfinder Camera/Monitor VF-302

Employee training, test commercials, sales presentations, casting sessions. You're in communications, you know the difference CCTV can make in your business.

Here's your chance to get all the essential equipment you need for practically half the usual price: A GE Videotape Deck plus a GBC Viewfinder Camera/Monitor VF-302. Don't miss this one.



- Combines camera and monitor
- Requires no professional cameraman
- Videotape review with built-in monitor eliminates necessity of extra expensive monitor
- Intercom
- Tally Lamps

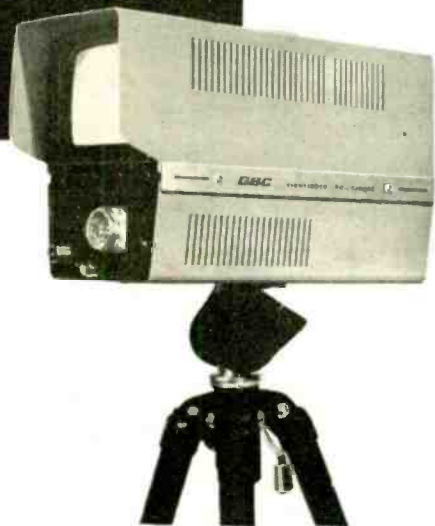

- Tapes interchangeable with all Sony CV Series recorders
- Handsome walnut cabinet
- Compact and lightweight
- Tapes live material and reviews tape playback right in the camera monitor

(*built by Sony for GE)

All types of video equipment available for sale, lease or rental.



GBC CLOSED CIRCUIT TV CORP.

74 Fifth Avenue, New York, N.Y. 10011 / Phone (212) 989-4433

Circle 13 on reader service card



**The fussiest fans
in the business
keep getting hooked
on our line.**

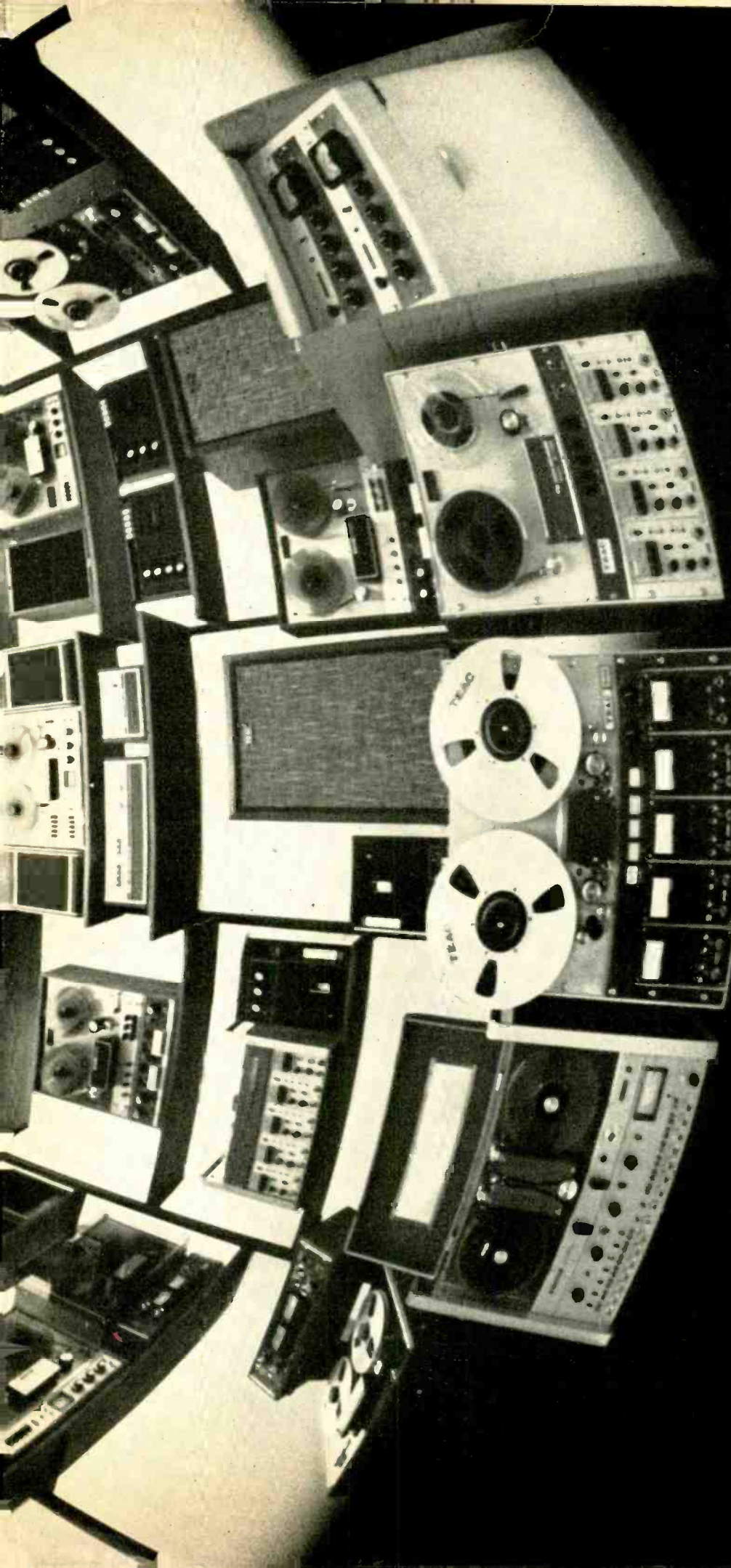

Today's audiophile is a demanding type. Demanding components for specific purposes. And demanding them when he wants them.

He's our kind of customer, and we've usually led the industry in meeting his demands. Before that, many of these components were available only in limited hand-made or professional supply.

We were the first to design

and build plug-in heads for home decks. First to make automatic reverse. And first on the home deck market over two years ago with four-channel stereo tape decks.

To stay first in new product concepts, we manufacture all our own critical components. This gives us the design flexibility that

other companies lack.

And we've found that projecting tomorrow's needs is the best way to keep reeling in today's fans.

TEAC®

TEAC Corporation of America
2000 Colorado Avenue
Santa Monica, California 90404



The does-it-all turntable at a do-it-yourself price.



It's the BSR McDonald 310/X, and it's the best buy in automatic turntables. Anywhere.

This is no "little brother" turntable, either. It's got a full-size platter, cue and pause control, low mass tone arm system and a visible stylus pressure indicator.

And because it's a famous BSR Total Turntable, it comes complete with a tinted dust cover, custom molded base and a Shure

BSR

McDONALD

M-75 magnetic cartridge—all factory-installed and balanced and included in the low price.

The BSR McDonald 310/X. It's perfect for people who want the best, no matter how little it costs.

Send for free full color catalog on all our automatic turntables. BSR(USA) Ltd., Blauvelt, N.Y. 10913

Circle 15 on reader service card

Don't shoot till you see the tenths of a volt.

The sure way to troubleshoot solid state TV is with a scope that measures DC.

Take Leader's five-inch LBO-53B:

It gives you a drift-free DC input, so you can see those tenths of a volt. It gives you a bandwidth to 10 MHz. And it gives you a sensitivity of 10 mv/cm or better.

Now for the shocker. You can have a Leader LBO-53B for just \$229, about half the price of any other scope with the same capabilities.

Since the proof is in the seeing, we direct you to your Leader distributor. Ask to see our color bar generators too; you haven't seen the finest until you've seen Leader's.

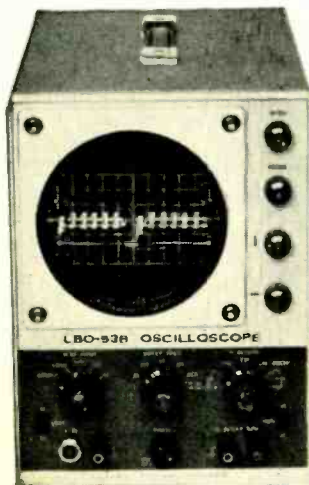

Seeing is believing.

Leader Instruments Corp.

37-27 27th Street, Long Island City, N. Y. 11101, (212) 729-7411

Circle 16 on reader service card

CORRESPONDENCE

(continued from page 18)

CAR TUNE-UPS

As the article stated, I tried to use a vtvm instead of a vom ("Tune Up With A Vom," April 1970 RADIO-ELECTRONICS). However, my vtvm read in the minus 0 range and, reversing the polarity, in the plus infinity range. What creates this problem?

ROBERT KILL

Worthington, Ohio

The article on tune-up with a vom was interesting, but I feel that aligning the time marks by pulling on the fan is unsafe. If the blades are bent and then restraightened, metal fatigue could cause the blade to break when the engine is operated.

ROBERT DAVIS

Ottawa, Kan.

My guess is that the vtvm user has a bad diode. The blocking diode, preferably of several hundred PIV, should be checked for a large resistance difference between forward and reverse values. The vtvm volt function will show the polarity of the coil terminal that connects to the points, and the vtvm and diode can be connected in series properly.

When you use the vtvm you will need to modify your calculations for the dwell setting. Vtvm's read down-scale from infinity rather than upscale as vom's do. Make the calculation for the voltage corresponding to your dwell setting exactly as described on page 24 in the article.

I got a reading of 80 on a 120 volt scale for a 30° dwell. For a vtvm subtract the voltage you get from the full-scale value and use that as the mark to set by. For example, $120 - 80 = 40$. With the values given in the article, you'd use the 40V position on the 120V scale with a vtvm, not 80V.

The fan-blade problem is correct in some cases, but most blades I've encountered are heavy enough to pull the engine into place for timing. A blade would be dangerous if restraightened, but common sense should guide you here.

LOUIS E. FRENZEL, JR.

Silver Spring, Md.

HELP!

I have endeavored, thus far without success, to locate a copy of the instruction manual and schematic drawing for a Smith-Lawrence, Inc. Model 851, Potentiometric DC Voltmeter.

I would appreciate any assistance your readers can provide in making this manual and schematic available.

RAYMOND HADLEY
207 Royal Palm Drive
Ft. Lauderdale, Fla.

R-E

Circle 17 on reader service card →

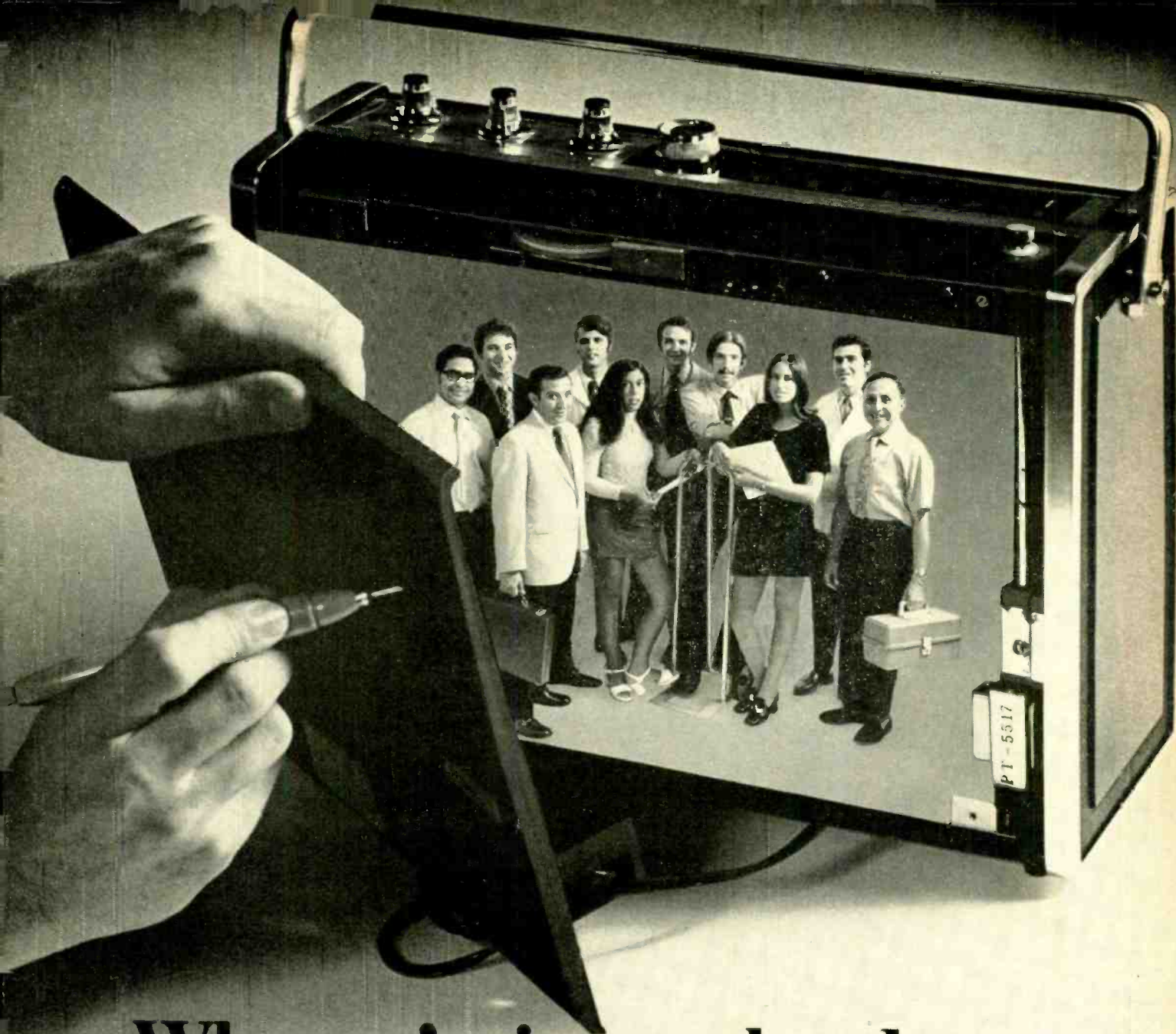

When we're in your hands, we're in good company.

We rely on you. For what you know. For your expert work on Panasonic products. And for the "service" you do for us. Providing the right kind of service for Panasonic products. Efficient. Professional. Yet personal. You take pride in your work. So do we.

That's why you're important to us. You're our local service facility. But you're not on your own. Because we've put together a service team to help you. To make you more important. A team of Panasonic people. Ready to work with you. And for you. Starting with technical specialists who check, and check, and check again. Every product we make. Before a product is made and after. And the field service specialists who work right along with you. Solving your particular problems. Even

training personnel.

And five strategically located Regional Parts Depots. And a big Central Parts depot. Not only there for stocking parts. But to answer questions about parts. And to back you up with all the assistance they can give. We provide specially trained instructors to work along with you. To show you the Panasonic way of servicing. The kind that makes Panasonic customers happy they bought Panasonic.

And of course, we do it all with only Panasonic parts. Designed, engineered and manufactured by us. To insure a consistent, high level of quality. Panasonic parts for Panasonic products. It makes sense. As much sense as our being there. Whenever, wherever. With all the special hands you may ever need.

PANASONIC
just slightly ahead of our time.

Matsushita Electric Corporation of America
National Headquarters, Service and Parts Division
10-16 44th Drive, Long Island City, N. Y. 11101



We make the microphones, too.



Since our job is to make your job easier, we've developed an entire line of ingenious, low-cost circuitry devices that take the headaches out of tough installations. For instance, Shure makes nearly a dozen different-type modular add-on *Mixers*, including a professional mixer. They're the talk of the industry. We offer an *Audio Control Center* to shape response to match room acoustics. Our *Level-Loc* effectively controls audio levels. In-line transformers, and plug-in problem solvers (such as phase reversers, attenuators, etc.) are instant cures for knotty problems. Interested? Write Shure Brothers Inc., 222 Hartrey Ave., Evanston, Ill. 60204.

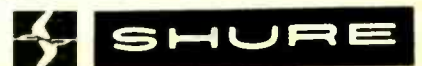

Circle 18 on reader service card



YOU THINK YOU'VE HAD FUN WITH ELECTRONICS IN THE PAST.

WAIT 'TIL YOU GET ONE OF THESE...



THIS NEW ELECTRONIC DEVICE IS THE "COMPULOGICAL TUTOR", A REAL COMPUTER THAT LETS YOU DO-IT-YOURSELF AND SHOWS YOU GRAPHICALLY AND DRAMATICALLY HOW ALL COMPUTERS WORK. YOU'LL NEVER GET TIRED OF USING IT . . . AND YOU'LL LEARN SO MUCH!

A product of imagination and inventiveness, developed by men who are themselves steeped in knowledge and proficiency with the finest commercial computers, the Compulogical Tutor is the newest and most exciting product of its kind available today. It performs the same basic functions as computers costing \$250,000 or more. It gives you all the instructive features of a superb trainer, with the intellectually stimulating pleasures of a highly sophisticated toy. Anyone from 8 to 80 can derive endless educational and entertainment value from the Compulogical Tutor, while gaining deep insights into the workings of commercial computers. In an age when so much of our lives is governed by computers, every informed citizen should have an understanding of these machines . . . their powers and their limitations. The Compulogical Tutor gives you this means for the first time, at a price anyone can afford. What can you learn from Compulogical Tutor? A lot of things that may sound difficult, but which in fact are amazingly simple when you observe them in practice. And you can learn them faster and easier with the Compulogical Tutor than by any other method. In no time at all, you'll have a good grasp of digital logic, the foundation of all modern computers. You'll learn the functions of the various logic blocks ("And", "Or", "Not", Etc.), concepts of Boolean algebra, binary numbers, truth tables, computer circuits, decision-making and error-detecting logic, computer storage, programming and many other fascinating aspects of computer operation. With your own hands, you'll program the Compulogical Tutor to handle hundreds of different problems and operations, giving you answers in millionths of a second. It adds, subtracts, multiplies and divides and you'll also learn how to apply the computer to practical problems of accounting, economics and finance. It's 100% solid-state, made with the finest transistors available to last for years. Convenient desk-size — portable — battery powered.

The Compulogical Tutor is not a "push-button" computer. All elements, except the basic circuitry which is located inside the master assembly board, are open and above-board. You, the operator, select the proper logic blocks for solving a particular group of problems. You then plug them in (as clearly explained in the instruction manual), link them up with the appropriate leads supplied. All inputs and outputs are clearly marked and explained. Answers are read out by means of colored lights adjoining slate panels on which numerical values are hand printed for each set of problems. In this manner, you achieve a maximum understanding of all the computer's functions and relationships.

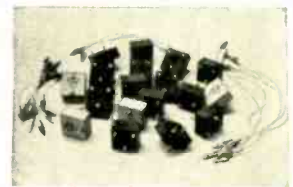
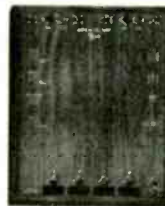

HERE IS JUST ONE OF THE FASCINATING PROBLEMS YOU CAN PERFORM ON YOUR COMPULOGICAL TUTOR:

"SINK THE BATTLESHIP"

2	1	7
3	8	4
6	9	5

This is an entertaining problem, easy to set up. You'll see it programmed on the board in the photograph, and a schematic diagram at right is shown at right. With the logic blocks in place and wired, you tell another person to select any number in the squares at left, but not to divulge this number to you. You then ask him the following questions.

- Is the number odd?
- Is the number in the first or third vertical row?
- Divide the number by four; is the remainder less than two?
- Is the square number greater than 3?

As he answers each question, you feed the answer into the appropriate inputs ("A", "B", "C", "D"). Each answer is instantly retaped and/or stored in the transistorized logic blocks. When all the answers have been fed in, you then read the computer output and it tells you exactly which of the numbers the other person had in mind. It never fails; it is infallible and precise, operating as it does on principles of pure logic. In the easy-to-read and easy-to-understand instruction manual which accompanies your Compulogical Tutor, you'll find hundreds of similar problems, and others more interesting and complex.

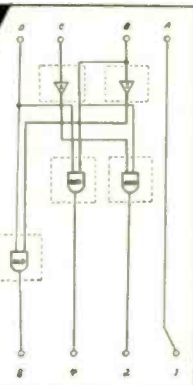

It isn't every day that you can buy a computer by mail. Because the Compulogical Tutor is so new, so exciting, so different, we decided to offer it to you direct by mail from the manufacturer, at the lowest possible price. It is not available in stores or from other sources. (Patent and Infringement clearances have been established on the Compulogical Tutor, and patent application has been filed with the U. S. Patent Office.) To get one or more by return mail, all you have to do is fill out and mail the handy order coupon at right. Or, just check the square and we'll send you a full-color brochure and all information at no obligation to you.

You receive everything shown above. The desk-size master assembly and control board; eighteen transistorized logic blocks; a big instruction manual (not pictured) which gives you hundreds of experiments, problems and computer operations that you can perform yourself. Everything is supplied except the batteries, which are standard flashlight type available anywhere.

Only **\$69⁹⁵**

THIS GUARANTEE IS YOUR PROTECTION
Each Compulogical Tutor is fully guaranteed to perform as advertised and to give you complete satisfaction. If you are not more than pleased with it in every respect, send it back and we will refund your purchase price immediately.

USE THIS CONVENIENT ORDER COUPON

COMPUSAD, INC.
16 Wetmore St.
P.O. Box 10
New York Mills, N.Y. 13417

GKJ

Please send at once **Compulogical Tutor(s)** at \$69.95, postpaid, with the understanding that if I am not more than satisfied in every way, I may return the Tutor(s) for a full refund.

- Full remittance enclosed; send postpaid.
- \$10 deposit enclosed; send C.O.D. for balance plus postage and fees.
- Send free color brochure at no obligation.

NAME _____
ADDRESS _____
CITY _____ STATE _____ ZIP _____

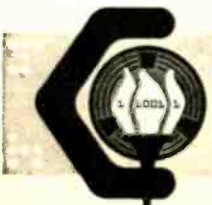

COMPUSAD, INC.
16 Wetmore St. — P.O. Box 10
New York Mills, N.Y. 13417

Circle 19 on reader service card

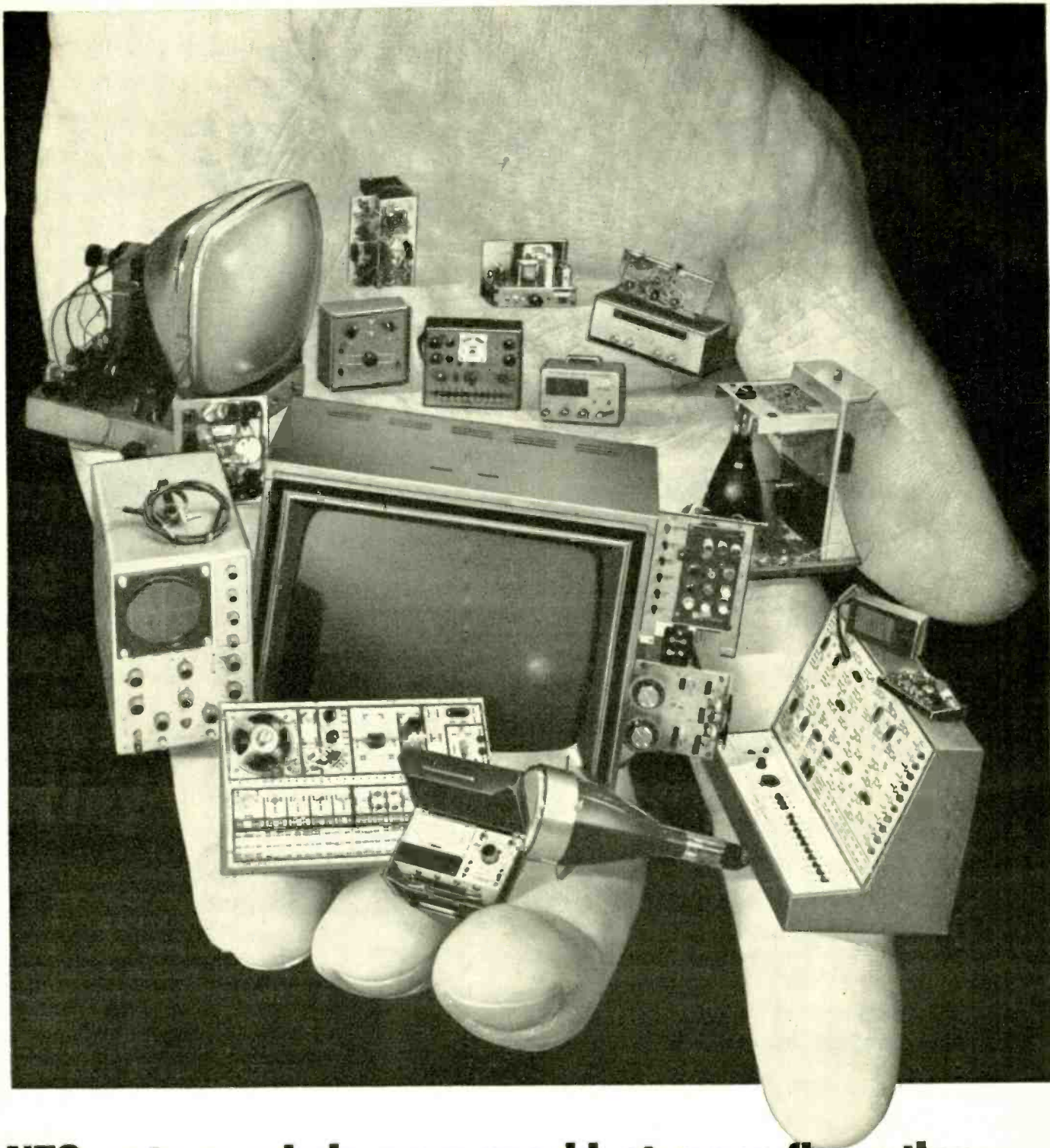

NTS puts a whole new world at your fingertips.

NTS home training can put a whole new way of life in the palm of your hand. A new, exciting job, a much bigger income is now easily within your reach.

NTS training is something special. We provide all the kits you need for the most effective training. National Technical Schools sends kits with every course, and teaches you to build and test a

wide range of professional equipment — the same kind of equipment you'll actually use on the job. That's the NTS "Project Method" — training that's practical and in-depth. You learn everything from fundamentals to the latest innovations. From beginning to end, NTS makes it fascinating and fun to learn this way. And all you need is a little

spare time and an interest in electronics.

Each year, men are moving into important new jobs, or their own businesses, straight out of NTS electronics training. NTS is what's happening to men everywhere. Check the coupon. Take hold of the career you want most. Do it now. No obligation. No salesman will call.

We pack your electronics course with kits to make your training fast. You'll enjoy every minute of it.

NTS COLOR TV SERVICING



**COLOR TV
295 SQ. IN. PICTURE**

NTS training provides an easy way to become a professional home-entertainment service technician. You receive a big screen Color TV with many unique features. The unit even includes self servicing equipment that permits you to make all normal test operations. No additional test equipment is needed for adjusting your set. In addition you get an AM-SW radio, Solid-State radio, Field-Effect Transistor Volt-Ohmmeter, and Electronic Tube Tester. You learn about Electronic principles and trouble shooting, hi-fi, multiplex systems, stereo, and color TV servicing.

NTS COMPUTER ELECTRONICS

This is the future. And it's happening now. The number of computers will increase many times in the next few years.

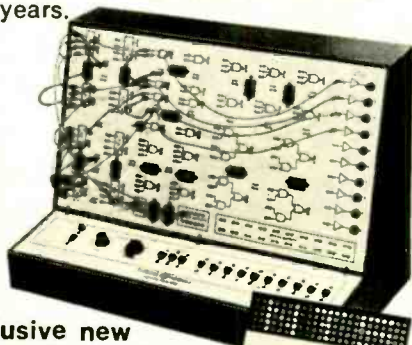

Exclusive new Compu-Trainer®

If card is missing check coupon and mail for free color catalog and sample lesson. Now.



National Technical Schools
4000 S. Figueroa St., Los Angeles, Calif. 90037
Please rush Free Color Catalog and Sample Lesson, plus information on course checked below. No obligation. No salesman will call.

NTS offers a solid grounding in computer operation, wiring, data processing and programming. One of the 10 important kits included is our exclusive Compu-Trainer®. It's a fully operational computer logic trainer — loaded with integrated circuits — the first ever offered in home study. It introduces you quickly to how, what, when and why of computers ... from theory to practical servicing techniques. This unit is capable of performing 50,000 operations per second.

NTS ELECTRONICS COMMUNICATIONS

Choose from two exciting courses to get into the big-paying fields of transmitting and receiving equipment: (1) The FCC License Course. (2) The Master Course in Electronic Communications (more comprehensive, with Citizens' Band Two-Way-Radio). Either Communications program qualifies you for your FCC First Class Commercial Radio-Telephone License — *NTS assures you will pass this FCC exam within six months after successfully completing your course or your tuition is refunded.* Kits include an Amateur-Phone 6 Meter VHF Transceiver — NTS exclusive, 6 transistor Solid-State Radio, Volt-Ohmmeter (fully transistorized).



5 Watt AM Transmitter/Receiver

NTS AUTOMATION/ INDUSTRIAL ELECTRONICS

Let NTS put you into the age of electronic controls. Systems Automation is rapidly becoming the emphasis of modern industry. Your NTS training in automation electronics includes equipment like a 5" wide band Oscilloscope. You also get the new NTS Electronics Lab. It's an exclusive NTS experimental laboratory — a complete workshop that simplifies learning about solid-state, miniature and integrated circuits.



5" Oscilloscope

CLASSROOM TRAINING AT LOS ANGELES

You can take classroom training at Los Angeles in sunny Southern California. NTS occupies a city block with over a million dollars in facilities devoted exclusively to technical training. Check box in coupon.

NATIONAL TECHNICAL SCHOOLS

WORLD-WIDE TRAINING SINCE 1905

4000 South Figueroa Street
Los Angeles, Calif. 90037, U.S.A.

APPROVED FOR VETERANS

Accredited Member: National Association of Trade and Technical Schools; National Home Study Council.

- Master Course in Color TV Servicing
- Color TV Servicing
- Master Course in TV & Radio Servicing
- Practical TV & Radio Servicing
- Master Course in Electronic Comm.
- FCC License Course
- Master Course in Electronics Tech.
- Industrial and Automation Electronics
- Computer Electronics
- Basic Electronics

Name _____ Age _____

Address _____

City _____ State _____ Zip _____

- Check if interested in Veteran Training under new G.I. Bill
- Check if interested only in Classroom Training at Los Angeles

Dept. 203-110

To call it "an amplifier" would be like calling a Porsche "Basic transportation."

There is unusual satisfaction that comes from fulfilling a prosaic task in a far from prosaic manner.

Hence this amplifying system: the Sony TA-2000 professional preamplifier and the Sony TA-3200F power amplifier. Together, they perform all an amplifier's standard tasks in a satisfyingly impeccable manner; but their 67 levers, switches, meters, knobs and jacks allow you to perform some interesting functions that are anything but standard.

Dual-purpose meters.

The two VU meters on the preamplifier front panel, for example, are no more necessary than a tachometer on an automobile. But they do serve the dual purpose of simplifying record-level control when the TA-2000 is used as a dubbing center, and of allowing you to test your system's frequency response and channel separation (as well as those of your phono cartridge), and to adjust the azimuth of your tape heads.

A broadcast/recording monitor console in miniature.

The TA-2000 resembles professional sound consoles in more than its VU meters. In addition to the 20 jacks and seven input level controls provided on its rear panel for permanent connections to the rest of your hi-fi system, the TA-2000 boasts a professional patch board in miniature on its front.

Thus, you can feed the inputs from microphones, electric guitars, portable recorders or other signal sources into your system without moving the preamplifier or disturbing your normal system connections in the least. And a front-panel Line Out jack feeds signals for dubbing or other purposes into an external amp or tape recorder, with full control of tone and level from the front-panel controls and VU meters.

The tone correction and filtering facilities are also reminiscent of professional practice, allowing a total of 488 *precisely repeatable* response settings, including one in which all tone controls and filters are removed completely from the circuit.

The amplifier — no mere "black box"

A power amplifier can be considered simply as a "black box" with input and output connections, a power cord, and an on/off switch; and such an amplifier can perform as well (or poorly) as the next one. But in designing the TA-3200F Sony took pains to match the amplifier's facilities to the preamplifier's.

Thus to complement the TA-2000's two pairs of stereo outputs, the TA-3200F has two stereo pairs of inputs, selected by a switch on the front panel. Other front panel controls include independent input level controls for both channels, a speaker

selector switch, and a power limiter (in case your present speaker should lack the power handling capacity of the next one you intend to buy).

Circuitry unusual, performance more so

The single-ended, push-pull output circuitry of the TA-3200F amplifier is supplied with both positive and negative voltages (not just positive and "ground") from dual balanced power supplies. This system allows the amplifier to be coupled directly to the speakers with no intervening coupling capacitors to cause phase shift or low-end roll-off (A switch on the rear panel does let you limit the bass response below 30Hz if you should want to, otherwise, it extends all the way down to 10Hz.)

The individual stages within the amplifier are also directly coupled with a transformerless complementary-symmetry driver stage, and Darlington type capacitorless coupling between the voltage amplifier stages.

As a result, in part, of this unique approach, the TA-3200F produces 200 watts of continuous (RMS) power at 8 ohms, across the entire frequency range from 20 to 20,000 Hz; IHF Dynamic Power is rated at 320 watts into 8 ohms (and fully 500 watts into a 4-ohm load).

But more important by far is the quality of the sound; intermodulation and harmonic distortion levels are held to a mere 0.1% at full rated output, and 0.03% at the more likely listening level of one-half watt. The signal-to-noise ratio is an incredible 110dB. And the full damping factor of 170 is maintained down to the lowest, most critical frequencies (another advantage of the capacitorless output circuit).

The companion TA-2000 preamplifier also boasts vanishingly low distortion and a wide signal-to-noise ratio, but this is less unusual in a preamplifier of the TA-2000's quality (and price). What is unusual is the performance of the phono and tape head preamplifier circuits; for though they have sufficient sensitivity (0.06mV) for the lowest-output cartridges (even without accessory transformers), these preamplifier circuits are virtually immune to overload — even with input signals 80 times greater than normal.

Their sole vice: they are hardly inexpensive

Of course, at a price of \$329.50 (suggested list) for the TA-2000 preamplifier, and \$349.50 (suggested list) for the TA-3200F power amp, this system cannot be considered other than a luxury. But then, it was intended to be. For there are those to whom fulfillment of prosaic tasks is

unfilling. And among them are not only many of our customers, but also many of our engineers. Sony Corporation of America, 47-47 Van Dam Street, Long Island City, New York 11101.

SONY®





special report

ALARMS STOP BURGLARS

Photo courtesy Malory Distrbuto Products

by **BILL GRACIE**

Police statistics show that your chances of becoming a burglary victim are growing rapidly. Last year in Los Angeles more than 65,000 burglaries were attempted as compared to only 36,000 in 1960. Across the nation, burglary was the most frequently committed crime. A properly installed burglar alarm will help shift the odds in your favor. This article shows how these systems work and what they can do for you. Turn the page and see . . .

WHILE CRIME DOESN'T PAY, FEAR OF CRIME DOES. AND while no American likes to admit that he isn't safe in his own home, a great majority of home owners realize they aren't and are installing burglar alarm systems at a rapid rate.

Last year in Los Angeles, the city with the highest crime rate in the nation, more than 65,000 burglaries were attempted as opposed to only 36,000 in 1960. Of the 65,000, over 36,000 were committed against residences and apartments. Across the nation, burglary was the most frequently committed crime.

Statistics such as these are responsible for the boom in burglar or intruder systems. Among the vast array of available devices you're bound to find the one that fits both your pocketbook and needs. Though not all of the available systems will do an adequate job of protecting you, most of them will when properly installed.

What do you really want to protect?

Since the majority of home owners and apartment dwellers insure the contents of their homes against theft, it's really our lives that we wish to protect. This should be kept in mind when considering a system. Protecting life is the single most important function of an alarm system. Unfortunately, not all of the available devices are designed with this in mind. However, a combination of techniques will do the job well.

How sophisticated a system you need depends upon the size and design of your home and how much you are willing to spend. The variety of products on the market range from battery operated single-station units that attach to a door or window, to space-age ultrasonic and microwave detectors similar to the ones used in Vietnam to detect troop movements. They'll do everything from ringing a bell and lighting a light, to dialing the local police station. Costs vary just as widely, ranging from \$5.95 to over a thousand dollars.

Unless you want to protect valuable art treasures, jewels, or furs, a self-installed system that will adequately protect your family should run from \$100 to \$500 for a one-family house and from \$100 to \$200 for the average four-room apartment.

What you'll get for this amount of money is protection from the amateur or petty thief. Police officials claim that this type of thief scares off quickly when an alarm goes off or a light suddenly flashes on. And if this type of thief knows your home is protected, he may not even attempt to enter it. Why should he take a chance when your neighbor's home is unprotected.

Vandals will also be kept out of your home. And while vandals are not generally after monetary items, they can give you a bigger headache than thieves. A recent vandalism case reported in Long Island, New York resulted in over \$10,000 worth of damage to a house, performed over a period of one week while the owners were away on vacation.

Petty thievery and vandalism are often committed by neighborhood teenagers. So upon successful installation of your system, demonstrate it for the neighbors. Word will quickly spread that your house or apartment is protected.

What's Available to do the Job?

Basically there are three different types of systems

that are suited to the homeowner. One or a combination of two techniques will afford you adequate protection no matter what the design of your home or apartment. The three systems include electromechanical or perimeter, photo-electric, and ultrasonic and rf systems.

Electromechanical or perimeter systems are the least expensive, but the most difficult to install. Photo-electric devices are seemingly easy to install and are comparable in price to perimeter systems, however, generally they will only cover a small area. Total protection generally necessitates several units, costing more money.

As might be expected, ultrasonic and rf units are the costliest, yet they can virtually be taken out of their box and plugged in for instant protection. So their high

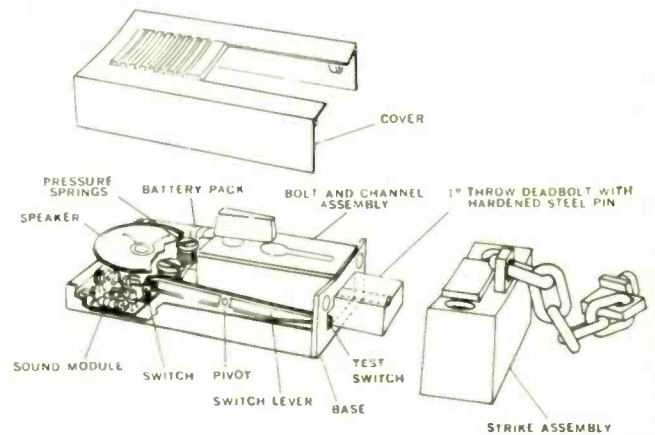

INTERESTING PERIMETER ALARM is this special entry lock made by 3-M. Pressure on the door, forcing the chain or even attempting to pick the cylinder sets off the battery operated, electronic alarm.

cost is off-set by low installation time and costs. The system you select will largely depend upon how much you want to spend and the design of your home.

Fire protection is an added feature of most systems. Low cost sensors (\$5 to \$10) will convert your intruder system into an effective fire alarm system as well.

Perimeter systems

Though the most difficult to install, electromechanical or perimeter systems offer the greatest degree of protection and flexibility for the money. The reason they are sometimes referred to as perimeter systems is that a properly installed system will surround your home with security. In a complete system all doors and windows are fitted with magnetic or contact switches that trigger the alarm when one is broken. Unless someone saws a hole through your roof or cuts a hole in a sliding glass door, the average thief is detected by such a system.

Since nearly every room is wired, adding fire protection to a perimeter system is easy. Heat or smoke sensors are simply wired into the same circuit the switches are on.

A basic perimeter system consists of a central control box or console (sometimes containing a key switch, batteries and horn) external bell or siren and window and door switches. An advantage of a perimeter system is that it may easily be expanded as desired or required. Some perimeter systems on the market today are single-station devices, that is, they

only protect a single door or window. However, in most cases, they can easily be expanded to afford complete protection.

Low cost perimeter systems are generally battery operated and contain an integral siren or horn, located in the console or control box. Before you purchase any system, ask to hear the alarm. Some units aren't loud enough to wake a sleeping baby.

More expensive and sophisticated perimeter alarms are both ac and dc operated. If there is a power failure or an intentionally cut power line, such units switch over to dc automatically and the system is still

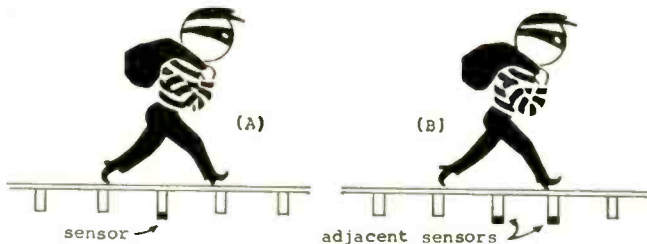

PRESSURE SENSORS DETECT MOVEMENT on a floor. They are not very practical for home use and tend to find applications in bank vaults.

Diagram courtesy Systron Donner

on. Such a system is valuable if you live in an apartment building where your fuse box is located outside your apartment. Ac operation also allows you to hook up a hefty alarm and operate internal or outside lights.

An effective system of any kind should include both integral and external alarms or bells. An external signal will alert neighbors and police while you are away. The internal alarm tells the intruder he's been detected and that it's time to get out—fast! Incidentally, if you plan to go away, instruct a dependable neighbor on the operation of your system, in case it accidentally goes off. And if you add fire protection to your system, use a different-sound alarm so you can easily distinguish between a fire and an intruder. If your system does not allow you to hook up ac accessories, a simple relay set-up will do the trick.

The actuating key switch is generally located in the control box inside your home or apartment. A delay of from 10 to 30 seconds is built into many systems, allowing you ample time to enter your house and deactivate the system (a feature of some systems is an instant or delay switch for use when you are inside the house). This delay works in reverse when leaving. Activation upon closing of a door is another variation in some systems.

If for some reason you prefer to have the actuating keyswitch outside the house, optional externally mounted key panels are available with some systems. If you intend to eventually install a complete and comprehensive system, look for a manufacturer that offers a complete line of accessories. It will make add-ons much easier.

An important component in any system and especially easy to include in a perimeter system is a series of panic buttons, which upon activation, will sound the signalling device. For the greatest degree of protection, the panic button should sound an alarm even when the system is deactivated. Thus, should a housewife not have the system activated during the day when doors and windows are open, she can sound the alarm should

an unwelcome visitor show up. Place panic buttons throughout the house and especially in rooms where a direct view of the entrance foyer is not available.

Windows and doors can be protected by either of three basic means. Magnetic or reed actuated switches have become very popular because of their reliability and ease of installation. They are especially convenient for doors, and cost around \$3.50 each. For windows the lever or contact switch is used for its simplicity and low cost (about \$1.50). Break-away wire is the most economical "switch" but it can only be used where a particular window or door is virtually unused. Break away wire is very thin and can not be seen at night. The device you choose will depend upon each situation. More exotic and costly switches which are activated by vibration or pressure are available but they are prone to false alarms. Use them only where such protection is essential.

Naturally, the more you spend the more features you'll get. For instance, some of the deluxe systems have power indicators, battery life testers, etc. The one thing you should add to your system is fire protection. This is done simply by wiring into the same circuit, small thermostats or temperature sensors which activate when a room reaches 130 to 135°F. For warmer climates or rooms, 190° units are also available. Trouble spots like boiler rooms, kitchens and laundry rooms are likely places to install these units.

If you are planning to install a perimeter system in a new, yet to be constructed house, ask the builder if

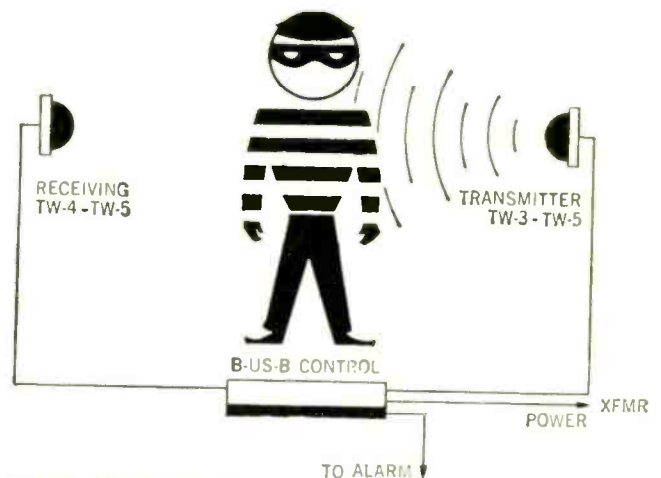

WHEN INTRUDER MOVES INTO protected area he upsets the existing energy field setting off the alarm.

Sketch courtesy Systron-Donner

you can wire the skeleton before the plasterboard is installed. This will greatly reduce the amount of work you'll have to do in cramped attics and crawl spaces.

Photoelectric systems

Unlike perimeter systems, photo-electric protection devices are designed to cover a single room or area. To provide the breadth of protection afforded by perimeter systems a photo-electric set-up would require several sets of photo-electric pairs. In addition, the optical alignment of such systems is tricky, and must be doublechecked. There are instances though, where a single photo-electric system strategically placed, will cover the critical portions of a home and at a very nominal cost.

Photo-electric systems usually consist of a light source and photocell sensor. While older systems used easy-to-fool incandescent light sources, modern versions utilize infrared, ultra-violet and modulated light sources which the average thief will find very difficult to "jimmy". A few systems even use relatively new IR (infrared) light emitting diodes as light sources. These gallium-arsenide diodes emit IR in the range of 9100 angstroms and provide the reliability and low power drain of semiconductors.

All photo-electric systems operate on the same basic principle—when a beam is interrupted, the resistance of the photo-cell increases and triggers an alarm. IR, UV (ultraviolet) and modulated beams are used to make the devices tamper proof.

Burglars vs space age electronics

It's doubtful that any thief will find a way to get by the space age protection afforded by ultrasonic, radar and microwave intruder systems. Representing the high technology portion of the burglar business, these devices are difficult to fool, easy to install but relatively costly to buy. Prices range from \$75 to about \$500.

Each of the three systems operate on the same principle—the Doppler effect. Simply, the Doppler effect dictates that movement within an energy field of an rf or ultrasonic signal will cause a change in the phase, frequency and amplitude of the energy pattern.

Operation of a typical system is illustrated by the diagram shown at right. In this system, an oscillator generates a 20 to 40 KHz signal (depending upon the particular model) which is fed to a piezoelectric transmitter and subsequently radiated throughout a room. Reflected ultrasonic waves from moving and stationary objects are received by a second piezoelectric crystal. Since a moving object causes a change in the characteristics of the original signal, a simple detector/reference circuit detects the difference in the signal and triggers an alarm. Filters help reduce the possibility of false alarms caused by extraneous signals.

Solid state electronics has made it possible to package these systems in a single box, looking something like a small hi-fi speaker. Other systems require the use of detectors (which must be connected to the transmitter) located in various parts of a room. Except for these multi-part set-ups, all the wiring required for a single-part system are bell, light and panic button circuits similar to those used in perimeter or photo-electric systems. Some of these systems are small enough, and portable enough, to take along on a trip to guard your motel or hotel room.

The basic difference between ultrasonic, radar and microwave systems lies in the frequency range within which they operate. Ultrasonic units operate at about 20 to 40 kHz; radar in the 450 to 500 MHz region, and microwave goes up in frequency where radar leaves off. These different frequency ranges bring about some inherent advantages and disadvantages for each.

Ultrasonic systems seem to be best suited for the average home. Their greatest advantage is that the radiated signal will not penetrate walls and is thus confined to a single room and is not disturbed by outside movement. However, so effective is the protection within a room that air turbulence caused by hot air or air condi-

tioning vents can cause a false alarm under some circumstances. Reducing the sensitivity setting will control this problem. However, to help overcome these unwanted problems, air turbulence compensators and sensitivity adjustments are provided. You'll have to find the right setting for your room.

Radar or higher rf intruder systems have their problems too. Their high frequencies and shorter wave lengths permit the signals to penetrate walls and glass panes, thus posing the problem of outside movements interfering with the system's operation. Also, commercial communications systems such as citizen's band and police radios might possibly trigger an alarm.

Microwave devices operating near and in the Gigahertz region are not at all disturbed by air turbulence or commercial communications systems. However, these units are generally more expensive than ultrasonic units and their radiating pattern is spherical in shape and therefore does not "fill" a room as ultrasonic units do.

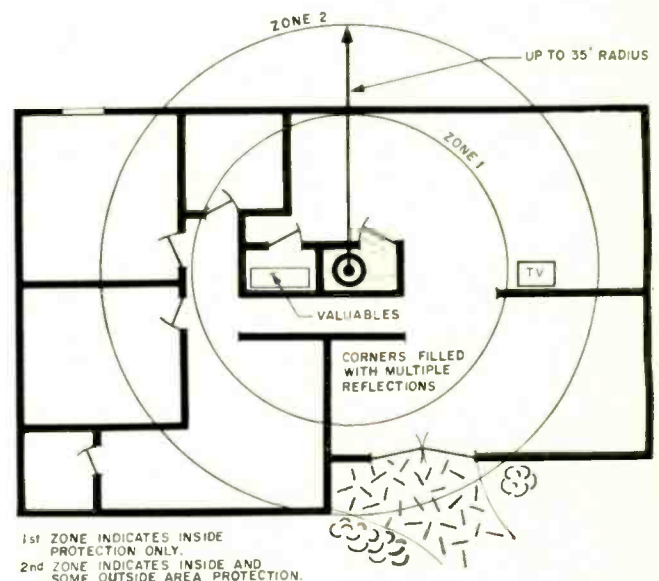

RF ALARM PENETRATES WALLS, so field of coverage must be carefully restricted or movement outside the house might trigger a false alarm. Sketch courtesy Systron-Donner.

Coverage accorded by all three techniques is about the same ranging from 15'X15' areas for the lower cost units, to 35' diameter areas for the higher power ones. Temperature and humidity changes will cause some variation in their range. Long corridors are relatively easy to protect with some units able to secure a 150-foot long space.

Good protection is afforded by a combination of perimeter and ultrasonic units. There are several ultrasonic units available that have provisions for adding perimeter system for supplementary protection. But no system is better than the installation job. Carefully consider possible entry points and make sure they are covered. Remember, an alarm positioned where it can't detect an intruder is worthless.

For a complete listing of burglar alarm manufacturers turn to pages 83, 94, 95, and 97. If you come up with a manufacturer we haven't listed, let us know. Write Burglar Alarms, c/o RADIO-ELECTRONICS, 200 Park Ave South, New York, N.Y. 10003. **R-E**

30 new IC circuits you can use

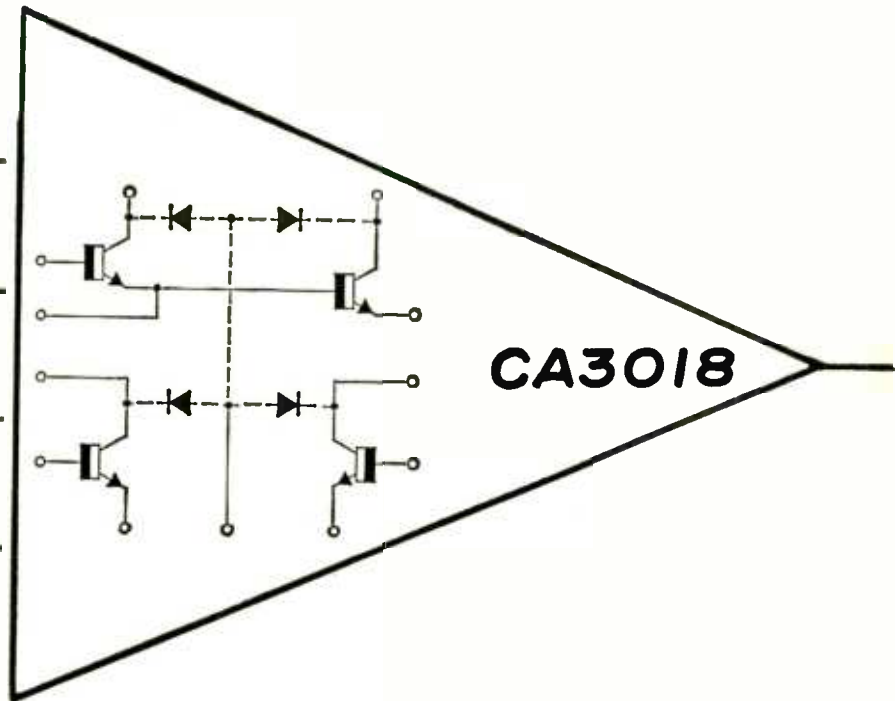

by R. M. MARSTON

Part II: Versatile four-transistor IC operates from dc to vhf. Build ultra-sensitive switches, ice alarms, smoke alarms, simple robot brain, automatic car light controls, heater and air conditioner controls, and more.

Ultrasensitive switches

The CA3018 is ideally suited for ultrasensitive switching applications. It can be used as a temperature-operated switch triggered by thermal changes of less than 0.5°C. It can become a light-operated switch that senses changes in light level too small to be detected by the human eye, such as those caused by a puff of cigarette smoke at a range of several feet.

In this section, we present seven ultrasensitive switching applications. All of them use the same basic operating principle.

In the basic circuit of an emitter-coupled dc differential amplifier (Fig. 16-a) Q1 and Q2 share common-emitter resistor R5. Transistor Q1's base is set at 6 volts by R1-R2; Q2's base is variable about 6 volts via R3-R4.

Due to the basic emitter-follower actions of Q1 and Q2, the voltage at the top of R5 is about 0.65 volt less than the larger of the two base voltages. So, if the two bases are at identical potentials, Q1 and Q2 are equally forward-biased and conduct by equal amounts. Under this condition the circuit is balanced.

If, on the other hand, Q2's base is made more positive than that of Q1, Q2 becomes more heavily forward-biased, and turns on harder than Q1. Simultaneously, R5's voltage rises in proportion to Q2's base voltage, reducing the forward bias of Q1.

ward bias of Q1.

Transistor Q1 becomes less forward-biased under this condition. Thus, the emitter coupling of the two transistors causes Q2 to conduct more and Q1 to conduct less when Q2 base voltage is increased. The reverse occurs when Q2's base voltage is lower than Q1's.

Note that the degree of conduction of the two transistors is dictated mainly by the difference between the two base

voltages, rather than by the absolute base potentials. Both Q1 and Q2 give a current and voltage gain between collector and base. If each transistor has a voltage gain of $\times 100$, a differential change of 10 mV on Q2's base causes a 1-volt change on Q2's collector.

Resistors R1 through R4 are in the form of a bridge, so the balance point of the circuit (at which Q1 and Q2's base potentials are equal) is determined solely by the relative values of these resistors and is independent of variations in supply voltage.

Since Q1 and Q2 are connected as a differential amplifier, thermal variations in the forward base-emitter voltages of the two transistors automatically cancel, particularly if Q1 and Q2 are part of an integrated circuit. The balance point of the circuit is thus independent of ambient temperature.

Finally, if R4 is adjusted so the circuit is near balance, Q2's collector voltage can be shifted 1 volt by differentially increasing Q2's base voltage by only (say) 10 mV. Since a standing bias of 6 volts is normally applied to Q2's base via voltage divider R3-R4, this shift in voltage is obtained by changing R4's value by less than 0.2%. The circuit balance is thus very sensitive to changes in the bias values of resistors R1 to R4, but is virtually independent of variations in actual supply voltage and ambient temperature. As a result, this circuit can be used as the basis of an exceptionally stable but sensitive resistor-operated electronic switch.

The basic differential circuit can be modified to act as a regenerative switch that drives a relay output (Fig. 16-b). Here, Q2's collector is direct-coupled to the base of pnp transistor Q3, and Q3 drives a relay load in its collector. Part of Q3's collector voltage is also fed back to Q2's base via R7 and the R4-R8 junction.

Suppose R4 is adjusted so that Q2

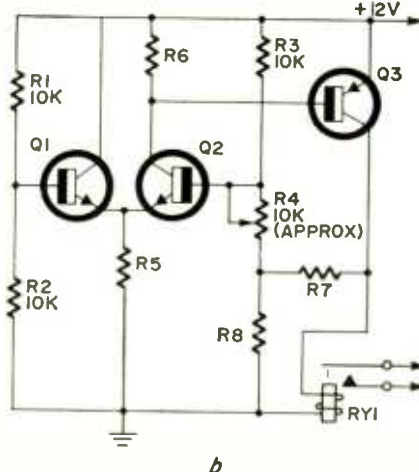
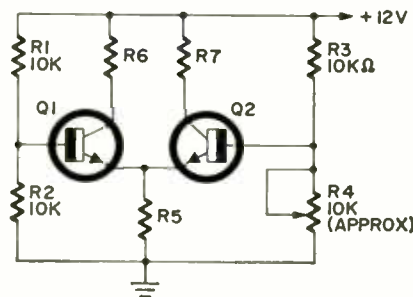
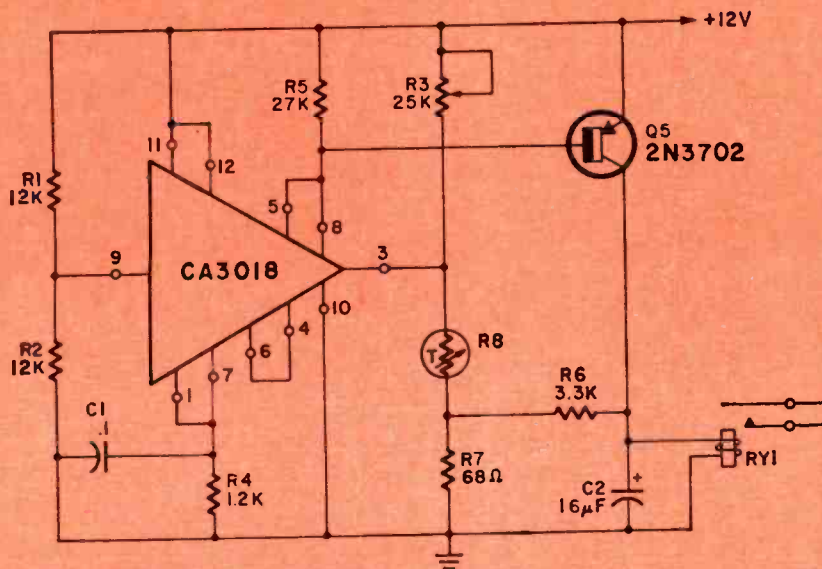
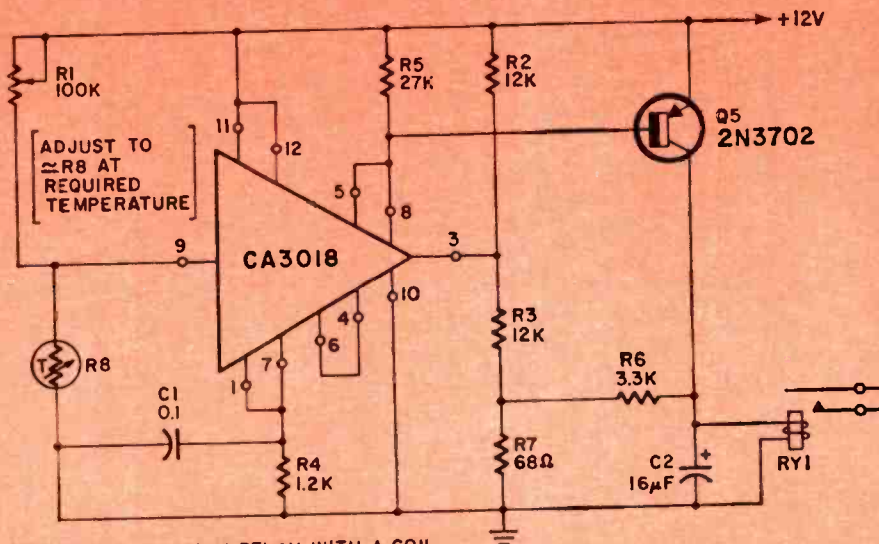

FIG. 16-a—EMITTER-COUPLED dc-differential amplifier. (b) same circuit modified to act as a regenerative switch that drives a relay.



NOTE: RY1 = ANY 12-V RELAY WITH A COIL RESISTANCE GREATER THAN 120Ω.
R8 = CARBON ROD THERMISTOR, MULLARD VA1066S, RCA KD2108, OR SIMILAR.



NOTE: RY1 = ANY 12-V RELAY WITH A COIL RESISTANCE GREATER THAN 120Ω.
R8 = CARBON ROD THERMISTOR, MULLARD VA1056S, MULLARD VA1067S, RCA KD2109, OR SIMILAR.

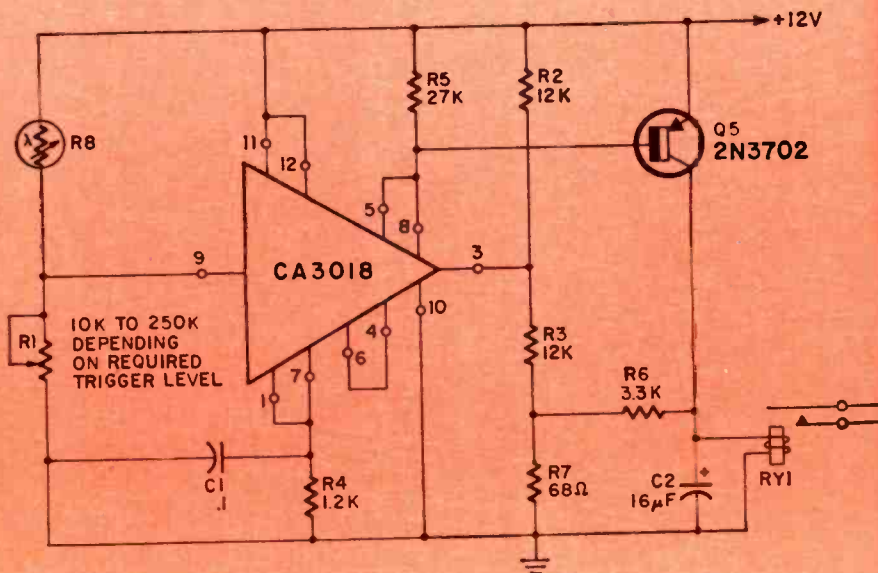

NOTE: RY1 = ANY 12-V RELAY WITH A COIL RESISTANCE GREATER THAN 120Ω.

is cut off. Now Q2 passes zero drive current into Q3's base and Q3 and the relay are off. Now adjust R4 so Q2 is biased on enough to apply a very small drive current to Q3's base. As Q3 starts to turn on, its collector moves towards the positive supply voltage.

A fraction of this rising voltage is fed back to the R4-R8 junction via R7, causing Q2's base voltage to increase. This increased base voltage turns Q2 and Q3 on even harder. A regenerative action takes place and Q3 is driven rapidly to saturation, and the relay goes on.

By selecting the value of R8, the triggering backlash of the circuit can be varied to suit individual needs—if R8 is given a very small value, the circuit can be adjusted so the relay turns on when R4 is 10,000 ohms, but does not turn off again until R4 is reduced to (say) 9900 ohms, giving a backlash of 100 ohms.

The overall action of the circuit of Fig. 16-b is fairly simple. R1 through R4 are wired in the form of a bridge which is balanced when R4 equals 10,000 ohms. If R4 is (say) 0.5% or more below 10,000 ohms, the bridge goes out of balance in such a way that Q2 is turned off, so Q3 and the relay are off also.

If, on the other hand, R4's value increases to within less than 0.5% of 10,000 ohms or is made greater than 10,000 ohms, the bridge either balances or goes out of balance and turns Q2 on. Either way, a regenerative action is set up between Q2 and Q3, and the relay is driven sharply on.

The circuit drives the relay on whenever R4's value reaches a pre-selected magnitude. This value can be set with an accuracy of a fraction of a percent. By replacing R4 with a thermistor or LDR (light dependent resistor), the circuit can be used as an ultrasensitive temperature- or light-operated electronic switch.

Fig. 17 shows how to use the CA3018 as a high-performance ice-warning indicator. Transistors Q3-Q4 (within the IC) are Super-Alpha-connected and used as one half of the differential stage (with input to pin 9). Transistors Q2-Q1, also Super-Alpha-connected, are used as the other half, with input to pin 3. Capacitor C1 prevents high-frequency instability of the differential stage, and C2 insures that supply transients do not cause erratic triggering of the regenerative section of the design.

In action, the relay goes on as soon as the thermistor temperature falls below its preset value. The triggering temperature can be varied over quite a wide range via R3.

When the unit is used as an ice-warning indicator, R3 is set so the relay goes on as soon as R8 falls below 0°C. The thermal backlash of the circuit is 0.5°C.—if the relay goes on when the temperature falls to 0°C, it goes off again when the temperature rises to 0.5°C.

FIG. 17 (top)—ICE-WARNING INDICATOR. Relay goes on as temperature falls.

FIG. 18 (center)—ULTRASENSITIVE light-operated switch is modification of Fig. 17.

FIG. 19 (bottom)—LIGHT-OPERATED switch turns on when it gets dark.

$\pm 0.5^\circ\text{C}$. Backlash can be increased, if required, by increasing R7's resistance.

This circuit is very valuable as an ice-warning indicator for a car. The thermistor is mounted on the front underside of the vehicle, about 10 inches above the road surface.

Alternatively, the unit can be used at home to turn on a heater when room temperature falls below a preset value.

The circuit can be modified for use as an excess-temperature indicator (Fig. 18). Now the relay goes on as soon as R8's temperature exceeds its preset value.

The circuit can be made to operate at any temperature between about 30°C to 110°C , using the thermistor types shown. Thermal backlash is 1°C at an operating temperature of 100°C . Other operating ranges require different thermistor types. Their resistive values must be between 2000 and 80,000 ohms at the selected trigger temperature.

This circuit can be used to give an indication of engine, gear-box, or brake-drum overheating in a car. It can automatically turn on air conditioning equipment, etc., when temperatures exceed a preset value.

Fig. 19 shows how the circuit can be made to work as an ultrasensitive light-operated switch, which turns the relay on as soon as light level falls below a preset value. The action can be modified so the relay goes on when the light rises above a preset value, by transposing R8 and R1.

Circuit sensitivity is so high that the relay can be operated by changes in light level caused by a puff of cigarette smoke at a range of several feet (changes too small to be detected by the human eye). As a result the unit makes a good ultrasensitive detector of smoke, fog, mist, etc. When used in applications of this type, the brilliance of the source illumination must be stabilized.

The circuit can be modified for use as a lighting slave (Fig. 20), which operates a car's parking lights automatically. It turns them on when the car is driven at night, and keeps them off when the car is used in daylight. It turns lights off automatically when the car is parked at night.

Power is applied to the unit via the car's ignition switch, and the relay contacts are wired in parallel with the vehicle's parking-light switch. R1-R11-R2-R3-D1-C1-C2 and R4 are wired as a dual-time-constant light-level integrating network to control the variable input voltage to the differential stage. The regenerative section of the unit has a moderately large value of backlash (via R10).

Because of the integrating network (when the car is in use) the relay is energized when the light level on R11 falls briefly below a value preset by R2. But the relay releases again only if the light fails to fall below that level again

FIG. 20 (top)—TURN CAR LIGHTS ON automatically with this simple IC circuit.
FIG. 21 (center)—ELECTRONIC LOCK uses variable resistor as its adjustable key.
FIG. 22 (bottom)—DIFFERENTIAL BALANCE DETECTOR can be used as a robot brain.

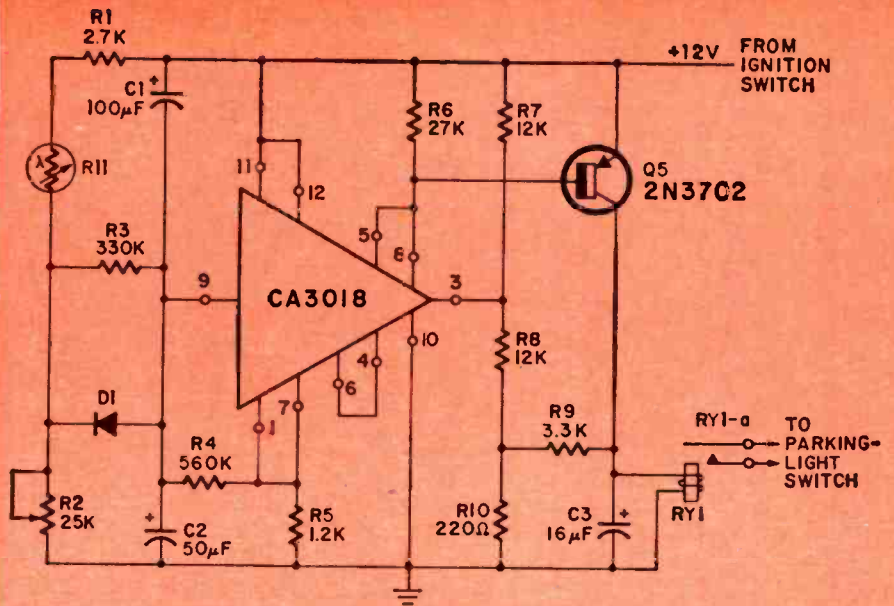

NOTE: D1 = GENERAL PURPOSE SILICON DIODE.
 RY1 = ANY 12-V RELAY WITH A COIL RESISTANCE GREATER THAN 120Ω .

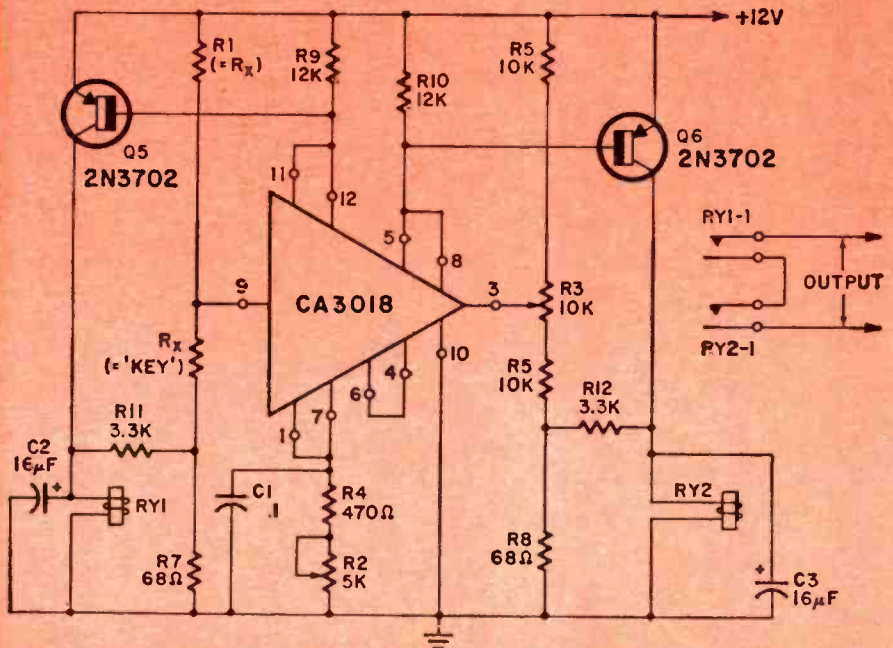

NOTES: R_x ('KEY') = R1 = ANY VALUE IN THE RANGE 100Ω TO 100K .
 ALL RESISTORS ARE 5% OR BETTER HI-STABILITY TYPES.
 RY1 AND RY2 = 12-V RELAYS, COIL RESISTANCE GREATER THAN 120Ω

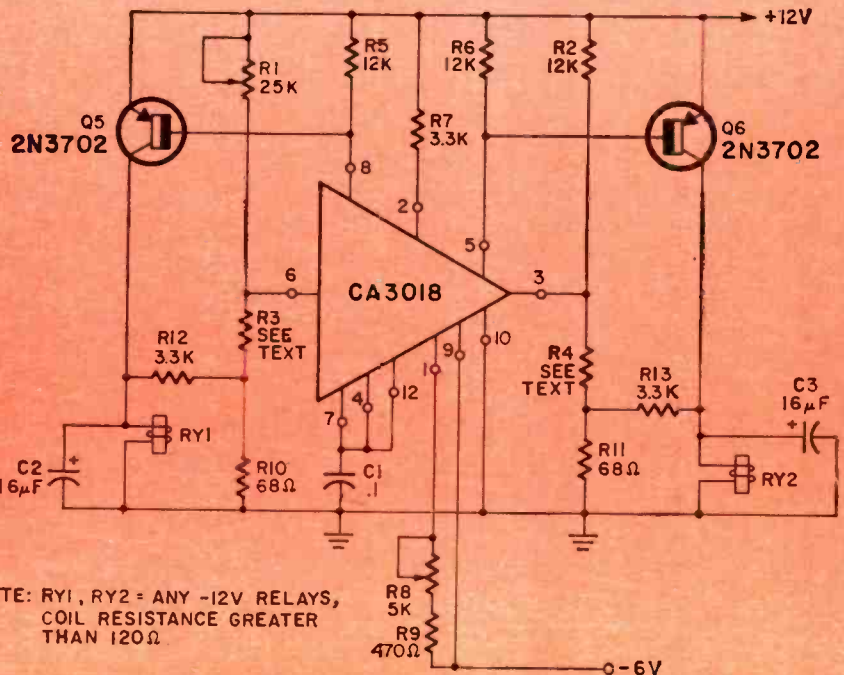

NOTE: RY1, RY2 = ANY 12V RELAYS, COIL RESISTANCE GREATER THAN 120Ω .

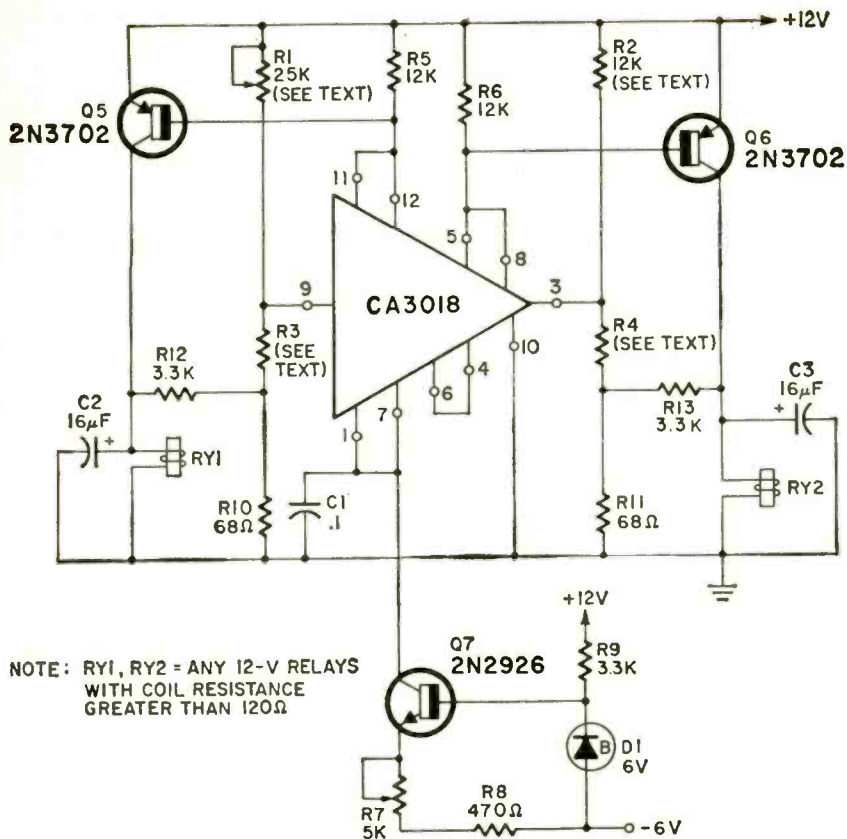

FIG. 23—HIGH-IMPEDANCE version of the differential balance detector of Fig. 22. Q7 and Zener diode D1 are used as a constant current source in this circuit.

within the following 30 sec. or so. The circuit is unaffected by sudden increases in light level, such as lightning flashes, etc. R2 is set so once the relay is on, it only turns off again when the light level reaching R11 rises to normal dusk or dawn values, and remains at those values for at least 30 seconds.

When the car is used at night, the relay and the lights turn on automatically in response to the low illumination on R11, and are unaffected by sudden transient increases in light level caused by street lights and lightning flashes. When the car is parked, power to the unit is cut off by the car ignition switch, so the lights go off automatically.

When the car is used in daylight, the lights are normally held off via R11. They will turn on automatically, however, if you drive under a bridge or through tunnel in which the light is below the preset level. They turn off again about 30 sec. after the vehicle emerges from the dark area.

Finally, when the vehicle is used on the threshold of dusk, the car lights turn on as soon as R11 illumination falls momentarily to a value perceptibly below that of the mean dusk level (when a shadow caused by a tree, a building or a passing vehicle falls on R11's face). The moderately high backlash of the circuit then insures that the lights do not turn off again until the illumination is held above the mean dusk level for at least 30 sec. (until the following morning). Thus, the cars lights operate without the slightest sign of flicker, even on the verge of dusk (or dawn).

When this unit is used in a vehicle, the LDR (light dependent resistor R11) should be mounted on the dash, with its

face looking into the car interior, so it is insensitive to bright external lights. When setting the trigger levels of the circuit via R2, shade the LDR face so the relay goes on, and then carefully trim R2 so that the relay just turns off again under dusk or dawn illumination conditions. Because of the long time constants of the unit's integrator network, at least 2 min. should be allowed to elapse between each trial adjustment of R2.

The CA3018 can be connected as a precision resistor-operated electronic lock too (Fig. 21). The circuit uses two relays and has a regenerative switching stage wired to each side of the differential amplifier. The two sets of relay contacts are wired in series, so there is an output only when both relays are switched on simultaneously. Resistor R_x is the "key" to the lock, and can have any value between 100 and 100,000 ohms. Resistors R1 and R_x must have nearly equal values, R3 balances small differences between R1 and R_x .

The two relays go on simultaneously only if the key (R_x) is the correct value. The tolerance of the circuit can be adjusted between about $\pm 0\%$ and $\pm 5\%$ via R2. If a wrong key is used, only one of the two relays operates—if R_x is too large, RY1 operates; if R_x is too small, RY2 is energized.

If this circuit is to be used as a practical electronic lock, the output should be taken via an additional 5- or 10-sec. delay relay, so the lock cannot be fiddled open with a variable resistor as the key.

The circuit can be modified for use as a differential balance detector (Fig. 22) which drives RY1 and RY2 on si-

multaneously only if R3 and R4 are equal. Balance is independent of the absolute values of R3 and R4 between 470 and 20,000 ohms.

This independence is obtained by using Q3 and Q4 as a constant-current generator in the tail of the Q1-Q2 differential amplifier stage, so voltage gain is independent of pin 3's and pin 6's bias voltages.

This particular circuit is intended for use as a "brain" in a simple robot animal. Simply replace R3 and R4 with a pair of matched thermistors or LDR's. In the LDR application, the LDR faces point toward a white line drawn on the ground, and the relay contacts control track-driving motors that move the animal forward. Relay RY1 operates the left-hand track, and RY2 the right-hand track.

When the animal is squarely over the white line, both LDR's are illuminated equally and both motors operate simultaneously to drive the animal forward. If the animal moves to the left of the line, the right-hand LDR is illuminated more than the left-hand one, RY2 drops out, and the left-hand track automatically moves the animal to the right until it is squarely over the white line again.

Similarly, if the animal moves to the right of the line, RY1 drops out, and the right-hand motor drives the animal back over the line. Thus, the animal automatically follows the path of the white line.

If you use thermistors, the animal can be made to automatically move toward or away from sources of heat.

Circuit sensitivity is very high, but can be controlled to a limited degree by R8. Sensitivity can be greatly reduced, if required, by wiring a fixed resistor (between 10 and 470 ohms) in series with the emitter of each of the differential transistors, Q1 and Q2.

Finally, in Fig. 23, there is a high-impedance version of the differential balance detector; here R3 and R4 can have any value between 1000 and 200,000 ohms. Resistor R1 must be $2 \times R3$, and R2 must be equal to R4.

This circuit is similar to that of Fig. 22, except that the differential stage is Super-Alpha-connected, and Q7 and Zener diode D1 are used as a constant-current source. (continued on page 69)



I didn't hurt it! Now we have an old, antique, electric grandfather clock.

NEW R-E EXCLUSIVE

Sound I.F. and
Quadrature Detector









With i.f. feedback coil

Kwik-Fix™ picture and waveform charts

by Forest H. Belt & Associates*

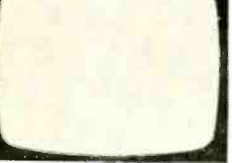
SCREEN SYMPTOMS AS GUIDES

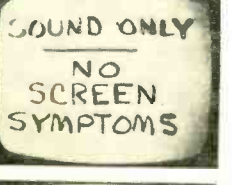
WHERE TO CHECK FIRST

SYMPTOM PIC	DESCRIPTION	VOLTAGE	WAVEFORM	PART
	No sync, accompanied by no sound	—	—	T1, if in output circuit of a sync-and-sound-i.f. amplifier stage
	Sound very weak; buzz and noise with volume control up	—	—	C1 open R6 high C6 shorted T1 open C7 open C8 leaky C9 open R3 open
	No sound	—	—	C2 open R6 open C4 shorted R9 open C10 shorted L1 open C10 leaky C11 open R5 open R5 high
	Sound very weak; may be distorted	—	—	R2 open R9 low C10 leaky
	No video; no sound	—	—	T1, if in output of video detector or video amp stage
	Sound critical at fine tuning; volume about normal	—	—	C3 open C5 open C6 open C8 open
	Sound critical at fine tuning; volume weak	—	—	C4 open
	Sound critical at fine tuning; volume above normal	—	—	C4 leaky

DC VOLTAGES AS GUIDES

change	to zero	very low	low	slightly low	slightly high	high
V1-cathode, pin-1 Normal 0.7 V	C3 shorted C4 shorted R3 open	C4 leaky R3 high	C3 shorted C4 leaky R2 low R3 high			R2 open R2 high R3 low
V1-grid, pin-2 Normal 0V	C4 shorted C4 leaky *R3 open *R3 high					
V1-plate, pin-3 Normal 75V	C4 shorted R3 open	C4 leaky R3 high	C3 shorted C4 leaky R2 low R3 high			R2 open R2 high R3 low
V2-cathode, pin-2 Normal 3.5 V	C7 shorted R5 shorted	R6 open	C8 leaky R6 high L1 open	C8 open		R5 open
V2-plate, pin-5 Normal 120 V	C10 shorted R9 open	C10 leaky L2 open	C6 shorted C7 shorted C8 open C10 leaky R5 low R5 shorted L2 shorted	C5 open R2 open R6 slightly high	C7 open C8 leaky R6 high	C7 open R5 open R6 open R9 low
V2-screen, pin-6 Normal 100 V	C8 shorted R6 open	C8 leaky R6 very high	C7 shorted C8 leaky R5 low R6 high		C8 open R6 low L2 open	R5 open
V2-quad-grid, pin-7 Normal 0V	*C7 shorted *C8 open *R5 low					

NOTES:

*Goes negative

Use this guide and the Waveforms Guide to help you pinpoint the faulty part.

All voltages are taken with sweep-generator signal applied (see Waveforms Guide notes.)

Measure each of the seven key voltages with a vtom.

For each, move across to the column that describes whatever change you find in that voltage.

Notice which parts might cause that change.

Finally, notice which parts are repeated in the combination of changes you find.

Test those parts individually for the fault described.

Signal and Control Effects

Station signal doesn't have much effect on dc voltages in these stages, except as already described for the bias at quad-grid-pin-7. It becomes more negative with stronger station signals.

Tuning the coils affects voltages only slightly.

Quick Troubleshooting

As is so common with stages that handle rf and i.f. signals, tuning is frequently the quickest way to spot a trouble. Before you try anything else, adjust the coils by the station-sound method.

Tune in the weakest TV station you get. Leave the antenna lead-in coupled loosely if necessary, but be sure you have a weak and noisy station signal.

Peak T1 and L1 for the loudest sound with least noise; a compromise between noise and sound strength may be necessary at first. Then tune quadrature coil L2 for loudest sound with least distortion. Finally, go back over all three adjustments. Try to end up with loudest sound, least noise, and least distortion.

If any coil doesn't respond, suspect it or the components near it in the circuit. If the coils seem to tune ok, but still don't produce normal sound, make quick voltage checks at V1-plate-pin-3, V2-plate-pin-5, and V2-screen-pin-6. If those tests don't tell you anything, consult the Voltages Guide above and Waveforms Guide on the next two pages.

Sweep-response waveforms are used here because they are more informative of stage operation than any other kind of waveforms would be.

Turn page for waveform guide

WAVEFORMS AS GUIDES

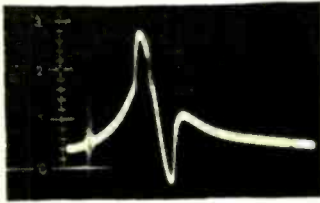

WF 1 Normal 0.3 V p-p

Taken at V1-grid-pin-2, this is response curve of the input tuned circuit. As indicated by the markers, this may not be centered at 4.5 MHz, because responses of tuned circuits farther along affect the overall response of the sound i.f. section. Amplitude may vary 30 to 50 percent. Curve shape is what's important (see Notes).

V p-p low	V p-p high	V p-p zero C1 open C2 open	 T1 mistuned up	 T1 mistuned down	 0.5 V p-p R2 open	 0.15 V p-p C4 open	 0.3 V p-p C5 open
			 0.3 V p-p C6 open	 0.25 V p-p R5 low	 0.3 V p-p R6 low	 0.2 V p-p C8 open	

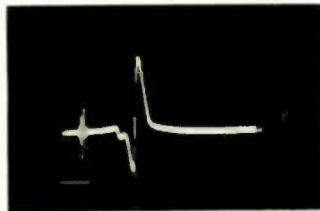

WF 2 Normal 3.0 V p-p

Taken at V1-plate-pin-3, this curve includes reflected response of L1. Also includes effect of feedback from extra turns of L1, through C5 to grid-pin-2. Still is not the shape you might expect, but note that 4.5-MHz (right-hand) marker is near center of irregular curve. The 4.08-MHz marker (left) gives you some reference from which to gauge the width of these response curves.

V p-p low	V p-p high	V p-p zero C1 open C2 open C6 shorted R2 open R3 open L1 shorted	 T1 mistuned up	 T1 mistuned down	 3.0 V p-p L1 mistuned	 2.0 V p-p R2 low	 1.5 V p-p C3 open
			 2.0 V p-p R3 low	 0.5 V p-p R3 high	 0.5 V p-p C4 open	 0.7 V p-p C4 leaky	 0.4 V p-p C5 open
			 0.5 V p-p R5 low	 0.2 V p-p R5 open	 0.2 V p-p C7 open	 0.3 V p-p R6 high	 0.3 V p-p C8 open

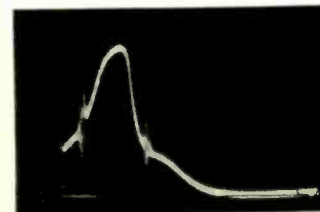



WF 3 Normal 3.5 V p-p

Taken at V2-grid-pin-1, this curve includes the response with all effects of L1. Shape is more like you might expect, combining the responses of the entire sound i.f. stage (V1). Curve is still slightly to left (down-frequency) of 4.5-MHz center, but that's normal. Don't let sweep width (on the generator) be too wide when you look at this waveform, or the curve will take an inaccurate shape.

V p-p low	V p-p high	V p-p zero C1 open C2 open C6 shorted C8 open R2 open R6 open R6 high L1 shorted	 L1 mistuned	 L1 mistuned	 3.5 V p-p R2 low	 0.5 V p-p C3 open	 1.0 V p-p C5 open
-----------	------------	----------------------------------------------------------------------------------------------------------	-----------------	-----------------	-------------------------	--------------------------	--------------------------

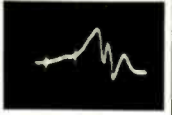

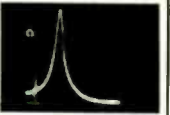
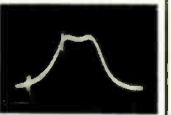
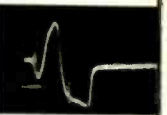

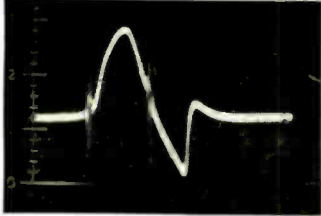

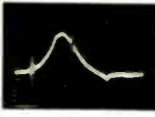

WAVEFORMS AS GUIDES

V p-p low	V p-p high	V p-p zero	 0.7 V p-p C6 open	 1.5 V p-p R4 open	 5 V p-p R5 open	 0.25 V p-p C7 open	 3.5 V p-p R6 low
-----------	------------	------------	-----------------------------------------------------------------------------------------------------------	-----------------------------------------------------------------------------------------------------------	----------------------------------------------------------------------------------------------------------	--------------------------------------------------------------------------------------------------------------	------------------------------------------------------------------------------------------------------------

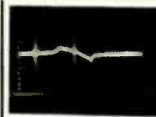

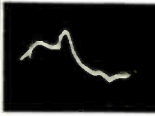
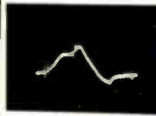
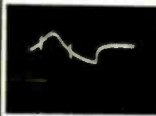
WF 4 Normal 3.0 V p-p

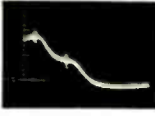



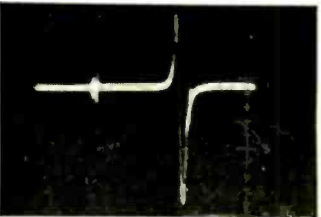







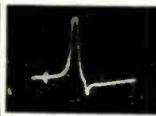

This is taken at quad-grid-pin-7. You can use a direct probe, but the shape shown here is with a demodulator probe. The 4.5-MHz marker is in the center of the slanted straight portion of the curve. The top left is rounded slightly, the bottom right is pointed. Patterns below show how mistuning L2 affects this waveform.

V p-p low	V p-p high	V p-p zero	 L1 mistuned	 L1 mistuned	 L2 mistuned	 L2 mistuned CW	 L2 mistuned CCW
		C1 open C2 open C4 open C6 shorted C7 open C7 shorted R2 open R3 open R5 open R6 open L1 open	 1.0 V p-p R3 high	 1.3 V p-p C5 open	 0.7 V p-p C6 open	 0.7 V p-p R5 high	 2.0 V p-p R5 low
			 0.5 V p-p R6 high	 2.0 V p-p C8 open	 1.5 V p-p C9 open		

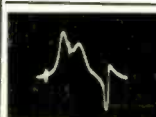

WF 5 Normal 15 V p-p

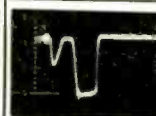
Taken following the dc-blocking capacitor at V2-plate-pin-5, this is the S-curve response of the quadrature detector. As you can see from the waveform patterns below, the shape and centering of the S-curve depends on *all* the tuned circuits in both stages. The slanted straight portion of the curve is very steep; the marker spreads itself all up and down it, making the marker somewhat indistinct.

V p-p low	V p-p high	V p-p zero	 station sound not cut off	 L2 off CCW*	 L2 off CW*	 L1 off CCW*	 L1 off CW*
		C1 open C2 open C4 open C6 shorted C10 shorted C11 open R2 open R3 open R9 open L2 open	 T1 off CCW*	 T1 off CW*	 R3 high	 C5 open	 C6 open
		 R5 high	 R5 low	 3.0 V p-p C7 open	 2.5 V p-p R6 high	 C8 open	 C9 open

NOTES: *from bottom of coil
Use this guide and the Voltages Guide to help pin down fault possibilities.
Before using this guide, carefully go through preliminary alignment of the sound i.f. section by the station-signal method (see

Quick Troubleshooting in text).
Check all five key waveforms. Readjust the scope input to suit the p-p size of each waveform.
Note amplitude. If it's low or high, check the parts listed under those columns.

Join "THE TROUBLESHOOTERS"

They get paid top salaries
for keeping today's
electronic world running

Suddenly the whole world is going electronic! And behind the microwave towers, push-button phones, computers, mobile radio, television equipment, guided missiles, etc., stand **THE TROUBLESHOOTERS**—the men needed to inspect, install, and service these modern miracles. They enjoy their work, and get well paid for it. Here's how you can join their privileged ranks—without having to quit your job or go to college in order to get the necessary training.

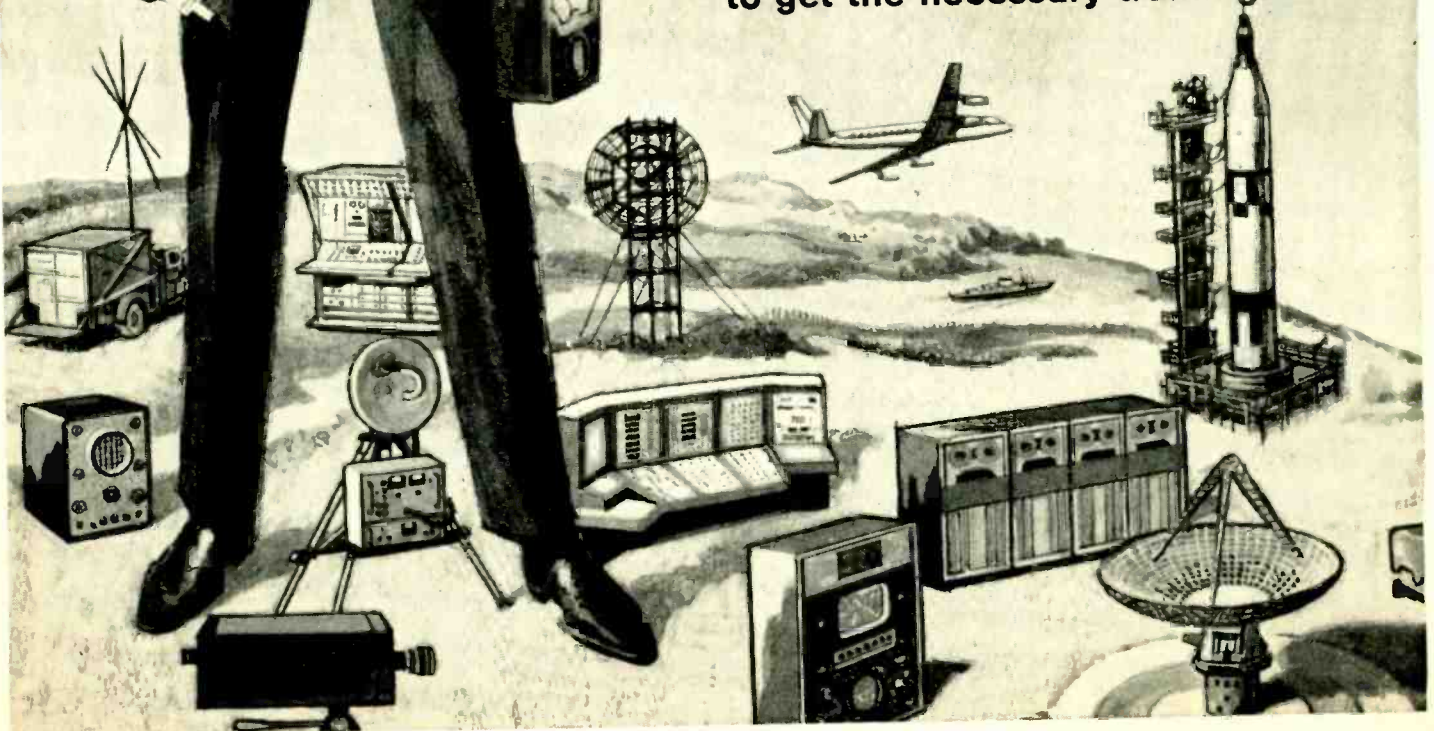

JUST THINK how much in demand you would be if you could prevent a TV station from going off the air by repairing a transmitter...keep a whole assembly line moving by fixing automated production controls...prevent a bank, an airline, or your government from making serious mistakes by servicing a computer.

Today, whole industries depend on Electronics. When breakdowns or emergencies occur, someone has got to move in, take over, and keep things running. That calls for one of a new breed of technicians—The Troubleshooters.

Because they prevent expensive mistakes or delays, they get top pay—and a title to match. At Xerox and Philco, they're called Technical Representatives. At IBM they're Customer Engineers. In radio or TV, they're the Broadcast Engineers.

What do you need to break into the ranks of The Troubleshooters? You might think you need a college degree, but you don't. What you need is know-how—the kind a good TV service technician has—only lots more.

Think With Your Head, Not Your Hands

As one of The Troubleshooters, you'll have to be ready to tackle a wide variety of electronic problems. You may not be able to dismantle what you're working on—you must be able to take it apart "in your head." You'll have to know enough Electronics to understand the engineering specs, read the wiring diagrams, and calculate how the circuits should test at any given point.

Learning all this can be much simpler than you think. In fact, you can master it without setting foot in a classroom...and without giving up your job!

For over 30 years, the Cleveland Institute of Electronics has specialized in teaching Electronics at home. We've developed special techniques that make learning easy, even if you've had trouble studying before. Our AUTO-PROGRAMMED® lessons build your knowledge as easily and solidly as you'd build a brick wall—one brick at a time. And our instruction is personal. Your teacher not only grades your work, he analyzes it to make sure you are thinking correctly. And he returns it the same day received, while everything is fresh in your mind.

Always Up-To-Date

To keep up with the latest developments, our courses are constantly being revised. This year CIE students are

NEW COLLEGE-LEVEL COURSE IN **ELECTRONICS ENGINEERING**

for men with prior experience in Electronics. Covers steady-state and transient network theory, solid state physics and circuitry pulse techniques, computer logic and mathematics through calculus. A college-level course for men already working in Electronics.

getting new lessons in Laser Theory and Application, Microminiaturization, Single Sideband Techniques, Pulse Theory and Application, and Boolean Algebra.

In addition, there is complete material on the latest troubleshooting techniques including Tandem System, Localizing through Bracketing, Equal Likelihood and Half-Split Division, and In-circuit Transistor Checking. There are special lessons on servicing two-way mobile radio equipment, a lucrative field in which many of our students have set up their own businesses.

Your FCC License—or Your Money Back!

Two-way mobile work and many other types of troubleshooting call for a Government FCC License, and our training is designed to get it for you. But even if your work doesn't require a license, it's a good idea to get one. Your FCC License will be accepted anywhere as proof of good electronics training.

And no wonder. The licensing exam is so tough that two out of three non-CIE men who take it fail. But our training is so effective that 9 out of 10 CIE graduates pass. That's why we can offer this famous warranty with confidence: If you complete a license preparation course, you get your FCC License—or your money back.

Mail Card for 2 Free Books

Want to know more? Send for our 44-page catalog describing our courses and the latest opportunities in Electronics. We'll send a special book on how to get a Government FCC License. Both are free—just mail the bound-in postpaid card. If card is missing, use coupon below.

ENROLL UNDER NEW G.I. BILL

All CIE courses are available under the new G.I. Bill. If you served on active duty since January 31, 1955, or are in service now, check box on card or coupon for G.I. Bill information.

CIE Cleveland Institute of Electronics

1776 East 17th Street, Cleveland, Ohio 44114

Cleveland Institute of Electronics

1776 East 17th Street, Cleveland, Ohio 44114

Please send me without cost or obligation:

1. Your 44-page book "How to Succeed in Electronics" describing the job opportunities in Electronics today, and how your courses can prepare me for them.

2. Your book on "How To Get A Commercial FCC License."

I am especially interested in:

- | | | |
|----------------------------------------------------|-------------------------------------------------|--------------------------------------------------|
| <input type="checkbox"/> Electronics Technology | <input type="checkbox"/> Broadcast Engineering | <input type="checkbox"/> First Class FCC License |
| <input type="checkbox"/> Electronic Communications | <input type="checkbox"/> Industrial Electronics | <input type="checkbox"/> Electronics Engineering |

Name _____ (PLEASE PRINT)

Address _____

City _____ State _____ Zip _____

Check here for G. I. Bill information.

RE-84

Putter With The Put

built around this fascinating semiconductor device

off voltage, the oscillation stops. The oscillations terminate after approximately 1 second.

The D13T can also be used as a Schmitt trigger, as shown in Fig. 17. The circuit can be considered a pnp transistor operated in the common-base mode, driving a common collector npn. With the variable resistor shorted out only linear amplification occurs. As the resistor is increased, regeneration makes the circuit perform as a Schmitt trigger.

The complementary SCR's ability to drive a load in the gate makes anti-coincidence circuit (Fig. 18) easy to implement. This circuit provides ground only to the one load selected first. If other loads are selected, the gates are reverse biased on the associated CSCR's until the first load is released. Note that two loads cannot be driven at one time since any load that is driving deprives all others of triggering voltage. Any number of loads may

be operated with this circuit at supply voltages up to 50 volts and load currents to 50mA. The 1N4156 stabistor (low-voltage reference diode) and 10K resistor provide gate trigger voltage for the CSCR, while the 1K resistor provides holding current.

A temperature-compensated battery voltage monitor using the CSCR is illustrated in Fig. 19. If battery voltage is low, trigger voltage is not applied to the C13Y gate by the voltage divider and the lamp stays off.

High current SCR triggers

Figures 20, 21 and 22 are also thyristor applications for the D13T1. Generally, it is necessary to trigger a high-current SCR from a pulse transformer secondary.

The circuit in Fig. 20 uses the slow-rising waveform on the transformer secondary to charge the 0.1- μ F capacitor through the diode. The capacitor stops charging at the peak

of the pulse. As the voltage across the secondary collapses, the D13T1 gate becomes forward biased and the device turns on. This quickly discharges the capacitor into the gate of the SCR. Measurement with a 0.1- μ F capacitor and a 20-ohm load resistor (instead of SCR gate) showed rise-times of 50 nsecs to 1 amp of pulse current.

The circuit in Fig. 20 requires that the total energy needed to trigger the SCR be delivered by the pulse transformer. Sometimes this is not possible. The circuit in Fig. 21 derives its trigger energy from the power line thereby using the pulse transformer secondary to trigger the D13T1. The voltage across C2 is initially derived through C1 and R1. When the voltage across C2 reaches the Zener breakdown voltage, the rest of the line voltage is absorbed across C1. Dissipation in the Zener diode is minimized by the time constant of R1 and C1. When a trigger pulse is applied to the transformer secondary across the D13T1 gate, the D13T1 triggers thereby discharging C2 rapidly into the SCR.

This same trigger technique can be used to convert a wide, low-amplitude pulse from a dc circuit into a sharp trigger pulse for ordinary SCR's. Figure 22 shows the arrange-

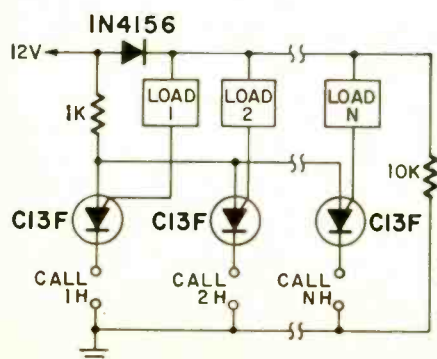
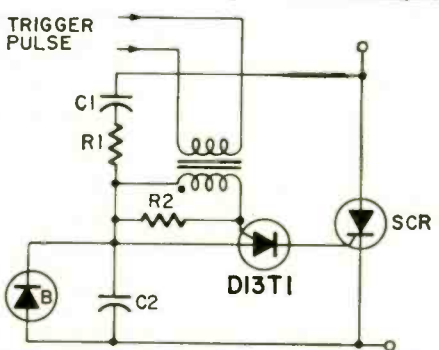
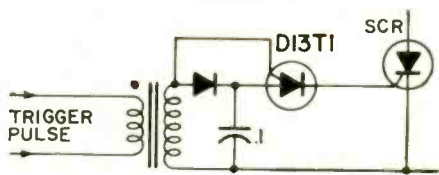
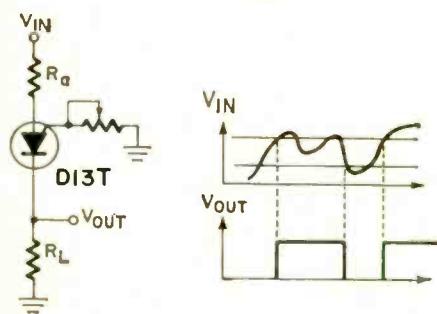
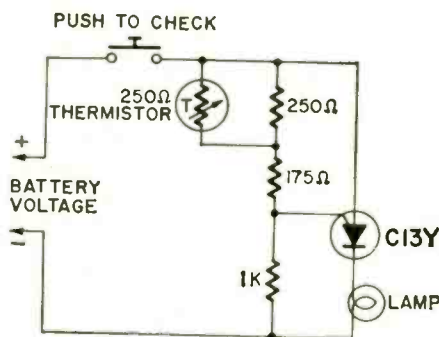
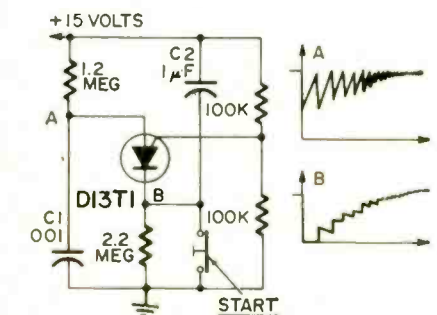

FIG. 16 (top left)—CHIRP OSCILLATOR output may be taken from PUT anode or cathode. FIG. 17 (middle left)—SIMPLE SCHMITT TRIGGER is equivalent to common-base pnp transistor driving a common-collector npn. FIG. 18 (left)—ANTI-COINCIDENCE CIRCUIT drives only the load selected first.

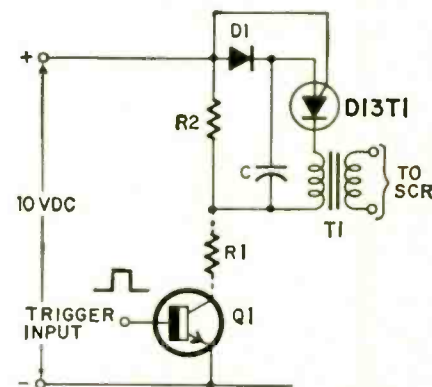

FIG. 19 (top left)—THREE-VOLT BATTERY TESTER. Temperature compensated circuit lights lamp when voltage is above about 2.5. FIG. 20 (middle left)—ISOLATED-GATE TRIGGER circuit for driving a high-current SCR. FIG. 21 (bottom left)—ISOLATED-GATE TRIGGER circuit for use when pulse transformer cannot supply total energy for SCR gate. FIG. 22 (above)—PULSE SHARPENER converts slow dc pulse into sharp a trigger for SCR's.

ment necessary. Here the dc circuit is considered as a 10-volt dc supply switched on via Q1 and R1. When Q1 is turned on, the C1, charges via diode D1. During this period, the D13T1 gate is back biased. When Q1 is switched off, the anode gate becomes forward biased via R2 and discharges C through the pulse transformer primary very rapidly. A circuit of this sort could be the interface between low-power integrated circuits such as the PA424 zero-voltage switch and high power SCR's.

CAREERS in ELECTRONICS

blueprint to your future



by **GEORGE G. GARMUS**

Kenneth E. Strandberg, at the left is manager of Technical Operations for G-E's Field Engineering Department in Phoenix, Ariz. He was interviewed by the author for this article.

Computer maintenance is really big business. Your electronic background may be all you need to get in on the ground floor.

THE EXPLOSIVE GROWTH OF THE computer industry has created numerous career opportunities for those trained in electronics. A new spectrum of technical specialties has been spawned by the computer industry in the past decade. These new specialists range from logic designers, systems engineers, programmers and input-output designers to computer field engineers. Attractive salaries, fringe benefits and job security are a common denominator of these specialties.

One of the most important and interesting jobs in the computer industry is computer systems maintenance. The electronic specialists who maintain and troubleshoot computer systems in the field are usually called field or customer engineers. Some computer manufacturers call their maintenance specialists field service engineers or representatives. However, the important fact is that computer maintenance men are responsible for keeping complex, expensive computer systems "on the air."

RADIO-ELECTRONICS zeroed-in on the facts about a career in computer maintenance by arranging an interview with an expert who maintained one of the very first commercial digital computer systems and now heads up General Electric's commercial computer maintenance training operations, Kenneth Strandberg. Ken is manager of Technical Operations for G-E's Field Engineering Department headquartered in Phoenix, Arizona.

Maintenance is a business

The role of the computer main-

tenance specialist is extremely vital. A billion dollar corporation's business activities can come to a standstill when its computer system is "down." The maintenance engineer must be able to think and act coolly under pressure while he's trying to correct a computer system problem. He must have a solid understanding of electronics, computer theory, programming and a high mechanical aptitude. Since computer systems are extremely complex he must be able to think in a logical, analytical manner.

Computer maintenance is at least a \$100 million business, ranking on par with manufacturing and sales. Most of the giant computer vendors have recognized this by establishing their computer maintenance operations as separate divisions or departments. In some instances more profit is made from maintenance contracts than from actual sales or rentals of computer systems.

The maintenance of computer systems is truly a "Big Picture" job. The typical field engineer's activities involve electronic circuit analysis, electromechanical adjustments, computer programming and analysis, complex diagnostic systems analysis, customer relations, logistics and business administration. He may, during the course of a month's activities, deal with people in design engineering, manufacturing, sales, training, programming, product planning and several levels of management at the customer's installation.

Computer maintenance is an evolving profession. The growing complexity of computer hardware and software requires special skills and insights to

achieve greater operational efficiency and reliability. Maintenance engineers are now considered an integral of the computer systems design team. Engineering courses on systems maintainability are becoming an increasingly important part of an engineering curriculum. Maintainability principles were developed by maintenance engineers. Also, maintenance engineering is now recognized as a professional specialty by engineering and trade associations such as BEMA (Business Equipment Manufacturers Association).

Qualifications for computer maintenance

The typical computer field engineer has at least 2 years of formal electronics training or armed forces training. Some of the best qualified men have had experience in the military as fire control technicians or in the army as missile systems electronic technicians. This type of training involves exposure not only to complex electronic systems but to intricate electromechanical systems as well.

The computer man must be equally skilled in maintaining both electronic and mechanical equipment. High-speed printers, magnetic and paper tape readers, card processors and similar equipment combine electronic, electrical, mechanical and electromechanical elements in their operations.

The candidate must be thoroughly familiar with pulse circuitry theory and be able to use oscilloscopes and voltmeters. He should be able to analyze complex waveforms—quickly and accurately.

When a computer system "goes down" it can be due to a number of reasons—component malfunctions or program errors. Therefore the candidate, in addition to possessing skills in electronics and mechanical aptitudes, must also have a strong talent for logical and analytical thinking. Unless he has this combination of skills he wouldn't be able to isolate the source of a computer trouble. He might spend precious minutes or hours chasing a trouble in an electronic unit—when it was actually a goof in the computer program! Or he might get hung up making adjustments on one of the high-speed printers.

He should have a clear understanding of present electronic theory and be able to read and correctly interpret



schematic diagrams. Equally important is his ability to get along with people effectively. Working under pressure at a customer's facility requires tact, empathy and integrity. Blowing up under pressure could result in having a computer system thrown out!

The computer field engineer should be a "self-starter"—requiring a minimum of supervision. Ideally, he should have many of those talents required to run your own business. That is, he recognizes the importance of time and money in his sphere of activities. He knows how to schedule the use of his time effectively.

Screening and training

At G-E, candidates are screened to determine their electronics knowledge, mechanical aptitudes and customer relations potential. He must present a personal appearance that is above average because of his constant contact with all levels of customer personnel. The candidate must be able to effectively communicate with a wide range of people, in both oral and written communications. He must be in good health and be bondable. The job interview and screening is usually done by a field engineering manager in the city in which the candidate is located. The general policy is hire candidates from cities in which they will work.

The salary ranges from approximately \$125 to \$300 per week for 40 hours. An inexperienced new trainee generally starts at the low end of the salary range. There is additional compensation at a rate of 1.5 or 2 times straight pay for overtime in excess of the straight 40 hours. The company provides life and medical insurance, sick leave and paid vacations to all field engineer reps.

The objectives of the training program are to provide the field engineer with a thorough educational program covering: data processing equipment installation and servicing; customer relations and site management.

The student's training program begins the day he becomes employed and continues through his career.

The new employee's first phase of training is an orientation period. Initially, he is assigned to work with field engineering personnel in the area where

he will be assigned for a period of 3 to 4 weeks. During this time he is familiarized with the computer maintenance business, its operations, maintenance procedures and is acquainted with the men with whom he will work.

G-E has found this is one of the most practical approaches to training computer field engineers—"seeing it the way it is." In the past, many students became confused when they thought what they learned in school didn't seem to jibe with what they saw in the field. Another benefit of this approach is that it instills a higher degree of confidence in the new student in the formal training program.

The second phase of training begins when the student reports to the Phoenix training center. His training at this time is centered around basic mechanics, diagnostic troubleshooting and equipment maintenance procedures. He works on actual computer systems and performs adjustments on electromechanical assemblies.

He is taught basic programming, computer operating methods, and is familiarized with software and typical applications programs. It is extremely important that the field engineer be able to determine why a type of trouble is causing a computing error. Is it a bug in the program? An operator goof? An electronic component malfunction? A mechanical unit out of adjustment? These are the questions that come up when a field engineer is zeroing in on a computer trouble.

The length of the student's training program ranges from 3 to 25 weeks, depending on the specific equipment to which he is initially assigned. There are an average of 12 to 14 students in each class at Phoenix. The school has an international flavor with students attending from Japan, France, Italy, Canada, Australia, Sweden, Holland and Mexico.

Upon completion of his training, the field engineer is returned to his district to assume his duties of equipment maintenance, customer relations and site management.

Continuous training and advancement

Computer technology is probably one of the fastest changing fields in engineering. Therefore, the field engineer must constantly keep his professional knowledge up to date. The experienced field engineer receives additional instruction through a comprehensive field training program. Field training is conducted at sites especially designed for the use of audio-visual training techniques. This

(turn page)

AT GE'S PHOENIX CENTER (top left) students study actual equipment to gain mastery of computer maintenance. SCOPE AND VOLTMETER (top right) combine with logical analysis to track down troubles. AUDIO AND VISUAL aids are used (2nd photo from top) to introduce actual equipment and techniques. TEAMWORK IS THE KEY (2nd from bottom) to maintaining the more complex equipment. GOOD MANUAL DEXTERITY (bottom) and a semiconductor background are prerequisites.

Photos by G-E.

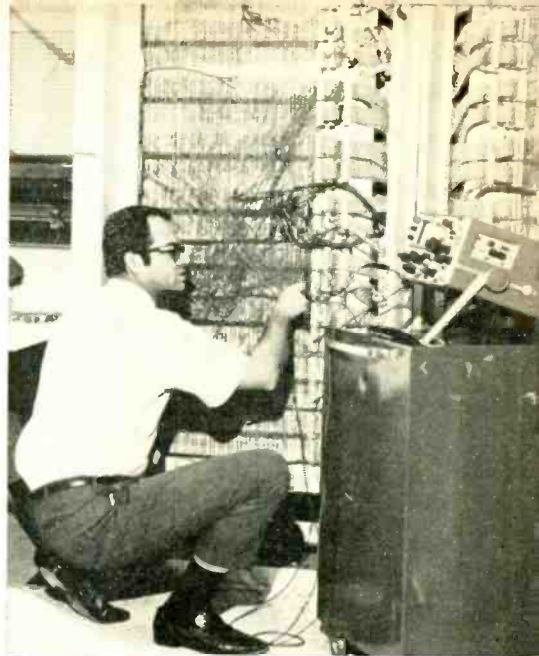

portion of his training is presented on audio tape with instruction books and associated materials. He is assisted in this period by a qualified tutor (another field engineer) who has had special training and is experienced on the equipment the student is studying.

Students return to the Phoenix training center for additional training on an average of once every 2.3 years. Special audio-visual training classes are also conducted at Phoenix for experienced field engineers. The teaching system is essentially the same used in the field training programs.

Training programs in the form of formal classes, seminars and workshops are conducted regularly in the field. "In a business such as ours where the technology is constantly changing," says Strandberg, "continued training is a must to maintain an organization of competent professionals."

There is only one criterion for advancement and this is performance. The prime factor in selecting the field engineer for promotion is how he puts his technical knowledge to work. Basically, there are two paths of advancement open to the field engineer. That of the specialist and that of management.

The field engineer progresses to specialist because of demonstrated technical, customer relations and administrative abilities. The specialist may then join the headquarters staff in technical operations where he will assist in the design and development of new equipment from the maintainability standpoint, or he may enter training operations where he will contribute to the development of new training programs.

The field engineer may proceed along the path toward a management goal, seeking a position as a district, regional or departmental manager. The path is of his own choosing and how he travels along this path depends on his ability and initiative.

The plusses for a career in com-

puter maintenance are that it is a job that uses a wide range of an individual's talents and presents an everlasting challenge to the "problem solver" . . . who also likes to work with his hands. It ties in that rare combination of dealing with very complex equipment and customer relations.

The challenge and variety of a field engineer's duties are hard to beat. Dealing with programming, sales, engineering, logistics, administrative and customer relations problems makes a field engineer's life very interesting. The status of the field engineer ranks high in the computer field and is continually improving. Good salaries and job security are another plus for a career in field engineering.

Like any profession, field engineering has its negative aspects. Working on rotating shifts is probably the most negative aspect of computer maintenance work. However, some field personnel find it to their liking. Being able to go golfing or fishing while everyone is busy at the office can be a plus to many outdoor enthusiasts. Another consideration is periodic relocation for those moving up the promotion ladder.

Computer maintenance outlook

The phenomenal growth of field engineering has increased the demand for qualified men. In 1960, there were approximately 10,000 field engineers in commercial computer systems maintenance in the entire industry. The estimated total in 1970 is about 25,000! The industry estimates that there will be a rock-bottom minimum of 50,000 required in 1980. If anything, most past estimates were entirely too light.

With the growing complexity of computer software, the use of micro-miniaturization techniques and solid-state technology, the professional requirements for field engineers will be raised to higher levels of technical competence. In all likelihood, we'll soon wit-



COMPLEX COMPUTER CIRCUITS take trained troubleshooting skills to repair.

ness the emergence of maintenance engineering majors in many college engineering programs.

There is now a trend toward developing field engineering specialists in computer software and programming. The growing complexity of computer software and the increasing use of integrated circuits is making it more difficult for the field engineer to zero in on the specific source of computer errors. Therefore, we will probably see the emergence of a team approach to computer troubleshooting. The software specialist's prime function will be to determine the most likely source of the trouble—hardware or software through rigorous diagnostic analysis. Once the basic area of the trouble is determined, the maintenance crew will then use further diagnostic techniques to isolate and correct the cause of the malfunction. **R-E**

POWER TOOLS

This issue, starting on the facing page, is the newest section of your Radio-Electronics Reference Manual. It continues the section on tools and should be inserted following the end of section one.

Other material, including nomographs, special subject reports and important reference tables and charts, will be published in this same format in future issues. Each month we will present 8 new pages for your manual. To put your book into shape, cut out the next four pages (two sheets) following the dashed lines. Then arrange the pages in the proper order (follow the numbers at the bottom of each manual page). Next fasten them together at the top.

If you wish you can purchase a special hardcover binder to keep your Reference Manual pages together. It has a dark blue fabric cover and is gold stamped Radio-Electronics Reference Manual. The cost is \$1.25, postpaid. Order from N. Estrada, 17 Slate Lane, Central Islip, N. Y. 11722.

POWER TOOLS

by **THOMAS R. HASKETT**

Unless your interest or work in electronics is very limited, you probably use power tools. They enable you to drill holes, cut a chassis or speaker-mounting hole, and sand a speaker enclosure.

Electric drills are versatile

Almost indispensable for cutting holes in metal, the common electric drill consists of a motor in a pistol-grip housing (Fig. 1). The motor

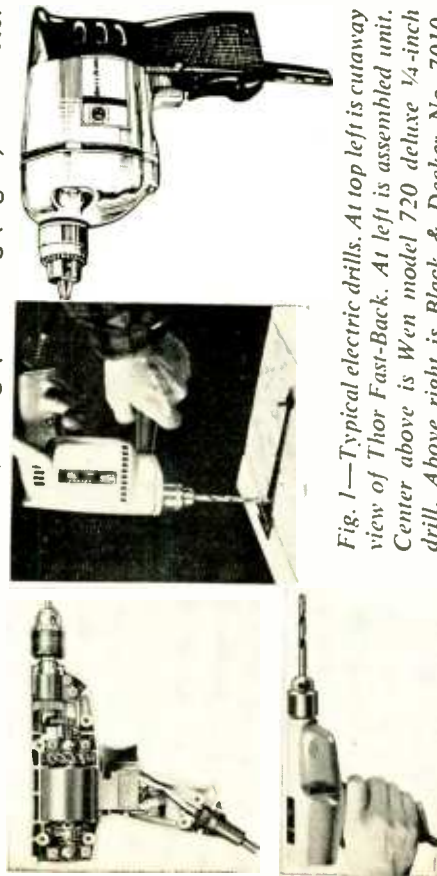

Fig. 1—Typical electric drills. At top left is cutaway view of Thor Fast-Back. At left is assembled unit. Center above is Wen model 720 deluxe 1/4-inch drill. Above right is Black & Decker No. 7010.

shaft is geared down to drive the chuck and the drill bit, which does the cutting. Most drills today have keyed chucks, which you turn with a key (furnished with the drill), causing the chuck to grip the bit. Some inexpensive drills use a knurled chuck which you twist with your hand. Such a chuck is not desirable.

Drills are rated by their chuck capacity and class of service. The three standard chuck sizes are 1/4", 3/8", and 1/2". Larger drills usually turn more slowly, since there is more work to be done. The average speed of a 1/4" drill is 2200 rpm; a 3/8" drill, 1000 rpm; and a 1/2" drill, 600 rpm. Of course, the larger drill has a larger horsepower rating, too (1/7 HP for 1/4" vs 2/5 HP for 1/2").

A standard or light-duty drill will do for general work, but a heavy-duty drill (in any of the above sizes) has a larger-horsepower motor and somewhat slower bit speed. Light-duty drills aren't intended for contin-

kit containing one each of the fractional sizes over a certain range. It's more useful to have several of the same often-used sizes, in case you break one when you can't easily obtain another.

Twist drills are made of one of two types of metal: **Carbon steel**, or **high-speed steel**. Carbon-steel (or **butter**) drills are useful only in soft materials such as wood or plastic, and don't work well in metal. High-speed twist drills, although more expensive, can be used in metal, wood, or plastic. They are marked HS or HSS.

Most drills come in standard lengths, and the length increases as the diameter of the drill does. Extra-long (**jobbers**) sizes are available, but are useful only when you have to cut a deep hole. Short shanks are better for close, precise work, as the drill is working closer in.

Normally, **straight-shank** drills are most useful, but to drill a hole larger than the chuck capacity of your drill, you may have to use a reduced-shank twist drill or bit. You don't get something for nothing, however; a reduced-shank type won't drill through as hard a material as a straight-shank model. Also, the tip tends to wobble and may cut a ragged hole. Also available are chuck adapters.

Many bits come with a quick-cut or split point; such a drill starts its own hole without walking around on the work.

The most convenient way of carrying and keeping bits is the kit mentioned previously. It has spaces for drills from perhaps 1/64" to 1/4" or 1/2". Cases are available for various size ranges.

To drill concrete or masonry, you must use a twist drill tipped with an extra-hard metal such as **carbide** or **Carbology**.

Notes on drilling

When you're drilling holes in a painted surface, cover it with masking tape or paper and lay out the hole centers with a pencil. Use a center punch first to indent the chassis; then drill through the paper and surface. Don't remove the paper until you've drilled all the holes. That way you're not as likely to mar the painted surface.

If you're drilling a hole in existing equipment, remove all glass ahead of time—vacuum tubes, meter movement, glass dial faces, etc. To prevent metal chips from clogging tube sockets and other receptacles, cover them with masking tape.

Drill holes larger than 1/4" in two or more steps. Drill a pilot hole first—say 1/8". Then enlarge it with the larger drill or reamer. For precision, cut larger holes (3/4" diameter and above) with chassis punches.

uous operation over long periods of time, and they can't be used for working thick, heavy metals without running the risk of overheating and damaging the motor. Heavy-duty drills can be used all day, and will do large jobs with ease, but they are a little bulky for small work and are more expensive than those rated for light duty.

For most chassis work, a 1/4" standard drill is adequate. A 1/2" drill is useful in construction and electrical work, and for industrial and broadcast electronics. It has a spade grip and crossbar handle for working with both hands. The 3/8" drill is something of a compromise between the other two, and usually has an auxiliary handle on the side of the case.

Some drills have a built-in **variable-speed control**, which lets you change speed to fit the hardness of the work. Some drills are **reversible**, a valuable feature when you have to back a drill out of a deep cut.

Most drills have universal motors, which will run on 117 Vac or dc. Another feature of interest is the position of the chuck key on the power cord. It's usually attached at the plug end of the cord. It should remind you to always pull the plug before changing bits. If the plug is in, a short at the trigger switch could start the motor and injure your hand.

At least one manufacturer—Black and Decker—offers a **cord-**



Fig. 2—Battery-powered drill is great for outdoors work. Unit shown here is made by Black & Decker. A rechargeable battery is used in this drill.

less or battery-powered 1/4" drill (Fig. 2). The batteries are rechargeable.

Drill bits aren't all alike

Also called **twist drills**, **drill bits** are available to cut holes from .0135" to 1". The most useful sizes for electronics work at No. 33 (to pass 4-40 screws), No. 28 (to pass 6-32 screws), No. 18 (to pass 8-32 screws), No. 11 (to pass 10-24 screws) and 1/4". Many people buy a

When drilling aluminum or brass, you can remove the burrs of these soft metals with a sharp knife. To remove burrs from a steel hole, use a countersink or a cold chisel and hammer.

Only sharp drill bits do a good job. It's not easy to sharpen bits, as the tip angle is critical. Kits are available to hold the bit at the correct angle for a grinder, but many people simply replace small bits when they become dull, and have the larger ones sharpened at a hardware store.

Drill accessories are numerous

You can extend the usefulness of any drill by acquiring special attachments designed for specific jobs. You can also buy a drill and several attachments and bits as a kit. A **wire wheel** or **cup brush** (Fig. 3) is handy for removing rust and scale, or for rough-polishing metal.

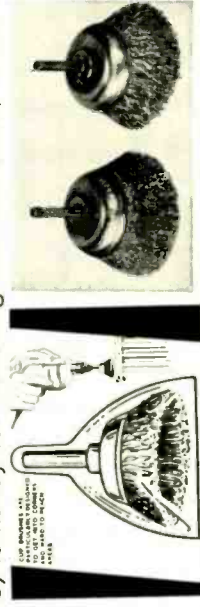

Fig. 3—Wire cup brushes are handy for removing rust and scale. Unit at left is made by Costal Abrasive. At right are brushes by Black & Decker.

Sandpaper discs and a **lambswool buffing wheel** are used with a **rubber disc** for backing. Both are handy for smoothing and polishing. A **grinding wheel** (Fig. 4) is made of abrasive stone and can be used to



Fig. 4—Grinding wheels are great for sharpening tools of all kinds. Costal Abrasive wheel is at left. Black & Decker unit is on the right. When using a grinding wheel in a hand drill, you must use a stand for the drill.

sharpen edged tools. The easiest way to perform this job is to clamp the drill body in an accessory **horizontal drill stand** (Fig. 5) and the stand in a vise. The **countersink** (Fig. 6) was mentioned above, and is used for putting a dimple in the work to take a flathead screw, as well as for cleaning the edges of a rough hole.



Fig. 5—Horizontal drill stands convert hand drill to a bench unit. Two units are shown above. At far left is Costal Abrasive stand. In the center is the Skill 45192 horizontal drill stand. Fig. 6—(above left) Costal countersinks.

To cut a hole larger than the largest drill bit you have, you can use a hole saw (Fig. 7), which comes in various sizes and uses serrated teeth to saw out the circle. It comes with an arbor and a pilot drill to start the hole. The same job can also be done with a fly or circle cutter (Fig. 8), which spins a cutting bit in a circle around the pilot drill. Unfortunately, a fly cutter is prone to wobble and cut a ragged hole.

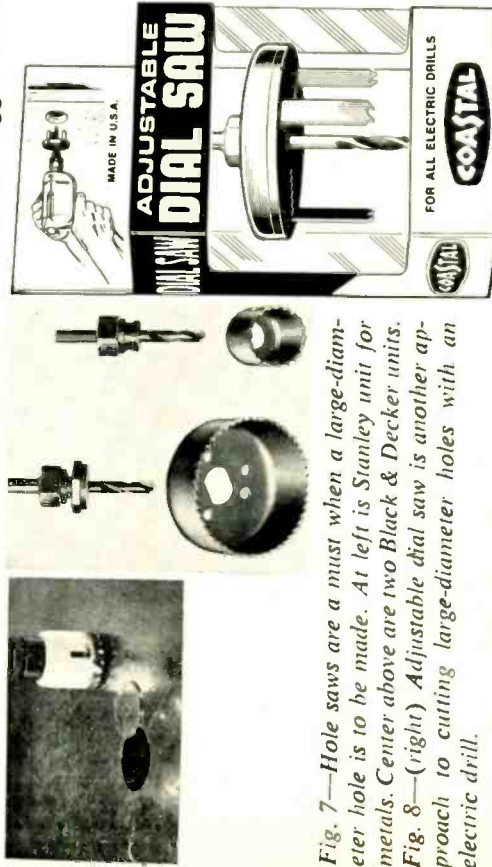

Fig. 7—Hole saws are a must when a large-diameter hole is to be made. At left is Stanley unit for metals. Center above are two Black & Decker units. Fig. 8—(right) Adjustable dial saw is another approach to cutting large-diameter holes with an electric drill.

Screwdriver bits (Fig. 9) are useful for extracting and installing tight screws when used with a special adapter.

One of the most recent additions to drill kits is the SCR speed

Less expensive saws run at a fixed speed, although some let you switch between two speeds. But it's sometimes useful to vary blade speed with work thickness, and the variable-speed saw does this job nicely.

Often a saber saw is used for cutting small curved areas and you have to turn the drill as you curve the cut. A few models are available which allow you to rotate the blade (Fig. 12) for easier curve cutting.



Fig. 12—Tilt while cutting circles makes the job a bit easier. Stanley 90486 speed-control saw is shown here.

Blades for your saber saw

A variety of blade types are made for saber saws. For scroll (curved) cutting of soft wood and plastic, thin, narrow blades are best. For straight cuts through plywood and hardwood, wider blades are used. Tougher blades with different teeth are recommended for hard, green, or wet wood. You have to use a hacksaw blade, of course, for metal. A knife blade is useful for cutting rubber, leather, tile, etc.

In any case, a coarse-toothed blade (less teeth per inch) is used for rough work, while a fine-toothed blade (more teeth per inch) is used for finish work. Most blades are about 3" long, but some are 4" or even 6", for deep work. In Fig. 13 you see the typical blade compared to the flush-cut blade. To use this type, you remove the guard at the front of the saw (it screws on) and insert the flush-cut blade in the saw. Then



Fig. 13—Saber-saw blades come in wide variety of sizes, shapes and types. There are blades for wood and metal, flush cut and standard. So pick the blade that meets your requirements. Units at left are made by Skill. Blades at right are P.A. blades.

control (Fig. 10), which gives you continuously variable speed, letting you match bit rpm to the hardness and thickness of the work. Some drill bodies are available with SCR speed control, while accessory units are made for drills not already equipped.

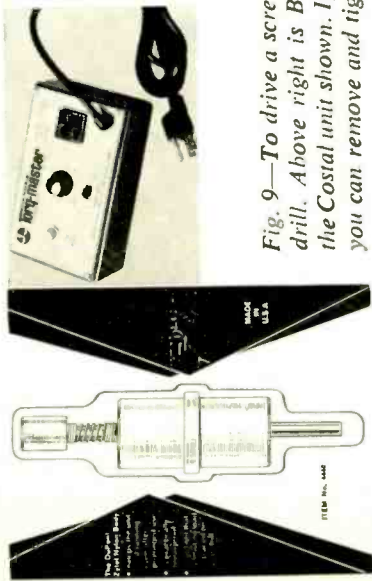

Fig. 10—Add on speed control turns most ac-powered tools into variable-speed units. Just insert control box between tool and wall outlet. Unit shown is made by Chicago Wheel.

Fig. 9—To drive a screwdriver bit with an electric drill. Above right is Black & Decker No. 7010, the Costal unit shown. If you have a reversible drill, you can remove and tighten screws with ease.

Electric saber saw

If you do any cabinet, carpentry, or chassis work, a very useful tool is the **saber saw** (Fig. 11). Also called a **portable jig saw**, it contains an electric motor which drives a reciprocating cam that moves a saw blade back and forth across a limited area. The best saws have universal motors which work on both ac and dc. The blade is in the front of the saw, on the bottom. Some models have a light above the blade so you can see where you're going.

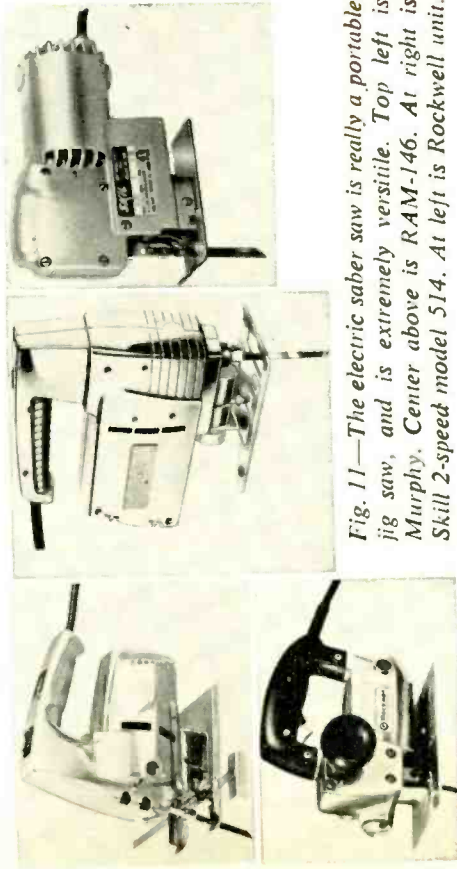

Fig. 11—The electric saber saw is really a portable jig saw, and is extremely versatile. Top left is Murphy. Center above is RAM-146. At right is Skill 2-speed model 514. At left is Rockwell unit.

you can cut up against a wall or corner.

Most saws run at a fixed speed, but **variable-speed** models are on the market. Of course, you can use most saber saws with accessory SCR speed controls.

Other power tools for you

For woodwork, cabinetry and carpentry, a **circular saw** (Fig. 14) is



Fig. 14—The circular saw is a powerful tool for all kinds of cabinetry and carpentry. It is not often used by a technician but should be a part of most power-tool kits. From left to right are the Ram Industrial Power Saw, the Rockwell Speedmatic, and the Thor E-732.

essential. It guides itself through a straight cut, can make cuts at a varying vertical angle, and cuts fast. Several blade types are used—**rip**, **crosscut**, **combination**—depending on whether you're making a rough or finish cut with or against the grain of the wood.

An **electric hand grinder** is useful for chassis and hobby work where you wish to do grinding, buffing, and shaping. The kit usually includes wheels and bits of several shapes and grits. You can deburr, carve, rout, and sand small areas with this tool.

A **bench grinder** is simply a bench-mounted grinding wheel about 6" in diameter for keeping edged tools sharp. Unless you have frequent need for this tool, you can probably get by with a grinding wheel and your hand drill.

It's a good idea to mark your tools for identification to prevent mistakes when lending or borrowing them. Using a sharp awl or pick is tedious; much easier is Dremel's Electric Engraver. This handy little tool is a small vibrator with a hard point. A variable control lets you adjust stroke length for the depth of cut you want and the hardness of the material. The tool cuts metal, ceramic, and glass.

More specialized tools exist—such as routers—but are seldom used in electronics.

R-E

New FM tuner

One IC replaces entire I.F. strip

- From rf to audio
- No tuned circuits
- Narrow bandpass
- High linearity
- Low distortion
- Phase-locked loop

An old circuit in a new IC may spell revolution in many radio circuits

by **LARRY STECKLER**
MANAGING EDITOR

A new kind of IC, a phase-locked-loop (PLL) has been developed by Signetics and Motorola. Other units by other manufacturers are soon to follow. This new unit makes it possible to replace tuned circuits in i.f. strips, demodulators, and other inductor-dependent circuits with an IC arrangement that completely eliminates the need for coils or transformers.

Shown on our cover this month is an FM tuner built around one of the Signetics IC's. It consists of a conventional FM front end of the type used in stereo FM tuners, which is coupled to a PLL IC. This IC takes the 10.7-MHZ output from the front end and converts it to audio. While the quality of this circuit is not equal to the performance of a conventional stereo tuner, it opens the door to a new approach to FM.

The PLL will likely find its way into many types of electronic equipment such as radio receivers, appliances, TV sets, tape recorders. Commercial uses include signal generators, detecting and decoding of tones, etc.

One major advantage of PLL in FM tuners is that mistuning and drift are eliminated. The PLL locks onto a station and its built-in VCO (voltage-controlled oscillator) keeps it on station.

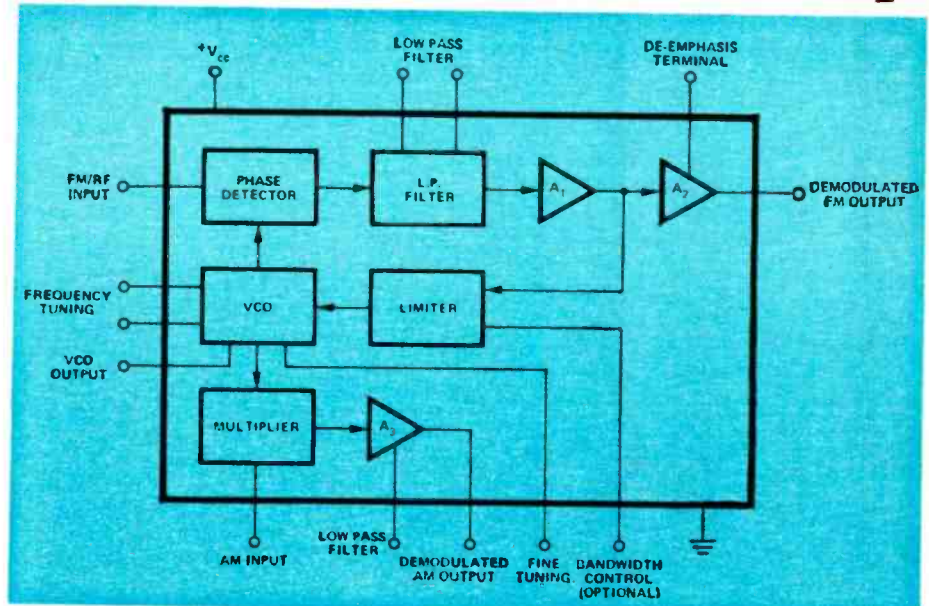

PLL in itself, is not a new idea. It has been used for several years to track satellites, stabilize the frequency of klystrons, and filter information out of noise. Unfortunately, in its discrete-component form the circuit is too costly and complicated to be used in consumer electronics.

As an IC, however, even the cost of this complex circuit is low, and we are likely to find the PLL appearing in many new kinds of equipment.

As shown in Fig. 1, the PLL is made up of four basic sections—the phase comparator, the low-pass filter, the amplifier, and a voltage controlled oscillator (VCO).

The phase comparator is a multiplier that mixes the input signal with the VCO signal to produce sum and difference frequencies

$f_s \pm f_o$. When the loop is in lock, the VCO duplicates the input frequency and the difference frequency ($f_s - f_o$) is zero. At this time, the output of the phase comparator contains a dc component.

The output of the comparator is filtered to remove the sum frequency component ($f_s + f_o$), while the remaining dc component is amplified and fed back to the VCO. It is this error voltage that drives the VCO keep f_s equal to f_o when the loop is in lock. The size of this error voltage is a direct function of the phase relationship between the VCO and the input signals.

If you want to see how error voltage is affected by the phase difference between the two signals, take a look at Fig. 2. Here the VCO signal is a square wave. When the loop is out of lock, and the differ-

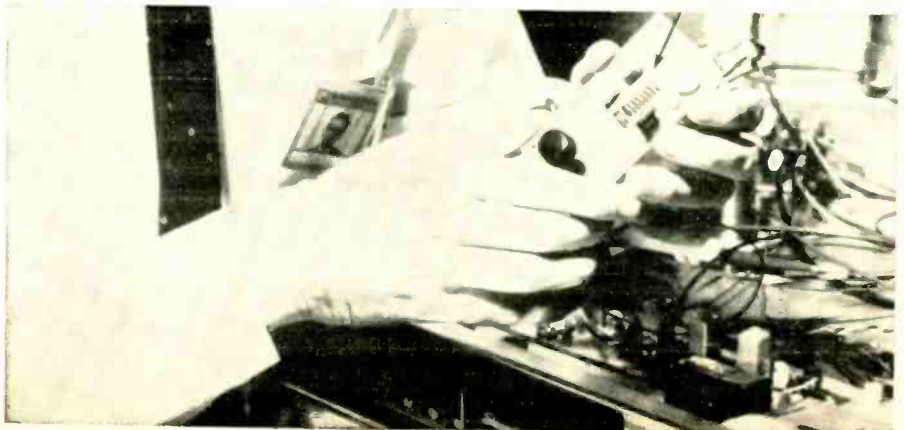

ence between f_i and f_o is large, both sum and difference signals are filtered by the low-pass filter and the VCO runs at its preset frequency.

But as the difference between f_i and f_o approaches the cutoff frequency of the low-pass filter, a beat note forms which tends to force the VCO frequency toward the input frequency. When this dc component of the beat note grows large enough, the VCO frequency reaches the input frequency and the loop locks. Therefore, lock sensitivity is a function of the lowpass filter. Once in lock, the loop will track signals over its entire lock range.

PLL applications

Some of the expected applications for PLL IC's include FM demodulation in FM tuners, FM telemetry and telephony, frequency-shift keying (FSK), and store-casting music (SCA) detection.

Other potential uses are in signal conditioning where the PLL can be used to filter unwanted sidebands from the input signal. The useful PLL output in this kind of application is from the VCO output signal.

Frequency multiplication is another application. For low orders of multiplication with small FM deviations the loop can be simply locked to a harmonic of the input signal. For very wide FM deviations or higher multiplication, the loop can be broken between the VCO and the phase comparator, and a frequency divider inserted. Now, when the circuit is in lock, the output of

the divider is at the same frequency as the input signal and the VCO runs at a multiple of this frequency, thus forming a precise frequency multiplier which tracks the input signal over a wide range.

Some circuits to try

Now let's take a look at some of the practical ways we can expect to use a PLL right now. In each of the four examples that follow, a Signetics SE/NE565 IC is used.

FM demodulation

The 565IC phase Locked Loop is a general-purpose circuit designed for high-linearity FM demodulation. During lock, the average dc level of the phase comparator output signal is directly proportional to the frequency of the input signal. As the input frequency shifts, it is this output signal which causes the VCO to shift its frequency to match that of the input. Consequently, the linearity of the phase comparator output with frequency is determined by the voltage-to-frequency function of the VCO.

Because of its unique and highly linear VCO, the PLL can lock to and track an input signal over a very wide range (typically $\pm 60\%$) with very high linearity (typically within 0.5%).

A typical FM demodulator circuit is shown in Fig. 3. The VCO free-running frequency is represented approximately by $f_o = 1/4R1C1$, and should be adjusted to be at the center of the input signal frequency range. Capacitor C1 can be any value, but resistor R1 should be within the range of 2000 to 20,000 ohms with an optimum value in the order of 4000 ohms. The source can be direct coupled if the dc resistances seen from pins 2 and 3 are equal and there is no dc voltage difference between the pins.

FIG. 1—PLL BLOCK DIAGRAM (below) illustrates basic operation of the phase-lock-loop.

FIG. 2—CORRECTION SIGNALS (left) are developed as shown here.

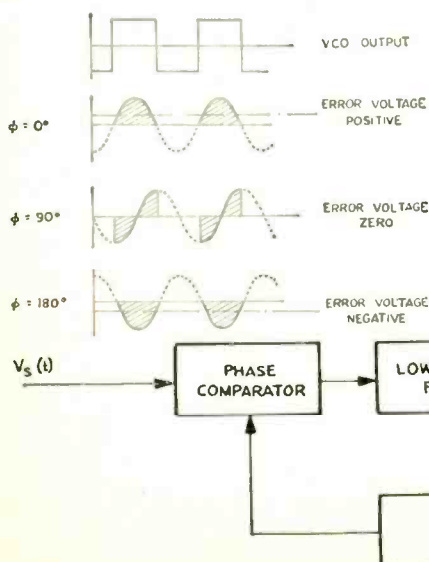

A short between pins 4 and 5 connects the VCO to the phase comparator. Pin 6 provides a dc reference voltage that is close to the dc potential of the demodulated output (pin 7). Thus, if a resistance is connected between pins 6 and 7, the gain of the output stage can be reduced with little change in the dc voltage level at the output. This allows the lock range to be decreased with little change in the free-running frequency.

In this manner the lock range can be decreased from $\pm 20\%$ of f_o (at $\pm 6V$).

A small capacitor (typically 0.0001 μ F) should be connected between pins 7 and 8 to eliminate possible oscillation in the control current source.

A single-pole loop filter is formed by capacitor C2, connected between pin 7 and positive supply, and resistance inside the IC of approximately 3600 ohms.

Frequency shift keying

FSK (frequency-shift keying) refers to data transmission by means of a carrier which is shifted between two preset frequencies. This frequency shift is usually handled by driving a VCO with the binary data signal so that the two resulting frequencies correspond to the "O" and "I" states (commonly called space and mark) of the binary data signal.

A simple circuit using the PLL to receive FSK signals of 1070 Hz and 1270 Hz is shown in Fig. 4. As the signal appears at the input, the loop locks to the input frequency and tracks it between the two frequencies with a corresponding dc shift at the output.

Loop filter capacitor C2 is chosen smaller than usual to eliminate overshoot on the output pulse, and a three-stage RC ladder filter is used to remove the carrier component from the output. The band

FIG. 3—FM DEMODULATOR using the PLL IC. Experimenters will enjoy this one.

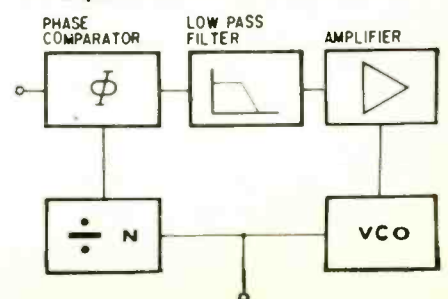

edge of the ladder filter is set approximately half way between the maximum keying rate (in this case 150 Hz) and twice the input frequency (approximately 2200 Hz). The output signal can now be made logic compatible by connecting a voltage comparator between the output and pin 6 of the loop. The free-running frequency is adjusted with RI to result in a slightly-positive voltage at the output when $f_{in} = 1070\text{Hz}$.

The input connection is typical for cases where a dc voltage is present at the source and therefore a direct connection is not desirable. Both input terminals are returned to ground with identical resistors (in this case, the values are chosen to effect a 600 ohm input impedance).

Frequency multiplication

There are two methods of doing this using the 565:

1. Locking to a harmonic of the input signal.
2. Including a digital frequency divider or counter in the loop between the VCO and phase comparator.

The first method is the simplest, and is used by setting the free-running frequency of the VCO to a multiple of the input frequency. A limitation to this scheme is that the lock range decreases as successively higher and weaker harmonics are used for locking. If the input frequency is to be constant with little tracking required, the loop can generally be locked to any one of the first 5 harmonics. For higher orders of multiplication, or for cases where a large lock range is desired, the second scheme is more desirable. An example of this might be where the input signal varies over a wide frequency range and a large multiple of the input frequency is required.

FIG. 4—FREQUENCY SHIFT KEYING is easily handled by a PLL in the circuit below. FIG. 7—SCA DECODER (bottom right) is another circuit that the PLL simplifies.

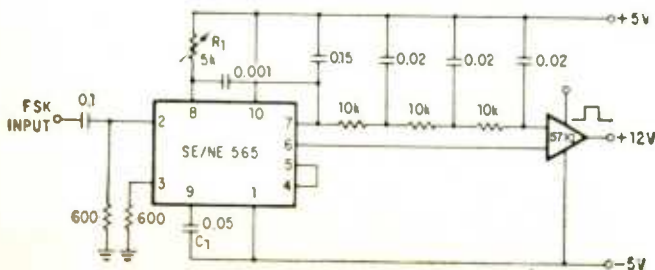

A block diagram of the second scheme is shown in Fig 5. Here the loop is broken between the VCO and the phase comparator, and a frequency divider is inserted. The fundamental of the divided VCO frequency is locked to the input frequency in this case, so that the VCO is actually running at a multiple of the input frequency. The amount of multiplication is determined by the frequency divider.

A typical circuit is shown in Fig. 6. To set up the circuit, the frequency limits of the input signal must be determined. The free-running frequency of the VCO is then adjusted by means of RI and CI (as discussed under FM demodulation) so the output frequency of the divider is midway between the input frequency limits. Filter capacitor C2 can be neglected, in this case, since it is generally desirable to have the capture and lock ranges as large as possible. The output can now be taken as the VCO square-wave output, and its fundamental will be the desired multiple of the

input frequency as long as the loop is in lock.

SCA decoder

Some FM stations are authorized by the FCC to broadcast uninterrupted background music for commercial use. To do this, a frequency modulated 67-kHz subcarrier is used.

The SCA signal can be filtered out and demodulated with the NE565 PLL without the use of any resonant circuits. A circuit for this application is in Fig. 7. This circuit

also serves as an example of operation from a single power supply.

A resistive voltage divider is used to establish a bias voltage for the input (pins 2 and 3). The demodulated (multiplex) FM signal is fed to the input through a two-stage high-pass filter, both to effect capacitive coupling and to attenuate the strong signal of the regular channel. A total signal amplitude, between 80 mV and 300 mV, is required at the input. Its source should have an impedance of less than 10,000 ohms.

The PLL is tuned to 67 kHz with a 5000 ohm potentiometer. Only approximate tuning is required, since the loop will seek the signal.

The demodulated output (pin 7) passes through a three-stage low-pass filter to provide de-emphasis and attenuate the high-frequency noise which often accompanies SCA transmission. Note that no capacitor is provided directly at pin 7. Thus, the circuit is operating as a first-order loop. The demodulated output signal is about 50 mV and the frequency response extends to 7 kHz.

R-E

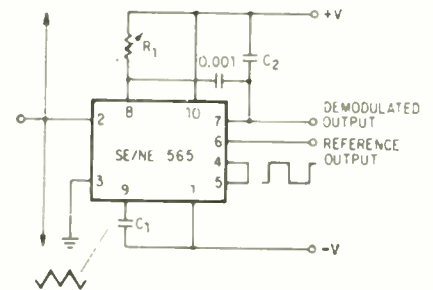
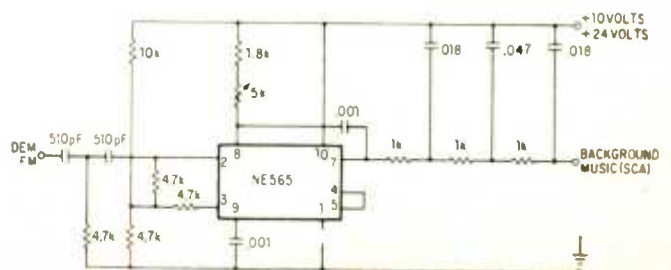
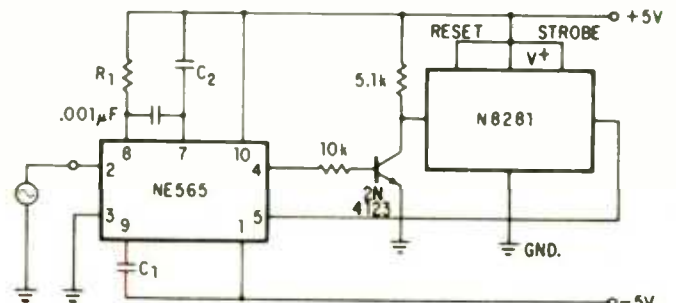
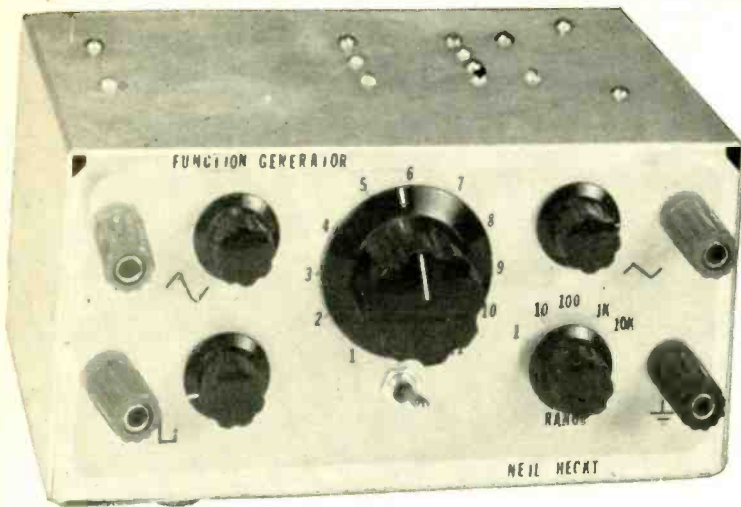

FIG. 5—(above) FREQUENCY MULTIPLIER that can be built around the PLL IC. FIG. 6—(below) ANOTHER FREQUENCY MULTIPLIER circuit variation.





Build with IC's

3-way

■ Sinewaves

by NEIL HECKT

For about \$40.00 this wide-range function generator will prove a most valuable addition to the work bench of the electronic experimenter or audiophile. It provides sine waves, triangle waves, and square waves simultaneously, from 1 to 110,000 Hz. Each output amplitude is constant regardless of frequency, and adjustable from zero to twenty volts P-P or more. Tuning is variable over one decade, with ten percent overlap on each range. A range selector provides five decade multiples of the vernier tuning.

The heart of the generator is three Motorola MC1709CG integrated-circuit operational amplifiers. Each contains the equivalent of 13 transistors, 2 diodes, and 15 resistors in a standard TO-5 package.

Theory of operation

The unit (Fig. 1) can be divided into three major parts. The oscillator sine-wave converter, and output amplifiers. The oscillator is a form of relaxation circuit called a hysteresis oscillator. It is composed of two integrated-circuit operational amplifiers IC and IC2.

Integrated circuit IC2 is connected as a voltage comparator with hysteresis feedback. Because of the high gain of the amplifier, if the non-inverting (+) terminal is slightly more positive than the inverting (-) terminal, the output will be the positive saturation level of +14 volts. Conversely, if the non-inverting input is more negative, the output will be the

negative saturation level, -14 volts.

Assuming the output is +14 volts, positive feedback applied to the non-inverting input via R9, keeps the amplifier latched in the positive saturation state. An increasingly negative voltage is applied to the input resistor R7. The ratio of R7 and R9 is such, that when the input reaches -10 volts, it cancels the +14 volt feedback. As the input goes slightly more negative, the amplifier switches to the negative saturation level. It remains in that state until the input exceeds +10 volts when a similar, but opposite reaction occurs causing the amplifier to latch again at the positive level.

Integrated circuit IC1 is connected as an integrator. If a positive voltage (E_{in}) is applied to the input resistor, R5, the output will try to swing negative. The voltage across the timing capacitor C_1 , (C1-C5) cannot change instantaneously, however, and the negative output thru the capacitor cancels out the positive input in an attempt to maintain the inverting terminal at zero volts. The cancelling current charges the capacitor at a linear rate toward -14 volts at $E_{in}/R5C_1$ volts per second. The opposite effect is true of negative inputs.

If comparator IC2 is latched in the +14-volt state, and some portion of the +14 volts is applied to the integrator input resistor, the integrator output will run down linearly toward -14 volts. Since the integrator output is connected to the comparator input, the comparator will switch to -14 volts when the integrator output equals -10 volts. This applies the opposite polarity to the integrator, and its output runs up linearly toward +14 volts. At +10 volts the comparator switches back to +14 volts com-

pleting one cycle. The cycle then repeats and the circuit oscillates at a constant rate.

The frequency of oscillation is a function of the applied voltage to the integrator (E_{in}), the integrator input resistor (R5), the feedback capacitor (C_1), and the trigger levels of the comparator ($E_o \text{ max}$) according to $F = E_{in}/4 E_o \text{ max} \times R5 \times C_1$. $E_o \text{ max}$ is set at 10 volts, R5 is 25,000 ohms, therefore $F = E_{in}/C_1$ where C_1 is in μf . Resistors R1, R2 and R3 are chosen to provide E_{in} from \pm to ± 11 volts, and C_1 is switched from 1 μF to 100 PF providing frequencies from 1 Hz to 110,000 Hz.

The output from the comparator is a 28-volt p-p square wave while the output of the integrator is a triangle of 20 volts p-p. The triangle wave output of the integrator is converted to a sine wave by the non-linear resistor/diode network R15-R30 and D7-D14.

Assuming the input to R29 and output across R30 are both zero initially, all the diodes are reverse biased by the bias voltage divider R15-R24. If the triangle wave is rising linearly toward +10 volts, its slope is reduced at the output by the voltage dividing action of R29 and R30. When the output reaches the bias level of D10, R25 is switched in parallel with R30, further reducing the slope. As the output increases still more, diodes D9, D8 and D7 conduct in turn (Fig. 2), each reducing the output slope by switching in R26, R27 and R28. The input triangle is therefore "distorted" into a quarter sine wave. As the triangle voltage decreases back toward zero, each diode is cutoff in reverse order to produce the second quarter sine wave. For negative half-cycles,

Waveform Generator

■ Squarewaves

■ Triangular waves

Add this solid-state waveform generator to your electronic workbench. 3 IC's keep it simple

PARTS LISTS

All resistors 1/2 watt, 10% unless noted

- R1—750 ohms
- R2—potentiometer, 2500 ohms, linear taper
- R3—270 ohms
- R4—22,000 ohms
- R5—27,000 ohms
- R6, R34—1500 ohms
- R7—10,000 ohms
- R8—5600 ohms
- R9—15,000 ohms
- R10, R35—potentiometer, 10,000 ohms, linear taper
- R11, R12, R31, R36, R37, R40, R41—100,000 ohms
- R13, R14, R38, R39, R42, R43—470ohms
- R15, R24—1000 ohms
- R16, R23—39 ohms
- R17, R22—68 ohms
- R18, R21—120 ohms
- R19, R20—220 ohms
- R25—47,000 ohms
- R26—18,000 ohms
- R27—10,000 ohms
- R28—510 ohms
- R29—27,000 ohms
- R30—potentiometer, 25,000 ohms, linear taper
- R32—68,000 ohms
- R33—82,000 ohms
- R44, R45—51 ohms, 2 ohms, 5%
- R46, R47—3.9 ohms, 3 watts
- C1—100 pF
- C6, C9—10 pF
- C2—0.01 μF
- C3—0.01 μF
- C4—0.1 μF
- C5—1.0 μF
- C7, C8—15 pF
- C10, C11—1000 μF, 30 volts, electrolytic
- C12—0.0056 μF
- J1, J2, J3, J4—4-way jacks
- T1—transformer, 118-volt primary, 40-volt center-tapped secondary, 1 amp
- BR1—full-wave bridge rectifier, 100 pIV, 1A or four 1N4004 or similar diodes
- D1 to D14—1N914
- Q1, Q3, Q5—2N4123
- Q2, Q4, Q6—2N4125
- IC1, IC2, IC3—MC1709CG IC op amp
- Miscellaneous: 6" x 4" x 3" utility box, knobs, stand-off terminals, hookup wire.

- D1 TO D14—1N914
- Q1, Q3, Q5—2N4123
- Q2, Q4, Q6—2N4125
- BR1—MDA 920A-3
- IC1, IC2, IC3—MC1709CG

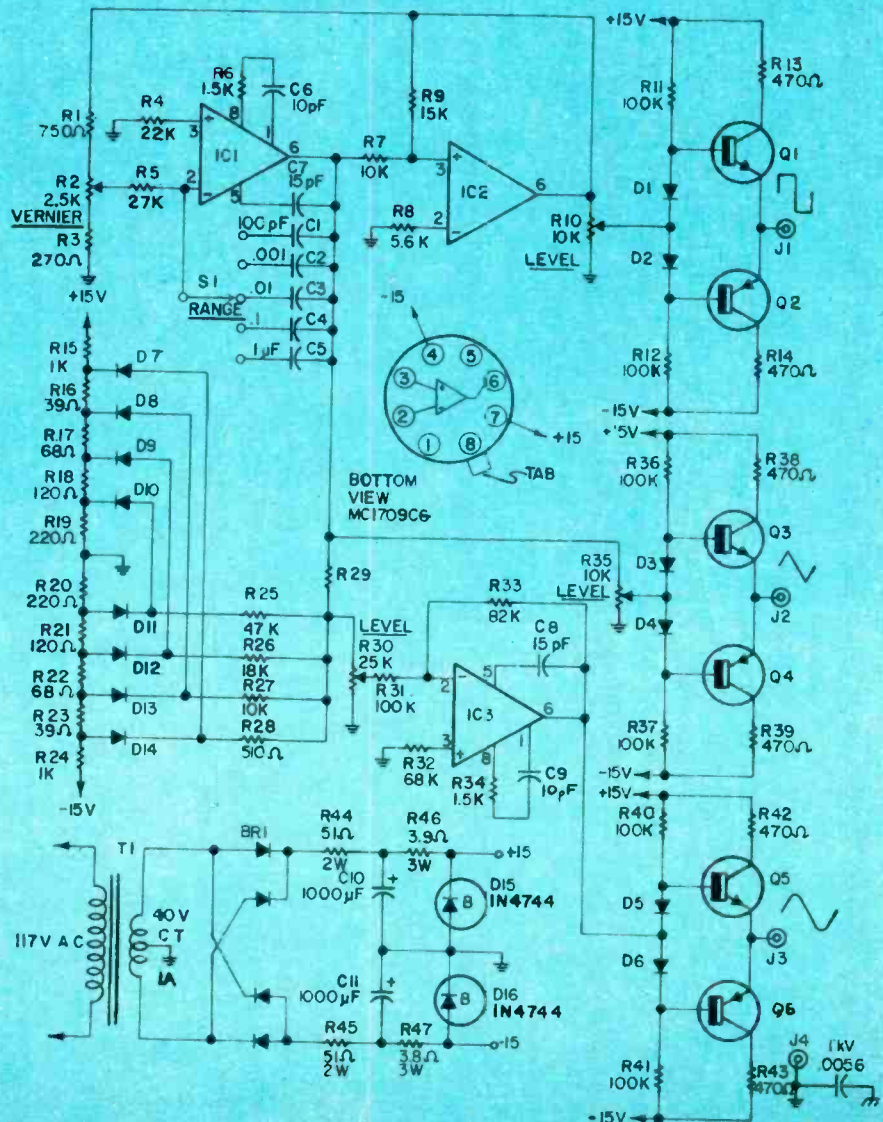

COMPLETE CIRCUIT OF WAVEFORM GENERATOR. Regulated power supply delivers +15 and -15 volts. Three IC amplifiers simplify construction drastically.

(continued on page 68)

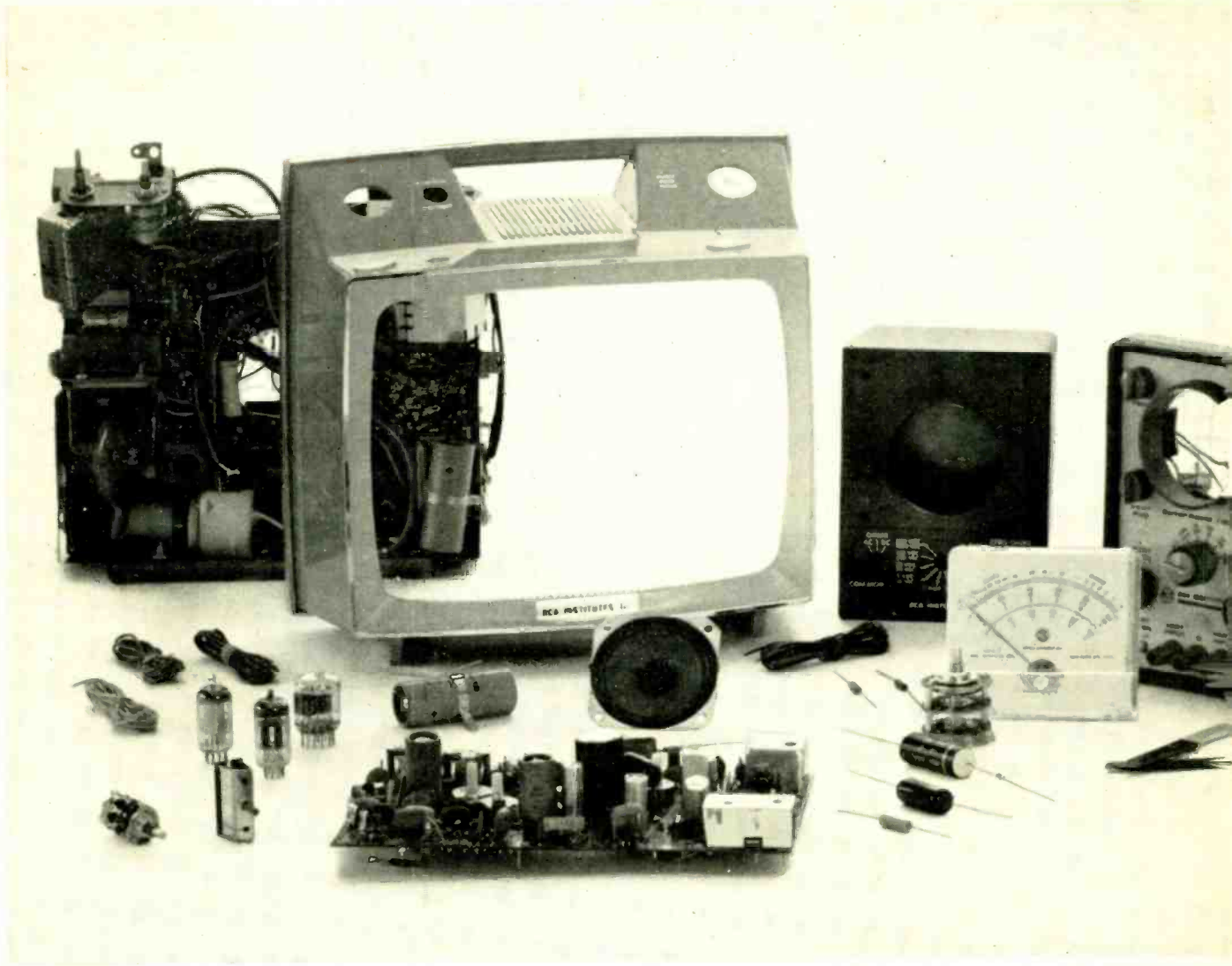

**Look! You get 25 kits...
more than ever before at no extra
cost...for your practical "hands-
on" learning of electronics and
TV with RCA Institutes Home
Training! Send postcard today!**

RCA



Now, RCA supplies 25 kits in its home-study career program—at no extra cost! Be sure to compare this with other home-study electronics programs. And note, you never have to take apart one kit to build another piece of equipment because there are literally thousands of parts making up the kits. Information on them is included in the catalogue which you'll get when you mail in the reply postcard or the coupon.

Absolutely practical, your kits are used to build such permanent, professional and useful equipment as an oscilloscope, a signal generator, a multimeter, and a fully transistorized breadboard superheterodyne AM receiver. They will give you years of valuable service.

In addition, an easy way to learn—the career programs are all based on the easy, step-by-step AUTOTEXT method. AUTOTEXT is unique and exclusive with RCA Institutes. Math and circuitry problems simply melt away! So check the wide range of electronics and TV career programs.

Eleven Career Programs: Television Servicing (including color TV and

CATV) • FCC License Preparation • Automation Electronics • Automatic Controls • Industrial Electronics • Nuclear Instrumentation • Electronics Drafting • *including these four all-new:* Semiconductor Electronics • Digital Electronics • Solid State Technology • Communications Electronics.

Also check the new Computer Programming course—trains you to work on today's largest data processing systems including IBM/360 and RCA Spectra 70, the Third Generation Computers.

You get tuition plans as flexible as you wish: pay-as-you-order or pay-by-the-month...you choose! No interest charges! No other electronics home study school offers both these choices.

Classroom training also available—day and evening coeducational classes start four times a year. No previous training required—you can take preparatory courses if you haven't completed high school.

Placement service, too—with RCA Institutes classroom training, you get the full benefits of the RCA Job Placement Service. RCA Institutes grad-

uates are now with companies that include Bell Telephone, GE, Honeywell, IBM, RCA, Westinghouse, Xerox, and major radio/TV networks. This placement service is also available to Home Study Graduates.

Veterans: enroll now—all courses are approved under the GI bill

Accredited Member National Home Study Council.

If reply postcard has been removed, mail this coupon.

•••••
• RCA INSTITUTES, INC.
• Home Study Dept. 758-011-0
• 320 West 31 Street, New York, N.Y. 10001

• Please send me free illustrated career catalog.

• Age _____

• Name _____
(please print)

• Address _____

• City _____

• State _____ Zip _____

• For GI information, check here

•••••

3-WAY GENERATOR
(continued from page 63)

diodes D11-D14 are cut in in a similar manner. The points at which the slope changes are not sharp, but are rounded by the non-linear forward resistance characteristics of the diodes as the current thru them increases.

The output of the converter is about 10 volts p-p. Operational amplifier IC3 is connected to give a gain of 2 so that 20 volts p-p are available.

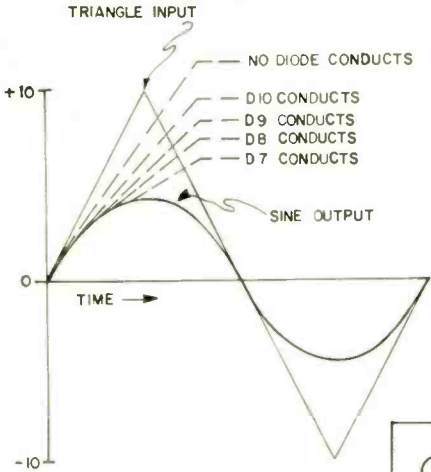

FIG. 2—DIODES MAKE A SINE WAVE out of a triangular wave.

INSIDE THE GENERATOR (top right) you can see how parts are set up.

PRINTED-CIRCUIT PATTERN (right) is half actual size.

PARTS LAYOUT (below) shows component location on the circuit board.

There are three output drives, one for each waveform. They consist of complementary emitter followers. Diodes, such as D1 and D2, compensate for the base-to-emitter drop of the transistors. For positive inputs, the npn transistor supplies the current to the load, and for negative inputs the pnp supplies the current. The 470-ohm resistors limit the current to prevent damage to the transistors, as well as provide an output impedance of about 500 ohms.

Construction techniques

A 3 x 4 x 6-inch chassis, such as a Bud AC-430 with BPA-1505 bottom plate makes an economical, compact cabinet. Mount power supply components on the inside top of the chassis box using insulated standoff terminals (Grayhill type 18-1 or similar). Mount all controls and binding posts symmetrically on one 3 x 6-inch face. After all components have been mounted in the chassis and on the PC board, connect the two thru twisted

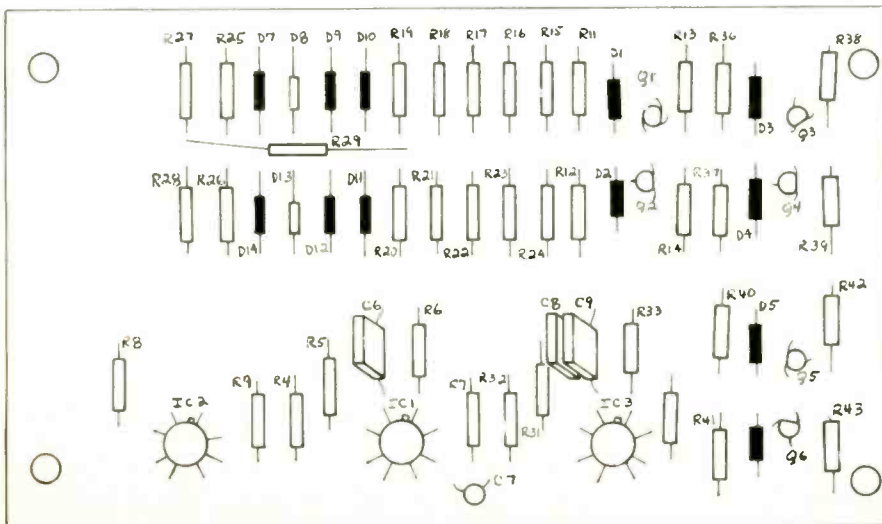
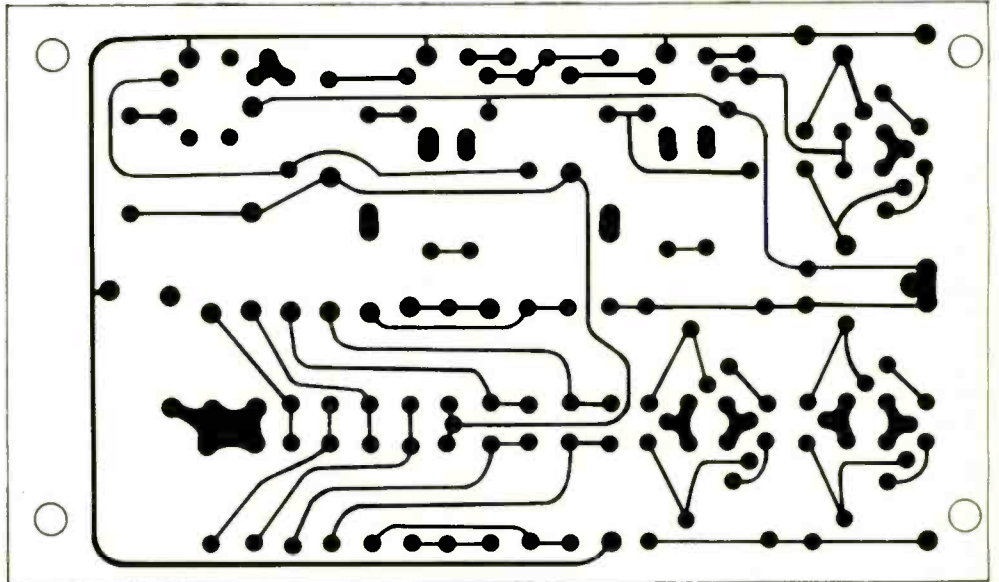
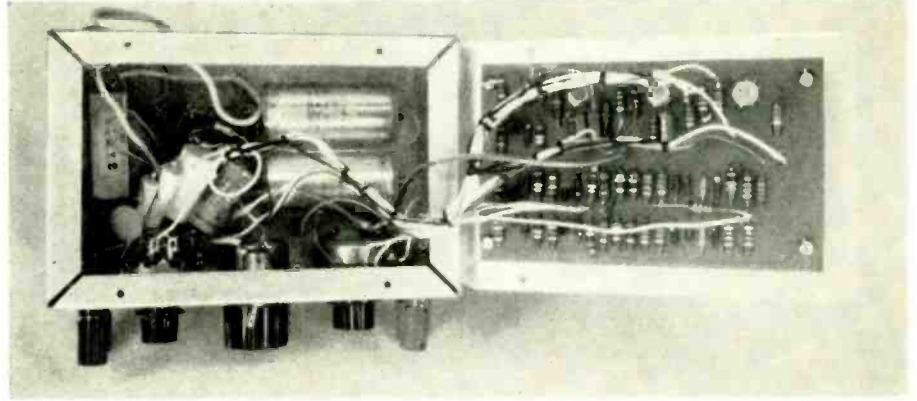

pairs of wires as per the wiring list.

Resistor R1 is connected from the top of R10 to the top of R2, and resistor R3 is connected from the bottom of R2 to the ground post.

The completed PC board is attached to the center of the bottom plate with 1/4-inch spacers.

The completed unit should be checked for proper operation. Notice there are no adjustments to be made. If all components are good, and the wiring is correct, the unit will function immediately.

After checkout is completed, fold the PC board up into the chassis in a manner similar to closing a book. Attach the bottom plate with four 1/4-inch No. 6 self-tapping screws. **R-E**

30 IC CIRCUITS

(continued from page 40)

The close parameter matching and tight thermal coupling of the CA3018's transistors result in exceptionally stable operation when they are used in the dc differential mode as a meter amplifier. The device outperforms conventional units in this type of application.

Fig. 24 shows how to connect the IC so it effectively increases the sensitivity of a 100- μ A meter to 1 μ A. Transistors Q3-Q4 and Q1-Q2 are wired in the differential mode as Super-Alpha emitter followers, with emitter loads R6 and R7 and with bias set by bridge network R1-R2-R3-R4. Resistors R5 and R9 enable the bridge bias network to be precisely balanced. Resistor R8 permits balancing the two emitter loads so the meter (connected between the emitters of the two emitter followers) reads zero when zero input is connected between the input terminals (pins 9 and 6) of the unit.

The emitter-follower actions of the circuit cause the design to deliver high current gain, but zero voltage gain, between the input terminals and the actual meter. The basic circuit gives a current gain of approximately 1000 times. This gain is subject to some variation with changes in ambient temperature.

In the interest of stability the actual gain of the circuit is reduced to only 100 by connecting SENSITIVITY control R10 across the input terminals.

To set up the circuit:

1. Set R10 (SENSITIVITY) to maximum, and R9 at mid-range. Short the input terminals, and adjust R8 for a zero reading on the meter.

2. Remove the short from the input terminals, and adjust R5 for a zero reading on the meter. Finalize the zero reading with R9.

3. Apply a 1 μ A current between

the circuit's input terminals. Then adjust R10 for full-scale deflection on the meter. The circuit is now ready for use.

Fig. 25 shows how to wire the IC as a dc millivoltmeter with a sensitivity of 200,000 ohms/volt, using a 100- μ A meter. Transistors Q1 and Q2 are used as a differential amplifier, with the meter connected between their collectors. Transistors Q3-Q4 are used as a constant-current generator in the differential amplifier's emitter line.

The circuit delivers both voltage and current gain between the input terminals (pins 6 and 3) and the meter. Resistor R_v acts as a range multiplier, and has a value of 200,000 ohms/volt—if the meter is required to read 10 volts full scale; R_v = 2 megohms.

To set up the circuit:

1. Short pins 3 and 6, and adjust R9 for zero meter reading.

2. Remove the short from pins 3 and 6, and with no input connected, adjust R5 for zero meter reading.

3. Connect the calculated value of R_v (depending on full-scale deflection voltage required), and apply the required voltage to the input terminals. Adjust R10 for full-scale meter deflection.

4. Recheck steps 1 and 2, and readjust if necessary.

Finally, Fig. 26 shows how to wire the IC as a dc millivoltmeter with a 2-megohm/volt sensitivity. The circuit is basically similar to Fig. 25, except that Q3-Q4 and Q1-Q2 are Super-Alpha-connected in the differential mode, and Q5 and D1 are used as the constant-current generator. Resistor R_v is given a value of 2 megohms/volt, depending on the full-scale deflection voltage required.

To set up the circuit:

1. Short pins 9 and 6, and adjust R7 for zero meter reading.

2. Remove the short from pins 9 and 6, and adjust R9 and R10 for zero meter reading.

3. Connect the calculated value of R_v, and apply the required full-scale deflection voltage to the input terminals. Adjust R8 for full-scale deflection.

4. Repeat steps 1, 2 and 3, and trim if necessary.

Since this circuit has very high sensitivity some care is needed in the construction to insure stable operation. The circuit must be well screened, to keep stray pickup away from the input network. Resistors R1-R3 and R2-R4 must be mounted close together, so they operate at similar temperatures. All must be 5% or better, high-stability types.

This circuit, and those of Figs. 24 and 25, can be used as multirange meters, by switch-selecting R_v values.

Schmitt trigger circuits

The high package density and gain-bandwidth products of the CA3018 make the IC ideal for compact, high-performance Schmitt trigger projects. Fig. 27 shows how to connect the IC as a simple Schmitt trigger with dc input and emitter-follower output. Transistors Q1-Q2 form the Schmitt, and Q4 acts as the emitter-follower output stage.

With zero input connected to the unit, the output is close to zero volts. When the input is raised to roughly $V_{\text{supply}} \times 0.22$, the Schmitt changes state and the output jumps up to a positive voltage. The trigger point of the circuit can be changed, if required, by using different R4 values. The circuit acts as a useful dc level sensor.

Fig. 28 shows how the circuit can be used as a simple sine/square converter. Here Q1 has a fixed bias applied via R1-R2 and R3, and the input signal is applied to the Schmitt via C1. The circuit needs a sine-wave input greater than 1 volt peak to peak for correct sine/square conversion, and gives a useful performance up to several hundred

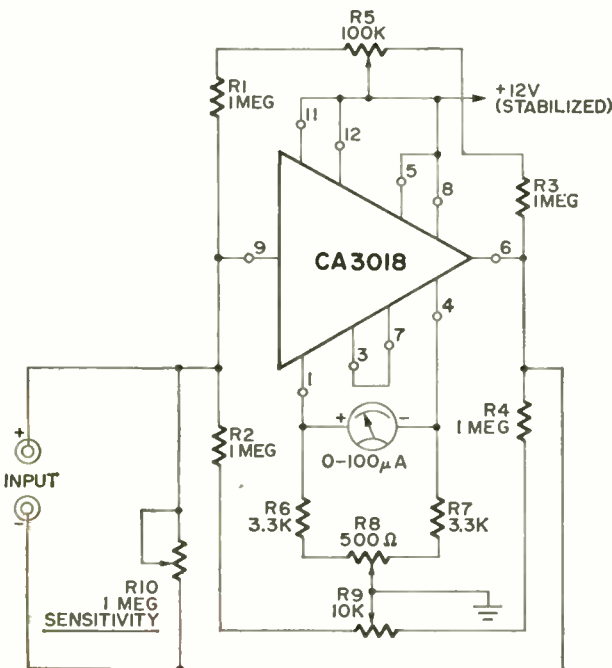

Fig. 24—ELECTRONIC MICROAMMETER uses 100- μ A meter and IC amplifier with 100X gain.

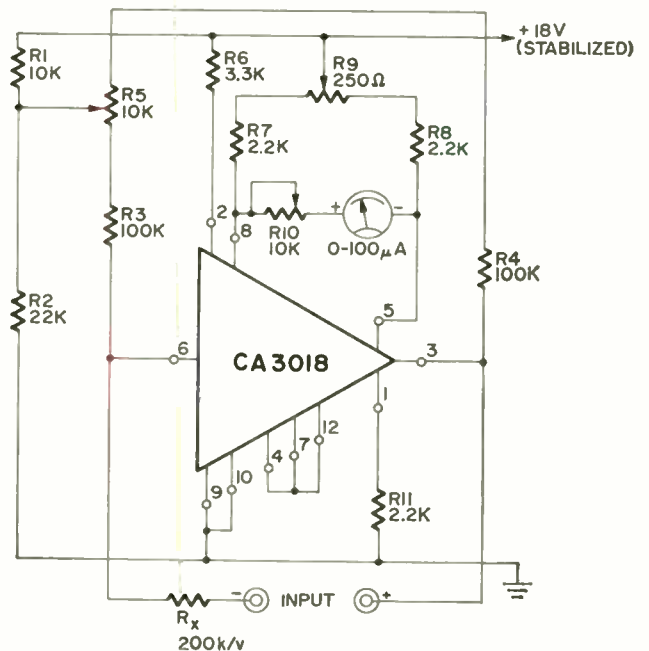

Fig. 25—ELECTRONIC MILLIVOLTMETER has IC amplifier. Make R_v switchable for multiple ranges.

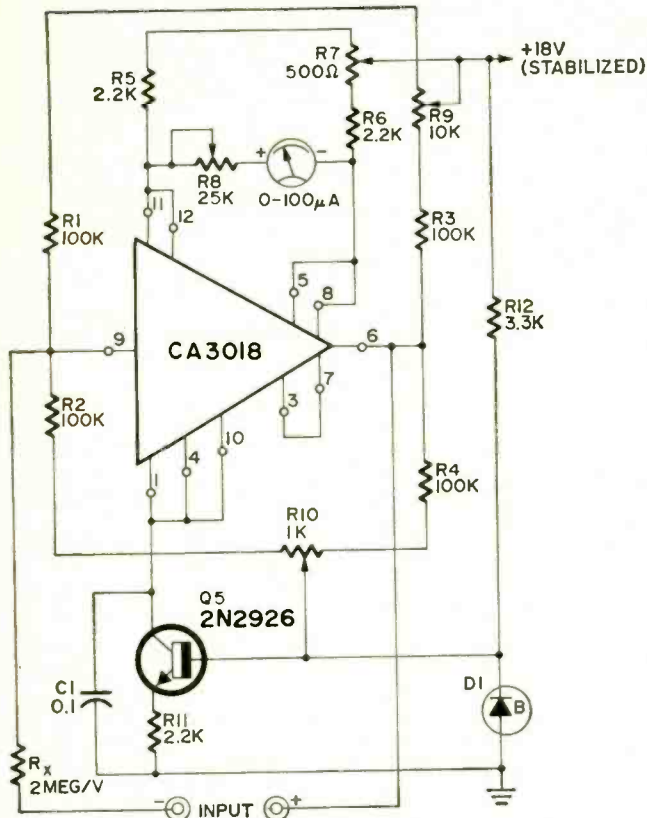

Fig. 26—TRANSISTOR AND DIODE raise this IC mV meter to 2 megs per volt.

kHz. Capacitor C2 is a speedup unit that reduces the output rise time.

Fig. 29 shows how to wire the IC so that it acts as a sensitive sine/square converter. Input impedance is 100,000 ohms and an input of only 50 mV peak to peak is needed for correct sine/square conversion.

Transistors Q3-Q4 are used as a Super-Alpha-connected common-emitter preamp with input connected to pin 9 and output direct-coupled to the input of the Q1-Q2 Schmitt trigger stage. The preamp is operated near saturation. The square-wave output of the circuit is taken from Q2's collector via C2, and the waveform is useful up to a couple of hundred kHz.

Multivibrators to try

The high package density and very high available current gain of the CA3018 also make the IC ideal for multivibrator projects. Fig. 30, for example, shows how the IC can be set up as a long-period stable multivibrator that operates at a frequency of 0.2 Hz—at 5 sec per cycle.

Transistors Q3-Q4 are wired in the Super-Alpha mode to form one half of the multivibrator. Transistors Q1-Q2 are wired in the Super-Alpha mode to form the other half. Because of the very high current gains of the Super-Alpha-connected transistors, the circuit can be given very high values of time-constant resistance (R1 and R2).

Two outputs are available from the circuit (one at pins 11 and 12, and the other at pins 5 and 9), and are in anti-phase. The operating period of the circuit can be increased, if required, by increasing the values of C1 and C2.

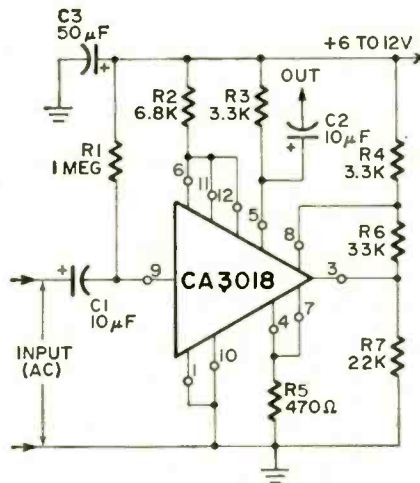

Fig. 31 shows how to connect the IC as a long period one-shot (or monostable) multivibrator, with emitter-follower output. Transistors Q3-Q4 are again wired in the Super-Alpha mode, and form one half of the multivibrator. Transistor Q2 forms the other half and Q1 is used as the emitter-follower output.

The output of the circuit (taken from R7's slider) is normally at zero volts, but rises to positive for a fixed period whenever the monostable is triggered. The period has a duration of approximately 2.5 sec/μF of C1's value—if C1 is 10 μF, the period is 25 seconds. The circuit can be triggered manually by momentarily operating S1, or electronically by a positive pulse on pin 3.

(continued on page 101)

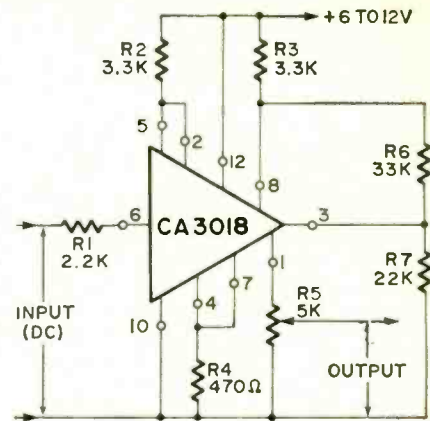

Fig. 27—SCHMITT trigger (right) is versatile pulse generator. Fig. 28 (below)—Schmitt trigger converts input sine wave to a square wave at the output.

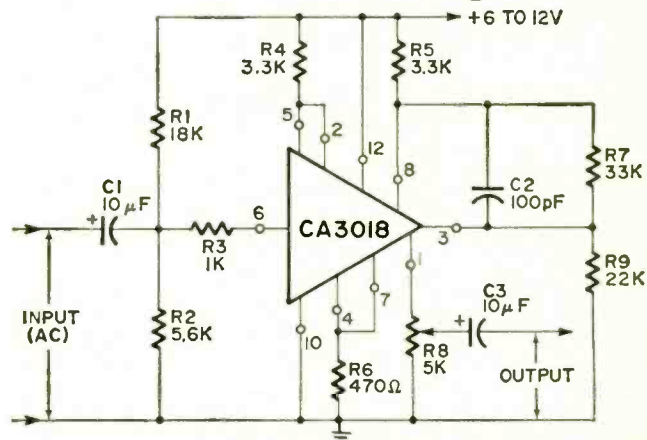
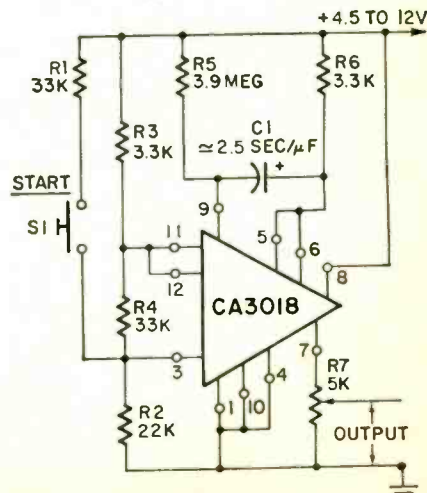
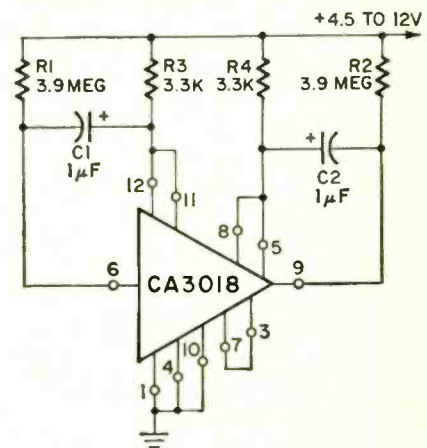
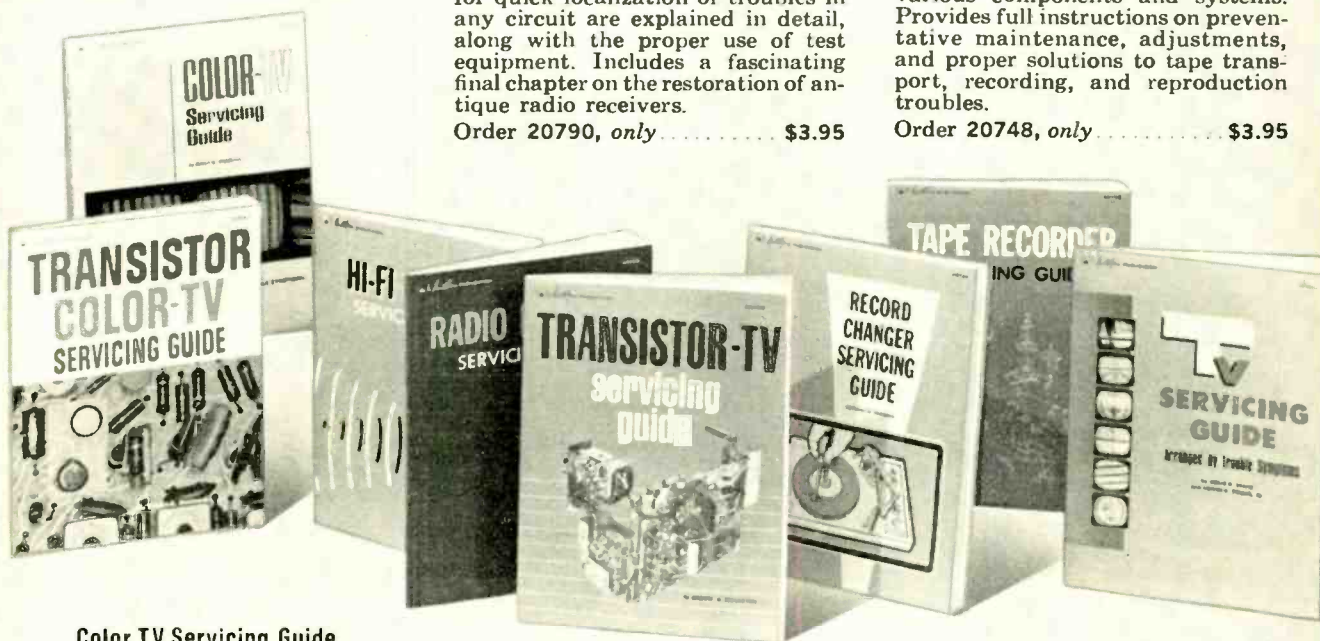

Fig. 29 (left), 30 (right) and 31 (below)—SENSITIVE SINE/SQUARE CONVERTER, low-frequency oscillator and a long-period one-shot multivibrator, respectively.



Sams Books

famous for
**Servicing
Know-How**



Hi-Fi Stereo Servicing Guide

by ROBERT G. MIDDLETON. A complete guide to effective servicing of a-m tuners, fm tuners, stereo-multiplex units, and audio amplifiers (all components, except record players and tape recorders). Includes hi-fi speaker system installations, trouble localization, and overall system evaluation. Also gives testing methods for verifying performance.

Order 20785, *only* \$3.95

Record Changer Servicing Guide

by ROBERT G. MIDDLETON. Presents the general principles of record changer design, followed by a detailed analysis of the working parts of changer mechanisms. Explains adjustment and lubrication procedures, diagnostic techniques for operating troubles, and the corrective measures required to remedy them. This is a thoroughly practical guide.

Order 20730, *only* \$3.95

Radio Receiver Servicing Guide

by ROBERT G. MIDDLETON. Presents the professional technician's approach. Covers troubleshooting and repair of a-m radio receivers, both solid-state and tube type. Methods for quick localization of troubles in any circuit are explained in detail, along with the proper use of test equipment. Includes a fascinating final chapter on the restoration of antique radio receivers.

Order 20790, *only* \$3.95

Tape Recorder Servicing Guide

by ROBERT G. MIDDLETON. Tells how to repair tape recorders profitably. Thoroughly explains the principles and characteristics of magnetic recorder circuitry, describing the various components and systems. Provides full instructions on preventative maintenance, adjustments, and proper solutions to tape transport, recording, and reproduction troubles.

Order 20748, *only* \$3.95

Color TV Servicing Guide

by ROBERT G. MIDDLETON. Shows how to apply fast troubleshooting techniques to color-TV repair using the famous Middleton system based on analysis of trouble symptoms illustrated by actual full-color picture tube photos. Clearly-written text explains possible trouble causes and diagnostic procedures. Final chapter explains in detail how to use color-bar generator.

Order 20358, *only* \$4.25

Transistor Color-TV Servicing Guide

by ROBERT G. MIDDLETON. Clearly explains the basics of the various circuits used in transistor color-TV receivers, including the most recent developments. Shows how to apply proper troubleshooting procedures based on analysis of trouble symptoms. Includes a wealth of circuit diagrams, charts, and picture tube and waveform photographs.

Order 20693, *only* \$4.50

Transistor-TV Servicing Guide

by ROBERT G. MIDDLETON. Second edition. Updated to provide full information on latest circuitry and many additional new test procedures. Clearly explains general transistor circuitry and servicing techniques and then proceeds through the receiver, section by section, describing various picture and or sound trouble symptoms and their remedies.

Order 20696, *only* \$3.95

TV Servicing Guide

by LESLIE D. DEANE and CALVIN C. YOUNG, JR. This is the famous guide used by more than 100,000 service technicians. Shows you how to apply quick troubleshooting procedures based on analysis of trouble symptoms illustrated by picture tube photos. Fully explains possible causes for each trouble symptom and then details proper diagnostic and repair procedures.

Order 20361, *only* \$3.25

HOWARD W. SAMS & CO., INC.

Order from your Electronic Parts Distributor,
or mail to Howard W. Sams & Co., Inc., Dept. RE-110
4300 W. 62nd St., Indianapolis, Ind. 46268

Send books checked at right. \$_____ enclosed

Send FREE 1970 Sams Book Catalog

Name _____

Address _____

City _____ State _____ Zip _____

- 20785
- 20730
- 20790
- 20748
- 20358
- 20693
- 20696
- 20361

Circle 22 on reader service card

NEW PRODUCTS

More information on new products is available from the manufacturers of items identified by a Reader Service number. Use the Reader Service Card on page 103 and circle the numbers of the new products on which you would like further information. Detach and mail the postage-paid card.

SOCKET WRENCH SET, Model No. 1001. This 14 piece, $\frac{1}{4}$ " square drive set can be used in seven different ways to drive both hex and square fasteners. Reach varies from $1\frac{1}{2}$ " to $9\frac{1}{4}$ " depending on combination. Includes reversible ratcheting handle with a short swing for close-quarter operation; $5\frac{3}{4}$ " spin-

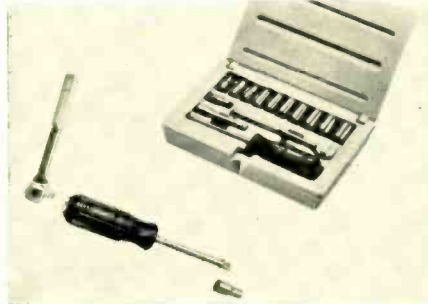

ner/extension with a drive socket insert permits use as a ratchet extension in addition to a regular nutdriver; nine sockets in hex sizes from $\frac{3}{16}$ " through $\frac{1}{2}$ "; two dual-purpose sockets with openings of $\frac{1}{4}$ " and $\frac{3}{16}$ " for square and hex nuts. Set is packaged in snap-lock case with a free set of personalized initials.—Xcelite, Inc. Orchard Park, New York 14127.

Circle 31 on reader service card

CHILLING SPRAY, Blue Frost,

tests entire assemblies for cold weather and high altitude operation. Troubleshoot for intermittents by heating chassis and spraying each suspected component for a few seconds. Healthy components will not be affected, but faulty ones will act up. To test entire units, place unit in cardboard box and flood with Blue Frost. Tight fitting metal parts that are difficult to mate can easily be pressed together if the inner part is first shrunk with the spray. Recommended for industrial or professional use only. Available in 8 oz. and 20 oz. cans.—Tech Spray, P.O. Box 949, Amarillo, Texas 79105.

Circle 32 on reader service card

HI-FI SPEAKERS, Model 10, delivers response from under 200 Hz to over 13 kHz with a single wide-range driver. This high flux drive unit has a $3\frac{3}{4}$ -inch long throw cone with a $\frac{3}{8}$ -pound ferrite magnet. The driver is mounted in a sub-enclosure that performs as a miniature air suspension unit. The dome center produces even dispersion without a whizzer cone. Response of the woofer is

above 200 Hz to eliminate boxiness or

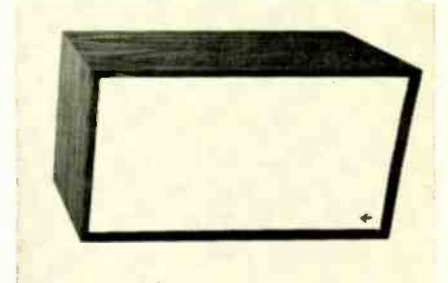

hints of a nasal effect. The free air cone resonance is just over 20 Hz. 8-ohm unit can handle 10-watts of audio. Enclosure measures $24 \times 14 \times 10\frac{1}{2}$ inches. . . . \$69.95, Audionics, 9701 S.E. Mill, Portland, Oregon 97216.

Circle 33 on reader service card

COMP-U-KIT LOGIC LAB I, consists of 10 assembled computer circuits, 20 patch cords and an instruction book. Dozens of games, experiments and puzzles can be assembled. No previous knowledge of computers or electronics required. It uses the same 54/74 TTL circuits used in

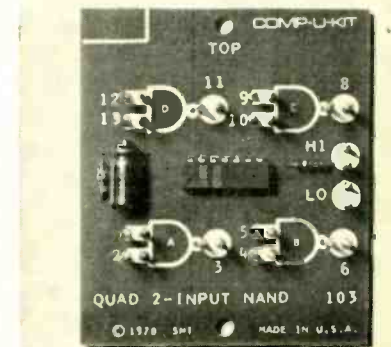

many modern computers. Experiment with circuits that include a two-stage binary counter, a three-stage shift register, or a counter with decoding. Modules can be added one at a time for advanced logic. \$39.00.—Scientific Measurements Co., 9701 N. Kenton Ave., Skokie, Ill. 60076.

Circle 34 on reader service card

CASSETTE TEST TAPE, X-87 Torquette, is a calibrated torque indicator.

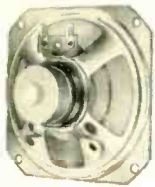
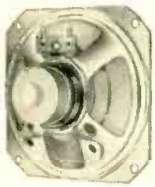

If you can't see the difference

and you don't hear the difference—



the long-lasting quality will tell you—

IT'S A QUAM!

The Quality line for every speaker need

QUAM

Quam-Nichols Company
234 East Marquette Road
Chicago, Illinois 60637
Phone: (312) HU-8-5800

Circle 23 on reader service card

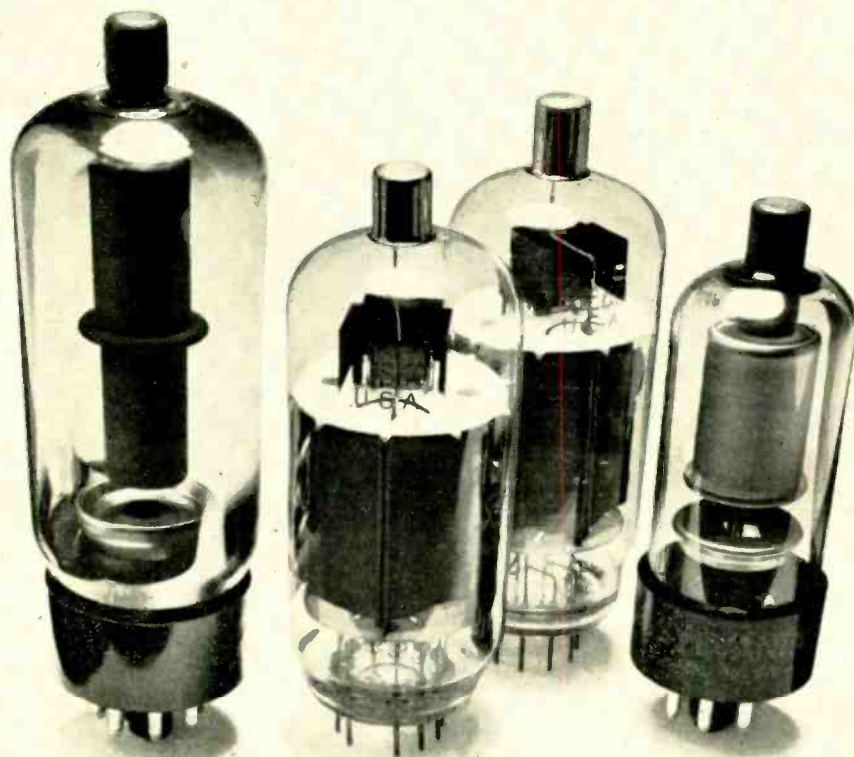

Our hot ones are the last to go.

The last thing you need is to be called back a day or two after you've replaced the sweep or high voltage tubes in somebody's color TV.

But, they're usually the first to go. Because they get so hot.

So we figured out how to cool them. Now, they last a lot longer.

Take our 6JE6C/6LQ6, for example. It's the horizontal deflection tube that takes such a beating when the set gets hot.

Well, we've given it special patented radiator fins that first absorb the heat and then radiate it out of the tube.

Now it runs cooler and lasts longer. Same for our 6JS6C.

Or take our 6BK4C/6EL4A. That's the shunt regulator that eliminates runaway high voltage. We gave this one a whole new anode and shield design to improve heat transfer and stability.

Now it also runs cooler and lasts longer.

Or take our 3A3B high voltage rectifier. This one's got leaded glass for added protection. And it lasts longer too.

So next time you have to replace any of the hot ones, just cool it. You'll both last longer.

SYLVANIA
GENERAL TELEPHONE & ELECTRONICS

User inserts Torquette in tape deck, and the tape take-up torque in grams per centimeter is read through the window by pressing the play button. Indicates condition of the clutch assembly, has high degree of repeatability, is direct reading and very accurate. Eliminates guess work for all technicians. \$6.90.—Hartak Instrument Co. P. O. Box 1, Fraser, Colorado 80442.

Circle 35 on reader service card

TRIGGERED OSCILLOSCOPE, Model 555. This 5" scope has a broad bandwidth (10-MHz, 5x expansion), sensitivity of 20 mV/cm. Solid-state circuitry, 9-position attenuator, and a built in square-wave oscillator for calibration functions. A wide sweep range of 1 μ sec/cm to 1 sec/cm handles both low frequency and transient signals. Weighs 24 lbs., measures 8" X 11" X 17". \$346.—Kikusui Electronics, c/o Marubeni-lida, Inc., 200 Park Ave., New York, N.Y. 10017.

Circle 36 on reader service card

CB BASE STATION, Model Titan III. Transmits and receives on either the upper or lower sideband of each channel providing 46 options. It also operates as conventional unit. Single sideband eliminates normal AM carrier and separates each channel into its upper and lower sidebands. The unit provides the F.C.C.



maximum of 15 watts P.E.P. power input. While transmitting full carrier AM, output is 3.5 watts minimum. Unit is equipped with 23 crystals with a tolerance of $\pm 0.015\%$. \$598.—Tram Corp. Lower Bay Road, Box 187, Winnisquam, New Hampshire. 03289.

Circle 37 on reader service card

RAYGUARD, is a device to warn of potentially dangerous X-radiation from color television sets. It monitors high voltage in the set, and warns the owner,



on a small meter, when the voltage exceeds levels set by the set manufacturer. Consists of a sensor unit which is in-

stalled in the set, and a meter placed in a bracket in the rear of the set. A needle on the meter enters a danger area when voltage exceeds limits.—Audio Equipment Co., Div. of Walter Kidde & Co., Clifton, New Jersey 07012

Circle 38 on reader service card

AC ADAPTER, Model BC9, for portable radios and cassette recorders. Has reverse polarity plug to adapt for both positive- and negative-ground equipment. Also has a four-way connector that

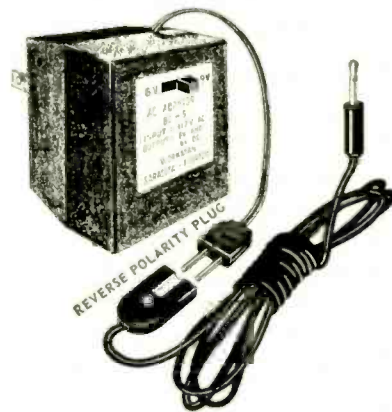

matches jacks on most equipment—3.5 mm plug, 3.5-mm jack, 2.1-mm coax power plug, and 2.5-mm miniature plug. In addition, the adapter has a switch to select 6- or 9-volt outputs.—Workman Electronic Prods., P.O. Box 3828, Sarasota, Fla. 33578

Circle 39 on reader service card

(continued on page 85)



LUBRA CLEAN

...A T.V. TUNER CLEANER THAT REALLY WORKS!

MADE ESPECIALLY FOR TELEVISION TUNERS

Finally, a tuner cleaner that really works. Apply LUBRA CLEAN and let it do the work for you. Physical cleaning and polishing contacts is no longer necessary. Simply apply—and LUBRA CLEAN continues to polish and lubricate tuner contacts for months after all other cleaners and lubricants have failed. Sold at leading dealers and distributors for \$2.98 per tube.



LUBRA CLEAN COMPANY

P. O. BOX 926 - MARTINSVILLE, VA. 24112 - PHONE (703) 638-1211

Circle 61 on reader service card

RADIO-ELECTRONICS

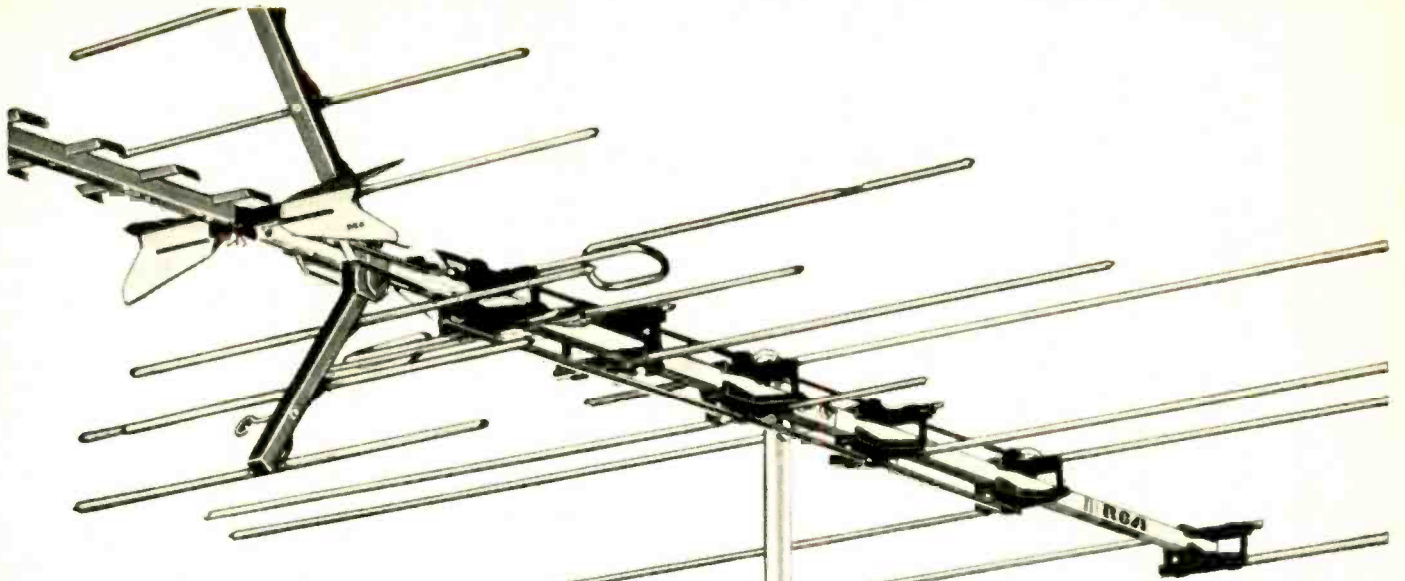

The new Permacolor antenna from RCA has:

**“Long-lasting” element/
feed line connections.**

**Waterproof,
polypropylene
insulators that pivot.**

Integrated UHF bow tie.

Rigid, square boom.

Tough vinyl finish.

**That ought to prove
RCA is serious about
the antenna business.**

So serious we've set up a new production facility at our Memphis plant. But before we manufactured a single antenna, our engineers literally started designing from scratch. The result? Permacolor.

Here are just a few reasons why RCA Permacolor antennas are different, and are an improvement over what you're now selling.

1. Durable connections/Perma-tuned circuits. All active elements (many perform more than one function) are solidly connected to a symmetrical aluminum feed line by riveted straps. This reduces reception failure due to flimsy or intermittent connections.
2. “Single unit” insulator/element. Insulators are polypropylene. Elements extend 5½ inches into the insulators. Elements and insulators pivot as a unit—lock in place—have no loose connections. No high stress points.
3. Bow tie and 110° corner reflector UHF Section integrated into a single downlead for better UHF reception.
4. Easy installation. Simply unfold and install. Permacolor antennas go up in one piece. No bag of bolts. Nothing to take apart and reassemble. Snap-off elements let you quickly tailor the antenna to reception requirements.
5. Tough, handsome blue and gold vinyl coating protects against weather and airborne chemicals.

The new RCA Permacolor Antenna is the antenna you can put up for good. See it now at your RCA Parts and Accessories distributor.

Parts and Accessories, Deptford, N.J.

RCA

New from Heath...in time

New Heathkit® solid-state modular color TV

The result of over five years in research and development, these sets represent one of today's greatest color TV values. Here's why: a total of 45 transistors, 55 diodes, 2 silicon controlled rectifiers, 4 IC's containing another 46 transistors and 21 diodes plus 2 tubes (picture and high voltage rectifier) combine to deliver performance and reliability unequalled by any conventional tube set. Other features include: MOSFET VHF tuner; high-gain 3-stage solid-state IF; emitter-follower output; automatic fine tuning; VHF power tuning; built-in degaussing plus manual degaussing coil; automatic chroma control; adjustable noise limiting and gated AGC; "instant-on"... sound instantly, picture in seconds; bonded-face, etched glass picture tubes; adjustable tone control; exclusive hi-fi outputs; and 48-hour factory service facility for modules. The sets are designed to be owner-serviced... the only sets on the market with this exclusive feature. A built-in dot generator, volt-ohm meter, and modular snap-out epoxy circuit boards make routine adjustments and service a snap... virtually eliminating service calls and offering significant savings over the life of the set. It all adds up to the color TV buy of a lifetime in the GR-270 and GR-370... ready now for Christmas giving!

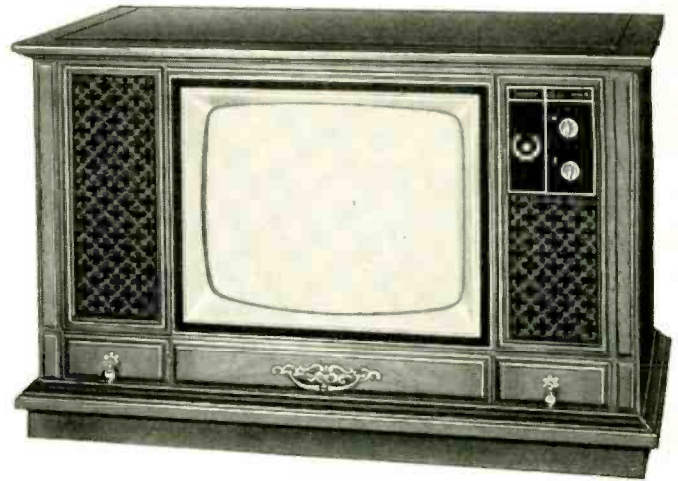

- Modular plug-in circuit board construction
- MOSFET VHF tuner and 3-stage IF
- Pushbutton channel advance
- Hi-fi sound outputs — for amplifier
- Designed for owner-servicing

Kit **GR-270**, 227" 20V tube, 114 lbs. **\$489.95***
 Kit **GR-370**, 295" 23V tube, 127 lbs. **\$559.95***
 Kit **GR-370MX, GR-370** with RCA matrix tube,
 127 lbs. **\$569.95***

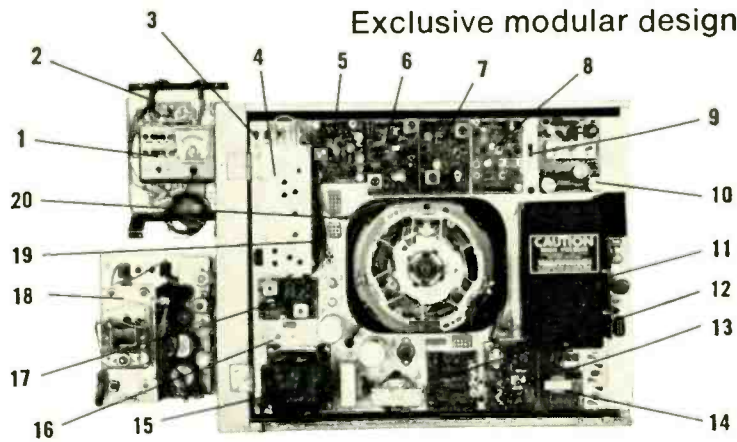

Exclusive modular design

- 1 Exclusive check-out meter
- 2 Tilt-out convergence/secondary control panel
- 3 Gun shorting switches
- 4 3-stage IF assembly
- 5 Plug-in AGC/Sync circuit board
- 6 Plug-in 3.58 MHz oscillator circuit board
- 7 Plug-in Chroma circuit board
- 8 Plug-in Luminance circuit board
- 9 Service and Dots switches
- 10 Plug-in Video Output circuit board
- 11 High voltage power supply
- 12 Plug-in Vertical Oscillator circuit board
- 13 Plug-in Horizontal Oscillator circuit board
- 14 Plug-in Pincushion circuit board
- 15 Conservatively-rated power supply components
- 16 Circuit breaker protection
- 17 Plug-in Sound circuit board
- 18 Master control panel
- 19 Hi-fi sound output
- 20 Plug-in wiring harnesses and connectors for faster assembly

Choice of factory-assembled cabinets

3 models in 295 sq. in.

Luxurious Mediterranean Cabinet... factory assembled of fine furniture grade hardwoods and finished in a flawless Mediterranean pecan. Statuary bronze trim handle. 30-1/2" H x 47" W x 17-3/4" D. Assembled **GRA-304-23**, 78 lbs. **\$129.95***



Deluxe Early American Cabinet... factory assembled of hardwoods & veneers and finished in classic Salem Maple. 29-1/2" H x 37-1/4" W x 19-3/4" D. Assembled **GRA-303-23**, 73 lbs. **\$114.95***

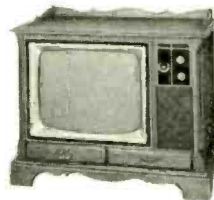

Contemporary Walnut Cabinet... factory assembled of fine veneers & solids with an oil-rubbed walnut finish. 29-1/2" H x 35-1/4" W x 19-7/8" D. Assembled **GRA-301-23**, 60 lbs. **\$74.95***



3 models in 227 sq. in.

Exciting Mediterranean Cabinet... assembled using fine furniture techniques and finished in stylish Mediterranean pecan. Accented with statuary bronze handle. 27-3/8" H x 41-7/8" W x 19-1/4" D. Assembled **GRA-202-20**, 85 lbs. **\$114.95***

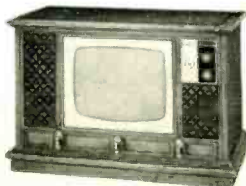

Contemporary Walnut Cabinet and Base Combination. Handsome walnut finished cabinet sits on a matching walnut base. Cabinet dimensions 20-1/2" H x 31-1/4" W x 18-5/8" D. Base dimensions 7-3/4" H x 27-3/4" W x 18-5/8" D. Assembled **GRA-203-20 Cabinet**, 46 lbs. **\$49.95*** **GRS-203-6 above cab.** w/matching base, 59 lbs. **\$59.95***

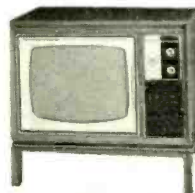

Handy Roll-Around Cart and Cabinet Combination. Features the **GRA-203-20 Roll-Around Cart**, 19 lbs. ... **\$19.95*** **GRS-203-5 Cart & Cabinet Combo**, 65 lbs. **\$59.95***

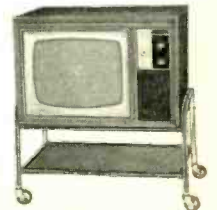

for Christmas giving

New Heathkit

Electronic Oven

...only \$399.95*

Now, through the miracle of microwave energy, a cooking revolution that frees you from conventional kitchen drudgery forever!

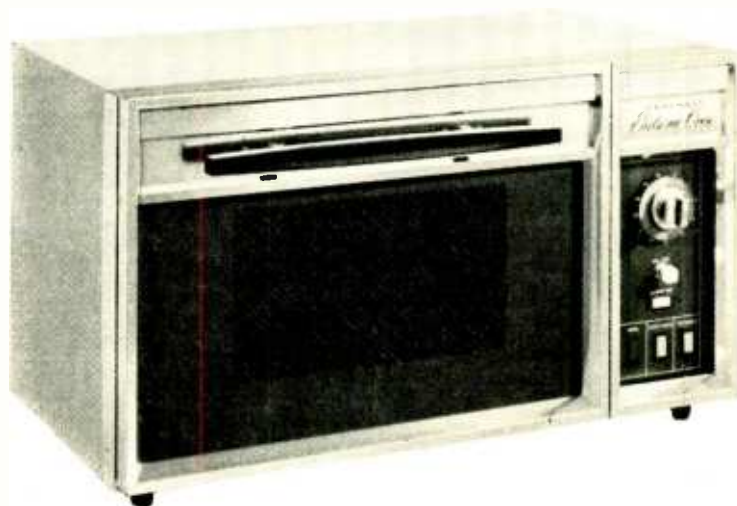

Imagine a baked potato in 4 minutes; baked beans in a little over 6 minutes; a five-pound roast in 45 minutes. This is the miracle of microwave cooking. And now Heath brings you this modern miracle for the first time in money-saving, easy-to-assemble kit form. For busy families on the go, meal preparation is a matter of minutes. You can cook on china, glass, or even paper dishes since only the food becomes hot. Your cooking dish can be your serving dish. Frozen foods can be defrosted in minutes for quick spur-of-the-moment frozen meals cooked right in their own containers. And there is not the slightest cause for concern about the safety of your Heathkit electronic oven. Exclusive door design prevents microwave leakage from the oven cavity. And with a SAFETY INTERLOCK SYSTEM UNIQUE IN THE INDUSTRY, not only does the oven stop cooking if the door is opened, but the door can't be opened unless the interlock is operating properly. A second independent door interlock is also provided for maximum protection. And all interlock mechanisms are tamperproof. Assembled in accordance with the

manual, the GD-29 meets all the new federal standards for safety and radio interference. No special precautions are required when operating. The Heathkit electronic oven is as safe as your conventional oven! Quality components are used throughout: magnetron tube by Litton, the uncontested leader in the field; avalanche diode circuitry for longer tube life; simplified wiring harness with push-on quick-connectors for reliability and ease of assembly. GD-29 prototypes endured grueling "life-tests" equivalent to over 60 years of continuous service...further assurance of uncompromised reliability. Another feature is portability: the Heathkit electronic oven operates on regular household current. Plug it in anywhere...on a countertop, a wheeled cart, in the kitchen, on the patio, at the cottage...anyplace a grounded 120V AC power outlet is available. Make this a Christmas to remember by putting a Heathkit electronic oven under the tree. It's a gift your wife will thrill to...and a present the whole family will enjoy...meal after meal after meal.

Kit **GD-29**, 80 lbs. **\$399.95***



New Heathkit portable solid-state color TV

- Big set performance, portable convenience
- MOSFET VHF tuner & 3-stage IF
- Modular, self-service design
- 102", 14 V picture tube



What do you do for an encore after you've created the solid-state GR-270 and GR-370 big-screen sets? Simple. Make them portable. That's virtually what's been done in the new Heathkit GR-169 solid-state portable color TV. Heath engineers took the same cool-running solid-state circuitry from the large screen chassis and packaged it in an easy-to-assemble compact chassis...with the same nine plug-in glass epoxy circuit board modules used in the big sets. In fact the only difference is the smaller preassembled horizontal deflection and high voltage power supply. The same MOSFET tuner and high gain 3-stage IF found in the big sets offer superlative color performance. And, as in the larger sets, complete owner-service features are provided by inclusion of built-in dot

generator and degaussing along with an exclusive volt-ohm check-out meter. 48-hour factory service facilities for modules are also provided with the GR-169. Other features include: built-in antennas and connections for external antennas; instant picture and sound; complete secondary controls available behind the hinged door on the front panel; high resolution circuitry for sharp, crisp pictures; adjustable noise limiting to keep external interference to a minimum. If you're looking for big set color fidelity and performance with portable convenience...put the new Heathkit GR-169 on your Christmas shopping list now!

Kit **GR-169**, 48 lbs. **\$349.95***

New Heath-gift ideas... for

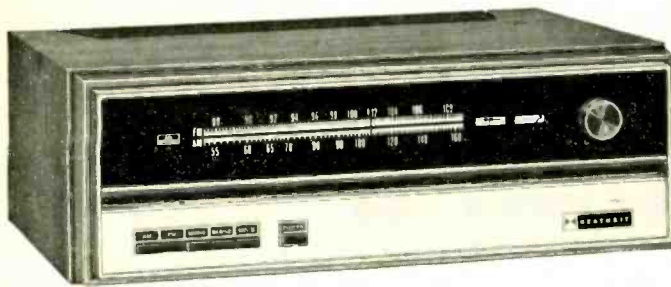

New Heathkit® AJ-29 AM-FM-FM stereo tuner

This is the feature-packed tuner section of the famous Heathkit AR-29 stereo receiver . . . now available as a stereo "separate." The pre-assembled, factory-aligned FM tuner boasts 1.8 uV sensitivity for whopping station pulling power using FET design for superior overload characteristics. Three IC's in the IF section offer superior AM rejection, hard limiting, temperature stability, and outstanding reliability. Other features include a computer-designed 9-pole L-C filter for greater than 70 dB selectivity; new "blend" and "mute" functions; and a built-in AM rod antenna that swivels for best reception.

Kit **AJ-29**, 19 lbs., less cabinet **\$169.95***
Assembled **AE-19**, oiled pecan cab., 9 lbs. **\$19.95***

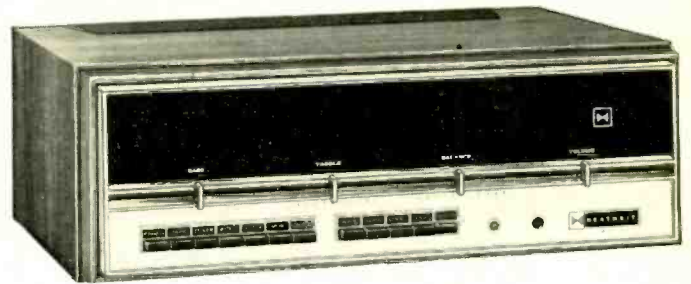

New Heathkit® AA-29 100-watt stereo amplifier

Power-packed amplifier section of the Heathkit AR-29, the AA-29 stereo "separate" marks another milestone in superior Heathkit amplifier design. Its 70-watts of continuous power is more than enough to drive even the most inefficient speaker systems. A massive, fully-regulated and filtered power supply, 4 conservatively heat sunk output transistors and the best IM and harmonic distortion specifications in the industry add up to sound fidelity you never expected to hear outside the theater. Modular plug-in circuit boards make assembly easier . . . snap out in seconds for future servicing.

Kit **AA-29**, 27 lbs., less cabinet **\$149.95***
Assembled **AE-19**, oiled pecan cab., 9 lbs. **\$19.95***

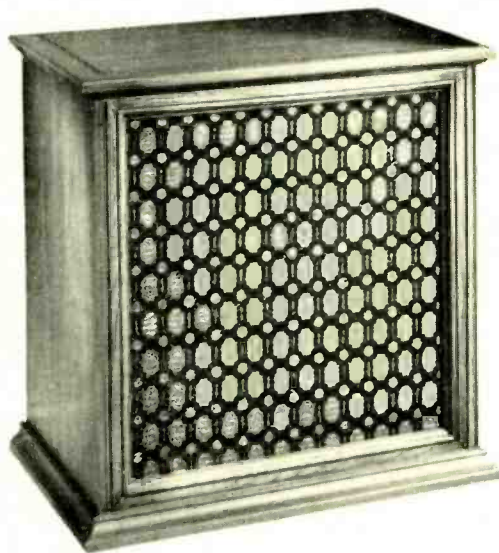

New Heathkit® floor model speaker systems

In the new Heathkit AS-101 and AS-102 speaker systems, Heath engineers have combined the best of both worlds of sound and beauty. The AS-101 Heath/Altec-Lansing 2-way system features a 15" woofer and sectoral horn delivering from 35 to 22,000 Hz with uncompromising accuracy. The AS-102 Heath/Bozak 3-way system uses a 12" woofer, 6" mid-range, and two 2 1/2" tweeters in an infinite baffle design to produce clean natural reproduction from 40 to 20,000 Hz. Both systems are housed in assembled Mediterranean pecan cabinets, 29 5/8" H x 27 3/4" W x 19 7/8" D.

Kit **AS-101**, 53 lbs. **\$259.95***
Kit **AS-102**, 39 lbs. **\$259.95***

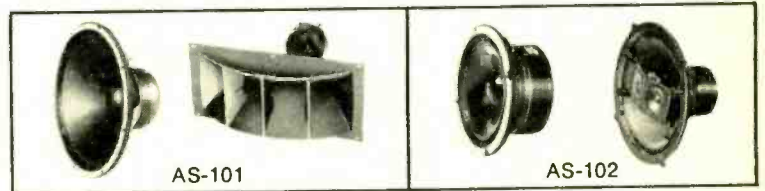

New Heath stereo equipment credenza



Romantic Mediterranean styling in wife-pleasing one-piece console design . . . yet with plenty of room for your favorite separate stereo components. Six-and-a-half feet of solid craftsmanship executed in North American Hickory veneers and solid oak trim, finished in oiled pecan. Completely assembled and finished, ready for installation of Heath or other components. Speaker enclosures

are ducted port reflex design, pre-cut for 12" speakers. An adjustable shelf has room for stereo receiver, cartridge or cassette tape player or separate tuner and amplifier. Below the shelf is room for your turntable and record storage. Accessory matching drawers on ball bearing slides are available for turntable and tape player.

Model **AE-101**, 90 lbs. **\$189.95***

home, shop and ham shack

New Heathkit® IC 15 MHz frequency counter...199.95*

A highly accurate, low cost frequency meter for anyone requiring accurate frequency measurements. Compare these features to counters selling for over twice this low price: accurate counting, 1 Hz to over 15 MHz; integrated circuitry; automatic trigger level for wide range input without adjustment; five digit readout with Hz/kHz ranges and overrange indicators for eight digit capability; high input impedance; storage circuitry for non-blinking, no-count-up readout; computer-type circuitry, no divider chain adjustment; temperature-compensated crystal time base oscillator; BNC input with cable; double-sided, plated-thru circuit board with sockets; three-wire, removable line cord; heavy-duty aluminum case handle/tilt stand and die cast zinc front panel; no special instruments required for accurate calibration.

Kit **IB-101**, 7 lbs. **\$199.95***



IB-101 SPECIFICATIONS: Frequency Range: 1 Hz to greater than 15 MHz. Accuracy: ± 1 count \pm time base stability. Gate Times: 1 millisecond or 1 second with automatic reset. Input Characteristics: Sensitivity: 1 Hz to 1 MHz, less than 100 mV rms. 1 MHz to 15 MHz, less than 250 mV rms. After 30 minutes warmup. Trigger Level: Automatic. Impedance: 1 Meg ohm shunted by less than 20 pf. Maximum Input: 200 V rms, DC-1 kHz. Derate at 48 V per frequency decade. TIME BASE: Frequency: 1 MHz, crystal controlled. Aging Rate: Less than 1 PPM/month after 30 days. Temperature: Less than ± 2 parts in 10^7 /degree C. 20 to 35 degrees C after 30 minutes warmup. $\pm .002\%$ from 0 to 50 degrees C. GENERAL: Readout: 5 digits plus overrange. Temperature Range: Storage; -55 to 80 degrees C. Operating; 0 to 50 degrees C. Power Requirements: 105-125 or 210-250 VAC, 50/60 Hz, 8 watts. Cabinet Dimensions: 8 1/4" W x 3 1/8" H x 9" D not including handle. Net Weight: 4 1/2 lbs.

See these and 300 other
Heath-gift suggestions at one of the
following Heathkit Electronic Centers:

Anaheim, Calif. 92805
330 E. Ball Road

Boston Area
Wellesley, Mass. 02181
165 Worcester St.

Chicago, Illinois 60645
3462-66 W. Devon Ave.

Chicago Area
Downers Grove, Ill. 60515
224 Ogden Avenue

Cleveland, Ohio 44129
5444 Pearl Road

Dallas, Texas 75201
2715 Ross Avenue

Denver, Colorado 80212
5940 W. 38th Ave.

Detroit, Michigan 48219
18645 W. 8 Mile Road

Fair Lawn, N. J. 07410
35-07 Broadway (Rt. 4)

Houston, Texas 77027
3705 Westheimer

Los Angeles, Calif. 90007
2309 S. Flower St.

Milwaukee, Wisc. 53216
5215 W. Fond du Lac

Minneapolis Area
Hopkins, Minn. 55343
101 Shady Oak Road

New York, N. Y. 10036
35 W. 45th Street

Philadelphia, Pa. 19149
6318 Roosevelt Blvd.

Pittsburgh, Pa. 15235
3482 William Penn Highway

St. Louis, Mo. 63123
9296 Gravois Ave.

San Diego Area
LaMesa, Calif. 92041
8363 Center Drive

San Francisco Area
Redwood City, Calif. 94063
2001 Middlefield Road

Seattle, Wash. 98121
2221 Third Avenue

Washington, D. C. Area
Rockville, Md. 20852

5542 Nicholson Lane

All Heathkit Electronic Centers are units of Schlumberger Products Corporation.
Heathkit Electronic Center Prices Slightly Higher.

During 1971, consult Heathkit Catalog Supplements and local newspapers for announcements of new Heathkit Electronic Centers opening in these places:

Long Island Area
Westbury, New York
Miami, Florida

San Francisco Area
El Cerrito, California
Cincinnati, Ohio

Los Angeles Area
Woodland Hills, California
Atlanta, Georgia

Prices listed are factory mail order.
Retail prices are slightly higher.

... or send for your FREE
factory mail order catalog



New Heathkit® HW-101 SSB transceiver

The Hams at Heath have done it again... with an updated version of the Heathkit HW-100, one of the most popular pieces of ham gear on the market! The HW-101 features improved receiver circuitry resulting in better than 0.35 uV sensitivity for 10 dB S+N/N. Image and IF rejection are better than 50 dB. Other improvements are a new 36-to-1 ball-bearing dial drive; new selectable SSB or CW filters and attractive new front-panel styling.

Kit **HW-101**, 23 lbs. **\$249.95***

New Heathkit wattmeter/SWR bridge



Two switch-selected ranges allow measurement of RF output from 10-200 W and 100-2000 W. Built-in calibrator permits 10% accuracy throughout the 80-10 M ham bands.

Kit **HM-102**, 3 lbs. **\$29.95***

HEATH COMPANY, Dept. 29-11
Benton Harbor, Michigan 49022 a Schlumberger Company

Enclosed is \$ _____, plus shipping.

Please send model (s) _____

Please send FREE Heathkit Catalog. Please send Credit Application.

Name _____

Address _____

City _____ State _____ Zip _____

*Mail order prices; F.O.B. factory.
Prices & specifications subject to change without notice. CL-394

ARROW AUTOMATIC STAPLE GUNS

CUT WIRE & CABLE INSTALLATION COSTS

... without cutting into insulation!

SAFE! Grooved Guide positions wire for proper staple envelopment! Grooved Driving Blade stops staple at right depth of penetration to prevent cutting into wire or cable insulation!

No. T-18—Fits wires up to 3/16" in diameter.

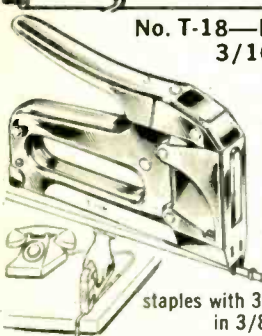

BELL, TELEPHONE, THERMOSTAT, INTERCOM, BURGLAR ALARM and other low voltage wiring.

Uses T-18 staples with 3/16" round crown in 3/8" leg length only.

No. T-25—Fits wires up to 1/4" in diameter.

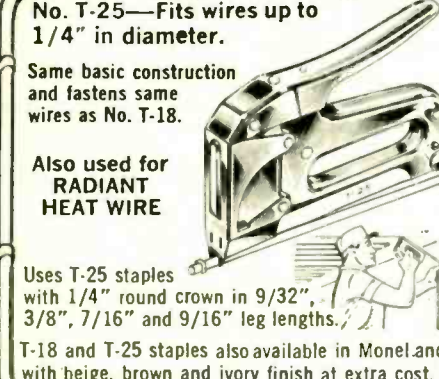

Same basic construction and fastens same wires as No. T-18.

Also used for **RADIANT HEAT WIRE**

Uses T-25 staples with 1/4" round crown in 9/32", 3/8", 7/16" and 9/16" leg lengths.

T-18 and T-25 staples also available in Monel and with beige, brown and ivory finish at extra cost.

No. T-75—Fits wires and cables up to 1/2" in diameter.

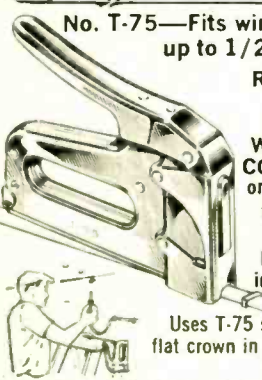

RADIANT HEAT CABLE, UF CABLE, WIRE CONDUIT COPPER TUBING or any non-metallic sheathed cable.

Also used as **DRIVE RINGS** in stringing wires.

Uses T-75 staples with 1/2" flat crown in 9/16", 5/8" and 7/8" leg lengths.

Arrow Automatic Staple Guns save 70% in time and effort on every type of wire or cable fastening job. Arrow staples are specially designed with divergent-pointed legs for easier driving and rosin-coated for greater holding power! All-steel construction and high-carbon hardened steel working parts are your assurance of maximum long-life service and trouble-free performance.

Ask your Electrical Supply Dealer or write for further details.

ARROW FASTENER COMPANY INC.
Saddle Brook, New Jersey 07663
"Pioneers and Pacesetters
For Almost A Half Century"
Circle 63 on reader service card

HOBBYISTS DELIGHT

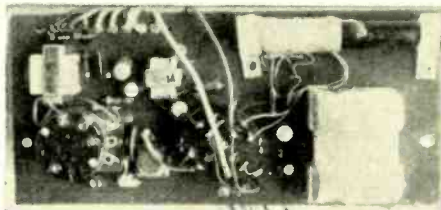

Stock No. B9082 3.95 2/7.00

ITS A TRF AM RECEIVER

An AM Voice Transmitter, a Modulated Code Oscillator contains:

- Volume/Gain Control
- On-Off Switch
- Tuning Capacitor
- Ferrite Coil
- Transmit/Receive Switch
- Output Transformer
- 9 Volt Battery Plug
- 3 Transistors
- RF Oscillator
- RF Amplifier
- Audio Output
- Needs only Speaker and mike

Complete with circuit diagram

Honeywell Boards 5 1/2" x 6". Loaded with late no. transistors, diodes, resistors and capacitors. 2 different boards \$1.00. 2 lb. Stock No. 9094

Honeywell Power Board contains 4 2N1137B 80 watt PNP power transistors, 8 Top Hat diodes, 8 precision resistors and 4 1N642 diodes \$1.25 ea. 2 lb. Stock No. B9093

Honeywell Computer boards, 4 1/2" x 12". Transistors, diodes, zeners, capacitors, precision resistors, heat sink, trimmers etc. 2 Different boards \$1.00. 3 lb. Stock No. B9082

B2040 Sangamo or Pyramid 4 1/4" x 1 3/4" 4000 MFD 50V 50 5/2.00
\$1.00 FREE WITH \$10.00 ORDER

Lots of other items—send for free flier: all merchandise fully guaranteed. Please include postage; excess will be refunded.

DELTA ELECTRONICS CO.
BOX 1, LYNN, MASSACHUSETTS 01903
Circle 64 on reader service card

EDI

THOUSANDS OF BARGAINS—TOP VALUES IN Electronic Parts

Transistors, Modules, Speakers, Stereo, HI-FI, Photo Cells and thousands of other Electronic Parts. Send for **FREE** Catalog



ELECTRONIC DISTRIBUTORS INC.
Dept. TA-2, 4900 Elston
Chicago, Ill. 60630

RUSH CATALOG

Name _____
Address _____
City _____ State _____ Zip Code _____

Circle 65 on reader service card

EQUIPMENT REPORT

GBC CLOSED-CIRCUIT TV SYSTEM

For manufacturer's literature, circle No. 96 on Reader Service Card.

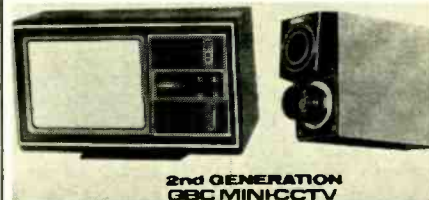

2nd GENERATION
GBC MINICCTV

A CLOSED CIRCUIT TELEVISION SYSTEM has many everyday applications. Some of them include seeing who's at the front door before opening it and keeping an eye on poolside activities from your kitchen. Combined with a video tape recorder, it makes a complete videotape system. Use the camera from the CCTV system to take the pictures you want to tape, the recorder to tape them, and the monitor to view what you taped.

CCTV systems come in many combinations. A basic system consists of a camera and monitor. A better system, like the GBC MC-15 described here, has a built-in audio channel.

The camera in the GBC system is light-weight and readily portable. It has only one cable dangling behind it. This links the video and audio signals from the camera to the monitor and carries operating power to the camera.

The camera has several interesting features. Its lens automatically adjusts to existing light levels to produce a proper picture. A microphone is built into the camera.

The only controls on the camera are focus and an on-off switch. This makes operation simple. An indicator lamp lets you know when the power is on. There is a mount for attaching the camera to a tripod.

The operating controls are on the monitor. There's the inevitable on-off switch, brightness and contrast controls, a volume control for the audio plus a push-to talk-button (the camera microphone becomes a speaker) and a focus adjustment that permits limited variation of focus from the monitor. The only other control is a standby switch.

After using the system I found picture quality excellent, the camera and monitor easy to use. The 2-way audio takes a little getting used to, but as soon as you remember not to talk while the other party does, you're in business. All in all, a system worth owning.—Warren Roy

NEW BOOKS

CBers' HOW-TO BOOK, by Leo G. Sands. Hayden Book Co., Inc. 116 W. 14 St., New York, N.Y. 10011. 5 1/2 x 8 1/4", 120 pp. Softcover, \$3.50.

Explains how to operate CB gear and includes tables for all CB codes and channels. Tells how to select and install the right unit, with analysis of mobile unit and base-station features. Walkie-talkies and phone patches also discussed. Covers test and repair techniques and modifications to improve operation.

1970 POPULAR TUBE/TRANSISTOR SUBSTITUTION GUIDE, by TAB editorial staff. Tab Books, Blue Ridge Summit, Pa. 17214. 224 pages, 5 1/2 x 8 1/2 in. Leatherette, \$4.95, paper, \$2.95.

First four sections cross reference popular American receiving tubes; commercial and industrial tubes are also covered. Third and fourth sections show substitutes for foreign tubes and base diagrams. Final four sections list transistors in a similar format.

COMPUTERS AND ARTIFICIAL INTELLIGENCE, by Robert G. Middleton. Howard W. Sams & Co. Inc., 4300 W. 62 St., Indianapolis, Ind., 46206. 126 pages, 5 1/2 x 8 1/2 in. \$3.95.

Early chapters describe analog and digital computers and basic logic circuits. Other topics discussed are: information theory, automation deductive logic, inductive logic; later chapters discuss possibilities that a computer might show true intelligence.

HANDBOOK OF OSCILLOSCOPES: THEORY AND APPLICATION, by John D. Lenk. Prentice-Hall, Inc., Englewood Cliffs, N.J. 07632. 212 pages, 6 1/4 x 9 1/4 in. Hardcover, \$10.95.

Supplements operating instructions of a scope by describing how to use them for everything from finding a diode's switching time to the hysteresis factor of a memory core. After scope-basics chapters, voltage, current, time, frequency and phase measurements are described. Other chapters explain scope use with sweep generators, checking components, amplifiers, communications gear, TV and industrial items.

COLOR TV—RECEPTION AND DECODING TECHNIQUE, by B. W. Osborne. Hart Publishing Co., 510 Sixth Ave., New York, N.Y. 9 1/4 x 6 1/4 in., 168 pp. Hardcover, \$12.50.

Presents circuits for color TV reception from antenna input circuit through decoder. Also introduces decoder design for color systems in use in different countries. Text will serve as an introduction to assessment of TV circuit performance in terms of waveform design. Covers signal-to-noise problems of vhf and uhf TV reception. Includes receiver input circuit, design for low distortion in the luminance and chrominance channels. NTSC decoder, PAL decoder, SECAM and NIR decoders, applications of waveform measurement techniques. R-E

NOVEMBER 1970

ALARM SYSTEM DIRECTORY

Acron Corp.
1209 River Ave. (Rte. 9)
Lakewood, N.J. 08701

Adcor Electronics
349 Peachtree Hills Ave.
Atlanta, Georgia 30305

Advanced Devices Laboratory
701 Kings Row
San Jose, Calif. 95112

Aerolarm
P. O. Box 806
Butler, N.J. 07405

Alarm Device Mfg. Co.
165 Eileen Way
Syosset, N.Y. 11791

Alarm Prods. International, Inc.
24-02 40th Ave.
L.I.C. New York 11101

Alarm Systems Co.
31807 Utica Rd.
Fraser, Mich. 48026

Alarmtronics Engineering, Inc.
154 California St.
Newton, Mass. 02195

Aljemk Industries, Inc.
5201 N.E. 12th Ave.
Ft. Lauderdale, Fla. 33308

Allied Radio Corp.
100 N. Western Ave.
Chicago, Ill. 60680

American District Telegraph Co.
155 Sixth Ave.
New York, N.Y. 10013

Ampex Corporation
401 Broadway
Redwood City, Calif.

(continued on page 94)

If you can't come to the world's newest, largest and most exciting electronics department store, we'll mail the store to you!

Exclusive! Knight-Kit and Science-Fair Kits. Build-your-own stereo, CB, automotive, ham radio, science, hobby, test, photography and more!

Exclusive! Realistic Life-time Tubes. The end of tube worries! We guarantee ours will last as long as your set—or we replace it FREE!

Exclusive! Battery-A-Month Club. Join the Club and get a powerful battery every month for a year—FREE



Exclusive! Big Choice of Audio Items... Factory-Direct Savings!

Allied TD-1099. 3-Head Stereo Tape Deck. One-piece head makes tape threading a snap. Walnut-grain case. \$179.95

Realistic STA-120. Wideband AM, FET-FM Stereo Receiver. 140 Watts. With case. \$269.95



1971 Allied Radio Shack Catalog
Thousands of electronic values!



Allied Radio and Radio Shack have joined forces to form the largest electronics distributing company in the world! This new 460-page catalog offers you famous-name brands, exclusive new products you'll find nowhere else and prices that only our combined buying power makes possible!

Mail Coupon To Address Below... or bring to Allied Radio Shack store for new 1971 catalog!

ALLIED RADIO SHACK, 100 N. Western Avenue 608
Chicago, Illinois 60680

Yes! I want your big new 1971 catalog. I enclose \$1 for mailing and handling (refundable with my first purchase of \$1 or more).

NAME _____
First Middle Last

ADDRESS _____
Street or Route and Box No.

CITY _____ STATE _____ ZIP _____

I enclose check money order cash

World's Largest! Over 800 stores in 48 states. See your phone book.

NEW

DUAL TRACE 5" TRIGGERED OSCILLOSCOPE

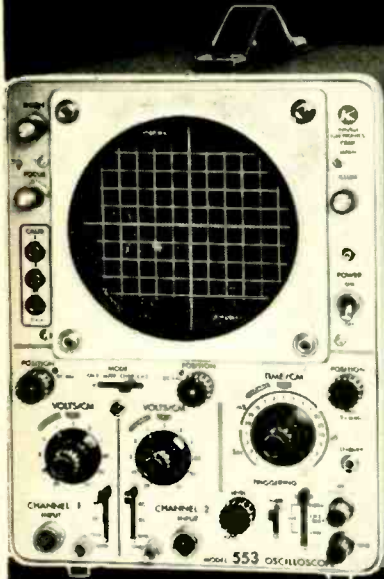

MODEL 553

Compare these features:

- Solid state circuitry
- High sensitivity—10MV/cm
- Low heat dissipation
- Extra wide bandwidth—7 MHz
- Lightweight—only 8½" high
- Simplified controls makes for easy operation
- Extremely reliable performance
- Built-in square wave oscillator for calibration functions
- Vertical channels
- AC/DC inputs
- FET protected input
- Wide sweep range—1 μ s/cm

ORDER ONE TODAY!

ONLY **\$538.00** COMPLETE

Call or write for **FREE** specification catalogs

kikusui
ELECTRONICS CORP.

Address all inquiries to

Marubeni-Iida (America) Inc.
200 Park Avenue, New York, N. Y. 10017
Telephone 212-973-7152

Circle 66 on reader service card

the Electronic Industry's Best CONTROL CLEANER/LUBRICANT

SUPER TROL AID

NO. 820 8oz. SPRAY CAN
ONLY **\$1.98** dealer net



- ❖ WITHSTANDS HIGH CHASSIS TEMPERATURES WITHOUT EVAPORATING OR OXIDIZING (-40°F to 280°F)
- ❖ DUAL ACTION — CLEANS OFF CORROSION AND DIRT, THEN LEAVES PROTECTIVE LUBRICATING COATING
- ❖ EXCELLENT FOR CONTROLS, SWITCHES RELAYS — ALL CONTACT DEVICES

CHEMTRONICS

1260 RALPH AVE.
BROOKLYN, N.Y. 11236

Circle 67 on reader service card

Now, industry's most effective cleaning tool is available to you, too. Precision-cleans hundreds of things you couldn't clean before. High frequency sound waves scrub tiny grooves, threads, joints, etched surfaces, enclosures, crevices. Solid state, automatic tuning, portable, engineered for continuous duty.

NEW ULTRASONIC DEEP-CLEANING TOOL

HANDY SONIC™

Tank size: 5"x5"x3" deep.
75 watts, 115 volts AC.
Heavy Duty Steel Housing.
Guaranteed 90 days.
\$69.95 delivered U.S.



Order your Handy Sonic, or more information, from
BRANSON INSTRUMENTS COMPANY
PARROTT DRIVE, SHELTON, CONN. 06484

Send _____ Handy Sonic Ultrasonic Cleaners @ \$69.95. I enclose
check money order Send _____ Handy Sonic information to

NAME _____
ADDRESS _____
CITY _____ STATE _____ ZIP _____

Circle 68 on reader service card

COMING NEXT MONTH

DECEMBER 1970

- **Build A Computer Lab** ICs, patchboards, and logic. It all adds up to a convenient way to learn how computers work by setting up actual computer logic circuits
- **Designing Semiconductor Hi-Fi Stereo Amplifiers**
First in a series of articles that shows how to custom-design the features you want into a solid-state amplifier
- **Darkroom Temperature Monitor**
Know what your solution temperatures are instantly and precisely
- **Building Solid-State Power Supplies**
Matt Mandl tells how to make the power supply you need for that special application

PLUS . . .

Jack Darr's Service Clinic
Your Career In Electronics
Kwik-Fix Troubleshooting Charts

NEW PRODUCTS

(continued from page 74)

CONTACT OVERHAUL KIT, for TV tuners, contains cleaning, polishing, and lubricating materials for switch contacts in all color and black & white TV tuners. Includes aerosol spray of degrea-



ser/cleaner for high pressure removal of "muck" from the surfaces with minimum of frost. An aerosol spray of lubricant completes the kit. Comes with instructions . . . \$5.50.—Castle TV Tuner Service, 5710 N. Western Ave., Chicago, Ill.

Circle 40 on reader service card

NEXT MONTH

R-E's Logic Laboratory is big news. Use it to discover the wonders of computer logic operations. Conduct experiments at home. Learn what makes computers tick.

NEW LITERATURE

All booklets, catalogs, charts, data sheets and other literature listed here with a Reader's Service number are free for the asking. Turn to the Reader's Service Card facing page 102 and circle the numbers of the items you want. Then detach and mail the card. No postage required!

PANEL METER CATALOG No D-70. Twenty pages packed with panel meter data. 1½", 2½", 3½", 4½", 5½", 6½", 7½", & 8½" models are described. Special units, including edgewise meters; wattmeters, and suspension meters are also included.—Triplett Corporation, Bluffton, Ohio 45817

Circle 41 on reader service card

ELECTRONIC ENGINEERING CAREERS for experienced electronic technicians are spelled out in a special 22-page booklet. Prepared for the person "planning his future", this fact-filled booklet details opportunities in the field of electronics today. It tells how to get the additional education required to take advantage of "the need for highly qualified people who really understand electronics".—Grantham School of Engineering, 1550 N. Western Avenue, Hollywood, Calif. 90027

Circle 42 on reader service card

ELECTRONIC KITS CATALOG, EICO 1970. Features do-it-yourself kits and factory-assembled electronic equipment. Lists color organs, strobes, translators, solid-state test instruments, electronic project kits, amateur shortwave equipment, Cortina stereo components, oscilloscopes, generators, power supplies, multimeters, probes and many others. Also includes an index of authorized dealers.—Eico, 283 Malta St., Bklyn, New York 11207

R-E

Circle 43 on reader service card



MISSILE BATTERY

The Only Lifetime Battery

Surplus—Ni-Cad plastic inter-plate battery cells at approx. 10% of government cost

Connect these 1.2 V. cells in series to make batteries of any voltage. (Example: 10 cells = 12 V. Batt.), or size to replace storage batteries on autos, motorcycles, boats, radio, etc. All the good characteristics not possessed by lead-acid and other alkaline batteries such as: Lifetime service, lighter wgt., constant voltage, high discharge rate (approx. 10 times AH cap.), operate at 100% cap. in temp. range —95° to +165°F., not harmed by storage, discharge, overcharge, or freezing. May be charged thousands of times with the only maintenance of adding distilled water and keeping clean. Select cell sizes to fit your application below.

Esse Type	AMF Hr	High	Width	Depth	Wgt. Oz.	Cost
AH4	4	6	2	1/2	6	1.49
AH4	4	6	2	1/2	6	2.95
AH6S	6	4	2-1/8	15/16	8	1.79
AH6	6	4-5/8	2-5/8	3/4	8	1.79
AH6R	6	4-1/2	2-5/8	11/16	8	2.95
AH10	10	4-3/4	2-3/4	1-3/16	16	2.29
AH10	10	4-3/4	2-3/4	1-3/16	16	4.95
AH12	12	5-3/4	2-5/16	1-1/16	18	2.79
AH34	34	9-1/4	3-1/8	1-3/8	52	4.95
AH60	60	11-1/4	5	1-3/8	104	5.95

SPECIAL CLOSE OUT!

Metal cased Ni-Cad cells, ideal for motor starting. 30AHM-30AH, 8-7/8x3x1-1/4, Wgt. 3-1/2 lbs. \$2.00
52AHM-52AH, 9x3x1-5/8, Wgt. 4-1/2 lbs. \$3.50
Send for complete list including made-up batteries. All cells guaranteed for satisfaction or money back. All cells not marked new are used but serviceable. Include postage on parcel post shipments.

ESSE RADIO COMPANY

Dept. RE-11
368 S. Meridian St.
Indianapolis, Ind. 46225

Circle 69 on reader service card

Your caddy is the only caddy our tubes fit.

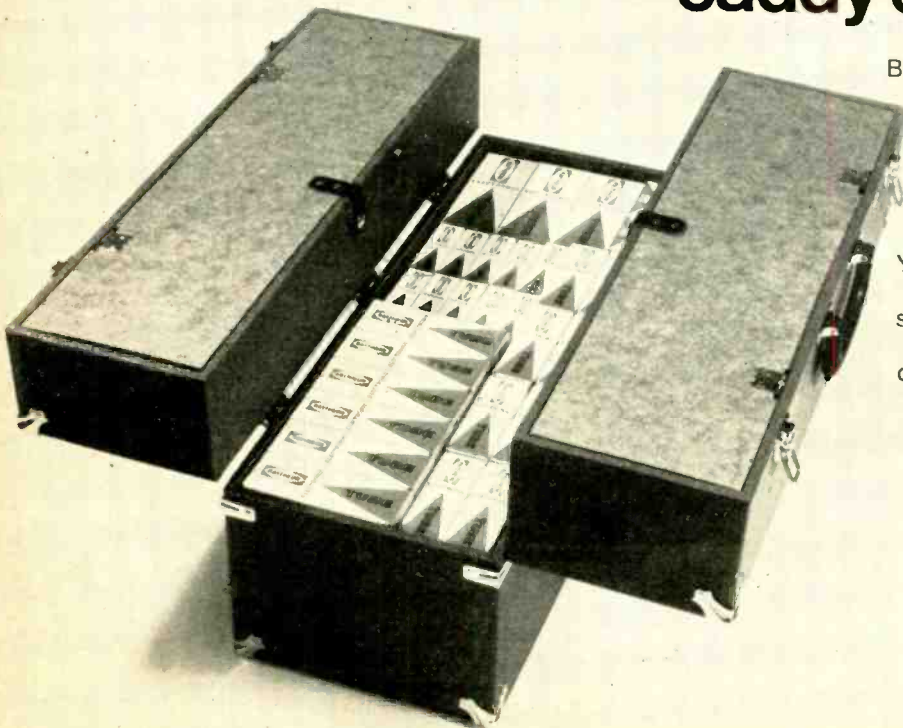

Because we market our tubes only through you—the independent serviceman.

We don't have service trucks or retail outlets. Our tube caddies are available only to you.

You see, we're independent too—the largest independent tube supplier in the business. We have to cooperate with you—not compete. Because we depend on you just as you depend on us.



Circle 70 on reader service card

**Mark Ten B...
the gift for
the man who has
everything.
It's new!
It's practical!
It's different!**

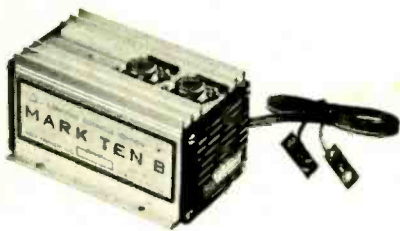

Christmas comes but once a year, but car problems continue year round. So why not give the gift that provides continuing pleasure and satisfaction... the Mark Ten B CD System.

Keeping your car in tune is important to the life of the car. What did your last tune-up cost? More and more, tune-ups are becoming a major maintenance expense, costing \$60 and up.

Now you can eliminate two out of three tune-ups (that's real savings). Delta's all new Mark Ten B CD System is made especially for foreign cars and modern American engines suffering from smog control devices, rough idle and poor fuel mix. The system is completely sealed, with handy switch for instant conversion. Quick installation — no rewiring. The Mark Ten B actually pays for itself in dollars saved.

You may even want to give yourself a Mark Ten B Christmas.

Order today!

"Delta Products, One Of America's
Finest Names In Electronics"

Mark Ten B Only **\$59⁹⁵** ppd.
(12v neg only)

Standard Mark Ten **\$44⁹⁵**



DELTA PRODUCTS, INC.

P.O. Box 1147 RE / Grand Junction, Colo.
(303) 242-9000

Please send me literature immediately:

Enclosed is \$ _____ Ship ppd. Ship C.O.D.

Please send:

___ Mark Ten B @ \$59.95

___ Standard Mark Ten (Assembled) @ \$44.95

___ 6 Volt: Neg. Ground Only ___ Positive Ground

___ 12 Volt: Specify ___ Negative Ground

___ Standard Mark Ten (Delakit) @ \$29.95

(12 Volt Positive Or Negative Ground Only)

Car Year _____ Make _____

Name _____

Address _____

City/State _____ Zip _____

Circle 71 on reader service card

The sure way to
**ELIMINATE
CALLBACKS**



Only Injectorall's new **BLUE LUBE** foam spray contains Oxident — an anti-oxidation chemical that cleans contacts, keeps them permanently clean and prevents callbacks. Eliminates picture streaking and intermittents with one application.

**INJECTORALL INJECTORALL
ELECTRONICS CORPORATION**

Great Neck, N.Y. 11024

In Canada:
CANADIAN GENERAL ELECTRIC LTD.
Ontario

Circle 72 on reader service card

**Build this pipelike
Schober Recital Organ**

for only

*\$1850!



*Includes finished walnut console. (Only \$1446 if you build your own console.) Amplifier, Speaker system, optional accessories extra.

You couldn't touch an organ like this in a store for less than \$4,000—and there never has been an electronic instrument with this vast variety of genuine pipe-organ voices that you can add to and change any time you like! If you've dreamed of the sound of a large pipe organ in your own home, if you're looking for an organ for your church, you'll be more thrilled and happy with a Schober Recital Organ than you could possibly imagine—kit or no kit.

You can learn to play it—and a full-size, full-facility instrument is easier to learn on than any cut-down "home" model. And you can build it, from Schober Kits, world famous for ease of assembly without the slightest knowledge of electronics or music, for design and parts quality from the ground up, and—above all—for the highest praise from musicians everywhere.

Send right now for the full-color Schober catalog, containing specifications of all five Schober Organ models, beginning at \$499.50. No charge, no obligation. If you like music, you owe yourself a Schober Organ!

The *Schober* Organ Corp., Dept. RE-84
43 West 61st Street, New York, N.Y. 10023

Please send me Schober Organ Catalog and free 7-inch "sample" record.
 Enclosed please find \$1.00 for 12-inch L.P. record of Schober Organ music.

NAME _____

ADDRESS _____

CITY _____ STATE _____ ZIP _____

Circle 73 on reader service card

IN THE SHOP

(continued from page 17)

times the normal current. Likely suspects, an internal leakage in the transistor or incorrect bias voltage on the base. So *that's* where we should start looking for the trouble.

We must learn to think in terms of "What is the *normal* reduction in this circuit?" In tube circuits they were all the same—more negative grid voltage, less plate current. In transistor circuits, a more-negative base voltage means less collector current *only* if the transistor is an npn! A negative voltage is a *reverse* bias (in the direction which *reduces* collector current) for npn's. For pnp's, a more-positive voltage reduces the collector current, since a positive voltage is reverse-bias for these.

I know that this is going to be hard to do, for some of us "set in our ways" old-timers. In fact, every now and then you'll probably find "up" or "down" sneaking into this space! The habits of a lifetime aren't easy to break; I write "Hertz" but I still say "cycles!" However, if you can discipline your thinking to use these terms, it will be a big help in dealing with circuit reactions in modern electronic equipment. And, frankly, the way things are now, we can use all the help we can get!

R-E

Service Clinic

By JACK DARR
SERVICE EDITOR

This column is for your service problems—TV, radio, audio or general and industrial electronics. We answer all questions individually by mail, free of charge, and the more interesting ones will be printed here.

If you're really stuck, write us. We'll do our best to help you. Don't forget to enclose a stamped, self-addressed envelope. Write: Service Editor, Radio-Electronics, 200 Park Ave. South, New York 10003.

Negative Pix, Old Conar TV

I've got a very weak negative picture on an old Conar 70 TV that I'm fixing up.—J. B., Dabneys, Va

Check the 6AS8 used as the 3rd video i.f. If the diode (video detector) has mount-leakage or is shorted that'll do it. Also see if the video output amplifier plate load resistor hasn't gone away up in value. This can cause the same symptoms too.

Intermittent color flashes

This color set works perfectly most of the time; every now and then the screen suddenly flashes a bright

blue. Sometimes, I can tap the chassis and make it flash. Changed tubes, checked picture tube, etc. Do you think this could be an intermittent heater-cathode short in the CRT?—R. G., Chickasha, Okla.

Possible, but let's exhaust all of the cheaper alternatives first! For one common cause of this symptom, check the plate connections to the B-Y color difference amplifier tube. If, as usual, there's a tiny rf choke in there, this can be intermittently opening. This lets the plate voltage jump away positive, and turns the blue gun hard on, causing the flash. Intermittent solder joints on the PC board in the same circuit can also cause identical symptoms.

This can affect any color, of course, not blue alone.

Fanout of R,G,B lines

The red, green and blue vertical lines fan out like a palm tree in this Silvertone color TV chassis. Controls don't seem to have a lot of effect on it. Top and bottom of the screen. What's going on?—A. M., Lake Charles, La.

This has been known to happen in these sets when the vertical centering control opens. This upsets the vertical convergence waveforms. Easy to check; just see if the vertical centering control will move the picture up and down. If it won't, there you are.

Yoke replacement

I have a Sharp TSP109A, with a bad yoke. Can't find a replacement listed for it, and can't get one from the company. Do you know of a U.S. manufacturer who makes one?—D. K., New York.

The Merit MDF-127 will replace this one. Your distributor may have to order it specially, but it'll fit.

Faint vertical bars

I've got faint vertical bars all the way across the screen, on a Sylvania D12 color chassis. These seem to show up mostly on black and white pictures. Checked tubes, etc. No help.—J. Q., Bangor, Maine.

Check the horizontal blanking amplifier transistor, Q604 (Q14 in photofacts). If you find the same pulse waveform on both base and emitter, there you are. This transistor is leaky. Replace it.

Hot horizontal output transistor

I've got a mysterious ailment in a little transistor TV. The horizontal output transistor gets very hot, I have no high voltage, and I get too much current. Everything else seems OK: no shorts in the flyback circuits, and the supply voltage is a little low. What's going on here? Tried a new

output transistor, and it gets hot too.—P. D., Tucson, Ariz.

Check the frequency of your horizontal oscillator. The drive pulses in transistor horizontal output stages must be of the right width, to get the correct ON time for the output transistor. They must also be at the right frequency. If the oscillator is running much too fast, you'll have pulses at the input, but there will be too many of them. This has the same effect as a too-wide pulse: it keeps the output transistor turned on too long, thus drawing too much current. Check with scope, comparing to video signal.

One line or three?

When I throw the switch to the

service position in color sets, I often get three separate lines. I thought you were supposed to get a single white line when you had the screens set correctly. How come?—R. G., Altoona, Penna.

When you set the switch to "service," you kill the vertical output stage. So, you lose your vertical dynamic convergence waveforms. Therefore, the three lines may or may not cover each other. Pay no attention to this; just set the three lines to equal intensity and turn it back to normal. Personally, I like to set screens so that the lines have just gone out. I think you get a more accurate adjustment by doing this. Others differ and have their own favorite adjustment. **R-E**

"Smartest decision I ever made!"

"I opened my first Allied Radio Shack store with a small investment . . . soon I'll own three"



"In 1968, I opened my first retail store in Portsmouth, N.H. Things happened fast and with the profits from that store I opened another in Dover, N.H. last July. Now I'm planning a third store in Lewiston, Maine. Believe me when I say the Allied Radio Shack plan is the greatest thing going in consumer electronics."

Tony Esposito



THE ALLIED RADIO SHACK PLAN CAN WORK FOR YOU!

Allied Radio Shack is a division of Tandy Corp. (NYSE) and the nation's biggest electronics store chain—over 850 stores! We offer a unique franchise opportunity to energetic men and women who want a retail business of their own. Within weeks, you can be the outright owner of a store like one of Tony Esposito's. You get the full benefit of our 50 years of experience, immediately. Here's your chance to be your own boss, to be a vital part of the community you select for your store, to achieve real success. And . . . you make no long-term financial commitment, you pay no fees or royalties.

OUR PROGRAM IS SUCCESS-DESIGNED

Our proven plan covers everything from grand opening to daily operations. A specially prepared Operations Manual guides you every step of the way. And continuing assistance is yours from the same Regional Manager who guides company-owned stores in your state. Dynamic catalogs, sales flyers and local newspaper ads keep the customers coming in. You benefit from creative merchandising, exclusive products, outstanding gross profit margins.

YOU'RE IN A CLASS BY YOURSELF

There is no other operation like ours—no one else can sell the same brands "right across the street." Most of your inventory will be Allied Radio Shack's own nationally famous, nationally advertised brands: Allied® and Realistic® hi-fi stereo, radios, phonos and Citizens Band equipment; PortaVision™ TV, Archer® antennas; Knight-Kit®; plus our own batteries, parts, hobby kits, records, tapes, tubes, test instruments, PA equipment, and more! Because these brands cannot be bought in other stores or catalogs, you get higher gross profit margins.

- ★ PROFITS
- ★ SECURITY
- ★ INDEPENDENCE

OPEN YOUR OWN STORE
IN YOUR FAVORITE STATE



CALL COLLECT
OR WRITE TO:

A. A. Bernabei
V. P. Franchise Division
Allied Radio Shack
2617 West 7th Street
Fort Worth, Texas 76107
Phone (817) 336-7163



SEND ME FULL FRANCHISE DETAILS Dept. A16

Name _____ Phone _____

Street _____

City _____ State _____ Zip _____

PRESS-AT-ANY-POINT TAPESWITCH ALARMS

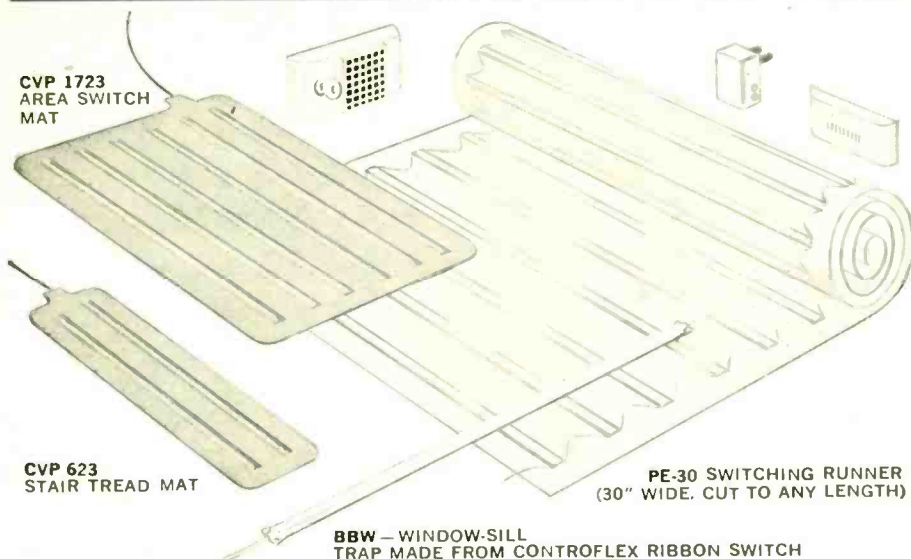

Tapeswitch ribbon and area switches are normally open, momentary contactors, activated when pressure is applied to any point of its length. Totally waterproof when properly end-sealed, it can be cut to any length, will withstand heavy forces without damage and flexed without shorting. Write for catalogue and technical bulletins.

CALL: Metro N.Y. 516-921-7700 • So. Calif. 213-445-1161 / 213-664-2125 • Chicago 312-421-6800 • Philadelphia 215-426-1700 • Dallas 214-357-0741

TAPESWITCH CORPORATION OF AMERICA

320 BROAD HOLLOW ROAD, FARMINGDALE, NEW YORK 11735 • (516) 694-6312

Circle 74 on reader service card

WORLD'S LARGEST SELECTION OF NEW & USED TV CAMERAS & ASSOCIATED EQUIPMENT WOW!

Selected Items from our Giant 25th Anniversary
Catalog & Reference Manual
\$1.00 ppd USA - \$2.00 Foreign
Free to requests on Company Letterhead

New NORELCO VTR model EL-3401A/54 Stock #29, 503



1" helical Scan Video Tape Recorder with inst. manual, head & cord. \$399.95
Shipping Wt. 150 lbs. FOB Rockville

FAIRCHILD TV-600 CAMERAS
Stock #6583



Brand new with vidicon & schematic; less lens. Regular price \$2719. Our price only \$995.

FAIRCHILD/DUMONT TC 200
TV CAMERA HEAD Stock #6577



Used, good condition \$39.95 With schematic. No lens or vidicon.



NEW!

#3800 - 48mm f1.9 Lens "C" mount adj. iris & focus \$21.95 plus post.

#4080 - 3 in 1 Lens 25mm f1.9 "C" mount with wide angle & telephoto attachments \$34.95 plus postage

DENSON ELECTRONICS CORPORATION

Longview St., PO Box 85

203/875-5198

Rockville, Conn. 06066

Circle 75 on reader service card

LOGIC DESIGN COURSE

Recently introduced by the Center for Technical Development, a new Ohio-based company, the Logic Design Program DDP-1 consists of a 6 x 10-inch PC board, a 13-lesson loose-leaf notebook along with 13 programmed learning tests and 10 breadboard project instruction sheets. All components for the lessons are provided with the kit, and the parts may be removed from the push-in terminals for repeated use.

By lesson three, you've derived the alpha and beta formulas for transistors, covered the forward and reverse bias characteristics of diodes, and have been introduced to transistor load curves. Lesson four looks at design procedures for simple inverters, showing how to find I_C , I_B , R_B and R_{BB} . Five is a study of emitter follower operation. Starting with lesson four, separate breadboard lesson sheets tell you how to install components on the PC board to measure (a voltmeter is needed) and observe what you've been studying.

The remaining lessons (6-14) describe logic circuits, starting with diode gates and truth tables. Diode transistor logic (DTL) and resistor transistor logic (RTL) are covered in seven and eight—with corresponding breadboard projects. The ON or OFF states of the circuits is indicated by small lamps, operated with two switches premounted on the board.

Next comes NAND/NOR gate design and set/reset flip-flops. Here's how a typical design example goes: "Design an SR flip-flop, using NOR gates capable of driving 6-volt, 150-ohm lamps. Use germanium transistors type 2N404. Make $V_{BB} = +3V$ and $R_C = R_L$." The lesson shows how to complete this design. At this stage all four of the premounted transistors are used in the breadboard projects.

The final four lessons (11-14) are on bistable and monostable flip-flops and Schmitt trigger design. Also covered are differentiation networks and commutating capacitors. A scope is useful—but not necessary—with these lessons to observe waveforms.

The course packs a lot of basic solid-state design theory into each of the brief lessons (each one is about 6 pages long). Examples and solutions for important design principles are provided in the lesson and tested in the sheets of the programmed course. The breadboard projects provide practice at wiring up components from simple schematics, and classroom instructors should find the non-permanent feature useful. Cost of the course is \$99.—John Williams

Circle 76 on reader service card →

NEW TUBES AND SEMICONDUCTORS

LONG-LIFE NEON LAMP

The A297 is a new neon lamp specifically designed for long-life use in a seven-bar numeric display. It is constructed with 7-mm electrodes in a glass envelope considerably longer than is necessary for an ordinary neon lamp. The longer glass envelope and shorter electrodes eliminates the

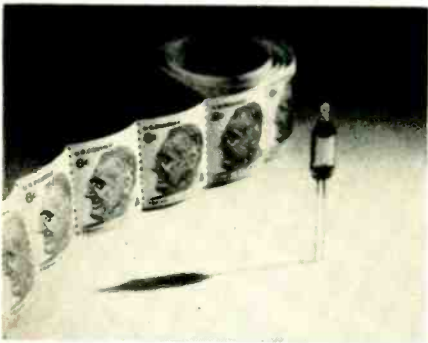

possibility of characteristics changes due to sputtering. As a result, the tip remains clear and its effective life, measured by light output, is considerably longer than a device with normal length electrodes in the envelope. Light is taken from the end of the envelope and applied to its segment of the seven-bar display.

The Signalite A297 has a breakdown voltage rating of 215 volts max and a maintaining voltage rating of 128 to 148 volts. Design current is 5 mA. The lamp is in a T2-size envelope that is 27/32 inch long and 0.244 inch in diameter.

For information, contact Signalite Inc., Neptune, N.J.

EPOXY SCR'S

The 2N5787 through 2N5792 are six new low-cost Fairchild SCR's with forward and reverse voltage ratings from 30 to 400 volts. They are electrical equivalents of the 2N5060 through 2N5063 and the Texas Instruments TIC-44 through TIC-47. Gate sensitivity is 10 μ A (typical) and on-state voltage drop is 1.0 volt (typical at 200 mA). All have a maximum current rating of 500 mA. Housing is Fairchild's TO-106 package, which has the same circular pin configuration as the TO-18 metal can. Guaranteed to operate at junction temperatures of -65° to $+125^{\circ}$ C. Ratings and prices (1 to 99) of these Fairchild devices are: 2N5787, 30 V, \$0.77; 2N5788, 60V, \$0.83; 2N5789, 100 V, \$0.96; 2N5790, 200 V, \$1.09; 2N5791, 300 V, \$1.61 and 2N5792, 400 V, \$2.00. **R-E**



•the
right
head
for your
recorder?

Your Nortronics distributor has it in stock!

Heads for over 2100 recorders, domestic and imported, almost certainly including yours. Excellent performance characteristics, long life, easy replacement.

ASK FOR FREE LITERATURE.



Nortronics
COMPANY, INC

6140 Wavzata Boulevard
Minneapolis, Minnesota 55416
Phone: (612) 544-0381

no other
heat gun...
offers
all these
attachments!

Attachments to speed your job... attachments that tailor Master heat gun airflow precisely to your needs... attachments that fit any existing Master flameless heat gun. No other line offers so many choices... including the exclusive patented cone for 1/4" concentrated heat, optional adjustable base, convenient carrying case, and the only U.L. listed gun available. Send for free 12 page catalog.



for shrinking
thermoplastic
tubing and film,
curing, forming,
melting, drying,
soldering.

MASTER HEAT GUNS

Racine, WI 53403

Circle 77 on reader service card

Who Needs a Tuner Wash?

Use

QUIETROLE Mark II Spray Pack

The product that cleans and lubricates better than any product you can buy and has been used for more years than any product of its kind.

The Choice of "Better Servicemen" Everywhere



Circle 78 on reader service card

TRY THIS ONE

DEMAGNETIZER

A simple tape head demagnetizer can quickly be made by attaching No. 14 household wire formed into a two-

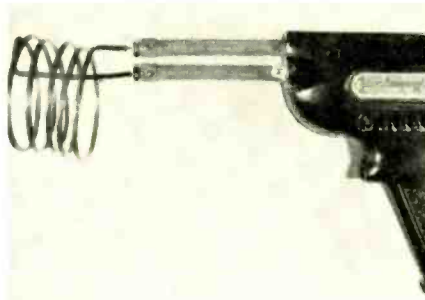

or three-inch coil to your pistol grip soldering gun. A reminder for this as well as all demagnetizers, always withdraw the field from the head before turning power off.—John F. Agee

REMOVING PC COMPONENTS

When you have to remove multiple-terminal components like tube sockets; i.f. transformers; etc. from printed circuit boards use this trick. Rather than heating each terminal successively and hoping that the solder remains molten until all the terminals are heated, form a piece of No. 12 or

No. 14 wire to fit down on the terminals of the part to be removed. Tin the wire and make sure it touches all the terminals. Then apply heat to two or three places along this "heat sink" with your soldering gun. The part may then be removed with a minimum of heat—avoiding needless damage to circuit board or component.—H. Josephs

FUSE SAVER

On some color TV's you find circuit breakers, and on others plug-in fuses. But when we make a service call and find a set with a blown fuse, we don't plug in a new fuse. Instead we made up a circuit breaker by taking the old plug-in fuse pins and soldering them to a breaker. Then we plug in the breaker until we find what is causing the fuse to blow. When repaired, we plug in the regular fuse. This way you can save a lot of fuses.—Harry J. Miller

GROMMETS FOR "FEET"

Inexpensive rubber grommets are a good substitute for regular "feet" for your construction projects. The grommets work just as well and are usually easier to obtain. The 1/4-inch inner-

SUPER VALUES

FREE \$1 BUY WITH EVERY 10 YOU ORDER

Only applies to "\$1" Buys

FREE GIFT WITH EVERY ORDER

KNOB SPECIAL

- 100 - ASSORTED RADIO KNOBS All standard types ... \$20 value **\$1**
- 50 - TV KNOBS - POPULAR TYPES For most sets **\$1**
- 25 - VERTICAL LINEARITY KNOBS Long shank ... Front mount ... miniature assortment **\$1**
- 30 - VERTICAL LINEARITY KNOBS ... Side mount ... Standard sizes **\$1**
- 25 - KNURLED RADIO KNOBS Hard to get ... Best selection **\$1**
- 25 ASSORTED CLOCK-RADIO KNOBS Best assortment. Most popular types **\$1**

ANY 6 KITS FOR \$5

STEREO HEADPHONES

- Hi-Fi Quality ... Complete with Stereo plug **\$5.95**
- 50 - TUBE CARTONS (colored) assorted sizes for Popular Tubes **\$1**
- 4 - 36" HI-FI CABLES RCA Mobled Phone plug at one end stripped and tinned leads on other end **\$1**
- 3' JUMPER CABLES Mate RCA Type Plug on Both Ends, 2 For **\$1.19**
- 50 - ASST. TERMINAL STRIPS all types, 1-1ug to 6-1ug **\$1**
- 2-G.E. PIECES OF EQUIPMENT stacked with over 200 useful parts **\$1**
- MOTOROLA HEP KIT—INTEGRATED CIRCUITS INCLUDES —One J-K flip flop, One Dual Buffer, One 4-Input Gate, Two Dual 2-Input Gates, All Five **\$3.95**

- 300 - ASST. 1/2 W RESISTORS Top Brand, Short Leads, Excellent Selection **\$1**
- 100—ASST 1/4 WATT RESISTORS stand. choice ohmages, some in 5% **\$1**
- 100—ASST 1/2 WATT RESISTORS stand. choice ohmages, some in 5% **\$1**
- 70 - ASST 1 WATT RESISTORS stand. choice ohmages, some in 5% **\$1**
- 35 - ASST 2 WATT RESISTORS stand. choice ohmages, some in 5% **\$1**
- 50 - PRECISION RESISTORS asst. list-price \$50 less 98% **\$1**
- 20 - ASSORTED WIREWOUND RESISTORS, 5, 10, 20 watt **\$1**
- 5 - TOGGLE SWITCHES SPST, SPDT, DPST, DPDT **\$1**
- 10—ASSORTED SLIDE SWITCHES SPST, SPDT, DPST, etc. **\$1**
- TRANSISTOR RADIO asst type good, bad, broken, as-is, potluck **\$1.50**
- TAPE RECORDER—assorted types good, bad, broken, as-is, potluck **\$4**
- \$20 - SHURE M7D DIAMOND NEEDLE exact replacement **\$3**
- SHURE M44 SERIES DIAMOND NEEDLE exact replacement **\$4.69**
- PICKERING V-15 DIAMOND NEEDLE Exact replacement **\$4.69**
- COLOR POWER TRANSFORMER — Good for most sets 2GR150 List Price—\$30.75 **\$6.95**
- 6 - TRANSISTOR RADIO EARPIECES wires complete with plug **\$1**
- 100' - FINEST NYLON DIAL CORD best size, .028 gauge **\$1**
- 10 - SETS PHONO PLUGS & PIN JACKS RCA type **\$1**

SARKES TARZIAN TUNER
41mc

Latest Compact Model good for all 41 mc TV's. BRAND NEW—

Best TUNER "SARKES TARZIAN" ever made—last word for stability, definition & smoothness of operation. An opportunity—to improve and bring your TV Receiver up-to-date. COMPLETE with Tubes **\$7.95**

- 2 - COLORBURST QUARTZ-CRYSTAL REPLACEMENT For most Color TV Sets. 3579, 545 KC **\$1.49**
- TV TUNER - asst. all new standard makes, Less tubes **\$1**
- G.E. STANDARD TUNER Model #ET-80N203 (ET-80N203) **\$6.95**
- TV TUNERS asst. all new standard makes, Including Tubes **\$3**
- 12—MINIATURE ELECTROLYTIC CONDENSERS For Transistor & miniature work **\$1**
- 10 - MINIATURE 456KC IF TRANSFORMERS Exceptional value —PC—1/2" & 3/8" **\$1**

- HEAVY DUTY COLOR FOCUS RECTIFIER 14,000 PIV @ 1 ma **\$1**
- UHF TUNER - TRANSISTOR TYPE Used in all TV sets **\$3.95**
- 50 - ASSORTED PRINTED CIRCUIT SOCKETS best types **\$1**
- ASTATIC #13T STEREO CARTRIDGE TRIDGE plug in, power point. **\$3.78**
- RONETTE STEREO CARTRIDGE latest dual sapphire flipover type **\$2**
- COLOR-TV RECTIFIER — Used in most color sets—6500 kv **\$1.95**
- 15 - ASST. ROTARY SWITCHES all popular types \$20 value **\$1**
- 15 - G.E. #NE-2 TUBES Neon Glow Lamp for 101 uses **\$1**
- 150' - BUSS WIRE #20 tinned for hookups, special circuits, etc. **\$1**
- 50 - .0033 DISC CERAMIC CAPACITORS C.R.L. **\$1**
- 3—ELECTROLYTIC CONDENSERS most popular number 50/30—150v **\$1**
- 7 - TV ELECTROLYTIC CONDENSERS desirable types **\$1**
- 5 - 6' LINE CORDS #18 Stranded Copper Wire **\$1**
- MOTOROLA PWR TRANSFORM 110v, CT 150/150v, 6.3v **\$1**
- 25 - #130 WESTINGHOUSE PILOT BULBS 5000 Hours. Same as #47 **\$1**
- 25—WESTINGHOUSE PILOT BULBS Your choice of #241, #154, #Pr-23 **\$1**
- 3—ELECTROLYTIC CONDENSERS C.D. 500 mfd—200 volts **\$1**

IMMEDIATE DELIVERY . . . Scientific light packing for safe delivery at minimum cost.
HANDY WAY TO ORDER: Pencil mark or write amounts wanted in each box, place letter F in box for Free \$1 BUY. Enclose with check or money order, add extra for shipping. Tearsheets will be returned as packing slips in your order, plus lists of new offers.
Minimum Order \$3.00

Please specify refund on shipping overpayment desired: CHECK POSTAGE STAMPS MERCHANDISE (our choice) with advantage to customer

BROOKS RADIO & TV CORP., 487 Columbus Ave., New York, N. Y. 10024 212-874 5600 TELEPHONE

diameter size requires a 3/8-inch mounting hole and are good for most small pieces of equipment. The 1/2-inch inner-diameter size are also avail-

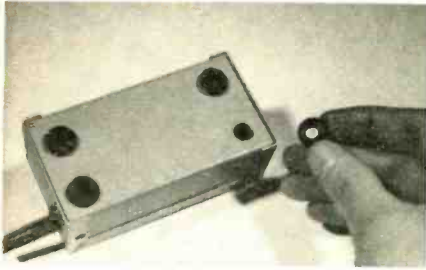

able for larger bulky units. For equipment that will be used on polished furniture, vinyl grommets may be best as they are less likely to spoil the waxed finish.—Robert E. Kelland

SOLDERING TIP SUBSTITUTE

Did you ever burn out a soldering gun (tip) while in the midst of an exciting and important project? And not a spare in the shack?

You can be saved by No. 12 or 14 bus bar wire. Cut a piece about 5" long, and shape into U form. Insert into the gun as usual and tighten. Then squeeze the tip in a vise so that the wires are only about 1/4" apart (near the U curve only). Then tin and use.

The substitute heats just like a ready-made tip and will give excellent results. It won't last nearly as long,

however. Bus-bar is sold at radio supply store, in 3-ft lengths and on 100-ft spools.—I. Queen

THIRD HAND FOR SOLDERING

Two hands aren't enough on some soldering jobs. Make a third hand by mounting a pair of spring-type

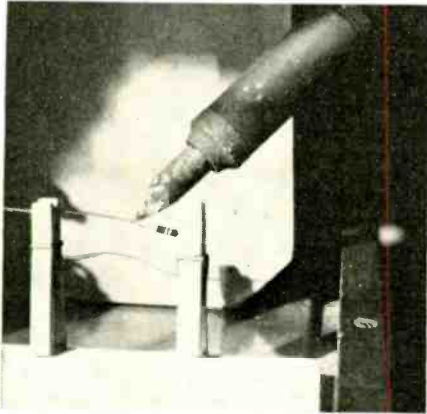

clothespins at an angle, on a small wood block. With the wire and component held in the grasp of the clothespins, your hands are left free to handle soldering iron or gun and the solder.—S. Clark. R-E

DID YOU MISS?

Back on page 59 is a story about a new IC that may someday replace the i.f. strip in all radio receivers. Do you know how it works?



PULSE GENERATOR ADAPTER

Now BLULYNE makes it possible to own your own quality lab pulse generator. Simply attach the output of your present sine or square wave generator to the BLULYNE APG-100 and you have a variable frequency, variable pulse width, variable amplitude pulse generator.

- Perfect for digital circuit work
- A valuable aid for the engineer, experimenter, technician, designer
- Up to 20 nanosecond risetimes
- Pulse width from 100 nanoseconds to 500 milliseconds.
- Not a kit. Completely factory wired and tested.
- Price at only 39.95

Write for information on this and other Blulyne Products.

- Power Supplies
- Pulse adapters
- Special Power Supplies

Blulyne Electronic Corporation
Dept. R, 3 Sand Springs Road,
Williamstown, Mass. 01267

Ask us to add it to your
MASTERCHARGE.

Circle 79 on reader service card

SHANNON MYLAR RECORDING TAPE

2 1/2" — 225' .. \$.17	7" — 2400' .. \$1.79
3" — 225' .. .19	7" — 3600' .. .2.95
3" — 300' .. .27	CASSETTE 60 minutes .89
3 1/4" — 600' .. .58	CASSETTE 90 minutes 1.54
5" — 600' .. .62	CASSETTE 120 minutes 1.97
5" — 900' .. .80	2 1/2" TAPE REEL .. .04
5" — 1200' .. .97	3" TAPE REEL .. .05
5" — 1800' .. 1.49	3 1/4" TAPE REEL .. .06
7" — 1200' .. .77	5" TAPE REEL .. .12
7" — 1800' .. 1.12	7" TAPE REEL .. .14

CANADIANS: Ordering is easy — we do the paperwork — try a small order

WESTINGHOUSE ALL TRANSISTOR HOME/OFFICE MESSAGE CENTER

Leaves messages for other for replay... Built in speaker/microphone for talk-into convenience... Records up to 3 minutes of messages... Illuminated signal shows when a message is waiting. Control adjusts playback volume without affecting recording volume... Capstan Drive... BRAND NEW SOLD AS IS \$7.95

IBM COMPUTER SECTIONS

8 assorted Units we sell for \$1 are loaded with over 150 valuable parts.

Incl. — Transistors, Condensers, Resistors, Heat Sinks, Diodes, Etc.

8 for \$1
100 for \$10

- 4 — TV ALIGNMENT TOOLS Most useful assortment #1 \$1
- 4 — TV ALIGNMENT TOOLS For Color TV #2 \$1.49
- 6 — TV COLOR ALIGNMENT TOOLS Most popular type \$2.79
- 5 — PNP TRANSISTOR general purpose, TO-5 case \$1
- 5 — NPN TRANSISTORS general purpose, TO-5 case \$1
- UNIVERSAL TV ANTENNA Back of set mounting 5 section rods \$1.98
- 50 — ASSORTED TRANSISTORS big factory sweep—sold as-is \$1
- 0 TO 200 MICRO AMP MINATURE METER 1 1/2 x 1 1/2 Wt. 3 Oz. Excellent S meter \$1
- 10 — STANDARD TRANSISTORS NPN & PNP 2N104, 2N114, etc. \$1
- 10—ASSORTED DIODE CRYSTALS 1N34, 1N48, 1N60, 1N61, etc. \$1
- 3 — TOP BRAND SILICON RECTIFIERS 1 amp. 1000 PIV \$1
- 20 — ASST. PILOT LIGHTS #44, 46, 47, 51, etc. \$1
- 50 — ASSORTED #3AG FUSES Popular ampere ratings \$1
- 4—50' HANKS HOOK-UP WIRE assorted colors \$1
- 100'—SPOOL SPEAKER WIRE 2 cond. mini zip, clear, 101 uses \$1.50
- 10 — ASST. RADIO & TV TUBES Every Tube a good number \$1
- UNIVERSAL MICROPHONE regular/remote/single & dual plug \$2
- CRYSTAL LAPEL MICROPHONE high impedance, 200-6000 cps \$5.95
- WESTINGHOUSE FM TUNER #476-V-006H01 (12)T8 Tube \$2.99
- WESTINGHOUSE FM TUNER #476-V-015D01 Transistor \$3.99
- 300 — ASSORTED HEX NUTS 2/56, 4/40, 5/40, 6/32, 8/32 \$1
- 250 — ASST. SOLDERING LUGS best types and sizes \$1
- 250 — ASST. WOOD SCREWS finest popular selection \$1
- 250 — ASST. SELF TAPPING SCREWS #8, #8, etc. \$1
- 150 — ASST. 6/32 SCREWS and 150 6/32 HEX NUTS \$1
- 150 — ASST. 8/32 SCREWS and 150—8/32 HEX NUTS \$1
- 150 — ASST. 2/56 SCREWS and 150—2/56 HEX NUTS \$1
- 150 — ASST. 4/40 SCREWS and 150—4/40 HEX NUTS \$1
- 150 — ASST. 5/40 SCREWS and 150—5/40 HEX NUTS \$1
- 500 — ASSORTED RIVETS most useful selected sizes \$1
- 500 — ASSORTED WASHERS most useful selected sizes \$1
- 100 — ASST. RUBBER BUMPERS for cabinet bottoms & other uses \$1
- 100—ASSORTED RUBBER GROMMETS best sizes \$1

RCA 110° FLYBACK TRANSFORMER

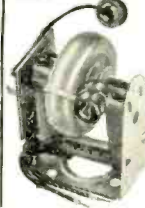

We scooped the Market Latest type — standard for all 110° TV's

RCA's design of large Coil produces 18KV—assuring adequate width Incl. Schematic Diagram application for any TV

List price \$13.90

Your price... \$3

10% off in lots of 3

110° TV DEFECTION YOKE for all type TV's Incl schematic \$3

"COMBINATION SPECIAL" RCA 110° FLYBACK plus 110° DEFECTION YOKE \$5

90° FLYBACK TRANSFORMER for all type TV's Incl schematic \$2

90° TV DEFECTION YOKE for all type TV's Incl schematic \$2

70° FLYBACK TRANSFORMER for all type TV's Incl schematic \$2

70° TV DEFECTION YOKE for all type TV's Incl schematic \$2

2 — TV CIRCUIT BREAKERS Rated 4.2 TO 5.0 AMPS, etc. \$1.19

70° COLOR YOKE For all round color CRT's \$10.95

90° COLOR YOKE For all Rectangular 19 to 25" Color CRT's \$10.95

MARKET SCOOP COLUMN

- 12" UNIVERSAL SPEAKER Top Quality Large Magnet \$4
- 10" PHILCO SPEAKER Top Quality Large Magnet \$2.69
- 8" UNIVERSAL SPEAKER Large Magnet—Special Buy \$2.49
- UTAH 8"—HEAVY DUTY 10 OZ. SPEAKER Ceramic Type—8 Ohm \$3.69
- 6"—ECONOMY SPEAKER Top quality 2.15 Mag. \$2.94
- 5" UNIVERSAL TWEETER 1 Oz. Magnet \$1.29
- UNIVERSAL 5 1/2" PM SPEAKER Alnico 5 magnet, quality tone \$1
- UNIVERSAL 4" PM SPEAKER With 5016 Output Transformer \$1
- 2 1/2" x 4" SPEAKER Special Buy 69¢
- 3 1/2" — ROUND SPEAKER Special Buy 59¢
- 25 — 3900-OHM-7w RESISTOR 10% Corning glass \$1
- 20 — .47-600V CONDENSERS White Ceramic C.D.—American \$1
- TV TWIN LEAD-IN 300 ohm 500' — \$7 100' — \$1.50 50' — \$1
- CO-AX CABLE RG59U grey or black 250'—\$9 100'—\$3.69 50'—\$2
- 5 — I.F. COIL TRANSFORMERS 456-kc for Transistor Radios \$1
- 5 — AUDIO OUTPUT TRANS. FORM Sub-min for Trans Radios \$1

Circle 80 on reader service card

This Christmas Give Security



Gift selection can be a problem. This year give a gift that will be truly appreciated . . . Security. DeltAlert ultrasonic intrusion detection security.

Burglary and vandalism are constant threats to your home, office or shop. With DeltAlert on the job, you have dependable and economical security. A silent ultrasonic blanket guards 150 to 300 square feet of critical space in the home or business.

When the ultrasonic blanket is disturbed by motion the system is activated, lights go on, and the separate DeltaHorn emits an ear-splitting noise . . . frightening off even the boldest intruder.

These sturdy units, finished in handsome walnut veneer, are maintenance free and plug right into the wall socket. The DeltaHorn plugs directly into the DeltAlert. Small, the DeltAlert is only 10³/₈" w x 3¹/₄" d x 3¹/₄" h and the DeltaHorn, 3¹/₄" square, the units blend inconspicuously into your decor.

This Christmas, give a lasting gift of security . . . security for your friends, your family and yourself. Order your DeltAlert Security today!

DeltAlert Only **\$69⁹⁵** ppd.
DeltaHorn Only **\$24⁹⁵** ppd.

"Delta Products, One Of America's Finest Names In Electronics"

DELTA PRODUCTS, INC.
P.O. Box 1147 RE / Grand Junction, Colo. 81501
(303) 242-9000

Please send me literature immediately: Enclosed is \$____. Ship ppd. Ship C.O.D.
Please send: _____ DeltAlert(s) @ \$69.95 ppd.
Please send: _____ DeltaHorn(s) @ \$24.95 ppd.
Name _____
Address _____
City/State _____ Zip _____

Circle 71 on reader service card



CLOCK MOVEMENTS
DIGITS RESETTABLE INDIVIDUALLY
Available in 50, 60 cy., all voltages, AC. UL approved motor, cord. One Year Guarantee.
#130 . . . 12-HOUR #131 . . . 24-HOUR

#100-24H
24 Hour
CLOCK

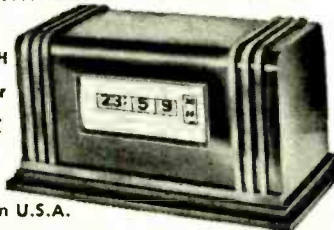

Made in U.S.A.

Complete Line: Delay, Interval and Cycle Timers, Digital Computers

PENNWOOD NUMECHRON CO.
TYMETER ELECTRONICS
7249 FRANKSTOWN AVE. PITTSBURGH, PA. 15208

Circle 81 on reader service card



AMAZING OFFER

RADIO & TV SERVICE DATA

Your best, complete source for all needed RADIO and TV diagrams and helpful servicing data. Most amazing values. Only \$2.50, \$3, \$4, per giant volume. Cover all important makes, models of all periods. Use this entire ad as your no-risk order form.

NO-RISK ORDER COUPON

TELEVISION SERVICE MANUALS

Supreme TV manuals are best for faster, easier TV repairs. Lowest priced. Factory data on practically all sets. Complete circuits, all needed alignment facts, wiring-board diagrams, waveforms, voltages, production changes, and double-page schematics. Only \$3 and \$4 per large annual manual. Check volumes wanted, send entire advertisement as your order form.

- New 1970 COLOR TELEVISION Manual, only \$4.
- New 1970 B-W TV, \$4. 1969 COLOR TV, \$4.
- 1969 B-W TV, \$4. 1968 TV, \$4. 1967 TV, \$4.
- 1966 TV, \$3. Additional 1965 TV, \$3.
- 1965 TV, \$3. 1964 TV, \$3. 1963 TV, \$3.
- Additional 1962 TV, \$3. Early 1962 TV, \$3.
- 1961 TV Manual, \$3. 1960 TV Manual, \$3.
- Additional 1959 TV, \$3. Early 1959 TV, \$3.
- 1958 TV Manual, \$3. Additional 1957 TV, \$3.
- 1955 TV, \$3. 1954 TV, \$3. 1951 TV, \$3.
- Master Index to all TV & Radio Manuals, 25¢.

RADIO DIAGRAM MANUALS

Get these low-priced radio manuals and simplify all repairs. Cover everything you may need from recent radios to prewar old-timers; all type radios, stereo, combinations, transistor portables, FM-AM, and auto sets. Large schematics, all needed alignment facts, printed boards, voltage data, dial stringing, hints. Volumes are big, 8-1/2 x 11", about 190 pages, each

- 1966. 1965. 1964. 1963. 1962. 1961.
- 1960. 1959. 1958. 1956. 1955. 1954.
- 1953. 1952. 1951. 1950. 1948. 1946.
- 1942. 1941. 1940. 1926-38, EACH, \$2.50
- 1965 Auto Radios, \$2.50 TV Service Course, \$3.
- Also New 1967-1969 Combined Radio Volume, \$4.

SUPREME PUBLICATIONS

1760 Balsam Road, Highland Park, ILL., 60035
Rush today TV and Radio manuals checked in no-risk order form of this ad. Send postpaid. I am enclosing full price. Satisfaction guaranteed.

Name: _____
Address: _____
City: _____ State: _____

ALARM SYSTEM DIRECTORY (continued from page 83)

Arrowhead Enterprises, Inc.
P. O. Box 191
Bethel, Conn. 06801

Artoller Lighting and Sound
141 Lanza Ave.
Garfield, N.J. 07026

Artonix Surveillance
716 Hanley Ct.
St. Louis, Mo. 63144

Astro Design, Inc.
P. O. Box 636
Melbourne, Fla. 32901

A.T.A. Control System, Inc.
980 W. 84th St.
Hialeah, Fla. 33014

Automatic Protection Systems
7809 Market St. Rd., P.O. Box 24207
Houston, Texas 77029

Ballistics Control Corp.
39-50 Crescent St.
LIC, New York 11101

Beckman Research & Mfg. Co.
111 W. Ash Ave.
Burbank, Calif. 91502

Bourns Security Systems
681 Old Willets Path
Smithtown, N.Y. 11787

Wm. J. Burns Int'l Detective Agency
Briarcliff Manor
New York 10510

Chicago Fire & Burglar Detection, Inc.
646 Roosevelt Rd.
Glen Ellyn, Ill. 60137

Coleman Engineering Co., Inc.
3121 W. Central Ave.
Santa Ana, Calif. 92702

Concord Electronics
1935 Armacost Ave.
Los Angeles, Calif. 90025

Continental Instruments Corp.
110 Atlantic Ave.
Lynbrook, N.Y. 11563

Controltronic Corp.
125 Hartwell St.
W. Boylston, Mass. 01583

Craig Corporation
2302 E. 15th St.
Los Angeles, Calif. 90021

Dadco, Inc.
2018 Hillside Ave.
New Hyde Park, N.Y.

J. P. Darby, Esq.
Dept. TS-60, Engel St.
Hicksville, N.Y. 11802

DeLaMar Electronics, Inc.
255 Elmer St.
Trenton, N.J. 08611

Delta Products Inc.
P. O. Box 1147
Grand Junction, Colo. 81501

Detection Systems, Inc.
Eyer Bldg., Dept. 3-51
E. Rochester, N.Y. 14445

Detector Industries Div.
The Seco Co.
P. O. Box 13443
Houston, Texas 77019

Detex Corp.
53 Park Place
New York, N.Y. 10007

Dialalarm Inc.
7315 Lankershim Blvd.
N. Hollywood, Calif. 91609

Diebold, Inc.
Centon, Ohio 44702

Electro Data, Inc.
Commerce Park
Danbury, Conn. 06810

Electro-Guard
Gerald Products
31st and N. Church St.
Hazelton, Penna.

Electronic Detection Corp.
16 Church St.
Greenwich, Conn. 06830

Electronic Systems
9 South St.
Danbury, Conn. 06810

Emergency Prods, Corp.
60 Lafayette St.
Newark, N.J.

Euphonics Marketing Co.
202 Park St.
Miami Springs, Fla. 33166

Falcon Alarms
1137, Route 33
Mountainside, N.J. 07092

Faraday, Inc.
Tecumseh, Mich. 49286

Fed-Alarm
5440 Alder St.
Houston, Texas 77036

Fire-Lite Alarms, Inc.
190 Fulton Terrace
New Haven, Conn. 06504

GBC-CCTV
747 Fifth Ave.
New York, N.Y. 10011

General Telephone and Electronics
730 Third Ave.
New York, N.Y. 10017

Guard Alarms
1771 Wilson Ave.
Chicago, Ill. 60640

Heath Co.
Benton Harbor, Michigan 49022

Holmes Electric Protective Co.
370 Seventh Ave.
New York, N.Y. 10001

Honeywell, Inc.
2701 Fourth Ave. S.
Minneapolis, Minn. 55408

Hy Gain Electronics Corp.
Box 868
Lincoln, Neb. 68501

Data Equipment and Systems
E. Union Ave.
Rutherford, N.J. 07073

Identilogic D.
3070 Miraloma St.
Anaheim, Calif. 92806

Itronics
2101 Auburn Ave.
Toledo, Ohio 43606

James Electronics
4050 N. Rockwell St.
Chicago, Ill. 60618

Javelin Electronics
5556 W. Washington Blvd.
Los Angeles, Calif. 90017

Jetco Electronic Industries, Inc.
P. O. Box 132
Huntsville, Texas 77340

Kerux Systems, Inc.
2350 Duke St.
Alexandria, Va. 22314

Walter Kidde & Co., Inc.
675 Main St.
Belleville, N.J. 07109

Lee Electric Inc.
309-311 51st St.
W. New York, N.J. 07093

The Llinear Corp.
347 Glasgow Ave.
Inglewood, Calif. 90301

M.R.L. Inc.
7227 Lee Highway
Falls Church, Va. 22046

Mallory Distributor Prods.
Box 1558
Indianapolis, Inc. 46206

Motorola Communications & Electronics
1301 E. Algonquin Rd.
Schaumburg, Ill. 60172

Multi-Elmac Co.
21470 Coolidge Hwy.
Oak Park, Mich. 48237

Multra-Guard Inc.
5712 Frederick Ave.
Rockville, Md. 20852

National Alarm Prods, Co.
1166 Hamburg Turnpike
Wayne, N.J. 07470

Nelson-Hershfield Electronics
1848 W. Campbell Ave.
Phoenix, Ariz. 85015

(continued on page 97)

SURPLUS ELECTRONICS BARGAINS

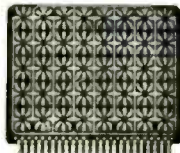

40 8 pin TO5



This mating connector is supplied with EACH card.

75% DISCOUNT, UNIVERSAL CIRCUIT CARDS

Large size cards, the easy inexpensive way to build, prototype, breadboard, items. Epoxy-fiberglass material, 4 1/2" X 5 1/2". Complete with 46 contact gold plated mating connector, with built in card guides. Original cost \$19.60 ea. Full instructions included.

- Circuit card and connector for 15 Dual-In-Line I.C.'s \$4.00
- Same as above, for 12 Flat-Pks \$4.00
- Same as above, for 24 10 pin TO-5 I.C.'s \$4.00
- Same as above, for 40 8 pin TO-5 I.C.'s \$4.00
- Same as above, for Discrete Components \$4.00
-
- M51/U Noise Cancelling Microphone used in AF pressure suits. 40 ohms imp., Uniform resp. 200-5000 Hz. 5/\$2.00
- Strip of 12 Sylvania 6ESB lamps with caps and sockets. Operate from I.C. outputs. List Price \$8.99 \$2.75
- Kodak high quality Projector Lens 32 mm. F.L., f/1.6 \$4.00
- Kodak high quality Projector Lens 16 mm F.L., f/1.6 \$2.50
- Delco DTS 423 400V Power Transistor \$11.00 list \$2.50
- Full Wave Bridge Rectifier Kit 50V, 2A \$1.50
- Zener Diode 12V 3 Watt 3/\$1.00
- Zener Diode IN429 6 volt reference 3/\$1.25
- I.C. 5470 J-K Flip-Flop 2/\$1.00
- GIANT 80 PAGE ILLUSTRATED CATALOG Jammed with BARGAINS in I.C.'s, Electronics, Optics, G.I. Watches etc. Free with any order, or send \$2.50 \$.25

ALL ITEMS POSTAGE PAID IN THE U.S.A.

B. & F. ENTERPRISES

PHONE: 617 532-2323
P.O. Box 44, Hathorne, Massachusetts 01937

Circle 82 on reader service card

NOW A ONE STOP SHOPPING CENTER FOR YOUR AUTO RADIO AND 8 TRACK STEREO PARTS. AT FACTORY DISCOUNTS

WE ARE AUTHORIZED PARTS DISTRIBUTORS FOR:

DELCO
BENDIX
MOTOROLA
LEAR JET
TENNA
METRA
AUTOMATIC
ON GUARD
CRAIG
PANASONIC
PHILIPS
BELLE WOOD
WARD
QUICKMOUNT
DEWEKO
AC SPEEDO

STEREO LOCK MOUNTS

SEND YOUR ORDERS WITH PART NUMBERS TO

Laran Electronics, Inc.

3768 Boston Road
Dept. 200 Bronx, N.Y. 10469
OR SEND MODEL, MAKE AND DESCRIPTION OF PART WANTED

Circle 83 on reader service card

sinclair PROJECT 60 Modular Stereo

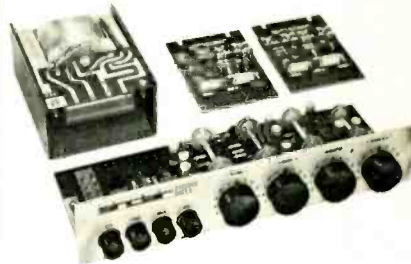

Sinclair Project 60 modules may be used together or separately in home or professional applications requiring high performance at modest cost. Complete Project 60 systems come supplied with necessary hardware to enable you to easily install the modules in cabinet or enclosure of your choice. The Project 60 modules are fully guaranteed for TWO YEARS. A stereo FM tuner will be available shortly. If you have not found the amplifier which meets your installation or performance requirements, the PROJECT 60 SYSTEM by Sinclair may be your answer.

The Sinclair Z-30/50 audio amplifier modules are of advanced design, using silicon epitaxial planar transistors for ruggedness and reliability. The Z-50 is basically the same as the Z-30 but uses higher current output transistors. The Z-30/50 may be used in numerous audio applications such as electronic music and instruments, sound reinforcement and laboratory work in addition to home stereo.

POWER OUTPUT: Z-30, 15 watts RMS; Z-50, 30 watts RMS; Both into 8 ohm loads.

FREQUENCY RESPONSE: 20 Hz* to 300 KHz ±1 db at normal level. *adjustable to meet installation requirements.

DISTORTION: Less than .02% at 1 KHz at any level up to maximum rated output.

OUTPUT IMPEDANCE: 3 to over 16 ohms. . . . May be used with electrostatic speakers.

SENSITIVITY: 250 mV high impedance.

OPERATING VOLTAGE: As low as 8 Vdc with reduced output.

SIZE: 3 1/2 x 2 1/4 x 1/2 inches

Z-30 \$15.95 Z-50 \$18.95

The Stereo 60 module is a matching unit in performance for use with the Z-30/50 modules but may be used with other amplifiers. The Stereo 60 features low distortion (less than .05%), three inputs, tape output, RIAA equalization within 1 db on magnetic input and operates over a wide voltage range from 9 to 50 Vdc. Size: 8 1/4 x 1 1/2 x 4 inches. \$29.95

The Sinclair ACTIVE FILTER UNIT may be used with the Project 60 systems plus specialized applications requiring a continuously variable rumble and scratch filtering system. The AFU uses SALLEN & KEY active filter stages to provide rapid rejection of unwanted frequencies (12 db per octave).

HF FILTER: Variable 5 KHz to 28 KHz.

LF FILTER: Variable 25 Hz to 100 Hz.

SINCLAIR ACTIVE FILTER UNIT \$20.95

POWER SUPPLIES

PZ-5: A standard 25-30 Vdc supply for use with the Project 60 modules \$13.95

PZ-6: A regulated supply adjustable from 15-45 Vdc; 1 1/2 amps at 35 Vdc. For use with Z-30s when maximum power is required \$23.95

PZ-8: A regulated supply adjustable from 35-50 Vdc providing over 3 amps of current. For use with Z-50s when maximum power is required \$37.95

SINCLAIR PROJECT 60 SYSTEMS are available from many dealers. If your dealer does not yet stock Sinclair products, order direct from Audionics.

AUDIONICS, INC.,
9701 S.E. Mill Street, Portland, Oregon 97216

Please ship the following:

- #1 Two Z-30's, PZ-5 and Stereo 60. \$74.95
- #2 Two Z-30's, PZ-6 and Stereo 60. 84.95
- #3 Two Z-50's, PZ-6 and Stereo 60. 90.95
- #4 Two Z-50's, PZ-8 and Stereo 60. 104.95

Other: _____

Name: _____

Address: _____

City: _____ State: _____ Zip: _____

All shipments F.O.B. Portland, Oregon re

Circle 84 on reader service card

CAN YOU QUALIFY
FOR MORE ^{income} RESPONSIBILITY
AS A **CIRCUIT DESIGNER?**



If you have a degree in engineering or formal training in electronics and work in the electronics industry, the Center for Technical Development's DIGITAL DESIGN PROGRAM (DDP-1) can make you more valuable as a trained circuit designer. DDP-1 is a new concept in practical home study courses designed to give you useable know-how fast. YOU CAN'T AFFORD TO WAIT ANOTHER DAY . . . WRITE FOR FULL DETAILS NOW!

We'll also send you information on our IC Logic and Power Supply courses.

Write Director, Dept. RE-110

THE CENTER FOR TECHNICAL DEVELOPMENT, INC.

517 East Main Street • Louisville, Ohio 44641

Circle 85 on reader service card

870-8

**TRUE TRIGGERED SWEEP
OSCILLOSCOPE/VECTORSCOPE**

**MODEL
TO-50**

- DC to 10 mhz frequency response
- .02 volt sensitivity
- Calibrated vertical attenuator
- Calibrated time base
- Supplied with combination Direct/Lo-Cap probe
- 5 X magnifier
- Automatic triggering mode
- 5" flat face tube edge-lit graticule



One Year Warranty
Made in U.S.A. **339⁵⁰**



See your distributor or write Dept. RE-11
LECTROTECH, INC.
4529 N. Kedzie Ave., Chicago, Illinois 60625

Circle 86 on reader service card

**CB Troubleshooter's
Casebook**

Compiled by
Andrew J. Mueller*

Case 1: Radio is dead. New batteries go dead when the switch is on for 30 seconds.

Common to: Midland 13-775B

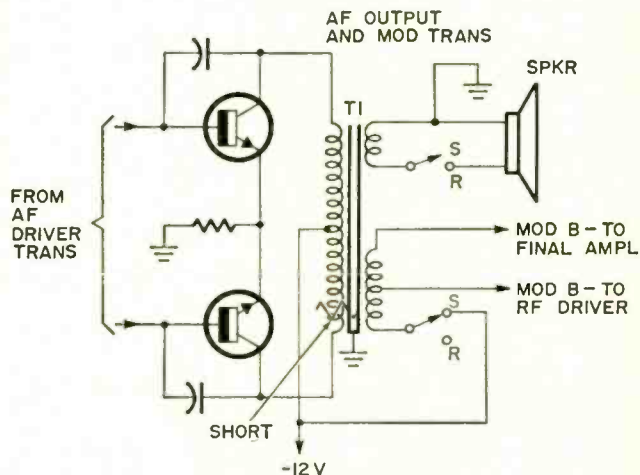

Remedy: Replace audio transformer, T1.

Reasoning: The audio output transformer primary has shorted to the core. This connects battery voltage directly to ground. Replacing T1 will restore normal operation.

Case 3: Radio receives poorly. Transmit is ok.

Common to: Pearce-Simpson Sentry

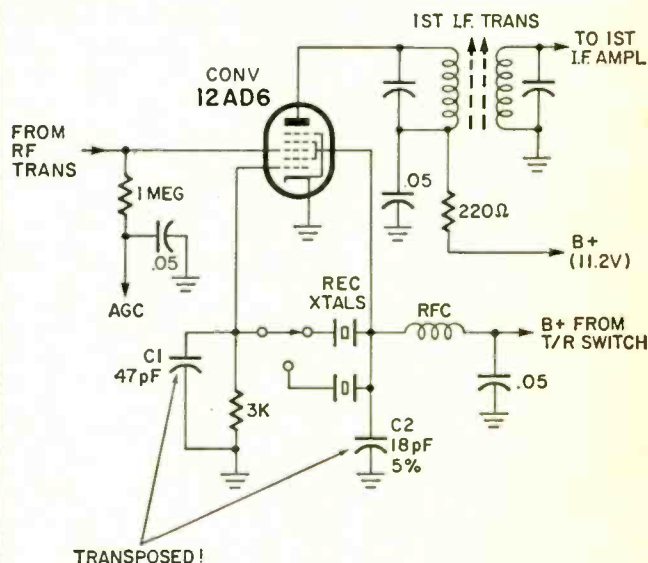

Remedy: Exchange C1 and C2

Reasoning: C1 and C2 influence the local oscillator injection voltage. From the factory these parts were reversed, reducing receiver sensitivity. When they are properly installed, sensitivity will return to normal. The schematic shows their proper locations. **R-E**

*Service Manager, Tel-Air Communications, Inc., Pewaukee, Wis.

ALARM SYSTEM DIRECTORY
(continued from page 95)

Normda Industries, Inc.
6330 Riverdale St.
San Diego, Calif. 92120

Notfier Co.
3700 N. 56th St.
Lincoln, Neb. 68504

On-Guard Corp. of America
343 W. 37th St.
New York, N.Y. 10018

Overly Manufacturing Co.
574 W. Otterman St.
Greensburg, Penna. 15602

Panasonic VTR/CCTV
200 Park Ave.
New York, New York

Penetray Lighting Prods. Inc.
615 Front St.
Toledo, Ohio 43605

PhotoMonitors, Inc.
62 Berkeley St.
Boston, Mass. 02116

Pinkerton Electro Security Co.
Div. Pinkerton's, Inc.
61 Sutton Rd.
Webster, Mass. 01570

Plessner Electronics
81 Bloomingdale Rd.
Hicksville, N.Y. 11801

Preventive Electronics
8348 Olive St. Rd.
St. Louis, Mo. 63132

Pytronics, Inc.
2343 Morris Ave.
Union, N.J. 07083

R.D. Products, Inc.
220 N. Washington St.
E. Rochester, N.Y. 14445

Radar Detection Systems, Inc.
6300 Northern Blvd.
East Norwich, N.Y. 11732

Radar Devices Mfg. Corp.
22003 Harper Ave.
St. Clair Shores, Mich. 48080

Record-O-Fone Div.
ElectroSpace Corp.
408 Concord Ave.
Bronx, New York 10454

S.P.S., Inc.
401 E. Walnut St.
Garland, Texas

Security Control Co.
362B Sanchez St.
San Francisco, Calif. 94114

Security Electronics, Inc.
Box 14224
Omaha, Neb. 68114

Singer Link Division
The Singer Co.
Birmingham, N.Y. 13902

Sonaguard Div.
119 Dover St.
Somerville, Mass. 02144

VTR Division
47-47 Van Dam St.
L.I.C. New York 11101

Space Guard Inc.
820 64th St.
Bklyn, N.Y. 11220

Squires-Sanders, Inc.
Martinsville Rd.
Liberty Corner, N.J. 07938

Systron-Donner
6767 Dublin Blvd.
Dublin, Calif. 94566

Tapeswitch, Corp.
545 Meacham Ave.
Elmont, L.I. N.Y. 11003

3M Company
3M Center
St. Paul, Minn. 55101

Unican Security Systems Corp.
P. O. Box 307
Plattsburgh, New York 12901

Wolfe Security Prods.
Pier 59
Seattle Wash. 98101

Zoomar, Inc.
55 Sea Cliff Ave.
Glen Cove, N.Y. 11542



More and More Technicians Say:
'We've tried cheaper substitutes . . . now WE'RE BACK TO DEPENDABLE, RELIABLE

"NO NOISE"

World's No. 1 TRUSTED NAME BRAND

- VOLUME CONTROL & CONTACT RESTORER
- TUNER-TONIC with PERMA-FILM
- EC-44 FOR ELECTRICAL CONTACTS
- TAPE-RECO HEAD CLEANER
- FRIGID-AIR CIRCUIT COOLER

All Guaranteed Non-Flammable, No Carbon Tet, Non-Toxic, Non-Drift Tuner Cleaner And Guaranteed Not To Affect Plastics.

The Only Brand Perfect For Color TV and Black & White

FREE extender assembly for pin-point application supplied with ALL NO-NOISE PRODUCTS.

Electronic Chemical Corp.
813 Communipaw Ave. / Jersey City, N. J. 07304

Circle 87 on reader service card



Olson ELECTRONICS

FREE Catalog

Fill in coupon for a FREE One Year Subscription to OLSON ELECTRONICS Fantastic Value Packed Catalog — Unheard of LOW, LOW PRICES on Brand Name Speakers, Changers, Tubes, Tools, Stereo Amps, Tuners, CB, Hi-Fi's, and thousands of other Electronic Values. Credit plan available.

NAME _____
ADDRESS _____
CITY _____ STATE _____
GIVE ZIP CODE _____

If you have a friend interested in electronics send his name and address for a FREE subscription also.

OLSON ELECTRONICS
Dept. LK, 260 S. Forge Street
Akron, Ohio 44308

Circle 88 on reader service card



Nothing replaces the reality of personal "in-class" instruction.

It builds your confidence through thorough preparation.

Professional success depends upon the quality of your training. You owe yourself the best. Anything less will be costly, takes much longer and requires more effort from you.

Take the shortest distance between you and your career. You'll be ahead in every day.

FREE LIFETIME PLACEMENT
VETERAN APPROVED



HEALD Engineering College

1215 Van Ness Ave.,
San Francisco, California 94109

Oldest and Largest Institution of its kind in the United States. (Since 1863)

Please send information on:

HEALD ENGINEERING COLLEGE

Bachelor of Science Degree Courses (36 months)

- Electronic Engineering
- Electrical Engineering
- Mechanical Engineering
- Civil Engineering Architecture (42 months)

HEALD INSTITUTE OF TECHNOLOGY
A division of Heald Engineering College

Technology Diploma Courses

- Electronic Engineering Technician (FCC) (15 months)
- Radio-Television Technician (FCC) (15 months)
- Mechanical Drafting (12 months)
- Electrical Drafting (12 months)
- Structural Drafting (12 months)

Name _____ Age _____
Address _____
City _____
State _____
Zip _____ Phone _____

Circle 89 on reader service card

MARKET CENTER

ELECTRONICS

TUBES 95% off. CCTV cameras, monitors, color monitors. Servicemen, hobbyists, free list. **J. KNIGHT TV**, 612 Gaines Avenue, Hot Springs, Ark. 71901

RADIO and TV Tubes 36¢ each. One year guaranteed. Plus many unusual electronic bargains. Free Catalog. **CORNELL 4217-E University**, San Diego, California 92105

PRINTED CIRCUITS for projects, Radio Electronics or others. Send page or black white drawing of circuit pattern. 20¢ square inch. Min. \$1.75 per board. Send remittance: **GENERAL PRINTED CIRCUITS**, Box 4013, Downey, Calif. 90241

RECEIVING & Industrial Tubes, Transistors, All Brands—Biggest Discounts, Technicians, Hobbyists, Experimenters—Request FREE Giant Catalog and SAVE! ZALYTRON, 469 Jericho Turnpike, Mineola, N.Y. 11501

SIX ORIGINAL DeFOREST VACUUM TUBES, KNOWN AS "ULTRAUDION" WITH MINIATURE LAMP BASES, AND IN ORIGINAL BOXES. BEST OFFER FOR ONE OR ENTIRE SIX TO: P. O. Box 1129, Jenkintown, Pa. 19106

COLOR Organ Kits \$7.50. Power Supplies \$2.75. Catalog, MURPHY, 294 Roslyn Avenue, Carle Place, N.Y. 11514

CONVERT any television to sensitive big-screen oscilloscope. Only minor changes required. No electronic experience necessary. Illustrated plans \$2.00. **RELCO-A25**, Box 10563, Houston, Texas 77018

USED, complete TV test equipment 970 Sams Photofact folder sets. GABLE, 110 Harris Street, Athens, Pa. 18810

TUBES—Lowest prices. Foreign-American. Obsolete, receiving, special purpose, transmitting tubes. Send for tube, parts catalog. UNITED RADIO COMPANY, 56-R Ferry St., Newark, N.J. 07105

DISCHARGE Ignition, Photoflash. Free catalog parts, kits. TRANSPARK, Carlisle, Mass. 01741

B & K, Sencor test equipment, discount prices, Free catalog and price sheet. FORDHAM RADIO, 265 East 149th Street, Bronx, NY 10451

AUDIO — HI-FI

741P TEXAS INSTRUMENT OPERATIONAL AMPLIFIERS—\$2.00 plus postage. BALL ELECTRONICS, Box 68, South Willington, Conn. 06265

RENT 4-track open reel tapes—all major labels—3,000 different—free brochure. STERIO-PARTI, 55 St. James Drive, Santa Rosa, Calif. 95401

CLASSIFIED COMMERCIAL RATE (for firms or individuals offering commercial products or services). 70¢ per word . . . minimum 10 words.

NON-COMMERCIAL RATE (for individuals who want to buy or sell personal items) 30¢ per word . . . no minimum.

FIRST WORD and NAME set in bold caps at no extra charge. Additional bold face at 10¢ per word. Payment must accompany all ads except those placed by accredited advertising agencies. 10% discount on 12 consecutive insertions, if paid in advance. Misleading or objectionable ads not accepted. Copy for January issue must reach us before Nov. 5.

CLASSIFIED ADVERTISING ORDER FORM

1	2	3	4	5
6	7	8	9	10
11	12	13	14	15
16	17	18	19	20
21	22	23	24	25
26	27	28	29	30
31	32	33	34	35

No. of Words { @ .30 Non-Commercial Rates } = \$
 { @ .70 Commercial Rate } = \$
 No. of Words in bold caps @ .10

Total Enclosed \$

Insert _____ time(s)

Starting with _____ issue

Payment must accompany order unless placed through accredited advertising agency 28

NAME _____

ADDRESS _____

CITY _____ STATE _____ ZIP _____

SIGNATURE _____

MAIL TO: RADIO-ELECTRONICS, CLASSIFIED AD DEPT., 200 PARK AVE. SOUTH, NEW YORK, N.Y. 10003

ADVERTISING INDEX

RADIO-ELECTRONICS does not assume responsibility for any errors which may appear in the index below.

READER SERVICE CARD NO.	PAGE
Allied Radio Shack	83
Allied Radio Shack, Franchise Division	87
63 Arrow Fastener Co., Inc.	82
84 Audionics, Inc.	95
82 B.F. Enterprises	95
9 B&K. (Division of Dynascan Corp.)	15
79 Blulyne Elec. Corp.	93
68 Branson Instruments Co.	84
80 Brooks Radio & TV Corp.	92-93
15 BSR USA Ltd.	24
85 Center For Technical Development, Inc.	96
4 Channel Master	7
5 Chapman Mfg. Co.	12
67 Chemtronics	84
21 Cleveland Institute of Electronics	46-49
19 Compusad, Inc.	27
CREI, Home Study Division of McGraw-Hill Book Co.	19-20
64 Delta Electronics Co.	82
71 Delta Products, Inc.	86, 94
75 Denson Electronic Corp.	88
87 Electronic Chemical Corp.	97
65 Electronic Distributors, Inc.	82
1 EICO, Electronic Instrument Co., Inc.	Cover 11
EMC, Electronic Measurement Corp.	12
69 Esse Radio Co.	85
13 GBC Closed Circuit Corp.	21
6 GC Electronics	13
2 Grantham School of Electronics	1
89 Heald Engineering College	97
62 Heath Co.	76-81
72 Injectorall Electronics Corp.	86
90 International Crystal Mfg. Co.	102
66 Kikusui Electronics Corp.	84
76 Lafayette Radio Electronics	89-90
83 Laran Electronics Corp.	95
16 Leader Instrument Corp.	24
86 Lectrotech, Inc.	96
61 Lubra Clean Co.	74
77 Master Appliance Corp.	91
National Radio Institute	8-11
National Technical Schools	28-31
Nortronics	91
88 Olson Electronics, Inc.	97
17 Panasonic	25
81 Pennwood Numechron Co.	94
11 Perma-Power	18
23 Quam Nichols Co.	72
78 Quietrole Co.	92
70 Raytheon Co.	85
RCA Electronic Components	Cover IV
97 Test Equipment	Cover III
RCA Institutes	64-67
RCA Parts & Accessories	75
12 Rye Industries, Inc.	18
8 S & A Electronics	14
22 Sams, Howard W.	71
7 Scarpa Labs Inc.	14
73 Schober Organ Co.	86
3 Sencore	5
18 Shure Brothers, Inc.	26
20 Sony Corp. of America	32
Supreme Publications	94
Sylvania	73
74 Tapeswitch Corp. of America	88
14 TEAC Corp. of America	22-23
10 Weller Electric Co.	16-17
MARKET CENTER	98-101
Alco Electronics	
Edmund Scientific Co.	
Lakeside Industries	
Music Associated	
92 Park Electronic Products	
95 Polypaks	
94 Solid State Sales Surplus Center	
SCHOOL DIRECTORY	100
Edison Technical College	
Tri-State College	
Valparaiso Technical Institute	

TRADE A TAPE. Got an 8-track cartridge or 4-track cassette you're tired of listening to? Send it to me, with \$2 and I'll send you another tape to replace it—music in a similar vein, of course. Special! New 4-track tapes \$1.50 each. List 25¢, refundable. **WARREN ROY**, 24 Straw Lane, Hicksville, NY 11801

BACKGROUND MUSIC, continuous, commercial-free. Solid-state **MUSICON SCA ADAPTER** plugs into any FM Tuner, Receiver. Line powered. 5 year guarantee! Only \$39 postpaid. **K-LAB**, Box 572R, South Norwalk, Conn. 06856

UNSATISFACTORY "live" recordings? Inexpensive new products for improved microphone fidelity and flexibility are available. Write **RUSSOUND, Inc.**, Dept. 3, Box 1015, Framingham, Mass. 01701

SAVE over 331/3 on a pair of one of the World's Best Speaker Systems. Shipped Direct to you from factory. Try them in your home for thirty days. **KGLL, INC.** Water Street, Lewiston, Maine 04240

NEW BSR record changers: \$13.00. McDonald 300-18.00; 400-\$20.00; 500-\$25.00; AM/FM component system-\$50.00. **DAVIS**, Dept. RE, 2737 Third Ave., Bronx, N.Y. 10451

CASSETTES CASH IN ON a tremendous All-year round market. Send for lowest pricing and details. Include \$1.00 for 2 cassettes samples. **DICTIONARY PRODUCTS, P.O.** Box DPK, Hallandale, Fla. 33009

GENERAL

COMPUTER-grade magtape. 2400X 1/2". \$2.00 ppd. **STINAFF**, 206 Magnolia Terrace, Pendleton, S.C. 29670

JAPANESE NEW PRODUCTS MONTHLY! \$1.00 Refundable. **DEERE**, 10639 Riverside, North Hollywood, Calif. 91602

PEP'S Dollar Sale

\$1 Money Back guarantee \$1

1 Amp Silicon Rectifier choice of package
Bullet—Miniature Glass—Metal

<input type="checkbox"/> 5-800V units \$1.00	<input type="checkbox"/> 4-50V units \$1.00	<input type="checkbox"/> 7 AMP SCR
<input type="checkbox"/> 4-1000V units \$1.00	<input type="checkbox"/> 3-100V units \$1.00	<input type="checkbox"/> 2-200V units \$1.00
<input type="checkbox"/> 3-1200V units \$1.00	<input type="checkbox"/> 2-200V units \$1.00	<input type="checkbox"/> 1-500V unit \$1.00
	<input type="checkbox"/> 1-800V unit \$1.50	

3 AMP Epoxy Package

<input type="checkbox"/> 10-100V units \$1.00	<input type="checkbox"/> 2-50V units \$1.00	<input type="checkbox"/> 20 AMP SCR
<input type="checkbox"/> 5-400V units \$1.00	<input type="checkbox"/> 1-300V unit \$1.50	<input type="checkbox"/> 2-50V units \$1.00
<input type="checkbox"/> 2-1000V units \$1.00		<input type="checkbox"/> 1-300V unit \$1.50

Gen Purpose PNP Germ Transistor Similar to 2N404

<input type="checkbox"/> 8 For \$1.00	<input type="checkbox"/> 2 AMP BULLET RECTIFIERS
	<input type="checkbox"/> 10-200V—\$1.00
	<input type="checkbox"/> 8-100V—\$1.00
	<input type="checkbox"/> 6-500V—\$1.00

ZENER DIODES 1 Watt

<input type="checkbox"/> 1 EA 4V-6V-8V-10V	<input type="checkbox"/> 20 Units \$1.00
<input type="checkbox"/> 4 units \$1.00	<input type="checkbox"/> Replaces 1N-34 1N-60
	<input type="checkbox"/> 1N-64 1N-295

GERM CLASS DIODES D07 GEN PURPOSE

<input type="checkbox"/> 20 Units \$1.00
<input type="checkbox"/> 1-1000V unit \$1.50

I.C. SUMMER SPECIAL
 14 Lead Dual In-Line Pkg.
 Perform same function as 700 series

Master Slave Flip Flop	75¢ @—\$3.00
Quad 2 Input NAND Gate	75¢ @—\$3.00

CIRCUIT BOARD COLOSSAL
 3 different groupings to choose from
 Typical samples below

A) 200 diodes—7 transistors—over 50 resistors—complete with board!

B) 32 transistors—over 100 resistors—capacitors—S.C.R.'s over 15 diodes—complete with board!
 Price \$1.75

C) 22-11 lead dual in-line I.C.'s—over 50 diodes—capacitors—4 transistors—over 50 resistors—complete with board!
 Price \$4.50

FULL WAVE BRIDGES

PRV	2Amp	3Amp	5Amp	10Amp
50V	1.25	1.35	1.50	1.70
100V	1.50	1.60	1.75	1.95
200V	1.75	1.85	2.00	2.20
400V	2.00	2.10	2.25	2.45
600V	2.50	2.60	2.75	2.95
800V	3.00	3.10	3.25	3.45

PARK ELECTRONIC PRODUCTS
 P. O. Box 78 N. Salem, N. H. 03073
 Tel. (603) 893-0276
 NO SALES TAX WE PAY POSTAGE

1000's OF UNUSUAL SCIENTIFIC BARGAINS including... SPECIAL UNIQUE PSYCHEDELIC LIGHTING for Fun, Profit, Effects!

CHROMATIC "MACHINE-GUN" STROBE



Red, Green, Blue & White light barrage the eyeballs every 6 seconds with this low-cost mechanical strobe that can run continuously without fear of burning up. Devastating effects over 500 ft. sq. area. Created by rotating color wheel in front of 100W 120V reflector floodlamp (incl.)—elements seem to flash on & off as colors fluctuate. Turns store windows, posters, parties into flashing, pulsating productions. Correction coded. Walnut cabinet. Brass handle. Reg. house current.
Stock No. 71,271EH (9 X 10 X 6 1/4") \$28.50 Ppd.

PSYCHEDELIC LIGHTING HANDBOOK



100 information packed pages! Fully explains latest in psychedelic lighting equipment, techniques, developments. Covers all facets of psychedelic light-show production including strobes, black lights, projectors, crystals, organic slides, mirrors, color organs, polarized color, light boxes. Music-Vision, etc. 8 1/2" x 11" looseleaf paper for 3 ring binder.
Stock No. 9100EH \$3.00 Ppd.

LONG-WAVE BLACK LIGHT FIXTURE



Extremely versatile, compactly designed, long wave (3200-4000 angstroms) black light (ultraviolet) fixture—eliminates harmful shorter wave ultraviolet rays. Use to identify minerals, fungi, bacteria—check for surface flaws, oil and gas leakage—perfect for displays with fluorescent paper, paints, chalk, crayons, trace powder. Incl. adjustable aluminum reflector, push-pull switch, connecting plug. Mount vert., horiz., or on corner. 10" L. 1 1/2" W. 1 1/4" H.
Stock No. 70,364EH (12" Diam.) \$12.50 Ppd.
Stock No. 60,124EH .. REPLACEMENT BULB .. \$4.75 Ppd.

MIRRORED BALLS BOUNCE LIGHT



Yesteryear's ballrooms echo in mirrored lights that ricochet to the beat of today's discotheque. Up to 1,000 lustrous, clear, hand-made glass mirrors on each ball create fantastic lighting effects. Motorized—they cast reflections that blow the mind! Ideal for light shows, displays, restaurants, hotels, and modern stores.
Stock No. 71,066EH (12" Diam.) \$30.00 Ppd.
Stock No. 85,180EH (16" Diam.) \$75.00 FOB
Stock No. 71,065EH (8" Diam.) \$17.50 Ppd.

NICKEL-CADMIUM BATTERY BARGAIN!



Terrific value—slightly used gov't surplus. Lightweight 5 cell, 6 volt, 4 Amp-hour battery with almost unlimited life. Extremely high current output. Techwares in 1 hour with Edmund kit. Won't deteriorate when left discharged. Minimum maintenance—few drops of water per year. Rugged, shock- and vibration resistant nylon case. Delivered partially charged, filled with electrolyte. 3 1/2" x 2" x 6", 2 lb.
Stock No. 70,942EH (BATTERY) \$15.00 Ppd.
Stock No. 70,807EH (CHARGER KIT) \$ 8.00 Ppd.

VISIBLE V-8 ENGINE



Hours of fun! Get thrill of building your own easily assembled engine from over 350 parts. Then push starter and watch it run. Crankshaft revolves, pistons move, valves open and close in sequence with spark plugs. Does everything but burn oil. 1/8" scale, molded in 4 colors. Same motor used in many auto-mechanic courses. Excellent, easy-to-understand "tech manual".
Stock No. 70,448EH \$13.50 Ppd.

1st LOW-COST VACUUM PUMP!



Nothing like it! Top-quality hand-held pump produces & maintains 25" of vacuum. Has instant release tab, 1 1/2" diam. stainless gauge (0-30"). 100's of uses—siphon noxious fluids, evacuate bell jars and castings, clean, retrieve, lift sterile objects, demonstrate Magdeburg hemispheres, bleed fuel lines, check leaks, etc. Lifts 40 lbs. with included "T" Lifter (2 1/2" diam. cup)—much more w/larger cup.
Stock No. 71,301EH \$12.00 Ppd.
Stock No. 71,300EH (without gauge/lifter) 5.50 Ppd.

3-CHANNEL COLOR ORGAN BARGAIN!



Create tremendous variety of unusual & beautiful lighting effects with this low-cost top-quality 1500-Watt unit (500 W. per channel). Compare with others selling for twice the price. Has pilot light, plus individual sensitivity controls and channel indicator lights. Can operate ten 150 W. "spots" or 200 "Christmas lights." Uses reg. house current—attaches to audio source w/RCA-type phone plug, or 6 to 180 power. Aluminized and overcoated 3" diameter /10 primary mirror, ventilated cell. Equatorial mount with locks on both axes. Equipped with 60X eyepiece and mounted Barlow lens. 3X under telescope, hardwood tripod.
FREE: "STAR CHART", 272-page "HANDBOOK OF HEAVENS"; "HOW TO USE YOUR TELESCOPE"
Stock No. 85,050EH \$29.95 Ppd.
Stock No. 85,055EH 4% \$94.50 Ppd.
Stock No. 85,086EH 6" \$239.50 FOB

3" ASTRONOMICAL TELESCOPE



See moon shots, orbits-stars, phases of Venus, planets close up. 60 to 180 power. Aluminized and overcoated 3" diameter /10 primary mirror, ventilated cell. Equatorial mount with locks on both axes. Equipped with 60X eyepiece and mounted Barlow lens. 3X under telescope, hardwood tripod.
FREE: "STAR CHART", 272-page "HANDBOOK OF HEAVENS"; "HOW TO USE YOUR TELESCOPE"
Stock No. 85,050EH \$29.95 Ppd.
Stock No. 85,055EH 4% \$94.50 Ppd.
Stock No. 85,086EH 6" \$239.50 FOB

ROTATING MULTI-COLORED LIGHT



Dazzling colors stream endlessly from constantly rotating light. Faceted, transparent globe has louvered drum inside with red, green, blue & yellow stars. Bulb heat rotates drum which projects flickering star points on walls, ceilings, etc. While individual globe facets present constantly changing array of brilliant colors. 9 1/2" star—approx. 12" high on bell-shaped base. Surprisingly light. Easily placed on table, TV, fireplace, or Xmas tree top.
Stock No. 71,000EH \$7.00 Ppd.

1st LOW-COST XENON STROBE!



Price breakthrough in bright, reliable electronic strobes. Variable flash rate—60 to 500 per minute. Long life—more than 1,000,000 flashes. Printed circuit board design. Safe, durable Bakelite case. Externally mounted bulb, plastic shield. 6 1/2" x 3 1/2" x 1 1/2" oz. Perfect for psychedelic, stop-action lighting effects for home light shows, parties, displays.
Stock No. 71,342EH \$24.95 Ppd.
BUILD-IT-YOURSELF STROBE KIT
Stock No. 71,343EH \$19.95 Ppd.

1st QUALITY OPAQUE UNDER \$200



Terrific Buy! Top Quality! Projects brilliant, sharp 1/2 ft. sq. image from 8" using up to 5" x 5" color. 6kW illustrations. Retains all original colors, proportions. Enlarges drawings, maps, etc. Revolutionary peanut-size quartz halogen lamp (50 hr. life). 200mm anastigmatic lens (3.5, 8" F.L.) unique internal reflecting system—size maximum brightness, entire field focus. Can be used upside down. Turbo-cooled. 5 1/2 ft. cord.
Stock No. 71,272EH (Wt. 11 1/4 lbs.) \$89.75 Ppd.

QUICK OCR "GO...NO-GO" TEST!

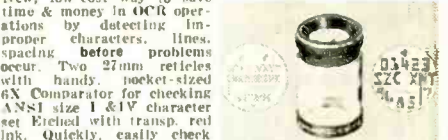

New, low-cost way to save time & money in OCR operations by detecting improper characters. Lines, spacing, before problems occur. Two 27mm reticles with handy, pocket-sized 6X Comparator for checking ANSI size I & IV character set. Etched with transp. red ink. Quickly, easily check character size, shape, skew & spacing; line spacing & skew; stroke width; voids, smudges, peaks, valleys, marks. English & metric scales.
No. 41,350EH (With Comparator) \$34.50 Ppd.
SIZE I RETICLE ONLY—#30,642EH \$11.00 Ppd.
SIZE IV RETICLE ONLY—#30,643EH \$10.75 Ppd.

MAIL COUPON FOR GIANT FREE CATALOG

148 PAGES—1000's OF BARGAINS Completely new 1971 edition. New items, categories, illustrations. Dozens of electrical and electromechanical parts, accessories. Enormous selection of Astronomical Telescopes, Unique Lighting Items, Microscopes, Binoculars, Magnifiers, Magnets, Lenses, Trisms. Many war surplus items. Mail coupon for catalog "E11".
EDMUND SCIENTIFIC CO.
 300 EDSCORP BUILDING
 BARRINGTON, N.J. 08007

NAME _____
 ADDRESS _____
 CITY _____ STATE _____ ZIP _____

EDMUND SCIENTIFIC CO. 300 EDSCORP BLDG. BARRINGTON, NEW JERSEY 08007

ORDER BY STOCK NUMBER • SEND CHECK OR MONEY ORDER • MONEY-BACK GUARANTEE

SCHOOL DIRECTORY

distinguished graduates

hold important engineering and management posts throughout U.S. Professionally-oriented college with outstanding placement record. Four-quarter year permits degree in three years. Dedicated faculty. Modern labs. Small classes. 400-acre campus. Accredited. Approved for vets. Moderate total costs. Enter Jan., March, June, Sept. For Catalog, write Director of Admissions, indicating career preference.



TRI-STATE COLLEGE
24110 College Avenue, Angola, Indiana 46703

EDISON TECH Train With Confidence

Occupational Training Specialists Since 1945—Engineering and Vocational Technicians in Demand Intensive Industry-oriented programs in Electronics Engineering Technology (Associate Degree in 72 wks); Electronics Technology; Electromechanical Drafting; Television Technology. Graduates in demand—train with confidence. Accredited by the Accrediting Commission, National Association of Trade and Technical Schools. Write for Cat. RE11.
EDISON TECHNICAL COLLEGE
4629 Van Nuys Bl. Van Nuys (Los Angeles) CA 91403

GET INTO ELECTRONICS

V.T.I. training leads to success as technicians, field engineers, specialists in communications, guided missiles, computers, radar and automation. Basic & advanced courses in theory & laboratory. Electronic Engineering Technology & Electronic Technology curricula both available. Associate degree in 20 mos. B.S. also obtainable. G.I. approved. Graduates in all branches of electronics with major companies. Start Sept. Feb. Dorms, campus. High school graduate or equivalent. Catalog.

VALPARAISO TECHNICAL INSTITUTE
Dept. C, Valparaiso, Indiana 46383

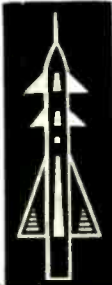

19.95 NEW AUDIO CONTROL CENTER FOR SWITCHING SYSTEMS INPUT/OUTPUT



Switch speakers located in every room or use to switch tuners, tape recorders, phonos. Black finish; push-push switches. 4-Stereo channel w/ RCA jacks. Other types too. Shipped postpaid.

ALCO Order: Box 1348RE
Lawrence, MA 01842

Rebuild Your Own Picture Tubes? With Lakeside Industries precision equipment, you can rebuild any picture tube!

For complete details, mail coupon.

Lakeside Industries
5234 N. Clark St.
Chicago, Ill. 60640
Phone: 312-271-3399

NAME.....
ADDRESS.....
CITY.....
STATE..... ZIP.....



ENJOY THE "MUSIC ONLY" FM PROGRAMS

M. A. D.

MUSIC ASSOCIATED'S DETECTOR for continuous, commercial-free music with ANY FM tuner or receiver



Kit \$49.50 Wired \$75.00 Cover \$4.95 List of FM stations with SCA authorization \$1.00. Excellent F.M. Monaural Tuner with M.P.X. Jack \$50.00

MUSIC ASSOCIATED
65 Glenwood Rd.,
Upper Montclair, N.J. 07043
phone 201-744-3387

MARKET CENTER

EDUCATION/ INSTRUCTION

ELECTRONICS Engineering. Day or evening classes. Bachelor of Science Program evenings. Associate in Science Program day or night. If you are married or if you must work for a living while obtaining your education, this is the college for you. Approved for Veterans. **WESTERN STATES COLLEGE OF ENGINEERING**, 970 West Manchester Avenue, Inglewood, Calif. 90301

TV TUNER REPAIRS—Complete Course Details, 12 Repair Tricks, Many Plans. Two Lessons, all for \$1. Refundable. **FRANK BOCEK**, Box 3236 (Enterprise), Redding, Calif. 96001

MEMORIZE, Study: "1970 Test-Answers" for FCC First and Second Class License.—plus—"Self-Study Ability Test." Proven. \$5.00. **COMMAND**, Box 26348-E, San Francisco, Calif. 94126

INVENTIONS & PATENTS

FREE "Directory of 500 Corporations Seeking New Products". For information regarding development, sale, licensing of your patented/unpatented invention. Write: **RAYMOND LEE ORGANIZATION**, 230-U Park Avenue, New York City 10017

INVENTORS: Protect your ideas! Free "Recom-

mended Procedure". **WASHINGTON INVENTORS SERVICE**, 422X Washington Building, Washington, D.C. 20005

INVENTIONS Wanted. Patented; Unpatented. **GLOBAL MARKETING**, 2420-AE 77th Ave., Oakland, Calif. 94605

WANTED

QUICK CASH . . . for Electronic EQUIPMENT, COMPONENTS, unused TUBES. Send list now! **BARRY**, 512 Broadway, New York, N.Y. 10012, 212 WALKER 5-7000

GOVERNMENT SURPLUS

DIFFERENT? You bet. Industrial and Government Electronic Surplus. Get your latest list now. **STARTRONICS**, Box 17127, Portland, Oregon 97217

JEeps Typically from \$53.90 . . . **Trucks** From \$78.40 . . . **Boats**, Typewriters, Airplanes, Multimeters, Oscilloscopes, Transceivers, Electronics Equipment. Wide Variety, Condition. 100,000 Bid Bargains Direct From Government Nationwide. Complete Sales Directory and Surplus Catalog \$1.00 (Deductible First \$10.00 Order). **SURPLUS SERVICE**, Box 820-REL, Holland, Michigan 49423

MANUALS for surplus electronics. List 25¢. **BOOKS**, 4905 Roanoke Drive, Washington, D.C. 20021

INTEGRATED CIRCUITS / RECTIFIERS SEMICONDUCTORS / TRIACS

TRIACS

PRV	1A	15A
100	.50	1.00
200	.80	1.40
300	1.10	1.80
400	1.40	2.20
500	1.75	3.00

ER900 TRIGGER DIODES. These bi-directional trigger diodes are one of the best and cheapest methods to trigger SCR's and triacs . . . 3/\$1.00

UNIUNCTIONS!

Similar to 2N2419. RBB of 5-7 stand off ratio of .6 and Ip of 12 with data sheet \$.80

N-CHANNEL FET'S TO-18 plastic units, low noise, low leakage, 25 volts source to gate, 50 ma gate current Gain to 9000 $\mu\text{mho's}$. \$.60

2N4303. P channel FET with a Q ms of 2000 ohms . . . \$.95

MM 2260. An NPN TO-5 silicon unit used for video output circuits in transistorized TV's, with a gain of 35 and Vcb of 75 \$.75

MOUNTING HARDWARE KITS.

These kits are used to mount our SCR's Zeners and Rectifiers etc. 6x32 stud (3, 12 amp rectifiers,

7A SCR's 6 sets/\$1.00
 $\frac{1}{4}$ x28 stud (30 amp. rectifiers,
20 amps SCR's) 4 sets/\$1.00

MRTL IC's

908 FULL ADDER75
912 HALF ADDER50
913 REGISTER50
940 JK FLIP FLOP50

TTL IC SERIES

DECADE DIVIDER \$3.95
RF 112 Dual JK Flip Flop . . . 1.25
MC 415 JK Flip Flop85
MC 400 Dual 4 input NAND/NOR gate70
4 Bit Storage Register . . . 1.25
9301 MSI ONE-OF-TEN DECODER 2.95

Silicon Power Rectifiers

PRV	3A	12A	30A
100	.09	.24	.50
200	.16	.35	.80
400	.20	.45	1.20
600	.30	.70	1.50
800	.40	.85	1.80
1000	.50	1.10	2.20

Terms: FOB Cambridge, Mass. Send check or Money Order. Include Postage. Average Wt. per package $\frac{1}{2}$ lb. No. C.O.D.'s. Minimum Order \$3.00

FIBRE OPTICS

$1/32"$ 2.5 mil. fibers in PVC packet. \$.33/ft.

COMPLETE LIGHT GUIDE BUNDLE

consisting of an 11" length of $1/32"$ dia. fiber optics with bound ends. \$2.00 ea.

Controlled Avalanche or Epoxy Rectifiers 1 AMP.

PRV	PRV
100	.07
200	.09
400	.11
600	.16
800	.20
1000	.30

LINEAR CIRCUITS

709C operational Amp . . \$1.30
SE 501 Video Amp . . . \$1.00
SE 518 Voltage Comparator \$1.00

Silicon Control Rectifiers

PRV	3A	7A	20A	70A
50	.30	.35	.70	
100	.40	.55	1.00	4.00
200	.60	.80	1.30	8.00
300	.80	1.00	1.70	
400	1.00	1.30	2.10	12.00
500	1.25	1.60	2.50	
600	1.50	1.90	3.00	16.00

BIGGER AND BETTER BARGAINS.

Send for our latest catalog featuring Transistors and Rectifiers; 325 Elm St., Cambridge, Mass.

OLID

Post Office Box 74D

TATE

Somerville, Mass. 02143

ALES

Tel. (617) 547-4005

Circle 94 on reader service card

It's The Biggest! It's The Most Popular PENNY SALE IN THE INDUSTRY!

ONE CENT



99¢
Each
2 for \$1.00

Type	Description	Case
<input type="checkbox"/> 900	Buffer	F
<input type="checkbox"/> 900*	Dual Buffer	F
<input type="checkbox"/> 903	Dual 3 input gate	5
<input type="checkbox"/> 903*	Dual 3 input gate	F
<input type="checkbox"/> 904*	Dual half adder	N
<input type="checkbox"/> 908	Full adder	5
<input type="checkbox"/> 909	Buffer	5
<input type="checkbox"/> 910	Dual two input gate	5
<input type="checkbox"/> 912	Half adder	5
<input type="checkbox"/> 913	Shift register	5
<input type="checkbox"/> 914/921	Dual 2 input gate	5
<input type="checkbox"/> 925	Dual 2 in. w/expand	N
<input type="checkbox"/> 926	Hi speed 923	F

Type	Description	Case
<input type="checkbox"/> 960	Dual buffer	S
<input type="checkbox"/> 923/940	J-K flip flop	S
<input type="checkbox"/> WC210**	2-3 in line driver	F
<input type="checkbox"/> WC215**	J-K flip flop	F
<input type="checkbox"/> WC226**	Triple 3 In. gate	F
<input type="checkbox"/> WC227**	10 In. Diode expand	F
<input type="checkbox"/> WC261**	Dual 4 in. gate	F
<input type="checkbox"/> WC266**	Quad 2 input gate	F
<input type="checkbox"/> SG-43	Dual 3 In. gate	N
<input type="checkbox"/> SG-123	Expandable 8 In. gate	N
<input type="checkbox"/> SG-163	Triple 2 in. bus driver	N
<input type="checkbox"/> NE-124**	R-S-T binary	F

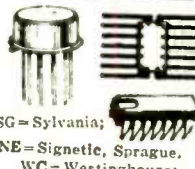

Code: * 2 identical ICs in 1 pak, ** DTL, otherwise RTL. F=flat pak; N=dual inline; 5=TO-5 case.

TEXAS-NATIONAL DTL TTL IC's!

Type	Description	Sale
<input type="checkbox"/> SN7350F*	Quad 2 input gate	.99
<input type="checkbox"/> SN7400N	Quad 2 input gate	.99
<input type="checkbox"/> SN7404N	Hex inverter	1.19
<input type="checkbox"/> SN7430F	8 input NAND gate	.99
<input type="checkbox"/> SN7440F	Dual 4 In. NAND buffer	.99
<input type="checkbox"/> SN7441N	BCD-to-Decimal decoder-drvr	5.95
<input type="checkbox"/> SN7442N	BCD-to-Decimal decoder	5.95
<input type="checkbox"/> SN7470F	J-K flip flop	.99
<input type="checkbox"/> SN7472N	J-K master flip flop	1.19
<input type="checkbox"/> SN7473N	Dual J-K master slave flip flop	1.49
<input type="checkbox"/> SN7474N	Dual 'D' type edge triggered flip flop	1.49
<input type="checkbox"/> SN7475N	Quad bi-stable latch	3.95
<input type="checkbox"/> SN7490N	Decade counter	4.95
<input type="checkbox"/> SN7492N	Divide by 12 counter	4.95
<input type="checkbox"/> SN7493N	4 Bit binary counter	4.95
<input type="checkbox"/> SN7302F*	Dual J-K flip flop with preset	1.29
<input type="checkbox"/> SN7304*	Dual J-K flip flop with preset & clear	1.49

* DTL, others TTL. F=flat pak. N=dual inline

IBM 4000 Bit MEMORY Only \$8.50
core plane, from computer #1401.

FAIRCHILD 741CAMP Only \$2.50
Same as 709 with frequency compensation.

FALL-CHRISTMAS LIMELITERS

<input type="checkbox"/> 2-FT. finished fiber optic lite pipe	\$1.00
<input type="checkbox"/> 709 OP AMPLifier	\$1.49
<input type="checkbox"/> 2-N CHANNEL plastic Fets 2N3819 Texas	\$1.19
<input type="checkbox"/> 2-UNIJUNCTION transistors 2N4891	\$1.19
<input type="checkbox"/> 1-IG MOS FET P channel 2N4353	\$1.00
<input type="checkbox"/> 5 CLAIREX photo elec cells pancake	\$1.19
<input type="checkbox"/> 3-TRIGGER diodes for Sers, Triacs	\$1.00
<input type="checkbox"/> 8-1 AMP 1000 PIV sil. rectifiers	\$1.19
<input type="checkbox"/> 10-1 AMP 800 PIV rectifiers	\$1.19
<input type="checkbox"/> 4 NIXIE tube driver transistors 2N4409	\$1.00
<input type="checkbox"/> 2-7-AMP 200 PRV acrs	\$1.19
<input type="checkbox"/> 2-WATT G-E PA237 audio amp	\$3.98
<input type="checkbox"/> 1-WATT WESTINGHOUSE WC334 audio amp	\$1.49
<input type="checkbox"/> 1-15-AMP Triac 200 PRV	\$1.49
<input type="checkbox"/> NE161J One shot multivibrator Signetic	\$1.79
<input type="checkbox"/> 2-MICRO reed switches 1" long	\$1.00
<input type="checkbox"/> 100 Transistors asst npn-pnp-pwr-no test	\$1.98
<input type="checkbox"/> WESTINGHOUSE positive volt regulator 0 to 40 VDC	\$1.19

10¢ Catalog on Fiber Optics, 'IC's', Semis, Parts

Terms: add postage. Rated: net 30, cod's 25%
Phone Orders: Wakefield, Mass. (617) 245-3829
Retail: 211 Albion, St., Wakefield, Mass.

POLY PAKS P.O. BOX 942R
LYNNFIELD, MASS 01940

Circle 95 on reader service card

30 IC CIRCUITS

(continued from page 70)

Finally, Fig. 32 shows how the IC can be wired as an ac/dc oscilloscope calibrator. In this circuit, Q1 and Q2 are wired as a free-running (astable) multivibrator, operating at a frequency of about 1 kHz. Diodes D1 and D2 protect the transistors against reverse base-emitter breakdown, and R5 allows presetting the mark-space ratio.

Output is clipped at about 6.5 volts by Zener-connected Q3, and is passed on to the R7-R10 attenuator network via emitter follower Q4. In use, R7 is adjusted so that a signal of 5 volts peak appears at the R7-R8 junction. Calibration voltages of 50 mV, 500 mV and 5 volts are then available at the outputs.

When S1 is set to the DC position, the multivibrator is switched out of circuit, but Q3, Q4 and the attenuator network are still operating. Dc calibration voltages of 50 mV, 500 mV and 5 volts are now available at the attenuator outputs. Due to Zener stabilization by Q3, these calibration voltages are virtually independent of supply line variations.

The unit can be calibrated initially by turning S1 to the DC position and connecting a sensitive (20,000 ohms/volt or greater) meter between the 5-volt terminal and ground. Then adjust R7 for precisely 5 volts output, and the unit is ready to use as a scope calibrator. R-E

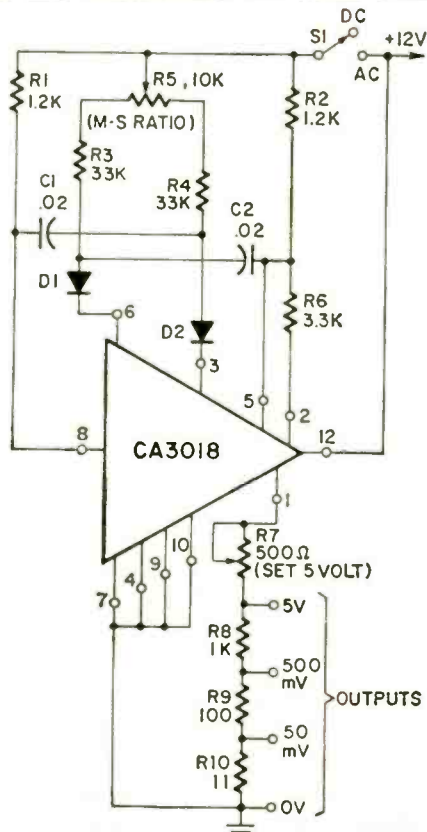

NOTE: D1, D2 = GENERAL PURPOSE SILICON DIODES
R8, R9, R10 = 5% TO 1% TYPES, DEPENDING ON CALIBRATION ACCURACY REQUIRED.

Fig. 32—OSCILLOSCOPE CALIBRATOR provides dc and peak-to-peak outputs.

U.S. GOV'T ELECTRONIC SURPLUS

Nationally Known-World Famous SURPLUS CENTER offers finest, most expensive, Government Surplus electronic units and components at a fraction of their original acquisition cost.

IBM COMPUTER POWER SUPPLY

(ITEM #22-934) -- Divisive, regulated multi-line for college labs, research labs, service shops, etc. Pure 100% wide range of voltages, 10" output voltages of 0, 12, 48, etc. Wide range of AC voltages available.

Finest transformers, filters, transistor load regulation system. Independent of line voltage fluctuations. Contains like separate output systems. Unit is furnished without small "regulating coil" which can be easily made or can be purchased. Data and circuit diagrams furnished. 30" x 12" x 10", 1.15 lbs.

Cost Gov't Over \$300.00 **\$24.95**

ONCE-IN-A-LIFETIME SPECIAL



BURGLAR-FIRE ALARM SYSTEM



(ITEM #1135-A) -- Dual alarm system gives warning of fire or break-in. Operates on 115-V AC. Control unit, 2-kHz flash light, emergency siren, 3-wire siren, siren, alarm, 100 ft. wire, instruction book, 12" x 12" x 12" (1.5 lbs.)

\$29.95

STANDARD DIAL TELEPHONE

(ITEM #715) -- Standard, commercial telephone came as used throughout U.S.A. Attractive polished black, like new condition. Use as extension phone in private systems or connect several phones together for local extension system. Full instructions are furnished. 9, 9 lbs.



Original Cost \$24.50 **\$7.49**

STEP-BY-STEP TELEPHONE SWITCH

(ITEM #7-905) -- Amazing telephone adapter switch. Local experimental item. When used with touch-tone telephone dial will select any number from 0 to 100, make extension or initiate system. Use in home, office, lights, start motors, etc. Complete with contact block, 13" x 6" x 3", (10 lbs.) Cost Over \$90.00



\$6.29

Telephone dial for use with above switch. Cost as (Item #709) **\$1.97**

MAGNETIC DIGITAL COUNTER (12 to 18-VDC)

(ITEM #21-959) -- Use to count electrically. Use to count number of times door is opened after burglar has entered to show changing prices, laboratory uses, etc. Will count 1 for each pulse and will transfer 10th count to next unit. 4 1/2" x 1 1/2" x 1 1/2" (1 1/2 lbs.)

Opt. Cost Over \$18.00 Each **\$1.99** Three For **\$4.99**

Typical Buys from our 1970 Catalogs

- \$ 10.00 115-Volt DPDT Relays..... **\$1.69**
- \$10.00 Regulated Transformer, Wide Range..... **\$14.91**
- \$ 75.00 20-Relay Telephone Panel..... **\$4.39**
- \$250.00 Gyroscope, Twin Rotor, 24V..... **\$9.89**

AC PROGRAM TIMING CLOCK

(ITEM #158) -- Zenith 113-VAC unit. Use for periodic signaling, work breaks, classes, turn on radio, etc. Ad. clips permit ON-OFF switching any time in 24-hour period. Also has "memory" feature. Can be multiple programmed. 12-wip. contacts. 8 1/2" x 5 1/2" x 4 1/2" (4 lbs.)



Cost Gov't Over \$10.00 **\$15.75**

SNAP AROUND VOLT-OHM-AMMETER

(ITEM #21-944) -- Measures AC current without opening the line. Simply press handle and snap alligator around the conductor. Reads currents from .25 to 125-amps. Reads voltages to 500. Test meters, appliances, etc. Three current ranges, 100-voltage ranges. With case, test leads. 7 1/2" x 3" x 1 1/2" (2 lbs.)

Net. Price \$39.95 **\$36.90**

Special Sale Correspondence Course in ELECTRICAL ENGINEERING \$8.79 Prepaid in U.S.A. \$10.79 Outside U.S.A.

(ITEM #A100) -- Obtain technical training at low cost! Lincoln Engineering School has suspended its Correspondence Courses because of rising costs. A limited number of Electrical Engineering Courses are available, but without the excellent grading service. The course consists of 15 lesson books, each with associated exams and standard answers. Book describing prize-winning Home Experimental Laboratory Plans furnished at no extra cost.

RUNNING TIME METER

(ITEM #21-888) -- Record number of operating hours of electric lights and electrical devices, such as refrigerators, furnaces, etc. Records total hours, months and hundredths of 2,000,000 hours. For 115-volt, 60-hz cycles. Size 4 1/2" x 3 1/2" x 1 1/2". Shipping weight 2 lbs. **\$4.39** Cost Over \$29.00



COMPUTER TRANSISTORS ON HEAT SINKS

IBM Computer Quality Units

(#22-928) -- Unit consists of one 130-watt power transistor on heavy plated aluminum heat sink. Many experimental uses. (1 lb.) Cost Gov't Over \$10.00 **\$1.99**

(#22-915) -- Unit consists of ten 150-watt power transistors, 2 mfd., several diodes, capacitors, resistors, etc. on heavy, ribbed aluminum heat sink. Ideal for use as initial speed control. (4 lbs.) Cost Gov't Over \$33.00 **\$4.91**

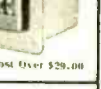

SEND 25¢ COIN OR STAMPS FOR CATALOGS

Order Direct From Ad. Money Back Guarantee.

SURPLUS CENTER DEPT. RE 110 LINCOLN, NEBR. 68501

NOVEMBER 1970

cash in on a GROWING NEW business...

INTERNATIONAL
CRYSTAL MFG. CO., INC.
10 NO. LEE • OKLA. CITY, OKLA. 73102

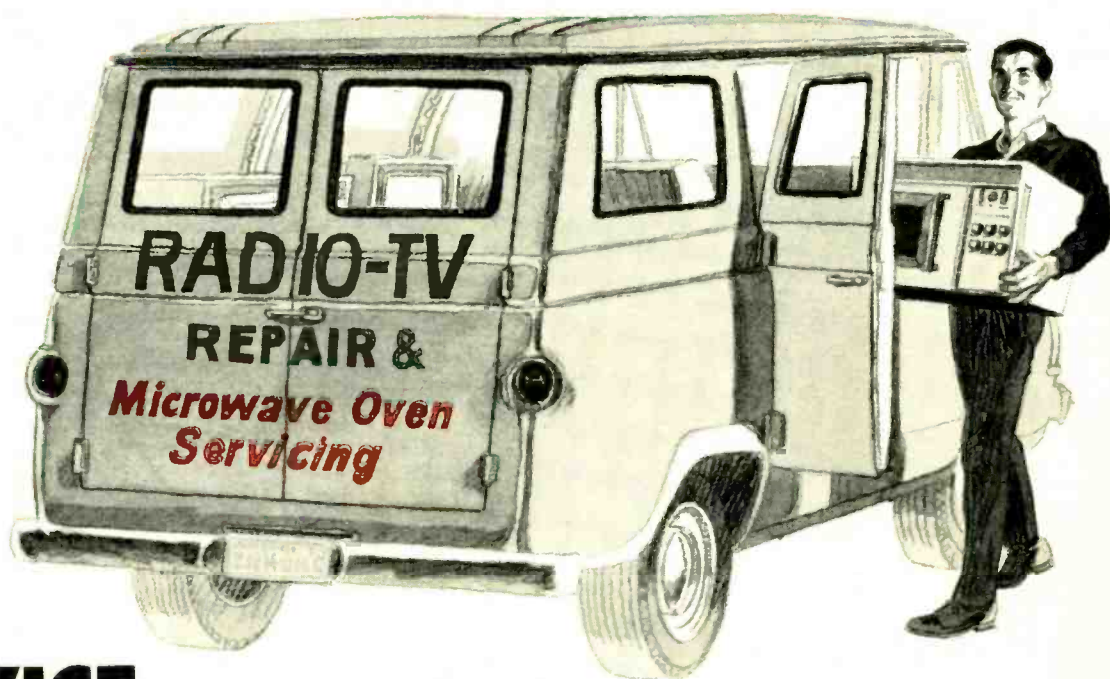

SERVICE MICROWAVE OVENS

Thousands of new microwave ovens are sold each year for commercial or home use. As oven sales continue to climb a brand new opportunity opens for those presently engaged in radio and television servicing. It's an opportunity to supplement your present income . . . or start an entirely new servicing business.

A majority of the franchised "fast food" eating establishments are using microwave ovens. Hundreds of restaurants are discovering the oven that will bake a potato in five minutes, heat precooked frozen food in minutes. Homeowners everywhere are becoming aware of the electronic oven which cuts cooking time from hours to minutes . . . even seconds. Prepare yourself now for this new servicing and maintenance business.

International Crystal Mfg. Co., a pioneer manufacturer of microwave ovens, has information regarding this space-age opportunity for skilled technicians. Write today for complete details.

ADDRESS INQUIRIES TO:
SERVICING INTERNATIONAL CRYSTAL MFG. CO., INC. 10 North Lee Oklahoma City, Okla. 73102

Circle 90 on reader service card

5 new RCA VOM's* Priced from \$9.95** to \$48.00**

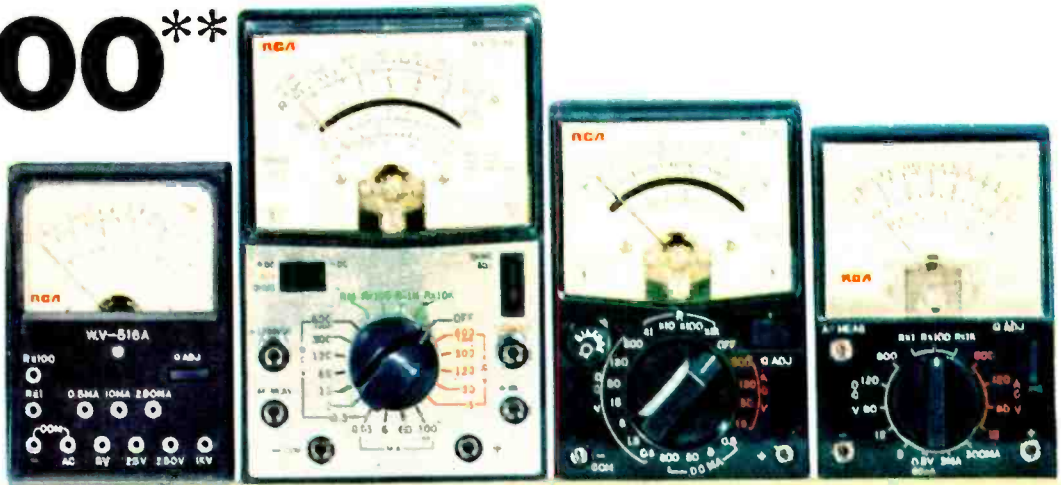

*Complete with test leads,
batteries and full
RCA warranty
(12 months parts and labor).

Input resistances
from 2000 to 100,000
ohms per volt.

**Optional Distributor Resale Price

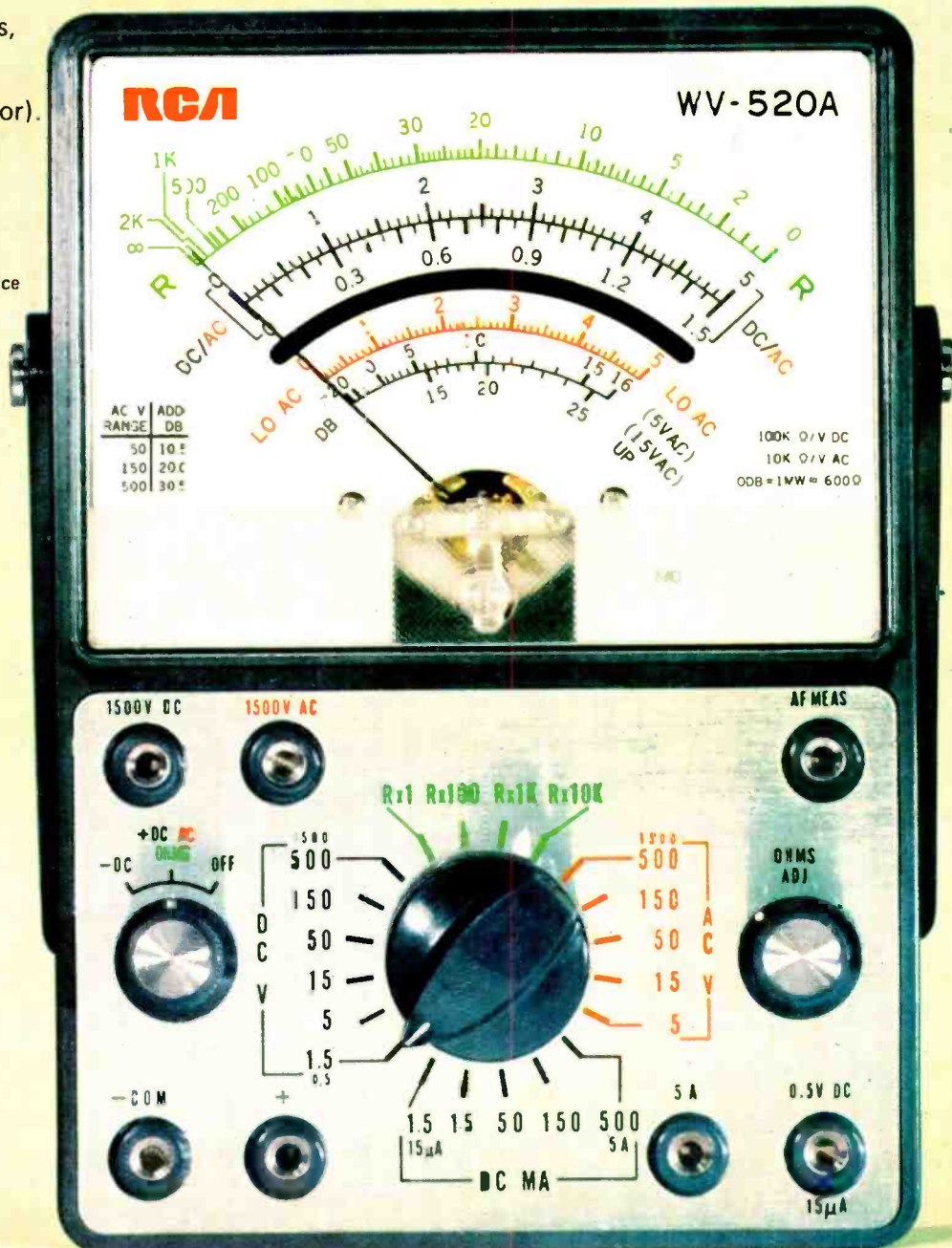



You'll profit from every minute of it.

Here's why:

With the development of new electronic home entertainment equipment, new problems arise. Because nothing tells a story the way pictures do, we're making audio visual slide/tape films available to our distributors to help you pinpoint and solve these problems. Faster. They're yours to see for the asking.

Whether you're an experienced service dealer or a newcomer, your participating RCA distributor can now help

you update your servicing know-how in three important phases of your business:

- RCA Color Picture Tube Installation Procedures and Associated Receiver Adjustments.
- RCA Television Servicing (Tube Replacement Techniques).
- RCA Transistor Servicing (Basic)

Ask your RCA Electronic Components distributor for a free show—today. Also ask for reference guides outlining the major steps and servicing short cuts covered by each show.

RCA|Electronic Components|Harrison, New Jersey 07029

Your Ticket to Faster Servicing Techniques!

