

Radio-^{IND}Electronics[®]

FOR MEN WITH IDEAS IN ELECTRONICS



BUILD R-E'S

FET dual-trace scope switch



PRO'S GUIDE

10 steps to best mike use



plus

PA Do's and Don'ts ■ Build a "Radar" Burglar Alarm ■ 8 Op-Amp Audio Circuits ■ Kwik-Fix Transistor Color TV Demodulators ■ Art Margolis' Case of the Hot Flyback

Dazzle your friends with lightworks.



Sound n' Color®

The *now* dimension to music pleasure. EICO All Electronic Solid-State Audio-Color Organs transform sound waves into moving synchronized color images. Connect easily to speaker leads of hi-fi or radio. From \$29.95.



Translators

The electronics you need to create audio-stimulated light displays to your own imagination. Actuates: Light Display Units, Strobe Lites, any lamp configuration (Xmas trees, patio lights, etc.). From \$24.95 kit, \$39.95 wired.



Strobe Lites

High-intensity bursts of white light from Xenon tube flash in cadence with each beat of audio. From \$24.95 kit, \$39.95 wired.

Build the Stereo Kits praised by experts.

All amplifier power ratings according to IHF standards. Cortina® designed and manufactured in U.S.A. and guaranteed by EICO.

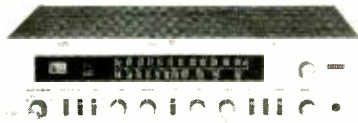

70-Watt AM/FM Stereo Receiver including cabinet. Cortina 3770, \$189.95 kit, \$279.95 wired.

70-Watt FM Stereo Receiver including cabinet. Cortina 3570, \$169.95 kit, \$259.95 wired.



150-Watt Silicon Solid-State Stereo Amplifier, including cabinet. For the audio perfectionist. Cortina 3150, \$149.95 kit, \$225 wired.

70-Watt Silicon Solid-State Stereo Amplifier, including cabinet. Cortina 3070, \$99.95 kit, \$139.95 wired.



FM Stereo Tuner including cabinet. Cortina 3200, \$99.95 kit, \$139.95 wired.



EC-1100
FM WIRELESS MIKE \$9.95

Build for fun and use with Eicocraft® jiffy project kits.

The newest excitement in kits. 100% solid-state and professional. Expandable, interconnectable. Excellent as introductions to electronics. No technical experience needed. Finest parts, pre-drilled etched printed circuit boards, step-by-step instructions. 36 kits to select from, \$2.50 to \$9.95. Just released: EC-2600 "Super Snooper" \$8.95; EC-2700 Police & Fire Converter



(lo band) \$7.95; EC-2800 Aircraft Converter \$7.95; EC-2900 Police & Fire Converter (hi band) \$7.95; EC-3100 2-Station Intercom (with cases) \$10.95; EC-3200 "Do-It-Yourself" PC Etching Kit \$4.95; EC-2300 Audio Preamplifier \$8.95; EC-2400 Bullhorn \$8.95; EC-2500 Fuzzbox \$8.95.



EC-1900 TREASURE FINDER \$9.95

Shape up your own car/boat with EICO Engine Analyzer

For all 6V/12V systems; 4, 6, 8-cyl. engines. Now you can keep your car or boat engine in tip-top shape with this solid-state, portable, self-powered universal engine analyzer.

Completely tests your *total* ignition/electrical system. Complete with comprehensive Tune-up & Trouble-shooting Manual. EICO 888, \$49.95 kit, \$69.95 wired.



The first and only solid-state test equipment guaranteed for 5 years.

Only EICO brings you laboratory precision and long life at lowest cost.

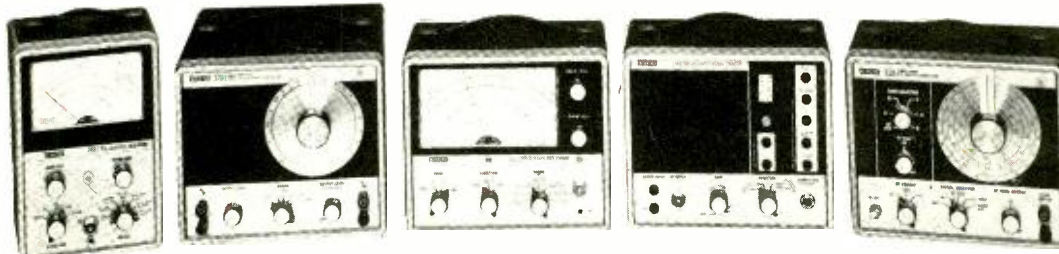

EICO 240 Solid-State FET-TVOM
\$59.95 kit, \$79.95 wired

EICO 379 Solid-State Sine/Square Wave Generator
\$69.95 kit, \$94.50 wired

EICO 242 Solid-State Deluxe FET-TVOM
\$69.95 kit, \$94.50 wired

EICO 150 Solid-State Signal Tracer
\$49.95 kit, \$69.95 wired

EICO 330 Solid-State RF Signal Generator
\$59.95 kit, \$84.50 wired

You save up to 50% with EICO Kits. Since 1945, Best Buys in Electronics. Over 3 Million EICO Instruments Now in Use.

FREE 1970 CATALOG

Send me FREE catalog describing the full EICO line of 200 best buys, and name of nearest dealer.



EICO Electronic Instrument Co., Inc.
283 Malta Street, Brooklyn, N.Y. 11207
Available In Canada

Name _____

Address _____

City _____ State _____ Zip _____



"ULTRAVOX SYSTEM" model 3121 INSTANT AUDITORIUM

The Geloso "ULTRAVOX" 3121 is a compact, self-contained lightweight, portable public address system. It consists of a sound column with built-in 25 Watts solid state power amplifier, self-contained batteries, collapsible floor stand for the column, cardioid dynamic microphone with collapsible floor stand and connecting cables. The entire system is contained in a custom-designed carrying case. Up to 20 auxiliary columns, No. 3126, can be connected in series whenever additional amplification is required.

- Will efficiently cover an area up to 5000 square feet
- Can be assembled in seconds!
- Directional and Controlled Sound Dispersion
- Cardioid Dynamic Microphone with Power-On-Off Switch
- Self-contained, for Indoor and Outdoor Use
- Can operate from AC line with Adapter No. 2/1

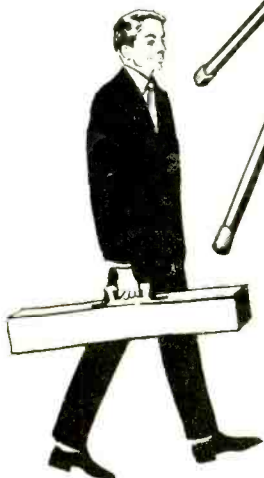

**portable as
a trombone**

WRITE FOR THE FREE 1970
GELOSO SOUND PRODUCTS CATA-
LOGUE — DEPT. P/M

- Microphones
- Amplifiers
- Speakers
- Mobile PA Systems
- Portable PA Systems

AMERICAN GELOSO ELECTRONICS, INC., 251 Park Ave. South, New York, N. Y. 10010
In Canada: Canadian Geloso Electronics, Ltd.
Canadian Factory Representative: William Cohen Corporation, 8900 Park Ave., Montreal

U.S. Phone 212 254-2282



Circle 2 on reader service card

← Circle 1 on reader service card

NEW & TIMELY

Volume 41 Number 7

RADIO-ELECTRONICS

July 1970

TV CAMERA TUBE BOOSTS LIGHT 150,000 X

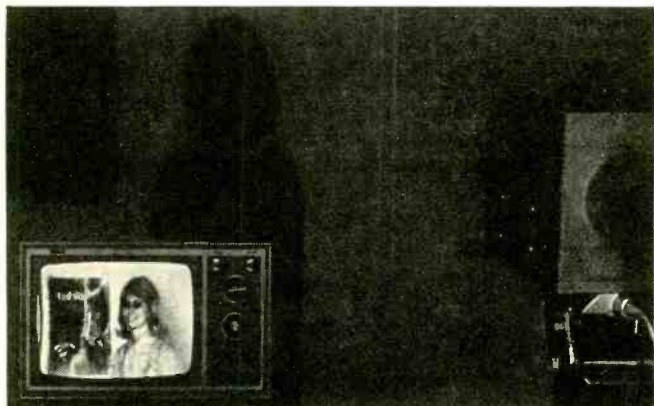

Starlight scene shows up on monitor like a studio setting. SIT tube combines secondary electron conduction techniques and silicon target.

HARRISON, N.J.—A super-sensitive TV camera tube that boosts the brightness of light 150,000 times is now available from RCA. The silicon intensifier tube (SIT) is currently aimed at specialized industrial and government markets. Future versions should permit improved colorcasts under poor light conditions.

Incoming light strikes a photocathode, which releases electrons that are accelerated through 10 kV to strike the silicon diode-array target. This target is an IC array of some 600,000 pn junction diodes.

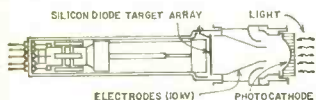

The diodes are reverse biased with the n-type substrate held at a positive potential and the scanned side near ground potential. Because of the depletion layer, each

diode acts as an elemental storage capacitor.

Photoelectrons create a large number of hole-electron pairs in the n-region. The holes move across the depletion region, discharging the



storage capacitors. An output signal is generated by the capacitive displacement current during the recharging of each capacitor by the scanning beam.

The SIT's, which can detect scenes on an overcast starlight night, can also take extreme overloads without burning or damage. Low lag characteristics prevent smear when a camera is panned across a scene.

A sampling price of \$15,000 each should come down to \$5,000 in quantities.

INSIDE SERVICEAMERICA

NEW YORK—RCA is ready to open the doors to its new organization, ServiceAmerica, formed to handle repairs of all makes of TV sets and other electronic home-entertainment equipment.

The first branches of this nationwide organization are scheduled to open shortly in Philadelphia. Before the end of this year another branch will open in San Francisco. A nation-wide setup is anticipated within 5 years.

The move, a controversial one, has drawn strong criticism from independent service technicians. With these protests in mind, RCA has spelled out, in detail, the operation of ServiceAmerica.

All parts used by the new company for repairing electronic equipment, including replacement CRT's, monochrome and color tubes, and transistors will be purchased

through local parts distributors on a competitive basis. There will be no nationwide purchasing plan. Test equipment for the service centers will be purchased in the same fashion. After the warranty period RCA parts and equipment will receive preference and will be used wherever practical. However, even these parts will be purchased through a local distributor and not direct from RCA.

Technicians for the new company will not be recruited initially from the existing service technician pool. Current estimates indicate that there is now a shortage of 100,000 to 125,000 technicians, and ServiceAmerica does not intend to increase that number. Instead, in their first operation, ServiceAmerica plans to use as many technicians from the RCA Service Company as

(Continued on page 14)

4-CHANNEL SOUND WILL BE ON CARTRIDGES

NEW YORK—A major marketing push for 4-channel sound in the home and car using eight-track tape was announced here.

RCA Records will introduce a new series of Quadrasonic Stereo & cartridge tapes this fall, which provide up to 25 minutes of music on tracks 2-4-6-8 and 1-3-5-7.

The player demonstrated here by RCA, the YZD-400, has two built-in and two external speakers (photo). A button on the compatible

player selects 4- or 2-channel (conventional) playback.

Motorola will sell a 4-channel, eight-track tape player for cars—the Quad-8. Hang-on units will be available late this year, and factory-installed players should be optional in 1972 or 1973 models, Motorola said.

The quadrasonic cartridges will be somewhat more expensive than conventional units, even with a slightly thinner tape and a less costly coating technique.

(N & T continued on page 6)

HEART PACEMAKER USES ATOMIC BATTERY

PARIS—A heart pacemaker powered by an atomic thermocouple battery has been implanted in a human patient for the first time. The lifetime of the power source is a minimum of 10 years and should be much longer. Widely used cadmium batteries must be replaced about

every 2 years by a doctor.

The nuclear device is 1½ inches in diameter and ½-inch thick. About 150 mg of plutonium 238 generates heat as it decays. A bismuth-tellurium compound used in the thermocouples converts the heat into electricity. A solid-state circuit generates about 70 pulses per minute to the coronary muscles, with the output varied on demand.



"Surround sound" from cartridges will be introduced this fall.

Radio-Electronics

July 1970 • Over 60 Years of Electronics Publishing

PUBLIC ADDRESS—AUDIO—STEREO

- 10 Steps To Best Mike Use** **23** William Wokoun
How to get the best results from microphone setups
- PA Do's and Don'ts** **33** Walter Salm
Selection and use of latest public address equipment
- FET—Op-Amp Audio Circuits** **46** Norman Doyle
Use transistors as potentiometers

BUILD ONE OF THESE

- FET Dual-Trace Scope Switch** **36** Thomas B. Mills
Study two waveforms at once—up to 1 MHz
- R-E's 'Radar' Burglar Alarm** **44** Kenneth F. Buegel
Part 2—Wiring Alarm, alignment and installation
- Build a Zener Power Box** **78** I. Queen

TELEVISION

- Kwik-Fix™ Troubleshooting Charts** **39** Forest Belt
Transistor X-Z demodulators in hybrid color TV
- Case of The Hot Flyback** **58** Art Margolis
Tracking down high voltage problems
- In The Shop** **67** Jack Darr
Those unknown tubes
- Service Clinic** **68** Jack Darr
- Inside The High-Voltage Regulator** **76** Matthew Mandl
Types of regulator circuits and service tips

GENERAL ELECTRONICS

- Looking Ahead** **4** David Lachenbruch
From Japan: Current happenings with future overtones
- 20 Triac Circuits to Build** **49** R. M. Marston
Part 2—More control applications for home and shop
- R-E Reference Manual** **60** Lewis A. Harlow
Know your meter
- Technical Topics** **71** Robert F. Scott
Solid-state regeneration . . . the superhet revisited

DEPARTMENTS

- | | | | | | |
|--|-----------|--------------------------|-----------|-------------------------------|-----------|
| CB Troubleshooter's Casebook | 81 | New Books | 80 | Noteworthy Circuits | 82 |
| Coming Next Month | 80 | New Literature | 90 | Reader Service Card | 91 |
| Correspondence | 16 | New Products | 83 | Technotes | 75 |
| New & Timely | 2 | | | Try This One | 70 |



Build this dual-trace scope switch and put it to work in audio troubleshooting and digital circuits. . . . see page 36



PA equipment has more versatility than ever. To find out how to wire up and use the latest gear see page 33

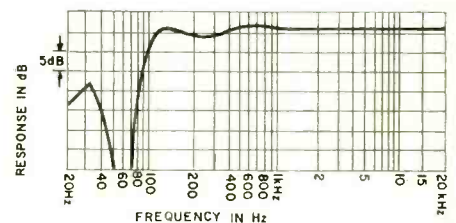

A response curve like this can be useful with some microphone setups. To find out why and how to get it see page 23

RADIO-ELECTRONICS, JULY 1970, Vol. 41, No. 7
 Published monthly by Gernsback Publications, Inc., at Ferry St., Concord, N. H. 03302
 Editorial, Advertising, and Executive offices: 200 Park Ave. S., New York, N.Y. 10003. Subscription Service: Boulder, Colo. 80302.
 Second-class postage paid at Concord, N. H. Printed in U.S.A. One-year subscription rate: U.S. and possessions, Canada, \$6.
 Pan-American countries, \$7. Other countries, \$7.50. Single copies 60¢. © 1970 by Gernsback Publications, Inc. All rights reserved.
 POSTMASTER: Notices of undelivered copies (Form 3579) to Boulder, Colo. 80302.



Radio-Electronics is indexed in *Applied Science & Technology Index* (formerly *Industrial Arts Index*)

LOOKING AHEAD

Volume 41 Number 7

RADIO-ELECTRONICS

July 1970

by **DAVID LACHENBRUCH**
CONTRIBUTING EDITOR

Electronics at Expo

OSAKA, JAPAN—Might as well call it Expotronics '70. Japan's world exposition is almost completely an electronics show from the computer-supervised parking lots to the video telephones scattered about the fairgrounds here in the rolling Senri Hills. Well over half of the pavilions use electronics in one form or another.

The Japanese are perhaps proudest of their innovation in multiplex television which started on Expo's opening day, but will continue as a permanent feature of NHK, the government-chartered broadcast service. The system is currently used by NHK's Tokyo and Osaka transmitters and requires special receivers or adapters, which are just going on sale. It uses a frequency-modulated sound subcarrier, and adapters are equipped with switching systems for main carrier, subcarrier or both (stereo). At present, it's used to transmit special Expo events in two languages, usually Japanese and English. In addition, The Doris Day Show is regularly broadcast in both the original English and dubbed Japanese—take your choice. Unadapted receivers pick up only the main (Japanese) sound carrier.

Stereophonic TV will be broadcast soon, and already hi-fi stores are offering combination TV tuners and switching systems for component audio equipment. In the stereo mode, the system becomes an L+R, L-R operation, similar to conventional FM stereo broadcasting.

Expo itself is computer-operated, via an "operation control center," which controls loudspeakers, changing electric signs, traffic signals, teleprinters, telex and telephones.

Computers monitor crowds

Underground coils at entrances and exits of each parking area detect the number of passing vehicles, and transmit this information to a computer which operates electric signs guiding vehicles to parking lots with vacant spaces in them. The computer also receives data on the flow of visitors from individual pavilions, 50 closed-circuit TV cameras, 100 guard boxes with dial cards for automatic reporting, all entrances and exits, and the moving sidewalks. Visitors may check on crowd conditions by looking at the electronic information maps at 18 sites around Expo. These show movement of visitors to each pavilion: Two white lights indicates that the wait is 20 minutes or less; white and red means a longer wait; two reds—bring your lunch.

Lost children and separated families are a big problem at world's fairs, and Expo handles it electronically, of course. Parents are asked to obtain children's tags at entrances; each tag bears a serial number and is pinned to the child, while the parent keeps a duplicate. If the child disappears, the parent proceeds to the nearest information booth, gives the serial number, which is fed to the computer and compared with numbers of strayed children found at various fair sites. Lost children are identified (and reassured) via video telephone.

Electronic newspapers are available at Expo. "Home facsimile" editions of *Yomiuri Shimbun* and its English-language sister *The Daily Yomiuri* are received from downtown Osaka and transmitted to the Livelihood and Industry Pavilion by a combination of telephone circuits,

microwave and laser beam and printed out by fiber-optic cathode ray tubes at 80 seconds per tabloid-size page. Another newspaper chain, Mainichi, is demonstrating home facsimile printing simultaneously with color TV reception, the fax information transmitted during the vertical blanking period.

Much of the electronics at Expo is just for fun. At the spectacular Hitachi pavilion, lucky Expogoes become airline pilots. Seated in a cockpit with aircraft controls, but with a closed-circuit color TV screen in place of a windshield, the "pilot" actually controls take-off and landing. The controls are geared to servo-controlled closed-circuit cameras focused on a large model of an airport and very real simulation is obtained. Upon "landing," if the pilot misses the airstrip, the TV screen turns red and crashing noises are heard.

Hitachi is also showing a laser color TV projection system with a 9 x 12-ft picture. Using the NTSC system, the projector has a beam-deflecting system consisting of a horizontal scanner with 16 mirror facets rotating at 60,000 rpm and a vertical scanner with 24 facets rotating at 150 rpm.

'Computopia' fun and games

The Furakawa Group exhibit, in a seven-storied pagoda, contains an electronics hall called "Computopia," which is full of computerized fun and games. In one game, a robot crane may be commanded by voice to "put the No. 1 ball in the red cylinder" or any other of a large combination of tasks. The robot will obey unless the demand is impossible—in which case it will talk back, in perfect Japanese. In another display, a computer plays a sophisticated form of tic-tac-toe with visitors. In still another, the visitor can play any series of notes on an electronic organ, and a computer then composes and plays five selections based on the notes—in waltz, blues, tango, samba, classic-style or modern, at the option of the computer. Another Furakawa device accepts written requests from female visitors on a special form, then prints out dress designs especially suited to their tastes.

An "electronic fortune-teller" is featured at the Sumitomo Group pavilion. An Expogoe sits in a chair in front of a closed-circuit camera. A computer analyzes his face, separating the image into 76,800 bits of information, and detects major facial characteristics. Based on nine different points (mouth, nose, jaw, etc.), the computer classifies the subject as one of 21 fundamental character types and plays back an audio tape analyzing his character on the basis of his facial characteristics. At the same time, a computer-made line drawing of the subject's face appears on the TV screen and he is presented with a computer print-out drawing of his face as a souvenir.

A corner of Sanyo's pavilion is devoted to the "family information system" of the future, consisting of a color TV set, video tape playback unit, 16mm movie projector, electronic calculator, closed-circuit TV, fax newspaper printer and stereo music center—all operated from a simple keyboard.

This is just a small sampling. At Expo, electronics is not only the guiding force and regulator, it's a major pre-occupation, and it's also for fun. More importantly, it symbolizes Japan's growing importance as a leader in the field of electronics.

R-E

THE CALECTRO SUPERMARKET



EVERYTHING IN ELECTRONICS!



VARIABLE BALANCE STEREO HEAD PHONE

Unique "Sound Level" control on each earpiece permits adjustment. Frequency range: 20 to 20,000 + cps. 6 1/2' cord with stereo plug. Impedance 4 to 15 ohms.
Cat. No. Q4-132 \$17.95 Net

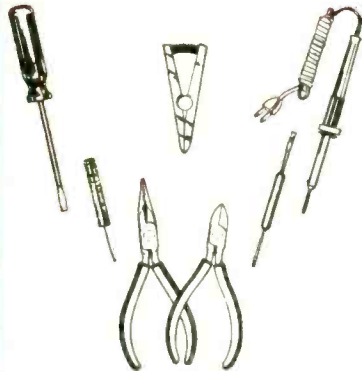

HOBBYIST'S SOLDERING AND TOOL KIT

Diagonals, long nose pliers, soldering iron and solder, solder aid tool, heat-sink, and screwdriver. An ideal gift item.
Cat. No. H3-378 \$7.95 Net.



TAPE RECORDER MICROPHONE

Outstanding performance on music and speech for the price. Low impedance matches late model solid state recorders. Removable desk stand 4 1/2' cord with dual plugs that fit most models. Freq. Response: 100-8k Hz Output: -77 dB. Impedance: 200 ohms
Cat. No. Q4-146 \$4.95 Net

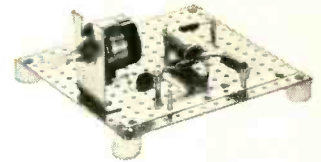

EXPERIMENTER'S CIRCUIT BOARD KIT

Contains a 3 3/4" x 4" perforated board, 15 terminals (No. J4-636) and 4 mounting feet w/screws. Build small circuits, hobby and science projects, etc.
Cat. No. J4-660 \$.98 Net

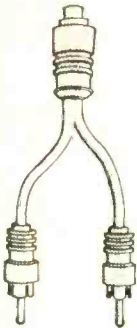

JD10 ADAPTORS

"JD" Audio Adaptor has a phono pick on one end and dual phono plugs on the other.
Cat. No. Q4-288 \$.99 Net

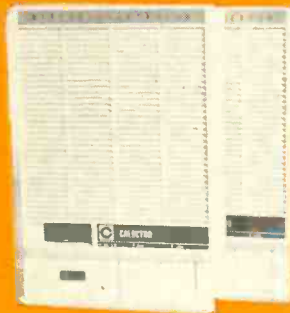

TWO STATION WIRELESS INTERCOM

Just plug into any electrical outlet. Completely portable. Expand system anytime with additional units. Two unit system complete in display pack.
Cat. No. N4-110 \$34.95 Net



MINIATURE LAMPS

Type PR2 • 2.5 volt • 0.50 amp • Cat. No. E2-430 • Pkg. of 2 \$.29 Net
Type PR3 • 3.5 volt • 0.50 amp • Cat. No. E2-431 • Pkg. of 2 \$.29 Net

STANDARD 1000 VOLT CAPACITOR

High quality, compact and reliable.

RESISTORS

Attractively packaged 2 per pack, showing values, color codes and formulas.



THE "GC CALECTRO HOBBYIST HANDBOOK"

The "GC Calectro Hobbyist Handbook" is available at your nearest Calectro Electronic Supermarket. One is located near you. WRITE TODAY and we'll rush you the name and address of your nearest Calectro Supermarket.



CALECTRO

G-C ELECTRONICS
A DIVISION OF
HYDROMETALS, INC.



400 SO. WYMAN ST. ROCKFORD, ILLINOIS 61101

New & Timely

LASER GENERATOR CUTS MASK TIME

MURRAY HILL, N.J.—

Complex circuit masks for IC's can be drawn in minutes instead of hours using a new laser pattern generator developed at Bell Labs.

Intricate masks that formerly required 12 hours of machine time can now be completed in about 12 minutes. The generator has a



moving table to hold an 8 x 10-inch photographic plate, an argon laser, modulators and lenses to control the laser beams. A 10-sided mirror (upper left in photo) rotates on air bearings to reflect the beam along 32,000 scan lines, each with 26,000 positions.

CORRECTION

A typographical error in last month's New & Timely altered the meaning of the last sentence in the "Scheiber 4-Channel Process" item (page 2). It should have read: "... gain-riding function. . . ."

TESTS MAY AID COLOR TV UNIFORMITY

NEW YORK—On-air tests of vertical interval reference (VIR) signals to achieve better color uniformity on home color TV sets are planned here this summer.

VIR signals would give stations a constant color reference to insure outgoing signals have the proper chrominance-to-luminance ratio and that the color burst represents a proper reference for the phase and amplitude of the chrominance signal.

The VIR signal contains chrominance, luminance and black-level references. It will be tested on line 20, during the vertical interval just before picture information starts.

An Electronic Industries Association committee is also studying the advisability of tightening tolerances on sync and burst timing specifications, and updating specifications on gamma, primaries and reference white.

GLASS STORAGE TUBE

CORNING, N.Y.—Using a new device in the computer field, a photochromic glass storage tube, Corning Glass Works is building an interactive computer terminal system and plotter.

Like film, photochromic glass contains silver halides. The glass, however, does not remain dark after exposure to light; it lightens slowly in darkness and rapidly under infrared illumination. Information to be displayed is stored in a 5-inch, phosphor-screen CRT mounted directly behind a faceplate of fiber optic material with photochromic cores. A dichroic mirror between the screen and faceplate permits ultraviolet

light from the screen to pass through and darken the faceplate as the scanning beam excites the phosphor screen.

To "read" the display, high-intensity green light is focused on the faceplate. The



light passes through the fiber optics, is reflected from the mirror back through the faceplate and focused by another lens on the projection screen.

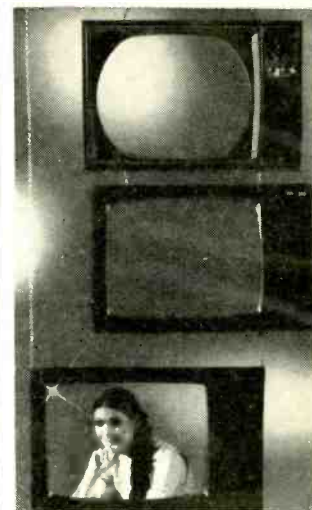

Wider and sharper: The new look in some 1971 color TV models to be introduced this summer will be a 25-inch diagonal picture tube. The tubes have a 3:4 aspect ratio (compared to the present 4:5), matching the true shape of broadcast pictures. The new 25V's have 315 square inches of viewable area. The 23V's (middle) have 295 square inches. Philco-Ford, who is making the 25V size, say a new electron gun makes their pictures 21% sharper. On top is the 21-inch round CRT mask.

(N & T continued on page 12)

NEXT MONTH

- Take a close look at the latest portable vtr circuits.
- Build a 12- or 24-hour digital clock with a built-in alarm.
- Build a universal alkaline battery charger.

Radio-Electronics

HUGO GERNSBACK (1884-1967)
founder

M. HARVEY GERNSBACK,
editor and publisher

LARRY STECKLER, managing editor

Robert F. Scott, W2PVG
senior technical editor

John R. Free, associate editor

Jack Darr, service editor

I. Queen, editorial associate

Matthew Mandl, contributing editor

David Lachenbruch, contributing editor

Frances McDowell, editorial assistant

Vincent P. Cicenja, production manager

Barbara Rosefelt, production assistant

H. Matysko, circulation

Cover by Harry Schlack

RADIO-ELECTRONICS is published by Gernsback Publications, Inc. 200 Park Ave. South New York, N.Y. 10003 (212) 777-6400

President: M. Harvey Gernsback
Secretary: Bertina Baer

ADVERTISING SALES

EAST
John J. Lamson, Eastern Sales Mgr. N.Y.C. (212) 777-6400

MIDWEST/Texas/Arkansas/Okla.

Ralph Bergen,
6319 N. Central Ave.
Chicago, Ill. 60646
(312) 792-3646

PACIFIC COAST/Mountain States

J. E. Publishers Representative Co.,
8560 Sunset Blvd., Suite 601
Los Angeles, Calif. 90069
(213) 659-3810
420 Market St. San Francisco, Calif.
94111, (415) 981-4527

SOUTHEAST

E. Lucian Neff Associates
25 Castle Harbor Isle
Fort Lauderdale, Florida 33308
(305) 566-5656

SUBSCRIPTION SERVICE: Send all subscription orders and correspondence to RADIO-ELECTRONICS, Subscription Department, Boulder, Colo. 80302.

MOVING? For change of address, allow six weeks, furnishing both the old and new addresses and if possible attaching label from a recent issue below. Otherwise please print clearly your name and address exactly as it appears on your label.

ATTACH LABEL HERE

name _____ (please print)

address _____

city _____ state _____ zip code _____

Mail to: RADIO-ELECTRONICS
SUBSCRIPTION DEPT., BOULDER, COLO. 80302

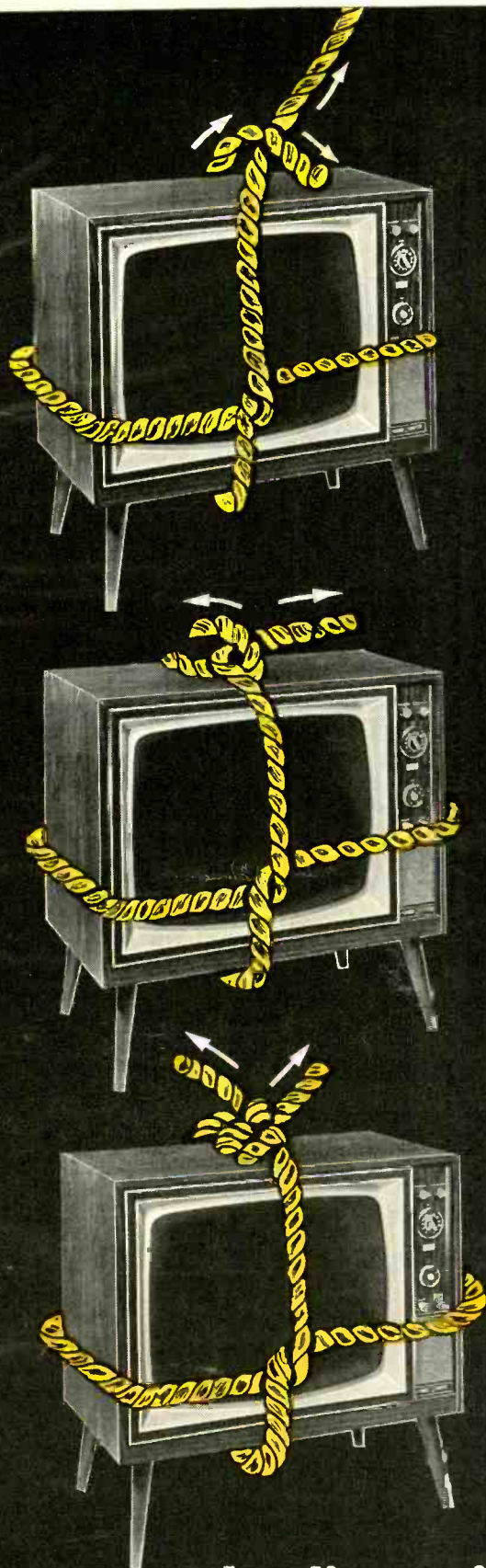

Want to **tie up** the service market?

Start with the Channel Master Opti-Vue Color CRT with the three year warranty, one TV set that needs a picture tube, and one customer.

Tell your customer how Opti-Vue guarantees the finest color he's ever seen for a full three years--- not just one or two. And how, just in case something should go wrong, he gets a free replacement. So it may cost a little more, but it's worth it. And the price is right, too!

Now, you've secured the part of the set he's most worried about he's sure to call you when any other part fails. You've tied up all his service business for a full three years by taking care of his knottiest problem, and, not unimportantly, your customer's very happy with his new color vision!

So go ahead and tie one on with

OPTI-VUE
The line with 3 year warranty!

CHANNEL MASTER

Div. of Avnet, Inc., Ellenville, N.Y. 12428

EXPERIENCE IS STILL YOUR BEST TEACHER

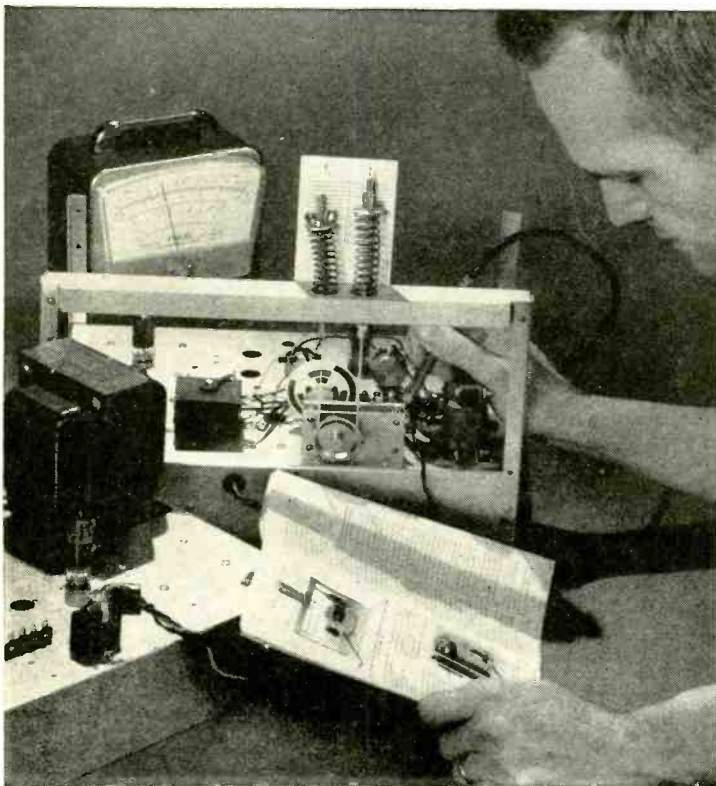

NRI designed-for-learning training equipment gives you priceless confidence because your hands are trained as well as your head.

Learning Electronics at home the NRI way is fast and fascinating. Read opposite page.



**OLDEST AND LARGEST
SCHOOL OF ITS KIND**

Accredited by the Accrediting Commission of the National Home Study Council

You get more for your money from NRI

—more value, more solid experience so essential to careers in Electronics. NRI's pioneering "discovery" method is the result of more than half a century of simplifying, organizing, dramatizing subject matter. In each of NRI's major courses you learn by doing. You demonstrate theory you read in "bite-size" texts programmed with NRI designed-for-learning professional lab equipment. Electronics comes alive in a unique, fascinating way. You'll take pleasure in evidence you can feel and touch of increasing skills in Electronics, as you introduce defects into circuits you build, perform experiments, discover the "why" of circuitry and equipment operation.

Almost without realizing it, the NRI discovery method gives you the professional's most valuable tool—practical experience. You learn maintenance, installation, construction and trouble-shooting of Electronic circuits of any description. Whether your chosen field is Industrial Electronics, Communications or TV-Radio Servicing, NRI prepares you quickly to be employable in this booming field or to earn extra money in your spare time or have your own full-time business. And you start out with training equivalent to months—even years—of on-the-job training.

NRI Has Trained More Men for Electronics Than Any Other School

—By actual count, the number of individuals who have enrolled for Electronics with NRI could easily populate a city the size of New Orleans or Indianapolis. Over three-quarters of a million have enrolled with NRI since 1914. How well NRI training has proved its value is evident from the thousands of letters we receive from graduates. Letters like those excerpted below. Take the first step to a rewarding new career today. Mail the postage-free card. No obligation. No salesman will call. NATIONAL RADIO INSTITUTE, Electronics Division, Washington, D.C. 20016.



L. V. Lynch, Louisville, Ky., was a factory worker with American Tobacco Co., now he's an Electronics Technician with the same firm. "I don't see how the NRI way of teaching could be improved."



G. L. Roberts, Champaign, Ill., is Senior Technician at the U. of Illinois Coordinated Science Laboratory. In two years he received five pay raises. Says Roberts, "I attribute my present position to NRI training."



Don House, Lubbock, Tex., went into his own Servicing business six months after completing NRI training. This former clothes salesman just bought a new house and reports, "I look forward to making twice as much money as I would have in my former work."



Ronald L. Ritter of Eatontown, N.J., received a promotion before finishing the NRI Communication course, scoring one of the highest grades in Army proficiency tests. He works with the U.S. Army Electronics Lab, Ft. Monmouth, N.J. "Through NRI, I know I can handle a job of responsibility."

APPROVED UNDER NEW GI BILL. If you served since January 31, 1955, or are in service, check GI line on postage-free card.

Circle 31 on reader service

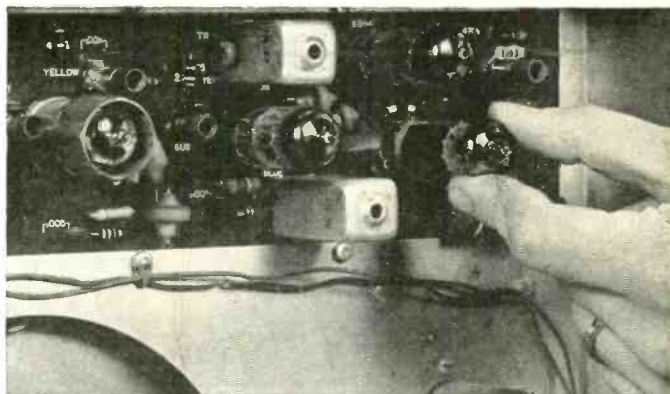

COLOR TV CIRCUITRY COMES ALIVE

as you build, stage-by-stage, the only custom Color-TV engineered for training. You grasp a professional understanding of all color circuits through logical demonstrations never before presented. The TV-Radio Servicing course includes your choice of black and white or color training equipment.

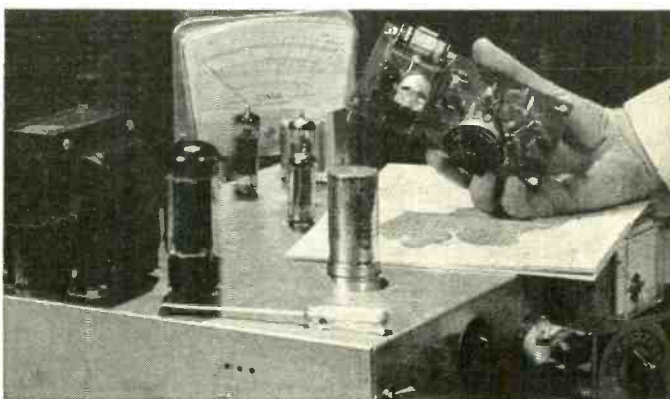

COMMUNICATIONS EXPERIENCE

comparable to many months on the job is yours as you build and use a VTVM with solid-state power supply, perform experiments on transmission line and antenna systems and build and work with an operating, phone-cw, 30-watt transmitter suitable for use on the 80-meter amateur band. Again, no other home-study school offers this equipment. You pass your FCC exams—or get your money back.

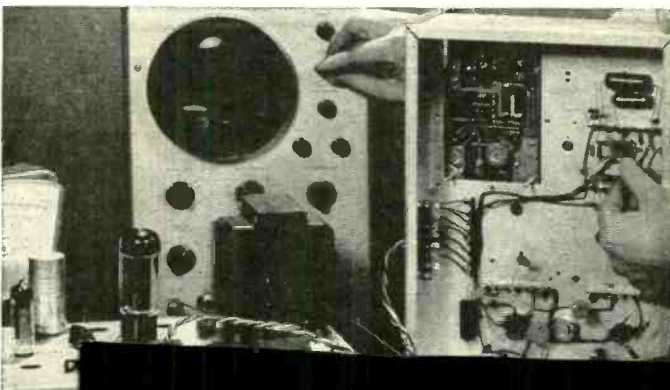

COM

can be course and us and ev simple tors, se

**flameless
1000°
heat**

Instant, precise heat for 1001 uses — shrink tubing, soldering-desoldering, forming, bonding, deburring, drying, setting adhesives. World's most complete line. Models from 200-1000° F. Send for new free Catalog 75.

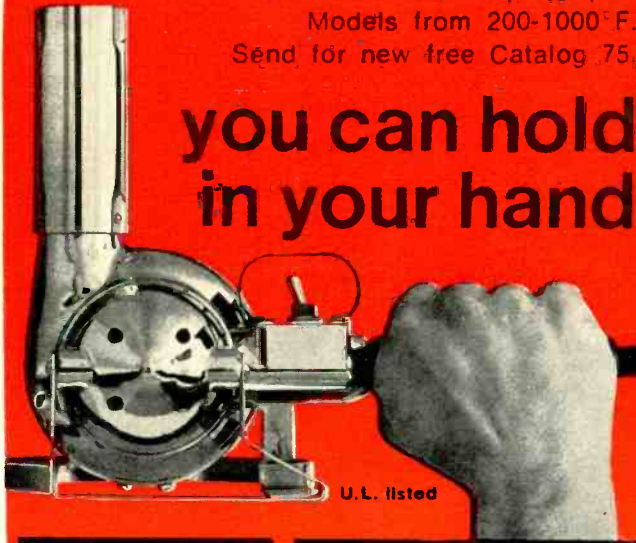

**you can hold
in your hand**

U.L. listed

MASTER HEAT GUNS

1745 FLETT AVE., RACINE, WI 53403

Circle 5 on reader service card



*It's yours
FREE
for the
asking!*



BA
**GIANT 260 PAGE
1971
RADIO-TV
ELECTRONICS
CATALOG**

**YOUR BUYING GUIDE FOR EVERYTHING IN ELECTRONICS!
RESERVE YOUR COPY NOW FOR DELIVERY IN LATE AUGUST**

New & Timely

(Continued from page 6)

RADIO CALL BOXES SUMMON HELP FAST

BOSTON—A new line of radio call boxes that can summon firemen, police, ambulance or road service with a 300-msec, coded AM signal in the 72-76-MHz range has been introduced.

The battery-operated system sends a daily test signal, reports on battery condition and will transmit a tamper/knockdown signal to a communications center console.



Optional plug-in modules permit one- or two-way voice communication. Gamewell, a Gulf & Western Systems Co., makes the emergency call boxes.

NEA SAFETY GROUP DESCRIBES TV FIRES

INDIANAPOLIS—Based on reports from independent service dealers, a National Electronic Association product safety committee recently released some estimates on TV fires.

Of some 4,000 TV failures annually that produce evidence of combustion, 800 actually ignite the cabinet, back cover or sizable component. The NEA survey found that no one brand was substantially more fire prone.

The on-off switch area caused 38% of the combustion, the flyback area

38%, the power supply 13% and miscellaneous parts and areas 16%.

Do-it-yourself repairs and failure to recognize warning signals were cited as prime causes of fires. Obvious malfunction clues listed were: snapping and popping, shrinking picture size, a weave in the picture and/or hum in sound, need to reset circuit breaker and using a set with a touchy on-off switch. NEA estimates half of the annual 8,000 TV fires are due to unqualified repair attempts (bypassing fuses and switches, adjusting high voltage wrong, using wrong value parts).



Local residents sample the services of an advanced, all-electronic telephone switching system being installed at Walt Disney World near Orlando, Florida. Equipped for abbreviated dialing, the system automatically completes a call after two or three digits are dialed. A "call back" feature notifies a caller when a busy phone becomes free. Residents of the 27,000-acre development will be able to "program" their telephones (by dialing two digits and another number) to have calls follow them when they visit a neighbor. The system is made by Stromberg-Carlson, a General Dynamics subsidiary.

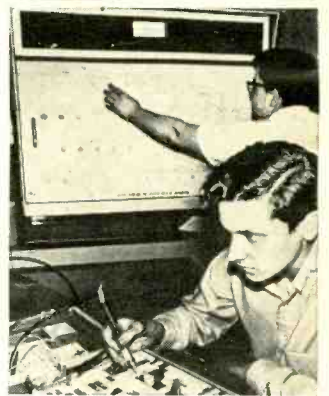

A new electronic simulator designed to rapidly train technicians for TV repair has been developed. The teaching device compels the student to follow a logical sequence of steps to analyze a problem, then solve it. A visual display section, which can show four slides simultaneously, presents a problem. The panel then shows which parts of a set could be used to diagnose the difficulty, and requires a specific series of buttons to be pressed. The device is being marketed by Educational Computer Corp. (N & T continued on page 14)

Circle 7 on reader service card →

"We have never tested a recorder at this price level that could match the 1200U. Its only real competition would seem to come from the \$500-and-up class of recorders."

— STEREO REVIEW, 1969

When it comes to performance, our A-1200U is the only professional-quality machine on the market for less than \$300. And we wouldn't con you pros.

True, this deck isn't set up with professional rack mountings, studio output lines or N.A.B. reels — it's designed for home use. But it's right at home with a lot of pros we know. And some of them insist on taking it to work in professional broadcast operation, too.

Why not? This model meets most of the accepted broadcast standards. If you heard one on the air, you'd never know the difference between the 1200 and a pro deck with all those fancy fittings.

It's our kind of craftsmanship, your kind of cost. Plenty of unique features, too, including everything it takes to make a TEAC.

So play it by ear. You'll like what you hear. And hearing is believing.

TEAC

TEAC Corporation of America
2000 Colorado Avenue
Santa Monica, California 90404

A-1200U

- Triple-motored drive system
- 3 precision heads for instant off-the-tape monitoring
- ADD recording for built-in sound-on-sound
- Mike-line mixing
- 4 independent preamplifiers
- Automatic tape lifter
- All-pushbutton controls
- Stereo echo for special sound effects



NEW COAX MATCHING TRANSFORMER

For UHF/VHF
Color/B&W TV

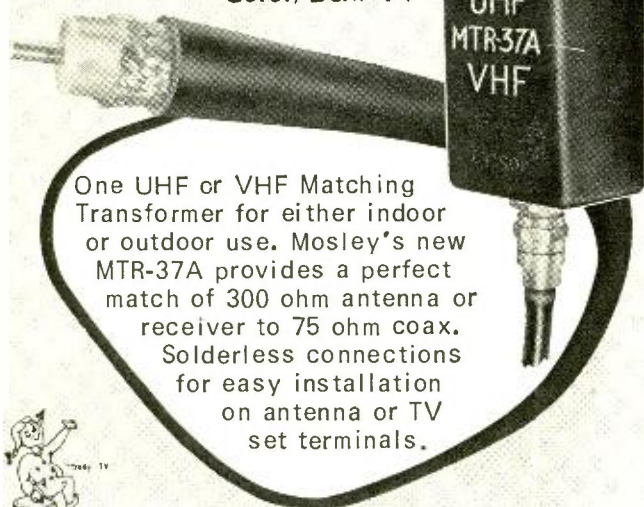

One UHF or VHF Matching Transformer for either indoor or outdoor use. Mosley's new MTR-37A provides a perfect match of 300 ohm antenna or receiver to 75 ohm coax. Solderless connections for easy installation on antenna or TV set terminals.



Write Dept. 160A for FREE detailed brochure.

Mosley Electronics, Inc. 4610 N. Lindbergh Blvd.,
Bridgeton Missouri 63042

Circle 8 on reader service card

Accuracy like a VTVM... Convenience like a VOM...

NEW BATTERY-OPERATED FET SOLID-STATE VOLT-OHMMETER #116

Easy-to-build KIT

\$29⁹⁵ #116K

Factory-Wired & Tested

\$39⁹⁵ #116W



Now you can get all the benefits of a VTVM (laboratory accuracy, stability and wide range) but with its drawbacks gone: no plugging into an AC outlet, no waiting for warm-up, no bulkiness. New Field Effect Transistor (FET) design makes possible low loading, instant-on battery-operation and small size. Excellent for both bench and field work.

Compare these valuable features:

- High impedance low loading: 11 megohms input on DC, 1 megohm on AC
- 500-times more sensitive than a standard 20,000 ohms-per-volt VOM
- Wide-range versatility: 4 P-P AC voltage ranges: 0-3.3, 33, 330, 1200V; 4 RMS AC voltage ranges: 0-1.2, 12, 120, 1200V; 4 DC voltage ranges: 0-1.2, 12, 120, 1200V; 4 Resistance ranges: 0-1K, 0-100K, 0-10 meg., 0-1000 meg.;
- 4DB ranges: -24 to +56DB.

Sensitive easy-to-read 4 1/2" 200 micro-amp meter. Zero center position available. Comprises FET transistor, 4 silicon transistors, 2 diodes. Meter and transistors protected against burnout. Etched panel for durability. High-impact bakelite case with handle useable as instrument stand. Kit has simplified step-by-step assembly instructions. Both kit and factory-wired versions shipped complete with batteries and test leads. 5 1/4" H x 6 3/4" W x 2 7/8" D. 3 lbs.

Send FREE catalog of complete EMC line and name of nearest distributor. RE-7

Name _____
Address _____
City _____
State _____ Zip _____

EMC

ELECTRONIC MEASUREMENTS CORP.
625 Broadway, New York, N.Y. 10012

Export: Pac-Mar Corp., 1270 B way, N.Y. N.Y. 10001

New & Timely

(Continued from page 12)

SERVICEAMERICA

(Continued from page 2)
possible. (The RCA Service Company will continue to operate as a separate company, even though it will compete with ServiceAmerica.)

The first offices in Philadelphia, will start operations with 20 trucks, one technician to a truck for field work, 5-10 shop bench men, and about 10-15 support personnel. All technicians will be union members (IBEW local), and pay scales will vary according to local conditions. Pay range is expected to begin at a low of \$94.50 for a grade 1 technician, and go up to \$158 for a journeyman, \$168 for a master tech and \$178 for a chief tech. (There will be no more than 1 chief tech to a branch office.)

Other technicians needed

for the new company's operations will be recruited largely from non-service-technician sources. They will come from technical schools and other electronic training schools, and will be required to have a basic knowledge of electronics.

After hiring, each prospective technician will undergo a four-week training course at a ServiceAmerica Training Center. There will be six training centers—located in Philadelphia, New York, Los Angeles, Chicago, Detroit and Miami. This course is followed by one week of on-the-job training at the branch where the technician will work. During the following 6 months, the new technician will spend 1 day a week with a journeyman technician to check and improve his skills.

METER SPOTS X-RAYS

CLEVELAND—A new meter designed to detect radiation emitted from color TV sets has been introduced by Victoreen Instrument Division. The meter, model 499,



detects both X-ray and gamma radiation, selling for \$79.50. Its range is from 0 to 1,000 counts per minute. The built-in detector is a Victoreen Geiger-Mueller counter tube.

LONG-PLAY CASSETTE

NEW YORK—Continuous-loop cassettes, which have capabilities similar to eight-track cartridges (plus a recording capability), are being introduced by TDK. The company, for the moment, is marketing the cassettes for educational and industrial applications instead of consumer use.

To prevent rewind, a device is used in the left-hand hole. Maximum playing time is 2 hours after players have been modified. This would give a 1-hour playing time for new 4-channel cassette recordings if they are put on the market.

UNDERWATER CAMERA USES 'SPACE' TUBE

PITTSBURGH—Technology used to produce low-light TV cameras for the Apollo program is being applied to underwater TV cameras by Westinghouse. The SEC image tubes respond rapidly to



scenes without smear. The small monitor (left) is sealed to prevent camera tube degradation in a high-pressure helium atmosphere. R-E

RADIO-ELECTRONICS

don't miss this opportunity

**If You Have What It Takes
to Qualify for Training in Electronics
We'll Not Only Train You...**

**We'll Help You Finance
Training and Help Place You
In the Job You Want!**

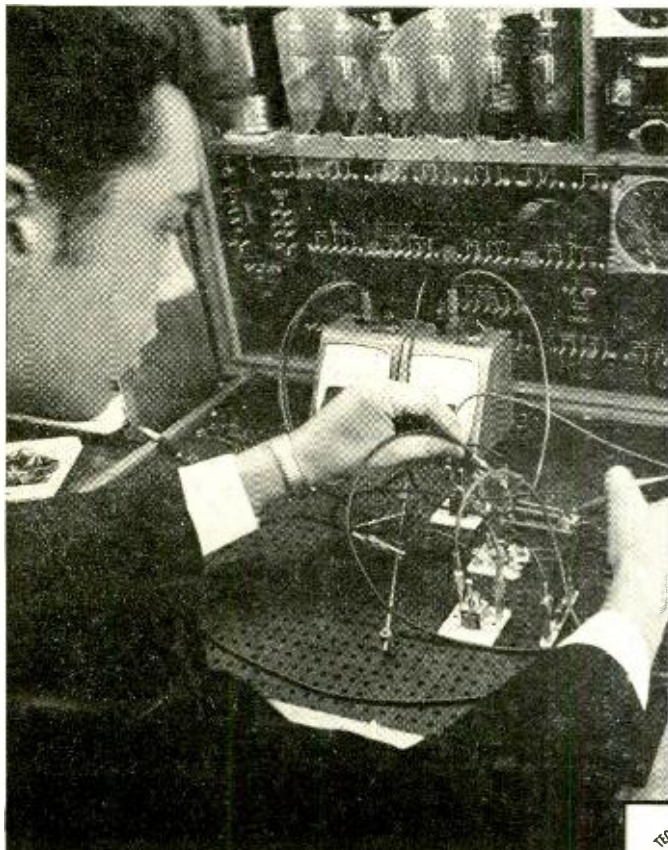
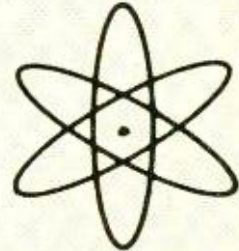

Just a few short years ago, who could have imagined electronic marvels like the micro-miniaturized printed circuit, no larger than the head of a pin . . . battery-powered heartbeat regulators . . . computers that make split-second calculations it would take the human brain years to duplicate! This is the amazing world of technology.

The demand for trained Electronics Specialists and Draftsmen is increasing every year! These are well-paid, prestige positions with practically unlimited opportunities for advancement. **In 12 months or less**, United Technical Institute can prepare you to take your place in this dynamic, expanding field. You can study right at home, in your spare time and at your own pace — or attend a UTI resident school near you.

Because UTI is an eligible institution under the Federally Insured Student Loan Program, you may attend the Institute on a government-guaranteed educational loan. And after you finish your training, we can help you find your first position!

Accredited Member of National Association of Trade and Technical Schools. Approved for Veteran Training.

Get the facts now! Just clip the coupon and send today for a **FREE, fact-filled book** describing the exciting opportunities in electronics, and how you can qualify for them. We'll rush your book by return mail so you can read it and decide for yourself. No obligation, of course. But don't delay — clip the coupon for your free book today! →



United Technical Institute

division of Career Academy

125 W. Wells St. Milwaukee, Wis. 53203

Dept. 07N215202

Please rush me your free 28 page booklet
with all the details on your Electronics course

Name _____ Age _____
(Please print)

Address _____

City _____ State _____ Zip _____

Phone _____

I am interested in: Classroom Study Home Study Facts on GI Bill

NOW— CHECK ALL TRANSISTORS IN OR OUT OF CIRCUIT ...

Flick function switch to left to check all regular transistors.

Flick function switch to right to check any FET.

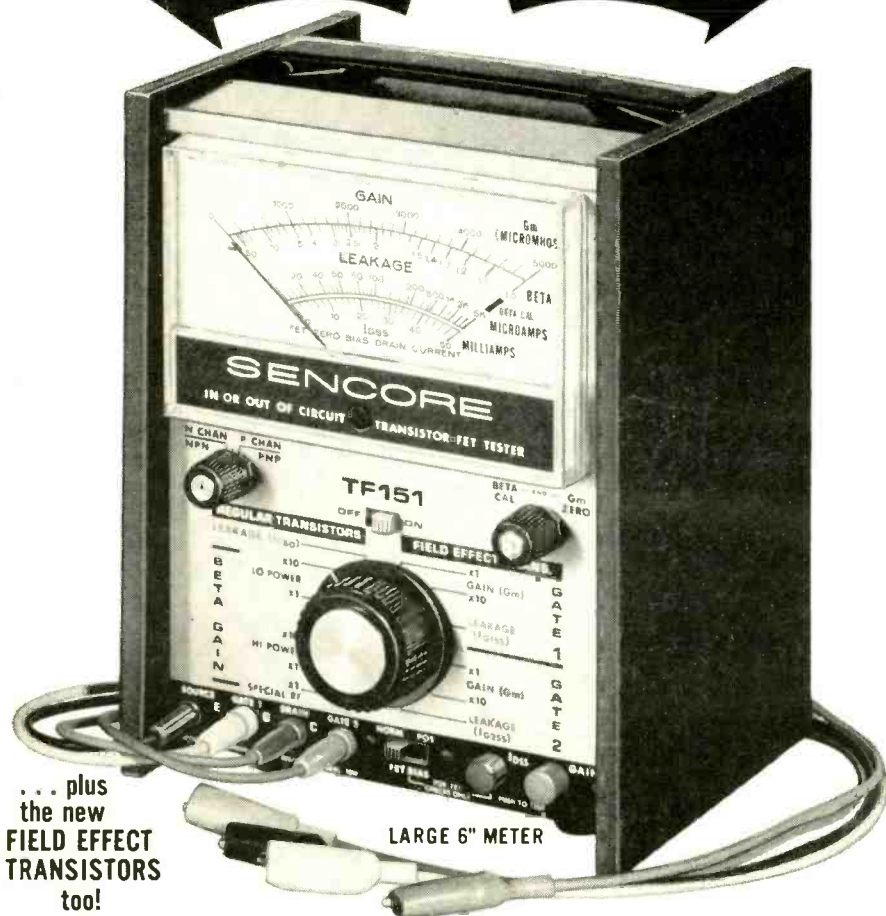

... plus the new FIELD EFFECT TRANSISTORS too!

LARGE 6" METER

You won't be stopped when you run into the new FETs that are wired into the latest hi-fi, newest TV receivers and nearly every other new device coming on the market. For the very first time, you can check them all, in or out of circuit. The TF151 works every time using tried and proven signal injection techniques. New, improved tests on special RF transistors and the latest high power transistors, mean that the TF151 is the only up-to-date transistor tester on the market. A new, exclusive setup book in rear compartment guides you to every test for over 12,000 transistors and FETs. The book is not needed for general service troubleshooting. Regular transistors are checked for beta gain and I_{cbo} leakage. FETs are checked for transconductance and I_{gss} leakage.

only \$129⁵⁰

NEW SENCORE TF17 compact in and out of circuit transistor FET tester. Same as TF151 except in new Sencore Handi case and with 4-1/2" meter. . . \$109.50

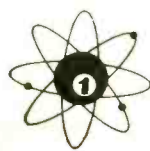

SENCORE

NO. 1 MANUFACTURER OF ELECTRONIC MAINTENANCE EQUIPMENT

426 SOUTH WESTGATE DRIVE, ADDISON, ILLINOIS 60101

Circle 10 on reader service card



PENNIAC WITH FORTRAN

I am enclosing a listing of my computer program, in FORTRAN, which uses the penny matching algorithms described in your Penniac article in the last issue (April) of R-E.

Any of your readers who has access to a time-shared computer with a FORTRAN compiler can try it out. It is easier than putting 66 IC's together.

The function RND in statement #50 returns a random number between 0 and .99999, the remainder of the program is written in a time-sharing version of FORTRAN.

C. R. LEWART
Holmdel, N. J.

Computer program for matching pennies:

```

DIMENSION M(8)
DATA L1 /"T"/
DO 10 I=1,8
10 M(I)=0
NGAME=0
NWIN=0
5 NGAME=NGAME+1
IF(NGAME.LE.2)GO TO 50
NX=(NPL1*NPL2+1)/2
NJ=NW2*4+NX*2+NW1+1
IF(M(NJ).EQ.0)GO TO 50
NPLAY=NPL1*M(NJ)
GO TO 51
50 NPLAY=INT(RND(0)*2.)
&*2-1
51 PRINT,"YOUR MOVE H OR T"
INPUT 1,L
1 FORMAT(A1)
MANPL=1
IF(L.EQ.L1)MANPL=-1
NWIN=NWIN-NPLAY*MANPL
IF(2-NGAME)57,55,58
57 IF(M(NJ).EQ.0)GO TO 56
IF(NPLAY.EQ.MANPL)GO
TO 55
M(NJ)=0
GO TO 55
56 M(NJ)=NPL1*MANPL
55 NPL2=NPL1
NW2=NW1
58 NPL1=MANPL
NW1=(NPLAY*MANPL+1)/2
IF(NPLAY.EQ.MANPL)GO
&TO 61
60 PRINT,"COMPUTER PRE
DICTED INCORRECTLY"
GO TO 62
61 PRINT,"COMPUTER PRE

```

(continued on page 22)

NEW!

TUN-O-BRITE
the
heavy duty
tuner spray
with
built-in
polishing
action!



BT-8 8 oz. \$2.39
BT-16 16 oz. \$3.49

SAVE \$4⁷⁸
**WHEN YOU
BUY THIS
6-PACK!**

AVAILABLE FROM YOUR
CHEMTRONICS DISTRIBUTOR

SEE THE DIFFERENCE

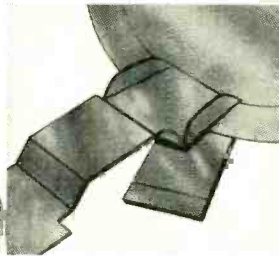

This tuner contact has been sprayed with an ordinary tuner cleaner. It looks clean, but close examination would reveal minute areas with corrosion and dirt.

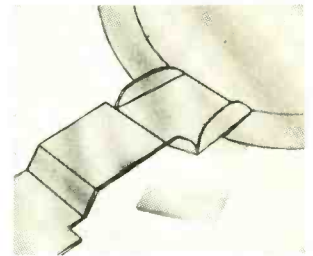

This tuner contact has been sprayed with new TUN-O-BRITE, with its built-in brighteners. It is not only clean, it has been polished shiny. There is absolutely no dirt or corrosion left to spread. What's more, the contact is protected by a film of ultra-long-lasting lubricant.

FEEL THE DIFFERENCE

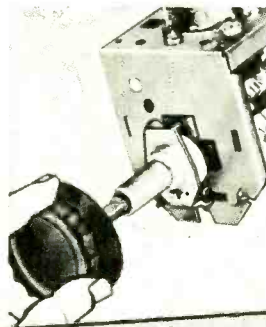

The extra heavy duty lubricant used in TUN-O-BRITE makes any tuner slide from channel to channel smoothly. Your customer will feel the difference immediately. When he sees bright, clear pictures on every channel and feels how smoothly the channels change, he'll know you've done something almost miraculous to his tuner.



CHEMTRONICS INC. 1260 RALPH AVENUE
BROOKLYN, N. Y. 11236

Circle 11 on reader service card

**“Get more
education
or
get out of
electronics**

...that’s my advice.”



**IN-DEPTH
COVERAGE OF
SOLID STATE
ELECTRONICS
...including
integrated circuits!**



Ask any man who really knows the electronics industry.

Opportunities are few for men without advanced technical education. If you stay on that level, you'll never make much money. And you'll be among the first to go in a layoff.

But, if you supplement your experience with more education in electronics, you can become a specialist. You'll enjoy good income and excellent security. You won't have to worry about automation or advances in technology putting you out of a job.

How can you get the additional education you must have to protect your future—and the future of those who depend on you? Going back to school isn't easy for a man with a job and family obligations.

CREI Home Study Programs offer you a practical way to get more education without going back to school. You study at home, at your own pace, on your own schedule. And you study with the assurance that what you learn can be applied on the job immediately to make you worth more money to your employer.

You're eligible for a CREI Program if you work in electronics and have a high school education. Our FREE book gives complete information. Mail postpaid card for your copy. If card is detached, use coupon below or write: CREI, Dept. 1407A, 3224 Sixteenth Street, N.W., Washington, D.C. 20010.



**CREI, Home Study Division
McGraw-Hill Book Company
Dept. 1407A, 3224 Sixteenth Street, N.W.
Washington, D.C. 20010**

Please mail me FREE book describing CREI Programs. I am employed in electronics and have a high school education.

NAME _____ AGE _____

ADDRESS _____

CITY _____ STATE _____ ZIP CODE _____

EMPLOYED BY _____

TYPE OF PRESENT WORK _____ G.I. BILL

I am interested in

Electronic Engineering Technology Computers

Space Electronics Nuclear Engineering Technology

Industrial Automation NEW! Electronics Systems Engineering

APPROVED FOR TRAINING UNDER NEW G.I. BILL

Who Needs a Tuner Wash?

Use
QUIETROLE
Mark II Spray Pack

The product that cleans and lubricates better than any product you can buy and has been used for more years than any product of its kind.

The Choice of "Better Servicemen" Everywhere



Circle 12 on reader service card

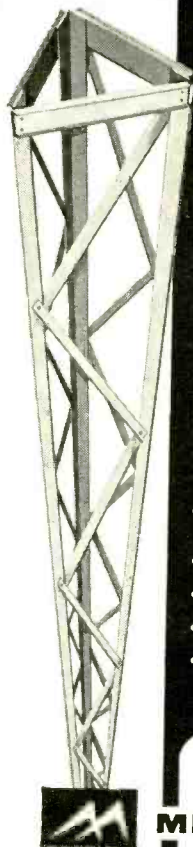

AL SERIES ALUMINUM TOWERS for uhf - vhf

Ideal for mounting industrial, commercial, citizens band, amateur, or television receiving antennas. Exceptional strength in proportion to weight qualities. Easy access to equipment mounted on the Microflect top mast extension. Other features are:

- 10 to 120 feet high in easy to erect 10 foot sections.
- Available factory assembled or in kit form.
- Lightweight, all aluminum, 10 foot sections weigh only 12½ lbs.
- Low maintenance, will never rust or require painting.
- Staggered ladder treads for easy climbing.
- Can be used for direct radiator at HF.
- Wide variety of mounting brackets and accessories available.

DISTRIBUTOR INQUIRIES INVITED

MICROFLECT

3575 25TH STREET
SALEM, OREGON 97302
AC 503-363-9267 TWX 510-599-0107

Circle 13 on reader service card

CORRESPONDENCE

(continued from page 16)

62 DICTED CORRECTLY"
PRINT, "TOTAL NUMBER OF
WINS =" ,NWIN
PRINT, " "
GO TO 5
STOP
END

A typical printout would look like this:
YOUR MOVE H OR T?H

COMPUTER PREDICTED
INCORRECTLY
TOTAL NUMBER OF
WINS =

1

YOUR MOVE H OR T?H

COMPUTER PREDICTED
CORRECTLY

TOTAL NUMBER OF
WINS =

0

etc.

We appreciate Mr. Lewart's interest and FORTRAN program. Perhaps, as he suggests, those with a line to a computer will want to try it. Let us know who wins the pennies.

NOTE TO JACK DARR

As a faithful reader of R-E for many years, I have always read your service column with the utmost interest. Even though we here in Europe do not have the same makes of electronic gadgets, it is really surprising how well your service information can be applied to many of the service problems we face here in everyday service. The reason for this, I believe, is the fact that basic circuits are used no matter who is the maker or where it is made.

It seems to me that you have always advocated that a service man in the electronic field should be open to any type of electronic unit that is not functioning properly.

In a small town you get all types of electronic units to work on. It would, of course, sometimes be far easier to specialize in certain types of home entertainment equipment but it is much more rewarding to be able to restore many different types of gadgets to their original specified standards. When it comes to what to take on or not to take on, I have always been inspired by your way of reasoning—that with solid knowledge and proper test equipment, no service problems should be turned away. **R-E**

IVAN ANDERSON
Lagans Radio och TV-service
Lagan, Sweden

Don't shoot till you see the tenths of a volt.

The sure way to troubleshoot solid state TV is with a scope that measures DC.

Take Leader's five-inch LBO-53B:

It gives you a drift-free DC input, so you can see those tenths of a volt. It gives you a bandwidth to 10 MHz. And it gives you a sensitivity of 10 mv/cm or better.

Now for the shocker. You can have a Leader LBO-53B for just \$229, about half the price of any other scope with the same capabilities.

Since the proof is in the seeing, we direct you to your Leader distributor. Ask to see our color bar generators too; you haven't seen the finest until you've seen Leader's.



Seeing is believing.

Leader Instruments Corp.

37-27 27th Street, Long Island City, N. Y. 11101, (212) 729-7411

Circle 14 on reader service card

PRO'S GUIDE

10 steps to best mike use

by WILLIAM WOKOUN

Whether you use microphones for tape recording or public address, follow these rules to get top performance from them

ANYONE WHO HAS EVER TAPE-RECORDED A friend's voice has heard the classic comment. "But that doesn't sound like me at all!" We might explain that bone conduction does distort the sound of your own voice, so you can never hear it directly the way it sounds to other people. The same thing holds true in a PA system.

After all, microphones—like cameras—don't lie. Or do they? Before you answer too promptly, read on. The kind of microphone you use, and the way you use it, has a great deal to do with how you will sound.

This article describes 10 "commandments" to help you make the best possible use of your equipment. Most of the suggestions are useful in public address work as well as recording.

Rule 1: *Use the best microphone you can get.*

Public address systems are chains of components—microphones, preamplifiers, power amplifiers and speakers. Every chain has its weakest link. In audio equipment, these weak links are the transducers that translate mechanical

energy into electrical signals, or vice versa. A modern audio system is limited, not by its amplifiers, but by its microphones and loudspeakers.

Perhaps you already have a microphone that's "good enough." But the odds are against you. As a rule of thumb, a microphone suitable for serious recording will cost you at least \$40, and very likely more. Like any other precision instrument, excellent microphones are expensive. You should shop for a microphone even more carefully than you shop for a turntable or an amplifier.

What kind of microphone should you buy? Nobody but the telephone company uses carbon microphones nowadays. Crystal microphones have limited frequency response. Ceramic microphones have wider and smoother frequency response, but their high impedance makes them susceptible to hum and interference. Condenser microphones, though excellent, are quite expensive and require high bias voltages.

A good ribbon microphone gives a natural quality that is hard to match, but is also expensive, relatively heavy

and limited to use indoors where there are no drafts. That leaves dynamic microphones—comparatively light, rugged and inexpensive.

Your microphone should have a wide frequency range. Its response should be flat within a couple of decibels down to at least 100 Hz and up to at least 10,000 Hz. The response curve should be flat, without mountains and valleys. The final test here is your own ear. Satisfy yourself that a familiar voice "sounds right."

Your microphone should have an output level high enough to drive your public address amplifier. It's true that you can compensate for low output by turning the volume control all the way

up, but only at the expense of degrading signal-to-noise ratio.

Choose a microphone with low-impedance output. Practically all low-impedance microphones have a standard impedance of 150-250 ohms, which will directly match most transistor pre-amplifiers. Tube preamps will require a step-up input transformer.

Low-impedance lines pick up less noise, hum and interference. If fluorescent lights or radio frequencies still cause interference, you can use a *balanced* line, adding an input transformer and grounding its center tap. And last but not least, low impedances allow you to use very long cables—up to hundreds of feet—without losing high frequencies.

Rule 2: Choose the microphone type that's best suited to the material you plan to handle.

A microphone is a single ear rather than a pair of ears. It registers only the loudnesses of sounds, not where they come from. Practically every microphone listens selectively—it favors sounds coming from its sensitive side (s). These variations in sensitivity make up a microphone's directional characteristics, or polar pattern.

There are only a few basic directional patterns:

- **Bidirectional**—sensitive on two opposite sides, and almost totally insensitive or "dead" everywhere else (Fig. 1-a). This characteristic is associated with ribbon microphones. While it's handy for excluding noises and reverberation, ribbon microphones are becoming rare.

- **Unidirectional**—more sensitive on one side than on the other side (Fig. 1-b). Some dynamic microphones are unidirectional. They have less sensitive sides, but there will still be some pickup, especially with low frequencies, from the so-called dead side.

- **Cardioid**—a heart-shaped pattern, with sharpened sensitivity to pick up sounds over a wide angle on one side, while discriminating against sounds from the other side (Fig. 1-c). This is a specific unidirectional type.

- **Supercardioid**—similar to a cardioid, but with a narrower beam of sensitivity (Fig. 1-c). Supercardioid mikes allow us to listen in one sensitive direction, while picking up a minimum of surrounding sound.

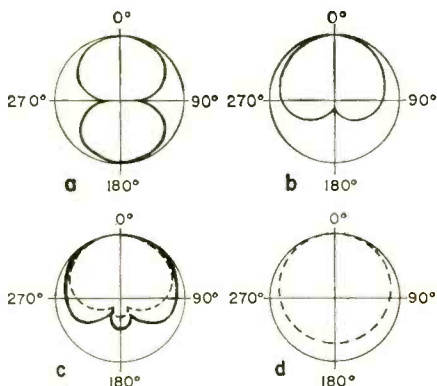
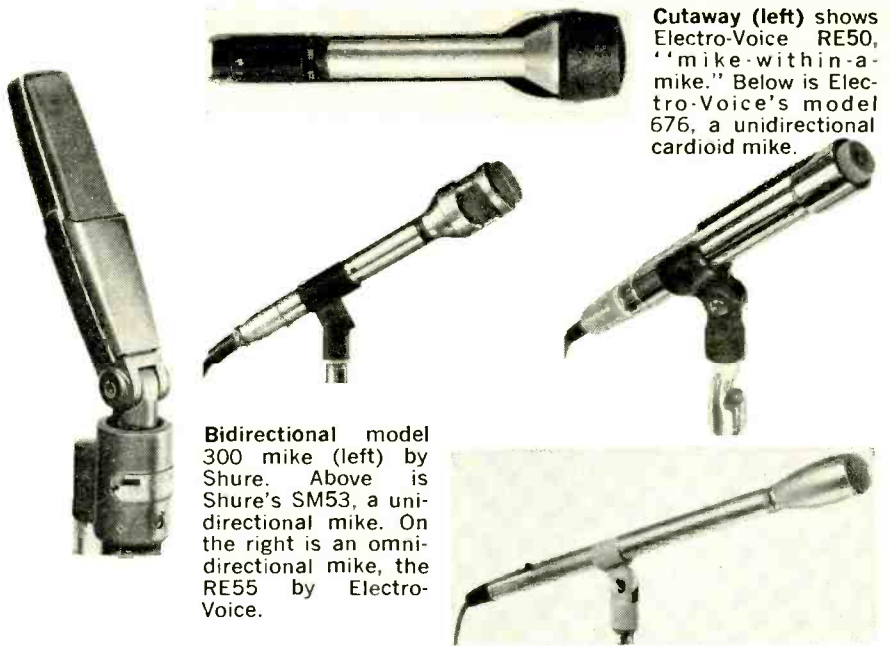

Fig. 1-a—Bidirectional pattern. b—Unidirectional pattern. c—Cardioid and supercardioid (dotted line). d—Omnidirectional pattern at 5,000 Hz.



Cutaway (left) shows Electro-Voice RE50, "mike-within-a-mike." Below is Electro-Voice's model 676, a unidirectional cardioid mike.

Bidirectional model 300 mike (left) by Shure. Above is Shure's SM53, a unidirectional mike. On the right is an omnidirectional mike, the RE55 by Electro-Voice.

TROUBLE	CAUSE	REMEDY
No sound	Defective cable or connector	Substitute spare cable (keep one on hand for trouble shooting)
	Microphone switch turned off	Turn switch on (if you don't use it, short the switch so it can't be turned off accidentally)
Low volume	Microphone too far from sound source	Move microphone closer to sound
	Microphone aimed poorly	Make sure microphone's most sensitive side is directly in front of sound source, and aimed directly at it
	Impedance mismatch (low-impedance microphone connected to medium- or high-impedance input)	Find correct impedances from data sheets, add input transformer between microphone and input
	Inadequate amplifier gain	Add preamplifier between microphone and input
Too much bass	Speaker talking away from microphone	Caution speaker to talk directly into microphone
	Microphone not aimed properly	Aim microphone's most sensitive side directly at speaker
Too much treble	Speaker too close to directional microphone	Move microphone farther away from speaker
	Microphone has uneven frequency response, or speaker talking into lavalier microphone	Have speaker talk across microphone (not into it)
	Impedance mismatch (amplifier impedance too low for microphone)	Check data sheets, make sure microphone is connected to proper load impedance
Popping (on p and t sounds)	Speaker too close to microphone	Move microphone farther away; have speaker talk across microphone; use wind screen on microphone
Distortion	Microphone too close to loud sound (overloaded microphone or preamplifier)	Move microphone farther away (Volume controls usually follow preamp; if preamp is overloaded, turning volume control down will not reduce distortion)
	Sound peaks too loud	Caution speakers and musicians to turn somewhat away from microphone during very loud passages; use compressor
	Vibration	Use microphone stand and shock mount; put rugs or padding underneath
Too much reverb	Microphone too far from sound	Move microphone closer
	Microphone near reflective surface	Move microphone away from walls, etc.
	Room too reverberant	Find room with more sound-



Unidirectional mike (left) with a supercardioid pattern (Shure's model 330). Below is Electro-Voice's supercardioid RE15. The Shure 579 SB (bottom) is unidirectional.

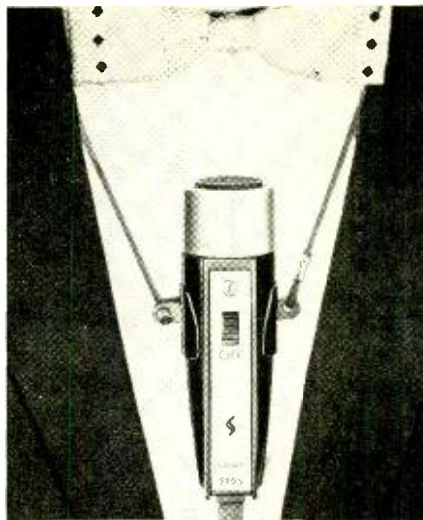

Shown in use as lavalier, Shure's 575S has an omnidirectional polar pattern.

• Omnidirectional—equal sensitivity to sounds on all sides, back or front, left or right, above or below (Fig. 1-d). No microphone fully satisfies this requirement at all frequencies. Nevertheless, some are called omnidirectional because they are more nearly omnidirectional than unidirectional.

Which is best? If you made recordings in a very quiet room with optimum reverberation time, it wouldn't make much difference what kind of directional pattern your microphone had. The omnidirectional one would be easiest to use.

But places we want to record in *do* have noises; if the radiator isn't gurgling, the refrigerator clicks on or your take-up reel squeaks. Many rooms have so much reverberation that speakers and singers sound like they're at the bottom of a deep rain barrel. A nondirectional microphone would pick up all of these unwanted sounds, giving you a very cluttered, amateurish feeling.

Directional mikes are easy to use, you simply focus them on the sound you want to pick up. You want a microphone as sensitive as possible on the live side, and as insensitive as possible on the nominally dead side.

If you will have a single person talking or singing, the best choice is a super cardioid microphone with a very narrow sensitive lobe.

To record groups of people or musical instruments you must use either more microphones with narrow sensitivity or one microphone with a wider pickup area.

In a two-microphone setup, the second microphone should be at least three times the distance from the sound source as the first microphone. Another way of putting this three-to-one ratio rule is to say the output of the second microphone should be at least 9 dB below the first.

If you use a single microphone, balance sounds by the way you position people and instruments around your microphone. Softer voices or quieter instruments should be closer, and directly in front of the mike. Loud instruments or voices should be farther away, and perhaps on one side of the microphone.

Be sure the microphone has nearly equal response at all angles (uniform polar pattern) or the off-axis pickup will be softer but "colored" as well.

Rule 3: Know your microphone.

Practically every quality microphone comes equipped with a sheet of technical data and instructions. The data sheet usually shows a polar plot of its directional response—where the live side or pickup area is, how wide an angle it spans, and how relatively insensitive the dead sides are. This polar diagram is not so complicated as it looks; study it thoroughly, and you will be able to position your performers by visualizing the pickup area.

Remember, however, that directional characteristics are measured in anechoic chambers, so they will not be contaminated by reflected sounds. Real-life conditions are more complicated.

Suppose you place a highly directional supercardioid microphone so its

TROUBLE	CAUSE	REMEDY
		absorbent surfaces (furniture, rugs, acoustical tiles) (try using clothes closet)
Too many room noises	Poor microphone placement	Move microphone closer to performer; position microphone so noises are on dead side; make sure live side doesn't face reflecting surface
	Room actually too noisy	Try to find quieter location for recording; turn off noises if you can; record late at night
Noises: Hiss	Volume control set too high	Amplifier requires a larger input signal; see "low volume"
Noises: Hum	Magnetic fields	Move microphone away from clocks, motors, power transformers, etc.; reorient microphone to position that minimizes hum; try repositioning cable
	Poor grounding	Check cable; make sure shield is connected at both microphone and amplifier
Noises: Buzz	Microphone picking up unwanted sounds	Move microphone nearer to desired sound if possible; control noise source
	Higher harmonics of hum	See "Hum"
	Rf interference from appliance	Locate offending appliance; install filter or turn it off
	Vibration	Use shock mount or padding under microphone stand
Noises: Crackle ("frying" noise)	Amplifier malfunction (seldom caused by microphone)	Repair amplifier; especially check transistors or tubes in first stage
Noises: Clicks, clunks and thuds	Mechanical shocks or vibration	Avoid touching or handling microphone; use shock mount or padding under stand
	Rf interference (from switches, thermostats, etc., when appliances are turned on or off)	Balance microphone line (add input transformer and ground center tap of primary); install rf filter; unplug appliance if possible; if using transistor equipment with ac adapter, try using batteries
	Intermittent connection (volume varies)	Check cable connectors for weak or broken solder joints; substitute a cable you know is good
	Loose element in microphone	Shake microphone gently; if you hear loud noises on tape, microphone should probably be returned to manufacturer for repairs

live side faces a plastered wall. The mike will ignore sounds coming from its dead side, but the wall reflects these sounds right into its most sensitive zone.

Place your microphone well away from large, solid surfaces. It's better to place a microphone in the middle of the room rather than on sides or in corners. It also helps if you angle the most sensitive axis so you minimize reflection into the live side.

Rule 4: Aim your microphone

To achieve good reproduced sound, you must recognize that a sound's frequency has much to do with how it travels. A low frequency—such as 100 Hz—behaves much like subsonic vibrations, tending to radiate in all directions and even to bend around corners. A high frequency—say, 10,000 Hz—acts more nearly like a beam of light: it travels mostly in a straight line, in a narrow cone that diverges only gradually. The low frequency components in the sound of a trumpet diverge over a wide angle, but the highs tend to keep going in a straight line. The sound has greatest "bite" or "presence"—that is, most highs—when your ear or microphone is directly in front of the trumpet's bell. If you want a softer, mellower sound, move the microphone to one side, or behind the trumpet player.



EV's RE15 mikes used on Dick Cavett show.

A person's speaking voice is directional, too. Low frequencies tend to spread out, while higher frequencies travel in narrowed beams. Although low-frequency vowels are the most intense components of speech, understanding what people say to you depends mostly on hearing the weaker, higher-frequency consonants. A person's voice will be most easily understandable if you hear it from a point directly in front of his mouth. Hence that is the best microphone position.

Microphones give better frequency response from some positions than they do from others, exactly as loudspeakers do. When we say a microphone is "flat up to 12,000 Hz," a qualification is that the sound source is directly in front of the microphone, on its most sensitive side. As we move the sound source to either side, away from this best axis, we begin losing highs. High-quality directional microphones, however, have very uniform polar fields throughout their frequency range.

Rule 5: Place your microphone close to the sound source.

We generally associate the inverse-square law with light, but it applies just as well to sound. When we multiply an object's distance by x , we are dividing its sound intensity by x^2 . Let's say you



Supercardioid RE11 by Electro-Voice has blast and pop filter wire screen.

are 2 feet from a microphone and move 4 feet from it. Your voice intensity at the mike will be a *fourth* of what it was before. If you had moved closer—to a distance of only 1 foot—the sound would have been four *times* more intense at the mike.

It's difficult to pick up sound sources that move around. Caution your performers not to move; they should pick a location that pleases them and stay there.

Close miking is the best way to eliminate (or at least reduce) extraneous noise.

However, many microphones will not perform well when the person speaking is only a few inches away. Sounds made by sharp air puffs—like *p* or *t*—cause overload and distortion. Bass response may be over emphasized and, finally, the mike often picks up breathing, teeth gnashing and tongue clicking. (Some microphones have built-in "pop" filters.) A realistic distance for picking up someone's voice is between 1 and 2 feet.

Close microphone positions sound "dry" because there is relatively little reverberation. To get a more reverberant sound, move your microphone toward a reflecting surface and away from the sound source. That, in turn, picks up more incidental noises along with the reverberation. Experimenting is the only way you can be sure what will happen. If your experiments disappoint you, try an electronic reverberation unit that can give more echo without picking up stray noises. In an auditorium, distant microphoning—even of soloists and solo instruments—may be desirable to include the acoustic character of the performing hall.

Rule 6: Avoid ambient noises.

Just as amateur photographers pose their models against overburdened clothes lines and telephone poles, so novice recordists set their microphones

near fans, air conditioners, radiators, and refrigerators.

Begin by sitting in the room where you record and listening carefully for an hour or so. What noises are there? Where do they come from? And what can you do about them?

If you can turn noise-makers off while you are recording, do so. You can do without air conditioning for an hour or so. You can unplug the refrigerator briefly without thawing frozen foods. You may be able to unplug your telephone, or leave it off the hook.

Many other noises will be with you whether or not you want them—passing trucks, children shouting at each other, your neighbors' television sets, etc. Try to make your recordings when there isn't so much noise, perhaps late in the evening. Second, move your microphone as far as possible from the noise. Finally, use a directional microphone, positioned so noises are on its dead side.

Rule 7: Avoid vibrations.

A transducer element that responds to puny airborne vibrations will also respond to the much stronger vibrations that come to it through the microphone case or its cable. Some manufacturers avoid this by putting the microphone inside another microphone case with vibration-absorbing material.

A very inexpensive microphone has severely limited frequency response, so it is comparatively hard to create vibration problems with a cheap microphone. A quality microphone's extended low-frequency response will faithfully reproduce many vibrations you do not want. Some of these vibrations will be below 100 Hz. Even if you don't notice the vibrations, they can modulate higher frequencies and cause distortion.

How can you isolate your microphone from these vibrations? First, use a sturdy mike stand—the heavier, the better. Table stands are handy, but they transmit shocks and vibrations from table to microphone. Some manufacturers market special shock mounts that fit between the top of the stand and the microphone proper.

A floor stand damps vibrations by forcing them to travel farther. Set your stand on a carpeted floor, rather than on tile or linoleum. Carpeted floors reduce vibration; they also reduce room reverberation and allow you to move around quietly. Where there are bare floors, play it safe by putting a small rug under your stand. Another solution to low-frequency vibrations is a high-pass filter. The response curve of the Electro-Voice 513 is shown in Fig. 2.

(continued on page 79)

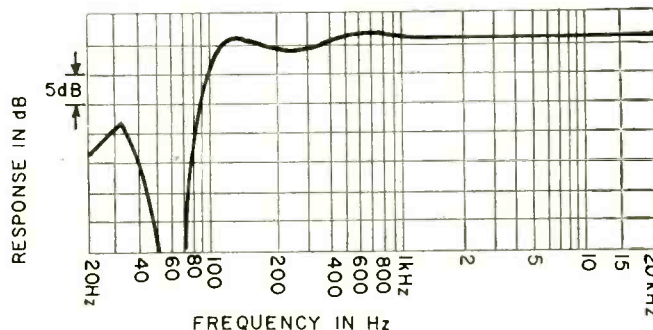
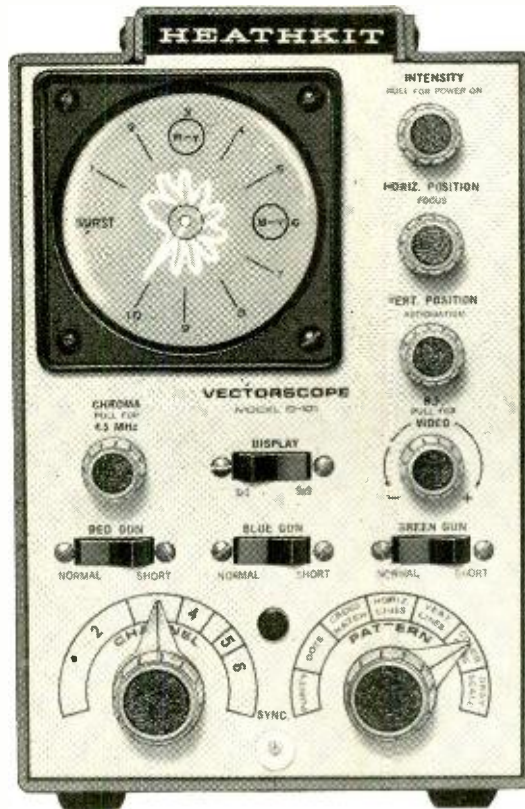

Fig. 2—Sharp cut-off, high-pass filter (EV's model 513) rejects noise and reverberation components below 100 Hz. At 60 Hz attenuation is over 30 dB.

Now a Heathkit® Solid State Vectorscope/Color Generator Only \$124.95*



Accurately Performs All Of These Adjustments:

- Raster
- Static & Dynamic Convergence
- Purity
- Gray Scale

- 3.58 MHz Oscillator
- Reactance Coil
- Phase Detector Transformer
- Demodulator Angle Check
- Chroma Bandpass Touch-Up

Kit IO-101, 12 lbs. \$124.95*

Fast switch selection of standard 9 x 9 display . . . or exclusive Heath "3 x 3" display

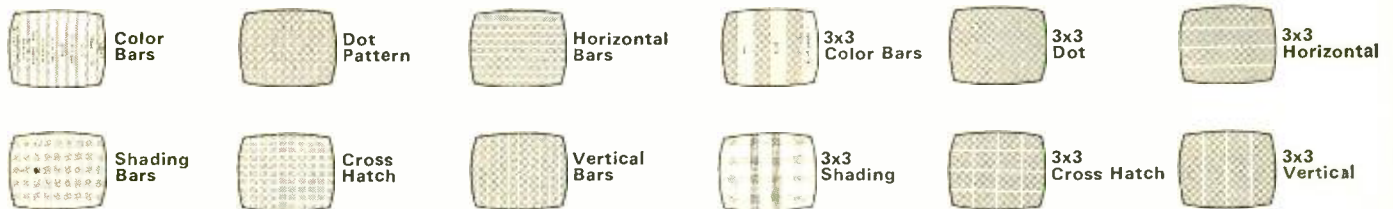

IO-101 SPECIFICATIONS — PATTERNS — Purity: Produces a snow-free raster for purity adjustments. **Dots:** 9 x 9 produces a display of 110 small dots. 3 x 3 produces a display of nine dots for convergence adjustments. **Crosshatch:** 9 x 9 produces a display of 11 vertical and 10 horizontal lines. 3 x 3 produces a display of three vertical and three horizontal lines for convergence and linearity adjustments. **Horizontal Lines:** 9 x 9 produces a display of 10 horizontal lines. 3 x 3 produces a display of three horizontal lines for vertical linearity and pin-cushion adjustments. **Vertical Lines:** 9 x 9 produces 11 vertical lines. 3 x 3 produces a display of 3 vertical lines for horizontal linearity and convergence adjustments. **Color Bars:** 9 x 9 produces a display of ten standard color bars. 3 x 3 produces a display of three standard color bars. A visual fingerprint (voltage pattern) of all ten color bars in the form of a petal pattern is displayed for color circuit servicing. **Gray Scale:** Provides a wide bar crosshatch pattern with six shades of brightness for color gun level adjustments. **OUTPUT SIGNALS — Video:** Greater than 1 volt peak-to-peak composite signal for composite signal injection beyond the video detector. **RF:** Variable to approximately 25,000 uV output, channels 2 through 6, for composite signal injection into the TV receiver antenna input terminals. **Sync:** Greater than 3.5 volts peak-to-peak signal for servicing sync circuits without video, or sets having separate video and sync demodulator phase adjustments. **GENERAL — Power Requirements:** 105-125 or 210-250 VAC, 50/60 Hz, 20 Watts. **Cabinet Dimensions:** 6 3/4" W x 9 1/4" H x 14 1/2" D. **Net Weight:** 9 1/2 lbs.

*The number of dots, lines, and bars indicated for a 9 x 9 display is the number displayed if the receiver under test has no overscan.



a Schlumberger company

HEATH COMPANY, Dept. 20-7
Benton Harbor, Michigan 49022

Please send FREE Heathkit Catalog

Please send IO-101 Specification Sheet

Enclosed is \$ _____ plus shipping.

Please send Model IO-101

Name _____

Address _____

City _____ State _____ Zip _____

Prices and specifications subject to change without notice.
*Mail Order Prices; F.O.B. Factory

TE-222R

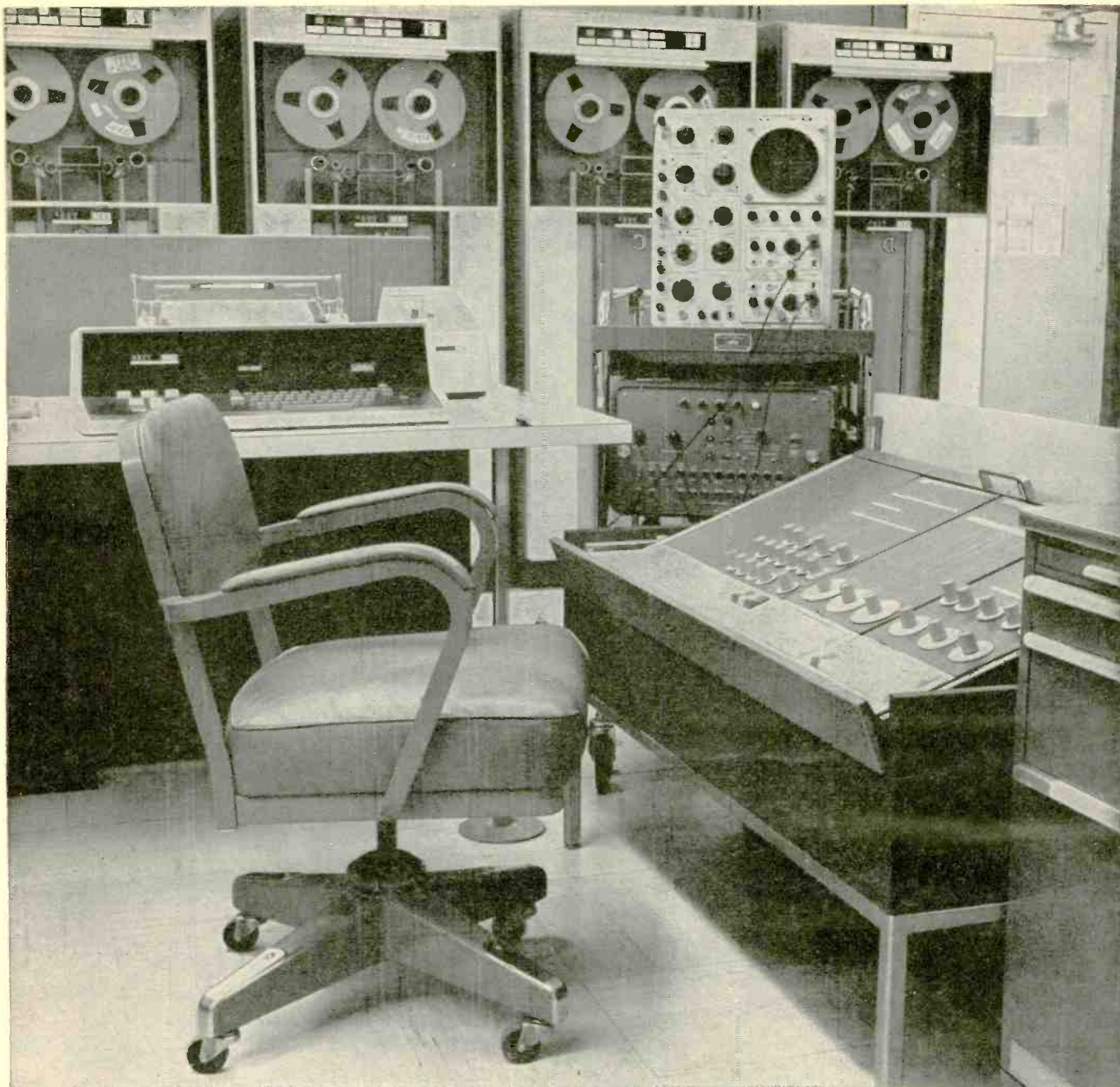

This important job (and its big salary) is reserved for a qualified electronics technician. It can be you!

It's a fact. There are *many thousands* of jobs like this available *right now* for skilled electronics technicians. What's more, these men are going to be in *even greater* demand in the years ahead. But how about you? Where do you fit into the picture? Your opportunity will never be greater...so act *now* to take advantage of it. The first step? Learn electronics fundamentals...develop a practical understanding of transistors, troubleshooting techniques, pulse circuitry, micro-electronics, computers and many other exciting new developments in this booming field. Prepare yourself now for a job with a bright future

...unlimited opportunity...lasting security...prestige... and a steadily-increasing salary.

Thousands of ambitious men are using Cleveland Institute of Electronics Training Programs as a stepping stone to the good jobs in Electronics. Why not join them? You will learn at home, in your spare time, and tuition is remarkably low. Read the important information on the facing page. Then fill out the postage-free reply card and drop it in the mail today. Without obligation we'll send you all the details. But act now...and get *your* high-paying job just that much sooner.

How You Can Succeed In Electronics

...Select Your Future From Six Career Programs

The "right" course for your career

Cleveland Institute offers not one, but six different and up-to-date Electronics Home Study Programs. Look them over. Pick the one that is "right" for you. Then mark your selection on the bound-in reply card and send it to us. In a few days you will have complete details...without obligation.

1. Electronics Technology

A comprehensive program covering Automation, Communications, Computers, Industrial Controls, Television, Transistors, and preparation for a 1st Class FCC License.



NEW!

2. Broadcast (Radio & TV) Engineering

Here's an excellent studio engineering program which will get you a 1st Class FCC License. Now includes Video Systems, Monitors, FM Stereo Multiplex, Color Transmitter Operation, and CATV.



3. First Class FCC License

If you want a 1st Class FCC ticket quickly, this streamlined program will do the trick and enable you to maintain and service all types of transmitting equipment.

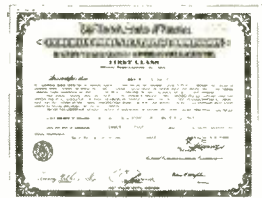

4. Electronic Communications

Mobile Radio, Microwave, and 2nd Class FCC preparation are just a few of the topics covered in this "compact" program...Carrier Telephony too, if you so desire.



5. Industrial Electronics & Automation

This exciting program includes many important subjects such as Computers, Electronic Heating and Welding, Industrial Controls, Servomechanisms, and Solid State Devices.



NEW!

6. Electronics Engineering

A college-level course for men already working in Electronics... covers Steady State and Transient Network Theory, Solid State Physics and Circuitry, Pulse Techniques, Computer Logic, and Mathematics through Calculus.



ENROLL UNDER NEW G.I. BILL. All CIE courses are available under the new G.I. Bill. If you served on active duty since January 31, 1955, or are in service now, check box on reply card for G.I. Bill information.

An FCC License...or your money back!

In addition to providing you with comprehensive training in the area indicated, programs 1, 2, 3, and 4 will prepare you for a Commercial FCC License. In fact, we're so certain of their effectiveness, we make this *exclusive* offer:

The training programs described will prepare you for the FCC License specified. Should you fail to pass the FCC examination after completing the course, we will refund all tuition payments. You get an FCC License... or your money back!

CIE's AUTO-PROGRAMMED® lessons help you learn faster and easier

Cleveland Institute uses the new programmed learning approach. Our AUTO-PROGRAMMED® lessons present facts and concepts in small, easy-to-understand bits...reinforce them with clear explanations and examples. Students learn more thoroughly and faster through this modern, simplified method. You, too, will absorb...retain...advance *at your own pace*.

Lifetime job placement service for every CIE graduate...at no extra cost

Once enrolled with CIE, you will get a bi-monthly listing of the many high-paying, interesting jobs available with top companies throughout the country. Many Cleveland Institute students and graduates hold such jobs with leading companies like these: American Airlines, American Telephone & Telegraph, General Electric, General Telephone and Electronics, IBM, Motorola, North American Aviation, New York Central Railroad, Raytheon, RCA, and Westinghouse.

CIE lessons are always up-to-date

Only CIE offers new, up-to-the-minute lessons in all of these subjects: Logical Troubleshooting, Laser Theory and Application, Microminiaturization, Single Sideband Techniques, Pulse Theory and Application, Boolean Algebra.



Full accreditation...your assurance of competence and integrity

Cleveland Institute of Electronics is accredited by the Accrediting Commission of the National Home Study Council. You can be assured of competent Electronics training by a staff of skilled Electronics instructors.

CIE Cleveland Institute of Electronics
1776 East 17th Street, Cleveland, Ohio 44114

If card has been removed, mail this coupon for 2 FREE BOOKS

Cleveland Institute of Electronics
1776 East 17th Street, Cleveland, Ohio 44114

Please send me without cost or obligation:

- Your 44-page book "How To Succeed In Electronics" describing job opportunities in Electronics today, and how your courses can prepare me for them.
- Your book on "How To Get A Commercial FCC License."

I am especially interested in:

- | | | |
|--|--|--|
| <input type="checkbox"/> Electronics Technology | <input type="checkbox"/> Broadcast Engineering | <input type="checkbox"/> First Class FCC License |
| <input type="checkbox"/> Electronic Communications | <input type="checkbox"/> Industrial Electronics & Automation | <input type="checkbox"/> Electronics Engineering |

Name _____ Age _____
(PLEASE PRINT)

Address _____

City _____ State _____ Zip _____

Check here for G.I. Bill information

RE-80

Circle 16 on reader service card



The long awaited and newly revised Sylvania Technical Manual is out. Complete and unexpurgated. The fantasy of every Independent Service Technician. Written anonymously by an agile team of Sylvania engineers. 32,000 components described in breathtaking detail. Including thousands of unretouched diagrams and illustrations. Discover the unspeakable thrill of new color TV Tubes, listed as never before. The ecstasy of 28,000 ECG Semiconductors.

From exotic Deflection Oscillators to a lurid account of Transistors and Rectifiers.

This book has what you want. Components for the man who knows what to do with them.

The 14th Edition of the Sylvania Technical Manual is not available in any bookstore. Your Sylvania Distributor is discreet. Speak to him.

“Electrifying”

SYLVANIA
GENERAL TELEPHONE & ELECTRONICS

DO'S & DONT'S

public-address

*Basic rules
for setting up the latest PA equipment*

by **WALTER G. SALM**

PUBLIC ADDRESS EQUIPMENT HAS come a long way in the transistor era. New amplifiers offer features that have been tried and refined over the years, along with the solid reliability of solid-state design. But the new equipment designs aren't a panacea; they just mean that gear will work better, given half a chance. There are still some basic ground rules to follow, although the picture may have changed somewhat in recent years.

First, there's a sharp delineation to make—between amplifiers designed strictly for public-address (PA) work, and the home-entertainment amplifier. The latter manages to creep into bona fide PA situations by virtue of its ready accessibility on the market when the local restaurant's proprietor goes prowling for a music system for his eatery. Often, he'll plunk down four or five hundred dollars for a stereo FM receiver, a couple of speakers, and will set it up himself.

Such a system is ok if he has enough power output and if the two speakers are reasonably well located. But soon, he decides that his room coverage isn't good enough: normal ambient room noise drowns out the sound at the far end. He decides that he needs some more speakers, and rightly so, but hasn't the foggiest idea of how to hook them up. Also, while he's at it, he'd like to string some ex-

tensions in his special party dining room. Fine. Let's tackle this problem first.

If his FM receiver is a tube-type unit, impedance matching is a straightforward hookup, paralleling speakers and using the lowest impedance transformer taps. Not so with solid-state equipment. Here, the power output is optimized for 8-ohm speaker impedance. Halve the speaker impedance by stringing two or more units in parallel, and you'll slash the power output drastically—by much more than 50% in many cases.

That amplifier needs a constant load and constant impedance across its output terminals, and the easiest way to do this is with an impedance-matching transformer. Two are needed for the ubiquitous stereo am-

plifier, with the terminals marked “-8” and “+8” connected to the amplifier's speaker terminals. The transformer's other terminals provide myriad impedance connections for most situations, from 4 to 16 ohms.

All right, you've got the impedances matched and the power output's ok: what about phasing? Simple? Not when doing back fill. You may end up with speakers at the rear of the room facing the main speakers. This can be a little sticky. If the speakers are all positively phased—the usual procedure—then you'll get lots of sound cancellation and other interference problems. Phase the two main, front-of-the-room speakers normally, checking them out with a monophonic program source with lots of bass in it.

Then shut off the main speakers and phase the rear speakers with each other, the same way. Now, connect the rear (front-facing) speakers 180 degrees *out of phase* with the front (rear-facing) speakers. This way, the rear speakers will be pulling when the front speakers are pushing and vice versa. If the speaker terminals aren't clearly marked to make this possible, try the mono program source again, this time with all four speakers on the line. Now change the phasing of the *rear pair* of speakers (since they're already in phase with each other). By the way, you'll run into this same problem with mono PA systems too, since there are lots of situations where

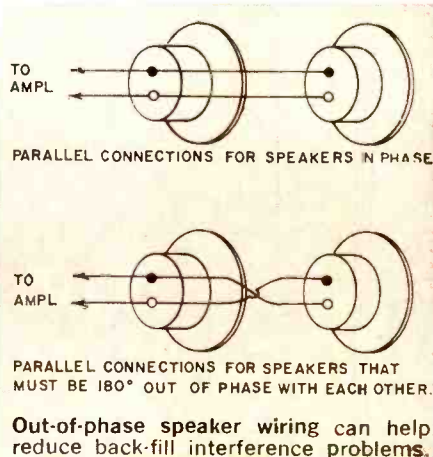

you'll need speakers facing each other.

When adding speakers in other rooms, it isn't as important to phase them with the main system, unless there's lots of residual sound coming through a large doorway or other opening. Just make certain the speakers in the remote room are phased with each other. If there is a cancellation problem with residual sound from other rooms, try reversing the phase for all the speakers in the room. Sometimes, 180 degrees out-of-phase may be the answer here, too, since sound from the main speakers may be out-of-phase by the time it gets there.

Power output is an all-important factor. You can probably estimate the correct amount of power needed for a given room, but what happens when the system has to be expanded? Allowing for future expansion can raise the initial installation cost, since a more powerful amplifier is called for. Part of this is simply a matter of good customer relations. Explain to your customer what different power levels mean in terms of equipment cost and future expansion. If he's at all forward-looking, he'll go along with you and opt for an oversize amplifier. Remember, it may not be oversize for long.

Power output needed is directly related to speaker efficiency. Remember this rule of thumb: average cone-type speakers have about 2% efficiency; high-quality theater-type cone speaker systems might have as much as 5% efficiency; horn-type PA speakers have about 15% efficiency. Thus,

TO 70.7 VOLT LINE

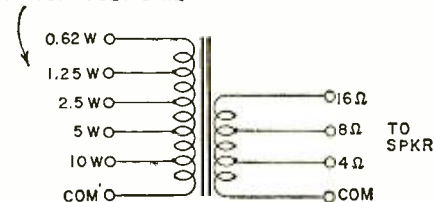

Speaker matching transformer matches impedance of PA speaker to 70.7-volt line output from the PA amplifier.

horn-type speakers (usually specified for outdoor use) can have efficiencies about 7.5 times that of run-of-the-mill cone speakers, and only about 1/7th as much power is needed. But horn-type speakers are more expensive and tend to have poor bass response.

While selecting appropriate speakers, keep the sound-column type in mind. These are especially useful for reinforcing sound from an auditorium stage. The sound column should be at least 5 feet from the auditorium floor, and the speaker should be angled down from the vertical. Sound reinforcing speakers aren't designed to fill the whole hall, but to cover parts of the audience beyond easy hearing distance of the stage. Close-in seats don't have to be covered as well by the speakers.

In large auditoriums, secondary reinforcing speakers may be needed, especially under balcony overhangs. Balconies frequently create dead spots of their own, and new speakers added here can be a big help. Because of the time lag (sound travels at 1129 feet-per-second at sea level) the sound from the stage speakers may be delayed enough to be out of phase with these secondary speakers. Thus, middle-hall speakers may have to be 180 degrees out of phase with the stage speakers just to be in proper phase with the sound. Again, the problem is solved the same way as for rear-of-the-room speakers that face forward, but you may have to adjust the secondary speakers' location to hit the 180-degree spot precisely.

Impedance matching can be a problem or not. Most of today's PA amplifiers use a multi-tapped output transformer with secondary taps of 4, 8 and 16 ohms plus constant impedance outputs of 25 volts and 70.7 volts. The beauty of the 70-volt system is that you can add almost any number of speakers at almost any dis-

tance from the amplifier without affecting the impedance or signal level. Each speaker has its own line matching transformer (they cost about \$3.00 each).

Designed for 25- or 70-volt lines, these transformers have a 500-ohm primary for connecting across the line, and a multi-tapped secondary—usually 4, 8 and 16-ohms—for matching with the speaker. Many of these transformers have additional taps marked off in watts at 4 ohms and 8 ohms. These extra taps give some additional flexibility in choosing power available to each speaker location. The transformer itself is small—about the

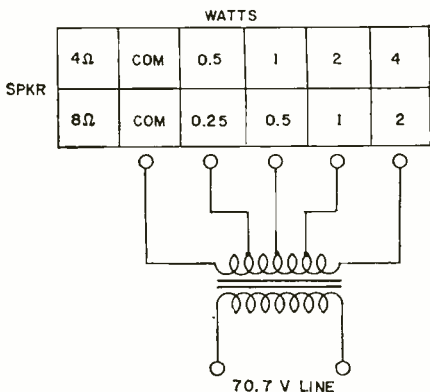

Taps on constant-voltage transformers let you pick power level speaker requires.

size of the output transformer for the old 50L6 tubes—and can usually be mounted directly on the speaker frame or certainly in the speaker enclosure.

One thing to remember—a 70-volt line means just that—there's 70 volts on it, so ordinary, flimsy speaker cable just won't do the trick. Wire gauge should be at least No. 18, and the heavier the insulation, the better. Regular ac lamp cord is far preferable to garden-variety speaker cable, while No. 16 Romex would be even better.

One other thing—if you do use a 70-volt line, check your local electrical code. Yes, that's right, the electrical code. In many localities, the 70-volt line qualifies as a full-fledged power line and might have to be enclosed in rigid conduit. If it does, drop down to a 25-volt system. It'll be cheaper and won't call for conduit.

The multi-tapped constant-impedance transformer has a wide selection of power taps for a given impedance. Thus you can select power levels for each speaker depending on speaker efficiency, location (high ambient noise, etc.) and other factors that affect appropriate power level. Again, the 25- or 70-volt line makes this possible.

Proper amplifier selection involves much more than just picking enough power output to do the job. There's also a question of 117-volt ac

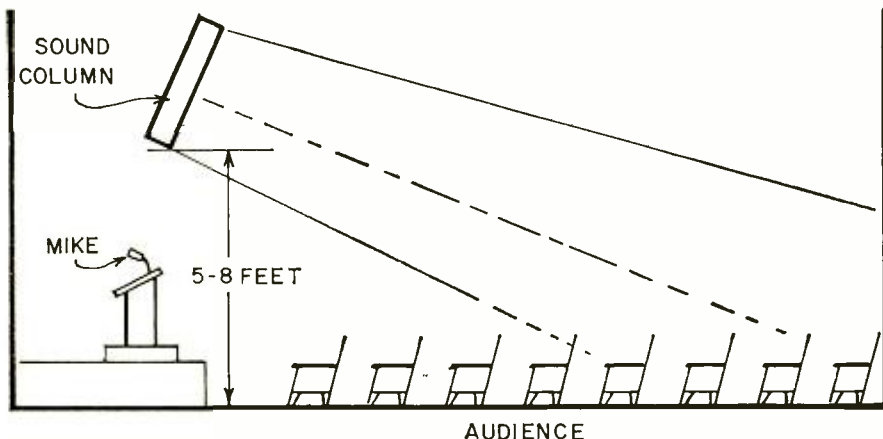

Sound columns, if carefully positioned, help cover farthest locations in audience.

Matrixing transformers (Microtran HM-90) keep a constant impedance and load across output of home-entertainment amplifiers. Photos (left, below) show outside and internal view of simple setup for stereo.

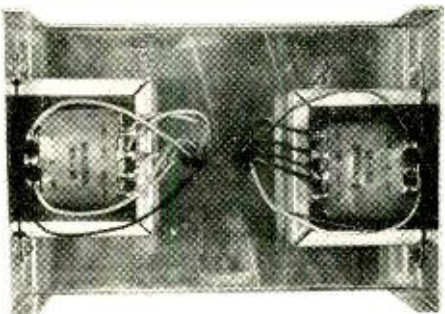
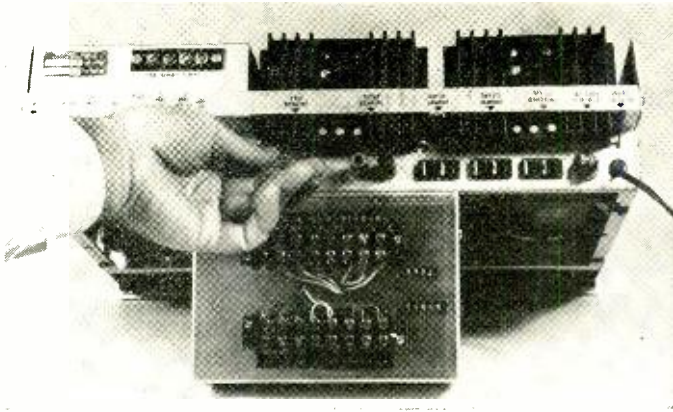

Many PA speakers, like Utah's above, have built-in transformers. At right is the Bogen MTX30B amplifier and the Utah SND-3 sound column.

and 12-volt dc operation, the number of microphone inputs and mixing channels, auxiliary inputs, microphone output relays and output transformer taps.

First is power level. Get enough without going overboard. We've already talked about how much power you may need, but again, we can't emphasize this point enough. Too little power at the amplifier will spell disaster the first time you fire up the system.

Distortion figures tend to improve as you go for the higher power rigs. A 30-watt amplifier running at 30 watts has a much higher distortion level than a 60-watt unit running at 30 watts. Also, cost per watt goes down drastically as the total power goes up. For example, a typical 30-watt unit may cost \$126 (\$4.20 per watt); a 60-watt amplifier, \$165.00 (\$2.75 per watt); a 120-watt unit \$217 (\$1.81 per watt). This should help you make up your mind if you're one of those believers in adding another 60 watts next year by paralleling the two amplifiers.

What about those mike inputs? It all depends on what your amplifier is going to be used for. In some jobs—especially mobile PA rigs—a single microphone input is all you'll need. But if you're miking a hall for a dis-

cussion group or seminar or meeting, you may need inputs for eight microphones with input mixing. That mixing is important. It lets you adjust each mike's relative level to compensate for different microphones and for different people with louder and softer voices. It also lets you cut back on microphones that are likely candidates for feedback.

A general rule-of-thumb for the number of microphone inputs needed:

- Mobile and circus barker type installations—one mike.
- Protestant church, two to four.
- Catholic church, from four to eight.
- Theater stage, five. Nightclub with dance band and vocalist, four.

Generally, the higher the amplifier power, the more microphone inputs it has. The amplifier should also have inputs for a phonograph, a tape recorder and an FM tuner. If the system is going to carry music through an industrial plant or large office area, the amplifier should have a cutout relay to turn off the music when the switchboard operator hits the press-to-talk button on the paging microphone.

In some auditoriums and large rooms, reverberation can be bad enough to degrade the overall system performance. A bass-cut control usu-

ally can help by attenuating frequencies below 300 Hz. Generally, it's also a good idea to cut the bass when re-entrant horns are used, since these speakers are susceptible to damage from high-energy, low-frequency signals. Most PA amplifier bass and treble controls offer enough attenuation range to take care of most specific problems of this kind.

Keep this 7-point checklist in mind when selecting the basic PA amplifier:

1. Maximum power you'll probably need two years from now.
2. Maximum number of microphones you'll ever need to use.
3. Power supply for both mobile and fixed use, if there's even a remote chance you'll ever do any mobile work.
4. Inputs for phono, tape and tuner.
5. Press-to-talk relay cutout.
6. Multi-tapped output transformer with 25- and 70.7-volt lines.
7. Bass and treble controls.

Bear in mind that phasing may be a bit different than with conventional home music systems, especially when speakers face each other or are some distance from the primary speakers. And keep those local electrical codes in mind if you elect to use a 70-volt line!

R-E

BUILD R-E'S

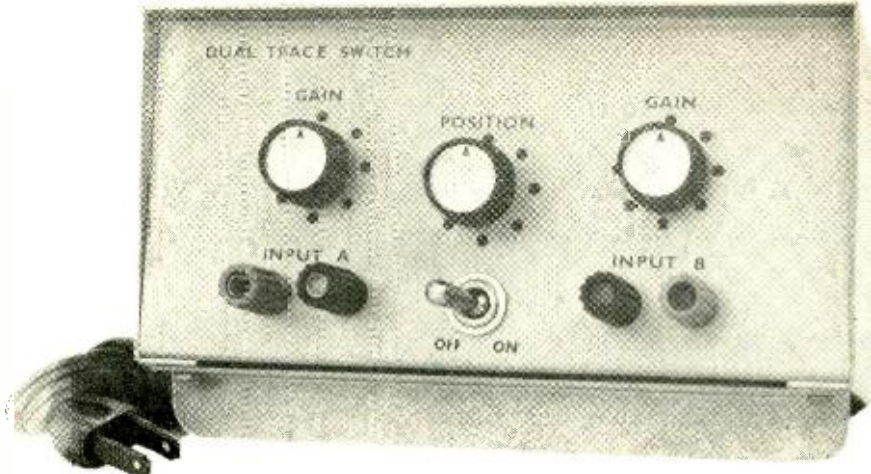

FET dual-trace scope switch

Lets you view two separate waveforms on single-beam CRT. Response up to 1 MHz—has dozens of practical uses for troubleshooting and experimentation

by **THOMAS B. MILLS**

TO THE INDUSTRIAL ELECTRONICS maintenance man, the experimenter and the service technician the value of the oscilloscope is unquestioned. But its role in sniffing out faulty amplifiers, measuring phase shift and analyzing circuit operation can be greatly enhanced by adding a dual-trace switching unit.

Modern laboratory oscilloscopes, in the thousand dollar bracket, include dual vertical-input amplifiers with a choice of chopped-trace or alternate-trace sweeps, while some actually have dual-beam CRT's.

The cost of a laboratory version is not practical for most of us, but you can inexpensively add a chopped-trace capability to your present scope at the vertical input.

With the dual trace, or dual

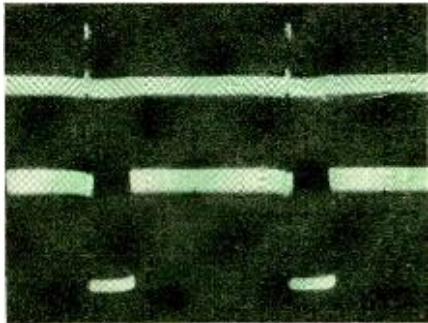

Fig. 2-a—Trigger pulse in upper trace drives a multivibrator whose output (bottom) can be viewed simultaneously.

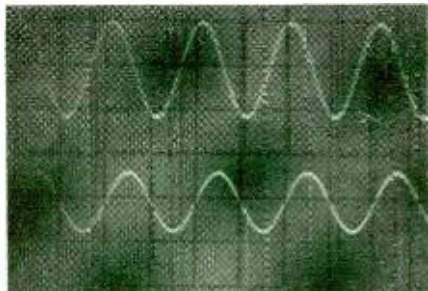

Fig. 2-b—Top trace is a sine-wave modulating signal, bottom trace is the demodulated signal from rf transmitter.

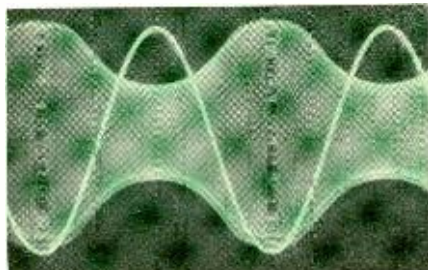

Fig. 3—Heterodyne zero beat in FM signal (vertical lines from negative peak).

sweep, you will be able to look at two waveforms simultaneously. For instance, when testing amplifiers you can observe the input and output together, instantly compare these signals and note if distortion or phase shift is present. For working with electronic counters and other digital circuits, a dual-trace presentation is almost indispensable to find out the relationship of one flip-flop output to another.

You might also use the dual trace for checking a modulation signal against a modulation envelope or for demodulation while testing a radio transmitter. Uses are limited only by the frequency response of the dual-trace switcher and oscilloscope. In some cases the frequency limitations may be circumvented by converting a high-frequency rf signal to a lower frequency within the handpass of the amplifiers.

This article describes a dual-trace switcher that may be constructed in a small box external to your scope. It is connected to the scope as shown in Fig. 1. The two unknown signals are applied separately to the two inputs. The switcher output goes to the single vertical input of the scope, and a sync line from one of the inputs is taken to the scope's external-sync input.

Frequency response of the input amplifiers is 300 kHz over the range of the gain controls. With the gain controls wide open so no attenuation of the signal takes place, the frequency response is up to 1 MHz. The dual-trace switcher is easier to use if the scope has a triggered sweep to make syncing of the trace independent

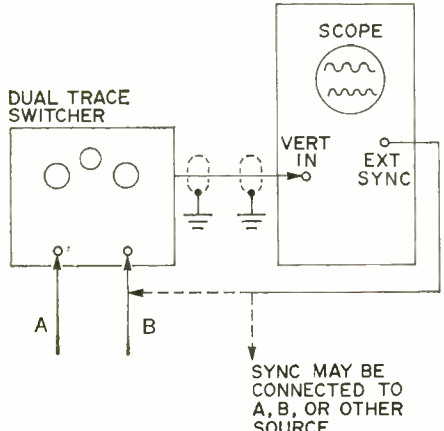

Fig. 1—Inputs to switcher are combined and fed to scope vertical input. External sync is taken at input or source.

of the input frequency.

Two examples of dual-trace switcher use are in Fig. 2. Fig. 2-a is an oscillogram of a trigger pulse on the upper trace, which drives a one-shot multivibrator giving an output shown on the bottom trace. The sweep speed is such that the chopping transients appear as a broadened base.

A second example, Fig. 2-b, is an oscillogram of a sine-wave modulating signal on the top trace and a demodulated signal on the bottom trace of the original modulation taken from an rf transmitter.

Fig. 3 shows a heterodyne zero beat in an FM signal that appears as a narrow band of horizontal lines running vertically from the negative sine-wave peak.

PARTS LIST

- All resistors 1/2 W, 10%
- R1, R2—47,000 ohms
 R3—25,000-ohm linear potentiometer
 R4, R5—100,000-ohm linear potentiometer
 R6, R7—4700 ohms
 R8, R9, R12, R13, R15, R18—2200 ohms
 R10, R11—820 ohms
 R14, R19—2700 ohms
 R16, R17—10,000 ohms
- Capacitors
 C1, C2—0.47 μ F, 600 volts
 C3, C4—10 μ F, 15 volts
 C5, C6—.002 μ F
 C7—.05 μ F
 C8—250 μ F, 30 volts
- Semiconductors
 D1, D2—1N3064 diode or equiv.
 D3, D4—1N4002 diode or equiv.
 Q1, Q2—2N5163 transistor, Motorola or Fairchild (selected for I_{DSS} match)
 Q3, Q4—2N3638 transistor, Motorola or Fairchild
 Q5, Q6—2N5134 transistor, Motorola or Fairchild
- Other parts
 T1—Triad F-94X transformer or equiv.
 S1—spdt switch
 MISC—3 3/8 x 7 x 3 1/2-inch cabinet (LMB W-2C), ac cord, knobs, terminal posts
- Kit with PC board and semiconductors only is available for \$10.00 from Solid State Services, 1720 Kimberly Dr., Sunnyvale, Calif. 94087

Fig. 4 (above)—FET's Q1 and Q2 boost inputs, which are chopped by Q3 and Q4 from Q5-Q6 pulses. Same-size PC board and component placement are below.

Note that the line between the two inner-most input connectors must go to plus 20 volts as do points "K" on PC board. Points "e" on board are for ground connections.

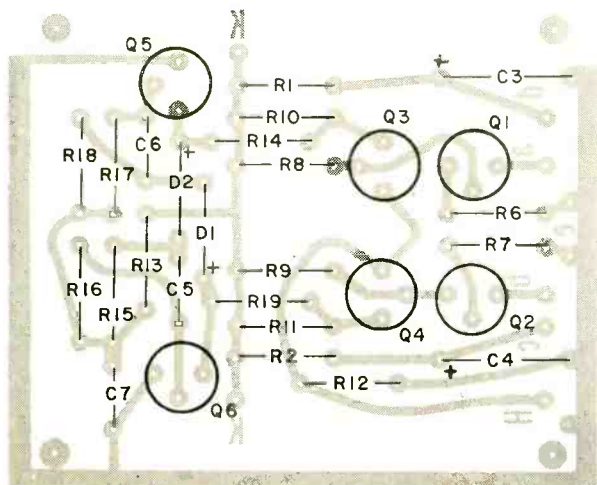

The superimposed sine-wave is the modulating signal that gives reference points for tuning to the maximum positive peak, maximum negative peak and carrier of the signal. In

this way the peak-to-peak deviation can be measured with a heterodyne converter, where the converter oscillator is on a low frequency that can be easily measured. The oscillator de-

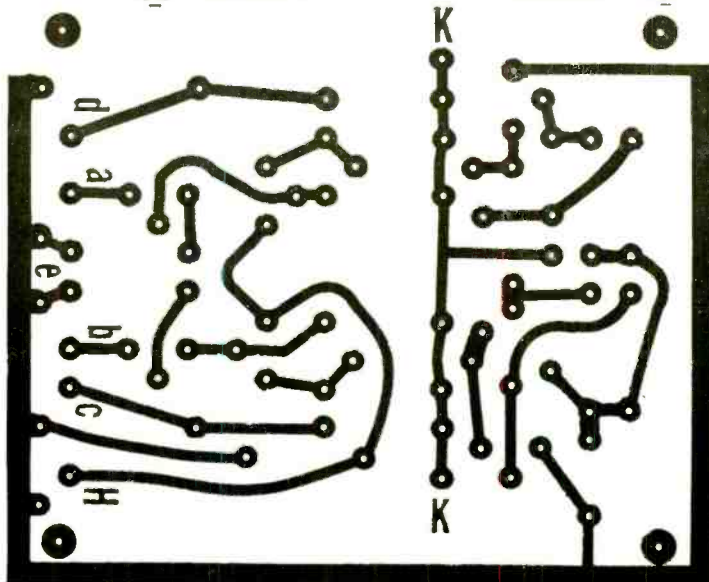
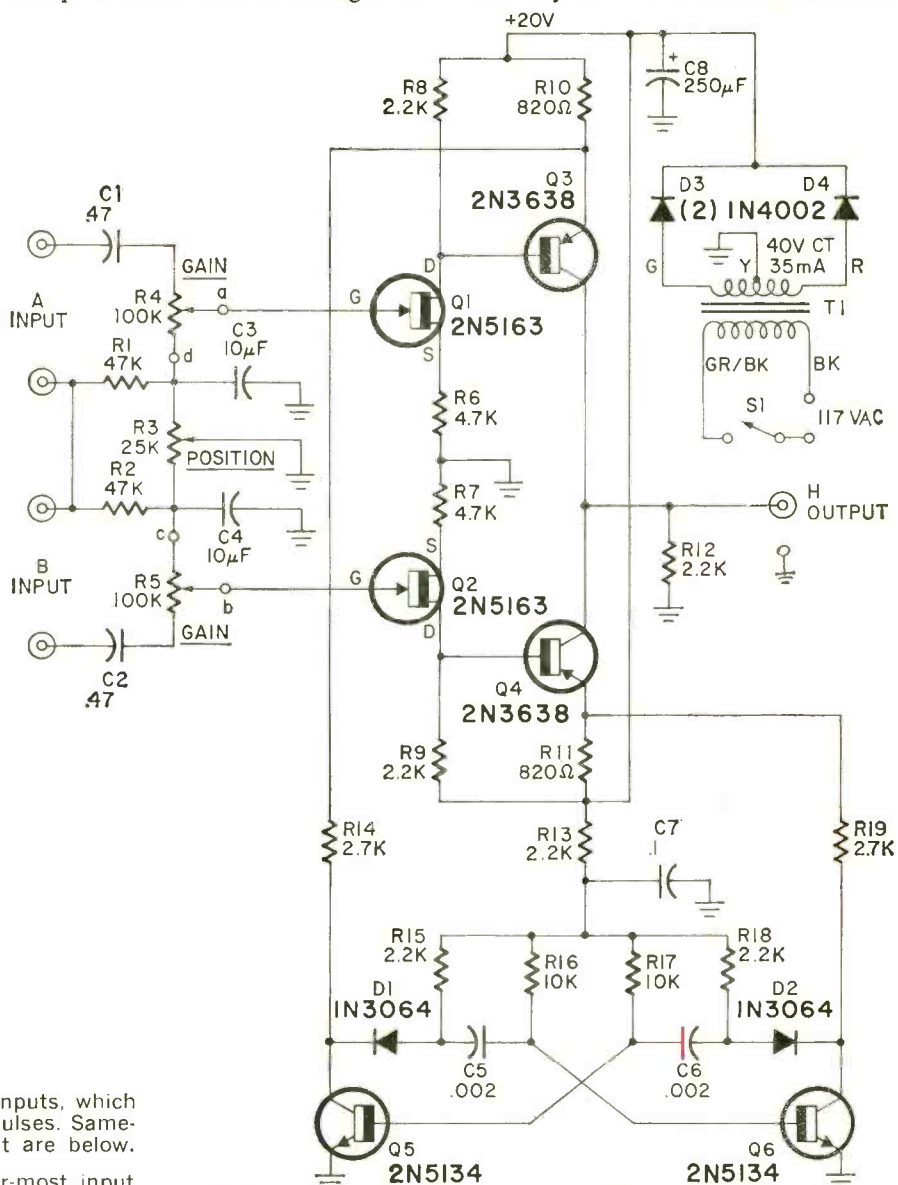

viation times the harmonic number is the measured signal's deviation. The amplitude of the rf varies in the oscillogram, not because of modulation, but because of the bandpass of the low-frequency amplifier used after the converter.

How the switcher works

A schematic diagram of the dual-trace switcher is shown in Fig. 4. Two inputs are attenuated by potentiometers R4 and R5 to a level within the range of the switcher's amplifier circuit. The signal is amplified by the input FET's, Q1 and Q2, and applied to the bases of Q3 and Q4, which act as switches. These are alternately gated on and off by the gating waveforms from Q5 and Q6. (Note that the dia-

gram does not indicate the drain and source terminals on Q1 and Q2. This is because the devices are bidirectional and may be placed either way in the circuit.

Transistors Q5 and Q6 are a free-running multivibrator whose frequency is determined by R16, R17, C5 and C6. Diodes D1 and D2 allow the voltage at the collectors of the multivibrator to rise very rapidly and thereby improve the switching speed.

As an example of how switching is accomplished, consider Q5 on; its collector is therefore at ground. The emitter of Q3 is at a potential below its base and is therefore off. At the same time, Q6 is off and its collector is "floating" so that no current flows in load resistor R19. The emitter of

Q4 is, therefore, 0.6 volt higher than the base and this transistor is operating in its normal mode. The output from either Q4 or Q3 is developed across R12, depending on which transistor is on. The output voltage across R12 is fed to the input of the oscilloscope in the setup.

Construction and use

Most of the circuitry can be built on the same-size printed circuit board shown. The entire circuit may be mounted in an aluminum box. Fig. 5 shows an inside view of the box. The PC board is mounted vertically on the back panel. The output jack is on the rear panel, where it is convenient to attach the vertical input of the scope.

After assembly has been completed, an oscilloscope should show a square wave of approximately 20 volts peak-to-peak at 40 kHz on the collectors of Q5 and Q6.

Next, connect a generator (either sine or square wave between 10 Hz and 100 kHz) to both inputs for a function check. The scope sync should *always* be obtained *externally* as shown in Fig. 1. A good sync source is at either input or the generator. The scope sensitivity should be set at or near maximum (0.5 volt p-p per inch or better).

Operation of the position control should move the two traces on the screen to any desired position. Gain controls R4 and R5 may be varied to produce a convenient display size on the scope. **R-E**

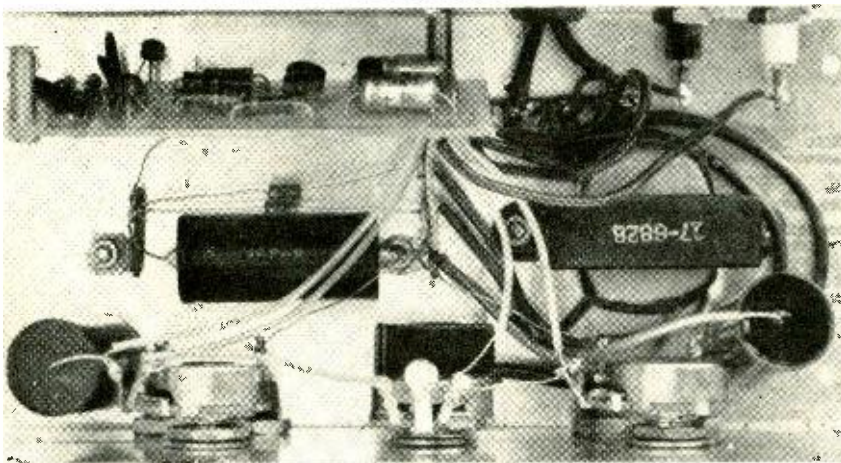
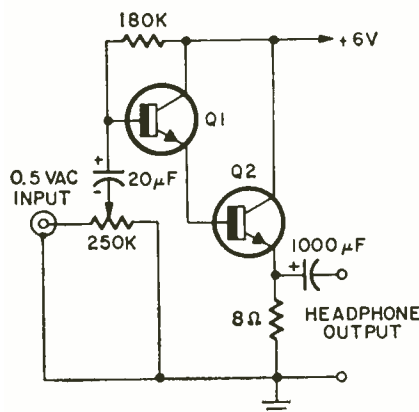

Fig. 5—Chassis view with cover removed from the case shows PC board mounted on the back panel. You may want to mount the dual-trace parts inside your scope.

Easy to build— TRANSISTOR HEADPHONE AMPLIFIER

Here is a low-power headphone amplifier that has application in numerous audio systems. Its circuit, simple and straightforward, consists of a modified Darlington-pair that eliminates the dc supply voltage flowing through the load. As can be seen from the schematic, the load has been replaced by a resistor and coupling capacitor. Transistor Q1 is an npn general-purpose audio type and Q2 is an npn 10-watt (or higher) transistor. The rectifiers (D1-D4) are 2-amp, 100 piv diodes.

The main advantage of this circuit is that a pair of expensive stereo



headphones cannot be damaged by excessive voltage. It was found experimentally that the load resistor did not reduce the performance of the circuit. Approximately 0.5 volt of drive voltage gives a good output listening

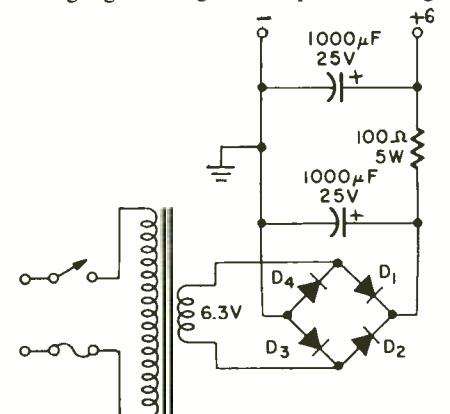

level. The power supply can be used to power two units for stereo. This circuit has proved to be of great value in monitoring the output of stereo tuners and broadcast-type tape machines with low-level monitor outputs.—Glenn C. Gutleben

NEW R-E EXCLUSIVE







Transistor X-Z Demodulators
in hybrid color TV

Kwik-Fix™ picture and waveform charts

by Forest H. Belt & Associates*

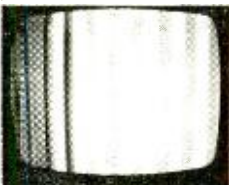
SCREEN SYMPTOMS AS GUIDES

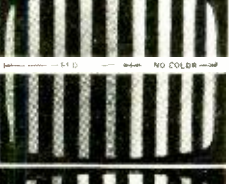
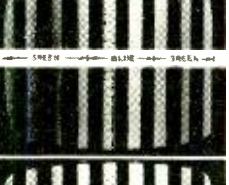
WHERE TO CHECK FIRST

SYMPTOM PIC	DESCRIPTION	VOLTAGE	WAVEFORM	PART
	No color at all; b-w bars only	Q1 base Q2 base	WF1	L1
	Weak color—blue or red, especially	Q2 collector	WF6	R7 R11
	Too much red; parasitic oscillation at left	Q1 collector	WF5	R8
	Too much blue; color smeared	Q2 collector	WF6	R9
	Red weak; colors float around	Q1 collector	use dc clue	R10
	Red on half of screen; rest monochrome	Q2 collector	WF6	R2 Q2
	Red missing; blue and green visible	Q1 collector	not much help	Q1 C2
	Green missing; red and blue visible	Q1 collector	WF5	R6 R3
	Green weak; screen half red, half blue	Q2 collector	WF6	L2 C3

*an Easy-Read™ feature by FOREST H. BELT & Associates © 1970

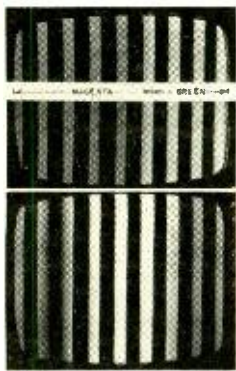

Screen half magento, half green

Mostly blue; red and green very weak

Q2 emitter

not much help

Not much help

WF5

L2

R8

NOTES:

Use this guide to help you find which key voltage or waveform to check first.

Study the screen colors, with color-bar generator fed into antenna terminals, the receiver's hue control set at center, and the color control about two-thirds up.

Most helpful clues to the fault are found at key test points indicated in Voltage or Waveform column.

Make the voltage or waveform check indicated for symptoms you see on the screen.

Use Voltage Guide or Waveform Guide to analyze results. For a quick check, test or substitute the parts listed as the most likely cause of the symptoms.

THE STAGES

This kind of color demodulator section is fairly new. It's one of the first solid-state demodulators since diode versions. (The other type uses an integrated circuit.) Chroma is fed to both transistors in the same phase. The 3.58-MHz reinsertion subcarrier goes directly to the X demodulator, but is phase-shifted before it's applied to the Z demodulator.

The output of the X demodulator is an R-Y color difference signal. Output of the Z demodulator is B-Y. Both signals are fed directly to color-difference amplifiers (covered in *Kwik-Fix*™ No. 14, next). A phase-shift network also feeds the R-Y to a third color-difference amplifier, where it is mixed with B-Y to form the G-Y signal needed by the tricolor picture tube. All three make the color picture.

SIGNAL BEHAVIOR

The chroma-sideband signal comes from the chroma output transformer—sometimes called bandpass transformer. In some chassis, there may be a chroma or color control between

the chroma amplifiers and the demodulator stages. In this version, L1 does the coupling, and R1 and R2 apply the signals to the bases of Q1 and Q2, respectively. Since the "splitting" is resistive, both signals are in the same phase when they reach Q1 and Q2.

The color-oscillator output transformer is the source of 3.58-MHz signal for the demodulators. The chroma sidebands must beat against this reinsertion subcarrier. That's how color or chroma information is recovered.

But each demodulator must recover a separate portion of the original color signal. So it's necessary to phase-shift the 3.58-MHz signal applied to one of them. In this demodulator system, the CW signal is shifted before being applied to Q2, the Z demodulator. Coil L2 and C1 do the phase-shifting, with R4 as their load.

Resistor R3 applies the direct 3.58-MHz input signal to the emitter of Q2. Because it's fed to the emitter, the CW signal in Q1 is 180° out of phase with chroma, which is fed to the base. The two signals are less than 180° apart in Q2.

(copy continues on page 43)

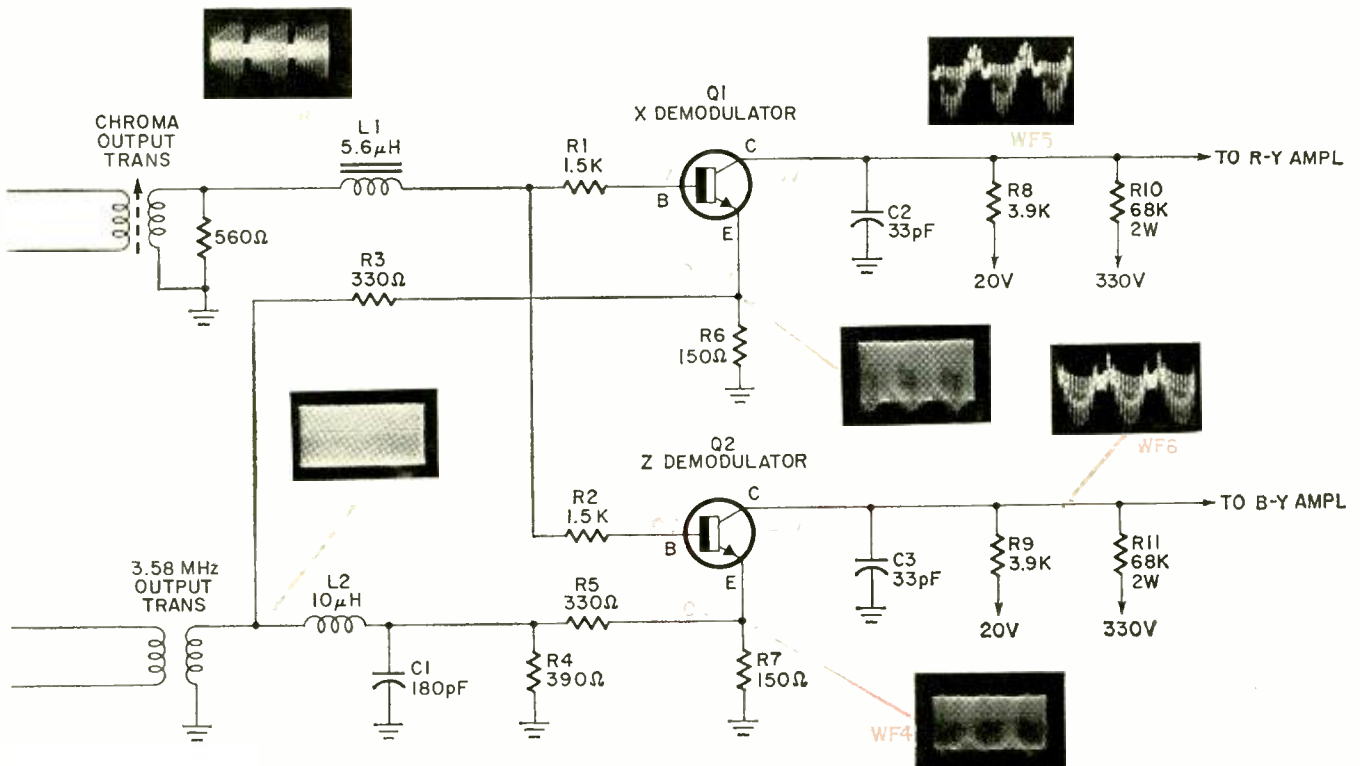

DC VOLTAGES AS GUIDES

Voltage change	to zero	very low	low	slightly low	slightly high	high
Q1 base Normal 0 volts.	R1 open* L1 open*					
Q1 emitter Normal 0.45 volt. Develops across R6, with R3 essentially in parallel. Holds Q1 past cutoff, but high input signal keeps average current high.	R1 open L1 open Q1 faulty		R3 open, high R6 low	R3 low	R4 low R8 open, shorted	R4 shorted R6 open, high C1 shorted
Q1 collector Normal 25 volts. Comes mainly from 330-volt line through R10. No significant changes with signal levels.	C2 shorted	R3 low	R3 low R6 open, high R10 open, high C1 shorted C2 leaky	R4 low R10 high L2 open	R6 low R8 high	R1 open R3 open, high R8 open R10 low ¹ L1 open Q1 faulty
Q2 base Normal 0 volts.	R2 open* L1 open*					
Q2 emitter Normal 0.34 volt. Develops across R7, with R5 essentially in parallel. Holds Q2 past cutoff, but high input signal keeps average current high.	R2 open L1 open Q2 faulty	R4 low R5 open, high C1 shorted L2 open	C1 shorted C1 leaky L2 open L2 shorted		R9 open R9 shorted	R7 open R7 high
Q2 collector Normal 26 volts. Comes mainly from 330-volt line through R11. No significant changes with signal levels.	C3 shorted	R11 open	R5 low R7 open, high R11 open, high C3 leaky	R2 shorted R11 high	R7 low R9 high L2 shorted	R2 open R4 low R5 open, high R9 open R11 low ¹ C1 shorted L1 open L2 open Q2 faulty
	*goes negative					

NOTES:

Use this guide to help you pinpoint the faulty part. All voltages taken with signal from color-bar generator fed into antenna terminals of receiver. Measure the six key voltages with a vtvm. For each, move across to the column that describes the change you find.

Finally, notice which parts are repeated in whatever combination of voltage changes you find. Test those parts individually for the fault described. Look for additional clues in the Waveform Guide. ¹Low R10 or R11 blows transistor. If either transistor is bad, measure these before replacing it.

WAVEFORMS AS GUIDES

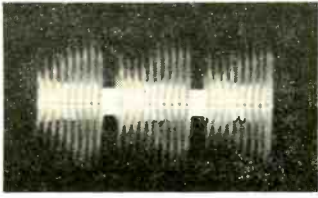

WF1 Normal 2.5 V p-p

Taken at the junction between L1 and R1-R2. This is the chroma-sideband signal from the bandpass or chroma amplifier. Exact amplitude depends on the setting of the color control in the receiver and the setting of the saturation control on the color-bar generator. Ten color bars are visible (but not in the first group, because of sync and blanking inside the scope).

V p-p low

V p-p high

V p-p zero



1 V p-p
L1 open



2 V p-p
R6 open, high



2.5 V p-p
R7 open, high

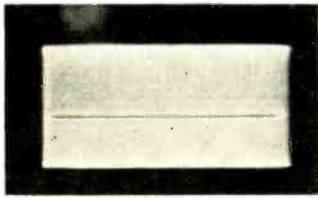

WF2 Normal 18 V p-p

This waveform is shown for reference only. It is taken from the secondary of the color-oscillator output transformer. This is the 3.58-MHz CW signal that mixes with chroma in the demodulators. If this waveform is missing, there is no color on the screen—just bars of black and white.

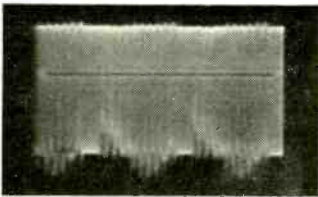

WF3 Normal 3 V p-p

Taken at the emitter of Q1. This is a combination waveform, showing both chroma bars and CW signal. You can see the bars modulated in the CW signal. Both must be present for proper demodulation to take place. The only way to be sure the CW signal is in proper phase is by the output signals (WF5).

V p-p low

V p-p high

V p-p zero

R3 high
R6 low

R3 low
R6 open, high



3 V p-p
R1 open
LL open



2 V p-p
R3 high



2 V p-p
R3 open

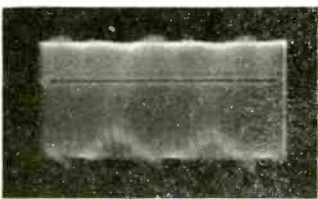

WF4 Normal 3 V p-p

Taken at the emitter of Q2. This is a combination waveform, showing both chroma bars and CW signal. You can see the bars modulated in the CW signal. Both must be present for proper demodulation to take place. The only way to be sure the CW signal is in proper phase is by the output signal (WF6).

V p-p low

V p-p high

V p-p zero

R4 low
R5 high
R7 low

R5 low
R7 open, high



3 V p-p
R2 open
R5 very low
L1 open



1 V p-p
L2 open





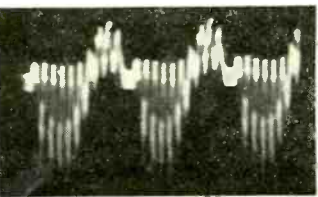









1.2 V p-p
C1 shorted



WF5 Normal 24 V p-p

Taken at the collector of Q1. This is output of the X demodulator; it's an R-Y signal—red without Y or brightness component. The first bar is lost in the blanking of the signal. The third bar is the longest, as it should be for R-Y. The chief direction is negative, although some bars go positive. When applied to the red grid of the CRT (after inversion in the color-difference amplifier), only negative bars (here) cause beam output.





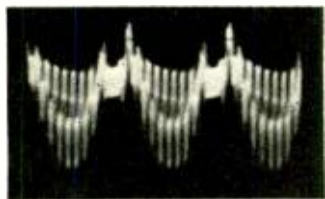







WAVEFORMS AS GUIDES

V p-p low C2 leaky	V p-p high	V p-p zero C2 shorted					
							
							



WF6 Normal 24 V p-p

Taken at the collector of Q2. This is output of the Z demodulator; it's a B-Y signal—blue without Y or brightness component. The first bar is positive. Counting on through, you see the sixth is the longest negative bar. As with WF5, only negative bars in WF6 cause beam output from the blue gun of the color CRT. The sixth bar should always be the longest, if CW oscillator phase and demodulation are correct.

V p-p low C3 leaky	V p-p high	V p-p zero C3 shorted					
							
							

NOTES:

Use this guide and the Voltages Guide to help you pin down fault possibilities.

Waveforms are taken with keyed-rainbow color-bar generator fed into antenna terminals of receiver. Hue control is centered, color control two-thirds up.

With the direct probe of the scope, check the waveforms at the six points shown. Set the scope sweep at H or

about 5 kHz, to show three cycles of the waveform.

Note amplitude. If it's missing, low or high, check the parts indicated under those columns.

Note waveshape. Pay special attention to which bars are positive and which negative. Note which is the furthest negative.

If there's a change in waveshape from normal, despite amplitude, check the parts indicated.

The transistors demodulate the chroma signal. Capacitors C2 and C3 eliminate whatever is left of the 3.58-MHz CW signal. Resistors R8 and R9 are the main output loads (R10 and R11 are larger in value and have little load effect).

The outputs are pure R-Y and B-Y signals. They are coupled to color-difference amplifiers (not shown).

The transistor bases are returned to ground through R1, R2 and the low-resistance winding of the chroma output transformer. There's very little base current. So, very little voltage develops between the bases and ground.

Bias for the transistors, then, depends on average dc in the emitter resistors. Resistors R6 and R7 have low values, but average current in the transistors is substantial, around 4 mA. Therefore, considerable bias voltage is developed.

Notice, it's reverse bias. That puts operation of these npn transistors down into class C. Voltage amplification of the demodulated signals is fairly high.

Collector voltages come primarily from the 330-volt line

through R10 and R11. The connections through R8 and R9 to the 20-volt line are for load matching. If R8 or R9 opens, the collector voltage goes up, not down.

You can also look at R8-R10 and R9-R11 as voltage dividers between the 330-volt line and the 20-volt line. If you look at them that way, Q1-R6 and Q2-R7 are branches in parallel with R8 and R9, respectively. Collector voltage therefore depends on how much voltage is dropped across R10 or R11 by the current drawn by those branches.

Dc voltages in these stages remain fairly stable through any changes in signal. Of course, there are no waveforms unless a color signal is being received.

You'll see changes in the levels of chroma waveforms if you turn the color level control, which isn't part of these stages. Changing the hue (or tint) control of the set has a noticeable effect on WF5 and WF6: the bars change positions and relative amplitudes as the control is turned. Keep the hue and color controls turned up about two-thirds.

R-E



Part 2—Add a wiring alarm, adjust and install the system

by **KENNETH C. BUEGEL**

LAST MONTH THE MAJOR OPERATING features of R-E's "radar" burglar alarm were described. Basically, the system detects reflected load changes on a micropower 400-MHz oscillator, activating whatever types of alarms you decide to use.

This concluding section provides PC patterns (pages 73-74) and tells how to adjust and install the alarm.

A large system with many TC1 heads might be disabled by severing a connecting cable to a head, thus providing safe access at a certain point. The wiring alarm circuit immediately initiates an alarm.

All TC1 heads will have a dc voltage near +6 volts at the junction of R14 and R15. On the WI board (Fig. 6) R41 and R42 hold the base of Q12 at about +4 volts. Resistor R44 sets the emitter voltage of Q12 at +3

volts. Transistor Q12 is not turned on nor are Q13 and Q14. Point W is held at ground potential.

If the +6 volts should disappear from any of the D7 inputs, its resistor (R40-1 or R40-2) would drop the voltage at the base of Q12 to about plus 1.2 volts. When Q12 saturates, Q13 and Q14 will turn on and point W will become positive. This point is also connected to W on the DE board and provides a rapid charge to C18, activating the relay and sounding the alarm.

The relay specified has a dpdt contact set with a 10-amp rating. Since the contact sets are isolated from each other they may simultaneously operate sirens, auto-dialers, etc.

The power supply (Fig. 7) is a simple full-wave battery-charging circuit which is always connected. The battery furnishes all alarm and system power. If the ac line input should be lost, Q32 is turned on and LM2 lights to indicate the loss of ac power.

In a residential system with four TC1 heads, a 35 amp-hr battery can furnish operation for over two weeks after loss of ac power. The system could conceivably be used on construction jobs to prevent material theft, a freshly charged battery being installed at regular intervals.

Construction

The majority of the system parts are on the various PC boards. The DE, AR and WI boards were mounted above the chassis on ¼-inch spacers with a large rubber grommet for wires from the boards. Two easier methods of wiring the system are possible. One way is to mount each board vertically by means of two small right-angle brackets. Another way to ease wiring is to mount the boards flat over a large rectangular cutout extending nearly to the mounting holes.

The TC1 board is mounted only by means of the standoff insulator that extends through the 4 x 5-inch face of a 4 x 5 x 6-inch metal box. Before placing any parts on the TC1 board, use the board as a template to determine the location of the insulator hole. Up to eight TC1 heads and AR boards may be used with each WI board. If the WI board is not used, 15 TC1 heads and AR boards may be used per system.

A chassis 8 inches wide and 2½ inches deep was used in the prototype. This provides a roomy layout without crowding. A separate ground return to each circuit board is necessary. Use No. 20 wire for power supply connections. The battery leads should be No. 16 wire or heavier.

Follow the component layout diagrams carefully and be especially care-

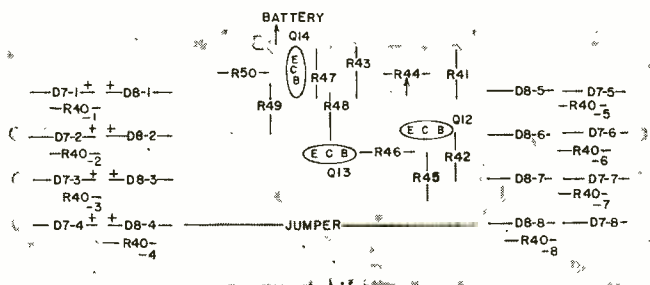
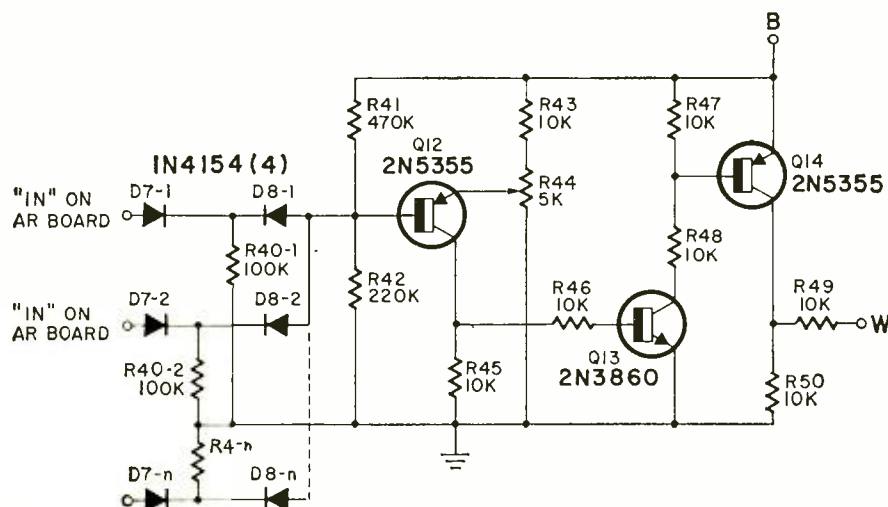

Fig. 6—Wiring circuit below triggers alarm if rf head wires are broken. On the left, parts placement is shown. (See above for location of PC patterns.)

PARTS LIST WI Wiring Alarm

R40-1, 2—100,000 ohms
R41—470,000 ohms
R42—220,000 ohms
R43, R45, R46, R47, R48, R49, R50—10,000 ohms
R44—5000-ohm, ¼W trimmer (CTS type)

X201R502B)
Q12, Q14—2N5355 transistor
Q13—2N3860 transistor
D7, D8—1N4154 diode
*WI circuit board, \$1.75; *WI complete kit, 4 inputs, \$7.45



ful in the power supply connections. A 12-volt battery can rapidly deliver several kilowatts of heat energy into a short circuit.

Testing and adjustment

The system can give the appearance of improper operation if not adjusted correctly and in a certain sequence. Fortunately, almost all improper settings result in an alarm.

1. If the WI board is used, connect a transceptor head to the AR board with the alarm-signal output. All other AR inputs must consist of a 4700-ohm resistor to ground, and also a 4700-ohm resistor to the battery. (The tap of this voltage divider simulates the output of a TC1.)

2. Connect the battery to the system. The AC POWER OFF light should turn on. Now plug in the line cord—this light should go off. Unplug the line cord; note that in a few seconds the light again comes on.

3. Due to the long time constants involved, the channel alarm lights may be almost continuously energized as the capacitors charge up. Wait at least 5 mins before proceeding. During this time set R21 on each AR board for minimum gain (maximum resistance in the emitter circuit). Also set the wipers on R58, R64 and R82 on the DE board to the point farthest from the ground end. Do not apply force to these trimmers!

4. When the 5 min period has expired, push alarm reset switch S1. All channel alarm lights should go out within 5 sec.

5. Set all channel ON-OFF switches to the ON position. Push test switch S2. All channel alarm lights should go on. Push S1 and reset the alarm.

6. Insert an ammeter in the battery circuit. Push S1 until the lights go out, and adjust the slider on R105 until the battery charges at a 0.1-amp rate with the line plug connected.

(The following tests involve repeated use of the test, alarm reset, and exit switches. To save space we will write only "Push T," "Push A," or "Push E.")

7. Set R53 so the wiper is shunting all of R53 (only R52 in the circuit). Resistor R58 determines the voltage level at which Q15 conducts. Normally this should be at about the point where the charge on C17 is approximately +3.0 volts. If the sensor head is set for maximum range (minimum R21 in the circuit) then very slight disturbances will soon charge up C17 if R53 is adjusted for maximum discharge time (all of R53 between R52 and ground).

In general, R53 should be shunted more as the gain is increased so the wiper positions of R21 and R53

should track each other.

Connect a dc vtvm or dc scope between C17 and ground. Connect a vom (on 12V range or higher) between point C and ground). Push A, Push T. Adjust R58 so that point C goes positive as the charge on C17 reaches 3 volts ± 0.2 volt. Push A.

8. Connect a 12-volt light between one of the normally open contacts of the relay and the battery. Ground the other NO contact. Resistor R64 sets the time between an alarm condition (point C becoming positive) and the relay operation. Push T and hold. When point C becomes positive, release T and start timing. Adjust R64 for desired delay.

9. The exit delay time is set by R82. Push T and hold until C becomes positive. Push E. After 15 sec set R82 until C goes to ground potential. Increase R82's setting until the exit time is at the desired point.

10. Push A. Push T and check alarm delay setting. Push E and check the exit delay setting.

11. Short any of the D7 inputs on the WI board to ground. Within a few seconds the relay should operate.

Installation

The TC1 heads must be connected as though they were a small transmitter. This means that the antenna requires a ground plane. Unless you need the maximum range this can be as little as a 3-foot length of hookup wire with the insulation removed in the center and the wire looped under one of the case screws. For the maximum range use two of these ground radials at right angles to each other.

The head must be suitably protected from the elements if mounted outside. A wide tape may be used to cover all box seams, or a commercial water-proofing compound may be applied to all seams. If cable length between the head and control unit is less than 40 feet, three-wire No. 20 cable is adequate. If the installation length runs more than 40 feet, use three-wire No. 20 shielded cable.

Although radio waves travel through walls, it has been found possible

to mount the heads under eaves if the wall insulation was of the aluminum-foil-backed type. An alarm was not generated by movement inside unless a person walked along with shoulders rubbing the wall.

Another installation problem of "inside vs. outside" discrimination was solved by removing siding over a 6-foot-square area and stapling sheets of heavy-duty aluminum foil over the area with a 3-inch overlap at each seam.

Placement of the heads should be carefully planned before the actual installation. Some cautionary advice is in order. Do not attempt to increase range by increasing antenna length; it will not change the range. Maximum range, in an open field, can be 45 feet. With many metallic objects in the area, such as fencing, concrete reinforcing rods, steel building panels, etc., it will usually be found necessary to run the channel gain at much less than maximum.

In general you will have a better system if you use more heads and set each one at a lower sensitivity. A possible modification which might improve the system would be to wire a switch to the R64 leads on the DE board. This switch could then select between two alarm delay times: a short delay when everyone was home and movement could come only from an intruder, and a long delay to allow sufficient time for the operator to enter and reset the system.

R-E

PARTS LIST

- Power Supply and Relay**
 R103—1000-ohm, 1/2 W
 R104—10,000 ohms
 R105—50-ohm, 50-watt adjustable
 C25—1000 μ F, 25V electrolytic
 D18, D19, D20, D23—1N4002 diode
 Q32—2N5355 transistor
 T1—117V pri, 24V CT sec transformer (Triad F40X or equiv)
 RY1—Parelco R10E1UZV185 or equiv. (12V coil, K5-ohm dc resistance, dpdt, 10A)
 LM2—12-14V, 25-40-mA pilot bulb
 S1, S2, S4—spst, momentary contact switch
 S3—spdt switch, 1 per channel
 F1—1/2-amp fuse
 PSZ-K, complete kit of relay and power supply parts, except T1, \$12.30
 Asterisked items are available from: TRANSITEK, P. O. Box 98205, Des Moines, Wash. 98016. Items are sent postpaid. Washington state residents include 4.5% tax.

Fig. 7—Circuit keeps battery charged, lighting LM2 if the power is cut off.

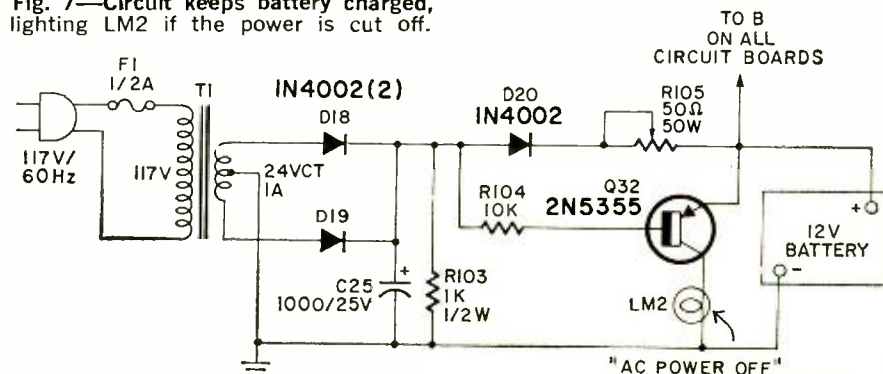

FET & OP-AMP



FET acts as variable resistance in op amp circuits. Learn how to build gain-controlled and

by **NORMAN DOYLE***

THIS ARTICLE DESCRIBES HOW AN IC OPERATIONAL amplifier can be used with a junction FET operating in its linear region. Gain control and bandpass control of audio-frequency signals, compressor amplifiers, and voltage-tuned filters are among the applications covered.

Component characteristics

The frequency response and basic configuration of the operational amplifier are in Fig. 1. Since this amplifier has built-in frequency compensation, it does not require external frequency-compensation networks. As with all operational amplifiers, the gain is given by $A=R_f/R_s$.

The junction FET is a depletion type, n-channel device in an epoxy package (Fig. 2). The shaded areas are the depletion regions surrounding the junctions. Varying the bias voltages makes the depletion regions move closer together, reducing channel width and increasing the FET's resistance. For small values of drain-to-source bias, the variations of channel resistance with gate-to-source bias are as shown in Fig. 3.

As you can see in Fig. 3, for small ac signals applied

between drain and source, the device presents a resistance whose value is determined by the gate-to-source voltage. (Note that an FET is often referred to as a unipolar transistor because the current in the channel is made up only of majority carriers, whereas in a bipolar transistor the current consists of carriers of both polarities.)

The channel resistance is given by the equation

$$R_{DS} = \frac{R_o}{1 - \left[\frac{8K_s E_o (\phi_n - V_{ti})}{qN_s d^2} \right]^{1/2}}$$

However, for our purposes, the following approximation is more than adequate.

$$R_{DS} = \frac{R_o}{1 - \frac{V_{GS}}{V_p}}$$

where V_{GS} is the gate-to-source bias, V_p the gate-to-source bias for pinch-off or zero conduction, and R_o the value of the channel resistance at $V_{GS} = 0$.

A word about distortion: The percentage of second-harmonic distortion as a function of drain-to-source signal

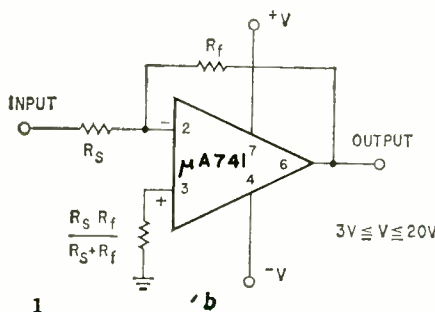
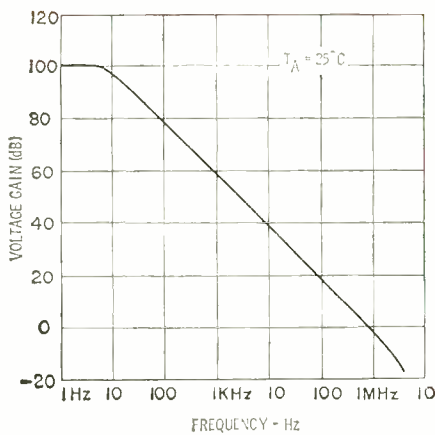
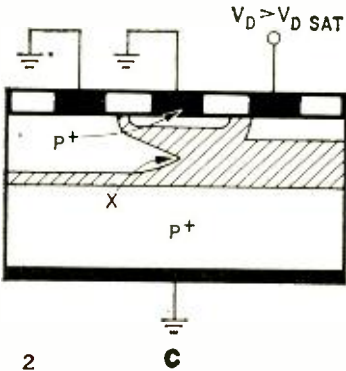
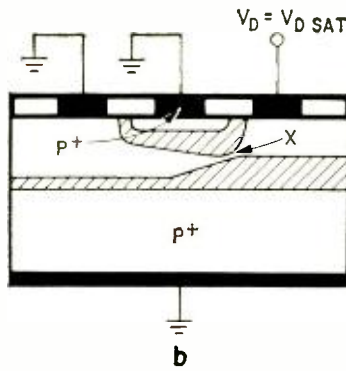
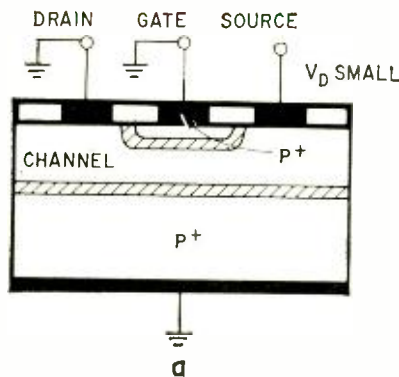

Fig. 1-a—Frequency response of the μ A741 op amp. b—Basic circuit configuration for the unit, which has a built-in frequency compensation.

Figs. 2-a-c(right)—FET resistance increases as bias voltage is increased and the depletion regions converge.

*Fairchild Semiconductor



2

c

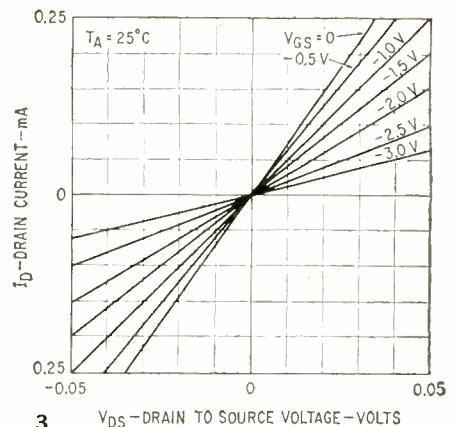

3

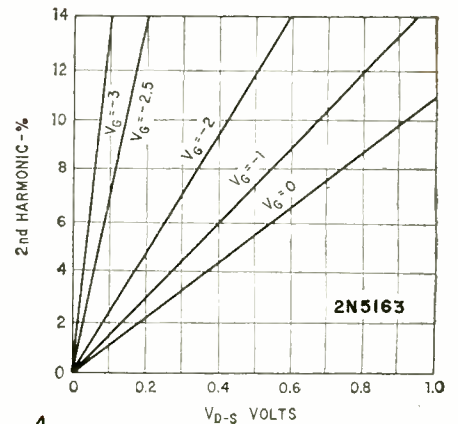

4

Fig. 3(top)—Graph shows 2N5163 resistance is determined by the gate-to-source voltage. Fig. 4 (above)—Second-harmonic distortion increases with signal and bias voltage.

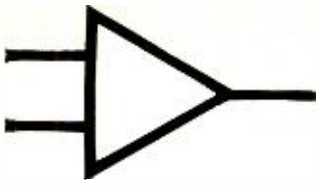

AUDIO CIRCUITS

compressor amplifiers, voltage-tuned active filters and voltage-controlled oscillators

voltage for various values of gate bias is in Fig. 4. These curves show that, to minimize distortion, we should work at the low-resistance (low-gate bias) end of the FET characteristic and keep the impressed signal voltage as low as possible.

Many circuits that use operational amplifiers must have a variable resistance to vary gain, frequency response or whatever. Frequently it is desirable to have this resistance variation controlled from a point far from the op amp. The FET fills this need well, since it obviates the use of long signal paths and permits more complex control characteristics than are possible with ordinary potentiometers. Let's consider some of these FET op amp combinations in practical circuits.

Gain-controlled amplifier

An amplifier whose voltage gain from input to output is given by $A = R_f/R_s$, is in Fig. 5. Now, R_s is the drain-source resistance of the FET and is controlled by V_{GS} , the gate-to-source voltage. Note that the FET source is always at ground, since this is a feature of the op amp. Thus the gate potential specifies the gate-source bias. The variation

in amplifier gain with gate voltage is shown in Fig. 6-a. The relationship between gain and temperature is in Fig. 6-b below.

A compressor amplifier

If we rectify the output of the amplifier, we can derive a dc voltage proportional to the signal level. If this dc voltage is used as the FET control voltage, it will stabilize the output level with variations in input. A simple circuit for this function is shown in Fig. 7. At higher input signal levels (where lower gain is desired), we reach the distortion condition described earlier. This is overcome by adding a shunt resistor across the FET. Now when the control range of the FET is exceeded, the amplifier performs normally.

The action of the circuit can be considerably tightened up by adding some gain in the feedback loop. A second op amp, which drives the rectifier while the output is taken from the first op amp, as before, is shown in Fig. 9. This circuit gives 2 dB change in output level for 30 dB change in input. The performance curves for both circuits are shown in Fig. 8.

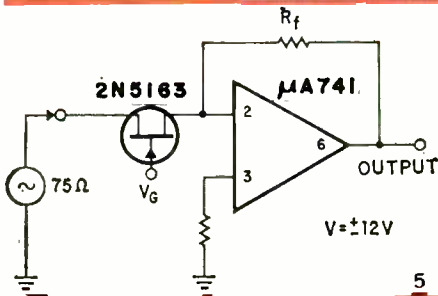

Fig. 5(left)—Amplifier gain is R_f/R_s , with R_s the FET's drain-source resistance, controlled by voltage V_{GS} .

Fig. 6-a(below)—Plot of Fig. 5 gain with changes in gate voltage. b—Changes in gain with temperature.

Fig. 7(right)—Output of op amp is rectified to control FET gate voltage; gain of amplifier is held constant.

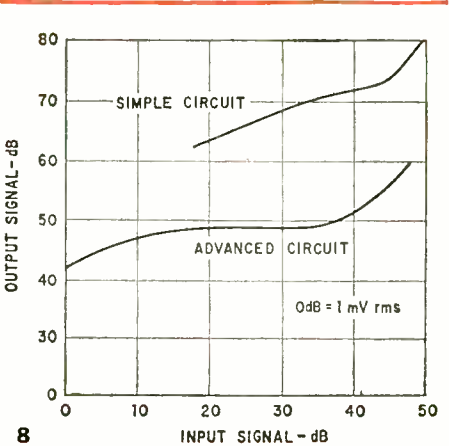
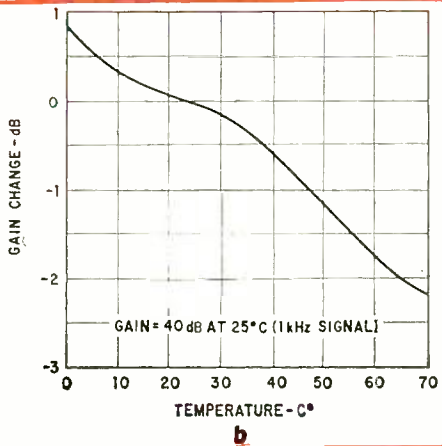
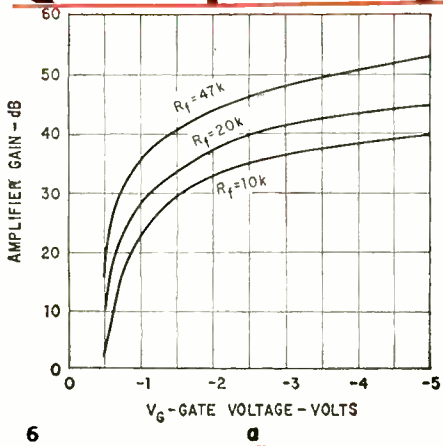
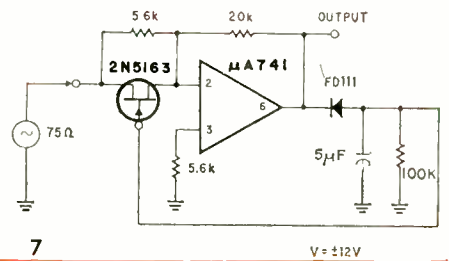

Fig. 9—Adding another op amp to Fig. 7 circuit provides gain in feedback circuit and improves circuit performance.

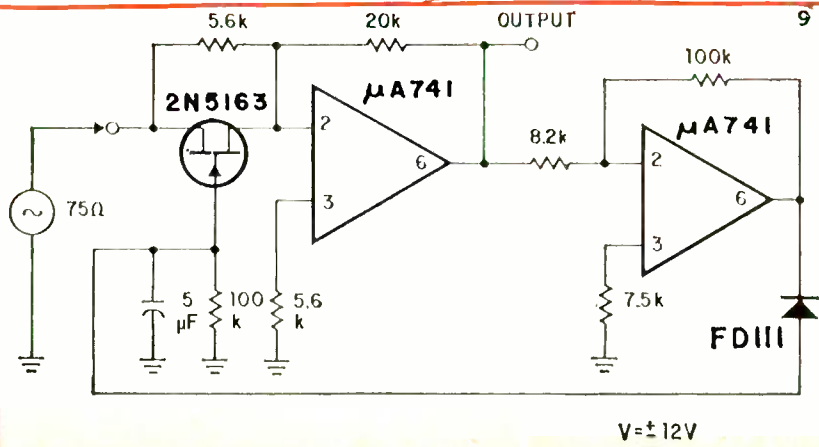

Fig. 8(above)—Performance curves of compressor amplifiers with and without gain in feedback loop.

Voltage-tuned active filter

The circuit in Fig. 10 is a fairly well-known active-filter configuration. The values of the various components are given by

$$R_1 = \frac{1}{2\pi\Delta AC}$$

$$R_2 = \frac{1}{\Delta\pi C}$$

$$R_3 = \frac{1}{2\pi C \left[\frac{2f_0^2}{\Delta} - \Delta A \right]}$$

where Δ is the 3-dB bandwidth in Hz, A the voltage gain and f_0 the center frequency. The advantage of this particular configuration, from our point of view, is that the center frequency is controlled solely by R_3 (for fixed values of all other components). Thus, by putting our FET in place of R_3 , we have a voltage-controlled filter, as shown in Fig. 11 below.

The filter performance for the component values in Fig. 11 is in Fig. 12-a. Since the bandwidth is fixed at 80 Hz, the Q varies from 2.5 at 200 Hz to 40 at 3.2 kHz. The gain of the filter is 26 dB and the maximum variation in gain over the tuning range is ± 1 dB.

When we come to thermal stability, the picture changes somewhat. The next set of curves (Fig. 12-b) show the variation in center frequency over the temperature range from 0°C to 70°C for various initial settings.

Under some conditions, the circuit makes a good digital thermometer. To understand a little more about these curves, we must look at the temperature response of the FET channel resistance, as shown in Fig. 12-c.

Note that for low-gate voltages the temperature coefficient is positive. As we get closer to pinch-off voltage the temperature coefficient approaches zero, and beyond pinch-off the drain-source resistance has a negative temperature coefficient. This effect, combined with the nonlinear R_{DS} vs V_{GS} characteristic, makes it very difficult to stabilize the device thermally and still maintain the filter tuning range. To keep the circuit simple, tuning range is

sacrificed for thermal stability. If we set our lowest desired frequency at FET pinch-off with a shunt resistor, and the upper frequency with a series resistor, as shown in Fig. 13, and confine ourselves to a one octave tuning range, we get better results.

The performance of this circuit is:

	Lower Tuning Freq. (380 Hz)	Upper Tuning Freq. (760 Hz)
Deviation at 0°C	-1%	-2.7%
Deviation at 70°C	+1.8%	+3%

How acceptable these figures are depends on the application. If the deviation is within the bandwidth and the tuning range is sufficient, then the requirements for a stable, tunable filter would seem to be met.

Voltage-controlled oscillator

It is a short step from an active filter to an oscillator (too short for some people). If we invert the filter output and feed a suitable portion back to the input, we can realize a voltage-controlled oscillator or VCO, as it is often called.

This circuit (Fig. 14) uses the same frequency-determining components as the original filter, and its output frequency covers the same range. Obviously, a sweep can be generated by applying a ramp at the gate. There is a variation in output amplitude over the range, however, and it might be useful to use our compressor amplifier as the feedback element here. This would make for a very amplitude-stable VCO. Of course the remarks made earlier about temperature stability would still apply. However thermal problems might possibly be overcome by the arrangement in Fig. 15.

Here the compressor delivers amplitude stabilization and has a level control. The op amp is being used as a low-pass filter (see Fig. 1), and its detected output, in conjunction with the frequency setup voltage, is used initially to set the oscillator output frequency. Any subsequent frequency change due to thermal changes within the loop will generate at the gate of the control FET a dc correction voltage which will tend to pull the frequency

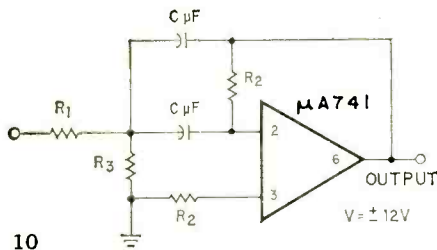

Fig. 10—Active-filter op amp circuit. R3 value sets center frequency.

Fig. 11(right)—Voltage-tuned active filter is obtained when the 2N5163 FET is used for resistor R3 in Fig. 10.

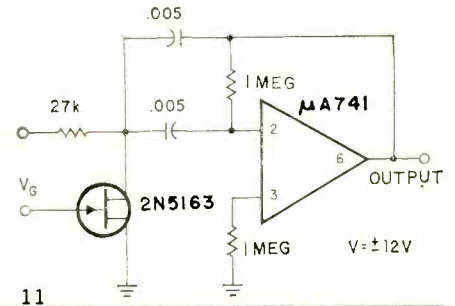
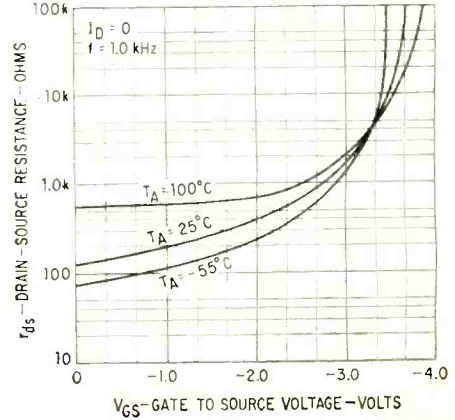
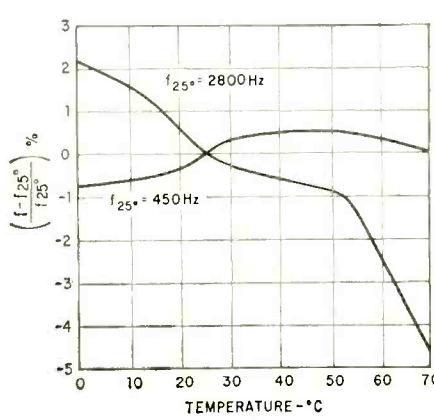
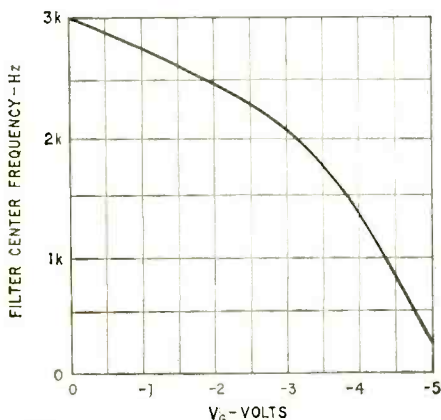

Fig. 12-a(below)—Performance of circuit in Fig. 11. b—Shift in center frequency with temperature. c—Temperature vs. channel resistance plot.



back to the set value. As may have been inferred, this system has not yet been tried, but it is suggested here as a logical combination of the basic building blocks described above.

Onward and upward

The principles involved here may be extended into the video-frequency range by a suitable operational amplifier. At frequencies where the drain-to-source capacitance of the FET becomes noticeable (above 1 MHz), it may be necessary to tune out this capacitance with a shunt inductance, thereby eliminating any undesirable phase shift

over the operating range of the circuit.

It is also apparent that the functions discussed here could be achieved using discrete devices as amplifiers. However, the op amp is such a simple, stable and versatile device that it is well worth using for these applications.

There is another advantage to the circuits described: no dc drain bias is used with the FET. This means that I_{DSS} (the drain current for $V_{GS} = 0$) variations are not a consideration and devices may be interchanged easily. The design of the various circuits should, however, include a consideration of $R_{DS(on)}$ (the drain-to-source resistance for $V_{GS} = 0$), which will vary from device to device. **R-E**

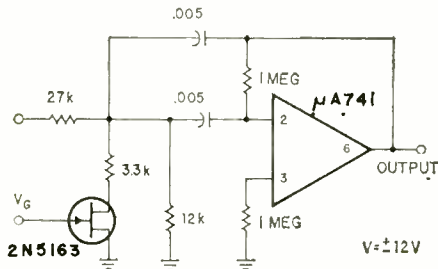

Fig. 13(above)—Circuit values for one-octave-tuning-range active filter. Fig. 14(right)—Voltage-controlled oscillator; filter output is inverted.

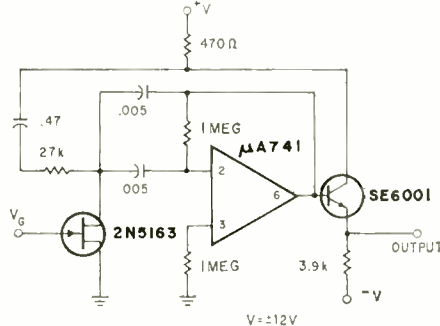
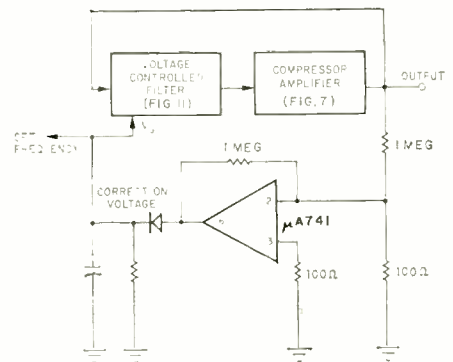

Fig. 15(right)—VCO with good amplitude stability uses compressor ampl.



IN THE FIRST PART OF THIS ARTICLE, last month, we looked at the theory of operation for triacs plus a few applications. Here are more practical circuits. (See part one for figure reference 10 or lower.)

A modified version of Fig. 10 is in Fig. 11. This circuit is ideal for use as a very sensitive temperature-operated line switch, giving a thermal backlash of only about 1°C. Base drive for Q2 is obtained from voltage divider R9-TH1. Thermistor TH1 has a negative temperature coefficient (its resistance increases as temperature decreases).

Zener diode D3 insures that Q2's base drive conditions are independent of variations in the low-voltage supply-line potential, and D1-D2 (general-purpose silicon diodes) temperature-stabilize the trip point of the transistor circuitry. As a result, the trip temperature is controlled purely by the temperature of the thermistor and is independent of the ambient temperature of the transistor circuitry.

The trip point of the circuit can be

set with an accuracy of 1°C, and thermal backlash is about 1°C. (If the triac turns ON when the TH1 temperature falls below, say 25°C, it will not turn OFF again until the temperature rises to 26°C.) This backlash can be increased, if required, by increasing the value of R8.

In this circuit the triac turns ON when the temperature falls below a preset value and goes OFF again when the temperature rises above that value. For reverse action (Q1 ON when temperature rises, OFF when temperature falls), interchange the positions of TH1 and R9. Thermistor TH1 can be any rod-type negative-temperature-coefficient unit with a resistance in the range 2,000 to 8,000 ohms at the required operating temperature.

Water-operated switch

The gate driving sections of the four circuits we have looked at in Figs. 8 to 11 have all been "live," and dangerous to the touch. None of them can be grounded. On the other hand, Fig. 12

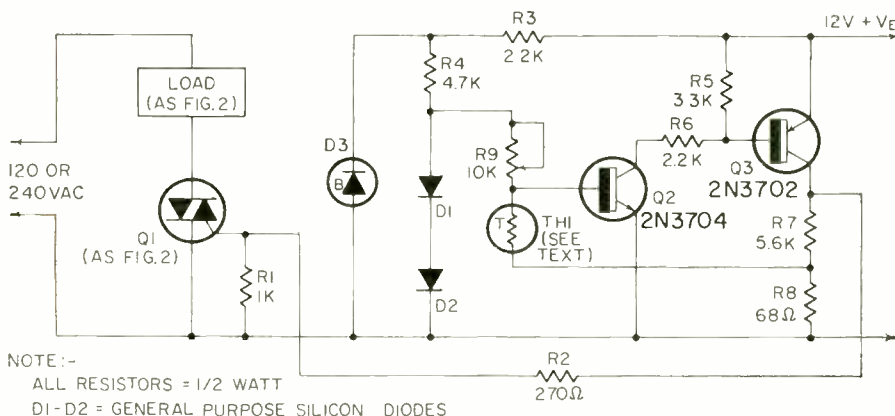

NOTE:- ALL RESISTORS = 1/2 WATT
D1-D2 = GENERAL PURPOSE SILICON DIODES

Fig. 11—Highly sensitive temperature-operated line switch. Thermistor turns on Q2 and Q3, which gates on the triac (Q1).

20 TRIAC CIRCUITS

Part 2—Triac and quadac circuits you can put to work around your home and shop

by R. M. MARSTON

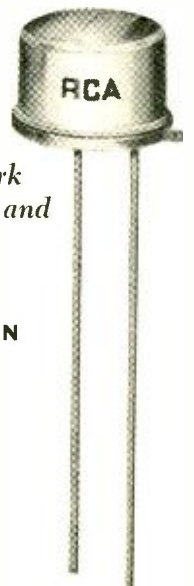

shows how the triac can be operated as a water-activated line switch, using a gate-driving circuit that is isolated from the line voltage and that can be safely grounded. The circuit is a modification of Fig. 5.

In this circuit the UJT is wired as a pulse generator to feed trigger pulses to the triac via T1. The UJT can operate only if the Q3 end of R2 is shorted to the 18-volt positive line. But in the diagram Q3 is normally off (when the probes are open circuit), so R2 is normally connected to the zero-volt (ground) line via R3 and the UJT is inoperative. The triac is normally OFF.

When, on the other hand, a resistance of less than about 120,000 ohms is connected across the probes, Q3 is driven to saturation. The top of R2 is effectively shorted to the 18-volt line, and the UJT oscillates and drives the triac ON.

When the probes are placed in water, the water acts as a resistance of considerably less than 120,000 ohms, and the triac operates. The circuit functions effectively as a water-operated switch.

Either one of the probes can be grounded, if required, since the probe circuitry is isolated from the power supply line via T1.

Phase-triggered power control

The triac circuits we have looked at so far have all been used for a simple ON/OFF type of power control. Either full power or zero power is applied to the load. Triacs can also be used to give very efficient variable power control in ac circuits with a system known as "phase triggering." The principle of phase triggering can be detailed with the aid of Fig. 13.

A basic phase-triggered variable-power control circuit is in Fig. 13-a. The triac and load are fed from an ac source. The triac's gate trigger signal is derived from MT2 via a variable phase-delay network and a trigger device. The phase-delay network permits delaying the ac signal to the trigger device, relative to that at MT2, by an amount variable from about 10° to 170°.

The trigger device is a voltage-operated "switch" that triggers ON and

fires the triac when a preset voltage is reached at the output of the phase-delay network.

If the phase-delay network is set for a 10° delay, the triac triggers ON in each half-cycle 10° after the MT2 potential reaches the preset voltage (the triac is turned ON shortly after the start of each half-cycle, and almost the full available line power is applied to the load).

If the phase-delay network is set for a 170° delay, the triac does not trigger ON until near the end of each half-cycle, so only a negligible part of the available line power is applied to the load. By varying the setting of the phase-delay network between 170° and 10°, the mean power to the load can be varied all the way from near zero to maximum, and the circuit acts as a variable-power controller. Since the triac is either full ON or full OFF at all times, very little power is lost in the triac, and the circuit is highly efficient.

The circuit waveforms that result in the basic circuit at different settings of the phase-delay network are in Fig. 13-b.

Since lamp brightness or electric motor speed is proportional to the power fed into the device, phase-triggered triac circuits can be efficient lamp dimmers and drill-speed controllers.

Triac lamp dimmers

The basic circuit of a simple triac lamp dimmer is in Fig. 14-a. Diode D1, a diac, acts as a high impedance until 35 volts is applied across it. At this point it switches sharply to a low-impedance ON state. When it is ON, it passes enough current (if the voltage is applied via a series resistor) so the voltage across it falls to about 30 volts (a 5-volt pulse is developed across the diac as it switches from the OFF to the ON state). The diac is a bidirectional device and gives symmetrical voltage triggering.

The R1-C1 series combination acts to give a voltage across C1 that can be varied in magnitude and shifted in phase (relative to Q1's MT2) by about 90° via R1. When the C1 potential reaches 35 volts the diac fires and partially discharges C1 to produce a 5-volt trigger pulse that turns the triac ON. As the triac goes ON, it self-latches for the rest of the half-cycle and removes the drive to the triggering network. At the end of the half-cycle, the triac turns OFF. It is triggered again in a similar manner on the following half-cycle, since both the diac and the triac are bidirectional devices.

When R1 is small, the voltage on C1 is nearly the same as that on MT2, and C1's phase shift is very small. Therefore, the triac fires early in each half-cycle.

When R1 is large, the peak voltage on C1 just reaches the 35 volts needed to trigger D1, and C1's phase shift is close to 90°. Since the peak of a half-wave occurs 90° after the start of the half-cycle, the net effect of the low voltage and near-90° phase shift on C1 is to delay the firing of the triac by about

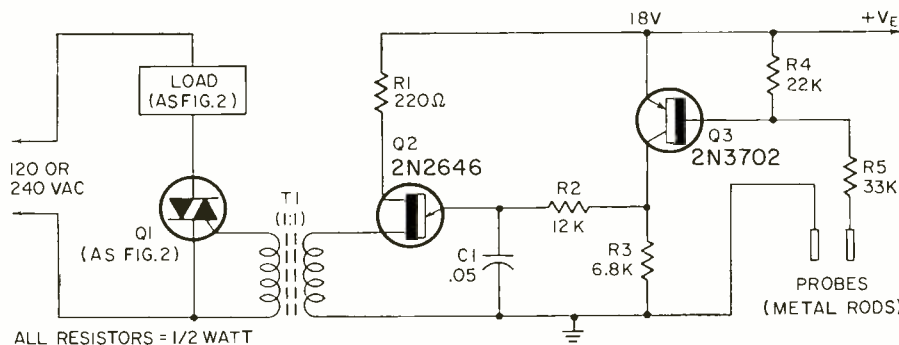

Fig. 12—Water-activated line switch. Resistance across probes trips Q3, which turns Q2 on, gating Q1 on through T1.

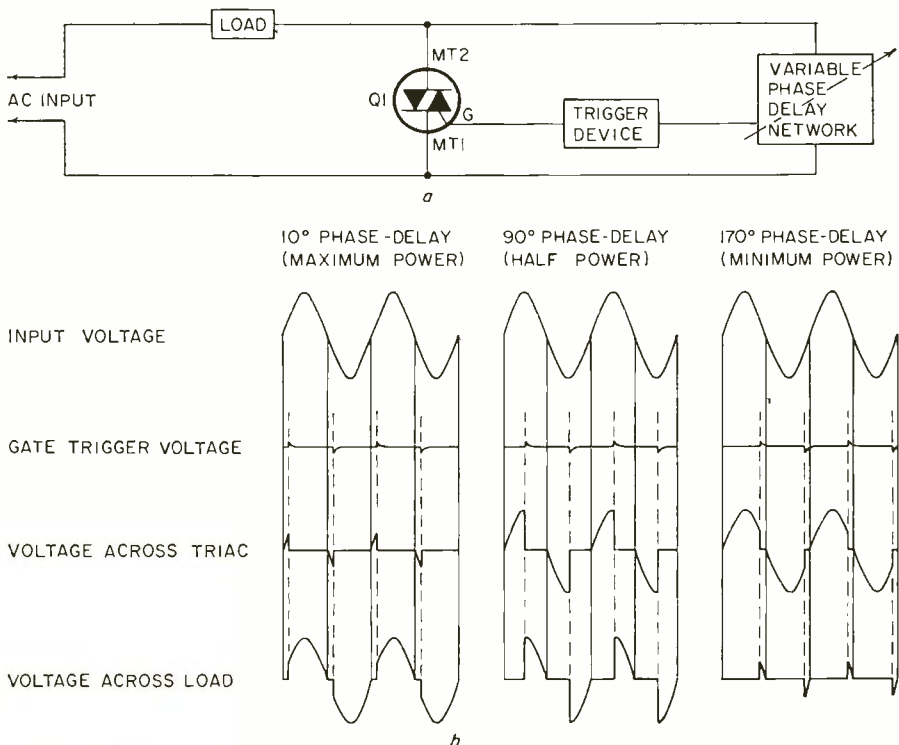

Fig. 13-a—Basic circuit for phase-triggered variable-power control. b—Waveforms in circuit for various phase delays.

170°. Now, the triac does not turn ON until near the end of each half-cycle. Thus, the R1-C1-D1 network permits delaying the firing of the triac between roughly 10° and 170° via R1, and the circuit acts as an efficient power controller in numerous applications.

In practice, this simple circuit must be modified slightly before it can be used. Since the triac switches from OFF to ON very sharply, and switches fairly high currents, the switching waveform of the circuit is very rich in harmonics. If these harmonics are fed into the supply line, they can cause interference on AM radios. The first modification that the circuit needs is an rf filter to keep higher harmonics out of the supply line.

Next, we must find a way to insure that, when R1 is set near its minimum value, the charge currents flowing to C1 via R1 are not so large that they damage R1. This protection can be a limiting resistor in series with R1.

Finally, to give a really satisfactory performance, the maximum effective value of R1 should be adjusted so lamp power only just falls to zero as R1 reaches its maximum value. This can be done by shunting R1 with a trimmer resistor (see Fig. 14-b for a practical circuit incorporating these modifications).

Here, R3 is the shunt trimmer resistor, R2 is the charge-current limiting resistor, and L1-C2 form the rf filter. L1 must have a current rating greater than that of the lamp load.

The circuit of Fig. 14-b makes a very useful lamp dimmer, but has two slightly annoying features. The first is that brightness control R1 has considerable hysteresis or backlash at its minimum setting (if the lamp finally goes fully OFF when R1 is increased to 250,000 ohms, it will not start to go ON again until R1 is reduced to about 200,000 ohms).

The second annoying feature is that, when R1 is reduced from the 250,000-ohm OFF position to the 200,000-ohm position, at which power is first fed to the lamp, the lamp burns initially at a fairly high brightness level. Both of these effects can be explained.

On each half-cycle C1 charges and discharges at a rate controlled by R1. The larger R1's value, the more slowly C1 charges and discharges. Now, let's suppose that the triac is fully OFF and R1's value is reduced to 201,000 ohms, where C1's voltage is not quite reaching the 35 volts needed to fire the circuit. Thus, C1 is discharging by nearly 35 volts and charging by nearly 35 volts on each half-cycle, giving a total voltage change of nearly 70 volts per half-cycle. Now if R1 is reduced to 200,000 ohms, C1's potential does reach 35 volts, and the diac fires the triac about 10° before the end of this first operative half-cycle. Therefore, very little power is applied to the lamp load. As the diac fires, however, it reduces the charge on C1 by 5 volts, to only 30 volts.

Consequently, on the following half-cycle C1 only has to discharge 30 volts and charge 35 volts to trigger the triac, giving a total voltage change of only 65 volts in this half-cycle. Since R1

is set at the same value as on the first operative half-cycle C1's charge reaches 35 volts earlier on the second half cycle than it did on the first. This time the triac fires appreciably earlier (about 30° before the end of the half-cycle) on this second half-cycle, and a substantial amount of power is applied to the lamp.

On all subsequent half-cycles C1 operates under the same conditions as on the second half-cycle (if R1's value is not altered), and the lamp continues to burn at appreciable power.

Once the circuit is operating and C1 is going through a 65-volt change on each half-cycle, R1 can be increased to about 249,000 ohms before the lamp finally turns fully OFF. Thus, very large phase-delay angles can be obtained, and the lamp can be operated at very low power levels. The backlash of R1 and the high initial brightness levels of the lamp are caused by the relatively large instantaneous voltage changes that occur on C1 as the diac and triac fire.

The practical circuit of an im-

proved lamp dimmer is in Fig. 15. It gives greatly reduced R1 backlash and permits relatively low initial turn-on powers. This improved performance is obtained by adding limiting resistor R4 in series with the diac, to reduce the magnitude of C1's discharge pulse, thus reducing the instantaneous voltage change on C1.

Even better performance can be obtained from the double-time-constant lamp-dimmer circuit shown in Fig. 16. This circuit works in roughly the same way as that of Fig. 14-b. But here the charge of time-constant capacitor C1 is

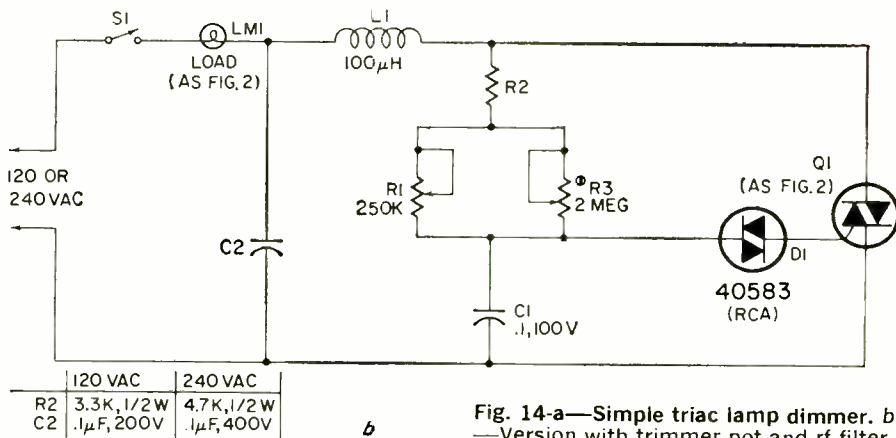
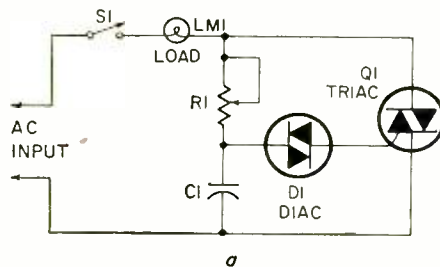

Fig. 14-a—Simple triac lamp dimmer. b—Version with trimmer pot and rf filter.

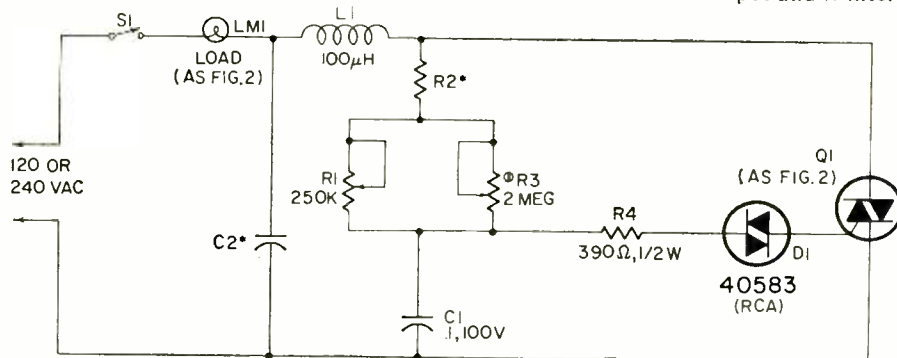

Fig. 15—Addition of R4 to the circuit in Fig. 14 reduces backlash effect of C1.

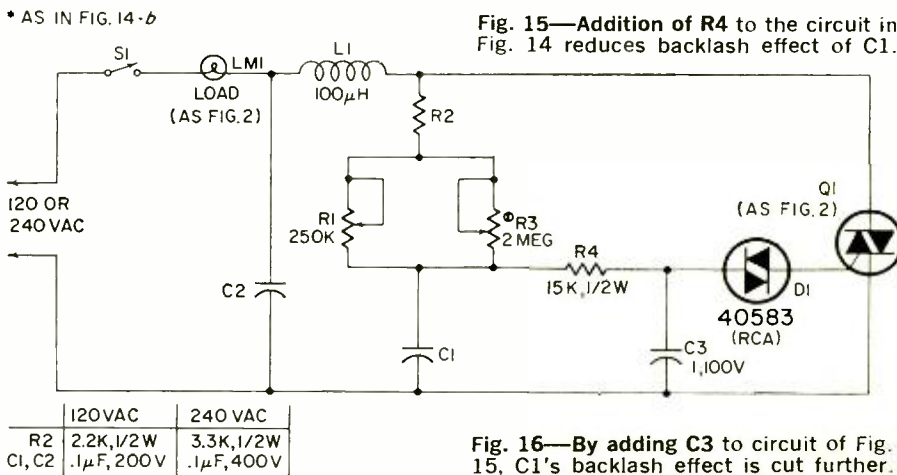
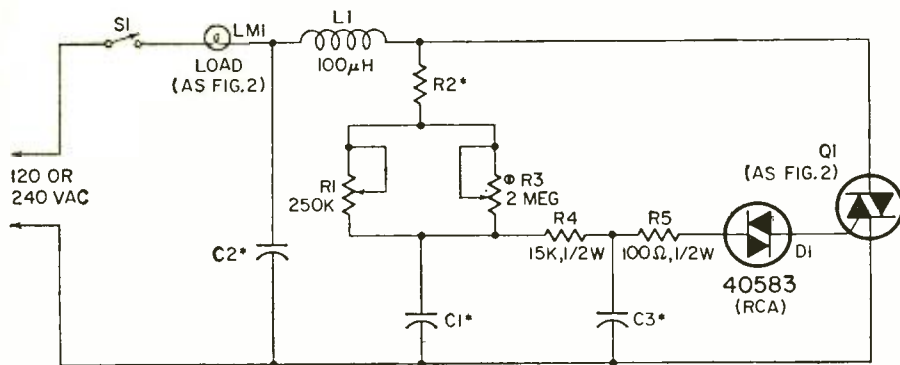
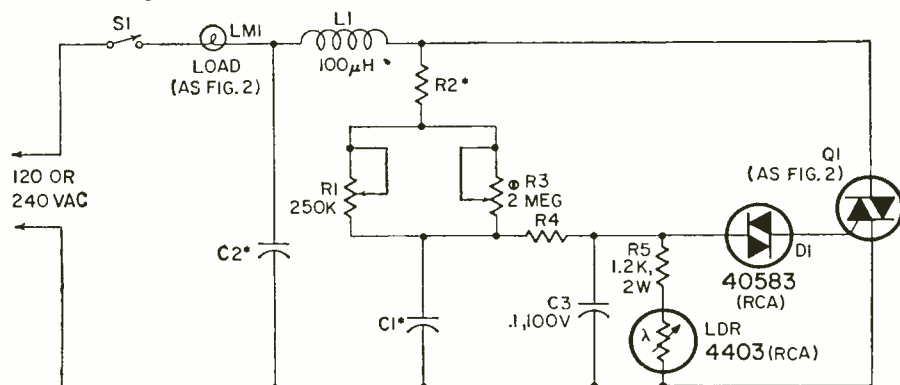

Fig. 16—By adding C3 to circuit of Fig. 15, C1's backlash effect is cut further.



* AS IN FIG. 16

Fig. 17—Backlash effect is minimized by adding R5 to the circuit in Fig. 16.



120VAC	240VAC
R4 15K, 2 WATT	8.2K, 2 WATT

* AS IN FIG. 16

Fig. 18—Automatic turn-on circuit added to double-time-constant lamp dimmer. Light decreases LDR resistance.

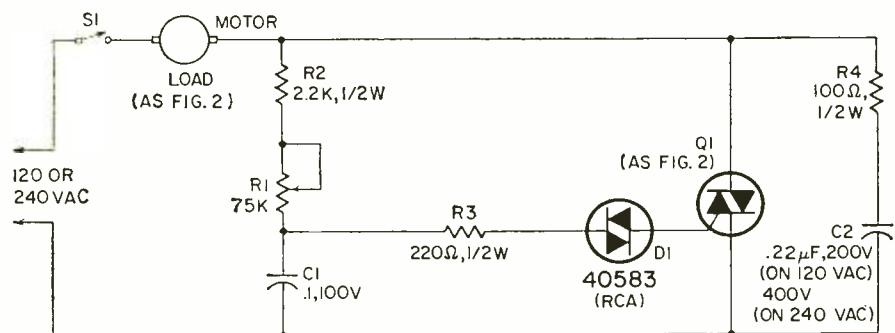
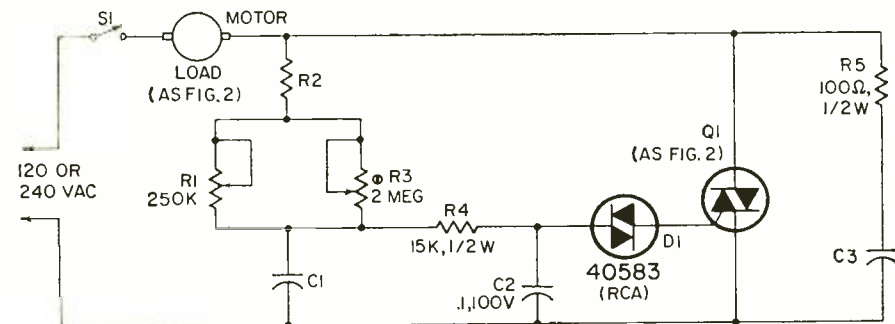

Fig. 19—Circuit for induction-motor speed controller. This setup varies speed from maximum to one-third of maximum.



120VAC	240VAC
R2 2.2K, 1/2W	3.3K, 1/2W
C1 .1µF, 200V	.1µF, 400V
C3 .22µF, 200V	.22µF, 400V

Fig. 20—Universal motor speed can be varied from zero to maximum by triac.

fed to slave capacitor C3 via the relatively high resistance of R4.

Consequently, C1 is at a slightly higher voltage than C3. When C3's voltage reaches 35 volts, the diac and triac

fire, and the diac reduces C3's potential to 30 volts. The voltage on C1 stays above 30 volts due to the isolation of resistor R4.

After the circuit has fired, there-

fore, C1 partially restores C3's charge via R4, and little net change takes place in the effective charge on C3 due to the firing of the diac. The circuit gives low hysteresis and a low initial turn-on lamp power.

Fig. 17 shows how the circuit can be improved to give virtually zero backlash on R1. Here the discharge current of C3 is limited by R5, so that when the diac fires, C3's voltage is reduced by considerably less than 5 volts. After triggering, C3 is more completely recharged via C1 and R4 and backlash is thus reduced to negligible proportions.

A minor snag with the circuits of Figs. 16 and 17 is that when R1 is increased to near its maximum value, the lamp may sometimes flash brightly for a few cycles just before final turnoff.

This happens because two time-constant networks are used and the total phase shift of C3's voltage may exceed 90°, making a total effective phase delay of more than 180° available. As a result, when R1 is set near its maximum value the triac may fire *after* the end of the correct half-cycle (at the start of the following half-cycle).

A simple way to overcome this snag is to gang S1 and R1 and adjust R3 so the lamp does not quite turn fully off when R1 is set to its maximum value. Thus, slight extra rotation of R1's spindle causes S1 to open, and we can switch off without a pre-turnoff flash.

Finally, Fig. 18 shows how the double-time-constant lamp dimmer can be modified to give automatic turn-on when ambient light levels drop. Under bright conditions the LDR acts as a very low resistance, and its resulting potential divider action with R4 prevents C3's voltage from reaching the firing potential of the diac, so the triac is fully OFF. Under dark conditions, the LDR acts as a very high resistance and does not appreciably limit C3's voltage. The triac therefore fires normally, and the lamp operates with a brightness dictated by the setting of R1.

Triac motor-speed controllers

Phase-triggered triac circuits can be used as effective speed controls for universal (ac/dc) electric motors. Such motors are used in electric drills, saws, etc. Phase-triggered triac circuits also give rather limited speed control of fixed-load shaded-pole and split-phase induction motors, like those in electric fans and some food mixers, etc.

Motors are basically inductive loads, however, and since triacs turn OFF when their main currents reduce to zero, there is a phase difference between the line voltage and the triac's currents that causes the triac to turn OFF sharply when the line voltage is at a value other than zero. When the triac turns OFF in each half-cycle, therefore, a substantial instantaneous value of line voltage is applied directly across its main terminals. If the rate of rise of this "commutating" voltage is above a certain value it can cause the triac to trigger back ON, and thus upset the phase-triggering operation of the circuit. When these circuits are used to control

motor loads, therefore, they must be modified to give a controlled rate of rise of turnoff voltage across the triac. This control can be obtained by wiring a simple "snubber" R-C network between the triac's main terminals.

Since the motor acts as an inductance in series with the supply line, it prevents the higher harmonics of the triac's switching waveform from being fed into the supply line, where they might cause interference on AM radios. The usual rf filter can be eliminated in such circuits.

Motor speed controller

The circuit of a practical induction-motor speed controller is in Fig. 19. The snubber network is formed by R4-C2. The circuit allows motor speed to be varied from maximum down to about one-third of maximum. An induction motor usually stalls if its speed is suddenly reduced below a "dropout" value determined by its loading condition and the phase setting of the triac circuit.

The speed of universal (ac/dc) motors, on the other hand, can be controlled all the way from near-zero to maximum using phase-controlled triacs. Fig. 20 shows the practical circuit of a useful drill-speed controller using a double-time-constant network. Any of the phase-delay networks shown earlier can, in fact, be used here. Again, R5 and C3 are used as a snubber network.

Quadrac control circuits

A quadrac can be described, in technical language, as a "gated bidirectional silicon thyristor with an integral trigger." It can also be described, in less technical language, as a triac with a built-in diac trigger diode. Thus, a single quadrac can replace both the diac and triac in each of the phase-triggered circuits described so far.

The conventional symbol used to represent a quadrac is in Fig. 21. Fig. 22 shows the bottom view and lead connections of these particular quadracs. A quadrac can be used in a simple lamp-dimmer circuit as in Fig. 23. It can be used in a double-time-constant lamp-dimmer circuit as in Fig. 24. Finally, Fig. 25 shows how it can be used as a drill-speed controller.

Maximum quadrac loads

These three circuits use either a 40511 (120 Vac) or 40512 (240 Vac) quadrac. These particular quadracs are supplied with a factory-attached heat radiator, and can handle rms currents up to 2.2 amps at ambient temperatures of 25°C. This means maximum load powers of 264 watts and 528 watts, respectively. They can, however, handle rms currents up to 6 amps if the case temperatures are kept to less than 75°C with the help of additional heat sinking, thus allowing maximum load powers of 720 watts and 1440 watts, respectively. Both quadracs can handle peak surge currents up to 100 amps for one duty cycle.

R-E

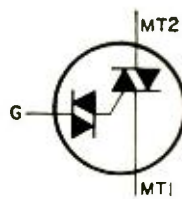

Fig. 21(above)—Symbol for the quadrac.

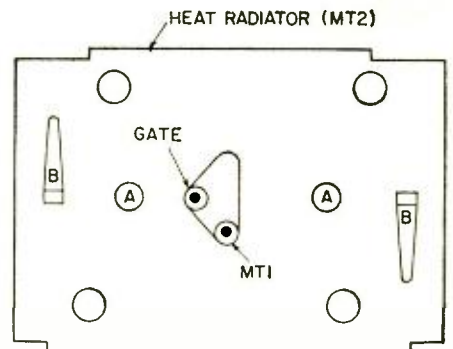
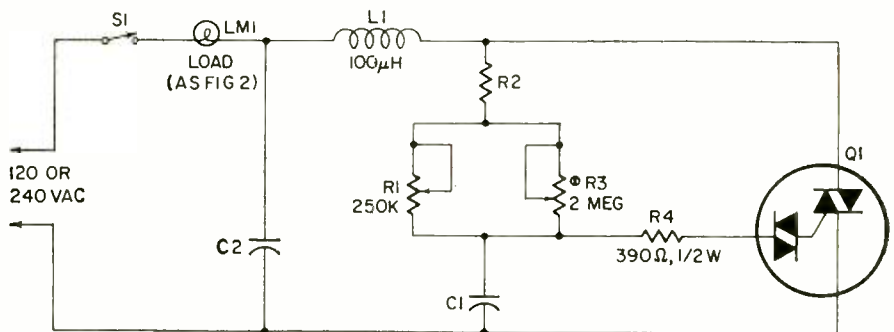

Fig. 22—Bottom view of lead connections on the integral heat sink for 40511's (RCA).

A = CHASSIS MOUNTING HOLES
B = PC BOARD MOUNTING TABS



	120 VAC	240 VAC
R2	3.3K, 1/2 W	4.7K, 1/2 W
C2	.1µF, 200V	.1µF, 400V
Q1	40511 (RCA)	40512 (RCA)

Fig. 21—Quadrac is triac with built-in diac trigger diode. Lamp-dimmer circuit here can handle 264 watts at 120 volts ac.

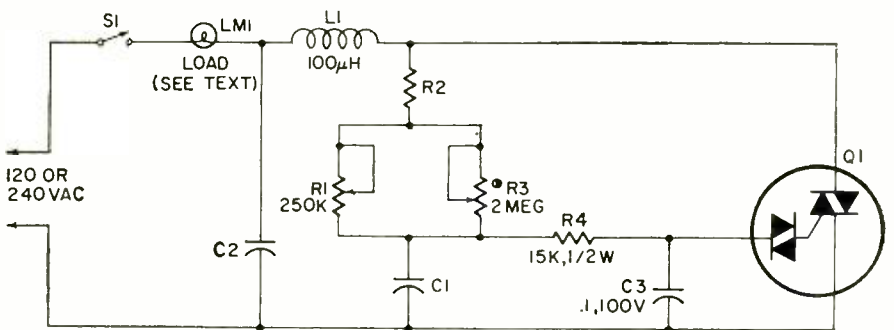

	120 VAC	240 VAC
R2	2.2K, 1/2 W	3.3K, 1/2 W
C1, C2	.1µF, 200V	.1µF, 400V
Q1	40511 (RCA)	40512 (RCA)

Fig. 22—Variation of circuit above uses double-time-constant effect to eliminate backlash. L1 helps to suppress rf noise.

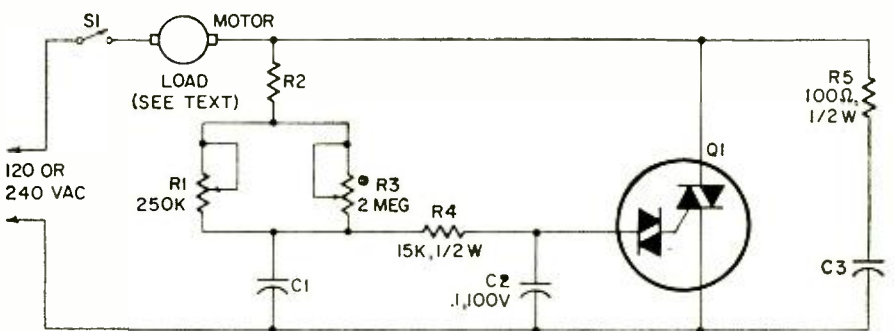

	120 VAC	240 VAC
R2	2.2K, 1/2 W	3.3K, 1/2 W
C1	.1µF, 200V	.1µF, 400V
C3	.22µF, 200V	.22µF, 400V
Q1	40511 (RCA)	40512 (RCA)

Fig. 23—Quadrac application in a drill-speed controller circuit. The quadracs listed have heat radiators attached.

Second in a series...

Can you solve these problems in electronics?

They're a cinch after you've taken RCA Institutes' new communications electronics program.

It includes new preparation for the FCC license plus the assurance of your money back if you fail to get it.

This one is quite elementary.

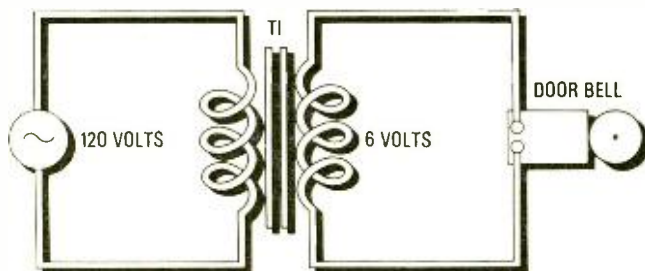

In this door bell circuit, which kind of transformer is T₁, —step-up or step-down?

Note: if you had completed only the first lesson of any of the RCA Institutes Home Study programs, you'd easily solve this problem.

This one is more advanced.

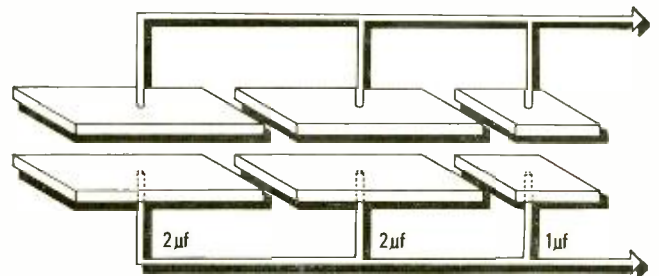

What is the total capacitance in the above circuit?

Note: you'd know the solution to the problem if you'd taken only the first two lessons in RCA's new Communications Electronics Program.

These are the lessons that prepare you step-by-step for an FCC License.

This license is a requirement for servicing all types of transmitting equipment and can help open doors to jobs commanding high income in communications, radio and broadcasting, aerospace, industrial automation and many others.

For a rewarding career with good pay, take that first step now. Send for complete information—mail the attached card.

Answers: Step-down.
5 μf

RCA Institutes Autotext learning method makes problem-solving easier... gets you started faster towards a good-paying career in electronics

Are you just a beginner with an interest in electronics? Or, are you already making a living in electronics, and want to brush-up or expand your knowledge? In either case, RCA has the training you need. And Autotext, RCA Institutes' own method of Home Training will help you learn more quickly and with less effort.

Wide Range of Courses

Select from a wide range of courses. Pick the one that suits you best and check it off on the attached card. Courses are available for beginners and advanced technicians.

Electronics Fundamentals
Black & White Television Servicing
(Transistorized TV Kit Available)
Color Television Servicing (Color TV Kit Available)
FCC License Preparation
Automatic Controls
Automation Electronics
Industrial Electronics
Nuclear Instrumentation
Electronics Drafting
Computer Programming



Build and keep this valuable oscilloscope.

Plus these new up-to-the-minute courses

Semiconductor Electronics
Digital Electronics
Solid State Electronics
Communications Electronics

Prepare for good paying positions in fields like these

Television Servicing
Telecommunications
Mobile Communications
CATV
Broadcasting
Marine Communications
Nuclear Instrumentation
Industrial Electronics
Automation
Computer Programming
Solid State
Electronics Drafting

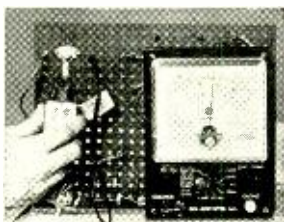

In the new program on Solid State Electronics you will study the effects of temperature and leakage characteristics of transistors.

RCA

Variety of Kits—Yours to Keep

A variety of RCA Institutes engineered kits are included in your program of study. Each kit is yours to keep when you've completed the course. Among the kits you construct and keep is a working signal generator, a multimeter, a fully transistorized breadboard superheterodyne AM receiver, and the all-important oscilloscope. These 4 kits are at no extra cost. Compare this selection with other home study schools.

Two Convenient Payment Plans

Pay for lessons as you order them. No contract obligating you to continue the course. Or, you can take advantage of RCA's convenient monthly payment plan. No interest charges!

Classroom Training Also Available

RCA Institutes operates one of the largest technical schools of its kind. Day and evening classes. No previous training is required. Preparatory courses are available. Classes start four times a year.

Job Placement Service, Too!

Companies like Bell Telephone Labs, GE, Honeywell, IBM, RCA, Westinghouse, Xerox, and major radio and TV networks have regularly employed graduates through RCA Institutes' own placement service.

All RCA Institutes courses and programs are approved for veterans under the new G.I. Bill.

Send Attached Postage Paid Card Today. Check Home Study or Classroom Training.

Accredited Member National Home Study Council.

IF REPLY CARD IS DETACHED, SEND THIS COUPON

RCA Institutes Inc.

Home Study Dept. 758-007-0
320 West 31 Street
New York, N.Y. 10001

Please send me FREE illustrated career catalog.

Name _____ Age _____
(please print)

Address _____

City _____ State _____ Zip _____

R_x for color TV overheating problems in . . . the case of the

Checker simplifies adjustment of horizontal output circuit.

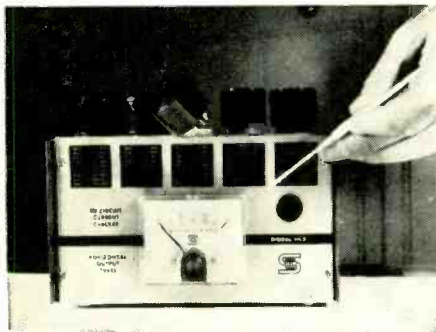

by ART MARGOLIS

FOR BLACK-AND-WHITE TELEVISION, a valid high-voltage repair test is to feel the flyback transformer. (After you turn the set off.)

If the flyback is hot, it's bad! No ifs ands or buts. It has shorted turns and needs replacement, which usually cures the trouble.

But this rule seldom holds true for color TV. Usually when a color flyback is overheating, it's because something is causing it to run hot. If the flyback continually runs hot it will go bad. However, replacing it won't help unless you get to the root of the trouble.

Pinpointing the reason for the hot flyback is based around performing a simple adjustment. Let's go through some case histories and I'll show you what I mean.

The repeated-burnout syndrome

We give a 90-day guarantee on receiving tubes sold over the counter. A year ago a doctor brought in a 6JE6 color horizontal tube that he had purchased about 6 months earlier. He wanted to exchange it for a new one. I pointed to our sign: "90 days. . . ."

"I normally wouldn't try to pull this," he said, "but it's the fourth one you sold me, and it's an expensive tube."

"In how long a time?" I asked.

He pulled out a sheaf of our receipts and removed four of them. They dated back over 2 years, all for 6JE6's, and each one had lasted about 6 months.

I said, "It's unlikely we've sold you four tubes with the same 6 months' life. There must be something about your color TV that's shortening the tube's life."

"That makes sense," he said, "why don't you come out for a service job?"

I followed him home and hooked a milliammeter into the cathode leg of the horizontal-output circuit. Then I turned on his RCA TV with a new tube installed and let it heat up about 5 minutes.

"Horizontal output tubes are especially critical in color TV," I explained. "They have certain characteristics and must operate within certain parameters. If they deviate, the tube either burns up or has its life shortened. The flyback transformer works with the output tube, and when the tube runs incorrectly the flyback runs too hot.

"It's essential that the output tube operate correctly. To check it, just see how much current is passing through the cathode. Each output tube has its own rating. A 6JE6 should pass 220 mA."

This set was running its output tube at about 140 mA. I turned off the set and felt the flyback. It was running with a hot core. The incorrect setting was shortening the output tube's life and the flyback was also in jeopardy.

To adjust the cathode current, an EFFICIENCY COIL (sometimes the HORIZONTAL LINEARITY COIL) is provided (Fig. 1).

I adjusted it, and the meter needle gradually rose to 220 mA. I buttoned up the TV. "I'll have to charge you for the service call and the tube. Your set was shortening its life," I said.

"Well, at least you're not charging me for prevention of flyback fail-

ure," he said, lighting his pipe.

A customer huffed and puffed a 23-inch Emerson color table model into the shop. "Boy, you advertise bring-in service, but this one is heavy," he said.

"You could have called us and I would have sent out a serviceman," I said.

"Then he'd add on a service charge."

I figured I better change the subject. "What's the problem," I asked as I removed the back.

"If I knew what was wrong I wouldn't have needed you, would I?"

I plugged in a cheater cord and turned on the TV. As I watched, the horizontal output tube came on, its plate structure turned cherry red. I pulled the plug and felt the core of the flyback. It was so hot I couldn't keep my fingertip on it. "Looks like you have a bad flyback and possibly some other trouble," I said.

"Well, fix it," he said. I wrote up a shop repair tag and he left.

On the bench I noticed the flyback started to smoke when I turned on the set. Any kind of sparking or smoking in a flyback indicates a replacement is needed, even though, like this one did, it looks new.

I called my supplier and ordered a new one. It was an exact replacement except for the letter B on the end of the part number instead of the original A.

A sheet of instructions explained that the B meant the output-tube screen resistor needed a new value, and the age takeoff required a new wiring hookup. That was all the sheet instructed.

I installed the new flyback with the changes and a new output tube. The picture came on beautifully. I let it play a few minutes and turned it off. Then I gave the flyback the "feel" test. The core was hot.

Even though the picture was perfect I knew the flyback couldn't run that hot for any length of time.

I re-examined the installation and

HOT FLYBACK

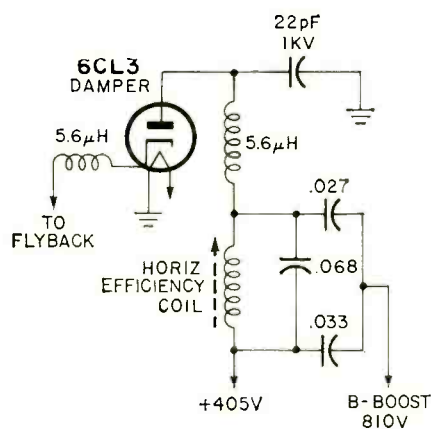

Fig. 1—Typical location of the horizontal efficiency coil. To obtain the correct horizontal output cathode current flow, adjust the efficiency coil.

it checked perfectly with the instruction sheet. Now what?

I connected a milliammeter into the cathode circuit of the output tube and turned on the TV. Voilà! The cathode current was running at about 260 mA instead of the 200 it was designed to operate at. I adjusted the EFFICIENCY COIL and gradually the current worked its way down to 200.

I conducted the feel test again. Success. The flyback was running cool.

When the customer came in, he said, "I see you fixed it." He tried to lift the table model, but his face got red and he put it back down. "How much to deliver this thing?" he asked.

"Just the regular service charge," I smiled.

He peeled off the cash and laid it alongside the check for the repair. "Deliver it, will you? But if my wife asks, the delivery is free, O.K.?"

The stubborn flyback

A large, practically new 21-inch Philco Color Home Theater was resting atop my bench when I returned from a few house calls.

"What's it there for?" I asked

the men, who were "busy" elsewhere.

"It's your turn on that dog," they replied.

I turned it on, and a picture crackled into view. However, the width was not quite wide enough and a thin white vertical line crunched the picture in slightly at the center.

I turned it off after about 5 minutes and felt the flyback. It was running too hot for comfort.

I looked over the shop repair tag. The set was originally brought in for extreme loss of width. The picture had shrunk about 4 inches on each side. The flyback had been found smoking and was replaced. The picture came on bright, spread out almost enough, but with the white line down the center. Also the flyback was running too hot.

I smiled at the men and attached a milliammeter into the cathode of the output tube. My smile faded, for the cathode current was exactly 210 mA, as called for.

That cleared the output-tube legs. The trouble was in the flyback circuit area. First thing I always do when a new trouble appears that wasn't there before is to examine our own work. Chances are good that during a complex replacement a mistake can be made and a new trouble induced.

I checked the old flyback with the new. The part numbers were identical. There was no instruction sheet contained in the box. I checked the wiring. We always make a wiring diagram during such a replacement. The wires matched, wire for wire. There was no error.

I reviewed the symptom. There seemed to be a mismatch. I adjusted the efficiency coil. The picture spread out and the line disappeared. But now the cathode current read 290 mA. The output tube and flyback would burn out in no time. I turned the coil back to 210 mA.

Next I pulled the factory notes on the set. I figured a good way to start was to check all the flyback

connections according to the schematic provided.

Then I saw it. The damper and yoke connections to the flyback were reversed (Fig. 2). This was the way the job had come into the shop. I reversed them as the schematic showed and turned on the set.

The picture came on. The cathode current dropped to about 160 mA. I looked at the picture. It was still scrunched up. "What the —?" I muttered.

A hand reached over my shoulder and began adjusting the efficiency coil. It was the bench man who'd worked on the set before and had been observing me closely out of the corner of his eye. As the meter hit 210 the picture came in perfectly. I gave the flyback the feel test. It was cool.

He fashioned a piece of solder into a star, attached it to my shop coat and saluted.

Mystery of the touchy sync

A 21-inch department-store-brand color TV was brought in by one of the roadmen. The shop repair tag read, "FLYBACK."

I turned on the TV. There was no high voltage. I tested the flyback. It was bad. The secondary winding had opened.

I obtained the replacement and installed it. The high voltage crackled back on and brightness appeared on the screen. I attached an antenna. Instead of a picture the screen was full of horizontal lines.

I adjusted the horizontal hold. The picture almost came in, but was locking on one end. I tried to center set it but couldn't. Then the picture would tear off into lines.

Meantime I checked my flyback installation. Uh, oh, the flyback was running hot. I figured I'd better straighten that out before attacking the secondary horizontal sync condition in the set.

An ammeter in the output cathode circuit read close to 300 mA. I tried

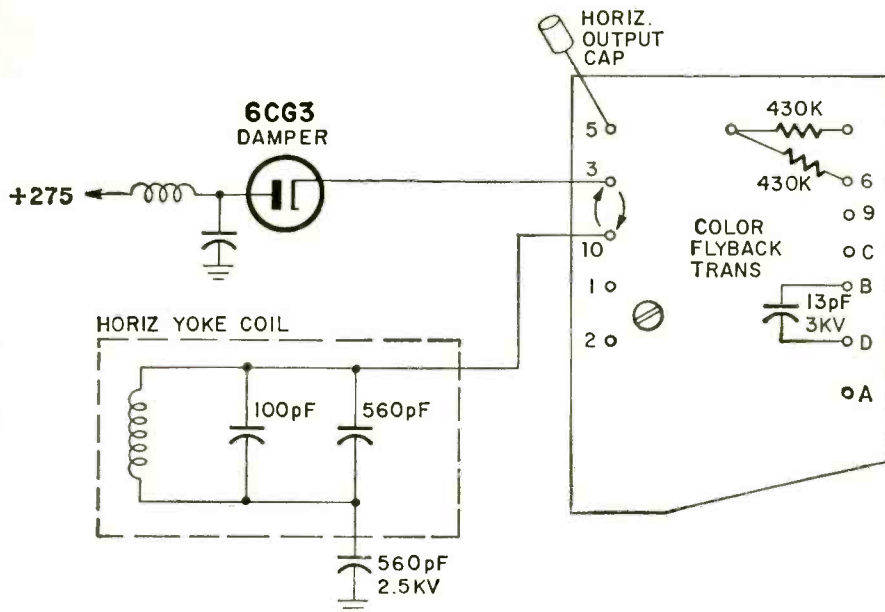

adjusting the efficiency coil, but it had little effect on the current drain. I shut off the TV.

I had two choices: try getting the output current back to normal or try clearing the horizontal sync condition. I decided to take the easy choice first: Clear the horizontal sync condition and see what happens.

However, I couldn't run the TV with the flyback so hot without damaging the new flyback. So I removed the horizontal output tube from the set and then turned it on. This shut down the entire high-voltage system.

Since the horizontal hold control wouldn't set, I started in the circuit containing the control, the horizontal oscillator.

First stop was the plate of the oscillator. I turned on the TV and took a dc voltage reading. There was supposed to be 265 volts dc at that point, but the meter read about 40 volts.

I traced back in the plate leg to see if any series component could be absorbing the missing voltage. I crossed over the horizontal-frequency coil and the voltage remained at 40. Then I crossed over the plate feed resistor. The voltage leaped to about

Fig. 2—Hot flyback in Philco Home Theater was caused by a reversal of damper and yoke connections (pins 10 and 3).

Fig. 3—Off-frequency horizontal oscillator (faulty resistor) caused a hot flyback. Horizontal hold did not work.

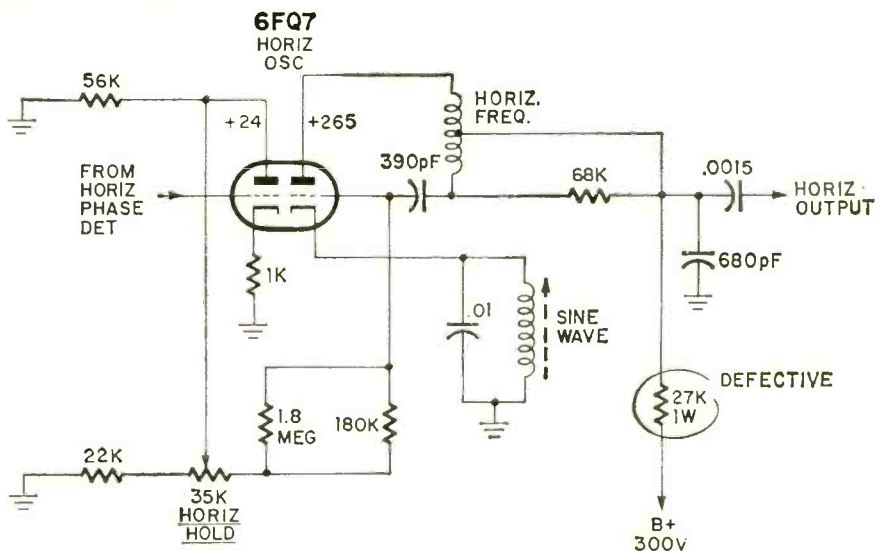

300 volts. Ah ha!

I turned off the TV and measured the resistor. Instead of 27,000 ohms, it read close to 1 megohm

(Fig. 3). I changed it, and the plate read 265 volts.

I reinstalled the horizontal output tube and heard the high voltage bristle around the picture-tube shell. I looked at the ammeter in the output cathode. It was no longer reading 300 mA, but was down to 240.

I adjusted the efficiency coil and the needle crept down to a safe 200 mA.

The picture was a screenful of lines. I adjusted the horizontal hold control and the picture snapped in at the center of the range.

Then I turned off the TV and gave the flyback the feel test. Excellent, it was now cool. The repair was complete.

The increased-value resistor had changed the frequency of the horizontal oscillator. This gave reduced feed to the horizontal output. This lowered the output tube's input and caused the tube to draw too much current, which in turn made the flyback run hot.

At any rate, hot flybacks cannot exist in a color TV. Whenever you

run across a hot flyback, whether the picture is good or bad, you have to cool it before putting the set back into operation. R-E

KNOW YOUR METER

This month Section II of your Radio-Electronics Reference Manual gets under way. We start off with an excellent article on how to get the most from your meter. Future material for this section will include a complete manual on TV antenna installation, as well as other similar material.

If you wish you can purchase a special hardcover binder to keep your Reference Manual pages together. It has a dark blue fabric cover and is gold stamped Radio-Electronics Reference Manual. The cost is \$1.00, postpaid. Order from N. Estrada, 17 Slate Lane, Central Islip, L.I., N. Y. 11722.

KNOW YOUR METER

by LEWIS A. HARLOW

Are you a little rusty on the operating and calibration instructions in your owner's manual? This addition to the R-E Reference Manual offers practical guidelines for good meter use. Learn how to check mechanical and electronic calibration, friction . . . correct for higher frequencies, and take low ohm readings properly

You own and use a meter, maybe several. Most meters come with an instruction manual which you have read and which you follow. This article covers aspects of meter operation which the manual may not have included. It also covers the why and the importance of some of the manual's rules and regulations.

What type of meter, for instance? In great detail, this is about the vom, the vtvm and the solid-state vom. Much of the information also applies to any other type of meter that you may own.

Balance test and zero set

Consider first the mechanical rather than electronic aspects of the instrument. With the meter face-up on a level table, rotate it clockwise until the pointer aims directly away from you. Adjust the mechanical zero set if necessary (not to be confused with the electronic zero set on a vtvm. Now lift the instrument to a vertical position and hold it with the pointer aiming straight up—the zero setting should remain accurate.

With the meter still held vertically, rotate it counterclockwise until the pointer aims horizontally to your left. Is the mechanical zero setting still accurate?

If the zero setting varies in any of these positions, the meter movement is out of balance, and the damage probably includes a pointer bent by a heavy overload or a reverse kick from misapplied positive or negative dc voltage. The cure for this is professional repair, which can be expensive, but you can live with it as is. Decide whether you want horizontal or vertical service, adjust the zero set in that position, and then stay with it.

R-E Reference Manual

II-1

pivot-and-jewel bearings—or dirt in the same area. To test for friction give the glass over the meter face a light tap after the pointer has come up presumably to the indication to be read. If the tap causes the pointer to move slightly, there is friction.

It may seem that the damped meter should be more likely to develop friction. This is not true. Damping is magnetic rather than mechanical restraint. A seemingly free-swinging undamped meter can be suffering from friction and will respond to the same corrective tap.

Again, the real cure is an expensive professional job, and again you can live with a meter that has a mild friction symptom. Just remember to tap every time you prepare to make a precision reading.

Calibrating your meter

It is not assumed that you will have access to super-accurate laboratory meters or power supplies. Calibrate according to the instructions in your meter manual. If your meter is a tube type, do not skimp on the recommended warm-up time which may range anywhere from 15 minutes to 48 hours.

If you are making a dc voltage calibration, the standard usually supplied is a fresh carbon-zinc D cell. Don't belittle the accuracy of this inexpensive standard. While fresh, its no-load test is a remarkably consistent 1.56 volts, and the meter to be calibrated with it will probably have a dot just beyond the end of its 1.5-volt dc scale. Split the dot with your calibration adjustment.

The most convenient household source of voltage for ac calibration is the power line, and you are told to measure either the full line voltage or a transformer-reduced part of it. (For instance, the dial light voltage).

Most power companies (but not all) attempt to standardize on 117 volts delivered to you. Check this figure via a phone call to the service department of your power company, and while you have this expert on the line, ask him about his peak load periods when the voltage may be a little low. Better still, ask him when you should calibrate your meter. He will probably warn you away from the hours between 4:00 and 11:00 PM.

Don't be completely satisfied with his answer. After your meter is fully calibrated to the best of your ability, run a 24-hour series of tests on your power line voltages. This will show you the dips of peak load

R-E Reference Manual

II-3

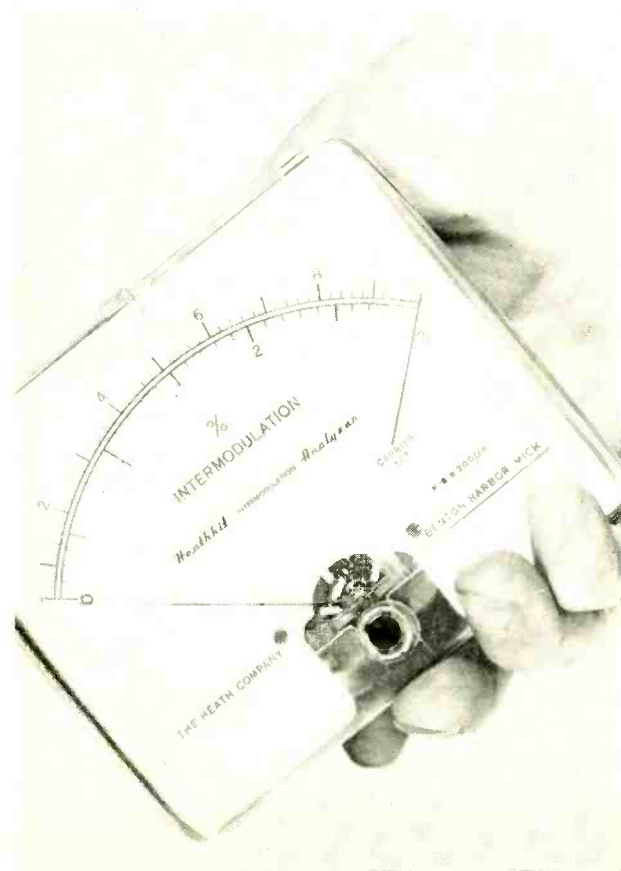

Meters deviating from zero after adjustment and rotation have balance problems.

A high-quality meter which has not lost its delicate balance adjustment through misuse can be twisted into almost any horizontal, vertical or intermediate position, and the pointer will stay accurately on zero. The manual for this high-quality meter though, may recommend that you use it horizontally "for utmost accuracy".

Damping (good) and friction (bad)

The pointer of a meter that is undamped or even underdamped will come up rapidly and oscillate a few times before settling to rest. The pointer of an accurately damped meter will come up smoothly and slowly and will not overshoot.

A well-damped meter offers this visible clue that it is a high-quality instrument that probably contains other hidden plus values like wear and corrosion resistant switches and half-percent range resistors.

Friction, in any meter, is the result of mechanical shock to the

and the leveled-off intervals between the peaks. With this information, you may want to recalibrate the ac function of the meter at a better time of day or night.

This initial calibration of dc and ac functions will not stay accurate forever. Tubes weaken, switches corrode or dust over, precision resistors can change in value, potentiometers can wear or get dirty, and soldering can react unpredictably over a period of time. The whole process of calibration should be repeated on a regular schedule. Once a year should be just about right.

Ohms calibration is not a part of preparing the meter to go into service. The ohms scale must be calibrated ahead of every resistance measurement (and don't forget to recalibrate the ohms scale every time you shift ranges).

Your meter and "accuracy"

The published specifications of your meter probably read "1% accurate on dc, 5% accurate on ac" or comparable figures for the meter you have selected. As for accuracy of resistance measurement, you are told the percentage accuracy of the range resistors. A general percentage estimate would be difficult because ohms are usually read from a logarithmic rather than a linear scale.

Consider this "1% accurate on dc". The phrase is the standard and ethical trade abbreviation for the following longer statement. "The error at any point of the scale will not exceed one percent of the full-scale reading."

Now brace yourself for rough going. "The magnitude of the error may be as great at half scale as at full scale, but it is twice as great a percentage of the actual reading. For this reason, the percentage accuracy of a reading taken on a low part of the scale may be quite poor."

(When the writer of the meter manual rereads the above paragraph, he realizes that he is getting pretty involved, so he makes a fresh start that is better all around.)

"For greatest accuracy of dc or ac measurement, choose a meter range that will result in a reading as close as possible to full scale." This is perfectly clear, it is absolutely true, and it applies to super meters, good meters and inexpensive meters.

The 3% or 5% ac accuracy specification of your meter should be

amplified to include "when reading 60-cycle sine-wave voltages." For ac voltages at the higher frequencies—say of audio measurements—the calibration does not hold quite constant. Up to 1000 Hz, you can believe what you see, but above that point you must compensate if you want maximum accuracy.

The following table comes from the manual of a high-quality meter. It will not apply directly to your meter, but a study of the table will show a typical direction and amount of error that can be applied to your meter with fair accuracy. The minus symbol means subtract divisions on the meter scale from readings observed.

Frequency	3-volt scale	12-volt scale	60-volt scale	300-volt scale
2 kHz	-1	-1	-1	-1
5 kHz	-2	-2	-2	-2
7.5 kHz	-3	-3	-3	-1.5
10 kHz	-5	-5	-3.5	-1
15 kHz	-7	-7	-5	plus 2
20 kHz	-9	-10	-7	plus 7

Ohms are best read at about half scale. On all ranges except the lowest, accuracy is dominated by the precision resistors in the meter. Two of them in series may double the error percentage, or they may cancel one another. The average result is close to the percentage accuracy in the meter specifications.

The reading of low ohms introduces a more touchy problem. As usual, the battery is in the circuit, but there is not much else in the way of resistance. Current is heavy because its path is quite free. The battery, if a single D cell, has an internal impedance of about 0.22 ohm when fresh. Under heavy load, this resistance increases rapidly. For most accurate results, measurements of unknowns with 10 ohms resistance or less should be made as a series of brief measurements. The operator should prepare in advance by studying the scale so as to be able to take off a fast and precise answer.

As the battery ages, its internal resistance increases, and under heavy load, the accuracy problem is even more critical. A battery should not be considered still useful when ohms-zero calibration can

volts, and the operator reads the answer on a dc volts scale and gets a slightly wrong answer.

3. Wrong graduation value. Any two side-by-side graduations on a dc or ac scale may be apart by a fraction of a volt, or by one volt, or two, or five, or some other multiple established by the range and the full scale marking of this range. Errors are very easy to make here.

4. Parallax error. It is not difficult to sense when you are reading a meter squarely head-on. Some meters have mirrored scales as a reminder that this should be done, but an unmirrored scale can be read just as precisely if the operator realizes that the whole responsibility is his.

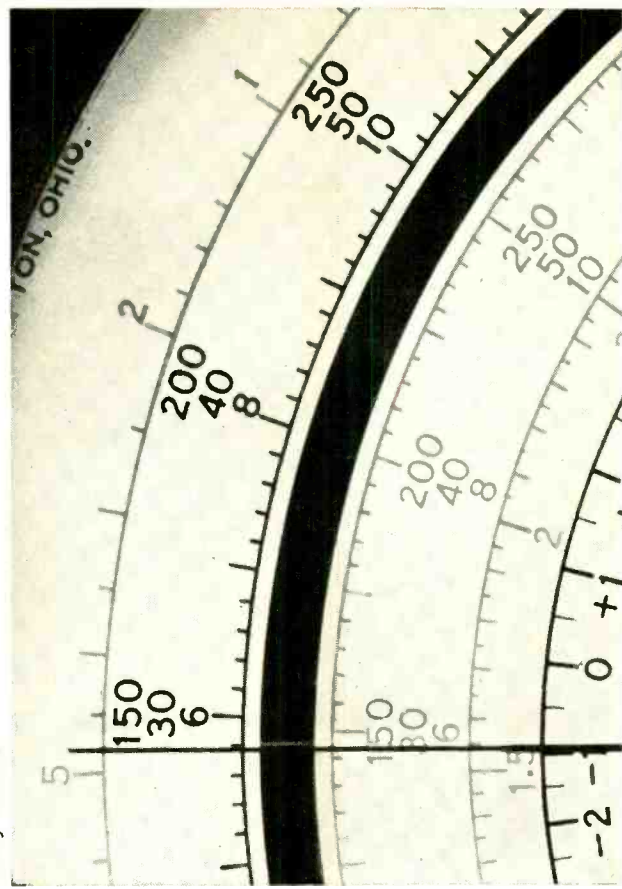

Mirror scales (black strip in photo) help you to watch out for parallax error.

5. Interpolation. It is not unreasonable to ask a sharp-eyed operator to split the space between graduations into four or five sub-units. On a 300-volt scale, for instance, the graduations are probably five volts apart. The reading can be precise to one volt, slightly more or less.

barely be reached. This battery should have been discarded some time before.

Accuracy vs. precision

The two words (accuracy and precision) are quite similar in other fields but not as they relate to meters. Here, accuracy is a quality of the instrument, and precision is a quality of the operator.

There are some things the operator can do completely wrong and others that he can do inadequately right. This does not mean that he is stupid in any way. There is a valid excuse for the errors and imprecisions that will be considered later.

Here is a list of five of these errors and imprecisions. The list is arranged from the most wrong to the most subtle.

1. **Wrong range.** The meter is switched properly and provides an accurate reading, but the operator blacks out temporarily and reads the answer in the X10 range instead of the X100 range.
2. **Wrong scale.** The meter is set correctly and indicating ac

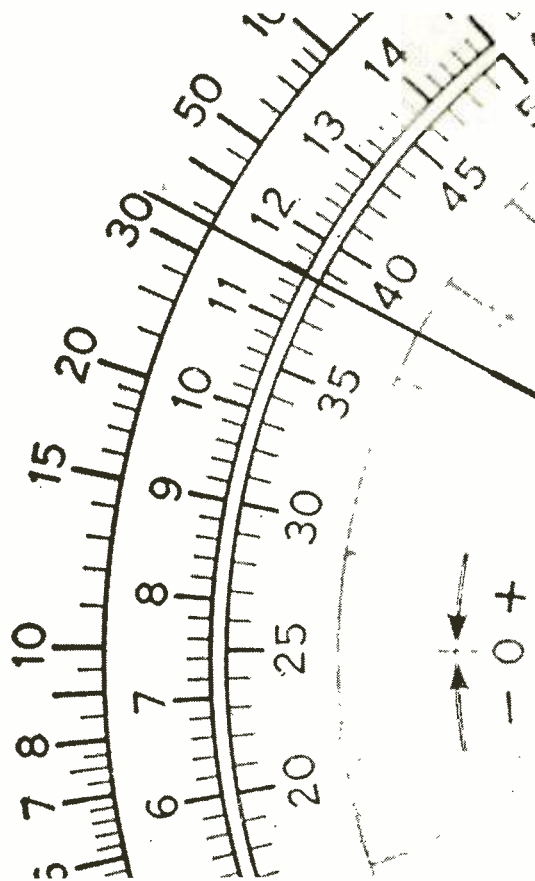

For precision with multi-scale meters, double, then triple check range settings.

R. M. S. VOLTS

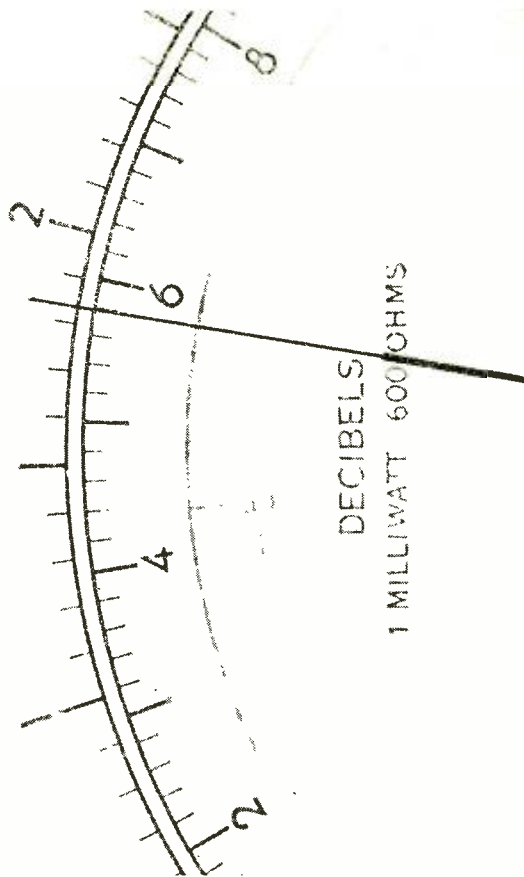

What's the reading on this meter? 5 volts? 6 volts? By careful interpolation, the space between the graduations can be split into four or five parts. Call it 5.79.

How to avoid imprecision

A multifunction meter is like a multiscale slide rule; both instruments must be used constantly if their operation is to be precise, fast and carefree. The average meter operator is working under a rather serious handicap. He is likely not to use his meter every day. As a result, when he does use it he is somewhat out of practice. This is not a situation for the amateur or semi-pro meter user to be ashamed of. It is the unavoidable result of the non-electronic life he must lead for most of his day.

On any job that involves a meter, think continuously about this human handicap, and force yourself to go slow. Check each step you take and then double check. After that, triple check. Only with this kind of respect for the complexity of your meter do you get from it what it is able and willing to give you.

In the Shop . . . With Jack

By **JACK DARR**
SERVICE EDITOR

Checking Unknown Tubes

EVERY ONE OF US HAS HAD THE MISERABLE experience of yanking the back off a TV set and finding tubes he's never seen or heard of. In many cases, your tube tester or manual hasn't either. From the tube-layout chart inside the cabinet, we can find out what a tube is used for—sound, video, horizontal output/damper, etc. If this happens to be the function that is not working, we should check the tube before we tear the chassis apart. But how?

There are ways. If there is a schematic of the set with it, you can identify the base pins of the elements. Even if there isn't, it's still possible.

Let's take the easiest first: with the schematic. Most of these will be dual or even triple types. As an example of this method, not too long ago I found a 24BF11 dual pentode for the first time. The tube is used for sound detector and audio output in a Truetone EIS1015A-69. Fortunately, the Western Auto Co. puts a nice big readable schematic in each set. The complaint was "no sound" with a good picture.

Setting the tube up on a test adapter (12-pin: Pomona TVS-12 Compactron) with lugs around the base, I checked the audio output section plate and screen voltages on pins 10 and 11; Fig. 1 shows a partial schematic. These were okay, and an audio signal went "Beep" through from the grid. That took care of the audio output half.

The detector screen voltage was 90 volts, as called for, but no plate voltage to speak of was present. I pulled tube

This column is for your service problems—TV, radio, audio or general and industrial electronics. We answer all questions individually by mail, free of charge, and the more interesting ones will be printed here.

If you're really stuck, write us. We'll do our best to help you. Don't forget to enclose a stamped, self-addressed envelope. Write: Service Editor, Radio-Electronics, 200 Park Ave. South, New York 10003.

and adapter to get at the 330K plate resistor on the PC board (behind it, of course). An ohmmeter indicated this was okay. I put tube and adapter back, then put a long, well-insulated test prod on the supply end of the 330K resistor. The voltage came up to its advertised 300 volts. At the load end of resistor, nothing.

Turned set off; waited for it to cool. Turned it on again with voltmeter on load end; voltage came up, but never reached normal value. Turned set off; waited 30 seconds. Read resistance from pin 7 plate to B—. Hmm; about 400 ohms. Pulled tube. 400-ohm resistance disappeared.

Diagnosis complete; 24BF11 tube shorted in sound detector section. Replacement, after we found one of the things, confirmed this. There is one more trick you can pull, in these circumstances, if the set does not have a series-heater string. Pull the tube, turn the set on, and read the voltage on the open plate terminal of the socket. This

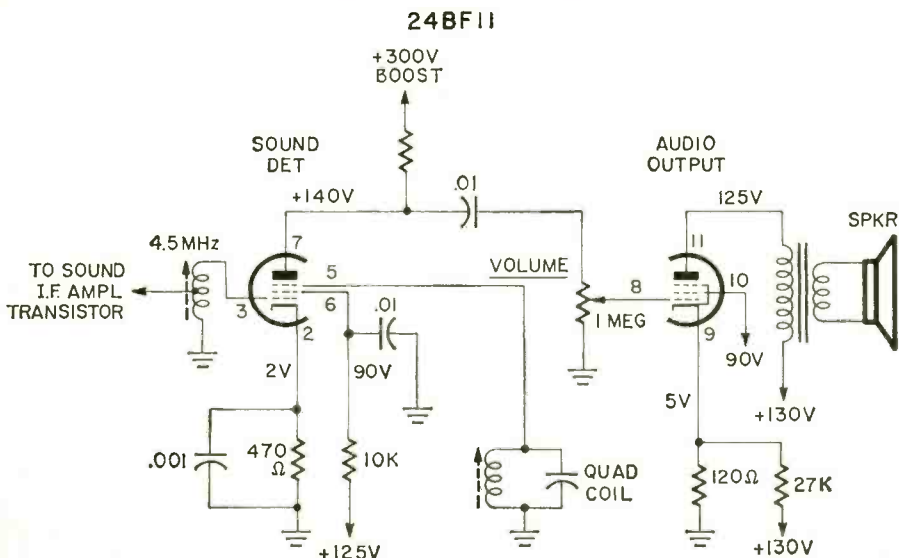
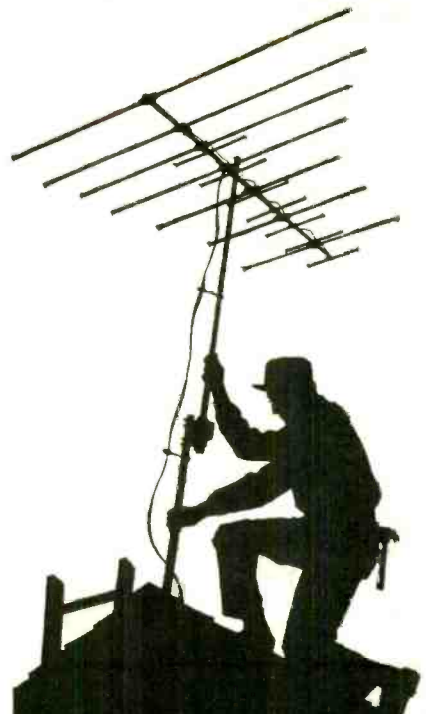

Fig. 1



When you're putting up an antenna, RCA supports it. With a complete line of hardware.

Chimney, wall, and roof mounts. Mastings. Guy wires, fittings . . . and standoffs, too. Whatever your requirements . . . RCA meets them with a complete line of Antenna Installation Hardware.

Every item in the line has been given that special attention to design and quality that you've come to expect from RCA.

Ask your RCA Distributor about the RCA antenna hardware line, and about his special deal on a hardware merchandiser for profitable "do-it-yourself" sales. Sell the hardware line with built-in consumer acceptance—RCA.

Parts and Accessories,
Deptford, N.J. 08096

RCA
Antenna
Installation Hardware

AT LAST . . .

TRANSITEK'S CATALOG
IS READY!

MANY NEW UNPUBLISHED
PROJECTS COMPLETE DE-
SCRIPTIONS GIVEN.

NEW KITS . . .

4 CHANNEL PREAMP
CHANNEL POWER AMP.

STUDIO QUALITY TAPE
ELECTRONICS

PROFESSIONAL PREAMPLIFIER

LEGAL CORDLESS PHONE —
WITH DIALING

RADAR TYPE ALARM SYSTEM
— COMPLETE

plus TUNERS, TESTGEAR —
MANY OTHERS

Send 25¢ in coin for
catalog & supplements to:

TRANSITEK

Excellence in electronics—by design

PO Box 98205, Des Moines, Wash.
98016

Circle 18 on reader service card

QUALIFY FOR YOUR FCC RADIOTELEPHONE LICENSE!

ICS has successfully trained thousands. Study at home, at your own speed, with the detailed personal attention of your highly qualified instructor. No time lost commuting to classes, or waiting for a class to catch up.

Course material includes detailed information on various FCC examinations and typical FCC examination questions, with answers explained in detail. Covers preparation for First, Second and Third Class tickets. Study one . . . or all three.

Your tuition refunded—or additional instruction provided—if you fail to pass your FCC exam after completing ICS instruction.

Don't wait—for full information send the coupon today.

ICS, Scranton, Pa. 18515

ICS International Correspondence Schools
Division of Intext D7942F

Mail to ICS, Scranton, Pa. 18515

Rush me free details on your warranted Radiotelephone License qualifying program.

Name _____ Age _____
(please print)

Address _____

City _____ State _____ Zip _____

Occupation _____

I am a veteran; tell me how I qualify for tuition refund under the new GI Bill.

Circle 19 on reader service card

should read the full B+ voltage, since there is no load except the voltmeter resistance. This will catch such things as shorted or leaky bypass capacitors, etc. Very handy for checking for leaky saw-forming capacitors in horizontal oscillators, as I found out later.

That's the easy way. Now for the hard way—no diagram, no base connections, no nothin'. Pull the tube, wipe the dust off the base, and get out the jeweler's loupe, or any high-powered magnifying glass. Shine a strong light across the base of the tube; even a pen-light will do. You can actually see the base pins and where they connect to the various elements. Make a sketch of a pentode, triode, etc. and trace the connections and write in pin numbers.

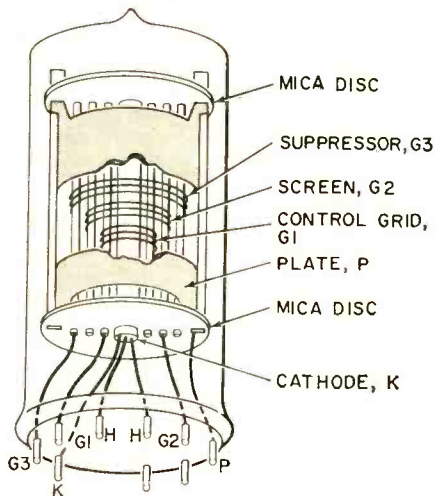

Fig. 2

This is easier than it sounds. Fig. 2 shows a sketch of what the bottom of the element assembly looks like. You can see the white heaters going up into the cathode sleeve. On either side of the cathode, the two rods are the control grid mounts. The ribbon connection to these can be traced to the base pin. They will be welded to the element support rod and the top of their base pin at each end. (You can also see if the ribbon is making good contact to the pin or rod; a broken weld can be spotted!)

The cathode sleeve is easy to identify. The next pair of rods "outward" will be the control grid, or G1. Next, the screen grid, then the suppressor grid, and last, the plate. You can see the side rods of the plate structure by looking above the round mica mount-spacer to be sure. Just count the pin numbers, and write them in on your rough drawing.

Once the pins are all identified, you can put the tube back in the set, or a test adapter, and read the important voltages—plate, screen, cathode, grid, etc. You can feed signals to the grid terminal of the adapter and see if they get through the tube.

If you have any trouble identifying the base-pin connections with the magnifying glass, get out a new familiar tube. Check its base connections on the schematic or in a tube manual, then cross check them on the tube itself. **R.E.**

Service Clinic

by JACK DARR
SERVICE EDITOR

Narrow-band scopes for color

I've got an old Heathkit 012 scope. Can I use it for servicing color sets, or will I have to modify it?—W. K., Winnipeg, Manitoba, Canada

Actually, there are very few scopes that are not suitable for color service if they're in good shape. In most cases, by using the scope and the picture-tube screen together, we can get all the information we want.

One thing is very helpful—knowing what the patterns on your scope look like at various points in the circuit. For example, on one of my old narrow-band scopes (up to a full 20,000 Hz!) I can see the burst signal at the burst-amplifier output. It doesn't look like the pictures in the textbooks, but I know what it means! Take some waveforms from a color set that is working, and you can tell about what to expect.

Horizontal instability

I had a funny one. While checking a Zenith 14N33Z portable on the bench, it was okay when it was facing me. When I turned it sidewise to look in the back, I got a loud hiss, and the horizontal hold got very unstable! Turning it back, it was all right!—R. Q., Ark.

If this hadn't happened to me, too, I wouldn't know the answer. With the set facing you, your bench antenna lead-in was going away from the chassis. Turning the set sidewise, the lead-in draped itself over the 2AS2 HV rectifier! So, you got all kinds of "stuff" coupled into the tuner! Just be careful that the lead-in doesn't get too near the HV section.

338-kHz converter coils

Where could I get coils to make a converter to tune to the 338-kHz weather band? Should I use a crystal-controlled oscillator?—W. P., St. Louis, Mo.

Try old car radios. If they have 260-kHz i.f. transformers, they should tune up to this frequency. If they won't, disconnect the resonating capacitors across each coil. Also, 455-kHz i.f. transformers can be tuned down to this frequency by adding small capacitors across coils.

Yes, use crystal control since you want only one frequency.

Short 3A3 life

3A3 tubes last about 10 days in a big color set; sometimes less. This is getting annoying, as well as expensive. What can I do?—W.T., Forestville, Conn.

One of two things. First, I'd check the cathode current of the horizontal output tube, boost voltage, etc., to make sure that the horizontal output stage was OK.

Last resort, you might try using some of the later, and slightly higher rated high-voltage rectifier tubes: 3CA3, which has a 3.6 volt filament at 225 mA, or the 3GN3. 3.15 V (same as 3A3) but at 225 mA. Zenith has a new high-voltage rectifier tube, the 3DB3, which is interchangeable with 3A3, but not vice versa. (Don't replace 3DB3's with 3A3's.) The 3DB3 is a little higher rated, and has lead-glass for X-ray protection.

Check the high-voltage regulator; if it's taking too much current, this could be the cause.

Filaments in series?

In a late model Zenith, I looked in and saw the damper tube dead. Put a new one in and nothing happened! Finally found out that the high-voltage regulator tube was dead, too. What the heck is going on here?—F.B., Ark.

This is normal, and intentional. New Zeniths have the damper and high-voltage regulator filaments in series. So, if the high-voltage regulator tube blows, the damper tube goes out, killing the horizontal output. The high-voltage is not allowed to rise to dangerous heights because of loss of high-voltage regulator loading. It's a safety feature, and a good one.

Slow loss of focus

I'm working on an RCA CTC-11 with a peculiar problem. It works fine when first turned on. After about 20 minutes you have to turn the kine-bias control down to keep a good picture in focus. Eventually, you have to turn the kine bias so far down that the picture is practically out. Get me started on this!—K.W., Chester, Pa.

You've got a thermal problem. Something is "heating up and going out." From the description, I suspect the focus voltage. Read the high voltage and focus voltage when the set is first turned on, and log the readings. After the trouble shows up, read the same voltages again, and you can tell what's happening.

Focus voltage should always be a percentage of the HV applied at the time. This is usually about 20%. When the trouble shows up, see if

both focus and HV have dropped by the same percentage. For example, the HV is down by 20% and the focus also down by 20%, of the "starting values." This would point to trouble in the source of both these voltages. In other words, the horizontal output tube, flyback, damper tube, etc.

If the HV stays up and the focus voltage goes down, or if they go down by different percentages, look for some trouble in the focus rectifier, tube or filter resistors, control, etc. Check the socket of the CRT. The focus element pin (9) often corrodes, and makes intermittent contact.

338-kHz converter coils

Where could I get coils to make a converter to tune to the 338-kHz weather band? Should I use a crystal-controlled oscillator?—W. P., St. Louis, Mo.

Try old car radios. If they have 260-kHz i.f. transformers, they should tune up to the frequency. If they won't, disconnect the resonating capacitors across each coil. Also, 455-kHz i.f. transformers can be tuned down to this frequency by adding capacitors in parallel across coils.

Yes, use crystal control since you want only one frequency; it's much more stable. **R-E**

Famous DeltAlert Anti-Theft System Adds High-Intensity Sound To Light!



When you have an intrusion detection system that already cuts theft potential 95% by automatically switching on lights, why add sound? Environmental Variance. EV is another way of saying that numerous individual and business premises are subject to varying levels of background noise, including cars, trucks, trains and industrial activity... as well as varying levels of outside people-traffic. This is why DeltAlert's new audio capability is the answer to Environmental Variance, and why it's your answer to total intrusion detection.

Horn sound is high-intensity, and the horn itself can be located away from the sensing unit. There is a ten second delay to allow authorized entry and access to the horn's on/off switch.

Order your DeltAlert system, complete with horn. You'll see how DeltAlert's variable sensitivity control and adjustable timing provides the most advanced sentry system on the market. Completely monitor and blanket areas fifteen to thirty feet. Easy to connect. No rewiring necessary.

DeltAlert, complete unit, ready to use.....only

\$59.95*

DeltaHorn, Complete with built-in delay.....Only

\$24.95

*Effective August 1, 1970. DeltAlert will increase to \$69.95 ppd.

SPECIFICATIONS:

Ultrasonic Frequency: 35 KHZ Δ
Area Coverage: 15-30 feet (depending on shape of area) Δ
Controls: On-Off Switch; Built in Timer; Variable Sensitivity Control Δ Output: 110-130V at 1 Amp. Δ Power Requirements: 110-130, 60 HzAC Δ Dimensions: 10 $\frac{3}{8}$ "W x 3 $\frac{1}{4}$ "H x 3 $\frac{1}{4}$ "D Δ Complete with 110-130V Drop Cord Δ Walnut designer finish.

Unit and all parts manufactured in U.S.A.



DELTA PRODUCTS, INC.

P. O. Box 1147 RE/Grand Junction, Colo. 81501

Please send me literature immediately.

Enclosed is \$ _____ Ship ppd. Ship C.O.D.
Please send DeltAlert DeltaHorn

Name _____

Address _____

City/State _____ Zip _____

Circle 20 on reader service card

PULSE GENERATOR ADAPTER

APG-100
(not illustrated)
APG-150



Now convert your sine/square wave generator to a high-speed lab quality pulse generator. No longer do you need to be limited with the standard test generator. Now BLULYNE makes it possible for you to have a laboratory variable pulse generator at less than one quarter the cost of a separate unit. Merely attach the output of your present sine/square wave generator to the input of the BLULYNE pulse generator adapter and you have fast rise and fall times, as well as variable pulse width, variable pulse amplitude, and variable frequency.

- Calibrate your scope at high frequencies (50 Mhz rise time).
- No need to buy a complete expensive generator.
- Perfect for the designer, experimenter, engineer, technician.
- Perfect for circuits requiring fast rise times.
- Use to control chopper circuits.
- Many more valuable uses.

Specifications:

Frequency range — 1 Hz to 10 Mhz.
Rise time — less than 20 nsec. (nanoseconds)
Fall time — less than 20 nsec. (nanoseconds)
Pulse width (variable)
100 nsec. to 500 msec. (50% duty max)
Pulse amplitude
(APG-100) 0.6v — 6.0v (unterminated)
(APG-150) 0.6v — 10.0v (unterminated)
Input Impedance — 5000 ohms
Output Impedance
(APG-100) 110 ohms
(APG-150) 50 ohms
Connectors
(APG-100) phono jacks
(APG-150) BNC
Price
(APG-100) not illustrated \$39.95
(APG-150) \$49.95

Write for illustrated literature for this and other BLULYNE products.

Blulyne Electronic Corporation
Dept. R, 3 Sand Springs Road,
Williamstown, Mass. 01267

Circle 21 on reader service card

IF YOU ARE A TV REPAIR MAN YOU NEED

TV TECH AID!

TV TECH AID is the best trouble shooting guide available today. It takes all the guesswork out of TV repair and is designed to help you solve your problems quickly and economically.

Each month you receive updated information on up to 40 different trouble-shooting cases. This important information is supplied to us by technicians, field reps and all the leading TV manufacturers.

You will find every symptom pictured with a clearly marked schematic of the particular faulty stage. The faulty components and corrections will also be listed to aid in repair. You go right to the source of the trouble without guesswork. In addition you get valuable information on current models as well as older models along with circuit changes and modifications as they occur.

TV TECH AID is the best investment you can make in your own business. The cost to you is only \$7.95 for a full years subscription. Send for it now . . . You'll be glad you did!

TV TECH AID
P.O. BOX 603
KINGS PARK, L. I.
NEW YORK 11754

ENCLOSED IS A CHECK OR M.O. FOR \$7.95 PLEASE SEND 12 ISSUES OF TV TECH AID TO:

NAME _____
ADDRESS _____
CITY _____
STATE _____ ZIP _____

Circle 22 on reader service card

TRY THIS ONE

POWER RESISTOR TRICK

The trick of connecting an adjustable or center-tapped power resistor to reduce its resistance while still maintaining full power dissipation has been around for quite a while. When a center-tapped resistor is connected as in Fig. 1, the resistance is reduced to one-quarter of the original value. For example, if you need a 0.25-ohm, 25-watt resistor and one is not available, you can use a 1-ohm, 25-watt resistor connected as in Fig. 1.

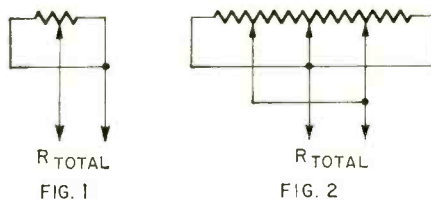

Why stop at a 25% reduction in resistance? By using an adjustable resistor with three sliders (adjusted for equal resistance between all adjacent taps), you can get one-sixteenth of the total resistance by wiring it as in Fig. 2. Seven sliders connected as in

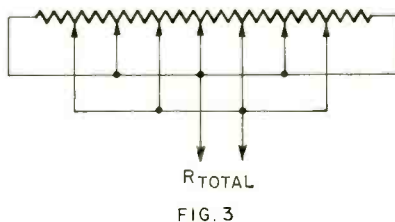
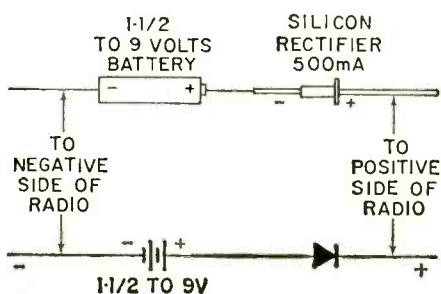

Fig. 3 reduces resistance to one sixty fourth of the original value. The length of the resistor is the limiting factor. It determines the number of sliders that can be used. I've used this scheme to make a very low-resistance, high-power load for high-current power supply tests.—*Herbert E. Pasch*

PROTECT THOSE TRANSISTORS

Does your youngster pull the batteries out of his transistor radio, CB transceiver or recorder and try to replace them himself? Many of the batteries can be inserted backward and



he can very easily wreck some of the transistors in the equipment.

You can prevent trouble very easily by placing a top-hat or similar silicon diode in series with the battery lead. Take either positive or negative battery lead that goes to the PC board and insert the diode as shown in the drawing. The diode will only let current flow in one direction and if the battery is inserted backward there is no voltage applied to the radio—*Homer L. Davidson*

"UNSOLDERING" AID

To unsolder both ends of a component on a printed-circuit board at the same time, bend a piece of bare No. 12 copper wire into keyhole shape and bolt it to the tip of the soldering gun.

Extra "keyholes" can be attached for components having multiple leads and the prongs easily adjusted to any dimensions.—*H. Josephs*

FREING COIL SLUGS

Often, coil slugs are so stuck that any attempt to turn them will result in a cracked slug, stripped hole or stripped alignment tool. If on the first tug the slug doesn't turn easily, don't force it. Insert an icepick into the hole and apply heat to the icepick with your soldering gun as near to the coil as is practical, for about one minute. Remove the icepick and insert the alignment tool into the slug and it will turn freely. We use this same trick on all types of slug-tuned coils and transformers.—*Harry J. Miller*

SLIP-ON SOLDERING TIP

This easy-to-make slip-on soldering tip is just the thing to use on transistor circuitry when all you have is a high-wattage soldering gun. As shown in the drawings and photo, flatten a short piece of copper tubing to

SLIP-ON SOLDERING TIP

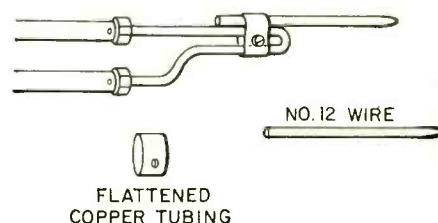

fit over the regular gun soldering tip and a piece of No. 12 copper wire. With the pointed and tinned wire on top, clamp it to the gun tip with a small screw and nut. Heat can be regulated by the position on the gun tip.—*Peter Legon* **R-E**

TECHNICAL TOPICS

by **ROBERT F. SCOTT**
SENIOR TECHNICAL EDITOR

This month we revisit the superhet, look at i.f. selectivity and actually build a receiver

All readers of R-E understand the operation of the basic superhet receiver as exemplified by the tiny transistor portable and the All-American Five tube-type radio. However, modern communications-type superhets incorporate numerous circuit innovations for improved stability, selectivity, sensitivity and signal-to-noise ratio. We plan to cover in detail many of these new circuits in *Technical Topics* but before we do, a brush-up on superhet basics is in order so you can better understand and apply the circuits discussed.

Figure 1 is a block diagram of a basic "all-wave" superhet covering from 550 kHz to 30 MHz. The tuned incoming signal is mixed with a tunable signal from the local heterodyne oscillator to produce a fixed-frequency signal of a lower frequency that contains all the modulation that is on the original signal. (The block diagrams shown here have separate mixer and oscillator stages but, in practice, these two functions may be combined in a single tube or transistor called a converter.)

This lower frequency—called the intermediate frequency or i.f.—is the difference between the incoming signal and the signal from the local oscillator. The basic superhet usually has an i.f. in the range of 450 to 470 kHz. This band of frequencies, like 1650 kHz and the 10.7-MHz FM i.f. is set by international agreement.

Most of the set's gain and selectivity is provided by the i.f. amplifier. The lower the i.f., the greater the selectivity available from a given number of stages or tuned circuits. An i.f. of about 455 kHz is a design compromise between selectivity—the ability to separate adjacent stations—and image rejection.

Recalling that the station we want to receive is on a frequency equal to the local oscillator frequency minus the i.f., the image frequency equals the local oscillator frequency plus the i.f. Stated another way, the image frequency is twice the i.f. above the desired signal. Thus, if a set with a 455-kHz i.f. is tuned to 5.000 MHz, its oscillator is tuned to 5.455 MHz and the image frequency is 5.455 MHz plus 455 kHz or 5.910 MHz.

At higher frequencies, one or two tuned stages ahead of the mixer cannot provide enough selectivity to prevent interference from a strong station on the image frequency. On the other hand, if a higher i.f. (1650 kHz for example) is used, a single tuned circuit ahead of the mixer can provide adequate image rejection, but a greater number of tuned i.f. circuits or crystal or mechanical filters must be used for good selectivity.

The superhet just described uses what we might call the "standard circuit." That is, the incoming signal and the heterodyne oscillator circuits are gang-tuned to develop a fixed i.f. that is lower, and therefore, the difference between the two variable frequencies. However, there is another possible—but less used—configuration for the standard superhet. In this instance, we have a fixed local oscillator and a tunable i.f.

For example, take a tuning range of 550 to 1650 kHz with a 2450-kHz fixed local oscillator. In this case, we use the sum frequencies as the i.f. ranging from 3.0 to 4.1 MHz. (Other 1.1-MHz sections of the frequency spectrum can be tuned by selecting suitable fixed oscillator frequencies.) If the input (signal) circuits are band-pass networks, all tuning is done at the intermediate frequency. The i.f. circuit would consist of a 3.0–4.1-MHz tunable amplifier followed by a detector. A superhet using this design would have good image rejection but would require quite a few well-designed gang-tuned circuits for adequate selectivity.

(When a tunable i.f. is used in modern design, it is usually followed

by a second mixer and fixed oscillator to develop a second i.f. at a fixed lower frequency. This system, double conversion, will be discussed shortly.)

Other variations in the standard superhet design have the local oscillator operating below the signal frequency. This arrangement is sometimes used in uhf sets in the interest of oscillator stability. Take, for example, a 450-MHz receiver using a 50-MHz i.f.—i.f.'s are generally higher in the uhf range for good image rejection. The oscillator frequency can be either 500 or 400 MHz. Since oscillator stability tends to fall off at higher frequencies, placing the local oscillator below the signal at 400 MHz would tend to improve overall stability.

Another scheme used for greater oscillator stability is to use the second harmonic of the oscillator on a lower band as the heterodyning signal for a higher band. This type of design was fairly common in receivers built around 1933–1946.

Assume that a designer of a broadcast and shortwave receiver wanted one shortwave band at 4.8 to 12 MHz and a second band going up to about 25 MHz. With a 455-kHz i.f., the local oscillator tunes from

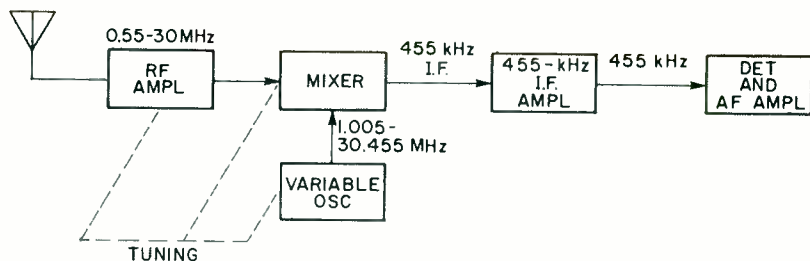

FIG. 1

The basic superhet block diagram (for tubes or solid-state) is in Fig. 1 above.

The simplest form of double superhet (Fig. 2) has a tunable first oscillator.

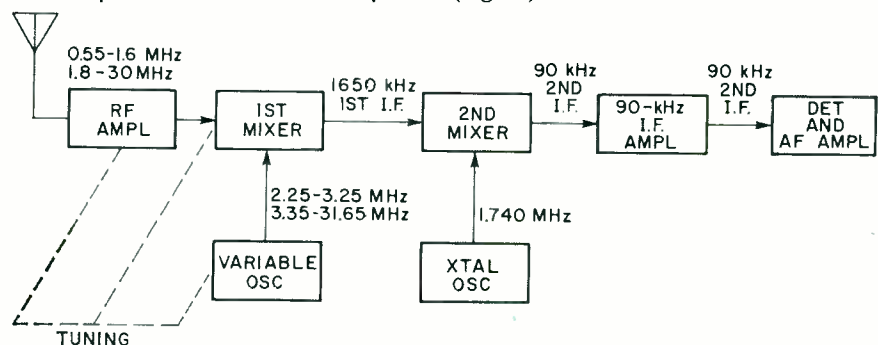

FIG. 2

5.255 to 12.455 MHz on the first shortwave band. By using the second harmonics of the oscillator (10.510 to 24.910 MHz), the higher tuning range will be 10.965 to 25.365 MHz if the oscillator's harmonic is *below* the signal frequency and 10.055 to 24.455 MHz if the oscillator is *above*.

The double-conversion superhet

The double-conversion superhet—or double superhet—is an attempt to provide adequate image rejection and selectivity. It uses *two* intermediate frequencies. The first, at some high frequency to minimize image interference, may be any frequency from around 1600 kHz to above 40 MHz. The i.f.'s are selected so neither falls on a frequency in the set's normal tuning range.

The block diagram in Fig. 2 shows a simple double-conversion superhet, covering from 550 kHz to 30 MHz. The local oscillator tuned circuits are ganged to the rf amplifier and mixer tuned circuits so its frequency is always 1650 kHz above the signal frequency. Since, as we have seen, we cannot use an i.f. that falls within the set's tuning range, there is a gap in the tuning range between 1.6 and 1.8 MHz.

The first i.f. signals are passed, either through a first i.f. (1650-kHz) amplifier or directly to the second mixer. Here, the first i.f. beats with the signal from a fixed oscillator—generally crystal controlled—to generate the *second* i.f. at a much lower frequency. Frequencies as low as 50 kHz have been used as the second i.f. but 90 kHz is used in the example in Fig. 2.

The crystal-controlled front end

A double-conversion amateur-band superhet with a crystal-controlled front-end (tuner) is shown in the block diagram in Fig. 3. In this circuit, the signal selected by the tuned antenna and mixer circuits beats with the fixed-frequency signal from a crystal-controlled oscillator. In this case, the i.f. is different for each incoming signal and the r.f. amplifier is tunable over this range.

For example, consider Band 3, 14.0 to 15.0 MHz. The crystal oscillator operates on 16.5 MHz. When the input is tuned to 14.0 MHz, the mixer output is 2.5 MHz. When tuning to 15.0 MHz, the difference frequency (i.f.) is 1.5 MHz. As the receiver is tuned from 14 to 15 MHz, the output of the first mixer (the first i.f.) is tuned from 2.5 to 1.5 MHz and is fed to the input of the second mixer. In this stage, the first i.f. is heterodyned (beat) against a signal from a 2-3-MHz variable-frequency os-

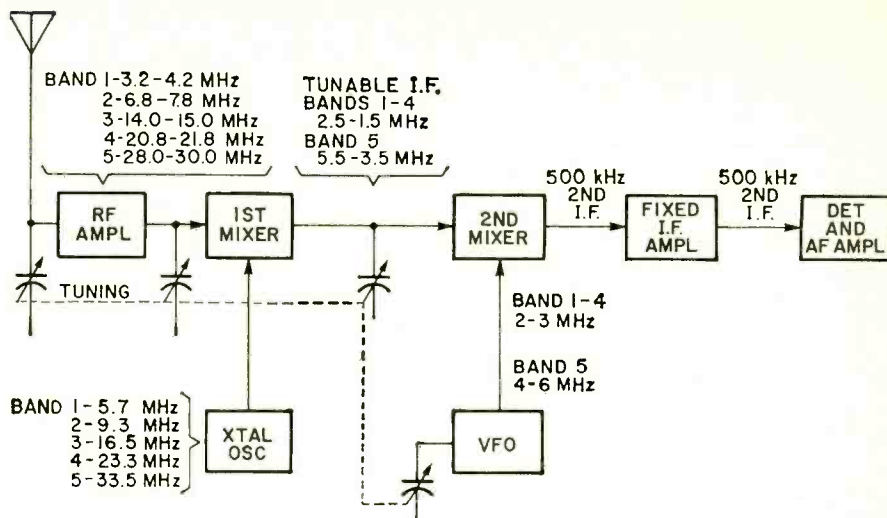

FIG. 3

Fig 3—Block diagram of high-performance ham-band double superhet. The first oscillator is crystal controlled for high stability. The first i.f. circuit is tunable.

illator (vfo) to produce a 500-kHz second i.f.

(Note that when using a crystal-controlled front-end; or when using a crystal-controlled converter with a broadcast receiver, the band of frequencies that you want to receive cannot be wider than the bandwidth of the first i.f.)

All amateur bands below 10 meters (28 to 30 MHz) are less than 1 MHz wide so the first four bands can be covered with one crystal each and the 2.5—1.5-MHz first i.f. Ten meters covers 2 MHz so the designer has a choice of breaking the band into two 1-MHz segments and using two crystals (30.5 and 31.5 MHz) or, as in Fig. 3, using only one crystal (33.5 MHz), shifting the first i.f. band to 5.5—3.5 MHz and using the second harmonics (4—6 MHz) of the vfo. In this way, the first i.f. bandwidth is increased to 2 MHz to handle the 28–30-MHz band without switching.

The 80-, 40-, 20-, and 15-meter bands (3.5–4.0, 7.0–7.3, 14.0–14.350 and 21.0–21.45 MHz, respectively) are all less than 500 kHz wide so some designers limit the first i.f. bandwidth to 500 kHz and use four crystals to cover 10 meters. In most cases, the antenna, mixer grid and first i.f. circuits are fixed-tuned bandpass networks, each designed to cover the desired 500-kHz spectrum. An antenna trimmer or peaking control is usually provided to tune the rf input circuit precisely to the incoming signal and to compensate for loading effects of the antenna. In this type of design, the vfo is the only variable-tuned circuit.

The double-conversion design in Fig. 3 inherently has better stability and more accurate calibration than the one in Fig. 2. It is much easier to design and build a highly stable vfo covering one relatively narrow band

of low frequencies and maintain good tracking with the antenna and mixer input circuits than it is to provide equal performance from a vfo covering several frequency bands.

I.f. selectivity

In any superhet, the amount of selectivity provided by the i.f. circuits should be determined by the type of signal being received and by the interference from adjacent stations. An i.f. bandwidth of 12 kHz (at 6-dB points) is desired for best fidelity from AM broadcast stations when there are no strong stations on adjacent channels. A bandwidth of 5 kHz may be used for international shortwave broadcasts. 2.4 kHz for amateur AM and single-sideband signals and 300 to 500 Hz for CW.

Most receivers provide three or four bandwidths: selected by a switch which may be a separate control or a part of the mode switch. At least one all-wave receiver features continuously variable i.f. selectivity ranging from 12 kHz for AM to 100 Hz for CW.

In future *Technical Topics* we will cover the theory and practical applications of such receiver circuits as Q multipliers, i.f. selectivity, automatic gain control, digital readouts, mixers, product detectors, noise limiters and noise blankers.

Speaking of receivers, let's build one

We oldtimers still have fond—and often exaggerated—memories of the two- and three-tube regenerative receivers that were our introductions to the mysteries of radio and the joys of shortwave listening and ham radio. Nostalgia isn't ours alone, it is world-wide.

In the "For Young Readers" column of *Electronics Australia*, Leo

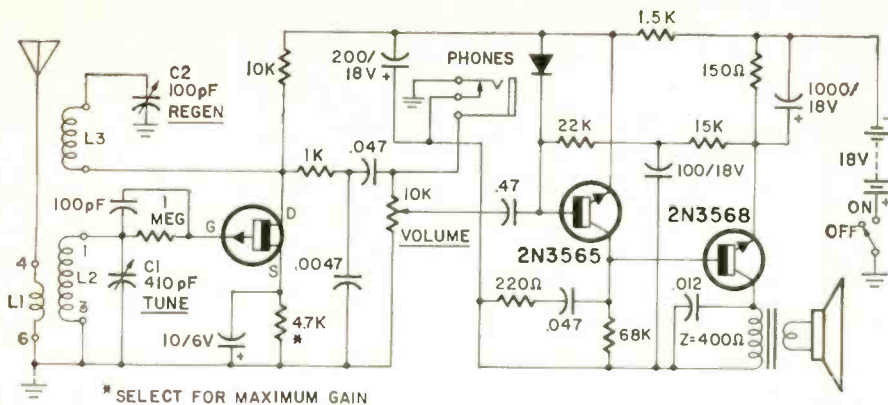

Fig. 4—Simple all-wave regenerator uses a 2N4360 FET detector. Pin 2 on coil socket goes to drain and pin 5 to C2. Diode is a BA100, 1N537 or equivalent.

Simpson presented a solid-state version of the regenerative set of 30 years ago. The set, Fig. 4, can be built as a 1-transistor model for use with high-impedance phones or a 2-transistor audio amplifier to drive a speaker.

A 2N4360 FET is the regenerative detector with feedback provided by a "tickler" coil (L3). Construction can be simplified by using one of the inexpensive IC audio amplifiers instead of the 2N3565-2N3568 amplifier in the original. The BA100 (or any similar silicon diode) prevents the audio input stage from being destroyed by voltage swings (around 8 V p-p) that develop if the regenerative detector is permitted to "squegg" or motorboat at low frequencies. This happens with high-gain detectors when the regeneration control, C2, is advanced too far, or L3 has too many turns or is wound too close to L2.

The coils are designed for a 410-pF tuning capacitor but you can use one section of a standard two-gang tuning capacitor from an old radio. You will need a good vernier (slow-motion) dial for accurate shortwave tuning. Better yet, use the vernier dial on a small variable capacitor—about 30 pF—shunted across C1.

Coil data is given in the table. Coils may be wound on Mayfair type 24-6P (Allied Radio catalog No. 47

A 6697) or equivalent 1 1/4", 6-prong forms. Be sure and note the pin connections for L2 and L3 (see Fig. 5). If, on any range, the detector does not oscillate, try reversing the connections to either L2 or L3. If it doesn't oscillate on the low-frequency end of a band, add more turns to L3 or move it closer to L2. If regeneration cannot be controlled by C2, remove a few turns from L3.

R-E

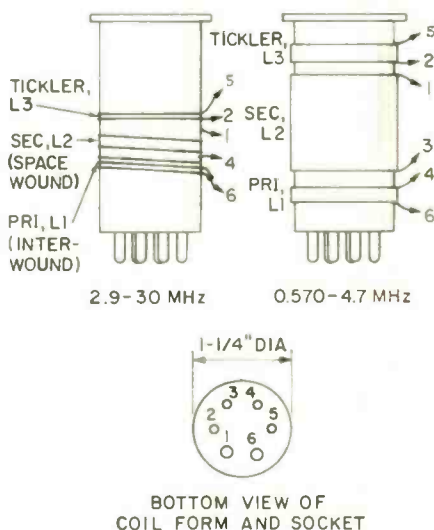

Fig. 5—How plug-in coils are wound. In the old days many coils were wound on Bakelite bases removed from old tubes.

COIL WINDING DATA

Coil	Frequency			
	0.570-2.0 MHz	1.8-4.7 MHz	2.9-11.2 MHz	8.2-30 MHz
L1	*15 turns, 3/16" from ground end of L2	*11 turns, 1/8" from ground end of L2	*5 turns, 1/16" from ground end of L2	*1 turn, inter-wound from ground end of L2
L2	*100 turns, closewound	#38 turns, closewound	#13 turns, spaced to occupy 1/2"	#4 turns spaced to occupy 1/2"
L3	‡40-60 turns, 1/8" from top end of L2	*20-35 turns, 1/8" from top end of L2	*9-15 turns, 1/8" from top end of L2	*4-6 turns, 1/8" from top end of L2

Coils are wound on 1 1/4" dia., 6-prong coils as in Fig. 5. Wire sizes are as follows: *No. 30 enameled wire, #No. 24 enameled wire, ‡No. 36 enameled

R-E'S "RADAR" BURGLAR STOPPER

Complete full-size circuit patterns

The diagrams on this page and page 74 wind up the material for the "Radar" Burglar Stopper. The five foil patterns shown on these two pages represent those you need to build your unit. All are actual size and can be easily duplicated. Of course, you can buy ready-made boards if you wish (see parts list). Remember, depending upon your needs you may need more than one of some of these boards. The TC1 board for example. You need a board for each sensor unit you build. So check your requirements before you start.

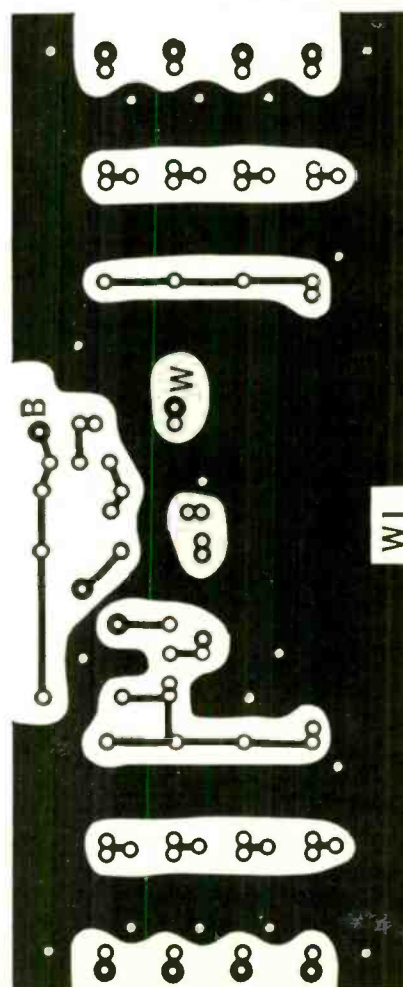

FOR THE FINEST
RECEPTION AVAILABLE

NEW SUPER "T"
VHF-FM-COLOR TARGET
ANTENNA SERIES

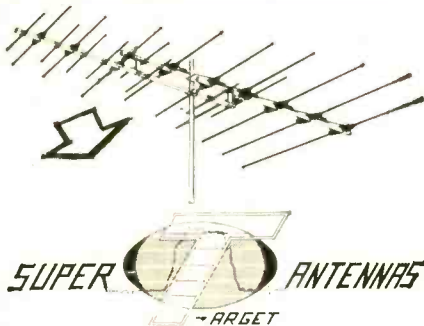

ELIMINATE THE NEED
FOR TWO ANTENNAS.

The best features of Log-Periodic and Yagi type arrays are combined for outstanding performance in Super Target Antennas. New, tougher aluminum alloy used for all elements. Rugged square boom construction. Unique construction features reduce installation time.

S & A ELECTRONICS INC.

210 W. Florence Street • Toledo, Ohio 43605

Circle 23 on reader service card

Olson

ELECTRONICS

FREE
Catalog

Fill in coupon for a FREE One Year Subscription to OLSON ELECTRONICS Fantastic Value Packed Catalog — Unheard of LOW, LOW PRICES on Brand Name Speakers, Changers, Tubes, Tools, Stereo Amps, Tuners, CB, Hi-Fi's, and thousands of other Electronic Values. Credit plan available.

NAME _____

ADDRESS _____

CITY _____ STATE _____

GIVE ZIP CODE _____

If you have a friend interested in electronics send his name and address for a FREE subscription also.

OLSON ELECTRONICS

Dept. LG 260 S. Forge Street
Akron, Ohio 44308

Circle 24 on reader service card

BURGLAR ALARM BOARDS

(continued from page 73)

THESE FOUR CIRCUIT BOARDS are required for the Radio-Electronics Burglar Stopper. The "RE" board (right) is for the lamp reset circuitry. The "TC1" board (below) is the transceptor head circuit. The "AR" board (below left) is the alarm receiver circuitry. The "DE" board (below right) is the circuitry for the timing delays. All foil patterns are shown actual size.

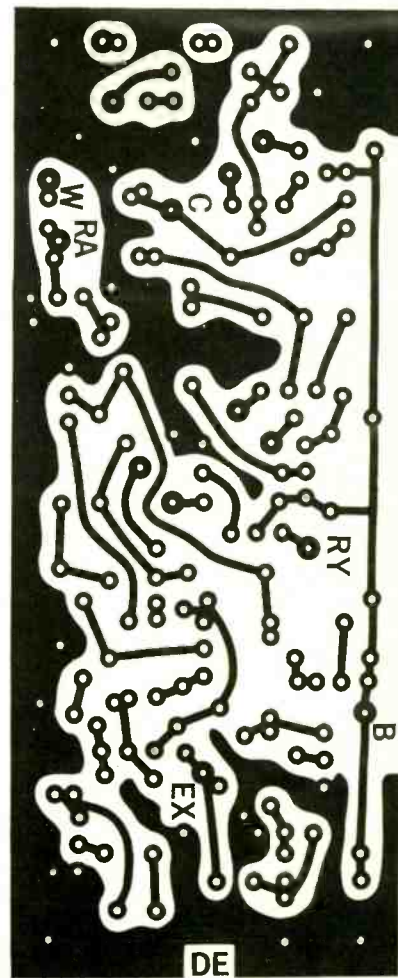
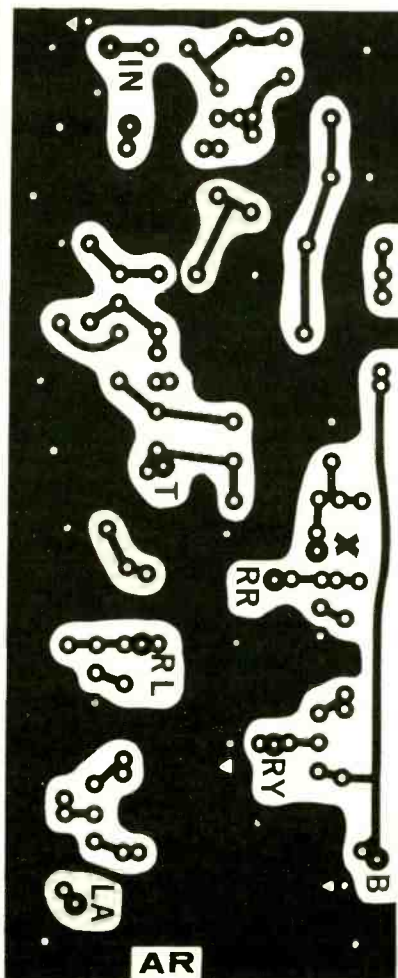
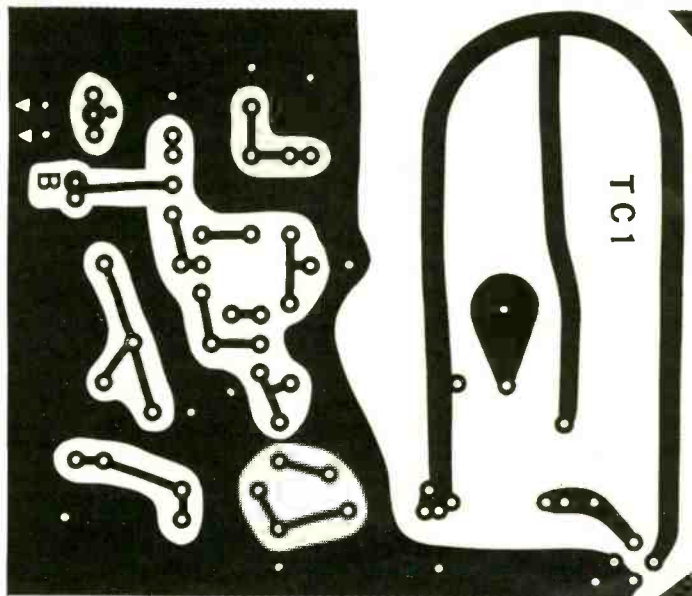
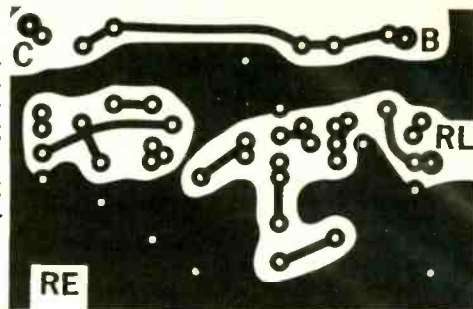

TECHNOTES

RCA SERIES G COLOR TV CHASSIS

Remote-controlled receivers using this chassis use a length of twin-lead for power to the pilot lamp. In some instances, particularly after normal servicing and during reinstallation of the tuner mounting assembly, the hot side of the lamp power lead may be pinched between the tuner mounting bracket and the chassis. Thus, shorting the lamp power to the chassis. The following corrective steps are to be taken when Series G receivers (remote control models only) come in for servicing:

1. Make a visual check of the pi-

lot lamp supply lines (twin lead) to see if it has been pinched or shorted by the tuner mounting bracket.

2. If the lead has been pinched or shorted, remove the tuner bracket and place a spaghetti sleeve over the pilot lamp leads.

3. Check the physical location of the pilot lamp series resistor (R95, 18 ohms, 1/2 watt). This resistor, see drawing, may be located close to the color remote motors. If necessary, take the following corrective action: Relocate terminal board leads and/or the body of the resistor so the resistor is at least 2-3 inches away from any of the remote control motors. This operation may involve a simple relocation of the terminal board further rearward on the TMA (tuner mounting assembly) bracket. Resistor R95 is accessible without pulling the TMA or the chassis.—*RCA Television Service Bulletin*

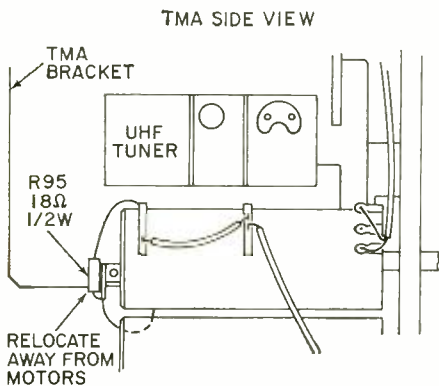

OLYMPIC CTC910 SERVICE HINTS

Intermittent tuner operation—

Check resistor R10. This 10,000-ohm, 1-watt unit is the mixer plate-load resistor and is easily accessible from inside the tuner.

Restricted focus range—Check the focus rectifier load resistor (R808, 68 megohms) for a possible change in value.

Poor vertical retrace suppression—Check, and replace if necessary, C420. This 0.05-μF capacitor may be leaky.

Excessive brightness and weak color—Check resistor R608; it may be open. This 15K resistor is located at pin 8 of V-18.—*Olympic Service Bulletin* **R-E**

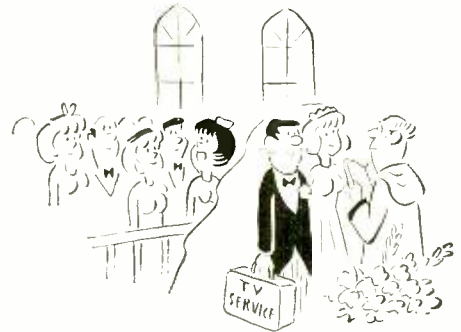

"He's lined up a string of motels where he can work out his honeymoon."

DID YOU MISS . . .

If you're going into digital electronics, take another look at the dual-trace scope switch on page 36.

Your caddy is the only caddy our tubes fit.

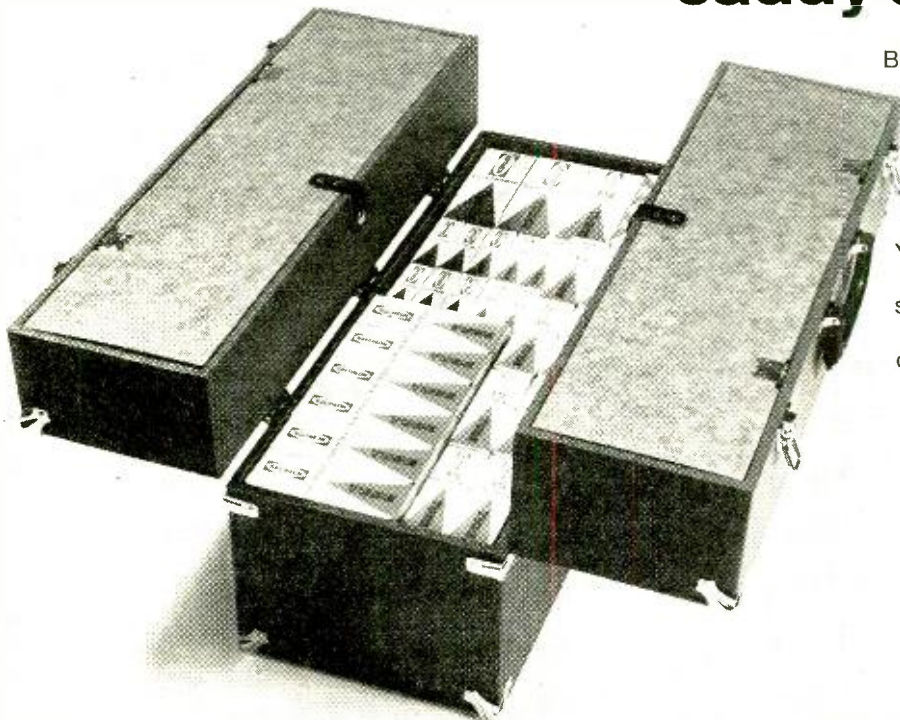

Because we market our tubes only through you—the independent serviceman.

We don't have service trucks or retail outlets. Our tube caddies are available only to you.

You see, we're independent too—the largest independent tube supplier in the business. We have to cooperate with you—not compete. Because we depend on you just as you depend on us.



Circle 25 on reader service card

FIX COLOR TV FAST!

Inside the High-Voltage Regulator

Find out how the new pulse-feedback regulator circuits work

by **MATTHEW MANDL**
CONTRIBUTING EDITOR

THE WIDELY USED SHUNT REGULATOR for high-voltage control in color TV is rapidly being replaced in late-model receivers. Instead of the 6BK4-A-type tube regulation, more and more sets use the solid state, pulse-feedback type and regulate the high voltage by changing the bias on the grid of the horizontal output tube.

There are a number of reasons for the switchover. Instead of an expensive tube, a rectifying diode or varistor is used. By eliminating the shunt regulator tube we also do away with one of the three possible sources of X-radiation (the other two being the high-voltage rectifier and the picture tube). Power consumption, shielding and space requirements are also reduced.

The pulse-feedback bias type of regulation varies the power input to the sweep system, while the shunt type acts as a variable load on the sweep circuits. Thus, operating principles of the two types of circuits differ considerably.

Diode type

A typical high-voltage regulation system using the pulse-feedback bias method is shown in Fig. 1. Here a pulse is obtained from a tap on the extra winding of the horizontal output transformer. (This extra winding also furnishes a pulse for keyed age, blanking, etc.)

Capacitors C3 and C4 are in series with the pulse-rectifier diode and these, in turn, are connected across the tapped portion of the extra winding of the output transformer. A positive pulse causes the diode to conduct

and C3 is charged negative with respect to the horizontal output tube grid. Resistors R1 and R2 act as voltage dividers, and C2 filters ripple and produces a dc bias. The amount of bias applied to the output tube depends on the pulse amplitude and the setting of the HV ADJUST potentiometer.

The drive signal from the horizontal oscillator also appears at the grid of the horizontal output tube and combines with applied bias to regulate conduction. Thus, the pulse amplitude at the high-voltage rectifier is also controlled and consequently the high-voltage amplitude.

When the brightness level of a scene increases there is an increased power drain on the horizontal deflection system and the high voltage tends to drop because of the increased load on the horizontal output amplifier. Consequently, the pulse obtained from the extra winding would also drop in amplitude. But now the pulse rectifier diode conducts less and the bias to the grid of the output drops. With less bias on the tube, conduction increases and increased power is applied to the deflection and high-voltage systems. Thus the preset high voltage is kept constant.

For dim scenes the high voltage would increase because of the reduced loading effect. Now the feedback pulse increases in amplitude, raising the bias on the output tube. This reduces power applied to the output system and brings the voltage back to normal. Since R6 and R7 are in series with the diode, R6 will regulate the degree of conduction and hence adjusts the amount of bias developed. Because the bias setting affects the high-voltage amplitude, R6 is used to adjust the high voltage to the proper level for normal operation.

Notice the width adjustment on this receiver. Shunting R10 decreases

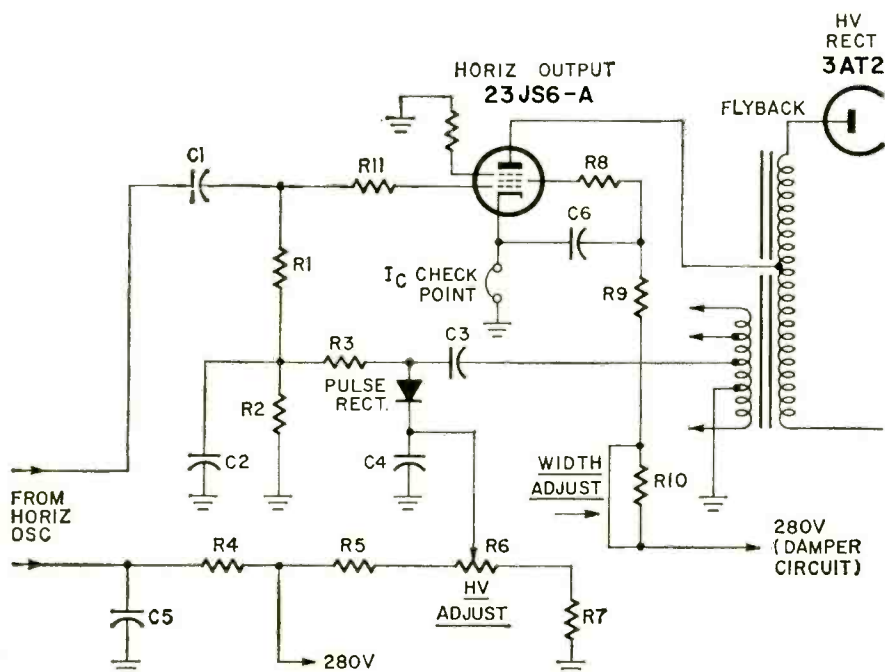

Fig. 1—Pulse-feedback bias technique uses pulse tapped from flyback, which is rectified to vary horizontal output grid bias. See text for circuit description.

the series resistance to the screen grid of the output tube and raises screen grid voltage for increased scan.

Circuit variations

Some circuit differences will be found in various color sets, though the basic operating principles are the same. For the system shown in Fig. 2,

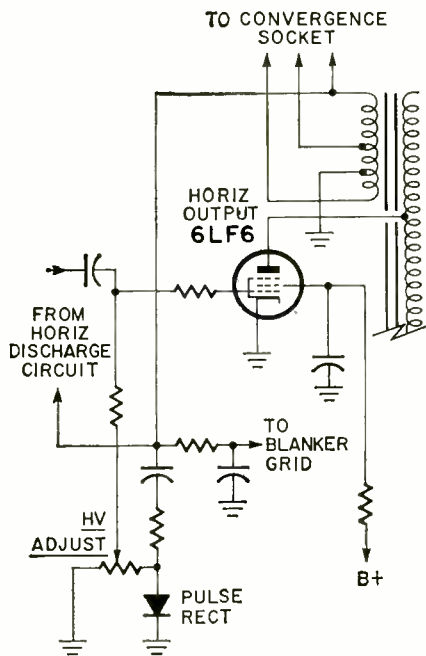

Fig. 2—Variation of circuit in Fig. 1 bridges pulse rectifier diode with adjust pot, then bias is applied to grid.

the HV ADJUST potentiometer picks off the negative bias (by shunting the pulse rectifier diode) and applies it directly to the grid of the output tube. Note the auxiliary transformer winding which supplies the pulse for the bias also furnishes convergence signals. Also, the blanker grid is supplied a blanking pulse from the same tap supplying the bias pulse. Consequently, troubles in the blanker or convergence circuits could affect the bias amplitude applied to the output grid.

In the Motorola TS-921 receiver the regulation system also incorporates a master brightness control (Fig. 3). Here, the bias applied to the horizontal output tube is also applied to the grid of the video amplifier and controlled by the potentiometer. The pulse-rectification and bias circuitry is similar to that shown in Fig. 1, with the HORIZ BIAS control tapping the junction between the bottom of the diode and the capacitor to ground. A high voltage adjustment therefore affects the setting of the master brightness control.

Varistor types

Some pulse-feedback bias regulation systems use a varistor instead of

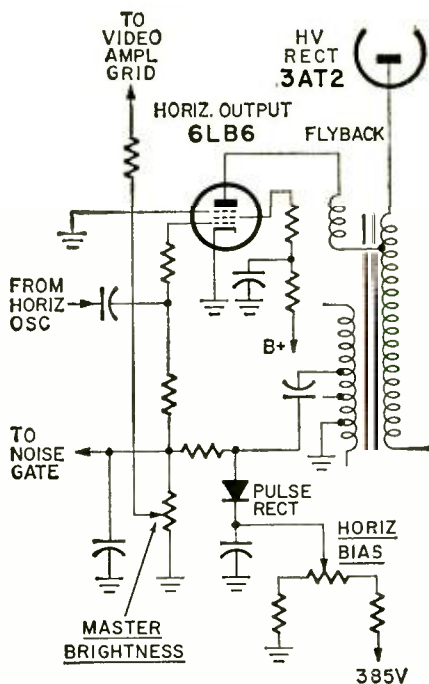

Fig. 3—Master brightness control in this Motorola circuit applies voltage from rectified flyback pulse to video amplifier grid.

a diode. The varistor is a voltage-dependent resistor (VDR), which has a decreasing resistance for higher voltages. As the voltage across the VDR gradually increases, the nonlinear resistance decrease causes the current through the VDR to increase to a greater degree. Thus, the VDR exhibits its rectifying characteristics just as the diode does. The VDR has a slight advantage over the diode rectifier because its nonlinear characteristics effectively stabilize line-voltage fluctuations (and hence dc voltages furnished by the power supply).

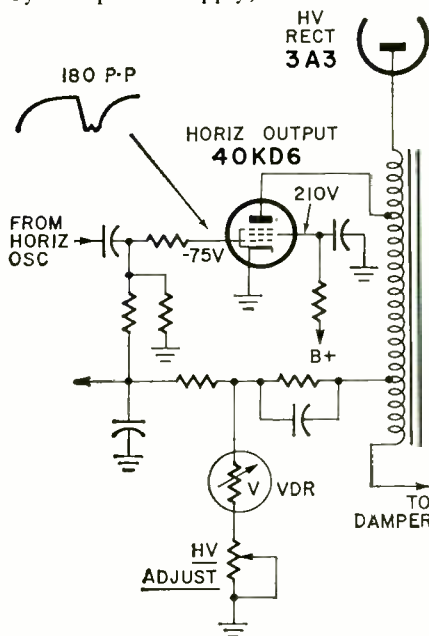

Fig. 4—Voltage-dependent resistor (VDR) circuit also biases horizontal output grid, since a VDR rectifies pulses.

A typical system using the VDR is shown in Fig. 4, for the Westinghouse V2656-1-2 series. The circuit function is similar to that of the diode types. The VDR rectifies the pulses and applies the resultant dc bias to the grid of the horizontal output tube. The average dc bias is about -75 volts, while the drive signal from the horizontal oscillator has a peak-to-peak voltage of 180.

Another high-voltage regulation system using a VDR is shown in Fig. 5 (G.E. chassis G-1). In Fig. 5, part

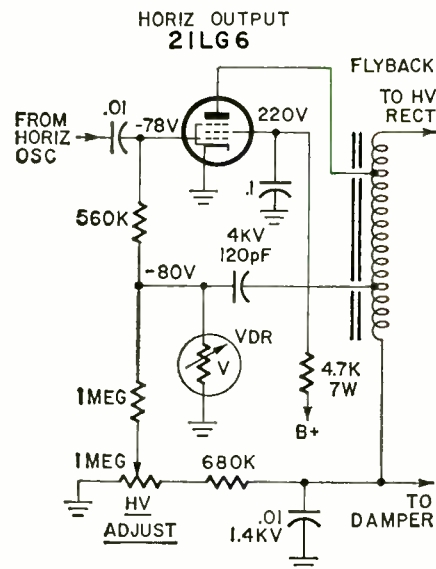

Fig. 5—Another VDR circuit, showing typical values and voltages to be checked.

values are given as well as voltages to indicate typical values to be checked during servicing. Note the high-voltage rating of the capacitors in the regulating circuit. Replace these, when necessary, with equal or higher voltage ratings.

Servicing hints

In any unregulated power supply, a variation in the current drawn by the load will cause a change in output voltage. In b-w receivers picture-tube beam current is considerably lower than that of a color tube, hence current changes due to picture brightness are small. With color tubes, beam-current changes are sufficiently high to affect the high-voltage level. With a fluctuating high voltage there would be changes in brightness, width, height and focus. In addition, blooming would occur and hue as well as convergence would suffer.

These troubles call for a check of the voltage-regulating system. Initially, the horizontal output tube should be checked. since a weak tube will reduce the power delivered to the deflection system. Next, test for proper screen grid voltage, grid bias volt-

age, and output voltage at the pulse rectifier. If such voltages are below normal, the low-voltage power supply should be checked because this is a common trouble source, particularly with older receivers.

Also test to see if the HV ADJUST potentiometer permits a variation of high voltage above and below that recommended for the receiver. If not, the rectifying diode may be defective or an open circuit may exist in the regulating network.

If the grid bias voltage from the regulating circuit is near normal, the trouble may be insufficient drive from the horizontal oscillator circuit. This is because both the drive signals and the rectified bias voltage contribute to the total high voltage produced. Use a high-impedance scope probe to measure the peak-to-peak voltage at the grid of the horizontal output tube and compare your reading with that rec-

ommended for the receiver. If below normal, try a new horizontal oscillator tube.

If poor regulation persists, test individual capacitors and resistors in the grid, screen-grid and pulse-rectification circuitry. If troubles are still present, the associated circuits which also obtain pulses from the auxiliary winding of the output transformer should be checked. Faults in these will be reflected to the pulse takeoff point and can interfere with regulation in the circuit.

A few precautions

When working on the horizontal output and high-voltage systems several precautions must be observed. Do not attempt voltage measurements at the anode of the horizontal output tube. When testing for high-voltage output be sure to use the proper high-

voltage probe. Don't operate any of the horizontal sweep circuitry with a tube removed, and if a new tube is inserted, don't turn the set on until the other tubes have cooled off. (If other tubes are hot, the warmup time of the new tube may overload the system.)

If it is necessary to turn the set on with the high-voltage compartment open or shields removed, make your tests as quickly as possible. Many manufacturers recommend safety goggles for close inspection of high-voltage circuitry. Remember that some X-rays are generated and prolonged exposure should be avoided.

Be careful in replacing pulse-rectifying diodes and varistors with so-called equivalent types. There may be sufficient differences in characteristics to hamper good regulations. Use exact replacements when possible. **R-E**

BUILD—Zener Power Box



By I. QUEEN

EDITORIAL ASSOCIATE

NEXT TIME YOU ASSEMBLE A SIMPLE experimental tube circuit, don't make its power supply, too. Just use two phono plugs for the A- and B-supply, and plug the experimental unit into a utility power supply like this one.

Contained in a box only 4 x 2 1/4 x 2 1/4 inches, this supply puts out fixed, regulated B-plus voltages of 50, (actually 47 volts with the diode used for D4), 100, 150 and 200. The filament or heater output is 6.3 volts ac at 0.6 amp. The output is available at two phono jacks, one for heater power and the other for plate. It is suitable for nearly any one or two-tube circuit, and is worth its weight in gold when you need it.

R3, R4 and R5 are chosen to limit current through the diodes (in this case, 15mA). Hum level is low, and can be reduced further by connecting a large capacitor (10 to 20 μ F, 250 V) from the junction of R1, R2 to chassis. **R-E**

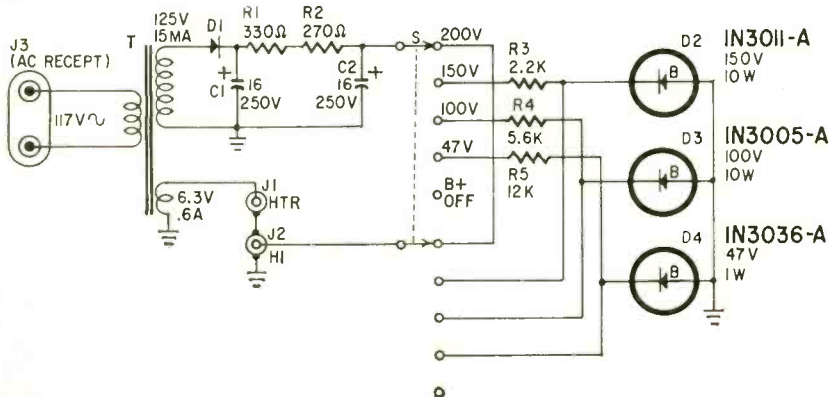
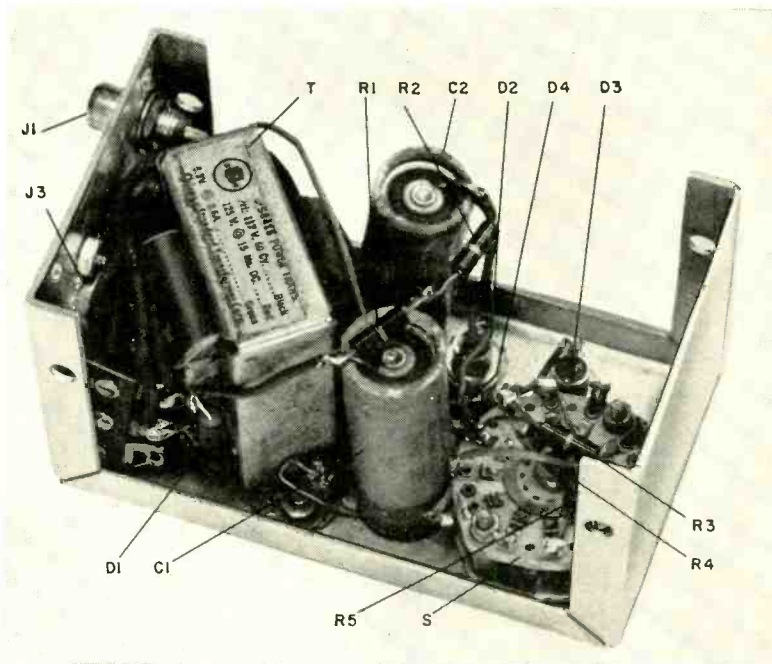

PARTS LIST

- R1—330 ohms } or one 560-ohm resistor
- R2—270 ohms }
- R3—5,600 ohms
- R4—2,200 ohms
- R5—12,000 ohms
- All resistors 1/2 watt, 10%
- C1, C2—16 μ F, 250 volts, electrolytic
- D1—silicon rectifier, 400 piv
- D2—Zener diode, 150 volts, 10 watts (Motorola 1N3011-A or equivalent)
- D3—Zener diode, 100 volts, 10 watts (Motorola 1N3005-A or equivalent)
- D4—Zener diode, 47 volts, 1 watt (Motorola 1N3036-A or equivalent)
- T—Power transformer, 6.3 volts at 0.6 amp, 125 volts at 15 ma (Stancor PS-8415 or equivalent)
- J1, J2—phono jacks
- Aluminum box, 4 x 2 1/4 x 2 1/4 inches
- S—double-pole 5-position switch

10 STEPS TO BEST MIKE USE
(continued from page 26)

The microphone cable is also sensitive to shocks and vibrations. Arrange your cable carefully so it hangs free, without touching the stand or anything else that could transmit noise. Leave a generous loop of cable at the base of the stand; it will help absorb the impact in case someone trips over the cable. Thread the cable under the base of the stand. If someone does trip, he will pull against the stand's heavy base, without tipping the stand over.



A popular microphone in the broadcast and entertainment field is the 635A by Electro-Voice. It has a built-in, four-stage blast filter for close-up work. It has an omnidirectional pickup pattern.



This Unidyne III (model 545) by Shure has a unidirectional polar pickup pattern. Response of this mike is 50-15,000 Hz. Has both high- and low-impedance outputs and the swivel adaptor shown.



A spherical "pop proof" wire-mesh grille on this Shure model 588SA "Unisphere" reduces unwanted sound on close-miking. Unit has a unidirectional cardioid pattern.

Rule 8: Check output levels.

Most tape recorders have some device for measuring output level—a meter, Magic-eye tube or even a neon light. You can safely set your gain control, then forget about it when you are taping from records, radio or television. These media use sophisticated electronic processors that limit loud passages and enhance very soft sounds.

But that's not true when you make a live presentation. Some people speak much louder than others do. Many people begin speaking quite loudly, then trail off to their normal volume. Others gradually creep toward the microphone, or shrink away from it.

In a PA setup, you've got to keep your eyes on the meter and your hand on the volume control—constantly. Try to make smooth, gradual changes that will keep the volume always within the optimum range on your indicator.

Don't let soft sounds get lost. Don't let loud ones blast and distort. Try to avoid changing your volume setting abruptly. Often it's better to let the sound overload for a few seconds while you reduce volume gradually, instead of snapping the control down sharply. [Some experts prefer to set the meter for recording peaks, then adopt a "hands off" policy.—Editor.]

A still better approach is using a compressor circuit to regulate gain automatically. A good compressor makes gain control so convenient that it's surprising more manufacturers haven't incorporated one to their gear.

Rule 9: Monitor—listen to what you're doing.

No photographer in his right mind would dream of pointing his camera at something and just absent-mindedly snapping the shutter. Even with the smallest, cheapest box camera, you look through the viewfinder to see what you're taking a picture of.

You should make your tape recordings as intelligently as you take pictures. Don't wait until you have completed an hour's reel of tape to find out it's not right—listen as you record. You can tell a great deal by hearing the sound over a small loudspeaker or a pair of headphones. This information gives you an opportunity to make changes and improvements while you are recording.

Rule 10: Finally—experiment!

The equipment you use and the place where you use it are unique. Your problems can never be quite the same as someone else's. But if you understand what your equipment can do—its strengths and its weakness—you can find the best way to record under your own particular conditions.

Experiment with different microphones and different placements. Compare them and modify them. You can use the two channels of a stereo recorder to good advantage, recording a different condition on each track so you can make A-B comparisons. Before too long, you will be able to pinpoint the standard microphone placements that work out best for the type of material you record. Standardizing these setups will make your future recordings easier, faster and better.

R-E

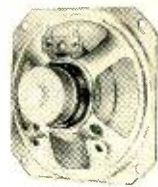
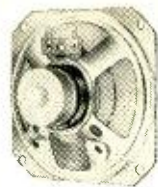

If you can't see the difference

and you don't hear the difference—

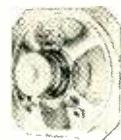

the long-lasting quality will tell you—

IT'S A QUAM!

The Quality line for every speaker need

QUAM

Quam-Nichols Company
234 East Marquette Road
Chicago, Illinois 60637
Phone: (312) HU-8-5800

Circle 26 on reader service card

COMPUTER BOARD SPECIAL

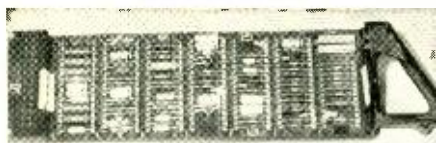

Honeywell Computer boards, 4 1/4" x 12". Transistors, diodes, zeners, capacitors, precision resistors, heat sinks, trimmers etc. 3 Different boards \$1.00. Stock No. B9082.

Stk. No.	ZENER DIODES		
B4010	1N751A	5.1 Volts, 400 mw	5/1.00
B4011	1N3039A	62 Volts, 1 Watt	3/1.00
B4012	1N3822	3.6 Volts, 1 Watt	5/1.00
B4013	1N3000B	62 Volts, 10 Watts	2/1.00
B4014	1N3048B	150 Volts, 1 Watt	3/1.00
B4015	1/4 M3.0	3 Volts, 1/2 Watt	4/1.00
B4029	1N429	5.6 Volts, 1 Watt	4/1.00

COMPUTER GRADE CAPACITORS			
B2040	Sangamo or Pyramid	4 1/4" x 1 3/4"	
	4000 MFD 50V		.50 5/2.00
B2039	Pyramid	4 1/4" x 3" 6000 MFD	
	75V		.75 3/2.00
B2035	Mallory	5 1/2" x 3" 31,500 MFD	
	25V	BRAND NEW 2.00	3/5.00

MISCELLANEOUS			
B4016	FET Field Effect Transistor	To-18 25 Volt Source to Gate N Channel	.50 5/2.00
B4017	Tunnel Diode Similar to 1N3717		.50 5/2.00
B9083	G.E. Hi Imp. Microphone	with switch	2.75
B9084	G.E. Hi Z Microphone	with switch and plug	3.00

Lots of other items—send for free flier; all merchandise fully guaranteed. Please include postage; excess will be refunded.



DELTA ELECTRONICS CO.
BOX 1, LYNN, MASSACHUSETTS 01903

Circle 27 on reader service card

Build this pipelike Schober Recital Organ for only

*\$1850!



*Includes finished walnut console. (Only \$1446 if you build your own console.) Amplifier, speaker system, optional accessories extra.

You couldn't touch an organ like this in a store for less than \$4,000—and there never has been an electronic instrument with this vast variety of genuine pipe-organ voices that you can add to and change any time you like! If you've dreamed of the sound of a large pipe organ in your own home, if you're looking for an organ for your church, you'll be more thrilled and happy with a Schober Recital Organ than you could possibly imagine—kit or no kit.

You can learn to play it—and a full-size, full-facility instrument is easier to learn on than any cut-down "home" model. And you can build it, from Schober Kits, world famous for ease of assembly without the slightest knowledge of electronics or music, for design and parts quality from the ground up, and—above all—for the highest praise from musicians everywhere.

Send right now for the full-color Schober catalog, containing specifications of all five Schober Organ models, beginning at \$499.50. No charge, no obligation. If you like music, you owe yourself a Schober Organ!

The Schober Organ Corp., Dept. RE-80
43 West 61st Street, New York, N.Y. 10023

- Please send me Schober Organ Catalog and free 7-inch "sample" record.
 Enclosed please find \$1.00 for 12-inch L.P. record of Schober Organ music.

NAME _____
ADDRESS _____
CITY _____ STATE _____ ZIP _____

Circle 28 on reader service card

NEW BOOKS

INFORMATION PROCESSING MACHINES by Panos A. Ligomenides. Holt, Rinehart, & Winston, 383 Madison Ave., New York, N. Y. 10017. 9 x 6 in. 358 pages, hard cover. \$10.95.

Intended for engineering, mathematics and science students, this book unifies and correlates the most important topics in the operation, organization and design of information processing machines. Primary emphasis is on functional and design aspects of these machines. The author presents his material in an orderly sequence starting with a survey of organization and operation followed by discussions of programming, coding and reliability, logic design, techniques of minimization and logical and sequential circuit design. He then goes into computer hardware to familiarize the reader with the elementary switching devices and circuits which make up the arithmetic and memory portions of an information processing machine.

ELECTRONIC TEST & MEASUREMENT HANDBOOK by John J. Schultz. Tab Books, Blue Ridge Summit, Pa. 17214. 5 1/2 x 8 1/4 in. 224 pages. \$7.95, hardbound; \$4.95, paperbound.

A complete set of practical troubleshooting procedures based on tried and tested measurement techniques. Intended for anyone involved with verifying or establishing proper operation, with checking claim performance, or with repairing a defective piece of equipment. Contains a variety of tests for receivers, transmitters, transceivers, antennas and a wide range of accessory equipment. Contents include general testing procedures, receiver tests and alignment, antenna and transmission line measurements, system and interference tests.

AUTOMOBILE TRAFFIC SIGNAL CONTROL SYSTEMS by Lionel M. Rogers and Leo G. Sands. Chilton Book Co., 401 Walnut St., Philadelphia, Pa. 19106. 9 1/2 x 6 in. 200 pages, hard cover. \$7.95.

If you need data on the design, installation and timing of electronic traffic control devices, this book should not be overlooked. It describes the basic criteria for the selection of equipment and explains in detail how to design and apply modern traffic control systems. Equipment, maintenance and various means for electrically interconnecting intersection controllers, vehicle detectors and central control devices are included.

INTRODUCTION TO NON-LINEAR NETWORK THEORY by Leon O. Chua. McGraw-Hill, 330 W. 42nd St., New York, N. Y. 10036. 8 x 6 1/2 in. 987 pages, hard cover. \$22.50.

This book covers both the theory and techniques for the analysis and synthesis of practical large signal circuits or, as they are also called, non-linear circuits. A knowledge of calculus is required.

R-E

COMING NEXT MONTH

AUGUST 1970

- **IC Digital Clocks**
Learn about a diode-readout, 44-IC "computer" wrist watch. Build two Nixie readout models: one with a programmed alarm, another superaccurate clock with a 10-MHz crystal.
- **Inside Portable VTR's**
Electronic photography is beginning to boom as vtr prices drop. Here's a detailed look at the circuits in the shoulder packs.
- **30 CA3018 Projects**
This four-transistor IC package can operate at 400 MHz and offers a theoretical current gain of 25 million times. Don't miss these practical applications.
- **Kwik Fix TM: Color Difference Amplifiers**
Follow the signal path on from the demodulators described this month. Symptoms, voltages and waveforms help you spot troubles quickly.

CB Troubleshooter's Casebook

Compiled by
Andrew J. Mueller*

Case 1: Radio blows fuses on 117 Vac.

Common to: Lafayette Comsat 25A

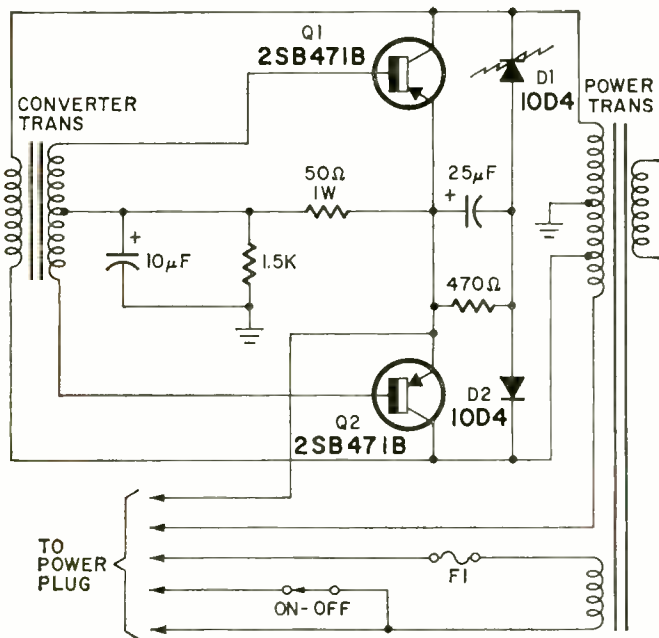

Remedy: Replace D1.

Reasoning: Diodes D1 and D2 are dampers or transient protectors across Q1 and Q2. They protect Q1 and Q2 against high-voltage spikes that could ruin the transistors. In this case D1 has shorted. This is causing a large alternating current to pass through it and D2 which will blow F1. Replacement of D1 will cure this trouble.

Case 2: The power transistors short after a few minutes of operation.

Common to: Pearce-Simpson Power Match

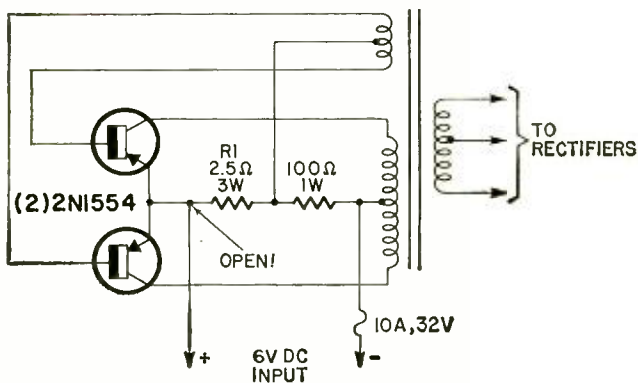

Remedy: Replace R1

Reasoning: R1 is one of the biasing resistors for Q1, Q2. It has opened, allowing maximum forward bias to be applied to the transistors. This causes excessive heating in the transistors and they finally break down and short.

Case 3: Unit does not receive. Transmits ok

Common to: Lafayette HB-625

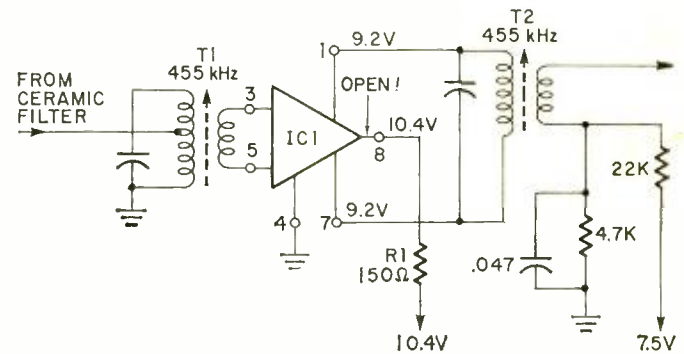

Remedy: Replace IC-1.

Reasoning: IC-1, i.f. amplifier, has opened. A voltage check at pin 8 reveals 10.4 V instead of the required 9.5 V. Since there is no voltage drop across R1, it appears that IC-1 is open. Replace IC-1 and align T1 and T2 to restore normal operation. **R-E**

*Service manager, Tel-Air Communications, Inc., Pewaukee, Wis.

FREE!

Would you like to see a clever, proven way to promote and advertise your Radio-TV-HiFi Repair Service?

Brings in new customers consistently — at minimum cost!

Fill in below for prompt, FREE details. (No salesman will call.)

H. K. Simon Co.
Box 236, Dept. RE-P
Hastings-on-Hudson, N. Y. 10706

NAME _____

ADDRESS _____

CITY, STATE _____

ZIP _____

My business is () full time
() part time

Circle 29 on reader service card

What's the ideal sound system?

Before you answer, you'll ask: "For what?" Because the system that's ideal for church sermons might be hopelessly inadequate for basketball games.

But you know all that. You may not know that somebody has finally put together a handbook in which specific systems, including amplifiers, preamps, mikes, speakers and accessories are recommended for specific applications in auditoriums, athletic fields, factories, restaurants, churches, gymnasiums, portable and mobile systems, etc.

That somebody is Bogen. And, as you would expect, this "Application Engineered Sound Systems" Handbook recommends a lot of Bogen components.

It also recommends a lot of equipment not made by Bogen as long as it's right for the job, and fits the budget. So you know this handbook is a useful tool, not some advertising gimmick.

The handbook, including binder, all present sheets and all future supplements, sells for only \$3.50.

BOGEN

Bogen Division, Lear Siegler, Inc.,
Paramus, N. J. 07652
Att: M. Sumbreg

Enclosed find my check for _____ copies of the "Application Engineered Sound Systems" Handbook @ \$3.50 each, post-paid.



NAME _____
ADDRESS _____
CITY _____ STATE _____ ZIP _____

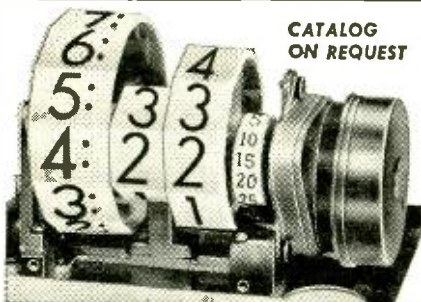

CATALOG ON REQUEST



CLOCK MOVEMENTS

DIGITS RESETTABLE INDIVIDUALLY

Available in 50, 60 cy., all voltages, AC. UL approved motor, cord. One Year Guarantee.

#130...12-HOUR #131...24-HOUR

Tymeter #90
Direct Read-
Out Interval
TIMER

by seconds,
minutes, 1/4 hr.,
1/2 hr., hour

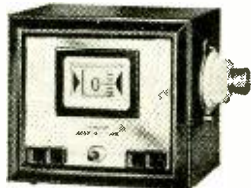

Made in U.S.A.

Complete Line: Delay, Interval
and Cycle Timers, Digital Computers

PENNWOOD NUMECHRON CO. TYMETER ELECTRONICS

7249 FRANKSTOWN AVE., PITTSBURGH, PA. 15208

Circle 30 on reader service card

NOTEWORTHY CIRCUITS

SIMPLE FLAME DETECTOR

Here is a flame detector (fire alarm) so simple even a child could assemble a model of it without difficulty—yet it will detect the flame of a match at a distance of one foot, a bonfire blaze at 6 to 10 feet, depending on its intensity.

The detector consists of nothing more than a Mallory Sonalert alarm, a photoconductive cell, and a 12-volt battery, all connected in series. The battery can consist of 8 size-C or size-D flashlight cells connected in series, or the equivalent in any other form.

The photoconductive cell has a very high resistance—of the order of megohms—in total darkness. Its resistance drops sharply, sounding the alarm, when it is exposed to light.

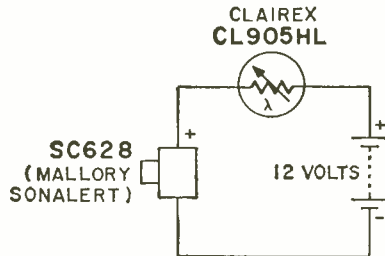

The photoconductive cell of the flame detector is intended to be located in a place of total darkness, such as an attic, or a dark corner of the basement; for example, behind an oil-burner furnace. The Sonalert unit can be located in the bedroom or kitchen.

Standby current through the circuit is in the microampere range. Thus, the battery will last a long time. It is well to check the setup from time to time, however, by lighting a wooden match in front of the photoconductive cell and listening for the alarm to sound. Make certain the window in the cell does not gradually become fogged with dust or accumulated grime.—*Frank H. Tooker*

A NEON-LAMP THRESHOLD AND POLARITY INDICATOR

This circuit was developed to rapidly identify telephone line-pairs and simultaneously to determine the dc polarity of the pair. Other uses will be apparent to the electronics technician and troubleshooter.

Since the open-circuit (i.e., telephones disconnected or cradled) dc

potential of the line was nominally 48 volts, the use of a standard 22.5-volt battery with a NE-2 neon lamp, made it readily possible to establish both the polarity and that at least 48 volts were present. In effect, this established that a live pair was involved and also indicated the proper connection information.

The head of a small nail is cleaned, tinned, and the nail soldered directly to the positive terminal of the battery (Eveready 412 or RCA VSO84) as the probe end. A layer of black plastic electrician's tape is wrapped around the battery, and the other

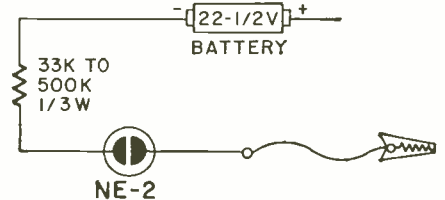

components neatly taped to it. The NE-2 is left partially exposed, of course, so that its indications are visible. A small alligator clip on a 10-12-inch lead completes the assembly.

In operation, when the nail probe is touched to a negative 48 volts, this voltage is in series-aiding with the 22.5-volt battery. The resultant summing to approximately 70 volts causes the neon lamp to ionize and glow. Reversed connection has a bucking (subtractive) voltage effect and the neon will not strike. If the alligator clip lead is made with red wire, it will enable convenient polarity determination, remembering that red is positive (or one can remember, *nail is negative*) when the neon is glowing.

Obviously this principle of voltage summing or bucking can be adapted to other dc voltage levels for circuit tracing and troubleshooting uses. Circuit refinements may extend the measuring threshold levels. However, all this circuit tells is a "yes—no" to the queries, "Is a minimum voltage (70 V — E_{nat}) present?" and, "What is the polarity?" Often these are quite sufficient data for the purposes at hand.

While this simple indicator does not replace a voltmeter, its compactness and simplicity make it a very useful adjunct to servicing circuits whose expected parameters are known.—*Aaron W. Edwards* **R-E**

NEW PRODUCTS

More information on new products is available from the manufacturers of items identified by a Reader Service number. Use the Reader Service Card on page 91 and circle the numbers of the new products on which you would like further information. Detach and mail the postage-paid card.

POLICE, FIRE & WEATHER MONITORS, Models COP-20H and COP-30L, are pocket-size, 3-channel high-band (148-175 MHz) and low-band (20-50 MHz) units. Monitor police, fire, weather, business plus standard AM broadcast band transmissions. Hum and noise minimized with adjustable squelch. Three crystal-controlled channels monitored with no coil changes. Has built-in battery level indicator, earphone, carrying strap and



built-in antenna. Black high-impact plastic cabinet with electro-plated chrome bezel and satin aluminum trim. \$33.50. Optional ac adapter, \$3.95. COP-50HL, twelve channel crystal-controlled monitor —6 high- and 6 low-band channels. Rf peaking control gives greater receiver sensitivity for specific channel. Tone control emphasizes highs or lows. Comes with ac and dc cables and mobile mounting bracket. \$139.95. Courier Communications, Inc., Hillside, N.J.

Circle 46 on reader service card

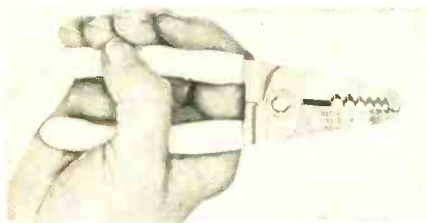

WIRE STRIPPER, Little 7, for stripping, cutting and looping all commonly used wire from Nos. 16 to 6 solid and 18 to 8 stranded. Six stripping holes. Cutting blade, 1/2" long to cut copper and aluminum conductors, UF, and Romex. Can be used for reaming 1/2" and 3/4" conduit. No. 18-850. \$2.50. Holub Industries, Inc., Sycamore, Ill.

Circle 47 on reader service card

SOLID-STATE TAPE DECK, T-600, records and plays back 4-track 2-channel stereo or 4-track 1-channel mono automatically or by touch-button control with automatic tape braking. Center capstan for automatic reverse or automatic repetition playbacks along with sensing tape. Has two 4-track 2-channel heads for re-

cording and playback and two 4-track 2-channel heads for erasing. Uses hysteresis-synchronous motor to ensure against speed variations due to line-voltage variations; optional operating speed choice of 7 1/2 ips and 3 3/4 ips; winding speed of 110 seconds for 1100-ft tape. Weaving



or curling prevented by built-in pressure regulator. Built-in solid-state preamp uses 18 transistors and 8 diodes with frequency response of 30-13,000 Hz at 3 3/4 ips or 30-20,000 Hz at 7 1/2 ips and signal-to-noise ratio of 50 dB. Wow and flutter less than 0.12% at 7 1/2 ips and less than 0.20% at 3 3/4 ips. \$299.95 with dust cover. Pioneer Electronics USA Corp., Farmingdale, N. Y.

Circle 48 on reader service card

MOBILE TELEPHONE, Tela-Page, for the person who rarely leaves his home town but is always in and out of his car. 12-channel automobile telephone, similar to auto stereo tape decks, unplugs and becomes "pocket pager." Unit beeps, speaker opens, user gets message. Used with common carrier, unit can make and receive calls from car to any phone in the world. Receiver can get calls in and



out of buildings, restaurants, theaters, job sites, etc. on city-wide basis. Cost determined by number of channels required. International Mobile Telephone Systems, 7129 Gerald Ave., Van Nuys, Calif. 91406.

Circle 49 on reader service card

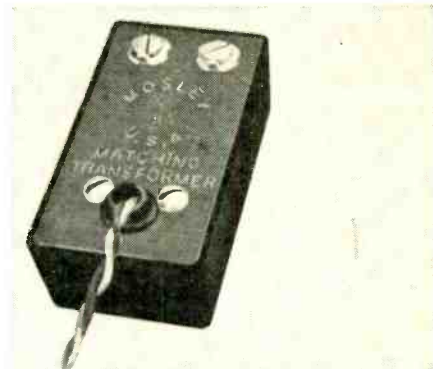

TRANSFORMER-BALUN FOR SWL ANTENNAS, Model TRS-57, adapts Mosley SWL-7 and RD-5 shortwave listening antennas (and any shortwave listening doublet) to receive standard broadcast bands below 4 MHz. On regular shortwave bands, TRS-57 acts as balun to give balanced receiver input. Installed with screwdriver. \$7.43. Mosley Electronics, Inc., Bridgeton, Mo. 63042.

Circle 50 on reader service card

FOUR MOBILE PA SYSTEMS ranging from 10 to 35 watts power output include standard and solid-state amplifier circuits, designed for direct-use indoor and outdoor applications where quick setup and operation are needed. 30-watt, all-weather car-top system with mounting bracket available. From \$160 for Portable 10 (10-watt system) to \$350 for Por-

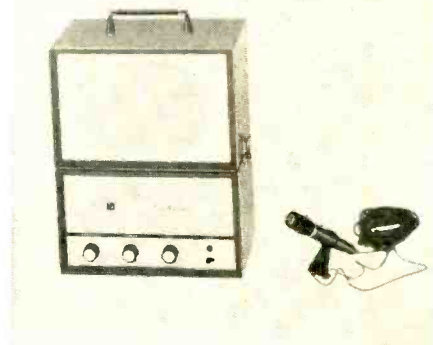

table 35 Car-Top 30, \$250. All systems include carrying case with handle. Amplifiers and speakers sized and matched for particular crowd capacities. Bell P/A Products Corp., 1209 No. 5th St., Columbus, Ohio 43201.

Circle 51 on reader service card

COMPULOGICAL TUTOR, teaches digital logic. User can be working out problems on it in 20 minutes. Intended for family use. You learn how logic is

applied to number systems and problems, understand fundamental concepts of Boolean algebra, logic building blocks and symbols, truth tables, basic theorems, computer circuits, the functional units of all digital computers, decision-making logic, error-detecting logic, computer storage and programming, etc. Adds, subtracts, multiplies, and divides in millionths of a second. Shows how to apply computer to practical problems of



accounting, economics and finance. Comes with all circuits, controls, logic blocks shown in photograph. Master assembly board comes with appropriate inputs and outputs (read with colored lights). Operates on dry-cell batteries (not provided) and will work for months with one set. Instruction manual of over 100 pages, explains computer concepts and outlines hundreds of specific projects and problems that can be worked out on it. \$69.95. Compusad,

Inc., New York Mills, N. Y. 13417.
Circle 52 on reader service card

SOUND MINI-COLUMNS engineered for low-level music background and paging systems. Quick clip-on polarized line terminals. Continuously variable thumb-type impedance selector. Model 10/96: 12 watts, 16 ohms, 4 lbs. 19 1/2" x 4" x 3 1/2". Model 10/97T: same as 10/96 with built-in line transformer. Impedance: 16, 50, 75, 100, 150, 250, 350 and 500 ohms for 25-V line systems. Model 10/98T: same as 10/96. Impedance: 16, 500, 750, 1,000, 1,500, 2,500, 3,500 and 5,000 ohms for 70-V line systems. American Geloso Electronics, Inc., 251 Park Ave. So., New York 10010.
Circle 53 on reader service card

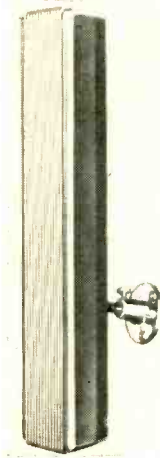

VHF MONITOR/SCANNER, Regency Hi/Lo Monitoradio Scanner. Computer patch board matrix that automatically receives 6561 combinations of both high- and low-band signals. Scans any mixture of frequencies in 30-50 MHz and 144-174 MHz ranges through 8 crystal-controlled channels. Can crossband monitor police, fire, radio, telephone and marine signals in either band. Searches

for signal, stops to monitor entire transmission and resumes search at end of transmission. Patch board matrix has 8 high and 8 low terminal programmers plus 8 crystal sockets. Sensitivity: 0.5 μV for low-band channels and 0.7 μV for high. Spec selectivity: 50 dB @ ±



15 kHz and 5 watt audio output is delivered. Complete with power cords for ac or 12V dc operation, detachable telescope antenna and mobile mounting bracket, \$169.00. Metal vinyl-clad cabinet has external speaker terminals and standard auto antenna jack on back panel. Regency Electronics, Inc., 7900 Pendleton Pike, Indianapolis, Ind. 46226.

Circle 54 on reader service card

ANTENNA ROTATOR, Prism-Matic PM-1, permanently synchronized, designed to pinpoint TV and FM stations in area. Can be mounted at any point on

WHERE THE ACTION IS!

FREE \$1 BUY WITH EVERY 10 YOU ORDER Only applies to "\$1" Buys **FREE GIFT WITH EVERY ORDER**

- 300 - ASST. 1/2 W RESISTORS Top Brand, Short Leads, Excellent Selection \$1
- 100-ASST 1/4 WATT RESISTORS stand, choice ohmages, some in 5% \$1
- 100-ASST 1/2 WATT RESISTORS stand, choice ohmages, some in 5% \$1
- 70 - ASST 1 WATT RESISTORS stand, choice ohmages, some in 5% \$1
- 35 - ASST 2 WATT RESISTORS stand, choice ohmages, some in 5% \$1
- 50 - PRECISION RESISTORS asst. list-price \$50 less 98% \$1
- 20 - ASSORTED WIREWOUND RESISTORS, 5, 10, 20 watt \$1
- 5 - TOGGLE SWITCHES SPST, SPDT, DPST, DPDT \$1
- 10-ASSORTED SLIDE SWITCHES SPST, SPDT, DPDT, etc. \$1
- TRANSISTOR RADIO asst type good, bad, broken, as-is, potluck \$1.50
- TAPE RECORDER—assorted types good, bad, broken, as-is, potluck \$4
- S20 - SHURE M7D DIAMOND NEEDLE exact replacement \$3
- SHURE M44 SERIES DIAMOND NEEDLE exact Replacement \$4.69
- COLOR POWER TRANSFORMER - Good for most sets 260/150 List Price—\$36.75 \$6.9
- 6 - TRANSISTOR RADIO EARPIECES wires complete with plug \$1
- 100' - FINEST NYLON DIAL CORD best size, .028 gauge \$1
- 10 - SETS PHONO PLUGS & PIN JACKS RCA Type \$1
- 3-PRINTED CIRCUIT IF TRANSFORMERS 4-Lug, 456 KC \$1

- COLOR-TV RECTIFIER - Used in most color sets—6500 kv \$1.95
- 15 - ASST. ROTARY SWITCHES all popular types \$20 value \$1
- 15 - G.E. #NE-2 TUBES Neon Glow Lamp for 101 uses \$1
- 150' - BUSS WIRE #20 tinned for hookups, special circuits, etc. \$1
- 50 - .0033 DISC CERAMIC CAPACITORS C.R.L. \$1
- RCA DAMPER DIODES # 120818 used in most color sets \$8.95
- 12—MINIATURE ELECTROLYTIC CONDENSERS For Transistor & miniature work \$1
- 10 - MINIATURE 456KC IF TRANSFORMERS Exceptional value —PC—1/2" x 1/2" \$1
- HEAVY DUTY COLOR FOCUS RECTIFIER 14,000 PIV @ 1 ma \$1
- 50 - OIL IMPREGNATED TUBULAR CAPACITORS Porcelain, Axial Leads—Most popular values \$3.25
- 2 - COLORBURST QUARTZ-CRYSTAL REPLACEMENT For most Color TV Sets. 357.9, 545 KC \$1.49
- TV TUNER - asst. all new standard makes. Less tubes \$1
- TV TUNERS asst. all new standard makes, including Tubes \$3
- WESTINGHOUSE STANDARD TUNER #470V122H01—(3GK5-6JCB) Tubes \$4
- UHF TUNER - TRANSISTOR TYPE Used in all TV Sets \$3.95

- ### MARKET SCOOP COLUMN
- 12" UNIVERSAL SPEAKER. Top Quality . . . Large Magnet \$4
 - 10" PHILCO SPEAKER Top Quality . . . Large Magnet \$2.69
 - 8" UNIVERSAL SPEAKER - Large Magnet—Special Buy \$1.94
 - UTAH 8" - HEAVY DUTY 10 OZ. SPEAKER Ceramic Type -8 Ohm. \$3.69
 - 6"-ECONOMY SPEAKER Top quality 2.15 Mag. \$1.94
 - 5" UNIVERSAL TWEETER 1 Oz. . . Magnet \$1.29
 - UNIVERSAL 5 1/2" PM SPEAKER Alnico 5 magnet, quality tone \$1
 - UNIVERSAL 4" PM SPEAKER with 50L6 Output Transformer \$1
 - 2 1/2" x 4" SPEAKER Special Buy \$6.9
 - 3 1/2" - ROUND SPEAKER Special Buy \$5.9
 - 25 - 3900-OHM-7w RESISTOR 10% Corning glass \$1
 - 20 - 47-600V CONDENSERS White Ceramic C.D.-American \$1
 - SPECIAL TUBE BUY 3C8B, 3DT6, 4CS6, 12AU7, 12BH7. Each \$4.9
 - 10 - ASST. RADIO & TV TUBES Every Tube a good number \$1
 - UTAH 8"-3 WAY CO-AX SPEAKER 30 Watts, 8 Ohm Special \$29.95
 - UTAH 12"-3 WAY CO-AX SPEAKER 45 Watts, 8 Ohm Special \$40.95

- ### KNOB SPECIAL
- 100 - ASSORTED RADIO KNOBS All standard types \$20 value \$1
 - 50 - TV KNOBS - POPULAR TYPES For most sets \$1
 - 25 - VERTICAL LINEARITY KNOBS Long shank . . . Front mount . . . miniature assortment \$1
 - 30 - VERTICAL LINEARITY KNOBS Side mount . . . Standard sizes \$1
 - 25-KNURLED RADIO KNOBS Hard to get . . . Best selection \$1
 - 25 ASSORTED CLOCK-RADIO KNOBS Best assortment, Most popular types \$1
- ANY 6 KITS FOR \$5
- 3-ELECTROLYTIC CONDENSERS C.D. 500 mfd—200 volts \$1
 - 3-ELECTROLYTIC CONDENSERS G.E.—200/30/4/10mfd—350 volts \$1
 - 3-ELECTROLYTIC CONDENSERS most popular number 50/30—150v \$1
 - 7 - TV ELECTROLYTIC CONDENSERS desirable types \$1
 - 5 - 6' LINE CORDS #18 Stranded Copper Wire \$1
 - MOTOROLA PWR TRANSFORM \$110V, CT 150/150v, 6.3v \$1
 - 25 - #130 WESTINGHOUSE PILOT BULBS 5000 Hours—Same as #47 \$1
 - 25—WESTINGHOUSE PILOT BULBS Your choice of #241, #154, #PR-23 \$1
 - 50 - ASSORTED PRINTED CIRCUIT SOCKETS best types \$1

IMMEDIATE DELIVERY . . . Scientific light packing for safe delivery at minimum cost.
HANDY WAY TO ORDER: Pencil mark or write amounts wanted in each box, place letter F in box for Free \$1 BUY. Enclose with check or money order, add extra for shipping. Tearsheets will be returned as packing slips in your order, plus lists of new offers.
Minimum Order \$3.00

Please specify refund on shipping overpayment desired: CHECK POSTAGE STAMPS MERCHANDISE (our choice) with advantage to customer

BROOKS RADIO & TV CORP., 487 Columbus Ave., New York, N. Y. 10024 212-874 5600 TELEPHONE



TV mast. Weight, 4½ lbs. Under most operating conditions, repeatability is 3° or less. No wind slippage and is useable in temperatures ranging from -40°F to +140°F. Motor reaches full torque before engagement to break ice accumulation. Solid-state control system insures repeatability of antenna direction. 117 Vac at ½ amp. Preassembled hardware supplied. **Blonder-Tongue Labs, 9 Alling St., Newark, N. J. 07102.**

Circle 55 on reader service card

STEREO RECEIVER, MODEL 2000A, 120 watt AM/FM unit features all solid state design, 4 IC's in i.f. section plus FET FM front end. Specs include 120 watts of IHF music power providing 43 watts per channel of continuous power at 4 ohms. FM tuner sensitivity: 1.8 µV (IHF); selectivity: better than 40 dB at 98 MHz; stereo separation better than 35 dB. Amplifier



section gives flat frequency response from 10 to 50,000 Hz ±1 dB. Has outputs for two separate stereo speaker systems and inputs for tape, phono, auxiliaries, recording or playback using 2 tape recorders. Preamps and main amplifiers are designed to be used separately with electronic crossover system. Are connected with phono-type connectors. All-silicon AM tuner is separate section incorporating one-stage rf and 3-gang variable capacitor to improve image rejection and eliminate beat and whistle noise inherent in AM signals. **Sansui Electronics Corp., 32-17 61 St., Woodside, N. Y. 11377.**

Circle 56 on reader service card

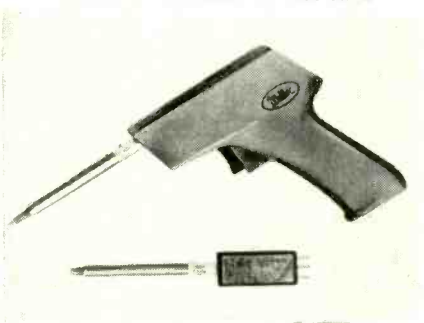

SOLDERING TOOL, Weller Temp-matic GT7A, transformerless. Has inter-

changeable, plug-in powerhead regulating temperature of 3/16" workpoint to below 700°F. Has one extra powerhead with 600°F workpoint (1/8"). Soldering points have special coating to slow corrosion. 120V, 60-cycle operation. **Weller Electric Corp., 100 Wellco Road, Easton, Pa. 18042.**

Circle 57 on reader service card

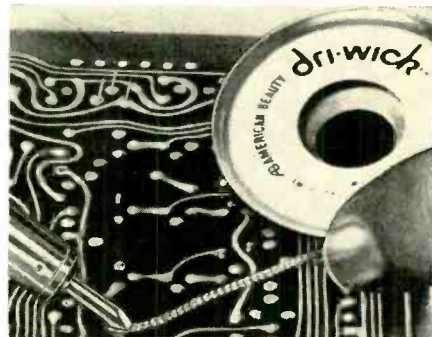

DESOLDERING TOOL ON A SPOOL, Dri-Wick, for easy desoldering electrical connections, to make rework or salvage of expensive circuitry practical. Desolders typical miniature connection in about one second at cost of about one cent. Woven of ultra-fine copper strands coated with water white rosin, and wound on self-closing spools. Operator lays Dri-Wick on joint, applies tip of 30-40W soldering iron to top of Dri-Wick, lifts iron and braid simultaneously. Solder is absorbed into braid. Available in 4 widths. **American Beauty, 6110 Cass Ave., Detroit, Mich. 48235.**

Circle 58 on reader service card

(continued on page 90)

CANADIANS: Ordering is easy — we do the paperwork — try a small order

WESTINGHOUSE ALL TRANSISTOR HOME/OFFICE MESSAGE CENTER

Leaves messages for other for replay... Built in speaker/microphone for talk-into convenience... Records up to 3 minutes of messages... Illuminated signal shows when a message is waiting. Control adjusts playback volume without affecting recording volume... Capstan Drive: **\$10** BRAND NEW SOLD AS IS **10%** off in lots of 3

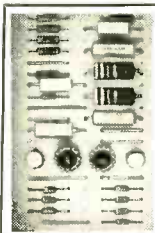

IBM COMPUTER SECTIONS

8 assorted Units we sell for \$1 are loaded with over 150 valuable parts. Incl. — Transistors, Condensers, Resistors, Heat Sinks, Diodes, Etc.

8 for \$1
100 for \$10

SHANNON MYLAR RECORDING TAPE

2½" — 225' .. \$.17	7" — 2400' .. \$1.79
3" — 225' .. .19	7" — 3600' .. 2.95
3" — 300' .. .27	CASSETTE 60 minutes .89
3¼" — 600' .. .58	CASSETTE 90 minutes 1.54
5" — 600' .. .62	CASSETTE 120 minutes 1.97
5" — 900' .. .80	
5" — 1200' .. .97	2½" TAPE REEL .. .04
5" — 1800' .. 1.49	3" TAPE REEL .. .05
7" — 1200' .. .77	3¼" TAPE REEL .. .06
7" — 1800' .. 1.12	5" TAPE REEL .. .12
	7" TAPE REEL .. .14

RCA 110° FLYBACK TRANSFORMER

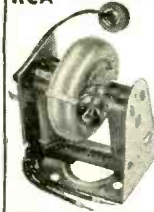

We scooped the Market Latest type — standard for all 110° TV's. RCA's design of large Coil produces 18KV — assuring adequate width Incl Schematic Diagram application for any TV. List price \$13.90. Your price **\$3** 10% off in lots of 3

110° TV DEFLECTION YOKE for all types TV's incl schematic **\$3**

"COMBINATION SPECIAL" RCA 110° FLYBACK plus 110° DEFLECTION YOKE **\$5**

90° FLYBACK TRANSFORMER for all type TV's incl schematic **\$2**

90° TV DEFLECTION YOKE for all type TV's incl schematic **\$2**

70° FLYBACK TRANSFORMER for all type TV's incl schematic **\$2**

70° TV DEFLECTION YOKE for all type TV's incl schematic **\$2**

2 — TV CIRCUIT BREAKERS Rated 4-2 TO 5-0 AMPS, etc. **\$1.19**

70° COLOR YOKE For all round color CRT's **\$10.95**

90° COLOR YOKE For all rectangular 19 to 25" Color CRT's **\$10.95**

WESTINGHOUSE FM TUNER #476-V-006H01 (12DT8 Tube) **\$2.99**

WESTINGHOUSE FM TUNER #476-V-015D01 Transistor type **\$3.99**

300 — ASSORTED HEX NUTS 2/56, 4/40, 5/40, 6/32, 8/32 **\$1**

250 — ASST. SOLDERING LUGS best types and sizes **\$1**

250 — ASST. WOOD SCREWS finest popular selection **\$1**

250 — ASST. SELF TAPPING SCREWS #6, #8, etc. **\$1**

150 — ASST. 6/32 SCREWS and 150 6/32 HEX NUTS **\$1**

150 — ASST. 8/32 SCREWS and 150—8/32 HEX NUTS **\$1**

150 — ASST. 2/56 SCREWS and 150—2/56 HEX NUTS **\$1**

150 — ASST. 4/40 SCREWS and 150—4/40 HEX NUTS **\$1**

150 — ASST. 5/40 SCREWS and 150—5/40 HEX NUTS **\$1**

500 — ASSORTED RIVETS most useful selected sizes **\$1**

500 — ASSORTED WASHERS most useful selected sizes **\$1**

100 — ASST. RUBBER BUMPERS for cabinet bottoms & other uses **\$1**

100—ASSORTED RUBBER GROMMETS best sizes **\$1**

MOTOROLA HEP KIT—INTEGRATED CIRCUITS INCLUDES One J-K Flip flop, One Dual Buffer, One 4-input Gate, Two Dual 2-Input Gates, All Five **\$3.95**

MOTOROLA EXPERIMENTER KIT HEC-2—9 Projects, instructions enclosed. Includes 2-FET, 2-Transistors. Tips on using "PETS" & Cross-reference Guide. **\$3.95**

2—MOTOROLA HEP-170 RECTIFIER 2½ AMPS and 1000V(PIV) Covers all GOMMA to 2500MA Units Voltage ranging from 50PIV to 1000 PIV **\$1**

4 — TV ALIGNMENT TOOLS most useful assortment #1 **\$1**

4 — TV ALIGNMENT TOOLS For Color TV #2 **\$1.49**

6 — TV COLOR ALIGNMENT TOOLS Most popular type **\$2.79**

5 — PNP TRANSISTOR general purpose, TO-5 case **\$1**

5 — NPN TRANSISTORS general purpose, TO-5 case **\$1**

100—TV TWIN LEAD-IN WIRE 300 ohm, deluxe heavy duty, clear **\$2**

UNIVERSAL TV ANTENNA Back of set mounting **\$1.98**

5 section rods **\$1**

50 — ASSORTED TRANSISTORS big factory scoop—sold as-is **\$1**

0 TO 200 MICRO AMP MINIATURE METER 1½ x 1½" Wt. 3 Oz. Excellent 8 meter **\$1**

10 — STANDARD TRANSISTORS NPN & PNP 2N404, 2N414, etc. **\$1**

10—ASSORTED DIODE CRYSTALS 1N34, 1N48, 1N60, 1N64, etc. **\$1**

3 — TOP BRAND SILICON RECTIFIERS 1 amp, 1000 PIV **\$1**

20 — ASST. PILOT LIGHTS #14, 46, 47, 51, etc. **\$1**

50 — ASSORTED #3AG FUSES popular ampere ratings **\$1**

4—50' HANKS HOOK-UP WIRE assorted colors **\$1**

100—SPOOL SPEAKER WIRE 456-ke for Transistor Radios 101 uses **\$1.50**

5 — I.F. COIL TRANSFORMERS 456-ke for Transistor Radios **\$1**

5 — AUDIO OUTPUT TRANSFORM Sub-min for Trans Radios **\$1**

POWER STAT-VARIAC — PRI. 12V 60CY. Sec. 3.5V—2 Amp. **\$2.95**

2—G.E. PIECES OF EQUIPMENT stacked with over 200 useful parts **\$1**

50 — ASSORTED MYLAR CONDENSERS popular selected types **\$1**

UNIVERSAL MICROPHONE regular/remote/single & dual plug **\$2**

CRYSTAL LAPEL MICROPHONE high impedance, 200-6000 cps **\$5.95**

STEREO HEADPHONES Hi-Fi Quality — Complete with Stereo plug **\$5.95**

50 — TUBE CARTONS (colored) assorted sizes for Popular Tubes **\$1**

4 — 36" HI-FI CABLES RCA Molded Phone Plug at one end stripped and tinned leads on other end **\$1**

3' JUMPER CABLES Male RCA Type Plug on Both Ends, 2 For **\$1.19**

50 — ASST. TERMINAL STRIPS all types, 1-lug to 6-lug **\$1**

Circle 106 on reader service card

MARKET CENTER

ELECTRONICS

RADIO AND TV TUBES 33¢ each. One year guaranteed. Plus many unusual electronic bargains. Free catalog. CORNELL 4217-E University, San Diego, Cal. 92105.

RECEIVING & INDUSTRIAL TUBES, TRANSISTORS, All Brands—Biggest Discounts. Technicians, Hobbyists, Experimenters—Request FREE Giant Catalog and SAVE! ZALYTRON, 469 Jericho Turnpike, Mineola, N.Y. 11501.

COLOR ORGANS, 2000 WATTS, \$19.95 Assembled; \$14.95 Kits, postpaid. Money-back Guarantee. CYBULSKI, Box 31174, Washington, D.C. 20031.

Ultra-sensitive and powerful METAL DETECTORS join the many who are finding buried coins, minerals, relics and artifacts. Don't buy till you see our free catalog of new models. Write JETCO—Box 132-RE, Huntsville, Texas 77340

EXCITING LISTENING! Police-Fire-Emergency calls on your broadcast radio. \$19.95 up! Retail-Wholesale. Also crystals-receivers, Scanners, dualband High/Low. Brochures 10¢. SALCH COMPANY, Woodsboro 43, Texas 78393.

THREE CHANNEL COLOR ORGAN Kit \$7.50. Power Supplies \$2.75. Catalog. MURPHY, 204 Roslyn Ave., Carle Place, N.Y. 11514.

CONVERT any television to sensitive Big-Screen Oscilloscope. Only minor changes required. No electronic experience necessary. Illustrated plans \$2.00. RELCO-A25, Box 10563, Houston, Texas 77018

TUBES—LOWEST PRICES. Foreign-American, Obsolete, receiving, special purpose, transmitting tubes. Send for tube, parts catalog. UNITED RADIO COMPANY, 56-R Ferry St., Newark, N.J. 07105.

Discharge IGNITION, PHOTOFLASH. Free catalog parts, kits. TRANSPARK, Carlisle, Mass. 01741

COMP-U-KIT. COMPUTER MICRO-CIRCUITS, a unique inter-connection method, and a book which tells all (about computer logic). Free illustrated literature. SCIENTIFIC MEASUREMENTS, C108, 9701 Kenton, Skokie, Ill. 60076.

JAPANESE NEW PRODUCTS MONTHLY! \$1.00. Refundable. DEERE, 10639 Riverside, North Hollywood, Calif.

TECHNICIANS & ENGINEERS. Teach yourself Computer Logic and advance professionally. COMP-U-KIT Logic Lab with modern type 74 microcircuits, a quality patch system, and our outstanding logic handbook is only \$39 postpaid. Free literature. SCIENTIFIC MEASUREMENTS, C108, 9701 Kenton, Skokie, Ill. 60076.

BUY DIRECT from AUTHORIZED DISTRIBUTOR, Westinghouse receiving tubes and Eveready batteries. Free catalog. EDISON ELECTRONICS, Box 2055, Edison, N.J. 08817.

ADVERTISING INDEX

RADIO-ELECTRONICS does not assume responsibility for any errors which may appear in the index below.

READER SERVICE CARD NO. PAGE
2 American Geosco Elec., Inc. 1

21 Blulyne Electronic Corp. 70
Bogen, Division of Lear Siegler, Inc. 82
106 Brooks Radio & TV Corp. 84-5
6 Burstein Applebee Company 12

4 Channel Master 7
11 Chemtronics 17
16 Cleveland Institute of Electronics 28-31
108 Cornell-Dubilier Cover III
CREI, Home Study Division of
McGraw-Hill Book Co. 18-21

27 Delta Electronics Co. 80
20 Delta Products, Inc. 69

1 EICO, Electronic Instrument Co. ... Cover II
EMC, Electronic Measurement Co. 14

3 G-C Electronics 5
17 Grantham School of Electronics 65-6

107 Heald Engineering College 90
15 Heath Co. 27

19 International Correspondence Schools .. 68
109 International Crystal Mfg. Co. ... Cover IV

14 Leader Instrument Co. 22

5 Master Appliance Corp. 12
13 Microlect 22
8 Mosley Electronics Inc. 14

31 National Radio Institute 8-11

24 Olson Electronics, Inc. 74

30 Pennwood Numechron Co. 82

26 Quam Nichols Co. 79
12 Quietrole Co. 22

RCA Institutes 54-57
RCA Parts & Accessories 67
25 Raytheon 75

23 S&A Electronics 74
28 Schober Organ Co. 80
10 Sencore 16
29 H.K. Simon Co., Inc. 81
Sylvania 32

7 TEAC Corp. of America 13
18 Transitek 68
22 TV Tech Aids 70

9 United Technical Institute, Division of
Career Academy 15

MARKET CENTER 86-89

95 Arcturus Electronics Corp.
Bele Electronics
92 Edmund Scientific Co.
Houle Mfg. Co.
Lakeside Industries
Music Associated
94 Park Electronic Products
91 Polypaks
93 Solid State Sales
Surplus Center

SCHOOL DIRECTORY 89

Tri-State College
Valparaiso Technical Institute

POLY PAKS SMASHES "IC" PRICES!

GE PA-237 2-WATT AUDIO AMPLIFIER  **\$2.95**

*Lowest Prices *Brand New!

2 watts continuous 9 to 27 volt supply, 8 mV sensitivity, includes 11 circuits, for phono, tape recorders, dictating, TV, FM, movie

Westinghouse WC334 one watt audio amp, TO-5 case **1.98**

TEXAS! NATIONAL! FAIRCHILD COUNTING "IC's"

Guaranteed! W/Spec Sheets Any 3 — 10% Discount!

- 958 Decade Counter \$4.95
- 959 Quad Latch 3.95
- SN7490 Decade Counter 5.50
- SN7475 Quad Latch 4.50
- SN7441 BCD Decoder 6.50
- 9301 1-to-10 Decoder 4.50
- 9306 BCD Up/Down Counter ... \$8.95
- 9300 4 Bit Univ. Shift Register \$2.49
- 9304 Dual Full Adder 4.95
- SN7493 4 Bit Binary Counter 4.95

LINEAR AMPLIFIERS

\$1.39 each, 3 for \$4.00

- 702C DC Amplifier
- 705C Operational Amp
- 710C Differential Comp.
- 711C Sense Amplifier



BRAND NEW! RTL-TTL 'ICS'

ALL GUARANTEED! With Spec Sheets!

Description	Price
SG43SD Dual 4 Input Nand/Nor Gate ...	TTL
W215F JK Flip Flop	DTL
W266F Quad 2 Input Gate	DTL
320T JK Flip Flop (fastest logic)...	ECL
900FF Buffer	RTL
908TU Full Adder	RTL
909TU Buffer	RTL
912TU Half Adder	RTL
913TU Shift Register	RTL
914TF Dual 2 Input Gate	RTL
923TF JK Flip Flop	RTL
960TU Dual Buffer	RTL
7470FX JK Flip Flop (35mhz)	TTL
7302FX Dual JK Flip Flop	DTL
7400XF Quad 2 Input Gates	TTL

• Low! Low Prices! **99¢** each **3 for \$2.75**

CODE: S=Sylvania, F=Fairchild, W=Westinghouse, X=Texas, F=Flat Pak; D=Dual Inline, T=TO-5 case, metal, U=unable to name maker. Give 1st, 2nd, and 3rd choices on case styles.

10 for \$1 SOLID STATE 1970 WINNERS

- Philco SC1600 Dual Mosfets \$3.98
- Fairchild 9601 Mono Vibrator \$2.98
- Fairchild 741 OP. Amplifier* \$2.98
- *frequency compensated 709
- Westinghouse Voltage Regulator 0 to 40 VDC Positive \$1.19
- Shockley Diodes, 4 layers 3 for \$1.19
- Neon & Nixie Driver 2N4410 4 for \$1.00
- SCR/Triac Trigger Diodes 4 for \$1.19
- 9989 4 Bit Binary Counters 4.95
- 9997 4 Bit Shift Registers 4.95

10¢ TO BUY BARGAIN CATALOG

Terms: add postage. Rated: net 30, cod's 2-5%. Phone Orders: Wakefield, Mass. (617) 245-3829. Retail: 211 Albion, St., Wakefield, Mass.

POLY PAKS P.O. BOX 942 R LYNNFIELD, MASS 01940

Circle 91 on reader service card

SOLDERING TIP FOR SOLID-STATE WORK

Most high-wattage soldering guns develop too much heat for safe use on semiconductors and some PC boards. In emergencies and for occasional jobs requiring low-level heat, you can modify your gun to do the job. Replace the original soldering tip with one made from No. 12 Copperweld (copper-clad steel) wire. It is easy to bend and holds the required shape. A tip made of Copperweld wire does not get as hot as one made of copper because of the greater resistance of the steel core.

For example, an all-copper tip normally used in my 150-watt soldering gun readily melted 40-60 solder. A Copperweld tip would not do so, but handled 60-40 solder nicely. As an added bonus, the home-made tip far outlasts the all-copper type supplied with the gun.—E. F. Ehlinger

DIGITAL CLOCKS

In the August issue electronic timepieces will be an important item. There are two construction articles on digital clocks for your home or desk and a feature story on the latest in electronic wristwatches. Would you believe a digital readout on your wrist?

U.S. GOV'T ELECTRONIC SURPLUS

Nationally Known-World Famous SURPLUS CENTER offers finest, most expensive, Government Surplus electronic units and components at a fraction of their original acquisition cost.

BURGLAR-FIRE ALARM SYSTEM
 • (ITEM #135-A) -- Dual alarm system plus warning of fire or breaking. Operates on 115-VAC. Control unit, 2-Kilohm flash fire, 2-megohm volume, 3-tone w/rotary actuators, alarm bell, 100 ft. wire, instructions. 8 1/2" x 7 1/2" x 3". (7 lbs.)
\$29.95

POCKET SIZE MULTI-RANGE TESTER
 • (ITEM #1017) -- Compact, 20,000-ohm/volt multimeter in excellent unit for testing electrical and electronic equipment, excellent for servicing transistorized equipment. Has precision resistors for extreme accuracy, 250-microamp D'Arsonval movement, 1/2" scale with superior readability on low ranges.
 • Specs: AC Volts: 0-10-50-25-1000, DC Volts: 0-5-25-125-250-500, DC Current: 0-250 mA, 0-50 microamps, Ohms: 0-10,000 and 1 Meg (expanded low ohm scale), Df: -20 to plus 22, overall size 3 1/2" x 2 1/2" x 1 1/2", Complete with leather case, 36" test leads, instructions, 1.5 lbs.
\$8.98

EXPANDED SCALE 0 - 15 DCVM
 • (#21-900) -- Brand new, expensive voltmeter reads 0 to 15-volts DC and 5 to 10-volts AC. Very useful for automotive and aircraft battery charge indicator, etc. D'Arsonval movement, black phenolic case, 7" x 5" x 2 1/2". (3 lbs.)
 List \$32.50 **\$12.95**

RUNNING TIME METER
 • (#DX-104) -- Use to record number of operating hours of electric filaments and electrical devices such as refrigerators, turntables, etc. Records total hours, tens and hundredths up to 9,999.99 hours, for 115-volt, 60-cycles. Size 4 1/2" x 3 1/2" x 2 1/2". Shipping weight 2 lbs.
\$5.69 Cost Over \$29.00

COMPUTER TRANSISTORS ON HEAT SINKS
 IBM Computer Quality Units
 • (#22-828) -- Unit consists of nine 150-watt power transistor on heat sink, ribbed aluminum heat sink. Many experimental uses. (1 lb.)
 Cost Gov't Over \$10.00 **\$1.99**

• (#22-915) -- Unit consists of two 150-watt power transistors, 2 pots, several diodes, capacitors, resistors, etc. on heavy, ribbed aluminum heat sinks, ideal for use as motor speed control. (4 lbs.)
 Cost Gov't Over \$35.00 **\$4.91**

ORDER FROM AD—WRITE FOR FREE CATALOG
 Include Money For Postage Money Back Guarantee

SURPLUS CENTER
 DEPT. RE-070 LINCOLN, NEBR. 68501

1000's OF UNUSUAL SCIENTIFIC BARGAINS including... SPECIAL UNIQUE PSYCHEDELIC LIGHTING for Fun, Profit, Effects!

NICKEL-CADMIUM BATTERY BARGAIN!

Terrific value—slightly used gov't surplus. Lightweight 5 cell, 6 volt, 4 Amp-hour battery with almost unlimited life. Extremely high current output. Recharges in 1 hour with Edmund kit. Won't deteriorate when left discharged. Minimum maintenance—few drops of water per year. Rugged, shock- and-vibration resistant nylon case. Delivered partially charged, filled with electrolyte. 3 1/2" x 9" x 3" 2 lb.
 Stock No. 70.942EH (BATTERY) ... \$15.00 Ppd.
 Stock No. 70.807EH (CHARGER KIT) ... \$ 8.00 Ppd.

PSYCHEDELIC LIGHTING HANDBOOK

100 information packed pages! Fully explains latest in psychedelic lighting equipment, techniques, developments. Covers all facets of psychedelic light-show production including strobes, black lights, projectors, crystals, organic slides, mirrors, color organs, polarized color light boxes, Music-Vision, etc. 8 1/2" x 11" looseleaf paper for 3 ring binder.
 Stock No. 9100EH ... \$3.00 Ppd.

LONG-WAVE BLACK LIGHT FIXTURE

Extremely versatile, compactly designed, long wave (3200-4000 angstroms) black light (ultraviolet) fixture—eliminates harmful shorter wave ultraviolet rays. Use to identify minerals, fungi, bacteria—check for surface flaws, oil and gas leakage—perfect for displays with fluorescent paper, paints, chalk, crayons, trace powder. Incl. adjustable aluminum reflector, push-pull switch, connecting plug. Mount vert., horiz., or on corner. 10" L., 1 1/2" W., 1 1/2" H.
 Stock No. 70.364EH ... \$12.50 Ppd.
 No. 60.124EH ... REPLACEMENT BULB ... \$4.50 Ppd.

NEW, LOW-COST GEM TUMBLER

Become a rockhound! Fascinating hobby... loads of fun, inexpensive, easy. Make jewelry of all kinds—decorative book-ends, table tops, etc. Simply tumble-finish readily available gemstones... then polish to high lustre... brings out beautiful colors. Rugged 3-lb. capacity tumbler w/continuous duty motor. Full instructions.
 Stock No. 70.374EH ... \$10.75 Ppd.
 6-lb. ROCK ASSORTMENT (10 TYPES)
 Stock No. 70.868EH ... \$ 9.00 Ppd.

TUNE IN AND TURN ON YOUR OWN

Psychedelic Light Show
 Take one bookshelf sized conservative looking oiled walnut finished light box—with its built-in kicker, an indie, controlled 3-channel color organ. Activate by attaching to hi-fi or stereo speaker. Plug in and switch on! Music fills the room and into pulsating life. Patterns are wild and wonderful, or soft and soothing—responding directly on time and intensity to music. Perfect home entertainment. Little cheaper of house current.
 Stock No. 80.126EH (18"Wx12"Hx9"D) ... \$49.95 Ppd.

NEW! PROJECTION KALEIDOSCOPE

A low cost unit with easily interchangeable 9" diam. liquid wheel. Projects variety of color patterns which do not repeat. Specially designed wheel, 3" projection lens and Edmund Visual Special Effects Projector make it all possible. Easily operated. Large screen image at short projection distance perfect for photo backgrounds, light shows, parties, dances, etc. Front or rear projection. Incl. 1 RPM 115V Motor, motor bracket, instructions.
 Stock No. 71.121EH ... \$94.50 Ppd.
 Stock No. 71.122EH (9" diam.) ... \$15.00 Ppd.

NEW \$99.50 HELIUM-NEON LASER!

Completely assembled, instant-starting w/ three times power output of comparable models. Steady, ripple-free light of moderate (safe) power. Excellent collimation. Particularly useful for studies, experiments in holography, interferometry, diffraction, optical alignment. Simple and safe to use—just plug in, switch on. The 1 1/2 lb. unit reaches 75% power in 2 secs.; full power, typically 0.5 milliwatt (0.3 mW minimum) in 3 mins. Beam divergence only 2 milliradians (far ahead of competition); beam only 2 cms at 40 feet.
 Stock No. 79.004EH ... \$99.50 Ppd.

3-CHANNEL COLOR ORGAN BARGAIN!

Create tremendous variety of unusual & beautiful lighting effects with this low-cost top-quality 1500-Watt unit (500 W. per channel). Compare with others selling for twice the price. Has pilot light, plus individual sensitivity controls and channel indicator lights. (Can operate ten 150 W. "spots" or 200 Christmas lights. Uses reg. house current—attaches to audio source w/RCA-type phone plug. 5 1/2" x 9 1/2" x 3 1/2". 2 1/2 lbs. Thermal setting plastic case. 6-ft. cord, including complete instructions.
 Stock No. 71.223EH ... \$34.95 Ppd.

TREASURE HUNT ON LAND & SEA

Find buried gold, silver coins, treasure. Powerful new electronic detector probes deep into earth, up to 2 1/2 feet in water in perfect safety. Sensitive enough to locate single coin, small nugget. Best fully transistorized loop detector at moderate price. Big 11 waterproof loop work through earth, wood, vegetation, salt water, snow or ice. Instant signal on wideview meter and headset tone when object detected. Rugged, lightweight (3 1/2 lbs.), trouble-free unit uses inexpensive 2 volt battery (included—130 hour life).
 Stock No. 80.134EH ... \$163.50 Ppd.

ROTATING MULTI-COLORED LIGHT

Dazzling colors stream endlessly from constantly rotating light. Faceted, transparent globe has lowered drum inside with red, green, blue & yellow stars. Bulb heat rotates drum which projects flickering star points on walls, ceilings, etc. while individual globe facets present constantly changing array of brilliant colors. 9 3/4" star—approx. 12" high on bell-shaped base. Surprisingly light. Easily placed on table, TV, fireplace, or Xmas tree top.
 Stock No. 71.000EH ... \$6.00 Ppd.

SPECIAL VISUAL EFFECTS PROJECTOR SET

Fantastic variety. Incredibly beautiful. Create floating, exploding, fiery bursts of color like "Symphony of Spheres", "Chromatic Starbursts", "Crystal Starbursts". Features 35mm 500 W. fan cooled projector. Produces big image at short distance. Accepts two 9" diam. wheels (Dry Kaleidoscope & Hexidoscope). 2 cylindrical accessories (6" Colored Cloud & 5" Hexidoscope w/six internal mirrored walls). Complete instructions.
 Stock No. 71.212EH ... \$79.50 Ppd.

81 "WILD" 35MM SLIDES

Created by Hollywood's premier special lighting effects man—Bob Berk. Produce fantastic backgrounds, light shows, psychedelic slide shows, etc. 81 pre-mounted slides especially selected for impact, vividness and/or intriguing scene. Range from "way-out" group of eyes to kaleidoscopic images, optical illusions, etc. Low-cost unduplicated sets fill popular Kodak Carousel tray. Ideal for modern presentations. Loads of fun for amateurs.
 Stock No. P-60.749EH—(Set A) ... \$22.50 Ppd.
 Stock No. P-60.750EH—(Set B) ... \$22.50 Ppd.

STEREO MICROSCOPE—Great Buy!

American made. High powered. Direct measurement. Up to 3" working distance—wide 3-dimensional field. 2 sets of objectives on rotating turret. Standard pair of wide field 10X Kellner Eyepieces give 23 power and 40 power clear, sharp, erect image. Interpupillary distance adjustable. 10-day free trial.
 Stock No. 85.056EH ... \$99.50 FOB

MAIL COUPON FOR GIANT FREE CATALOG

148 PAGES—1000's OF BARGAINS
 Completely new edition. New items, categories. Illustrations. Dozens of electrical and electromagnetic parts, accessories. Enormous selection of Astronomical Telescopes, Microscopes, Binoculars, Magnifiers, Magnets, Lenses, Prisms. Many war surplus items; for hobbyists, experimenters, workshop, factory. Mail coupon for catalog "E11".

EDMUND SCIENTIFIC CO.
 300 EDCORP BUILDING
 BARRINGTON, N.J. 08007

NAME _____
 ADDRESS _____
 CITY _____ STATE _____ ZIP _____

ORDER BY STOCK NUMBER • SEND CHECK OR MONEY ORDER • MONEY-BACK GUARANTEE
EDMUND SCIENTIFIC CO. 300 EDCORP BUILDING
 BARRINGTON, NEW JERSEY 08007

Circle 92 on reader service card

MARKET CENTER

TUBES, OBSOLETE, LOWEST PRICE. Send 20¢ refundable for list. WALKER, 617 Avalon Ave., Virginia Beach, Va. 23462.

GENERAL

NEW SOLDERING AID: Versatile chemical gel stops damaging heat flow. Prevents remelt of nearby solder joints and damage to delicate components. Performance guaranteed. \$2.95 lb. postpaid. DYNATEK INDUSTRIES, Dept. R-7, Box 24268, Cleveland, Ohio 44124.

FREE "Directory of 500 Corporations Seeking New Products." For information regarding developments, sale, licensing of your patented/unpatented invention. Write: **RAYMOND LEE ORGANIZATION**, 230-U Park Avenue, New York City 10017.

SCHEMATICS, DIAGRAMS, OLD RADIOS, \$1.50 TVs, \$2.50 GORDIE'S TV, Hustisford, Wis. 53034

AUDIO - HI-FI

WRITE for highest discounts on components, recorders, tapes, from franchised distributors. Send for FREE monthly specials. CARSTON, RFD #3, Route 7, Brookfield, Conn. 06804

Tapemates makes available to you ALL 4-TRACK STEREO TAPES. All Labels—postpaid to your door—at tremendous savings. For free brochure write: **TAPEMATES CLUB**, 5280 RE West Pico Blvd., Los Angeles, Calif. 90019.

TAPE RECORDER SALE. Brand new nationally advertised brands, \$10.00 above cost. Amazing discounts on stereo components. **ARKAY ELECTRONICS**, 1028-E Commonwealth Avenue, Boston, Mass. 02215

ENJOY THE ULTIMATE in stereophonic sound, using stereo headphones, \$20.00 per pair. **LASSITER**, Box 474, Port Hueneme, Calif. 93041.

SAVE OVER 33 1/3 on a pair of one of The World's Best Speaker Systems. Shipped direct to you from factory. Try them in your home for thirty days. **KGLL INC.**, Water St., Lewiston, Maine 04240

RENT 4-TRACK OPEN REEL TAPES—all major labels—3,000 different. Free brochure. **STEREO-PARTI**, 55 St. James Drive, Santa Rosa, Cal. 95401

INVENTIONS & PATENTS

INVENTIONS WANTED. Patented; Unpatented. **GLOBAL MARKETING**, 2420-AE 77th Ave., Oakland, Calif. 94605

INVENTORS: protect your ideas! Free "recommended procedure". **WASHINGTON INVENTORS SERVICE**, 422X Washington Building, Washington, D.C. 20005

GOVERNMENT SURPLUS

JEEPS Typically from \$53.00 . . . Trucks From \$78.40 . . . Boats, Typewriters, Airplanes, Multimeters, Oscilloscopes, Transceivers, Electronics Equipment, Used. 100,000 Bid Bargains Direct From Government Nationwide. Complete Sales Directory and Surplus Catalog \$1.00 (Deductible First \$10.00 Order). **SURPLUS SERVICE**, Box 820-REL, Holland, Michigan 49423

HOBBYISTS, EXPERIMENTERS; BLACK AND WHITE TELEVISION CONVERTED TO COLOR BY MEANS OF A NEW PATENTED COLOR CONVERTER ADAPTOR. INSTALLATION ALL DO IT YOURSELF. WRITE FOR FREE BROCHURE. BELE ELECTRONICS CORP., 111 N.E. SECOND AVE., MIAMI, FLORIDA 33132.

EDUCATION/ INSTRUCTION

FCC First Class License in six weeks—nation's highest success rate—approved for Veterans Training. Write **ELKINS INSTITUTE**, 2603E Inwood Road, Dallas, Texas 75235

LEARN TO REPAIR T.V. TUNERS—How I earn \$10 per hour. Introduction, Contents, Details of Complete Course, Twelve REPAIR TRICKS, PLANS for Special Probes and Power Supplies, Two Complete Sample Lessons, All for \$1. Refundable. **FRANK BOCEK**, Box 3236 (Enterprise), Redding, California 96001.

ELECTRONICS ENGINEERING. Day or evening classes. Bachelor of Science Program evenings. Associate in Science Program day or night. If you are married or if you must work for a living while obtaining your education, this is the college for you. Approved for Veterans. **WESTERN STATES COLLEGE OF ENGINEERING**, 970 West Manchester Avenue, Inglewood, California 90301

MEMORIZE, STUDY: "1970 Tests-Answers" for FCC First and Second Class License.—plus—"Self-Study Ability Test." Proven. \$5.00. **COMMAND**, Box 26348-E, San Francisco 94126.

WANTED

2 WALKIE TALKIES, World War II type. **SELWYN LUBEN**, 3641 Troost, K.C., Mo. 64109.

QUICK CASH . . . for Electronic EQUIPMENT, COMPONENTS, unused TUBES. Send list now! **BARRY**, 512 Broadway, New York, N. Y. 10012, 212 WALKER 5-7000.

CASH PAID for your **PRECIOUS METAL**, scrap silver, gold, platinum, sludges circuitry plated material. **ACME REFINING & SMELTING**, 454 N. Green, Chicago, Illinois 60622.



MAKE BITS FOR SPECIAL SCREWS

Instead of lugging a variety of screwdrivers spilling out of your tool kit, just cut some short driver blades from pieces of 1/16-inch steel. Grind the sides to snug-fit into a hex-nut driver, and grind a suitable point on the short blade. A number of the short blades made up to fit special-slot screws, take up little space in the tool box.—S. Clark

PHILLIPS SCREW HOLDER

When I can't find a locking-type screwdriver for holding Phillips screws in hard-to-reach places, I just slip a pocket pencil clip around the

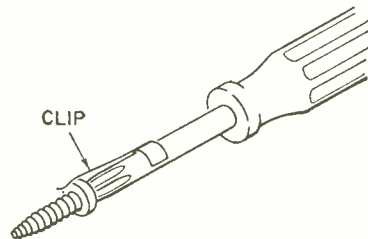

shaft of the Phillips screwdriver so the bottom of the clip presses against the screwhead, firmly holding it positioned for easy handling.—Harry J. Miller

INTEGRATED CIRCUITS & RECTIFIERS SEMICONDUCTORS & TRIACS

ER900 TRIGGER DIODES. These bidirectional trigger diodes are one of the best and cheapest methods to trigger SCR's and triacs. . . 3/\$1.00

UNIJUNCTIONS! Similar to 2N2419. RBB of 5-7 stand off ratio of .5 and 1p of 12 with data sheet \$1.00

N-CHANNEL FET'S TO-18 plastic units. low noise, low leakage, 25 volts source to gate, 50 ma gate current Gain to 3000 μ mho's. \$.80

NEON LIGHT OR NIXIE TUBE DRIVERS. An NPN. TO-18. SI Transistor. With a VCBO of 120 . . . 3/\$1.00

MOUNTING

HARDWARE KITS.

These kits are used to mount our SCR's Zeners and Rectifiers etc. 6x32 stud (3, 12 amp rectifiers. 7A SCR's) 6 sets/\$1.00 1/2" 28 stud (30 amp. rectifiers, 20 amps SCR's) 4 sets/\$1.00

TRIACS

PVR	10A
100	1.20
200	1.75
300	2.25
400	2.75
500	3.25

SE 161 ONE SHOTS . . . \$1.95
US 908 FULL ADDERS85
US 913 REGISTERS85
US 940 JK FLIP FLOP85

TTL IC SERIES

DECADE DIVIDER \$3.95
RF 112 Dual JK Flip Flop . . . 1.50
MC 415 JK Flip Flop85
MC 400 Dual 4 input NAND/NOR gate85
4 Bit Storage Register . . . 1.75
9301 MSI ONE-OF-TEN DECODER 2.95

Silicon Power Rectifiers

PRV	3A	12A	30A
100	.09	.24	.50
200	.16	.35	.80
400	.20	.45	1.20
600	.30	.70	1.50
800	.40	.85	1.80
1000	.50	1.10	2.20

Terms: FOB Cambridge, Mass. Send check or Money Order. Include Postage. Average Wt. per package 1/2 lb. No C.O.D.'s. Minimum Order \$3.00

WE LEAD THE WAY IN SERVICE AND QUALITY

Send for our latest catalog featuring Transistors and Rectifiers; 325 Elm St., Cambridge, Mass.

FIBRE OPTICS 1/32" 2.5 mil. fibers in PVC packet. \$.33/ft.

COMPLETE LIGHT GUIDE BUNDLE

consisting of an 11" length of 1/32" dia. fiber optics with bound ends. \$2.00 ea.

709C OPERATIONAL AMPL. \$1.45 ea.
Controlled Avalanche or Epoxy Rectifiers 1 AMP.

PRV	PRV
100 .07	600 .16
200 .09	800 .20
400 .11	1000 .30

Silicon Control Rectifiers

PRV	3A	7A	20A	70A
50	.35	.45	.70	
100	.50	.65	1.00	4.00
200	.70	.95	1.30	8.00
300	.90	1.25	1.70	
400	1.20	1.60	2.10	12.00
500	1.50	2.00	2.50	
600	1.80	2.40	3.00	16.00
700	2.20	2.80		

OLID
Post Office Box 74D

TATE
Somerville, Mass. 02143

ALLES
Tel. (617) 547-4005

Circle 93 on reader service card

ENJOY THE "MUSIC ONLY" FM PROGRAMS

M. A. D.

MUSIC ASSOCIATED'S DETECTOR
for continuous, commercial-free music
with ANY FM tuner or receiver



Kit \$49.50 Wired \$75.00 Cover \$4.95 List of FM stations with SCA authorization \$1.00. For complete information write or call:

MUSIC ASSOCIATED
65 Glenwood Rd.,
Upper Montclair, N.J. 07043
phone 201-744-3387

WHOLESALE TO ALL

Breadboard Kits—"RF" Kits—"PC" Kits—Perf. Phenolic Board—Copper Clad Board—Cowl Type Electronic Cabinets—Heat Sinks—Solid State Hobby Kits—Solderless Connectors—Hardware Kits—Transistor Sockets and many more items. Send for free catalog from: H. M. C. Sales—P. O. Box 276—Santa Susana, California 93063

PEP'S Dollar Sale

\$1 Money Back guarantee \$1

1 Amp Silicon Rectifier
choice of package
Bullet—Miniature Glass—Metal
 5-800V units \$1.00
 4-1000V units \$1.00
 3-1200V units \$1.00

3 AMP Epoxy Package
 10-100V units \$1.00
 5-400V units \$1.00
 2-1000V units \$1.00

5 AMP Epoxy Package
 8-100V units \$1.00
 6-200V units \$1.00
 3-800V units \$1.00

SILICON STUD MOUNT
12 AMP
 5-100V units \$1.00
 2-800V units \$1.00
 1-1000V units \$1.00

SILICON STUD MOUNT
20 AMP
 3-100V units \$1.00
 1-1000V unit \$1.00

7 AMP SCR
 4-50V units \$1.00
 3-100V units \$1.00
 2-200V units \$1.00
 1-500V unit \$1.00
 1-800V unit \$1.50

20 AMP SCR
 2-50V units \$1.00
 1-300V unit \$1.00

Gen Purpose PNP
Germ Transistor Similar to 2N404
 8 For \$1.00

ZENER DIODES
3 Watt

10 Volts
 3 units \$1.00
ZENER DIODES 1 Watt
1 EA 4V-6V-8V-10V
 4 units \$1.00

GERM GLASS DIODES
DO7 GEN PURPOSE
 20 Units \$1.00
Replaces 1N-34 1N-60 1N-64 1N-295

I.C. SUMMER SPECIAL
14 Lead Dual In-Line Pkg.
Perform same function as 7000 series
Master Slave Flip Flop 75¢ @—\$5-\$3.00
Quad 2 Input Nand Gate 75¢ @—\$5-\$3.00

16 Bit Memory Cell—\$4.25
14 Lead Dual In-Line Pkg.

CIRCUIT BOARD COLOSSAL

3 different groupings to choose from
Typical samples below

- A) 4 I.C. mounting blocks—3 transistors—over 25 resistors complete with board! Price \$1.25
B) 32 transistors—over 100 resistors—capacitors—S.C.R.'s over 15 diodes—complete with board! Price \$1.75
C) 22-14 lead dual in-line I.C.'s—over 75 diodes—capacitors—20 transistors—over 50 resistors—complete with board! Price \$4.50

FULL WAVE BRIDGES

PRV	2Amp	3Amp	5Amp	10Amp
50V	1.25	1.35	1.50	1.70
100V	1.50	1.60	1.75	1.95
200V	1.75	1.85	2.00	2.20
400V	2.00	2.10	2.25	2.45
600V	2.50	2.60	2.75	2.95
800V	3.00	3.10	3.25	3.45

PARK ELECTRONIC PRODUCTS

P. O. Box 78 N. Salem, N. H. 03073
Tel. (603) 893-0276

NO SALES TAX WE PAY POSTAGE

Circle 94 on reader service card

LATEST ARCTURUS SPECIALS

- Color focus rectifiers, 14,000 P.I.V. at 1 MA, 99¢ each, 6.5 KV—79¢
- Color TV yokes 70° & 90° types. Fit almost all sets \$10.95.
- 1700 Transistor types—39¢
- DS-501, 2N278 power transistor types. Cat. #349, 69¢
- HEP170, Motorola HV/Current epoxy silicon rectifiers, 2.5 amps at 1,000 PIV, 49¢
- Fully transistorized UHF tuners. Fit most sets. Cat. #UHF567, \$4.95 each.
- UHF tuners, 1 tube type. Fit most sets. Cat. #UHF3, \$3.95 each.

Complete listings of electronic items at similar bargain prices are available. Write for our latest catalog. Minimum order \$5.00, plus postage.

ARCTURUS ELECTRONICS CORP.

502-22nd St., Union City, N.J. 07087
Dept. MRE
Phone: 201-864-5568

Circle 95 on reader service card

SCHOOL DIRECTORY

distinguished graduates

hold important engineering and management posts throughout U.S. Professionally-oriented college with outstanding placement record. Four-quarter year permits degree in three years. Dedicated faculty. Modern labs. Small classes. 400-acre campus. Accredited. Approved for vets. Moderate total costs. Enter Sept., Jan., March, June. For Catalog, write Admissions.



TRI-STATE COLLEGE
2470 College Avenue, Angola, Indiana 46703

GET INTO

ELECTRONICS

V.T.I. training leads to success as technicians, field engineers, specialists in communications, guided missiles, computers, radar and automation. Basic & advanced courses in theory & laboratory. Electronic Engineering Technology & Electronic Technology curricula both available. Associate degree in 29 mos. B.S. also obtainable. G.I. approved. Graduates in all branches of electronics with major companies. Start Sept., Feb., Dorm. campus. High school graduate or equivalent. Catalog.

VALPARAISO TECHNICAL INSTITUTE

Dept. C, Valparaiso, Indiana 46383



Rebuild Your Own Picture Tubes?

With Lakeside Industries precision equipment, you can rebuild any picture tube!

For complete details, mail coupon.

Lakeside Industries
5234 N. Clark St.
Chicago, Ill. 60640
Phone: 312-271-3399
NAME.....
ADDRESS.....
CITY.....STATE.....ZIP.....



CLASSIFIED COMMERCIAL RATE (for firms or individuals offering commercial products or services). 70¢ per word . . . minimum 10 words.

NON-COMMERCIAL RATE (for individuals who want to buy or sell personal items) 30¢ per word . . . no minimum.

FIRST WORD and NAME set in bold caps at no extra charge. Additional bold face at 10¢ per word. Payment must accompany all ads except those placed by accredited advertising agencies. 10% discount on 12 consecutive insertions, if paid in advance. Misleading or objectionable ads not accepted. Copy for September issue must reach us before July 5.

CLASSIFIED ADVERTISING ORDER FORM

1	2	3	4	5
6	7	8	9	10
11	12	13	14	15
16	17	18	19	20
21	22	23	24	25
26	27	28	29	30
31	32	33	34	35

No. of Words { @ .30 Non-Commercial Rates } = \$
 { @ .70 Commercial Rate }

Total Enclosed \$
Insert _____ time(s)

Starting with _____ Issue

Payment must accompany order unless placed through accredited advertising agency 28

NAME _____

ADDRESS _____

CITY _____ STATE _____ ZIP _____

SIGNATURE _____

MAIL TO: RADIO-ELECTRONICS, CLASSIFIED AD DEPT., 200 PARK AVE. SOUTH, NEW YORK, N.Y. 10003

There's no substitute
for **SUCCESS...**



JAMES WONG—Research Engineer
Heald Engineering College Graduate

or IN-CLASS INSTRUCTION!

In electronics, it's the training that makes the difference. Employers require well-trained men and the first thing checked is where you gained your knowledge.

HEALD GRADUATES have many job offers with starting salaries often in excess of \$10,000 per year. AND advancement is rapid.

GET STARTED NOW. Be a

DRAFTSMAN—12 months
TECHNICIAN—15 months
ENGINEER (B.S. Deg.)—36 months
ARCHITECT (B.S. Deg.)—42 months

YOU are eligible for HEALD ENGINEERING COLLEGE if you have a high school education or the equivalent.

Increased income starts with success—success starts with your move to Heald. Send now for FREE brochures with more information on Heald in San Francisco and your future in Engineering.

FREE LIFETIME PLACEMENT SERVICE
VETERAN APPROVED



WRITE TODAY FOR DETAILS

HEALD Engineering College

1215 Van Ness Ave., San Francisco, California 94109

Please send me information about:

- ARCHITECTURE
ENGINEERING: Civil Electrical
Electronic Mechanical
TECHNOLOGY: Electronic Engineering
Technician (FCC)
Radio-Television Technician (FCC)
DRAFTING: Mechanical Electrical
Structural

I am interested in Day Evening courses
Also send an application.

NAME _____ AGE _____

ADDRESS _____

CITY _____

STATE _____

ZIP _____ PHONE _____

Circle 107 on reader service card

NEW PRODUCTS

(continued from page 85)

FET VOM, B & K model 176. Solid-state unit is battery-operated, features complementary symmetry circuit protecting FET's from over-voltage transients and provides balanced temperature compensation. Ac frequency response to 3 MHz, fuse and diode protected against accidental overloads. Rf accessory probe extends frequency range to 250 MHz. High voltage accessory probe extends voltage range to 60 kV with input impedance greater than 1,000 megohms, insulated case eliminates shock hazard. 8 dc ranges: from 0.5 to 1,500V full scale; accuracy: $\pm 2\%$ full scale; impedance:



11 megohms. 8 rms ac ranges: from 0.5 to 1,500V full scale; accuracy: $\pm 3\%$ full scale; input impedance: 10 megohms shunted by 65 pF on 0.5 V range and 36 pF on remaining ranges; frequency response: $\frac{1}{2}$ db 9 Hz to 1 MHz. Ohmmeter: 7 ranges: RX1 to RX1 meg.; mid-scale reading: 10 megohms (on RX1 range); accuracy: $\pm 3\%$ scale arc. Dc current: 6 ranges: 150 μ A, to 5 A full scale; accuracy: 2% full scale; internal voltage drop: 200 mV. Multipliers: 1% precision type; frequency compensated for ac. Power supply: amplifier: two 9-volt batteries in series, regulated for constant 13 V dc; ohmmeter: one 1.5 V "C" cell. Size: 7 x 9 x 3 $\frac{1}{2}$ ". Weight: 5 lbs., 2 oz. \$99.95. Optional probes: rf, \$11.95; high voltage, \$15.95. Dynascan Corp., 1801 W. Belle Plaine Ave., Chicago, Ill. 60613.

Circle 60 on reader service card



WIRELESS REMOTE SWITCH, Knight-Kit KG-203, controls radios, TV's, lamps or other electrical appliances up to 40 ft away. Any electrical device up to 600 watts can be plugged into remote switch receiver and turned on or off with transmitter. Receiver plugs into ac; transmitter uses 9 V battery. \$16.95. Wired, model A-2909 \$19.95. Allied Radio Corp., 100 N. Western Ave., Chicago, Ill. 60680. R-E

Circle 61 on reader service card

NEW LITERATURE

CONNECTOR SELECTOR is a slide-rule that catalogs Amphenol's Min-Rac 17 series connectors. The user places the arrow in horizontal window to one of six family types (fixed contact, high density, encapsulated contact, hard dielectric, Poke-Home, or power/coax) shown, then reads Amphenol pin-and-socket connector characteristics, such as temperature range, insulator material, contact size, wire sizes accepted, electrical specs and shell material plating.—Amphenol Industrial Div., Chicago, Ill. 60650

Circle 62 on reader service card

CATALOG, Series 54/74 TTL Integrated Circuits (Catalog CC 201) includes 424 pages of data sheets on every circuit in TI's three TTL 54/74, 54H/74H and 54/74L series. The MSI functions listed are data selectors/multiplexers, decoders, memories/latches, shift registers, counters, parity generators/checkers, and arithmetic elements, linear, systems, interface, DTL, ECL, MOS, series SNF/SNG TTL and custom circuits.—Texas Instruments Inc., Inquiry Answering Service, P.O. Box 5012—M/S 308, Dallas, Tex. 75222

Circle 63 on reader service card

EDMUND 1970 CATALOG No. 701 offers kits, components, products in astronomy, optics, electronics, chemistry, physics, math, microscopy, photography, psychedelics, and behavioral science. Caters to experimenters, hobbyists, students, gadgeteers, researchers, educators, scientists and children. Satisfaction guaranteed or money refunded within 10 days of purchase. Postage paid on most items. Edmund Scientific Co., 300 Edscorp Bldg., Barrington, N. J. 09007

Circle 64 on reader service card

Write direct to the manufacturers for information on items listed below:

MICROPHONES AND ACCESSORIES—Public address, tape recording, broadcast and Entertainment. Floor stands, booms, holders, line transformers, cables, connectors, screens, solid state portable mixer-preamplifier, low-level music and paging system; baffles with speakers; mobile solid-state sound systems, amplifiers, paging system; reflex trumpets.—American Gelsco Electronics, Inc., 251 Park Ave. So., New York, N.Y. 10010

In Canada: William Cohen Corp., 8900 Park Ave., Montreal.

MICROPHONE CATALOG, Astatic Microphones, catalog M-69, features illustrations, descriptions and specifications for mobile use, communications, public address, paging, recording, broadcast and all sound uses. Includes mike Selector Guide to assist in choice of mike for specific application. Astatic Corp., Conneaut, Ohio 44030.

PROTOTYPE CHASSIS SYSTEMS available in more than 500 sizes from 2" x 2" x 1" to 17" x 17" x 4" and a complete line of matching terminals and terminal boards in a variety of sizes are described with charts, measurements and photos. Prices listed. Write to Aracon Electronics Inc., 344 E. 49 St., New York, N.Y. 10017

1969 GENERAL CATALOG, 52 pages, comprises 375 electronic test accessories for which photos, dimension drawings, schematics, specs, features and operating ranges are presented. In addition, booklet also describes many typical applications and information helpful to designers and test engineers.—Pomona Electronics Co. Inc., 1500 E. 9 St., Pomona, Calif. 91766 R-E

DID YOU MISS . . .

• Do you know what a quadrac is and how to use one for dimming lights and motor speed control? If not, see page 49.

• What can cause an overheating flyback transformer? See page 58.

Circle 108 on reader service card

The Re-Place



Capacitor Replacements for
Crosby and B & W TVs, Radios,
Stereo, Hi-Fi

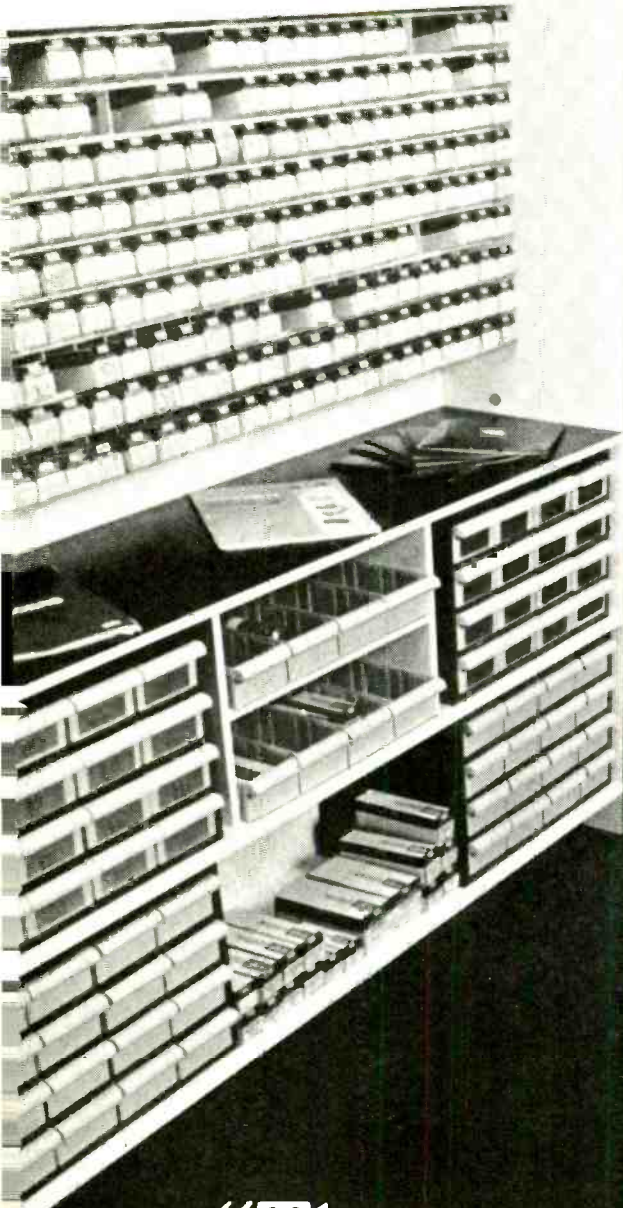

“These capacitors practically sell themselves, like in a supermarket!”



Says Alexander Wellington, owner of Sylvan-Wellington, Inc., New York City, in speaking about The Re-Place, Cornell-Dubilier's new capacitor replacement center. "I am amazed at the increase in turnover, and the ease of selling."

A pioneer in electronic servicing, Mr. Wellington was also one

of the first of those alert distributors who have installed The Re-Place in their stores.

The Re-Place is both a showcase and a self-service

store within a store, all in a compact 5' x 2' area. It organizes capacitor inventory and makes it easy for customers to select and to buy from a complete stock of twist-prong aluminum electrolytics, tubular electrolytics, miniature electrolytics, ceramic discs and mica capacitors.

You can provide instant service to your customers with The Re-Place—and profitably increase your turnover, too. Call your CDE Representative today. Or write for full information about The Re-Place.™

CDE CORNELL-DUBILIER

There Is a Difference In Quartz Crystals

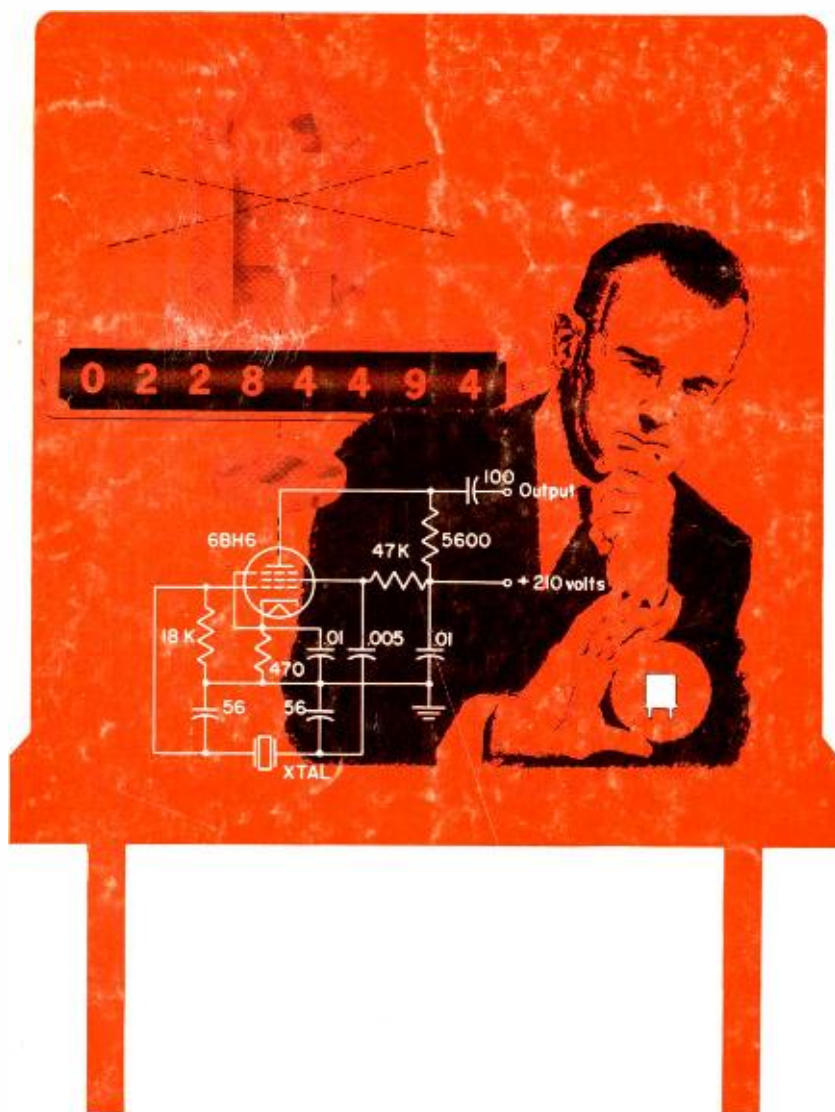

Space age communication equipment demands a crystal that meets all standards of technical advancement. Crystals that were acceptable some years ago do not meet present day specifications. As a general rule, your crystal must be selected from the best quartz . . . (no throw off cuts). Tight tolerances demand selected angles of cut. The x-ray is important in making this selection. The crystal should be preaged with stress cycling. It should be checked for frequency change vs temperature change. It must be checked for optimum spurious response. It should be calibrated to frequency with the correct oscillator. International Crystals are manufactured to meet today's high accuracy requirements. That's why **we guarantee all** International crystals against defective materials and workmanship for an unlimited time when used in equipment for which they were specifically made.

WRITE FOR CATALOG



CRYSTAL MFG. CO., INC.
10 NORTH LEE
OKLAHOMA CITY, OKLA. 73102

Circle 109 on reader service card