

Complete 1969 Color Set Directory

60c ■ JAN. 1969

# Radio-Electronics®

TELEVISION • SERVICING • HIGH FIDELITY

## SPECIAL ISSUE COLOR TV 1969

How Color TV Works  
Spot Color Faults Fast

Build: Beginners Dot-Bar Generator

561256 OLS B0245N97 DEC72 2

W H DELSCHLAGER

BX 245

BROWNS HILLS NJ 08015

Will tomorrow's  
color sets use  
**QUICK-  
CHANGE  
MODULES**

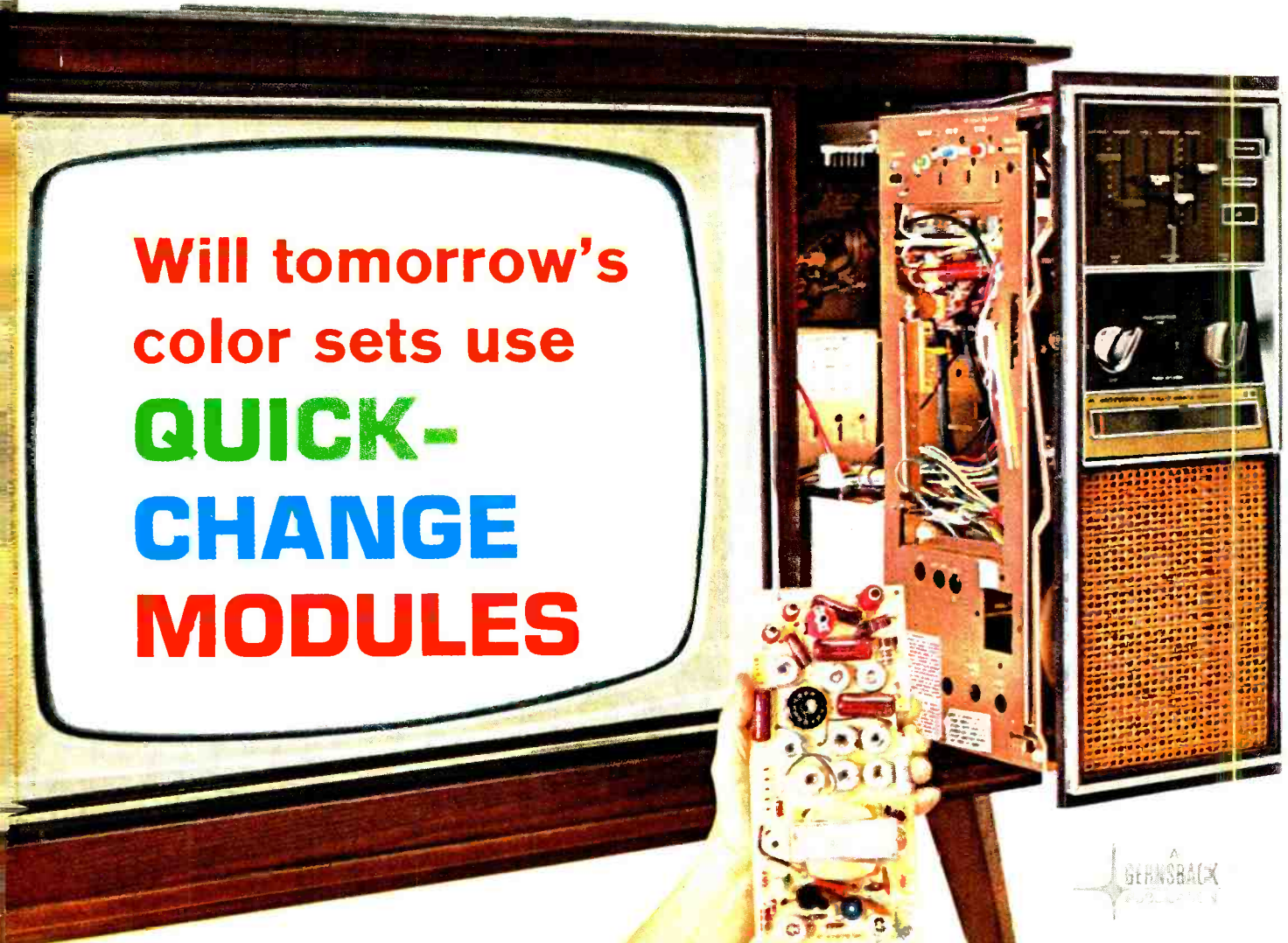

A  
GERNSBACK  
PUBLICATION

# EICO Makes It Possible

Uncompromising engineering—for value does it!  
You save up to 50% with Eico Kits and Wired Equipment.



## Cortina Stereo

THE VERDICT IS IN. High fidelity authorities agree:

Cortina's engineering excellence, 100% capability, and compact dramatic esthetics all add up to Total Stereo Performance at lowest cost.

NEW

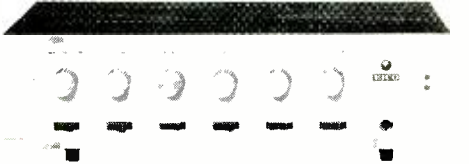

A Silicon Solid-State 70-Watt Stereo Amplifier for \$99.95 kit, \$139.95 wired, including cabinet. Cortina 3070

NEW

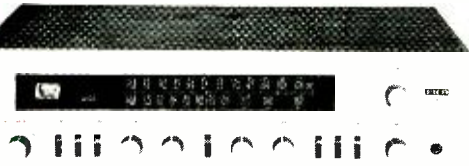

A Solid-State FM Stereo Tuner for \$99.95 kit, \$139.95 wired, including cabinet. Cortina 3200.

A 70-Watt Solid-State FM Stereo Receiver for \$169.95 kit, \$259.95 wired, including cabinet. Cortina 3570.

NEW Silicon Solid State 150-Watt Stereo Amplifier designed for audio perfectionists. Less than 0.1% harmonic distortion, IM distortion. Less than 0.6% at full output. Controls and inputs for every music source. \$149.95 kit, \$225.00 wired including cabinet. Cortina 3150.

NEW 70-Watt Solid State AM/FM Stereo Receiver for \$189.95 kit, \$279.95 wired including cabinet. Cortina 3770.

## Eicocraft

The newest excitement in kits.

100% solid-state and professional.

Fun to build and use. Expandable, interconnectable. Great as "jiffy" projects and as introductions to electronics. No technical experience needed. Finest parts, pre-drilled etched printed circuit boards, step-by-step instructions.

EC-100 Electronic Siren \$4.95, EC-101 Electronic Burglar Alarm \$6.95, EC-102 Electronic Fire Alarm \$6.95, EC-200 Electronic Intercom \$5.95, EC-300 Audio Power Amplifier \$5.95, EC-400 Electronic Metronome \$3.95, EC-500 Tremolo \$9.95, EC-600 Electronic Light Flasher \$3.95, EC-700 Electronic "Mystifier" \$4.95, EC-800 Photo Cell Nite Lite \$4.95, EC-900 Power Supply \$8.95, EC-1000 Code Oscillator \$2.50, EC-1100 FM Wireless Mike \$9.95, EC-1200 AM Wireless Mike \$9.95, EC-1300 Electronic VOX \$8.95, EC-1400 Solid State FM Radio \$9.95, EC-1500 Solid State AM Radio \$8.95, EC-1600 Electronic Bongos \$7.95

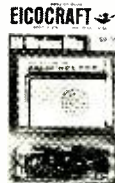

### 6 EXCITING NEW PROJECTS

EC-1700 Ham/CB Vox \$8.95, EC-1800 Electronic "TOX" \$8.95, EC-1900 "Treasure Finder" \$9.95, EC-2000 Electronic Organ \$9.95, EC-2100 Electronic "Eye" \$9.95, EC-2200 "Magic Switch" \$9.95

## Color n' Sound

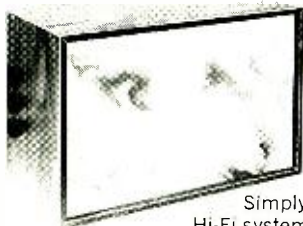

Add a new dimension to your music system. Introducing the first inexpensive solid-state electronic system which provides true synchronization of color with sound. Watch the music you love spring to life as a vibrant, ever shifting interplay of colors.

Simply connect to speaker leads of your Hi-Fi system (or radio). Kit can be assembled in several hours — no technical knowledge or experience necessary. Kit \$49.95, Wired \$79.95.

## Automotive

### EICO 888—Car/Boat Engine Analyzer.

For all 6V/12V systems; 4, 6, 8-cyl. engines.

Now you can keep your car or boat engine in tip-top shape with this solid-state, portable, self-powered universal engine analyzer. Completely tests your total ignition/electrical system.

Complete with a Tune-up & Trouble-shooting Manual. Model 888; \$49.95 kit, \$69.95 wired.

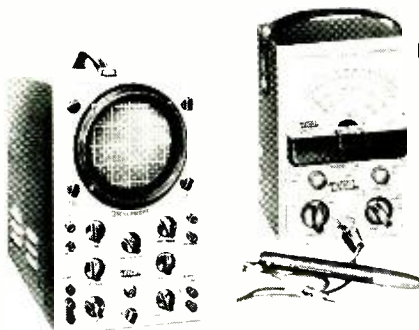

Model 232 Peak-to-Peak VTVM. A must for color or B&W TV and industrial use. 7 non-skip ranges on all 4 functions. With exclusive Uni-Probe.® \$34.95 kit, \$49.95 wired.

## Test Equipment EICO®

100 best buys to choose from.

"The Professionals"  
—laboratory precision at lowest cost.

Model 460 Wideband Direct-Coupled 5" Oscilloscope. DC-4.5mc for color and B&W TV service and lab use. Push-pull DC vertical amp., bal. or unbal. input. Automatic sync limiter and amp. \$99.95 kit, \$149.95 wired.

### FREE 1969 CATALOG

EICO Electronic Instrument Co., Inc.  
283 Malta Street, Brooklyn, N.Y. 11207

Send me FREE catalog describing the full EICO line of 200 best buys, and name of nearest dealer.

Name \_\_\_\_\_  
Address \_\_\_\_\_  
City \_\_\_\_\_  
State \_\_\_\_\_ Zip \_\_\_\_\_

Circle 8 on reader service card

# F.C.C. COMMERCIAL OPERATOR LICENSE

## Training

is part of the Grantham

## A. S. E. E.

[Associate in Science in Electronics Engineering]

### DEGREE CURRICULUM

In today's world of electronics employment, an FCC license is important – sometimes essential – but it's not enough! Without further education, you can't make it to the top. Get your FCC license without fail, but don't stop there. To prepare for the best jobs, continue your electronics education and get your Associate Degree in Electronics.

This is good common sense for those who want to make more money in electronics. It also makes sense to prepare for your FCC license with the School that gives degree credit for your license training — and with the School that can then take you from the FCC license level to the Degree level.

The first two semesters of the Grantham degree curriculum prepare you for the first class FCC license and radar endorsement. These two semesters, in addition to other parts of the Grantham

This booklet **FREE!**

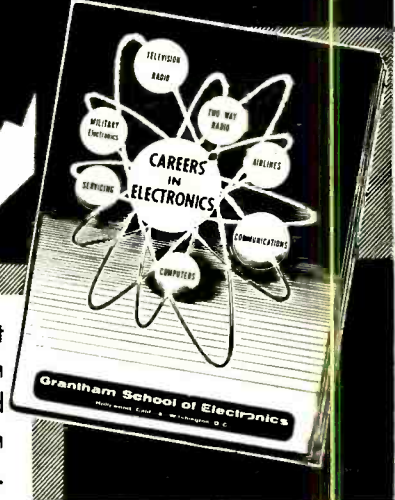

This free booklet explains what an FCC license and ASEE degree can do for your future.

degree curriculum, are available by correspondence\* at very reasonable tuition. *The ASEE Degree can be earned by correspondence with a minimum of two weeks in residence.*

#### Accreditation, and G.I. Bill Approval

Grantham School of Electronics is *accredited* by the Accrediting Commission of the National Home Study Council, and is *approved* for both correspondence and resident training under the G.I. Bill. Mail the coupon, or simply write or telephone for your free copy of our Associate Degree Bulletin which gives complete details of our educational program.



## GRANTHAM School of Electronics



\*Semesters 1, 2, and 3 of the Grantham electronics curriculum are available *also in resident classes* at our Washington, D.C. school — at the address shown below.

• Established in 1951 •

### Grantham School of Electronics

1505 N. Western Ave. or 818 18th Street, N.W.  
 Hollywood, Calif. 90027 Washington, D.C. 20006  
 Telephone: Telephone:  
 (213) 469-7878 (202) 298-7460

**Grantham School of Electronics** RE 1-69  
 1505 N. Western Ave., Hollywood, Calif. 90027

Please mail me your free catalog, which explains how Grantham training can prepare me for my FCC License and Associate Degree in electronics. I understand no salesman will call.

Name \_\_\_\_\_ Age \_\_\_\_\_

Address \_\_\_\_\_

City \_\_\_\_\_ State \_\_\_\_\_ Zip \_\_\_\_\_

# NEW & TIMELY

Volume 40 Number 1

RADIO-ELECTRONICS

January 1969

## CENTER WIRED FOR SOUND

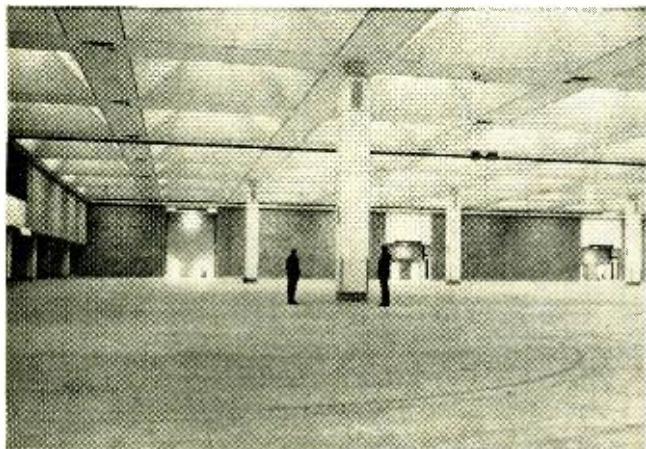

Philadelphia's new Civic Center has been wired for sound on a grand scale with 103 speakers distributed throughout the center's arena, ballrooms, cafeterias, underground garages, 57 meeting rooms and convention show area. Most of the speakers are concealed in columns, and all can be controlled from a 4-rack control center.

But that's not all. For greater flexibility, the sound system includes 7 remote-location equipment racks and 17 remote-control panels. A maze of microphone jacks is spaced throughout the center within 30' of each other. The Bogen Communications Division of Lear Siegler, Inc. designed and built the system to blanket the center's 321,000 square feet with sound.

## LASER INTRUSION DETECTOR

Interrupted photocell beams have opened supermarket doors for years. Now the Army is using this principle to maintain security with an RCA-built alarm system that uses *pure* light beams. The transmitter and receiver units, including batteries, are cigarette-pack size to simplify concealment. A gallium arsenide injection laser in the transmitter is aligned with the receiver unit when the detec-

tor is set up. Any interruption of the light pulses between the units triggers a signal from the receiver, which can be monitored by a remote alarm unit.

### COLOR TV PATENTS

A federal court has finally granted a patent to RCA for its photographic method of depositing phosphor dots on CRT faces—17 years after filing application. Philco lost a

### IN THIS ISSUE

Trying to decide which color TV you should buy? See the 4-page color TV buyer's guide on page 42. It spells out all the important features of more than 100 of the 1969 color sets. Select the set that really fits your needs.

long legal dual. The patent, one of more than 1000 in the color TV field, is considered fundamental for competitive production of color CRT's. RCA may now seek royalties from tube manufacturers using the process.

Under a 1958 agreement, RCA made 100 of its early color patents available to the color TV industry, but claims royalty on post 1958 patents.

Rare-earth red phosphors used in combination with sulphide blue and green phosphors is another color patent in the courts. GT&E's Sylvania lays claim to the rare-earth discovery, now used in most color tubes.

## IMPROVED PHOTO-MULTIPLIER

This extremely sensitive photomultiplier tube could play an important role in unlocking the mysteries of DNA molecules or distant "pulsar" radio sources in the galaxy. The improved photomultiplier is 10 times as efficient as those currently in use. Photomultipliers use a series of "dynodes" to amplify primary electrons generated when weak incoming light strikes the material in the first dynode stage. RCA scientists



have discovered that gallium phosphide used in the important first stage now enables a photomultiplier to discriminate between light sources that may generate one, two, three or more primary electrons. This should make it possible to "see" details of nuclear, astronomical and biological events never observed before.

## LOOKING AHEAD

By **DAVID LACHENBRUCH**  
CONTRIBUTING EDITOR

### Looking into 1969

In technology, each year brings some completely undreamed-of developments, as well as some already on the timetable. We can't attempt to forecast the surprise ones but, from our vantage point, concentrating principally on the areas of direct interest to the consumer, we think Electronics 1969 will see these developments:

### Color television

Although the new year probably won't see widespread acceptance of any unconventional color picture tubes (of the nonshadow-mask variety), it could well see a new, far more compact, shadow-mask type. This new tube will have a wider deflection angle (perhaps 110° or 120°, as compared to the standard 90° angle of today's tubes). Combined with solid-state or hybrid circuits, it can make possible extremely portable color sets. The new compact tube probably will appear by late 1969 in the "portable" sizes—18" diagonal and smaller—where it is badly needed.

(continued on page 4)

## ELECTRONIC BARTENDER

Here's a computerized bartender that serves any one of 23 drinks in 4 seconds flat—provided you're lucky or smart. The electronic bartender is coupled with a one-arm bandit that registers the number of drinks won or dispenses tokens that can be

# Radio-Electronics

January 1969 • Over 60 Years of Electronics Publishing

## SPECIAL FEATURES

- Step Toward Tomorrow With Quick-Change Modules** ..... 32 ..... Larry Steckler  
*Color TV: what's now, what's coming*
- Buyer's Guide to 1969 Color Sets** ..... 42 ..... Len Buckwalter  
*More than 100 color receivers you can buy*

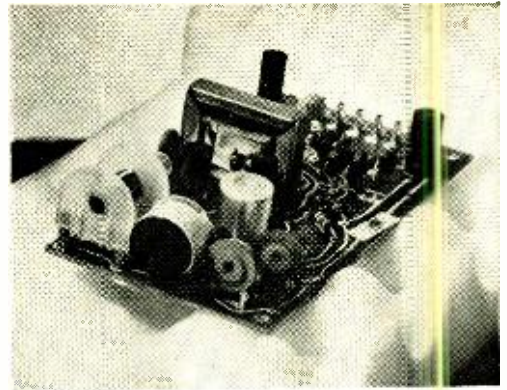

Plug-in modules like this one keep the Quasar color set at home even during "shop" repairs.

see page 32

## COLOR TELEVISION

- In The Shop... With Jack** ..... 24 ..... Jack Darr  
*More on color tv signal tracing*
- How Color TV Works** ..... 35 ..... Matthew Mandl  
*Here's how that color gets on the screen*
- Spot Color Faults Fast** ..... 58 ..... Matthew Mandl  
*All you need is a vtm and scope*
- New Color TV Circuits** ..... 61 ..... Robert F. Scott  
*Inside the '69 color sets*
- Service Clinic** ..... 92 ..... Jack Darr

## BUILD THIS ONE

- Build: Beginner's Dot-Bar Generator** ..... 50 Bennett C. Goldberg  
*Portable unit has simplified circuit*

## AUDIO

- Electronic Music For Do-It-Yourselfers** ..... 38 ..... Robert C. Ehle  
*Create your own music—on a budget*
- What's Behind Audio Amplifier Specs** ..... 70 ..... Peter Sutheim  
*The real meaning of those mysterious numbers*

## GENERAL ELECTRONICS

- Looking Ahead** ..... 2 David Lachenbruch  
*Current happenings with future overtones*
- IC's Foil Change Cheaters** ..... 40
- How the J-K Flip Flops** ..... 54 .. Leonard E. Geisler  
*Logic circuits are simple*
- ABC's of Transistors** ..... 56 .. Sylvania Technical Staff  
*How to check transistor stages*

## DEPARTMENTS

- |                        |                                      |                         |
|------------------------|--------------------------------------|-------------------------|
| Correspondence .....14 | New Products .....81                 |                         |
| New & Timely ..... 2   | New Tubes and Semiconductors .....94 | Readers Service .....78 |
| New Literature .....88 | Noteworthy Circuit .....96           | Technotes .....91       |

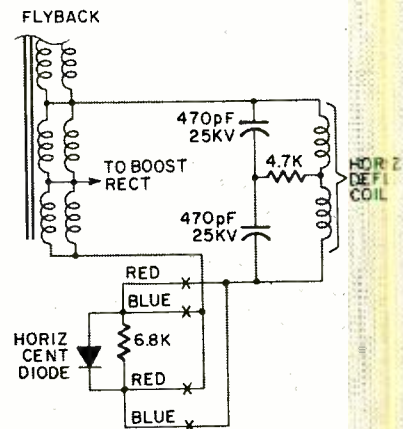

The '69 color sets use a heap of new circuits. This is one of them. You'll find 11 more new ones inside. see page 61

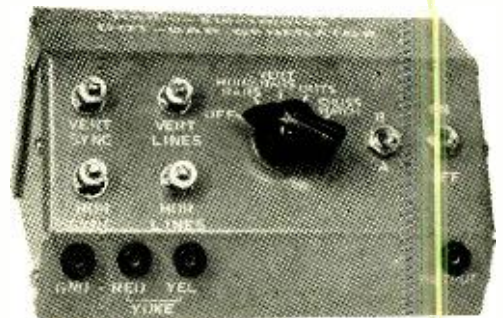

Portable dot-bar generator makes it a cinch to set up a color TV. Use it to get better color pictures.

see page 50

RADIO-ELECTRONICS, JANUARY 1969, Vol. 40, No. 1  
 Published monthly by Gernsback Publications, Inc., at Ferry St., Concord, N. H. 03302  
 Editorial, Advertising, and Executive offices: 200 Park Ave. S., New York, N.Y. 10003. **Subscription Service: Boulder, Colo. 80302.**  
 Second-class postage paid at Concord, N. H. Printed in U.S.A. One-year subscription rate: U.S. and possessions, Canada, \$6.  
 Pan-American countries, \$7. Other countries, \$7.50. Single copies: 60¢. ©1968, by Gernsback Publications, Inc. All rights reserved.  
**POSTMASTER: Notices of undelivered copies (Form 3579) to Boulder, Colo. 80302.**



Member.  
 Institute of High Fidelity.  
 Radio-Electronics is indexed in  
*Applied Science & Technology*  
*Index (formerly Industrial*  
*Arts Index)*

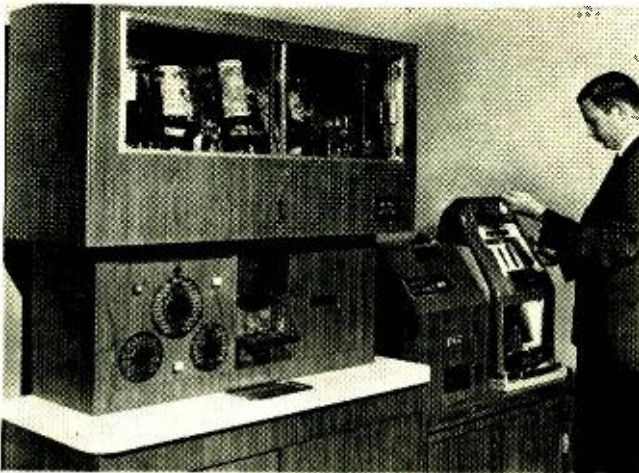

used later. In the 48 states where such games of chance are illegal, the slot machine can be equipped with a unit containing up to 1000 random questions and six pushbuttons to answer multiple-choice questions. The "Slot-Troic-803" is made by K & M Electronics Co., a Baltimore firm.

## LOOKING AHEAD

Other color TV advances are likely to be evolutionary—afc being included in all but the lowest-priced sets, more convenient uhf tuning and possibly a varactor-diode tuner which virtually eliminates mechanical contacts.

### Warranties and service

With "consumer protection" an increasing concern of the government, there will be much pressure to make warranties more understandable and meaningful. There will be an increasing trend to include labor in warranties—particularly on TV sets—and, quite possibly, toward longer in-warranty periods.

In an attempt to ease servicing headaches in the future, several manufacturers may adopt the modular-construction approach, permitting entire circuits to be replaced in the customer's home and repaired later in the shop or factory.

### Television by cable

"CATV," which used to stand for "Community Antenna Television," will complete its metamorphosis in 1969 into "Cable TV," meaning complete acceptance of the inevitability of television as a closed-circuit as well as broadcast medium. The FCC, which currently seems to lean away from the idea of program originations or commercials via cable to the home (although it has no rules against these practices), will take a comprehensive new look at the future of the concept of TV-by-wire. Technology will now permit at least 20 or 25 simultaneous channels on a single CATV cable, and before the year is over some local systems could be offering that many programs.

### Tape gear—audio and video

The various cartridge concepts will continue to grow in popularity—the 8-track continuous loop still primarily as an automotive music-maker and the cassette as a portable and home device. Major steps will be made to improve the frequency response and reliability of the cassette recorder. Although the cassette will make some inroads in the audiophile market, most true high-fidelity enthusiasts will con-

tinue to prefer the reel-to-reel approach. By year's end, reel-to-reel recorders in the under-\$100 price range will have virtually disappeared, yielding to the cassette.

One longitudinal-scan home color recorder will probably reach the market, at \$1000 to \$1500 for a complete console, including 23" color set. However, its principal use will be as an off-the-air recorder, since no home-priced color camera or library of prerecorded material will be available during the year.

The Columbia Broadcasting System's EVR (Electronic Video Recorder), an electronic film attachment to play (but not record) material through color sets, should be available in prototype models.

### Phonographs and records

The trend to compact phonograph systems and air-suspension speakers even in relatively low-priced models will intensify. Audio components will move from the "class" to the "mass" market, but with some deterioration of sound quality as new low-end "price leaders" are introduced.

The 3 $\frac{7}{8}$ " mini-disc, aimed at the youth market, will go nationwide. Play-as-you-walk phonographs for these thin, flexible records will be available under several brand names.

### Radio

In the table radio, there will be new emphasis on sound quality, with a profusion of sets with air-suspension speakers. A large number of relatively high-priced sets will feature diode tuning in place of the more common mechanical type. Automobile radios will appear in entirely new configurations to satisfy government safety regulations. In some cases, they'll be moved completely from the dashboard and may feature diode controlling pushbuttons on armrests or in central consoles, with the chassis readily accessible in the trunk.

R-E

## Phonon Amps & IC MOSFETs

Two new devices developed at General Telephone & Electronics Labs may eventually find use in improved TV, FM and computer circuitry. One of the developments is called a phonon amplifier because it employs acoustic waves to amplify rf signals. The phonon is the basic unit of acoustic energy. GT&E scientists discovered they could greatly cut noise in phonon-amplified rf signals by ca-

pacitively coupling the piezoelectric ceramic and n-type silicon elements of the amplifier together with a thin layer of glycerol. The "static" problem was a major disadvantage in earlier phonon amplifiers.

An input rf signal to the ceramic plate is converted to an acoustic wave, part of which moves through the adjacent silicon. This wave is given a "kick" by electronic carriers in the silicon that are

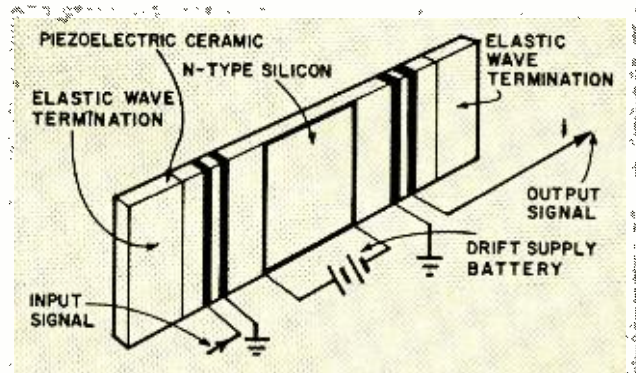

# Here's a new, complete ICS course in TV Servicing that costs less than \$100.

**With the first two texts, you can repair 70 percent of all TV troubles.**

You need no previous experience to take this complete, practical course in TV Repairing.

You don't even have to know a vacuum tube from a resistor. Yet in a matter of months, you can be doing troubleshooting on color sets!

Course consists of 6 texts to bring you along quickly and easily. 936 pages of concise, easy-to-follow instruction, plus 329 detailed illustrations. You also receive a dictionary of TV terms geared directly to course material so you'll understand even the most technical terms. The dictionary will come in handy even after you've finished your course.

Instruction is simple, very easy to grasp. Photos show you what a TV screen looks like when everything is normal, and what it looks like when trouble fouls it up. The texts tell you how to remedy the problem, and why that remedy is best.

Quizzes are spotted throughout the texts so you

can check your progress. At the end of the course, you take a final examination. Then you get the coveted ICS® diploma, plus membership in the ICS TV Repairman Association.

By the time you've finished the course, you should be able to handle tough, multiple TV problems, on color sets as well as black and white.

This new TV Servicing and Repair Course has been approved by National Electronic Associations for use in their Apprenticeship program. Because of its completeness, practicality and price, it is the talk of the industry. The cost is less than \$100—just slightly over ½ the price of any comparable course on the market today. Remember, the sooner you get started on your course, the sooner you'll be turning your spare time into real money. Fill out the coupon today. And we will rush to you all information, no obligation.

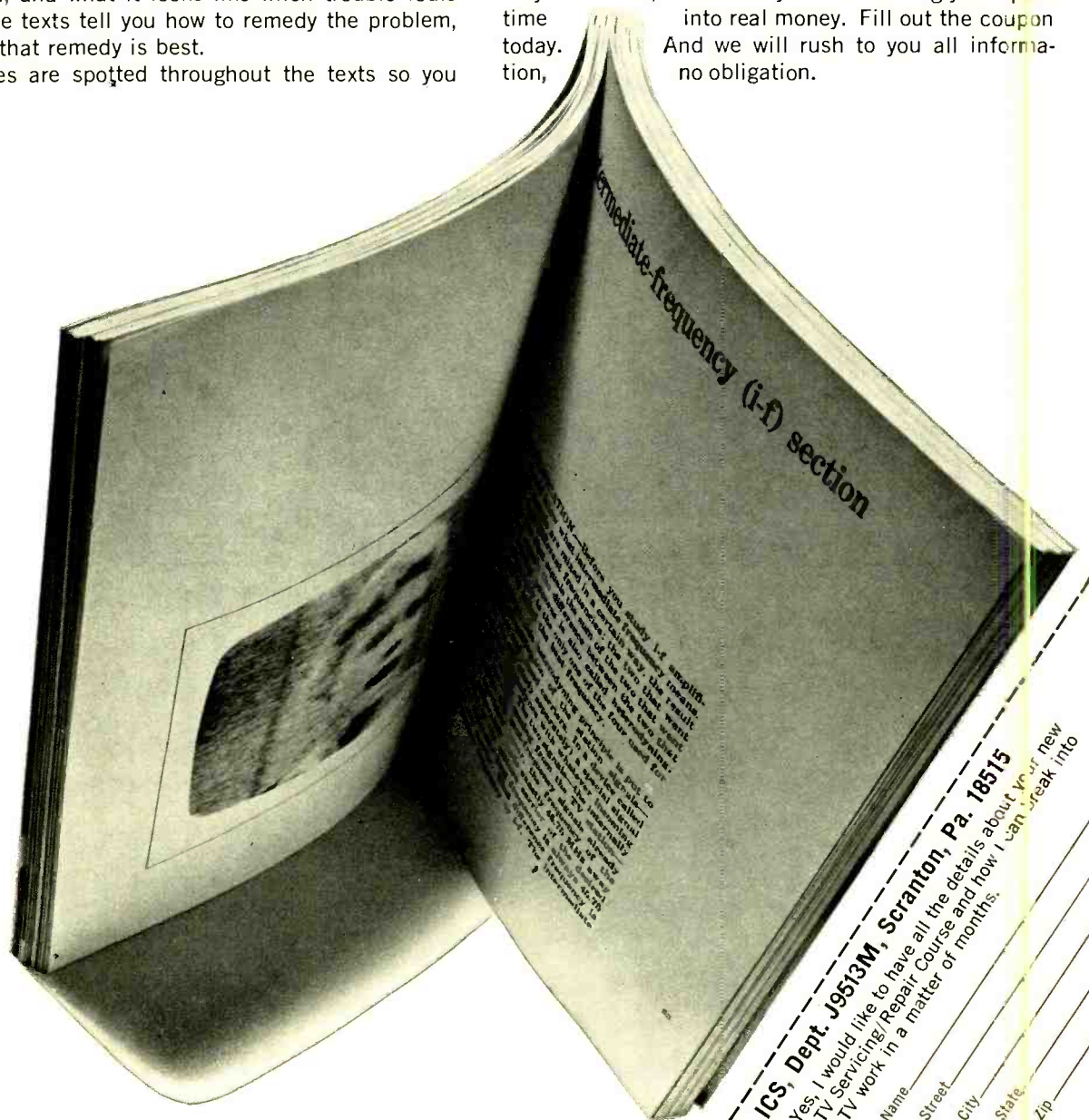

**ICS, Dept. J9513M, Scranton, Pa. 18515**

Yes, I would like to have all the details about your new TV Servicing/Repair Course and how I can break into TV work in a matter of months.

Name \_\_\_\_\_  
Street \_\_\_\_\_  
City \_\_\_\_\_  
State \_\_\_\_\_  
Zip \_\_\_\_\_

Circle 9 on reader service card

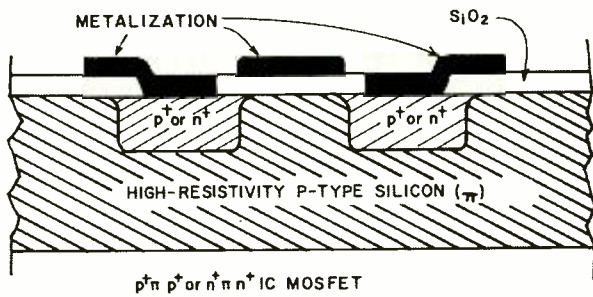

made to travel faster than the acoustic wave by a dc potential. Clear, stronger rf signals are then obtained when the amplified wave induces a voltage in the output electrodes. The device, which can be used to generate intermediate frequencies when a second frequency is introduced during oscillation, has been operated in the 1-4-MHz range.

GT&E's second recent development is a technique for fabricating metal oxide field effect transistors (MOSFET's) in integrated circuits. When both p- and n-type channels are included in IC circuits, the complementary arrangement offers faster operating speeds and lower power demands. But until now these circuits have been difficult to fabricate because both p- and n- channels must be put into separate opposite conductivity regions.

The new GT&E device, called a "p+πp+MOSFET," has both p and n channels fabricated on a high-resistiv-

ity, p-type silicon substrate. This single substrate technique greatly simplifies production of complementary MOSFET IC's for computer memories and digital switching circuits.

### 3D STRAIN TEST

Holography — lensless, three-dimensional photography that illuminates the subject with laser light—is now being used to test the toughness of metals. The dark, pointed area at the top of the photo is a notch 50/1000 inch



wide made as a metal sample is pulled apart. Strain contours are made visible as interference fringe patterns (light and dark areas) by viewing the metal through its own superimposed holographic image.

Dark areas seen in the photograph represent permanent strain contours at successive elevation differences of half a wavelength (12 millionths of an inch) of the illuminating laser light.

## Glass Semiconductors Developed

A solid-state physics development involving the switching characteristics of glassy amorphous semiconductors may eventually bring about a size and price cut in some semiconductors.

Compounds such as oxide- and boron-based glasses and materials that contain tellurium and chemically similar elements can be made to act electrically like diodes and magnetic memory cores. Unlike the orderly crystalline structure of semiconductors that require complex and expensive doping, the glassy materials have a disordered (amorphous) atomic structure.

Two new switching devices using the materials have been developed and are being manufactured by Energy Conversion Devices, a Michigan firm. Called the Ovonic Threshold Switch (OTS) and Ovonic Memory Switch (OMS) by the developer and company president, Stanford R. Ovshinsky, the devices can switch both alternating current and direct current equally well. Ordinary semiconductor p-n type junctions have a preferred



Developer of the new devices, Stanford R. Ovshinsky, demonstrates the conducting state (right) and non-conducting (disordered) state of polymer structures.

## Radio-Electronics

**HUGO GERNSBACK** (1884-1967)  
founder

**M. HARVEY GERNSBACK**,  
editor and publisher

**LARRY STECKLER**, managing editor

**Robert F. Scott**, W2PWG  
senior technical editor

**John R. Free**, associate editor

**Jack Darr**, service editor

**I. Queen**, editorial associate

**Matthew Mandl**, contributing editor

**David Lachenbruch**, contributing editor

**Carrie Ng**, editorial assistant

**Bruce Ward**, production manager

**Elizabeth Shincel**, production assistant

**G. Aliquo**, circulation manager

Cover by Harry Schlack

RADIO-ELECTRONICS is published by Gernsback Publications, Inc. 200 Park Ave. South New York, N.Y. 10003 (212) 777-6400

President: M. Harvey Gernsback  
Vice President-Secretary: G. Aliquo

### ADVERTISING REPRESENTATIVES EAST

John J. Lamson, Eastern Sales Mgr.

**MIDWEST/N.&S. Car., Ga., Tenn.**  
Robert Pattis, the Bill Pattis Co., 4761 West Touhy Ave., Lincolnwood, Ill. 60646 (312) 679-1100

### W. COAST/Texas/Arkansas/Oklahoma

J. E. Publishers Representative Co., 8380 Melrose Ave., Los Angeles, Calif. 90069, (213) 653-5841; 420 Market St. San Francisco, Calif. 94111, (415) 981-4527

### UNITED KINGDOM

Publishing & Distributing Co., Ltd., Mitre House, 177 Regent St., London W.1, England

**SUBSCRIPTION SERVICE:** Send all subscription orders and correspondence to RADIO-ELECTRONICS, Subscription Department, Boulder, Colo. 80302.

**MOVING?** For change of address, allow six weeks, furnishing both the old and new addresses and if possible attaching label from a recent issue below. Otherwise please print clearly your name and address exactly as it appears on your label.



name (please print)

address

city state zip code

Mail to: RADIO-ELECTRONICS  
SUBSCRIPTION DEPT., BOULDER, COLO. 80302



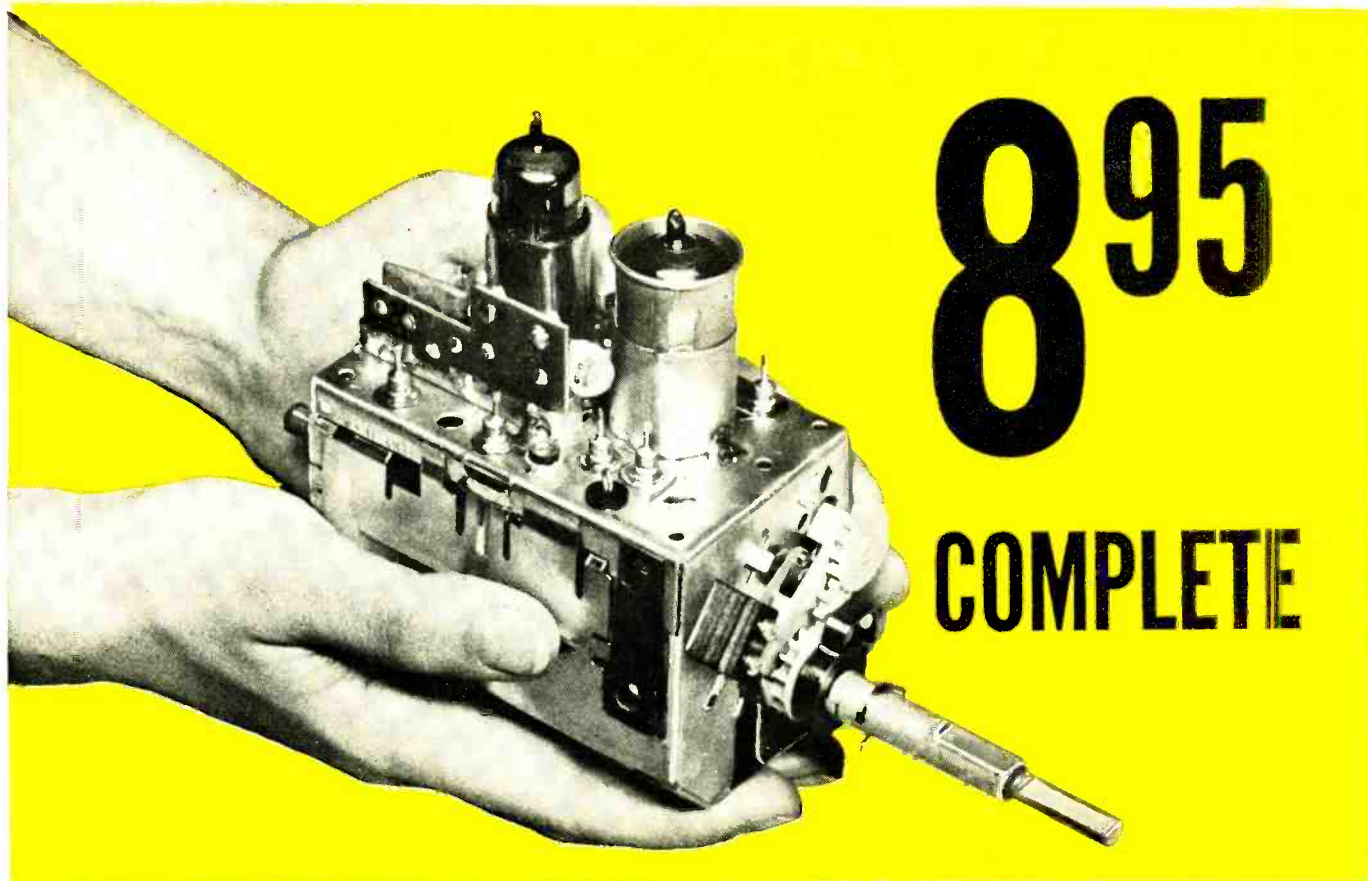

# 895 COMPLETE

Castle, the pioneer of television tuner overhauling, offers the following services to solve ALL your television tuner problems.

● **OVERHAUL SERVICE** — All makes and models.

- VHF or UHF tuner \$9.95
- UHF-VHF combination (one piece chassis) \$9.95
- TRANSISTOR tuner \$9.95
- COLOR tuner \$9.95  
(Guaranteed color alignment . . . no additional charge)

Overhaul includes parts, except tubes and transistors.

Simply send us the defective tuner complete; include tubes, shield cover and any damaged parts with model number and complaint. Your tuner will be expertly overhauled and returned promptly, performance restored, aligned to original standards and warranted for 90 days.

UV combination tuner must be single chassis type; dismantle tandem UHF and VHF tuners and send in the defective unit only.

And remember—for over a decade Castle has been the leader in this specialized field . . . your assurance of the best in TV tuner overhauling.

● **CUSTOM REPLACEMENTS**

Exact replacements are available for tuners that our inspection reveals are unfit for overhaul. As low as \$12.95 exchange. (Replacements are new or rebuilt.)

● **UNIVERSAL REPLACEMENTS**

Prefer to do it yourself?

Castle universal replacement tuners are available with the following specifications.

STOCK No.	HEATERS	SHAFT		I.F. OUTPUT		PRICE
		Min.*	Max.*	Snd.	Pic.	
CR6P	Parallel 6.3v	1¾"	3"	41.25	45.75	8.95
CR7S	Series 600mA	1¾"	3"	41.25	45.75	9.50
CR9S	Series 450mA	1¾"	3"	41.25	45.75	9.50
CR6XL	Parallel 6.3v	2½"	12"	41.25	45.75	10.45
CR7XL	Series 600mA	2½"	12"	41.25	45.75	11.00
CR9XL	Series 450mA	2½"	12"	41.25	45.75	11.00

\*Selector shaft length measured from tuner front apron to extreme tip of shaft.

These Castle replacement tuners are all equipped with memory fine tuning, UHF position with plug input for UHF tuner, rear shaft extension and switch for remote control motor drive . . . they come complete with hardware and component kit to adapt for use in thousands of popular TV receivers.

Order universal replacements out of Main Plant (Chicago) only.



## CASTLE TV TUNER SERVICE, INC.

MAIN PLANT: 5715 N. Western Ave., Chicago, Illinois 60645

EAST: 41-96 Vernon Blvd., Long Island City, N.Y. 11101

Circle 10 on reader service card

# You get more for your money from NRI-

## America's oldest and largest Electronic, Radio-TV home-study school

Compare if you like. You'll find—as have so many thousands of others—that NRI training can't be beat. From the delivery of your first lessons in the remarkable, new Achievement Kit we send you, to "bite size," easily-read texts and carefully designed training equipment . . . NRI gives you more value.

Shown below is a dramatic, pictorial example of all of the training materials included in just one NRI Course. *Everything* you see pictured below is included in low-cost NRI training. Other major NRI courses are equally complete. Text for text, kit for kit, dollar for dollar—your best home-study buy is NRI.

All this is yours—from Achievement Kit to the only Color TV specifically designed for training—when you enroll for NRI's TV-Radio Servicing course. Other courses are equally complete. But NRI training is more than kits and "bite-size" texts. It's also personal services which have made NRI a 50-year leader in the home-study field. Mail the postage-free card today.

**Approved under GI BILL**  
If you served since January 31, 1955, or are in service, check GI line in postage-free card.

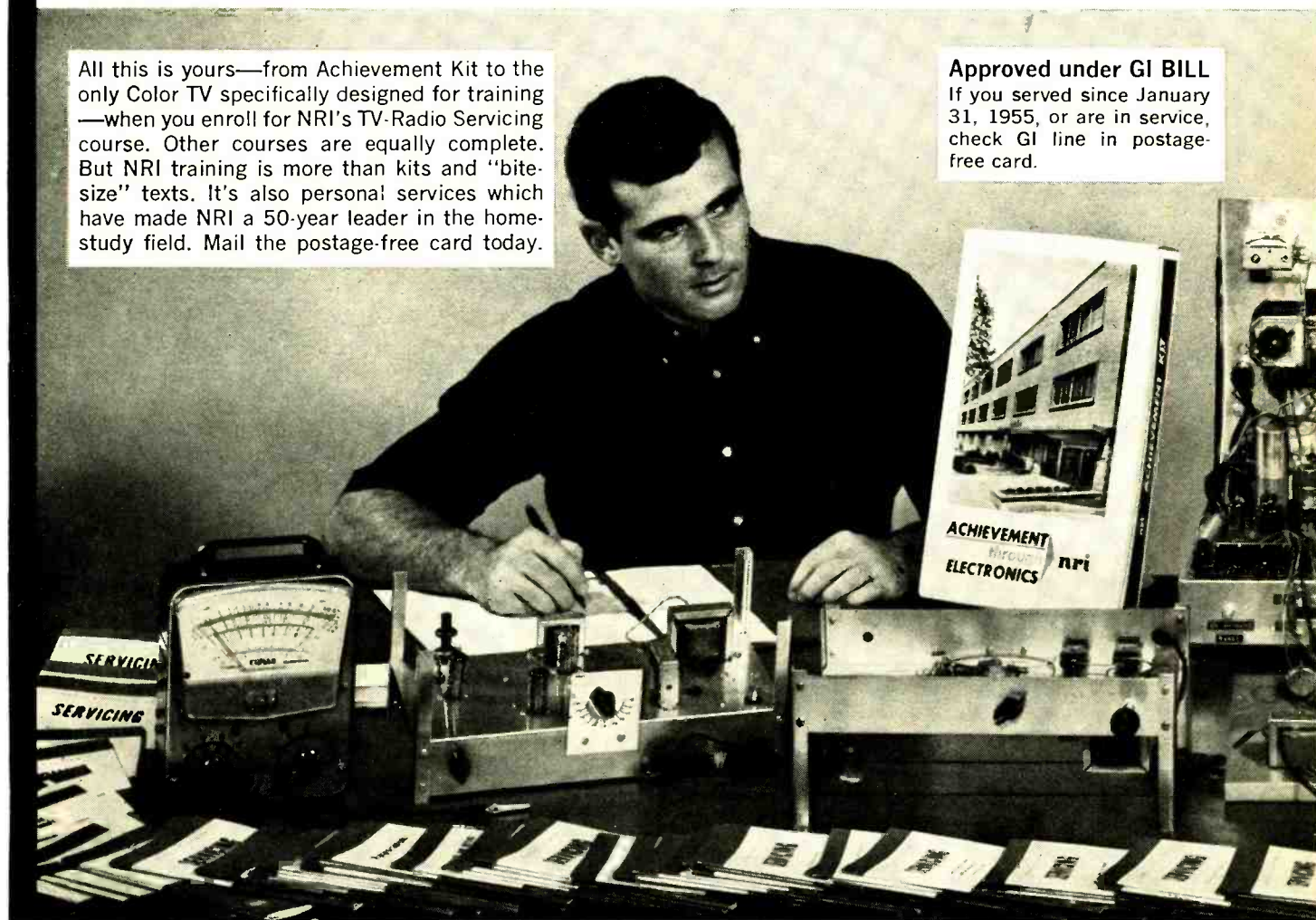

## GET A FASTER START WITH NRI'S NEW EXCLUSIVE ACHIEVEMENT KIT

The day we receive your enrollment application we mail out your Achievement Kit. It contains everything you need to make an easy, fast start in the Electronics training of your choice. This attractive, new starter kit is an outstanding, logical way to introduce you to home-study as NRI teaches it . . . an unparalleled example of the value of NRI training . . . training that is backed up by a dedicated staff and the personal attention you should expect of a home-study school. It is your first of a number of special training aids carefully developed by the NRI laboratories to make your adventure into Electronics absorbing, meaningful. What's in the Achievement Kit? Your first group of lesson texts; a rich vinyl desk folder to hold your study material; the industry's most complete Radio-TV Electronics Dictionary; valuable reference texts; lesson answer sheets; pre-addressed envelopes; pencils; pen; engineer's ruler—even postage. No other school has anything like the NRI Achievement Kit.

## LEARNING BECOMES AN ABSORBING ADVENTURE WITH NRI TRAINING KITS

Electronics comes alive with NRI training kits. What better way to learn than by doing it? That's why NRI pioneered and perfected the "home lab" technique of learning at home in your spare time. You get your hands on actual parts and use them to build, experiment, explore, discover. NRI invites comparison with training equipment offered by any other school. Begin NOW this exciting program of practical learning. It's the best way to understand the skills of the finest technicians—and make their techniques your own. Whatever your reason for wanting to increase your knowledge of Electronics . . . whatever your field of interest . . . whatever your education . . . there's an NRI instruction plan to fit your needs, at low tuition rates to fit your budget. Get all the facts about NRI training plans, NRI training equipment. Fill in and mail the attached postage-free card today. No salesman will call. NATIONAL RADIO INSTITUTE, Washington, D.C. 20016.

OVER 50 YEARS OF LEADERSHIP



IN ELECTRONICS TRAINING

Accredited by the Accrediting Commission of the National Home Study Council

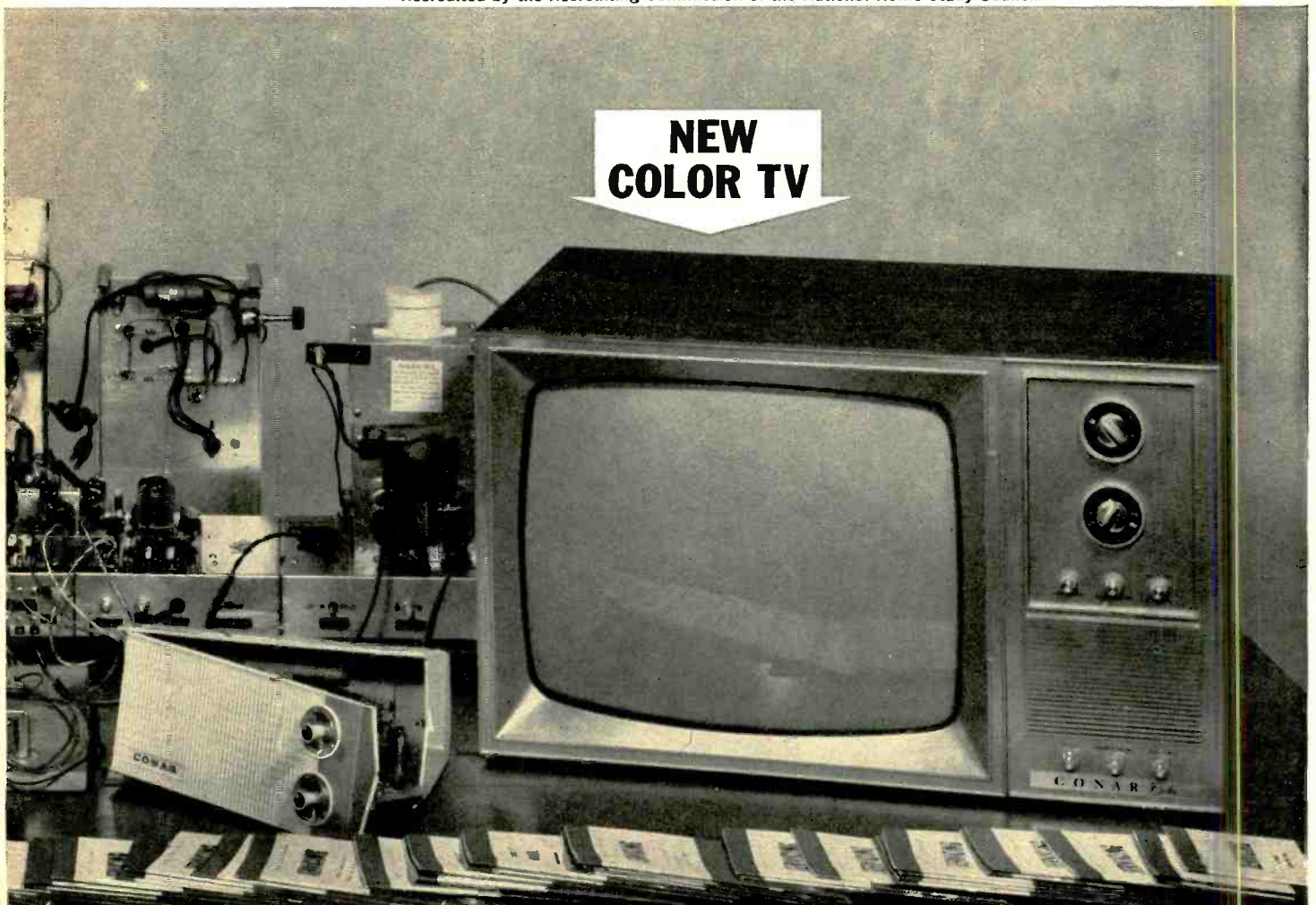

# Weller®

**makes first class  
soldering the easiest  
part of any job**



## The original Dual Heat Soldering Guns

Preferred by technicians for their fast heating copper tips, exclusive trigger-controlled dual heat, and high soldering efficiency. Available in 3 wattage sizes, each with spotlight.

100/140-watt Model 8200, 145/210-watt Model D-440, and 240/325-watt Model D-550. Also in complete kits:

## Dependable MARKSMAN Irons in a size for every job



Ideal for deep chassis work and continuous-duty soldering, Marksman irons outperform others of comparable size and weight. All five feature long-reach stainless steel barrels and replaceable tips.

- 25-watt, 1 3/4-oz. Model SP-23 with 1/8" tip (In kit with extra tips, soldering aid, solder—Model SP-23K)
- 40-watt, 2-oz. Model SP-40 with 1/4" tip
- 80-watt, 4-oz. Model SP-80 with 3/8" tip
- 120-watt, 10-oz. Model SP-120 with 1/2" tip
- 175-watt, 16-oz. Model SP-175 with 5/8" tip

## 25-watt Technician's Iron for intricate circuit work



Industrial rated pencil iron weighs only 1 3/4 ounces, yet delivers tip temperatures to 860°F. Cool, impact-resistant handle. All parts readily replaceable. Model W-PS with 1/8-inch tapered tip.

**Also available:** A new Battery Operated Iron for use with 12 volt battery or 12-24 volt AC/DC source. Complete with 12 ft. cord and battery clips. Model TCP-12.

Complete Weller Line at your Electronic Parts Distributor.

**WELLER ELECTRIC CORPORATION, Easton, Pa.**

WORLD LEADER IN SOLDERING TOOLS  
Circle 11 on reader's service card

current direction.

When voltage is applied to an CTS, it remains an insulator until a threshold voltage is reached. It then switches rapidly (150 trillionths of a second) into conduction and conducts as long as current exceeds a critical value. Depending on its thickness and composition, threshold voltage may range from about two to several hundred volts. The OMS is similar, except it remains in its conducting state when current is removed, and blocks current when a pulse is again applied.

The firm forges a number of "spectaculars" for the devices, such as flat TV displays and pocket-size computers. The devices can be produced cheaply in sizes as small as 0.005 of an inch across.

## WIDE-RANGE ELECTROSTATIC HORN

A really new type of loudspeaker—an electrostatic horn—was described to the 20th Convention of the Audio Engineering Society, held recently in New York City. It was developed by engineers of the Technical University of Prague. Josef Merhaut, of that university, explained the speaker to members of the society.

Electrostatic speakers, he stated, have been noted for their wide frequency range. But because the impedance of the air ahead of them drops with decreasing frequency, they become less efficient on the lower ranges, and most direct-coupled electrostatic speakers are supplemented with a cone-type

## ELECTRONIC MUSIC

**Making your own electronic music is easier than you think. To learn nine new techniques for doing it yourself, see the feature article starting on page 38. It's written by an expert and details a whole flock of tricks you can do at home. You'll use your tape recorder.**

speaker for the bass and part of the mid-range.

By using plugs somewhat reminiscent of the phase-equalizer plug in a diaphragm-type horn speaker, it is possible to couple a number of comparatively large-area moving diaphragms to the horn throat, thus greatly increasing the impedance presented to the foil diaphragm. The resulting horn speaker has reasonably high efficiency in its low-frequency range and is subject only to the ordinary cutoff limits of horn-type loudspeakers.

## RAINBOW READOUTS

A digital-display vacuum tube for alphanumeric readout that offers high intensity and low power consumption can also be filtered for any color from red through yellow, green, blue, violet, and white. Called the Digivac S/G by its manufacturer, Tung-Sol, the tube utilizes a cold cathode and seven anodes coated with phosphorescent material that glows pale green when supplied with 10 to 40 volts. Small-quantity sales will be about \$5 each through dealers. **R-E**

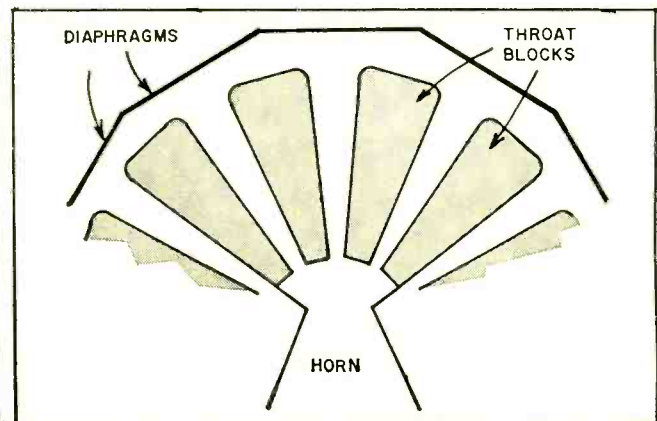

# The absolute end of an old fear.

**ANNOUNCING:** The new B&K Sweep/Marker Generator. Does for TV sets what no other instrument or instruments can do. It makes alignment of color as well as black & white TV sets simpler, easier than ever.

We've remembered all your old fears about TV alignment. Especially color. So now you can forget them.

In the past, a marker generator and a separate sweep generator were used with a marker adder and a bias supply. All four of these now are combined in one easy-to-use instrument.

(We've made benchwork so much simpler by doing away with the need for hooking together a lot of cables and costly instruments.)

The Sweep/Marker Generator is both an instrument and a guide. As a guide, the bandpass

and chroma bandpass curves are visually reproduced and the individual markers are clearly indicated by lights—right on the front panel—for quick, easy reference.

As an instrument, the Sweep/Marker Generator not only generates the marker frequencies (all crystal controlled), but also sweeps the chroma bandpass, TV-IF, and FM-IF frequencies.

See it soon at your B&K distributor or write us for advance information on the product that makes TV alignment procedures of old a fearless operation: simple, fast, accurate. The new Sweep/Marker Generator, Model 415.



A Division of DYNASCAN CORPORATION  
1801 W. Belle Plaine • Chicago, Illinois 60613  
Where electronic innovation is a way of life.

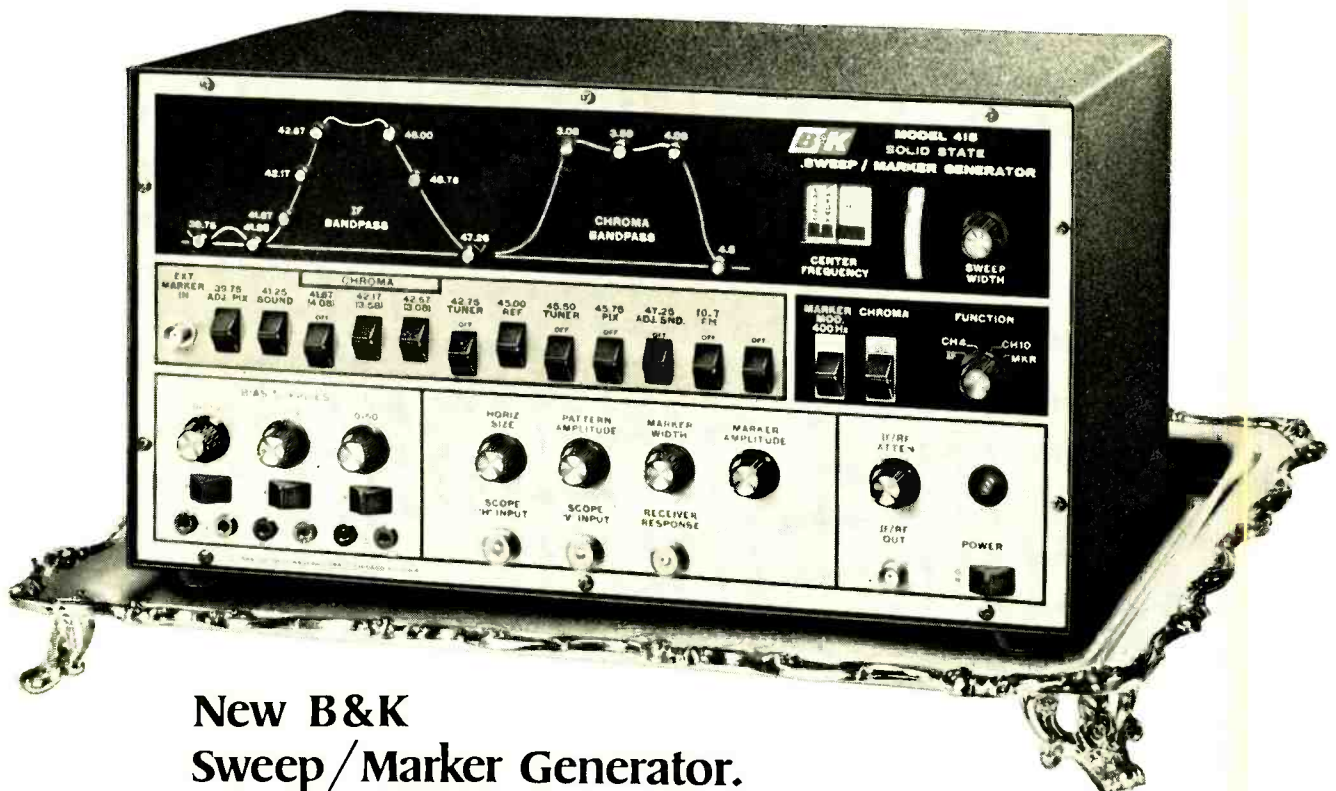

**New B&K  
Sweep/Marker Generator.**

Circle 12 on reader service card

# NEW DELTA DESIGN!

MODEL 3000 FET VOM

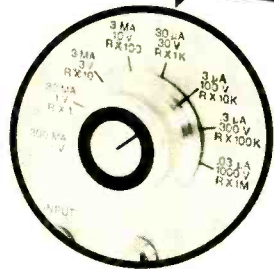
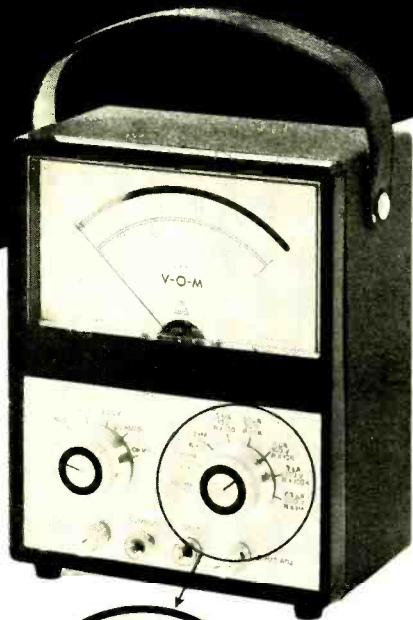

*A unique  
and efficient  
instrument  
bridging the gap  
between a  
multimeter and a  
digital voltmeter!*

Delta, pioneer of the famous Mark Ten® CD System, now offers a compact, versatile, and extremely sensitive VOM which combines FETs and ICs for extreme accuracy. Compact (6½" W x 8" H x 3½" D), portable, wt. 3¾ lbs. In full production at only

**\$74.95**  
ppd.

## Would you believe:

1. Mirror scale 200µ A D'Arsonval meter
2. Integrated circuit (IC) operational amplifier for extreme accuracy
3. FET input stage with current regulator
4. Two stage transistor current regulator and Zener diode on OHMS for absolute stability and accuracy
5. Voltage clippers for protection of input stage
6. Fully temperature compensated for low low zero drift
7. Ten turns ZERO and OHMS adjust potentiometers
8. Epoxy glass circuit boards and metal case
9. Enclosed switches
10. Uses readily available type AA cells
11. Uses standard test leads for maximum flexibility and ease of measurement
12. 10 Megohms input impedance

Available in Kit form:  
Feedback network with pre-selected components to eliminate all final calibration. Ready to use when assembled!

Kit:  
Only **\$59.95** ppd.



**DELTA PRODUCTS, INC.**

P. O. Box 1147, Grand Junction, Colorado 81501

I enclose \$\_\_\_\_\_ Please send postpaid:  
\_\_\_\_\_ Model 3000 FET VOMs @ \$74.95 assembled  
\_\_\_\_\_ Model 3000 FET VOMs @ \$59.95 kit form

Name \_\_\_\_\_

Address \_\_\_\_\_

City/State \_\_\_\_\_ Zip \_\_\_\_\_

DP 8-7

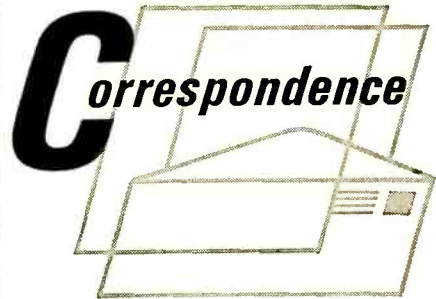

## WIPER PAUSE CONTROLLER

With regard to the problem of not being able to turn off the wiper pause controller (July 1968) there is a remedy that does not require extra parts. Connect the cathode of D1 to the +12-volt supply point, and to one end of S1. Connect the other end of the switch to the junction of the 33,000- and 1,000-ohm UJT resistors. When the switch is opened, all voltage is removed from the UJT, and it cannot fire.

It is not advisable to remove D1, as the diode provides suppression of inductive turn-off transients generated by the wiper motor. Without D1, these transients may quickly damage the SCR.

The pause controller as described will not operate on many foreign cars, in particular the Volvo. These cars use a three-contact park switch which also grounds the motor winding at the park position. On-off switching is done in the positive supply lead, and there is no point which, if grounded, will cause the wiper motor to start. (I am testing a version of the controller to overcome this difficulty by also switching the positive side, but it is not yet completed.)

RICHARD A. STANLEY  
Captain, USA Signal Corps  
Fort Monmouth, N.J.

*If there's anyone out there who is still having troubles with the Windshield Wiper pause controller you better read Captain Stanley's letter carefully. We've asked the captain to send us his solution to the three-contact switch problem when he's ready.*

## I LIKE R-E

I imagine you hear from your readers mostly when they have complaints. Well, for a change, here is a ludo. I have been a subscriber to RADIO-ELECTRONICS for so many years that it has gone through many name changes, and consider it most valuable as a source of state-of-the-art material.

In particular, I refer to such articles as Don Lancaster's DOTnBAR

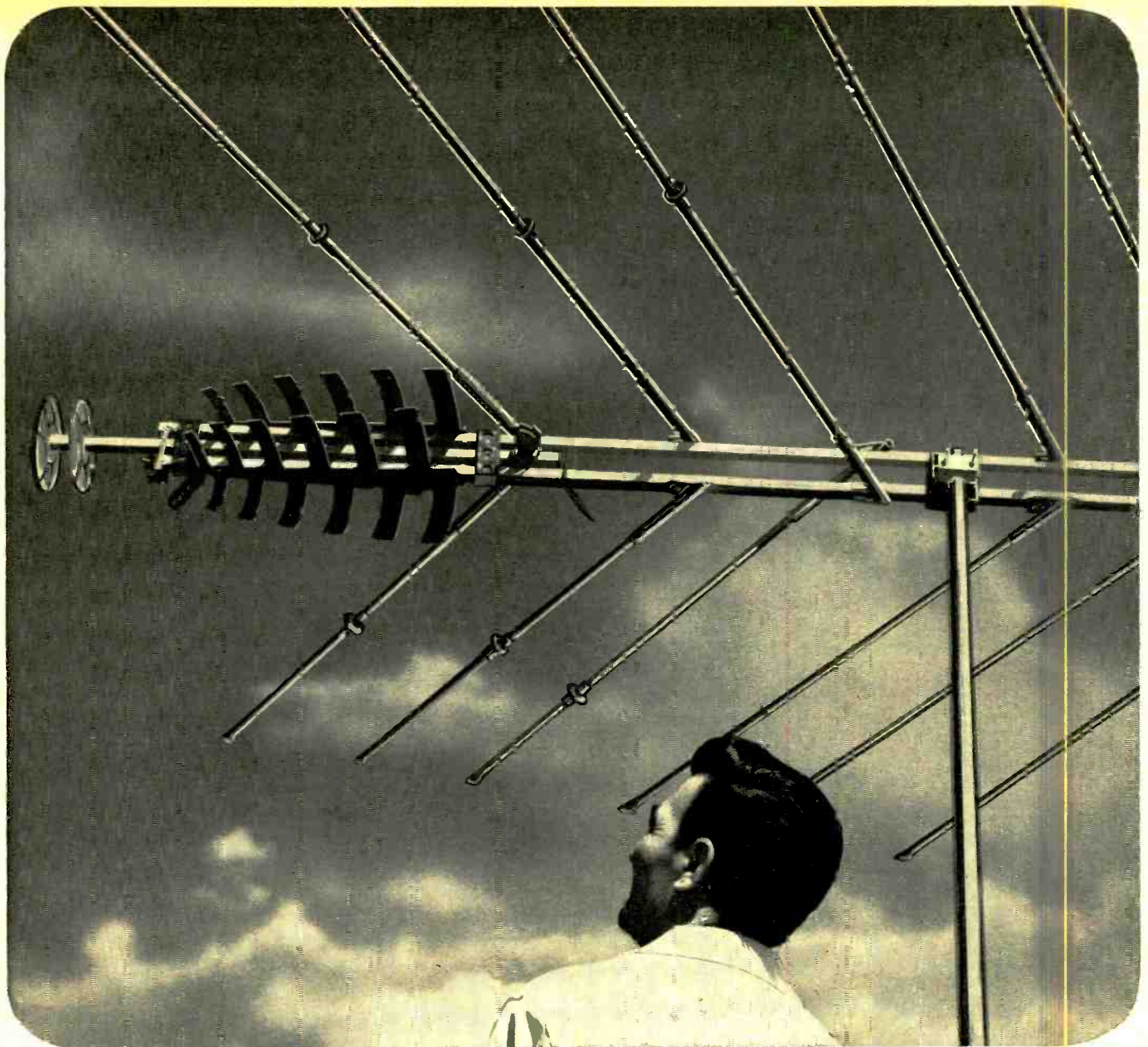

## Professional installers count on antenna gain not the numbers game.

If you count elements when you buy antennas, you might be shortchanging yourself and short-circuiting your customer's reception. It's *performance* that counts.

And that's where JFD Color Laser and Log Periodic antennas outclass all other all-channel antennas. Only patented JFD capacitor-coupled perform *double duty* — respond on the fundamental *and* harmonic modes. Actually *multiply* gain and signal-to-noise ratios over larger multi-element

(*but less efficient*) antennas.

That's why professional installers who count on antenna *gain* (not the numbers game) prefer JFD Color Lasers and LPV Log Periodics. Call your JFD distributor and prove it on your next installation.

*Did you know that JFD now markets a great new line of solid state Snow-Plow and Program Center amplifier-distribution systems? Ask your distributor!*

FROM JFD — ORIGINATORS OF THE ANTENNA THAT REVOLUTIONIZED RECEPTION

# **JFD**® Color Laser and LPV Log Periodic TV antennas.

**JFD ELECTRONICS CO.**

15 Avenue at 62 Street, Brooklyn, N.Y. 11219

JFD International, 64-14 Woodside Ave., Woodside, N.Y. 11377 JFD Canada, Ltd., Ontario, Canada

JFD de Venezuela, S.A., Avenida Los Haticos 125-97, Maracaibo, Venezuela

LICENSED UNDER ONE OR MORE OF U.S. PATENTS 2,958,081, 2,985,879, 3,011,168, 3,108,280, 3,150,376, 3,210,757, RE. 25,740 AND ADDITIONAL PATENTS PENDING IN U.S.A. AND CANADA. PRODUCED BY JFD ELECTRONICS CO. UNDER LICENSE FROM THE UNIVERSITY OF ILLINOIS FOUNDATION. LICENSED UNDER ONE OR MORE OF U.S. PATENTS 2,955,287 AND 3,015,827 AND ADDITIONAL PATENTS PENDING.

Circle 14 on reader service card

# WHO

stands to benefit most from Color TV? Everyone, including the service technician, has a lot to gain. That's why Sprague wants to help you get your fair share of this increasing business.

# NEEDS

of the service technician are of great importance to Sprague. That's why we supply capacitors with the exact ratings required to meet the exacting requirements of Color TV.

# COLOR

has been both boon and bane of the service trade. While it has added to service volume, it has also caused some headaches. That's why Sprague is constantly striving to simplify Color TV capacitor selection.

# TV?

Yes, TV repair represents a big portion of your business. And color is boosting it even higher. You do faster, surer work with Sprague replacement capacitors for Color TV.

Sprague Products Company,  
81 Marshall St., North Adams, Mass. 01247.

**THE BROAD-LINE PRODUCER  
OF ELECTRONIC PARTS**



Circle 15 on reader service card

pattern generator in the July 1967 issue—I built this with complete satisfaction, and wish you would pass this acknowledgment on to him. The intellect that can produce this complex device deserves all the recognition we can give—the design of the printed circuit board was a major achievement, and there were no mistakes in it.

I have just finished the "Dipper and Crystal Oscillator" in the August 1968 issue, with splendid results. It is a professional instrument, and I can think of no way that it could be better. As a matter of interest, I eliminated C1, C3, C4, C5 and C6 and replaced them all with a two-section broadcast superhet variable capacitor. It works just fine and readily goes as low as 200 kHz and as high as 38 MHz. Naturally, the 365-pF section replaces C6 and the oscillator section replaces C3, and the single broadcast capacitor then takes the place of all the other capacitors except C2. Battery positive must be run direct to the drain through rfc or you will not be able to use my method with crystals instead of a coil.

I need to add a color bar function to my DOTnBAR generator. Mr. Lancaster mentioned that it could be done but thought it too expensive. I had no trouble making a stable oscillator, but don't know where to inject it to get bars—I can get fine colored lines with the function switch set on vert lines and injecting my offset carrier just ahead of the channel 3 oscillator, but how do I get a bar pattern?

ARTHUR R. RICHARDS  
Belleville, Ill.

*Many thanks for the kind words, Arthur, but I'm afraid that adding the color bar function is extremely difficult. We'll forward your letter to Don Lancaster. Perhaps he can help you out.*

## AUDIO TECHNICIANS— WHERE ARE YOU?

I may as well admit right now that I am not a really regular reader of your magazine—I buy it only when you include articles on musical instrument amplification.

I suppose this is the best place, though, to bring up a small problem of mine. I just called the biggest repair shops in town, about a dozen in all, to find none able to fix my bass amplifier.

I don't know how this sounds from the technician's point of view, but it seems to me that anyone who can perform surgery on a solid-state



The New 1969 Improved Model 257 **A REVOLUTIONARY NEW**  
**TUBE TESTING OUTFIT**

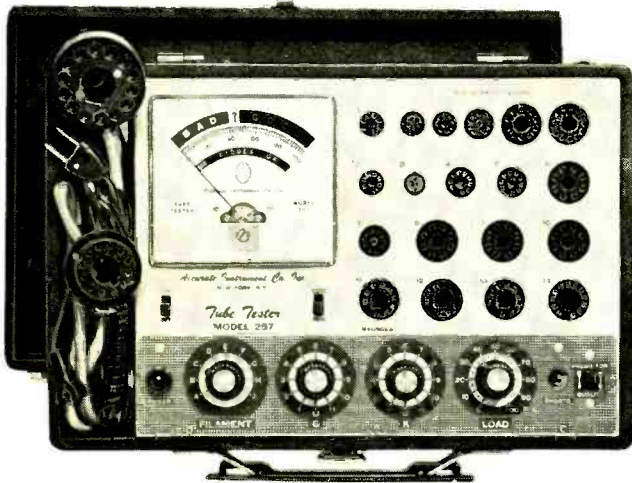

**COMPLETE WITH ALL  
 ADAPTERS AND ACCESSORIES,  
 NO "EXTRAS"**

**STANDARD TUBES:**

- ✓ Tests the new Novars, Nuvistors, 10 Pins, Magnovals, Compactrons and Decals.
- ✓ More than 2,500 tube listings.
- ✓ Tests each section of multi-section tubes individually for shorts, leakage and Cathode emission.
- ✓ Ultra sensitive circuit will indicate leakage up to 5 Megohms.
- ✓ Employs new improved 4½" dual scale meter with a unique sealed damping chamber to assure accurate, vibration-less readings.
- ✓ Complete set of tube straighteners mounted on front panel.

**BLACK AND WHITE PICTURE TUBES:**

- ✓ Single cable used for testing all Black and White Picture Tubes with deflection angles 50 to 114 degrees.
- ✓ The Model 257 tests all Black and White Picture Tubes for emission, inter-element shorts and leakage.

**COLOR PICTURE TUBES:**

- ✓ The Red, Green and Blue Color guns are tested individually for cathode emission quality, and each gun is tested separately for shorts or leakage between control grid, cathode and heater. Employment of a newly perfected dual socket cable enables accomplishments of all tests in the shortest possible time.

The Model 257 is housed in a handsome, sturdy, portable case. Comes complete with all adapters and accessories, ready to plug in and use. No "extras" to buy. Only . . . . .

**\$47<sup>50</sup>**

**NOTICE**

We have been producing radio, TV and electronic test equipment since 1935, which means they were making Tube Testers at a time when there were relatively few tubes on the market, way before the advent of TV. The model 257 employs every design improvement and every technique learned over an uninterrupted production period of 32 years. Accurate Instrument Co., Inc.

**SEND NO MONEY WITH ORDER**  
**PAY POSTMAN NOTHING ON DELIVERY**

Try it for 10 days before you buy. If completely satisfied then send \$10.00 and pay the balance at the rate of \$10.00 per month until the total price of \$47.50 (plus P.P., handling and budget charge) is paid. If not completely satisfied, return to us, no explanation necessary.

ACCURATE INSTRUMENT CO., INC.

Dept. 618 2435 White Plains Road, Bronx, N. Y. 10467

Please rush me one Model 257. If satisfactory I agree to pay \$10.00 within 10 days and balance at rate of \$10.00 per month until total price of \$47.50 (plus P.P., handling and budget charge) is paid. If not satisfactory, I may return for cancellation of account.

Name \_\_\_\_\_

Address \_\_\_\_\_

City \_\_\_\_\_ Zone \_\_\_\_\_ State \_\_\_\_\_

Save Money! Check here and enclose \$47.50 with this coupon and we will pay all shipping charges. You still retain the privilege of returning after 10 day trial for full refund

Circle 16 on reader service card

**Hunting for a better job?**

**Here's the  
license  
you need  
to go after  
the big ones**



**A Government FCC License can help you bring home up to \$10,000, \$12,000, and more a year. Read how you can prepare for the license exam at home in your spare time—with a passing grade assured or your money back.**

**I**F YOU'RE OUT TO BAG A BETTER JOB in Electronics, you'd better have a Government FCC License. For you'll need it to track down the choicest, best-paying jobs that this booming field has to offer.

Right now there are 80,000 new openings every year for electronics specialists—jobs paying up to \$5, \$6, even \$7 an hour... \$200, \$225, \$250, a week... \$10,000, \$12,000, and up a year! You don't need a college education to make this kind of money in Electronics, or even a high school diploma.

But you *do* need knowledge, knowledge of electronics fundamentals. And there is only one nationally accepted method of measuring this knowledge... the licensing program of the FCC (Federal Communications Commission).

**Why a license is important**

An FCC License is a legal requirement if you want to become a Broadcast Engineer, or get into servicing any other kind of transmitting equipment—two-way mobile radios, microwave relay links, radar, etc. And even when it's not legally required, a license proves to the world that you understand the principles involved in *any* electronic device. Thus, an FCC "ticket" can open the doors to thousands of exciting, high-paying jobs in communications, radio and broadcasting, the aerospace program, industrial automation, and many other areas.

So why doesn't everyone who wants a good job in Electronics get an FCC License and start cleaning up?

The answer: it's not that simple. The government's licensing exam is tough. In fact, an average of two out of every three men who take the FCC exam fail.

There is one way, however, of being pretty certain that you will pass the FCC exam. And that is to take one of the FCC home study courses offered by Cleveland Institute of Electronics.

CIE courses are so effective that better than 9 out of 10 CIE graduates who take the exam pass it. That's why we can back our courses with this iron-clad Warranty: Upon completing one of our FCC courses, you must be able to pass the FCC exam and get your license—or you'll get your money back!

**They got their licenses and went on to better jobs**

The value of CIE training has been demonstrated time and again by the achievements of our thousands of successful students and graduates.

**2 NEW CIE CAREER COURSES**

1. **BROADCAST (Radio and TV) ENGINEERING**... now includes Video Systems, Monitors, FM Stereo Multiplex, Color Transmitter Operation and CATV.
2. **ELECTRONICS ENGINEERING**... covers steady-state and transient network theory, solid state physics and circuitry, pulse techniques, computer logic and mathematics through calculus. A college-level course for men already working in Electronics.

Ed Dulaney, Scottsbluff, Nebraska, for example, passed his 1st Class FCC License exam soon after completing his CIE training...and today is the proud owner of his own mobile radio sales and service business. "Now I manufacture my own two-way equipment," he writes, "with dealers who sell in seven different states, and have seven full-time employees on my payroll."

Daniel J. Smithwick started his CIE training while in the service, and passed his 2nd Class exam soon after his discharge. Four months later, he reports, "I was promoted to manager of Bell Telephone at La Moure, N.D. This was a very fast promotion and a great deal of the credit goes to CIE."

Eugene Frost, Columbus, Ohio, was stuck in low-paying TV repair work before enrolling with CIE and earning his FCC License. Today, he's an inspector of major electronics systems for North American Aviation. "I'm working 8 hours a week less," says Mr. Frost, "and earning \$228 a month more."

**Send for FREE book**

If you'd like to succeed like these men, send for our FREE 24-page book "How To Get A Commercial FCC License." It tells you all about the FCC License... requirements for getting one... types of licenses available... how the exams are organized and what kinds of questions are asked... where and when the exams are held, and more.

With it you will also receive a second FREE book, "How To Succeed In Electronics." To get both books without cost or obligation, just mail the attached postpaid card. Or, if the card is missing, just mail the coupon below.

**ENROLL UNDER NEW G.I. BILL.** All CIE courses are available under the new G.I. Bill. If you served on active duty since Jan. 31, 1955, or are in service now, check box on reply card for complete details.

**CIE Cleveland Institute of Electronics**

1776 E. 17th St., Cleveland, Ohio 44114

Accredited Member National Home Study Council  
A Leader in Electronics Training... Since 1934



**Cleveland Institute of Electronics**

1776 East 17th Street, Cleveland, Ohio 44114

Please send me without cost or obligation:

Your 44-page book "How to Succeed In Electronics" describing job opportunities in Electronics today, and how your courses can prepare me for them.

Your book on "How To Get A Commercial FCC License."

I am especially interested in:

- |                                                  |                                                    |
|--------------------------------------------------|----------------------------------------------------|
| <input type="checkbox"/> Electronics Technology  | <input type="checkbox"/> Electronic Communications |
| <input type="checkbox"/> Broadcast Engineering   | <input type="checkbox"/> Industrial Electronics    |
| <input type="checkbox"/> First Class FCC License | <input type="checkbox"/> Electronics Engineering   |

Name \_\_\_\_\_

(PLEASE PRINT)

Address \_\_\_\_\_

City \_\_\_\_\_

State \_\_\_\_\_ Zip \_\_\_\_\_ Age \_\_\_\_\_

Check here for G.I. Bill information

**RE-56**

# HICKOK

## DMS 3200 DIGITAL MEASURING SYSTEM (Fully solid state with IC's)



This all-solid-state precision measurement system offers unlimited expansion capability through plug-in additions, resulting in a specialized instrument for each type of measurement. New plug-ins now broaden the measurement capability of this field-proven unit. Over 10,000 are in use at present.

Scaling controls make possible resolution of up to seven digits on the three-digit display by utilizing the overrange capability of many of the plug-ins, thus providing high resolution and accuracy with minimum investment. Companion devices such as the PR 4900 Digital Printer and 1050 Digital Set-Point Controller further extend the utility of the DMS 3200 System.



- |                                                                                    |       |
|------------------------------------------------------------------------------------|-------|
| DC VOLTMETER PLUG-IN DP 100                                                        | \$175 |
| 00.1 mv to 999. volts<br>± 0.1% rdg ± 1 digit                                      |       |
| DC MICROVOLTMETER PLUG-IN DP 110                                                   | \$450 |
| 0.001 mv to 999.9 volts<br>± 0.05% rdg ± 1 digit<br>4-digit resolution             |       |
| AC VOLTMETER PLUG-IN DP 130                                                        | \$375 |
| 0.01 mv to 999. volts<br>± 0.1% rdg ± 1 digit<br>22 Hz to 1.0 MHz                  |       |
| EVENT COUNTER/SLAVE PLUG-IN DP 140                                                 | \$90  |
| Up to 1,000,000 counts/sec<br>Cascade with second DMS to<br>obtain 6-digit display |       |
| 1 MHz COUNTER PLUG-IN DP 150A                                                      | \$230 |
| 00.1 Hz to 999. kHz<br>± 0.0005% rdg ± 1 digit<br>7-digit resolution               |       |
| 80 MHz COUNTER PLUG-IN DP 160                                                      | \$395 |
| 00.1 Hz to 80.0 MHz<br>± 0.00005% rdg ± 1 digit<br>7-digit resolution              |       |
| OHMMETER PLUG-IN DP 170                                                            | \$275 |
| .001 ohm to 999. megohms<br>± 0.1% rdg ± 1 digit<br>Microamp test current          |       |
| CAPACITY METER PLUG-IN DP 200                                                      | \$275 |
| .001 picofarad to 9,999 mfd<br>± 0.1% rdg ± 1 digit<br>Low DC test voltage         |       |
| TIME INTERVAL METER PLUG-IN DP 210                                                 | \$230 |
| 0.01 ms to 999. seconds<br>± 0.0005% rdg ± 1 digit<br>Period or time interval      |       |
| DC CURRENT METER ADAPTER D 310                                                     | \$90  |
| .0001 microamp to 9.99 amps<br>± 0.15% rdg ± 1 digit                               |       |

color TV can surely figure out a simple 50-watt amplifier. I'm not mad at anyone, but there are sure a lot of amplifiers in this town, and the guy who could do good work on them could clean up.

And now that the manufacturers are going to solid-state, it looks like things can only get worse.

Since I'm here, I might also mention that I still haven't found any speakers capable of 50 watts of bass. Heck, I use an EV SRO-15 and two Jensen Bass Lifetime twelve's and can't turn the volume above a quarter of the way without death distortion. I must admit, I haven't tried JBL's, which are the *only* speakers to use for any kind of power. I guess they're my last chance.

Well, thanks for hearing me out, and say thanks to Jack Darr for me. He's hip.

HIL PAPROCKI  
Rochester, N.Y.

### I WANT A PREAMP

Many readers must have tape decks which have preamplifiers, but no provision for monitoring with 8-ohm headphones.

When making recordings away from the amplifier with which the deck is usually used, I need a small amplifier which will be fed by the deck preamps and which will drive 8-ohm phones. It must be good enough to enable judging the quality of the tape recording. It should also be able to drive two small speakers. But it must be as simple and inexpensive as possible. Volume controls usually necessary, tone controls optional, no frills.

How about giving us a design for a simple, practical stereo amplifier which will serve this purpose?

CARL HARTMAN  
E. Lansing, Mich.

*We'd like to Carl, but don't have a unit that meets all of your specs. As soon as we do get an article on such a unit we'll rush it into print.* R-E

### COMING NEXT MONTH

Don't miss February's special photography features—two construction projects and a look at the latest electronic camera circuits.

- Build A Professional Electronic Photoflash
- Digital Photo Enlarging Timer
- Electronics in Photography

HICKOK ELECTRICAL INSTRUMENT COMPANY, 10514 Dupont Ave., Cleveland, Ohio 44108

Circle 18 on reader service card

# There's nothing wrong with the set.



You fixed the picture a week ago, now you're back repairing your repair job. And paying for it.

Replacement parts are supposed to last longer than that.

Like electrolytic capacitors. If they're wound in computer-grade, 99.99% pure aluminum foil, they'll hold up for a long time at continuous temperatures of 85 C.

Like Arcolytic capacitors do.

Even though they cost the same as any other home entertainment capacitor. And come in more than 2000 exact replacement values to maintain the set's stability.

Any Arcolytic distributor can fill you in on the whole line of

*Circle 19 on reader service card*

Arcolytic types—twist mounts, printed circuit twist mounts, tubular electrolytics (including very high capacitance values) and miniature tubulars in the smallest physical sizes. He can also sell you Elmenco capacitors.

Then you won't have to do repair jobs twice. If the lady in the set seems to be missing something, a week after you've done a repair job, it's her problem. Not yours.

## **Loral Distributor Products**

A DIVISION OF LORAL CORPORATION  
Pond Hill Industrial Park, Great Neck, New York 11022



# watts-ville!

**New BELL P/A  
MODULAR AMP line  
has 20, 45, 90  
and 200W output  
—RMS ratings**

*Man, what a power output range!  
And what a variety of input  
configurations . . . practically  
unlimited . . . with up to 8 input  
modules arrangeable in any  
combination (even with separate  
muting and limiting functions!)*

The only p.a. amps with FET's  
up front for true Hi Z input (or  
bal. lo Z with trans.). All silicon  
solid state design.

Exclusive, fully automatic  
output circuit protection saves  
time, labor, components . . .  
eliminates guesswork. *See your  
local electronics distributor,  
or send for full specs.*

**BELL** p/a  
professional appeal

BELL P/A PRODUCTS CORPORATION  
1209 North Fifth St., Columbus, Ohio 43201

Circle 20 on reader's service card

## In the Shop . . . With Jack

By **JACK DARR**  
SERVICE EDITOR

### MORE ON SIGNAL TRACING COLOR CIRCUITS

LAST MONTH, WE TALKED ABOUT signal tracing through the color amplifier and demodulator stages. Now let's go back to the bandpass amplifiers and the burst circuits. These can cause some funny problems—funny-peculiar, definitely not funny-ha ha. Things like intermittent color sync on weak signals and weak color on all stations.

If you have weak burst or sync, the bars won't lock as tightly as they should. Turn the color control on the bar-dot generator down to at least half-normal and make sure the bars do hold steady. Your scope patterns will have a tendency to jitter horizontally, too. This can usually be cured by picking up a pulse from the TV's horizontal sweep (clip a test lead to the yoke leads, etc., and feed this into the scope's "Ext Sync" jack).

Here is a place to check that interaction between the horizontal hold control and the color sync. The basic symptom shows up when the horizontal hold control is turned too far on either side. You do not lose horizontal sync, as you would expect, but you do lose color sync.

Like all such problems, it's simple once you find out what's causing it. Here it is. The burst signal is always gated. Keyed on by the gating or keying pulse from the flyback, it's the same as gated age. The difference is that the color burst is very slim, about 4 to 6  $\mu$ sec.

In an age circuit the gating pulse has to hold the gate open only long enough to let the age tube sample the peak value of the horizontal sync voltage. So, the sync and the gate pulse can slide back and forth for a comparatively long interval before they get completely out of step and the picture will hold horizontal sync over a wide range of movement of the hold control.

Not so with the slim slick color burst, though. It won't wait around for the gate. The horizontal pulse must open the gate at *exactly* the right moment or this burst pip won't get

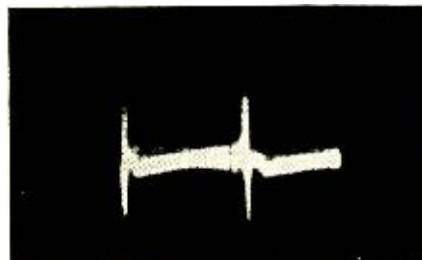

Fig. 1—Burst pulse at color afpc diode.

through. The gate will slam shut and we lose the burst, leaving the 3.58-MHz oscillator free to wander.

So check the burst pulse at the output of the gated amplifier. A good place to do this is at the color afpc phase detector diode. It looks like Fig. 1, a very sharply peaked pulse with a straight base line. There is nothing here but burst. You might also check the gate pulse on the burst amplifier grid. It comes from a small winding on the flyback and is positive-going, at about 50 volts p-p in RCA's along about the CTC16's. Motorola comes out with about 80 volts p-p on the phase detector diode, and the gating pulse is 175 volts p-p. Check the schematic for the correct amplitude on your set.

Probably the best fix for this problem is a careful horizontal oscillator setup, including the ringing coil. Then make sure that the hold control is set near the center of its rotation, so the gating pulse and burst are as

This column is for your service problems—TV, radio, audio or general and industrial electronics. We answer all questions individually by mail, free of charge, and the more interesting ones will be printed here.

If you're really stuck, write us. We'll do our best to help you. Don't forget to enclose a stamped, self-addressed envelope. Write: Service Editor, Radio-Electronics, 200 Park Ave. South, New York 10003.

TV ghosts beware! We've got a full line of ghost-fighting antennas and we're out to get you. With all our experience in the TV business, you've got plenty of reason to be scared.

Wait till you try to creep through our 1/2" seamless tubing. You'll never make it. Or just try to cross our double booms. They'll set you straight.

And to make your life even more difficult, we've

dipped our antennas in anti-corrosive material inside and out. So there'll be no rusty morsels for you to thrive on.

Take a word of warning. Before you choose another living room to haunt, check the roof. Make sure a Sylvania antenna isn't installed. Because if it is, you don't stand a ghost of a chance.

**SYLVANIA**  
A DIVISION OF  
GENERAL TELEPHONE & ELECTRONICS

## Sylvania goes into the ghost-fighting business.

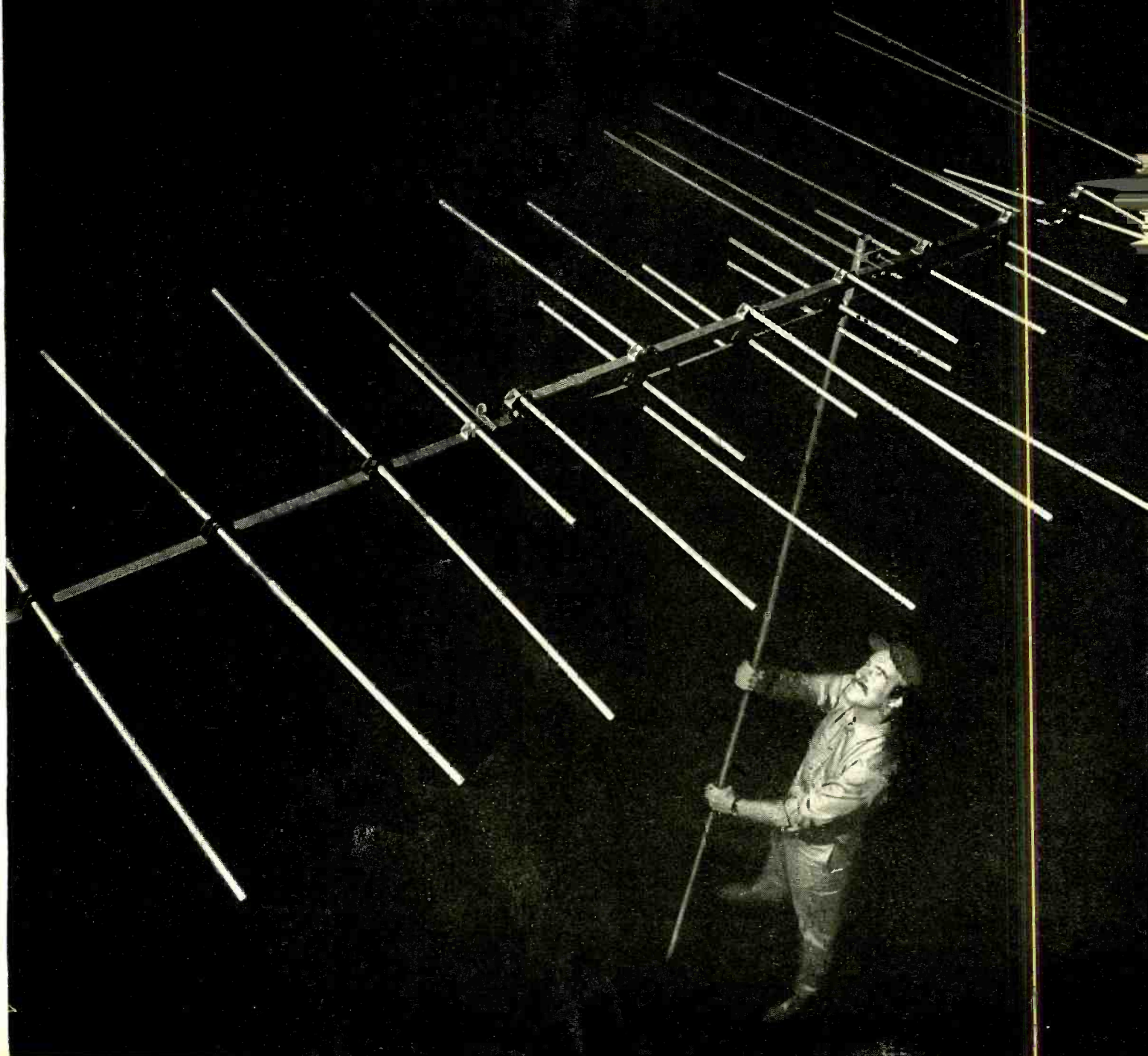

# RATCHET-TYPE CHIMNEY MOUNT

With Stainless Steel  
Strapping

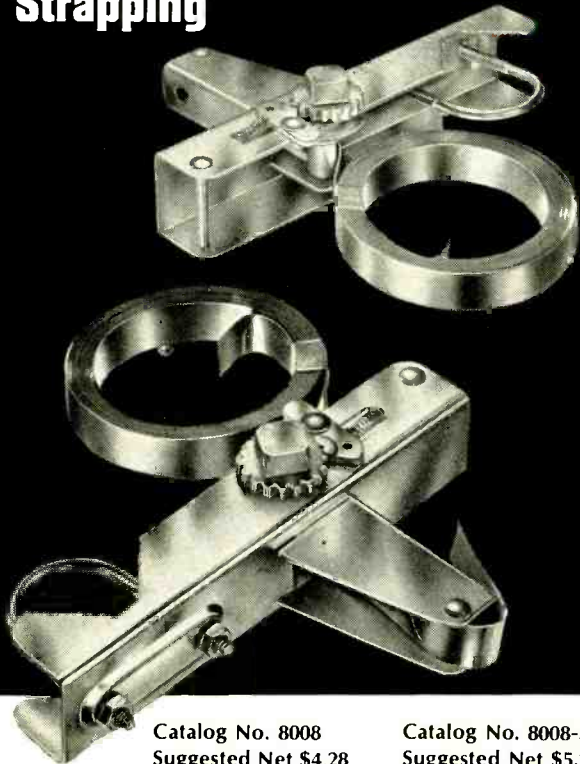

Catalog No. 8008  
Suggested Net \$4.28  
(12' lengths)

Catalog No. 8008-L  
Suggested Net \$5.10  
(18' lengths)

New in design... tops in materials... first in service life. Here is the quality-constructed two-bracket chimney mount designed to give maximum service in high wind, seasonal storms, adverse weather conditions. Available with 12 or 18-foot lengths of stainless steel strapping to fit any chimney, a locking "U" bolt that accepts antenna masts up to 1 1/2" in diameter. This mount installs in minutes, requires only a single wrench to secure to chimney. Buy with confidence from the world's largest basic manufacturer of television hardware... you'll make your job easier, faster, and more profitable... more satisfying to your customer.

Always insist on **GC**...  
you'll get more for your money, everytime!



**GC ELECTRONICS**  
A DIVISION OF HYDROMETALS, INC.  
MAIN PLANT: ROCKFORD ILL. U.S.A.



Giant FREE Catalog...

Only GC gives you everything in electronics... has for almost 40 years. Match every part and service need from over 10,000 quality items. Write for your copy today!

Circle 22 on reader's service card



has  
everything  
in  
**TELEVISION  
HARDWARE**

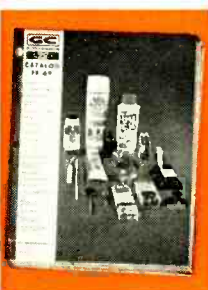
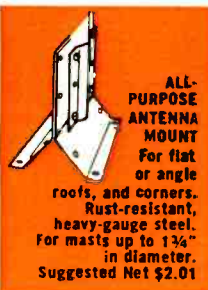

near to centered, or in time, with each other as possible. You can also check the gating pulse for shape.

The normal pulse is a pretty sharply peaked, tall waveform. If the peak is too narrow, check all components between the pulse source on the flyback and the burst amplifier grid. A slightly leaky capacitor or a resistor that's changed value can distort the pulse, adding to the confusion and possibly cause a reduction in the pulse amplitude.

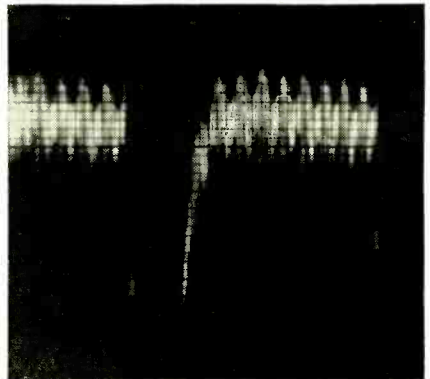

Fig. 2—"Comb" pattern of a color-bar generator taken at bandpass amplifier plate. The gap is the horizontal blanking pulse, which goes off scope screen.

If you think the color signal is weak, you'll find the normal amplitude on the schematic, in the bandpass amplifier grid circuit. If this is a two-stage amplifier, grid and plate p-p voltages will be given. You'll recognize the waveform the instant you see it. It makes the familiar comb pattern when a color-bar signal is used (Fig. 2).

For example, in the 908 Motorola series, we find 11.0 volts p-p on the grid of the first color i.f. tube and 27 volts p-p on its plate. Then, with a 1.3-volt p-p signal on the second color i.f. grid (through transformer, accounting for the voltage loss), we should have 18 volts p-p on the plate, a gain of about 13.

Even the 3.58-MHz CW signal can be traced. A narrow-band scope won't show you individual cycles of this high-frequency wave, but you will see a straight-topped bar. Its amplitude can be checked. Try your scope out on a color set that is working and you'll be able to tell what normal amplitude ought to be.

For the phasing of the CW signal, you won't need the scope. Just look at the screen. If red is red and green is green, phasing is ok! It doesn't have to go off very far before you can spot phasing error. Also, the high-bar test mentioned last month uncovers phasing troubles. **R-E**





## Another benchwarmer?

Not this one. Our new B&K Diagnostic Oscilloscope is more than re-engineering of an old model to keep pace with TV technology. It is instead a basic departure from all other oscilloscopes. A departure that has simplified a complex instrument to make it easier for you to use. But there's something else.

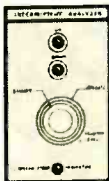

What this oscilloscope has is exclusive. An Intermittent Analyzer with electronic memory—and optional remote Audio/Visual Alarm.

With it, the elusive intermittent conditions that make so many TV sets tough dogs can now be detected and identified in your absence. Preset one control.

When the faulty stage is detected, you'll know about it as soon as you come back from service calls. Then run the scope overnight to check another set for an intermittent condition.

All this adds up to greater shop efficiency, more time for profit-making service calls and a lot more mileage out of a very fine diagnostic oscilloscope.

An oscilloscope that shows vector patterns exactly as specified by color TV manufacturers. (All vectorscope inputs and controls are conveniently located on the front panel.) Also allows you to read peak-to-peak voltages in all ranges on a double-scale calibrated screen—just by turning a switch. (As the range is selected, the appropriate scale lights automatically.)

Circle 23 on reader service card

Automatic synchronization locks in all patterns at any signal level or frequency. There are also fewer controls and these are positioned for easier operation.

Give our Diagnostic Oscilloscope some thought. It's worth it not to be sidelined with a benchwarmer. See your B&K Distributor or drop us a note for detailed literature on Model 1450 and our full-line test equipment catalog, AP-24.

**DIAGNOSTIC OSCILLOSCOPE**  
Model 1450, Net: \$279<sup>95</sup>



B & K Division of DYNASCAN CORPORATION  
1601 W. Belle Plaine - Chicago, Illinois 60613  
Where electronic innovation is a way of life.

**Someone  
should develop  
an easy way  
to learn  
electronics at  
home**

**RCA Institutes  
did!**

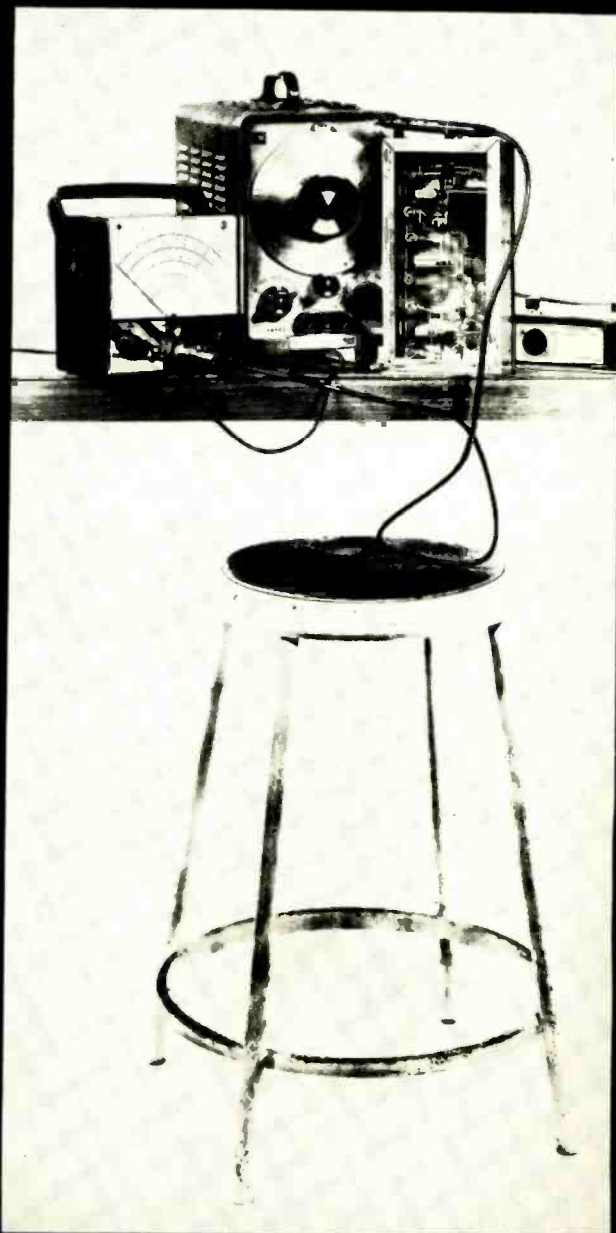

Here is a whole new approach to learning electronics at home! RCA Institutes, one of the nation's largest schools devoted to electronics, has developed a faster, easier way for you to gain the skills and the knowledge you need for the career of your choice. Here for the first time is a student-proved, scientifically designed way to learn. If you have had any doubts in the past about home training in electronics—if you have hesitated because you thought you might not be able to keep up—or that electronics was too complicated to learn—here is your answer! Read how RCA Institutes has revolutionized its home training ideas!

**NEW CAREER PROGRAMS  
BEGIN WITH "AUTOTEXT"  
INSTRUCTION METHOD!**

**Start to learn the field of your  
choice immediately!  
No previous training or  
experience in electronics  
needed!**

With this new revolutionized method of home training you pick the career of your choice—and RCA Institutes trains you for it. RCA's Career Programs assure you that everything you learn will help you go directly to the field that you have chosen! No wasted time learning things you'll never use on the job! The Career Program you choose is especially designed to get you into that career in the fastest, easiest possible way!

And each Career Program starts with the amazing "AUTOTEXT" Programmed Instruction Method—the new, faster way to learn that's almost automatic! "AUTOTEXT" helps even those who have had trouble with conventional home training methods in the past. This is the "Space Age" way to learn everything you need to know with the least amount of time and effort.

**CHOOSE A CAREER PROGRAM NOW**

**Your next stop may be the job of your choice.** Each one of these RCA Institutes Career Programs is a complete unit. It contains the know-how you need to step into a profitable career. Here are the names of the programs and the kinds of jobs they train you for. Which one is for you?

**Television Servicing.** Prepares you for a career as a TV Technician/Serviceman; Master Antenna Systems Technician; TV Laboratory Technician; Educational TV Technician.

**FCC License Preparation.** For those who want to become TV Station Engineers, Communications Laboratory Technicians, or Field Engineers.

**Automation Electronics.** Gets you ready to be an Automation Electronics Technician; Manufacturer's Representative; Industrial Electronics Technician.

**Automatic Controls.** Prepares you to be an Automatic Controls Electronics Technician; Industrial Laboratory

Technician; Maintenance Technician; Field Engineer.

**Digital Techniques.** For a career as a Digital Techniques Electronics Technician; Industrial Electronics Technician; Industrial Laboratory Technician.

**Telecommunications.** For a job as TV Station Engineer, Mobile Communications Technician, Marine Radio Technician.

**Industrial Electronics.** For jobs as Industrial Electronics Technicians; Field Engineers; Maintenance Technicians; Industrial Laboratory Technicians.

**Nuclear Instrumentation.** For those who want careers as Nuclear Instrumentation Electronics Technicians; Industrial Laboratory Technicians; Industrial Electronics Technicians.

**Solid State Electronics.** Become a specialist in the Semiconductor Field.

**Electronics Drafting.** Junior Draftsman, Junior Technical Illustrator; Parts Inspector; Design Draftsman Trainee Chartist.

**SEPARATE COURSES**

In addition, in order to meet specific needs, RCA Institutes offers a wide variety of separate courses which may be taken independently of the Career Programs, on all subjects from Electronics Fundamentals to Computer Programming. Complete information will be sent with your other materials.

**2 CONVENIENT PAYMENT PLANS**

RCA Institutes offers a unique tuition plan that lets you progress at your own pace. You only pay for lessons as you order them. You don't sign a contract obligating you to continue the course. There's no large down-payment to lose if you decide not to continue.

However, if you desire, RCA Institutes also offers a convenient monthly payment plan.

**VALUABLE EQUIPMENT**

You receive valuable equipment to

keep and use on the job—and you never have to take apart one piece to build another.

**New—Programmed Electronics Breadboard.** You now will receive a scientifically programmed electronic breadboard with your study material. This breadboard provides limitless experimentation with basic electrical and electronic circuits involving vacuum tubes and transistors and includes the construction of a working signal generator and superheterodyne AM Receiver.

**Multimeter and Oscilloscope Kits At No Additional Cost.** You will receive with most RCA Institutes Career Programs the instruments and kit material you need to build a Multimeter and Oscilloscope. The inclusion of both these kits is an RCA extra.

**CLASSROOM TRAINING  
ALSO AVAILABLE**

RCA Institutes maintains one of the largest schools of its kind in New York City where classroom and laboratory training is available in day or evening sessions. You may be admitted without any previous technical training; preparatory courses are available if you haven't completed high school. Coeducational classes start four times a year.

**JOB PLACEMENT SERVICE, TOO!**

Companies like IBM, Bell Telephone Labs, GE, RCA, Xerox, Honeywell, Grumman, Westinghouse, and major Radio and TV Networks have regularly employed graduates through RCA Institutes' own placement service.

**SEND ATTACHED POSTAGE PAID CARD  
FOR COMPLETE INFORMATION, NO OB-  
LIGATION.**

All RCA Institutes courses and programs are approved for veterans under the new G.I. Bill.

Accredited Member  
National Home Study Council

IF REPLY CARD IS DETACHED—SEND THIS COUPON TODAY

RCA INSTITUTES, Inc., Dept. REQ-29  
320 West 31st Street, N.Y., N.Y. 10001

Please rush me FREE illustrated catalog. I understand that I am under no obligation.

Name \_\_\_\_\_ Age \_\_\_\_\_

(please print)

Address \_\_\_\_\_

City \_\_\_\_\_

State \_\_\_\_\_ Zip \_\_\_\_\_



**step toward  
tomorrow with**

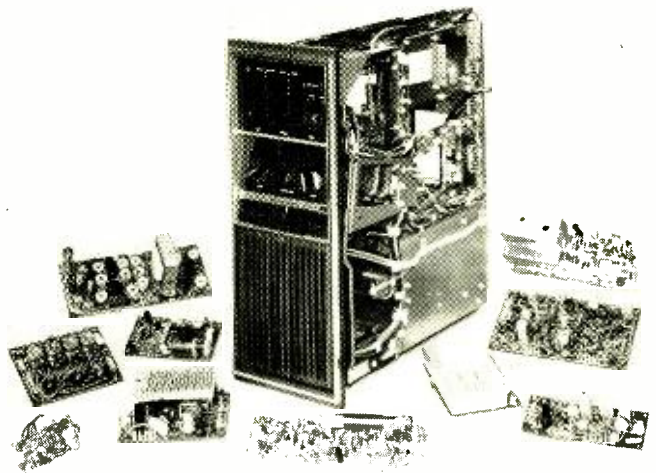

# QUICK-CHANGE MODULES

**By LARRY STECKLER**  
MANAGING EDITOR

TV ON THE BLINK? AND YOU'RE GOING TO HAVE TO WAIT two weeks to get the set back? And that big basketball game is *this* Saturday? Sure hope you have a good friend or two around.

But this kind of situation is on its way out. More and more TV sets are being built around plug-in subassemblies that permit almost "instant" repair, right in your home. This is especially important to the color set owner as these sets tend to be large, bulky, and heavy.

## The first steps to plug-ins

Setchell-Carlson started the ball rolling a few years back when they introduced a set made up of several plug-in subchassis. Their intention was that the set, should it break down, could easily and rapidly be put back into service. All the technician had to do was to locate the defective sec-

tion, unplug it, and plug in a good replacement section.

However, this system did have one drawback. Few technicians actually carried replacement plug-in chassis. Notwithstanding, these sets are still being made in both a black-and-white and color chassis.

Sony tried it next. They're selling a black-and-white portable in which the entire works is on a single, large circuit board. They have two reasons in mind—one is faster service and the other, even more important, easier access to the chassis. If you've ever seen how crowded the insides of some portables get, you'll know what I mean.

## Quick-change circuit boards next

Now Motorola is the newest member of the club. They've come up with a plug-in approach in their Quasar chassis. You know the one, the set "with the works in the drawer." This chassis consists of 10 plug-in sections. Each one is completely contained on a single printed-circuit

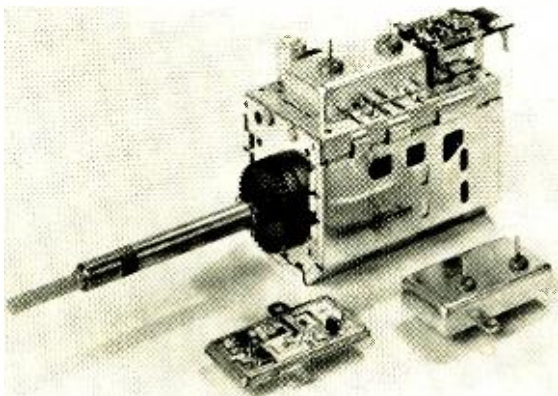

*This chf tuner (above) has a plug-in hybrid IC that contains all the active components essential to proper tuner operation. It's made by Oak Electronics and should be turning up in TV sets soon. The photo at the right shows an IC on a plug-in Quasar circuit card. One day soon that IC may replace the card.*

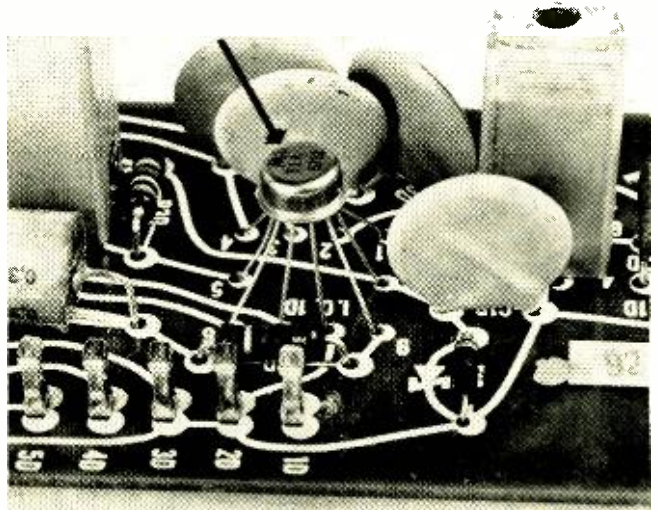

board that "plugs into" the main chassis frame. Again the theory behind this move is that this set is one that won't ever have to go to the shop.

Instead, should the solid-state circuit act up, the technician has only to locate the defective board, unplug it, and replace it with a new one. To repair the defective board, rather than having to cart an entire color chassis to his shop, he has to take only the board along. I understand that Motorola is providing a repair service for technicians for defective boards—probably on some kind of exchange basis plus a flat-rate repair charge. Also Motorola has available a special Quasar caddy that contains a complete set of replacements for this set.

### Will everyone be doing it?

It is more than likely that in the near future almost every set maker will be following the plug-in approach in one form or another. The result may not be at all like the Setchell-Carlson subchassis or the Motorola circuit boards, but some system is likely. Some set makers are already talking about an all IC (integrated circuit) color set. In such a receiver the plug-ins would be the IC's themselves.

If this sounds like pie in the sky to you you missed the announcement of the new Oak Electronics TV tuner. It incorporates a plug-in hybrid IC that contains every active transistor, resistor and capacitor essential for complete vhf TV tuner operation. Should something other than the switching elements in the tuner fail, the entire module is replaced, in minutes, right in the customer's home.

Is the cost of such a module high? Yes. But look at the savings that counterbalance it. The technician doesn't have to take the tuner apart and then perhaps ship it off to some tuner repair service center, wait till it comes back, and then reinstall it. As a result, the total cost of this kind of tuner repair would probably remain the same. But the set wouldn't have to be removed from the set owner's home nor would it be out of service for a full week or two.

Picture the same situation scaled up to a color receiver with, oh say, 12 plug-in IC's. Sure there'll be problems. Sure there'll be a multiplicity of plug-in modules and stocking problems. But like it or not, problems or not, this is a probable picture of the future.

### Will picture tubes get larger?

The only way picture tubes, color picture tubes, are likely to get larger is if someone comes up with an entirely new approach. The vacuum-tube CRT in use today is probably as large as it is practical to build this type of tube. I know there was and still is a 27" black-and-white CRT—but not very many are in use. And are they ever expensive!

Our first step toward really larger screens will very possibly come in the form of some kind of projection technique. It will probably work, but it is just as probable that it would not be accepted by the viewing (and set buying) public. Remember, we once had black-and-white projection systems. But the optics that went into those systems were no end of trouble. Even so simple a task as cleaning the mirror and lens was a job to be avoided.

### Flat tubes are likely

A more practical approach, and the one that must eventually develop, is the flat picture tube. It may not be as far away as you think. One version of a flat black-and-white CRT, made by Hughes Aircraft, is currently being used by the Air Force. It's built right into the windshield of

some of our new jet fighters that are flying today.

Several other forms of flat color picture tubes have also been described. There may not be any in use today, but they are coming. Personally, I look forward to the day that a color screen is just unrolled when you want to watch and folded up out of sight when you're through watching.

The most recent development that might lead to a flat television picture tube is the Orshinsky effect. A sketch of a flat TV screen made by this process is shown below. It's only a dream today, but tomorrow?

### Smaller sets too

But TV is going in two directions. Sets are getting smaller just as fast as they are getting larger. These days it's almost safe to predict that the wristwatch TV, perhaps even a color wrist TV will be with us soon. It will take a lot more development work with IC's to make it so, but it is no longer in the realm of science fiction.

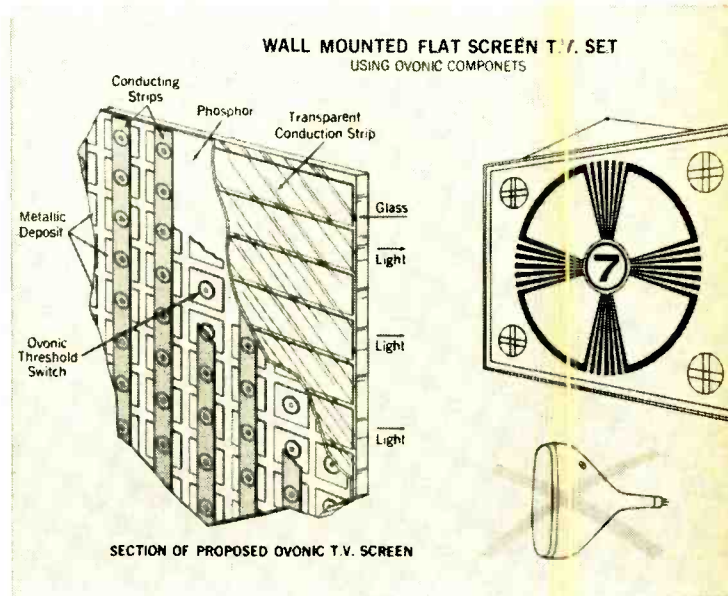

*Flat screen TV? One possible approach is shown here. I'd like to be able to hang one of these sets on my livingroom wall now. But it's just a concept on the drawing board so I'll have to wait.*

### 3-D TV is with us now

Three-dimensional TV systems are already being used by industry. They are particularly handy where remote control of some instrument or remote handling of some product is required. Existing systems are bulky, awkward and expensive. But better ones will come. One day it may be possible to wrap a screen around three corners of your "TV room" and watch the 3-D color picture float in front of your eyes. My only hope in this direction is that it's a direct-vision system. Not one with which you've got to wear special glasses. One side note: A patent has already been issued for a 3-D CRT. It uses a group of phosphor screens lined up one behind the other to create the depth illusion. I've never seen it work, but I have seen the proposal.

### Color videotape recordings

We are currently seeing the beginning of the TV tape age. Several videotape recorders are being made for home use right now. One of the newest systems is built to look

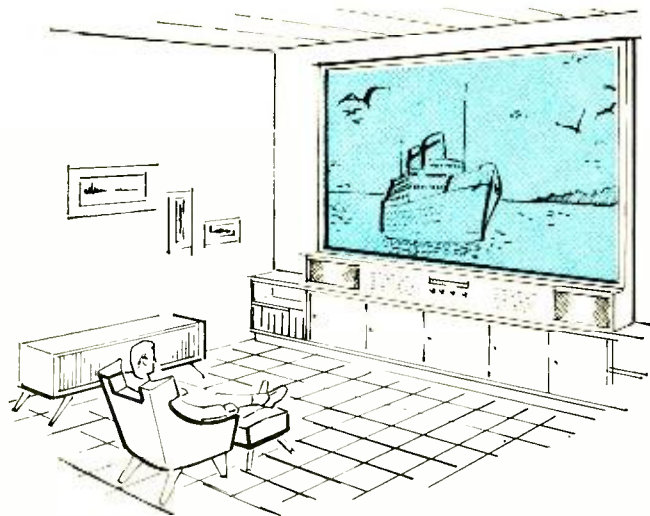

*When TV walls become possible this is what your TV room may look like, RCA did the sketch this scene is based on but they won't say when they'll make this set. Ten years is a good guess.*

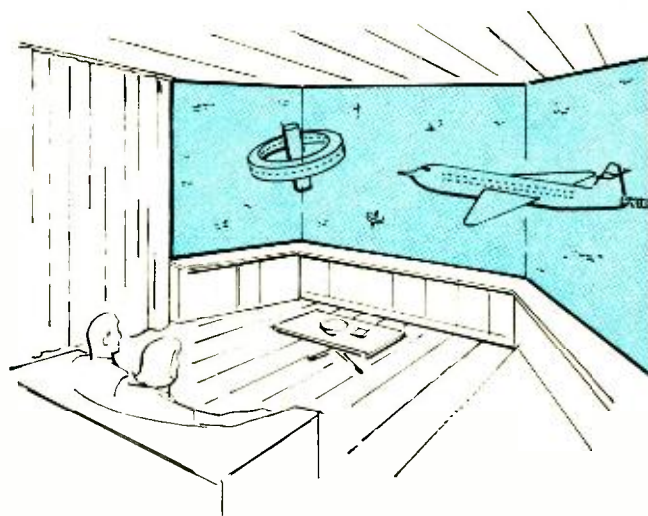

*Even 3-D sets are possible. Some 3-D systems are actually in use today, but they are a far cry from the type of setup you see here. We turned our art department loose to dream up this one.*

and behave like an 8-mm movie camera. It uses a 6-minute cartridge and plays back through any TV set. Just hook up to the antenna terminals. Its inventors claim that it can sell for about \$500—that's about half the price of existing units. But let me stress one thing: This is a laboratory model. It is not yet in production nor has any manufacturer yet said that he would build the unit in quantities.

But the next step from this black-and-white system is a color video tape recorder (VTR). Here again future development of the IC is probably what it is needed to make such units available at a reasonable price. You may say impossible, but I remember when you had to pay \$500 for a 7" black-and-white TV that was loaded with some 30 vacuum tubes and produced a ho-hum picture. Look at what you can get for \$500 today in a large screen color set.

### Color Picturephones

In most large cities today you can make arrangements

to talk to someone, long distance, via Picturephone. In the not too distant future it may be possible to do the same thing right from your home. Carry that just one little step further and you can do it via a color Picturephone. Ridiculous. No! Future? Yes! That same color Picturephone will allow you to do your shopping without ever leaving your home. Dial (pardon me—punch out) the number for the supermarket, for example, and you'll see displayed the various items on sale that day. Using the telephone keyboard punch out the codes for the items you want and they'll be delivered later. You'll get your bill for them too. The same process would also hold true for any other kind of shopping you might care to do.

Color TV today is just scratching the surface. Perhaps it's just starting to scratch the surface. Either way I'm sure my predictions will tend to underestimate rather than overestimate future developments. Either way it's going to be fun to see how my final score comes out. **R-E**

## Late Breaking Color-TV News

In the preceding article projection color TV systems were mentioned briefly. However, there is one such system now under development. Some prototype color receivers have already been built by the firm, Harries Electronics Corporation. They first showed versions of this set a couple of years ago. At that time it fared rather badly as the picture appeared dim and not as good as what was already available.

However, Harries now says they have a newer version of the set in operation in New York and have offered **RADIO-ELECTRONICS** an opportunity to see the set in operation. We are taking them up on their offer and will deliver a complete report on this set as soon as we have seen it.

### New kind of color CRT

From France comes word of a "new" kind of color CRT. The tube, a variation of the Chromatron

is said to offer two advantages over the American-style shadow-mask tube—it offers double the brightness and has a flat faceplate (this means the screen has no curvature at all . . . the tube itself is not a flat "hang-on-the-wall" type).

It does, however, differ from the Chromatron. One major difference is that the post acceleration grid is actually imbedded in the glass faceplate. It is not "hung" inside the tube in front of the screen. The added sturdiness of this arrangement makes a 23-inch version of the tube possible.

Reports from Europe indicate that substantial numbers of these tubes have already been made. Obviously the French manufacturer would like to interest US set makers in the new tube, but we don't know how successful they have been. A more detailed report on this new tube and how it works is also scheduled. Our reporter in France is working on it now. . . .

# How Color TV Works

Color TV fundamentals can be easy

By **MATTHEW MANDL**

CONTRIBUTING EDITOR

TRUE OR FALSE?

- Both black-and-white and color use 15,750 Hz for the horizontal scan.
- Both systems use 60 Hz for the vertical sweep frequency.
- The 3.58-Mhz color subcarrier is received simultaneously with the black-and-white video carrier.
- As with b-w, a color receiver uses a single detector for both video and sound demodulation.

If you said "true" to any one of these statements you were wrong! Every statement is *false!* This little quiz emphasizes some of the important differences between color TV and b-w TV. The more we know about such differences, the easier color TV is to understand. The nice part is that we don't have to delve into complex math either to explain or understand the basic principles.

## The color signals

The optical system of a color television camera filters the colors it gets from a given scene and breaks them into three primary colors. For the *additive* color mixing process that is used, the primary colors are *red*, *blue*, and *green*. Thus, camera pick-up tubes produce individual ac signals which represent red, blue, and green, and vary in amplitude according to the individual color intensities.

Like black-and-white signals, color signals must modulate a carrier

so they can be transmitted to the receiver. Normally, if we use a specific bandwidth for transmission, there wouldn't be room to include a new set of signals. Fortunately, in black-and-white transmission, the sideband signal information tends to cluster around the harmonics of the 15,750-Hz horizontal sweep frequency. This signal bunching leaves separate gaps in the frequency spectrum into which we can sandwich the color signals.

Since we already have a black-and-white carrier, we call the color carrier the *subcarrier*. This subcarrier must have a frequency just right to put the color signals in the spaces between the clusters of sidebands horizontally related. Mathematically, a subcarrier which is an odd multiple of one-half the horizontal sweep frequency would do the trick.

An approximately satisfactory subcarrier frequency is obtained when we take one-half the horizontal sweep frequency and multiply it by 455. But we run into trouble because of interference with the sound carrier. To avoid this, 15,734.264 Hz is used for the horizontal sweep frequency for color transmission. To keep the vertical sweep properly related, it operates at 59.94 Hz. The result is a subcarrier frequency of 3.579545 MHz (approximately 3.58 MHz) which is just right for odd-harmonic relationships for both picture and sound carriers.

The 15,734-Hz horizontal sweep frequency and the 59.94-Hz vertical sweep are close enough to the 15,750 Hz and 60 Hz of black-and-white to maintain good sync lock.

Using a 3.58-MHz subcarrier didn't solve all problems. If the subcarrier (with its sidebands) is re-

ceived at the set, the subcarrier can cause interference and other problems. Hence, the subcarrier is not transmitted—only the sidebands of color signals. This *suppressed-carrier* type transmission is often used by other services for narrow-band interference-reducing practices.

Suppressing the subcarrier means that the color receiver must have a separate oscillator to generate the missing color carrier for insertion into the sidebands for proper detection of color signals. This is done with a crystal-controlled oscillator to maintain the necessary stability.

Still another problem was the overabundance of modulating signals (red, blue, and green). To reduce these, the individual color signals were changed into a combined set of two called the *I* and *Q* signals. To reduce cross-talk during color reception, the *I* signal is sent with one sideband extending to 1.48 MHz and the other side consisting of a vestigial section of about 500 kHz wide. The *Q*, however, is transmitted in double-sideband fashion, each sideband 500 kHz from the suppressed subcarrier as shown in Fig. 1.

The 3.58 MHz oscillator in the receiver must be kept in *sync* with the subcarrier at the transmitter, or false color rendition results. To do this, a special signal consisting of about 9 cycles of 3.58 MHz is transmitted during each horizontal blanking. This signal is called a *burst* and occurs during blanking following the sync signal (Fig. 2).

To make color compatible so the program produces a picture on a b-w set, a *luminance* or brightness signal designated as *Y* is included. The *Y*

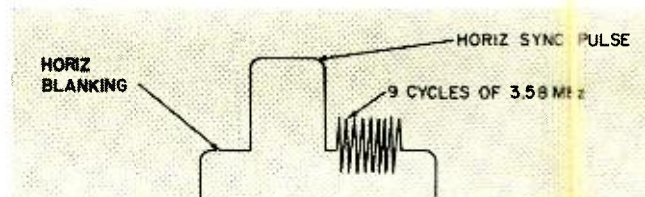
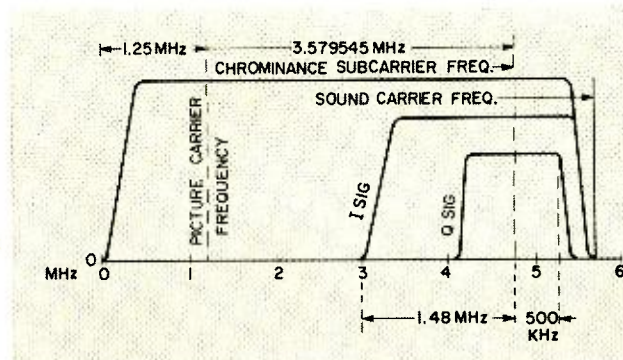

Fig. 1—(left) Color information in the American 6-MHz channel width is carried in a suppressed subcarrier—a picture modulated sideband 3.58 MHz above the picture carrier. Fig. 2—(above) A burst of about 9 cycles at 3.58 MHz is transmitted after each horizontal sync pulse. It is used to sync the 3.58-MHz color oscillator in the TV receiver.





out of the bandpass amplifier during black-and-white reception. The circuit which does this is known as the *color killer* (Fig. 5).

The video signal input is applied to both the grid of the burst amplifier and the bandpass amplifier. A high positive potential is applied to the cathode of the burst amplifier, making the grid relatively negative and normally cutting off this tube. A positive pulse is applied to the grid and causes conduction. Since this pulse comes from the horizontal output system, it occurs only during horizontal blanking, permitting the 3.58-MHz sync burst to be amplified and applied to the phase detector of the subcarrier oscillator circuitry.

When the phase detector receives the burst signal it develops a negative potential which is applied to the color-killer tube grid and keeps this tube cut off.

A positive pulse from the horizontal system is also applied to the plate of the killer tube. Since no positive B voltage is applied to this anode, the pulse takes its place. Since the grid is held at cutoff, however, no current flow occurs through the tube.

When there is no burst signal (during reception of a black-and-white picture) the phase detector receives no signal and no cutoff bias is applied to the killer tube. Now this tube conducts. Electron flow from cathode to plate and down through the 220,000-ohm resistor to ground sets up a negative polarity at the grid of the bandpass amplifier as shown in Fig. 5. Thus, the bandpass amplifier tube becomes nonconducting for the video signal.

The shunting capacitor acts to filter the pulse voltage at the anode of the killer tube to convert it to fairly steady-state dc. A color-killer manual control is usually placed in the grid circuit of the killer tube for critical adjustment of killer function.

In addition to the color-handling circuitry described, diode-resistor-coil combinations are used for convergence purposes. For a color receiver to show white, the red, blue, and green beams must converge into one area to produce white. If any single beam is misaligned, color fringing occurs.

For color, approximately 25 kV is essential for large-screen brilliance. Similarly, several thousand volts are necessary for application to the focus electrode. To maintain constant high voltages, regulators are used in the high-voltage section. A portion of the high voltage is tapped for focus purposes, or a transformer tap is used with either a tube or stacked selenium rectifiers.

**R-E**

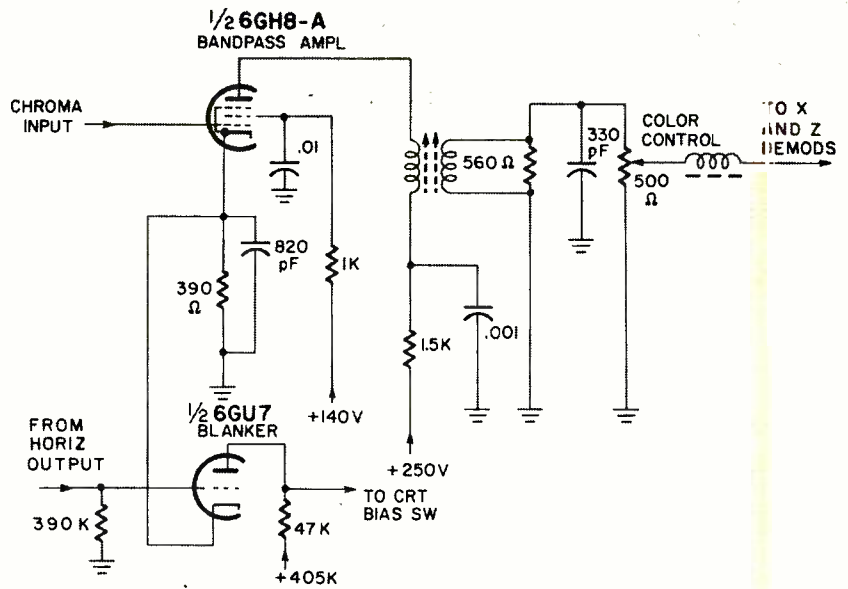
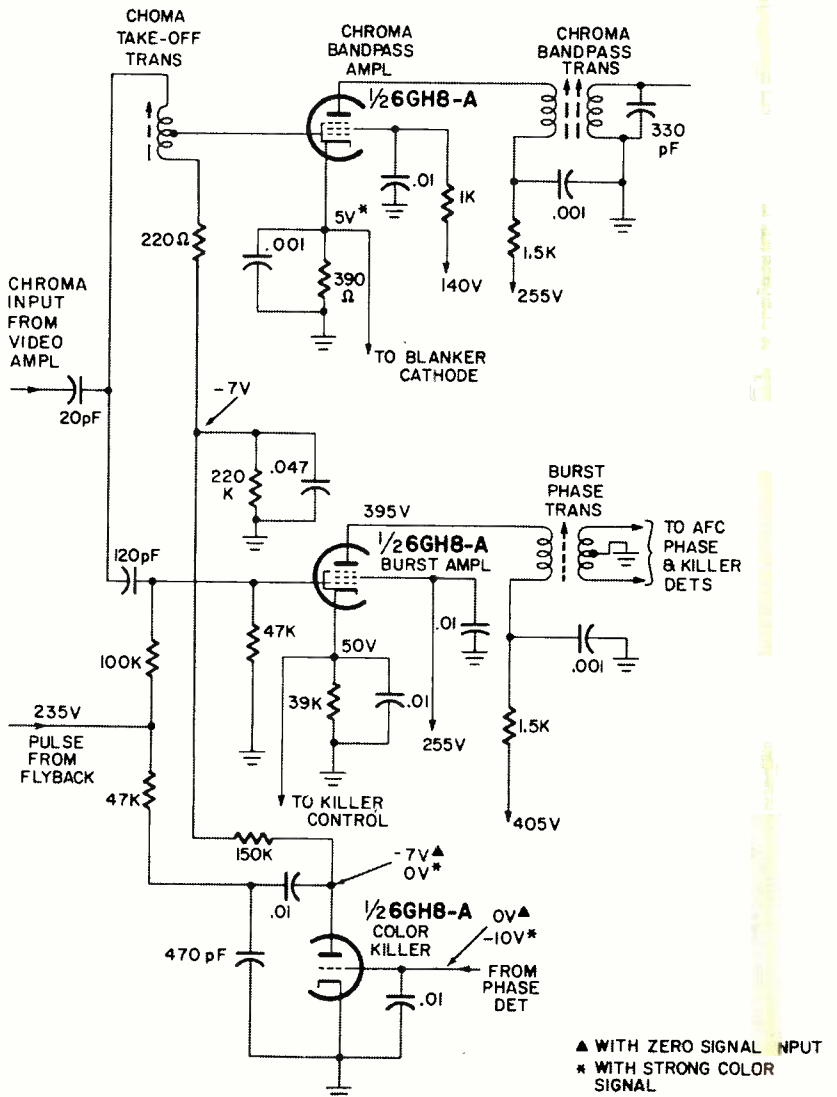

Fig. 4—Bandpass amplifier prevents sync and burst signals from reaching CRT, and boosts color signals for demodulation. Bandpass amplifier is gated off by the blanker, which conducts only when it is triggered by horizontal sweep output pulses.

Fig. 5—Typical color killer is normally biased off through burst signal action. Tube conducts only during b-w transmission, cutting off the bandpass amplifier.



▲ WITH ZERO SIGNAL INPUT  
\* WITH STRONG COLOR SIGNAL

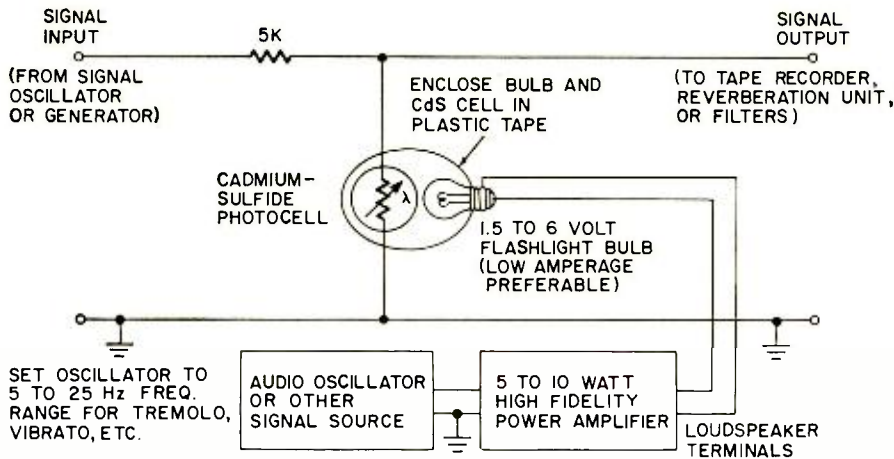

Fig. 3—A modulator and envelope controller can be built with a low-current bulb and cadmium sulfide cell. Frequency response is limited by the bulb response time.

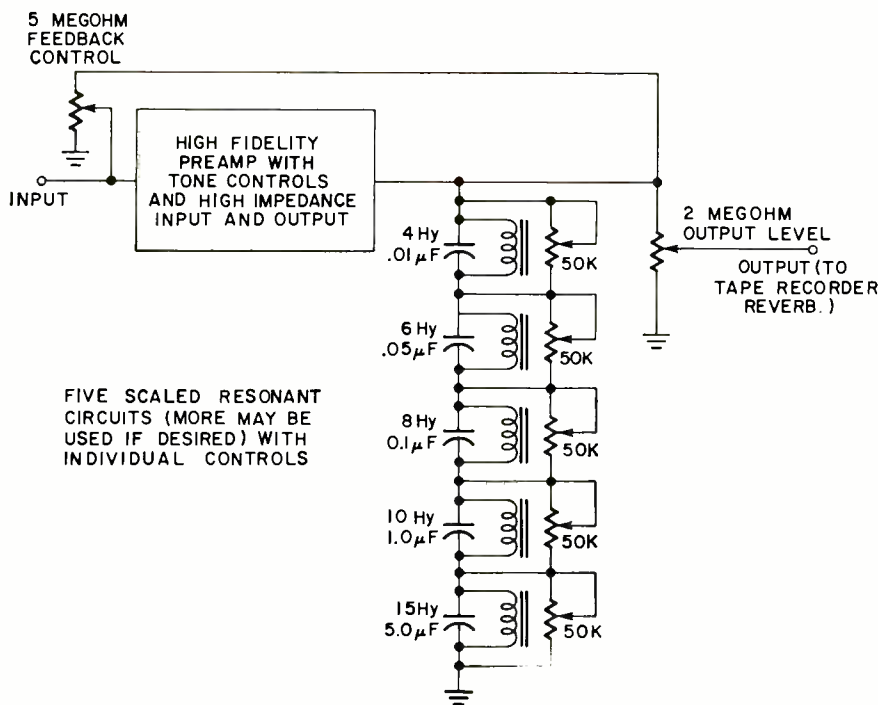

Fig. 4—Resonant equalizers use LC circuit string and a preamplifier with positive feedback. For high-Q filters, impedance at tie-in point must be sufficiently high.

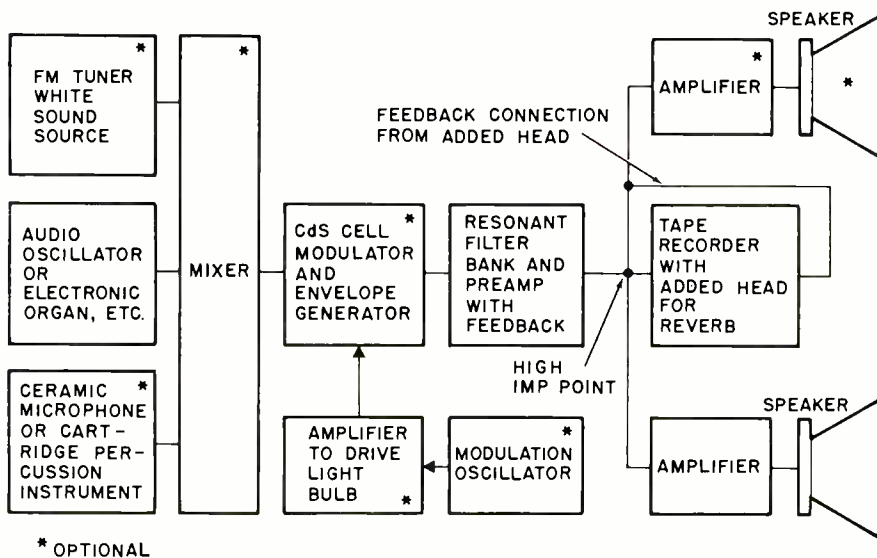

Fig. 5—Block diagram shows suggested interconnections of devices described.

two. In fact, one well-known electronic music laboratory (Brandeis University) used a bank of oscillators with each one connected to a key on a keyboard. The oscillators are preadjusted to the desired frequency and amplitude wanted from each one. Then the oscillators may be played from the keyboard as a regular musical instrument.

**Build a CdS-Cell Modulator.** A light-controlled volume control is easily assembled with cadmium sulfide photoelectric cells (Fig. 3). By using a high-fidelity amplifier to drive a light bulb, a type of amplitude modulation can be produced. The frequency response of the modulation channel is limited by the response time of the light bulb, so use a small, low-current bulb (such as a flashlight bulb) that responds faster than larger bulbs.

**Build a Resonant Filter.** Resonant filters are easily made by putting a paper capacitor (0.1 to 5  $\mu\text{F}$ ) in parallel with an iron-core choke of the type used in power supplies (2 to 15 henries). A bank of these filters can be made up easily from parts found in most experimenters' junk bins.

Put the smallest capacitor across the smallest inductor and grade the sizes up to the biggest (Fig. 4). Put a potentiometer across each parallel-resonant circuit, and wire the circuits in a series string from a high-impedance point in the audio circuit to ground. If the impedance at the point is too low, the Q of the resonant filters will suffer. The ideal point is the input to a typical vacuum-tube amplifier, which usually has an impedance of 470,000 ohms.

You may want to try connecting a filter bank at a point between two stages in a preamplifier or after the first stage of the power amplifier. The higher the impedance, the better the resonance achieved in the filters. For this reason, transistor amplifiers usually won't work with the circuit unless it is isolated with special vacuum-tube or FET amplifiers.

**FM Tuner for White Sound.** The smooth hiss heard between stations on a sensitive FM tuner or television receiver is white sound. It is a basic sound for synthesizing various percussive sounds (by filtering and modulating as described later). Simply tune a receiver off station and feed its output into a mixer, filter or tape recorder. The de-emphasis network must be disabled.

**Preamp Resonant Filter or Oscillator.** Connecting the output of a preamplifier with tone controls back to the input will cause the preamplifier

to oscillate at the frequency of maximum amplification (set by the tone controls and equalizers). If the feedback connection is made through a potentiometer, the amount of feedback can be controlled and set to a point just below oscillation.

This will convert the preamplifier into a resonant equalizer, adding a great deal of color to sounds passing through the preamplifier from tape recorder, microphone, records, etc. If this technique is combined with the resonant filter bank described earlier some very sharp resonant-filter bandwidths can be achieved. Use a vacuum-tube preamplifier (like the old McIntosh with equalizers and tone controls), and connect the resonant filter bank across the output before the feedback potentiometer (Fig. 4).

One word of caution with respect to the feedback circuit: if the phase is not correct, negative feedback rather than positive feedback will result. Insert the feedback signal into the cathode circuit rather than the grid input of the first preamplifier stage (a solder connection rather than the input jack). Negative feedback causes a reduction in amplification, while positive feedback yields an increase in amplification and a tendency to oscillate.

These nine techniques are all available to the amateur experimenter, and most can be assembled inexpensively and with little effort. Combined with the simplest audio sound system, all the basic techniques of an electronic music synthesizer can be available to the beginner or the experimenter with a limited budget. These basic techniques of electronic music synthesis are:

- Signal generation (oscillators, white-sound sources, etc.)
- Modulation and envelope control
- Filtering
- Reverberation
- Tape manipulation (dubbing, splicing, tape loops, speed changes, reversal, sound overlays)
- Recording and high-fidelity reproduction

#### Interconnecting components

Once the experimenter has acquired or built some of the devices listed above he is ready to interconnect them and start synthesizing electronic music. If he has a sound generator or two (an oscillator and an electronic organ for example), a modulator, a resonant filter, a tape

recorder with a reverberation head added and a high-fidelity sound system, he is ready to start.

In comparing the electronic music gear described here with commercial synthesizers, the main deficiency of our equipment is in the area of controls. Professional synthesizing equipment permits much more variety in external controls, and in the capability of modulating and interconnecting units. The following are recommended ways of interconnecting various components described in this article:

**Sound Sources and Amplitude Modulation.** It is desirable to have two sound sources and a simple amplitude modulator. The sound sources are used as an *audio* signal source and a *modulation* signal source, which does not have to be in the audible range. In the case of the simple modulator described earlier, frequency range is limited by the response time of the light bulb. Thus, only low-frequency modulation (such as vibrato or tremolo) and envelope-control modulation (where the amplitude of one signal follows the envelope of another signal) is available.

**Filtering and Reverberation.** After passing through the modulator, the signal should pass through the filters and then to the tape recorder reverberator (Fig. 5). The final sound product will then be recorded on the tape for future use.

If the user has two tape recorders, one can be used for reverb and the other to record the final product. The reverberation tape recorder, incidentally, can be any old machine since quality requirements are greatly reduced if it doesn't produce the final recording as well as reverberation. Of course the recording should be made on the best tape recorder available.

**Dubbing, Splicing and Reproduction.** It will probably be desired to copy material from one tape to another. To do this only one tape recorder is required. A second tape deck can be used with any high-fidelity preamp with equalization for tape heads. For splicing applications it is desirable to have a tape deck with removable head covers.

If the original recording is monaural, try simulating stereo by splitting the highs into one channel and the low frequencies into another with two preamps or the tone controls on a stereo preamp. Also try dubbing the tape into two channels and simulate moving sound sources by advancing one record level while reducing the other.

R-E

## IC's Foil Change Cheaters

COFFEE-BREAK COUNTERFEITERS WITH photocopied bills and professionals who regularly cheat vending machine bill-acceptor mechanisms may soon become a thing of the past. Using two new integrated circuits developed by Texas Instruments, this plug-in amplifier is being used by Transmarine Corp. to make bill-changer mechanisms that are foolproof.

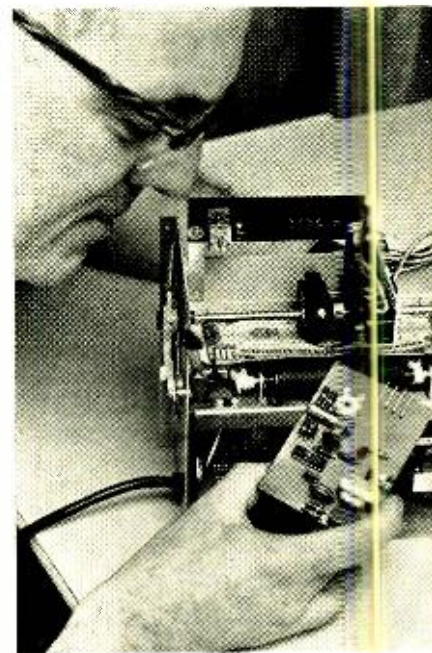

High temperatures, humidity, line-voltage changes and soiled bills won't disrupt the new changers. Earlier devices depended on photocell arrays to measure light on the face of a bill. Signals from the cells fed to unstable transistor amplifiers sometimes accepted photocopies and *rejected* genuine bills.

The new acceptor analyzes the intaglio printing detail of bills. As a tray containing the bill is pushed into the acceptor, a sensing switch turns on an infrared radiation source. This radiation passes through the moving bill at a selected point in the bill design, through an exact replica of the area and strikes a silicon cell. The cell then generates electronic pulses, but only a real bill generates the correct number and size of pulses. The IC can even differentiate between signals generated by infrared penetration of U.S. Mint ink and paper, and the best ink-paper combination that is available to counterfeiters.

The plug-in amplifier, which can update the circuits in some of the company's older machines, can be modified to accept "foreign" pulses. A version used in Sweden, for example, lets motorists operate self-service gas stations.

R-E



# 1969 COLOR SETS

Three basic types of sets are available—all transistor, all tube, and hybrids that are a combination of both tubes and transistors. The all-transistor sets tend to be more costly, top-of the line models. In return for the higher price tag you normally get longer trouble-free service and a set that requires less power to operate. Also, you'll find many of the smaller screen sets use transistor circuits to keep heat to a minimum and to cram-in all the needed circuitry.

But the really important news for 1969 is in the features. You've got a choice between hand-wired and printed-circuits. Here, you've got to decide for yourself. There are advantages on both sides, but don't let this be the only deciding factor. Don't forget to look at the other features too.

Take automatic fine tuning for one. This is an extra that can save you



Toshiba Spectrum III C3A.

MANUFACTURER	MODEL	CHASSIS	SCREEN SIZE (DIAG. IN.)	TYPE SET								FEATURES								PRICE
				COMBINATION	CONSOLE	TABLE	PORTABLE	TUBE	TRANSISTOR	HYBRID	PRINTED CIRCUIT	HAND WIRED	AUTO FINE TUNING	FINE TUNING INDICATOR	AUTO DEGAUSSING	AUDIO TAPOFF	STONE CONTROL	INSTANT PLAY	COLOR FIDELITY	
Heath Co.	GR-681	—	23	.	.	.	.	.	.	.	.	.	.	.	.	.	.	.	.	\$ 499.95*
	GR-295	—	23	.	.	.	.	.	.	.	.	.	.	.	.	.	.	.	.	\$ 449.95*
	GR-227	—	20	.	.	.	.	.	.	.	.	.	.	.	.	.	.	.	.	\$ 399.95*
	GR-180	—	18	.	.	.	.	.	.	.	.	.	.	.	.	.	.	.	.	\$ 349.95*
Hitachi	CNA-24T	—	18	.	.	.	.	.	.	.	.	.	.	.	.	.	.	.	.	\$ 369.95
	CFA-550	—	14	.	.	.	.	.	.	.	.	.	.	.	.	.	.	.	.	—
JVC NIVIVO	7208	—	—	.	.	.	.	.	.	.	.	.	.	.	.	.	.	.	.	\$ 299.95
	150	—	18	.	.	.	.	.	.	.	.	.	.	.	.	.	.	.	.	\$ 329.95
	151	—	18	.	.	.	.	.	.	.	.	.	.	.	.	.	.	.	.	\$ 339.95
Magnavox	IC6250	—	18	.	.	.	.	.	.	.	.	.	.	.	.	.	.	.	.	\$ 369.50
	IC6300	—	20	.	.	.	.	.	.	.	.	.	.	.	.	.	.	.	.	\$ 429.50
	IC6402	—	21	.	.	.	.	.	.	.	.	.	.	.	.	.	.	.	.	\$ 398.50
	IC6800	—	23	.	.	.	.	.	.	.	.	.	.	.	.	.	.	.	.	\$ 479.50
	IC6902	—	23	.	.	.	.	.	.	.	.	.	.	.	.	.	.	.	.	\$ 559.50
	IC7011	—	23	.	.	.	.	.	.	.	.	.	.	.	.	.	.	.	.	\$ 815.00
	IC7600	—	23	.	.	.	.	.	.	.	.	.	.	.	.	.	.	.	.	\$ 750.00
	IC7645	—	23	.	.	.	.	.	.	.	.	.	.	.	.	.	.	.	.	\$ 1095.00
Midland	15-218	—	18	.	.	.	.	.	.	.	.	.	.	.	.	.	.	.	.	\$ 369.95
Motorola	CP468EN	C14TS-924	14	.	.	.	.	.	.	.	.	.	.	.	.	.	.	.	.	\$ 299.95
	CT550EW	C18TS-921	18	.	.	.	.	.	.	.	.	.	.	.	.	.	.	.	.	\$ 379.95
	CT670EW	K20TS-921	20	.	.	.	.	.	.	.	.	.	.	.	.	.	.	.	.	\$ 439.95
	CT800EN	N23TS-921	23	.	.	.	.	.	.	.	.	.	.	.	.	.	.	.	.	\$ 469.95
	CU868EW	P23TS-921	23	.	.	.	.	.	.	.	.	.	.	.	.	.	.	.	.	\$ 499.95
	LK837EW	M23TS-921	23	.	.	.	.	.	.	.	.	.	.	.	.	.	.	.	.	\$ 925.00
	WU870EW	C23TS-915	23	.	.	.	.	.	.	.	.	.	.	.	.	.	.	.	.	\$ 649.95
	TL853ES	AC23TS-915	23	.	.	.	.	.	.	.	.	.	.	.	.	.	.	.	.	\$ 789.95
	MD850EW	E23TS-915	23	.	.	.	.	.	.	.	.	.	.	.	.	.	.	.	.	\$ 1275.00
Muntz TV	24811P	—	18	.	.	.	.	.	.	.	.	.	.	.	.	.	.	.	.	—
	3322M	—	22	.	.	.	.	.	.	.	.	.	.	.	.	.	.	.	.	—
	5581	—	23	.	.	.	.	.	.	.	.	.	.	.	.	.	.	.	.	—
	5453	—	23	.	.	.	.	.	.	.	.	.	.	.	.	.	.	.	.	—

\* Cabinet and remote control are additional



change. It will automatically keep the color setting constant throughout changes of cameras, programs and program materials. Set makers are working on an automatic tint control, but haven't come up with one.

Remote control is again a convenience and in color sets an expensive convenience. It will add more than \$50 to the price of the set. One suggestion here. A remote control for a color set must do more than just permit channel selection and volume control. It should also control color and tint. If it doesn't you'll find yourself having to get up from your easy chair to make these adjustments.

Since most controls do include these adjustments, modern color remotes tend to be 7-channel or 7-button devices. They are elaborate and delicate—you can't just throw them around any old way. But used properly they can prove very handy.

Price, though listed last, is probably considered first. It often is the limiting factor. Prices shown here are recommended factory list prices and will vary somewhat from store to store and city to city. As with any other major purchase, once you've decided on the make or model you want to buy, it pays to dick around and shop. Only one warning though . . . once you've decided on the set you want don't let yourself be switched. But do get the set you like at the best possible price.

R-E

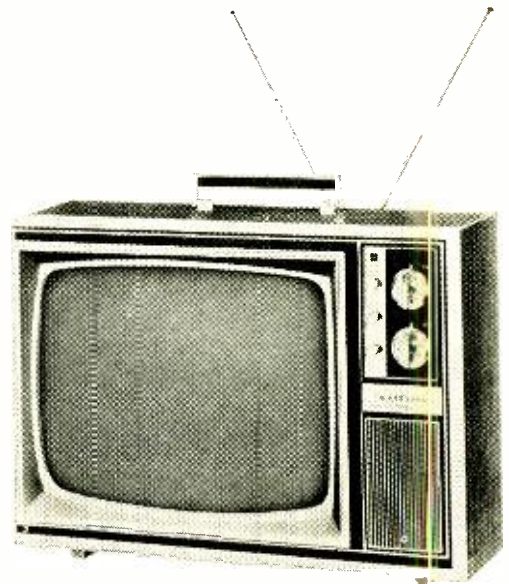

Panasonic Palermo model CT-93P.

MANUFACTURER	MODEL	CHASSIS	SCREEN SIZE (DIAG. IN.)	TYPE SET			TYPE CIRCUIT		FEATURES										PRICE			
				COMBINATION	CONSOLE	TABLE	PORTABLE	TUBE	TRANSISTOR	HYBRID	PRINTED CIRCUIT	HAND WIRED	AUTO FINE TUNING	FINE TUNING INDICATOR	AUTO DEGAUSSING	AUDIO TAPOFF	TOPE CONTROL	INSTANT PLAY		COLOR FIDELITY	AUTO COLOR CONTROL	REMOTE CONTROL
Satchell-Carlson	2400M0	—	23	•				•														\$ 730.00
	2500C0X	—	23	•				•														\$ 795.00
Sharp	CN-50P	—	12				•															\$ 269.95
	CN-52T	—	18			•																\$ 349.95
Sony	7010	—	7				•															\$ 429.95
Sylvania	CB30GY	D11	14				•															—
	CD13W	D05	18				•															\$ 369.95
	CE31W	D06	20			•																\$ 429.95
	CF500E	D08	23			•																\$ 449.95
	CF507W	D12	23			•																\$ 499.95
	CF240CR	D10	23			•																\$ 1200.00
	CFNP20BT	D13*	23			•																\$ 995.00
Symphonic	TCT195	—	18				•															—
Westinghouse	C984A19	—	14				•															\$ 329.95
	C988A19	—	18				•															\$ 389.95
	C990A19	—	20				•															\$ 399.95
	C990A39	—	20				•															\$ 459.95
	C993A49	—	23			•																\$ 549.95
	C993A67	—	25			•																\$ 900.00
Zenith	Z3504-1	15Y6C15	14				•															\$ 329.95
	Z3906	16Z7C19	18				•															\$ 369.95
	Z4203	20Y1C50	20				•															—
	Z5208	16Z7C50	20				•															—
	Z4501J	20Y1C50	23				•															\$ 469.95
	Z4512	20Y1C50	23			•																\$ 529.95
	Z4507	20Y1C50	23				•															—
	Z8530	16Z7C50	23			•																\$ 975.00
	Z8550	16Z7C50	23			•																\$ 1225.00

\*Color Slide Theatre

**“Get more  
education  
or  
get out of  
electronics  
...that’s my advice.”**





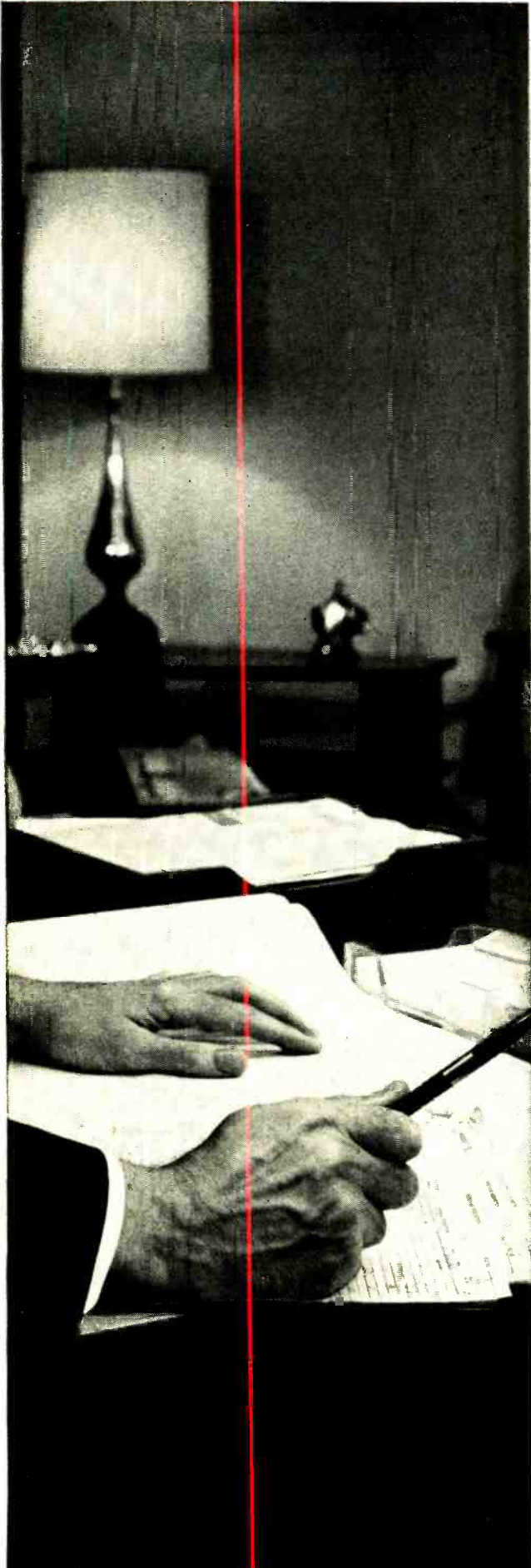

**Ask any man who really knows the electronics industry.**

Opportunities are few for men without advanced technical education. If you stay on that level, you'll never make much money. And you'll be among the first to go in a layoff.

But, if you supplement your experience with more education in electronics, you can become a specialist. You'll enjoy good income and excellent security. You won't have to worry about automation or advances in technology putting you out of a job.

How can you get the additional education you must have to protect your future—and the future of those who depend on you? Going back to school isn't easy for a man with a job and family obligations.

CREI Home Study Programs offer you a practical way to get more education without going back to school. You study at home, at your own pace, on your own schedule. And you study with the assurance that what you learn can be applied on the job immediately to make you worth more money to your employer.

You're eligible for a CREI Program if you work in electronics and have a high school education. Our FREE book gives complete information. Airmail postpaid card for your copy. If card is detached, use coupon below or write: CREI, Dept. 1401H, 3224 Sixteenth Street, N.W., Washington, D.C. 20010.

Founded 1927



Accredited Member of the National Home Study Council



**CREI, Home Study Division**  
**McGraw-Hill Book Company**  
**Dept. 1401H 3224 Sixteenth Street, N.W.**  
**Washington, D.C. 20010**

Please send me FREE book describing CREI Programs. I am employed in electronics and have a high school education.

NAME \_\_\_\_\_ AGE \_\_\_\_\_

ADDRESS \_\_\_\_\_

CITY \_\_\_\_\_ STATE \_\_\_\_\_ ZIP CODE \_\_\_\_\_

EMPLOYED BY \_\_\_\_\_

TYPE OF PRESENT WORK \_\_\_\_\_  G.I. BILL

I am interested in  Electronic Engineering Technology  
 Space Electronics  Nuclear Engineering Technology  
 Industrial Electronics for Automation  
 Computer Systems Technology

**APPROVED FOR TRAINING UNDER NEW G.I. BILL**

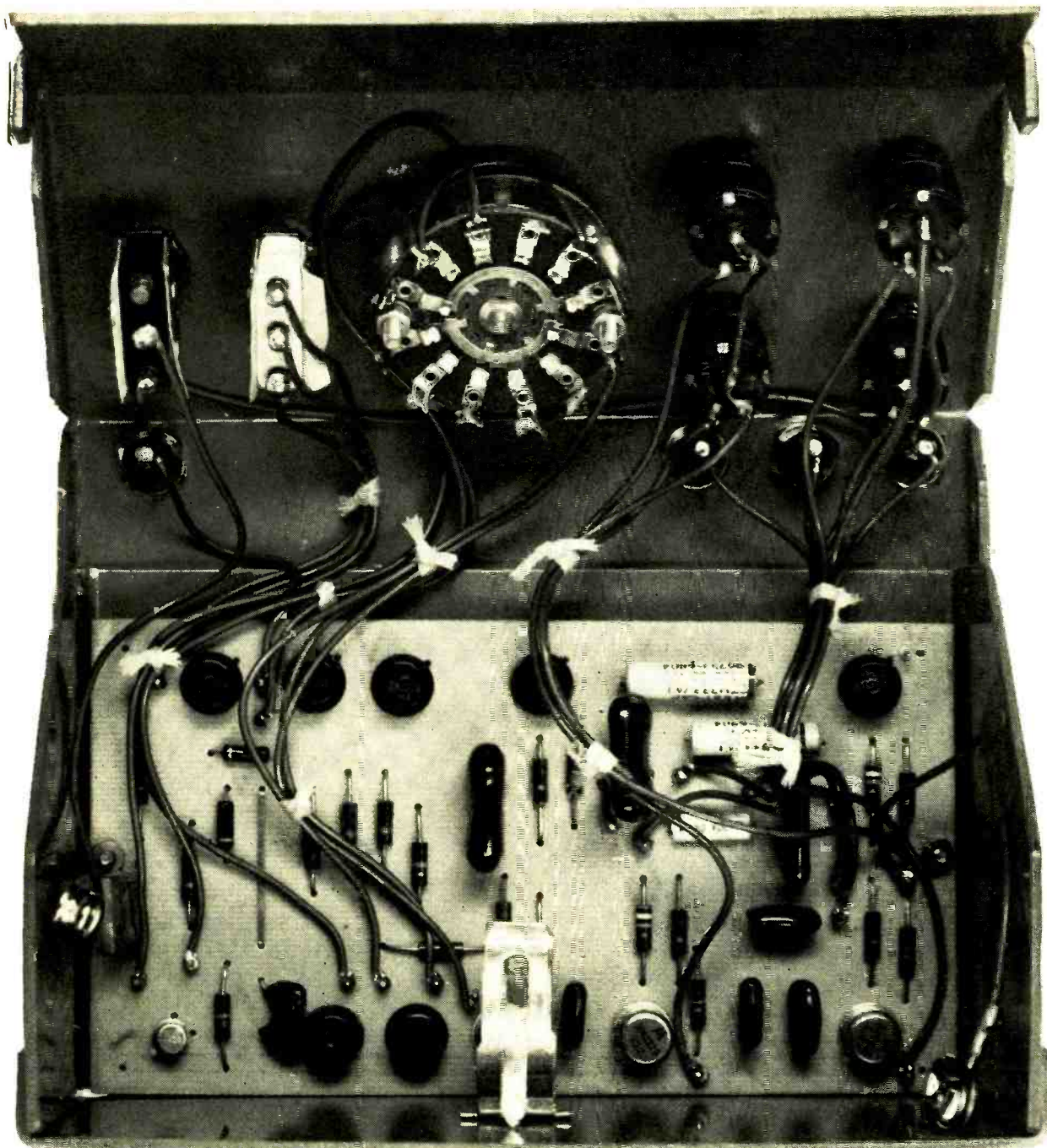

# BUILD BEGINNER'S

**Get top quality pictures from your color TV**

By **BENNETT C. GOLDBERG**

IF YOU'D LIKE AN INEXPENSIVE, functional and compact Dot-Bar generator to insure your color set always has "hi-fi" color, this project is for you.

Construction is simplified with the actual-size printed-circuit drawing shown. The unit (Fig. 1) operates on a 9-volt battery, fits in a small metal

box, and puts out horizontal and vertical lines, dots and a cross-hatch pattern.

A second similar circuit (Fig. 2) is a Cross-Hatch generator that can be installed in any set with a service switch. It can be used when convergence circuits are adjusted.

## How does it work?

The function of the Dot-Bar Generator is shown in the block diagram in Fig. 3. The circuit is straightfor-

ward and explained as follows:

Transistors Q1 and Q2 form a free-running multivibrator which produces a square wave output. Because of the variation in tolerances of the components, one transistor will conduct before the other.

An increase in collector current for transistor Q1 causes a decrease in its collector voltage and a corresponding reduction in regenerative feedback through capacitor C2 to the base of transistor Q2. As a result, the current

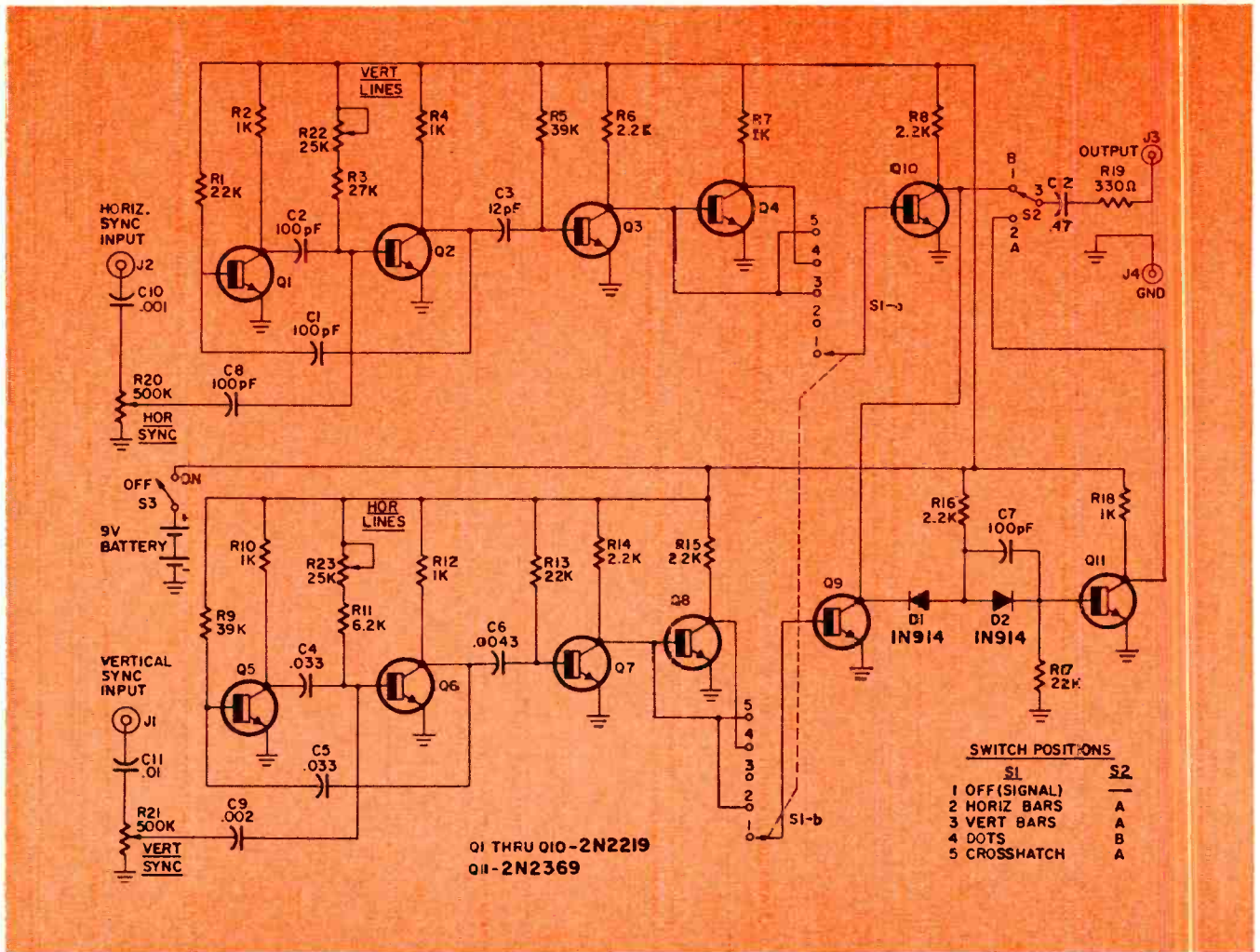

Fig. 1—Circuit for Dot-Bar generator. Transistors Q1-Q2 form a free-running multivibrator synchronized by 15,750-Hz horizontal sweep pulses, and Q5-Q6 operate as a 900-Hz multivibrator, synced by 60-Hz pulses from the vertical sweep circuit.

#### PARTS LIST

**Resistors** ¼ watt or more, 10%  
 R1, R13, R17—22,000 ohms  
 R2, R4, R7, R10, R12, R18—1000 ohms  
 R3—27,000 ohms  
 R5, R9—39,000 ohms  
 R6, R8, R14, R15, R16—2200 ohms  
 R11—6200 ohms  
 R19—330 ohms  
 R20, R21—500,000-ohm ½-watt linear potentiometer, Mallory SU-50 or similar  
 R22, R23—25,000-ohm ½-watt linear potentiometer, Mallory SU-29 or similar

#### Capacitors

C1, C2, C7, C8—100 pF, 100V, 10% mica  
 C3—12 pF, 100V, 5% mica  
 C4, C5—0.033 μF, 50V, 5% disc ceramic  
 C6—0.0043 μF, 100V, 5% mica  
 C9—0.002 μF, 100V, 10% mica  
 C10—0.001 μF, 500V, 20% mica  
 C11—0.01 μF, 500V, 20% disc ceramic  
 C12—0.47 μF, 50V disc ceramic

#### Semiconductors

Q1-Q10 (Fig. 1), Q1-Q8 (Fig. 2)—2N2219  
 Q11 (Fig. 1), Q9 (Fig. 2)—2N2369

D1-D2—1N914 diodes

#### Switches

S1—2-pole, 5-position, nonshorting rotary, Centralab PA-1003 or equal

S2—Spdt

S3—Spst

MISC—11 transistor sockets, 9-V battery (NEDA No. 1600 or equivalent), tip jacks and plugs, circuit board, sloping-panel case at least 5¼" wide, 3" deep and 2¾" high, test leads and clips.

# DOT-BAR GENERATOR

through Q2 decreases steadily as the current through Q1 increases until Q2 is cut off. Capacitor C2 then discharges until forward bias is re-established across the base-emitter junction of Q2. Current through Q2 then decreases until Q1 is cut off. Capacitor C1 is coupled from the collector of Q2 to the base of Q1 so the cycle is repeated.

A positive input trigger pulse, 15,750-Hz, from the horizontal sweep circuits of the television receiver is

used to sync the multivibrator. The frequency of the multivibrator is set for a multiple of 15,750 Hz by adjusting R22.

The multivibrator operates at 180 KHz, which produces approximately 12 lines. There is enough variation in the adjustment of R22 to provide more or fewer lines as desired.

Transistors Q5 and Q6 operate as a 900-Hz multivibrator. Its frequency is adjusted by R23. A 60-Hz positive trigger pulse from the verti-

cal sweep circuits of the receiver is used to sync this multivibrator.

Transistor Q3 is a pulse shaper. Capacitor C3 and resistor R5 are connected as a differentiator network. Transistor Q3 is biased on by R5. The negative-going differentiated edge of the square wave of multivibrator Q1 and Q2 turns transistor Q3 off. This produces a positive, 0.1-μsec-wide, 180-kHz pulse.

Transistor Q7 is also used as a pulse shaper, but a 50-μsec-wide, 900-

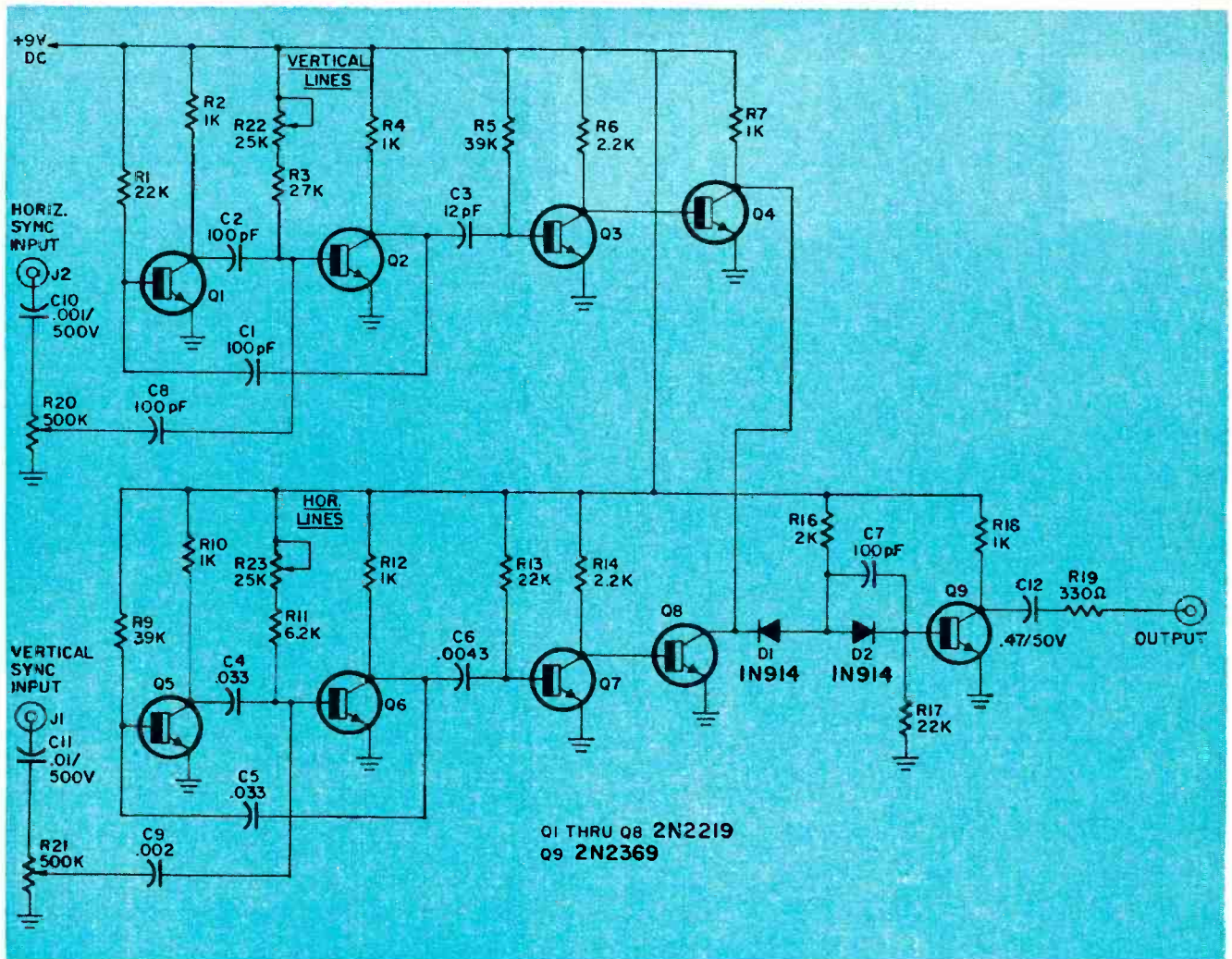
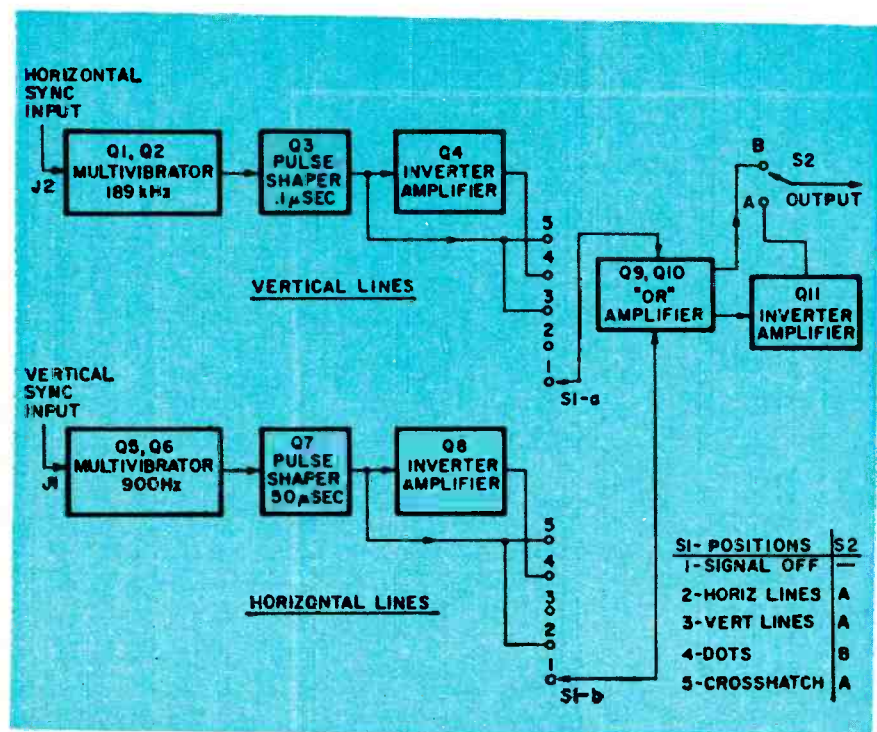

Fig. 2—Cross-hatch generator circuit that can be installed in sets with service switches. The 180-kHz output of Q3 and 900-Hz Q7 output are combined at R7. The signal is inverted and fed to the last video amplifier of the set through the service switch.



Hz rate positive pulse is obtained.

Transistors Q4 and Q8 are inverting amplifiers. Transistors Q9 and Q10 have a common-collector load and perform an "or" function. Transistor Q11 is a low-impedance inverting output driver.

Switch S1 selects the required mode of operation to form the desired output signal to the bases of transistors Q9 and Q10. Switch S2 selects the correct output phase to the receiver.

Circuit operation of the cross-hatch generator (Fig. 2) uses transistors Q1 and Q2, Q5 and Q6 as multivibrators. Transistors Q3 and Q7 are pulse shapers, Q4 and Q8 is the OR

Fig. 3—Block diagram shows operation of Dot-Bar generator. After shaping, both multivibrator outputs are inverted and amplified by Q4 and Q8. Transistors Q9-Q10 operate as an OR amplifier with function switch S1. S2 selects output phase.

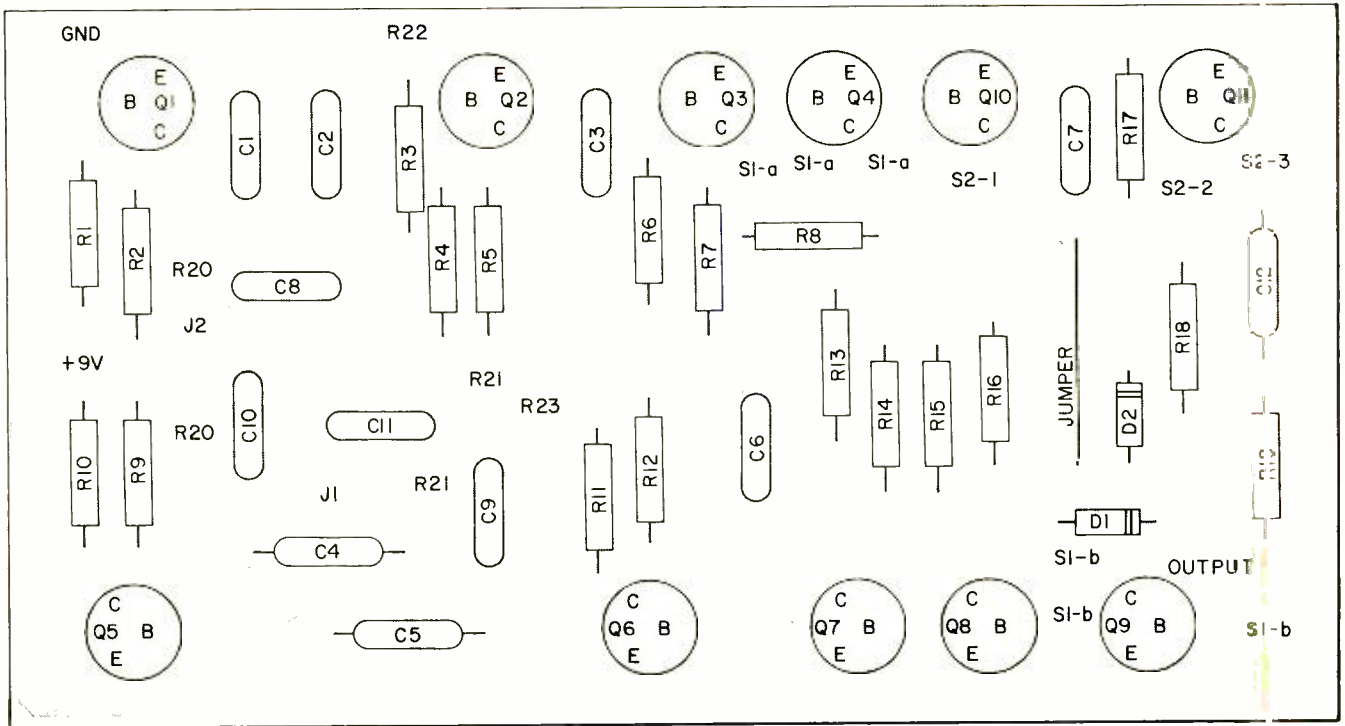

Placement of components on PC board as seen from component side.

amplifier and Q9 is the inverting and output amplifier. Since the switches are eliminated in this circuit, the outputs of Q3 (a 0.1- $\mu$ sec, 180-kHz positive pulse) and Q7 (a 50- $\mu$ sec, 900-Hz positive pulse) are applied to the bases of Q4 and Q8 combining these two frequencies at the common collector R7. This produces a cross-hatch pattern and is inverted by Q9 to give the proper output phase.

#### How to build it

A printed circuit was developed for Fig. 1, but it can also be built using breadboard material such as Vector board. All parts should be of good quality, but nothing is critical to the circuit except C3 and C6. Since they determine the pulse widths, they should be as close to the specified value as possible.

The transistors are silicon npn small-signal high-frequency types having excellent rise and fall times. I did not try any of the economy planar passivated transistors such as the 2N3855 or the 2N3856, but do not see why they won't work in this circuit as they are very similar to the 2N2219 and the 2N2369 transistors.

After completion, apply power and check the current. It should be near 50 mA for the dot-bar circuit and about 40 mA for the cross hatch circuit.

#### Using the generator

Both generators require external horizontal and vertical synchronization. To provide it, clip the horizontal lead, J2, of the generator to the insulation on the red lead of the deflection yoke (*clip only, do not solder*). Clip the vertical lead, J1, of the generator to the insulation on the yellow lead of the deflection yoke. If you have any problem with vertical sync, connect clip J1 to any of the leads of the vertical output transformers or terminal "C" on the convergence board of color receivers like the RCA CTC-15, 16 series.

Connect the ground lead of the generator to the receiver chassis. Connect the output of the generator to the grid of the last video amplifier using a test socket adapter.

Now set the channel selector to a local station. This will provide synchronization for the sweep circuits of the receiver and generator. Next set generator circuit to cross-hatch pattern and adjust R20, R22 and R21, R23 until the pattern stays in sync.

There should be 12 horizontal and 15 vertical lines when the generator is in sync. Some minor adjustment of the vertical hold on the color receiver may be required.

Adjust brightness and contrast controls for the sharpest patterns. Now you can set S2 to position B for dots and A for other modes. This applies the correct phase signal to the video amplifier grid, producing white lines and a black background on the receiver picture tube. Program pictures will also be in the background.

R-E

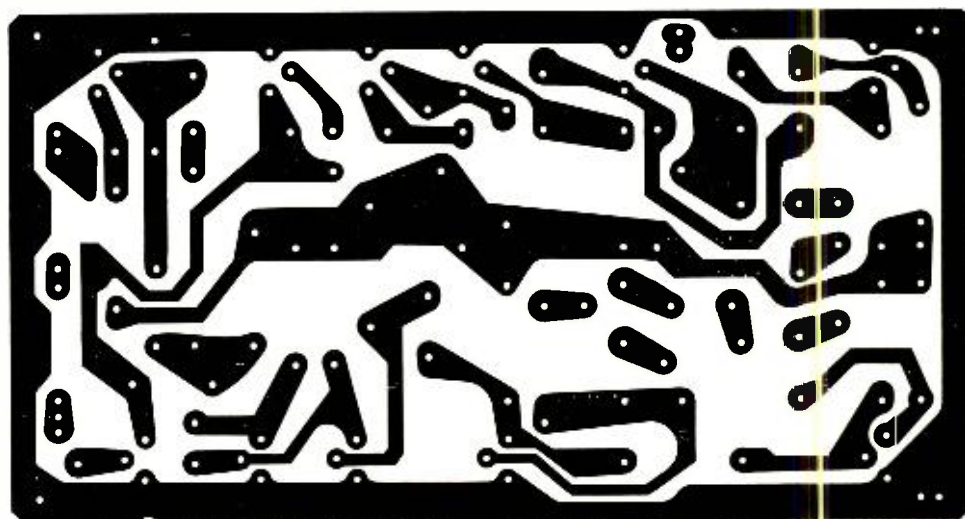

Reproduction of PC board used by author. Board is shown actual size as it is used.

# How the J-K Flip-Flops

Four steps to understanding a useful IC logic device

By LEONARD E. GEISLER\*

BASIC LOGIC CIRCUITS SUCH AS THE AND, OR and NOT operate without memories. The AND circuit, for example, will provide a logic ONE output only when all inputs to the circuit are also logic ONE simultaneously. Otherwise, the circuit remains in a logic ZERO state.

Logic circuits that can be placed in either of two stable states and "remember" this state until switched to another are called *bistable* or flip-flop.

In various combinations these bistable circuits form register, counter, storage and other essential digital circuitry. The JK flip-flop described is ideal for counting and divider circuits since it has one output pulse for each two input pulses.

## Basic NAND circuit

Study the circuit diagram of the basic two-input NAND element (Fig. 1). Assume input terminals *a* and *b* are at ground potential; Q1's base is tied to B+ through a biasing resistor, causing forward bias as long as one or both input terminals are grounded. The forward bias applied to Q1's base causes Q1 to go into saturation, grounding Q2's base. (Q1 cannot draw much collector current because of the very high reverse base-collector resistance, R1, internal to Q2.)

With Q2 cut off because of the ground level at its base, its collector potential rises toward B+ and its emitter potential falls to ground. Transistor Q3's base, tied to Q2's collector, sees the positive rise in potential; Q3 saturates, carrying terminal *c* toward B+. At the same instant Q4 sees vir-

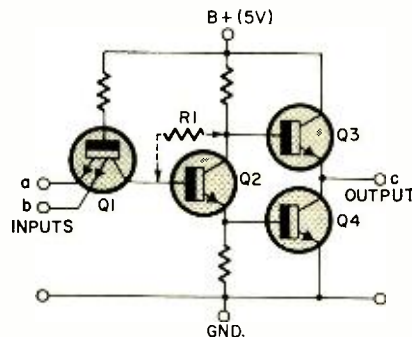

A- BASIC 2-INPUT NAND ELEMENT (INSIDE THE IC CHIP)



B- BASIC 2-INPUT NAND LOGIC SYMBOL (POWER CONNECTIONS USUALLY OMITTED FOR SIMPLICITY)

Fig. 1—With one or both inputs grounded, Q1 is at saturation, holding NAND off.

tual ground potential and cuts off. If either of the input terminals is raised from ground, Q1 operating conditions do not change. But if *both* input terminals are raised from ground, Q1 cuts off and the current previously flowing through the base-emitter diode in Q1 now flows through the base-collector diode path to Q2's base, causing Q2 to saturate.

As Q2 saturates, its collector potential drops toward ground and its emitter potential rises toward B+. Transistor Q2's ground-going collector potential causes Q3 to cut off. Now Q2's rising emitter potential pulls Q4 into saturation (Q4 draws collector current from B+ through an external load), and Q4's collector potential drops to virtually ground level.

In computer designer jargon, a ground-level signal is usually called "logic ZERO" and a high-level signal is called "logic ONE." To simplify descriptions, the ZERO condition at an input or output terminal is signified by a bar above the terminal designator. Thus,  $\bar{a}$  means that terminal *a* is at virtual ground level (or logic ZERO). Absence of the bar indicates the signal input is at the high level (or logic ONE). In Boolean algebra, the input conditions required for a NAND to produce either a high (logic ONE) or low (logic ZERO) output can be shown in the following formulas:

$$(a \cdot \bar{b}) + (\bar{a} \cdot b) + (\bar{a} \cdot \bar{b}) = c \quad (1)$$

and

$$a \cdot b = c \quad (2)$$

Note that only (2) above produces a logic ZERO output. The dot signifies "and" and the plus sign "or."

## Two NANDs make a flip-flop

To produce a simple "set-reset" flip-flop, two two-input NANDs are connected as shown in Fig. 2. The cross coupling insures that the flip-flop will toggle (change states) only when the correct input conditions are present.

For example, assume that NAND 2N1's output is high and NAND 2N2's output is low (this is indicated in the figure by numeral 1 next to terminal *c* of 2N1 and  $\bar{1}$  next to 2N2 terminal *c*). What conditions exist at the input terminals to produce the outputs shown?

By examining the formulas and the flip-flop logic diagram we conclude that 2N2 must have terminals *a* and *b* high for a ZERO output, satisfying formula (2). In practice, 2N1's terminal *a* is also high; both inputs are

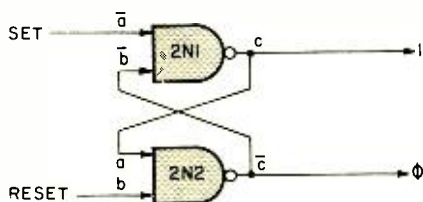
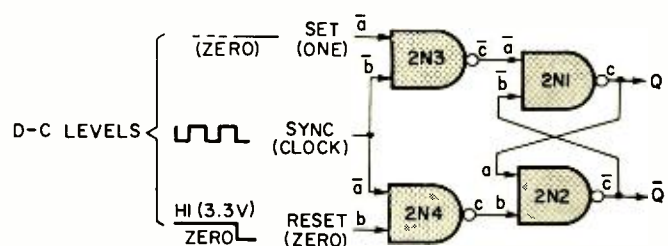

Fig. 2—Two NAND elements connected as shown make a set-reset (RS) flip-flop.

Fig. 3—Addition of two more NANDs will provide for clock-pulse sync of the RS flip-flop. Flip-flop toggles whenever clock pulse occurs simultaneously with data pulse.



high at all times except when the flip-flop is toggled to the other state by momentarily grounding the appropriate input terminal.

### Clocked RS flip-flop

The simple set-reset (RS) flip-flop is used generally where simple pulse-train counting or frequency dividing is required without regard to either output state or synchronism with other pulses in a system. For more precise applications two more NANDs are added to the RS flip-flop (Fig. 3), and one input is tied each to a clock-pulse source.

Now when the clock pulse occurs while either input is being pulsed, the flip-flop toggles (provided, of course, the set or reset pulse is applied to the side opposite the one which is high). Note that addition of the two NANDs reverses the sign of the activating pulses; now a positive-going pulse is required to toggle the flip-flop.

By adding another input to the NAND flip-flop elements of Fig. 3 (removing the two-input NANDs and substituting two three-input NANDs), the clocked flip-flop (Fig. 4), is improved considerably since the output can be set or reset to a desired state before starting the counting operation. This means, for example, a count can always be started at zero, or a given quantity can be counted or recorded, and the counter can then be reset to zero for the next counting operation.

### JK flip-flop

All the flip-flops described have one common failing: they can be tricked into "racing" or dithering between states if both signal inputs are pulsed simultaneously. The JK flip-

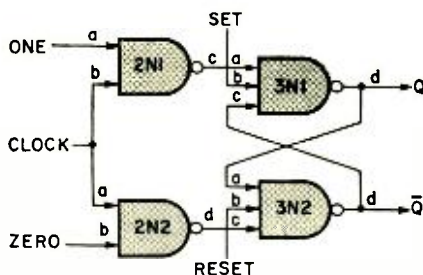

Fig. 4—By using 3-input NANDs in place of the NANDs in Fig. 3, flip-flop can be started at zero independent of input.

flop has been developed to correct such a problem (Fig. 5). Adding another flip-flop to the circuit in Fig. 4 makes a master-slave device that responds in a very predictable fashion to simultaneous input pulses; it simply toggles each time the clock pulse coincides with the data pulses (complementary inputs).

The logic elements and connections comprising a JK flip-flop are in Fig. 5. Two three-input and one one-input NANDs, 3N1, 3N2 and 1N1, together with two two-input NANDs, 2N1 and 2N2, form the "master" flip-flop element. Two more two-input and two three-input NANDs form the "slave" flip-flop element (2N3, 2N4, 3N3 and 3N4). Slave output is cross-coupled back into the master input for combining with J and K inputs and clock pulses.

Internal quiescent levels of all individual logic elements are shown by the lower-case letters next to each element terminal. Remember, a bar above a letter signifies that the designated terminal is at the logic ZERO level, and letters without the bar indicate logic ONE level at the designated terminal. The flip-flop operates in the

following manner.

Assume dc reset has placed Q low, Q high, and the clock pulse (train) has just gone high and J is high. The dc conditions within the circuit package are indicated by the various lower-case letters at this moment in time.

As the clock pulse falls to ZERO, 3N1-d goes high, adding to 2N1's input. 2N1-c starts to go low, but the stored charge in D1 holds 2N1-c high just long enough that the ONE coming from 1N1-b can add at 2N3's input, subsequently setting 2N3-c low to shift 3N3-a high. By now D1 has discharged and 2N2-a can go low with 2N1-c to complete the toggling of the master flip-flop (2N2-c high). At this moment, the clock pulse has again gone high and 1N1-b has already gone low, and 2N4-c remains high so as to not interfere with the other ONES at 3N4's inputs.

Earlier, the Q-output, ZERO-level feedback to 3N2-c changed to a ONE level, making the K input ready to accept a data-ONE level (whether one is forthcoming is immaterial at the moment). The Q-output, ONE-level feedback to 3N1-a when Q goes to ZERO cancels the effect of the J ONE level.

This means that only a ONE level at the K input will reset the flip-flop to its former state. Should the J-input level stay at ONE as the K level shifts to ONE, the flip-flop will toggle as just stated. If both J and K levels remain at ONE, the flip-flop will toggle again on the next negative-going clock-pulse edge, and will continue toggling as long as both inputs are high. If the J, K and clock inputs are tied to B+ and the dc set and reset terminals are used, the flip-flop works as an RS flip-flop. **R-E**

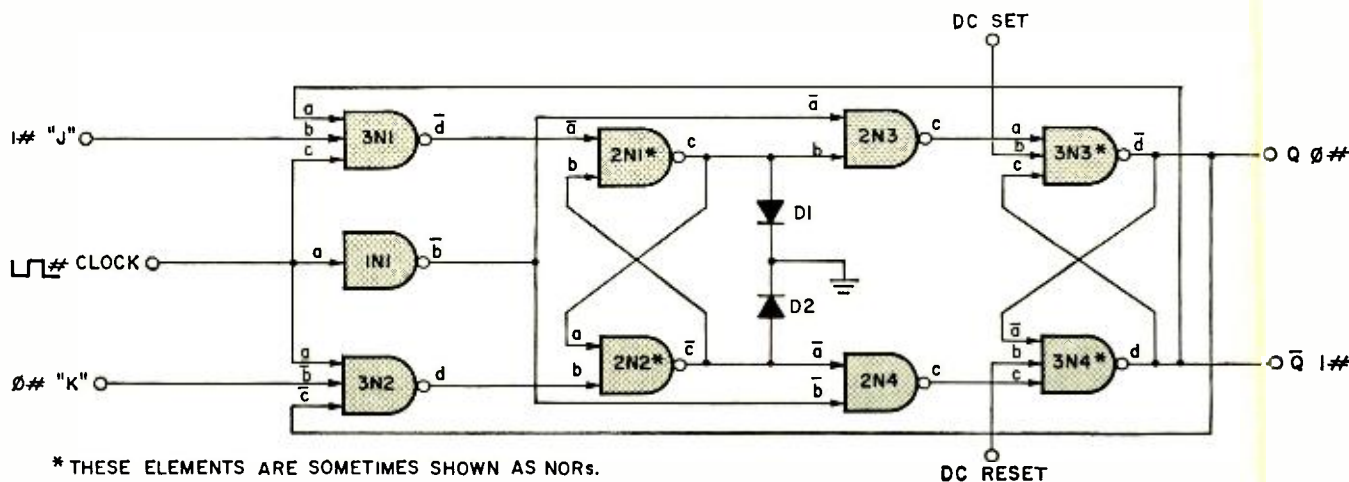

\* THESE ELEMENTS ARE SOMETIMES SHOWN AS NORs.  
 # INPUTS AND OUTPUTS SHOWN AT A MOMENT IN TIME.

Fig. 5—Functional logic diagram of the J-K flip-flop. Additional flip-flop (see Fig. 4) prevents simultaneous input "racing."

# ABC's of

by SYLVANIA TECHNICAL STAFF

DEFECTS IN TRANSISTOR CIRCUITS CAN BE LOCALIZED BY MEASURING the voltage on the transistor terminals, since the defective component often upsets the current drawn by the stage. The change from normal causes a different voltage to develop across the resistive components in the circuit.

A typical transistor circuit with voltmeter checkpoints is shown in Fig. 1.

The emitter resistor is common to both the input and output circuits, so voltage drop  $V_{em}$  across the resistor, is a result of the total transistor base and collector current. This voltage drop is a good indicator of transistor current. Collector current can be determined by simply measuring the voltage drop across decoupling resistor  $R_4$  and using Ohm's law.

If the voltage across the emitter resistor,  $R_3$ , is off, we then want to know if the transistor can control current. If we determine that the transistor base is not capable of control, we can assume the transistor is defective. If we find the base is capable of current control, we would then assume that the stage is biased incorrectly, indicating a defective bias resistor or other component such as a shorted coupling capacitor.

One way of determining if the transistor base is capable of controlling the current is by temporarily adding to or subtracting from the bias voltage and noting if there is a corresponding change in voltage drop across emitter resistor  $R_3$  or decoupling resistor  $R_4$  (see Fig. 2).

Suppose the emitter voltage is higher than normal. Since the current must be high, we temporarily remove the forward bias from the stage and determine if this will reduce the voltage drop across  $R_3$ . One common way of removing forward bias is to short the base and emitter together using a small screwdriver. This may not, however, always give a clear indication of current control.

A more certain way is to use a short piece of jumper wire to connect the base back to the same source potential as the emitter, which in (Fig. 2) is ground. This positively removes any forward bias.

If, after the forward bias is removed, as indicated the drop across the emitter resistor does not fall to a low value, the base element is not able to control the current and the transistor is probably defective. If the voltage drop across the emitter resistor does fall to a very low value, the base can control current, the transistor is probably good.

If measuring the emitter voltage discloses an abnormally low reading, try increasing the forward bias temporarily to determine if the base element can control the current (see Fig. 3). Temporarily connect the base to the collector through a series resistor  $R$  similar in value to bias resistor  $R_2$ . Obviously, first make sure that collector voltage is present.

If the transistor base element has control of the current, connecting the resistor as shown should increase the voltage drop across resistor  $R_3$ . This indicates that the transistor is probably good and a biasing defect such as  $R_1$ ,  $R_2$ , or a shorted  $C_5$  is indicated. If attaching the resistor as indicated does not increase the current, the transistor is open.

The procedure can be simplified for most transistor in-circuit testing by the following procedure.

Measure collector voltage. If it is lower than the supply voltage, the transistor is conducting. With the meter still on the collector, short the base to the emitter. If collector voltage rises to the supply voltage, the transistor is not shorted and can be turned off. This simplified procedure will not always work; i.e., a collector connected to ground. But as experience in servicing transistor circuits is gained, it becomes easier to see

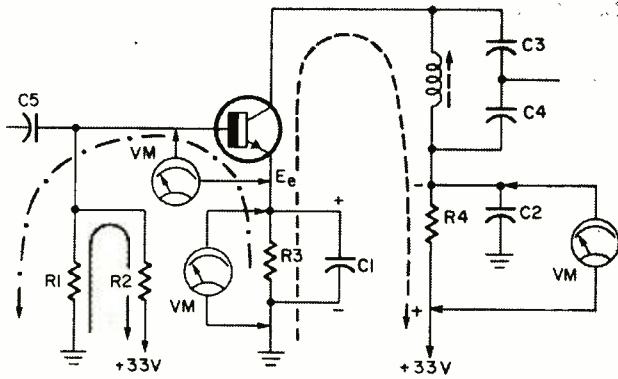

TEMPORARILY SHORT TO REMOVE FORWARD BIAS

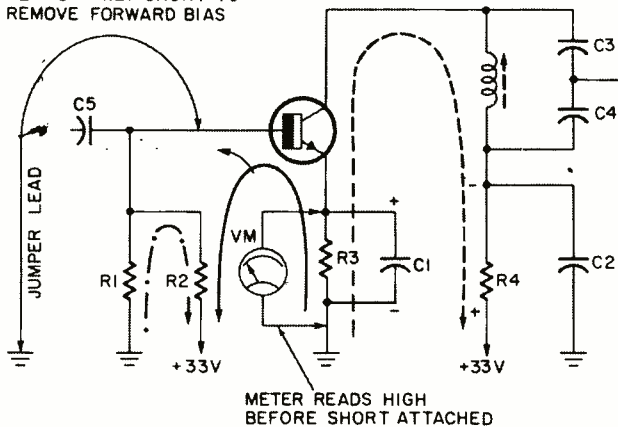

TEMPORARILY ADD RESISTOR TO INCREASE FORWARD BIAS  
RESISTOR SIMILAR IN VALUE TO  $R_2$

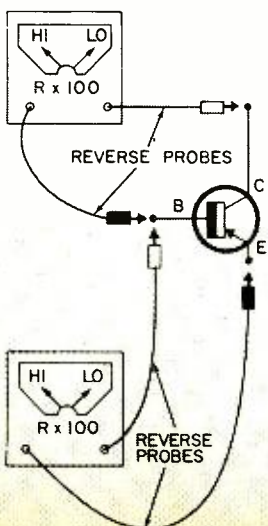
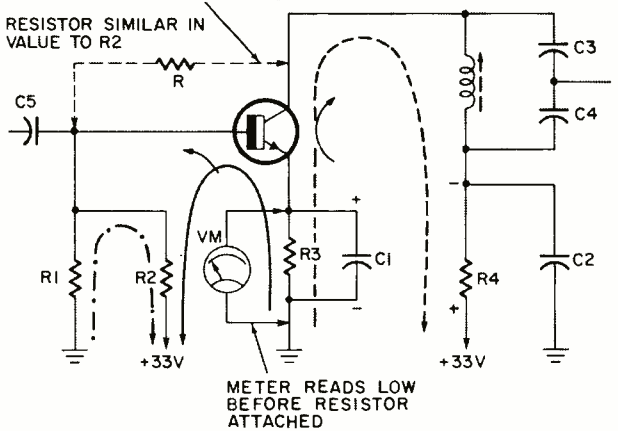

## SILICON DIODES

LOW - READING SHOULD BE UNDER 1000 OHMS.  
HIGH - READING SHOULD BE AT LEAST TWO TIMES THE LOW READING.

## GERMANIUM DIODES

LOW - READING SHOULD BE UNDER 500 OHMS.  
HIGH - READING SHOULD BE AT LEAST TWO TIMES THE LOW READING.

(NOTE - HIGH READINGS CAN BE MUCH HIGHER THAN SPECIFIED)



# Transistors

where this technique is applicable and it certainly is a fast, simple way to evaluate a transistor without removing it.

Once you are sure the transistor cannot control current, it is usually advisable to remove the transistor. This will allow you to measure the bias resistor values without the inaccuracies of having the transistor junctions across them. Every effort should be made to determine that a particular stage does contain a defect before removing the transistor. If a transistor appears to be open by the above checks, before removing it from the circuit, check it as follows.

## In-circuit diode checks

Use an ohmmeter on its R times 100 scale to check each of the two diodes in a transistor (Fig. 4). To check the collector diode, connect one lead to the base and the other to the collector and note the reading. Reverse the leads and note the second reading.

The lowest reading should be under 500 ohms for germanium transistors and under 1000 ohms for silicon transistors. The high readings should be at least two times the low reading. Perform the same test on the emitter diode to check the transistor completely. Make these checks with power removed from the circuit. Detector and age diodes can be checked in the same manner.

## Transistor operating class C

In a class C stage where collector current flows for relatively short intervals of time, dc voltage measurements on the transistor differ from those in a class A stage.

Check forward bias on pnp transistors by connecting the positive voltmeter lead to the emitter and the negative lead to the base (see Fig. 5). Read the bias indication directly on the meter. Measuring the emitter and base voltages to ground, and subtracting them, is not reliable or accurate.

The collector will vary as a function of base voltage and input signal (see Fig. 6). The input signal has the same magnitude in all three cases. When the base voltage is 0.65 volt, the input signal adds to and subtracts from the base voltage and we get a linear output. This is class A operation and the average collector current is a constant value.

When base voltage is 0.5 volt, only the positive-going half cycle of the input signal effectively adds to the base voltage, causing an increase in collector current. The negative portion of the input signal drives the transistor into cutoff. This can be likened to class B operation where collector current flows for only one-half the cycle.

When base voltage is 0.4 volt, the transistor is in cutoff and no collector current flows. Only the most positive portion of the input signal causes collector current which is in pulses representing the positive peaks of the input signal. A class C stage is usually biased into cutoff so no collector current flows until the input signal turns the stage on.

It becomes apparent that the amount of base to emitter voltage or forward bias measured on a stage will depend upon whether the stage is operating class A, B or C.

To demonstrate how voltages will vary from a class A stage to a class C stage, we can make the class A amplifier into an oscillator as shown in Fig. 7.

The usual forward bias will not be found on converter and oscillator transistors since bias varies with frequency of oscillation. The emitter and base voltages of oscillators and converters are shown nearly equal on the schematics, although they do vary somewhat. If a radio converter has a steady 0.2-volt bias when it is tuned, the oscillator is probably not functioning.

That's it on transistor stage checking. Next time we'll take a detailed look at transistor tests and circuit applications. **R-E**

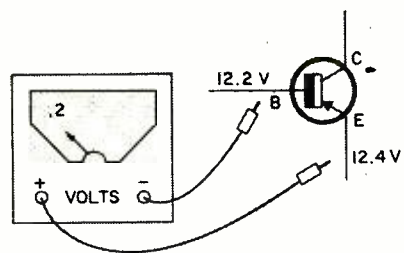

MEASURE BETWEEN BASE AND EMITTER

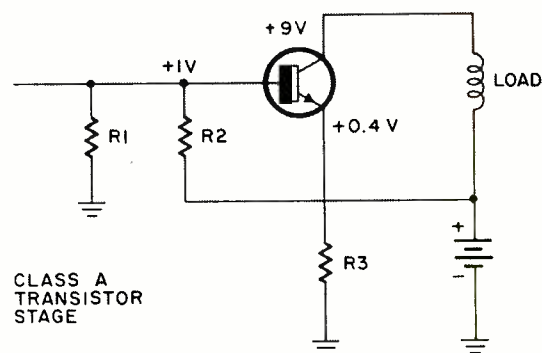
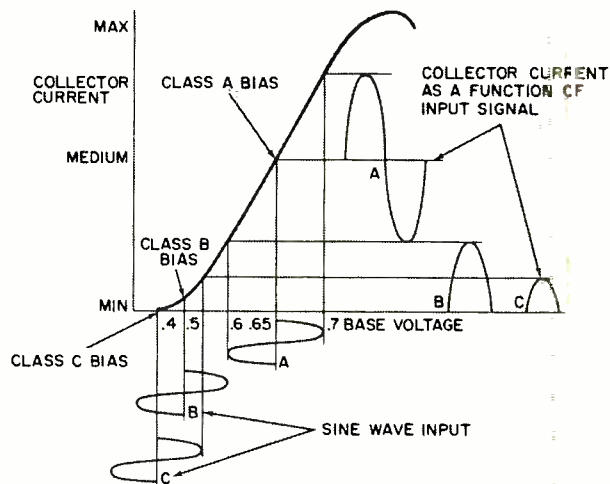

CLASS A TRANSISTOR STAGE

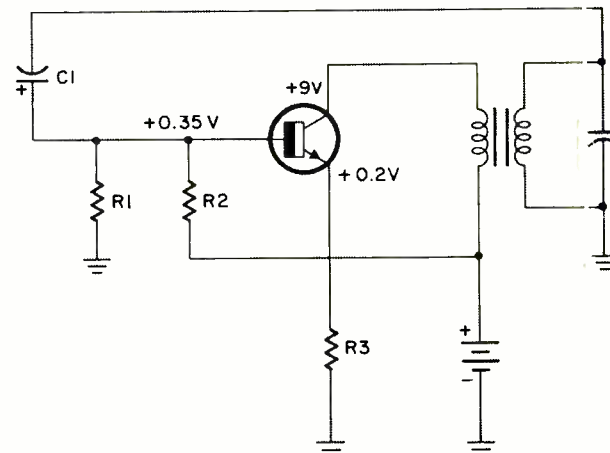

TRANSISTOR OSCILLATOR

# Spot Color Faults Fast

Simple tests with meter and scope pinpoint color troubles

By **MATTHEW MANDL**  
CONTRIBUTING EDITOR

RAINBOW, CROSSHATCH AND DOT GENERATORS are useful to set color balance, check chroma circuitry, adjust linearity and correct convergence. Frequently, however, our old standbys, the vtm and scope, are all you need to localize many color circuit faults. Similarly, tube and transistor checkers are a must in any fully equipped shop, but this doesn't mean they are vital to every servicing job.

When we have a general idea of circuit function and can relate it to trouble symptoms, we can simplify tests. In many instances we can pinpoint defective parts with minimal test equipment this way.

## Bandpass and burst amplifiers

In color sets amplified video signals from the last video amplifier must have the 3.58-MHz burst and sync signals removed before they reach the chroma amplifiers and picture-tube grids. At the same time video signals must also be removed so only the burst signal is applied to the 3.58-MHz oscillator. This signal treatment and routing is done by the band-

pass and burst amplifiers in the color circuits.

A typical system is shown in Fig. 1. It is used in the Westinghouse V2656 color receiver chassis. The amplified video signals are applied to both the burst and bandpass amplifier grids. The 3.58-MHz burst signal occurs during the last part of the horizontal blanking, hence a pulse from the horizontal output circuit is used to gate the burst amplifier *on* only during blanking.

For the circuit shown in Fig. 1 this is done by initially establishing a high bias between grid and cathode by using a high-value cathode resistor (82K). Plate current flow increases cathode voltage and makes the grid relatively negative with respect to the cathode.

With high bias, amplification is down and, if an additional dc signal is present at the grid, the tube cuts off. During the horizontal blanking interval, however, a high-voltage positive pulse is applied to the burst amplifier's grid. This decreases bias and raises conduction and amplification. The synchronizing 3.58-MHz burst now appears in the anode circuit of the burst amplifier and is applied to the

3.58-MHz phase detector and oscillator tube.

For the bandpass amplifier the bias is set so the tube conducts and amplifies normally between horizontal blanking pulses. When blanking occurs, the bandpass amplifier tube is driven into cutoff and the sync and burst signals are removed from the output. Sometimes the blanking signals are applied directly to the cathode.

Often, however, a separate blanker is used to bring the pulse to the level needed for proper bandpass tube triggering. As shown in Fig. 1, the high-voltage positive pulse is applied to the grid of the blanker tube. Current flow through the blanker must go through the common-cathode resistor shared by the bandpass amplifier.

Thus, when the horizontal pulse appears at the grid of the blanking tube, it causes a high current flow. This current increase through the 390-ohm common-cathode resistor increases bias for the bandpass amplifier tube and cuts it off. The sync and burst are removed from the output chroma signals. The latter are then applied to the X and Z amplifiers and finally to the red, blue and green amplifiers preceding the color CRT.

Fig. 1—Burst amplifier VI-a, gated by flyback pulses, passes only burst signals to the phase detector and 3.58-MHz oscillator.

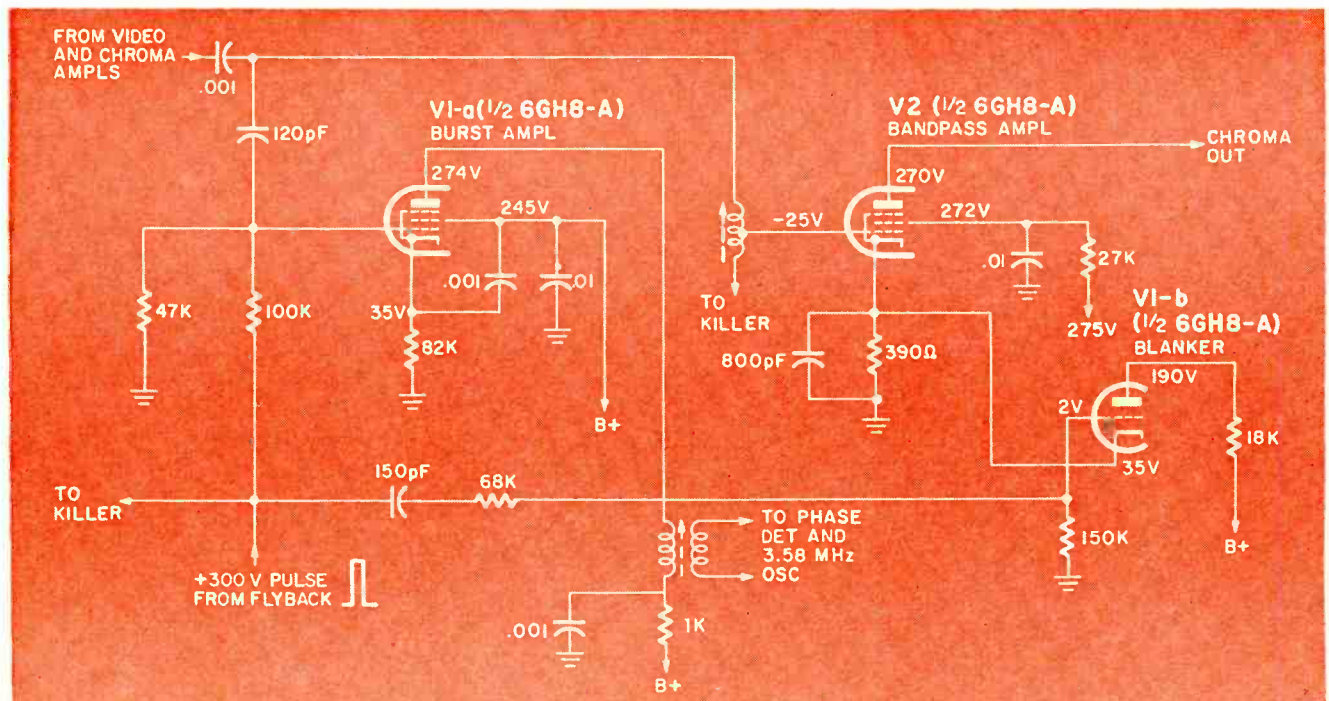

Troubles in the burst amplifier can cause loss of color sync, incorrect colors and color bands diagonally across the screen. Bandpass amplifier troubles can cause loss of color, herringbone interference lines or poor color contrast. If such troubles appear suddenly in a set which has been working properly, don't adjust phase controls in the 3.58-MHz section or turn the slug in the chroma takeoff coil to the bandpass amplifier until you've made other tests. It is highly unlikely that these would be mistuned suddenly. (This can occur because of shorted turns or excessive heat expanding coil forms.)

After the set has been on a while, if you find a lukewarm or cold tube, you've found the trouble. If you suspect tubes you can interchange similar types with others in the receiver to see if faults are transferred to the interchanged circuit involved or remain with the original circuit. If faults remain in the same circuit, chances are the tube is OK.

If the trouble still persists, check for the horizontal pulse at the grids of the burst and blanker tubes. The scope pattern will appear as shown in Fig. 2. For the receiver shown, the peak-to-peak voltage at the grid of the burst amplifier should be 67.5. Less than this will not provide sufficient conduction and amplification of the burst.

The peak-to-peak voltage of the pulse at the grid of the blanker should be 185. Because of the series 150-pF capacitor, the waveshape at the blanker grid will be modified somewhat, but will still resemble Fig. 2. If no signal

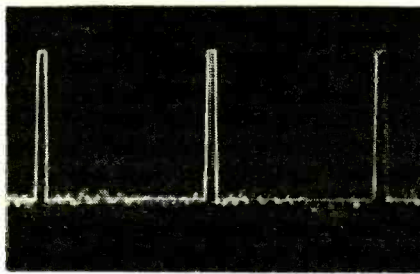

Fig. 2—Horizontal pulse on burst and blanker tube grids. Signal voltage on V1-a should be 67 volts p-p.

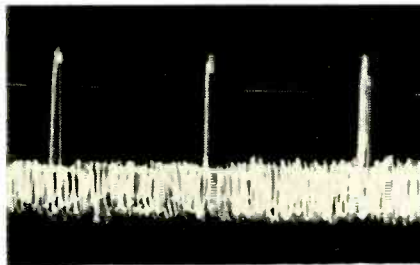

Fig. 4—Composite video as it appears on the plate of chroma amplifier in circuit below. Spikes are blanking and sync.

appears at this grid, look for an open 150-pF series capacitor or an open 68,000-ohm series resistor.

If pulse amplitudes are normal, use your vtvm to check voltages indicated on the schematic. Low anode or screen voltages call for a check of series resistors. Improper cathode voltages affect bias and are caused by defective cathode resistors or leaky (or shorted) cathode bypass capacitors. The voltage at the cathode of the bandpass amplifier, for instance,

is 35 while grid voltage is  $-25$ . Thus, grid bias is actually 60 volts (read between grid and cathode) and any change here affects bandpass operation. If a series resistor is overheated (such as the 27,000-ohm screen resistor in the bandpass amplifier) look for shorted bypass capacitors which are bleeding excessive current through the resistor. Don't replace such a resistor without first checking the bypass capacitor.

### Chroma amplifier

In a number of sets the bandpass amplifier is preceded by a chroma amplifier that boosts the signal level. A typical one used in the Sylvania DO-9 chassis is shown in Fig. 3. This is a hybrid receiver, using both transistors and tubes. The chroma amplifier receives its signal from the first video amplifier emitter circuit.

Again, a quick scope test at the anode of the chroma amplifier can cut troubleshooting time. Here the composite video waveform should appear as shown in Fig. 4. The high-amplitude pulse signals represent the blanking and sync which accompany the video signal. To obtain this waveform the receiver must, of course, be tuned to a station. If this signal appears at the chroma amplifier output the circuit is OK, provided phase is correct. Sometimes an inoperative tube will have enough interelectrode capacitance to pass a signal to a sensitive scope, but the pulse will be inverted.

If trouble symptoms are still present, voltage checks will help pinpoint the faulty component. Make

Fig. 3—Chroma amplifier in hybrid Sylvania DO-9 chassis receives signal from first video amplifier. Fig. 4 shows 6EW6's output.

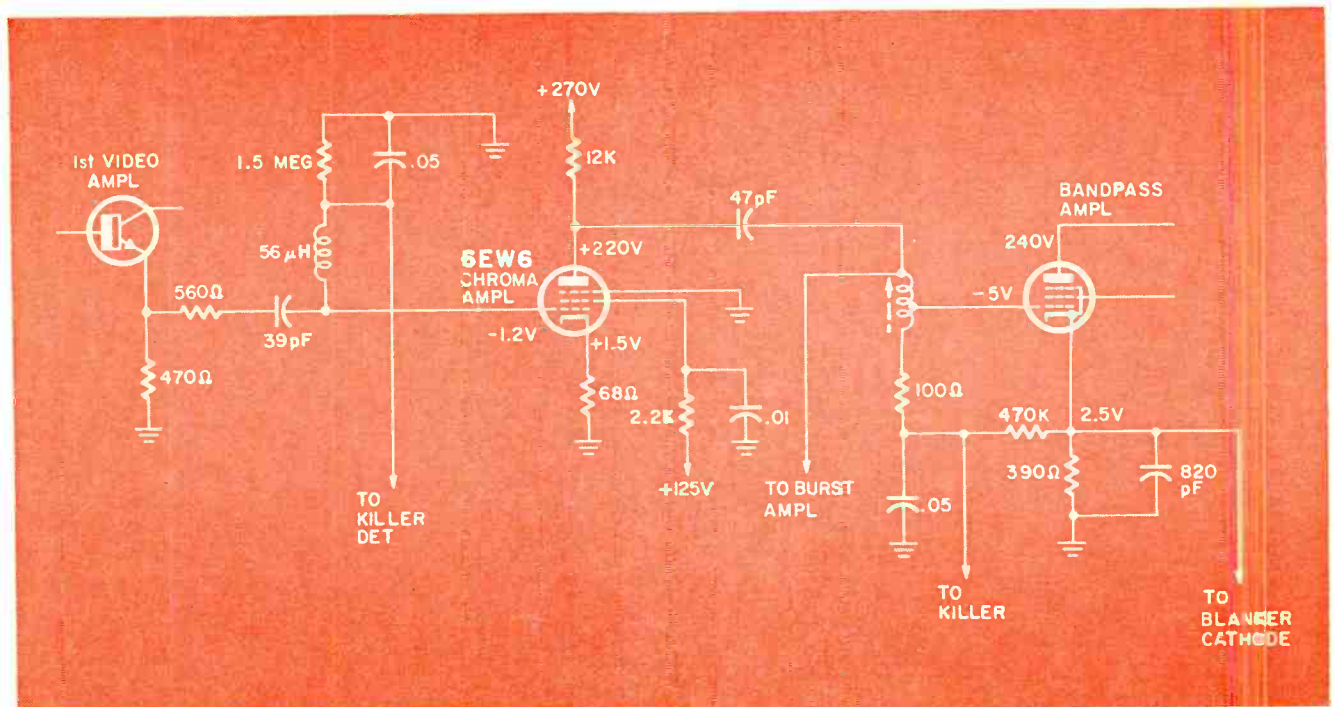

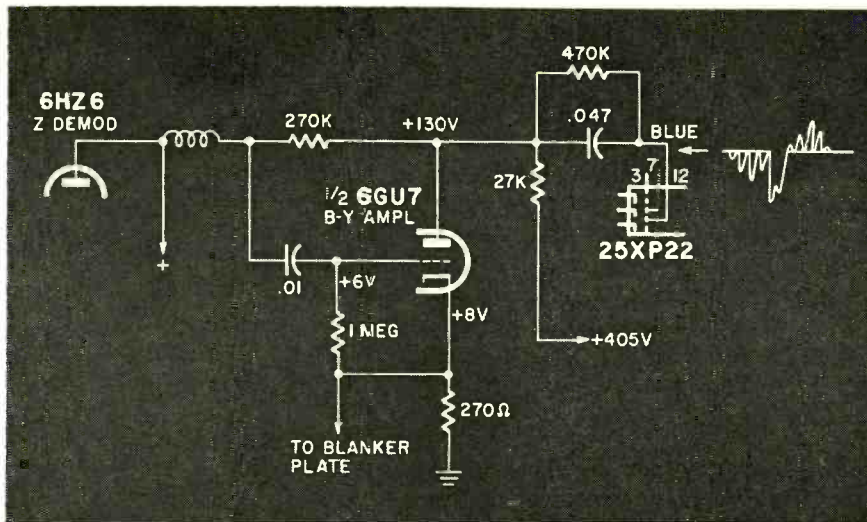

Fig. 5—Typical B—Y amplifier (RCA CTC35 series). Set uses two dual-triode 6GU7's.

sure the coupling capacitor between the chroma amplifier and the band-pass amplifier is not leaky, for it will change bias on the bandpass stage. Voltages may vary slightly from those shown on schematics, but if they are off by more than 5% or 10%, check resistor valves and bypass capacitors (for leakage or shorts).

#### B—Y amplifier troubles

A typical B—Y amplifier stage is shown in Fig. 5. Color distortion appeared on the screen as an absence of blue tones. This receiver uses two dual-triode 6GU7 tubes in this section, one for the R—Y and B—Y amplifiers and the other for the G—Y amplifier and the blanker.

To save tube-checking time two 6GU7 tubes were interchanged, but the symptoms did not change. The chroma-signal waveform at pin 12 of the picture tube should have had the general appearance indicated in Fig.

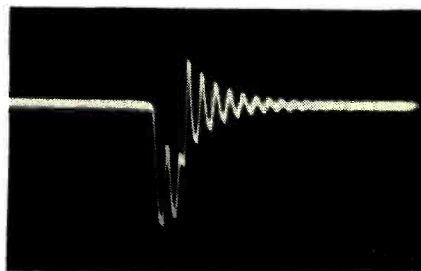

Fig. 6—Cold solder joint caused B—Y distortion in this oscilloscope display.

5. However, a scope test produced instead the pattern shown in Fig. 6. This indicated an intermittent condition, with an output signal produced only periodically. The waveform was also distorted and did not have the necessary gradual rise and decline of positive signals.

A voltage check indicated a high cathode voltage, with an occasional intermittent voltage flicker. The resistor was removed and checked. Its

value was correct. Instead of replacing it with a new one, the old one was resoldered into the circuit and proper operation was restored. From the appearance of the original soldered joint near the cathode end it was logical to assume that a cold-solder joint caused the trouble.

#### Agc defects

The same simplified servicing techniques can, of course, be applied to other stages of a color receiver, including those not directly associated with color signals. In an agc system, for instance, the vtm and scope will again check every signal, voltage and component.

Modern receivers use *keyed* automatic gain control to minimize noise interference and reduce flutter from passing airplanes. A typical system using the pentode section of a 6GH8-A is shown in Fig. 7. Note the cathode voltage is higher than both the grid and plate voltages. The plate voltage must be higher than the cathode voltage for conduction to occur.

Similarly, the grid voltage must be raised to be nearer the cathode voltage so the reduced bias will permit conduction. Hence, *both* plate and grid voltages affect tube conduction.

A positive spike-type pulse is obtained from the horizontal output stage and applied to the plate of the agc tube. The video signal is applied to the grid but isn't strong enough to overcome the cutoff bias of the agc tube. The blanking and sync tips, however, have a high amplitude and overcome grid bias. Because the sync tips synchronize the horizontal oscillator, they occur at the same time as the spike-type pulse applied to the plate. Hence, only during this time does the tube conduct.

The signal at the grid is amplified and inverted at the plate (negative direction) and filtered by the resistor-capacitor networks at the output into dc bias for the rf and i.f. stages.

If the incoming station fades slightly, sync tips will be lower and less current will flow through the tube. Hence, less agc bias is developed and the i.f. and rf stages have increased gain to compensate for the signal fading. Since the filter network need only smooth out the 15.750-KHz ripple, a short time-constant circuit is used and the system diminishes the effects of rapid signal-amplitude changes caused by varying signal reflections from airplanes.

The simplified checks we've discussed are intended to serve as guidelines for shortcuts in servicing. You will save time if you understand circuit function and logically approach test procedures. **R-E**

Fig. 7—Keyed agc circuit in Magnavox T924 cuts interference from passing airplanes.

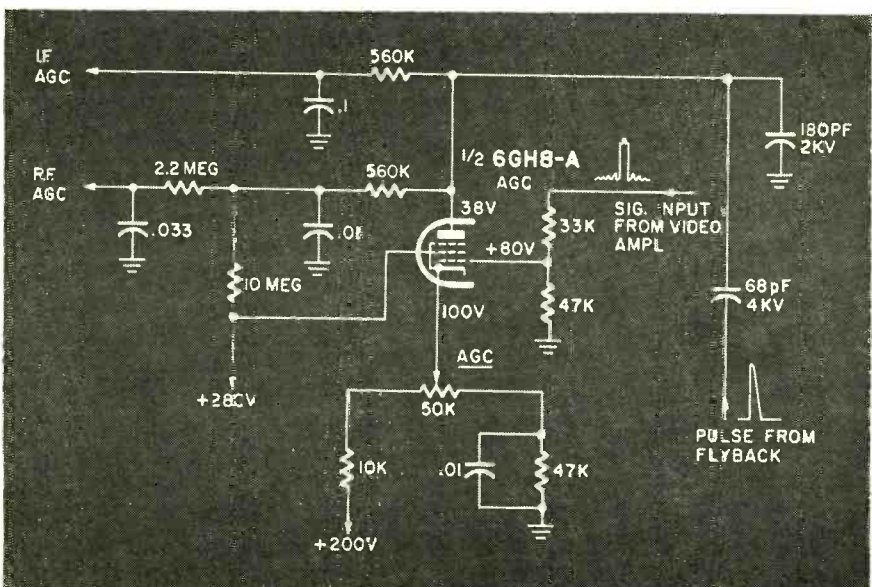

# New Color TV Circuits

The '69 sets are really new. Here's a look at the circuits that make them work

By **ROBERT F. SCOTT**  
SENIOR TECHNICAL EDITOR

IF YOUR KNOWLEDGE OF COLOR TV circuits stops with the CTC 16 and you have found this good enough for most servicing problems, you are in for a rude awakening. It looks like 1969 is the year of the color TV revolution and you'll have to get on the ball if you expect to keep up with the game.

Nearly every manufacturer has something new and different in at least one of his models and many have almost all new lines. Descriptions of all the new circuit innovations would be more fitting as the title of a book than a single magazine article. Many of the new circuits are the result of transistorization. Several sets are now all solid state and a great many are hybrid models using tubes and transistors or integrated circuits (IC's).

From time to time, in the past, one or two manufacturers have come out with something new in the way of circuitry but a few new circuits a year never overwhelmed anyone. This year, it is different. There are many more new circuit developments this year and almost as many versions as there are manufacturers using them. Some of the new circuits you'll find in 1969 sets include:

- Automatic fine tuning
- Solid-state tuners
- Low-voltage focus CRT's
- Automatic brightness limiters
- Multi-stage agc systems for solid-state tuners and i.f. amplifiers
- Solid-state video i.f. amplifiers
- Transformerless ("hot-chassis") sets
- Line-voltage selectors
- Fine-tuning indicators
- Improved color-killer circuits
- Hybrid vertical and horizontal deflection circuits

Let's select some of the more interesting circuit innovations and give them a rapid once over.

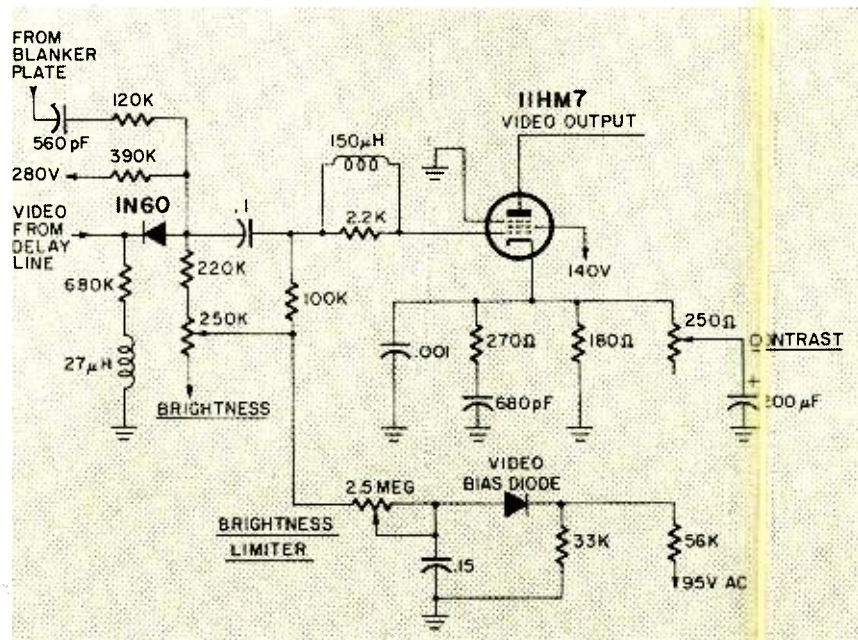

Fig. 1—There's an automatic brightness limiter built into the new RCA CTC 36 color chassis. It insures that picture brightness does not shift with line voltage variations.

The automatic brightness limiter used by RCA in their CTC 36 chassis insures that picture brightness does not shift with variations in line voltage. The brightness control circuit (Fig. 1) is in the grid return of the second video amplifier. Negative grid bias for this stage is developed by rectifying approximately 95 volts ac tapped off the series heater string. The BRIGHTNESS LIMITER control sets the negative bias voltage level and thus determines the maximum brightness that can be reached by adjusting the BRIGHTNESS control.

If line voltage rises, the input to the video bias (rectifier) diode increases. This boosts the bias on the video output tube and cuts back the drive to the CRT cathodes, reducing brightness to the proper level. When line voltage drops, the picture tends to dim and the bias on the 11HM7 falls. This increases the tube's plate current, increasing the drive to the CRT and restores brightness to normal.

The automatic brightness limiter circuit is adjusted at the factory under controlled conditions. When resetting is needed, do it in the shop, if possible.

However, you can do the job in the field. Make sure that screen and drive controls are properly adjusted. Then turn the BRIGHTNESS control to maximum and the CONTRAST control to minimum. Use a small "hex" tool or insulated screwdriver to adjust the BRIGHTNESS LIMITER control so the picture just blooms. Now, return CONTRAST and BRIGHTNESS controls to normal.

Do not attempt to use the BRIGHTNESS LIMITER control to compensate for drastic brightness changes. Instead, locate the source of the trouble and correct it.

## The Motorola version

Automatic brightness limiting is built into the Motorola TS-915 and TS-919 solid-state color chassis. Its purpose is to eliminate the possibility of excessive beam current which shortens the life of the picture tube and to prevent excessive loading on the horizontal sweep circuit which generates high voltage for the picture-tube anode and focus electrode through a conventional flyback power supply.

The circuit is shown in Fig. 2.

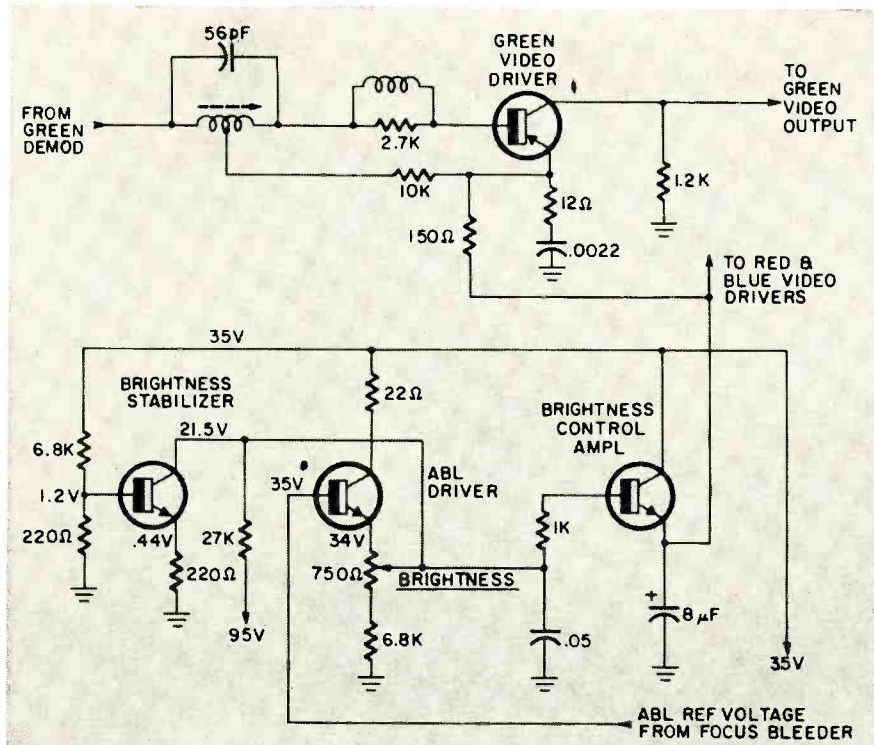

Fig. 2—Brightness in the Motorola RS-915 and TS-919 is controlled by varying the emitter bias on the color drivers which are direct-coupled to the color CRT cathodes.

Brightness is controlled by varying the emitter bias on the three color drivers which are direct-coupled to the CRT cathodes through the color output stages. The manual brightness control is in the emitter return of the abl (automatic brightness limiter) transistor. Advancing the control turns on the color video drivers and causes the

three color video output stages to pass more current. This increased drive on the CRT cathodes increases picture brightness.

The abl reference voltage tapped off the focus voltage divider determines the relative CRT beam current. As the focus voltage increases, the abl driver begins conducting and

causes the brightness control amplifier to draw more current. Its emitter circuit is the source of emitter bias for the three color video drivers. Thus, the increase in control-amplifier emitter current increases conduction in the video drivers and picture-tube cathodes. This raises the beam current and the resulting load on the high-voltage source drops the focus and reference voltages to the predetermine level.

If the focus voltage drops—indicating excessive beam current or horizontal sweep circuit loading—the abl driver and brightness control amplifier draw less current. This reduces the forward bias on the color video amplifiers and increases CRT bias, thus compensating for the initial increase in beam current.

The brightness stabilizer regulates the voltage applied to the abl circuit to prevent variations in brightness with B-plus voltage changes.

### Solid-state agc keyer

The Packard Bell 98C18 and 98C19 are hybrid color chassis using vacuum-tube tuners and a three-stage video i.f. using npn transistors. Most sets with solid-state i.f. amplifiers are designed to use forward agc. That is, an increase in forward bias reduces circuit gain. But, since the vacuum-tube tuner requires a negative agc voltage, reverse (negative-going) agc bias is used on the i.f. amplifiers. The circuit of the Packard Bell keyed agc system is shown in Fig. 3.

Transistor Q207, the agc keyer, operates in the same way and performs the same functions as a vacuum-tube agc keyer. Composite video is fed to its base and a positive keying pulse from the flyback is fed to the collector through a blocking capacitor and diode D1. The base-emitter junction is back-biased so the transistor conducts only during the 1/15,750th of each second when the horizontal sync and flyback pulses appear simultaneously on the base and collector. The amount of agc bias voltage developed in the collector return circuit depends on signal strength as determined by the sync-pulse level.

Under "no-signal" conditions, the keyer transistor is cut off and the i.f. agc line is biased positive at around 1.5 volts from two 140-volt voltage dividers. One divider consists of R256, R260 and R254-a (in parallel) and R253. The other consists of R258, R259, D2 and R253. D2 is forward biased.

When a signal is tuned in, the keyer conducts and develops a negative voltage—determined by signal strength—at the anode end of D2.

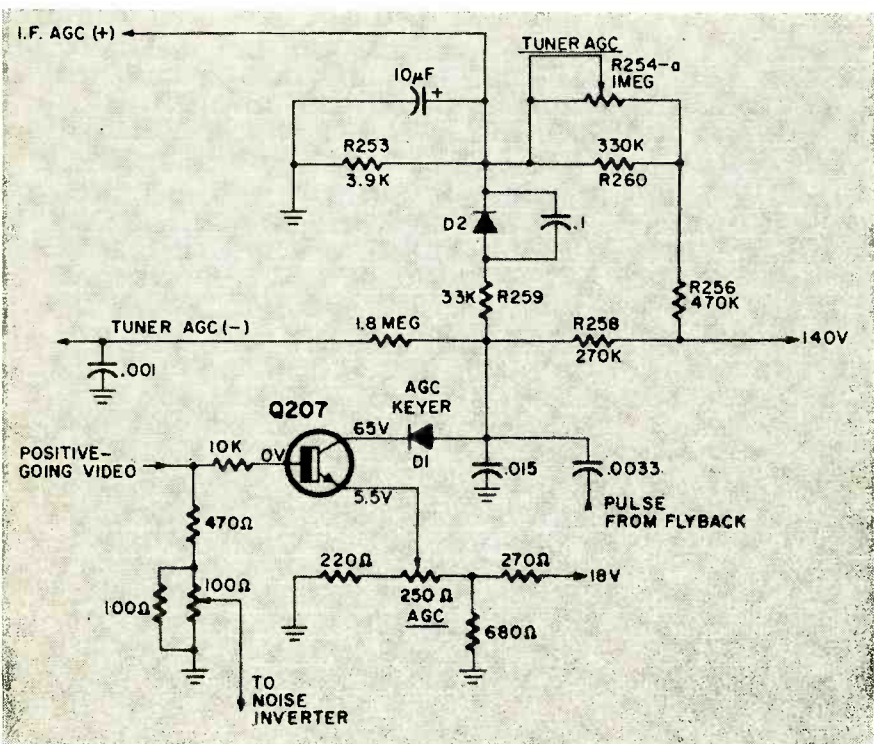

Fig. 3—Keyed agc for the Packard-Bell 98C18 and 98C19 chassis must provide both negative and positive agc voltages. Negative agc goes to the tuner. Positive agc to i.f.

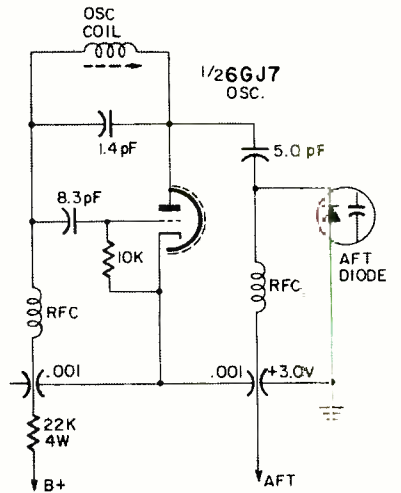
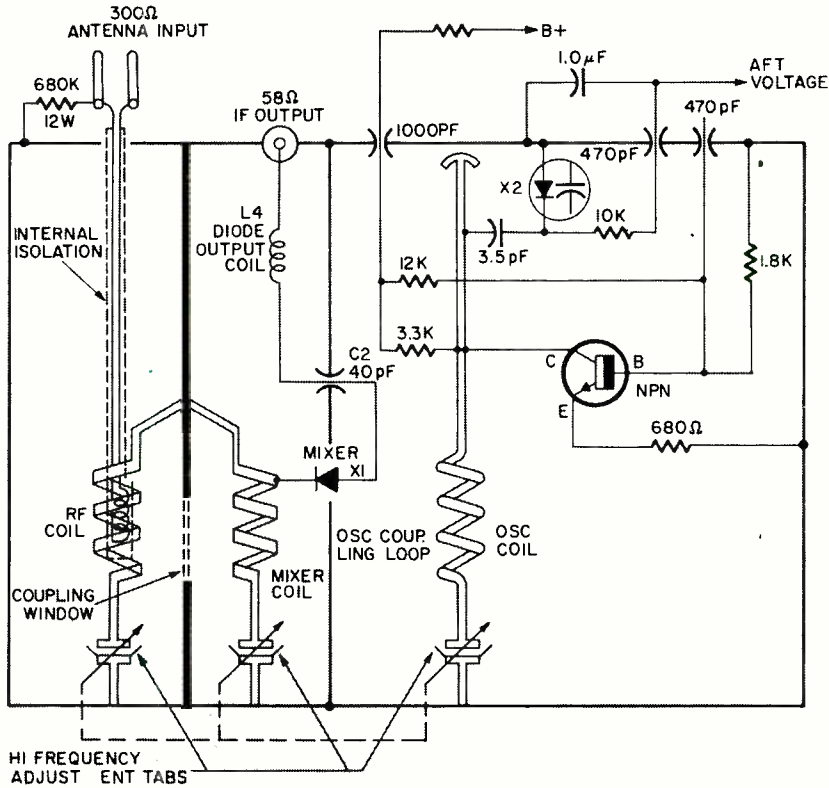

Fig. 5—Here's a basic aft tuner circuit (above) as it is used in a vhi tuner. The variable-voltage capacitance diode is again connected across the oscillator coil.

Fig. 4—This uhf tuner (left) has automatic fine tuning. The circuit is quite similar to the afc circuits used in FM receivers. A voltage-variable capacitance diode is connected across the oscillator coil.

This negative voltage causes the voltage on the i.f. agc line to drop to a less positive level. When the i.f. agc voltage drops to around 0.8, D2 stops conducting and clamps the voltage on the i.f. agc line at this level. The tuner now receives a negative agc voltage that varies in level with signal strength

above D2's cutoff point. The greater the signal strength, the greater the tuner's agc bias.

To adjust agc, set the tuner agc control for maximum snow in the picture and then back off to just pass the point where snow disappears. Then, adjust the MASTER AGC control

for optimum performance on the weakest channel without overloading on the strongest.

#### Automatic fine tuning circuits

Automatic fine tuning (aft) circuits in TV receivers are quite similar to afc circuits in FM receivers. A

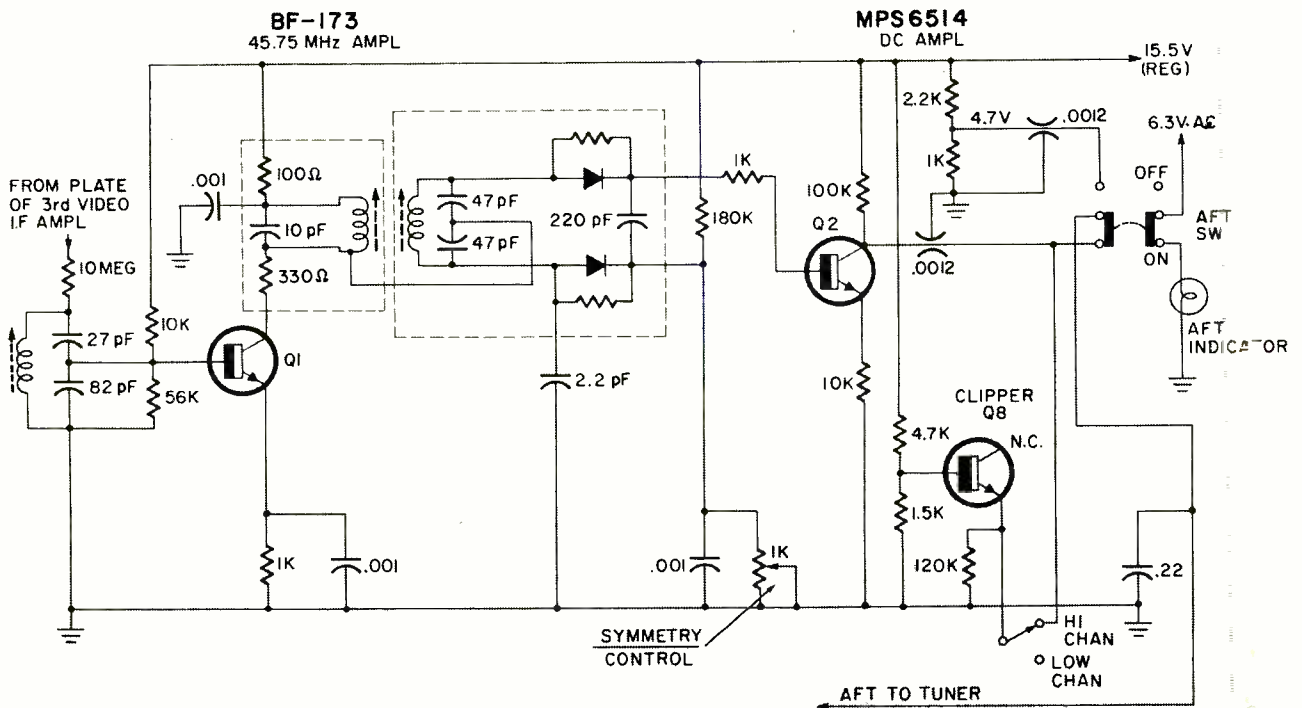
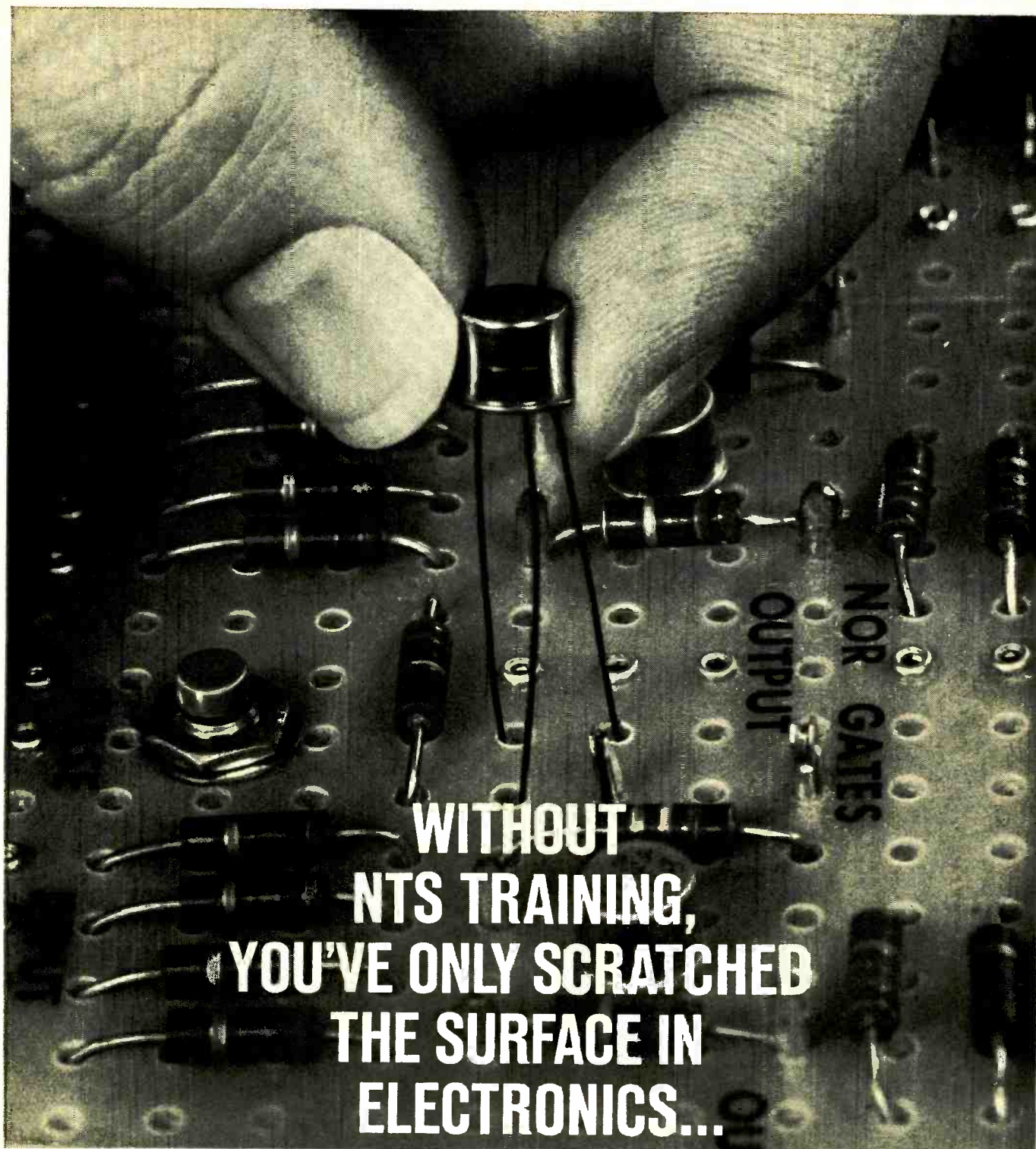

Fig. 6—In Electrohome's C5 chassis automatic fine tuning is built into the 45.75-MHz video i.f. circuit. A signal taken off the discriminator is amplified, clipped and then fed to the tuner as a correction signal that pulls the oscillator to the correct frequency.



Only NTS penetrates below the surface. Digs deeper. Example? Take the above close-up of the first transistorized digital computer trainer ever offered by a home study school.

It's called The Compu-Trainer®—an NTS exclusive. Fascinating to assemble, it introduces you to the exciting world of computer electronics. Its design includes advanced solid-state NOR circuitry,

flip-flops, astable multivibrators and reset circuits. Plus two zener and transistorized voltage-regulated power supplies. The NTS Compu-Trainer® is capable of performing 50,000 operations per second.

Sound fantastic? *It is!* And at that, it's only one of many *ultra-advanced* kits that National Technical Schools offers to give you incomparable, in-depth career training.

**PROVE IT YOURSELF. SEND FOR OUR NEW CATALOG. SEE THE LATEST, MOST ADVANCED KITS AND COURSES EVER OFFERED BY A HOME STUDY SCHOOL.**



# NTS...THE FIRST HOME STUDY SCHOOL TO OFFER LIVE EXPERIMENTS WITH INTEGRATED CIRCUIT KITS

You build a computer sub-system using the new, revolutionary integrated circuits. Each one, smaller than a dime, contains the equivalent of 15 resistors and 27 transistors.

And your kits come to you at no extra cost. These kits are the foundation of the exclusive *Project-Method* home study system... developed in our giant resident school and proven effective for thousands of men like yourself.

With Project-Method, all your kits are carefully integrated with lesson material. Our servicing and communication kits are *real* equipment—not school-designed versions for training only. As you work on each of the projects, you soon realize that even the most complicated circuits and components are easy to understand. You learn *how* they work. You learn *why* they work.

NTS Project-Method is a practical-experience approach to learning. The approach that works *best!* An all-theory training program can be hard to understand — difficult to remember. More than ever before you need the practical experience that comes from working with real circuits and components to make your training stick.

## NTS SENDS YOU KITS TO BUILD THESE IMPORTANT ELECTRONICS UNITS!

- ◆ 25" COLOR TV
- ◆ 21" BLACK & WHITE TV
- ◆ SOLID-STATE RADIO
- ◆ AM-SW TWIN-SPEAKER RADIO
- ◆ TUBE-TESTER
- ◆ TRANSCEIVER
- ◆ COMPU-TRAINER®
- ◆ VTVM
- ◆ SIGNAL GENERATOR
- ◆ 5" OSCILLOSCOPE

See them all illustrated in  
the new NTS Color Catalog.

**CLASSROOM TRAINING AT LOS ANGELES:** You can take classroom training at Los Angeles in sunny California. NTS occupies a city block with over a million dollars in facilities devoted exclusively to technical training. Check box in coupon.

## NATIONAL TECHNICAL SCHOOLS

WORLD-WIDE TRAINING SINCE 1905

4000 So. Figueroa Street, Los Angeles, Calif. 90037

### APPROVED FOR VETERANS



Accredited Member: National Home Study Council  
Accredited Member: National Association of  
Trade and Technical Schools



### COMMUNICATIONS

This transceiver is included in Communications courses. You build it. With it, you easily prepare for the F.C.C. license exam. You become a fully-trained man in communications, where career opportunities are unlimited.

### 25" COLOR TV ▼

Included in Color TV Servicing Courses. With it you advance yourself into this profitable field of servicing work. Color is the future of television, you can be in on it with NTS training.

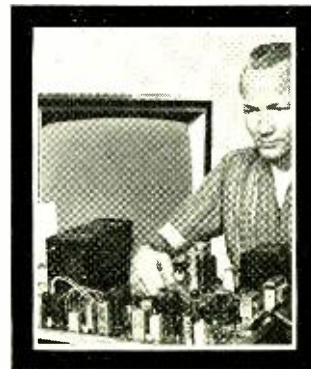

### YOUR OPPORTUNITY IS NOW

New ideas, new inventions, are opening whole new fields of opportunity. The electronic industry is still the fastest growing field in the U.S. There's a bigger, better place in it for the man who trains today. So, whatever your goals are — advanced color TV servicing, broadcasting, F.C.C. license, computers, or industrial controls, NTS has a highly professional course to meet your needs.

GET THE FACTS! SEE ALL NEW COURSES AND KITS OFFERED IN THE NEW NTS COLOR CATALOG. SEND THE CARD OR COUPON TODAY!



There's no obligation. You enroll by mail only. No salesman will call.

### NATIONAL TECHNICAL SCHOOLS

Dept. 205-19

4000 S. Figueroa St., Los Angeles, Calif. 90037

Please rush Free Color Catalog and Sample Lesson, plus information on field checked below. No obligation.

- |                                                                     |                                                            |
|---------------------------------------------------------------------|------------------------------------------------------------|
| <input type="checkbox"/> MASTER COURSE IN COLOR TV SERVICING        | <input type="checkbox"/> PRACTICAL TV & RADIO SERVICING    |
| <input type="checkbox"/> COLOR TV SERVICING                         | <input type="checkbox"/> FCC LICENSE COURSE                |
| <input type="checkbox"/> MASTER COURSE IN TV & RADIO SERVICING      | <input type="checkbox"/> INDUSTRIAL & COMPUTER ELECTRONICS |
| <input type="checkbox"/> MASTER COURSE IN ELECTRONIC COMMUNICATIONS | <input type="checkbox"/> STEREO, HI FI & SOUND SYSTEMS     |
|                                                                     | <input type="checkbox"/> BASIC ELECTRONICS                 |

NAME \_\_\_\_\_ AGE \_\_\_\_\_

ADDRESS \_\_\_\_\_

CITY \_\_\_\_\_ STATE \_\_\_\_\_ ZIP \_\_\_\_\_

- Check if interested in Veteran Training under new G.I. Bill  
 Check if interested ONLY in Classroom Training at Los Angeles.

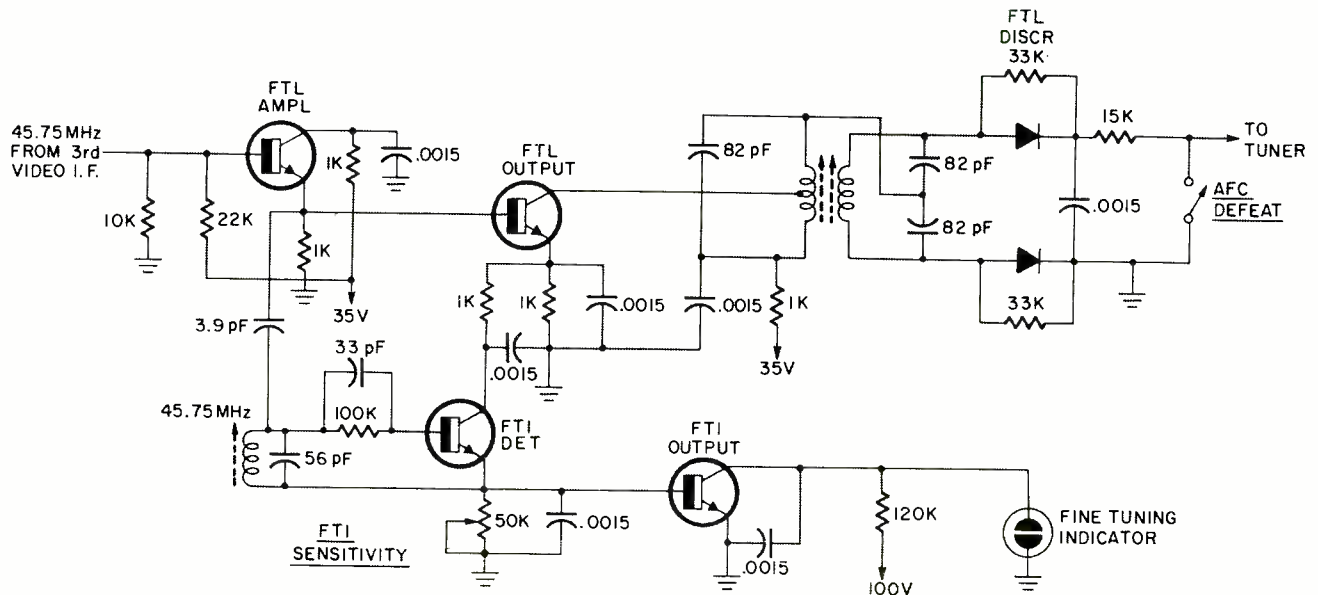

Fig. 7—This aft circuit has a tuning indicator which lights only when the automatic tuning circuit is misadjusted. The circuit is used in the Motorola TS-915 and TS-919 solid-state chassis. The switch across the discriminator output should be marked AFT, not AFC.

voltage-variable capacitance diode is connected across the oscillator coil in the tuner.

When the oscillator is exactly on frequency the video i.f. carrier is precisely at 45.75 MHz and the output of an aft discriminator is zero. When the fine tuning control is set too high or too low, the video i.f. shifts away from 45.75 MHz and the discriminator applies a positive or negative correction voltage that varies the diode capacitance in the direction needed to retune the oscillator to the correct frequency. The circuit of a uhf tuner with aft is shown in Fig. 4 and basic circuit of the oscillator in a vhf tuner is shown in Fig. 5.

Electrolock aft is one of several new features introduced in Electrohome's C5 chassis. The fine-tuning range is controlled to prevent the user

from gross mistuning and to insure that the automatic fine tuning circuit locks in on the correct channel when the aft button is pushed.

The solid-state aft circuit in this hybrid chassis is shown in Fig. 6. A part of the 45.75-MHz video i.f. carrier signal is amplified by Q1 and then fed to a Foster-Seeley discriminator. The discriminator output is a dc voltage that varies above or below a constant "on-channel" reference point when the fine tuning control is incorrectly set. This dc voltage is amplified and then applied to voltage-variable capacitance diodes in the vhf and uhf tuner oscillators.

When the aft circuit is turned off the capacitance diodes are biased from a regulated 4.7-volt source. When the aft is turned on and the set tuned to one of the low vhf channels,

the aft control voltage follows the voltage at the collector of Q2. When the set is switched to one of the high vhf channels, Q3 is switched in to the circuit to limit aft range and prevent lockout. Its emitter-base junction is used as a Zener clipper, limiting control voltage swing to 5.6 volts.

**Fine Tuning Lock (FTL)** is what Motorola calls the aft circuit in the TS-915/919 chassis. The circuit, which has a tuning indicator, is shown in Fig. 7. The emitter-follower couples the 45.75-MHz video i.f. carrier to the output stage which drives the discriminator. The discriminator is tuned for zero voltage output when fed with a 45.75-MHz signal. Incorrect tuning causes the video i.f. carrier to fall above or below 45.75 MHz so the discriminator produces a correction voltage that automatically pulls the tuner oscillator to the correct frequency.

The emitter follower also feeds the video i.f. carrier to the FTI (Fine-Tuning Indicator) detector. If the fine tuning control is set at the correct point, the 45.75-MHz video i.f. carrier is rectified in the base-emitter junction of the detector and biases the transistor on. The positive voltage developed across the FTI SENSITIVITY control turns on the FTI output stage. The voltage drop across the 120,000-ohm collector resistor is so large that the neon FTI indicator lamp cannot fire. If the fine tuning control is misadjusted while the AFT DEFEAT switch is closed, the detector output drops, the FTI output stage turns off and the indicator lamp comes on.

The fine-tuning indicator used in some models is in Fig. 8. When the

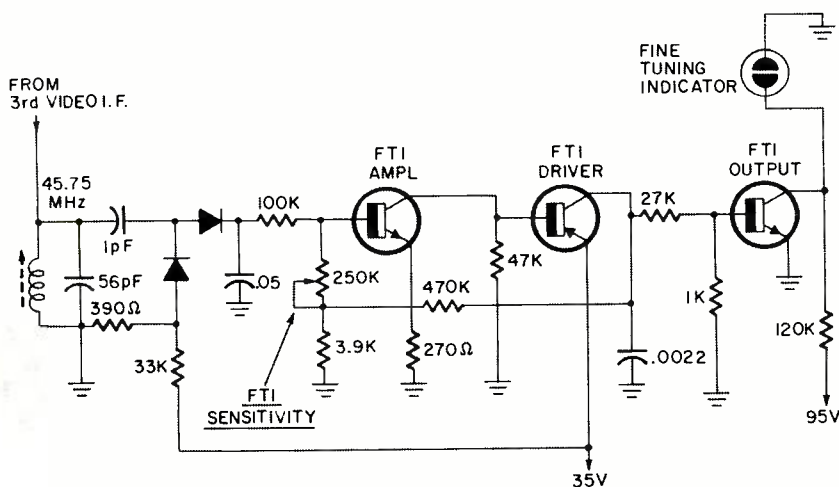

is a variation of the circuit of Fig. 7. As before, when the circuit is properly adjusted, the lamp does not light. It's also used by Motorola in 1969.

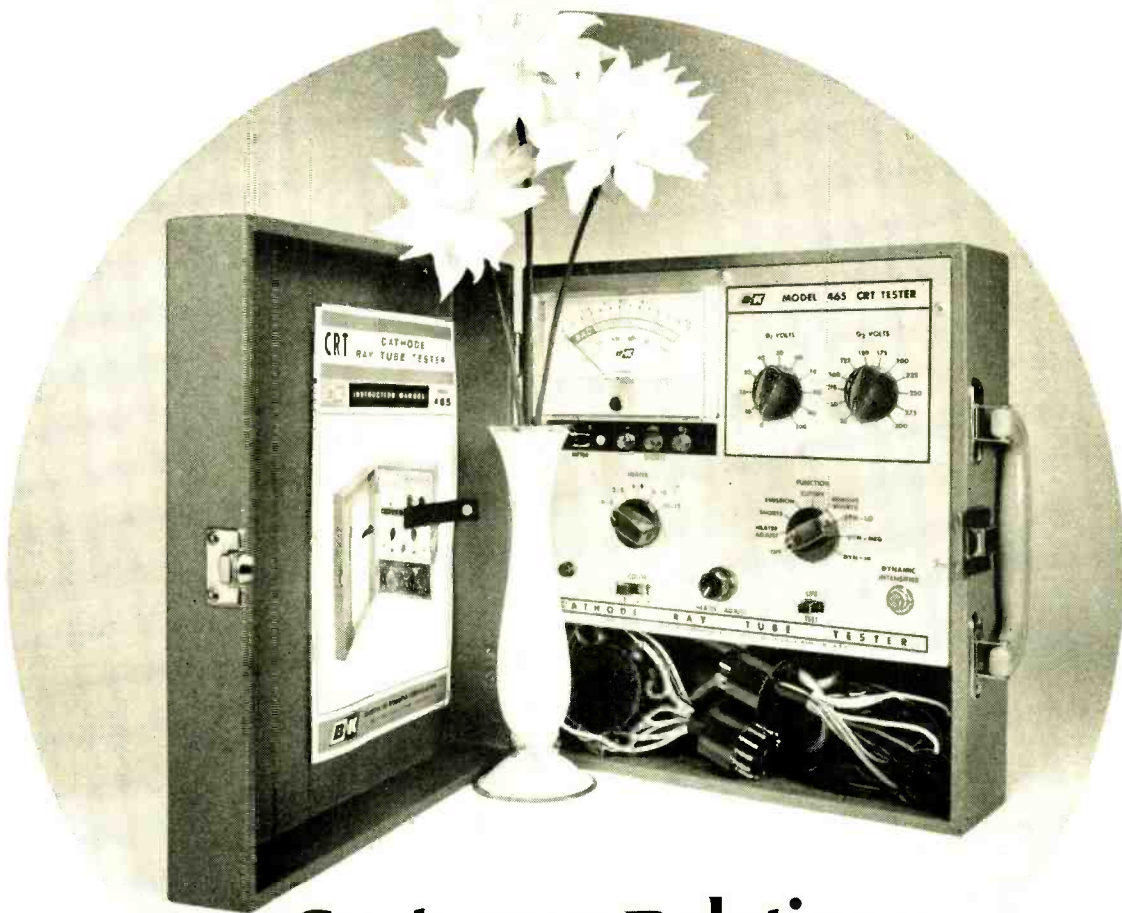

## Customer Relations Specialist.

That's you. When you turn on your B & K tester / rejuvenator. A real customer pleaser (even the tough ones). At the same time, it ups your income and quickly pays for itself. This has been proved time and again:

First, by showing your customer, right in the home, the true condition of his picture tube. And how long it will last. (New picture tube sales are easier to justify when your customer is right there to see for himself.)

Second, by rejuvenating the picture tube, while your customer watches, relieved that he's been temporarily spared a major expense. You can do this as a part of your service or for an additional fee which you can offer to apply toward later purchase of a picture tube.



Third, by being able to test and repair all black & white and all color tubes, imports as well as American, in a few minutes. Without removing the picture tube from the TV set.

For shop use, of course, it's a must—for your customer's sake, or to validate your claim on an in-warranty picture tube.

Special B & K time-controlled rejuvenation-process safeguards the picture tube.

Adjustable heater voltage is metered and continuously variable from 0 to 13 volts. G-1 and G-2 voltages are completely and continuously variable.

All this enables you to pinpoint the desired voltage and make the most accurate possible tests, even on future CRT types.

Circle 25 on reader service card

(How's that for non-obsolescence in an era of planned obsolescence?)

Color picture tubes are checked by testing each color gun separately just as the manufacturer would do it. (In fact, this CRT tester has become the commonly used diagnostic tool of the industry.)

The B & K 465 is the professional serviceman's tester

If you would like to enlist the aid of this "customer relations specialist," see your B & K Distributor or drop us a note and ask for Catalog AP-24.

**CRT Tester/Rejuvenator  
Model 465 Net: \$89.95**



B & K Division of DYNASCAN CORPORATION  
1801 W. Belle Plaine - Chicago, Illinois 60613  
Where electronic innovation is a way of life.

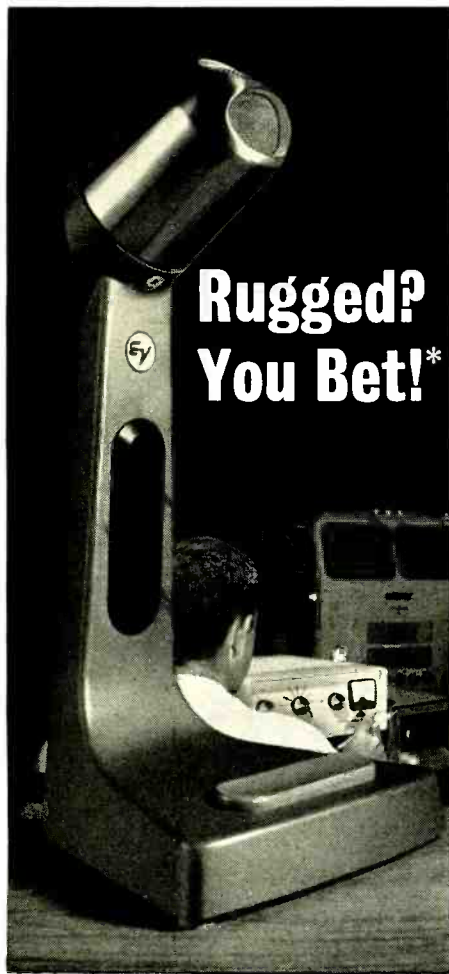

**Rugged?  
You Bet!\***

**Model 619 Dynamic \$28.50 NET**  
**Model 719 Ceramic \$16.50 NET**

**Ey** These new beauties are tough. No fragile plastics or lightweight metal. Tough baked enamel finish plus heavy chrome plating guarantees lasting good looks.

Just touch the big bar to talk. It latches "on" with a simple, sliding motion. Or move it to the grip-to-talk position on the stand riser in just minutes, with only a screwdriver. DPDT telephone-type leaf switch operates both voice and relay circuits, or electronic switching with the 619 (Hi-Z) and 719.

For top quality, choose Model 619 dynamic with exclusive E-V Acoustalloy® diaphragm. Smooth, peak-free response from 70 to 10,000 cps at -56 db output insures highest talk power and full modulation. Hi-Z or balanced Lo-Z.

Or choose the economical Model 719 ceramic. Response is from 80 to 7,000 cps at -56 db output.

Try one of these rugged new beauties today. You'll find that your rig never sounded — or looked — so good!

**ELECTRO-VOICE, INC.** Dept. 192E,  
613 Cecil Street, Buchanan, Michigan 49107



\*We cover our bet with a *lifetime* Guarantee. If any 619 or 719 ever fails, just send it to us. We'll repair it at nominal cost. But if there's even a hint that our workmanship or materials weren't up to par, the repair is on the house — even 30 years from now! Fair enough?

to 25% higher than the figure obtained in a continuous sine-wave test. Remember that a *doubling* of power (100% increase) is a 3-dB increase in loudness, which is just audible. So a music-power measurement seems to be little else but a clever way of quoting a superficially more impressive figure, despite all the labored technical rationalizing.

The difference between 90 and 110 watts is insignificant from an audio standpoint, but apparently not from a sales standpoint. So music power, or dynamic power, will probably hang on, even though a number of manufacturers have refused to play the game and continue to rate their amplifiers by the continuous sine-wave method.

#### Distortion you can hear

The term distortion usually refers to the spurious products generated by *nonlinearity*.

Two kinds of phenomena occur when signals are applied to a non-linear amplifier. For one thing, harmonics (integral multiples) of the input signal are generated. When a 1,000-Hz tone is fed into any real amplifier, some energy appears at 2,000, 3,000, 4,000 Hz and so on. Because all hi-fi amplifiers use push-pull output circuits, the even harmonics generated in the output circuit (in this case 2,000, 4,000, etc.) are cancelled if the output stage is properly balanced. Of course, even harmonics generated in an earlier, single-ended stage are not cancelled by a subsequent push-pull stage.

The other thing that happens is *modulation*. Any nonlinearity results in spurious signals equal to the sum and difference of the original tones. These are sidebands, produced by modulation. Exactly the same phenomenon produces an AM radio wave, and is also responsible for the i.f. in a superheterodyne receiver.

Such spurious tones, called *intermodulation distortion (IM)*, are more likely to be irritating than simple harmonics are, because they don't correspond to tones in the overtone pattern of musical instruments. Amplifier-produced harmonics are somewhat masked by the harmonics generated by the musical instruments themselves, but modulation sidebands are not.

Although these two phenomena always occur together, they can be measured separately and by different methods. A harmonic distortion measurement is the older of the two, and is still held by many engineers to be the most valid check on an amplifier's nonlinearity. But an IM measurement

**Use your electronics know-how to sell profitable automatic telephone answering systems**

One of the fastest growing businesses in America today is the automatic telephone answering business. Thousands of installations are being made every day at physicians, small businesses, etc. wherever there is a need for automatic answering of phones while somebody is not in the office. Record-O-Fone, the pioneer in telephone answering systems has openings for dealers, salesmen and service technicians. The local Record-O-Fone distributor can provide you with product, training and the sales aids to do a big business. You can earn an excellent income on a full-time or part-time basis.

Your electronics know-how gives you a decided edge. You build confidence because you know your product better. You are able to handle installations easily. Get into the automatic telephone answering system business with Record-O-Fone. Use coupon.

**RECORD-O-FONE** Div. of ElectroSpace Corp., 408 Concord Avenue  
Bronx, New York 10454 (212) 585-5300 Dept. RE

Name ..... Address .....  
City ..... State ..... Zip .....  
Phone RE 1/69

Circle 27 on reader service card

has much to recommend it too, and neither will probably ever emerge as a clear favorite.

Neither method tells all. In fact, both measurements together can still leave some important things unsaid. The trouble is that the usual, simple method of measuring harmonic distortion says nothing about the kinds of harmonics that are present, or their relative magnitudes.

Higher, odd-order harmonics (like fifth, seventh, ninth and so on) tend to be more audible for a given power level than lower, even-order harmonics (second, fourth). Because the harmonic distortion meter simply nulls out the fundamental and reads what's left, there is no way of knowing, from the meter scale alone, whether that 0.5% reading represents mostly second harmonic or mostly thirteenth. This is one point at which specs take leave of listening quality, and shows one way in which two amplifiers, identical by measurement, can sound quite different.

A more informative way to check the effects of nonlinearity is to measure each harmonic separately with a wave analyzer. This is much more time-consuming, and the results are a bore to read. All good manufacturers do it, but none seem to publish the results, which would go something like "0.01% second, 0.08% third, unmeasurable fourth, 0.01% third, unmeasurable higher order distortion."

The amount of distortion that is tolerable has never been definitely established. It depends on the kind of distortion, the kind of program material, the loudness, the frequency range, the acuteness of the listener, the noise level in the room, and probably other factors. Although the fact that the distortion percentages in top-quality equipment have decreased a whole order of magnitude in the past 10 years seems significant, it is a moot question whether the ordinary listener can hear even 1% of low-order harmonic distortion at full output. Typical maximum-power distortion figures for good amplifiers are now in the vicinity of 0.1%.

#### Power bandwidth

For about the past 10 years, many hi-fi manufacturers have been specifying power bandwidth for a given percentage of harmonic distortion. This ingeniously ties together three important ratings, which, being interdependent anyway, ought to be given in such a way as to show their relationship.

A complete power bandwidth spec might read as follows: Power bandwidth 20 to 20,000 Hz at 1% THD (total harmonic distortion). No-

## BEST SELLING SAMS BOOKS FOR EVERY ELECTRONICS INTEREST

### NEWLY PUBLISHED AND IMPORTANT!

#### 101 Questions & Answers About Fixed Radiocommunications

A valuable reference for all who work with microwave and other fixed radio systems. Covers long distance, high-frequency voice and tele-type communications, short range vhf and uhf links, low-density and high-density microwave multi-channel transmission of telephone, telegraph, data, tv, and other intelligence. Essential for anyone who designs, operates, or maintains fixed radio communications systems. Includes examples of specifications of microwave and other types of fixed radio systems.  
Order 20584, only ..... \$3.95

#### Using & Understanding Miniature Neon Lamps

Describes the neon lamp in detail: electrode size, gases used, firing, extinction voltages, aging characteristics, and maintenance. Explains its uses as an indicator, voltage regulator and voltage reference, oscillator, pulse generator, flasher, and applications in computers. Includes fascinating, easy-to-build circuits for the experimenter. Also includes the characteristics of most available neon lamps.  
Order 20698, only ..... \$2.95

#### Novel Electronics Circuits

Offers 77 novel circuits and devices for the experimenter, ham, or technician. Circuits range from functional devices, such as light sensor, audio oscillator, and infra-red sensor, to unusual scientific types, such as an electronic lock and an earth telephone. Includes thorough descriptions and illustrations for each device.  
Order 20692, only ..... \$2.50

#### Short-Wave Listener's Guide—3rd Ed.

Lists all short-wave stations by country, city, call letters, frequency, power, and transmission time. Includes Voice of America and Radio Free Europe stations and a listing of stations operating behind the Iron Curtain. With conversion chart and handy log. Order 20695, only ..... \$2.25

#### Amateur Radio SSB Guide

Essential for anyone owning or planning to build or buy ssb equipment. Covers basic principles, purpose of ssb transmission; detailed analysis of the balanced modulator circuit and its application in a typical transmitter. Includes schematic diagrams for those interested in building or troubleshooting ssb transmitters and receivers, along with circuit analysis.  
Order 20629, only ..... \$3.95

#### Learn Electronics Through Troubleshooting

A new and practical approach to learning and understanding electronics theory. Provides a thorough grasp of the subject through the technique of solving practical troubleshooting problems. Includes two appendices containing valuable reference data. Order 20651, only ..... \$6.95

#### Motorcycle Service Manuals—2nd Ed.

Provides full information on how to service virtually every present-day scooter or motorcycle. The two volumes cover hundreds of popular domestic and foreign models.  
Vol. 1. Order 20665, only ..... \$4.95  
Vol. 2. Order 20666, only ..... \$4.95  
2-Vol. Set. Order 20667, only ..... \$9.50

### RECENT AND TIMELY BESTSELLERS

#### 101 Questions & Answers About CATV and MATV

Describes the growing applications of catv (community antenna television) and matv (master antenna television) in the fields of home entertainment, schools, public safety, and industry. Fully covers equipment and system designs and installations, and the future for this field.  
Order 20655, only ..... \$2.50

#### 101 Questions & Answers About Color TV

Here are the complete and clear answers to the most frequently asked questions about color tv: about its basic theory, installation, servicing, and modifications. Answers are reinforced by dozens of schematics, illustrations, and photographs. Order 20624, only ..... \$1.75

#### ABC's of Electrical Soldering

An invaluable book on the art of soldering—what it is and does, how to make a good connection, how to make solder repairs. Explains solder alloys, fluxes, soldering irons, instant-heat guns, production soldering, and other connecting methods. Order 20627, only ..... \$2.95

#### How to Repair Major Appliances

This fact-packed volume explains theory, functioning, major components, and repair of refrigerators, freezers, washing machines, dryers, ranges, dishwashers, garbage disposers, room air conditioners, water heaters, humidifiers, and dehumidifiers. Order 20650, only ..... \$4.95

#### Semiconductor Handbook

Here, in one comprehensive heavily illustrated volume, is the most complete, modern source-book for industrial semiconductor data. Covers latest circuitry in a wide variety of applications; provides full data on industrial semiconductors, including grown-junction, alloyed-junction, drift, MADT, mesa, planar, and epitaxial mesa types.  
Order 20620, only ..... \$5.75

#### 49 Easy Transistor Projects

Provides simple, easy instructions, schematic diagrams, and parts lists for building a-m and f-m radios, light relay controls, audio amplifiers, code-practice oscillators, and test equipment, using inexpensive or salvage parts. A fascinating, instructive book.  
Order 20617, only ..... \$1.75

#### More Bestselling Sams Titles

ABC's of Transformers and Coils.  
Order 20612, only ..... \$2.50

Understanding Electronic Test Equipment.  
Order 20613, only ..... \$4.50

101 Questions and Answers About CB Operations. Order 20604, only ..... \$2.50

Modern Dictionary of Electronics, 3rd Ed.  
Order 20600, only ..... \$9.95

ABC's of Vacuum Tubes.  
Order 20576, only ..... \$2.95

### HOWARD W. SAMS & CO., INC.

Order from any Electronic Parts Distributor, or mail to Howard W. Sams & Co., Inc., Dept. RE-1 4300 W. 62nd St., Indianapolis, Ind. 46268

Send books checked at right. \$ \_\_\_\_\_ enclosed.

Send FREE 1969 Sams Book Catalog

Name \_\_\_\_\_

Address \_\_\_\_\_

City \_\_\_\_\_ State \_\_\_\_\_ Zip \_\_\_\_\_

- |                                |                                |
|--------------------------------|--------------------------------|
| <input type="checkbox"/> 20584 | <input type="checkbox"/> 20624 |
| <input type="checkbox"/> 20698 | <input type="checkbox"/> 20627 |
| <input type="checkbox"/> 20692 | <input type="checkbox"/> 20650 |
| <input type="checkbox"/> 20695 | <input type="checkbox"/> 20620 |
| <input type="checkbox"/> 20629 | <input type="checkbox"/> 20617 |
| <input type="checkbox"/> 20651 | <input type="checkbox"/> 20612 |
| <input type="checkbox"/> 20665 | <input type="checkbox"/> 20613 |
| <input type="checkbox"/> 20666 | <input type="checkbox"/> 20604 |
| <input type="checkbox"/> 20667 | <input type="checkbox"/> 20600 |
| <input type="checkbox"/> 20655 | <input type="checkbox"/> 20576 |

Circle 28 on reader service card



**finger-  
tip availability**

**AEROVOX  
HAS EVERY  
EXACT  
REPLACEMENT  
TWIST PRONG AFH  
ELECTROLYTIC**

Why fool with "jerry-rigged" electrolytics when there's an Aerovox exact replacement to give you the right rating and the right size? Aerovox actually stocks all twist prong AFH electrolytics—this means off-the-shelf availability...not "we'll build it for you if you order it" delivery.

Available in singles, doubles, triples and quads, these popular types are now manufactured in new values for filter bypass applications in color TV as well as radio, black and white TV and amplifier equipment. Many values are now being used for industrial applications.

Aerovox AFH Twist Prong Electrolytics feature ruggedized prongs and mounting terminals, high purity aluminum foil construction, improved moisture resistant seal and 85°C operation. Here is the quality you need to protect your professional reputation.

Go to your Aerovox Distributor for a perfect electrolytic fit—he will deliver exactly what you want in less time than it takes to tell. Ask him for the new Aerovox Servicemen's Catalog #SE-567 or ask us. We'll be happy to send one your way.



DISTRIBUTOR SALES, New Bedford, Mass. 02741

Circle 30 on reader service card

tice that nothing is said about flatness (a plus/minus dB figure) or power output. What that spec means is that over the range from 20 to 20,000 Hz this amplifier will put out not less than half its rated power (say 50 watts, at 1% harmonic distortion). In practice, this usually means it will put out a full 50 watts over most of the audio range, but the power available at 1% distortion will fall to 25 watts at the extremes of 20 Hz and 20 kHz.

If that sounds dreadful, it isn't really. Half power is only 3 dB down, and 3 dB is about the smallest change in loudness that can be detected reliably in program material. All other things being equal, 25 watts would sound just noticeably less loud than 50.

Power bandwidth, then, is defined as the frequency range bounded by the two frequencies at which the power falls to half its midrange value.

All this can be shown most convincingly by a graph, but it is seldom published in that form because graphs take up space and many people don't know how to read them anyway. Even so a power bandwidth spec is more meaningful than a frequency response spec, which is often taken at 1 watt or some very low power. It is, after all, *power* that counts when pushing a speaker cone back and forth. It is important to know what strength an amplifier can muster at its frequency extremes.

#### Sensitivity, gain and overload

The difference between power output and gain is important. A mike or phono preamp, for example, has lots of voltage gain (typically 40 to 50 dB, or a factor of 100 or more), but negligible power output, in terms of what's needed to drive a speaker (perhaps a milliwatt at most). In effect, the gain, or sensitivity, of an amplifier establishes how much signal voltage is required at the input to drive the amplifier to its full rated output. Typically this figure is between 1 and 5 mV for tape-head, mike and phono inputs, and 100 mV to 1 volt for high-level (tuner, auxiliary or tape-monitor) inputs, regardless of the power output rating of the amplifier.

To the extent that every currently manufactured amplifier has enough gain to accommodate just about every common input device, sensitivity is not an important specification. What is more to the point is the *overload margin* of the input stages. The preamp part of an amplifier comes before the volume control; so if the signal is great enough to overload the input stage, there will be distortion that cannot be eliminated by turning down the volume.

The output of a phono pickup is rated by playing a record with a known, standard level of modulation—usually a few millivolts but sometimes as high as 25 mV. (I am not talking here about replacement type crystal or ceramic pickups, whose output can go as high as several volts.)

What is often forgotten is that modern recordings have a very wide dynamic range, and heavy groove modulation (assuming the pickup can trace it in the first place) can generate pickup terminal voltages of 100 mV or more. So it is important to be sure that the preamp stages of a hi-fi amplifier

**15 patterns!**

Color Bar Pattern Generator

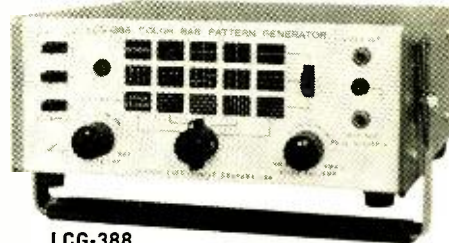

LCG-388

Pattern appears instantly when turned on, and has laboratory standard stability. Only 3 1/4 x 7 3/4 x 7 3/4, and weighs about 4 1/2 lbs.

- Crystal controlled oscillator.
- Flipflop and logic circuitry assure highest operating stability
- One receiver input to TV antenna
- Two selectable TV channels
- Chroma level control — 0 to 200%
- Horizontal line flickering prevented by progressive scanning
- Video output
- Gun killers for convergence adjustments
- Trigger output for scope synchronization

ONLY \$149

**LEADER  
INSTRUMENTS CORP.**

24-20 Jackson Avenue  
Long Island City, New York  
(212) 729-7410

Circle 31 on reader service card

will not be overloaded by the highest probable signal voltages. A complete amplifier specification should state that the preamp will generate negligible distortion with input voltages up to 150 to 200 mV.

### The other end: noise

It's useful to think of an amplifier's capability in terms of *dynamic range*: the amplitude range between the loudest and softest sounds. At the loud end, dynamic range is limited by overload and the onset of distortion. At the low-level end, the dynamic range is limited by *noise*. Strictly, noise is anything undesired in the reproduction, but it is usually used to mean residual noise in the absence of any signal. Hum, hiss, shot noise, and frying noises due to parasitic oscillations are all examples. Because the noise is usually broad-band in character, something like white noise, any signal quieter than the noise will be masked and inaudible.

In a good amplifier, the noise level ought to be at least 65 dB below rated output, through the phono or tape-head input. Even 70 dB is not uncommon. It should be even better through the high-level inputs (75 to 85 dB). The figure that tells how far below maximum output the noise is, is also the dynamic range of the amplifier.

The dynamic range of a symphony orchestra is between 70 and 80 dB, so you can see that modern, low-noise, low-distortion equipment is just about adequate to handle it. However, that raw dynamic range is often compressed somewhat to accommodate the limitations of commercial recording and broadcasting.

### Stability and overload recovery

Everyone who has worked with electronics knows that an amplifier can become an oscillator, given the right gain, feedback and phase. At certain points in the frequency range of an audio amplifier, the negative feedback—which tends to make the amplifier self-correcting, reduces certain forms of noise and distortion and broadens the bandwidth—can turn positive. Then the feedback has precisely the opposite effects. Even if the amplifier doesn't oscillate continuously, it may produce short bursts of oscillation at a high frequency on certain kinds of signal waveforms, or it may be triggered into a damped low-frequency oscillation by a sudden overload, or it may develop a peak in its response curve. Sudden changes in power-line voltage can also trigger instability. Every inductive or capacitive device is a phase shifter, as are transistors.

So in addition to striving for low noise and distortion, the design engi-

neer must make sure his amplifier is inherently and unconditionally stable. This means testing it with a variety of inductive and capacitive loads, since real speakers are hardly ever purely resistive. Conventional speakers usually look inductive to an amplifier, a situation that is complicated by the inductors and capacitors in the crossover networks, while electrostatic speakers are capacitive. Some amplifiers cannot be used with electrostatic speakers. A complete set of specs will talk about stability, even though it is difficult to establish stability criteria in numbers.

Another inscrutable that can make two otherwise identical amplifiers sound different is *overload recovery*. Largely because of time constants in coupling, decoupling and filtering circuits, curious things can happen when an amplifier is socked with a high-amplitude transient. One typical effect in tube amplifiers occurs when a signal is big enough to drive a grid positive. The grid-cathode circuit rectifies the signal and charges the coupling capacitor in such a way as to cut off (or at least overbias) the tube until the grid resistor allows the charge to leak off. In this way, a momentary overload for half a cycle can spoil the quality of the sound for perhaps a full second after the overload disappears. Feedback compounds the trouble rather

## HALF PRICE!

Yes! Half the price you would normally pay for:

- Guitar Amplifiers • Speaker Cabinets
- P. A. Amplifiers • Sound Columns
- Strobe Lights • Color Organs

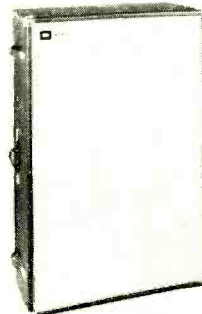

How? With **MYRIAKIT!**

**MYRIAKIT** offers you great equipment in kit and semi-kit form, each including easy to follow step-by-step instructions to insure proper and accurate assembly.

WRITE FOR FREE CATALOG TO:

MYRIAKIT CORP.

1043 N. Main St., Akron, O. 44310

Name \_\_\_\_\_

Address \_\_\_\_\_

City \_\_\_\_\_ State \_\_\_\_\_ Zip \_\_\_\_\_

Circle 34 on reader service card

# Clever Kleps



Test probes designed by your need — Push to seize, push to release (all Kleps spring loaded).

**Kleps 10.** Boathook type clamp grips wires, lugs, terminals. Accepts banana plug or bare wire lead. 4¾" long. **\$1.19**

**Kleps 20.** Same, but 7" long. **\$1.39**

**Kleps 30.** Completely flexible. Forked-tongue gripper. Accepts banana plug or bare lead. 6" long. **\$1.47**

**Kleps 40.** Completely flexible. 3-segment automatic collet firmly grips wire ends, PC-board terminals, connector pins. Accepts banana plug or plain wire. 6¾" long. **\$2.39**

**Kleps 1.** Economy Kleps for light line work (not lab quality). Meshing claws. 4½" long. **\$.99**

**Prof 10.** Versatile test prod. Solder connection. Molded phenolic. Doubles as scribing tool. "Bunch" pin fits banana jack. Phone tip. 5½" long. **\$.79**

All in red or black — specify.

For additional information, write for our complete catalog of — test probes, plugs, sockets, connectors, earphones, headsets, and miniature components.

Available through your local distributor, or write to:  
**RYE INDUSTRIES, INC.**  
126 Spencer Place, Mamaroneck, N.Y. 10543

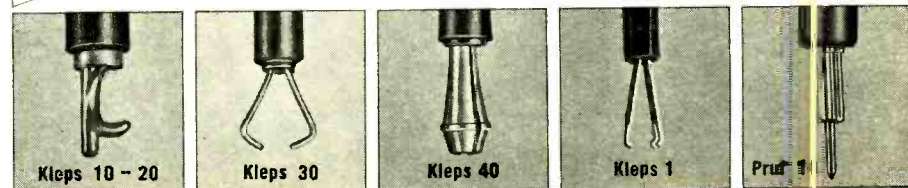

Circle 35 on reader service card

## Scott's new LR-88 receiver takes the



out of kit building

Ladies and children needn't leave the room when you build Scott's new LR-88 AM/FM stereo receiver kit. Full-color, full-size assembly drawings guide you through every stage . . . wires are color-coded, pre-cut, pre-stripped . . . and critical sections are completely wired and tested at the factory.

In about 30 goof-proof hours, you'll have completed one great receiver. The LR-88 includes FET front end, Integrated Circuit IF strip, and all the goodies that would cost you over a hundred dollars more if Scott did all the assembling.

Performance? Just check the specs below . . . and write to Scott for your copy of the detailed LR-88 story.

**LR-88 Control Features:** Dual Bass and Treble; Loudness; Balance; Volume compensation; Tape monitor; Mono/stereo control; Noise filter; Interstation muting; Dual speaker switches; Stereo microphone inputs; Front panel headphone output; Input selector; Signal strength meter; Zero-center meter; Stereo threshold control; Remote speaker mono/stereo control; Tuning control; Usable sensitivity, 2.0  $\mu$ V; Harmonic distortion, 0.6%; Frequency response, 15-25,000 Hz  $\pm$  1.5 dB; Cross modulation rejection, 80 dB; Selectivity, 45 dB; Capture ratio, 2.5 dB; Signal/noise ratio, 65 dB; Price \$334.95 (Recommended Audiophile Net)

## You'll swear by it

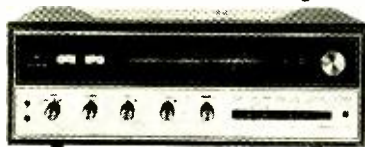

# SCOTT®

H. H. Scott, Inc.,  
Dept. 570-01, Maynard, Mass. 01754  
Walnut case optional

© 1968, H. H. Scott, Inc.

Circle 100 on reader service card

## A Great NEW

# TV LAMP CLOCK

Takes the Guesswork  
Out of Telling Time!

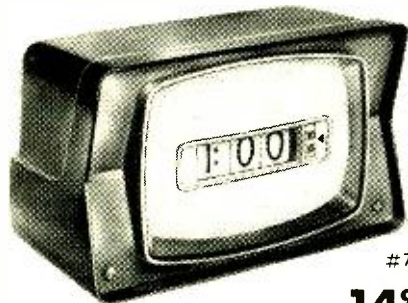

#765

POSTPAID **14<sup>95</sup>**

Dual lighting. Gives your eyes a stare-break. Relieves TV eyestrain. Comforting nightlight for bedroom or nursery. Walnut plastic case. 4" H, 7" W, 3 3/8" D. One year Guarantee. Made in U.S.A.

At Your Dealer, or DIRECT FROM

**PENNWOOD NUMECHRON CO.**

7249 FRANKSTOWN AVE., PITTSBURGH, PA. 15208

Please send #765 TV Lamp Clock at \$14.95 Post Paid. Enclosed is  Check,  Money Order. No C.O.D.'s.

Name \_\_\_\_\_

Address \_\_\_\_\_

City \_\_\_\_\_ State \_\_\_\_\_

Zip Code \_\_\_\_\_ RE 169

Circle 32 on reader service card

Fill in coupon for a FREE One Year Subscription to OLSON ELECTRONICS' Fantastic Value Packed Catalog—Unheard of LOW, LOW PRICES on Brand Name Speakers, Changers, Tubes, Tools, Stereo Amps, Tuners, CB, Hi-Fi's, and thousands of other Electronic Values. Credit plan available.

NAME \_\_\_\_\_

ADDRESS \_\_\_\_\_

CITY \_\_\_\_\_ STATE \_\_\_\_\_

GIVE ZIP CODE \_\_\_\_\_

If you have a friend interested in electronics send his name and address for a FREE subscription also.

**OLSON ELECTRONICS**

311 S. Forge Street Akron, Ohio 44308

Circle 33 on reader service card

www.americanradiohistory.com

than reducing it. During the process, the power supply voltage has probably dropped 20% and risen again.

There are no standards for gaging overload recovery, and few amplifier makers say anything about it. But how quickly the amplifier recovers, and just how it responds to an overload in the first place, has a profound effect on its listening quality. The "model" amplifier spec with this article gives a concise and meaningful statement about overload recovery.

### Impedance and damping

There's confusion here, too, because of the two meanings of the expression "output impedance." A tube amplifier with an output transformer has output taps marked 4, 8 and 16 ohms. These figures indicate the nominal value of load impedance the amplifier should "see" so that the output tubes will operate as they were intended.

But the speaker, looking back into the amplifier, sees a very different impedance—perhaps a fraction of an ohm—because of negative voltage feedback. The smaller this looking-backward impedance, the more nearly the speaker feels short-circuited when it tries to move independently of what the amplifier tells it to do, and the better damped it is. Nominal speaker impedance divided by the looking-backward source impedance of the amplifier is *damping factor*.

Most modern speaker systems are inherently well damped, so there is a legitimate question as to whether a damping factor in excess of 10 offers any benefit. Some claim it does, others claim it only reduces the bass output of the speaker. Either way, when the internal resistance of the amplifier gets down to a small fraction of an ohm, it is swamped by the unchangeable resistance of the speaker voice coil and of the connecting leads to the speaker. Some amplifiers have damping factors of 100 or more, but anything greater than 10 or 20 is not much use.

### There's more

We've covered only a few of the many things that can be measured and described about an audio amplifier, but these are probably the most significant in terms of listening quality. Other things that can be important are transient response (rise time), measured with square waves or, better, with tone bursts; tone control range and slope; rumble and scratch filters, short-circuit protection and the desirability of certain features. We can talk about those in another article.

R-E





# GREAT BOOKS ON ELECTRONICS

**436—PRACTICAL COLOR TV SERVICING TECHNIQUES.** Loaded with easy-to-understand methods for locating and correcting color TV troubles. Includes several dozen case-history analyses of color TV problems—from antenna terminals to picture tube. 304 pps., with 8-page foldout schematic section. 230 illus. **\$4.95**



**428—PINPOINT TV TROUBLES IN 10 MINUTES.** A quick-answer guide to over 700 TV circuit troubles. Uses 63 large-size photos of different picture troubles, keyed to trouble-finding charts which identify over 700 probable defects. 372 pps. **\$4.95**

**133—JACK DARR'S SERVICE CLINIC.** Answers to hundreds of questions, selected for lasting usefulness and grouped under convenient categories. 192 pps. **\$2.95**

**476—MODERN TV CIRCUIT & WAVEFORM ANALYSIS.** Explores the newest transistorized integrated circuit and tube-type receivers—both color and monochrome. Includes functional descriptions of various circuit types, the troubles you may encounter, and the waveforms you should observe for them. 250 pps., 175 illus. **\$4.95**

**401—TV TROUBLESHOOTER'S HANDBOOK.** A carefully-planned reference source of over 350 tried and tested solutions to "tough-dog" TV servicing problems. 192 pps., 125 illus. **\$1.95**

**60—RAPID TV REPAIR.** Lists over 500 troubles alphabetically. Helps you fix the toughest TV troubles fast. Completely cross-referenced. Illustrated with photos and schematics. 224 pps. **\$3.95**

**414—SERVICING TV RECEIVER CIRCUITS.** Contains the TV service data most needed for troubleshooting both monochrome and color receivers. 224 pps. **\$2.95**

**126—SERVICING AGC CIRCUITS.** Reveals everything that can go wrong with AGC circuits and how to correct the trouble. 204 pps. **\$3.95**

**240—FET APPLICATIONS HANDBOOK.** A comprehensive compilation of field-effect transistor circuit design data, written especially for practicing engineers. **\$12.95**

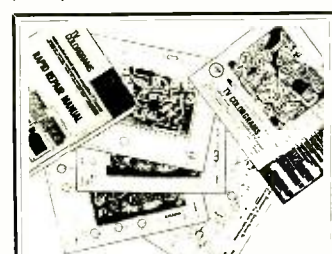

## Color-Coded Schematics for 1500 TV Sets at 1.3¢ Per Set

Yes, now you can speed-repair 1500 popular TV receivers for just about 1¢ each... with the serviceman-proved COLOR-CODED TV COLORGRAMS... which were a real bargain at their original total price of \$102.50. Now, offered at only \$19.95! Each COLORGRAM chart is clearly color-coded to show signal-flow, continuity, test points, and voltages. Each COLORGRAMS Service-Pak contains everything you need to service a whole series of TV sets—including a complete color-keyed master schematic providing an overall view of the receiver circuit and a Rapid Repair Manual. What do you get for your money? 50 complete Service-Paks (each Pak originally selling for \$1.95) containing data on approximately 1500 TV sets. PLUS a 148-page MASTER-INDEX. Order No. T-444 **only \$19.95**

**1101—ELECTRONIC CIRCUIT DESIGN HANDBOOK.** Over 500 tried and tested circuits for control, regulation, protection, filtering and suppression, comparison, amplification, oscillation, alarm, counting and timing, testing and measuring, power supplies, detection and sensing, display and readout, gating and logic, relay and switching, and signal generation. 320 pps., 8½ x 11" **\$14.95**

**484—TV SERVICING GUIDEBOOK: Problems & Solutions.** A guide to TV receiver troubles, their causes and cures. Step-by-step for isolating defects. 176 pps. **\$3.95**

**136—NEW WAY TO SERVICING COLOR TV.** Emphasizes the practical aspects of troubleshooting that you really need to get difficult-to-repair sets back in top working order, fast. 192 pps. **\$3.25**

**123—COLOR TV REPAIR.** Covers color circuits, ABC's of color TV servicing, antennas and boosters, replacing the color picture tube, servicing the chroma circuits, unexpected causes of TV color failure, servicing tips, etc. 160 pps. **\$2.95**

**430—PINPOINT TRANSISTOR TROUBLES IN 12 MINUTES.** Troubleshooting charts and service procedures for practically every type of transistorized device, including amplifiers, radio receivers, radio transmitters, power supplies, test instruments, and special equipment. 495 pps. **\$7.95**

**474—MODERN ELECTRONIC TROUBLESHOOTING.** Deals with today's electronic servicing problems on a practical level. Uses modern test instruments and advanced troubleshooting procedures to cope with the special problems created by printed boards and solid-state circuitry. 256 pps., over 100 illus. **\$4.95**

## Save \$4.65 on Transistor Library



This complete 8-volume Library covers every facet of transistor technology—from basic theory to advanced servicing techniques and practical devices you can build and use. More than 1,300 pages packed with latest information on transistor theory and practice offers you the opportunity for a more secure future in electronics... at a substantial savings!

- Transistors—Theory & Practice **\$2.95**
  - Transistors **\$1.95**
  - New Skill-Building Transistor Projects and Experiments **\$3.95**
  - Basic Transistor Course **\$3.95**
  - Transistor Circuits **\$2.95**
  - Transistor Projects **\$2.95**
  - Getting Started with Transistors **\$3.95**
  - Transistor Techniques **\$1.95**
- Ordered separately, these eight books retail for \$24.60. You can save \$4.65 on the special 8-volume combo. Order TL-8 **Only \$19.95**

**427—NEW WAYS TO DIAGNOSE ELECTRONIC TROUBLES.** Easier, more efficient ways to diagnose troubles in radio, TV, and electronic circuits. 288 pps. **\$4.95**

**424—TEN-MINUTE TEST TECHNIQUES FOR ELECTRONICS SERVICING.** Step-by-step techniques for localizing trouble in any kind of equipment—tube or transistor—"Time and Temper Savers" offer practical hints. 176 pps., 125 illus. **\$2.95**

**78—RAPID RADIO REPAIR.** Lists symptoms and cures alphabetically in four handy sections: Receivers, Techniques, Servicing, Charts. 224 pps. **\$2.90**

**429—EASY WAY TO SERVICING RADIO RECEIVERS.** How to diagnose and correct troubles in any kind of AM receiver, tube or transistor. Over 100 illus. **\$3.95**

**59—SERVICING RECORD CHANGERS.** Clear, practical approach to solving the difficult job of repairing automatic record changers. 224 pps. **\$3.95**

**58—MAINTAINING HI-FI EQUIPMENT.** Tells how to correct mechanical and acoustical troubles as well as electronic faults. 224 pps. **\$4.95**

**120—HI-FI TROUBLES.** Tells how to maintain audio systems... why you have troubles, how to locate them, and how to fix them. **\$3.95**

**107—RADIO SERVICING MADE EASY.** A 2-volume course filled with data on servicing AM, FM, citizens band, marine, transistor, communications, and auto receivers. 2 volumes, 380 pps. **\$7.20**

**86—INSTALLING HI-FI-SYSTEMS.** A practical, down-to-earth guide to the make-up of good component hi-fi systems and built-in housing, including construction of cabinets. 224 pps., 152 illus. **\$4.95**

**64—UNDERSTANDING HI-FI CIRCUITS.** Analyzes the hi-fi system so you can decide which is best for your taste and budget. 224 pps. **\$2.90**

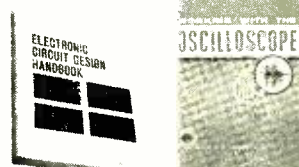

**67—ELEMENTS OF TAPE RECORDER CIRCUITS.** Covers characteristics of a high-quality tape amplifier, head and tape characteristics, bias current, equalization requirements and circuits, oscillators, record-level indicators, minimizing noise and hum. 224 pps. **\$2.90**

**79—DESIGNING AND BUILDING HI-FI FURNITURE.** How to have a hi-fi system that looks as good as it sounds. **\$4.95**

**472—WORKING WITH THE OSCILLOSCOPE.** Large size illustrations show exactly how to measure phase shift, check amplifier response, test transistors, check color TV bandpass response and demodulator action, horizontal deflection systems, and major TV circuit outputs. 104 pps., BIG 8½ x 11" size. **\$4.95**

**483—99 WAYS TO USE YOUR OSCILLOSCOPE.** 99 different analysis tests, encompassing just about every application a service technician might encounter. 192 pps., profusely illustrated. **\$4.95**

**57—THE V.T.V.M.** Describes how to get the most out of the electronic workhorse in TV troubleshooting, am-fm alignment and repair, servicing audio amplifiers, ham shack uses, etc. 224 pps. **\$3.50**

**438—HOW TO USE YOUR VOM-VTM & OSCILLOSCOPE.** Whether you want to know more about how these instruments work, or how to use them in everyday applications, this "3-in-1" guide contains the answers. 192 pps., 120 illus. **\$3.95**

**131—TEST INSTRUMENTS FOR ELECTRONICS.** Modifications and additions to increase the efficiency and capabilities of your vom, vtvm and scope. 192 pps. **\$2.95**

**54—PROBES FOR TEST INSTRUMENTS.** How to use probes for quicker, more accurate testing. 224 pps. **\$2.50**

**470—TRANSISTOR CIRCUIT GUIDEBOOK.** Written for the technician needing information on transistor circuit operation, or for the hobbyist, experimenter, circuit designer seeking guidelines to the construction of useful devices. 100 circuits. **\$4.95**

**30—HANDBOOK OF SEMICONDUCTOR CIRCUITS.** Complete operational data for amplifiers, oscillators, logic and switching circuits, power supplies, and various nonlinear circuits. 448 pps. **\$7.95**

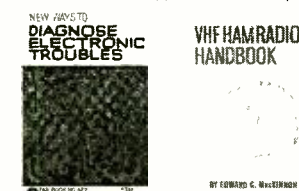

**72—OSCILLOSCOPE TECHNIQUES.** Shows how to use the scope in scores of applications. 224 pps. **\$3.95**

**104—BASIC RADIO COURSE.** Revised edition of a classic text. 224 pps. **\$4.95**

**130—BASIC OSCILLATOR HANDBOOK.** Tells you everything there is to know about oscillators, how they work, how to design them, etc. 160 pps. **\$2.95**

**100—BASIC MATH COURSE FOR ELECTRONICS.** Quick, short-cut way to learn the language of mathematics as it applies to electronic shop practice. 152 pps. **\$4.50**

**Save \$4.85 on Databook Library**

Here is the first place to look for authoritative answers to your toughest electronics problems—whether you are working with theoretical applications or practical projects. You focus quickly on the answers you want, reducing hours of figuring to seconds. The great value of the data books is in their organization. You'll keep them at your elbow continuously to save time, effort, and trouble.

**Charts & Nomographs for Electronics Technicians and Engineers** **\$5.95**

**The Handbook of Electronic Tables** **\$4.95**

**Electronic Design Charts** **\$5.95**

**Electronic Data Handbook** **\$4.95**

Buy all four volumes at the special money-saving combination price of **\$21.80**—a \$4.85 discount from the regular list price.

Order DL-4 **Only \$16.95**

**464—ELECTRONIC HOBBYIST'S IC PROJECT HANDBOOK.** 50 projects you can build from inexpensive integrated circuit components, plus a section of schematics for 32 of the most popular ICs. **\$3.95**

**105—BASIC TV COURSE.** Perfect introduction to TV for the beginner, excellent refresher for the experienced man. **\$4.95**

**462—104 EASY TRANSISTOR PROJECTS YOU CAN BUILD.** For everyone from hobbyist-experimenter to experienced hams and audiophiles. Truly a project builder's "dreambook"! 224 pps. **\$3.95**

**112—LEARN ELECTRONICS BY BUILDING.** A stimulating and practical approach for beginners of all ages. 208 pps. **\$4.95**

**468—104 HAM RADIO PROJECTS FOR NOVICE & TECHNICIAN.** A well-rounded assortment of antenna devices, an-lho equipment, CW aids, interference suppressors and eliminators, power supplies, preamps and preselectors, receivers and converters, transmitters, and transmitter-receiver accessories. 192 pps. **\$3.95**

**135—RADIO CONTROL MANUAL (Revised 2nd Edition).** Long-time favorite on radio control of model planes, boats, cars, rockets, etc. 192 pps. **\$3.95**

**216—RADIO NEWS HANDBOOK.** A handbook for both aspiring and experienced broadcast journalists. 176 pps. **\$7.95**



**460—VHF HAM RADIO HANDBOOK.** VHF hints and kinks, transmitters, antennas, equipment modifications, receiver and modulator circuits, plus 25 VHF construction projects. 176 pps., 100 illus. **\$3.95**

**69—ELECTRONIC HOBBYIST'S HANDBOOK.** Scores of tested and debugged circuits for building garage-door openers, amplifiers, oscillators, power supplies, control and photo devices, etc. 160 pps. **\$2.95**

**83—FUN WITH ELECTRICITY.** A great way to start a youngster on a career in electronics. 128 pps. **\$2.95**

**70—ELECTRONIC PUZZLES AND GAMES.** How to build fascinating electronic games with the simplest tools. 128 pps. **\$2.50**

**93—RADIO CONTROL HANDBOOK.** Complete information on simple and complex control systems, motor and auxiliary controls, receivers, transmitters, power supplies, relays, installation of parts, adjustments and tests. 304 pps. **\$4.95**

**122—ADVANCED RADIO CONTROL.** The control problem, superregen and superhet control receivers, frequency decoders, pulse decoders, design and operation of proportional control servomechanisms, fundamentals of rockets, etc. 192 pps. **\$4.95**

## NO RISK COUPON — MAIL TODAY

TAB BOOKS, Blue Ridge Summit, Pa. 17214 **RE-19**  
Please send me the books listed below. (Save postage; remit with order)

I enclose \$.....  Please invoice on 10-day FREE trial

Name .....

Address .....

City ..... State ..... Zip .....

Circle 37 on reader service card

## RADIO-ELECTRONICS READER SERVICE

Here's how you can get manufacturers' literature fast:

1. Tear out the post card on the facing page. Clearly print or type your name and address. **Include zip code!**
2. Circle the number on the card that corresponds to the number appearing at the bottom of the **New Products, New Literature or Equipment Report** in which you are interested.  
For literature on products **advertised** in this issue, circle the number on the card that corresponds to the number appearing at the bottom of the advertisement in which you are interested. Use the convenient index below to locate quickly a particular advertisement.
3. Mail the card to us (no postage required in U.S.A.)

**GAVIN INSTRUMENTS, INC.** (Subsidiary of Advance Ross Corporation (Cover III) Circle 148  
**GBC ELECTRONICS** (p. 70) Circle 24  
**GC ELECTRONICS COMPANY** (p. 26) Circle 22  
**GC ELECTRONICS COMPANY** (p. 83) Circle 110  
**G & G RADIO SUPPLY COMPANY** (p. 101) Circle 144

**HEALD COLLEGES** (p. 88) Circle 116  
**HEATH COMPANY** (p. 84-85) Circle 111  
**HICKOK ELECTRICAL INSTRUMENT COMPANY** (p. 22) Circle 18

**INTERNATIONAL CRYSTAL MFG. COMPANY** (p. 102) Circle 147  
**INTERNATIONAL TEXTBOOK COMPANY** (p. 5) Circle 9

**JFD ELECTRONICS CORPORATION** (p. 15) Circle 14  
**JUDSON RESEARCH AND MANUFACTURING COMPANY, INC.** (p. 82) Circle 108

**KENZAC COMPANY** (p. 98) Circle 139

**LEADER TEST INSTRUMENTS** (p. 74) Circle 31  
**LORAL DISTRIBUTOR PRODUCTS** (Division of Loral Corporation) (p. 23) Circle 19

**MERCURY ELECTRONICS CORPORATION** (p. 81) Circle 106  
**MICROFLAME, INC.** (p. 91) Circle 117  
**MUSIC ASSOCIATED** (p. 97) Circle 128  
**MYRIAD PRODUCTS CORPORATION** (p. 75) Circle 34

**OLSON ELECTRONICS, INC.** (p. 76) Circle 33

**PENWOOD NUMECHRON COMPANY** (p. 76) Circle 32  
**POLY PAKS** (p. 101) Circle 146

**RCA TEST EQUIPMENT** (Cover IV) Circle 149  
**READING IMPROVEMENT PROGRAM** (p. 95) Circle 126  
**RECORD-O-FONE** (Division of Electro Space Corporation (p. 72) Circle 27  
**RYE INDUSTRIES, INC.** (p. 75) Circle 35

**SAMS AND COMPANY, INC. HOWARD W.** (p. 73) Circle 28

**SCA SERVICES COMPANY** (p. 95) Circle 123  
**SCHOBER ORGAN CORPORATION, INC.** (p. 88) Circle 115

**SCI ELECTRONIC IGNITION** (p. 96) Circle 127  
**SCOTT, INC., H. H.** (p. 76) Circle 100

**SECO ELECTRONICS** (p. 86) Circle 112  
**SENCORE** (p. 93) Circle 121

**SOLID STATE SALES** (p. 99) Circle 140  
**SPRAGUE** (p. 16) Circle 15

**SYLVANIA** (Subsidiary of General Telephone & Electronics (p. 25) Circle 21

**TAB BOOKS** (p. 77) Circle 37

**WARREN ELECTRONIC COMPONENTS** (p. 100) Circle 142  
**WELLER ELECTRIC COMPANY** (p. 12) Circle 11

**ACCURATE INSTRUMENT COMPANY, INC.** (p. 17) Circle 16  
**AEROVOX CORPORATION** (p. 74) Circle 30  
**ARCTURUS ELECTRONICS CORPORATION** (p. 98) Circle 138  
**ARROW FASTENER COMPANY, INC.** (p. 96) Circle 125

**BELL P/A PRODUCTS CORPORATION** (p. 24) Circle 20

**B & K MANUFACTURING COMPANY** (Division of Dynascan Corporation) (p. 13) Circle 12

**B & K MANUFACTURING COMPANY** (Division of Dynascan Corporation) (p. 27) Circle 23

**B & K MANUFACTURING COMPANY** (Division of Dynascan Corporation) (p. 71) Circle 25

**BROOKS RADIO AND TV CORPORATION** (p. 94-95) Circle 124

**BURSTEIN-APPLEBEE COMPANY** (p. 91) Circle 119

**CARINGELLA ELECTRONICS, INC.** (p. 82) Circle 107  
**CASTLE TV TUNER SERVICE, INC.** (p. 7) Circle 10

**CLEVELAND INSTITUTE OF ELECTRONICS** (p. 18-21) Circle 17

**(Slide Rule)** (p. 82) Circle 109

**COLETRONICS** (p. 97) Circle 129  
**CORNELL ELECTRONICS COMPANY** (p. 100) Circle 143

**DELTA PRODUCTS, INC.** (p. 14) Circle 13  
**DELTA PRODUCTS, INC.** (p. 86) Circle 113

**DELWYN** (p. 92) Circle 120

**EDMUND SCIENTIFIC COMPANY** (p. 99) Circle 141  
**ELECTRONIC CHEMICAL CORPORATION** (p. 94) Circle 122

**EICO ELECTRONIC INSTRUMENT COMPANY, INC.** (Cover II) Circle 8

**FAIR RADIO SALES** (p. 101) Circle 145

# NEW PRODUCTS

More information on new products is available free from the manufacturers of items identified by a Reader Service number. Use the Reader Service Card at the left and circle the numbers of the new products on which you would like further information. Detach and mail the postage-paid card.

**TELEPHONE DIALING ALARM.** Tele-Larm, Model T-10 is an automatic warn-



ing unit which notifies by telephone a responsible person whenever a condition

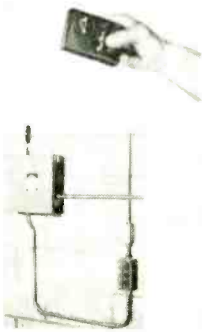

**RADIO CONTROL LINE.** Designed for remote automatic operation of garage and warehouse doors, lighting, conveyors, alarms and pumps. Consists of 10 systems of 1-, 2- and 3-channel receivers. Each includes a portable, single-channel test transmitter and a receiver for distances up to 1/2 mile. During signal transmission, systems can be used for momentary, on-off switching or as a combination. Receiver responds to proper pulsed coding signals only.—Perma-Power Co.

Circle 46 on reader service card

**AM/FM STEREO RECEIVER, Model DB250,** all-silicon, solid-state, has a rated output of 75 watts; FM selectivity at 60 dB provided by ceramic filters; harmonic distortion of 0.8% at full rated output; frequency response from 20 to 20,000

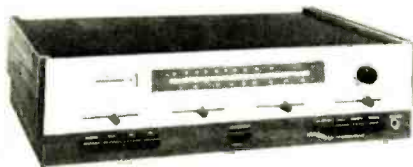

Hz. AM section includes mechanical filter for improved selectivity. Amplifier section couples directly to 4 loudspeakers. Earphones can be used alone or with local/remote speakers. \$279.95 with enclosure.—Bogen Communications

Circle 47 on reader service card

**PLIERENCHI,** made of forged steel with black oxide finish and polished head, is a complete workshop in one tool. Its parallel jaws and 10-to-1 gear ratio provide 1-ton gripping power in all positions so it can replace most types of wrenches and pliers. Also used as wire cutter and tool-



maker's clamp. Ideal for mechanic and maintenance man as well as for the home workshop fan. Model 86060, \$6.25, is 7" long with 3 accessory jaws available. Model 86070 is 8 1/2" long, lists at \$7.95.—Vaco Products Co.

Circle 48 on reader service card

## DISHONEST

“ You might think so when you see Mercury's unbelievable values. You get all the equipment you need for fast, accurate, profitable Color TV servicing at low, low prices. We tell it like it is. ”



Kit—\$10995  
Wired—\$15995

**Model 3000—5" High Sensitivity 5 Mc OSCILLOSCOPE VECTORSCOPE** Precision engineered to fill all your requirements: for waveform observation—Color and B/W. Top quality construction and circuitry make model 3000 ideal for TV technicians, electronic experimenters, development engineers as well as for applications in Technical Schools and Industry. Includes vectorscope calibrations on the calibrated Graticule, permitting vectorscope analysis through access to the deflection plates a matter of unit. A significant analysis tool in Color TV servicing. **VERTICAL AMPLIFIER:** Sensitivity—10 Mv RMS/Cm • Frequency Response—10 Hz to 5 Mc  $\pm 3$  Db • Rise Time—0.08 Microsecond. **HORIZONTAL AMPLIFIER:** Frequency Response—5 Hz to 500 KHz  $\pm 3$  Db • Sweep Range—5 Hz to 500 KHz, continuously adjustable.

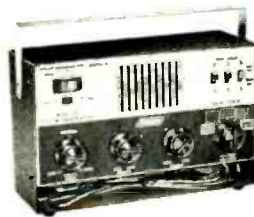

\$8495 (Available in AC operated model \$9995)

**Model 1901—Solid State, Battery Operated COLOR GENERATOR**

Offers every essential feature needed to install and service Color TV. Pre-tested rock solid pattern stability under extremes of heat and cold. Exclusive: Line Width and Dot Size Adjustment • Crystal Controlled • Gun Killers. \$8995

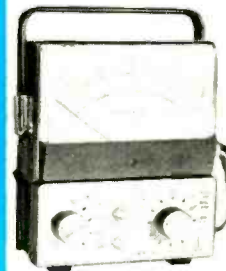

**Model 4000—FIELD EFFECT VOLT-OHM-MILLIAMMETER—6" METER**

High impedance, Solid State unit assures instant operation and permanent operating stability. Combines advantages of standard VTVM and FET circuitry. DC current ranges up to 1 Amp. Operates on both AC and battery.

\$6995

ALL MERCURY TEST EQUIPMENT GUARANTEED FOR ONE FULL YEAR! UPDATED TUBE TEST DATA AVAILABLE ON ALL UNITS.



**MERCURY ELECTRONICS CORPORATION**  
315 ROSLYN ROAD, MINEOLA, N. Y. 11501 • (516) 742-5400

CANADA: WILLIAM COHEN CORP., 8900 PARK AVE., MONTREAL 11  
EXPORT: SINGER PRODUCTS CO., INC., 95 BROAD ST., N. Y. C. 10004, U. S. A.

## NEW! SOLID STATE KITS

FOR ANY  
TAPE RECORDER

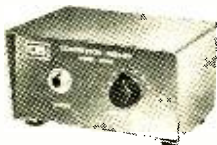

### Automatic Recording-Level Control

Low-noise distortionless compressor — preamp easily installs in mike line. Easy-to-build kit with complete instructions.

MODEL ACP-1 KIT . . . \$18.50

### Voice / Sound Actuated Controller

Voice operate any tape recorder, ham and CB transmitter. Ideal for intrusion alarms. Built-in relay switches up to 1 amp. Easy-to-build kit with complete instructions.

MODEL VOX-1 KIT . . . \$18.50

### Other Kits

Audio Amplifiers ■ Power Supplies  
Test Equipment ■ Treasure Locators  
and many others

FREE Data sheets with circuit description, diagram and specifications for all kits.



CARINGELLA ELECTRONICS, Inc.  
P.O. Box 327 ■ Upland, California 91786  
Phone 714-985-1540

Circle 107 on reader service card

WE DON'T CLAIM  
OUR ELECTRONIC  
IGNITION SYSTEM  
IS BEST



OUR  
CUSTOMERS DO!

WRITE TODAY FOR FREE LITERATURE

JUDSON

RESEARCH AND MFG. CO.  
ODNSHOHOCKEN, PA., U.S.A.

Circle 108 on reader service card

dangerous to human life or property arises. Serves as a burglar or fire alarm when tripped by any switch; it will call the police or the fire department and then the person concerned. Multiple calls are recorded by using a standard cartridge of 2-track, 20-minute recording tape with an adapter and a plug-in telephone on a 12-V lantern battery.—Electro-Photo Products Co.

Circle 49 on reader service card

STEREO TAPE RECORDER, Model RK-825, 4-tracks, solid-state circuit. Frequency response  $\pm 3$  dB, 40–15,000 Hz at 7½ ips;  $\pm 3$  dB, 40–10,000 Hz at 3¾ ips; wow and flutter under 0.23% rms at 7½ ips; under 0.35% at 3¾ ips. Three



speeds: 1½, 3¾ and 7½ ips. Input sensitivity: mike, 0.5 mV; aux., 100 mV. Monitor output: 16-ohm speaker or low-impedance stereo headphones. Complete with two 600-ohm mikes. \$139.95.—Lafayette Radio Electronics

Circle 50 on reader service card

COLOR TV KIT. Model GR-681 TV with 295-sq. in. screen, vhf/uhf channels 2 through 83. Built-in power vhf channel selection and cable-type remote control and ac line taps for voltages higher and lower than 120. \$499.95. Ac-

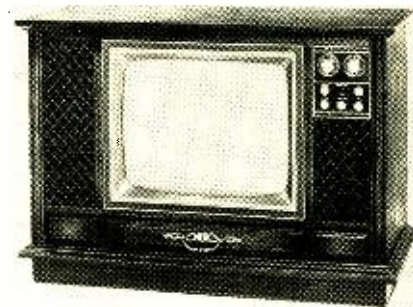

cessory kit Model GRA-681-6, a wireless remote control consists of a remote receiver and a transmitter. Changes volume and vhf channel and adjusts color. \$59.95.—Heath Co.

Circle 51 on reader service card

10-IN-1 ELECTRONIC PROJECT KIT No. 28-202 contains parts and illustrated instructions for building a germanium-diode radio, transistor amplifier, germanium-diode radio with transistor, code-practice oscillator, low-signal oscillator, radio-TV signal generator and two-person code practice oscillator, transistor ra-

## NOW! Solve Electronics Problems fast with New Patented Slide Rule.



That's right! This amazing new Electronics Slide Rule will save you time the very first day you use it. It's a patented, all-metal 10" rule that features special scales for solving reactance, resonance, inductance and circuitry problems . . . an exclusive "fast-finder" decimal point locator . . . widely-used formulas and conversion factors for instant reference. And there's all the standard scales you need to do multiplication, division, square roots, logs, etc.

Best of all, the CIE Electronics Slide Rule comes complete with an Instruction Course

of four AUTO-PROGRAMMED lessons. You'll quickly learn how to whip through tough problems in a jiffy while others plod along the old-fashioned "pad and pencil" way.

Electronics Slide Rule, Instruction Course, and handsome, top-grain leather carrying case . . . a \$50 value for less than \$25. Send coupon for FREE illustrated booklet describing this Electronics Slide Rule and Instruction Course and FREE Pocket Electronics Data Guide. Cleveland Institute of Electronics, 1776 E. 17th St., Dept. RE-160, Cleveland, Ohio 44114.

\*TRADEMARK

GET BOTH FREE!



Send  
coupon  
today →

### Cleveland Institute of Electronics

1776 E. 17th St., Dept. RE-160, Cleveland, Ohio 44114

Send FREE Electronics Slide Rule Booklet. Special Bonus: Mail promptly and get FREE Pocket Electronics Data Guide too!

NAME \_\_\_\_\_ (Please Print)

ADDRESS \_\_\_\_\_ COUNTY \_\_\_\_\_

CITY \_\_\_\_\_ STATE \_\_\_\_\_ ZIP \_\_\_\_\_

A leader in Electronics Training... since 1934

Circle 109 on reader service card

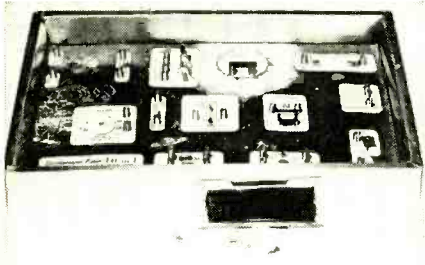

dio, signal tracer and wireless mike. Completed projects powered by a battery or light-sensitive solar energy cell. \$7.95 less battery.—Radio Shack

Circle 52 on reader service card

**90-WATT INSTRUMENT AMPLIFIER, KG-387.** 5 3/4" x 19" x 8 3/4", solid-state, with a speaker system including two 12" speakers. May be used for one instrument or a combination. Dual

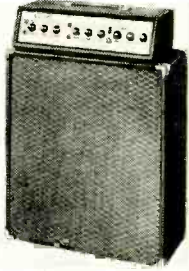

channels, each with 2 inputs. Normal channel has volume, treble and bass controls. Second channel has reverb and tremolo with separate intensity and rate controls. Signal-to-noise ratio: 60 dB below rated power output; input sensitivity: 40 mV for rated output; input impedance: 500,000 ohms. \$169.95 with case and speaker system.—Allied Radio Corp.

Circle 53 on reader service card

**SOLDER PRODUCTS.** Depend-a-Bond line of solders is designed for the novice for electrical work and for joining all types of metal surfaces. Comes in handy

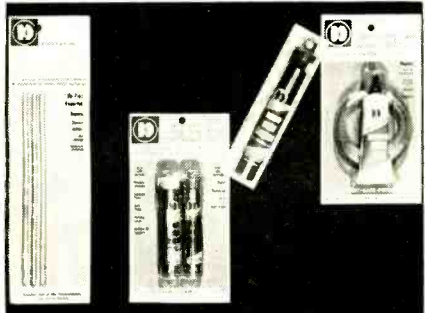

blister packs, individual cartoned spools and bars with easy-to-follow instructions and a comprehensive list of applications.—Alpha Metals Inc.

Circle 54 on reader service card

**BELL PA AMPLIFIER, MOD Series,** consists of 4 models for 20, 45, 90 and



200 watts. Solid-state, all have automatic output circuit protection (with indicator

# NUVI-TRAN

## tuner cleaner



New from  
**GC**...  
Quality Leader  
in Electronic  
Chemicals

CATALOG NO. 5555  
Suggested Net \$2.29

A new aerosol, specifically formulated for cleaning sensitive nuvistor and transistor tuners. NUVI-TRAN is non-conductive, non-toxic, will not induce drift or detune neutralizing circuit. Safe for all plastics used on TV tuners, NUVI-TRAN leaves no residue, works in seconds. NUVI-TRAN is an exclusive GC product... another quality reason for leadership in electronic chemicals for over 40 years.

Always insist on **GC**...

you'll get more for your money, every time!

**GC ELECTRONICS**

DIVISION OF HYDROMETALS, INC.

MAIN PLANT: ROCKFORD, ILL. U.S.A.

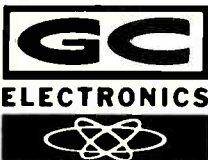

**Giant New FREE Catalog!**...

Only GC gives you everything in electronics... has for almost 40 years. Match every part and service need from over 10,000 quality items. Write for your copy today!

Circle 110 on reader service card

**GC**

has  
everything  
in  
**CHEMICALS**



**SPRA-LUBE**  
Cleaner-lubricant for  
all color TV tuners.  
Cat. No. 8888  
8-oz. Aerosol Can  
Suggested Net \$1.99



**DC-29 Silicone**  
Heat Sink Compound  
Cat. No. 8109-S  
1-oz. Tube  
Suggested Net \$2.83



**EPOXY GLUE**  
Super grip, fast set.  
NASA approved.  
Cat. No. 347  
2-Tube Kit  
Suggested Net \$2.50



# "Performance-Plus" Kits For Shop And

**NEW**  
kit IG-18  
**\$67<sup>50</sup>**

wired IGW-18  
**\$99<sup>50</sup>**

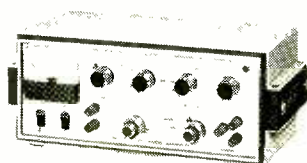

## HEATHKIT IG-18 Solid-State Sine-Square Wave Generator

A precision source of sine or square waves at a low kit price . . . that's the new solid-state IG-18 from Heath. Delivers 5% accuracy thru the wide range of 1 Hz to 100 kHz. The sine wave section features less than 0.1% distortion thru the audio range, 8 output voltage ranges from 0.003 to 10V, switch-selected internal 600 ohm load or external load and metered output of both voltage & dB. The square wave section has a 50 nS rise time and three output voltage ranges from 0.1 to 10 V P-P. Both sine & square waves are available simultaneously and the frequency is switch-selected for constant repeatability and fast operation. Circuit board construction makes the new IG-18 easy to build . . . new Heathkit styling and engineering excellence make it easy to use. Put the new IG-18 on your bench now. 10 lbs.

kit IM-18  
**\$28<sup>50</sup>**

wired IMW-18  
**\$47<sup>95</sup>**



## HEATHKIT IM-18 VTVM

The new Heathkit IM-18 continues the features that made the IM-11 famous . . . 7 AC and 7 DC voltage ranges that measure from 0-1500 volts full scale . . . 7 ohms ranges for measurements from 0.1 ohm to 1000 megohms . . . the convenience of a single probe . . . 11 megohm input impedance . . .  $\pm 1$  dB 25 Hz to 1 MHz response . . . precision 1% resistors . . . DC polarity reversing position on the function switch . . . RMS & P-P AC voltage and dB measurement capability . . . precision  $4\frac{1}{2}$ " 200 uA meter for extra sensitivity. In addition, the new IM-18 has 120 V. or 240 V. AC wiring options, new Heathkit styling and a 3-wire line cord for safety. 5 lbs.

## HEATHKIT IM-28 "Service Bench" VTVM

The new Heathkit IM-28 has the same performance specifications as the new IM-18 above, but it also has other features that put it in a class by itself, like a large, easy-to-read 6" meter . . . extra 1.5 & 5 volt AC ranges for additional accuracy . . . convenient gimbal mounting . . . "Set and Forget" calibration — all controls are adjustable from the front panel with a screwdriver . . . smooth ten-turn vernier control of Zero and Ohms Adjust for greater accuracy and easier setting . . . 120/240 VAC wiring options . . . safe 3-wire line cord. The new look of Heath instrumentation styling is evident too — handsome brown & beige color scheme, and new knobs that are easy to grip and fast to read. 7 lbs.

kit IM-28  
**\$36<sup>50</sup>**

wired IMW-28  
**\$56<sup>95</sup>**

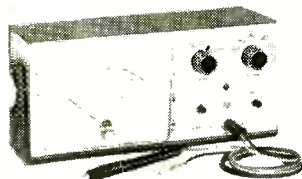

kit IM-38  
**\$39<sup>50</sup>**

wired IMW-38  
**\$54<sup>95</sup>**

## HEATHKIT IM-38 Laboratory AC VTVM

For all around general service work, audio design or laboratory analysis, there isn't a better value than the new Heathkit IM-38 AC VTVM. Here's why — 10 voltage ranges measure from 0.01 to 300 volts RMS full scale . . . extended frequency response of 10 Hz to 500 kHz at  $\pm 1$  dB . . . 10 megohm input on all ranges for higher accuracy . . . wide —52 to +52 dB range . . . VU-type ballistic meter damping . . . very low AC noise . . . 120 or 240 VAC wiring options and new Heathkit styling in sharp beige & brown with an easy-to-grasp, easy-to-read knob. 5 lbs.

kit IP-18  
**\$19<sup>95</sup>**

## HEATHKIT IP-18 1-15 VDC Power Supply

If you work with transistors, this is the power supply for you. All solid-state circuitry provides 1-15 VDC at up to 500 mA continuous. Features adjustable current limiting, voltage regulation, floating output for either + or — ground, AC or DC programming, circuit board construction, and small, compact size. 110 or 220 VAC. 5 lbs.

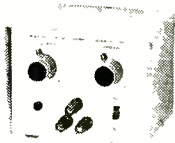

kit IT-18  
**\$24<sup>95</sup>**

## HEATHKIT IT-18 In-Circuit Transistor Tester

In-Circuit transistor testers don't have to be expensive, and the IT-18 is proof of that . . . tests DC Beta 2-1000, in or out-of-circuit . . . leakage  $I_{cbo}$  and  $I_{ceo}$  current 0-5000 uA out-of-circuit . . . identifies NPN or PNP devices . . . tests diodes in or out-of-circuit for opens & shorts . . . identifies unknown diode leads . . . matches PNP & NPN transistors. The IT-18 is completely portable — runs on just one "D" cell. Easy to use too . . . rugged polypropylene case, attached 3' test leads, big  $4\frac{1}{2}$ " 200 uA meter, all front panel controls, 10-turn calibrate control. 4 lbs.



kit IM-17  
**\$21<sup>95</sup>**

## HEATHKIT IM-17 Solid-State Volt-Ohm Meter

Another very popular volt-ohmmeter from Heathkit engineering and it's easy to see why — all solid-state circuitry . . . high impedance FET input, 11 megohms on DC, 1 megohm on AC . . . 4 AC voltage ranges . . . 4 DC voltage ranges . . . 4 ohm ranges . . .  $4\frac{1}{2}$ " 200 uA meter . . . 3 built-in test leads . . . DC polarity reversing switch . . . zero-adjust & ohms-adjust controls . . . continuous 12-position function switch. And that's not all — the IM-17 is battery powered for complete portability and comes in a rugged polypropylene case with built-in handle. Simple circuit board assembly. 4 lbs.

kit IO-18  
**\$84<sup>95</sup>**

wired IOW-18  
**\$139<sup>95</sup>**

## HEATHKIT IG-57 Solid-State Post Marker/Sweep Generator

The new IG-57 plus a 'scope is all you need . . . no external sweep generator required. Switch selection of any of 15 crystal-controlled marker frequencies (you can view up to six different frequencies on one 'scope trace). Select the sweep range and you are ready to instantly see the results of any changes you make. Four markers for setting color bandpass, one for TV sound, eight at 1F frequencies between 39.75 & 47.25 MHz plus picture and sound carrier markers for channels 4 & 10. Three sweep oscillators produce the 5 most-used ranges . . . color bandpass, FM IF, color & B&W IF and VHF channels 4 & 10. Save hundreds of dollars and put full alignment facilities in your shop too — order your IG-57 now. 14 lbs. Kit IG-14, same as IG-57 w/o the sweep, 11 lbs. \$99.95.

## HEATHKIT IO-18 Wide-Band 5" 'Scope

The New Heathkit IO-18 is destined to be the world's most popular 'scope, just as its predecessor, the IO-12 was. Features 5 MHz bandwidth, the famous Heath patented sweep circuit — 10 Hz to 500 kHz in 5 ranges, two extra sweep positions which can be preset to often-used rates, frequency compensated vertical attenuation, built-in P-P calibration reference, Z-axis input, retrace blanking, wiring options for 120 or 240 VAC operation and new Heathkit styling in beige and brown. 24 lbs.

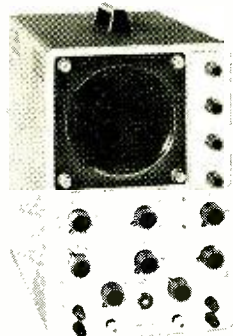

kit IG-57  
**\$135<sup>00</sup>**

wired IGW-57  
**\$199<sup>00</sup>**

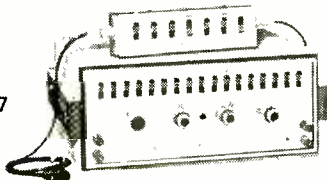

# Home... From The Leader



Now There are 4 Heathkit Color TV's...  
All With 2-Year Picture Tube Warranty

## NEW Deluxe "681" Color TV With Automatic Fine Tuning

The new Heathkit GR-681 is the most advanced color TV on the market. A strong claim, but easy to prove. Compare the "681" against every other TV — there isn't one available for any price that has all these features. Automatic Fine Tuning on all 83 channels... just push a button and the factory assembled solid-state circuit takes over to automatically tune the best color picture in the industry. Push another front-panel button and the VHF channel selector rotates until you reach the desired station, automatically. Built-in cable-type remote control that allows you to turn the "681" on and off and change VHF channels without moving from your chair. Or add the optional GRA-681-6 Wireless Remote Control described below. A bridge-type low voltage power supply for superior regulation; high & low AC taps are provided to insure that the picture transmitted exactly fits the "681" screen. Automatic degaussing, 2-speed transistor UHF tuner, hi-fi sound output, two VHF antenna inputs... plus the built-in self-servicing aids that are standard on all Heathkit color TV's but can't be bought on any other set for any price... plus all the features of the famous "295" below. Compare the "681" against the others... and be convinced.

**GRA-295-4**, Mediterranean cabinet shown... \$119.50  
Other cabinets from \$62.95

## Deluxe "295" Color TV... Model GR-295

Big, Bold, Beautiful... and packed with features. Top quality American brand color tube with 295 sq. in. viewing area... new improved phosphors and low voltage supply with boosted B+ for brighter, livelier color... automatic degaussing... exclusive Heath Magna-Shield... Automatic Color Control & Automatic Gain Control for color purity, and flutter-free pictures under all conditions... preassembled IF strip with 3 stages instead of the usual two... deluxe VHF tuner with "memory" fine tuning... three-way installation — wall, custom or any of the beautiful Heath factory assembled cabinets. Add to that the unique Heathkit self-servicing features like the built-in dot generator and full color photos in the comprehensive manual that let you set-up, converge and maintain the best color picture at all times, and can save you up to \$200 over the life of your set in service calls. For the best color picture around, order your "295" now.

**GRA-295-1**, Walnut cabinet shown... \$62.95  
Other cabinets from \$99.95

## Deluxe "227" Color TV... Model GR-227

Has same high performance features and built-in servicing facilities as the GR-295, except for 227 sq. inch viewing area. The vertical swing-out chassis makes for fast, easy servicing and installation. The dynamic convergence control board can be placed so that it is easily accessible anytime you wish to "touch-up" the picture.

**GRA-227-1**, Walnut cabinet shown... \$59.95  
Mediterranean style also available at \$99.50

## Deluxe "180" Color TV... Model GR-180

Same high performance features and exclusive self-servicing facilities as the GR-295 except for 180 sq. inch viewing area. Feature for feature the Heathkit "180" is your best buy in deluxe color TV viewing... tubes alone list for over \$245. For extra savings, extra beauty and convenience, add the table model cabinet and mobile cart.

**GRS-180-5**, table model cabinet and cart... \$39.95  
Other cabinets from \$24.95

## Now, Wireless Remote Control For Heathkit Color TV's

Control your Heathkit Color TV from your easy chair, turn it on and off, change VHF channels, volume, color and tint, all by sonic remote control. No cables cluttering the room... the handheld transmitter is all electronic, powered by a small 9 v. battery, housed in a small, smartly styled beige plastic case. The receiver contains an integrated circuit and a meter for adjustment ease. Installation is easy even in older Heathkit color TV's thanks to circuit board wiring harness construction. For greater TV enjoyment, order yours now.

**kit GRA-681-6**, 7 lbs., for Heathkit GR-681 Color TV's... \$59.95

**kit GRA-295-6**, 9 lbs., for Heathkit GR-295 & GR-25 TV's... \$69.95

**kit GRA-227-6**, 9 lbs., for Heathkit GR-227 & GR-180 TV's... \$69.95

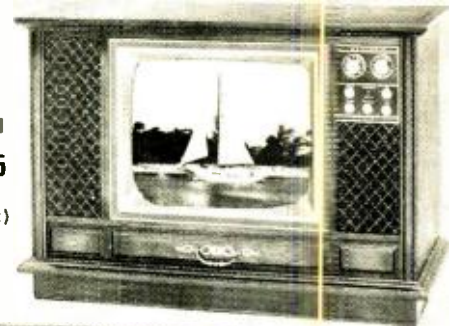

kit GR-681

**\$499<sup>95</sup>**

(less cabinet)



kit GR-295

now only

**\$449<sup>95</sup>**

(less cabinet)



kit GR-227

now only

**\$399<sup>95</sup>**

(less cabinet)



kit GR-180

now only

**\$349<sup>95</sup>**

(less cabinet)



New Wireless TV Remote Control For GR-295, GR-227 & GR-180

**\$69<sup>95</sup>**

New Wireless TV Remote Control For GR-681

**\$59<sup>95</sup>**



### NEW

### FREE 1969 CATALOG!

Now with more kits, more color. Fully describes these along with over 300 kits for stereo/hi-fi, color TV, electronic organs, electric guitar & amplifier, amateur radio, marine, educational, CB, home & hobby. Mail coupon or write Heath Company, Benton Harbor, Michigan 49022.

HEATH COMPANY, Dept. 20-1  
Benton Harbor, Michigan 49022  
In Canada, Daystrom Ltd.

Enclosed is \$\_\_\_\_\_ plus shipping.

Please send model (s)  
 Please send FREE Heathkit Catalog.  
 Please send Credit Application.

Name \_\_\_\_\_

Address \_\_\_\_\_

City \_\_\_\_\_

State \_\_\_\_\_

P \_\_\_\_\_

CL-351

Prices & specifications subject to change without notice

# Build this exciting Schober Console Organ for only \$925!\*



\*Includes finished walnut console. (Only \$716 if you build your own console.) Amplifier, speaker system, optional accessories extra.

You couldn't touch an organ like this in a store for less than \$1800—and there never has been an organ of the Console II's graceful small size with 22 such pipelike, versatile voices, five-octave big-organ keyboards, and 17 pedals! It sings and schmaltzes for standards, pops, old-time favorites, speaks with authority for hymns and the lighter classics, all with a range of variety and satisfying authenticity you've never found before in an instrument under church or theatre size. If you've dreamed of an organ of your own, to make your own beautiful music, even if your home or budget is limited, you'll get more joy from a Schober Console II than any other "home size" organ—kit or no kit.

You can learn to play it. And you can build it, from Schober Kits, world famous for ease of assembly without the slightest knowledge of electronics or music, for design and parts quality from the ground up, and—above all—for the best praise from musicians everywhere.

right now for the full-color Schober catalog, giving specifications of all five Schober Organs, beginning at \$599.50. No charge, no tax. If you like music, you owe yourself a Schober Organ!

**Her Organ Corp., Dept. RE-62**  
 143 West 14th Street, New York, N.Y. 10023  
 Enclose Schober Organ Catalog and "Sample" record.  
 Enclose \$1.00 for 12-inch L.P. Organ music.  
 NAME \_\_\_\_\_  
 ADDRESS \_\_\_\_\_  
 CITY \_\_\_\_\_  
 STATE \_\_\_\_\_  
 ZIP \_\_\_\_\_

Circle 115 on Reader Service Card

## NEW LITERATURE

All booklets, catalogs, charts, data sheets and other literature listed here with a Reader Service number are free for the asking. Turn to the Reader Service Card facing page 78 and circle the numbers of the items you want. Then detach and mail the card. No postage required!

**1969 CONSOLE HANDBOOK.** "At Home with Stereo." 20 pages, fully illustrates the new line of Scott stereo consoles in decorator-styled room settings. Included are many informative features on hi fi, choosing the correct model for individual room decor and complete explanations in non-technical terms.—**H. H. Scott Inc.**

Circle 59 on reader service card

**PRECISION TOOLS** for electronics, telecommunications and industry are illustrated in detailed drawings with dimensions and specifications in *Catalog No. 200A*, 24 pages. Over 500 various spring adjusters, gauges, burnishers and miscellaneous hand tools are described. A convenient metric-to-inches conversion chart included.—**Jonard Industries Corp.**

Circle 60 on reader service card

**PRECISION VOLTMETERS**, 16 pages with 18 questions and answers on voltage measurement as well as the difference between digital and differential voltmeters, speed of measurement, the relationship between accuracy and resolution, ac measurements and specmanship.—**John Fluke Mfg. Co.**

Circle 61 on reader service card

**ANTENNAS AND PREAMPLIFIERS.** *Form Nos. 836 and 913* describe antennas in the *Channel-Spinner Series*, 82 channels, uhf/vhf/FM, for suburban to medium fringe areas. *Form 928* features the *Colorstar Series*, for color TV in the medium and extreme fringe areas. Specs and price list of five models of *Level-line* preamplifiers are available in a 1-page catalog.—**Antennacraft Co.**

Circle 62 on reader service card

**SPEAKER SYSTEMS** of exceptionally smooth overall frequency response and very low bass distortion are featured in 4-page *Form No. HK-033-C*. Two models: *HK-40*, 50 watts with impedance of 4 ohms, and *HK-20*, 35 watts, 8 ohms. Dimensions and prices are listed.—**Harman-Kardon**

Circle 63 on reader service card

**HI-FI EQUIPMENT** designed to produce the finest sound reproduction are featured with specs in a 4-page short-form catalog. Stereo power amplifiers from 70-200 watts include *Models 35D, 80 MRM, 35 MRM and 911* as well as preamp *Models CC-1, CC-2 and CC-50S*.—**C/M Laboratories**

Circle 64 on reader service card

**TV-FM ANTENNAS** to fit any requirements in any geographical location, from fringe to urban, with special emphasis on full-frequency focus are described with color diagrams in 12-page brochure *A-100-813*. Construction and component parts are briefly outlined and illustrated. Prices listed.—**Sylvania Electronic Products Inc.**

Circle 65 on reader service card

Write direct to the manufacturers for information on items listed below:

**1969 CATALOG, FR-69**, 304 pages, a buyers guide of all major GC products, lists a complete selection of electronic components, test leads, chemicals, tools, TV hardware, antennas etc. Numerical and alphabetical indexes provide easy reference.—**GC Electronics**, 400 S. Wyman St, Rockford, Ill. 61101 **R-E**

88 RADIO-ELECTRONICS

## There's no substitute for SUCCESS...



JAMES WONG—Research Engineer  
Heald Engineering College Graduate

## or IN-CLASS INSTRUCTION!

In electronics, it's the training that makes the difference. Employers require well-trained men and the first thing checked is where you gained your knowledge.

**HEALD GRADUATES** have many job offers with starting salaries often in excess of \$10,000 per year. AND advancement is rapid.

GET STARTED NOW. Be a

DRAFTSMAN—12 months  
TECHNICIAN—15 months  
ENGINEER (B.S. Deg.)—36 months  
ARCHITECT (B.S. Deg.)—42 months

YOU are eligible for **HEALD ENGINEERING COLLEGE** if you have a high school education or the equivalent.

Increased income starts with success—success starts with your move to Heald. Send now for FREE brochures with more information on Heald in San Francisco and your future in Engineering.

FREE LIFETIME PLACEMENT SERVICE  
VETERAN APPROVED



WRITE TODAY FOR DETAILS

## HEALD Engineering College

1215 Van Ness Ave., San Francisco, California 94109

Please send me information about:

- ARCHITECTURE   
 ENGINEERING: Civil  Electrical   
                   Electronic  Mechanical   
 TECHNOLOGY: Electronic Engineering  
                   Technician (FCC)   
                   Radio-Television Technician (FCC)   
 DRAFTING: Mechanical  Electrical   
                   Structural

I am interested in Day  Evening  courses  
Also send an application.

NAME \_\_\_\_\_ AGE \_\_\_\_\_  
 ADDRESS \_\_\_\_\_  
 CITY \_\_\_\_\_  
 STATE \_\_\_\_\_  
 ZIP \_\_\_\_\_ PHONE \_\_\_\_\_

Circle 116 on reader service card



# FREE

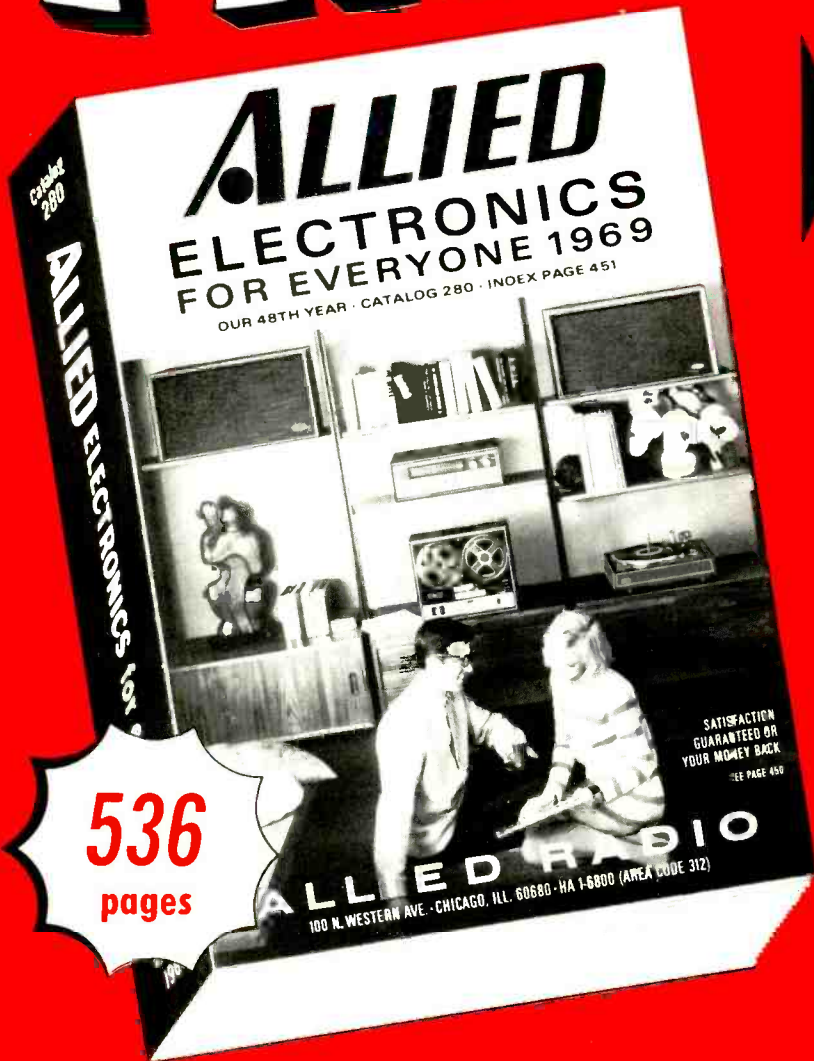

## New 1969 Allied Catalog

Brand new! Fresh off the press! Allied's 1969 Catalog... 536 fascinating pages jam-packed with the very latest in Hi Fi, Tape Recorders, CB, Kits, Radios, Tools, Electronic Parts, Books. Probably nowhere else on earth will you find such a complete selection of everything in electronics... and virtually all new as tomorrow! Literally thousands of items... many of them never shown before. Allied's all new 1969 Catalog makes wonderful reading... and it's yours absolutely FREE! Tear off the card... mail it in today... and we'll rush you your own personal copy of the newest and most complete book of what's new in electronics... Allied's 1969 Catalog!

**NO MONEY DOWN—24 MONTHS TO PAY!**  
**Low Monthly Payments to fit your budget.**

**DO A FRIEND A FAVOR—give him this card to send for his FREE ALLIED CATALOG**

*fill this card out!*

048

PLEASE PRINT

NAME

First

Middle

Last

ADDRESS

CITY

STATE

ZIP

**MAIL IT NOW!**

*free!*  
**ALLIED**  
**1969**  
**CATALOG**

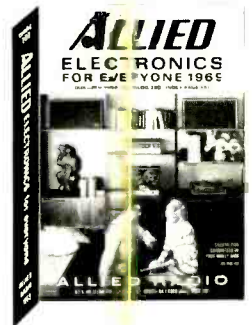

WORLD'S LARGEST SELECTIONS. SATISFACTION  
 GUARANTEED OR YOUR MONEY BACK

*fill this card out!*

049

PLEASE PRINT

NAME

First

Middle

Last

ADDRESS

CITY

STATE

ZIP

**MAIL IT NOW!**

*free!*  
**ALLIED**  
**1969**  
**CATALOG**

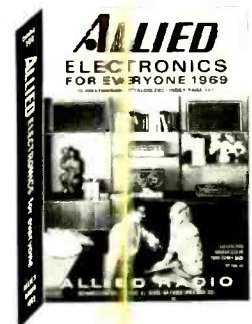

WORLD'S LARGEST SELECTIONS. SATISFACTION  
 GUARANTEED OR YOUR MONEY BACK

# FREE

## 1969 ALLIED CATALOG

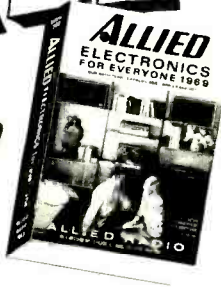

TO:  
**ALLIED RADIO**  
P.O. BOX 4398  
CHICAGO, ILLINOIS 60680

PLACE  
STAMP  
HERE



## Why Buy by Mail from **ALLIED?**

Because you buy from the  
most unique store in the world!

**Why do hundreds of thousands of people...** electronics experimenters, music lovers, engineers, Amateur operators, professional radio-TV servicemen, kit builders, hobbyists, hi-fi fans, and just plain "bargain-hunters"... *order tens of millions of dollars* worth of merchandise-by-mail from ALLIED each year?

**Variety, selection, price, and quality-testing** are the answers! If we can satisfy the experts...we can satisfy you! Our continuous program of quality-testing assures you that everything you buy meets the highest standards. And nowhere else on the face of the earth are so many famous brands (and so many different models of every brand), gathered together to choose from. When it comes to *parts* that both beginners and experts need...ALLIED is the one source that has them *all*.

**Thousands and thousands of items to choose from...** and you'll like shopping from ALLIED because you do it in your easy chair. Our entire stock is spread before you, as it could never be in a conventional store. It takes ALLIED over 500,000 square feet of floor-space (with merchandise stacked to the ceiling!), to keep on hand all the items you hold in *one hand* when you pick up an ALLIED catalog.

**You never had shopping so good,** as when you do it at home with this famous book to guide you. No clerk, no expert, no salesman in all the world could begin to supply you with the wealth of facts, the exact specifications, the comparable data—all at your fingertips in this popular book. Almost anything you may want or need or have an interest in...is pictured, priced, and described in detail. You'll discover things you never knew existed. You'll find bargains unmatched anywhere else you may shop. You'll revel in choices, varieties, and selections beyond imagination. You'll find a whole new way to buy both the commonplace and the rare, the inexpensive and the luxurious.

**Best of all**—with an ALLIED Credit Fund Account, you pay no money down, and take up to 2 years to pay!

## Shop Where the Experts Buy— Choose from the Biggest and Most Fabulous Selection Ever Gathered Together:

- |                             |                           |                        |
|-----------------------------|---------------------------|------------------------|
| STEREO HI-FI                | FM, AM & VHF<br>RADIOS    | TOOLS &<br>HARDWARE    |
| ELECTRONIC<br>& HOBBY KITS  | PORTABLE<br>TV SETS       | BOOKS                  |
| TAPE RECORDERS<br>AND TAPES | AMATEUR GEAR              | CAMERAS                |
| CITIZENS BAND<br>EQUIPMENT  | INTERCOMS                 | NEEDLES                |
| WALKIE-TALKIES              | P.A. EQUIPMENT            | HEADPHONES             |
| SHORTWAVE<br>RECEIVERS      | TEST EQUIPMENT            | MICROPHONES            |
| PHONOGRAPHS                 | ANTENNAS                  | INTEGRATED<br>CIRCUITS |
| SPEAKERS                    | TUBES AND<br>TRANSISTORS  | WIRE &<br>CABLE        |
| RECORD CHANGERS             | AUTOMOTIVE<br>ELECTRONICS | PARTS AND<br>BATTERIES |

# FREE

## 1969 ALLIED CATALOG

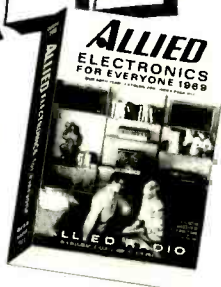

TO:  
**ALLIED RADIO**  
P.O. BOX 4398  
CHICAGO, ILLINOIS 60680

PLACE  
STAMP  
HERE

# TECHNOTE

## DYNACO SCA-35 AMPLIFIER

For owners who want some high-frequency boost along with the bass boost provided by the loudness switch, I suggest they try the following modification adapted from the Scott model 299.

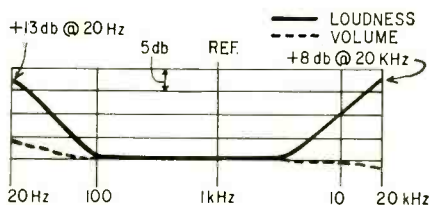
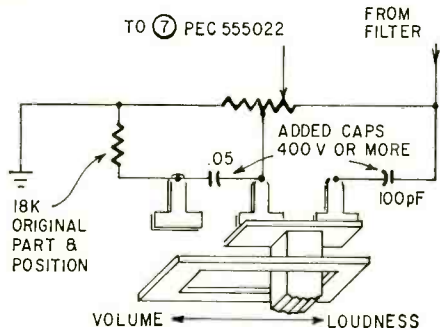

The dpdt VOLUME-LOUDNESS has one unused leg in each channel. The diagram (one channel) shows how capacitors are added. I feel that the modification more closely compensates for normal losses at low volume levels. The graph shows the circuit response. There is a slight rise (3 to 5 dB) at 20 Hz with the switch in the volume position. —Joseph A. Kaufman

R-E

## IDEAL GIFT

(HAND-SIZED)

# Gas Welding Torch

5000° Pinpoint Flame Welds, Brazes, Solders

(Self Contained. No wires or connections needed.)



Ideal for workshop, electrical/ electronic repair, labwork, miniature gasblowing, wiring, jewelry making.

FREE LITERATURE

## MICROFLAME, INC.

Division of Printed Circuits, Inc.  
7800 Computer Avenue, Dept. 000  
Minneapolis, Minnesota 55424  
Area 612 - 927-5681

Circle 117 on reader's service card

# EIGHT INSTRUMENTS IN ONE

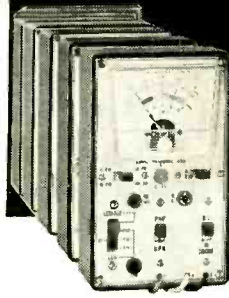

- Out-of-Circuit Transistor Analyzer
- Dynamic In-Circuit Transistor & Radio Tester
- Signal Generator
- Signal Tracer • Voltmeter
- Milliammeter
- Battery Tester
- Diode Checker

## Transistor Analyzer Model 212

Factory Wired & Tested — \$19.50  
Easy-to-Assemble Kit — \$13.50

YOU DON'T NEED A BENCH FULL OF EQUIPMENT TO TEST TRANSISTOR RADIOS! All the facilities you need to check the transistors themselves — and the radios or other circuits in which they are used — have been ingeniously engineered into the compact, 6-inch high case of the Model 212. It's the transistor radio troubleshooter with all the features found only in more expensive units. Find defective transistors and circuit troubles speedily with a single, streamlined instrument instead of an elaborate hook-up.

### Features:

Checks all transistor types — high or low power. Checks DC current gain (beta) to 200 in 3 ranges. Checks leakage. Universal test socket accepts different base configurations. Identifies unknown transistors as NPN or PNP.

Dynamic test for all transistors as signal amplifiers (oscillator check), in or out of circuit. Develops test signal for AF, IF, or RF circuits. Signal traces all circuits. Checks condition of diodes. Measures battery or other transistor-circuit power-supply voltages on 12-volt scale. No external power source needed. Measures circuit drain or other DC currents to 80 milliamperes. Supplied with three external leads for in-circuit testing and a pair of test leads for measuring voltage and current. Comes complete with instruction manual and transistor listing.

EMC, 625 Broadway, New York 12 N. Y.

Send me FREE catalog of the complete value-packed EMC line, and name of local distributor.

NAME \_\_\_\_\_ RE-1

ADDRESS \_\_\_\_\_

CITY \_\_\_\_\_ ZONE \_\_\_\_\_ STATE \_\_\_\_\_

# EMC

ELECTRONIC MEASUREMENTS CORP.  
625 Broadway, New York 12, New York  
Export: Pan-Mar Corp., 1270 Broadway, N.Y. 1

# FREE

## GIANT 1969 RADIO-TV ELECTRONICS CATALOG

228 GIANT VALUE-PACKED PAGES



YOUR BUYING GUIDE FOR . . . TV's, Radios, Recorders, Phonos, Amateur and CB equipment, electronic parts, tubes and test equipment . . . plus featuring B-A's famous bargain packed section!

WRITE FOR YOUR FREE CATALOG TODAY!

BURSTEIN-APPLEBEE CO., Dept. RE-A  
3199 MERCIER ST., KANSAS CITY, MO. 64111

Name \_\_\_\_\_

Address \_\_\_\_\_

City \_\_\_\_\_

State \_\_\_\_\_ Zip Code \_\_\_\_\_

Circle 119 on reader's service card

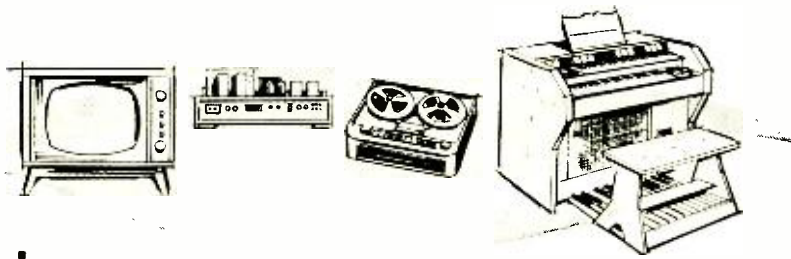

give your  
**COLOR-TV &  
 HI-FI STEREO**  
 heat problems  
 the **AIR**



only  
**\$14.85**  
 complete

install a DELWYN

*Whisper Fan*<sup>®</sup>

Everyday, everywhere, fans are at work cooling billions of dollars worth of electronic equipment in computers, missile and airborne electronics. Now, you can have this same kind of proven protection in your home electronic equipment. You need never miss your favorite TV program or the music you want because of heat-caused part failures.

Quickly and easily installed, no extra hardware needed, the Delwyn Whisper Fan keeps a steady stream of fresh cool air circulating over all heat generating components.

Use a Delwyn Whisper Fan in your Color-TV, Hi-Fi Stereo, electronic organ, tape recorder and other home electronic equipment. Guard against costly repair bills — add years of service-free life to your home entertainment equipment.

See your local dealer for a convincing demonstration. The Delwyn Whisper Fan is aerodynamically designed by Rotron, the world's leading supplier of cooling devices for electronic equipment.



Box 195 B, Route 28  
 Kingston, New York 12401

Circle 120 on reader's service card

# Service Clinic

By JACK DARR  
 SERVICE EDITOR

## Drive "Slipping", CTC5 Color TV

*In an RCA CTC5 color TV chassis, I get about 18 KV when the set is turned on. After about 2 minutes, my grid drive, on the 6CB5 horizontal output tube, is -34 volts, after 5 minutes it's down to -28, and about 10 minutes later, it's zero and the 6CB5 plates are red-hot.*

*Another technician has replaced almost everything on the output side of the 6CB5 trying to fix this. The wave-*

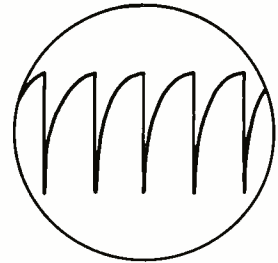

A

*form on the 6CB5 grid looks at first like (a), then in 5 minutes like (b) and then like (c). What do you think this is?—R. B., Los Angeles, Calif.*

This looks more like horizontal oscillator trouble! You can see from the flattening of the drive waveform that something is happening in that grid circuit. Several possibilities: First, check out that horizontal oscillator all the way

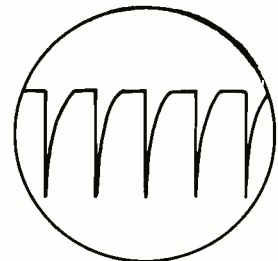

B

through. To make sure, you could kill the oscillator, and substitute a drive signal from a working TV set, feeding it directly to the 6CB5 grid through a small blocking capacitor. (Many 90° and 110° black-and-white sets have high grid-drive voltages, and will give you plenty of drive—at least enough to help you decide whether this is a drive problem or something else.)

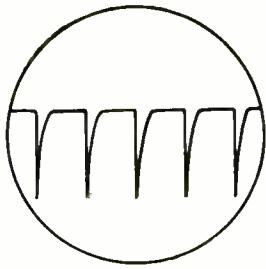

C

The trouble might be gas or grid emission in the 6CB5 itself, or a slight leakage in one of the capacitors in the grid circuit, or a drifting resistor. Note the flattening of the tops of the wave; this means that something is not letting this signal reach normal peak amplitude.

### Floating Bar in Raster and Picture

We have several sets, mostly color, and the same problem shows up on all of them. It's a light-colored horizontal bar, wider than a blanking bar, that floats slowly up the screen without seeming to affect the picture. Colors seem to shift slightly as the bar goes past them. Since these are all in the same building, it may be something in the wiring. What do you think?—R. F., Baltimore, Md.

I have a deep suspicion, although you didn't mention it, that these sets are all on a master antenna system! If so, and the symptom is common to all of them, I'd go through some of the line and distribution amplifiers and look for one with a very poor power supply filter!

This has happened in several instances on community antenna systems, and the cure is the same: better filtering in the broad-band rf line amplifiers. Hum here will cause the B+ voltage on the tubes to change at a 120-cycle rate and give you a sort of AM on the rf signal. Some of the smaller amplifiers use resistors in the B+ instead of a choke. Replacing them with a small choke seems to stop the bars every time. (You can tell which amplifier to check first by checking to see which sets in the building are affected and following the signal distribution lines back toward the amplifiers and antennas.) R-E

This column is for your service problems—TV, radio, audio or general and industrial electronics. We answer all questions individually by mail, free of charge, and the more interesting ones will be printed here.

If you're really stuck, write us. We'll do our best to help you. Don't forget to enclose a stamped, self-addressed envelope. Write: Service Editor, Radio-Electronics, 200 Park Ave. South, New York 10003.

**FAR SUPERIOR TO ANY VTVM OR VOM**

**--and for less money**

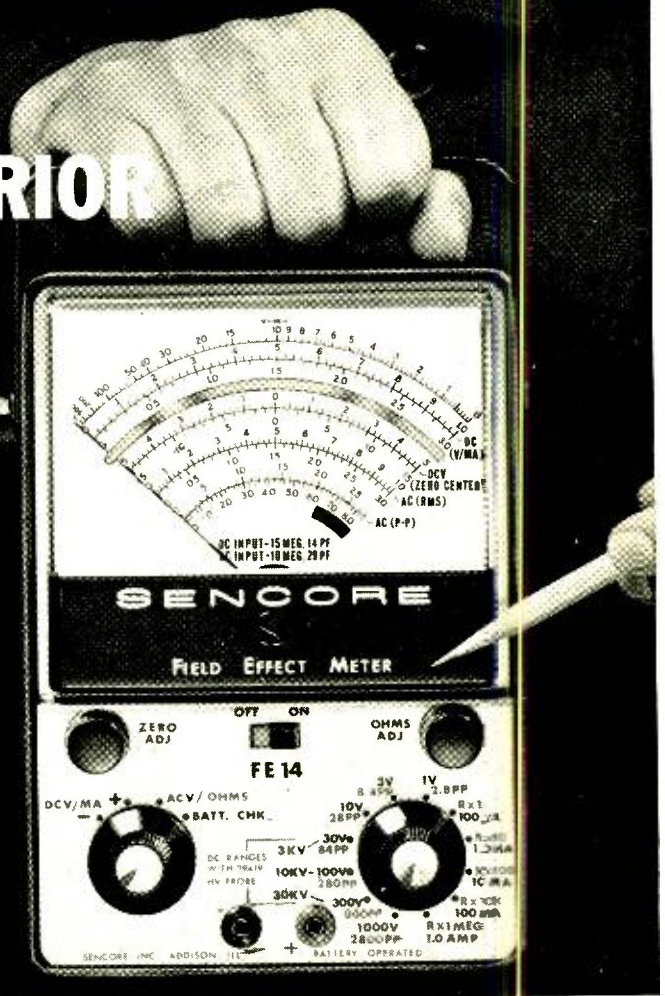

## NEW FIELD EFFECT MULTIMETER

Here is the revolutionary new approach to circuit testing, the solid state Sencore FIELD EFFECT METER. This FE14 combines the advantages of a VTVM and the portability and versatility of a VOM into a single low-cost instrument. This is all made possible by the use of the new space age field effect transistor that is instant in action but operates like a vacuum tube in loading characteristics. Compare the features of the FIELD EFFECT METER to your VTVM or VOM.

Minimum circuit loading — 15 megohm input impedance on DC is better than a VTVM and up to 750 times better than a 20,000 ohm per volt VOM — 10 megohm input impedance on AC is 20 times better than a standard VTVM. The FIELD EFFECT METER is constant on all ranges, not like a VOM that changes loading with each range.

Seven AC peak-to-peak ranges with frequency response to 10MHz. Seven zero center scales down to 0.5 volt. Five ohmeter ranges to 1000 megohms. DC current measurements to 1 ampere. Full meter and circuit protection. Mirrored scale. Low current drain on batteries — less than 2 milliamps. Built-in battery check. Unbreakable all-steel vinyl clad case. Optional Hi-Voltage probe adds 3KV, 10KV and 30KV ranges with minimum circuit loading for greatest accuracy in the industry... \$9.95.

**Only Sencore offers the FIELD EFFECT METER. Ask for it by name at your distributor.**

**only \$69.95 (less batteries)**



**SENCORE**

NO. 1 MANUFACTURER OF ELECTRONIC MAINTENANCE EQUIPMENT

426 SOUTH WESTGATE DRIVE, ADDISON, ILLINOIS 60101

Circle 121 on reader's service card



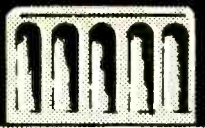

More and More Servicemen Say:  
 "We've tried cheaper substitutes . . . now  
 WE'RE BACK TO  
 DEPENDABLE, RELIABLE  
**"NO NOISE"**

World's No. 1 TRUSTED NAME BRAND

- VOLUME CONTROL & CONTACT RESTORER
- TUNER-TONIC with PERMA-FILM
- EC-44 FOR ELECTRICAL CONTACTS
- TAPE-RECO HEAD CLEANER
- FRIGID-AIR CIRCUIT COOLER

All Guaranteed Non-Flammable, No Carbon Tet, Non-Toxic, Non-Drift Tuner Cleaner And Guaranteed Not To Affect Plastics.

The Only Brand Perfect For Color TV and Black & White

FREE extender assembly for pin-point application supplied with ALL NO-NOISE PRODUCTS.

**Electronic Chemical Corp.**

813 Communipaw Ave. / Jersey City, N. J. 07304

Circle 122 on reader's service card

## NEW TUBES AND SEMICONDUCTORS

### IC POWER AMPLIFIER

Designed for power amplifier applications from dc to 30 kHz, the NS7634 can be used either as a single-ended class-A amplifier or, by using a pair, in class-B service. It uses thick-film resistors and silicon transistors on a ceramic substrate and is mounted on an integral heat sink. Over 3 watts of audio can be obtained in class-A operation and up to 15 watts per pair in class B.

The schematic and basing diagrams and the circuit of a 2-watt amplifier are shown. For 2 watts, the output supply voltage is 24, and the primary impedance of the power transformer is 120 ohms. Typical characteristics are: Output current 300 mA, bias supply current (current to input stages) 5 mA, input resistance 10,000 ohms, transconductance 0.5 mhos, input voltage for maximum output swing 0.35 V rms, frequency response (power output 3 dB down) 35 kHz.

Full specifications and application notes can be obtained from National Semiconductor Corp., Santa Clara, Calif.

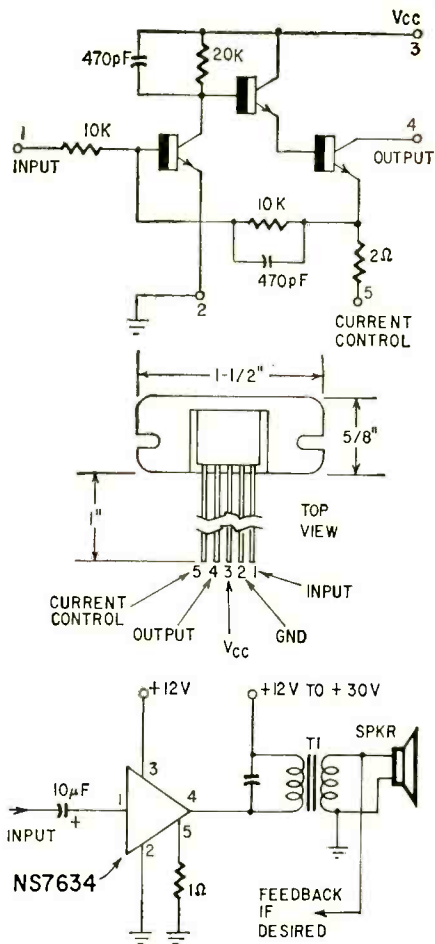

# CALLING ALL SMART BUYERS

FREE \$1 BUY WITH EVERY 10 YOU ORDER Only applies to "\$1" Buys FREE GIFT WITH EVERY ORDER

- |                                                                                                                                                                                                                                                                                                                                                                                                                                                                                                                                                                                                                                                                                                                                                                                                                                                                                                                                                                                                                                                                                                                                                                                                                                                                                                                                                                                                                                                          |                                                                                                                                                                                                                                                                                                                                                                                                                                                                                                                                                                                                                                                                                                                                                                                                                                                                                                                                                                                                                                                                                                                                                                                                                                                                                                                                                                                          |                                                                                                                                                                                                                                                                                                                                                                                                                                                                                                                                                                                                                                                                                                                                                                                                                                                                                                                                                                                                                                                                                                                                                                                                                                                                                                                                                                                                                                                                                                                                      |                                                                                                                                                                                                                                                                                                                                                                                                                                                                                                                                                                                                                                                                                                                                                                                                                                                                                                                                                                                                                                                                                                                                                                                                                                                                                                                                                                                                                                                  |
|----------------------------------------------------------------------------------------------------------------------------------------------------------------------------------------------------------------------------------------------------------------------------------------------------------------------------------------------------------------------------------------------------------------------------------------------------------------------------------------------------------------------------------------------------------------------------------------------------------------------------------------------------------------------------------------------------------------------------------------------------------------------------------------------------------------------------------------------------------------------------------------------------------------------------------------------------------------------------------------------------------------------------------------------------------------------------------------------------------------------------------------------------------------------------------------------------------------------------------------------------------------------------------------------------------------------------------------------------------------------------------------------------------------------------------------------------------|------------------------------------------------------------------------------------------------------------------------------------------------------------------------------------------------------------------------------------------------------------------------------------------------------------------------------------------------------------------------------------------------------------------------------------------------------------------------------------------------------------------------------------------------------------------------------------------------------------------------------------------------------------------------------------------------------------------------------------------------------------------------------------------------------------------------------------------------------------------------------------------------------------------------------------------------------------------------------------------------------------------------------------------------------------------------------------------------------------------------------------------------------------------------------------------------------------------------------------------------------------------------------------------------------------------------------------------------------------------------------------------|--------------------------------------------------------------------------------------------------------------------------------------------------------------------------------------------------------------------------------------------------------------------------------------------------------------------------------------------------------------------------------------------------------------------------------------------------------------------------------------------------------------------------------------------------------------------------------------------------------------------------------------------------------------------------------------------------------------------------------------------------------------------------------------------------------------------------------------------------------------------------------------------------------------------------------------------------------------------------------------------------------------------------------------------------------------------------------------------------------------------------------------------------------------------------------------------------------------------------------------------------------------------------------------------------------------------------------------------------------------------------------------------------------------------------------------------------------------------------------------------------------------------------------------|--------------------------------------------------------------------------------------------------------------------------------------------------------------------------------------------------------------------------------------------------------------------------------------------------------------------------------------------------------------------------------------------------------------------------------------------------------------------------------------------------------------------------------------------------------------------------------------------------------------------------------------------------------------------------------------------------------------------------------------------------------------------------------------------------------------------------------------------------------------------------------------------------------------------------------------------------------------------------------------------------------------------------------------------------------------------------------------------------------------------------------------------------------------------------------------------------------------------------------------------------------------------------------------------------------------------------------------------------------------------------------------------------------------------------------------------------|
| <ul style="list-style-type: none"> <li><input type="checkbox"/> AMPLIFIER 110v AC-DC, 5 Watt<br/>Wired — Phono, Comb, Intercom,<br/>etc. needs 3-12AX7, 2-50L6-as is \$3</li> <li><input type="checkbox"/> NYLON PRINTED CIRCUIT TOOL<br/>For Lead Bending &amp; Dressing, will<br/>not scratch Boards . . . . . \$1</li> <li><input type="checkbox"/> 50 — ASST. DISC CERAMIC<br/>CONDENSERS popular numbers . . \$1</li> <li><input type="checkbox"/> 100 — ASST. MICA CONDEN-<br/>SERS some in 5% . . . . . \$1</li> <li><input type="checkbox"/> 2 — POWER TRANSISTORS Re-<br/>place 2N155, 2N176, 2N301, etc. \$1</li> <li><input type="checkbox"/> HYTRON POWER TRANSISTOR<br/>H.V. replaces 15501, 2N173, etc. \$1</li> <li><input type="checkbox"/> 10 — SPEAKER PLUG SETS<br/>defuse type, 2 conductor . . . . \$1</li> <li><input type="checkbox"/> 10 SETS — DELUXE PLUGS &amp;<br/>JACKS asst. for many purposes . \$1</li> <li><input type="checkbox"/> 10 — SETS PHONO PLUGS &amp;<br/>PIN JACKS RCA type . . . . . \$1</li> <li><input type="checkbox"/> 10 — SURE-GRIP ALLIGATOR<br/>CLIPS 2" plated . . . . . \$1</li> <li><input type="checkbox"/> 50 — ASSORTED PRINTED CIR-<br/>CUIT SOCKETS best types . . . . \$1</li> <li><input type="checkbox"/> 100 — STRIPS ASSORTED SPA-<br/>GHETTI handy sizes . . . . . \$1</li> <li><input type="checkbox"/> UNIVERSAL 4" PM SPEAKER 79¢<br/>Alnico 5 magnet, quality tone . .</li> </ul> | <ul style="list-style-type: none"> <li><input type="checkbox"/> 100—ASST ¼ WATT RESISTORS<br/>stand. choice ohmages, some in 5% \$1</li> <li><input type="checkbox"/> 100—ASST ½ WATT RESISTORS<br/>stand. choice ohmages, some in 5% \$1</li> <li><input type="checkbox"/> 70 — ASST 1 WATT RESISTORS<br/>stand. choice ohmages, some in 5% \$1</li> <li><input type="checkbox"/> 35 — ASST 2 WATT RESISTORS<br/>stand. choice ohmages, some in 5% \$1</li> <li><input type="checkbox"/> 50 — PRECISION RESISTORS<br/>asst. list-price \$50 less 98% . . . \$1</li> <li><input type="checkbox"/> 20 — ASSORTED WIREWOUND<br/>RESISTORS, 5, 10, 20 watt . . . \$1</li> <li><input type="checkbox"/> 4 — TOGGLE SWITCHES<br/>SPST, SPDT, DPST, DPDT . . . . \$1</li> <li><input type="checkbox"/> 10—ASSORTED SLIDE SWITCHES<br/>SPST, SPDT, DPDT, etc. . . . . \$1</li> <li><input type="checkbox"/> \$15.00 TELEVISION PARTS<br/>"JACKPOT" best buy ever . . . . \$1</li> <li><input type="checkbox"/> 7 — TV ELECTROLYTIC CON-<br/>DENSERS desirable types . . . . \$1</li> <li><input type="checkbox"/> 15 — ASST. ROTARY SWITCHES<br/>all popular types \$20 value . . . \$1</li> <li><input type="checkbox"/> 3 — TOP BRAND 35W4 TUBES \$1</li> <li><input type="checkbox"/> METER SENTRY—SOLID STATE<br/>Protects meter movements up to<br/>25 amps surge . . . . . 99¢</li> </ul> | <ul style="list-style-type: none"> <li><input type="checkbox"/> TRANSISTOR RADIO asst type \$1.50<br/>good, bad, broken, as-is, potluck .</li> <li><input type="checkbox"/> TAPE RECORDER — assorted types<br/>good, bad, broken, as-is, potluck . \$4</li> <li><input type="checkbox"/> 100 — ASST. TUBULAR CON-<br/>DENSERS .001 to .47 to 600v . . \$1</li> <li><input type="checkbox"/> TV TUNERS asst. all new standard<br/>makes, less Tubes . . . . . \$1</li> <li><input type="checkbox"/> TV TUNERS asst. all new standard<br/>makes, including Tubes . . . . . \$3</li> <li><input type="checkbox"/> 32' — TEST PROD WIRE<br/>deluxe quality, red or black . . . \$1</li> <li><input type="checkbox"/> HEARING AID AMPLIFIER<br/>Incl. 3 Tubes, Alnico, etc. (as is) . \$1</li> <li><input type="checkbox"/> 50 — #3AG FUSES ½ AMP<br/>popular type with pigtailed . . . . \$1</li> <li><input type="checkbox"/> 10 — STANDARD TRANSISTORS<br/>NPN &amp; PNP 2N404, 2N411, etc. . . \$1</li> <li><input type="checkbox"/> 10—ASSORTED DIODE CRYSTALS<br/>1N34, 1N48, 1N60, 1N64, etc. . . \$1</li> <li><input type="checkbox"/> S4 ELECTRIC FOOT SWITCH<br/>deluxe type for any equipment . . \$1</li> <li><input type="checkbox"/> 6 — TRANSISTOR RADIO EAR-<br/>PIECES wired complete with plug \$1</li> <li><input type="checkbox"/> 1—SQ. YARD GRILLE CLOTH<br/>most popular brown &amp; gold design \$2</li> <li><input type="checkbox"/> \$20—SHURE M-7D DIAMOND<br/>NEEDLE exact replacement . . . . \$3</li> </ul> | <h3>MARKET SCOOP COLUMN</h3> <ul style="list-style-type: none"> <li><input type="checkbox"/> 12" OXFORD SPEAKER, Top \$4<br/>Quality . . . Large Magnet . . . .</li> <li><input type="checkbox"/> 10" PHILCO SPEAKER \$2.69<br/>Top Quality . . . Large Magnet . .</li> <li><input type="checkbox"/> 8"—ECONOMY OXFORD \$1.69<br/>SPEAKER . . . . . 2.15" Mag.</li> <li><input type="checkbox"/> MOTOROLA PWR TRANSFORM \$1<br/>110v, CT 150/150v, 6.3v . . . . .</li> <li><input type="checkbox"/> 10 — TRANSFORMERS assorted \$1<br/>Audio Outputs, Chokes, I. F., 's, etc.</li> <li><input type="checkbox"/> 10 — ASST. RADIO &amp; TV TUBES \$1<br/>Every Tube a good number . . . .</li> <li><input type="checkbox"/> 50 — ASSORTED TRANSISTORS \$1<br/>big factory scoop-sold as-is . . . .</li> <li><input type="checkbox"/> 20—ELECTROLYTIC CONDENSRS \$1<br/>Fine asst.-too numerous to mention</li> <li><input type="checkbox"/> 20 — ASST. VOLUME CONTROLS \$1<br/>All desirable good types . . . . .</li> <li><input type="checkbox"/> 100 — RADIO &amp; TV SOCKETS \$1<br/>Asst. — too numerous to mention .</li> <li><input type="checkbox"/> 100 — RADIO &amp; TV KNOBS \$1<br/>Asst. — too numerous to mention .</li> <li><input type="checkbox"/> 25 — 3900-OHM-7w RESISTOR \$1<br/>10% Corning glass . . . . .</li> <li><input type="checkbox"/> 20 — .47-600V CONDENSERS \$1<br/>White Ceramic C.D.-American . . .</li> </ul> |
|----------------------------------------------------------------------------------------------------------------------------------------------------------------------------------------------------------------------------------------------------------------------------------------------------------------------------------------------------------------------------------------------------------------------------------------------------------------------------------------------------------------------------------------------------------------------------------------------------------------------------------------------------------------------------------------------------------------------------------------------------------------------------------------------------------------------------------------------------------------------------------------------------------------------------------------------------------------------------------------------------------------------------------------------------------------------------------------------------------------------------------------------------------------------------------------------------------------------------------------------------------------------------------------------------------------------------------------------------------------------------------------------------------------------------------------------------------|------------------------------------------------------------------------------------------------------------------------------------------------------------------------------------------------------------------------------------------------------------------------------------------------------------------------------------------------------------------------------------------------------------------------------------------------------------------------------------------------------------------------------------------------------------------------------------------------------------------------------------------------------------------------------------------------------------------------------------------------------------------------------------------------------------------------------------------------------------------------------------------------------------------------------------------------------------------------------------------------------------------------------------------------------------------------------------------------------------------------------------------------------------------------------------------------------------------------------------------------------------------------------------------------------------------------------------------------------------------------------------------|--------------------------------------------------------------------------------------------------------------------------------------------------------------------------------------------------------------------------------------------------------------------------------------------------------------------------------------------------------------------------------------------------------------------------------------------------------------------------------------------------------------------------------------------------------------------------------------------------------------------------------------------------------------------------------------------------------------------------------------------------------------------------------------------------------------------------------------------------------------------------------------------------------------------------------------------------------------------------------------------------------------------------------------------------------------------------------------------------------------------------------------------------------------------------------------------------------------------------------------------------------------------------------------------------------------------------------------------------------------------------------------------------------------------------------------------------------------------------------------------------------------------------------------|--------------------------------------------------------------------------------------------------------------------------------------------------------------------------------------------------------------------------------------------------------------------------------------------------------------------------------------------------------------------------------------------------------------------------------------------------------------------------------------------------------------------------------------------------------------------------------------------------------------------------------------------------------------------------------------------------------------------------------------------------------------------------------------------------------------------------------------------------------------------------------------------------------------------------------------------------------------------------------------------------------------------------------------------------------------------------------------------------------------------------------------------------------------------------------------------------------------------------------------------------------------------------------------------------------------------------------------------------------------------------------------------------------------------------------------------------|

IMMEDIATE DELIVERY . . . Scientific light packing for safe delivery at minimum cost.  
 HANDY WAY TO ORDER: Pencil mark or write amounts wanted in each box, place letter  
 F in box for Free \$1 BUY. Enclose with check or money order, add extra for shipping.  
 Tearsheets will be returned as packing slips in your order, plus lists of new offers.

Name . . . . .  
 Address . . . . .  
 . . . . .  
 . . . . .

Cost of goods . . . . .  
 Shipping . . . . .  
 estimated . . . . .  
 TOTAL . . . . .

Please specify refund on shipping overpayment desired:  CHECK  POSTAGE STAMPS  MERCHANDISE (our choice) with advantage to customer

**BROOKS RADIO & TV CORP., 487 Columbus Ave., New York, N. Y. 10024** 212-874 5600 TELEPHONE

**COMPLEMENTARY POWER TRANSISTORS**

The 2N5190 through 2N5195 make up a series of 40-80-volt, 40-watt, 4-ampere silicon power transistors for power amplifier and switching circuits. The 2N5190 through 2N5192 are npn's and the 2N5193 through 2N5195 are pnp's. Each of these Motorola transistors has its complementary in the series. Power dissipation is 40 watts at 25°C and must be derated 320 mW/°C above 25°C. Junction and storage temperature range is -65°C to +150°C. Other pertinent characteristics of these complementary pairs are:

Maximum ratings	2N5190	2N5191	2N5192	2N5193	2N5194	2N5195
V <sub>CEO</sub>	40 Vdc	60 Vdc	80 Vdc	40 Vdc	60 Vdc	80 Vdc
V <sub>CB</sub>	40 Vdc	60 Vdc	80 Vdc	40 Vdc	60 Vdc	80 Vdc
I <sub>C</sub>	4 amp	4 amp	4 amp	4 amp	4 amp	4 amp
I <sub>B</sub>	1 amp	1 amp	1 amp	1 amp	1 amp	1 amp
I <sub>CEO</sub>	1 mA	1 mA	1 mA	1 mA	1 mA	1 mA
I <sub>CBO</sub>	2 mA	2 mA	2 mA	2 mA	2 mA	2 mA
I <sub>CBO</sub>	100 μA	100 μA	100 μA	100 μA	100 μA	100 μA
h <sub>FE</sub> , min/max	25/100	25/100	20/80	25/100	25/100	20/80
I <sub>O</sub> = 1.5 amp						
V <sub>CE</sub> = 2 V						

# Why Do You Read So Slowly?

A noted publisher in Chicago reports there is a simple technique of rapid reading which should enable you to increase your reading speed and yet retain much more. Most people do not realize how much they could increase their pleasure, success and income by reading faster and more accurately.

According to the publisher, anyone, regardless of his present reading skill, can use this simple technique to improve his reading ability to a remarkable degree. Whether reading stories, books, technical matter, it becomes possible to read sentences at a glance and entire pages in seconds with this method.

To acquaint the readers of this publication with the easy-to-follow rules for developing rapid reading skill, the company has printed full details of its interesting self-training methods in a new booklet, "How to Read Faster and Retain More" mailed free to anyone who requests it. No obligation. Send your name, address, and zip code to: Reading, 835 Diversey Parkway, Dept. 684-011, Chicago, Ill. 60614. A postcard will do.

Circle 126 on reader's service card

## Enjoy Relaxing Background Music at Home with NO COMMERCIALS!

Our SCA-1 Decoder makes possible the reception of this "private" musical programming, transmitted by nearly 400 FM stations around the country. Your FM tuner or receiver can recover this "hidden" music with the simple addition of an SCA-1 Decoder.

Hook-up takes minutes... full instructions supplied with each unit. SCA-1 is self powered... uses exclusive, new solid-state circuitry (3-FET's, 2-IC's, 3-NPN's). Works with any quality FM tuner or receiver.

### Same unit that appeared as Construction Project in AUDIO, Oct. 68

If you'd rather buy than build from scratch... send check or m.o. for either.

- SCA-1 (Wired, ready to use) \$64.50
- SCA-1K (Kit, all needed parts) \$49.95
- PC Board, Wired, less power supply \$49.95
- Etched, drilled p.c. board plus reprint of full construction plans. \$10.00.

One year parts guarantee.

Free brochure & local SCA station list upon request.

### SCA Services Co.

Box 601 Port Washington, N. Y. 11050

Circle 123 on reader's service card

**CANADIANS: Ordering is easy — we do the paperwork — try a small order**

### Integrated Circuits At Prices You Can Afford

Motorola HepKit Includes

- One J-K Flip Flop
- One Dual Buffer
- One 4-Input Gate
- Two Dual 2-Input Gates

**ALL FIVE JUST \$3.95**

ALSO Tips On Using I.C.s. Including an Integrated Circuit Cross Reference Guide & 8 I.C. Project Circuits

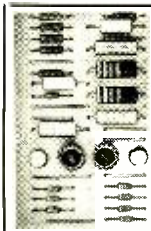

### IBM COMPUTER SECTIONS

8 assorted Units we sell for \$1 are loaded with over 150 valuable parts. Incl. — Transistors, Condensers, Resistors, Heat Sinks, Diodes, Etc.

**8 for \$1  
100 for \$10**

### SHANNON MYLAR RECORDING TAPE

2 1/2" — 225' .. \$ .15	7" — 2400' .. \$1.59
3" — 225' .. .17	7" — 3600' .. .278
3" — 300' .. .24	CASSETTE 60 minutes .89
3 1/4" — 600' .. .49	CASSETTE 90 minutes 1.54
5" — 600' .. .52	CASSETTE 120 minutes 1.97
5" — 900' .. .67	
5" — 1200' .. .86	2 1/2" TAPE REEL .. .04
5" — 1800' .. 1.29	3" TAPE REEL .. .05
7" — 1200' .. .69	3 1/4" TAPE REEL .. .06
7" — 1800' .. .99	5" TAPE REEL .. .12
	7" TAPE REEL .. .14

- |                                                                                                                             |                                                                                                          |                                                                                                                   |                                                                                                                                                                                                                                                                                              |
|-----------------------------------------------------------------------------------------------------------------------------|----------------------------------------------------------------------------------------------------------|-------------------------------------------------------------------------------------------------------------------|----------------------------------------------------------------------------------------------------------------------------------------------------------------------------------------------------------------------------------------------------------------------------------------------|
| <input type="checkbox"/> BONANZA "JACKPOT" not gold, not oil, but a wealth of Electronic Items—Money-Back-guarantee ... \$5 | <input type="checkbox"/> ALL AMERICAN TUBE KIT 12BA6, 12BE6, 12AV6, 50C5, 35W4—total list \$0.70 ... \$2 | <input type="checkbox"/> RECORDING TAPE SPLICER \$1.49 handy, accurate, compact ...                               | <input type="checkbox"/> RCA 110° FLYBACK TRANSFORMER We scored the Market Latest type — standard for all 110° TV's RCA's design of large Coil produces 18KV—assuring adequate width Incl Schematic Diagram applicable for any TV List price \$13.90 Your price .. \$3 100% off in lots of 3 |
| <input type="checkbox"/> 300 — ASSORTED HEX NUTS 2/56, 4/40, 5/40, 6/32, 8/32 ... \$1                                       | <input type="checkbox"/> 2—G.E. PIECES OF EQUIPMENT stacked with over 200 useful parts \$1               | <input type="checkbox"/> 40 — ASSORTED TV KNOBS all standard types, \$20 value ... \$1                            | <input type="checkbox"/> 110° TV DEFLECTION YOKE for all types TV's incl schematic ... \$3                                                                                                                                                                                                   |
| <input type="checkbox"/> 250 — ASST. SOLDERING LUGS best types and sizes ... \$1                                            | <input type="checkbox"/> 50 — ASSORTED MYLAR CONDENSERS popular selected types ... \$1                   | <input type="checkbox"/> 25 — VERT. LINEARITY KNOBS Long shank ... best asst. ... \$1                             | <input type="checkbox"/> "COMBINATION SPECIAL" RCA 110° FLYBACK plus 110° DEFLECTION YOKE \$5                                                                                                                                                                                                |
| <input type="checkbox"/> 250 — ASST. WOOD SCREWS finest popular selection ... \$1                                           | <input type="checkbox"/> 3 — TOP BRAND SILICON RECTIFIERS 1 amp, 1000 PIV ... \$1                        | <input type="checkbox"/> 50 — ASST. TERMINAL STRIPS all types, 1-lug to 6-lug ... \$1                             | <input type="checkbox"/> 90° FLYBACK TRANSFORMER for all type TV's incl schematic ... \$2                                                                                                                                                                                                    |
| <input type="checkbox"/> 250 — ASST. SELF TAPPING SCREWS #6, #8, etc. ... \$1                                               | <input type="checkbox"/> 20 — ASST. PILOT LIGHTS #44, 46, 47, 51, etc. ... \$1                           | <input type="checkbox"/> 25 — INSTRUMENT POINTER KNOBS selected popular types ... \$1                             | <input type="checkbox"/> 90° TV DEFLECTION YOKE for all type TV's incl schematic ... \$2                                                                                                                                                                                                     |
| <input type="checkbox"/> 150 — ASST. 6/32 CREWS and 150 6/32 HEX NUTS ... \$1                                               | <input type="checkbox"/> 50 — ASSORTED #3AG FUSES popular ampere ratings ... \$1                         | <input type="checkbox"/> 1 — LB SPOOL ROSIN-CORE SOLDER 40/60 top quality ... \$1                                 | <input type="checkbox"/> 70° FLYBACK TRANSFORMER for all type TV's incl schematic ... \$2                                                                                                                                                                                                    |
| <input type="checkbox"/> 150 — ASST. 8/32 SCREWS and 150—8/32 HEX NUTS ... \$1                                              | <input type="checkbox"/> 4 — 50' HANKS HOOK-UP WIRE assorted colors ... \$1                              | <input type="checkbox"/> TWEezer: — Stainless steel — #5 Made in Switzerland—For fine work ... \$1                | <input type="checkbox"/> 70° TV DEFLECTION YOKE for all type TV's incl schematic ... \$2                                                                                                                                                                                                     |
| <input type="checkbox"/> 150 — ASST. 2/56 SCREWS and 150—2/56 HEX NUTS ... \$1                                              | <input type="checkbox"/> 100' — SPOOL SPEAKER WIRE 2 cond, mini zip, clear, 101 uses ... \$1             | <input type="checkbox"/> 3—ELECTROLYTIC CONDENSERS most popular number 50/30—150v ... \$1                         | <input type="checkbox"/> 20 — ASSORTED TV COILS I.F. video, sound, ratio etc. ... \$1                                                                                                                                                                                                        |
| <input type="checkbox"/> 150 — ASST. 4/40 SCREWS and 150—4/40 HEX NUTS ... \$1                                              | <input type="checkbox"/> 5 — I.F. COIL TRANSFORMERS 450-ke for Transistor Radios ... \$1                 | <input type="checkbox"/> UNIVERSAL MICROPHONE regular/remote/single & dual plug ... \$2                           | <input type="checkbox"/> 100 — ASSORTED RUBBER BUMPERS for cabinet bottoms & other uses ... \$1                                                                                                                                                                                              |
| <input type="checkbox"/> 150 — ASST. 5/40 SCREWS and 150—5/40 HEX NUTS ... \$1                                              | <input type="checkbox"/> 5 — AUDIO OUTPUT TRANSFORM Sub-mini for Trans Radios ... \$1                    | <input type="checkbox"/> CRYSTAL LAPEL MICROPHONE high impedance, 200-6000 cps ... \$5.95                         | <input type="checkbox"/> 100—ASSORTED RUBBER GROMMETS best sizes ... \$1                                                                                                                                                                                                                     |
| <input type="checkbox"/> 500 — ASSORTED RIVETS most useful selected sizes ... \$1                                           | <input type="checkbox"/> 5 — PNP TRANSISTORS general purpose, TO-5 case ... \$1                          | <input type="checkbox"/> 25 — KNURLED RADIO KNOBS Hard to get ... best selection ... \$1                          | <input type="checkbox"/> 50 — TUBE CARTONS (colored) assorted sizes for Popular Tubes ... \$1                                                                                                                                                                                                |
| <input type="checkbox"/> 500 — ASSORTED WASHERS most useful selected sizes ... \$1                                          | <input type="checkbox"/> 5 — NPN TRANSISTORS general purpose, TO-5 case ... \$1                          | <input type="checkbox"/> CHAPT ZU DI MITZIA "JACK POT" Double your money back if not completely satisfied ... \$1 | <input type="checkbox"/> 4 — TV ALIGNMENT TOOLS most useful assortment ... \$1                                                                                                                                                                                                               |
| <input type="checkbox"/> 100 — ASST. RUBBER BUMPERS for cabinet bottoms & other uses ... \$1                                | <input type="checkbox"/> 20 PENLITE BATTERIES 1 1/2v ... \$1                                             | <input type="checkbox"/> STEREO HEADPHONES Hi-Fi Quality ... Complete with Stereo plug ... \$5.95                 | <input type="checkbox"/> 100' — TV TWIN LEAD-IN WIRE 300 ohm, deluxe heavy duty, clear ... \$2                                                                                                                                                                                               |
| <input type="checkbox"/> 100—ASSORTED RUBBER GROMMETS best sizes ... \$1                                                    | <input type="checkbox"/> 15—BATTERIES C-cell similar 935 ... \$1                                         | <input type="checkbox"/> 50 — TV ALIGNMENT TOOLS most useful assortment ... \$1                                   |                                                                                                                                                                                                                                                                                              |
|                                                                                                                             | <input type="checkbox"/> 10—BATTERIES D-cell similar 950 ... \$1                                         |                                                                                                                   |                                                                                                                                                                                                                                                                                              |
|                                                                                                                             | <input type="checkbox"/> 5—BATTERIES (Transistor) similar 216 \$1                                        |                                                                                                                   |                                                                                                                                                                                                                                                                                              |
|                                                                                                                             | <input type="checkbox"/> UNIVERSAL 5 1/2" PM SPEAKER Alnico 5 magnet, quality tone ... \$1               |                                                                                                                   |                                                                                                                                                                                                                                                                                              |

# ARROW Automatic STAPLE GUN TACKERS

Specially designed for SAFE — FAST — SECURE WIRE & CABLE FASTENING

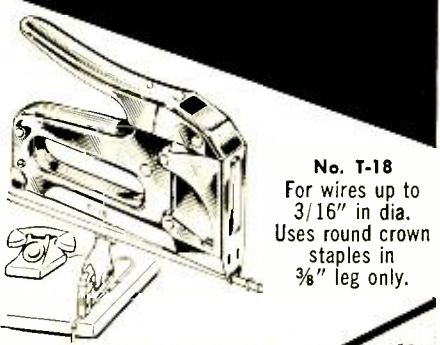

**No. T-18**  
For wires up to 3/16" in dia. Uses round crown staples in 3/8" leg only.



**No. T-25**  
For wires up to 1/4" in dia. Uses round crown staples in 9/32", 3/8", 7/16", and 9/16" leg.

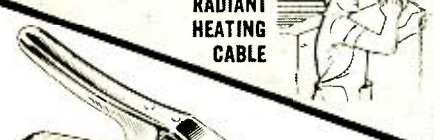

**No. T-75**  
For wires and cables up to 1/2" in dia. Uses tack-pointed staples in 9/16", 5/8" and 7/8" leg.

**SHEATHED CABLE, RADIANT HEATING CABLE, WIRE CONDUIT, COPPER TUBING, DRIVE RINGS, ETC.**

- All-steel, chrome finish.
- Jam-proof mechanism for trouble-free operation

**SAFE!** Driving blade automatically halts staple at right depth of penetration! Can't cut or injure wires and cables.

**FAST!** Powerful single stroke action shoots staples in 1/1000 of a second! Saves 70% in time, effort and efficiency!

**HOLDS!** Staple points diverge to imbed firmly in wood. Rosin-coated for tremendous holding power!

Write for catalog and information.

**ARROW FASTENER COMPANY INC**  
Saddle Brook, New Jersey 07863  
"Pioneers and Pacesetters For Almost A Half Century"

# NOTEWORTHY CIRCUIT

## ULTRA-SHARP ANTENNA TRAP

Most of us are, by now, familiar with the use of Q-multipliers as a means of increasing the i.f. selectivity of inexpensive ham-band and general-coverage all-wave receivers. Within recent months, I've run across two circuits in which a Q-multiplier was used to increase the selectivity of antenna wavetraps and one in which it was used to sharpen an LC-type audio filter. One of the wavetraps was designed to eliminate broadcast interference from strong local stations. The other was used to

receiver. Use the primary—for L2; the secondary—the tuned winding—for L1, and random-wind about 30–40 turns of No. 28–30 enameled wire for L3. If the circuit does not oscillate at any setting of the regeneration control, try reversing the connections to either L2 or L3. If this doesn't work, try interchanging connections to L2 and L3.

European type OC44 and OC170 transistors worked well in the prototype. Almost any germanium pnp transistor designed for AM mixers, oscillators or converters should work.

The tuned circuit is very sharp, so use a vernier tuning dial on C1. To adjust the circuit, tune in the interfering signal with the Q-multiplier turned off. Set C1 for maximum attenuation. (The receiver should have a tuning indicator or S-meter because it is hard to make the adjustments by listening tests alone.) Set R1 to the positive end of its range and turn on the Q-multiplier. Rock C1 while slowly advancing the regeneration control to the point of maximum attenuation. Above this point, attenuation drops just before oscillation. **R-E**

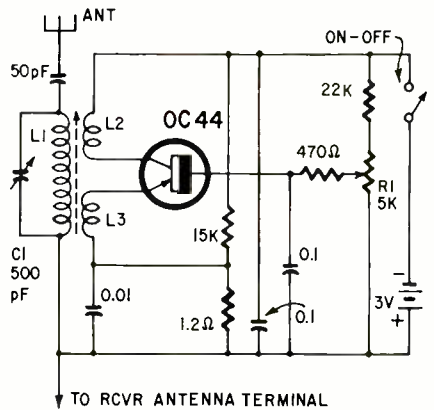

attenuate interference from a French TV station whose video carrier was within the passband of a desired Swiss TV station.

The broadcast-band wavetraps described here was taken from *The Radio Constructor* (London, England). The wavetraps (see diagram) consists of L1–C1, a parallel-tuned circuit connected in series with the outside antenna and the antenna coil on the receiver and tuned to the interference frequency. The transistor is a common-base amplifier with feedback winding L2 in the collector circuit.

Potentiometer R1 is the regeneration control. As the slider is moved toward the negative end, the transistor bias and gain increase until the circuit breaks into oscillation. If the control is set just below the point of oscillation, the regeneration increases the effective Q of the trap and interference rejection is around 20 dB better than with L1–C1 alone.

The original circuit used a commercial coil designed for a regenerative broadcast receiver. This type coil is not available in this country so you'll have to "roll your own." You might start with a two-winding antenna or rf transformer salvaged from an old broadcast

## MORE POWER! MORE GAS MILEAGE! INSTANT START!

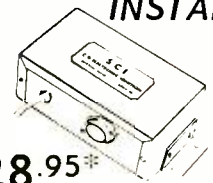

\$28.95\*

—all through SCI electronic ignition

SCI MODEL CD-101 provides 32,000 volts evenly from ignition turn-on to full power. Gas combustion is at peak efficiency always due to uniformity of spark. Voltage is constant no matter how cold your battery. Plugs and points usually last 3 times longer. You'll feel the difference both in the performance of your car and the savings in your pocket. The SCI electronic ignition is complete, contains eight high reliability semi-conductors and is hand-wired on a rugged fiberglass circuit board. Simple installation. Guaranteed for ninety days. (For negative ground vehicles only.)

**SCI** P.O. BOX 27 (RE)  
BOSTON, MASS. 02131

Enclosed is \$28.95\* (plus 75¢ shipping and mailing cost) for one SCI MODEL CD-101 electronic ignition.

NAME .....  
ADDRESS .....  
CITY ..... STATE ..... ZIP .....



ENJOY THE "MUSIC ONLY" FM PROGRAMS

# M. A. D.

MUSIC ASSOCIATED'S DETECTOR  
NO COMMERCIALS—NO INTERRUPTIONS

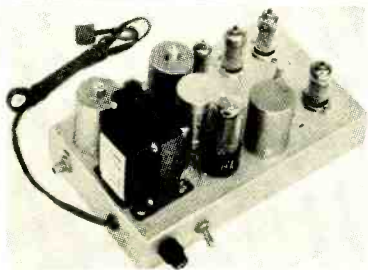

It's easy! Just plug Music Associated's Sub Carrier Detector into multiplex jack of your FM tuner or easily wire into discriminator. Tune through your FM dial and hear programs of continuous commercial-free music you are now missing. The Detector, self-powered and with electronic mute for quieting between selections, permits reception of popular background music programs no longer sent by wire but transmitted as hidden programs on the FM broadcast band from coast to coast. Use with any FM tuner. Size: 5 1/2" x 9". Shipping weight approx. 7 lbs.

**KIT \$49.50**

(with pre-tuned coils, no alignment necessary)

**WIRED \$75.00** (Covers extra \$4.95 ea.)

Current list of FM Broadcast stations with SCA authorization \$1.00

## MUSIC ASSOCIATED

65 Glenwood Road, Upper Montclair, N. J.  
Phone: (201)-744-3387 07043

Circle 128 on reader service card

# TUBE TESTER OWNERS

WE HAVE THE LATEST TUBE DATA AND ADAPTERS FOR →

Don't let your tube tester become obsolete

- EICO
- HEATH
- JACKSON
- KNIGHT
- MERCURY
- NRI-CONAR
- PRECISION
- SYLVANIA

CLIP AND MAIL COUPON TODAY

- COLETRONICS SERVICE INC.
- 1744 Rockaway Ave.,
- Hewlett, N.Y. 11557
- Please send me information on
- Model No. \_\_\_\_\_ and Make \_\_\_\_\_
- Name \_\_\_\_\_
- Address \_\_\_\_\_
- City \_\_\_\_\_ State \_\_\_\_\_ Zone \_\_\_\_\_

Circle 129 on reader service card

# SCHOOL DIRECTORY

## GET INTO ELECTRONICS

V.T.I. training leads to success as technicians, field engineers, specialists in communications, guided missiles, computers, radar and automation. Basic & advanced courses in theory & laboratory. Electronic Engineering Technology & Electronic Technology curricula both available. Associate degree in 29 mos. B.S. also obtainable. G.I. approved. Graduates in all branches of electronics with major companies. Start Feb., Sept. Dorms, campus. High school graduate or equivalent. Catalog.

VALPARAISO TECHNICAL INSTITUTE  
Dept. C, Valparaiso, Indiana 46383



## distinguished graduates

hold important engineering and business administration posts throughout U.S. Professionally-oriented college with outstanding placement record. Four-quarter year permits degree in three years. Fine faculty. Modern labs. Small classes. 300-acre campus. Accredited. Approved for vets. Modest costs. Enter March, June, Sept., Jan. For Catalog, write Adm. Director.



TRI-STATE COLLEGE  
2110 College Avenue, Angola, Indiana 46703



## Learn Electronics for your SPACE-AGE EDUCATION at the center of America's aerospace industry

No matter what your aerospace goal, you can get your training at Northrop Tech, in sunny Southern California.

COLLEGE OF ENGINEERING. Get your B.S. degree in engineering in just 36 months by attending classes year round. Most Northrop Tech graduates have a job waiting for them the day they're graduated!

A & P SCHOOL. Practical experience on real aircraft. One-year course prepares you for F. A. A. A & P certificate. WRITE TODAY FOR CATALOG.

NORTHROP INSTITUTE OF TECHNOLOGY  
1199 W. Arbor Vitae, Inglewood, Calif.

## Coming Next Month

In February R-E talks photography. We lead off with a roundup of what's new and exciting from an electronic standpoint. Then we follow up with two construction articles—a high-power electronic photoflash and a digital darkroom enlarging timer.

But that's not all. There's also an article on how to outwit electronic snoopers. It tells you how the eavesdropper works, about the equipment he uses and how to foil his efforts to listen in.

Then there are complete plans for a 4-channel mixer to go with the guitar amplifier you built last November. And there's a hang-on attachment for your vom that turns it into a direct-reading picofarad meter.

Don't miss these exciting features plus lots more in the February issue of RADIO-ELECTRONICS.

JANUARY 1969

97

## U.S. GOV'T ELECTRONIC SURPLUS

Nationally Known-World Famous SURPLUS CENTER offers finest, most expensive, Government Surplus electronic units and components at a fraction of their original acquisition cost.

ORDER DIRECT FROM AD or WRITE FOR CATALOGS

### (IBM) SILICON DIODE RECTIFIERS

"Great Buys" in top quality, surplus, silicon diode rectifier units. (IBM Computer Units)

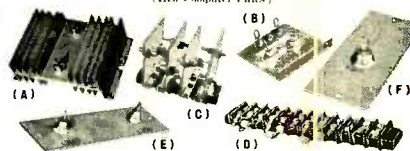

- (#REC-4) -- Two 12-amp., 50-V. silicon diodes on finest aluminum sinks. (1 lb.) ..... (A) **\$2.69**
- (#22-925) -- Two 15-amp., 150-V. silicon diodes on finest aluminum sinks. (1 lb.) ..... (B) **\$1.31**
- (#11-949) -- Eight 13-amp., 100-V. silicon diodes on heavy copper heat sinks. (1 lb.) ..... (C) **\$3.97**
- (#11-900) -- Six 15-amp., 100-V. silicon diodes on Kulkra strip. Very versatile. (1 lb.) ..... (D) **\$1.71**
- (#22-926) -- Two 25-amp., 50-V. silicon diodes on heavy copper heat sinks. (1 lb.) ..... (E) **\$2.69**
- (#22-914) -- One 25-amp., 50-V. silicon diodes on heavy copper heat sink. (1 lb.) ..... (F) **\$1.81**

### COMPUTER TRANSISTORS ON HEAT SINKS

IBM Computer Quality Units

# (#22-928) -- Unit consists of one 150-watt power transistor on heavy ribbed aluminum heat sink. Many experimental uses. (1 lb.)

Cost Gov't Over \$10.00 **\$1.99**

# (#22-915) -- Unit consists of ten 150-watt power transistors, 3 pots, several diodes, capacitors, resistors, etc. on heavy ribbed aluminum heat sinks. Ideal for use as motor speed control. (4 lbs.)

Cost Gov't Over \$35.00 **\$4.91**

### COMPUTER GRADE FILTER CAPACITORS

• Latest design, high MK units. Eliminate need for expensive chokes. 2-1/2" diam. x 4-1/2" (1-1/2 lbs.) Orig. List over \$2.75

- (#C-14-1) -- 15,500-MF @ 10-Volts ..... **99**
- (#C-14-2) -- 1500-MF @ 150-Volts ..... **98**
- (#C-14-3) -- 5000-MF @ 55-Volts ..... **97**
- (#C-14-7) -- 12,500-MF @ 10-Volts ..... **\$1.19**
- (#C-14-12) -- 750-MF @ 25-Volts ..... **98**

### RUNNING TIME METER

# (#DX-104) -- Use to record number of operating hours of electric lights and electrical devices such as refrigerators, furnaces, etc. Records total hours, tenths and hundredths up to 9,999.99 hours, for 115-volt, 60-cycles. Size 4 1/2" x 3 1/2" x 2 1/2". Shipping weight 2 lbs. **\$5.69** Cost Over \$29.00

### 12 and 24-VOLT TRANSFORMER

# (#15-920) -- General Electric 115-volt, 60-cycle to 12 and 24-volts, 750-watts. Capacity 42-amps. — 24-volts, 64-amps. at 12-volts. Useful for battery chargers, running D.C. motors, etc. 7 1/2" x 5 1/2" x 3 1/2" (1 lb. 8 oz.) Cost Gov't Over \$35.00 **\$16.72**

### EXPANDED SCALE 0 - 15 DCVM

# (#21-900) -- Brand new, extensive voltmeter reads 0 to 15-volts DC and 5 to 15-volts AC. Very useful for automotive and aircraft battery charge indication, etc. W/Arsonal movement, black phenolic case. 7 1/2" x 5 1/2" x 2 1/2" (3 lbs.) List \$32.50 **\$12.95**

### SILICON DIODES

# (#21-900) -- New, perfect, Westinghouse #77B-V, 275-amp., 50-volt, #1N1044. Fine for high-current rectifier. (1 lb.) List Over \$15.00 **\$5.90**

### DIGITAL READ-OUT UNIT

# (#EE-17) -- Sophisticated electronic unit contains 5-digit "read-out" electric motor gear train, relays, etc. 3 1/2" x 6 1/2" x 7 1/2" (10 lbs.) Cost Gov't \$250.00 **\$3.97**

### TYPICAL BUYS FROM OUR 1969 CATALOGS

- the new 1969 Catalogs (Vol. #1 and #2) contain hundreds of tremendous buys in electronic equipment, power plants, welding generators, battery wrenches, hoists, electric golf carts, hydraulic cranes, walkie-talkies, tape recorders, fluidular surveying instruments, all types 12-volt power motors, blowers, rags, etc.
- \$100.00 Automatic Telephone Step Switches ..... **\$9.95**
- \$275.00 Geared Battery Motors For Electric Cars **\$26.95**
- \$ 30.00 Standard Dial Handset Telephones ..... **\$7.50**
- \$ 4.50 Power Transformer (15V to 25V) ..... **\$1.21**
- \$ 37.50 750-Watt Transformers (15V, to 24V) ..... **\$19.81**
- \$650.00 Power Plant 5000-Watts, 115-Volts ..... **\$135.00**
- \$ 30.00 115-Volt AC Watt-hour Meters ..... **\$5.95**
- \$ 42.50 115-Volt, 35-Amp. Clock Timer Switch ..... **\$8.91**
- 15-Vol. Discontinued Correspondence Course In Electrical Engineering ..... **\$8.79**



SEND 25c COIN OR STAMPS FOR CATALOGS

All items FOB Money Back Guarantee

## SURPLUS CENTER

DEPT. RE 018 LINCOLN, NEBR. 68501

# MARKET CENTER

## GENERAL

**MAGNETS.** All types. Specials-20 disc magnets, or 2 stick magnets, or 10 small bar magnets, or 8 assorted magnets. \$1.00. **MARYLAND MAGNET COMPANY**, 5412-G Gist, Baltimore, Maryland 21215.

**TREASURE HUNTERS! PROSPECTORS!** Relco's new instruments detect buried gold, silver, coins. Kits, assembled models. Transistorized. Weighs 3 pounds. \$19.95 up. Free catalog. **RELCO-A25**, Box 10839, Houston, Texas 77018

**GIFTS, Radios, Cameras. Bedrock Prices! MANDARIN**, 214 Shaws Building, Hongkong.

## ELECTRONICS

**JAPANESE ELECTRONICS NEW PRODUCTS MONTHLY!** Only \$1. Satisfaction/Refund. **DEE 10639-RE** Riverside, North Hollywood, Calif. 91602

### "ARCTURUS" SALE

- 1700 transistor types at 39¢ each.
  - 40 watt germanium power transistor, same as Delco 501. 2N278 (etc.). Cat. = 349, 59¢ each.
  - Color TV cartridge focus rectifier 6.5 kv. Used in every color TV. Cat. = CFR-20, 79¢ each.
  - Motorola 2500 ma. at 1000 piv. high voltage/current epoxy silicon rectifier, axial leads. Cat. = HEP-170, 49¢ each.
  - 2 Printed circuit I.F. transformers. 4 lug. 455 kc input and output. cat. = 1909P4, 99¢ each.
  - RCA UHF transistor type TV tuners, KRK-120 (long-shaft) cat. = UHF-20; KRK-120 (short-shaft) cat. = UHF-21, each \$4.98.
  - RCA VHF transistor type TV tuners, KRK-146, cat. = VHF-74, \$9.99 each.
  - Transistorized U.H.F. tuners used in 1965 to 1967 TV sets made by Admiral, RCA, Motorola, etc. Removable gearing may vary from one make to another. Need only 12 volts d.c. to function. No filament voltage needed. Easy replacement units. Cat. = UHF-567, \$4.95.
  - U.H.F. Tuner-original units as used in TV sets such as RCA, Admiral, etc. covering channels 14 through 82, as part = 94D173-2. Complete with tube. Drive gearing is removable. Can be used in most sets. Cat. = UHF-3, \$4.95.
  - Color yokes, 70" for all round color CRT's. Cat. = XRC-70, \$12.95, 90" for all rectangular 19 to 25" color CRT's. Cat. = XRC-90, \$12.95.
  - Kit of 30 tested germanium diodes. Cat. = 100, 99¢.
  - Silicon rectifier, octal based replacement for 5U4, 5Y3, 5AS4, 5AW4, 5T4, 5V4, 5Z4. With diagram. Cat. = Rect-1, 99¢ each.
  - 7", 90° TV bench test picture tube with adapter. No ion trap needed. Cat. = 7BP7, \$7.99.
  - Tube cartons 6AU6 etc. size, \$2.15 per 100. 6SN7 etc. size, \$2.55 per 100. 5U4GB size, \$2.95 per 100. 5U4G size, 3¢ each.
- Send for complete free catalog. Include 4% of dollar value of order for postage. \$5 MINIMUM ORDER. Canadian check, 8% dollar differential.

**ARCTURUS ELECTRONICS CORP.**  
502-22nd St., Union City, N.J. 07087  
Dept. MRE  
Phone: 201-864-5568

Circle 138 on reader service card

**SOLAR FLYING SAUCERS**—(New sun powered—no motors) How to build easily for less than \$5 using styrofoam and plastic bags. Many sizes—designs. Complete descriptions, plans, drawings, \$1. Guaranteed. **SPACETRONICS** Box 31043-RE, San Francisco, Calif. 94131.

**FIND BURIED TREASURE!**  
10-DAY MONEY BACK GUARANTEE  
**TREASURE PROBE**  
\$18.88 p.p.d. ALL TRANSISTORIZED



3 ft. portable detector finds buried metal objects, Signals location with loud audible sound. Detects gold, silver, metallic ore and nuggets of all kinds. Find lost coins, jewelry, indian artifacts, civil war souvenirs. Treasureprobe guaranteed to equal detectors selling to \$150 or your money back. Absolutely complete, sensitive earphone, 9v battery, nothing else to buy.

**TO ORDER:** Send check, cash or money order, \$5.00 deposit for COD in N.J. add 5% tax. **TREASUREPROBE Dept. RBG**, P.O. Box 228, Toms River, N.J. 08753

### LIKE MUSIC WITHOUT COMMERCIALS?

The SCA-2B Sub-Carrier Adapter makes it possible for you to enjoy the background music transmitted on a 67KHz sub-carrier on many FM stations. (These programs cannot be heard on a FM set without an adapter) In the US there are approximately 400 FM stations authorized by the FCC to transmit the 67KHz programs. If you are within 50 miles of a city of 100,000 or more, it is probable that you are within the satisfactory reception range of one or more of these stations. If in doubt write for a list of such stations in your area.



Patent Pending  
Sub-Carrier Adapter, Model SCA-2B with two 36" shielded cables. Price \$39.95.  
117 Volt AC Operated Power Supply, PS-9, Price \$4.95.

#### SCA-2B FEATURES

SIZE: 4" x 2 7/8" x 1 1/8". • Simple plug-in connections to your FM tuner/amplifier. (If your FM tuner does not have a multiplex output jack, we supply hook-up information). • No installation adjustments • All silicon transistors • Operates from our PS-9 Power Supply or 6 to 12 volts D.C.

#### One Year Factory Guarantee

For Custom Installations: Completely Wired SCA-2 PC card (size: 2 1/2" x 3" x 3/4") with installation instructions for \$34.95. Also available SCA-2 installed in AC operated Panasonic 7-Transistor AM-FM Radio Model R-F6137 \$61.95.

Write for Dealer Quantity Discounts.

Commercial use of these units is not advised, unless the consent of the originating station is obtained.

Send order to **KENZAC Co.**  
P.O. Box 66251, Houston, Texas 77006

Circle 139 on reader service card

**RADIO-ELECTRONICS** does not assume responsibility for any errors which may appear in the index below.

Accurate Instrument Company, Inc. ....	17
Aerovox Corporation .....	74
Allied Radio Corporation .....	89, 90
Arcturus Electronics Corporation .....	98
Arrow Fastener Company, Inc. ....	96
Bell P/A Products Corporation .....	24
B & K Manufacturing Company (Division of Dynascan Corporation) .....	13, 27, 71
Brooks Radio and TV Corporation .....	94-95
Burstein-Applebee Company .....	91
Caringella Electronics, Inc. ....	82
Castle TV Tuner Service, Inc. ....	7
Cleveland Institute of Electronics .....	82, 18-21
Colronics .....	97
Cornell Electronics Company .....	100
CREI, Home Study Division of McGraw-Hill Book Company .....	46-49
Delta Products, Inc. ....	14, 86
Delwyn .....	92
Electronic Chemical Corporation .....	94
EICO Electronic Instrument Company, Inc. ....	Cover II
EMC Electronic Measurement Corporation ..	91
Electro-Voice, Inc. ....	72
Gavin Instruments, Inc. (Subsidiary of Advance Ross Corporation) .....	Cover III
GBC Electronics .....	70
GC Electronics Company .....	26, 83
Grantham School of Electronics .....	1
Heald Colleges .....	88
Heath Company .....	84-85
Hiekok Electrical Instrument Company .....	22
International Crystal Mfg. Company .....	102
International Textbook Company .....	5
JFD Electronics Corporation .....	15
Judson Research and Manufacturing Company, Inc. ....	82
Leader Test Instruments .....	74
Loral Distributor Products (Division of Loral Corporation) .....	23
Mercury Electronics Corporation .....	81
Microflame, Inc. ....	91
Music Associated .....	97
Myriad Products Corporation .....	75
National Radio Institute .....	8-11
National Technical Schools .....	64-67
Olson Electronics, Inc. ....	76
Pennwood Numechron Company .....	76
Poly Paks .....	101
RCA Institutes .....	28-31
RCA Parts and Accessories .....	87
RCA Test Equipment .....	Cover IV
Reading Improvement Program .....	95
Record-O-Fone (Division of Electro Space Corporation) .....	72
Rye Industries, Inc. ....	75
Sams and Company, Inc., Howard W. ....	73
SCA Services Company .....	95
Schober Organ Corporation, Inc. ....	88
SCI Electronic Ignition .....	96
Scott, Inc., H. H. ....	76
SECO Electronics .....	86
Sencore .....	93
Sprague .....	16
Surplus Center .....	97
Sylvania (Subsidiary of General Telephone & Electronics) .....	25
TAB Books .....	77
Weller Electric Company .....	12
<b>MARET CENTER</b> .....	98-101
Edmund Scientific Company	
Fair Radio Sales	
G & G Radio Supply Company	
Kenzac Company	
Solid State Sales	
Terado Corporation	
Treasure Probe	
United Radio Company	
Warren Electronic Components	
<b>SCHOOL DIRECTORY</b> .....	97
Northrop Institute of Technology	
Tri-State College	
Valparaiso Technical Institute	

RADIO-TELEVISION DIAGRAMS, 50 pound carton, prepaid, \$14.95. Sams Photofacts, 75 through 345, \$1.50 each. HARTFORD, 1760 Balsam, Highland Park, Ill. 60035.

33µF-35V TANTALUM CAPACITORS \$4.50 value, 5 for \$2.00, 25 for \$7.00. 14" X 12" fiberglass epoxy printed circuit board, an \$8.00 value only \$3.95. Catalog 20¢. FRANKS SCIENTIFIC CO., P.O. Box 156, Martelle, Iowa 52305.

CONVERT any television to sensitive Big-Screen Oscilloscope. Only minor changes required. No electronic experience necessary. Illustrated plans \$2.00. RELCO-A25, Box 10563, Houston, Texas 77018

INTEGRATED CIRCUIT KITS: computer, audio, others. New catalog free. KAYE ENGINEERING, Box 3932-D, Long Beach, California 90803.

RECEIVING & INDUSTRIAL TUBES, TRANSISTORS, All Brands—Biggest Discounts. Technicians, Hobbyists, Experimenters—Request FREE Giant Catalog and SAVE! ZALYTRON, 469 Jericho Turnpike, Mineola, N.Y. 11501.

RADIO & TV TUBES 33¢ each. One year guaranteed. Plus many unusual electronic bargains. Free catalog. CORNELL 4217-E University, San Diego, California 92105

21st CENTURY SCIENCE PRODUCTS. Incredible science products of the future, available now! Amazing catalog and gift—50¢. R. J. GRAHAM, 171 East Bank, Fond Du Lac, Wisconsin 54935.

BUILD several sensitive metal detectors from our 20 page book. Fully transistorized circuitry. Easily followed diagrams and instructions. \$4.00. TRIONICS, Box 164J, Brewer, Maine 04412.

New Sensitive TREASURE METAL DETECTORS. New low prices. Professional models from \$29.95 to \$129.50. Write for free catalog today. JETCO ELECTRONICS, Box 132-RE, Huntsville, Texas. 77340

REMOVE COLOR TV plastic encapsulated convergence rectifier 5-7-9 pin, RCA number 118244, from print board in seconds with your solder gun and our tip. Send \$3.95. Specify large or small, weller or wen, 250 tip. SOD-R-AID, P.O. Box 94753, Okla. City, Okla. 73109.

Discharge IGNITION, PHOTOFLASH. Free catalog parts, kits. TRANSPARK, Carlisle, Mass. 01741

SEMICONDUCTOR AND PARTS CATALOG over 100 pages free to Canadians, U. S. 50¢. J & J ELECTRONICS, Box 1437, Winnipeg, Manitoba, Canada.

REGULATED POWER SUPPLIES, all transistor, \$4.75 to \$8.50. Dimmer motor controls, \$3.98. PhotoCell Controls, \$2.75. 10 AMP Triacs, \$1.75. Zeners, \$.25. Diodes, \$.05. Surplus catalog. MURPHY, 204 Roslyn, Carle Place, N. Y. 11514.

## INVENTIONS & PATENTS

FREE "Directory of 500 Corporations Seeking New Products." For information regarding developments, sale, licensing of your patented/unpatented invention. Write: RAYMOND LEE ORGANIZATION, 230-U Park Avenue, New York City 10017.

INVENTIONS WANTED. Patented; Unpatented. GLOBAL MARKETING, 2420-AE 77th Ave., Oakland, Calif. 94605

## EDUCATION/ INSTRUCTION

ELECTRONICS ENGINEERING. Day or evening classes. Bachelor of Science Program evenings. Associate in Science Program day or night. If you are married or if you must work for a living while obtaining your education, this is the college for you. Approved for Veterans. WESTERN STATES COLLEGE OF ENGINEERING, 970 West Manchester Avenue, Inglewood, California 90301.

# YOUR SERVICE AND QUALITY LEADER

**AVALANCHE MODE TRANSISTORS**, used for TRIGGERING SCR's & TRIACS with diagrams. 3/\$1.00

**UNIUNCTIONS**  
Similar to 2N2419 Rbb of 5-7, stand off ratio of .6 and Ip of 12, with data sheet \$1.50

**ZENERS**  
1 Watt 6.8-68V \$4.00  
10 Watt 6-200V \$7.75

**MOUNTING HDWE KITS**  
These kits are used to mount our SCR's, zeners, & rectifiers etc.

6 x 32 (3 + 12 Amp rectifiers, 7 Amp SCR's) 6 sets/\$1.00  
1/4 x 28 (20 + 40 Amp rectifiers (20 Amp SCR's) 4 sets/\$1.00

PRV	AMP
100	.07
200	.09
400	.12
600	.18
800	.22
1000	.35

**EPOXY AND CONTROLLED AVALANCHE RECTIFIERS**  
1 AMP

**N-CHANNEL PLASTIC TO-18 FET'S**. Low noise, low leakage, gate current, gain to 9000µ mhos. \$1.00

IN2326 voltage & temperature compensating diodes 4/\$1.00



POST OFFICE BOX 74D  
SOMERVILLE, MASS. 02143  
TELEPHONE (617)547-4005

Send For Our Latest Catalog Featuring Transistors and Rectifiers  
325 Elm Street, Cambridge, Mass.

## TRIACS

TO-66  
5 AMPS

PRV	
100	.90
200	1.40
300	1.75
400	2.25
500	2.60

**CADMIUM SELENIDE PHOTO CONDUCTIVE CELLS**. Dark resistance of 500 megohms, Sensitivity of 1-4.99 µa/ft candle with data sheet \$1.00

**500 Hfe PLASTIC TRANSISTORS (NPN) TO-18**, S1 unit sim to 2N3565. 4/\$1.00

**HIGH-VOLTAGE NPN 150V VBCBO** at 2.5A, hi gain in TO-66 pack \$1.75

**2N1163 a TO-3 PNP GERMANIUM TRANSISTOR** rated at 35v and a gain of 50 at 25 amps. \$1.75

### Silicon Power Rectifiers

PRV	3A	12A	40A
100	.09	.30	.75
200	.16	.50	1.25
400	.20	.70	1.50
600	.30	1.00	1.80
800	.40	1.25	
1000	.55	1.50	

## INTEGRATED CIRCUITS



9030 8 bit memories \$4.95

**LINEAR CIRCUITS**  
FM IF AMPLIFIERS \$ .90  
702C WIDE BAND DC AMPL. \$3.50  
709C OPERATIONAL AMP. \$4.50  
710C HI SPEED DIFF. COMPARATOR \$5.00  
711C DUAL COMPARATOR \$5.00

**DIGITAL RTL CIRCUITS**  
2-914 QUAD 2 INPUT GATE \$1.25  
900 BUFFER \$1.25  
925 DUAL 2 INPUT GATE EXPANDER \$1.25  
923 JK FLIP FLOP \$1.25  
2-923 DUAL JK FLIP FLOPS \$1.50

**NEON LIGHT or MIXIE TUBE DRIVERS**. An NPN TO-18, Si Transistor with a VBCBO of 120 3/\$1.00

### Silicon Control Rectifiers TO-66 pack Studs

PRV	3A	7A	20A	70A
50	.35	.45	1.00	
100	.50	.65	1.00	4.00
200	.70	.95	1.30	8.00
300	.90	1.25	1.70	
400	1.20	1.60	2.10	12.00
500	1.50	2.00	2.50	
600	1.80	2.40	3.00	16.00
700	2.20	2.80	3.50	

Terms: FOB Cambridge, Mass. Send check or Money Order. Rate companies 30 days net. Include postage. Average Wt. per package 1/2 lb. No COD's. Minimum Order \$3.00

Circle 140 on reader service card

MAIL ORDER

# SHOPPING MART

UNUSUAL VALUES

A selection of products available by mail for readers of Radio Electronics. All merchandise sold on a money-back guarantee. Order direct by Stock Order No. Send check or M. O.



YOUR MUSIC IN DAZZLING ACTION with



### DRAMATIC BREAKTHROUGH IN AUDIOVISUAL ENJOYMENT

See your favorite music translated into fantastically colorful patterns; each note creating its own unique, everchanging image in perfect time with the music. Easily attached to stereo, radio, tape recorder. Send 25c in coin for 16-page booklet. #0006EH

No. 85.181EH WALNUT CABINET MODEL ..... \$99.50 FOB  
No. 71.030EH 8" SET ..... 45.00 Ppd.  
No. 71.009EH 8" DO-IT-YOURSELF KIT ..... 22.50 Ppd.

### EXPERIMENTAL FUN WITH TESLA COIL



Generator with coil, etc., transmits extremely high frequency electromagnetic radiation (millions of cycles per second)—through space. Lights fluorescent tube 2 ft. away, ionizes gases, performs total of 21 fascinating experiments. Incl. Neon Lamp, discharge electrode, 2 radiation antenna plates. Generates 5,000 V. for 110 V. 60-C. AC. Meas. 6"x8". Stock No. 70.301EH . . . \$44.00 Ppd.



### 3" ASTRONOMICAL TELESCOPE

See stars, moon, phases of Venus, planets close up. 40 to 180 power—famous Mt. Palomar reflecting type. Aluminized & overcoated 3" diameter f/10 primary mirror, ventilated cell. Equipped with 60X eyepiece and mounted 3X finder scope, hardwood tripod. FREE: "STAR CHART"; "HANDBOOK OF HEAVENS"; "HOW TO USE YOUR TELESCOPE"

Stock No. 85.050EH \$29.95 Ppd.  
4 1/4" REFLECTOR TELESCOPE  
Stock No. 85.105EH \$84.50 FOB  
6" REFLECTOR TELESCOPE  
Stock No. 85.086EH \$199.50 FOB

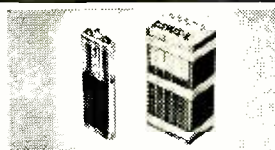

### Ni-Cd BATTERY BARGAIN

Terrific value—slightly used gov't surplus. Lightweight 5 cell, 6 volt, 4 Amp-hour battery with atmosphere limited life. Extremely high current output. Recharges in 1 hour with Edmund kit. Won't deteriorate when left discharged. Minimum maintenance—few drops of water per year. Rugged, shock-and-vibration resistant nylon case. Delivered partially charged, filled with electrolyte. 3 1/4" x 2 1/2" x 6 1/2" 2 lb.

Stock No. 70.942EH (battery) ..... \$15.00 Ppd.  
Stock No. 70.807EH (charger kit) ..... \$ 8.00 Ppd.



### NEW LOW-COST GEM TUMBLER

Become a rockhound! Fascinating hobby... loads of fun, inexpensive, easy. Make jewelry of all kinds—decorative bookends, table tops, etc. Simply tumble-finish readily available gemstones... then polish to high luster... brings out beautiful colors. Rugged 15 lb. tumbler w/continuous duty motor compares to units selling for many times its price.

Stock No. 70.874EH \$10.75 Ppd.  
6-LB. ROCK ASSORTMENT (10 TYPES)  
Stock No. 70.868EH .. \$ 9.00 Ppd.

### GET FREE CATALOG



148 PAGES — 1000'S OF BARGAINS  
Completely new 1985 edition. New item categories, Hites ratings. Dozens of electrical and electromagnetic parts, accessories... enormous selection of Astronomical Telescopes, Microscopes, Binoculars, Magnifiers, Magnets, Lenses, Prisms. Many war surplus items for hobbyists, experimenters, workshops, factories. Mail coupon for catalog "FREE"

NAME.....  
ADDRESS.....  
CITY.....  
STATE.....ZIP.....

ORDER BY STOCK NUMBER • SEND CHECK OR MONEY ORDER • MONEY-BACK GUARANTEE

**EDMUND SCIENTIFIC CO.** 300 EDSCORP BUILDING  
BARRINGTON, NEW JERSEY 08007

Circle 141 on reader service card

# SILICON RECTIFIER SALE

IMMEDIATE DELIVERY  
FULLY GTD NEWEST TYPE  
AMERICAN MADE FULLY TESTED



## 1 AMP TOP HAT AND EPOXIES

PIV	SALE	PIV	SALE	PIV	SALE
50	.05	800	.18	1800	.80
100	.07	1000	.27	2000	1.20
200	.08	1200	.40	3000	1.40
400	.10	1400	.52	4000	1.85
600	.14	1600	.67		

## "SILICON POWER DIODE STUD MOUNT"

PIV	3A	6A	12A	50A	100A	160A
50	.06	.16	.20	.50	.85	2.25
100	.07	.21	.25	.73	1.05	2.65
200	.09	.29	.38	1.23	1.60	3.50
400	.15	.39	.49	1.45	2.50	4.25
600	.19	.53	.73	1.75	3.75	6.50
800	.29	.74	.95	2.20		
1000	.38	.85	1.10	2.60		

**SPECIALS!** Stud Rect. 25 AMP-500 PIV—  
**SPECIALS!** \$1.05 Ea. or 10 for \$9.00 Special  
**SPECIALS!**

Fil. Trans. 117V at 6.3V C.T. 10 AMP Special \$1.25  
Sangamo Type DCM 10000 MFD 25 VDC \$.85 Ea.

Heat Sink 2 LBS 500 AMP your cost \$1.40  
Value \$7.00

Westinghouse 160 AMP, 500 PIV SILICON HI-POWER  
STUD RECTIFIER IN1666.  
Limited quantity. \$5.10 ea. 10 for \$45.00

100 Different Precision Resistors  
1/2—1—2 Watt 1/2%—1% TOL \$1.25

Asst transistor Kit. P.N.P.—N.P.N.  
All popular types. Unchecked  
100 for \$2.95 500 for \$9.95

Computer Grade Condenser 15,500 MFD  
12 VDC American Mfg. .75 ea.

NEW DIODE KIT ALL POPULAR TYPES  
IN34, IN34A, IN48, IN60, IN64 etc. 100 for \$ 4.00  
BEST QUALITY 500 for \$15.00

Money Back guarantee. \$2.00 min. order. Include  
additional \$ for postage. Send check or money  
order. C.O.D. orders 25% down.

Warren Electronic Components

230 Mercer St., N. Y., N. Y. 10012 • 212 OR 3-2620

Circle 142 on reader service card

# MARKET CENTER

FCC First Class License in six weeks—nation's  
highest success rate—approved for Veterans  
Training. Write ELKINS INSTITUTE, 2603E In-  
wood Road, Dallas, Texas 75235

RADIO ANNOUNCING, learn by tape \$1.00.  
JACK, 207 King Drive, Jackson, Mississippi,  
39208.

COMPUTER PROGRAMMING—the big oppor-  
tunity career—new recognized correspondence  
course. No maths needed. Free brochure.  
CANADIAN INSTITUTE OF SCIENCE AND  
TECHNOLOGY, V63 Adelaide St. W., Toronto.

LEARN MORSE INTERNATIONAL CODE in half  
hour by use of forty-five word mnemonic. Mail  
check or money order for one dollar to: MNE-  
MONICS ASSOCIATES, 55 Church Street, White  
Plains, N. Y. 10601.

## AUDIO - HI-FI

RENT 4-track open reel tapes—all major labels  
—3,000 different—free brochure. STEREO-  
PARTI, 55 St. James Drive, Santa Rosa, Ca.  
95401

WRITE for highest discounts on components,  
recorders, tapes, from franchised distributors.  
Send for FREE monthly specials. CARSTON,  
RFD #3, Route 7, Brookfield, Conn. 06804

HI-FI COMPONENTS, Tape Recorders, at guaran-  
teed "WE will not be undersold" prices. 15-day  
moneyback guarantee. Two-year warranty. NO  
Catalog. Quotations Free. HI-FIDELITY CENTER,  
239R East 149th St., N.Y., N.Y. 10451

SPEAKER REPAIR. Hi-Fi, guitar, organ speakers  
reconed good as new at fraction of new speaker  
price. For details and Reconing Center in your  
area write WALDOM ELECTRONICS, INC.  
9155-4, Dept. RE. 4625 W. 53rd St., Chicago,  
Ill. 60632

## SERVICEMEN • EXPERIMENTERS!

### IF YOU WISH TO PURCHASE BRAND NEW TUBES

RECEIVING—SPECIAL PURPOSE BC  
TUBES AT OUTSTANDING MONEY SAV-  
ING VALUES.

WE CARRY THE LARGEST STOCK OF OB-  
SOLETE AND THE LATEST TYPES OF  
EUROPEAN AND OTHER IMPORTED  
TUBES.

WE HAVE THE MOST UP TO DATE TUBES  
LISTED PLUS THE HARD TO GET TYPES.  
DON'T CONFUSE OUR TUBES WHICH  
ARE NEW WITH THE PULLOUTS AND  
REJECTS. SEND FOR OUR CATALOG.

### UNITED RADIO COMPANY

ESTAB. 1920

56 FERRY ST., NEWARK, N.J. 07105

## ONE YEAR GUARANTEE! TUBES!

# 33¢

PER TUBE

100 OR  
MORE TUBES

30¢ ea.

Special!

With Every \$10 Order

25¢ PER  
TUBE

Your Choice  
Of These Sizes

6AG5  
6W4  
6AU6

6CB6  
6J6

# CORNELL

Tubes are New or Used and So  
Marked Lab Tested, Ind. Boxed  
Branded & Code Dated

6D6	OZ4	6AU4	6X4
6DA4	1B3	6AU5	6X8
6DE6	1H5	6AU6	7B6
6DQ6	1J3/1K3	6AV6	7C5
6EA7	1L4	6AW8	7N7
6EM5	1T4	6AX4	7Y4
6F6	1U4	6BA6	10DE7
6FQ7	1X2	6BC5	12AE6
6GH8	3BZ6	6BG6	12AT7
6H6	3DG4	6BJ6	12AU7
6J5	5U4	6BL7	12AX7
6J6	5U8	6BN4	12BA6
6K6	5V4	6BN6	12BE6
65A	5Y3	6BN8	12BH7
65A7	6A6	6BQ6	12C5
65H7	6A8	6BQ7	12SN7
65J7	6AB4	6BZ6	12W6
65K7	6AC7	6C4	25L6
65L7	6AF4	6C6	25Z6
65N7	6AG5	6CB6	35W4
65Q7	6AK5	6CD6	84/6Z4
6U7	6AL5	6CG7	5687
6U8	6AN8	6CG8	6350
6V6	6AQ5	6CM7	6463
6W4	6AT6	6CZ5	7044
6W6	6AT8		

## Prestige & Success as an ELECTRONICS EXPERT!



### HOME STUDY COURSES

TV SERVICING  
\$3.50

RADIO SERVICING  
\$3.00

BOTH COURSES \$6.00

### 2 STATION INTERCOM

12<sup>95</sup>

A.C. 110 VOLT  
TRANSISTORIZED  
INTERCOM!

## ONE YEAR GUARANTEE! DUMONT TUBES!

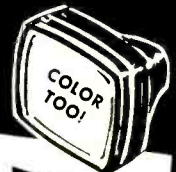

Brand New Except Glass!

TUBE TYPE	DUD DEP.	TUBE PRICE
19XP4	3.00	21.95
21AMP4	1.00	14.95
21CBP4	1.00	14.95
21CEP4	3.00	18.95
23FP4	5.00	24.95
21FJP22	20.00	79.95
23EGP22	35.00	119.95
25AP22	27.50	99.95
23AHP4	5.00	24.95
24AEP4	1.00	22.95

Please remit full tube price plus  
dud deposit with order. Dud de-  
posit will be returned immedi-  
ately upon postpaid return of dud.  
No C.O.D.'s on picture tubes. All  
duds returned for refund must be  
under full vacuum.

FREE!  
CORNELL'S  
NEW  
CATALOG!  
WRITE FOR  
YOUR COPY  
TODAY!

### RED & BLACK TUBE CARTONS

High Gloss, Clay Coated, Built in Diag. Partitions

SIZE	TUBE SIZE	10 CARTONS	100 CARTONS
MIN.	6AU6	.29	2.59
GT.	65N7	.39	3.49
LG.GT	5U4GB	.59	5.29
G.	5U4G	.89	7.99

NO SUBSTITUTIONS WITHOUT YOUR PERMISSION!

YOUR ORDER FREE IF NOT SHIPPED WITHIN 24 HRS.

Terms: Orders over \$5.00: Add 3c per tube shipping. Prepay in full  
and avoid C.O.D. charges. Send \$3.00 deposit on C.O.D. orders.  
Orders under \$5.00: Add 3c per tube plus 50c handling. Canadian  
and Foreign Orders: add approx. postage. No C.O.D. orders. Com-  
bine varied orders to bring order over \$5.00.

DEPT. RE-1 4217 UNIVERSITY  
SAN DIEGO, CALIFORNIA 92105

Circle 143 on reader service card

## WANTED

QUICK CASH . . . for Electronic EQUIPMENT, COMPONENTS, unused TUBES. Send list now! BARRY, 512 Broadway, New York, N. Y. 10012, 212 WALKER 5-7000

WANTED: Manufacturer to market receiver with novel crystal filter providing s.s.b. capability. Patent applied for. ATLANTIC ELECTRONICS LABS, 1607 Holly Blvd., Manasquan, N. J. 08736.

## GOVERNMENT SURPLUS

JEEPS Typically from \$53.90 . . . Trucks from \$78.40 . . . Boats, Typewriters, Airplanes, Multimeters, Oscilloscopes, Transceivers, Electronics Equipment, Used, 100,000 Bid Bargains Direct From Government Nationwide. Complete Sales Directory and Surplus Catalog \$1.00 (Deductible First \$10.00 Order). SURPLUS SERVICE, Box 820-REL, Holland, Michigan 49423

## AC POWER FROM YOUR CAR OR BOAT BATTERY

Standard home electricity (60 cycle, 117 volts) for small appliances, record players, tape recorders, tools, etc.

Inverters from 25 to 600 watts, priced as low as \$15.95.

See your Electronics Parts Dealer, or write



**terado CORPORATION**  
1053 Raymond Ave., St. Paul, Minn. 55108

## NEW G&G CATALOG! MILITARY ELECTRONICS



24 PAGES crammed with Gov't Surplus Electronic Gear—the Biggest Bargain Buys in America! It will pay you to

SEND 25¢

for your copy—Refunded with your First Order!

**BC-645 TRANSCEIVER**, 15 tubes, 435 to 500 Mc. Easily adapted for 2 way wire or radio on Ham, Mobile, Television Experimental and Citizens' Bands. With tubes, less power supply in factory carton. Brand new. **\$16.95**



**SPECIAL PACKAGE OFFER**, BC-645 Transceiver, Dynamotor and all accessories, including mounting, UHF Antenna, Assemblies, control box, complete. BRAND NEW **\$26.95**

**AN APR-4Y FM & AM RECEIVER "FB" FOR SATELLITE TRACKING!**

High precision lab instrument, for monitoring and measuring frequency and relative signal strength, 48 to 4400 Mc. in 3 tuning ranges. For 110 x 60 cycle AC. Built-in power supply. Original circuit diagram included. Checked out, perfect. **\$88.50**

LIKE NEW . . . . . All Tuning Units Available for Above

### SCR-274-N, ARC-5 COMMAND SET HQ!

Freq. Range	Type	Exc. Used	BRAND NEW
<b>RECEIVERS, Complete with Tubes</b>			
190-550 Kc.	BC-453	\$18.95	\$23.50
3-6 Mc.	BC-454	\$16.50	\$21.50
6-9.1 Mc.	BC-455	\$14.95	\$19.95
1-3 Mc.	R-25		\$21.50
<b>TRANSMITTERS, Complete with Tubes</b>			
4-5.3 Mc.	BC-457	\$ 6.95	\$11.95
5.3-7 Mc.	BC-458	\$ 6.95	\$12.95
7.9-1 Mc.	BC-459	\$17.95	\$22.50
2-1.3 Mc.	T-18		\$10.95
3-4 Mc.	T-19	\$10.50	\$14.95

IF YOU DON'T SEE WHAT YOU WANT, write us! Chances are, we can ship immediately from our huge stocks, or we can get it for you—at Lowest Published Prices!

**TERMS:** Either 25% Deposit with order, balance C.O.D.—OR—Remittance in Full. Minimum Order \$5.00. All shipments F.O.B. our warehouse, NYC. All merchandise subject to prior sale and price change.

**G & G RADIO SUPPLY COMPANY**  
Telephone: (212) CO 7-4605  
75A Leonard St., New York, N.Y. 10013

Circle 144 on reader service card



# FREE Catalog of The WORLD'S FINEST GOV'T SURPLUS ELECTRONIC BARGAINS

Now BIGGER and BETTER Than Ever!

MAIL THIS COUPON NOW!

NAME: \_\_\_\_\_  
ADDRESS: \_\_\_\_\_  
CITY: \_\_\_\_\_ STATE: \_\_\_\_\_ ZIP NO.: \_\_\_\_\_

FAIR RADIO SALES • Box 1105 • Lima, Ohio 45802

Circle 145 on reader service card

## \$100,000 "EYE SEE" BONANZA BY POLY PAK INTEGRATED CIRCUITS!

### PENNY SALE!

By far the biggest Integrated Circuit Sale in our history, NOBODY! That's right NOBODY under-sells Poly Paks. Imagine—buy 1 Integrated Circuit at our bargain price and get the 2nd one for ONLY 1¢ . . . that's right ONE CENT! NO LIMIT PER ITEM! Every item guaranteed as advertised. All include data on Integrated Circuits, schematics, and/or hookups, and as much as 40 circuits. THIS OFFER IS LIMITED



Fairchild No.	EACH	2¢ MORE
<input type="checkbox"/> 900	Buffer	1 for 1.49 2 for 1.50
<input type="checkbox"/> 902	R-S Flip Flop	1 for 1.49 2 for 1.50
<input type="checkbox"/> 903	3 In. Gate Nand/Nor	1 for 1.49 2 for 1.50
<input type="checkbox"/> 903-903*	3 Input gate Nand/Nor	1 for 1.49 2 for 1.50
<input type="checkbox"/> 904-904*	Half adder	1 for 1.49 2 for 1.50
<input type="checkbox"/> 910	Dual Two Input Gate	1 for 1.29 2 for 1.30
<input type="checkbox"/> 914	Dual Two Input Gate	1 for 1.29 2 for 1.30
<input type="checkbox"/> 914-914*	Dual Two Input Gate	1 for 1.49 2 for 1.50
<input type="checkbox"/> 915	Dual 3 Input Gate Nand/Nor	1 for 1.49 2 for 1.50
<input type="checkbox"/> 923	JK-Flip Flop	1 for 1.49 2 for 1.50
<input type="checkbox"/> 923-923*	JK Flip Flop	1 for 1.69 2 for 1.70
<input type="checkbox"/> 925	Dual 2 Input Gate, Expander	1 for 1.49 2 for 1.50
<input type="checkbox"/> 927	Quad Inverter	1 for 1.49 2 for 1.50
<input type="checkbox"/> 930	Dual 4 Input Gate Nand/Nor	1 for 1.49 2 for 1.50
<input type="checkbox"/> 933	Dual Input Gate, Expander	1 for 1.49 2 for 1.50
<input type="checkbox"/> 944	Dual 4 Input Power Gate	1 for 1.49 2 for 1.50
<input type="checkbox"/> 945	Clocked Flip Flop	1 for 1.69 2 for 1.70
<input type="checkbox"/> 946	Quad 2 Input Gate Nand/Nor	1 for 1.49 2 for 1.50
<input type="checkbox"/> 948	Clocked Flip Flop	1 for 1.69 2 for 1.70
<input type="checkbox"/> 950	AC Binary	1 for 1.98 2 for 1.99
<input type="checkbox"/> 952	Dual 2 Pin Input Inverter Gate	1 for 1.29 2 for 1.30
<input type="checkbox"/> 954	Dual 4 Input and Gate	1 for 1.29 2 for 1.30
<input type="checkbox"/> 955	8 Input and Gate w/2 output	1 for 1.29 2 for 1.30
<input type="checkbox"/> 956	Dual 2 Input Buffer	1 for 1.29 2 for 1.30
<input type="checkbox"/> 957	Dual Rank (hold) Flip Flop	1 for 1.98 2 for 1.99
<input type="checkbox"/> 961	Dual 4 Input Gate w/expander	1 for 1.49 2 for 1.50
<input type="checkbox"/> 962	Triple Gate	1 for 1.49 2 for 1.50
<input type="checkbox"/> 963	Triple Gate	1 for 1.49 2 for 1.50

\* Two identical IC's in one package

### 1 AMP TOP HAT AND EPOXIES

PIV	Sale	PIV	Sale	PIV	Sale
50	5¢	800	19¢	1800	82¢
100	7¢	1000	29¢	2000	1.25
200	8¢	1200	42¢	3000	1.50
400	10¢	1400	55¢	4000	1.95
600	15¢	1600	69¢		

Actual Size →

### 1 AMP MICROMINIATURE SILICON RECTIFIERS

PIV	Sale	PIV	Sale
50	5¢	600	15¢
100	7¢	800	19¢
200	8¢	1000	29¢
400	10¢		

### "GLASS AMP" SILICON RECTIFIERS

ONE AMP	PIV	Sale	PIV	Sale
50	5¢	600	19¢	
100	7¢	800	21¢	
200	9¢	1000	32¢	
400	12¢	1200	45¢	

PRV may be exceeded without the rectifier breaking down.

### NE-2 NEON BULBS 20 for \$1

Terms: add postage. Rated: net 30. coil's 25%  
Phone Orders: Wakefield, Mass. (617) 245-3829  
Retail: 211 Albion, St., Wakefield, Mass.

**GIANT 1969 CATALOG ON:** Parts, Rectifiers 10¢  
 Transistors, SCRs, I.C.'s, Equipment, Etc.

**POLY PAKS** P.O. BOX 942R  
LYNNFIELD, MASS 01940

### Buy 10 PAKS & CHOOSE 1 FREE

- 50 COILS AND CHOKES, if, rf, ant, osc, pe, link, etc. \$1
- 65 HALF WATERS, to 1 meg, 5% popular values to \$1
- 60 HI-QUALITY RESISTORS, 1/2, 1, 2W asst values \$1
- 10 RCA PHONO PLUGS & JACK SETS, tuners, etc. \$1
- \$25 SURPRISE PAK: transistors, rect, diodes, etc. \$1
- 2-PC INFRA-RED DETECTOR & FILTER SET science project
- 2 FIELD EFFECT TRANSISTORS, n channel, hobby \$1
- 50 TERMINAL STRIPS, 1 to 8 lug types \$1
- 3 PHOTO ELECTRIC CELLS, hi. imp., schematic \$1
- 3 TRANS'OR AMPLIFIER, WIRED, 3x2x3/4" schematic \$1
- 10 PRINTED CIRCUIT BOARDS, copper clad 100 uses \$1
- 10 TRANSISTOR SOCKETS, for pnp & npn types \$1
- 10 PANEL SWITCHES, toggle, slide, micro, rotary \$1
- 40 CORNING "LOW NOISE" resistors, popular 5% \$1
- 40 "MICRO" RESISTORS, 1/10W, 5% Helby mus \$1
- 50 GERMANIUM GLASS DIODES, 1N34, 1N18 no test \$1
- 40 TOP HAT SILICON RECTIFIERS, no test asst values \$1
- 25 EPOXY RECTIFIERS, silicon asst, no test \$1
- 40 PRECISION RESISTORS, 1/2-2W, 1% asst values \$1
- 30 TRANSISTORS, rf, if, audio, osc, no test \$1
- 60 TUBULAR CONDENSERS, to .5mf to 1KV, asst \$1
- 50 DISC CONDENSERS, to .05mf npo, temp, coef, asst \$1
- 60 TUBE SOCKETS, receptacles, plugs, auto, etc. \$1
- 30 POWER RESISTORS, to 25 watts, to 24E ohms \$1
- 6 "IBM" COMPUTER BOARDS, many trans, diodes \$1
- 3 2N3563 TRANSISTORS, npn, 600mc, 100V, fe, epoxy \$1
- 10 VOLUME CONTROLS, to 1 meg, switch too! \$1
- 10 ELECTROLYTICS, to 100mf, tubular too, asst \$1
- 50 RADIO & TV KNOBS, asst colors & styles \$1
- 10 TRANS'OR ELECTROLYTICS to 100mf, asst values \$1
- 40 "MICRO" CONDENSERS, for transistor circuits \$1

Circle 146 on reader service card

The FM-2400C provides an accurate standard frequency signal for testing and adjustment of mobile transmitters and receivers at pre-determined frequencies between 25 and 500 MHz. Up to 24 crystals may be inserted into the meter. The frequencies can be those of the radio frequency channels of operation, and/or of the intermediate frequencies of the receivers between 5 MHz and 40 MHz. Frequency stability (standard)  $\pm .001\%$  from 32° to 122 F. Frequency stability with built-in thermometer, calibrated crystals and temperature corrected charts, .00025% from +25°F

to +125°F. (.000125% special 450 MHz crystals available)

FM 2400C (Meter Only).....	\$445.00
RF Crystals	
Hi Band.....	\$24.00 ea.
Lo Band.....	15.00 ea.
IF Crystals.....	8.00 ea.

Write for free catalog.



**CRYSTAL MFG. CO., INC.**  
10 NO. LEE • OKLA. CITY, OKLA. 73102



Now With Solid State Circuitry & Rechargeable Batteries

# ICM FM-2400C frequency meter....

- Completely Portable
- Tests Predetermined Frequencies 25 MHz - 500 MHz

Circle 147 on reader service card

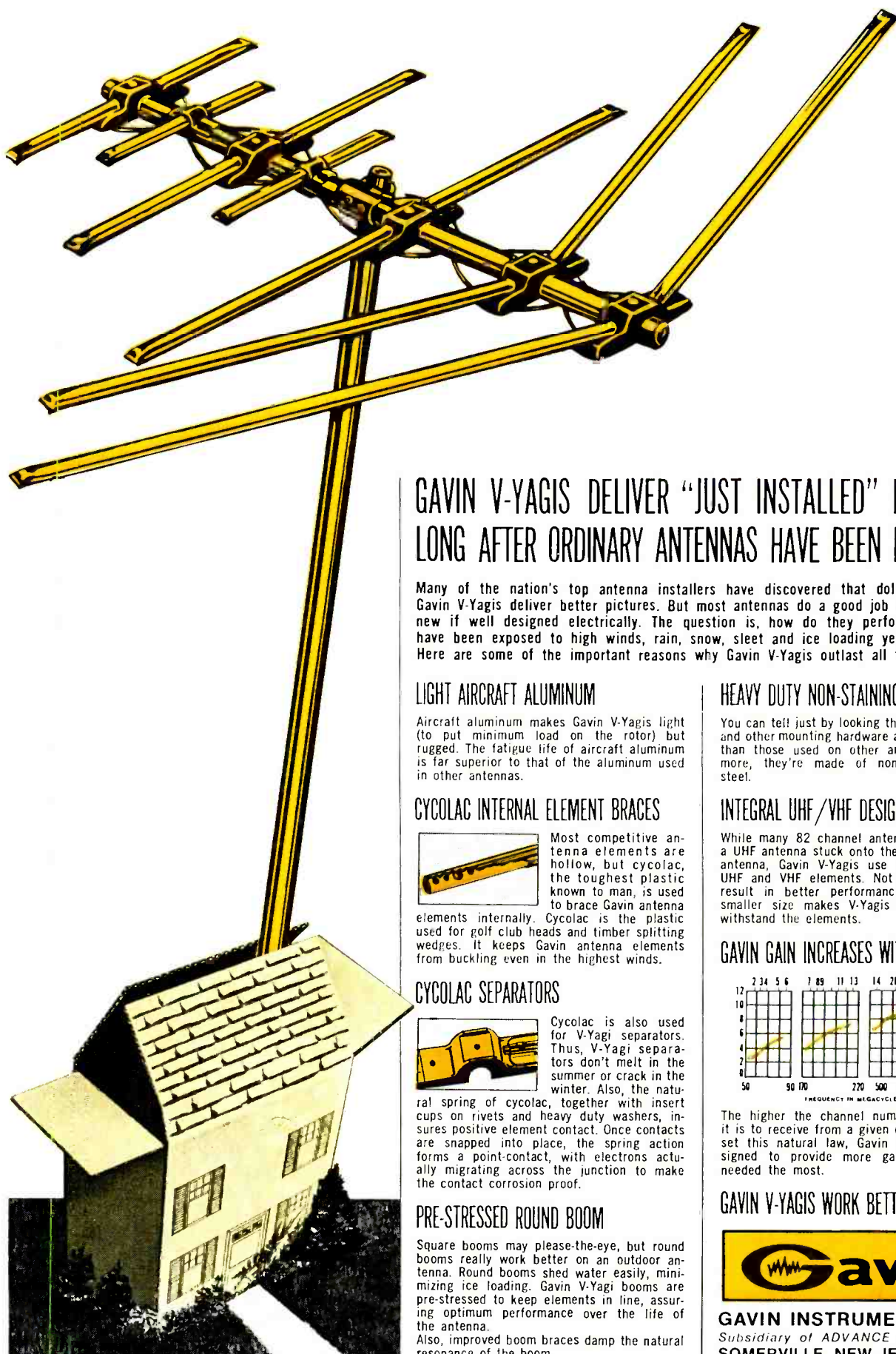

## GAVIN V-YAGIS DELIVER "JUST INSTALLED" PICTURES LONG AFTER ORDINARY ANTENNAS HAVE BEEN REPLACED

Many of the nation's top antenna installers have discovered that dollar for dollar, Gavin V-Yagis deliver better pictures. But most antennas do a good job when they are new if well designed electrically. The question is, how do they perform when they have been exposed to high winds, rain, snow, sleet and ice loading year after year? Here are some of the important reasons why Gavin V-Yagis outlast all the others.

### LIGHT AIRCRAFT ALUMINUM

Aircraft aluminum makes Gavin V-Yagis light (to put minimum load on the rotor) but rugged. The fatigue life of aircraft aluminum is far superior to that of the aluminum used in other antennas.

### CYCOLAC INTERNAL ELEMENT BRACES



Most competitive antenna elements are hollow, but cycolac, the toughest plastic known to man, is used to brace Gavin antenna elements internally. Cycolac is the plastic used for golf club heads and timber splitting wedges. It keeps Gavin antenna elements from buckling even in the highest winds.

### CYCOLAC SEPARATORS



Cycolac is also used for V-Yagi separators. Thus, V-Yagi separators don't melt in the summer or crack in the winter. Also, the natural spring of cycolac, together with insert cups on rivets and heavy duty washers, insures positive element contact. Once contacts are snapped into place, the spring action forms a point-contact, with electrons actually migrating across the junction to make the contact corrosion proof.

### PRE-STRESSED ROUND BOOM

Square booms may please-the-eye, but round booms really work better on an outdoor antenna. Round booms shed water easily, minimizing ice loading. Gavin V-Yagi booms are pre-stressed to keep elements in line, assuring optimum performance over the life of the antenna. Also, improved boom braces damp the natural resonance of the boom.

### HEAVY DUTY NON-STAINING HARDWARE

You can tell just by looking that Gavin U bolts and other mounting hardware are more rugged than those used on other antennas. What's more, they're made of non-rusting plated steel.

### INTEGRAL UHF/VHF DESIGN

While many 82 channel antennas are simply a UHF antenna stuck onto the front of a VHF antenna, Gavin V-Yagis use fully integrated UHF and VHF elements. Not only does this result in better performance initially but smaller size makes V-Yagis better able to withstand the elements.

### GAVIN GAIN INCREASES WITH FREQUENCY

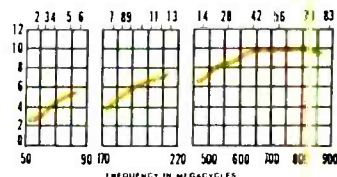

The higher the channel number, the harder it is to receive from a given distance. To offset this natural law, Gavin V-Yagis are designed to provide more gain where it is needed the most.

### GAVIN V-YAGIS WORK BETTER LONGER



**GAVIN INSTRUMENTS, INC.**  
 Subsidiary of ADVANCE ROSS CORP.  
 SOMERVILLE, NEW JERSEY 08876

Circle 148 on reader service card

# color



The **RCA WT-509A** Picture Tube Tester is a precision instrument in the famous RCA tradition. It tests both color and black and white picture tubes for emission quality, interelectrode leakage, and shorted elements. It's all solid-state AND IT'S ONLY \$118.00.\*



The **RCA WR-64B** Color-Bar/Dot/Crosshatch Generator has for years been the finest instrument of its type. Exceptionally stable, portable, it's a precision instrument designed for use in the laboratory and factory as well as for servicing on-the-bench and in-the-home. AND IT'S ONLY \$129.00.\*



The **RCA WR-502A** "CHRO-BAR" color-bar generator has even more features than the famous WR-64B. It's all solid-state, battery operated. It provides color bars, dots, crosshatch, vertical lines, horizontal lines, blank raster. It has rock-solid stability. All new circuit design. THE "CHRO-BAR" IS ONLY \$168.00.\*

\*Optional Distributor resale price.

For a complete catalog of descriptions and specifications for all RCA test equipment see your RCA Test Equipment distributor or write RCA Electronic Components, Commercial Engineering, Department No. A-39W, Harrison, N.J. 07029.

LOOK TO RCA FOR INSTRUMENTS TO TEST/MEASURE/VIEW/MONITOR/GENERATE

# RCA

Circle 149 on reader service card

www.americanradiohistory.com