

MASTER

50c

MAY 1966

Radio-Electronics

TELEVISION • SERVICING • HIGH FIDELITY

A GERNSBACK PUBLICATION

HUGO GERNSBACK, Editor-in-chief

Narrow-band Scopes for Color TV

How to Read Capacitor Codes

Crowhurst on Followers

Home Video Recorders:

- Who makes them
- What they cost to buy, to run
- How they work



WALLACE MATYKA 11/66
86 JENNINGS RD
BRISTOL JOHN

If you think
all replacement tubes are alike,
you've got a surprise coming

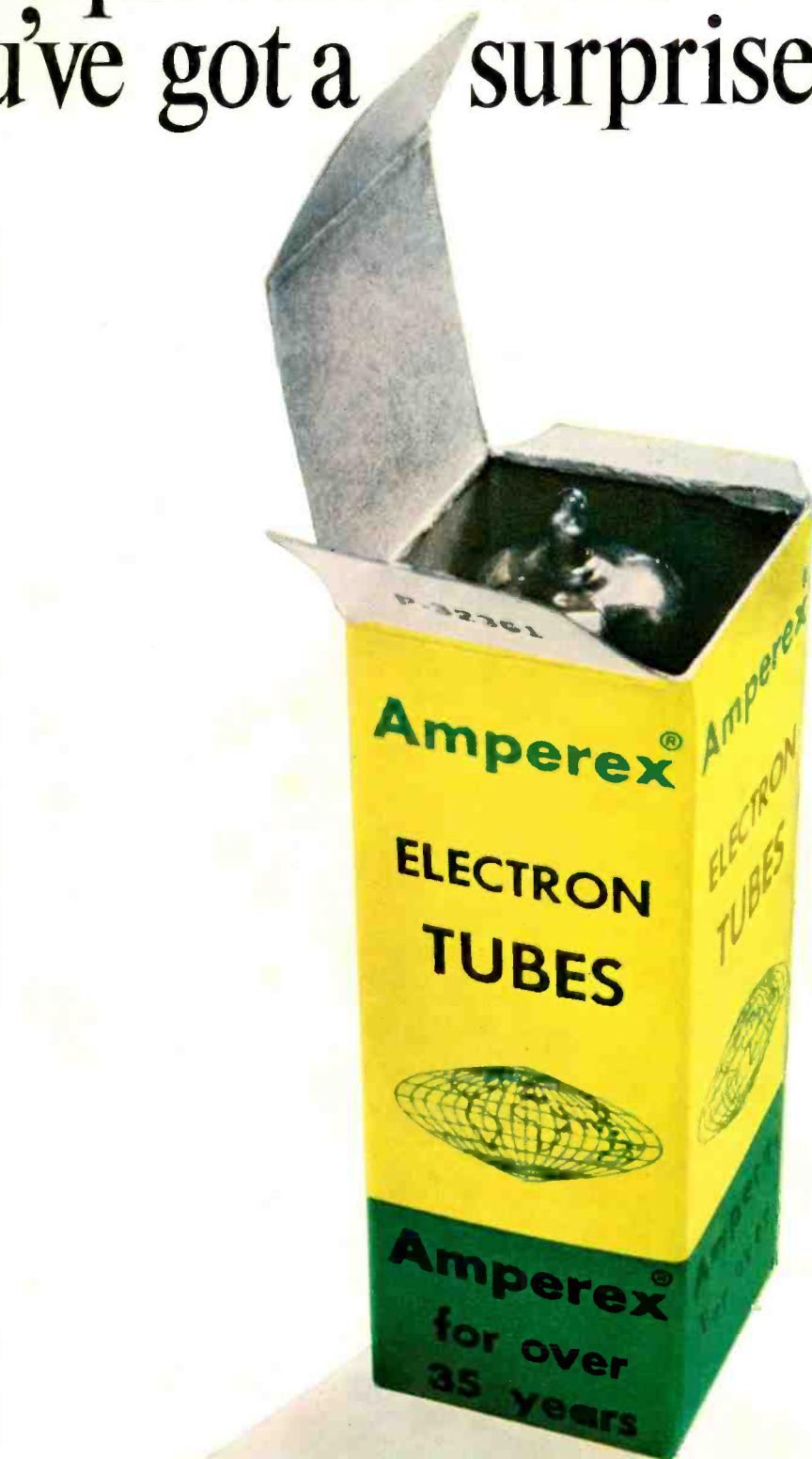

© 1966, AMPEREX ELECTRONIC CORP., HICKSVILLE, L. I., NEW YORK 11802
Circle 7 on reader's service card

ARE YOU NEXT?



HOW MUCH WOULD YOU LOSE IF BURGLARS STRUCK TONIGHT?

TECHNICAL INFORMATION

The RADAR SENTRY ALARM is a complete U.H.F. Doppler Radar System which saturates the entire protected area with invisible r.f. microwaves. It provides complete wall to wall—floor to ceiling protection for an area of up to 5,000 square feet. Without human movement in the protected area, the microwave signal remains stable. Any human movement (operation is unaffected by rodents and small animals) in the area causes the doppler signal to change frequency approximately 2 to 4 cps. An ultra-stable low frequency detector senses this small frequency change, amplifies it and triggers the police type siren—which is heard up to a half mile away.

In addition, the RADAR SENTRY ALARM's protection can be extended to other areas with the use of the following optional accessories:

- remote detectors for extending coverage to over 10,000 sq. ft.
- rate of rise fire detector U.L. approved for 2,500 sq. ft. of coverage each (no limit on the number of remote detectors that can be used)
- hold-up alarm
- central station or police station transmitter and receiver (used with a leased telephone line)
- relay unit for activating house lights
- battery operated horn or bell which sounds in the event of: powerline failure; equipment malfunction or tampering

Cash? Color Sets? Stereos? Portables? Consoles? Tubes? Test Equipment?

Add it up. What's the total? . . . \$1,000.00? . . . \$5,000.00? . . . \$10,000.00? . . . more?

Can you afford a loss like that?

Can you afford to be out of work for two or three weeks because your test equipment was stolen? Or smashed? Because if a burglar isn't satisfied with your haul . . . he'll smash everything in sight.

And don't count on insurance to cover your losses . . . At best, you'll get only partial restitution . . . and nothing for all the time you lose.

When will your time come?

We hope . . . never.

Install a "RADAR SENTRY ALARM" security system . . .

And we know never!

But there's another reason why you should install "RADAR SENTRY ALARM" in your business. Before you know it you'll be installing them all over town. Because everyone needs protection. Of the more than 100 million buildings . . . stores, offices, factories, schools, churches and homes . . . only a small percentage are protected by an effective security system.

You can sell them! And you don't have to be a super salesman either. For hundreds of electronics professionals like yourself are selling them . . . all across the country. All you have to do is demonstrate it. It sells itself. A glance at the technical information shows why. It's the most unique, effective and advanced security system available.

Here is a list of just some customers who are protected by RADAR SENTRY ALARMS: U.S. Government; U.S. Air Force; Detroit Board of Education; Catholic Diocese of North Carolina and Detroit; Hundreds of Businesses, homes and factories.

You, too, can protect your possessions and property . . . the same way you earn them . . . ELECTRONICALLY . . . with a "RADAR SENTRY ALARM". And at the same time expand your business in a totally new area that yields high profits.

Don't wait.

Write today for complete details.

**RADAR SENTRY ALARMS
BY DAY . . . PROFITS
BY NIGHT . . . PROTECTION**

RADAR SENTRY ALARM

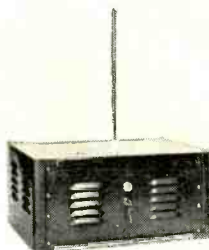

Circle 8 on reader's service card

Mail to: RADAR DEVICES MANUFACTURING CORP.
22003 Harper Ave., St. Clair Shores, Michigan 48080



Please tell me how I can protect and expand my business with Radar Sentry Alarm. I understand there is no obligation.

Name _____

Address _____

City _____ State & Code _____

Radio-Electronics

MAY 1966 VOL. XXXVII No. 5

Over 55 Years of Electronic Publishing

EDITORIAL

- 33 Color TV Has a Problem Forest H. Belt

TELEVISION

- COVER STORY 34 Home Video Tape Recorders: They're Coming in the Windows! ... Fred Shunaman
About a dozen machines at prices within reach of many individuals and institutions
- 49 Build a Flashlight-Operated TV Silencer Fred Blechman
—or radio or hi-fi silencer (for when the phone rings)

GENERAL

- 24 Service Clinic Jack Darr
Finding Coax Cable Breaks
- 38 Zener Power Supply for Transistor Radios ... Marvin J. Moss and Robert E. Beville
Like a permanent battery for servicing
- CAREER SERIES 40 Your Future in Microwave Ray D. Thrower
Could you join the growing number of top technical men in microwave work?
- 48 What's Your EQ?

AUDIO-HIGH FIDELITY-STEREO

- 51 Followers: Cathode, Plate and Others Norman H. Crouhurst
Useful tube and transistor circuits, and a practical hookup for proving a point
- 62 Equipment Report: The Editall KP-2 Tape-Splicing Block

TEST EQUIPMENT

- 47 The Detroit Dummy Basil Barbee
Rf power meter borrows auto idea of making lamps do work of meter
- 54 Using a Narrow-Band Scope for Color TV Robert G. Middleton
Certain signals can be fed direct to plates
- 64 Knight KG-635 DC-Wideband Oscilloscope

ELECTRONICS

- 44 Build the Multi-Alarm Charles J. Schauers
This electronic siren can be put to work in home, shop, store or car
- 58 How to Read Capacitor Codes Martin Clifford
Some order to the chaos of color dots

RADIO

- 57 Mobile Transmitter Notes Larry Loper
Hints from a mobile-communications service shop
- 80 The Lowdown on Touch Tuning Robert F. Scott
Some radios use clockwork tuning motors

THE DEPARTMENTS

- 16 Correspondence
91 New Books
79 New Literature

- 73 New Products
68 New Semiconductors & Tubes
4 News Briefs

- 90 Noteworthy Circuits
85 Technotes
87 Try This One
48 50 Years Ago

- 70 Reader's Service Page

HUGO GERNSBACK, *editor-in-chief*. M. HARVEY GERNSBACK, *publisher*. FOREST H. BELT, *editor*. Robert F. Scott, W2PWG, *technical editor*. Peter E. Sutheim, *associate editor*. Jack Darr, *service editor*. I. Queen, *editorial associate*. Wm. Lyon McLaughlin, *technical illustration director*.

RADIO-ELECTRONICS, May 1966, Volume XXXVII, No. 5. Published monthly by Gernsback Publications, Inc., at Ferry Street, Concord, N. H. 03302. Second-class postage paid at Concord, N. H. Printed in U.S.A. One-year subscription rate: U. S. and possessions, Canada, \$5. Pan-American countries, \$6. Other countries, \$6.50. Single copies: 50¢. © 1966, by Gernsback Publications, Inc. All rights reserved. POSTMASTERS: Notices of undelivered copies (Form 3579) to Boulder, Colo. 80302.



Member,
Institute of High Fidelity
Radio-Electronics
is indexed in
Applied Science
& Technology Index
(Formerly
Industrial Arts Index).

At Sea  On Land  In the Air 

Job Opportunities are G-R-O-W-I-N-G for DeVRY-TRAINED ELECTRONICS TECHNICIANS

DeVry Tech President Inspects Electronic Devices Aboard the World's Longest Ship . . . S.S. FRANCE . . . Pride of the French Line Fleet!

Thousands of men 18-45 who knew nothing about Electronics when they first contacted DeVry Tech are now EARNING GOOD MONEY in JOBS THEY LIKE because they took advantage of this invitation:

Send the coupon below for free, no-obligation FACTS about JOB OPPORTUNITIES in Electronics . . . plus details on our PROVED methods of helping men prepare for a start in this field.

Many who sent coupons are now in some of the most interesting and promising jobs imaginable – working aboard ships similar to the S.S. FRANCE, or at missile centers, or in TV studios. They are in Computer work, Radar, Automation and Industrial Control, Radio and Television, or other exciting branches of this vast, growing field.

These men discovered they didn't have to be technical wizards or have an advanced education to prepare for careers in Electronics. No . . . a real desire to get ahead is far more important!

Eye-opening facts describe DeVry's amazingly simplified and practical spare time educational programs designed especially for men unable to leave their homes. Also included are details of the industry – recognized day and evening programs in our Chicago or Toronto Laboratories. Yours for the asking, too, are facts on the actual job placement service DeVry Tech offers all its graduates. ACT NOW and soon you may be among the well-prepared DeVry men starting out in the better-paying opportunity field of Electronics. Send the coupon today.



Probably few other men in America are more closely identified with electronics education than T.J. Lafeber, DeVry Tech president. Since 1931, he has headed a pioneer school that has turned out thousands of graduates who went on to make good in the field. Commandant Joseph Ropars of the S.S. France is telling Lafeber he has heard DeVry Tech spoken of favorably in many ports of call.

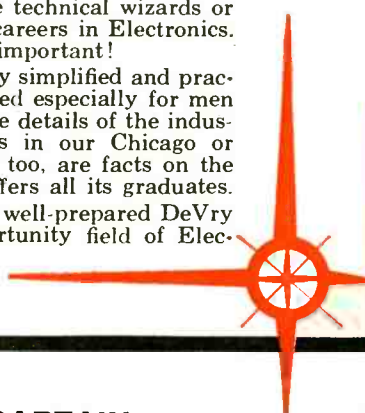

A CAPTAIN'S CAPTAIN

Remarkable developments in electronics have helped make possible such luxury liners as the S.S. France, of which Joseph Ropars is commandant. Ropars is known as a captain's captain, one of the most popular masters of the French Line's trans-atlantic fleet.



DeVRY
Technical Institute
CHICAGO • TORONTO

**Get Two Free Booklets!
Mail Opportunity Coupon Today.**

DeVRY TECHNICAL INSTITUTE
4141 Belmont Ave., Chicago, Ill. 60641 Dept. RE-5-W
Please give me your two free booklets, "Pocket Guide to Real Earnings" and "Electronics in Space Travel"; also include details on how to prepare for a career in Electronics. I am interested in the following opportunity fields (check one or more):

- | | |
|--|---|
| <input type="checkbox"/> Space & Missile Electronics | <input type="checkbox"/> Communications |
| <input type="checkbox"/> Television & Radio | <input type="checkbox"/> Computers |
| <input type="checkbox"/> Microwaves | <input type="checkbox"/> Industrial Electronics |
| <input type="checkbox"/> Automation Electronics | <input type="checkbox"/> Broadcasting |
| <input type="checkbox"/> Radar | <input type="checkbox"/> Electronic Control |

I AM INTERESTED IN AUTOMOTIVE AND MAINTENANCE ELECTRICITY. Please supply further information.

NAME _____ AGE _____
ADDRESS _____ APT. _____
CITY _____ STATE _____ ZONE _____

Check here if you are under 16 years of age

Available in Canada

2099

ACCREDITED MEMBER OF NATIONAL HOME STUDY COUNCIL

NEWS BRIEFS

GAS LASER WITH HIGHER POWER

The world's most powerful gas laser can emit 280 watts of coherent light energy continuously at better than 10% efficiency. Its concentrated beam can melt and vaporize even refractory materials used in high-temperature furnaces. Some ruby lasers have attained higher peak power but emit their energy only in pulses. Gas lasers, which generate sustained radiation suitable for telecommunication and

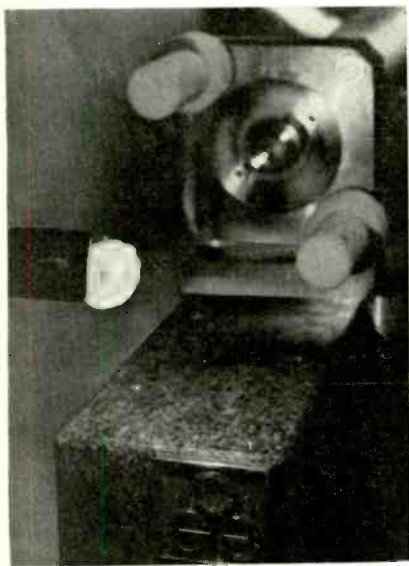

other uses, have previously achieved outputs of some 130 watts. Developed by Compagnie Générale d'Electricité, in France, this new laser uses a discharge tube containing carbon dioxide, helium and nitrogen to produce 10.59-micron-wavelength infrared rays.

ELECTRONIC SPACE STUDY

A rocket-propelled 210-lb payload, plunging back into the Earth's atmosphere at 18,000 mph, used a continuous telemetry channel to help test low-density heat-shield material. The experiment provided essential test data by radio to down-range ships and aircraft.

A delayed telemetry system is used to transmit information about the 1-minute communications blackout that occurs during re-entry.

NASA also launched a series of nine rockets to make meteorological investigations of the upper atmosphere. Grenades (special explosive charges) are ejected and detonated at programmed altitudes between 20 to 60 miles, over widely spaced geographic areas. The position of each grenade at

detonation is determined by radio measurements of range, azimuth and elevation. The time of arrival and direction of sound waves caused by the detonations are measured by sensitive microphones on the ground. As a result, wind directions and speeds, atmospheric densities, pressures, and temperatures can be determined.

In other tests, pulsed laser radar will be used for upper-atmosphere investigations under an agreement between the Swedish Space Research Committee (SSRC) and NASA. The principal scientific objective is to determine height, distribution and scattering properties of cosmic dust and aerosol particles during the presence and absence of noctilucent clouds (faintly luminous clouds which can be seen at heights of 75 to 90 kilometers at high latitudes at dusk or sunrise).

A pulsed ruby laser, an extremely high-energy light source concentrated into a narrow spectral line and confined to a very narrow beam, has been selected for this purpose. The laser radar operates on the same principle as ordinary radar, but uses the laser beam instead of a radio beam. Returns are detected by a photomultiplier receiving unit and fed into a memory unit where they are analyzed automatically. Stored information is displayed either on an oscilloscope and photographed, or punched on tape for further evaluation.

COMPUTERS IN USE ON ALL FRONTS

Computers are finding their way into the news, being used in all sorts of unusual ways.



The USS Enterprise, first nuclear-powered carrier to enter battle, brings into action off Vietnam a new automated combat-direction system which provides Navy commanders with information from the battle zone. Called NTDS (Naval Tactical Data System), the system is described as "an advanced ship-board system for command and control of a tactical situation."

NTDS provides a ship's combat-operations team with a comprehensive

information picture of ships, aircraft, and submarines—friend and foe—gathered by shipboard radars and other sensors, compiled by computers,



and displayed before the eyes of the command team on NTDS consoles. The Enterprise's system uses a Hughes Aircraft Co. Scanfar radar-computing system—a fixed-array radar and data-processing complex that detects and automatically tracks hundreds of targets simultaneously. It stores and displays information relating to aircraft on a variety of missions.

Back home, a cooperative program in the Minneapolis-St. Paul area allows eight hospitals to share common computer facilities for improving patient service and hospital administration. The program is the start of a nationwide information network which will connect hospitals to a central computer complex that will provide a range of accounting, administrative, and hospital management services, at a cost substantially less than if each hospital had its own computer.

At a demonstration, the 292-bed Abbott Hospital sent and received accounting information over telephone lines to a pair of Honeywell 200 computers about 4 miles away at the Minnesota Blue Cross Cooperative Data Center. The computers processed some of the data, stored some for future use, and upon request automatically transmitted patient-billing information to Abbott. In less than 90 seconds, complete bills were printed and given to discharged patients.

Inventory control, purchasing of hospital supplies and nonperishable foods, employee payroll and personnel records, property accounting for hospital equipment and facilities, preventive-maintenance scheduling, and general accounting will be added later this year and in 1967. Applications more directly related to patient care will be developed in gradual stages—for example, a dietary-management program based on nutritional and cost

continued on page 6

Plain Talk from Kodak about tape:

Giving your tape library a longer prime of life

How long can you keep a recorded tape? As of today, nobody knows for sure. Recording companies have tapes dating back to the late 1940s that are still in fine shape. Actually, the aging problem for tape is somewhat akin to the ones faced by movie-makers. Their problems are tougher, though . . . movie-makers have to worry about latent chemical reactions, greater mechanical strains, etc. And yet, we can see movies made more than a half century ago if the films have been given proper care and expert duping. Like photographic films, many audio tapes are made on ace-

goes for tapes. One obvious safeguard is to keep tapes away from strong magnetic sources like large electric motors or transformers which could demagnetize a recording.

Keep it clean. Tapes hate dirt just as much as regular records do. Thanks to sturdy, one-piece construction, Kodak's new "library décor" box helps keep dirt out . . . won't fall apart over the years as conventional tape boxes sometimes do. And this new box looks better. Play it clean too, of course. Clean your recorder heads, capstans, rollers and guides regularly with a cotton swab moistened with one of

keep your tapes in the "tails out" format rather than rewinding them. The uneven winding induced in the tape by fast rewinding can cause physical warping of the tape over a period of time. Here too, you're better off with KODAK Tapes because KODAK 5" and 7" Thread-Easy Reels are of dynamically balanced, one-piece construction. This gives you freedom from wobbles and pulsations on both "record" and "rewind". . . keeps the tape under smoother tension . . . just what the doctor ordered for long tape life. The need for smooth winding can not be overemphasized.

Last but not least, it's a good idea to dupe your really old tape recordings onto fresh KODAK Tape in order to standardize on KODAK Tape quality. That's an interesting subject all by itself, and we'll try to devote a "Plain Talk" to it soon!

KODAK Tapes on DUROL and polyester bases are available at electronic, camera and department stores. To get the most out of your tape system, send for free 24-page "Plain Talk" booklet which covers the major aspects of tape performance. Write Department 940, Eastman Kodak Company, Rochester, N. Y. 14650.

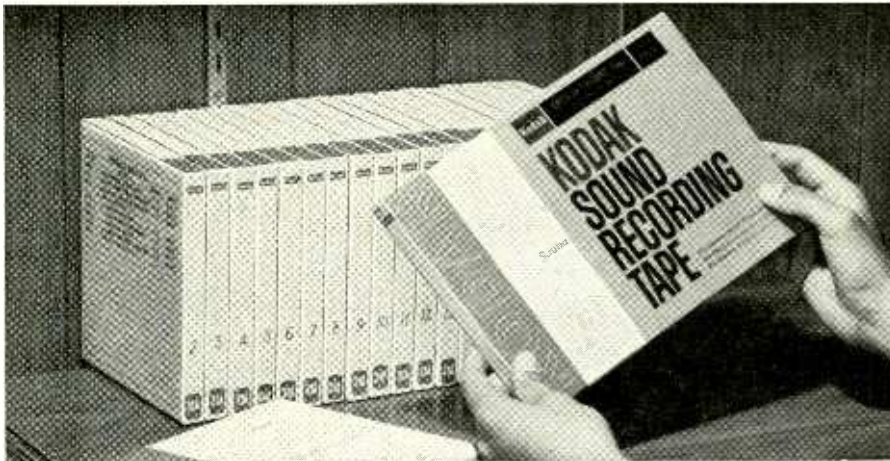

tate base. Ours is Kodak's famous DUROL Base, the stronger, tougher triacetate (we also make KODAK Tapes with a tempered polyester base for extra toughness or for long-play applications). Lab tests show that DUROL Base holds up as well as photographic film. So . . . tape wise, there's no reason your great grandchildren won't be able to enjoy your present efforts.

T.L.C. makes the big difference. Tender loving care is a must when saving anything worthwhile. The same

the commercial cleaners sold for that purpose. Use a degausser periodically to remove any magnetization of recording heads.

Keep it cool. Tapes should be kept away from extremes of temperature and humidity. High temperatures may affect the plastic support and increase the possibility of print-through . . . the transfer of magnetic signals from one layer of tape to the next.

Keep it "backwards." For truly valuable recordings, a good trick is to



EASTMAN KODAK COMPANY, Rochester, N. Y.

Circle 10 on reader's service card

factors to improve meals served to patients.

In the field of travel, a new system of passenger check-in and load control is now in its sixth month of operation at Pan American in New York. The heart of the system is an IBM 1440 computer. Agents communicate with the computer using a Bunker-Ramo Teleregister "interrogator" which combines a small TV screen and a keyboard. When a passenger checks in, the agent punches the flight number and the first two letters of the passenger's last name. In less than a second the display shows all reservations



meeting this description. The agent selects the correct name, and the computer then shows the complete pas-

senger record—name, initials, class of service, destination, number of infants, etc.

The special CRT device used in the system has a display capacity of nine lines, each of 42 characters. Data transmission between interrogators and computer is at the rate of 42,000 characters per second. The display sets connect to two universal control units, which supply delay-line storage and multiplexing. The control units feed



into a single interface unit which in turn connects to an IBM 1441 processing unit. Remote positions at ticket counters transmit over Data-phones on a 1200-character-band (150 character-per-second) telephone line. The high-speed memory has 16,000 positions. An additional 2 million characters can be stored on discs—sufficient for all programs, active flights, permanent aircraft and flight files, and training data.

Cornell University will soon be able to allow some of its scholars, administrators, and students to ask questions of a fact-stuffed, lightning-fast, \$3 million central computer and receive immediate answers. This facility is a time-sharing multiple-access computer that can be used simultaneously

continued on page 12



BRITEN UP YOUR DAY (AND HERS) WITH KINGS MEN AFTER SHAVE AND MEN'S COLOGNE

You get them FREE with Perma-Power Britener Packs—Masculine, refreshing, and luxurious Kings Men will brace your skin and your spirits! You'll see it at fine men's toiletry counters; but a generous bottle is Perma-Power's gift to you when you buy a convenient Vu-Brite or Tu-Brite pack. (Who says Christmas comes just once a year?)

VU-BRITES—Brighten TV pictures with the world's best-selling Britener! Your choice of Kings Men Cologne or After-Shave Free with either twelve-pack—series or parallel—at the special \$9.95 price.

TU-BRITES—If the base is right, the boost is right... and you can be sure the price is right! 4 assorted Tu-Brites (usually \$2.25 each dealer net) for only \$8.95... plus the Kings Men as our gift!

PERMA-POWER COMPANY

5740 North Tripp Avenue • Chicago, Illinois 60646
Phone: (Area 312) 539-7171



Circle 11 on reader's service card

RADIO-ELECTRONICS is published by Gernsback Publications, Inc.
Chairman of the Board: Hugo Gernsback
President: M. Harvey Gernsback
Vice President-Secretary: G. Aliquo
Vice President-Treasurer: Charles A. Raible

Editorial, Advertising, and Executive offices: 154 West 14th Street, New York 10011.
Circulation Office: Boulder, Colo. 80302.

SUBSCRIPTION SERVICE: Send all subscription correspondence and orders to RADIO-ELECTRONICS, Subscription Department, Boulder, Colo. 80302. For change of address, allow six weeks, furnishing both the old and new addresses and if possible enclose label from a recent issue.

ADVERTISING REPRESENTATIVES: East: John J. Lamson, Eastern Sales Manager, RADIO-ELECTRONICS, 154 West 14th Street, New York 10011, 212 AL 5-7755; Midwest: P. H. Dempers Co., 5555 N. Lincoln Ave., Chicago, Illinois, 60625, 312 561-0220; South Central: Media Representatives, Inc., 7900 Carpenter Freeway, Dallas, Texas 75247, 214 ME 1-4480; West Coast: J. E. Publishers' Representative Co., 8380 Melrose Avenue, Los Angeles, California, 90069, 213-653-5841; 420 Market Street, San Francisco, California, 94111, 415-981-4527; United Kingdom: Publishing & Distributing Co., Ltd., Mitre House, 177 Regent St., London W.1, England.

WELCOME ABOARD!

International's "FLYING SHOWROOM 66" will visit your area soon. Welcome aboard this fabulous electronic flying display.

During 1966, International's Martin 202 Flying Showroom will tour cities throughout the United States, bringing with it displays of International electronic equipment and products, plus a technical staff available for consultation. ■ A space age electronic show for Citizens Radio dealers and users, Amateur Radio operators, users of commercial 2-way radio, manufacturers requiring special electronic products, radio experimenters and hobbyists. ■ If you are a manufacturer, radio equipment dealer, Amateur or Citizens Radio Club, or other interested groups, we will attempt to schedule a specific time and date to visit your area. Watch for announcement or write International Crystal Manufacturing Co., Inc. for details.

Discuss your technical and engineering requirements with International's staff. See how International electronic products can work for you.



Circle 12 on reader's service card

Discover the excitement of learning Electronics with training kits NRI sends you

New Achievement Kit Custom Training Kits "Bite Size" Texts

Only NRI offers you this pioneering method of "3-Dimensional" home-study training. It's the result of more than half a century of simplifying, organizing, dramatizing subject matter. As an ambitious man you can effectively learn the Electronics field of your choice the NRI way. But NRI training is more than kits and texts. It's personal services, too, which have made NRI a 50-year leader in the home-study field.

YOU GET MORE FOR YOUR MONEY FROM NRI

Everything that you see here is included in just one NRI course. Other courses are equally complete, yet you'll be surprised at the low cost. Text for text, kit for kit, dollar for dollar—your best home study buy is NRI.



*Earn \$3 to \$5 an hour
spare or full time in*
**TV-RADIO
SERVICING**

Want to earn extra money? Looking for a good paying job? Interested in your own full-time business? Radio-TV Servicing is the branch of Electronics offering all these opportunities. In addition to teaching you the facts, NRI shows you how to earn while you learn.

You can learn quickly how to install, maintain and service tube and transistor home and auto radios, TV sets (including booming Color TV), hi-fi and stereo, public address systems. Like thousands of others, you can be earning \$3 to \$5 an hour in spare-time starting soon after you enroll.

*There's glamor and
success awaiting you in*
**BROADCASTING—
COMMUNICATIONS**

Good paying, fascinating positions await competent Communications Operators and Technicians. Broadcast stations, commercial stations, ships, aircraft, land vehicles all need men who know how to maintain and repair transmitting and receiving equipment. With closed-circuit TV, Facsimile, Microwave, Radar, Telemetry and all the communications needs of the Space Age, you can see how important training in this field has become. NRI training includes preparation for your First Class Radiotelephone FCC License.

*And you must pass the FCC exam
or NRI refunds your tuition in full!*

*Move ahead in America's
fast moving industry as an*
**ELECTRONICS
TECHNICIAN**

There is a serious shortage of qualified Electronics Technicians. Electronics has found its way into hundreds of areas not even dreamed of ten years ago: offices; manufacturing; medical and dental uses; transportation; space exploration; government and military equipment . . . there's no end of opportunity for trained men. This course stresses the basic principles around which most Electronic devices are built; prepares you for many current job openings. Prepare now. Learn Automation, computers, data processing, ultrasonics, telemetry. Whatever your interest in Electronics, you'll find an NRI training plan for you. Check the course of most interest to you on the postage-free card and mail it today for your free NRI Catalog. No obligation. No salesman will call. NATIONAL RADIO INSTITUTE, Washington, D. C. 20016.

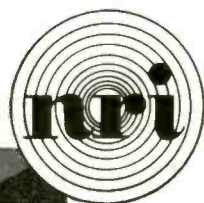

**More than
50 years of leadership
in Electronics Training**

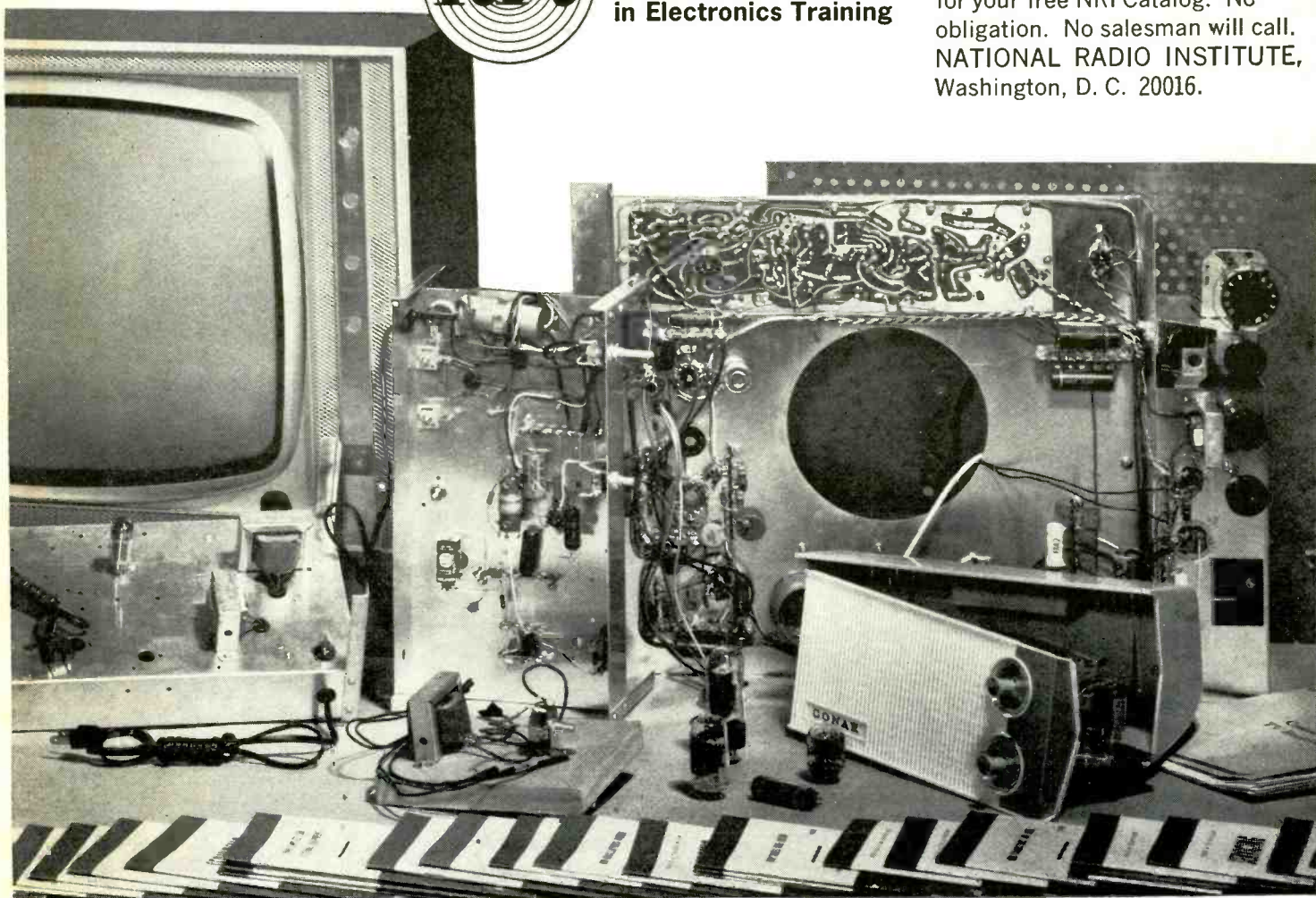

Complete TUNER REPAIR

\$9.50

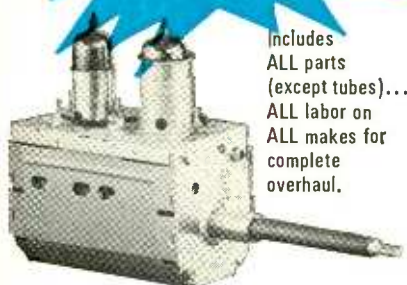

Includes
ALL parts
(except tubes)...
ALL labor on
ALL makes for
complete
overhaul.

FAST, 24-HOUR SERVICE with FULL YEAR WARRANTY

Sarkes Tarzian, Inc., largest manufacturer of TV and FM tuners, offers unexcelled tuner overhaul and factory-supervised repair service.

Tarzian-made tuners received one day will be repaired and shipped out the next. More time may be required on other makes. Every channel checked and realigned per original specs. And, you get a full, 12-month guarantee against defective workmanship and parts failure due to normal usage. Cost, including labor and parts (except tubes) is only \$9.50 and \$15 for UV combinations. Replacements at low cost are available on tuners beyond practical repair.

Always send TV make, chassis and Model number with faulty tuner. Check with your local distributor for Sarkes Tarzian replacement tuners, parts or repair service. Or, use the address nearest you for fast, factory-supervised repair service.

TUNER SERVICE  CORPORATION

*(Factory-supervised tuner service
authorized by Sarkes Tarzian)*

MIDWEST—817 N. Pennsylvania St.,
Indianapolis, Ind. Box 1642
Tel: 317-632-3493

EAST—547-49 Tonnele Ave.,
Jersey City, New Jersey
Tel: 201-792-3730

WEST—SARKES TARZIAN, Inc.,
Tuner Service Division
10654 Magnolia Blvd., N. Hollywood, Calif.
Tel: 213-769-2720

Manufacturers of Tuners, Semiconductors,
Air Trimmers, FM Radios, AM-FM Radios,
Audio Tape and Broadcast Equipment

NEWS BRIEFS continued

by 40 or more individuals, some of who may be in their own offices a mile or more away. A Cornell spokesman noted that "it will permit us to develop new applications of electronic computers and new ideas in teaching and in data processing for other university needs."

At the University of California (San Francisco), a new language called "Computest" allows man and machine to communicate with each other. Dr. John A. Starkweather demonstrated how a computer gives tests and how it can participate in an interview. The IBM 1620 computer, although not yet programed to a point that allows its use with patients, is proving valuable as a teaching tool for students in the health sciences. The interviewer and the machine communicate by a typewriter attached to the computer, and programs are written in a "Computest" vocabulary related to normal speech.

BRITISH TOWN USES COMPUTER IN BRIDGE DESIGN

A computer is being used to help design a bridge over the River Aire in Yorkshire. The bridge, to be constructed by cantilevering from each bank, with the two sections finally joined by a pin, is the first of its type to be built in England. If conventional bridge-design techniques were used, they would block the river's small navigable channel.

A Honeywell 400 computer is computing the profile of each of the 64 sections of the bridge to correct shrinkage, stress and creep problems that could prevent the bridge from meeting exactly at midpoint over the river.

The county also plans to use the computer in constructing roads, by having it provide data on proper road curvature and camber. The computer can produce perspective drawings that permit road and bridge designs to be viewed from different angles—a technique used by engineers to correct misalignments and other design errors.

TAPE RECORDERS FOR SOLDIERS IN VIETNAM

Too much mud, not enough money for equipment, and an urgent need for tape recorders. These were some of the problems revealed by Gene Schram, Jr., executive director for the USO Pacific Command, in a letter acknowledging receipt of six tape recorders from Craig Panorama, Inc. and Sayer Brothers, both of Los Angeles. The tape recorders are being used at the only four USO centers in operation in South Vietnam—at Tan Son Nhut, Qui Non, Nha Trang and Saigon. The USO director added: "We will always

need tape recorders and radios. Anything you and your friends can do at home to swell the 'kitty' will do more than words of mine can express."

COLOR TV LEADS HOME-ENTERTAINMENT GROWTH

Color television leads the latest upsurge in sales of home-entertainment equipment, just as black-and-white did a year ago. Improvements in technology have also instilled new life in radio and phonograph markets. New tape recorders and electronic organs have opened other fields for expansion.

The US market absorbed 11.6 million television receivers in 1965, according to a tabulation, an increase of more than 50% over the 7.76 million TV sets produced in 1955. The 1965 total included 1 million imported receivers.

The sale of color TV sets last year practically doubled over 1964 to reach 2.7 million sets.

INERTIAL NAVIGATION SYSTEM IN JETS

The first commercial inertial navigation system to be used in airline operations will enable Alitalia's new DC-8 Super 62 jets to operate without navigators in any part of the globe, including polar regions, without reference to celestial or ground-based navigational aids.

The Douglas Aircraft Co. has announced an order for the Sperry SGN-10 inertial navigation system for installation in their new DC-8 Super 62 jetliners which will be delivered to the Italian flag carrier in early 1967.

Produced by Sperry Rand's Sperry Gyroscope Co. Div., the system will serve not only as the basic navigation reference but will also be the attitude- and heading-reference source for the autopilot and flight instruments. END

CALENDAR OF EVENTS

AES (Audio Engineering Society) Thirteenth Annual Convention, Apr. 25-28; Hollywood Roosevelt Hotel, Los Angeles, Calif.

1966 INTERMAG (International Conference on Magnetism), Apr. 20-22; Liederhalle, Stuttgart, Germany

SWIEEEO (Southwestern IEEE Conf.), Apr. 20-22; Dallas Memorial Auditorium, Dallas, Tex.

NATESA (National Alliance of TV & Electronic Service Associations) Spring Conference, Apr. 23-24; St. Louis, Mo.

International Instruments, Electronics & Automation Exhibition, May 23-28; Olympia Hall, London, England

National Electronics Week, May 29-June 5; Civic Auditorium, San Francisco, Calif.

42nd Annual EIA Convention, June 7-9; Continental Plaza Hotel, Chicago, Ill.

1966 IEEE Communications Conference, June 15-17; Sheraton Hotel, Philadelphia, Pa.

“Sure,
you work hard,
but that’s not
enough...”

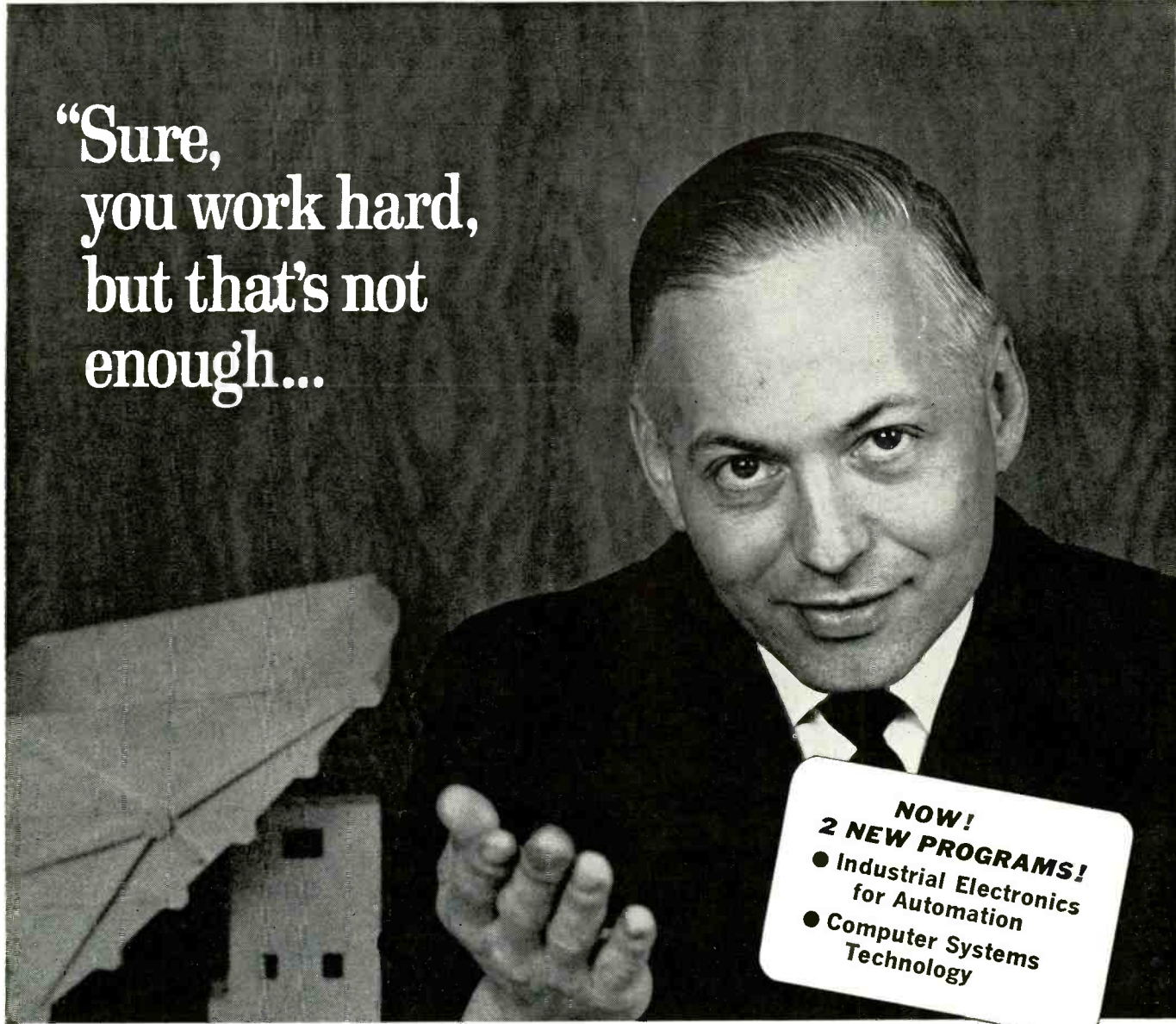

**NOW!
2 NEW PROGRAMS!**

- Industrial Electronics for Automation
- Computer Systems Technology

...you need more education to get ahead in electronics”

No matter how hard you work, you can't really succeed in electronics without advanced, specialized technical knowledge.

Going back to school isn't easy for a man with a full-time job and family obligations. But CREI Home Study Programs make it possible for you to get the additional education you need without attending classes. You study at home, at your own pace, on your own schedule.

CREI Programs cover all important areas of electronics including communications, servomechanisms, even spacecraft tracking and control. You're sure to find a program that fits your career objectives.

You're eligible for a CREI Program if you have a high school education and work in electronics. Our FREE book gives all the facts. Mail coupon or write: CREI, Dept. 1405-D, 3224 Sixteenth Street, N.W., Washington, D. C. 20010

SEND FOR FREE BOOK



Accredited Member of the National Home Study Council



The Capitol Radio Engineering Institute

Dept. 1405-D, 3224 Sixteenth Street, N.W.

Washington, D.C. 20010

Please send me FREE book describing CREI Programs. I am employed in electronics and have a high school education.

NAME _____ AGE _____

ADDRESS _____

CITY _____ STATE _____ ZIP CODE _____

EMPLOYED BY _____

TYPE OF PRESENT WORK _____

- I am interested in Electronic Engineering Technology
 Space Electronics Nuclear Engineering Technology
 NEW! Industrial Electronics for Automation
 NEW! Computer Systems Technology

What does
JFD[®]
have that other TV
antenna manufacturers
wish they had?

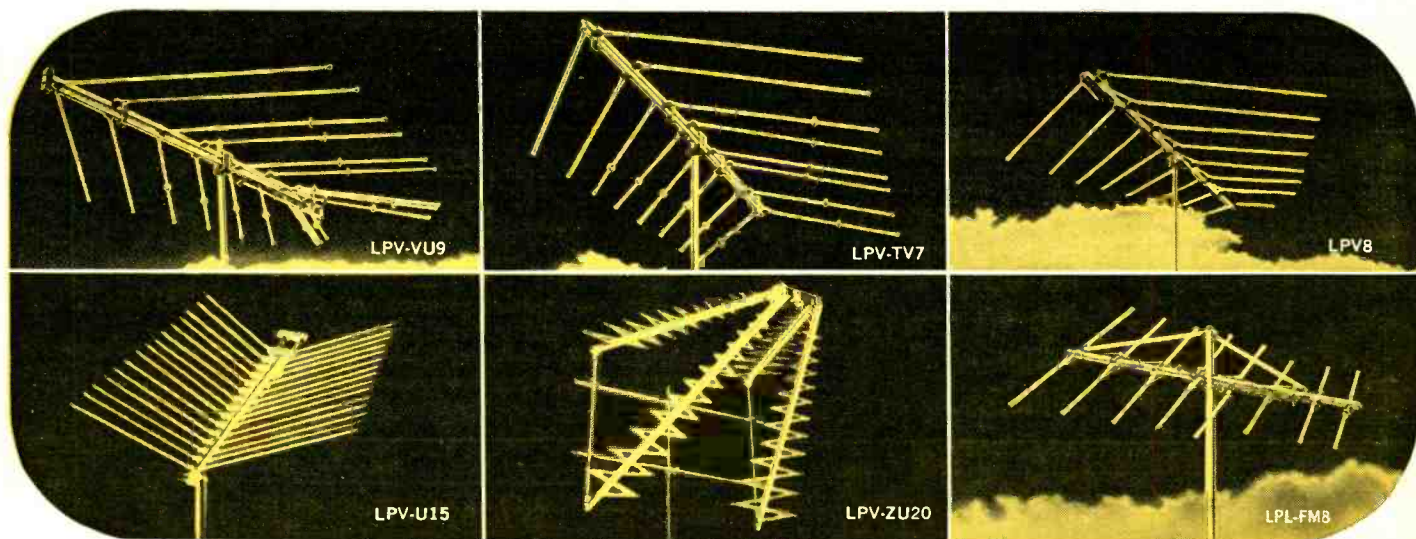

the

JFD[®]

LPV[®]
COLOR
LOG PERIODIC

Circle 14 on reader's service card

14

Mr. Dealer:

Don't let other antenna makers "snow" you with claims of how their antenna "break-throughs" work so sensationally you hardly need a TV set to get a picture.

They've got little choice.

Ever since the LPV Color Log Periodic was introduced by JFD back in '62, our competitors' engineers have been going around in circles. They've copied it down to the rivets. They've camouflaged their use of the log periodic principle with terms such as "energy distribution."

They've imitated its name by calling their "V-log," "Super-log" and -log.

(fill-in-yourself)

They've tried to equal its performance with "half-size" compacts—(but you can't send a midget to do a man's job—this just doesn't work.)

They still don't know whether to knock it... fight it... join it... or how to live with it.

We say the proof of it all is the picture your antenna delivers to your customer's set. That is where the JFD LPV Color Log Periodic conclusively demonstrates its basic performance superiority.

If you're looking to give your customers the finest and truest color... crispest black & white... more VHF and UHF channels... even better FM stereo—don't compromise your professional reputation with "antenna-compromises." Rely on the patented JFD LPV Color Log Periodic as do so many tens of thousands of knowledgeable service-dealers.

We don't expect you to take our word for it either. Let the picture (and your profits) be the proof.

Exactly WHAT the JFD LPV Color Log Periodic has that other so-called antenna "break-throughs" would like to have!

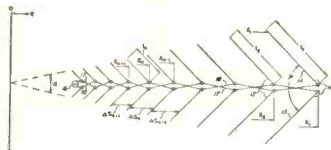

$$\frac{L(n+1)}{L_n} = \tau$$

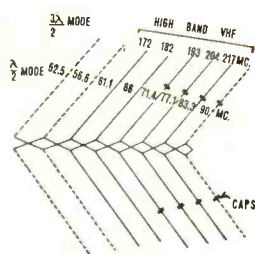

- ONLY the JFD LPV delivers genuine **frequency-independent** performance. The **entire** antenna (not part of the antenna as in other ordinary antennas) responds to **every** channel.
- ONLY the JFD LPV follows the **patented log periodic** design of the University of Illinois Antenna Research Laboratories.
- Only the JFD LPV uses **Cap-Electronic** (capacitor-coupled) elements. This permits (1) precise and independent tuning for optimum performance in **both** fundamental **and** harmonic modes—**plus** (2) increased capture area—**plus** (3) directors tuned to perform on **all** bands, not just one. The result is **higher gain**, **narrower** directivity, **higher** front-to-back ratios for brilliant color, better-than-ever black & white—on channels 2 to 83.

ADVERTISED IN
LIFE

NATIONALLY ADVERTISED IN LIFE. Month after month, 32 million readers of LIFE are being exposed to the reasons why the JFD LPV works best.



COLORFULLY ADVERTISED OVER TELEVISION. Spectacular motion-picture commercials in full-color are pre-selling millions of present and prospective color TV owners.

25 DIFFERENT LPV LOG PERIODICS TO CHOOSE FROM. Interested in VHF? ... UHF? ... VHF/UHF/FM? Whether it's just one band or all, town or country, you get the precise antenna-answer when you make it an LPV Color Log Periodic. Interested in more facts? Just write us.

MERCHANDISED IN DEPTH. Banners, direct mail, newspaper mats, radio/TV commercials . . . you name it JFD's got it to help you sell your way to top antenna profits.

• A WORD ABOUT OUR PATENTS . . . Eleven different U. S. patents and patents pending embrace the scientific advances of the JFD LPV—more than any other outdoor TV antenna. Our competition's attorneys are burning the midnight oil trying to find loopholes and ways to circumvent this patent protection which assures you of getting the **only** genuine antenna designed according to the **original patented log periodic** design of the famous **University of Illinois Antenna Research Laboratories**.

LICENSED UNDER ONE OR MORE OF U.S. PATENTS 2,958,081; 2,985,979; 3,011,158; 3,108,280; 3,150,375; 3,210,767; RE. 25,740 AND ADDITIONAL PATENTS PENDING IN U.S.A. AND CANADA. PRODUCED BY JFD ELECTRONICS CORPORATION UNDER EXCLUSIVE LICENSE FROM THE UNIVERSITY OF ILLINOIS FOUNDATION.

AT THE MOMENT OF TRUTH THE PICTURE IS THE PROOF
WHY JFD LPV COLOR LOG PERIODICS WORK BEST!

JFD ELECTRONICS CORPORATION

15th Avenue at 62nd Street, Brooklyn, N.Y. 11219
JFD International, 64-14 Woodside Ave., Woodside, N.Y. 11377
JFD Canada, Ltd., Canada

See what's NEW from JFD at BOOTH #2101 in San Francisco Parts Show June 3, 4, 5

ATTENTION! CB OPERATORS

save on citizens radio equipment

Discontinued Models From International Radio Exchange

Select that extra transceiver for mobile or base installation, or equip a new station. Our stock includes International types as well as other makes.

*Write Today for A
Complete List of
Equipment in Stock*



RADIO EXCHANGE
18 NO. LEE, OKLA. CITY, OKLA. 73102
Division Of International Crystal Mfg. Co.
Dealing In Used Citizens
Radio Equipment



Circle 15 on reader's service card



The story
of your career
in electronics
surely hasn't been
written yet.

But you may find the preface
to it on page 31

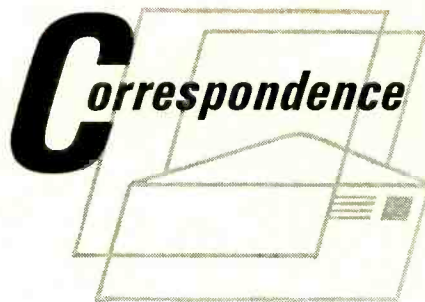
✓
WELL, IT'S ALMOST PERFECT P52

Dear Editor:

The "Component Curve Tracer" in the November 1965 issue is a very useful piece of test gear. But there is another component you can't check with it. [The article mentioned that frequency crystals and batteries couldn't be checked with the Curve Tracer.—*Editor*] If you test a small, low-power SCR you'd expect to get a diode curve on the scope. However, due to the small capacitance of a low-power SCR, the display indicates a dead short. An SCR that checks as shorted on the Component Curve Tracer comes up as good on a Tektronix curve tracer.

TAD E. COWELL

Seattle, Wash.

[Author Fred Blechman comments: "The low voltage in the Component Curve Tracer makes it difficult to test every type of component. The operator should try a known-good component to be familiar with its characteristic trace; from then on, abnormalities in other parts of the same type will be readily apparent. The Component Curve Tracer is still a simple and almost universal quick-check."]

OUR CHANGE HERTZ SOME READERS

Dear Editor:

You have taken a perfectly good term—cycles—that has a valid intrinsic meaning, and which has been used for ages in applications relating to that meaning, and substituted for it the word "Hertz," which has no meaning at all. If this stands, and the trend continues, engineering education of the future will become as idiotic and inefficient as the medical field now is. (I am now a physician, having entered medicine after 20 years in engineering.)

Can you actually give a good reason for this word change?

ROBERT C. BEARD

Indianapolis, Ind.

[We have received many letters asking us why we changed. One reason is that the new term follows the practice adopted by the National Bureau of
continued on page 22

successful service shop beats rising costs with B&K television analyst

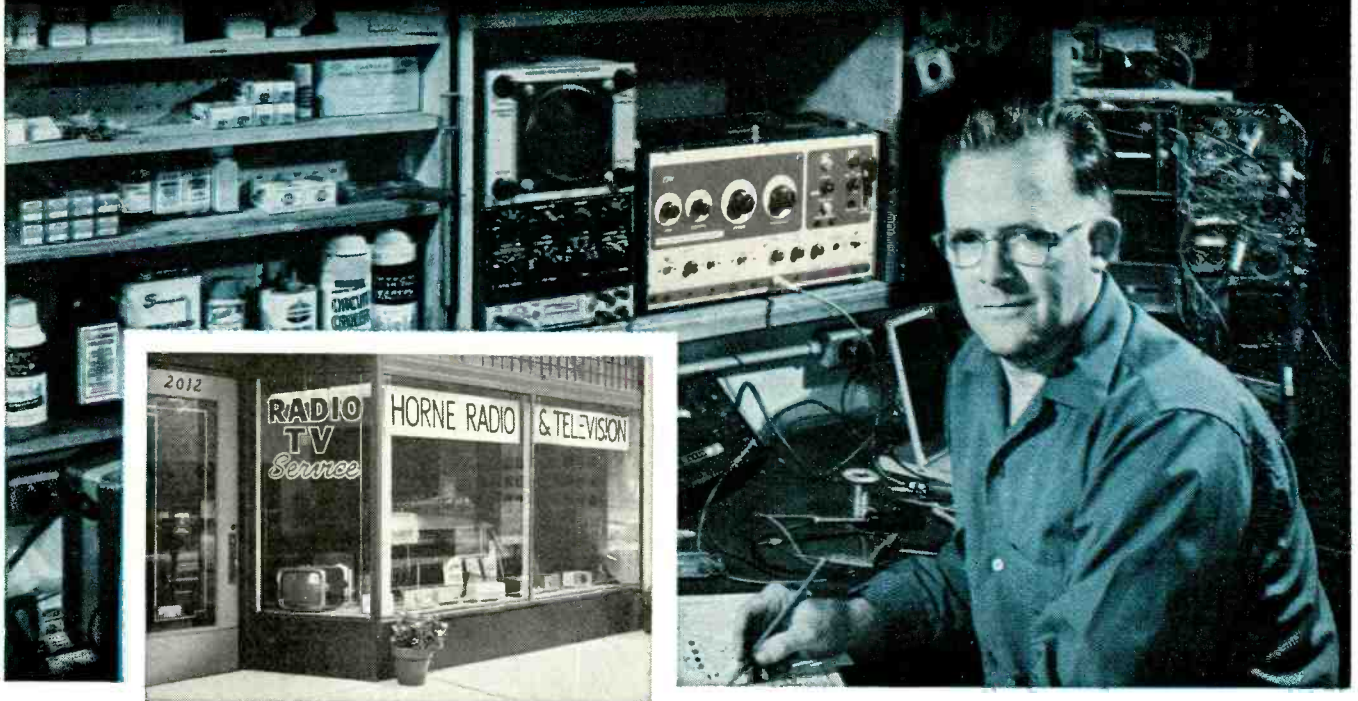

"As every serviceman knows, major TV repairs represent an increasingly large part of the service business and the average time per repair has increased"...

says Willard Horne of Horne Radio and Television in Evanston, Illinois.

After more than 25 successful years in the service business, twenty of them in the same location, Mr. Horne can be considered an authority on how to keep a business profitable. Mr. Horne says, "In order to be successful, our 3-man shop has to be competitive on the large jobs as well as the small ones. With the increase in bench time that we were experiencing and the limitations on what we could charge, there was a reduction of profit that had to be stopped. Then we bought a B&K Model 1076 Television Analyst."

"Now our customers get the same extra-value service on the big repairs and the small ones," said Mr. Horne. "We use the Television Analyst for troubleshooting a wide variety of complaints,* particularly for those that require touch-up align-

ment, location of IF overloads and color convergence. We are more competitive now that we use the B&K Television Analyst because we spend far less time on the jobs that used to be dogs, with benefits both to the shop and our customers."

* B&K Model 1076 Television Analyst checks every stage in a black and white or color TV receiver. Nine VHF RF channels, 20 to 45 MC IF, audio, video, sync, bias voltage and AGC keying pulse are available. The model 1076 provides its own standard test pattern, white dot, white line crosshatch, and color bar pattern slide transparencies. It includes a blank slide which can be used for closed-circuit-TV display floor promotion. Its net price is \$329.95.

Find out how you will increase your TV service profits with a B&K Model 1076. See your distributor or write for Catalog AP 22.



B & K MANUFACTURING CO.
DIVISION OF DYNASCAN CORPORATION
1801 W. BELLE PLAINE AVE. • CHICAGO, ILL. 60613
Canada: Atlas Radio Corp.,
Export: Empire Exporters, 123 Grand St., New York 13, U.S.A.

Circle 16 on reader's service card

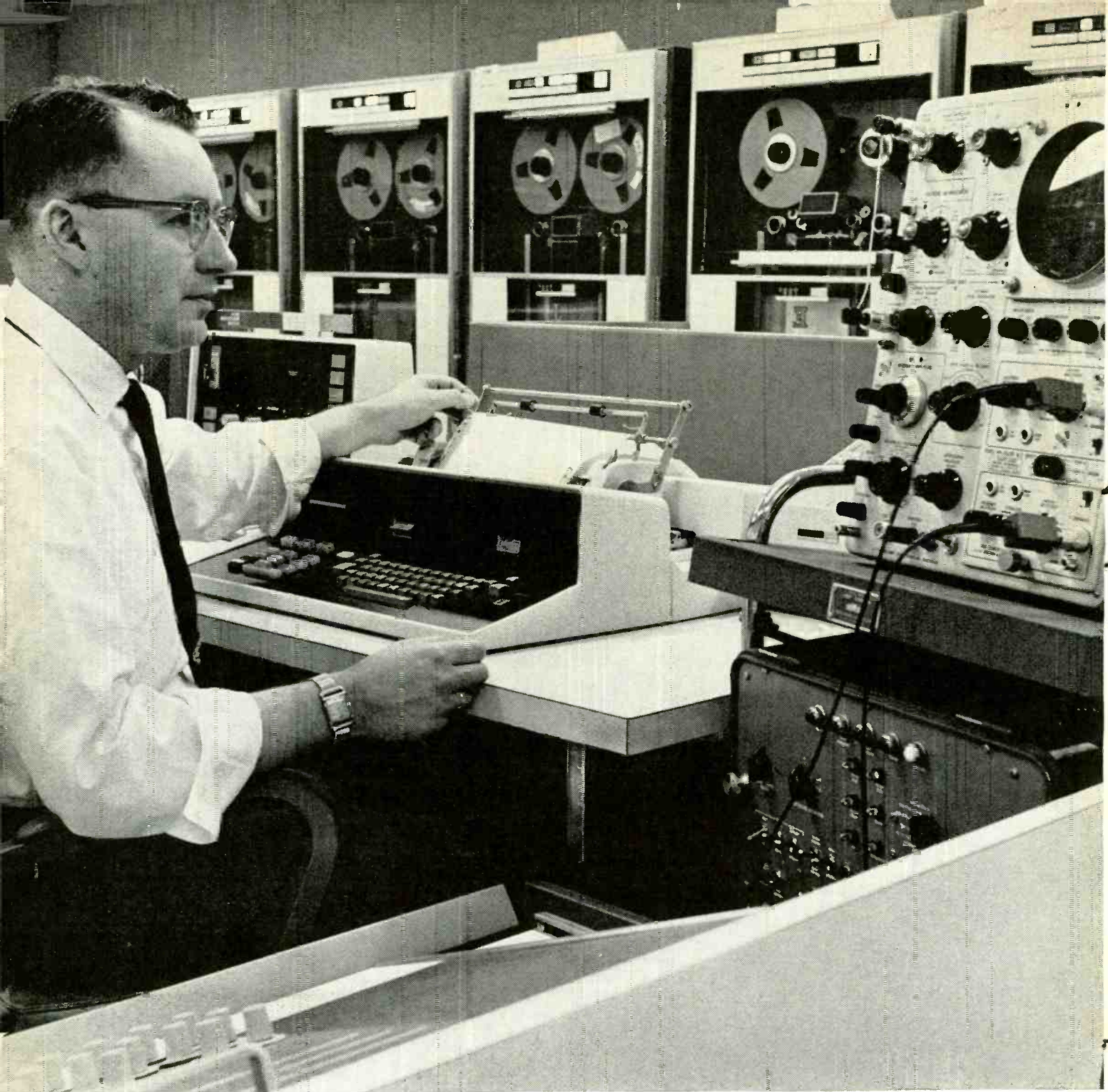

Why Fred got a better job . . .

I laughed when Fred Williams, my old high school buddy and fellow worker, told me he was taking a Cleveland Institute Home Study course in electronics. But when our boss made him Senior Electronic Technician, it made me stop and think. Sure I'm glad Fred got the break . . . but why him . . . and not me? What's he got that I don't. There was only one answer . . . his Cleveland Institute Diploma and his First Class FCC License!

After congratulating Fred on his promotion, I asked him what gives. "I'm going to turn \$15 into \$15,000," he said. "My tuition at Cleveland Institute was only \$15 a month. But, my new job pays me \$15 a week more . . . that's \$780 more a year! In

twenty years . . . even if I don't get another penny increase . . . I will have earned \$15,600 more! It's that simple. I have a plan . . . and it works!"

What a return on his investment! Fred should have been elected most likely to succeed . . . he's on the right track. So am I *now*. I sent for my three *free* books a couple of months ago, and I'm well on my way to Fred's level. How about you? Will you be ready like Fred was when opportunity knocks? Take my advice and carefully read the important information on the opposite page. Then check your area of most interest on the postage-free reply card and drop it in the mail *today*. Find out how you can move up in electronics too.

How You Can Succeed In Electronics

... Select Your Future From Five Career Programs

The "right" course for your career

Cleveland Institute offers not one, but five different and up-to-date Electronics Home Study Programs. Look them over. Pick the one that is "right" for you. Then mark your selection on the reply card and send it to us. In a few days you will have complete details ... without obligation.

1. Electronics Technology

A comprehensive program covering Automation, Communications, Computers, Industrial Controls, Television, Transistors, and preparation for a 1st Class FCC License.



2. First Class FCC License

If you want a 1st Class FCC ticket *quickly*, this streamlined program will do the trick and enable you to maintain and service all types of transmitting equipment.

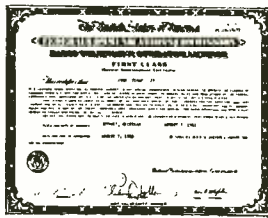

3. Broadcast Engineering

Here's an excellent studio engineering program which will get you a 1st Class FCC License and teach you all about Program Transmission and Broadcast Transmitters.



4. Electronic Communications

Mobile Radio, Microwave, and 2nd Class FCC preparation are just a few of the topics covered in this "compact" program ... Carrier Telephony too, if you so desire.

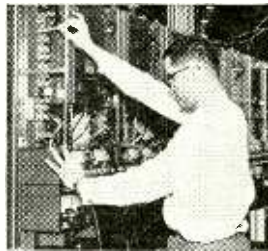

5. Industrial Electronics & Automation

This exciting program includes many important subjects such as Computers, Electronic Heating and Welding, Industrial Controls, Servomechanisms, and Solid State Devices.



An FCC License ... or your money back!

In addition to providing you with comprehensive training in the area indicated, programs 1, 2, 3, and 4 will prepare you for a Commercial FCC License. In fact, we're so certain of their effectiveness, we make this *exclusive* offer:

The training programs described will prepare you for the FCC License specified. Should you fail to pass the FCC examination after completing the course, we will refund *all* tuition payments. You get an FCC License ... or your money back!

CIE's **AUTO-PROGRAMMED** lessons help you learn faster and easier

Cleveland Institute uses the new programmed learning approach. Our **AUTO-PROGRAMMED*** lessons present facts and concepts in small, easy-to-understand bits ... reinforce them with clear explanations and examples. Students learn more thoroughly and faster through this modern, simplified method. You, too, will absorb ... retain ... advance *at your own pace*. *TRADEMARK

NEW
in
1966

Only CIE offers new, up-to-the-minute lessons in all of these subjects:

- Logical Troubleshooting
- Laser Theory and Application
- Microminiaturization
- Single Sideband Techniques
- Pulse Theory and Application
- Boolean Algebra

Free nationwide job placement service ... for life, for every CIE graduate

Once enrolled with CIE, you will get a bi-monthly listing of the many high-paying interesting jobs available with top companies throughout the country. Many Cleveland Institute students and graduates hold such jobs with leading companies like these: American Airlines, American Telephone and Telegraph, General Electric, General Telephone and Electronics, IBM, Motorola, North American Aviation, New York Central Railroad, Raytheon, RCA and Westinghouse.



Full accreditation ... your assurance of competence and integrity

Cleveland Institute of Electronics is accredited by the Accrediting Commission of the National Home Study Council. You can be assured of competent electronics training by a staff of skilled electronics instructors.

Your Future In Electronics Is Up To You. Make It A Brighter One. Mail Reply Card Today.

CIE

Cleveland Institute of Electronics

1776 East 17th Street, Dept. RE-18, Cleveland, Ohio 44114

for your stereo—hi-fi
radio and television
amateur
equipment...



Only
\$14.85

Whisper Fan
KIT

assures top performance
and extended
component life

Without adequate ventilation, your equipment is heating itself to death—smothered by cabinets, enclosures and wall installations. Every component is a heat generator that severely affects equipment performance and life.

NOW...you can beat the heat that wrecks the set by installing a Rotron Whisper Fan Kit. Breathing 60 cubic feet of cool air over, under and around every component, the Whisper Fan improves performance by minimizing drift due to temperature change within the enclosure. Requires only 7 watts, just pennies a week to operate, the Whisper Fan reduces service calls by up to 40%.

installs in minutes

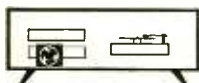

Compact...only
4 1/16" square and
1 1/2" deep, it can
be set in a corner

or mounted on the rear panel in minutes. The Whisper Fan Kit comes complete with special mounting hardware, plug and cord for electrical connections and detailed installation instructions. Write for complete details or ask your dealer.



ROTRON mfg. co., inc.
WOODSTOCK, NEW YORK
ORiole 9-2401

Circle 17 on reader's service card

CORRESPONDENCE continued

Standards and numerous respected manufacturing corporations and scientific journals. As to why NBS adopted it, we won't speak for them, but it does bring American terminology into line with continental European practice, which has used the Hertz for many, many years.

[That's mere conformity, true. A more logical reason is that "cycles" alone is not really accurate. The correct unit is "cycles per second," which leads to somewhat unwieldy abbreviations like "cps" or "c/s." Since "Hz" is defined as cycles per second, "60 Hz" is really more accurate than the common "60 cycles."

[The physical sciences have set a long and honorable precedent for naming units after researchers associated with them: volt, ampere, ohm, farad, gauss, newton, joule, and many others. That practice is no more or less silly than making Columbus Day a bank holiday or minting a Kennedy half dollar. Nonsentimental people may bristle at the thought; but the fact remains that it is much easier to talk of a *newton* of force than of a kilogram-meter-per-second-per-second.—Editor]

**COPING WITH
"SILENT"-PROJECTOR NOISE**

Dear Editor:

I would like to add a few suggestions to the article "Add Sound to Your Home Movies" (March R-E). In ordinary 16-mm sound projectors, the case around the machinery deadens the noise of the projector drive. Silent-film projectors usually do not have a case. The noise from the mechanism is annoying enough during the showing of a film, but it is especially serious when recording a synchronized sound track for a film as it is being shown. Especially when lip-sync sound is being recorded, it is usually necessary to stay close to the projector.

Anyone interested in noise-free movie sound recordings should read a booklet called *Magnetic Sound Recording for Motion Pictures*, published by Kodak and available at most photo stores. While the book is intended for magnetic-stripe sound-on-film recording, much of it applies to recording with a separate tape recorder.

One more thing to remember: If either the film or the tape is spliced after cutting out some material, an equivalent length of material must be cut out of the other medium, otherwise the sound and picture will be out of sync. If material is added to one, an equivalent amount must be added to the other.

STEPHEN A. KALLIS, JR.
Huntsville, Ala. END

Let these experts
answer your questions on
COLOR TV servicing

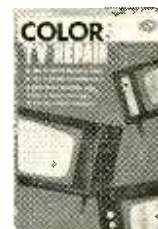

**Color TV
Repair**

10 servicing experts who write for Radio-Electronics magazine reveal tested techniques, practical ideas, tricks-of-the-trade. Shows how to pinpoint defective color section fast, describes trouble-shooting with a color bar generator, outlines causes of TV failure. Includes servicing of chroma circuits, etc. 160 pages, paperback.

Order #123\$2.95

Servicing Color TV

by Robert G. Middleton. A practical book that shows how to service color TV sets and make money doing it. Includes facts on signal tracing, test equipment, color sync servicing, chroma circuit servicing, matrix testing, etc. 224 pages, paperback.

Order #65\$2.90

TV Sweep Oscillators

by Harry E. Thomas. A practical, non-mathematical handbook that explains relaxation oscillators, pulse techniques, transistorized oscillators, sawtooth generators, synchronization, failure analysis, sweep oscillator servicing, etc. 226 pages, paperback.

Order #119 (at parts jobbers only) ...\$3.95

**Horizontal Sweep
Servicing Handbook**

by Jack Darr. Gives you fast, simple methods of locating and repairing troubles in the sweep system. Practical shortcuts, developed on the bench for rapid isolation of trouble. Includes horizontal oscillator, multivibrator, output stage, etc. 224 pages, paperback.

Order #115\$4.10

Order from your Electronic Parts Distributor today, or mail to:

Gernsback Library, Inc., Dept. RE-566
154 West 14 Street, New York, N. Y. 10011

Send the following books:

- #123 (\$2.95)
- #65 (\$2.90)
- #115 (\$4.10)

I enclose \$..... (prices 10% higher in Canada)

Name

Address

City State Zip

My distributor is

No Waiting In This Line



Kit GR-53A **\$375⁰⁰** (less cabinet)

Step Right Up And Enjoy The True-To-Life Pictures Of A HEATHKIT® 21" COLOR TV... Now Available For Immediate Delivery!

Supply Catches Demand. Until recently, this unique color TV kit has been on a reservation basis due to the nation-wide shortage of color tubes. However, at the moment we have them in stock for immediate right-to-your-front door delivery.

The Only 21" Color TV You Can Align & Maintain! You degauss, converge and adjust the picture ... *anytime* you decide color purity needs it. Exclusive "built-in self-servicing facilities" coupled with simple-to-follow instructions and detailed color photos show you exactly what to do and how to do it. Results? Clean, beautifully sharp color pictures day in and day out.

Only 21" Color TV You Can Install 3-Ways! Mount it in a wall, your own or either Heath cabinet. Picture tube is warranted for a year, all other parts for 90 days.

From Parts To Pictures In Just 25 Hours! As easy to build as an audio amplifier. And you enjoy the savings (quality compares to sets costing up to \$200 more). Easy credit terms available, too. Get the full story in your FREE Heathkit catalog!

Kit GR-53A, all parts except cabinet for wall mounting, 125 lbs. . . . **\$375.00**
Assembled GRA-53-7, walnut wood cabinet (illustr.), 82 lbs. . . . **\$108.00**
Assembled GRA-53-6, walnut-finished hardboard cabinet, 51 lbs. . . . **\$46.50**

Heathkit®/Thomas "Coronado" Transistor Organ!



Kit GD-983
\$799⁰⁰

All Genuine Thomas Factory-Fabricated Parts! Boasts 17 organ voices, two 44-note keyboards, rotating Leslie plus 2-unit main speaker system, 28-notes of chimes, 13-note heel & toe pedalboard, color-tone attack & repeat percussion, all-transistor 75-watt EIA peak power amplifier, luxurious hand-crafted walnut cabinet with matching bench. Liberal credit terms available. 245 lbs.

Play In Minutes Instead Of Months...

With This New
Heathkit®/Thomas
COLOR-GLO
Organ



Kit GD-325
\$349⁹⁵
(less bench)

Just Match Up The Colors With Your Left Hand, the letters with your right hand ... and you play complete songs with melody, harmony and bass ... even if you've never played an organ before! When you're finished, just flip a switch and the Color-Glo key lights disappear, leaving a beautiful spinet organ. Includes 10 organ voices, two 37-note keyboards and more! 153 lbs. Matching walnut bench, 18 lbs. \$24.95



FREE! World's Largest Kit Catalog!

108 pages! Over 250 easy-to-build kits for stereo/hi-fi, amateur radio, shortwave, test, marine, CB, educational. Mail coupon or write Heath Company, Benton Harbor, Michigan 49022.



Heath Company, Dept. 20-5
Benton Harbor, Michigan 49022

Enclosed is \$ _____, plus shipping.

Please send model (s) _____.

Please send FREE Heathkit Catalog.

Name _____

Address _____

City _____ State _____ Zip _____

Prices & specifications subject to change without notice.

CL-241

Circle 18 on reader's service card

SERVICE CLINIC

By JACK DARR Service Editor

Finding Coax Cable Breaks

A little applied ingenuity will often save you a lot of time. You can use conventional test instruments in unusual ways to do jobs that could stymie a lesser man!

ting off 6 inches from each end and replacing both plugs. This will fix *most* opens, for the ends of a cable get the hardest wear, from bending and flexing. However, you've whacked off a foot,

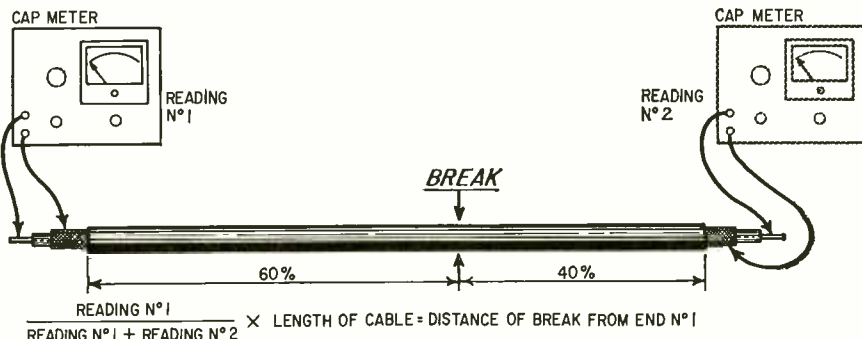

In audio work, for instance, you find a lot of shielded cables. Suppose you have a shielded, jacketed cable, and it's open. Where's the break? Same problem applies to coax cable.

You can use the old method of cut-

and maybe it's going to be too short now, huh? Let's pin-point the break a little more exactly.

An ohmmeter can't tell you, of course, but your capacitance tester will! An open cable like this is just a "long

capacitor." Connect one end of the cable to your capacitance tester and measure the capacitance between the center conductor and the shield. Note the value, then repeat the test on the other end. You can use the ratio between the two readings to tell you, to the inch, where the inner conductor is open.

I tried this out on a deliberately broken piece of cable. At one end, I read 60 pF; as the other end, 40 pF. So, the break was exactly 60% of the way from that end, and 40% from the other. (Don't lose track of which end is which!)

Anyhow, all shielded or coaxial cable has so many pF per foot, depending mostly on its diameter. The regular audio cables are pretty small and have pretty high capacitance. You can also use this method on open coax lead-in cable. Rf cable, like RG-59/U, has a much smaller capacitance (21 pF) per foot. You really don't need that information, though. All you need to know is the ratio between the two capacitances and the overall length of the cable, and you've got it made. You can find the break with a yardstick.

As I said, most breaks show up at the ends of the cables. So, if you have a cable that ought to have about 100 pF, say, and you can read 99 pF at one end and practically nothing at the other, there you are—the break is at the low-capacitance end, probably right at the plug.

Finding a shorted cable is another matter. You've got a very low resistance here, especially in rf cables. Audio cables, the smaller ones, will have some resistance; enough to make it easier. If you have a very-low-resistance ohmmeter scale on your vom or vtm, this will help. On one with about 5 ohms center-scale, you can read a resistance of 1 or 2 ohms without trouble. Repeat the test at each end of the cable. The short will be nearer the low-resistance end. If a typical audio cable has a short at one end, you will get an absolute zero reading there, and perhaps 1 ohm at the other end. Since a lot of the short-circuits we find are actually at the plugs themselves, this will give you some idea

continued on page 26

"... one of the finest stereo FM tuners we have tested and... easily the best kit-built tuner we have checked."

Hi Fi/Stereo Review April 1966

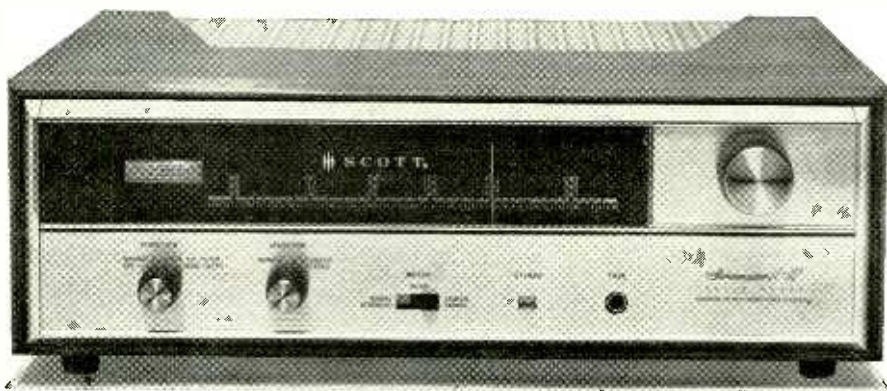

"The Scott LT-112 met or exceeded all its specifications that we were able to check. Its sensitivity was 2.1 microvolts (rated 2.2). Harmonic distortion at 100 per-cent modulation was about 0.5 percent (rated 0.8 per-cent). Capture ratio was 2.4 db (rated 4 db). Hum was -66 db, which is the lowest we have ever measured on a tuner . . . it is a logical choice for anyone who wants the finest in FM reception at a most reasonable price."

Build the stereo tuner that has won rave reviews from audio experts . . . the Scott LT-112. Here are the same features, performance, quality, and reliability you'd expect from Scott's finest factory-wired solid-state tuners . . . the only difference is, you build it. LT-112 price, \$179.95.



For complete information on the Scott LT-112 solid-state FM Stereo tuner kit, write: H. H. Scott, Inc., Dept. 570-05, 111 Powdermill Road, Maynard, Mass. Export: Scott International, Maynard, Mass. Prices and specifications subject to change without notice. Prices slightly higher west of Rockies.

Circle 19 on reader's service card

This column is for your service problems—TV, radio, audio or general and industrial electronics. We answer all questions individually by mail, free of charge, and the more interesting ones will be printed here.

If you're really stuck, write us. We'll do our best to help you. Don't forget to enclose a stamped, self-addressed envelope. Write: Service Editor, Radio-Electronics, 154 West 14th Street, New York 10011.

FINCO

COLOR-VE-LOG ANTENNAS

FOR UHF, VHF, FM RECEPTION

ALL-BAND UHF-VHF-FM ANTENNA

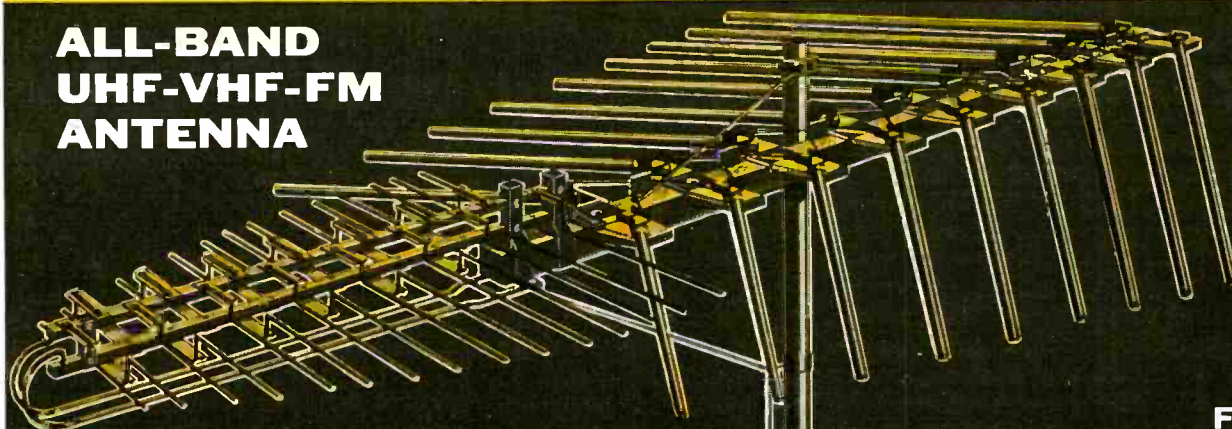

FINCO
Model UVF-24
\$59.95 list

The one antenna that does the work of 3! Gives startlingly clear black and white pictures and beautiful color on both UHF and VHF television channels — plus the finest in stereophonic and monophonic sound reproduction.

FINCO Model UVF-18—\$42.50 list
FINCO Model UVF-16—\$30.50 list
FINCO Model UVF-10—\$18.50 list

SWEPT-ELEMENT VHF-FM ANTENNA

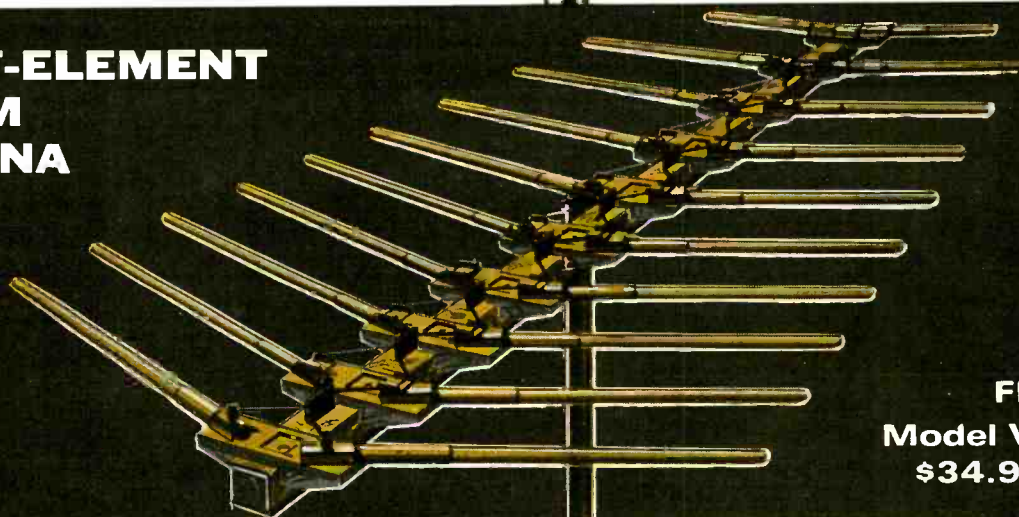

FINCO
Model VL-10
\$34.95 list

FINCO's Color-Ve-Log challenges all competition! Its swept-element design assures the finest in brilliant color and sharply defined black and white television reception — as well as superb FM monaural and stereo quality.

FINCO Model VL-18—\$54.50 list
FINCO Model VL-15—\$46.95 list
FINCO Model VL-7—\$23.95 list
FINCO Model VL-5—\$16.95 list

Featuring FINCO's exclusive Gold Corodizing

FINCO COLOR-VE-LOG

Prices and specifications subject to change without notice

THE FINNEY COMPANY • 34 W. Interstate Street • Bedford, Ohio

Write for beautiful color brochures Number 20-322, and 20-307, Dept. RE

WHY bother with makeshift twist-prong capacitor replacements?

When you substitute capacitor sizes and ratings, you leave yourself wide open for criticism of your work . . . you risk your reputation . . . you stand to lose customers. It just doesn't pay to use makeshifts when it's so easy to get the exact replacement from your Sprague distributor!

Get the right SIZE,
right RATING every time
with improved



**SPRAGUE
TWIST-LOK®
CAPACITORS!**

1,863 different capacitors to choose from!

The industry's most complete selection of twist-prong capacitors, bar none. Greater reliability, too. Exclusive Sprague cover design provides a leak-proof seal which permits capacitors to withstand higher ripple currents.

GET YOUR COPY of Sprague's comprehensive Electrolytic Capacitor Replacement Manual K-107 from your Sprague Distributor, or write Sprague Products Co., 81 Marshall Street, North Adams, Mass.



WORLD'S LARGEST MANUFACTURER OF CAPACITORS

48-126-62 R1

Circle 21 on reader's service card

of where to look, anyhow.

There's one more way of finding stubborn shorts, if your ohmmeter won't go low enough. It's a lot more spectacular, too! Ground the shield to a TV chassis, and touch the end of the HV lead to the center conductor of the cable. Since most shorts are only minor ones, one or two strands of fine wire, the chances are that this will "blow the short out," or at least flash over inside the cable, and you can look for the smoke! You can do it with the B+ voltage, in most cases. (Be sure the B+ is well fused, just on general principles!) Incidentally, on clear-plastic-insulated cable, this is easiest of all. You can see the fireworks! You have nothing to lose: if you can't find the short, your customer's going to have to buy a whole new cable anyhow.

This, by the way, is a handy little trick for finding cable troubles in coaxial-cable antenna-distribution systems in apartments and motels. Open both ends of the cable and check the capacitance, and you'll find the break without having to pull cable out of the walls! Don't have to take the plugs off, either.

Restoring old Patterson radio

I've just picked up an old "Patterson" 86AW four-band table radio, in pretty good shape, but it looks as if there have been a few "unauthorized modifications." Among other things, one socket is stamped "59," and there's a 59 in the socket, but that is a 2.5-volt tube, and the set has a 6-volt heater line. I'd like to get this thing back in shape. Where can I find a schematic and service data on it?—P. M., Hollywood, Calif.

You'll find the service data for this set on page "Patterson 6-3" in John F. Rider's "Perpetual Radio Troubleshooter's Manual," Vol. 6. It will be listed in the index as a model 186AW, but it's the same set.

You mentioned a mismarked socket. This comes from a revolting habit manufacturers had in those days of using up leftover sockets from previous runs! The socket marked "59" must be for the 6A6 driver tube. Feeds the two 42's in the output stage. Look for the .02- μ F coupling capacitors connected between the plates (pins 2 and 6) of the 6A6 socket, to the grids (pins 4) of the 42 sockets; these, of course, can be identified by the output transformer connections to their plates, on pins 2.

Intermittent raster, CTC9A

I found an RCA CTC9A color set with an intermittent that's bugging me. The raster disappears after about 20 minutes. High voltage OK. It'll stay off for 3-4 minutes, then pop! there it is

continued on page 28



BREAKTHROUGH...

TALK RIGHT THROUGH SKIP AND NOISE INTERFERENCE WITH THE NEW JOHNSON MESSENGER "350" SINGLE SIDEBAND CB TRANSCEIVER.

The Strategic Air Command, U.S. Signal Corps and overseas telephone companies pioneered single sideband because they required dependable, long range communications, particularly when operating conditions were at their worst. They proved that single sideband penetrated jumbled skip signals, atmospheric noise and other interference with clean, sharp clarity.

Now this "talk power" is yours for CB communication with the new Johnson Messenger "350" single sideband transceiver. The Messenger "350" will give you up to 30% more range than ordinary CB communication. Under severe skip and noise conditions, the "350" can deliver up to 3 times the range previously possible.

Maximum legal power input with single sideband provides output equivalent to 3 times ordinary AM talk power.

Johnson engineering superiority gives you these features in the Messenger "350": Automatic level control that lets you talk as loudly as you like without exceeding legal power limits—and with no speech clipping

- Adjacent channel interference virtually eliminated
- Crystal stability of .001%
- 3-watt audio output on receive or P.A.
- Dependable operation from -20° to +140° F.
- Solid state circuitry throughout—no tubes, no mechanical relays
- Optional plug-in AC power supply for base operation
- Optional Power Pack for high-power, hand carried field operation.

All these and more are yours when you move up to single sideband with the Johnson Messenger "350". Ask your authorized Johnson Dealer to demonstrate it today!



E. F. JOHNSON COMPANY

2321 10TH AVENUE S. W., WASECA, MINNESOTA 56093

Please send me my FREE booklet—Why Single Sideband?

Name _____

Street _____

City _____ State _____ Zip _____

Circle 22 on reader's service card

again. The plate voltage on the video output tube jumps from 34 to 440 when the raster goes out; screen voltage jumps 100 volts at the same time, and cathode voltage goes from a normal 5 up to 10. —J. S., Big Spring, Tex.

You've found it. While it would be a good idea to check the high voltage very carefully to be sure that it is OK with the raster off, this video amplifier trouble looks like the real villain.

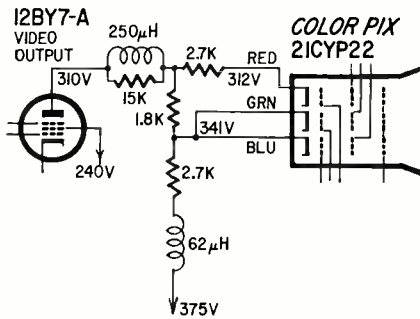

Since all color sets use "pure" dc coupling back at least as far as the video output, anything that affects the voltage on the video amplifier plate will also affect the CRT cathode voltage! The schematic shows how they're hooked up.

In the ordinary CRT, what happens when you increase the cathode voltage by 100 volts? You cut the beam off completely and the raster goes out! This is

what's happening here. Quite a few resistors could be causing it, or it could be due to a bad tube, or even to a loose or dirty connection on the video amplifier tube socket. (Open the plate circuit and what happens? The voltage goes up.)

So, you'll just have to take the schematic and trace that plate circuit back to the voltage source. If you do, you'll find out where the voltage is going wrong. Since you're getting a "rise" that is much more than the normal no-load voltage, it might pay to look for an "odd" trouble, like a leakage or accidental wiring short between the 385-volt line and the boost, etc. That 100-volt jump is too much for something like an open plate on the 12BY7; that tube doesn't pull that much current. Be sure that all your cathode connections on the CRT are tight, and check the contrast control for an intermittent connection.

Bigger resistors?

I've had several cases lately where resistors burned out. They looked awfully little to me. Would it be better to replace them with heavier ones, say 1-watt size instead of 1/2-watt?—C. W., Oakland, Calif.

Yes and no. A resistor burns out because too much current flows through

it. This is caused by a short or leakage somewhere else! So, a burned resistor is a sign of trouble. In many cases, the designer deliberately uses 1/2-watt resistors so they will blow as soon as there is a short in the circuit. For example: the little surge resistors used in ac-dc tube radios, the 1KΩ resistors used as filters in TV plate and screen circuits, especially in video i.f.'s, and so on.

Best way to make sure about resistor ratings is to check the current through the resistor, or measure the drop across it, and figure the power being dissipated. END

NEW TOOL FOR UNDERWATER TREASURE HUNTERS

This exciting undersea prospecting instrument has opened new vistas for the treasure seeker. Drop this device in the water to discover if there's anything down there worth diving for. Great shortcut for archeologist and treasure hunter alike.

Coming in June

RADIO-ELECTRONICS

Microelectronics and Solid State Special Issue

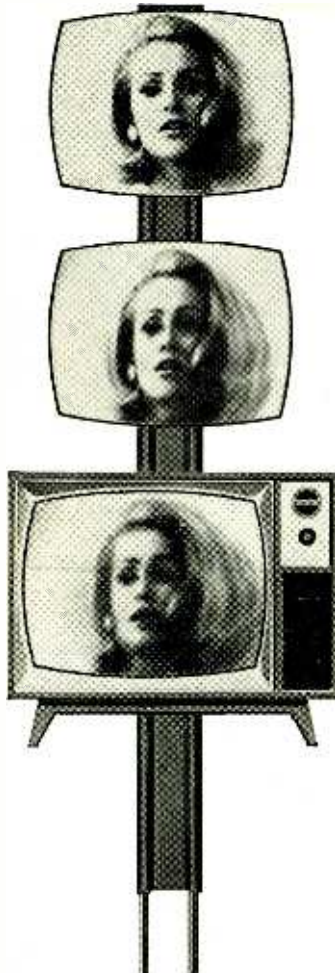

amazing new
engineering achievement
from JERROLD!

82-CHANNEL COLORAXIAL™ CABLE

**Delivers unheard-of low loss and top
82-channel color performance**

At last, a TV transmission line with TV studio quality reception for homes, TV shops, appliance stores and MATV systems. It comes ready-to-install in 50 and 75-foot sweep-tested coils with factory attached connectors. And it's actually less expensive than some twinlead.

New 82-Channel Coloraxial Cable causes less loss than shielded twinlead, and it's comparable to new twinlead in a typical home installation. What's more, twinlead losses increase with age—coax losses remain constant. And Coloraxial cable lasts 10 times longer than twinlead.

For full profit, and excellent TV reception, try Jerrold's low-loss Coloraxial cable on your next antenna installation. After all, you and your customers deserve the best.



JERROLD ELECTRONICS CORPORATION
Distributor Sales Division
401 Walnut St., Philadelphia, Pa. 19106



Circle 23 on reader's service card

SEND CARD FOR RCA'S NEW 1966 HOME STUDY CAREER BOOK TODAY

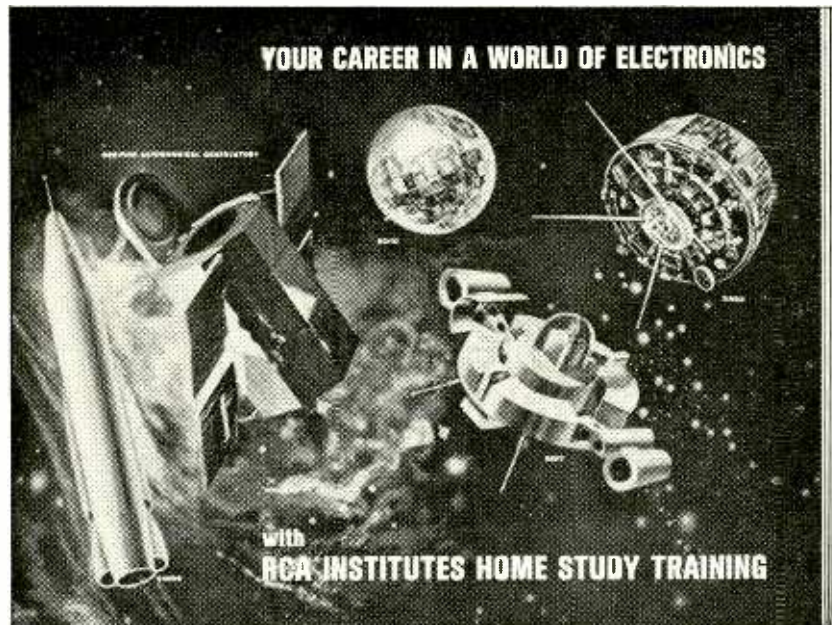

CUT THE TIME BETWEEN NOW AND SUCCESS

- Find out about RCA Institutes Career Programs.
- Learn about the amazing "Autotext" programmed instruction method—the easier way to learn.
- Get the facts about the prime quality kits you get at no extra cost.
- Read about RCA Institutes' Liberal Tuition Plan—the most economical way for you to learn electronics now.
- Discover how RCA Institutes Home Training has helped its students enter profitable electronic careers.

Lots more helpful and interesting facts too! Send postage-paid card for your FREE copy now. No obligation. No salesman will call.

RCA INSTITUTES, Inc. Dept. RE-56
350 West 4th Street, New York, N. Y. 10014

RCA Institutes also offers
Classroom Training.
Catalog free on request.
(Courses also available in Spanish)



The Most Trusted Name in Electronics

Circle 24 on reader's service card

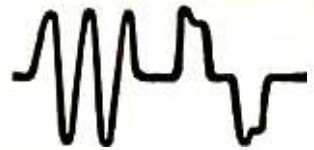

Using Dual Trigger Diodes in SCR Control Circuits

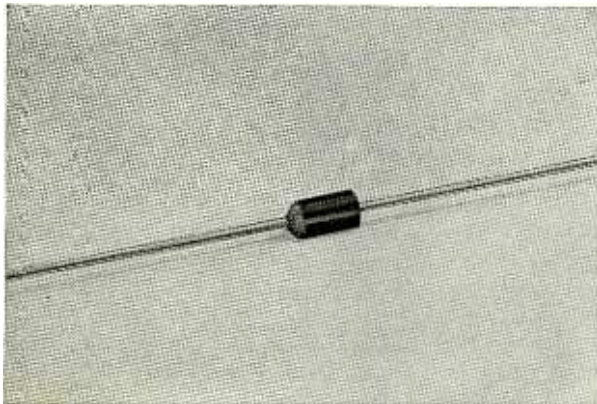

The new Mallory dual trigger diode has many interesting applications in control circuits, as a means of supplying adjustable voltage peaks to the gate of an SCR or a bi-switch.

First, let's look at this device. It's somewhat like two zener diodes connected back to back. If you apply AC to it, the trigger will only allow current to pass during that part of each half cycle when applied voltage exceeds its rated firing voltage. So it's sort of a clipper. And as such it's an ideal way to feed pulses to switch on an SCR.

The light dimmer circuit diagrammed here is an example of how the dual trigger can be used. You might want to try this out. It's easily assembled in compact space to fit into a standard wall switch receptacle. Dress it up with a decorator-styled knob and panel, and you've got a high-fashion lighting system handling up to 750 watts. For details, write to Mallory or circle Reader Service number.

In this circuit, the dual trigger feeds the gate of a bi-switch (or dual SCR). The resistor-capacitor combination in series acts as a voltage divider. At the zero resistance end of the control, zero voltage is applied to the SCR gate through the trigger diode, and there's no load current. As you turn up the control, you apply more voltage to the trigger until you exceed its firing point; then you begin to allow current through the lamp load. The higher you turn up the control, the more voltage pulse goes to the SCR gate, and conduction through the SCR takes place during a greater portion of each half cycle . . . since the trigger fires in both directions. Net result: continuous control of lighting current *without* the heat dissipation of a power rheostat.

The Mallory STD dual trigger diode has several qualities which make it especially useful for this kind of control. Its breakover characteristic is symmetrical in both directions within 5%. And it has a "snap back" action, shown by the reverse traces at each end of the trigger characteristic curve; that is, past the breakover point, resistance suddenly decreases and current increases. This is the correct control characteristic for working with the SCR. The STD dual trigger, by the way, is only $\frac{3}{8}$ " long and $\frac{3}{16}$ " in diameter, so it fits practically anywhere, and has an insulated case.

See your Mallory Distributor for complete data and for STD dual triggers for your own experimentation. Breakdown voltage ratings go from 24 to 120 volts. Mallory Distributor Products Company, a division of P. R. Mallory & Co. Inc., Indianapolis, Indiana 46206.

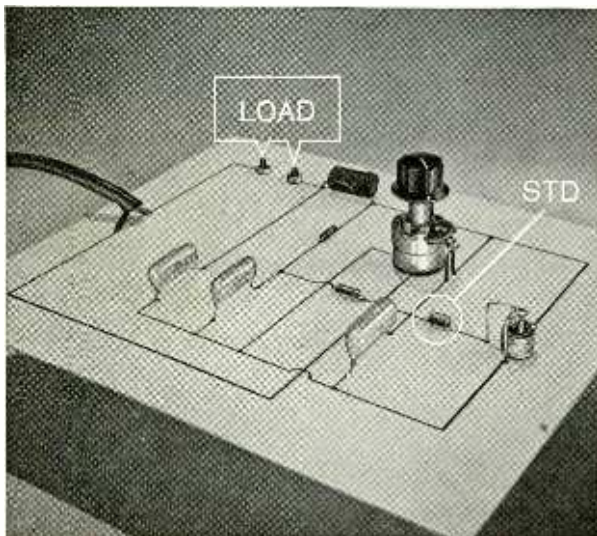

Semiconductor devices and arrangements disclosed herein may be covered by patents. Neither disclosure of any information herein nor sale of semiconductor devices by P. R. Mallory & Co. Inc. conveys any license under patent claims covering combinations of semiconductor devices with other devices or elements.

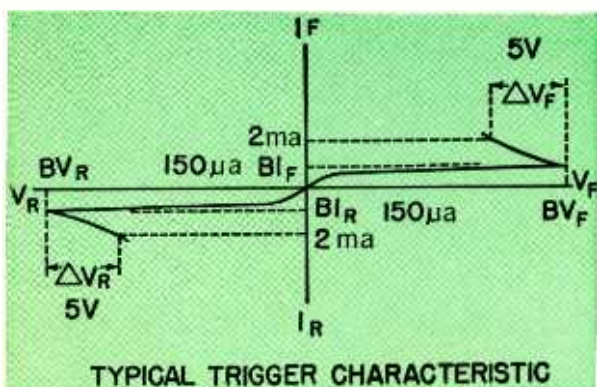

Circle 25 on reader's service card



Color TV Has a Problem

Color TV has invaded nearly 5 million American homes, a little less than 10% of all that have television. Why don't the other 90% have color?

One factor is no doubt cost. But, color receivers are available now priced lower than many monochrome models—often less than small-screen monochrome sets were priced only a few years ago. If you question those who *can* afford color, yet don't have it, a common answer goes: "I don't like the pictures. The colors aren't true."

Their complaint is well founded. Today's most annoying color-TV problem is caused by slight chroma-phase differences among the three networks, among stations, from film chain to film chain—even from camera to camera in the same studio. No matter how carefully chroma phase is adjusted in each, these few degrees of difference create annoying hue changes for viewers.

No sooner does a color-TV viewer get the HUE or TINT control set for a good flesh tone than the scene changes to another camera and some actor's face turns sickly green; another camera change is just as likely to make a fair-skinned starlet look purple.

And the flesh tone itself poses a slight difficulty. What if the actor has a deep tan? Or, suppose a dancer is momentarily flushed with excitement or from exertion in the preceding scene. Under either circumstance, adjusting hue—even in a closeup—is anything but precise. Then, before the viewer can hardly move the knob, the scene may become a fast-action sequence and further adjustment is impossible.

There's been a tendency to pretend, at least publicly, that the problem doesn't really exist. But it does nevertheless, and mass magazines and newspapers have been needling the industry because of it. We may as well face this inherent problem and set about solving it.

What color television needs now is some way to assure precise phase agreement among the 3.579545-MHz bursts at *all* cameras, film chains, stations, networks, and *color sets*. At least three approaches come to mind, and there must be many more.

One possibility would involve a Standard Hue

Card and a resulting Standard Hue Signal. The card might contain seven bars: black, yellow, black, flesh, black, white, and black. Every studio camera and film chain would be set up initially to reproduce this Standard Card faithfully, and then would be fed the Standard Hue Signal automatically between "takes" so the operator could match the card at all times, thus maintaining a standard, precise phase alignment. The Standard Hue Card could be flashed for a few seconds at the start of each show, before or after each commercial, and with each station-ident card, for viewers to use and for checking retransmission. All local stations and network relay points would make sure they were duplicating the Standard Hue Signal exactly each time it was transmitted. Such a system would be complex, but might be workable with proper cooperation and coordination.

A second possibility is a 3.579545-MHz standard signal, critically phase-controlled throughout the US by some primary source such as WWV. If chroma from all color-TV stations were phase-locked to this single primary source, one setting of the HUE or TINT control at any color receiver should hold the colors true for all programs.

A third idea could be used with either of the other two approaches or (perhaps better) could be developed to function independently. This would be a circuit or device that automatically compensates for any color-phase variation—right in the color receiver! This approach would eliminate some of the worry about phase differences at points of program origin. Solving the phase-difference problem at the receiving end would be the most satisfactory way from many points of view, although it is merely "wiring around the trouble" rather than curing the trouble itself.

There are undoubtedly other approaches. The important thing is not really *how* it's done. What is important is the challenge this color-phase problem lays before the designers of tomorrow's color-TV receivers. Whoever devises a workable solution will eliminate one of the last reasons the public has found for not making color-TV ownership unanimous.

—Forest H. Belt

HOME VIDEO TAPE RECORDERS: THEY'RE COMING IN THE WINDOWS!

Two basic methods are in use: helical recording and linear recording. Read how they work, see their advantages and disadvantages

By FRED SHUNAMAN

NOT MANY PEOPLE REALIZE IT, BUT TELEVISION RECORDING came in almost as soon as television. At first, TV programs were recorded simply by photographing TV pictures on ordinary motion-picture film. Speed compatibility was a problem—30 frames per second in TV, versus 24 in motion pictures—but it was soon overcome, and much TV was recorded for rebroadcast. The process was slow: the film had to be developed before it could be used, and it was expensive—much film had to be thrown away after being used once. Engineers wondered: Why not use magnetic tape recording? Playback could be instantaneous, and the tape could be erased and re-used indefinitely.

But tape recordings, at least at that time, had a high-frequency limit of about 15 kHz, and at least 2.5 MHz would be needed for TV recording.

Engineers here and in Britain tried different approaches. The British divided the frequency band into several segments and then recorded them on tape as separate tracks, at tremendous tape speed. Bing Crosby Enterprises, in the United States in 1954, used a 12-track tape with an electronic switch to record a little bit of the signal on each track, then start back on the first track about the time it had moved out from the gap in the recording head. The television signal was divided among the tracks in time instead of in frequency.

At about the same time, RCA's Harry Olson demonstrated a system that recorded linearly—like an ordinary tape recorder. He used five tracks for color TV. Three were used for the three colors, one for sync, and one for audio. The secret of Olson's method was tape speed. The tape passed the head at 30 feet per second. It was hoped that with improve-

Spinning-head assembly on Sony TCV-2010.

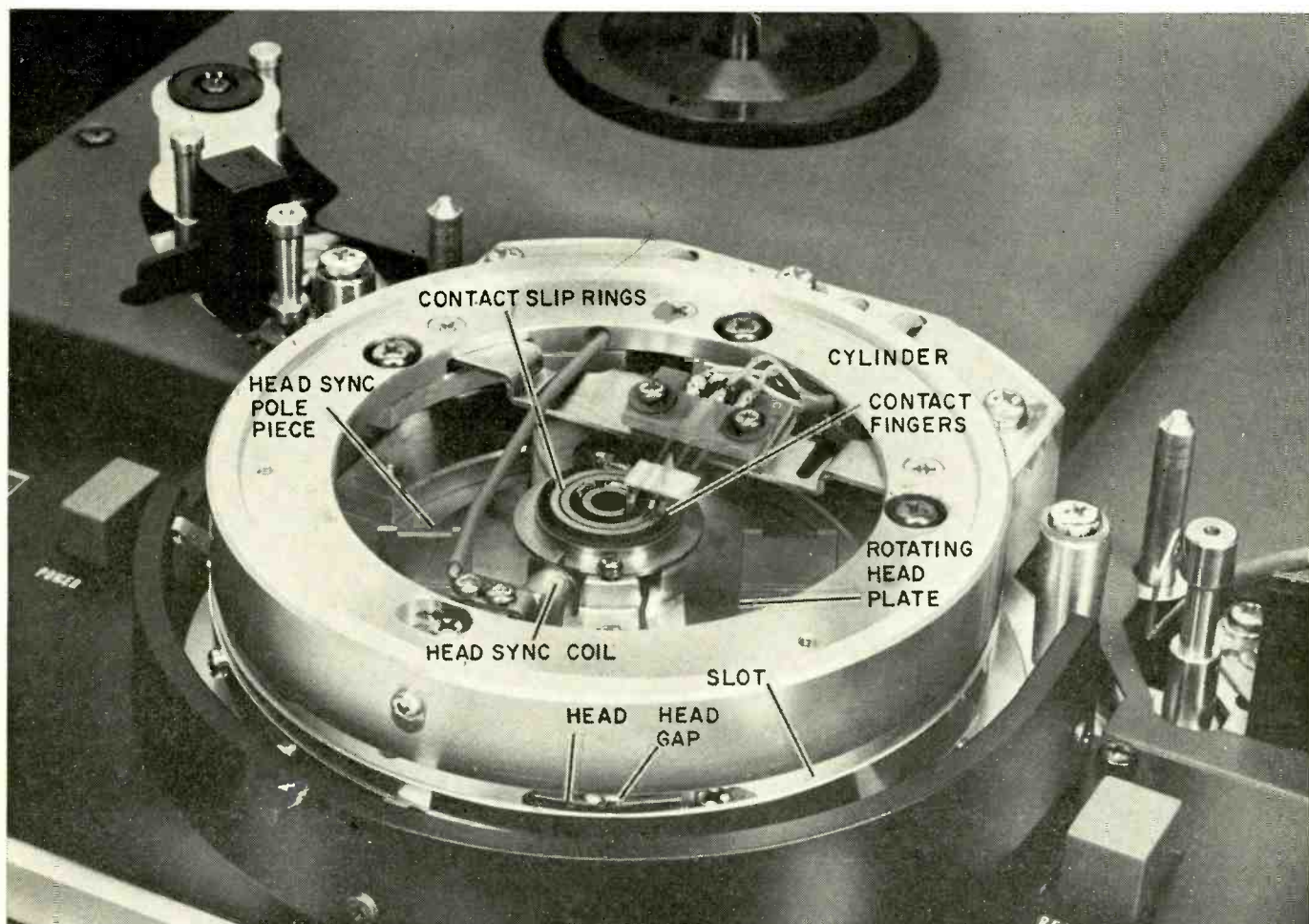

Maker	Model	Weight (lb)	Recording method	Tape speed (ips)	Tape width (in.)	Video bandwidth	Horiz. resol. (lines)	Price	Remarks
AMPEX	VR-6000	98	1 head helical	9.6	1	20 Hz–2.5 MHz	250	\$1,095 or \$1,495	2 models—one with video control center
AMPEX	VR-7000	80	1 head helical	9.6	1	30 Hz–3.5 MHz ±3 dB	310	\$3,150 or \$5,945	For educational–commercial–industrial use. Avail. as recorder only or complete CCTV system
FAIRCHILD	VI-5001	65	longitudinal	60	¼	200 Hz–2 MHz	180	NA	
LOEWE OPTA	600	40	1 head helical	7.5	1	3.5 MHz	310	\$2,995	
PANASONIC	NV7000	54.5	2 heads helical	12	½	2 MHz+	200+	\$1,500	Price includes recorder, camera, monitor and all accessories
PAR	Par-Vision	NA	longitudinal	60 30	¼	2.5 MHz 1.8 MHz	180 140	\$400 \$600	
PHILIPS (NORELCO)	EL-3400	100	1 head helical	9	1	2.5 MHz ±6 dB	285	\$3,450	
SHIBADEN	SV-700	66	2 heads helical	7.5	½	3 MHz	300	approx. \$1,000	
SONY	TCV-2010	66	2 heads helical	7.5	½	NA	180	\$995	
VICTOR		NA	2 heads helical	11.8	½	NA	NA	(\$556)	Japanese price
WESGROVE	VKR-500	NA	longitudinal	90, 120, 144	¼	NA	NA	\$650 (\$450 kit)	

NA = Not announced

ments in tape it might be possible to lower the speed.

But before that development was complete, something else entered the picture.

The transverse recorder

Ampex announced a new method of recording in 1956. Instead of running the tape at high speed, the head as well as the tape was moved. A drum that carried four small heads, only one of which was in contact with the tape at any time, spun at more than 14,000 revolutions a minute, while the tape moved forward at moderate speed. Even with this arrangement, it seemed impossible to record the whole band, from at least as low as 30 Hz to 4.5 MHz. Therefore, the video signal was frequency-modulated onto a carrier from 1 to 7 MHz wide, reducing the frequency range from 150,000-to-1 to a mere 7-to-1.

This *transverse scan* system solved most of the problems of television recording, at least for large broadcast stations that could afford to pay nearly \$50,000 for each machine. RCA soon brought out a closely similar television recorder and most large TV stations did install one or the other. But there was still a need for tape recording in educational institutions, for example, where the usefulness of ordinary closed-circuit television could be extended tremendously with the help of recording. But the cost kept all but the largest institutions from considering it seriously.

Helical recording

Then, late in 1959, the Japanese firms Toshiba and Sony announced, almost simultaneously, another type of moving-head video tape recorder. The tape was wrapped diagonally around a cylinder inside of which the moving head (or heads) spun (Fig. 1). Instead of short tracks almost directly across

the tape, the new helical scanning method made longer diagonal ones. The plethora of equipment needed on the multi-head transverse scanners (to synchronize the various tracks, to keep the heads at exact speed, etc.) immediately became unnecessary, and the price—a much reduced \$12,000—reflected that. The quality, however, was not always quite what was needed for broadcasting.

Then, on June 8, 1965, after rumors and announcements over nearly 2 years, Sony demonstrated a practical video tape recorder, the TCV-2010, intended for home use. The price quoted was \$995. Shortly afterward, other manufacturers



Ampex VR-6000, a helical-scan recorder.

demonstrated machines that they stated would be sold at prices slightly higher than Sony's. The prices, however, turned out to be rather more than just slightly higher, and at this writing, no comparably priced helical-scan recorder has reached the market. (Concord, Roberts and 3M are rumored to be readying machines in the \$1,000 range.)

The Sony recorder uses helical scan, with two rotating video heads and a stationary audio/control head. The tape is 1/2 inch wide, with the audio/control track along one edge and the video recorded in the long slanting tracks typical of the helical recorder (Fig. 2). Tape speed is 7 1/2 ips. It runs 1 hour on a 7-inch (2,370-ft) reel of tape; rewind time is 6 minutes.

A special feature of the Sony is that it has its own TV set, which monitors the recording and shows the playback. The recorder can be connected to a standard TV receiver by a technician, and Sony demonstrated such a combination recently. The monitor can also be used as a conventional television receiver, and is of course used to record TV programs off the air. It has its own telescoping antenna, good for strong-signal areas.

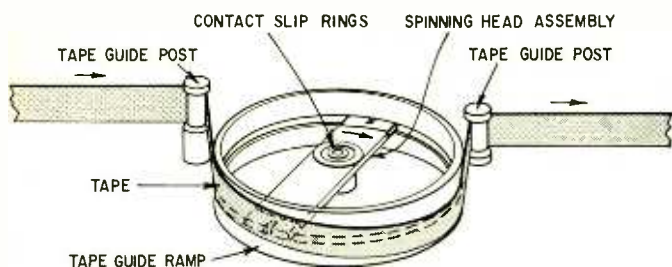

Fig. 1—How slanting tracks are recorded on tape with heads spinning in horizontal plane. Tape leaves head assembly about its own width lower than it enters. It is kept firmly against spinning heads by controlled tension.

The electronics of the TCV-2010 includes some 76 transistors, 38 diodes, 4 thermistors and a single semiconductor rectifier in the power supply.

The head speed is comparatively slow—30 revolutions per second—or a tape-to-head speed of approximately 300 inches per second. Adjustments are simple and operation easy. Set up in RADIO-ELECTRONICS' editorial office, the camera was operated by inexperienced personnel, who were able to record and play back good pictures of scenes on the street below, as well as office scenes.

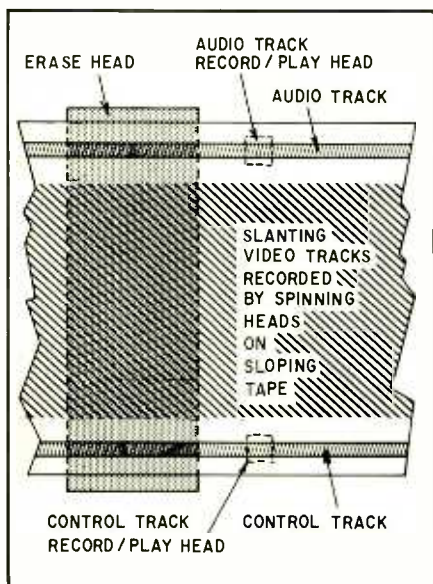

Fig. 2—Slanting video tracks on one kind of helically scanned tape. Video is erased all at once by normal type of ac erase head that spans full width of video area. New signal is recorded by spinning heads on slanting tape, as in Fig. 1. Audio and control tracks are recorded with conventional fixed heads.

Shortly after the Sony first appeared, both Philips (Norelco) and Ampex announced and demonstrated low-cost video recorders. Pictures were excellent. The prices, however remained at a level between the expected price for a home-type instrument (around \$1,000) and the industrial-type recorders in the \$10,000-and-up class. Both these recorders are intended to work with an ordinary television set of any size. The Norelco has a particularly ingenious method of coupling to the TV set for off-the-air recording. A shield is slipped over the last i.f. tube in the set and the signal picked up by capacitive coupling.

A color recorder

Not content with a black-and-white-only recorder, Sony continued research and, late last winter, unveiled a color TV recorder, which will also record and play back in black-and-white. It can be used with any standard color TV receiver (an adapter is needed). Present users of the black-and-white Sony recorder will be able to purchase equipment to modify their machines for color.

The color recorder is housed in the same case as the earlier recorder and the weight is the same. Tape speed is higher—12 inches per second. Other specifications are roughly the same as for the TCV-2010. The played-back color picture—as seen at a demonstration—would have been accepted by the ordinary viewer as a program straight off the air.

Two other monochrome recorders—Panasonic and Shibaden—were announced very recently, but at the time of writing had not yet reached the American market, and detailed information on them was not available. They are expected to sell for near \$1,000. Another company, Victor of Japan, which supplies Delmonico, is considering exporting its VTR to the USA. Its price in Japan is about \$560.

Linear recorders

Meanwhile, proponents of the so-called linear (longitudinal) type of recording continued their work. Fairchild's Winston Research Corp. demonstrated a recorder that uses 1/4-inch, high-quality tape at a speed of 60 or 120 inches per second. The recording time with 8-track tape on an 11 1/2-inch reel is 2 hours (15 minutes a pass) and rewind time is about 5 minutes.

Another concern, Wesgrove, has actually built and sold recorders in limited quantities, and had recorders on the market before the home-style Sony. The Wesgrove is a direct descendant of the Telcan unit, first mentioned in RADIO-ELECTRONICS in October, 1963. It uses 1/4-inch audio tape at a speed of 90, 120 or 144 inches per second, and records up to 1 hour on an 11 1/2-inch reel, double track. Quality is lower than that of the single-track Fairchild industrial machine, but so is the price: \$650 (\$450 in kit form). How one of these recorders worked when constructed from a kit was described in our June 1965 issue.

Still another contender, Par Ltd., has been engaged in developing a linear-type recorder for some years. Pictures of gradually improving quality have been demonstrated at regular intervals, and the system continues to show promise. Par puts four tracks on the tape, with audio on one and video on another, thus recording for 1 hour in two passes on an 11 1/2-inch reel. Incidentally, one of the byproducts of the development has been a new tape transport system (RADIO-ELECTRONICS, Jan. 1966, page 4) which may find application not only on other television recorders but also in audio. So (unless some of the companies not yet on the market change their positions before this is printed) Sony appears to be the only tape recorder with a commercial-grade television picture that sells for less than \$1,000.

What can you do with it?

While many home viewers will want to use a video tape recorder for strictly amateur purposes, the Sony recorder is

especially adapted to small institutions or individuals who have special reasons for using such an instrument. There are many strictly domestic uses for the recorder. Most important is probably recording programs when you can't get to the set. If you're out for an evening, the recorder can be set up with a timer clock to turn it on at the right moment and let it run for a preset time. And if there are two simultaneous programs you want to see, you can watch one and record the other.

A living "sound and vision" record of growing children is many times more effective than a purely photographic record (or the sound tape records that some parents are now making).

The amateur sportsman may find such a recorder useful. (Akio Morita, chairman of American Sony, told how he used his video recorder to improve his golf form.) But the professional finds it *necessary*. Football games have been filmed and the films studied by the coaches or shown to the teams for instruction and exhortation. Teams have already started using VTR's for that purpose. Playback is immediate, there are no processing costs, and the tape can be erased and reused as often as required.

Actors, educators and even politicians can use the recorder to see themselves as others see them. A comedy routine can be polished without aid from a consultant, and a speaker or teacher can improve his strong points and correct unfortunate mannerisms. (More than one political candidate in the recent past has listed poor appearance on television as one of the factors that contributed to his defeat.)

And educational institutions, which have already made a start with the intermediate industrial type recorders, will find

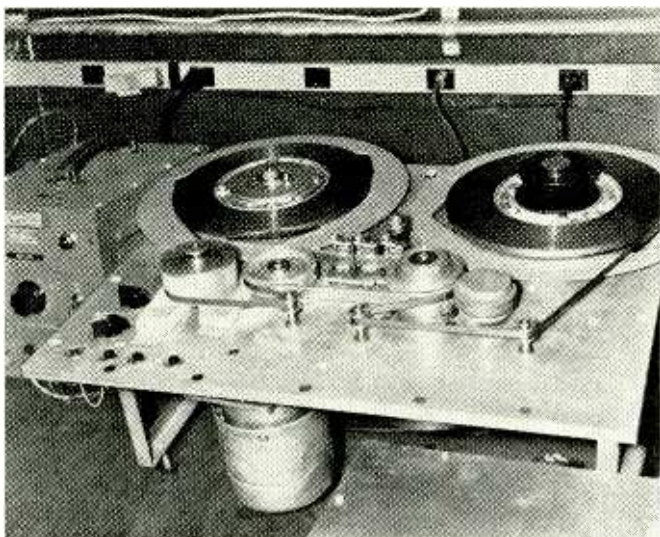

Par, Ltd. is working on a longitudinal recording system that uses this unusual transport designed especially to reduce flutter and dropouts caused by poor tape-to-head contact. Seamless belt, around two large drums next to heads, is driven by capstan and both pulls and supports tape as it flies past heads.

recorders at one-tenth the former price much more attractive. Special lectures and demonstrations can be shipped the same way film is now, but sooner after the event. With modifications, VTR's can be hooked into a school's closed-circuit TV system.

What will it cost?

The initial cost—for any tape recorder likely to be on the market in the near future—will hardly be less than about \$1,000. The other main cost is tape. A 30-minute reel costs \$29.95—a 1-hour reel \$39.95 (these figures are for the Sony recorder). This sounds high until you remember that—unlike home movie film—magnetic tape can be erased and used over



Norelco EL3400 video tape recorder

and over again. Thus much editing waste and the cost of film that didn't turn out so well is eliminated. The head assembly, which will run for some 1,000 hours of recording or playback, can be replaced for under \$100.

An innovation like low-cost television tape recording requires two main ingredients: a need, and a technology sufficiently developed to meet that need. The need is here; thousands of educators, entertainers, athletic directors and ordinary individuals will attest to that. The technology is coming so fast that many people already consider it "here." The video quality of the better "low-priced" machines is at least as good as what we're accustomed to seeing on home TV. Even the least expensive recorders produce a picture good enough for many applications where fine detail isn't necessary. Color recording is around the corner—Sony hopes to have its new machine out late in 1967.

So it looks as though low-cost video tape recording may be about to become just as economical, just as reliable, and just as firmly implanted as home movies became some 20 years ago. END

AS WE GO TO PRESS

Recent development: magnetic-disc video recording from Sony in two versions. One, to sell for around \$1800, records and reproduces 40 full-color still pictures (slides) automatically, unattended. It records slow-scan on a 10-mil spiral track at a disc speed of 1800 rpm.

The other, the Videomat, is a coin-op black-and-white video record/playback machine. It records 30 seconds of action on the same spinning magnetic disc, then automatically plays it back twice on a 19-inch monitor.

Sony's demo followed close on the heels of a mysterious announcement from abroad that CBS Laboratories had introduced a nonmagnetic full-color motion video and sound recording system on disc. No commercial plans were mentioned, and calls to CBS produced vigorous and complete denials from officials there.

The Westinghouse "Phonovid" system of recording black-and-white slides plus sound on long-play phonograph discs, introduced last year (July 1965 RADIO-ELECTRONICS p. 9), is still undergoing further development.



Supply being used to replace 9-volt round battery in transistor portable. Meter shows current drain to be about 7.5 mA.

Zener Power Supply For Transistor Radios

Simple, low-cost supply has four voltage taps, no controls, low ripple
MARVIN J. MOSS and ROBERT E. BEVILLE

ALMOST ALL TRANSISTOR RADIOS TODAY are powered by a battery voltage which is some multiple of 3. Most common is the 9-volt battery. This supply, using Zener diodes, will deliver regulated 3, 6, 9, or 12 volts at a current drain of up to 50 mA to an external load. Designed primarily for servicing small transistor radios, it can also be used as a battery eliminator, life extender, or charger, or to power small experimental circuits.

Good regulation and very low ripple are its characteristics. You can build the supply for about \$10 by shopping carefully for the components listed. Of course, electrical equivalents can be used, but they may cost more.

The Zener-regulated supply, (Fig. 1) is a shunt-regulated voltage source. The 24 volts from T is rectified by a bridge, D1 through D4, and filtered by a two-section R-C filter. The two Zener

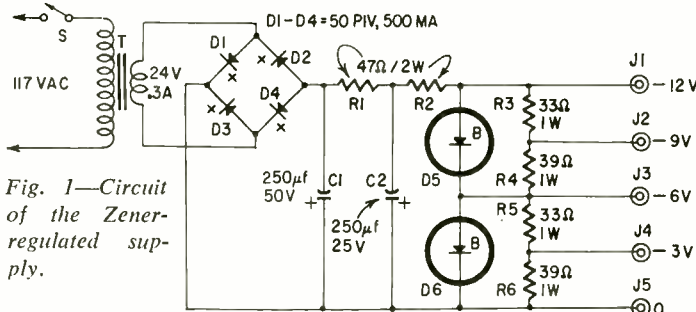

Fig. 1—Circuit of the Zener-regulated supply.

- C1—250 μ F, 50 volts, electrolytic
- C2—250 μ F, 25 volts, electrolytic
- D1, D2, D3, D4—silicon rectifiers (top-hat style), 50 piv. 500 ma (Radio Shack 27B1099, or equivalent)
- D5, D6—6- or 6.3-volt Zener diodes, 1 watt (Radio Shack 27B1133 or equivalent)
- J1-J5—Binding posts (Lafayette 99R6233 kit of 10, or equivalent)

- R1, R2—47 ohms, 2 watts
- R3, R5—33 ohms, 1 watt
- R4, R6—39 ohms, 1 watt
- S—spsst slide switch
- T—filament transformer, 24 volts, 0.3 amp (Burrstein-Applebee 18B506 or equivalent)
- Aluminum case, 5 x 4 x 3 in. (Bud Minibox CU-2105A or equivalent)
- Terminals, miscellaneous hardware

diodes are in series so that 6 volts is available across either one or 12 across both. For the 3- and 9-volt supply points, it was necessary to use low-resistance dividers across each Zener diode.

The Zener diodes have approximately 80 mA flowing through them and 6 volts drop across each. When an external load is connected across the di-

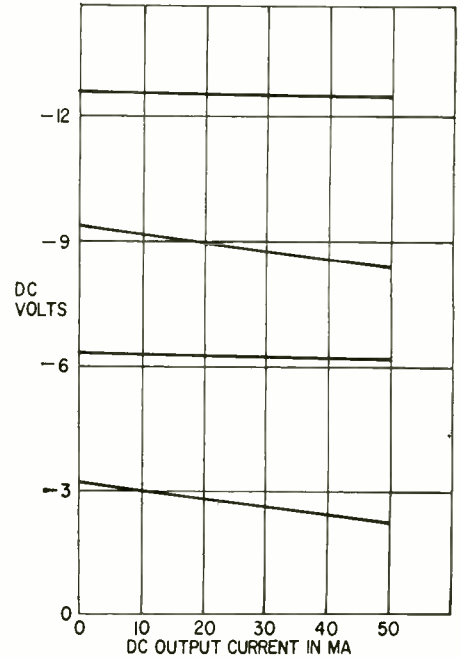

Fig. 2—Regulation at each output up to 50 mA.

odes, some of the 80 mA flows through the load and the remainder flows in the Zener diodes. However, the voltage will remain essentially constant until all current flows through the load and none through the diodes.

The resistance values in the dividers are purposely unbalanced to provide the correct output voltage when loaded to 10–25 mA. The output impedances of the 6- and 12-volt points are low—about 2 ohms. This is highly desirable, since most of the higher-drain transistor radios operate from either 12 or 6 volts. The output impedance at the 3- and 9-volt points is approximately 20 ohms. This higher impedance has not been a handicap with small transistor radios designed to use 9-volt batteries or a pair of penlight cells (3 volts). Their current drain is usually limited to 10 mA or so, except at high volume levels, when the current drain can be as high as 25 mA.

Fig. 2 shows the regulation of each output for currents up to 50 mA. The 6- and 12-volt outputs remain substantially constant. The effect of the higher output impedances of the 3- and 9-volt sources is evident for currents above 25 mA. But since 9-volt radios usually operate at approximately 10 mA, regulation is still adequate.

TABLE 1—MAXIMUM RIPPLE

Supply volts	Ripple (volts rms)
-3	.001
-6	.001
-9	.003
-12	.006

This power supply will dissipate approximately 6 watts when turned on, so the case will get slightly warm during normal use.

No wiring precautions are necessary in constructing this supply, except for observing electrolytic capacitor polarity.

Zener-diode breakdown voltages vary, in general, by several percent. After the circuit is wired and checked, use the diode whose voltage is nearest 6 as D5. This makes the output voltages at the intermediate points closer to 3 and 6 volts, percent-wise.

Get a used 9-volt battery and carefully remove the top with the two connectors. Wire this with flexible leads to the power supply, and you can eliminate clip leads to the battery plug in the radio. Clip leads are necessary with other types of radios. Be especially polarity-conscious at all times with transistor radios!!

Because the power supply has a floating ground, either polarity is available. And, by using the center (-6) binding post as a ground reference, both +6 and -6 volts can be used simultaneously.

No voltmeter is necessary with this power supply, but its versatility can be extended by adding a 50-mA meter in series with the lead to the positive terminal (Fig. 3). This enables you to monitor continuously the current to the radio under test to determine whether it is within the specified limits. Currents appreciably higher shorten battery life and may indicate open or off-value resistors in the bias networks or possibly a shorted transistor. Low readings suggest open bias resistors, transformer wind-

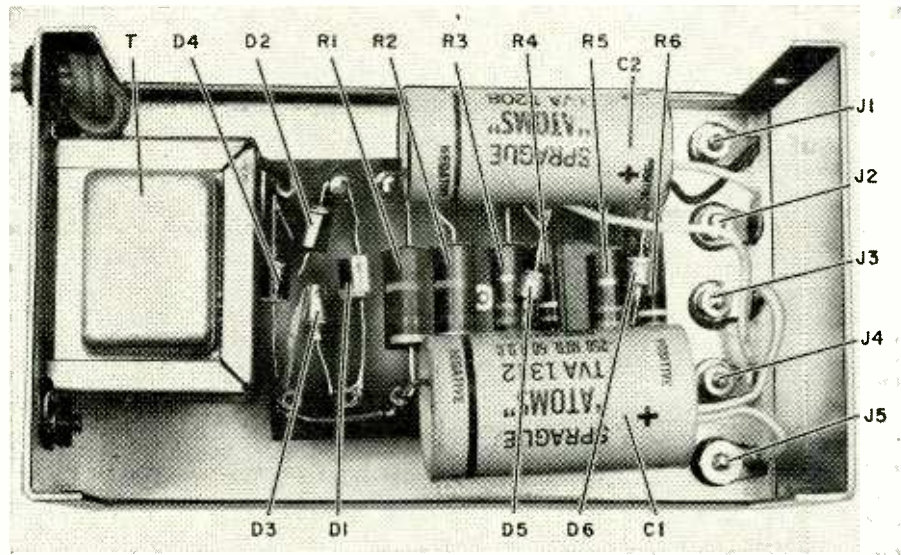

Despite small case size, parts are not particularly crowded.

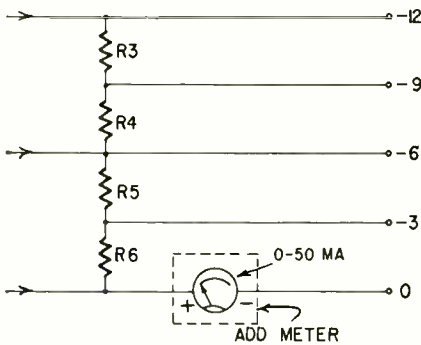

Fig. 3—Where to add a milliammeter.

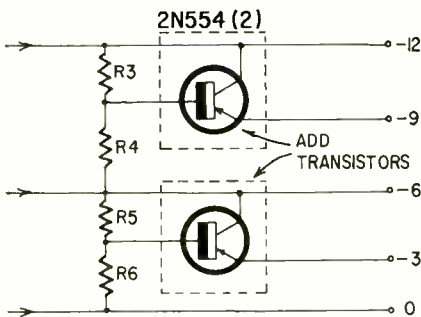

Fig. 4—Adding power transistors as emitter-follower current amplifiers improves regulation at 3- and 9-volt terminals.

ings or transistors.

The higher output impedances of the 3- and 9-volt points can be substantially reduced by inserting a transistor as shown in Fig. 4 in each of the two outputs. Any inexpensive power transistor will work fine here—for example, the 2N554. This will add another \$2 to the cost, since heat-sink mounting kits must be purchased for each transistor also.

This Zener-regulated power supply will pay for itself in a very short time around the service shop. Because there is no need to set a control to a particular voltage, servicing transistor radios can be more efficient and profitable. END

TUNED BYPASS CAPACITORS

In vhf transmitters and receivers it is often desirable to have certain elements of a tube or transistor at rf ground. Disc ceramic bypass capacitors are commonly used. By carefully trimming the leads of these capacitors we can make them series-resonant. This will make the impedance even lower than with the bypass alone. One home-brew 50-MHz transmitter was completely cured of spurious signals and parasitic oscillations by properly resonating its bypass capacitors at the operating frequency.

FREQUENCY	LEAD LENGTH FOR RESONANCE		
	CAPACITOR VALUES		
	pF	pF	pF
28 MHz (10 m)	50	100	2.2" 1.1"
50 MHz (6 m)	—	4.4"	0.7" 0.26"
144 MHz (2 m)	0.9"	0.4"	— —
220 MHz (¾ m)	0.4"	—	— —

This method does not absolutely guarantee to solve all spurious signal problems, but it is certainly simple enough to apply and will almost certainly reduce some faults. Either the chart shown or a grid-dip meter can be used to determine the resonant frequency of the capacitor.

In the chart, lead length is given for some of the vhf bands with typical disc ceramics with No. 20 tinned leads. All values were obtained with a B & W grid-dip meter. They will probably be different for other types of capacitors.—Irwin Math, WA2NDM

Radio-Electronics Is Your Magazine! Tell us what you want to see in it. Your suggestions may make it a better magazine for the rest of the readers as well as yourself. Write to the Editor, RADIO-ELECTRONICS, 154 West 14th St., New York, N. Y. 10011.

BENCH

TESTED

A RADIO-ELECTRONICS editor who used the supply for several home workshop jobs reported that the unit measured up to (or even exceeded) the authors' specifications in every respect. He found it easy to use. The multiple outputs were especially useful for one experimental circuit that required a "tapped" battery—1½ volts on one side, 3 on the other. (Dividers can be used to get fractional voltages, just as was done to get 3 volts from 6, and 9 from 12.) Ripple was completely inaudible.

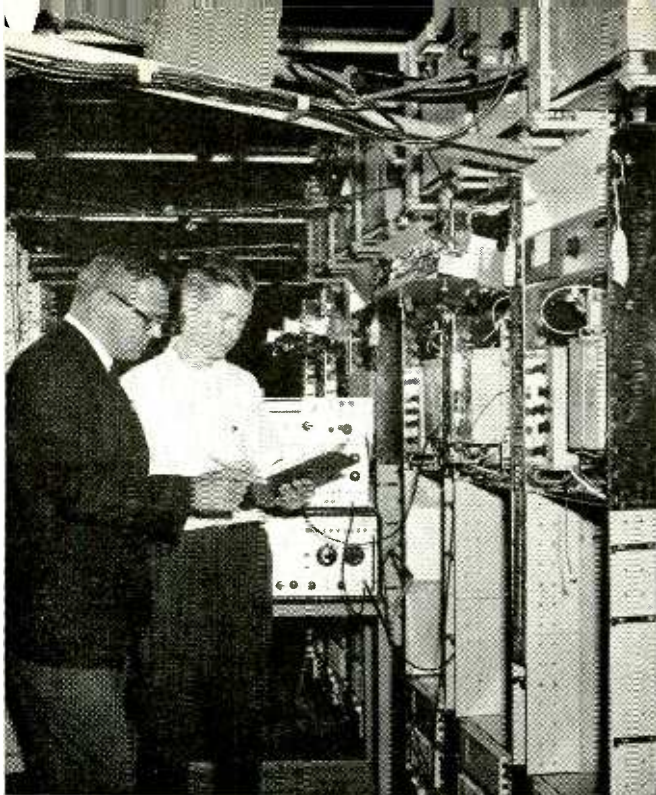

Jim Reeve, right and Don Shaffer, left, study test results on Lenkurt class 75A microwave equipment. Apparatus is undergoing rigorous tests before being shipped to Alma Hill site of N.Y.-Pa. microwave CATV system.

YOUR FUTURE IN MICROWAVE

Giant microwave radar antenna is part of Air Force AN/EPS-17 installation at Laredo, Tex. It watches missiles launched at White Sands and other places. General Electric developed the 15-story-high, 100-foot-wide structure.

USAF photo

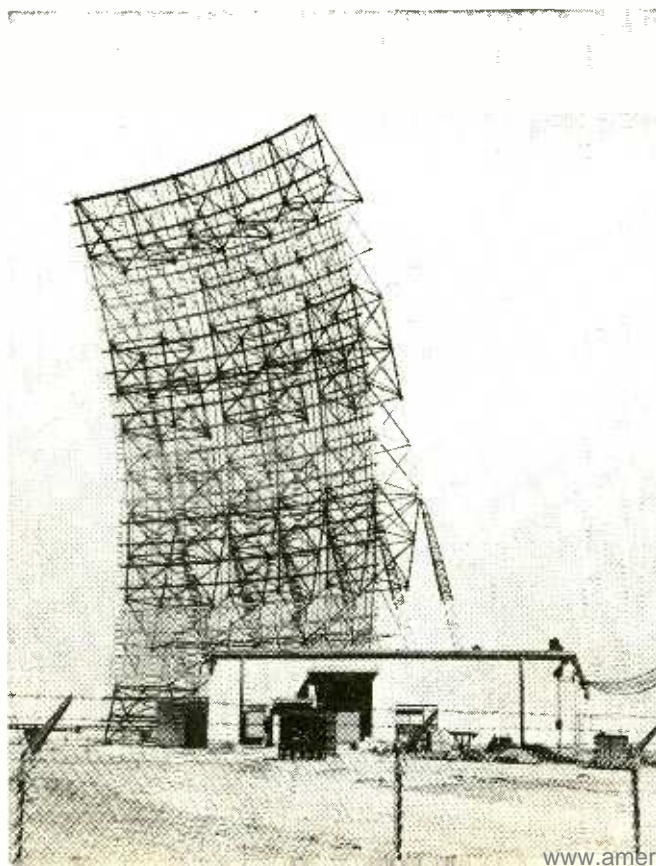

CAREER OPPORTUNITIES—Fifth of a series

Read about a field begging for qualified technicians and engineers . . . learn how you can break into it

By RAY D. THROWER

THE POPULATION EXPLOSION IS CREATING A JOB FOR YOU! Increased demands for goods and services has created a need for more and more private communication systems for video, data and voice.

Just how does this mean a job for you? In the 17 years or so since the first commercial microwave systems began operation, the demand for more systems has resulted in more openings for skilled technicians and engineers than there are men to fill them.

The Federal Communication Commission's latest annual report shows slightly more than 60,000 Second Class Radio Telephone licenses issued. Of this class license (needed for working on "on the air" transmitters), estimates indicate that approximately one-fifth, or 12,000, are "non-practicing" in communications. Of the remaining 48,000, it is estimated that roughly 25% are non-practicing because they are in supervisory positions. This still leaves a pool of about 36,000 practicing licensed technicians to service *all* categories of transmitting and receiving equipment (excluding broadcast radio and TV, for which a First-Class license is required). Current estimates show that microwave *alone* needs 24,000 technicians!

Why is microwave becoming so popular? With it, companies can do away with open-wire and aerial cable facilities exposed to storm and ice breakage. They can forget about buried cable systems that are frequently cut by construction crews and farmers' plows. Relatively inexpensive mountain-top repeater sites and small plots of land in more expensive areas are very appealing to businesses when compared to the costs for hundreds of miles of open wire and buried-cable right-of-way. Just think of all those property owners that have to be dealt with for cable and wire systems!

One of the more important technical reasons for using microwave is that it can carry a larger number of voice channels, wideband video or high-speed data circuits with less distortion and fewer repeater stations than its cable-carrier counterparts. The FCC has aided the development and use of microwave and has made special provisions for tying in with educational TV systems.

A private microwave system can provide up to 960 simultaneous voice circuits on one transmitter and receiver, without interference. Developments promise thousands of circuits on one transmitter/receiver. Fig. 1 shows how 600 circuits can be stacked.

Frequencies above the usual 30 GHz are not far off, either. A recent issue of *Microwaves* reported successful propagation studies of equipment operating at 90,500 MHz.

Some systems are small and relatively inexpensive (\$40,000 or so), while others are large and complex and may run \$5,000,000 to \$20,000,000 or more. In the last year and a half, Western Union began service between New York and the West Coast on its new \$80,000,000 transcontinental microwave system. Links to other eastern cities are being built.

With new systems being added daily, communication companies are pressed to find qualified technicians. As the need for technicians and engineers grows, so grows the need for able supervisors. So, the chance for advancement in an advancing field is limited only by your ability.

If you have little electronics background, some companies will hire you as a trainee, giving you on-the-job training and sending you to company-sponsored schools. The pay may be low at first, but the training you'll get will pay off in later years. And, while you're working, don't pass up the chance to take some night-school courses. More and more employers

are giving first consideration to the guy who has shown his spirit by trying to learn just a little more. Of course, if you're a real glutton for self-punishment, you can get a full-time job on a night maintenance shift and go to school full time during the day. And don't forget correspondence courses.

"Well," you might ask, "exactly what kind of job is there for me in microwave? This must take years of experience and education." Let's meet a few people who have worked with it.

Jim Reeve is 26, has been with Lenkurt Electric Co., Inc. for over 4 years since he got out of the Air Force and has been in electronics generally since 1957. Jim is a Senior Technician in Lenkurt's System Test Microwave Group. After the microwave equipment has been built on the production line, Jim and his associates completely align the systems before they are shipped out for installation. This involves actually operating the equipment as it will operate in the system when it is installed. The only difference is that instead of using antennas to radiate the signal and having some 30 miles between transmitter and receiver, Jim has to work on the equipment "back-to-back", that is, with transmitter and receiver a few feet apart. To weaken the signal in that close-by setup, Jim uses special microwave attenuators to simulate the "path loss" the system is designed for.

In his 4 years with Lenkurt, the leading supplier of microwave and carrier system equipment to the US independent telephone industry, Jim has worked on a lot of equipment for telephone, oil and utility companies, railroads and others.

I asked Jim what had been the most interesting microwave project he had worked on.

"Oh, that's easy! It was the educational TV system equipment Lenkurt built for Nebraska's educational system" (Fig. 2).

"Why was this one more interesting than the others?"

"Well, I graduated from Omaha Tech High School and Nebraska is my home country." He smiled nostalgically. "And with all the familiar names tagged on the equipment scheduled for each repeater site, I felt right at home with that gear. I could just see that old microwave beam going right across the country around the North Platte River."

I asked if he had taken any science courses in high school that helped him get into electronics.

"Sure did! I had three years of high school electronics at Omaha Tech. It's a great school," Jim said enthusiastically. "Actually, we didn't realize how lucky we were there. I always thought every school system had a technical program. I found out how wrong I was when I got to tech school in the Air Force. Most of the guys had never heard of Ohm's law!"

"What schools did you go to in the service, Jim?" I asked.

He laughed. "A lot of them." With a grin, he added. "And sometimes we thought they would never end, the way the instructors pounded information into our heads. One thing about it, though. Those service schools will teach it to you. Any guy that really wants a technical education should see what kind of programs are available through military service schools.

"The one I learned the most about microwave in was Radar Tech School at Keesler Air Force Base, Mississippi. I was down there for about a year and then they sent me to Scott AFB, Illinois, for 6 months to Communications School. I learned a lot about radio there."

All together, Jim says he spent over 2 years of his 4-year hitch going to school. Did his military training have anything to do with his getting on with Lenkurt Electric?

"You bet your boots it did! I probably wouldn't have been able to get on if I hadn't had my training in the service. I figure I got a pretty expensive education that I never could have afforded on my own."

Jim, his wife Diana and their new daughter Lynda enjoy living on the San Francisco peninsula, where Jim's company is located. They appreciate the ease of living in California, the facilities available for entertainment and education in and

around the peninsula. And Jim thinks working for Lenkurt, a prestige company in communications, is a wonderful opportunity for him professionally.

When overtime schedules permit, Jim attends Foothill College in Los Altos, Calif. He has completed about 2 years of full college work by going to night school for 3½ years. He hopes to get his degree in a few more years, majoring either in electrical engineering or physics, so he can get into some of the more complex work with microwave and communication.

"Breadboarding and testing are interesting", acknowledges Jim, who builds much of his own hi-fi equipment, "but I like microwave work the best. We've always been razzed in here about when we're going to get our plumber's card, working on the waveguides and all. It's called 'plumbing' in the electronics trade, and I guess anybody that works with it gets ribbed."

His advice to anyone thinking of entering microwaves or electronics generally is to get plenty of science and math



Satellite communication systems will provide worldwide phone, video and data channels. Orbiting relays will be serviced by satellite "shuttle bus" with crews on several-month tours of duty.

background in high school if there is no electronics vocational program in your school.

Jim Reeve is an example of the thousands of technicians that will be needed in the next few years. People like Jim will be moving up in a few years to engineering and administrative positions, which means even more technicians will be needed.

In addition to the technicians, thousands of engineers are going to be needed. According to a report prepared by the Bureau of Labor Statistics for the National Science Foundation, demands for new engineering personnel will exceed 700,000 by 1970. With only about 450,000 to be available, there will be a deficit of more than 250,000. Of these, about 10,000 will be needed to fill engineering gaps, principally in the telecommunications field associated with microwave. What will these engineers do? Let's choose an example, and get an idea of what it takes to be "an engineer".

Don Shaffer is a displaced Missourian who came to Lenkurt Electric Co., Inc., by way of Arizona, where he worked as an engineer for a power company.

At Lenkurt, Don is a transmission engineer. The title belies what Don and his fellow transmission engineers do. They do the microwave path surveys for the microwave systems that Lenkurt engineers. Whenever a customer comes to Lenkurt for a microwave system, Don or one of the other transmission engineers goes to the customer's area, locates suitable sites for microwave repeaters, determines the path loss, the size and type of antennas required, tower heights to get away from things such as Fresnel-zone interference, and designs the system path.

Once Don has gathered his background data and photographs (the camera seems to be the engineer's best friend on field surveys), he returns to Lenkurt's offices in San Carlos, California, where he formalizes his report, prepares graphs and charts from the field data, and selects the best photographs for publication. Then, the entire report is sent to Lenkurt's printing plant where it is reproduced and bound in book form, and copies sent to the customer. Don says this is a rewarding type of engineering in that he sees his end product all neatly prepared in book form.

Don, who is a registered professional engineer, says, "We sure have to be accurate. A difference of just a few feet can make the difference between a microwave path working or not working. And if it doesn't work, our figures are right there in black and white, and it doesn't take long to figure out who goofed where. But with all the computer help we have now, errors just hardly exist any more."

Don enjoys his work, even though it takes him away from home frequently, and that is the only bad feature about it.

"It's a great chance to see a lot of country and travel", he says, "and it's almost a vacation every time we go out. This way, I get to scan a lot of country and pick the places where I want to take my vacation.

"Our favorite time is the fall of the year", he laughed when being interviewed. "That's when each of the hunters in our crowd hopes to be the one selected to do the path study that inevitably comes from the hunting country. It's all business during the week, but when the weekend comes, we all want a try for some of that venison!"

Don, a licensed ham operator (W6BLO), likes to work 80-meter CW. He enjoys building his equipment, but says, "If I did any building now, with all my traveling, I'd never get to do any operating." So, he contents himself with commercial equipment and tinkering on small projects.

Don's background includes graduation from the University of Missouri with a bachelor of science in electrical engineering in 1959. He was graduated from Memphis High School in Memphis, Mo. in 1949 and has been interested in radio since he was 16 in 1947. He was originally licensed as a ham in Missouri with the call W0YYE. Besides his ham ticket, Don's licenses include an FCC First Class Radiotelephone license. "I guess the first-class license is about one of the hardest to get", he admits. "It took only one try for my second-class ticket, but I had to go back for two additional tries before I got the first." He looked with pride at the blue license hanging on his wall. "It was worth it, though."

"The most difficult thing about microwave", according to Don, "is keeping up with advances in the state of the art. New

Fig. 1—Stacking 600 voice circuits on one transmitter: this is the modulation plan of a Lenkurt Electric Co. 46A system. Microwave systems can provide up to 960 simultaneous, noninterfering voice channels.

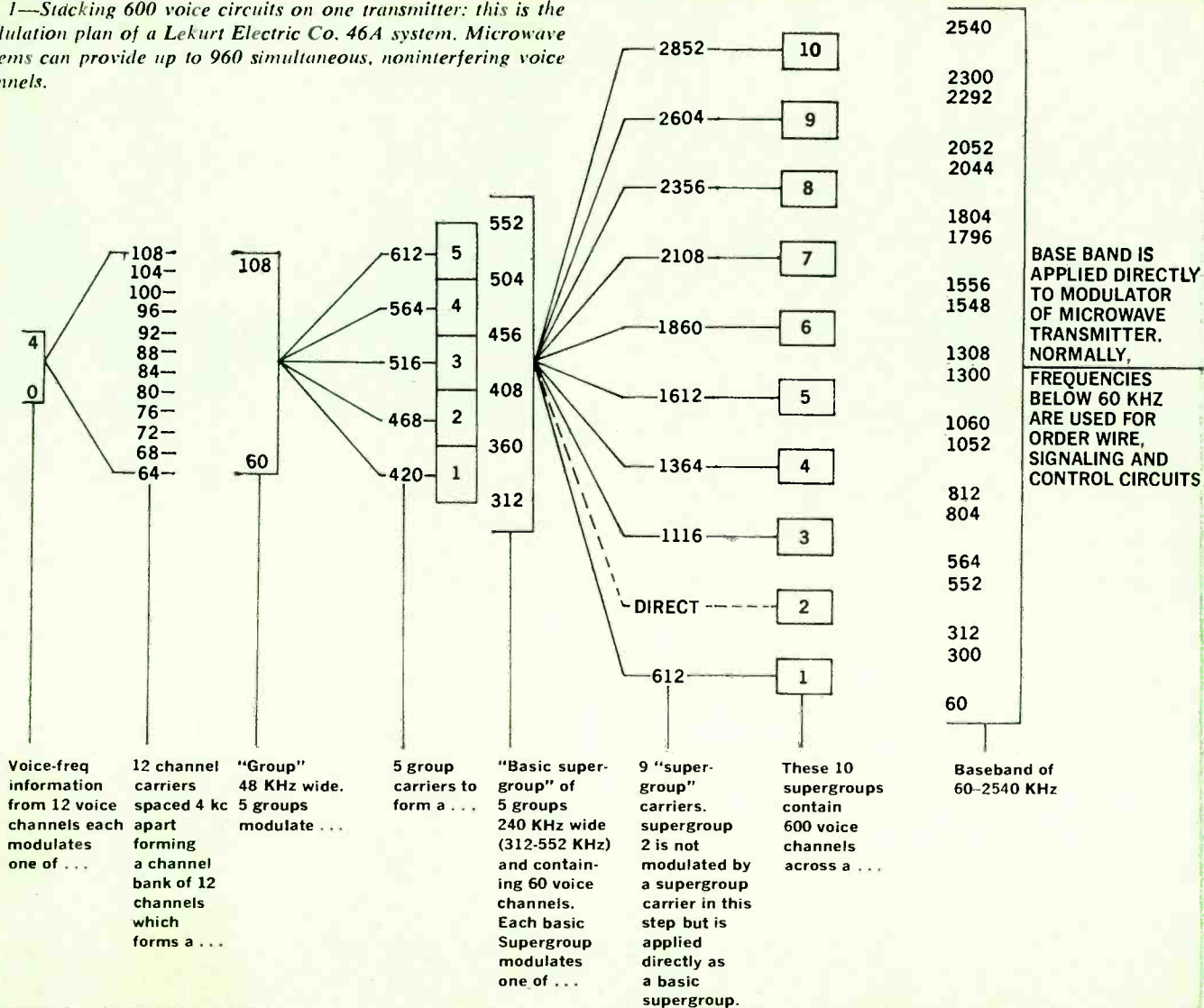

developments in equipment and new discoveries in theory and application of old knowledge to new areas make it pretty difficult to keep ahead—or even keep up with what's going on."

Advice to newcomers in the field? Don says, "Learn your basics *very well*, because even the most complicated electronic circuits are derived from a few basic principles."

With three years in microwave work behind him, Don's only comment about the future of microwave is "Unlimited!"

Now you'll ask, "How and where can I get into microwave work?" Finding the right job, of course, is a personal venture and requires a lot of leg-work. One of the best helps when looking for a job is to have a short résumé of your background. Make several copies (but not carbons), and be prepared to hand or send one to every man who interviews you.

The places to look are unlimited. Practically every community of any size now has at least one microwave facility. There are some in some pretty remote areas as well. If the station in your area is an unattended one, chances are there will be a small sign on the building or fence that will tell you who it belongs to. One thing about job hunting of any kind: don't be bashful. If there is no way of finding out who operates a particular microwave station, try taping a note with your name, address and intention, to the door of the station.

A good percentage of state and county governments are now using or planning microwave systems for administration and enforcement. For instance, Nevada is planning a microwave system (Fig. 3) to run from Reno in the north to Las Vegas in the south and from Reno east to Elko and from Elko south to around Las Vegas where it will tie in with the Reno-Las Vegas leg of the system. When completed, the system will handle two ETV circuits for the University of Nevada as well as approximately 120 voice communication channels.

Nevada is only one of many state governments supplementing their commercial telephone circuits with their own microwave systems. To find if your state has or plans similar programs, contact your state director of communications or state civil service commission. Usually, these jobs have no training programs. They normally require experienced people with at least a second-class license. Some states have on-the-job training programs in many vocational areas. These programs are open to high school students part-time during school and full-time during the summer. These part-time ventures often work into full-time jobs with excellent futures for the high school graduate. Again, check with your state civil service commission, state director of communications or high-school vocational training director.

You can find out who is putting in microwave systems by subscribing to trade journals. These magazines usually tell of the issuance of FCC construction permits ("CP's") as well as other pertinent information in the communication industry. Two side advantages to subscribing to the trade journals: you can pick up a lot of technical education just by reading the ads, and you might even find that job waiting for you in the classified "help wanted" section of the magazines. One good source for the independent telephone industry is *Telephony*, published weekly at 608 Dearborn St., Chicago, Ill. Subscription rate is \$4.50 per year. Another trade magazine is the *Microwave Journal*, published monthly at 610 Washington St., Dedham Plaza, Dedham, Mass. Subscription rate is \$1 per year. *Microwave Journal* deals mostly with industrial and military application of microwave. Between the two, you should be able to get a pretty good cross-section of the industry. You can subscribe to only one if you already know the area you wish to explore.

Time was, in the communication industry, when there was little turnover; few jobs were available to the newcomer. The expansion of microwave communications has made many jobs available. There is still stability, but it is no longer static stability. After a few years in one place, if you feel you have progressed as far as you can, professionally, you can find more rewarding work elsewhere. In fact, many technicians and engineers recommend two or three changes during the

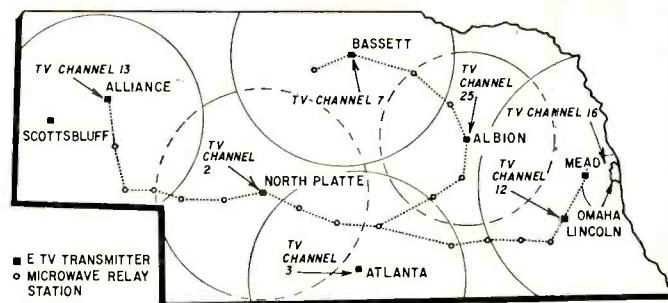
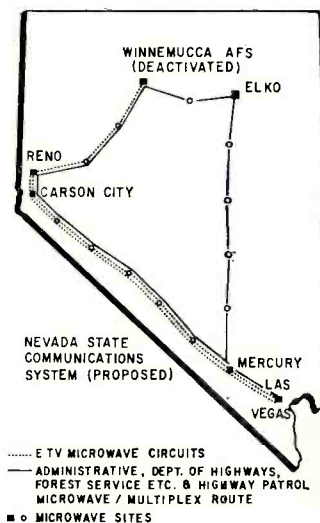

Fig. 2—Nebraska educational TV system is scheduled for completion in 1967. It will include 20 microwave relay stations and six ETV transmitters. System will supplement normal school programs, and continue them during severe winter weather when schools can't open. Mead-to-Atlanta link, about 200 miles, has been completed at this writing.

Fig. 3—Nevada microwave ETV links will tie University of Nevada Reno and Las Vegas campuses. Old Winnemucca Air Force radar site is expected to be used for training university personnel in ETV operation. Nevada Highway Patrol will have vhf repeaters on mountaintops to receive signals from patrol cars. Signals will feed microwave systems and be relayed to distant mountain installations, then be restored to vhf band. Thus any patrol car in the state can reach centrally located base station.



first 10 years to get a broad knowledge of the communication industry. A broad background will be profitable for yourself and your ultimate employer. Remember, the requirements for getting into microwave vary all the way from a high-school education to an advanced college degree with 15 or 20 years experience. But, there are engineers without degrees as well as maintenance men with master's degrees in engineering. It all depends on what you want and how much effort you are willing to put forth. Formal education, though important, is not the main consideration to every microwave employer. You will always be more valuable, though, with as much training and experience as you can get, so don't turn down any opportunities. Get that second-class radio license, if possible. It can open many doors and pave the way for professional advancement.

We've talked a bit about the past and some of the present of microwave. What's in store for the future? Communication experts see the day not too far distant when a series of stationary satellites above the earth will beam thousands of messages and supply dozens of video and data circuits to all points on the globe. Special remote pickups will be available on a moment's notice via satellite microwave. Already, scheduled satellite communication is a reality across continents. And one day, say the experts, it will be cheaper and a lot less trouble to have maintenance personnel stationed for 3-, 6- or 12-month tours of duty on a centrally located satellite. If a malfunction occurs on one of the relay satellites, special bypass circuits will be put into operation while a maintenance man hops into a special shuttle craft, punches the button for the preprogrammed coordinates of the station in trouble and gets there in a matter of minutes, across thousands of miles. After maintenance, he shoots back to the mother satellite.

Who will he be? Maybe you?

END

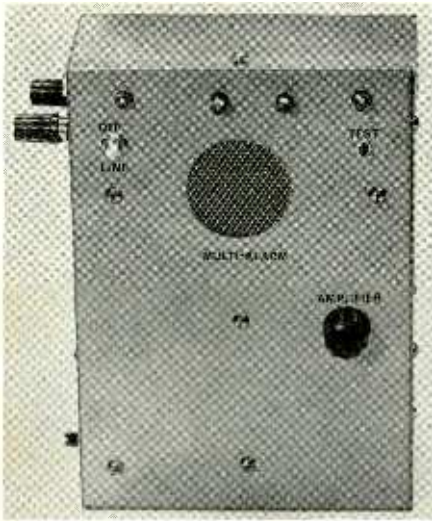

Multi-Alarm box contains everything but the sensor—switch, thermistor, photocell, etc.

BUILD THE MULTI-ALARM

CHARLES J. SCHAUERS

All-electronic alarm stands guard over your home, warns of fire, power failure, forced entry and dozens of other potential catastrophes

THE MULTI-ALARM IS AN ELECTRONIC warning device that emits a loud, piercing sirenlike sound that can be heard clearly above household sounds (including a blaring TV). Coupled to a 4- or 5-watt amplifier connected to a 6- or 8-inch speaker, it can be heard more than five blocks away.

Used with inexpensive outboard devices, it can warn of fire, overheated electrical equipment, a malfunctioning air-conditioning system, the beginning of rain, a child falling into an unattended swimming pool, attempted entry into a home or garage, power failure due to a blown fuse or shorted wiring. Other uses are limited only by your imagination.

With parts in most experimenters' junk-boxes, the Multi-Alarm can be built for less than \$15.

Circuits

For the distinctive "siren" signal, a very simple relaxation oscillator is used. The sound generated by the little unit begins at around 15 Hz and rises to around 500 Hz. When the highest frequency is reached, the sound pulsates between about 450 and 500 Hz. Fig. 1 shows the simple circuit.

A minimum of 300 volts dc is needed to operate the oscillator. This can come from an existing power supply in a radio receiver, public-address amplifier or other equipment. A 300-volt battery can also be used, but its cost (around \$8) is higher than the cost of the high-voltage supply shown in Fig. 2.

The supply shown in Fig. 2 is a modified Hartley oscillator. It provides (after quadrupling) a dc voltage between 300 and 500. Any good high-gain transistor is used. Powered by a 9-volt battery, the supply is instant-starting and very reliable.

Although International Rectifier Corp. type U10HP selenium rectifiers were used, other high-voltage units may be used as long as the piv (peak inverse voltage) rating is around 400 to 500.

Any amplifier may be fed with the "siren" oscillator. With an amplifier that has a high-impedance input (such as a microphone input), connect directly from the 470,000Ω output resistor and ground. An input transformer (Lafayette 99 R 6034) is used to feed the Lafayette PK-544 transistor amplifier (now stock No. 99 R 9037) used in the Multi-Alarm.

The Lafayette amplifier is a complete unit and can't be built from scratch for that price (\$6.95), unless you are fortunate enough to have an unusual collection of miniature parts. It and the transformer can be ordered from Lafayette Radio Corp., 111 Jericho Tpke., Syosset, N.Y. 11791.

With 350 mW output into a 3-inch speaker, the amplifier can be heard throughout an eight-room house above the usual household noises.

To warn of ac power-line failure due to any reason (including electrical fires), the circuit shown in Fig. 3 was incorporated in the Multi-Alarm.

Although a 117-volt ac relay may eliminate the transformer and some other components, heat and eventual chattering may become a problem. I decided to use an inexpensive low-current relay.

A 6-volt transformer (Knight 61 U 416 or equivalent), two diodes and two capacitors supply doubled voltage (at low current) for the relay; a Lafayette 99 R 6091. The diodes used are 1N645 surplus units. Other inexpensive diodes such as the 1N38 may be used as well.

When the control unit is ON LINE, the relay contacts are open. Any interruption of line voltage will allow the contacts to close, turning on the amplifier and oscillator.

Interconnection and construction

Fig. 4 shows how the unit is interconnected.

The entire unit was constructed in a Minibox 7 x 5 x 3 inches. Parts layout is not critical. The amplifier and oscillator chassis (on which the input transformer is mounted) should be oriented for minimum hum pickup from the relay transformer.

Although two 9-volt (or two 8.2-volt mercury) batteries are used, one is sufficient. If the device is used often, battery life is longer with two batteries—one for the amplifier and one for the siren high-voltage supply.

To hold the batteries in position, I made two clips from cable clips; these I bolted to the chassis.

The speaker was fastened to the

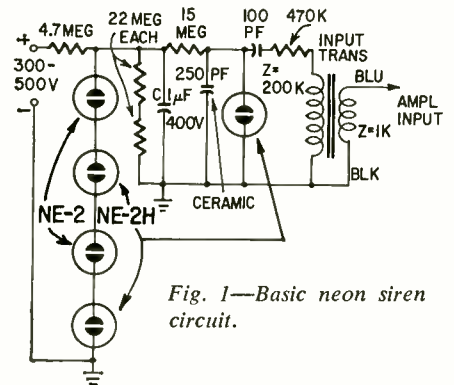

Fig. 1—Basic neon siren circuit.

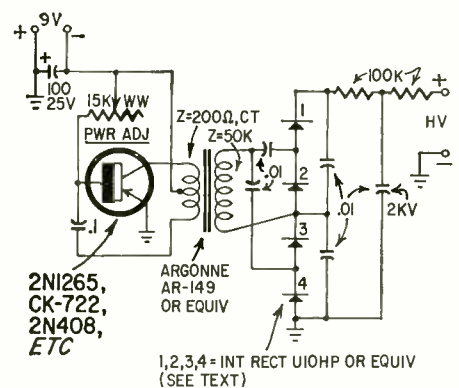

Fig. 2—Low-current high-voltage supply for siren.

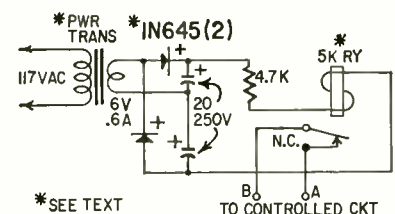

Fig. 3—Relay supply.

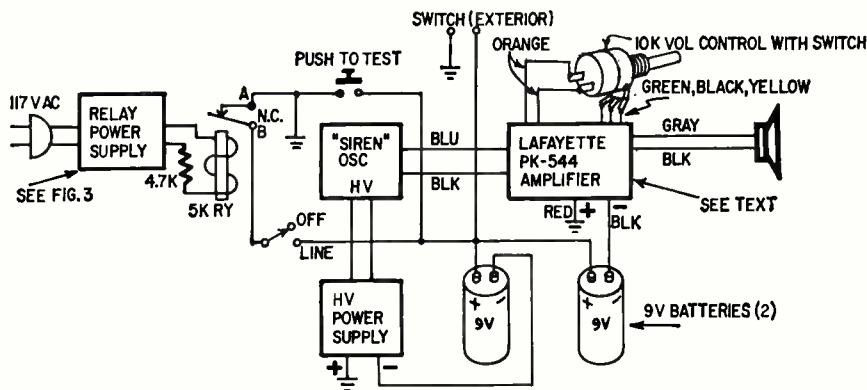

Fig. 4—Hookup of the complete Multi-Alarm.

Minibox with small clips. I cut holes for the speaker with a 1½-inch chassis punch and covered them with metal screen. The hole in the chassis back, directly opposite the speaker, permits a louder output.

How it operates

With a switching (sensing) device connected to the Multi-Alarm switching terminals (two binding posts on the top left of the unit), the device will go on when the external circuit is closed—whether the unit is off or on line. The battery circuits for the amplifier and the high-voltage power supply are activated.

The POWER ADJUST pot in the base of the transistor in the high-voltage power supply (Fig. 2) is adjusted for quick starting. Adjust the pot so that the four neon lamps fire. As they do, the tone of the oscillator will descend and then rise until capacitor C again charges to the firing voltage of the neon bulbs. (Incidentally, to mount the neon bulbs rigidly in the holes cut for them, use high-voltage corona cement.)

The volume of the amplifier may be adjusted with the pot on the front panel. If you need only visual indication from the unit, the amplifier can be turned off separately.

A test push switch on the upper right of the front panel may be used to check the unit off or on line.

With the Multi-Alarm's 117-volt ac cord plugged in and the small toggle switch on the upper left panel front placed in the LINE position, any power failure will activate the unit. Off-line, the switch is turned to off. This makes the unit available for portable use—in a car, for example.

Booster amplifier

Fig. 5 is the diagram of an amplifier using one power transistor. It can be added to the Multi-Alarm along with a 6- or 8-inch speaker to provide enough sound for nearly any warning application. A small relay capable of handling at least 2 amps must be used to turn the amplifier off and on with the Multi-Alarm. (Input and output transformers

are Lafayette AR-172 and 33 R 7501, respectively.)

Uses for the Multi-Alarm

Fire alarm. The Multi-Alarm was constructed originally for fire warning. However, it can be used very effectively in other warning applications. To detect fire, temperature-sensitive button switches were used. These came from Lafayette Radio Corp. For 135°F or 200°F operation; they cost only \$1.95 each plus postage for 3 oz. The 135°

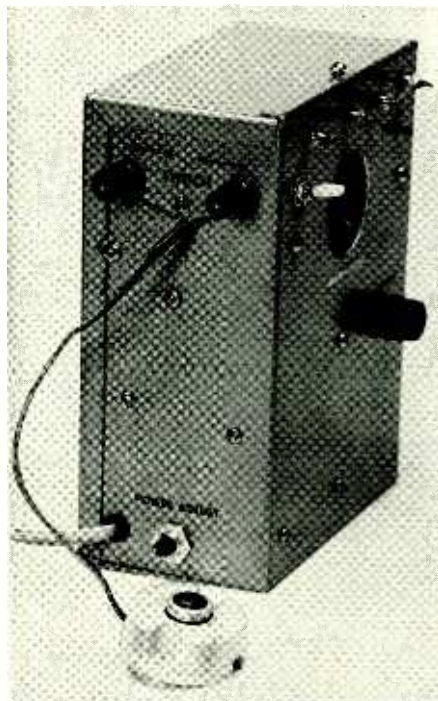

Side of main Multi-Alarm box. Device in foreground is temperature-sensitive button switch, which can be used with the Multi-Alarm to make a fire warning.

model is stock No. 14 R 8202; the 200° model, 14 R 8203.

The button switches are mounted in each room as high as possible and connected in parallel. The "fire line" is then connected to the Multi-Alarm switch terminals. The Multi-Alarm is plugged into the house power system and the control switch placed on LINE.

Do not install the temperature-sensing buttons close to radiators, hot-air registers or any other heat-producing devices.

Incidentally, with the Multi-Alarm mounted in the engine compartment of a car, a 200°F sensing button may be placed near the manifold. Should some auto thief make off with the car, the heat from the manifold will cause the button switch to close and turn on the Multi-Alarm. No thief will drive far with a siren screaming!

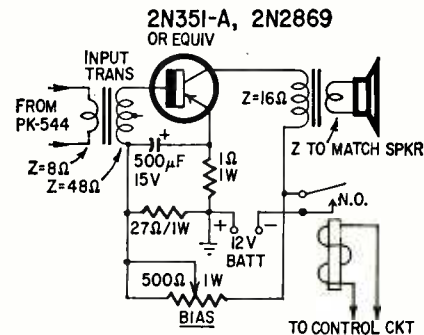

Fig. 5—5-watt power amplifier stage, driven from prefab amplifier, can be used for noisy or outdoor applications.

Should you take an extended vacation, take the Multi-Alarm to a neighbor and connect it with your "fire line." Should a fire start while you are gone, the neighbor can call the fire department in time.

On the car. In addition to using the Multi-Alarm for theft protection, it can be wired to the backup light or turn signals to warn pedestrians (especially children). It can also be connected to the door domelight switch to operate if a door is opened (or partially open). This will also serve as car protection when you are on camping or hunting trips, and must park your car some distance away.

If the unit is to be operated exclusively in the car, the car (12-volt) battery can be used instead of the 9-volt units. Three volts more will not damage either the high-voltage power supply or the amplifier.

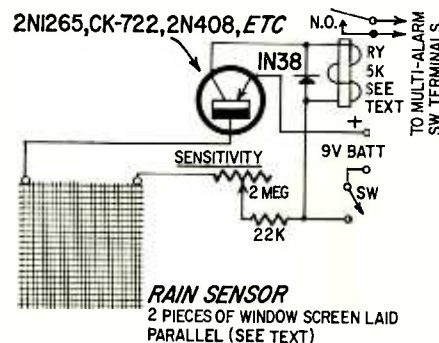
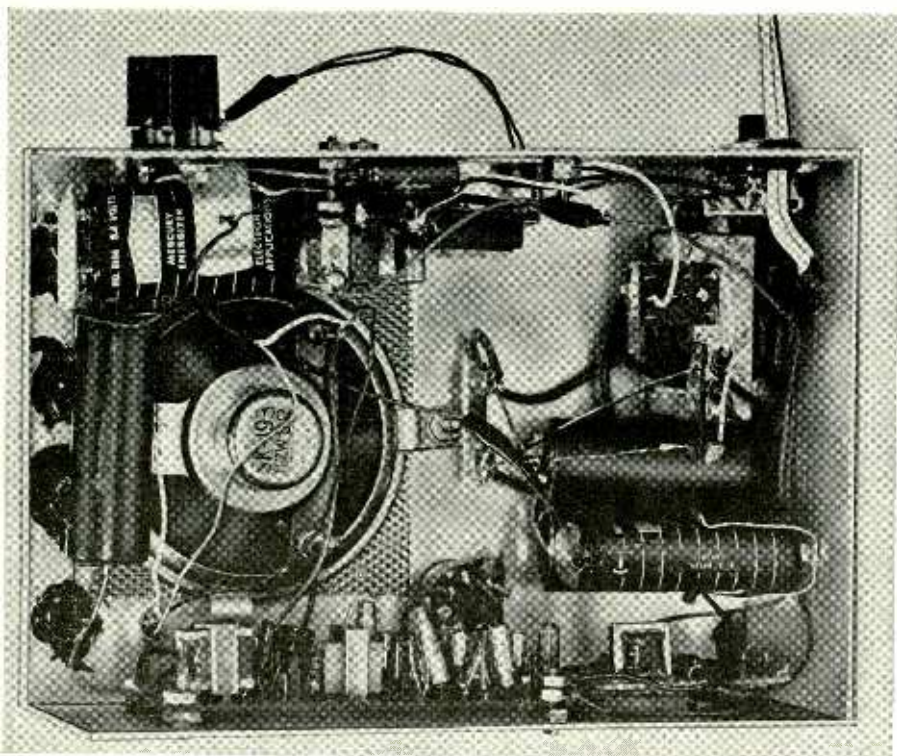

Fig. 6—Rain warning device uses home-made sensor.



Components fit easily around walls and floor of case. At the bottom (actually a side wall) is the prefabricated transistor amplifier. Separate batteries are used for amplifier and siren power supplies.

Rain alarm. Fig. 6 shows a rain-alarm circuit. The relay contacts of the rain sensor are connected to the Multi-Alarm switch terminals. When the sensor recognizes rain, the relay is closed, actuating the Multi-Alarm.

The sensing element is made from two 4-inch square pieces of copper screen insulated (at the corners) from each other. When a drop or two of rain "shorts" the two pieces of screen, the transistor is biased on and closes the relay.

This device can be connected into the motor control circuit of a convertible auto-top system to close the top when it rains. The sensor device can be modified to rectangular shape and mounted just below the top of the windshield.

Swimming-pool warning. Kids will do the unexpected when no one is around; this includes falling into an unattended swimming pool. If a water-wave-operated switch is used with the Multi-Alarm (and perhaps the 4-watt amplifier), everyone in the neighborhood will be warned when a child falls into an unattended pool. A light-weight float can be fastened to a Microswitch, or you can try a pendulum that closes a set of contacts when the disturbance makes it swing.

Over-temperature warning. To warn that electronic equipment temperatures are at a dangerous level, or that an air-conditioning system is not operating properly, the device shown in Fig. 7 can be used with the Multi-Alarm.

The sensing element in this case is a thermistor in a bridge circuit. The sensor may be placed at any remote location, and the unit adjusted, with the 3,000Ω pot, to operate when a certain temperature level has been exceeded. A high-scale (up to 250°F) thermometer can be used to set the instrument.

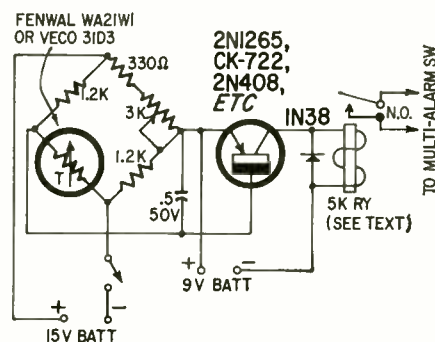

Fig. 7—Thermistor bridge gages temperature changes. Thermistor alone can be at end of long line, even in relatively inaccessible spots.

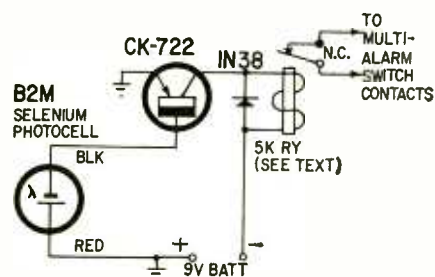

Fig. 8—"Light-out" warning.

If desired, a 0–5-mA meter may be placed in series with the collector of the transistor and calibrated to read temperature. One caution: Be sure the transistor is well ventilated.

Light-out warning. The simple device shown in Fig. 8 is used with the Multi-Alarm to let you know that an important light (such as an obstacle light) is out. As long as light falls on the photocell (daylight or electric light), the relay contacts are open. Should night come and the electric light fail to function, the alarm will sound.

Intrusion warning. Pressure or other switches may be installed on doors or windows of a building and connected to the Multi-Alarm as a warning of intruders. A separate switch to disconnect the unit at each door or window should be installed so that the door or window can be opened normally without releasing the alarm. Perhaps one master switch can be placed at or near the unit to handle all entrances and exits.

So, you see, the Multi-Alarm can be used in many important ways, and it's fun to play with, too. No doubt you can think of other uses for this versatile warning device. The sensitive relays in Figs. 6, 7 and 8 may be Sigma 4F's, Potter and Brumfield GB5D's or Lafayette No. 99 R 6091's. END

CEILING HAS EARS

A conference room that can "communicate" with its occupants is nearing completion at the Federal Aviation Agency (FAA) Aeronautical Center in Oklahoma City. It's a room in which the ceilings have ears and the walls have voices.

A flick of a switch can cause the room to dim its lights, create pictures on its walls, draw back curtains to reveal magnetic chalkboards, and talk via audio tapes. The room can repeat conversations that took place within its walls only seconds before.

The room contains an AM-FM-multiplex tuner, tape recorder, phono turntable, projection TV tuner, 16-mm projector, and stereophonic speaker system.

The second—and more complicated—sound system is designed to pick up and amplify voices within the room and to tape-record conversations at the conference table. Overhead microphones feed words spoken at the table into amplifiers and back into dual-cone speakers in the ceiling. These microphones and speakers are engineered by LTV-University so that words picked up by mikes in the front of the room are amplified more in the speakers at the back of the room, and vice versa. Feedback from speakers to microphones is practically nonexistent at ordinary loudness levels. END

Cheap-to-build rf power meter does away with expensive meter movements by brightness-comparison trick

THE DETROIT DUMMY

By BASIL BARBEE

LIKE A DETROIT "IDIOT LIGHT," THIS handy little rf power meter uses panel lamps instead of an expensive meter movement. But most *unlike* the idiot light, it makes fairly accurate measurements.

Many CB operators use four No. 47 bulbs in series-parallel as a dummy antenna. Although the resistance of the dummy varies with the rf power, this scheme works very well. Even the actual power output can be estimated by an experienced eye, although the accuracy of the estimate depends a lot on the room brightness.

The Detroit Dummy is a refinement of the popular four-47 dummy. Since the eye can compare the brightness of two or more adjacent bulbs accurately, not even a photocell is necessary.

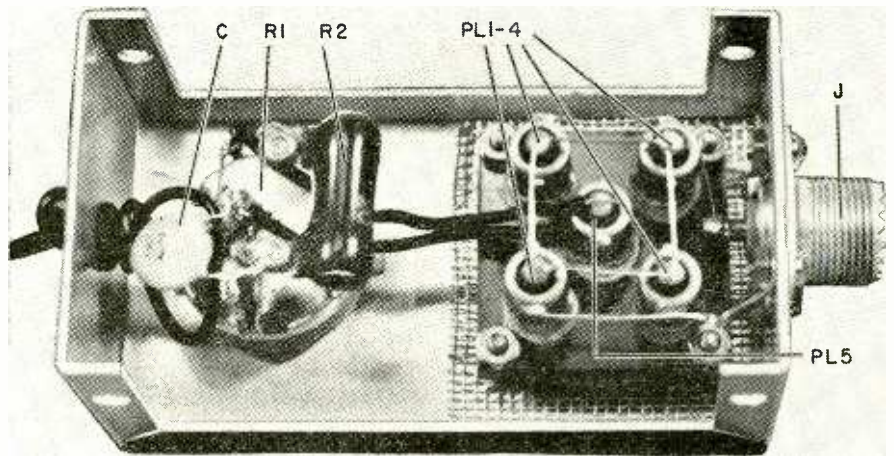

Wiring is simplicity itself. Bulbs will last for years of intermittent use, so are soldered in directly, without sockets.

The four 47's of the conventional dummy are mounted in $\frac{3}{8}$ -inch holes near the corners of a $1\frac{1}{2}$ -inch-square piece of $\frac{1}{4}$ -inch thick Bakelite at the end of the case next to the SO-239 coax connector. In the center of the Bakelite subpanel is a fifth 47, which is powered by either dc or ac taken from the car battery or other convenient source. Its brightness is controlled by the 40-ohm potentiometer. R2 drops the usual 12.6-volt source down to 6.3 volts. (For a 6-volt battery or 6.3-volt transformer, omit R2.) The .0047- μ F capacitor bypasses the battery lead to ground to prevent radiation.

A $1\frac{3}{8}$ -inch round hole in the front of the case lets you look at the lights. This hole is covered with aluminum screen to protect the bulbs and complete the rf shielding.

How to use it

The instrument's coax receptacle is connected to the transmitter output by a short piece of coax cable. Power plug P is inserted into the car's cigarette-lighter socket, or, for bench operation, connected to a 12-volt ac source.

When you key the transmitter, the four bulbs of the dummy antenna light. Rotate the potentiometer knob until the brightness of the center bulb matches that of the other four. The power in watts being dissipated by the dummy load can be read from the potentiometer dial after you've calibrated it.

- C—.0047- μ F disc-ceramic capacitor
- J—SO-239 coaxial receptacle
- P—cigarette-lighter plug
- R1—pot, 40 ohms, linear taper
- R2—20 ohms, 5 watts (omit for use with 6-volt supply)
- PL1-PL5—No. 47 pilot lamps, all from same carton
- Aluminum box, 4 x $2\frac{1}{8}$ x $1\frac{1}{8}$ in. (Bud CU-3002A or equivalent)
- $1\frac{1}{2}$ -in.-square piece Bakelite
- 2-in. square piece aluminum window screen
- Any length zip-cord, ribbon lead, etc. for connection to P
- Miscellaneous hardware

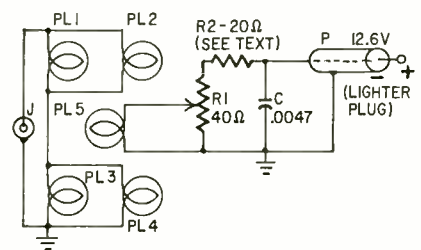

Circuit of the Detroit Dummy.

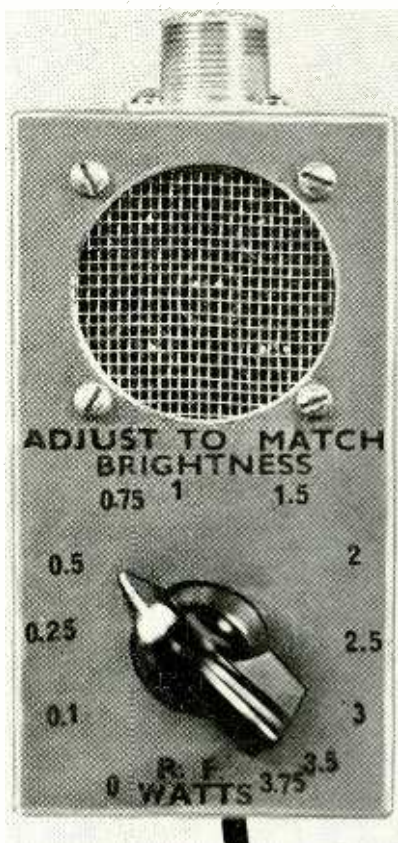

Glowing bulbs are watched through screened hole. Screen prevents rf interference by keeping radiation confined inside the box.

Potentiometer Calibration
Per cent of rotation

Rf watts	12.6 v	6.3 v*
0	0	0
0.1	11	13
0.25	20	26
0.5	30	38
0.75	40	49
1	46	56
1.5	58	69
2	70	79
2.5	80	85
3	88	91
3.5	96	97
3.75	100	100

* R2 shorted out.

Separate columns of percentage rotation are given for 12.6- and 6.3-volt calibrations. The difference arises from the better voltage regulation with R2 shorted out, and from the variation of the bulb's resistance with temperature.

Since the resistance of a four-47 dummy dissipating 3.75 watts is only 42 ohms while the usual RG-58/U coax cable is rated at around 53 ohms, and since the resistance of incandescent bulbs varies with power, the coax cable connecting the Detroit Dummy to the transmitter should be as short as possible to prevent standing waves. In any event it should be very short compared to a quarter-wavelength (that is, not more than a foot or so at CB frequencies). The length of the dc (or ac) cable is unimportant as long as it does not cause excessive voltage drop. Even 25 feet wouldn't hurt.

Accuracy of the Detroit Dummy is unaffected by ambient light, since we're matching the illumination of one bulb to that of other identical bulbs. Of course bright sunlight will make it impossible to judge the brightness of the bulbs at low powers, but indoors even 0.1 watt can be read if the room is not too brightly illuminated. END

TESTING TRANSISTORS WITH AN OSCILLOSCOPE

is the best way to get to know them. (Ohmmeter tests don't tell all.) Learn how to interpret the traces on the screen, how to match transistors, how to pick the best one for a particular job.

Coming in June

RADIO-ELECTRONICS

Microelectronics and Solid State Special Issue

WHAT'S YOUR EQ?

Conducted by E. D. CLARK

Black-Box Equivalent

Can you develop an equivalent circuit for the contents of the box in the diagram? The procedure is to connect a variable voltage source across the input terminals and note the resultant current

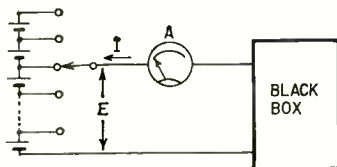

readings in the reference direction shown. The following results were obtained: When $E = 12V$, $I = 2A$; $E = 6V$, $I = 0$; $E = 0V$, $I = 2A$.

What's the equivalent circuit of the black box?—Phillip Cutler

Capacitor Puzzler

In the diagram, $C1$ ($1 \mu F$) is initially charged to 2 volts with the polarity shown. The switch is now closed at $t = 0$. Can you determine the final voltages across the two capacitors and their polarities?—S. G. Joshi

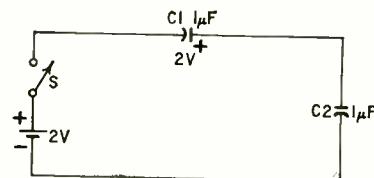

3-Way Switching?

The No. 222 (2.5-volt) flashlight bulb mounted on this black box may be switched on or off by either *spst* switch (usually three wires and three-way

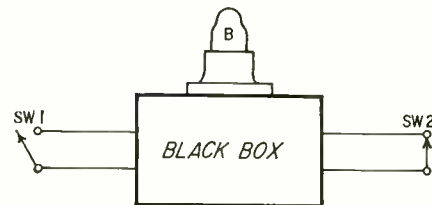

spdt switches would be used). There is a battery in the box. What else? No tubes, relays or semiconductors are involved.—Albert S. Lombard

Three puzzlers for the student, theoretician and practical man. Simple? Double-check your answers before you say you've solved them. If you have an interesting or unusual puzzle (with an answer) send it to us. We will pay \$10 for each one accepted. We're especially interested in service stinkers or engineering stumbers on actual electronic equipment. We get so many letters we can't answer individual ones, but we'll print the more interesting solutions—ones the original authors never thought of.

Write EQ Editor, Radio-Electronics, 154 West 14th Street, New York, N. Y. 10011.

Answers to this month's puzzlers are on page 89.

50 Years Ago

In Gernsback Publications
In May, 1916
Electrical Experimenter

- Locating Vessels at Sea by Radio and Sound Waves
- Washington's Birthday Amateur Radio Relay
- Designing a Spiral Antenna
- A Balanced Detector
- Construction of a Wireless Telephone Set



BUILD A FLASHLIGHT OPERATED TV SILENCER

By FRED BLECHMAN

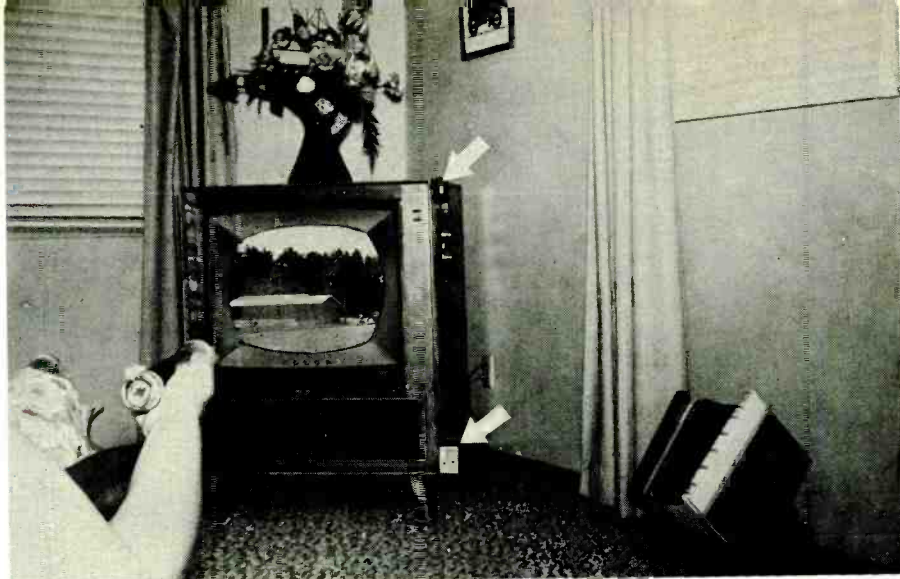

Kill TV sound from 15 feet away with just a flick of the wrist! Reset cell is upper unit.

The TV Silencer is a wireless speaker "killer" which uses an ordinary flashlight as a "gun." By shooting at either of two photoelectric eyes, you can kill the speaker or bring it back to life!

The TV Silencer costs about \$11 to build from all new parts, and installation requires only a very minor change to your speaker circuitry. It operates from the power line—no batteries are required. A unique latching circuit requires only a momentary "shot"—you do *not* have to hold the flashlight on target during the entire commercial. The "killing" is almost instantaneous.

Circuit description

The circuit of the TV Silencer is shown in Fig. 1. The filament transformer, chosen because it is small and inexpensive, does not supply enough voltage with a conventional half-wave rectifier to operate the circuit. Therefore, two inexpensive diodes, D1 and D2, and two low-voltage electrolytic capacitors, C1 and C2, are wired as a

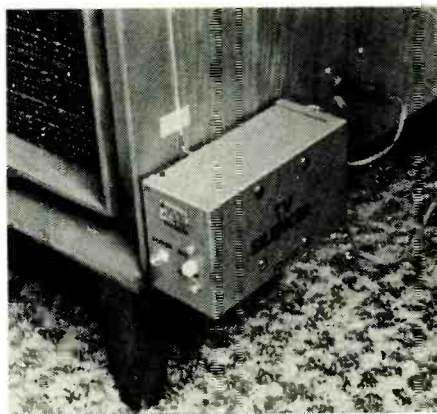

Silencer circuitry is built into unobtrusive metal box near bottom of TV cabinet. Plug is P2 of Fig. 1—to speaker circuit. Wire up side of cabinet goes to reset cell.

full-wave voltage doubler, boosting the output to 20 volts. Two transistors, Q1 and Q2, are wired in the common-emitter configuration, with sensitive plate relays RY1 and RY2 as collector loads. Photocells PC1 and PC2, which have a very high resistance in the dark,

keep the transistors almost cut off, so both relays are de-energized. The TV speaker is connected through contacts A-B of RY1.

Now let's assume the flashlight beam strikes PC1. The resistance drops down to only a few thousand ohms, and Q1 is thrown into conduction. The emitter-collector current energizes RY1, and speaker contacts A-B open, disabling the TV speaker. Notice that now-closed contacts B-C of RY1 connect the full supply voltage (through contacts A-B of de-energized relay RY2) to the coil of RY1, latching RY1 closed.

To return the speaker to operation, the flashlight is aimed at PC2, which throws Q2 into conduction. This closes relay RY2, opening the latching circuit to RY1. Therefore, RY1 drops out, and the speaker is connected again through contacts A-B and the set's sound is restored.

All this may sound complex, but it works very smoothly and positively, with no annoying time lags. A regular two-cell flashlight will operate the Silencer from about 20 feet away; a three-

- C1, C2—100 μ F, 15 volts, electrolytic
 - D1, D2—general-purpose diodes, silicon or germanium (Lafayette stock no. 19 R 1505 or equivalent)
 - J1—single-hole-mounting phono jack (GC Electrocraft 33-804 or equivalent)
 - J2—closed-circuit phone jack
 - P1—finger-grip phono plug (GC Electrocraft 33-769 or equivalent)
 - P2—phone plug, PL-55 type (2-conductor)
 - PC1, PC2—cadmium sulfide photocell 1 meg total darkness to 1,500 ohms at 100 foot-candles (Lafayette 99 R 6306)
 - PL—NE-2 neon lamp
 - Q1, Q2—general-purpose p-n-p audio transistors (Lafayette 19 R 1502 or equivalent)
 - R—100,000 ohms, $\frac{1}{2}$ watt
 - RY1, RY2—5,000-ohm spdt relays 1- to 2-ma sensitivity (Lafayette 99 R 6091 or equivalent)
 - S—spst slide or toggle switch
 - T—filament transformer, 6.3 volts, 1 amp (Lafayette 33 R 3702 or equivalent)
- Aluminum and plastic boxes, wire, hardware, phenolic board (see text for construction suggestions)
- Lafayette Radio Electronics Corp., 111 Jericho Turnpike, Syosset, N.Y. 11791

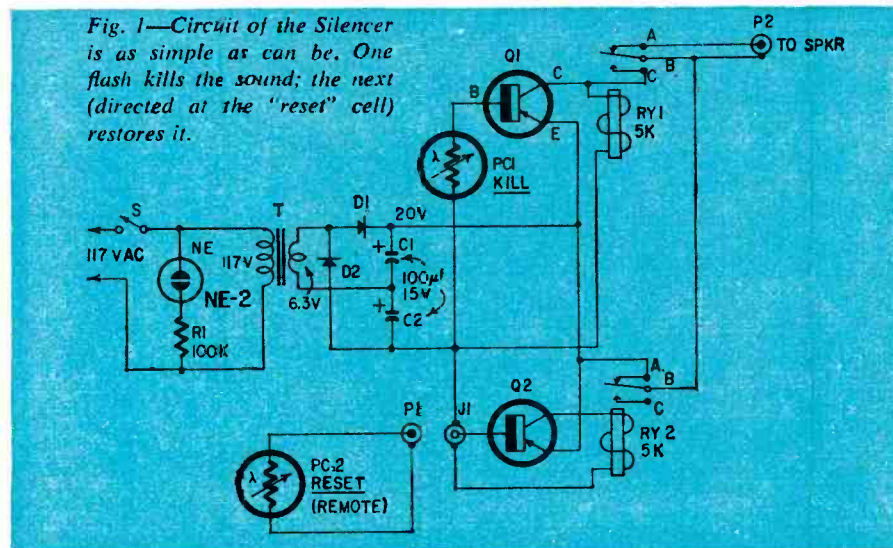
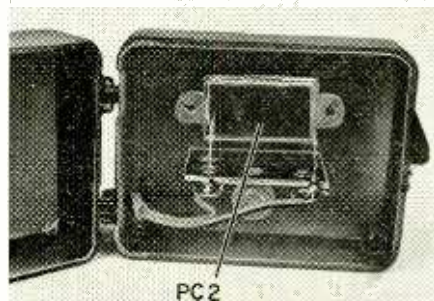

Fig. 1—Circuit of the Silencer is as simple as can be. One flash kills the sound; the next (directed at the "reset" cell) restores it.

cell flashlight is usable to about 40 feet. However, don't expect to use the Silencer in brightly lighted rooms, or during the daytime; it will lock-in on the high ambient light level. The TV Silencer is designed to operate in the normal televiewing situation—nighttime, with some room lighting. To make it meet other requirements would greatly complicate the circuitry and increase the expense.

must be placed far enough apart so that the flashlight beam doesn't cover both simultaneously. I put PC1 in a Minibox, with all the circuitry, and mounted it on the lower side of my TV. This is near the speaker and fairly well out of sight, yet an easy target for the flashlight. PC2 was placed all by itself in a separate small plastic box attached farther up the side of the TV

Switch S, photocell PC1 and the pi-



How reset cell PC2 is mounted, with two-terminal solder-lug strip, in plastic box.

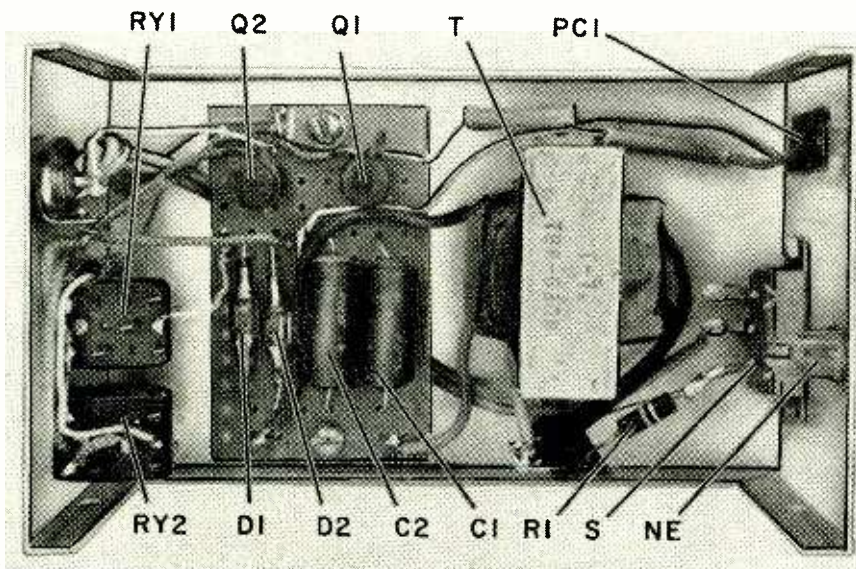

How to wire the Silencer. Layout and wiring are completely noncritical.

Parts may be substituted as you like, except for the photoconductors and relays, which have been selected for their particular characteristics and low cost. D1 and D2 may be any general-purpose diodes (the low current and low voltage even allow the use of signal diodes, such as the 1N34) and the transistors can be any general-purpose p-n-p four-for-a-dollar variety, similar to the 2N107 or CK722. Electrolytic capacitors C1 and C2 must each be rated no less than 12 volts. The transformer, selected for low cost and small size, is actually much overrated for this task, but smaller units cost more.

Construction

Construction is straightforward. There is no critical wiring. PC1 and PC2

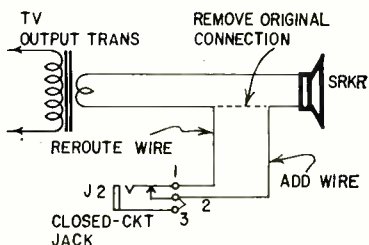

Fig. 2—Simple changes to TV set's speaker wiring for normal operation without Silencer.

lot light are placed on the end of the Minibox to present the smallest view from the front of the TV set. The power and speaker lines, and the connection going to PC2, are at the other end of the box.

If you use the Silencer with an ac-dc (power-transformerless) TV set, insulate the relays by mounting them on phenolic board, since the relay mounting frames are in direct contact with the armatures (contact B). If, by some mischance, the TV speaker lead connected to the B contacts of the relays were at power-line potential, the Silencer chassis would also be "hot" unless the relays are insulated from the case.

The circuit intentionally uses a transformer for isolation to prevent any possible power-line short circuit between the TV set and the Silencer. A simpler Silencer design, using no tran-

sistors and operating directly from the power line, is unsafe, so don't try it!

The photoconductors are most easily mounted by cementing them behind a rectangular cutout. In the plastic box used to house PC2, a two-terminal strip provides tie points for the photoconductor leads. Small speaker or earphone wire connects PC2 through an insulated connector at the Minibox. If you use a single-hole mounting RCA type phono jack for the connector, mount it in a rubber grommet for quick and easy insulation.

Bench checkout is simple, but must be carried out in subdued light. Use a flashlight battery and bulb in series as a substitute for the speaker. With PC2 connected, but separated a few feet from the main unit, plug in the Silencer power cord and turn on the switch. The pilot light should go on instantly, and the "speaker" (bulb) should stay on. Now back away 10 feet or so and trigger PC1 with a flashlight. The "speaker" bulb should go out instantly, and should stay out when the flashlight beam is removed. Wait about 30 seconds to make sure everything is stable, and then trigger PC2 with the flashlight; the bulb should come on instantly. Operate the unit several times to ensure proper action. Difficulties can be traced to inverted diode or capacitor polarities, improper transistor hookup or incorrect wiring.

The simple modification to your TV speaker wiring, as shown in Fig. 2, involves adding a closed-circuit jack. Simply remove the wire at one speaker terminal and reroute it to terminal 1 of the added jack J2, which may be located at any convenient spot. Add a wire between terminals 2 and 3 of J2 and run a new wire from J2, terminal 2, to the speaker lug just vacated. Now, with the mating plug from the TV Silencer installed, the speaker circuit is controlled by relay RY1. When the plug is removed, J2 closes the circuit so that it works just as it did before.

You'll really appreciate the golden silence available at the flick of your wrist when you put the TV Silencer on your set. Give it a try. You'll wonder how you didn't go batty without one! END

BENCH



TESTED

A Radio-Electronics Editor reports: "This is a useful and effective device. With a two-cell flashlight, I killed and revived the speaker by shining the light on the cells in turn. Moderate room lighting can be

tolerated, but no light should fall directly on either cell. The flashlight should be a focusing type, both for sufficient illumination and to prevent activating both cells at once. The two-cell light was effective over at least 15 to 20 ft."

Followers: Cathode, Plate and Others

Some of electronics' most useful circuits—tube or transistor—are ones where output "follows" input, in phase. They change impedances, isolate circuits . . .

By NORMAN H. CROWHURST

THE CATHODE FOLLOWER IS AN OLD FAVORITE and we occasionally hear about plate followers and transistorized equivalents of these circuits. The word "follower" originated to explain the action, but sometimes its implication gets taken too far. So let's look at the whole group.

In the cathode follower, cathode voltage is supposed to follow grid voltage. Where the source of grid voltage applied may have a high impedance, the duplicate produced at the cathode provides an abundant supply of current, at low impedance (Fig. 1). That's the notion. Another description of the cathode follower says it has 100% voltage feedback. And because it has 100% feedback, it is assumed that the waveform must be perfect.

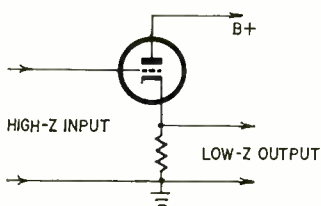

Fig. 1—Basic cathode-follower idea. As grid is driven negative, current through tube decreases, as does current through cathode resistor. That means less voltage drop across the resistor—so its top end gets closer to ground potential: more negative, like the grid.

Readers of RADIO-ELECTRONICS know, from previous discussions of this subject, that "tain't necessarily so." That 100% feedback statement means that the feedback fraction, beta (β), is unity, or 100%. The erroneous notion follows from confusing that beta with the feedback factor ($1 + A\beta$). If the latter were infinite, gain would be zero dB, and the voltage-gain-with-feedback expression,

$$\frac{A}{1 + A\beta}$$

would have to equal 1.

Making this substitution and doing a little algebra, to solve for beta, we find the feedback fraction has to be

$$\beta = 1 - \frac{1}{A}$$

which is quite realizable in theory. To achieve it in practice, if the gain of a tube, with a particular plate load and operating point, is 50 (ratio, not dB), beta needs to be 49/50, or 0.98. Put 0.98 of the load in the cathode and the other .02 of it in the plate, and take the output from plate to cathode (Fig. 2), and you have no gain (unity gain, that is).

In practical use, the cathode follower's output is always taken from

cathode to ground, which upsets the gain calculation of the last paragraph. Actual-

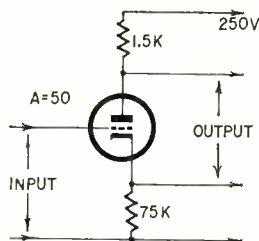

Fig. 2—Circuit for theoretical unity-gain stage (see text).

ly, gain of a cathode follower is always a fractional ratio, nearly 1, or slightly negative in dB. In the example just read, the gain proves to be 50/51, approximately 0.98 (as a ratio) or -0.2 dB.

This can be applied to a practical circuit as shown in Fig. 3. A bias resistor of 1,000 ohms sets the correct operating point for the 12AX7 with a 75,000-ohm plate load. This load is connected from the lower end of the bias resistor to ground. The circuit will have a gain of 50/51 (-0.2 dB) and will reduce distortion by the feedback factor of $1 + 50 = 51$. The source impedance presented at the output is the reciprocal of the tube's transconductance. The grid-return resistor, shown as 1 megohm, is effectively multiplied by the same factor of 51, in determining the circuit's effective input impedance (loading), and its grid-to-cathode capacitance is divided by 51.

If the tube's distortion at full swing, with the plate load used, is 5%, working as a follower will reduce distortion to about 0.1%. Assuming the transconductance is 1,250 μ mhos, the source resistance at the output is about 800 ohms.

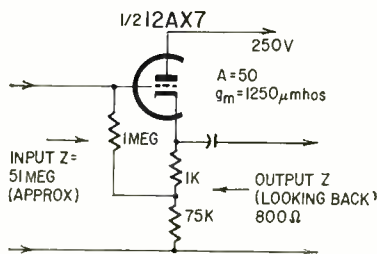

Fig. 3—Practical cathode follower using 12AX7 with working gain of 50.

Now comes the hitch. Using the classic power-matching formula, the cathode follower is expected to work into a load equal to its output source resistance, while retaining its other advantages. (Please don't write to "correct" me in what I am about to say! In re-

sponse to previous articles about this, readers have quoted their college professors and misquoted textbooks such as Terman and goodness knows what, to prove me wrong! If you don't believe what I say, try it. Set up the circuit and measure it for yourself.)

The cathode follower of Fig. 3 has a gain of -0.2 dB, only if no load is connected. It has a distortion of 0.1%, only if no load is connected. An output load equal to the cathode-to-ground resistor will reduce gain to about -0.3 dB and increase distortion to about 0.15%. But put on a matching load and it's a very different story.

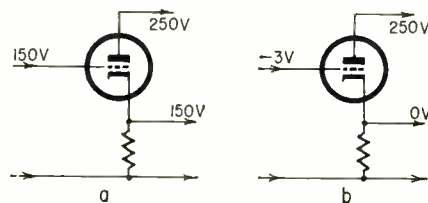

Fig. 4—Limits of cathode-follower action, for circuit of Fig. 3. In (a), grid is driven positive until its voltage equals cathode's. Then tube saturates and positive signal peaks are clipped off. In (b), grid is driven negative enough to cut off tube, bringing cathode voltage to zero. Further negative excursions of signal are chopped off. Note tremendous signal "swing" available with cathode follower—0 to 150 volts at cathode. But grid must swing from -3 to 150 volts: a greater range than cathode signal.

Couple an 800-ohm load to a tube with a transconductance of 1,250 μ mhos, and working gain drops from 50 to precisely 1. Not only that, but the distortion without feedback at full swing jumps from 5% to about 30% as a result of loading. Acceptable input swing is also cut drastically. The feedback factor is now 2 instead of 51, so follower gain drops from 0.98 to 0.5 (or from -0.2 to -3 dB), distortion jumps from 0.1% to 15%, and the available output voltage drops by about 50:1, because the tube only delivers about the same current swing. If the unloaded cathode follower delivered 50 volts rms at 0.1% distortion, the "matched" follower will deliver only 1 volt at 15% distortion!

Apart from the fact that loading destroys the advantage of a cathode follower, the normal limit to its working range is sometimes overlooked. One would think it's obvious that, with a 250-volt plate supply, a cathode follower could not handle a 300-volt signal, but the limits do get forgotten. Cathode volt-

age must always be a little positive of grid voltage, by the same amount the grid is momentarily negative from cathode (measuring the same voltage the opposite way).

The more positive the grid goes, the higher the tube current and the less the *momentary* cathode-to-grid voltage must be. When this difference reaches zero, the grid starts to conduct, as in any other tube circuit, abruptly clipping the waveform. At the other end, the grid can go negative of ground only by a voltage equal to grid cutoff for the operating load line chosen. Fig. 4 shows relative voltages at these instants.

From the fact that loading destroys the low-distortion advantage of a cathode follower, we can see just where the follower is and isn't practical. It is *not*, as has sometimes been claimed, an improved substitute for a line-matching output transformer—the line transformer does a better job, where *matching* is required. But for providing a *low-impedance source* to an output line, for example from an FM tuner, preamplifier or control center, either in a home high-fidelity or professional system, a cathode follower does serve better than a line transformer, *provided it connects only to a high-impedance input*.

[With certain transistor emitter follower circuits, it is possible to produce *source* impedances so low that they will work effectively into load impedances of 600 ohms or less (see the "Transistor Line Transformer", April RADIO-ELECTRONICS). But this is still *not matching*, and the material in the preceding paragraph still holds. The load should not be less than 100 times the effective source resistance if the properties of the cathode or emitter follower are to be kept.—*Editor*]

Plate follower

Here plate current is supposed to follow cathode current, input being applied to the cathode, with the grid grounded. A larger voltage is available at the plate than is presented to the cathode (Fig. 5). This circuit is a little more difficult to visualize, because in practice we have to provide somewhere for the cathode current to "go". But first let's treat it as an "ideal" follower.

Without any other connection to the cathode, plate current must equal cathode current, unless the grid is more positive than the cathode (cathode negative

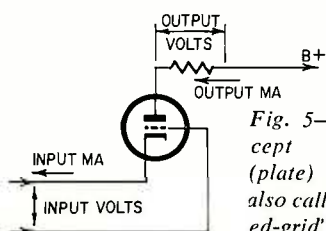

Fig. 5—Basic concept of anode (plate) follower—also called "grounded-grid" stage.

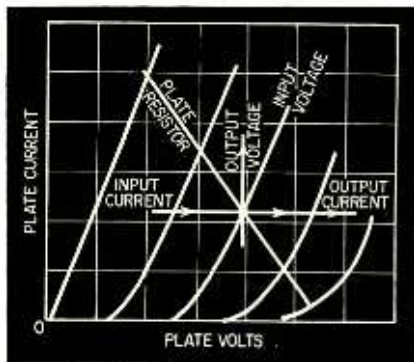

Fig. 6—Plate-follower relationships shown on load line.

of grid, or ground). So, if a certain input current is fixed, plate voltage will be fixed by the drop in the plate resistor (Fig. 6). Cathode voltage is fixed as the equal and opposite of the grid voltage that would be required for this plate voltage and current combination. If cath-

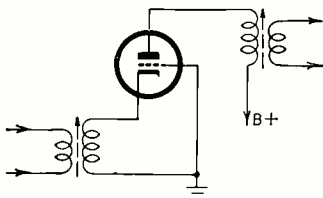

Fig. 7—Practical plate follower is very simple, if dc resistance of input winding is large enough to produce sufficient grid bias.

ode current is changed, the change in cathode voltage must be equal to the change in plate voltage, divided by the working voltage gain of the tube. This means the effective resistance in the cathode circuit, presented as a load impedance to the input source current, is the plate resistor divided by the working voltage gain of the tube.

This circuit is subject to the same limitations as the cathode-follower circuit at cutoff and at zero grid voltage. It has no negative feedback, so the voltage and resistance transfer ratio is as non-linear as the tube's characteristics from the operating point chosen.

When one tries to provide a constant-current input circuit to the cathode, while also achieving correct bias, a difficulty appears: the first requires a high input resistance and the second a much lower value of resistance between cathode and ground. The circuit can be used in its true form only in conjunction with a transformer, either tuned to a specific frequency or a wide-band audio type (Fig. 7). The impedance presented by the transformer to the cathode must be high enough to achieve essentially constant-current input, while the winding resistance (padded, if necessary), between cathode and ground, sets up correct bias.

For this reason, the plate follower

has found little use in audio circuits. It has proved useful in higher-frequency radio circuits (usually under the name "grounded grid"), where it helps keep unwanted circuit interaction at a minimum, by using lower working impedances throughout than do other tube circuits. The *cathode* follower provides a low output source impedance, but a very high input loading impedance. The plate follower loads down its input source and the output impedance is no higher than conventional plate circuits. Thus it serves in the nature of an impedance stepup, at constant current, so voltage gain is the same as impedance stepup effect.

Transistor versions

The transistor version of the cathode follower is an emitter follower (Fig. 8). Bias is simpler for an emitter follower than for a cathode follower. But the result has certain differences. In the cathode follower, the source resistance is governed by the tube's transconductance. In the emitter follower, the relevant parameters are working-current gain *ratio* and the source resistance pre-

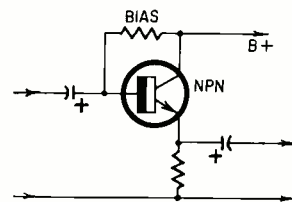

Fig. 8—Basic emitter follower for n-p-n transistor. Looks and works much like cathode follower.

sented to the transistor. With the tube, the source resistance the grid sees is almost completely irrelevant. With the transistor, base source resistance controls the reflected source resistance almost entirely.

Transistor gain varies along its characteristic, so the reflected source and load resistances (it works both ways

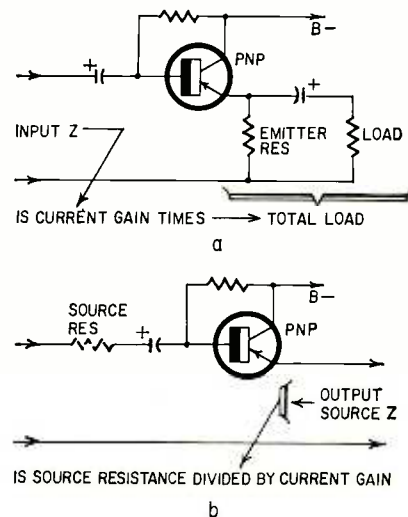
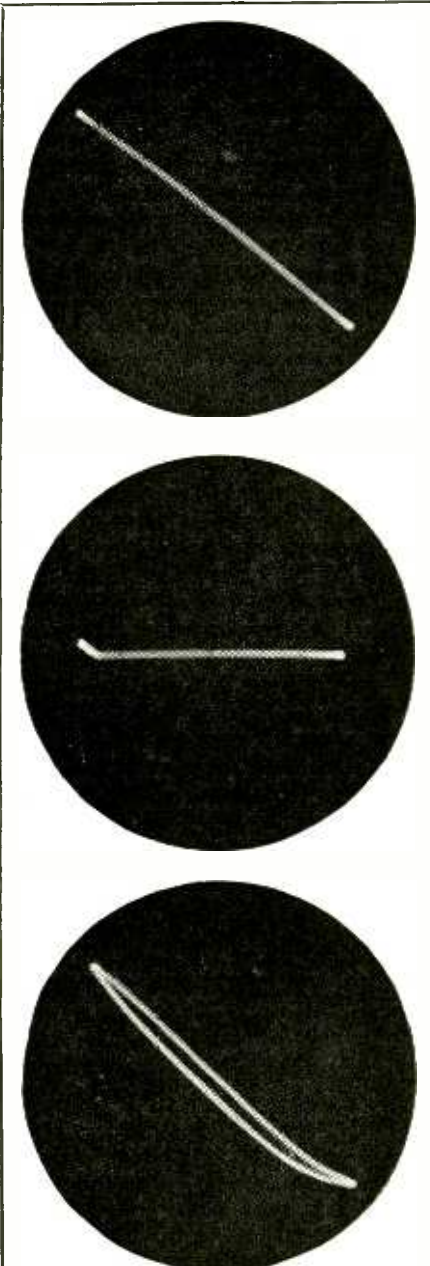

Fig. 9—Impedance reflection in emitter follower.



These scope traces, made with emitter follower of Fig. 10, show the drastic effect of hanging a "matching" load onto the output. This applies equally well to tube cathode followers. Trace 1 was made with output open-circuited (unloaded) and a supply of 12 volts. There is almost no distortion, and gain is very nearly 1. Connecting load of 15 ohms to match internal source impedance results in trace 2. Transistor is almost completely cut off except at left end of trace, where small amount of signal gets through. Distortion would be unbearable. Trace 3 shows what happens when input is reduced (with load still connected) so entire signal is amplified. Signal voltage had to be cut to 0.3 rms—one-tenth of signal used in trace 1. Output was only 0.15 volt—indicating gain has dropped to 0.5 instead of almost 1. Curvature of trace 3 indicates severe distortion; opening of loop shows phase shift between input and output signals.

—Fig. 9) will change at different points on the waveform, to some extent. However, the emitter follower is essentially like the cathode follower in being a voltage-follower device: the emitter voltage closely follows the base input voltage.

But in this respect its action is subject to limitations like its tube counterpart. Fig. 10 shows the circuit with which the accompanying photographs of scope traces were taken. With the output open-circuited, input and output voltages, using a 12-volt supply, measured 3 volts rms (both almost identical, as shown by the straight-line trace 1). Connecting the matching load (calculated at 15 ohms, here) limits the output, causing the transistor to be cut off most of the way, with only a little kink at the left end, where it still transmits signal (trace 2). Cutting down the input to where cutoff no longer occurs (trace 3), the input measures 0.3 and the output 0.15 volt. Note the curvature, which indicates substantial distortion.

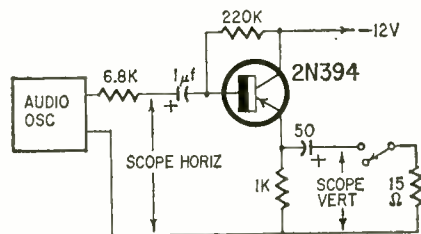

Fig. 10—Circuit used in making scope traces shown in photographs.

The transistor version reflects impedances both ways, which the tube version does not. The input impedance presented by an emitter follower is its load impedance (including reactance, if any) multiplied by the current gain ratio (h_{re}), plus the base-to-emitter ac resistance of the transistor (measured at constant collector voltage), which is usually relatively small. The output source impedance is the source impedance presented to the base divided by the current gain ratio, plus base-to-emitter resistance (measured with collector open), which gain is relatively small.

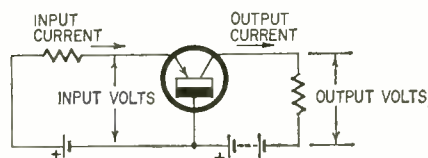

Fig. 11—Transistor equivalent of plate follower is common-base stage.

The transistor equivalent of the plate follower is more basic to the transistor—it is the grounded-base configuration (Fig. 11). The difficulty of separating bias and input source impedance functions is not encountered, so the cur-

rent-follower action can easily be realized.

Just as in the tube version, there is no inherent feedback, except for a small amount included in the transistor's internal parameters. Any nonlinearity of the transistor working in this mode is not reduced in any way by the so-called follower action. However, most recent transistor types have quite good linearity—better than tubes. The main difficulty with this configuration is that it requires supplies of opposite polarity for the emitter and collector circuits. END

Global Navigation-Communications Is Subject of Much Attention

Pan American Airlines recently completed tests of an inertial navigation system that can be used on airliners. With inertial guidance, used till now only for navigating space vehicles, flights can hold courses within less than 10 miles—important for forthcoming supersonic flights and in today's crowded airlines.

At almost the same time, Communications Satellite Corp. (Comsat) proposed a satellite system that will provide worldwide vhf communications for all global flights. The first satellite would be sent into synchronous orbit over the North Atlantic, where present hf communications are often blocked by weather.

The National Aeronautics and Space Administration (NASA) has gone a step further and suggests a global satellite system that will provide both navigation and communications facilities, simultaneously. The proposed principle of the "NavSat" system is reminiscent of that used presently in ground-based VORTAC (vhf omnirange and tacan) facilities for aircraft navigation over the U.S.

One antenna on the spinning satellite would generate a pulsed reference signal, while other antennas would transmit a directional continuous beam. The result: a plane or ship could take a position fix at almost any instant that would be accurate within a mile. A computer, with suitable readout, could show continuous position readings to the pilot or navigator.

Combining the automatic navigation information with voice facilities would offer worldwide traffic control even at supersonic speeds. END

Radio-Electronics Adopts Hertz

RADIO-ELECTRONICS is now using the term *hertz*—recently adopted officially in the United States—in place of cycles in all references to frequency. This term has been used for many years in other countries. Hz, kHz and MHz, abbreviations for hertz, kilohertz and megahertz, are replacing cycles, kc and mc in all recently edited material. You may run across the older abbreviations in copy set in type before the change.

Using a Narrow-Band Scope for Color TV

You think it's impossible? Read how to get revealing information from even 200-kHz scopes

By ROBERT G. MIDDLETON

IS THE TITLE ABOVE A MISTAKE? NOT at all. You *can* use a narrow-band scope in color TV servicing, but you have to know how. Your narrow-band scope has extremely wide-band response (out to about 50 MHz) when you feed signals directly to the CRT deflecting plates. Let us see how easily we can check chroma-demodulator operation with such a scope. There are several ways; let's assume first that you are going to use a color generator which supplies R — Y and B — Y signals.

Connections

The output from the color generator is fed to the input terminals of the color TV receiver. How shall we connect the narrow-band scope? Fig. 1 shows a typical terminal board on the rear of a scope, and the connections to the CRT. Note that if you disconnect the jumpers between 1 and 6 and be-

tween 2 and 7, the vertical deflecting plates are open-circuited. Similarly, if you disconnect the jumpers between 4 and 9 and between 5 and 10, the horizontal deflecting plates are open-circuited. Thus we can connect leads to 1 and 2 and drive the vertical plates, disregarding the vertical amplifier. Likewise, we can connect leads to 4 and 5, and drive the horizontal plates.

The frequency response is enormous, although a fairly high signal voltage must be applied for full-screen deflection. In some cases, ample signal voltage is available direct from the color receiver. But before we get down to actual patterns, note that merely disconnecting the jumpers in Fig. 1 disables not only the vertical and horizontal amplifiers, but also the centering controls, so you can't use them to position the spot on the screen. This is not so desirable in practical work, so we connect

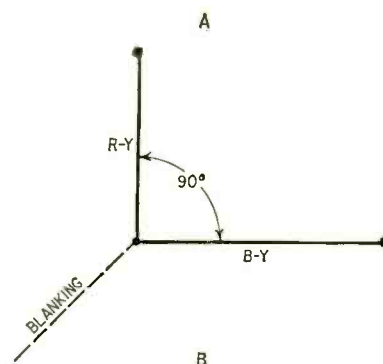
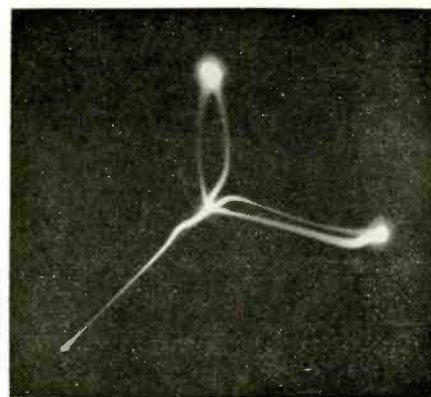

Fig. 5-a—Actual R—Y vs B—Y vector plot on scope screen; b—Ideal relationship.

3-megohm resistors between terminals (Fig. 2). (A few scopes already have such resistors on the back of the terminal board, but many do not.)

Now the centering controls operate normally. The 3-meg resistors provide almost complete isolation from the vertical and horizontal amplifiers. How about the grid terminals? Forget them—we are not concerned with intensity modulation of the pattern. Note that, although we have two connections to the vertical plates (terminals 1 and 2), we seldom have a push-pull signal from a color receiver to drive both terminals. Therefore, we ground terminal 2 for ac (Fig. 3). We also ground terminal 4 (horizontal) for ac, for the same reason.

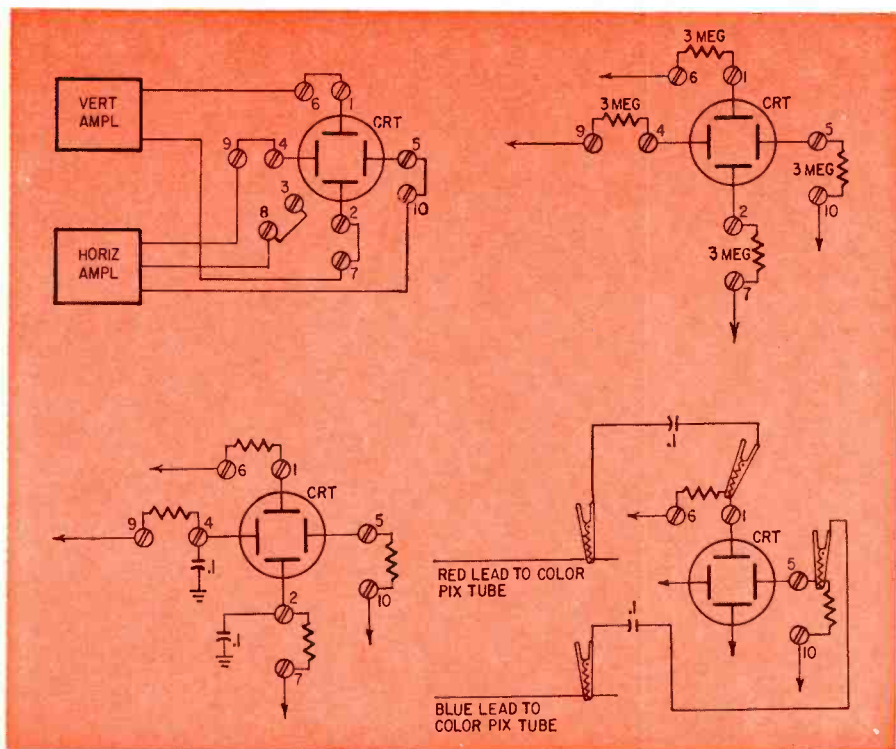

Fig. 1 (left, above)—Many scopes have jumper wires or links for direct access to deflection plates. Substituting resistors (Fig. 2, right) allows use of scope's centering controls while isolating plates from amplifiers. Fig. 3 (left, below)—Ac-grounding one of each pair of plates with capacitors. Fig. 4 (right)—Clip-leads with 0.1- μ F capacitors connect ungrounded plates to color circuits.

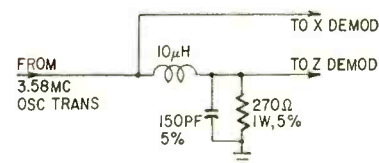

Fig. 6—3.58-MHz quadrature phase-shift network sometimes needs slight alterations.

You may ask, "Since terminals 2 and 4 are grounded for ac, why not merely leave the jumpers between 2 and 7, and 4 and 9?" The reason is simply that jumpers will not provide a good ac ground. The internal circuitry of the scope is resistive and capacitive, and sometimes inductive also. Hence, we isolate the internal circuitry with 3-meg

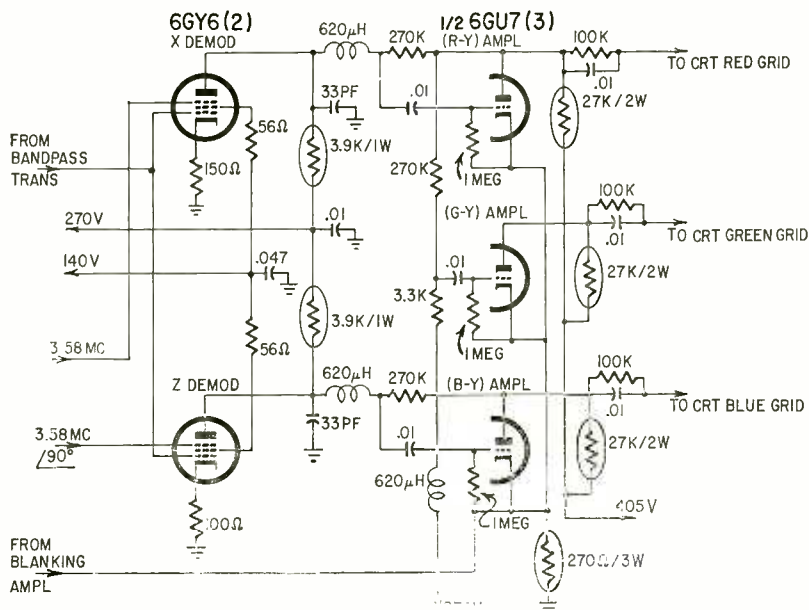

Fig. 7—Circled resistors can cause phase errors if their values drift off.

resistors, and get a good ac ground with 0.1- μ F capacitors.

Connecting the color-TV chassis

Now, terminals 1 and 5 are the active terminals of the CRT, which we will drive from the color receiver. This is done as in Fig. 4. The series blocking capacitors prevent dc from the receiver circuits from displacing the pattern on the CRT screen. Note what we are doing in Fig. 4. We are applying the R - Y signal to the CRT vertical plate, and the B - Y signal to the CRT horizontal plate. Switch the color generator to R - Y and B - Y output, and you will see on the scope screen the pattern illustrated in Fig. 5.

This is an undistorted pattern which shows whether the chroma demodulators have a phase error or not. You could not get this pattern by feeding the signals through the scope amplifiers. Hardly any service scopes have enough horizontal-amplifier bandwidth to display the B - Y signal without severe distortion. Only wide-band service scopes have sufficient vertical-amplifier bandwidth to display the R - Y signal without distortion. However, you can believe what you see when you use the Fig. 4 test method.

Pattern analysis

Ideal and actual pattern displays are shown in Fig. 5. Obviously the receiver response shown in the photo is less than ideal. This means that reproduced colors will be a bit off hue. What do we do about it? We must trim up the phase-shift network in the 3.58-MHz feed lines to the chroma demodulators. Older color receivers had quadrature transformers with adjustable slugs; this made it easy to adjust phase. Recent re-

ceivers generally have simplified circuitry with fixed components (Fig. 6). Hence, a phase correction can be made only by adjusting the values of the resistor or capacitor in Fig. 6.

You will sometimes find instructions for small changes of R or C values in supplementary service data. In any case, the procedure is to determine the values that give a quadrature (90°) output in the Fig. 5 pattern. It is assumed, of course, that tubes have been tested. A weak or otherwise defective chroma demodulator or amplifier tube can simulate a phase error. It should not be necessary to change the R or C value in Fig. 6 very much to reach quadrature. If a large change is required, the trouble is actually elsewhere. Check the plate-load resistors and the common-cathode resistors noted in Fig. 7. An off-value resistor can cause an apparent phase error, which would be falsely attributed to the Fig. 6 network.

Display of I and Q phases

Most color generators provide an I and Q output, in addition to R - Y and B - Y. Using the test connections of Fig. 4, switch the generator to I and Q output. A typical scope pattern is shown in Fig. 8-a. Comparison with the ideal relations (Fig. 8-b) reveals that there is a demodulator phasing error, as before, although it is not alarmingly large. When the circuit components such as those in Fig. 7 all have correct values, patterns in Figs. 5 and 8 will both be very close to ideal.

Note that distortion can be caused by overload. In other words, if you advance the color-intensity control on the receiver too far, you can make the scope pattern occupy the entire screen

area—but it is also likely that the traces will bend and become displaced. So it is good practice to work with a pattern about two-thirds of screen size. In any case, try turning the color-intensity control up and down a bit, to see if the scope pattern changes in shape. Keep below the point of chroma overloading. The slight looping of the traces in Figs. 5 and 8 is normal, and is caused by less than perfect transient response in the chroma circuitry and color generator. The patterns have three key points, seen as white dots. These are the zero-volt or origin, and the terminations of the two vectors.

Simultaneous color bar phases

Using the same test setup, switch the color generator next to its six-bar simultaneous position. You will see a scope pattern like Fig. 9. Again, if you compare the photo with the ideal phase diagram, it is evident that there are phase errors. This situation corresponds to noticeable errors in hue on the picture-tube screen (Fig. 10). The remedy, of course, is again to check out the components that affect phase, or apparent phase.

It is now obvious why we started the tests with R - Y and B - Y signals. If you observe the pattern of Fig. 9 at the outset, there are six phases to evaluate instead of two. This can make preliminary analysis confusing. How-

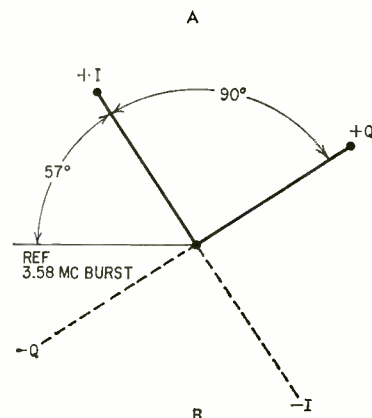
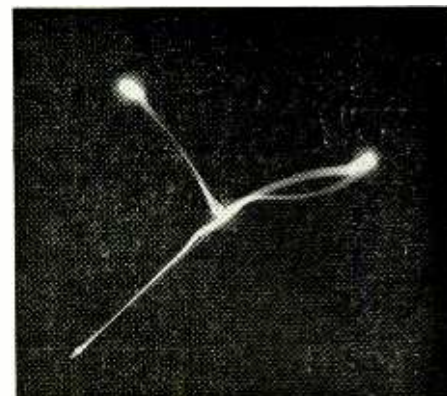

Fig. 8—I and Q representation: a—actual; b—ideal.

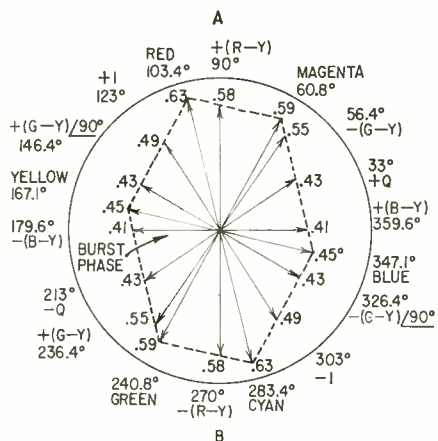
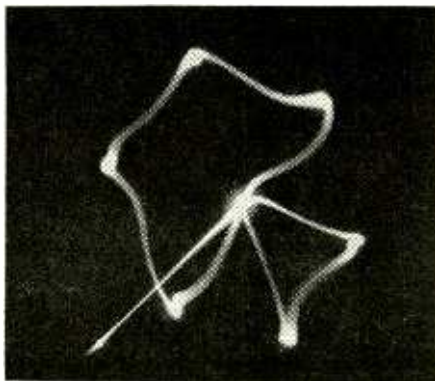

Fig. 9-a—Six-bar phase display on scope screen; b—Ideal phase relations.

ever, one of the bars in a bar display is white. While the white bar is being scanned, there is no chroma output. Hence, the scope beam rests at the origin in Fig. 9-a while the white bar is traversed—there is no beam displacement away from the zero-reference point. Therefore, we see six key points in the vector pattern, plus the origin.

Keyed-rainbow signal pattern

Suppose you are using a keyed-rainbow generator instead of an NTSC generator. [You'll find a complete discussion of these two types of generator, and the unkeyed-rainbow type as well, on page 59 of Jan. issue—*Editor*] Scope connections remain the same as in Fig. 4. But applying a keyed-rainbow signal to the receiver results in a scope display

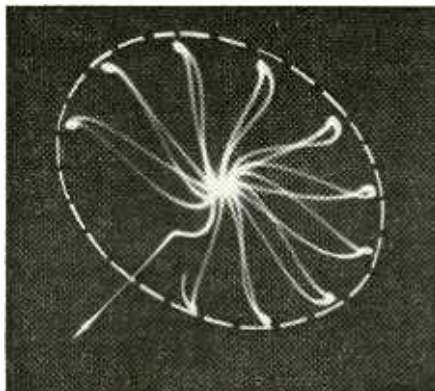

Fig. 10—Elliptical outline that leans indicates chroma phasing error.

like Fig. 10. This photo indicates a chroma phasing error. Observe how the ellipse “leans” to the left. In other words, the major axis of the elliptical outline is not straight up and down on the scope screen. We expect to see an elliptical outline formed by the tips of the vectors, but this ellipse should appear with its axes vertical and horizontal on the scope screen. The remedies for chroma phasing errors have already been mentioned.

A chroma phasing error corresponds to incorrect hues and brightnesses of the keyed-rainbow pattern on the screen of the color picture tube. When the chroma circuitry has the correct values for its phase-determining components, the chroma-bar hues and relative brightnesses will be correct, and you will get an upright ellipse on your scope. You can even use an unkeyed-rainbow pattern. On the color picture tube it looks like a continuous “shading” of hues, without distinct bars. The scope pattern is a continuous ellipse, without the “spokes” of Fig. 10. Pattern evaluation is the same as for a keyed-rainbow signal.

Single-bar chroma signals

Some color signal generators provide only one bar at a time, as shown in Fig. 11. Individual signals are equally suitable for demodulator phase checks using the test setup of Fig. 4. It is necessary, however, to observe one vector first, and then to switch the generator and observe the other vector. The basis of the test is that the R - Y channel normally has no output when a B - Y signal is applied, and that the B - Y channel normally has no output when an R - Y signal is applied. You must not touch the receiver's hue control when you switch from R - Y to B - Y signal inputs.

Turning the receiver's hue control rotates the pattern on the scope screen. At the outset, you may adjust the hue control. For example, apply an R - Y signal, and turn the hue control to make the vector appear straight up and down on the scope screen. This is an arbitrary and convenient reference position. Then, without touching the hue control, switch the generator to B - Y output. The vector should then be displayed horizontally on the scope screen. Otherwise, there is a phase error in the chroma circuits. Note, too, that when you use single-bar signals, the origin will shift when you switch the generator. This is normal. The scope input is an ac waveform, and its average value will fall at the same point—this point is different for the R - Y and B - Y vector displays.

Space limitations prevent further discussion of how to use narrow-band scopes in color TV service. However,

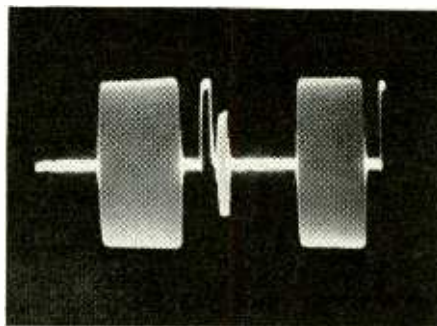
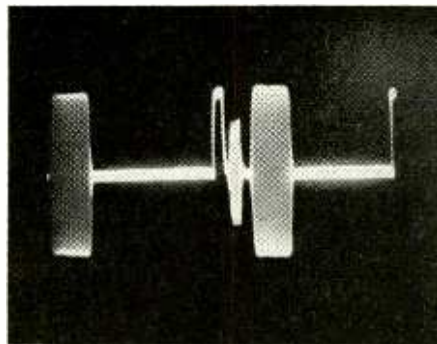

Fig. 11-a—Single B-Y signal; b—Single R-Y signal.

if you readers are interested, we will explain some of the other aspects of advanced servicing techniques in a future article. END

MATH OPERATIONS QUIZ

YOU DON'T NEED TO BE A MATHEMATICAL wizard to work the problems below. They use small, simple numbers and can be solved readily—if you know how. This is a test of your knowledge of mathematical notation rather than your ability to do arithmetic. Each of the numbers below is equal to some definite quantity.

Score 15 for each correct answer. 60 is above average. 75 is very good, and 90 is excellent. 105 is, of course, perfect.

- | | |
|--------------|---|
| 1. $4!$ | 5. j^3 |
| 2. $4^{1/2}$ | 6. 3^0 |
| 3. j^2 | 7. $\begin{vmatrix} 2 & 1 \\ 4 & 3 \end{vmatrix}$ |
| 4. 2^{-1} | |

24. This is a short way of writing $4 \times 3 \times 2 \times 1$. It is read “4 factorial.”
2. This is another way of writing $\sqrt{4}$.
- 1. By definition, j is equal to $\sqrt{-1}$, so j^2 is $\sqrt{-1} \times \sqrt{-1}$.
- $1/2$. A negative exponent indicates a reciprocal.
- $3 < 90^\circ$. The result is a vector 3 units long and perpendicular to the point of origin.
1. Any quantity raised to zero power is equal to 1.
2. This is a determinant, and it is evaluated by writing $(2 \times 3) - (1 \times 4)$.

—John Collins

between them, or both, to indicate the direction in which to read the dots. Note that the coding does not include the dc working voltage. The voltage rating may vary from 100 to 1,000 volts dc. Manufacturers may give case sizes to supply information about the working voltage.

The first dot in the upper row indicates a mica capacitor. This is followed by the first and second significant figures. The color dot at the lower right is the multiplier. The dot preceding this is the tolerance while the lower left-hand dot is the characteristic. The color for the characteristic will be brown, red, orange, yellow or green.

Example: What can we learn about a capacitor that has white, green and brown dots across the top, and brown, red and brown across the bottom?

The white first dot indicates that we have a mica capacitor. The next two colors are the first two significant figures of capacitance, 5 and 1. We read this as 51. Our multiplier, brown, at the lower right, is 10. Multiplying this by 51 (51×10) gives us 510 pF or 510 $\mu\mu\text{F}$, the nominal value of capacitance. The characteristic (lower left dot) is brown. Fig. 2 shows that this corresponds to the letter B, and Fig. 3 indicates that this characteristic is not given. The lower center dot is red. Fig. 2 shows that the tolerance is $\pm 2\%$.

Manufacturers' codes

The codes given in Figs. 1, 2 and 3 are EIA codes. Capacitors may also be stamped with the values (in figures) of capacitance and tolerance, or with nothing more than a manufacturer's code number. A manufacturer's code might be a number such as D15. His catalog would show the full number as D15E301JN3. The number immediately following the letter E (which indicates the characteristic) reveals the capacitance. The first two digits are the first and second significant figures of capacitance. The last digit is the multi-

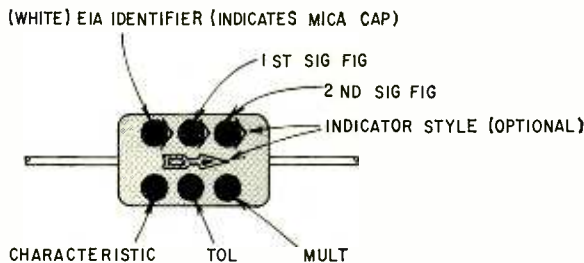

Fig. 4—How to read six-dot EIA mica-capacitor code. If first dot is black instead of white, capacitor conforms to MIL-C-5A specs, almost identical to data given in Fig. 2.

plier. In Fig. 5 the capacitance is shown as 301. The last digit is the multiplier and represents the number of zeros to follow the first two numbers. Thus, we have 30 followed by 0, or 300 pF. If the last number had been 2 instead of 1,

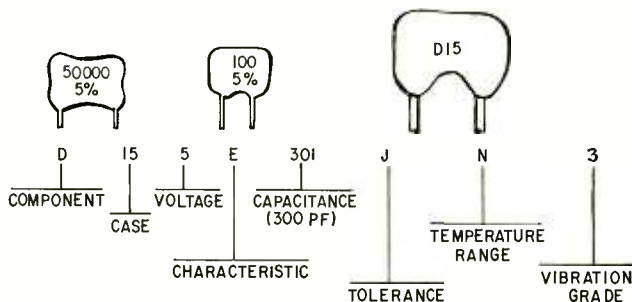

Fig. 5—"Manufacturer's code" for micas.

the capacitance would have been 3,000 pF.

Mica cap—the nine-dot code

The nine-dot code is similar to the six-dot code except that both sides of the capacitor carry information. One side, with six dots, is identical to the usual six-dot code. The three

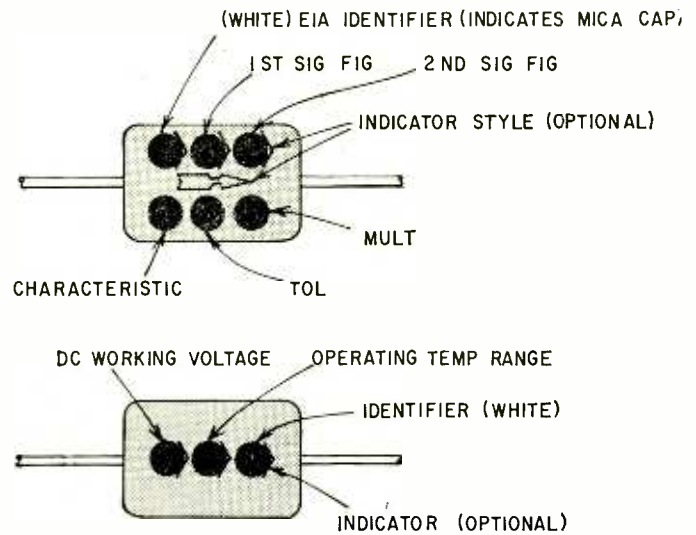

Fig. 6—Standard EIA nine-dot mica code.

dots on the other side, as shown in Fig. 6, indicate the dc working voltage and the operating temperature range. The final dot is an identifier and repeats the identifier information on the front of the capacitor.

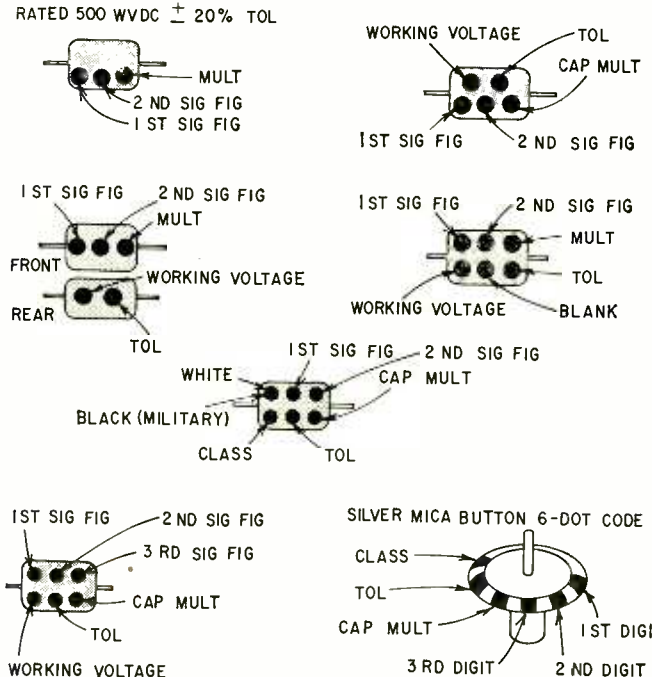

Fig. 7—Three-, five- and six-dot codes that have been used for mica capacitors.

Mica cap—three to six dots

A variety of codings, ranging from three to six dots, have been used for mica capacitors, as shown in Fig. 7. While this coding is obsolete, tremendous quantities were manufactured and you will inevitably meet capacitors with such coding in your work.

← X P56 mobile XTR NOTE

Paper capacitors—tubular, oil-filled

Known as tubulars because of their cylindrical shape, these units may come encased in paper or plastic, and will have an EIA color code consisting of five or six bands. Oil-filled capacitors, used in high-voltage power supplies and transmitters, are grouped with the tubulars since their dielectric is also paper. Since they are fairly large, their capacitance and working voltage are often stamped directly on the case.

To read the value of a paper tubular, hold the capacitor so the color bands are toward the left. Fig. 8 supplies the code for molded paper tubulars.

The difference between a five-color and a six-color band is in the voltage rating. A capacitor with five colors follows the voltage rating given in Fig. 8. If the capacitor

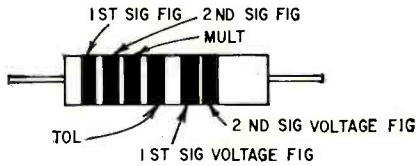

Fig. 8—EIA code for molded paper tubulars.

has six colors, the last two (at the right when you hold the capacitor with the maximum number of bands at the left) are both used for the voltage rating. Multiply the value represented by these two colors by 100, or move the decimal point two places to the right.

Example: What is the nominal capacitance, tolerance and dc working voltage of a molded paper tubular whose color coding is brown, black, yellow, orange, brown, red?

Taken together, the first two colors represent 10. The multiplier, yellow, adds four zeros, making the nominal capacitance 100,000 pF or 0.1 μ F. The fourth color, orange, indicates a tolerance of $\pm 30\%$. The last two colors, brown and red, show that the voltage rating is 12×100 , or 1,200 volts.

If a molded paper tubular has a rating of 1,000 volts or less, only five colors are used, the end color representing the voltage indicated in Fig. 8.

Flat molded paper and film capacitors

The dielectric is the same as that of the tubular units, hence the coding follows that given in Fig. 8. The coding is

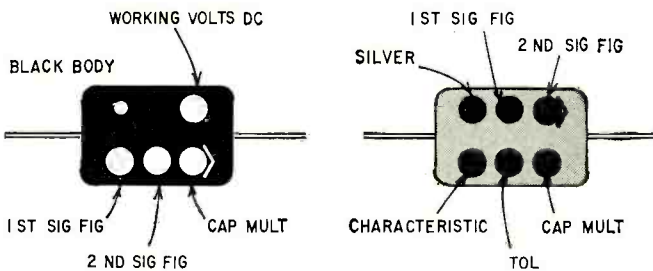
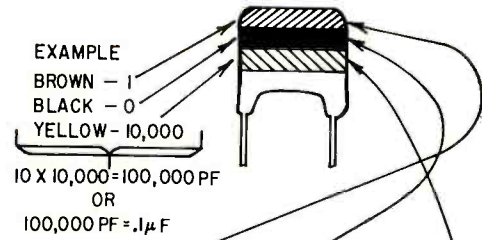

Fig. 9—Types of color coding used for molded-paper flat capacitors.

in the form of dots, not bands, and may follow either of the systems shown in Fig. 9. Unlike paper tubulars, though, flat rectangular paper units may or may not carry a color coding to indicate the working voltage. When the voltage rating is not part of the code, it is usually given by the capacitor's dimensions.

Some color-banded capacitors, about the size and shape of a cough drop or piece of Chicklets gum, have a Mylar or similar polyester film dielectric. The top band is the first digit, and the band below is the second. The band closest



COLOR	1 ST DIGIT	2 ND DIGIT	MULTIPLIER
BLACK	0	0	1
BROWN	1	1	10
RED	2	2	100
ORANGE	3	3	1,000
YELLOW	4	4	10,000
GREEN	5	5	100,000
BLUE	6	6	1,000,000
VIOLET	7	7	10,000,000
GRAY	8	8	100,000,000
WHITE	9	9	1,000,000,000

Fig. 10—Coding used on some Mylar or polyester film capacitors.

to the leads is the decimal multiplier. A drawing of a representative capacitor is shown in Fig. 10 along with its color coding chart.

Ceramic capacitors

Available in a variety of styles, this type may be either

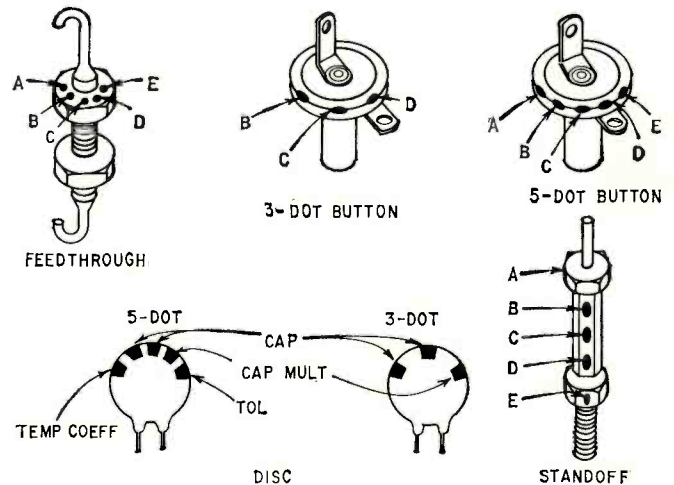

Fig. 11—Miscellaneous types of ceramic capacitors: A—temperature coefficient; B—first significant figure; C—second significant figure; D—decimal multiplier; E—tolerance.

fixed or variable and coded by dots or bands. Disc types may be color-coded or may have the capacitance value and other data printed on the unit. The coding may be three, five or six dots or bands. Fig. 11 shows miscellaneous types of ceramic capacitors while Fig. 12 illustrates the coding of tubular types. A summation of the EIA coding for five- and six-color systems is given in Figs. 13 and 14.

Miniature molded ceramics

When these units use four colors in their code, the first two colors are the first and second significant figures of capacitance. The third color is the multiplier and the last color is the tolerance. The colors are numbered according to the

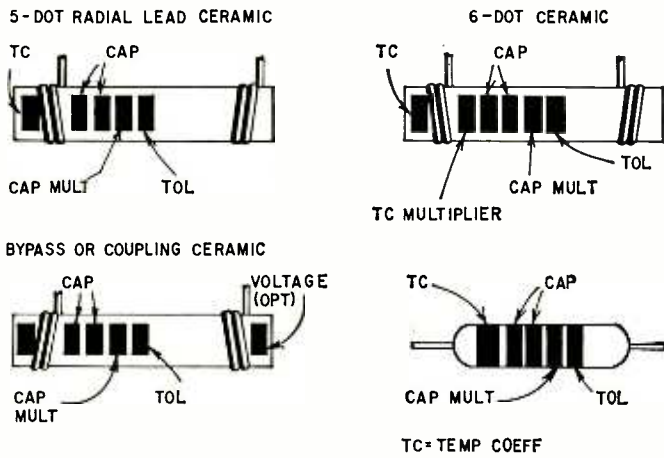

Fig. 12—Coding for tubular ceramics.

- | | |
|--------------|--|
| First color | Temperature coefficient of capacitance |
| Second color | First significant figure of capacitance |
| Third color | Second significant figure of capacitance |
| Fourth color | Decimal multiplier of capacitance |
| Fifth color | Tolerance of capacitance |
| First color | Sig fig of temp coeff of capacitance |
| Second color | Mult to apply to sig fig of temp coeff |
| Third color | First sig fig of capacitance |
| Fourth color | Second sig fig of capacitance |
| Fifth color | Decimal mult of capacitance |
| Sixth color | Tol of capacitance |

Fig. 13—Tubular ceramic capacitor EIA five-color system (top); six-color system (bottom).

Color	1st and 2nd sig fig of cap	Decimal mult of cap	CAPACITANCE TOLERANCE	
			10 pF or less	over 10 pF
Black	0	1	± 2.0 pF	± 20%
Brown	1	10	± 0.1 pF	± 1%
Red	2	100		± 2%
Orange	3	1000		± 3%
Yellow	4	10000		
Green	5		± 0.5 pF	± 5%
Blue	6			
Violet	7			
Gray	8	0.01	± 0.25 pF	
White	9	0.1	± 1.0 pF	± 10%

Color	Temperature coefficient of capacitance (5-dot System)	Sig fig of temp coeff of cap (6-dot system)	Mult to apply to sig fig of (6-dot System)
Black	0 ppm/°C	0.0	-1
Brown	-33 ppm/°C	—	-10
Red	-75 ppm/°C	1.0	-100
Orange	-150 ppm/°C	1.5	-1000
Yellow	-220 ppm/°C	2.2	-10000
Green	-330 ppm/°C	3.3	+1
Blue	-470 ppm/°C	4.7	+10
Violet	-750 ppm/°C	7.5	+100
Gray	General purpose	General purpose	+1000
White	General purpose		+10000

ppM = parts per million (per degree Centigrade)

Fig. 14—EIA color code for ceramic capacitors.

EIA code given in Fig. 1. In some cases, though, manufacturers use a coding system of their own.

Military coding

Capacitors manufactured for the military may find their way into surplus. A representative marking consists of a nine-letter code—actually, a combination of numbers and letters, such as CY30C362J. Fig. 15 gives the description of the capacitor type, the corresponding military style designation and the applicable MIL specification.

Description	Coding	MIL spec
Paper	CN	MIL-C-91A
Paper	CP	MIL-C-25A
Mica	CB	MIL-C-10950A
Mica	CM	MIL-C-5A
Ceramic	CV	JAN-C-81
Ceramic	CC	JAN-C-20A
Ceramic	CK	MIL-C-11015A
Glass	CY	MIL-C-11272-A
Air	CT	JAN-C-92
Tantalum	CW	MIL-C-18211
AC Electrolytic	CJ	MIL-C-25102 (US Air Force) MIL-C-14006 (Signal Corps)
Electrolytic (Aluminum)	CE	JAN-C-62

Fig. 15—Military designations and corresponding spec numbers for capacitors.

The number 30 following the letters CY refers to the case size. The letter C following the number 30 refers to the characteristic. You can obtain this information by consulting Fig. 3, given earlier. The number 362 gives us the nominal value of capacitance. The first two figures, 36, are the first two digits of capacitance. The number 2 represents the multiplier, and indicates the number of zeros to follow. In this example, the capacitance is 3.600 pF. If the multiplier had been the number 1, the capacitance would have been 360 pF. If it had been a zero, the capacitance would have been 36 pF.

The last letter of the part number marked on the capacitor is the tolerance and is given in Fig. 16.

Capacitors made to military specifications may be coded with a combination of numbers and letters, but may also use the EIA code with some small modifications. Thus, molded micas will conform to MIL-C-5A military specs and EIA specification RS-153. In the six-dot code the dielectric identification (first dot to the left, upper row) is white for EIA and black as the MIL-C-5A color.

- F = 1%
- G = 2%
- H = 3%
- J = 5%
- K = 10%
- M = 20%

Fig. 16—Tolerance values of capacitors coded to military specifications. Figures are plus/minus percentages of nominal capacitance.

CN	Cap, paper—nonmetal case
22	Shape & dimensions
A	Characteristic
E	Voltage
202	Capacitance
N	Capacitance tolerance

Fig. 17—Military designation for tubular plastic-cased capacitors.

The military designation for plastic molded tubulars is CN22AE202N. The characteristics corresponding to this number are given in Fig. 17. However, the capacitor color coding follows the EIA system given in Fig. 8. END

One of a series of brief discussions
by Electro-Voice engineers

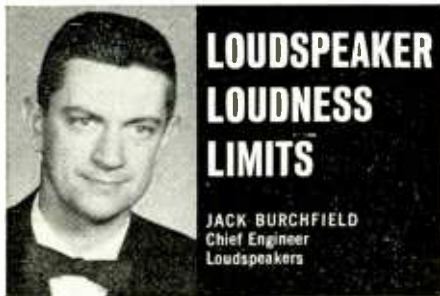

We are frequently asked how loudly a specific loudspeaker can be played without distortion or danger of destruction. This question is not easily answered when asked in regard to home or studio music reproduction.

If the material to be reproduced is a simple sine wave, voice coil heating is the normal controlling factor, and the point where excessive heat (or excessive voice coil travel) is reached can be simply determined. However, steady-state sine waves are not typical of most program material, and this power limit is unrealistic when applied to musical reproduction.

One out-standing characteristic of musical energy is its transient nature. Even when an orchestra plays a sustained high level chord with no audible variation, the combined waveform shows markedly fluctuating peak energies. These peaks are formed when each constantly changing waveform adds to the energy of other waveforms.

Typically, energy peaks in music will reach a level up to ten times the average or R.M.S. value. The relatively low average level tends to protect the speaker from high heat build-up even at extremely high listening levels.

In laboratory studies, we have applied up to 100 watts of musical program material to E-V high fidelity speakers with no apparent distortion and no signs of immediate failure due to heat or fatigue. One fact became quickly evident. The absolute loudness limit for most high fidelity systems lies not with the speaker, but rather with the amplifier.

Careful oscilloscope analysis revealed that waveform distortion appeared first at the amplifier output, usually in the form of clipping. The loudspeaker faithfully reproduced this distorted waveform, giving rise to the subjective analysis that the speaker was being "overdriven." Substitution of a more powerful amplifier with greater reserve power at the same acoustic output, eliminated the "speaker distortion" completely!

The problem of maximum loudness in any system is further complicated by the growing trend toward speaker systems of medium and low efficiency. If a speaker system, by design, trades six or eight db of efficiency for other benefits (wider range or smoother response), it necessarily places a heavier burden on the amplifier to provide a clean signal at high levels.

The absolute limitations of any speaker system based on peak performance requirements are very difficult to objectively state. Listening tests have proved to have the greatest validity to date, yet results vary from listener to listener, and with the frequency and duration of the peaks.

A realistic rating for most small speaker systems would be in the order of eighty to one hundred watts peak handling power. To realize this potential requires an amplifier of forty to fifty watts rating (based on peak performance twice that of the steady-state rating).

For technical data on any E-V product, write:
ELECTRO-VOICE, INC., Dept. 563E
613 Cecil St., Buchanan, Michigan 49107

Electro-Voice
SETTING NEW STANDARDS IN SOUND

EQUIPMENT REPORT

The Editall KP-2 Tape-Splicing Block

Circle 26 on reader's service card

THE EDITALL SPLICING BLOCK HAS LONG been a standard among professionals, though it seems to appeal to a smaller proportion of amateurs. Perhaps the amateurs are misled by its simplicity: it's just a solid block with a shallow, curved trough running along it, and two narrow slots perpendicular to the surface on which the block is resting.

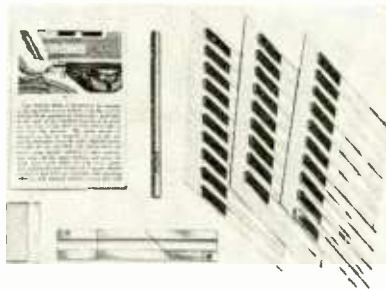

The tape to be edited is laid along the curved trough, which is undercut slightly to lock the tape in place. Running a single-edge razor blade through one of the narrow slots cuts the tape cleanly in one stroke. One of the slots is at the standard 45° angle to the length of the tape, while the other is at right angles to it. The 45° slot is the more commonly used, since it makes a smoother, less abrupt transition between the two tape sections being spliced. The 90° slot can be used for splicing leader in, but more commonly it is used as a marker. The spacing between the two slots is exactly the same as that between the playback head gap and the right-hand edge of the head cover of Ampex professional, Premier Tapesonic, and perhaps some other machines as well. Most pros mark their tapes where they exit from the head cover, put this mark opposite the 90° slot on the Editall block and cut at the 45° slot.

By marking the tape while it's still on the playback head, you run the risk of dirtying the head with your crayon and altering the head alignment by your pressure on it. On recorders whose head-to-cover-edge distance is not the same as on Ampexes, a mark can be painted at a distance from the playback head gap that corresponds to the spacing between the Editall's slots, and the tape marked at this point for cutting.

The new Editall KP-2 block differs from earlier models in that it is made of plastic, rather than aluminum, and has both an adhesive strip and screw holes, giving a choice of mounting methods. The plastic version may

or may not wear as well as the metal (which lasts practically forever, subject only to a very slight widening of the cutting slots after many thousands of splices), but no wear was evident after 50 splices had been made on it.

The KP-2 comes in a kit containing an instruction book, a marking crayon, a cutting blade and 30 "Editabs." The very thorough instruction booklet explains how to use the Editall system and gives the basics of tape editing practice clearly and concisely. The black marking crayon provided adheres well to the tape backing, but is invisible on black-oxide tapes, such as the new 3M Scotch 201, 202, 203 and 290, for which a yellow crayon would be best. The blade, an ordinary single-edge razor blade, should be replaced whenever it begins to tear or stretch rather than slice the tape (which happens frequently with polyester tapes), but blades are available at all drugstores and can be bought very cheaply in boxes of 100 or more at art-supply stores.

The biggest nuisance of tape splicing—no matter what splicer is used—is usually the application of the splicing tape. The Editall system uses $7/32$ -inch tape that is laid lengthwise along the tape and requires no edge trimming (if you're careful). The new Editabs, 30 of which are included with the KP-2 kit, make splicing even easier. They consist of a precut length of $7/32$ -inch splicing tape, mounted on a slightly less adhesive, clear plastic strip a full $1/4$ inch wide. To splice, merely place the Editab over the splicing point, press down until the splicing tape adheres, then pull off and discard the clear backing. The Editabs make proper alignment of the splicing tape a bit simpler, and eliminate the problem of dirtying the adhesive surface of the splicing tape with your fingers.

The Editall system is about the most precise editing tool readily available. No other splicer or system that I have tried is as simple and none lends itself so readily to adding and subtracting those tiny bits of tape that may rep-

Continued on page 64

WHAT'S NEW IN MICROELECTRONICS and SOLID STATE?

Find out in an entire issue devoted to the most important electronics developments in recent years! A treasure-chest of facts, features and permanent reference material on microelectronics and semiconductors. Read about a development that is completely new and startling!

Coming in June

RADIO-ELECTRONICS

**Microelectronics and Solid State
Special Issue**

New Professional DC 'Scope Heathkit® IO-14

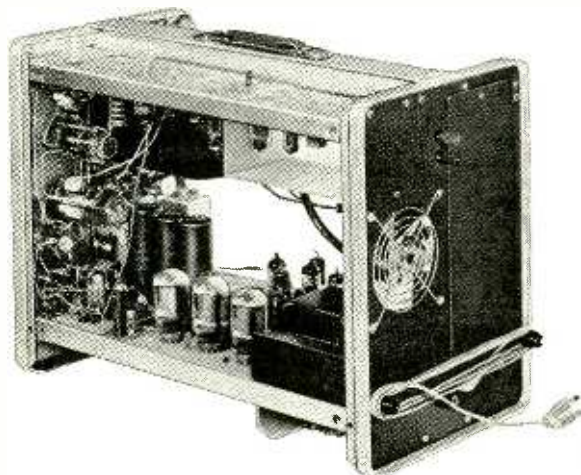

Kit **\$299**
 Factory Assembled **\$399**

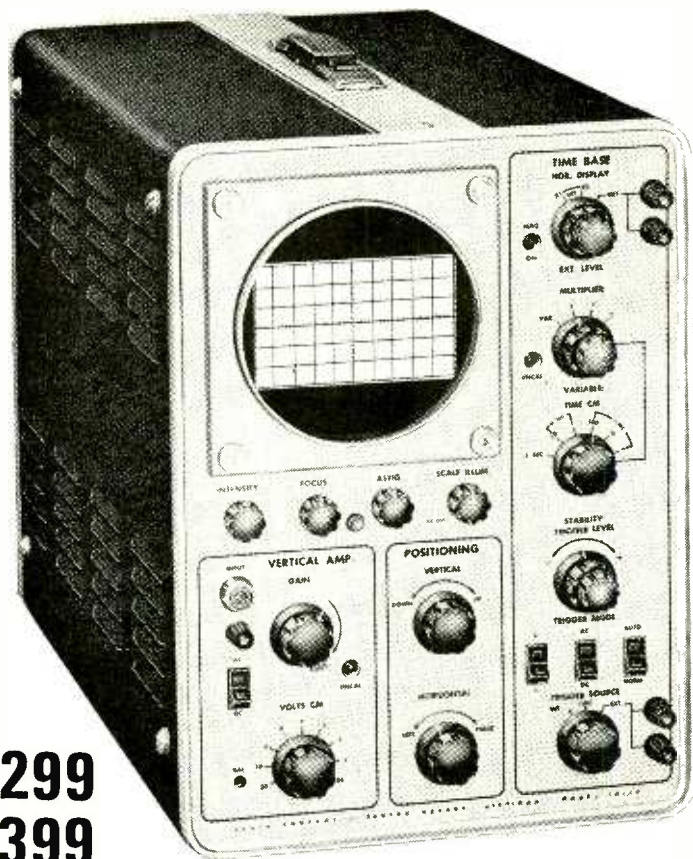

Eighteen Years Ago Heath Broke The Price Barrier On Oscilloscopes With A Low-Cost Scope For Hams, Hobbyists, And Service Technicians. Now Heath Breaks The Price Barrier Again! . . . With A Precision, Fast-Response, Triggered Sweep, Delay Line Oscilloscope For The Serious Experimenter, Industrial Or Academic Laboratory, And Medical Or Physiology Research Laboratory.

- A high stability 5" DC oscilloscope with triggered sweep • DC to 8 mc bandwidth and 40 nanosecond rise time • Vertical signal delay through high linearity delay lines—capable of faithful reproduction of signal waveforms far beyond the bandwidth of the additional circuitry • Calibrated vertical attenuation—from 0.05 v/cm to 600 volts P-P maximum input • Calibrated time base • 5X sweep magnifier • Forced air cooling • Input for Z axis modulation • Input for direct access to vertical deflection plates • Easy circuit-board construction & wiring harness assembly • Components are packaged separately for each phase of construction • Easy to align • Fulfills many production and laboratory requirements at far less cost than comparable equipment—particularly scopes capable of fast-rise waveform analysis • No special order for export version required—wiring options enable 115/230 volt, 50-60 cycle operation

Here Is A Truly Sophisticated Instrument . . . designed with modern circuitry, engineered with high quality, precision-tolerance components, and capable of satisfying the most critical demands for performance. The IO-14 features precision delay-line circuitry to allow the horizontal sweep to trigger "ahead" of the incoming vertical signal. This allows the leading edge of the signal waveform to be accurately displayed after the sweep is initiated.

The IO-14 Provides Features You Expect Only In High Priced Oscilloscopes. For example, switches are quality, ball-detent type; all major control potentiometers are precision, high-quality sealed components; all critical resistors are 1% precision; and circuit boards are low-loss fiber glass laminate. The IO-14's cabinet is heavy gauge aluminum. Its CR tube is shielded against stray magnetic fields, and forced air ventilation allows the IO-14 to be operated under the continuous demands of industrial and laboratory use.

Kit IO-14, 45 lbs. **\$299.00**
 Assembled IO-14, 45 lbs. **\$399.00**

IO-14 SPECIFICATIONS—(Vertical) Sensitivity: 0.05 v/cm AC or DC. Frequency response: DC to 5 mc, —1 db or less; DC to 8 mc, —3 db or less. Rise time: 40 nsec (0.04 microseconds) or less. Input impedance: 1 megohm shunted by 15 uuf. Signal delay: 0.25 microsecond. Attenuator: 9-position, compensated, calibrated in 1, 2, 5 sequence from 0.05 v/cm. Accuracy: ±3% on each step with continuously variable control (uncalibrated) between each step. Maximum input voltage: 600 volts peak-to-peak; 120 volts provides full 6 cm pattern in least sensitive position. (Horizontal) Time base: Triggered with 18 calibrated rates in 1, 2, 5 sequence from 0.5 sec/cm to 1 microsecond/cm with ±3% accuracy or continuously variable control position (uncalibrated). Sweep magnifier: X5, so that fastest sweep rate becomes 0.2 microseconds/cm with magnifier on. (Overall time base accuracy ±5% when magnifier is on.) Triggering capability: Internal, external, or line signals may be switch selected. Switch selection of + or — slope. Variable control on slope level. Either AC or DC coupling. "Auto" position. Triggering requirements: Internal; 1/2 cm to 6 cm display. External: 0.5 volts to 120 volts peak-to-peak. Horizontal input: 1.0 v/cm sensitivity (uncalibrated) continuous gain control. Bandwidth: DC to 200 kc ±3 db. General 5ADP31 or 5ADP2 Flat Face C.R.T. interchangeable with any 5AD or 5AB series tube for different phosphor characteristics. 4250 V. accelerating potential. 6 x 10 cm edge lighted graticule with 1 cm major divisions & 2 mm minor divisions. Power supply: All voltages electronically regulated over range of 105-125 VAC or 210-250 VAC 50/60 cycle input. (Z Axis) Input provided. DC coupled CRT unblanking for complete retrace suppression. Power requirements: 285 watts. 115 or 230 VAC 50-60 cps. Cabinet dimensions: 15" H x 10 1/2" W x 22" D includes clearance for handle and knobs. Net weight: 40 lbs.

FREE! 1966 Heathkit Catalog



108 pages . . . many in full color . . . describe over 250 Heathkits for the lab, hobbyist, and industry.

Heath Company, Dept. 20-5
 Benton Harbor, Michigan 49022

- Enclosed is \$ _____, plus shipping for model (s) _____
 Please send FREE Heathkit Catalog & full IO-14 specifications.

Name _____

Address _____

City _____ State _____ Zip _____

Prices & specifications subject to change without notice.



TE-142

Circle 30 on reader's service card

COMPLETE TUNER OVERHAUL

9⁹⁵

ALL LABOR AND PARTS (EXCEPT TUBES & TRANSISTORS)*



COLOR TUNERS **GUARANTEED COLOR ALIGNMENT — NO ADDITIONAL CHARGE**

Simply send us the defective tuner complete; include tubes, shield cover and any damaged parts with model number and complaint. Your tuner will be expertly overhauled and returned promptly, performance restored, aligned to original standards and warranted for 90 days.

UV combination tuner must be single chassis type; dismantle tandem UHF and VHF tuners and send in the defective unit only.

Exact Replacements are available for tuners unfit for overhaul. As low as \$12.95 exchange. (Replacements are new or rebuilt.)

And remember—for over a decade Castle has been the leader in this specialized field . . . your assurance of the best in TV tuner overhauling.

CASTLE
TV TUNER SERVICE, INC.

5715 N. Western Ave., Chicago 45, Illinois
41-96 Vernon Blvd., Long Island City 1, N. Y.

For service in Canada write to Chicago or use reader service card in this magazine.
*Major parts are charged extra in Canada.

Circle 31 on reader's service card

resent the attack of a piano note or the last dying wisp of a sneeze. The new plastic version of the Editall with its lower cost and the convenient Editabs should make the Editall system as common in amateur use as it already is in professional.—*Ivan B. Berger*

Price: \$3.50

Knight KG-635 DC-Wide-band Oscilloscope

Circle 27 on reader's service card

I HAD BEEN SHOPPING AROUND FOR AN oscilloscope for some time when Allied Radio's Knight-Kit division announced the KG-635, dc-to-5.2-MHz (megacycle) scope with a number of attractive features. A study of the schematic convinced me, not only that of all the scopes in its price range this seemed to be the best buy, but also that this new model appeared to be worth telling about in **RADIO ELECTRONICS**.

So I ordered the kit and started building. Things like this are always spare-time ventures, so I won't alarm anyone by mentioning the actual time that elapsed between getting the kit and finishing the scope. But as good a tally as it was possible to keep, with all sorts of irregular interruptions, indicates that it took only about 23 hours to build the scope—not bad considering that there

are no printed or etched circuits of any kind, no wiring harnesses, no preassembled sections. This is a real-solid, honest-to-gosh *kit!*

The instructions are superb. The few minor errors in the book had already been noted on a mimeo insert; a few more minor typos turned up, but otherwise the assembly manual is a magnificent piece of work.

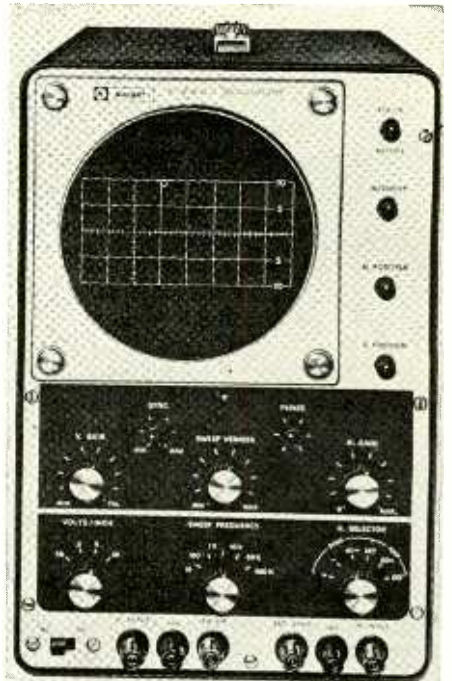

The scope is about as close as you can get to a "professional" or "lab" scope without actually getting one of those. Vertical response is flat (within 3 dB) from dc to 5.2 MHz; sensitivity is 17 millivolts rms per inch. The sweep circuit is a sophisticated one with amplified, polarity-switchable sync (internal, external or line), and appears to be linear even out to the limits of the horizontal amplifier's frequency range (down about 2 dB at 400 kHz). Sweep synchronization is effective at very small display amplitudes, even at 3 or 4 MHz.

The trace is bright enough for most shop applications, though a hood over the bezel is helpful with certain kinds of room lighting. It is not as sharp as on a couple of 3-inch scopes I have known and loved. No amount of juggling of the intensity, focus and astigmatism adjustments would crisp it to quite that point, but this is quite normal with the larger trace size from the 5-inch CRT, which largely compensates for the reduced sharpness.

The vertical amplifier attenuator is a switch with four positions: .05, 0.5, 5 and 50 volts peak to peak per inch. It is frequency-compensated in the usual way with adjustable trimmer capacitors. Some day, as one of a number of "personalizations", I would like to install an attenuator with finer steps—such as .05, 0.15, 0.5, 1.5, 5, 15, and 50 volts.

can you
give your
electronics
career more
mo
men
tum?

See new p 79

PAGE 31 OFFERS YOU MORE INSIGHT INTO THE SUBJECT.

64

Although there is a vernier vertical gain control, it is normally left wide open, at the CAL position, so that the scope, once calibrated, can be used to measure peak-to-peak voltages at a glance. As a result, a waveform slightly too small to observe well on one range (the 5-volt range, say) disappears off the top and bottom of the screen on the next more sensitive range (0.5 volt in this case). And turning the continuously variable vertical gain control disrupts the calibration. This is not a serious problem unless you frequently measure with the scope. I use it mainly to examine waveforms, and for that the present arrangement is fine.

The scope's circuitry is not vastly different from that of other modern instruments of its class. It does use some very modern tubes (all RCA's and Mullard's, by the way) in the vertical amplifier—real high-transconductance jobs like a pair of 6LF8 triode-pentodes and a pair of 6HS6 pentodes. Shunt and series peaking hold the response up into the 5-MHz region, after which the gain drops off rapidly. The vertical amplifier is of course direct-coupled throughout.

Drift is held down by a combination of voltage regulation (a 0A2 and a NE-2 in the power supply), heavy degeneration in each stage and, at the beginning, by a 15- to 25-hour aging period that is recommended before any adjustments are attempted.

If dc amplification isn't wanted, a slide switch throws a 0.1- μ F, 600-volt capacitor in just before the input attenuator, preventing dc voltages at the input terminals from deflecting the spot.

MANUFACTURER'S SPECIFICATIONS

VERTICAL

Sensitivity: 17 mV rms/inch. Calibrated at .05V p-p/inch

Response: ± 1.5 dB dc to 5.2 MHz; color band-pass ± 0.5 dB

Overshoot: less than 6%

Rise time: 70 nsec

Input impedance: 3 megohms shunted by 35 pF

Attenuator: frequency-compensated, calibrated; .05, 0.5, 5 and 50 V p-p/inch

HORIZONTAL

Sensitivity: 0.6 V rms/inch

Response: ± 1.5 dB 1 cycle to 400 kHz

Expansion: 2 times

Positioning: all parts visible

Inputs: Internal time base, 60 Hz (phase-controlled), and external

Input impedance: 7 megohms shunted by 25 pF

Linear time-base ranges: 10-100, 100-1,000 Hz 1 kHz-10 kHz, 10 kHz-90 kHz, 90 kHz-400 kHz

Synchronization: + internal, - internal, 60 cycles, external. Sync limiting for semi-automatic operation with level control. Locks on waveform fundamentals to 5 MHz and on display amplitudes as low as 0.1 inch

External sync sensitivity: 150 mV rms at 1 kHz

Line sync: 60 Hz, phase-variable

Calibration voltage: 60 Hz sine wave, 100 mV p-p at front-panel jack

Z-axis input: -10 V for beam cutoff; impedance 1 megohm

Size: 7 $\frac{7}{8}$ x 11 $\frac{1}{8}$ x 15 $\frac{1}{2}$ inches

Weight: 25 lb

Tubes: 12 including CRT and 2 rectifiers

Power: 110-130 Vac, 50-60 Hz, 112 watts power transformer primary tapped for adjustment to local line voltage

Price: \$99.95 kit, \$149.95 wired

Intensity modulation of the CRT beam is available through a normally shorted jack on the back of the scope. A 10-volt peak negative-going signal will cut off the beam.

The kit was a joy to build, although a long job. All parts, structural, mechanical, electronic, were obviously of good quality and everything fit together perfectly. Most of the capacitors in the scope are either Mylar or polystyrene, for low leakage and high stability. All the sockets are molded—no wafers.

Much of the wiring is laid out so

that resistors and capacitors span the space between two lugs on two terminal strips a couple of inches apart. This keeps parts parallel, which not only looks nice but makes checking, inspection and—if necessary—troubleshooting easy. Plastic cable ties are used extensively, and one large bundle is laced along a structural member with good old waxed lacing cord (supplied, of course).

Large, clear, accurate drawings, in the book and on large folded sheets, are provided wherever they can be a help.—

Peter E. Sutheim

END

Let's Look Inside The Dynamic Microphone



THIS is no ordinary microphone. It's a University Dynamic. Its manner of working is no less complex than a modern day computer. Its system of elements is a carefully integrated electromechanical network in a critical acoustical area. Without showing it, it's really quite a bit more than it appears to be—you have to listen to know the results of its performance.

For example—you move toward a flurry of activity on a busy street corner and witness a man-on-the-street interview. To you and other observers the conversation is barely audible above the noise of people and traffic. But to radio listeners the conversation is clear and unaffected by the sounds of the city... They are remote... in the background where they belong. This is the distinct advantage of a microphone with a good directional pick-up pattern.

To demonstrate another case in point—Imagine yourself an unseen observer in a conference room of a large organization. A tape recorder, fed by a single microphone in the center of the conference table, is in use to store all that is said. Many speak at once; some face away from the microphone; it appears that all that is said may never be recorded, but every word is captured on the magnetic tape for later review.

Microphones, but they are different in design, to serve different applications. The first is a highly directional (cardioid) dynamic microphone, sensitive only to the areas of sound intended for radio transmission or recording... proportionally attenuating sounds emanating from adjacent unwanted areas. The second is a highly omnidirectional dynamic microphone sensitive to sounds in all surrounding areas, specifically designed to pick up all sounds.

University makes only dynamic microphones, and they have the precision and reliability of modern day computers. Look at the inside to confirm this. The bullet shaped dome of the directional cardioid is a precise and significant component of the system. It smoothes the vital mid-range to provide a more dynamic, natural quality of sound. Filters, in a special configuration, soften sudden bursts of sound, minimize sibilants and protect the inner components from dust, dirt and the elements. A series of ducts further extends the performance of the microphone's transducer element providing gross and fine tuning (similar to the bass ducts of a speaker system) to sharpen the directional characteristics and reinforce the bass response.



The unusual, rugged, yet highly sensitive characteristics of the exclusive University UNILAR diaphragm are responsible for the remarkable high frequency performance of the University Dynamic Microphone—sharp, bright, clear and transparent. The UNILAR diaphragm is not easily seen in the precision cut-a-way shown above. It is extremely light and sliver thin, rugged and virtually indestructible. It could easily withstand torturous bursts of sound and vibration, even without the "extra-measure-of-protection" blast filter screen in the assembly. This feature alone guarantees continued distortion-free and trouble-free performance... and, it is only one of many features that make the University Dynamic Microphone the choice of professionals and recording buffs. No matter what the nature of sound, University captures the live natural quality that makes the difference right from the start... better than other microphones costing \$10, \$15 or even \$20 more. And, the exclusive University warranty gives you five times as long to enjoy this "lively sound." Stop at a franchised University Dealer today and try for yourself. Get more info too! Write to Desk E-69, UNIVERSITY SOUND, P. O. Box 1056, Oklahoma City, Oklahoma 73101... we'll send you a FREE copy of "MICROPHONES 66."



Model 800 Directional (Cardioid) Shock Mounted



Model 2000 Omni-Directional



Model 2050 Omni-Directional With Switch & Switch



Model 8100 Directional (Cardioid) With Shock Mounted



Model 2040 Omni-Directional With Switch



Attaché 6000 Miniature Directional (Cardioid) With Lavalier

Both are University Dynamic

Circle 32 on reader's service card

NOW! ADD TO OR COMPLETE YOUR PHOTOFACT® LIBRARY AT PRESENT LOW PRICES!

UNTIL JULY 1, 1966—
SAVE
\$123⁷⁵
on your purchase
of a 225-Set
PHOTOFACT LIBRARY
ORDER NOW!



Until July 1, 1966, you can buy a **PHOTOFACT LIBRARY** (minimum of 60 Sets) at the present low Easy-Buy contract price of \$1.95 per Set—you save 55¢ per Set—
you save over \$120.00 on a 225-Set Library purchase!

(After July 1, 1966, PHOTOFACT prices go up: Single Sets 1 through 200 go to \$3.00 each; Single Sets 201 through current issues go to \$2.50 each)

ACT NOW! THERE'S NEVER BEEN A DEAL LIKE THIS:

NO INTEREST, NO CARRYING CHARGE LIBRARY EASY-BUY PLAN

- Yes—no interest—no carrying charge—no other deal like it!
- Only \$10 down—30 months to pay while the Library earns for you!
- Prepaid transportation to your shop.
- Add-on privilege of a year's advance subscription to current PHOTOFACT Sets on same contract.

4 WAYS TO SELECT YOUR LIBRARY

1. Complete your present PHOTOFACT Library.
2. Order a "Starter" Library of 225 Sets. (Sets 451-675—coverage from 1959 to 1964—only \$14.29 per month).
3. Order by brand name and year—see the handy selection chart at your Sams distributor.
4. Order a *complete* PHOTOFACT Library.

FREE

the famous
14-volume



NEW STANDARD ENCYCLOPEDIA!

RETAIL
VALUE
\$149⁵⁰

FREE with the purchase of a
PHOTOFACT LIBRARY consisting
of 225 or more Sets... an invaluable
TREASURY OF KNOWLEDGE for your family—a complete, authoritative, indispensable reference library for your home!

ACT NOW!
Offer ends
June 30, 1966

SAVE OVER \$120.00! Order your Photofact Library today!

See your Sams Distributor or write for Easy-Buy Library details to Howard W. Sams & Co., Inc., 4300 W. 62nd St., Indianapolis, Indiana 46206

Circle 33 on reader's service card

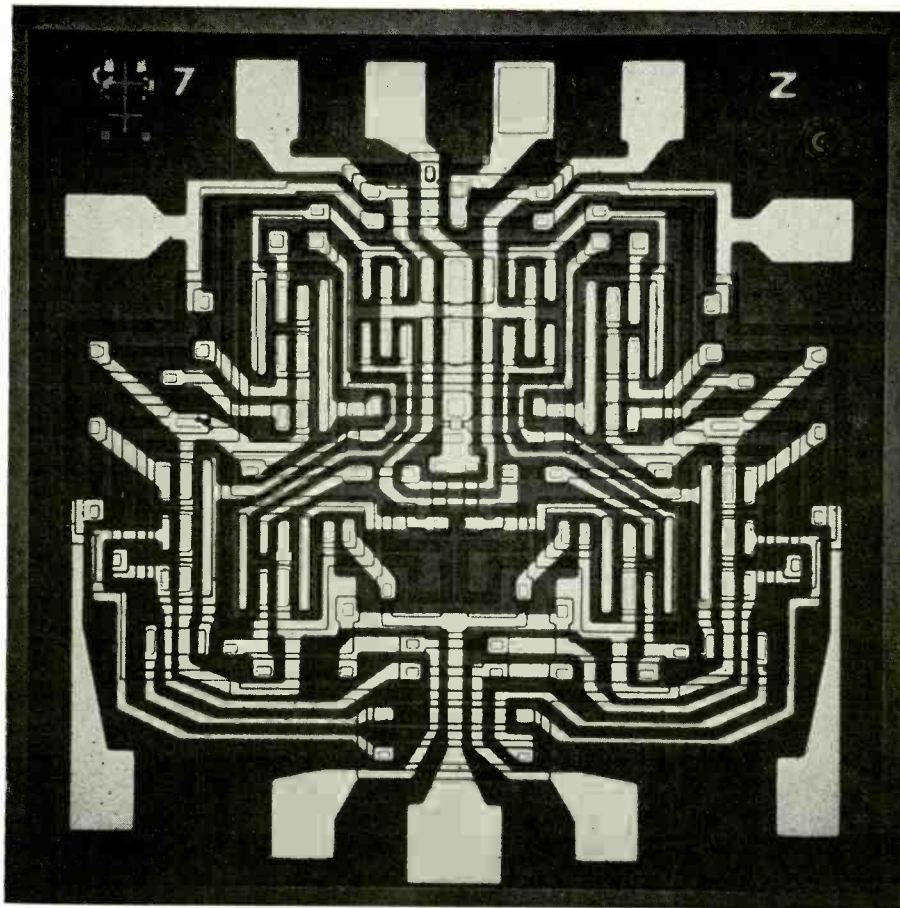

MICROELECTRONICS and SOLID STATE SPECIAL ISSUE . . .

- ★ The *entire* June issue of Radio-Electronics will concentrate on bringing you up-to-the-minute on microelectronics and semiconductors!
- ★ Get the facts on a development that is new, startling, never published before!
- ★ Hear new Editor Forest H. Belt sound off on progress and problems in the field of consumer microelectronics.
- ★ Read attention-holding articles on transistorized ignition systems, an electronic siren, improving flash pictures, underwater treasure-hunting devices!
- ★ Receive permanent reference material including an outline of how an integrated circuit evolves, fundamental transistor concepts told in a new way, plus new product and equipment reports!
- ★ Important servicing features including articles on repairing solid state phonos, testing transistors with an oscilloscope, testing oscillators in portables!
- ★ Practical help, from features on microcircuits in television and a look at chromatron circuitry . . . to an all-silicon regulated power supply, a versatile transistor checker, plus many more.

Coming next month in RADIO-ELECTRONICS

on sale May 19 at newsstands and parts distributors.

**Police, fire,
ambulance emergency
calls, CD, weather...**

tune in on the Squires-Sanders FM Alert

First crystal FM emergency receiver at a down-to-earth price. Two crystal receive channels plus tunable control. Sensitive, selective, stable receiver. Smooth, adjustable squelch. Choice of two models: FM Alert 152-152 to 174 mc; or FM Alert 30-30 to 50 mc. Only \$89.95. Matching speaker \$9.95. Sold by communications specialists, or write Squires-Sanders Inc., Martinsville Rd., Millington, N. J. 07946

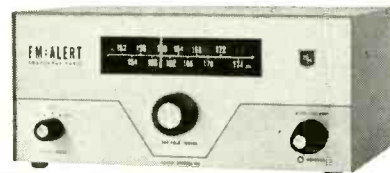

Squires Sanders



Circle 116 on reader's service card



**The Heart
of your
Radio
is Its**



**INSIST ON
CQC***

* Controlled Quality Crystals available only from Texas Crystals dealers. Extensive precision testing throughout manufacture enables Texas Crystals to unconditionally guarantee their frequency control crystals. Use of Texas Crystals in space program and by other governmental agencies is evidence of the quality you can count on.

*If your dealer can't supply your needs,
send his name with your
request for catalog to our plant nearest you.*



**TEXAS
CRYSTALS**



Division of Whitehall Electronics Corp.

1000 Crystal Drive Fort Myers, Fla. 33901 4117 W. Jefferson Blvd. Los Angeles, Calif. 90016
Phone: 813-936-2109 Phone: 213-731-2258

Circle 117 on reader's service card

brand new
... and very important ...

QUAM COLOR TV REPLACEMENT SPEAKERS PREVENT COLOR PICTURE DISTORTION

OFTEN CAUSED BY STRAY
MAGNETIC FIELDS FROM
ORDINARY LOUSPEAKERS



When you use an ordinary loudspeaker in a color TV set, you're looking for trouble ... picture trouble. The external magnetic fields from standard loudspeakers will deflect the primary color beams, causing poor registration and distorted pictures.

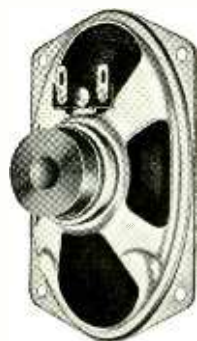

QUAM RESEARCH SOLVES THIS PROBLEM

An entirely new construction technique, developed in the Quam laboratories, encases the magnet in steel, eliminating the possibility of stray magnetic fields and the problems they cause! These new Quam speakers have been eagerly adopted by leading color TV set manufacturers. Quam now takes pride in making them available for your replacement use. Five sizes (3" x 5", 4", 4" x 6", 5 1/4", 8") ... in stock at your distributor.

QUAM

QUAM-NICHOLS COMPANY

234 E. Marquette Rd. • Chicago, Ill. 60637

Circle 34 on reader's service card

NEW SEMI- CONDUCTORS AND TUBES

THE RISE OF THE FIELD EFFECT

The electronics industry seems to be getting more and more excited about the versatility of field-effect transistors. In many ways, they seem less critical and touchy about circuit constants than transistors are. They are less temperature-sensitive. And, of course, one of their principal features is their extremely high input impedance, which results from the fact that they normally work with their gate-source junctions (input terminals) reverse-biased. Leakage currents in the sub-nanoampere range (well under one-billionth of an ampere) are common. Input impedances of 400 megohms are easily achieved. Noise figures are extremely low.

At a recent Texas Instruments seminar, one engineer spoke of a 48-MHz crystal oscillator using a field-effect transistor which maintained its frequency within approximately 150 Hz over a temperature range of 0 to 100°C. No temperature-compensation was used—the circuit was extremely simple, just a basic triode design—and the temperature variation was applied to the transistor only.

Another possible advantage of FETs is that they "look" so much like tubes, as far as circuit design is concerned. Once again it is becoming common to talk of transconductance, to get bias by putting a dropping resistor in the source (cathode) lead, to have input impedances of hundreds of megohms. This can make it easier for many people—those who never quite felt at home with the "strange" characteristics of ordinary transistors—to jump in with both feet and exploit the benefits of solid-state devices.

One precaution was emphasized at the TI seminar. Field-effect transistors can be ruined in the twinkling of an eye by an accumulation of static charges around them. If the static voltage gets high enough, it will puncture the gate-to-source junction permanently, making the transistor worthless. The simplest solution seems to be to keep a shorting link across the transistor leads until after installation.

Siliconix, Inc. has just introduced a line of n-channel junction field-effect transistors designed primarily for low-power audio work. Input current is very low (I_{GSS} 10 pA maximum). Input ca-

pacitance is only 3 pF. These units, the 2N4117, -4118 and -4119, should make excellent high-input-impedance audio or dc amplifiers, choppers or electrometer devices. The transistors differ principally in their rated currents: I_{DSS} maximum of .09, 0.24 and 0.6 mA, respectively, for the three types in numerical order. They come in the TO-72 can. Quantity prices are in the \$10 range.

LOW-COST VVC DIODES

Have you got around yet to experimenting with voltage-variable capacitance diodes? They are very effective tuning and modulating devices, varying their junction capacitance more or less linearly with applied reverse-bias voltage. (While every junction diode will do that, the VVC's are designed to do it—with a predictable change of capacitance for a known change of voltage, and with higher Q than ordinary diodes.)

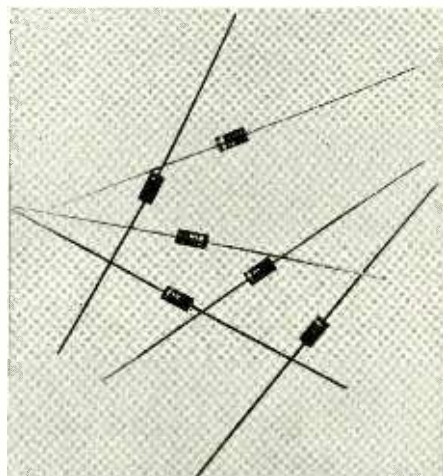

What brings this subject to mind is the introduction of a new line of voltage-variable capacitance diodes from Somerset Electronics Corp. The SV-1748 and SV-1650 series feature minimum Q of 150 and 200, respectively, at 50 MHz, and guaranteed tuning ratios (1-to-15-volt range) of 2.6 or better. They can be used for tuning, afc or modulation up to 1 Gc. Nominal capacitances range from 6 to 56 pF at 4 volts reverse bias. The diodes are priced at \$1.50 each in 100-quantity lots from Somerset Electronics Corp., PO Box 115, Manville, N.J. 08835. END

UP-A-TREE AT REPAIRING SOLID-STATE PHONOS?

No need to let mishaps with solid-state phonographs throw you. Expert Homer L. Davidson takes the mystery out of making repairs quickly and easily. He tells what goes wrong and how to fix it in practical detail.

Coming in June
RADIO-ELECTRONICS
Microelectronics and
Solid State Special Issue

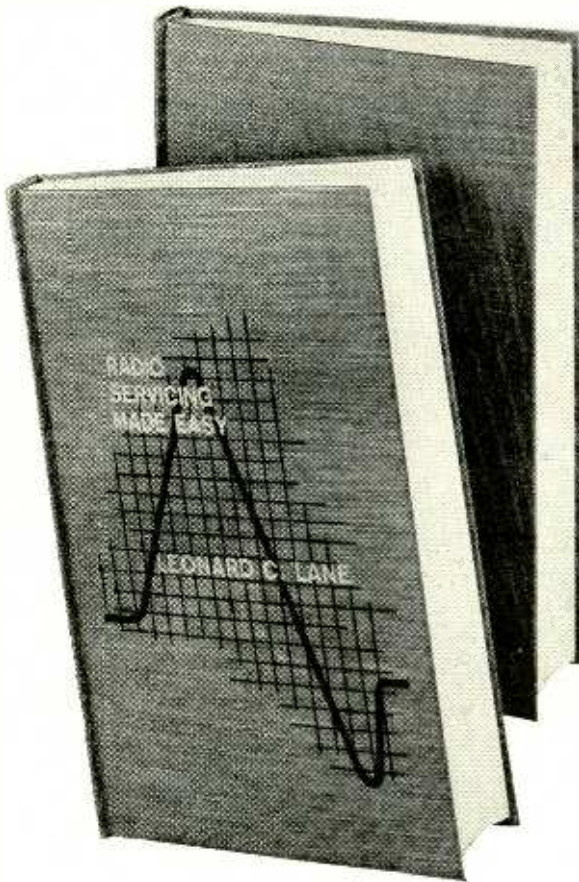

If you don't know how to service radios but you'd like to learn fast—

Get these two great books . . . a \$9.90 value

only **99¢**

by joining the Electronics Book Club today!

RADIO SERVICING MADE EASY—by Leonard C. Lane.

Here is a wonderfully helpful set of two handbooks written by an expert with years of practical servicing experience. He tells you everything you want and need to know about radio servicing today. Nothing is left out. You get down-to-earth facts and techniques you can use at once, including many tricks-of-the-trade never put in print before. Just a few of the eye-opening things you'll discover: Working With Transistors/Getting started. What is a reference point? Approaching the transistor. Pairs of diodes. Testing Transistors and Printed Circuits/Checking transistors. In-circuit transistor testing. Troubles. Measurements. Replacing resistors and capacitors. Servicing Transistor Radios/Batteries. Stage-by-stage analysis. Typical circuits. Servicing Auto Radios/Installation and removal. Servicing. Using signal generator. AM Receivers/Frequency range. Ac-dc power supplies. Troubleshooting. FM Receivers/AM-FM Tuners/Communications Receivers/Tuning troubles. Receiver analysis. Noise limiters. Marine receivers/Marine frequencies. Receiver circuitry. Checking the direction finder. Rf amplifier stage. Mobile Radio. Plus many other subjects.

Here is an extraordinary offer to introduce you to Gernsback Library's famous Electronics Book Club, specially designed to help you increase your know-how and earning power.

WHY SHOULD YOU JOIN!

Whatever your interest in electronics—radio and TV servicing, audio and hi-fi, industrial electronics, communications, electronics as a hobby—you'll find that the Electronics Book Club will help you get the job you want, keep it, improve it, or make your leisure hours more enjoyable. By broadening your knowledge and skills, you'll build your income and electronics enjoyment as well.

WHAT BOOKS ARE OFFERED?

From Gernsback Library and other leading publishers come the country's most respected books in the field of electronics. All are deluxe, hard-covered books of permanent value, offered at considerable cash savings to members, regardless of higher retail prices.

TYPICAL CLUB SELECTIONS:

Servicing AGC Circuits
Reg. \$6.00—Club price \$4.95
(You save \$1.05)

Probes For Test Instruments
Reg. \$4.60—Club price \$3.35
(You save \$1.25)

Diode Reference Book
Reg. \$6.25—Club price \$4.95
(You save \$1.30)

TV Sweep Oscillators
Reg. \$6.00—Club price \$4.95
(You save \$1.05)

Color TV Repair
Reg. \$4.60—Club price \$3.25
(You save \$1.35)

Handbook of Electronic Tables
Reg. \$4.95—Club price \$3.50
(You save \$1.45)

Elements of Electron Physics
Reg. \$5.65—Club price \$4.45
(You save \$1.20)

Transistor Reference Book
Reg. \$6.00—Club price \$4.50
(You save \$1.50)

Audio Design Handbook
Reg. \$5.00—Club price \$3.75
(You save \$1.25)

Electronics Data Handbook
Reg. \$4.60—Club price \$3.25
(You save \$1.35)

Mandl's Television Servicing
Reg. \$8.95—Club price \$7.95
(You save \$1.00)

Electrical Appliance Service Manual
Reg. \$6.75—Club price \$5.75
(You save \$1.00)

Basic Math Course for Electronics
Reg. \$6.45—Club price \$5.15
(You save \$1.30)

The V.T.V.M.
Reg. \$4.60—Club price \$3.35
(You save \$1.25)

Basic Transistor Course
Reg. \$5.75—Club price \$4.50
(You save \$1.25)

Industrial Electronics Made Easy
Reg. \$5.95—Club price \$4.35
(You save \$1.35)

Horizontal Sweep Servicing Handbook
Reg. \$5.75—Club price \$4.50
(You save \$1.25)

The Oscilloscope
Reg. \$5.20—Club price \$3.95
(You save \$1.25)

HOW THE CLUB WORKS

The Electronics Book Club will send you, every other month, the News Bulletin describing a new book on a vital area of electronics. As a member, *you alone* decide whether you want a particular book or not. You get 2 books now for 99¢ and need take only 4 more within a year, from a wide selection to be offered. And the Club *saves you money* on the books you take, regardless of higher retail prices.

HOW TO JOIN

Simply mail the coupon today. You will be sent your two-handbook set—RADIO SERVICING MADE EASY, which regularly sells for \$9.90. We will bill you 99¢ (plus a few cents postage). If you are not pleased with the set, send the books back within 10 days and membership will be cancelled. Otherwise, you will enjoy all these benefits:

- ★ Get two books immediately for 99¢
- ★ Free 10-day examination privilege.
- ★ Continuous cash savings.
- ★ Free charts given with many books.
- ★ You alone decide which books you want. Books are returnable.
- ★ Club books are practical working tools, written by experts.

Gernsback Library, Inc., Electronics Book Club, Dept. RE56
154 West 14th Street, New York, N.Y. 10011

Please enroll me in the Electronics Book Club and send me the TWO-HANDBOOK SET: RADIO SERVICING MADE EASY. Bill me only 99¢ plus shipping. If not pleased, I may return both books in 10 days and this membership will be cancelled.

As a member, I need only accept as few as 4 additional books a year—and may resign any time after purchasing them. All books will be described to me in advance, every other month, in the Club Bulletin, and a convenient form will always be provided for my use if I do not wish to receive a forthcoming book. You will bill me the special Club price for each book I take (plus a few cents postage)—regardless of higher retail prices. Offer good in U.S.A. and Canada only.

Name (please print)

Address

City State Zip Code

SAVE! Enclose your 99¢ now with this coupon and we will pay postage. Same return guarantee privilege.

The following free advertising material is available through

RADIO-ELECTRONICS READER'S SERVICE

ALLIED RADIO CORP. (Pg. 83) Catalog.	Circle 115
AMPEREX (Second Cover) List of replacement tubes.	Circle 7
B & K MANUFACTURING CO. (Pg. 17) Test equipment catalog AP-22.	Circle 16
BROOKS RADIO & TV CORP. (Pg. 86-87) Information sheets and price lists of tubes and parts.	Circle 120
CASTLE TV TUNER SERVICE (Pg. 64) Information on complete tuner overhaul by mail.	Circle 31
CHARLES ENGINEERING (Pg. 78) Information on Wizard 300 TV-FM antenna Coupler.	Circle 112
CLEVELAND INSTITUTE OF ELECTRONICS (Pg. 77) Electronics slide rule booklet and data guide.	Circle 111
CORNELL ELECTRONICS CO. (Pg. 94) Catalog and price list of tubes and parts.	Circle 130
COYNE ELECTRONICS INSTITUTE (Pg. 91) Book: "Your Opportunities in Electronics."	Circle 127
DATAK CORP. (Pg. 88) Folder and sample of "instant lettering."	Circle 122
DE VRY TECHNICAL INSTITUTE (Pg. 3) Booklets "Pocket Guide to Real Earnings" and "Electronics in Space Travel."	Circle 9
EASTMAN KODAK (Pg. 5) "Plain Talk" booklet on major aspects of tape performance.	Circle 10
ELECTRONIC COMPONENTS CO. (Pg. 92) Information on rectifiers and transistors.	Circle 128
FINNEY CO. (Pg. 25) Booklets on Color Ve-Log Antennas.	Circle 20
GRANTHAM SCHOOL OF ELECTRONICS (Pg. 91) Brochure on FCC license preparation.	Circle 126
HALLICRAFTERS (Pg. 75) Information on Hallicrafters CB-19 Transceiver.	Circle 108
HEALD'S ENGINEERING COLLEGE (Pg. 89) Catalog and registration application.	Circle 124
HEATH COMPANY (Pg. 23, 63) Catalog and specifications on DC 'Scope Heathkit 10-14.	Circle 18, 30
INTERNATIONAL CRYSTAL MFG. CO. (Pg. 7) Catalog of Citizens Band transceivers and dealer list.	Circle 12
INTERNATIONAL RADIO EXCHANGE (Pg. 16) List of citizens radio equipment in stock.	Circle 15
JERROLD ELECTRONICS CORP. (Pg. 28) Information on 82-channel coloraxial cable antenna.	Circle 23
JFD ELECTRONICS CORP. (Pg. 14-15) Brochure 1039 on LPV-TV log periodic antennas.	Circle 14
JOHNSON, E. F. (Pg. 27) Booklet, "Why Single Sideband?", about Messenger "350" single sideband CB transceiver.	Circle 22
LAFAYETTE RADIO ELECTRONICS (Pg. 79) Catalog.	Circle 114
LAMPKIN (Pg. 76) Booklet ("How to Make Money in Mobile Radio Maintenance") and information on Lampkin meters.	Circle 109
MALLORY DISTRIBUTOR PRODUCTS CO. (Pg. 32) Information on STD dual trigger diodes.	Circle 25
MERCURY ELECTRONICS CORP. (Pg. 85) Specifications on Mercury Model 501 component substitutor in a Wire-it-Yourself Kit.	Circle 118
MUSIC ASSOCIATED (Pg. 74) Information on Music Associated's Sub Carrier Detector for "music only" programs on FM Broadcast Band.	Circle 107
PERMA-POWER COMPANY (Pg. 6) Information on Perma-Power Vu-Brite and Tu-Brite Packs for brightening TV pictures.	Circle 11
POLY PAKS (Pg. 95) Information on Semiconductors.	Circle 131
QUAM-NICHOLS CO. (Pg. 68) Information on color TV replacement speakers.	Circle 34

Here's how you can get manufacturers' literature fast:

1. Tear out the post card on the facing page. Clearly print or type your name and address.
2. Circle the number on the card that corresponds to the number appearing at the bottom of the New Products, New Literature or Equipment Report listing in which you are interested. For literature on products advertised in this issue circle the number on the card that corresponds to the number appearing at the bottom of the advertisement in which you are interested, or use the convenient checking list in the column at the left.
3. Mail the card to us (no postage required in U. S. A.)

QUIETROLE CO. (Pg. 87) Information on lubricant and cleaner for scratchy, noisy tuners and controls of TV and radio.	Circle 121
RADAR DEVICES (Pg. 1) Information on protecting and expanding your business with Radar Sentry Alarm.	Circle 8
RADIO SHACK (Pg. 96) Catalog and Bargain Bulletins.	Circle 132
RCA INSTITUTES (Pg. 31) Home Study Career Catalog.	Circle 24
ROTRON MFG. CO., INC. (Pg. 22) Details on Whisper Fan Kit for ventilating stereo, hi-fi, radio, TV, amateur equipment.	Circle 17
RYE SOUND CORP. (Pg. 86) Information on "Clever Klips 30" test probe.	Circle 119
SAMS, HOWARD W. CO. INC. (Pg. 66) Information on Photofact Library Plan and Encyclopedia Offer.	Circle 33
SCOTT, H. H., Co. INC. (Pg. 24) Information on the Scott LT-112 Solid-State FM Stereo Tuner Kit.	Circle 19
SENCORE (Pg. 78) Information on Sencore Mighty Mite tube checker.	Circle 113
SPRAGUE PRODUCTS CO. (Pg. 26) Sprague's Electrolytic Capacitor Replacement Manual K-107.	Circle 21
SQUIRES-SANDERS INC. (Pg. 67) Information on FM Alert emergency band receivers.	Circle 116
TEXAS CRYSTALS (Pg. 67) Catalog on Controlled Quality Crystals.	Circle 117
UNITED RADIO CO. (Pg. 93) Parts catalog.	Circle 129
UNIVERSITY SOUND (Pg. 65) Microphone catalog.	Circle 32
WARREN ELECTRONIC COMPONENTS (Pg. 90) Information on Silicon Rectifiers.	Circle 125
WINDSOR ELECTRONICS INC. (Pg. 74) Information on making extra money with the Windsor System of Picture Tube rebuilding.	Circle 110
WINEGARD CO. (Pg. 89) Fact-finder #242 with information on Chroma-Tel antenna.	Circle 123

NEW PRODUCTS

More information on new products is available free from the manufacturers of items identified by a Reader's Service number. Turn to the Reader's Service Card facing page 70 and circle the numbers of the new products on which you would like further information. Detach and mail the postage-paid card.

Hz = Hertz = cycles per second; kHz = kilocycles; MHz = megacycles

CHOPPER-STABILIZED OPERATIONAL AMPLIFIER, model 210, in same price range as premium differential-type op amps. 20-MHz small-signal bandwidth; 100-volt/ μ sec slewing rate; 10^8 dc open-loop gain (160 dB); 3- μ V p-p noise (dc to 2 Hz); 1- μ V/ $^{\circ}$ C and 2-pA equiv-

quency response. Response in "normal" position: 40-15,000 Hz; "less bass" 100-15,000 Hz. 150 Ω impedance. Has line-shortening on-off switch, satin chrome finish, 20 feet of cable.—Turner Microphone Co.

Circle 48 on reader's service card

BOOKSHELF SPEAKER SYSTEM, the *Wharfedale W30*, has acoustic-compensation circuit with "Full" and "De-

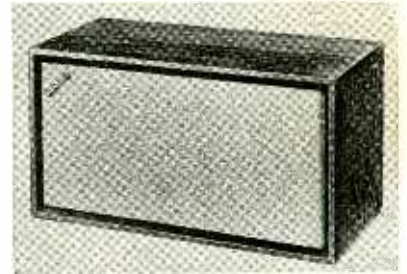

Emphasis" positions. In De-Emphasis (for hard-surfaced rooms) response range from

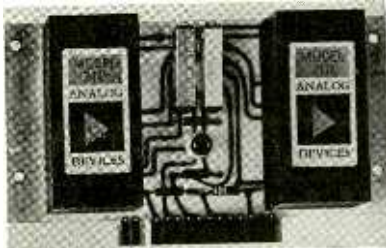

alent offset for every 1% supply voltage change. Above specs maintained -25 $^{\circ}$ C to +85 $^{\circ}$ C. Input impedance 500K; output \pm 10V at 20 mA. Mounts on PC board; packaged in 3-cu. in. epoxy-encapsulated module. Chopper-driver circuit operates from \pm 15-Vdc supply.—Analog Devices

Circle 46 on reader's service card



CABLE CLIPS, adhesive-backed *Scotchflex*. Available in 4 sizes to handle bundles or jacketed cable from $\frac{1}{8}$ - to $\frac{1}{2}$ -in. diameter.—3M Co.

Circle 47 on reader's service card

CARDIOID MICROPHONE, model 505, advanced version of *model 500*, features adjustable bass response. Rotary



"normal"—"less bass" switch switches in ferrite-core inductor modify to low-fre-

Who has the most complete interchangeability guide in the semiconductor industry?

Semitron has it . . . in spades! Our latest Semiconductor Replacement and Interchangeability Guide features exact replacements for over 5000 types of Transistors, Rectifiers, Diodes, etc., each exceeding minimum specs. It's the world's most extensive guide and price list—a must for every electronic service technician, engineer and experimenter.

For your Guide (Wall Chart or 8 Page Booklet) go to see your Semitron distributor for a FREE copy, or send 25¢ directly to Semitronics to cover handling costs. Order your semiconductors from the world's largest selection—at Semitronics, where you always get **more for your money.**

Semitronics CORPORATION

Dept. RE-5

265 CANAL STREET
NEW YORK, N.Y., 10013
PHONE: (212) 226-5401-2

Please send me the Semitron Interchangeability Guide for 25c each to cover handling & postage.

8 Page Booklet.....8½" x 11"

Wall Chart22" x 26½"

Name.....

Address

City/State..... Zip Code.....

Enjoy the "music-only" programs now available on the FM broadcast band from coast to coast.

- NO COMMERCIALS •
- NO INTERRUPTIONS •

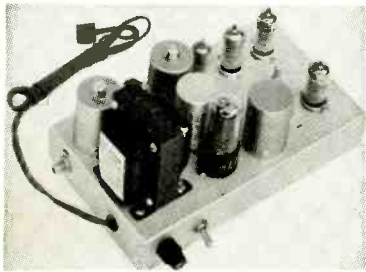

It's easy! Just plug Music Associated's Sub Carrier Detector into multiplex jack of your FM tuner or easily wire into discriminator. Tune through your FM dial and hear programs of continuous commercial-free music you are now missing. The Detector, self-powered and with electronic mute for quieting between selections, permits reception of popular background music programs no longer sent by wire but transmitted as hidden programs on the FM broadcast band from coast to coast. Use with any FM tuner. Size: 5½" x 6". Shipping weight approx. 7 lbs.

KIT \$49.50

(with pre-tuned coils, no alignment necessary)

WIRED \$75.00 (Covers extra \$4.95 ea.)

Current list of FM Broadcast stations with SCA authorization \$1.00

MUSIC ASSOCIATED

65 Glenwood Road, Upper Montclair, N. J.
Phone: (201)-744-3387

Circle 107 on reader's service card

500 to 8,000 Hz is depressed 3-4 dB, while leaving the range from 8,000 to 20,000 Hz relatively unattenuated. 19 x 19 x 9¼ in.—British Industries Corp.

Circle 49 on reader's service card

SOLID-STATE RECEIVER (SIX HUNDRED) AND AMPLIFIER (SIXTY). Both deliver 60 watts output at 4, 8, and 16Ω. Two sets of speaker terminals individually controllable. Rf sensitivity 2



μV. Response 10-100,000 Hz. Harmonic distortion 0.5%. Stereo separation (at 1 kHz) 65 dB. Magnetic phono, tuner, tape inputs. Power 117 volts 60 Hz. 15½ x 3¼ x 8½ in., 12 lb.—Audio Dynamics Corp.

Circle 50 on reader's service card

SINGLE/SIDEBAND TRANSCEIVER, model SB-72, 72 modes of operation on 24-channels. USB, LSB, AM. Built-in power supply for 12- and 117-volt operation. 13 tubes, including compactrons and



Nuvistors, give 23-tube performance. Microphone on coiled cable. 5½ x 10½ x 12 in., 17½ lb.—General Radiotelephone Co.

Circle 51 on reader's service card

MUSICAL INSTRUMENT HEADPHONE AMPLIFIER. Plug guitar, or any electrified instrument, into *Solo-Phone*,



connect one or two sets of headphones to it. Only the user hears instrument.—10¼ x 3½ x 3 in., 2 lb.—Shure Bros. Inc.

Circle 52 on reader's service card

3-SPEED MONAURAL TAPE RECORDER, model 122. 3,600-ft tape recording time: 12 hrs at 1½, 6 hrs at 3¾, 3 hrs at 7½ ips. Power: 60 W, 117 V, 60 Hz.

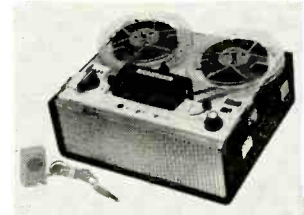

All-transistor. Response: 50-12,000 Hz at 7½. Bias: ac on record, erase. Output impedance 8Ω. 3-digit precision counter. 14 x 6½ x 11 in., 17-lb.—Concord Electronics Corp.

Circle 53 on reader's service card

LIQUID GRAPHITE loosens and lubricates locks, hinges, etc., then evaporates, leaving graphite powder. Steel oiler

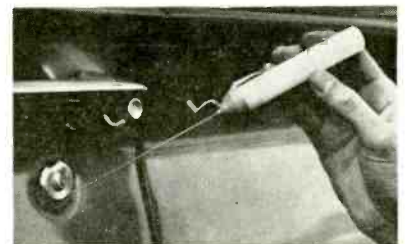

tube extends and retracts, reaches inside any mechanism up to 9½ in. from hand.—Armite Laboratories

Circle 54 on reader's service card

SIGNAL-SEEKING SOLID-STATE AUTO RADIO, Titan ETB-1600. 9-transistor, 2-diode, 1-thermistor circuit design. 10-μV sensitivity; 100-4,000 Hz audio with dual-polarity system operating on 12-volt dc positive or negative ground.

RADIO-ELECTRONICS

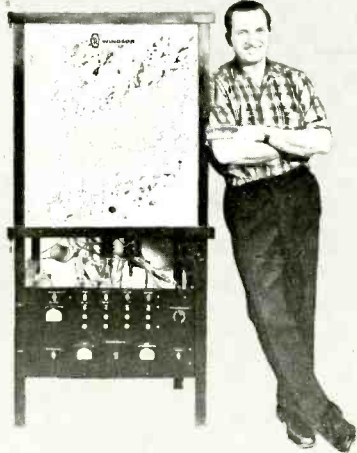

fat, ugly machine that can make you a lot* of money.

Just so you'll be sure . . . it's an oven. Not for pies. Nor cakes. Not even for pizzas. It's for television picture tubes, and performs chores like tube evacuation, cathode bombarding, induction heating, and more. Most important, it is part of the exclusive Windsor System of picture tube rebuilding — your key to a business you can run (right along with what you're doing right now), and make extra money with in amounts you might not have thought possible (*like \$4,000, \$5,000, \$10,000 a year and more!).

Sound good? Then send for the full story. Write direct, or circle our number right away. Who knows, that happy guy in the picture could be you.



WINDSOR ELECTRONICS, INC.
999 North Main Street
Glen Ellyn, Illinois 60137

Circle 110 on reader's service card

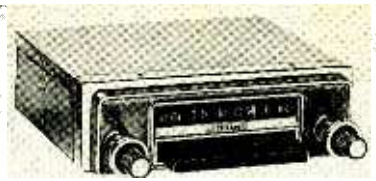

Maximum current drain 460 mA with 3.2-watt output. Separate 6½-in. 8Ω speaker for in-dash or rear-deck mounting. 2 x 6½ x 4½ in., 4 lb, 4 oz.—New-Tronics Corp.

Circle 55 on reader's service card

GLOBE SPEAKERS NOW DETACH. Project G-2 adds detachability feature to Project G, twin Sound Globe



speakers. Globes lift off arms and can be used as satellite speakers anywhere in the house.—Clairtone Electronics

Circle 56 on reader's service card

DYNAMIC MICROPHONES, model DM-70 shown here. Four versions: 200, 600, 10,000, 50,000 ohms. Sensitivity -60 dB at 1 kHz. Response 80-15,000



Hz. 7-ft. single-conductor shielded cable with standard phone plug. 4½ in. high, 15/16-in. diameter 2¾ oz.—Sonotone Corp.

Circle 57 on reader's service card

COLOR-AMP TRANSISTORIZED TV/FM ANTENNA BOOSTER, No. 99-4018, to improve signal for color-TV and FM multiplex receivers. Built-in lightning-protected circuit, high-pass filter which re-



jects CB. 117-volt, 60-Hz ac power supply, uses standard 300Ω twin-line. Handles 2 TV or FM receivers. 2 lb.—Lafayette Radio Electronics Corp.

Circle 58 on reader's service card

12-CHANNEL CB TRANSCEIVER, model 712 Sentinel 12 (mobile companion to Sentinel 23). 12 crystal-controlled



transmit and receive channels; complete tunable reception of all 23 CB channels. Adjustable squelch and noise limiter, switches for 3.5-watt PA, spotting and

100-mW operation. Transistorized dual power supply operates from 12 Vdc and 117 Vac. 4¾ x 12 x 7½ in., 15 lb.—EICO Electronic Instrument Co.

Circle 59 on reader's service card



TWO NEW SILICON POWER TRANSISTORS, 2N3738 and 2N3739, in-

Hallicrafters' new CB-19 transceiver is about as sleek and trim and compact as an infantry boot.



That's why there's room for the "S" meter, the receiver tuning VFO, the king-size communications speaker and unsurpassed basic performance —for only \$149.95



hallicrafters

5th and Kostner Aves.
Chicago, Ill. 60624

Export: International Div. Available in Canada through Gould Sales Co.

"Quality through Craftsmanship"

- 8 crystal-controlled channels. 23-channel receiver tuning with frequency spotting switch.
- Built-in, amateur-type "S" meter. ■ All-electronic push-to-talk circuitry. ■ Dual conversion, superheterodyne receiver. Superior sensitivity—less than 1 microvolt for 10 db S/N.
- Hallicrafters' exclusive "Racket Buster" built-in noise limiter.

Circle 108 on reader's service card

tended as audio amplifiers in line-operated sets with Class-A power output of 1 to 3 watts, or Class-B range from 5 to 20 watts. Maximum collector-emitter voltage rating of 225 V (2N3738), 300 V (2N3739). Min-max current gains are 40 and 200 when operating at collector-emitter voltage of 10 V. Devices can be used over collector-current range of 10 to 250 mA; minimum current-gain-bandwidth product of 15 MHz.—Motorola Semiconductor Products Inc.

Circle 60 on reader's service card

SSB CB TRANSCEIVER, the *Messenger 350*, up to 30% greater range over ordinary 5-watt AM CB transmitters. 12-

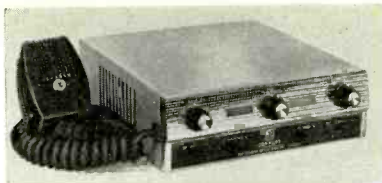

volt operation; optional ac power supply. Upper or lower sideband selection on each channel. Can be used as 3-watt public-address amplifier. 8 x 2½ x 9½ in.—E. F. Johnson Co.

Circle 61 on reader's service card

STEREO HEADPHONES, model MB-K64S, only 5 oz. Foam-rubber ear-

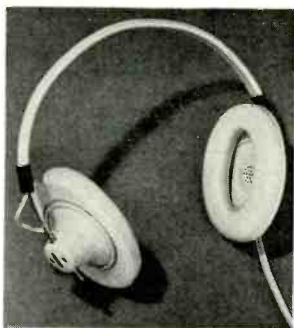

pads, range 20–17,000 Hz. 17Ω. 8-ft cable. From Mikrofons, West Germany.—Stanford International

Circle 62 on reader's service card

COMPONENT-MOUNTING SHIELDED "BLACK BOXES" provide shielded protective packages for custom-designed voltage dividers, passive or active networks, attenuators, isolation net-

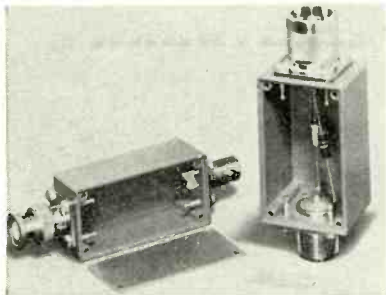

works, etc. Blue-painted aluminum; 12 models in 2 sizes. Solder turret terminals. Operating range: -55°C to +150°C.—Pomona Electronics Co., Inc.

Circle 63 on reader's service card



AUTOMATIC VOLUME CONTROL FOR SOUND SYSTEMS, the 212 *Soundservo*. Attack time 1 msec for

6-dB reduction. 2 seconds nominal release time. Response 20–20,000 Hz ±0.75 dB (with 20-dB compression). Distortion less than 0.1%. Noise level better than -100 dBm. Maximum compression 50 dB. Typical output variation ±3 dB for 40-dB variation on input. Insertion loss 3–6 dB. Input or output: high impedance unbalanced (50,000Ω); low impedance balanced or unbalanced (50 and 200Ω). Input level: -67 dBm to -17 dBm. Output: -70 dBm to -20 dBm. Power: 117 volts, 56/60-Hz ac 3 watts. 2½ x 2½ x 6½ in., 3 lb.—Vega Electronics Corp.

Circle 64 on reader's service card

BUTTON CELL BATTERIES, rechargeable nickel cadmium. Charging time 4 to 5 hrs, reduced 75%. Can withstand overcharge up to 24 hrs. Cells range



from 0.83- to 1.354-in. diameter; can be supplied for up to 12 volts and capacities from 80 to 500 mAh.—Gulton Industries

Circle 65 on reader's service card

8-PIECE DESOLDERING KIT, model 300-K, contains pencil-style desoldering iron, 6 tips of sizes .038–.090,



metal stand for iron, tip cleaning tool. Metal box measures 10 x 3½ x 1½ in.—Enterprise Development Corp.

Circle 66 on reader's service card

CIRCUIT-TRIMMING RESISTOR, the *VariZistor*, combines features of precision resistor with adjustability of trim-

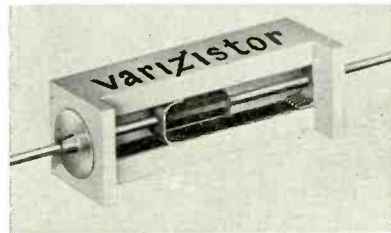

mer potentiometer. Consists of thin-film resistance element bonded to inside surface

Earn Extra Income
in **MOBILE-RADIO MAINTENANCE!**

CITIZENS BAND
AIRCRAFT... MARINE
... PUBLIC SAFETY ...
BUSINESS AND INDUSTRIAL
RADIO
961,000 new transmitters added
last year, with the curve still
going upward!

MEASURE FREQUENCY with the LAMPKIN 105-B

- Just this ONE instrument . . . with no extra crystals or factory adjustments . . . will measure ALL channels from 100 KC to 175 MC. Only \$295.00.
- Ample accuracy for all mobile transmitters except for split-channels above 50 MC—for these use inexpensive accessory PPM Meter.
- Pin-point signal generator for receiver final alignment.
- Internal quartz crystal standard . . . correctable to WWV.

MEASURE FM DEVIATION with the LAMPKIN 205-A

- Just this ONE meter measures all mobile channels, 25 MC to 500 MC.
- Reads instantaneous true peak swing due to FM modulation.
- Set selective-calling tone signals using 0–1.25 KC or 0–2.5 KC ranges of 205-A Quad Scale, \$340.00. Dual Scale model, 12.5 KC and 25 KC ranges, only \$290.00.
- Oscilloscope jack for true wave form.
- 3-inch meter indicates directly in peak KC.



105-B 205-A

FREE BOOKLET!

Send for "HOW TO MAKE MONEY IN MOBILE-RADIO MAINTENANCE".

MAIL COUPON TODAY!

At no obligation to me, please send free booklet and information on Lampkin meters.

Name _____

Address _____

City _____ State _____ Zip _____

LAMPKIN LABORATORIES, INC.
MFA Div., Bradenton, Fla. 33505

Circle 109 on reader's service card

of ceramic housing. Body slides to provide $\pm 20\%$ change in resistance. Multicontact wiper between insulator and lead runs through body of unit, making contact with resistance element to provide circuit continuity. Approximate 20% variation in resistance value, above and below nominal value. Resistance values from 0.5 Ω to 1M Ω available in 42 units. Wattage ratings $\frac{1}{4}$ -1 watt.—Vacco Electronics Div., Vacco Valve Co.

Circle 67 on reader's service card

FIXED ATTENUATOR PAD for pulse, video and rf applications. Available in any value from 1-60 dB in 1-dB steps. Standard impedances: 50, 75, 93 Ω . Stand-

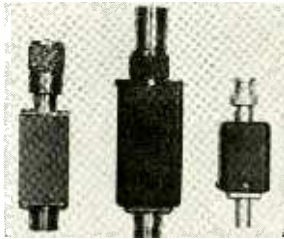

ard connectors UHF, N, BNC. UHF and BNC attenuators rated at $\frac{1}{2}$ watt; type N at 1 watt.—Holland Electronics

Circle 68 on reader's service card

COMPACT RECORD PLAYER, model SP20. 4-speed manual player, semi-counterbalanced arm with adjustable stylus pressure. Tracks as light as 2 grams, full-size weighted turntable, interchangeable



able plug-in head which takes any cartridge. After play, arm returns to rest, shuts off automatically. 14 $\frac{1}{2}$ x 12 $\frac{1}{2}$ x 3 $\frac{1}{2}$ in.—British Industries Corp.

Circle 69 on reader's service card

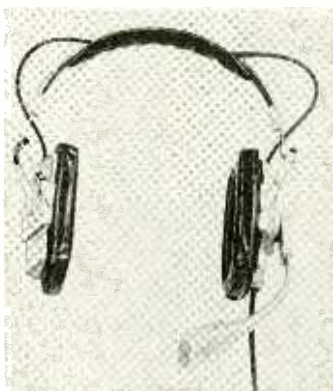

HEADSET-MICROPHONE ASSEMBLIES have foam-filled earcushions;

MAY, 1966

NO COMPETITORS

Nobody else but **EMC** designs in so much value



Full-view meter gives direct, clear-cut quality indications.

Three heavy-duty controls for quick set-up of all tests. Check a fistful of tubes in the time it often takes to test one.

12 slide switches for individual selection of tube pins provides versatility in testing, prevents obsolescence.

Compact, lightweight portability. Use it on the bench or in the field.

Full complement of sturdy sockets accepts compactron (12-pin), muvistor, novar, 10-pin, 9-pin, octal, loctal, and miniature tubes.

Precise programming. Only one socket per tube-base configuration prevents accidental plug-in.

THE MODEL 213 saves you time, energy, money ■ Checks for shorts, leakage, intermittents, and quality ■ Tests all tube types including magic eye, regulator, and hi-fi tubes ■ Checks each section of multi-purpose tubes separately ■ Gives long, trouble-free life through heavy-duty components, including permanently etched panel ■ Keeps you up to date with FREE, periodic listings on new tubes as they come out ■ Your best dollar value in a tube tester. Available in high-impact bakelite case with strap: \$28.90 wired; \$18.90 in kit form. Wood carrying case (illustrated) slightly higher.



ELECTRONIC MEASUREMENTS CORPORATION
625 Broadway, New York 12, New York
Export: Pan-Mar Corp., 1270 B'way, N. Y. 1, N. Y.

EMC, 625 Broadway, New York 12, N. Y.

Rush me FREE catalog describing all EMC value-loaded test instruments and name of local distributor.

NAME _____

ADDRESS _____

CITY _____ ZONE _____ STATE _____

RE-5

LOOK! A NEW ELECTRONICS SLIDE RULE with complete instruction program



Here's a great new way to solve electronic problems accurately, easily . . . a useful tool for technicians, engineers, students, radio-TV servicemen and hobbyists. The Cleveland Institute Electronics Slide Rule is the only rule designed specifically for the exacting requirements of electronics computation. It comes complete with an illustrated Instruction Course. You get four AUTO-PROGRAMMED lessons . . . each with a short quiz you can send in for grading and consultation by CIE's expert instructors.

See for yourself. Learn how to whip through

all kinds of reactance, resonance, inductance, AC and DC circuitry problems in seconds . . . become a whiz at conventional computations too!

This all-metal 10" rule is made to our rigid specs by Pickett, Inc. . . . comes complete with top grain leather carrying case and Instruction Course. A \$50 value for less than \$20. Send coupon for FREE illustrated booklet and FREE Pocket Electronics Data Guide, without obligation. Cleveland Institute of Electronics, 1776 E. 17th St., Dept. RE-122, Cleveland, Ohio 44114. *TRADEMARK

GET BOTH FREE!

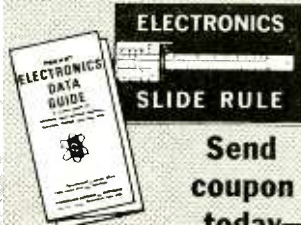

Send coupon today →

Cleveland Institute of Electronics

1776 E. 17th St., Dept. RE-122, Cleveland, Ohio 44114

Send FREE Electronics Slide Rule Booklet. Special Bonus: Mail promptly and get FREE Pocket Electronics Data Guide too!

NAME _____ (Please Print)

ADDRESS _____ COUNTY _____

CITY _____ STATE _____ ZIP _____

A leader in Electronics Training . . . since 1934

Circle 111 on reader's service card

TUNED ON THE LINE

for maximum flow of signal to the set.



That's right!—and that's why Wizard 300 coupling instantly improves both the range and quality of TV-FM signal response—and that's why Wizard 300 couplers immediately convert ordinary reception to excellent reception—why weak, "out of reach", TV-FM signals frequently come into focus—**That's why** (without amplification) no difficulty is experienced in serving up to twenty TV receivers from a single antenna in medium to strong signal areas—and that's why the only limitation to the number of TV receivers which can be effectively operated in a non-amplified master antenna system is the signal strength available at the antenna—and that's why Wizard 300 couplers are regarded as the most valuable means of signal transfer in the distribution of TV-FM signals—and that's why hundreds of thousands of Wizard 300 couplers have been sold—why this uniquely versatile coupler is used in homes, duplexes, motels, apartments, TV sales rooms and housing projects—why professional master antenna system installers as well as the two-three-four-set families use Wizard 300 couplers—Wizards have many astonishing performance advantages—"Tuned on the line for maximum flow of signal to set".

WIZARD COUPLERS contain no moving parts nor thermionic devices—no resistors—no capacitors—no inductances. Its case is of premium weather-resistant plastic material—it is therefore, literally indestructible and maintenance free—designed expressly for twinlead (ribbon)

If you are unable to obtain Wizard couplers from your dealer, order directly from us—List \$1.95 ea.—

.....
 CHARLES ENGINEERING INC., 3421 N. Knoll Dr., Los Angeles, Calif. 90028

 NAME

 ADDRESS

 CITY STATE

Circle 112 on reader's service card

are lightweight. Earphone elements supplied in impedances of 20, 150, 300Ω. Sensitivity 105 dB at 1,000 Hz (ref 0 dB .0002 dyne/cm² with input of 1 mW). Frequency range: 100–4,500 Hz; harmonic distortion less than 2% with 1 mW applied. Six mike types available.—Roanwell Corp.

Circle 70 on reader's service card



Circle 71 on reader's service card



CONSTANT-VOLTAGE TRANSFORMER, the *Multi-Tap CVR*, available in six power ranges: 40, 75, 150, 225, 300, 450 VA. Line regulation of 1% or less, current limiting and isolation from primary voltage; otherwise operates in manner similar to tapped multiple-output transformer. Taps arranged on one side

of transformer so voltages may be tapped off from minimum to maximum voltage of particular model in increments of about 10%. All *Multi-Tap* models operate in full-wave center-tapped or bridge-type circuits with stock silicon rectifiers.—Sola Electric

Circle 72 on reader's service card

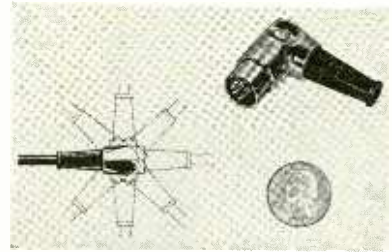

RIGHT-ANGLE AUDIO PLUG has 8 mounting options. Entry routes spaced every 45° in circle on plane parallel with panel or chassis mounting position of plug. 3/8-in. movement along axis of plug required to connect or disconnect; less than 1 1/2-in. total distance needed to mount plug.—Switchcraft Inc.

Circle 73 on reader's service card

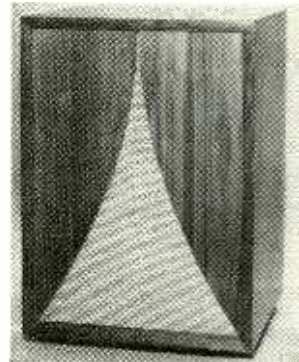

SPEAKER SYSTEM, X-15 (Karlson). Bass down to 12 Hz in only 4.5 cu ft. 15-in. organ speaker with 100 watts max power. Efficiency approx 40%. 1/2-in. cone travel required for highest levels, minimizing Doppler, intermodulation, harmonic distortion. Cone breakup eliminated. Audibility threshold 1μW. 28 x 20 x 14 in., 65 lb. Walnut finish or unfinished birch.—K.R.C. Corp.

Circle 74 on reader's service card



MOISTURE GAGE, model 101, comes with prong-type electrode, carrying strap, battery charger. Accuracy better than ±2% at 70°F. 6 1/4 x 5 1/4 x 2 1/2 in., 2 lb.—Henry Francis Parks Lab

Circle 75 on reader's service card

WHAT YOU SHOULD KNOW ABOUT MICROCIRCUITS IN TELEVISION

Special issue on microelectronics and solid state brings you important servicing know-how on microcircuits in television. Gives the latest dope on keeping the new sets running smoothly. Other features include an outline of how an integrated circuit evolves, fundamental transistor concepts told in a new way, things to build, plus new product and equipment reports!

Coming in June **RADIO-ELECTRONICS**

MY BACK IS KILLING ME!
 I'VE LUGGED THIS STUFF ALL DAY
 AND STILL HAVE TWO CALL-
 BACKS TO GO! MY TUBE CHECKER
 LIED TO ME AND I
 RAN OUT OF
 TUBES FOR
 SUBSTITUTION!

**WISE UP OLD BUDDY! GET
 YOURSELF A MIGHTY MITE...
 NEVER LETS YOU DOWN AND
 IS AS EASY TO CARRY AS YOUR
 LUNCH BOX! I MADE
 10 CALLS ALREADY
 AND SOLD FIVE
 EXTRA TUBES I
 WOULDN'T HAVE
 CAUGHT BY
 SUBSTITUTION!**

YE OLDE TUBE TESTER

YE OLDE BEAT UP TON AND A HALF TUBE CADDY

JOE'S TV SERVICE

MIGHTY MITE

"Finds 'em Fast... Checks 'em All!" SENCORE MIGHTY MITE TUBE CHECKER
 NOW CHECKS OVER 3,000 TUBES

Circle 113 on reader's service card

NEW LITERATURE

All booklets, catalogs, charts, data sheets and other literature listed here are free for the asking with a Reader's Service number. Turn to the Reader's Service Card facing page 70 and circle the number of items you want. Then detach and mail the card. No postage required!

PHONO AND RECORD ACCESSORIES CATALOG, P-661. 16 punched pages of record-care kits, strobe and light kits, brushes, chemical aids, phono cushions, acoustic insulation, etc.—**Robins Industries Corp.**

Circle 76 on reader's service card

INDICATOR LIGHTS CATALOG, L-178A, 12 pages, presents full line of two-terminal, fully insulated subminiature incandescent and neon indicator lights for mounting in 15/32- and 17/32-in. clearance holes. New unified part number system.—**Dialight Corp.**

Circle 77 on reader's service card

TAPE RECORDING GLOSSARY, pocket-size, 16 pages, largely nontechnical definitions of tape recording terms.—**Pofee Electronics**

Circle 78 on reader's service card

1966 IRON-CORE COMPONENTS CATALOGS. Volume I features 52 pages of transformers, inductors, magamps; Volume II, 24 pages of wave filters, high-Q coils and inductors. Cross-index on front cover.—**United Transformer Corp.**

Circle 79 on reader's service card

CONDENSED CATALOG, "The Catalog of Compactrons," publication ETG-3983, 20 pages, lists 97 G-E compactrons and their characteristics compared to conventional tubes.—**General Electric Co.**

Circle 80 on reader's service card

MINICONIC HANDBOOK, Bulletin 201, 8 pages plus price sheet, gives specs and theory of operation, installation, and designing your own circuit for Miniconic phono cartridges and tone arms.—**Euphonics Marketing**

Circle 81 on reader's service card

REPRINT, "Designing a Ducted-Port Bass-Reflex Enclosure," from *Electronics World*, Jan. 1966, 5-page article—with illustrations, of course.—**Jensen Mfg. Div.**

Circle 82 on reader's service card

1966 GENERAL CATALOG, describes, in 44 pages, full line of precision components including batteries, capacitors, circuit breakers, controls, flashlights, jacks and plugs, rectifiers, resistors, semiconductors, timers, vibrators.—**Mallory Distributors**

Circle 83 on reader's service card

1966 SPRING CATALOG, no. 663, 108 illustrated pages of CB equipment, auto accessories, musical instruments, hi-fi components, TV sets, etc.—**Lafayette Radio Electronics**

Circle 84 on reader's service card

MIDGET LIGHT CATALOG, 1966, describes Midgi-Mates (miniature drivers and encoders), Alpha-Lite (alpha-numeric microminiature readout displays), technical data, specs and prices on entire line.—**Pmlites Inc.**

Circle 85 on reader's service card

BROCHURE of specs on Irish 200 Series professional recording tape and 190 Series (semi-professional). Economy Emerald type also described. 6-page foldout.—**Morhan National Sales Co.**

Circle 86 on reader's service card

"SCOTCH" ELECTRICAL PRODUCTS CATALOG, 8 pages, photos and applications of electrical tapes, connectors, splicing kits, resins, splicing materials, sealers, flat cable systems, splice sleeves, mounting plates, cable clips.—**Dept. D6-59, 3M Co.**

Circle 87 on reader's service card

1966 CATALOG. 432 pages of complete product descriptions on more than a million items of electronic, electrical components. Company has 5 warehouses throughout country.—**Federated Purchaser, Inc.**

Circle 88 on reader's service card

ENCAPSULATED-BATTERY BROCHURE, Bulletin VO-113a, 4-page, looseleaf punched, illustrated. Describes VO series of encapsulated alkaline rechargeable batteries.—**Gulton Industries**

Circle 89 on reader's service card

HI-FI/STEREO COMPONENT data sheets, on speaker systems, model 16 amplifier, model 18 tuner. Reprints of magazine reports, grouped under title "What Do the Critics Say about KLH?"—**KLH Research and Development Corp.**

Circle 90 on reader's service card

Write direct to the manufacturers for information on the items listed below:

SEMICONDUCTOR REPLACEMENT/INTERCHANGEABILITY GUIDE lists replacements for about 5,000 semiconductors: transistors, diodes, silicon rectifiers, selenium rectifiers, selenium diodes, TV color rectifiers. Free at Semitron dealer or 25¢ for postage to **Semitronics Corp.**, 265 Canal St., New York, N. Y. 10013

Live Better Electronically With

LAFAYETTE RADIO ELECTRONICS

FREE!



512 Pages
1966 Catalog 660

Featuring Everything in Electronics for
• HOME • INDUSTRY • LABORATORY
from the
"World's Hi-Fi & Electronics Center"

Mail the Coupon Today for Your
FREE 1966 Lafayette Catalog 660

LAFAYETTE Radio ELECTRONICS
Dept. JE-6, P.O. Box 10
Syosset, L.I., N.Y. 11791

Send me the Free 1966 Lafayette Catalog 660 JE-6

Name

Address

City

State Zip

(Please Give Your Zip Code No.)

Circle 114 on reader's service card

exactly
where do you
plan to go
in

electronics



PAGE 31 CAN HELP YOU MAP IT OUT.

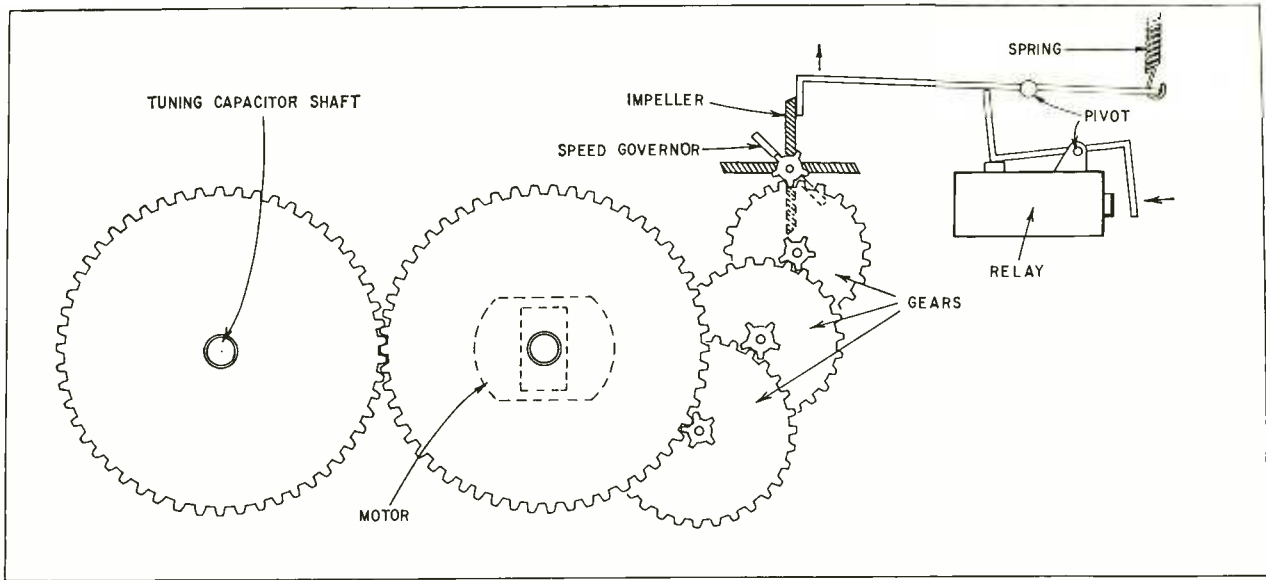

Fig. 1—Clockwork motor saves weight and battery power. Impeller provides speed regulation and instant stopping.

The Lowdown on Touch Tuning

Lazy-man's automatic tuning systems are popping up even on lightweight portable radios.

By **ROBERT F. SCOTT**
TECHNICAL EDITOR

AUTOMATIC TUNING SYSTEMS, POPULAR features of many prewar radios, are here again! Just touch a button and tune in a station automatically. Let's take a look at four typical circuits and see how they work.

In the early 1950's they were adapted for some auto radios. Now, search or signal-seeking tuning has been added

to a number of transistor portables and several hi-fi tuners and receivers. In all cases, the search tuning system is started manually and stopped automatically when the incoming signal is tuned in.

The automatic tuning system used in several imported portables is developed around a clockwork motor and a new 360° tuning capacitor. The capacitor makes it unnecessary to reverse the tuning motor at the end of each 180°

sweep of the tuning capacitor. The basic clockwork tuning mechanism is shown in Fig. 1.

The spring motor is wound by turning a winding key alternately clockwise and counterclockwise as you would twist the stem on a watch. The motor is geared to the tuning capacitor and to an impeller. The impeller turns at approximately 10,000 rpm and makes 3.-364 revolutions for each revolution of the tuning capacitor. It has four blades that can be latched by the relay armature and two additional blades that control its speed by air resistance.

Pressing the auto-tune button either depresses the relay armature or energizes the relay coil to release the impeller. The motor turns the tuning capacitor until a station is tuned in and a trigger signal releases the relay. The lever drops into the impeller, stopping it instantly. The tuning capacitor stops turning and the tuning cycle is completed. Contacts on the relay mute the receiver and defeat the afc system during tuning, and set the radio's sensitivity to the desired level.

Radar-Matic tuning

This is Panasonic's name for the signal-seeking system used in their model R-1000 10-transistor AM portable. The Radar-Matic circuit is shown in Fig. 2. The AUTO TUNE switch is an spdt snap-action type that returns to its

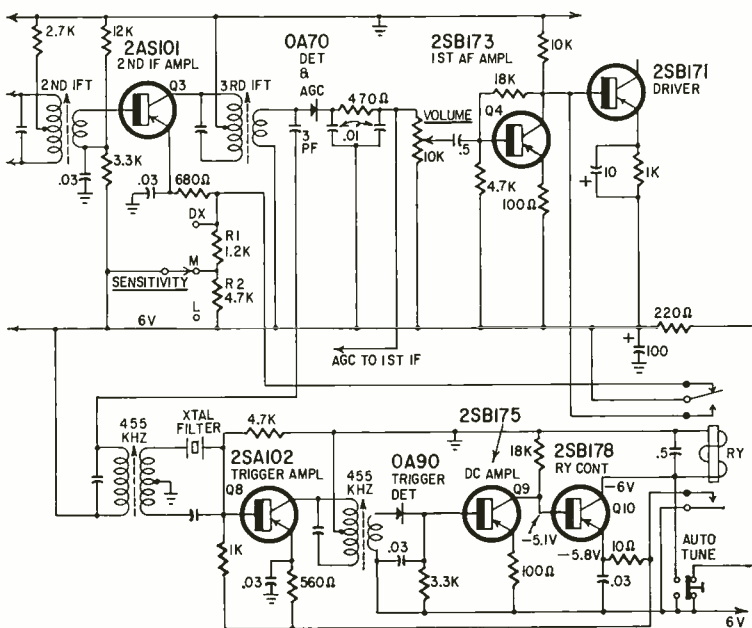

Fig. 2—Panasonic R-1000's "Radar-Matic" circuit uses system of Fig. 1, plus this circuit.

4 easy ways to increase your know-how on microelectronics and solid state!

How to Build Tiny Electronic Circuits

By *Morris Moses*. Explains "miniaturized" electronics to the hobbyist, experimenter and service technician. Not only takes the mystery out of "making it smaller", but is a veritable "how to do it" of electronic miniaturization. Covers sub-miniaturization, microminiaturization, high-frequency receiver, molecular electronics, meter amplifiers, tone generators, semiconductor thermometers, making tools, preamplifiers, comparators, pocket radios, photorelays, components, techniques, modules, practical projects and devices, construction and repair hints. 192 pages.

Order #117 Softbound \$4.15

Getting Started With Transistors

By *Louis E. Garner, Jr.* Transistor know-how begins with this volume. Shows how transistors began, how to read electronic diagrams, how transistors work, facts on oscillators, transistor types, diodes, phototransistors, rectifiers, transistor ratings, testing transistors. Excellent text, diagrams and photographs carry you through every phase of transistors to give you a complete grasp of the subject. 160 pages by an expert in the field.

Order #116 Softbound \$3.95

Fundamentals of Semiconductors

By *M. G. Scroggie*. Provides a complete background in semiconductor devices, beginning with basic facts on electrical conduction through transistors, rectifiers, photoelectric devices, thermistors, varistors, diodes, cryosars, etc. Supplies enough theory in a simple way to make it possible to understand more advanced literature. Also explains how the special properties of semiconductors are being applied in many kinds of useful devices. Dozens of charts, diagrams and photos. 160 pages.

Order #92 Softbound \$2.95

Printed Circuits

By *Morris Moses*. Build-it-yourself circuits for miniature amplifiers, receivers, and many other transistor devices. Written especially for the radio ham, TV and radio service technician, and the home experimenter. Specializes in practical techniques and methods. Shows how to repair printed-circuit and subminiature assemblies. 224 pages jam-packed with illustrations.

Order #81 Softbound \$2.90

Order from your Parts Distributor or Mail to:
Gernsback Library Inc., Dept. RE 56
154 West 14th Street, N.Y., N.Y. 10011

Please send the following books. I enclose \$.....

117 (\$4.15) 116 (\$3.95)

92 (\$2.95) 81 (\$2.90)

Prices 10% higher in Canada.

Name

Address

City State Zip

My Distributor is

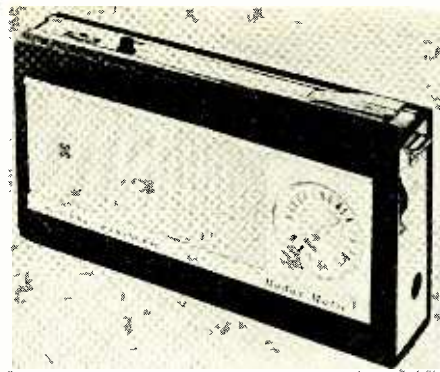

Panasonic R-1000 Radar-Matic. Automatic tuning control is in top right corner.

trigger pulse turns off Q10 and de-energizes the relay instantly.

There is a slight mechanical delay between the time the relay is released and the time the tuning capacitor stops. To overcome this, the relay circuit is designed so the trigger pulse occurs about 2 kHz off center frequency (455 kHz) and the capacitor stops when the i.f. carrier is exactly in the center of the passband.

Hitachi TH-900

Fig. 3 is a simplified version of the automatic tuning system used in the Hitachi TH-900. When the AUTO TUNE button is pressed, the normally open relay contacts are closed manually. The lower set of contacts disconnects the speaker and completes the collector circuits of Q1 and Q2. Q2's collector current energizes the relay, locking it in and releasing the spring-type tuning motor.

The i.f. oscillator (Q1) is a bfo tuned to the center of the i.f. passband (455 kHz). Mixer D1 heterodynes the signals from Q1 and the output of the second i.f. amplifier. The resulting audio beat is passed through an R-C network that greatly accentuates the low frequencies, and then fed to the input of the set's audio amplifier.

The signal is tapped off the base of one of the push-pull output transistors and fed back to the anode of D2. D2 is back-biased by the negative voltage (about 0.25 volt) on Q2's base. When the audio beat is within a few hundred

cycles of zero beat, the signal intensity is high enough to override D2's back-bias and develop a positive voltage that cuts off Q2, releasing the relay and stopping the motor. The 39,000-ohm resistor in Q2's base circuit is selected so the tuning motor comes to a stop just as the i.f. carrier is centered in the passband.

The Sony approach

The Sony AFM-152 is an automatic-tuning deluxe 15-transistor AM-FM set featuring a 2-way speaker system, separate bass and treble controls, sleep timer, recorder and MPX output jacks, battery indicator, dial lamps and wired remote on-off, volume and tuning controls. The AFM-152's automatic tuning system is shown in Fig. 4. This set has a reversible dc motor.

The TUNE switch consists of two ganged pushbuttons: one for tuning left to right and the other for tuning right to left. Both are ganged to the START switch. Search tuning is started by pressing the TUNE RIGHT or TUNE LEFT buttons and is stopped automatically by a voltage pulse derived from the i.f. circuit. The relay is shown in the de-energized position as it is after a station is tuned in. The first (top) set of double-throw contacts connects the afc line to the variable-capacitance diode in the FM oscillator circuit. The second and third sets of contacts connect the motor across the 9-volt battery through Q4's emitter-collector circuit. Capacitor C is charged through the third set of contacts and the transistor is held at cutoff by the positive voltage on its base. The bottom contacts complete the emitter circuit of the audio output stage.

Momentary pressure on a TUNE button closes the START switch and energizes the relay through the 10-ohm resistor. The bottom relay contacts open the output transistors' emitter circuits and close Q3's emitter circuit. Q3's collector current keeps the relay energized. The second contact connects the motor to the negative side of the battery. The third contact set connects the motor to the positive side of the battery and, at the same time, shorts capacitor C through the base resistor. The motor starts and turns the tuning capacitor toward the next station.

The i.f. signal is tapped off just ahead of the AM and FM detectors and fed to search amplifier Q1. The input and output transformers in this stage are special narrow-band units. AM selectivity is further sharpened by a 455-kHz ceramic filter. When a station is tuned in so its carrier is centered in the i.f. passband, the signal is rectified and amplified, driving Q3 to cutoff and releasing the relay.

As the relay returns to its normal position, the motor is connected in se-

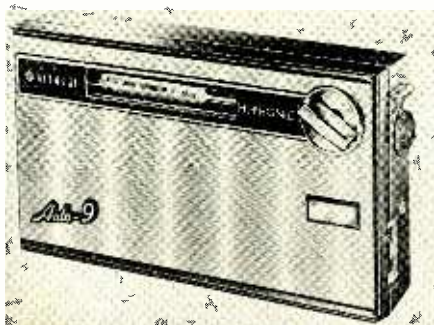

Hitachi TH-900 Auto-9 has drum dial.



Take your toughest electronics problems to the Gernsback Book Rack at your parts distributor —for instant answers!

When you need immediate answers to thorny electronics problems, go directly to the Gernsback Library Book Rack at your favorite electronics parts distributor. This unique information center will automatically give you accurate answers to every imaginable electronics problem you may face. You'll find answers on radio and TV servicing, transistors, hobby projects, test instruments, audio, hi-fi, stereo, tape recording, communications, industrial electronics, to name just a few areas. Each book is written by an expert and designed to give you practical assistance in the field you desire. So check the Gernsback Rack at your parts distributor when you have a question. You'll increase your know-how and get more fun out of electronics as well.

Servicing AGC Circuits

By Harry E. Thomas. This practical how-to-do-it manual first shows you everything that can go wrong with AGC circuits and then goes on to reveal all you need to know to correct the trouble. Enables you to locate breakdowns quickly, in AGC circuits, and then make your repairs rapidly and intelligently. Specific service approaches are plainly spelled out so you can use them immediately. Special emphasis is placed on TV troubleshooting, giving you the devices and techniques used in modern circuitry. Easy-to-read explanations, helpful illustrations, readily understood charts give you the information you need to start servicing AGC circuits as soon as you've read the book. 204 pages, softbound, available through parts jobbers only.

Order #126\$3.95

Color TV Repair

By 10 Servicing Experts. Top technicians like David R. Anderson, Ed Bukstein, Jack Darr, Homer L. Davidson, Art Margolis, Robert Middleton and Warren Roy have created here, an important tool for the profit-minded service technician. Tells you clearly and concisely just what can go wrong in color TV receivers and how to fix them. First each trouble symptom is described in detail, then a perfect solution is provided for the problem. Book covers color circuits, ABC's of color TV servicing, antennas and boosters, replacing the color picture tube, how to pinpoint the defective color section fast, servicing the chroma circuits, unexpected causes of TV color failure, troubleshooting with a color bar generator, color servicing tips, plus a glossary of color TV terms. In addition, the volume is crammed with photos and schematics. 160 pages, softbound.

Order #123\$2.95

TV Sweep Oscillators

By Harry E. Thomas. A giant reference and practical working tool for every service technician and engineer who wants to know what can go wrong with sweep oscillators and how to repair them. Covers relaxation oscillators, pulse techniques, transistorized oscillators, failure analysis, sawtooth generators, synchronization, sweep oscillator servicing, AFC in horizontal circuits, multivibrators and blocking oscillators. Completely illustrated, 226 pages, softbound, available at parts jobbers only.

Order #119\$3.95

Horizontal Sweep Servicing Handbook

By Jack Darr. Gives you fast, simple methods of locating and repairing troubles in the sweep sys-

tem. Shows you lots of practical shortcuts developed on the bench for the rapid isolation of trouble. Written by an expert in the field and packed with schematics to help you do a better job. 224 pages, softbound.

Order #115\$4.10

The Handbook of Electronic Tables

By Martin Clifford. Here is an effective new approach to solving electronics problems. You don't have to make mathematical computations, or carry a slide rule or memorize any formulas whatsoever. Every answer you will ever need is worked out for you in 160 fact-packed pages of accurate electronic tables. Simply take the figures of your electronics problems and turn to the appropriate table. Then move your finger across the table and read the answer, instantly. You'll find these tables are easy to use, offer a wide choice of solutions and provide a high degree of accuracy. Softbound.

Order #125\$2.95

Electronics Data Handbook

By Martin Clifford. Gives you the most-needed formulas and data in electronics. Tells exactly which formula to use to solve a problem. Provides an easier formula if there is one. Shows what substitutions, if any, can be made in formulas. 160 pages, softbound.

Order #118\$2.95

Hi-Fi Troubles

By Herman Burstein. High fidelity is complex and sophisticated and the more complex it is, the more apt it is to develop troubles. This book tells you how to maintain your audio system to keep it in peak condition for peak performance. It shows you why you have troubles, how to locate them, how to fix them. Most important, it shows you what *not* to do. *Hi-Fi Troubles* saves both time and money and helps solve problems like these: excessive hum; deteriorating equipment; noise in switches, tubes, resistors, etc.; distortion; bass and treble problems; installation; problems faced by kit builders; stereo and tape completely illustrated, softbound.

Order #120\$3.95

Probes for Test Instruments

By Bruno Zucconi and Martin Clifford. A probe is a link. It is a device you connect between a test instrument like a scope or v.t.v.m. and a radio or TV set being repaired. The finest scope or v.t.v.m. is limited by the *kind* of probe you use, and by *how much* you know about putting probes to work for you. Now comes this valuable handbook showing you in clear detail exactly what probe to use for a particular job. Covers

crystal-demodulator probes, voltage-doubler probes, balanced probes, low-capacitance probes, high-voltage probes, isolation probes, direct probes, specialized probes, vacuum-tube and semiconductor probes. 224 pages, softbound. Newly Revised.

Order #54\$2.50

The Oscilloscope

By George Zwick. Enables technicians to become masters of the scope. Incorporates newest uses and techniques. Covers waveforms, the cathode-ray tube, sweep systems, typical oscilloscopes, alignment, oscilloscope techniques, tests and measurements, experiments using the oscilloscope. The book is fully illustrated. 224 pages, softbound.

Order #108\$3.65

The V.T.V.M.

By Rhys Samuel. Get the most out of this electronic workhorse. Explains V.T.V.M. circuits and how and why they work. Gives many new time-saving uses. Eleven important chapters tell all: instrument characteristics, how the V.T.V.M. works, meter scales, probes and cables, using the V.T.V.M., TV troubleshooting, AM-FM alignment and repair, servicing audio amplifiers, the V.T.V.M. in the ham shack, miscellaneous applications, troubleshooting the V.T.V.M. 224 pages, completely illustrated, softbound.

Order #57\$2.50

How to Get the Most out of your VOM

By Tom Jaski. Get more mileage out of this versatile instrument. A complete analysis including theory and practical usage, plus important chapters on construction. 224 pages, illustrated, softbound.

Order #85\$2.90

Order from your Parts Distributor or Mail to:
Gernsback Library, Inc., Dept. RE 56
154 West 14th Street, N.Y., N.Y. 10011

Please send the following paperback books.
 I enclose \$

<input type="checkbox"/> 123 (\$2.95)	<input type="checkbox"/> 54 (\$2.50)
<input type="checkbox"/> 115 (\$4.10)	<input type="checkbox"/> 108 (\$3.65)
<input type="checkbox"/> 125 (\$2.95)	<input type="checkbox"/> 57 (\$2.50)
<input type="checkbox"/> 118 (\$2.95)	<input type="checkbox"/> 85 (\$2.90)
<input type="checkbox"/> 120 (\$3.95)	Prices 10% higher in Canada.

Name

Address

City State Zip

My Distributor is

Get these books at your parts distributor or mail ➔

TECHNOTES

BATTERY HOLDER BECAME BATTERY

An item of industrial electronics I was working on was unstable. After much checking and substitution, I found the trouble in the battery holder, which held a mercury cell that supplied bias for an electrometer tube.

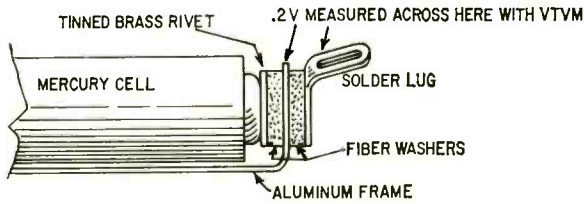

Slight leakage from the cell had found its way between the brass contact and the aluminum bracket of the holder. The resulting battery action produced a potential of about 0.2 volt which varied from day to day, probably depending on the humidity.

Replacing the battery holder corrected the trouble.
—John Terrell

ADMIRAL G13 CONVERGENCE YOKES

You may encounter some early G13 convergence yokes on which the static convergence magnet sticks or becomes intermittent when the thumb wheel is rotated. In such cases the magnet may be stuck to the coil impregnating wax or may be binding against the bronze clip core spring under the magnet wheel.

To correct this condition, loosen the clamp and remove the convergence yoke from the CRT neck. Disassemble the three pole-piece exciters. To remove the cover from the pole-piece exciter, carefully insert a screwdriver or knife blade between the plastic cover and the back near one of the four heat-sealed pins. Pry the two pieces apart gently at each of the four pins and remove the cover by first separating the two pieces at the end opposite the thumb wheel until the iron pole shoes are cleared, then separate the thumb-wheel end and remove cover completely. Take care not to lose the spring washer from the top of the thumb wheel. Remove the thumb wheel assembly which consists of the round magnet, spring washer and plastic thumb wheel.

Examine the round magnet for a copper color on the core-contacting surface. If this color shows on the magnet, then press the bronze clip core spring into the case until it is below the surface of the ferrite core to prevent rubbing. If the core shows excessive wax on the surface where the round magnet fits, remove the excess with a cleaning fluid that will not damage plastic.

Reglue the round magnet to the thumb wheel with a vinyl or epoxy resin cement. Before you apply cement, check that the side of the round magnet which will contact the pole piece has the greatest attraction to it—apply the cement to the *WEAK* side. Also be sure that the cement doesn't run down the side or the center hole of the magnet and interfere with the fit of the magnet to the core. Allow to dry.

Replace the thumb wheel assembly in position on the pole-piece core and assemble the unit in the reverse order of disassembly. As the cover is placed over the iron pole shoes, guide the thumb wheel into its socket. Press the cover and back together and reseal the four posts with a hot soldering iron.

Assemble the three pole-piece exciters so that the clamp is on the left hand side of the unit with blue up and facing the thumb wheel.—Admiral Service News Letter

MAY, 1966

... places a complete range of components at your fingertips for fast substitution ...

The Model 501 provides all the substitutes for electronic components you want and need in your every day work... Carbon Resistors — Power Resistors — Capacitors — Electrolytics — Crystal Diodes — Selenium Power and Silicon Power Rectifiers.

ELECTRONICS CORPORATION
Manufacturers of quality electronic products
315 Roslyn Road, Mineola, N. Y. 11501

IN CANADA: William Cohen Corp., EXPORT, Mcgahan Exporting Corp., 458 Broadway, New York, N. Y. 10013

Model 501 COMPONENT SUBSTITUTOR

... the instrument acclaimed by servicemen, engineers and school shops now available in a wire-it-yourself KIT!

step-by-step illustrated instructions make the Model 501 easy-to-build...

\$25.95 Net
Model 501K Kit

\$39.95 Net
Model 501 Wired

Substitutes for any one of over 80 component values

Will substitute up to 4 different components at the same time

A surge protector switch prevents arcing, sparking, or heating of electrolytics

Electrolytics are discharged automatically

See the Model 501 at your distributor or write for complete specifications

Circle 118 on reader's service card

POOR AM RECEPTION

In R-E Technotes for December 1964, page 85, Herbert Greenberg describes a difficulty due to leakage between windings in the i.f. transformer in a small ac-dc radio, and recommends replacing the transformer. If the leakage is actually between the coils, this is undoubtedly the best method of repair.

However, in some cases the leakage is between the two trimmer capacitors at the top of the i.f. can. Dust, probably containing moisture-gathering materials, settles on top of the mica insulator. In damp weather a film of moisture forms. When the radio is turned on, current from B + flows through this film to ground via the avc bus. The current carbonizes the organic materials in the dust film, and lays down what is equivalent to a deposited-film resistor. Current flowing through this "resistor" upsets the avc bias, and causes the effects described by Mr. Greenberg. A simple repair is possible.

Remove the can from the i.f. transformer and examine the mica insulator between the trimmers. A dark film on the surface of the mica indicates trouble. With a sharp knife or razor blade, carefully scrape off this film, avoiding damage to the insulator. A magnifying lens or binocular magnifier is very useful here. After replacing the can, touch up the alignment, and finally stick a piece of tape over the holes in the can to prevent recurrence of this trouble.

—Roger Winters

EICO 249 VTVM DRIFT

Although accurate, this vtm has a strong zero drift. The problem was solved by allowing the tube heaters to remain on continuously and switching only the B-plus on and off. The same method can be applied to many other instruments that drift.—Allan Glaser

END

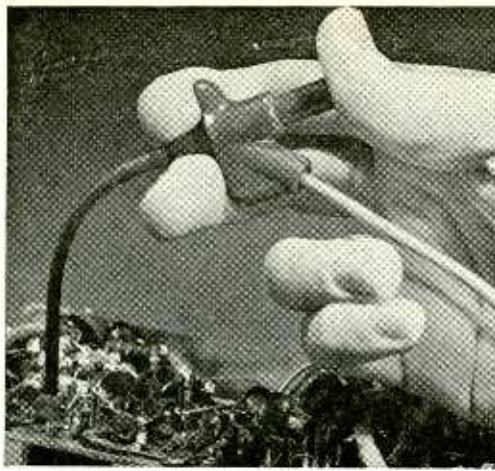

Clever Kleps 30

Push the plunger. A spring-steel forked tongue spreads out. Like this  Hang it onto a wire or terminal, let go the plunger, and Kleps 30 holds tight. Bend it, pull it, let it carry dc, sine waves, pulses to 5,000 volts peak. Not a chance of a short. The other end takes a banana plug or a bare wire test lead. Slip on a bit of shield braid to make a shielded probe. What more could you want in a test probe?

\$1.47



Available through your local distributor, or write to:

RYE INDUSTRIES INC.

126 Spencer Place, Mamaroneck, N.Y. 10543

Circle 119 on reader's service card

"MOVING OUT SALE" PORT OF N. Y. AUTHORITY TAKING OVER 13 BLOCKS FOR TRADE CENTER & WE'RE IN IT!

We must unload 3 BULGING WAREHOUSES . . . at the GREATEST PRICE SLASH in Electronic History!

We will have 2 Places to serve you — Uptown at 2271 Broadway, Downtown still pending — Sale may end soon — HURRY, HURRY, HURRY.

FREE \$1 BUY WITH EVERY 10 YOU ORDER

Only applies to "\$1" Buys

FREE GIFT WITH EVERY ORDER

- 1000—ASST. HARDWARE KIT \$1 screws, nuts, washers, rivets, etc.
- 250—ASST. SOLDERING LUGS \$1 best types and sizes
- 250—ASST. WOOD SCREWS \$1 finest popular selection
- 250 — ASST. SELF TAPPING SCREWS #6, #8, etc.
- 150—ASST. 6/32 SCREWS and 150 6/32 HEX NUTS
- 150—ASST. 8/32 SCREWS and 150—8/32 HEX NUTS
- 150—6/32 HEX NUTS and 150—8/32 HEX NUTS
- 150—ASST. 2/56 SCREWS and 150—2/56 HEX NUTS
- 150—ASST. 4/40 SCREWS and 150—4/40 HEX NUTS
- 150—ASST. 5/40 SCREWS and 150—5/40 HEX NUTS
- 500—ASSORTED RIVETS most useful selected sizes
- 500—ASSORTED WASHERS most useful selected sizes
- 100 — ASST. RUBBER & FELT FEET FOR CABINETS best sizes
- BONANZA "JACKPOT" not gold, not oil, but a wealth of Electronic Items—Money-Back-guarantee
- 100'—MINIATURE ZIP CORD \$1 2 conductor, serves 101 uses
- 5—LINE FILTER COILS 110v, 117v, 2.5mh. dual, many uses
- 10 SETS — DELUXE PLUGS & JACKS asst. for many purposes
- 10 — SETS PHONO PLUGS & PIN JACKS RCA type
- 10 — SURE-GRIP ALLIGATOR CLIPS 2" plated
- 4—50' SPOOLS HOOK-UP WIRE 4 different colors
- 200'—BUSS WIRE #20 tinned for hookups, special circuits, etc.
- 100 — STRIPS ASSORTED SPAGHETTI handy sizes
- 100—ASSORTED RUBBER GROMMETS best sizes
- 50—ASSORTED PRINTED CIRCUIT SOCKETS best types
- 20—ASSORTED VOLUME CONTROLS less switch
- 7—ASSORTED VOLUME CONTROLS with switch
- 20—ASST. PILOT LIGHTS #44, 46, 47, 51, etc.

RCA 110° FLYBACK TRANSFORMER



We scooped the Market Latest type — standard for all 110° TV's
RCA's design of large Coil produces 18KV—assuring adequate width
Incl Schematic Diagram application for any TV
List price \$13.00
Your price . . . **\$3**
10% off in lots of 3

- 90° FLYBACK TRANSFORMER \$1 for all type TV's incl schematic
- 70° FLYBACK TRANSFORMER \$1 for all type TV's incl schematic
- 70° TV DEFLECTION YOKE \$1 for all type TV's incl schematic
- 4 — TV ALIGNMENT TOOLS most useful assortment
- 20—ASSORTED TV COILS I.F. video, sound, ratio, etc.
- 40—ASSORTED TV KNOBS all standard types, \$20 value
- 20—ASSORTED GRID CAPS for 1B3, 1X2, 6BG6, 6BQ6, etc.
- 100 — ASSORTED TV PEAKING COILS all popular types

- TV TUNERS — VHF, UHF, COLOR new & complete closing out odds & ends buy asst & get all 3 types ea **\$4**
- 7 — ASST. TV ELECTROLYTIC CONDENSERS popular selection
- \$15.00 TELEVISION PARTS \$1 "JACKPOT" best buy ever
- 3 — COLOR-TV CRT SOCKETS \$1 wired leads, for all color TV's
- 10 — ASST UHF TUNER STRIPS \$1 standard 16 to 67 \$50 value
- 1—RB SPOOL ROSIN-CORE \$1 SOLDER 40/60 top quality
- 2—G.E. PIECES OF EQUIPMENT \$1 stacked with over 200 useful parts
- 10—ASSORTED DIODE CRYSTALS \$1 1N34, 1N48, 1N60, 1N64, 1N82
- 10—TOP BRAND TRANSISTORS \$1 NPN & PNP 2N404, 2N414, etc.
- TRANSISTOR RADIO asst type \$1.50 good, bad, broken, as-is, hotluck
- 20 — EXPERIMENTER'S COIL \$1 "JACKPOT" assorted for 101 uses
- 5 — ASSORTED TRANSFORMERS \$1 Radio, TV and Industrial

IMMEDIATE DELIVERY . . . Scientific light packing for safe delivery at minimum cost.
HANDY WAY TO ORDER: Pencil mark or write amounts wanted in each box, place letter F in box for Free \$1 BUY. Enclose with check or money order, add extra for shipping. Tearsheets will be returned as packing slips in your order, plus lists of new offers.

Name Cost of goods
Address Shipping estimated
TOTAL

Please specify refund on shipping overpayment desired: CHECK POSTAGE STAMPS MERCHANDISE (our choice) with advantage to customer

Circle 120 on reader's service card

TRY THIS ONE ✓

USE YOUR SCOPE FOR SWEEP-SIGNAL SUBSTITUTION

Your scope will be more useful in bench work if you bring the sawtooth deflection voltage out to the front panel, for use in signal-substitution tests of horizontal and vertical sweep circuits. As shown in Fig. 1, the sawtooth is taken off from the "hot" horizontal deflecting

plate of the scope. In push-pull stages, either horizontal plate can be used.

To use the test signal, disconnect the input end of the grid capacitor from the output tube and run a test lead from the scope sawtooth post to the grid capacitor (Fig. 2). If you are testing the horizontal system, operate the scope sweep oscillator at 15,750 Hz, or 60 Hz if you are testing the vertical output system. Adjust the horizontal gain control of the scope for the right drive. If you obtain a raster on the screen of the picture tube, the output system is OK.

Although it is not always necessary to open the lead to the grid capacitor, this may be found necessary to obtain adequate drive when the receiver drive circuit has relatively low impedance.

With this small modification, a scope becomes a complete horizontal and vertical system analyzer.—Robert G. Middleton

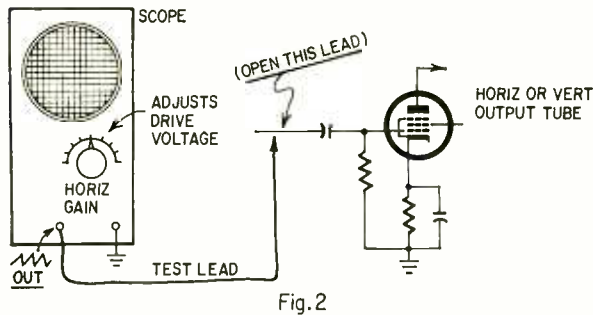
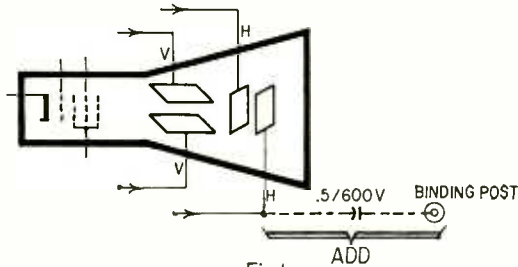

there's
**EXTRA
PROFIT in
NOISECTOMIES***

QUIETROLE

IS HARMLESS TO PLASTICS

Harmless to metal... non-conductive, non-inflammable and non-corrosive. Zero effect on capacity and resistance.



* a simple quick operation performed by Doctors of Electronics with the aid of Quietrole to cure scratchy, noisy tuners and controls of TV and radio. Fast set recovery with no ill side-effects assured. Saves time... makes money for servicemen.

At Your Distributor... Ask for Quietrole by Name.



manufactured by
QUIETROLE CO.
Spartanburg, South Carolina

Circle 121 on reader's service card

CANADIANS: Ordering is easy . . . we do the paperwork . . . try a small order

SARKES TARZIAN TV TUNER 41mc

Latest Compact Model—good for all 41 mc TV's.
BRAND NEW—MONEY BACK GUARANTEE



Best TUNER "SARKES TARZIAN" ever made—last word for stability, definition & smoothness of operation. An opportunity—to improve and bring your TV Receiver up-to-date.

COMPLETE with Tubes & Schematic... \$7.95

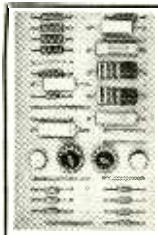

IBM COMPUTER SECTIONS

8 assorted Units we sell for \$1 are loaded with over 150 valuable parts.

Incl. — Transistors, Condensers, Resistors, Heat Sinks, Diodes, Etc.

8 for \$1
100 for \$10

HIGHWAY AM-FM PORTABLE RADIO

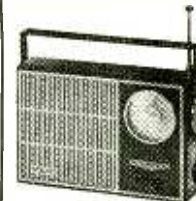

Elegance in Ebony & Chrome
14 Transistors — A Powerhouse of Quality Reception with AFC Operates on 4 "C" Cells
22" Telescoping FM Antenna & Personal listening attachment
Money refund — if not better than any Known Brand selling for even twice the price
8"x5 1/4"x2 1/4" — 4 lbs

COMPLETE... \$19.50

- | | | | |
|---|---|---|---|
| <input type="checkbox"/> 50 — ASSORTED MYLAR CONDENSERS popular selected types... \$1 | <input type="checkbox"/> TELEPHONE JACK or PLUG make any telephone portable... ea 50¢ | <input type="checkbox"/> 100 — ASST. CERAMIC CONDENSERS Some in 5%... \$1 | <input type="checkbox"/> 1 — SQ. YARD GRILLE CLOTH \$1 most popular brown & gold design |
| <input type="checkbox"/> 5 — ASST. SELENIUM RECTIFIERS 65ma, 100ma, 300ma, etc. \$1 | <input type="checkbox"/> TELEPHONE RECORDING DEVICE place it under telephone... \$1 | <input type="checkbox"/> 100 — ASST. MICA CONDENSERS some in 5%... \$1 | <input type="checkbox"/> UNIVERSAL 2" PM SPEAKER Alnico 5 magnet, quality tone... 29¢ |
| <input type="checkbox"/> 50 — RADIO & TV SOCKETS all type 7 pin, 8 pin, 9 pin, etc. \$1 | <input type="checkbox"/> CRYSTAL LAPEL MICROPHONE high impedance, 200-6000 cps... \$1 | <input type="checkbox"/> 100 — ASST 1/4 WATT RESISTORS stand. choice ohmages, some in 5%... \$1 | <input type="checkbox"/> UNIV. 3" x 5" PM SPEAKER Best type for Radios, TV, Etc. 75¢ |
| <input type="checkbox"/> CLEAN UP THE KITCHEN "JACKPOT" Big Deal only one to a customer... \$1 | <input type="checkbox"/> TAPE RECORDER — assorted types good, bad, broken, as-is, potluck \$4 | <input type="checkbox"/> 100 — ASST 1/2 WATT RESISTORS stand. choice ohmages, some in 5%... \$1 | <input type="checkbox"/> UNIVERSAL 4" PM TWEETER SPEAKER for FM, Hi-Fi, etc. 59¢ |
| <input type="checkbox"/> 4 — TRANSISTOR RADIO EARPIECES wired complete with plug \$1 | <input type="checkbox"/> 4 — SHOCKPROOF SCREWDRIVERS best sizes incl Philips... \$1 | <input type="checkbox"/> 70 — ASST 1 WATT RESISTORS stand. choice ohmages, some in 5%... \$1 | <input type="checkbox"/> UNIVERSAL 4" PM SPEAKER Alnico 5 magnet, quality tone... 69¢ |
| <input type="checkbox"/> 3 — STANDARD SAPPHIRE NEEDLES for all thumbscrew cartridges \$1 | <input type="checkbox"/> 50 — BALL POINT PENS Retractable, assorted colors... \$1 | <input type="checkbox"/> 35 — ASST 2 WATT RESISTORS stand. choice ohmages, some in 5%... \$1 | <input type="checkbox"/> 3 — AUDIO OUTPUT TRANSFORMERS 50t.6 type... \$1 |
| <input type="checkbox"/> 50 — G.E. FLASHLIGHT BULBS #PR-9, 2.7 volts... \$1 | <input type="checkbox"/> 100 — MIXED DEAL "JACKPOT" Condensers, Resistors, Surprises... \$1 | <input type="checkbox"/> 50 — PRECISION RESISTORS asst. list-price \$50 less 98%... \$1 | <input type="checkbox"/> 10 — SPEAKER PLUG SETS deluxe type, 2 conductor, wired... \$1 |
| <input type="checkbox"/> 10 — ASSORTED SLIDE SWITCHES SPST, SPDT, DPDT, etc. \$1 | <input type="checkbox"/> 300 — ASST. 1/2 W RESISTORS Top Brand, Short leads, excellent... \$1 | <input type="checkbox"/> 20 — ASST'D WIREWOUND RESISTORS, 5, 10, 20 watt... \$1 | <input type="checkbox"/> \$15.00 RADIO PARTS "JACKPOT" handy assortment... \$1 |
| <input type="checkbox"/> CHAPT ZU DI MITZIA "JACKPOT" double your money back if not completely satisfied... \$1 | <input type="checkbox"/> 100 — MOLDED TUBULAR COND. Top brand, short leads, excellent... \$1 | <input type="checkbox"/> 100 — ASST. TERMINAL STRIPS all types, 1-lug to 6-lug... \$1 | <input type="checkbox"/> 50 — ASST. TUBULAR CONDENSERS .001 to .47 to 600v... \$1 |
| <input type="checkbox"/> 10 — ASST. RADIO ELECTROLYTIC CONDENSERS \$1 | <input type="checkbox"/> 50 — ASSORTED #3AG FUSES popular assorted ampere ratings... \$1 | <input type="checkbox"/> 25 — INSTRUMENT POINTER KNOBS selected popular types... \$1 | <input type="checkbox"/> 20 — IIT SELENIUM RECTIFIERS 65ma for Radios, Meters, Chargers, Transistors, Experiments, etc. \$1 |
| <input type="checkbox"/> 3 — ELECTROLYTIC CONDENSERS 50/30-150v... \$1 | <input type="checkbox"/> 5 — I.F. COIL TRANSFORMERS sub-min for Transistor Radios... \$1 | <input type="checkbox"/> 50 — ASST. RADIO KNOBS all selected popular types... \$1 | <input type="checkbox"/> 30 — ROTARY SWITCHES popular DPST, 1/2" flatted shaft... \$1 |
| <input type="checkbox"/> 20 — STANDARD TUBULAR CONDENSERS .047-600v... \$1 | <input type="checkbox"/> 5 — AUDIO OUTPUT TRANSFORM Sub-min for Trans Radios... \$1 | <input type="checkbox"/> 5 — PNP TRANSISTORS general purpose, TO-5 case... \$1 | <input type="checkbox"/> 20 — ASSORTED TUBES Radio, Television and Industrial... \$1 |
| <input type="checkbox"/> 20 — BENDIX CONDENSERS .007-2000v \$15 value... \$1 | <input type="checkbox"/> 4 — TOGGLE SWITCHES SPST, SPDT, DPST, DPDT... \$1 | <input type="checkbox"/> 5 — NPN TRANSISTORS general purpose, TO-5 case... \$1 | <input type="checkbox"/> ALL AMERICAN TUBE KIT \$2 Top Standard Brand — 12BA6, 12BE6, 12AV6, 60C5, 35W4... \$1 |
| | <input type="checkbox"/> 15 — ASST. ROTARY SWITCHES all popular types \$20 value... \$1 | <input type="checkbox"/> 2 — POWER TRANSISTORS No. 1 Replace 2N155, 2N176, 2N301, etc. \$1 | <input type="checkbox"/> 5 — RCA 1U4 TUBES brand new boxed, also serves as a 1T4... \$1 |
| | | <input type="checkbox"/> 10 — ASST DUAL CONTROLS for Radio, TV, Hi-Fi, Stereo, etc. \$1 | |

BROOKS RADIO & TV CORP., 84 Vesey St., Dept. A, New York 7, N.Y. TELEPHONE COrtlandt 7-2359

Because you've got to SEE it to BELIEVE it
..... we will send you a FREE sample!

instant lettering®

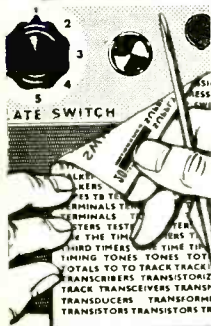

DATAMARK

— the easy new way to label your projects!

Just rub over the pre-printed words or symbols with a ballpoint pen and they transfer to any surface — looks like finest printing! Label control panels, meter dials, letter on anything!

LOOK FOR **instant lettering**®

DATAMARK SETS only \$1.25 each — at leading electronic distributors

DATAMARK SETS AVAILABLE FOR:

- Amateur Radio, CB
- Audio, Hi-Fi, TV
- Experimenter Home Intercom
- Industrial Test Equipment
- Switch & Dial Markings
- Alphabets & Numerals in 1/8", 1/4" and 1/2"

— each set has black, white, and gold

SEND FOR FREE SAMPLE RE-4

THE DATA CORPORATION
85 HIGHLAND AVENUE • PASSAIC, N. J. 07055
Circle 122 on reader's service card

PROFESSIONAL PARTS STORAGE

Here's a convenient, inexpensive way to store a large number of different-valued capacitors or resistors in a rela-

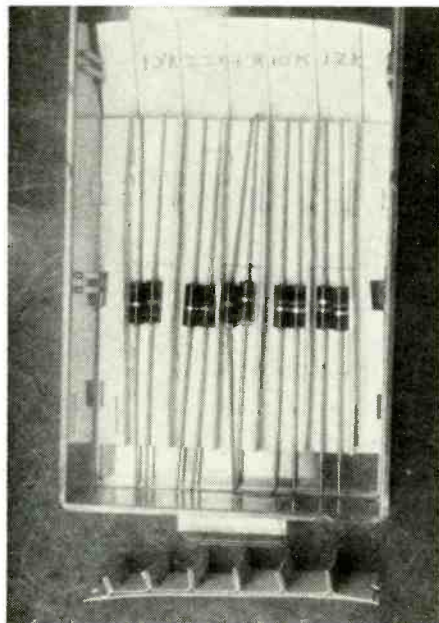

tively small number of plastic parts drawers. A component can be found extremely quickly with this system. One index card is folded as shown and stapled to a flat index card. The two are trimmed to fit the drawer, and a small card at the back is used for labeling parts according to value and voltage or

wattage. Tweezers are handy for removal of 1/2-watt resistors. The range of values in each drawer should be labeled on the front of the drawer and the drawers should be arranged in order of increasing resistance or capacitance as should the individual compartments of each drawer. There should be a compartment for each standard value to provide for expansion of your stock, rather than just for the parts you presently own.—Ronald S. Newbower

FREEDING STUCK TUNING SLUGS

I unstuck tuning slugs with the help of a file tang and my soldering gun. Stick the tang into the slug and apply heat to the file as shown until the slug loosens. Remove the heat but keep twist-

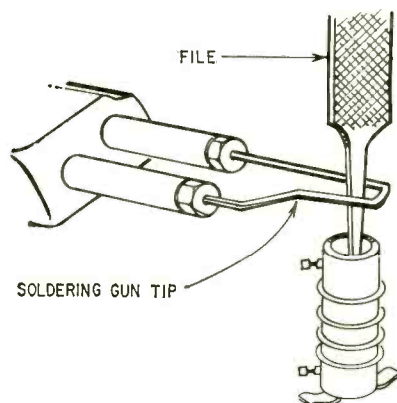

ing the slug back and forth until it cools. Then align the coil with the usual tools, and reseal the slug with wax or a cement that softens with heat.—Peter Legon

CHEATER JUMPER OUTLET

Wall outlets in homes are often hard to get at. It can be inconvenient to plug in your cheater cord and test equipment on a service call.

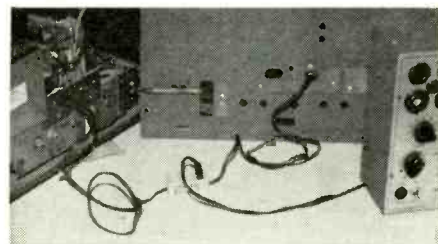

A simple way to get around this is to use a jumper cord from the back of the TV (which is already plugged in) to the TV itself. Then an outlet along the jumper cord is a very convenient way to get power to your test equipment.—Stanley E. Bammel

STYROFOAM FOR KIT BUILDERS

A block of styrofoam can come in handy when you're building a kit. After sorting the small parts, press one lead of each part, in order, into the styrofoam. Now the parts are handy when you need them, won't roll around the bench top and can be neatly stored in a drawer or on a shelf when it's time to quit.—Albert Koehler

RADIO-ELECTRONICS

Now save hours of design time with GERNSBACK LIBRARY'S new

ELECTRONIC DESIGN CHARTS

By Norman H. Crowhurst

A comprehensive collection of nomographs in one convenient book.

Simplifies design procedures. Saves hours of time and effort on computations. Helps solve virtually every electronic design problem quickly. Eliminates uncertainty and mistakes. Large, accurate, clear charts on 8 1/2 x 11 page size. Lies flat or stands up.



Permanently cloth-bound **\$5.95**

Money-back guarantee within 10 days if not completely satisfied with book

GERNSBACK LIBRARY, Inc., Dept. 566
266 West 14th Street, New York, N. Y. 10011

Enclosed is \$_____. Please send _____ copy(ies) of Electronic Design Charts @ \$5.95.

Name _____

Street _____

City _____ State _____ Zip Code _____

- 59 CHARTS
- 128 PAGES
- FULL EXPLANATION
- EASY-TO-READ TEXT

An invaluable, convenient working tool for engineers and technicians with useful charts like these: Frequency and Wavelength • Reactance and Frequency • Time Constants • Input Chokes • Vector Addition of Complex Quantities • Parallel Resistors and Series Capacitors • AND 53 OTHER CHARTS.

BOOKS PURCHASED FOR PROFESSIONAL PURPOSES ARE TAX DEDUCTIBLE

WHAT'S YOUR EQ?

These are the answers. Puzzles are on page 48.

Black-Box Equivalent

An equivalent circuit can be developed by noting the open-circuit voltage (when $I = 0$) and short-circuit current (when $E = 0$). The open-circuit voltage tells us if there is any voltage source within the box. Since an external 6 volts was required for $I = 0$, it follows there must be a 6-volt bucking source inside.

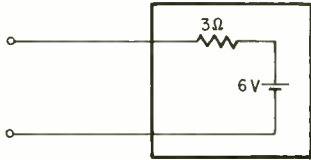

The current that flows through a short circuit across the output terminals ($E = 0$) is determined solely by the internal voltage and internal impedance.

The diagram shows the equivalent circuit of the black box.

Capacitor Puzzler

We can replace the charged capacitor $C1$ with its equivalent—a 2-volt source in series with an uncharged $1\text{-}\mu\text{F}$ capacitor. The diagram shows the final-state conditions after the switch is closed.

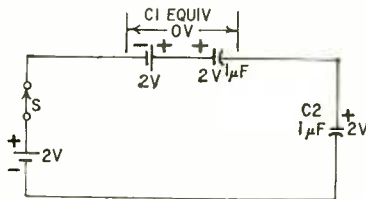

The two voltages add to an effective 4 volts. Since $C1 = C2$, this voltage divides equally between the two capacitors. The final voltage across $C2$ is 2 volts with upper plate positive. The final voltage across $C1$ (or its equivalent) is zero ($2V - 2V = 0V$).

3-Way Switching?

The box contains, in addition to the battery, two 5-ohm resistors or equivalent. I used a 10-ohm wirewound adjustable resistor with the slide in the center connected to battery.

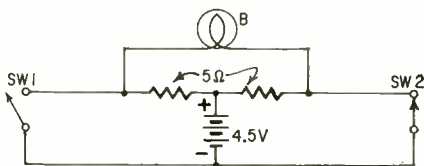

If either switch is on when the other is off, the bulb will light. If both

switches are on or both off, the bulb does not light. This is a variation of the Wheatstone bridge.

Lots of Solutions

Several readers have written in about the "Series-Parallel Circuit" puzzle (Feb. '66 issue). In essence, the comments stated that, although the given solution is correct, it is but one of an infinite number of correct solutions.

For total resistance of 1,250 ohms, $R5$ can vary between $272\frac{2}{11}$ ohms and infinity, with an appropriate value between infinity and $1,818\frac{2}{11}$ ohms for $R4$.

One reader made a complete analysis of the circuit and produced this formula for $R5$ in respect to $R4$ in kilohms:

$$R5 = \frac{0.75R4 + 3.75}{2.75R4 - 5}$$

Although most of the possible values of $R4$ or $R5$ would be fractional, with respect to the other, here are some whole-number values:

$R4$ (ohms)	$R5$ (ohms)
2,000	10,500
2,500	3,000
10,000	500

Sorry, fellows! Our fault for not inserting restrictions on the problem to yield a unique solution. END

Meet Winegard Chroma-Tel

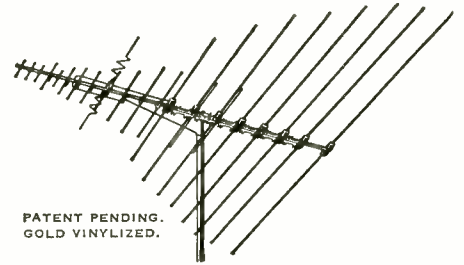

PATENT PENDING.
GOLD VINYLIZED.

First 1/2 size all-band (UHF, VHF, FM) antenna with full size power

- Delivers Brilliant Color, Beautiful Black and White, Full-Tone FM Sound
- Brings in All the UHF, VHF and FM Stations in Your Area

Now there's an All-Band (UHF, VHF, FM) antenna that is actually half the size of most other all-band antennas. It eliminates half the bulk, half the wind loading, half the storage space, half the truck space and half the weight of ordinary all-band antennas... without sacrificing one bit of performance! Features Winegard's new Chroma-Lens Director System and impedance correlators.

Compare size, cost and performance... you'll choose Winegard Chroma-Tel every time. Ask your distributor or write for Fact-Finder #242 today.

3 Models from \$17.50 list.

Winegard Co. ANTENNA SYSTEMS

3000 Kirkwood • Burlington, Iowa

Circle 123 on reader's service card

ELECTRONICS



Engineering-Technicians

Bachelor of Science Degree, 30 Months
Save Two Years' Time

- Radio-Television Plus Color Technician (12 Months)
- Electronics Engineering Technology (15 Months)
- Electronics Engineering (B.S. Degree)
 - Electrical Engineering (B.S. Degree)
 - Mechanical Engineering (B.S. Degree)
 - Civil Engineering (B.S. Degree)
 - Architecture (B.S. Degree) (36 Months)

The Nation's increased demand for Engineers, Electronic Technicians, Radio TV Technicians is at an all time high. Heald Graduates are in demand for Preferred High Paying Salaries. Train now for a lucrative satisfying lifetime career.

Approved for Veterans

DAY AND EVENING CLASSES

Write for Catalog and Registration Application. New Term Starting Soon.

HEALD'S

ENGINEERING COLLEGE

Est. 1863—103 Years
Van Ness at Post, RE
San Francisco, Calif.

Your Name

Address

City

State

Circle 124 on reader's service card

don't leave us behind WHEN YOU MOVE!

Postal regulations require that you pay extra postage on all magazines forwarded to you at a new address. Copies will not be forwarded free, and we cannot replace lost copies.

To insure delivery at your new address please notify us now, or at least 6 weeks in advance of your moving. Write in old and new address below, if possible include the address label from your last issue.

Thank you.

Please mail this form today to:

Radio-Electronics

SUBSCRIPTION DEPARTMENT
Boulder, Colo. 80302

NEW ADDRESS (Please print)

Name _____

Address _____

City _____

State _____ Zip Code _____

Attach label here or write OLD ADDRESS

Name _____

Address _____

City _____ State _____ Zip Code _____

SILICON RECTIFIER SALE

IMMEDIATE DELIVERY
FULLY GTD NEWEST TYPE
AMERICAN MADE FULLY TESTED

750 MA-SILICON "TOPHAT" DIODES

LOW LEAKAGE FULL LEAD LENGTH

PIV/RMS	PIV/RMS	PIV/RMS	PIV/RMS
50/35	100/70	200/140	300/210
.05 ea.	.07 ea.	.10 ea.	.12 ea.
PIV/RMS	PIV/RMS	PIV/RMS	PIV/RMS
400/280	500/350	600/420	700/490
.14 ea.	.19 ea.	.23 ea.	.27 ea.
PIV/RMS	PIV/RMS	PIV/RMS	PIV/RMS
800/560	900/630	1000/700	1100/770
.35 ea.	.45 ea.	.60 ea.	.75 ea.

ALL TESTS AC & DC & FWD & LOAD SILICON POWER DIODE STUDS

D.C. AMPS	50 PIV 35 RMS	100 PIV 70 RMS	150 PIV 105 RMS	200 PIV 140 RMS
3	.08 ea.	.12 ea.	.16 ea.	.22 ea.
12	.25	.50	.65	.75
35	.65	.90	1.25	1.40
50	1.50	1.75	2.20	2.60
100	1.60	2.40	2.40	3.00

D.C. AMPS	300 PIV 210 RMS	400 PIV 280 RMS	500 PIV 350 RMS	600 PIV 450 RMS
3	.27 ea.	.29 ea.	.37 ea.	.45 ea.
12	.90	1.30	1.40	1.65
35	2.00	2.35	2.60	3.00
50	3.25	4.00	4.75	6.00
100	3.60	4.50	5.25	7.00

"SCR" SILICON CONTROLLED RECTIFIERS "SCR"							
PRV	7 AMP	16 AMP	25 AMP	PRV	7 AMP	16 AMP	25 AMP
25	.50	.75	1.00	250	1.75	2.15	2.50
50	.60	.90	1.25	300	2.00	2.40	2.75
100	.80	1.25	1.50	400	2.40	2.75	3.25
150	.90	1.60	2.00	500	3.20	3.40	3.80
200	1.25	1.80	2.25	600	3.40	4.00	4.50

SPECIALS! SPECIALS!

100 Different Precision Resistors
1/2-1-2 Watt 1/2-1% TOL \$1.25

Asst transistor Kit. P.N.P.—N.P.N.
All popular types. Unchecked

100 for \$2.95 500 for \$9.95

TEXAS INSTRUMENT—POWER TRANSISTOR—85
WATT—DIFFUSED NPN, SILICON MESA
TYPE 2N424 FACTORY NEW \$1.50 EA

Computer Grade Condenser 15,500 MFD
15 VDC American Mfg. .75 ea.

Type IN34 DIODE GLASS .07 ea 100 for \$5

Money Back guarantee. \$2.00 min. order. Plus shpg
charge. Include check or money order. C.O.D. orders
25% down.

Warren Electronic Components

230 Mercer St., N. Y., N. Y. 10012 • OR 3-2620

Circle 125 on reader's service card

NOTEWORTHY CIRCUITS

NOVEL FLASHER CIRCUIT

Here is a simple flasher circuit that you'll probably find lots of use for.

The usual transistor light flasher consists of a multivibrator with an incandescent lamp in series with one of the transistors. Battery drain is fairly high because of the current needed to light the lamp to normal brilliance. This type of circuit is often used to warn of road hazards.

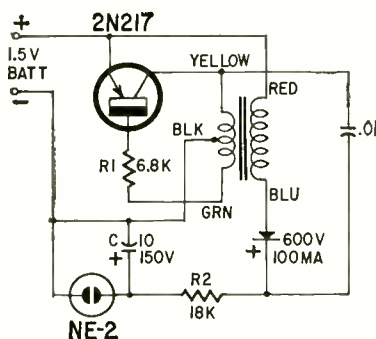

The circuit shown here draws much less current. It uses a single transistor and a neon lamp. The neon lamp is not as bright as an incandescent lamp so it cannot be used as a warning device which must be visible from a distance. However, it makes a neat little pilot lamp for transistorized test instruments. Power drain is only 15-20 mA at 1.5 volt so a single penlight cell can be used.

The circuit is a blocking oscillator which develops a high peaked voltage. This voltage is rectified and used to charge capacitor C. When the charge reaches around 70 volts, the NE-2 fires. C discharges to around 60 volts and the lamp goes out. The cycle repeats and the lamp flashes about once every 2 seconds.

The transformer has a 20K primary and 2K center-tapped secondary. (I used an Argonne AR-103 from Lafayette Radio.) Its polarity must be correct for maximum voltage output. Experiment with the values of R1 and R2 for maximum power out with minimum battery drain.—I. Queen

PILOT LAMP DOES DOUBLE DUTY

Here is a circuit in which a single lamp operates both as a pilot and a blown-fuse indicator. When power is applied to the circuit and the fuse is intact the lamp glows. If the fuse blows the lamp flashes. It can be built into any ac operated equipment.

The circuit has two advantages. First, it combines the fuse-indicating

and pilot lamp functions into one circuit. Thus, in equipment such as hi-fi amplifiers, where the controls are mounted in plain view, the addition of an unattractive indicating fuse holder is unnecessary. Second, you can build it for as little as 79 cents even if you have to buy all the parts; while the indicating fuse holder, resistor and pilot lamp normally used would cost about \$1.58.

The operation of the circuit is simple. With the fuse intact R1 and R2 are in parallel, current flows through R1 and R2, through the diode and charges the capacitor. When the voltage across the capacitor reaches 65 the lamp fires and starts to deionize. The parallel resistance of R1 and R2 is small enough so that the lamp cannot completely deionize before the capacitor voltage has again reached the lamp's firing point. Therefore the lamp stays lit constantly and does not flicker. With the fuse blown R1 and R2 are no longer in parallel and current flows first through one and then the other as the line polarity shifts. The increase in resistance in the charging path is great enough to bring the lamp flash rate down to one flash a second.

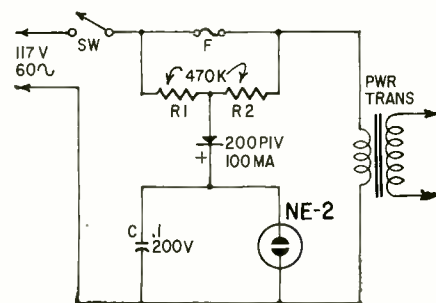

Construction of the circuit is not critical. The simplest arrangement is to place all the parts except the lamp in the area around the power supply transformer, dressing the lamp leads close to the chassis. If this is not done, circuit location and lead dress could feed a buzz into stages with low signal levels such as rf front ends and low-level audio stages.

Any diode that meets the ratings specified can be used. Any change in the other parts will shift the pulse rate of the lamp and either cause a flicker in the pilot lamp function or the lamp will not light when the fuse blows.

The parts could come from a junk box, but if you have to buy all the parts, use a "Buss" fuse block rather than a panel mounted holder. A diode from a bargain sheet will greatly reduce the overall cost.—D. G. Neale

END

SCHOOL DIRECTORY

Get Your First Class Commercial F.C.C. LICENSE and earn your A.S.E.E. DEGREE

Now is the time to Move Up! Increase your salary and prestige by acquiring the knowledge and documents that industry pays for. Get your F.C.C. first class commercial license, and then continue (if you wish) for your A.S.E.E. degree.

Grantham offers *resident* training in which each semester prepares you for an occupational objective as follows: Semester I—communications technician with first class F.C.C. license; semester II—television technician; semester III—computer technician; and semester IV—electronics *engineering* technician with an A.S.E.E. degree.

Grantham offers *home study* training in (1) F.C.C. License Preparation, and (2) Communications Engineering Technology.

The A.S.E.E. degree can be earned by 16 months of resident training, or by a combination of the Communications Engineering Technology course by home study and two semesters (8 months) in residence.

Get the facts from our free catalog. Write or phone us at one of the addresses listed below. Ask for *Catalog 67-E*.

Grantham School of Electronics

1505 N. Western Ave., Hollywood, Cal. 90027
(Phone: HO 9-7878)

408 Marion Street, Seattle, Wash. 98104
(Phone: MA 2-7227)

818-18th St., NW, Washington, D.C. 20006
(Phone: 298-7460)

Circle 126 on reader's service card

LEARN Electronics Engineering AT HOME

Fix TV, design automation systems, learn transistors, complete electronics. College level Home Study courses taught so you can understand them. Earn more in the highly paid electronic industry. Computers, Missiles, theory and practical. Kits furnished. Over 30,000 graduates now employed. Resident classes at our Chicago campus if desired. Founded 1934. Catalog.

AMERICAN INSTITUTE OF ENGINEERING AND TECHNOLOGY
1139 W. Fullerton Pky., Chicago, Ill. 60614

start your career here

Tri-State graduates hold important engineering and business administration posts throughout the U. S. Tri-State is a small professionally-oriented college in the beautiful lake section of NE Indiana. Excellent faculty . . . well-equipped labs . . . new library and residence halls . . . 300-acre campus . . . small classes . . . rich tradition. Modest costs. Four-quarter year permits degree in three years. One-year Drafting-Design Certificate program. For Catalog, write Director Admissions indicating career interest. Graduate placement outstanding!



TRI-STATE COLLEGE

2456 College Avenue, Angola, Indiana

ENGINEERING DEGREES

Associate—Bachelor
Electronics—Mechanical
earned by

HOME STUDY

Resident Classes Also
Available if Desired
Specify course preferred



PACIFIC INTERNATIONAL COLLEGE OF ARTS & SCIENCES

Primarily a correspondence school

Chartered 1935

5507M Santa Monica Blvd. Hollywood, Calif. 90038

Learn Electronics for your SPACE-AGE EDUCATION at the center of America's aerospace industry

No matter what your aerospace goal, you can get your training at Northrop Tech, in sunny Southern California.

COLLEGE OF ENGINEERING. Get your B.S. degree in engineering in just 36 months by attending classes year round. Most Northrop Tech graduates have a job waiting for them the day they're graduated!

A & P SCHOOL. Practical experience on real aircraft. One-year course prepares you for F.A.A. A & P certificate. WRITE TODAY FOR CATALOG.

NORTHROP INSTITUTE OF TECHNOLOGY
1199 W. Arbor Vitae, Inglewood, Calif.



A JOB or a POSITION ?

The difference is ELECTRONIC MATHEMATICS

NOW! A NEW WAY TO LEARN—I. H. S. I. WAY. A complete home study course in electronic math to help you get the position you want—MORE MONEY—MORE RESPECT.

COURSE PREPARED BY COLLEGE PROFESSORS who have lectured to thousands of men on math and engineering. You learn at home quickly, easily —AS FAST as you want.

YOU SIGN NO CONTRACTS Pay only if satisfied—you owe it to yourself to examine the INDIANA HOME STUDY INSTITUTE COURSE IN ELECTRONIC MATH. FREE BONUS—if you join now, a refresher course in basic arithmetic.

Write for Brochure—No Obligation
THE INDIANA HOME STUDY INSTITUTE
Dept. RE-5, P.O. Box 1189
Panama City, Fla. 32402

LEARN

ELECTRONICS

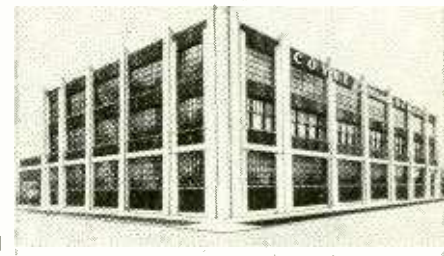

FOUNDED 1899

NOT-FOR-PROFIT

COYNE ELECTRONICS INSTITUTE

Electronics Engineering Technology	—	Degree (2 Yrs.)
Electrical-Electronics Technician	—	Diploma (40 Wks.)
TV-Radio-Electronics Technician	—	Diploma (40 Wks.)
Combined Electronics Technician	—	Diploma (80 Wks.)
Practical Electrical Maintenance	—	Diploma (32 Wks.)
Practical Refrigeration Air Conditioning and Appliance Repair	—	Diploma (24 Wks.)
Specialized Industrial Electronics	—	Diploma (16 Wks.)
Introduction to Electricity-Electronics	—	Certificate (8 Wks.)
FCC First Class Radiotelephone	—	Certificate (100 Hrs.)

Special finance plans. Part time employment service while in school. Also Free graduate employment service.



Use this coupon to get our FREE BOOK

"YOUR OPPORTUNITIES IN ELECTRONICS"

COYNE ELECTRONICS INSTITUTE, Dept. of Electronics 56-N
1501 W. Congress Parkway, Chicago, Illinois 60607

Name _____ Age _____

Address _____ Phone _____

City _____ Zone _____ State _____

Unlike most other schools, we do not employ salesmen

Circle 127 on reader's service card

GET INTO ELECTRONICS

V.T.I. training leads to success as technicians, field engineers, specialists in communications, guided missiles, computers, radar and automation. Basic & advanced courses in theory & laboratory. Electronic Engineering Technology and Electronic Technology curricula both available. Assoc. degree in 29 mos. B.S. also obtainable GI approved. Graduates in all branches of electronics with major companies. Start Sept., Feb. Dorms, campus. High school graduate or equivalent. Catalog.

VALPARAISO TECHNICAL INSTITUTE
Department C. Valparaiso, Indiana



tional calculus to solve engineering problems. Both lumped and distributed circuits are discussed.

DICTIONARY OF ELECTRONICS AND WAVE-GUIDES, compiled by W. E. Clason. American Elsevier Publishing Co., Inc., 52 Vanderbilt Ave., New York, N. Y. 10017. 6 x 9 in., 833 pp. Cloth, \$26.75

This standard English/American—French, Spanish—Italian—Dutch—German dictionary has been brought thoroughly up to date in this second edition. The body of the dictionary is arranged in English/American, and there are indexes for each of the other languages. Not only single words, but phrases like "maximum frequency of oscillation" are defined. END

NEW BOOKS

ELECTRONIC ANALOG AND HYBRID COMPUTERS, by Granino A. Korn and Theresa M. Korn, McGraw-Hill Book Co., 330 W. 42 St., New York, N.Y. 10036. 6 x 9 1/4 in., 584 pp. Cloth, \$17.50

A thorough treatment of the subject, with very complete references and bibliography at the end of each chapter. Requires engineering mathematics.

TUBE SUBSTITUTION HANDBOOK, Vol. 8. Howard W. Sams & Co., Inc., 4300 W. 62 St., Indianapolis 6, Ind., 5 1/2 x 8 1/2 in., 124 pp. Paper,

\$1.50. (A pocket-sized handbook is included for a total price of \$2.25).

Contains over 11,000 substitutions: receiving and pix tubes, subminiatures, foreign types, etc. The pocket edition lists only receiving and pix tubes.

UNIFIED CIRCUIT THEORY IN ELECTRONICS AND ENGINEERING ANALYSIS, by J. W. Head and C. G. Mayo. Iliffe Books, Ltd., Dorset House, Stamford St., London, S.E.1, England. 5 1/2 x 8 1/2 in., 174 pp. Cloth, 42s, 9d

These authors shows how to use opera-

MARKET CENTER

BLACK/WHITE OR COLOR

THE ONLY SAFE NON-DRIFT TV TUNER CLEANERS

AVAILABLE AT ALL DISTRIBUTORS

CHEMTRONICS

BROOKLYN, N. Y. 11236

Astonishing!

- **3 HOUR STEREO ALBUMS**
- **CLASSICS / POP / JAZZ / VOCAL VARIETY / SHOW / DANCE**

\$1195*

*SUGGESTED RETAIL PRICE

Ask your local dealer or write for complete catalog information to **TAPE-MATES, 5280 W. Pico Blvd., Los Angeles, Calif. 90019.**

BIG CATALOG

World's "BEST BUYS" in GOV'T. SURPLUS Electronic Equipment

FULL OF TOP QUALITY ITEMS—

Transmitters, Receivers, Power Supplies, Inverters, Microphones, Filters, Meters, Cable, Keys, Phones, Antennas, Chokes, Dynamotors, Blowers, Switches, Test Equipment, Headsets, Amplifiers, etc., etc. **SEND 25¢ (stamps or coin) for CATALOG and receive 50¢ CREDIT on your order.** Address Dept. RE.

FAIR RADIO SALES

P.O. Box 1105 • LIMA, OHIO • 45802

FREE CATALOG!

148 PAGES • NEARLY 4,500 BARGAINS

OPTICS • SCIENCE • MATH

Completely new 1966 edition. New items, categories, illustrations. Dozens of electrical and electromagnet parts, accessories. Enormous selection of Astronomical Telescopes, Microscopes, Binoculars, Magnifiers, Magnets, Lenses, Prisms. Many war surplus items; for hobbyists, experimenters, workshop, factory. Write for catalog "EH."

CLIP AND MAIL COUPON TODAY

EDMUND SCIENTIFIC CO., Barrington, N. J. 08007
PLEASE SEND ME FREE CATALOG "EH"

Name

Address

City..... State..... ZIP.....

GENERAL

TV SERVICE ORDER BOOKS for use with your rubber stamp. Duplicate or triplicate. Low cost. Write for FREE 32 PAGE CATALOG and Special Rubber Stamp Offer. **OELRICH PUBLICATIONS, 6556 W. Higgins, Chicago, Ill. 60656.**

SAFEGUARD PRIVACY! New instrument detects electronic "bugs", wire-tapping and snooping devices. Free information. **DEE EQUIPMENT, Box 7263-E8, Houston 8, Texas.**

CONVERT ANY TELEVISION to sensitive Big-Screen Oscilloscope. Only minor changes required. No electronic experience necessary. Illustrated plans \$2.00. **RELCO-A25, Box 10563, Houston 18, Texas.**

PRINTING PRESSES. Type, Supplies. Lists 5¢. **TURNBAUGH SERVICE, Mechanicsburg, Pa.**

LOSING Hair? Balding? Dandruff? Free copyrighted booklet. **DR. SHIFFER LABORATORIES, 529 Euclid Arcade, Cleveland, Ohio 44115.**

Rectifiers & Transistors

SILICON DIODES

Amps	100 PIV	200 PIV	400 PIV	600 PIV
.75°	.07	.10	.14	.21
3	.14	.22	.28	.40
15	—	.75	1.20	1.55
35	—	1.30	2.00	2.70

Amps	700 PIV	800 PIV	900 PIV	1000 PIV
.75°	.25	.32	.40	.55
3	.49	.58	.67	.78
15	1.70	1.85	2.25	2.50
35	3.15	3.60	4.50	4.80

1100 PIV 70¢, 1200 PIV 85¢, .75 Amp
*Top Hat, Epoxy, or Flangeless

10 Watt Sil. Zener Stud, 20%, 12-200v 95¢ ea.
1 Watt Zener, axial, 20%, 8-200v 50¢ ea.
Sil. diode Stud, 1500 PIV, 300 ma. 50¢ ea.
Sil. diode, 1500 PIV, 50 ma. axial 3/\$1.00
Hoffman Sil. Epoxy diodes, 200 ma.
3000 PIV 98¢ 6000 PIV \$2.49
Thermistor bead, 900 or 1200 ohm, 600°F. 2/\$1.00

SILICON POWER TRANSISTORS

4W, 2N498, TO-5 50¢ 40W, 2N1047, TO-57 \$1.40
15W, 2N2989, TO-5 75¢ 50W, 2N1022, TO-53 \$1.50
30W, 2N2151, TO-60 \$1.25 50W, 2N1724, TO-67 \$1.50

2N1300 series, NPN or PNP 6/\$1.00
Sil. Junction diodes, 1N200 series 15/\$1.00
70 amp. Stud, 50 PIV \$2.50, 100 PIV \$3.50
Amplifier, 6 Tubes, new, 3 Lbs. \$1.49
Nickel Cadmium Battery, 9 1/2 oz, 8 amp hr \$1.95
Precision Resistors, assorted 120/\$1.98
200—1/2w resistors, assorted \$1.98
130—1w resistors, assorted \$1.98
Radio Knobs for 3/4" shafts 120/\$1.98
2 Watt Pots, assorted 15/\$1.00
10 Lbs Power Resistors, 5-60w \$1.98
10 Lbs Oil Capacitors, assorted \$1.98
Mercury Batteries, 5.4v, 3/4" x 1" 4/\$1.00

Varicap-Voltage Variable Capacitor			
27, 47, or 100 pf at 4v., 4:1	\$1.25		
150 W Germanium Power (Diamond Case)			
2N1021	\$1.00	2N1022	\$1.25
20 W Germanium Power (internal heat sink)			
2N1038	4/\$1.00	2N1039	3/\$1.00
2N1040	2/\$1.00	2N1041	60¢
Add 10¢ ea. for external heat sink			

Silicon Controlled Rectifiers

PRV	.75A	7A	16A	PRV	.75A	7A	16A
25	—	—	.48	300	1.20	1.80	2.20
50	—	.45	.70	400	1.70	2.20	2.70
100	—	.70	1.20	500	1.95	3.00	3.30
200	.80	1.15	1.70	600	2.30	3.20	3.90

*Top Hat, 7 & 16 Stud
Money back guarantee. \$2.00 min. order, include postage.
Write For Free Catalog.

Electronic Components Co.
Box 2902B, Baton Rouge, La. 70821

ADVERTISING INDEX

RADIO-ELECTRONICS does not assume responsibility for any errors which may appear in the index below.

Allied Radio Corp.	83
Amperex Electronic Corp.	Second Cover
B & K Manufacturing Co., (Div. of Dynascan Corp.)	17
Brooks Radio & TV Corp.	86-87
Capitol Radio Engineering Institute, The	13
Castle TV Tuner Service, Inc.	64
Charles Engineering, Inc.	78
CLASSIFIED	92-95
Cleveland Institute of Electronics	18-21, 77
Cornell Electronics Co.	94
Datak Corporation, The	88
DeVry Technical Institute	3
Eastman Kodak Company	5
Electro-Voice, Inc.	62
Electronic Measurement Corp. (EMC)	77
Finney Co.	25
Gernsback Library, Inc.	22, 69, 82, 88
Hallicrafters	75
Heald's Engineering College	89
Heath Company	23, 63
IBM Corporation	Third Cover
International Crystal Mfg. Co.	7
International Radio Exchange	16
Jerrold Electronics Corporation (Distributor Sales Division)	28
JFD Electronics Corp.	14-15
Johnson, E. F.	27
Lafayette Radio Electronics	79
Lampkin	76
Mallory Distributor Products Company (Div. of P. R. Mallory & Co., Inc.)	32
Mercury Electronics Corporation	85
Music Associated	74
National Radio Institute	8-11
Perma-Power Company	6
Poly Paks	95
Quam-Nichols Co.	68
Quietrole Co.	87
Radar Devices	1
Radio Shack	96
RCA Components & Devices Tubes	Fourth Cover
RCA Institute, Inc.	16, 31, 64, 79
Rotron	22
Rye Sound Corporation	86
Sams & Co., Inc., Howard W.	66
Sarkes-Tarzan, Inc. (Tuner Service Div.)	12
Scott, Inc., H. H.	24
Semitronics Corp.	73
Senore	78
Sprague Products Company	26
Squires-Sanders, Inc.	67
Tarzan, Inc. Sarkes (Tuner Service Div.)	12
Texas Crystals (Div. of Whitehall Electronics Corp.)	67
United Radio Co.	93
University Sound (Div. of LTV Ling Altec, Inc.)	65
Warren Electronic Components	90
Windsor Electronics, Inc.	74
Winegard Co.	89
MARKET CENTER	92-95
Alco Electronics	
Chemtronics	
Edmund Scientific Co.	
Electronic Components Co.	
Fair Radio Sales	
TAB	
Tape-Mates	
SCHOOL DIRECTORY	91
American Institute of Engineering & Technology	
Coyne Electronics Institute	
Grantham School of Electronics	
Indiana Home Study Institute, The	
Northrop College of Science & Engineering	
Pacific International College	
Tri-State College	
Valparaiso Technical Institute	

Circle 128 on reader's service card

WANTED

QUICK CASH . . . for Electronic EQUIPMENT, COMPONENTS, unused TUBES. Send list now! BARRY, 512 Broadway, New York, N. Y. 10012, 212 WALKER 5-7000.

SERVICES

METERS—MULTIMETERS REPAIRED and calibrated. BIGELOW ELECTRONICS, Box 71-B, Bluffton, Ohio.

SAMS PHOTOFACTS. Radio \$1. Television \$2. Old Radio Diagrams \$1. SERVAIDE, Box 3412B, Harrisburg, Pa. 17105.

AUDIO—HI-FI

RENT STEREO TAPES—over 2,500 different—all major labels—free brochure. STEREO-PARTI, 1616 Terrace Way, Santa Rosa, Calif.

WRITE for highest discounts on components, recorders, tapes, from franchised distributors. Send for FREE monthly specials. CARSTON, 1686-R Second Ave. N.Y.C. 10028

HI-FI COMPONENTS, Tape Recorders, at guaranteed "WE will not be undersold" prices. 15-day moneyback guarantee. Two-year warranty. NO Catalog. Quotations Free. HI-FIDELITY CENTER, 239R East 149th St., N.Y., N.Y. 10451.

TAPE RECORDER SALE. Brand new, latest models, \$10.00 above cost. ARKAY SALES, 1028-E Commonwealth Ave., Boston, Mass. 02215.

HI-FIDELITY COMPONENTS, Ham Marine and Communication equipment at considerable savings. If you want to save money write us for our low prices on all your needs. AIREX RADIO CORP., 85 (RE) Cortlandt St., N.Y., N.Y. 10007

HI-FI Equipment at largest discount. Catalog. MENDOTA FURNITURE CO., Mendota, Minnesota.

STEREO TAPES. Save up to 60% (no membership fees, postpaid anywhere USA). Free 60-page catalog. We discount batteries, recorders, tape accessories. Beware of slogans "not undersold," as the discount information you supply our competitor is usually reported to the factory. SAXITONE, 1776 Columbia Road, Washington, D. C. 20009

BUSINESS AIDS

JUST STARTING IN TV SERVICE? Write for FREE 32 PAGE CATALOG of Service Order books, invoices, job tickets, phone message books, statements and file systems. OELRICH PUBLICATIONS, 6556 W. Higgins, Chicago, Ill. 60656. New Hyde Park 5, N.Y.

1,000 Business Cards, "Raised Letters" \$3.95 postpaid. Samples. ROUTH RE12, 2633 Randleman, Greensboro, N. C. 27406.

BUSINESS OPPORTUNITIES

New scientific transistor instrument detects buried coins, treasures. Will detect gold, silver, copper, iron, etc. \$19.95 up. Free catalog. RELCO-A-25, Box 10563, Houston 18, Texas.

ELECTRONICS

BARGAINS in Canadian Electronic equipment and surplus. Send \$1.00 for giant catalogs. ETCO, Dept. R, 520 Fifth Avenue, New York 36, N.Y.

PROFESSIONAL ELECTRONICS PROJECTS—Organs, Timers, Computers, etc.—\$1 up. Catalog 25¢. PARKS, Box 25565, Seattle, Wash. 98125.

TRANSISTOR ignition kits, components. Free diagrams. ANDERSON ENGINEERING, Epsom, N.H. 03239

RADIO & TV TUBES 33¢ each. One year guaranteed. Plus many unusual electronic bargains. Free catalog. CORNELL, 4217-E University, San Diego, California 92105

TUBES. "Oldies", latest. Lists free. STEINMETZ, 7519 Maplewood, Hammond, Indiana, 46324.

HARD-TO-GET TUBES IN STOCK

BRAND NEW—1 YR. GUARANTEE

Type	Price	Type	Price	Type	Price	Type	Price
200-00A	3.50	6AU5	1.75	6Y8	1.18	12SQ7	1.35
01A	2.75	6AU6	.74	6V6GT	.76	12SR7	1.79
1A7	1.75	6AU8	1.68	6W4	.86	12V6	1.35
1AX2	.95	6AW6	1.35	6XW6GT	1.02	12W6	1.35
1B3	.95	6AX5	.96	6X8	.59	13GF7	1.76
1H5	1.50	6AX5	1.23	6X5GT	.77	14A4	1.45
1L6	3.95	6B7	2.75	6X8A	1.20	14A5	1.45
1L4	1.10	6BA	5.95	6Y6GA	1.45	14E7	1.85
1L6A	1.98	6B7	2.75	6Z4/84	1.25	14AF7	1.85
1L6C	1.80	6B8	2.66	7A4	2.25	14B6	1.90
1LD5	1.95	6BA8	7.0	7AS	2.00	14DB	1.95
1LE3	1.25	6BA8	1.48	7AG	2.69	14C5	1.75
1LH4	2.80	6BE6	.81	7A7	2.70	14C7	2.33
1LN5	2.25	6BH6	1.54	7B7	2.95	14E6	1.39
1N5	1.85	6BK5	1.35	7AF7	2.34	14F7	3.10
1P5	2.00	6BK7	1.38	7AC7	2.85	14F8	2.23
1R4	.80	6BQ6	1.55	7AD7	1.28	14H7	1.95
1R5	1.10	6BQ7	1.43	7AU7	.93	14J7	1.95
1S5	1.10	6BX7	2.10	7B4	2.52	14N7	1.95
1T5	.80	6C5M	1.95	7B7	3.02	14Q7	1.95
1U4	1.05	6C6	2.50	7B8	2.85	14X7	1.75
1V	2.00	6C7	2.95	7BB	2.14	14Y4	1.75
1V2	.83	6C7	.95	7C5	1.25	22	1.00
1V6	2.75	6C8	1.15	7C6	2.75	24A	1.50
2A5	2.50	6C9	1.95	7C7	1.86	25	.75
2A5	2.50	6CL8	1.40	7E5	2.00	25CD6	1.40
2A6	4.50	6CM7	1.05	7E6	1.25	25DN6	2.28
2NA5	1.95	6CQ7	1.10	7F7	1.84	25E5	1.64
2X2A	1.95	6CQ7	1.10	7F7	1.84	25E5	1.64
3A3	1.18	6CW4	1.80	7F8	3.10	25E6	1.10
3A7	1.39	6CX8	1.42	7G7	2.25	26	1.10
3B7	2.39	6D05	3.10	7H7	2.85	27	1.75
3BN4	1.08	6D4	1.75	7J7	2.50	30	1.40
3BZ6	.83	6D6	2.50	7K7	3.05	32	1.25
3CB6	1.48	6D7	1.95	7L7	3.10	33	1.15
3DG4	1.48	6DN6	3.05	7N7	2.71	34	1.25
3DT6	.88	6DN7	1.45	7O7	1.85	35A5	2.10
3AN8	1.10	6DQ4	.96	7P7	2.22	35B	1.32
3V4	.95	6DQ5	3.10	7Q7	2.22	35W4	.39
4BQ7	1.52	6DQ6	1.39	7V7	1.74	35Y4	1.70
4B8	1.35	6E5	2.25	7W7	2.49	35Z3	1.74
4B8	1.35	6F5	2.25	7X7	2.85	36	1.50
4CB6	.82	6F5GT	1.72	7X7	2.85	36	1.50
5AM8	1.50	6F6G	1.95	7Y4	2.35	37	1.25
5AN8	1.64	6F7	1.75	7Z4	2.35	39/44	1.25
5AQ5	.89	6F8	3.08	7Z4	2.35	39/44	1.25
5A58	1.64	6GK5	1.50	8AU8	1.46	41	1.50
5AT8	1.48	6H28	2.10	8B05	1.03	42	1.94
5AZ4	2.00	6I6	1.34	8C7	1.86	43	2.75
5BQ7	1.49	6J6A	.95	8F07	.92	45/2A3	3.25
5BR8	1.59	6J7	1.88	8CJ7	1.28	46	.95
5C8	1.64	6J7C	1.75	8C8	1.86	47	1.25
5J6	1.25	6J8	2.50	8J8	1.38	48	4.00
5U4	.73	6K6GT	.93	10DE7	1.23	49	3.50
5V4	1.35	6K7	1.90	12A8	2.95	50A5	2.20
5X8	1.40	6L6CC	1.65	12AT6	.63	50C5	.74
5Y3	.61	6L7M	2.58	12AT7	1.95	50L6	.98
5Z3	1.54	6N7M	1.85	12AU6	1.74	50X6	2.10
5Z3	1.54	6P5	2.50	12AU7	.86	50Y6	1.55
5Z4	3.00	6Q7	2.05	12AV6	.58	50Y7	1.52
6A7	3.05	6S7	1.95	12AX4	.92	53	3.50
6A8	2.49	6S8GT	1.60	12AX7	.89	55	2.75
6B4	.92	6SA7M	1.60	12BA6	.59	56	1.45
6B7	2.50	6S87Y	2.25	12BE6	.61	57	1.75
6AC5	2.24	6S07	1.49	12BH7	1.79	58	1.75
6AC7	1.75	6SF5	1.10	12B06	1.58	59	3.50
6AF3	1.18	6SF7	2.40	12BR7	1.14	70L7	.99
6AD5	1.03	6S7	1.69	12B8	1.35	71A	1.25
6AC7	2.25	6SHT	1.50	12M7	2.49	75	2.60
6AH4	1.25	6SJTGT	1.49	12K8M	2.95	76	1.75
6AK5	1.69	6SJT7M	1.65	12L6	1.32	77	2.00
6AL7	2.45	6SK7	1.60	12L8	.50	78	1.75
6AM8	1.25	6SK7M	1.58	12Q7	1.50	80	1.75
6AN8	1.43	6SL7GT	1.25	12SA7	1.59	83	1.75
6AQ7	1.59	6SN6T	.94	12SC7	1.86	84	3.00
6AR5	.94	6SQ7GT	1.33	12SF7	2.33	58V1	3.00
6AS5	.99	6SR7	1.50	12SG7	1.72	6146	2.75
6AT7	2.85	6S7M	1.86	12SH7	1.86	6336	4.75
6AT6	.72	6T8	1.20	12S7	1.50	6550	4.00
6AT8	1.49	6T9	1.46	12SK7	1.40	807	.75
6AU4	1.28	6U5	2.75	12SL7	1.33	KT-88	4.95

OUR MINIMUM ORDER \$5.00

POSTAGE EXTRA

SEND FOR COMPLETE TUBE CATALOG OF OVER 3500 ADDITIONAL TYPES

UNITED RADIO CO.

P.O. BOX—1000 R5, NEWARK, N.J.

Circle 129 on reader's service card

CLASSIFIED ADVERTISING ORDER FORM

For complete data concerning classified advertising please refer to box elsewhere in Market Center section.

1	2	3	4	5
6	7	8	9	10
11	12	13	14	15
16	17	18	19	20
21	22	23	24	25
26	27	28	29	30
31	32	33	34	35

No. of Words { @ .30 Non-Commercial Rate } = \$ _____
 { @ .60 Commercial Rate }

Total Enclosed \$ _____

Insert _____ time(s)

Starting with _____ issue

Payment must accompany order unless placed through accredited advertising agency 56

NAME _____

ADDRESS _____

CITY _____ STATE _____ ZIP _____

SIGNATURE _____

MAIL TO: RADIO-ELECTRONICS, CLASSIFIED AD DEPT., 154 WEST 14TH ST., NEW YORK, N.Y. 10011



visit us during
National Salvation Army Week
MAY 22-29, 1966
Service Unlimited
... TO THOSE IN NEED

MARKET CENTER

BEFORE You Buy Receiving Tubes, Transistors, Diodes, Electronic Components & Accessories . . . send for Giant Free Zalytron Current Catalog, featuring all STANDARD BRAND TUBES all Brand New Premium Individually Boxed. One Year Guarantee—all at BIGGEST DISCOUNTS in America! We serve professional servicemen, hobbyists, experimenters, engineers, technicians. WHY PAY MORE? ZALYTRON TUBE CORP., 469R Jericho Turnpike, Mineola, N.Y. 11502

TV CAMERAS, transmitters, converters, etc. Lowest factory prices. Catalog 10¢. VANGUARD, 196-23 Jamaica Ave., Hollis, N.Y. 11423.

SURPLUS PARTS CATALOG. Send for free catalog listing hundreds of up-to-date electronic components at down-to-earth prices. ELECTRONIC CONTROL DESIGN COMPANY, P.O. Box 1432-P, Plainfield, N.J. 07061.

TV Tuners Rebuilt and Aligned per Manufacturers specifications. All Makes—Color-B&W. Only \$9.50. We ship COD Ninety Day written guarantee. Ship complete with tubes or write for free mailing kit and dealer brochure. VALLEY TUNERS, 5641 A Cahuenga Blvd., North Hollywood, California.

MESHNA CONVERTER KITS, converts car radio for shortwave reception. Police, fire, marine. 30-50mc, 100-200mc, marine. Any kit \$5.00. Completely wired for use \$15.00. MESHNA, Lynn, Mass. 01904.

LAMP-APPLIANCE PARTS. Wholesale catalogue 25¢. SECO 112 South 20th Street, Birmingham, Alabama 35233.

BEGINNERS, BUILDERS Giant catalog—25¢, refundable. LABORATORIES, 993-B, Redwood City, California 94064.

Silicon Power Diodes Studs & P.F.*				
D. C. Amps	50Piv 35Rms	100Piv 70Rms	200Piv 140Rms	300Piv 210Rms
12	.30	.50	.70	.85
18*	.20	.30	.75	1.10
45	.80	1.25	1.80	2.25
150	2.50	2.90	3.50	4.50
240	3.75	4.75	7.75	10.45

D. C. Amps	400Piv 280Rms	500Piv 350Rms	600Piv 420Rms	750Piv 525Rms
12	1.10	1.30	1.55	1.75
18	1.50	2.00	2.70	3.40
45	3.25	3.50	3.90	4.50
150	5.40	6.50	7.50	12.00

5U4 Silicon Tube Rep. \$2 @. 6 for \$10
5R4 Silicon Tube Rep. \$5 @. 2 for \$9

"TAB" SILICON 1-AMP DIODES Factory Tested
*NEWEST TYPE! LOW LEAKAGE Gtd.!

Piv/Rms	Piv/Rms	Piv/Rms	Piv/Rms
50/35	100/70	200/140	300/210
.07	.10	.12	.15
400/280	500/350	600/420	700/490
.20	.25	.30	.35

Piv/Rms 800/560 .40
Piv/Rms 900/630 .50
Piv/Rms 1000/700 .55
Send 25¢ for Catalog

*ALL TESTS AC & DC & FWD & LOAD!

1700 Piv/1200Rms @ 750Ma \$1.20 @. 10 for \$10
Name 1100Piv/770Rms 75c @. 26 for \$11

"TAB" TERMS: Money Back Guarantee. Our 21st year. \$2 Min. order prepaid 48 states U.S.A.
111 G-A Liberty St., N. Y. 6, N. Y.
SEND 25¢ Phone: REctor 2-6245 for CATALOG

FREE Catalog. Electronic parts, tubes. Wholesale. Thousands of items. Unbeatable prices. ARCTURUS ELECTRONICS RE, 502-22 St., Union City, N. J. 07087

TV TRADES wanted "as is" Hi Prices paid. TV WHOLESALE OUTLET CORP., 467 Columbus Avenue, N.Y., N.Y.

JAPAN & HONG KONG Electronics Directory. Products, components, supplies. 50 firms—just \$1.00. IPPANO KAISHA LTD., Box 6266, Spokane, Washington 99207.

NUMERIC READOUT 9⁹⁵

MINIATURE SIZE, compact, incandescent numeric readouts have new-type, long-life 30,000 hour lamps. Machined aluminum stack-plate design permits close side-by-side mounting. Digit size 3/4" high. Specify 6V or 14V model.

SHIPPED PREPAID WHEN CHECK ACCOMPANIES ORDER

ORDER FROM **ALCO ELECTRONIC PRODUCTS, INC.** LAWRENCE, MASSACHUSETTS



NEON AC/DC ELECTRIC TESTER
FOR HOME AUTO SHOP
SPECIAL! 59¢

Special!
With every \$10 Order
25¢ per tube
(No Limit) from this list:

6AG5 6SN7
6AU6 6J6 6SA
6AQ5 6K6 6W4

CORNELL TUBES
1 YR. GUARANTEED

Mutual Conduction Lab-tested, Individually Boxed, Branded and Code Dated Tubes are new, or used and so marked

21 PICTURE TUBES
1395
1 Yr. Guar.
* Aluminized
Pay Dues Deposit
COD or Send Dues
with Order

Special!
59¢

33¢ PER TUBE

100 TUBES OR MORE:
30¢ PER TUBE

all purpose ELECTRONIC CLEANER
89¢ plus 25¢ shipping

SILICON RECTIFIERS
750 MA 400 P.I.V.
69¢ PAIR

CHEATER CORDS
29¢ plus 5¢ shipping

DIODES / RECTIFIERS
sensational **39¢** per pack plus 5¢ shipping

STOP TV A RADIO NOISES INSTANTLY!
99¢ plus 10¢ shipping

NOISE FILTER
99¢ plus 10¢ shipping

SOLDERING GUN
SPECIAL LOW PRICE **2.99** plus 20¢ shipping

PRESTIGE & SUCCESS are yours as an ELECTRONIC EXPERT

FOR CORNELL CUSTOMERS ONLY by special arrangement with the publisher, these amazing bargains are available.

COMPLETE RADIO SERVICING AND BASIC ELECTRONICS COURSE ONLY \$3.00 (\$2.50 + 50¢ packaging charges)

NEW PRACTICAL TV TRAINING COURSE ONLY \$3.50 (\$3.00 + 50¢ packaging charges)

Both above courses **\$6.00**

RADIO-TV/TUBE TESTER
TEST AND REPAIR TV & RADIO SETS APPLIANCES
\$2.89 plus 30¢ shipping

TUBE SUBSTITUTES
\$1.25

PICTURE EXPANDER
99¢

CORNELL ELECTRONICS CO.
Dept. RE 5 4217 University Ave., San Diego, Calif. 92105

Other tubes at low prices—send for free list
NO SUBSTITUTIONS WITHOUT YOUR PERMISSION

TERMS: Add 3¢ per tube shipping. Orders under \$5.00 add 3¢ per tube shipping plus 50¢ handling. Canadian orders add approximate postage. Send 25¢ deposit on C.O.D. orders. No C.O.D. orders under \$5.00 or to Canada. No 24 hr. free offer on personal check orders.

3-DAY MONEY BACK OFFER!

FREE ELECTRONICS catalog. Tremendous bargains. **ELECTROLABS**, Department C-251G, Hewlett, New York 11557.

MAGNETS—Alnico, Ceramic, Flexible, assemblies. What you need, we have. Special-Powerful pocket magnet, \$1.00. **MARYLAND MAGET**, 5412-G Gist, Baltimore, Maryland 21215

TELEVISION ATTACHMENT, switches off commercials, etc. sound and picture. **QUEEN ELECTRONIC RESEARCH**, 720 South Main Street, Ashboro, North Carolina

HORIZONTAL DEFLECTION CIRCUIT METER Simply point at TV Screen. Meter indicates performance—Good, Bad, Intermittent. No connection to TV required. Regular price \$19.50. New low price \$12.95. **TROY ELECTRONICS** 6324 N. Troy, Chicago, Illinois 60626

TRANSISTOR TV CAMERA KIT now available! 17 transistors—printed circuit. Excellent performance. Complete kit only \$149.50, less vidicon. Other kits available. \$18.95 up. Informative catalog—25¢. **ATV RESEARCH**, Box 396R, So. Sioux City, Nebr. 68776

OCTOPULSE ELECTRONIC IGNITION, Silicon Reliability! Fail Safe! Simplest installation yet! Positive, negative ground models, same low price \$24.95. Money back guarantee! **HANDEBOIS, INC.** 4371 W. 138th Street, Hawthorne, California 90250

FREE! Egypt, 10¢ handling. Approvals, **BELLET R-E**, Hazel Park, Michigan 48030

GOVERNMENT SURPLUS

GOVERNMENT SURPLUS Jeeps from—\$52.50, Voltmeters from—\$1.05, Transmitters from—\$6.18, Oscilloscopes, Walkie-Talkies, Multimeters. Typical "As Is" Bid Bargains from Uncle Sam. Tremendous variety. Exciting free list. Write: **ENTERPRISES**, Box 402-F9, Jamaica, New York 11430.

ZIP

stands for the Post Office Department's new Zoning Improvement Plan. When renewing your **RADIO-ELECTRONICS** subscription, or sending us a change of address, please let us know what your ZIP Code is. We'll add it to your address mailing plate ... and you'll get speedier delivery

service from the Post Office. By the way, when writing to us, address:

RADIO-ELECTRONICS,
154 West 14 St.,
New York, N. Y.
10011



CLASSIFIED COMMERCIAL RATE (for firms or individuals offering commercial products or services): 60¢ per word . . . minimum 10 words.
NON-COMMERCIAL RATE (for individuals who want to buy or sell personal items): 30¢ per word . . . no minimum.

Payment must accompany all ads except those placed by accredited advertising agencies. 10% discount on 12 consecutive insertions, if paid in advance. Misleading or objectionable ads not accepted. Copy for July issue must reach us before May 10th.

WORD COUNT: Include name and address. Name of city (Des Moines) or state (New York) counts as one word each. Zone or Zip Code numbers not counted. (We reserve the right to omit Zip Code if space does not permit.) Count each abbreviation, initial, single figure or group of figures or letters as a word. Symbols or groups such as 8-10, COD, AC, etc., count as one word. Hyphenated words count as two words. Minor over-wordage will be edited to match advance payment.

72 page illustrated Government Surplus Radio, Gadgets Catalog 25¢. **MESHNA**, Nahant, Mass.

EDUCATION/ INSTRUCTION

LEARN ELECTRONIC ORGAN SERVICING. New home study course covering all makes electronic organ including transistors. Experimental kits—schematics—trouble-shooting. Accredited NHSC-GI Approved. Write for free booklet. **NILES BRYANT SCHOOL**, 3631 Stockton Blvd., Dept. F, Sacramento 20, Calif.

HIGHLY—effective home study review for FCC commercial phone exams. Free literature! **COOK'S SCHOOL OF ELECTRONICS**, Craigmont, Idaho 83523.

FCC LICENSE in 6 weeks. First Class Radio Telephone. Results Guaranteed. **ELKINS RADIO SCHOOL**, 2603E Inwood, Dallas, Tex.

SLEEP LEARNING. Hypnotism! Tapes, records, books, equipment. Details, strange catalog **FREE. RESEARCH ASSOCIATION**, Box 24-RD, Olympia, Wash.

BROADCASTING, Communications Electronics taught quickly—resident classes; correspondence. Free details. Write: Dept. 4, **GRANTHAM SCHOOLS**, 1505 N. Western, Hollywood, Calif. 90027

REI First Class Radio Telephone License in (5) weeks Guaranteed. Tuition \$295.00. Job placement free. **RADIO ENGINEERING INSTITUTE**, 1336 Main Street, Sarasota, Fla.

B.Sc. DEGREE (Engineering) by home study. Send \$1. for 1966 prospectus. **CIST**, Suite 655, 263 Adelaide St. W., Toronto, Canada

TELEVISION TROUBLESHOOTER answers all your service problems. Waste no time on book theory. Spot faults in minutes. Used by "pros" in repairing all makes and models. Write, specifying black/white, or color. **NATIONAL TECHNICAL RESEARCH LABS**, 6413 S. Western Avenue, Whittier, California

FCC First Class License in six weeks. Bob Johnson **RADIO LICENSE TRAINING**, 10600 Duncan, Manhattan Beach, California

NEW CONCEPT in Electronic Training Aids for schools, for information write **ELECTRO-SCHMATIC**, 4708 Alabama Street, El Paso, Texas 79930.

EMPLOYMENT OPPORTUNITIES

FOREIGN EMPLOYMENT information. Construction, other work projects. Good paying overseas jobs with extras, travel expenses. Write only: **FOREIGN SERVICE BUREAU**, Dept. RE, Bradenton Beach, Florida 33510.

"**EMPLOYMENT RESUME GUIDE**". Simplified Writing Instructions. Examples—\$2.00. **MAGNETIC**, Box 3677-REV, Washington 20007

FREE! PLUS CHOOSE ANY \$100 ITEM FREE

\$25 WORTH OF TRANSISTORS RECTIFIERS RESISTORS CONDENSERS DIODES & ETC

Add 25¢ for handling

BOTH FREE WITH ANY \$10 ORDER

DAP 198 **IGNITION TRANSISTOR** 2N1073A 2N1073B 10 Amps 60-120V

750 MIL TOP HAT AND EPOXIES

1000 PRV 3 for \$129

ZENER VOLTAGE REGULATORS 1 WATT

3 For \$1.

Volts	Volts	Volts	Volts	Volts	Volts	Volts	Volts
6.8	10	15	22	33	47	68	100
7.5	11	16	24	36	51	75	110
8.2	12	18	27	39	56	82	120
9.1	13	20	30	43	62	91	130

LOW NOISE FETS FROM CRYSTALONIC Vacuum Tube Equivalent

\$195 **ELEC.WORLD** November, for uses in hookups.

WORTH \$24 **CG10** N-channel

- 60 CERAMIC CONDENSERS, discs, npo's, to .05 \$1
- 10 TRANSISTOR ELECTROLYTICS: 10mf to 500mf \$1
- 50 COILS & CHOKES, if, rf, ant, osc, & more . \$1
- 10 ELECTROLYTICS, to 500mf, asst PP & tubulars \$1
- 10 VOLUME CONTROLS, to 1 meg, switch too! \$1
- 60 HI-Q RESISTORS, 1/2, 1, 2W, 1% & 5% values \$1
- 60 TUBULAR CONDENSERS, to .5mf, to 1Kv, asst \$1
- 40 DISC CONDENSERS, 27mf to .05mf to 1KV \$1
- \$25 SURPRISE PAK: transistors, rect, diodes, etc \$1
- 30 POWER RESISTORS, 5 to 50W, to 24 Kohms \$1

"ONE PRICE" SCRS!

Imagine 7-amp, 16-amp and 25-amp at one price! Just check the proper amp and PRV blocks.

PRV	7-Amps	16-Amps	25-Amps
25	.25	1.50	.80
50	.45	2.00	1.15
100	.70	2.50	1.35
			300 1.75
			400 2.25
			500 2.50
			600 2.95

- 2—500MC, 2N70R NPN Silicon planar TO-16 . \$1
- 25 GERMANIUM & SILICON DIODES, no test . \$1
- 25 TOP HAT RECTIFIERS, silicon, 750ma, no test \$1
- 3 2-WATT PLANAR TRANS'RS, 2N697, 100mc \$1
- 25 "EPOXY" SILICON RECTIFIERS no test . \$1
- 10 2-6amp RECT's, studs, silicon, 50 to 400V \$1
- 10 PHILCO MAT HI-FREQ. TRANSTRS, untested \$1
- 3 2N706 500MW, 300MC NPN PLANAR, TO 16 . \$1

750 MIL TOP HAT AND EPOXIES

PIV	Sale	PIV	Sale	PIV	Sale
50	5¢	600	19¢	1400	95¢
100	7¢	800	29¢	1600	1.10
200	9¢	1000	51¢	1800	1.35
	13¢	1200	69¢	2000	1.50

- 15 PNP TRANSISTORS, CK722, 2N35, 107 no test \$1
- 15 NPN TRANSISTORS, 2N35, 170, 440, no test \$1
- 30 TRANSISTORS, r.f. audio osc-ifs, T05 no test \$1
- 10 FAMOUS CK722 TRANSISTORS, nnp no test \$1
- 5 2N107 TRANS'RS, by GE, pnp, pop, audio pak \$1
- 3 40-WATT TRANSISTORS PNP, stud, 80V \$1
- 4 2N21 3 TRANSISTORS, mixer-conv. TO22 . . . \$1
- 85 WATT 2N1212 PLANAR, drift, 10mc, non . . . \$1
- 85 WATT 2N424 PLANAR, silicon, TO-53 non \$1

10¢ FOR OUR "SUMMER" BARGAIN CATALOG ON: Semiconductors Poly Paks Parts

POLY PAKS TERMS: Send check, money order. Add postage—4¢. wt. per pak 1 lb. Ref'd net 30 days. COD 25% deposit.

P.O. BOX 942R
50. LYNNFIELD, MASS.
"PAK-KING" of the world

Circle 131 on reader's service card

RADIO SHACK BOOK OFFER!

Double-Barreled Bonus Offer for Readers of "Radio Electronics"

62-1050 • A RADIO SHACK PUBLICATION • PRICE 2.00

TITLE	PAGE
1. Crystal Diode Receiver	12
2. One Transistor Radio	14
3. Three Transistor Radio	15
4. Loudspeaker Cabinet	17
5. Sun Powered Radio	18
6. Portable Electronic Megaphone	20
7. Safety-Light Flasher	21
8. Continuity Tester	23
9. Electric Maze	24
10. Code Instructor	25
11. Advanced Code Instructor	27
12. Electronic Timer	29
13. Photo Exposure Meter	31
14. Electronic Metronome	32
15. Electronic Organ	33
16. Hi-Fi Power Meter	35
17. Audio Generator	36
18. Transistorized Power Amplifier	37
19. Transistor Tester	39
20. Burglar Alarm	40
21. Photo Exposure Meter	42
22. Slave Flash	43
23. All-Transistor Amplifier	44
24. Home Broadcast Station	47
25. Field Strength Meter	48
26. Wireless Code Transmitter	57
27. Loudspeaker Microphone	59
28. Mike Pre-amplifier	61
29. All-Transistor Intercom	62
30. Alarm Alarm	63
31. Color Comparator	65
32. Clearance Light Flasher	66
33. Short Wave Converter	68
34. Citizens Band Transmitter	70
35. Transistorized XYM	72
36. Simple Tachometer	73
37. Telephone Pickup	74
38. Directional Microphone	75
39. Stereo Balancer	77
40. Stereo Phasor	78
41. Appliance Tester	79
42. Electronic Stethoscope	80
43. Audio Mixer	81
44. Appause Meter	82
45. S-Meter	84
46. BFD	85
47. Big-Voice Megaphone	87
48. Short-the-Circuit	89
49. Battery Eliminator	92
50. Acoustic Receiver	93

50 EASY TO BUILD PROJECTS

including Instructions and Master Parts List!

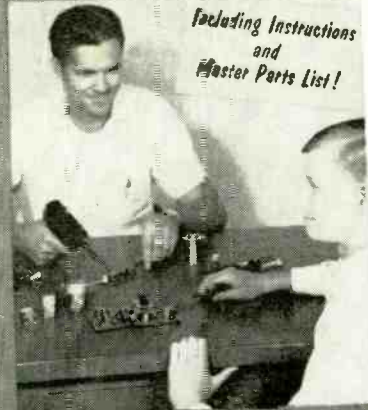

96 PAGES OF DO-IT-YOURSELF ELECTRONICS

96 Page You-Do-It Introduction to Basic Transistor Electronics!

Reg. \$2.00

WITH COUPON **ONLY**

50¢

(Postpaid)



FREE:
Radio Shack Bargain Catalogs — Plus Special Sale Flyers for 1 Full Year!

Fascinating, educational 96-page book with easy-to-follow directions and diagrams. Build 50 transistor circuits — from a basic radio to a 2-way intercom, with all but 2 battery-operated . . . safe even for school boys. Includes complete list of all parts and prices, all available at every Radio Shack store.

NOW — 85 Radio Shacks in 22 States!

ARIZONA	1
CALIFORNIA	15
COLORADO	1
CONNECTICUT	6
ILLINOIS	1
MAINE	1
MARYLAND	1
MASSACHUSETTS	13
MINNESOTA	2
MISSOURI	3
NEW HAMPSHIRE	1
NEW MEXICO	1
NEW YORK	6
OHIO	1
OKLAHOMA	2
OREGON	1
PENNSYLVANIA	3
RHODE ISLAND	2
TEXAS	18
UTAH	1
VIRGINIA	1
WASHINGTON	3

CLIP, FILL IN COUPON and MAIL TODAY!

Send to: Radio Shack Corporation
2727 West 7th St., Fort Worth, Texas, 76107

RE-566

- Please rush me a copy of your \$2 Electronic Project Book for just 50¢ (enclosed), postpaid.
- Send me Radio Shack's current catalog and all Bargain Bulletins as they come off the press.

Name _____

Street _____

City _____

State _____

Zip _____

Circle 132 on reader's service card

Where
will you stand
10 years from today,
when half
of what you now
know becomes
obsolete?

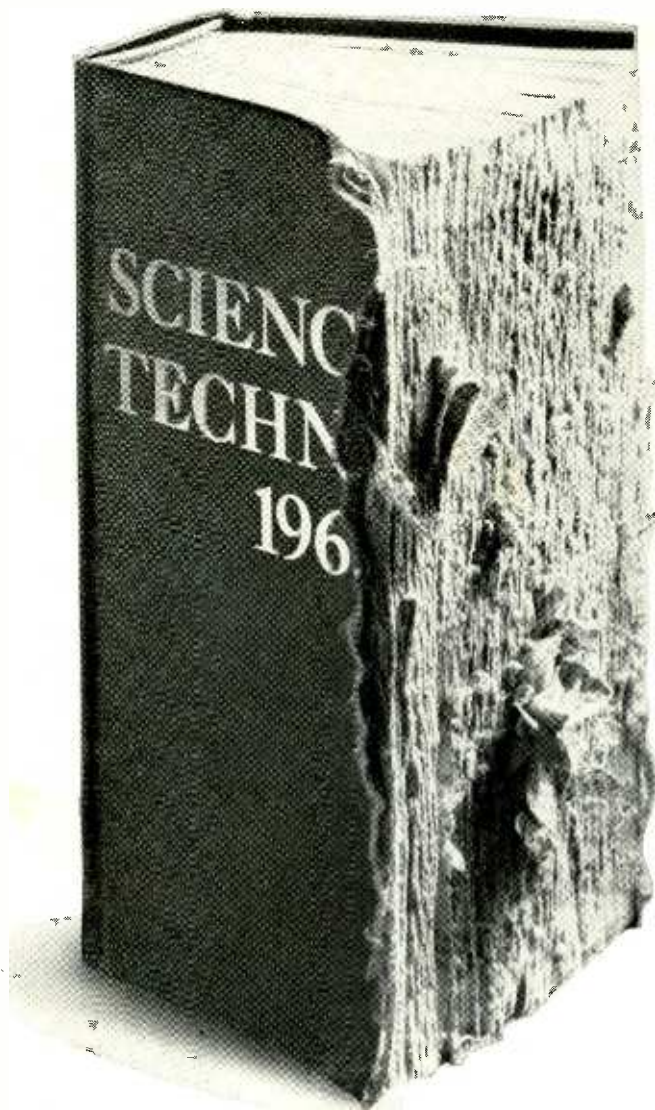

Right now you're steeped in the latest technologies. But 10 years from now half of this knowledge will be obsolete. And half of what you will need to know isn't even available today.

To keep up, you'll have to spend an increasing amount of your time in professional study. Many concerned technicians realize this fact. And it's one reason they've joined the IBM team.

They know that today IBM is a leader in science and technology. A dynamic company whose people and systems are at work on almost everything new in the world today. The discovery of new knowledge. The design of new products. The development of new solutions to a host of problems. IBM is an exciting company. It enables you to stay technologically "hot" throughout your career—and provides you with real opportunity for advancement.

So why don't you keep abreast of the times—and your technology? To see how IBM can help you keep technologically "hot" and your career "going," please write, outlining your qualifications, to M. A. Haeussler, Dept. 649S, IBM Corporate Headquarters, Armonk, New York 10504.

IBM is an Equal Opportunity Employer (M/F).

IBM®

Now in one handbook...the service information you need for 12 makes of color TV sets



TABLE OF CONTENTS

- INTRODUCTION
 HOW TO USE THIS HANDBOOK
 ABBREVIATIONS USED IN THIS HANDBOOK
 Section 1. CHASSIS INDEX
 CHASSIS LAYOUTS
 Section 2. PURITY ADJUSTMENTS
 Section 3. CONVERGENCE ADJUSTMENTS
 STATIC CONVERGENCE (general)
 DYNAMIC CONVERGENCE (specific)
 Section 4. BLACK-AND-WHITE SETUP ADJUSTMENTS
 Section 5. PHASE AND MATRIX ADJUSTMENTS
 Section 6. COLOR AFPC FIELD ADJUSTMENTS
 Section 7. MISCELLANEOUS ADJUSTMENTS
 Section 8. FUSES AND CIRCUIT BREAKERS
 Section 9. TEST EQUIPMENT FOR COLOR TV SERVICING
 Section 10. RECEIVING TUBES FOR COLOR TV

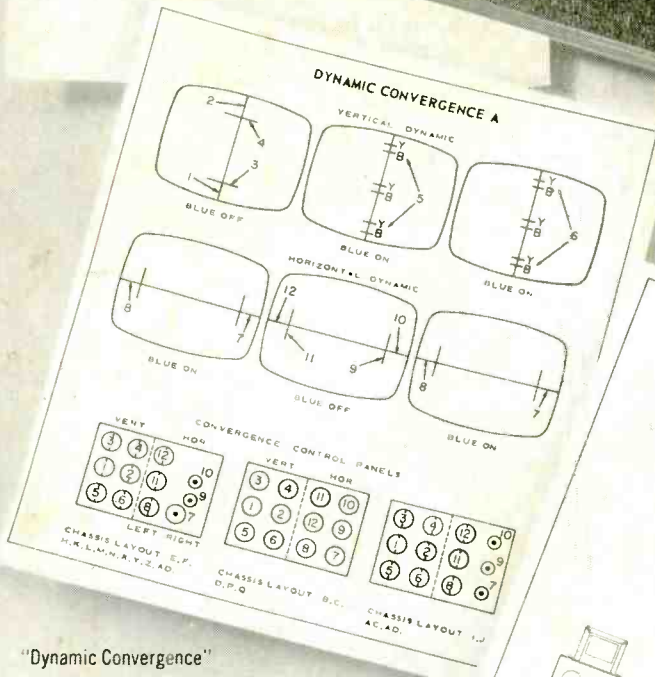

"Dynamic Convergence"

Just look up the chassis number of the set you are working on in the CHASSIS INDEX and you will be guided to the proper sections of the 140-page RCA Color TV Service Handbook. All the information is based on the manufacturer's own service notes. You'll want to carry a copy in your tube caddy on every color TV service call.

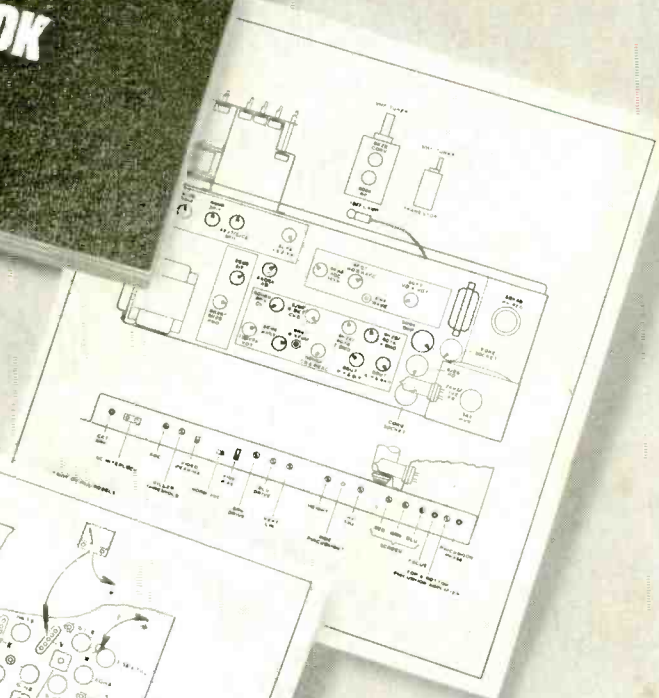

"Color AFPC Field Adjustments"

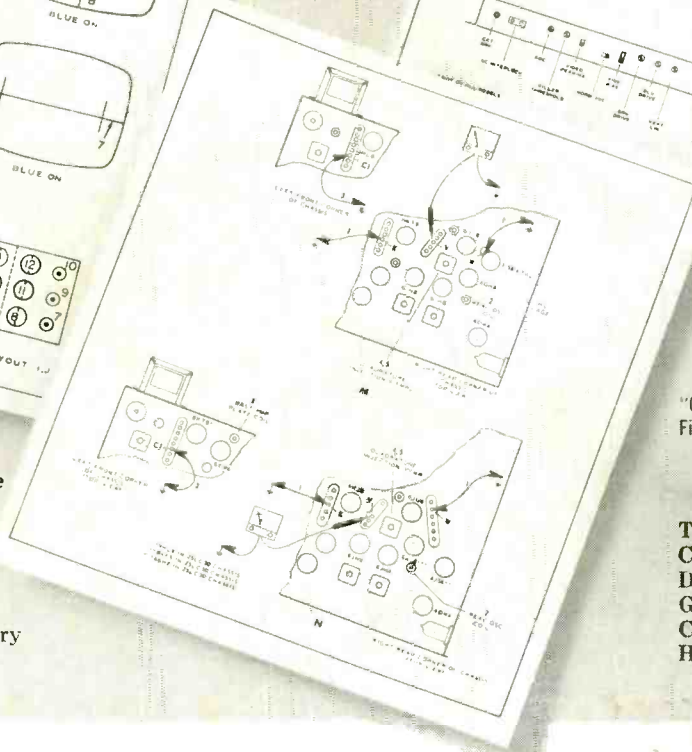

"Chassis Layouts"

TO KEEP UP WITH COLOR, SEE YOUR RCA DISTRIBUTOR ABOUT GETTING THE RCA COLOR TV SERVICE HANDBOOK (1A1553).

RCA ELECTRONIC COMPONENTS AND DEVICES, HARRISON, N.J.



The Most Trusted Name in Electronics

RCA's personal quality performance program aims for missile-type reliability in commercial receiving tubes. Under this program thousands of RCA people have pledged to strive for error-free performance so that when you replace with RCA receiving tubes you're sure of a satisfied customer.