

**TEST
INSTRUMENT
ISSUE**

HUGO GERNSBACK, Editor-in-Chief NOV. 50c

Radio-^{IND} Electronics

TELEVISION • SERVICING • HIGH FIDELITY

GERNSBACK
PUBLICATION

**10 Ways to Get More
From Your VTVM & VOM**

**How to Calibrate
Your Instruments**

**Use Test Equipment
To Save Your Time!**

**Meters for Beginners
How Do They Work?**

Schlack

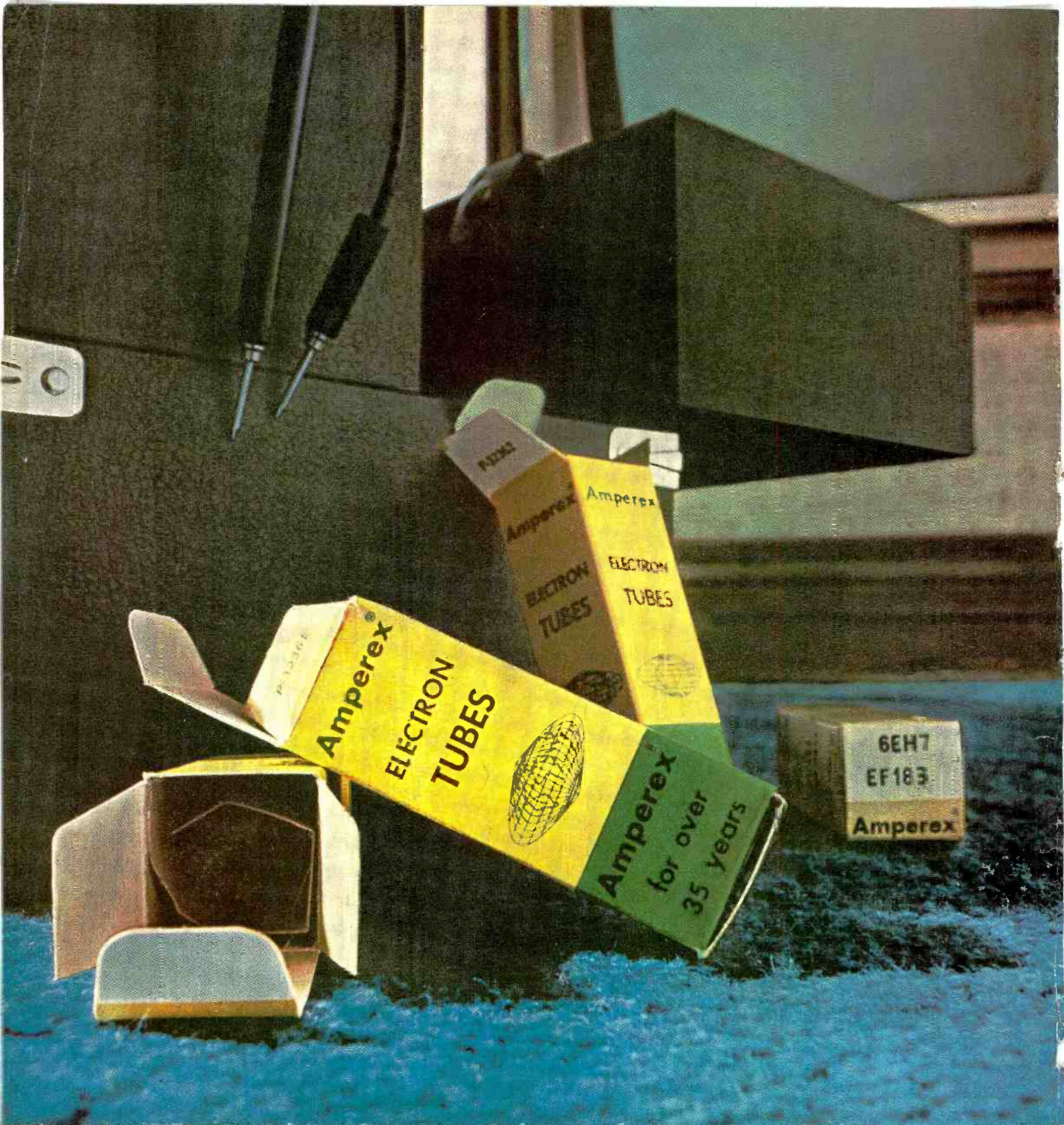

How to replace top quality tubes with identical top quality tubes

Most of the quality TV sets you are presently servicing were designed around special Frame Grid tubes originated by Amperex. More and more tube types originated by Amperex are going into the sets you'll be handling in the future.

Amperex Frame Grid tubes provide 55% higher gain-bandwidth, simplify TV circuitry and speed up your servicing because their extraordinary uniformity virtually eliminates need for realignment when you replace tubes.

Amperex Frame Grid Tubes currently used by the major TV set makers include:

2ER5 2GK5 2HA5 3EH7 3GK5 3HA5 4EH7 4EJ7 4ES8 4GK5 4HA5 5GJ7
6EH7 6EJ7 6ER5 6ES8 6FY5 6GJ7 6GK5 6HA5 6HG8 7HG8 8GJ7

If your distributor does not yet have all the Amperex types you need, please be patient—in some areas the demand keeps gaining on the supply.

Amperex Electronic Corporation, Hicksville, Long Island, New York 11802.



THE 6201
THE 312
THE SPHERICON
THE 315-C
THE COBREFLEX

AND NOW...

UNIVERSITY REVOLUTIONIZES THE ART OF SPEAKER DESIGN (again) WITH THE NEW, LOW-COST MUSTANG LINE!

(Priced from \$19.00 to \$32.00—guaranteed for five years!)

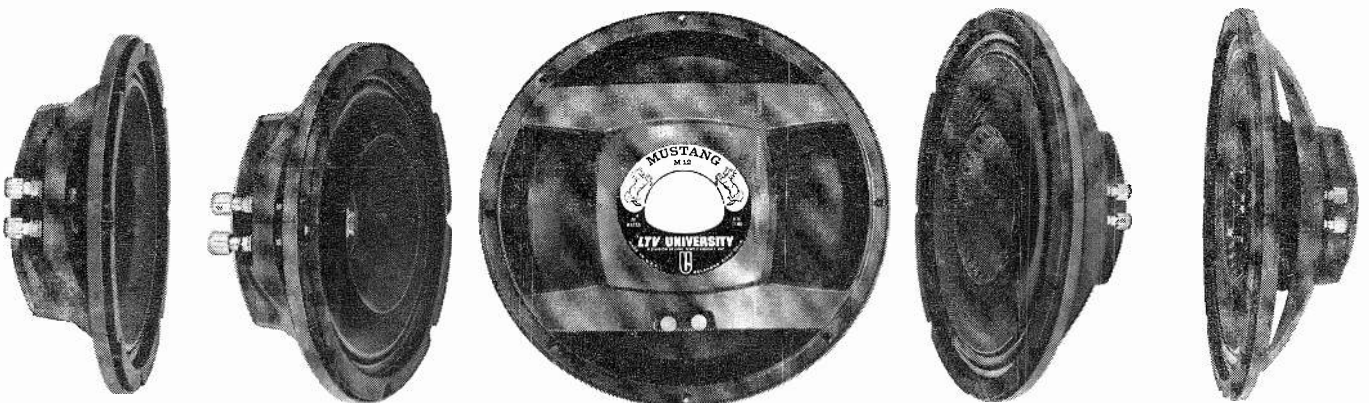

*M-8, 8" Single-Cone
Full-Range Speaker
\$19.00*

*M-8D, 8" Two-Way
Full-Range Speaker
\$19.50*

*M-12, 12" Single-
Cone Full-Range
Speaker \$20.50*

*M-12D, 12" Two-
Way Full-Range
Speaker \$21.00*

*M-12T, 12" Three-
Way Full-Range
Speaker \$32.00*

Ask any audiophile about the 6201, 312 and other professional University speakers. If he owns one, his eyes will light up, his praise will sound like poetry. Now, after extensive testing and experimentation with new types of cone materials, magnets, voice coils, even to the most minute part, University introduces Mustang—the first and *only* line of low-cost die-cast speakers so uncompromised in construction, they are unconditionally guaranteed for five years!

We invite you to compare Mustang to all other brands—including higher priced models. If you want exciting, yet natural, cleanly defined sound—if you want the “most” in dependability—if you want an ultra-thin speaker of highest quality, you want a University Mustang component speaker.

FEATURES (a few): Frequency response of unprecedented uniformity—35 to beyond 22,000 cps with the Model M-12T! Longthrow voice coils for optimum bass with minimum power. New, specially treated curvilinear diaphragms to prevent undesirable resonances. All parts electroplated to prevent distortion caused by corrosion. Sturdy die-cast frames for precision alignment of all parts. Design permits front or rear baffle mounting. High (30 watt) power handling capacity. Optimum performance may even be achieved with amplifiers of under 10 watts. Write: Desk RE-11, LTV University, 9500 West Reno, Oklahoma City, Oklahoma.

 **LTV
UNIVERSITY**
A DIVISION OF LING-TEMCO-VOUGHT, INC.

Radio-Electronics

NOVEMBER 1964 VOL. XXXV No. 11

Over 55 Years of Electronic Publishing

EDITORIAL

- 35 Flying Saucers—Myth Or Fact?.....Hugo Gernsback

AUDIO-HIGH FIDELITY-STEREO

- 49 Save Turntables From Too-Early JunkingGlen F. Stillwell
61 Cooking Up An AmplifierJack Darr
Utility audio design without tears (low-power jobs)
72 Equipment Report: Thorens TD-224
Record-Changing Turntable

ELECTRONICS

- 43 Electronic Muscle Exerciser
56 Baby Flash.....Melvin S. Lieberman

GENERAL

- 57 What's Your EQ?
62 Service Clinic.....Jack Darr

RADIO

- 39 Case Of The Built-In MotorboatHugh Kenner

TELEVISION

- 47 Sync Clippers: How And WhyJack Darr
A lively and thorough explanation of these vital TV circuits

TEST INSTRUMENTS

- 36 This Transistor Voltmeter Has High Input Impedance!David L. Phippen
Ever wish you could use your 11-meg vtm anywhere? Build this little meter!
40 10 Ways To Get More Use From Your VOM and VTVMWayne Lemons
Little adapters for experimenters and technicians
44 Meters For BeginnersRobert G. Middleton
Fundamental passive meter circuits in everyday use
50 A Roundup of Low-Cost FM Stereo GeneratorsLeonard Feldman
Specs and comments on four new units with prices down where you can see them
53 Use The Right Equipment—And Save TimeG. M. Roberts
TV service isn't profitable unless you can do it fast
58 When In Doubt, Calibrate!R. N. Centerville
How to keep shop vom's and vtm's reading accurately
64 Equipment Reports: Hallicrafters HM-1, Standard Kollsman VUT-1,
Emcee 1118-D
*Vacuum-Tube Volt-Milliameter, Vhf-to-Uhf Translator,
Precision Voltage References*

THE DEPARTMENTS

- | | | | | | |
|--------|----------------|-----|----------------------------|-----|-------------------|
| 70, 72 | Corrections | 82 | New Products | 101 | Technicians' News |
| 22 | Correspondence | 74 | New Semiconductors & Tubes | 93 | Technotes |
| 91 | New Literature | 6 | News Briefs | 106 | Try This One |
| 110 | New Patents | 104 | Noteworthy Circuits | 57 | 50 Years Ago |
| 112 | New Books | | | | |



Member,
Institute of High Fidelity
Radio-Electronics
is indexed in
Applied Science
& Technology Index
(Formerly
Industrial Arts Index).

HUGO GERNSBACK, editor-in-chief and publisher. M. HARVEY GERNSBACK, editor. Fred Shunaman, managing editor. Robert F. Scott, W2PWG, technical editor. Peter E. Sutheim, associate editor. Jack Darr, service editor. I. Queen, editorial associate. John J. Lamson, eastern sales manager. Wm. Lyon McLaughlin, technical illustration director.

GERNSBACK PUBLICATIONS, INC., 154 W. 14 ST., N.Y. 10011, AL 5-7755. Board Chairman Hugo Gernsback, President M. Harvey Gernsback, Secy. G. Aliquo, Treas. Charles A. Raible

Choose Your Tailor-Made Course in N.T.S. "PROJECT METHOD" ELECTRONICS!

Now! N.T.S. — one of America's oldest leading home-study and resident technical schools — offers you GREATER CAREER OPPORTUNITIES IN ELECTRONICS. N.T.S. "Project Method" home training lessons are shop-tested in the Resident School in Los Angeles. You work on practical job projects, learn to use shop manuals and schematics. Your N.T.S. training is individual. You proceed at your own pace. The Schools' practical methods, plus more than 60 years of experience, have helped thousands of students all over the world to successful careers. Prepare now for a secure future in one of 8 N.T.S. Electronics Courses designed to fit your own particular needs.



Work on the electronic "brains" of industry — computers, data processing and other automation equipment. Become a TV-Radio Technician, an electronics field engineer, or succeed in your own business.

CHOOSE YOUR FIELD — INSURE YOUR FUTURE!

- 1 ELECTRONICS-TV-RADIO-SERVICING & COMMUNICATIONS** A basic course thoroughly covering fundamentals of electronics, radio, TV servicing and communications.
- 2 MASTER COURSE IN ELECTRONICS-TV-RADIO, PLUS ADVANCED TV & INDUSTRIAL ELECTRONICS** This course covers everything included in Course No. 1 plus Automation and every phase of the Electronics industry.
- 3 FCC LICENSE** Preparation for this government license essential for interesting jobs in radar, radio, television, communications, guided missiles, many others. Upon completion of this course, if you do not pass the FCC exam for a 1st Class Commercial Radiotelephone License your tuition will be refunded.
- 4 RADIO SERVICING (AM-FM-Transistors)** Train for radio sales and service with dealer or distributor.
- 5 TELEVISION SERVICING (Including Color)** Covers installation, adjustment, repair and servicing of black and white and color television . . . prepares you for your own sales and service business.
- 6 STEREO, HI-FI AND SOUND SYSTEMS** A growing field. Prepares you to build, install and service modern sound equipment for home or industry.
- 7 BASIC ELECTRONICS** Gives you the fundamentals you must know to build on for a future Electronics career. Also offers an excellent background for Salesmen, Purchasing Agents, and others in Electronics.
- 8 ELECTRONICS MATH** Simple, easy-to-follow instructions in the specialized math you need in many electronics jobs.

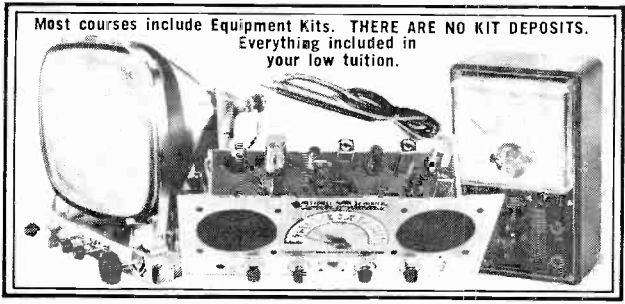

CLASSROOM TRAINING AT LOS ANGELES

You can take classroom training in our famous Resident School at Los Angeles in Sunny Southern California. N.T.S. is the oldest and largest school of its kind. Associate in Science Degree also offered in our Resident Program. Check Resident School box in coupon for full details.

HIGH SCHOOL AT HOME

Learn easily. New modern method. National also offers accredited high school programs for men and women. Take only subjects you need. Study at your own pace. Latest approved textbooks — yours to keep — everything included at one low tuition. Check High School box in coupon for information.



MAIL COUPON TODAY FOR FREE BOOK AND SAMPLE LESSON

In Field of Your Choice. You enroll by Mail — and Save Money. No Salesmen: This means lower tuition for you. Accredited Member N.H.S.C.



NATIONAL TECHNICAL SCHOOLS

4000 S. Figueroa St., Los Angeles, California 90037

Please Rush FREE Electronics "Opportunity Book" and actual sample lesson on course checked below:

- Electronics-TV-Radio Servicing & Communications
- Master Course in Electronics-TV-RADIO Advanced TV & Industrial Electronics
- FCC License
- Radio Servicing (AM-FM-Transistors)
- Television Servicing (Including Color)
- Stereo, Hi-Fi and Sound Systems
- Basic Electronics
- Electronics Math

Dept. RG-114

Name _____ Age _____

Address _____

City _____ State _____ Zip _____

- Check here if interested ONLY in Classroom Training at L.A.
- Check here for High School Department Catalog only.



NATIONAL TECHNICAL SCHOOLS

WORLD-WIDE TRAINING SINCE 1905
4000 S. Figueroa St., Los Angeles, California 90037



NEWS BRIEFS

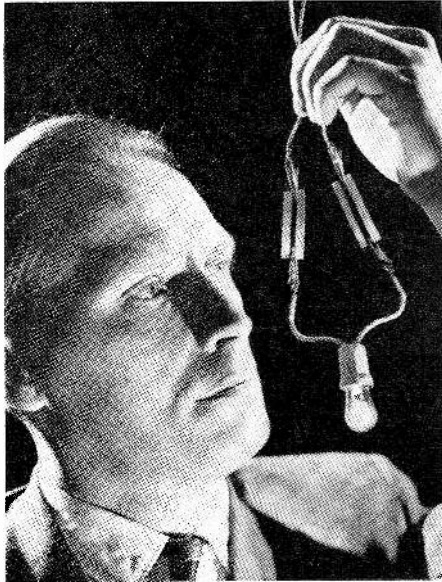

G.E. research scientist, Dr. John H. Lupinski, holds a lamp lighted by current flowing through the thin black strips of special plastic material painted on an ordinary white plastic insulator.

NEW PLASTICS ARE CONDUCTORS

A new family of conductive plastics has been announced by scientists of the General Electric Research Laboratory, Schenectady, N.Y. While these conductive plastics are far below metals in their ability to conduct, they have many characteristics which will make them useful in a large variety of new applications.

The degree of conductivity can be controlled, an additional advantage. Dr. Guy Suits, G-E vice president and director of research, however, warns that the plastics will require additional development before they can be placed on the market.

FCC POSTPONES DATE FOR NEW CB RULES

The Federal Communications Commission postponed the effective date of its clarifications of the Citizens Band regulation from November 1 to an indefinite date. It was stated that several petitions for reconsideration of the rules are outstanding, and that these petitions might not be disposed of until the middle of November. There was a feeling that the FCC might modify its proposed new rules as a result of the representations. The proposed rules, which would have

considerably restricted hobby uses of the Citizens Band in favor of straight communications use, had aroused considerable controversy. Some manufacturers, notably Robert Halligan, president of Hallicrafters, thought that the new rules would increase the use of CB radio sharply, stating "The change will drastically increase the usefulness of the bands for those who really need two-way radio." On the other hand, a number of concerns, including Lafayette Radio, one of the country's largest distributors and manufacturers of CB equipment believed that the Commission's order would "adversely affect that portion of the general public which uses the Citizens Radio Service to satisfy important needs recognized to exist by the Commission."

RCA DELIVERS 25-INCH COLOR SETS

According to an estimate made at press time, new 25-inch RCA color-TV sets should now be in dealers' hands.

The announcement, largely unexpected by trade and press alike, was made on Sept. 17 by RCA Group Executive Vice President W. Walter Watts at the opening of a new \$8-million color-picture-tube plant in Lancaster, Pa.

The first 25-inch sets will range in price from about \$800 to about \$1,300. Lower-price models are expected after the first of the year.

RAZOR BLADES RECORD LIGHTNING

The used razor blade is well known as an electronic instrument, and was used as a detector in many a crude razor-blade radio by soldiers overseas in the last war. However, Russian scientists are beginning to use the blades for high-voltage measurements, according to a recent issue of the Russian *Electric Stations*.

According to the magazine, a wooden holder for two razor blades is mounted on a 220-kv transmission-line tower. One blade is placed 30 millimeters from one of the tower uprights, and the other about 200 millimeters from it. A framework carrying a single turn of high resistance wire is mounted on the upright and a third blade placed in it.

The blades, magnetized by the lighting stroke, are "read" by passing them rapidly through a coil of wire under carefully predetermined conditions, and measuring the resultant current. From that information, engineers can

find, from the most distant razor blade, the largest current passing through the tower. From the one near the upright, they know how many times lightning struck, and from the one inside the coil, they know the maximum rate of change of the current passing through the tower. Currents up to 75,000 amperes were recorded in the razor-blade "memories", according to the Russian engineer.

NEW 3-YEAR INSTITUTE FOR ELECTRONIC TECHNOLOGISTS

A new nonprofit 3-year school, the Capitol Institute of Technology, has been opened in Washington. Founded by the Capitol Radio Engineering Institute, it has its own officers and board of directors, separate from CREI. The new institute will take over all resident student work, leaving correspondence and international school divisions to CREI. Students who graduate from CIT will receive the degree of Associate in Applied Science.

RANGEFINDERS NOW USE LASERS



One of the new range finders, as it appeared during the testing period.

Eight laser rangefinders have been delivered to the Army by the Radio Corporation of America. Four of the devices, known as "Laser Distance Measuring Equipments," have been undergoing tests since March.

The laser is a ruby-rod type, and is pulsed. The time the light pulse requires to travel to the target and back is measured to find the range of the target. It can thus determine range accurately and rapidly from a single location without giving warning to the enemy, as a radar device would.

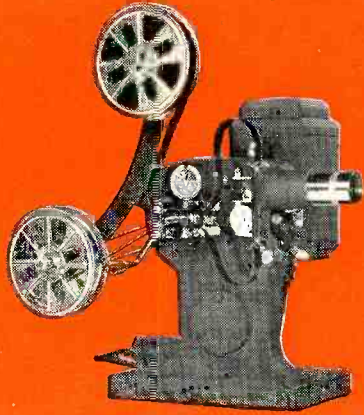

Prepare
At HOME or
in our CHICAGO
or TORONTO
Laboratories

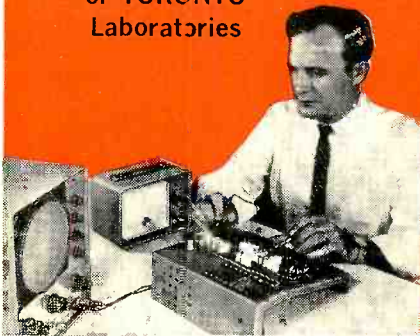

'Learn-by-seeing'
training MOVIES

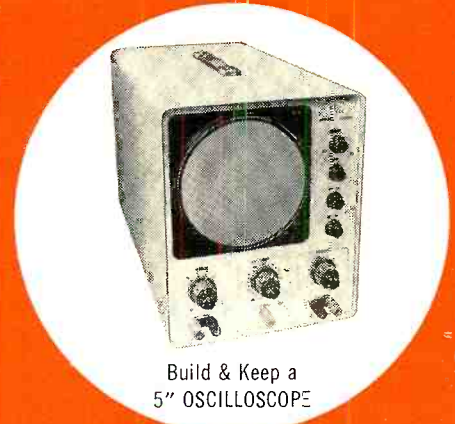

Build & Keep a
5" OSCILLOSCOPE

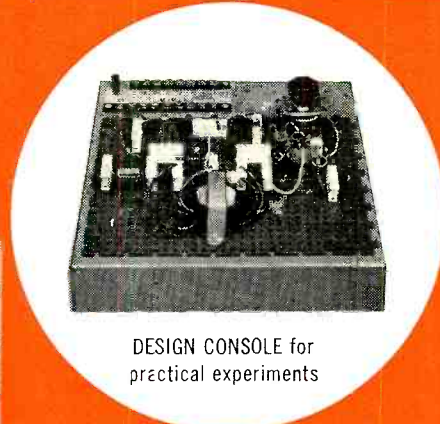

DESIGN CONSOLE for
practical experiments



Build & Keep a
TRANSISTORIZED METER

DeVRY TECH SUPPLIES ALL THIS AND MORE TO PREPARE YOU TO

Become an Electronics Technician

Would a career as an ELECTRONICS TECHNICIAN interest you? Perhaps you would like the Computer field . . . Instrumentation . . . Radio and Television . . . Automation or Control System work . . . a Space and Missile job. If so, READ ON.

Using DeVry's highly effective "programmed" texts - AND ALL OF THE PRACTICAL EQUIPMENT PICTURED ABOVE, many men, *probably much like you*, are now preparing at home in their spare time for wonderfully interesting, good-paying careers in every major branch of the vast, growing electronics industry. Others are

learning day or evening in our well-equipped Chicago or Toronto Laboratories.

You don't have to be a "super type" to get started toward a career in electronics! Far more important to success are ambition, average education and intelligence, interest in mechanical or electrical things.

SOUND INTERESTING? Then see for yourself how YOU may get ready to join the many DeVry graduates now enjoying good jobs, fine salaries and real progress in one of today's outstanding fields-ELECTRONICS. Mail the coupon today for no-obligation details.

FREE!

Send for these two information-packed booklets NOW!

EMPLOYMENT SERVICE

DeVry's highly effective Employment Service is available to all graduates at no additional cost.



DeVry Technical Institute

Chicago • Toronto
4141 Belmont Avenue
Chicago, Illinois 60641

DeVRY TECHNICAL INSTITUTE
4141 Belmont Ave., Chicago 41, Ill., Dept. RE-11-U

Please give me your two free booklets, "Pocket Guide to Real Earnings" and "Electronics in Space Travel"; also include details on how to prepare for a career in Electronics. I am interested in the following opportunity fields (check one or more):

- | | |
|--|---|
| <input type="checkbox"/> Space & Missile Electronics | <input type="checkbox"/> Communications |
| <input type="checkbox"/> Television and Radio | <input type="checkbox"/> Computers |
| <input type="checkbox"/> Microwaves | <input type="checkbox"/> Broadcasting |
| <input type="checkbox"/> Radar | <input type="checkbox"/> Industrial Electronics |
| <input type="checkbox"/> Automation Electronics | <input type="checkbox"/> Electronic Control |

Name _____ Age _____

Address _____ Apt. _____

City _____ Zone _____ State _____

Check here if you are under 16 years of age.

Canadian residents: Write DeVry Tech of Canada, Ltd.
2094 970 Lawrence Avenue West, Toronto 19, Ontario

NOW, MORE THAN EVER...

THE FINEST SERVICE IN TV TUNER OVERHAULING

CASTLE TV TUNER-EAST HAS MOVED TO NEW LOCATION WITH IMPROVED FACILITIES

In Long Island City near Postal Concentration Center to provide faster service by mail.

All other U.S. and Canadian Servicemen will get the same fast service from CASTLE-CHICAGO and CASTLE-CANADA.

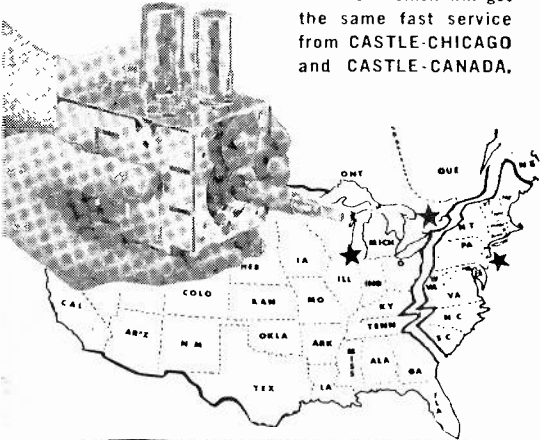

**ALL MAKES
ALL LABOR
AND PARTS
(EXCEPT TUBES)*
ONE PRICE**

995

ONE LOW PRICE INCLUDES ALL UHF, VHF AND UV COMBINATION* TUNERS

Simply send us your defective tuner complete; include tubes, shield cover and any damaged parts with model number and complaint. 90 Day Warranty.

Exact Replacements are available for tuners unfit for overhaul. As low as \$12.95 exchange. (Replacements are new or rebuilt.)

*UV combination tuner must be of one piece construction. Separate UHF and VHF tuners must be dismantled and the defective unit only sent in.

Pioneers in TV



Tuner Overhauling

CASTLE TV TUNER SERVICE, INC.

EAST: 41-96 Vernon Blvd., Long Island City 1, N. Y.
MAIN PLANT: 5715 N Western Ave., Chicago 45, Illinois
CANADA: 136 Main Street, Toronto 13, Ontario

*Major Parts are additional in Canada

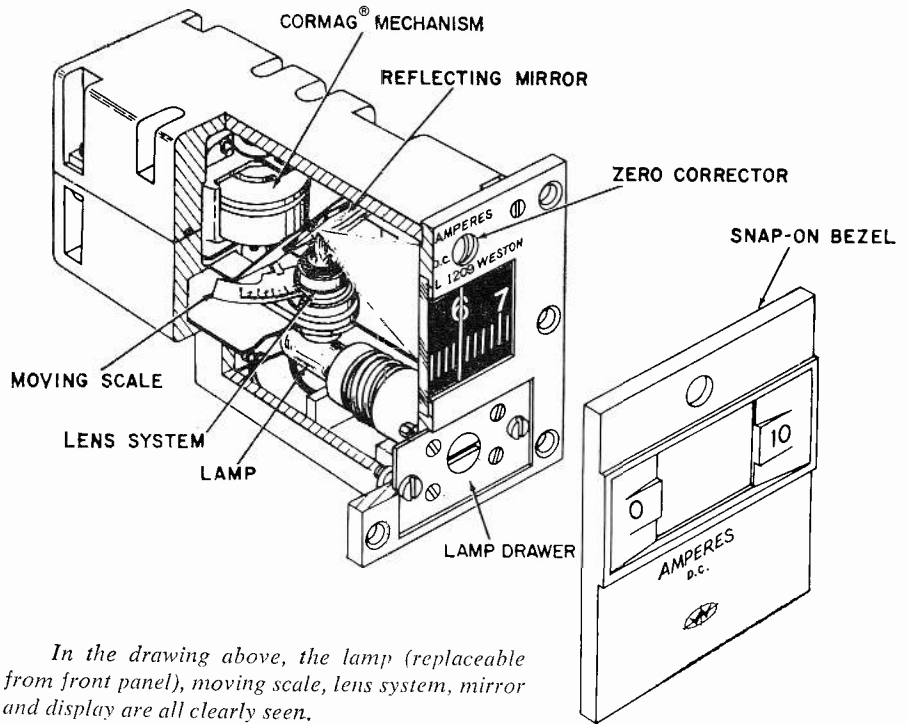

In the drawing above, the lamp (replaceable from front panel), moving scale, lens system, mirror and display are all clearly seen.

COMPACT PRECISION METERS USE PROJECTION OPTICS

A new meter design, which will permit a previously unheard-of combination of accuracy and compactness, has been announced by Weston Instruments. The new *Projected Moving Scale Meter* compresses into a 2-inch width a presentation which would previously have required a 9-inch-wide meter.

In a conventional meter, a moving pointer travels over a fixed scale. In the new Weston meter, a small moving scale actuated by the meter travels in front of a lens system. Light passing through the scale and the lens is reflected from a small mirror, and pro-

jected in magnified form to the meter face. Only that portion of the scale needed to read the measured value is projected, making it possible to have a relatively small face.

INTERFERENCE FROM FM?

The large number of new FM stations is reflected in an increasing number of complaints of interference in the upper vhf television band—in almost exact second-harmonic relationship to the FM band.

A serious but sometimes unexpected trouble is caused when the FM signal overloads the input stage of the TV receiver, generating additional harmonics. In one city, such severe interference was created that an FM station had to shut down after running only one day. It was later given a different channel.

The problem is said to be especially severe in fringe areas where boosters are used to push up weak TV signals.

INTENSE RADIATION BELT MAY SURROUND MARS

Reports to the International Astronomical Union indicate that Mars may have an extremely intense belt of radiation. This would show that Mars has a magnetic field, like that of the earth. The observations resulting in these conclusions were made by the 250-foot Jodrell Bank (England) radiotelescope on a 21-cm wavelength.

NTSC AND PAL TV SYSTEMS ARE MADE COMPATIBLE

A switchable NTSC-PAL TV set was demonstrated at the Milan Color

continued on page 12

Advertising Representatives:

EAST John J. Lamson Eastern Sales Manager Radio-Electronics 154 West 14th Street New York, N.Y. 10011 (212) Algonquin 5-7755	MIDWEST P. H. Dempers Co. 740 North Rush Street Chicago, Illinois 60611 (312) Michigan 2-4245
---	--

SOUTHEAST Neff Associates 15 Castle Harbor Isle Fort Lauderdale, Fla. (305) LOgan 6-5656	J. Sidney Crane, Assoc. 22 Eighth St., N.E. Atlanta 9, Ga. (404) TRinity 2-6720
---	--

TEXAS/ARKANSAS
Media Sales Co. 2600 Douglas Avenue, Irving, Texas 57060. (214) BLackburn 5-6573

WEST COAST/OKLAHOMA Husted-Coughlin, Inc. 1830 W. 8th Street Los Angeles 57, Calif. (213) 389-3132	Husted-Coughlin, Inc. 444 Market Street San Francisco 11, Calif. (415) GARfield 1-0151
---	---

UNITED KINGDOM
Publishing & Distributing Co., Ltd., Mitre House, 177 Regent St., London W.1, England

Subscription Service: Address form 3579 and correspondence to Radio-Electronics, Subscriber Service, 154 West 14th Street, New York, N. Y. 10011. When requesting a change of address, please furnish an address label from a recent issue. Allow one month for change of address.

RCA Test Instruments...

EVERYTHING YOU NEED FOR ACCURATE TV ALIGNMENT*

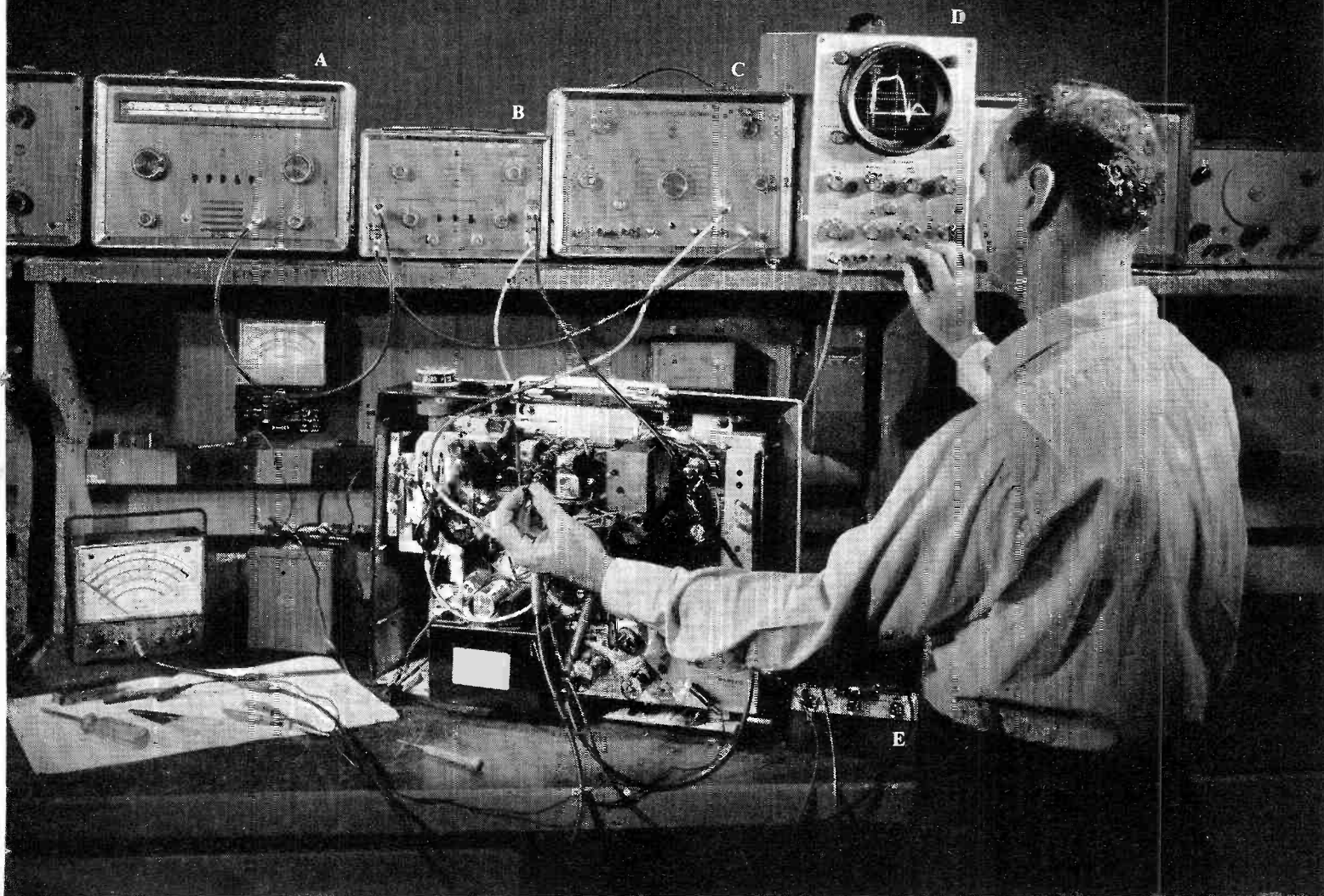

Checking overall frequency response (RF and IF) in a portable E&W TV receiver using the test instruments indicated in the block diagram below. Pattern on oscilloscope screen is an overall response curve with dual markers: one at picture-carrier frequency and one at sound-carrier frequency.

(A) RCA WR-99A CRYSTAL-CALIBRATED MARKER GENERATOR

Supplies a fundamental frequency RF carrier of crystal accuracy for aligning and trouble-shooting color and B&W TV receivers.

- Most-used IF and RF frequencies indicated on the dial scale
- Sound and picture carrier markers available simultaneously

\$242.50* complete with output cable.

(B) RCA WR-70A RF/VF/IF MARKER ADDER

For use with a marker generator and a sweep generator. Used for RF, IF, and VF sweep alignment color and B&W TV receivers. In visual alignment techniques, it eliminates distortion of sweep response pattern.

\$74.50* complete with four coaxial cables

(C) RCA WR-69A TELEVISION FM SWEEP GENERATOR

For visual alignment and troubleshooting of color and B&W TV receivers, and FM receivers.

- IF/Video output frequency continuously tunable from 50 Kc to 50 Mc

• Sweep-frequency bandwidth continuously adjustable from 50 Kc to 20 Mc on IF/Video and FM; 12 Mc on TV channels

\$295.00* Complete with RF output cable and IF/Video output cable.

(D) RCA WO-91A 5-INCH OSCILLOSCOPE FOR COLOR-TV

A heavy-duty, wideband precision scope, essential for TV alignment and troubleshooting.

- New 2-stage sync separator assures stable horizontal sweep lock-in on composite TV signals
- Dual bandwidth: 4.5 Mc at

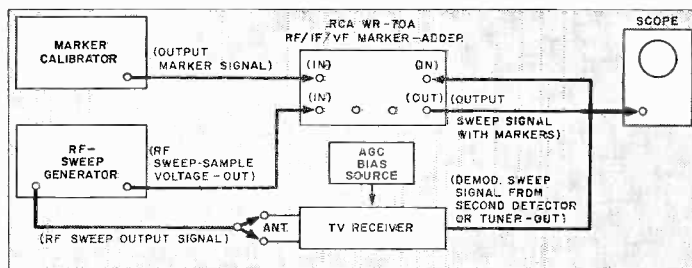

0.053 volt rms/in. sensitivity. 1.5 Mc at 0.018 volt rms/in. sensitivity

\$249.50* including direct/low capacitance probe and cable, ground cable, and insulated clip.

(E) RCA WG-307B TV BIAS SUPPLY

Three separate dc output voltages each adjustable from 0 to

–15 volts provide bias voltages for aligning RF, IF and other circuits of COLOR and black and white TV receivers. **\$11.95***

See them all at your Authorized RCA Test Equipment Distributor.

**Optional Distributor Resale Price All prices are subject to change without notice. Prices may be higher in Alaska, Hawaii and the West.*

RCA ELECTRONIC COMPONENTS AND DEVICES, HARRISON, N. J.



The Most Trusted Name in Electronics

fast, accurate, never lets you down . . .

New Burn-out,
stick proof meter!

NEW
SPEEDY
SET-UP
BOOKLET

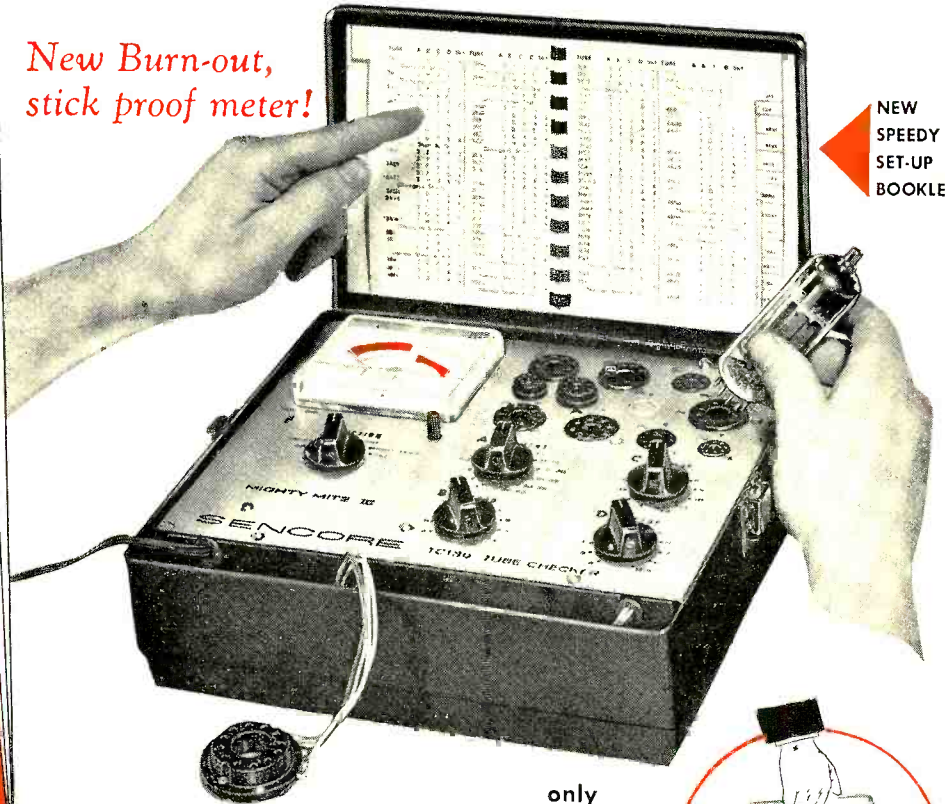

NEW

IMPROVED

**MIGHTY
MITE**

NEW

Lower voltage checks for Nuvistors and all new frame grid tubes as demanded by tube manufacturers, but not found on other tube checkers.

NEW

Speedy indexed set-up cards to reduce "look-up" time. No more cumbersome booklets, or incomplete charts.

NEW

Simplified panel layout reduces set-up time — prevents set-up errors.

NEW

Streamline styling with rounded corners and rubber feet, prevents marring Furniture — presents that "Professional look".

only

NEW TC 130

\$7450

Checks them all . . .

including Novars, Compactrons, Nuvistors, 10 pin tubes — plus Picture Tubes!

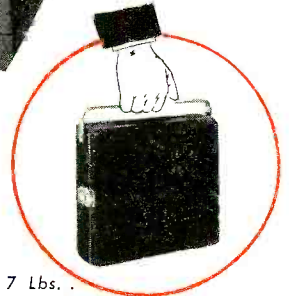

Only 7 Lbs. . .
Smaller Than A Portable Typewriter

Here's the famous MIGHTY MITE, America's fastest selling tube checker, with an all-new look and many new exclusive features. MIGHTY MITE III brings you even greater portability, versatility and operating simplicity beyond comparison. Controls are set as fast and simply as A-B-C right from the speedy set-up cards in the cover. The new functional cover can be quickly removed and placed in a spot with more light for faster reading of the set-up data or "cradled" in the specially designed handle as a space saver as shown above. New unique design also prevents cover from shutting on fingers or cutting of line cords as in older models.

In a nut shell . . . the MIGHTY MITE III is so very popular because it checks for control grid contamination and gas just like the earlier "eye tube" gas checkers (100 megohm sensitivity) and then with a flick of a switch, checks the tube for inter-element shorts and cathode emission at full operating levels. Sencore calls this "the stethoscope approach" . . . as each element is checked individually to be sure that the tube is operating like new. User after user has helped coin the phrase "this checker won't lie to me". Most claim that it will outperform large mutual conductance testers costing hundreds of dollars more and is a real winner in finding those "tough dogs" in critical circuits such as color TV and FM stereo.

**See Your Parts Distributor-- And See
The Mighty Mite III For Yourself!**

SENCORE

"Quality at its finest"

**426 SOUTH WESTGATE DRIVE
ADDISON, ILLINOIS**

see what's new for 1965 in the Wonderful World of *knight-kits*[®]



\$7995
less case

KG-854 54-Watt Solid-State Stereo Amplifier Kit—absolutely superb performance, a pleasure to build. No output transformers; precision self-resetting circuit breakers; printed circuit board and military-type terminal board for easy assembly. Nothing like it at the price!



\$9995
less case

KG-765 All-Transistor Stereo FM-AM Tuner Kit—delivers the most exciting stereo sound imaginable. Features automatic stereo MX indicator light; FM-AM signal-strength tuning meter; factory-assembled and aligned IF strip and FM front-end. Superb quality—incomparably low in cost.



\$8995

C-560 5-Watt CB Transceiver Kit—for 110-130 v. AC/12v. DC; terrific sensitivity; 6-crystal-controlled channels; 23-channel manual tuning; preassembled and tuned Nu-vistor RF stage; solid-state power supply; 2-stage IF; adjustable squelch, and much more. A super-value in latest CB design.

\$1588

KG-275 Exposure Meter Kit—latest super-sensitive cadmium-sulphide type; accurately measures both reflected and incident light; 2-range meter; push-button selection for low and high light levels; color-coded scales to calculate proper lens opening and shutter speed. Professional quality—outperforms far costlier units.



\$3495

with switchable probe



KG-625 6" VTVM Kit—king-sized for accuracy; 1/2-volt full-scale DC range; 200 microamp movement; reads peak-to-peak AC volts directly; precision 1% film-type resistors; single switchable AC-ohms/DC test probe. Terrific value.

\$4995

with cable & leads



KG-375 Universal Auto Analyzer Kit—great for auto tuneups—checks generator, alternator, regulator, wiring, both 6 and 12-volt, all engines. Big 7" meter; solid-state circuitry; self-powered. Packed with exclusive features—at lowest cost.

\$1995

KG-225 Wireless Intercom Kit—transistorized and wireless—newest, finest, most advanced intercom kit you can buy. All units are Masters; all originate calls. Squelch circuit eliminates interference. Add stations as needed. Amazingly low priced.

knight-kit

GUARANTEE

Buy any Knight-Kit. Build it. Operate it. You must be satisfied or we refund your money.



see many other great *knight-kits*[®] including best-sellers like these!



\$9995
less case

KG-870 70-Watt Solid-State Stereo Amplifier Kit—packed with dozens of deluxe features to bring you spectacular performance at low, low cost. The last word in easy assembly and breathtaking sound.



\$6995

C-22 5-Watt CB Transceiver Kit—top quality at lowest price; for 110-130 v. AC/12 v. DC; 5 crystal-controlled channels, 22-channel manual tuning; adjustable squelch; ANL; Pi-net output, and more.



\$3995

"Star Roamer" 5-Band Superhet Short-Wave Receiver—band-switched ranges; electrical bandspread; "S" meter; ANL; IF sensitivity control—tops for lowest-cost world-wide radio reception.



\$9995

T-150A 150-Watt AM/CW Transmitter Kit—covers 80 through 10 meter ham bands; electrical bandspread; controlled-carrier modulation; stable VFO; "spot" switch; chirp-free cathode keying; front panel key jack. The price is unbeatable.



\$888

Famous C-100 less battery Walkie-Talkie Kit—all-transistor; range up to 1/4 mile; crystal-controlled xmitter for channel 7; fun to build and use. Owned by thousands. Lowest-priced Walkie-Talkie kit available anywhere.



\$2495

KG-620 4 1/2" VTVM Kit. 7 with leads ranges each, AC v., (RMS & P-P), DC v., ohms, and db. 11 megohm input. Extended response — ±1 db, 30 cps to 3 mc. Easy-reading 2-color meter scale. A dollar-stretching value.



\$1995

Transistorized Electronic Tachometer Kit—registers 0-8000 rpm, with 3% full-scale accuracy; Zener diode regulation; universal mount. Rugged; reliable. Tops in value and performance.



\$3595

600-B Tube Tester Kit—tests over 2300 types; checks for quality, continuity, shorts, open elements and gas; cathode-emission type; fast setup. Excellent value.

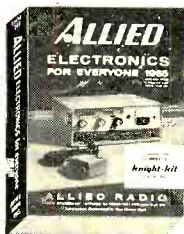

Free Send for 490 page 1965 **ALLIED CATALOG!**

SEE THE FULL SELECTION OF KNIGHT KITS: Stereo Hi-Fi, CB, Hobby, Shortwave, Ham, Test Instrument, Intercom—PLUS the world's largest selection of electronic equipment.

satisfaction guaranteed or your money back

EASY TERMS: Take advantage of the Allied Credit Fund Plan

ALLIED RADIO

The World's Largest Electronic Supply House

NOVEMBER, 1964

ALLIED RADIO, Dept. 2-LL
100 N. Western Ave., Chicago, Illinois 60680

Send FREE 1965 Allied Catalog.

Ship me the following Knight-Kit(s): _____

Name _____
PLEASE PRINT

Address _____

City _____ State _____ Zip _____

send for
FREE
CATALOG



- Tests TV and Radio Tubes —both old and new
- Tests all Novars
- Tests Nuvisors, 10-pin Tubes, and 12-pin Compactrons
- Tests Voltage Regulators, Thyratrons, Auto Radio Hybrid Tubes, European Hi-Fi Tubes, and Many Industrial Types

B&K PROFESSIONAL QUALITY AT LOW COST

Model 600 Compact Portable Dyna-Quik Makes Tube Testing Quick, Accurate, Profitable!

It's amazing how quickly you can accurately check out tubes on every call—sell more replacements, and make more money—with this up-to-date, low-cost professional quality tube tester.

Checks for all shorts, grid emission, leakage, and gas. Checks each section of multi-section tubes separately. Checks tube capability under simulated load conditions. Rejects bad tubes, not good tubes. Quickly reveals tube condition, saves customers, stops call backs, increases servicing profit.

Exclusive adjustable grid emission test. Sensitivity to over 100 megohms. Phosphor-bronze socket contacts.

Complete tube listing in handy reference index.
Handsome, sturdy leatherette-covered carry-case.
Size 8½" x 11" x 4½". Net, \$74.95

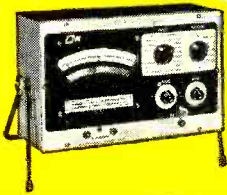

**QUICK, DIRECT, ERROR-FREE
READINGS WITHOUT MULTIPLYING**

Model 375
VTVM
Net, \$89.95



Model 360
V O Matic
Net, \$59.95

See Your B&K
Distributor
or Write for
Catalog
AP21-E



B & K MANUFACTURING CO.

Division of DYNASCAN CORPORATION
1801 W. BELLE PLAINE • CHICAGO 13, ILL.
Canada: Atlas Radio Corp., 50 Wingold, Toronto 19, Ont.
Export: Empire Exporters, 253 Broadway, New York 7, U.S.A.

ARROW AUTOMATIC STAPLE GUNS

FOR WIRES & CABLES UP TO 1/2" IN DIAMETER

UP TO 3/16"	UP TO 1/4"	UP TO 1/2"
No. T-18	No. T-25	No. T-75

For faster, safer, more secure fastening of telephone wire, intercom wire, bell wire, thermostat wire, radiant heating wire, Hi-Fi, TV & radio wire — or any other WIRE. Tapered striking edge gets into close corners!

Write for Catalog

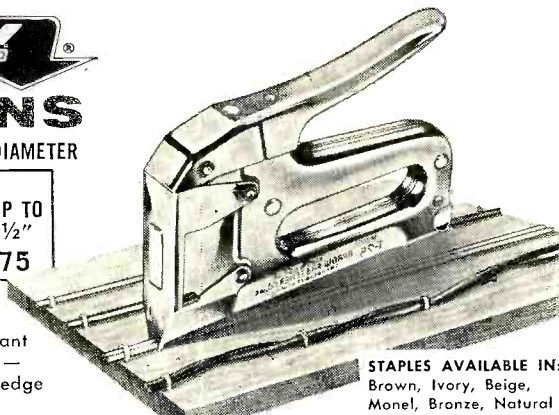

STAPLES AVAILABLE IN:
Brown, Ivory, Beige,
Monel, Bronze, Natural

ARROW FASTENER COMPANY, INC.

1 Junius Street • Brooklyn 12, N. Y.

NEWS BRIEFS

continued from page 8

TV convention, by Walter Bruch, manager of Telefunken Colour TV Labs. The set was a standard NTSC receiver made switchable by inserting adapters. Bruch presented the demonstration to show the close technical relationship between the American and German systems. He stressed that any ideal features of the NTSC system used in the United States and Japan should be retained, but that by adding the features of PAL, the weaknesses in hue representation can be avoided.

(PAL, SECAM, NTSC and, more recently, ART, are all systems of color television proposed for European adoption. The main objection to NTSC is that under certain transmission conditions, the reproduced colors may vary from the correct ones. PAL proposes to correct this by reversing the color distortion in each line transmitted, so that when all the lines are combined, the color distortion will be balanced out.)

CALENDAR OF EVENTS

17th Annual Conference on Engineering in Medicine & Biology, Nov. 16-18; Cleveland-Sheraton Hotel, Cleveland, Ohio
10th Conference on Magnetism & Magnetic Materials, Nov. 16-19; Raddison Hotel, Minneapolis, Minn.
15th Annual Vehicular Communications Symposium, Dec. 3-4; Cleveland-Sheraton Hotel, Cleveland, Ohio

NEW EDUCATIONAL TOY IN SPIRIT OF TV



The GE Show 'n Tell Phono Viewer.

A unique children's educational toy, *Show 'n Tell Phono Viewer*, developed by General Electric, looks like an 11-inch television set. The screen is actually a slide-film viewer, and it is combined with a four-speed phonograph and transistor amplifier.

A 3-year-old child is supposed to be able to load both film and record and turn the set on. The Show 'n Tell Phono Viewer then offers a number of programs, including fairy tales and car-

toons, children's favorite classics, history, science and space, the world we live in and steps to knowledge.

LOW-COST ELECTRONIC RANGES?

With the development of a low-cost magnetron tube, the possibility of mass production of microwave ranges for \$400 to \$500 retail, about half the cost of current home units, were predicted by Amperex Electronic Corp. Henry M. Steenbeke, product manager of Amperex special-purpose tubes, noted that range and vending-machine manufacturers have shown considerable interest in the development of the tube.

ELECTRONICS COURSE ON TV

A course in basic electronics, "Electronics at Work," is now being telecast in Boston, New York, Philadelphia and Altoona, Pa. It consists of ninety 30-minute sessions beginning with electrostatics and dc and progressing through TV communication systems. Study guides, including lecture material and illustrations, are available through stations carrying the program or from Electronics at Work, Box 66, West Columbia, S.C.

The course is offered by WQED—Pittsburgh, WHY—Philadelphia,

WFBG-TV—Altoona, WGBH—Boston and WNBT—New York. Broadcast times can be obtained from the stations.

ATOM VIBRATIONS NEW BASIS OF TIME

The Twelfth International Conference of Weights and Measures this year will move toward a more precise standard of measurement of time, the vibrations of the cesium atom. (The present standard is based on the length of the year 1900.) The length of the second will remain unchanged, but the greater precision will be important to scientists, because time, measured in millionths or billionths of a second, is one of the key dimensions in physics.

BRIEF BRIEFS

The Paris International Exhibition of Electronic Components will take place April 8 to 13, 1965, at the Parc des Expositions (Fairgrounds), Porte de Versailles, Paris. With it, there will be a series of International Talks on Memory Techniques, to be held at Unesco House.

The exhibition, first set up in 1934 and made international in scope in 1958, is the oldest and, to many, the most important event of its kind.

A continuous-wave output power of more than 1 watt is claimed for a new gas-discharge laser, developed by Raytheon Co., research division. The output is in the visible spectrum, with principal wavelengths at 4,880 and 5,145 Angstroms. Input, according to a Raytheon spokesman, is over 5 kilowatts.

A proposed cable distribution system of pay-TV in the Raleigh-Durham, N.C., area is being opposed by the Raleigh Committee for Free TV, in a petition signed by more than 4,500 residents of the area. Four separate cable promoters got preliminary approval in July from the Raleigh City Council to offer pay-TV service, but the citizens don't seem to want it.

Sperry Gyroscope has a pocket-sized machine for joining microcircuits into electronic products. The process is an automated soldering technique that uses jets of hot hydrogen gas to bond the tiny microcircuits onto cards that form the guts of a complex "black box".

Scientists at Bell Labs have a continuously operating gas laser that emits radiation at wavelengths as long as 133 microns. The longest wavelength previously reported was 85.147 microns.

Robert C. Sprague, chairman and treasurer of Sprague Electric Co. of North Adams, Mass., predicts that total sales of the electronics industry in the US will grow from a current volume of \$15 billion to nearly \$25 billion in 1973.

END

FREE NEW 1965 GIANT CATALOG



100's of pages packed with savings

NO MONEY DOWN
PLUS REVOLVING
CHARGE ACCOUNT

FOR 38 YEARS THE
OUTSTANDING
**MONEY
SAVING**

BUYING GUIDE FOR:

- Stereo & Hi-Fi Systems and Components
- Tape Recorders
- Electronic Parts, Tubes, Books
- Phonos & Records
- Ham Gear
- Test Instruments and Kits
- Cameras and Film
- Public Address
- Citizens Band
- Transistor & FM-AM Radios.

RUSH COUPON TODAY

BURSTEIN-APPLEBEE CO. Dept. 43,
1012-14 McGee St., Kansas City 6, Mo.

Rush me the FREE 1965 B-A Catalog.

NAME _____

ADDRESS _____

CITY _____ STATE _____

NOW! get this **BIG BONUS** with your purchase of a **PHOTOFACT® Library!**

FREE! this deluxe new
**Four-Drawer
FILE CABINET**
(with full-drawer suspension)
worth \$55.00 — available only
with your purchase of a
PHOTOFACT LIBRARY
consisting of **200 SETS**
plus valuable Free extras!

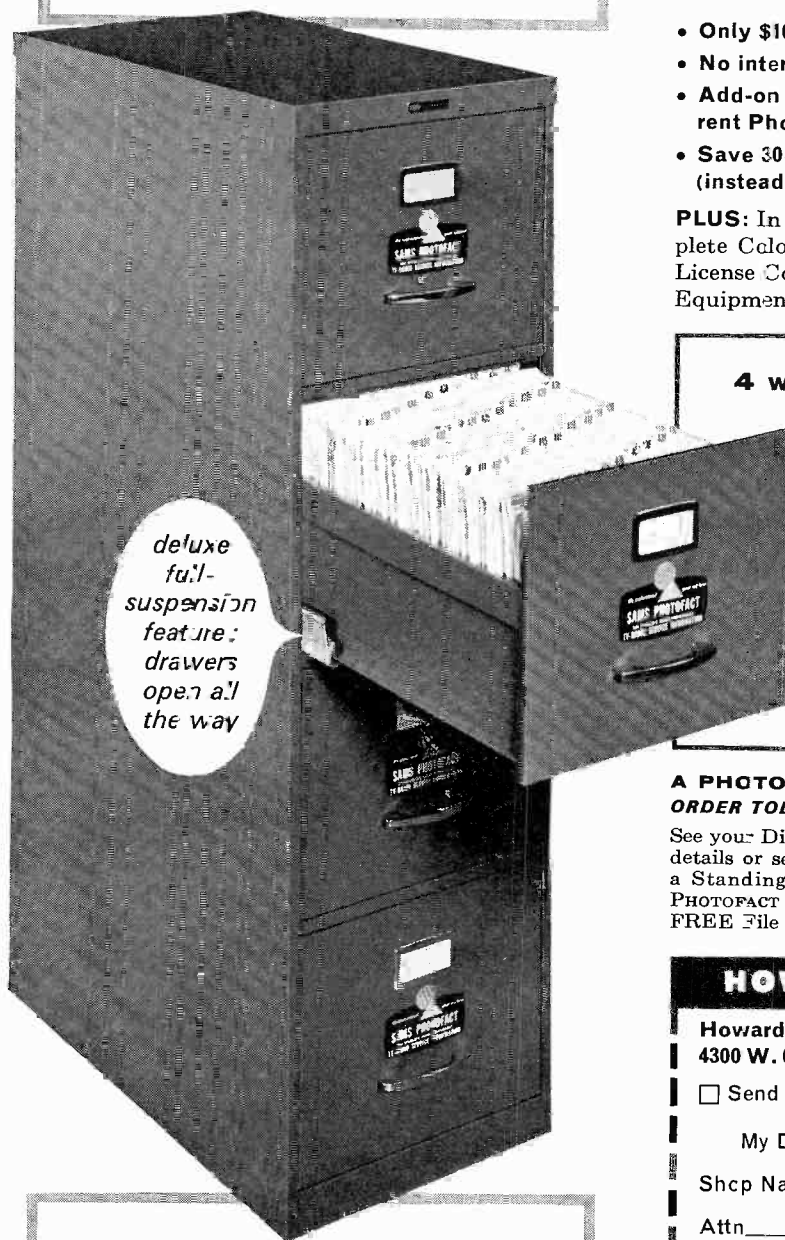

deluxe
full-
suspension
feature:
drawers
open all
the way

**boost your earning power—own and use
the world's finest TV-radio service data**

Now, more than ever, it pays to own a PHOTOFACT Library —the time-saving troubleshooting partner guaranteed to help you earn more daily. Now, you can start or complete your PHOTOFACT Library the special Easy-Buy way, and get absolutely FREE with your purchase, the deluxe 4-drawer File Cabinet worth \$55.00, plus valuable extras described below!

OWN A PHOTOFACT LIBRARY THE EASY-BUY WAY:

- Only \$10 down • 30 months to pay
- No interest or carrying charges • Prepaid transportation
- Add-on privilege of a year's advance subscription to current Photofact data, on the same Easy-Buy contract
- Save 30¢ per Set—special \$1.95 price applies on Easy-Buy (instead of regular \$2.25 price)

PLUS: In addition to the deluxe File Cabinet, you get a complete Color TV Servicing Course, 2nd Class Radiotelephone License Course, Transistor Radio Servicing Course, and Test Equipment Guide!

4 WAYS TO SELECT YOUR PHOTOFACT LIBRARY

1. Complete your present PHOTOFACT Library
2. Order a PHOTOFACT "Starter" Library—200 Sets (Sets 401-600—coverage from 1958 to 1963—only \$12.66 per month).
3. Order by brand name and year—see the handy selection chart at your distributor.
4. Order a complete PHOTOFACT Library—get FREE File Cabinets to accommodate the entire library, the Courses listed above, plus an 8-volume Set of "101 Ways" Test Instrument books worth \$18.50.

A PHOTOFACT LIBRARY PAYS ITS OWN WAY— ORDER TODAY AND GET THE FREE BONUS EXTRAS

See your Distributor for PHOTOFACT Easy-Buy details or send coupon today! Ask also about a Standing Order Subscription to current PHOTOFACT and Specialized Service Series—FREE File Cabinet also available!

**GET THE
DETAILS
NOW**

HOWARD W. SAMS & CO., INC.

Howard W. Sams & Co., Inc. Dept. REF-II
4300 W. 62nd St., Indianapolis, Ind. 46206

Send full information on Easy-Buy Plan



My Distributor is: _____

Shop Name _____

Attn _____

Address _____

City _____ State _____ Zip _____

Offer for Limited Time Only—Act Now!

Winegard COLORTRON Antenna



The Colortron Antenna's "BALANCED DESIGN" is the Winegard secret of superior color reception!

It takes a combination of high gain, accurate impedance match, complete band width and pinpoint directivity to make the perfect color antenna. Only the Winegard Colortron gives you all 4 with **BALANCED DESIGN**.

What is Balanced Design? It's not enough to design an antenna for high gain alone and expect good color reception. A high gain antenna without *accurate impedance match* is ineffective. Or an antenna with *good band width* but *poor directivity characteristics* is unsuitable for color. The Winegard Colortron is the one antenna with *balanced design*, excellence in *all* the important characteristics that a good color antenna requires.

For example:

Gain and Bandwidth—A superior color antenna must have high gain and complete bandwidth as well. But the response must be *flat* if it is to be effective. Peaks and valleys in the curve of a high gain antenna can result in acceptable color on one channel and poor color on another.

No all-channel VHF-TV antenna has more gain with complete bandwidth across each and every channel than the Colortron. Look at the Colortron frequency response in this oscilloscope photo.

Note the consistent high gain in *all* channels. Note the absence of suck-outs and roll-off on end channels. The flat portion of the curve extends on the low band from the channel 2 picture carrier past the channel 6 sound carrier. On the high band, it is flat from the channel 7 picture carrier to the channel 13 sound carrier. There is less than $\frac{1}{2}$ DB variance over any channel.



Impedance Match—the two 300 ohm "T" matched Colortron driven elements have far better impedance match than *any* antenna using multiple 75 ohm driven elements. The Colortron transfers *maximum* signal to the line without loss or phase distortion through mismatch. Winegard's "T" matched driven elements cost more to make, but we know the precision results are well worth the added manufacturing expense . . . because a mismatched antenna causes loss of picture quality which *might* get by in black & white, but becomes highly disturbing in color.

The oscilloscope photo here shows the Colortron VSWR curve (impedance match). No current VHF-TV antenna compares with it across all 12 channels.

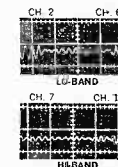

...made for color!

Directivity—Equally important for superior color pictures is freedom from interference and ghosts. Therefore, an antenna with sharp directivity and good signal-to-noise characteristics is necessary. Extraneous signals picked up at the back and sides produce objectionable noise and ghosts in black and white reception . . . frequently ruin color reception.

Winegard's Colortron has the most ideal directivity pattern of any all channel VHF antenna made. It has no spurious side or large back lobes . . . is absolutely dead on both sides. Colortron does not pick up extraneous signals, and even has a higher front-to-back ratio than a single channel yagi.

Look at this Colortron polar pattern. No other VHF-TV antenna has sharper directivity on a channel-for-channel comparison.



BALANCED DESIGN COLORTRONS HAVE SUPERIOR MECHANICAL FEATURES, TOO!

Every square inch of the Colortron has been engineered for maximum strength, minimum weight and minimum wind loading. Even the insulators are designed for low wind resistance. The result

is a streamlined, lightweight antenna that stays stronger longer. Colortrons have been wind tested to 100 mph.

Colortrons are simpler to put up, too. Easier to carry up a ladder and mount on a high mast. No extra weight and bulk to frustrate the antenna installer.

And, you can see the difference in quality when you examine a Winegard COLORTRON. The GOLD ANODIZED finish is bright weather-proof gold that *won't fade*, rust or corrode. It's the same finish specified by the Navy for military antennas. Full attention is paid to every detail.

Winegard Helps You Sell—does more national advertising than all other brands combined. When you sell Winegard, you sell a brand your customer knows . . . backed by a *written factory guarantee of satisfaction*.

It's not surprising that Winegard leads the field in the number of antennas installed with color sets. And Colortrons have been installed by the hundreds of thousands for black and white sets too—for the antenna that's best for color is best for black and white as well. Why don't you try a *balanced design* Colortron and see for yourself?



COLORTRON ANTENNA
Model C-44 - Gold Anodized • \$64.95

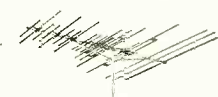

COLORTRON ANTENNA
Model C-43 - Gold Anodized • \$69.00



COLORTRON ANTENNA
Model C-42 - Gold Anodized • \$34.95



COLORTRON ANTENNA
Model C-41 - Gold Anodized • \$24.95



Winegard Co.

3013-K KIRKWOOD • BURLINGTON, IOWA



Will the Space Age eliminate your job in

*MANY HOURS
OF ROUTINE
WORK required to put
together conventional
circuitry are eliminated
by the molecular
circuitry used in
this tiny video
amplifier.*

(Photo courtesy of Westinghouse)

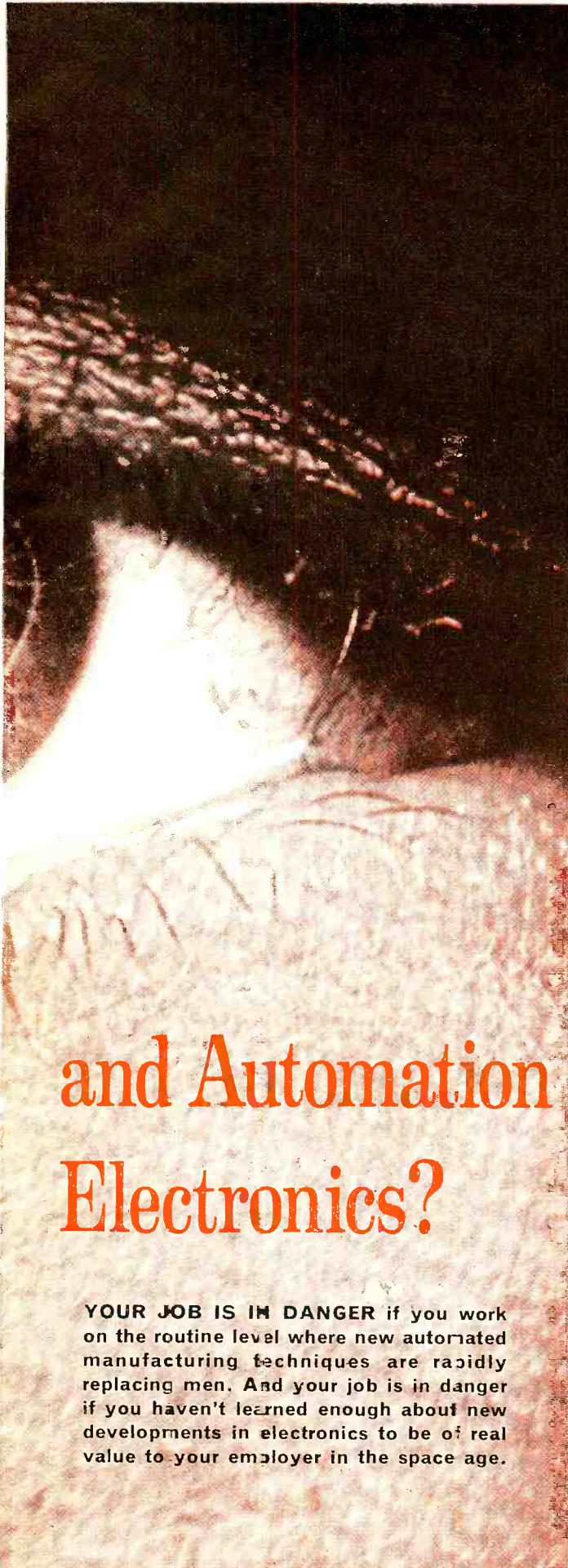

and Automation Electronics?

YOUR JOB IS IN DANGER if you work on the routine level where new automated manufacturing techniques are rapidly replacing men. And your job is in danger if you haven't learned enough about new developments in electronics to be of real value to your employer in the space age.

Protect your future through the New CREI Programs in Space Electronics

Will the space age end your career in electronics? Or will it open up new opportunities for you? What happens depends on whether or not you supplement your education in electronics with the new knowledge needed to make you a valuable employee today. The new CREI Programs in Space Electronics offer you the up-to-date knowledge employers want and need.

SPACE DATA SYSTEMS—Includes multi-channel recording, analog to digital conversion systems, data acquisition and processing.

SPACECRAFT TRACKING AND CONTROL—Includes such areas of space technology as orbit calculation and prediction, inertial guidance, electromagnetic wave generation, space surveillance and environment.

AEROSPACE RADAR ENGINEERING—Includes specialized knowledge of surveillance radar, antennas, receivers, components and microwave equipment used in space applications.

- The first extension programs developed specifically to help men in electronics apply their experience to the space effort.
- Content developed to meet employment requirements as determined by consulting government and private organizations in the space field. Text material prepared in leading space-oriented organizations.

CREI also offers specialized education in these important areas of electronics: **Automation, Industrial, Nuclear, Servomechanisms, Computers, Radar, Communications, Aeronautical, Navigational and Television.**

You are eligible for these programs if you work in electronics and have a high school education.

FREE BOOK gives full information on CREI programs.



For your copy, mail postpaid card or write: CREI, Dept. 1411-B, 3224 Sixteenth St., N. W., Washington, D. C. 20010

THE CAPITOL RADIO ENGINEERING INSTITUTE
Accredited Member of the National Home Study Council



new "stati-lite" noise reducer!

Drastically reduces receiver noise by continuous dissipation of static discharge. Exclusive orbital design — no pointed ends to create sparking.

Antenna Specialists proudly present...

NEW Model M-117 omni-directional

SUPER MAGNUM
citizens band base station antenna

that gives you at least
10% MORE TRUE GAIN
than any other omni-directional CB base antenna made!

far more rugged construction!
Over twice the contact area at telescope joints (no swaging!) — far stronger. Heavier-gauge seamless tubing than any other brand. Screws on both sides for firm electrical connection.

super "Power-Play" transformer!
Super-heavy coil permanently encased in water-proof, rugged plastic housing. Forward power measurement: full five watts. VSWR: a fabulous 1.17 — best by far. Heavier mounting hardware takes masts up to 1½"!

full ½-wave "solid state" radials for maximum RF decoupling!
We simply mean solid aluminum, 108" radials (four of 'em!) for maximum RF decoupling of radiator, easiest installation — and greatest load bearing.

TURN YOUR MAGNUM INTO A
SUPER MAGNUM IN 15 MINUTES —
GET 3.75 TRUE DB. GAIN! MODEL M-118

Complete conversion kit contains four 108" radials; "Stati-lite" Noise Reducer and all hardware.

"Stripes of Quality"

the antenna specialists co.
12435 Euclid Ave., Cleveland, Ohio 44106 • Export Div. 67-14 Woodside Ave., Woodside, N.Y.

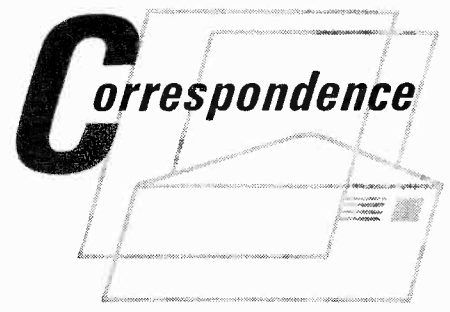

WE MISSED THE "MISTOR"

Dear Editor:

Although your article "Watch Those Shifty Resistors" (August, page 33) covers the majority of remotely adjustable resistors, author Carl Henry has overlooked an important development, the magnetoresistor. One version of this flux-controlled resistor is manufactured under the trade name Mistor by American Aerospace Controls, Farmingdale, N.Y.

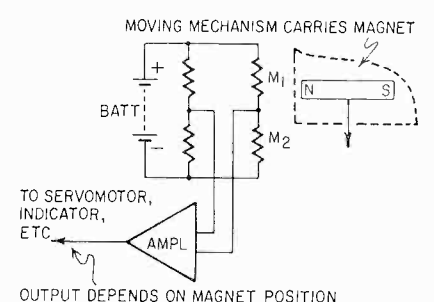

OUTPUT DEPENDS ON MAGNET POSITION
Fig. 1

CURRENT I IN COIL INCREASES ONE MAGNETORESISTANCE, DECREASES OTHER, UNBALANCES BRIDGE

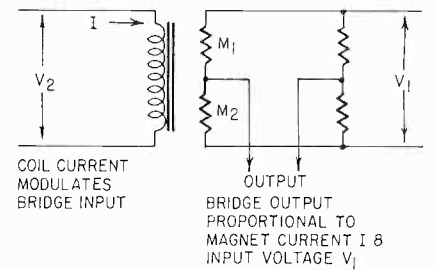

COIL CURRENT MODULATES BRIDGE INPUT
OUTPUT BRIDGE OUTPUT PROPORTIONAL TO MAGNET CURRENT I & INPUT VOLTAGE V₁
Fig. 2

Like some of the other controllable resistors cited in the article, magnetoresistors are used in Wheatstone-bridge circuits for maximum output.

There are two basic applications: electromechanical controls, using a permanent magnet as the source of controlling field, and electronic controls, using a wound magnetic core to control bridge unbalance.

Figs. 1 and 2 typify these two basic arrangements. The electromechanical version, Fig. 1, is balanced when both magnetoresistors M₁ and M₂ are influenced equally by the permanent magnet. Bridge output is then zero, or "null". At other positions of the

TRAM

ENGINEERED FOR TOP PERFORMANCE
MANUFACTURED FOR QUALITY
GUARANTEED FOR RELIABILITY

BEFORE YOU BUY—CHECK THE SPECS... WRITE TO:

TRAM ELECTRONICS INCORPORATED
P. O. BOX 187, WINNISQUAM, N. H.

Citizen's Band TRANSCEIVERS
Mobile & Base

SUBSCRIBE TO RADIO-ELECTRONICS

1 YEAR \$5.00 2 YEARS \$9.00 3 YEARS \$12.00

RADIO-ELECTRONICS, 154 WEST 14th ST., NEW YORK, N.Y. 10011



Technician Approved Test Equipment... SAVES VALUABLE MONEY-MAKING TIME...

Model 501 COMPONENT SUBSTITUTOR

Places a complete range of components at your fingertips for fast substitution

CARBON RESISTORS: 24 values from 10 ohms to 5,600,000 ohms • **POWER RESISTORS:** 20 values from 2.5 ohms to 15,000 ohms • **ELECTROLYTICS:** 17 values from 4 mfd. to 230 mfd. • **RECTIFIERS**—(Universal): Crystal diodes—all general purpose low voltage types Selenium power rectifiers—up to 500 ma., 800 PIV Silicon power rectifiers—up to 750 ma., 800 PIV

SPECIAL FEATURES: Substitutes up to 4 different components at the same time • A surge protector switch prevents arcing, sparking or heating of electrolytics • Electrolytics are discharged automatically • Size 10"x6¼"x4½".

Dealer Net ... \$3750

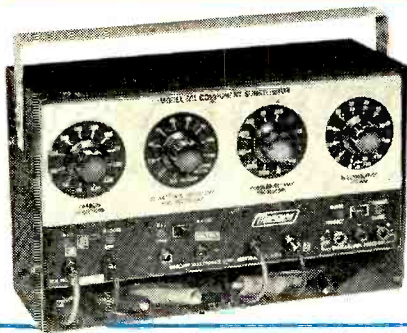

Model 1400 IN-CIRCUIT CAPACITOR TESTER

Eliminates the time consuming method of unsoldering and resoldering when checking capacitors...

NEW

EXCLUSIVE!

Special low test voltage of 2.9 volts AC provided to prevent damage to the new low voltage electrolytics use in transistorized equipment

SIMPLE TO OPERATE

Test leads connect across the capacitor in-circuit... set range switch and it automatically indicates shorted or open capacitors

SPECIFICATIONS

SHORTS TEST—Detects shorted capacitors of all type in-circuit with shunt resistance as low as 6 ohms.

OPEN TEST—Detects open capacitors for all values in-circuit down to 7 mmfd., with shunt resistance as low as 150 ohms.

VALUE TEST—Indicates value of electrolytics in-circuit from 2 mfd. to 450 mfd.

• Size: 10"x6¼"x4½". Dealer Net ... \$2950

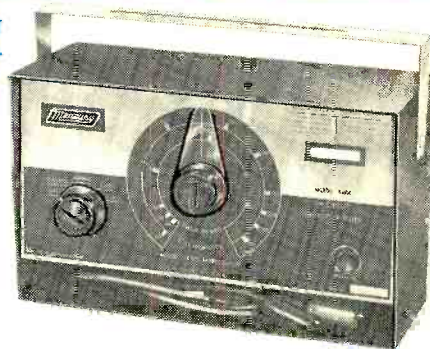

Model 1000 MUTUAL CONDUCTANCE TUBE TESTER

A true dynamic mutual conductance tube tester at an amazingly low price!

Tests all tube types, old and new including Novars, Nuvistors, Compactrons, 10-pin type, battery type, foreign, hi-fi, Thyratrons, voltage regulators and most industrial types • Tests picture tubes • Tests for true dynamic mutual conductance (Gm) • Tests for shorts, leakage and gas • Lever switches provide complete versatility in accommodating all tube types and basing arrangements—today and in the future • Checks each section of multi-section tubes separately • Automatic line voltage regulation • Long lasting phosphor bronze tube sockets • Two-tone etched aluminum panel

Dealer Net ... \$7995

• Size: 14"x9½"x4¾".

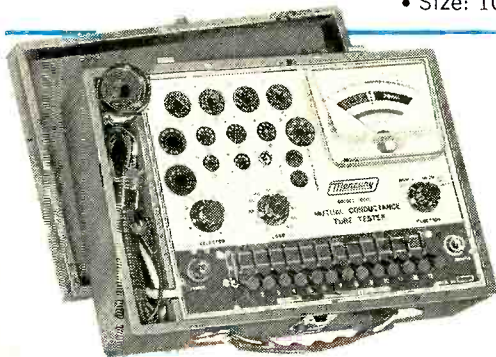

MERCURY SELF-SERVICE TUBE TESTERS

Modern eye-stopping testers... big income producers in any location

Here is everything you want in self-service tube testers at down-to-earth prices. **VERSATILITY**—Tests emission, shorts and gas of over 1400 tube types including the very latest NUUVISTORS, NOVARS, COMPACTRONS, 10-PIN type, etc... Also tests fuses, pilot lights, 6 and 12 volt auto radio vibrators, all type batteries under load. **SMART APPEARANCE**—Modern cabinet design finished in rich green and white color combination with gold trim. **QUALITY FEATURES**—Completely self-service... only two easy-to-use controls are required to test any tube... Easy-to-read quick flip tube charts list over 1400 tube types... Engineered to accommodate new tube types as they are introduced... Etched aluminum panel always retains its handsome appearance... 63 phosphor-bronze beryllium tube sockets assure positive contacts and long life.

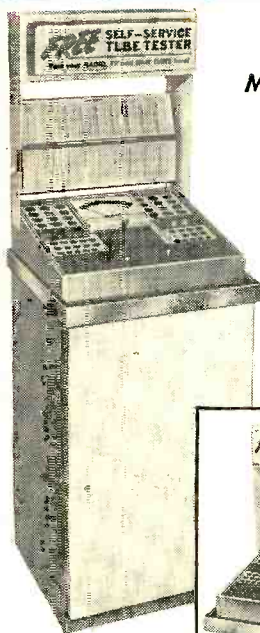

Model 202-LB
(Lo-Boy Floor Model)
Dealer Net \$18450

Model 202-C
(Counter Model)
Dealer Net \$12995

Model 203-LB
(Deluxe Lo-Boy Floor Model)
Dealer Net \$25450

Model 203-C
(Deluxe Counter Model)
Dealer Net \$16695

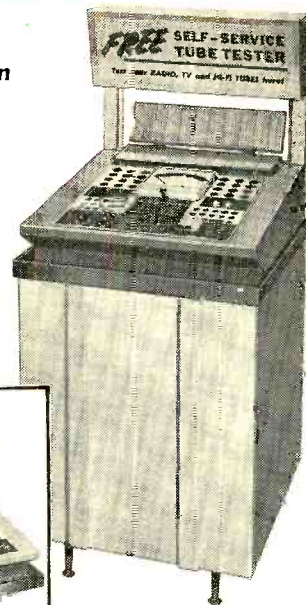

Available at your local parts distributor... Write for complete Mercury test equipment catalog

MERCURY ELECTRONICS CORPORATION, 111 ROOSEVELT AVENUE, MINEOLA, NEW YORK

GOOD VIEWS

Servicemen across America agree ...

JERROLD PARALOG

FOR BEST PERFORMANCE, MOST SATISFIED CUSTOMERS

Paralog is sweeping the country . . . and it's no wonder! From Washington to Winston-Salem, TV service dealers tell us that Paralog performance is outstanding—even in the toughest reception areas. Dealers in every part of the U. S. find that customer satisfaction is a sure thing with powerful Paralog antennas.

What's more, these are men with years of antenna experience, and the kind of know-how that made them make extensive comparisons with competitive antennas before taking on the Paralog line. Has it paid off? Well, Russ Helveston, of Morrisville, Pa. says that "My antenna business is growing faster

than ever now," while Eugene Doll of Perham, Minn. tells us that "Business has been terrific on Paralogs."

Best of all, rugged, easy-to-install Paralog antennas come with better, built-in profits, the kind that make it mighty worthwhile to "sell up to a Paralog."

What about *your* antenna requirements? Have *you* made a side-by-side comparison of your present antennas against the Jerrold Paralog line? If not, be ready to switch! Have your Jerrold distributor show you *why* Paralog is the fastest-growing antenna line in the country today.

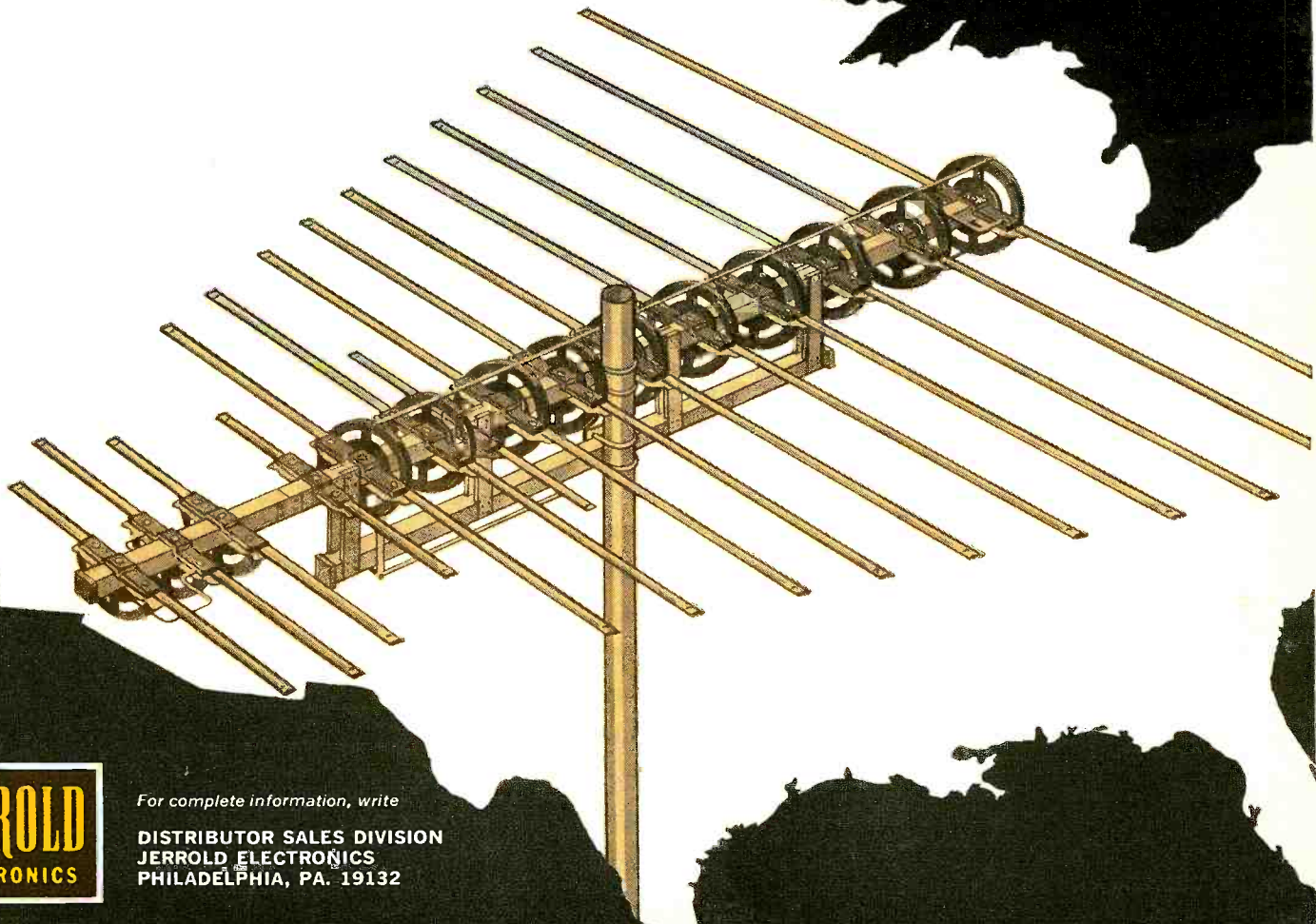

JERROLD
ELECTRONICS

For complete information, write

DISTRIBUTOR SALES DIVISION
JERROLD ELECTRONICS
PHILADELPHIA, PA. 19132

TRAVEL FAST!



**RALPH LEENDERS, LEENDERS' TV,
EVERSON, WASHINGTON**

"We use Paralog Antennas because of their outstanding performance and their rugged construction."



**RALPH CLARK, VALAS TV CORP.,
DENVER, COLORADO**

"As the largest TV sales and service company in Colorado, we can't afford to use anything but the best. After extensive comparisons and field testing, we found the Paralog to be exactly the antenna we had been looking for."



**W. B. WEIDNER, ED MARLING
STORES, INC., TOPEKA, KANSAS**

"I've found that it pays to sell up to a Paralog. Profits are much better than on the economy antennas, and I wind up with a more satisfied customer every time."



**EUGENE DOLL, DOLL'S TV,
PERHAM, MINNESOTA**

"Business has been terrific on Paralogs in our territory. And no wonder. Everybody who buys a Paralog is happy with the reception. We've gone to Paralog 100%."



**TED WAINSCOTT,
T & H SERVICE & SALES, INC.
ANDERSON, INDIANA**

"The Paralog has proven to be far superior to any other antenna in this area. You can't beat the performance, especially on the hard-to-get channels."



**RAY MAGER,
MONTGOMERY WARD, LIMA, OHIO**

"Paralog works better than any other VHF antenna ever made. We had 200 calls within two weeks. Some of our customers pull in Cleveland, over 160 miles away, consistently."



**RUSS HELVESTON, MAKEFIELD TV,
MORRISVILLE, PENNSYLVANIA**

"It's very tough to get New York channels in this area, but since I've been using Paralog antennas, I can offer *guaranteed reception* to my customers. My antenna business is growing faster than ever now."



**W. RAYMOND JONES, JONES TV
& RADIO SERVICE,
WINSTON-SALEM, N. CAROLINA**

"We've been using TACO antennas for 15 years. In fact, we've installed several thousand. The new Paralogs are the most powerful and rugged antennas we've ever used."

TUNER REPAIRS

Includes ALL parts (except tubes)...
ALL labor on ALL makes for complete overhaul.

\$95.00

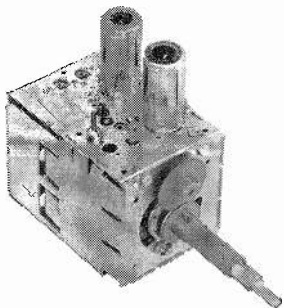

FAST, 24-HOUR SERVICE
with FULL YEAR WARRANTY

Sarkes Tarzian, Inc., largest manufacturer of TV and FM tuners, maintains two completely-equipped Service Centers, offering fast, dependable tuner repair service. Tarzian-made tuners received one day will be repaired and shipped out the next. More time may be required on other makes. Every channel checked and realigned per manufacturer's specs. Tarzian offers full, 12-month guarantee against defective workmanship and parts failure due to normal usage. Cost, including all labor and parts (except tubes), is only \$9.50 and \$15 for UV combinations. No additional costs. No hidden charges. You pay shipping. Replacements at low cost are available on tuners beyond practical repair.

Always send TV make, chassis and Model number with faulty tuner. Check with your local distributor for Sarkes Tarzian replacement tuners, parts, or repair service. Or, use the address nearest you for fast factory repair service.

SARKES TARZIAN, INC.
TUNER SERVICE DIVISION

Dept. 200
537 South Walnut St.,
Bloomington, Indiana
Tel: 332-6055

Dept. 200
10654 Magnolia Blvd.,
North Hollywood, Calif.
Tel: 769-2720

MANUFACTURERS OF TUNERS, SEMICONDUCTORS,
AIR TRIMMERS, FM RADIOS, AM-FM RADIOS,
AUDIO TAPE and BROADCAST EQUIPMENT

permanent magnet, the bridge is unbalanced since the magnet influences one magneto-resistance more than the other.

This circuit is sensitive to position and direction of magnet movement. In some applications it is equivalent to a linear differential transformer; in others it provides a no-contact trigger for tachometers, stroboscopes, etc., driven from a rotating shaft.

An advantage of the magneto-resistance transducer (as a trigger for electronic ignition systems, say) is that the output voltage is independent of shaft speed (induction principle is not involved).

Electronic use of the magneto-resistance bridge is widespread, since coil current provides an isolated control of bridge output. The device can be used as a current-controlled attenuator (for age systems, for example), as a remotely controlled fader in audio systems, and in many other control applications.

Besides use of the magneto-resistance bridge with coil control for circuit adjustment, other applications for the same package include analog multipliers, modulators, mixers, detectors, phase discriminators and power-measuring transducers.

STANLEY FROUD

New York, N.Y.

OLD "RADIO-CRAFTS" AVAILABLE

Dear Editor:

I have the following issues of *Radio-Craft* magazine (RADIO-ELECTRONICS after October 1948) available for sale. Anyone want them?

1939—October, November

1940—February, July, September

1943—November, December

1944—complete year

1945—May missing

1946-1957—complete

1958—January through May

RAYMOND M. GIERKE

3317 41st Ave. So.

Minneapolis, Minn. 55406

THE "THIRD-HAND" THEME

Dear Editor:

My compliments to RADIO-ELECTRONICS! You've scooped the electronic magazine field again by being the first to come out with news of the accessory every experimenter and technician has been awaiting.

I refer, of course, to the third hand on the technician featured on your August cover. I have been in the same predicament many times: one hand working on the underside of a chassis, one hand on the top, and in desperate need of a third to secure some loose component.

Unfortunately, you omitted some important information. I assume that

the accessory hand is a bio-electronic revolution which can be attached to the elbow—but is it available in left only? As I am right-handed, I would much rather have an added right hand.

Please publish the name of the manufacturer, his address and the price of this much-needed item in your next issue. I would have written directly to the manufacturer, but I couldn't find his name anywhere in the magazine. Too bad. He could clean up.

HOWARD RUSSELL, JR.

Akron, Ohio

[You've heard of the technician with two left hands, I'm sure. RADIO-ELECTRONICS went out and found him! (Seriously, it was all done with mirrors.) —Editor]

RESISTORS SPLIT, BUT NOT TOO WELL

Dear Editor:

The resistor splitting circuit, published in the August issue on page 86 ("Resistors 'Split' Transformer Winding"), results in unbalanced audio drive to the push-pull tubes. At 3 kc the drive to grid 1 will be some 6 db below the drive to grid 2. This is due to the capacitance to core at the starting end of the secondary being considerably greater than the capacitance at the outer end.

As shown in Fig. 1 here, a capaci-

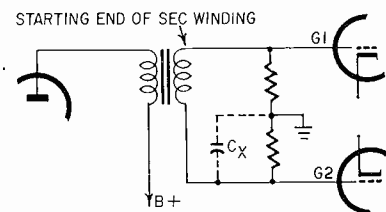

Fig. 1

tor C_x added across the resistor on the "undropped" side will help compensate. Exact value must be found by experiment; it will usually lie between .001 and .005 μ f.

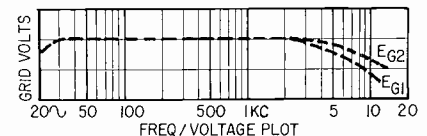
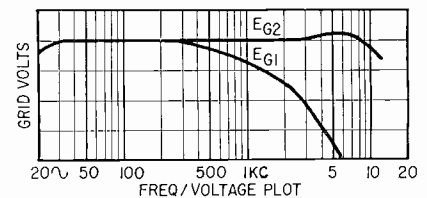

Fig. 2

C_x resonates with the secondary to raise the voltage at grid 1 and lower it at grid 2 above about 2 kc. This is suitable only for "voice-quality" equip-

you get **PRODUCT PLUS** from your Sylvania Distributor

suddenly

COLOR TV
HAS A NEW
RED STANDARD

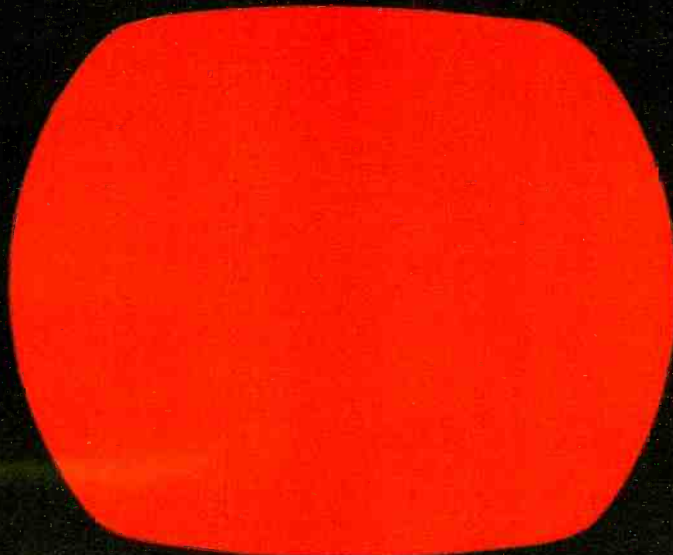

Sylvania's new EUROPIUM RED.

New **COLOR BRIGHT 85** picture tube brings more natural color to television and increases monochrome brightness 43%.*

The startling news in the television industry is Sylvania's new picture tube, and its new, truer red phosphor.

EUROPIUM RED, developed at GT&E Laboratories, is the brightest red known to the industry. And, to match it, now the full brightness of blue and green is used. The result is a color picture tube that gives the entire television industry a boost.

Because the **COLOR BRIGHT 85** tube is *really* bright, dealers can demonstrate color TV effectively in normally lighted showrooms. As the set's brightness is adjusted, the colors remain true—not shifting to unnatural tones in the highlights of the picture.

Another thing, black and white performance is far better than you've ever seen before in a color tube. Be-

sides the increased brightness, there's improved contrast in a sharp, vivid picture.

The new, exciting **COLOR BRIGHT 85** picture tube is a product plus from Sylvania for the entire color television industry, and particularly for dealers. In color, as in black and white, you know it's good business to handle the Sylvania line.

SYLVANIA
SUBSIDIARY OF
GENERAL TELEPHONE & ELECTRONICS GTE

NEW CAPABILITIES IN: ELECTRONIC TUBES • SEMICONDUCTORS • MICROWAVE DEVICES • SPECIAL COMPONENTS • DISPLAY DEVICES

*Tests show the **COLOR BRIGHT 85** tube is 43% brighter, on the average, than standard color picture tubes.

ment. "Before" (top) and "after" curves are shown in Fig. 2.

W. LEEMON, W8TLW/A8TLW
Fairview Park, Ohio

INTERESTED IN MEDICAL ELECTRONICS

Dear Editors:

I would like to get in touch with people interested in medical electronics (not too advanced). Specifically, I am looking for circuit diagrams. (with data if possible) of a portable transistorized heart pacemaker, a good stethoscope amplifier and an instant body-temperature reading device. Perhaps one of your readers could send me some diagrams. I

will repay him for his trouble and for the postage.

I find your do-it-yourself articles especially helpful. But we often have to make our own or find substitutes here, so if you published values of transformers and coils, as well as the name of the manufacturer, it would save us some calculations.

I would like to see more articles about medical electronics. It would speed diagnosis, and often help to cure a patient.

DR. CARLOS PERES DA COSTA
Largo da Camara
Mapusa, Bardez, Goa
India

TRANSLATION, DUPLICATION, EXASPERATION

Dear Editor:

The letter from Stu Kellogg in your September issue ("Reds Should Be Read") points out that a recent RADIO-ELECTRONICS article describes a circuit very similar to one that appeared in a Russian book published last year. Mr. Kellogg suggests that American scientists and technicians miss a lot because of the language barrier. Your May editorial puts the case more strongly: "The amount of effort and money that goes into these foolish duplications is not only wasted but a constant source of embarrassment."

Spectrum Translation & Research, Inc., translates scientific and technical material into English. Most of our work is Russian into English, but we also handle other European and Asian languages.

We want to establish a translation program to meet the specific needs and interests of American scientists and technicians. What sort of material would they like translated?

W. BAKALINSKI
Vice President
Spectrum Translation & Research, Inc.
New York, N. Y.

[Readers who have ideas for Mr. Bakalinski might write to him at 207 E. 37 St., New York 16, N.Y.—Editor]

BUILT METAL LOCATOR

Dear Editor:

Congratulations on the quality of your articles. Information I got from your magazine helped me develop a small magnetic device which will react to a positive or negative magnetic field in an ore sample. I've recovered several gold nuggets from nearby creeks with it.

GENE YAWN
Nelson, Ga.

BETTER, LONGER TAPES FROM MIDGET RECORDERS

Dear Editor:

I have some suggestions for increasing tape playing time and improving the quality of recording with small rim-driven imported tape recorders. Using 1/2-mil tape and replacing the 3-inch reels with 3 1/4-inch reels increases usable playing time quite a bit. I also drilled a hole in the tape-head protective cover and inserted a pin to prevent the erase magnet from rubbing on the tape. Using bulk-erased tape and disabling the erase magnet helps reduce background noise.

I have subscribed to the Gernsback publications for 30 years, and find my back issues the finest source of reference material available.

MELVIN PLOENNIES
Marquette, Mich. END



NEW! STANCOR COLOR TV REPLACEMENT GUIDE*

GET A COPY FROM YOUR NEAREST STANCOR DISTRIBUTOR.

FLYBACK	
MFG. PART No.	STANCOR PART No.
75069-2	---
77090-2	---
79097-501 942635-501)	---
90102-501 106141-501)	HO-600C
YOKE	
D1031 D1032)	---
D1802	DY-90AC
193-502	DY-90AC
193-505 (62-804X)	DY-90AC
193-507 (62-802)	DY-90AC
VERTICAL OUTPUT	
2-1	---
2	---
1-1	VO-700C
2	VO-700C
POWER	
80D83-503	---
80D85-1	P-9000C
CHOKE	
74B18-20	C-2708
74B24-2 (110465-2)	C-2708
74B25-3	C-2708
AUDIO OUTPUT	
79B66-7	A-3337
79B66-9	---
79B87-8	A-8092
79B89-8	A-8092
79C10-2	---

*Complete part to part cross reference for FLYBACKS, YOKES, VERTICAL OUTPUTS, POWER TRANSFORMERS, CHOKES, AUDIO OUTPUTS AND VERTICAL OSCILLATORS.

ELECTRONIC MARKETING DIVISION
3501 W. ADDISON STREET • CHICAGO, ILLINOIS
National Sales and Warehousing Agent

ESSEX WIRE CORPORATION
WAREHOUSES IN:
CHICAGO
DALLAS
NEW YORK
LOS ANGELES

BUILD, EXPERIMENT, EXPLORE, DISCOVER WITH NRI CUSTOM-DESIGNED TRAINING KITS



BUILD YOUR OWN PHONE/CODE TRANSMITTER

Here is one of seven training kits you get in the NRI Complete Communications Course. With it, you get *actual practice* in building a crystal-controlled phone/code transmitter and putting it on the air, actual practice in many aspects of commercial transmitter operation (modulation, "clamping" circuits, key filters, etc.). This kit—as with all NRI kits—features the most modern circuits and parts. It complies with FCC regulations and can be put on the air simply by attaching to an antenna. Be a part of the "life line" of the Space Age. Enroll for NRI's Complete Communications training.

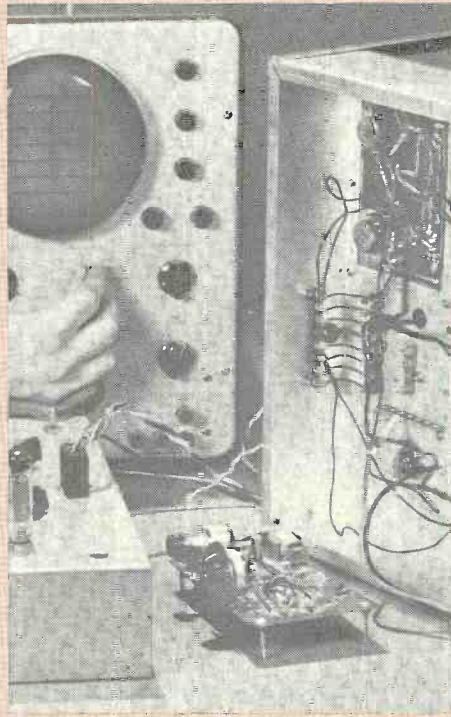

BUILD ACTUAL ANALOG COMPUTER CIRCUITS

Industry, business offices, the government and military all need trained Electronics Technicians. In NRI's Complete Industrial Electronics Course you progress through 10 custom-designed training kits, topping off your studies by building this analog computer with which you solve simple mathematical problems, experiment with feedback control systems and digital logic elements. This kind of practical experience as you train prepares you to step into a good paying position ready to do your knowledgeable best. Prepare now the NRI way for Industrial Electronics.



BUILD A CUSTOM-ENGINEERED TELEVISION RECEIVER

Want to make \$3 to \$5 an hour in your spare time? Want your own full-time or part-time business? NRI's complete course in Radio-TV Servicing offers these money-making opportunities. NRI starts you with the ABC's of Electronics. You learn how to install, maintain and service stereo hi-fi, radios, PA systems and TV sets (including color). Included in your training are eight NRI-designed training kits; the final one is this complete, custom-designed table model TV receiver you build yourself. You learn servicing procedures you will use on the job—and earn *extra money* as you train. Enroll now.

10 NRI Home-Study Plans to Choose From—Mail Card

Whatever your interest in Electronics . . . whatever your education . . . whatever your need . . . before you decide on any school you'll want to investigate NRI's extensive list of training plans and practical, thorough, absorbing training methods. NRI training equipment and "bite-size" programmed texts are the finest money can buy, the finest highly skilled instructors and engineers can design and perfect for you. Mail the postage-free card for your copy of the NRI catalog. NATIONAL RADIO INSTITUTE, Electronics Div., Washington, D.C. 20016.



**Our 50th Year of Leadership
in Electronics Training**

SEE OTHER SIDE ▶

FIRST CLASS
PERMIT
NO. 20-R
Washington, D.C.

BUSINESS REPLY MAIL

NO POSTAGE STAMP NECESSARY IF MAILED IN THE UNITED STATES

POSTAGE WILL BE PAID BY

NATIONAL RADIO INSTITUTE

3939 Wisconsin Avenue

Washington, D.C. 20016



Get a fast start in Electronics Training with NRI's NEW ACHIEVEMENT KIT

The day you enroll with NRI we send you this remarkable, new Achievement Kit, worth many times the small amount you invest to start your training. And it's only the start, only the first example of the unique ability of NRI to apply 50 years of leadership in home-study Electronics training to the technical challenges of today. What's in the Achievement Kit? You get your first group of lesson texts in the NRI course of your choice; a rich, vinyl desk folder to hold your work; preprinted lesson answer sheets; your NRI Student Identification Card; the industry's most complete Radio-TV Dictionary; valuable reference texts; envelopes; imprinted pencils; pen; engineer's ruler and even your first postage. Start your training this exciting, absorbing way. No other school has anything like it. Pick the field of your choice from NRI's 10 training plans and mail the postage-free card for your NRI catalog. Do it now.

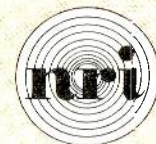
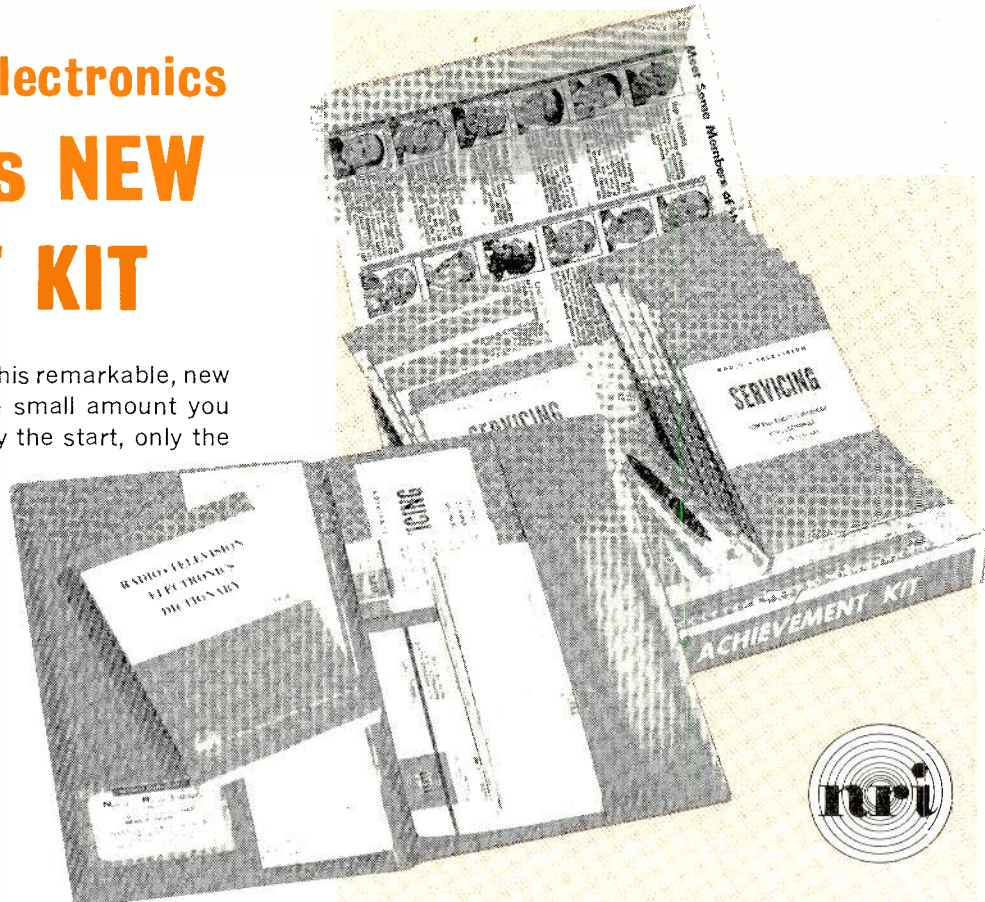

NOW 10 WAYS to train at home with NRI

Join the thousands who gained success with NRI



"I want to thank NRI for making it all possible," says Robert L. L'Heureux of Needham, Mass., who sought our job consultant's advice in making job applications and is now an Assistant Field Engineer in the DATAmatic Div. of Minneapolis-Honeywell, working on data processing systems.

His own full-time Radio-TV Servicing Shop has brought steadily rising income to Harlin C. Robertson of Oroville, Calif. In addition to employing a full-time technician, two NRI men work for him part-time. He remarks about NRI training, "I think it's tops."



Even before finishing his NRI training, Thomas F. Favaloro, Shelburne, N.Y., obtained a position with Technical Appliance Corp. Now he is foreman in charge of government and communications division. He writes, "As far as I am concerned, NRI training is responsible for my whole future."

"I can recommend the NRI course to anyone who has a desire to get ahead," says Gerald L. Roberts, of Champaign, Ill., whose Communications training helped him become an Electronic Technician at the Coordinated Science Laboratory, U. of Illinois, working on Naval research projects.



SEE OTHER SIDE

National Radio Institute, Electronics Div.
Washington, D.C. 20016

4 F

Please send me your catalog. I have checked the field(s) of most interest to me. (No salesman will call.)

- | | |
|--|---|
| <input type="checkbox"/> TV-Radio Servicing | <input type="checkbox"/> Basic Electronics |
| <input type="checkbox"/> Industrial Electronics | <input type="checkbox"/> Electronics for Automation |
| <input type="checkbox"/> Complete Communications | <input type="checkbox"/> Aviation Communications |
| <input type="checkbox"/> FCC License | <input type="checkbox"/> Marine Communications |
| <input type="checkbox"/> Math for Electronics | <input type="checkbox"/> Mobile Communications |

Name _____ Age _____

Address _____

City _____ State _____ Zip Code _____



ACCREDITED MEMBER NATIONAL HOME STUDY COUNCIL

- 1 TV-RADIO SERVICING** Learn to fix TV sets (including color), radios, stereo hi-fi, PA systems, etc. A profitable field full or part-time.
- 2 INDUSTRIAL ELECTRONICS** Learn principles, practices, maintenance of Electronic equipment. Covers computers, servos, telemetry, multiplexing, other subjects.
- 3 COMPLETE COMMUNICATIONS** Comprehensive program covering broadcasting, mobile, marine, aviation communications. Learn to operate, maintain transmitting equipment. Prepares for FCC License.
- 4 FCC LICENSE** Prepares you quickly for First Class License exams. Every Communications station must have licensed operators. Also valuable to Service Technicians.
- 5 MATH FOR ELECTRONICS** A short course of carefully prepared texts for engineers, technicians, others needing a quick review of math they must use in Electronics.
- 6 BASIC ELECTRONICS** Practical, fundamental short course of 26 lessons teaching terminology, components, basic principles of Electronics. Ideal for salesmen, hobbyists, others.
- 7 ELECTRONICS FOR AUTOMATION** Not for the beginner, but for the man with some basic knowledge of Electronics. Covers process control, ultrasonics, electromechanical measurements, other Automation subjects.
- 8 AVIATION COMMUNICATIONS** For the man who wants to work in and around planes. Learn about direction finders, loran, shoran, radar, markers, landing systems. Prepares for FCC License.
- 9 MARINE COMMUNICATIONS** Much Electronic equipment is used on commercial ships and pleasure craft. Learn operation, maintenance of transmitters, direction finders, depth indicators, radar, etc. Prepares for FCC License.
- 10 MOBILE COMMUNICATIONS** Learn to install, operate, maintain mobile equipment and associated base stations as used by police and fire depts., taxi companies, etc. Prepares for FCC License.

NOTE: You *must* pass FCC exams on completion of any NRI communications course or your tuition payments are refunded in full.

**CUT OUT AND MAIL
FOR FREE CATALOG**

How to deliver the best signal...

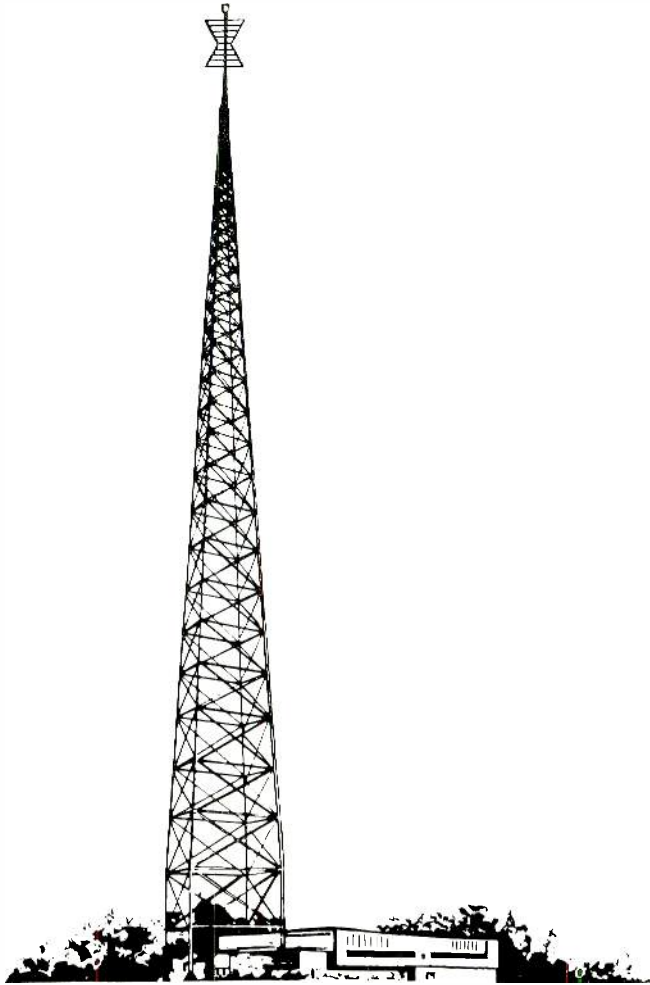

from here...



to here

BLONDER-TONGUE leader in UHF and VHF product design
dedicates Fall, 1964 to better TV reception with the

BLONDER-TONGUE VAL·U·RAMA

How TV signal amplifiers improve reception

by Ben H. Tongue

(President, Blonder-Tongue Laboratories)



TV amplifiers can improve TV reception in many cases. There are, however, situations where no improvement is to be expected. This article will cover both situations to help you recognize potentially profitable installations.

Amplifier performance is determined by the level of internally generated noise (snow), amplification level, and degree of freedom from overload by strong local signals. Amplifiers are used as follows:

1. INCREASE CONTRAST Low cost TV sets generally have insufficient gain for weak signal reception. Old TV sets (low or high cost) often have aged tubes and insufficient gain. Low gain generally is the cause of poor contrast on weak signals. If the contrast of "snow" when the TV set is operating at full gain (no signal input) is much less than picture contrast on a strong signal, low gain is at fault.

A good amplifier, indoor or outdoor, will improve poor contrast caused by low gain. Contrast is reduced if the transmission line from antenna to TV set has a high loss. Noise (snow) is also increased by this condition. Let us assume that a good antenna is well installed and that quality transmission line is used (flat twinlead for VHF and round foam-filled twinlead for UHF).

TABLE 1	FREQUENCY	Length for 3db Loss	
	Low Band VHF (Ch 3-6)	50' Wet	300' Dry
	High Band VHF (Ch 7-13)	26' Wet	158' Dry
	Low Half UHF (Ch 14-48)	45' Wet	90' Dry
	High Half UHF (Ch 49-83)	37' Wet	74' Dry

2. REDUCE SNOW Snow appears when the TV signal-to-noise ratio is reduced. A good antenna reduces snow because of increased signal pickup. Transmission line loss increases snow because it reduces the signal reaching the first amplifier stage (booster or tuner RF stage). This reduces the signal-to-noise ratio. Here's how snow can be minimized:

- a. Increasing signal pickup by using a higher gain antenna.
- b. Using an amplifier which generates less noise than the TV input stage.

c. Amplifying at the antenna. If the amplifier has the same noise figure as the TV set tuner, the amplification overcomes transmission line loss, and the picture signal-to-noise ratio is nearly the same as if the TV set were at the antenna.

Point "A" applies at all times. Point "B" generally applies to low cost (tetrode tuner) and older TV sets when the amplifier is mounted near the set. Point "C" applies when the transmission line loss is appreciable. (See table 1). In this case we can improve the initial signal-to-noise ratio by using a low noise mast-mounted amplifier.

3. OVERCOME SPLITTING LOSSES Splitting a signal to drive several TV sets causes loss to each set. If the signal power is divided among two sets, each will receive 1/2 the original power (3db loss). This is equivalent in points "1" and "2" to an extra 3db of transmission line loss. The solution is amplification before splitting. This can restore contrast and re-establish signal-to-noise ratio (or even improve it).

One transistor amplifiers are most susceptible to overload. Two transistor amplifiers are much less susceptible, performing about the same as single tube units. Two tube and dual section tube amplifiers overload least. Frame-grid tubes provide exceptionally low noise and last longer than ordinary tubes. If interference occurs, attenuation filters can be used.

BLONDER-TONGUE TV/FM SIGNAL AMPLIFIERS

Brilliant color TV, sharp black and white TV and lifelike FM stereo reception require strong, clean signals. To provide TV viewers with the best possible reception in any area of the country, Blonder-Tongue offers the world's largest selection of signal amplifiers. There are VHF amplifiers, UHF amplifiers, FM amplifiers. And, for the first time, all-channel TV amplifiers covering every channel from 2 to 83.

When you select a Blonder-Tongue amplifier, you can always be sure of getting the best amplifier for your specific reception problem. There are mast-mounted amplifiers designed to take advantage of the best signal-to-noise ratio available at the antenna for weak signal areas. There are indoor amplifiers, that offer convenient installation and can provide excellent results where there are relatively strong signals. You also have a choice of either tubed or transistor amplifiers. For example, transistor amplifiers offer greater gain and are most effective in weak signal areas where there are no strong local channels to cause overload.

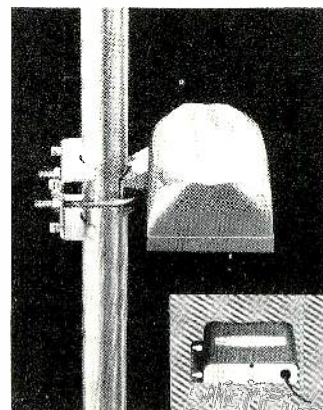

The finest signal amplifiers in the world are also the easiest to install. Many of the mast-mounted amplifiers feature the exclusive 'Miracle Mount'. All mast mounted amplifiers feature a separate remote power supply which can be installed easily indoors near the set. Finally, secure, positive 300 ohm connections can be made in a jiffy with Blonder-Tongue patented stripless terminals.

The chart on the right hand page will serve as a guide that will help you select the best signal amplifier for your area.

ALL CHANNEL



U/Vamp-2



V/U-ALL2

UHF



U-BOOST

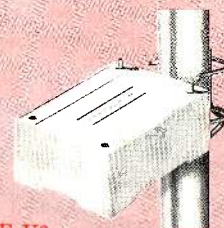

ABLE-U2

Blonder-Tongue amplifier that's best for you

BLONDER-TONGUE SIGNAL AMPLIFIERS—VHF, UHF, VHF-UHF, FM

	MODEL	DESCRIPTION	COVERS CHANNEL	OUTPUT'S	NET
MAST MOUNTED	U/Vamp-2	World's first mast-mounted UHF/VHF amplifier. 2 transistors. Built-in FM filter. Remote AC power supply. Separate inputs for UHF and VHF. Single 300 ohm input at power supply accepts combined UHF/VHF twinlead.	2-83	1	\$33.25
	Vamp-2	Mast-mounted VHF amplifier. 2 transistors. Separate remote AC power supply. Strong overload handling capability. 2 or more sets.	2-13	2	\$25.85
	Vamp-1	Mast-mounted transistor VHF amplifier. Separate remote AC power supply. FM trap.	2-13	1	\$17.10
	Vamp-2-75	Mast-mounted 75 ohm VHF home TV amplifier system. 2 transistors. Uses coax cable. Single 75 ohm output can be split to 2 or more TV sets. Strong overload handling capability. Remote AC power supply. FM trap.	2-13	1 (75 ohm)	\$29.55
	AB-3	Deluxe, mast-mounted TV/FM amplifier. Low noise frame-grid tube. Can be used up to a mile from AC source. 75 and 300 ohm outputs.	2-13, FM	1 (75 or 300 ohms)	\$78.50
	ABLE-U2	Mast-mounted UHF amplifier. 2 transistors. Uniform response on all UHF channels. Remote power supply. Miracle Mount.	14-83	1	\$26.95
INDOOR	V/U-ALL2	World's first indoor UHF/VHF amplifier. 2 transistors. FM filter. Single 300 ohm input accepts combined VHF/UHF twinlead. 2 sets.	2-83	2	\$27.50
	B-24c	Indoor VHF/FM amplifier. Uses high gain, low-noise frame-grid dual-section tube. 4 sets.	2-13, FM	4	\$17.25
	IT-4	Indoor transistor VHF/FM amplifier. Excellent interset isolation. Up to 4 sets.	2-13, FM	4	\$19.95
	B-42	Indoor VHF/FM using high gain, low noise, frame-grid tube. Up to two sets.	2-13, FM	2	\$14.25
	U-BOOST	Indoor tuneable UHF amp Frame-grid tube.	14-83	1	\$17.35
	HAB	Deluxe, indoor VHF/FM amplifier for professional home installations.	2-13, FM	1 (75 ohm)	\$49.65
	FMB	Indoor FM amplifier Ideal for stereo and regular FM. Uses frame-grid tube.	FM	1	\$14.55

VHF



Vamp-2-75



HAB

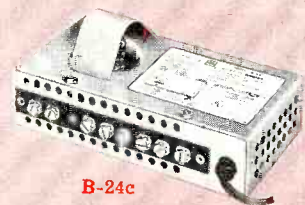

B-24c

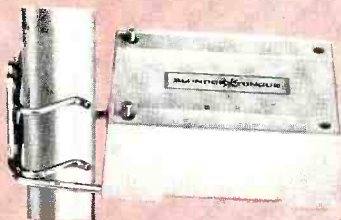

Vamp-1

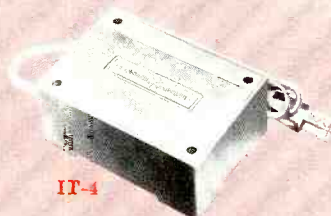

IT-4



B-42

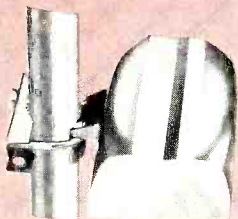

Vamp-2

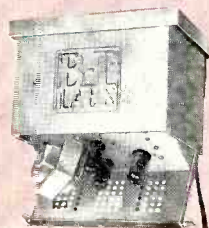

AB-3

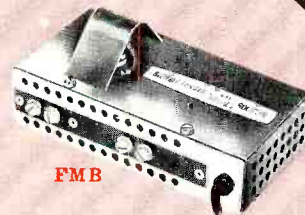

FMB

UHF converter and antenna guide

Selection of right converter and antenna critical for UHF



by I. S. Blonder

Chairman of the Board,
Blonder-Tongue Laboratories, Inc.

There has been a long-standing prejudice against UHF. Since the band opened in 1952, many otherwise knowledgeable technicians have considered UHF reception to be inferior to VHF. Yet the recent New York City tests conducted by the FCC have proved that this is simply not so.

There is a reason for this paradox — equipment. In 1953, the state of the UHF art was relatively primitive. Today, experienced manufacturers like Blonder-Tongue are able to produce equipment capable of providing UHF reception that is, in many ways, superior to VHF.

The latest advance in UHF converters is solid-state circuitry. The use of transistors and tunnel diodes insures longer-life and generally lower noise figures. Also, the Blonder-Tongue patented tuners provide pinpoint, drift-free tuning. The result is brilliant color pictures and sharp black and white reception.

As for antennas, UHF has a definite advantage over VHF. Because the UHF wavelength is so small, high gain, efficient antennas are small and cost little. The periodic principle proved so successful in the U.S. Satellite program is especially applicable to UHF. The Blonder-Tongue Golden Dart (outdoor) and Golden Arrow (indoor) antennas utilize this principle.

While they are compact, these antennas provide more gain than the large VHF yagis. What's more important, their patterns are clean, rejecting unwanted "ghost" signals.

With a little extra care in selecting and installing UHF equipment, you can often provide your customers with better UHF pictures than they've been watching on VHF.

Blonder-Tongue UHF converters

These all-channel UHF converters, your best investment in TV enjoyment, add channels 14-83 to your present set. They are particularly suited to meet the critical demands of color TV. The new BTX-11 and BTX-99 converters retain traditional Blonder-Tongue features such as peak performance on all UHF channels, easy installation and reliable, long-term operation. To these well-known features have been added the advantages of all-transistor circuitry; maximum stability for drift-free performance and lower noise figure for snow-free reception. The BTX-44 employs a tunnel diode circuit for excellent, low cost battery operation.

Blonder-Tongue UHF antennas

The UHF antennas are designed to match the high performance standards on all UHF channels of our famed UHF converters. They employ the well-known Periodic principle, to provide uniform, high gain across the entire UHF spectrum for sharp, ghost-free pictures. Full bandwidth makes these UHF antennas excellent for color and black & white TV.

The Golden Dart is an outdoor UHF antenna which comes completely pre-assembled with nothing to snap out, no screws to tighten. The Golden Arrow is an indoor UHF antenna, which outperforms all other available indoor UHF antennas.

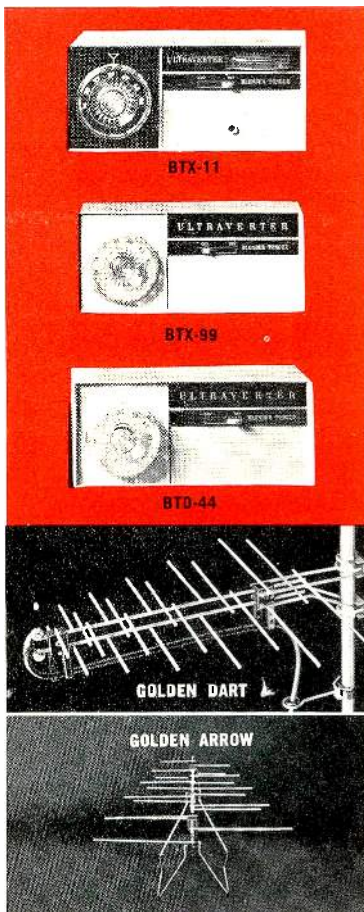

ALL-CHANNEL UHF CONVERTERS

DESCRIPTION	EFFECTIVE RECEPTION RANGE*	INPUT CHANNELS	OUTPUT CHANNELS	NET
BTX-11 — Deluxe all-channel, all-transistor UHF converter/amplifier. Adds all UHF channels to any set. Triples TV signal strength. Easiest tuning with dual-speed channel selector.	Used with an outdoor antenna anywhere up to 50 miles from station. With indoor antenna, up to 25 miles.	14-83	5 or 6	\$31.20
BTX-99 — All-channel, all-transistor UHF converter. Adds all UHF channels to any set. Provides maximum signal power. Drift-free, distortion-free.	Can be used with indoor antenna for prime signal areas and outdoor antenna up to 25 miles from station.	14-83	5 or 6	\$19.85
BTX-44 — All-channel, tunnel diode UHF converter. Utilizes tunnel diode for maximum reliability. Operates on ordinary flashlight battery which lasts from 6 to 9 months.	Can be used with indoor antenna for prime signal areas and outdoor antenna up to 25 miles from the station.	14-83	5 or 6	\$13.20

ALL-CHANNEL UHF ANTENNAS

DESCRIPTION	EFFECTIVE RECEPTION RANGE*	FRONT-TO-BACK RATIO	NET
GOLDEN DART outdoor UHF antenna. Uses Periodic principle, 11 working elements for uniform high gain across the entire UHF spectrum.	Up to 50 miles.	20db min.	\$3.55
GOLDEN ARROW indoor UHF antenna. Employs 10 working elements to provide constant high gain and matched impedance. Full Bandwidth — flat response.	Up to 20 miles.	20db min.	\$2.70

*In weak signal areas, use a model Able-U2 UHF amplifier.

ENJOY BETTER TV RECEPTION WITH BLONDER-TONGUE.

SAVE DURING THE VAL-U-RAMA NOW GOING ON.



BLONDER-TONGUE

9 Alling Street, Newark, New Jersey 07102

Canadian Div.: Benco Television Assoc., Ltd., Toronto, Ont.
home TV accessories • closed circuit TV
• community TV • UHF converters • master TV

FLYING SAUCERS - MYTH OR FACT?

... *Why the Recently Increased Belief in Unproved Phenomena?* ...

Since the airplane has become universal—and long before that—people all over the world have been exceedingly interested in atmospheric and optical sky phenomena. An unbelievable, almost religious, fervor has arisen on the controversial subject of flying saucers.

One would think that only the credulous would be caught in such a trap. Not so. Many semiprofessionals, highly intelligent students, airplane pilots on overseas runs, ministers, amateur scientists, newspaper columnists and scores of others have “observed” and even photographed these phenomena regularly and reported on them in depth in the press all over the world with increasing frequency. For 20 years, we have never given a talk without being questioned about the possibility of flying saucers.

In spite of the protests of serious scientists about their existence, the subject of flying saucers is very much in the public mind and interest seems to be increasing.

Even the Air Force keeps track of most of the reported saucer sightings, and usually has very good explanations for all but 2.09%, which are admittedly unexplained, according to a *Newsweek* report of March last year.

These are usually called UFO's—*Unidentified Flying Objects*. The abbreviation is now even a good dictionary term.

There are scores of UFO associations and clubs all over the map, such as the British UFO Association. One New York magazine editor who publishes a flying-saucer monthly even wants a world UFO association.

Then there is a rabid believer in England who never gives up—Antoni Szachnowsky, erstwhile from the 2nd Polish Corps in 1945, who organized a 300-member Anglo-Polish UFO Research Club. It was he, also, who founded the British UFO Association.

How many people have been initiated into the Flying Saucer Club? While no trustworthy statistics exist, from all the evidence we have gathered from many sources, there certainly must be millions.

One sure evidence can be found in the hundreds of books on flying saucers, particularly in Europe, behind the Iron Curtain and in the United States.

There is little point in contradicting the gullible and overcredulous. This world-wide literature is too easy and too good a money-maker for a certain type of unprincipled publisher, motivated only by fast trash sales.

Why do people believe in this extraordinary, unscientific cult? On both sides of the Iron Curtain the fixed belief is that “the Enemy” is the greatest culprit. Both sides are convinced that we spy on each other continuously via the flying saucers.

Those a little more sophisticated—or more romantic—feel certain that the UFO's are extraterrestrial, come from our own solar system or originate from neighboring stars.

Now let us for a minute apply ordinary science logic

to these arguments, and reason why, despite its long history and its cult following of millions the flying saucer just won't stand up.

1. While thousands of airplanes have been shot up and brought down, while hundreds of others have been wrecked in accidents and destroyed and the evidence found—*not a single flying saucer has ever been shot down, nor has one accidentally been destroyed, grounded or ever been found*. These facts are significant.

2. In these days of electronic progress, no verifiable radar echo has ever been recorded against a flying saucer. Yet in many of these so-called sightings the objects were reported as being certainly much less than a hundred miles distant. But we have no difficulty in getting radar echoes from the moon, 238,000 miles away, or even from Venus, more than 40 million miles distant.

3. Some people insist that UFO's have indeed been recorded, and cite as evidence the unexplained blips on radar screens that used to be called “angels.” But there has been no report of “angels” being coincident with sightings of UFO's—indeed there was such a lack of obvious visible cause that for a time it was believed that angels were produced by discontinuities between cold and warm layers of air. More recently, the discovery that “angels” are produced by flocks of migrating birds pulled the carpet entirely out from under the proponents of the flying-saucer theory.

Another significant point: If a flying saucer from any point in the solar system were to visit the vicinity of the earth, the pilots or operators would necessarily have to keep in contact with their own world. Let us assume, too, that these creatures are far ahead of us. They would have to use some sort of electromagnetic communication—radio, optics (such as lasers), etc. Yet we have never yet intercepted such signals, despite our advanced search radios, our radio-astronomy observatories and our sensitive optical observatories. Why? Because flying saucers are a myth; *they just do not exist—so far*.

Instead of reading romantic nonsense or fantastic science fiction, people might well read the outstanding scientific book on this controversial matter: *Flying Saucers*, by Dr. Donald H. Menzel, of Harvard College Observatory, Harvard University. Says its foreword:

“... of the natural origins of flying saucers from mirages and sundogs all the way back to Ezekiel's wheels in the Bible.

“In this book a top-flight scientist who has seen many a so-called flying saucer himself explodes every one of the current myths about their nature and origin. People who like to be scared or mystified may not want to agree with what Dr. Menzel has to say—but everyone who wants to know the real answer will find it in these pages. And the answer banishes forever the ‘little men,’ the foreign power's guided mis-

continued on page 92

This Transistor Voltmeter Has High Input Impedance!

A single field-effect transistor is the key to this meter's 11-megohm input resistance. Completely portable

By DAVID L. PIPPEN

One of the most promising applications of the unipolar field-effect transistor (fet) is in portable equipment that requires a high input impedance—like a voltmeter. Since the fet has essentially the same general characteristics as a vacuum tube—high input resistance and moderate output resistance, it should compete readily with vacuum tubes in high-input-impedance voltmeters. The dc fet voltmeter or fetvm described here is a compact, dependable instrument of moderate cost. Its input resistance is approximately 11 megohms, and it measures dc from 1 to 1,000 volts full scale.

Fig. 1-a shows a bar of silicon that has been doped with an n-type impurity. On each side of the bar, p-type impurities have been introduced to form a p-n junction on each side. The p-type materials on either side of the bar are connected to form a single connection. One end of the bar is the *source*; the other end, the *drain*. The center connection is called the *gate*. This device is called an *n-channel fet*.

A *p-channel fet* can be constructed if the bar is doped with p-type material and the center portion doped with n-type material, as shown in Figure 1-b.

A p-channel fet is biased as shown in Fig. 2. Notice that the gate bias supply is connected to *reverse-bias* the p-n junction formed by the p-type bar and the n-type gate. Notice also that the battery connected from source to drain allows current to flow through the bar. With the gate disconnected as in Fig. 2-a, this current is limited by the resistivity of the bar and the load, R_L . Reverse-biasing the gate causes the input circuit (gate to source) to have a very high resistance (as in a reverse-biased junction diode).

With a small gate battery connected (Fig. 2-b), the current flow through the bar decreases due to the enlarged depletion region around the p-n junction (represented by the cross-hatched area). Should the gate voltage be increased much more, the depletion regions formed on each side of the bar

merge as in Figure 2-c. This condition allows no current to flow through the bar. The gate voltage that cuts off the current through the bar is called the *pinchoff voltage*.

So the fet, like the vacuum tube, is a normally on device that requires a gate voltage of proper polarity to turn it off. Since the input circuit is a reverse-biased p-n junction, its resistance is high. Fet's are now on the market with input resistances in the order of 100 *gigaohms* (1 gigaohm = 10^9 ohms).

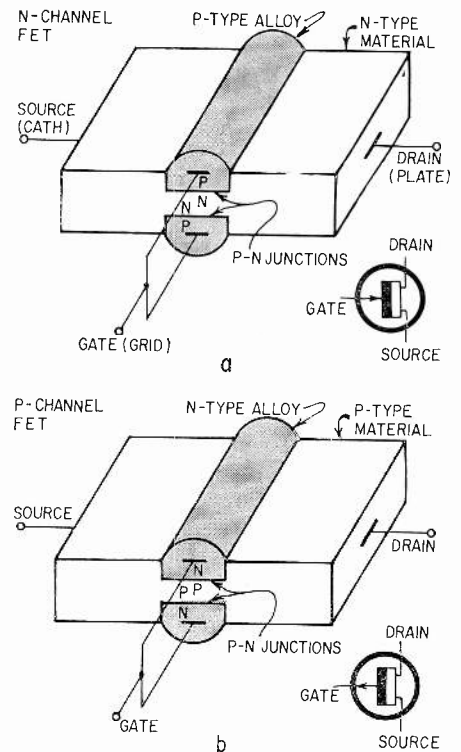
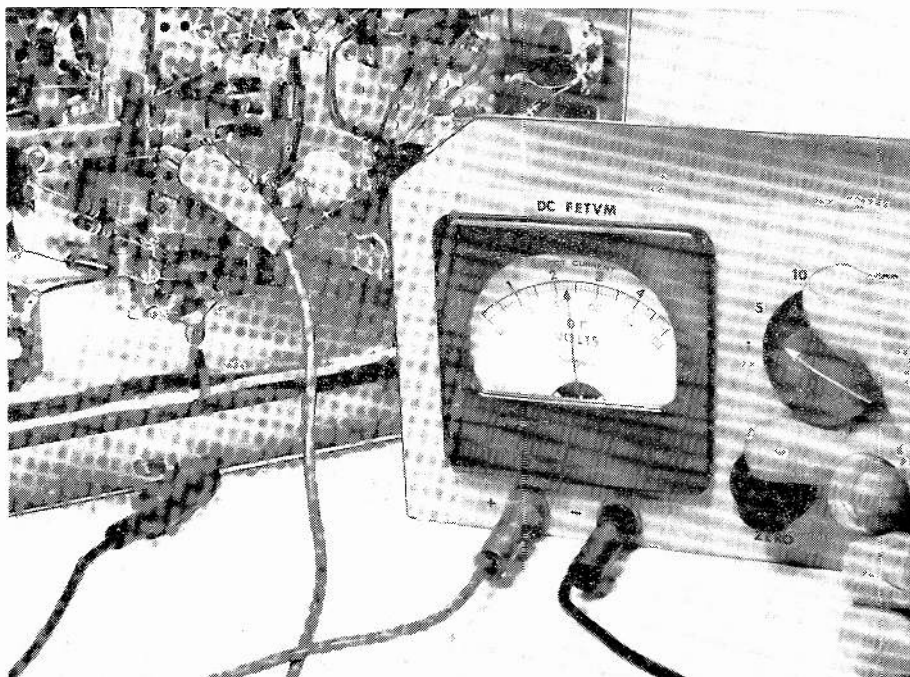

Fig. 1—The two kinds of field-effect transistors and their schematic symbols.

Two outstanding advantages of the fet over vacuum tubes are that it requires no filament power and that there is a choice of polarities—either a p-channel or n-channel device may be selected. The p-type fet requires a negative drain-to-source battery and a positive gate-to-source voltage to pinch off drain current. The n-type fet is the opposite.

The field effect transistor voltmeter in action



BENCH



TESTED

A RADIO-ELECTRONICS editor, who used the instrument for a time, reports: "This meter works very well and compares favorably with a vtvm. Accuracy was good on all ranges, except that the 10-volt range seemed to indicate a little high. Perhaps a value of 750,000 ohms would be better [as R11]. "Drift is negligible, readings are stable on all ranges."

The usual vtvm differential amplifier circuit requires two active elements—two triodes, transistors or fet's. Since most commercial fet's are relatively expensive at this time, a two-battery circuit was chosen for economy. It needs only one fet.

A 100- μ a, 1,900-ohm meter-movement was used as the voltage indicator and two 9-volt transistor radio batteries for the power supply.

Fig. 3 is the schematic of the dc fetvm. BATT 1 causes upscale current to flow in the meter. BATT 2 is adjusted to offset this current flow. Thus the meter is balanced and the pointer reads zero. A negative voltage on the gate causes the fet to conduct more, upsetting the balance. The meter pointer moves upscale. Switch S1 is the range selector. R5 is the gate return resistor, and the .01- μ f capacitor C shunts ac pickup from the gate circuit.

You have probably noticed the unconventional input attenuator circuit used in the fetvm. A much higher input resistance can be obtained with the conventional fixed-value, tapped-divider arrangement, but the balance pot will have to be readjusted each time the range selector is switched. More expensive fet's would probably alleviate this problem, but several 2N2386's tried in this circuit all acted the same.

These fet's had sufficient minority current flow in the p-n junction to make the gate bias change slightly when the gate return resistor was changed. This

- BATT 1, BATT 2—9-volt "transistor radio" battery (Burgess 2U6 or equivalent)
 - C—.01 μ f, ceramic, 50 vdc (or higher)
 - J1, J2—banana jacks or binding posts
 - M—100- μ a meter movement, 1,900 ohms (Simpson model 27 or equivalent)
 - Q—2N2386 field-effect transistor (Texas Instruments)
 - R1—pot, 5,000 ohms
 - R2—pot, 2,000 ohms
 - R3—10,000 ohms
 - R4—430 ohms
 - R5—22 megohms, 5%
 - R6—200,000 ohms
 - R7—7,200 ohms
 - R8—15,000 ohms
 - R9—75,000 ohms
 - R10—150,000 ohms
 - R11—820,000 ohms
 - R12—1.75 megohms
 - R13—10 megohms
 - R14—1 megohm
- Resistors R6 through R14 inclusive are 1% tolerance. All others may be 10% except R5. S1—single-pole, 7-position shorting rotary switch (Centralab 1000 or equivalent) S2—dpst toggle switch Case or chassis (see text) Terminal boards or strips; miscellaneous hardware

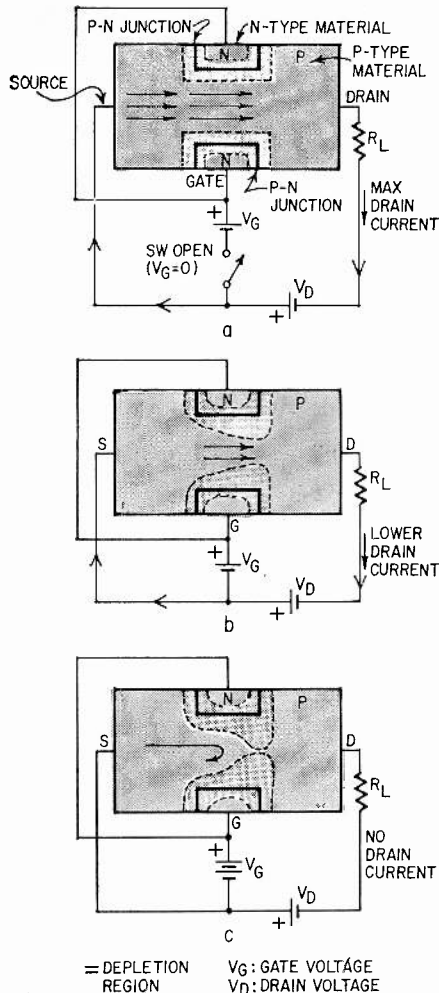

Fig. 2—A p-channel fet and how it is controlled from saturation to cutoff. In (a), the gate voltage is zero and current flows unimpeded through channel from source (S) to drain (D). In (b), small reverse bias between gate and channel sets up electric field that tends to "pinch off" current flow. In (c), gate field is great enough to pinch off channel current completely. Because gate is always reverse-biased, no current flows in gate circuit and fet's input resistance is very high.

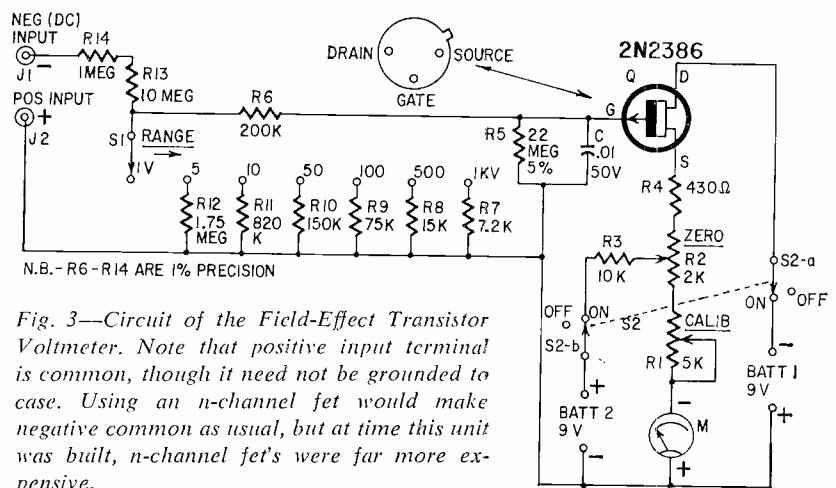
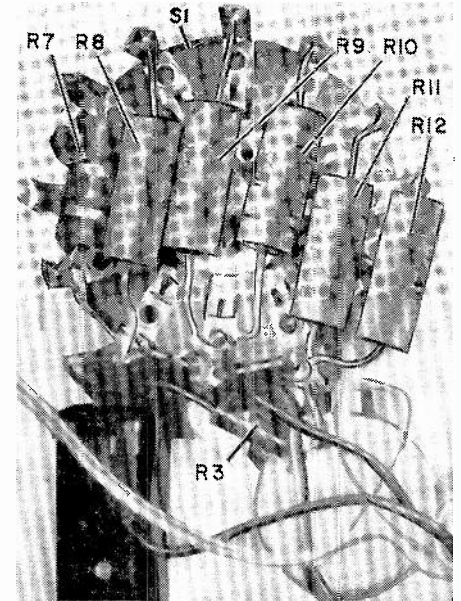

Fig. 3—Circuit of the Field-Effect Transistor Voltmeter. Note that positive input terminal is common, though it need not be grounded to case. Using an n-channel fet would make negative common as usual, but at time this unit was built, n-channel fet's were far more expensive.

in turn caused the drain current to change and the pointer to move off zero. Placing isolating resistor R6 between the gate and the attenuator network eliminated that. This lowered the input resistance, but it is still approximately 11 megohms (equal to that of service vtvm's).

Should you want a higher input resistance, a 50- μ a, 2,000-ohm move-



How the switch is wired

ment can be used in the same circuit. This will allow input resistor R13 to be increased to 22 megohms.

Putting it together

Construction is simple. No special layout is required. Any meter movement with similar resistance and sensitivity will probably work as well as the one used in this circuit.

Multiplier resistors R7 through R12 should be within 1% of the value indicated. (R7 and R12 can be made up of two resistors in series to obtain the correct total.) The chassis is a Bud AC-430 which measures 4 inches deep by 6 inches wide by 3 inches high. A

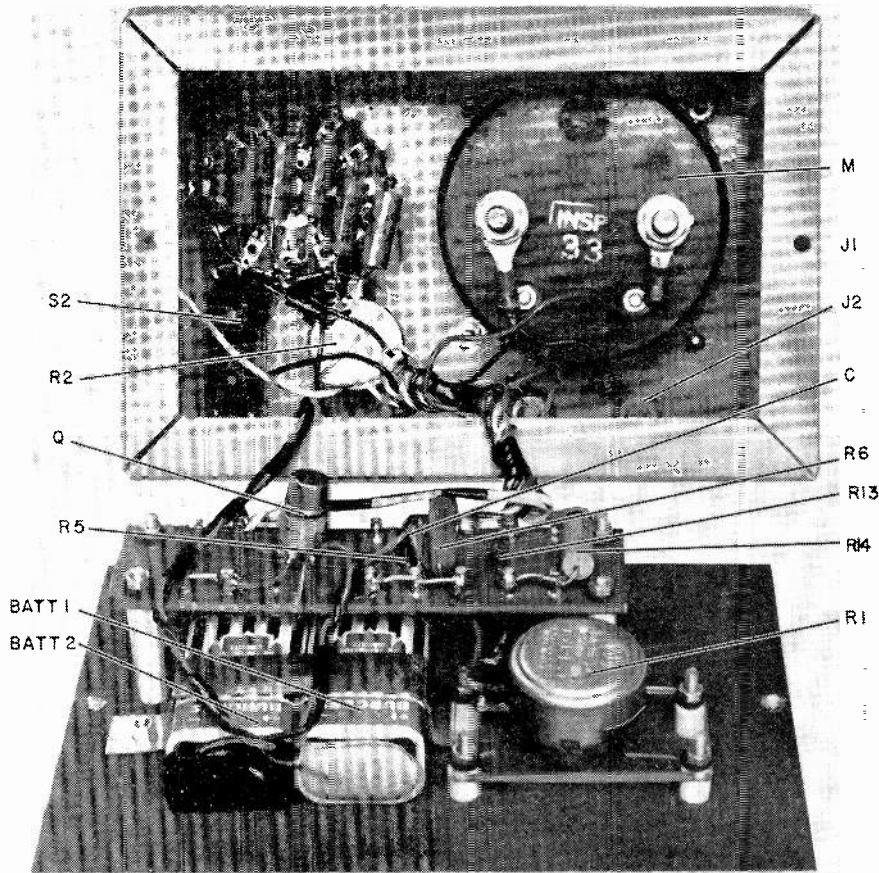

Rear view of meter, with all components

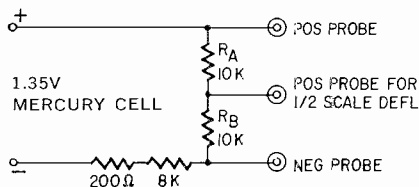

Fig. 4—Simple two-voltage calibrator for the fetvm. If you plan to wire this up permanently and keep it handy, you might wire a switch in series with the battery to keep from draining it constantly (though current is only about 50 microamps).

much smaller unit could be designed with a smaller meter movement and chassis.

Texas Instruments sells a line of germanium fet's that are much cheaper than the one used in this meter (the TIX-880 to -883) and perhaps would

work as well in the circuit given. They sell for less than \$3.

The 100- μ a meter face was modified slightly. A typewriter eraser was used to erase the original "microamperes" using 12-point press-on type letters such as Datak sold at electronics, art and blueprint supply houses. The 0-5-volt scale and the meter case were also lettered with the Prestype.

The component board, the two batteries and the balance potentiometer were mounted on the back panel. The balance pot was mounted so that it could be adjusted without removing the back. The back panel was made from 1/8-inch-thick aluminum, cut to fit the dimensions of the chassis.

Calibration is also very simple. Fig. 4 shows a voltage-divider network, used with a 1.35-volt mercury cell to

Close-up view of the component board

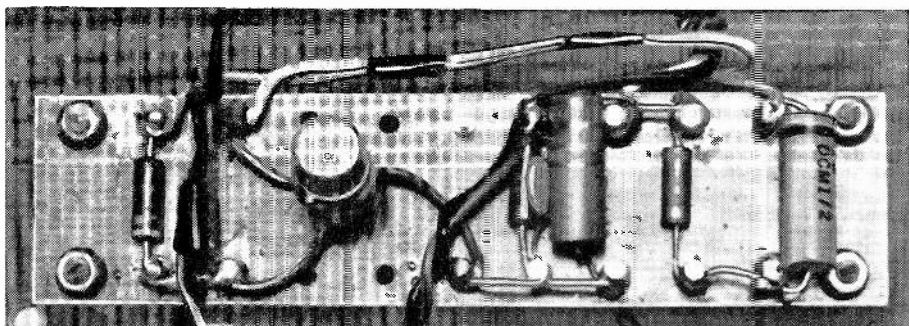

make an accurate calibration source.

1. Set range switch S1 to the 1-volt position. Adjust calibrate pot R1 to maximum resistance.

2. Switch the fetvm to on.

3. Short the probes together and adjust the balance control for zero meter reading.

4. Place the probes across resistors R_A and R_B (Fig. 4).

5. Carefully adjust calibrate potentiometer R1 for full-scale deflection.

6. Remove the probes from the calibration source, short them together and adjust the balance control for zero meter reading.

7. Repeat steps 4 and 5.

8. Place the probes across R_B . The meter should now read half scale.

The completed instrument is accurate to within 1% of full scale for measurements within the upper two-thirds of the scale. It is stable and zero-drift is no problem.

Remember that there is no "on" indication light and that the instrument draws current even when the meter is zeroed. Therefore, be sure to turn the instrument off when it is not in use. END

Yoke-Checking: The Finger Method

YOU CAN DETERMINE EASILY WHETHER A TV set's yoke is defective without removing the chassis. Just take its temperature with your finger!

If you discover that a set has no B-boost voltage, you might suspect a shorted horizontal winding in the yoke. If you could establish that in the customer's home, without pulling the chassis, you'd be ahead by a bit. Remove the yoke from the CRT neck but leave it connected. Lay it on or near the chassis where it won't short accidentally against some other component.

Plug the power cord into the set, turn the set on and let it cook for 2 or 3 minutes. Disconnect the cheater and feel around inside the yoke windings. If you find a hot spot, the yoke windings are shorted internally.

Never touch the yoke with power applied to the chassis!

You may want to go one step further to prove definitely that the yoke is defective. Disconnect one of the wires to the horizontal windings. This takes them out of the flyback circuit. Now check the boost voltage. It should be back to normal, or possibly slightly higher than normal, since the yoke is normally a load on the horizontal deflection circuit.—G-E Service Talk

Case of the BUILT-IN MOTORBOAT

By HUGH KENNER

THE COMPLAINT WAS MOTORBOATING, but not right away. For the first hour you just heard the music, but after that you couldn't hear anything but the noise. It sounded like someone with a fast hammer was inside the speaker cabinet. Only on FM: that pointed to the tuner—a Bell, model 2520. Had it ever given trouble before? Yes, the same trouble, a couple of years ago. A ten-dollar service call had driven it away. Now it was back. In fact it had come back very quickly. They'd been living with it for months. Could I, as a friend, suggest something?

Before the back was off the wooden enclosure, I was able to suggest that we fry some eggs. The wood was hot to the touch a foot back of the tuner, despite large ventilating holes. The tuner itself was too hot to move. When I finally got its cover and bottom plate off, discolored metal around the power supply filter showed where to start checking. A shorted electrolytic, probably, and the others had finally quit from overheating? I took the tuner home for surgery.

Then I got my first surprise. The factory electrolytic, a three-section can type, wasn't in the circuit at all. It was probably the one that had stopped working 2 years ago (a quick check showed that it certainly wasn't operable now), and the repairman hadn't bothered to find a replacement. Instead he had wired in three separate pigtail sections under the chassis. That had meant, of course, new tie points for the three resistors, R30, R31, R32 (Fig. 1-a). They had formerly been wired to the lugs on the capacitor can. With the schematic open in front of me, I started the 2-minute job of identifying them.

Surprise two: R30 was nowhere to be found! C1-a went to ground directly from pin 7 of the rectifier. Yet there were still three big power resistors in sight, and—surprise three—they were all of them tied to pins on the rectifier socket. What was more, one of them, a 6,000-ohm unit, seemed to lead off to ground. A few minutes' work with ohmmeter and pencil, and my scratch pad had a new drawing (Fig. 1-b).

When those pigtail capacitors went in 2 years ago, the unused lugs on the

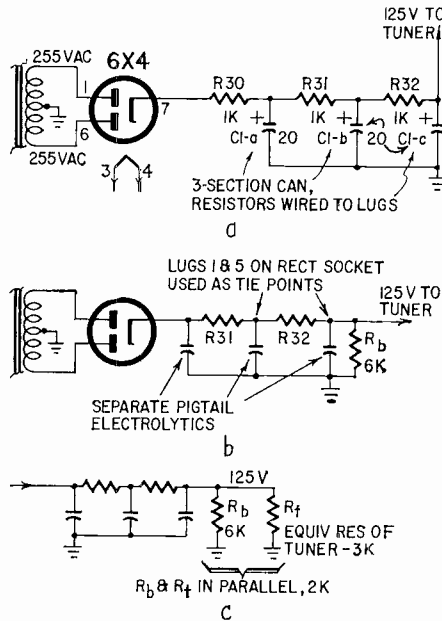

rectifier socket became tie points. Good enough. But a 6X4 has only two unused pins (2 and 5), whereas the circuit needs three. So Mr. Lazybones had simply eliminated R30, and coped with the resulting excess B-plus by running a bleeder to ground (R_b , Fig. 1-b). Unlike a series resistor, a bleeder doesn't need an additional tie point.

Reflecting dimly on the implications of this bleeder, I commenced restoring the circuit to the form in which it had left the design table: a mounting screw for a new tie point, R30 restored, R_b out. Then I turned the tuner on and did a little arithmetic while it warmed up.

Approximately 40 volts was being dropped across R30. So the circuitry drew 40 ma. Each of those three resistors drew I^2R , or $.04 \times .04 \times 1,000$ watts, 1.6 watts apiece, a total of 4.8 watts of heat dissipation under the chassis.

Now what happens when we drop R30 and add the bleeder? Let's suppose Mr. Lazybones asked himself that 2 years ago. Maybe he worked it out like this. The bleeder drops the full B plus to ground: 125 volts across 6,000 ohms: E^2/R , or 2.6 watts. And 1.6 watts apiece for R31 and R32, 5.8 watts total. Just

20% more than the design value. Give him this much credit: if he carried his figuring that far before reaching for the soldering iron, he saw no particular risk. One extra watt won't cook anything.

But: although that bleeder gets the B-plus down to the 125 volts the designer ordered, it brings it down by dragging extra current through the source impedance. The power supply doesn't know whether it's feeding an FM tuner, a load resistor or a moustache curler. To a source of dc, everything that draws current feels like a resistive load. The tuner (which draws 40 ma, remember?) feels like a 3,000-ohm load across that 125-volt source. Add the bleeder, and you've got another 6,000 ohms in parallel with that (Fig. 1-c). 6K and 3K in parallel, equivalent resistance 2K. 125 volts through 2K, 62.5 mils. That's 50% more current than before. And the heating effect rises with the square of the current.

So now R31 and R32, with 62.5 ma through them, are drawing 4 watts apiece, or 8 watts; and 2.6 watts for the bleeder, 10.6 watts, more than twice what we had before. And that's just resistor heating. Don't forget that the source impedance through which that extra current is dragged includes the transformer.

By the time the heat from its windings has soaked up through several pounds of metal, the transformer, even under normal conditions, is radiating more heat under the tuner cover than all the circuit resistors put together. And once again, heat increases as the square of the current. Raising the current from 40 ma to 62.5 increases the transformer heat $2\frac{1}{2}$ times. Did Mr. Lazybones say something about a mere 20%?

From the moment the "doctored" tuner was turned on, we were getting twice as much resistor heat as the design called for, and within a hour, more than twice as much transformer heat. Under a pancake cover, where heat circulation is figured pretty closely, all that extra heat was cooking the electrolytics, raising their series resistance, while the power supply's ac impedance crept up and up. Hence the motorboating, built in, inevitably built in, by a technician who thought he was curing it for good and saving himself work at the same time.

When I went back to the tuner, it was running as cool as you please. Six hours later it was still cool. Three months later it's still in daily service. I never did have to replace those electrolytics. Just getting their ambient temperature down to something reasonable was all they wanted to work perfectly.

Very likely none of it would have happened if the rectifier had been a 5Y3. Mr. Lazybones would have found another tie point on the socket! END

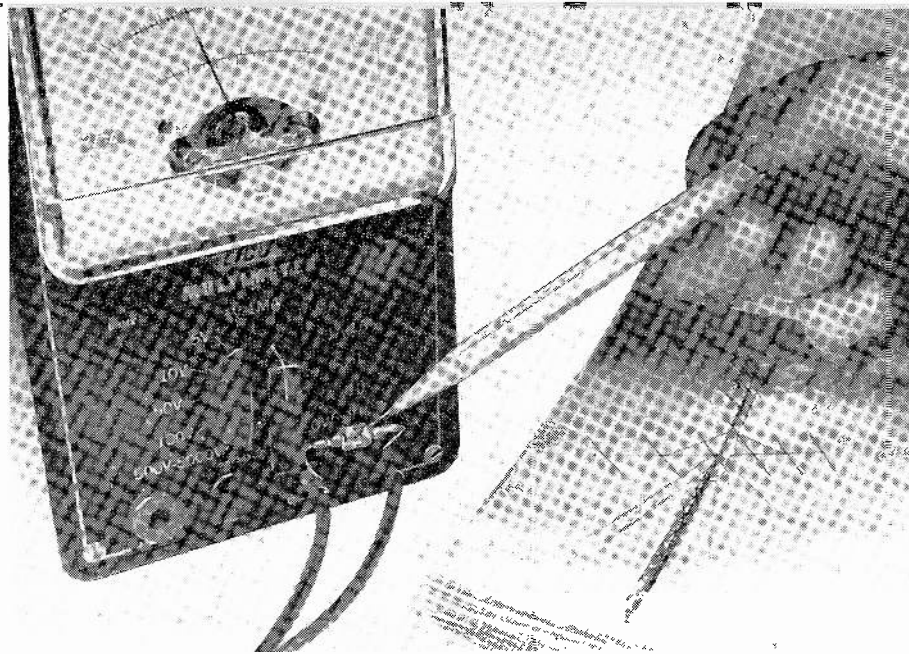

10 Ways To Get More Use From Your VOM and VTVM

By WAYNE LEMONS

None of us use the common pieces of test equipment as much as we would if we had some simple accessories to go along with them. Most of us would probably build these accessories if they didn't require too much time or special parts. Here are some simple plans for equipment that can be built in an hour or so and that can save you many precious hours in service or experimental work. At the end is the plan for a device that combines four of the simple devices into one enclosure and gives you a special instrument you can use on several kinds of jobs.

1. Field Strength Meter

With today's widespread use of two-way radio we often need some way of telling whether a transmitter is working, judging its relative output power and peaking the antenna circuit. A single diode (1N34, 1N64, etc.) will

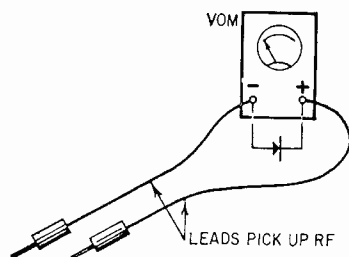

Fig. 1—Diode across meter leads rectifies rf. Use dc range.

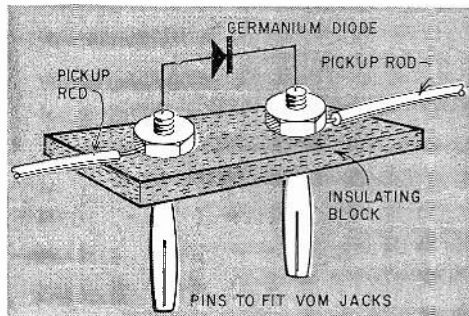

Fig. 2—More permanent and useful adapter for rough rf checks. Rods can be cut to resonate.

turn your vom into a portable field-strength meter (Fig. 1). The test leads act as a pickup antenna. If you want a more elaborate and slightly more satisfactory device, Fig. 2, shows one that plugs into your meter instead of the test leads. The rigid mounting of the pickup antenna is better since the wires will be suspended in space symmetrically and provide somewhat better accuracy, especially when making relative output measurements from one transmitter to the next.

The length of the pickup antenna is not critical though output will be higher if each antenna rod is cut for the frequency desired.* For lower frequencies, use the circuit of Fig. 3 if you need more sensitivity. Use your

*Quarter wavelength in inches = $\frac{2770}{F_{mc}}$

vom on direct current or voltage ranges, depending upon the sensitivity you need.

2. Checking CB power output and modulation

You can use either your vtvm or vom for this. Build the circuit of Fig. 4 into a small metal box. Be sure to use 2-watt carbon or other noninductive resistors. This circuit makes an ideal dummy antenna capable of safely absorbing the 2½ to 3½ watts of rf output encountered in CB transmitters. By

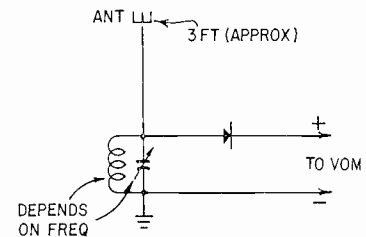

Fig. 3—Simple field-strength meter.

tapping off with the diode as shown, and using your vom or vtvm on DC VOLTS, each volt reading will indicate approximately 1 watt of antenna power. For example, a reading of 3 volts means that the transmitter is capable of radiating approximately 3 watts of power from a properly matched antenna system.

For making relative modulation checks, speak into the microphone while watching the meter. The power output should increase about 22½%. This is called upward modulation. If power output decreases (downward modulation), something is wrong with the transmitter.

3. Read alternating current and power

Most vom's or vtvm's make no provision for reading alternating current, though often that would be a help. Fig. 5 is a simple way of making such readings. Built into a small box with ac connectors, it is easy to use and no disconnects have to be made.

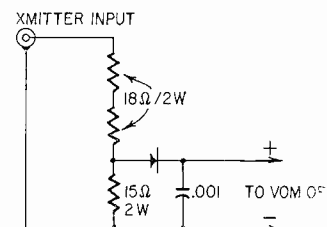

Fig. 4—CB wattmeter taps off small rf voltage from 51-ohm dummy load.

One-ohm resistors are not hard to find. Unless current is extremely heavy, the voltage drop will not affect operation, yet can be measured easily. With a 1-ohm resistor there will be 1 volt drop across the resistor for each ampere of current.

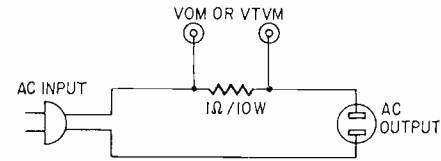
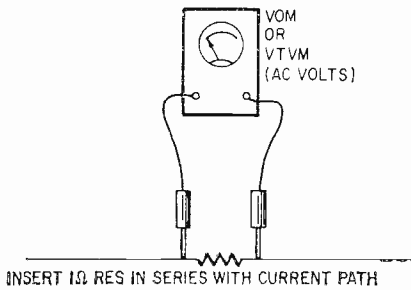

Fig. 5—To measure current, insert 1-ohm resistor in circuit and measure drop across it.

Ac power in watts is a product of volts times amperes if the circuit has a power factor of 1. TV and radio devices are close enough to unity power factor—for all practical purposes the wattage equals the voltage across the load multiplied by the current through it.

4. A resonance checker

How often have you picked an old i.f. transformer out of your junkbox and wondered if it was still OK and whether it was tuned to 262 kc, 455 kc, or some other frequency? Fig. 6 shows different methods of finding out just by using your signal generator and vtvm.

In Fig. 6-a capacitor C should be as small as will still allow a usable deflection on the meter. Since this capacitor is effectively in parallel with the resonant circuit, too large a capacitor will cause an erroneous reading. For

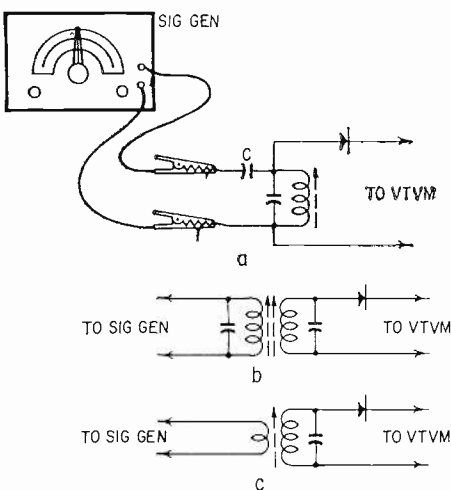

Fig. 6—Three ways of checking i.f. transformers. (a) shows a single winding being checked with signal applied through a small capacitor C. In (b), one winding of transformer couples signal to other—no capacitor. In (c), low-impedance base winding of transistor i.f. transformer couples test signal to tuned winding.

i.f. and broadcast frequencies, a 10-pf capacitor is about right, since it will simulate the actual stray capacitances in the circuit when the transformer is wired in. For higher frequencies the capacitor may be reduced.

Fig. 6-b shows an alternate method. The low generator impedance will “swamp” one winding but the other should “peak up”. Reverse the transformer to check both windings.

Fig. 6-c is for transistor i.f. transformers. In this case only one resonant circuit is used and the base (untuned) winding pretty well matches the output of the signal generator.

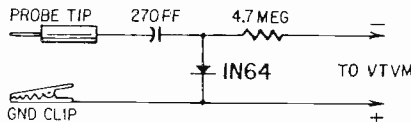

Fig. 7—Rf probe for vtvm. Build the whole thing into some kind of tubular shield.

If the transformer or resonant circuit is good, you should get a definite and pronounced peak on the meter when the signal generator is tuned to its resonant frequency. You can also get some idea about the Q of the circuit: a high-Q circuit will produce a sharper peak.

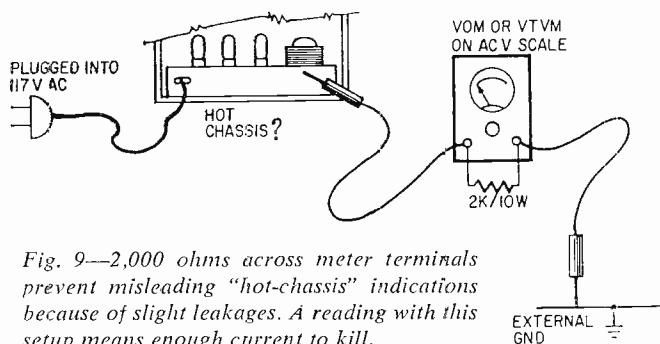
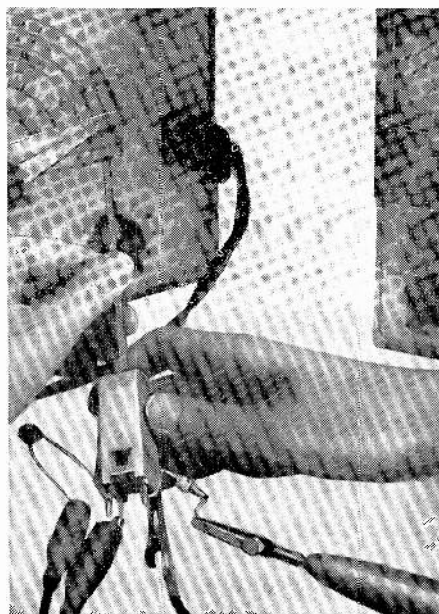

Fig. 9—2,000 ohms across meter terminals prevent misleading “hot-chassis” indications because of slight leakages. A reading with this setup means enough current to kill.

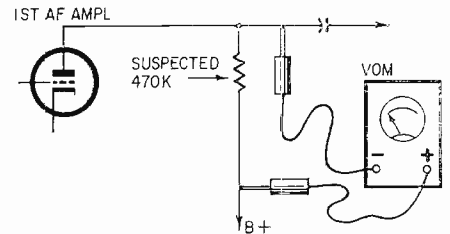

Fig. 8—A vom can be a resistor, where values are not critical.

Instead of the diode, you can of course use the rf probes supplied by many manufacturers for their vtvm's. Fig. 7 is the schematic of a commercial rf probe that uses an isolation capacitor to block dc from the diode. The diode is shunt-connected so that it will have a dc return path (otherwise broken by the blocking capacitor). The resistor isolates the cable capacitance from appearing across the diode. This kind of probe, if carefully designed, is useful to around 250 mc and loads the circuit little. You can build one like it in a miniature tube shield or other small probelike enclosure.

5. A resistance substitute

You don't have to watch a professional technician long before you see him use his vom as a temporary resistance substitute in a suspected circuit. A case in point might be distorted or weak audio output from a TV or radio. This kind of trouble often results from an open or changed-value resistor in the plate or screen circuit.

A 20,000-ohm-per-volt meter on the 50-volt range is a 1-megohm resistor (Fig. 8). You can get other values by simply rotating the range switch. This 1-megohm resistor will substitute for resistors within 200% or 300% of that value in audio circuits. Placing the meter across the suspected resistor may bring the sound back loud and clear and prove the trouble really is what was suspected.

A vom on its 500-volt range can determine whether the age bucking resistor is open and causing a snowy picture. The resistor is usually in the neighborhood of 10 megohms.

Tricks such as this, intelligently used, are the difference between the mechanic and the artisan.

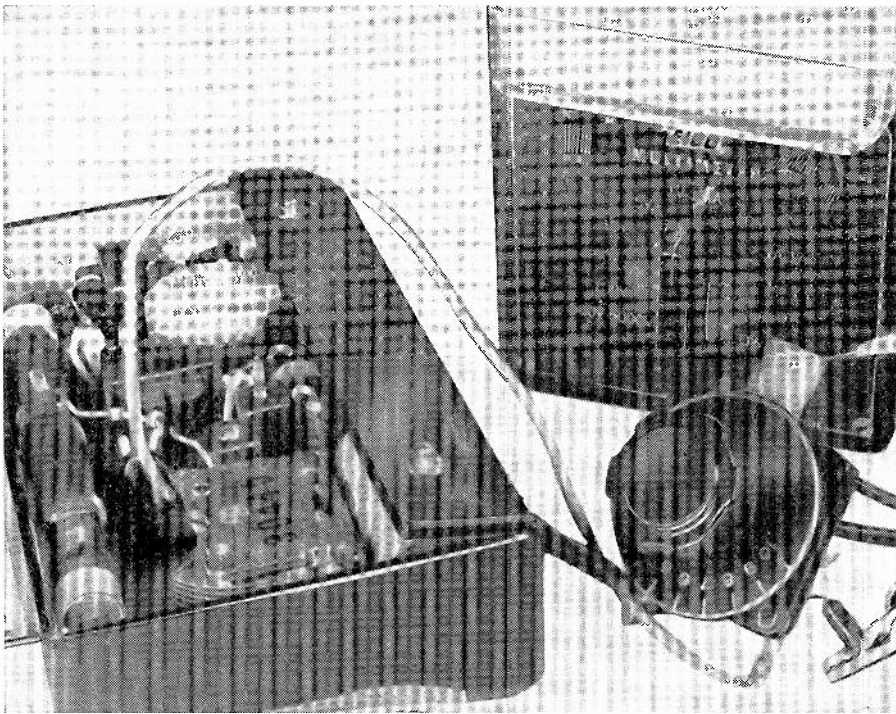

6. Checking "hot" chassis

With sensitive meters, we may find some voltage reading from a chassis to an external ground regardless of which way the ac plug is inserted. This is a case where we must "desensitize" the meter by using the circuit of Fig. 9. With this circuit, small, harmless leakages, such as through a 1-megohm resistor, will not register on the meter. But if there is enough leakage current to be lethal, the 2,000-ohm resistor will not affect the voltage reading.

7. Checking transistor radio drain

One of the single most important measurements in transistor radio servicing is battery current drain. Nearly any vom can be pressed into service here by using one of the devices of Fig. 10. Fig.

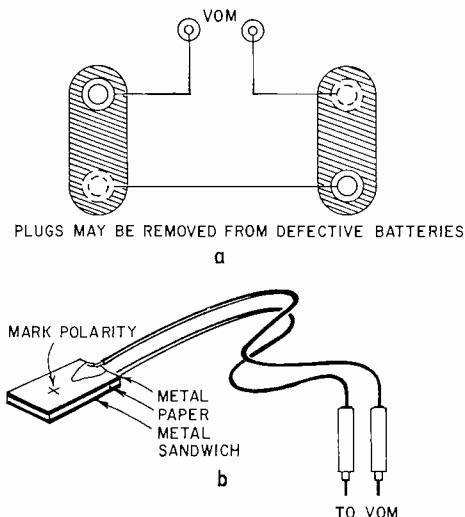

Fig. 10—Current-measuring adapters for transistor portable radios. The one in (a) is for 9-volt batteries with two terminals on one end; the one in (b) is for "flashlight" type cells.

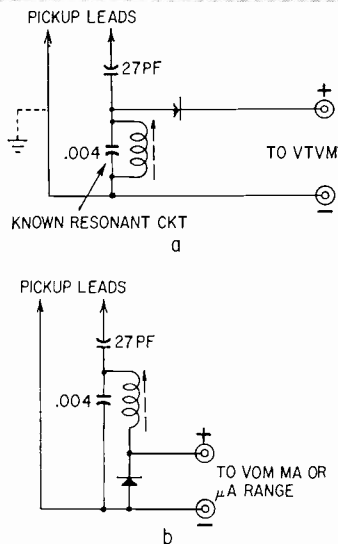

Fig. 11—Either of these circuits—(a) for vtvm, (b) for vom—can check whether a TV horizontal oscillator is on frequency.

10-a is self-explanatory. For Fig. 10-b, cut two pieces of thin metal ("shim stock" purchased at auto supply houses is ideal) separated by a strip of paper (glued in place) that overlaps the edges of the metal just slightly. Wires connected to the metal strips are used as meter leads. This device can be inserted between flashlight type batteries or between batteries and connectors so that the meter is in series and reads total current flow.

Some vom's have too much resistance for this job and can cause the radio to motorboat, but most meters are all right on current ranges of 100 ma or more.

8. Checking horizontal oscillator frequency

The circuit in Fig. 11-a or 11-b

will let you check the horizontal oscillator frequency in a TV set. Actually, this circuit can be used for almost any low or medium frequency by changing the coil-and-capacitor combination. Here a regular 50-mh horizontal ringing coil is used.

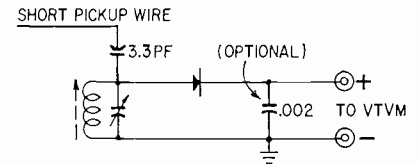

Fig. 12—This adapter "sniffs out" the local oscillator signal in AM radios. Is it there? The right frequency?

To check horizontal frequency, the circuit should first be calibrated using a operating TV with the picture locked in. Adjust the ringing coil for maximum meter reading. To use on a suspected TV circuit, connect the input lead to the grid of the horizontal amplifier tube. Vary the set's horizontal hold controls. The meter reading should peak at some point of the adjustment. If it doesn't, either the horizontal oscillator is considerably off frequency or it isn't working at all. An off-frequency oscillator may result in complete loss of high voltage even though grid drive to the horizontal amplifier measures normal or even high.

This circuit will pick up enough signal to operate most vom's when it is connected to the grid of the horizontal amplifier, or, if the amplifier is working, from radiation when the pickup wire is placed near the plate circuit or flyback transformer. For added sensitivity and stability, use a ground wire to the TV chassis.

9. Checking local oscillators

The circuit in Fig. 12 is wonderful for checking transistor radios. It is not always easy to be sure that the oscillator is working, and much harder to tell whether it is working at the right frequency.

All that you need is this circuit in a small box. With an operating radio, calibrate three or four reference points on the capacitor dial. (A radio with a 455-kc i.f. has an oscillator frequency of 455 kc plus the station frequency to which it is tuned. If the radio is tuned to 600 kc, the oscillator should be at 1055 kc.)

The coil is a ferrite-core type adjustable antenna coil. The capacitor is variable from about 10 to 365 pf. It is better, but not absolutely necessary, if you remove a few turns from the antenna coil so that the tuning range will fall in the 800-kc to 2,000-kc vicinity. This will let you cover just about all the broadcast band for either 455- or 262-kc (most car radios) i.f. systems.

ELECTRONIC MUSCLE EXERCISER

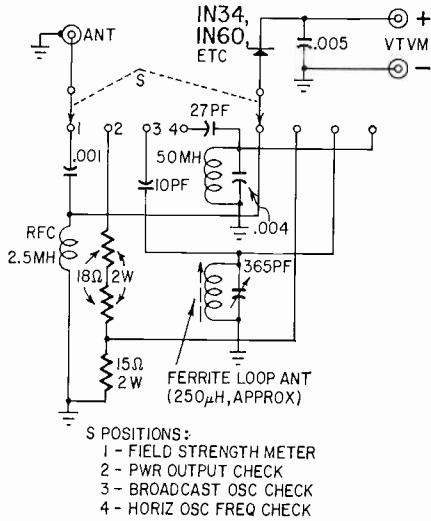

Fig. 13—Composite adapter combines functions of four circuits into one.

This circuit works well with higher frequencies. Just use an appropriate coil-and-capacitor combination.

10. Meter use-extender combination

Fig. 13 shows a circuit that may be built in a small metal box with appropriate connectors. It performs four of the previously discussed applications (1, 2, 8 and 9) and makes a versatile and important extra piece of test gear when used with your vom or vtvm.

The first position is a broad-band field-strength circuit. The rf choke may be salvaged from an old TV—a peaking coil from the video circuit. The .001- μ f capacitor is not critical. Its purpose is to block an accidental application of dc.

The second position is the dummy antenna, power and modulation check for CB radios.

The third position is the wave-meter type detector for checking oscillators in broadcast radios.

The last position is for checking TV horizontal oscillator frequency.

Wiring is not extremely critical, but wires should be kept as short and direct as possible. All the components can be mounted directly to the switch contacts, jacks or ground for rigidity.

All these circuits have been tested and unless otherwise specified will work with a vtvm or a 20,000-ohm-per-volt vom and, in some cases, with a less sensitive vom. The basic meter movement of a 20,000-ohm-per-volt unit is 50 μ a; in a 1,000-ohm-per-volt it is 1 ma, so it is obvious that the 1,000 has 20 times less sensitivity than the 20,000.

Today the 20,000-ohm-per-volt meter is no longer a luxury. Several fairly accurate ones sell for less than \$30—some for less than \$20. END

EARLY ELECTRICAL EXPERIMENTERS discovered that an electric shock applied to a section of the body causes muscles to contract in that area. Today, some doctors and physiotherapists prescribe controlled low-voltage electric impulses in treating certain muscular disorders, maintaining or restoring muscle tone and for exercising muscles in local areas. Many of the machines in use today are in large office type consoles.

Micro Precision Corp. of Brooklyn, N. Y., has devised a miniature portable electronic muscle exerciser that

it expects to market within the near future. The unit uses transistors and measures 3 x 4 x 1 inch—about the size of two packs of cigarettes. The instrument (see schematic) uses a 14-volt NiCad battery and has a built-in trickle charger.

The output wave is a carrier whose frequency is variable from 20 to 4,000 cycles. It is modulated by pulses with both on and off times adjustable from 0.1 to 7 seconds. The output across 1,000 ohms—the average body resistance between the applicator electrodes—is 15 volts. END

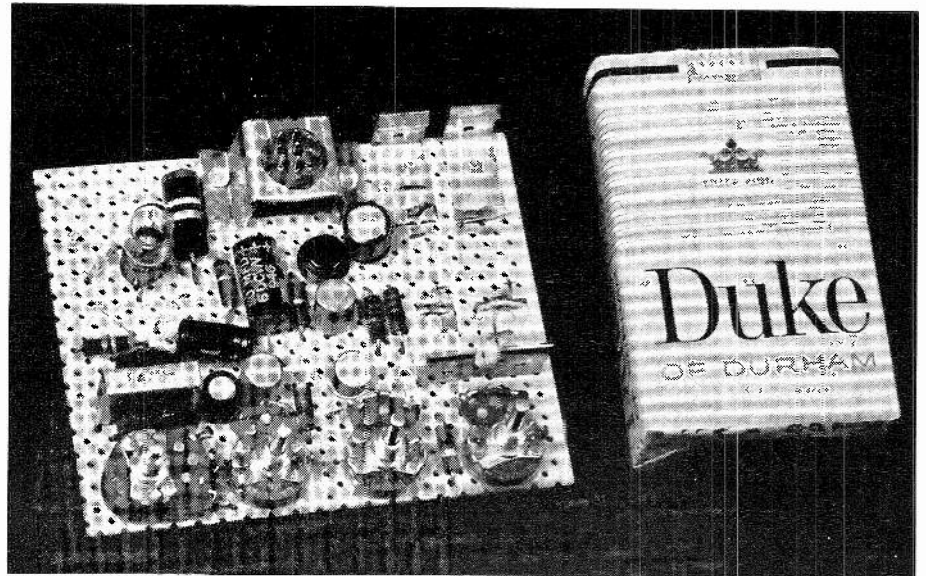

Under-chassis view of the instrument.

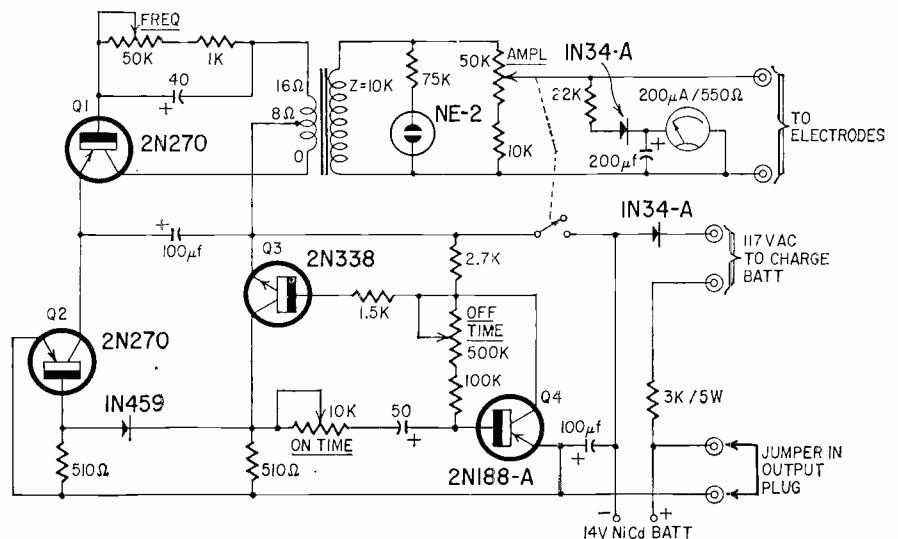

Circuit of electronic muscle exerciser. Q1 is the carrier oscillator, Q2 is the modulator and Q3 and Q4 form multivibrator-type pulse generator.

Meters for Beginners

HOW DO THEY WORK?

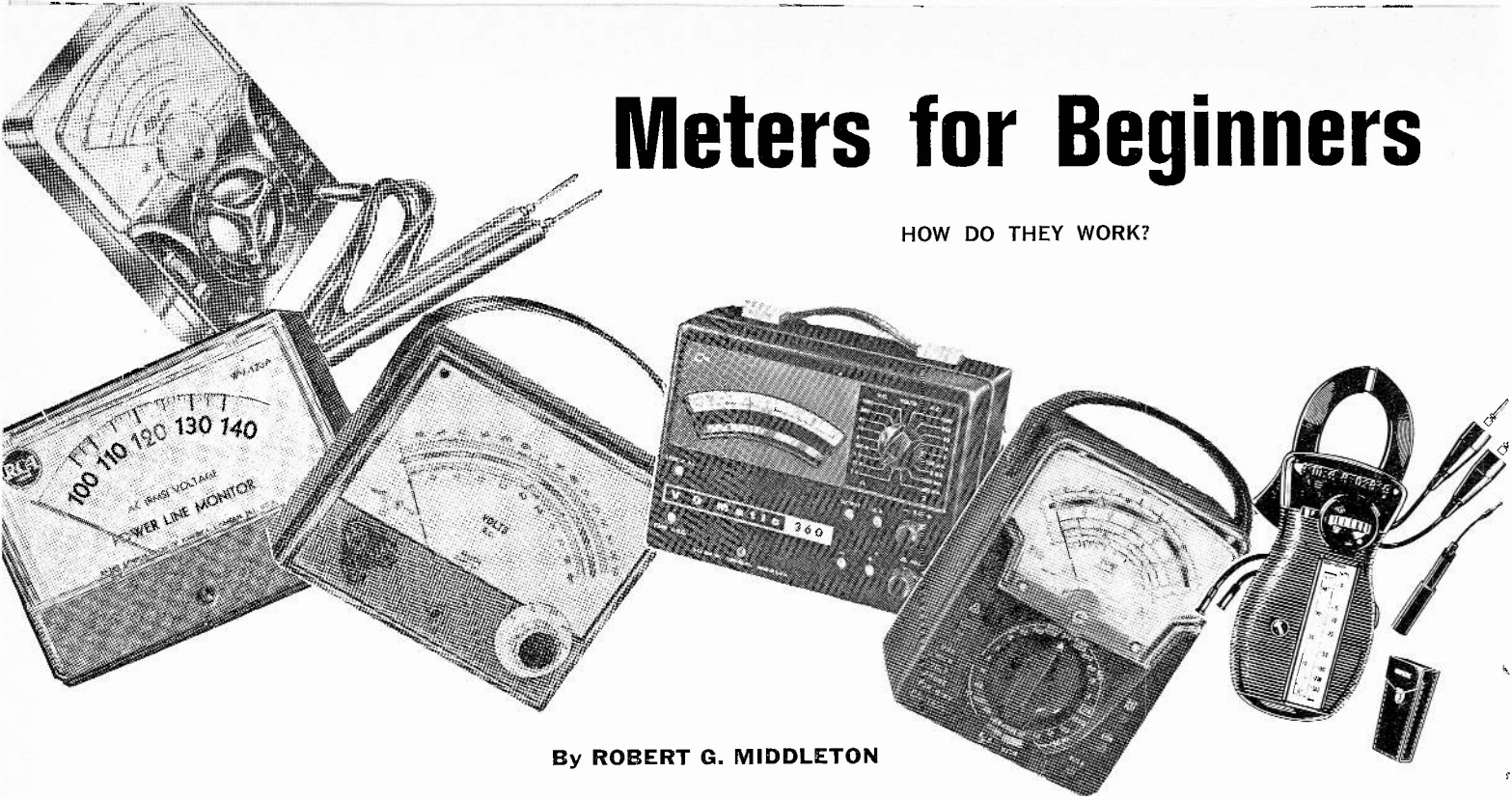

By ROBERT G. MIDDLETON

THE MOST WIDELY USED ELECTRIC MEASURING instruments are voltmeters, milliammeters and ohmmeters. They measure the quantities stated in Ohm's law: $I = E/R$.

Most voltmeters are hooked up to measure either ac or dc voltages. Milliammeters for ac are less common, simply because voltage is measured much more often than current in practical work. On the other hand, resistance is measured almost as often as voltage. Hence, we would expect to find ac ohmmeters in wide use—and we do. Generally found in separate units called

capacitor testers, they are calibrated not in ac ohms, but in microfarads.

How basic meters work

The heart of a meter is its movement (Fig. 1). Basically a current-indicating device, it responds to dc only. To measure dc voltage, a multiplier resistor must be connected in series with the meter (Fig. 2). Now, if a rectifier is connected in series with the movement (Fig. 3), we get an ac voltmeter.

A vom has several current ranges, and the current-indicating circuit is elaborated as in Fig. 4. This is a milliammeter configuration with three ranges. It responds to dc only. A simple change of test-lead connections changes the configuration into a dc ammeter (Fig. 5). The ammeter function is *not* wired into the switch circuit, because the switch contacts are small and will not carry heavy currents satisfactorily.

A practical dc voltmeter must also have several ranges (Fig. 6). Note here that the voltmeter circuit has comparatively high input resistance, compared with the milliammeter circuit—this distinction is typical of nearly all voltage and current instruments. There are occasional exceptions. For example, in checking some of the low dc voltages in transistor circuits, a 0.25-volt full-scale voltage range can be useful. In such

case, you can use the 50- μ a range of a vom as a voltmeter, with full-scale deflection at 0.25 volt.

An *ohmmeter* is obtained by switching an internal battery into the measuring circuit in (Fig. 7). Note how the circuitry is arranged basically to indicate the current that flows from the internal battery through the resistor under test. However, the scale used on this function is calibrated in ohms. This is a simple and convenient circuit arrangement, al-

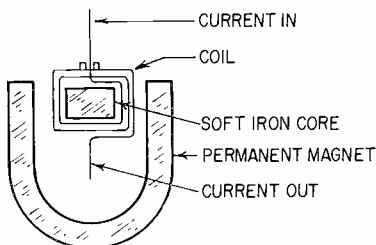

Fig. 1—Principle of d'Arsonval (moving-coil) meter movement.

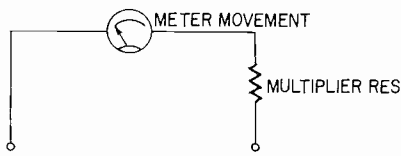

Fig. 2—Basic dc voltmeter circuit; movement in series with multiplier resistor.

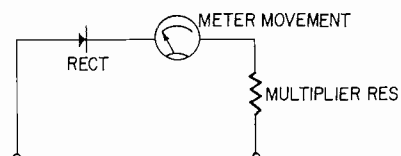

Fig. 3—Basic ac voltmeter circuit: rectifier added.

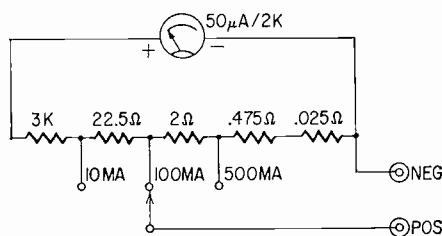

Fig. 4—Practical milliammeter circuit.

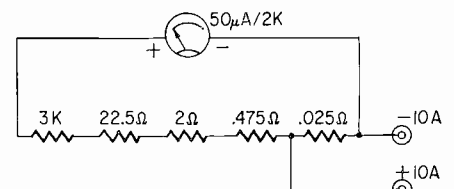

Fig. 5—Ammeter circuit is electrically same as Fig. 4, but separate terminals are brought out to avoid high current through range-switch contacts.

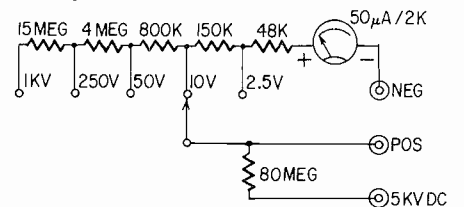

Fig. 6—Practical dc voltmeter circuit.

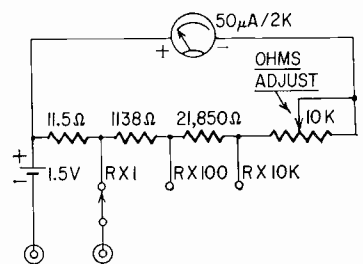

Fig. 7—Practical ohmmeter circuit.

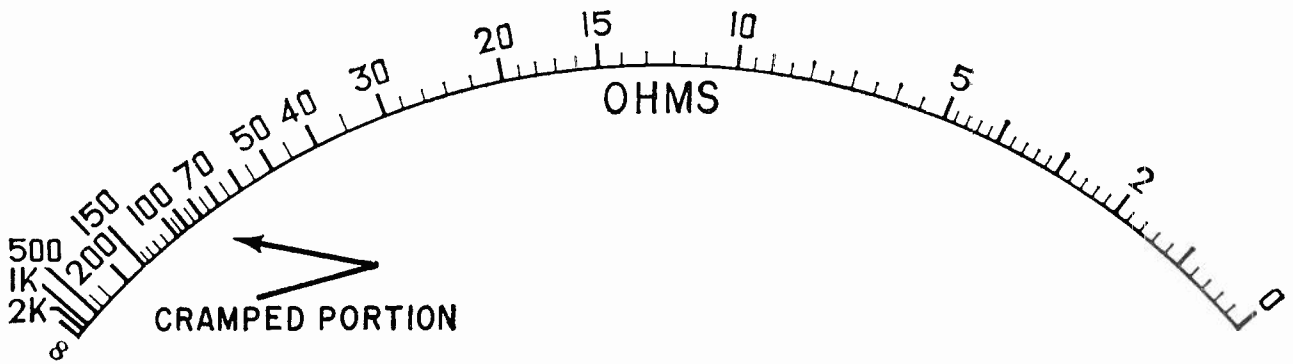

Fig. 8—Ohmmeter circuit of Fig. 7 results in nonlinear scale.

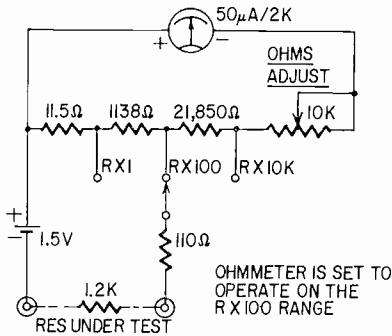

Fig. 9—Ohmmeter reads half-scale when resistance being measured equals internal meter-and-network resistance.

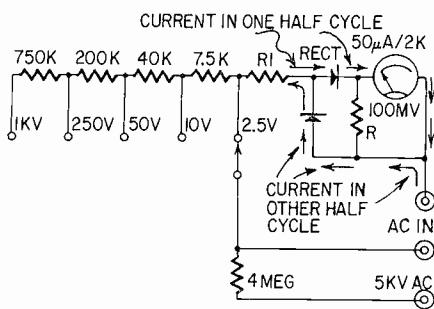

Fig. 10—Practical ac voltmeter circuit, with shunt and series rectifiers.

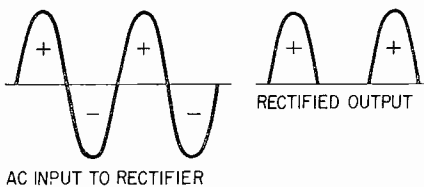

Fig. 11—In Fig. 10, half sine waves (alternate half cycles) flow through the meter movement.

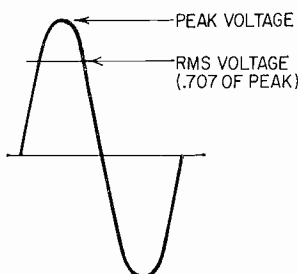

Fig. 12—The meaning of root-mean-square (effective) voltage.

though it results in a nonlinear ohms scale cramped at the high end (Fig. 8). When the resistor under test has the same value as the total input resistance of the ohmmeter, the pointer deflects to one-half of full scale (Fig. 9).

A practical *ac voltmeter* must also have several ranges. Hence, a multiplier is used, illustrated in Fig. 10. Two rectifiers are used in this circuit, although only one of them supplies current to the meter movement. The series rectifier supplies the rectified output in Fig. 11. Why, then, is the shunt rectifier used at all? It is because the series rectifier is not 100% perfect. It conducts some slight current in the reverse direction, although its back resistance is high.

To obtain the effect of a higher back resistance, the shunt rectifier is used. It provides a low-resistance shunt path around the meter to prevent any reverse current from flowing through the movement. Calibrating resistors R and R1 in Fig. 10 are set at the factory. The scale of the ac voltmeter reads in *rms volts*. An rms (root-mean-square) ac voltage is one that has the same *heating effect* as an identical value of dc voltage. The heater in a vacuum tube will get just as hot whether it is supplied with 6.3 volts dc or with 6.3 *rms* volts ac. It so happens that an rms voltage is 0.707 of the *peak* voltage in a *sine* wave (Fig. 12).

Because ac voltmeters like the one diagrammed in Fig. 10 are calibrated to read rms voltages of sine waves, these instruments will *not* read the rms voltage of a square wave or a sawtooth or any complex wave. Thus, this type of ac voltmeter must be restricted to measuring sine-wave voltages. This is no great handicap; other types of instruments (especially the oscilloscope) are avail-

able for measuring the voltages of complex waves found in TV receivers.

How about measuring *alternating current*? The simplest, if not the most convenient, method is to insert a precision resistor in series with the line, and to measure the alternating voltage across the resistor (Fig. 13). Then, the current can be calculated by Ohm's law. For example, if you measure 2 volts across the 5-ohm resistor, the current flow is evidently 0.4 ampere. A somewhat more professional method of measuring alternating current is to use a current transformer ahead of the voltmeter (Fig. 14).

Complete vom circuit

The complete circuit for a standard vom is shown in Fig. 15. The fuse in the common lead is a protective device. Since the ohmmeter has a low input resistance on the R × 1 range, the 11.5-ohm resistor could be burned out if the test leads were accidentally connected into a "live" circuit. The fuse will blow in such case, protecting the ohmmeter circuit.

Note also in Fig. 15 that the two instrument rectifiers are connected in a bridge circuit with two 5,000-ohm resistors. In this configuration, *full-wave* rectification takes place (Fig. 16). This does not change the ac voltage indication, because the meter scale is calibrated to read rms volts, as it is in the case of the half-wave configuration. It is interesting to observe the meter current in each case (Fig. 17). When a half-wave instrument rectifier is used in a vom, the movement responds to 0.318 of the *rectified peak* voltage, and the scale is calibrated to indicate 0.707 of peak. On the other hand, when a full-

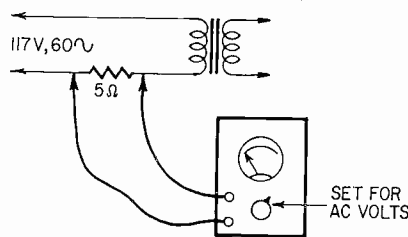

Fig. 13—One way of measuring alternating current: measure drop across series resistor.

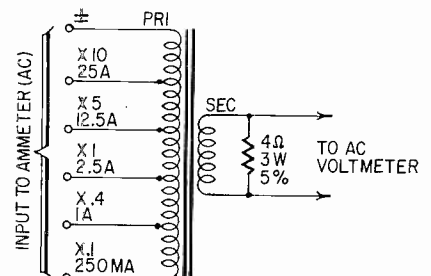

Fig. 14—Current transformer is another way of measuring alternating current.

wave instrument rectifier is used in a vom, the movement responds to 0.636 of the rectified peak, and the scale is calibrated as before to indicate 0.707 of peak. Basically, therefore, the full-wave arrangement is twice as sensitive as the half-wave configuration.

Observe the shaded areas in Fig. 17. These emphasize the equal areas in the rectified current sine wave, which determine the average value of the rectified wave. This is 0.318 of peak for a half-rectified sine wave, and 0.636 of peak for a full-rectified sine wave.

Voltmeter sensitivity

All voltmeters have a rated sensitivity which is specified as ohms per volt. What does this mean? This rating refers to the input resistance of the voltmeter. To find the ohms-per-volt sensitivity of a vom, divide the full-scale indication on any range into the input resistance on that range. Thus, if your meter has an input resistance of 50,000 ohms on its 2.5-volt range, its sensitivity is 20,000 ohms per volt. This same meter will have an input resistance of 200,000 ohms on its 10-volt range. In other words, a vom has the same sensitivity on all ranges, but the input resistance is low on the low ranges, and high on the high ranges. A 20,000-ohms-per-volt meter has 100 megohms of input resistance on its 5,000-volt range.

It must not be supposed that a vom will have the same ohms-per-volt rating on its ac voltage range. Thus, a meter which has 20,000-ohms-per-volt sensitivity as a dc-meter, commonly has 1,000- or 5,000-ohms-per-volt sensitivity on its ac-voltage function. Meters with half-wave rectifiers may have an ac sensitivity of 1,000 ohms per volt, while meters with full-wave rectifiers generally have one of 5,000 ohms per volt. Why the difference? Because instrument rectifiers are contact rectifiers. To control the characteristics of contact rectifiers satisfactorily, lower-impedance circuits must be used than on the dc function. Hence, vom's using contact rectifiers will necessarily have lower input resistance on their ac-voltage function.

The sensitivity of a meter matters to the technician, because it tells him how much the meter will load a circuit, or, it indicates that circuits exceeding a certain impedance cannot be tested accurately. In practical work, we prefer to keep the input resistance of the vom at least 10 times higher than the impedance of the circuit under test. Thus, in measuring ac voltages with a vom, it is usually desirable to use as high a range as possible that will still provide a readable indication. In this way, the measurement error due to loading is minimized. END

Fig. 17—Full-wave and half-wave rectified sine waves compared.

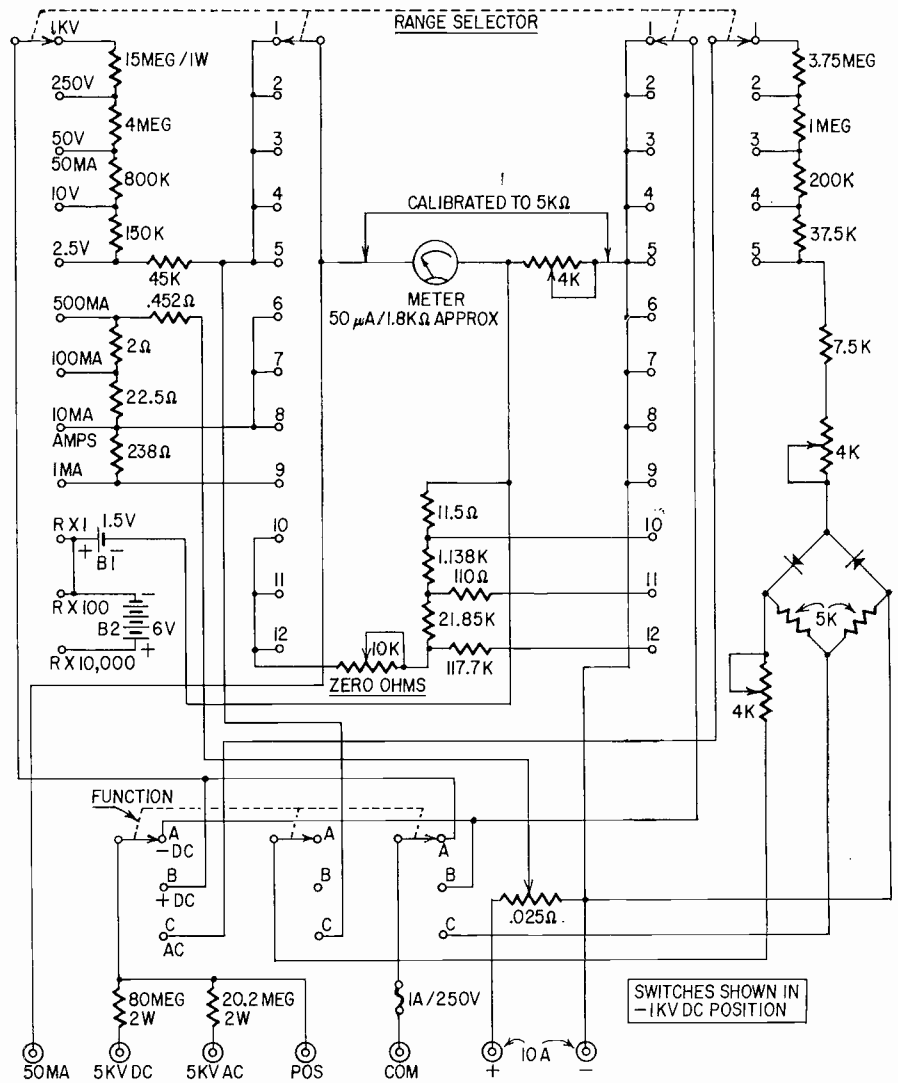
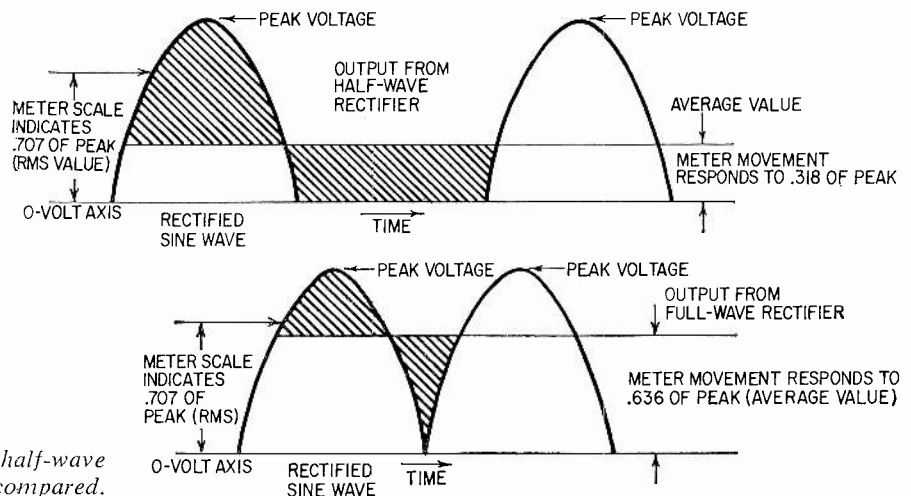
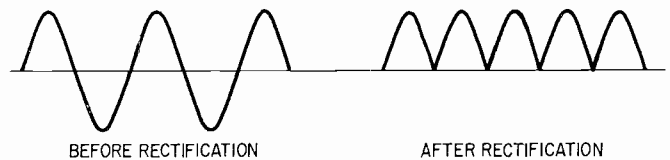

Fig. 15—Typical complete vom circuit.

Fig. 16—Full-wave rectified dc uses both halves of ac cycle.



SYNC CLIPPERS: HOW AND WHY

Another installment in Radio-Electronics' basic TV series.
How sync clippers work, what they do, and how to handle their troubles

By JACK DARR
SERVICE EDITOR

SYNC CIRCUITS ARE IMPORTANT: CUSTOMERS will complain about rolling, jumping pictures long before anything else. Some sync clipper circuits can look pretty wild, but they're all based on a very simple vacuum-tube action.

In a TV signal, the top 25% is sync; the rest, video. We have to chop off the top quarter. To do that we use the grid-voltage-plate-current curve of a tube. If we feed a signal into a tube biased in class A, we get it all back (Fig. 1-a). In class B, we can take out only a part of it (Fig. 1-b). So, we can feed in a video signal, bias the tube

right and "clip off" only sync (Fig. 2).

That's where we get the name "sync clipper." We take this pair of electronic scissors and trim off only what we want—the sync, without any video. Why? If we let video get into the sync circuits, we get jitter, because the sync must always be at a constant amplitude. Video is always changing, and we don't want that.

I like "sync clipper"; you'll find "sync separator" on some diagrams. The circuit actually "clips"; the sync isn't separated in the tube, but in the plate circuit. How? Let's see.

In modern US TV design practice, vertical sync works on *amplitude* and horizontal sync on *phase*. Vertical sync pulses actually "fire" the vertical oscillator directly. This action depends on their voltage (amplitude). Horizontal sync depends on phase more than on voltage. The sync and a comparison pulse from the oscillator are fed to a phase-comparer circuit; the dc output from that controls the oscillator, and not the sync itself.

How do we separate these two parts? Feed the composite sync, with 60-cycle vertical pulses and 15,750-cycle horizontal pulses, into a two-branch circuit in the plate load of the tube, as in Fig. 3. How can this "separate" 'em? Look at the capacitors. The reactance of a capacitor varies inversely with the frequency. So, we use very small capacitors in series with the horizontal sync. In Fig. 3, the 100-pf coupling capacitor has 100,000 ohms reactance at 15,750 cycles, but 26.5 megohms at 60 cycles. It's going to pass a lot more horizontal sync than vertical.

In the vertical circuits, you'll find big capacitors *in series* (low loss to 60 cycles) and almost as big ones used as *bypasses* (low-impedance paths to ground for 15,750 cycles) plus big series resistors. So, the high-frequency horizontal sync goes off to ground and the low-frequency vertical sync goes on through. The R-C network shown is a "vertical integrator". It has a very low

reactance to ground for high-frequency signals, and a high series resistance, from the big resistors. It also combines the equalizing pulses into nice clean vertical sync pulses.

Sync clipper action depends on *bias*. You'll find several circuits used to make sure that this stage gets the right bias all the time. Notice that in the circuit of Fig. 3 the grid resistor goes to B-plus. Fig. 4 shows the voltages found in an actual circuit. What?—12 volts negative on the control grid? How can this be, when the grid is connected back to 125 volts? Look at the size of that resistor—15 megohms! This tube is very heavily driven; note the 65-volt peak-to-peak video signal on the grid. So we regulate the amount of negative bias it can develop by returning the grid resistor to B-plus. This positive voltage helps to hold the grid voltage constant.

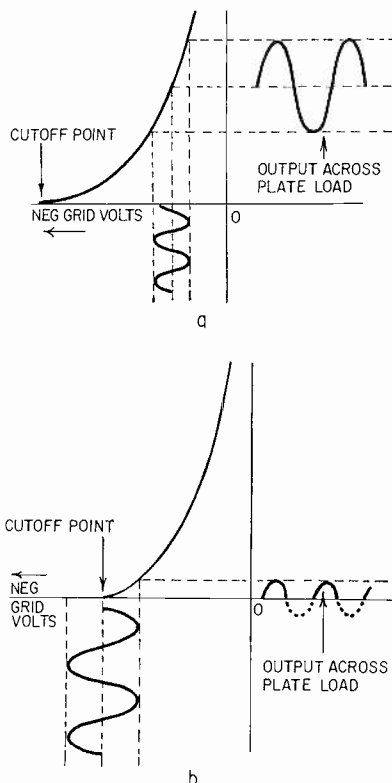

Fig. 1-a—In class-A amplifier, bias and signal voltages are adjusted so that signal is amplified (theoretically) without distortion. Fig. 1-b shows what happens when signal swings negative and positive around bias near cutoff: only positive peaks of signal appear. Everything else is clipped off and left behind.

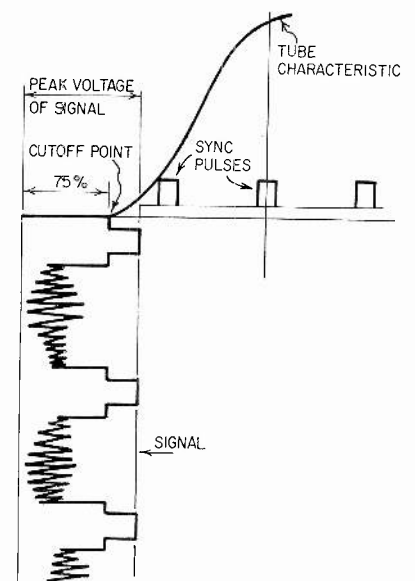

Fig. 2—How idea of Fig. 1 works with video and sync. Video signals simply drive tube further into cutoff, and don't appear in output. Sync pulses alone drive tube into conduction and are amplified.

Watch out for the big resistors in this circuit. They're always more critical than we think. Although we might think, "Oh, well, 15 megs, what the heck! If it does go off a little, it's so big it won't make much difference!" The heck it won't! Look where it is: in the *grid* circuit! It takes only a few volts here to make a *lot* of difference. These big rascals *are* critical. If you have troubles, check each of them to be sure that they're still within tolerance. They can upset the bias and cause troubles.

Servicing

Now let's see how to check these circuits, find faults, and repair 'em. Might just as well turn the scope on

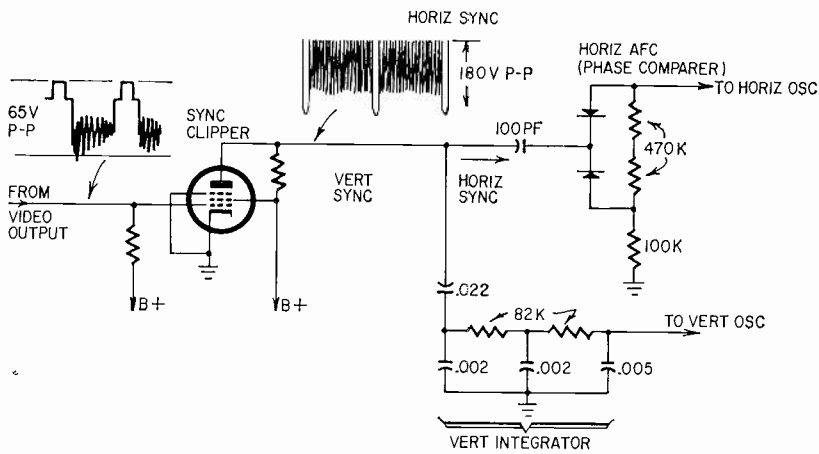

Fig. 3—Sync separation depends on the fact that vertical sync pulses occur 60 times a second, while horizontal ones come along 15,750 times a second. Small capacitor lets horizontal pulses through, rejects vertical. Vertical pulses pass through vertical integrator, which shunts away horizontal pulses.

right now, because we want to know things that only the scope can tell us.

If you have sync trouble, the first thing to do is sit back, take a good look at it and analyze the symptoms. Which sync is out, horizontal or vertical? Or both? This tells us where to start looking. No matter how many sync clippers are used, they'll fit the general scheme of Fig. 5.

Be logical: if both synes are out, check circuits that handle the composite sync. If either one is out and the other OK, then check only the parts that carry the bad one. For example: if in Fig. 3 you had no vertical sync, you would check the vertical sync circuit going to the integrator and oscillator, not the horizontal afc circuit!

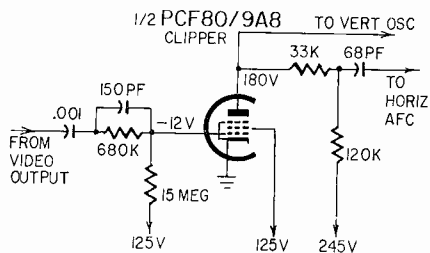

Fig. 4—Voltages found in actual sync clipper circuit. Note negative grid bias, despite connection to B-plus.

Do the "standard" service procedure first: replace the tube(s) and check all voltages. You'll fix most of 'em this way. Don't look for horribly complicated troubles till you get all the simple ones fixed!

After that, get the scope, with a low-capacitance probe (these circuits are all very-high-impedance) and start looking. Check the input first, of course. You should find the video signal on the input grid, looking like Fig. 6. It may not be exactly like that, nor like the

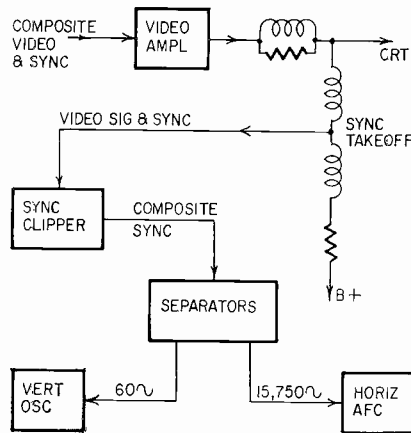
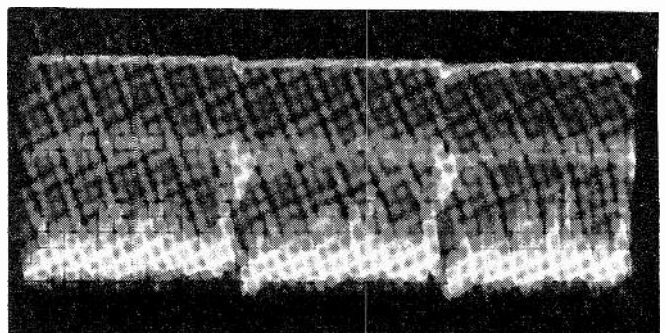

Fig. 5—Block diagram applies to just about all sync clipper-separator circuits. Details vary from model to model.

ideal video signal with 25% sync and 75% video. It comes from a tap on the video amplifier plate load, and may go through some kind of a filter network on the way. However, if it's OK, there'll be plenty of sync there. At this point, watch out for sync compression! Your sync trouble may be caused by sync clipping in the video i.f., video amplifier, etc. Check age setting, and so on, before you tear up the sync circuits! The scope'll show you if there is any trouble.

Fig. 6—Composite video signal at sync clipper grid. Slight compression of whites at bottom is OK in this case, but watch for compression of sync pulses, top.



If this signal is OK, look in the plate circuit. You'll find the composite sync looking like Fig 7. The blur in the middle is horizontal sync pulses, and the bright vertical streaks are vertical sync. This is with a 30-cycle sweep. Check the amplitude against the value shown on the schematic. Note that we're getting not only clipping but amplification out of this tube. Some circuits have no amplification, but merely clip; check the peak-to-peak voltages given on the schematic, to be sure.

If you have vertical troubles, follow the vertical sync, from the plate, down through the integrator to the sync input of the vertical oscillator. You'll have to kill the oscillator, by pulling the tube or unhooking the B-plus, otherwise the large pulses from the oscillator will mask the sync completely. The vertical sync at the oscillator input should look like Fig. 8 and should be within 10% of the amplitude shown on the schematic.

Horizontal sync can be checked in the same way, but you don't have to kill the oscillator, since the sync pulses themselves never get any farther than the afc circuits. Check for the presence and amplitude of the comparison pulses while you're there.

Troubles in sync circuits

Trouble in sync circuits is caused by weak tubes, leaky paper, ceramic or mica capacitors. Don't overlook the little mica coupling capacitors used to feed sync pulses into circuits! They can go bad just like any others! (A lot of us old-timers have a regrettable tendency to think they can't, but they sure can!) Also, check for resistors that have drifted off value. Watch out for big resistors: 3, 5 or even 15 megohms are often used in voltage-divider circuits, and are they ever critical! Because of the numerous parallel paths in such circuits, always lift one end of a resistor before measuring it.

Don't change values of resistors to "make it work". If it won't work with the original part-values, something else is wrong. Probably a capacitor with a very small leakage. In circuits like this, even a 5-megohm leakage in a capacitor can play hob with things like cutoff bias.

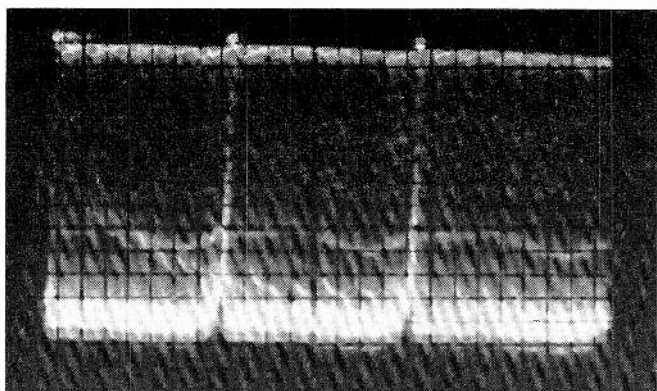
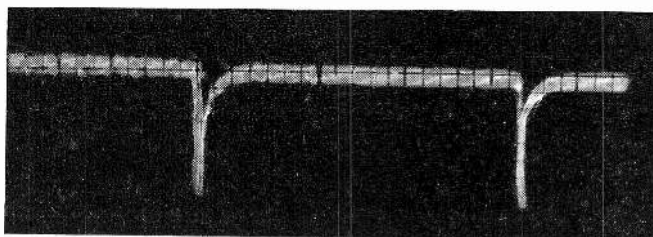

Fig. 7—Composite waveform at sync clipper plate. Small sharp spikes are vertical pulses; blur between them, horizontal pulses. A little video is left (white bar along bottom). That much is all right.

Fig. 8—Model vertical sync pulses. Vertical oscillator was killed by removing tube. Check amplitude of these against waveforms in service data.



You'll find different versions of these circuits. One is shown in Fig. 9. The vertical sync is taken off at the cathode and horizontal from the plate. Incidentally, although we showed pentodes before, this is a triode. Makes no difference in the basic action; pentodes are often used because they give gain, as well as clip sync.

Another form you'll find is the "noise-immune" sync clipper (Fig. 10). This uses a tube like a 6BE6, etc., with two control grids. Grid 3 does most of the work; it has a large video signal, taken from the video output, and works exactly like the circuits previously described. Grid No. 1 (nearest the cathode) has a very small video signal from the video detector, opposite in phase to that on grid 3.

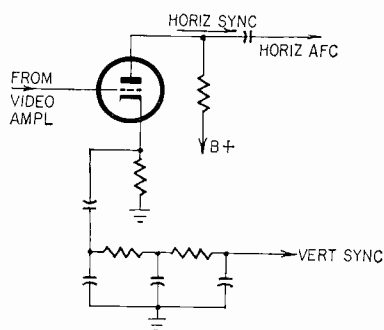

Fig. 9—In some circuits, horizontal sync comes from plate of tube, vertical from cathode.

Forget grid 1 for now. The rest of the tube works exactly like any other sync clipper. The bias on grid 1 is set so that the normal video signal there has no effect on the electron stream in the tube. If a noise pulse comes along, it will drive grid 1 negative (toward cutoff), and cut

off the electron stream. Because this grid is so near the cathode, only a small voltage on it will have a great effect. Now the noise pulse has cut its own throat: because the tube is cut off, the noise pulse can't get through to the

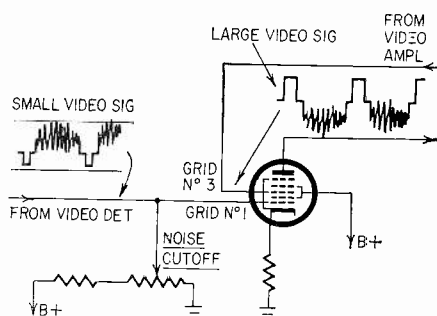

Fig. 10—Noise-immune sync clipper. Text explains how this circuit works.

plate circuit. Because of their "fly-wheel" action, the two oscillators keep on running without sync until the noise pulse has left and the sync clipper conducts again.

The level at which this action starts is controlled by a variable bias. This is known as Range Finder, Fringe-Lock, and by other names. It sets the bias so that in ordinary circumstances, grid 1's signal is just below the level at which it will have any effect on the tube's plate current. Watch out for this control: if someone has turned it, it will clip off not only the noise, but the sync as well! Be sure that this isn't happening before you go into the rest of the circuits. Symptoms: loss of both syncs, and, usually, a slightly torn-up picture. Best thing, while servicing, is to set this control all the way "out", so that this circuit can't have any effect. Then, when you finish, readjust it.

So there you are. Using a scope with a low-capacitance probe, a volt-

meter and your noodle, you can chase out sync troubles in a jiffy. You can follow sync spikes through a circuit just as easily as a video or rf signal! **END**

Save Turntables from Too-Early Junking

THOUSANDS OF TURNTABLES AND PHONO-motors are junked annually because of some minor defect or malfunction. Many of these can be easily renovated and made into serviceable record players. While they may not provide hi-fi reproduction, they will give their users much pleasure.

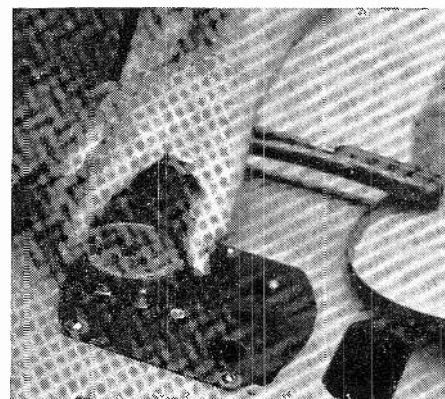

These are frequent turntable troubles:

1. *Turntable slippage.* To cure this, masking tape is sometimes applied to the inside rim. This changes the speed and is unsuitable if you are a music lover. If the slippage is the result of worn idler or drive surface (this can be easily determined by inspection), a coat of rubber cement or an application of powder resin might be the simple cure. However this will rarely end the slippage because it often results from a weakened pressure spring. Increase the spring tension and the trouble will disappear.

2. *Noisy operation.* Often the fault of a dry turntable or idler shaft. The remedy is obvious. Rough spots on the inner surface of the rim can cause a clicking sound. Another rather frequent cause of noise is metal-to-metal contact when the motor is set in motion. I discovered an example of this recently when I noticed that the speed-change arm was contacting the head of a motor mount screw. A bit of insulating material ended the trouble and prevented a quality unit from being discarded. Flat spots on the rubber driving disc can cause noisy operation. In some cases the rubber surface can be smoothed out with sandpaper.

3. *Motor inoperative.* When a turntable motor won't run, don't overlook the obvious: loose contacts in the plug or at the motor terminals. A turntable motor rarely burns out. When it fails, a poor connection is almost invariably the cause of the trouble.—Glen F. Stillwell

A Roundup of Low-Cost FM Stereo Generators

Servicing multiplex tuners and receivers need no longer be a pastime of the idle rich! It's getting so you can hardly afford not to have one!

By **LEONARD FELDMAN**

UNTIL VERY RECENTLY, THE TECHNICIAN confronted with defective FM stereo receivers or tuners had to face two unpleasant alternatives. He could either attempt to repair the equipment by using a station signal or he could purchase one of the many fine FM-stereo signal generators—at \$300 to \$1,000.

Fortunately, at least four new pieces of equipment have been introduced in the last few months. Any one of them will enable you to test and repair FM stereo equipment. All these new models are priced from \$100 (for the Heathkit model IG-112 in kit form) to around \$250. Considering that most of them can also double as an FM rf generator, it may be well to weigh the advantages of approaching FM stereo troubles with professional test equipment.

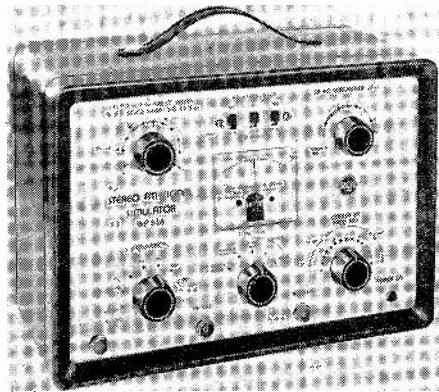

RCA WR-51A Stereo FM Signal Simulator

This compact instrument generates all the signals for complete service and maintenance of multiplex adapters or mono and stereo FM receivers:

1. Composite stereo output signal for either left or right channel, and a special "phase test" signal (L + R in phase) for accurate phase adjustment of subcarrier transformers. These signals can be modulated internally with 400-, 1,000- or 5,000-cycle frequencies.
2. A variable-level, crystal-controlled 19-kc subcarrier signal for checking "lock-in".
3. Four additional sine-wave sig-

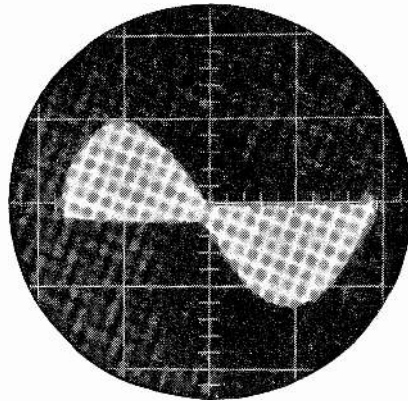

Fig. 1—Composite stereo signal consisting of left-only 1-kc tone and 19-kc pilot. (From RCA WR-51A.)

nals, 28, 38, 48 and 67 kc, for adjusting the bandpass networks in stereo receivers.

4. A 100-mc carrier, adjustable ± 0.8 mc to a quiet point in the FM band. This may be frequency-modulated with the composite stereo or monophonic information, with deviation adjustable from 0 to 75 kc.

5. 100-mc sweep, with range adjustable from 0 to 750 kc at a 60-cycle rate, permitting overall rf/i.f. alignment checks.

6. Crystal-controlled 5.35-mc signal to provide a 10.7-mc intermediate-frequency marker, and harmonic markers at 90.95, 96.3, 101.65 and 107 mc for rf alignment of a complete FM stereo tuner or receiver.

The rf output (which measures about 0.1 volt) can be attenuated in three steps of 20 db each, for a total of 60 db. At full attenuation, therefore, the output is about 100 μ v, low enough to check over-all FM circuitry under semi-fringe conditions. Loose-coupling the rf cable to the receiver under test will attenuate the signal further. I used this equipment for more than a month and found it reliable and extremely versatile. Fig. 1 is a scope photo of the audio composite signal available at the "composite signal" (COMP SIG/AUDIO) output when a "left only" or "right only" signal of 1,000 cycles is selected. Fig. 2 shows a composite output when 5,000 cycles is the mod-

ulating "left only" or "right only" signal. At this higher frequency, I was able to sync the scope to discern clearly the outline of 5 kc as well as the "suppressed subcarrier" frequency of 38 kc. The 19-kc pilot signal, clearly superimposed on the waveform of Fig. 1, was deliberately turned off in Fig. 2 for clarity.

The WR-51A also has a zero-center meter for checking balance. You will still need an ac vtvm for setting up proper levels.

With this equipment, as well as the Heath IG-112, either left or right signal only can be selected. It is not possible to feed one frequency to the left channel while another is fed to the right. Also, since there are no terminals for external modulation, separation can be checked only up to 5,000 cycles. It is true that if separation is still good at 5,000 cycles, it is likely to be good at 15,000 cycles. But it would be nice to be able to check.

Separation in the composite signal is better than 30 db—as good as or better than the maximum separation capability you're likely to encounter in any commercial FM stereo receiving equipment.

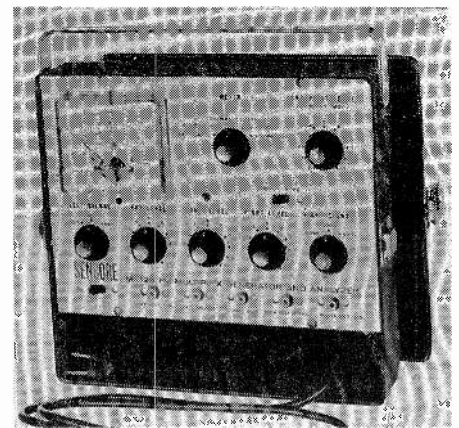

Sencore MX129 FM Multiplex Generator & Analyzer

Forgetting for a moment that this unit is all-transistor (and hence the most compact stereo generator I have seen), the novelty in its design approach merits detailed discussion.

The MX129 is extremely rugged and lightweight, making it ideal for "on the scene" analysis and troubleshooting. But its portability is limited to weight only, for it—like the other units—requires a 117-volt line despite its solid-state circuitry. Signals at the various output jacks include:

1. FM-rf carrier with composite multiplex audio signal, much like that described earlier.
2. Multiplex audio frequencies formed either by 60 cycles (derived from a 6.3-volt winding on the power transformer) or by 1,000 cycles from a built-in audio generator.

3. Full control over left- and right-channel amplitude. This is the design departure that makes this unit so different. Instead of having a "mono" switch position, a monophonic signal is created by applying equal left and right signals of the same frequency. Whenever $L = R$ you have, in effect, a monophonic signal by definition. Carrying this design philosophy further, Sencore makes available two external inputs into which can be fed any modulating frequencies. Thus, you can apply (from a separate audio generator) 10,000 cycles to one channel and 1,000 cycles to the other, and check channel separation by listening (or watching a scope) for what "sneaks" through.

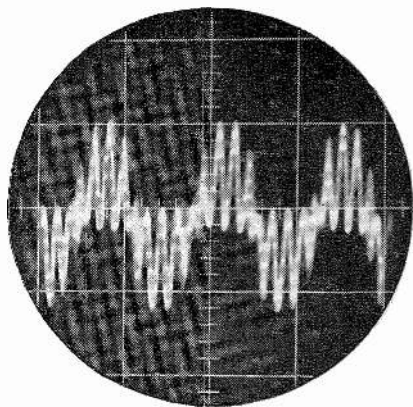

Fig. 2—Composite stereo signal with 5-kc left-only modulation. The 19-kc pilot has been killed; rapid fluctuations you see are 38-kc switching waves (or subcarrier sidebands, if you like to look at it that way).

Because of the external modulation provisions, you could even simulate an actual stereo musical program with records or tapes. Even without external signal sources, the built-in 60-cycle sig-

nal can be fed to one channel while the built-in 1-kc tone is fed to the other.

4. A 19-kc pilot, calibrated directly in modulation percentage, can be used without audio modulation by simply turning down left and right audio controls completely.

5. An external 67-kc signal for SCA (subscriber background music) trap adjustment.

A built-in meter circuit is used to set controls of left and right channels as well as the level of the composite signal. Wisely, since the meter is there anyway, its circuits are made available externally so that it can be used as an ac meter with 3- and 30-volt peak-to-peak ranges.

The rf cable provides a signal at about 100 mc. This can be shifted with a screwdriver adjustment from the front panel to avoid interfering with a station.

Unlike the other two units discussed, there is no means for attenuating rf strength (except by loose coupling), so it is not easy to judge receiver performance at low signal strengths. In fact, no mention is made of the rf amplitude. I judged it fairly high, probably in the order of 3,000–5,000 μV .

With this instrument, you must use a scope to monitor the composite signal, at least until you become familiar with the controls and know exactly where to set them. For example, Fig. 3 is a photograph of the composite signal that would be obtained if the operator desired a left-channel signal only but failed to turn the RIGHT LEVEL control down completely. With such a signal fed to the FM receiver or multiplex adapter, you might waste a good deal of time wondering why you're not getting the 20- or 30-db channel separation you expected. Still, the flexibility of being able to control left and right separately is useful.

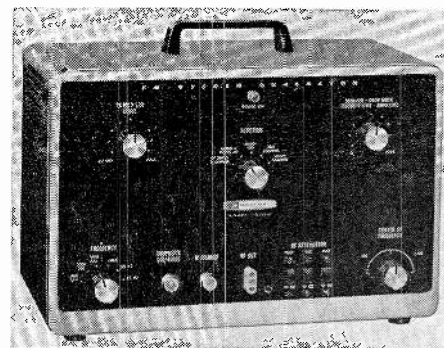

Heath IG-112 FM Stereo Generator

As usual, the Heathkit version of a stereo generator is a masterpiece of design, intended particularly for the technician or hobbyist who doesn't mind spending a few hours with pliers and soldering iron. When built according to instructions, this piece of equipment provides just about everything needed for FM stereo work. The design follows the RCA approach.

Signals generated by the IG-112 include an audio or composite stereo signal for multiplex adapter adjustments, or an rf carrier modulated by these same signals for overall receiver alignment and checking. A sweep function is also provided for overall rf-i.f. alignment with marker frequencies at 10.7, 90.95, 96.30, 101.65 and 107 mc. You can select either right- or left-channel signals as well as a PHASE TEST position for accurate adjustment of stereo subcarrier tuned circuits.

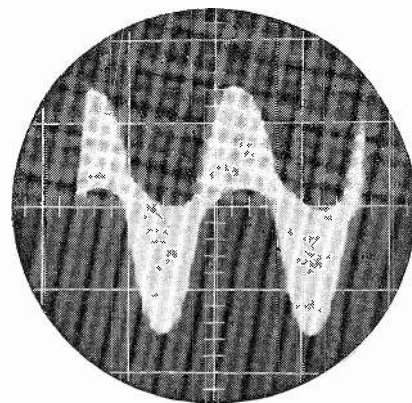

Fig. 3—Improper composite resulting from some left-channel signal in right channel, or vice versa. This is poor separation; can be the fault of multiplex section or of poorly aligned i.f. or detector in tuner.

Switch-selected audio frequencies include 400 cycles, 1 kc, 5 kc, 19 kc, 38 kc and SCA frequencies of either 65 or 67 kc. Note that 28 and 48 kc, deemed necessary by RCA, are not present in this equipment and are considered by Heath to be of minor importance. The 19-kc pilot signal is shown in Fig. 4.

FM STEREO GENERATORS

FEATURES	RCA WR-51A	SENCORE MX129	HEATH IG-112	HICKOK 727
Circuitry	tubes	transistors	tubes	transistors
FM frequency	100 mc \pm 800 kc	100 mc \pm 5, — 10	100 mc \pm 2	100 mc \pm 250 kc
Rf sweep	yes	no	yes	no
Xtal markers	yes	no	yes	no
Rf atten.	60 db (20-db steps)	none	60 db (20-db steps)	none
Int. audio	400 cycles, 1 kc, 5 kc, 19 kc, 28 kc, 38 kc, 48 kc, 67 kc	60 cycles, 1 kc, 19 kc, 67 kc	400 cycles, 1 kc, 5 kc, 19 kc, 38 kc, 65 kc, 67 kc	1 kc, 19 kc, 38 kc, 67 kc
Ext. modulation	no	yes	no	no
L & R signals	L or R	both simult.	L or R	L, R, or sidebands
19-kc amplitude	adjustable	adjustable	adjustable	adj. 3 steps
Crystal-controlled 19 kc	yes	yes	yes	yes
Mono FM	yes	yes (make L = R)	yes	yes
Recommended aux. equip.	scope, ac vtvm	scope	scope, ac vtvm	scope, ac vtvm
Meter	yes, for channel balance only	yes	no	no

The rf signal is 100 mc, plus or minus about 2 mc, and it can be attenuated in 20-db steps for a total of 60 db.

Since the Heath unit is so similar to the factory-assembled RCA generator, I thought I would investigate its kit-building aspects once I established that performance and waveforms were excellent.

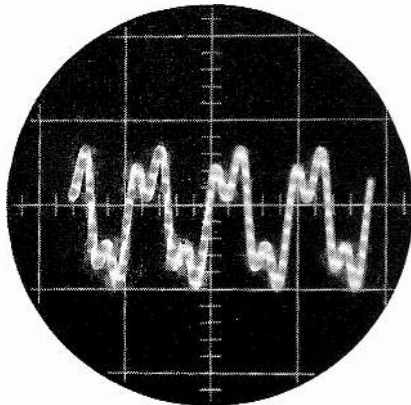
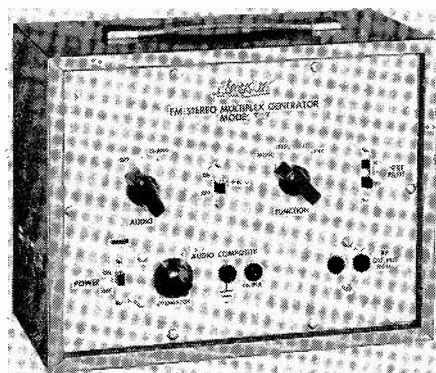

Fig. 4—The 19-kc pilot from Heath generator contains considerable second harmonic (38 kc). That doesn't affect anything.

As usual, a clean, open circuit layout provides easy access to all components for greatly simplified assembly. While I didn't actually assemble this particular unit, I did remove it from its case to examine the work involved. About two evenings of spare time would be my estimate for the time required to assemble the kit from a cold start.

All the units described provide all necessary cables. Heath was even thoughtful enough to send along a piece of 300-ohm lead terminated in the popular "clothespin" clip which attaches so easily to the antenna terminal screws of commercially built receivers.



Hickok model 727 FM-Stereo Multiplex Generator

The Hickok model 727 is all-transistor and quite light and compact, measuring only 11 x 8½ x 5 inches. It weighs only 6 pounds. It is the first unit I have seen that is battery-operated (22½-volt battery, not included with the instru-

ment). While this feature might at first seem inconsequential, it does have its advantages when servicing in the field. Often all ac receptacles in the vicinity of the hi-fi rig are occupied by tuners, amplifiers, turntables, etc. The instruction manual indicates that a separate ac power supply is available for use in the shop, to prolong battery life.

The following signals are available at the output jacks of the model 727:

1. An FM-rf carrier modulated with the composite audio signal, whose frequency is a nominal 100 mc at a signal strength of approximately 500 μ V.

2. Composite signal (audio) with a choice of L only (1 kc), R only (1 kc), mono (1 kc), separate 19-kc-only input, separate 38-kc signal and a SCA (67 kc) signal for aligning SCA rejection traps. This is the first of this group of generators I have seen that enables the user to examine subcarrier sidebands only (L - R). This is possible because the basic circuitry of the instrument adheres to the original concept of producing a stereo signal:

Produce an L + R signal and an L - R signal to amplitude-modulate the 38-kc subcarrier and then suppress the subcarrier itself, leaving only L - R sideband information. Thus, by turning off the L + R slide switch on the instrument, it is possible to work with the L - R component alone. This is particularly helpful when you work with some earlier multiplex adapters which followed the same circuit philosophy, for the L - R circuits of the adapter can be aligned separately and independently of the rest of the circuitry.

3. The 19-kc signal is adjustable in switching steps of 0%, 5% and 10% of composite signal. The 5% position is useful for insuring correct lock-in of any 19- or 38-kc oscillators in the receiver under less-than-optimum signal strength.

Hickok's model 727, though it lacks some of the features of the other units tested (such as multiple audio frequencies, attenuation facilities and external modulation provisions), is adequately designed for use in the field and on the bench for servicing adapters and overall FM stereo receivers. It cannot take the place of an rf generator for FM alignment, because it has no 10.7-mc output and only one FM-band rf signal. But since nearly all shops already have an rf signal generator, this won't be too bad.

Already more than 300 stations across the country are transmitting FM stereo all or part of the time. More will be coming on the air each month. With stations airing so much stereo, sales of stereo FM receivers and adapters are mushrooming and this means more service business for the technician who has the proper know-how and the proper equipment. END

Longer Life For Ceramic Transmitting Tubes

SOME ENGINEERS HAVE HAD TROUBLE from short-lived 4CX250-B, 4X250-B or 4X150-A final amplifier tubes. Microscopic examinations of some of the defunct tubes have shown that their lives had been limited by high filament voltage.

Variations of line voltage from normal maintained for a long time cause excessive cathode heating. If a normal 6.0-volt filament is operated 0.5 volt above its rated voltage, the cathode temperature is increased by 25° C. This results in twice the normal barium loss and effectively reduces the cathode life by one-half.

When an indirectly heated cathode is heated above its normal operating temperature (approximately 825° C), the oxide material is deposited on cooler surfaces surrounding the cathode. If this keeps up, enough barium will be evaporated to cause loss of emission, high primary control-grid and screen-grid emission with heater leakage.

This problem shows up as frequent unexplainable high-voltage fuse failures. They are caused by initial arcing to the stringers of barium built up on the cathode, which then clear themselves. Regulated filament supply is recommended for these transmitting tubes. The panel voltmeter monitoring the filament voltage should be calibrated accurately against a 1% laboratory instrument of known accuracy.

The filament voltage limits on this family of tubes are 6.0 volts \pm 5%, or a maximum range of 5.7 to 6.3 volts. For longest tube life, the filament voltage should never exceed 6.0.—E. H. Marriner, W6BLZ



"Well, you just grab the old blown out tube like this . . ."

Use the Right Equipment —and Save Time

"Remember that time is money."

—Benjamin Franklin, 1748

By G. M. ROBERTS

Test equipment is a status symbol, a merchandiser and a time-saving tool. Your test equipment is also a money-making machine. What does it do for you as a status symbol? It encourages a professional attitude, which promotes personal efficiency. Don't minimize motivation. If you have better test equipment than your competitor, the laws of human nature will drive you to live up to your own self-image. You simply can't escape the urge to "show up" the screwdriver mechanic who is groping in the dark.

How is test equipment a merchandiser? When customers walk into your shop, they are impressed by an array of businesslike (and to them mysterious) test instruments. You immediately command respect. When you call at a customer's home, he won't argue if "the machine shows that the big tube is bad." If you have to pull the chassis and give a comparatively high estimate, a few preliminary voltage measurements will reduce sales resistance.

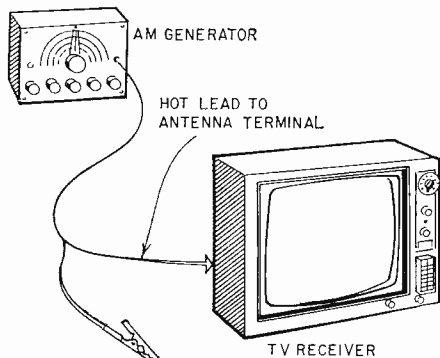

Fig. 1—Check for a dead local oscillator.

At the bench, test equipment is a time-saving tool. Troubleshooting has not been automated, and probably never will be. On the other hand, instrument analysis is an important approach to automation which you should exploit to the greatest possible extent. Don't overlook the capabilities of even the most basic test instruments. You might be wondering whether a vertical oscillator is supplying an output. Your vom will give you the answer. Set it to

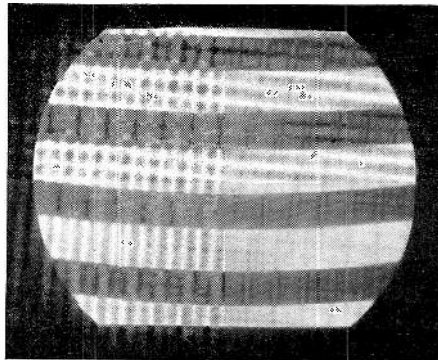

Fig. 2—AM signal generator makes this kind of pattern on TV screen.

the "output" function. If you get a 75-volt reading, the trouble is not in the oscillator.

Of course, this 75-volt reading will not jibe with the waveform voltage specified in the receiver service data. For example, a 75-volt reading is typical for a waveform specified at 150 peak-to-peak volts. However, you can determine whether the waveform is there, or not.

There are two reasons for the low reading of a vom in this type of test. First, the blocking capacitor in the vom circuit on its "output" function, is typically a 0.1- μ f capacitor, which drops 60-cycle voltage appreciably. Second, the input resistance of a vom is comparatively low, which results in circuit loading. If your vom has a half-wave rectifier instead of a full-wave rectifier, the reading will be still lower because half the waveform will be rejected by the meter circuitry. The rejected half-cycle might have a much higher peak voltage than the accepted one.

Also, a vom is calibrated to read rms voltages of sine waves. It will read high on a square wave but low on a pulse because of the differing form factors. Hence, the vom is useful chiefly to check for the presence or absence of complex waveform voltages. If you find waveform voltage at the input end of a coupling capacitor, but no voltage at the output, you have saved a lot of time over trial-and-error component replacement.

The AM generator

Ordinary signal generators often gather dust on the shelf, instead of saving time at the bench. We know, of course, that an rf generator provides a quick check for a dead local oscillator, although we sometimes overlook this basic test. If a TV receiver has appreciable snow in the raster, but no picture, there may be a defect in the local-oscillator circuit. To check, merely connect the "hot" lead from an AM generator to one of the set's antenna terminals (Fig. 1). Use unmodulated output, and tune the generator through the nominal oscillator frequency on an active channel. If a picture pops on the screen, you know at once where to find the trouble.

If no picture appears, you can use the AM generator to find out where the signal stops. Pull the rf amplifier tube and inject a signal through a small blocking capacitor at the plate terminal of the socket. Set the generator for amplitude-modulated output, and tune through the channel to which the receiver is set. If bars appear on the screen (Fig. 2), the trouble is in the input circuitry of the tuner. You can make a similar test at the mixer plate. If the first test gives no bars, tune the generator to the receiver's i.f. when testing at the mixer plate. These three simple tests often save a lot of time in localizing trouble.

Though you might sometimes think that a signal could be injected conveniently at the "looker" point (TP in Fig. 3), this is not practical. A series resistor (such as R) is often present. This resistor creates a low-pass filter action which effectively kills a high-frequency signal. Such test points are suitable for measuring dc voltages only.

Remember to clamp the agc line to eliminate the possibility of agc trouble, which might be biasing the rf amplifier to cutoff. When no snow appears in the raster, the agc voltage

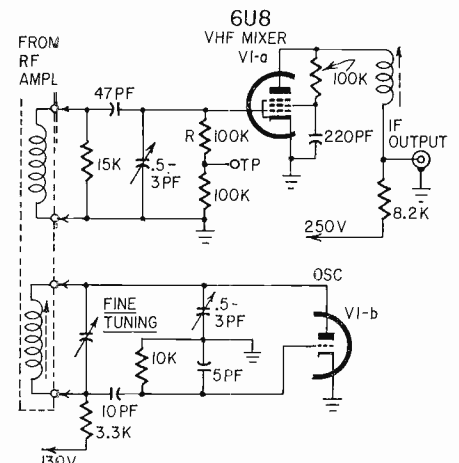

Fig. 3—Resistor R, together with stray capacitance, attenuates any rf signal injected at TP.

should always be checked or clamped at the outset. But if the no-snow symptom persists, use the AM generator and a blocking capacitor to inject signals step by step through the i.f. strip. Use amplitude-modulated output, and tune the generator to the receiver's i.f. When you come to the first "live" stage, a bar pattern will appear, as in Fig. 2.

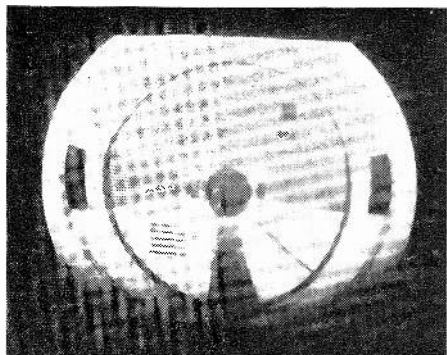

Fig. 4—60-cycle raster shading.

Use your scope

Even a low-priced scope can save a vast amount of time at the bench. For example, suppose you are tackling a symptom of raster shading (Fig. 4). This might be power-supply trouble, but there is no evidence of picture pulling in this example. And if the symptom persists after bridging the filter capacitors, what then? Since the brightness variation is from top to bottom of the screen, a spurious 60-cycle voltage must be getting in. It is time to reach for the scope. Dc measurements will get us nowhere.

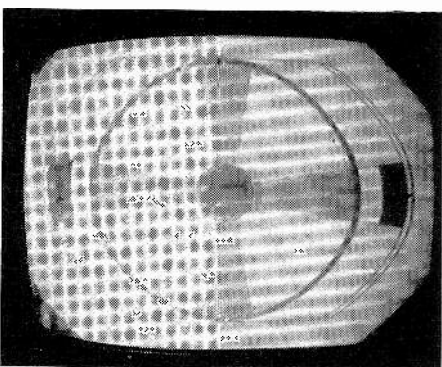

Fig. 5—15,750-cycle raster shading.

Set the scope for 30-cycle deflection, and check the waveforms at the picture-tube socket terminals. One of the dc supply lines may have a large sawtooth voltage. Or the video signal may be riding on a sawtooth base line. The sawtooth (or distorted sawtooth) is the tipoff. Follow back through the defective circuit, and you will find the trouble—it's usually a faulty decoupling capacitor in the vertical or the vertical-and-horizontal sweep sections.

The same test principles apply when shading varies from left to right

(Fig. 5). In this situation, a spurious 15,750-cycle waveform is gaining entry to the picture tube. Set the scope for 7.875-cycle deflection, and check the waveforms at the picture-tube socket terminals. Determine which lead is feeding in the spurious waveform, and follow back through the defective circuit—you will usually spot a defective decoupling capacitor. I tackled this symptom a while back in a chassis that had been dubbed a tough dog by another shop—which did not have a scope. I fired up my scope, and luck was with me—in less than 2 minutes I tracked a spurious sawtooth down to a buried electrolytic.

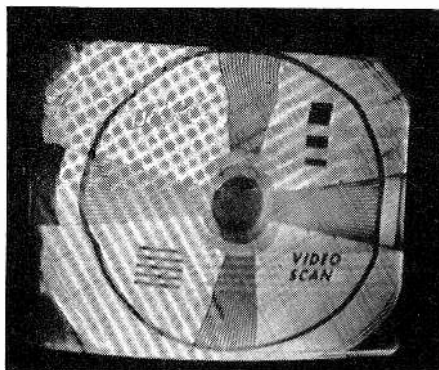
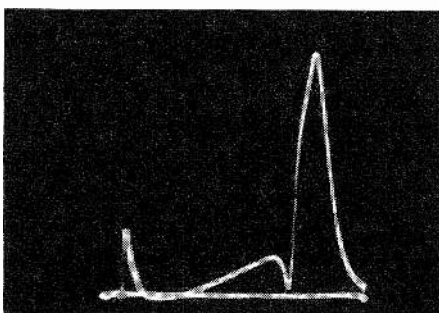

Fig. 6—Smeared picture, sync pulling and poor low-frequency response (top) are all due to serious misalignment (bottom).



Shading modulation voltage

A few picture-shading problems are trickier. For example, the video signal might not be riding on a sawtooth, but instead might be modulated along both top and bottom by a sawtooth (or distorted sawtooth) voltage. In such case, the trouble must be tracked down in the signal circuits. When sawtooth modulation is encountered, the raster itself is uniformly bright. But as soon as a picture signal is applied, the shading symptom appears. First, use a low-capacitance probe and check the agc line to see if it is feeding

an ac waveform to the rf and i.f. sections. A defective agc filter can result in a substantial 15,750-cycle "sawtooth" waveform.

If the age section is cleared in the scope test, check each dc supply line to the rf and i.f. sections. At one or more stages you are sure to find a spurious ac voltage with the dc. The scope will then lead you to the circuit defect that is making pulsating dc out of supposedly pure dc. It's usually an open capacitor which no longer decouples a branch circuit as the manufacturer intended it to do.

Poor frequency response

Test equipment can save much time in troubleshooting poor frequency response. Fig. 6 shows a symptom of picture pulling, smear and vertical wedges with higher contrast than horizontal wedges. Readjusting the fine-tuning control slightly tore the picture up completely. This threw suspicion on the i.f. amplifier, rather than on the rf section or video amplifier. It was time to set up the sweep generator and scope to find out for sure.

A check of the i.f. response curve immediately verified the picture analysis. The curve was highly peaked, had far too little bandwidth and displayed a severe suckout at the low-frequency end. Preliminary attempts at alignment changed the curve shape, but failed to bring it anywhere near normal shape and bandwidth. At least one i.f. stage was defective, but which? A stage-by-stage check was in order.

Response of the third stage was checked first, and looked about normal. As shown in Fig. 7, this curve has reasonable bandwidth, a broad top and no suckouts. However, a sweep signal applied at the input of the second i.f. stage displayed a very poor curve which could not be corrected by the slug adjustments. Now I knew that the trouble was in the second stage. An open capacitor? Replacing the bypass capacitors made no change.

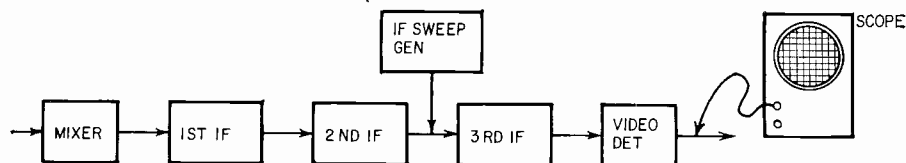
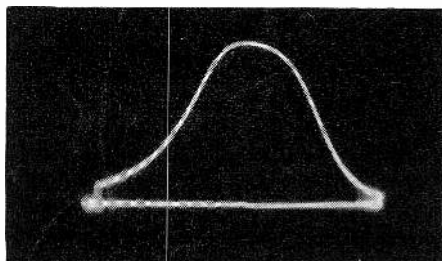

Fig. 7—Third i.f. stage's response was OK.

I concluded that the i.f. transformer must be the culprit. Disassembling and inspecting it pinpointed the defect: a growth of corrosion between the turns at the end of the secondary. Replacing the transformer and doing a complete i.f. alignment resulted in a good-quality picture. Screwdriver mechanics might argue that the trouble would have been found eventually, if a sweep generator and scope hadn't been used. But the important question is: how long is "eventually"? *Unquestionably, the instrument approach did save time—and time is money.*

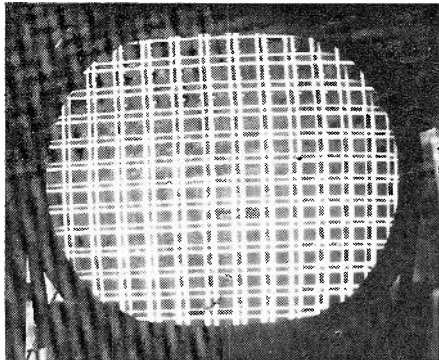

Fig. 8—Misconverged crosshatch pattern.

The color bit

Have you tried to converge a color picture tube on a station signal? If you have, you are already sold on crosshatch or dot generators. It just can't be done otherwise. Fig. 8 shows a crosshatch pattern on a misconverged color picture tube. Crosshatch is generally preferred for preliminary convergence, with a switch to a dot pattern for final trimming. Fig. 9 is an example of a badly misconverged dot pattern. You might prefer to use dots or crosshatch exclusively. This is quite practical. It's chiefly personal preference.

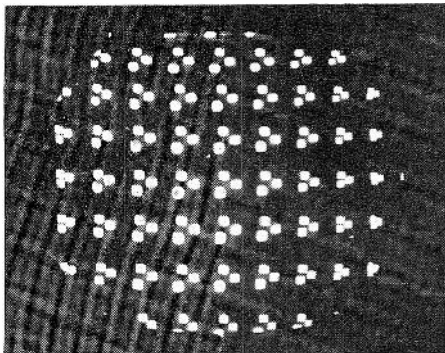

Fig. 9—Misconverged dot pattern.

Loss of color signal can be vexing and time-consuming unless you use a wide-band scope. With a good scope, you can start at the video detector output and trace the chroma signal step by step all the way to the picture tube. Fig. 10 shows a color TV station signal at the output of the video detector. You can't pick out the chroma from the black-and-

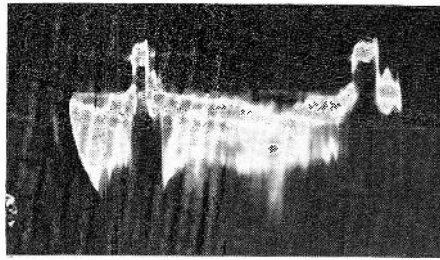

Fig. 10—Color TV station signal.

white camera signal, but the color burst on the back porch of the sync pulse shows that the chroma is coming through.

Next, a check at the output of the bandpass amplifier will show whether the chroma is getting through it (Fig. 11). You could do a lot of guesswork here and waste time without a wide-band scope. If you use a color bar gen-

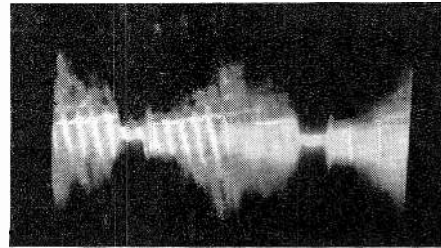

Fig. 11—Output from bandpass amplifier.

erator, the waveform will be much cleaner, and will stand still on the scope screen. Fig. 12 shows the normal appearance of R - Y and B - Y signals at the bandpass-amplifier output. Of course, if you find little or no waveform voltage here, stop right there and start checking dc voltages, resistances and capacitances.

Check bandpass alignment last. Unless a screwdriver mechanic has been at work, it is not likely that loss of chroma will be due to poor frequency response. When you do check alignment, a demodulator probe must be used with the scope (Fig. 13) to display the response curve in standard form. A video-frequency sweep generator is also required; it must sweep over a range of about 1.5 to 4.5 mc.

The next check for a no-color complaint is at the input of the chroma demodulators. Both the output from the bandpass amplifier and from the sub-carrier oscillator must be fed in here. A

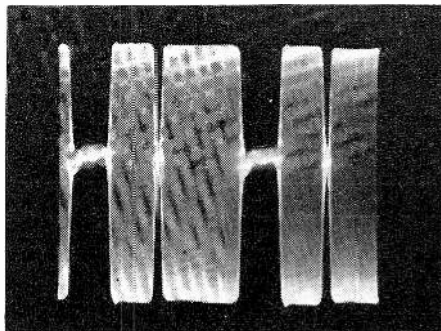

Fig. 12—Color bar signals—R - Y and B - Y.

wide-band scope will display the 3.58-mc oscillator signal as a sine wave, if it is arriving. If the signals are normal at the input, check the outputs of the chroma demodulators. Fig. 14 shows a typical pattern obtained when an NTSC generator is used. Although you can use a color TV station signal to determine whether a demodulator is working or not, it is impossible to make demodulator adjustments without a color generator of the rainbow or NTSC type.

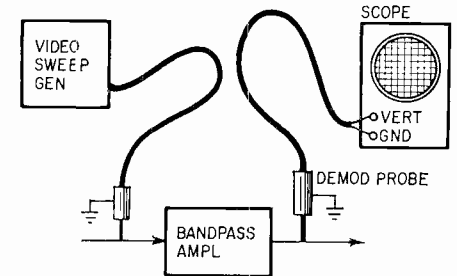
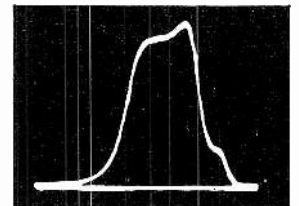

Fig. 13—You must use a demodulator probe to check bandpass frequency response.



If necessary, trace the chroma signal through the following amplifiers to the picture tube. Chroma signal tracing is basically no more difficult than i.f. signal tracing, except that you must know how color circuits work. *It is almost unbelievable that a shop would tackle color TV service without a wide-band scope and color bar generator. Yet, it does happen. A shop in Southern California tried it, and one of their early jobs was a no-color complaint. Using only black-and-white test equipment, the job took nearly 2 weeks before a cold-solder joint was found almost by accident in the chroma circuitry.*

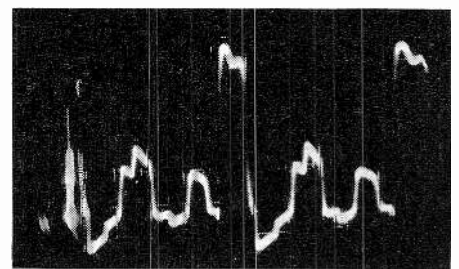

Fig. 14—Output from chroma demodulator shows distorted waveform.

In conclusion, test equipment does not cost—it pays. Any shop in business to make money cannot compete without a full complement of time-saving tools. Electronic servicing is an exacting profession, which demands both professional knowledge and professional equipment.

END

Get livelier baby pix with this electronic birdie

BABY FLASH

By MELVIN S. LIEBERMAN

HAVE YOU EVER NOTICED THAT BABIES open their eyes wide and look in the direction of the flash when a flash picture has been taken? Unfortunately, this happens after the exposure has been made, and so you miss one of the best possible baby poses. By using a pre-flash technique, you can bring about a good pose which can be captured with the picture-taking flash. This unit was designed for that purpose. You will notice a great improvement in the quality of your pictures when you use this pre-flash technique.

This "Baby Flash," or electronic birdie, is very simple and can be built for about \$21. Its cost will quickly be covered from a stepped-up good-picture to poor-picture ratio.

The unit is small enough to be hand-held (3 x 4 x 5 inches). The flash switch is positioned so that you can press it with your right thumb while you hold the unit. You can direct the baby's gaze merely by flashing the unit from the point at which you want the baby to look. The photographer, or an assistant, can operate this unit.

If you wish, you may mount this unit on your camera with a simple bracket. Fire the Baby Flash manually to strike a pose and then shoot a picture with your camera, firing the picture-taking flash.

I used a stroboscopic tube because it was cheap, because I wanted to flash the unit in quick succession at times and because I needed only a few watt-seconds. I built the unit in a Bud Minibox. The finished Baby Flash has a rating of 1.8 watt-seconds, which is more than adequate. The U-35A tube can be used up to 100 watt-seconds.

When the unit is turned on by switch S1, capacitor C1 charges to 300 volts through R1, the de-ionizing resistor (Fig. 1). Charge time is very short. Resistors R2 and R3 divide the voltage and allow capacitor C2 to charge to 150 volts. When pushbutton S2 is pressed, capacitor C2 discharges through the primary of T1, producing a 3- to 5-kv pulse in the secondary winding, which is



Your junior assistant can be in charge of this.

connected to the grid of V1. This pulse voltage starts the ionization of V1; thereafter, capacitor C1 supplies current to V1 through terminals 3 and 5. The current from C1 produces a brilliant flash. (Terminals 3 and 5 can be interchanged—polarity is not important.)

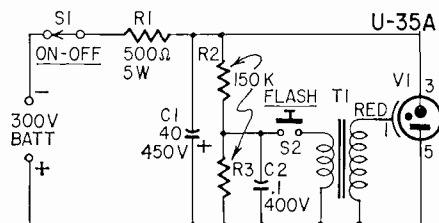

Circuit of the Baby Flash.

If you like, add a camera sync plug to this unit and use it for tabletop photography or photomicrography, since at closeup ranges only a low watt-second value is needed. There is room in this box to parallel two additional capacitors with C1. With 120 μ f for C1, the flash rating would be 5.4 watt-seconds.

Terminal 4 of the tube socket was

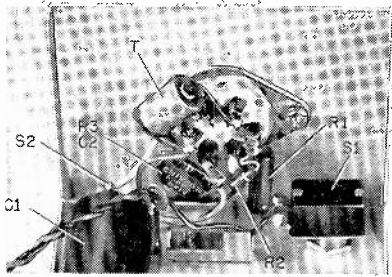

Location of the parts. None of the wiring is critical, and can be finished off in a few minutes.

used as a tie point for the junction of R2, R3, C2 and one side of switch S2. Terminal 6 of the socket was used as a tie point for the other side of S2 and one of the primary leads of T1. None of the wiring is critical, and any arrangement may be used.

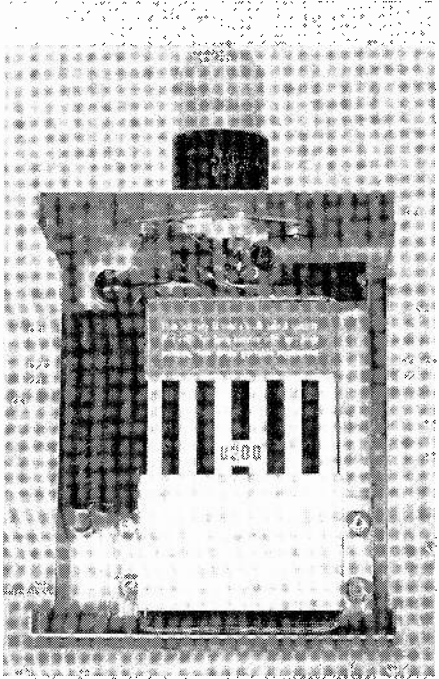

Instrument is completely self-contained. The case has room for even the battery.

- R1—500 ohms, 5 w
- R2, R3—150,000 ohms, 1/2 w
- C1—40 μf, 450 volts, electrolytic (Cornell Dubilier Type BR 40-450 or equivalent)
- C2—0.1 μf, 400 volts
- S1—SPST switch
- S2—N.O. pushbutton (Grayhill 23-1 or equivalent)
- T1—Ignition transformer (Anglo ST-25)
- V1—Stroboscopic tube (Anglo U-35A)
- BATT—Battery, 300 volts (Burgess U200)
- Minibox, Bud CU-3005-A
- Socket, 6 pins
- Aluminum strip for battery bracket
- Battery plugs
- Miscellaneous hardware

I've found this Baby Flash an invaluable accessory to my photograph paraphernalia. The power drain is very small, so the battery will last just about its normal shelf life.

Here's wishing you good baby-picture taking!

END

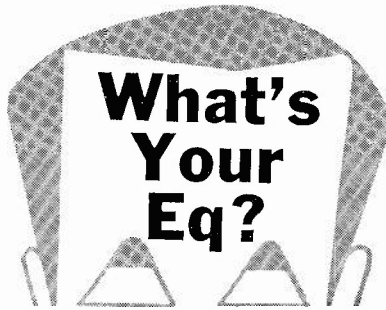

Conducted by
E. D. CLARK

Three puzzlers for the students, theoretician and practical man. Simple? Double-check your answers before you say you've solved them. If you have an interesting or unusual puzzle (with an answer) send it to us. We will pay \$10 for each one accepted. We're especially interested in service stinkers or engineering stumbers on actual electronic equipment. We get so many letters we can't answer individual ones, but we'll print the more interesting solutions—ones the original authors never thought of.
Write EQ Editor, Radio-Electronics, 154 West 14th Street, New York, N. Y. 10011.
Answers to this month's puzzle are on page 95.

Double Bridge Sensitivity

Mr. E. D. Clark, our EQ editor, comments on the item of the above title which was on page 36 of the June issue:

A bridge with two variable arms will yield double the output of a bridge with a single variable arm, if the detector has infinite resistance. If the detector is a current-operated device such as a d'Arsonval voltmeter or ammeter (that is, *doesn't* have infinite resistance), the output ratio is *greater* than 2:1!

Using the same values as in the original EQ and reducing each circuit to its

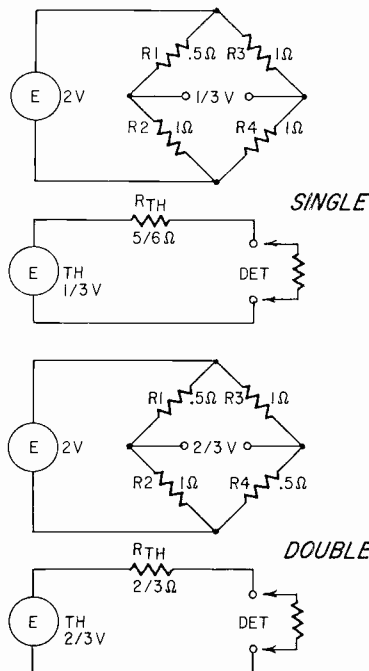

Thevenin equivalent, we get simplified schematics like the ones in the diagram.

For instance, a 1-volt 100-ohm-per-volt voltmeter or 10-ma (100-ohm) milliammeter would yield the following readings:

$$\frac{1/3}{100 + 5/6} = \frac{2}{605} \text{ amp, or } \frac{200}{605} \text{ volt (single)}$$

$$\frac{2/3}{100 + 2/3} = \frac{2}{302} \text{ amp, or } \frac{200}{302} \text{ volt (double)}$$

The ratio is slightly greater than 2:1. Now, going to the extreme, using a "perfect" (zero-resistance) ammeter:

$$\frac{1/3}{5/6} = 0.4 \text{ amp (single)} \quad \frac{2/3}{2/3} = 1 \text{ amp (double)}$$

The output ratio is now 2.5:1.

Ferris Wheel

This network has six resistors connected as shown to six independent 2-

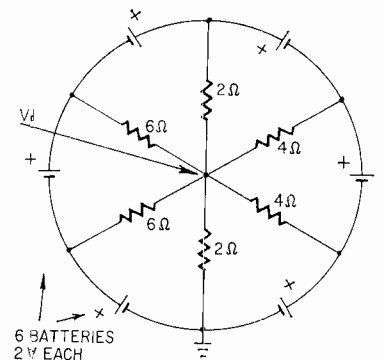

volt sources (considered ideal). What is the voltage at the junction V1?—E. D. Clark

Two Meters

The diagram shows a series circuit which includes two pulsing contacts, a dc ammeter (d'Arsonval type), an ac ammeter (rf type), and a 12-ohm resistor. The circuit has a total dc resist-

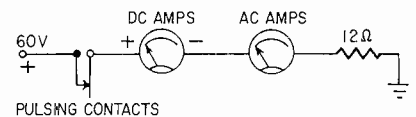

ance of 12 ohms and no residual reactance. If the contacts are adjusted to open and close at the rate of 60 pulses per second, and pulse width is 2/300 second, what reading will be shown on each ammeter?—Kendall Collins

50 Years Ago

In Gernsback Publications
In November, 1914
Electrical Experimenter

High Voltage Discharges Thru Vacuum Tubes.

A Simply Made Loading Coil, by Stuart Sandreuter.

Crystal Detectors and Electrothermal Action, by Dr. W. H. Eccles.

Making a Hot-Wire Ammeter, by H. Caine.

How to Recharge Dry Cells, by Leo J. Prindiville.

WHEN IN DOUBT, CALIBRATE!

Keep your meters at their rated accuracies without breaking into the National Bureau of Standards. Just a mercury cell, a few precision resistors and a power supply will do.

BY R. N. CENTERVILLE

TODAY, ELECTRONIC TECHNICIANS, LABORATORY workers and experimenters must calibrate their test equipment accurately. How much accuracy do you need? And how can you calibrate your instruments to the necessary accuracy? Accuracy is relative. Laboratory standards are higher than service standards. Laboratories may use primary standards, while service shops will generally use secondary standards.

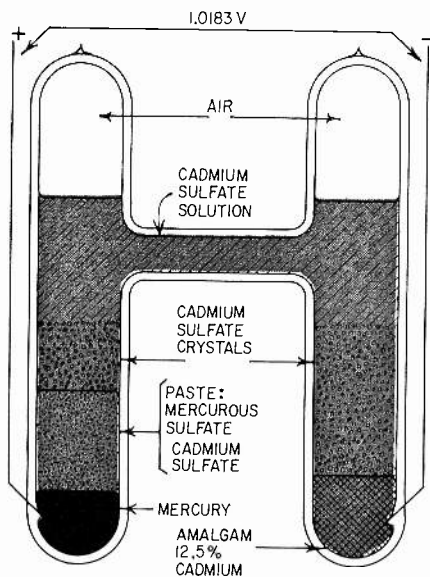

Fig. 1—What's in a Weston cell.

The primary standard of voltage is the Weston cell (Fig. 1), used in laboratories. It has an emf (source voltage) of 1.0183 volts at 20°C. The cell is customarily balanced against a variable-voltage source, to avoid drawing current from it. If the cell supplies appreciable current, its terminal voltage decreases because of polarization. After the cell stands idle, its terminal voltage will return to 1.0183.

Any voltmeter calibrated from a standard cell is called a secondary standard. This term implies that there is necessarily a calibration error, though it might be very small.

Calibrated voltmeters are widely used as secondary standards in laboratories and shops. A high-quality dc voltmeter of this type has a rated accuracy of 0.1% of the full-scale reading and costs \$345. If a lab technician is satisfied with a rated accuracy of 0.5% of full-scale reading, a single-range (300 volts) laboratory type dc voltmeter can be purchased for \$55. But a color TV

receiver can be serviced satisfactorily if dc voltages can be measured to an accuracy of $\pm 10\%$.

Dc "standards" for shop use

Most mercury cells have an emf of 1.357 volts. They are good as voltage references. A few mercury cells are manufactured with a manganese-dioxide blend and have an emf of 1.4 volts (the voltage is marked on the cells) these are less desirable as voltage-reference cells. You can make direct emf measurements on mercury cells with vom's and vtm's, because the effects of polarization are negligible at small current drains. If a mercury cell has occasional drains up to 1 ma, its terminal voltage will still be within 1% of 1.357 volts after several years. After 3 years, aged mercury cells have a long-term stability as accurate as 0.1%.

Since most service vom's and vtm's are rated for an accuracy of $\pm 3\%$ of full scale on dc voltage ranges, mercury cells are quite adequate voltage references. One mercury cell is used to check the first dc voltage range. If the reading is off by more than 3%, either the meter movement is defective, or a multiplier resistor is bad.

If the scale reading is still off after the multiplier is cleared, the meter movement is the culprit. Defective meters should be returned to the factory or to a repair depot. They usually read low, because the permanent magnet has lost flux (possibly from excessive jarring) or because the pointer has been bent by accidental overloads. Zener-diode protection for vom movements is cheap and worth while. Accuracy is affected only a small fraction of 1% by the diode.

Checking the higher dc ranges

Higher dc voltage ranges can be checked by using mercury batteries instead of a single mercury cell. This is economical only for the second, and possibly the third, range. Hence, a bench power supply may be used, with its output voltage calibrated against a

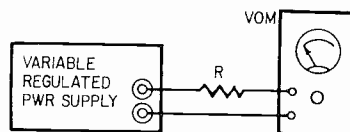

Fig. 2—Precision resistor R checks high ranges by allowing you to measure a high voltage accurately on a low-voltage scale. Then you set meter to high-voltage scale and measure again without resistor. Same reading?

mercury cell (or battery). Fig. 2 shows how to do this. In this example, a vom is under test. Suppose it is a 20,000-ohm-per-volt instrument with a 2.5-volt first range, and you wish to check its 250-volt range. Since the reciprocal ("1 over the . . .") of full-scale current equals the ohm-per-volt value, the vom will draw 50 μ a at full scale on each range.

You have checked the first range against a mercury cell, and found it to be accurate. Now set the power supply in Fig. 2 to 250 volts, using the 2.5-volt range of the vom and a series resistor R. The input resistance of the vom is 50,000 ohms on that range ($2.5 \times 20,000$ ohms). Hence, R must have a value of 4.95 megohms, by Ohm's law, to give a current flow of 50 microamperes with 250 volts applied. Make up the 4.95 megohms from series-connected 1% resistors. A $\frac{1}{4}$ -watt size is ample.

Set the power supply for full-scale indication on the 2.5-volt range of the vom. Now you know that the power supply is set accurately to 250 volts. Measure this voltage directly (without the resistor) on the 250-volt range of the vom. If the reading is unsatisfactory, the associated multiplier resistor(s) must be replaced.

The same general application of Ohm's law can be used to check any dc voltage range of any vom, including 1,000- or 100,000-ohm-per-volt instruments. Just be careful of your arithmetic and decimal places. With a vtm, arithmetic is simpler, because the input resistance is the same on all dc ranges.

Checking ac ranges

Mercury cells and bench power supplies are just as useful for checking the ac voltage ranges of a vom. The ac reading is related to the dc reading. After the dc voltage indication is known to be accurate, you need merely to check ac scale readings from a known reference dc reading, using a suitable scale factor.

What is the scale factor? If your vom uses a half-wave instrument rectifier (check the manual), the ac scale will normally read 2.22 times the dc scale reading. If your vom uses a full-wave rectifier, the ac scale will normally read 1.11 times the dc scale reading. For example: a vom with a half-wave instrument rectifier reads 1.35 volts when tested with a mercury cell on the dc voltage function; you will expect to read

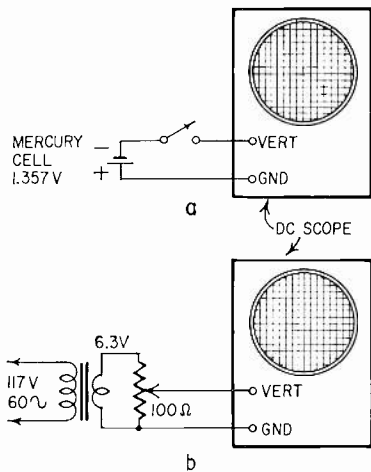

Fig. 3-a—Mercury cell across dc-scope input terminals deflects beam. In (b), sine wave is adjusted for same deflection peak to peak. Now you know the exact peak-to-peak value of the sine wave.

3 volts when the vom is switched to ac. Remember that the dc voltage must be applied in proper polarity for the half-wave rectifier. If you use the wrong polarity, the meter will read zero, or possibly a small reverse voltage. Simply reverse the test leads. If your vom has a full-wave rectifier, you should measure 1.11 times the dc voltage, with the instrument set to ac, and the reading should be the same when the test leads are reversed. If readings are not correct both ways, one or more of the rectifier sections are defective.

When you use a power supply to check the higher ranges, remember that the input resistance of the vom is less on ac than on dc—it might have a 1,000- or 5,000-ohm-per-volt rating on ac ranges. Enter the correct value in your Ohm's law calculations.

Vtvm on ac

When calibrating the ac ranges of a vtvm, an intermediate step is required because those ranges do not respond to dc. An accurate ac source is required. If you have a good dc scope, a convenient method of comparing dc and ac

voltage is shown in Fig. 3. When the switch is closed (Fig. 3-a) the scope base line deflects up or down, depending on polarity (Fig. 4). The deflection corresponds to the voltage of the mercury cell. Next, apply an adjustable ac voltage (Fig. 3-b). Advance the input until the sine-wave deflection is the same height as the previous dc deflection (Fig. 5). Then the peak-to-peak ac voltage is equal to the reference dc voltage.

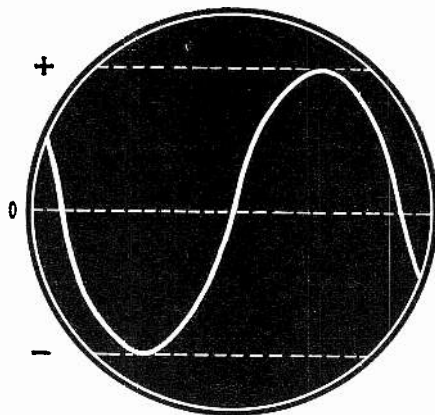

Fig. 5—Mark line where dc-deflected beam came to rest; then adjust ac peaks to same level.

Finally, apply this ac voltage to the vtvm and observe the peak-to-peak scale reading. If the reading is not the same as the reference dc voltage, the vtvm is out of calibration. Consult the manual for the location of the ac calibrating control(s), and make the necessary adjustments. Since you are working with peak-to-peak values, the waveform provided by the transformer in Fig. 3-b is of no concern. However, calibration accuracy depends directly on the scope's accuracy. In other words, unless the scope's sensitivity is the same for dc as for 60-cycle ac, there will be a calibration error.

A quick check for equal ac and dc sensitivity in a dc scope: with the circuit shown in Fig. 3-a, use a key (preferably a "bug") as the switch. Then, make a series of rapid dots, and observe the

"pulse" pattern on the scope screen. The pulses should be deflected exactly to the same height as that produced by steady dc deflection (Fig. 4). However, if the pulses are deflected to a greater or lesser height, the scope is not suitable for calibration. In this test, the steady dc source is "chopped" into an ac pulse waveform. It gives a critical test of dc vs. ac sensitivity.

Ohmmeter check

After the vom or vtvm has been checked on its dc and ac functions, test the ohmmeter function. This is very simple. All you need is a few 1% resistors. It is good practice to check the center-scale indication of the ohmmeter on each resistance range. A typical vom has three resistance ranges, with center-scale values of 12, 1,200 and 120,000 ohms. On the other hand, a typical vtvm has seven resistance ranges with center-scale values of 10, 100, 1,000, 10,000, 100,000, 1,000,000 and 10,000,000 ohms. If an ohmmeter does not indicate reasonably accurate resistance values, the internal battery may be off value.

Rated accuracy of an ohmmeter is based on its rated accuracy for dc voltage indication. For example, the vom or vtvm might be rated for an accuracy of $\pm 3\%$ of full-scale indication on dc volts. Accordingly, there will be a "spread" of 15 volts on the 250-volt range. This is the rated "arc of error," which applies also to the accuracy of ohmmeter indication. We have to use "arc of error" because the ohmmeter scale is nonlinear. Fig. 6 illustrates this. Of course, the arc of error for a particular instrument might be different from the example of Fig. 6. Check the manual for the accuracy rating of your instrument.

Milli- and microammeters

It might seem simple to check the accuracy of a vom on its current ranges. Basically, it is simple. However, the beginner often overlooks the fact that a milliammeter or microammeter has a different input resistance on each range. This must be taken into account in most cases. Fig. 7 shows the test setup for checking accuracy. A 1% resistor R is connected in series with a mercury battery and the vom. The current flow is given by Ohm's law. Observe that the total circuit resistance consists of R plus the internal resistance of the vom.

This internal resistance might be given in the instrument manual. If it isn't, check the circuit on the range to be calibrated. For example, Fig. 8 shows the circuit for a vom on its 100- μ a range. The input resistance is 2,500 ohms. If a 1.35-volt mercury cell is used in the Fig. 7 configuration, the to-

Fig. 4—You can easily measure the exact distance the beam travels from its normal no-input resting place.

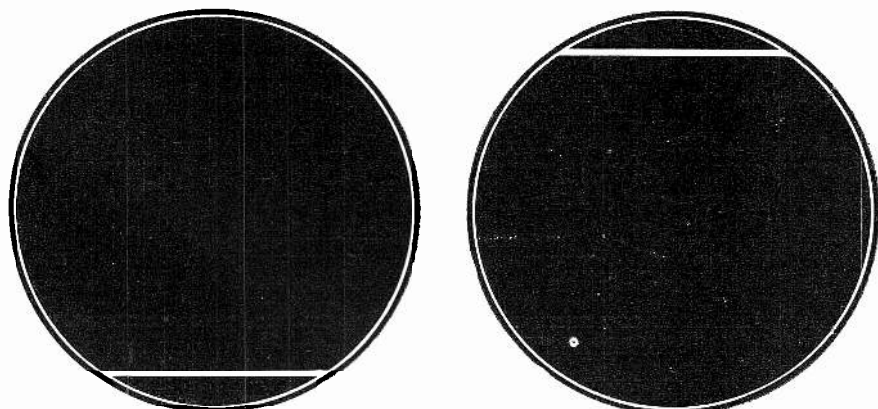

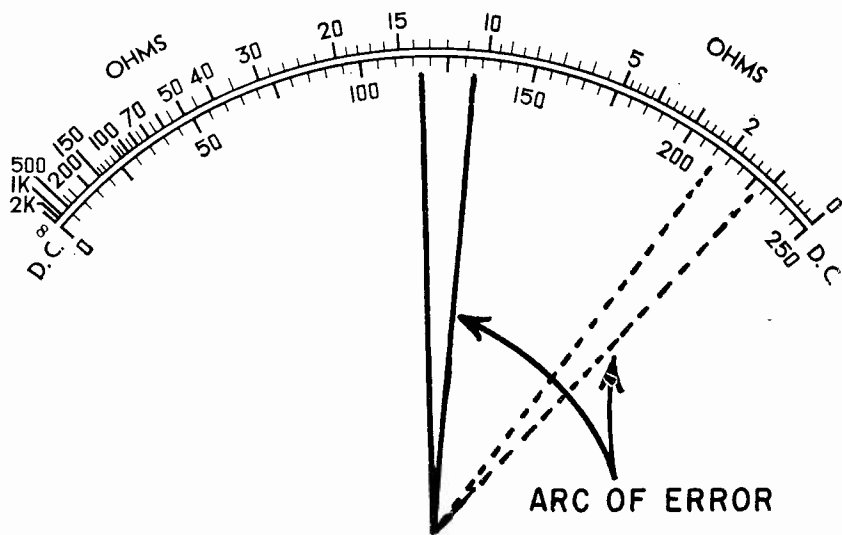

Fig. 6—Arc of error on ohmmeter scale is determined by total plus-and-minus dc voltage error. Note how same-size arc covers about 3 ohms at center scale, only about 1 ohm at right.

tal circuit resistance must be 13,500 ohms for full-scale indication. Since the vom has 2,500 ohms input resistance, R must have a value of 11,000 ohms. If you forgot the input resistance of the vom, you would conclude falsely that the meter was seriously in error.

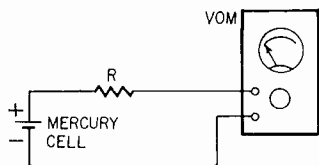

Fig. 7—Test setup for checking current-scale accuracy.

Ammeter checks

High-current ranges of a vom cannot be so easily checked in the shop. Small cells or batteries have an internal resistance which cannot be neglected when substantial current is drawn, and low-resistance "standards" are not readily available nor are they easy to work with. Fig. 9 shows how a battery must be regarded as connected in series with an internal resistance when comparatively large currents are drawn. The value of that resistance is not constant. It varies with the current value, and with the time the current flows.

You can use a storage battery as a "standard" voltage source, by measuring its terminal voltage with a calibrated dc voltmeter. However, note that, if you use a 6-volt battery, the to-

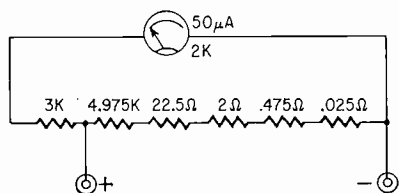

Fig. 8—Circuit of a vom switched to 100- μ a dc range.

tal circuit resistance for a 10-ampere flow will be 0.6 ohm. The input resist-

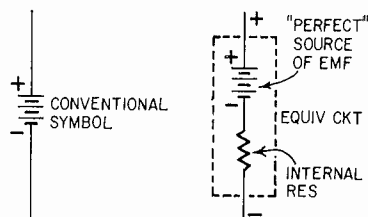

Fig. 9—Usual battery symbol doesn't tell all. In series with every battery's emf is an internal resistance that depends on design of battery, its state of charge, its age, temperature, amount of current being drawn, etc.

ance of a typical vom on its 10-ampere range is .025 ohm (Fig. 10). The "standard" resistance will accordingly have to be 0.575 ohm for a 10-ampere deflection. You can see that lead resistance, contact resistance and internal resistance of the storage battery can all be significant in this situation.

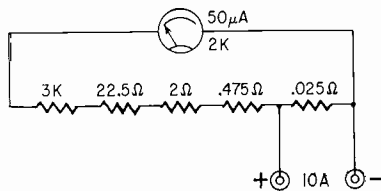
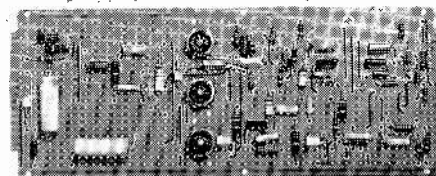

Fig. 10—Circuit of a vom switched to 10-ampere dc range.

For a rough check of high-current indication accuracy, connect two (or more) ammeters in series, and hook the combination into a high-current circuit to see whether their indications agree reasonably well. If both instruments read about the same, the probability is rather good that both are accurate. This method eliminates any error from circuit resistance, because the same current, whatever it might be, flows through both instruments. END

New Circuit Board Is Ready-Printed



An interesting new circuit board for designers and experimenters, introduced by Vero Electronics of Farmingdale, N.Y., makes it unnecessary to etch your own board. The board already has a number of copper strips running its full length, pierced with enough holes to make it possible to mount any component. By laying out a diagram on a special design sheet, it becomes practical and simple to make up your own printed circuit layout. The board can become more useful by paralleling two or more strips for ground or high-voltage buses, and by drilling holes to interrupt break copper strips, making it possible to use portions of the same strip for different purposes.

An Appeal to Reason



Service shops of all kinds everywhere are plagued with curious, friendly, chatty people who wander about poking at things and asking questions of the technicians. This can be a distracting nuisance to them, as well as a potential danger to the visitor.

The photo shows the polite but unmistakably firm approach used by our shop to keep customers from getting mixed up with the tools and chassis. —Harry J. Miller

COOKING UP AN AMPLIFIER

Ground rules for designing your own
little general-purpose amplifier

By JACK DARR
SERVICE EDITOR

EVERY TECHNICIAN OUGHT TO BE AS FAMILIAR with the circuit below as he is with his own signature! Why? Because it's the basic foundation on which nearly all audio amplifiers are built. Parts values and tube types change, but this circuit will always be in there somewhere.

How can you use it? Well, say we need a small amplifier for a certain job. We figure out what we need, then set it up accordingly. For example, we want 5 watts power output. This being the first thing, we look in the tube book to find a tube that will give us that. How about a 6V6? There are several other types, but this is about as common and cheap a tube as we can find. Rugged, too. (A 6AQ5 is the seven-pin miniature version of the 6V6, also usable.) According to the tube book, it'll give us 4.5 watts with 250 volts on plate and screen. Near enough. Our power supply has to furnish this, at a maximum of 54 ma, so we set this up for at least 65-70 ma so that we have a generous safety factor.

Output transformer? Pick it to fit the job, from any catalog. A 6V6 has a 5,000-ohm recommended load impedance; say we're going to use an 8-ohm speaker. That's all we need. Look for a transformer listed as "5,000 ohms to 8 ohms, 5 watts."

Now, we set up the bias. Book says 12.5 volts for this amount of output. So, at a nominal 50-ma total plate and screen

current, a 250- (or 220- or 270-) ohm resistor (R5) will give us 12.5 volts bias.

In the first stage, we need enough voltage amplification to build up the input to the right amount to drive our 6V6 to full output. Class-A, with 12.5 volts bias, we can use a maximum peak-to-peak signal voltage of 25. (Bias voltage, doubled.) This is a maximum value, remember, so we could get by with a bit less. However, voltage amplification isn't hard to get.

Let's say our input will be from a phono cartridge that has an output of about 1 volt. So, we need a minimum amplification of 25. Well, how about a 6AV6—another good, common, cheap tube. Book says, 100 volts plate, -1 volt on the grid, and, with the right plate load, we'll get voltage gain near 100 (theoretically). Good! Might have some left over! For such a high- μ triode, we want to use a high plate load (R3) to take advantage of the gain available. So we use (on general good-practice principles) a resistor of 100,000 ohms or higher.

The 6V6-GT grid resistor (R4) is effectively in parallel with the 6AV6 plate load (the coupling capacitor here is always large enough to have very small reactance at mid-frequency. It can be neglected in this formula, the two resistors being figured as if they were in parallel, which they are, as far as the *signal*

voltage developed across them is concerned). So it should be at least 270,000 ohms.

Using the lowest values should give us a voltage gain of almost 50, and this is plenty. We can use something like a 250,000-ohm to 2-megohm pot across the input, and control the gain there. For ceramic phono cartridges, the value should be at least 1 megohm.

For a straight, simple amplifier, without any frills or feedback, the simplest kind of bias for the 6AV6 is *grid-leak* bias, which we can get just by using a high-value grid resistor, R2 (anything from 3 to 10 megohms will do). This saves figuring and wiring in a cathode bias resistor and maybe a bypass capacitor for it, but if you plan to use a volume control (R1) as shown, you must isolate its slider (for dc) with a capacitor (C1) to prevent shorting the bias voltage to ground when the slider is at minimum volume.

Now, there's the basic circuit. The little filter in the input tube line uses a dropping resistor (R6) big enough to hold the 6AV6 plate voltage down to what we want, and to decouple it from the 6V6 supply line. With a 1-ma plate current, even I can figure it out!

You'll lose 1 volt for every 1,000 ohms! So, with a 100,000-ohm plate load resistor, we'd need 200 volts at the bottom of it. If our B-plus is 250 volts, as we said, for the 6V6, we'll have to get rid of another 50 volts, and this makes the resistor 47,000 ohms (nearest commercial 10% value). Capacitor C4 can be any size big enough to prevent feedback: from about 0.1- μ f up to about 40- μ f electrolytic.

Now, we can add anything we want. More gain? Bypass the 6V6 cathode resistor with about a 25- μ f electrolytic (C3). Add a high-cut tone control by hooking a .05- μ f capacitor in series with a 250,000-ohm pot from the 6AV6 plate to ground. Add feedback via the dotted line from the voice coil to the cathode of the 6AV6. (If the amplifier yowls when you hook it up, reverse the output transformer secondary connections.) And on and on. This is a basic amplifier, and you can put all the refinements you want on it, but you've got build this first.

I'll admit this is what they call cookbook engineering, but you can whomp up some mighty tasty dishes out of a good cookbook, and the average tube manual's a pretty good cookbook.

Don't ignore the resistance-coupled amplifier charts at the back of the RCA and Sylvania receiving tube manuals. They give assortments of values for just about every tube you can expect to use as an audio voltage amplifier, and are very quick and easy to use. If you need a preamp or more elaborate tone controls, you'll find 'em in the back of the RCA manual.

END

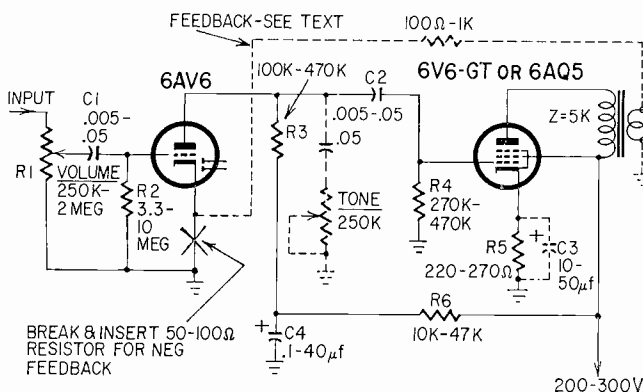

Foundation of practically all audio amplifiers: voltage amplifier drives power amplifier. Essentials are shown in solid lines; optional frills, dotted.

EICO's complete new color TV lab for the pro

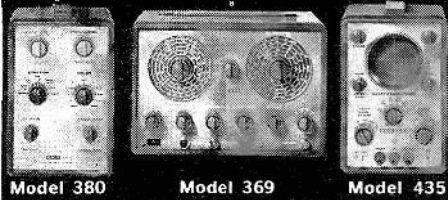

Color TV servicing is a job for professionals—and Eico's new color TV test equipment is designed to their requirements. Critical professionals know they can depend on EICO for accuracy, reliability, and laboratory standard performance.

PROFESSIONAL PERFORMANCE COLOR TV TEST INSTRUMENTS

(A) MODEL 380 SOLID STATE N.T.S.C. STANDARD COLOR SIGNAL & DOT-BAR GENERATOR (PAT. PEND.) Completely standard 100% fully saturated N.T.S.C. color signals, including both chrominance and luminance signals exactly as specified. Color burst is precisely gated and delayed according to N.T.S.C. standards. Phase angles are permanently established by a linearly distributed delay line. No adjustments are ever required. Provides square "clean" waveforms without significant overshoots or ringing. In addition to generating 11 different color signals, one at a time, for hue and demodulator adjustments, the Model 380 generates dots, cross-hatch, horizontal lines, and vertical lines for convergence and linearity adjustments. Both video and RF outputs are provided, with gain controls. Three crystal-controlled oscillators for color burst and color information, convergence and sync signals, and RF output on TV channel. Outstandingly compact and weighs only 4 lbs. Kit \$129.95. Wired \$169.95.

(B) MODEL 369 TV-FM SWEEP & POST-INJECTION MARKER GENERATOR (CRYSTAL-CALIBRATED) For visual alignment of color or B&W TV, and FM receiver RF & IF circuits. Five sweep ranges from 3-220 mc and four marker ranges from 2-225 mc, plus a crystal marker oscillator. Sweep circuit is purely electronic. Retrace blanking. A 3-stage AGC circuit. Amplitude of the sweep signal is constant even when the widest sweep width of 20 mc is used. Only the sweep signal is applied to the circuit under test. The markers are added, and the combined signal is fed to a 'scope. Kit \$89.95. Wired \$139.95.

(C) MODEL 435 DC WIDEBAND 3" OSCILLOSCOPE You'll be able to complete many more color or B&W TV service calls on location if you can take your 'scope with you. EICO's 435 is really portable (1/3 the size of conventional 5" scopes) and fully equipped to do the job. Quality equal to or better than the finest 5" TV service scopes is achieved with a far sharper, brighter trace on a flat-face CRT. Flat from DC-4.5mc (+1, -3db). Zener diode-controlled square wave calibrating voltage, edge-lit calibration grid. Automatic sync full retrace blanking. Kit \$99.95. Wired \$149.95.

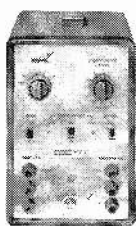

ONE MORE MATCHING INSTRUMENT EQUIPS YOU FOR FM STEREO SERVICING. MODEL 342 FM MULTIPLEX SIGNAL GENERATOR. A compact instrument for test or alignment of multiplex circuits of FM Multiplex Stereo receivers. Enables you to quickly measure and adjust channel separation and balance, or the input level needed for synchronization or switch-over to stereo operation.

Kit \$99.95. Wired \$149.95.

Visit the EICO exhibit in the Pavilion of American Interiors at the World's Fair.

EICO EICO Electronic Instrument Co., Inc. 131-01 39th Avenue, Flushing, N.Y. 11352 Send new 1965 catalog featuring more than 230 EICO products RE-11		
Name _____		
Address _____		
City _____	Zone _____	

by Jack Darr
Service Editor

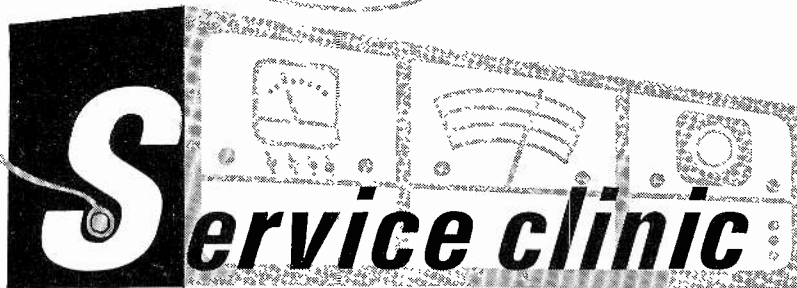

This column is for your service problems—TV, radio, audio or general and industrial electronics. We answer all questions individually by mail, free of charge, and the more interesting ones will be printed here.

If you're really stuck, write us. We'll do our best to help you. Don't forget to enclose a stamped, self-addressed envelope. Write: Service Editor, Radio-Electronics, 154 West 14th Street, New York 10011.

HOW ACCURATE IS "ACCURATE"? GOOD question. Like all of the others in this bewildering business, one with several answers. Our instruments are always more accurate than our interpretation of their readings! Let's see why.

Some people speak of "service-type" meters condescendingly, as if they weren't quite good quality. This is just not so. A good vom or vtvm, in good condition, will be accurate to within $\pm 2\%$ of full scale; one make even has a $\pm 1.5\%$ rating. What do you want? The typical "laboratory" meter has about 1% accuracy. (There is another difference besides 1% less accuracy: price. Good service vom, \$50-75. Lab meter, same ranges, \$550-\$750!)

Plus or minus 2% of full scale on a 100-volt scale, at half-scale, means that 48 to 52 volts is within tolerance. Is this bad? No, sir! That last word gives us the clue—tolerance, the technician's friend. The equipment we work with has a *much* greater tolerance!

We measure voltage, current and resistance; most of us use combination instruments—vom or vtvm's. They'll have about the same accuracy on all functions. Read the fine print in TV and radio parts lists. Resistors, 10% or even 20%; electrolytic capacitors, -10%, +50%; paper capacitors, 10% and 20%. Even the ac input voltage is "105-120 volts"! This means, if we take "worst case" conditions, that with all tolerances leaning the same way, we could have an error in the set itself up to about 40%! This seldom happens, of course, but it could.

So, we've got a lot of leeway in the voltages and parts values. Remember, al-

most all voltages in TV and radio sets are determined by dropping resistors. So they can't be more accurate than the resistors themselves. At last I'm getting to the point: with such wide tolerance in resistors and voltages, *we don't need lab quality instruments to measure them!*

"Error" is always given as percentage of full-scale deflection. On a 100-volt scale, $\pm 2\%$ means plus or minus 2 volts; on a 10-volt scale, plus or minus 0.2 volt. Remember this while servicing, and you'll save a lot of time.

Learn to interpret voltage readings for what they mean instead of what they actually are; make a mental allowance for tolerance. What this reading means in terms of circuit conditions is far more important than the actual reading in tenths of a volt! If a certain tube element calls for 100 volts, and your reading is between 90 and 110 volts, go on. The trouble isn't there. Don't waste time trying to read this as "97.65 volts"! Now, if you get 50 volts or 150 volts, start looking; something is wrong around there. This is way beyond tolerance.

This will apply to the great majority of voltages, especially in ac-operated equipment. Transistor radios will be slightly more demanding, because of the very low voltages. But again, *percentage error is what counts.*

For maximum accuracy in ac-powered sets, make sure that the line voltage is set at exactly 117 volts. This is the "design center", and the voltage at which the readings on the schematic were taken. Check the little box down in the corner of the diagram. Also—this is one that a lot of us overlook—*most readings are taken with no signal input!* A strong input signal can alter a lot of readings, especially in agc-controlled stages, sync separator plates and grids, big amplifiers with class-AB or class-B outputs, and so on.

To get accurate readings in sensitive circuits, take them at a point where your measuring instrument will cause the least circuit disturbance. For instance, reading grid voltage on an audio amplifier tube with a vtvm won't affect things too much, because of the low frequencies. Reading grid voltage in the video i.f. will detune the stage enough so that

readings will be off. Here, read bias by measuring the cathode voltage; after all, that is the bias!

You can overdo things in taking meter readings, and especially in figuring. You want to figure out the value for some part. You'll read voltage, current or resistance with a 2% meter, and then take two of these and work out the third. So, you happily read your voltmeter: "87.25 volts." (Error No. 1: with a meter (full-scale) error of 2%, you're reading this to two decimal places! This implies an accuracy of .01%! Where'd you get it?) Now, you take a resistance reading as "50.75 ohms". (Same thing—Error No. 2.) You use all of these figures in your calculations and come up with an answer to 4 places after the decimal point! You now have an accuracy of .0001%. Really?

To save a lot of math, which no one likes anyhow, round off the figures. 87 volts, 50 ohms (or 51). After all, at 2%, there is some doubt even about the accuracy of the last figure *before* the decimal point! So your answer will still be well within the 10–20% tolerance of the actual circuit.

For maximum accuracy in readings, try these tips. Use the lowest possible scale, and get the reading as near to the center of the scale as you can. A d'Arsonval meter is most accurate in the middle 50% of the scale. Maximum error in the first and last quarters of the scale.

Take your readings at points where they'll cause the least circuit disturbance, from detuning or shunting. Look for "tricks" that will let you spread out the reading and use a lower scale. For example, in reading bias on transistor radios; let's say the base voltage is 11.2 and the emitter 11.8 volts. Don't use the 15-volt scale. Read the voltage between base and emitter on a 2-volt (or 1.5-volt) scale. 2% of 2 volts is a lot less than 2% of 15 volts. Error is always a percentage of full-scale deflection.

Cheer up. Your instruments are *completely* satisfactory for what you're using them for. After all, it's not the exact voltage reading that we want. We need a reading close enough to give us information about what's happening in the circuit! Our *interpretation* of that tells us where the trouble is!

Another mystery set

I enclose the block diagram of a TV set I have on the bench. No model number; it's a Tele-Tone. Can you tell me what model this is?—L. M. B., Towson, Md.

This, frankly, is a guess, but I think it's somewhere around a TV-149 or TV-259 (Sams 56-22 or 57-21, respectively). Check this out by going to your distributor and looking at the folders,

comparing the chassis photos with the set.

What you'll wind up doing is what we all have to do once in a while: using a "similar" chassis of the same make. TV designers tend to use the same circuits in quite a few chassis. For example, the Tele-Tone engineers probably used the same horizontal oscillator circuit in four or five sets of the same vintage. So, if your trouble is there, look up a set made at the same time, check the tubes used, and so forth.

The Marker Adder and the Square Wave

I built the marker adder described in the July 1963 issue. Now, I've got trouble. When I feed a square-wave signal through it, the leading edges are rounded off. I've checked every part in it, but all seem to be OK.—W. G., New York, N. Y.

You're being a little bit too strict! In sweep alignment work, we do *not* need a very high frequency response. Most of the stuff we work with is actually down around 60 cycles! Even the markers themselves are actually the "low-frequency" parts of the beat between two high-frequency signals.

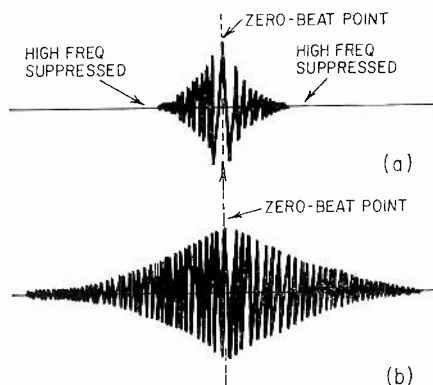

All we need from a marker is a narrow band of frequencies near the zero beat between marker signal and sweep signal (a). "Hi-fi" response in marker equipment lets too-high beats through, makes a fuzzy extended marker that is almost useless (b).

Then, too, a square wave is about the roughest test you can give any amplifier. Even on a 100-cycle square wave, the amplifier must be flat to far on up the line, say to at least the 10th harmonic, to avoid rounding the edges.

Notice in the article that Mr. Wiles says "Low-frequency response in the 6AU6 pip amplifier has been *purposely limited* . . ." and "High frequency response is also limited, to keep markers narrow and sharp." Remember the trick of shunting a small capacitor across a scope input to make markers sharper? Same thing. I'd say your unit's ok. END



HERE'S ONE WAY TO COOL A HOT AMPLIFIER

but here is a **BETTER WAY**

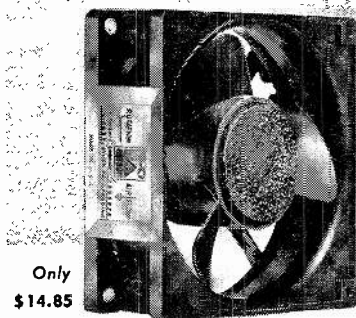

Only \$14.85

the **ROTRON**

Whisper Fan
KIT

Beat the heat that wrecks the set by installing a Rotron Whisper Fan Kit. Breathing 60 cubic feet of cool air over, under and around every heat-generating component, the Whisper Fan improves performance by minimizing drift due to temperature change within the enclosure. Requires only 7 watts, just pennies a week to operate. Measuring only 4 1/8" square and 1 1/2" deep, it can be set in a corner or mounted on the rear panel in minutes. Comes complete with mounting hardware, plug and cord for electrical connections and installation instructions.



Write for details or see your local dealer.

ROTRON mfg. co., inc.
WOODSTOCK, NEW YORK
ORiole 9-2401

test equipment report

Hallicrafter HM-1 Vacuum-tube Volt-Milliammeter

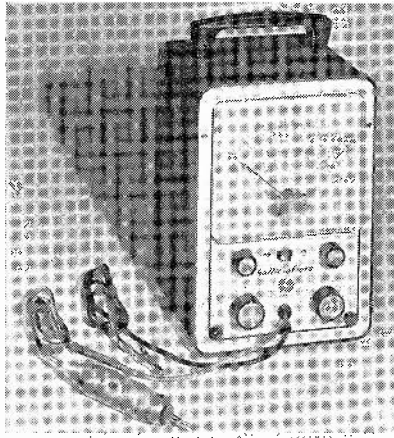

CURRENT TESTS ARE IMPORTANT IN semiconductor circuits. So important that this new vtvm kit includes current ranges of 1.5, 5, 15, 50, 150 and 500 ma (at 3% of full-scale accuracy) as well as ac and dc voltage and, of course, resistance ranges.

The milliamperage ranges of the HM-1 are not part of the electronic cir-

cuitry. They can be used whether the power switch is on or off—the power cord does not even have to be plugged in.

The 500- μ a meter movement is bridged by the current shunt, which protects it. This, along with the usual meter damping, protects the moving parts from all but severe physical shock.

Dc volts

Ranges: 0-1.5, 5, 15, 150, 500 and 1,500 volts full scale. Up to 30,000 volts with accessory high-voltage probe.

Input resistance: 11 megohms (1 megohm in probe) on all ranges.

Accuracy: $\pm 3\%$ full scale.

Ac volts

Ranges: 0-1.5, 5, 15, 50, 150, 500 and 1,500 rms scales; 0-4, 14, 40, 140, 400, 1,400, 4,000 peak-to-peak.

Frequency response: ± 1 db, 25 cycles to 1 mc on 1.5- and 5-volt ranges (600 ohm source). 50 kc to 250 mc with accessory high-frequency probe.

Accuracy: $\pm 5\%$ full scale.

Input impedance: 1 megohm shunted by 135 pf on any scale (measured at input terminals).

Ohms

Ranges: Scale with 10 ohm-center $\times 1$, $\times 10$, $\times 100$, $\times 1000$, $\times 10K$, $\times 100K$ and $\times 1MEG$. Measures 0.1 ohm to 1,000 megohms with internal battery.

Dc Ma

Ranges: 1.5, 5, 15, 150 and 500.

Accuracy: $\pm 3\%$ full scale.

Size: 8- $\frac{1}{2}$ x 5- $\frac{1}{2}$ x 5- $\frac{3}{4}$ inches.

Weight: 4- $\frac{3}{4}$ lb.

Price: \$29.95 kit, \$59.95 wired.

Wiring this kit has been simplified by somewhat unusual terminal strips. They are similar to the ones used on some TV receivers before printed circuits became so popular with the production cost accountants.

It is not necessary to wrap the wire ends or component pigtails to secure them before they are soldered several steps later in the construction. Just poke them into the hole and they will stay there until all the other leads have been inserted. The chassis is then turned over and all the wired terminals soldered at once. Just make sure that you use enough solder and cook the joint long enough to prevent rosin joints. Poor soldering here can be even harder to locate than with conventional terminals.

To be sure you make the correct connections the first time, be slow and careful in wiring the selector switch—you will save many hours of troubleshooting later. It is difficult to make a mistake, if you follow the instructions completely. They are self-checking, and vari-colored wiring makes it even harder to go wrong.

One important step should not be bypassed. It is very important, and quite normal, to age the dual triode used in the vtvm circuit. Unless the tube is properly aged it may be impossible to get a constant zero reading when switching from - dc to + dc functions. Calibration will not be reliable, and it is annoying to have to zero the meter every time the function switch is rotated from one mode to another.

To speed tube aging, temporary jumpers are connected into the circuit. The grids and cathodes are connected together and the instrument is left on for some 60 hours.

The same results can be obtained just by letting the vtvm "cook" on the shelf without any temporary jumpers—it just takes longer.

Even if it is necessary to age the tube for a week, it is well worth the added stability of measurements made with the HM-1.—Elmer C. Carlson

GREAT NEW SCOTT KITS! AT A NEW LOW PRICE!

Have fun... save money... build the world's best stereo... with great new stereo kits from Scott. Scott's full-color instruction book and matching Part-Charts make these kits a breeze to put together... and, they'll give you and your family years of trouble-free enjoyment. The LT-110B FM stereo tuner incorporates famous Scott Sonic

Monitor and factory-wired, pre-aligned silver-plated front end and Time-Switching multiplex sections for top reception and stereo quality even in fringe areas. The LK-48B stereo amplifier includes switched front headphone output, powered center channel output for driving extension speakers, and many other unique Scott features.



LT-110B FM Stereo Multiplex Tuner \$139.95

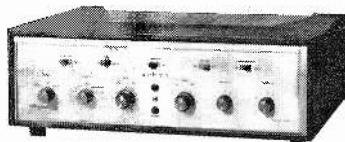

LK-48B 80-Watt Stereo Amplifier Kit \$129.95

FREE 24 PAGE BOOKLET

H. H. SCOTT, INC., 111 Powdermill Road, Maynard, Mass.

570-11

Rush me Scott's free 24-page Custom Stereo Guide:

Name _____ Address _____

City _____ State _____ Zip _____

SCOTT®

Export: Scott International, 111 Powdermill Road, Maynard, Mass.
Canada: Atlas Radio Corp., 50 Wingold Avenue, Toronto

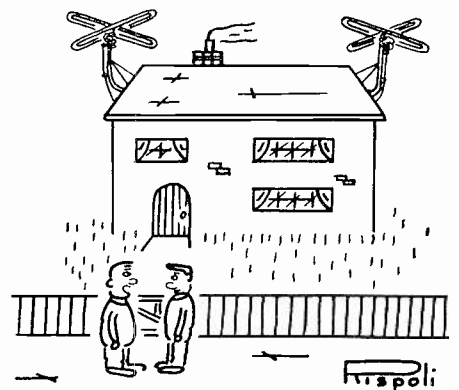

"I believe he's just installed a stereophonic system."

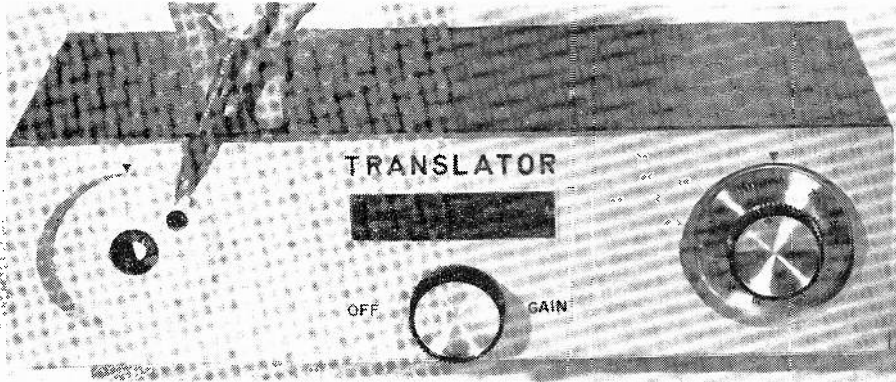

Vhf fine-tuning slugs for each channel are accessible through this hole behind vhf channel-selector knob.

Standard Kollsman VUT-1 Vhf-to-Uhf Translator

WITH FCC REGULATIONS REQUIRING ALL TV manufacturers to install uhf tuners on sets built since last April, we are going to see an upsurge in uhf activity. More sets will be coming into our shops to be checked for uhf operation. If the local station is not yet broadcasting full-time, checking may not be easy.

Uhf test equipment has been scarce in most shops because of the low demand and the high price. This Standard Kollsman translator is a sensible and economical answer to the problem of supplying a high-quality uhf test signal. The idea is simplicity itself and virtually

foolproof. A vhf antenna lead is connected to the vhf input terminals on the translator. The vhf dial is set for an active channel in your area. The uhf dial on the translator is set to any channel from 14 to 83. A lead from the uhf terminals is connected from the translator to the uhf terminals of the set to be checked. The uhf dial on the TV is set for the same channel as the one selected on the translator.

The signal picked up from the vhf station is now converted to a uhf signal that can be picked up on a uhf receiver.

continued on page 70

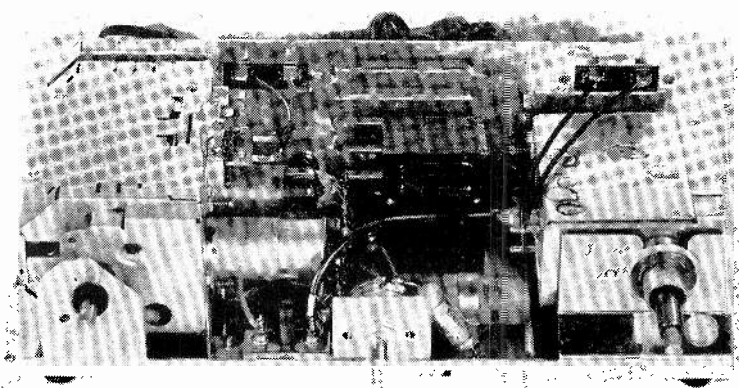

Inside, vhf tuner is on left and uhf on right. Power supply is in center.

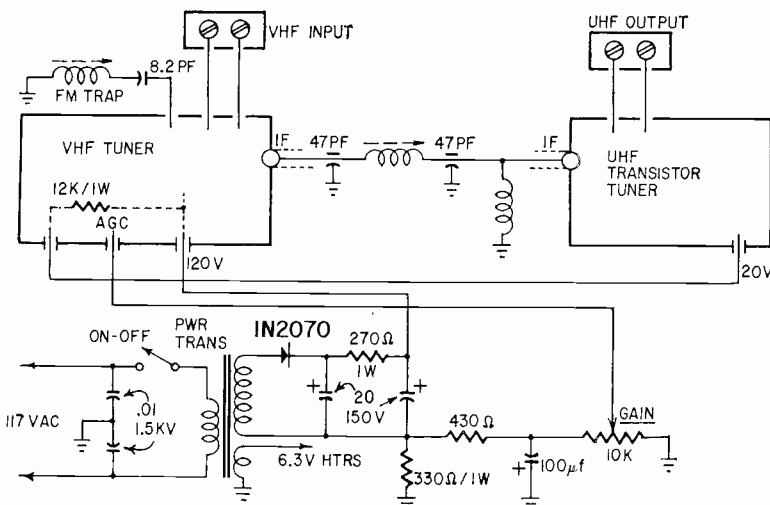

Block diagram of the VUT-1. It is hardly more than a vhf tuner, a uhf tuner and a common power supply.

**FOR
MOBILE
EQUIPMENT**



only \$5.95
user net

TRANSISTORIZED VIBRATOR ELIMINATOR VI-TRAN ELIMINATES VIBRATOR HASH INCREASES EFFICIENCY

The new Vi-Tran is a solid state vibrator eliminator for mobile units using mechanical vibrators. It has a high efficiency rating, conserves power, boosts output, eliminates noise, and costs only \$5.95. No tools required to install it; the Vi-Tran just plugs in.

The Vi-Tran is superbly engineered and thoroughly field tested. Oscillates as low as 5 volts; environmental test: -50°F. to +180°F. Power is maximum as authorized by FCC.

Two models are available:

- VE-194 P (vibrator pin #1 pos.)
- VE-195 N (vibrator pin #1 neg.)

In a dustfree aluminum case. Blister with complete installation instructions on card. Now at your local parts jobber or dealer. Or write:



I.E.H. Mfg. Co., Inc.

102 Prince St., New York, N.Y. 10012
(212) OR 7-1881 — TWX 212-867-7990

Subsidiary of Industrial Electronic Hardware Corp.

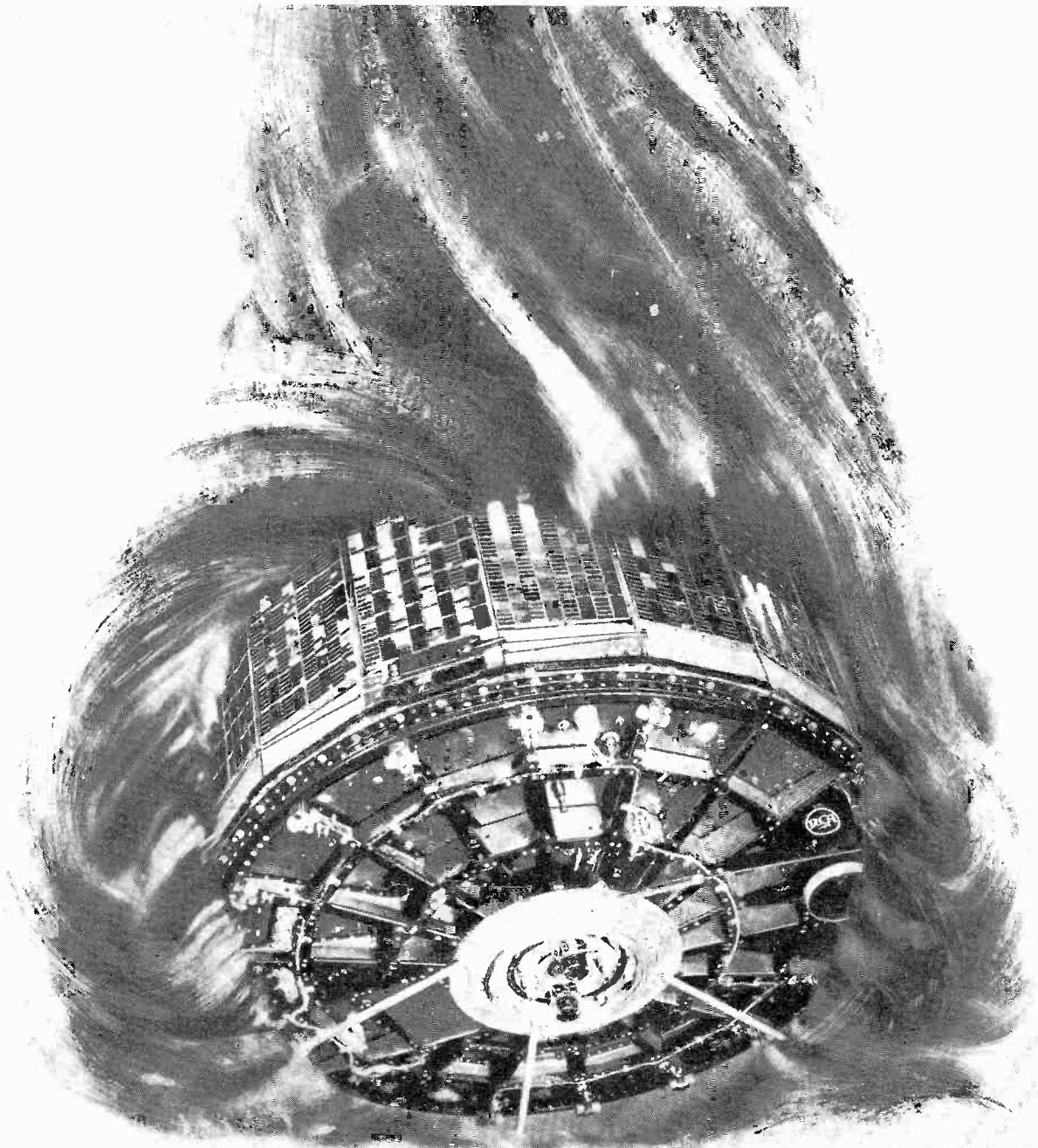

are you ready

FOR THE NEW AGE OF ELECTRONICS SPECIALIZATION?

RCA Institutes Home Training can help protect your future and increase your earning power

Career Security is Today's Problem. Before you finish reading this, another significant step forward will be made in some field of Electronics. A new advance in nuclear instrumentation. A breakthrough in automatic controls. An important development in computer programming. And so on. How will this affect your future? Will your career in Electronics be secure? These are today's vital career questions.

RCA Institutes Specialized Training is the Answer. Whatever field you may now be in, or no matter how advanced your present Electronics training may be, RCA Institutes has a Home Training Course exactly suited to your needs. With

RCA Institutes Specialized Training you can help to secure your present career and be in a better position to advance yourself. It's today's best career insurance.

Advanced Standing Available. If you are a person who works in Electronics, or who has had Electronics Training in the past, you may apply for Advanced Standing in any of the RCA Institutes Home Training Courses. If you are just starting out, you can also be assured of the same opportunities for professional success and security. RCA Institutes has Home Training Courses specifically designed to give you the required fundamental background on which to build a career.

HOME TRAINING

CHOOSE ANY OF THESE SPECIALIZED COURSES

- Automation Electronics
 - Automatic Controls
 - Industrial Applications
 - Nuclear Instrumentation
- Digital Techniques
 - Computer Programming
 - Transistors
 - Mobile Communications
- Communications Electronics
 - FCC License Preparation
 - Monochrome and Color TV
 - Drafting

RCA Institutes Home Training Courses are complete, step-by-step, easy to understand units. You get top quality equipment, and all kits furnished to you are yours to keep and use on the job. Doesn't it make sense to protect the investment you've

already made in your career, and look forward to a future of increased earning power? Send the attached postcard today for complete information. It won't cost you anything, and it may mean a great step forward to you. Act now!

JUST STARTING OUT IN ELECTRONICS? BEST HOME TRAINING TODAY IS RCA!

Full selection of beginning courses to choose from. Master the essentials of Electronics and go on to a profitable career now!

Faster, Easier Way to Begin — Exclusive With RCA Institutes. If you are considering a future in electronics, now is the time to start! The RCA "AUTOTEXT" Instruction Method developed by RCA and introduced by RCA Institutes, will help you master the fundamentals of electronics almost automatically. It is a system of programmed instruction, which has been proved with thousands of students. Even people who have had trouble with conventional home

training methods in the past, are finding it easier and more fun to begin their training this new way.

Liberal Tuition Plan. RCA Institutes liberal tuition plan affords you the most economical possible method of home training. You pay for lessons only as you order them. If, for any reason, you should wish to interrupt your training, you may do so and you will not owe one cent until you resume the course. No long-term obligations.

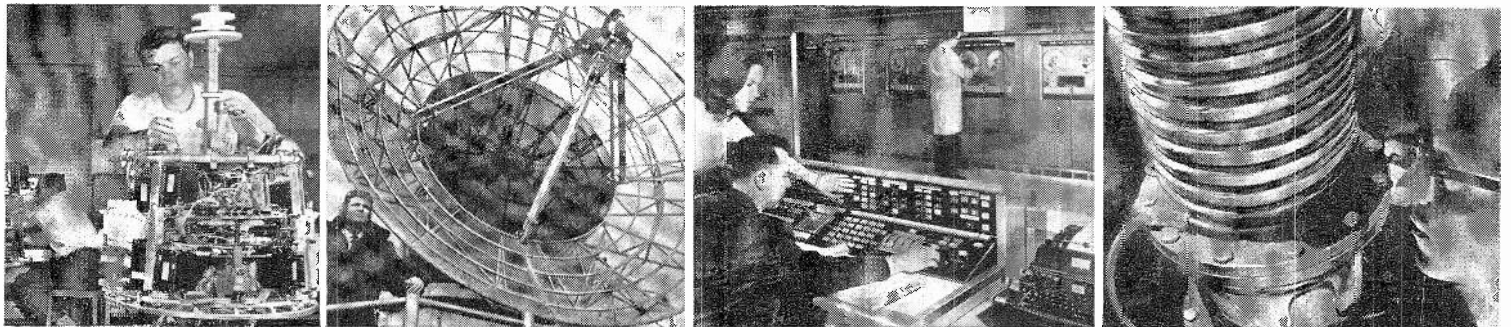

CLASSROOM TRAINING AVAILABLE

RCA Institutes Resident School in New York City offers classroom training that will prepare you to work in rewarding research and production positions in many fields of electronics. No previous technical training required for admission. You are eligible even if you haven't completed high school.

Coeducational Day and Evening Classes. You can prepare for a career in electronics while continuing your part-time or full-time employment. Regular classes start four times a year.

Free Placement Service. RCA Institutes Resident School graduates are now employed in important jobs at military installations, with important companies such as IBM, Bell Telephone Labs, General Electric, RCA, in radio and TV stations and in communications systems all over the country. Many other graduates have opened their own businesses. A recent New York Resident School class had 91% of the graduates who used the FREE Placement Service accepted by leading electronics companies, and had their jobs waiting for them on the day they graduated!

SEND POSTCARD FOR FREE ILLUSTRATED BOOK TODAY! SPECIFY HOME STUDY OR CLASSROOM TRAINING.

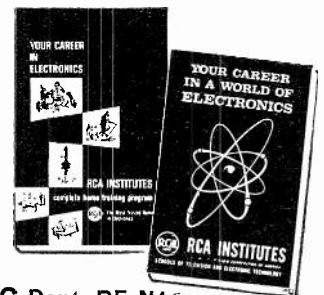

RCA INSTITUTES, INC. Dept. RE-N4

A Service of the Radio Corporation of America,
350 West 4th St., New York, N. Y. 10014



The Most Trusted Name In Electronics

testing...

IT'S EASY TO USE ELECTRONIC TEST EQUIPMENT

Larry Klein and Ken Gilmore

This book describes the basic electrical and electronic test instruments and outlines the techniques for using them. An extremely wide range of test instruments is covered, from very simple VOM to VTVM through signal generators, oscilloscopes, distortion analyzers and related accessories. 192 pp., illus. □ #308, paper, \$4.00.

1

PRACTICAL OSCILLOSCOPE HANDBOOK, 2 VOLS.

Rufus P. Turner

An up-to-date guidebook for everyone who wants to use the oscilloscope effectively in a wide variety of test situations. Volume I describes the operating principles and characteristics of the instrument and gives step-by-step directions for common tests and measurements. Volume II considers industrial and laboratory applications of the oscilloscope. 240 pp., illus. □ #339, paper set, \$5.90; □ #339-H, all in one cloth binding, \$6.95.

2

MODERN ELECTRONIC VOLTMETERS

Sol D. Prenskey

Reviews fundamental principles of the basic instrument, and covers the well-established service VTVM and transistor voltmeter test procedures. Also explains the more advanced voltmeters used in shop, industrial and scientific work. 232 pp., illus. □ #264, paper, \$4.95.

3

RECENT RIDER RELEASES

Advanced Servicing Techniques, Volume I

Paul Zbar and Peter Orne

Sponsored by the Electronic Industries Assn.

This is the first of two authoritative texts describing the latest servicing procedures for home electronic equipment.

Volume I covers all the modern troubleshooting and servicing techniques for every phase of color and black-and-white television. It also discusses transistorized and printed circuitry. Volume II, covering home audio equipment, coming off press in November. 298 pp., illus. □ #0363, Vol. I, cloth, \$8.25.

How to Service UHF TV

Allan Lytel

A guide for understanding the principles and peculiarities of uhf operation and the servicing of uhf front ends. A detailed analysis of essential uhf features plus step-by-step servicing procedures for uhf tuners and converters. 127 pp., illus. □ #382, paper, \$3.50.

Clip this ad and check the books you want to examine FREE. After 10 days, you can either remit payment, plus postage, or return the books without obligation. Mail to Dept. 753 —

JOHN F. RIDER PUBLISHER, INC.

116 West 14th Street, New York, New York 10011

Name _____

Address _____

City _____ Zone _____ State _____

70

Continued from page 65

For example, you can pick up channel 3 on the translator and "rebroadcast" it to a TV set on channel 26 (or any other uhf channel).

The circuit is a sort of "backward" superhet. The vhf signal is coupled into a 12-channel vhf tuner, where it is changed to a 40 mc i.f. This i.f. is then fed to the i.f. circuit of the transistor uhf tuner, where it beats against the uhf oscillator and is changed to a uhf frequency (diagram). A gain control prevents overload by placing a variable negative voltage on the agc input to the vhf tuner. A dropping resistor inside the vhf tuner reduces the voltage to the approximately 20 necessary.

The vhf tuner has adjustable slug-tuning for each channel, accessible through a hole behind the vhf channel knob. The uhf tuner uses continuous tuning with a vernier that locks in after a small rotation to provide "speed" tuning across the uhf band. For price, see your distributor.—Wayne Lemons.

Precision Voltage Reference Decades

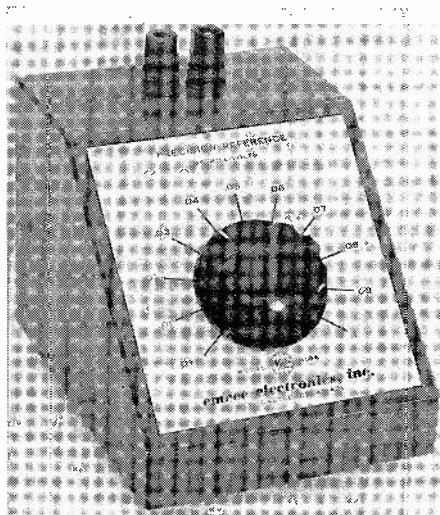

THE EMCEE PRECISION VOLTAGE REFERENCES offer an easy and accurate way to check calibration of scopes, amplifiers, meters, recorders, etc. They have a large decade scale on a sloping panel and are mounted in walnut-finished Bakelite cases. Each measures 4½ inches wide, 5½ inches long and 5¾ inches deep, and weighs 2 lb.

Four decades (the 1118A, -B, -C and -D) are available in separate units. Maximum values are 0.1, 1.0, 10 and 100 mv. The photo shows a 10-100- μ V

decade. Output is available at multiples of 10 μ V in this particular unit.

All units are accurate to within 0.5%. The voltage divider resistors are rated at 0.25% and are trimmed with high-value resistors shunted across them. Each is self-contained with its own power supply, a mercury cell with life of over 14,000 ma-hr, which equals a year or more. Output resistance of each decade is extremely low. In each case it equals the maximum mv scale reading. Thus, the 10-100-mv decade has an output resistance of only 100 ohms. Readings are accurate over a temperature range of 0-40°C. Short circuits do not affect accuracy of the output.

More than one decade may be connected in series to cover a wide range. The diagram shows how to connect all four decades to measure an unknown voltage. The indicator may be any sensitive galvanometer or dc detector. Each decade is adjusted until deflections from the unknown and the reference are identical. Then the unknown is read off the dials. For example, it may be 50 mv on the first decade, 4 on the second, 0.8 on the third and .07 on the last. Then the unknown is 54.87 mv. Scopes and meters may be calibrated by connecting the four units in series and applying the total voltage across the instrument's input terminals.

A single decade is useful for checking linearity as well as accuracy of a meter. For a microammeter, for example, the 10-100-mv decade may be connected with a limiting resistor (if necessary) in series to obtain full-scale reading. Then the decade provides a check of meter reading every 10% over the scale.

Each of the four decades is priced at \$39.50.—I. Queen

CORRECTION

A 24-26-volt, 1-amp center-tapped filament transformer is used to power the selective photoelectric circuit on page 38 of the July issue. A Stancor F-6469 or equivalent was recommended in the parts list. Somebody goofed. This transformer is not center-tapped. The Triad F-40X is the only center-tapped transformer with these ratings that we can find in consumer catalogs.

Our thanks to Mr. John L. Van Orden of Tacoma, Washington, for letting us know that he couldn't find the center tap on the transformer specified.

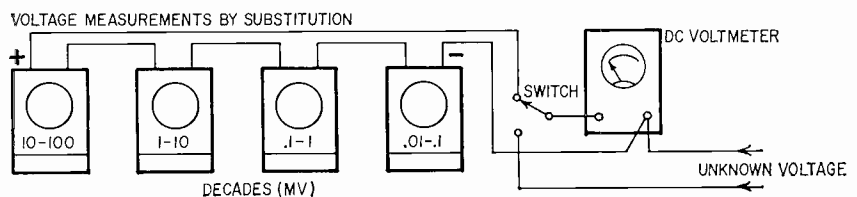

SAVE UP TO \$449...



Kit GD-983
\$849⁰⁰
 (Includes Bench)

\$125 Down
 As low as \$27 per month

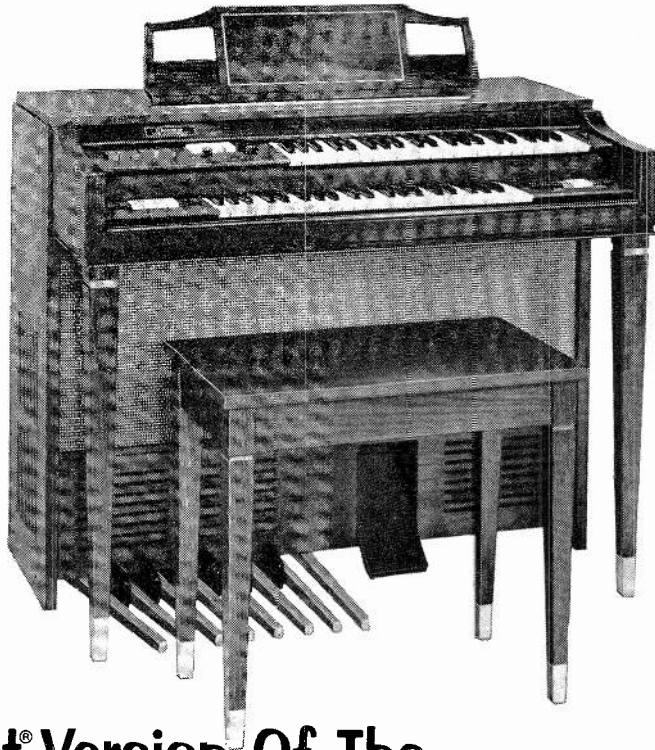

On This NEW Heathkit® Version Of The Thomas "Coronado" All-Transistor Organ!

A Professional Organist's Dream With A Beginner's Simplicity!

That's the new Heathkit/Thomas "Coronado" All-Transistor Organ with every deluxe organ feature you've ever dreamed of for complete versatility! And it's all wrapped up in a luxurious piece of walnut furniture that will be the show-piece of any home. It's all yours to enjoy at a savings that can't be found anywhere else... up to \$449! It's like getting 1/3 off!

Simple To Build, Simple To Play!

You don't have to be an electronics wizard to build it, nor a professional organist to play it. Famous Heath "Engi-nuity" has reduced assembly of this magnificent instrument to simple-to-perform steps that require no special talents, knowledge or tools. Makes a fascinating, enjoyable project for the entire family! And the famous Thomas "Musical Fun Book" is included to start you easily playing many favorite tunes immediately. A special, recorded, 48-lesson course is also available at a \$30 savings to provide you with a firm and lasting knowledge of music... lets you learn at your leisure! Before you know it, you'll be creating the sounds of an entire orchestra!

Each and every component in the GD-983 is a genuine Thomas factory-fabricated part. And its advanced all-transistor circuitry means less heat, better tone, longer life, and virtually trouble-free performance.

You even tune the organ yourself with the aid of a prealigned tone generator and a special counting method... requires no special "musical ear"!

What's It Like To Own This Beautiful Organ? Playing this luxurious Heathkit/Thomas "Coronado" is truly a rewarding activity that becomes more exciting, more fascinating each day! Just think of its many advantages!

- 1. A Hobby For The Whole Family**... every one from Mom to Junior can share the fun and ease of building and playing it. Provides a creative common family interest.
- 2. Develops Musical Interest & Expression**... less complicated than other instruments, the organ is ideal for teaching children as well as grown-ups a priceless knowledge and appreciation of music.
- 3. Parties Come Alive**... you're a one-man band when friends gather for an evening of fun. And teens love the rhythm and bounce of its wealth of musical effects.
- 4. Provides A Wholesome Creative Outlet**... helps you unwind, forget your problems, and ease tensions.

Check the features, then send for the demonstration record and hear it for yourself. You'll agree that there's not a better organ buy on the market today than the Heathkit/Thomas "Coronado"!

Kit GD-983, Organ & matching walnut bench, 290 lbs. \$849.00

Compare These Features With Organs Costing Twice As Much!

- 17 true organ voices • Two full-size 44-note keyboards • Built-in 2-speed Leslie speaker plus 2-unit Main speaker system • 28 notes of melodious chimes for hundreds of chime variations • 13-note heel & toe pedal board, range C thru C • New stereo chorus for exciting "stereo" effects • Color-tone Attack, Repeat & Sustain Percussion... the only organ to give you all 3 • Treble accent • Reverb • Manual Balance • Pedal Volume Control • Expression Pedal • Headset outlet for private playing • 5-year warranty on transistor tone generators • 75-watt peak power transistor amplifier • Hand-crafted, full-bodied, walnut-finished cabinet, completely assembled • Matching bench included.

HEAR IT YOURSELF!

Convince yourself by sending for a 7", 33 1/3 demonstration record! Order No. GDA-983-2 for Deluxe GD-983 organ, GDA-232-5 for low-cost GD-232A organ. Each record 50c. Do it now!

Save \$150 On The
 Heathkit/Thomas
 "Largo" Organ!

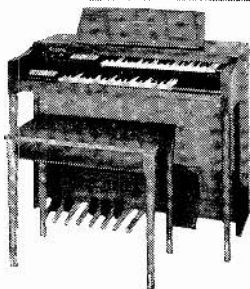

- 10 true organ voices • Variable Repeat Percussion for additional effects • Two 37-note keyboards • 13-note heel & toe bass pedals • 20-watt peak power amplifier • Walnut cabinet • Transistorized plug-in tone generators... warranted for five full years • Expression pedal.

Kit GD-232A, organ only, 158 lbs. \$349.95

HEATH COMPANY, Dept. 20-11-1

Benton Harbor, Michigan 49023

Please reserve GD-983

Organ for Nov. delivery.

Enclosed is \$ _____.

Please send model _____.

Please send Free 1965 Heathkit Catalog.

Name _____
 (Please Print)

Address _____

City _____ State _____ Zip _____

Prices & specifications subject to change without notice. CL-192

MORE EXCITEMENT FROM QUAM!

you can easily
handle any
auto radio speaker
replacement

with Quam speakers and
rear seat kits — multi-taps
and exact replacements —

Eight speaker sizes handle virtually any auto radio replacement—but size alone is not enough. You need the right voice-coil impedance—and QUAM has it! Choose multi-tapped models for stocking convenience; or, for specific applications, one of the 25 Quam exact replacements. (In addition, any Quam speaker may be special-ordered with any voice-coil impedance for an extra \$1.00 list. This service is a QUAM exclusive.)

Write for your free copy of the Quam Auto Radio Speaker Replacement Guide. It gives complete replacement information on front and rear seat speakers for auto radio models from 1955 to 1963.

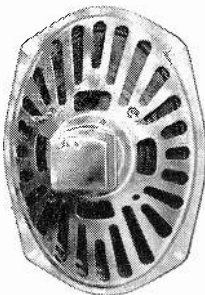

New Quam Multi-Tap Speakers in 5"x7", 6"x9", and 4"x10" sizes. Taps for 10, 20, and 40 ohm impedances.

QUAM

QUAM-NICHOLS COMPANY
234 E. MARQUETTE ROAD
CHICAGO, ILLINOIS 60637

AUDIO EQUIPMENT REPORT

Thorens TD-224 Turntable and Record Changer

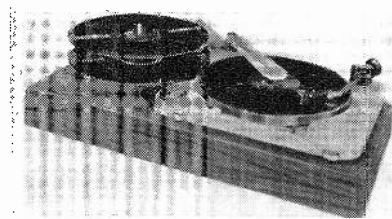

IT DOESN'T LOOK LIKE THE FAMILIAR "record changer." Nor does it look exactly like a "turntable." No spindle or shaft protrudes straight or eccentrically from the center of the moving turntable. And there is an unusual configuration of two "arms" extending out and away from the left side of the unit. You don't stack records above the turntable, as one usually does with a record changer. You don't lift the stack off the turntable at the end of the completed cycle of play, either. You do stack the records on the upper of the two left side arms. You do remove them from the lower side arm. How the "stack" gets from the upper to the lower side arm is a bit of automation that is fascinating to watch.

Imagine a firm but gentle hand removing an individual record from a stack alongside a turntable, placing it carefully on the turntable, waiting until the record is played, lifting it gently and placing it on another stack. Then the hand moves back to the stack of unplayed records and repeats the procedure automatically.

There are specific benefits in such a technique for playing records automatically. Never is there more than one record on the moving turntable. This enables the relationship between the stylus axis and the record being played, and between the plane of the pickup arm and the turntable's surface, to remain constant.

The result is that vertical tracking error is as small as it would be with a conventional, manually operated turntable, and is maintained constant. Record groove and stylus wear are not increased as they often are in a stacking type of player.

The turntable-changer mechanism is unusually quiet for a machine that performs so many complex functions. It takes approximately 21 seconds from the time the REJECT lever is actuated for the mechanism to raise the pickup arm automatically, remove and stack the played record, pick up a fresh disc and place it on the turntable and then lower the pickup to the starting groove. No doubt the smoothness is due to the use of ball bearings and large-diameter pil-

lars for critical sliding and interlocking members. Extravagant use is made of castings for sections subjected to torsion and special stresses.

A further benefit of having no more than one record on the moving turntable at any time is that motor torque is constant throughout the complete cycle of playing the stack of records. This assures constant turntable speed.

A stroboscope is built into the unit. A "window" in the turntable deck just in front of the moving turntable lets you view a dot pattern by a neon lamp.

The speed adjustment is a knob placed coaxially with the 16-, 33 $\frac{1}{3}$ -, 45- and 78-rpm selector. The speed is adjusted only for 33 $\frac{1}{3}$ rpm. The manufacturer claims that it will then be correct for the other three settings, and will be constant within 0.1%.

A cute touch is the device that cleans the records as they play. The manufacturer says that up to eight records or a $\frac{3}{4}$ -inch stack can be handled. This is conservative because I repeatedly played ten 12-inch records without jamming or mechanical interference. Records of any diameter from 7 to 12 inches can be intermixed.

The pickup arm is the well known Thorens BTD-12S. Two cartridge shells are supplied. The arm is equipped with ball bearings on all axes. The pickup is electrically muted, without clicks, during the change cycle.

So often the instruction manual is terribly neglected by the manufacturer. [And by the user!—*Editor*] In this case, the manual has been given first-rate treatment. At the very beginning of the instructions a bold-face phrase asks, "Are you anxious to start playing?" Then there is an asterisk (*) and "Follow these signs for the essential instructions for installation and final adjustments before play," and a large dot (•) with, "Follow these signs for essential operating instructions."

The Thorens TD-224 is by no means small. The base (an accessory) measures 27 inches wide, 14 $\frac{1}{2}$ inches deep, and 4 $\frac{1}{2}$ inches high. Height requirement is 9 $\frac{3}{4}$ inches overall. The changer sells for \$250 less cartridge. Walnut base is \$25.

Incidentally, the TD-224 can also be operated as a manual transcription turntable. The manufacturer suggests that you handle your records as gently as the changer does.—*Leon A. Wortman*

CORRECTION

In last month's Audio Report, the price of the University Tri-Planar speaker system was quoted incorrectly. It should have been \$79.95.

Regardless Of What You Pay For Other Color TV

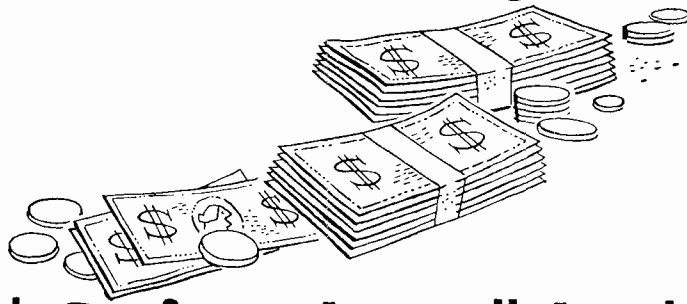

It Can't Perform As Well As This One...

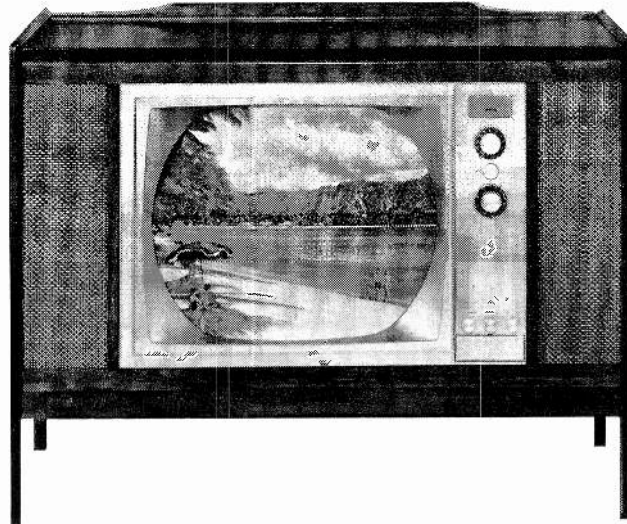

And Yet A Heathkit® Set Costs As Little As \$399!

Exclusive Heath Features For Unequalled Performance! That's right. No matter how many of your hard-earned dollars you pay for another brand of color TV, *none* can equal the performance of the Heathkit All-Channel, High Fidelity 21" Color TV! Why? *All* color sets require minor periodic adjustments to maintain peak picture performance. The Heathkit GR-53A is the *only* set with a "built-in service center" that provides the facilities for perfect picture adjustments. Heath's simple-to-follow instructions & detailed color photos show you exactly what to look for and how to achieve it . . . quickly, easily! You become the expert! Result? Beautiful, true-to-life color pictures day in and day out . . . and *no* costly color TV service calls for simple picture alignment!

And since you service & maintain the set yourself, a costly service contract isn't required! Heath warrants the picture tube for 1 year, all other parts for 90 days.

No Trade-In Required!

Keep your present set as a handy "second" set for the den, bedroom, children's room, etc.

Quick & Easy To Assemble!

No special skills or knowledge required. All critical assemblies are factory-built and tested. Simple step-by-step instructions take you from parts to picture in just 25 hours!

Convenient Time-Pay Plan!

Only 10% down, and the rest in easy monthly installments. Get *free* catalog for full details.

Finest Components, Most-Advanced Circuitry With the Heathkit GR-53A you're assured of the finest parts and most advanced color TV

circuitry that money can buy . . . at up to \$200 savings. You enjoy rock-steady pictures with no overlap or color fringing.

But Don't Take Our Word For It!

See the special articles on the Heathkit GR-53A in the May issue of *Popular Electronics*, June issue of *Radio-TV Experimenter*, February issue of *Popular Mechanics*, April issue of *Science & Mechanics*, and the August issue of *Radio-Electronics!*

Now Compare The Features . . . And The Price!

In addition to the ones already mentioned, there's the high definition 70° 21" color tube with anti-glare bonded safety glass; 24,000 volt regulated picture power; 27 tube, 8 diode circuit; deluxe Standard-Kollsman VHF tuner with push-to-tune fine tuning for individual channels and transistorized UHF tuner for all-channel (2-83) reception; automatic color control and gated AGC for peak performance; line thermistor for longer tube life; two hi-fi outputs plus tone control; transformer operation; chassis & tube mounting on sturdy one-piece metal support for easy set-up and servicing; plus a low price of only \$399.

Use The Coupon & Order Yours Now!

And be sure to check the appropriate box to get your Free new 1965 Heathkit Catalog with complete descriptions & specifications of the GR-53A as well as over 250 easy-to-build kits!

Kit GR-53A, chassis, tubes, mask, UHF & VHF tuners, mounting kit, and special 6" x 9" speaker, 127 lbs. \$399.00

The Only Color TV You Can Install 3 Ways!

1. In New Heathkit Deluxe Walnut Cabinet (Illust. above), model GRA-53-7, 85 lbs. \$115.00
2. In Heathkit walnut-finished hardboard cabinet (Illust. below), model GRA-53-6, 52 lbs. . . \$49.00
3. In a wall, bookshelf, or custom cabinet!



FREE! 1965 Heathkit Catalog!



HEATH COMPANY, Dept. 20-11-2
Benton Harbor, Michigan 49023

Enclosed is \$ _____, plus shipping.
Please send Model(s) _____.

Please send FREE 1965 Heathkit Catalog.

Name _____ (Please Print)

Address _____

City _____ State _____ Zip _____

CL-193
Prices & specifications subject to change without notice.



Use the

Magneraser[®]

—the Original and still the best!

Quickly erases a reel of magnetic tape or sound film of any size or type. Erasure is 100% complete even on severely overloaded tape. Lowers background noise level of unused tape 3 to 6 db. Also demagnetizes record-playback and erase heads. Only \$24.00. Two-Year Guarantee. Available at your dealer's or write us.

New ULTRA-SENSITIVE FLUTTER METER

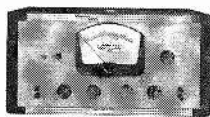

With built-in Three-Range Filter, 3 kc Test Oscillator, High Gain Preamplifier and Limiter. Filter Ranges: 0.5 to 6 cps; 0.5 to 250 cps; 5 to 250 cps.

Designed for rapid visual indication of flutter and wow. Meets standards set by the IEEE . . . Condensed Specs.: Input Voltage, 0.001 to 300 Volts; Ranges, 0.01 to 3%; Limiter Range, 20 db.; Oscillator (built-in), 3000 cycles; Net Price, \$495.00 . . . Write for complete specifications and free 12-page booklet on Flutter

AMPLIFIER CORP. of AMERICA

398 Broadway, New York 13, N. Y. • WO 6-2929

build your own bozak

URBAN OR EARLY AMERICAN INFINITE-BAFFLE SPEAKER CABINETS

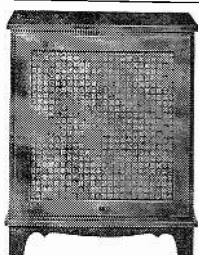
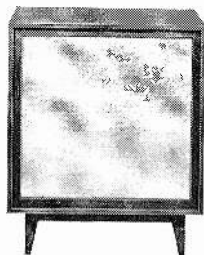

For the Bozak 2-way B-300 and 3-way B-302A Speaker Systems. Complete Kits for easy assembly and finishing.

Bozak

See your Franchised Bozak Dealer DARIEN / CONNECTICUT

New Semiconductors and Tubes

LOW-PRICE SILICON PLANAR LINE

A wide line of mass-produced silicon planar transistors aimed at "consumer" applications as well as industrial uses has been announced by General Electric. The devices have the features common to most silicon devices: wide operating temperature range, low leakage and long life.

One type, the 2N2926, is priced at 22 cents each in quantities of 100,000—a bit more than you'll need at first, but that means that silicon transistors, till now limited mostly to high-priced industrial and military stuff, may begin appearing in radios, hi-fi's, TV sets and so forth.

The cases of these transistors are epoxy, 0.185 inch in diameter and 0.260 inch high.

Ratings vary widely with intended use, but the general-purpose types have an h_{fe} (small-signal current gain) of 75 to 180 *minimum* at 1 kc, collector-to-emitter breakdown ratings of up to 50 volts, and a gain-bandwidth product (typical) of 160.

11LQ8, 22JU6

These two new tubes are designed to meet the demands of television. The 11LQ8 is a 9-pin miniature tube containing a medium- μ triode ($\mu = 46$) and a high-transconductance, sharp-cutoff pentode ($g_m = 21,000 \mu\text{mhos}$). The triode may be used in general-pur-

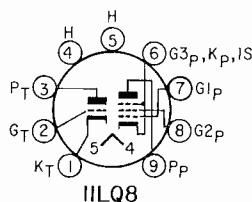

pose voltage amplification, as sync separator or sound i.f. amplifier. The pentode is suited as a video output stage. It has a controlled plate-current "knee" so that it is linear at low plate voltages—like 125. At that voltage, it draws approximately 19 ma plate current and

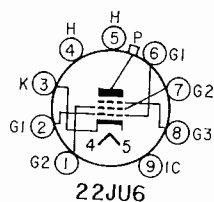

3.8 ma screen current with a cathode resistor of 82 ohms.

The 22JU6 is a horizontal output

tube with a novar base and a 22-volt 0.45-amp heater. It, too, is designed to operate at remarkably low B-plus voltages—around 140. Plate dissipation is 17 watts maximum; average cathode current, 275 ma maximum; transconductance, 7,000 μmhos . The plate is designed especially to minimize secondary emission, and the tube as a whole is made to respond to low grid 1 driving voltages.

Grid 3 is brought out to a separate base pin so that a positive voltage can be applied to it to minimize "snivets".

HF SILICON POWER TRANSISTORS

Progress in high-frequency, high-power, high-gain transistors continues. The limitation now is not so much frequency or power (plenty of transistors can deliver several watts at 50 or 100 mc or more), but gain. The silicon structures for those frequencies always seem to end up with little power gain—often as little as 4 to 6 db ($2\frac{1}{2}$ to 4 times).

A new line from Clevite Semiconductor, the 3TE100 series, has reasona-

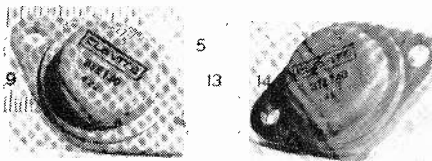

ble gain with considerable power. The 3TE120, the highest-power device in the line, in a "diamond" TO-3 case, can put out more than 50 watts of rf at 70 mc, with 8 db gain, at a supply voltage of 28. Key to the new design is the emitter-to-case connection (instead of collector to case, as usual). This reduces input and feedback capacitances, according to the manufacturer.

Other units in the line show decreasing output powers and increasing gains. The 3TE160, at the other end, delivers 0.6 watt with 14.7 db gain at 70 mc, 40 volts supply.

The one factor we didn't juggle above is price: still to be reckoned with. The smallest of the lot, the 3TE160, costs \$12. The biggest, the 3TE120, with its low gain and all, costs \$185.

3-AMP LEAD-MOUNT RECTIFIERS

A new MR1030 series of silicon rectifiers just announced by Motorola offers a 3-amp continuous forward rectified current rating in a lead-mounting (not stud-mounting) package. Pretty good, hey? You have your choice, too, of whether you want a lead out each end or both leads out the same end (axial or single-ended, respectively), and whether you want normal polarity (cathode to case) or reverse polarity (anode to case, denoted by an "R" after the type number).

These units should be especially interesting to all who want to build medium-to-high-current transistor power supplies, battery chargers, etc., but balk at the mounting problems for stud-

continued on page 80

For The Stereophile With An Eye...

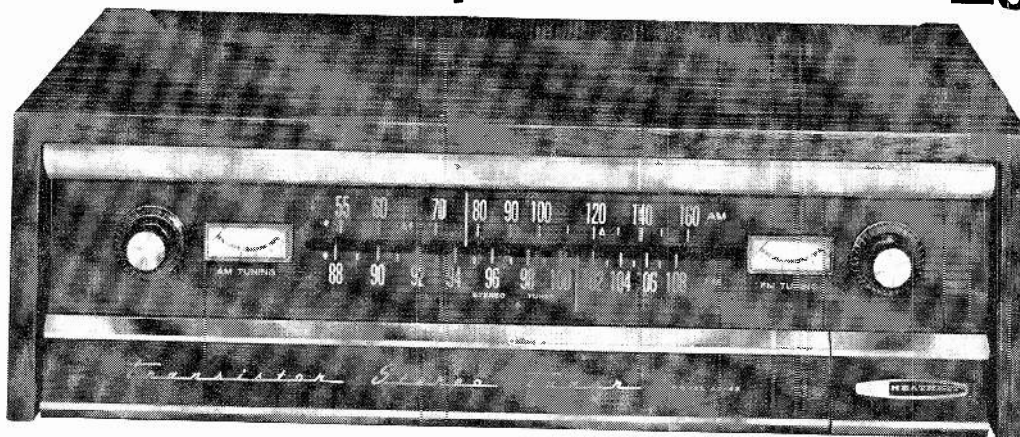

As Appreciative As His Ear...

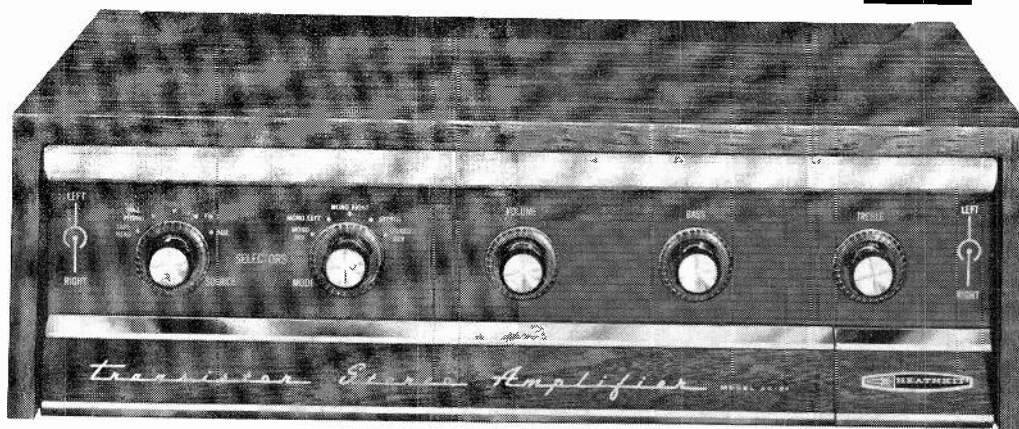

New Heathkit® Deluxe Transistor Stereo!

Luxurious New Walnut Cabinet Styling!

Do you consider appearance as carefully as performance when choosing stereo components? If you do, then you'll delight in the *new look* of Heathkit Deluxe Transistor Stereo! Sleek, richly warm walnut cabinets. Clean, uncluttered charcoal gray upper front panels. Soft, refracted panel lighting. Hinged, lower front walnut panels to neatly conceal all secondary controls and avoid accidental system setting changes. Beautiful enough to capture the spotlight in any room!

And The Sound?

As modern and beautiful as the new styling. Transistor sound with its broad, clean, unmodified response . . . no compromising! Add cool, instant operation, simplicity of assembly and the low Heath prices . . . and you have the best value in transistor stereo today — bar none!

Under These Beautiful Cabinets . . .

you'll find the most advanced solid-state circuitry. The magnificent Heathkit AJ-43 Stereo Tuner features 25 transistors and 9 diodes . . . wide-band AM, FM & FM Stereo to satisfy any listening wish . . . *automatic* switching to stereo plus an automatic stereo indicator light that signals when stereo is received . . . filtered left & right channel outputs for direct, beat-free stereo recording . . . separate AM & FM tuning meters . . . automatic frequency control to lock in de-

sired station for rock-steady, drift-free reception . . . automatic gain control that eliminates "blasting" or "fading" of incoming signals, keeps volume constant . . . adjustable FM squelch to let you tune across the dial *without* annoying between-station noise . . . stereo phase control for maximum separation, minimum distortion . . . and a factory-built & aligned FM "front-end" tuner and 5-stage FM I.F. circuit board for quick, easy assembly!

Matching Heathkit AA-21 Stereo Amplifier!

This superb unit boasts a 26 transistor, 10 diode circuit that produces 70 watts continuous, 100 watts IHF music power at ± 1 db from 13 to 25,000 cps. And you enjoy complete freedom from microphonics, effortless transient response, and cool instant operation . . . characteristics unobtainable in tube-types.

In addition, there are complete controls, plus all inputs and outputs to handle any program source & most speaker impedances. Circuit safety is assured with 5 fast-acting, bi-metal circuit breakers . . . no fuses to replace ever! Transformerless output circuit and multiple feedback loops provide fine fidelity and low distortion levels.

With its encapsulated, epoxy-covered circuit modules and five stable circuit boards, the AA-21's assembly is fast, simple and fun . . . requires *no* special skills or knowledge!

Please Your Ear, Your Eye & Your Sense Of Value!

Choose this matched Heathkit Transistor Stereo pair now for better performance and appearance at lower cost!

Kit AJ-43C, tuner, 19 lbs. \$129.95
Kit AA-21C, amplifier, 29 lbs. \$149.95



FREE 1965 HEATHKIT CATALOG
See these and over 250 other exciting Heathkits available in easy-to-build kit form. Save 50% or more by doing the easy assembly yourself! Send for your free catalog today!

HEATHKIT

HEATH COMPANY, Dept. 20-11-3
Benton Harbor, Michigan 49023
In Canada: Daystrom, Ltd., Cooksville, Ontario

Enclosed is \$ _____, plus shipping.
Please send Kit _____

Please send FREE 1965 Heathkit Catalog.

Name _____
(Please Print)

Address _____

City _____ State _____ Zip _____

Prices & specifications subject to change without notice HF-177

No matter what job you have today CIE can help you move ahead ...fast!



It's a fact. The men holding down high-paying, challenging jobs in electronics have one thing in common . . . they *know* practical electronic theory. And now . . . thanks to Cleveland Institute of Electronics . . . you can join this select group of successful men. First, find "you" in the picture. Second, read about the CIE Program that matches your present occupation. Third, fill out the postage-paid reply card and drop it in the nearest mail box. You'll soon see why modern, effective CIE Home Study has helped thousands move ahead in electronics . . . can do the same for you. But act now. The demand will never be greater for ambitious men who *prepare* themselves for the top jobs in electronics.

1 Radio-TV Servicemen: Boost your business fast. Get your Commercial FCC License and service mobile radios used by police and fire departments, taxi and truck fleets . . . also maintain marine electronics, broadcast station equipment, CB, etc. CIE's First Class FCC License program is the quick risk-free way to prepare for the tough FCC exam. Switching to a job in industry? With our comprehensive Electronics Technology program under your belt . . . you're a cinch to get just the one you want.

2 "Ham" Operators: Turn that hobby into a profitable profession. Prepare for a rewarding job at one of the country's 5,000 Commercial Radio and TV stations. CIE's Broadcast Engineering program will teach you how to select, use, maintain all types of Radio and TV station broadcasting equipment; also prepares you for the First Class FCC License.

3 Communications Specialists: Want a top job with a telephone company, a railroad, a pipeline company or any firm with a big stake in communications? CIE's Electronic Communications program will change that wish to reality. Covers mobile radio, microwave; carrier telephony, too, if you want it. Gets you a Second Class FCC Ticket.

4 Military Electronic Specialists: Staying in . . . or getting out, CIE's Electronics Technology program will help nail down your next promotion . . . or land that first high-paying job in civilian life. You'll learn new electronic principles . . . know how to apply them for troubleshooting all types of electronic equipment.

5 Electricians: Electronics is here to stay! CIE's Industrial Electronics and Automation program takes the mystery out of "exotic" new industrial control systems, electronic heating and welding, servomechanisms, solid state devices, ultrasonics, X-ray . . . has everything you need to understand your new electronic equipment.

6 Ambitious Men . . . anywhere: Electronics is the world's fastest-growing industry . . . a 17 billion dollar business that's grown 400% in the last 10 years. Right now there are thousands of good steady jobs just waiting for trained men. CIE's Electronics Technology program provides

complete understanding of electronics theory and fundamentals . . . prepares you for the First Class Commercial FCC License. Whether you're in Electronics now . . . or just thinking about changing to this exciting career field; whether you work in industry, business, government, or the military . . . this is the program for you.

CLEVELAND INSTITUTE HOME STUDY IS FAST, ECONOMICAL, EFFECTIVE. HERE'S WHY:

Modern up-to-date material . . . including three exciting new subjects. Every day . . . the Electronics Industry sees new developments in equipment, design methods, application techniques. CIE lesson material keeps pace. For example . . . our new Troubleshooting lessons give you a fast, systematic method of locating faults on *any* electronic equipment. New lesson material on Transistors covers this vital subject clearly, concisely . . . shows how they work, where and how you use them. And a new Micro-miniaturization lesson describes all types of micro components . . . explains such critical subjects as integrated circuits and microwatt electronics. It's the kind of knowledge you want—the kind of knowledge you'll use!

An FCC license . . . or your money back. All CIE Programs (except Industrial Electronics and Advanced Engineering) are backed by our famous Commercial FCC License Warranty: "*If you fail the FCC exam for the License specified after completing your program . . . all tuition will be refunded.*" Compare this to any other FCC License offer. You'll see it's about as close to a sure thing as you'll ever find!

"Check-point" programmed learning . . . plus FCC Progress Reviews. CIE Home Study works! You learn at *your* best learning speed. All material comes in small, easy-to-understand segments . . . is "locked-in" by examples, diagrams, explanations. You learn thoroughly . . . and remember what you learn! And FCC Licensing Programs include special Progress Reviews covering hundreds of questions and answers just like those on the FCC License Exam.

Free nationwide job placement service . . . for life, for every CIE graduate. Every 60 days . . . while you're a student and after graduation CIE will send you an up-to-date list of many high-paying job opportunities with top companies across the country. We'll also provide you with 200 professionally-prepared resumes to help you land the job you want!

Thirty years of experience . . . highly qualified instructors . . . accredited. Since 1934, Electronics home study has been Cleveland Institute's *only* business. Our instructors are experts in electronics and are currently training some 15,500 students. We are accredited by the Accrediting Commission of the National Home Study Council. This Commission has been approved by the U. S. Office of Education as a "nationally recognized accrediting agency" under the terms of Public Laws 82-550 and 85-864.

Now is the time
to make your move in Electronics
Mail Reply Card Today



Cleveland Institute of Electronics

Dept. RE-97 1776 East 17th Street Cleveland, Ohio 44114

continued from page 74

mount rectifiers in a bridge circuit.

The 3-amp current rating is at an ambient temperature of 75°C, by the way—about the temperature of really hot household tap water. The units are available in peak-inverse-voltage ratings

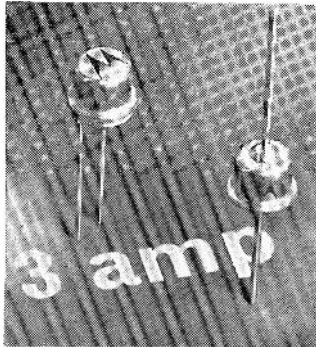

from 50 to 600 volts, numbered MR1030, -1031, etc., to -1036. Half-cycle surge rating is 300 amps.

The high heat-dissipation capability is a result of "increased semiconductor junction area combined with a slight increase in lead diameter." Prices start at about \$0.55 for the 50-volt rectifier (quantity 1-99 pieces). All units are about 3/8 inch in diameter by about 3/8 inch high.

DTG 1000, 2000, HI-POWER GERMANIUMS

Two new series of germanium high-

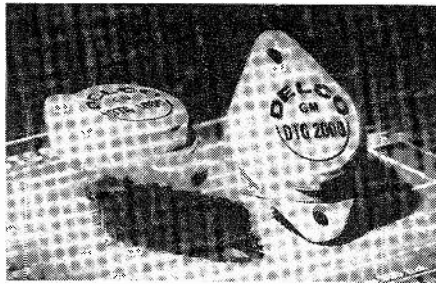

power transistors with current ratings of 15 and 25 amperes, respectively, are available from the Delco Radio Div. of General Motors Corp. Selected units have collector-to-emitter voltage ratings as high as 325—rather unusual for germanium transistors. The DTG 1000 series is intended for auto ignition and for TV horizontal and vertical deflection output stages, or wherever a high peak power needs to be switched.

All members of the series are in the TO-3 diamond-shaped package.

AFC VARIABLE-CAP DIODES

A new voltage-variable-capacitance diode, designed specifically for afc and tuning in home-entertainment FM sets, has been announced by Texas Instruments, Inc. The principal attraction of the new device, called the A660, is its Q of 230 at 50 mc, compared to average Q's of 20 for similar competitively priced diodes.

Another feature is the close production tolerances maintained for the

diode. Both Q and capacitance values are claimed to "track" very well from one diode to another, which is expected to simplify mass production of FM front ends, for example.

The A660 diode is relatively inexpensive compared to previous variable-capacitance diodes—\$1.25 in quantities from 1 to 99 to original-equipment manufacturers. Additional information is available from Semiconductor Components Div., Texas Instruments, Inc., 13500 North Central Expressway, Dallas, Tex. END

Q-Multiplier Sharpens Code Reception

WHEN LISTENING TO CW SIGNALS, YOU can use much higher selectivity than on AM. Indeed, this is one of the advantages of code over phone. An i.f. amplifier can be modified very easily to add selectivity and gain, making it more useful for CW reception. Instead of ground-

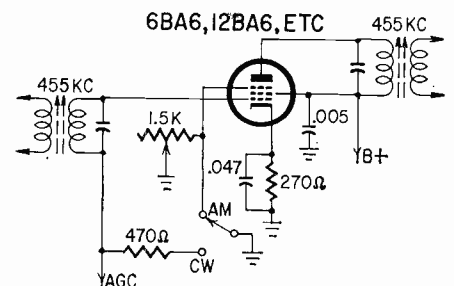

ing the suppressor, a variable resistor is connected in series, to cause regeneration.

For the sharpest tuning, the 1,500-ohm resistor is adjusted slightly below the point of oscillation with the switch in CW position. The switch also shorts out the agc (or avc) to receive code. When switched to AM, the suppressor is grounded and agc restored.

Increasing the resistance further results in oscillation. Then the circuit becomes a bfo, as well as an i.f. amplifier.

This circuit is disclosed in patent 3,107,333, issued to Robert J. Orwin and assigned to Hallcrafters Co.—*J. Queen*

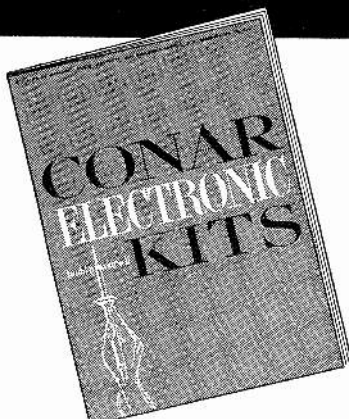

Your new copy is waiting

FREE! For fun and pride in assembly, for long years of pleasure and performance, for new adventures in creative electronics mail the coupon below and get Conar's brand new catalog of quality do-it-yourself and assembled kits and equipment. Read about items from TV set kits to transistor radios . . . from VTVM's to scopes . . . from tube testers to tools. And every item in the Conar catalog is backed by a no-nonsense, no-loopholes, money-back guarantee! See for yourself why Conar, a division of National Radio Institute, is just about the fastest growing entry in the quality kit and equipment business.

CONAR

MAIL THIS COUPON NOW

CONAR 3939 Wisconsin Ave., Washington 16, D.C. MC4C
Please send me your new catalog.

Name _____

Address _____

City _____ State _____ Z-Code _____

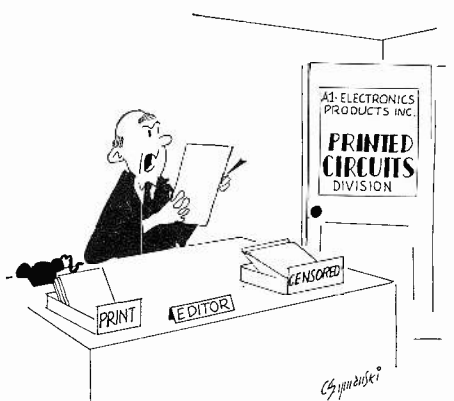

"Where's the illiterate who spells 6BR8 with a single cathode?"

Which Stereo Receiver Is Your Best Value?

BRAND	IHF POWER	TUNER	CIRCUIT	PRICE
A	70 Watts	AM-FM FM Stereo	Transistor	\$369.95
B	80 Watts	AM-FM FM Stereo	Tubes	\$374.50
C	100 Watts	AM-FM FM Stereo	Transistor	\$619.95
D	70 Watts	FM Stereo	Tubes	\$429.90
E	66 Watts	AM-FM FM Stereo	Transistor	\$195.00
F	60 Watts	FM Stereo	Tubes	\$354.45
G	60 Watts	AM-FM FM Stereo	Tubes	\$273.90
H	100 Watts	AM-FM FM Stereo	Transistor	\$579.90
I	70 Watts	AM-FM FM Stereo	Tubes	\$269.95

**IF YOU CHOOSE E GO DIRECT TO THE COUPON
& COLLECT \$75 TO \$425 SAVINGS!**

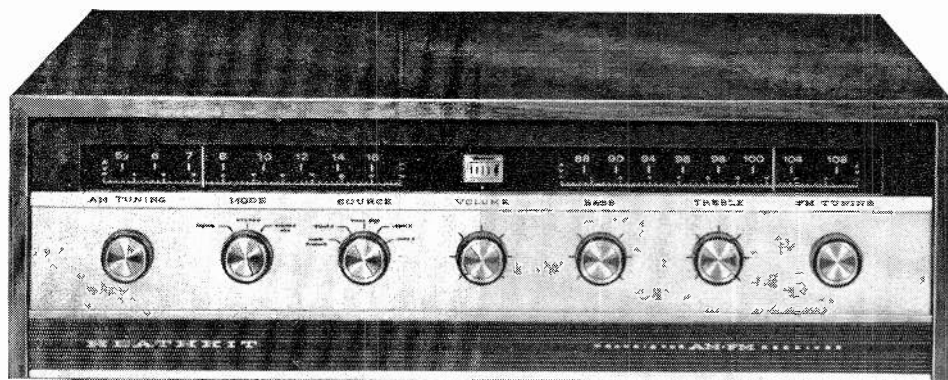

“E” is the Heathkit AR-13A All-Transistor, All-Mode Stereo Receiver. It's the first all-transistor stereo receiver kit. It costs from \$75 to \$425 less than the finest stereo receivers on the market today. This alone makes the AR-13 unique. But dollar savings are only one reason why it's your best value.

Even if you can afford to buy the costliest model, you can't buy better performance. Start with the AR-13A's 43-transistor, 18-diode circuit. It's your assurance of cool, instant, “hum-free” operation; long, trouble-free life; and the quick, clean, unmodified response of “transistor sound” . . . characteristics unobtainable in tube types.

Next, there's wide-band AM, FM, FM Stereo tuning for distortion-free reception to delight the most critical ear. It has two preamps. And its two power amplifiers provide 66 watts of IHF Music Power, 40 watts of continuous sine-wave power. And it's all housed inside one luxurious, compact walnut cabinet . . . just add two speakers for a complete stereo system.

There are plenty of operating conveniences, too. Like *automatic* switching to stereo; automatic stereo indicator; filtered tape recorder outputs for direct “beat-free” stereo recording; dual-tandem controls for

simultaneous adjustment of volume, bass, and treble of both channels; 3 stereo inputs; and a separate control for balancing both channels. The AM tuner features a high-gain RF stage and a high Q rod antenna. The FM tuner has a built-in line cord antenna plus external antenna connectors.

In addition, there's a local-distance switch to prevent overloading in strong signal areas; a squelch control; AFC for drift-free reception; plus flywheel tuning, tuning meter, and lighted AM & FM slide-rule dials for fast, easy station selection. The secondary controls are concealed under the hinged lower front gold aluminum panel to prevent accidental system setting changes. Both of the AM and FM “front-ends” and the AM-FM I.F. strip are pre-assembled and prealigned to simplify construction.

Compare its impressive specifications. Then go direct to the coupon, and order the AR-13A. Now sit back and relax . . . you've just saved \$75 to \$425 without compromising!

Kit AR-13A, 34 lbs. \$195.00

SPECIFICATIONS—AMPLIFIER: Power output per channel (Heath Rating): 20 watts/8 ohm load, (IHF Music Power Output): 33 watts/8 ohm load. **Power response:** ±1 db from 15 cps to 30 kc @ rated output. **Harmonic distortion:** (at rated output) Less than 1% @ 20 cps; less than 0.3% @ 1

kc; less than 1% @ 20 kc. **Intermodulation distortion:** (at rated output) Less than 1%, 60 & 6,000 cps signal mixed 4:1. **Hum & noise:** Mag. phono, 50 db below rated output; Aux. inputs, 15 db below rated output. **Channel separation:** 40 db. **Input sensitivity:** Mag. phono, 6 MV. **Outputs:** 4, 8, & 16 ohm and low impedance tape recorder outputs. **Controls:** 5-position Selector; 3-position Mode; Dual Tandem Volume; Bass & Treble Controls; Balance Control; Phase Switch; Input Level Controls; Push-Pull ON/OFF Switch. **FM: Tuning range:** 88 mc to 108 mc. **IF frequency:** 10.7 mc. **Frequency response:** ±3 db, 20 to 15,000 cps. **Capture ratio:** 10 db. **Antenna:** 300 ohm balanced (internal for local reception). **Quieting sensitivity:** 3½ uv for 30 db of quieting. **Image rejection:** 30 db. **IF rejection:** 70 db. **Harmonic distortion:** Less than 1%. **STEREO MULTI-PLEX:** **Channel separation:** (SCA Filter Off) 30 db, 50 to 2,000 cps. **19 KC & 38 KC suppression:** 45 db down. **SCA rejection:** 35 db down from rated output. **AM: Tuning range:** 535 to 1620 kc. **IF frequency:** 455 kc. **Sensitivity:** 30 uv @ 600 kc; 9 uv @ 1000 kc. **Image rejection:** 40 db. **IF rejection:** 55 db @ 1000 cps. **Harmonic distortion:** Less than 2% with 1000 uv input, 400 cps with 30% modulation. **Hum and noise:** 40 db. **Overall dimensions:** 17" L x 5½" H x 14½" D.



FREE CATALOG

Send for your Free copy today! Fully describes over 250 exciting Heathkits at savings of 50% or more! Choose from the world's largest selection of quality instruments in easy-to-assemble kit form!



HEATH COMPANY, Dept. 20-11-4
Benton Harbor, Mich. 49023

- Enclosed is \$195.00 plus freight. Please send Model AR-13A Stereo Receiver.
- Please send Free Heathkit Catalog.

Name _____

Address _____

City _____ State _____ Zip _____

HF-173

new Products

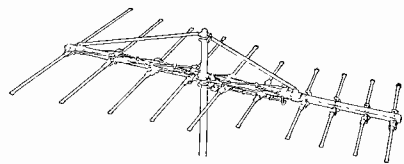

LOG PERIODIC FM STEREO ANTENNA, *LPL-FM10*, provides 4.1 db more gain than 10-element FM yagi. The array of L-shape log periodic dipoles is of back-fire, front-fed type with front-to-back ratios up to 26 db. The L-dipoles employ transmission-line transformers and 180° phased feeder harness to insure precise 300-ohm impedance. Narrow beamwidths and minor lobe levels reject reflected signals. Dipoles are 1/2-in. aluminum tubing, and entire antenna is gold alodized. Factory preassembled.—**JFD Electronics Corp.**, 15 Ave. & 62 St., Brooklyn 19, N. Y.

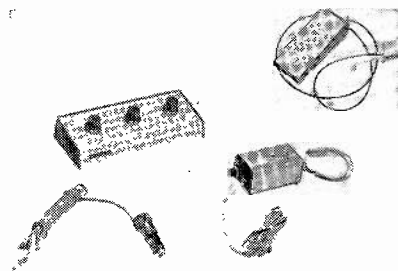

PORTABLE TAPE RECORDER ACCESSORIES. Four new accessories for the Sony model 801-A *Tape recorder*: *FS-4* foot switch; *DCC-3* 12-volt battery converter that plugs into auto lighter and stabilizes voltage changes of car battery; *AC-91* ac converter for 117-volt 60-cycle ac; *MX-10K* microphone mixer with three line and mike inputs. Also available *TP-4S* telephone pickup for recording telephone conversations.—**Superscope Inc.**, 8150 Vinland Ave., Sun Valley, Calif.

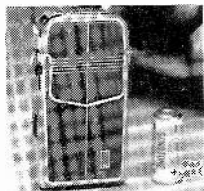

CERAMIC MICROPHONE HEARING AID, *model 300*, uses low-impedance ceramic microphone which does not pick up magnetic hum and is not affected by temperature and humidity. Has separate off-on switch, volume control and control for switching to automatic volume control, telephone pickup or microphone. Five separate tone and level controls compensate for a wide range of hearing losses.—**Sonotone Corp.**, Elmsford, N. Y.

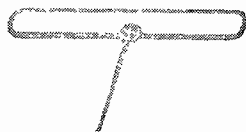

CONNECTOR PIN CONTAINS FUSE, addition to *Picofuse* line. Has one end of a tiny *Picofuse* terminated in a pin that is part of a multi-pin connector and was developed for aerospace computer, communications, instruments and other subminiature applications. Factory-installed in any diameter male pin having a large enough barrel to accept the .078-in. diameter fuse. Ratings from 1/4 to 5 amps at 125 volts, with short-circuit interrupting capacity of 300 amps at 130 vdc.—**Littelfuse, Inc.**, 800 E. Northwest Highway, Des Plaines, Ill.

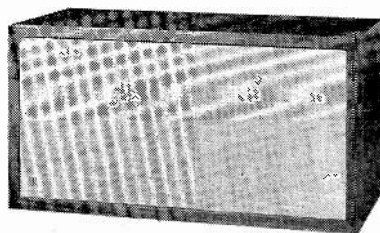

SPEAKER, *model AR-4*, in oiled walnut enclosure or unfinished pine. 19 x 10 x 9 in. Acoustic suspension with 8-inch woofer and 3 1/2-in. wide-dispersion tweeter.—**Acoustic Research, Inc.**, 24 Thorndike St., Cambridge, Mass. 02141



SQUARE-WAVE GENERATOR, *Squaremaker, ME-109*, converts an audio or video oscillator into a high-quality square-wave generator. No batteries or power connections are required; the transistors are powered direct from the input sine wave. Frequency and amplitude are adjustable over a wide range by oscillator controls. Typical performance data: 50 nanoseconds rise time; up to 35 volts output; useful as a trigger for 1 cycle to 1 megacycle; square-wave frequency range of 15 cycles to 500 kc.—**Monterey Electronic Products**, 651 Cannery Row, Monterey, Calif.

PORTABLE VOM, *model 80*, packaged in console-type case, features a tilted meter face and refractive anti-parallax scale. Reads ac and dc volts, direct current and ohms; has 1% dc and 1 1/2% ac accuracy. Output meter scale. Dc voltage

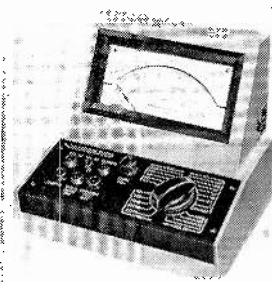

ranges at 20,000 ohms per volt: 0.25, 1, 2.5, 10, 25, 50, 100, 250, 1K, 5K. Ac voltage ranges at 5,000 ohms per volt: 2.5, 10, 50, 250, 500, 1,000 and 5,000. Direct current ranges: 50 microamperes, 1, 10 and 100 ma, 1 and 10 amperes. Case of shock-resistant resin, with self-storing leads which fit under a clip at the back.—**Weston Instruments, Inc.**, 614 Frelinghuysen Ave., Newark 14, N. J.

UHF ANTENNA, the *Tracker*, uses incident-wave principle with tangent paraboloid reflector system. Frequency response across all channels (14 to 83) with measured gain of ±13 db. Impedance match into 300 ohms is 1.5:1 or better at all uhf frequencies. 4 feet high, of anodized aluminum with snaplock hardware.—**Winegard Co.**, Burlington, Iowa.

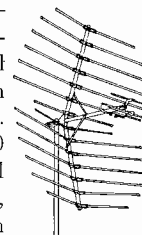

PRERECORDED STEREO TAPES, a new series for operation at 3 3/4 inches per second, providing 2 hours of continuous music at prices directly competitive with phonograph records. Average frequency response of ±3 db, 40 cycles to 12 kc, signal-to-noise ratio 48 db and flutter of 0.12%. Tapes are manufactured with automatic reverse signal so they reverse themselves and play both sides without handling when played back on Ampex 2000 line recorders.—**Ampex Corp.**, 401 Broadway, Redwood City, Calif.

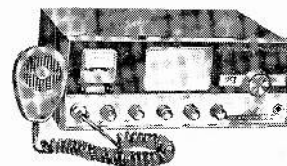

23-CHANNEL CB TRANSCEIVER, the *HB-400*, crystal-controlled with receiver tuning variable ±2.5 kc. Dual-conversion receiver has 0.3-μv sensitivity and plug-in facilities for *model HA-200* selective call unit. Built-in 117-vac/12-vdc power supply. Ceramic push-to-talk mike. 12 x 5 x 10 in.—**Lafayette Radio Electronics Corp.**, 111 Jericho Turnpike, Syosset, N. Y.

AC/DC TRANSCEIVER, *model CB-9*, has 6 crystal-controlled channels plus full-channel receiver tuning with spotting

NEW STANDARD-BEARERS!



Deluxe Heathkit® SB Series!

SB-200 KW Linear Amplifier..... \$200!
 • 1200 watts P.E.P. input SSB—1000 watts CW
 • 80 through 10 meter band coverage • Built-in SWR meter—Antenna relay—Solid-state power supply • Automatic Level Control (ALC) • Shielded, fan-cooled amplifier compartment • Pre-tuned cathode input circuit for maximum efficiency & low distortion • Circuit-breaker power supply protection—no fuses • Designed for 120/240 volt operation.

Neat, compact and transportable (only 35 lbs.). The sturdy, yet lightweight construction of the SB-200 is achieved through the use of a heavy-gauge one-piece aluminum chassis that is partitioned for extra strength and isolation of circuits. Easy assembly is assured with clean, open circuit layout and high quality, well-rated components. The modern low-profile styling of the SB-200 makes it a neat, compact desk-top linear that is ideal for use anywhere!

Kit SB-200, 42 lbs...... \$200.00
Note: Unit suitable for overseas operation.

SB-200 SPECIFICATIONS—Band coverage: 80, 40, 20, 15 & 10 meters. **Maximum power input:** 1200 watts P.E.P. SSB, 1000 watts CW. **Driving power required:** 100 watts. **Duty cycle:** SSB, continuous voice modulation; CW, 50% (key down time not to exceed 5 min.). **Third order distortion:** 30 db or better at 1000 watts P.E.P. **Output impedance:** 50 to 75 ohm unbalanced; variable pi-output circuit. SWR not to exceed 2:1. **Input impedance:** 52 ohm unbalanced; broad-band pre-tuned input circuit requires no tuning. **Meter functions:** 0-100 ma grid current, 0-1000 ma plate current, 0-1000 relative power, 1:1 to 3:1 SWR, 1500 to 3000 volts high voltage. **Front panel controls:** Load; Tune; Band; Relative Power Sensitivity; Meter Switch, Grid-Plate-Rel. Power-SWR-HV; and Power Switch, on/off. **Tube complement:** Two 572B/T-160-L (in parallel). **Power requirements:** 120 volts AC @ 16 amperes (max.), 240 volts AC @ 8 amperes (max.). **Cabinet size:** 14 1/2" W x 6 1/2" H x 13 3/4" D. **Net weight:** 35 lbs.

SB-300 SSB Receiver..... \$265!
 • Complete coverage of 80 through 10 meter amateur bands • All crystals included, plus provision for VHF converters • Hermetically sealed 2.1 kc crystal bandpass filter • Built-in 100 kc crystal calibrator • Smooth, non-backlash venier dial mechanism • 100 cps stability after initial warmup • 1 kc dial calibrations—100 kc per dial revolution (provides bandspread equal to 10 feet per megacycle) • Provision for transceive operation with SB-400 Transmitter • Prebuilt linear master oscillator (LMO), wiring harness and two heavy-duty circuit boards for fast, easy assembly.

Kit SB-300, less speaker... 22 lbs. \$265.00
SBA-300-1 Optional AM Crystal Filter (3.75 kc)
 1 lb. \$19.95
SBA-300-2 Optional CW Crystal Filter (400 cps)
 1 lb. \$19.95
SBA-300-3 (6 meter converter), 2 lbs..... \$19.95
SBA-300-4 (2 meter converter), 2 lbs..... \$19.95
Export model available for 115/230 VAC, 50-60 cps; write for prices.

SB-300 SPECIFICATIONS—Frequency range (megacycles): 3.5 to 4.0, 7.0 to 7.5, 14.0 to 14.5, 21.0 to 21.5, 28.0 to 28.5, 28.5 to 29.0, 29.0 to 29.5, 29.5 to 30. **Intermediate frequency:** 3.395 megacycles. **Frequency stability:** 100 cps after warmup. **Visual dial accuracy:** Within 200 cps on all bands. **Electrical dial accuracy:** Within 400 cps on all bands. **Backlash:** No more than 50 cps. **Sensitivity:** Less than 1 microvolt for 15 db signal plus noise-to-noise ratio for SSB operation. **Modes of operation:** Switch selected: LSB, USB, CW, AM. **Selectivity:** SSB: 2.1 kc at 6 db down, 5.0 kc at 60 db down (crystal filter supplied). AM: 3.75 kc at 6 db down, 10 kc at 60 db down (crystal filter available as accessory). CW: 400 cps at 6 db down, 2.5 kc at 60 db down (crystal filter available as accessory). **Spurious response:** Image and IF rejection better than 50 db. Internal spurious signals below equivalent antenna input of 1 microvolt. **Power requirements:** 120 volts AC, 50/60 cps, 50 watts. **Dimensions:** 14 1/2" W x 6 1/2" H x 13 3/4" D.

SB-400 SSB Transmitter..... \$325!
 • Built-in power supply • Complete transceive capability with SB-300 Receiver • Linear Master Oscillator frequency control • Built-in antenna change-over relay • All crystals supplied for complete 80-10 meter coverage • Automatic lever control for higher talk power, minimum distortion • 180 watts PEP SSB, 170 watts CW • Crystal filter type SSB generation • Operates SSB (upper or lower sideband) & CW • VOX & PTT control in SSB operation, VOX operated CW break-in • Crystal controlled heterodyne oscillators • 1 kc dial calibration—100 kc per dial revolution • Dial bandspread equal to 10 feet per megacycle • 500 kc coverage per band-switch position • Switched 120 V AC for external antenna relay • Sturdy, lightweight, heavy-gauge aluminum construction throughout • Neat, modern "Low-Boy" styling! • Variable loading!

Kit SB-400, 33 lbs...... \$325.00
Export model available for 115/230 VAC, 50-60 cps; write for prices.

SB-400 SPECIFICATIONS—Emission: SSB (upper or lower sideband) and CW. **Power input:** 170 watts CW, 180 watts P.E.P. SSB. **Power output:** 100 watts (80-15 meters), 80 watts (10 meters). **Output impedance:** 50 to 75 ohm—less than 2:1 SWR. **Frequency range:** (mc) 3.5-4.0; 7.0-7.5; 14.0-14.5; 21.0-21.5; 28.0-28.5; 28.5-29.0; 29.0-29.5; 29.5-30.0. **Frequency stability:** Less than 100 cps per hr. after 20 min. warmup. **Carrier suppression:** 50 db below peak output. **Unwanted sideband suppression:** 55 db @ 1 kc. **Intermodulation distortion:** 30 db below peak output (two-tone test). **Keying characteristics:** Break-in CW provided by operating VOX from a keyed tone (Grid block keying). **ALC characteristics:** 10 db nominal @ 0.2 ma final grid current. **Noise level:** 40 db down from single tone output. **Visual dial accuracy:** Within 200 cps (all bands). **Electrical dial accuracy:** Within 400 cps (all bands). **Audio input:** High impedance microphone or phone patch. **Audio frequency response:** 350 to 2450 CW at 6 db. **Power requirements:** 80 watts STBY, 260 watts key down @ 120 V AC line. **Dimensions:** 14 1/2" W x 6 1/2" H x 13 3/4" D.



FREE 1965 CATALOG

See the wide array of Heathkit Amateur Radio Equipment available at tremendous do-it-yourself savings! Everything you need in "mobile" or "fixed" station gear with full descriptions and specifications... Send for Free copy!

HEATH COMPANY, Benton Harbor, Michigan 49023
 In Canada: Daystrom, Ltd., Cooksville, Ontario

Enclosed is \$ _____, plus shipping.

Please send model(s)

Please send free 1965 Heathkit Catalog.

Name _____ (Please Print)

Address _____

City _____ State _____ Zip _____

Prices & specifications subject to change without notice.

AM-150



Dept. 20-11-5

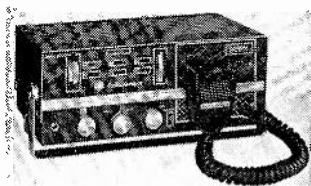

switch and S-meter. All-electronic push-to-talk circuitry. 100% modulation and receiver sensitivity of $1 \mu\text{v}$ for 10-db signal-to-noise ratio claimed. Output 3.2 watts. Drop-down chassis feature. 14 lb, 12 x 7 x 5 in. Ready to operate either base or mobile.—Hallcrafters Co., 100 E. Ohio St., Chicago, Ill. 60611

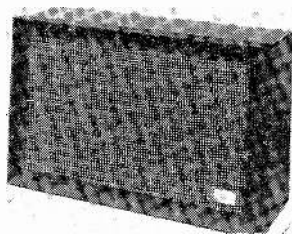

MINIATURIZED HI-FI SPEAKER SYSTEM, Mini-Flex II. Frequency response of 45 to 18,000 cycles. 6½-in. woofer with 3½-in. mid-range cone, separate tweeter and crossovers at 800 and 2,000 cycles. 15 x 9½ x 6 in.—LTV University, 9500 W. Reno, Oklahoma City, Okla.



SPRAY CLEANER, Kontakt 60. For contacts, switches and components. Leaves lubricant film, protects parts from corrosion, is non-conductive. Injector tubing for hard-to-reach areas. 6 oz.—Jonard Industries Corp., 3733 Riverdale Ave., Bronx 63, N.Y.

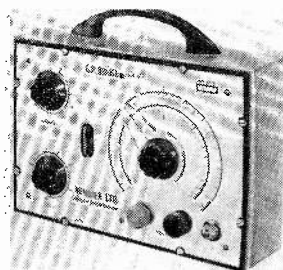

TRANSISTOR CAPACITANCE RESISTANCE BRIDGE, model 62. Uses 9-volt transistor battery, checks capacitors in range of 1 pf to 100 μf , resistors in range of 100 ohms to 100 megohms. Controls: range, power factor %, bridge tuning (C

and R), test jacks. 6% x 4% x 2% in., less than 2 lb.—Path Products Corp., 55 Halley St., Yonkers, N.Y.



TAPE-HEAD CLEANER, No-Noise Tape-Recorder Head Cleaner dissolves oxide and lubricant deposits resulting from recorder operation. Contains no carbon tet, won't affect plastics, is nonflammable and nontoxic. Applied with 5-inch plastic extender push-button assembly.—Electronic Chemical Corp., 813 Communipaw Ave., Jersey City 4, N. J.

SLIDE RULE for electronic engineers and technicians has scales for solving reactance and resonance-frequency problems. Locates decimal points and provides widely used formulas and conversion

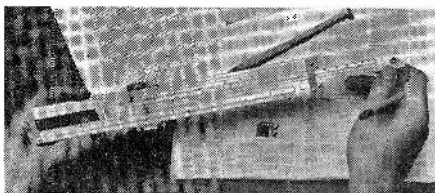

factors not found on other scales. Included is 123-page manual with several hundred practice problems.—Cleveland Institute of Electronics, 1776 E. 17 St., Dept. 100, Cleveland, Ohio 44114



ALL-WEATHER VINYL ELECTRICAL TAPE, No. 104, has dielectric strength of 10,000 volts and insulation resistance of more than 100,000 megohms. .0035 in. thick, will elongate 200% before breaking; ultimate tensile strength 22 lb per in. of width; peel strength 20 oz per in. of width. Plastic container with built-in cutter.—International Resistance Co., 414 N. 13 St., Philadelphia, Pa. 19108

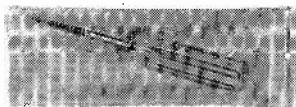

TAPPING TOOL, the 3-in-1, taps holes to 10-32, 8-32 or 6-32 thread all on one hardened tool-steel blade. Has shock-proof, breakproof and nonabsorbent handle.—Vaco Products Co., 317 E. Ontario St., Chicago, Ill. 60611

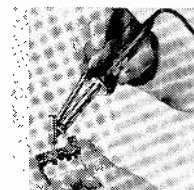

PENCIL DESOLDERING/RE-SOLDERING IRON, Endeco model 300, for removing and replacing miniature components in printed-circuit boards and conventional wiring

is 8 in. long and weight 3½ oz. Rated 40 watts at 115 volts and delivers a 720°F tip temperature. Tips are available in 5 sizes; the .080-in. is standard.—Enterprise Development Corp., PO Box 55144, 1102 E. 52 St., Indianapolis, Ind. 46205

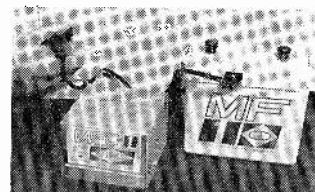

SEALED LEAD-ACID BATTERIES, MF-1, MF-2, for portable power devices, can be built into tools and appliances or carried by shoulder strap or belt hook. 5- and 7½-lb sizes never require addition of water or acid, hydrometer readings or cleaning of metallic cell connectors. MF-1 (6-volt) produces 1.1 amperes at 8-hr rate, 1.35 (6-hr), 2.3 (3-hr), 5.3 (1-hr), 8.2 (½-hr), 16.5 (5-min). MF-2 (12-volt) produces 0.8 amps (8-hr), 1 (6-hr), 1.7 (3-hr), 3.6 (1-hr), 5.4 (½-hr), 10.2 (5-min).—Exide Industrial Marketing Div., ESB Co., Rising Sun and Adams Aves., Philadelphia, Pa. 19120

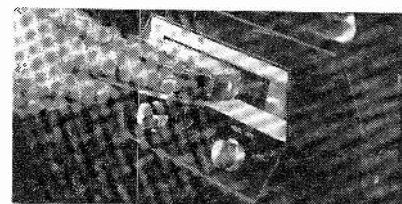

TAPE PLAYER FOR CARS, Auto-Mate, designed to accept a sealed plastic cartridge with a continuous 2-track magnetic tape, has universal bracket and can be used in cars, trucks or boats equipped with AM radios in the 800–1,000-ke range. Has its own transistorized amplifier-oscillator circuit, feeds oscillator output at about 900 ke through antenna circuit of the radio.—J. Herbert Orr Enterprises, Inc., Opelika, Ala.

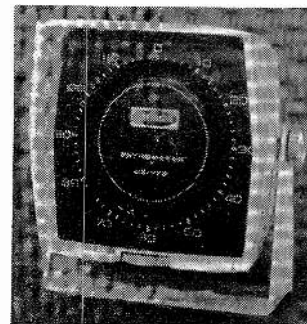

BUDGET-PRICED FATHOMETERS. The DE-720A has a 60-foot scale

and the DE-722 is scaled to 120 feet. Both use magnetic keying and transistors and draw only 12/100 amp. Can be supplied with any of 3 optional transducers.—Raytheon Co., Lexington, Mass. 02173

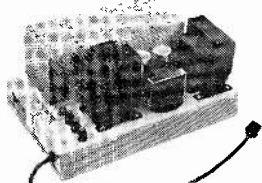

LOW-HIGH BAND-EXTENDER AMPLIFIER, model LHE 501 R, handles low- and high-band TV and FM signals. Has 2 output terminals: one to extend feeder lines; the second (-20 db) to split the line or feed a distribution amplifier. Low- and high-band gain and tilt controls, flat frequency response, long-life silicon rectifiers, 10,000-hour tubes.—**Entron, Inc.**, 2141 Industrial Parkway, Silver Spring, Md.

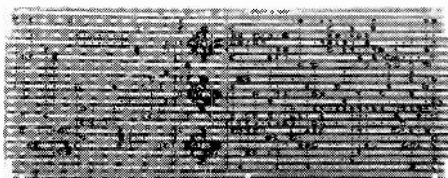

PROTOTYPE CIRCUIT BOARD, Veroboard, 1.55-mm-thick synthetic resin-bonded paper laminate, to which are bonded a number of strips of copper .38 mm thick, pierced with matrix of holes and protected with flux preservative. Copper strips carry 1 amp with only 1°C rise above ambient; 5 amps with 39°C rise. Resistance .045 ohm per inch. Comes in 18-inch lengths, fully pierced, double-sided, plug-in type or plain.—**Vero Electronics Inc.**, 48 Allen Blvd., Farmingdale, N.Y.

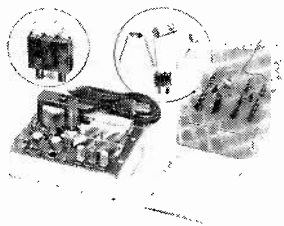

SOLDERLESS BREADBOARD CIRCUIT KIT, model BB-1, has 2 types of plug-in connectors, perforated chassis and optional dc power supply. Kit includes 40 T-3 connectors with 3 electrically connected lugs for plugging in a number of components, and 10 T3S connectors, with 3 electrically isolated lugs for accepting individual component leads. Optional with kit is model PS-100 dual-voltage, transistor-regulated dc power supply.—**Buckeye Stamping Co., Electronics Div.**, 555 Marion Rd., Columbus, Ohio 43207

PORTABLE SCOPE, type 321A, is 5¼ x 8¼ x 16 in. and weighs 18 lb. Oper-

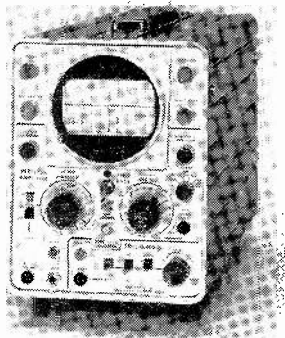

ates from 4 to 4½ hr. on internal rechargeable batteries from any dc source of 11.5 to 35 volts, or from any ac source of 50 to 800 cycles. Passband is dc to 6 mc, maximum calibrated sensitivity is 10 mv/¼ in. div. Wide-range time base provides calibrated sweep speeds to 0.5 μsec per division; a ×5 magnifier extends this sweep to 0.1 μsec/div.—**Tektronix, Inc.**, PO Box 500, Beaverton, Ore. 97005

23-CHANNEL AM TRANSCEIVER, model CAM-88 Cobra, has integral crystal synthesizer. Double-conversion super-het receiver has 2 stages of i.f. amplification. Meter on front panel measures incoming signal strength on receive and

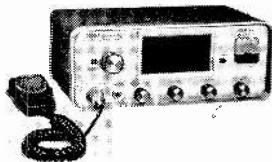

relative power output on transmit. Audio volume control for both CB reception and public address. Auxiliary speaker plug at rear. Transistorized universal ac/dc power supply operates on both 117 vac and 12 vdc. Mounting bracket for car installation. Earphone jack on front panel.—**B&K/Mark, Div. of Dynascan Corp.** 1801 W. Belle Plaine Ave., Chicago, Ill.

ELLIPTICAL STYLUS CARTRIDGE, 880PE. Frequency response: 8 to 30,000 cycles; 8.0 mv per channel output voltage; channel separation more than 30 db; load impedance 47,000 ohms; weighs 10 grams; 20 × 10⁻⁶ cm/dync compliance; ½ to 4 grams tracking force; .2 x .9-mil bi-radial elliptical hand-pol-



ished diamond stylus; 4 terminal output; standard 7/16-or ½-inch mounting centers. Elliptical stylus for the 880PE is available as a replacement for the ones on the 880 and 880P.—**Empire Scientific Corp.**, 845 Stewart Ave., Garden City, N. Y.

NEW SAM'S BOOKS

BRAND-NEW Enlarged 8th Edition
of the famous Howard W. Sams

Tube Substitution Handbook



Now Lists Over 11,000
Tube Substitutions!
Still Only \$1.50

The most complete and up-to-date DIRECT tube substitution guide available—now lists over 11,000 substitutions for all types of receiving and picture tubes. Contains 7 convenient sections: 1. Cross-reference of all American receiving tubes. 2. Picture tube substitutions. 3. Cross-reference of miniature tubes. 4. Industrial substitutes for receiving tubes. 5. Substitutions for communications and special-purpose tubes. 6 and 7—cross-reference of American and Foreign tubes. Each section tells when and how to make proper substitutions, and how to cross-reference between sections for additional substitutions. Worth its weight in gold in your tube caddy and on your bench. 128 pages; 5½ x 8½". Order TUB-8, still only \$1.50

Short-Wave Listener's Guide

by H. Charles Woodruff. Most useful of all books for the short-wave hobbyist. Four comprehensive sections include: 1. Alphabetical listing of short-wave stations by country and city, plus call letters, power output, frequency, transmission times. 2. Listing of stations in numerical order by frequency, including location. 3. Six separate listings by 4-hour periods throughout the day and night, showing what stations are "on-the-air" during any given time period. 4. Listing of clandestine stations operating from behind the "iron curtain," and communist-controlled stations operating in free countries. A fascinating and important book for every short-wave fan. \$125 64 pages; 5½ x 8½". Order SLG-1, only \$125

Howard W. Sams Transistor Specifications Manual

Contains electrical and physical parameters for virtually all transistors now in use. Electrical parameters include maximum collector to base, emitter to base, collector to emitter voltages; maximum collector amperes, power dissipation, and operating temperatures; also lists frequency gain and leakage parameters. Physical Outlines section provides physical data, dimensions, and other information required to install units. An invaluable reference for anyone working with semiconductors. 160 pages; 5½ x 8½". Order HTA-1, only \$295

Sams Basic Electricity/Electronics (5 Vols.)

New, unique positive training course worth hundreds of dollars. Uses the latest programmed method for quick, effective learning.

- Vol. 1. Basic Principles & Applications
- Vol. 2. How AC & DC Circuits Work
- Vol. 3. Understanding Tube & Transistor Circuits
- Vol. 4. Understanding & Using Test Instruments
- Vol. 5. Motors & Generators—How They Work

(Complete Set contains over 1300 pages; 1250 illustrations; 51 chapters; in sturdy slipcase)

Order ECV-50, only \$1995

Fundamentals of Data Processing

by Allen Lytel. A most timely introduction to modern computer data processing methods. Explains how computers are built, how they work, and how to use them. Chapters cover: Computers and History; Desk Calculators; Punched-Card Machines & Applications; The Language of Logic (Boolean Algebra); Functions of a Digital Computer; Computer Arithmetic; Storage & Memory; Input & Output Devices; Programming; Data Processing in Business; Computers in Science & Engineering; Computers in Industry; Analog Computers; A Business & Scientific Computer. 320 pages; 5½ x 8½". \$695 Order DPS-1, (softbound), only \$695 Order DPH-1, (hardbound), only \$7.95

HOWARD W. SAMS & CO., INC.

Order from your Sams Distributor today, or mail to Howard W. Sams & Co., Inc., Dept. RE-11, 4300 W. 62nd Street, Indianapolis, Ind. 46206

Send me the following books:

- TUB-8 HTA-1 DPS-1
 SLG-1 ECV-50 DPH-1

\$ _____ enclosed. Send FREE Booklist

Name _____

Address _____

City _____ State _____ Zip _____

My Distributor is _____

IN CANADA: A. C. Simmonds & Sons, Ltd., Toronto 7

CAR OWNERS SAY ...

*"Terrific," "Fabulous,"
"Improves radio 100%!"*

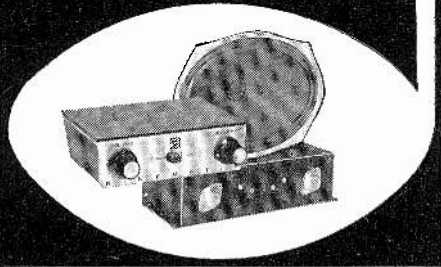

VERBA-MATIX
America's Prestige
REVERBERATION

The only system with

- 4 Transistors • Heavy 7 oz. Ceramic-Magnet Speaker • Complete Control Panel (with Reverb % Control) • No Drilling, No Screws, for easy installation • Fits all Cars, Neg. or Pos. Ground (12 volt) • All Speakers 2 to 40 ohms • No Noise Driving Over Bumps.

Made in U.S.A.

For complete details see your
Distributor or write
Dept. RE-11



kinematix, inc.

2040 W. Washington Blvd.,
Chicago, Illinois 60612
Area Code 312 666-0066

NEW PRICES from
QUIETROLE



**the oldest, most
widely proved and
sold radio and TV
lubricant**

- | | |
|------------------------------------|----------------|
| 2 oz. bottle
with dropper | LIST
\$1.49 |
| 4 oz. bottle | LIST
2.54 |
| 4 oz. bottle
(brush-n-cap) | LIST
2.64 |
| 8 oz. bottle | LIST
5.07 |
| 6 oz. spray can —
with extender | LIST
2.79 |
| 3 oz. spray can
— with extender | LIST
1.79 |

Quietrole is your guarantee of the most effective, quick silencer of noisy radio and TV controls — the quality product that is a top value. Get Quietrole at quality jobbers.

Some territories still available for experienced representation.



PROTECTIVE TIPOVER SWITCH automatically shuts off ignition of any motor vehicle when it overturns. A mercury switch, it could be used in many applications as a position-oriented switch with its automatic on-off feature when tilted past 45°.—Waber Electronics, Inc., Hancock & Somerset Sts., Philadelphia, Pa. 19133

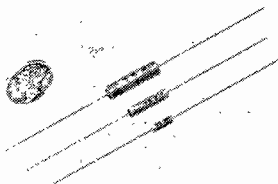

MINIATURE TANTALUM CAPACITORS, MTP, in 15 standard ratings, were developed for Minuteman II program. Operating temperatures from -55° to +85°C, all values polarized. Standard tolerance ±20%. Ratings range from 4 µf at 50 wvdc to 450 µf at 6 wvdc. Four case sizes from 0.115-in. diameter x 0.312-in. long up to 0.225-in. diameter x 0.764-in. long.—Mallory Distributor Products Co., Indianapolis, Ind. 46206

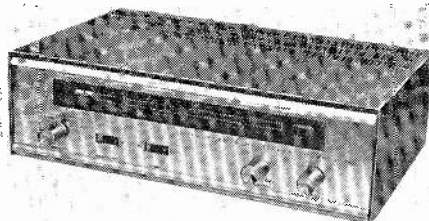

AM/FM STEREO TUNER, LT-325, produces an audible signal in both channels when a stereo station is tuned in. Tuner sensitivity 2 mv for 20-db signal-to-noise ratio. Frequency response from 15 to 15,000 cycles ±1 db, channel separation better than 38 db at 400 cycles. Variable afc and multiplex noise filter. Built-in ferrite loop antenna for AM reception; 300-ohm impedance antenna input for FM reception. 14¾ x 5¾ x 9¾ in.—Lafayette Radio Electronics Corp., 111 Jericho Turnpike, Syosset, N. Y.

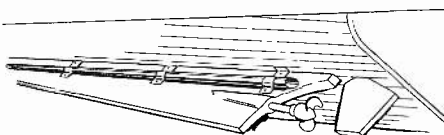

MARINE ELECTRICAL GROUND SYSTEM, kit No. MD-14, provides 13.8 sq ft of grounding surface and is designed to be used on both single- and dual-engine craft with minimum keel length of 9 feet. Has 2 heavy-gage copper tubes, 8 ft long and 1¼ in. in diameter, strapped to each

side of boat's keel with brass mounting strips and bolts. Only 7 holes needed for permanent mounting, with just one hole through the hull.—Heathkit Co., Benton Harbor, Mich.

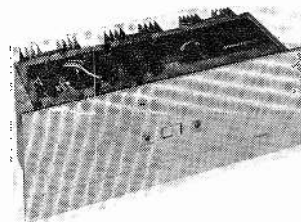

ALL-TRANSISTORIZED 100-WATT AMPLIFIER, model TA100, for continuous-duty service. Has: 100 watts rms (200 watts peak) output; thermally controlled protective relay; overload protective relay; frequency response ±1½ db, 50 to 15,000 cycles; distortion less than 5% at rated output (less than 3% at 80 watts); noise level 80 db below rated output.—Rauland-Borg Corp., 3535 W. Addison St., Chicago, Ill. 60618

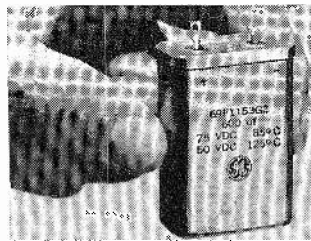

TANTALUM CAPACITORS, series KSR, available in 5 case sizes from 180 to 2,400 µf with tantalum hermetic seal. Temperature range of -55°C to +125°C; between 10 and 150 volts with polar construction. Developed for Minuteman program.—General Electric Co., 392 S. Stratford Rd., Winston-Salem, N. C.

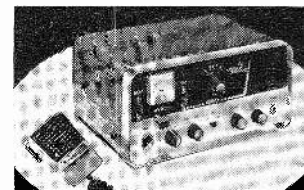

DUAL-POWER-SUPPLY TRANSCEIVER, Romper has 8 crystal-controlled transmit and receive frequencies, 7 of them internal and the 8th plugged into a socket in the front panel. Operator can insert crystal cut for any of 23 channels. Operates on 117 volts ac or 12 volts dc. Power consumption on ac is 75 watts normal; on dc 6.5 amps at 12 volts. Uses 10 tubes and 5 diodes—7 dual-purpose tubes provide 17-tube performance. Dual-conversion receiver portion uses 7.5-mc and 455-kc i.f.'s. Relay switching. Frequency range 350 to 3,500 cycles. Squelch adjustable from ¼ µv to about 50 µv. Normal rf and af output is 3 watts; terminals for 3.2-ohm external speaker. 11½ x 5½ x 7¾ in.—Regency Electronics, Inc., 7900 Pendleton Pike, Indianapolis, Ind.

FREE

MAIL
CARD
TODAY

WORLD'S LARGEST ELECTRONICS CATALOG
WITH THE BIGGEST SAVINGS IN ALLIED'S HISTORY

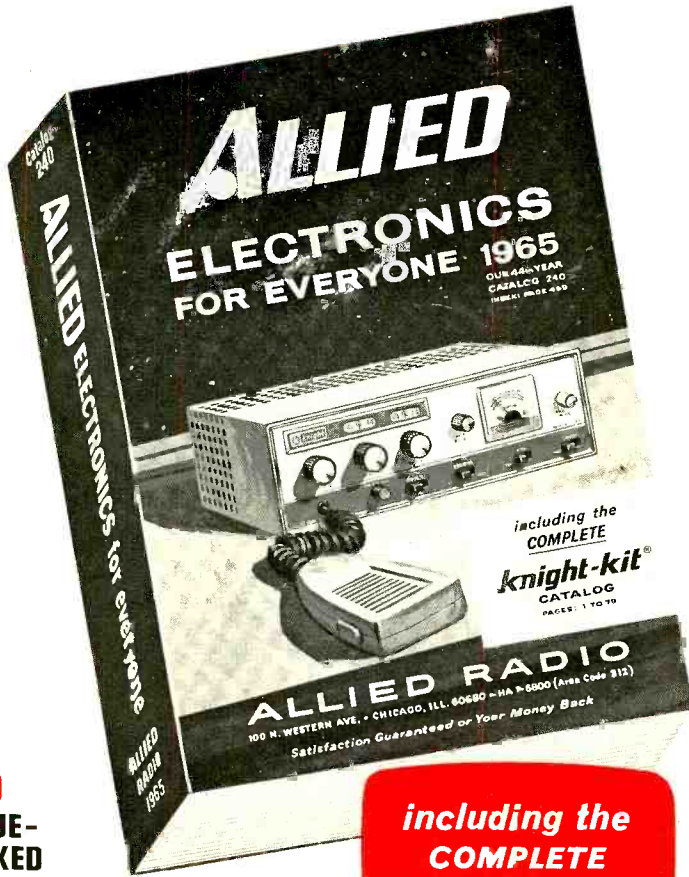

490
VALUE-
PACKED
PAGES

including the
COMPLETE
knight-kit®
CATALOG

send today for your money-saving

ALLIED 1965 CATALOG

BIGGEST SELECTION • BIGGEST SAVINGS ON:

PLUS

SPECIAL PRODUCTS
AND EXCLUSIVE
VALUES AVAILABLE
ONLY FROM

ALLIED

EXTRA! BARGAIN PARTS SECTION!

satisfaction guaranteed or your money back

EASY TERMS: Use the Convenient Allied Credit Fund Plan

- Famous Build-Your-Own Knight-Kits®
- Our Own Knight® Stereo Hi-Fi
- Other Famous-Make Stereo Components & Complete Systems
- Tape Recorders and Tape
- Phonographs and Accessories
- FM-AM and AM Radios
- CB Transceiver Values
- PA Systems & Intercoms
- Ham Station Equipment
- Test and Lab Instruments
- Automotive Electronics Equipment
- TV Tubes, Antennas, Accessories
- Parts, Tubes, Transistors
- Tools and Hardware • Books

SEE
OTHER
SIDE

For your FREE 1965 ALLIED Catalog, fill in card, detach and mail now. (Please give other card to an interested friend.)

SEND
CARD
TODAY

MAIL
NOW

Name _____
PLEASE PRINT

Address _____

City _____ Zone _____

State _____

2-L

SEND CARD TODAY
for your
FREE
ALLIED
1965 CATALOG

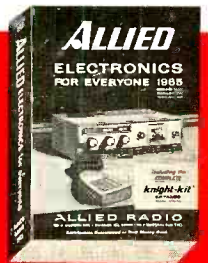

LOWEST PRICES ANYWHERE!

Name _____
PLEASE PRINT

Address _____

City _____ Zone _____

State _____

2-L

SEND CARD TODAY
for your
FREE
ALLIED
1965 CATALOG



SAVE AS NEVER BEFORE!

MAIL NOW



FREE

send for your money-saving

ALLIED 490-PAGE

1965 ELECTRONICS CATALOG

WORLD'S LARGEST • BIGGEST SELECTION
WITH THE BIGGEST SAVINGS IN ALLIED'S HISTORY!

1965 *knight-kits*[®]—save more than ever



NEW
Electronic Exposure Meter—ultra-sensitive, professional performance



NEW
Electronic Auto Analyzer for troubleshooting ignition systems

NEW
KG-834 Solid-State 54-Watt Stereo Hi-Fi Amplifier—at amazing low cost



NEW
King-size 6" VTVM—tops in accuracy at the lowest price



NEW
C-560 Deluxe CB Transceiver with transistorized power supply

See many other outstanding do-it-yourself kits: Hi-Fi, Hobby, Citizens Band, Amateur, Intercom, Test Instrument—wonderfully easy to build—savings up to 50%.

NEW STEREO HI-FI—most for your money



NEW
Knight KN-330 Stereo Hi-Fi Receiver—top performance at a new low price



NEW
Knight KN-990A Deluxe Hi-Fi Record Changer at tremendous savings

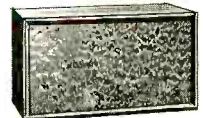

NEW
Knight KN-2350 Speaker System—acoustic suspension type at lowest cost

CITIZENS BAND TRANSCEIVERS—top values in CB

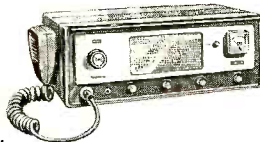

NEW
Knight KN-2565 23 Channel CB Transceiver—a deluxe performer at big savings



NEW
Knight KN-2580 8-Channel CB Transceiver, with transistorized power supply

PLUS: Tape Recorders and Tape • Phonographs & Accessories • FM-AM and AM Radios • Ham Station Equipment • Test and Lab Instruments • Automotive Electronics Equipment • PA Systems and Intercoms • Top Values in Power Tools, Soldering Guns, Hardware • Biggest Selection of TV Tubes, Antennas, Parts, Tubes, Transistors, Books... everything in Electronics for everyone.

FREE

SEND CARD TODAY FOR YOUR 1965 ALLIED CATALOG, and give one card to an interested friend.

satisfaction guaranteed or your money back

EASY TERMS: Use the convenient Allied Credit Fund Plan to make your purchases.

ALLIED RADIO

100 N. Western Ave., Chicago, Illinois 60680

TO:

ALLIED RADIO

P. O. Box 4398

CHICAGO, ILLINOIS 60680

PLACE
STAMP
HERE

TO:

ALLIED RADIO

P. O. Box 4398

CHICAGO, ILLINOIS 60680

MAIL NOW

PLACE
STAMP
HERE



INDOOR-OUTDOOR SOUND COLUMNS, CSO-4 and CSO-6, with four and six 8-inch speakers, respectively. CSO-4 handles 80 watts, has frequency response of 70 to 17,000 cycles. Sound projected in horizontal pattern of 120° and vertical pattern of 22°. CSO-6 handles 120 watts, frequency response of 65 to 14,000 cycles. Horizontal pattern of 120° and vertical pattern of 16°.—LTV University, 9500 W. Reno, Oklahoma City, Okla.



CERAMIC MICROPHONE, model No. 30-902 for multiple applications. Hand-held or placed on desk. Built-in stand folds flush in back of unit; 6-ft cable terminated with RCA type phono pin plug. For tape recorders, CB transceivers, PA and paging systems.—GC Electronics Co., 400 S. Wyman St., Rockford, Ill.

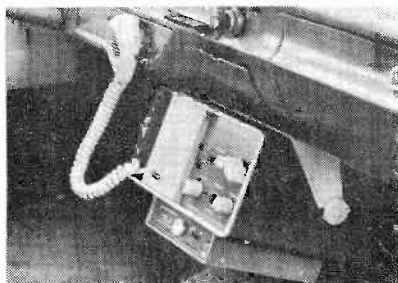

TRANSCEIVER SQUELCH SYSTEM, Ray-Call encoder-decoder accessory for most two-way radios. When set is transmitting, Ray-Call actuates receiver to which it is attached only when coded tone from similar unit is transmitted. Transistorized, operates from 12 vdc or 117 vac. 1 1/2 x 5 1/2 x 7 in.—Raytheon Co., Lexington, Mass. 02173

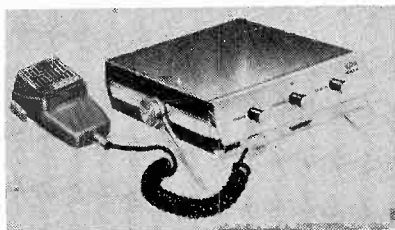

ALL-SILICON CB TRANSCEIVER, model 5000, for short-range communications (1-20 miles). Plug-in power packs adapt unit for operation on 6, 12, 28 and 32 volts dc or 117 volts ac. Front check-

out through test pins in microphone connector allows checkout of modules while set in use. Snap-in modules for replacement of transmitter, receivers, audio, control and power supply modules.—Pace Communications Corp., 520 W. 182 St., Gardena, Calif. 90247

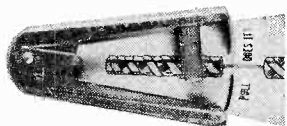

WIRE STRIPPER AND CUTTER, Strip-It handles all wire sizes, fits in palm of hand. Fingertip stop adjustment. Insert end of wire, close jaws, twist and pull—wire ready for connection to terminal. Replaceable tool-steel blades.—Audio-

phonics Corp, 95 Rantoul St., Beverly, Mass. 01915



AC INDUCTIVE CURRENT SENSOR, models A and B. Current transformers for reading ac on ac vtvm or scope. Model A measures 100 μ a to 10 amps at 400 cycles. Insertion impedance .001 ohm (one low-impedance turn) Model B covers 10 μ a to 1 amp; impedance .03 ohm. Round and square types. Accuracy $\pm 1\%$ (standard model); $\pm 0.1\%$ with screw adjustment.—M. B. Gilbert Co., Inc., Box 45824, Los Angeles, Calif. 90045 **END**

All specifications from manufacturers' data.

Perma-Power HOLIDAY SPECIAL!
GENUINE
EVERSHARP
CARTRIDGE FOUNTAIN PEN
in deluxe gift package
YOURS
FREE
WITH EVERY VU-BRITE 12-PACK

This is not a cheap ballpoint, or an advertising giveaway. It's the identical top quality ritings r men (manufactured by Parker) you've seen in retail stores for \$2.95. It makes a perfect gift—and it's Perma-Power's gift to you when you buy 12 Vu-Brites.

BRIGHTER TV PICTURES MEAN BRIGHTER SMILES ON YOUR CUSTOMERS' FACES!
Bring fading, dull picture tubes back to original brilliance with Vu-Brite—the leading single-purpose britener. Model C-401 Parallel, C-402 Series.



LOOK WHAT YOU SAVE!

12 Vu-Brites—usual dealer net	\$10.68
Eversharp pen and cartridge	2.95
TOTAL VALUE	\$13.63
SPECIAL OFFER	9.95
TOTAL SAVINGS	\$ 3.68

HURRY! DEAL ENDS DECEMBER 15, 1964

Perma-Power COMPANY • 5740 N. TRIPP AVE. • CHICAGO, ILL. 60646

SPECIAL INTRODUCTORY OFFER!

Join the Gernsback Electronics Book Club today, and get this outstanding practical two-volume set

only 99c

(Regularly \$9.90 . . . Originally a \$25 Training Course!)

with membership in
the Gernsback Electronics Book Club

New Shortcuts to TV Servicing by Leonard C. Lane was originally prepared as a complete course in TV servicing. This two-volume set will show you how to repair television receivers quickly and easily. There's no theory or math. Instead, you learn to repair television receivers in a minimum amount of time by recognizing certain symptoms. Profusely illustrated with hundreds of photographs, illustrations and schematics

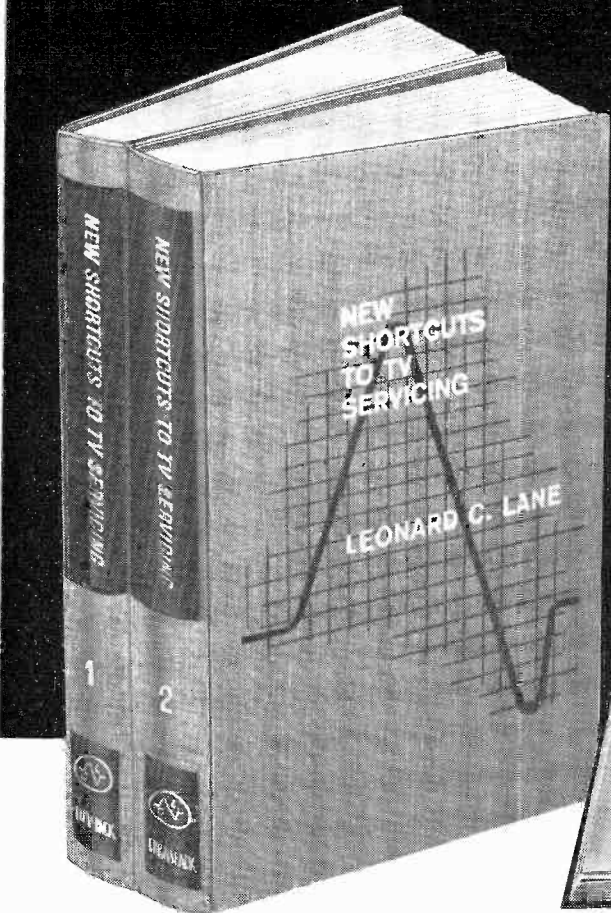
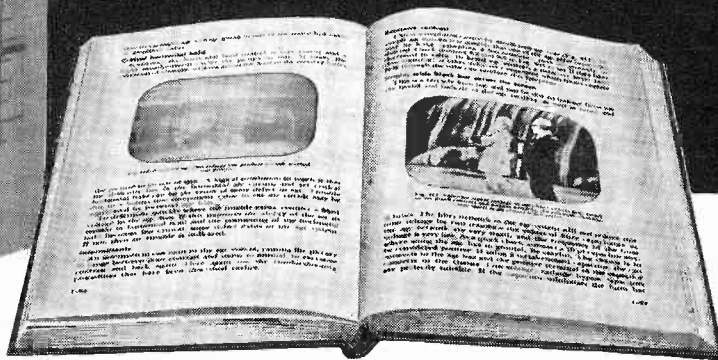

Here is a fabulous offer to introduce you to Gernsback Library's famous Electronics Book Club, specifically designed to help you increase your knowledge and earning power.

WHY SHOULD YOU JOIN!

Whatever your interest in electronics — radio and TV servicing, audio and hi-fi, industrial or defense electronics, electronics as a hobby — you'll find that the Electronics Book Club will help you get the job you want, keep it, improve it, or make your leisure hours more enjoyable. By broadening your knowledge and skills, you'll build your earning power and electronics enjoyment as well.

WHAT KIND OF BOOKS ARE OFFERED?

From Gernsback Library and other leading publishers come the country's most respected books in the field of electronics. All are deluxe, hard-covered, attractive looking books of permanent value — books you'll want to own and keep in your personal, professional library.

HOW THE CLUB WORKS

The Electronics Book Club will send you, regularly, a newsy bulletin

describing in detail the club selection and alternates. You may select one or more books — or reject all books offered that month. You agree to accept only 4 additional books from the many offered in the next 12 months. You may cancel anytime after that.

HOW TO JOIN

Simply fill out and mail the coupon today. You will be sent your two-volume set of "New Shortcuts to TV Servicing," which regularly sells for \$9.90. We will bill you 99¢ (plus a few cents postage). If you are not satisfied with the set, send the books back within 10 days and membership is cancelled. The selections listed are typical of those you'll be able to choose from at the special reduced club member's price.

TYPICAL CLUB SELECTIONS:

- | | |
|---|--|
| Electronics Data Handbook
Reg. \$4.60—Club price \$3.25
(You save \$1.35) | Audio Design Handbook
Reg. \$5.00—Club price \$3.75
(You save \$1.25) |
| Basic TV Course
Reg. 5.75—Club price \$4.85
(You save 90¢) | Elements of Tape Recorder Circuits
Reg. \$5.00—Club price \$3.75
(You save \$1.25) |
| Basic Transistor Course
Reg. \$5.75—Club price \$4.50
(You save \$1.25) | Basic Math Course for Electronics
Reg. \$6.45—Club price \$5.15
(You save \$1.30) |
| How to Build Tiny Electronic Circuits
Reg. \$5.85—Club price \$4.95
(You save 90¢) | The V.T.V.M.
Reg. \$4.60—Club price \$3.35
(You save \$1.25) |
| Radio Servicing Made Easy (2 Vols.)
Reg. \$9.95—Club price \$7.75
(You save \$2.20) | Transistor Reference Book
Reg. \$6.00—Club price \$4.50
(You save \$1.50) |
| The Oscilloscope
Reg. \$5.20—Club price \$3.95
(You save \$1.25) | Industrial Electronics Made Easy
Reg. \$5.95—Club price \$4.35
(You save \$1.60) |
| How to Make Money Operating Your Own Radio and TV Service Business
Reg. \$5.00—Club price \$3.75
(You save \$1.25) | Fundamentals of Semiconductors
Reg. \$4.60—Club price \$3.25
(You save \$1.35) |
| Elements of Electron Physics
Reg. \$5.65—Club price \$4.45
(You save \$1.20) | Tubes and Circuits
Reg. \$4.95—Club price \$3.75
(You save \$1.20) |
| Electronic Design Charts
Reg. \$5.95—Club price \$4.95
(You save \$1.00) | Hi-Fi Made Easy
Reg. \$5.00—Club price \$3.75
(You save \$1.25) |
| Horizontal Sweep Servicing Handbook
Reg. \$5.75—Club price \$4.50
(You save \$1.25) | Basic Industrial Electronics Course
Reg. \$5.95—Club price \$4.70
(You save \$1.25) |
| Basic Radio Course
Reg. \$5.75—Club price \$4.85
(You save 90¢) | The Story of Stereo
Reg. \$5.00—Club price \$3.60
(You save \$1.40) |
| | How to Fix Transistor Radios & Printed Circuits (2 vols.)
Reg. \$9.95—Club price \$6.50
(You save \$3.45) |

GERNSBACK LIBRARY, INC.

154 West 14th Street, New York, N. Y. 10011

114 A

Enroll me as a member of the G/L Electronics Book Club. Start my membership with the two-volume set **NEW SHORTCUTS TO TV SERVICING** for only 99c (plus a few cents postage). Thereafter, send me the club bulletin describing the current selection which I may purchase at a special discount price if I wish. I understand that my only obligation is to purchase just 4 additional books within the next 12 months, and that I may cancel anytime thereafter. I also understand that I may cancel immediately, simply by returning the two-volume set within 10 days.

Name _____

Address _____

City _____ State _____ Zip _____ Code _____

We pay postage if you send your remittance with this coupon. You have the same return privilege. Remittance enclosed.

booklets
New Literature
catalogs charts

KIT CATALOG, Heathkit 1965 catalog 810/50. 108 pages, 16 in full color, illustrating more than 250 electronic kits. Many new products include a new deluxe transistor electronic organ, 21-in. all-channel high-fidelity color TV receiver, and Heath/Mitchell Fotoval computer system, company's latest entry in the photographic equipment field. For the service technician there's a new FM stereo generator kit, plus new kits for hams and CB'ers.—**Heath Company**, Benton Harbor, Mich.

ELECTRONICS CATALOG, No. 240, for 1965. 490 pages including parts, hardware, hi-fi components, CB and ham gear, PA and intercom, recorders, test instruments, small-screen portable TV sets, over 100 Knight-Kits, antennas, accessories.—**Allied Radio Corp.**, 100 N. Western Ave., Chicago, Ill. 60680

CCTV CATALOG, 8 pages with photos and specs of a full line of CCTV equipment—cameras, monitors, lenses, housings, video and distribution equipment and accessories—for education, institutional and industrial use.—**Blonder-Tongue Labs**, 9 Alling St., Newark, N.J. 07102

TEST EQUIPMENT CATALOG, 16 pages, looseleaf punched, photos and specs of test equipment for radio and TV servicing, air conditioning, refrigeration and heating.—**Simpson Electric Co.**, 5200 W. Kinzie St., Chicago, Ill. 60644

1965 CATALOG, No. 650. 516 pages of electronics components, stereo-hi-fi, Citizens-band equipment, tape recorders, ham gear, test instruments, radios, TV's, cameras, optics, marine equipment, auto accessories, tools, books, etc.—all major manufacturers plus Lafayette's own components.—**Lafayette Radio Electronics Corp.**, 111 Jericho Turnpike, Syosset, N.Y.

PHONO-DRIVE WALL CHART, 22 x 34 in., lists round and flat rubber belts, rubber tires, fabric drive belts, idler wheels, pressure rollers, turret drives, pulleys, drive wheels, interwheels and miscellaneous phono drive items.—**Walsco Electronics Div. of GC-Textron Electronics**, 400 S. Wyman St., Rockford, Ill.

SUPPLEMENT to electronic components catalog 32, on Fastatch II control system. 8 pages with resistance curves. Controls and accessories necessary for assembly of exact replacements for single, dual, triple and quadruple single-shaft controls, dual concentric controls and units with switches.—**Centralab Distributor Sales Dept.**, Box 591, Milwaukee, Wis. 53201

BROCHURE MY with photos, specs and prices on Delta series of hi-fi 12- and 8-inch unitary loudspeakers.—**Jensen Mfg. Co.**, 6601 S. Laramie Ave., Chicago, Ill. 60638.

AUDIO PRODUCTS CATALOG, SAH-76, 16 pages, illustrated with specs on ceramic cartridges, equalizers, crystal cartridges and tonearms, replacement needles, microphones, speakers, enclosures, headsets, rechargeable battery cartridges.—**Sonotone Audio Products**, Elmsford, N.Y.

CATALOG of Add-On-Circuits. 24 pages with photos, diagrams of interconnecting amplifiers, converters, single-sideband filters, multivibrator ± 10 dividers, oscillators, power supplies, variable capacitors, potentiometers, transformers, etc.—**International Crystal Mfg. Co., Inc.**, 18 N. Lee, Oklahoma City, Okla. 73102

INTERCHANGEABILITY GUIDE, No. T-330B. 24-page guide to interchangeability of foreign and domestic transistors, diodes and rectifiers with Tung-Sol "ET" line. Pocket-size.—**Tung-Sol Electronic Inc.**, 1 Summer Ave., Newark 4, N.J.

PASSIVE ELECTRONIC NETWORKS. 6-page foldout leaflet describes antenna dividing and coupling networks, test couplers, traps for vhf, uhf TV and FM-stereo. Photos, specs and reference chart.—**Channel Master Corp.**, Ellenville, N.Y.

DATA SHEET, 464 PFHH, specs on Picofuse series of subminiature ceramic fuses (7/32 x 5/64 in. diameter, less than 1/5 gram) for computer, microelectronic and aerospace instrument circuits.—**Littelfuse, Inc.**, Picofuse Lit. Dept., 800 E. Northwest Highway, Des Plaines, Ill.

DATA SHEET on model 601 ultra-low-range (.001-ohm) ohmmeter and high-capacitance (3,000- μ f) meter. Photo and specs.—**Conant Labs**, Box 3997 Bethany Sta. Lincoln, Neb.

NICKEL-CADMIUM BATTERIES CATALOG (GEA-7678). 12 pages, illustrated with curves, tables. Applications on standard rechargeable, sealed, button and cylindrical cells.—**General Electric Co.**, Schenectady 5, N.Y.

2-WAY RADIO LEAFLET. 4-page description of Com-Pak model 800 FM pocket 2-way radio (solid-state) with photo and specs.—**Comco, Inc.**, Coral Gables 34, Fla.

CATALOG, Digest-K. 16 pages, 2 colors with photos and specs of spectrum analyzers, communications systems analyzers, frequency response plotters, telemetry system test instruments, telephone system measuring sets, accessories, signal generators, and other test instruments.—**Panoramic Instruments, Singer Co., Metrics Div.**, 915 Penbrock St., Bridgeport 8, Conn.

Any or all of these catalogs, bulletins, or periodicals are available to you on request direct to the manufacturers, whose addresses are listed at the end of each item. Use your letterhead—do not use postcards. To facilitate identification, mention the issue and page of RADIO-ELECTRONICS on which the item appears.

UNLESS OTHERWISE STATED, ALL ITEMS ARE GRATIS. ALL LITERATURE OFFERS ARE VOID AFTER SIX MONTHS.

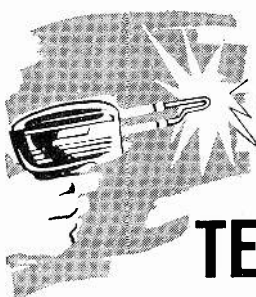

hallicrafters quality is the BIG NEWS in TEST INSTRUMENT KITS

... and hallicrafters engineered quality means outstanding specifications and performance ... plus simplified construction!



NEW "Fail-Proof" soldering terminal strips simplify making of positive connections.

NEW assembly ease. Mechanical parts are riveted to the chassis at the factory.



CAPACITANCE DECADE

Kit HD-1

Ideal for experimental and service work requiring precision capacitors. Sixteen commercial slide switches give total variability in 100 pf steps. Uses silv. mica capacitors and long lasting stable defilm capacitors. Range .0001 to 1.0 mfd in four decades. Price \$14.95



RESISTOR DECADE Kit HD-2

Use to substitute known-value precision resistors in a circuit. Resistors are one-watt, 10%. Twenty-eight commercial slide switches give total variability in 1-ohm steps. Range: 1 ohm to 10 ohms in seven decades. Price \$14.95



CONDENSER TESTER Kit HC-1

Handy service bench instrument for checking unknown condenser and resistor values under operating conditions. Has precision tuning eye for easy operation. Four capacitance ranges: 10 mmf to 2,000 mfd. Three resistance ranges: 0.5 ohm to 5 megohms. Price \$29.95



5-INCH OSCILLOSCOPE Kit HO-1

A perfect scope for servicing color TV sets. Has full 5 Mc. bandwidth. Tube is 5 UPI. One-volt peak-to-peak source attenuator permits voltage measurements over range of 10,000 to 1. Retrace blanking amplifier provided. Phasing is continuously variable from 0 to 140°. Has two axis (beam) modulation. Price \$84.95



BATTERY ELIMINATOR Kit HP-1

Reliable source of 6- or 12-volt DC power for servicing car radios, including transistor and "hybrid." AC ripple less than .25%; exceptionally low. Voltage ranges 0-8 volts and 0-16 volts. Also use as battery charger. Has voltage and current panel meters. Price \$49.95

R.F. GENERATOR Kit HG-1

Generates frequencies from 50 kc. to 55 Mc. in six steps. Calibrated harmonics in two steps from 55 Mc. to 220 Mc. Low frequency range exceptionally stable. Accuracy 1 1/2% of the reading. R.F. output .1-volt. Bandswitch assembly pre-wired and calibrated. Price \$29.95

VACUUM TUBE VOLT MILLIAMETER Kit HM-1

Has an exclusive built-in milliammeter circuit, available at the turn of a switch. Illuminated meter and separate front panel On-Off switch. Has seven AC, DC voltage ranges, from 1.5 to 1500; seven ohmmeter ranges, 0 to 1,000 megohms; and six milliammeter ranges, 1.5 to 500. Price \$29.95

Look for this display



at your Authorized Hallicrafters Kit Headquarters!



hallicrafters

Master Kits

For FREE Catalog, write Dept. 15-K, 5th & Kostner Aves., Chicago 24, Ill.

Everything you ever wanted in a CB transceiver!

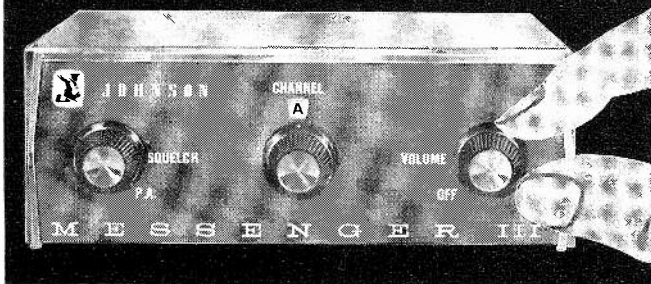

Newest! Most Versatile! Most Power Out!

The 11 channel "Messenger III" will change every idea you ever had about what a Citizens Band unit should offer! Tiny, all transistor, it's really quiet, really hot! Interchangeable for base or mobile—use it as a full 5-watt battery powered portable pack set or a 3-watt PA system. The "Messenger III", with an aerospace transistor developed for the "Relay" communications satellite, delivers more power output with maximum legal input! Double conversion receiver with high 1st I.F. provides excellent spurious and image rejection. Set-and-forget "Volume" and "Squelch" controls make it possible for the first time to work "close-in" or at extended range with initial settings. Furnished with dynamic microphone—full line of accessories available for selective calling, portable field pack, or public address use!

Cat. No. 242-150.....\$189.95 Net

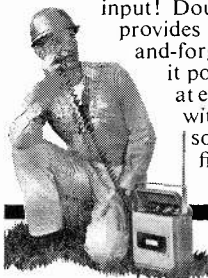

WRITE TODAY for details on the "Messenger" CB line—or see your distributor!



E. F. JOHNSON COMPANY

2510 Tenth Ave. S.W. • Waseca, Minnesota

Please send full details on the "Messenger" CB line.

NAME _____

ADDRESS _____

CITY _____ STATE _____

continued from page 35

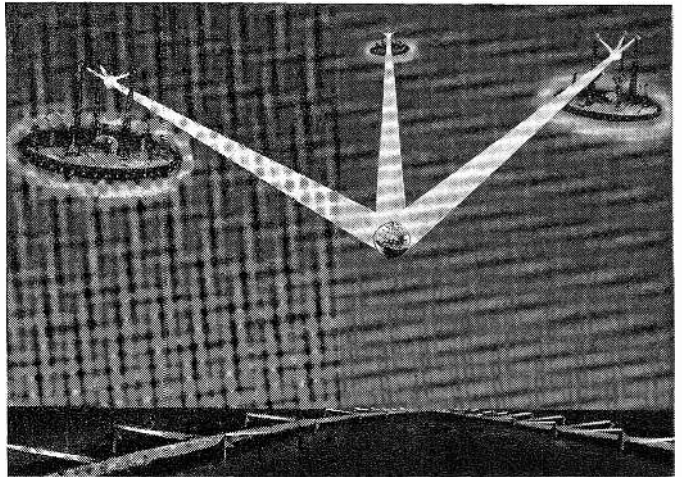

Forty-nine years ago the magazine *The Electrical Experimenter* published a science fiction story; Baron Münchhausen's New Scientific Adventures, which ran serially for many months. The November 1915 installment pictured three flying saucers which an interplanetary space flyer held captive by the Martians. The yellow Martian rays also held the humans captive by paralyzing them.

siles, the space ships, and all the other highly-colored scare stories.

"But truth is stranger than fiction, and Dr. Menzel does far more than debunk. Flying saucers are real, he says, as real as rainbows—and just as hard to catch. Moreover there is nothing new about them: from the famous air-ship of 1897, similar sights (and similar scares) have been known throughout history. These optical ghosts in all their variety of size and shape and color and motion are about for anyone to see: what is new, in our supposedly more rational society, is the air age—more people look at the sky, from below and from above, than ever before." * —H.G.

* *Flying Saucers*, published by Harvard University Press, has been out of print for several years. It can be found in most large libraries, or possibly in the following book stores: American Library Service, 353 West 48 St., New York, N. Y.; Barnes & Noble, 105 Fifth Ave., New York, N. Y.; Stechert-Hafner, Inc., 31 East 10 St., New York, N. Y.; Superbooks, PO Box 34, Gedney Station, White Plains, N. Y.; Book Bargains by Mail, 516 Sherman Ave., Pittsburgh, Pa.

EIGHT INSTRUMENTS IN ONE

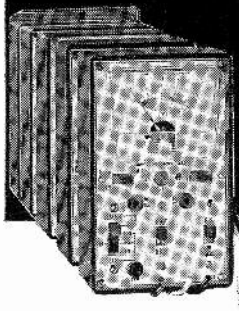

- Out-of-Circuit Transistor Analyzer
- Dynamic In-Circuit Transistor & Radio Tester
- Signal Generator
- Signal Tracer • Voltmeter
- Milliammeter
- Battery Tester
- Diode Checker

Transistor Analyzer Model 212

Factory Wired & Tested — \$18.50
Easy-to-Assemble Kit — \$13.50

YOU DON'T NEED A BENCH FULL OF EQUIPMENT TO TEST TRANSISTOR RADIOS! All the facilities you need to check the transistors themselves — and the radios or other circuits in which they are used — have been ingeniously engineered into the compact, 6-inch high case of the Model 212. It's the transistor radio troubleshooter with all the features found only in more expensive units. Find defective transistors and circuit troubles speedily with a single, streamlined instrument instead of an elaborate hook-up.

Features:
Checks all transistor types — high or low power. Checks DC current gain (beta) to 200 in 3 ranges. Checks leakage. Universal test socket accepts different base configurations. Identifies unknown transistors as NPN or PNP.

Dynamic test for all transistors as signal amplifiers (oscillator check), in or out of circuit. Develops test signal for AF, IF, or RF circuits. Signal traces all circuits. Checks condition of diodes. Measures battery or other transistor-circuit power-supply voltages on 12-volt scale. No external power source needed. Measures circuit drain or other DC currents to 80 milliamperes. Supplied with three external leads for in-circuit testing and a pair of test leads for measuring voltage and current. Comes complete with instruction manual and transistor listing.

EMC, 625 Broadway, New York 12, N. Y.

Send me FREE catalog of the complete value-packed EMC line, and name of local distributor.

NAME _____ RE-11

ADDRESS _____

CITY _____ ZONE _____ STATE _____

EMC

ELECTRONIC MEASUREMENTS CORP.
625 Broadway, New York 12, New York
Export: Pan-Mar Corp., 1270 B'way, N.Y. 1

COMING NEXT MONTH

ALL-TRANSISTOR ELECTRONIC SWITCH

Make your scope do many of the things for which you would normally need an expensive double-beam oscilloscope. This unit takes two input signals and displays them simultaneously on your scope face. Has two separate amplifiers for the input signals as well as the switching apparatus.

TRANSISTOR SPEED CONTROL FOR HO RAILROADS

Get realistic starting, coasting and braking effects with this easy-to-build unit. Gives your youngster's model railroad stock the "feel" and momentum of a big locomotive. Makes a fine Christmas gift.

BUILD A HIGH-QUALITY TRANSISTOR RADIO

Non-critical in layout and construction, this 10-transistor receiver compares favorably with the better name-brand sets. Construction on copper-clad board gives the advantage of printed circuitry without its problems.

WHAT DO YOU NEED FOR A GOOD SHOP?

Just what equipment is needed to check everything you need to test in TV and radio work? What items would be good to have but aren't absolutely necessary, and what ones can you get along without?

DECEMBER RADIO-ELECTRONICS

ON SALE NOVEMBER 17

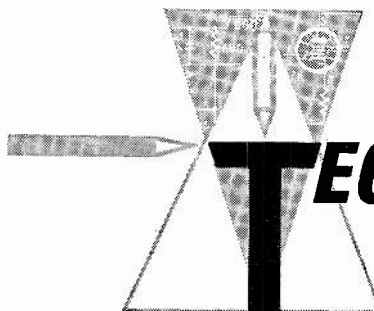

TECHNOTES

HV RECTIFIER TROUBLE

If you have had trouble keeping 1X2's from destroying themselves because of internal arcing, here's a quick cure. The trouble usually shows up on older sets that have had new power and output tubes installed, raising the high voltage to a point where the 1X2 is operating close to its peak voltage. The solution is to place a resistor between the plate cap and the plate lead from the flyback transformer so the peak voltage is reduced. Use the smallest value between 270,000 ohms and 1 megohm that drops the voltage enough. If it is dropped too much, brightness and CRT life will suffer. Use a 1-watt resistor and wrap one lead around the cap. Bend the other lead so it fits snugly into the cap of the transformer lead. If the set is in for a major overhaul, it's a good idea to solder one in on the socket if the factory left it out.—*George Hrischenko*

CORRECTING VERTICAL ATTENUATOR IN EICO 460 SCOPE

Owners of the Eico model 460 oscilloscope may be interested to know that there is an error in the voltage attenuator circuit of this otherwise outstanding service instrument. The error shows up only in the $\times 10$ position of the attenuator and causes voltage amplitude measurements made with this attenuator position to be approximately 10% low. The error is due to the loading effect of R6 on R2, R2 being the resistor

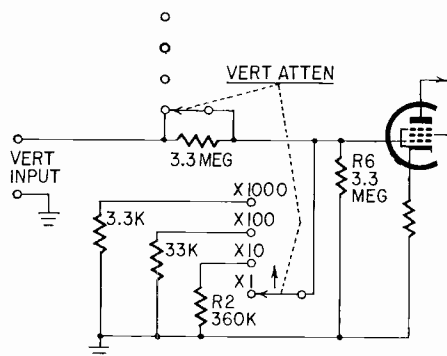

which is switched into the vertical attenuator circuit when the attenuator is placed in the $\times 10$ position. (See diagram)

To correct that, R2 should be changed from 360,000 ohms to 413,000 ohms. There are two ways around that odd value. Several 390,000 ohm, 10% resistors can be measured until one is found with value of 413,000 ohms. If this is impractical, a pair of 820,000 ohm, 5% resistors may be connected in parallel. The resulting combination will have an equivalent resistance of 410,000 ohms, sufficiently close to the desired value.

Corrected this way, the scope will give equally accurate voltage measurements at all settings of the vertical attenuator.—*Peter J. Profera*

EXTREME CALIBRATION SHIFT IN BROWN INDUSTRIAL RECORDERS

Late-model Brown Electronic recording instruments may be equipped with a constant-voltage unit that replaces the standard cell and No. 6 dry cell. When you service one of these, for the complaint that it gives a reading twice as high

as normal, check the output of the Zener constant-voltage unit. If the output is 0.5 volt instead of 1 volt, the trouble is most often a leaky filter capacitor inside the unit. It is a 20- μ f 150-volt electrolytic mounted on the printed circuit board. The capacitor (Brown part No. 365356) must be replaced.—*F. G. Lewis*

MECHANICAL FAILURE IN ADMIRAL TV TUNER

The Admiral disc type tuner, first used in portables like the 14YP3, fails because the front disc loosens on the shaft. Angular misalignment between the two discs prevents their contacts from making contact at the same time. Hence, no picture or sound.

Look inside and you will see that the detent washers between the V-slots of the disc and the V-projections of the white

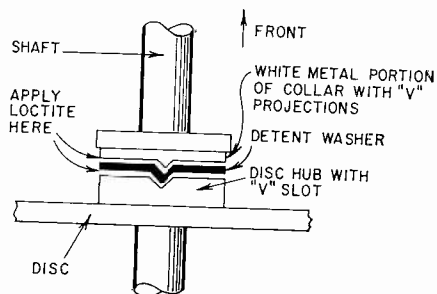

metal portion of the shaft collar assembly are no longer tight. (See drawing.) To repair, rotate the front disc until its contacts engage their stationary fingers properly, then put a few drops of Loctite (Grade A) into the joint and let it harden.

This repair is much simpler than replacing the assembly or trying to put a pin through the shaft.—*H. Q. Duguid*

ADMIRAL 19W1: VERTICAL JUMP

An intermittent short in the vertical output transformer caused the picture to jump up and down. Adjusting the height

ENGINEERS and TECHNICIANS

Stateside & Overseas

COMMUNICATIONS FIELD ENGINEERS

Must have a minimum of 4 years' maintenance in any one of the following:

- TELEPHONE-INSIDE & OUTSIDE PLANT
- RADIO FREQUENCY INTERFERENCE
- TROPOSCATTER/MICROWAVE
- NAVIGATIONAL AIDS—GROUND

RADAR FIELD ENGINEERS

Stateside assignments for men with 8 years in ground radar system and 2 years' technical education.

COMPUTER MAINTENANCE TECHNICIANS

Minimum of 3 years' maintenance experience on FSQ-7 or FSQ-8 systems, Stateside openings.

Qualified candidates please send complete resume to Mr. Don Kirkland, Dept. 804

PHILCO TECHREP DIVISION

A Subsidiary of Ford Motor Co.

P.O. Box 10

FT. WASHINGTON, PA. 19034

An Equal Opportunity Employer

BECOME A RADIO TECHNICIAN

for only \$26.95

BUILD YOUR RADIO

CIRCUITS AT HOME

with the New Progressive
RADIO "EDU-KIT"®

All Guaranteed to Work!

PRACTICAL HOME RADIO COURSE
only \$26.95



Reg. U.S. Pat. Off.

NOW INCLUDES

- ★ 12 RECEIVERS
- ★ 3 TRANSMITTERS
- ★ SQ. WAVE GENERATOR
- ★ AMPLIFIER
- ★ SIGNAL TRACER
- ★ SIGNAL INJECTOR
- ★ CODE OSCILLATOR

TRAINING ELECTRONICS TECHNICIANS SINCE 1946

- ★ No Knowledge of Radio Necessary
- ★ No Additional Parts or Tools needed
- ★ Excellent Background for TV
- ★ School Inquiries Invited
- ★ Attractively Gift Packed

FREE EXTRAS

- SET OF TOOLS • RADIO & ELECTRONICS TESTER • ELECTRIC SOLDERING IRON • TESTER INSTRUCTION MANUAL • MEMBERSHIP IN RADIO-TV CLUB • CONSULTATION SERVICE • HI-FI GUIDE • QUIZZES • TV BOOK • FCC AMATEUR LICENSE TRAINING • RADIO BOOK • PRINTED CIRCUITRY • PLIERS-CUTTERS • ALIGNMENT TOOL • WRENCH SET • CERTIFICATE OF MERIT • VALUABLE DISCOUNT CARD

WHAT THE "EDU-KIT" OFFERS YOU

The "Edu-Kit" offers you an outstanding PRACTICAL HOME RADIO COURSE at a rock-bottom price. Our kit is designed to train Radio & Electronics Technicians, making use of the most modern methods of home training. You will learn radio theory, construction, servicing, basic Hi-Fi and TV repairs, code, FCC amateur license requirements.

You will learn how to identify radio symbols, how to read and interpret schematics, how to mount and lay out radio parts, how to wire and solder, how to operate electronic equipment, how to build radios. Today it is no longer necessary to spend hundreds of dollars for a radio course. You will receive a basic education in radio, worth many times the small price you pay, only \$26.95 complete.

THE KIT FOR EVERYONE

The Progressive Radio "Edu-Kit" was specifically prepared for any person who has a desire to learn Radio. The "Edu-Kit" has been used successfully by young and old in all parts of the world, by many Radio Schools and Clubs in this country and abroad. It is used for training and rehabilitation of Armed Forces Personnel and Veterans throughout the world.

The Progressive Radio "Edu-Kit" requires no instructor. All instructions are included. Every step is carefully explained. You cannot make a mistake.

PROGRESSIVE TEACHING METHOD

The Progressive Radio "Edu-Kit" is the foremost educational radio kit in the world, and is universally accepted as the standard in the field of electronics training. The "Edu-Kit" uses the modern educational principle of "Learn by Doing." Therefore, you will construct radio circuits, perform jobs and conduct experiments to illustrate the principles which you learn.

You begin by examining the various radio parts included in the "Edu-Kit." You then learn the function, theory and wiring of these parts. Then you build a simple radio. With this first set, you will enjoy listening to regular broadcast stations, learn theory, practice testing and troubleshooting. Then you build a more advanced radio, learn more advanced theory and techniques. Gradually, in a progressive manner, and at your own rate, you will find yourself constructing more advanced multi-tube radio circuits, and doing work like a professional Radio Technician.

Included in the "Edu-Kit" course are 20 Receiver, Transmitter, Code Oscillator, Signal Tracer, Signal Injector, Square Wave Generator and Amplifier circuits. These are not unprofessional "bread board" experiments, but genuine radio circuits, constructed by means of professional wiring and soldering on metal chassis, plus the new method of radio construction known as "Printed Circuitry." These circuits operate on your regular AC or DC house current.

In order to provide a thorough, well-integrated and easily-learned radio course, the "Edu-Kit" includes practical work as well as theory; troubleshooting in addition to construction; training for all, whether your purpose in learning radio be for hobby, for career, or for professional advancement. Materials ranging from simple circuits to well-advanced topics in Hi-Fi and TV. Your studies will be further aided by Quiz materials and our well-known FREE Consultation Service.

THE "EDU-KIT" IS COMPLETE

You will receive all parts and instructions necessary to build 20 different radio and electronics circuits, each guaranteed to operate. Our Kits contain tubes, tube sockets, variable electrolytic, mica, ceramic and paper dielectric condensers, resistors, tie strips, coils, hardware, tubing, punched metal chassis, instruction manuals, hookup wire, solder, selenium rectifiers, volume controls, switches, knobs, etc.

In addition, you receive Printed Circuit materials, including Printed Circuit chassis, special tube sockets, hardware and instructions. You also receive a useful set of tools, a professional electric soldering iron, and a self-powered Dynamic Radio & Electronics Tester. The "Edu-Kit" also includes Code Instructions and the Progressive Code Oscillator. In addition to the F.C.C. type Questions and Answers for Radio Amateur License training. You will also receive lessons for servicing with the Progressive Signal Tracer and the Progressive Signal Injector, and a High Fidelity Guide and Quiz Book. Everything is yours to keep.

J. Statistis, of 25 Poplar Pl., Waterbury, Conn., writes: "I have repaired several sets for my friends, and made money. The "Edu-Kit" paid for itself. I was ready to spend \$240 for a course, but I found your ad and sent for your Kit."

UNCONDITIONAL MONEY-BACK GUARANTEE

The Progressive Radio "Edu-Kit" has been sold to many thousands of individuals, schools and organizations, public and private, throughout the world. It is recognized internationally as the ideal radio course.

By popular demand the Progressive Radio "Edu-Kit" is now available in Spanish as well as English.

It is understood and agreed that should the Progressive Radio "Edu-Kit" be returned to Progressive "Edu-Kits" Inc., for any reason whatever, the purchase price will be refunded in full, without quibble or question, and without delay.

The high recognition which Progressive "Edu-Kits" Inc. has earned through its many years of operation and the public is due to its unconditional insistence upon the maintenance of perfect engineering, the highest instructional standards, and 100% adherence to its Unconditional Money-Back Guarantee. As a result, we do not have a single dissatisfied customer throughout the entire world.

ORDER FROM AD - RECEIVE FREE BONUS
RADIO & TV PARTS JACKPOT WORTH \$15

- Send "Edu-Kit" Postpaid. I enclose full payment of \$26.95.
- Send "Edu-Kit" C.O.D. I will pay \$26.95 plus postage.
- Send me FREE additional information describing "Edu-Kit."

Name _____
Address _____

Progressive "EDU-KITS" Inc. 1186 Broadway, Dept. 231-G
Hewlett, N. Y.
(ATT: S. GOODMAN, M.S. in ED., PRES.)

and linearity controls for a slightly shorter picture made the picture hold still because it cut down on the current through the output tube and transformer. If it had been a defect in the vertical oscillator stage, adjusting the output controls would have had no effect on the jumping.—*Alfred L. Hollinden*

LEEDS & NORTHRUP TYPE S WHEATSTONE BRIDGE

When the battery selector switch was turned to the internal-battery position, with the external supply of 45 volts connected, R2 shunt resistor burned out. After checking the

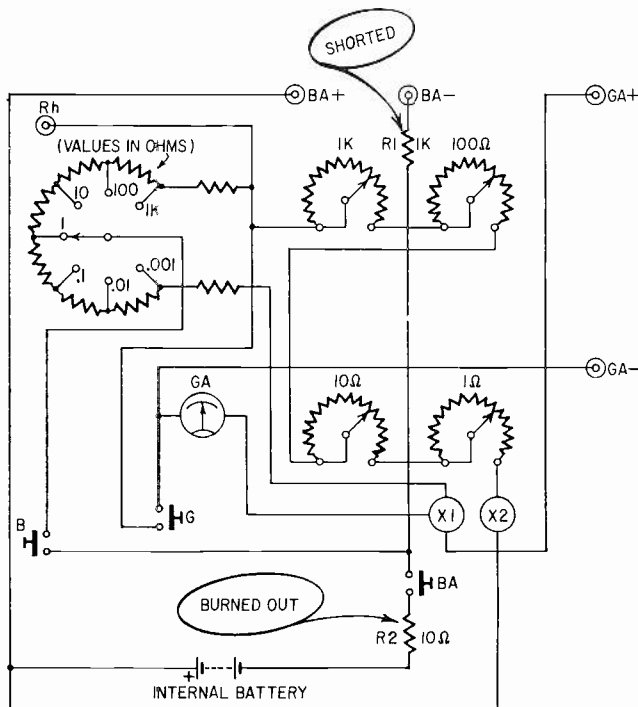

circuit, I found that R1, a dropping resistor in the external supply circuit, was shorted, placing the full load across R2, which burned out.

R1 is a 1/2-watt 1,000-ohm resistor, located at the left of the battery switch. R2 is a 10-ohm shunt, located at the battery switch.—*Clyde Rehberg*

CLEVELAND DIALAMATIC

The ram of a Cleveland Dialamatic (electronically controlled turret lathe) failed to go into low speed in the feed position.

The cam-operated switch controlling the latching relay checked defective. Closer inspection revealed that the basic Microswitch was OK but the roller actuator was hanging up because of dirt under the overtravel plunger.—*R. C. Roetger*

VERTICAL BOUNCE IN RCA CTC9

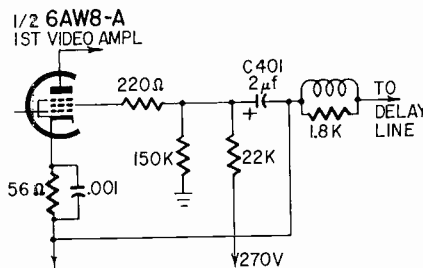

C401, located on the video board, is often the cause of vertical troubles on this chassis. Just cut one end loose, and, if the vertical bounce disappears or the weak vertical sync is gone, replace it with 2- or 5-µf.—*Arthur Richman* END

Answers to

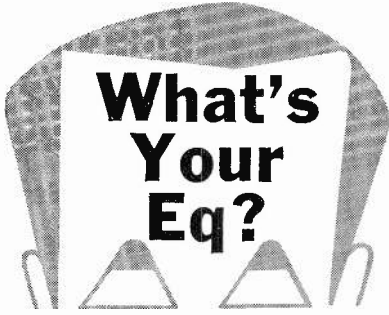

This month's puzzles are on page 57

Ferris Wheel

From Kirchhoff's current law, we see that the algebraic sum of the currents into any junction is equal to zero. As the outer end of all resistors is at a fixed voltage, V_1 is the only unknown. Assuming V_1 to be 1 volt (any value would do), the current directions are assigned as shown. The equation for the junction currents is now written:

$$\frac{6 - V_1}{2} + \frac{4 - V_1}{4} + \frac{2 - V_1}{4} + \frac{4 - V_1}{6} + \frac{2 - V_1}{6} - \frac{V_1}{2} = 0$$

Using LCD of 12, then eliminating denominators:

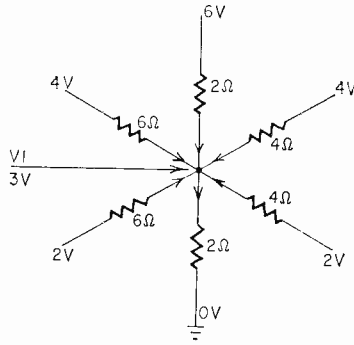

$$36 - 6V_1 + 12 - 3V_1 + 6 - 3V_1 + 8 - 2V_1 + 4 - 2V_1 - 6V_1 = 0$$

Collecting terms:

$$66 - 22V_1 = 0 \quad V_1 = 3$$

All branch currents, if needed, now fall easily into place.

Two Meters

The dc ammeter indicates average-current values while the ac ammeter indicates effective or rms-current values. The straight-line graph is used to illustrate their difference. The graph shows a complete cycle of rectangular pulse current in relation to a time base of five 1/300-second intervals. Referring to the figure, the following equation expresses average current, or the dc ammeter reading:

$$\text{dc ammeter reading} = \frac{\text{pulse width} \times \text{peak current}}{\text{total cycle time}}$$

Thus: dc ammeter reading =

$$\frac{2/300 \times 5}{5/300} = 2 \text{ ampere}$$

The ac ammeter reading is determined by finding the square root of the average value of the squares of the current during the time divisions of one cycle. The current values are: 5, 5, 0, 0,

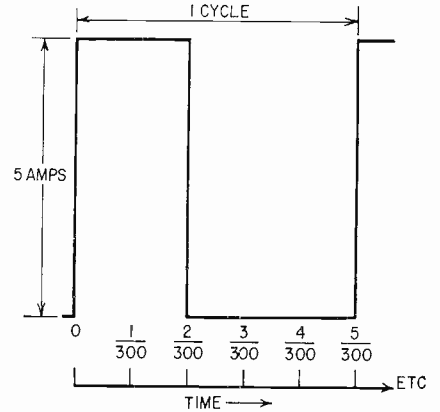

and 0; the sum of their squares 50, and the average 10 amperes. The ac ammeter reading is the square root of 10, or 3.162 amperes.

TV-RADIO Servicemen or Beginners...

2 WEEKS FREE TRIAL!

Just Send name for **Coyne's** Seven Volume **Job-Training Library!**



The First Practical TV-RADIO-ELECTRONICS Shop Library!

Answers ALL Servicing Problems QUICKLY... Makes You Worth More On The Job!

Put money-making, time-saving TV-RADIO-ELECTRONICS know-how at your fingertips—examine Coyne's all-new 7-Volume TV-RADIO-ELECTRONICS Reference Set for TWO WEEKS at our expense! Shows you the way to easier TV-Radio repair—time saving, practical working knowledge that helps you get the BIG money! How to install, service and align ALL radio and TV sets, even color-TV, UHF, FM and transistorized equipment. New photo-instruction shows you what makes equipment "tick." No complicated math or theory—just practical facts you can put to use immediately. Over 3,000 pages; 1200 diagrams; 10,000 facts! Ready to use in shop or home.

SEND NO MONEY! Just mail coupon for 7-Volume TV-Radio Set on FREE BOOK below. If you keep the set, pay only \$5 after TWO WEEKS and \$4 per month until \$32.95 plus postage is paid. Cash price only \$29.95. Or return set at our expense in TWO WEEKS and owe nothing. Offer limited, so act NOW!

"LEARNED MORE FROM THEM THAN FROM 5 YEARS WORK!"
"Learned more from your first two volumes than from 5 years work."
—Guy Bliss, New York
"Swell set for either the serviceman or the beginner. Every service bench should have one."
—Melvin Masbruch, Iowa.

KEEP FREE DIAGRAM BOOK EVEN IF YOU RETURN THE SET

We'll send you this big book. "150 Radio-Television Picture Patterns and Diagrams Explained" ABSOLUTELY FREE just for examining 7-Volume Shop Library on TWO WEEKS FREE TRIAL! Shows how to cut servicing time by reading picture-patterns, plus schematic diagrams for many TV and radio sets. Yours to keep FREE even if you return the 7-Volume Set! Mail coupon TODAY!



Like Having An Electronics Expert Right At Your Side!

ALL 7 BOOKS HAVE WASHABLE, VINYL CLOTH COVERS

- VOL. 1—EVERYTHING ON TV-RADIO PRINCIPLES! 300 pages of practical explanations; hundreds of illustrations.
- VOL. 2—EVERYTHING ON TV-RADIO-FM RECEIVERS; 403 pages; fully illustrated.
- VOL. 3—EVERYTHING ON TV-RADIO CIRCUITS! 336 pages; hundreds of pictures and circuits.
- VOL. 4—EVERYTHING ON SERVICING INSTRUMENTS! How they work, how to use them. 368 pages; illustrated.
- VOL. 5—EVERYTHING ON TV TROUBLESHOOTING! Covers all types of sets, 437 pages; illustrations, diagrams.
- VOL. 6—TV CYCLOPEDIA! Quick and concise answers to TV problems in alphabetical order, including UHF, Color TV and Transistors; 868 pages.
- VOL. 7—TRANSISTOR CIRCUIT HANDBOOK! Practical Reference Transistor Applications; over 200 Circuit Diagrams; 472 pages.

FREE BOOK—FREE TRIAL COUPON!

COYNE SCHOOL PUBLICATIONS, Dept. RE114, 1455 W. Congress Parkway, Chicago 7, Illinois

Yes! Send me COYNE'S 7-Volume Applied Practical TV-RADIO-ELECTRONICS Set for TWO WEEKS FREE TRIAL. Include "Patterns and Diagrams" book FREE!

Name _____ Age _____
Address _____

City _____ Zone _____ State _____

Check here if you are sending \$29.95 in full payment. Same TWO WEEK Money-Back Guarantee applies.

Coyne SCHOOL PUBLICATIONS
Dept. RE114, 1455 W. Congress Parkway, Chicago 7, Ill.

LAFAYETTE RADIO ELECTRONICS

FREE!

1965 CATALOG No. 650

Over 500 Pages! *Featuring Everything
in Electronics for*

HOME • INDUSTRY • LABORATORY

from the "World's Hi-Fi & Electronics Center"

- Stereo Hi-Fi—All Famous Brands Plus Lafayette's Own Top-Rated Components
- Citizens Band—Transceivers, Walkie-Talkies and Accessories
- Tape Recorders
- Test Equipment
- Radios, TV's, and Accessories
- P.A. Equipment; Intercoms
- Cameras; Optical Goods
- Marine Equipment; Auto Accessories
- Musical Instruments; Tools; Books and MUCH MORE

BUY ON TIME—
Use Lafayette's
famous Easy-Pay
Credit plan . . . up to
24 Months
to Pay



See the Largest Selection in Our 44-Year History

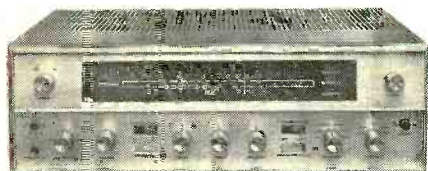

19950

New LR-800 70-Watt Complete AM-FM Stereo Multiplex Receiver features a tuned nuvistor "front-end" and an FM "Stereo-Search" multiplex indicator. Excellent sensitivity, frequency response, and low distortion specs. Imported, 99-0005WX.



9395

New LT-325 AM/FM Multiplex Tuner combines simplicity, flexibility, and superb styling. 20-Tube performance provides a great variety of features, including a new audible tone "Stereo Search System." Imported, 99-0001WX.



4995

Model LA-224 24-Watt Stereo Amplifier combines high performance, beautiful styling and low price to give you a truly brilliant stereo performer. Full control facilities for integration with all hi-fi music sources. Imported, 99-0017WX.

HEADQUARTERS FOR THE HI-FI ENTHUSIAST

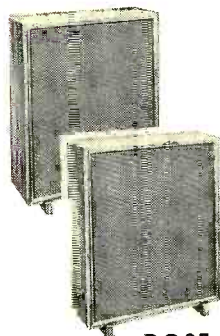

3995
2 for
78.50

Model SK-300 "Decor-ette V" Slim 5-Speaker System utilizes the 5 most important speakers you may ever own. Four 6½" woofers and one 2½" cone-type tweeter designed to give optimum performance in a 4¼" thin oil walnut enclosure. Response from 50 to 18,000 cycles. Imported, 99-0008WX.

Lafayette 2-Station Transistorized Intercom features inter-unit tone calling, push-button operation and beautiful styling. A single 66 foot plug-in connecting cord allows for fast and simple hook-up. Powered by one inexpensive 9-volt battery. AC power supply/battery charger available. Imported, 99-4526.

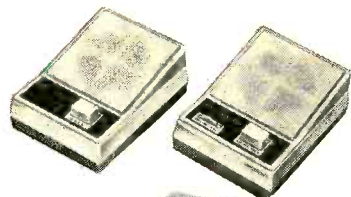

995

Model RK-142 Deluxe Portable Tape Recorder perfect for the home, school, or office. Records and plays ½ track monaural at two speeds. Specially designed lever type motion switch gives fool-proof operation. Complete with dynamic microphone, connecting cables, and empty 7" reel. Imported. 99-1512WX.



5995

Mail The Attached Card or Coupon TODAY For Your FREE LAFAYETTE 1965 Catalog

LAFAYETTE is HEADQUARTERS

For CB and AMATEUR EQUIPMENT

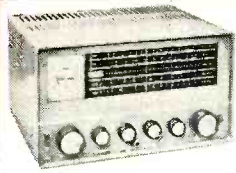

64⁹⁵

Deluxe Model HA-63 Short-wave Receiver is an excellent choice for the beginning shortwave listener or novice amateur. Covers 550 KC to 30mc in 4 bands and features electrical band-spread on all frequencies. 7 Tube circuitry gives outstanding selectivity and sensitivity. Imported, 99-2534WX



22⁹⁵

"Explor-Air"™ 4-band short wave receiver kit—an ideal way of introducing yourself or your children to the fascinating world of electronics and shortwave listening. Detailed step-by-step instruction book makes this kit a pleasure to build. 19-0905. Cabinet available for 2.85. 19-0906



59⁹⁵

Three New Deluxe Lafayette Receivers for monitoring police, fire department, aircraft, civil defense, or commercial communications. 10-Tube performance features high sensitivity, variable squelch, and fully tuned RF stage. Imported. Model HA-50 30-50Mc 99-2525WX
Model HA-55 108-136Mc 99-2527NX
Model HA-52 152-174Mc 99-2526WX

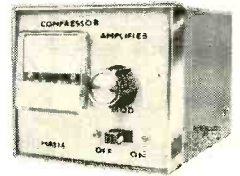

25⁹⁵

The New Model HA-115 audio compressor amplifier instantly and automatically increases the "talking power" of your citizens band transceiver by increasing the average modulation of the transmitter section. Works with all popular CB units. 42-0117.



25⁹⁵

2 for 49.95

HE-29C 9-Transistor Walkie-Talkie provides two-way communications up to 1.5 miles. Powered by six penlight batteries with life expectancy of 55 hours. An AC power supply is also available. Specify channel. Imported, 99-3020CL.



19⁹⁵

2 for 38.75

Model HA-85 6-Transistor "Walkie-Talkie" transmits and receives up to 1 mile. Ideal for sports, boating, construction and recreation. Complete with leather case, earphone, batteries, and crystals for the channel of your choice. Imported, 99-3013CL.

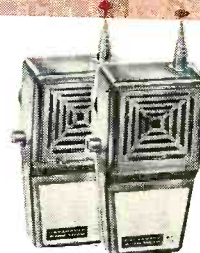

10⁹⁵

2 for 21.00

The HA-70A—a wirec pocket-size 3-transistor walkie-talkie with countless exciting short range applications. Complete with crystal, carrying case, and 9-volt battery. Imported, 99-3011L.



6⁹⁵

Lafayette Stainless Steel CB Mobile Antenna—an outstanding buy with outstanding features. Chrome plated swivel ball mount base permits mounting on any surface. Lug terminals for easy hook-up to coaxial cable. Imported, 99-3034WX.

EXCLUSIVE LAFAYETTE WIRED TEST EQUIPMENT



9⁹⁵

New! 20,000 Ohms-Per-Volt Multitester at Lafayette's low, low price. Has every needed range for testing appliances, radio, etc. 40 microampere meter movement and 1% precision resistor for accurate readings. Imported, 99-5008. Pigskin carrying case available for 1.75, 99-5009.



26⁹⁵

Lafayette VTVM with all the ranges and accuracy you need for audio, radio and TV applications. Giant 6½" full-view meter accurately measures AC peak-to-peak, AC RMS, DC voltage, and resistance. Leather case and accessory RF probe available. 38-0101

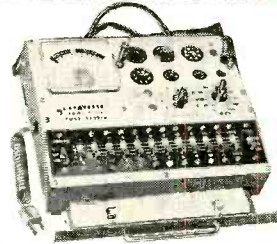

19⁹⁵

Lafayette Tube Checker packed with features at a price you can afford. Accurately checks over 1600 tubes including new compactrons and nuvistors. Handy, easy to read slide out tube chart. Imported, 99-5011.

SEND TODAY FOR YOUR FREE 1965 CATALOG

LAFAYETTE RADIO ELECTRONICS

Mail Order and L. I. Sales Center

111 Jericho Turnpike, Syosset, L. I., New York

New York, N. Y. 100 Sixth Ave. Brooklyn, N. Y. 2265 Bedford Ave. Scarsdale, N. Y. 691 Central (Park) Ave. Paramus, N. J. 182 Route 17

Jamaica, N. Y. 165-08 Liberty Ave. Bronx, N. Y. 542 E. Fordham Rd. Newark, N. J. 24 Central Ave. Plainfield, N. J. 139 W. 2 St.

Boston, Mass. 584 Commonwealth Ave. Natick, Mass. 1400 Worcester St.

New! New York City Store! Watch For Opening Soon!

LAFAYETTE RADIO ELECTRONICS

Dept. JK4-1 P.O. Box 10

Syosset, L.I., N.Y. 11791

- Send me the FREE 1965 Lafayette Catalog 650
 \$..... enclosed; send me.....
(Prices do not include shipping charges).

Name.....

Address.....

City..... State..... Zip.....

LAFAYETTE ...Headquarters For Citizens Band Equipment

NEW! LAFAYETTE 23-CHANNEL CRYSTAL-CONTROLLED DUAL CONVERSION 5-WATT CB TRANSCEIVER WITH ADVANCED "RANGE-BOOST" CIRCUIT

- 13 Tubes, 8 Diodes
- Low Noise Nuvistor RF & Mixer
- 5 Double-tuned IF Transformers

Model HB-400 **Only 169⁵⁰**

- Frequency Synthesis For 23 Channel Crystal Controlled Transmit & Receive
- No Extra Crystals Needed
- Dual Conversion Receiver with 3/10 uv Sensitivity
- Delta Tuning
- Variable Squelch, Variable Noise Limiter
- Illuminated "S" and RF Output Meter
- Push-to-Talk Ceramic Mike
- "Range-Boost" provides high average Modulation—increases Effective Range
- Built-in Dual Power Supply, 117VAC, 12VDC
- "Vari-Tilt" Mobile Bracket For Easy Installation
- Plug-in Facilities for Lafayette Selective Call Unit
- Compact, 12"Wx10"Dx5"H



Double Side Band Full Carrier

NEW! LAFAYETTE ALL-TRANSISTOR DUAL CONVERSION 5-WATT CB TRANSCEIVER FEATURING AUTHENTIC MECHANICAL FILTER



Includes .003% Tolerance Crystals for Frequency Stability!

Small, Compact—Only 3" High!

- 100% Solid-State . . . Full 5-Watt Performance!
- 11 Rugged Silicon Mesa Transistors Used in Critical Areas
- Small, Compact—Only 3" High!
- Low Battery Drain—Less Than 350 ma on Receive, 850 ma on Transmit!

MODEL HB-500 **Only 139⁵⁰**

- 12 Crystal-Controlled Transmit & Receive Positions
- 23 Channel Tunable Receiver with Spotting Switch
- 15 Transistors, 5 diodes with Printed Circuit Construction
- Dual Conversion Receiver with 5/10 μ V Sensitivity
- Mechanical Filter For Razor-Sharp Selectivity
- Variable Squelch, Automatic Noise Limiter, "S" meter
- Dependable Sealed Relay Switching
- Fits Anywhere—Only 11 $\frac{1}{2}$ "Wx6 $\frac{1}{2}$ "Dx3"H
- For 12VDC (optional 117VAC Transistorized power Supply available)
- Supplied With Crystals for Channel 12, special Mobile bracket, Push-to-Talk Dynamic Mike and Mobile power cable.

NEW! LAFAYETTE DELUXE 8-CHANNEL DUAL CONVERSION 5-WATT CB TRANSCEIVER SUCCESSOR TO THE FAMOUS LAFAYETTE HE-20C

Model HB-200 **ONLY 109⁵⁰**

- 9 Tubes plus 3 Silicon Diodes plus 2 Crystal Diodes for 17-Tube Performance
- Super Sensitivity—1 Micro-volt or Less
- 8 Crystal Receive Positions plus 8 Crystal Transmit Positions plus 23-Channel Tunable Receive
- Push-to-Talk Microphone
- Dependable Relay Switching
- Illuminated Meter with 3-Position Switch
- Adjustable Squelch and Automatic Noise Limiter
- Spotting Switch
- Built-in 117 Volt AC Power Supply with 12 Volt DC Mobile Transistorized Power Supply
- Plug-in facilities for Lafayette Selective Call Unit
- With Bracket Handle, Push-to-Talk Ceramic Mike, Pair of Transmit and Receive Crystals for Channel 15 plus Crystal for Dual Conversion.



MADE IN U.S.A.

Lafayette 516—Pg. 1964 Catalog No. 650. Write:
Lafayette Radio Electronics Corp., Dept. JK4-1, P.O. Box 10, Syosset, L. I., N. Y. 11791

technicians' News

RE-ELECT DORST AS NATESA PRESIDENT

Larry Dorst, Milwaukee, has been re-elected president of the National Alliance of Television & Electronics Service Associations at the group's annual meeting in the Edgewater Beach Hotel.

Tom Hudson, Lynchburg, Va., was named secretary-general. He succeeds Earl Steffes, Kansas City, Mo.

Treasurer is Len Gregson, Davenport, Iowa, who succeeds H. O. Eales, Oklahoma City.

Other officers include: Carl Johnston, Washington, D. C., succeeding Richard E. Ambrose, Norfolk, Va., as Eastern vice president; John Gibson, Roanoke, Va., succeeding Mr. Hudson as Eastern secretary.

King Camden, Kansas City, Mo., succeeds T. L. Childs, Fort Smith, Ark., as West Central vice president, and Nolan Boone, Little Rock, Ark., succeeds Clarence Thole, St. Paul, Minn., as West Central secretary.

Clyde Ellis, Seattle, Wash., succeeds Alan Pickel, Los Cruces, N. M., as Western vice president. Raymond Tuszinski, Butte, Mont., was re-elected Western secretary.

Lyle Green, Oak Park, Ill., and Andy Archie, Nashville, Tenn., were re-elected East Central vice president and secretary, respectively.

HAROLD WILLIAM LAKEMAN

Harold William Lakeman is sought by the Federal Bureau of Investigation as a fugitive on a charge of rape. He allegedly raped a 13-year old girl on the evening of July 9, 1958 in Lexington, Mass.



Lakeman, pictured here, fled the Boston area. His car was located abandoned on July 23, 1958, at Rocky Hill, Conn. The fugitive has worked as a stock clerk and cleaner for a bus company and as a messman in the U. S. Merchant Marine from 1942 to 1945. Prior to Lakeman's flight from Massachusetts, his occupation was television repairman and he was formerly a partner in a television repair business.

Lakeman is a white American, born Oct. 24, 1923 at Lynn, Mass. He is 5 feet 8 inches tall, weighs 176 pounds, has blue eyes and brown hair. He has a small scar on the bridge of his nose.

Any person who can furnish information concerning Harold William Lakeman's whereabouts is urged to notify immediately the nearest office of the Federal Bureau of Investigation. Consult the first inside page of your phone book for the number.

No action should be taken which would in any way endanger a member of the public.

CATV: THREAT TO INDEPENDENT TECHNICIAN?

Frank Moch, executive director of the National Alliance of TV & Electronics Service Associations, called community antenna television (CATV) a threat to the independent technician in

precise POWER LAB

Operates your whole shop!

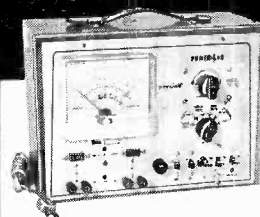

A Complete POWER SUPPLY IN ONE UNIT either KIT or WIRED

- A Battery Eliminator • A Battery Charger
- A High Current Line Voltage Variac • An AC Line Voltage Meter • An AC Line Ammeter • An AC Line Wattmeter • An AC Line Isolation Transformer • A Low Voltage, High Current AC Supply • A DC Line Voltage Variable Supply • A DC High Current Ammeter • An AGC Bias Box

DC power available is 0-30 v. at 10 amps and 110-180 v. at .075 amps. (1 amp intermittent) AC power: 0-24 v. at 20 amps; 90-140 v. at 10 amps continuous (1000 watts) and 20 amps intermittent (2000 watts) without isolation; 90-140 v. at 3 amps (300 watts) with isolation. Meter reads AC DC current to 20 amps, AC DC voltage to 180 v; power to 2 KW. 12 x 8 1/2 x 5 1/4". For 110-120 v, 60 cycle AC.

- MODEL 713-K (kit) (300 watts of isolation) NET \$69.95
- MODEL 713-W (wired) NET 89.95
- MODEL 711-K (kit) (100 watts of isolation) NET 59.95
- MODEL 711-W (wired) NET 74.95

Send for complete catalog of the Precise line of Oscilloscopes, Voltmeters, Decade Boxes, Signal Generators, Power Supplies, Tube Testers.

PRECISE ELECTRONICS AND DEVELOPMENT CORP.

Division of Designatronics, Inc.
76 East 2nd St., Mineola, L. I., N. Y.

Injectorall Super 100 tuner cleaner is ...

SAFE for nylon shafts and plastics in tuners!

SUPER 100 is a fast drying spray cleaner and lubricant that is excellent for TV tuners. It cleans contacts sparkling clean and evaporates quickly leaving a lubricated coating.

FREE! 6 oz. spray can with 6 inch steel needle a \$1.95 value... when you buy a 16 oz. bench size SUPER 100 with steel needle.

Cat. No. 100-16-6—\$3.60 Net

CAT. NO. 100-8

INJECTORALL

SUPER 100

TUNER CLEANER AND LUBRICANT

cut out coupon and take to your distributor for **FREE OFFER**

You get FREE!

1 Injectorall SUPER 100 (#100-6) 6 oz. size worth \$1.95 with the purchase of one 16 oz. SUPER 100.

Offer expires December 31, 1964.

Coupon void if taxed, prohibited or restricted by law. Cash value 1/20 of 1 cent.

INJECTORALL ELECTRONICS CORP.
BROOKLYN 14, NEW YORK

his keynote address before the annual meeting of the association.

CATV, he said, was originally operated by local groups, and was intended to supply TV to communities isolated by mountains or having other special problems. But, he said, "suddenly the movie industry is pouring money into it at the rate of \$25 million at a time. Major antenna companies are investing large amounts of money and only a few days ago a major network was reported as buying 18 small cable TV companies in the East. And talk of systems for big cities is running wild."

Mr. Moch believes that the real danger in these systems is that they "will cloak themselves with a quasi-utility status and, when that happens, the cable company will supply the program, the means of bringing the program, the set and the maintenance so as to assure the public the most use, and thus the most revenue for themselves."

Moch also told the group that the NATESA apprentice program may help fight the current war on poverty, and has already made "great strides." NATESA, as the only accepted agency administering the apprentice program, will soon have the help of a full-time paid agent of the Labor Department in launching the program on a nationwide basis.

The NATESA annual convention was held in Chicago August 14-16.

SERVICE, EXCISE, AIRED BY TEXANS

Service problems, the uhf market and relief from Federal excise taxes on all-channel receivers were among the topics taken up at the Texas Electronics Association's annual convention at Galveston. The emphasis at all the meetings was increased profits through effective management decisions.

RCA distributed transcripts of testimony in behalf of excise tax relief before the House Ways and Means Committee at the convention. The testimony had been delivered by RCA's Delbert L. Mills.

The Houston Better Business Bureau distributed a circular pointing out ways to eliminate misleading advertising.

D. W. Donald, a Fort Smith, Ark., technician, said in his talk before the group that the service industry has the second highest mortality rate in the nation. "We often fail to seek out business, and when we get it, we often make inept sales with far-reaching effects," he said. He urged more advertising, improved shop appearance, more effective personal contact, quicker response to service calls and detailed checkups when on a service call.

W. D. Renner of the Howard W. Sams Co., Indianapolis, echoing the sentiments of Mr. Donald, said that too often servicing is considered something to

be written off as a loss or to be juggled in the hope of breaking even. Noting that electronics repair involves far more than just television and radio, he urged members to go after business fixing other kinds of electronic equipment. "Somebody has to repair them," he noted, "and if you don't, someone else will."

Scott Hansen, manager, dealer development, distributor sales operations, General Electric Co., discussed methods for stepping up sales. Among his suggestions were: concentrating price groups in display, stepup pricing through offering a better bargain than the advertising leaders, and add-on sales.

OTHER NATESA CONVENTION NEWS: INDIVIDUAL MEMBERS; CATV BLAST

The National Alliance of TV & Electronic Service Associations is going after individual service dealers for membership in areas where it does not have an affiliate. The decision came in the last moments before adjournment of the group's annual convention.

Frank Moch, NATESA executive director, explained that this is the first time NATESA is ignoring any organization in an area where there is no affiliate.

The individual will become a member of the national body and, when there are enough members in an area, a group will be formed.

"MOVING OUT SALE" N.Y. PORT OF AUTHORITY TAKING OVER 13 BLOCKS FOR TRADE CENTER & WE'RE IN IT!

We must unload 3 BULGING WAREHOUSES . . . at the GREATEST PRICE SLASH in Electronic History!

FREE \$1 BUY WITH EVERY 10 YOU ORDER

Only applies to "\$1" Buys

FREE GIFT WITH EVERY ORDER

- \$27 MERCURY RECTIFIER TESTER \$7 tests all types, brochure on request
- \$50 STARLITE AM-FM RADIO \$17 Deluxe 7-Tube, as-is but easy to repair—complete with Tubes . . .
- PLAYBOY 6 TRANSISTOR RADIO \$6 Style, Quality, Performance money-refund basis—Complete . . .
- STARLITE TAPE RECORDER \$10 Brand new, Complete, worth double
- \$50 STARLITE AM-FM RADIO \$28 12 Transistors, Deluxe quality, sold on a money refund basis—complete
- CRYSTAL LAPEL MICROPHONE \$1 High impedance, 200-6000 cps . . .
- UNIVERSAL 5" PM SPEAKER \$1 Alnico 5 magnet, quality tone . . .
- UNIVERSAL 4" PM SPEAKER \$1 Alnico 5 magnet, quality tone . . .
- ELECTROSTATIC 3" TWEETER SPEAKER \$1 for FM, HI-FI, etc. . . .
- 2 — UNIVERSAL 2 1/4" PM SPEAKERS \$1 for Radios, Intercom, as multiple Speakers, etc. . . .
- 4 — AUDIO OUTPUT TRANSFORMERS \$1 50L6 type
- 3 — AUDIO OUTPUT TRANSFORMERS \$1 6K6, 6V6
- 4—TOGGLE SWITCHES \$1 SPST, SPDT, DPST, DPDT
- 15—ASST. ROTARY SWITCHES \$1 all popular types \$20 value . . .
- 100'—STANDARD ZIP CORD \$1 2 conductor #18 white or brown
- 100'—MINIATURE ZIP CORD \$1 2 conductor, serves 101 uses . . .
- 100—ASST. RADIO KNOBS \$1 all selected popular types
- 100—RADIO & TV SOCKETS \$1 all type 7 pin, 8 pin, 9 pin, etc.
- 100—ASST. TERMINAL STRIPS \$1 all types, 1-lug to 6-lug
- 100—ASST. CERAMIC CONDENSERS \$1 some in 5%
- 100—MICA CONDENSERS \$1 Micamold 180mmf-1000v, 10% . . .
- 100 — ASSORTED 1/2 WATT RESISTORS \$1 some in 5%
- 70 — ASSORTED 1 WATT RESISTORS \$1 some in 5%
- 35 — ASSORTED 2 WATT RESISTORS \$1 some in 5%
- 50—PRECISION RESISTORS \$1 asst. list price \$50 less 98% . . .
- 20 — ASS'TED WIREWOUND RESISTORS, 5, 10, 20 watt
- 6 — ASST. SELENIUM RECTIFIERS \$1 65ma, 100ma, 300ma, etc.
- 25 — SYLVANIA HEAT SINKS \$1 for Transistors, etc.
- 50—ASSORTED MILAR CONDENSERS \$1 .001 to .47
- 4—CD ELECTRO CONDENSERS \$1 10/10/10—450 volts
- 4 — AEROVOX ELECTROLYTIC COND \$1 15/15/15—450/250/100v

TV BARGAIN COLUMN

- STANDARD TV TUNER 41 mc \$5 Complete with Tubes & Schematic . . .
- STANDARD TV TUNER 21mc \$5 Complete with Tubes & Schematic . . .
- G.E. TV POWER TRANSFORMER \$4 250ma, 360/360v, 6.3-9A, 5v-3A . . .
- \$15.00 TELEVISION PARTS \$1 "JACKPOT" best buy ever
- 4 — TV ALIGNMENT TOOLS \$1 most useful assortment
- \$12 TV FLYBACK TRANS 90° \$1 for all type TV's incl schematic
- 90° TV DEFLECTION YOKE \$1 wired network, schematic diag. . . .
- 70° FLYBACK TRANSFORMER \$1 universal incl schematic diagram
- 70° TV DEFLECTION YOKE \$1 wired network, incl schematic . . .
- 3—TV VERT OUTPUT TRANS \$1 universal 10:1 ratio for all TV's . . .
- 4—DUMONT VERT OSC TRANS \$1 incl schematic for many TV uses
- 20—ASSORTED IV COILS \$1 I.F. video, sound, ratio, etc.
- 40—ASSORTED TV KNOBS \$1 all standard types, \$40 value . . .
- 4 — TV ELECTROLYTIC CONDENSERS \$1 Sprague 80-250v
- 7 — ASST. TV ELECTROLYTIC CONDENSERS \$1 popular selection
- 5—TV CHEATER CORDS \$1 with both plugs

MARKET SCOOP COLUMN

- JOBBER BOXED TUBES . . . \$35¢ each New RCA, Westinghouse, Tungsol 1A6, 1AD5, 1AH4, 1S4, 1S8, 1AL5, 3AV6, 3BA6, 3BE6, 3H8, 3BY6, 4RC5, 4BN6, 4BS8, 4BU8, 4CB6, 4CS6, 4CV5, 5BF8, 6A6, 6AH6, 6B7, 6CL6, 6J7, 6ST7, 6T7, 6U7, 8AU8, 12AU8, 12BA6, 12BK6, 12FK6, 12U7, 17L6, 35W4, 4523, 801A, GL48T, 27, 33, 35. Your choice, any amount
- \$200 SONOTONE HEARING AID \$5 Complete less Earpiece & Batteries
- 1000—ASST. HARDWARE KIT \$1 screws, nuts, washers, rivets, etc.
- 1000—ASSORTED RIVETS \$1 most useful selected sizes
- 1000—ASSORTED WASHERS \$1 most useful selected sizes
- 20—ITT SELENIUM RECTIFIERS \$1 65ma for Radios, Meters, Chargers, Transistors, Experiments, etc.
- 6—IBM COMPUTER SECTIONS \$1 loaded with Transistors, Condensers, Diodes, Resistors, Etc.
- STEREO PHONO AMPLIFIER \$2 wired—each channel 3 watt
- BONANZA "JACKPOT" not gold, not oil, but a wealth of Electronic Items—Money-Back-guarantee . . .
- \$17.50 WEBSTER DIAMOND \$1 CARTRIDGE Stereo
- WEBSTER #P-2-1, AB-1, MC-3 \$1 CARTRIDGES your choice
- TOP BRAND RADIO & TV TUBES \$1 60/10/10%—Brochure on Request

BROOKS RADIO & TV CORP., 84 Vesey St., Dept. A, New York 7, N.Y. TELEPHONE Corlanti 7-2359

In other business, a resolution construed as an indirect slap at community-antenna television (CATV) and pay television, was approved at the final session of the NATESA annual convention.

The resolution reads: "Be it resolved that this Alliance goes on record as being opposed to any form of TV programming, regardless of the method used, which in any way limits the rights of professional independent service business to compete."

RCA SALES WINS NATESA AWARD

The National Alliance of TV & Electronics Service Associations "Friends of Service" award has been given to RCA Sales Corp. This is the first such award to the TV set division.

Continuing awards were voted to the RCA Tube Division; Finney Co., antenna manufacturer; Tung-Sol Tubes; Raytheon Tubes; Sylvania Tubes; Philco Accessory Division; General Electric Tubes and the Howard W. Sams & Co. Zenith Radio was given a continuing award as Friend of Service in the set division.

DIRECT MAIL TECHNIQUES BRING IN CUSTOMERS

Mail is an effective medium for getting service business, said former

NATESA president Vincent Lutz, speaking before the Alliance's annual national convention.

Lutz told members that his experience with direct mail has shown that it pays off better than any other medium he has used.

To be effective, Lutz said, the campaign must be continuing, and should be "individualized" by the use of such things as commemorative stamps.

A few days after a service call, his company sends the customer a "thank-you letter."

He also recommended Christmas cards as a valuable tactic, provided that they are sent so the customers receive them by about Dec. 1. That way "the customer will remember the card because it probably will be one of the first he receives."

This delicious little morsel appeared in *ERSDA*, the official publication of the Electronic Retail Service Dealer's Association, Calgary, Alberta.

"We note with some glee that one of our larger tube-selling drug emporia has been rapped on the knuckles for selling electronic accessories in contravention of the Lord's Day Act.

"With God's help we may beat these fellows." END

How Fast Can You Read?

A noted publisher in Chicago reports there is a simple technique of rapid reading which should enable you to double your reading speed and yet retain much more. Most people do not realize how much they could increase their pleasure, success and income by reading faster and more accurately.

According to this publisher, anyone, regardless of his present reading skill, can use this simple technique to improve his reading ability to a remarkable degree. Whether reading stories, books, technical matter, it becomes possible to read sentences at a glance and entire pages in seconds with this method.

To acquaint the readers of this magazine with the easy-to-follow rules for developing rapid reading skill, the company has printed full details of its interesting self-training method in a new book, "Adventures in Reading Improvement" mailed free to anyone who requests it. No obligation. Simply send your request to: Reading, 835 Diversey Parkway, Dept. 4488, Chicago, Illinois 60614. A post-card will do.

HOTTEST DEAL EVER OFFERED! RCA #CTC-11 COLOR TV CHASSIS \$86

We scooped the market—Wired complete (less Tubes & CRT) need minor finishing touches or parts, incl. Schematic Including full Set of Tubes (less CRT) . . . \$99

- | | | | |
|--|--|--|--|
| <input type="checkbox"/> 3 AMPHENOL CO-AX CONNECTORS NO-239, PL-239, M-359 or asst \$1 | <input type="checkbox"/> CHAPT ZU DI MITZIA "JACKPOT" double your money back if not completely satisfied \$1 | <input type="checkbox"/> \$15.00 RADIO PARTS "JACKPOT" handy assortment \$1 | MARKET SCOOP COLUMN |
| <input type="checkbox"/> 250-ASST. SOLDERING LUGS best types and sizes \$1 | <input type="checkbox"/> 10-6' ELECTRIC LINE CORDS with plug standard brands \$1 | <input type="checkbox"/> 50-RCA LUCITE RADIO KNOBS popular type w. indicator pointer \$1 | <input type="checkbox"/> 20-RCA 954 TUBES \$1 |
| <input type="checkbox"/> 250-ASST. WOOD SCREWS finest popular selection \$1 | <input type="checkbox"/> 4-50' SPOOLS HOOK-UP WIRE 4 different colors \$1 | <input type="checkbox"/> 5-VARIABLE CONDENSERS assl. popular super-net types \$1 | <input type="checkbox"/> 10-ASSORTED TUBES Radio, Television and Industrial \$1 |
| <input type="checkbox"/> 250-ASST. SELF TAPPING SCREWS #6, #8, etc. \$1 | <input type="checkbox"/> 100'-INSULATED SHIELDED WIRE #20 braided metal jacket \$1 | <input type="checkbox"/> 50-ASSORTED PRINTED CIRCUIT SOCKETS best types \$1 | <input type="checkbox"/> 10-SYLVANIA 1U4 TUBES brand new Jan., individual cartons also serves as 1U4 \$1 |
| <input type="checkbox"/> 150-ASST. 6/32 SCREWS and 150-6/32 HEX NUTS \$1 | <input type="checkbox"/> 32'-TEST PROD WIRE deluxe quality, red or black \$1 | <input type="checkbox"/> 35-INSTRUMENT POINTER KNOBS selected popular types \$1 | <input type="checkbox"/> ALL AMERICAN TUBE KIT \$2 Top Standard Brand — 12BA6, 12BE6, 12AV6, 50C5, 35W4 |
| <input type="checkbox"/> 150-ASST. 8/32 SCREWS and 150-8/32 HEX NUTS \$1 | <input type="checkbox"/> 100'-HI-VOLTAGE WIRE for TV, special circuits, etc. \$1 | <input type="checkbox"/> 100'-FINEST NYLON DIAL CORD best size, .028 gauge \$1 | <input type="checkbox"/> 3-TOP BRAND 35W4 TUBES \$1 |
| <input type="checkbox"/> 150-6/32 HEX NUTS and 150-8/32 HEX NUTS \$1 | <input type="checkbox"/> 200'-BUSS WIRE #20 (tinned for hookup, special circuits, etc.) \$1 | <input type="checkbox"/> 20-ASST. PILOT LIGHTS #44, 46, 47, 51, etc. \$1 | <input type="checkbox"/> CLEAN UP THE KITCHEN "JACKPOT" Big Deal only one to a customer \$1 |
| <input type="checkbox"/> 100-ASST. RUBBER & FELT FEET FOR CABINETS best sizes \$1 | <input type="checkbox"/> 50-ASSORTED TV PEAKING COILS all popular types \$1 | <input type="checkbox"/> 10-ASST. DIODE CRYSTALS 5-1N60 and 5-1N64 \$1 | <input type="checkbox"/> 5-TOP HAT SILICON RECTIFIERS 500ma-300v \$1 |
| <input type="checkbox"/> 10-ASSORTED SLIDE SWITCHES SPST, DPDT, etc. \$1 | <input type="checkbox"/> 3-1/2 MEG VOLUME CONTROLS with switch, 3" shaft \$1 | <input type="checkbox"/> 3-ELECTROLYTIC CONDENSERS 50/30-150v \$1 | <input type="checkbox"/> 2-TOP HAT SILICON RECTIFIERS 750ma-600v top quality \$1 |
| <input type="checkbox"/> 50-ASSORTED #3AG FUSES Popular assorted ampere ratings \$1 | <input type="checkbox"/> 5-ASST. 4 WATT WIRE-WOUND CONTROLS \$1 | <input type="checkbox"/> 3-ELECTROLYTIC CONDENSERS Mallory 20/20-450v \$1 | <input type="checkbox"/> 5-I.F. COIL TRANSFORMERS sub-min for Transistor Radios \$1 |
| <input type="checkbox"/> 50-STRIPS ASSORTED SPAGHETTI handy sizes \$1 | <input type="checkbox"/> 10-ASSORTED VOLUME CONTROLS less switch \$1 | <input type="checkbox"/> 10-ASST. RADIO ELECTROLYTIC CONDENSERS \$1 | <input type="checkbox"/> 5-AUDIO OUTPUT TRANSFORM sub-min for Trans Radios \$1 |
| <input type="checkbox"/> 100-ASSORTED RUBBER GROMMETS best sizes \$1 | <input type="checkbox"/> 5-ASSORTED VOLUME CONTROLS with switch \$1 | <input type="checkbox"/> 50-ASST. TUBULAR CONDENSERS .001 to .47 to 600v \$1 | <input type="checkbox"/> 5-PNP TRANSISTORS general purpose, TO-5 case \$1 |
| <input type="checkbox"/> 10-SURE-GRIP ALLIGATOR CLIPS 2" plated \$1 | <input type="checkbox"/> 10-SETS DELUXE PLUGS & JACKS best asst for many purposes \$1 | <input type="checkbox"/> 20-GOODALL TUBULAR CONDENSERS .047-600v \$1 | <input type="checkbox"/> 5-NPN TRANSISTORS general purpose, TO-5 case \$1 |
| <input type="checkbox"/> 10-SETS PHONO PLUGS & PIN JACKS RCA type \$1 | <input type="checkbox"/> 15-RADIO OSCILLATOR COILS standard 456kc \$1 | <input type="checkbox"/> 20-BENDIX CONDENSERS .007-2000v \$15 value \$1 | <input type="checkbox"/> 5-ASSORTED TRANSFORMERS Radio, TV and Industrial \$1 |
| | <input type="checkbox"/> 3-I.F. COIL TRANSFORMERS 456kc, most popular type \$1 | <input type="checkbox"/> 100-FAHNSTOCK CLIPS \$1 | <input type="checkbox"/> 100-MIXED DEAL "JACKPOT" Condensers, Resistors, Surprises \$1 |
| | | | <input type="checkbox"/> 1-SQ. YARD GRILLE CLOTH most popular brown & gold design \$1 |

IMMEDIATE DELIVERY . . . Scientific light packing for safe delivery at minimum cost. HANDY WAY TO ORDER: Pencil mark or write amounts wanted in each box, place letter F in box for Free \$1 BUY. Enclose with check or money order, add extra for shipping. Tearsheets will be returned as packing slips in your order, plus lists of new offers.

Name _____ Cost of goods _____
Address _____ Shipping estimated _____
TOTAL _____

Please specify refund on shipping overpayment desired: CHECK POSTAGE STAMPS MERCHANDISE (our choice) with advantage to customer

Olson

FREE

Fill in coupon for a FREE One Year Subscription to **OLSON ELECTRONICS' Fantastic Bargain Packed Catalog**—Unheard of **LOW, LOW, DISCOUNT PRICES** on Brand Name Speakers, Changers, Tubes, Tools, Stereo Amps, Tuners, CB, Hi-Fi's, and thousands of other Electronic Bargains. Credit plan available.

NAME _____
 ADDRESS _____
 CITY _____ ZONE _____ STATE _____

If you have a friend interested in electronics send his name and address for a FREE subscription also.

OLSON ELECTRONICS, INC.

313 S. Forge Street Akron, Ohio 44308

try **This one**



LACQUER THINNER SECURES PLASTIC KNOBS

When you want a plastic knob to stay permanently secure and never loosen or be removed from a component or tool, put a few drops of lacquer thinner inside the knob, wait a few seconds and re-install the knob. Let it set 5 minutes before using. It'll never get loose again.—*Stan Clark*

MAGNET "FEELS" TRANSFORMER FIELDS

When you want to gage the strength of a stray magnetic field around a power transformer or motor, grip a small permanent magnet between thumb and forefinger and bring

it near the transformer while the transformer is under load.

You'll feel the 60-cycle vibrations in your fingers, and moving the magnet around will give you a fair qualitative idea of the size and shape of the field.—*Tom Jaski*

METER BORROWING SAVES EXPENSE

I often need a 200- μ a meter movement for experimental circuits. The one in my vtm is just that, but using it always meant getting inside the case to

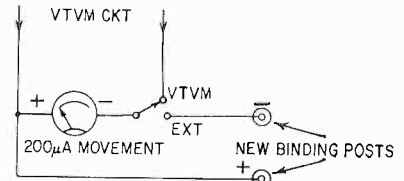

disconnect it from the vtm circuit.

I changed that by mounting an spdt slide switch and a pair of binding posts on the side of the case, wired as shown in the diagram.

When you've installed the binding posts, mark the meter polarity on the case next to them. Be sure that whatever circuit you use the meter in won't force enough current through to damage it.—*Albert Koehler*

HIGH-VOLTAGE CAPACITORS OUT OF COAX CABLE

When the need arose for some high-voltage capacitors of values not available from electronic supply houses, I concocted some very satisfactory substitutes by making flat coils 3 or 4 inches in diameter, consisting of several turns of RG-59/U coaxial cable. The

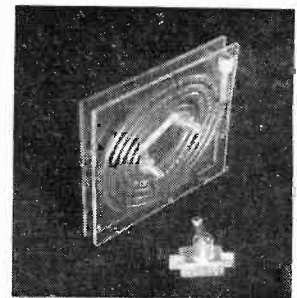

solid conductor served as one "plate" while the shield, stripped back a few inches to prevent flashovers, served as the second.

It worked so well that several different lengths were coiled and mounted permanently between clear acrylic plastic plates with terminals. The cable insulation will easily withstand repetitive pulses of 15 kv for several months without failure.

RG-59/U has a capacitance of 21 pf per foot.—*John W. Deely*

TUBES

One Year Guaranteed
 Dual Conduction Lab-tested Individually boxed, Branded and Code Dated
 Tubes are new, or 1942-1950 marked.

21 PICTURE TUBES
 139¢ Aluminized Pay Dvd Deposit 600 or Send Dvd With Order

12AV6	21A4W
12AX7	21A5W
12BD6	21A6W
12BH7	21A7W
12BL6	21A8W
12BW7	21A9W
12CA5	21A10W
12CN7	21A11W
12CS7	21A12W
12DA6	21A13W
12EA6	21A14W
12EA7	21A15W
12EA8	21A16W
12EA9	21A17W
12EA10	21A18W
12EA11	21A19W
12EA12	21A20W
12EA13	21A21W
12EA14	21A22W
12EA15	21A23W
12EA16	21A24W
12EA17	21A25W
12EA18	21A26W
12EA19	21A27W
12EA20	21A28W
12EA21	21A29W
12EA22	21A30W

TUBE CARTONS

TUBE CARTONS
 HIGH GLOSS CLAY COATED RE-PRINTABLE WITH INK IN DIAGONAL PARTITIONS

SIZE	TUBE SIZE	PRICE PER 10 CARTONS
MINI	6AU6	29¢
GT	6SN7	39¢
LG	6X4	59¢
G	6Y4	89¢

Finest ELECTRONIC CLEANER

all purpose ELECTRONIC CLEANER
79¢ plus shipping
 Contains amazing new TUBES cleaner. Instantly cleans without leaving residue. Cleans and shines. No rust. No unpleasant smell. Non-corrosive. Guaranteed. Restores original life to all controls and contacts. Moisturizes for hard to reach places with each can.

DIODES/RECTIFIERS

39¢ per pack sensational KIT VALUE!
 This is a kit of the most popular electronic diodes. It contains a variety of diodes for your use. The kit includes a variety of diodes for your use. The kit includes a variety of diodes for your use.

Electronic SOLDER

29¢
 Many plastic containers convenient for shop and home use. Excellent for fast melting and easy flow. Guaranteed for electronic work. Quality guaranteed in detail.

TERMS: Add 3¢ per tube shipping. Orders under \$5.00 add 3¢ per tube shipping plus 50¢ handling. Canadian orders add approximate postage. Send 25% deposit on C.O.D. orders. No C.O.D. orders under \$5.00 or to Canada. No 24 hr. free offer on personal check orders. 5-DAY MONEY BACK OFFER!

33¢ PER TUBE
30¢ PER TUBE
 100 TUBES OR MORE:

If Not Shipped in 24 hrs. YOUR ORDER FREE!

0Z4	6AT6	6CD6	6EM5	6SC7	6V6	12BH7
1B3	6AT8	6CF5	6F6	6SH7	6W1	12BL6
1H5	6AU4	6CG7	6H5	6SJ7	6W6	12BY7
1J3	6AU5	6CG8	6I5	6SK7	6X4	12CS
1L4	6AU6	6CM7	6J6	6SL7	6X5	12CA5
174	6AV6				7A7	12SN7
1U4	6AW8				7B8	12SQ7
1X2	6AX4				7B7	25L6
3CB6	6BA6				7B8	25Z6
5U4	6BC5				35W4	35Z4
5V4	6BD6				7C5	35Z3
5Y3	6BG6				7N7	35Z5
6A6	6BH6				7Y4	50L6
6A8	6BJ6				12AD6	24
6AB4	6BL7				12AE6	27
6AC7	6BN4				12AF6	41
6AG5	6BN6				12AT7	45
6AK5	6BQ6	6C25	6K6	6SN7	12AU7	47
6AL5	6BZ6	6D6	6K7	6SQ7	12AX7	75
6AN8	6C1	6DA4	6Q7	6SR7	12BA6	77
6AQ5	6C6	6DE6	6S4	6U7	12BQ6	78
6AS5	6CB6	6DQ6	6SA7	6UR	12BL6	84
					12BF6	84

Other tubes and CRT's at low prices—send for free list
NO SUBSTITUTIONS WITHOUT YOUR PERMISSION

Special!
 With every \$10 Order
25¢ per tube
 (No Limit) from this list
 6AG5 6SN7
 6AU6 6J6 6V6
 6AQ5 6K6 6W4
 Console Srd. Serv. Tube Tester
\$3.95

Prestige & Success are yours as an ELECTRONIC EXPERT!

FOR CORNELL CUSTOMERS ONLY by special arrangement with the publisher these amazing bargains are available.

COMPLETE RADIO SERVICING AND BASIC ELECTRONICS COURSE ONLY \$3.00
 157 pages • 50 illustrations • 12 lessons on circuits, electronic theory, instruments, vacuum tubes, 1000 appliances, different problems, trouble shooting, service hints. Home use for the beginner. Includes a complete course and complete manual is priced at only \$3.00. Nothing else you can buy. Use this training to get ahead in radio and as your introduction to TV work.

NEW PRACTICAL TV TRAINING COURSE ONLY \$2.50
 157 pages • 50 illustrations • 12 lessons on circuits, electronic theory, instruments, vacuum tubes, 1000 appliances, different problems, trouble shooting, service hints. Home use for the beginner. Includes a complete course and complete manual is priced at only \$2.50. Nothing else you can buy. Use this training to get ahead in radio and as your introduction to TV work.

CORNELL ELECTRONICS CO.
 Dept. RE 11 4217 University Ave., San Diego, Calif. 92105

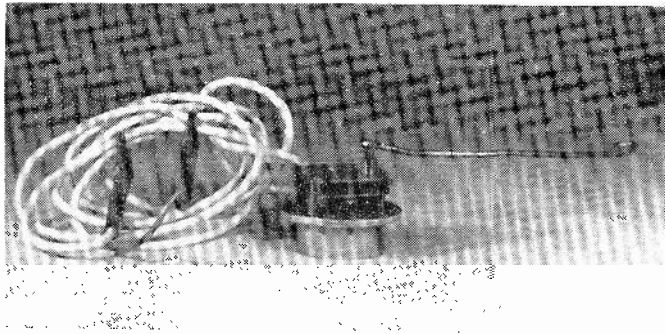

chronous motor—the type used for display rotators or timing devices. The photo shows a Bristol Motors model 444-C, a 60-cycle 4-rpm device salvaged

from a rotating wristwatch display. When the shaft is spun at 16 rpm by the "crank", a 250-cycle 300-mv signal comes out. The output impedance is

3,000 ohms. Attach an output cable and put alligator clips on its other end.

This unit is great for chasing low-frequency rattles out of speaker enclosures, especially guitar speaker boxes. Spin the shaft; as it slows down, the audio range is swept smoothly. A resonant rattle can't easily escape detection. The "generator" takes 10 seconds to slow down from 32 rpm, and make a smooth sweep from 500 cycles down. The output is pure sine wave. The rotator arm is 4 inches in length and is brazed onto the rotator shaft.

The unit in the photo is made by Bristol Motors, Old Saybrook, Conn.—
Steve P. Dow

continued on page 109

SCHOOL DIRECTORY

GET INTO ELECTRONICS

V.T.I. training leads to success as technicians, field engineers, specialists in communications, guided missiles, computers, radar and automation. Basic & advanced courses in theory & laboratory. Electronic Engineering Technology and Electronic Technology curricula both available. Assoc. degree in 29 mos., B.S., also obtainable. G.I. approved. Graduates in all branches of electronics with major companies. Start Feb., Sept. Dorms, campus. High school graduate or equivalent. Catalog.

VALPARAISO TECHNICAL INSTITUTE
Department C, Valparaiso, Indiana



Learn Electronics for your SPACE-AGE EDUCATION at the center of America's aerospace industry

No matter what your aerospace goal, you can get your training at Northrop Tech, in sunny Southern California.

COLLEGE OF ENGINEERING.
Get your B.S. degree in engineering in just 36 months by attending classes year round. Most Northrop Tech graduates have a job waiting for them the day they're graduated!

A & P SCHOOL. Practical experience on real aircraft. One-year course prepares you for F.A.A. A & P certificate. **WRITE TODAY FOR CATALOG.**
NORTHROP INSTITUTE OF TECHNOLOGY
1199 W. Arbor Vitae, Inglewood, Calif



A JOB or a POSITION ?

The difference is ELECTRONIC MATHEMATICS

NOW! A NEW WAY TO LEARN—I. H. S. I. WAY. A complete home study course in electronic math to help you get the position you want—**MORE MONEY—MORE RESPECT.**

COURSE PREPARED BY COLLEGE PROFESSORS who have lectured to thousands of men on math and engineering. You learn at home quickly, easily—**AS FAST** as you want.
YOU SIGN NO CONTRACTS
Pay only if satisfied—you owe it to yourself to examine the **INDIANA HOME STUDY INSTITUTE COURSE IN ELECTRONIC MATH.**
FREE BONUS—if you join now, a refresher course in basic arithmetic.

Write for Brochure—No Obligation
THE INDIANA HOME STUDY INSTITUTE
924 East Columbia Avenue
Fort Wayne, Indiana

EARN Electronics DEGREE

You can earn an A.S.E.E. degree at home. College level HOME STUDY courses (taught so you can understand them. Continue your education, earn more in the highly paid electronics industry. Missiles, computers, transistors, automation, complete electronics. Over 27,000 graduates now employed. Resident school available at our Chicago campus—Founded 1934. Send for free catalog.

American Institute of Engineering & Technology
1139 West Fullerton Parkway, Chicago 14, Ill.



Engineering Technician
A.S. Degree—2 Years
Electronics Engineer
B.S. Degree
Evening Courses Available

ELECTRONIC TECHNICAL INSTITUTE
970 W. Manchester Ave., Inglewood, Calif.
4863 El Cajon Blvd., San Diego, Calif.

MICROWAVE TECHNIQUES—TV INDUSTRIAL ELECTRONICS COMPUTERS—RADIO TRANSMITTERS—RADAR—TRANSISTORS

FOR AN ELECTRONICS CAREER
Write For Free Catalog RE
WEEKLY TUITION

PHILADELPHIA WIRELESS TECHNICAL INSTITUTE
1533 Pine Street Philadelphia 2, Pa.
Founded in 1908 • A Non-Profit Corp.

SCIENCE/ ENGINEERING

ASSOCIATE & BACHELOR OF SCIENCE PROGRAMS

Get into fastest-growing fields of Physics, Mathematics, Engineering (Nuclear, Electronic, Electrical); also Engineering Technology (Nuclear, Electronic). Optional four-quarter, all-year schedule allows finishing four-year B.S. degree programs in 3 yrs.; A.S. degree in 2 yrs. Fall Quarter enrollments limited. Send for college Catalog (R-11).

NORTHRIDGE COLLEGE OF SCIENCE & ENGINEERING

18758 Bryant Street, Northridge, Calif.

Get Your First Class Commercial F. C. C. LICENSE QUICKLY!

Career opportunities in *communications electronics* are almost unlimited. Prepare now. Let Grantham train you—by correspondence, or by classroom and laboratory instruction. Get your *first class commercial F.C.C. license* in as little as 3 months, or at a slower pace if you prefer. Then, continue in more-advanced electronics training if you wish. Diploma awarded. Our catalog gives full details.

Learn how our training can prepare you for your F.C.C. license; write or telephone the School at any one of the teaching divisions listed below, and ask for "Catalog 47."

Grantham School of Electronics

1505 N. Western Av., **LOS Angeles**, Cal. 90027
(Phone: HO 9-7878)

408 Marion Street, **Seattle**, Wash. 98104
(Phone: MA 2-7227)

3123 Gillham Road, **Kansas City**, Mo. 64109
(Phone: JE 1-6320)

818-18th St., NW, **Washington**, D.C. 20006
(Phone: 298-7460)

B. S. Degree in 36 months

Small professionally-oriented college. Four-quarter year permits completion of B.S. Degree in three years. Summer attendance optional. *Engineering:* Electrical (electronics or power option), Mechanical, Civil, Chemical, Aeronautical. *Business Administration:* General Business, Accounting, Motor Transportation Administration. One-year Drafting-Design Certificate program. Outstanding placement of graduates. Founded 1884. Rich heritage. Excellent faculty. Small classes, 200-acre campus. Well equipped labs. New library. Residence halls. *Modest costs.* Enter Jan., March, June, Sept. For catalog and View Book, write Director of Admissions.



TRI-STATE COLLEGE

24114 College Avenue • Angola, Indiana

when it's time to think of college
you should read this
FREE CAREER BOOKLET
about electronics at

MSOE

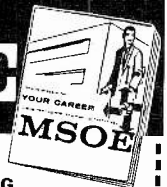

MILWAUKEE MS-220 SCHOOL OF ENGINEERING

Dept. RE-1164, 1025 N. Milwaukee Street
Milwaukee, Wisconsin 53201

Tell me about an engineering career through residence study in:

Electrical fields Mechanical fields

Name.....Age.....

Address.....

City, State.....

ADVERTISING INDEX

Radio Electronics does not assume responsibility for any errors which may appear in the index below.

Allied Radio Corp.	11, 87-88
Amperex Electronic Corp.	Second Cover
Amplifier Corp. of America	74
Antenna Specialists Co., The	22
Arrow Fastener Co., Inc.	12
B & K Manufacturing Co., (Div. of Dynascan Corp.)	12
Blonder-Tongue	31-34
Bozak	74
Brooks Radio & TV Corp.	102-103
Burstein-Applebee Co.	14
Capital Radio Engineering Institute, The	18-21
Castle TV Tuner Service, Inc.	8

CLASSIFIED	112-113
Cleveland Institute of Electronics	76-79, 113
Conar (Div. of National Radio Institute)	80
Cornell Electronics Co.	106
Coyne Electronics Institute	113
Coyne School Publications	95
DeVry Technical Institute	7
Dynaco, Inc.	104
EICO Electronics Instrument Co., Inc.	62
Electronic Measurements Corp. (EMC)	92
Gernsback Library	90
Hallcrafters	109
Heald's Engineering College	91
Heath Co.	71, 73, 75, 81, 83
I.E.H. Manufacturing Co., Inc. (Subsidiary of Electronic Hardware Corp.)	65
Injectorall Electronics Co.	101
International Crystal Manufacturing Co. Inc.	114

Jensen Manufacturing Co. (Div. of the Muter Co.)	Third Cover
Jerrold Electronics	24-25
Johnson Co., E. F.	92
Kinematix, Inc.	86
Lafayette Radio Electronics	96-100

MARKET CENTER	110-111
Mercury Electronics Corp.	23
National Radio Institute	29-30, 104
National Technical Schools	5
Olson Electronics, Inc.	106
Perma-Power Co.	89
Philco-Techrep Division (Subsidiary of Ford Motor Co.)	93
Polypaks	108
Precise Electronics & Development Corp. (Div. of Designatronics, Inc.)	101
Progressive "Edu-Kits", Inc.	94
Quam-Nichols Co.	72
Quietrole Co.	86
RCA Electronic Components & Devices	9, Fourth Cover
RCA Institutes	66-69
Reading Improvement Program	103
Rider Publishing, Inc., John F.	70
Rotron Manufacturing Co., Inc.	63
Sams & Co., Inc., Howard W.	15, 85
Sarkes Tarzian, Inc. (Tuner Service Div.)	26

SCHOOL DIRECTORY	107
Scott, Inc., H. H.	64
Sencore	10
Shure Brothers, Inc.	13
Stancor (Electronic Marketing Div.)	28
Sylvania (Subsidiary of General Telephone & Electronics)	27
Tarzian, Inc., Sarkes (Tuner Service Div.)	26
Tram Electronics, Inc.	22
United Radio Co.	105
University, LTV (Div. of Ling-Temco-Vought, Inc.)	3
Vaco Products Co.	109
Winegard Co.	16-17



Your gift speaks for America when you feed hungry people with \$1 Food Crusade packages through CARE, New York 10016.

TEXAS INSTRUMENT

150 WATT TRANSISTORS

Similar to 2N1907, 2N1046. Ignition, switching, TO3 case

WORTH \$18.00 **1.98** EACH

15 AMP, 10 MC, 60V to 100V

TO36/50 WATT TRANSISTORS

UNTESTED GOLD CASE

Poly Pak First **3 for \$1**

TESTED TRANSISTOR SCRs

Silicon Controlled Rect.

PRV	AMP	AMP	AMP
50	1.00	1.25	1.50
100	1.30	1.55	1.80
150	1.75	2.10	2.25
200	2.35	2.75	2.90
250	3.00	3.45	3.60
300	3.65	4.10	4.25
350	4.35	4.80	5.00
400	5.05	5.55	5.80

PRE-XMAS DOUBLE BONUS

\$25

FREE WORTH OF Transistors Rectifiers Condensers Diodes Knobs Coils, etc.

PLUS FREE CHOOSE ANY \$1 ITEM FREE

Get Both Bonuses Free with \$10 Orders

1-AMP-600V SYLVANIA EPOXY RECTIFIERS

SILVER AXIAL LEADS

5 for 1.00

COMPARE UP TO 10.00

SPECIAL SALE

30 Transistors

Trs. rf, audio, etc. TO3 cases. Untested.

30 for \$1

85 WATT SILICON MESA \$1

2N424

ELECTROSTATIC TWEETER

MADE BY LORENZ FOR GRUNDIG - 4" sq. Illustration resembles tweeters in stock

1.49

WORLD'S MOST POPULAR \$1 PARTS PAKS

- 10 PANEL SWITCHES, rotary-micro-slide-power ..\$1
- 30 POWER RESISTORS, to 50W, to 24 Kohms ..\$1
- 50 MICA CAPACITORS, to .01mf, silvers too ..\$1
- 10 VOLUME CONTROLS, to 1 meg, switch too ..\$1
- 50 RADIO & TV KNOBS, asstd. colors, styles ..\$1
- 10 TRANSISTOR ELECTROLYTICS, 10 to 100mf ..\$1
- 25 RADIO-n-TV SURPRISE, wide variety ..\$1
- 1 INFRA-RED PHOTO DETECTOR TRANSDUCER ..\$1
- 1 INFRA-RED PARABOLIC REFLECTOR & FILTER ..\$1
- 50 ONE WATTERS, resistors, asstd values, 5% too ..\$1

10 WATT ZENERS

TESTED

WRITE FOR OTHER VOLTAGES EA.

6V	60V
8V	70V
12V	80V
20V	90V
30V	110V
42V	100V
48V	124V

3-TRANSISTOR AMPLIFIER

Only 3"x2"x3/4" Printed Circuit W/rect. subminiature W/T transistors

1.95

- 40 "TEXAS" PRECISION RESISTORS, asst., 1% \$1
- 60 CERAMIC CONDENSERS, discs, npo's to .05mf \$1
- 4 TRANSISTOR TRANSFORMERS, asst, worth \$25 \$1
- 40 WORLD'S SMALLEST RESIST., 5% too, 1/10W \$1
- 40 SUBMINIATURE COND., to .05mf, ceramf too \$1
- 3 "TINY" V. CONTROLS, w/sw, 2K, .5 meg, 1 meg \$1

SILICON POWER DIODE STUDS

Amps	Volts	Sale	Amps	Volts	Sale
1	200	37c	25	300	1.60
6	400	59c	300	1.75	1.50
6	600	89c	400	1.95	1.75
6	800	89c	600	2.50	1.50
10	50	49c	50	1.05	1.25
10	100	69c	100	1.29	1.40
10	200	88c	150	1.50	1.40
10	300	1.19	200	1.79	1.50
10	400	1.37	300	1.99	1.75
10	50	99c	300	2.50	1.50
25	100	1.29	50	1.50	1.25

FACTORY TESTED SEMI-KON-DUCTORS

- 1 3N35 TETRODE 150mc transistor, silicon ..\$1
- 5 SUN BATTERIES TO 1 1/2" sizes, lite sensitive ..\$1
- 3 2N255 PWR TRANSISTORS, or equal, TO3 case ..\$1
- 25 SEMI-KON-DUCTORS: transistors, diodes, rect. ..\$1
- 5 GENERAL ELECTRIC 2N107 type, pnp trans ..\$1
- 1-RHEEM 2N1613 3W. 120 MC. silicon planar. ..\$1
- 10 PHILCO MAT HI-FREQ. TR'SISTORS, untested ..\$1
- 2 2N964 EPITAXIAL MESA, 500 MC, PNP, TO-18 ..\$1
- 6 ZENER DIODES, upright styles, assorted ..\$1
- 2 TRANSISTOR 1N429 ZENER REFERENCES ..\$1
- SILICON PLANARS: 2N497, 2N498, each ..\$1
- 4 SUBMINIATURE 2N131 TRANSISTRS, rf-if, pnp ..\$1
- 4 CK721 TRANSISTRS in new aluminum case, pnp ..\$1
- 2 'MESA' 4-WATT TRANSISTRS, nnp, silicon, TO5 ..\$1
- 6 TRANSISTOR RADIO SET, osc-ifs-driver, p-p ..\$1
- 2-25-AMP SILICON STUD RECTIFIERS ..\$1
- 20 WATT NPN SILICON MESA 2N1648 tr'sistors ..\$1
- 4 G.E. 2N170RF TRANSISTORS ..\$1
- 3 2N1264 UHF TRANSISTORS, 300 mc TO 5 case ..\$1
- 6 TOP HAT RECTIFIERS, 750 mil, 400 volts ..\$1
- 1-SILICON NPN 'PLANAR' 2N718, TO18 100mc ..\$1
- 3 1-WATT ZENER DIODES, axial leads, 6V ..\$1
- 4 SYLVANIA 2N35 NPN, transistors, TO22 ..\$1
- 6 2N112 TYPE IF, OSC TRANSISTRS, TO22 Untested ..\$1
- 1 2N706 500MW, 300MC NPN PLANAR, TO18 ..\$1
- 3 TEXAS 20W TRANS'RS, 2N1038, heatsink, TO5 ..\$1
- 2CB5 35W PWR TRANSISTRS, 2N1434, pnp, stud. ..\$1
- 10 FAMOUS CK722 TRANSISTORS, pnp ..\$1
- 15 PNP TRANSISTORS, asst types and cases ..\$1
- 15 NPN TRANSISTORS, asst types and cases ..\$1
- 2-2N341 NPN SILICON TRANSISTORS, 1 watt ..\$1
- 3 CBS 20-WATT TRANSISTRS, pnp, stud. 2N1320 ..\$1
- 25 TOP HAT RECTIFIERS axial lead. 750 mil unit ..\$1
- 1 FAIRCHILD FM708 nnp silicon planar, TO46. ..\$1
- 15 'TEXAS' SWITCHING TRSTRS, pnp-nnp, TO5 ..\$1
- 25 GERMANIUM DIODES, 1N34, 1N48 untested ..\$1
- 10 POWER TRANSISTORS, 10W, TO3 cases, untested ..\$1
- 10 ZENERS, gold, axial leads, untested ..\$1
- 25 "GLASS" TINY SIL. DIODES, axial, untested ..\$1
- TRANSISTRON 25 AMP SCR, 100 PRV ..\$1
- 6 TEXAS 750 MIL, 40 volt epoxy rectifiers ..\$1
- 10 SYLVANIA 30MC TRANS., like 2N247, unt. ..\$1
- 6 AMP, 1000V STUD RECTIFIER, 2 for ..\$1.49

10¢ FOR OUR XMAS BARGAIN CATALOG ON:

Semiconductors Poly Paks Parts

POLY PAKS

TERMS: send check, money order, include postage-avg. wt. per pak 1 lb. Rated, net 30 days. CODs 25%

P.O. BOX 942R
SO. LYNNFIELD, MASS.
"PAK-KING" OF THE WORLD

CLASSIFIED ADVERTISING ORDER FORM

Please refer to heading at top of classified section for complete data concerning terms, frequency discounts, closing dates, word count, etc.

1	2	3	4	5
6	7	8	9	10
11	12	13	14	15
16	17	18	19	20
21	22	23	24	25
26	27	28	29	30
31	32	33	34	35

_____ { @ .30 Non-Commercial Rate }
 No. of Words { @ .55 Commercial Rate } = \$ _____

Total Enclosed \$ _____

Insert _____ time(s)

Starting with _____ issue

Payment must accompany order unless placed through accredited advertising agency. 114

NAME _____

ADDRESS _____

CITY _____ STATE _____ ZIP _____

SIGNATURE _____

MAIL TO: RADIO-ELECTRONICS, CLASSIFIED AD DEPT., 154 WEST 14TH ST., NEW YORK, N.Y. 10011

continued from page 107

CLIP AND GROMMET MOUNT NEON LAMP

The NE-2 neon bulb is often an attractive choice as a pilot lamp because of its low cost, small size, rugged construction and remarkably low power consumption. At the same time, it can do other jobs in many circuits, such as a waveform generator or voltage refer-

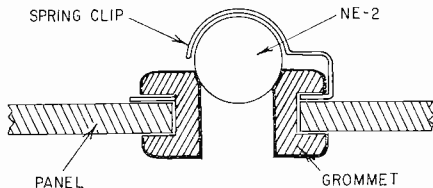

ence. But many experimenters don't take advantage of it because of mechanical difficulties in mounting this baseless bulb.

I've found it convenient to mount NE-2's in spring clips like that shown in the diagram. The clip can be cut from any available thin sheet metal—even an old tin can. The clip is fastened to the panel with a grommet such as those used by dressmakers and sold in a variety of colors at the notions counters of most department stores. The grommet, which is selected in a color to harmonize with the panel, not only holds the assembly in place, but also provides an attractive "lens" for the light.—John P. Wentworth

SHORT-TEST BOX

I recently revived this ancient gadget for use with TV and small electrical appliances, which sometimes blow fuses.

I start with the switch in the SHORTS position. If the 100-watt bulb lights brightly, there's a short in the set. If not, I switch to TEST.

Sometimes, after voltage checks show the need for resistance checks, I forget to shut off the TV. The red jewel on the 6-watt pilot light warns me—usually!

In the SHORTS position the 6-watt

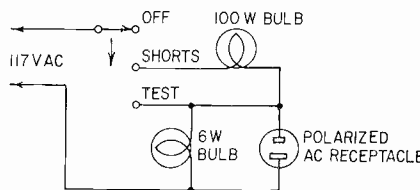

pilot light dims if I plug in an appliance, which shows absent-minded me that I'm still on SHORTS.—Nate Silverman

TUBE-CADDY SPEAKER SPEEDS AUDIO CHECKS

Each of our service technicians has a small test speaker installed in his tube caddy. Its leads are long enough to reach the chassis for checking audio output on service calls.—Stan Clark END

! WIN !

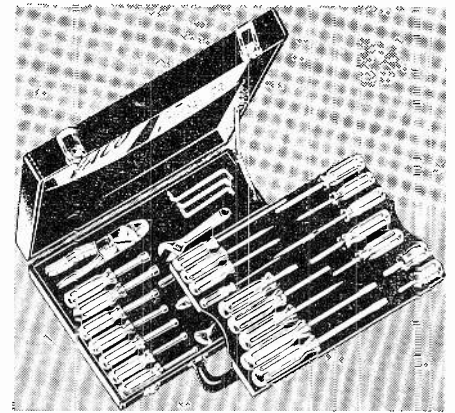

THIS 40 PIECE SET OF TOP QUALITY

VACO TOOLS
 in a beautifully fitted luggage case
\$100.00 Value

Get FREE entry blank at your hardware, automotive, electrical or electronic outlet—no purchase necessary, or write VACO.

VACO PRODUCTS CO.

317 E. Ontario Street • Chicago, Illinois

WHEN YOU ORDER BY MAIL

Be sure to include your name and address. Use your zip code number if you know it. Type or print if you can—if not, write clearly. Don't send cash! Remit by check or money order. Include allowances for postage charges if you know the weight of what you're ordering. Mention you saw it in RADIO-ELECTRONICS.

ELECTRONICS

Engineering-Technicians

Bachelor of Science Degree, 30 Months
 Save Two Years' Time



The Nation's increased demand for Engineers.

Electronic Technicians, Radio TV Technicians is at an all time high. Heald Graduates are in demand for Preferred High Paying Salaries. Train now for a lucrative satisfying lifetime career.

- Radio-Television Plus Color Technician (12 Months)
- Electronics Engineering Technology (15 Months)
- Electronics Engineering (B.S. Degree)
 - Electrical Engineering (B.S. Degree)
 - Mechanical Engineering (B.S. Degree)
 - Civil Engineering (B.S. Degree)
 - Architecture (B.S. Degree) (36 Months)

Approved for Veterans

DAY AND EVENING CLASSES

Write for Catalog and Registration Application. New Term Starting Soon.

Your Name _____

Address _____

City _____

State _____

HEALD'S

ENGINEERING COLLEGE

Est. 1863—101 Years
 Van Ness at Post, RE
 San Francisco, Calif.

new July 21, 1967
Pat. 3,130,349

Patents

Transistor Flasher

Patent No. 3,130,349

Henry R. Mallory, Greenwich, Conn. (Assigned to P. R. Mallory & Co., Inc., Indianapolis, Ind.)

Q1 and Q2 are connected so that only one of them is conducting at any time. For example, if Q1 conducts, it drives Q2's base more positive and blocks it. The CL4 photo cell is placed where it is affected both by lamp illumination and by ambient light. The lamp lights only when Q2 conducts.

In daylight the resistance of CL4 is low. Therefore considerable current can flow from the negative battery terminal to the base of Q1, which conducts. The lamp remains dark. In darkness, CL4 has high resistance, and very little base current can flow to Q1. It blocks Q2's base, which is negative at this time, permits the transistor to

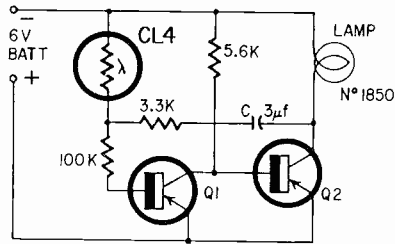

conduct. The lamp lights and illuminates CL4, lowering its resistance, as in daylight. This extinguishes the lamp.

The lamp will flash on and off at a rate determined by the charge and discharge of C. With values shown, the frequency is once per second. The duty cycle is 10% on, 90% off.

Zener Cathode Bias

Patent No. 3,129,388

Richard E. Lang, Concord, and Charles H. Smith, Attleboro, Mass. (Assigned to USA as represented by Secretary of Navy)

Zener diodes improve efficiency and increase power output of an amplifier, whether class A, B

or C. As shown in the schematic, they are used in the cathode circuit to stabilize bias. There is no need for a separate bias battery, and no degeneration due to a resistor. There is no frequency

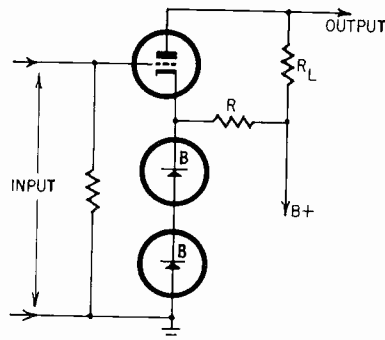

discrimination as when a cathode bypass capacitor (even a large one) is used.

The Zeners (one or more may be needed) can be energized from the plate supply as shown. Resistor R may not be needed in circuits where total cathode current is great enough.

RADIO-ELECTRONICS

SUB CARRIER DETECTOR

for the reception of background music programs (continuous music without commercials) now being transmitted as hidden programs on the FM broadcast band from coast to coast. Use with ANY FM tuner. Detector plugs into existing multiplex output of tuner or easily wired into discriminator.

COMPLETE KITS \$45.00,
SELF POWERED DETECTOR \$75.00

MUSIC ASSOCIATED

Sound systems since 1950
65 Glenwood Road,
Upper Montclair, New Jersey
phone 744-3387, area code 201

BRAND NEW 8YP4 TV TEST TUBE

"A must for every serviceman" (Radio Electronics, Jan. 1964 issue, page 32)—Only \$17.95. Send check or money order for immediate delivery to:

SAMSON KINESCOPE INC.
250 N. Goodman St.
Rochester N.Y. 14607

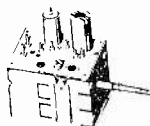

TV TUNERS REBUILT
and Exchanged \$9.50 plus ship. chgs.
All Makes-Models ONLY* \$9.50 plus ship. chgs.

- Includes All Parts Except Tubes
- Aligned to Factory Specifications
- 90 Day Full Warranty
- *Practical repairs

Ship tuner complete with tubes, broken parts, tuner cover. Give model # and state complaint.

VALLEY TV TUNER SERVICE • PO 9-4730
5641-A Cahuenga Blvd., North Hollywood, Calif.

FREE CATALOG!

148 PAGES • NEARLY 4,000 BARGAINS
OPTICS • SCIENCE • MATH

Completely new 1965 edition. New items, categories, illustrations. 148 new, easy-to-read pages packed with nearly 4000 items. Dozens of electrical and electromagnetic parts, accessories. Enormous selection of Astronomical Telescopes, Microscopes, Binoculars, Magnifiers, Magnets, Lenses, Prisms. Many war surplus items; for hobbyists, experimenters, workshop, factory. Write for catalog "EH".

CLIP AND MAIL COUPON TODAY

EDMUND SCIENTIFIC CO., Barrington, N. J.
PLEASE SEND ME FREE CATALOG "EH"

Name _____
Address _____
City _____ State _____

TREASURE FINDERS

Supersensitive new transistor models detect buried gold, silver, coins, firearms. Locate Indian burial grounds, explore beaches, shacks, ghost towns. \$19.95 up. FREE CATALOG.

RELCO Dept. RE-11: BOX
10563, Houston, Texas 77018

Rectifiers & Transistors

750 ma Silicon diodes "Epoxy" or "Top Hat"			Silicon Power Diode Studs 3 amps				
PIV	PIV	PIV	PIV	PIV	PIV		
50	5¢	600	25¢	6¢	300	30¢	
100	7¢	*700	30¢	50	8¢	400	35¢
200	10¢	*800	38¢	100	14¢	500	45¢
400	15¢	*900	48¢	150	18¢	600	55¢
500	20¢	*Top Hat only	200	25¢			All Tests

Full Leads, Tested, Guaranteed, American made 10 Watt Silicon Zener studs, 5V-100V, any voltage \$1.25 ea.

10 Watt Silicon diffused stud power regulators & double anode clippers, 10V-120V, any voltage \$1.49 ea. Hi-Voltage-Silicon epoxy diode, 2 1/2" x 3/8" x 1/2", mounting holes, 8" glass insulated leads, original factory package.

Hoffman—3000 PIV-200ma. (orig. \$15.00) \$1.95 ea.
Hoffman—6000 PIV (3000 PIV Tap)-200ma (orig. cost \$3u.00) \$4.50 ea.

Thermistor, glass bead, 1200 ohms, 600°F, factory packed by Victory Engr., 32A3, Long Leads 2/\$1.00

20 Watt Germanium (Internal Heat Sink)

2n 1038 6 for \$1.00 2n 1039 4 for \$1.00 2n 1040 3 for \$1.00 2n 1041 2 for \$1.00 2n 1042 4 for \$1.00 2n 1043 3 for \$1.00 2n 1044 2 for \$1.00 2n 1045 70¢

150 Watt Germanium Hi-Freq Power
100 Volts, 20 amp., 2n 1046 \$1.50 ea.
100 Volts, 20 amp., 2n 1907 \$1.95 ea.

150 Watt Germanium Power
2n 250 3/\$1.00 2n 457 80¢ 2n 1022 \$1.25

2n 251 2/\$1.00 2n 458 90¢ 2n 702, 100mc, Silicon 40¢
2n 456 70¢ 2n 1021 \$1.00 2n 703, 150mc, Silicon 60¢

Germanium Switching Transistors, 150mw, Long Leads, Tested 6 pnp-\$1.00 2 npn-\$1.00

Small-signal Transistors, flat case, short printed circuit board leads, new, assorted numbers, tested 15/\$1.00 Nickel-Cadmium Battery-6 1/2 oz.—6" x 2" x 1/2"—5 amp-hrs-\$1.25 ea.

Silicon Controlled Rectifiers								
PRV	7	16	25	PRV	7	16	25	
amp.	amp.	amp.	amp.	amp.	amp.	amp.	amp.	
25	.30	.60	.90	200	1.50	2.10	2.60	
50	.60	.90	1.10	300	2.30	2.70	3.10	
100	1.00	1.50	1.80	400	2.70	3.10	3.85	
150	1.30	1.80	2.30	500	3.45	3.95	4.45	
ALL TESTS, STUD TYPE	600	3.70	4.70	4.90				

Money back guarantee, \$2.00 min. order, include postage, Catalogue 25¢

ELECTRONIC COMPONENTS CO.
Box 2902B Baton Rouge, La. 70821

Please mention
RADIO-ELECTRONICS
when writing to advertisers

SILICON RECTIFIER SALE

IMMEDIATE DELIVERY
FULLY GTD AMERICAN MADE NEWEST TYPE FULLY TESTED

750 MA-SILICON "TOPHAT" DIODES

LOW LEAKAGE FULL LEAD LENGTH			
PIV/RMS	PIV/RMS	PIV/RMS	PIV/RMS
50/35	100/70	200/140	300/210
.05 ea.	.09 ea.	.12 ea.	.16 ea.
400/280	500/350	600/420	PIV/RMS
.20 ea.	.24 ea.	.32 ea.	700/450
			.40 ea.
PIV/RMS	PIV/RMS	PIV/RMS	PIV/RMS
800/560	900/630	1000/700	1100/770
.48 ea.	.55 ea.	.70 ea.	.75 ea.

ALL TESTS AC & DC & FWD & LOAD

SILICON POWER DIODE STUDS				
D.C. AMPS	50 PIV 35 RMS	100 PIV 70 RMS	150 PIV 105 RMS	200 PIV 140 RMS
3	.12 ea.	.18 ea.	.22 ea.	.30 ea.
12	.65	.75	.90	1.70
35	.90	1.15	1.50	2.80
100	1.50	1.90	2.30	2.80
100	1.75	2.15	2.55	3.15

D.C. AMPS	300 PIV 210 RMS	400 PIV 280 RMS	500 PIV 350 RMS	600 PIV 450 RMS
3	.40 ea.	.45 ea.	.50 ea.	.65 ea.
12	1.10	1.35	1.50	1.70
35	2.35	2.55	3.00	3.50
100	3.50	4.20	5.25	7.00
100	3.75	4.60	5.65	8.00

"SCR" SILICON CONTROLLED RECTIFIERS "SCR"

PRV AMP	7	16	25	PRV AMP	7	16	25
25	.50	.85	1.20	250	2.30	2.65	3.10
50	.85	1.20	1.40	300	2.60	3.00	3.40
100	1.30	1.80	2.20	400	3.40	4.00	4.15
150	1.60	2.10	2.60	500	4.25	5.00	5.25
200	1.75	2.40	2.90	600	4.00	5.00	5.25

Money Back guarantee. \$2.00 min. order. Orders F.O.B. NYC. Include check or money order. Shpg. charges plus. C.O.D. orders 25% down.

Warren Electronic Components

230 Mercer St., N. Y., N. Y. 10012 • OR 3-2620

Transistors, Diodes, Rectifiers, Zeners, F.E.T., Lytics, Tantalums, Transformers, speakers. See October issue or catalog. Deluxe Ignition system, 6-12 volt negative grd. "Tungsol" factory packed, complete instructions World's smallest radio KIT, 7/8 x 3/4 x 1/4 — 3 transistors \$21.95
Walkie-Talkie-CB., metal case, crystal controlled, 5 transistors, no license req., Batt. & Ant. included. \$33.80 a pair
2N1742 "Philco" transistor, mounted on PC board, 1 1/4" sq. with sub-min crystal, thermistor, hi-freq. coil can be used as transmitter, converter, etc. 2.00
LIGHT SENSITIVE MICROAMMETER, (Kodak) in 1" x 2 1/4" box, sub-min. 2.50
2 Watt amplifier KIT-3 transistors, schematic, etc. 3.00
Transistor tester KIT, with schematic and meter. 5.00
Microphone "Turner-model 80", \$15.95 list, special \$11.95
Nylon pulley wheels for dial cords. 15/\$1.00
Test Equipment, VTM'S, VOM'S, Scores, etc. Used. Write for list PC Boards, 2 RCA 2N408 transistors, 2 RCA 1N2326 diodes \$1.00
Potentiometers, 1 watt Linear "IRC", 250, 25K, 50K, ohms .3/\$1.00
Dual Banana Plugs, "General Radio" 274N .30
Telephone Jacks—JJ033—Boxed 8/\$1.00
Transistor socs., "Cinco" 10/\$1.00
Write for free catalog—Minimum order \$3 prepaid Postage free in U.S.A.
TRANSISTOR UNLIMITED COMPANY—TUCCO
Post Office Box 442, Great Neck, L.I., N.Y.
Warehouse & Office—462 Jericho Turnpike Mineola, L.I., N.Y.—516 PT 7-7221

Flying Device

PATENT No. 3,120,363

Glenn E. Hagen, Fresh Meadows, N.Y. (Assigned to Electronatom Corp., New York, N.Y.)

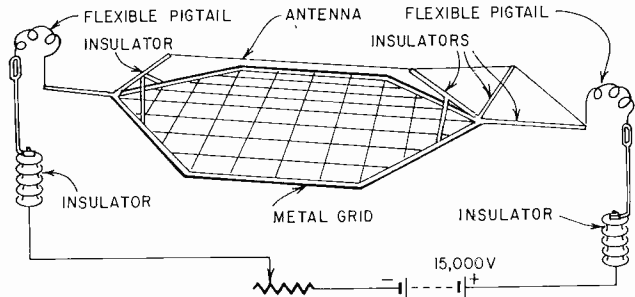

This device consists of an insulating frame which carries a grid of fine wires. The wires are connected to a source of high-voltage negative dc. Above this grid, and insulated from it, is a single-wire antenna connected to the positive terminal.

Positive ions are emitted downward from the antenna and attracted by the grid to provide lifting power. In one experiment, the frame was approximately 4 x 6 in. and the antenna was 2 in. above the grid. All wires were 2.5 mils in diameter.

Controlled-Volume Recorder

Patent No. 3,132,213

Douglas E. Taylor, Westport, and William F.

Mitchell, Fairfield, Conn. (Assigned to Dictaphone Corp., Bridgeport, Conn.)

A dictating machine can be started and stopped by the voice signal, as shown here. The audio

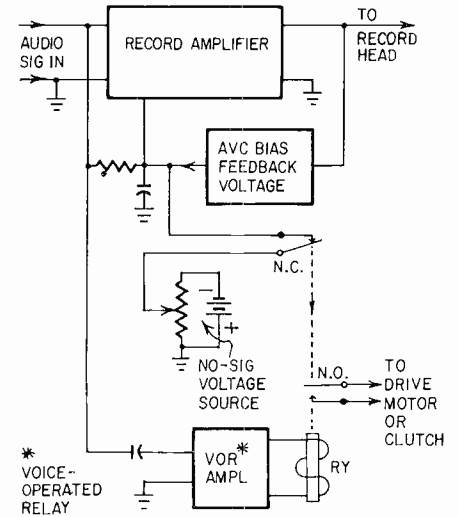

actuates a voice-operated relay (VOR) whose contacts close the motor circuit. Other contacts open at this time, to permit normal action on the amplifier.

During a pause (when the relay is not energized) a negative battery voltage is added to the avc supply. It reduces amplifier gain and prevents the loud "pop" that would otherwise occur when the audio resumed. The pop happens because amplifier gain is maximum when there is no avc to hold it down.

MARKET CENTER

Build with Wood **INEXPENSIVELY** with...

POWER TOOLS

you can buy **BELOW WHOLESALE!**

You can now save over 70% on professional quality power tools by buying by mail from the factory. New catalog shows guaranteed savings on Tilt Arbor Power Saws, Precision Belt Sanders, Jointer-Planers, Radial Drill Presses, etc. Over 500,000 satisfied users.

SEND FOR **FREE CATALOG**

American Machine & Tool Co. Dept. RE-114
Royersford, Pa. 19468

FREE Catalog

OF THE WORLD'S FINEST ELECTRONIC GOV'T SURPLUS BARGAINS



HUNDREDS OF TOP QUALITY ITEMS — Receivers, Transmitters, Microphones, Inverters, Power Supplies, Meters, Phones, Antennas, Indicators, Filters, Transformers, Amplifiers, Headsets, Converters, Control Boxes, Dynamometers, Test Equipment, Motors, Blowers, Cable, Keyers, Chokes, Handsets, Switches, etc., etc. Send for Free Catalog—Dept. RE.

FAIR RADIO SALES
2133 ELIDA RD. • Box 1105 • LIMA, OHIO

POWERMAKER



\$44.95

- AC POWER ANYWHERE
- 120 Volts, 60 Cycles
- 300 Watts Output
- Runs off 12 Volt Battery
- Write or Order Now

California residents add 4%
Shipped anywhere U.S.A. add \$2.00
TOPAZ INCORPORATED
3802 Houston St. San Diego, California 92110

WANT BACK ISSUES?

Back numbers of most issues of RADIO-ELECTRONICS are available upon request. This year's issues 50¢; Last year's issues 55¢; Previous year 60¢, etc., up to a maximum of \$1 per copy. **RADIO-ELECTRONICS**, 154 West 14th St., New York, N. Y. 10011.

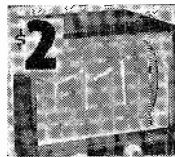

Convert any television to sensitive **BIG-SCREEN OSCILLOSCOPE** with minor, inexpensive changes. Ingenious circuit. No electronic experience needed to follow our clearly illustrated plans. **TECHNICIANS, HAMS, EXPERIMENTERS, BROADCASTERS.** Use in shop, school, lab. Any set—any size screen. **FULL PLANS \$2**

RELCO, Dept. RE-11, Box 10563, Houston 18, Tex.

NEW NON-COMMERCIAL RATE FOR CLASSIFIED ADS
See classified section for details

Solve Electronics Problems Fast With Special New Slide Rule

Professional, high quality instrument . . . specifically designed for electronic engineers and technicians . . . made to our rigid specs by Pickett & Eckel. Has special scales for solving reactance and resonance frequency problems. Accurately and quickly locates decimal points. Carries widely used formulas and conversion factors not found on any other slide rule. Comes complete with top-grain leather carrying case, illustrated instruction manual, 90 day consultation service — all for just \$14.95. Carries lifetime guarantee against defects in material and workmanship.



SEND COUPON TODAY

TO: CLEVELAND INSTITUTE OF ELECTRONICS

1776 E. 17th St., Dept. RE-104, Cleveland, Ohio 44114

- Please send me your electronics slide rule. I am enclosing \$14.95. (If not fully satisfied after 10 day trial, CIE will refund payment.)
- Please send additional descriptive literature.

Name _____ (Please Print)
Address _____
City _____ State _____ Zip _____

"TAB", SILICON 750MA* DIODES

NEWEST TYPE! LOW LEAKAGE			
Piv/Rms	Piv/Rms	Piv/Rms	Piv/Rms
50/35	100/70	200/140	300/210
15	09	15	15
Piv/Rms	Piv/Rms	Piv/Rms	Piv/Rms
400/280	500/350	600/420	700/490
.20	.24	.32	.40
Piv/Rms	Piv/Rms	Piv/Rms	Piv/Rms
800/560	900/630	1000/700	1100/770
.48	.55	.70	.75

ALL TESTS AC & DC & FWD & LOAD!

1700Piv, 1200Rms @ 750Ma \$1.20 @ 10 for \$10
same 1100Piv/770Rms 75c @ 16 for \$11

"TAB" * SCR's * TRANSISTORS * DIODES!!!

Full Leads Factory Tested & Gld U.S.A. Mfg.
PNP 50Watt/15Amp HiPower TO36 Pkg! 2N441, 442, 277, 278, D5501 up to 50 volts/VCBO \$1.25 @ 5 for \$5
2N278, 443, 174 up to 80V @ 2 for \$5
PNP 10Watt/3A-2NI55, 156, 238, 242, 254, 255, 256, 257, 301, 351 c35 @ 4 for \$1
PNP/Signal up to 350MW T05 c25 @ 6 for \$1
NPN/Signal IF, RF, OSC, T05, OVS, c25 @ 6 for \$1
PNP 2N670/300MW c35 @ 4 for \$1
PNP 2N671/1Watt c50 @ 3 for \$1
Silicon PNP T05 & T018, Pkg c25 @ 5 for \$1
TO36, T03, Pkg Mica Mfg Kit 5 for \$1
Power Heat Sink Finned 80 Sq \$1.25 @ 5 for \$5
3 Amp/T03/Pwr Transistors Untested 10 for \$1
Pwr Transistors T03/3A Untested 10 for \$1
Stabistor Diodes up to one Watt 5 for \$1
Silicon Diodes 35 Amp Studs Untested 3 for \$1
Silicon Diodes epoxy/750Ma Untested 25 for \$1

Sil. Presift 18A up to 100 Piv 4 for \$1
Micro or MuSwitch CSD 35 Amp/AC-DC 3 for \$1

Silicon Power Diodes Studs & P.F.*

D.C. Amps	50V Piv	100V Piv	150V Piv	200V Piv
3	35Piv	70Piv	105Rms	140Rms
12*	.12	.18	.25	.30
12*	.40	.60	.70	.85
18*	.25	.45	.60	.85
35	.85	1.10	1.40	1.60
100	1.75	2.15	2.50	3.10
240	4.50	5.70	6.90	8.40
D.C. Amps	500Piv	600Piv	500Piv	600Piv
3	210Rms	280Rms	350Rms	420Rms
12	.40	.45	.50	.60
12	1.10	1.20	1.40	1.55
18*	1.00	1.30	1.40	1.60
35	2.25	2.50	2.85	3.40
100	3.10	4.60	5.65	8.00
240	16.50	24.50	24.50	35.00

2N1038 4/\$1, 1039 3/\$1, 1010 2/\$1, 1011 \$1
2N258, 539, 510/3 Amp 2 for \$1
Zener 50/60V Auto Ignition 5 for \$1
100V Auto Ignition Transistor 3 for \$1
Kit Zeners 100 Mw to 10W Ass'd 3 for \$1

"SCR" SILICON CONTROLLED RECTIFIERS!

PRV	7A	16A	25A	PRV	7A	16A	25A
25	.85	1.85	1.20	250	2.40	2.75	3.20
50	.85	1.40	1.40	300	2.70	3.20	3.70
100	1.35	1.80	2.20	400	3.25	3.60	4.25
150	1.65	2.20	2.70	500	4.00	4.45	4.90
200	1.85	2.20	3.00	800	4.50	5.15	5.65

Silicon Diodes 3&6 Amp Studs Untested 12 for \$1
Glass Diodes 1N34/48/60/64 Untested 20 for \$1

"TAB" TERMS: Money Back Guarantee! Our 18th year, \$2 Min. order F.O.B. N.Y.C. Add ship charges or to C.O.D. Add subj. charges shown subject to change.
111-GP Liberty St., N. Y. 6, N. Y.
Send 25c Phone: RECOR 2-6245 for Catalog

LOW-COST BUSINESS AIDS FOR RADIO-TV SERVICE

Order books, invoice forms, job ticket books, service call books, cash books and statement books for use with your rubber stamp. Customer file systems, book-keeping systems, many others. Write for **FREE 32 PAGE CATALOG** now.

OELRICH PUBLICATIONS
6556 Higgins Rd., Chicago, Ill. 60656

new Books

TUBE SUBSTITUTION HANDBOOK, Vol. 7. Howard W. Sams & Co., Inc., 4300 W. 62 St., Indianapolis 6, Ind. 5½ x 8½ in., 128 pp. Paper, \$1.50.

A listing of over 10,000 American and foreign tubes. Special types, pix tubes and subminiatures are included.

UNDERSTANDING TRANSISTORS, by Milton S. Kiver. Allied Radio, 100 N. Western Ave., Chicago 80, Ill. 6 x 9 in. 64 pp. Paper, 50 cents.

Interesting little booklet, covering fundamentals and containing large numbers of simple transistor circuits.

103 SIMPLE TRANSISTOR PROJECTS, by Tom Kneitel. John F. Rider Publisher, Inc., 116 W. 14 St., New York, N.Y. 10011. 5½ x 8½ in. 120 pp. Paper, \$2.75.

Contains everything from simple receivers through frequency standards to Geiger counters. Schematics exceptionally large and clear.

CALCULUS FOR THE ELECTRONICS TECHNICIAN, by Allan Lytel. Howard W. Sams & Co., Inc., 4300 W. 62 St., Indianapolis, Ind. 5½ x 8½ in. 160 pp. Paper, \$3.95

Tells his reader what calculus is, then presents the subject in a little more detail than the average textbook. No attempt is made to relate the various examples to electronics problems.

ENGINEERING MATHEMATICS, by Kenneth S. Miller. Dover Publications, Inc., 180 Varick St., New York 14, N.Y. 6 x 8½ in., 417 pp. Paper, \$2.

Linear differential equations, Fourier series, Laplace transforms and probability theory are among the advanced topics presented here for graduate engineers. Excellent for original study or for review.

SCHWARZ-CHRISTOFFEL TRANSFORMATION AND ITS APPLICATIONS, by Miles Walker. Dover Publications, Inc., 180 Varick St., New York 14,

N.Y. 5½ x 8½ in., 116 pp. Paper, \$1.25.

Elementary explanation of this important method for solving engineering problems of force fields and fluid flow. The reader must know calculus and complex algebra.

ABC'S OF LASERS AND MASERS, by Allan Lytel. Howard W. Sams & Co., Inc., 4300 W. 62 St., Indianapolis 6, Ind., 4300 W. 62 St., Indianapolis 6, Ind. 5½ x 8½ in., 95 pp. Paper, \$1.95.

An introduction to these amazing devices, and how they are used.

ENCYCLOPEDIA OF HIGH FIDELITY, 6 vols., each by a different author (John Borwick, Ed.). Focal Press, Inc., 20 E. 46 St., New York, N.Y. 10017. 5¼ x 8¾ in., approx. 1,500 pp. total all 6 vols. Cloth, in slip case, \$9.50 each vol., \$49 for whole set.

One entire volume devoted to each major division of audio. Titles: *Amplifiers, Loudspeakers, Tape Recording and Reproduction, Radio Reception, Acoustics, Disc Recording and Reproduction.* Each is written by a different author, an expert in his field. Coverage is from the very simple, for

DON'T BUY any special purpose or industrial transmitting tubes until you receive our special quotations. Lowest prices in USA. Cash paid for brand new tubes of all descriptions irrespective of age or quantity. **UNITED RADIO CO.,** Newark, N.J.

ELTEC LABS. "Bailey Zero Beat" Freq. Meter Model #550 serial #153 (20-500 MC.) Used 6 months. Excellent. First check \$390.00 F.O.B. C. D. KIDDER 939 S. Central Ave., Canonsburg, Pa. 15317.

GOVERNMENT SURPLUS CATALOG. Radios, Parts, Lenses. Send 10¢. **MESHNA,** Nahant, Mass.

JAPANESE MERCHANDISE from Radio to Camera. Any inquiries answered. Information, catalogs and Price-list \$1.00. **TOMIO UENO,** No. 538 Shibamatacho, Katushikaku, Tokyo.

METERS — SURPLUS. New, Used, panel and portable. Send for list. **R. J. HANCHETT,** P.O. Box 1898, Riverside, Calif. 92507

TUBES. VT-269-717A. Replaces 6SK7, 6AK5, etc. 5/\$1.25. Free Klystron with each order. **D. J. MARINCH,** Box 75423, Los Angeles, Calif. 90005.

SYLVANIA Model 300 CCTV camera 4 lens turret with 1-25 MM. lens RF output with 300 ohm matching X FMR. Used 10 hours, in orig. carton. First check \$275.00 F.O.B. **C. D. KIDDER,** 939 S. Central Ave., Canonsburg, Pa. 15317.

SELLING ENTIRE INVENTORY of experimental laboratory. Send for free list. \$1.00 for trial assortment of diodes, capacitors, transistors, etc. Free diode for inquiry while supply lasts. **B. H. INDUSTRIES,** Box 5174, Pasadena, Calif.

FREE CATALOG: Wholesale electronic parts and equipment. **WESTERN COMPONENTS,** Box 2581, El Cajon, Calif.

TRANSISTORIZED Treasure Detectors Find buried gold, silver, coins. \$19.95 up. Kits available. Free catalog. **RELCO-A25,** Box 10563, Houston 18, Texas.

General

TV SERVICE ORDER BOOKS for use with your rubber stamp. Duplicate or triplicate. Low cost. Write for **FREE 32 PAGE CATALOG** and Special Rubber Stamp Offer. **OLRICH PUBLICATIONS,** 6556 W. Higgins, Chicago, Ill. 60656.

Canadians

CANADIANS We buy sell repair test equipment; Eico #360 TV-FM sweep generator on hand assembled \$67.00. Dargel TV Radio **SMALL APPLIANCE REPAIR,** 966 Queen St., West Toronto 3, Ont., Canada.

GIANT SURPLUS BARGAIN PACKED CATALOGS. Electronics, Hi-Fi, Shotwade, Amateur, Citizens Radio, Rush \$1.00 (Refunded). **ETCO,** Box 741, Dept. R. Montreal, Canada.

CANADIANS Have you seen **ELECTRON,** Canada's own Service and Hobby magazine? Subscription \$3.50. **ELECTRON,** Box 796, Montreal, Canada.

Classified Ads

COMMERCIAL RATE (for firms or individuals offering commercial products or services): 55¢ per word . . . minimum 10 words.

NON-COMMERCIAL RATE (for individuals who want to buy or sell personal items): 30¢ per word . . . no minimum.

Payment must accompany all ads except those placed by accredited advertising agencies. 10% discount on 12 consecutive insertions, if paid in advance. Misleading or objectionable ads not accepted. Copy for January issue must reach us before November 14th.

WORD COUNT: Include name and address. Name of city (Des Moines) or of state (New York) counts as one word each. Zone or Zip Code numbers not counted. (We reserve the right to omit Zip Code if space does not permit.) Count each abbreviation, initial, single figure or group of figures or letters as a word. Symbols or groups such as 8x10, COD, AC, etc., count as one word. Hyphenated words count as two words. Minor over-wordage will be edited to match advance payment.

Electronics

PRINTED CIRCUIT BOARDS. Hams, Experimenters. Catalog 10¢. **P/M ELECTRONICS,** Box 6288, Seattle, Wash. 98188.

7" TV TEST TUBE—\$6.99. Tubes 6146—\$2.95; 6211 (12AU7 equiv.) 39¢, 3 for \$1. Germanium diodes, tested, equiv. 1N34, 1N60 etc., 30 for 61¢. Tophat silicon rectifiers, 750MA—1000 PIV 75¢. Transistors, tubes, resistors, condensers, etc. bargain priced. Free catalog. **ARCTURUS ELECTRONICS,** Dept. RE, 502-22nd St., Union City, N.J. 07087.

CONVERT any television to sensitive, big-screen oscilloscope. Only minor changes required. No electronic experience necessary. Illustrated plans \$2. **RELCO,** Box 10563, Houston 18, Tex. **DIAGRAMS FOR REPAIRING RADIOS** \$1.00. Television \$2.50. Give make, model. **DIAGRAM SERVICE,** Box 1151 RE, Manchester, Conn.

TV CAMERAS, transmitters, converters, etc. Lowest factory prices. Catalog 10¢. **VANGUARD,** 190-48-99th Ave., Hollis, N.Y. 11423.

GOVERNMENT SURPLUS JEEPS—\$62.50. Voltmeters — \$1.05. Transmitters — \$6.18. Oscilloscopes, Walkie-Talkies, Multimeters. Typical Surplus Prices. Exciting Details Free. Write: **ENTERPRISES,** Box 402-F20, Jamaica, N.Y. 11430

PROFESSIONAL ELECTRONICS PROJECTS — Organs, Timers, Computers, etc.—\$1 up. Catalog 25¢, refundable. **PARKS,** Box 1665, Seattle, Wash. 98125.

FREE ELECTRONICS CATALOG. Tremendous bargains. **ELECTROLABS,** Department C-232G, Hewlett, N.Y. 11557.

TRANSISTOR IGNITION. Three transistor \$14.95. Also complete system, 400:1 coil \$15.00. Catalogue, write. **ELECTRO-MART,** 1616 South 81st Milwaukee, Wis. 53214.

SALVAGE CIRCUIT BOARDS packed with dozens of transistors, diodes, miniature transformers, capacitors etc. Assortment "A" \$5.00, "B" \$4.00, "C" \$3.00, all different, postpaid. **ENGINEERING ASSOCIATES,** 434 Patterson Road, Dayton, Ohio 45419.

RADIO & TV TUBES 33¢. Free List. **CORNELL,** 4217-E University, San Diego, Calif. 92105.

COMPONENT QUOTATIONS—TAPES Mylar 1800' postpaid \$1.59 each. Recorder Sale 40%. **BAYLA,** Box 131RE Wantagh, N.Y.

DIAGRAMS. Radio \$1.00 TV \$1.30. **SCHEMATICS** 618 4th Street, Newark, N.J. 07107.

RESISTORS, newest type metal-oxide film. ¼, ¼, ½, 1 watt \$.07-\$.12 each, 18-470,000 ohms. Resistor Kits, Copper Circuit Board, Capacitors, Battery Motors, High Barrier Terminal Blocks, etc. Write **FARNSWORTH ELECTRONIC COMPONENTS,** 88 Berkeley Street, Rochester 7, N.Y.

PRINTED CIRCUIT BOARDS, High quality, fast delivery. Free Catalog and Sample. **LEIGHTON ELECTRONICS,** Box 281, Leighton, Pa. 18235.

DIAGRAMS plus complete service information. Television \$2, Radio \$1. **SERVICAIDE,** Box 3412, Harrisburg, Pa. 17105.

BEFORE You Buy Receiving Tubes, Test Equipment, Hi-Fi Components, Kits, Parts, etc. . . send for our Giant Free Zalytron Current Catalog, featuring all STANDARD BRAND TUBES all Brand New Premium Individually Boxed, One Year Guarantee—all at BIGGEST DISCOUNTS in America! We serve professional servicemen, hobbyists, experimenters, engineers, technicians. **WHY PAY MORE? ZALYTRON TUBE CORP.,** 469R Jericho Turnpike, Mineola, N. Y.

"COIL WINDING METHODS" Handbook — 50¢. Experimenter's catalog 250 exclusive items — 25¢, refundable. **LABORATORIES,** 1131-B Valota, Redwood City, Calif.

the beginner in electronics. to the highly sophisticated, for the experienced designer who wants new ideas or a comprehensive reference work. Mathematical approaches are used for those who can benefit by them, but no knowledge of math is necessary to understand the material. British, but it shows up only in tube and transistor types and a few matters of style. A goldmine for the audio engineer or technically oriented audiophile.

ON THE EARLY HISTORY OF RADIO GUIDANCE, by Benjamin Franklin Miessner. San Francisco Press, 255 12 St., San Francisco, Calif. 5 1/4 x 8 1/2 in., 86 pp. Paper, \$2.75

The author's own account of his role in developing radio guidance while in the employ of John Hays Hammond. Throws some additional light on the controversy between Hammond and Purington and Lloyd Espenschied (*Proceedings of the IRE*, 1957-1959).

REPLACEMENT GUIDE FOR TV AND AUTO RADIO CONTROLS (Volume 6), compiled by Howard W. Sams Engineering Staff. Howard W. Sams & Co., 4300 W. 62 St., Indianapolis 6, Inc. 8 1/2 x 11 in., 192 pp. Paper, \$1.

Lists recommended replacement controls produced by Centralab, Clarostat, CTS-IRC and Mallory for more than 38,000 TV models and 1,500 auto radios produced from 1947 through 1964.

A PROGRAMMED COURSE IN BASIC TRANSISTORS, by New York Institute of Technology, Alexander Schure, project director. McGraw-Hill Book

Co., 330 W. 42 St., New York, N.Y. 10036. 7 x 10 in., 473 pp. Paper, \$7.95

A very large and complete work, using the reinforced-response approach. May depend to some extent on outside reading, since some of the answers require using words not previously introduced in the text.

RCA RECEIVING TUBE MANUAL, RC-23. *Electronic Components & Devices*, RCA, Harrison, N.J. 5 1/4 x 8 1/4 in., 608 pp. Paper, \$1.25

The latest edition, RC-23, has been expanded to 608 pages from the 544 pages of the RC-22. The technical data section, containing more than 400 pages, covers active RCA receiving types. Renewal and discontinued types are combined in a 50-page tabular section, containing data on over 500 tubes. END

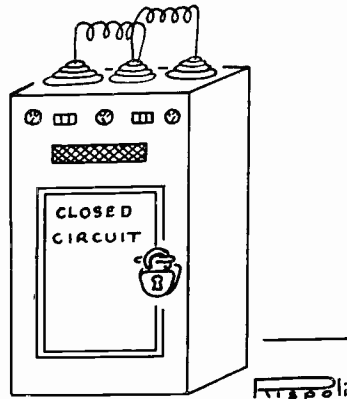

MONEY IN MAIL ORDER. Details 35¢. JACK BENNETT, Box 222, Lewes, Del.

Audio—Hi-fi

TAPE recorders, Hi-Fi components, Sleep-learning equipment, Tapes, Unusual values. Free catalog. DRESSNER, 1523 Jericho Turnpike, New Hyde Park 5, N.Y.

WINDSOR TAPE CLUB members HEAR BEFORE THEY BUY. Free "samplers" of new releases. Save on tape purchases—all major labels. Free Brochure—WINDSOR TAPE CLUB, Dept. A, Windsor, Calif.

HI-FI COMPONENTS, Tape Recorders, at guaranteed "WE will not be undersold" prices. 15-day moneyback guarantee. Two-year warranty NO Catalog. Quotations Free. HI FIDELITY CENTER, 1797 (R) 1st Ave., New York, N.Y. 10028.

SAVE 30-60%. Stereo music on tape, FREE! 50 page discount catalog. Blank tape, recorders Norelco speakers. SAXITONE, 1776 Columbia Road, Washington, D.C. 20009.

LP's like new. Top Labels. \$1.00 Lists—Refunded first order. MUSIK HILLBURN, P.C. Hillburn, N.Y. 10931.

DISCOUNT RECORDS—All labels free list—Write CLIFF HOUSE, Box 42-R-11, Utica, N.Y. WRITE for highest discounts on components, recorders, tapes, from franchised distributors. Send for FREE monthly specials. CARSTON, 125-R East 88. N.Y.C. 10028.

FOR SALE IMMEDIATE DELIVERY 980' long-2" wide Mylar Recording Tape for use with Soundcriber recorder models #116 and #124. Made for government to military specifications. New in sealed original cartons. Cost 980'—\$9.80. Would normally cost from manufacturer \$9.50 for 300'. Tremendous value. GOLDEN STATE SALES, INC., 1604 W. 139th St., Gardena, Calif.

ATTENTION. ANTIQUE Edison Cylinder. Phonographs released from storage. Display price sheet sent. TRACY STORAGE, 114 State, Brewer, Maine.

LOW STEREO QUOTES. Components. Recorders. HI-FI, Roslyn, Pa. 19001.

RENT STEREO TAPES—over 2,500 different—all major labels—free brochure. STEREO-PARTI, 1616 Terrace Way, Santa Rosa, Calif.



COYNE
TRAINS YOU
IN SPARETIME
AT HOME

TELEVISION
COLOR TV-
RADIO-ELECTRONICS

Coyne—and only Coyne—can give you this modern, TV Home Training. Easy to follow 2156 photos and diagrams covering Radios-TV, Color, UHF, Transistors. We also show you how to start making money while learning, right at home. Get your basic training at home, then make a flash finish with 2 weeks of actual shop work in Chicago under direction of same instructors who guide our resident students.

LOW COST—Easy to Pay
You don't pay for costly "put together" kits. Small monthly payments and low, low cost make it easy for everyone to train. Free employment service for graduates—or we show you how to start your own service business on a "shoestring." Send name today for complete facts and valuable book on Television. No salesman will call. Everything mailed free, postpaid.

Coyne Electronics Institute
Not for Profit
1501 W. Congress Parkway
Dept. 84-H5, CHICAGO 7, ILL.

FREE
of Extra Charge
to Graduates
TWO WEEKS
Shop Training in Chicago

No increase in home training cost, but the day you graduate you will be entitled to two full weeks of personal instruction on actual projects in the great Shop-Labs of Coyne in Chicago—without one cent of extra tuition whatsoever.

FREE Just Send Name

No charge. No obligation. No salesman will bother you. Just send name for free copy of big 24 page book on quickest, lowest cost way to train for top pay job or business of your own... Mail coupon today.



COYNE ELECTRONICS INSTITUTE, Dept. 84-H5
1501 W. Congress Parkway, Chicago 7, Ill.
Please mail free book and offer of two weeks personal training in Chicago without extra tuition for home study graduates. Explain low monthly payments.

NAME _____ AGE _____
ADDRESS _____
CITY & STATE _____

EDUCATION/INSTRUCTION

SLEEP LEARNING. Hypnotism! Tapes, records, books, equipment. Details, strange catalog FREE. RESEARCH ASSOCIATION, Box 24-RD, Olympia, Wash.

LEARN ELECTRONIC ORGAN SERVICING. New home study course covering all makes electronic organ including transistors. Experimental kits—schematics—trouble-shooting. Accredited NHSC-GI Approved. Write for free booklet. NILES BRYANT SCHOOL, 3631 Stockton Blvd., Dept. F. Sacramento 20, Calif.

HIGHLY—effective home study review for FCC commercial phone exams. Free literature! COOK'S SCHOOL OF ELECTRONICS, Craigmont, Idaho 83523.

EARN TOP \$ in INDUSTRIAL WRITING part or full time—free lance or for industry! Learn professional secrets at home in spare time. No tech. know-how necessary. Prepare manuals, brochures, ads, reports little as six months. Get free book. ATWS Dept. 1, 5504 Hollywood Blvd., Hollywood 28, Calif.

FCC LICENSE in 6 weeks. First Class Radio Telephone. Results Guaranteed. ELKINS RADIO SCHOOL, 2603E Inwood, Dallas, Tex.

BUSINESS AIDS

1,000 Business Cards, "Raised Letters" \$3.95 postpaid. Samples. ROUTH RE11, 2633 Randleman, Greensboro, N.C. 27406.

1,000 EMBOSSED BUSINESS CARDS, \$3.85. Free Samples. CHAMBERS, 8316-2 Hanon, Ft. Worth, Texas. 76108.

INVENTORS. We will develop, help sell your idea or invention, patented or unpatented. Our national manufacturer clients are urgently seeking new items for outright cash sale or royalties. Financial assistance available. 10 years proven performance. For free information, write Dept. 53, WALL STREET INVENTION BROKERAGE, 79 Wall Street, New York, N.Y. 10005.

1000 BUSINESS CARDS \$3.90. Samples. MTL PRINTING, Box 947, Chicago, 60690.

JUST STARTING IN TV SERVICE? Write for FREE 32 PAGE CATALOG of Service Order books, invoices, job tickets, phone message books, statements and file systems. OELRICH PUBLICATIONS, 6556 W. Higgins, Chicago, Ill. 60656.

WANTED

QUICK CASH... for Electronic EQUIPMENT, COMPONENTS, unused TUBES. Send list now! BARRY, 512 Broadway, New York, N.Y. 10012, 212 WALKER 5-7000.

G.R. H.P. L&N, etc. Special tubes, manuals, military electronics. ENGINEERING ASSOCIATES, 434 Patterson Road, Dayton 19, Ohio.

SERVICES

TV TUNERS Rebuilt and Aligned per manufacturer specification. Only \$9.50. Any Make UHF or VHF. We ship COD Ninety day written guarantee. Ship complete with tubes or write for free mailing kit and dealer brochure. JW ELECTRONICS, Box 51 D, Bloomington, Ind.

METERS—MULTIMETERS REPAIRED and calibrated. BIGELOW ELECTRONICS, Box 71-B, Bluffton, Ohio.

RCA TEST EQUIPMENT. Authorized Repair & Calibration Center. Nationwide. EDWIN BOHR/ELECTRONICS P.O. Box 4457 Chattanooga, Tenn. 37415.

BORROW \$1,233 AIRMAIL! Repay \$54 for twenty-nine months. State licensed. POSTAL FINANCE, Dept. 16-V, Kansas City 1, Kan.

SPEAKER RECONING. Satisfaction Guaranteed. C & M RECON CO., 18 E. Trenton Ave., Morrisville, Pa.

TRANSISTORIZED products dealers catalog, \$1. INTERMARKET, CPO 1717. Tokyo, Japan.

ALL MAKES OF ELECTRICAL INSTRUMENTS AND TESTING equipment repaired. HAZELTON INSTRUMENT CO., 128 Liberty St., New York, N.Y.

Business Opportunities

HIGH WEEKLY EARNINGS! Address-mail letters featuring real merchandise. Get \$10 with every order—keep \$8 profit. Supplies furnished. Free particulars. MODERN MERCHANDISING, Box 357, Oceanside, N.Y.

NOW DIRECT CRYSTAL CONTROL TO 160 mc With AOC Plug-In Transistor Oscillators

- Portable Signal Standards • Signal Generators For Receiver Alignment • Band Edge Markers
- Frequency Markers For Oscilloscopes • Quick-Change Plug-In Oscillators • Accessory Cases

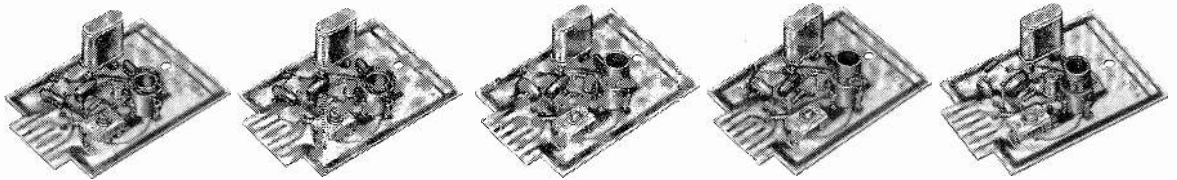

HIGH FREQUENCY (20 mc – 160 mc)

Five transistor oscillators covering 20 mc - 160 mc. Standard 77°F calibration tolerance $\pm .0025\%$. The frequency tolerance is $\pm .0035\%$. Oscillator output is .2 volts (min) across 51 ohms. Power requirement: 9 vdc @ 10 ma. max.

OSCILLATOR TYPE	OSCILLATOR RANGE	CRYSTAL TYPE	TEMPERATURE TOL. -40°F to 150°F	OSCILLATOR (LESS CRYSTAL) PRICE	CRYSTAL FREQUENCY	CRYSTAL PRICE
OT-24	20-40 mc	CY-7T	$\pm .0035\%$	\$ 9.10	20-60 mc	\$ 6.90
OT-46	40-60 mc	CY-7T	$\pm .0035\%$	9.10	60-100 mc	12.00
OT-61	60-100 mc	CY-7T	$\pm .0035\%$	15.00	101-140 mc	15.00
OT-140	100-140 mc	CY-7T	$\pm .0035\%$	15.00	141-160 mc	18.00
OT-160	110-160 mc	CY-7T	$\pm .0035\%$	15.00		



18 NORTH LEE OKLAHOMA CITY, OKLA.

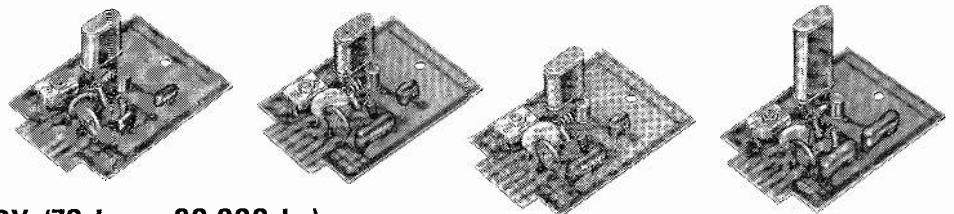

LOW FREQUENCY (70 kc – 20,000 kc)

Four transistor oscillators covering 70 kc - 20,000 kc. Trimmer capacitor for zeroing crystal. When oscillator is ordered with crystal the standard will be $\pm .0025\%$. Oscillator output is 1 volt (min) across 470 ohms. Power requirement: 9 vdc @ 10 ma. max.

OSCILLATOR TYPE	OSCILLATOR RANGE	CRYSTAL TYPE	TEMPERATURE TOL. -40°F TO + 150°F	OSCILLATOR (LESS CRYSTAL) PRICE	CRYSTAL FREQUENCY	CRYSTAL PRICE
OT-1	70-200 kc	CY-13T	$\pm .015\%$	\$7.00	70-99 kc	\$22.50
					100-200 kc	15.00
					200-499 kc	12.50
OT-2	200-5,000 kc	CY-6T	200-600kc $\pm .01\%$	7.00	500-849 kc	22.50
			600-5,000kc $\pm .0035\%$	7.00	850-999 kc	15.00
OT-3	2,000-12,000 kc	CY-6T	$\pm .0035\%$	7.00	1,000-1,499 kc	9.80
OT-4	10,000-20,000 kc	CY-6T	$\pm .0035\%$	7.00	1,500-2,999 kc	6.90
					3,000-10,999 kc	4.90
					11,000-20,000 kc	6.90

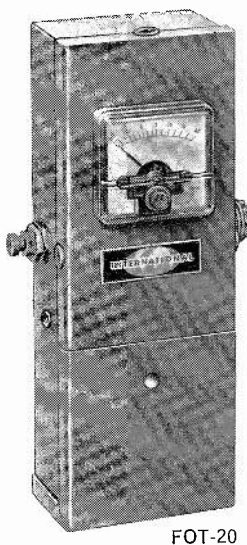

FOT-20



FOT-10

AOC OSCILLATOR CASES

Small portable cases for use with the OT series of plug-in oscillators. Prices do not include oscillators. (When oscillator and crystal are ordered with FOT-10 case a 77° F tolerance of $\pm .001\%$ may be obtained at \$2.00 extra per oscillator/crystal unit. When oscillator/crystal units are ordered with FOT-20 case, a single unit can be supplied with temperature calibration over a range of 40° F to 120° F. Correction to $\pm .0005\%$. Add \$25.00 to the price of FOT-20 and oscillator/crystal unit.)

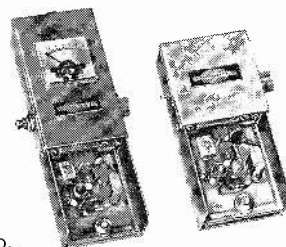

FOT-20 For high accuracy calibration requirements. Includes battery and output jack, output meter circuit and battery check, as well as thermistor temperature measuring circuit. **\$87.50**

FOT-10 Basic case with battery and output jack for general wider tolerance applications. **\$14.50**

MT-1 Oscillator board mounting kit. **\$4.95**

Order direct from International Crystal Mfg. Co.

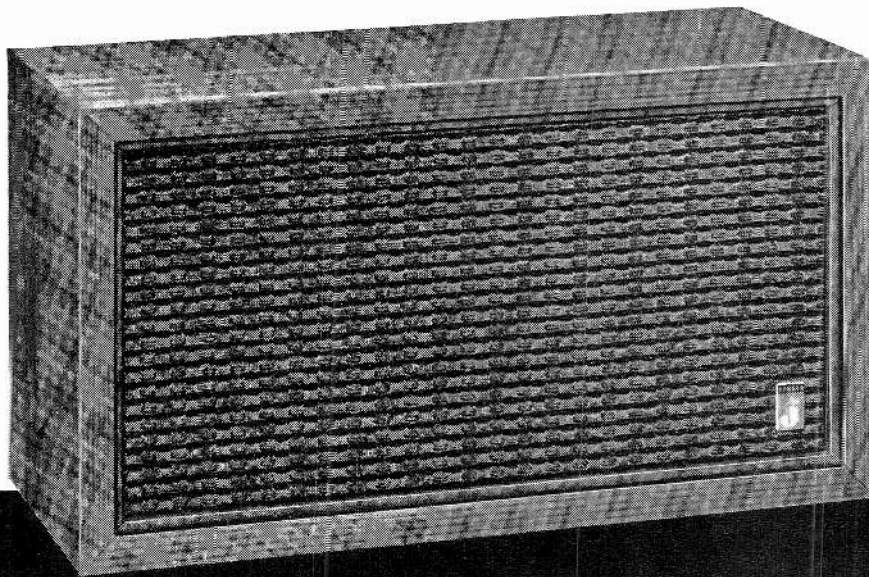

BREAKTHROUGH!

Jensen's NEW PR-50 . . . Outstanding hi-fi performance in a ½ cu. foot enclosure

The PR-50 introduces an outstanding breakthrough in extremely compact design without loss of performance. It is the first effective, full-range high fidelity system to be completely contained in a ½ cubic foot enclosure. Its statistics will impress — such as the exceptionally flat response: only 3 db down at 48 and 20,000 cycles, and ± 3 db inside this range. The PR-50's special woofer can reproduce 40-cycle bass tones cleanly and clearly. Because no "shaping networks" are needed, all available amplifier power goes to drive the speakers. The new E-100 SONO-DOME® gives the PR-50 a unique smoothness of mid-range and high-frequency response with a remarkably uniform radiation pattern. Full L/C crossover network. H-F control. Cabinetry of genuine Walnut oil finished veneers with harmonizing grille fabric. See your high fidelity dealer. You'll be amazed that so much sound costs so little . . . only \$69.50.



Specially developed new small woofer in a rigid cast housing for superb bass response.

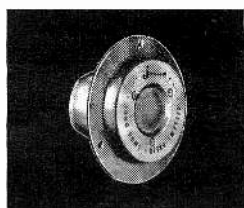

New E-100 SONO-DOME® for exceptional smoothness of midrange and high frequency response.

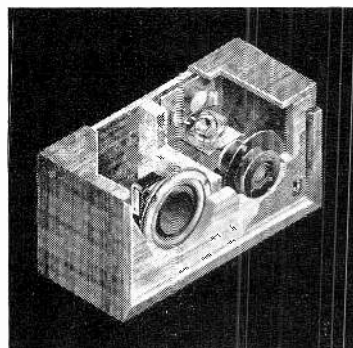

Cutaway view shows components and L/C network in a sophisticated glass fibre damped acoustic enclosure.



—For complete description of JENSEN loudspeaker products—write for Catalog 165-K.

JENSEN MANUFACTURING COMPANY / DIVISION OF THE MUTER COMPANY / 6601 SOUTH LARAMIE AVENUE, CHICAGO 38, ILLINOIS
 Canada: Radio Speakers of Canada, Ltd., Toronto • Argentina: Ucoa Radio, S. A., Buenos Aires • Mexico: Eapartel, S. A., Naucalpan, Mex.

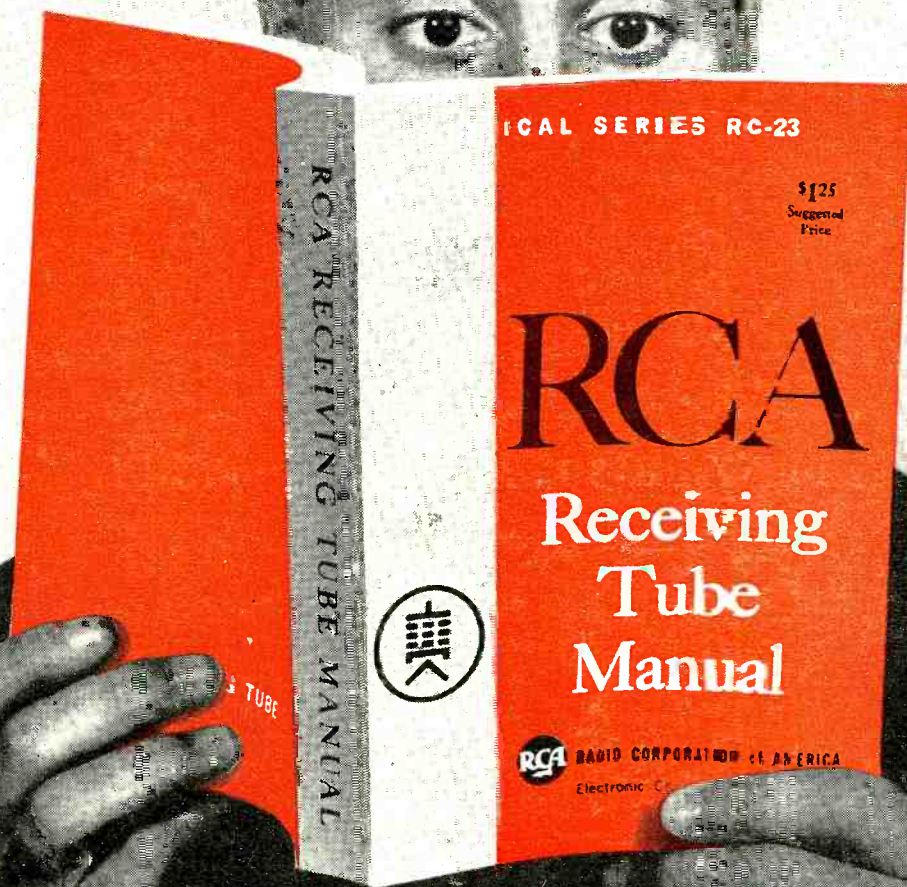

You can't put it down!

THE BRAND NEW RC-23!

Latest and best edition of the famous RCA Receiving Tube Manual

Look at the great new features of the best selling tube manual in the industry:

- ★ A record 608 data-packed pages
- ★ In addition to data on over 1,000 receiving tubes, the RC-23 includes data on color and 3&W picture tubes, voltage-reference tubes, voltage-regulator tubes
- ★ New format, new type-face for easier reading
- ★ Popular circuit section with its many timely, practical tube applications
- ★ Revised and expanded Applications Guide covering 42 specific function classifications

Now available from your local authorized RCA Tube Distributor

RCA ELECTRONIC COMPONENTS AND DEVICES, HARRISON, N. J.



The Most Trusted Name in Electronics